

AMERICAN BUILDER

WORLD'S GREATEST
BUILDING PAPER

A N D B U I L D I N G A G E

PUBLIC LIBRARY
FEB 18 1947
DETROIT

FEBRUARY 1947
PRICE 35 CENTS



B. M. CLARK

Building Products on Review



It's what's INSIDE that Counts!

YES... "ingredients" make the big difference in quality of performance whether the product is a fine watch or a fine building material.

Secret of the success of so many Celotex building products, for example, is the cane fibre at their core.

These long, tough cane fibres form an interlocking "bridge" with each other—endow Celotex board with high tensile strength and endurance, good insulating value, yet extreme lightness and workability. It's easy to handle, easy to apply, economical to use.

What's more—special Celotex processing renders the board wind, water, heat, cold and vermin-resistant... makes it one of the most practical building materials on the market.

Look to The Celotex Corporation for these quality cane fibre building products. And remember: on literally *millions* of building jobs, they've *proved* beyond a shadow of a doubt that *they've got the inside quality that counts!*

Quick Facts on Celotex Siding—a typical Celotex cane-fibre building material

Ideal for farm structures, garages, warehouses, most any low-cost building. Does 4 jobs in one application: 1. Sheathing; 2. Insulation; 3. Exterior Finish; 4. Structural Strength. Has high insulating value; requires no maintenance. Just nail to frame and caulk—and the job's done!

Tongue and Groove joint on long edges of 2' x 8' panels.

Core of genuine Celotex Cane Fibre Board furnishes structural strength and insulation.

All edges and sides sealed against moisture by coating of asphalt.

Extra coating of asphalt on exterior side.

Exterior surface of firmly imbedded mineral granules, providing durable, colorful finish.

Colors: Green or Bufftone.

Sizes: 3/8" thickness—4' x 8' with square edges.

7/8" thickness—2' x 8' with T & G joints on long edges.

7/8" thickness—4' x 8' and 4' x 10' with square edges.

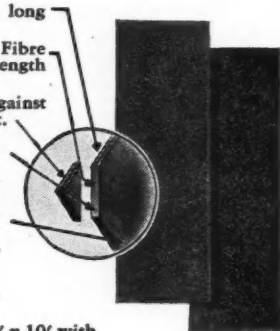

CELOTEX
REG. U.S. PAT. OFF.
BUILDING PRODUCTS

THE CELOTEX CORPORATION • CHICAGO 3, ILLINOIS

Published monthly by Simmons-Boardman Publishing Corporation, 105 W. Adams St., Chicago 3, Ill. Subscription price, United States, Possessions and Canada: 1 year, \$3.00; 3 years \$5.00. Foreign countries: 1 year, \$10.00; 3 years, \$20.00. Single copies 35 cents. Entered as second-class matter Oct. 11, 1930, at the Post Office at Chicago, Illinois, under the act of March 3, 1879, with additional entry as second-class matter at Mount Morris, Illinois. Address communications to 105 W. Adams St., Chicago 3, Illinois.

SPACIOUSNESS

... borrowed from the outdoors!

At first glance this looks like a large room—but look again. That feeling of spaciousness comes from the generous window treatment—the opening of the wall to outdoor view and sunshine.

You'll find this an effective, economical way to "enlarge" any room in the house. Fenestra's standardized line offers a *right* window for every room. These standard units can be combined to make picture windows *with ventilation*, as shown here. There's a window of right height for over the kitchen sink—another for over the buffet—others that combine to make an ideal corner window. And so on.

In all of them you'll find the same features that appeal to housewives. Easy opening ... with finger-tip control. Easy washing ... from inside the room. Screens that fit inside ... so uniform that no marking or numbering is necessary. Narrow frames and muntins add beauty inside and out, and provide larger glass areas for more daylight.

Fenestra Windows have been designed for easy installation, too. From the home buyers' viewpoint—and from your viewpoint, as well—they are modern windows in every sense of the word. Write for full details on types and sizes. Detroit Steel Products Company, Dept. AB-2, 2260 East Grand Blvd., Detroit 11, Michigan.

★ ★ ★

*See the Fenestra Exhibit
at the*

**NATIONAL ASSOCIATION
OF HOME BUILDERS SHOW**

Hotel Stevens, Chicago

February 23-27, 1947

Space 162

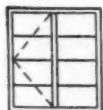
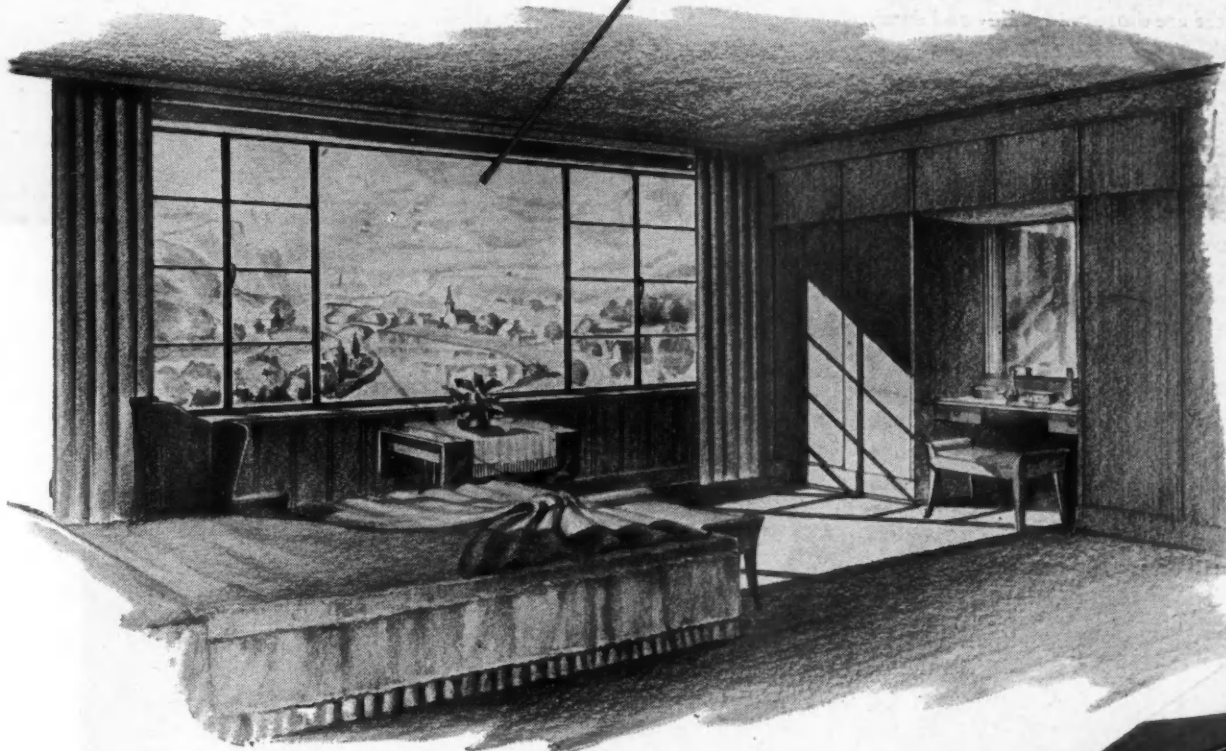

2414N



34 MO

(muntins omitted)



2414N



FENESTRA STANDARD TYPES

illustrated above

Efficiently-designed Heating Systems

NOW INCLUDE
THE



ELECTRIC QUIKHETER

No matter how efficient your regular heating system may be, there are always times when extra heat is not only a comfort and convenience but an almost necessity.

There are those cold, chilly and damp mornings, for instance, when the regular heating plant is not in operation. Then, there are those cold, blustery days, when wind and cold just will seep into the room and chill it. Or there are those times when it seems hours before heat begins to filter into the house from the regular heating plant.

Ⓔ Electric Quikheters are ideal for situations such as these. Easy to operate, requiring only the flip of a conveniently-located switch, they send forth billows of warm air that will change the temperature of the average room in three to five minutes.

Install one of these attractive, convenient, fuel-saving, comfort-giving units in your home today and thus provide against unusual weather variations.

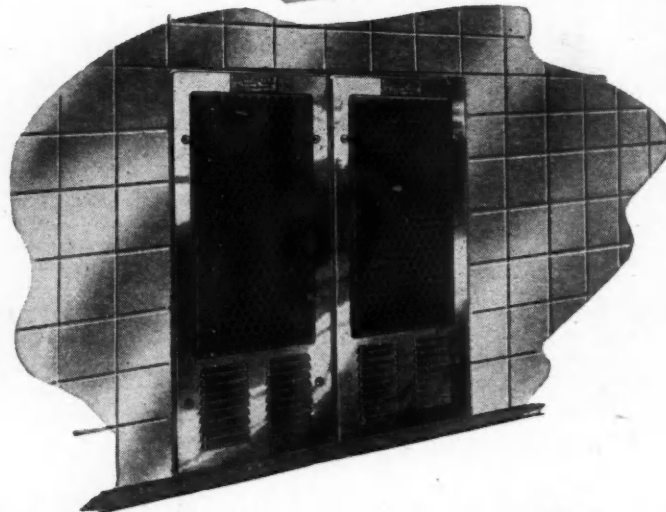
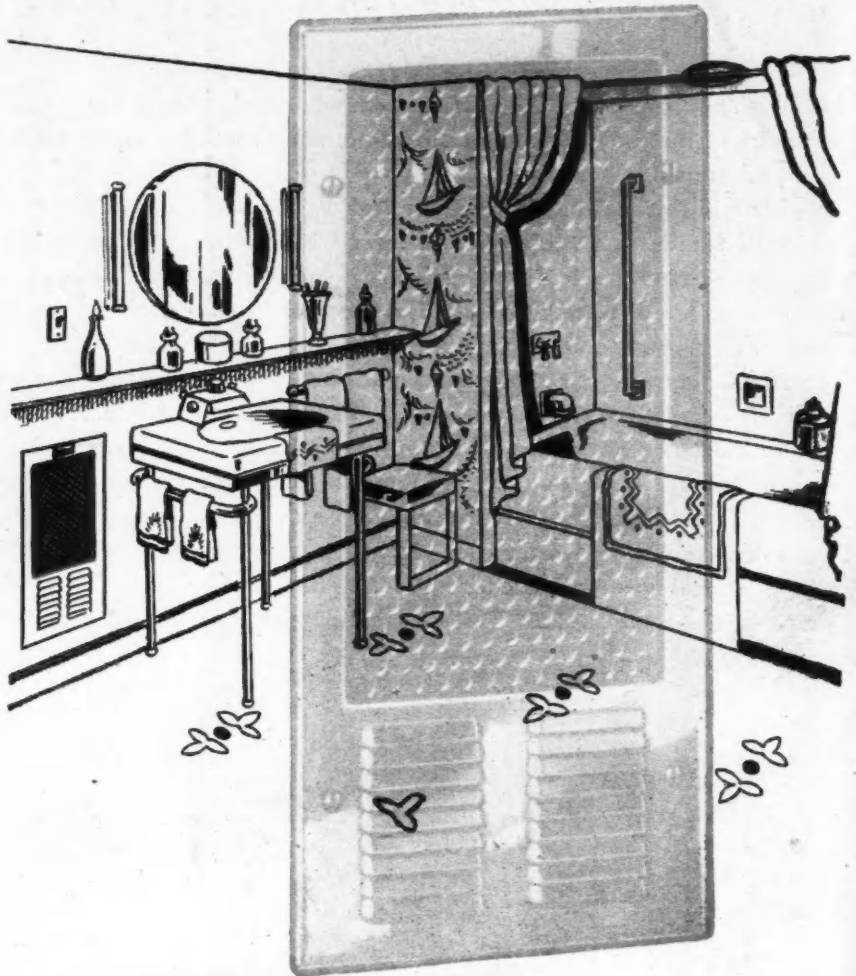

Now Available

Built-in Ⓔ Electric Quikheters are available in single units of 1,000 and 1,500 watts and twin units of 2,000 and 3,000 watts, for immediate delivery. Contact your nearest electrical contractor for details or send for Bulletin No. 77.

MAKERS OF...
BUSDUCT
PANELBOARDS
SWITCHBOARDS

Frank Adam
ELECTRIC COMPANY
ST. LOUIS, MISSOURI

SERVICE EQUIPMENT
SAFETY SWITCHES
LOAD CENTERS
ELECTRIC QUIKHETER



For Outside Walls —
GIVE YOUR CUSTOMERS

Double FOR THEIR MONEY!

Build with double-duty Insulite and do a little bragging. Insulite Sheathing does two things for the price of one: (1st) *Sheathes*; (2nd) *Insulates*. That's double service for the money—a feather in your cap. Where else in today's era of high building costs can you tell a customer, "Here's one spot at least where you get *double* for your money!"



ONE MATERIAL
Double USAGE

INSULATES AS IT
BUILDS AS IT

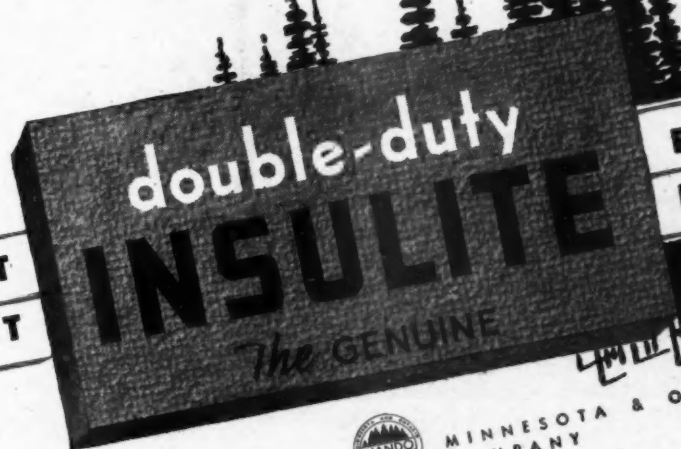

BUILDS
INSULATES

"Insulite" is a registered
trade mark, U.S. Pat. Off.

DIVISION OF PAPER  MINNESOTA & ONTARIO COMPANY

THIS →
or
THIS ↘

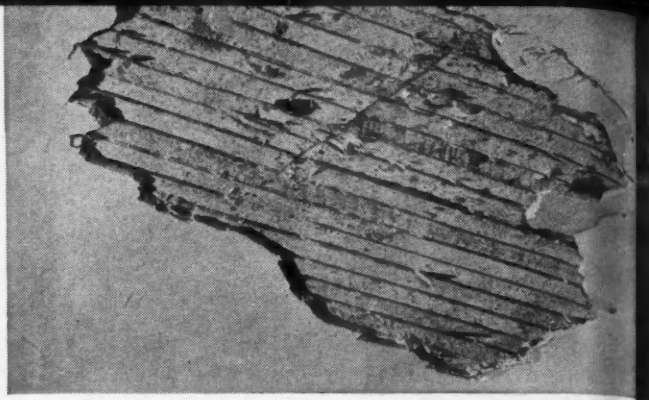

As a result of developments in dry wall construction, there is an increasing insistence that walls and ceilings be constructed of crackproof materials. This feeling is reflected in repair and modernization business as well as in new construction.

In home after home, architects, contractors and carpenters have proved it to themselves—the best material for ceiling repair and modernization is CRACKPROOF Upson Panelling. These panels go on easily right over old plaster . . . make a ceiling as beautiful as it is durable.

Like most good building products today, Upson Panels are not always available. But start now to list the jobs you'll do more profitably, more satisfactorily when these Panels are again in full supply. THE UPSON CO., Lockport, N. Y.

An Upson ceiling complements and enhances beauty of the library in the Lancaster, Ohio, home of Robert Geisy, nationally known lumberman.

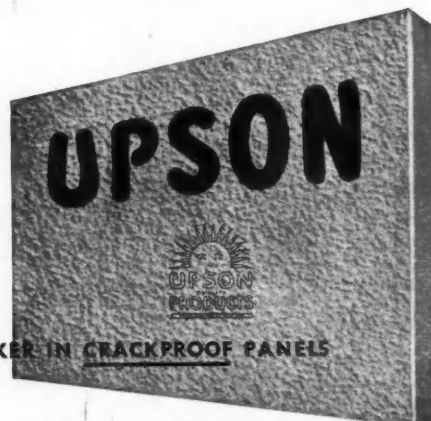

PACEMAKER IN CRACKPROOF PANELS

Upson Quality Products Are Easily Identified by the Famous Blue-Center

AMERICAN BUILDER

AND BUILDING AGE

F O U N D E D — 1 8 7 9

FEBRUARY

VOL. 69

1947

NO. 2

C O N T E N T S

AMERICAN BUILDER and BUILDING AGE

(originally "Carpentry and Building") with which are incorporated National Builder, Permanent Builder and the Builder's Journal, was founded Jan. 1, 1879. Names registered in U.S. patent office and Canadian registrar of trade mark. Published by the SIMMONS-BOARDMAN PUBLISHING CORPORATION, 105 West Adams Street, Chicago 3, Illinois; 30 Church Street, New York 7, New York.

Samuel O. Dunn, Chairman of the Board; James G. Lyne, Vice-President—Assistant to Chairman; Henry Lee, President; Roy V. Wright, Vice-President and Secretary; Robert H. Morris, J. S. Crane, C. J. Wageman, H. E. McCandless, Vice-Presidents; John T. DeMott, Treasurer.

Other Offices

Washington 4, D.C.: Nat'l Press Bldg.
Ann Arbor, Mich.: 1080 Stein Road
Seattle 1, Wash.: 1038 Henry Bldg.
San Francisco 4: 300 Montgomery St.
Los Angeles 14: 530 West Sixth St.
Dallas 4, Texas: 2909 Maple Ave.

SUBSCRIPTION PRICE

United States and Possessions and Canada, 1 year, \$3.00; 3 years, \$5.00; foreign countries, 1 year, \$10.00; 3 years, \$20.00. Single copies, 35 cents each. Subscribers are requested to state company connection, nature of business, title or position. Address W. L. Taylor, Circulation Manager, 30 Church St., New York 7.

Field Staff: C. L. Conley, J. H. Free, C. R. Hartung, Ralph I. Henry, Joe Sanders, Dick Whittington.

Copyright 1947 by Simmons-Boardman Publishing Corporation



Members of the Associated Business Papers (A.B.P.) and of the Audit Bureau of Circulations (A.B.C.) Printed in U.S.A.

AMERICAN BUILDER HAS THE LARGEST CIRCULATION OF ANY TRADE JOURNAL IN ANY FIELD

Publisher's Page	11
Our Readers Say	14
Trends	23
Monthly Review of NAHB	35
Editorial	99
Building Products on Review	100
Quality Houses in Two Distinctive Builder Projects ...	100
Story and a Half House in Modern Style	104
Building Value Into Low Cost Houses	106
Daytona Village, Multiple Garden Apartment Project ..	112
Anicka Blueprint House No. 2	114
Home Can Be Built in Sections	119
A Six Thousand Dollar House in High Cost Area ...	120
Sixty-eight Ways to Plan Your Kitchen	122
Branch Bank for Industrial Neighborhood	124
Architect's Office and Store Building	126
Preview of Three Manufactured Low Cost Small Houses	128
Modern Interiors Use Standard Materials	130
Built-ins with Modern Lighting	131
What About the Telephone?	132
A Doctors' Clinic, the Modern Trend	134
Entertainment in Every Room with Built-in Radio ...	135
Cooperative Apartment Project for Veterans	136
Air-Entraining Cement for Structural Concrete	138
Well Styled Store Builds Sales	140
Private Builders Provide Better Negro Housing	142
How-to-Do-It Department and Better Detail Plate ...	144
Beware "Word of Mouth" Agreements	146
Catalogs	150
On and Off the Record	153
Index to Advertisers	208

Samuel O. Dunn, Publisher Edward G. Gavin, Editor
Robert H. Morris, Business Manager

Lyn E. Arent, *Managing Editor and Art Director*; B. H. Wambolt, *Associate Editor*; Sterling H. Albert, *Eastern Editor and Research Director*; Arthur V. Hansen, *Architectural Editor*; Bernard L. Johnson, *Western Editor*; Dola Parr, *Production Director*; Joe Sanders, *Southwestern Editor*; Richard Gavey, *Research Assistant*; Margaret C. Carroll, *Asst. to the Editor*.

Editorial Office, 105 West Adams Street, Chicago 3.

To Give Your New Homes
That Extra Appeal, Choose
CHRYSLER AIRTEMP
AUTOMATIC HOME HEATING

WINTER AIR CONDITIONERS
YEAR-ROUND AIR
CONDITIONERS • FURNACES
BOILERS • OIL BURNERS
STOKERS • WATER
HEATERS



CHRYSLER Airtemp products, backed by Chrysler Corporation engineering and mass production skill, are known for fine quality, dependability. National advertising has given them wide acceptance. This name on the heating equipment gives your new houses greater value. You can choose the heating you prefer—warm air, steam, hot water, vapor (gas, oil or coal fired). For details, write Airtemp Division of Chrysler Corporation, Dayton 1, Ohio; in Canada—Therm-O-Rite Products, Ltd., Toronto.

WINTER AIR CONDITIONER
Successor To The Furnace

A BETTER TYPE OF HEAT
Circulates filtered, properly moistened,
warm air to every room—automatically!

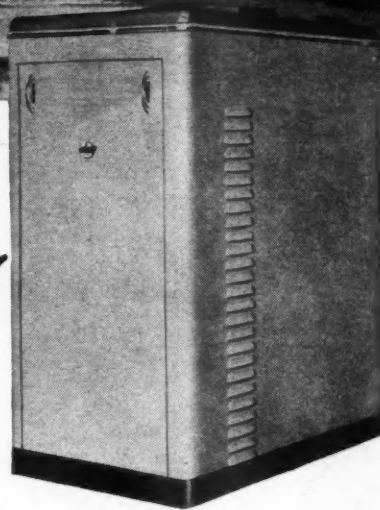

Automatically Yours

© 1947 Chrysler Corporation



AMERICA'S MOST COMPLETE LINE
OF HOME HEATING EQUIPMENT!

HEATING • AIR CONDITIONING • COMMERCIAL REFRIGERATION

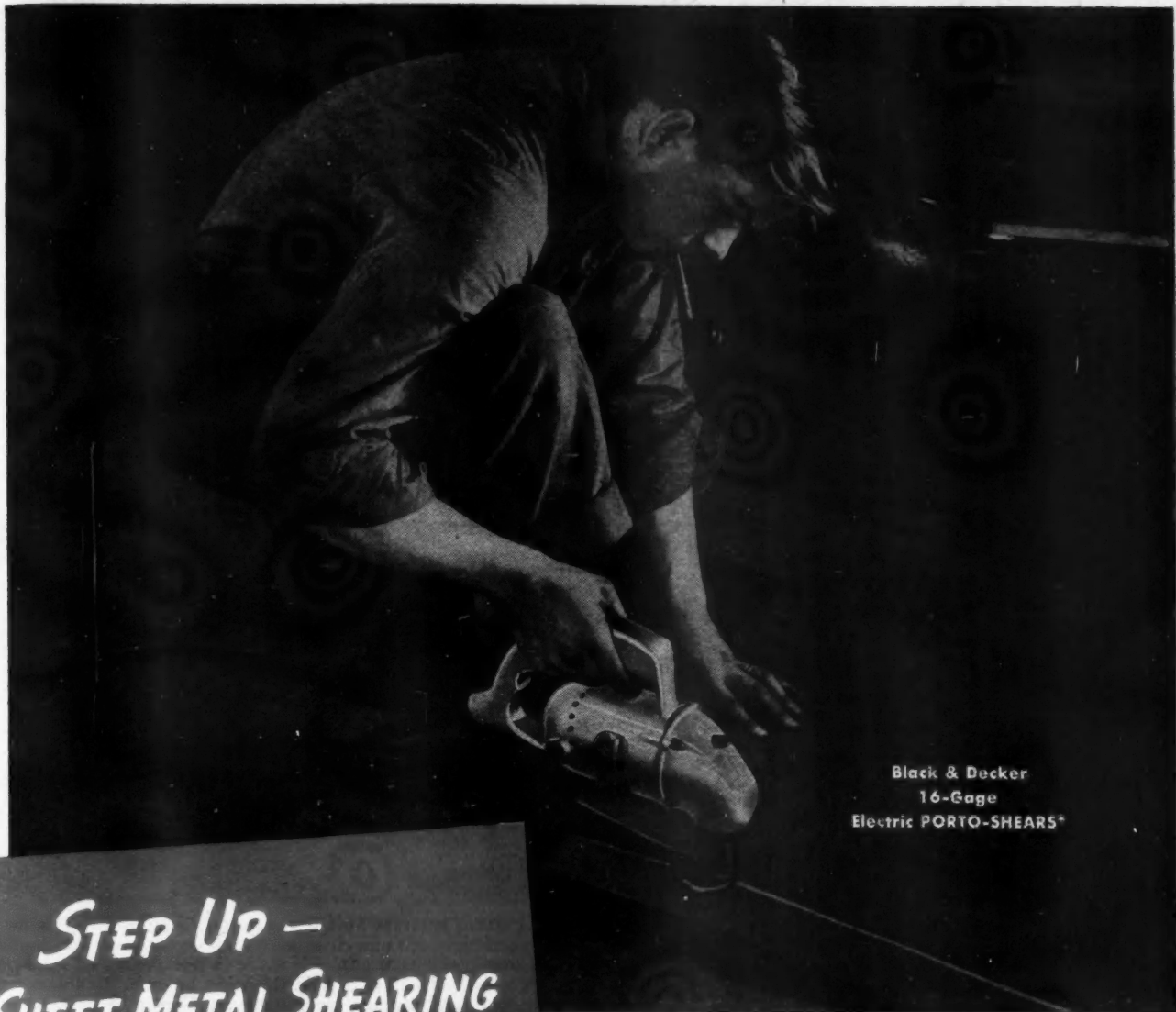

Black & Decker
16-Gage
Electric PORTO-SHEARS*

**STEP UP —
SHEET METAL SHEARING
SAVE MONEY,
MUSCLE, MANPOWER**

*Trade Mark Reg. U. S. Pat. Off.

irregular patterns, curves down to $\frac{3}{4}$ " radius, without fear of rejects. There are no burrs or ragged edges, either, because PORTO-SHEARS make cleaner, smoother, more accurate cuts.

CUT MANY MATERIALS

Black & Decker 16-Gage PORTO-SHEARS cut up to rated capacity in steel or galvanized iron—about one gage thinner in Monel or stainless—50% above rating in copper, aluminum, lead and other non-ferrous metals. Can be adapted to cut thin sections of laminated wood or sheet plastics.

SEE YOUR BLACK & DECKER DISTRIBUTOR. He'll be glad to give you full information on time-saving PORTO-SHEARS—or help you with any other tooling problem. For your free copy of our complete catalog, write to: The Black & Decker Mfg. Co., 666 Pennsylvania Ave., Towson 4, Md.

BLACK & DECKER Electric PORTO-SHEARS combine powerful shearing action with surprisingly rapid speed. They cut sheet metal too tough for snips. Speed up jobs where snips are slow. Feed easily with only a light forward pressure.

CUTTING OPERATION ALWAYS VISIBLE

You can watch PORTO-SHEARS cut through the work. That's why it's easier to follow straight lines,

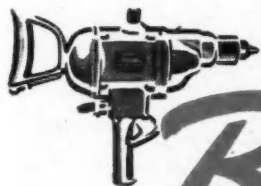

LEADING DISTRIBUTORS EVERYWHERE SELL

Black & Decker

PORTABLE ELECTRIC TOOLS

Performance
that's Efficient
and Economical...

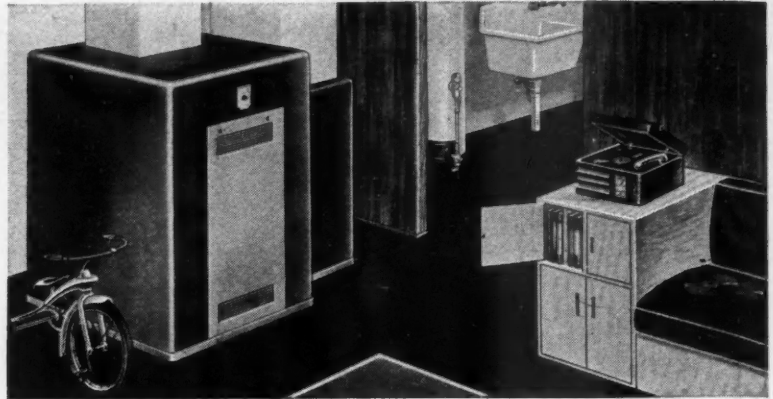

The WESTMORELAND Oil Fired Winter Air Conditioner with its smart, trim lines, lends beauty and distinction to this basement game room. Available as a completely coordinated oil heating unit with American-Standard's own Arcoflame Burner, or for use with any other standard burner. Made in 7 sizes, with capacities at the register ranging from 95,000 to 330,000 Btu. For homes of practically any size.

Design
that's Striking
and Practical...

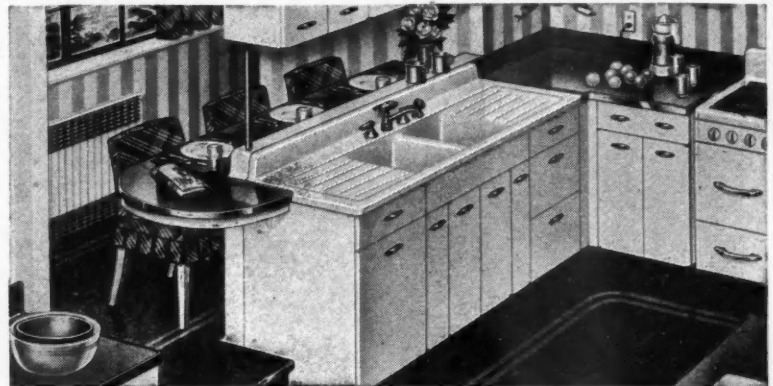

The trim, efficient ROYAL HOSTESS Sink is the center of interest in this modern kitchen. Designed for maximum cleanliness and convenience, this double-compartment, double-drainboard model is made in one piece—of rigid cast iron finished with a heavy coating of Acid-Resisting Enamel. A cabinet provides spacious drawers and storage compartments. Comes in white and a choice of many colors.

AMERICAN-Standard

HEATING PLUMBING

■ You're sure of lasting client satisfaction when you specify American-Standard Heating Equipment and Plumbing Fixtures. They're performance-proved—for efficiency and economy. They're sturdily constructed—for serviceability and long life. They're smartly styled—to harmonize with any interior . . . to fit any room arrangement. They're as fine as money can buy. Yet they cost no more than others . . . and for modernization, are available on a convenient Time Payment Plan. For details, see your Heating and Plumbing Contractor. American Radiator & Standard Sanitary Corporation, P. O. Box 1226, Pittsburgh 30, Pennsylvania.



Serving the Nations' Health and Comfort

LOOK FOR THIS MARK OF MERIT—It identifies the world's largest line of Heating and Plumbing Products for every use . . . including Boilers, Warm Air Furnaces, Winter Air Conditioners, Water Heaters, for all fuels—Radiators, Convectors, Enclosures—Gas and Oil Burners—Heating Accessories—Bathtubs, Water Closets, Lavatories, Kitchen Sinks, Laundry Trays, Brass Trim—and specialized products for Hospitals, Hotels, Schools, Ships, and Railroads.



PUBLISHER'S PAGE

"Planning" Versus Experience

THE fantastic difference between the post-war conditions predicted by government "planners," and the post-war period we are having, should not be allowed to be disregarded by anybody. It is *actual experience*, and should be emphasized by defenders of private enterprise now and used by them in future against socialistic policies the advocacy of which will never stop.

Remember the "National Resources Planning Board?" Appointed by President Roosevelt, its "planners" said that maintenance of "full employment" in peace time should be the objective of all policy. "Full employment" had been caused during the war by government planning, controls and spending. If government spending were drastically reduced, and controls abandoned, we would soon have another depression and 8 to 12 million unemployed. Hence, said the planners, after the war ended many controls must be continued, and we must be ready to begin huge government spending on "public works," on housing, on anything and everything that the ingenious minds of zealous bureaucrats and socializers could think up.

Well, government expenditures have been reduced about \$60 billion a year. Most controls have been abandoned. And we have had, not unemployment, but "full employment"—so "full" that most employers cannot get enough labor or get labor to do efficient work. Government sources estimate last year's national income at \$164 billion—largest in history—and predict \$180 billion in 1947.

Why this fantastic difference between what the New Deal's "planners" predicted and what has occurred? They did not know the economic facts of life. They thought the nation's economy was ill when it was merely pregnant! They believed that if not given their nostrums it might die, whereas, it has had twins.

What has occurred had occurred before, when there was no New Deal to

prevent it. The fundamental fact is *increase of population*. It increased 35 million in the quarter of a century ending with 1920, which year in the last post-war period corresponded with 1947 in the present post-war period. It has again increased 35 million since 1920. From the depression of the 90's through 1920 the increase of population was accompanied by almost unbroken prosperity and expansion due to an economy untrammelled by government controls, or big government spending, or heavy taxes. The increase of population after 1920 was accompanied by (1) a depression that was needlessly prolonged for years by economically unsound New Deal policies of "planning," spending and taxing, and (2) an unprecedented war effort. Owing to *both* there developed unprecedented shortages of almost everything.

This increase of population and these shortages have been confronted since the war by huge buying power accumulated in the hands of the people and in the treasuries of business during the war. Hence the present full employment—which has been provided, be it noted, by that same archaic, inefficient and despised system of private enterprise, which according to the "economists" of the left, never could provide it again.

Now they predict a "bust" closely following the "boom." There were signs of "busts" in 1920 and in 1929; and they came. There are no signs now of a "bust" in the near future. But government, labor, or business can turn the present boom into a bust by doing the things that caused "busts" before—for example, pushing up wages, or prices of commodities, or prices of securities in defiance of the economic law of gravitation.

Samuel O. Drun,

Specify the screening that can't rust!

8 ADVANTAGES OVER METAL SCREENS

- Permanent — can't rust.
- No upkeep — never needs painting.
- Cannot "bleed" and stain house.
- Easier installation — handles like cloth, cuts with scissors.
- Safer installation — no jagged edges or sharp splinters.
- Six times impact strength of metal.
- Tinted for smarter appearance.
- One-fifth weight of metal.

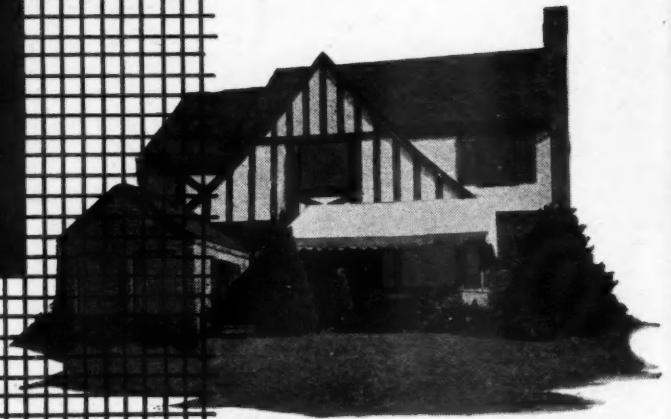

Firestone

Velon*

TINTED SCREENING

All metals oxidize, some more rapidly than others. When used in fine strands for screening, any metal will disintegrate before the combined attack of moisture, wind, salts and acids present in every atmosphere.

Velon screens can't corrode, can't rust. Yet *Velon* costs no more than good metal screening.

And *Velon* gives you these other advantages over metal screening: no upkeep, never needs painting... cannot "bleed" and stain building... easier installation: handles like cloth, cuts with scissors... safer installation: no jagged edges or sharp splinters... six times the impact strength of metal... one-fifth the weight of metal.

Specify *Velon*... now available in standard widths and gauges. For full-color booklet on *Velon*, and free samples, write Firestone, Akron.



Listen to the Voice of Firestone Monday Evenings over NBC

*TRADE MARK

THIS IS IT... *Now* YOU CAN BUILD
YOUR BLOCK PLANT
APPLEY *All The Way*

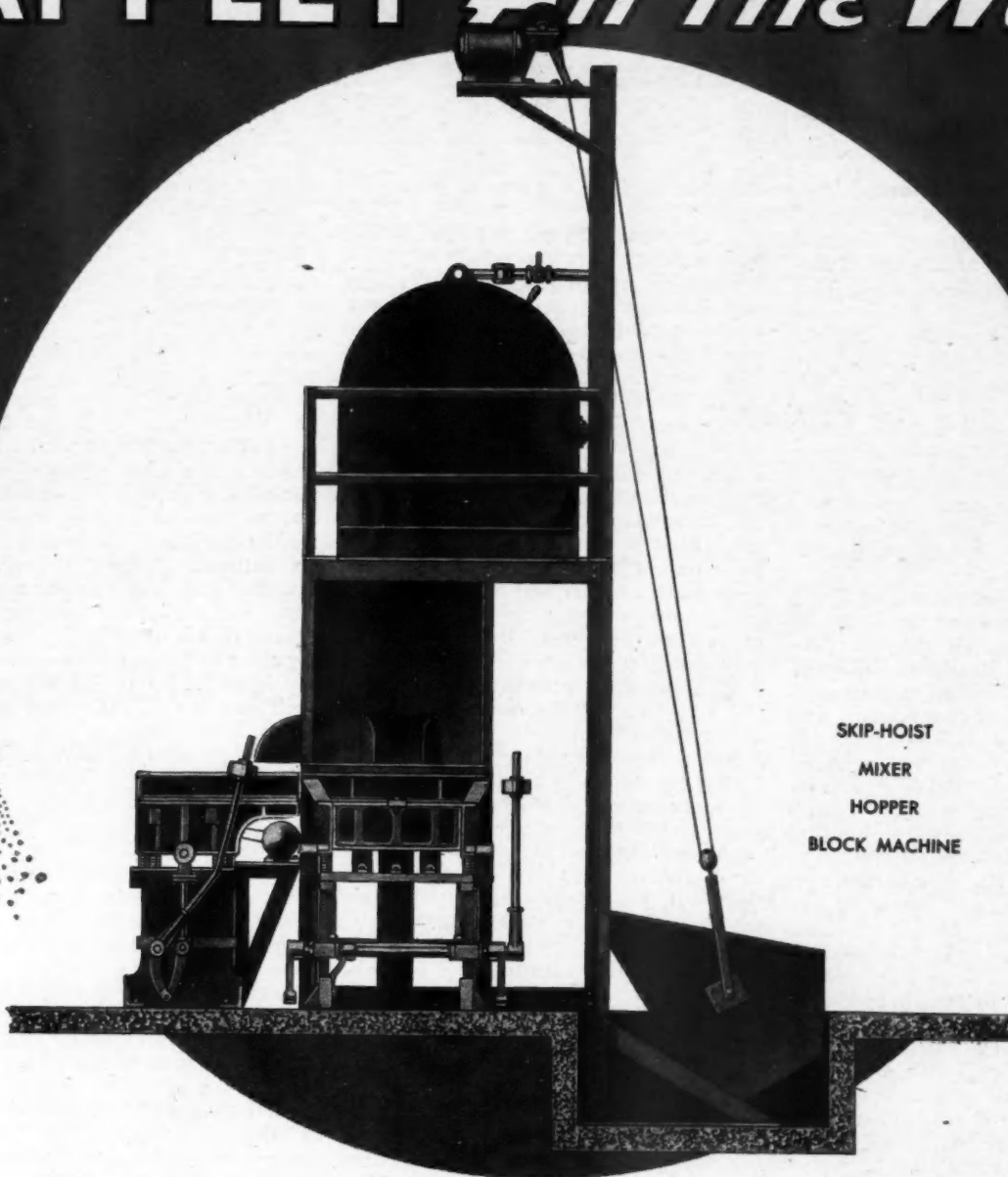

SKIP-HOIST
MIXER
HOPPER
BLOCK MACHINE

A complete, precision-built, Appley production line is now ready for you. You can manufacture all the way from the rough aggregate to the finished block with dependable Appley machines. The new SKIP-HOIST, MIXER and HOPPER have been engineered with the same

fidelity that gave THE LITTLE GIANT block machine its reputation for hard work and earnings... The name of J. W. APPLEY & SON stands behind these new, companion machines to THE LITTLE GIANT, and to the manufacturer that means *reliability, economy and production.*

J. W. APPLEY & SON

INCORPORATED

P. O. BOX 849 STATION A

ST. PETERSBURG 2, FLORIDA

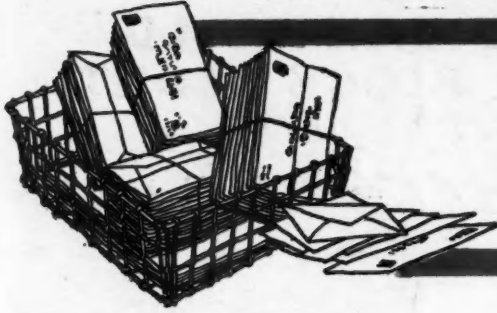

Our Readers Say:

Opposes lifting restrictions

To the Editor: Home builders' associations, officers of planning commissions, real estate organizations, building and loan institutions, promoters, etc., are shouting with joy over the recent order of President Truman removing building restrictions.

Their joy will be short lived. The grave injustice to the general public contained in the order will be universally recognized within six short months. The mechanics of the order are such that the small amount of housing now dribbling through will have completely disappeared by that time.

We have only sufficient mechanics and materials at present time to take care of twenty-five per cent of construction requests. Doubling the number of construction requests will double the amount of confusion and bewilderment now blooming abundantly in every phase of the industry.

The order will skyrocket construction prices. Builders of small apartments and homes are now bidding frantically for necessary materials to complete. Double the number of bidders and a child will tell you what will happen to material prices. In some cases the efficiency of the building trades mechanic is now comparable to a skillful portrayal of the slow motion picture act. With a great increase in the demand for labor, that efficiency will quickly sink to an all-time low.

As expected, the veterans will be hardest hit. Where it now takes seven months to complete his home, it will take slightly better than twelve months in the future. The highly overpriced strawberry box now being offered to him at \$10,000 will be costing \$13,000 by next Labor Day.

The thousands of home hungry citizens, who are also rejoicing over this order, with their magazine cuts, pictures of better homes and home-made plans, will find it necessary to take their own pulse, to recover from shock they receive when presented with approximate cost of their dream homes.

The tens of thousands of apartment seekers will have a wait of at least four more years, before apartments will be available in any appreciable number. At present costs you have to get \$23 per room per month to make the investment economically sound. Removing building restrictions will quickly step that figure up to \$29 per room or

\$116 per month for a four-room apartment.

True enough, there are thousands of individuals (not veterans) so hard pressed for housing they would gladly pay \$116 for a four-room apartment. But what will happen to the invested capital in the apartment building a year or two from now when the pin enters the balloon?

Certainly private capital will not invest funds in apartment buildings at present inflated construction prices, knowing well that in just a few years the same \$116 apartment will go begging for \$50 per month. Maybe our government plans on one hundred per cent loans on present inflated prices to anyone wishing to construct an apartment building. If such is the case, bear in mind that when the balloon suddenly turns into a pancake, the loss incurred by our government will be shared alike by all taxpayers.

Removing building restrictions makes certain three things: (1) It will be years before apartments are available for the tens of thousands of veterans and other citizens, at a price they can afford to pay. (2) Construction will be stepped up briskly on factories, bowling alleys, commercial buildings, race tracks, automobile agencies, riding academies, schools, night clubs, railroad depots, dance halls, airports, taverns, churches, golf clubs, etc. (3) Removing restrictions cannot and positively will not relieve our housing shortage. It does, however, suggest to those seeking shelter that they play Eskimo and sleep in the snow.—JOHN J. MANGAN, Chicago, Ill.

Building control blues

To the Editor: I desire to give you in writing something of a case history of this investment I made some years ago.

In 1929 through the Oil City Chamber of Commerce, the writer was selected to serve as chairman of a special committee called to work out some plan for housing office men that were to be brought here. After making a survey of the desirability of purchasing a sufficient amount of land to build houses for office men with an income at that time of \$200 to \$350 per month, a plot of ground was selected at a price of \$38,000; the fact is the writer placed a cash payment as required as an option. This plan finally fell through, due to the fact only a

small number of men moved here.

Our small company then decided to purchase this plot, and paid the above amount in cash. We started to develop, by placing 36-inch storm sewers as required by the city at a depth in some places of 15 feet; also sanitary sewers, water mains, and concrete paving and curbs for two blocks. This completed all work of this character for twenty lots. Nine of these lots were sold and built upon.

After the above work was completed, the depression developed, and no one was interested in building a residence. Then the war started and we naturally desired to help, out, and nothing was done for five more years. Now we are again held up, for the reason this is in a vicinity where a better class of houses is desired—I would say from \$12,000 to \$15,000 houses. We built one for \$27,000 when costs were down.

Do not forget we have paid taxes on this property for fifteen years and have not received a nickel of income from this property for fifteen years on our investment. After crediting what we have received for the lots we sold, we still have an investment of \$50,083.70 at this time.

We will sell this property at this time for eighty per cent of the above amount if anyone is interested in the purchase of same.

We are interested in the G.I.'s, in fact two out of three of my sons are G.I.'s, but I still cannot convince myself that we are being treated fairly. Do not forget this is our money. It does not belong to the federal government.—L. O. BOUQUIN, Oil City, Pa.

Wants restrictions lifted

To the Editor: I have been a subscriber of your publication for the past 25 years, and I want to comment on the lead that your editorial department has been taking on the question of elimination of regimentation of the builders by the various government bureaus in Washington.

For the past four years, I have been president of the Republican Assembly, with the avowed purpose of getting government out of building. I own several acres of industrial properties in Oakland, as well as many lots, but I cannot do any building until all limitations have been taken off.—HENRY E. TWEED, Oakland, Calif.

Now... CLEAR SPANS UP TO SIXTY-FOUR FEET

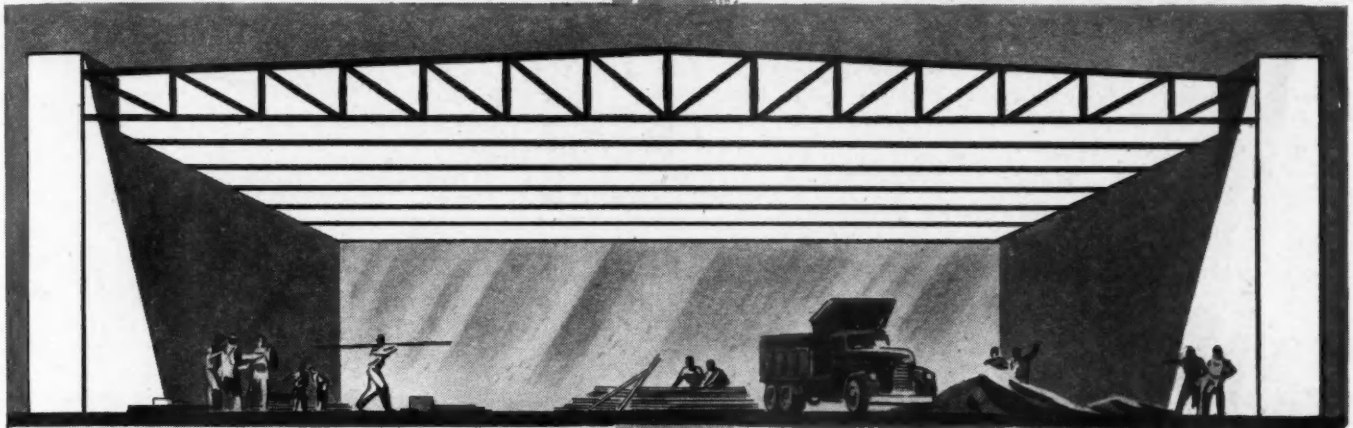

WITH TRUSCON CLERESPAN Joists

● Truscon "Clerespan" Joists can be used advantageously in buildings for all types of service regardless of their location. They are ideally adaptable for the safe, fire-proof construction of garages, halls, auditoriums, gymnasiums, factories and other structures where wide, column-free areas are required.

Truscon "Clerespan" Joists offer these distinctive features:

1. Can be used for unusually wide spans up to 64 feet.
2. Equally adaptable to roof and floor construction.
3. Economical in cost.
4. Light in weight.
5. Fire-resistant.
6. Easily and speedily erected.
7. Can be accurately located in a structure and easily inspected.
8. All connections electrically arc welded.
9. Open web system allows passage of pipes and conduits.
10. Completely shop fabricated, and reach the job ready to install.

Ask experienced Truscon engineers for assistance in helping you develop efficient floor areas with Truscon Clerespan Steel Joists.



Send for this free catalog.

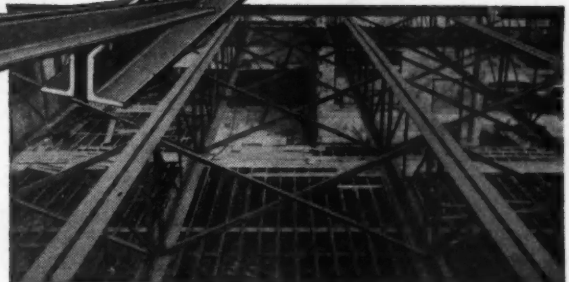

● Typical roof construction with Truscon Clerespan Joists

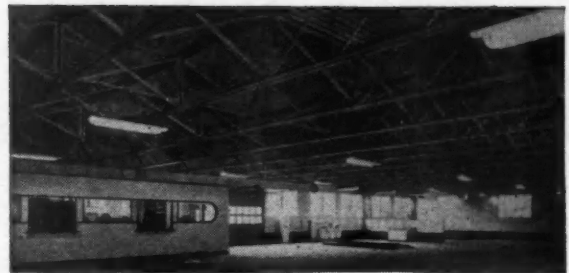

● Wide, column-free areas achieved with Truscon Clerespan Joists

TRUSCON STEEL COMPANY

Reg. U. S. Pat. Off.
YOUNGSTOWN 1, OHIO • Subsidiary of Republic Steel Corporation

Manufacturers of a Complete Line of Residential Double Hung Windows . . . Residential Casements . . . Security and Basement Windows . . . Screens and Storm Sash . . . Metal Lath Products . . . Industrial Steel Doors . . . Coal Chute Doors . . . Steel Lintels . . . Concrete Bars . . . Welded Steel Fabric.

Build 'em
SMALL **BIG**
Beautiful FUNCTIONAL

TRADE MARK
REG. U. S. PAT. OFF.

HomeOla
THE HOUSE OF
AMERICA'S
MILLIONS

A \$16,000 home or a \$3,000 cottage can now be built with the new HomeOla house designs and parts. We'll furnish complete equipment—or you can supply it—not in some far off "dream day", but **RIGHT NOW!**

Two of the standard designs and two of the combination designs of HomeOla manufactured houses are illustrated. Not shown are smaller units which may be erected as cottages, tourist cabins or added as wings to standard models.

Factory-machined and insulated panels

are on two and four foot modules; sills, girders and beams, roof trusses, panels and other parts, including plumbing, are all standardized—so you can build whatever kind of house you want with HomeOla parts—and build it fast. Extra rooms are simple to add *at any time*. HomeOla parts are stocked by retail material yards from coast to coast.

If there isn't a HomeOla house parts dealer near you, phone or wire us for complete information about one or a hundred houses.

THE HOMEOLA CORPORATION 9 SOUTH CLINTON STREET • CHICAGO 6, ILLINOIS
MANUFACTURERS OF STANDARDIZED HOUSE PARTS



PLAN NOW
FOR *Cool Comfort*
NEXT SUMMER



KOOLSHADE[®]
SUN SCREEN

BLOCKS SUN HEAT RAYS *Outside* **THE WINDOW**

The most efficient shading device ever developed

Comparative tests prove KoolShade gives more effective shade than awnings, venetian blinds or window shades. Up to 90% of sun heat rays are blocked and radiated *outside the window*. Vision from inside is not cut-off or blurred . . . every elusive breeze drifts through. Paper-thin slats, in effect, form a miniature outside venetian blind. Sun-exposed rooms stay as much as 15 degrees cooler.

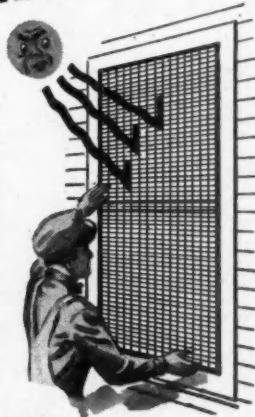

NOTE THESE VALUABLE FEATURES

- Permanently set at 17° angle for greatest shading efficiency.
- Prevents the fading of valuable drapes and furnishings.
- Easy and inexpensive to install—will not rust, rot or rattle.
- Fits neatly and smoothly into modern architectural design.
- Durable bronze KoolShade also effective as insect screen.

Air conditioning becomes more effective and less costly

Sun heat rays pouring through unshaded windows build up room temperatures and put a heavy load on air conditioning equipment. The American Society of Heating and Ventilating Engineers state in their 1940 guide, ". . . by reflecting, absorbing and radiating most of the sun's heat rays *outside the window*, KoolShade has been shown to account for as much as 75% of the cooling necessary."

An overloaded air-conditioning unit can become effective by installing KoolShade. On new installations an excellent cooling job can be accomplished with lighter, less expensive equipment if KoolShade is used on all sun exposed windows—electricity and maintenance costs are lowered by reducing the load on present equipment.

Ingersoll Steel Division
Borg-Warner Corp., Dept. B2
310 South Michigan Ave., Chicago 4, Ill.

Please send free sample and literature.

Name

Company

Address

City State



You Are Invited
to our exhibit at the
NAHB SHOW
Stevens Hotel, Chicago
February 23-28
and to a
More Complete Showing of
the Ingersoll Utility Unit
at the
Casino Room, Congress Hotel

Your local distributor
will be there to schedule
orders for 1947 delivery



Production line of Ingersoll Utility Units. Here basic plumbing connections for the Ingersoll's kitchen and bathroom fixtures are fitted into the frame of the engineered core by journeymen plumbers.

Acres of mechanical cores about to move onto the final assembly line where they become a single engineered utility unit. Ready for shipment with ALL equipment for Kitchen, Bathroom and Heating Plant.

Furnaces, electrical connections, hot water heaters and all basic plumbing are tied-in to form the complete core of the Ingersoll Utility Unit.



Ingersoll

UTILITY UNIT
TRADE MARK

INGERSOLL UTILITY UNIT

NOW IN VOLUME PRODUCTION!

*Shipments being made
daily; hundreds of units
already installed!*

Builders in half a dozen states are rapidly piling up actual on-the-job experience in installing the Ingersoll Utility Unit. They and their sub-contractors agree that Ingersoll's accurately engineered, practically designed Utility Unit not only speeds construction, but gives them an excellent workmanlike installation that adds greatly to the utility and appearance of any home.



Here is the bathroom side of the Ingersoll Utility Unit installed and in use. Note also the recently installed unit at the right . . . see how neatly kitchen utilities and bath fixtures tie into the central mechanical core.

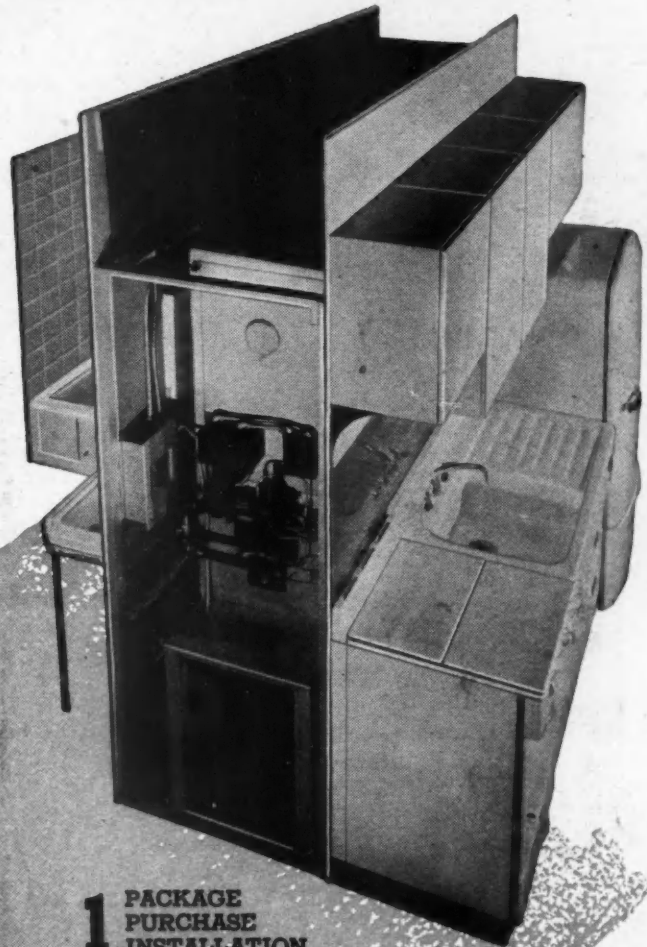

1 PACKAGE PURCHASE INSTALLATION

The Ingersoll Utility Unit can solve many of your 1947 building problems. Mail the coupon today for the Ingersoll book of house plans specially designed for the efficient use of this Unit.

Ingersoll

UTILITY UNIT
TRADE MARK

Ingersoll Steel Division
Borg-Warner Corp., Dept. B2
310 S. Michigan Ave., Chicago 4, Illinois

Please send me a free copy of the Ingersoll book of house plans.

Name.....

Company.....

Address.....

City..... State.....





Dexter originated the tubular lock and latch in 1924. The leadership of being "first" has been maintained by being "best." They are the first choice of progressive builders because they install easier, faster, and because they assure guaranteed lifetime satisfaction.

The TUBULAR LOCK and LATCH was invented by DEXTER

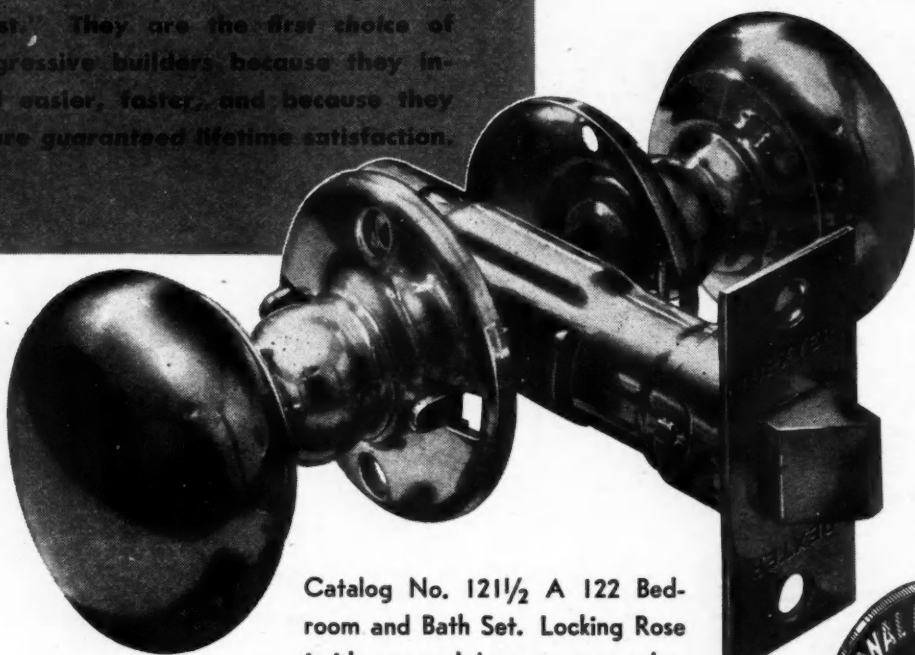

Catalog No. 121 1/2 A 122 Bed-room and Bath Set. Locking Rose inside, passed by emergency key outside. Solid wrought brass trim.

NATIONAL BRASS COMPANY, Mfrs.
Grand Rapids, Michigan

MAKERS OF BUILDERS, CABINET, SCREEN DOOR
AND SHELF HARDWARE

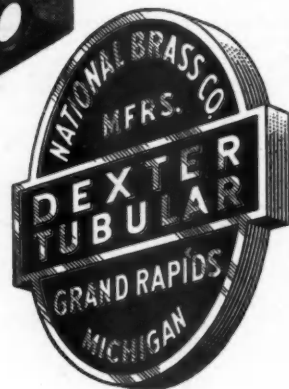

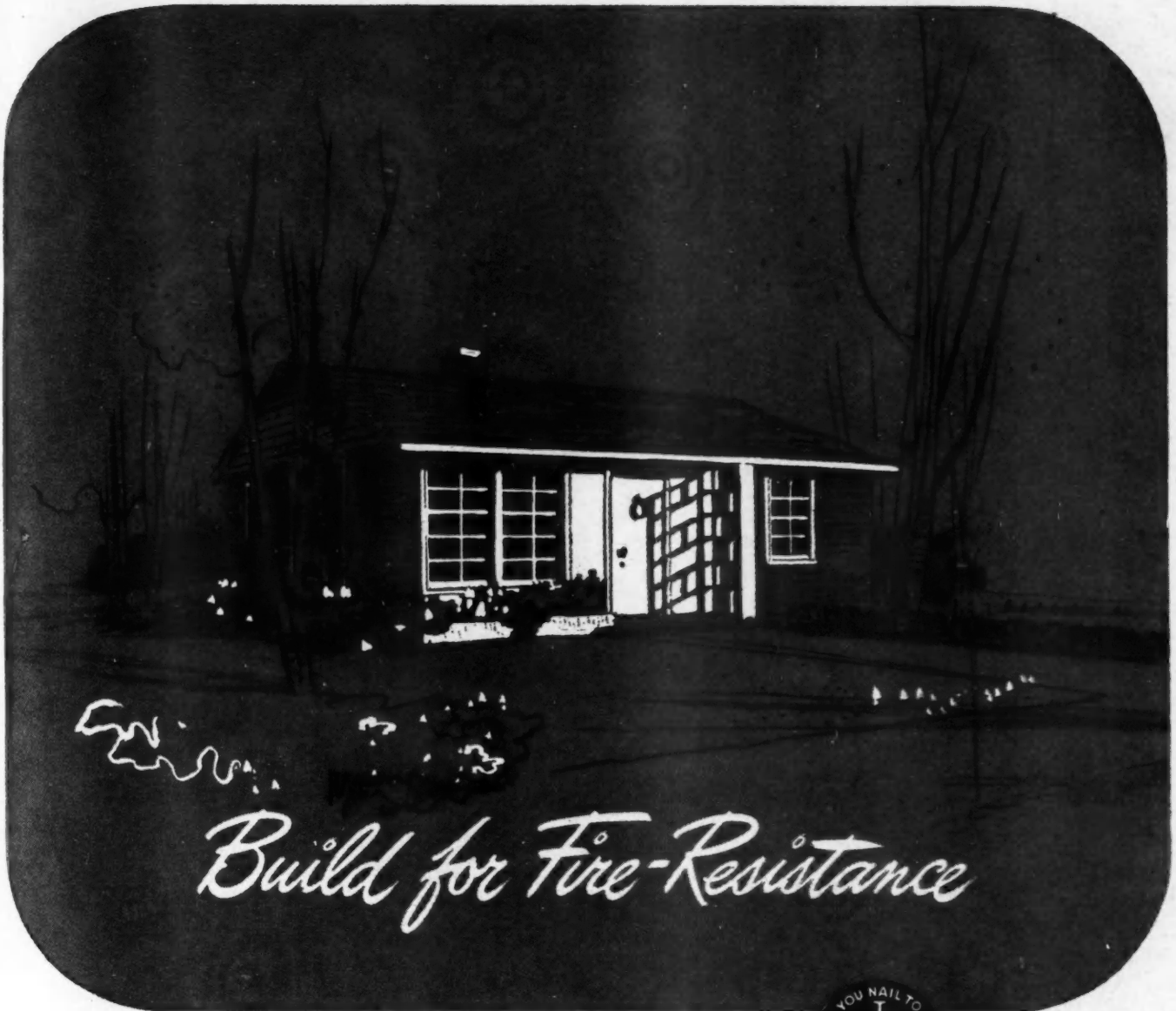

Build for Fire-Resistance

Stran-Steel framing is a building product of Great Lakes Steel Corporation



Stran-Steel provides a highly practical, economical method of fire-resistant construction for light buildings. This modern framing material is not only non-inflammable itself, but also permits the most efficient use of fire-resisting collateral materials.

Freedom of choice in selecting collateral materials is made possible by the *nailing groove* in Stran-Steel framing members. This patented feature, exclusive to Stran-Steel, enables workmen to nail other building materials directly to the steel framing members. Construction with Stran-Steel is fast, rigid, durable . . . assures longer building life and simplifies maintenance problems.

Build lasting value into homes, apartment buildings and light commercial and industrial structures

. . . build with Stran-Steel! For further information, see Sweet's File, Architectural, Sweet's File for Builders, or the January issue of Building Supply News.

BUILD WITH



GREAT LAKES STEEL CORPORATION

Stran-Steel Division • Dept. 30 • Penobscot Building • Detroit 26, Michigan

UNIT OF NATIONAL STEEL CORPORATION



**You can't
horse around
with this fact!**

● You can't afford to "horse around" with the demonstrated fact that unless new homes are wired for *ELECTRIC RANGES*, they're not modern now, and will be even farther behind the times a few years hence. Survey after survey proves that statement.

Protect your reputation by building houses that are truly modern. Avoid kick-backs by including wiring for an Electric Range.

An Electric Range requires only: 3-wire service from point of cut-in to the distribution panel; a minimum of two No. 6 wires and one No. 8 wire; a 60-amp. switch with overload protection and a 3-wire circuit from the distribution panel to the range outlet in the kitchen. Make this your minimum wiring specification.

Electric Range Section
NATIONAL ELECTRICAL
MANUFACTURERS
ASSOCIATION
155 East 44th Street
New York 17, N. Y.

A-B STOVES
ADMIRAL
CROSLEY
ELECTROMASTER
ESTATE HEATROLA
FRIGIDAIRE
GENERAL ELECTRIC
GIBSON
HOTPOINT
KELVINATOR
LEDO
MONARCH
NORGE
QUALITY
UNIVERSAL
WESTINGHOUSE



TO KEEP THEM MODERN . . .

wire your houses
FOR ELECTRIC RANGES

PR
and
ligh
tabl
all-t
prod
whe
seas
key
put
logs
item
com
start
TI
shor
with
trol
tion,
seve
in 19
war
wate
nails
mon
total
erab
dem
tubs
ers'
sect
creas
corr
steel
cont
well
Co
early
prod
boar

20
150
100
50
1
0 M

TRENDS

BUILDING MATERIAL — EQUIPMENT — APPLIANCES

PRODUCTION of building materials and equipment for houses and other light load structures continues to establish new postwar records and some all-time records. With this composite production curve upward at a time when on-site construction activity is seasonally retarded, output of many key materials will exceed the amount put in place. This should reduce backlogs and help to fill pipelines for many items, especially those not required to complete some 400,000-odd new home starts unfinished in 1946.

There are still some raw material shortages, chiefly in the metals, but with the removal of government controls and a more settled labor situation, these shortages will diminish in severity and should disappear entirely in 1947. Production of such items as warm air furnaces, sinks, lavatories, water closets, cast iron soil pipe and nails has hit record highs in recent months. **Despite good production totals, however, there is still considerable unbalance between supply and demand on cast iron soil pipe, bathtubs, lavatories, water closets, builders' hardware, wiring fixtures and insect screen cloth.** Although price increases early in January presaged early correction of some maladjustments in steel, this condition is expected to continue with some degree of severity well into 1947.

Contrary to many predictions made early in 1946, the lumber industry produced an estimated 34,000,000,000 board feet last year, the highest total

since 1942 when the figure was 36,000,000,000. This development has eased the lumber supply problem in most quarters. Procurement of pine shop lumber for woodwork, especially sash and doors, continues to be a major bottleneck for that industry.

Both price factors in the building cost index continued to rise into the first weeks of 1947, although for the first time since before the war builders were inquiring about prices and confining purchases to actual requirements on most major items. This is especially true in regard to lumber where, with a greatly improved supply situation, manufacturers were meeting price resistance. There are definite indications buying of all building materials and equipment is going on a more cautious basis.

Despite the rise in building index cost factors in 1946, it is probable that builders on the whole will be able to show some reductions in house building costs in 1947. This will result from more cautious buying of all components of the house plus major economies in labor costs. It is not beyond the realm of possibility that an appreciably improved supply situation may cause prices to soften on some of the major home building items. The savings in labor costs will be accomplished by having a steady flow of materials to the job site to permit maximum man-hour efficiency, plus elimination of the need for compliance with numerous government regulations.

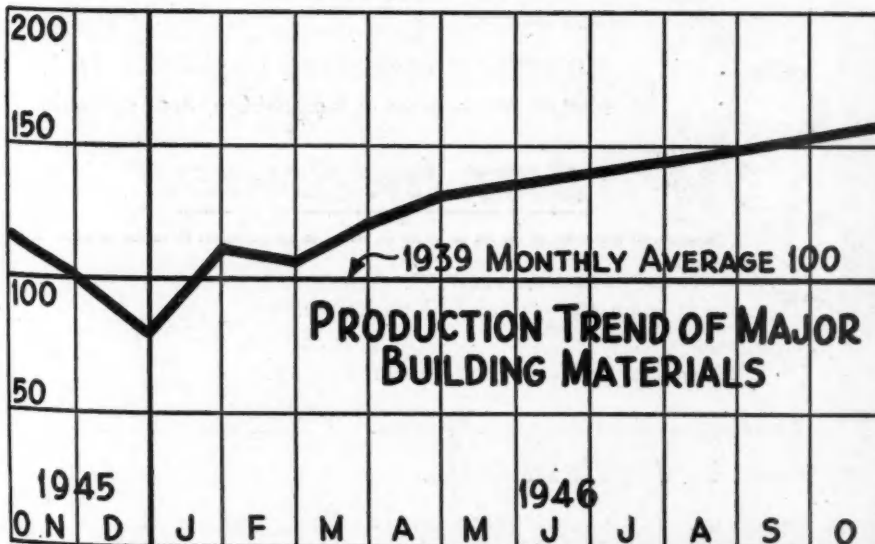

Production figures from U.S. Department of Commerce



Surveys* show that women want Electric Water Heaters because of the following advantages: (1) **SAFE** (flameless, fumeless); (2) **CLEAN** (smokeless, sootless); (3) **ADAPT-ABLE** (permits short hot water lines; requires no flue or vent); (4) **TROUBLE-FREE** (as electric light); (5) **ECONOMICAL** (plenty of hot water all the time at low cost). That's why you should plan to install a modern Electric Water Heater in every house you build!

*1944 NEMA survey revealed 3 times as many women preferring Electric Water Heaters as owned them at that time.

Electric Water Heater Section
NATIONAL ELECTRICAL MANUFACTURERS ASSOCIATION
 155 East 44th Street, New York 17, N. Y.

- ADMIRAL • B & F • CLARK • ELECTRONMASTER •
- FOWLER • FRIGIDAIRE • GENERAL ELECTRIC • HOTPOINT •
- HOTSTREAM • KELVINATOR • MONARCH • NORGE •
- PEMCO • REX • RHEEM • SEIDELHUBER • SELECTRIC •
- SMITHWAY • THERMO-GRAY • THERMO-WATT •
- UNIVERSAL • WESTINGHOUSE

A HOUSE WIRED FOR
 AN ELECTRIC RANGE IS ...

ALREADY WIRED FOR AN
Electric
WATER HEATER!

Announcing

a new Building Material that
moisture will not penetrate!

BARRIERCOAT



Only BARRIERCOAT provides
all these practical advantages

EASY TO APPLY: Barriercoat can be applied by unskilled workmen, and at normal temperatures. No heating necessary. Consistencies for brushing, spraying, troweling. Applied to surface layer of cement or mortar plaster. Self-leveling. Brush and spray coats dry in 8 hours—trowel mastic in 72 hours.

PERMANENT PROTECTION: Locks deep into surface pores. Dries as homogeneous, resilient mass—no laminated characteristics. Forms an unbroken, time-defying film which will not crack or disintegrate as long as the building stands.

ECONOMICAL: Barriercoat reduces labor costs, spreads well and requires no heating equipment or fuel. Only 2 coats ordinarily, no excessive brushing. Gallon covers about 100 sq. ft., first coat; 150 sq. ft., second coat.

HIGHLY EFFECTIVE: Impregnable barrier against moisture-transmission, seepage, soil electrolysis, corrosive and erosive attack of inorganic acids, alkalis and salts. Protects walls from blistering, cracking, and disintegrating.

SERVICE PROVED: Leading chemical and building supply concerns, and U. S. and foreign government services specify BARRIERCOAT. Protects concrete, wood and metal. Proves in widely diversified applications over extended period of years.

for moisture-proofing

**BASEMENT WALLS, FLOORS,
FOUNDATIONS ... for
moisture-vapor proofing of
insulated siding**

BARRIERCOAT is a natural, pure species of hydrocarbon—impervious to acids, alkalis and salts—and a barrier to moisture-vapor transmission and seepage. Readily applied to basement walls (preferably on outside surfaces), floors and insulated siding. Makes good homes better, more attractive to buyers. Send coupon for complete details.

CARBOZITE PROTECTIVE COATINGS, INC.
811 South Main Street • Greensburg, Pennsylvania

SEND FOR BOOKLET!



CARBOZITE PROTECTIVE COATINGS, INC.
811 South Main Street, Greensburg, Pa.

Gentlemen:

Please send me booklet on BARRIERCOAT.

Name _____

Street _____

City _____

State _____

THERE'S BUILDER ECONOMY *AND* CUSTOMER SATISFACTION IN...



REYNOLDS *Lifetime* ALUMINUM WEATHERBOARD SIDING

COMBINE the faster erection and first-cost economy of sheet siding with the attractive appearance of "clapboard" lines. It all adds up to what both you and your customer desire—for either new construction or re-siding. Reynolds Lifetime Aluminum Weatherboard Siding is available to you *right now* in unlimited quantities... at mass production prices.

This is a rust-proof, rot-proof, sturdy aluminum sheet... crimped to simulate 4" clapboard, with $\frac{3}{8}$ " butt casting a pleasing shadow line. Special aluminum corner posts finish off walls handsomely. Nails are inconspicuously placed under the crimps. Application is simple, quick. Painting is unnecessary for protection... but easy to do when preferred. Convenient lengths—8', 10', 12'—with 24" vertical coverage.

And you have another big sales point in the effective insulation which aluminum gives—reflecting up to 95% of ra-

diant heat, outward in summer, inward in winter.

You are assuring your customer not only good appearance and lifetime economy, but extra comfort and heat saving as well... when you build with Reynolds Lifetime Aluminum Weatherboard Siding.

IF YOU SEE RUST
YOU KNOW IT'S NOT
ALUMINUM



Available now—through established trade channels. Detailed literature on request.

REYNOLDS METALS COMPANY
Building Products Division Louisville 1, Kentucky

REYNOLDS LIFETIME ALUMINUM

WEATHERBOARD SIDING



Sheet crimped in simulation of 4" clapboard. 8, 10 and 12 feet, 24" coverage.

CLAPBOARD SIDING



Individual clapboards fit together, covering all nails. 8" exposed surface, 12' lengths.

SINGLES

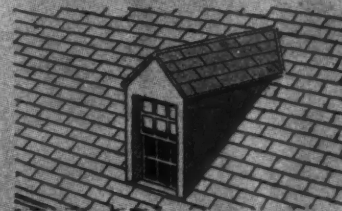

Completely interlocking, covering nails. Coverage, 8" x 14 $\frac{1}{2}$ ". Shadow line, $\frac{1}{4}$ ".

"SNAP-SEAL" ROOFING

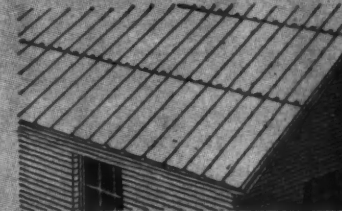

Sheets interlock, all nails covered, weather-tight. 6, 8, 10 and 12 feet, 24" coverage.

CORRUGATED ROOFING AND SIDING



Extra thick (.024")—therefore sturdier, yet lighter. 6, 8, 10, 12 feet, 26" wide.

S-V CRIMP ROOFING AND SIDING

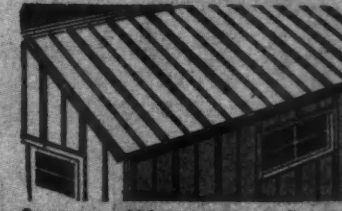

Some extra thickness means sturdier sheet yet lighter. 6, 8, 10, 12 feet, 24" coverage.

Also Aluminum, Sods, Trusses, Window Frames, Garage Doors, Reflective Insulation and complete Aluminum Houses.

See the Reynolds exhibit at the National Association of Home Builders Convention in Chicago

BUILD WITH ALCOA ALUMINUM

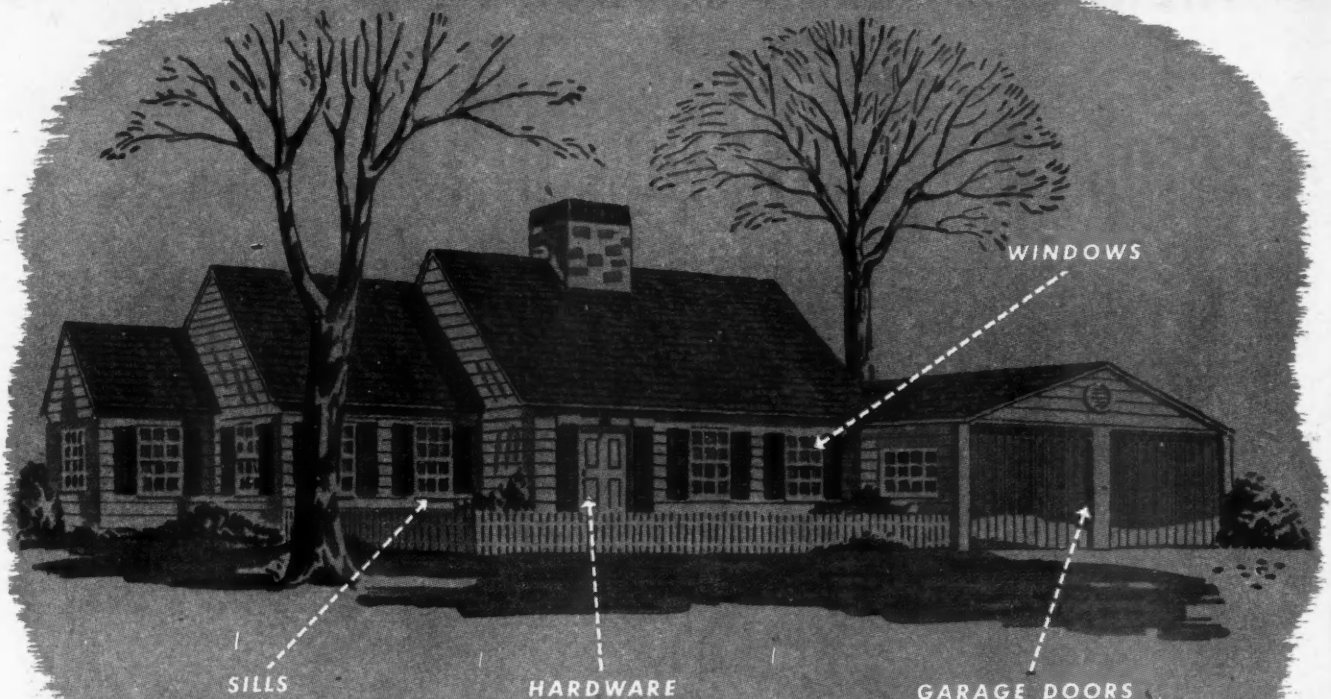

FOR HOMES THAT LAST

FOR HOMES THAT SELL

Profitable home building calls for quick construction, quick sales and satisfied customers. You have all of those when you include products of Alcoa Aluminum in the homes you build. Specify aluminum in your next construction job.

WINDOWS AND SCREENS

Aluminum windows, manufactured in a variety of standard sizes and designs, are delivered to the building site ready for installation. No sash or cords to install, no painting is required. Aluminum screens are long-lasting and stainproof.

WINDOW SILLS

Window sills of Alcoa Aluminum can be laid in a fraction of the time that it takes to lay sills of brick, stone or other materials. Once in, costs are over. They never rust, rot or warp.

HARDWARE

Aluminum hardware blends with all types of decoration, adds a note of modern design to new homes. Nonstaining, nonrusting, it keeps its good appearance despite time and constant use.

GARAGE DOORS

Quick selling points for any home are easy-to-open, nonwarping garage doors of Alcoa Aluminum. Light in weight, they can be installed in less time and with less labor than conventional garage doors. Once in, they never need painting; never stick or rust.

For information on these and many other building products made of Alcoa Aluminum, write to ALUMINUM COMPANY OF AMERICA, 1914 Gulf Building, Pittsburgh 19, Pennsylvania. Sales offices in leading cities.

MORE people want MORE aluminum for MORE uses than ever

ALCOA FIRST IN ALUMINUM



IN EVERY COMMERCIAL FORM

Now...you can saw from
FRAME to TRIM
 ...right on the job!



**MONARCH * UNI-POINT is First with a
 PORTABLE radial saw built of magnesium !**

LIGHTEST— Rust-proof magnesium, war-proven for toughness, makes the Portable Monarch Uni-Point the lightest 12-inch radial saw in the world . . . permits construction so compact it slides right through a 30-inch doorway. Now, at a low first cost, you can have Monarch Uni-Point's extra profit advantages from frame to trim, right on your building job.

AT LEAST 25% FASTER— Exclusive one point cutting with the Portable Monarch Uni-Point, ends costly waste motions . . . slashes one-fourth from your saw time. Pay yourself this extra dividend of nearly two whole days' sawing time saved each week.

ALL-PURPOSE— The new Portable Monarch Uni-Point makes every kind of

production cut in wood. From a rafter compound miter to stairway stringer routing, it is a matter of seconds. Its rigidity and machine tool construction assure absolute accuracy. Its 3 by 16-inch crosscut and 20½-inch ripping capacity is greater by far than any other radial saw of similar size and mobility.

SAFEST— The portable Monarch Uni-Point has no jutting arm, so there's never any menacing obstruction while you saw or lay out work. This and other outstanding protection features make this revolutionary magnesium radial saw your safest bet for more profitable production. Get more facts about the amazing savings possible. Send for the Portable Monarch Uni-Point booklet today.



Write for your
**FREE
 MONARCH PORTABLE booklet**

**A MONARCH UNI-POINT
 TO FILL EVERY NEED**

See this lightweight Model TNT and the stationary Model AJ, for heavier production, at Booth 55, the National Association of Home Builders' annual convention and exposition, Stevens Hotel, Chicago, February 23rd-27th, 1947.

AMERICAN SAW MILL MACHINERY CO. 50 MAIN STREET
 HACKETTSTOWN, N. J.
 Manufacturers of Saw Mill and Woodworking Machinery

*Trademark Reg. U. S. Pat. Off.

IMPORTANT!
 —for a watertight
Asphalt Shingle Roof

WATCH THESE TROUBLE SPOTS!

9 OUT OF 10 LEAKS are usually the result of im-
 properly applied valleys and flashings.

WATER DOESN'T GO THROUGH shingles but it
 can go around them. The efficiency of shingle roofs
 can be impaired by inadequate valleys and flashings.

THESE ARE THE TROUBLE SPOTS. Careful ap-
 plication by experienced workmen will pay divi-
 dends...insure a tight roof...eliminate complaints.

EXTRA CARE should be taken with valleys and
 flashings when re-roofing over old roofs, for the
 original valleys and flashings probably cannot be
 relied on. New valleys and new flashings are usually
 necessary. (Particularly important is the flashing
 where shingles meet vertical walls.)

THE TEXAS COMPANY

...manufacturers of Texaco Asphalt Shingles and Roofing





Yes,
We're On The Road Back
to
**INCREASED PRODUCTION
BUT—**

It's a long road, and too soon to predict
how far we must travel before booking
orders.

Recent further easing of building
restrictions is good for your
morale . . . and ours . . .
but the net result is still
heavier demand for
flooring we don't
have.

**WHILE YOU'RE
STILL WAITING**
Be Sure Of These Two Facts:

1. We're exerting our
utmost effort to *catch up*.
2. We're making certain that
Bradley quality is *kept up*.



BRADLEY LUMBER COMPANY *of Arkansas*

Manufacturers of Pre-Finished (Straight-Line) Flooring
in

Oak, Beech and Pecan.

WARREN,

ARKANSAS

HOME BUILDING CONTRACTORS *NOW*



Insulating Efficiency Equal to 12" Brick Wall

Tests by F. B. Rowley (Prof. of M. E., Univ. of Minn.), Midwest Research Institute and National Housing Authority. The easily applied blanket insulation, coupled with the reflective insulation of aluminum makes the Butler Boulevard an all climate home—cool in warm countries and warm in cold regions.

Home building contractors are invited to visit and inspect exhibition homes at Kansas City, Galesburg and Minneapolis.

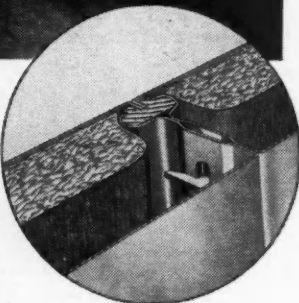

You Can Finish The Interior In Metal Or Any Conventional Material Such As Lath and Plaster, Plywood, Composition Board, Etc.

Note the wood furring strip above. It's locked into the jaws of the metal stud. It's grooved to receive and hold inside walls of metal. Or, to it may be attached plywood, sheetrock, composition board, or lath for plastering. Customers choice of interior decorative wall finishes may be applied. EXTERIOR WALLS ARE TREATED FOR CONVENTIONAL PAINTING WITH PLAIN, SAND FINISH OR STUCCO TEXTURE. From every standpoint Butler Built Boulevard Homes are arrangeable to present varying customer appeal.

At left, compact utility room.

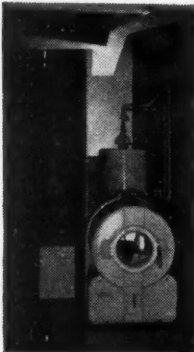

A Packaged Home Which You Can Construct in 20 Modern, Yet Traditionally Styled Arrangements To Fit Customer Personalities.

People are living in Butler Built Aluminum Houses—enjoying a new high in safety and comfort—a new low in economy of ownership and maintenance. At Butler plants production is going up fast. Deliveries are being made. Home building contractors are constructing others to suit individual tastes from precision parts delivered on the site in packages. No waiting. All materials of uniformly high quality. No need to resort to inferior materials or substitutes. From foundation to finished home is a matter of about 3 weeks. Think what that means to your turnover. Here is a combination of factory and on-the-site construction which brings the modernity of metal to home building as surely and soundly as it came to motor cars, planes, trains and ships.

Studded Metal Panels Key-lock Together To Form One of Strongest of Structural Systems.

The Key to speedy, high strength home construction is an entirely new patented system of structural members integrally formed into panel sections of skin stressed aluminum. Placing a panel and key-locking it into position is a matter of minutes. It is a simple operation comparable to setting studs and attaching sheathing and siding in conventional construction. Framework, walls, partitions, ceilings and steel rafters can be constructed in 3 or 4 days. Throughout, the construction is such as to facilitate window and door hanging, wiring, plumbing and other finishing operations.



Boulevard Homes

BUTLER BUILT

Reg. U. S. Pat. Off.

OF ALUMINUM OR STEEL

ONE EVERY 80 MINUTES



Price with Althou Boulevard tractor conven for alt

You Can START and FINISH HOMES In DAYS Instead of MONTHS!



Model featured—No. 2231773 and



Priced to compete with conventional construction.

Although of Aluminum, the base price of Butler Built Boulevard Homes is such as to permit home building contractors in most areas to finish and sell profitably against conventional construction. Garage, breezeway and extras for altering the styling are nominally priced.

Now Being Delivered—Now Being Lived In. Sold Only To Qualified Home Building Contractors.

Butler Built Boulevard Homes, F.H.A. financed, are being lived in. Deliveries are being made. Production is going up rapidly toward a potential factory capacity of 3 every 4 hours. Home building contractors WHO want to cash in on going production and a growing trend should SEND FOR FULL DETAILS NOW, then visit our exhibition homes.

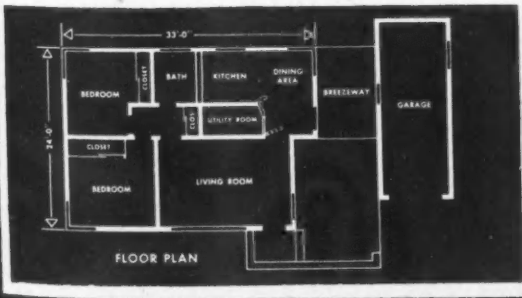

BUTLER MANUFACTURING COMPANY

Factories: Kansas City, Galesburg, Minneapolis

SEND COUPON TO

7366 E. 13th St., Kansas City 3, Mo. Or
966 Sixth Ave. S. E., Minneapolis 14, Minn.

We plan to build _____ homes. Send full information.

FIRM NAME _____

ADDRESS _____

CITY _____ STATE _____

CHROMEDGE'S COMPLETE
TUBE-PACKAGING GETS MY VOTE!



CHROMEDGE FITS EVERY NEED—
RIGHT ON THE NOSE!



YOU CAN'T BEAT B&T'S
CHROMALITE FINISH
FOR LASTING
RUB-PROOF
BEAUTY!



From every angle CHROMEDGE offers more

REG. U. S. PAT. OFF.

CHROMEDGE DOES
WONDERS
FOR MY
KITCHEN-
AND BATH



CHROMEDGE advantages are all-inclusive—important to every-one who specifies, distributes, sells, installs or uses decorative mouldings. For example, Chromedge gives you simplified tube packaging that protects your stock, simplifies handling, speeds inventory, cuts scrap losses . . . a streamlined choice of ready-to-ship stock lengths that fit every need . . . the *biggest* selection of highly *practical* designs, assuring easy, low-cost installation on *any* part of *every* job . . . special features like the famous, original Chromalite Finish that *does not rub off black*, stands up longer under all kinds of wear and tear. And remember, Chrom-edge trims are designed, extruded (or manufactured) and packed for shipment right at the B & T Metals Company plant . . . you get all the advantages of dealing with *one* group who is responsible for the *whole* fabricating job! If you don't have full details on Chromedge and the B & T dealer policy, write today!

THIS REBATE PLAN
MEANS EXTRA PROFITS!



CHROMEDGE DEALER REBATE BONUS		
★ 6-MONTH BONUS PERIODS ★		
1. January 1st to June 30th.		
2. July 1st to December 31st.		
★ BONUS SCHEDULE ★		
For Purchases of:		Rebate
1. Not less than \$300.00		4%
to not more than \$599.00		
2. Not less than \$600.00		6%
to not more than \$799.00		
3. Not less than \$800.00		8%
to not more than \$900.00		
4. Not less than \$1000.00		10%
and above		

The **B & T** Metals Company
Columbus 16, Ohio

This attractive *matched set* of trims for all materials from $\frac{1}{8}$ " to $\frac{1}{2}$ " in thickness, is typical of the famous Chromedge line!

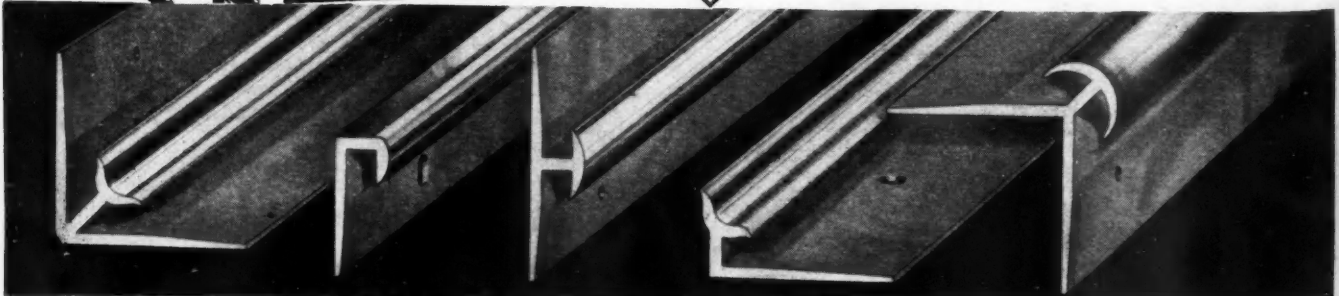



Why buy an obsolete compressor when you can get a JAEGER?



60 and 105 ft. trailers for builders.

With their giant "ultra-lapped" valves, slower piston speeds, bigger air receivers, interchangeable precision parts, full force feed lubrication and latest type Continental, International and Caterpillar engines, Jaeger "AIR PLUS" Compressors are delivering cooler air for less cost in fuel and upkeep than any compressor you've ever owned. Ask for Catalog JC-5.



JAEGER "SURE PRIME"

... the only pumps with protected performance

All-weather enclosures keep them clean, dry, quicker-starting, smoother running — for the life of the pump.

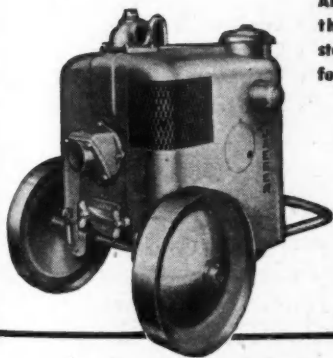

Extra powered, conservatively rated and faster and doubly-sure to prime, a Jaeger is a more efficient pump to start with and maintains that high efficiency for longer years of life. Sizes to 10". Send for Catalog P-45.

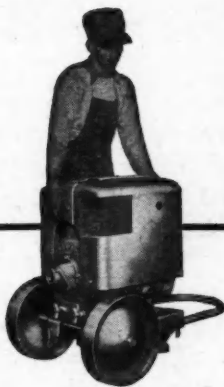

Quickly accessible

JAEGER MIXERS for big, low-cost yardage

AUTOMATIC SKIP SHAKER SPEED LOADER

DIRECT DRIVE FROM AUTOMOTIVE-TYPE TRANSMISSION

TRUE MACHINED STEEL DRUM TRACKS

BIGGER FUEL TANK, PROTECTED RADIATOR and OVERSIZE POWER

JAEGER SPEEDLINE

Ask your Jaeger distributor to show you these and many other advanced features developed in 3 1/2S, 6S, 11S and 16S size trailers, by the world's largest manufacturer of concrete, plaster, mortar mixers.



3 1/2S "AUTO-LOADER" with Measuring Batch Hopper that automatically SHAKES the load in, quick-as-a-flash. Good for 15 to 20 EXTRA batches a day—today's fastest small mixer on the road and on the job.

3 1/2S "BIG BOY" TILT-TRAILER: Huskiest half-bag tilter Jaeger has ever built, with the famous Dual-Mix "V"-bottom drum that **DOUBLES** the mixing action and speeds the discharge.

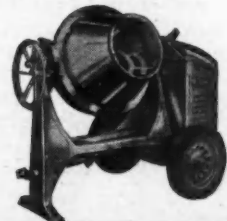

THE JAEGER MACHINE COMPANY

521 Dublin Avenue, Columbus 16, Ohio — Distributors in 120 Cities

REGIONAL OFFICES:

8 E. 48th St.
NEW YORK 17, N. Y.

226 N. LaSalle St.
CHICAGO 1, ILL.

235-38 Martin Bldg.
BIRMINGHAM 1, ALA.

THE ELJER CRYSTAL FOUNTAIN

Chrome-Plated Fittings — with Non-Squirting Bubbler



- Vitreous China
- Easy to Clean
- Easy to Keep Clean
- Automatic Pressure Regulator

THE CRYSTAL FOUNTAIN
#-1395

- Non-Squirting Bubbler
- Chrome-Plated Fittings
- Drainage Face Strainer
- Permanent Finish

High in quality, low in price, the attractive Eljer Vitreous China Crystal Fountain features gleaming chrome-plated fittings and a *completely automatic* regulator that maintains a steady stream height—regardless of variations in supply pressure. Water *cannot* be squirted by placing a finger over the nozzle. That's a real plus-value in schools, factories and public buildings.

When planning, building or remodeling most all types of structures, you can wisely recommend extra Eljer Crystal Fountains in convenient locations at small additional cost. No other fountain in a comparative price range offers the features of the Eljer Crystal . . . and it's a money-maker, too. *For complete information, see your Eljer Distributor or write Eljer Co., Ford City, Pennsylvania.*

SEE ELJER NATIONAL ASSOCIATION OF HOME BUILDERS EXPOSITION • CHICAGO, ILL., FEB. 23RD TO 27TH

ELJER CO. . . . FACTORIES AT
 FORD CITY, PA. • SALEM, OHIO • LOS ANGELES, CALIF.
 SINCE 1904 MAKERS OF FINE PLUMBING FIXTURES

NATIONAL ASSOCIATION OF HOME BUILDERS
 NEW
 Bob Key
 With relaxa
 dustry
 NAH
 Expo
 Chic
 shoul
 Job."
 Robe
 and
 and
 pace
 note
 when
 In
 addr
 Cort
 that
 woul
 he t
 Amo
 the g
 NH
 er R
 dier
 A
 will
 accep
 Chic
 Fore
 Griff
 Cad
 resp
 ing,
 C
 gan,
 criti
 has
 Oth
 the
 pres
 Jr.,
 Cor
 Del



MONTHLY REVIEW

NEWS OF THE NATIONAL ASSOCIATION OF HOME BUILDERS AND AFFILIATED ASSOCIATIONS

Bob Gerholz, Past President, to Keynote 1947 NAHB Convention

With the first effects of the government's relaxation of controls being felt by the industry, it was inevitable that the theme of NAHB's mammoth 1947 Convention and Exposition, to be held in the Stevens Hotel,



ROBERT P. GERHOLZ

Chicago, during the last week of this month, should be "Private Enterprise Can Do the Job." And, it was just as inevitable that Robert P. "Bob" Gerholz, 1944 president and nationally known Flint, Mich., builder and developer, should be selected to set the pace for this important meeting in a keynote speech on Monday afternoon, Feb. 24, when the convention sessions officially begin.

In announcing that Mr. Gerholz would address the opening session, Frank W. Cortright, executive vice president, reported that several other distinguished persons would also appear on the program of what he termed "the largest convention yet." Among the acceptances are those of two of the government's two chief housing officials, NHA Administrator and FHA Commissioner Raymond M. Foley and Housing Expediter Frank R. Creedon.

Assurance that the veterans' point of view will be ably expounded is apparent in the acceptances from National Commander-in-Chief Louis E. Starr of the Veterans of Foreign Wars, National Commander Paul Griffith of the American Legion, Richard Cadwallader, chairman of the committee responsible for the Legion's report on housing, and other important spokesmen.

Congressman Jesse P. Wolcott of Michigan, who in the past has been an outspoken critic of the government's housing policies, has also sent word that he will be present. Others who accepted invitations to address the convention include Morgan L. Fitch, president of NAREB; James C. Downs, Jr., president of the Real Estate Research Corp.; Hobart C. Brady of Wichita; and Deloss Walker of Chicago.

President Meyerhoff "Takes On" Public Housing Advocate in Radio Debate

In a nationwide broadcast over the facilities of the Columbia Broadcasting System, NAHB President Joseph Meyerhoff recently debated the question, "What Should the Government Do Now About Veterans Housing?" with well known Washington public housing lobbyist, Lee Johnson, execu-

the housing field. It must not through its program to aid veterans on an emergency basis set up a planned or socialized economy in housing."

In his opening statement, Mr. Johnson, not unexpectedly, said, "Real estate lobbies and home builders have stated that they can



tive secretary of the National Public Housing Conference.

The program, "Open Hearing," a regular CBS weekly discussion feature, was moderated by CBS newsman Winston Burdett, who appears between Mr. Meyerhoff (left) and Mr. Johnson, in the above photograph.

In his opening statement, Mr. Meyerhoff declared: "The nation's home builders since October, 1945, have conscientiously struggled with and without government directives to provide new homes for veterans. But, whether a veteran gets a new home or new apartment is of less importance than that he gets a comfortable, decent home at a price he can afford to pay. This can best be accomplished by building a really large volume of lower cost and moderate cost housing, quickly, so that the total supply of houses can be increased and the cost of existing houses and apartments be reduced through the economic law of supply and demand."

Mr. Meyerhoff continued by pointing out that the only way to build housing in volume is "through the operation of our competitive free enterprise system" and concluded his opening statement with: "And above all, government through its actions, as well as through its statements, must regain the confidence of the industry in its desire to make private enterprise work in

do the complete job if let alone. Now they have the opportunity to prove their contentions—their candidates for top executive posts now sit as housing administrator and housing expediter. These groups scored a tremendous victory at the expense of the American people. For nearly a year, the President, through his Administrator Wilson W. Wyatt, gave this country vigorous, constructive leadership. That hope is gone; how long the veteran's patience will hold out is a question.

"The one hope that I can see for salvaging a housing program for this nation is the early passage of the Wagner-Ellender-Taft General Housing Bill."

Mr. Meyerhoff countered this argument with the statement, "If materials and labor are available, we can build all the housing the nation needs. That's our job, and we'll do it. We agree with President Truman that 1947 can be the biggest home construction year in history."

As was to be expected these two proponents of opposing housing philosophies did not reach agreement on the question during the broadcast. Impartial listeners reports, however, were unanimous in stating that President Meyerhoff's case for private building sounded more plausible than Mr. Johnson's plea for more government regimentation and the W-E-T bill.

Officials of New Texas Association Meet



The officers and trustees of the newly formed Texas Association of Home Builders held their first regular meeting recently in San Antonio for the purpose of creating by-laws and transacting other business incidental to getting the Association underway.

Although all members of the official family were not in attendance, the above photograph, taken during the meeting, shows the majority of the new officers and trustees. They are, left to right, J. C. Watts, executive vice president, Houston Home Builders Association; Dow J. Zabolio, secretary, Houston; Grover Godfrey, execu-

tive secretary, Home Builders Association of Dallas; Avery Mays, vice president of Area I, Dallas; E. P. Lamberth, trustee, Dallas; A. J. Crow, trustee by proxy, Dallas; William G. Farrington, trustee, Houston; V. F. Buchek, president, San Antonio; Lee B. Miller, executive secretary, San Antonio Home Builders Association; Carl M. Brown, first vice president, Dallas; Mrs. Aleen Salmon, treasurer, Amarillo; Peggy Seale, Amarillo; K. S. Reynolds, president, Texas Panhandle Home Builders Association, Amarillo, and W. C. Schutts, Jr., trustee by proxy, Amarillo.

Metropolitan New York Home Show will Be Staged April 19-26

To help dramatize what promises to be the greatest building season the area has enjoyed in many years, the Home Builders' Council of New York, New Jersey and Connecticut is sponsoring the Metropolitan Home Show in Grand Central Palace, New York City, April 19-26. The show is to be presented in conjunction with Campbell-Fairbanks, nationally-known promoters of the Sportsmen's Show, the New England



Home Exposition, and other exhibitions.

Shown in the photograph, signing the Home Show contract, is Henry J. Shaheen, chairman of the Council. Otto J. Hartwig, secretary of the Council, is seated at his left and Charles W. Strong, representing Campbell-Fairbanks, is at his right.

Following the closing of the negotiations, Mr. Shaheen declared, "With a constant and steady flow of materials promised for the spring we expect the greatest volume of new construction in the home field we have ever known. We plan to show the home-hungry public what it can reasonably expect from us, the builders, in the months and years ahead. The latest ideas and developments in the way of products, appliances, equipment and design will be offered, with a stringent effort on our part to keep

out the 'illusory' and 'miracle-promising' in any form. As realistic builders, we know what we can deliver and we are anxious to deliver it.

"Present indications are that exhibitors will include nationally-known materials and equipment manufacturers, trade and consumer magazines in the home field, suppliers and manufacturers of home furnishings, and several of our well-known builder members."

The Home Builders' Council includes the Long Island Home Builders Institute, the Home Builders Association of Northern New Jersey, the New Jersey Home Builders Association, the Home Builders Association of Westchester and the Home Builders Assn. of Southwestern Connecticut.

Northern New Jersey Builders Hold Annual Dinner Meeting

National leaders in the home building industry were guests of the Home Builders Association of Northern New Jersey at its annual dinner meeting held January 17 in the Hotel Pennsylvania, New York. Arthur R. Storms, of Teaneck, N. J., chairman of the banquet committee, reported an attendance in excess of 500 members and guests.

The principal feature of the program was the installation of the 1947 slate of association executives headed by Emmanuel M. Spiegel, of Dumont, N. J., as president. Former secretary of the association, he succeeds Ralph Carletta, of Hasbrouck Heights, N. J., who completed two consecutive terms as president.

Other incoming officers are Carl S. Carlson, of Fairlawn, vice president; Charles Costanzo, of West Englewood, treasurer, and Joseph A. Goldman, of Dumont, secretary. Mr. Carletta was chosen to represent the association as a national director of NAHB.

Washington Home Builders Aid Veterans Bilked in House Deal

A unique achievement in building good will for home builders has been chalked up by the Home Builders Association of Metropolitan Washington. Under the leadership of President Edward R. Carr, the association went to the rescue of a group of veterans and their families in a situation which could have spelled a setback for every home builder in the nation's capital.

The incident arose when a real estate operator went bankrupt after accepting deposits from some 150 veterans for houses he proposed to build. He accepted deposits totalling around \$165,000, in amounts ranging from \$500 to \$1,000, and put 27 houses under construction which he was unable to complete.

Alarmed by failure to get the houses they had been promised, the veterans called a meeting, invited the press, and aired their grievances. The operator was declared bankrupt, and the veterans were stranded. The story made sensational reading, and immediately demands were heard for a Congressional investigation of all home building.

Realizing that the situation brought about by one individual could reflect unfairly and harmfully on all home builders, Mr. Carr and his directors went to work. In a meeting with the victims they offered to develop a plan to salvage the project already started, or to have reputable Washington builders build homes for them in established subdivisions. In the latter event, Mr. Carr proposed that materials dealers and others involved grant trade discounts that could be passed on to the veterans so that the funds put into deposits might be equalled.

The frank approach of the Washington home builders and their genuine efforts to help the veterans won instant praise throughout the capital. The veterans involved, touchy over their experience, applauded Mr. Carr when he declared: "This is a sincere effort to prove to you veterans that we aren't quite as bad as some of our government critics paint us."

In addition, Mr. Carr told *American Builder*: "It shows again that the integrity of organized Home Builders counts; is needed today to carry through the complex operation of building houses."

Benton Lefton Heads Cleveland

At an installation meeting held last month Benton Lefton, prominent suburban Cleveland home builder and developer, was inducted as president of the Home Builders Association of Greater Cleveland, to succeed Nicholas F. Molnar, 1946 president.

Other officers installed at the same time were: Fred Volk, vice president, Maurice J. Fishman, treasurer, and Everett C. Andrews, secretary.

New trustees elected include Mr. Andrews, Al Azolino, Alex Brusino, Elmer DeFogie, Mr. Fishman, Robert Gaiser, James Humel and Ben Rosing, all for a two-year period. Trustees chosen for one-year terms are Leonard Gunderson, George Seltzer and Peter Sepper.

Messrs. Molnar and Lefton, Hugh Selby and George J. Goudreau were also named to represent the group as NAHB directors.

Arrangements Being Completed For Chicago Home Show

The Chicago Metropolitan Home Builders Association is busy completing plans and arrangements for their big Chicago-land Home Show to be conducted at the Chicago Coliseum, May 17 to 25, 1947. This is the first Chicago postwar home show and promises to be the largest and most complete in the history of Chicago.

The show will be managed by Paul S. VanAuken, well known to all home build-



ARTHUR E. FOSSIER

ers for his outstanding achievements in handling the NAHB conventions.

Arthur E. Fossier, popular president of the Chicago group, is putting his usual intelligent, aggressive talents as a leader to work on the project, which was conceived as a result of urgent and extensive demands from present and prospective home owners in the Chicago area for a comprehensive display of the newest and best in products, methods and services pertinent to the planning and building of homes. This show will be the crowning achievement in Mr. Fossier's successful tenure as president of the Chicago builders, because his term of office will expire in June.

James F. Bonnell Joins Long Island Home Builders Staff



JAMES F. BONNELL

The appointment of James F. "Jim" Bonnell (shown above), former eastern editor for *American Builder*, as assistant secretary of the Long Island Home Builders Institute and the Home Builders Council of New York, New Jersey and Connecticut was announced recently in a joint statement

Cortright's Column

By Frank Cortright



Executive Vice-President, National Association of Home Builders of the United States

National interest in record-breaking production of homes in 1947 is very much in evidence. The first two messages of President Truman to the Congress devoted considerable attention to the subject. Housing bills were promptly introduced even before Congressional committees were formally designated. The need for more rental housing is receiving very great emphasis. It looks like a lively year ahead.

Home builders are ready and able to build all the homes the nation needs if the government will cooperate with industry. That's the real key to the situation. Proper and orderly aid in financing rental housing will produce more rental units than all the preachments in the book. We hope we get it.

Housing demand is still far ahead of supply, both actual and potential. Housing production is in worse position than other consumer commodities from standpoint of production catching up to demand. However, fantastic estimates of need should not be confused with capacity of the market to absorb production.

We certainly won't be encouraged to put up the rental housing we would all like to see if the government is to jump further into the business of building, owning and renting housing itself. No surer remedy to choke off production by private builders could be devised than another big burst of public housing. Public housing spells the end of home building, one of the prime forces in our economy.

FHA's efforts to encourage construction of three and four family rental units and all types of multiple construction deserve the earnest attention of home builders. FHA is asking for cooperation, and the industry is anxious to give it. As an industry, we are just as concerned as Mr. Foley to see a healthy construction of rental housing everywhere. Many of our builders have achieved excellent records in this field. We will certainly increase this activity if FHA opens the way, but it will have to make appraising procedures realistic.

Mortgage financing availability appears ample . . . Mortgage foreclosures rate at lowest point in history, something like three foreclosures per 100,000 population; lower even than the delirious days of the 20's. This, of course, affects mortgages psychologically, and agencies such as Veterans' Administration are warning against home purchasing at today's "values." These agencies are apparently cognizant of what Wenzlick (Real Estate Analyst Inc., St. Louis) calls "a common trend toward over-lending." Interest rates still down, even show some further downward trend, possibly because of the great volume of refinancing as well as because of accumulated capital reserves of the big lending institutions . . . There seems to be no indication of the tightening of the availability of mortgage financing for the standard type of project.

Rapid elimination of the "we've-gotta-control-everything" philosophy in Washington is essential to make a high-production year possible. That process has been started. We hope it will be consistently followed. FHA's procedural changes for processing rental projects are another contribution in this direction. Maybe we're really on the way now.

I hope so.

by Kalman Klein, president of the Long Island builders group, and Henry J. Shaheen, chairman of the Council.

Mr. Bonnell inaugurated the Builders' News Review section—now the Monthly Review section—when *American Builder*, in October, 1944, began regularly report-

ing the complete activities of NAHB and its affiliated local associations. Since resigning from the position eastern editor last year, Mr. Bonnell has been associated with the building material publicity firm of Rider & Keister, New York. His new office will be in Rockville Center, L. I.

New Houston Home Builders Officials Meet

Dow J. Zabolio, prominent Houston builder and president of San Jacinto Homes, has been named president of the Houston Home Builders Association for 1947. The election of Mr. Zabolio, who succeeds Frank

numerous accomplishments during 1946. "We have had a great leader in Mr. Sharp," he said. "We know how much he has contributed to this organization during the past year and the nation knows how

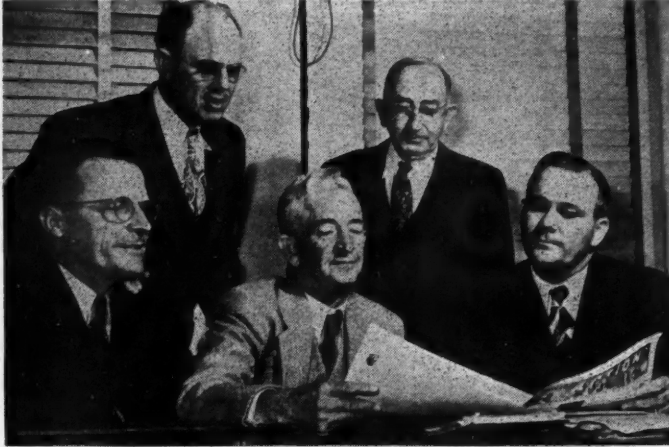

SHOWN in the photo above (left to right) are: J. C. Watts, Miles Strickland, Preston R. Plumb, C. R. Brace, and Dow J. Zabolio.

W. Sharp, took place at the association's annual meeting recently.

Other officers named by the association were J. C. Watts, executive vice president, Preston R. Plumb, of Plumb and Mitchell, vice president, Miles Strickland, treasurer and C. R. Brace, secretary.

In his acceptance speech before some 150 members of the association, Mr. Zabolio praised the membership and its leader for

much he has contributed to the housing program with his tremendous developments here in Houston."

Reporting on the year's activities, Mr. Watts listed some of the highlights of the year, including the association's large delegation to the Chicago convention last February, and the work of William G. Farrington and Frank Sharp in the national association's activities.

NAHB Headquarters Staff Has Numerous Service Departments

While the National Association has been going through the rapid expansion that increased its membership from only a few hundred in early 1942 to 12,000 today, its Washington staff has been going through a similarly rapid expansion.



"JIM" Hoag and Mary Ellen Walsh.

The two-man staff of 1941 and early 1942 had increased to five by 1943 and to eight by 1944. In 1945 the Washington staff grew to ten and in 1946 it reached the total of 23 members. During the past year three new divisions were created by the Executive Committee to serve the requirements of the ever-growing membership. They are: Membership department, headed by "Jim" Hoag, membership secretary, and Mary Ellen Walsh, secretary. Department for committee organization and legislative activities, headed by Larry Hansen, with



LARRY Hansen and Mildred Lutz.

Mildred Lutz, as secretary. Department for expediting materials under Materials Expediter James Heaton, and Jeanne Aumiller, secretary.

Personnel of each of these departments is shown in the accompanying photographs.



JAMES Heaton and Jeanne Aumiller.

Stephen Kovach, Jr. Again Heads Allegheny County Group

At its annual meeting, held recently, the Home Builders' Association of Allegheny County elected Stephen Kovach, Jr., president to succeed Fred C. Brown, 1946 president of the association. Other officers elected were: W. S. Tussey, first vice president; Frank Corace, second vice president; Edgar Hagel, secy.; Ralph Scherger, treas.

After serving as president of the Allegheny County group in 1942 Mr. Kovach



STEPHEN KOVACH, JR.

joined the United States Air Force Engineers as a Captain, and was discharged in March, 1946, with the rank of Lt. Col.

Directors elected for 1947 are: W. B. Dixon, Jr., Felix Caste, C. W. Isner, A. N. Young, N. J. LeJeune, George Levin, T. F. Karr, Gust Larson, Fred Favo, Jacob Simon, and T. A. Rauch.

Memphis Re-elects Goodwin

John B. Goodwin, 1946 president, was chosen to again head the Home Builders Association of Memphis at its annual meeting recently. Other officers elected were: William B. Clark, first vice president, who succeeds himself, I. A. Dobson, second vice president, Charles H. Freeburg, secretary-treasurer. Mrs. Neva Wash continues as



executive secretary of the organization.

Directors elected for 1947 include: Harry Dermon, Ben P. Dlugach, Mason Ezzell and J. Ripley Greer.

Last month the association was host to the national association's Slum Clearance Committee, which includes Frank Kirkpatrick, Milwaukee, Ben Wileman, Oklahoma City, Ernest Henry and Larry Hansen, Washington.

Shown in the photo above are: Seated (l. to r.)—Messrs. Goodwin and Dobson. Standing, (l. to r.)—Messrs. Clark, and Freeburg.

Home Builders 1947 Annual Convention and Exposition Will Break All Records

National meeting to be held February 23 to 27 at The Stevens Hotel in Chicago



W. HAMILTON CRAWFORD

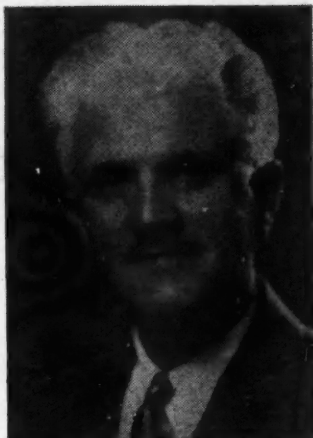

PAUL S. VAN AUKEN

In four years the National Association of Home Builders' annual convention and exposition has grown from a "capacity crowd of 400 from 40 states" and no exhibits into the mammoth 1947 event expected to attract some 10,000 visitors, and with more than 120 major exhibits covering more than 40,000 square feet of floor space, under the capable direction of Paul S. Van Auken, convention and exposition director.

Nationally-known and recognized authorities appear on the programs. The exhibits feature new designs, materials products and services of interest to every one of America's thousands of private home builders. Those who have attended earlier Conventions well know the wealth of ideas and material to be obtained. Many have said "The heart of the Convention program is the panel-discussion." Home builders come to the Convention to learn building facts and to gain building ideas and they have endorsed the panel plan as the best method to improve their building knowledge and techniques.

This year the panels will cover such vital topics as Community Planning and Shopping Centers; Veterans Housing; Financing Outlook and Availability; Apprentice Training, Wages, and Productivity of Labor; and Enlarged Markets Through New Materials and Methods. Other special panels will be conducted by representatives of the industry to demonstrate new uses for tried building materials.

Although the opening date for the 1947 Exposition is Sunday, Feb. 23, and the Convention commences the

next day, Feb. 24, many home builders are making their plans to journey to Chicago earlier for committee meetings and directors' sessions. These are set to begin Feb. 20. Final Convention proceedings are scheduled for Thursday, Feb. 27, after which all the delegates with the exception of the new Board of Directors will call it "a day." The new Board will hold sessions on Thursday, Feb. 27, and Friday, Feb. 28.

The annual national convention and exposition idea sprang from the November, 1943, "War Conference" of 400 Home Builders from about 40 states at the Hotel Cleveland, Cleveland, O. Enthusiasts proclaimed it "a capacity crowd." It took wings with the first full-blown meeting, when 3,000 from 42 states thronged to the Sherman Hotel, Chicago, in January, 1945.

The idea soared to heights unexplored when 6,000 building professionals registered for the 1946 Convention and Exposition, held in The Stevens Hotel—the world's largest—in Chicago.

Today, the talk is of attendance in terms of more than 10,000, Home Builders, and others identified with the vast home building industry from every state in the Union; or, as W. Hamilton Crawford, convention and exposition committee chairman, puts it, "from coast to coast, and border to border."

In 1943, NAHB President Fritz B. Burns, said: "Private building would have been stopped long ago had it not been for the effective and vigilant efforts of the Home Builders' Emergency Committee and NAHB. And, in 1944, President Robert P. Gerholz added, "We are now organized to make our voices heard throughout the length and breadth of America. Truly, we are the 'voice' of the vast building industry."

When in 1945, Joseph E. Merrion was elected to the presidency an optimistic note prevailed and the convention theme was "The Shape of Homes to Come." A somewhat different note was sounded, however, when 1946 President Joseph Meyerhoff, in keynoting that important session, declared: "It is appropriate that the Home Builders of the Nation accept as their primary responsibility a program of 'Homes and Jobs for Veterans.'"

Today, as the great 1947 NAHB Convention and Exposition nears . . . again at The Stevens Hotel in Chicago . . . a bright, new era looms before the nation's great home building industry as a strange era in government nears an end.



JOSEPH MEYERHOFF
President



BEN C. WILEMAN
1st Vice President



GEORGE J. GOUDREAU
Secretary

GROWING UP! The Story of the National Association of

THE TIME was November, 1941—one brief month before Pearl Harbor. Washington had become a gathering place for representatives of major industries who wished to discover how their lines of activity would function in the war economy that seemed inevitable. Members of the home building industry were particularly interested in the government's program—for a presidential "stop order" had already called a halt to all residential construction.

It was under these conditions that a group of the nation's leading builders decided that the home building industry needed a national organization, that a recognized voice for the industry was the only means by which the government could be informed that builders were ready and capable to build homes for the hordes of war workers who were converging on the nation's industrial cities.

Although the nucleus of NAHB had come into being in 1923 when the National Association of Real Estate Boards segregated its builder membership into the "Home Builders and Subdividers Division," NAHB in its present form dates back only six years to these pre-Pearl Harbor weeks. NAREB offered its facilities as a medium for the development of the much-needed organization, and it was under its sponsorship that NAHB got off to its start. The executive officer chosen to head the new organization was Frank W. Cortright, who remains in the position. First offices were at 1737 K Street, N. W., in Washington. The staff—including Cortright—totaled two!

The early activities of the NAHB were carried on through the Home Builders' Emergency Committee which was headed by Hugh Potter, later Housing Coordi-

nator. One of the main accomplishments of the Committee in these early days was to have the home builders' case presented before the President and largely as a result of this the construction "stop order" was lifted and replaced by a limitation order.

NAHB "got off to a hurried start," in the words of one of its founders. Its original membership roster contained the names of many of the most important builders of the nation, but numerically it was weak. First aim of the young organization was to build up its numbers so it could earn the right to speak as the voice of the home building industry. Fritz Burns of Los Angeles, NAHB's first president, traveled throughout the country to urge builders to join the organization so that it could represent their interests. Burns considered this an emergency matter; he was convinced that the welfare of the industry rested on the outcome of this drive for adequate industry representation. One of the early members says, "Fritz Burns was the first real messenger of the need for unity of action in the industry. He did a real job."

Working together was a new idea for the home building industry—builders had traditionally been "lone wolves." Some builders preferred to try to maintain this individualistic policy, but many builders

recognized the need for NAHB and membership tripled during the course of the year. It has at least doubled in each succeeding year.

While the drive to gain recruits was waged throughout the country, Cortright was setting himself to the task of getting acquainted with the ways of official Washington. "Within a few months," reports an associate, "he had gained the confidence and respect of every man in government who had to do with housing." As the membership roster grew and NAHB became increasingly recognized as spokesman for the industry, the Association became a medium through which government and industry exchanged views. Heads of government departments came to meetings of the Emergency Committee and there heard of the problems that home builders faced. Their projected orders were discussed in committee sessions so that wrinkles could be ironed out before the orders were promulgated.

Control was a new factor in the home building industry; many builders resented the government's activities while admitting that some regimentation in wartime was necessary. A veteran builder tells of the work of NAHB: "The building industry didn't take kindly to control—it wasn't used to control. It was the NAHB and Frank Cortright largely that produced a cooperative spirit between government and the home building industry at a time when considerable friction had been expected to develop between these two groups."

In May, 1943, NAHB had grown to sufficient stature to stand alone. At that time it gave up its affiliated status with the National Association of Real Estate Boards to take up an independent existence.



FRITZ B. BURNS



ROBERT P. GERHOLZ



JOSEPH E. MERRION



MILTON J. BROCK
Treasurer

Home Builders

In August, the National Association of Home Builders and the National Home Builders Association effected a merger. The Home Builders Association—an organization which also dated from the early days of the national emergency—had a membership roughly equal in size to that of NAHB. Its executive director, William J. Guinan, and its president, Harold Schulenburg of Detroit, frequently met with NAHB officials to discuss the problems which builders all over the country faced in common and in time the plan for merger was developed.

The merger brought new and valuable members into the NAHB fold. It also brought organizational changes for NAHB. NAHB's Board of Directors was doubled so that adequate representation could be given to the enlarged membership. At the same time, new by-laws were devised which gave every local association representation in the National Association in proportion to its size. In this way the Association's democratic practice developed of having at least one representative of every local on its Board of Directors. This plan has also given NAHB's Board of Directors a national point of view since every city of major size is represented on the Board.

For the 1944 term, Robert P. Gerholz of Flint, Michigan, assumed the presidency. During his tenure of office, NAHB experienced a notable membership gain. The year also saw the formation of many new locals. Local associations already in existence were encouraged to strive for new members, to strengthen their positions in their communities. Inspirational talks by Mr. Gerholz—on the value of "united efforts"—spurred these advances.

By 1945, when Joseph E. Merrion of Chicago succeeded to the presidency, NAHB had achieved one of its primary aims—it was recognized in government circles as the authoritative voice of the men who were building the major portion of

NAHB Officials Talk of the Future

Let's Not Forget!

—President Meyerhoff

The home building industry is looking forward. Now, at a time when the relaxation of controls is enabling them to make long-range plans for the future once again, home builders are scanning the horizons.

It's helpful to take a look into the future. It's also helpful to keep in mind the lessons of the past. Home building is just emerging from a period of the strictest regimentation. We have learned many lessons.

One of the things we learned during recent years is that men who are newcomers to the housing business can't direct us in the business of housing. The men in charge of government programs in the past have not seen the problem in its basic terms because on the whole they were not sufficiently familiar with the home building industry. Lesson Number One, therefore, is this: Government activities concerning home building can be properly directed *only* by men who know the industry.

Another thing we have learned regards artificial pricing. The government's scheme to produce a surplus of building materials by an artificial system of rigged prices failed utterly. Lesson Number Two: Man cannot invalidate the laws of economics.

Lesson Number Three stems from government's attempt to provide "emergency" temporary housing. Here government failed to understand that temporary shelter could only be at the expense of permanent housing, which requires the same materials. Lesson Number Three is obvious: No one can build more houses than for which there are materials.

We must remember: What has been tried before may be tried again! We have learned the hard way—Let's Not Forget!

A Great Future!

—Exec. Vice Pres. Cortright

Since 1947 is still a comparative newcomer, it is appropriate to try to look into the future—a risky business, at best. As Shakespeare has pointed out: "We know what we are, but know not what we may be." But, risky or not, home builders, with large investments and a long period before turnover, find it necessary to base their operations on predictions of events to come.

Are we to have a boom? Or will some economist's theory of a recession be borne out? Or will it be something in between these two extremes? These are questions the home builder can ask himself. Even the economists can't agree. Some say that a combination of inflationary factors and declining purchasing power will produce a sharp decrease in the volume of business just at the time when production is nearing its peak.

Other economists, equally reputable, see a long period of prosperity ahead. They predict that the accumulated demand for the products of American manufacture plus a stored-up purchasing power of the public will combine to produce a sustained period of high-volume business.

Faced with two such opposing views, one can only pay his money and take his choice. My personal prediction is that the demand for housing is so acute in most sections of the country that only a prolonged severe depression can prevent 1947 from being "home building's biggest year," and the next ten years from becoming "Home building's greatest decade." Time alone will prove whether these confidences are justified. It appears, though, that the period ahead is a promising one for our nation's home builders!

emergency wartime residences. Now it could speak out for the home building industry. One member described it in these words, "We had become 'non-ignorable.'"

During Merrion's term, NAHB held its first National Exposition in Chicago. Sponsored by the Chicago Association, which had the courage to assume a real financial risk for an entirely novel undertaking, the Exposition came off on a larger scale than had been thought possible. Its success guaranteed that from that time on the Exposition would be an annual event.

Joseph Meyerhoff of Baltimore, 1946 president, brought to the office the experience he had gained in two terms as treasurer. He also brought a wide experience with public housing, slum clearance, and Federal Housing Administration procedure and regulations. The year saw an expansion of the Association's services;

a legislative department, a public relations department, and a materials expediting and regulations department were added to NAHB and the activities of the membership promotion department were accelerated. During 1946 NAHB gave much of its attention to the problem of how housing for veterans could best be provided. The year also saw increased emphasis on the work of NAHB's committees and increased responsibilities for the committee heads.

While the Association has been going through the rapid expansion that increased its membership from only a few hundred in early 1942 to 12,000 today, its Washington staff has been going through a similarly rapid expansion. The two-man staff of 1941 and early 1942 had increased to five by 1943 and to eight by 1944. In 1945 the Washington staff grew to ten and
(Continued to page 154)



NATIONAL ASSOCIATION OF HOME BUILDERS OF U. S.

Board of Directors

EXECUTIVE COMMITTEE

PRESIDENT.....Meyerhoff, Joseph, Baltimore, Md.	SECRETARY.....Goudreau, Geo. J., Cleveland, Ohio
1st VICE PRESIDENT....Wileman, Ben C., Oklahoma City, Okla.	PAST PRESIDENT.....Merrion, Jos. E., Chicago, Ill.
TREASURER.....Brock, Milton J., Los Angeles, Calif.	Crawford, W. H., Baton Rouge, La.
Carr, Edward R., Washington, D.C.	

REGIONAL VICE PRESIDENTS

Olson, John, Worcester, Mass.
 Mezger, Gustav A., Roslyn Heights, L.I., N.Y.
 Smith, Frank J., Philadelphia, Pa.
 Buchannan, J. Wesley, Washington, D.C.
 Johnson, Wallace E., Memphis, Tenn.

Boggs, L. J., Atlanta, Ga.
 Malowney, Charles R., Tucson, Ariz.
 Lindop, John Cummings, River Forest, Ill.
 Pearson, S. G., Minneapolis, Minn.
 Duke, Ralph S., University City, Mo.

Farrington, William G., Houston, Texas
 Brockbank, Alan, Salt Lake City, Utah
 Gore, Charles T., Denver, Colo.
 Simms, L. C., Portland, Oregon
 Stoneson, Ellis L., San Francisco, Calif.

1946 DIRECTORS

Abbey, M. Sanford, Rochester, N.Y.
 Adamson, Alex, Salt Lake City, Utah
 Atkinson, W. P., Oklahoma City, Okla.
 Babcock, C. I., Miami, Fla.
 Bailey, Glenn, Santa Ana, Calif.
 Bane, Mark C., Richmond, Va.
 Barlow, George G., Syracuse, N.Y.
 Becker, Gustav A., Point Pleasant Beach, N.J.
 Berkley, Robert M., Clayton, Mo.
 Bevacqua, Joseph, Rochester, N.Y.
 Blietz, Irvin A., Evanston, Ill.
 Bohannon, David D., San Mateo, Calif.
 Bonelli, Paul E., Portland, Ore.
 Bowman, N. J., Salt Lake City, Utah
 Bready, Robert, Baltimore, Maryland
 Brown, Fred C., Bridgeville, Pa.
 Burgher, Ballard, Dallas, Texas
 Burkhard, Paul, Glendale, Calif.
 Burns, Fritz B., Los Angeles, Calif.
 Carletta, Ralph, Hasbrouck Heights, N. J.
 Carlson, L. Z., Minneapolis, Minn.
 Cederlund, Donald L., Grand Rapids, Mich.
 **Chamberlain, James R., Chattanooga, Tenn.
 Chamberlin, Donal L., Kenwood, Chevy Chase Md.
 Chandler, W. C., Memphis, Tenn.
 Clarke, George S., Savannah, Ga.
 Closs, Willard E., Summit, N.J.
 Colomb, C. Earl, New Orleans, La.
 Coogan, Thomas P., Miami, Fla.
 Dean, Frank E., Albion, Michigan
 Dixon, William B., Pittsburgh, Pa.
 Driskell, Joseph, Fort Worth, Texas
 Durbin, Harry J., Detroit, Mich.
 Elliott, Wm. J., El Paso, Texas
 Enes, Bernard, Pittsburgh, California
 Erwin, H. A., Lorain, Ohio
 Evans, Col. Wm. H., Long Beach, Calif.
 Fike, P. R., Ellwood City, Pa.
 Fite, L. E., San Antonio, Texas
 Fossier, Arthur E., La Grange, Ill.
 Gamble, James C., Denver, Colo.
 Genrich, J. Harold, Snyder, N.Y.
 Gensler, Edwin H., Struthers, Ohio
 Gerety, Edward J., Fairfield, Conn.

Gerholz, Robert P., Flint, Mich.
 Gibbs, Lawrence B., Los Angeles, Calif.
 Goodyear, George S., Charlotte, N.C.
 Gould, Emil J., Miami, Fla.
 Graham, James, Brooklyn, N.Y.
 Graves, A. H. M., Indianapolis, Ind.
 Hahn, Grant, Spokane, Washington
 Hanburg, A. E., Newington, Conn.
 Hartmann, Arnold, Newton Centre, Mass.
 Haverstick, Joseph B., Dayton, Ohio
 Heraty, Phil, Oakland, Calif.
 Heritage, Paul E., Petersburg, Fla.
 Hicks, Keith, East Lansing, Mich.
 Hykes, Lew, Seattle, Washington
 Hyle, Walter L., Akron, Ohio
 Joern, Charles E., La Grange, Ill.
 Johnson, Axel V., San Mateo, Calif.
 Johnson, Walter S., Niagara Falls, N.Y.
 Jones, C. Braddock, Baltimore, Md.
 Kagey, J. M., Miami, Fla.
 Keller, Granville, South Bend, Ind.
 Kelley, C. B., Nashville, Tenn.
 Kessler, Paul, Cilina, Ohio
 Kirkpatrick, Frank, Milwaukee, Wis.
 Klein, Kalman, New Hyde Park, L.I., N.Y.
 Knight, C. Finley, Jacksonville, Fla.
 Knoch, A. A., Canton, Ohio
 Kuhlman, Edmund, Detroit, Mich.
 Leenaars, Peter J., Battle Creek, Mich.
 Lewis, John R., Chicago, Ill.
 Lindeman, Jr., H. A., Indianapolis, Ind.
 Lockwood, Rodney W., Detroit, Mich.
 McAbee, F. R., Seattle, Washington
 McIlvain, Jr., Thomas, Cincinnati, Ohio
 McKeon, Chris D., San Francisco, Calif.
 McMurray, E. T., Des Moines, Iowa
 Macht, Morris, Baltimore, Md.
 March, James H., Tacoma, Washington
 Marsh, Jr., Lex, Charlotte, N.C.
 Miller, George W., Detroit, Mich.
 Moller, E. C., Altadena, Calif.
 Molnar, Nicholas F., Rocky River, Ohio
 Morrison, J. T., Louisville, Ky.
 Morrogh, J. Francis, Beaumont, Texas
 Mortensen, Cliff, Seattle, Washington
 Muth, Russell A., Philadelphia, Pa.

Nelson, Orville K., Minneapolis, Minn.
 Nixon, George F., Chicago, Ill.
 Odell, R. W., Denver, Colo.
 Olson, Arthur, Glenbrook, Conn.
 Orleans, Alfred P., Philadelphia, Pa.
 Parkinson, William, Omaha, Nebr.
 Percy, Jr., John G., Buffalo, N.Y.
 Petersen, Arvid C., Birmingham, Mich.
 Poag, George A., Ft. Wayne, Ind.
 Pomeroy, Donald T., Syracuse, N.Y.
 Potter, Hugh, Houston, Texas
 Prather, Hugh E., Dallas, Texas
 Read, Maurice G., Berkeley, California
 Reid, Wallace E., Detroit, Mich.
 Roberts, H. Cedric, Burbank, Calif.
 Sandberg, Edwin, Portland, Ore.
 Sarshik, Morris, Camden, N.J.
 Schaaf, Julius J., Erie, Pa.
 Schultz, Niels, Millbrae, Calif.
 Seale, Fred M., Amarillo, Texas
 Selby, Hugh G., Lakewood, Ohio
 Shaheen, Henry J., Cranford, N.J.
 Shapter, Jr., Walter J., Columbus, Ohio
 Sharp, Frank W., Houston, Texas
 Shepherd, Everett, Birmingham, Ala.
 Shields, Hamilton L., South Portland, Maine
 Shoup, Francis P., Decatur, Ga.
 Simons, A. P., Dallas, Texas
 Smith, Otis, Larkspur, Calif.
 Stein, Jack, Dayton, Ohio
 **Sturdevant, Harold V., Toledo, Ohio
 Sundin, Clark B., Worcester, Mass.
 Swope, David, Tarrytown, N.Y.
 Taplin, Clinton R., Milwaukee, Wis.
 Taylor, Earl W., Providence, R.I.
 Taylor, John, Kansas City, Mo.
 Taylor, Waverly, Washington, D.C.
 Thorman, H. C., San Antonio, Texas
 Todd, W. B., Fort Worth, Texas
 Turner, Morris W., Tulsa, Okla.
 Vadnais, George, Springfield, Mass.
 Wells, Ralph W., Kansas City, Mo.
 Wimble, Maynard, Flint, Mich.
 **Wobig, Edward G., Saginaw, Mich.
 Woodbury, F. Orin, Salt Lake City, Utah

**1946 Directors holding office until successor is elected and qualified.

AFFILIATED LOCAL ASSOCIATIONS OF THE NAHB OF THE U. S.



As of January 15, 1947

ALABAMA

Birmingham Association of Home Builders
 President—Sam E. Russell, Birmingham.
 Exec. V. Pres.—J. L. Baswell, Birmingham.

CALIFORNIA

Home Builders Institute
 President—Lawrence B. Gibbs, Los Angeles.
 Secy. & Mgr.—Clifford L. Rawson, Los Angeles.
 Building Contractors Association of California, Inc.
 President—E. C. Moller, Altadena.
 Exec. Secy.—Edward M. Sillos, Los Angeles.
 Peninsula General Contractors and Builders Assn.
 President—Frank Burrows, Burlingame.
 Ex. V. Pres.—Harry E. Smith, Burlingame.
 Associated Home Builders of Alameda County
 President—Philip F. Heraty, Oakland.
 Ex. V. Pres.—George H. Sharp, Oakland.
 Marin Builders Association
 President—Otis Smith, Larkspur.
 Exec. Secy.—Walter W. Carter, San Anselmo.
 Associated Home Builders of San Francisco, Inc.
 President—J. C. Johnson, San Francisco.
 Exec. Secy.—Milton W. Morris, San Francisco.
 General Contractors Association of Contra Costa Co.
 President—Bernard E. Enas, Pittsburg.
 Secy. & Mgr.—R. C. Kuhns, Richmond.
 Home Builders Association of San Joaquin County
 President—Fred Heinz, Stockton.
 Secretary—H. M. Haughey, Stockton.

COLORADO

Denver Association of Home Builders
 President—R. W. Odell, Denver.
 Exec. Secy.—Stanley C. Brandenburg, Denver.

CONNECTICUT

Home Builders Association of Hartford County, Inc.
 President—Henry F. Tetraut, W. Hartford.
 Secretary—D. R. Shively, Hartford.
 Home Builders Association of Southwestern Conn.
 President—William H. Hobby, Stamford.
 Asst. Treas. & Secy.—Harry Trimmer, Stamford.
 Greater Bridgeport Builders Association
 President—Frank Hackett, Bridgeport.
 Secretary—Thornton Barrett, Bridgeport.

DELAWARE

Home Builders Association of Delaware
 President—Alfred J. Vilone, Wilmington.
 Exec. Mgr.—Francis E. McCann, Wilmington.

DISTRICT OF COLUMBIA

Home Builders Association of Metropolitan Wash.
 President—Edward R. Carr, Washington.
 Ex. Director—Ernest F. Henry, Washington.

FLORIDA

Home Builders Association of Jacksonville
 President—Chas. E. Commander, Jacksonville.
 Secretary—Fred Thellman.
 Builders Association of South Florida
 President—J. M. Kagey, Miami.
 Exec. Secy.—George S. Miller, Miami.
 Home Builders Association of Greater St. Petersburg
 President—John Schaefer, St. Petersburg.
 Secretary—Harrison Fox, St. Petersburg.

GEORGIA

Home Builders Association of Atlanta
 President—David T. Nicholas, Atlanta.
 Exec. Secy.—Roy C. Tiffin, Atlanta.
 Home Builders Association of Savannah
 President—B. Taylor Smith, Savannah.
 Secretary—Mrs. Geraldine Berry, Savannah.

ILLINOIS

Chicago Metropolitan Home Builders Association
 President—Arthur Fossier, La Grange.
 Exec. Secy.—Marlin C. Huggett, Chicago.

INDIANA

Home Builders Association of Fort Wayne
 President—Ralph L. Shirmeyer, Fort Wayne.
 Exec. Director—Geo. A. Poag, Fort Wayne.
 Marion County Residential Builders
 President—Robt. R. Mason, Indianapolis.
 Exec. Secy.—Elmer M. Meadley, Indianapolis.
 South Bend-Mishawaka Home Builders Association
 President—Herbert M. Weaver, South Bend.
 Secretary—Granville W. Keller, South Bend.

IOWA

Home Builders Association of Des Moines
 President—James R. Leverett, Des Moines.
 Secretary—Elmer E. Okey, Des Moines.
 Quad City Assn. of Home Bldrs.
 President—Fred B. Agnew, Davenport.
 Secretary—Robert H. Redding, Rock Island.

KENTUCKY

Associated Home Builders of Louisville
 President—Thos. J. Morrison, Louisville.
 Exec. Secy.—W. Arthur Sorrell, Louisville.

LOUISIANA

New Orleans Chapter of NAHB
 President—Earl Colomb, New Orleans.
 Ex. V. Pres.—A. R. Lundquist, New Orleans.

MAINE

Home Builders Association of Maine
 President—Clinton Benson, Portland.
 Secretary—Clifford L. Swan, Portland.

MARYLAND

Home Builders Association of Maryland
 President—Robert Brady, Baltimore.
 Exec. Secy.—C. Philip Pitt, Baltimore.

MASSACHUSETTS

Home Builders Association of Greater Boston
 President—Anthony Taurasi, Boston.
 Exec. Secy.—H. Whittemore Brown, Boston.
 Home Builders and Contractors Association (Springfield)
 President—Arthur Penn, West Springfield.
 Secretary—Fred G. Pothier, Springfield.
 Master Home Builders Association of Worcester
 President—William C. Anderson, Auburn.
 Secretary—Milton A. Thompson, Worcester.

MICHIGAN

Builders Association of Metropolitan Detroit
 President—James I. Tuckett, Detroit.
 Ex. Director—William J. Guinan, Detroit.
 Assistant—H. A. MacMillan.
 Flint Association of Home Builders
 President—Maynard Wimple, Flint.
 Secretary—Jay C. Troxel, Flint.
 Grand Rapids Home Builders Association
 President—Donald L. Cederlund, Grand Rapids.
 Secy.—Treas.—Frank E. Ederle, Grand Rapids.
 Lansing Home Builders Association
 President—Daniel Smith, Lansing.
 Exec. Secy.—Howard Walsh, Lansing.
 Saginaw Valley Builders Association
 President—Vern Jones, Saginaw.
 Secretary—W. T. Nagle, Saginaw.
 Home Builders Association of Branch and Calhoun Counties
 President—George J. Hughes, Albion.
 Secretary—Richmond J. Ray, Albion.
 Battle Creek Association of Home Builders
 President—Vernard E. Troxel, Battle Creek.
 Secretary—Clayton R. Rice, Battle Creek.

MINNESOTA

Minneapolis Contractors and Builders Association
 President—O. K. Nelson, Minneapolis.
 Exec. Secy.—Robert Hendershott, Minneapolis.
 St. Paul Home Builders Association
 President—Gene Hurley, W. St. Paul.
 Exec. Secy.—Selmer Rockney, W. St. Paul.

MISSISSIPPI

Home Builders Association of Jackson
 President—F. R. Kimbrough, Jackson.
 Secretary—C. T. Harris, Jackson.

MISSOURI

Home Builders Division of the Kansas City Real Estate Board
 President—John V. Walker Jr., Kansas City.
 Exec. Secy.—Frank Loren, Kansas City.
 Home Builders Association of Greater St. Louis
 President—Adrain Koch, St. Louis.
 Office Secretary—Guy A. Palmer, St. Louis.

NEBRASKA

Omaha Chapter of NAHB
 President—Axel E. Seastedt, Omaha.
 Secretary—Harvey E. Rasp, Omaha.

NEW JERSEY

New Jersey Home Builders Association
 President—Willard E. Closs, Summit.
 Exec. Secy.—Charles C. Deubell, Jr., Newark.
 Home Builders Association of Northern New Jersey
 President—Emanuel M. Spiegel, Dumont.
 Exec. Secy.—M. C. Carroll, Hackensack.
 New Jersey Shore Builders Association
 President—Benjamin T. Kenney, Point Pleasant.
 Ex. Officer—Gustav A. Becker, Point Pleasant.
 Home Builders League of Southern Jersey
 President—Wm. V. Higgins, Camden.
 Exec. Secy.—Wm. E. Johnson, Philadelphia.

NEW YORK

Long Island Home Builders Institute
 President—Kaiman Klein, New Hyde Park.
 Exec. Secy.—O. J. Hartwig, Rockville Centre.
 Niagara Home Builders
 President—Alfred J. Virtuoso, Niagara Falls.
 Secretary—Frank J. Hilbert, Niagara Falls.
 Niagara Frontier Builders Association
 President—Harold Genrich, Snyder.
 Exec. Secy.—George F. Prong, Buffalo.
 Rochester Home Builders Association
 President—Joseph Bevacqua, Rochester.
 Exec. Secy.—J. Raymond Tobin, Rochester.
 Better Builders Association of Onondaga
 President—Earl E. Schopfer, Syracuse.
 Secretary—Albert E. Barlett, Syracuse.
 Home Builders Association of Westchester, Inc.
 President—Irving A. Lipsig, New Rochelle.
 Exec. Secy.—N. William Knight, Mt. Vernon.

NORTH CAROLINA

Charlotte Association of Home Builders
 President—C. D. Spangler, Charlotte.
 Secretary—W. M. Spurrier, Charlotte.

OHIO

Home Builders Association of Greater Akron
 President—Harry C. Long, Akron.
 Secretary—Phil J. Franz, Akron.
 Home Builders Association of Canton
 President—A. A. Knoch, Canton.
 Secretary—Thomas P. Jones, Canton.
 Home Builders Association of Greater Cincinnati
 President—Francis A. Handy, Cincinnati.
 Exec. Secy.—Richard M. Sandberg, Cincinnati.
 Ohio Home Builders Association (Affiliated State Association)
 President—Jack Alexander, Akron.
 Secretary—David Spitznaugle, Toledo.
 Home Builders Association of Greater Cleveland
 President—Benton Lefton, Euclid.
 Exec. Secy.—James V. Funaro, Cleveland.
 Columbus Home Builders Association
 President—Wilburn K. Kerr, Columbus.
 Exec. Secy.—Miss Lee Hansen, Columbus.
 Montgomery County Builders Association
 President—Jack Stein, Dayton.
 Ex. Director—Dayton.
 Lorain Home Builders Association
 President—O. A. Hafely, Lorain.
 Secretary—Richard T. Ward, Lorain.
 Toledo Association of Home Builders
 President—Harold Sturdevant, Toledo.
 Secretary—Ray Murnan, Toledo.
 Home Builders Association of Mahoning Valley
 President—Burton C. Smith, Youngstown.
 Exec. Secy.—C. E. McGranahan, Youngstown.
 Northwestern Ohio Contractors and Bldrs. Assn.
 President—Paul Kessler, Celina.
 Secretary—Rex Snapp, Lima.

OKLAHOMA
 Oklahoma Home Builders Association
 President—Manly M. Moore, Oklahoma City.
 Exec. Secy.—J. C. Grimes, Oklahoma City.
 Tulsa Home Builders Association
 President—Otis E. Nidiffer, Tulsa.
 Exec. Secy.—Mrs. George Wilder, Tulsa.

OREGON

Portland Home Builders Association
 President—Paul E. Bonelli, Portland.
 Exec. Secy.—Carlos Huntington, Portland.

PENNSYLVANIA

Elwood City Home Builders Association
 President—Ralph J. Herge, Elwood City.
 Exec. Secy.—R. J. Schill, Elwood City.
 Home Builders Association of Erie
 President—Julius J. Schaaf, Erie.
 Secretary—Harry E. Baughman, Erie.
 Home Builders Association of Philadelphia and Suburbs
 President—John M. Zerbey, Philadelphia.
 Ex. V. Pres.—William E. Johnson, Philadelphia.
 Home Builders Association of Allegheny County
 President—Fred C. Brown, Bridgeville.
 Ex. Director—Normine W. Watkins, Pittsburgh.

RHODE ISLAND

Home Builders Association of Rhode Island
 President—Anthony Cianci, Providence.
 Exec. Secy.—Roy Worrrell, Providence.

TENNESSEE

Home Builders Association of Memphis
 President—John B. Goodwin, Memphis.
 Exec. Secy.—Mrs. Neva Wash, Memphis.
 Nashville Home Builders Association
 President—John U. Wilson, Nashville.
 Secretary—C. W. Russell, Nashville.
 Home Builders Association of Chattanooga
 President—Harry Gilbert, Chattanooga.
 Secretary—Creed W. Maynard, Chattanooga.

TEXAS

Home Builders Association of El Paso
 President—John J. Love, Jr., El Paso.
 Secretary—Wm. J. Elliott, El Paso.
 Home Builders Association of Sabine Area
 President—Roy Hayes, Port Arthur.
 Exec. Secy.—George Irvin, Beaumont.
 Home Builders Association of Dallas
 President—Hal Moseley, Dallas.
 Exec. Secy.—Grover A. Godfrey, Dallas.
 Texas Panhandle Home Builders Association
 President—K. S. Reynolds, Amarillo.
 Exec. Secy.—Aleen Salmon, Amarillo.
 Home Builders Association of Fort Worth
 President—A. C. Luther, Fort Worth.
 Exec. Secy.—Mrs. Murry Hart, Ft. Worth.
 Houston Home Builders Association
 President—Frank W. Sharp, Houston.
 Ex. V. Pres.—J. C. Watts, Houston.
 San Antonio Home Builders Association
 President—V. F. Buchek, San Antonio.
 Exec. Secy.—Lee B. Miller, San Antonio.

UTAH

Utah Home Builders Association
 President—C. Taylor Burton, Salt Lake City.
 Exec. Secy.—Arch Webb, Salt Lake City.

VIRGINIA

Home Builders Association of Richmond
 President—Earl H. Wicker, Richmond.
 Exec. Secy.—C. G. Yagel, Richmond.

WASHINGTON

Seattle Master Builders
 President—Cliff Mortenson, Seattle.
 Ex. V. Pres.—V. H. Dent, Seattle.
 Tacoma Home Builders Association
 President—Edw. P. Miller, Tacoma.
 Home Builders Association of Spokane
 President—Frank J. Snider, Spokane.
 Secretary—Miss Ruby Nikofich, Spokane.

WISCONSIN

Milwaukee Builders Association
 President—Frank Kirkpatrick, Milwaukee.
 Acting Secy.—Miss Florence King, Milwaukee.

List of NAHB Exposition Exhibitors— and Where to Find Them on the Exhibit Floor

**Impressive List of Manufacturers Will Have Colorful Displays
of Building Materials, Equipment and Services on Exhibit at
Home Builders Big Annual National Convention and Exposition**

NAME OF EXHIBITOR	BOOTH NO.	NAME OF EXHIBITOR	BOOTH NO.
Air Control Products.....	23	Kohler Co.	92, 93, 94
Air-O-Cell Co.	119	Legion Stainless Sink Corp.....	126
Altorfer Brothers Co.....	102	R. G. LeTourneau, Inc.....	24
The Aluminum Window Corp.....	68, 69	Mall Tool Co.....	109
The American Brass Co.....	138	Jay G. McKenna, Inc.....	16
American Builder	74	Mesker Brothers Iron Co.....	54
American Central Manufacturing Corp.....	116	Metal Building Products, Inc.....	38
American Floor Surfacing Machine Co.....	121, 122	Minneapolis-Honeywell Regulator Co.....	34
American Gas Association.....	8	L. J. Mueller Furnace Co.....	80, 81
American Radiator & Standard Sanitary Corp.....	75, 76, 77, 78	Mullins Manufacturing Corp.....	65, 66, 83, 84
American Saw Mill Machinery Co.....	55	Nash-Kelvinator Corp.	1
American Telephone & Telegraph Co.....	86	National Adequate Wiring Bureau.....	41, 42
Apex All Weather Products Co.....	140	National Coal Association.....	147, 148, 149, 150
Arketex Ceramic Corp.....	19	National Electric Products Corp.....	128
Associated Projects Co.....	146	National Life Insurance Co.....	26
Bell & Gossett Co.....	56, 57	New Castle Products Co.....	89
Berry Door Corp.....	72, 73	Norge Div., Borg-Warner Corp.....	62
Better Homes & Gardens.....	85	Norge-Heat Div., Borg-Warner Corp.....	39
The Bilco Co.....	115	NuTone, Inc.	143
Briggs Manufacturing Co.....	133, 134	Owens-Corning Fiberglas Corp.....	132
Bryant Heater Co.....	36, 37	Owens-Illinois Glass Co.....	137
The Philip Carey Manufacturing Co.....	161	Parents Magazine	108
Coco Steel Products Corp.....	96	Practical Builder	14
Celotex Corporation	4	Pratt & Lambert, Inc.....	70
Ceresal Chemical Corp.....	141	Premier Metal Products Corp.....	142
Chicopee Manufacturing Corp.....	17	Reynolds Metals Co., Aluminum Div.....	163
Chrysler Corp.....	105, 106, 107	Rilco Laminated Products Co.....	125
Clay Products Association.....	139	A. E. Rittenhouse Co., Inc.....	101
The Coleman Co., Inc.....	99	R. O. W. Sales Co.....	30
Commonwealth Edison Co.....	95	F. C. Russell Co.....	114
Crane Co.	31, 32, 33	Sav-U-Time Sales Co.....	127
Crosley Corp.....	15	Sarvel, Inc.	5, 6, 7
Culligan Zeolite Co.....	18	Shreveport Engineering Co.....	79
Detroit Steel Products Co.....	162	Skilsaw, Inc.	44
DeWalt Products Corp.....	154	A. O. Smith Corp.....	151, 152, 153
Duplex, Inc.	117	Southern Galvanizing Co.....	131
Edison General Electric Appliance Co.....	104	Speakman Co.	25
Eljer Co.	97, 98	N. B. Spurgeon Co.....	113
Electro-Matic Doorman, Inc.....	71	Standard Dry Wall Products, Inc.....	3
Equipment Engineering Co.....	144, 145	Sterling Tool Products Co.....	110
Fiddes-Moore & Co.....	47	Stokol Stoker Co., Inc.....	136
Flintkote Co.....	91	Strand Building Products.....	100
Frigidair Division, General Motors Corp.....	63	Surface Combustion Corp.....	67
Gate City Sash & Door Co.....	111	Tile-Tex Co., Inc.....	88
General Electric Co.....	50, 59, 60, 61	Timber Engineering Co.....	130
Gilman Brothers	21	Tracy Manufacturing Co.....	185
Great Lakes Steel Corp., Stran-Steel Div.....	9, 10	Truscon Steel Co.....	43
Harrison Steel Cabinet Co.....	120	United States Gypsum Co.....	48, 49, 50
Hill Termite Control Systems.....	13	United States Plywood Corp.....	156, 157
Edward Hines Lumber Co.....	22	Universal Sanitary Manufacturing Co.....	103
E. F. Hodgson Co.....	87	Universal Zonolite Insulation Co.....	118
Homasote Co.	124	Victor Electric Products, Inc.....	64
Home Planners, Inc.....	82	Weatherbest Corp.	40
Hoosier Industries, Inc.....	129	Henry Weis Manufacturing Co., Inc.....	123
Horton Mfg. Co.....	135	Westinghouse Electric Corp.....	27, 28, 29
Ingersoll Steel Div., Borg-Warner Corp.....	2	Wheeler, Osgood Co.....	20
Insulite	112	White-Rodgers Electric Co.....	46
International Oil Burner Co.....	160	Zegers, Inc.	12
Johns-Manville Sales Corp.....	158, 159		
Kimberly-Clark Corp.	35, 90		

Coming to Chicago?

Be sure to visit the fully-equipped
*Cemesto Pre-Engineered Home

ERECTED BY CONTRACTORS

MARTIN H. BRAUN and FELIX NELSON

(Members of the Metropolitan Home Builders Assn. of Chicago)

For

The Celotex Corporation

Members of the National Association of Home Builders attending their annual convention and exposition at Hotel Stevens, February 23-27, 1947, will have an opportunity to inspect one of these attractive, permanent Cemesto Homes which are being erected by progressive builders throughout the United States.

Demonstration Home located immediately adjoining Hotel Stevens on East Seventh Street. Obtain admission tickets at Celotex Booth, N.A.H.B. Exposition. You'll be welcome!

THE CELOTEX CORPORATION

120 So. LaSalle Street, Chicago 3

*Cemesto—one of the famous Celotex Building Products

*Reg. U.S. Pat. Off.



The **NEW, Simple Garage Door Opener** with a Foolproof Electronic Control . . . that Operates all types of Garage Doors!

SEE IT AT THE BUILDERS' SHOW!



It's revolutionary . . . the Garage Door Opener, midget in size, that does a giant size job! **ELECTROMATIC SERVICEMAN** is simple and compact . . . a positive-acting threaded screw lifts or lowers any garage door. Far surpasses all other garage door openers yet is priced within easy reach of everyone who has a garage. Installation is easy, winter or summer. Only five screws install door lift unit and electric motor to any garage, out of the way, practically out of sight. The Electromatic Serviceman is always in alignment. Has a foolproof safety feature. The electronic energizing unit installed in your car activates the opener by an entirely new radio wave principle. A button installed in your garage or house . . . and presto! . . . your door is open or closed, as you desire!

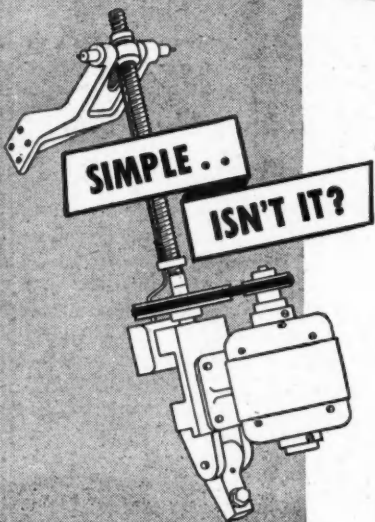

- **NO DIGGING!** . . . minimizes tedious and costly installation. Easily installed, winter or summer.
- **NO WIRES TO STRETCH!** . . . house-to-garage connection utilizes same radio wave transmission as does auto-to-garage.
- **NO HORN TO HONK!** . . . no annoyance to family and neighbors.
- **NO LIGHTS TO FLASH!** . . . no one else has the "key" to your garage.
- **SIMPLE...COMPACT!** . . . entire assembly can easily be transported in the trunk of an automobile.

DISTRIBUTOR FRANCHISES!

Distributor franchises are now being granted for the desirable and profitable *Electromatic Serviceman*. Complete information will promptly follow your inquiry. Address the National Distributor, noted below:



ELECTROMATIC SERVICEMAN, Inc.

19720 W. Eight Mile Road

Detroit 19, Michigan

S
Dis
W
Fl
Da
Id
Bo
Ill
Ch
1
Ke
Lo
Lo
Ne
Ma
Ba
Mi
Fl
Gr
Ro
Mi
St
Me
Bi
Mi
Ne
Gr
Ne
Re
Ne
No
Ne
Ca
No

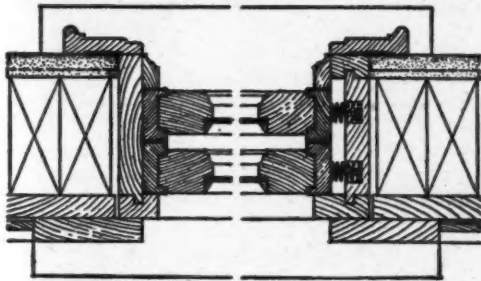

Typical plan at j a m b s showing spring tension feature which takes up all expansion and contraction of sash.

R.O.W. SPRING CUSHION WINDOWS

for HOMES THAT SELL

No Weights, Cords or Pulleys

A definite step forward in the "miracle postwar" home demanded by today's buyers is the R.O.W. Spring Cushion Window. R.O.W. Windows cost no more than conventional double-hung windows, yet they are furnished as a complete, prefabricated, weather-stripped unit. Standard in design and fit all types of construction, frame, brick, stone veneer and solid masonry. May be equipped with standard screens and storm sash. Easy to open and close and remain securely in any desired position. Either or both sash may be instantly removed without removing stops, allowing 100 per cent window opening for summer ventilation.

These Features Sell Homes

1. Both sash are removable instantly—without removing stops or other parts.
2. Sash holds firmly in any position without cords.
3. Non-corrosive steel springs maintain even pressure against sash sides.
4. Minimum heat loss. Leakage 22.1% less than government specifications.
5. Even pressure. Cannot stick. Will not rattle.
6. Broken panes easily replaced. Easily cleaned or painted.
7. NO CORDS—NO WEIGHTS—NO PULLEYS.

R. O. W. SALES CO.

ROYAL OAK, MICHIGAN

See or Write These Licensed R.O.W. Window Dealers

District of Columbia
Washington—Johnson & Wimsatt, Inc.
Florida
Daytona Beach—Eastern Sash & Door Co.
Idaho
Boise—Boise Sash & Door Co.
Illinois
Chicago—R.O.W. Window Unit Co. of Illinois.
Kentucky
Louisville—Kister Co.
Louisiana
New Orleans—Davis Mfg. Co.
Maryland
Baltimore—Dealers Warehouse & Supply Co.
Michigan
Flint—Flint Sash & Door Co.
Grand Rapids—Porter Hadley Co.
Royal Oak—Royal Oak Wholesale Co.
Missouri
St. Louis—Imse-Schilling Sash & Door Co.
Montana
Billings—Billings Sash & Door Co.
Missoula—Interstate Lumber Co.
Nebraska
Grand Island—Sothman Co.
Nevada
Reno—Rocky Mount Mfg. Co. of Nevada.
(Dealer for Arizona, California, New Mexico, Nevada, Utah.)
New England States
North Bergen, N. J.—General Woodcraft Corp.
New Jersey
Camden—Johnson & Wimsatt, Inc.
North Bergen—General Woodcraft Corp.

New York
Binghamton—A. Roberson & Sons.
Buffalo—Whitmer Jackson Co.
New York—General Woodcraft Corp., North Bergen, N. J.
North Dakota
Fargo—Dakota Sash & Door Co.
Ohio
Canton—Mahoney Sash & Door Co.
Columbus—Throop Martin Co.
Oklahoma
Muskogee—Hope Lumber Co.
Oklahoma City—Warr Lumber Co.
Ontario, Canada
Sarnia—Belton Lumber Co., Ltd.
Oregon
Salem—Oregon Pulp & Paper Co.
Pennsylvania
Pittsburgh—Adelman Lumber Co.
South Dakota
Watertown—Watertown Sash & Door Co.
Virginia
Rocky Mount—Rocky Mount Mfg. Co.
(Dealer for Alabama, Florida, Georgia, New Jersey, North and South Carolina, Pennsylvania, Virginia, West Virginia, Maryland, Delaware.)
Washington
Seattle—Acme Millwork, Inc. (Distributor for Alaska.)
Spokane—Spokane Sash & Door Co. (Distributor for Idaho, Montana, Oregon, Washington, Wyoming.)
Wisconsin
Merrill—Wisconsin Window Unit Co.
Wyoming
Cheyenne—Wyoming Sash & Door Co.



See the R.O.W. Spring Cushion Window at the N.A.H.B. Show

PRESENTING THE NEW, MODERNIZED



ELKAY *Lustertone*

STAINLESS STEEL CABINET SINKS

Whether your contract calls for a new construction job or a modernization project, there's an

ELKAY
Lustertone
CABINET SINK
that will meet every individual requirement.

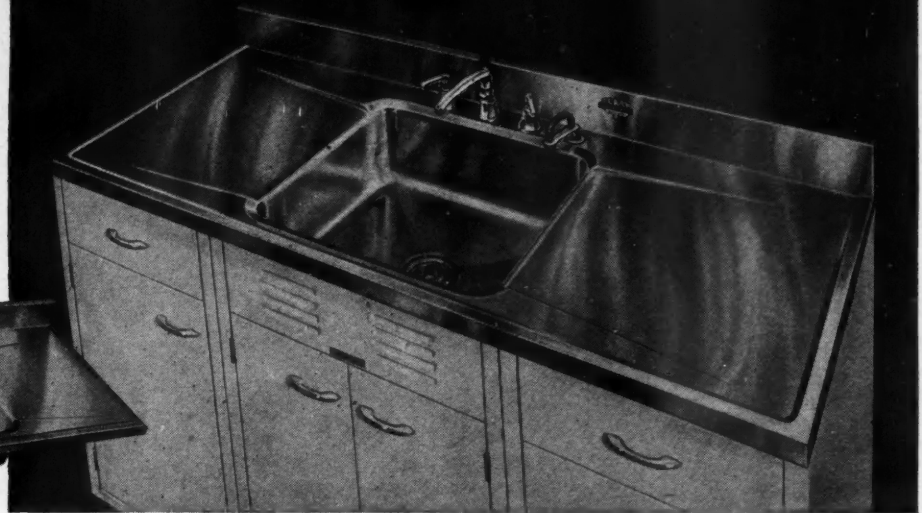

9 Points of Superiority

- 1 ELKAY "Lustertone" Cabinet Sinks are built of 18 U. S. standard gauge (extra heavy) genuine solid 18-8 stainless steel.
- 2 The stainless steel tops are bonded to and reinforced with heavy gauge formed metal.
- 3 Drainboards, sink bowls, rims, and splashers are welded integral into one sheet of metal.
- 4 All corners in sink bowls—horizontal, lateral and vertical—are rounded to 1 3/4 inch radius.
- 5 Intersections where sink bowls meet drainboards are welded and rounded to a large radius.
- 6 Intersections where drainboards meet back and return end splashers and where back splashers meet return end splashers have rounded corners.
- 7 Drainboards have a definite, liberal fan shaped pitched area insuring positive drainage.
- 8 Front and back surfaces adjacent to the sink bowls are pitch-beveled to provide additional drainage.
- 9 Entire underside of sink top and bowls is sound deadened.



ELKAY
"Sturdibilt"
STAINLESS STEEL SINK BOWLS

These bowls can be supplied in any size to meet individual requirements. Built of 18 gauge stainless steel. All corners are covered to 1 3/4" radius. They are made with 1" flat rim or with shelf for deck type faucets. These bowls are especially designed to be used with linoleum or other composition tops.

5 Standard Sizes

ELKAY "Lustertone" Stainless Steel Cabinet Sinks are offered in five standard sizes. The 54 inch and 60 inch sinks are furnished with 18" x 20" single bowls; the 72 inch sinks are furnished with either 18" x 25" single bowls or 18" x 34" double bowls; the 84 inch sinks are furnished with 18" x 34" double bowls. All bowls are 7 1/2 inches deep. ELKAY "Lustertone" Sinks are equipped with stainless steel basket type strainers. They can be supplied with the latest design "Deck type" chrome finished faucets and spray. All standard sinks have 4 inch back splashers.

CUSTOM-BUILT SINKS

In addition to these five standard sizes, ELKAY Stainless Steel Cabinet Sinks can be supplied in any size and shape to meet individual requirements. Send us your specifications.

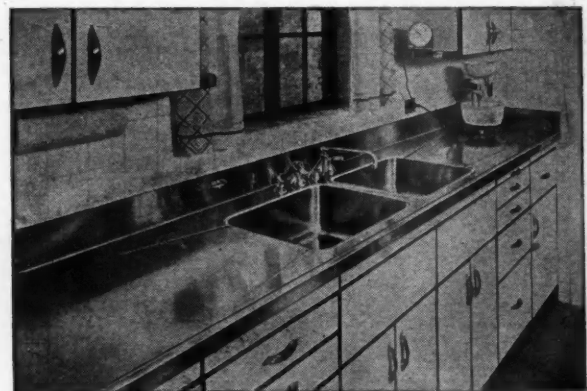

A new beautifully illustrated Folder giving complete information about the ELKAY "Lustertone" Cabinet Sinks is now ready for you. Send for folder A. B. 147.

ELKAY PRODUCTS ARE AVAILABLE THROUGH PLUMBING CONTRACTORS

ELKAY MFG. CO., 1874 South 54th Avenue, Chicago 50, Illinois

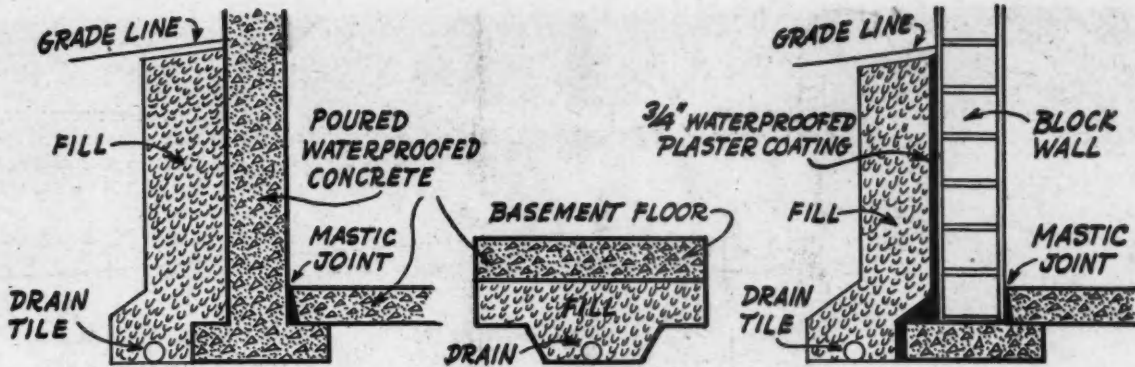

Monolithic or poured walls made with Medusa Waterproofed Gray Cement are waterproofed all the way thru. Waterproofing is built into the walls.

Floors made with Medusa Waterproofed Portland Gray Cement contain water repelling material throughout every inch.

Concrete block or clay tile can be set in waterproofed mortar, then given an exterior 3/4" plaster coating of Medusa Waterproofed Gray Cement—Interiors may be finished with same treatment.

How to get dry basements by "WATERPROOFING AS YOU BUILD"



Building dry basements—basements that stay dry at every season of the year—is easy. The answer is to *protect as you build* with Medusa Waterproofed Gray Portland Cement. *It builds waterproofing into concrete.**

WHY BASEMENTS GET DAMP:

Water is absorbed into concrete by capillary action—the same way ink is drawn up into a blotter. This water works through walls and floors to cause damp or wet basements. By well-built construction and by using Medusa Waterproofed Gray Portland Cement for floors, mortar and plaster coats, monolithic walls—you completely eliminate capillary action and water entrance. This cement has a water repelling material ground in during manufacture that repels water at the surface. This means concrete made with Medusa Waterproofed Cement, has a waterproofing locked in the mass for the lifetime of the floor, wall, or plaster coating. Waterproofing can't chip or peel because it's distributed throughout every inch of the concrete. Water can't get started—basements stay dry.

AUTOMATIC WATERPROOFING

There's nothing extra to do when you *build waterproofing into concrete* with Medusa Waterproofed Gray Portland Cement. No extra time is required—no added supervision. Medusa Waterproofed Cement is mixed and placed exactly as ordinary cement, but you get lifetime waterproofing as a bonus for your client!

LOCKS IN WATERPROOFING

Use Medusa Waterproofed Cement to assure dry basements. Make certain it's in concrete, concrete building units, and in mortar. *Build waterproofing into the walls.* It's the safe, easy way to get dry basements.

Write for booklets—"How To Waterproof Concrete, Stucco and Masonry" and "Integral Waterproofing Explained". They're free to dealers and builders. You'll find each is full of helpful information and especially useful for training green help.

*Where Medusa Waterproofed Cement is not available use Medusa waterproofing paste or powder.

MEDUSA PORTLAND CEMENT CO.
1002 Midland Building, Dept. "G"
Cleveland 15, Ohio

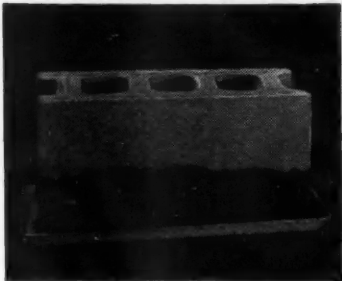

An ordinary concrete block was set into a pan of water. Ten minutes later, this picture was taken. Notice how capillary action has taken place. This is the way water works into basements—makes them wet and damp.

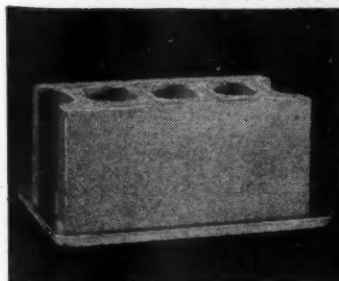

A block made with Medusa Waterproofed Gray Cement was placed into a pan of water—No capillary action took place. Waterproofing was automatically built into this block when Medusa Waterproofed Portland Cement was used.

MEDUSA

"FIFTY-FIVE YEARS OF CONCRETE PROGRESS"



Part of the attractive, four-family apartment project built in Columbus, Ohio, by CAPITOL PROPERTIES, INC.

Ohio builder chooses KIMSUL* Insulation above all others for all types of construction



Installing light, flexible KIMSUL* in a CAPITOL PROPERTIES, INC. home. It is easy—just cut KIMSUL to desired length, expand it, and staple to ceiling joists.

Like Don M. Casto, important builders, architects, and contractors everywhere are specifying KIMSUL Insulation. With a "k" factor of 0.27, KIMSUL is one of the most efficient insulations ever developed for insuring home comfort. Designed on the scientific principle of many-layer construction, KIMSUL automatically provides uniform insulation coverage. Prefabricated and pre-stitched, it's easy to install. It's pleasant to handle because it's so clean—no dust, no

irritating after-effects to skin of workmen. And KIMSUL is resistant to fire, moisture, fungus; it is termite-proof... won't sag, sift, or settle.

These qualities—and many more—account for the outstanding performance of KIMSUL in all types of construction. They are the reasons why it is wise for you to include KIMSUL in any building specification. For complete information, write Kimberly-Clark Corporation, KIMSUL DIVISION, Neenah, Wis.

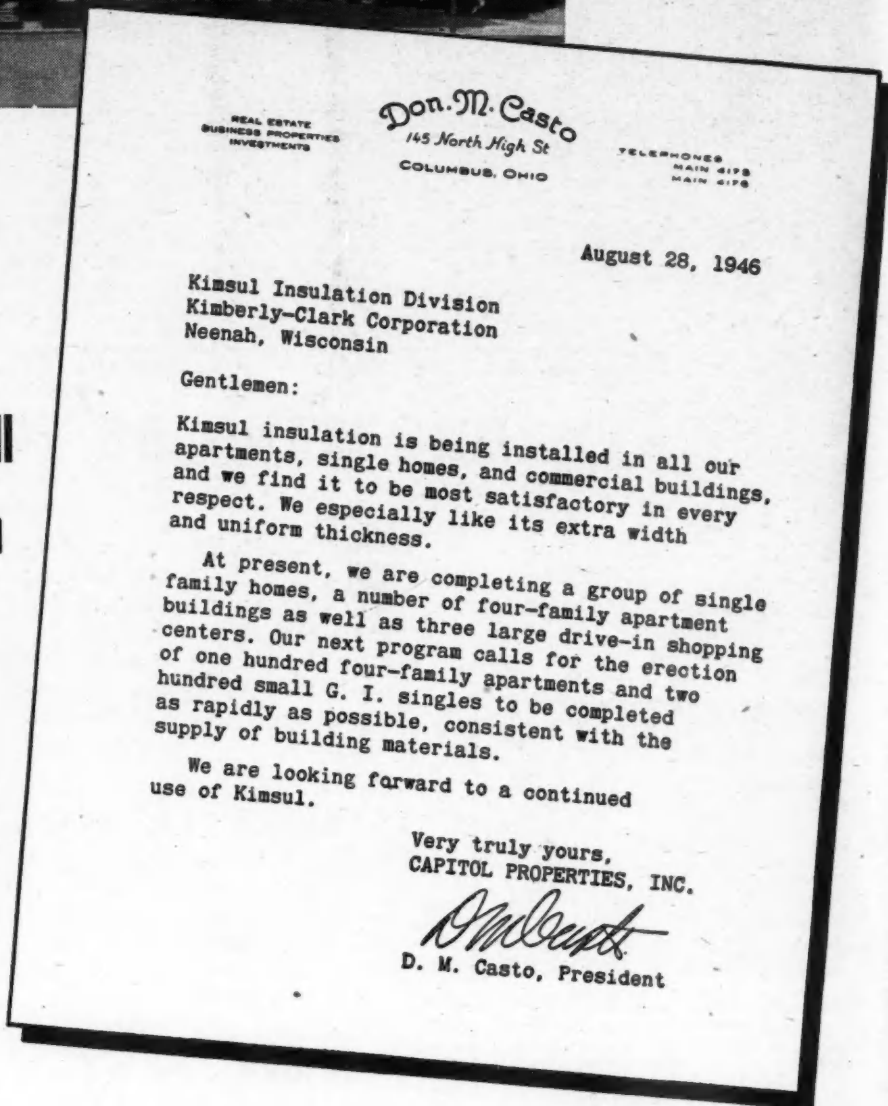

REAL ESTATE
BUSINESS PROPERTIES
INVESTMENTS

Don. M. Casto
145 North High St
COLUMBUS, OHIO

TELEPHONES
MAIN 4128
MAIN 4178

August 28, 1946

Kimsul Insulation Division
Kimberly-Clark Corporation
Neenah, Wisconsin

Gentlemen:

Kimsul insulation is being installed in all our apartments, single homes, and commercial buildings, and we find it to be most satisfactory in every respect. We especially like its extra width and uniform thickness.

At present, we are completing a group of single family homes, a number of four-family apartment buildings as well as three large drive-in shopping centers. Our next program calls for the erection of one hundred four-family apartments and two hundred small G. I. singles to be completed as rapidly as possible, consistent with the supply of building materials.

We are looking forward to a continued use of Kimsul.

Very truly yours,
CAPITOL PROPERTIES, INC.

D. M. Casto
D. M. Casto, President



We are producing all the KIMSUL Insulation we possibly can, but due to the great demand, distributors may have some difficulty in supplying KIMSUL dealers as promptly as usual.



*KIMSUL (trademark) means Kimberly-Clark Insulation

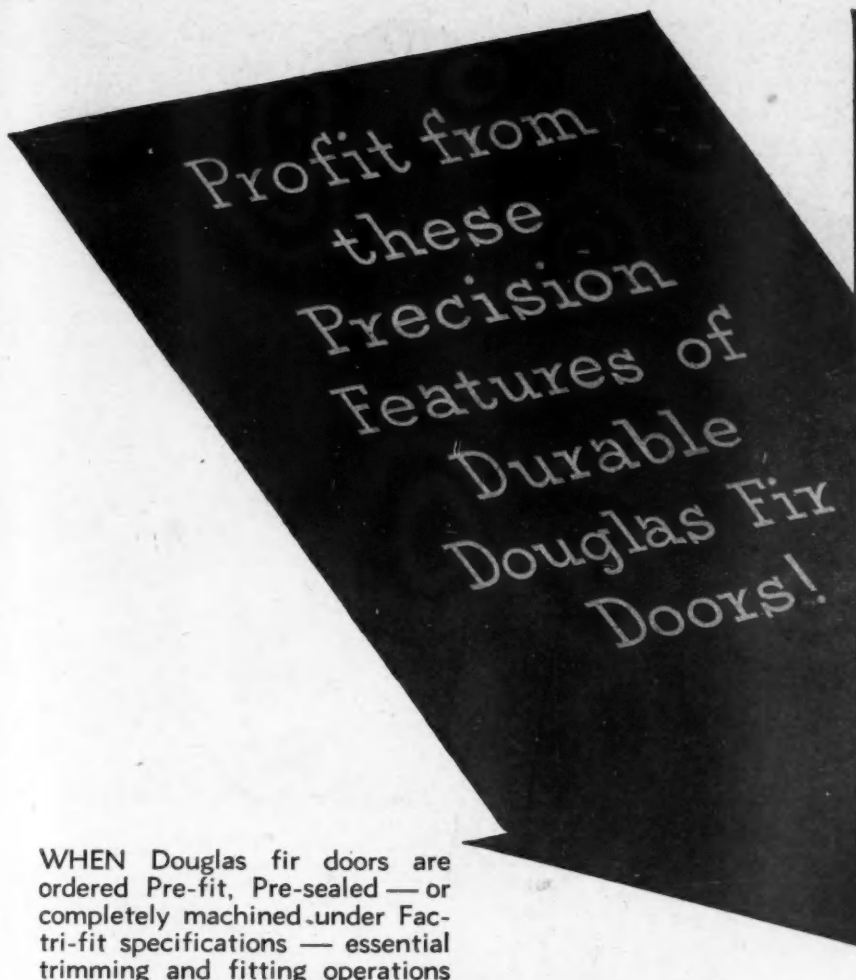

WHEN Douglas fir doors are ordered Pre-fit, Pre-sealed — or completely machined under Factri-fit specifications — essential trimming and fitting operations are performed at the door plant by modern, high-speed, precision tools. As a result, these fine doors — manufactured of all-heartwood Douglas fir, the wood made durable by nature — reach the job ready to install. Time and

labor are saved; a trimmer, more attractive installation is assured. The slight additional cost is more than offset by on-the-job economies.

PRE-FIT

Douglas fir doors may be ordered pre-fit to exact size. No finish cutting or fitting — no sawing or planing — is necessary on the job.

MORE FIR DOORS ARE COMING SOON

It is true that the supply of Douglas fir doors will continue critical for a number of months, due to the present shortage of shop lumber. But it is ALSO true that production is increasing substantially as controls are lifted. More Douglas fir doors are coming! Soon warehouse and dealer stocks should reflect this production upswing. Keep in touch with your regular source of supply.

PRE-SEALED

Douglas fir doors may be ordered pre-sealed . . . a feature which improves dimensional stability, reduces moisture absorption, and eliminates the need for one prime coat.

FACTRI-FIT

Douglas fir doors may also be ordered completely machined — not only pre-fit, but gained for hinges and mortised or bored for locks as well. Doors will be grade-marked, as in the past, for ease in specification and ordering. They'll be better doors in every way.

FIR DOOR INSTITUTE

Tacoma, 2, Washington

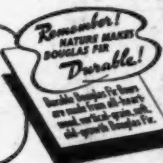
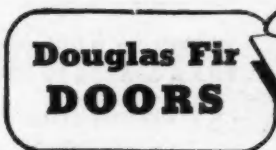

The National Association of Fir Door Manufacturers



It shouldn't happen to a Home Owner!

● Dependability and low cost make Bituminous Coal the leading home-heating fuel, as every architect and builder well knows.

And as stoker developments and improved local services make coal an "automatic" fuel as well, the advantages of coal heat will be even more pronounced.

So even when a client of yours *insists* on some other fuel for his new home, make sure his house plans don't tie him to that choice forever.

This means, make sure his plans provide: (1) A chimney with sufficient flue capacity to burn coal efficiently; (2) Sufficient space adjacent to the heating unit for eventual coal storage and stoker installation.

The cost of such sensible precautions is slight. And they may add greatly to the future value of the home.

Coal supplies uniform, *steady* warmth throughout every portion of each room. For there's always a fire in the furnace—no "pop on and pop off" periods that permit accumulated heat to rise to the ceilings and leave floor areas dangerously cold. That, plus its low cost, is why more than 4 out of every 7 homes in the United States now heat with coal!

BETTER AND BETTER THINGS ARE COMING FROM COAL!



As you undoubtedly know, the modern research facilities of the Bituminous Coal industry are hard at work not only to make coal a still better fuel, but also to devise new, low-cost *automatic* equipment that will make coal-heating even cleaner, more comfortable, more convenient and more economical. This makes it all the more important that every new home built today be planned to permit the eventual burning of coal—no matter what fuel may initially be selected.

BITUMINOUS COAL

BITUMINOUS COAL INSTITUTE
Washington, D. C.

Affiliate of NATIONAL COAL ASSOCIATION



FIVE AND ONE-HALF BILLION FEET



Last year the Western Pine industry produced five and one-half billion feet of lumber. This is the greatest production and has resulted in the largest volume of lumber shipments made in any peacetime year of the industry's history.

How about 1947 . . . will this record be equalled? Here is the answer. . . The Western Pine timber resources will, under private management, support production at the 1946 level indefinitely and at the same time provide a more than adequate timber reserve.

The manufacturers in this industry constantly recognize the essential role the retail lumber dealer, the wholesaler, the building contractor, the architect, and the industrial buyer

play in marketing Western Pine products. It is with this in mind that we have continued to advertise Idaho White Pine, Ponderosa Pine, and Sugar Pine continuously through the war years, as well as during the present period of excessive demand.

We truly value our long standing, cordial business relationship with our many dealer and builder friends. Through a continuation of our combined efforts in producing and marketing Western Pine products, we look with optimism beyond these difficult times to the prospect of bright business years ahead . . . years of business in an economy of peace and free enterprise.

WESTERN PINE ASSOCIATION

YEON BUILDING • PORTLAND 4, OREGON

IDAHO WHITE PINE • PONDEROSA PINE • SUGAR PINE • THESE ARE THE WESTERN PINES
SOLD BY RETAIL LUMBER DEALERS

MORE THAN WINDOWS!

Andersen



ANDERSEN COMPLETE WOOD HORIZONTAL GLIDING WINDOW UNITS

- Frame, glazed sash, weatherstripping, hardware, double glazing, screen.
- Factory fitted for easy operation.
- Wood parts chemically treated to prevent decay and termites.
- Leakproof, weatherproof Andersen frame design.

The famous Andersen Window Unit with sash that glide from side to side—yet, when closed, are in the same plane. The Horizontal Gliding Window has sash that can be removed from the frame in one easy operation. Sash move on glides that rest on tracks built into sill. Exceptional weather tightness achieved by special frame design, efficient weatherstripping, exclusive sill construction and double glazing panels.

ESPECIALLY ADAPTED TO LARGE OPENINGS

Available in sizes up to nearly six feet high and wide—so it is an excellent choice for homes designed for a maximum of window area. Units may be combined in expansive WINDOWALLS or in fenestrated corners.

FOR COMPLETE DETAILS, SIZES AND PRICES, SEE YOUR ANDERSEN DISTRIBUTOR,
OR WRITE ANDERSEN

ANDERSEN BASEMENT WINDOW UNIT—a prefabricated, packaged unit;

Andersen

MORE THAN WALLS!

Windowalls



ANDERSEN COMPLETE WOOD CASEMENT WINDOW UNITS

The Andersen Casement Window Unit has been known for 14 years as the "tightest" window on the market. Built for a lifetime of trouble-free service, it employs "refrigerator-type" sash design, weatherstripped and has double-glazing panels on inside—applied easily to the sash. Screen is inside—sash moved by a roto-gear operator that works through the sill, independently of sash.

BAYS, CORNERS, PICTURE WINDOWS—BY COMBINING STOCK UNITS

From the stock layouts and sizes offered, designers may form countless variations in bays, corner windows and picture window combinations. Several combinations with fixed sash are also offered as stock items.

FOR COMPLETE DETAILS, SIZES AND PRICES, SEE YOUR ANDERSEN DISTRIBUTOR,
OR WRITE ANDERSEN

- Frame, glazed sash, weatherstripping, hardware, double glazing, screen.
- Factory fitted for easy operation.
- Wood parts chemically treated to prevent decay and termites.
- Leakproof, weather-proof Andersen frame design.

weatherstripped, glazed, sash in place; toxic-treated wood; standard sizes

Corporation



houses sell with P&L

Good color will sell your houses faster. In every community the buyers' demand has been for good decoration. Today, outdated and poorly thought out color plans lag far behind in the bidding for home buyers' satisfaction and good-will.

With the new, inviting, up-to-the-minute Pratt & Lambert Paint colors, you "give 'em what they want when they want it." There's no need for wasting time on costly mixing and tinting when your painter can use P&L ready-mixed colors.

These distinctive colors satisfy the most discriminating tastes. They were keyed to modern decorative trends by actual test use on over a thousand typical homes. The builder who is thinking not only in terms

of present day quick sales, but also when competition arrives, will find that these P&L Paint colors add value and zest to his sales.

Let us help you with the efficient application of these paints, enamels and stains by sending you the new P&L painting specifications for low-cost, medium-priced and high-grade homes. Pratt & Lambert-Inc., 80 Tonawanda St., Buffalo 7, N. Y.

PRATT & LAMBERT
paint and varnish



put
Beauty
 into your plans
 with
 the NEW
 Curtis Woodwork



This new Curtis entrance—Design C-1733—can be used successfully on one or two-story houses of any structural material. H. Roy Kelley, architect.

COST need not be the enemy of beauty—if you include the new Curtis Woodwork in your house plans. For Curtis entrances—mantels—china closets—stairways and other stock woodwork—will fit into the most moderate building budget. And the great variety of Curtis Woodwork gives you freedom in planning to fit a wide variety of individual needs and tastes. Architecturally correct in design—built

like fine furniture—Curtis Woodwork is the answer when beauty and quality, at reasonable cost, are demanded.

Ask your Curtis dealer to show you the new Curtis Woodwork Style Book—an entirely new and different way of presenting the new Curtis woodwork line. Measuring 15 x 19 inches, this book contains 100 pages of beautiful woodwork styles in natural home settings—many photographs in full color.

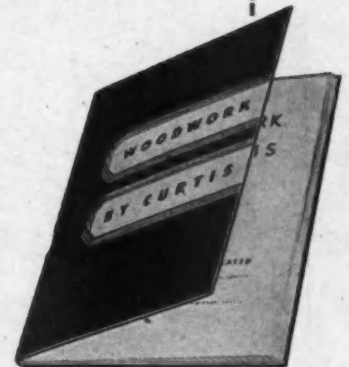

Beautiful new china closet by Cameron Clark, architect. A formal and dignified design that is best suited to large rooms. Also made with open front. Corner installation only. Design C-6505.

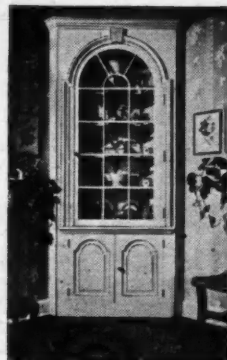

The bowed fascia of this Curtis mantel accentuates its simple charm. One of the many new Curtis designs, it follows the tradition of the 18th Century. Design C-6074, by George W. Stoddard, architect.

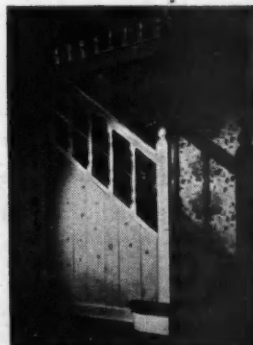

Curtis standard stair parts make up this beautiful stairway. These parts allow widest latitude in designing stairways for any size and style home.



Mail the coupon for complete, illustrated literature.

Curtis Companies Service Bureau
 AB-2W, Curtis Building
 Clinton, Iowa
 Gentlemen: Please send me booklets on the new Curtis Woodwork and the new Silentite Window line.

Name.....
 Address.....
 City.....State.....

NEW AND REVOLUTIONARY PORTABLE SAW

*Speeds up home
building*



NORDBERG-BUDAY *Has Everything*
You Want in a **POWER SAW**

Has
SPEED

The table, arbor and power unit rotates instantly to change to cross, rip and miter cuts. With the lumber remaining on the ball bearing roller, extension tables, unnecessary handling of lumber is eliminated in making any change in cutting angle.

Has
PORTABILITY

Weighs only 340 pounds — light enough to be easily carried by two men. Gasoline powered, it is truly portable and completely independent of power lines, although electric motor drive can be supplied if desired.

Has
CAPACITY

Cross-cuts a 4" x 4" or a 3" x 12", rips a 4" x 4" or to a width of 40 inches.

Has
VERSATILITY

Will make cross and miter cuts, straight and bevel rips, cuts tenons, rabbets and grooves.

If a saw with all these features will reduce your lumber cutting costs, write for Bulletin 132 and the name of your Nordberg-Buday distributor who will demonstrate this saw on his show-room floor.

NORDBERG MFG. CO., Milwaukee 7, Wis.

NORDBERG-BUDAY PORTABLE POWER SAW

Simply turn the Table. Then make the Cut

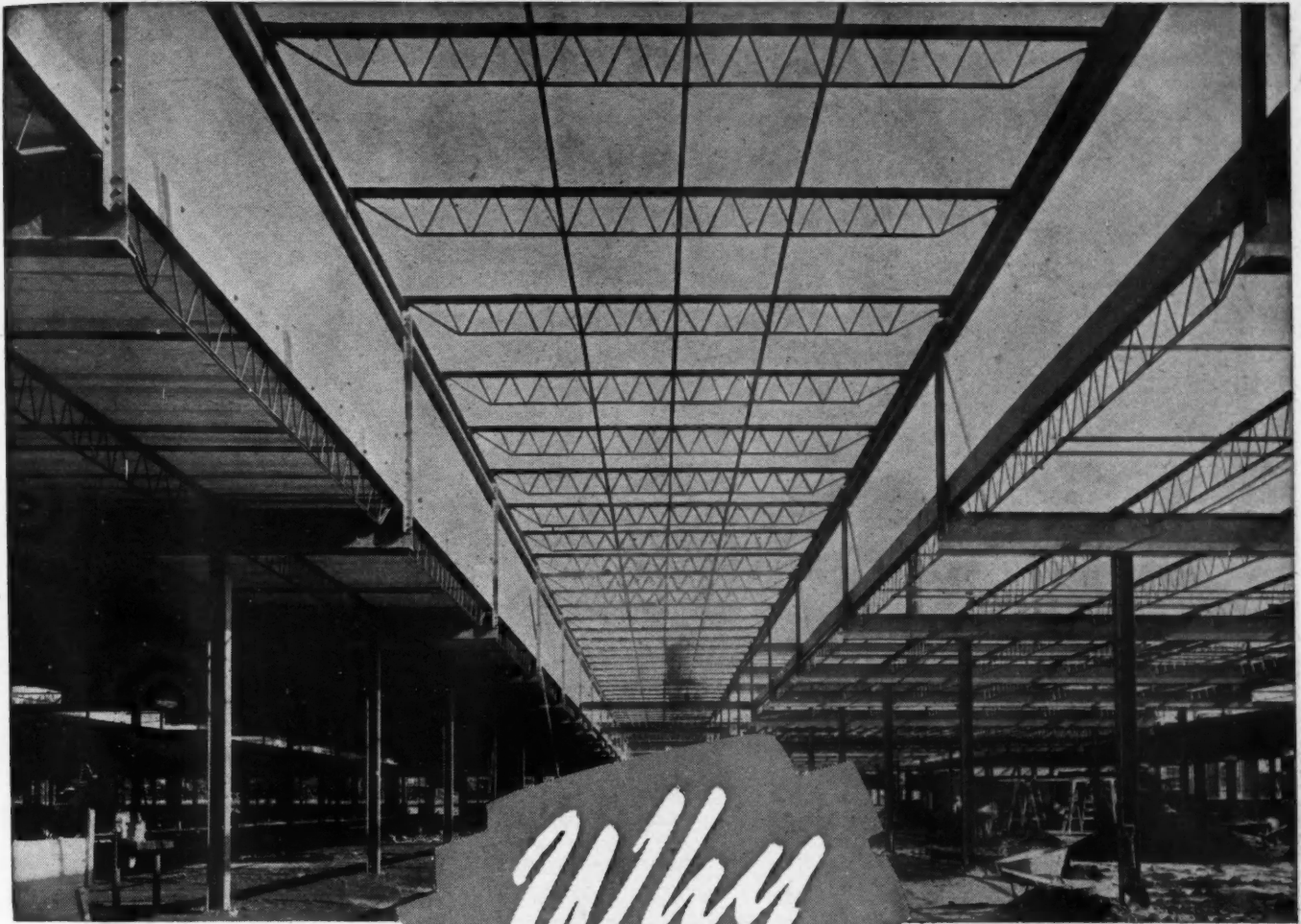

Why

OPEN WEB STEEL JOISTS?

In the light occupancy buildings of tomorrow, speedy, economical erection and greater utility are paramount. Consider why steel joists are ideal for such structures: Easier to install than wood—conceal pipes and conduits within the floor system—eliminate shrinkage, preventing cracking of ceilings and partitions—termite proof—fire resistant. Particulars available from our field engineers.

WHY SPECIFY CECO JOISTS?

1. Wide top chords provide exceptional lateral rigidity.
2. Twin chords permit secure attachment of floor and ceiling by wire ties or bolts.
3. Hairline contact of bottom chord with plaster prevents streaking.
4. Bearing plates are securely attached, thus eliminating loose parts.
5. Shielded arc welds withstand three times the designed stress.
6. Ceco steel joists are approved by the Steel Joist Institute.

Ceco catalogs are in Sweet's Architectural File

CECO STEEL PRODUCTS CORPORATION

GENERAL OFFICES: 5701 West 26th Street, Chicago 50, Illinois

Offices, warehouses and fabricating plants in principal cities

**CECO
STEEL**

In construction products **CECO ENGINEERING** *makes the big difference*

ZONOLITE* INSULATING CONCRETE IDEAL FOR RADIANT HEATING



* Radiant Heating Coils resting on Zonolite concrete ready for topping of ordinary concrete.

Another new development for builders—FLOORS THAT INSULATE! By using Zonolite Insulating Concrete for grade level floors in commercial structures or homes, cold and dampness can be eliminated. Heat loss into ground will be avoided.

Zonolite Insulating Concrete floors are made by mixing a specially graded Zonolite brand of vermiculite with Portland cement. This insulating concrete can be placed directly on the ground (vapor seal often placed on ground first) forming a fireproof, rot proof, termite proof, vermin proof floor base.

When radiant heating is specified, these floors are particularly desirable as a base for the coils or ducts. After laying the coils on this highly efficient and permanent base, they should then be covered with ordinary concrete. This enables the room to heat faster and reduces fuel consumption.

Whenever a floor is constructed on grade level, regardless of whether or not it has radiant heat, Zonolite Insulating Concrete should be specified. Because of the low heat capacity of Zonolite Insulating Concrete, condensation on the floor surface on warm, humid summer days is avoided.



Cutaway view of basementless house showing how layer of Zonolite Insulating Concrete laid on the ground and covered with a topping of ordinary concrete eliminates loss of heat downward.

ZONOLITE CONCRETE FLOORS REDUCE DEAD LOAD IN HIGH BUILDINGS

Zonolite Insulating Concrete, when used as a fill over steel pan floors, reduces dead load. When used in this way, the fireproofness of the building is greatly increased as Zonolite is one of the most fireproof materials known. Zonolite Concrete aggregate weighs as little as six pounds per cubic foot.

Send now for complete information about Zonolite Concrete Floors.



UNIVERSAL ZONOLITE INSULATION CO.

Dept. AB-27, 135 S. La Salle St.
Chicago 3, Ill.

MAIL COUPON FOR DETAILS

SEE YOUR LOCAL LUMBER AND BUILDING MATERIAL DEALER

Universal Zonolite Insulation Co.
Dept. AB-27, 135 S. La Salle St., Chicago 3, Ill.

Please send details on Zonolite in its various forms and dealer proposition.

Name.....

Address.....

City.....State.....

Zonolite is the registered trademark of Universal Zonolite Insulation Co.



NEW SHORT CUT TO . . .
BIGGER, QUICKER PROFITS

Save time and money, increase salability and owner satisfaction of the houses you build by installing "American Home" metal casement windows. They come to the job unit packaged, glazed (if desired), completely prefabricated with wood surround and outside wood trim, ready to install with hammer and nails requiring only five minutes of a semi-skilled workman's time. And they actually cost *less*, installed, than any other type window available today.

Stocked and sold by better building supply dealers everywhere. Supply is still short, but improving. Write today for descriptive folder. Mesker Brothers, Sales Div. A827, 4342 Geraldine, St. Louis 15, Mo.

SINCE 1879

Mesker Windows

RESIDENTIAL • COMMERCIAL • INDUSTRIAL

MESKER
 "American Home"

STEEL OR ALUMINUM
**CASEMENT
 WINDOWS**

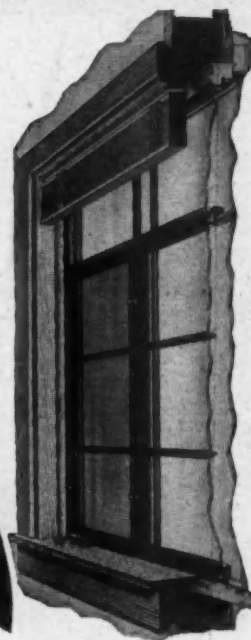

PREFABRICATED COMPLETE
 WITH OUTSIDE TRIM

- More exclusive features than any other window on the market.
- Nationally advertised for consumer acceptance.
- Quickly, cheaply, installed in frame, brick-veneer or brick construction.
- Harmonizes with any architectural style.
- The only metal casements designed for outside metal storm sashing.
- Metal storm sash opens automatically with window vent.
- Rotary operator opens and closes with a twist of the wrist.
- Locks top and bottom automatically when closed.
- Safely attached inside screens are interchangeable. No marking for storage — no painting necessary.
- Permanently weather-tight, cannot swell, shrink, warp, rattle or stick. Keeps heat in and weather out.

THE MODERN WINDOW
 FOR MODERN HOMES

Look at the facts! There's no speculation, no wishful thinking when you specify Gas. It is the preferred fuel in 21 million out of 24 million urban homes and the odds are still growing. Naturally there must be a valid reason why people continue to want Gas . . . particularly in this period of change and progress. The answer is conclusive. Gas is progressive! It is modern from every angle, in every way. *Gas as a fuel* is clean, fast, easy to regulate. *Gas service* is economical—and even more important—always available. *Gas appliances* combine the most in satisfaction with the least in work. And that goes for water-heating, refrigeration, house heating and air-conditioning as well as for cooking. Remember, more clients will want your services tomorrow—if you give them what *they* want with Gas, today!

BUILD FOR TOMORROW. . . VIT



The kitchen that's 10 years

ahead of the times

Even the *shape* of this latest "New Freedom Gas Kitchen" is new! It introduces the modified semi-circular plan—for greater efficiency in a smaller space. Notice how near the refrigerator is to the range . . . and how few steps need be taken to put the food on the table and then clear the dirty dishes to the sink. Yet for all of its work-saving compactness, this kitchen has so much light and air, it would never make a woman feel "hemmed in."

the ro
look at t
the new
ed than ev
clock-co
looks comp
if off (eve
faster .
gh-boil.
flexible
heats—b
perfect hea
cleaner
ng from s
cooler .
o-burners
econo
ery burn
akes be
at heat c
really br
when c
real fla
"custo
s range
styles (c
piler—v
any othe
tagger
sures ev
nge bui
standards
d cooki



Better from your point of view, too!

Feature for feature, modern Gas ranges cost less than any other type. They look smarter, last longer without expensive overhauls; are simpler to install, require no costly utility connections. In fact, you couldn't find a cooking appliance that guarantees more overall satisfaction both from your own *and* your customers' point of view! See your local Gas Company for complete technical details on new Gas ranges and all other Gas appliances.

WITH WHAT THEY WANT TODAY!

The range that's 10 ways better for cooking

Look at this list and it's easy to see the new automatic Gas range is more modern than ever—by more women than ever!

clock-controlled... Gas comes on... cooks complete oven meal... turns itself off (even when nobody's home).

faster... burners light instantly to high-boil.

flexible... flame not limited to 3, 5 or 7 heats—but can be turned to precisely perfect heat for every cooking job.

cleaner... burners set to prevent clogging from spill-overs.

cooler... no lingering heat long after burners are off.

economical... "click simmer" on every burner saves fuel and food.

bakes better... oven is ventilated so that heat circulates evenly on every level.

really broils... meats look and taste better when quick-seared and flavor-sealed by real flame.

"custom-built" for every family... only Gas ranges come in such a wide selection of styles (4, 6 or 8 burners—high or low boiler—with or without griddle—and many other "choice" features).

tagged "CP"... the buying guide that assures every woman of a Gas range built to industry-wide standards of safety, modernity and cooking excellence.

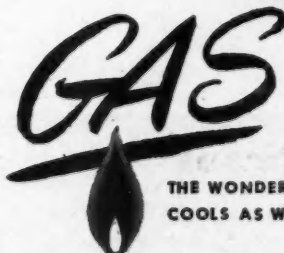

AMERICAN GAS ASSOCIATION

THE WONDER FLAME THAT COOLS AS WELL AS HEATS

"is new...
reater
erator
taken to
the dirty
ving
d air, it
in."

...Certainly, all these homes have STEEL DOOR FRAMES!

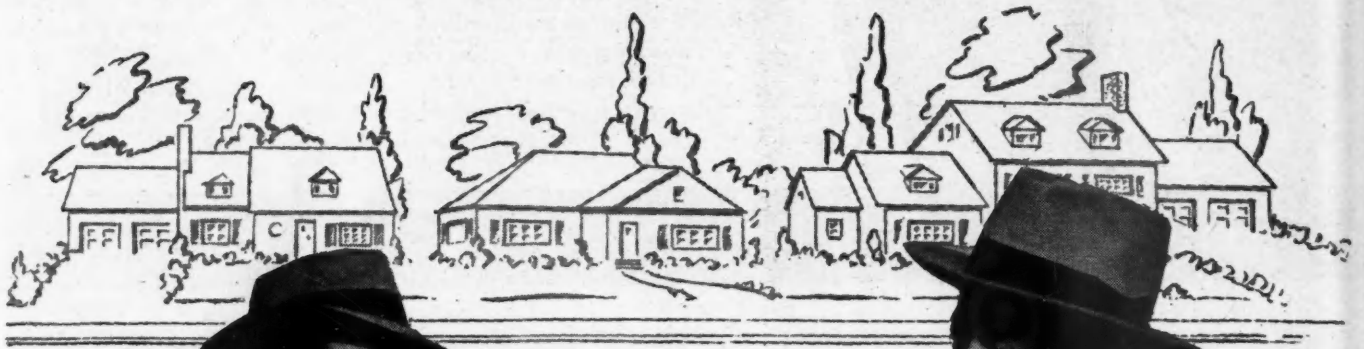

Home buyers are asking about steel door frames because they understand the advantages of wear-resistant, rigid, permanent steel construction.

And builders are using AETNA STEEL DOOR FRAMES because the one-piece, all-welded construction means that they can be installed in a fraction of the time it takes to erect multiple unit frames. Hinges come welded to the AETNA FRAME, bronze strike plate is furnished and frames are prime coated at the factory.



Send for this descriptive booklet.

AETNA STEEL PRODUCTS CORPORATION

Manufacturers of Quality Hollow Metal Doors, Trim and Elevator Enclosures

EXECUTIVE OFFICES: 61 Broadway, New York 6, N. Y.





**What a World of
Difference
The Right Finish
Makes**

In floors, too...

**IT'S THE *Finish*
THAT COUNTS!**



America's Beauty Floors

BRUCE FINISHED FLOORS ARE 8 WAYS BETTER THAN ON-THE-JOB FINISHES

- 1. Smooth Sanding**—Each strip is sanded to perfect smoothness on precision sanders. No sander marks.
- 2. Prime Condition**—Finishing starts immediately after sanding. No "raised grain". Moisture content is right.
- 3. Perfect Filling**—Highest quality silex filler is rubbed into Bruce Flooring as it moves down the finishing line.
- 4. Thorough Sealing**—Finish penetrates into wood, seals pores against dirt and wear. Beautifies the grain.
- 5. Infra-red Drying**—Applies heat uniformly. Welds finish into tough, even film. No "unfavorable drying weather".
- 6. Extra Buffing**—High-speed brushes burnish finish into wood, provide a harder, smoother surface for waxing.
- 7. Superior Waxing**—Special wear-resistant Bruce Floor Wax is applied evenly, then polished with brushes and buffers.
- 8. Ready to Use**—No waiting around for finishing, no floor jobs ruined by finishes being walked on before dry.

E. L. BRUCE CO., MEMPHIS, TENN. • *World's Largest Manufacturer of Hardwood Floors*

BRUCE FINISHED FLOORS

Business and professional men we

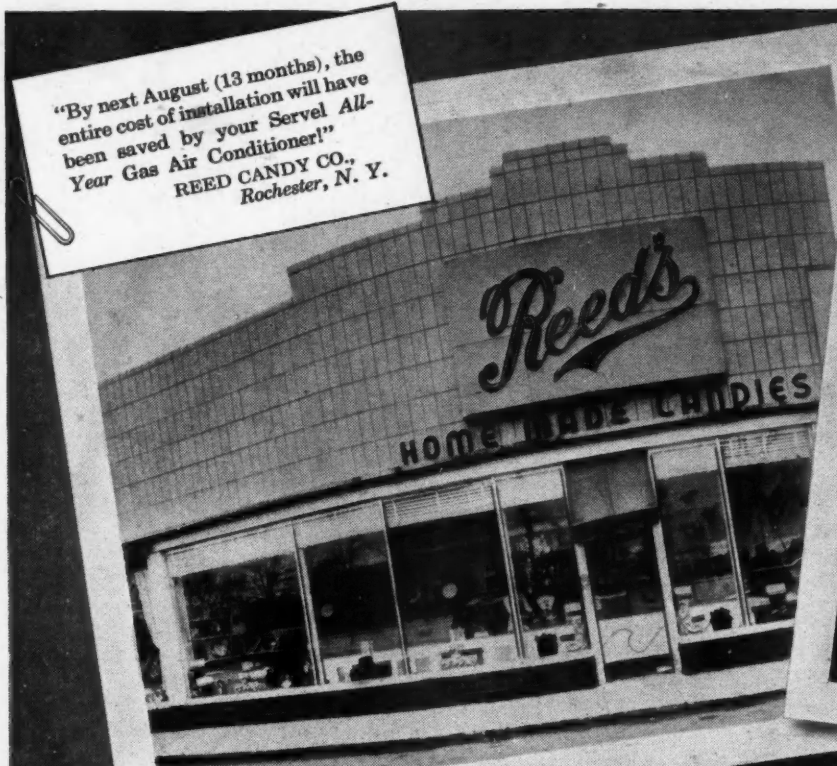

"By next August (13 months), the entire cost of installation will have been saved by your Servel All-Year Gas Air Conditioner!"
 REED CANDY CO.,
 Rochester, N. Y.

"... has actually enabled our watchmakers to work on many days which, without air conditioning, would have been unbearable."
 W. M. WRIGHT,
 Silver Springs, Md.



"... Much favorable comment has been received from my patients. I will be happy to recommend your equipment at any time to any one."
 D. V. LONGO, M. D.,
 New Orleans, La.

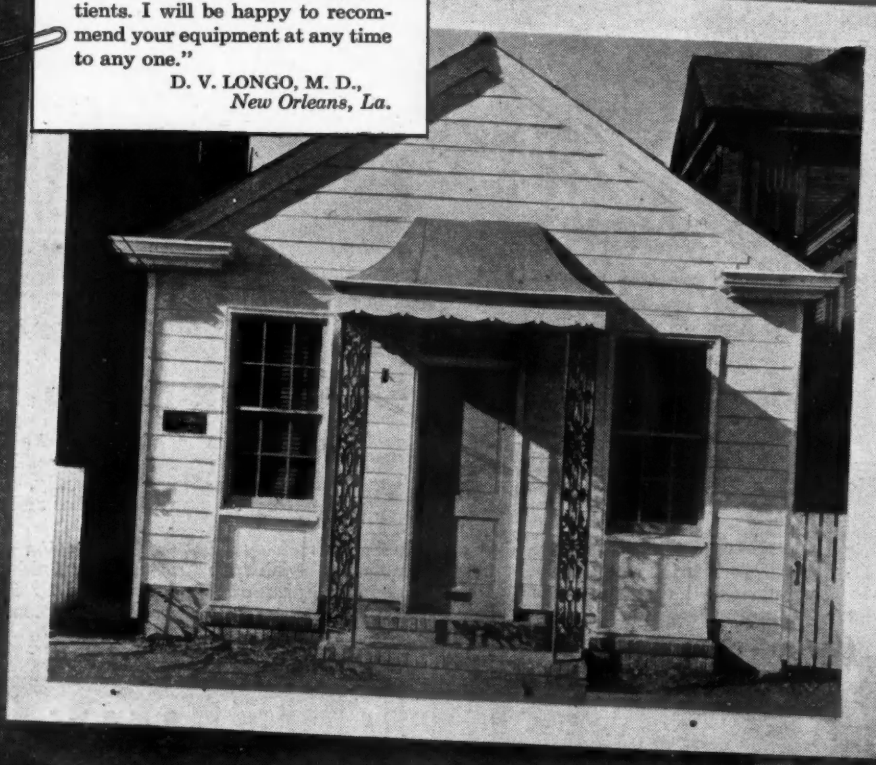

welcome this "new quality of living"

Servel All-Year Gas Air Conditioning ideal for stores, offices, clinics, etc.

Here are just a few of the money-making advantages you give your clients when you specify Servel *All-Year* Gas Air Conditioning for their stores, offices, laboratories and other commercial uses.

More efficient working conditions! Increased store traffic. Less "sick time" lost from work! Better employee relations! Low-cost comfort *the year round!*

The enthusiastic comments you see at the left are typical of hundreds received from commercial, as well as residential, users in every part of the country. They offer eloquent proof of the ability of the Servel unit to provide the benefits of complete, year-round air conditioning in every climate and under every type of working condition.

This revolutionary new conditioner—complete in one compact unit—cools and dehumidifies the air in summer, heats and humidifies it in winter. The year round it filters dirt, dust and pollen from the air. It assures cleaner, quieter, refreshingly comfortable working conditions through every season, no matter what the climate outdoors.

Get more information today on how you can provide your business and commercial clients with this profit-making "new quality of living." Get in touch with your local gas company, or write direct to Servel, Inc., 1702 Morton Avenue, Evansville 20, Indiana.



"... certainly goes a long way toward raising the morale of our office workers."

L. P. KENT & CO.,
Washington, D. C.



Servel

All-Year GAS AIR CONDITIONER

TRIED . . . PROVED . . . SUCCESSFUL
*From Boston to San Diego . . .
. . . From Bismarck to Miami*

The Servel *All-Year* Gas Air Conditioner is operating in hundreds of installations from coast to coast. Some have been running for more than six years. The equipment is tried, tested . . . and approved by users everywhere.

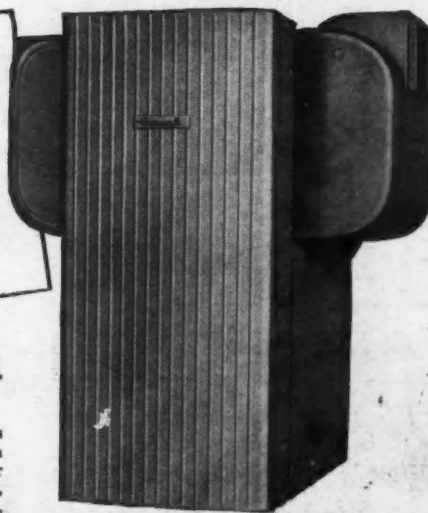



← With this to work from it looks like a near impossible task to make a modern station. How well Architect J. A. Lippett succeeded is shown in the "After" photograph. Insulux Glass Block is used also in the interior of the remodeled building around the ticket window.

As trim a small community railroad station as you'll see anywhere is in service at LaPlata, Mo.—thanks to a skillful remodeling job by the Atchison, Topeka & Santa Fe Railroad. Notice how Insulux Glass Block frame the doorways and the use of corner panels of Insulux. Insulux improves almost any remodeling.

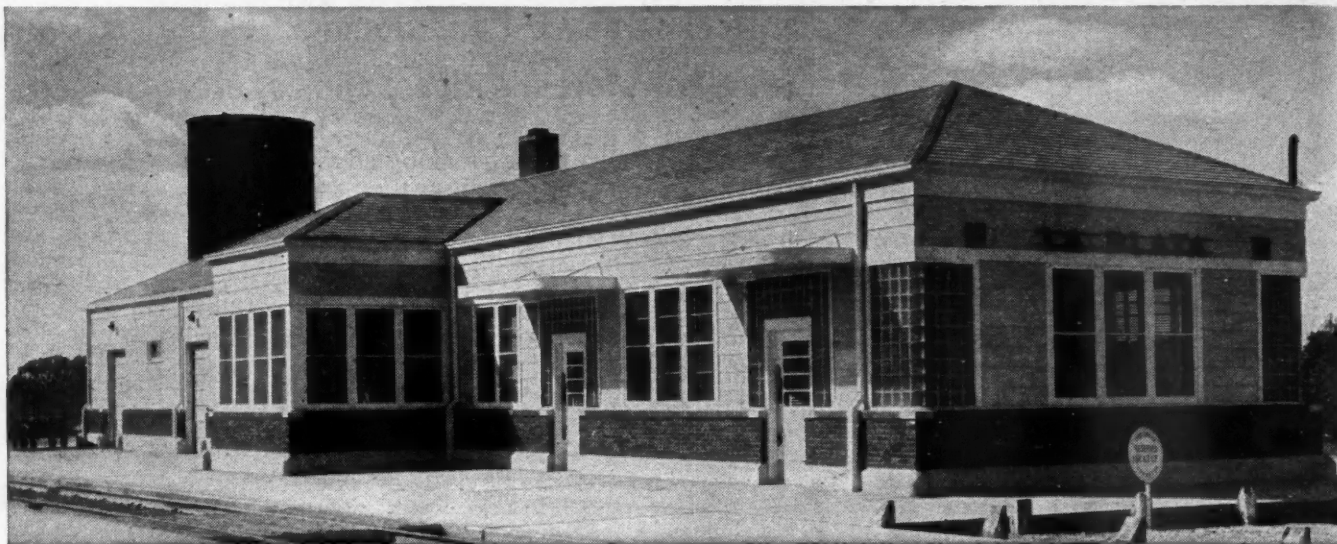

Out for profitable remodeling?

See how Insulux Glass Block
"sparks" a job

MANY builders have found Insulux Glass Block an ideal material for remodeling work.

Panels of Insulux can be advantageously used in both interior and exterior of homes, stores, offices, factories—almost every class of building. Insulux provides light with privacy, while reducing heat loss and the transmission of outside noises. Furthermore, Insulux does not rot, rust or corrode and painting is not needed.

This versatile building material is easily and profitably installed. Send the coupon for details.

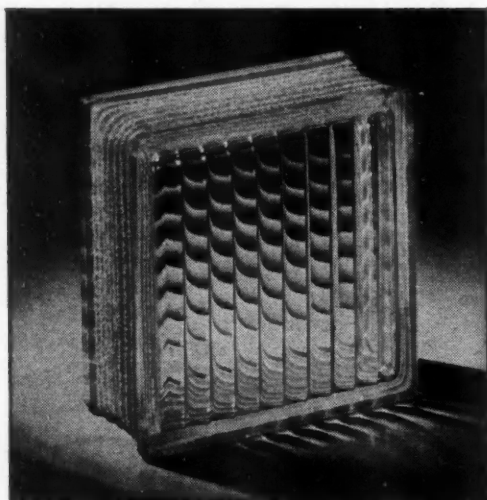

OWENS - ILLINOIS

INSULUX

GLASS BLOCK

Insulux Glass Block is a profit-maker for builders. It is available in three sizes, many functional and decorative patterns. Investigate!

MAIL COUPON FOR FREE BOOKLET

OWENS-ILLINOIS GLASS COMPANY,
Insulux Products Div., Dept. D-52, Toledo 1, Ohio.
Gentlemen: Please send me, without obligation,
your booklet entitled, "Rx for the Improvement
of Buildings."

Name _____

Firm Name _____

Address _____

City _____ State _____



Spreaders are placed about 30" to 36" centers. A few nails hold the four 8" form boards in place. The boards can be used later as roof sheathing. Concrete will encase ends of beams to provide a fire stop and support for a bearing partition.



Complete form with 1/4" reinforcing rods clipped in place. Sill is clipped to beam and space has been provided for heat duct.

*A rigid steel and concrete floor is
easy to install - easy to sell.*

You will find that you can quickly adapt your plans and methods to provide your houses with J&L Junior Beam steel and concrete floors. The job will move smoothly and money will be saved by eliminating troublesome plaster cracks, sagging doors, stuck windows and creaking floors. At a glance your prospects will see the advantages of the strong non-shrinking, vermin proof, fire resistant, rigid steel and concrete floor.



JONES & LAUGHLIN STEEL CORPORATION
PITTSBURGH 30, PA.



how to add Character to Privacy . . .

More rooms . . . with more doors to close against intrusion! That's a big point with thousands of families who are tired of living in overcrowded homes. And you can add character—distinction—to privacy by choosing doors of Ponderosa Pine.

With their correct architectural proportions and shadow lines, Ponderosa Pine paneled doors increase your scope in planning because they give you a wide choice of design at moderate cost. Ponderosa Pine windows, too, make it possible for you to plan more beautiful windows without a cost penalty. Remember that Ponderosa Pine is easy to decorate—holds paint firmly and can take hard use with a smile.

You'll want a copy of "Today's Idea House"—the 32-page Ponderosa Pine booklet showing how doors, windows and frames of Ponderosa Pine can aid your planning. Mail the coupon for your copy.



These stock design doors of Ponderosa Pine add character to the hallway. Note the two closets flanking the entrance to the living room.

The Best is Yours with...

Ponderosa Pine

WOODWORK

"Today's Idea House" treats doors and windows functionally—in terms of what they can do to make living more convenient and more comfortable. Send today for this booklet—your copy is waiting.

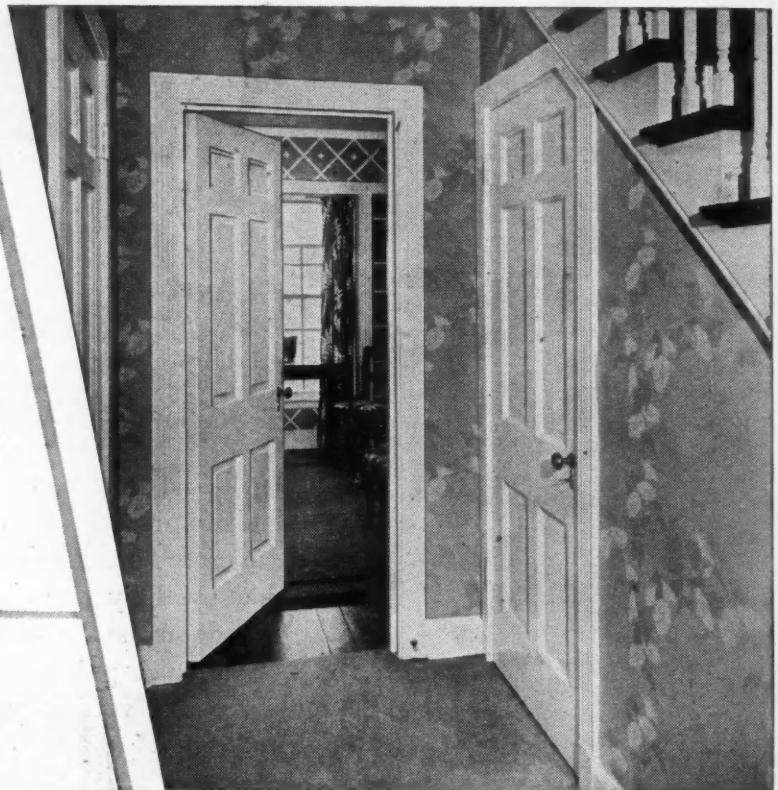
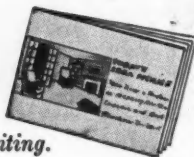

Ponderosa Pine Woodwork
Dept. PAB 2, 111 West Washington St.
Chicago 2, Illinois
Please send me a free copy of "Today's Idea House."

Name

Address

City Zone State

HERE'S NO ^{market} PLACE LIKE HOME

Better Homes and Gardens

READ BY MORE THAN 3,000,000 FAMILIES
FEBRUARY 1947 • 25¢

WE HELP WITH YOUR CLIENTS!

Don't miss these articles in our February number:

A Cold-Climate House with a Warm-Climate Plan—basementless house with big glass areas planned by Harold Spitznagel, Sioux Falls, for South Dakota weather.

What You Should Know about Above-Ground Construction—second in a series that helps educate your clients, makes your job easier.

Modern Suits the Southwest—including some original ideas for cutting costs.

It's solid stuff like this, month after month, that's made Better Homes & Gardens America's leading building magazine for your clients.

America's First Service Magazine

1947 Color Schemes by Dorothy Davenport

Circulation Over 3,000,000

LOOK at the Profit Advantages P&H

Pre-Assembled Homes OFFER YOU!

They're Available . . . Easy To Erect And Sell . . .
Highest Quality Materials Used . . . Features
That Appeal To The Public

Your profits are assured when you erect and sell P&H Pre-Assembled Homes. They're packed with features that appeal to home buyers. P&H Pre-Assembled Homes assure your prestige, too . . . for only the highest quality materials are used in their construction.

So be sure to find out how profitable the erecting and selling of P&H Pre-Assembled Homes can be. They are the result of 11 years' experience in the building of Pre-Assembled Homes . . . and over 60 years' manufacturing experience in building the famous line of P&H Overhead Cranes, Excavators, Hoists, Welders, etc. Send the coupon today for full information.



The WH-5 model P&H Pre-Assembled Home. One of several pleasingly different exterior styles available.

Features

- Conventional design that appeals to the public
- Designed to permit personalized treatment of trim and finishes
- Corner windows
- Attic louvers
- Narrow window trim
- Designed for economy in heating, ease in ventilation
- Extra storage and closet space

Note the attractive variation in the exteriors of these P&H Pre-Assembled Homes.



FREE!

Quality!

In the construction of P&H Pre-Assembled Homes only the highest quality materials are used. Listed here are only a few: Johns-Manville Rock Wool Insulation and Balsam-Wool Insulation, Douglas Fir Lumber, Brass Hardware, Weather-stripped Windows, Bronze Screens, etc.

These detailed floor plans, elevations, photographs, and material lists are offered free to operative builders and realtors in Wisconsin, Indiana, Illinois, Michigan, Ohio, Missouri and Iowa where P&H Pre-Assembled Homes are now available for delivery.

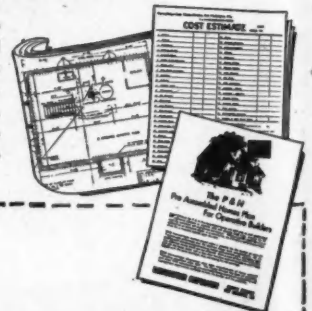

Mail Coupon Today

P&H Pre-Assembled Homes
302 Spring Street
Port Washington, Wisconsin

Please send me without cost or obligation complete information on P&H Pre-Assembled Homes.

Name.....

Address.....

City..... State.....

P & H PRE-ASSEMBLED HOMES
302 Spring Street
Port Washington, Wisconsin

HARNISCHFEGER
CORPORATION

EXCAVATORS - ELECTRIC CRANES - ARC WELDERS **P&H** HOISTS - WELDING ELECTRODES - MOTORS

handy facts on insulating any type of construction ... BALSAM-WOOL data sheets

Braced frame—balloon frame—platform frame
—all can be effectively insulated with Balsam-Wool. These handy Balsam-Wool Data Sheets show just how to do it. Here's authentic information on applying insulation, condensed into "capsule" form—yet authentic and complete. Balsam-Wool Data Sheets cover a wide variety of insulation subjects—and they're yours for the asking. Mail the coupon now for your complete set!



Balsam-Wool APPLICATION DATA SHEET SEC. 8 No. 2

APPLICATION OF BALSAM-WOOL TO A BALLOON FRAME

DOUBLE-THICK BALSAM-WOOL
HEADER
TUCKED BETWEEN STUDS
STANDARD BALSAM-WOOL
HEADER

WALL SECTION
SCALE 1/8"=1'

WOOD CONVERSION COMPANY
First National Bank Building
St. Paul, Minnesota
BALSAM-WOOL Products of Weyerhaeuser • NU-WOOD

Balsam-Wool APPLICATION DATA SHEET SEC. 8 No. 3

BALSAM-WOOL APPLICATION TO A PLATFORM FRAME

DOUBLE-THICK BALSAM-WOOL
TUCKED BETWEEN JOISTS
STANDARD BALSAM-WOOL

WALL SECTION
SCALE 1/8"=1'

WOOD CONVERSION COMPANY
First National Bank Building
St. Paul, Minnesota
BALSAM-WOOL Products of Weyerhaeuser • NU-WOOD



SEALED INSULATION

BALSAM-WOOL • Products of Weyerhaeuser • NU-WOOD

WOOD CONVERSION COMPANY
Dept. 119-2, First National Bank Building
St. Paul 1, Minnesota

Please send me set of Balsam-Wool Application Data Sheets.

Name

Address

City.....State.....

How to Adapt Weldwood Paneling to Stock Door and Window Frames

For new construction or remodeling, you'll find it quick and easy to use Weldwood Plywood with stock sashwork.

Here are four methods selected from those illustrated in the Weldwood Installation Booklet. You'll find a host of other helpful and valuable suggestions for the many interesting structural details possible with this versatile material.

This profusely illustrated booklet is yours for the asking. Write for your free copy today.



Plastics and Wood
Welded for Good

Waterproof Weldwood for exterior use is bonded with phenol formaldehyde synthetic resin. Other types of water-resistant Weldwood for interior applications are manufactured with extended urea resins and other approved bonding agents.

WELDWOOD Plywood

Weldwood Plywood and Mengel Flush Doors are products of

UNITED STATES PLYWOOD CORPORATION
New York 18, N. Y.

THE MENGEL COMPANY, INCORPORATED
Louisville 1, Ky.

Distributing units in Baltimore, Boston, Brooklyn, Chicago, Cincinnati, Cleveland, Detroit, High Point, Los Angeles, Newark, New York, Oakland, Philadelphia, Pittsburgh, Rochester, San Francisco, Seattle. Also U. S. - Mengel Plywoods, Inc. distributing units in Atlanta, Dallas, Jacksonville, Louisville, New Orleans, Houston, St. Louis. In Canada: United States Plywood of Canada, Limited, Toronto. Send inquiries to nearest point.

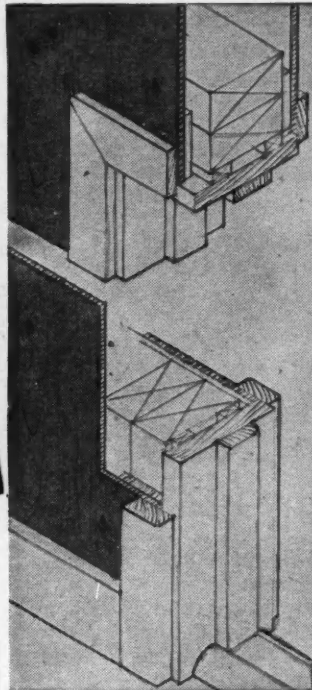

This detail shows a simple but effective method of adapting Weldwood Plywood to an inside door jamb during new construction. Weldwood is brought flush, and covered with stock molding.

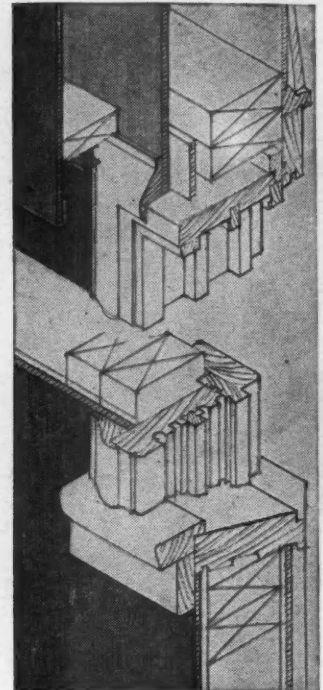

Dri-bilt construction, with Weldwood adapted to stock window frame. Note the unique plywood valance, concealing all fixtures. Easily made from Weldwood during construction.

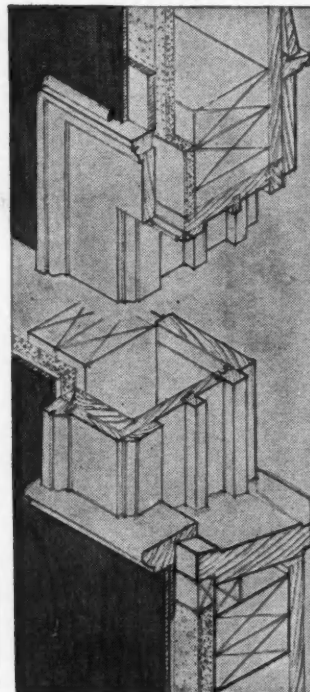

Double-hung window in standard plaster wall construction, with back band casing. Banding must be thick enough to install small molding around opening, to cover fitting imperfections.

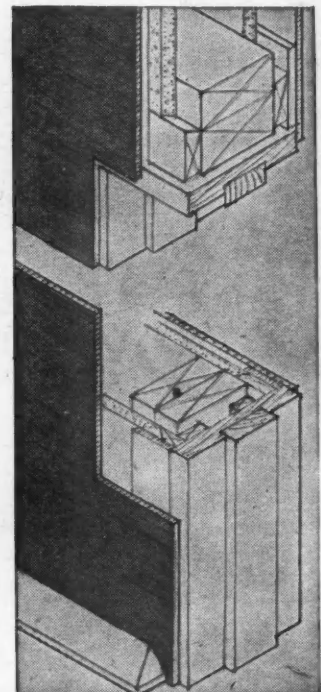

You can use Weldwood equally well without any type of casing, as this detail of an interior door opening shows. This method is equally satisfactory for new construction or remodeling.

plan on
Marlitz
 walls

for easy installations

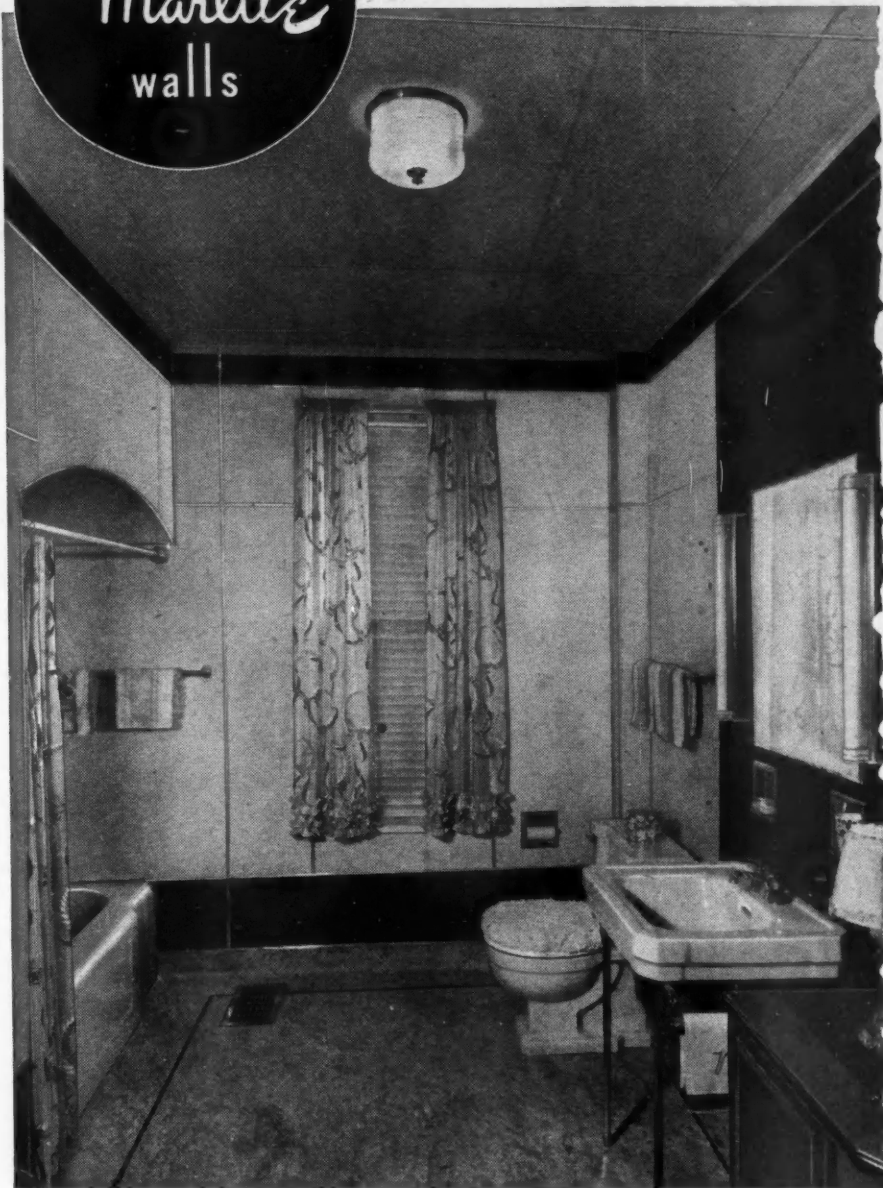

- For wainscot installation, draw level line at desired panel height. Cut panel to size with saw and plane.

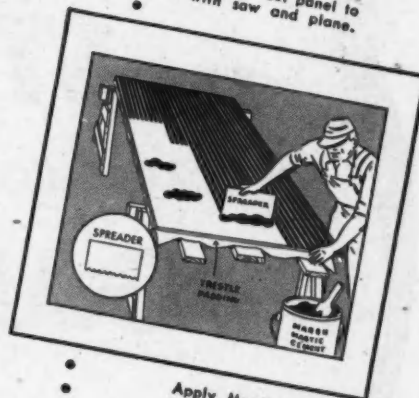

- Apply Marsh Mastic cement uniformly to the back of the panel.



- Install Marsh "panel-tested" moldings for a job of finished beauty. Place panel on the wall. Write for the complete installation instructions.

You don't need special tools to install Marlitz plastic-finished wall and ceiling panels. They're EASY to install . . . go up fast, too, over old walls or new. Sold by leading dealers everywhere, Marlitz is available in a wide range of colors and patterns for all types of applications—wherever colorful interiors are wanted. See our Catalog in Sweet's File, Architectural, or write to the factory for details. Marsh Wall Products, Inc., 23 Main Street, Dover, Ohio.

For Creating Beautiful Interiors . . .



Marlitz
 PLASTIC-FINISHED
 WALL PANELS

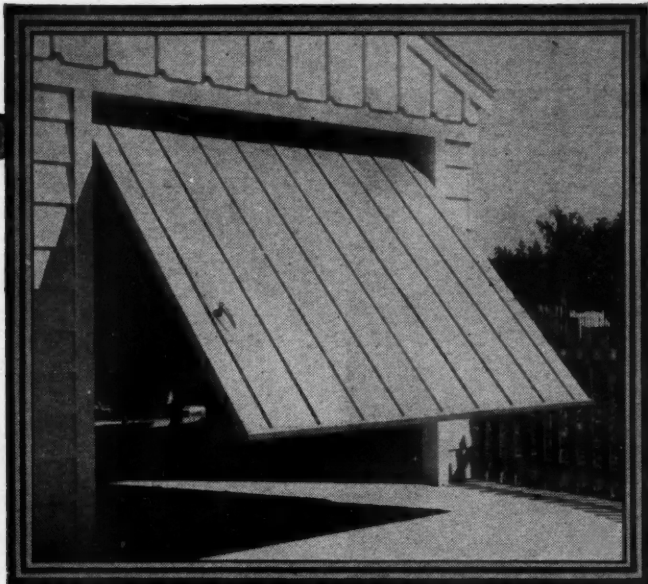

**Ready Now,
by the
Carload!**

The **STRAND**

*Overhead
Canopy-Type*

ZINC-COATED RUST-RESISTING STEEL

GARAGE DOOR

**The Strongest Door in America . . .
Built Like a Battleship—of STEEL!**

Last year, we couldn't build enough of these STRAND Garage Doors! Now—our production lines are turning them out to meet the demand!

The STRAND Door is, without question, the finest CANOPY-TYPE Garage Door available. ALL STEEL — electrically welded — definitely SAFE. Can be installed in MINUTES—operates with finger-tip touch—assembled at the factory—no problems on the job.

It's a real profit maker, too—the right door to step up your sales volume throughout the year.

SEE YOUR JOBBER NOW!

**WRITE OR WIRE FOR
DESCRIPTIVE FOLDERS!**

**See the NEW
STRAND
Receding
Garage Door**

at the
**HOME BUILDERS
CONVENTION**
STEVENS HOTEL—CHICAGO
February 23-27
Another Leader by STRAND!

STRAND Building Products Company

1818 Buhl Building

Detroit 26, Michigan



ANOTHER big Gold Bond campaign in the Saturday Evening Post starts in February. Full page ads in full color all during 1947 featuring smartly styled exteriors and interiors done by leading architects and designers.

Remember last year's Gold Bond ads, a few pictures of which are shown at the left? Builders liked that series and they questioned if we could turn out another campaign as good. Well, we've done it. Wait until you see these new ads and you be the judge.

While Gold Bond Products are, of course, mentioned in every ad, the underlying theme is "Pride of Home Ownership." Jim and Mary want to build but they're getting awfully tired waiting. These ads will help to keep the idea still sparking. Actually this campaign is designed to do a job for the whole building industry.

You'll build or
remodel better with
Gold Bond

NATIONAL GYPSUM COMPANY • BUFFALO 2, N. Y.

Over 150 Gold Bond Products including gypsum lath, plaster, lime, wallboards, gypsum sheathing, rock wool insulation, metal lath products and partition systems, wall paint and acoustical materials.

When you think of

WATERPROOFING

You think of

BONDEX
cement paint

For **6** very good reasons

- 1 **Performance** — Bondex has proven its ability to check dampness in every type of climate the world over (in 90 foreign countries besides the U. S. A.).
- 2 **Reputation** — Bondex is favorably known by homeowners who have used it and by millions more who have read Bondex advertising.
- 3 **Economy** — Bondex is priced to make it practical for all types of structure. It fits every budget from modest homes to mansions and institutions.
- 4 **Ease of Application** — Bondex is easy to apply with brush or spray — so simple that it's become a "staple" in the building and construction trade.
- 5 **Color** — Bondex provides an effective, inexpensive way for "exterior decorating" buildings after erection to suit individual tastes. Comes in white and 12 colors.
- 6 **Patented Formula** — Bondex is manufactured by a patented process which makes its bonding characteristics unique. That's why it out-sells all other cement paints combined.

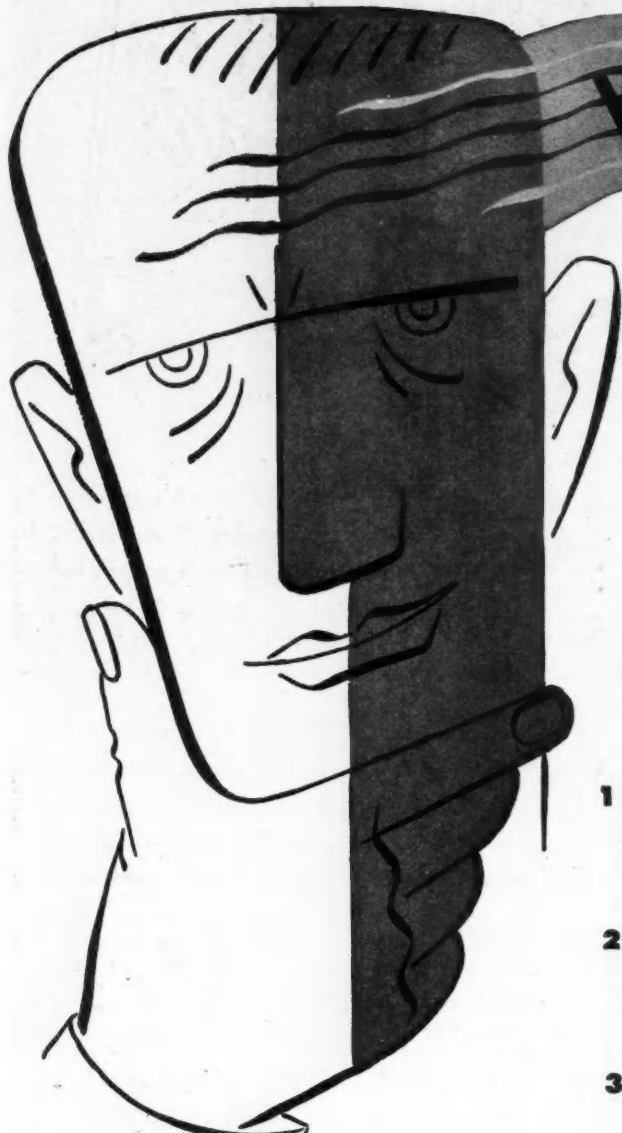

specify

BONDEX

- For Exteriors, Basements and Foundations
- On Concrete or Cinder Block, Stucco, Brick and Masonry
- For full information and new Bondex color chart, WRITE —

THE REARDON CO.
St. Louis 6 • Chicago 9 • New York 6
Los Angeles 21 • Montreal 1

The Secret's in the Swivel!

It's One of the Big
Eubank Features That Make
This Cabinet Ironing Board
Ideal for New or Old Homes!



The Eubank patented cast aluminum swivel support makes this cabinet ironing board a "must" in your planning. It allows the board to swing through a wide arc for convenience in use . . . means the board can be installed where space is limited. Sturdy! Requires a rough opening only 14" x 57 1/4" x 3-3/4". Attractive cabinet design, easy to install either before or after plastering. If your lumber dealer does not have this improved cabinet board, write the distributor nearest you.

Built by
L. H. EUBANK AND SON
Inglewood, Calif.
National Sales Representative
HARBOR PLYWOOD CORPORATION
Hoquiam, Wash.

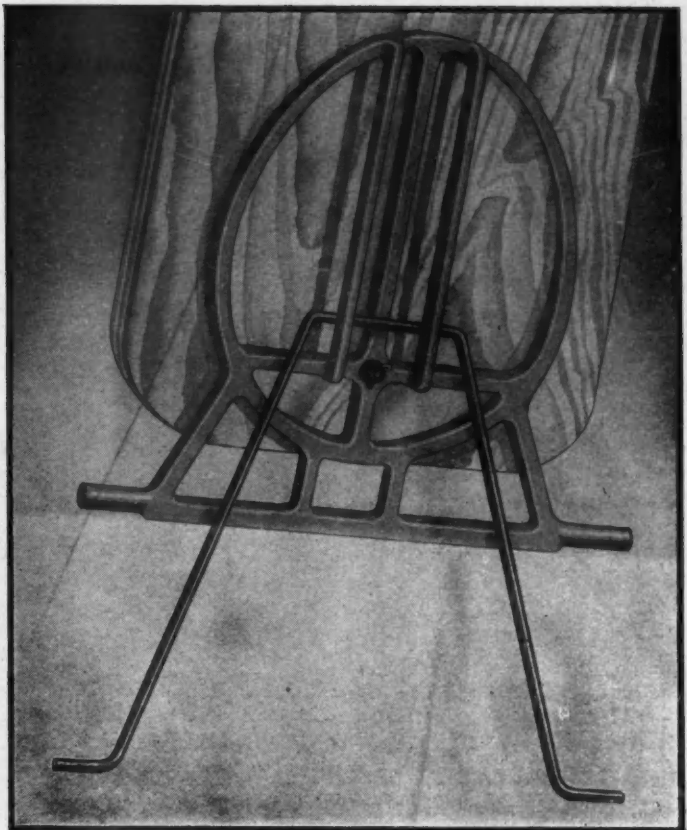

DISTRIBUTORS: Arizona - Arizona Sash & Door Co., Phoenix; Southwestern Sash & Door Co., Phoenix & Tucson Arkansas - Dyke Bros., Fort Smith, Little Rock & Texarkana California - L. H. Eubank & Son, Inglewood Connecticut - Wm. H. Short Lumber Co., West Hartford District of Columbia - Harbor Sales Co., Inc., Washington Florida - Harbor Plywood Corp., Jacksonville, Miami & Tampa Georgia - Harbor Plywood Corp., Atlanta Illinois - Harbor Plywood Corp., Chicago Indiana - E. W. Camp Plywood Co., Inc., Indianapolis Iowa - Tip Top Distributing Co., Cedar Rapids, Des Moines & Storm Lake Kentucky - E. W. Camp Plywood Co., Inc., Louisville Louisiana - Davidson Sash & Door Co., Lake Charles; New Orleans Sash & Door Co., New Orleans Maryland - Harbor Sales Co., Inc., Baltimore Massachusetts - Kimball Lumber Co., Watertown Michigan - E. E. Anderson Lumber Co., Detroit; Anderson-Dietrich Lumber Co., Lansing Missouri - Dyke Bros., Joplin & Kansas City Nebraska - Omaha Hardwood Lumber Co., Omaha New Jersey - Jersey Millwork Corp., Jersey City; J. R. Quigley Co., Gloucester City New Mexico - Southwestern Sash & Door Co., Albuquerque; The New Mexico Co., Albuquerque New York - Alpert Woodworking Corp., Brooklyn; Davis Plywood Corp., Rochester; Kimball Lumber Corp., Schenectady Ohio - E. W. Camp Plywood Co., Inc., Cincinnati; Davis Plywood Corp., Cleveland, Columbus & Toledo Tennessee - Cole Manufacturing Co., Memphis Texas - Davidson Sash & Door Co., Austin; Houston Sash & Door Co., Houston; Southmost Sash & Door Co., Harlingen; Texas Sash & Door Co., Fort Worth; Geo. C. Vaughan & Son, San Antonio Washington - Harbord Mercantile, Aberdeen; Lundgren Dealers Supply, Tacoma.

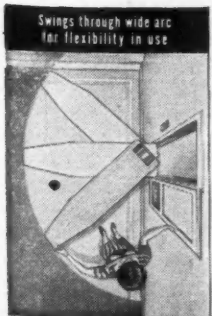

Swings through wide arc for flexibility in use

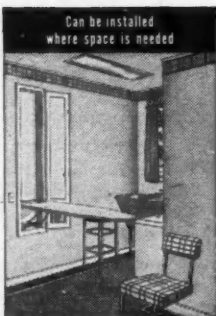

Can be installed where space is needed

All Women Want
These Improved Features
Found in the



Swivel Type Cabinet Ironing Board

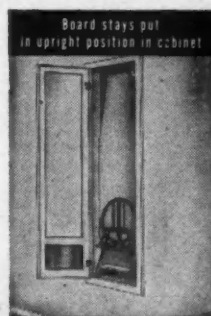

Board stays put in upright position in cabinet

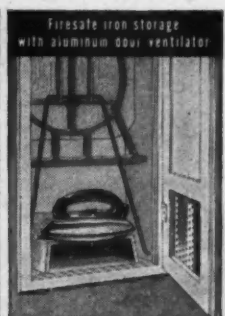

Fireproof iron storage with aluminum door ventilator

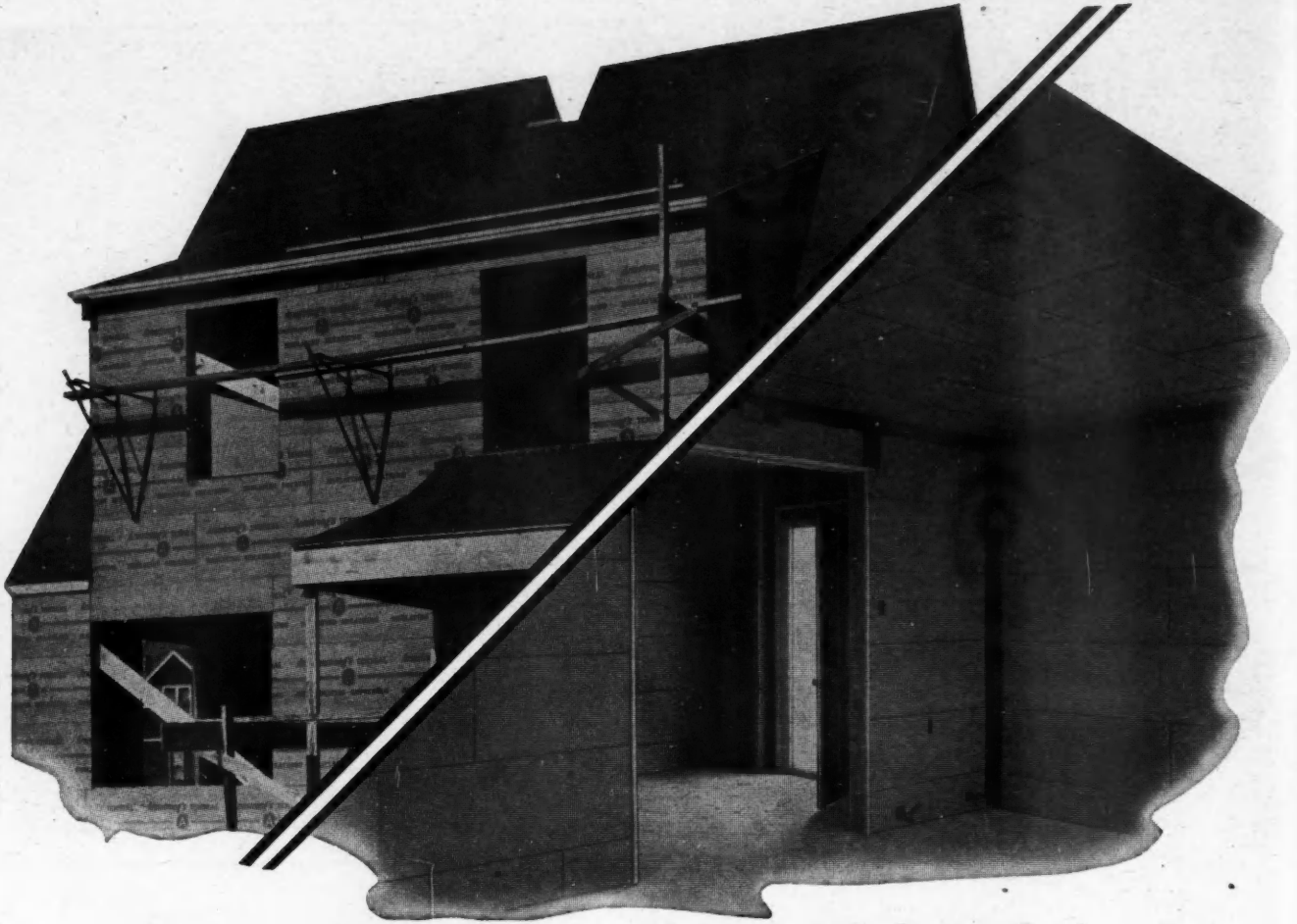

Temseal Sheathing plus Temlok Lath for "DOUBLE-INSULATED" CONSTRUCTION

Here's a practical building method that reduces time and costs . . . produces stronger houses . . . provides efficient insulation. It combines the structural and insulating advantages of both Temseal Sheathing and Temlok Lath. With this "double-insulated" construction, no other insulation is required to assure a heat-tight building.

Temseal Sheathing insulates efficiently on the outside—and braces the structure strongly. Temlok Lath insulates on the inside—and provides a firm, moisture-resistant surface for rapid plastering.

"Double-insulated" construction reduces labor to a minimum, too. Shiplapped 2' x 8' Temseal Sheathing and 18" x 48" Temlok Lath

are lightweight and easy to put up quickly on the job.

Both of these products are rigid boards of compressed wood fiber. Passage of heat and cold is arrested by millions of tiny cells and sealed air spaces. Temlok and Temseal are highly resistant to dry rot, fungus, and vermin.

You may well find that "double-insulated" construction will reduce heating plant costs. A smaller boiler, fewer or smaller radiators are required in a well insulated house.

For more information about Temseal Sheathing or Temlok Lath, write to Armstrong Cork Co., Building Materials Division, 1602 Ross Street, Lancaster, Pennsylvania.



Armstrong's Insulating Wool...made of efficient Fiberglas[®], comes in flexible rolls, batts, and pouring wool. It will not burn, decay, sag, or settle and withstands rough handling.



Armstrong's Monowall... decorative interior finish panelboard in attractive Streamline-Designs, plain colors, and Tile-Designs for kitchens, bathrooms, and all walls where easy cleaning is of greatest importance.

Temseal, Temlok, and Monowall are registered trade-marks.

* T.M. Reg. U. S. Pat. Off., Owens-Corning Fiberglas Corp.

ARMSTRONG'S BUILDING MATERIALS

TEMLOK • INSULATING WOOL • MONOWALL • HARDBOARDS

It's not the scarcity of glass...
**it's the immensity
 of the demand!**

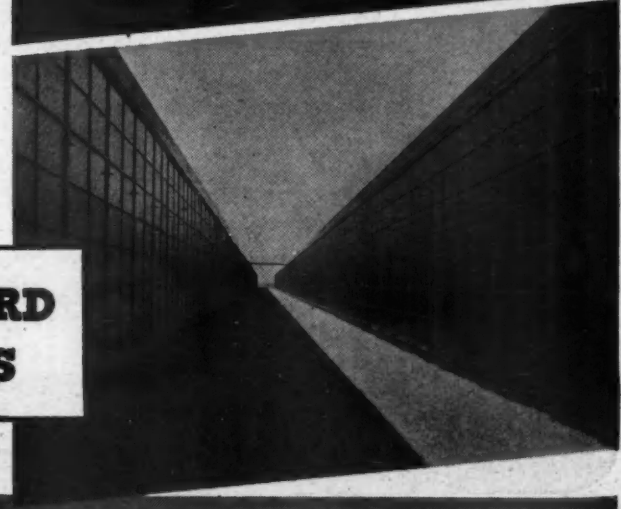
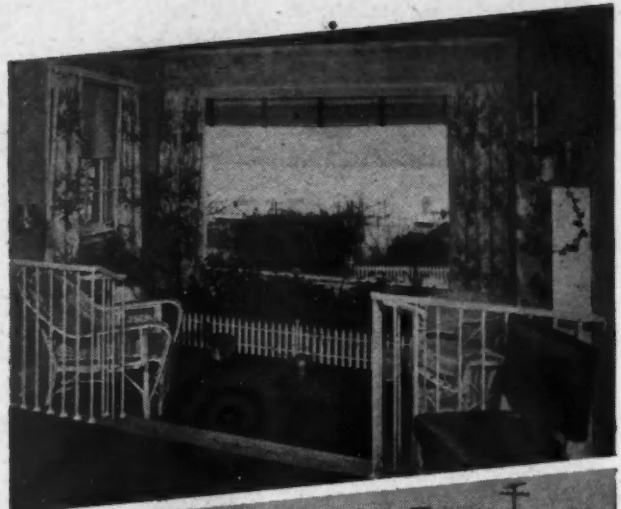

Having trouble getting the glass you need? Then we think you deserve an explanation.

We're making more glass than ever before—but there's not enough to go around. Why? Because today's homes, stores, factories and cars are *all* using more glass. The definite trend to larger windows, from the mansion to the temporary home, requires more glass. Add to this the fact that more thousands of new homes are being built and you have an idea why glass may be difficult to get.

We've built new plants... expanded existing ones... installed new equipment... added hundreds of employees. Still the orders pile up. This is especially true of *Thermopane**—the original windowpane that insulates.

We suggest that you get your orders in to your L·O·F Distributor as soon as plans are completed and sizes determined. Libbey·Owens·Ford Glass Company, 1827 Nicholas Building, Toledo 3, Ohio.

*Reg. U. S. Pat. Off.



LIBBEY·OWENS·FORD
a Great Name in **GLASS**



MEN WHO KNOW CHOOSE CELLULITE

Flameproof COTTON INSULATION



Architects, Builders, Building Supply Dealers . . . men who know . . . choose CELLULITE Flameproof COTTON INSULATION every time because they know it has no equal.

Government tests show that CELLULITE COTTON INSULATION is up to 36% more efficient . . . keeps any building more comfortable with less fuel

than any other commercial insulation. Read for yourself the amazing story of CELLULITE COTTON INSULATION. Simple and easy to install . . . never packs down . . . always fluffy . . . repels vermin . . . thoroughly flameproofed.

Send for Senator Claghorn's new book — "It's No Joke, Son", IT'S FREE.



VISIT our display, BOOTH 21, National Home Builder's Exposition, The Stevens Hotel, Chicago, February 23-27.

THE GILMAN BROTHERS COMPANY

GILMAN • Established 1897 • CONNECTICUT



V-
ne
th
in
ch
he
he
re
M

REGISTRATIONS SHOW IT—OPERATORS KNOW IT!

90 **6** H.P.
YOUR PICK OF POWER
100 **8** H.P.

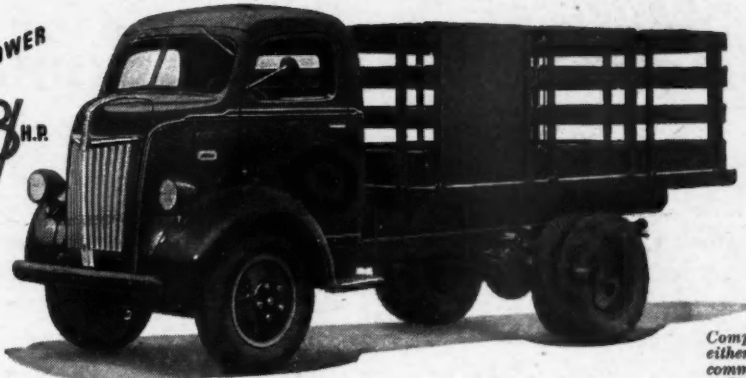

Compactness and splendid performance in either tough, slow going or open-road service commend the Ford heavy duty 2-ton C.O.E. unit, with its dual-range rear axle and auxiliary springs. This 168-inch-wheelbase unit has a 12-foot Ford Platform Stake body.



"FORD TRUCKS LAST LONGER!"

ONE big reason:

FORD SPRINGS STAND UP!

Ford spring engineering provides unsurpassed endurance. Ford special alloy spring steel, with tensile strength of 200,000 pounds per square inch, assures high fatigue resistance, while deflection rates scientifically proportioned to each vehicle's gross weight assure good riding with generously ample load capacity. Long-wearing shackle bushings of steel-backed bronze reduce maintenance expense. Ford special, wrapped "safety eyes" on heavy duty front springs (illustrated) reduce stress on main leaves, afford longer life and extra safety. Hydraulic double-acting shock absorbers on light duty models further ease the ride and control the load.

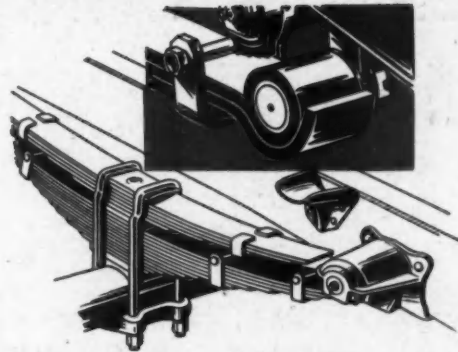

ONLY FORD GIVES YOU ALL THESE LONG-LIFE TRUCK FEATURES: Your choice of two great engines, the 100-H.P. V-8 or the 90-H.P. Six—semi-centrifugal clutch that needs no maintenance lubrication—rear axle design that takes all weight-load off the shafts ($\frac{3}{4}$ -floating in half ton units, full-floating in all others)—heavy channel section frames, *doubled* between springs in heavy duty models—big, easy-action brakes, with heavy, cast drum surfaces, non-warping and score-resistant—extra-thick sheet metal in cabs, cowls,

skirts and fenders—all told, more than fifty such examples of Ford endurance-engineering. That's why **FORD TRUCKS LAST LONGER** . . . why 7 out of 11 of all Ford Trucks built since 1928 are still in service. No wonder the average age of all Ford Trucks in use is nearly 9 years! Stamina is built into them! See your Ford Dealer NOW!

FORD TRUCKS

MORE FORD TRUCKS IN USE TODAY THAN ANY OTHER MAKE

Stock Sizes Mean *Door and Plywood* Dividends for Our Customers—

Percentage-wise, it's quite a dividend. By concentrating all our production on stock size doors and plywood, production can be increased a minimum of one-third.

For instance, the man-hours required to cut three lights, will produce a complete stock door. Odd sizes and other special details further limit production

by added labor and material demands. The elimination today of all special doors — and concentration of our manpower and machines on stock sizes is a policy dictated by our customers' needs. It means more Roddiscraft Doors and Plywood for everybody — plus stocks in the warehouses for delivery where and when you want them.

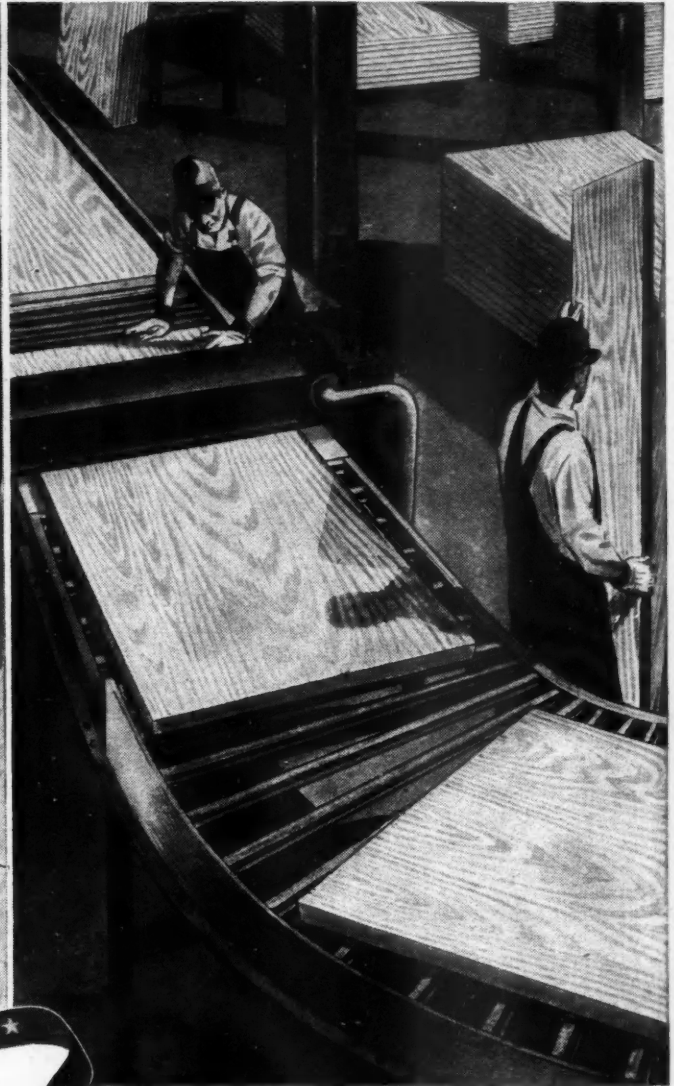
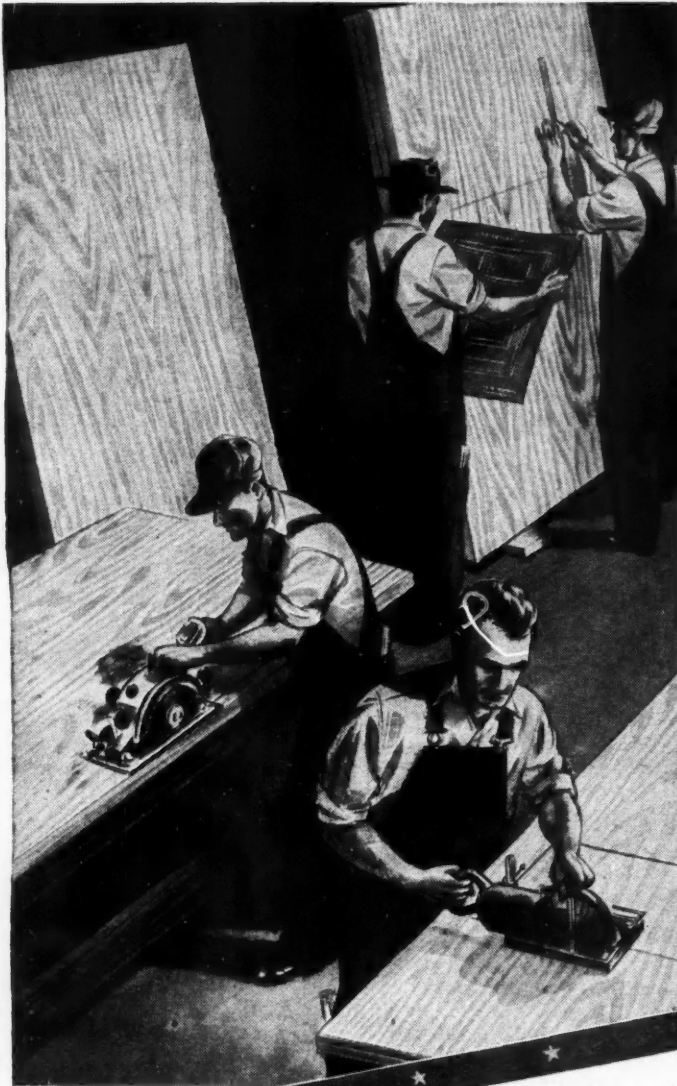

Roddiscraft
Roddis Lumber & Veneer Co.
MARSHFIELD, WISCONSIN

Roddiscraft WAREHOUSES

CAMBRIDGE 39, MASS. 229 Vassar Street
CHICAGO 8, ILL. 1440 W. Cermak Road
CINCINNATI 2, OHIO. 457 E. Sixth Street
DALLAS 10, TEXAS. 2800 Madill Street
DETROIT, MICH. 11855 E. Jefferson Ave.
KANSAS CITY 8, MO. 2729 Southwest Blvd.
LOUISVILLE 10, KENTUCKY ... 1201-5 S. 15th Street
LONG ISLAND CITY, N. Y. ... Review & Greenpoint Ave.
MARSHFIELD, WIS. 115 S. Palmetto Street
MILWAUKEE 8, WIS. 4601 W. State Street
NEW YORK CITY, N. Y. 920 E. 149th Street
SAN ANTONIO, TEXAS. 727 N. Cherry Street

DEALERS IN ALL PRINCIPAL CITIES

BUILD NOW! BUILD BETTER -WITH ALUMINUM SIDING

*Send for this
new booklet of
specifications*

Have you investigated *Hoess Aluminum Clapboard Siding*?
Do you know that each section is made of rolled aluminum
sheet, beveled like wood siding and formed to interlock
with other sections? Do you know that when it has been applied
and painted, it looks exactly like wood siding?

And that you can apply it over ordinary sheathing — or
that *sheathing can be eliminated* when a 2" blanket of insulation is used
as instructed? Do you realize that this siding is *rustproof, rotproof, weatherproof* and *termite-proof*?

Do you realize that an aluminum surface reflects 95% of all radiant heat outward
in summer—inward in winter? Or that leading builders who have
used *Hoess Aluminum Clapboard Siding* say it is *the answer*
to *lifetime durability* in
low cost housing?



Hoess Aluminum Clapboard Siding is simple, easy and economical to apply.

It is in volume production now. It is being distributed through regular building material channels. *Send now for descriptive booklet of specifications and prices. Use the convenient coupon below!*

See us at
Booth No. 38
NAHB Exhibition
Chicago, Feb. 23rd—27th.

METAL BUILDING PRODUCTS, INC.

Pioneer Fabricators of Aluminum Clapboard Siding

Dept. 13, 8825 Grinnell Street, Detroit 13, Michigan

Send me descriptive booklet and prices of Hoess Aluminum Clapboard Siding.

Name _____
Name of Company _____
Address _____
Nature of Business _____

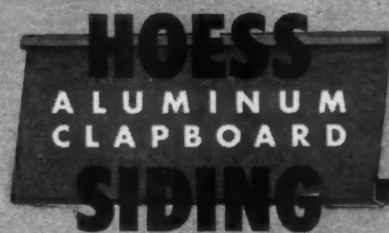

A BETTER SHEATHING JOB IN 1/3 LESS TIME!

...That's what you get with

**ARKANSAS
SOFT PINE**



Look for the trade mark at your dealer's

Center and End-Matched Sheathing



Goes on fast... end joints eliminate trimming at stud and joist centers.

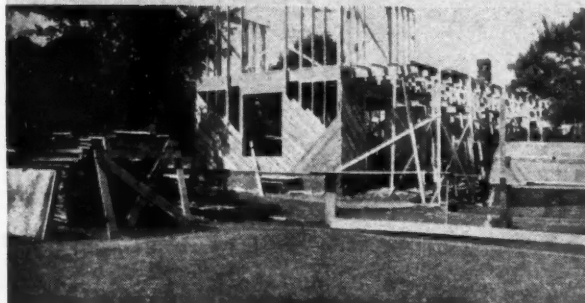

Gives extra reinforcement at frame corners... soft texture nails without splitting... works easily.

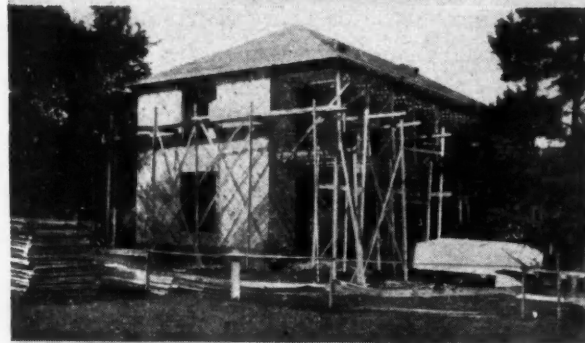

Matching prevents air leakage under exterior window and door trim.

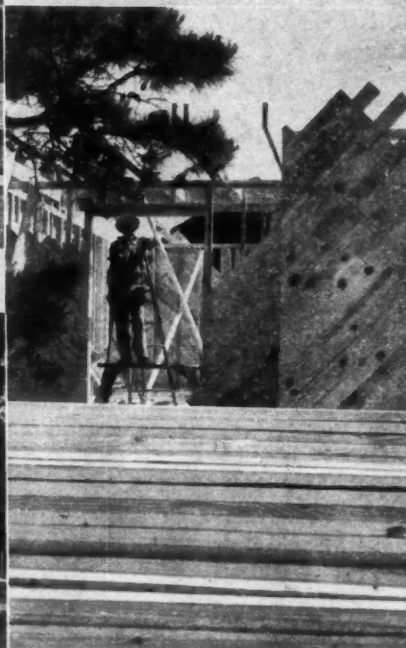

Facilitates use of short lengths in narrow spaces.

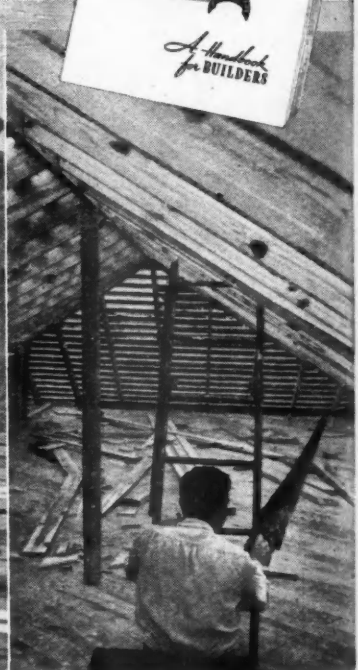

Impervious to rain during construction. Doesn't swell.

Center and end-matched sheathing shows you in these jobs just one of the many better-profit values in Arkansas Soft Pine. New improvements like this, along with extra soft texture, light weight and bright color, qualify Arkansas Soft Pine as the leading all-purpose framing and finishing lumber for every item from foundation to Satin-like Interior Trim.

With OPA controls off and the end of priorities drawing near, Arkansas Soft Pine will resume its normal flow through dealers' hands. While you're waiting, send for free copy of the Arkansas Soft Pine Handbook. It brings you specifications, structural details and much useful information. Write today.

ARKANSAS SOFT PINE BUREAU
988 Boyle Bldg., Little Rock, Arkansas

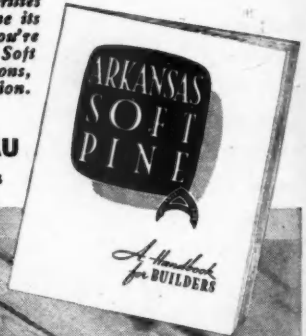

THE Salter-Glauber LINE OFFERS QUALITY • SERVICE • PROFITS

Specify Salter Masterpieces in Brass for Your
Plumbing Fittings and Trim Requirements

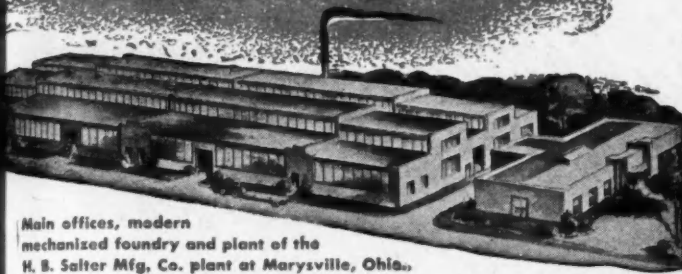

Main offices, modern mechanized foundry and plant of the H. B. Salter Mfg. Co. plant at Marysville, Ohio.

For **QUALITY** embodying "firsts" in appealing design and superior construction, the plumber and the building trade as a whole can rely on the Salter-Glauber line to furnish complete customer satisfaction, Salter "EZE" CLOSE valve construction, precision machining, individual testing of each fixture and extra lustrous chrome finishing are a few of the inherent qualities of perfection built into all fixtures.

For **SERVICE** the new mechanized facilities and the production capacities of seven associated plants are coordinated to provide ever-increasing quantities of regular and improved patterns of fixtures needed to meet the urgent requirements of the building industry. During the stress of present conditions, even our expanded production may fall short of your requirements. Nevertheless, you can rest assured that our distribution will be equitable and you will receive your proportionate share of our ever-increasing volume.

For **PROFITS** today, and for years to come, you will reap the benefits of the quality and service through the accepted superiority and the customer satisfaction every Salter-Glauber fixture provides.

For information on the complete Salter-Glauber line, please consult your plumbing goods supplier or Salter sales representative.

H. B. SALTER MFG. CO.

20 Ninth St. Marysville, Ohio
and Division, THE GLAUBER BRASS MFG. CO., Kinsman, Ohio

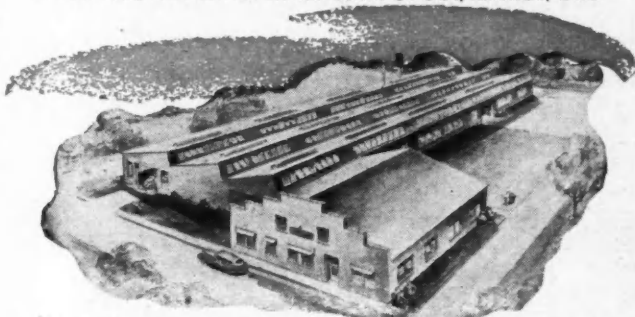

The Glauber Brass Mfg. Co. plant at Kinsman, Ohio, is especially equipped for producing the brass goods for which they have enjoyed an enviable national reputation.



NEW Salter AUTOMATIC 2-VALVE BATH and SHOWER FIXTURE



JUST LIFT



And the flow is automatically diverted from spout to shower.

S-436 — Masterpiece Art-Design fixture complete with self-cleaning shower assembly and snap lock trip-lever wash. "EZE" CLOSE valve construction — 5" between centers with 1" adjustment for "roughing-in" variations.



TO SHOWER

TO BATH



Note the special "L" connection which permits the water flow to be automatically diverted from the tub to the shower. Valve automatically drops to tub position when hot and cold valves are closed.

THRUSH

Forced Circulating
FLOW CONTROL HOT WATER HEATING

CEILING, FLOOR
 OR WALL COIL

FOR
Radiant Heating
 SYSTEMS

1. Thrush Circulator
2. Flow Control Valve
3. No. 201 Radiant Heat Control
4. No. 4 Relief Valve
5. No. 12 Filling Valve
6. Water Heater
7. Pressure Tank

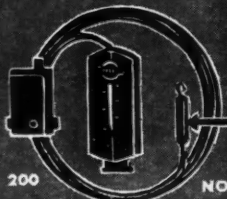

FEELER
 TUBE

NO. 200 NO. 201

THRUSH RADIANT
 HEAT CONTROL

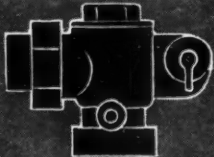

THRUSH FLOW
 CONTROL VALVE

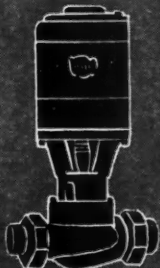

THRUSH WATER
 CIRCULATOR

THRUSH Forced Circulating Flow Control System is the best and most economical method of controlling warm water heat. It regulates water temperature to maintain absolutely uniform comfort, night or day, regardless of outdoor weather. It provides constant Radiant Heat. The feeler tube, an integral part of the Thrush Radiant Heat Control, senses the slightest change in water temperature and acts automatically to restore room temperature before it can drop more than a fraction of a degree. Operating cost is low because continuous circulation is not required. The Thrush Circulator normally operates only a few minutes out of each hour and firing unit operating periods are shorter. For more information write Dept. G-2 or ask your Wholesaler.

H.A. THRUSH & COMPANY
 PERU • INDIANA

TIME is MONEY—Save BOTH Use *Tru-sized* DOORS and JAMBS

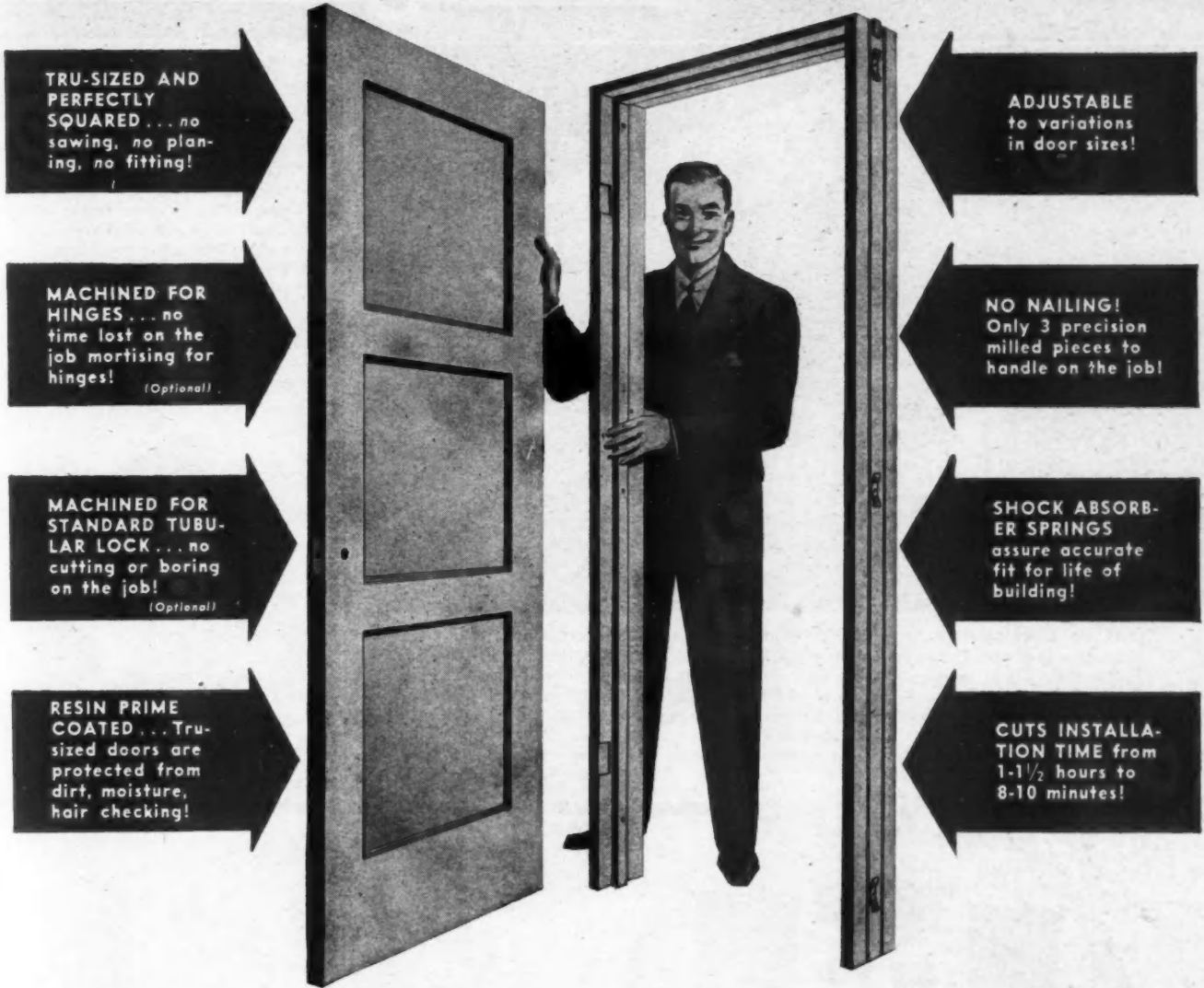

TRU-SIZED AND PERFECTLY SQUARED... no sawing, no planing, no fitting!

MACHINED FOR HINGES... no time lost on the job mortising for hinges! (Optional)

MACHINED FOR STANDARD TUBULAR LOCK... no cutting or boring on the job! (Optional)

RESIN PRIME COATED... Tru-sized doors are protected from dirt, moisture, hair checking!

ADJUSTABLE to variations in door sizes!

NO NAILING! Only 3 precision milled pieces to handle on the job!

SHOCK ABSORB-ER SPRINGS assure accurate fit for life of building!

CUTS INSTALLATION TIME from 1-1/2 hours to 8-10 minutes!

Here's a real team to go to work for you—Tru-sized Doors and Tru-sized Jambs!

Two of the most recent developments of Wheeler Osgood research, Tru-Sized Doors and Tru-sized Jambs together do a better job FASTER! Ordinary door and jamb installations do not compare with this amazing, new combination.

The combined savings of time, work and money—with the additional advantage of a permanently accurate installation—make the Tru-sized Door and Jamb combination a "natural" for building America's much-needed homes!

THE WHEELER, OSGOOD COMPANY

Plants and General Office: Tacoma 1, Washington

- NEW YORK OFFICE 1326 Empire State Building, New York 1, New York Phone: Penn. 6-2954
- CHICAGO OFFICE 134 So. LaSalle Street, Chicago 3, Illinois Phone: State 5335-6-7
- SAN FRANCISCO OFFICE 3045 19th Street, San Francisco, California Phone: Valencia 2241
- LOS ANGELES OFFICE P. O. Box 7685 Del Valle Station, Los Angeles 15, California Phone: Vandike 6326
- TACOMA OFFICE 1216 St. Paul Avenue, Tacoma 1, Washington Phone: Main 8101

There's a Pittsburgh Glass for



THERE ARE 2 LINES of Pittco Metal for you to choose from in store front work. Pittco De Luxe, with its rugged strength, beautiful finish, wide selection of carefully styled members, helps you to build store fronts of true distinction. Pittco Premier, lighter in weight and more moderately priced, is noteworthy for its beauty, its modern styling, and its quick, easy installation.



Pittco De Luxe Double Face

LOTS OF MERCHANTS in your territory want to remodel their stores, inside and out, for better business. Help them do it *right* . . . with Pittsburgh Glass and Pittco Store Front Metal. Your prospects know these products through consistent advertising . . . know they are undisputed leaders in the field. They help to attract customers and stimulate sales . . . whether used for individual remodeling jobs, or on community projects for group modernization, where you cooperate with local merchants, civic groups, bankers and architects to modernize whole "Main Streets" at one time.



A LITTLE EXTRA GLASS means a lot of extra charm. That's a good thing to remember when you're trying to build homes with extra appeal. Every nickel spent for glass shows up in a way easily seen and appreciated. A few PC Glass Blocks around an entrance door, for example . . . they guard privacy, admit daylight, and add to home beauty.



PEOPLE LIKE MIRRORS. Structural mirrors in living, dining or bedrooms reflect light, color and movement, make rooms seem bigger. "Spruce up" mirrors can be put in entrance halls and kitchens. And every home needs several full-length door mirrors. Your customers want plenty of mirrors. And they help increase your profit.

CARRARA S
time . . . th
bathrooms
splash pan
We will gl
showing how
* Bu
P

for every building need



CARRARA STRUCTURAL GLASS is smart, colorful, easy to clean, and lasts a lifetime . . . that's why you'll find it the ideal material for walls or wainscots of bathrooms and kitchens. It's fine, too, for window sills, fireplace surrounds, splash panels, built-in shelves. 10 pleasing colors.

We will gladly send you free our special "Builders Kit" which includes illustrated literature showing how you can use glass effectively on all types of jobs in which you are interested.

*Build it better with

Pittsburgh Glass



"PITTSBURGH" stands for Quality Glass and Paint

WHEN YOUR CLIENTS want insulated windows, tell them about **TWINDOW** . . . "Pittsburgh's" new window with built-in insulation! Completely pre-fabricated, it consists of two or more pieces of glass with a hermetically sealed air space between, and a stainless steel protecting frame. It reduces heat loss through windows, minimizes downdrafts at windows, adds to comfort the year round, and won't frost or fog, except under very severe conditions. Installs as easily as a single pane of glass.

For general glazing purposes, Pittsburgh Polished Plate Glass, or Pennvernon Window Glass, will meet any need.

Pittsburgh Plate Glass Company
2000-7 Grant Building, Pittsburgh, Pa.
Please send me without obligation your
"Builders Kit" of illustrated literature.

Name.....
Address.....
City..... State.....

PITTSBURGH PLATE GLASS COMPANY

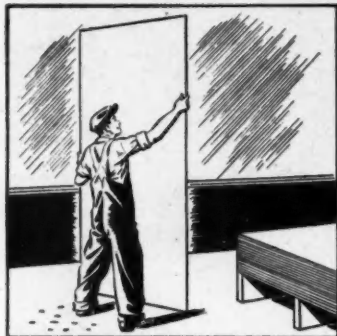

CONVENIENT SIZES

Supplied in handy 4' x 8' sheets, in thicknesses of 3/16", 1/4", 3/8".

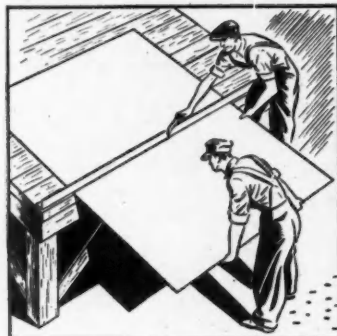

EASY CUTTING SAVES TIME

Cutting Apac to size and shape is a cinch—just score with a sharp tool, snap off over a straight-edge.

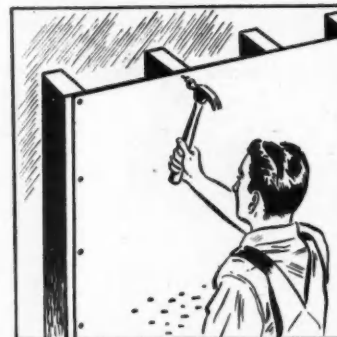

EASY TO APPLY

Fastens permanently in place with either nails or screws.



GOES UP FAST

32 square feet at a time... saves many man hours. And once up, Apac lasts a lifetime!

ASBESTOS IN ACTION



This modern two story poultry house—of unit design—has a roof and side-walls of Apac, making it resistant to fire, pecking, weather, termites, rodents.

LOOK at the advantages of K&M "Century" APAC

HERE is the solution to many of your building problems... K&M "Century" Apac, the asbestos board that has as many uses as a building has surfaces. Equally adaptable to buildings for farms, homes or Industry, Apac is a durable, economical material that cannot burn, rot or rust, and never needs painting or other upkeep.

Check the outstanding features shown here... add in Apac's low first cost... and you will see clearly how Apac can help you build more profitably.

Original manufacturers of asbestos-cement roofing shingles in this country.



KEASBEY & MATTISON COMPANY • AMBLER • PENNSYLVANIA

OVER 30,000,000

CONSUMER SALES MESSAGES THIS SPRING

TO BUILD

GREATER PROFITS VOLUME

FOR YOU!

● This spring in the nation's best-read magazines—over 30,000,000 sales impelling messages will build consumer acceptance for you, which means greater profits and larger volume. Premier Aluminum Windows give you every desirable feature — competitive price, ease of installation, modern appearance . . .

See your Sash and Door Jobber Today For Complete Details, Sizes, Prices.

- Easy to Install
- Easy to Service
- No Putty
- No Leakage, Sash Glazed with Everseal
- Weatherproof
- Built-in Stainless Steel Weatherstripping
- Positive Lock
- Spring Sash Balances
- Rustproof
- Double Strength Glass

JOBBERS: Delivery within 30 days of your order!

Premier ALUMINUM Windows

WORLD'S LARGEST MANUFACTURERS OF ALUMINUM WINDOWS

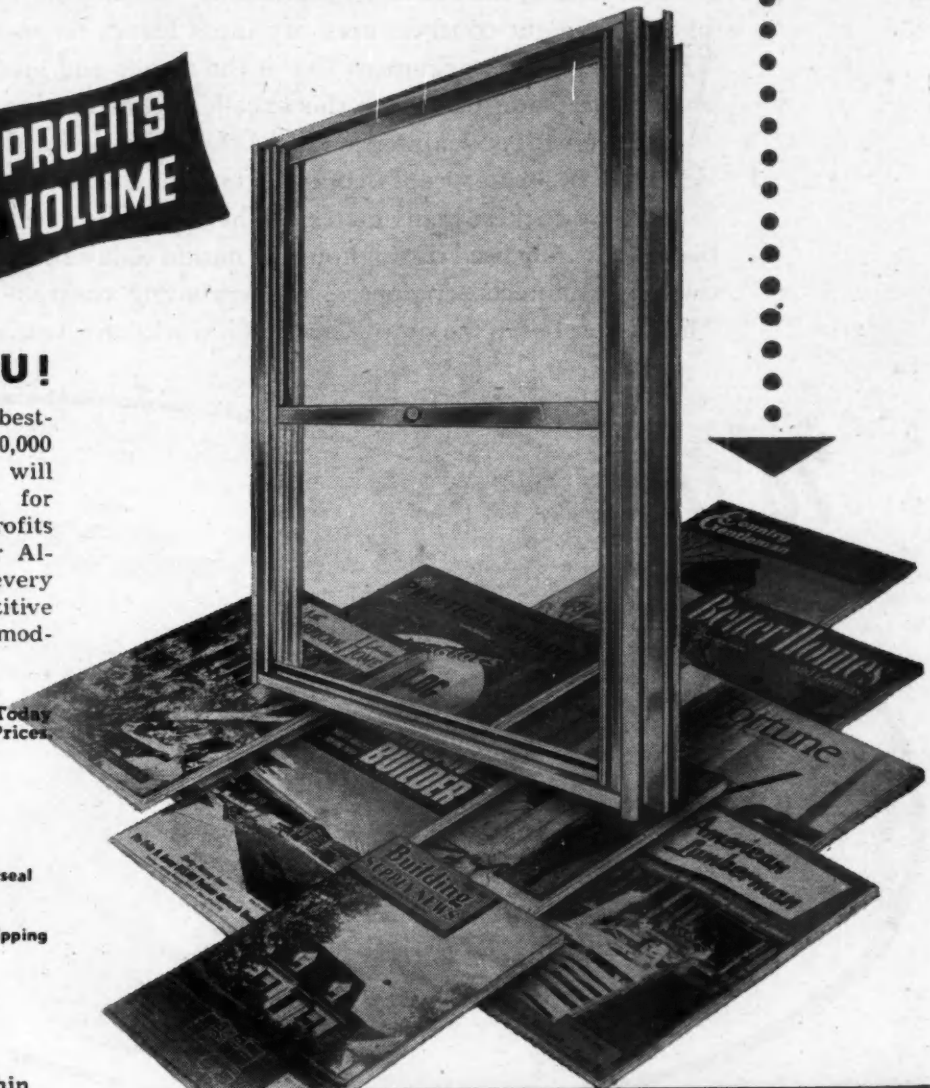

Reg. U.S. Pat. Off.

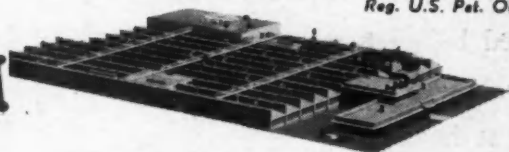

PREMIER METAL PRODUCTS CORPORATION
SKY HARBOR • P. O. BOX 1271
PHOENIX, ARIZONA

Why **AQUELLA** is a "must" on every concrete masonry unit job!

As everyone in the construction industry knows, the water permeability of light weight concrete masonry units leaves no room for argument! The only possible argument lies in the means and methods of applying an *effective* water barrier to this excellent construction material.

You are well acquainted with the claims made for the many materials designed to "waterproof" concrete masonry units.

But despite these many materials there must be a reason why Aquella is being so widely used throughout the nation today and acclaimed by home owners, architects, engineers, waterproofing contractors and builders! The answer lies in the simple fact that it works on an *entirely new principle!*

To Illustrate:

- 1 Here is an Aquellized concrete masonry unit filled with water. Naturally, there is no leakage.
- 2 But what happens if the Aquella surface coating is scraped off? To answer that, we scraped away this portion, and there's still no leakage. This may be slightly puzzling until you study the photograph of the third step...
- 3 The enlargement of a small, sawed-away section of the above block, which shows the way Aquella penetrates to fill and close the microscopic pores of the surface. It is the filling of the pores—not essentially the surface coating—which stops the penetration of water.

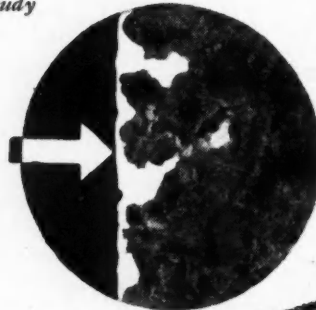
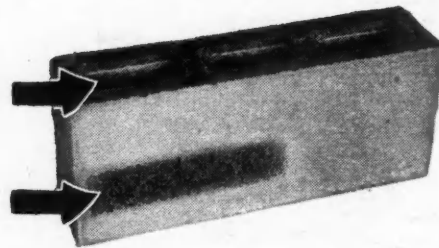

SEE OUR CATALOG IN SWEET'S

Is it any wonder then, that in a cinder concrete block tower test, Aquella withstood the pressure exerted by an 8 ft. hydrostatic head of water, equivalent to approximately 500 lbs. pressure per sq. ft. at the base?

We would like to send you details of this test. It is contained in our booklet, "Aquella and Concrete Masonry Construction." This booklet also

contains many illustrations of the uses of Aquella in concrete masonry construction throughout the United States, and should prove very interesting to all in the construction industry. It is yours for the asking.



PRIMA PRODUCTS, INC.
Dept. C, 10 East 40th Street, New York 16, N. Y.

DO IT THE AMERICAN WAY

Save time... Cut costs!

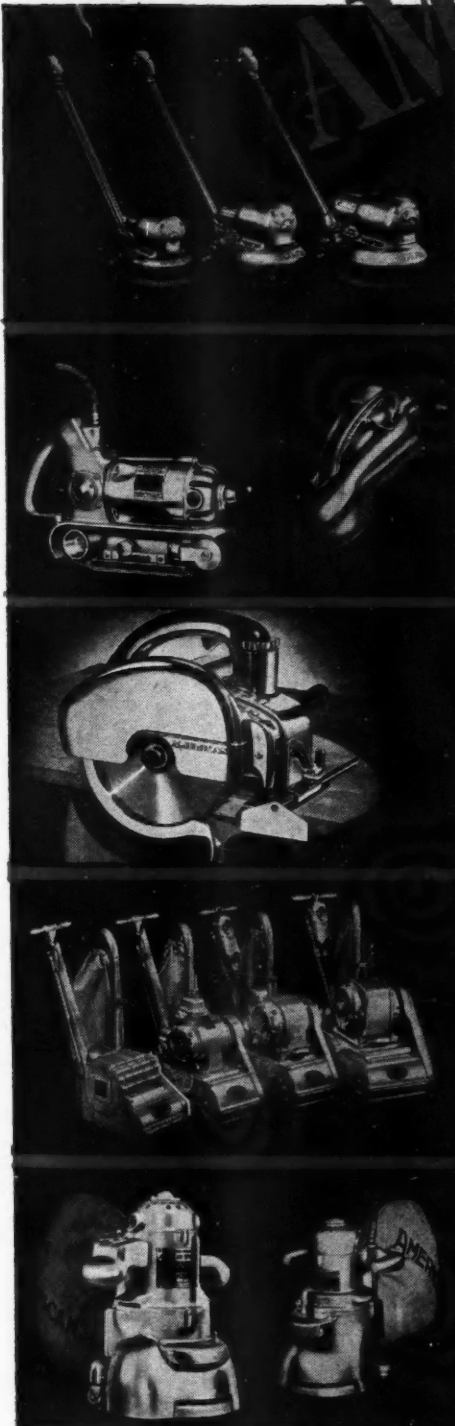

AMERICAN

MAINTENANCE MACHINES

Keep floors in tip-top beauty with American DeLuxe floor maintenance machines. Can be used for polishing, disc sanding, steel wooling, and scrubbing. Operates either on wheels or as riding-on-head. Many other models... 10" to 17" discs.



AMERICAN

SMALL SANDERS

A handy pair of portable sanders. The Sander-plane, a belt sander or the Speedy Spinner semi-flexible disc sander will eliminate much hand sanding. Hundreds of uses for these machines.



AMERICAN

PORTABLE POWER SAW

New Portable Electric Saw by American combines big-power with easy handling... clean-cut modern design... smooth no-jerk starting... simple accurate adjustment of depth and angle... telescoping guard... many advanced features: Motor develops 1 1/2 H.P. 6500 RPM. 8" blade for 2 7/8" straight cut. Efficient, stall-proof for scores of uses.



AMERICAN

FLOOR SANDERS

A famous line-up! Four sanders with 8 and 12 inch drum widths, including Little American, Light Eight, Standard Eight and Standard Twelve. American-built for smooth, uniform sanding.



AMERICAN

FLOOR EDGERS

American Spinner disc-type sander finishes right up to edges of floors, stairs, closets... eliminates tedious handscraping. 5 1/2" and 7" discs.



● All AMERICAN products built to top standards of Quality, Performance and Dependability. You can be sure of a better job—with less time and lower cost—when you rely on an AMERICAN! Check your needs now!

The American Floor Surfacing Machine Co., Toledo 3, Ohio.

MAIL COUPON FOR MORE DETAILS!

American Floor Surfacing Machine Co.
511 So. St. Clair St., Toledo 3, Ohio

Send illustrated bulletins and prices on the following which I have checked. No cost or obligation.

- Polishers Belt Sander Speedy Spinner
- Portable Saw Floor Sanders
- Floor Edgers

Name _____

Street _____

City _____ State _____



**Cut costs—save time—
in Veterans' Housing
with MODULAR BRICK and TILE**

Cutting costs and saving time are mighty important to veterans' housing.

Modular brick and tile go a long way toward accomplishing these ends.

Masonry construction costs have not increased as much as other types of construction. And with the introduction of new modular sizes of brick and tile—it is predicted that savings up to 20% in the cost of masonry construction may be achieved.

These savings will result primarily because modular brick and tile fit together with windows and doors and other building materials of modular dimensions. Costly cutting and alterations on the site are greatly reduced.

Construction time, too, will be saved by reduction

of these costly site-operations — formerly unavoidable in many cases. Saving time means saving dollars.

More time and dollars are saved because modular brick and tile speed and simplify estimating and planning.

And as always, brick and tile give homes of durable beauty, great fire-safety and low upkeep and maintenance costs.

Two FREE booklets are available, "8 Small Homes of Brick and Tile," and "Announcing Modular sizes of Brick and Tile." Send 25 cents for our booklet, "Brick and Tile Cavity Walls," of great value in low cost housing. Address Structural Clay Products Institute, Dept. AB-2, 1756 K Street, N. W., Washington 6, D. C.

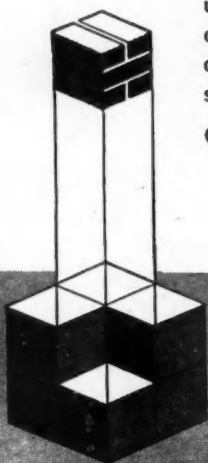

SCDI
STRUCTURAL CLAY PRODUCTS INSTITUTE
WASHINGTON, D. C.

Now it will be built with Modular-Designed
BRICK AND TILE



Climatrol gives your clients "climate control" for the indoor comfort they demand today!

Mueller Climatrol provides True Indoor Comfort by conditioning and handling air in the home . . .

Comfort is a basic quality all your clients expect in their homes. Climatrol is your assurance of providing home owners with True Indoor Comfort — and winning their lasting good will for a job well done.

Indoor Comfort depends on the condition of the air in the home. When you select a Mueller Climatrol system — basically designed to condition and handle

air for "climate control" — you enable your clients to enjoy today's high standards of Indoor Comfort. And you provide a system designed to be adapted easily to future air-conditioning developments.

The Climatrol line is complete, enabling you to select the right equipment for each job. Each Climatrol unit is specially designed for efficient operation with a specific fuel — gas, oil, or coal; each is smart and modern in appearance — and engineered for the utmost comfort, convenience, and economy.

Recommend and specify Mueller Climatrol—a name backed by 90 years of specialization in home comfort.

Write for Bulletins.



L. J. Mueller Furnace Co., 2016 W. Oklahoma Ave., Milwaukee 7, Wis.

MUELLER
Climatrol

**No More Worry
on this Job...
THREE HINGES.**

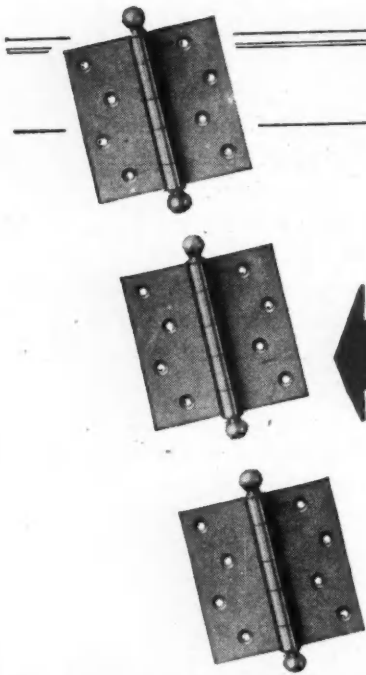

← **VISIBLE Mark
of Good
Construction**

STANLEY

Trade Mark

HARDWARE · HAND TOOLS · ELECTRIC TOOLS

THE STANLEY WORKS, NEW BRITAIN, CONNECTICUT

REMEMBER THREE HINGES TO A DOOR

AMERICAN BUILDER

L D I T O R I A L

Salute to NAHB

WHEN the 80th Congress convened in January, restrictions on building had been relaxed somewhat; the President apparently had admitted the failure of the so-called Wyatt program; there was a new Housing Expediter, an experienced builder with realistic views; there was a new Housing Administrator, a capable executive who commands the respect of the building industry; and building material production was approaching, and in many cases surpassing, prewar quantities.

On the other hand, there still were rent controls; restrictions on commercial and industrial building; restrictions on the size of house that can be built; set aside percentages for producers and distributors; premium payments and guaranteed markets; the promise by Senator Taft of another omnibus bill or series of housing control bills in place of the late Wagner-Ellender-Taft bill; and left wing elements in and out of government were reported to be inspiring a torrent of new housing control bills.

All in all, the picture is brighter than it was a year ago when the third annual convention of the National Association of Home Builders opened in Chicago. But while the OPA and Wyatt are gone, and the duplicity of NHA finally has been proved by Senators Wherry and Ferguson, the battle against a regimented housing industry is far from being won. Perhaps a turning point has been reached. Whether it has or not, notable victories have been won. Many of them would have been impossible without NAHB.

The association, holding its fourth annual convention in Chicago this month, was born through the desperate need to unite home builders in a common battle for survival, and to gain the right to build postwar homes for Americans. Today, it stands high among the recognized and respected forces in the industry resistance to public housing, and to the inevitable decline in housing quantity and housing standards that results from government control. The end of the battle is not near, but it is in sight. When the day comes on which public housing and government controls are removed as threats to American economy, the NAHB can then assume its greatest and permanent function—the assumption of full and unqualified responsibility for housing in America, as the price of industry freedom.

Great as have been the deeds of NAHB in its short four-year history, its true greatness and its brightest accomplishments lie ahead. Builders have learned through the bitter frustration of their best efforts under government control that the price of paternalistic government aid and direction is the sacrifice of individual economic freedom, with resulting inability to meet housing needs. It is necessary now to recognize that the price of individual economic freedom, and the rights of individual builders to carry housing to new heights, is the collective assumption of complete responsibility for housing quantity and housing standards.

That price can be paid only through the active functioning of hundreds of strong local organizations of builders operating at grass roots levels, and thereby furnishing the collective power that is the indispensable nationwide organization operating at the national level. Failure to develop NAHB and increase its strength, and failure of NAHB to recognize and assume its clear cut responsibility for housing can mean the beginning of the end of free private enterprise in America.

American Builder salutes NAHB, congratulates it on its accomplishments, makes no apologies for its differences of opinion in the past or possible differences in the future, and expresses complete confidence in the association's ability to grow in numbers and in stature, and to fulfill its destiny.

BUILDING PRODUCTS ON REVIEW

**A Pictorial Parade
Of New and Improved
Materials and Equipment**

PROGRESS in building design as a general rule follows development of new materials and equipment by manufacturers. The host of new materials and equipment created and produced by manufacturers in the last few years, plus refinements in those which were already in use, have changed materially the exterior architectural lines as well as the interior layout of homes being built today.

In the following pages of this issue of *American Builder*, a large number of these products are presented with a photograph and a brief description of each item. Obviously it is impossible in the limited space allotted to present all the products of all manufacturers or even to list all the merits and outstanding features of those which do appear. Supplementary information will be found in the advertising pages of this and other issues. In addition, each product presented in the pictorial review has a key number and the coupon on page 137 can be used to obtain details.

Many of the products illustrated in this issue will be on display at the National Association of Home Builders Convention and Exposition at the Stevens Hotel in Chicago February 23-27.

Quality Houses in Two Distinctive Builder Projects

The continued high character of the development at Gorge View Park and Homecliff in Lewiston, New York, is assured through the type of houses contemplated for immediate construction



ATTRACTIVE marker calling attention to the development.

BUILDING PRODUCTS ON REVIEW — BUILDING

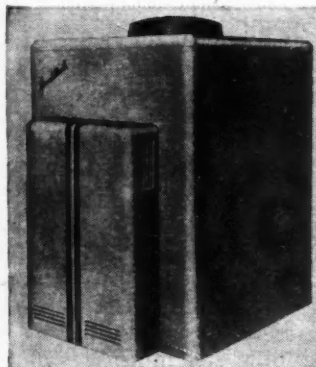

AB2770—Surface Combustion Corp., Toledo, announces its new Janitrol series of gas-fired gravity furnaces in two sizes—75,000 and 100,000 BTU. The combustion chamber and radiator assembly for both sizes is of all-welded 18-gauge special steel. Automatic controls assure maximum efficiency.

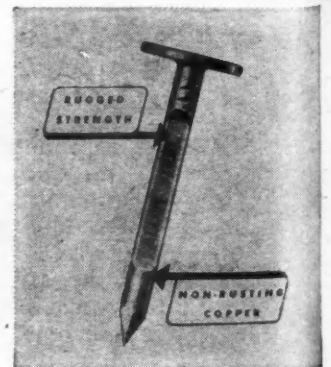

AB2776—Copperweld Steel Co., Glassport, Pa., is producing nails made of rust-resisting copper molten-welded to a high strength steel core. The copper covering is not damaged by hammering because the sharp points, well-centered heads and stiff steel cores make them easy to drive.

I N t
di
W
High
assoc
in mi
acter
respe
purch
Th
each
view
devo
norm
sand
is ty
now
Ho
mate
Gorg
erate
but r
cons

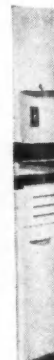

AB2764
draws,
standa
with
open
hardw
positi
steel

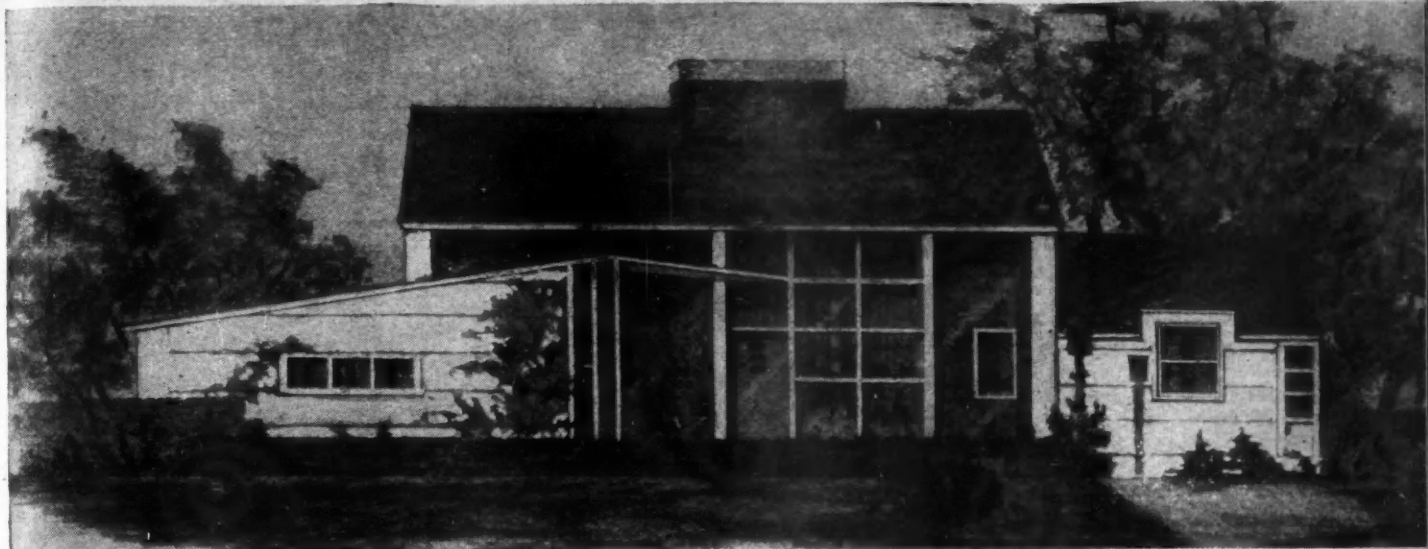

AN unusual plan and elevation developed for medium size house.

IN the planning of the Gorge View and Homecliff subdivisions, located in Lewiston Heights, N.Y., the Walter S. Johnson Bldg. Co. of Niagara, and John N. Highland, architect, of Buffalo, N.Y., who has been associated with Mr. Johnson in these projects, have kept in mind the thought of constantly improving the character of the houses that are to be erected in each respective development, and to give the prospective purchaser a greater value for his money.

These two developments are distinctly different from each other. Gorge View Park, with its magnificent view of the turbulent waters of the Niagara, has been devoted exclusively to the type of dwelling that would normally be marketed for from twenty to thirty thousand dollars. The rendering of the house shown above is typical of the houses that will soon be under way now that restrictions have been lifted.

Homecliff subdivision, which is located approximately two miles in a northeasterly direction from Gorge View, was intended to be a development of moderate priced homes, particularly available to the veteran, but rising building costs have brought the overall total considerably above the ceiling limitation. This project

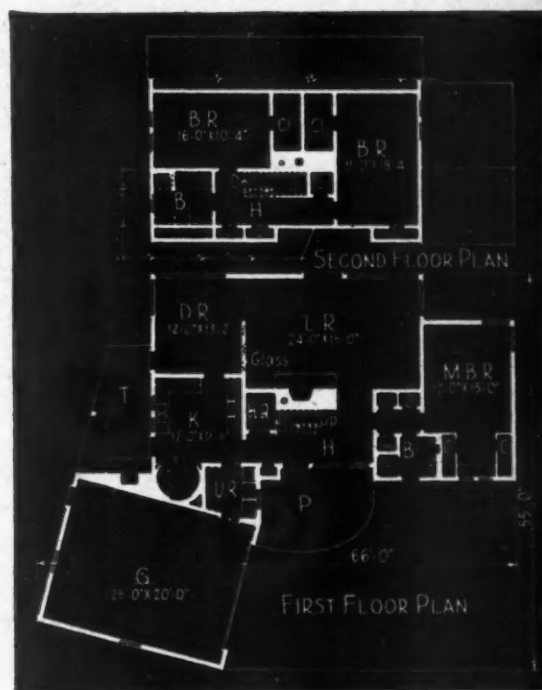

BUILDING PRODUCTS ON REVIEW — BUILDING PRODUCTS ON REVIEW — BUILDING PRODUCTS ON REVIEW



AB2764—The Kitchen Maid Corp., Andrews, Ind., has redesigned its line of standard unit cabinets to harmonize with latest trends in kitchen development. Cabinets are principally of hardwood, doors of solid wood composition and drawers of heavy gauge steel with wood fronts and guides.

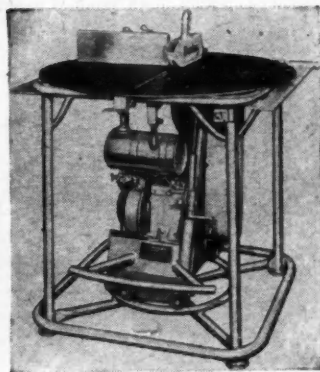

AB2715—The new Nordberg-Buday saw is especially designed for use where frequent changes in cutting angles are necessary. An outstanding feature is the rotating table and saw operating as a unit. It is only necessary to rotate the table to the desired angle, drop the lock pin in place and cut.



AB2750—A new double-hung aluminum window featuring spring type sash balances, built-in stainless steel weatherstripping and glazing without putty is being manufactured by Premier Metal Products Corp., Phoenix, Ariz. It is available in either two-light or four-light models in 30 graduated sizes.



AB2766—Bar-Brook Breezebuilder attic fans, made by Bar-Brook Mfg. Co., formerly Shreveport Eng. Co., Shreveport, La., are being produced in four models with capacities from 7,500 to 21,000 cubic feet per minute. They have an all-steel frame, 3-point motor mounting, graphite-impregnated bearings.



THE substantial character of the house shown in the sketch at right presages that the future development of the Homecliff subdivision will be even better than the present. Floor plans of this house are below.

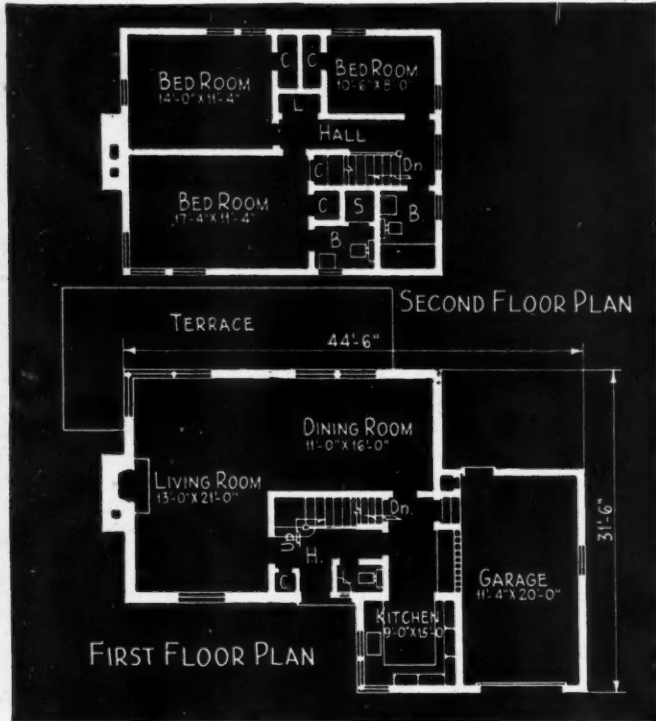

was started about four years ago, at which time five houses had been completed when the advent of the war stopped further activities. With the close of hostilities ten additional houses have been started and completed.

The overall project as developed by Mr. Johnson calls for a total of fifty-five houses to be constructed on lots having a frontage of 100 to 130 feet to 225 feet in depth. Wide, sweeping curves to the streets give each home site full visibility from all sides. Bounded on the rear by Lewiston Heights which lends scenic beauty and protects the development from encroachment by undesirable neighborhoods, Homecliff is assured lasting beauty and value. From the rear lot lines to the front of the development there is a gradual slope of approximately fifty feet, providing ideal drainage and an unobstructed view of the fertile table land that extends to Lake Ontario. In the planning of the subdivision, the lots have been staggered so that each home will be free from any obstructions to this view.

In the construction of the homes completed in these two developments, it has been the policy of the Walter S. Johnson Bldg. Co. to use, wherever possible, products and materials that have proved themselves to be of high caliber. The same consideration is given to the designs of the houses which are constantly being changed to

BUILDING PRODUCTS ON REVIEW — BUILDING PRODUCTS ON REVIEW — BUILDING PRODUCTS ON REVIEW

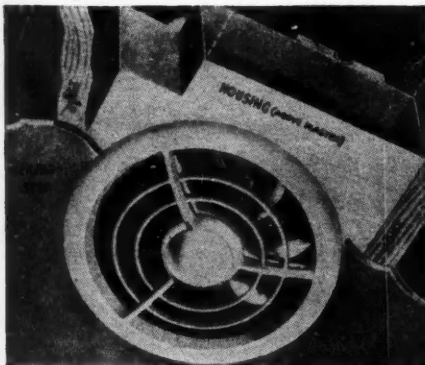

AB2723—Pryne & Co., Los Angeles, have combined the principles of fan and blower in their new Blow-Fan for quick removal of fumes from kitchens. Designed for ceiling installation, they are made in three sizes. Newest addition to the line is a combination fan and light. The recessed light built into the ceiling ventilator provides ample light plus ventilation above the kitchen range.

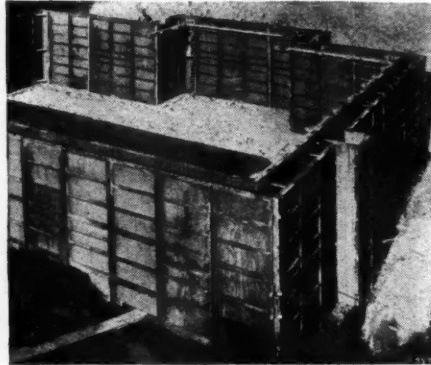

AB2710—Uni-Form foundation panels, made by Universal Form Clamp Co., Chicago, assure uniform thickness from top to bottom with no necessity for "spacers" or other internal bracing when used with Uni-Form ties. Assembly with ties and tie keys locks the panels into a rigid form which requires alignment at the top and one side only. Stripping may be done by one man.

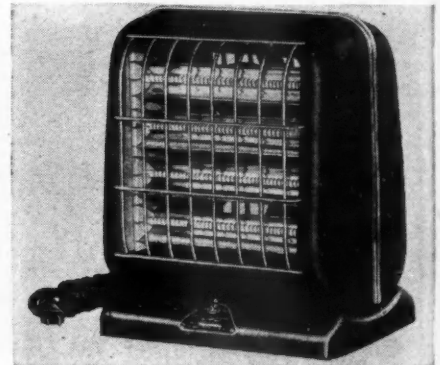

AB2734—Recently introduced by Emerson Electric Mfg. Co., St. Louis, was this compact, portable combination radiant and fan-type heater. It is equipped with four heating elements that glow in front of concave, chromium-plated, radiant heat reflectors. A slow-speed 8-inch fan forces 150 cubic feet of air per minute over the heating surfaces. It has a capacity of 4275 BTU per hour.

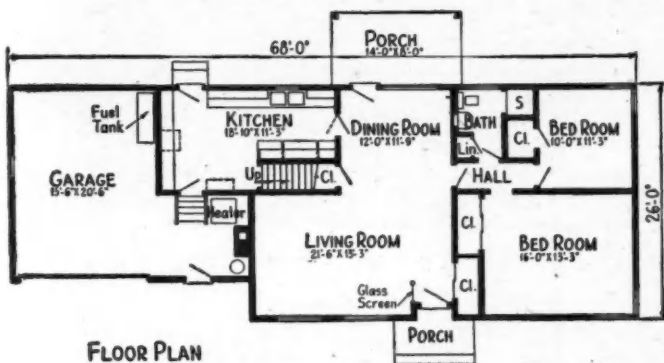

FLOOR PLAN

THE builder has used to good advantage the sloping terrain of the Homecliff development by building low, rambling, ranch type houses, as shown on this page, on the high side of the street, and two-story houses on the low side, in order to obtain a uniform, level appearance of the roof lines. The plan of house above is shown at left.



A LIVING room terrace or court is formed by the extension of the two wings on the low rambling house shown above.

conform to the public thinking, and the innovations and styling that are setting the pace in home design today.

The design of the low, rambling type dwelling shown above is the product of the Walter S. Johnson Co. organization. The later designs, as exemplified by the rendering of the house shown on the opposite page, have been done by John N. Highland, architect, Buffalo, N. Y. This architect has established an enviable reputation for fine homes in this area, and is being used extensively by developers of large subdivisions because of his vast experience and his clear-cut designs.

BUILDING PRODUCTS ON REVIEW — BUILDING PRODUCTS ON REVIEW — BUILDING PRODUCTS ON REVIEW

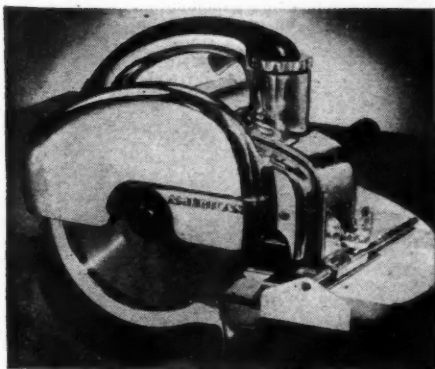

AB2736—American Floor Surfacing Machine Co., Toledo, announces development of a new portable electric saw powered by a 1½ H. P. motor with direct power gear drive to an 8-inch blade. It has a free running speed of 4500 R.P.M. Other features include an improved elevating mechanism for accurate adjustment of depth of cut; a telescoping guard easily retracted and locked out of the way.



AB2700—A special display of some new products by U.S. Plywood Corp. Left to right: Flexmetl, paper-thin fine wood veneer bonded to metal backing; Leatherwall, colored lengths of genuine leather for walls and ceilings; Flexglass, rectangles of mirrored and patterned glass on fabric; Faxwood, flexible wood veneer only 1/85th of an inch thick bonded to a fabric backing.

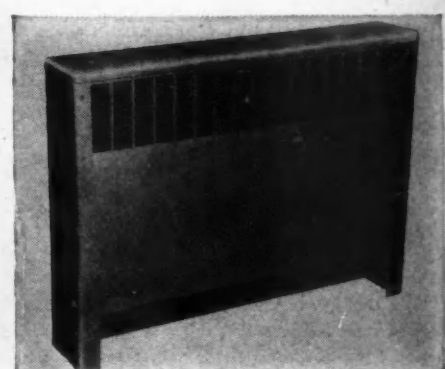

AB2704—Engineers of the Trane Co., LaCrosse, Wis., developed this new convactor-radiator, which may be installed as an exposed floor cabinet or as a semi-recessed unit. A universal header permits either top or bottom connections at each end for any gravity or forced hot water system or two-pipe steam system. The complete line contains 57 sizes in three standard depths and lengths.



A COMBINATION of plywood, bevelled siding, and a balcony rail of woven wood has produced a house of pleasing proportions.

Story and a Half House in Modern Style

THE ground floor area of the house shown on these pages was dictated by the fact that the foundations were already poured.

This was one of sixty other houses in a development being built by the firm of Kulien and Wollander at Lakewood Center, a suburb of Tacoma, Wash.

W. A. Wollander, who decided to make this place his own home, was plagued by the thought that the existing floor area would not be sufficient for his needs in the event that he followed the overall pattern established for the rest of the development. Thus, to obtain sufficient room he was forced to consider an

arrangement involving a second floor.

His first design studies were in the traditional Colonial style, but as he considered many of the new innovations and features of the modern concept of a house, his subsequent studies deviated further away from the traditional each time, with the

BUILDING PRODUCTS ON REVIEW — BUILDING PRODUCTS ON REVIEW — BUILDING PRODUCTS ON REVIEW

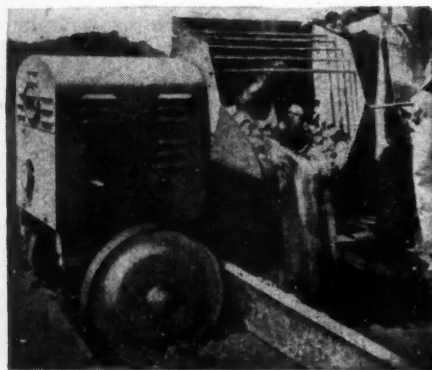

AB2720—The Chain Belt Co., Milwaukee, announces its 1947 Rex mortar and plaster mixer. Special features include adjustable scrapers and structural steel blades; sealed bearings; two position telescopic tow pole, adjustable for either truck or car hitch; and a four horsepower, air-cooled engine. The engine cover opens away from shoveling side to protect engine and gear box.

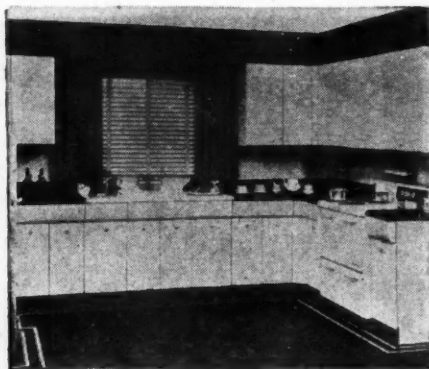

AB2727—One of the outstanding features of this new American Kitchen, designed by American Central Mfg. Corp., Connersville, Ind., is the absence of door and drawer handles. Doors are actuated by double-acting spring hinges which eliminate the need for door catches. Drawers glide on plastic bearings. Curves at top and bottom of all doors and drawers eliminate sharp edges.



AB2702—The three models of General Bronze Corporation's oil-burning forced warm air furnaces were recently announced. The furnaces are completely self-contained and embody a number of special design features. The dual cabinet principle employed keeps outer cabinet surfaces cool at all times while at the same time preheating the returning flow of cold air.



Designed and built at Lake-wood Center, Tacoma, Wash., by W. A. Wollander of the "Wollander Better Builder Plans" service

THE plan arrangement shown at right is adapted to conform to outdoor living. Another view below and at right shows the relation of garage to house with both units tied together by means of the pergola extension.

result that he has obtained a very modern appearing house in addition to retaining the steep roof so necessary to accommodate the space required.

This house has many features that are unusual considering its size. The living room, dining room and entrance hall are one large area without any dividing partitions other than a fabric curtain which can be pulled across on a track to separate the dining room. Built-in units prevail in every room. Sliding doors between bedrooms permit them to be made into one large room if occasion demands.

The enjoyment of the summer in this northwestern area is further enhanced with the aid of the outdoor living room. This area is enclosed with a 6½ foot high fence, which is made of green cedar 2 x 4s, ripped to ½" thickness, woven like a basket and stained a mahogany red color. Provided with a full basement, oak floors, forced air furnace, sheef rock and papered walls, with Linowall on walls and ceiling of kitchen and bath, it makes an ideal home for a medium sized family.

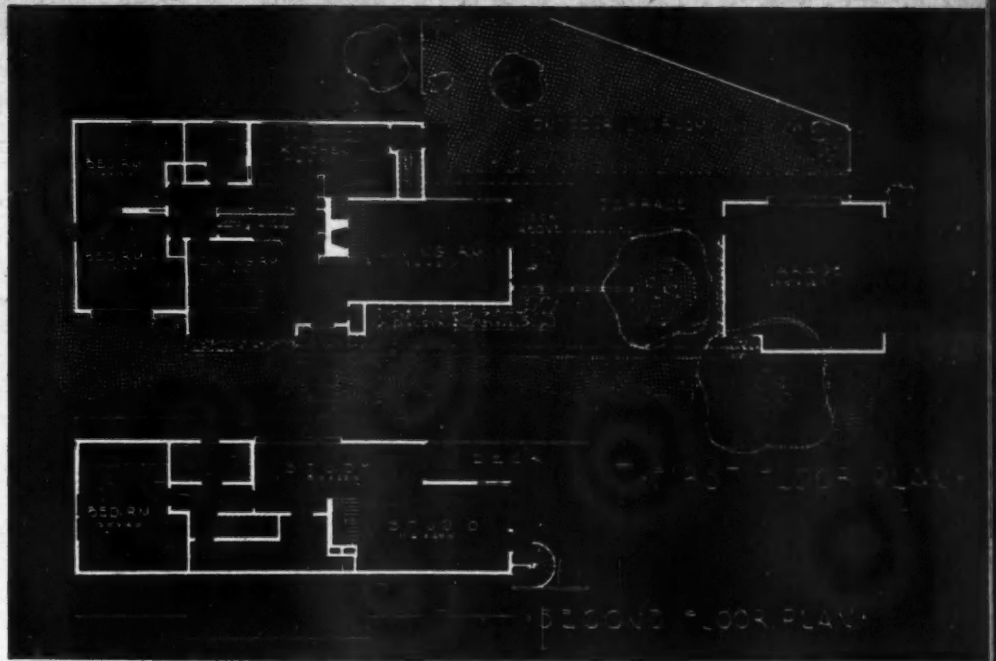

BUILDING PRODUCTS ON REVIEW — BUILDING PRODUCTS ON REVIEW — BUILDING PRODUCTS ON REVIEW

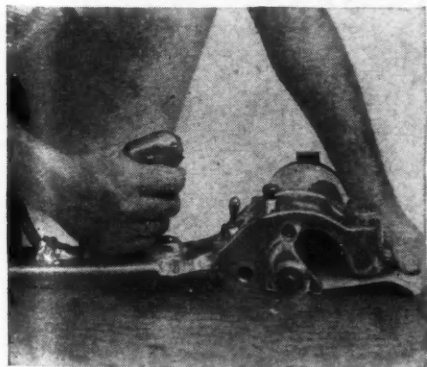

AB2712—Stanley Electric Tools, New Britain, Conn., announce the new Stanley-Carter power plane, with the patented one-piece spiral cutter. The plane surfaces up to 2½ inches in width without cutter marks or waves on paper-thin cuts. Each plane is furnished with a grinding attachment which permits sharpening cutter on the job. It operates on ordinary domestic power service.



AB2772—A newcomer in the low temperature insulation field has been announced by Dow Chemical Co., in the form of Styrofoam, which is Styron expanded 40 times. It is a pure white, light weight, multicellular mass of foamlite material. It will be available for home construction when production is increased. Pieces shown in photograph above each weigh about 2¼ pounds.



AB27115—The low, wide seat rim tub is featured in designs by the Eljer Co., Ford City, Pa., with the entire family of Eljer fixtures being related in design. The firm produces vitreous china as well as cast iron bathroom fixtures and brass fittings. The one-piece and bolted closet combination with the integral china overflow and ground-in valve seat is another of its featured products.

BUILDING VALUE Into Low Cost Houses

**Flint Builder Maintains
Reputation for Quality in
Face of Adverse Material
and Labor Conditions**

WARTIME SHORTAGES with their attendant restrictions and regulations were a challenge to Robert Gerholz, past president of the National Association of Home Builders, who handles the home building phase of the business of Gerholz-Healy, Inc., Flint, Mich. G. F. Healy is in charge of sales and financing. Several hundred houses which have been finished, along with an extensive development now under way, stand as visible proof of how well the challenge was met without sacrificing quality, convenience, livability or economy in the houses that were built.

After 25 years of successful home building operation in Flint, Mr. Gerholz knows his market well. His market also knows him well and his reputation for putting quality into economically-priced houses has not been marred in the least. Last year 110 houses were finished to complete the Gerholz-Healy Bassett Park addition and at present work is under way on the Mott Park addition of 300 homes with houses going under roof at the rate of three a week.

The five-room, story and one-half houses with attached garages, many with fireplaces, are priced from \$8,350 to \$10,000. Standard equipment includes an oil



ROBERT GERHOLZ



G. F. HEALY

Gerholz-Healy give modern treatment to conventional materials and also make practical use of new products and equipment

or gas-fired forced warm air furnace, kitchen ventilating fan, built-in package receiver, full-length mirror in each bedroom, two full-size medicine chests in each bathroom, all copper water piping, Carrara splash plate behind all kitchen ranges, weatherstripped doors and windows, built-in-stairway to second floor, clothes chute, 30-gallon heavy duty automatic gas-fired water heater, upward-acting door and plastered interior in all garages. Oak flooring is used throughout except in bathrooms where floors and walls are tiled, and in kitchens where floors are covered with linoleum. Practically all houses are of frame construction throughout with asphalt shingle roofs and bevel siding or shingles over insulating board sheathing on the outside. Inside walls are plastered and painted. Special interior treatment also includes cove ceiling in living room and built-in wall alcoves to accommodate telephones.

Of special interest is the wide variation in exterior and interior appearance of the houses, all of which are constructed from three basic floor plans and twelve primary elevations. Mr. Gerholz and his architect, Charles Noble, of Detroit, have achieved some outstandingly attractive effects by clever use of window areas,

BUILDING PRODUCTS ON REVIEW — BUILDING PRODUCTS ON REVIEW — BUILDING PRODUCTS ON REVIEW

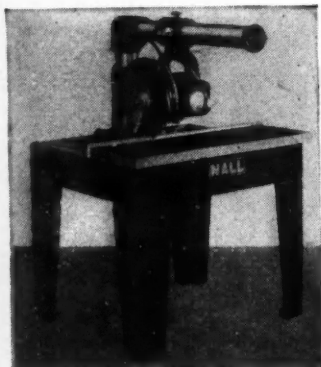

AB27104—The new Nell radial woodworker carriage mechanism is completely different from anything previously used. It travels on three endless chains of steel balls, eliminating roller bearings. The same lever used to clamp the machine in adjustment also releases the tapered finder pins.

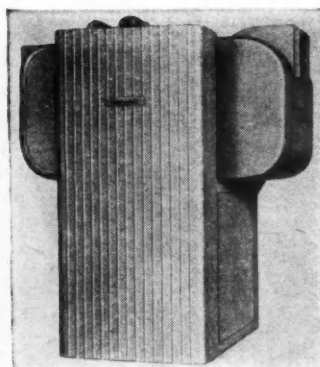

AB2790—The Servel all-year gas air conditioner provides heat tempered with moisture in winter and cools and removes excess humidity in summer. The unit operates on a variable capacity system adjusting house temperature to gradual outdoor changes with no rapid changes inside.



AB2739—This fully automatic 38-inch Norge kitchen range of flush-to-wall design has three fast-heating surface cooking units, a deep-well cooker with seven cooking speeds, a plate-warming drawer, two utensil drawers, smokeless broiler and other special features. It is white, and is trimmed in chrome.

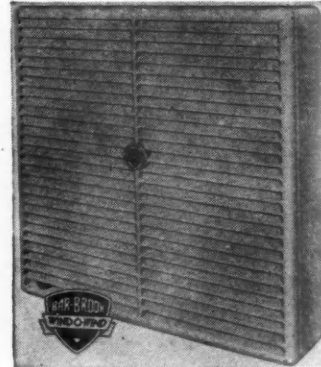

AB2767—The Windo-Wind window fan of Bar-Brook Mfg. Co., formerly Shreveport Engineering Co., Shreveport, La., is 5/4 in. thick and 30 in. square to fit most standard windows without extending into the room. The fan operates at two speeds, powered by a motor which eliminates belt drive.



GERHOLZ-HEALY spent \$54,000 for landscaping in Bassett Park development.

dormers, small porch effects and attached garage treatment. To remove any further appearance of monotony, building lines are staggered so that houses in any one block are never in a straight line.

Mr. Gerholz uses conventional on-site construction methods and by careful cost-keeping has found this to be the most economical for his size and type of opera-

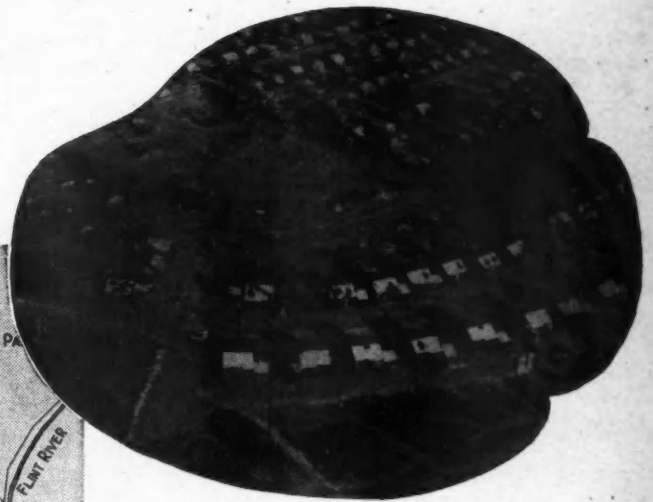

PLAT at left and air view above of new 300-home Mott Park development. Streets are laid to conform with land contour to minimize need for grading. Seward Mott is consultant in land planning.

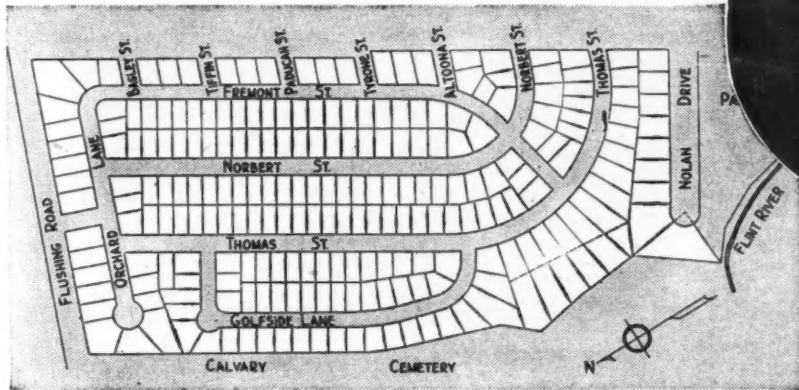

BUILDING PRODUCTS ON REVIEW—BUILDING PRODUCTS ON REVIEW—BUILDING PRODUCTS ON REVIEW



AB2765—A new principle of heating has been employed by Day and Night Mfg. Co., Monrovia, Calif., in Panelray wall heaters. The vented, gas wall heaters radiate infra-red heat. All heater parts are above floor level. They are available in three sizes and in dual models for adjacent rooms.

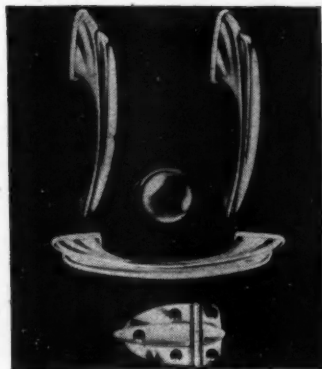

AB2749—These are the new Stratoline patterns by American Cabinet Hardware Corp., Rockford, Ill. Door catches, door pulls, drawer pulls, knobs and hinges are matched to provide complete unity of design and beauty. Units are made of neo die cast, an improved zinc die cast of extra high strength.

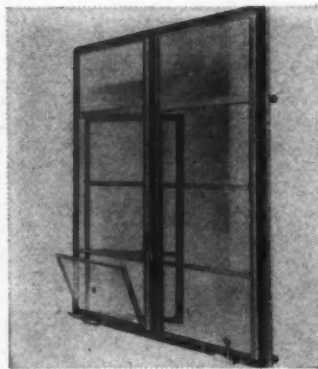

AB2787—A new aluminum frame storm window for metal residence casements has been developed by Ceco Steel Products Corp. It provides complete inside coverage of the casement, including fixed lights and operative ventilators. Placed inside, they permit operation of the casement units.



AB2773—Lumite plastic insect screen, made by The Chicopee Mfg. Corp., from Saran, a product of Dow Chemical Co., has unusual tensile strength and resilience. In addition to springing back to its original shape after hard blows or steady pressure, it is also resistant to rust and corrosion.

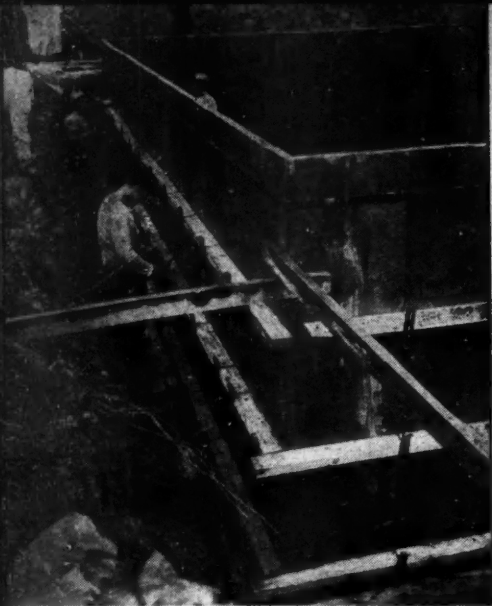

THESE forms were used for 150 basements



WIDE lots permit expansive front elevations with breezeway and garage.



tion. Foundations are poured with ready-mixed concrete. Crews of experienced, loyal men, some of whom have been with Mr. Gerholz for 18 years, are highly-trained and very efficient in their work. Power tools used on the job include 20 Speedmatic power hand saws, bench saws for cutting trim, powered Sterling hand sanders, and floor sanders. Mr. Gerholz is confident he could build up to 25 houses per week using his present methods without sacrificing efficiency or economy.



BACK yards and access facilities to them are planned as carefully as fronts. Note rear door and large window in house above.

BUILDING PRODUCTS ON REVIEW - BUILDING PRODUCTS ON REVIEW - BUILDING PRODUCTS ON REVIEW



AB2791—Incorporating many new refinements in design and operation, the new 1947 model Servel gas refrigerators are now being shown. Some of the features include shelves running full width, a trigger release on the ice cube and dessert trays, a flexible cube release plus the big frozen food locker.

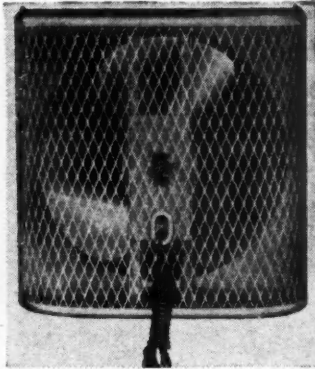

AB2789—The Emerson Electric Mfg. Co., St. Louis, offers a new electric window-type cooler fan. Finished in ivory enamel, cabinet dimensions are 24x24 inches square and 9 inches deep and can be mounted in any window with a minimum opening of 20 inches square. The fan exhausts 3,500 cu. ft. per min.

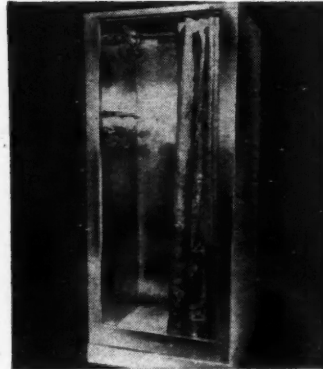

AB2781—The Niagara Shower Co., Los Angeles, Calif., has announced a new shower unit made of non-corrosive aluminum, finished with a semi-gloss surface. It is equipped with chrome hand rail, soap dish, fixtures and curtain rod or glass door. It is produced in two sizes, 30x30 or 34x34 inches.

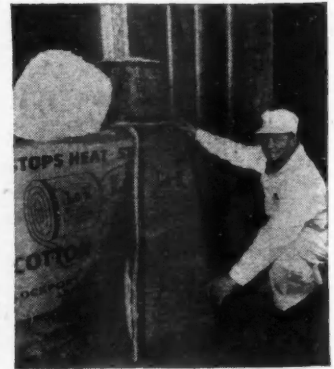

AB2753—Lo-K cotton insulation, made by the Lockport Cotton Batting Co., is available in rolls to meet standard construction practice. It is carried in 16 and 24-inch O. C. and in thicknesses ranging from 3/4 to 3 1/2 inches. It is thoroughly fireproofed and backed with waterproofed paper.



MR. GERHOLZ is using larger windows and more of them in his newest houses. Note distinctive window treatment in this group.



KITCHEN counter and cabinet extension form division between kitchen and dining room. This treatment in several variations is used universally by Gerholz-Healy. The 11 1/2" fan is standard in all kitchens. At right are two more of the numerous varied window treatments which contribute immeasurably to both interior and exterior attractiveness of these well designed houses.



BUILDING PRODUCTS ON REVIEW — BUILDING PRODUCTS ON REVIEW — BUILDING PRODUCTS ON REVIEW

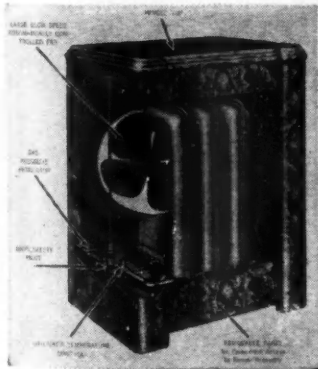

AB2799—The Tennessee Enamel Mfg. Co., Nashville, announces the new Temco gas-fired forced air heater. Built-in temperature control, safety pilot and pressure regulator assure fully automatic operation. A large, slow-speed fan provides even heat distribution for the units produced in two sizes.



AB27109—The Winco ventilator shown here installed in glass block to provide light along with privacy and ventilation in a bathroom is designed especially for use in glass block. In addition to its adaptability for new home construction it is also fitted for hospitals, stores, offices, etc.

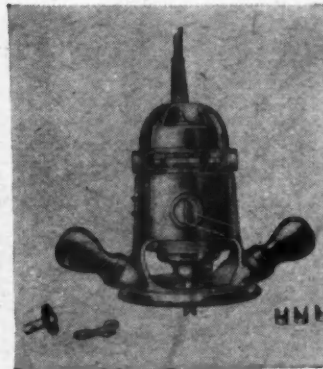

AB2793—A new base makes the Stanley-Carter hinge butt router easier to adjust for depth. A complete turn of knob on the base releases motor for removal or for quick depth adjustment. A turn of knob to right locks motor firmly in base, and half turn to left permits adjustment for depth of cut.



AB2768—The new Heatilator fireplace units provide a scientifically proportioned form combining damper, fire-box, smoke dome and downdraft shelf around which masonry can be easily built. No firebrick is needed. Heatilator is designed to save and circulate fireplace heat in the room.



ALTHOUGH Mr. Gerholz has expanded glass areas more than one-third in both front and rear of his houses, he plans to use more.



GERHOLZ-HEALY have been fabricating their own kitchen cabinets, shown here, as a stop-gap during the critical shortage period.



ONE of three basic plans which are varied with 12 elevations.

BUILDING PRODUCTS ON REVIEW — BUILDING PRODUCTS ON REVIEW — BUILDING PRODUCTS ON REVIEW

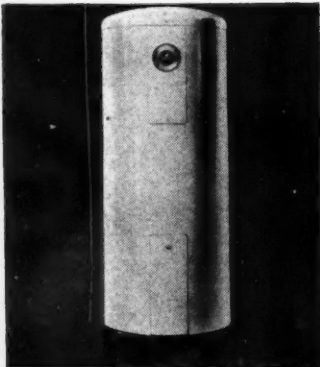

AB2757—The Frigidaire Division of General Motors is now producing glass-lined automatic electric hot water heaters in both 30 and 50 gallon models. Equipped with either one or two heating units, they are designed especially for soft-water areas. Three inches of glass wool provide insulation.

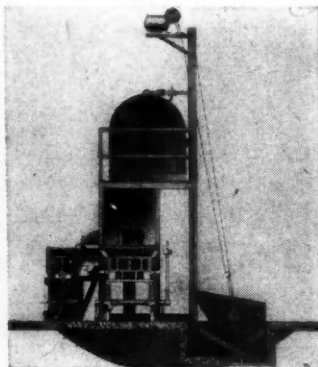

AB2754—The addition of this complete machined assembly to the popular Little Giant line of concrete block making machines is announced by J. W. Appleby & Son, St. Petersburg, Fla. This assembly includes mixer, skip hoist, hopper and block machine that can be fed singly, by twos or by tandem threes.

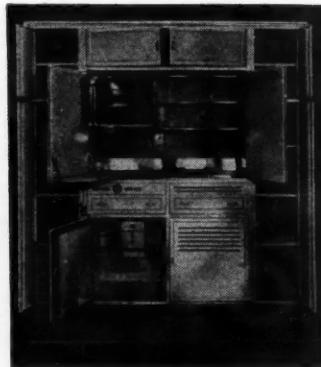

AB27107 — The new all-steel Parsons Pureaire gas kitchen occupies less than eight square feet of floor space yet it is complete with range, sink, oven, refrigerator—all full size. In addition there is ample working and storage space. The patented design makes the kitchen self-ventilating.

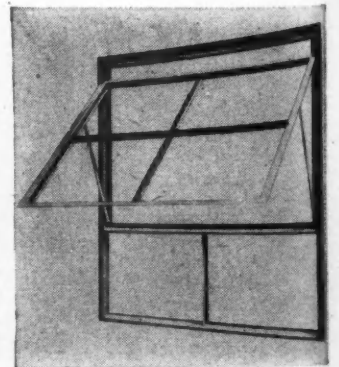

AB2761—The Copco Steel and Engineering Company's new commercial projected sash is being delivered in quantities. These units provide ventilators that swing outward from the bottom and slide down from the top for fast cleaning. The ventilator may be opened to any angle up to 75 degrees.



ANOTHER standard kitchen-dinette combination. Note Thermopane window with glass block sidelights overlooking back yard.



THIS bathroom treatment is standard in Gerholz houses. Glass block provides ample light and Winco ventilator fresh air.

Products Which Are Standard in Gerholz-Healy Houses

- Barrett asphalt shingles
- Calotex and Insulite insulating board sheathing
- Weatherbest shingle siding, double-coursed
- Ren-o-cel two-inch cotton blanket insulation
- USG Rocklath and plaster
- R.O.W. double-hung sash windows
- Andersen casements
- Libbey-Owens-Ford Thermopane windows
- Pittsburgh plate glass Twindow
- Pittsburgh glass block
- Carrara splash back
- Winco ventilators
- Lawson bathroom cabinets
- Briggs or Standard plumbing fixtures
- Corbin hardware
- Copco and Donley package receivers
- Donley basement sash
- Adams dome dampers
- Morgan woodwork
- Crane heavy-duty 30 gallon gas-fired automatic hot water heater
- Mueller gas-fired warm air furnaces
- Norge oil-fired warm air furnaces
- Ilg exhaust ventilator fans
- G. E. refrigerators and ranges
- Bendix washers
- Devco house paint (two-coat system)
- Pratt & Lambert interior house paint
- Berry upward-acting garage doors
- Crawford upward-acting garage doors
- Calcium chloride for winter concrete mix
- All financing by Michigan National Bank of Flint

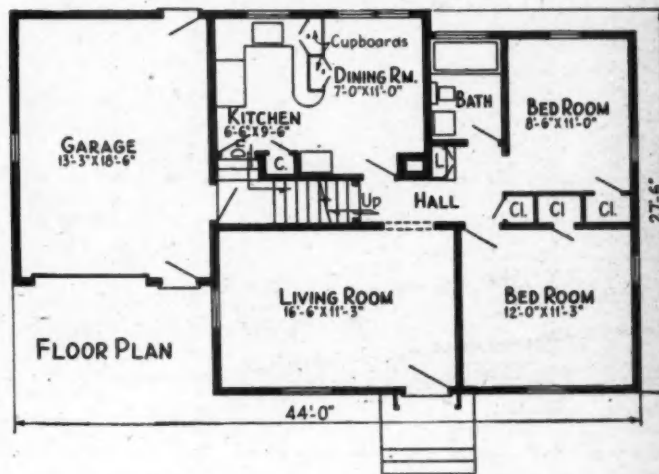

ANOTHER of the basic floor plans used by Gerholz-Healy.

BUILDING PRODUCTS ON REVIEW - BUILDING PRODUCTS ON REVIEW - BUILDING PRODUCTS ON REVIEW

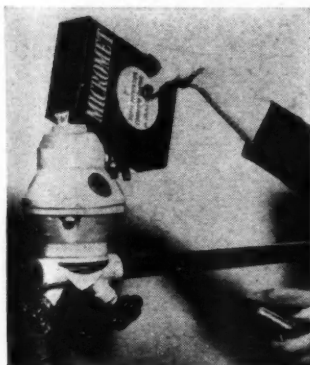

AB2794—Calgon, Inc., has developed a new type Micromet feeder by which the special chemical is fed into domestic water lines to inhibit corrosion, "red water" and scale. Once the feeder is installed, any housewife can fill the feeder with the chemical, which dissolves at a slow rate.

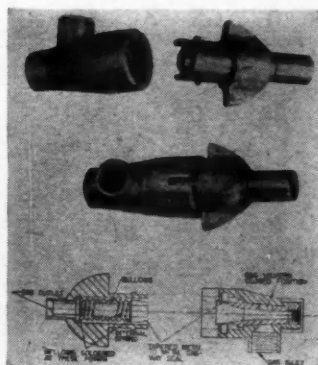

AB2795—This is a modified model of an automatic plug-in connector for portable gas appliances developed by the American Gas Association laboratories. Illustrated above, the model is shown disconnected and connected including a cross-sectional view of working parts. It will be mass produced.

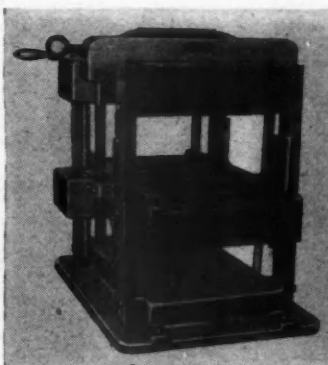

AB2751—This new combined planer and jointer has been developed by Oxford Engineering, Inc., Detroit. Geared power feed rolls and pressure rolls in an unique arrangement assure continuous power feed of stock and simplify both planing and jointing. Adaptable for portable or permanent setup.

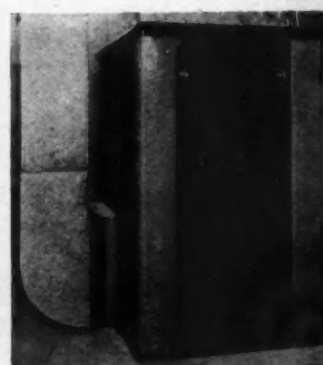

AB2796—This shows one of the installations of the new Norge oil-burning forced warm air furnaces being placed in the new houses built by Gerholz-Healy in Flint, Mich. Plans call for the installation of one of these furnaces in each of the 300 new houses in Mott Park.

Daytona Village, a Multiple Garden Apartment Project

A 200-dwelling unit development has demonstrated that individualized heating has resulted in operating economies over central plant heating



FRED L. LEWIS, developer, owner-operator of Daytona Village garden apartments.

DAYTONA VILLAGE located in Dayton, Ohio, is one of the first multiple-dwelling projects in the country for medium-income families to have individualized heating for its two hundred rental units of one- and two-bedroom suites.

The impression obtained of Daytona Village is one of spaciousness—none of the crowding so common in apartment house groups. Instead of tall, close-set buildings facing a common court, fine two-story buildings stand each on its own wide

lawn. The roads, instead of being laid out in a straight, monotonous line, follow a long sweeping curve. When this development is completed, it will contain more than fifteen buildings located on eighteen acres of ground.

All buildings (planned and completed) are of Colonial or Georgian design. Fashioned of brick, colors are varied, in some cases painted white. Sufficient uniformity of style preserves the appearance of a unified plan with sufficient variation

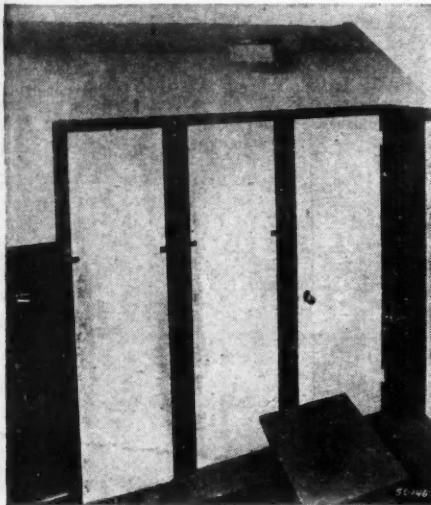

JANITROL forced warm air heating units installed in hall closets between apartments.

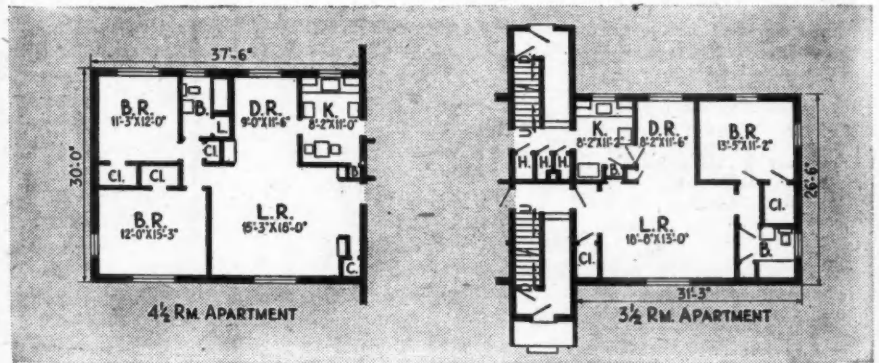

THE floor plans are essentially the same throughout all buildings in Daytona Village. They are composed of 3 1/2 and 4 1/2 room units with heaters placed between the two stairs.

BUILDING PRODUCTS ON REVIEW—BUILDING PRODUCTS ON REVIEW—BUILDING PRODUCTS ON REVIEW

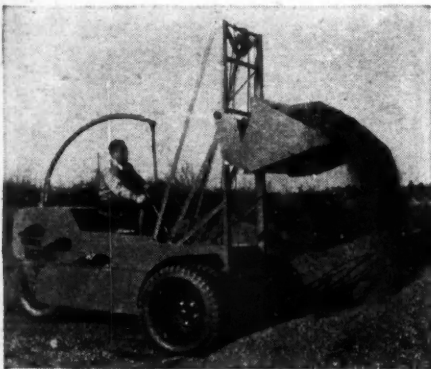

AB2746—Refinements in the new Model "B" Scoopmobile made by Mixermobile Manufacturers, Portland, Ore., have been announced. Complete control of the bucket is now accomplished by two hand levers actuating an entirely new pickup, hoisting and discharging mechanism. This eliminates "shock" loading. Design of the bucket itself has been changed to eliminate spillage over rough terrain.

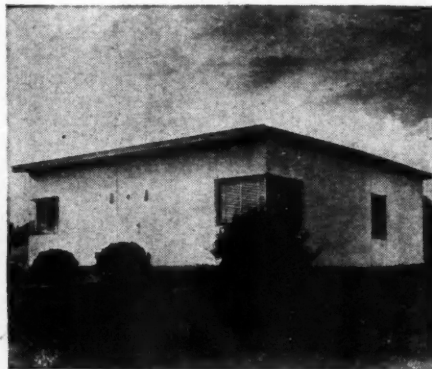

AB2743—The five-room house shown here was built with expanded structural plastic laminate panels marketed by the Bakelite Corp., New York. It weighs only one ton. The structural laminates are adhered to a core of expanded paper structure impregnated with phenolic resin. These materials have the highest strength-weight ratio of any structural material developed up to this time.

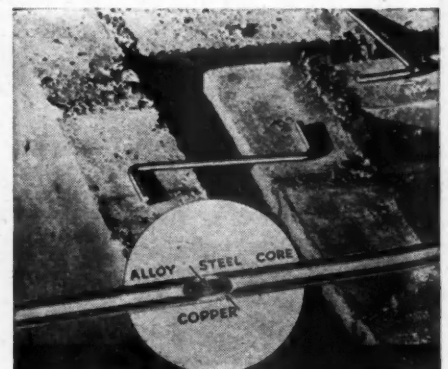

AB2709—These new wall ties developed by the Copperweld Steel Co., Glassport, Pa., combine the rust-resisting life of copper with the strength of steel. Made in a modified "Z" shape, they have a thick copper covering surrounding and molten-welded to a tough core of high strength alloy steel. Breaking strength of these new wall ties is approximately two tons.

to achieve charm and freshness.

Speaking as an investor and developer, Mr. Lewis says that Daytona Village is one of the most satisfactory types of low-cost housing that he has had occasion to observe. Referring to the planning stage of this development, he says: "We were considering central plant heating with ash handling equipment, chimney, coal storage and piping to fifteen buildings. At this point in our planning, the local gas company stepped in with estimates on individualized gas heating for the project. Although the figures showed the marked economies possible were incontrovertible, we shared the common impression that gas was too expensive for heating this type of project, and it was with some trepidation that we made the plunge.

"It is difficult now to understand, in the light of our experience with this type of heating, why we should have doubted.

"Each Daytona suite is equipped with a 60,000 Btu, forced air Janitrol heating unit. Because of their



BUILDINGS spaced apart on winding streets give the effect of a residential area.

compactness, these units are installed in closets in the back hall off the kitchen. By standardizing on the size of the heating unit, no excess stock of spare parts is necessary. We carry three extra motors for the entire project and have no maintenance difficulties. It is a simple matter to adjust the units for smaller suites as they occur in the building.

"With gas at 50 cents per 1,000 cubic feet, the average annual cost per suite is \$71. This includes cooking, hot water, laundry dryers and heat-

ing. Of this total amount, the heating cost alone averages \$37 annually. The average cubage is 6500. Halls are heated by transmission through the walls.

"The people in Daytona Village are delighted with the individualized heating arrangement. Each living unit has its own thermostat and can have the temperature desired. They consider this method a modern luxury, even though it actually is an economy from the project management's viewpoint."

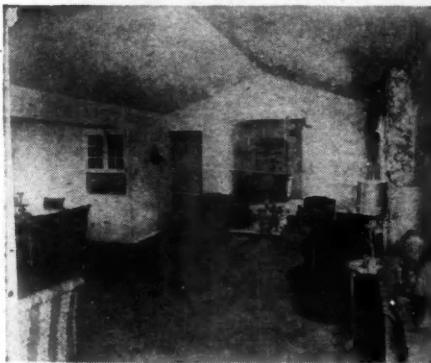

TYPICAL living and dining room. Furred beam between rooms conceals warm air duct.



THE building above is an eight-suite unit which is one of a number comprising this development. Each building is individually designed in the Colonial tradition.

BUILDING PRODUCTS ON REVIEW - BUILDING PRODUCTS ON REVIEW - BUILDING PRODUCTS ON REVIEW

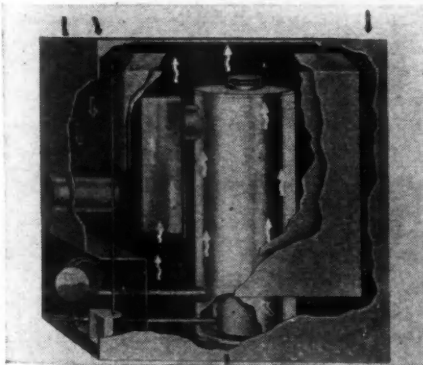

AB2738—This new automatic oil-burning floor furnace has been developed by Norge-Heat division of Borg-Warner Corp. Of 50,000 BTU bonnet capacity, it has a draft booster to assure proper mixture of fuel and air. The Lo-lite pilot uses a minimum of fuel oil when furnace is not turned up and an oil flow adjuster is easily operated from the grille. Dimensions are 24 1/4 x 24 1/4 x 40 1/4 inches.

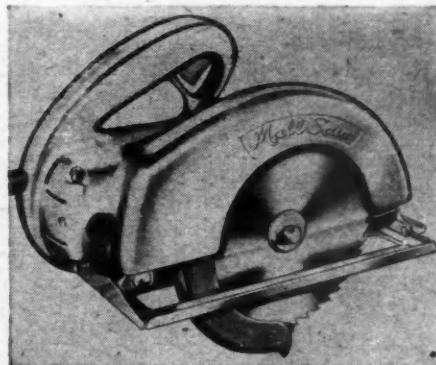

AB2714—The Mall Tool Co., Chicago, recently added this new saw to its line of portable power tools. Built in two sizes, Models 70 and 86, their cutting capacity is 2 1/4 and 2 3/8 inches respectively. They may be adjusted to make angle cuts up to 45 degrees. The automatic safety guard always keeps the blade covered except where cutting. The larger model, 86, weighs 17 1/2 pounds.



AB2741—Hoess aluminum clapboard siding is manufactured by Metal Building Products, Inc., Detroit. It consists of a section of rolled aluminum sheet, beveled like wood siding and formed to interlock with other sections. Each section is formed with a "U" shaped channel at the bottom. The top edge is rolled over so it interlocks with the "U" channel of section above it.

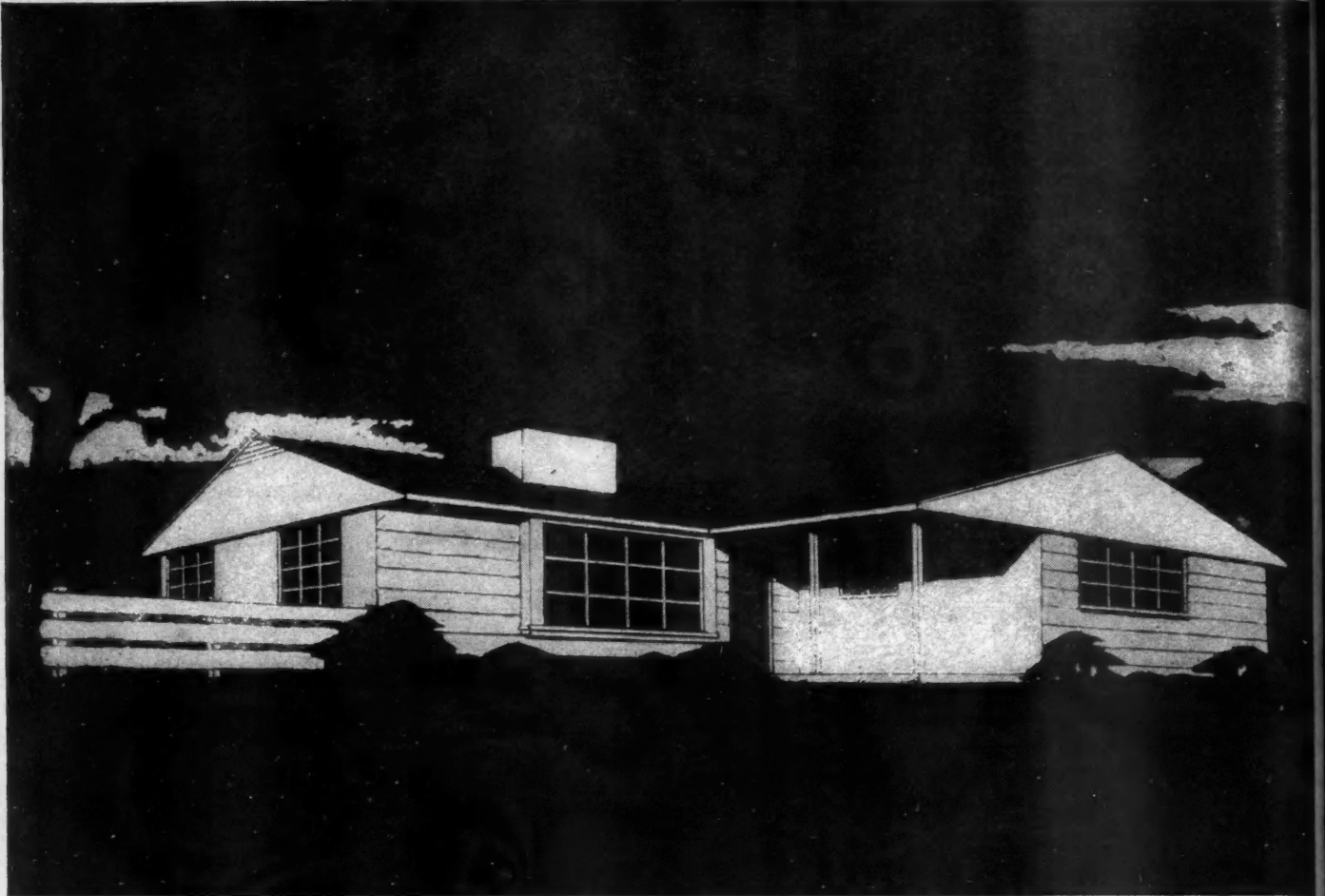

THE modest ranch type house shown above with its long, horizontal lines is striking in its simplicity.

A N I C K A

BLUEPRINT

HOUSE No. 2

Simplicity the Keynote—

PRESENTED on this and the accompanying pages is another in the series of blueprint homes designed by Walter T. Anicka, architect, Ann Arbor, Mich.

Following along in the prevailing trend of the building public, Mr. Anicka has designed another rambling ranch type house which, in spite of its broad ground coverage, can be erected in built-up communities where building lots are limited to fifty feet in width and are serviced by an alley in the rear to accommodate a garage.

The logical location for a house of this character, however, is on a broad, level piece of ground where ample opportunity is available for combining the functions of normal living with out-of-doors facilities.

One of the features of this house is the ease of circulation. The location of the kitchen in relation to the front and side entrance doors is excellent. The house is divided into three definite zones—sleeping, living and

cooking—each one separate from the other, yet all functioning as one unit.

Simplicity, both in exterior design and layout, has been the prevailing thought in the mind of the designer. This has been accomplished without any sacrifice in appearance. V-grooved, flush redwood siding on exterior walls, with flush plywood on the gable ends, provides a wide, smooth, unbroken surface, capped with an asphalt shingle roof.

With the exception of the large fixed wood sash in living room, all the windows throughout are steel casements. All the space has been utilized to full advantage. The combination living and dining area provides an overall length of thirty feet. The kitchen is a combination of laundry and breakfast nook, which is separated by a corrugated glass partition. A total of nine closets provide ample storage space throughout the first floor. Heating plant and other facilities are located in the partially excavated basement.



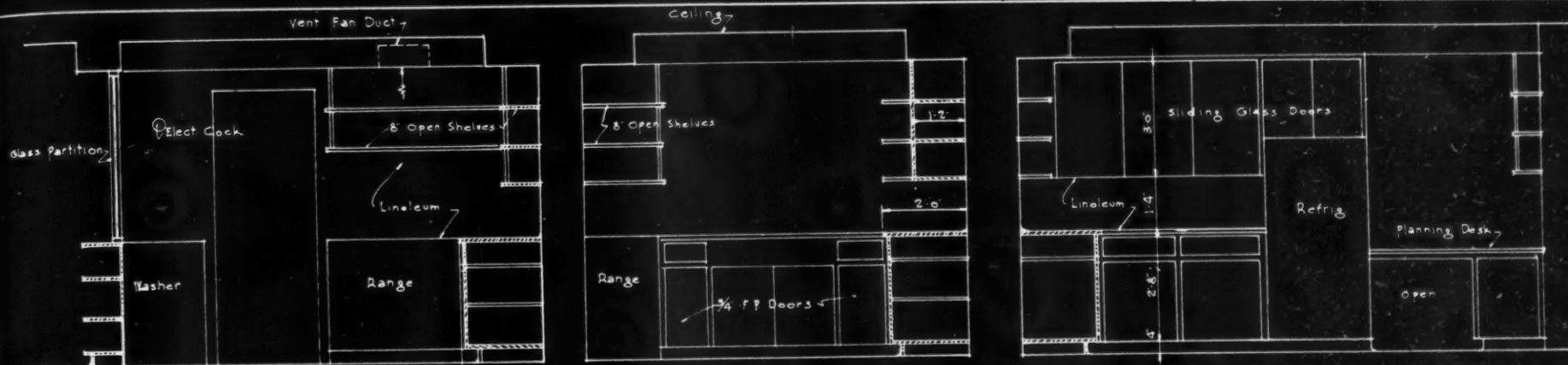

KITCHEN DETAILS

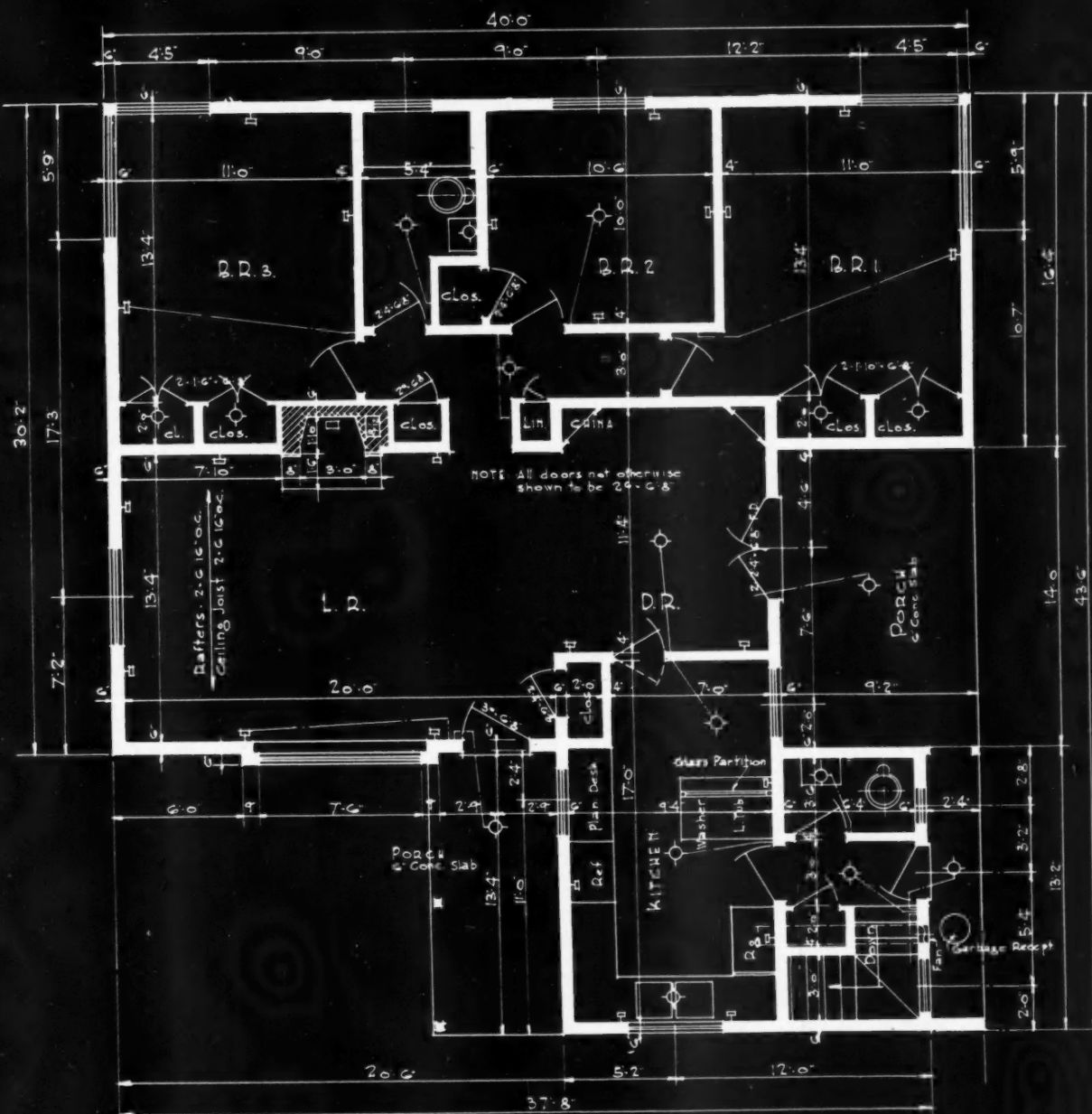

FIRST FLOOR PLAN

SCALE 1/8" = 1'-0"

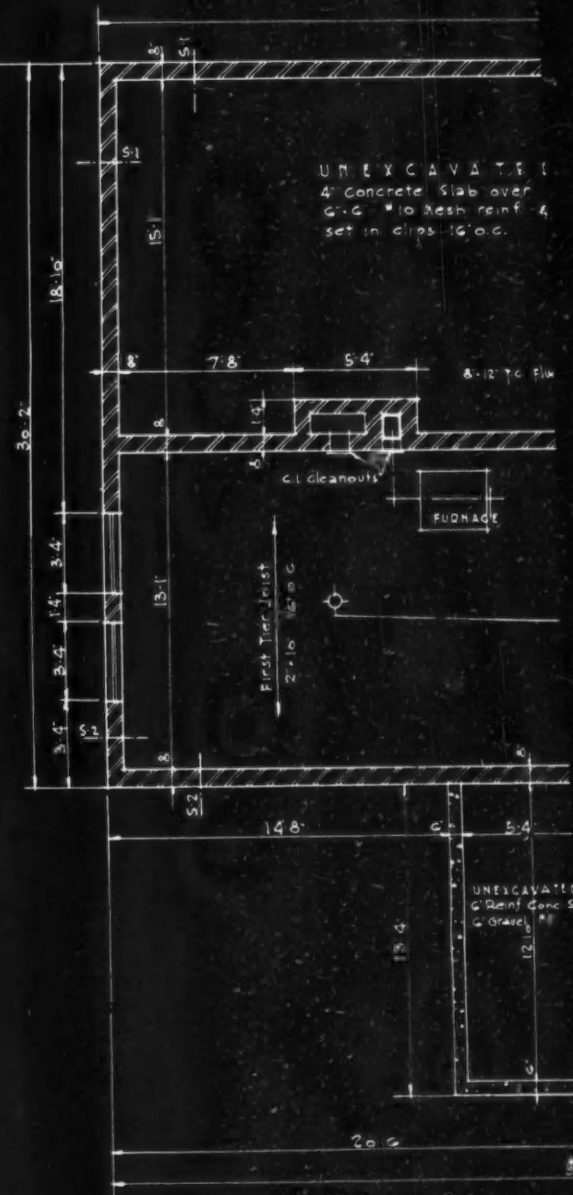

BASEMENT

NOTES:

1. FOOTINGS UNDER ALL WALLS 8" DEEP &
2. EXTERIOR OF ALL WALLS IN EXCAVATED TO BE WATERPROOFED
3. ENTIRE BASEMENT TO HAVE 4" CONCR
4. INSTALL GALV. IRON AREAS AT ALL SA

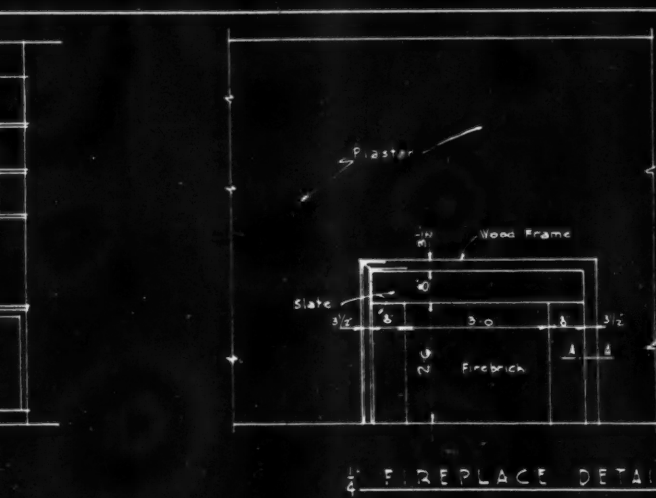

FIREPLACE DETAIL

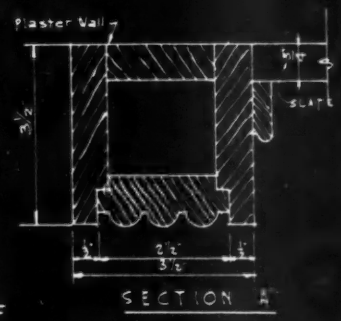

SECTION A

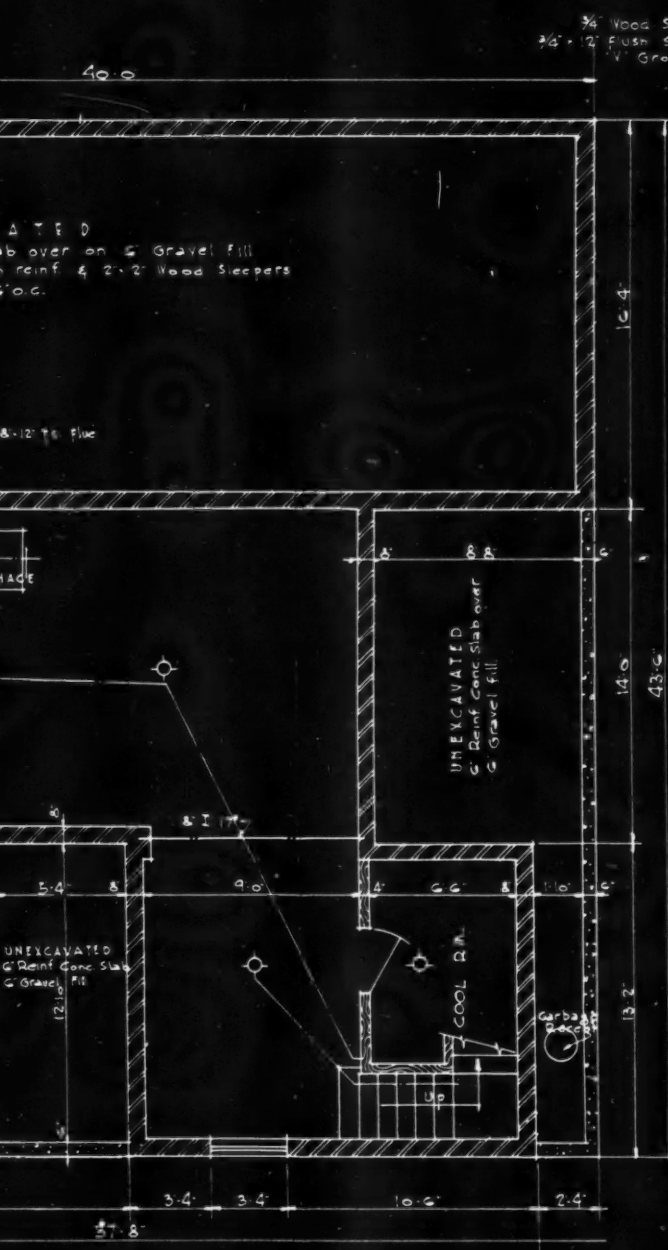

FOUNDATION

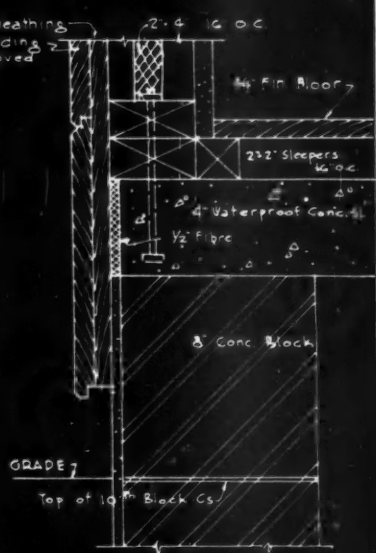

SECTION S-1

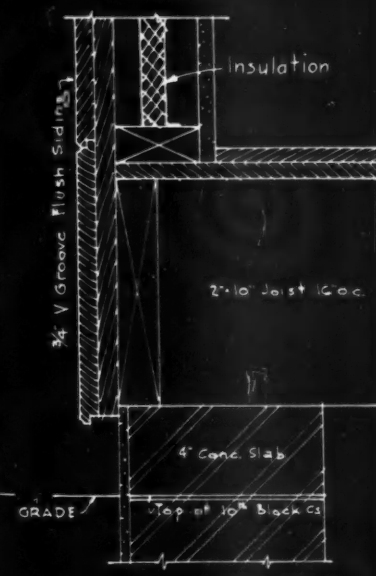

SECTION S-2

SCALE 3/8" = 1'-0"

8" DEEP x 20" WIDE
UNEXCAVATED PORTIONS
4" CONCRETE FLOOR
AT ALL SASH

DESIGN NO. AB 115
 AMERICAN BUILDER BLUE PRINT SERIES
 Designed By
 WALTER T. ANICKA ARCHITECT.
 Ann Arbor Michigan
 Simmons Boardman Pub Corp, 105 W Adams St, Chicago, Ill.

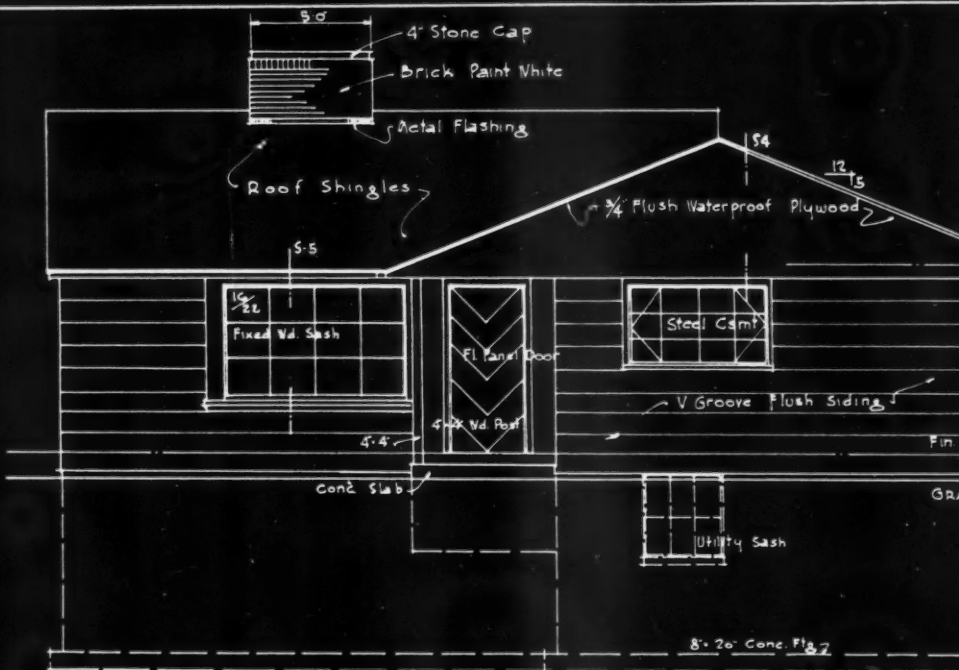

FRONT ELEVATION.

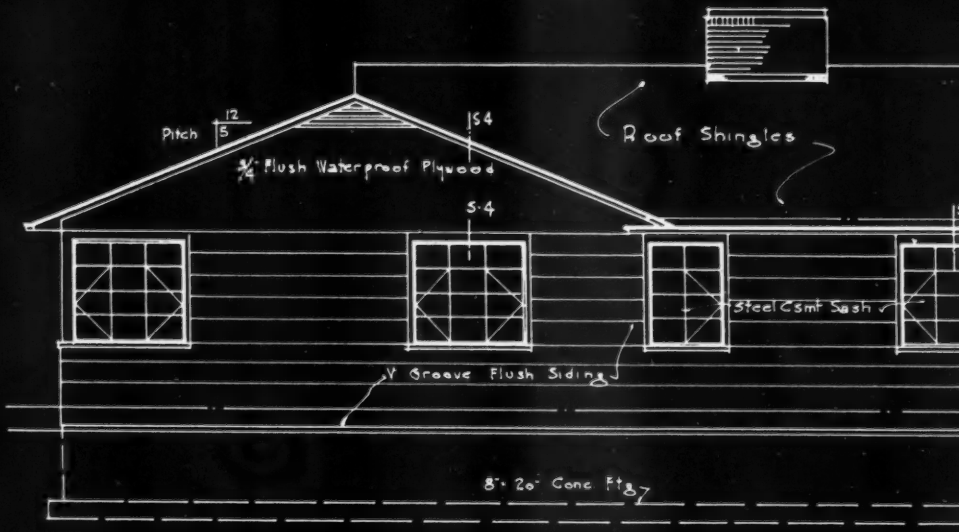

REAR ELEVATION.

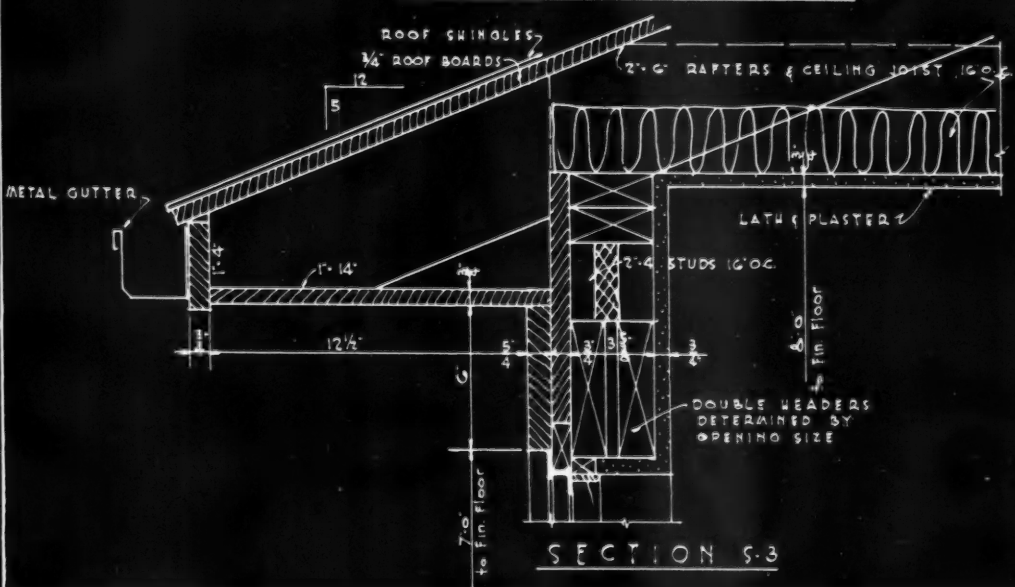

SECTION S-3

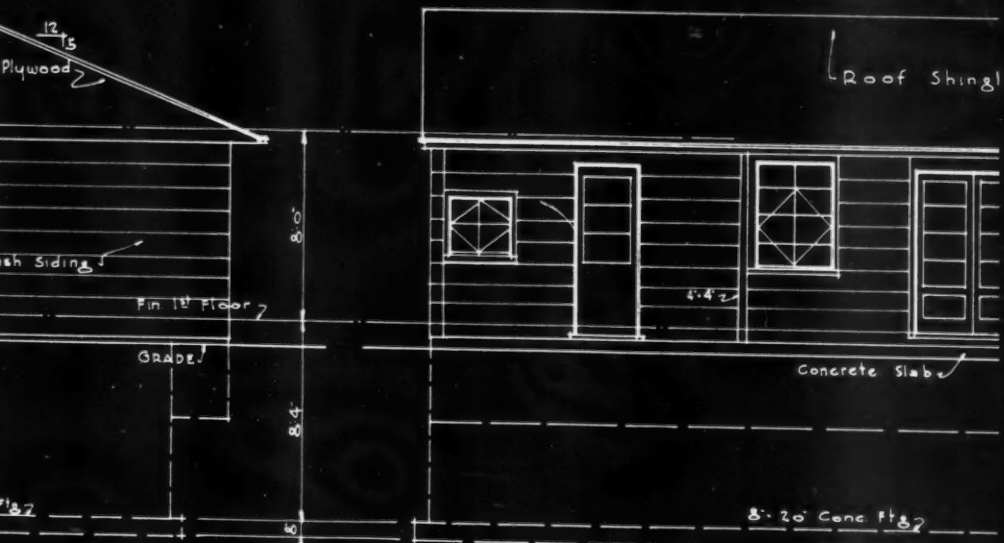

RIGHT SIDE

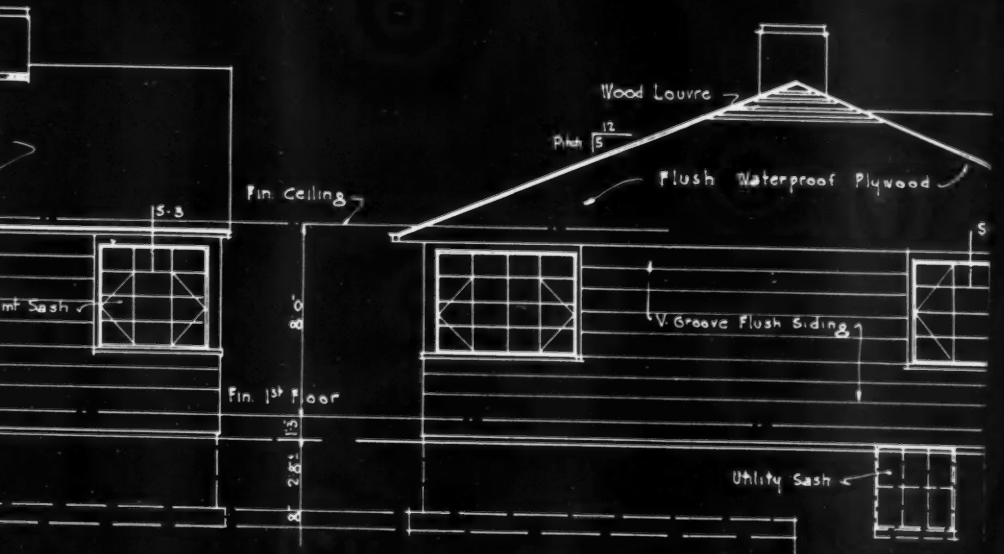

LEFT SIDE

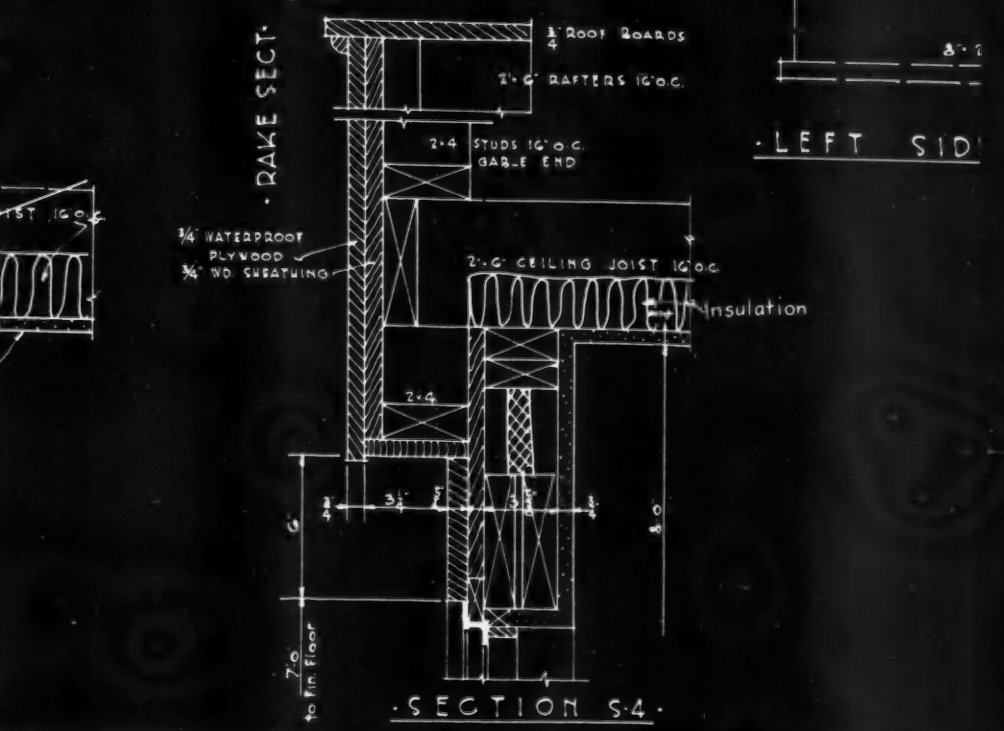

SECTION S-4

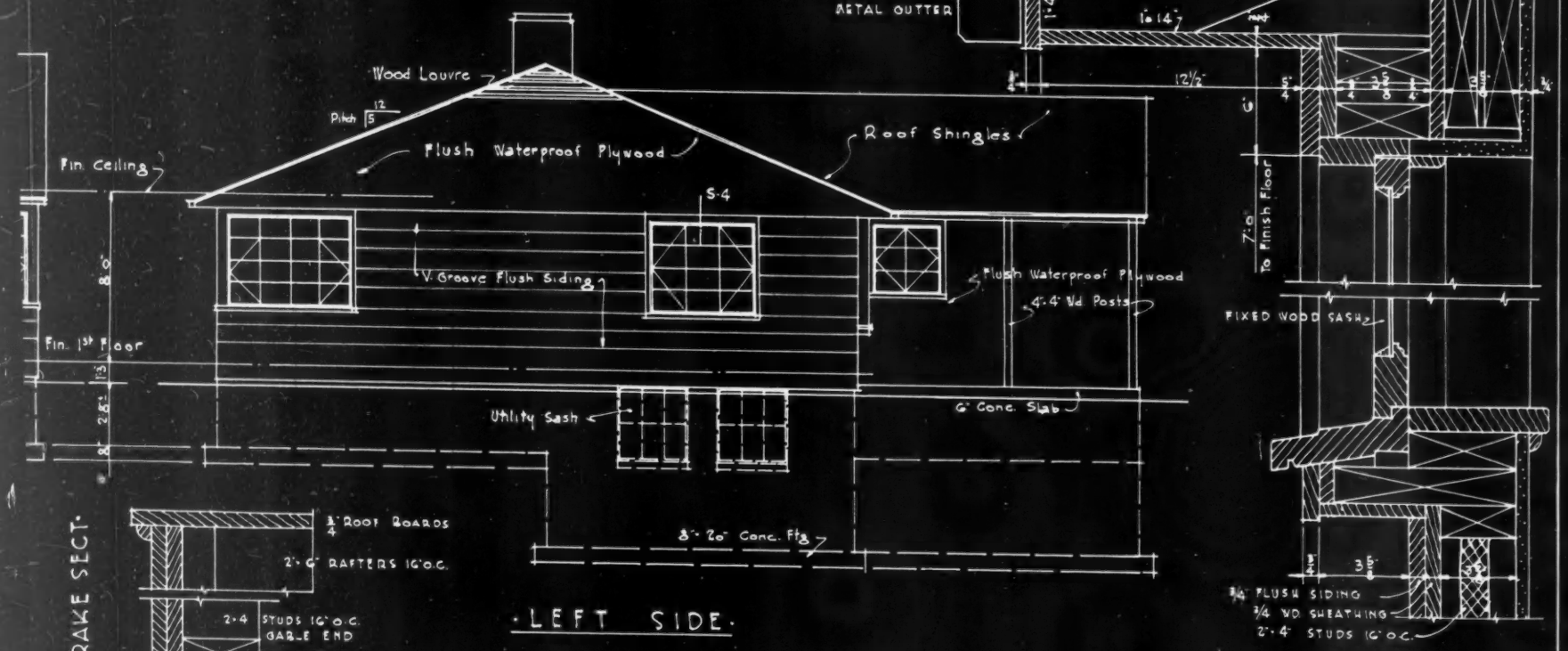
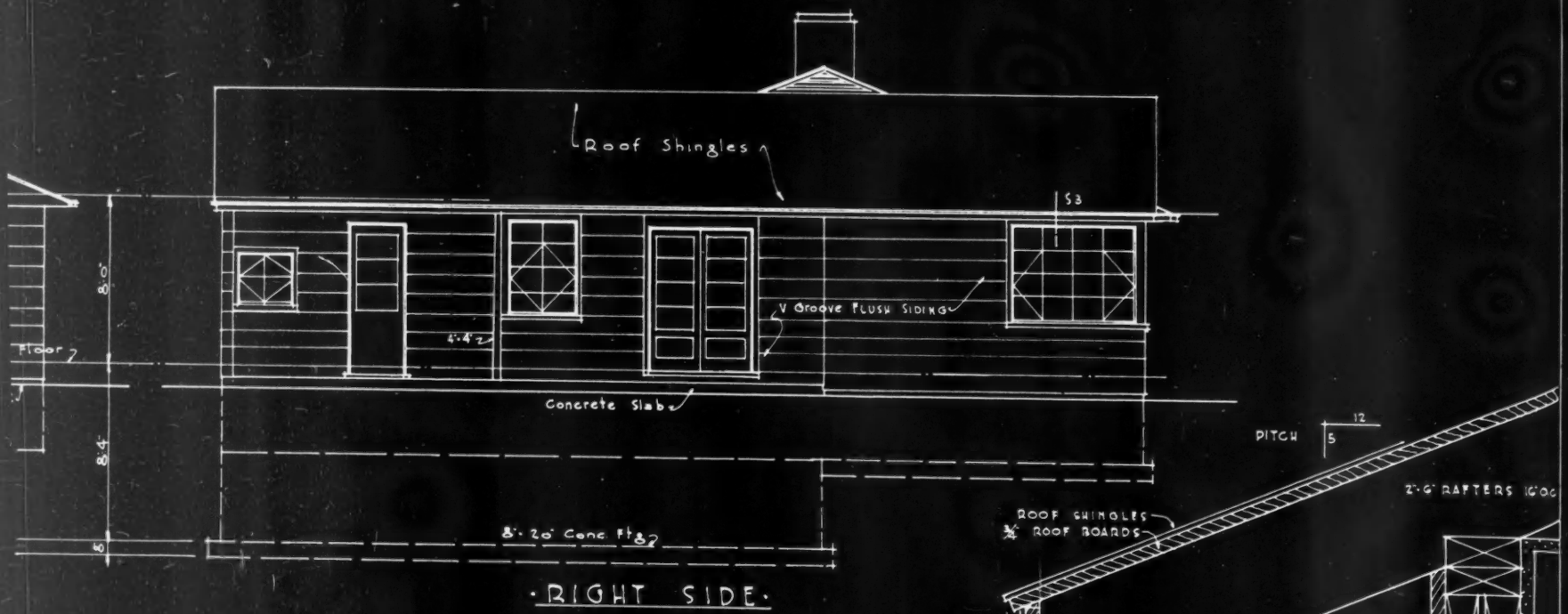

DESIGN No. AB 115
 AMERICAN BUILDER BLUE PRINT SERIES
 Designed By
 WALTER T. ANICKA ARCHITECT.
 Ann Arbor Michigan.

Simmons Boardman Pub. Corp. 105 W. Adams St. Chicago, Ill.

Am

Ho

Bu

A

and

bee

cro

T

com

livin

rag

rari

at s

the

eral

tag

Val

L

brow

plan

ting

the

T

of t

inte

BUILD

AB277

Minne

tem,

of he

furna

heati

west

er ra

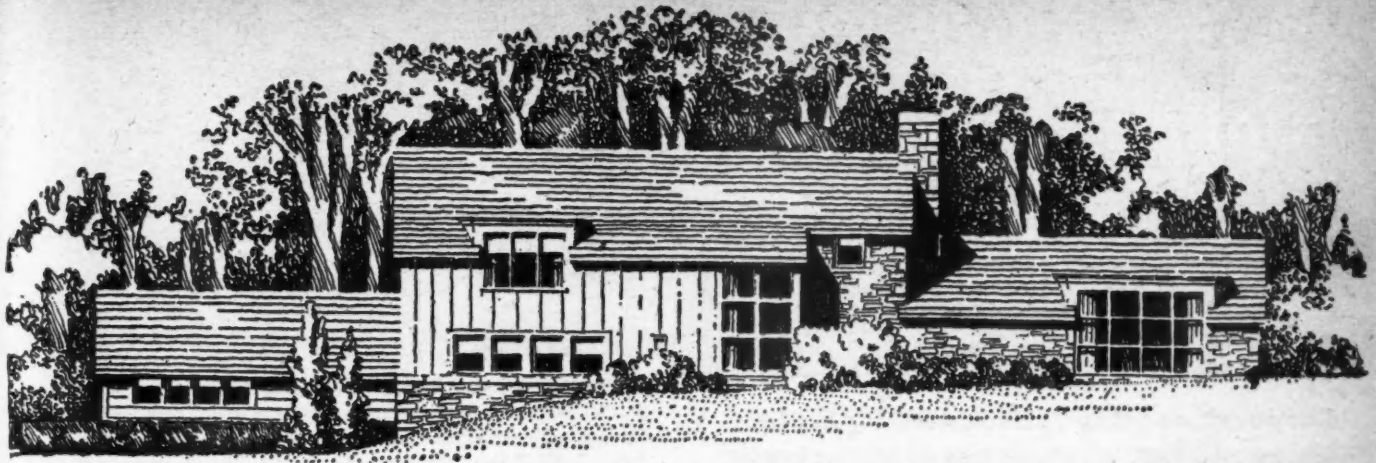

Home Can Be Built in Sections

A HOME which can be built in three sections, as the time, money and desires of the owner dictate, has been designed by Maxwell A. Norcross, architect, Cleveland, Ohio.

The center portion is sufficiently complete for immediate comfortable living and has two floors. The garage wing may be omitted temporarily, and the studio may be added at some future time. The design of the home was made to follow a general horizontal line, taking advantage of a slope of the site in Chagrin Valley where it will be built.

Ledge stone, redwood siding stained brown, and shingle-tile roof were planned to harmonize with a rural setting. Glass areas take advantage of the view.

This house is designed for a family of three, with both the man and wife interested in art—hence the studio.

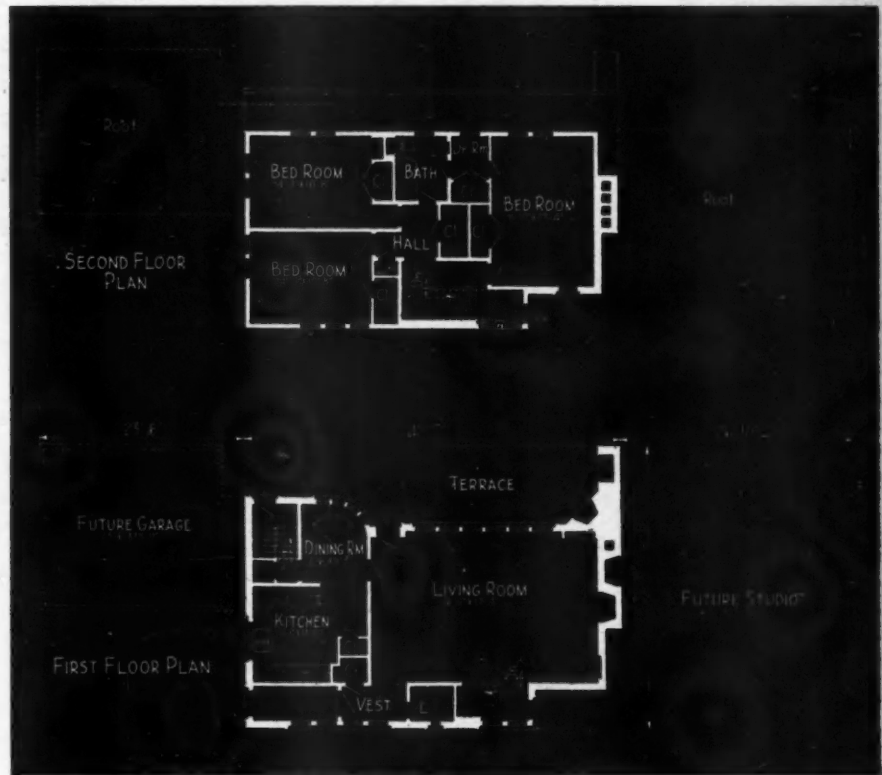

BUILDING PRODUCTS ON REVIEW — BUILDING PRODUCTS ON REVIEW — BUILDING PRODUCTS ON REVIEW



AB2771—This "brain," consisting of the Minneapolis-Honeywell Moduflow system, automatically controls the flow of heat from the Electromode electric furnace, new postwar product for home heating in the TVA area, Pacific Northwest and other regions where low power rates make electric heat practical.

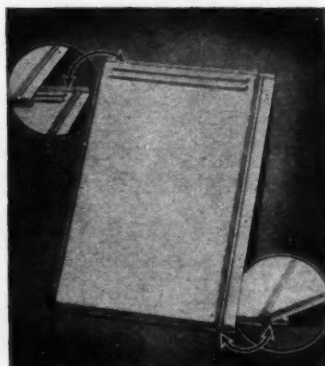

AB2777—The Southern States Iron Roofing Company's new Everwear aluminum shingle is turned under as well as down to form a "channel type" edge for strength. The shingles, 9-3/16x13 3/4 inches in size, lock together covering all nail heads. Shipping weight of a square of 146 shingles is 40 pounds.

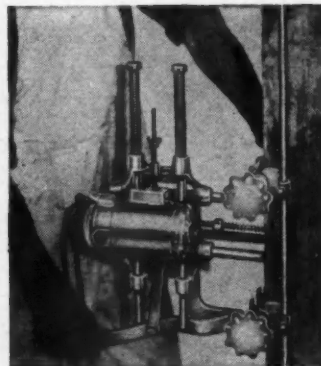

AB2778—The new Stanley-Carter lock mortiser is among lightest weight tools of this kind on the market and will cut a finished mortise in less than 30 seconds. Only four adjustments are required to change from one size lock to another, total changeover time consuming about a minute and a half.

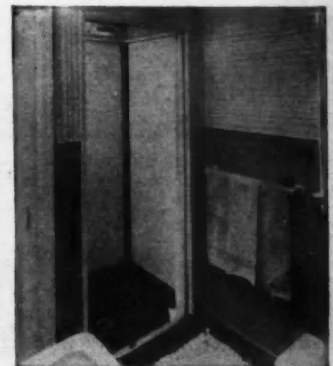

AB2759—Cognizant of the trend toward greater use of stall showers in home construction, the Henry Weis Mfg. Co., Elkhart, Ind., has refined its product. A low-cost, trouble-free installation, the Weisway provides a self-contained, leak-proof job not affected by settling or requiring reinforcement.

A Six Thousand Dollar House in High Cost Area



ABOVE, the principals in the Painesville project. Left to right: H. R. Templeton, vice president, Cleveland Trust Co.; George B. Payne, builder; Milton J. Ludwig, realtor; J. Wallace Green, architect; A. G. Tame, manager, Cleveland Trust's Painesville branch.

Cooperative effort, stimulated by Builder George B. Payne, produces unique results

A COMMENDABLE teaming up of private industry and private capital is producing low-cost housing for veterans in an area where costs have always been among the highest in the country. Coming at a time when the term "low-cost housing" has practically lost its meaning in any conversation below five figures, the Painesville Civic Housing, Inc., project, in the Cleveland suburb of Painesville, Ohio, makes refreshing news. It is especially refreshing when there is mention of four rooms, bath, attached garage and utility room, and a 60 x 200 foot lot, all in the same paragraph with a price figure of \$6,000 and carrying charges approximating \$40 a month.

George B. Payne, Painesville builder, is completing fifty such low-cost veterans' houses under a uniquely practical plan which has proceeded with the realistic and enthusiastic cooperation of the community, and a hard-working triumvirate of architect, real estate agent and branch bank manager. The fortunate veteran buyers, each of whom is being chosen by a special community committee, even face the pleasant prospect that the final price of the house may beat the low estimate of \$6,000. If so, the savings will be pro rated to each buyer as a mortgage reduction.

Here's how this it-can-happen-here construction project came about:

As the pressures of reconversion and demobilization mounted early in the spring of 1946, Mr. Payne, Milton J. Ludwig, a Painesville realtor, and Architect J. Wallace Green in company with A. G. Tame, manager of The Cleveland Trust Company's Painesville branch, called on Cleveland Trust's vice-president Harry R. Templeton. They discussed veterans' housing and as they talked it quickly became apparent that houses being built were in most cases too costly for the average veteran's budget. It seemed equally clear that the basic housing need of the typical veteran was, first, for minimum shelter to be made available as quickly and inexpensively as possible, but of such a type that the veteran could add to his property over a period of time and thus protect and enhance his investment.

Following an afternoon's discussion of mutual experience in the low-cost housing field the men went back to Painesville. Mr. Ludwig located a tract of land, well situated in Painesville and adequate to provide 60 x 200 foot plots for fifty low-cost houses. Mr. Payne began to wrestle with construction problems such as shortages of critical materials. Mr. Green, joining with Mr. Payne, worked diligently to design the low-cost house illustrated on these pages. They solved the flooring and heating problems in one swoop by adopting a poured concrete floor with radiant heating pipes laid in the con-

BUILDING PRODUCTS ON REVIEW—BUILDING PRODUCTS ON REVIEW—BUILDING PRODUCTS ON REVIEW

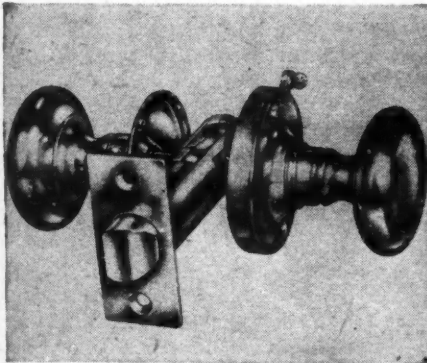

AB2726—The Technical Glass Co., Los Angeles, has announced its new lock set equipped with solid cast, one-piece aluminum door knobs finished in satin or chrome plating. The improved locking mechanism concealed in the rose permits opening without a key from the outside in case of emergency. A firm pull on the outer knob accompanied by a half turn will release the latch.



AB2744—The floor in this kitchen is tiled with colorful Vinylite plastic floor covering marketed by Bakelite Corp., New York. The material is resistant to wear and abrasion, fruit acids, oils, greases, and moisture. The firm is also producing Vinylite resin-coated cloth upholstery material for modern interior decoration where utility must be matched with appearance.

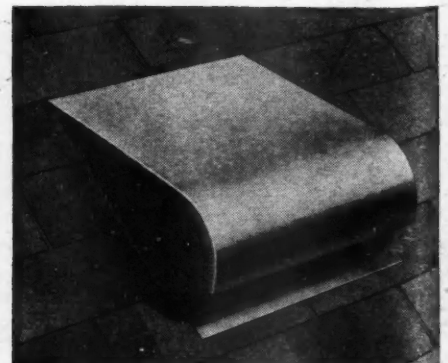

AB2729—A new item with the Swartwout Co., Cleveland, is an attic or under-roof space ventilator for hip or four-sided roofs. Of welded, all-steel construction, the lower part of the ventilator opening is equipped with a baffle to exclude weather and the 36-square-inch free area is covered with insect screen. Integral flashing permits weather-tight installation on any roof pitch.



STREET scene of Bulder Payne's G.I. houses under construction showing variety gained by reversing plan and changing roof lines.

crete. They evaluated every item of construction to see what final finishing jobs (such as closets) could be left to the buyer without impairing the immediate shelter utility or permanent investment value of the houses. As it became evident that the new enterprise could achieve most of its challenging objectives, a non-profit corporation, Painesville Civic Housing, Inc., was set up with a \$500 capital structure. The Cleveland Trust Company then loaned the new corporation, on its notes, the funds necessary to acquire the land and agreed to advance additional sums as construction progressed.

Needless to say, the progress of the whole project has been a day-to-day feature in the Painesville papers. But interest was not confined to local folks. Private builders, realtors and bankers from all over the nation have requested details on this low-cost housing program.

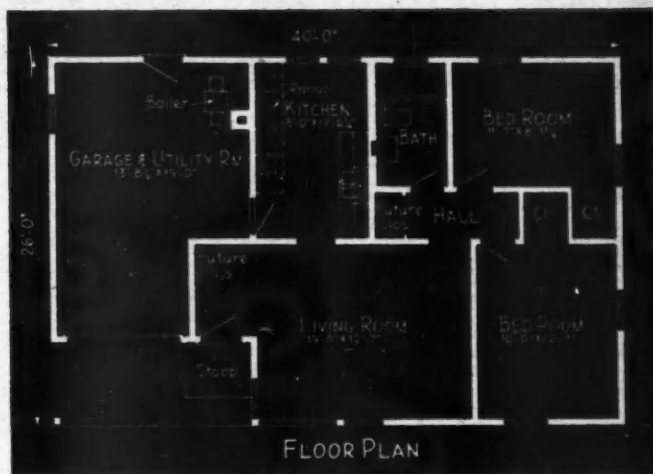

FLOOR PLAN



PLAN (upper right) is first floor plan of above house.

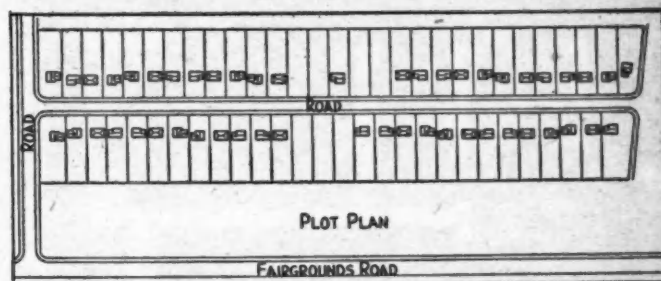

PLOT PLAN

ARRANGEMENT of houses on lots is shown in above plot plan.

BUILDING PRODUCTS ON REVIEW - BUILDING PRODUCTS ON REVIEW - BUILDING PRODUCTS ON REVIEW

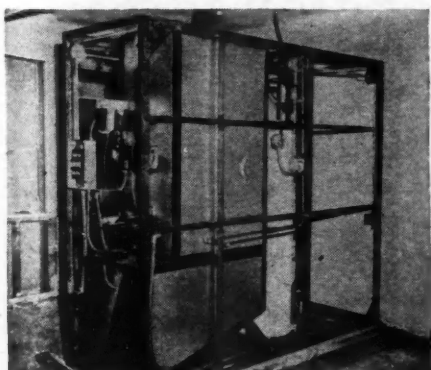

AB27110—This is the kitchen-laundry side of the factory-fabricated and assembled Ingersoll utility unit core showing the furnace and air filter as well as the blower, fuel pump, thermostatic connections and electrical distribution lines and controls. The water heater is at rear end of furnace. Around this compact "core," the kitchen, bathroom and laundry facilities are built.



AB2722—First mass production of transparent mirrors has been announced by Libbey-Owens-Ford. At left, above, a residence caller looks into a transparent mirror in which she can see only her reflection but the occupant from the other side of the pane (right, above) can see through it without making her presence known before deciding whether to admit the caller.

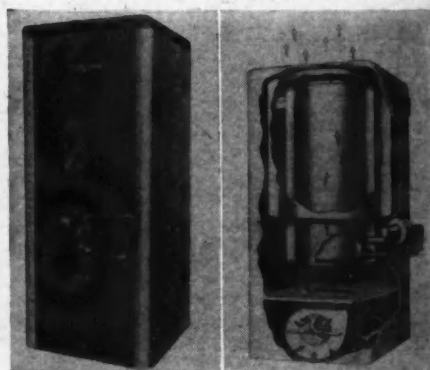

AB2737—The Norge-Heat division of Borg-Warner Corp. announces this automatic oil-burning forced warm air furnace of 70,000 BTU capacity. The pressure-vaporizing burner with automatic draft is entirely thermostatically controlled. It has the exclusive "permolain" coated steel heat exchanger. Dimensions are 26x26x56 to fit easily in an average basement, closet or utility room.

Sixty-eight Ways to Plan Your Kitchen

First of Westinghouse Better Homes Department's Electric Home Planning Series features fundamentals of kitchen planning and design

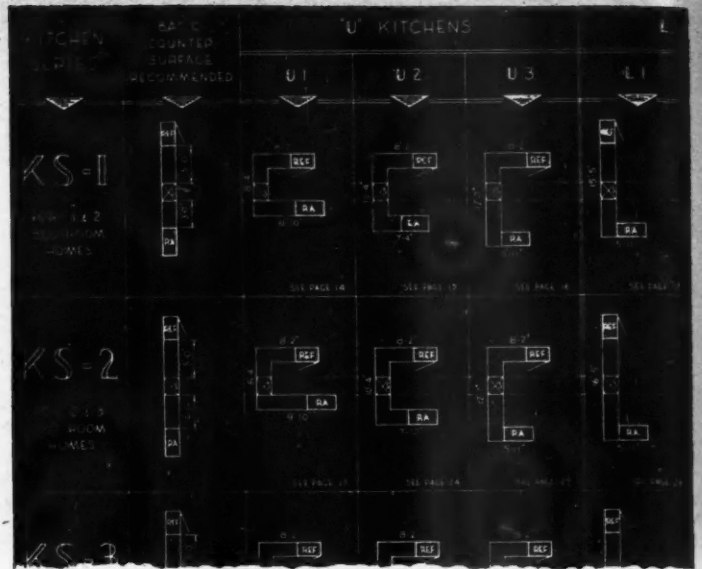
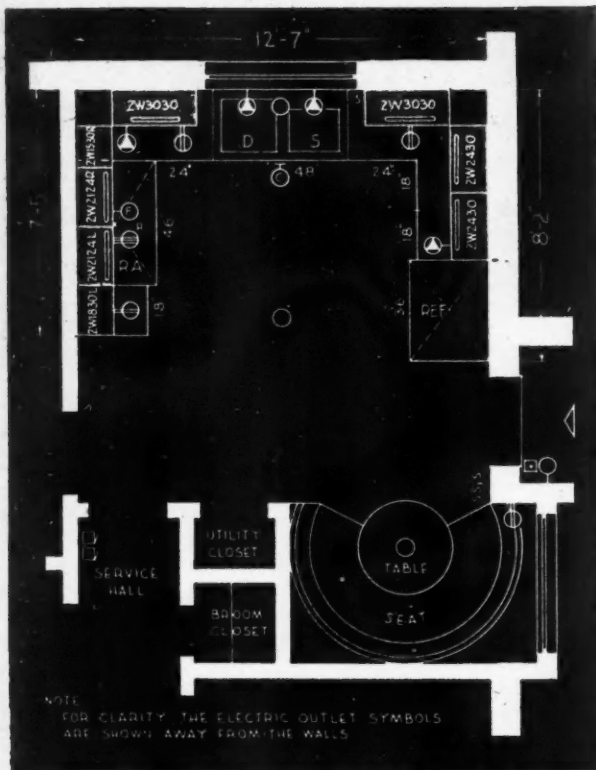

ABOVE diagram from the Westinghouse Electric

HOME BUILDERS and architects will be provided with practical data on space requirements and construction details for accommodating electrical equipment in the home in a new series of manuals planned by Mr. A. Carl Bredahl, manager of the Westinghouse Better Homes Department. The first of these manuals, "Planning the Kitchen Electrically," is just off the press and will be on display and made available for the first time at the National Association of Home Builders Annual Convention and Exposition, in Chicago, this month.

In outlining the series to the editors of *American Builder*, Mr. Bredahl said, "The original Westinghouse Kitchen Planning Manual was issued in 1937. Since then, continued research and practical applications have been made by our Home Economics Department, Home Building Department and Better Homes Department. As a result of these studies, we have developed an entirely new approach to planning of the electrical kitchens, which is reflected in the first of our electric home planning series. We have also included valuable information on lighting,

PLAN at left illustrates a specific application of planning principles.

BUILDING PRODUCTS ON REVIEW - BUILDING PRODUCTS ON REVIEW - BUILDING PRODUCTS ON REVIEW

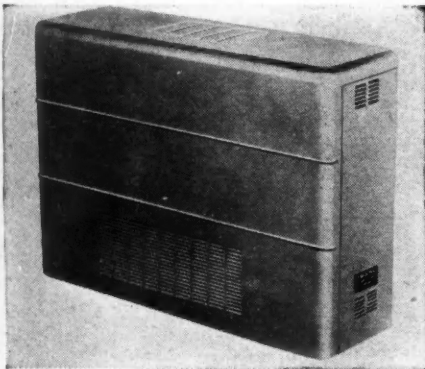

AB2705—The Trane Co., LaCrosse, Wis., announces development of its new Custom-Air system of air conditioning for the multi-room, multi-story building. The room units recirculate and filter air supplied by a central system through either high or low pressure ducts. The self-powered room units require no motive power from the primary air system which operates independently.

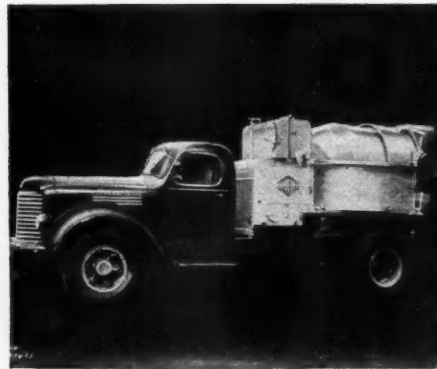

AB2733—The new Smith-Mobile truck mixers, made by T. L. Smith Co., Milwaukee, embody such refinements as: selective dual water injection system for job mixing or mixing in transit; fully enclosed water pump valve and piping within motor housing for protection in cold weather; syphon-type water tank equipped with a single lever-operated, poppet-type three-way valve; and others.

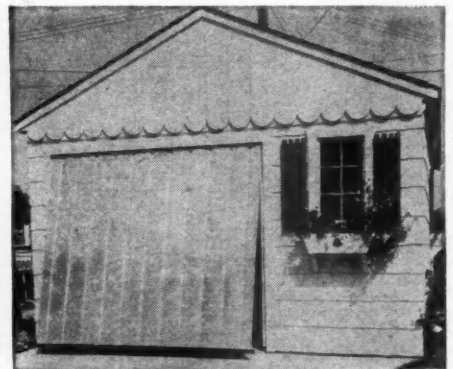

AB2742—The new Wilson aluminum garage door, made by Wilson Foundry and Machine Co., Pontiac, Mich., is rubber weatherstripped at top and bottom and made to fit standard 7x8-foot garage door openings. Two men can perform the installation without special tools. Weighing 101 pounds, it is hung on lubricated ball bearings with dual lifting mechanisms for good weight distribution.

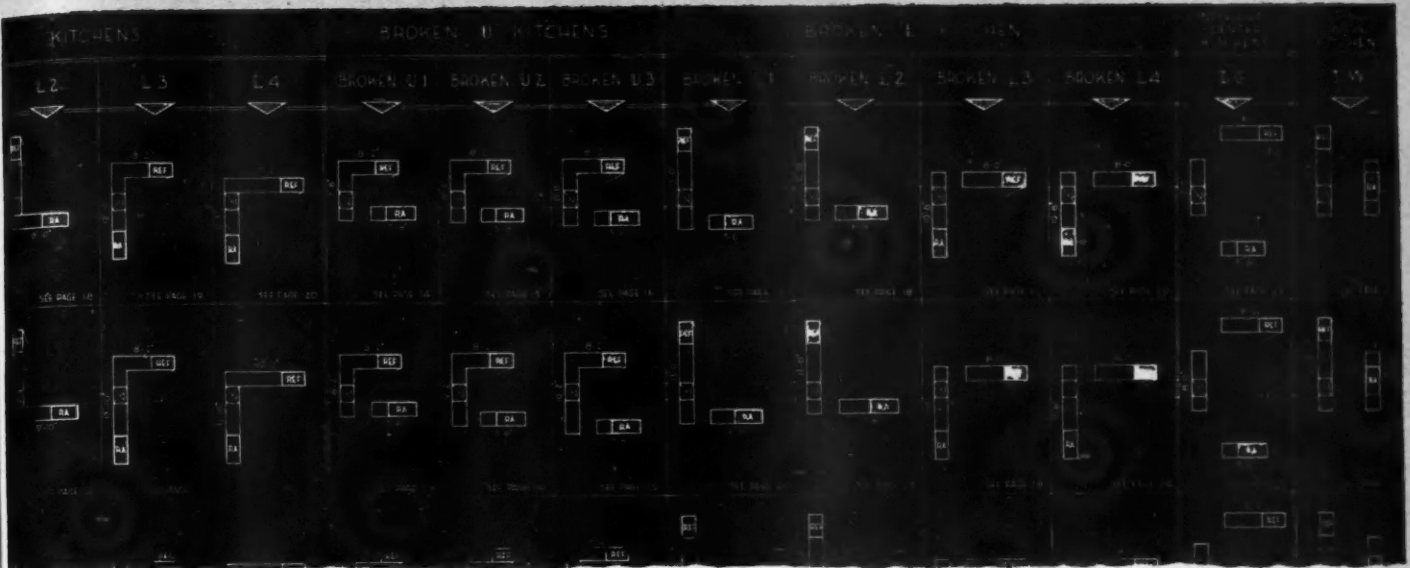

Home Planning Manual No. 1 shows a part of the "key plan series" illustrating the seventeen basic kitchen layouts for each series.

ventilation, and wiring requirements which should be of inestimable help to the nation's home builders, architects and home designers.

"In preparing a layout of a home, the designer is faced with the cold reality of working into the design the space requirements, clearances and construction details for accommodating the many electrical items of equipment. Lighting, particularly from concealed sources, be it incandescent, fluorescent or black lighting, demands careful study and requires architectural and structural treatment to accommodate it.

"The electric appliances that are so necessary for convenience of living—appliances that *make* the kitchen, the laundry and the utility rooms—require more than simply 'space allowance'; an entire ensemble, such as the electric kitchen, must be properly fitted into the pattern of the house design. Then, finally, but by no means least, comes the planning of the electrical system of distribution from the local electric company's point of service entrance to each and every location in the home requiring electrical connections.

"It is with this in mind that we have planned the issuing

of a series of pamphlets to be used as guides by the designer of homes.

"In connection with these we took into account that there are various levels of design, say from the small area or lower cost home to the home of greater size and cost. Thus these guides to electrical planning have homes divided into four groups, namely: 'Thrifty,' 'Budget,' 'Ideal,' 'De Luxe,' starting with a home having the minimum of electrical equipment (but still considered within the realm of 'Electrical Living'), and then three additional homes graded up, each group in the upward move taking advantage of added conveniences for Electrical Living."

In the kitchen manual, Mr. Bredahl applies the principle of dividing the homes into four series and, after discussing the fundamentals of kitchen planning, basic kitchen layouts and design details, shows the application of the rules to four specific house plans, each one having an added number of electrical conveniences. In using the kitchen manual, the designer, after determining the proper "kitchen series," selects one of seventeen layouts from a key plan sheet. Detailed layouts follow the key plans, listing equipment required for the particular arrangement.

BUILDING PRODUCTS ON REVIEW — BUILDING PRODUCTS ON REVIEW — BUILDING PRODUCTS ON REVIEW

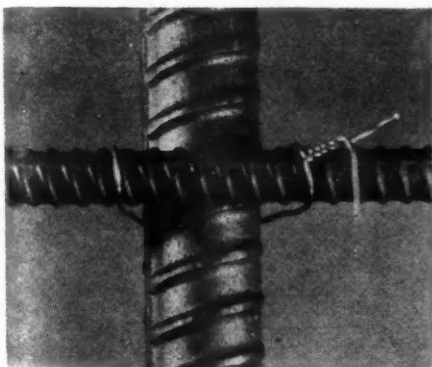

AB2707—Here is the improved design of Hi-Bond reinforcing bars developed by Inland Steel Co. for Joseph T. Ryerson & Son, Chicago. The reversed double helical ribs afford greater grip between steel and concrete. Interlocking ribs permit bars to be held securely in the position in which they are placed. Note simplicity of tie wire used to hold bars in position.

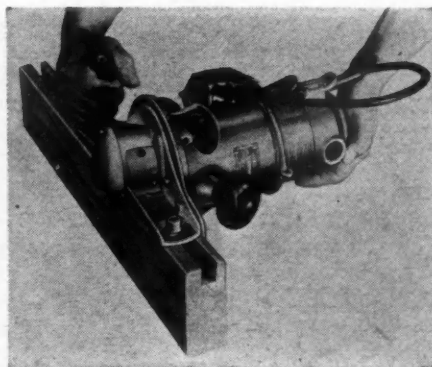

AB2713—This new portable electric groover was developed by Stanley Electric Tools, New Britain, Conn. It cuts square or round bottom grooves 1/2-inch wide, square groove 1/4-inch deep or curved groove 5/16-inch radius. The special base can be removed to provide a complete one H.P. hand router for decorative moulding cuts, etc. Operates on domestic current.



AB2745—The Arketex Ceramic Corp., Brazil, Ind., announces glazed structural tile for interior and exterior construction is available in a wide selection of sizes, textures and permanent non-fading colors, from white through delicate tints to bold, full-bodied tones. The firm now has three modern rotary kilns in continuous operation to satisfy a tremendously active demand for tile.

Branch Bank for Industrial Neighborhood

J. Lister Holmes & Associates, Architects



TAKING the bank to the depositors by the erection of branch banks in outlying neighborhoods is a present-day trend. Such a bank to serve the busy industrial section to the south in Seattle has been erected recently for the Seattle-First National Bank; Paul Carlson, general contractor; J. Lister Holmes & Associates, architects. It is a building 60 by 110 feet of poured concrete and Roman brick

vener construction, the front being faced with squared stone in large units. This bank has its own auto parking lot adjacent for the convenience of its drive-in customers.

The style is a restrained modern, impressive and dignified in its simplicity. The interior has one large general banking room approximately 57 by 74 feet with 22-foot ceiling back to the balcony line where the vaults, rest rooms and work areas are located. Daylighting is from a series of long windows, 4 by 17 feet and glazed with non-glare glass, in both sidewalls. The entrance is of the striking high type and features glass and aluminum. The floor is of green and red terrazzo, counter tops black and gold marble.

Lawrence M. Arnold, chairman of the bank, states that this building will serve as a model for a state-wide expansion program for his banking organization, to be inaugurated as soon as materials and labor become available.

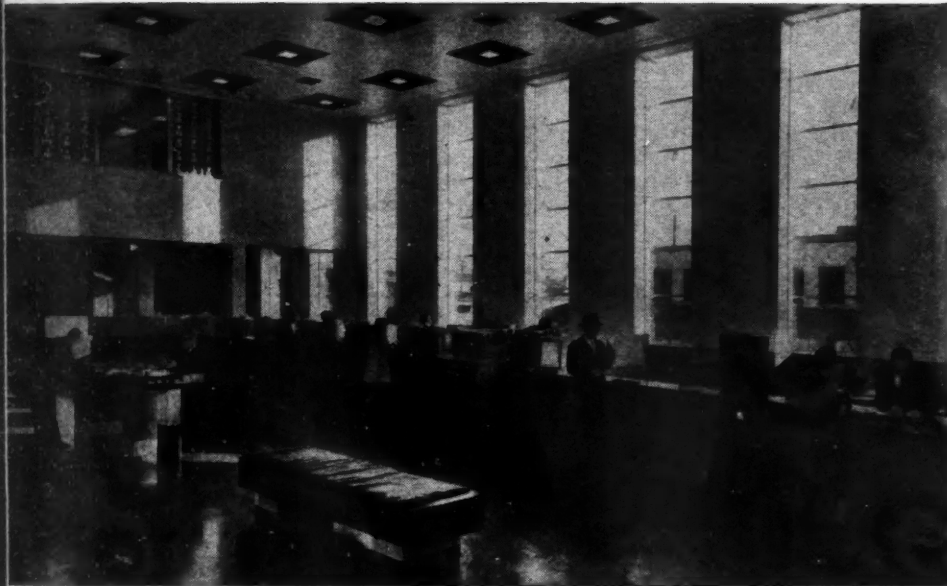

UPPER LEFT: Imposing entrance to bank features glass and aluminum. LEFT: Main banking room has an air of spacious dignity.

BUILDING PRODUCTS ON REVIEW - BUILDING PRODUCTS ON REVIEW - BUILDING PRODUCTS ON REVIEW

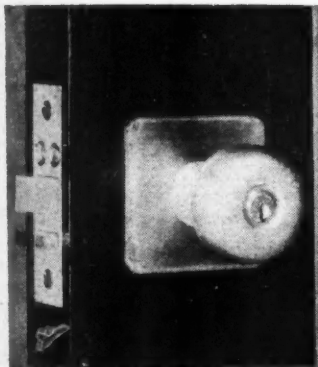

AB27101—Sargent & Company's new integrallock, mortise type. This lock, made of pressure-formed metals and precision engineered, was designed before the war and is now being produced in bronze, brass and chrome finishes. There are two basic types, mortise and cut-out, with 11 functions for each type.



AB2775—A new steel door frame welded to form a complete integral unit of jamb, head and two sides of trim has been announced by Aetna Steel Products Corp. Prime coated at the factory, it is designed for standard 1 3/8 and 1 3/4-in. door thickness. Hinges are welded to frame at the factory.

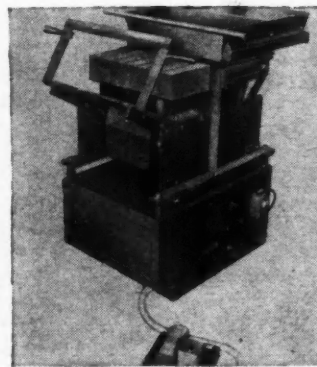

AB2780—Since introducing its Model 750 Vi-Brik-Crete concrete product making machine, the R. S. Reed Corp., Three Rivers, Mich., has added a feeding drawer type hopper and strike off to make the operation easier and faster. The totally enclosed roller assembly assures long life for vital parts.

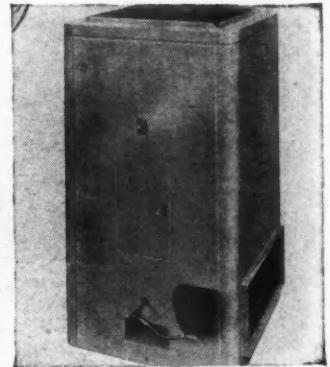

AB2785—The Appliance Division, Evans Products Co., Plymouth, Mich., has started production on a new automatic gravity-circulation, oil-burning furnace for basement installation. The furnace is equipped with an injection jet vaporizing pot type burner with a bonnet capacity of 70,000 BTU per hour.

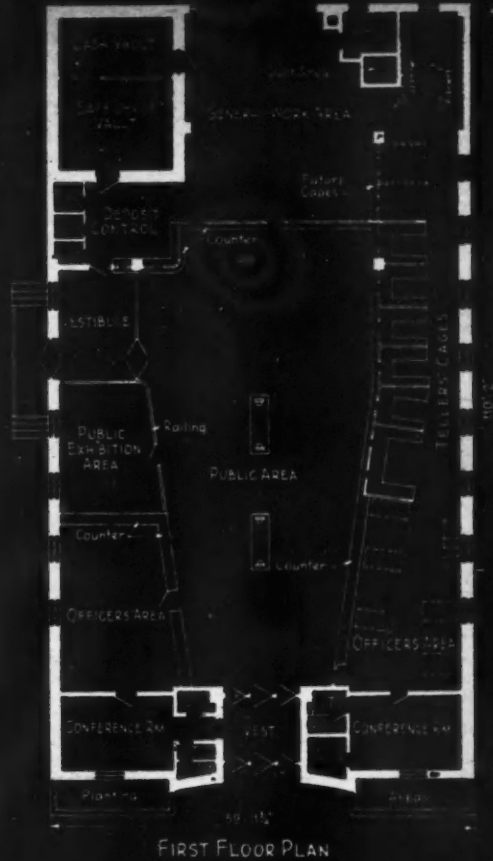
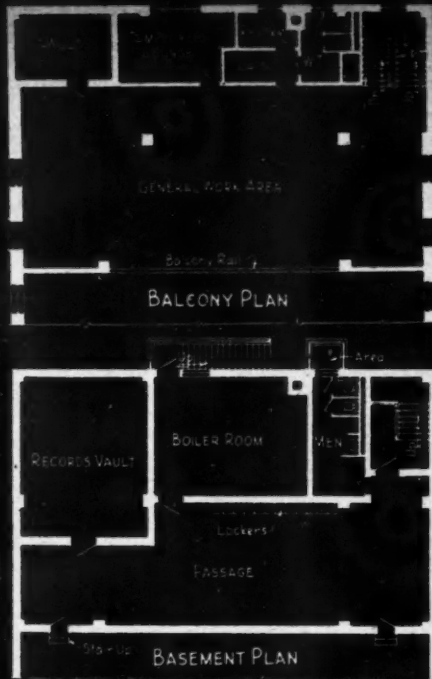

BUILDING PRODUCTS ON REVIEW — BUILDING PRODUCTS ON REVIEW — BUILDING PRODUCTS ON REVIEW

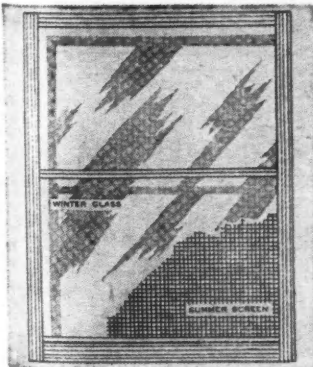

AB2752—AlSCO, Inc., Akron, Ohio, has developed a new extruded aluminum combination storm window and summer screen. Special features include a channeled frame to prevent heat loss and quick interchangeability from the interior on the same operating principle as ordinary double hung windows.

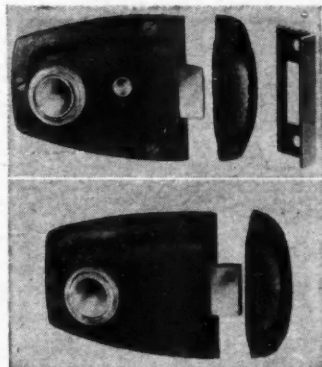

AB27100—Sargent & Company's new dead lock and newest night latch, both of which are to be available after Mar. 1st. Both have a black wrinkle finish with cast brass, wrought brass and extruded brass for other parts. An extra quarter-turn of the key dead-locks the latch bolt to prevent prying back.

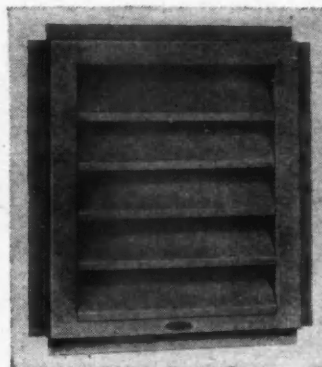

AB2763—The Swartwout Co., Cleveland, is introducing its new ventilating louver for residence attics, featuring one-piece frame and welded blade construction. One model with baffle flanges is designed for new buildings covered by siding, the louver being fastened outside the sheathing.



AB27105—This 1947 Hotpoint automatic washer performs soaking, washing and rinsing at one setting of dial at right of panel. Dials at left are for water temperature and washing time. The machine, with capacity for nine pounds of clothes, uses the agitator principle and has over-sized rubber wheels.



VIEW looking into drafting room from receptionist's desk. Note the abundance of light.

By establishing a rental unit on the first floor of this building, the architect is assured of income, as well as providing ample space for his own operations



A CORNER in Mr. Carlson's private office. The lannon stone fireplace with over-mantel is the dominant feature of this room.

Architect's Office

AFTER Elmer C. Carlson, architect, Chicago, Ill., obtained his release from the Army in December, 1945, he attempted to secure the office where in past years he had carried on the practice of architecture. He found that it was bound under lease to another party, and after searching diligently for other suitable office space without avail, he came up with the idea of building his own place.

The lot was purchased and within four and a half months he was located in his new quarters. The character of the building as it was finally conceived and carried out was determined by the value of a rental area being located on the first floor, and the advantage of his office being placed on the second floor away from the noise and dirt of the street. Although the lot is only twenty feet wide there is ample space on the second floor for a large drafting room, receptionist's space, reception room and a large private office, as indicated on the plans.

A portion of the drafting room is partitioned off with

BUILDING PRODUCTS ON REVIEW—BUILDING PRODUCTS ON REVIEW—BUILDING PRODUCTS ON REVIEW



AB27108—Workmen above are installing Sisalation on studs in new house construction. This product is an effective insulation against winter cold and summer heat in addition to serving as a moisture barrier. It is a product of the Sisalkraft Co., Chicago., which also makes copper-armored Sisalkraft.

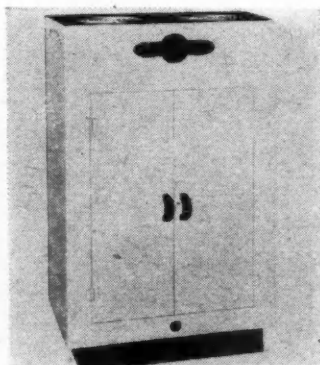

AB2756—The Steadi-Glo Pullmanette electric stove was designed by Appliance Industries of America, Chicago, to meet cooking requirements of a small housekeeping room or trailer. The unit has a range of six cooking heats. It is finished in black and white heavy duty enamel. Handles are black bakelite.

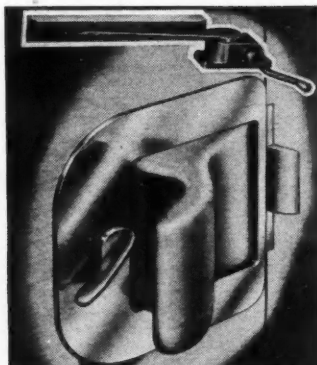

AB2783—The two products shown here are being made by Parlyn, Ltd., Los Angeles. The door lock and latch operates by pulling to open doors opening outward and pushing to open doors inward. Above the latch is the new burglar-proof casement window operator made of special Zamak.

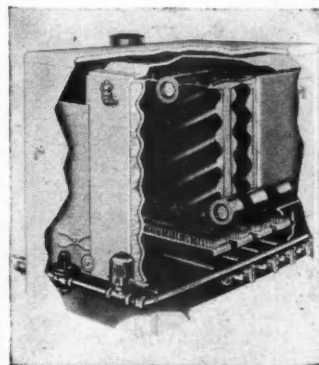

AB2701—The new U.S. Radiator Series 22 Capitol gas boiler is adaptable to steam, vapor, or hot water heating. Narrow corrugated vertical serpentine flues between sections provide intimate contact with hot gases. Automatic secondary air control is provided by a damper door in jacket casing.

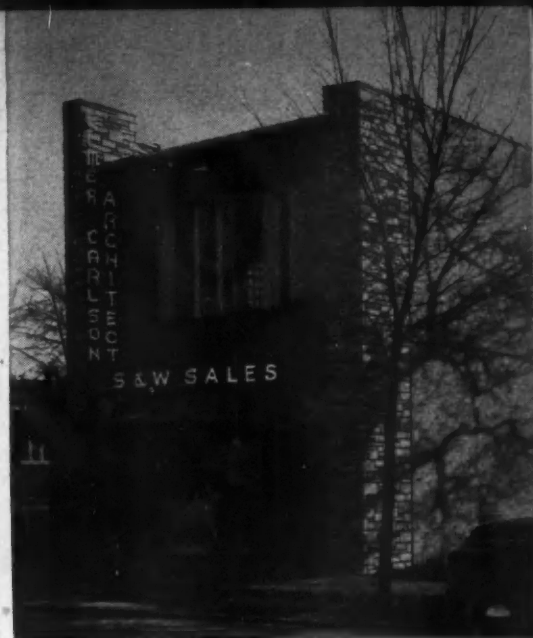
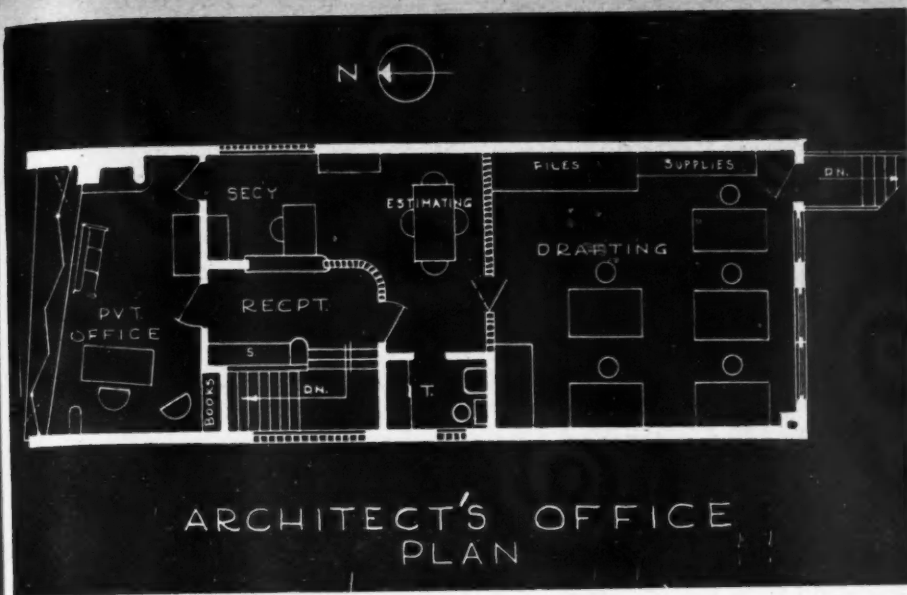

FLOOR plans of store and architect's office shown above. Lannon stone, terra cotta and metal used effectively on exterior.

and Store Building

a glass block railing to provide space for a table for estimating purposes. Glass blocks have been used extensively both on the exterior and the interior as noted on the photographs to reflect light back into some of the darker areas. One wall of the large private office is entirely paneled with vertical grained oak in a block pattern. The opposite wall is embellished with a large natural fireplace of lannon stone extending the full height of the room and with all joints of stonework well raked. The north wall is entirely of plate glass above the window sill, divided into three V-shaped bays of a saw-tooth pattern. This V-shaped glass arrangement provides ample light and clear vision looking out, but obscures the vision of those looking in. It also has a tendency to deflect the sun's rays and to break the monotony of the conventional front.

The roof framing consists of 4 x 10 in. ceiling beams spaced 4 feet on centers over which a 2 in. thick Cemento board is laid, with wood sheathing and a five-ply prepared roof to cover the entire area.



ANOTHER view in the architect's office which extends across the front of the building. Entire west wall finished in paneled oak.

BUILDING PRODUCTS ON REVIEW—BUILDING PRODUCTS ON REVIEW—BUILDING PRODUCTS ON REVIEW

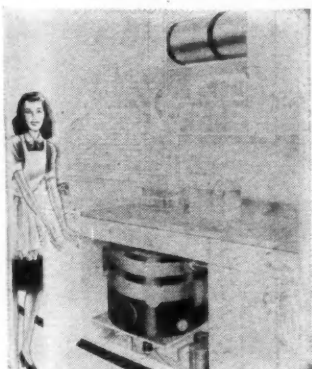

AB2784—This is the new Miller boiler-burner unit without its streamlined steel jacket, for installation in an ordinary kitchen cabinet. Compactness and heating efficiency are achieved by the heat Spiralator. Note hot water tank mounted in overhead cabinet. Unit also serves as year-round hot water heater.

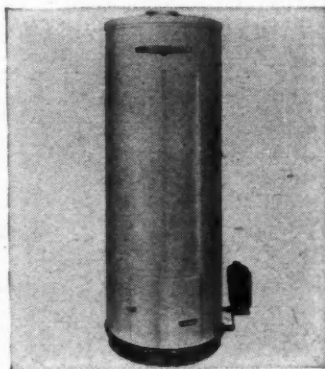

AB2797—The "Scotch Pilot" automatic draft regulator is a special feature of the new Norge 30-gallon oil-burning water heater. A temperature control permits "dialing" of water temperature preferred. Overall floor space required is 18x23 inches, and height of the unit is 4 feet 5 inches.

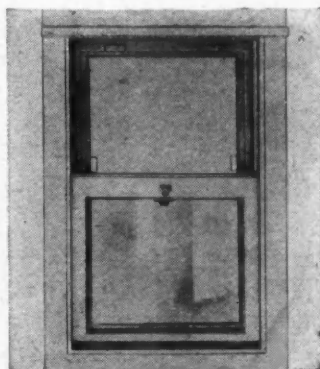

AB27103—The F. C. Russell Company's Rusco all-metal combination window incorporates storm sash and screen in one unit. Lowering or raising the sash fulfills seasonal needs for either storm window or screen. It is made of rust-resisting steel galvanized, and finished with baked-on enamel.

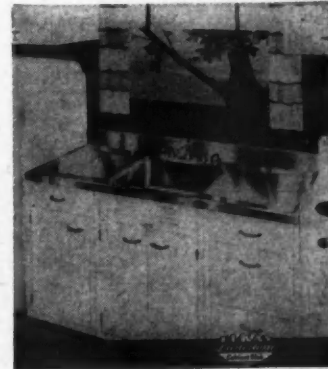

AB2747—Stressing extra heavy gauge thickness and electrically welded construction, Elkay Manufacturing Co., Chicago, announces a refined line of stainless steel cabinet sinks. The entire under side of sink tops and bowls is sound deadened in addition to reinforcement with heavy metal.

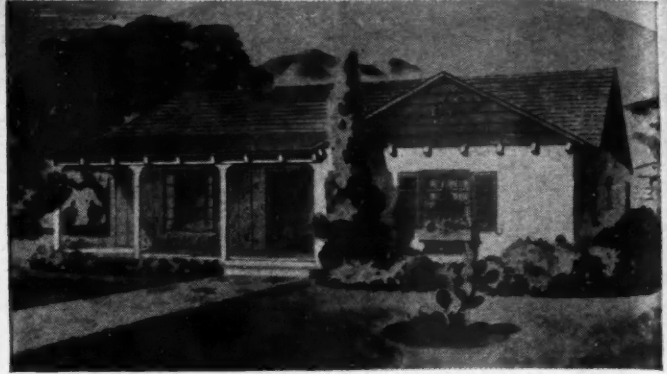

COMPLETELY finished interlocking wood sections bolted together.

Designed for California Climate



FLOOR PLAN

THE public is becoming realistic about prefabricated or manufactured houses. Erroneous talk by government planners plus the fertile imaginations of Sunday supplement writers previous to the close of World War II had convinced many prospective new home owners that in a matter of months houses would be coming off production lines like automobiles did before the war—and that they would be about as easy to buy and move on a lot in some subdivision.

Much advice and publicity on the part of experienced prefabricated house manufacturers and conventional home builders partially deflated the false impression. Actual experience is putting the whole subject on a practical basis. Changes in the design and methods of house construction and the materials used in them, like changes in our mode of living, have always been evolutionary—not revolutionary. The industry is undergoing changes now, like it always has. How fast they come depends on how well manufacturers and builders adapt new materials and methods to the financial and livability requirements of consumers.

Manufactured houses have been coming on the market regularly. They have appeared in a variety of designs, constructed of many different materials. Those manufacturers who have produced houses with merit at prices in line with what housing costs today have found the market interested and prepared to absorb output.

THIS two-bedroom house is being manufactured by Hamill & Jones, Los Angeles. Wall panels are made up of conventional 2 x 4 studs with siding on the exterior and plywood or predecorated wallboard on the interior. Floor and roof sections are also prefabbed. A pilot house was erected in nine and one-fourth hours working time. It is priced at \$3,515 without plumbing, wiring, hardwood floors or erection cost. Approximate finished cost is \$6,000 in the Los Angeles area.

BUILDING PRODUCTS ON REVIEW — BUILDING PRODUCTS ON REVIEW — BUILDING PRODUCTS ON REVIEW

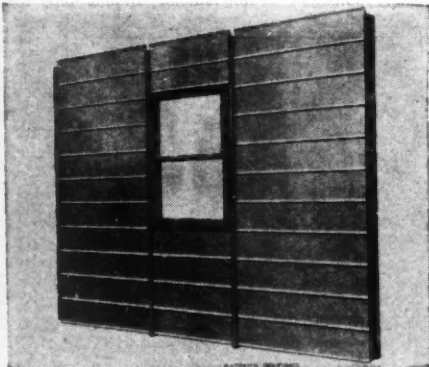

AB2728—Compo-Miracle Products Co., Berkley, Mich., has developed a prefabricated exterior wall section of rigid aluminum siding applied over an insulation board framed with conventional studs. The wall units are produced in four- and three-foot widths and in eight-foot heights. Window units include double hung steel sash, weatherstripped and glazed, in wood frames.

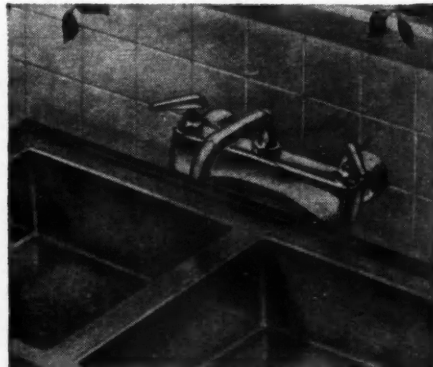

AB2725—This is the newest addition to the line of Commodore kitchen swing-spout faucets manufactured by the General Tire and Rubber Company of California, Pasadena. The long swing spout which extends 6 1/2 inches is made from brass stampings and machined brass fittings, silver brazed. This firm, a newcomer in the plumbing field, is currently producing about 100,000 units monthly.

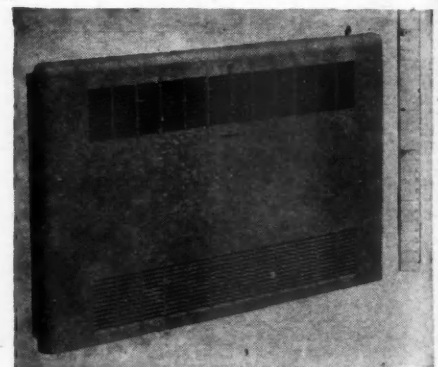

AB2706—Young Radiator Co., Racine, Wis., was one of the first convactor manufacturers to standardize a line of heating units. Shown here is its partially recessed Streamaire convactor that can be installed in wall recesses either before or after plastering because special "Z" bars are spot-welded to sides of the enclosure to govern distance convactor will project into the room.



THIS h

Tr

ADM
of fou
at 24
ard ty
floor
with
factor
limiti
age er
hours
the fa
of lan
erecti

BUILD



AB2711
dishwa
ing di
double
to air
uct is
rate
inches.



THIS house can be erected in from six to six and one-half hours.

Traditional Design for the East

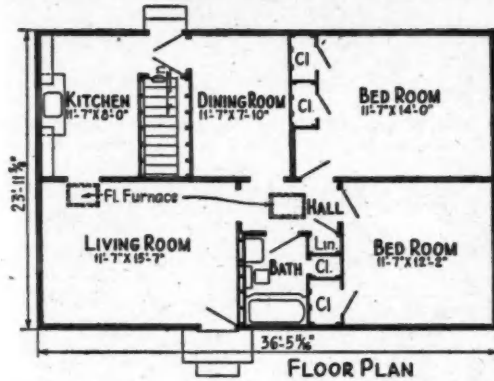

ADMIRAL Homes, West Newton, Pa., are now in production on factory-built houses which range in sizes of four, five and six rooms with basic dimensions starting at 24 x 28 and running up to 24 x 44 feet. With 36 standard types of panels they furnish about 50 combinations of floor plans. Exteriors are standard waterproof plywood with one coat of sealer and a white primer applied at the factory. Because of demand adjacent to the plant they are limiting distribution at present to a 200-mile radius. Average erection time by their dealers is six to six and one-half hours. Doors and windows are installed in the panels at the factory. Prices range from \$5,800 to \$8,500 exclusive of land, but including full basement, heating, plumbing, erection work, etc.

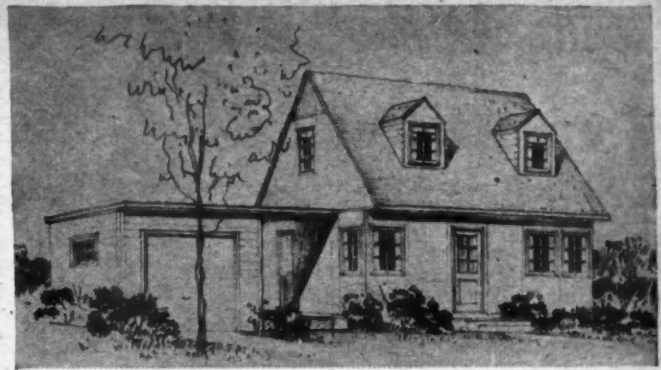

THE new Model 14 story-and-a-half HomeOla now in production.

Adaptable to Any Climate Area

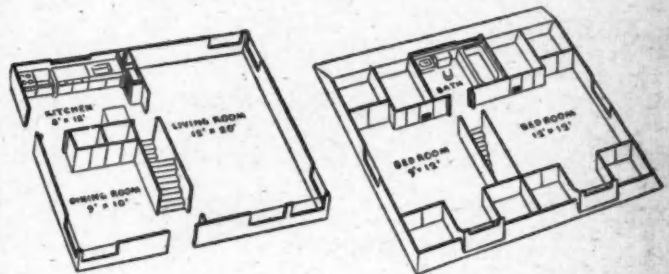

THE HomeOla Corporation, Chicago, began production early in February on the Model 14 house shown here. This house, the third model to be announced, is of story-and-a-half design with bath and two bedrooms upstairs. It is the only model announced by this firm to date which must be erected on a full basement. Both first and second floors are supported by steel beams under plywood floor panels four feet square. Roof panels are also completely fabricated at the factory. Sales price for all parts of the Model 14, including all equipment, such as heating, plumbing, wiring, etc., is \$3,220 F. O. B. Four additional HomeOla models are to be announced this spring. The Model 11 and Model 21, the latter a one-story house, have been in production for many months, and thousands have been sold and erected by dealers in all parts of the United States and are satisfying veterans' needs.

BUILDING PRODUCTS ON REVIEW - BUILDING PRODUCTS ON REVIEW - BUILDING PRODUCTS ON REVIEW

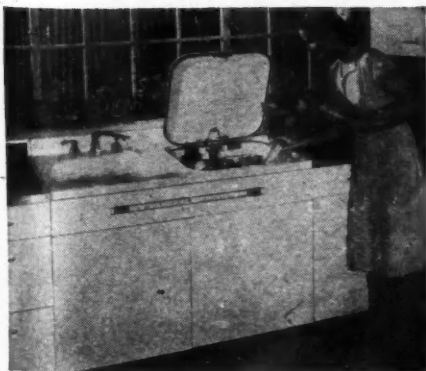

AB27113—The new General Electric automatic dishwasher performs all the functions of washing dishes, including pre-rinsing, washing, then double-rinsing and raising the lid for the dishes to air-dry quickly in their own heat. The product is a complete individual appliance for separate installation in any available space 24x25 inches. It will take up to 100 pieces of china.



AB27111—The J. N. Vikre Co., Minneapolis, developed this sash holder. When installed, spring tension adjusted accurately with the screw holds sash at whatever level desired without the use of sash balances or weights and cords. In addition to serving as a sash holder, the product eliminates window rattling. Only one sash holder is required to each sash for satisfactory results.



AB27116—The Ruberoid Co. has started production of a new asphalt shingle called Dubl-Coverage Tite-Ons. By means of an ingenious locking device each shingle is securely locked to adjacent shingles at four points, in addition to being nailed to the roof deck with four concealed nails. These shingles give double coverage over the entire roof area and triple coverage at the points where they lock.

Modern Interiors Use Standard Materials

Photos by Armstrong Cork Company



THE installation of asphalt tile in this camera shop in Milwaukee, Wis., shown above, is of old rose with a large disc of black.

A CUSHIONTONE ceiling in Cleveland, Ohio, office is shown at left.

BELOW is seen a black rubber tile installation with white strips.

TODAY science and architecture are collaborating to produce elements available for better living, by contributing new products and endowing them with usefulness and beauty. The materials with which modern man builds are many and varied. They divide themselves into two basic groups; first, those which are the direct product of nature, such as wood and stone, and second, those that require manipulation by the hands of man before they acquire their finished form.

In this modern age, linoleum, with its allied products, such as asphalt tile, rubber tile, etc., is becoming more widespread and general in its use, as it applies to the average home, commercial and industrial structures than ever before. Its durability, quietness and easy-to-clean properties make it ideal for most installations.

The former drab appearance of floors is now rapidly being changed through the intelligent use of colors and patterns. Tiles are now available in a wide range of attractive colors and sizes which make possible an almost endless number of pleasing designs and floor patterns which can be offered to the building public.

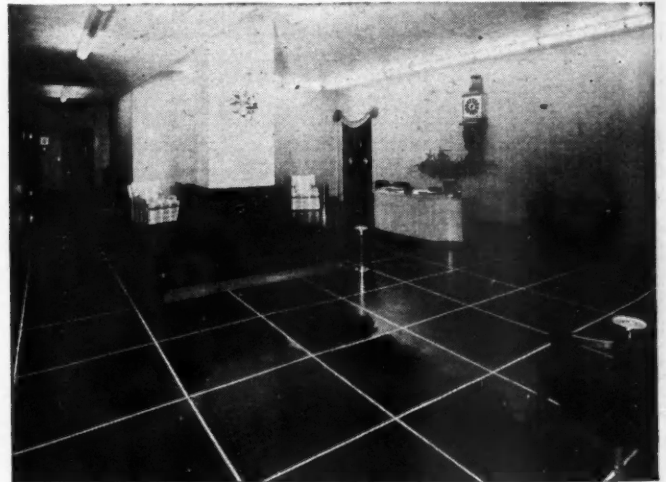

BUILDING PRODUCTS ON REVIEW — BUILDING PRODUCTS ON REVIEW — BUILDING PRODUCTS ON REVIEW

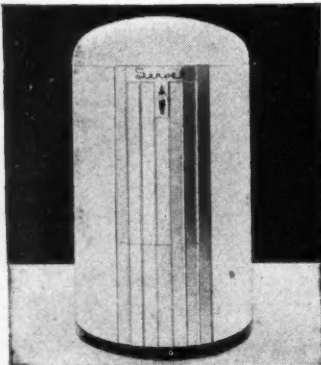

AB2792—This is the new automatic ball-type gas-fired hot water heater announced by Serval. Special burners are available for use with natural, manufactured or bottled and tank gas. The tank is round and made of toughened copper. An unusual feature is the internal heat-exchanger through tank.

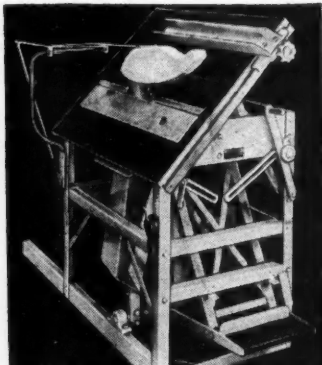

AB2788—The Paxson Co., Dowagiac, Mich., is now in production on four models of the Bearcat portable power saws. Two basic models, including the XJR shown above, are each supplied in either fixed-top or tilting-top models, the latter offering a full range of square, angle or bevel cuts.

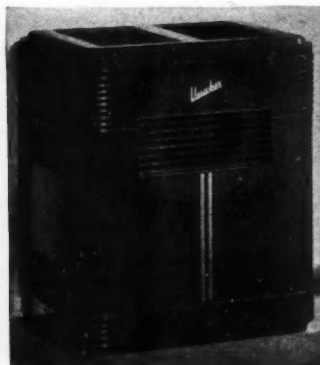

AB2769—One of the nation's foremost designers created the distinctive cabinet for the newest Quaker oil space heater. The new heater is equipped with the Quakerrol unit to overcome chimney deficiencies and save fuel by synchronizing the flow of air with the flow of oil at every flame setting.

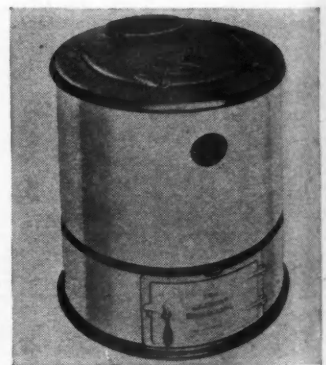

AB2758—The Majestic Company, Huntington, Ind., has announced its new model incinerator, with a capacity of three bushels. A special slotted cast iron lining in the fire chamber allows heat and flames to circulate, drying moist garbage and burning it completely. Draft opening is at top.

DECOR
bedroom
the b

LIGHT
and d
den.

BUILD

AB2798
of the
autom
freezer
more b
well-kn
There i
lection

Built-ins with Modern Lighting Combine Utility with Beauty

Photos by F. S. Lincoln, N. Y.



DECORATIVE lighting in this combination bedroom-den increases the effectiveness of the built-in bed, bookcases and desk.



A LIGHTED valance makes a focal point of the corner picture window.



LIGHT for reading in bed is both adequate and decorative in the combination bedroom-den. The surrounding shelves are lighted.

RECESSED fluorescent lighting strips used throughout the newly remodeled rooms of the Sylvania Lighting Center provide comfortable illumination without an apparent source and make light an integral part of the decorations.

In one corner and on the sidewall of the combination bedroom-den shown on this page are fluorescent strips concealed behind the window valance to dramatize this area and provide sufficient light for moderate seeing tasks, and also adding the same cheerful note as furnished by sun pouring in through the windows.

This room, designated as a combination bedroom-den, can also be used as a hobby room, study or a game room, suitable for a college or business man or woman, as well as a teen-ager. The wooden panel in the picture at the left becomes a full sized bed at night, and the lighted shelves provide general illumination. As the desk is opened the shielded fluorescent light concealed in it comes on automatically. This same desk can be opened over the bed to provide a serving table in the event of illness. A built-in vanity is concealed in top of cabinet at far left.

BUILDING PRODUCTS ON REVIEW — BUILDING PRODUCTS ON REVIEW — BUILDING PRODUCTS ON REVIEW

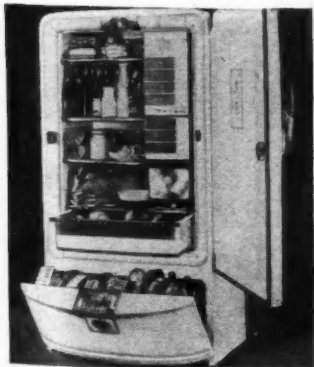

AB2798—Some of the special features of the new Norge refrigerator include automatic defrosting, extra large freezer, larger beverage storage space, more bulky food storage area and the well-known Norge Rollator compressor. There is a deep glass container for collection and disposal of defrost water.

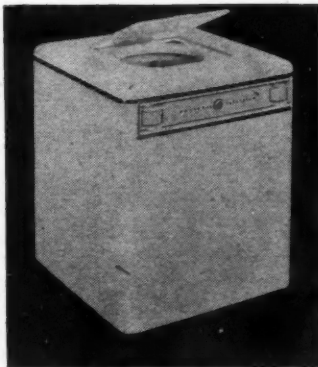

AB2786—General Electric has just announced this new automatic washer with a number of refinements. It controls the water temperature, soaking, washing, rinsing and drying, empties the tub and shuts itself off. When mounted on casters, it can be moved anywhere easily.



AB2731—A scaffold unit featuring a new principle of design has been announced by the Bil-Jax Manufacturing Co., Swanton, Ohio. The welded, all-metal units are fully adjustable in height and length, holding to a minimum the number of units required on a job. Adjustment is by screws.



AB2718—The Building Products Division of Reynolds Metals Co., Louisville, is producing the aluminum shingles shown here. Special locking features make them easy to install and assure weathertightness. The air space formed under each shingle prevents capillary action of water.

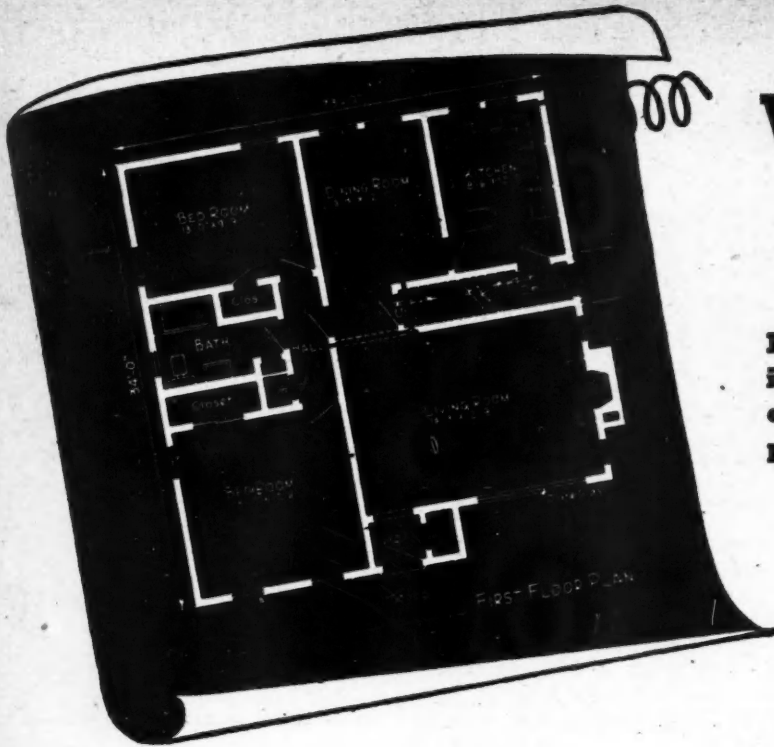

What About the Telephone?

Built-in facilities for telephone wiring have proved to be a necessity and are now among the many improvements going into new homes



THE telephone has now been recognized as an integral part of home life. The prospective home owner not only wants his telephones where they will be most convenient to use; he also expects his telephone wiring to be concealed. A new home is not modern throughout unless the telephones are installed at planned locations.

The wiring of modern homes is directly affected by the use of new materials for walls, the omission or reduction of trim around windows and doors, the absence of baseboards, and the inclusion of offset partitions, fire stops, bridging or diagonal bracing, insulation and finished basements. These and other modern building practices increase the difficulty of attaching wiring to wall and ceiling surfaces, and make such wiring more conspicuous. Those who plan and build new homes must see to it, therefore, that sufficient wiring channels and telephone outlets for present and future needs are provided before or during construction. After construction

is completed, changes to provide for these needs are costly, and not always satisfactory.

Telephones can, of course, be installed without wiring channels and outlets. When these facilities are lacking, however, the telephone wires must usually be run where they will be plainly seen, along trim or woodwork and sometimes on walls. Exposed wiring in a new home reveals that adequate wiring facilities were not included in the building plans.

Telephone wiring channels are easy and inexpensive to install between walls when provision for them is made before construction starts. The cost of providing sufficient outlets for possible future needs is small if the installation is made during construction. Once a home has been built without proper wiring channels, however, it is generally not practical to conceal the telephone wires. Exposed wiring in a home usually indicates lack of adequate planning.

BUILDING PRODUCTS ON REVIEW — BUILDING PRODUCTS ON REVIEW — BUILDING PRODUCTS ON REVIEW

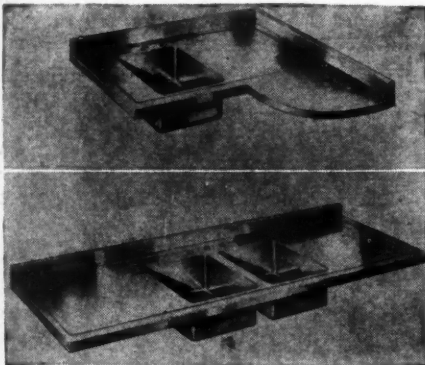

AB2740—The Just Manufacturing Co., Chicago, announces refinements in its line of Radiluxe stainless steel sinks. The sinks and cabinet tops are made with single or double bowls, in straight, "U" or "L" types. In addition to fabricating standard sizes, the firm makes a practice of fabricating to specifications necessary to meet special dimensions or installations.

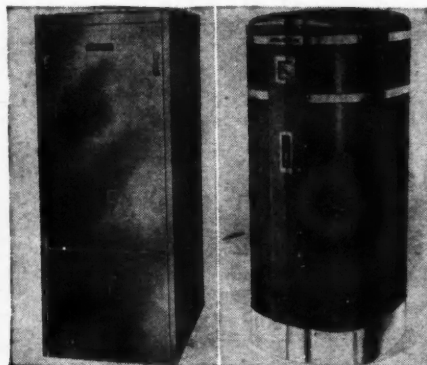

AB27114—Above at left is the General Electric oil-fired warm air conditioner being produced in sizes for any type house—large, medium or small. At right above is the General Electric oil-fired boiler for either steam or hot water systems. In addition to many special structural and functional features, these units are designed with the object of presenting a compact and pleasing appearance.

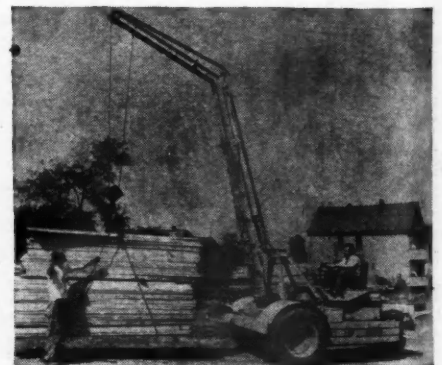

AB2730—The Silent Hoist Winch and Crane Co., Brooklyn, announces development of its Krane Kar mobile swing boom crane for handling building materials. The machine will handle and transport lumber, sand, gravel, cement blocks; palletized loads of brick, pipe, lime, coal, clay products, etc., in quantities of any size up to a maximum of ten tons. One engine provides power for work and travel.

Preferred locations for telephones vary with the individual home owner's desires, but it is generally agreed that the most desirable locations are those easily accessible to the living and working areas of the home.

In a one-story house the preferred locations are: kitchen, a centrally located spot between the living and dining room, and master bedroom.

On the second floor of a two-story house the preferred locations include: master bedroom and sewing room.

If it appears likely that additional telephones will be needed at a later date, they should be installed at the time of building. Such outlets are particularly useful to plug-in portable instruments. The extra outlets for portable telephones are useful in homes where certain rooms are used only occasionally, such as guest room, sewing room, etc. Thus the instrument may be carried from one location to another as desired.

Telephone outlets are simply metal boxes such as are generally used for supporting electric service switches, but which are installed exclusively for telephone use. Where portable instruments are specified, the telephone company places a jack in the outlet box and provides a suitable cover. The outlets may be placed at any convenient location, but should be protected from mechanical injury and from undue exposure to moisture. While outlets may be placed at any height above the floor, 18 inches is generally considered the most suitable. Quite often the building plans permit the use of a wall space for a constructed recess or niche. In such cases the outlet should be installed there.

The outlets should be connected by a wiring channel to some part of the basement or attic where surface wiring does not affect the appearance of the surroundings. In some cases adequate raceways can be provided by running a few feet of pipe to an unfinished part of the house. In others the raceway may have to be extended to the point in the basement or utility room where the protector cabinet is located, or to a location outside the house.

Obviously the extent of the arrangements for telephone service will vary with the size and appointments of the home. In some cases a complete installation will be in keeping with the general appearance of the house. In a modest dwelling certain facilities will not be required. In all cases, however, provision should be made for the outlets and for the raceway or channel from these outlets to a point where the wiring does not detract from the appearance of the surroundings.

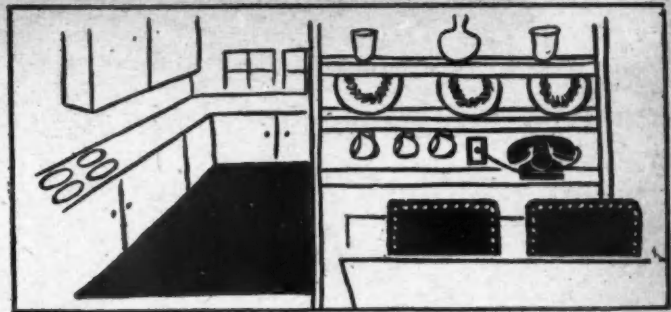

ACCESSIBILITY to working areas is provided by a telephone in the kitchen where it is convenient for the housewife.

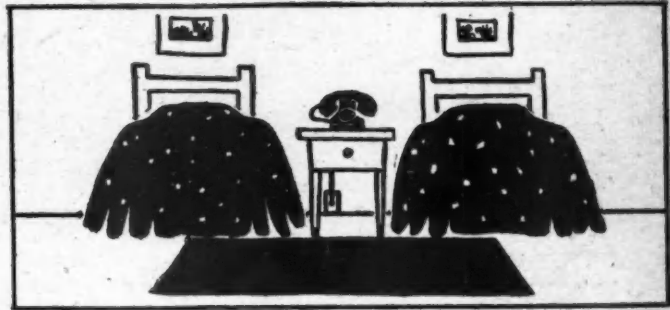

EMERGENCY calls are received conveniently through a plug-in in the bedroom, an outlet not to be overlooked.



A PORTABLE telephone in recreation room saves many steps.

BUILDING PRODUCTS ON REVIEW - BUILDING PRODUCTS ON REVIEW - BUILDING PRODUCTS ON REVIEW

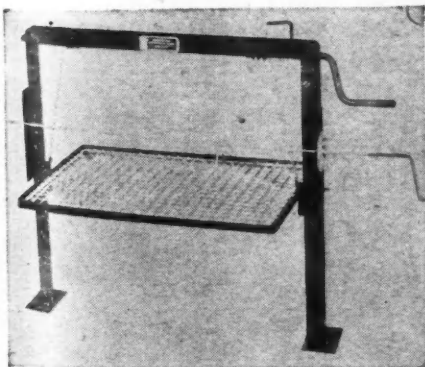

AB2724—The Southern Barbeque-Grill Co., Glendale, Calif., offers this model with a cooking area 18x24 inches. The light, removable grill is made of special steel for cooking and is easily cleaned. All grills include a hand turned spit with heat control adjustments. An electric powered spit unit is available with stainless steel spit and electric motor which will fit any Southern Barbeque-Grill.

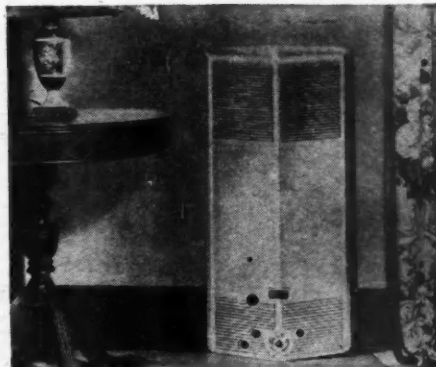

AB2717—The Heating Research Corp., Muncie, Ind., recently announced its new Saf-Aire gas-fired space heater which vents combustion fumes without pipes, ducts, flues or chimneys. The all-aluminum unit is designed for individual room use. Made in two sizes, 10,000 and 20,000 BTU an hour, it is completely self-contained and operates on natural, manufactured or liquefied petroleum gas.

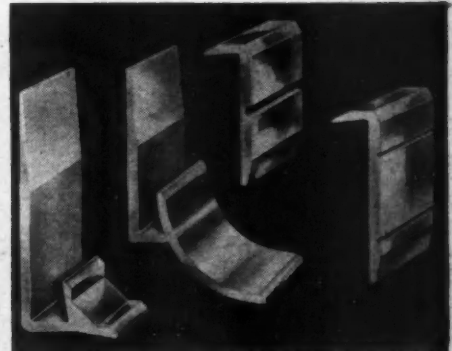

AB2732—Marsh Wall Products, Inc., Dover, Ohio, has added six new extruded aluminum mouldings to the varied lines already made. Left to right, above, are inside corner or edging; single flange cove, and two designs in counter-nosing. The new batten strip and tag moulding is not shown here. The firm recently announced a new packaging tube which provides easy identification of stocks.

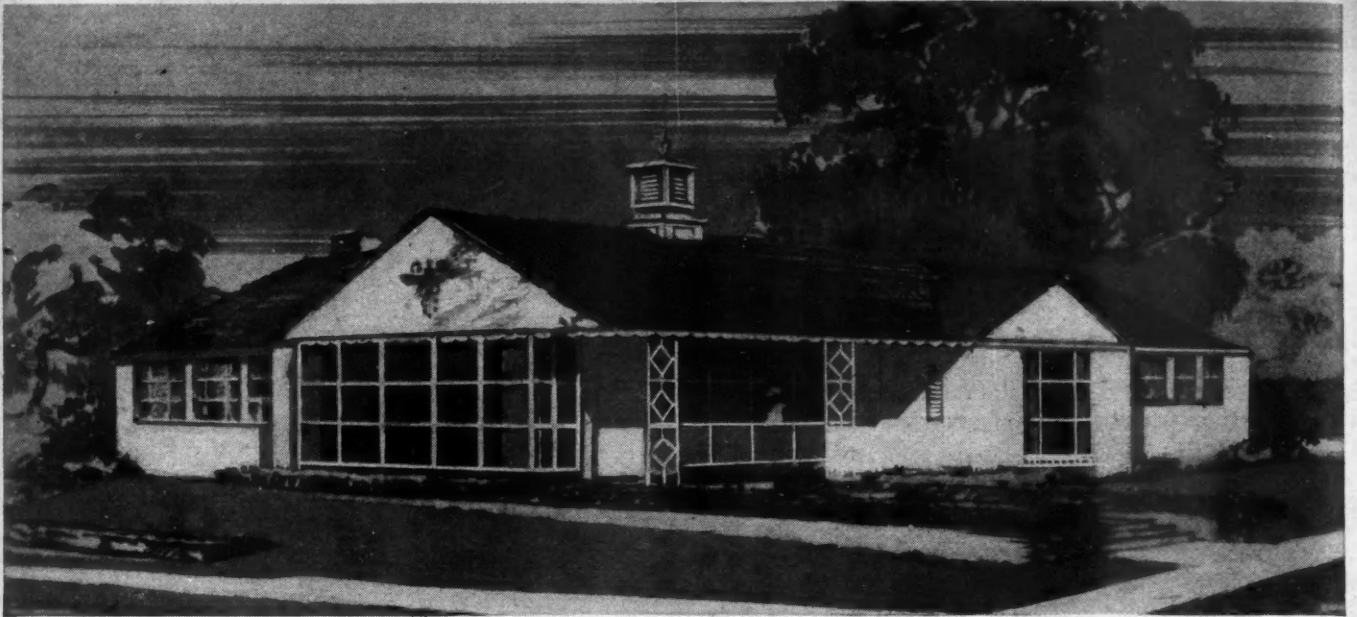

ARCHITECT'S sketch of a building which will house the activities of several doctors, to be located outside the congested area.

A Doctors' Clinic, the Modern Trend

FOLLOWING the trend which is so prevalent among those of the medical profession who have an established practice, Dr. R. B. Link and Dr. A. W. Wiley of Tacoma, Wash., have had William Arild Johnson, A.I.A., and Associates, architects and engineers, Everett, Wash., design a private clinic. This building is to be located in a high class residential area. Its design follows in general the pattern established by the homes in this community. The exterior walls are surfaced with face brick and stucco with wood shakes on the roof. The floor is concrete placed on the ground, covered with asphalt tile.

The advantages of this type of building are many. It gets away from the cramped quarters of the typical office building, permitting the doctor to carry on all phases of his work under one roof. Ample parking space is always available. It provides a dignified and ethical form of advertising.

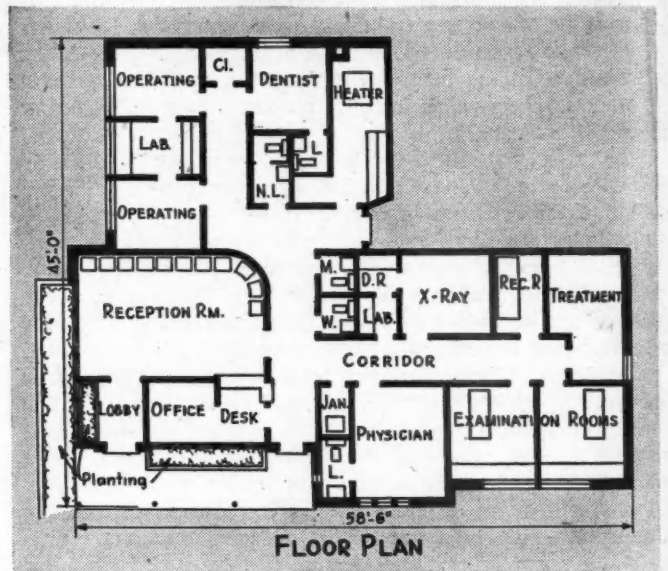

WELL defined arrangements of activities shown in plan above.

BUILDING PRODUCTS ON REVIEW - BUILDING PRODUCTS ON REVIEW - BUILDING PRODUCTS ON REVIEW



AB2774—The revolutionary new True-Sized door jamb developed by the Wheeler, Osgood Co., cuts carpenter time hanging a door from 1½ or 2 hours to 8 to 10 minutes. Three precision-milled pieces go together without nailing and are adjustable to variations in sizes of doors.

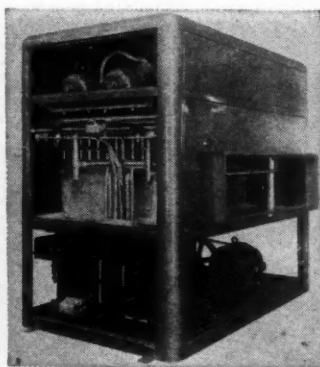

AB27102—The Drayer-Hanson, Los Angeles, new reversed cycle refrigeration system, Airtopia, provides all functions of air conditioning automatically, heating, humidifying, cooling, dehumidifying, filtering and circulating. The only energy utilized is electricity. No heating elements are used.

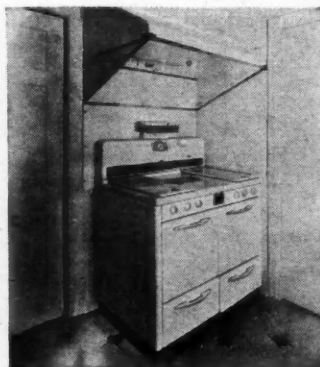

AB2760—This is one of the new models of kitchen ventilating equipment developed by the Vent-A-Hood Co., Dallas, Texas. Made of bonderized metal with a white baked enamel finish and chrome trim, they feature a grease trap and easy installation. They fit 90 per cent of domestic cooking equipment.



AB2755—This hose reel is being manufactured by the Davis Pattern and Manufacturing Co., Detroit. It can be installed on basement ceiling or wall for either hot or cold water line. Built of aluminum, it will turn the water on or off and retrieves and rewinds the hose automatically.

Am
 Er
 W
 A
 wor
 radi
 ope
 Sou
 T
 a po
 ord
 and
 The
 tele
 in t
 othe
 spac
 men
 In
 rece
 It v
 of v
 cov
 15,0
 qua
 ity
 H
 any
 quin
 man
 cati
 with
 elec
 T
 a pa
 the
 desi
 swi

AB27
 is be
 cago
 direc
 tapp
 wall
 it
 mete

Entertainment in Every Room With Built-in Home Radio

New device, to be functional part of the home, will be distributed by mill-work jobbers through lumber dealers

A NEW type built-in radio and home sound system has been designed and engineered as a functional part of the home and is to be distributed by mill-work jobbers through retail lumber dealers. The new radio system, known as Reeves Soundcraft, was developed by Hazard E. Reeves, president of the Reeves Sound Studios, New York.

The Soundcraft system consists of four major parts—a portable tuner or station selector, an amplifier, a record player and a speaker or speakers, plus an antenna and the necessary wiring to connect the various units. The portable tuner, which is about the size of a cradle telephone, is the only part of the system that appears in the room, all other units being built in the walls or other suitable space. The amplifier, which takes up a space 9 x 14 x 8 inches, can be placed in a closet, basement or attic.

Initial production will provide for standard AM reception only, but an FM tuner will be provided later. It will be available with two classes of speakers, both of which can operate off the same amplifier. One will cover the complete range of human hearing from 30 to 15,000 cycles per second. The other will deliver sound quality equal to or better than that of the highest quality console machines.

Home builders and architects will be able to select any combination of types or number of speakers required to suit specifications of the home owner. The manufacturers have given special effort to the simplification of the wiring system so that it can be installed with the general wiring contract by any competent electrician.

The speakers and their connections are mounted on a panel for ease of installation. Special outlets to receive the plug-in jack of the tuner cord can be provided where desired in the rooms that have speakers. An on-and-off switch can be provided at each speaker location.

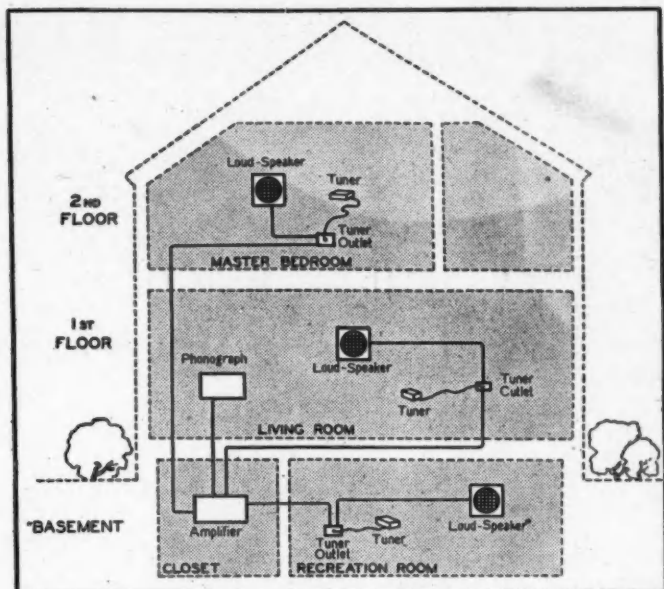

DRAWING above shows typical installation of the Soundcraft system with which a single tuner and amplifier make it possible to listen to high fidelity radio and phonograph anywhere in the home. Diagram illustrates system's flexibility.

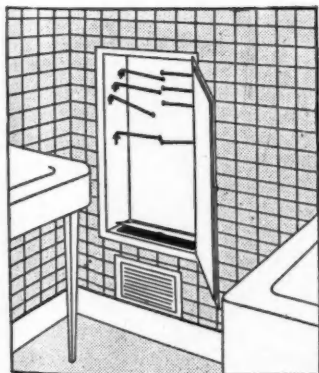
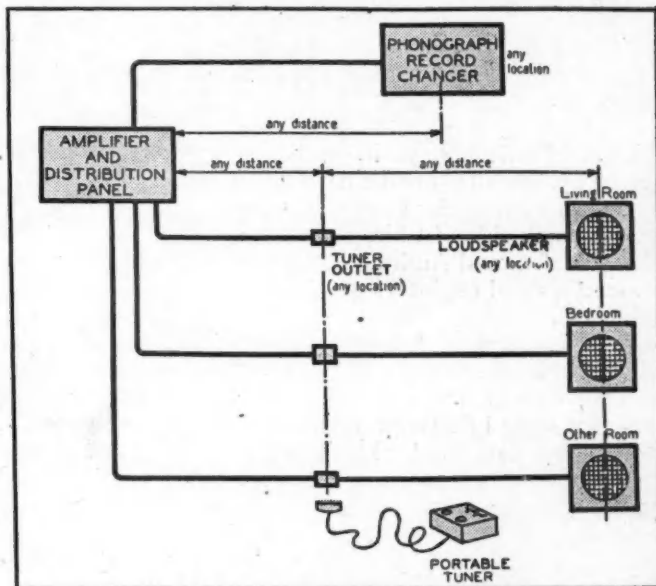

AB27104—This flush-wall drying cabinet is being made by Meck Products, Chicago. It can be installed in the wall, directly over a hot air register and tapped into hot air flue through a well at the bottom of the cabinet. It is constructed of heavy sheet metal and finished in baked enamel.

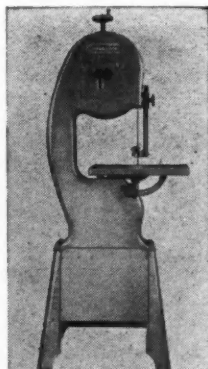

AB2782—A new all-purpose band saw of unusual design for use on plastics and wood has been developed by Livingston Mfg. Co., South Gate, Calif. Although designed for wood it may also be used for metals. The frame and guard are a one-piece casting with vertical cutting clearance of 10 inches.

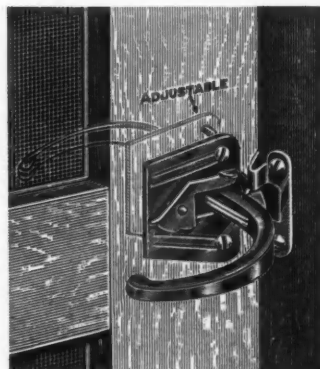

AB2779—A distinctively styled, stronger screen door latch with cast brass, bronze or aluminum handles is now being produced by the Ideal Brass Works, St. Paul, Minn. The stamped handle, which the firm has been making since 1940, is used now only in their steel screen door latches.

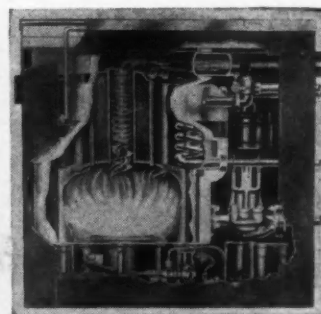

AB2703—This is a cross-section of the new automatic oil-fired boiler-burning heating unit made by Miller Co., Meriden, Conn. Although it is so compact it will fit in an ordinary kitchen cabinet, it has sufficient capacity to provide hot water radiation for heating small homes in addition to heating hot water year 'round. The Miller-developed heat Spirator provides high efficiency.

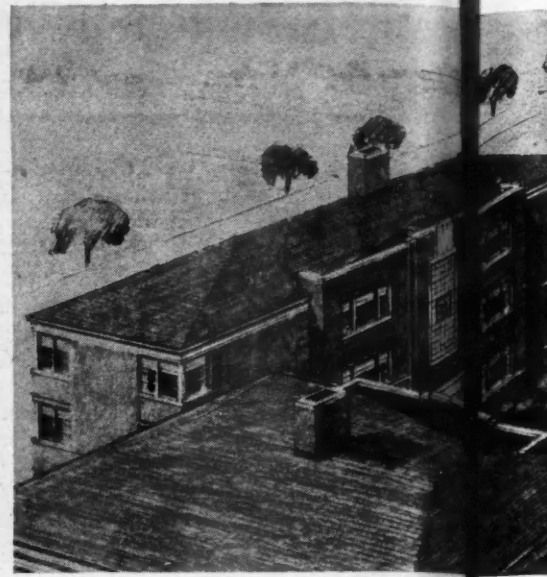

VIEW at left indicates progress that has been made in the construction of seven apartment buildings comprising this project.

Cooperative Apartment Project for Veterans

SEVEN buildings, each containing six apartments, are being erected on a large rectangular piece of ground on the north side of Chicago by John H. McMahon and Andrew P. Rebori, contractors and engineers of Chicago, Illinois.

This cooperative housing project will provide apartment homes for 42 families of war veterans. McMahon says that some 1,800 applications have already been received. These are in the process of being screened, and the selection of tenant-owners is now under way.

Each building will be three stories high, plus basement which will con-

Work is under way on the \$400,000 project to provide co-op apartment homes for 42 veterans' families

tain numerous community facilities available for the use of all owners as needed. These include laundry, storage space, locker rooms and children's playrooms. Each apartment will include a large living room, a combination dining room and kitchen, two bedrooms and one bath.

"For the benefit of the veteran buyers, the project is being organized

along cooperative lines," said McMahon. "A corporation is to be created for each building; the six veterans whose applications are accepted for each of the buildings will contract to buy an undivided one-sixth interest in the land and the community space of the building, and one-sixth interest in the building, consisting of one of the dwelling units."

"As soon as the buyers receive title to their interest, each will execute the necessary G.I. loan papers and mortgage papers to secure a 25-year loan to pay the balance of the purchase price. The down payment will be \$970 for an apartment costing \$8850. The

BUILDING PRODUCTS ON REVIEW — BUILDING PRODUCTS ON REVIEW — BUILDING PRODUCTS ON REVIEW

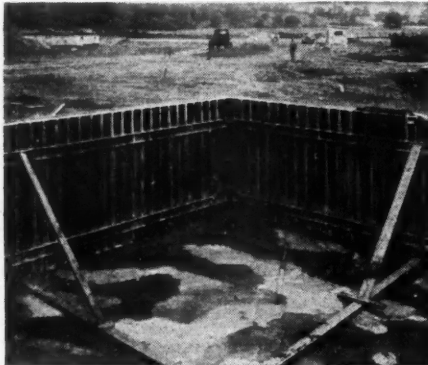

AB2711—The Irvington Form & Tank Corp., Irvington, N.J., has developed a new type form made up of steel channel units joined into panels with wedge bolts. A hammer is the only tool needed for assembly of the units which weigh 30 to 45 pounds. Studs or joists are not needed for support and 2x4 walers line up the panels. Different widths permit easy dimensional adjustments.

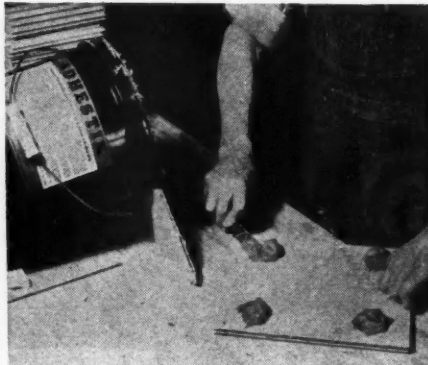

AB27117—A workman is shown here applying Adhestik to Nu-Wood insulating tile. Adhestik is a permanently plastic adhesive used wherever it is not practical to use nails in applying insulating board tile. Applied in dabs directly to the tile, each unit is placed in position and moved back and forth to provide a good bond between the surface to which the tile is being applied and the tile itself.

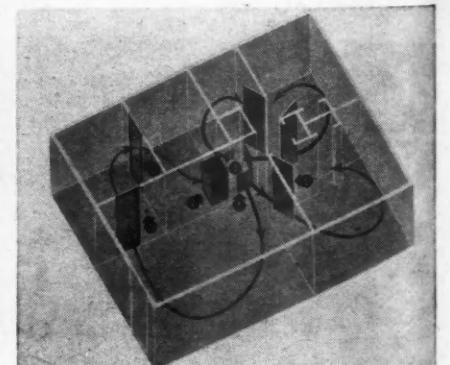

AB27112—A small home heating system for basement houses or apartments has been developed by Mechanical Home Systems, Inc., Chicago, known as Mechanicore. Fired by city gas, bottled gas or oil, a large fan forces warm air through a specially-designed plenum to eliminate ducts and yet obtain heat distribution to all rooms automatically in an infinite variety of room layouts.



ARCHITECT'S sketch showing a bird's-eye view of the buildings facing a long center court.

veteran will then convey his interest to his building corporation in exchange for one-sixth of its stock, and for a permanent proprietary lease on his particular apartment," McMahon explained.

"Each buyer's stock will be pledged to the corporation in the usual manner to insure the proper payments as he

has agreed," he said. "He will pay his mortgage payments, plus his share of the regular taxes and operating expenses of the building, each month as though it were rent. He will own one-sixth of the corporation which in turn will own the building, and thus he will be owner of his own home in this apartment project," he concluded.

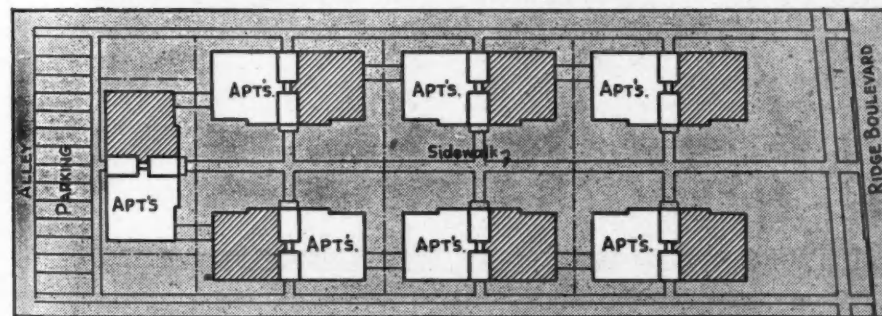

OVERALL plot plan, with buildings facing court. Typical apartment plan at right.

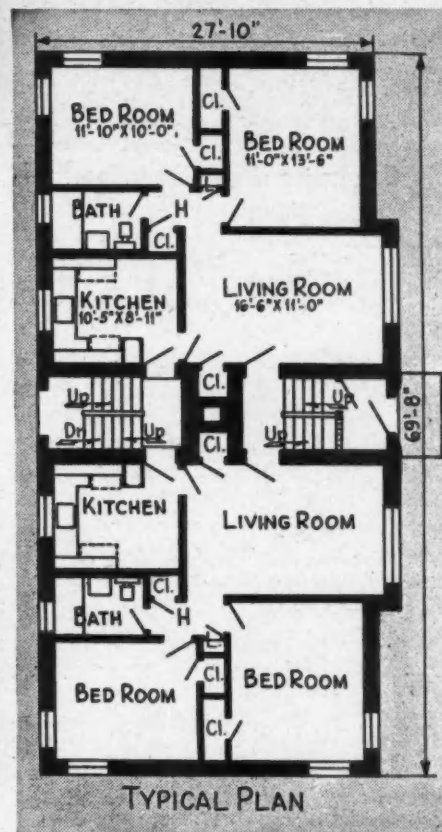

TYPICAL PLAN

BUILDING PRODUCTS ON REVIEW - BUILDING PRODUCTS ON REVIEW - BUILDING PRODUCTS ON REVIEW

Additional items in the New Products Review and Preview appear on page 156 and following. In filling out the coupon at right, please designate the products about which you desire information by number preceding description of item.

For information, write numbers of products on lines below and mail coupon to:

American Builder, Readers' Service Dept.
105 W. Adams St., Chicago 3, Ill.

.....

.....

.....

.....

.....

NAME

ADDRESS

CITY..... STATE.....

base-
veloped
known
d gas
a spe-
s and
auto-
ayouts.



HOUSES in Kansas City, Mo., built with Haydite blocks made with Universal-Atlas Duraplastic air-entraining cement.

Air-Entraining Cement for Structural Concrete

CONTINUOUS research in the manufacture and use of Portland cement in the past thirty to thirty-five years has brought steady improvement in a great variety of cement and concrete products and applications. Perhaps the most striking advances have been the development of the water-cement ratio theory of a quarter-century ago, and the more recent and probably lesser known discovery that air-entraining Portland cement produces concrete for many uses with properties not possible or not easily possible with ordinary Portland cement.

Air-entraining cement is ordinary Portland cement to which an air-entraining agent has been added for the purpose of introducing air cells in the finished concrete. It was developed originally to produce longer wearing surfaces in concrete pavements by giving the concrete greater resistance to the stresses developed by alternate freezing and thawing, and to cut down surface scaling from the use of de-icing compounds on pavements. Tests conducted on pavements over a period of years have indicated increased durability, and have led to methods for controlling the amount of air entrained, and thus to the predetermination of increased plasticity and workability, and decreased segregation and bleeding.

Tests have shown that cements from different mills require different amounts of air-entraining agent for satisfactory results, and that with the amount of agent determined for the cement produced at a given mill, the amount of air entrained does not vary with mixing time. Other tests show that low mixing temperatures affect air-entrained and non air-entrained cements in the same way; that the use of calcium chloride increases the development of early strength in both kinds of concrete; and that air-entrained cement, with or without calcium chloride, offers increased resistance to scaling.

It was natural that after the new cement had proved itself in paving work and airport runways, builders, concrete block manufacturers, and operators of ready-mix plants would inquire about the feasibility of air-entrained cement for concrete building products. Among the first of these were the block manufacturers, constantly seek-

ing to cut down their breakage percentages, and increase output. Since the cost of air-entrained cement to the user is the same as the cost of ordinary Portland cement, several concrete block manufacturers conducted experiments of their own, producing blocks from both kinds of cement under identical conditions.

Permits Wetter Mix for Block Machines

Air-entraining cement permits the use of more water than ordinary cement without sacrifice of strength, and thus the dry or semi-dry mixes used for cement block can be wetter. This permits better feeding through block machines. An ordinary cement mix as wet as this in some block machines would cause the concrete to stick, and fail to feed uniformly into the mold box. It was found that the additional water permitted with air-entrained cement, sometimes as much as a half-gallon a bag, decreased the surface cracks in the blocks. The decrease in surface cracks, aggravated by the least carelessness in handling from block machines to curing racks, improved the quality of the blocks, and decreased the failures. Generally, more uniform products were produced, appearance was improved, resistance to water penetration was heightened, and no additional expenses were incurred in the manufacturing process. One of the recent housing developments employing concrete blocks made with air-entrained cement was that of the Chrysler Homes Corp. in Kansas City, Mo. Some of the houses in the development are shown in an accompanying photograph. The blocks are characterized by an absence of edge tear, by exact edges and corners, and by uniform face texture. Haydite aggregate was used in the blocks for the Kansas City houses, but improved texture has been observed in blocks with all types of aggregate where air-entrained cement has been used, and without regard to whether the machine used was a vibrator, mechanical tamper or hand tamper. A number of water resistance tests on cured blocks have been made. All of them show superior resistance on the part of blocks made with air-entrained cement. Several of the tests on blocks made in the same plant were per-

formed by inverting a milk bottle full of water on the top surface of blocks made with ordinary cement and air-entrained cement. The water passed through the outer shell of the former in a few minutes, whereas no water passed through the latter in 24 hours.

Big Advantage with Coarse Aggregates

Greatest improvement in appearance and decline in breakage was reported particularly in cases where coarse aggregates were used. This was due to compactness resulting from increased plasticity.

Recently, the use of the new cement has been expanded to embrace all types of concrete work in building and engineering construction. Home builders have adapted it to the construction of foundations and driveways. Improved workability, and practical absence of segregation or bleeding have brought it into prominence for repair work on such structures as dams where the concrete is subject to alternate thawing and freezing, and to the continuous abrasive action of flowing water. For foundation work on houses the workability feature produces wall surfaces free from pockets and sand streaks.

A recent outstanding example of the use of air-entrained cement for all structural concrete purposes was the office building constructed for the LeTourneau Co. of Georgia at Vicksburg, Miss. An accompanying photograph shows the building, designed by Bryant E. Hadley, architect. In addition to the sidewalks and exterior stairs, the foundations, sills, lintels and floors were formed with concrete made with air-entrained cement.

Reduced bleeding and increased durability are accomplished in concrete made with air-entrained cement through the action of the entraining agent and the small amounts of sodium and potassium compounds that are present in all Portland cements. When water is added to cement containing a small amount of air-entraining agent (animal fats, vegetable oils or resins) the alkalis are dissolved, and small amounts of soap are formed. The soap can be made beforehand and added at the grinding mill or at the concrete mixer. The mixer whips a small amount of air into the concrete. The soap forms, and the air becomes entrapped in uniformly distributed microscopic air bubbles, which repel each other and do not unite to form large bubbles. Numbering billions per cubic foot, the bubbles act as fine aggregate, permit reduction of both sand and water, and reduce or eliminate segregation and bleeding. The bubbles act like ball bearings holding



SIDEWALK made with Duraplastic air-entraining Portland cement.

apart the particles of fine and coarse aggregate, and permitting them to roll freely on the bubbles, but not through or around the bubbles. Thus, the particles are not permitted to settle or move from their relative positions. Because of the action of the bubbles there are few or no channels formed by segregation or bleeding, but only small channels formed by the water retained in the cement paste. When water enters these, the expansion of freezing water or of crystallizing salts does no damage to the concrete, partly because of the small volume relative to the surface of the channels, and partly because of the cushioning effect of the air in the small voids left by the bubbles.

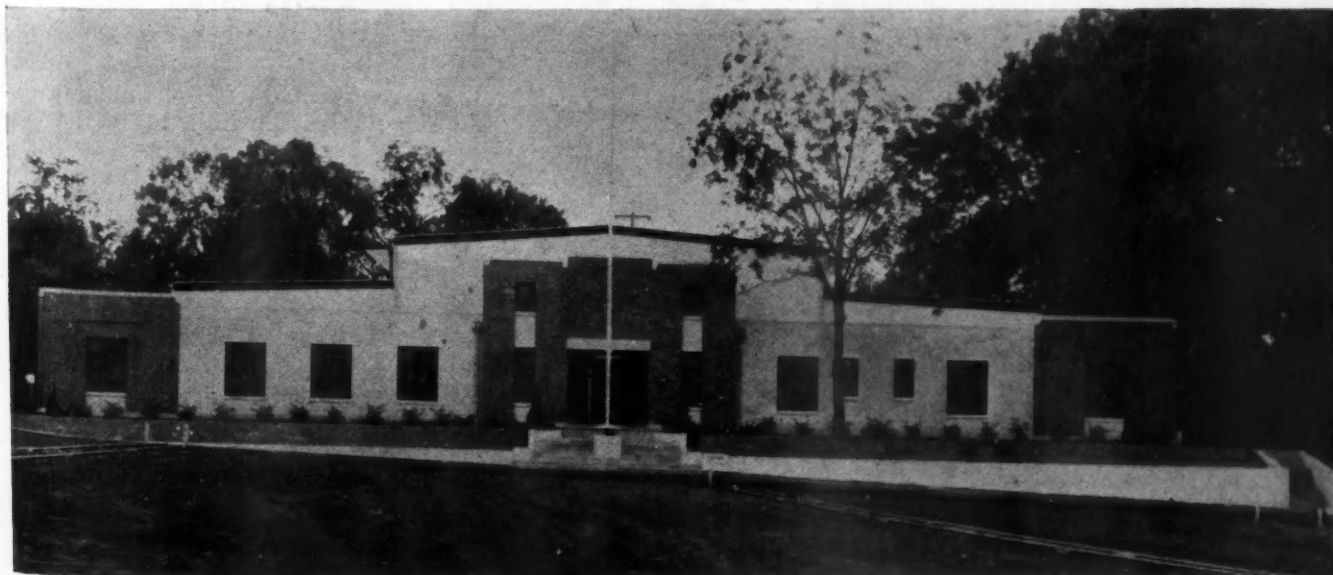

AIR-ENTRAINING cement was used for foundations, sills, lintels and floors in this Vicksburg, Miss., office building.



VIEW of the store looking towards the rear. Its overall length is divided into sections which permit an attractive informal arrangement.

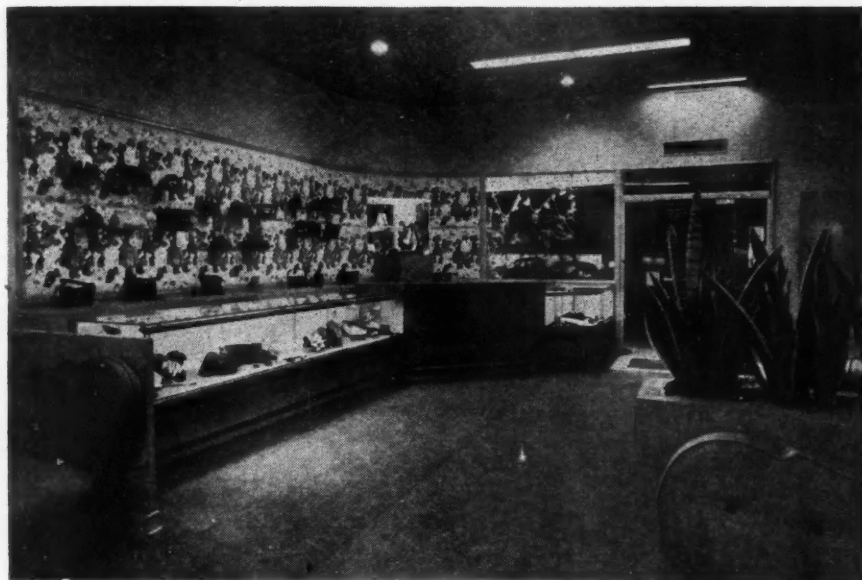

RICH wall fabrics and display cases form a backdrop for the showing of accessories.



PINK Tennessee marble fireplace set in mirror-paneled wall adds note of comfort.

Well Styled

The Sax Shoe Store in Gary, Indiana, has been designed to obtain an effect that would take it out of the commonplace. Through the mediums of wood, glass, and a startling color scheme, this aim has been accomplished

WITH the completion of the remodeling work, a new high point in retail shoe store development has been established in Gary, Ind. Designed by Frank J. LaPasso, Chicago architect, for A. A. Sax, Gary, Ind., it represents the latest thoughts and innovations in this type of store planning.

The exterior surfaces up to the second floor sills are faced with pink granite on which are placed neon letters. Ample display space is provided by two show windows. Seen on the right upon entering is a large curved window which is used for feature displays. On the opposite side is a smaller box-type window, used for casuals and accessories. An all-glass door and sidelights provide an unobstructed view of the interior of the store.

Within the store, large mirrored panels extending from floor to ceiling tend to increase the spacious appearance of the salesroom. The

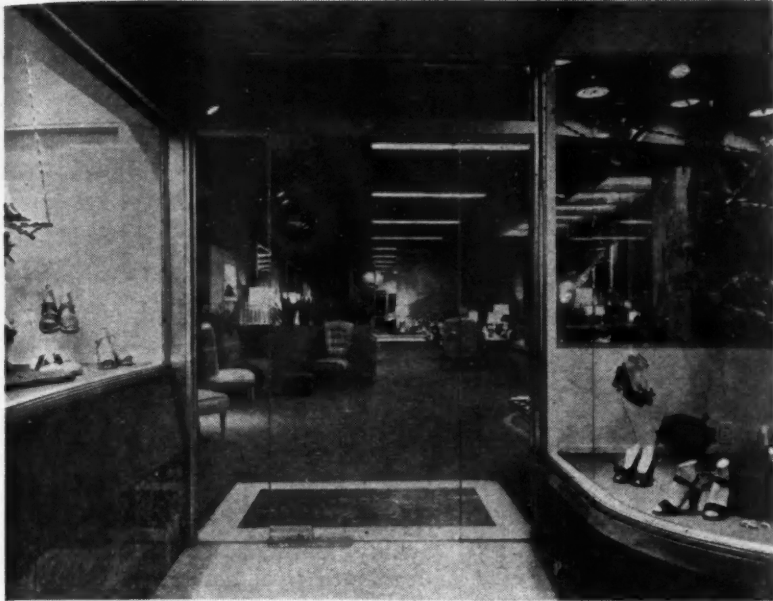

AN all-glass door affords a complete view of interior from street.

Store Builds Sales

deep egg-plant color used on the walls and ceiling produces a very dramatic effect. The furniture used throughout the store has all been custom-made from the architect's designs. It is upholstered in empire green, fuchsia, and chartreuse colored materials, as well as beige and fuchsia flowered fabrics.

Mirrors have been used effectively in the extension of the oak paneled, curved wall at the rear of the salesroom; the reflection of the sectional divisions which embraces a planting area in each increases its depth. A fireplace of pink Tennessee marble has been placed in the center of the large mirrored panels on the north wall. Above is a concentration of light in a large flat ceiling fixture forming a cap piece for wall treatment.

The interior display of merchandise features four large shadow boxes that are built into the walls and accessory display cases and shelves. Large stock and receiving room is convenient to the salesroom. Cold cathode lighting has been employed throughout and the entire store is completely air conditioned.

DRAWING, below, shows store front remodeling. Floor plan at right.

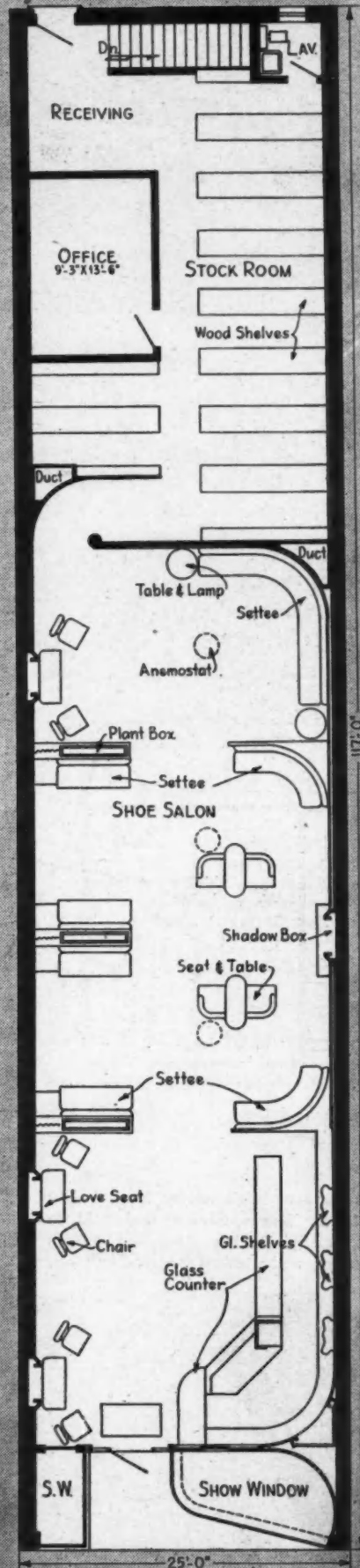
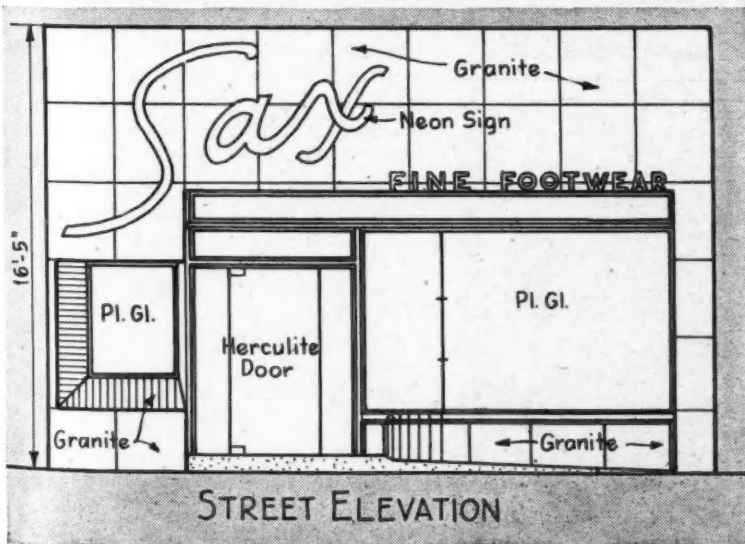

47.
ent.
d
ry,
ed
at
the
nd
his
ed
re-
point
has
De-
ago
nd.,
and
store
the
pink
neon
pro-
n on
arge
for
osite
low,
An
wide
erior
ored
ceil-
ious
The

Private Builders



New addition of 166 low-cost good quality single-family dwellings developed especially for negroes. Five four-family apartment buildings being built to rent exclusively to negroes

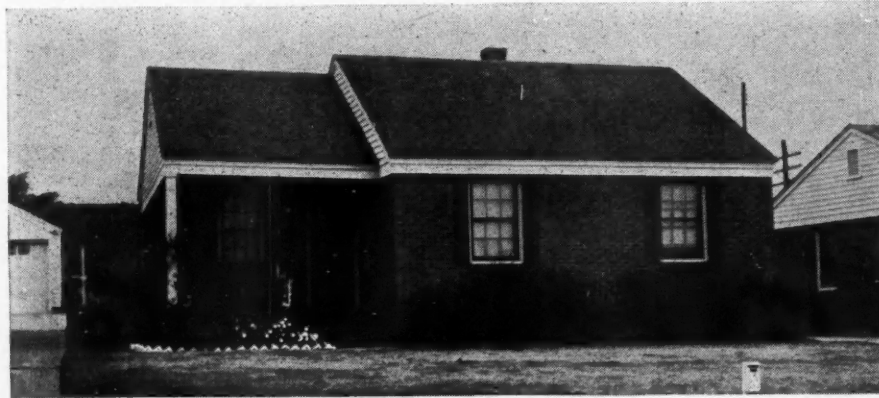

WITHIN the last two years a new subdivision of low-cost good quality housing for negroes has been developed by Oklahoma City home builders. Carverdale Addition was platted into 188 building sites exclusively for Negroes in May 1944, and by the end of 1946, 166 single-family two-bedroom houses had been erected and sold for prices in the \$5,500 to \$7,000 range.

THE house above was built by John Martin in the new Carverdale Addition for negroes. Completed in 1945 the sale price was \$6,250. Floor plan is at left.

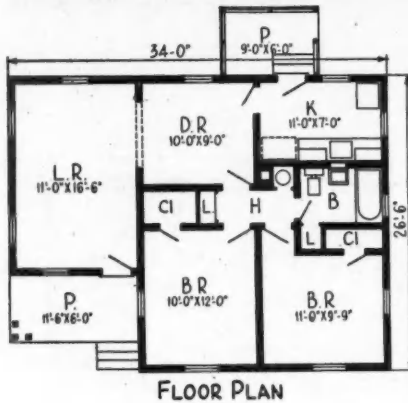

THE two-bedroom brick veneer home below was built by Roger Givens and sold to a negro family in July 1945 for \$5,850. Front entrance and window reversed on plan.



Building restrictions in the addition specify that all lots are for occupancy by members of the negro race for residential purposes only. Restrictions also prohibit the use of any trailer, basement, tent, shack, barn or other outbuilding for residence, either temporarily or permanently. No residential structure is permitted on a lot with an area of less than 4,750 square feet or a width of less than 50 feet at the front building line.

The one-story houses in this addition, which are restricted to a minimum floor area of 700 square feet, are all constructed according to Federal Housing Administration standards and will meet requirements for a 100 per cent G.I. loan. The present average purchase price on the houses in Carverdale Addition is \$6,800. All assessments for pavement and utilities are paid.

Practically all the houses are basementless with brick veneer exterior up to gable ends, built over several basic floor plans but with sufficient variation in front elevation to eliminate the appearance of row housing. Floors are oak and heat is provided by floor furnaces. Bathrooms are finished with tile and are equipped with quality plumbing fixtures.

Several Oklahoma City home builders assumed the job of constructing these attractive, low-cost homes for negroes. Each builder took over a group of lots and with his own crews and methods completed his portion of the addition. Definite standards were established and adhered to so that the finished

Provide Better Negro Housing in Oklahoma City

project is a credit to everyone who participated in its completion in addition to relieving a housing problem for the Negro race in Oklahoma City.

In constructing homes for sale in Carverdale Addition, Roger Givens, Oklahoma City builder, encountered a number of Negro families with means who did not desire to purchase a home but were interested in renting good housing. He proceeded to acquire a plot at 1404-1420 East Ninth St. with 250 feet of frontage 150 feet deep. Last year the Givens firm completed construction of five four-family apartment units on this site. Each building has a 48-foot frontage and is 36 feet deep, placed in a semi-circle around a court to be landscaped facing the street. The buildings have two units on the first floor and two on the second, each of approximately 800 square feet, consisting of two bedrooms, living room, kitchen with built-in dining space and tiled bath, with a shower over the tub.

Oak flooring is used throughout with floor furnaces providing heat on the first floor and wall panel heaters on the second floor. The kitchens in these units are especially well planned and constructed. Good quality kitchen cabinets with ample storage space cover one wall above and below a tiled work counter. The built-in leatherette dinette set with round table provides ample dining facilities in roomy surroundings. Kitchen floor is covered with asphalt tile and all windows are equipped with venetian blinds. A large expanse of glass block in the upper half of the exterior wall enclosing the stairway to the second floor provides plenty of daylight in the hallway.

These four-family apartment units, planned and constructed for rent to negroes, have been designated as the "Modern Air" apartments. They will rent at \$50 per month unfurnished, including water, and garbage removal. The quality of construction and attractive appearance of these apartment units have improved the appearance of the street on which they are built, and when completed and landscaped will add immeasurably to the value of surrounding property.

In carrying out this program of housing for negroes, Mr. Givens, along with other Oklahoma City home builders, is definitely planning to discourage any possibility of developing blighted or slum areas in the city. In doing this they are not only assuring that such property will remain definitely on the active tax producing rolls of the municipality, but they are making a definite contribution toward better standards of living.

BELOW is a partial view of the five four-family apartment units to rent for \$50 per month. Floor plan is at right.

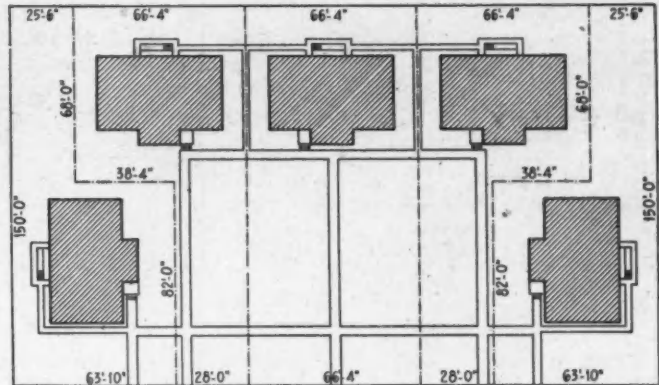

PLOT plan for Modern Air negro apartments built by Roger Givens.

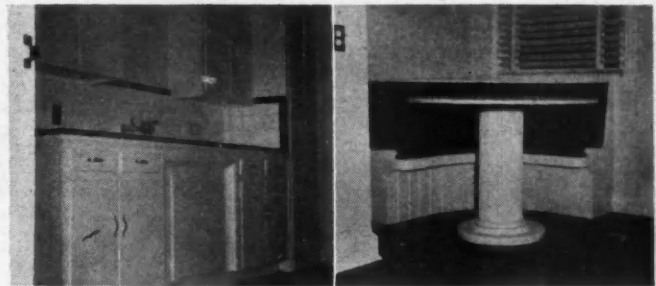

AMPLE kitchen cabinets, tiled work counter and built-in dinette.

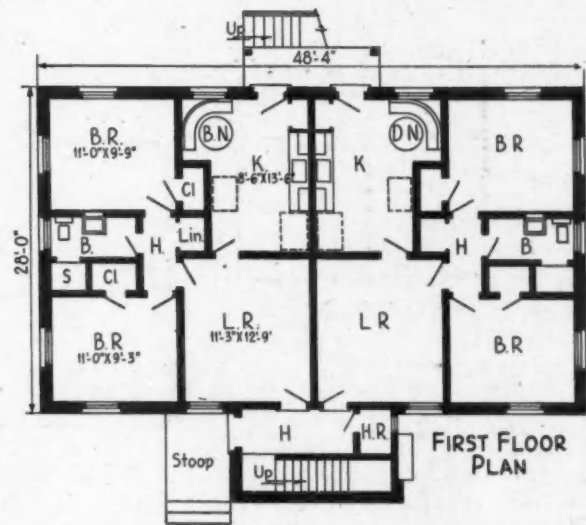



How-To-Do-It Pointers

How to Make an Emergency Brick Carrier

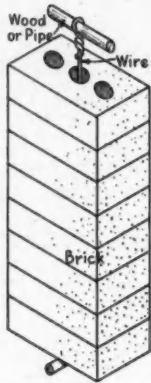

W. A. Woodard, Volga, S. D., submits the following: For carrying brick up a ladder when building chimneys, twist a 1" eye on both ends of a piece of smooth wire through center holes of brick. Slip a wood dowel rod through eyes and carry by one end as shown.

How to Tighten Loose Stud in Metal Seat

Geo. T. Mann, Fort Meyers, Fla., submits the following: To tighten a loose stud without marring the threads with wrench or pliers, start it into the seat with fingers. Then run a nut part way down the stud. Then pull a second nut down on the first one and tighten, until the stud is as tight as desired. Then hold the bottom nut firmly and loosen the top one. Both can then be easily removed and the stud is ready for use.

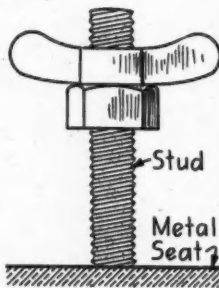

How to Make a Guide Block for Window Pulleys

Cecil J. Walters, Newton, Kans., submits the following: A block as shown will make easy the job of boring holes for pulley mortises in window jambs. Make block as shown and place screws through the wood according to measurements. The block should be laid flush with outside edge or against blind stop. Tap lightly and bore the spotted marks with a $\frac{5}{8}$ inch bit.

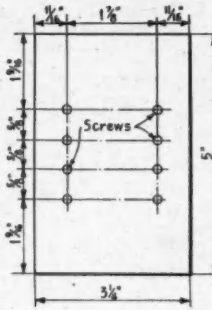

How to Make a Mortise Lock Boring Gauge

Irwin Ingle of Bondurant, Ia., in presenting the following suggestion, says: "This gauge gives uniform desired depth of mortise, and prevents the bit from ever breaking through the panel stile."

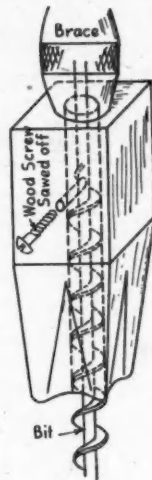

How to Make a Drill That Will Not Break

John Menkveld, Grand Rapids, Mich., in submitting this idea, says: When drilling hardwood for nail holes, instead of using drills which break very easily, I use a nail of the same size and flatten the point by laying on top of another hammer. Then I pinch off head and file the sides of the flattened part to a sharp edge like a drill point. This will last for a long time.

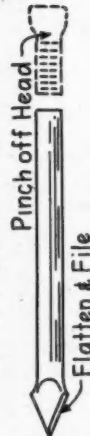

AMERICAN B

Kitchen and Dining Requirements in a Medium Sized House

By R. J. Alexander

THE area of a floor plan devoted to food storage, food preparation and dining requires more study than any other portion of the plan. If satisfactory results are to be attained, then care to insure convenience must be combined with skillful designing to gain a pleasing appearance.

The detail sheet presented by the *American Builder* this month is intended to show the young designer or builder what is required in the kitchen and dining space of a small five- or six-room house.

No attempt has been made to show the construction details of the cabinetwork; in a majority of the houses they would be factory built. Many millwork factories make kitchen units in various designs and sizes—designs that can be assembled into any desired arrangement of cabinets, and sizes that can be adjusted to fit almost any given area or wall space.

Base units (underneath the counter top) consist of drawer units and pan cupboards, or a combination of the two having both drawers and doors. Units that may be used under standard sinks and those having metal flour and sugar bins are also available.

Wall units are made in various sizes to be used over base units, and shorter ones to be used over ranges and refrigerators. Some manufacturers make cabinets for trays, spices and special equipment.

Broom closets, corner cabinets, and open corner shelves are other factory-built units that may be used to gain greater convenience and originality in the kitchen plan.

It is good practice to have a door separating the kitchen from the living portion of the house. This door may be between kitchen and dining room or dining room and living room, depending on the arrangement. For this purpose a sliding door is desirable. This type of door is now available for use in a standard 2x4" stud partition.

A convenience quite often overlooked is ample storage space for dishes. Extra storage space may be provided for in the dinette and the cabinets may become a design feature.

Manufacturers of kitchen sinks, ranges and refrigerators have played a leading part in making today's kitchens more convenient and attractive, and offer many suggestions that help in efficient planning.

No. D. 28. DETAILS OF KITCHEN & DINETTE CABINETWORK

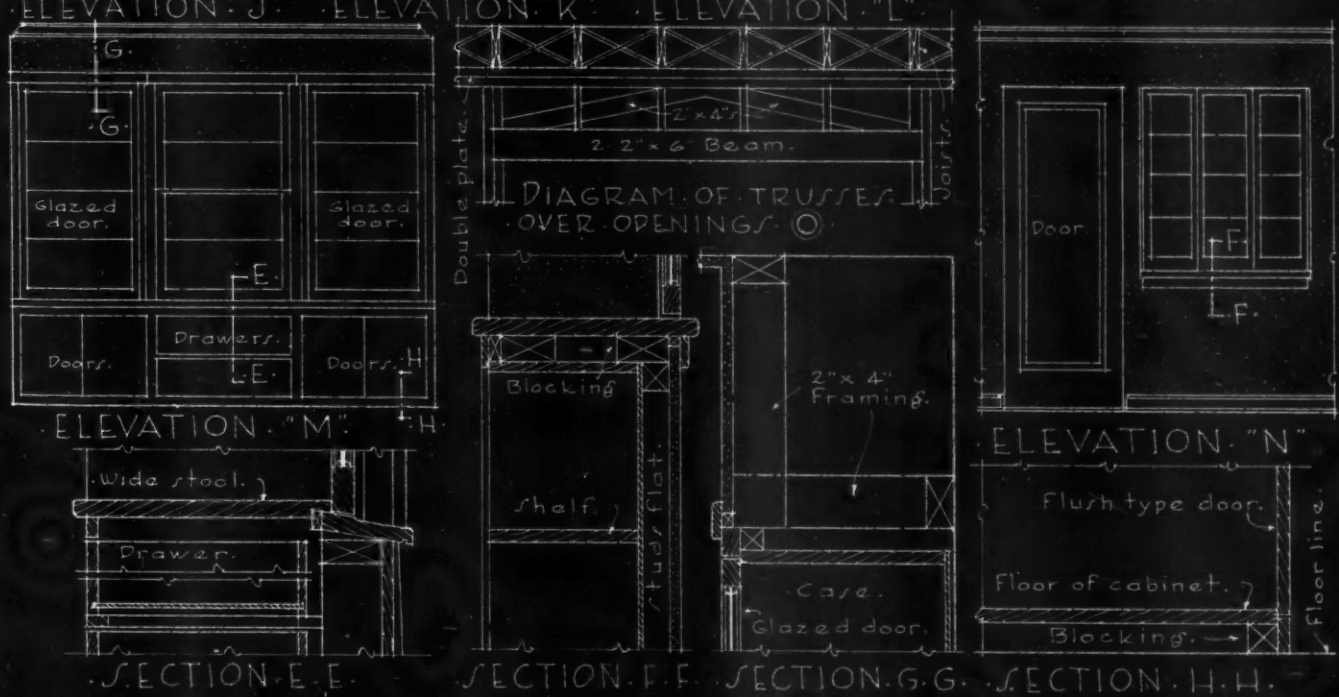
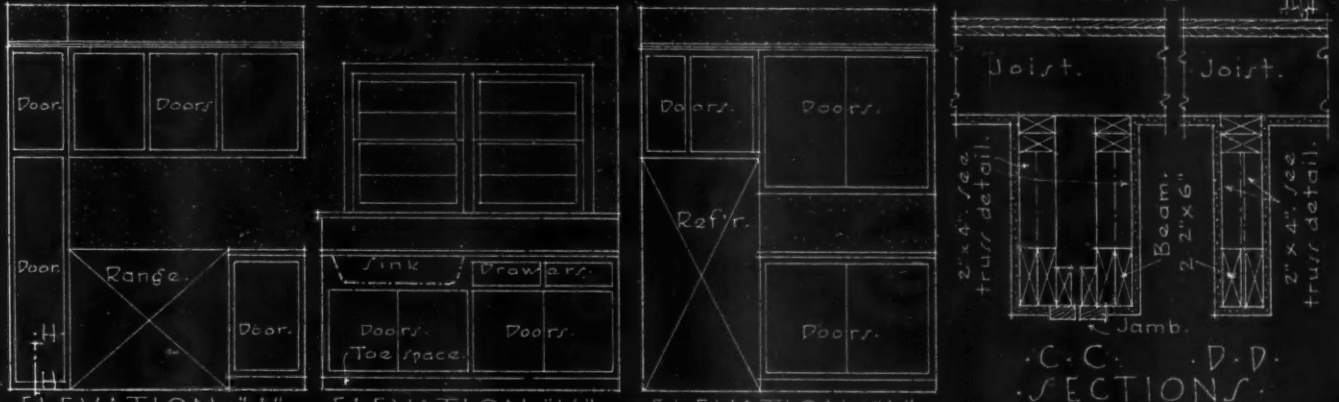
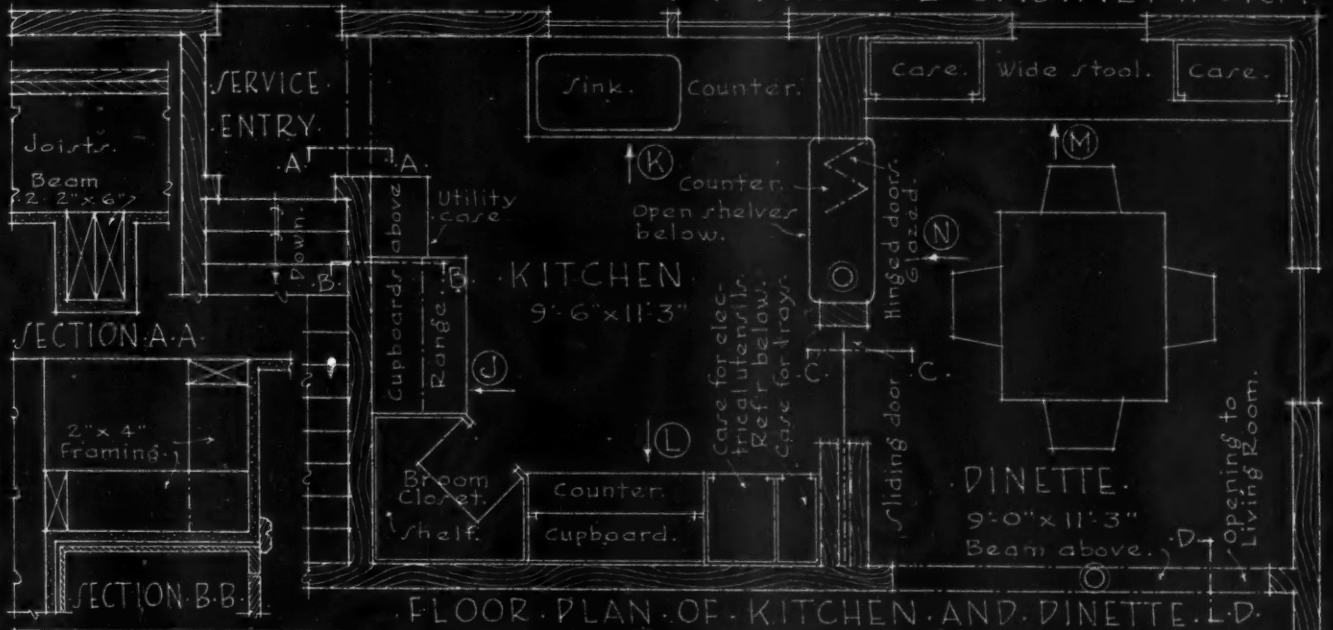

BEWARE

'Word of Mouth' Agreements When Building Joint Driveways



IN this era of building booms, materials and labor permitting, the question of the importance of proper driveways should not be overlooked. Of course, where the ground area involved is ample, with perhaps room to spare, this may present no difficulty.

But where a building site is scant, the construction of a joint driveway may halve the expense, and result in the saving of valuable space. However, since such an agreement will concern an interest in real estate it should be in writing; otherwise, it may amount to no more than a mere license, revocable by either party at any time, perhaps to the injury of the other party. Danger here! For example:

Owners Construct Joint Driveway

In one case, the plaintiffs and the defendants were adjoining home owners. They agreed, "word of mouth," to build a joint driveway on the dividing property line. Each of the parties set aside four feet, making a driveway eight feet in width that ran to the back of their lots to their garages. The cost of the work was shared between them.

All went well for a number of years. The plaintiffs landscaped their lot, built concrete steps, and made other improvements assuming the driveway was to be permanent. Then one day, for reasons not given in the report, the defendants announced they intended to build a fence on the line that would run down the middle of the driveway; that they had decided to build a driveway entirely on their property.

The plaintiffs objected to this destruction of the driveway, and

claimed an easement in that part of it contributed by the defendants. This claim was based upon their verbal, word of mouth, agreement when the driveway was built as a joint passageway. Plaintiffs thereupon filed suit for an injunction to prevent the defendants from interfering with their use of the driveway.

Plaintiffs won in the lower court. On appeal, the higher court in reversing the decree reasoned:

What the Court Decided

"The agreement by which the [plaintiff's] claim an easement to use a four-foot strip of the [defendant's] land was a verbal agreement. It is fundamental that an easement in lands cannot be created by parol, but only by grant or by prescription, which presumes a grant."

But the plaintiffs pointed to the expense they had incurred in improving their lot, in contemplation of the driveway being a permanent fixture. Contending that these facts should take the case out of the general rule, and perforce entitle them to an easement as claimed. In denying this contention, the court had this to say:

"In the pending case no showing is made that the [defendants] either directly or indirectly urged, persuaded, or induced the [plaintiffs] to make the landscaping and improvements upon their property. These improvements were all made by the [plaintiffs] on their own lot and were not for the benefit of the [defendants] or their land.

"From the record it appears that the agreement between the litigants is nothing more than a parol license with reciprocal features, and at the

time the verbal agreement was made, *** nothing was said or done which made the license perpetual or indicated that it would persist for a definite period. It was therefore revocable by either party at any time. ***

"Simply because the [plaintiffs] improvidently made improvements *** and will be put to expense in revamping their lot and constructing their own driveway does not present a situation where the exception to the general rule will apply. The Statute of Frauds clearly acts as a prohibition to relief. Decree reversed." (172 N.E. 820)

Conclusion

The foregoing case was decided upon its facts, as all cases of this kind must necessarily be decided. And too, under facts wherein the enforcement of a legal right would constitute a fraud, the courts may base a right of easement upon a parol agreement that involves an interest in land.

However, generally speaking, such an easement may only be predicated upon an instrument in writing. So in the absence of exceptional circumstances, that creates an exception to the general rule, a parol, verbal, or word of mouth, agreement will not support such a claim.

In the light of which, where an easement is sought, as opposed to a mere license, in land, the grant should be reduced to black and white. Writing. And, as an illustration of the possible danger in overlooking this rule, when entering into joint driveway agreements, the case reviewed may well be had in mind by home owners and builders.



To Give More IN OVERHEAD TYPE DOORS

- More Service • More Convenience
- More Dependability
- Lasting "Good Looks"

All these **Rō-Way** gives... all are made possible by these 5 exclusive features

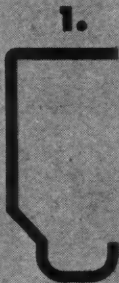

1. FRICTION-REDUCING TRACK

Makes rollers ride away from the track sidewall. Provides extra clearance... gives greater strength... assures easy, operation.

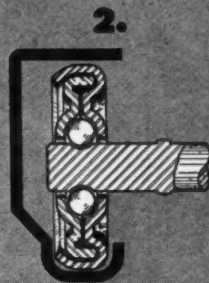

2. "DOUBLE-THICK TREAD" TRACK ROLLERS

Each rolling smoothly on seven ball bearings.

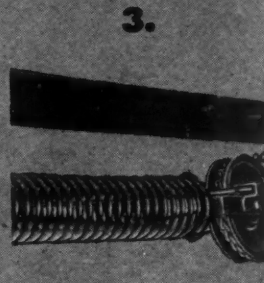

3. "TAILOR-MADE" POWER SPRINGS

Each individually "Power-Metered" to give just the right lift to the weight of the door.

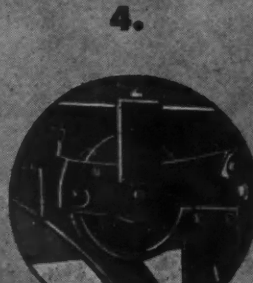

4. "CROW'S FOOT" OUTER BEARING SUPPORT

Holds sheave wheel in permanent alignment... no twist or sag to cause friction or binding.



5. RUSTPROOF HARDWARE

Parkerized and painted... after fabrication.

Users get more in an overhead type door when you specify

Rō-Way OVERHEAD TYPE DOORS

See our catalog in Sweet's

Sales and installation service is available all over America

ROWE MANUFACTURING COMPANY

718 HOLTON STREET

GALESBURG, ILL., U.S.A.

There's a Rō-Way for every Doorway!



SPECIFY PRACTICAL BEAUTY FOR HOMES

Include Modernfold Doors in your plans. These strong, durable doors are fabric-covered for beauty—metal-framed for rigidity and strength.

ELIMINATES SWING AREA. Because Modernfold is accordion-like in its opening and closing action, it does not require the area conventional doors consume for their swing. Modernfold makes accessible and usable every inch of floor and wall space.

EASY, ECONOMICAL ROOM DIVISION. Rooms can be changed to suit the occasion. For instance, with the doors closed, two smaller rooms are available. Fold the closure to the walls, and the entire area is consolidated.

FABRICS IN A WIDE VARIETY OF COLORS. Modernfold Doors can be selected to match any color scheme. They can be made to fit any opening—small or large.

WRITE FOR FULL DETAILS. Modernfold Doors can be used in any room in the house—in existing or new construction. They are also applicable to commercial buildings.

*Doors can be shipped in 30 to 45 days
after order is accepted at factory*



NEW CASTLE PRODUCTS

NEW CASTLE, INDIANA

Dealers in all principal cities in the United States and many foreign countries.

KOVEN

**WATERFILM BOILERS
FOR ECONOMICAL
QUICK
HEAT!**



THE home of today, built to the requirements of modern living, demands a heating unit that will provide dependable, economic comfort. That's why so many home-owners, architects and industrial builders insist on the quick-heating KOVEN WATERFILM BOILER, whose patented construction gives you the most in heating satisfaction—and an abundance of domestic hot water.

The WATERFILM is a special favorite with homemakers because its attractive design adds to a finished basement and blends smartly with any surroundings. For large or small homes, apartment houses and industrial plants, the KOVEN WATERFILM BOILER offers the ultimate in economical heating comfort.



**EVEN ROOM
TEMPERATURE**

**THROUGHOUT
THE HOUSE!**

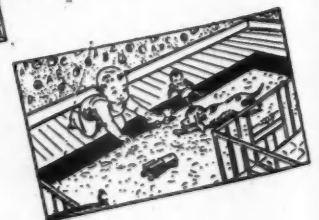

WATERFILM BOILERS, Inc.
154 Ogden Avenue, Jersey City 7, N. J.
Plants: Jersey City, N. J. • Dover, N. J.

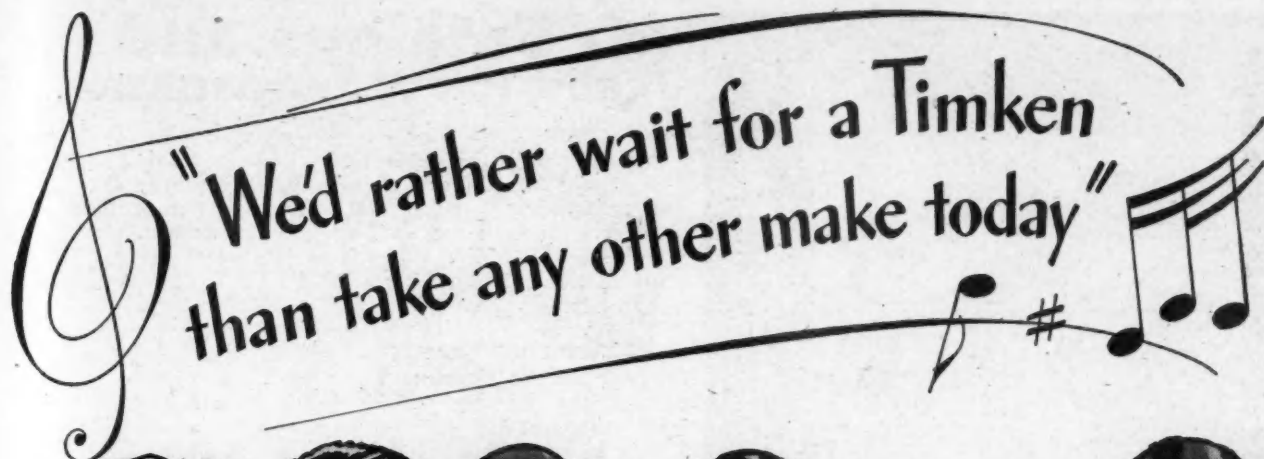

In Babylon, N. Y., buyers all sang the same song!

It's plain as day to Frank Swanson, president of Swanson, Inc., Timken dealers in Babylon, N. Y.—*Buyers prefer to wait for Timken Oil Heat, rather than accept immediate delivery of any other make.*

Here's Timkeneer Swanson's experience:

Six homeowners in one city block had placed orders for Timken Wall-Flame Oil Burners. Naturally, all of them wanted installation *at once.*

Timkeneer Swanson was installing Timken Wall-Flame Oil Burners as rapidly as received, and in sequence of orders. But to help these six homeowners, special arrangements were made for installation of a few pressure burners of a well-known make.

And what happened when Frank Swanson suggested this scheme? He got a flat "NO" for an answer. Every one of the six said, "No thanks! I'd rather wait for a Timken."

Exceptional? No, not at all! It's a story that has been repeated time and time again across the

country. Timken Dealers find cancellations as scarce as the proverbial hens' teeth. *The more burners Timken Dealers receive (and they're receiving them at a record rate), the longer their waiting lists grow!*

There's one simple reason: *Homeowners are convinced that Timken quality is the best possible buy.*

Brand preference for Timken grows more marked every day, and that's a song Timken Dealers enjoy!

TIMKEN

Silent Automatic

HEAT

TIMKEN SILENT AUTOMATIC DIVISION
The Timken-Detroit Axle Company
JACKSON, MICHIGAN

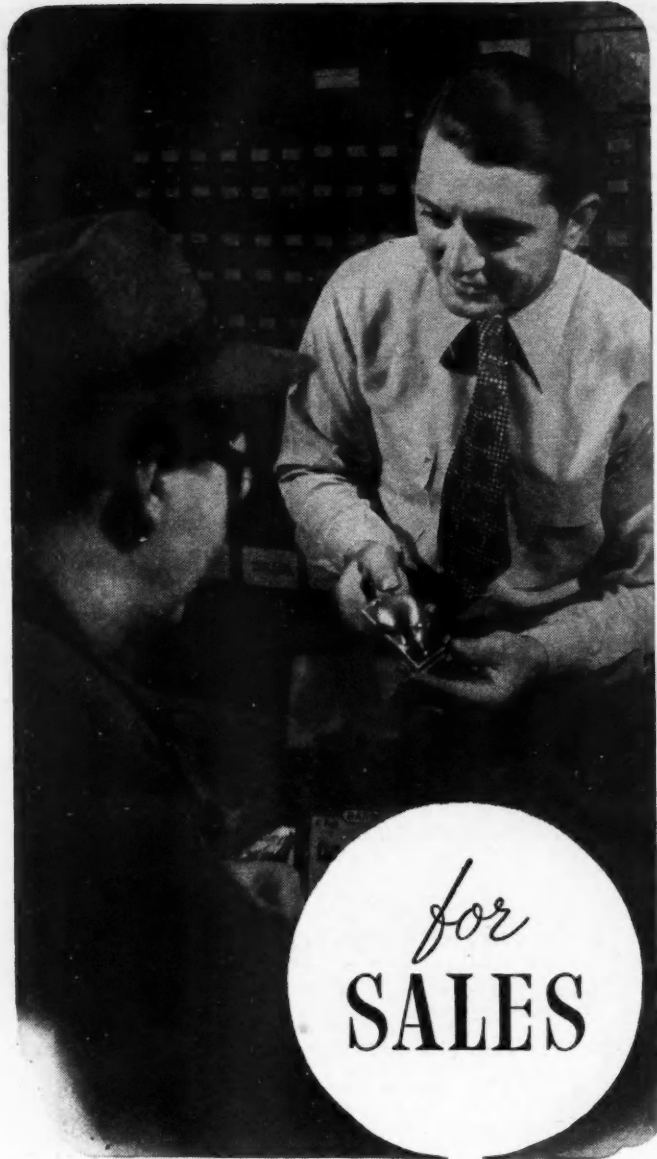

MANY things help put "SELL" in BUILDERS HARDWARE . . . easy application, strength and permanence, smooth operation, charm of appearance, correctness of design. To these vital qualities BARROWS adds more: Completeness of line, trustworthy craftsmanship, and a name which has stood high in excellence and builder-acceptance for over a half century. The BARROWS LINE of builders hardware is a trusted and *protected* line of feature-ful beauty combined with utility . . . and assures authorized dealers of increasingly profitable sales.

BANK ON

BARROWS
NORTH CHICAGO, ILLINOIS

Catalogs and HOW-TO-DO-IT INFORMATION

289—ORANGEBURG PIPE—A non-metallic pipe of special composition is the subject of a 20-page catalog prepared by The Fibre Conduit Company, Orangeburg, N.Y. Besides featuring the pipe's many uses—from house to sewer, as conductor line, outside downspout, protective covering for other pipe lines—the book gives detailed instructions, using charts to illustrate, on installation methods.

290—INSULATION BOOKLET—entitled "How To Put Your Home in the Comfort Zone with Kimsul" is available from the Kimberly-Clark Corporation, Neenah, Wis. Pointing out how Kimsul saves fuel in winter and resists heat in summer, the book goes on to illustrate and describe how the product is manufactured and applied to new and old homes.

291—COLORFUL NEW CREO-DIPT CATALOG—deals with the Creo-Dipt Zephyrs, of the Creo-Dipt Co., Inc., North Tonawanda, N. Y. Made of the finest grade red cedar shingles stained in beautiful colors for outer wall use, the Zephyrs have square butts and parallel sides with back and tip smooth-sawn for a snug, even fit. The book highlights their advantages—durability, insulation, application, beauty, color, true economy—as well as describes and illustrates their use over Zephyr insulation backing board.

292—AUTOMATIC CONTROL OF RADIANT PANEL HEATING—The important relationship between design and control from the standpoint of fundamental theory is the essence of the above book. Prepared by the Minneapolis-Honeywell Regulator Company, 2747-53 Fourth Ave. So., Minneapolis, 8, Minn., after extensive research and test work, the book contains diagrams, charts, and photographs, together with information on the use of the graphs for determining the required performance of a heating installation under control.

293—4 BY 4 WIREWA—is described and illustrated in the latest revision of Catalog No. 445 by National Electric Products Corp., Chamber of Commerce Bldg., Pittsburgh 19, Pa. Examples of installing this 4" x 4" enclosed metal duct for housing and protecting electric wires and cables, together with photographs and schematic drawings of all component parts, are featured.

294—EXHAUST FAN CATALOG—entitled "Emerson - Electric Exhaust Fans for Business and Industry" has just been released by The Emerson Electric Manufacturing Company, St. Louis, Mo. Its 16 pages tell how and where to use exhaust fans, how to determine size and type required, and methods of installation. It is a handy reference piece.

SERVICE COUPON—CLIP and MAIL to CHICAGO

Readers Service Department, (February 1947)
American Builder,
105 W. Adams St., Chicago 3, Ill.

Please send me additional information on the following product items, or the catalogs, listed in this department:

Numbers

Name

Street

City State.....

OCCUPATION*

*Please note that occupation must be stated if full service is to be given.



Motor and saw arbor are one unit. Pivot it 90°, the finder locks the blade parallel to the fence and you're ready to rip. You get full power with no transmission loss.

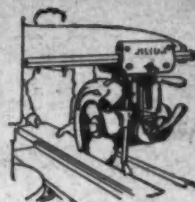

You can make birds' mouth cuts in five rafters at a time with one pull of the carriage. Perfect cuts at any pitch, all uniform and accurate.



THEY GO UP FASTER

when there's a

WILSON

on the job!

Here's a rugged, rigid, precision engineered radial saw that two men can handle with ease and take from job to job! It's a real worker, accurate, speedy and safe, with many features exclusive to the Wilson.

Tapered finding pins, wide column and widely spaced tracks assure absolute rigidity and precision work. Column and arm are aluminum. Any job goes faster and easier with a Wilson. You save time and make money! Current delivery on the Wilson Speedcutter is 30 days. Write to the address nearest you for a catalog, or to request a demonstration.

*The model illustrated is the SPEEDCUTTER—weighs only 298 lbs.
Available in: 2 hp single phase—110 and 220 volts—60 cycle
3 hp single phase—220—440 and 550 volts—60 cycle
There is also a WILSON master model 5 hp and 7½ hp.*

REALLY RUGGED



A 252 pound machinist perched on the arm of a Wilson saw to demonstrate its rugged construction! The arm still makes a right angle with the column, and the machine stands firmly on all four legs.

Manufactured by **FRANKLIN MACHINE COMPANY, Providence, R. I.**

Timesavers, Inc.
104 South 21st Street
Philadelphia, Pa.

Strongridge Ltd.
10-12 Davidson St.
St. Catharines, Ontario

Something new on wheels...
 ...to multiply your skilled manpower

NALL MOBIL-SHOP

...the portable NALL RADIAL WOODWORKER

BUILDERS: Here it is...the *first* really portable shop...designed and made for home builders.

- The Mobil-Shop goes places and does things—it rolls to the job—goes to work easily—no heavy lifting.
- The Mobil-Shop has a built-in New Nall Radial Woodworker—powerful, versatile and rugged.
- The Mobil-Shop works inside as well as outside—rolls through any standard door.
- The Nall in the Mobil-Shop gets its power through an electric cable on a reel—for other power tools, too.
- The Mobil-Shop has easily attached extension tables for simple, fast, multiple cutting.
- The Mobil-Shop is a rugged weatherproof storage place for tools, hardware, etc.—Lock it up and leave it on the job.

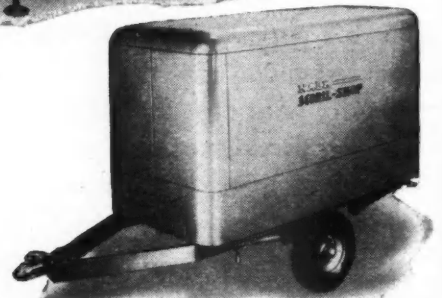
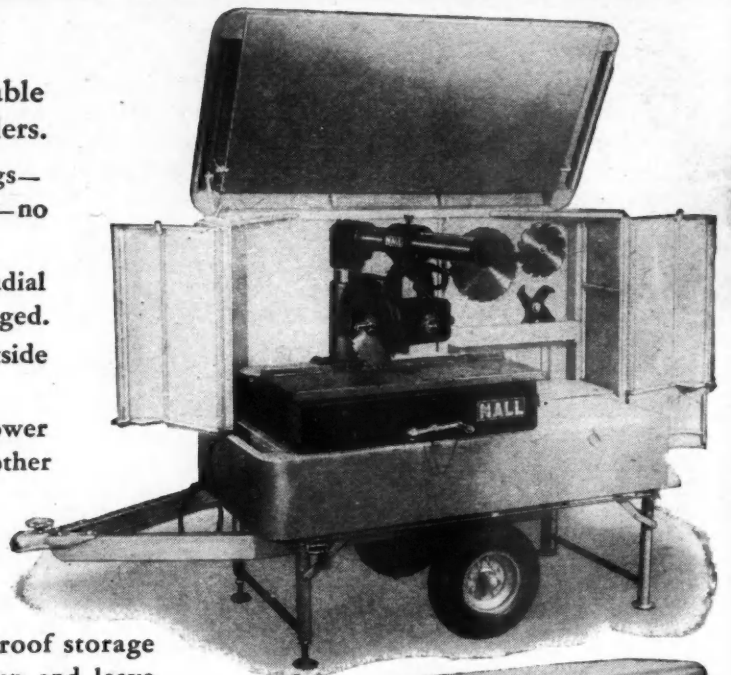

Get all the details of the new Mobil-Shop, Mister Builder, and figure the time and labor savings you can have.

Wire...phone...write us—or ask Your Equipment Engineer to call

SEE IT AT THE HOME BUILDER'S SHOW CHICAGO • FEB. 23-29

MORE BUILDING *per man, per hour...*

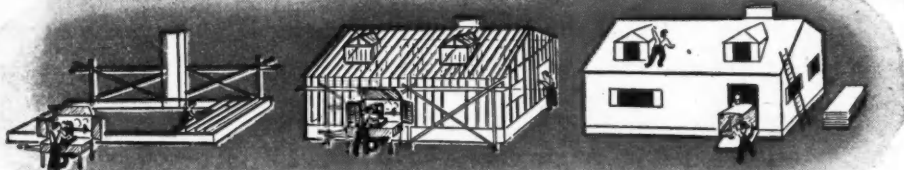

... from foundation to interior trim!

EQUIPMENT ENGINEERING Co.

Representatives *Division of The NALL Corporation* ST. CHARLES, ILL. **Everywhere**

NALL RADIAL WOODWORKER on Legs

write for bulletin

SEN...
 the Sen...
 be take...
 that ho...
 Ellend...
 spite h...
 cessor...

SOCI...
 that M...
 getting...
 legislat...
 issue t...
 sary e...
 for the...

THE
 velt's l...
 more a...
 yet to...
 technic...
 prefer...
 which...
 of the...
 and co...
 close...
 paralle...
 White...
 Mr. T...
 Truma...
 nique...

INCO
 by ma...
 behavi...
 single...
 has be...
 vate e...
 wing...
 wing...
 enigm...
 believ...
 social...
 and h...
 campa...

SOCI
 out 10...
 social...
 who f...
 make...
 Wyatt...
 his g...
 diffic...
 hard...

SIGN
 when...
 Mr. Y...
 housi...
 not s...
 down...
 that t...

News, Views
and Comments

On and Off the Record

SENATOR TAFT—It is possible that the Senator's views on housing need not be taken too seriously in spite of the fact that he lent his name to the Wagner-Ellender bill in its revised form, and despite his promise to come up with a successor to W-E-T.

SOCIAL ISSUE—It begins to appear that Mr. Taft is not really so intent on getting slum clearance and other housing legislation as he is on getting a social issue to champion as a supposedly necessary element in his expected campaign for the Presidency.

THE TECHNIQUE—Even Mr. Roosevelt's bitterest critics admit that he knew more about getting elected than any man yet to appear on the political scene. His technique was to have at least one, and preferably a dozen hot social issues with which to campaign. With the example of the master vote getter to guide him, and considering the fact that Mr. Taft's close association with national politics parallels Mr. Roosevelt's tenure in the White House, it is not unnatural that Mr. Taft and other aspirants to Mr. Truman's job should borrow the technique of the master.

INCONSISTENT—It has been noted by many close observers of Mr. Taft's behavior in the Senate that with the single exception of public housing he has been a forthright champion of private enterprise. Mr. Taft with the left wing on housing and with the right wing on everything else has been an enigma. There is another reason for believing that he looked upon a little socialized housing as not very dangerous, and having the elements of a good hot campaign issue.

SOCIALIZED HOUSING—Through-out 1946 it certainly looked like a great social issue. Everybody but the builders, who know better, tried hard enough to make it a social issue. Even Wilson Wyatt, whose obvious intelligence makes his gullibility as a Housing Expediter difficult to understand, had to learn the hard way, and went down learning.

SIGN OF THE TIMES—Could be that when Mr. Taft saw what happened to Mr. Wyatt as a champion of socialized housing he decided that the issue was not so hot after all, or that Mr. Wyatt's downfall was a sign of the times, and that by 1948, regardless of what housing

looks like now as an issue, it would be dead as a social issue in 1948 than a Grand Banks mackerel is after it is salted and boxed for shipment.

RED LIGHT—Then, too, maybe Mr. Taft saw in the events of Nov. 5 a red light against socialistic proclivities, and the assumption by government of permanent authority over private enterprise.

INTEREST IN LABOR—Anyway, it was notable, and possibly significant, that he requested the chairmanship of the Senate labor committee. Labor always has been at least a warm issue. Right now, as an issue, it has a temperature of about 211 degrees, and while it probably will cool somewhat, it hardly can be expected to cool much below 160 degrees before 1948, and that is still a good temperature for a hot issue.

UNIVERSAL APPEAL—Making up a good campaign issue based on labor requires no departure from a firm and consistent belief in free private enterprise. Quite the contrary. Free labor is the basis of free enterprise. Furthermore, everybody is interested in labor, and nobody in his right mind wants to see labor hurt. An intelligent political approach to the labor problem would be a great service to the entire nation, and one that could sweep the leader of such an approach into the White House.

168,000 VETERANS—That is the number of vets of World War II who applied to the Chicago Housing Center for housing accommodations. Of the 168,000, 97.2 per cent wanted to rent, and the remaining 2.8 per cent wanted to buy. Of those who wanted to rent, 88.3 per cent wanted apartments, and only 8.9 per cent wanted to rent houses. *American Builder* said substantially that a year ago, but so great was the desire to corral vets' votes, rather than find out what kind of housing vets wanted, that nobody in Washington paid any attention.

THE RESULT—The increase in rental apartments over a year ago is substantially nothing. The maintenance of fixed rental ceilings has kept all available apartments tied up in the hands of war-time occupants, and denied them to vets. And even the votes did not turn up in the places where they were expected.

ON THE
RECORD AT
SARGENT & COMPANY

THE
NEW

SARGENT
INTEGRALOCK
PRECISION BUILT

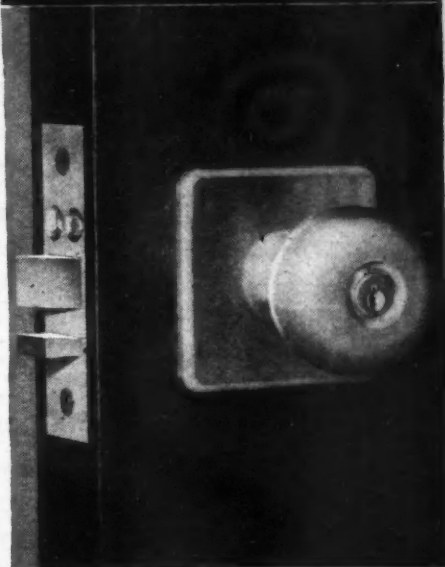

Precision-made of pressure formed metals, the new Sargent Integralock is one of the strongest, safest locks ever made . . . and one of the handsomest with which you can grace the door of a home.

All exterior parts are solid brass or bronze. Inside, there are 30% fewer moving parts, all made of high-strength brass and steel. Each knob and escutcheon is an integrated factory assembly. Two machine screws clamp the assembly to the door, assuring foolproof installation and perfect alignment.

Available in a number of bronze, brass and chromium finishes, the mortise type Integralock is now being displayed by Sargent distributors. The cut-out type will be available soon. Get all the facts on this vastly superior lock.

*Trade Mark



SARGENT & COMPANY
NEW YORK • NEW HAVEN, CONN. • CHICAGO

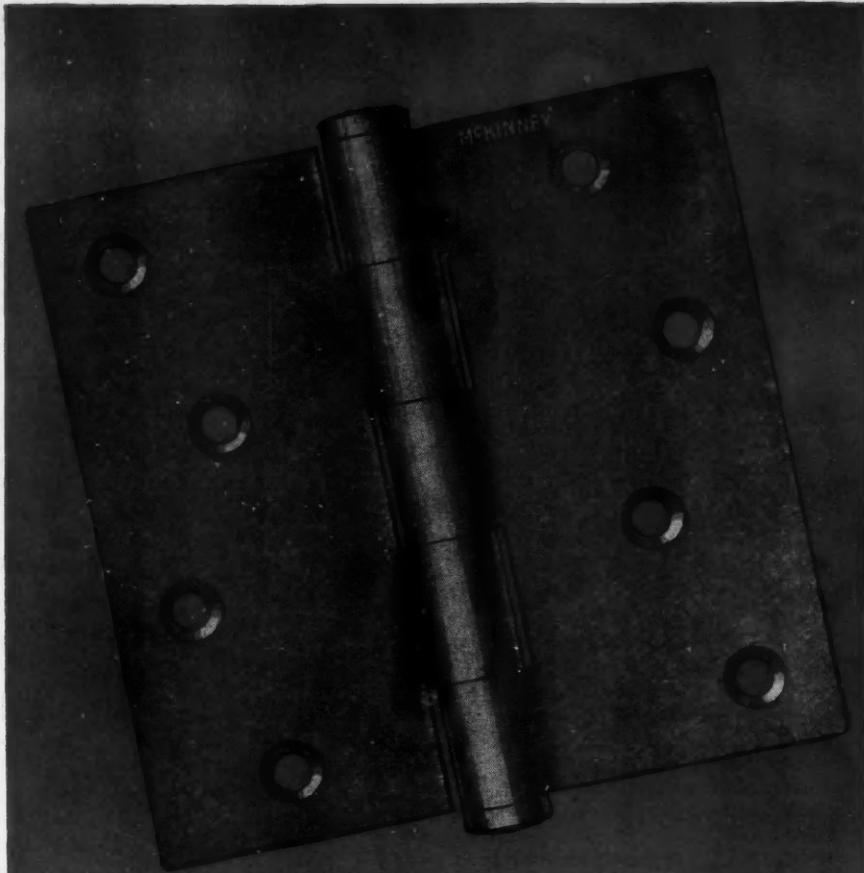

BUTT HINGES

*Quality
Hardware
Since 1865*

MCKINNEY

MANUFACTURING COMPANY

PITTSBURGH 12, PENNSYLVANIA



GROWING UP!—

(Continued from page 41)

in 1946 it reached the total of 23 members. In addition, a Chicago office operates all-year round to assure a smooth-functioning convention. The increasingly heavy demands of the membership for information and services as well as the membership growth were the causes of the staff expansion. The year saw the Association established in new offices at 1028 Connecticut Avenue, N.W., but six months after its move to larger quarters the Association found itself once again straining at its seams.

Now, in its sixth year, NAHB has successfully weathered its formative years. Its voice is recognized as the voice of the home building industry and its officers as the chief defenders of the industry when it is attacked by the exponents of public housing and controlled economy.

NAHB is also recognized as one of the chief sources of information on the home building industry. The Washington Letter, issued weekly, has become famous as a source of industry news. Written and edited by Frank Cortright, the Washington Letter is read widely by Congressmen and government officials as well as by home builders; it is known as a news letter and an expression of the real opinions of home builders rather than as an organizational "puffsheets."

NAHB committees study the problems of the industry and suggest solutions. They inquire into new building methods and materials, study the best methods to clear slums and rebuild blighted areas, strive for the bettering of relations between labor and the industry, investigate possible ways to improve the financing methods of the industry.

"It took a war to get the home builders together," says a member. "But peace hasn't lessened the necessity for NAHB. Home builders had to learn the value of cooperation the hard way—and it's a lesson they are not forgetting."

Among the continuing aims of NAHB: To assure the observance of ethical practices and high standards of construction by the industry.

To aid the industry to increase the efficiency of its techniques, decrease its building costs.

To see that the needs of the home building industry are recognized by government officials.

To defend the industry from attacks by the proponents of a socialized home building industry.

To secure for the home building industry the recognition by the public that home building is one of the great American industries and that on the activities of the home builders depends a large share of the economic well-being of the nation.

* * *

New Paint Factory at Toronto

CONSTRUCTION of a new \$1,000,000 factory at Long Branch, on the outskirts of Toronto, Ontario, Canada, has been announced by E. D. Griffin, vice president in charge of the paint division of the Pittsburgh Plate Glass Co. The new plant will produce a complete line of paint, varnish and enamel products.

DOES ALL

Quickly- Accurately- Safely!

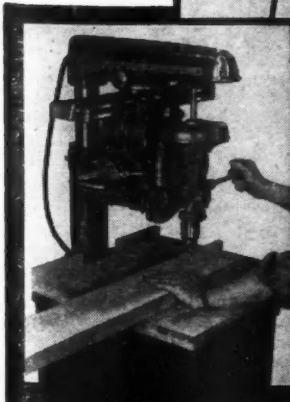
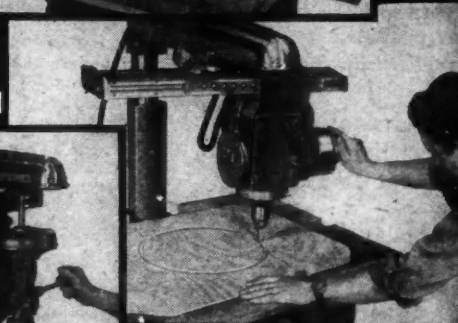
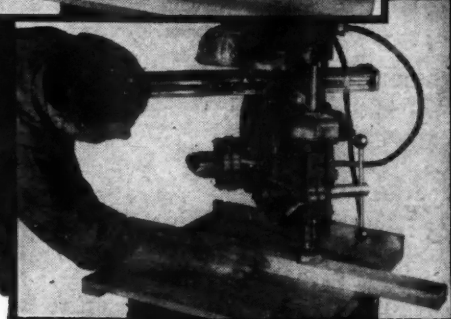
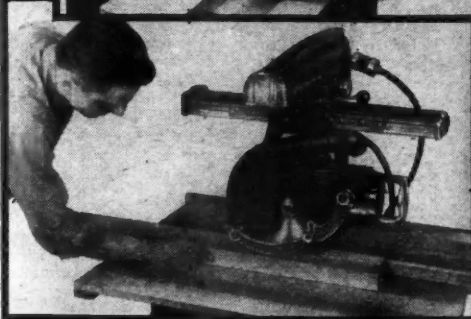
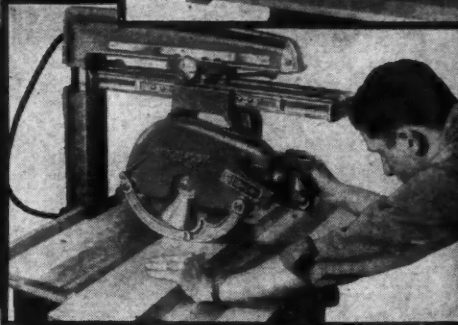
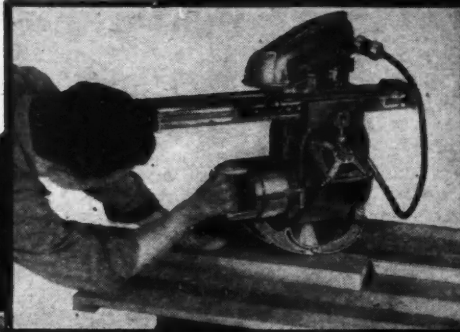

Operations illustrated above show: Left Hand Bevel Miter - Cross Cutting - Ripping - Planing - Circle Routing - Drilling

It's no longer necessary for the contractor or builder to take a whole truckload of single purpose wood working machinery out to the job. The MULTIPLEX will handle practically anything that comes up, and efficiently too. The rugged, yet precision, construction of the exclusive Versatile Elbow or center pivot track arm means accurate cuts at any angle. Greater mitering capacity -- difficult left hand as well as conventional right hand miters up to 90° handled with ease. No idle travel of cutting head. The carefully calibrated eye-level scales permit quick set ups for any operation.

As optional equipment for Model 30A and 40A saws only, a radial arm drill press, quickly attached, makes possible many other wood working operations.

Write for full information and name of nearest dealer.

MULTIPLEX

Radial-Arm Saws

RED STAR PRODUCTS · INC.

3455 VEGA AVENUE, CLEVELAND, OHIO, U. S. A.

A Ready Reference to Proved Operating Economy!

KINNEAR



KINNEAR Rolling Doors

The efficiency and economy of Kinnear Rolling Doors are *proved*—by performance records, cost records and maintenance records on thousands of installations. That's why you are sure of a sound investment when you refer your door problems to Kinnear!

Many operating advantages are built into Kinnear's famous interlocking-steel-slat curtain. By rising vertically into a compact space above the lintel, they save floor, wall and ceiling space . . . open out of reach of damage by wind or vehicles . . . require no "clearance" area for operation . . . clear the entire doorway when opened. They also assure *extra* protection against fire, intrusion, accidental damage, and the elements. Kinnear Rolling Doors are built any size, for old or new construction. *Write* for details!

THE KINNEAR MANUFACTURING CO.
 1560-80 Fields Ave., Columbus 16, Ohio
 1742 Yosemite Ave., San Francisco 24, Calif.
 Offices and Agents in all Principal Cities

Motor Operation

Kinnear Motor Operators offer extra convenience, save time, and encourage prompt door closure that cuts heating and air-conditioning costs. Push-button controls can be placed at any number of convenient points, and any number of doors may be centrally operated.

**SAVING WAYS
 in
 DOORWAYS**

**KINNEAR
 ROLLING DOORS**

Building Products on Review

(Continued from page 137)

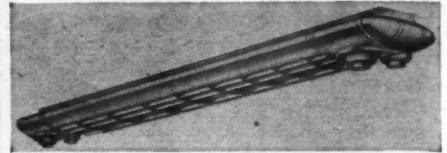

AB27121—Westinghouse has announced a new merchandiser store lighting system assembled from matched fluorescent and spotlight units. These can be combined into an illumination system planned to fit the lighting problem of any particular kind or size of store. Spotlights can be aimed to high-light displays located anywhere within large areas under the actual fixtures. Both the fluorescent and the spotlight units are available for surface and pendant mounting.

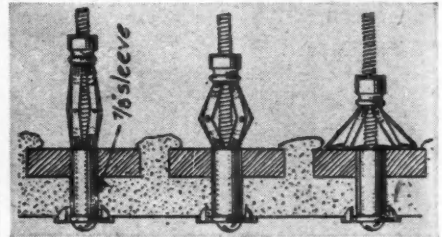

AB2721—A new simple, positive and inexpensive anchor bolt has been developed by the Molly Corp., Detroit. The bolt forms its own socket which will not disengage or drop down when bolt is removed. The four-way spider anchor conforms to any condition to provide good anchorage, even in lightest construction. Practical use proves it works equally well in any type of wall or floor from solid masonry to pulp board, and installation is simple and speedy for anyone with a screwdriver. It is especially well adapted for securing bath fixtures, lighting fixtures, etc. The bolts are made in a full range of sizes, both in length and body diameter.

AB2753—The National Life Insurance Company offers specialized financing service for builders, contractors and lumber dealers in its novel "Packaged Mortgage." This permits the sale of a complete, fully-equipped home financed under one low-cost loan. Under this plan new kitchen appliances, such as gas or electric ranges, refrigerators and other major kitchen appliances, are considered part of the real estate. All financing is covered by the single "Packaged Mortgage" instead of a house mortgage plus the customary installment financing. Payments remain uniform throughout the life of the loan instead of being heavy during the first few years as with installment buying. This plan is more economical because costs of installment financing are avoided.

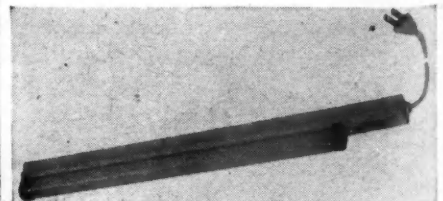

AB27120—The Wiremold Co., Hartford, Conn., announces a new line of single and multiple 15-watt fluorescent units, low power factor, 110-125 volt, 60 cycle. These compact units come, without the lamp, wired and ready to install. Most of the single

(Continued to page 158)



Kelvinator's
NEW
"SPACE SAVER"
6 cubic feet
in the floor space
of a 4!
 SEE IT AT THE BUILDER'S SHOW
 HOTEL STEVENS, CHICAGO,
 BOOTH NO. 1

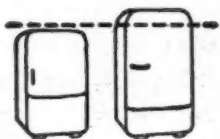

Only 3 7/8 inches higher and with almost the identical floor space, yet has a full six cubic foot capacity instead of four! It's the answer to the prayer of every architect, builder and home owner who ever struggled with the problem of getting a big family-sized refrigerator into a modern small kitchen. Whether your problem is small kitchens in new homes or the replacements of inadequate refrigerators anywhere, Kelvinator has your solution—the new "Space Saver."

Kelvinator quality throughout . . . with these great features

High Speed Freezer of stainless steel for permanence and faster concentrated cold . . . ample room for frozen foods, too.

Handy Chilling Tray of unbreakable drawn aluminum.

Extra Room for tall bottles on both sides of freezer. You can remove any shelf for storage of bulky foods.

Sturdy Plated Shelves of closely spaced welded

bars—dishes slide easily, but won't tip over. **Beautiful Exterior** of welded steel with a lustrous long-wearing Permalux finish that's stain-resistant.

Polarsphere Power Unit . . . the famous trouble-free, money-saving, cold-making mechanism, sealed in steel and permanently lubricated.

Kelvinator



DIVISION OF WASH-KELVINATOR CORPORATION, DETROIT



REFRIGERATORS • ELECTRIC RANGES • HOME FREEZERS • WATER HEATERS

What's A Home Without A Kitchen?

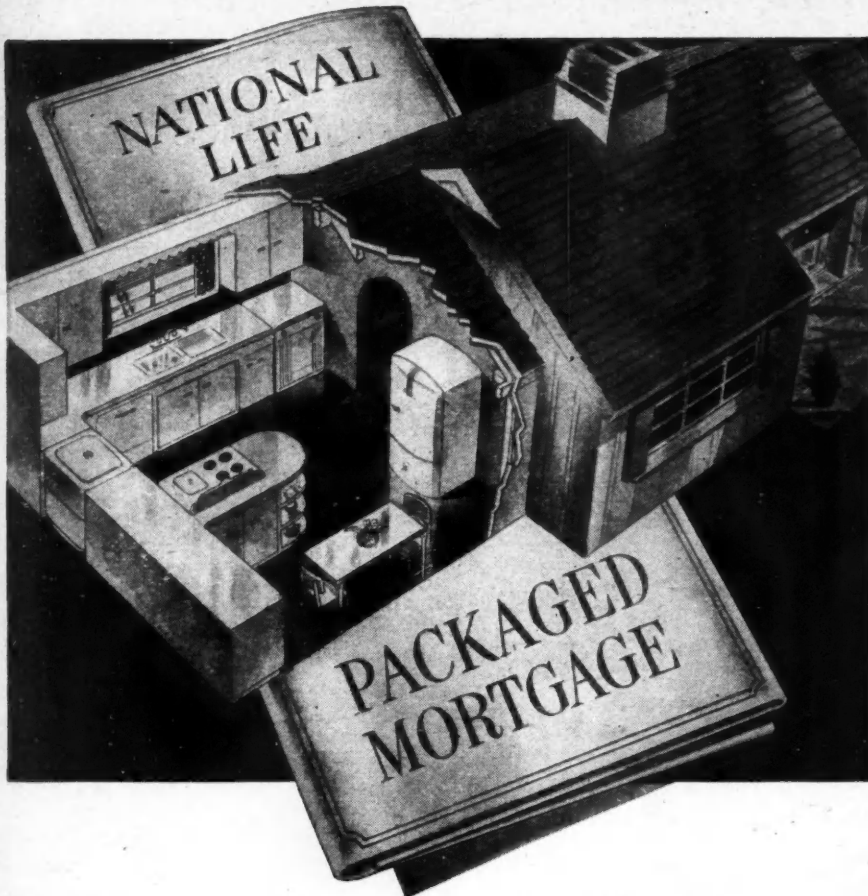

Modern Plan includes Appliances as Real Estate

Now your clients and prospects can include the cost of their major new household appliances in one convenient mortgage contract, along with house and land. Ranges, refrigerators, home freezers, dishwashers, garbage-disposing sinks, and home laundry equipment all come under the lien of National Life's "Packaged Mortgage." Home-buyers deal with only one lender, have no extra bills right at the start, actually save money over conventional installment financing. Get the facts on this new plan that makes houses easier to buy . . . easier to sell. Send coupon below now.

NATIONAL LIFE INSURANCE COMPANY HOME OFFICE— VERMONT MONTPELIER,

A Mutual Company, founded in 1850, "Solid as the granite hills of Vermont"

CLIP AND MAIL THIS COUPON NOW

NATIONAL LIFE INSURANCE Co., DEPT. B-7, MONTPELIER, VT.

Please send me full information on your new, low-cost, all-inclusive plan for home-financing, and address of your nearest loan correspondent.

Name

Business or Home Address



(Continued from page 156)

units are 21 in. long overall, and the longest is 21 3/4 in. Cross section measurements are 1 1/4 in. wide by 7/8 in. deep. Finished in white enamel, the units are furnished in a number of variations for different types of installation.

...

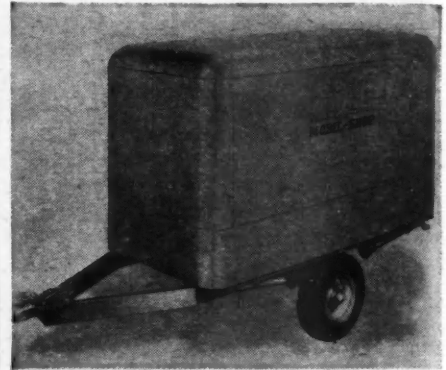

AB27118—This is the new Nall Mobil-Shop developed by the Equipment Engineering Co. division of the Nall Corporation. The simplified Nall Radial Woodworker, which was announced in December, has been mounted on a specially designed trailer for easy transportation to job sites. The trailer unit is 32 inches wide and approximately 5 1/2 inches in height, permitting it to be moved easily by two men in and out of houses under construction. The Mobil-Shop, in addition to being equipped with the new Nall Radial Woodworker, also houses and transports the extension table, 100 feet of electric cable on a reel, along with necessary adjustment tools, extra saw blades, etc. When the saw is set for use, built-in jacks take the weight off the wheels and springs.



...



AB27116—The R. O. W. Sales Co. spring cushion window sash employs no weights, cords or pulleys. Small steel springs press the sash guides against the sash permitting it to be raised or lowered easily. Complete weather-tightness is assured by weatherstripping while its special design permits instant and easy removal and replacement by merely pressing the sash toward the springs.

(Continued to page 160)

SEE

Janitrol

at the Home Builders Convention Chicago

FOR ALL THAT'S NEW IN GAS HEATING

HERE'S a quick preview of coming attractions . . . some of the things you'll want to be sure to look for in the Janitrol gas-heating display at the Convention and Exposition, National Association of Home Builders, Chicago.

NEW RADIANT PANEL HEATING SYSTEMS. Models, plans, and photographs show forced warm air applications for ceiling heat . . . forced hot water systems for ceiling, floor, or wall installations. Complete with information on duct or piping arrangements, engineering methods, and installation practices.

NEW JANITROL GAS-FIRED HEATING EQUIPMENT. Newly styled for the big postwar housebuilding market. Actual cutaway sections of Janitrol's unique operating principles will be shown. A scale model lucite house, detailing the newest types of heating systems will also be exhibited.

You can expect a warm welcome from the Janitrol organization. We hope you will make the Janitrol display one of your important stops . . . for a chat, or an interesting explanation of the latest engineering advancements incorporated in the new Janitrol gas heating equipment.

SURFACE COMBUSTION CORPORATION • TOLEDO 1, OHIO



**BOOTH 67
CONVENTION AND EXPOSITION
NATIONAL ASSOCIATION OF HOME BUILDERS
FEBRUARY 23-27
HOTEL STEVENS, CHICAGO**

(Continued from page 158)

MORE THAN 5 OUT OF EVERY 10 FAMILIES PLANNING TO BUILD WANT SEPARATE SHOWERS

Of 11,428 families with building plans now under way well over half will have separate showers (not just a shower over the tub) in their new homes.



This answer was given in a recent survey made by Better Homes & Gardens. Names for the survey were supplied by F. W. Dodge Corporation. In the \$5,000 price group 45% said their plans include a separate shower. As the home price increased the percentage rose—to 65% in the \$15,000 class.

These figures check with other carefully made surveys. They all reflect the rapidly growing demand for the full enjoyment and convenience of shower bathing which only the separate shower affords.

The quality of Weisway Cabinet Showers has been a big factor in winning this acceptance of Cabinet Showers as standard bath equipment.

INSTALL

Weisway CABINET SHOWERS

Product of the pioneer manufacturer in this field.

Quality-proved, service-tested through years of actual use.

Vitreous porcelain receptor, with exclusive "foot-grip, no-slip floor."

Precision built, leakproof, easy to install.

Models for homes in every price class.

Write now for detailed information, without obligation to you.

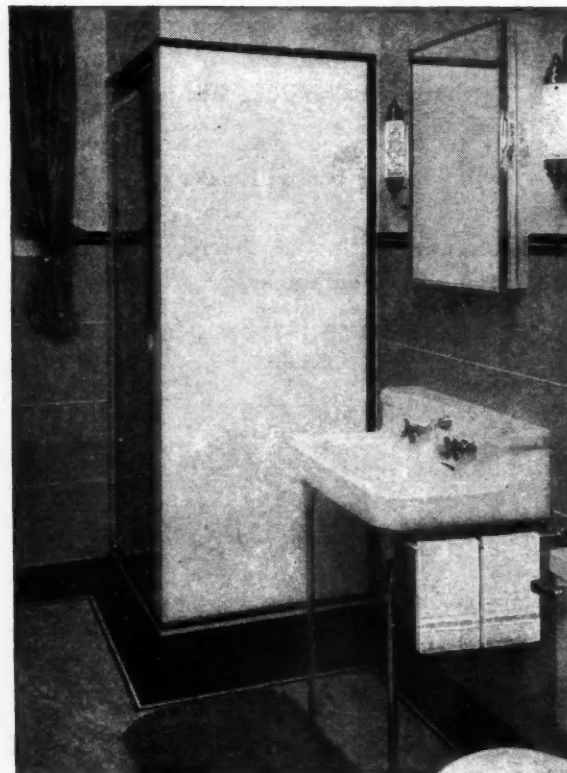

HENRY WEIS MFG. CO., INC., 201 Weisway Bldg., Elkhart, Indiana

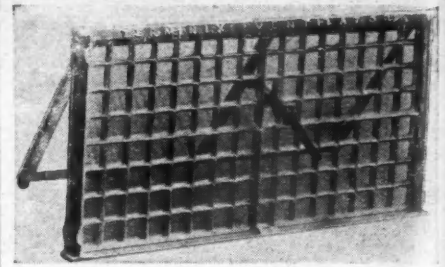

AB2735—A new type foundation ventilator has been developed by E. L. Bruce Co., Memphis, titled Terminix ventilator. It is made of cast aluminum, with a built-in screen and adjustable glass shutter which can be opened or closed from outside to eliminate the need for temporary ventilator covers in cold weather. Even when the shutter is closed light penetrates beneath the structure.

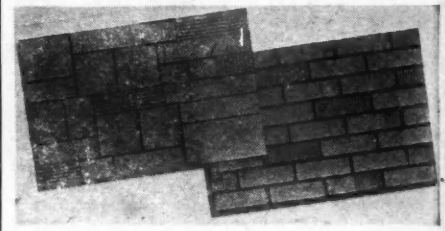

AB27119—The Ford Roofing Products Co., 111 W. Washington St., Chicago, has introduced a new type Ford-V-Neer panel siding using Fiberglas as the structural base material. Completely inorganic so it will not decay, absorb moisture or shrink, the Fiberglas base is also light in weight and extremely strong, permitting the use of larger panels. It cuts easily and has high insulating qualities. The new Ford-V-Neer is furnished in panels 5/8 inch thick, 24x36 inches square, shiplapped on four edges. It is available in either brick or stone pattern, in a wide variety of colors. The fact that it is produced in large panels and is easy to cut and fit around openings makes it economical to apply.

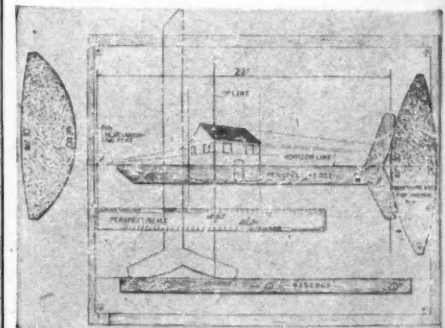

AB2719—The Letterite Co., Fort Washington, Pa., has developed a device for drawing perspectives quickly and easily. The kit consists of a "perspectiscale," with units diminishing in uniform progression instead of remaining constant as in an ordinary scale; a "perspective edge," for making all lines in the perspective drawing; two "vanishing arcs" with edges synchronized with other scales against which the "perspective edge" bears; and a vertical line "base edge."

N. A. Holmer Heads Mineral Wool Association

N. A. HOLMER of Minneapolis was elected president of the Industrial Mineral Wool Institute of New York at the organization's annual meeting held in Cleveland. Mr. Holmer is vice president in charge of sales for The Carney Co., Inc., of Mankato, with Minneapolis offices at 125 South Fifth Street.

been
ttled
um,
hut-
e to
vers
osed

W.
new
as
anic
the
nely
It
The
ick,
ges.
ern,
it
and
ply.

has
ckly
e,"
ead
a
er-
ges
er-
e."

as
ial
rk
ng
ce
he
th
th



Saw with the saw that's easy to use in any position

DON'T JUST SAW IT...

SKILSAW IT!



A wonderful combination of perfect balance, compactness, minimum weight and ample power makes SKILSAW the handiest saw you can own. It's the result of a quarter century of pioneering in the portable saw field. Ask your distributor today about a demonstration.

SKILTOOLS



MADE BY SKILSAW, INC.

SKILSAW, INC.
3033 Elston Ave., Chicago 30, Ill.
Factory Branches in Principal Cities

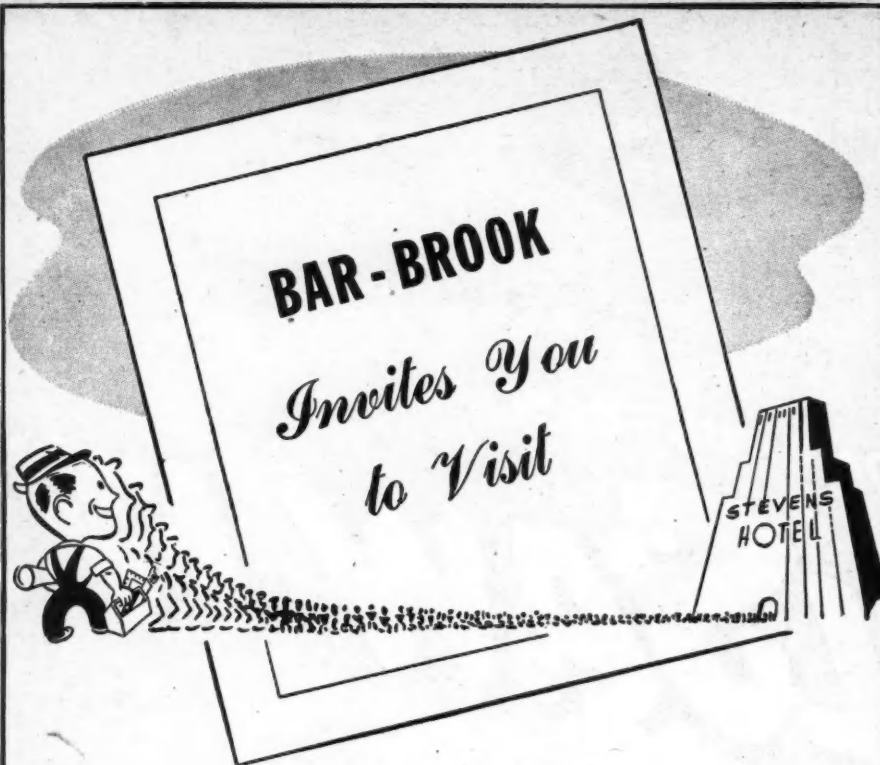

The BAR-BROOK FAN Exhibit SPACE 79



**NATIONAL HOME BUILDERS EXPOSITION
STEVENS HOTEL CHICAGO
Feb. 23 - 27, 1947**

Cool, refreshing breezes will be exhibited at Space 79 of the NAHB Exposition—cool, refreshing breezes made by the BAR-BROOK BREEZEBUILDER Attic Fan and the BAR-BROOK WINDO-WIND Window Fan. Both these efficient cooling appliances will be shown, and colorful, animated displays will demonstrate the basic "how's" and "why's" of BAR-BROOK cooling. So plan now to visit the BAR-BROOK Fan Exhibit, and learn about inexpensive dependable cooling for homes, schools, offices, apartments, and other buildings. . . . Or if you can't attend the exposition, write us today for information about BAR-BROOK FANS!



**BAR-BROOK
WINDO-WIND
FAN**

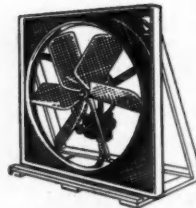

**BAR-BROOK
BREEZEBUILDER
ATTIC FAN**



BAR-BROOK MFG. CO., INC.
(Formerly Shreveport Engineering Company)

1553 Texas Avenue . . . Shreveport, La., U. S. A.



Kitchen Designers To Serve Builders



KITCHEN design specialists who will be at NAHB convention and exposition Feb. 23-27.

AN actual demonstration of how the Hotpoint Institute plans its kitchens will be staged at the National Association of Home Builders Convention and Exposition at the Stevens Hotel, Chicago, February 23-27.

A specially designed display manned by kitchen designers who will make actual plans for visitors will highlight the Hotpoint display. Also included will be a complete all-electric kitchen and a home laundry.

Asserting that planned kitchens for a majority of new homes are the greatest new product for home builders in postwar, an official predicted that most builders would work in cooperation with local electric utilities and appliance specialists to provide modern complete kitchens in their houses. The trend is to make appliances a part of the building, just as some kitchen cabinets were before the war and are today.

Hotpoint's 1947 automatic electric sink that encloses a Disposall and automatic dishwasher will be shown in the display kitchen at the show. This unit does its entire job after one small button is pressed—an operation that consists of spraying, rinsing, washing and heat-drying the dishes with no further attention from the housewife. Its construction with front opening that affords a work surface top, and permits the spray and rinse to originate from above the dishes, has overcome the objections that housewives sometimes express to older models.

Officials of Hotpoint announced that visitors will be presented with a package of kitchen planning information to assist builders or dealers in setting up planning departments in their offices or stores.



GAS RANGES

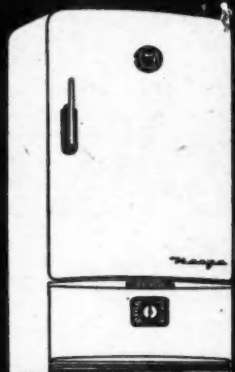

"ROLLATOR" REFRIGERATORS

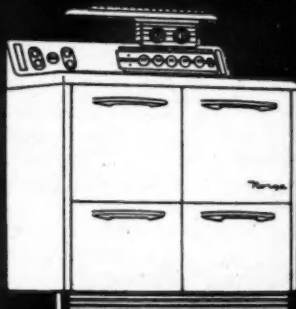

ELECTRIC RANGES

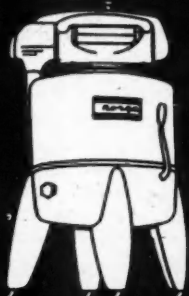

"RO-TA-TOR" WASHERS

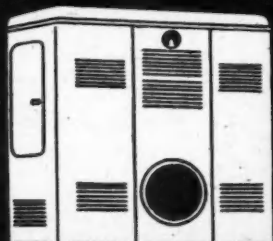

HOME HEATERS

NORGE

**MEETS THE EXACTING
REQUIREMENTS OF ARCHITECTS
AND BUILDERS**

The designers and engineers at Norge are practical men. As a result, the products they build are both artistically and functionally successful . . . meeting the exacting requirements of architects and builders.

A BORG-WARNER INDUSTRY

Norge is the trade-mark of Norge Division, Borg-Warner Corporation, Detroit 26, Michigan. In Canada: Addison Industries, Ltd., Toronto, Ontario.

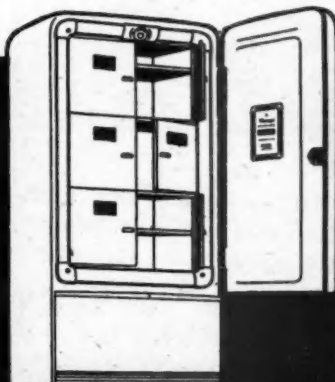

HOME AND FARM FREEZERS

SEE
NORGE
BEFORE YOU BUY

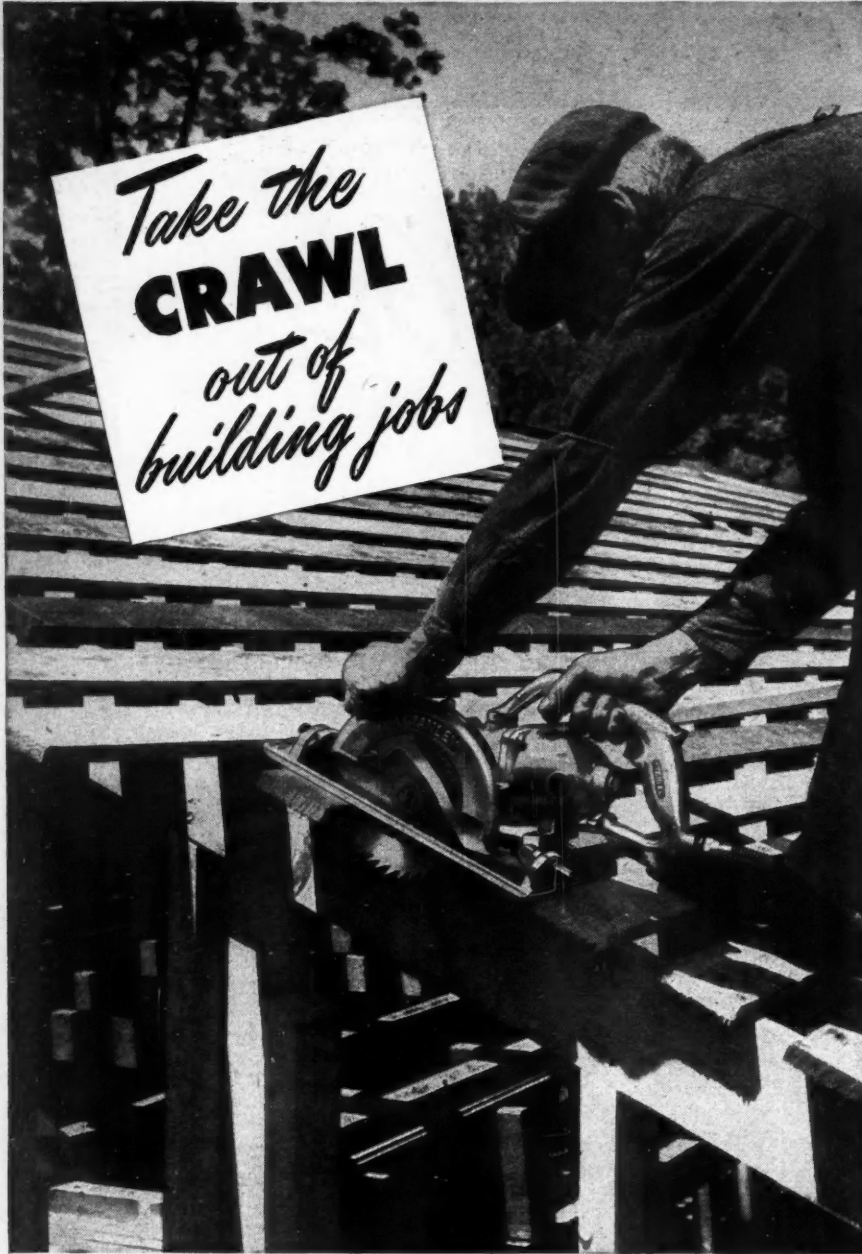

LET a good worker up off his knees and onto his feet. Give him a fast-cutting Stanley W8 Safety Saw . . . and stand back. See the job that was just crawling along really get going.

The W8 has a heat-treated aluminum alloy base for light, easy handling. Duplex handle, exclusive Stanley feature, with two independently operating trigger type, double-pole switches, provides comfortable grip in any position. Simple wing nut adjustment for depth of cut. Capacity: $2\frac{3}{4}$ ". Tilting base permits bevel cuts up to $2\frac{1}{16}$ " at 45° angle. Combination rip and crosscut blade. Sealed ball bearings, self-lubricating. Operates on either A.C. or D.C. *Write for full description.* Sold by leading distributors. Stanley Electric Tools, New Britain, Connecticut.

STANLEY

Trade Mark

HARDWARE · HAND TOOLS · ELECTRIC TOOLS

Briggs Purchases Republic Brass

THE Briggs Manufacturing Company of Detroit, Mich., producer of the Briggs Beautyware plumbing fixtures, has announced the purchase of the Republic Brass Company of Cleveland, Ohio. Republic is well known in the plumbing industry, having been a manufacturer of outstanding reputation for thirty years.

The acquisition of Republic Brass, together with the recent purchase of the John Douglas Company of Cincinnati, enables Briggs to manufacture and supply a complete line of bathroom fixtures of its own make and design, as well as kitchen sinks and laundry trays.

W. D. Robinson, president of Briggs, in announcing the purchase of the Republic Brass Company, stated, "There will be no change in the management of the Republic Brass Company nor in its sales and distribution policies. Richard Blywise will continue as general manager and Robert Blywise will continue as assistant general manager."

* * *

Devlin Becomes Plywood Chief

APPPOINTMENT of Charles E. Devlin as managing director of the Douglas Fir Plywood Association, Tacoma, Wash., has been announced by E. W. Daniels, chairman of the industry management committee and president of the Harbor Plywood Corporation.

Devlin, former Spokane newspaperman, succeeds W. E. Difford, who resigned to enter private business. Harrison Clark of Tacoma continues as assistant manager, and Winston H. McCallum becomes the new publicity director. McCallum has been assistant to Devlin since 1941 and formerly handled publicity for the Rainier National Park Co. and the National Park Service at Mount Rainier.

* * *

Aluminum Now Ranks As Second Metal of Industry in Volume

IN a year-end statement to the press, George R. Gibbons, senior vice president of Aluminum Company of America, revealed that phenomenal wartime demand and the resulting post-war acceptance of aluminum have boosted this product to the position of second-ranking metal, in terms of volume produced, of peacetime industry. Iron (steel) alone is produced in larger volume today, according to Mr. Gibbons.

Also significant, he says, was the marked shift of emphasis in demand for aluminum from transportation to architectural and building as the fields requiring the largest percentage of this lightweight metal.

The fact that the nation's capacity for producing new aluminum is at present four times as great as in the highest pre-war year and amounts to well over one billion pounds per year accounts for aluminum's rapid growth to maturity in the peacetime family of metals. During

(Continued to page 166)

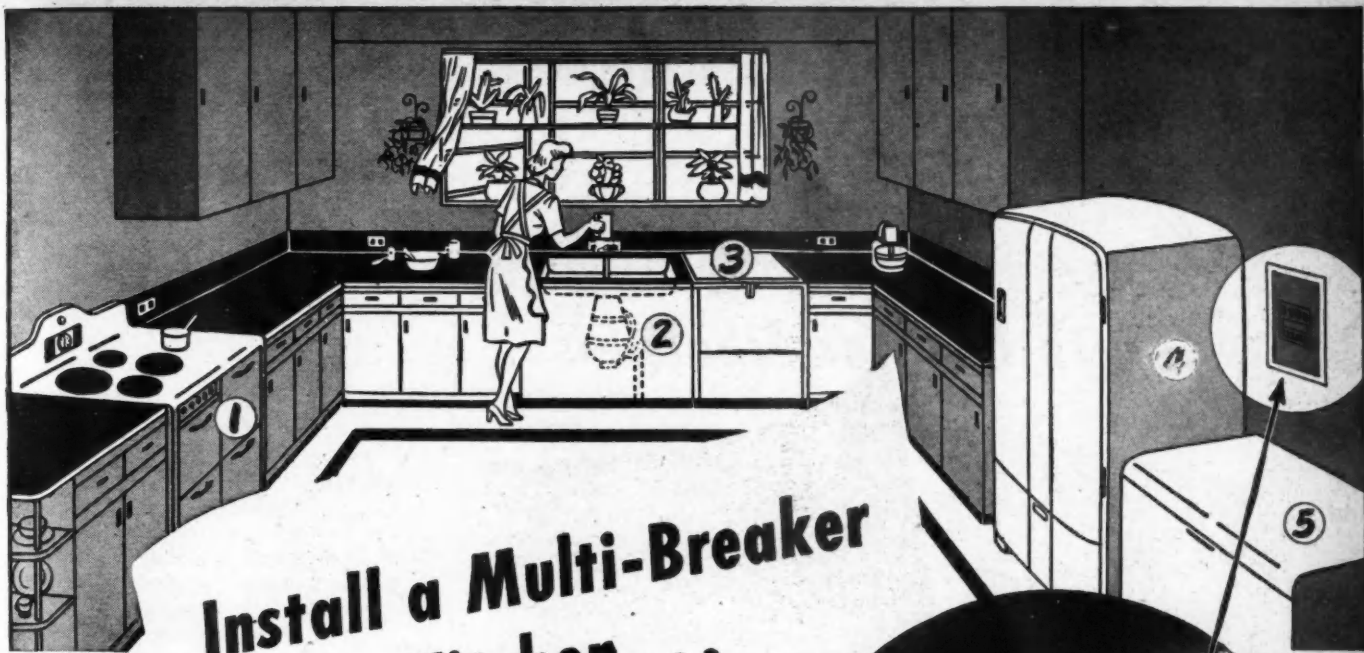

Install a Multi-Breaker in the Kitchen . . .

**—THE IDEAL SERVICE FOR
BUILT-IN APPLIANCES**



IN HOMES YOU BUILD with modern "built-in" kitchens, include a kitchen-installed Square D Multi-breaker to control the electrical "built-in" appliances.*

The Square D Multi-breaker provides the necessary disconnecting means required by the National Electrical Code, in addition to furnishing separate automatic overload protection for the wiring serving each major appliance. A Multi-breaker providing this added convenience and protection, installed in the kitchen, costs your customers no more (sometimes less) than the old-fashioned method of running long circuit wires from a remote point.

Multi-breakers eliminate fuses completely. Current is cut off automatically when a short circuit or overload occurs. A simple movement of the lever restores current after the cause of the overload has been removed. There are no delays, nothing to replace.



**Permanently built-in electrical appliances now may be included in house-financing plans in many states.*

Protect major appliance circuits with a **MULTI-BREAKER**

Top illustration shows Square D Multi-breaker located in kitchen and arranged to control general lighting and these major kitchen appliance circuits:

- 1 • Range**
- 2 • Garbage Disposal Unit**
- 3 • Dishwasher**
- 4 • Refrigerator**
- 5 • Food Freezer Unit**

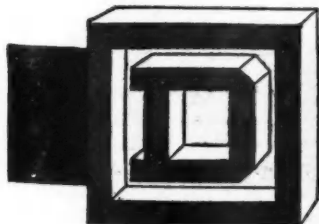

SQUARE D COMPANY

DETROIT • MILWAUKEE • LOS ANGELES

A NEW FORD-V-NEER

... with base of Fiberglas*

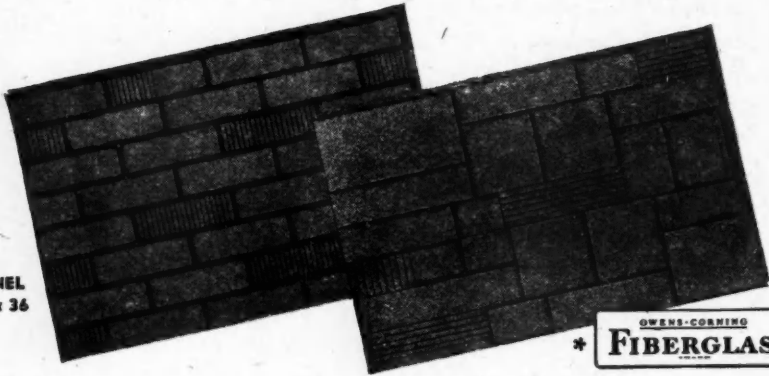

NEW PANEL
SIZE 24 x 36

... an improvement in siding so sensational that it makes conventional sidings out-of-date!

By using Fiberglas in place of the usual organic fiber base, Ford has developed a new and revolutionary type of siding. It marks the greatest advance in years in the use of structural materials for the manufacture of siding.

The Fiberglas base cannot absorb moisture, will not rot or decay, will not burn, and is termite-proof. These are only a few of many outstanding features that make this new Ford-V-Neer a leader in a new era of greatly improved sidings.

This new Ford siding made with Fiberglas retains every advantage of the old type base, and adds new desirable qualities that other bases do not have. Indeed, it is hard to imagine any important quality that Ford-V-Neer does not now bring to the modernizing and weather-proofing of buildings.

* FORD-V-NEER is a product of the Ford Roofing Products Co. A rigid panel-type exterior wall covering $\frac{3}{8}$ " thick, made up of five thicknesses of moistureproof material, including Fiberglas. Available in brick or stone pattern (see above) in a wide variety of colors. Panels are 24"x36", with ship lap edges on four sides. When sealed with Ford-V-Neer plastic, it makes a solid weather-tight job. Panels are perfectly matched and can be cut and fitted around windows and gables.

Fiberglas Brings These Advantages To Famous Ford-V-Neer:

1. Because it is made from inorganic material it cannot rot or decay.
2. It is fireproof.
3. It cannot absorb moisture.
4. Its fibers of inorganic glass are vermin and termite proof.
5. Though light weight, it is extremely strong and durable.
6. It combines high insulating qualities with excellent sound absorption.
7. It cannot shrink — it is easy to cut.



FORD ROOFING PRODUCTS CO.
111 WEST WASHINGTON ST., CHICAGO 2, ILL.

ASPHALT ROOFINGS • SHINGLES
SIDINGS • FORD-V-NEER

(Continued from page 164)

1946, nearly all of the war-built, government-owned aluminum plants capable of economical peacetime operations were leased or sold to private industry. There are now three major producers serving the nation as sources of new aluminum. In addition, hundreds of manufacturers throughout the country became fabricators of aluminum products during and since the war.

A recent estimate by the Civilian Production Administration indicated that 1946 production of new aluminum in the United States will total about 836 million pounds. While this is almost three times as much as was produced by the nation in 1938, it represents only about two-thirds of the rated annual capacity which is now approaching full production. The lag was caused primarily by reconversion problems incident to disposal of government-owned plants and readying these facilities for peacetime operation. Actual production in 1947, according to an estimate by CPA, should approximate 1,260,000,000 pounds.

Basic aluminum prices, reduced by 25 per cent since the start of World War II, are now relatively lower than ever before in the face of general price rises for competitive metals. The price advantage, plus the widely expanded familiarity of thousands of artisans with the handling of aluminum as the result of war work, offer firm indication that aluminum's future position is strong and that the industry will find even broader markets for its products. This indication is further bolstered by the many new techniques and versatile new alloys of aluminum which have been developed within the last six years.

Among the outstanding applications, new and old, which are creating the present tremendous demand for aluminum in the architectural and building fields are: corrugated aluminum sheet for farm and industrial roofing and siding; metalclad buildings; prefabricated residential and other building; residential garage doors; heating and ventilating ducts; architectural trim and fixtures; lightning rods and conductors; windows, storm sash and screens; venetian blinds; metal awnings; nails; hardware; and numerous other uses. The greatest increase has been in the use of aluminum for residential windows. During 1946 more than 500,000 such windows were manufactured; it is estimated that well over 2,000,000 will be manufactured in 1947.

* * *

Concrete Industries[®] Exposition February 17-20 At Chicago

THE National Concrete Masonry Association will hold its annual convention at the Hotel Sherman, Chicago, Feb. 17, 18, 19, and 20.

Highlights of the session will be open forum meetings where fundamental issues may be discussed with leaders of the industry and a huge display of machines available for the manufacture of concrete products.

Why the WILSON EASY-LIFT Is "America's Finest Garage Door"



- Special center mounting bracket for double doors.
- Double steel pulleys and rollers for smooth operation.
- Special brackets for extra reinforcement of the frame.
- Special double rollers for smooth operation.
- Special double rollers for smooth operation.
- Special double rollers for smooth operation.

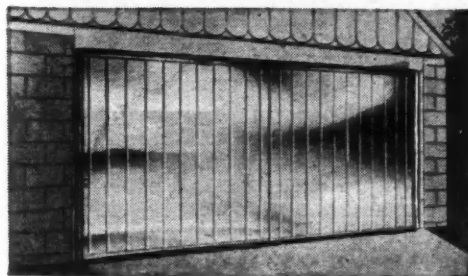

For double door installations with no center post—the *Wilson Twindoor Easy-Lift* is suspended by a special center mounting bracket. Each door operates independently of the other.

It's *aluminium* It operates on **FLOATING TENSION!** Only garage door made with wholly concealed dual lifting mechanisms (pat. applied for). Easiest operating garage door ever built! Only all-welded aluminum door operating on ball bearings, available today! For details of our Profit Plan, ask your distributor or—

MAIL THIS COUPON!

THE WILSON FOUNDRY & MACHINE CO.
15 Wilson Avenue, Pontiac, Michigan

Please send me literature on the Wilson Easy-Lift and details of your Profit Plan.

_____ (name)
 _____ (name of company)
 _____ (address)
 _____ (nature of business)

WILSON
 Easy-Lift
 GARAGE DOORS

The REEL-LINE Disappearing Clothesline



This magical clothesline is a natural accessory for the modern home... and now, with more new families building their ideal modern home than ever before, the Reel-Line Disappearing Clothesline is an extremely sellable article. Housewives need and want this streamlined item... for its utmost utility makes washday tasks easier... and backyards more attractive. With the receptive market opening before the Reel-Line Disappearing Clothesline, distributors, jobbers and wholesalers should be ready to sell this useful, new appliance.

Easy to use.
Assembled on 2 7/8" diameter steel pole. Six feet high, after being set in concrete.
Three 65-foot strands of non-corrosive wire.
All aluminum castings. Disengaging handle at 4' height for easy rewinding.

	EASY TO PUT UP	NO SAG	
	EASY TO REWIND	OUT OF SIGHT OUT OF THE WAY	

THE REEL-LINE CORPORATION
TERRELL, TEXAS

Low-Cost, Fire-Resistant Factory Building

Modern steel frame, fire-resistant factory built at cost of \$3.00 a square foot

THE H. K. Ferguson Co., industrial engineers and builders, has developed a modern, steel frame, fire-resistant factory building which can be erected at a cost of three dollars a square foot on the present market.

Although the building is not a specialized structure for a heavy industry, the design represents minimum requirements and is directed primarily toward a goal of low first cost without

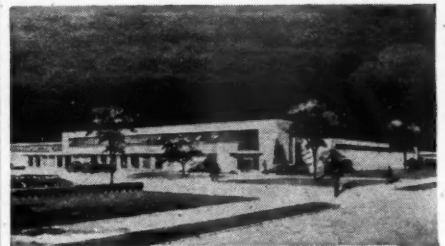

sacrificing any desirable features required for low-cost maintenance or satisfactory production layouts.

Ferguson engineers maintain the three dollar per square foot cost could be achieved in any application of the new design in quantities of 250,000 or more square feet of floor space. The three dollar price assumes ideal site conditions in either a metropolitan or rural area. The low cost construction figure is also predicated on two principal factors—simplicity of building design and simplicity of erection.

The design of the building is based on the use of standardized components throughout. An example is the structural-steel frame, which requires only 5.2 pounds of steel per square foot of floor space.

The steel design is such that every beam, every column and every purlin in the structure is identical. This reduces steel fabrication costs and simplifies erection.

The mass production principle is also carried out in other building units. All interior footings are identical and all wall footings are the same, a technique which permits re-use of concrete forms over and over again. The same principles apply to heating, general lighting, plumbing, sprinkler and sewer systems. Other economies include special roof design and the elimination of masonry above the window sash line. Exterior of the modern building is painted concrete block. Floor is five-inch reinforced concrete with a monolithic finish and ceiling height is 16 feet or less. The structure contains its own projection-type heating system, complete with boilers, firing equipment and other boiler house auxiliaries.

Sits in floor—Requires no extra space. No basement needed.

Flat-register or dual-wall-head types go anywhere in house.

Easy, low-cost installation—No air ducts, no excavation cost.

Easily located for all-over-the house comfort and warm floors.

Low-cost, automatic, clean!—meets today's customers-demands!

Models for gas or oil, to fit fuel needs in your area.

DESIGNED BY BEN V. LAMBORN, WICHITA, KAN.

How Features That Increase Coleman Floor Furnace Popularity ALSO HELP CUT BUILDING COSTS

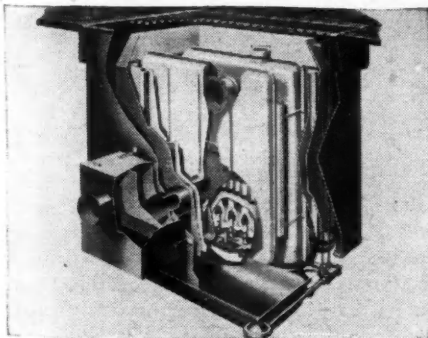

Exclusive Coleman features: Cut-away view, above, shows how Coleman features draw cold air off floor, re-warm it and circulate it 35% faster than obsolete designs, provide unusually even warmth, from ceiling down to well-warmed floors. (Gas or oil models.)



Easy installation, with or without basement: In new house, saves basement cost; saves furnace-space in utility room. A complete, packaged unit. Saves cost of ducts. Yet—Coleman engineering often makes it give more efficient heating than many basement furnaces.

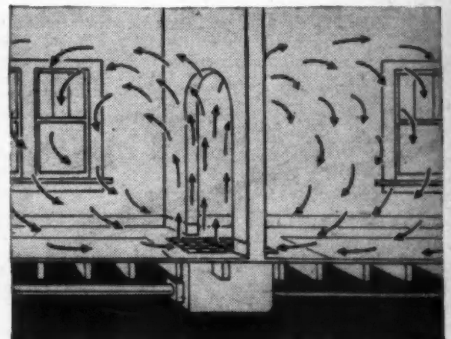

Coleman "Moves-the-Heat": Cut-away house shows how Coleman Floor Furnace is installed—set *in* the floor; not above it, not in the basement. Easily hooked to gas or oil lines and to chimney vent. A quick, clean, satisfactory installation in 3 to 4 hours average time.

The Coleman Co., Inc., Dept. AB-652, Wichita 1, Kas.; Philadelphia 8, Pa. (Terminal Commerce Bldg.); Los Angeles 54, Calif.

AUTOMATIC

Coleman

HEATING

On the boards...

1,500,000
New Customers for
Lo-K

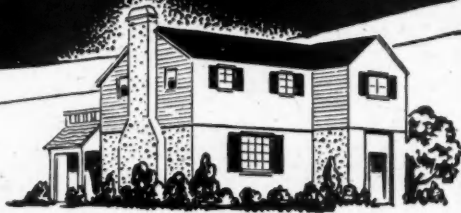

... Because Cotton
Out-Insulates All Others!

On the architects' drawing boards, in the minds of progressive builders, and in the dreams of home-hungry Americans, the plans are now being formed for the 1,500,000 new homes that will be built in the next three years. Estimated cost: \$12,000,000,000.

When people spend that much money for anything, they expect and deserve the best. That's why architects, contractors and building supply dealers everywhere are recommending Lo-"K" flameproofed Cotton Insulation. They've checked the facts. They know that dollar for dollar, inch for inch, cotton out-insulates all others and Lo-"K" is the finest of cotton insulation.

Check these 7 points of Lo-"K" Superiority

Greater insulating efficiency proven by thermal conductivity rate of only 0.24.

Lighter in weight, only .875 lbs. per cubic inch.

Easy to handle. Blanket roll cut installation time and costs;—fits snugly.

Economical, pays for itself through greater fuel savings.

Flameproofed. Resists blow-torch temperature of 1800° F.

Lasts indefinitely. Highly resistant to moisture, rot and vermin.

Non-irritating to the skin.

Mail this coupon today for the complete story of America's #1 Insulation!

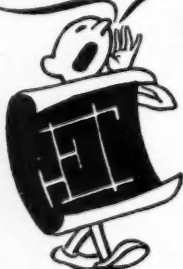

Lo-K
flameproofed
COTTON INSULATION

Lockport Cotton Batting Co.
Lockport, New York Dept. AB-2
Gentlemen:
Please send full details on Lo-"K" flameproofed Cotton Insulation to:
Name.....
Address.....
City.....Zone.....State.....
 Architect Dealer Contractor

BILCO OFFERS
All the advantages...
none of the drawbacks of
OUTSIDE CELLAR DOORS

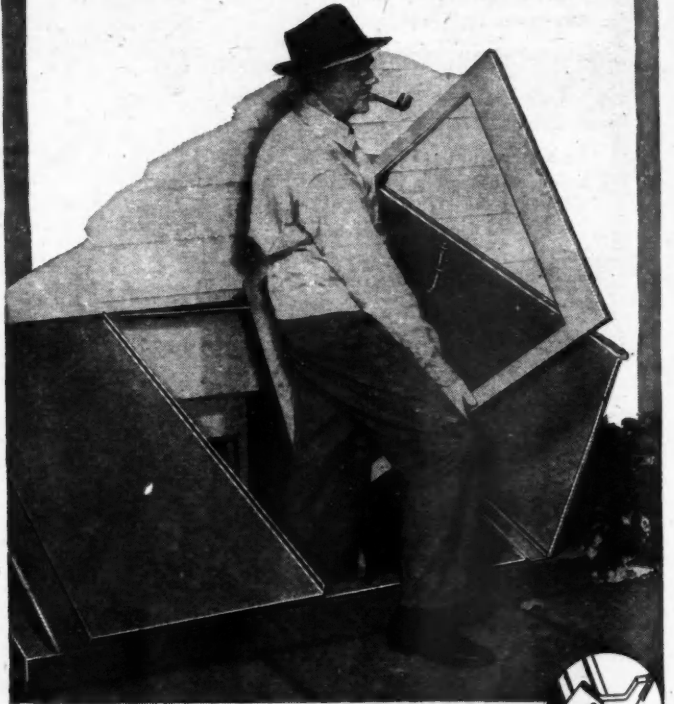

Automatic Safety Catch... doors can't blow shut

Complete accessibility to the basement makes an outside cellar entrance a major convenience for any home owner. Bilco coppersteel cellar bulkhead doors last as long as the house itself. An automatic safety catch on the lower hinge of each door keeps it from being blown or knocked shut but is easily released by hand or foot. Their flange construction and sliding bolt lock keep Bilco doors weather and tamperproof.

Whether you are building to sell or on contract, you can count on it — your prospective owner will ap-

plaud a Bilco installation. Nationally advertised — thousands in use. Available at leading building supply houses, Bilco bulkheads are compactly packaged with all bolts for assembly... can be installed in less than an hour in either masonry or frame construction by any semi-skilled workman.

Complete literature free on request, plus names of Bilco dealers in your locality. The Bilco Company, 165 Hallock Avenue, New Haven, Connecticut. Also makers of Bilco roof scuttles, sidewalk and elevator doors and vault covers. Visit our booth at the annual convention and exposition of the National Association of Home Builders.



Complete bulkhead packaged for shipment, ease in handling and stocking by dealers.

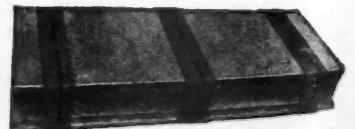

"First with the Finest"
ARKETEX

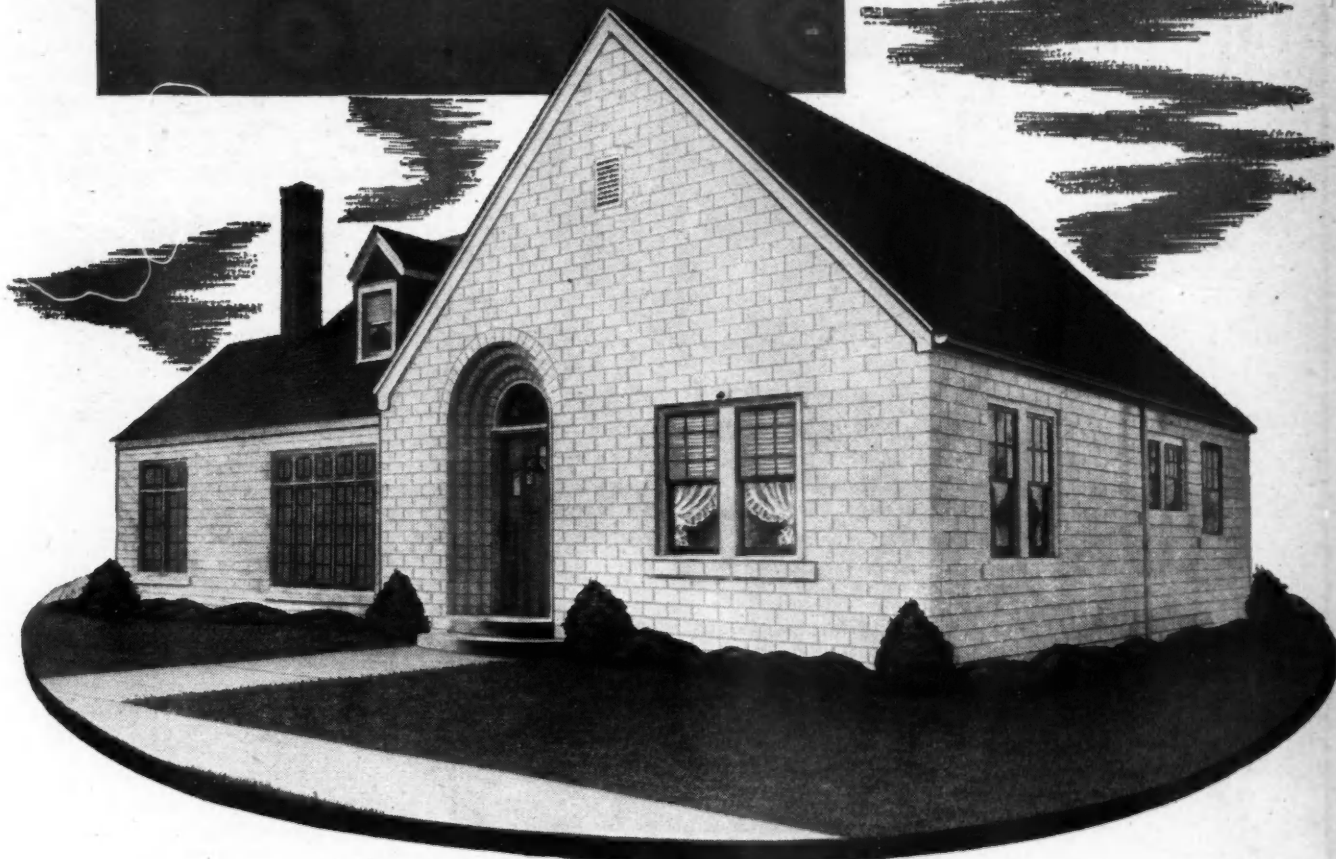

FOR COMFORTABLE LIVING

Modern construction methods for today's modern comfortable living demand modern material—Arketex Ceramic Glazed Structural Tile combining three-fold requirements of beauty, permanency, and economy.

Arketex is beautiful! Available in a range of bright colors from delicate tints through bold, full-bodied tones.

Arketex is permanent! The lustrous, non-fading colors keep their original freshness forever . . . will not craze, crack, scar, or mar.

Arketex is economical! Unlike ordinary building materials, it is a permanent wall and finish all in one—the first cost is the only cost. No periodic painting or refinishing necessary.

Practical architects and builders know their clients will recognize and appreciate good judgment in construction materials. That's why it pays to—Always specify Arketex—*first with the finest!*



ARKETEX CERAMIC CORPORATION • BRAZIL, INDIANA

AMERICA'S *Finest* HOME SHOWS



Building America's finest Home Shows is the EXCLUSIVE business of the Curry National Home Show organization, one of the few such institutions in the U. S. Trained experts in their field. Specialists in showmanship.

An established annual Home Show in your city would be an outstanding civic event. Everyone interested in the building industry will join hands with you—your local business and civic leaders, your manufacturers and distributors. An established Home Show will strengthen your Association in many ways. New interest from your members—more support and recognition from all.

Curry National Home Shows:

... have their own booths, complete properties and set pieces; handle ALL DETAILS such as advertising, selling, special designing, public relations and financing.

On Deck at the Chicago Convention

Representatives of Curry National Home Shows will be at the Stevens Hotel during the convention. Ask the Stevens Hotel telephone operator to connect you with our president, Ira W. Curry.

CURRY NATIONAL HOME SHOWS

Address all inquiries to **GROVER A. GODFREY, Secretary-Treasurer**
Chamber of Commerce Building **DALLAS, TEXAS**

Monsanto Chemical Announces Formation of Western Division

THE Monsanto Chemical Company of St. Louis, Mo., has announced the formation in Seattle of a Western Division to supervise continually expanding operations centered on the Pacific Coast.

The new operating division consists of four plants which were formerly the principal units of I. F. Laucks, Inc., but which have been operated by Monsanto as a subsidiary since 1944. Prominent in the manufacture of plywood glues, paint and wood preservatives, the plants are located at Los Angeles, Calif., Lockport, N.Y., Portsmouth, Va., and Seattle, Wash., where a \$2,000,000 three-year construction program is scheduled to start this spring.

Harry P. Banks, president of the Laucks organization, has been elected



HARRY P. BANKS

vice president of Monsanto and general manager of the Western Division. Banks joined I. F. Laucks in 1918, became vice president and manager of I. F. Laucks, Inc., Seattle, in 1920, and succeeded I. F. Laucks as president in 1944.

The new division is the fifth major operating unit of the company and in combination with Monsanto's facilities for manufacturing raw materials makes Monsanto the largest producer of plywood adhesives in the world.

* * *

Ingersoll Exhibit to Be Held at Congress

THE Casino room of the Congress hotel, Chicago, will be the scene of the 1947 exhibit of the Ingersoll Steel utility units during the week of Feb. 23.

Coinciding with the convention days of the National Association of Home Builders, the exhibit will open officially Monday morning, Feb. 24, to all NAHB members. A private preview for NAHB directors will be given Sunday afternoon, Feb. 23.

The 1947 exhibit, arranged as a logical working sequence to the 1946 show by Roland D. Doane, chief executive of Ingersoll Steel's sales department, requires more than 8,000 square feet of space. Superb showmanship, color, and animation will feature the exhibit which extends the Ingersoll unit education into three new departments: production, distribution, and installation.

Did You Get Your Copy? Send the Coupon...

See How I-B-R Is Making America's Home Builders Conscious of Radiant Heating Benefits.

Never before has the story of Hot Water and Steam Heating been presented to home planners in so colorful and adequate a manner! Sponsored by the Institute of Boiler and Radiator Manufacturers, this booklet is the keynote of a sustained advertising program to drive home the outstanding advantages of Radiant Heating in all its forms.

Here in twenty-four pages is a world of interesting, practical heating information for home planners... alive with illustrations in brilliant color... non-technical... a pleasure to read. "Enjoy Better Living" pictures all the reasons why today's builder gets more for his money when he installs Radiant Heat—whether a Radiator, Baseboard, Panel or Convective system! Its story is authoritative—based on scientific investigation of heating methods in the I-B-R Research Home at the University of Illinois.

A valuable help to Builders

"Enjoy Better Living" brings you up to date on the many amazing things modern heating science has devised to make a home supremely comfortable. It is interesting, instructive reading—send the coupon for your copy.

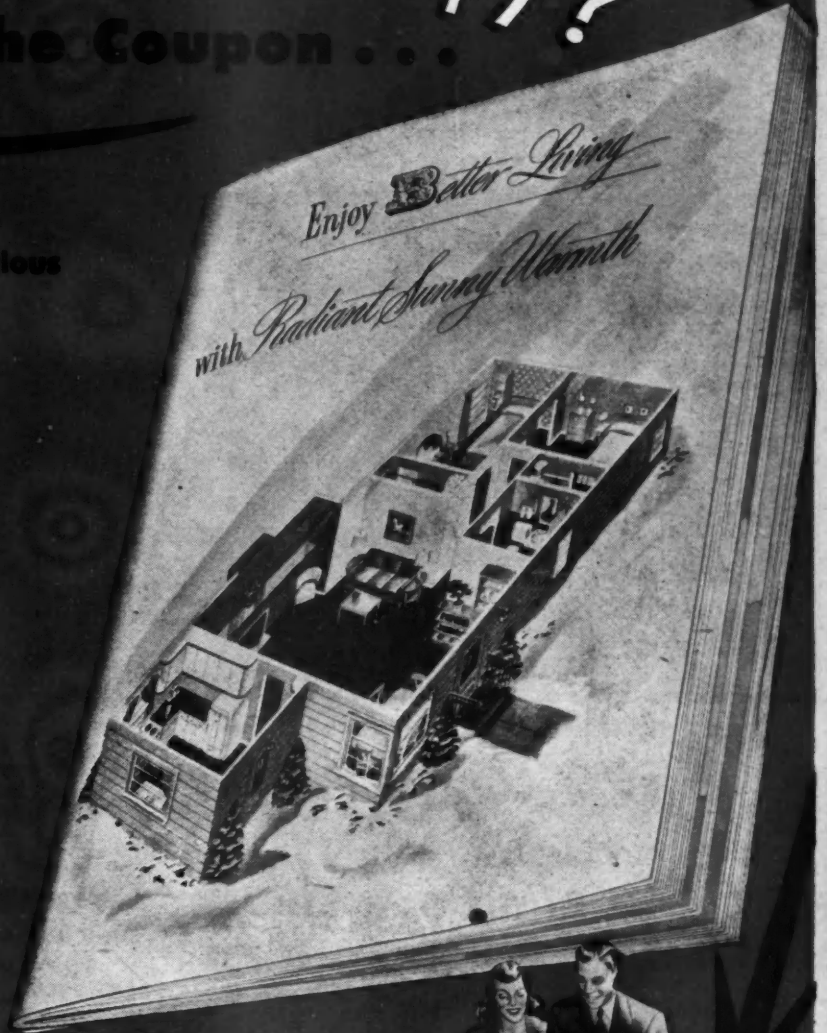

I-B-R Advertising Reaches Millions Every Month!

These popular home service magazines with nation-wide circulations are used to offer "Enjoy Better Living" to America's best building prospects.



The Institute of Boiler and Radiator Manufacturers
60 E. 42nd St., Dept. TF-1, New York 17, N. Y.
Send at once a free copy of "Enjoy Better Living with Radiant Sunny Warmth."

Name.....
Address.....
City..... Zone..... State.....

The Institute of Boiler and Radiator Manufacturers

60 East 42nd Street, New York 17, N. Y.

★ Blueprint PLANS
 FROM AMERICAN BUILDER MAGAZINE

12 COMPLETE BLUEPRINTS
 21 HOMES - 7 GARAGES



MOCK, indicated how our better explained by the low, sweeping roof and other picture window.

A Modern Adaptation of a French Farm House

This house, designed by Philip Maber, Chicago architect, has the freedom of contemporary planning, and still retains the classic balance that is reminiscent of best of old world atmosphere.

THE characteristics of the French farm house with variations to adapt the style to modern materials and conditions were used by Philip B. Maber, Chicago architect, in designing this comfortable home for A. J. Jaska, Urbana, Ill. The builder was Frank J. Schwartz, also of Urbana.



Perfect symmetry was obtained in the front elevation by clever handling and treatment of the window and door units. Blinds flanking the entrance door balance the porch opening at the opposite side, and the large living room window centered under the middle doorway acts as a focal point of symmetry. The window, in addition to this function and that of providing ample daylight for the interior, also emphasizes the horizontal lines of the front elevation, which are heightened further by quoins on both sides of the entrance and porch. The exterior walls are composed brick painted white. The roof is covered with asphalt shingles in a deep maroon, providing a pleasing contrast to the walls.

The chief characteristic of the plan is compactness which is achieved without sacrifice of easy circulation from room to room. The unusual location of the front stairway permits it to be included in the large dormer at the rear of the house, and allows ample space for two large bedrooms on the second floor.

A GRACIOUS fireplace would add character to the living room.

American Builder's New

No Other Planbook Like It!

Here is a practical plan book for every Home Builder and Home Seeker. Instead of merely pictures with miniature "plans," as in the ordinary "planbooks," American Builder's New Blueprint Planbook actually shows large, accurately drawn blueprints. All homes in this book have been designed by nationally famous architects and it contains 12 complete blueprints suitable for accurately estimating construction costs of these attractive homes and garages.

Wide Selection of Architectural Styles

To give as wide a selection of architectural styles as possible, Cape Cod, Modern, Ranch and Colonial Homes are illustrated. All are exceedingly well

planned and are adaptable to any climate both as to style and construction.

Valuable Handbook for Builders

American Builder's New Blueprint Planbook will be a valuable sales aid to you. Colorful plastic binding permits it to open and stay flat while in use. The blueprints open up to 16½ inches by 11½ inches. You can help your customers visualize the house from all sides, as all four elevations are shown. Furthermore, the large size plans assist your customers to obtain a better idea of the relative sizes of rooms than is possible with ordinary "planbooks." In addition, important details are shown, and each plan is illustrated with a large, clear photograph of the house.

In fact, no customer can fail to be impressed with the splendid material in this book.

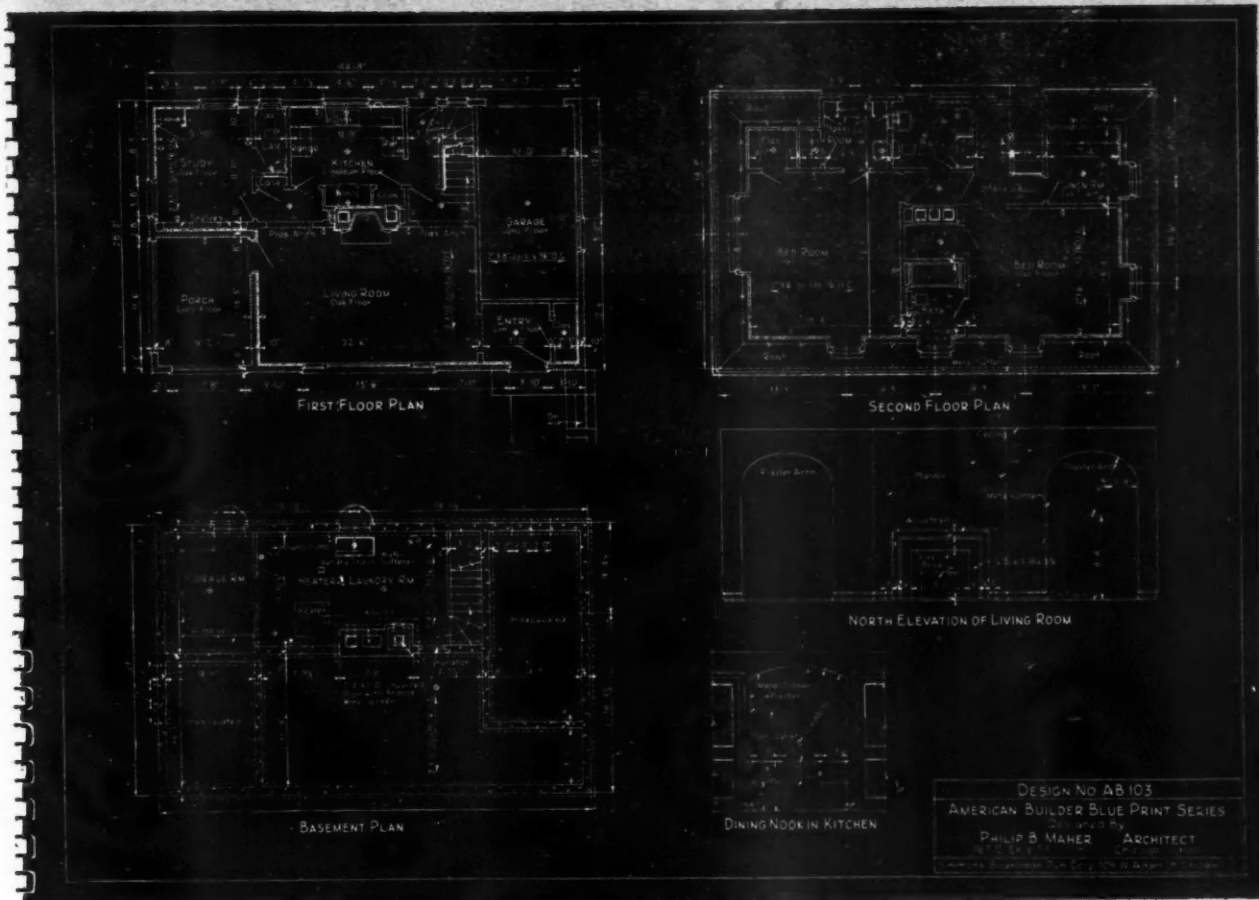

BLUEPRINT PLANBOOK

Other Valuable Features

Other pages contain valuable suggestions for interior treatments together with several built-ins. Many excellent garage designs are included, indicating exterior treatments to conform to architectural style of the home.

Orders are being filled in the order of their receipt. It is suggested that you place your order promptly. First edition is limited owing to paper shortages.



● Use this new Blueprint Planbook as a sales tool—Use it to accurately estimate building costs—Use it for ideas on Built-Ins and ideas on garage styles that will harmonize with the exterior design treatment of the house.

12 Complete Blueprints
21 House Designs
Garages — Built-Ins

\$2.50

ORDER TODAY

American Builder and Building Age,
Book Service Department
30 Church Street, New York 7, N. Y.

Gentlemen:

Enclosed is a _____ check or _____ money order for \$2.50 for which please send a copy of your Blue Print Planbook to:

Name

Street

City

State 2-47

Here's Why DEALERS PREFER

NU-ART ALACROME MOULDING

*Check these
Facts*

BIG PROFITS

You make a higher percentage of profit per dollar of sales on Nu-ART Mouldings than on almost any other item you handle.

WE PAY FREIGHT

even on orders as small as \$10 net.

PACKED BETTER

Nu-ART Mouldings are shipped in strong wooden boxes instead of weak paper shipping tubes. This is more expensive for us but insures delivery to you in perfect condition.

SCREWS FURNISHED

Nu-ART Mouldings come with the nail or screw holes drilled, and the necessary nails or screws furnished.

BEAUTIFULLY POLISHED

Nu-ART Mouldings are polished to a beautiful luster. Each length is placed in a protective Kraft tubing.

These are a few of our 200 standard sections



FREE!

Write today for our new 1947 catalog showing complete line of Nu-ART Mouldings and Edgings, with price list.



MACKLANBURG • DUNCAN CO.
OKLAHOMA CITY 1, OKLAHOMA

"If It's Lumber, Call Our Number"



MRS. Peggy Wunsch, left, and Mrs. Alene Beckford, of Oklahoma City, who started a lumber yard last May and now have a going, profitable concern.

WOMEN have always confessed a fascination for the retail lumber and building material business, but three Oklahoma City women have become interested in it as a means of livelihood.

Despite acute material shortages, Mrs. Arlene Beckford, a former social worker, Mrs. Peggy Wunsch, a lawyer, and Mrs. Estelle Parker started business last May 3 on a tract waist-high with weeds, and have compiled an amazing record for accomplishment. They have erected a store and office building, lumber sheds, etc., and stocked them with materials. Today the firm is a going, profitable enterprise.

"Realizing our lack of knowledge, we set about to learn everything we could about building materials, how they are used and how they are sold. Right from the start, our idea is to know the lines so well we will not have to take our bonnets off to any men in the industry," says Mrs. Wunsch. "Thoroughness is our keynote and we believe it entirely responsible for the progress we have made."

An example of how they carry out the thoroughness idea was several days spent in the laboratories and factory of the Seidlitz Paint and Varnish Co., Kansas City, to gain first-hand information on the processing, grinding and merchandising of paints.

* * *

Fourteen New Plants for Wood Preserving Industry

THE largest expansion in the history of the nation's wood-preserving industry can be expected to occur in 1947, according to J. F. Linthicum, Chicago, (Continued to page 178)

HEATFORM

The Superior Heat Circulating Fireplace

The HEATFORM is a double walled metal unit. A perfect guide for the masonry walls. It consists of firebox, throat, and damper. It costs but little, if any more, because it saves labor and materials used for constructing the old time fireplace.

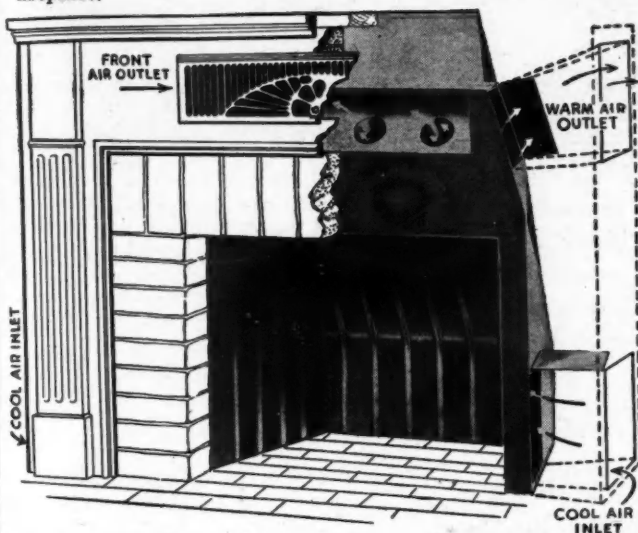

YOUR CUSTOMERS EXPECT YOU TO RECOMMEND AND FURNISH THE BEST

Compare the Heatform with any other fireplace and you'll be convinced that it delivers more heat and gives more years of service.

MORE HEAT because: larger air chambers surround firebox and throat thus more heating surface over which the air passes.

MORE HEAT, AND GREATER AIR VELOCITY, because: lower and upper heating chambers are connected by air passages at each side and also thru the throat.

MORE YEARS OF SERVICE, because: of the RIBBED construction of the boiler plate firebox.

MORE YEARS OF SERVICE, because: dead-air pockets in the rear heating chamber are eliminated by the round air flues thru the throat which draw a large portion of the air over the hottest heating surface (the lower rear sloping back wall where the most heat is generated). This prevents deterioration of metal.

MORE YEARS OF SERVICE, because: there are no exposed metal parts beneath the chimney to rust out.

Heatforms are designed and manufactured by the pioneer of the industry and are proven by 25 years of use.

Write for complete information today—and prepare to serve your customers who see our national advertising in leading home building magazines.

SUPERIOR FIREPLACE COMPANY

Manufacturers of

HEATFORMS, Form Dampers, Blade Dampers, Fuel Grates, Ash Dumps, Cleanout Doors, and Drape Screens.

1708 E. 15th St.

Los Angeles 21, Calif.

Miracle Walls

by

TYLAC

*Beauty
Economy
Permanence*

Not just another product

TYLAC is the name of the finest in permanent wall paneling. It is the Trade Mark, the escutcheon, the guarantee which only the finest in prefabricated wall coverings symbolizes.

Today, TYLAC is a household word for quality—earned through an experience of 20 years of Quality fabrication—20 years of unceasing research to make this better product—BEST.

Craftsmen make TYLAC. Men and women whose pride in their skill, and their product, have made it possible for everyone, everywhere to enjoy the many advantages of superiority that TYLAC provides.

Jobbers and Dealers are building liberal profits by offering this fine wall covering, with confidence, to a discriminating public everywhere. Demand for TYLAC is terrific—unprecedented. This causes some delay in our otherwise prompt delivery. We can, however, make immediate shipments of TYLAC Metal Mouldings, TYLAC Adhesive Cement and other accessories. Remember, TYLAC is worth waiting for.

TYLAC COMPANY MONTICELLO, ILLINOIS

PIONEERS IN THE PREFABRICATED WALL PANEL INDUSTRY

— the new **INTERNATIONAL**

OIL BURNING FURNACE...

*designed especially for
basement-less homes*

Thousands of installations in basement-less homes during the past seven years have made possible this new development in home heating that offers builders for the first time the advantage of a compact automatic furnace that distributes the heat over the floors—where it is needed, and at the same time provides low cost installation and economical operation.

**Only 4.1 square feet of
floor space required**

Fits into a 23" x 27" closet. The flue outlet connects directly from top of furnace, saving long chimney runs. Handsome furniture styling permits appropriate placement in a hall or niche.

Warm Floors

Offers a wide variety of installations—the warm air can be circulated down through underfloor ducts connected to baseboard grills or directed over the floors from grills connected at sides, front or back of furnace just above the floor level. Especially ideal for cement slab construction as ducts can be cast into the floor.

Quiet—Economical—100,000 BTU Capacity

Designed especially for homes up to 7 rooms—100,000 B. T. U. outlet capacity. Fully automatic. Luxurious quietness in operation is provided by our exclusive high capacity, heavy-duty floating blower which is completely spring mounted. Assures maximum heating comfort throughout the home as well as utilization of all heated air for greatest efficiency and economy.

Order through your heating contractor

On display at the
National Home Builders
Show in Chicago—
February 23 to 27.
Space # 160.

International
OIL BURNER CO.

Park and Spring Avenues • ST. LOUIS 10, MO.

(Continued from page 176)

president of the American Lumber and Treating Co. Composed now of more than 180 plants, the industry expects to add at least 14 plants during 1947.

Mr. Linthicum's own organization, which operates 10 plants throughout the country, will put two of the largest new units into production—one at Baltimore, Md., and the other at Everett, Wash. The greatest previous growth of the industry occurred in 1928 when 11 wood-preserving plants were opened.

If lumber production continues upward and treating chemicals, principally creosote, become more plentiful, the output of treated forest products in 1947 will probably top the preceding year, Mr. Linthicum stated. Final figures for 1946 are expected to show that more than 3¼ billion board feet of wood was chemically-alloyed to resist fire, rot and insects.

He cautioned, however, that unless the nation's coal situation is stabilized, railroads and public utilities may be unable to carry out long deferred maintenance and badly needed expansion for lack of vital creosoted cross ties and electrical transmission poles.

The normal flow of creosote, a by-product of coke manufacture, from the steel industry to wood-preserving plants has been crippled by past coal strikes, he explained. In addition, foreign imports, usually accounting for approximately 27 per cent of the U.S. creosote consumption, have fallen far below pre-war levels.

"USE YOUR ATTIC"



For free information, see your building material dealer or write—

MARCO STAIRWAYS
BOX 7A, LUCCA, N. DAK.

BUILDERS JUST CAN'T BELIEVE IT!

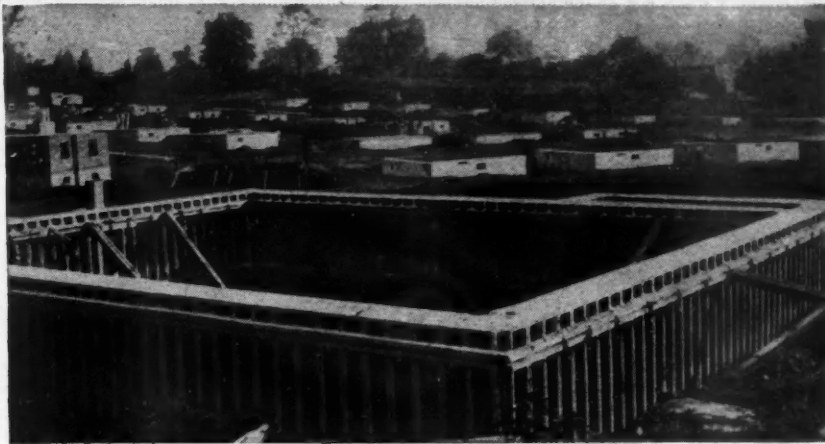

**Less Than 23/4c
Per Square ft.
for Concrete
Form Labor**

YES, until they do it themselves. Builders just can't believe they can get a foundation every day at less than 23/4c per sq. ft. of contact surface, but Atlas Speed Forms are making this stupendous record on thousands of houses. The 23/4c includes cost of erection, installing chases, doors and windows, inserts, pouring, stripping and moving. Steel Forms, good for indefinite use, go together easily and quickly with wedge bolts. No studs or joists needed. Concrete finish is uniform and smooth.

Now Available for Sale or Rent

Write for Complete Facts

Irvington Form & Tank Corp.
Irvington 1, N. Y.

A Contractor writes—

"As one of the largest contractors of foundation work in this area, we have tried every variety of form we ever heard of and find you really have something in Atlas speed forms. These forms are easy to handle, easy to work, easy to strip. They give us straight walls and especially save us concrete. That is all anyone can ask.

We, as you know, are getting a foundation every day with one set of forms. We used them 128 times on one job alone."

Very truly yours,

(signed) LOUIS BELLI,
69-11 165th St., Flushing, L. I.

ATLAS Labor-Saving SPEED FORMS

New Answer to an Old Problem!

At one low material and labor cost, reflective Sisalation takes care of two of your most important building needs:

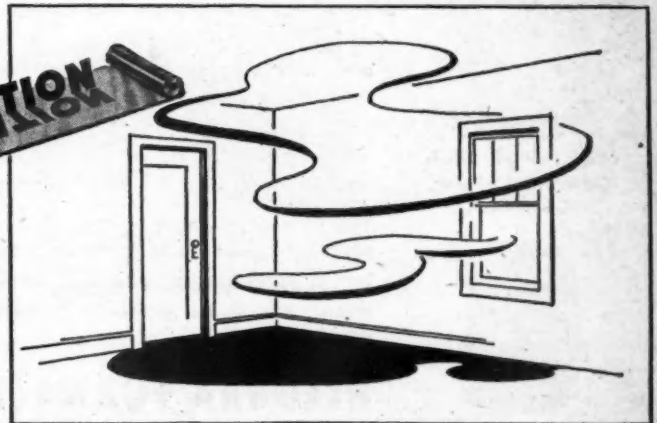

1. LOW COST INSULATION

SISALATION reflects radiant heat very much as a mirror reflects light. In frame or brick construction, Sisalation creates two reflective air spaces which offer amazing resistance to heat loss through the wall. Reenforcing insures speedy, intact application.

2. MOISTURE-VAPOR BARRIER

SISALATION acts as a positive moisture-vapor barrier, preventing moisture-laden air within the home from reaching the cold outer walls, where condensation of moisture would cause deterioration of structural materials. Every home can now afford its big advantages.

The SISALKRAFT Co., 205 W. WACKER DRIVE, CHICAGO 6, ILLINOIS

A "COME-PACKED" HEATING UNIT FOR YOUR COMPACT HOUSE...

The New
NIAGARA
GAS-FIRED
WINTER AIR CONDITIONER



NIAGARA
Model 10-75VAC



for UTILITY ROOM OR APARTMENT INSTALLATION

● Truly fitting today's needs, this new Niagara, Model 10-75VAC, is a compact unit that brings modern automatic winter air conditioning to small homes at a low initial cost and low operating cost.

Designed especially for installation in utility rooms and apartments, Model 10-75VAC is only 21" wide and 32½" deep at the base (draft hood extends 7¼" at right, making over-all width 28¾"). Combustion chamber, side radiator and flue pipe are made of heavy gauge Toncan iron. Blower, filter and enclosed controls are readily accessible through removable front panels. Air inlet may be located at back, either side or bottom. Output at bonnet 60,000 BTU. Burners for natural, manufactured or mixed gases. The unit is shipped as a package unit, completely assembled.

The complete Niagara line includes both gas-fired and coal-fired furnaces for any domestic installation—backed by 55 years' experience in building residential heating equipment. See your Niagara dealer or write for descriptive literature.

NIAGARA FURNACE DIVISION
THE FOREST CITY FOUNDRIES COMPANY
2500 WEST 27TH STREET • CLEVELAND 13, OHIO

NIAGARA

GRAVITY AND WINTER AIR CONDITIONING UNITS

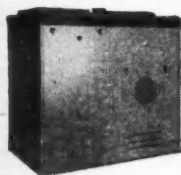

Series 20 Gas-Fired Winter Air Conditioning Unit—CAST IRON

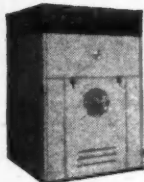

Series 20 Gas-Fired Gravity Furnace—CAST IRON



Series 10 Gas-Fired Gravity Furnace—STEEL

Remodeling with Aluminum Siding



ALUMINUM is used here for re-siding job.

IN the photo above workmen are shown applying aluminum bevel siding over old siding to give the house a new exterior covering. There is considerable potential for use of this product for residing, providing the first jobs are completed in the correct manner.

Aluminum's vulnerability to damage by galvanic action dictates that a substantial barrier of some type be applied between the new siding and
(Continued to page 182)

PRODUCES
28 BRICKS PER MINUTE
VI-BRIK-CRETE
NEW HOPPER SPEEDS MOLDING



- MODERATE INITIAL INVESTMENT
- 60 VIBRATIONS PER SECOND
- LOW PRODUCTION COST
- FOR QUALITY CONCRETE BRICKS
- EASY TO OPERATE
- STURDY

ALSO MANUFACTURERS OF THE
LITTLE DAVE BRICKMAKER
LOW COST HAND OPERATED MACHINE

R. S. Reed Corporation

340 EAST HOFFMAN ST.
THREE RIVERS, MICHIGAN

HI-SPEED OPERATION IS NORMAL FOR COMETS

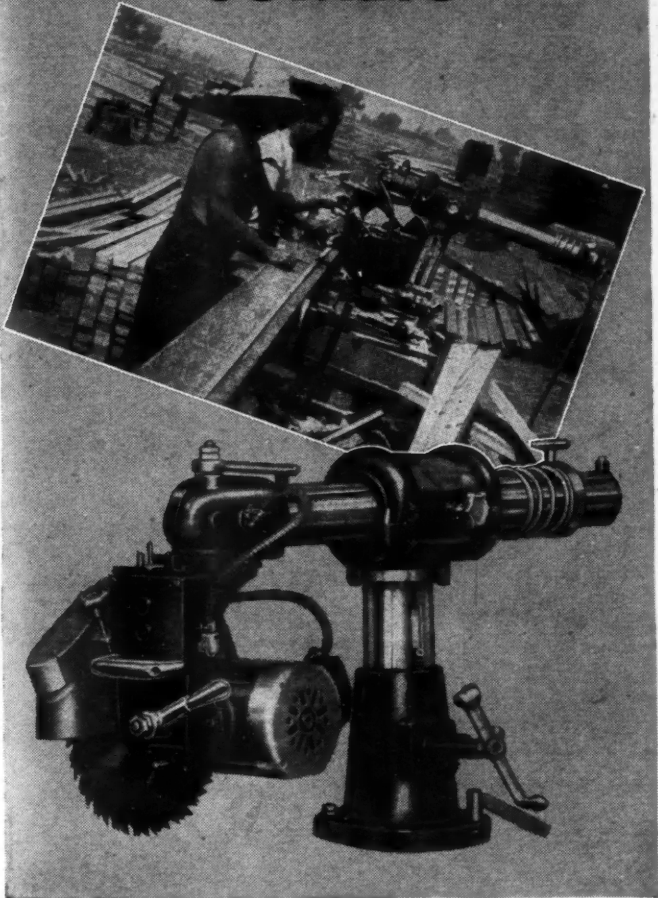

Their very name implies speed above average. And for Comet Radial Power Saws hi-speed operation is but a normal function. Comets are powered to cut fast; to cut smoothly and with precision. And today Comet Saws are known for their endurance as much as for their blazing cutting speed. To builders all this means more profit per job. Order Comets from your dealer or write direct.

CONSOLIDATED MACHINERY & SUPPLY CO., LTD.
2029-33 Santa Fe Avenue, Los Angeles 21, California

COMETS cut quicker

Automatic CONTROLS...

Buy the Package

GENERAL CONTROLS presents four of their convenient packaged sets for compact inventory and simple installation. Here are four of many precision built, field proved package sets most frequently desired by gas heating contractors and engineers. Buyers can select complete sets in compact cartons, each set includes essential units required. Get improved performance at lower costs through ENGINEERED adaptability.

T-90 STANDARD THERMOMETER SET

Set combines improved B-60 gas valve, flush mounting Thermometer Thermostat and Pilot Generator. Positive remote temperature control for gas-fired furnaces.



T-30 GAS HEATING SET

This set includes silent K-38 two-wire gas valve, T-70 two-wire metrotherm, and 115-24 volt transformer. Ideally adaptable to gas-fired boilers, wall and floor furnaces, conversion burners and warm air furnaces.



BX-230 STANDARD THERMOSTAT SET

BX-230 includes B-60-6B diaphragm gas valve, PG-6 Pilot Generator, and T-80-4 Thermometer type Thermostat with night cut-off. For wall and floor furnaces, circulators, etc.



T-40 GAS HEATING SET

This set includes two stage Thermostat, dual solenoid valve and Transformer. Provides fully automatic, hi-low firing, maintaining ideal temperature control and lower fuel cost.



For complete specifications covering the GENERAL CONTROLS broad line of Automatic Pressure, Temperature and Flow Controls see the new 1946 Catalog 52C. For Gas Heating Controls, request Service and Instruction Manuals.

GENERAL CONTROLS

Manufacturers of Automatic Pressure, Temperature & Flow Controls

THE RIGHT "SPOTS" TO SAY "FRANTZ"

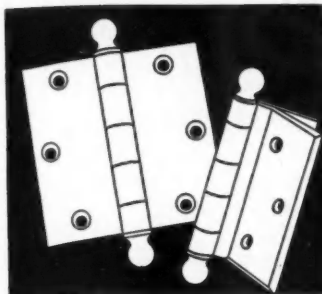

FOR DOORS

The Frantz line of *Guaranteed Builders' Hardware* includes hundreds of hinge styles and sizes of durable wrought steel construction . . . available in all standard finishes. Illustrated are Ball Tip Butt Hinge No. 441 and Half Surface Butt Hinge No. 365.

FOR WINDOWS

Attractiveness in sash hardware is a "must" and Frantz offers the latest in modern design . . . the finest finishes. Illustrated are Sash Lock No. 320, Beveled Sash Lift No. 310 and Bar Sash Lift No. 315.

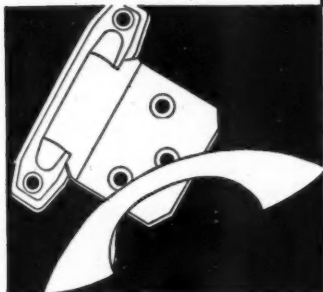
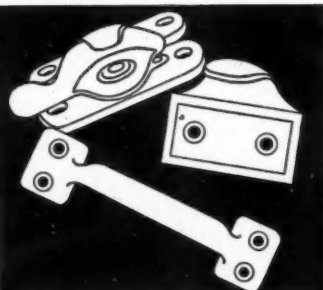

FOR CABINETS

Smartly-styled cabinet hardware is in great demand for the modern kitchen. Frantz offers some distinctive items in this line. Illustrated are No. 120 Door or Drawer Pull and No. 491 Hinge.

FOR BARN

Handling heavy barn doors with ease, is simple with Frantz "Glide" Door Hanger and Track . . . the original water-shed type. Illustrated are No. 111 Track and No. 1 reinforced Hanger, which cannot be derailed . . . will fit any thickness door.

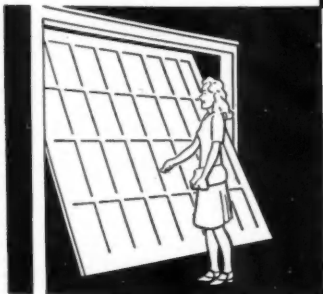
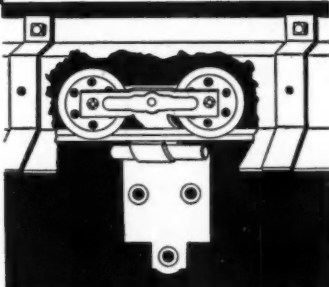

FOR GARAGES

Garage doors open quickly, effortlessly with Frantz "Over-the-Top" Door Equipment. Doors can harmonize with building architecture because "Over-the-Top" can take custom-built, one-piece doors up to 18' wide, 12' high and up to 720 lbs. weight.

• Save time and trouble by installing Frantz Builders' Hardware. Order from one, reliable source . . . your nearest Frantz dealer. Customer satisfaction is guaranteed by Frantz's quarter-century experience in manufacturing quality hardware.

FRANTZ

GUARANTEED BUILDERS HARDWARE

FRANTZ MANUFACTURING CO., STERLING, ILLINOIS

Among the modern conveniences going into the Gernholz-Healy, Inc., project homes featured in this issue . . . are hundreds of

WINCO VENTILATORS

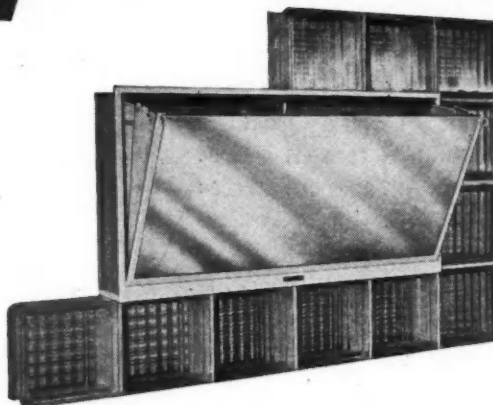

For offices, stores, and home baths and kitchens. Exterior glass block construction is not complete without Winco Ventilators.

Admits light and ventilates like a window—will not admit rain, flies or insects when open. Entire unit in enameled frame sets in mortar—complete with interior "vaned" glass panel and exterior bronze screen which are removed during construction. 6 sizes: for 6" blocks and 8" blocks.

—and WINCO VENTILATING FANS

EASY ASSEMBLY

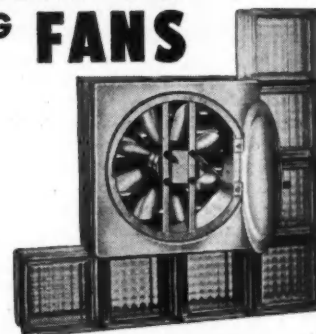
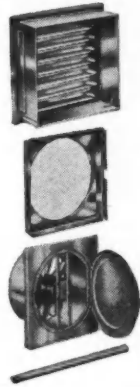

Beautiful-Efficient

For home kitchens and offices. Metal frame easily installed in 6" or 8" glass blocks, in openings of 1 or 4 block displacement or in standard frame walls. Others for 9" to 13" brick walls. Complete with fan, motor and automatic door switch.

Detailed specifications, illustrated literature and prices on these modern Winco installations sent upon request.

WINCO

Ventilator Co. INC.

1435 VERONICA AVE. • ST. LOUIS 15, MO.

A Practical Working Manual
on Frame Building Layout,
Materials and Construction

DWELLING HOUSE CONSTRUCTION

by Albert G. H. Dietz, Sc. D.

Assistant Professor of Building
Engineering and Construction,
Massachusetts Institute of Technology.

DWELLING HOUSE CONSTRUCTION
is a comprehensive guide to frame build-
ing construction, explaining all of the
steps involved in the complete erection
of a house, from the original inspection
of the site to the final coats of paint.

- Full information is given about the problems of excavation and soils.
- Foundations and the design of footings are emphasized.
- Chimneys and fireplaces are analyzed in detail.
- Roofing and flashing are carefully considered.
- Insulation is discussed in full.

Interior and exterior finishes are given close attention, as are hardware, painting, and many other parts of the dwelling house.

Of immediate use to Architects, contractors, builders, manufacturers, and to all those people who have waited patiently for the opportunity of building their own homes, this authoritative encyclopedia of home-building fundamentals is heavily illustrated, with accurate and functional directions for each process described.

Just Published **\$6⁰⁰**
AT ALL BOOKSTORES

With the publication of **DWELLING HOUSE CONSTRUCTION**, Van Nostrand initiates an integrated and thoroughly practical series of works on the principal types of modern building construction and servicing prepared under the editorship of Walter C. Voss, head of the Building Engineering and Construction Department of the Massachusetts Institute of Technology. If you are interested in receiving information about new titles as they appear, address letter or postcard to Department B, the

D. Van Nostrand Company, Inc.
250 Fourth Avenue, New York 3, N. Y.

Upson Fund Helps USO

THE "Keep 'Em Smiling" committee of The Upson Company, Lockport, N. Y., has been honorably discharged. Throughout the war the committee kept in close touch with the scores of Upson people in the armed services and forwarded to them contributions both of money and gifts from their fellow-workers. When James J. Upson of the sales division (center, below) was named chairman of the Lockport Junior Chamber of Commerce committee in charge of residential solicitation for the USO campaign in Lockport, it was decided to liquidate the committee by donating the balance of the committee's funds to the USO campaign. H. M. Kinzley, export sales manager (at right below), is shown giving the committee's check to L. E. Broeffle, chairman of the Industrial division of the Lockport USO campaign fund.

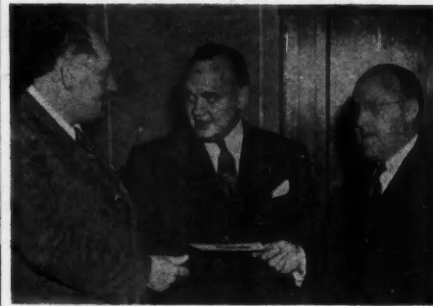

L. E. Broeffle, James J. Upson, H. M. Kinzley.



Stainless Steel Sinkbowls

Legion sinkbowls are seamless drawn from one piece of solid or single clad stainless steel... No welds, rough edges, ridges or grooves to cause leaks, corrosion or cracks where dirt may lodge... Light in weight, yet rigid and long-wearing... Oblong, square, round or oval shapes.

Write for catalog sheet.



**LEGION
STAINLESS SINK CORP.**

21-13 40th Avenue, Long Island City 1, N. Y.

KNIFE-GRIP BRACKETS

cut scaffolding costs...
save lumber • labor • time

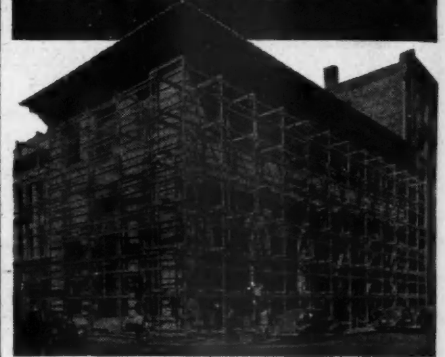

Knife-Grip steel brackets and ordinary dressed 2 x 4's and 4 x 4's are all you need to build sturdy scaffolding easily and quickly at savings up to 70 per cent in construction costs.

MANY USES. Scaffolds built with Knife-Grip brackets meet the needs of carpenters, plasterers, brick masons, and painters.

FAST. No nails . . . no bolts . . . no special tools. Two men using only one hammer can erect a 2-story scaffold, 16 ft. long, in 20 minutes.

STURDY. Knife-Grip brackets lock vertical and horizontal timbers to give workmen complete security.

LOW COST. Built for years of hard service. Inexpensive. Lumber can be used again and again.

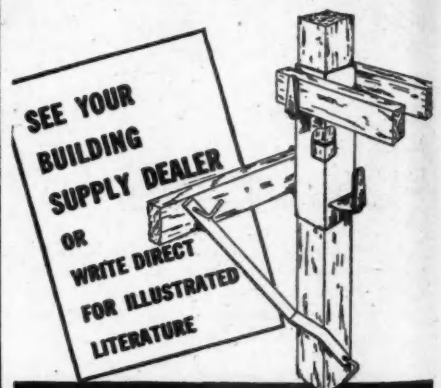

NORTHWEST

Tube and Metal Fabricators

2658 S. E. Tenino Street, P. O. Box 2310

PORTLAND 14, OREGON

BILT-WELL WOODWORK

... is the choice of discriminating builders everywhere. It is produced from Ponderosa Pine by master craftsmen, and is a leader in the building field.

CABINETS

China, Corner
Ironing Board
Kitchen
Linen
Medicine
Telephone

BREAKFAST NOOKS

SCREENS

Door
Window

SHUTTERS

DOORS

Combination
Exterior
Garage
Interior
Screen

STAIR PARTS

STORM SASH

ENTRANCES

Large
Small

WINDOWS

Barn
Basement
Casement
Double-Hung
Garage

GABLE SASH

LOUVRES

MANTELS



Any House is a Better House WITH CONCRETE FLOORS

Any house, whether built of concrete, brick or frame, can have the advantages of a firesafe, sag-proof concrete subfloor. And nothing that a contractor can build into a house of any material will give the owner more in firesafety, structural stability and security or contribute more to durability, low maintenance expense, *low annual cost.*

Requirements are Simple

Concrete residence floors offer no construction difficulties to the average builder. The essential requirements are an approved floor design, ordinary skill in form building and a knowledge of the fundamentals of concreting.

Tell Your Customers

Tell your customers how concrete subfloors may be covered with hardwood strip or parquet flooring; rugs or all-over carpets; linoleum, rubber or cork tile; concrete, ceramic or asphalt tile, any finish they wish—different in every room if need be to fit all purposes.

Write for literature on how to build concrete subfloors for residences. Free on request. Distributed only in the United States and Canada.

PORTLAND CEMENT ASSOCIATION

Dept. A2-3, 33 W. Grand Ave., Chicago 10, Ill.

A national organization to improve and extend the uses of concrete
... through scientific research and engineering field work

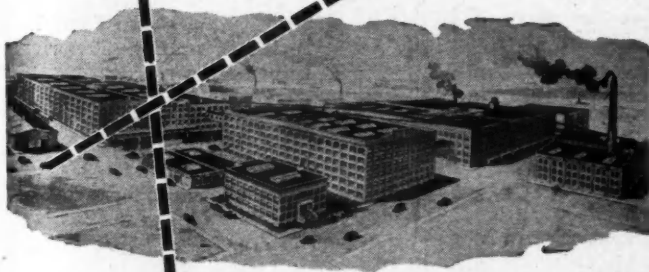

CARR, ADAMS & COLLIER CO.
Dubuque, Iowa



Manufacturers of
**BILT-WELL
WOODWORK**

**HOT WATER
FOR EVERY HOME
AT LOWER
FIRST COST
WITH Sav-U-time**

Sav-U-time push button control, side-arm heater and boiler can all be installed for much less than the usual automatic hot water heater. Yet the result is practically identical!

Sav-U-time helps owner pay for home because cost of operation is up to 50% less than that of an automatic hot water heater. This saving helps him meet amortization payments.

Sav-U-time is simple, inexpensive to install; only ordinary doorbell type wiring is required.

Leading builders in Philadelphia, Detroit, Rochester and other cities have been specifying Sav-U-time regularly for years in new home developments and home modernization. Why not you?

Available Now! While automatic gas water heaters are still in short supply, side-arm heaters and boilers can be had. And we can supply Sav-U-time immediately!

How Sav-U-time works: At the touch of a button in bath, kitchen or laundry, Sav-U-time starts or shuts off gas water heater. Red light above button glows while gas is on. Should user forget to shut it off, thermostatic feature turns gas off automatically.

See Sav-U-time at the National Association of Home Builders Show in Chicago... write for details (use coupon below). You'll find many other reasons beside those listed above for installing Sav-U-time in every home you build or remodel.

Sav-U-time
200 Manhattan Street
Rochester, New York

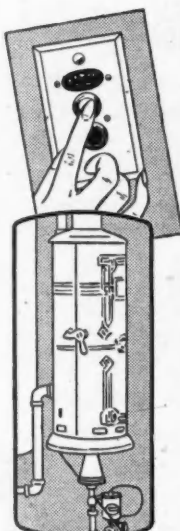

Sav-U-time Sales Co.
200 Manhattan St., Rochester, N.Y.

Please send full information on Sav-U-time Gas Water Heater Push Button Control.

Please send details on a Sav-U-time Dealership.

Name _____

Address _____

City _____ Zone _____ State _____

**Price Readjustment in 1947,
Business Editors Predict**

"PRESSURE from management for higher prices and from labor for higher wages will continue, but consumer resistance will turn the price spiral down and most labor will finally decide to give production a chance to help their standard of living rather than strike for higher wages," is the consensus of 130 business, trade, and technical magazine editors.

"Much will depend on buyers' backlog of savings, which have been overestimated," the editors state. "There has been an increase in everything which touches on living and, in spite of higher salaries, there are not many consumers with money in the bank to pay outrageous prices."

Expressing their opinions in a survey conducted by the National Conference of Business Paper Editors, the editors, all recognized authorities in their respective fields, warn that failure to halt the wage-price spiral, prolonged strikes for higher pay, and failure to maintain a high rate of man-hour production may result in a serious business recession.

This shaking down in the price structure may be nothing more than a mild readjustment of an overgrown buyers' market and will be most noticeable in consumer goods, except heavy durables, and less noticeable in industrial raw materials and supplies. These fields, it is predicted, will be bolstered by the requirements of the building industry.

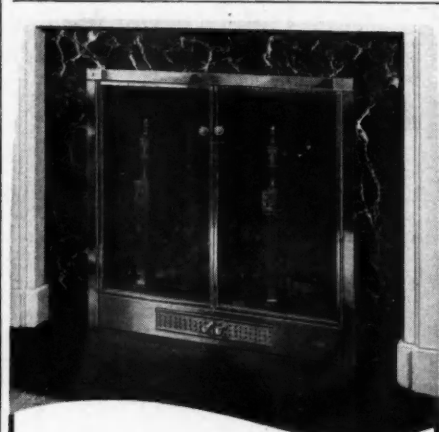

More Profits in 1947

FOR THE DEALER WHO SELLS THE
THERMO-LITE GLASS FIREPLACE SCREEN

It's the new, full-vision fireplace fixture that gives even flowing heat, positive safety, beauty, cleanliness, less fuel cost through lower heat loss. No servicing. Easily installed. Year-round appeal. Get your share of the rapidly growing Thermo-Lite market.



THE GALANOT PRODUCTS CO.
ALLIANCE, OHIO

Send dealer opportunity details in _____

(name of city)

(name and address) (a)

SECOND EDITION

**SIMPLIFIED
CARPENTRY
ESTIMATING**

By **J. DOUGLAS WILSON**

Head of the Building Trades Department,
Frank Wiggins Trade School,
Los Angeles, California

and **CLELL M. ROGERS**

Mathematics Instructor,
Venice High School, Venice, California

A practical text on carpentry estimating, covering rough lumber, finish lumber and hardware, in which the parts of a house are analyzed under six main divisions. Material lists, short cut rules and tables supplement the text and guard against anything being overlooked in making up the final estimate. Valuable information is given for making labor time estimates.

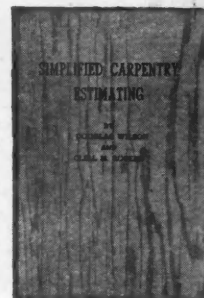

While designed as a beginner's text the Second Edition is complete enough for the use of builders and lumber dealers. Simple arithmetical methods for accurate estimating, are given. Helpful tables that save much time in figuring and a full index make the book suitable for quick reference in the shop or on the job.

Contents

Estimating Fundamentals. Foundation Material. Framing. Exterior Finish. Interior Finish. Hardware. Building Information. Estimating Short Cuts. Labor Hours per Unit of Work. Carpentry mensuration. Mathematical Reference Tables. A Guide to Home Planning. Index. 1945. 2nd. 288 pages, 123 illustrations, 60 tables, 5x7, \$3.00.

Book Department

**AMERICAN BUILDER
and BUILDING AGE**

30 Church Street New York 7, N. Y.

RENTAL HOUSING

THE BUILDER'S **1947** ANSWER TO THE NATION!

CRAWFORDS

**FABRICATED
MULTIPLE
UNITS**

FHA LEADS THE WAY

- Processing Requirements Simplified
- Authority Decentralized
- Short Cut Cost Estimate Procedure
- 32 Year Amortization Period
- Commitments Amended During Construction
- Pre-arranged Release Clause in Mortgage Insured Construction Advances.

VETERAN GROUPS ENDORSE RENTAL PROGRAM

MANY MULTIPLE UNIT COMBINATIONS POSSIBLE
WITH CRAWFORD STANDARD UNITS

WRITE FOR DISTRIBUTORSHIP NOW

CRAWFORD COMPANY

MANUFACTURERS—HOUSES, BUILDINGS—LUMBER, RELATED PRODUCTS

BATON ROUGE 1, LOUISIANA

FOR STRONGER CAVITY WALLS



...ALWAYS USE

NON-RUSTING

Copperweld
WALL TIES

● You can be sure of permanent strength and safety in cavity wall construction when you use Copperweld Wall Ties to bond the walls together.

Copperweld Wall Ties give you the high strength of alloy steel—made permanent by a heavy protective covering of non-rusting copper. The two metals, inseparably united by our exclusive Molten-Welding Process, provide a breaking strength of about 2 tons—a breaking strength that remains constant since these ties cannot rust and will not deteriorate in the wall.

These cavity wall ties are available for immediate shipment. They are made in two sizes—6" and 8"—and are packed 500 of one size to a box.

Specification Bulletin mailed on request.

COPPERWELD STEEL COMPANY
GLASSPORT, PA.

SALES OFFICES IN PRINCIPAL CITIES



Time-Tested
Copperweld Nails
will help you do
a better job!

THE KITCHEN IS THE HEART OF THE HOME

Plan a kitchen that has all the modern conveniences of gas even though you are building beyond the gas mains.

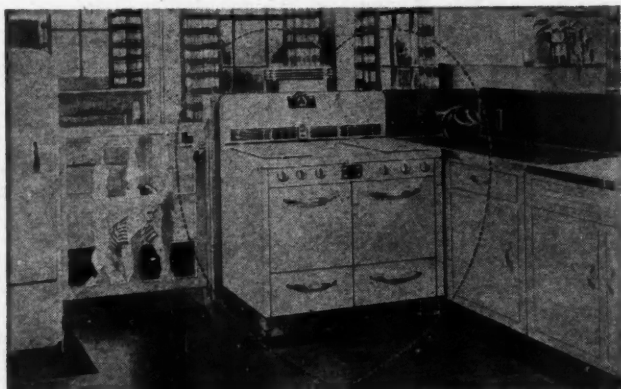

Specify **"PYROFAX"**
GAS SERVICE

"Pyrofax" gas burns just like city gas—it operates the same appliances such as a Magic Chef gas range, a silent Servel refrigerator, and an automatic water heater. "Pyrofax" gas brings new economy, convenience and cleanliness to country homes—with modern automatic "Pyrofax" gas service your clients will have no service interruptions, no dirt or odor. "Pyrofax" gas is distributed in most states east of the



Rockies. Write to Dept. B3, "PYROFAX" GAS DIVISION, 30 EAST 42nd ST., NEW YORK 17, N. Y. for complete information and the name of the nearest distributor.

PYROFAX

TRADE-MARK

SUPERIOR GAS SERVICE FOR 25 YEARS



COOKING • WATER HEATING
REFRIGERATION • ROOM HEATING
BEYOND THE GAS MAINS



**MORE HEAT AND
FLEXIBILITY WITH A**

DONLEY

HEATSAVER FIREPLACE

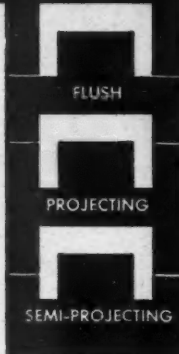

MORE HEAT

because -

Four exclusive features in the Donley Heatsaver fireplace result in extra heat output—output that approaches the heating ability of a small furnace. These plus-heat features are:

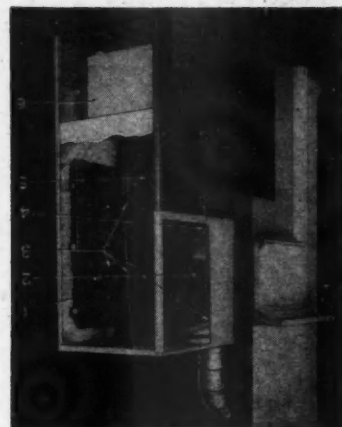

FIRST—Convection sheets inside the Heatsaver warm air chamber prevent hot spots, keep the air moving close to all the heated surfaces, eliminate the need for an insulating blanket and increase heat output of the fireplace—an exclusive in the Donley Heatsaver.

SECOND—The Heatsaver makes the greatest use of the hottest surface in the fireplace—the sloping back wall above the fire. A central heat passage starting just above the surface carries the hot air to the outlets. This Donley exclusive feature increases speed of air flow, insures no "lazy air", reduces heat wastage and makes for much greater heating efficiency.

THIRD—Heatsaver's warm air chamber takes heat not only from the fire box walls, but also from the hot surfaces surrounding the hot flue gases in the smoke chamber above the fire—another exclusive Donley feature.

FOURTH—The heat-trapping, non-reflecting, square-end firebox of the Heatsaver changes skin-toasting, radiant heat into efficient, circulating, room-heating air—one more Donley exclusive.

MORE FLEXIBILITY because the extra heat from a Donley Heatsaver gives you more freedom in placement of the fireplace and more capacity for heating extra rooms. The increased stack effect of the Heatsaver lets you draw cold air from across the room (in under-floor ducts): has been used to heat a distant room on the same floor level. Another flexibility feature of Heatsaver is the fact that you can install it with the fireplace front flush with the wall, fully projecting into the room or only partially projecting.

MORE FACTS FOR MORE PROFITS—Get the complete story on sizes and installation of Donley Heatsaver fireplaces. This information is in the illustrated book "Donley Devices for Home Builders and Owners". A free copy of this helpful book will be sent on request—write for yours today.



THE DONLEY BROS. CO.

13910 MILES AVENUE • CLEVELAND 5, OHIO

"Here's another Prestile ad... Their advertising is sure clicking!"

"Easy to understand why! Prestile tileboard has many advantages people want... low cost... smart colors... and very important, an oven-baked finish that lasts. Prestile national advertising is a real help!"



• Right now, demand for this quality tileboard exceeds supply. Prestile national advertising is designed to keep demand at a high level... for the day when ample supply is available.

PRESTILE

"Its Lasting Beauty is Baked In"

PRESTILE MANUFACTURING COMPANY
2860 Lincoln Avenue, Chicago 13, Illinois

GRAND RAPIDS

Invisible

SASH BALANCE

10 Sizes Meet 95% of all Home Requirements

The Grand Rapids Invisible Sash Balance is popular with dealers and builders because it is simple and easy to order and maintain a balanced stock. Ten sizes meet 95% of the usual residential requirements and the complete, easily understood instructions printed on every carton make them easy to install. Then, too, they are easily adjusted. A tension chart is included with the instructions and builders know that it is unnecessary to remove screws or trim to make a tension adjustment.

Home owners like the Grand Rapids Invisible because it is smooth in performance, trouble-free and dependable in all climates and under varying conditions.

SEE OUR CATALOG IN SWEET'S

Send for SASH BALANCE CATALOG which contains complete information on sash balance sizes, directions for installing, etc. All fully illustrated.

GRAND RAPIDS SASH PULLEYS

No. 103 has plate, roller bearing type and Nos. 175, 109, 110 sawtooth drive type sash pulleys cover 95% of all sash pulley requirements.

GRAND RAPIDS HARDWARE COMPANY
GRAND RAPIDS · MICHIGAN



65%
OF HOME BUILDERS PLAN TO KEEP OUT KITCHEN SMOG!

TWO independent national surveys disclose that 65% of the people who expect to build houses soon plan to install electric exhaust fans! And

Blo-Fan
CEILING VENTILATORS!

rate high on the popularity list! For Blo-Fan is more than a fan—more than a blower. It combines the advantages of both, giving *volume plus power*. Blo-Fans are installed in the ceiling—directly over the source of unwanted air. In kitchens, gamerooms, laundries, bathrooms, these powerful exhaust fans capture cooking grease, smog and odors, as they rise—before they can spread to soil interior decorations.

Contractors the country over are cashing in on the public preference for the exclusive features of Blo-Fans. You'll find Blo-Fan Ceiling Ventilators in both the correct sizes and prices for all types of homes.

*Distributed by Franchised
Electrical and Ventilating
Wholesalers*

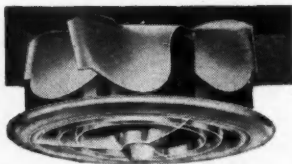

PRYNE & CO. INC.
LOS ANGELES 54, CALIF.
NEW YORK • CHICAGO • HOUSTON • SAN FRANCISCO

**Good News
for
Busy Builders**



MODEL 70

**2 New ELECTRIC
Mall Saws**
REG. U.S. PAT. OFF.
**MODELS
70 and 86**

Here are two new ways to cut construction costs—the Model 70 and Model 86 MallSaws. Designed for the building field, these new MallSaws have capacities of 2¼" and 2⅞", respectively, on straight cuts in rough or dressed lumber . . . 2" and 2-5/16", respectively, on 45 degree angle cuts. They crosscut, rip, bevel cut, dado, groove and multiple cut with speed and accuracy. Perfect balance keeps the weight of the saw on the long end of the board to allow one-hand operation, and an automatic blade guard protects the operator. Special blades equip each saw for grooving asbestos board, tile and concrete and for cutting light gauge metals. Available in two voltages—110-volt AC-DC or 220-volt AC-DC.



Visit our Exhibit at the Home Builders' Convention, Space 109—or write for literature and prices

MALL TOOL COMPANY
7737 South Chicago Ave., Chicago 19, Ill.
*25 Years of "Better Tools for Better Work"

Mall REG. U.S. PAT. OFF. **PORTABLE POWER TOOLS**

“ BUILD RIGHT WITH ALWINTITE ”

SEE US AT BOOTH 68-69 NATIONAL HOMEBUILDERS SHOW

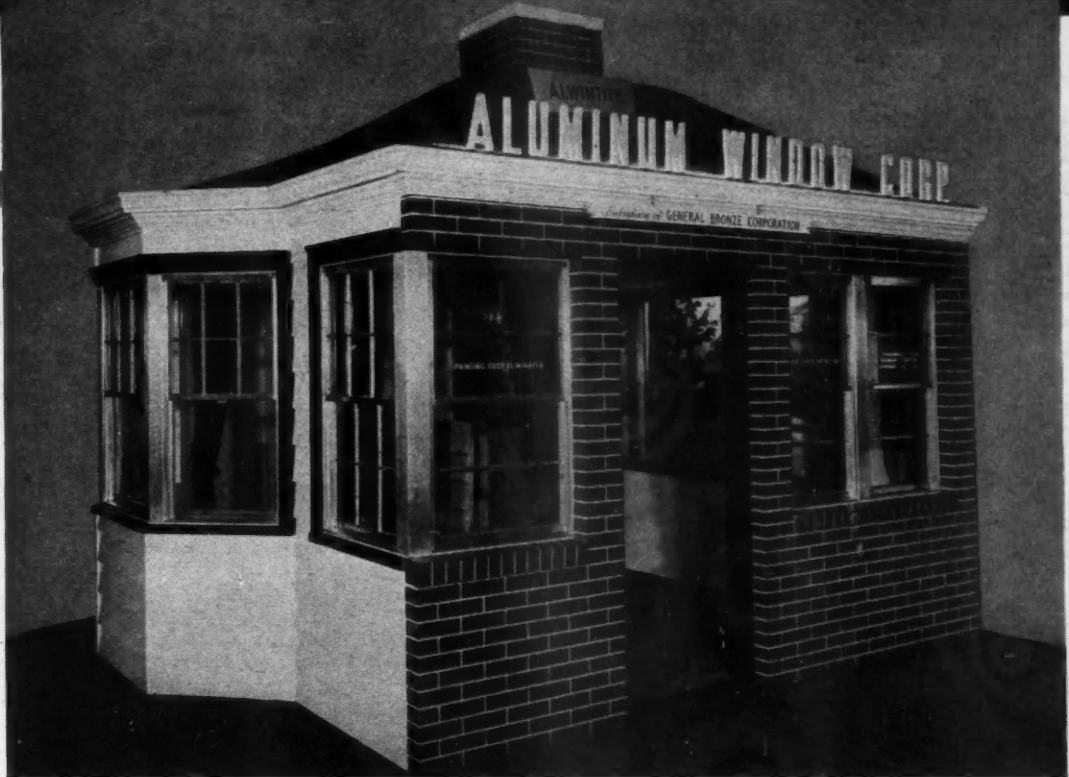

Select **THE ALUMINUM WINDOW**
with a 35-year background

In selecting stock aluminum windows, there are two outstanding qualifications that you should consider. One is the basic design of the window, the other, its construction.

ALWINTITE windows have been designed and manufactured by experts in the field of quality windows — experts with more than 35 years' experience in window manufacture. These windows embody many exclusive, patented features formerly found only in expensive, custom-built windows.

When you select and install ALWINTITE aluminum windows you can be sure of a truly fine window—a window that will satisfy your most exacting customers—a window that will give years of satisfactory service.

ALWINTITE aluminum double-hung windows are available in 12 stock sizes, with 4 muntin arrangements to select from. Use them in the new houses you build. They will add to your reputation as a “quality” builder.

For the complete story on ALWINTITE aluminum windows and name of your nearest distributor, see our exhibit at Booth 68-69 National Homebuilders Show or write direct to The Aluminum Window Corporation (*A subsidiary of General Bronze Corporation*), 34-20 Tenth Street, Long Island City 1, N. Y.



aluminum
WINDOWS

Harborite

SINGLE-PLY

As Available . . .

Harbor Presents

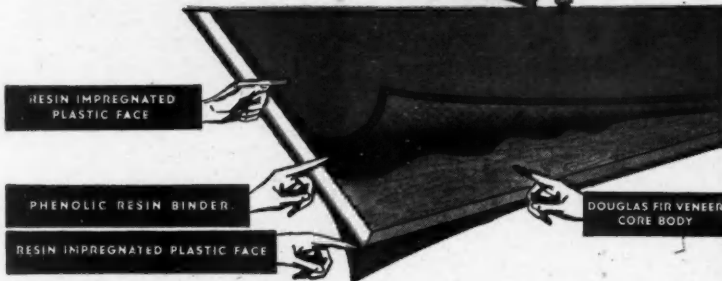

Harborite is Harbor Plywood's time-proven, resin-impregnated, plastic-faced plywood. The smooth, grainless, weatherproof surfaces—of a pleasing brown color—are of phenol-type resin-impregnated plastic, permanently bonded to the Douglas fir core body. Two types of core body are available—single-ply, with the plastic faces applied to both sides of a single sheet of veneer as shown above. Multi-ply—shown at the right—is made with a cross-banded plywood core body.

HARBORITE PANELS—Single or Multi-Ply

Stock Panels	Width	Length	Thickness
Single-Ply	36" up to 48"	96" up to 144"	1/8" & 3/16" Nominal
Multi-Ply	36" up to 48"	96" up to 144"	1/4" to 1-3/16"

A check list of proven uses include siding for railway refrigerator cars, buses, trucks and trailers; cabinet work, table tops, concrete forms, signs, toys, sports equipment, and a wide range of utility items.

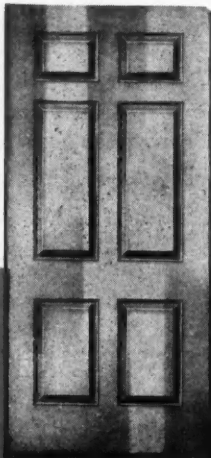

HARBOR OFFERS DOORS PRECISION-MADE OF DOUGLAS FIR AND OTHER WOODS UNDER THE TRADE NAME HARBOR

Durable, attractive Harbor Sag-Nott entrance and interior doors may be ordered pre-fit to exact opening size, mortised and gained, pre-primed as well. Save time and labor on the job, assure better installations.

Harborite

MULTI-PLY

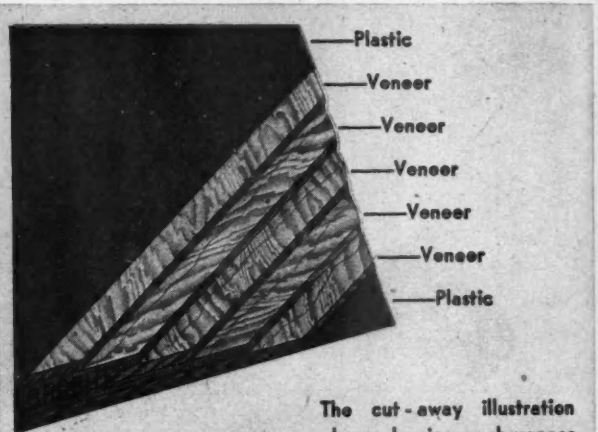

The cut-away illustration above showing each veneer of the core body and showing the two plastic faces serves to reveal the importance of the plastic overlay to the plywood panel. New service and appearance values are added.

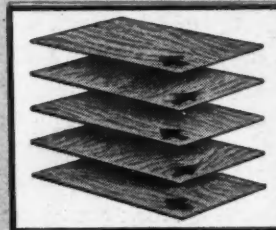

The core body for Harborite Multi-Ply is composed of the cross-laminated veneers as illustrated above.

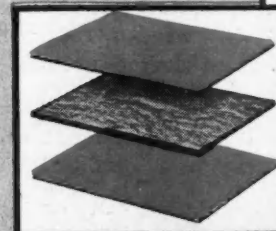
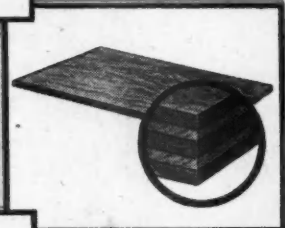

The resin-impregnated overlay is bonded to the plywood core body. The resulting product is in logical sequence of plywood improvement and manufacture.



HARBOR PLYWOOD CORPORATION

General Offices . . . Hoquiam, Washington

These Products

... through Retail Dealers

SUPER-Harbord

WATERPROOF TYPE
DOUGLAS FIR PLYWOOD

SUPER-Harbord is the original exterior or waterproof type of Douglas fir plywood. Its world-wide reputation for quality was firmly established before it added an unmatched war service record. In manufacturing the product the component veneers are bonded with a unique process employing a phenol-aldehyde type synthetic resin set in a hot press under normal plywood pressures. The resin was developed on the Harbor premises and is manufactured from chemicals purchased in bulk.



Harbord

MOISTURE-RESISTANT TYPE
DOUGLAS FIR PLYWOOD

Harbord is the regular moisture-resistant type Douglas fir plywood of Commercial Standard quality. It is manufactured by the latest improved hot-plate method. This type is the type of panel material popularly used for wall-board, cabinet work, sheathing and other home construction and for utility purposes.

SUPER-Harbord Giant

PLYWOOD PANELS EXTEND PLYWOOD'S USES

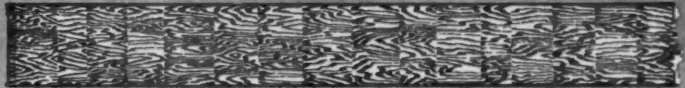

ANY LENGTH, MAXIMUM WIDTH OF NINE FEET

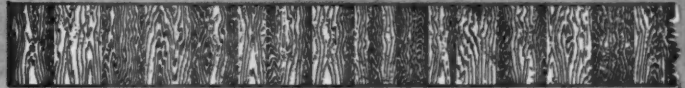

ANY WIDTH, MAXIMUM LENGTH OF NINE FEET

Giant-size SUPER-Harbord panels are produced to order by joining standard-size panels with a special scarf joint. Any length Giant panels may be produced with a maximum width of 9 ft. unsanded (8 ft. 6 in. sanded). The special scarf joint develops the full strength of the panels which are joined. The Giant sizes extend the usefulness of the product and have solved many construction problems in the marine, railway, and other transportation fields. For example, the Giant panels are used for planking and decks of boats of many sizes which



Scarf Joint, Ratio 1" to 12"

are constructed for pleasure or work service. The sides, floors and roofs of buses, trucks, trailers and railway cars capitalize upon the added strength and ease of fabrication of the larger units of SUPER-Harbord. Likewise, designers of other types of construction have been quick to appreciate that similar unit-type construction reduces the number and bulk of framing members; hence, it increases usable cubage and reduces over-all weight. Giant panels of Harborite are also produced to order. The same basic scarf-joint technique permitting a barely perceptible joint-line is used to produce the large size plastic-faced panels.

HARBOR DISTRIBUTES THE NEW EUBANK PATENTED, SWIVEL-TYPE CABINET IRONING BOARD

The Eubank patented swivel support allows board to swing through a wide arc for flexibility . . . holds it rigidly upright in cabinet when not in use. Can be installed where space is limited.

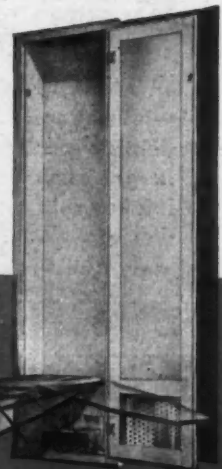

DISTRIBUTING WAREHOUSES AND SALES OFFICES IN FOLLOWING CITIES:

Atlanta, Ga., Aberdeen and Tacoma, Wash., Baltimore, Md., Chicago, Ill., Cincinnati, O., Indianapolis, Ind., Jacksonville, Miami and Tampa, Fla., Kansas City, Mo., Los Angeles and San Francisco, Calif., Louisville, Ky., Omaha, Neb., Philadelphia, Pa., Washington, D.C., Watertown and Worcester, Mass.

Nation-wide distributing offices now offer a number of related products. Look to Harbor for the newest and most useful items.

A Sensational New Stride in Heating!



THE *Coroaire* HI-BOY GAS FIRED WINTER AIR CONDITIONER

NOW! A brand new basement-installed gas heating unit—with the same remarkable efficiency and economy as the COROAIRES console heater—and the same profit advantages! That's the COROAIRES HI-BOY! It heats, cleans, humidifies and filters for complete winter air conditioning.

Here's the answer

The heart of the COROAIRES HI-BOY is the famous patented Venturi tube heat exchanger, made of cast iron. That means greater efficiency, greater distribution of heat, greater heating capacity. You get it because of a 5 sq. in. to 1 sq. in. wiping surface on the exterior and a 28-foot flue travel—against 6 to 8 foot flue travel on other conventional types of heat exchangers. It's the dream of every heating engineer, builder, distributor, dealer and user!

The COROAIRES HI-BOY is sturdily built—finished in Blue Hammerloid enamel. A.G.A.-approved controls—quiet operation—complete safety features. Write today for Booklet c-802 for full information and specifications. The Coroaire Heater Corporation, Cleveland 15, O.

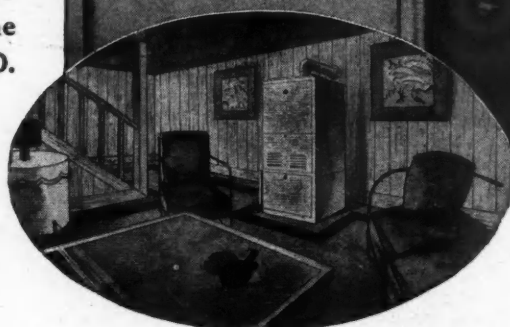
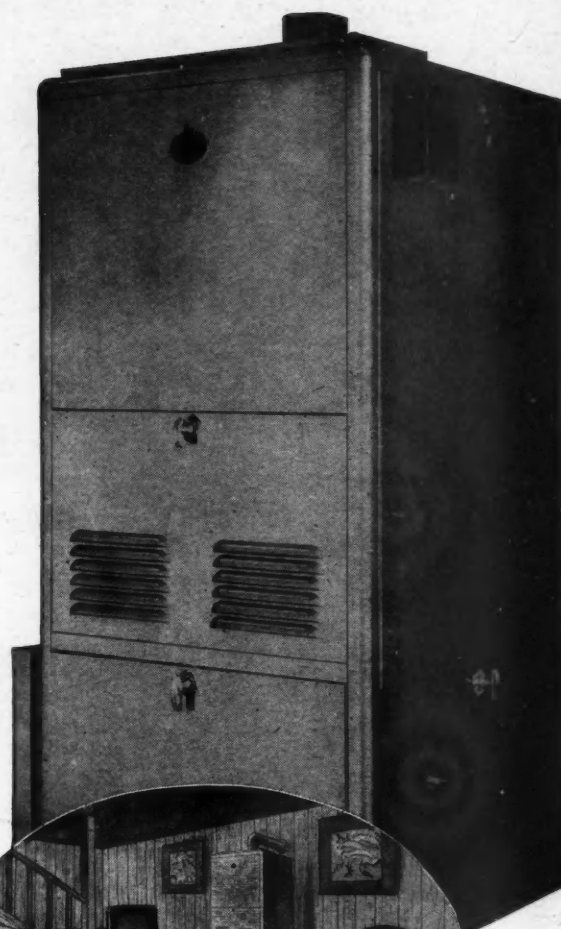

The COROAIRES HI-BOY is so completely a self-contained package unit that it will fit into any basement decorative scheme.

SPECIFICATIONS

COROAIRES HI-BOY—Model 85-S-HB	
width overall	26"
depth overall	28"
height overall	59 ¹ / ₁₆ "
intake (cold air)	16" x 25"
discharge	8" x 25"
weight	566 lbs.

THE COROAIRES HEATER CORPORATION
CLEVELAND 15, OHIO

Universal LEVEL-TRANSIT



**MOST PRACTICAL
ALL-AROUND BUILDER'S
INSTRUMENT
EVER DESIGNED!**

Highly accurate, amazingly rugged, the Universal Level-Transit does all survey and check-up operations in building and road construction!

Quickly convertible from level to transit, its novel type of design protects parts which were formerly exposed to damage and inaccuracies. Other features include: a patented ball-bearing race, lock and release lever system, and perfect alignment adjustments.

12" Telescope, 25 power, horizontal guarded circle, Verniers to 5 minutes, Vertical arc, 3".

Write today for full details and free booklet "How to lay out building lots."



MANUFACTURERS OF
INSTRUMENTS FOR ENGINEERS,
SURVEYORS AND BUILDERS.
301 West Court St., Milwaukee 12, Wis.

FIREPLACE UNITS

for ALL Your Customers!

More sales—better profits for you—because you carry the Bennett line—fireplace units to fit *every* customer's requirement. Only BENNETT builds *two* types of fireplace units, to meet *all* building needs.

For tightly constructed, fully insulated, weather stripped homes . . .

BENNETT

Fresh-Aire FIREPLACE UNIT

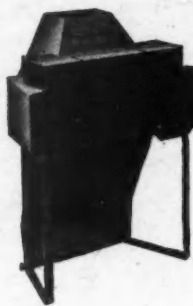

Fresh air, from *outdoors*, is heated and circulated thruout the room. No loss of expensive furnace heat up the chimney . . . no cold, unhealthy floor drafts—and *no smoke!*

The unit *cannot* interfere with the traditional beauty of the fireplace—it's hidden within the masonry. Mantel may be designed with complete freedom. . . . Easier and quicker to build.

For camps, cottages, southern homes, playrooms . . .

BENNETT

Warm-Aire FIREPLACE UNIT

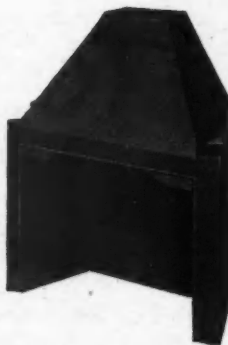

Draws cool air from *floor level*, heats and recirculates it . . . *throughout the whole room!* Keeps air fresher. Furnishes a complete form for the mason—saves your customers' construction and operation costs. . . . No smoke. Adaptable to *any* mantel design.

For ANY Fireplace . . .

Flexscreen
REG. U. S. AND FOREIGN PAT. OFF.

THE SAFETY FIREPLACE CURTAIN

Write us at
247 Market Street

BENNETT-IRELAND INC.

Chartered in 1906
NORWICH, NEW YORK

Built For The Building Trade

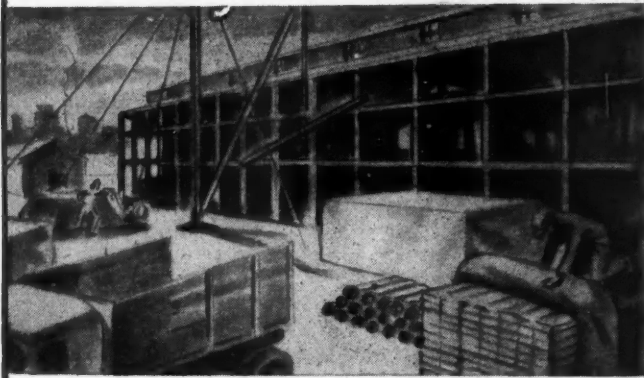

Your customers need triple-reinforced Fulton tarps on every job to protect material and tools from weather. Offer them this tough, all-weather tarp when they come in for building supplies.

Fulton's triple-strength rope holes are lined with metal grommets that won't rust... the strong, high-count canvas is permanently *pressure impregnated* with Fulton's exclusive weather and mildew treatment.

These new, stronger Fulton tarps, backed by 75 years' reputation for value, are sold through appointed dealers. Eight Fulton factories are strategically placed to give you quick service.

FULTON BAG & COTTON MILLS

Manufacturers Since 1870

New Orleans St. Louis Dallas Kansas City, Kans.
 Denver Atlanta Minneapolis New York



NOW AVAILABLE

the original inside screens that roll up and down like a window shade

ROLSCREENS in a house are a "trademark" of good planning. They are a year 'round advertisement for the builder who puts them in. They help to keep a house up-to-date and protect its salability over the years. A big part of your business is selling **CONVENIENCE**. ROLSCREENS help you to do it easier and better than any other window accessories. 10-year guarantee.

CONVENIENCE OF ROLSCREENS SELLS ON SIGHT

Once in place . . . always in place. That's Rolcreens! No putting up! No taking down! No storing! No painting! No seasonal repairs! Installed and operated on the inside. For *all* types of windows—both old and new construction.

EASY TO INSTALL on all types old and new windows

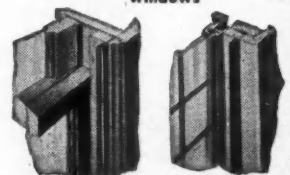

Double-Hung Application

Casement Application

DEALERS WANTED

A number of choice territories are open for Building Specialty Dealers with facilities to sell and install ROLSCREENS. If interested, **WRITE TODAY** for details.

No special mill work, no special fitting or cutting. Installation made to either of the above windows quickly and easily, due to new type guide channels.

GOOD DELIVERIES — ROLSCREEN orders are being filled and shipped with reasonable promptness. On your next job, include ROLSCREENS. **WRITE** for interesting **FREE** literature and measuring directions.

Pella ROLSCREENS

ROLSCREEN COMPANY, 527 Main Street, Pella, Iowa

Made by Makers of Famous Pella Venetian Blinds and Casement Windows



Handle **MORE**
Weatherstripping
with
CARTER
GROOVERS

YOU CAN use the KA electric weatherstrip tool to groove window sash for any type of weatherstripping. Cutters for $\frac{1}{8}$ " to $\frac{3}{32}$ " width grooves are available for use with the tool. Operates on 110 volts, from regular house current. Motor is $\frac{3}{8}$ H.P. with speed of 18,000 R.P.M.

The same motor used in KA Weatherstrip Groover fits into a special base with guide for grooving door bottoms to take weatherstripping.

With these tools you can handle more weatherstripping jobs at greater profit. Write for full information. Stanley Electric Tools, Stanley-Carter Sales Dept., 133 Elm Street, New Britain, Connecticut.

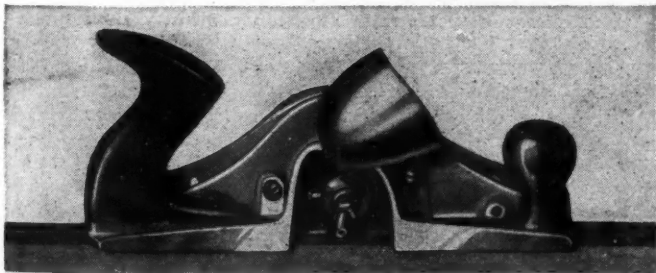

(Above)
KA Weatherstrip Groover - Cuts $\frac{3}{16}$ " deep groove in window sash for weatherstripping. Choice of cutters to match width of weatherstrip material. Plugs in house current.

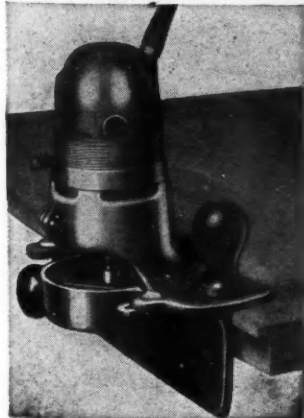

(Left)
Door Bottom Weatherstrip Groover. Same motor as KA tool, used in special base. Cuts grooves from $\frac{1}{2}$ " to $1\frac{1}{8}$ " deep, adjustable to width cut desired.

STANLEY

Trade Mark

HARDWARE · HAND TOOLS · ELECTRIC TOOLS

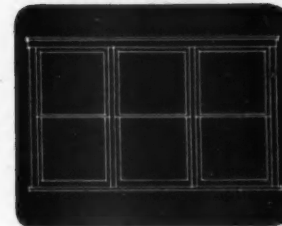
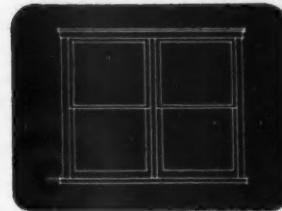
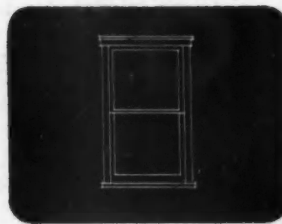

NARROW
MULLIONS
AND TRIM

Both Inexpensively
Attained With

DUPLIX
FLAT SASH
BALANCE

Narrow mullions and narrow trim—the modern styling that helps sell homes—are economically achieved with **DUPLIX**—the *only* Adjustable Flat Sash Balance.

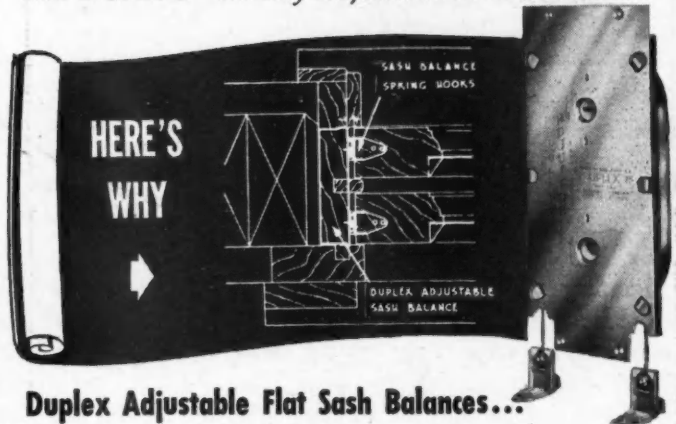

Duplex Adjustable Flat Sash Balances...

1. . . . require no special framing for overhead balance space.
2. . . . require no stud mortises at sides.
3. . . . are installed in virtually the pulley stile thickness about halfway between sill and head jamb.
4. . . . entirely eliminate cords, weights and weight boxes.
5. . . . and just *two sizes* meet 98% of all residential building needs, which simplifies ordering, stocking and installing.

CONSULT SWEET'S FILES - BUILDERS OR ARCHITECTS
(Sold through jobbers and dealers only)

Booth
117
NAHB
Show,
Chicago,
Feb.
23 to 27.



628 North LaPeer Drive
Los Angeles 46, California

For Remodeling and New Construction

FIREDAIRE

FIREPLACE AND FURNACE

Means Extra Profits for YOU

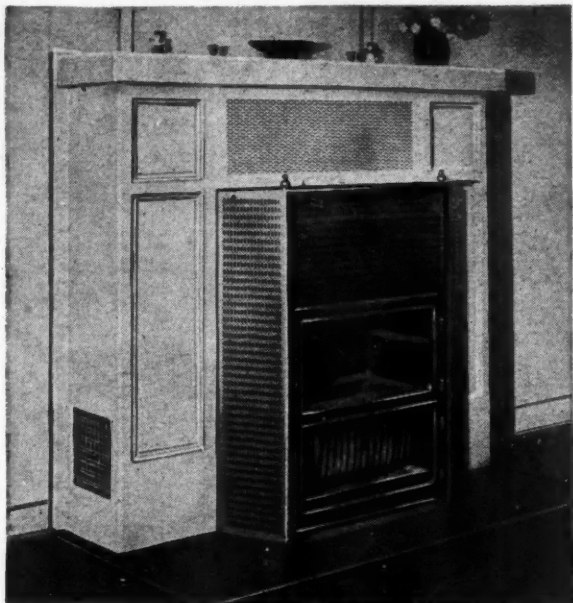

USED AS AN OPEN FIREPLACE

No need to sublet the heating contract for that remodeling job or for those homes you are building for veterans. Install Fireaire and keep the extra profit.

Connect it to any 8"x8" flue without alteration to brick work or damage to interior walls. Set up the heating unit with warm air registers to adjoining rooms if desired; bolt the handsome, all-steel, cabinet mantel in place. Any handy man can do it in a jiffy.

The place is transformed! The cheer of an open fireplace—the mellow comfort of recirculated air—no drafts, no smoke, no smell, no exposed smoke pipes and no wasted floor space.

For winter comfort, attach the doors to Fireaire. The fireplace becomes a furnace, capable of heating from 3 to 7 rooms on 1 or 2 floors. Burns any fuel. Holds fire overnight.

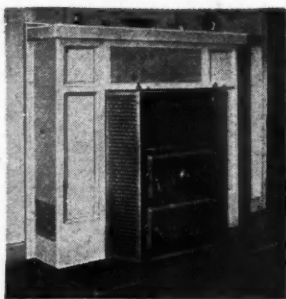

USED AS A FURNACE

Fireaire is available in complete range of sizes and models. Moderate prices and immediate deliveries. Write today for Contractor's proposition.

★

THE EDWARDS MANUFACTURING CO.
912-942 BUTLER ST. CINCINNATI 2, O.

CONTRACTORS and BUILDERS

Start the New Year right

WITH

THOROSEAL

THOROSEAL fills and seals cracks and all other defects in the surface, equalizes the absorption of each individual unit comprising the surface without checking or cracking.

The surface of any type of old or new stucco walls, manufactured block, brick or tile can be waterproofed and protected with THOROSEAL.

Contractors, homeowners and every type building owner have water problems, wet basements and defective exterior walls, which need sealing and protection.



An example of disintegrated stucco surface on an otherwise well-built home and how the stucco was sealed, waterproofed and interior of home made dry with one heavy application of THOROSEAL.



The above photograph shows the same stucco home after it received one heavy application of THOROSEAL, which, after being applied for one year, shows no leakage or dampness on the interior of the building.

Finish coat of SNOW WHITE QUICKSEAL will be applied during 1947.

Have your local lumber or building supply dealer order for you.

Standard Dry Wall Products, Inc.
BOX X NEW EAGLE, PENNA.

This is it!

**THE PUMP THAT'S
The Talk of the Trade**

**BARNES NEW UNIVERSAL
DRIVE 1½-INCH AUTOMATIC
CENTRIFUGAL PUMP...**

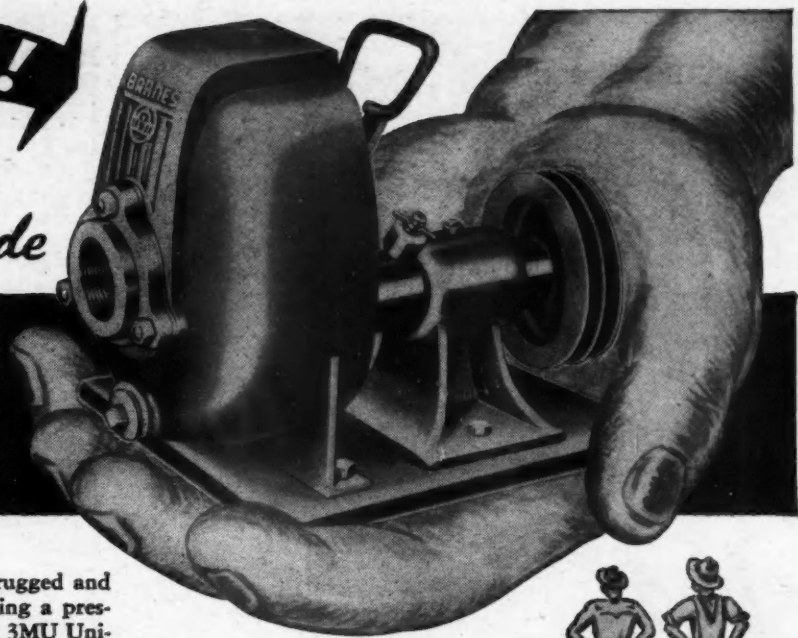

It's feather-weight and midget-sized—but as rugged and as potent as the atom when it comes to delivering a pressure-packed torrent of water—is this brand new 3MU Universal Drive 1½-inch Automatic Centrifugal Pump. And it's designed to utilize any power source—belt driven from tractor, jeep or any gasoline engine or direct shaft-coupled to electric motor.

So light (35 lbs.) it can be carried with one hand, its powerful non-clogging impeller will cascade a torrent of water up to 5700 gallons an hour with

pressure up to 35 pounds per square inch. The same Automatic Prime, Barnes Superseal, Direct Flow Suction, Non-Clogging Impeller and all other special features found in Barnes' famous "33,000 for 1" Pumps are in the new 3MU Automatic Centrifugal. It's the handiest implement on the place for contractors, industrial plants, municipalities, farmers and gardeners or wherever a power source is available.

You get all these in Barnes' New 3MU Automatic Centrifugal Pumps, plus the fact that they are now ready for delivery. If you order now, there'll be no waiting.



BARNES MANUFACTURING CO.
Quality Pump Manufacturers for 50 Years
MANSFIELD, OHIO

GREAT NEWS for Builders, Contractors & Others Interested In HOME BUILDING PROJECTS

Strathmoor of Detroit Offers This
**24X34 "Factory-Bilt" Sectional
5-ROOM HOME**

*Choice of 4 Elevations
and 16 Variations of
Floor Plan Size*

*Includes Oil Heating Unit
and Kitchen Appliances*

To Sell for
\$44⁰⁰
PER MONTH
Approx. FHA Terms

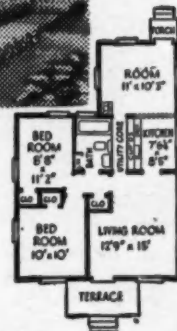
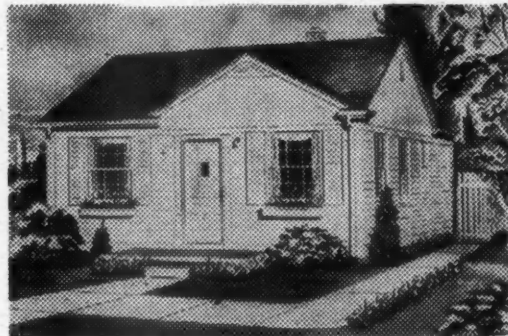

The Strathmoor Company, makers of nationally-known "Factory-Bilt" Homes, with four plants now in operation, has plans to supply 25,000 homes in 1947. Over 500 of this attractive Model H5, pictured, can be delivered weekly—a two-bedroom home with gable front or porch, may be erected with basement or utility room—available in 16 size variations, 4 of which include the famous Ingersoll Utility Core consisting of heating, plumbing, electric refrigerator, stove, hot water tank and steel kitchen cabinets. It's a builder's dream for Title VI financing. Special promotional help by trained factory representatives on all projects of 50 or more homes. (Also larger "Factory-Bilt" Homes available.)

ALSO
Special Plan For
Distributors To
Handle 14x20
"FACTORY-BILT"
GARAGES

Write or Wire At Once for Information
ADDRESS: R. B. RANDALL, GEN. SALES MGR.

THE STRATHMOOR COMPANY
14000 GRAND RIVER AVE. DETEROIT 27, MICH.

Structural Reinforcing or other Blding Steel Shipped from Stock

Write for Stock List—
your guide to over 10,000
different kinds, shapes
and sizes of steel for
quick shipment from ten
plants.

Joseph T. Ryerson & Son, Inc. Plants at Chicago, Milwaukee, St. Louis,
Cincinnati, Detroit, Cleveland, Buffalo, Boston, Philadelphia, Jersey City.

RYERSON

Residential Construction Contracts Establish New Record in 1946

INVESTMENT commitments for residential construction reached an all-time high in the thirty-seven states east of the Rocky Mountains during 1946, it was reported today by F. W. Dodge Corporation. The total valuation of contracts awarded was \$3,142,102,000 which compares with \$2,788,318,000 for 1928, the last record-breaking year.

On the basis of floor area of residential building called for in contracts awarded, however, 1946 stood fourth with a total of 516,256,000 square feet as against 568,382,000 in 1928 and 559,499,000 in 1925. The 1946 figure reflects the current higher building costs, the Dodge corporation reports.

Last year's residential contracts called for the construction of 446,625 dwelling units of which 76,372 were apartment buildings; 50,459 one-family dwellings for owners' occupancy; 21,794 two-family dwellings; and 3,509 combination projects such as stores and apartments.

* * *

Austin K. Thomas Named Sales Manager by Chain Belt

AUSTIN K. THOMAS has been appointed sales manager of its Construction Machinery Division, the Chain Belt Company of Milwaukee, Wis., has announced.

Mr. Thomas has a background of over 20 years' association with the construction machinery industry. After graduating from the College of Civil Engineering of Cornell University, he spent several years in active construction work. Next, he entered the employment of a large eastern manufacturer of construction machinery, working first as a service engineer, then as a member of the sales department, and lastly as manager of a district sales office. He then joined the organization of a construction machinery distributor.

After becoming affiliated with Chain Belt Company, Mr. Thomas was named eastern district manager, with offices in Philadelphia. During the war years, his office was located in Washington, D. C.

Versatile Fred W. Wappat Electric Hand Saws



CUT LUMBER *and over 20 other building materials*

Fast . . . Accurately . . . in any Position . . . at Less Cost!

With a Fred W. Wappat Electric Hand Saw on your job, you have more power than you'll ever need (with thorough operator protection), assuring continuous high-speed cutting . . . you get absolute accuracy, thanks to visible cutting line and rigid, simple angle settings on saw frame . . . top performance is maintained whether saw is trimming sub-flooring, wall sheathing, or hung inverted for ripping operations . . . your operating and maintenance costs are minimized through such features as the Fred W. Wappat lubricating system, and special Fred W. Wappat-designed gears, produced under our rigid shop standards.

In addition to working lumber, you can quickly fit your Fred W. Wappat Saw with special blades and cut over twenty other tough building materials, from insulating board to light metal sheets, still utilizing the Fred W. Wappat basic advantages! Write today for full information, or ask for free copy of Bulletin S-10!

High-Speed Portable Electric Tools • Radial Guides • Service and Parts for Wappat and Alta Tools

FRED W. WAPPAT • 135 Valley St. • MAYVILLE, N.Y.

On Chautauqua Lake

CUT JACK-RAFTERS OR WIDE PANELS THE EASY, FAST, ACCURATE WAY, with an improved Fred W. Wappat Radial Guide. Inexpensive, portable, in models from 25" to 120" capacity. Ask for free copy of Bulletin S-8, today!

**ALLMETAL WEATHERSTRIP
BRASS AND WHITE METAL THRESHOLDS**

Efficient weather protection and wide selection to meet individual conditions are provided by the extruded metal weatherstrip shapes illustrated herein. Each shape is available in either brass or white metal.

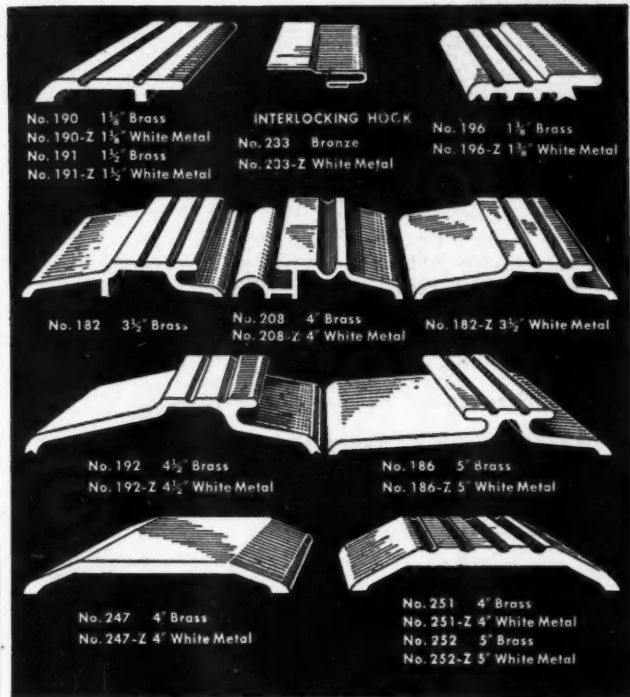

These shapes are cut to size required, drilled and countersunk. Screws are furnished. Interlocking shapes are provided with an appropriate hook for installing on bottom of door. Write for prices and catalogue of complete weatherstrip line.

ALLMETAL WEATHERSTRIP CO., 2248 North Knox Ave., Chicago 29, ILL.

4
BIG REASONS WHY

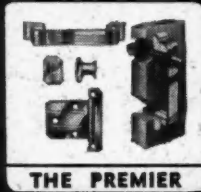

NATIONAL LOCK CABINET HARDWARE
is EASY and PROFITABLE to sell

- 1 Choice of four distinctively designed sets—each set is perfectly matched. Catches, Pulls, Knobs and Hinges are all styled in harmonious patterns.
- 2 Finished in lustrous, gleaming, easy-to-clean chromium. Here is beauty combined with rugged utility.
- 3 Packed in attractive envelopes — clearly printed for quick identification. Envelopes are packed in space-saving cartons.
- 4 Envelope packing eliminates loss of screws and small parts. Instructions for installing are packed with all Catches.

NATIONAL LOCK COMPANY
Cabinet Hardware Division • Rockford, Illinois



*A Natural Leader . . .
because it is Nature's own Insulation!*

Insl-Cotton Is a Natural for Profits

Because it is LIGHT WEIGHT... Blanket type...easy to install...minimum labor costs...fast application.

- ECONOMICAL
- FLAME-PROOF AND FIRE-RETARDING
- MOISTURE RESISTANT
- HARMLESS TO HANDLE
- NON-SETTLING
- VERMIN RESISTANT
- GOVERNMENT INSPECTED

YES, Insl-Cotton is as near perfect an insulation as money can buy —because it is made of cotton, nature's own insulator! Cotton's tiny hollow fibers provide millions of dead air spaces to form an almost perfect barrier to heat or cold. The Insulation Division of the Taylor Bedding Mfg. Co. processes cotton and makes it flame-proof, then, by "layer-building" it, scientifically felts it into fluffy layers that provide literally millions of additional dead air spaces, thus increasing the already high insulating value of cotton. No other type of insulation, on the market today, has a greater insulating value than Insl-Cotton—its "K" value of 0.24 is the lowest of the ten other popular types.

* *Certified*—No other insulation except flame-proof, fire-retarding cotton insulation can make this claim. The Government tests and certifies Insl-Cotton insulation.

INSL-COTTON DIVISION

Taylor Bedding Mfg. Co.

TAYLOR, TEXAS

TAYLOR MADE
INSL-COTTON

MAIL THIS ORDER COUPON TODAY

INSL-COTTON DIVISION
Taylor Bedding Mfg. Co., Taylor, Texas

Gentlemen:
Please send specifications and full information on INSL-COTTON.

Name _____

Address _____

City and State _____

Check Here: Distributorship Architect Contractor

DEALERS • DISTRIBUTORS—Some territories still open for competitively priced Insl-Cotton. Write today for details.

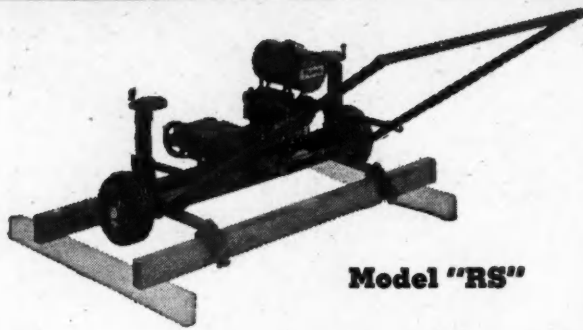

Model "RS"

Eliminate slow, back-breaking work with

Whiteman RODDING MACHINES

The Lightweight Rodding Machine produces better concrete . . . saves time and money. Rods the slab to a perfect level, compacted . . . ready for floating and finishing. For slabs 3 to 10 feet wide. Also in Model 44, for slabs 10 to 20 feet wide.

Write or wire for details of Rodding Machines and Floating-Finishing Machines.



Whiteman MANUFACTURING COMPANY

3249 Casitas Avenue Los Angeles 26, California

ASSURE LASTING BEAUTY with

Lustro-Ware

BUILT-IN BATHROOM FIXTURES

CHIP PROOF

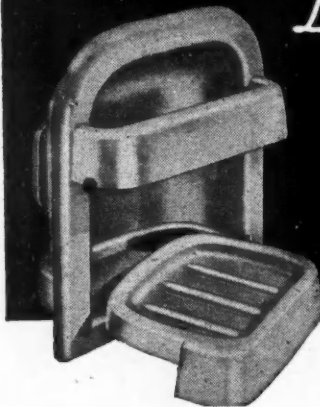

Recessed soap dish with or without grab bar. Note soap dish tray may be removed for easy cleaning.

These glistening recessed fixtures in white and colors are unsurpassed for modern design and sparkling beauty. And when it comes to easy installation and service, Lustro-Ware is "tops" — no chipping, checking, or breaking like porcelain. Lustro-Ware always looks like new, since this material is resistant to stains, acids and alkalis. Write today for literature and prices.

The Lustro-Ware built-in line includes soap dishes, paper holders, toothbrush and tumbler holders, towel bars and robe hooks. Screw fastened type also available.



Monthly Carrying Charges Reduced by FHA

A REDUCTION in monthly carrying charges on financing of new multiple housing projects has been announced by FHA Commissioner Raymond M. Foley. The lower carrying charges will result from extension of mortgage maturities by five years or more under a new amortization formula.

The action reduces the monthly principal curtailment on mortgages insured under Section 608 of Title VI by changing the minimum required initial principal payment on a level annuity basis from 2 per cent to 1½ per cent of the original face amount of the mortgage.

Applying the 1½ per cent initial amortization rate with interest at 4 per cent on a level annuity basis will mature a loan in 32 years and 7 months, payable in 391 monthly payments. In the event the interest rate is less than 4 per cent a year, the monthly payment will be reduced and the maturity of the mortgage extended by a somewhat further amount. The average mortgage insured under Section 608 previously has had a maturity of 27 years and 7 months, or slightly longer.

* * *

Minimum Standards for Design And Fabrication of Glued Laminated Structural Lumber Covered in Folio

THE West Coast Lumbermen's Association, Portland, Oregon, will send upon request its recently published folio dealing with the recommended minimum standards for design and fabrication of glued laminated structural lumber.

Part I of the booklet covers the special factors to be considered in designing laminated structural members, the grades of lumber demanded, and appropriate working stresses.

Part II contains recommended specifications for the materials (lumber and glue), and their preparation for use. Proper stress transferring joints are covered, as are specifications for workmanship.

Architects, engineers, building officials will find the booklet a valuable reference piece.

Ideal "Dual Purpose" Hinges
ENABLE YOU TO REDUCE YOUR INVENTORY!

For Storm and Screen Doors, Casement Sash, etc, Size 3" x 2¾" only

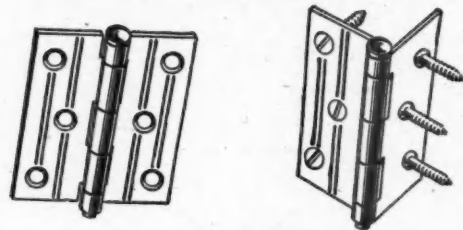

No. 323 can be used as either full surface or half surface by reversing one leaf.

No. 323CD (Dull Cadmium) \$4.14 List Doz. Pr.
No. 323US4 (Dull Brass Plated) \$5.52 List Doz. Pr.
Solid Brass Pins Slightly Extra

Packed one pair per envelope with screws—
one doz. pair per box

We also make a hinge No. 324 which can be used as either full mortise or half surface by reversing one leaf.

Sold Only Through Hardware Distributors

"Satisfaction Guaranteed"



ST. PAUL, MINN.

250 E. Fifth St.

Manufacturers of Builders Hardware Specialties, such as Ideal Screen Door Latches, Barn Door Latches, Storm Sash Adjusters, Screen Door Hinges, Casement Sash Friction Stays and Other Popular Items

WAGNER DOOR HANGERS

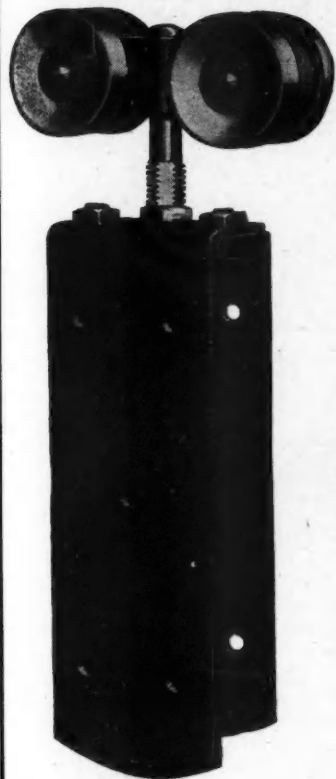

AND TRACKS
FOR
INDUSTRIAL
USE!

★
**HEAVY
DUTY**

Can be furnished with Ball Bearing, Roller Bearing or Hyatt Roller Bearing Trolley for doors up to 1,000 lbs.—2¼-3½" thick.

WAGNER HANGERS
also available for doors up to 2,000 lbs.

Ask your Jobber or Dealer.

**WAGNER
MANUFACTURING
COMPANY**
Dept. AM-247
CEDAR FALLS, IOWA



Touch of Magic

SELLS KITCHENS SELLS HOMES

Builders say an easy, low-cost installation of a modern Vent-A-Hood Kitchen Ventilator works magic in selling kitchens to women—and SELLS HOMES FASTER.

Designed for beauty with glistening white baked enamel finish, all chrome trim, splash panel to protect walls and utility light. Engineered for efficiency with patented centrifugal exhaust unit and grease-trap to remove food odors and greasy vapors. Venting is direct to flue or through simple metal ducts.

Investigate Vent-A-Hood for homes you're building or planning.

Write for descriptive literature, quotations.

VENT-A-HOOD

THE MODERN KITCHEN VENTILATOR

The Vent-A-Hood Co., Plantation Drive-Hines Boulevard, Dallas, Texas

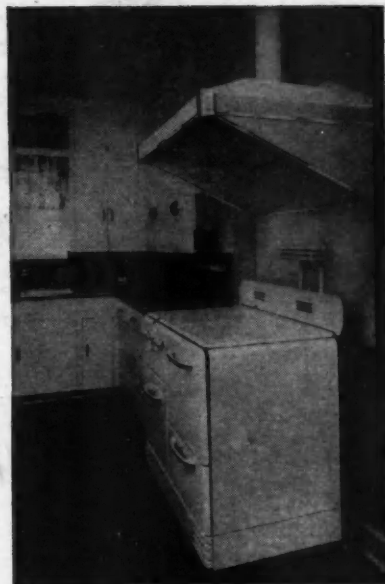

YOU SHOULD BE Making Money WITH FORD CEMENT BLOCK MACHINES

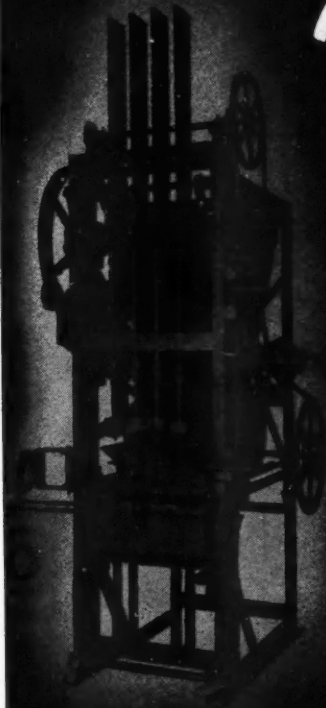

Match These Qualities!

Ford machines are rugged—made to stand the gaff—can turn out four 8 x 8 x 16 blocks a minute—handle so easily, three men alone can make 1500 to 1600 blocks a day . . . manufacture 30 different types of cement blocks—are one of the lowest priced tamping machines on the market . . . write today for complete information.

FORD CEMENT BLOCK MACHINE CO.
CEDAR FALLS, IOWA

You can build it

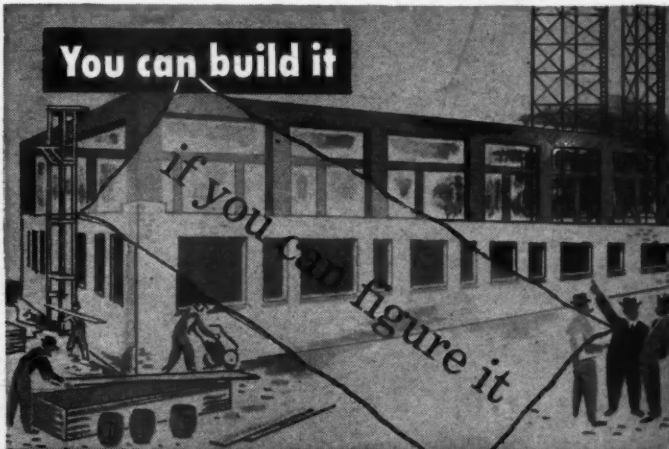

LEARN ESTIMATING IN SPARE TIME

Figure big or little jobs quickly and accurately the Tambllyn way for **DEPENDABLE** profits! Analyze current building costs. Learn the simple, easy Tambllyn System of Estimating — in your **SPARE TIME!** Used by successful contractors for more than 20 years. Try it for 10 days at our expense!

The Tambllyn System

MAIL NOW

Tambllyn System, Johnson Bldg., AB2, Denver 2, Colo.

Send me Tambllyn System on 10 day trial. I will pay \$5 per month until \$30 is paid if I keep it. If not, I will return it.

NAME _____

ADDRESS _____

CITY _____

STATE _____

SEND NO MONEY! TRY IT BEFORE YOU BUY!

SANDER

FAST
PORTABLE
ELECTRIC

•
FOR
BUILDERS
CARPENTERS
PAINTERS
&
CONSTRUCTION
MEN



Use the Sterling Sander for all types of jobs on wood, metal and plastics. Excellent for sanding dry wall construction, undercoats, primers and finished coats of paint. The Sterling 1000 is many times faster than hand sanding . . . it's simple to operate, vibrationless, light weight.

Write for descriptive folder now! Sterling Tool Products Co., 370 East Ohio Street, Chicago 11, Illinois.



STERLING 1000 SANDER

PORTABLE ELECTRIC

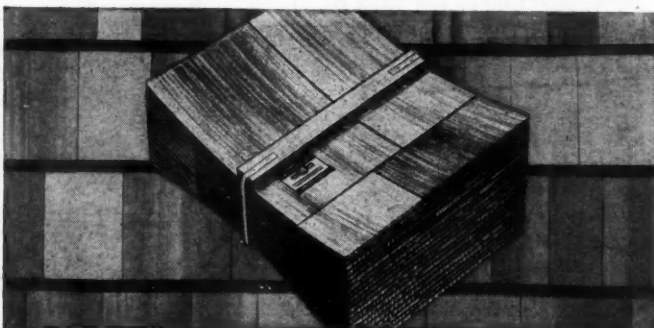

The Certigrade Label Protects You and Your Customers

The Certigrade label on a bundle of Red Cedar Shingles means that the grade is up to specifications—guaranteed by inspection. Specify "Certigrade" on your orders for Red Cedar Shingles.

RED CEDAR SHINGLE BUREAU

5508 White Building • Seattle 1, Washington
509 Metropolitan Building • Vancouver, B. C., Canada



Red Cedar SHINGLES

SOLD BY RETAIL LUMBER DEALERS

Wall Paper Institute Opens New Offices in New York City

THE new and attractive offices just opened by the Wall Paper Institute at 400 Madison Ave., New York, are an excellent example of how wall paper can be applied in good taste to any business organization.

Using wall paper as their motif, the decorators, Intramural, Inc., have tied the individual offices together by having complementary colorings lead the eye from one room to another.

The individual papers, selected from regular stock lines, were chosen as being most appropriate for office use. A green

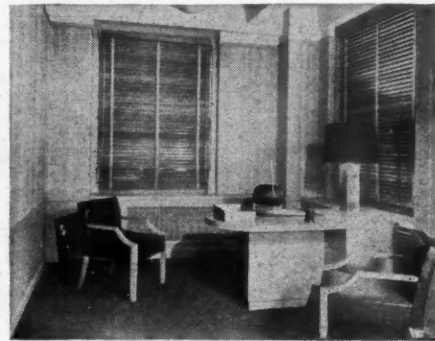

WORK room at Wall Paper Institute.

floral on white background was selected for the reception room, while the work room, pictured above, features a blue-green woven stripe paper and blending woodwork as suitable background for its blond furniture. The more traditional patterns were used for the executive offices, and a geometric design of Greek key influence was picked for the area occupied by clerical workers so there would be no distracting patterns to catch their eyes.

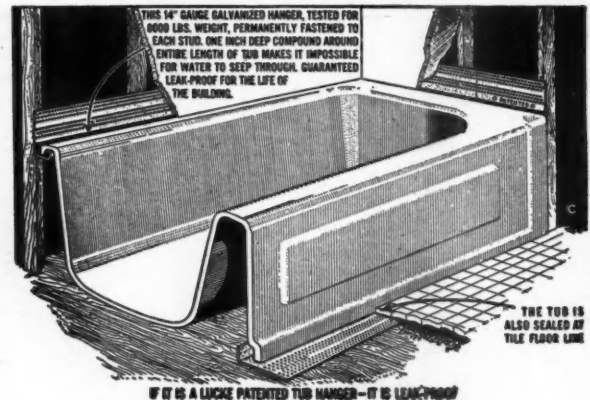

Investigate Lucke Before You Build or Modernize BATHROOMS

Eliminate Maintenance costs, even a hair crack will not give way to a leak.

Lucke Means Permanence

Its installation is the only expense.
Pays Dividends in expense free Bath tub installations.

NOW AVAILABLE

Manufactured By

William B. Lucke Inc.

WILMETTE

ILLINOIS

FASTER • MODERN • STREAMLINED

New SMITH 11-S

Equipped with *Air-Cooled* ENGINE

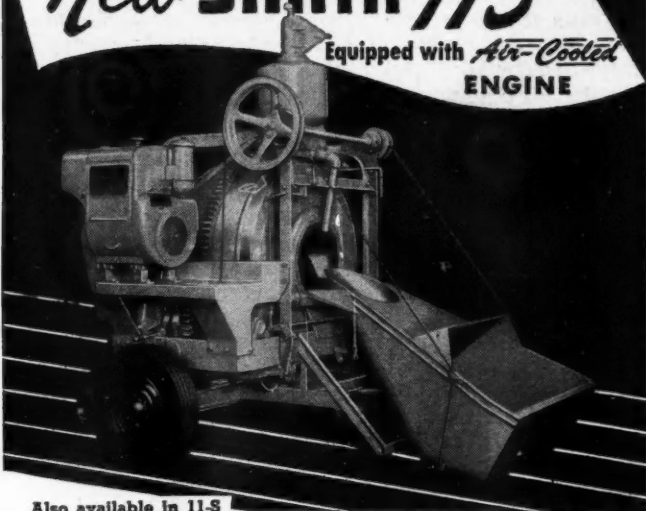

Also available in 11-S
- 4-wheel, and 7-S
- 2-wheel, End Dis-
charge Models, with
choice of air-cooled or
radiator-cooled engine.

Compact, lightweight, trailer mixer. Fast towing with spring-mounted axle, roller bearing wheels and pneumatic tires. Turns out more concrete per day. Lowers mixing costs. Also available with radiator-cooled engine. Write for literature.



THE T. L. SMITH COMPANY
2849 N. 32nd Street • Milwaukee 10, Wisconsin

MIXERS

Famous for Performance on the World's Greatest Projects

All of these shares having been sold, this announcement appears as a matter of record only.

NEW ISSUE

300,000 Shares

WILLIAM H. HARMAN CORPORATION

Class A Stock
(Without Par Value)

This is under no circumstances to be construed as an offering of these shares for sale, or as an offer to buy, or as a solicitation of an offer to buy, any of such shares.

SMITH, BARNEY & CO.

January 20, 1947

REID-WAY "8"

floor sanders

**Only ONE*
Moving
Part**



Write Dept. AB for descriptive folder on REID-WAY floor surfacing equipment.

**in the sander, proper*

REID-WAY, INC.

2917 First Avenue, SE.

Cedar Rapids, Iowa

MOLLY
SCREW ANCHORS

MOLLY SCREW ANCHORS have proved easy, sturdy and inexpensive for installing wall fixtures and accessories. Secure without disfiguring walls.

They install easily — by anyone — in any wall from solid concrete to thin fiber-board. Attach or replace wall fixtures by simply removing bolt . . . threaded anchor stays in place.

Ask Your Building Supply or Hardware Dealer

MOLLY CORPORATION
2-260 General Motors Building — Detroit 2, Mich.

New POCKET CATALOG of Building Needs



- Typical Majestic Items . . .
- Circulator Fireplaces
 - Underground Garbage Receivers
 - Home Incinerators
 - Outdoor Fireplaces
 - Coal Chutes
 - Fireplace Dampers

SEND FOR YOUR FREE COPY

Here is current data on Majestic Building Products in a handy, 32-page, pocket-size catalog just off the presses. Convenient for on-the-job reference. Your copy is ready. Write today!

The Majestic Company

834 Erie Street, Huntington, Indiana

MAJESTIC - Nationally Known and Advertised for 40 Years

Radiiluxe means

New Beauty and Efficiency in STAINLESS STEEL CABINET SINKS

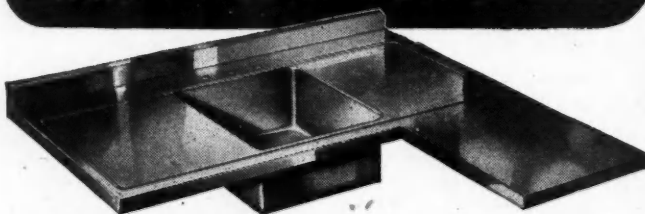

- DOUBLE-PITCH DRAINBOARDS
- IN-BUILT ANTI-SPLASH RIM ON BOWLS

These latest Just Line developments provide beauty and utility in keeping with today's modern kitchens. Double-Pitch Drainboards give smooth, complete drainage—no channels to clean—no grooves to endanger fine glassware. A smooth, effective Anti-Splash Rim extends around entire perimeter of bowl.

NEW FREE BULLETIN describes Radiiluxe Sinks with single or double bowls, with or without drainboards; straight, "U" or "L" types . . . standard sizes or custom-fabricated to your specifications. Also stainless steel counter and cabinet tops. Write today.



Stainless Steel CABINET SINKS CABINET TOPS SCULLERY SINKS SINK BOWLS TOILET SHELVES LAVATORIES STRADDLE STANDS and Special Units

Just Manufacturing Co.
4610-20 W. 21st Street, Chicago 50, Illinois

Expansion to Mark Automatic Control Industry in 1947

THE year ahead will see further expansion on the part of the automatic controls industry, according to Harold W. Sweatt, president, Minneapolis-Honeywell Regulator Company. This will follow a record year which saw production and sales at new peacetime highs despite all the difficulties of production, shortages of raw material and scarcities of trained manpower.

Although the industry as a whole was unable to make any substantial reduction in its backlog of orders and thus enters 1947 with almost a full year's orders already on the books, it is generally expected that the close of the year will witness the return of the type of market which will require intensified selling, Mr. Sweatt stated.

Basically the concept of automatic control has broadened on all fronts with home owners and industry alike seeking new means of achieving comfort, economy and efficiency in the home, office or factory. Automatic heating alone, for example, will be included in approximately 30 per cent of all new houses built during 1947. This compares with about 10 per cent in prewar years.

In anticipation of the return of a buyers' market, Mr. Sweatt reports, sales forces are being greatly expanded. Since automatic control salesmen must be engineers as well as salesmen, such expansion is a comparatively slow process. Also at least a year's training is required before a man may assume the full responsibilities of a salesman.

Production schedules for 1947 are larger than in 1946 and manufacturing facilities are being expanded throughout the entire industry, Mr. Sweatt reports.

"Basically, the people in the automatic controls industry are in agreement that we are today in the beginning of a long term expansion period which will witness not only a greater diversity of products made, but also a greater use of all automatic control products in the home and in industry at large."

SAWS RAFTERS WITHOUT MARKING!

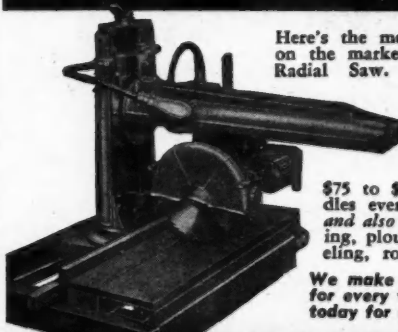

Here's the most practical contractor's saw on the market today—the Wallace No. 1 Radial Saw. With the exclusive Wallace Angulator, it cuts rafters complete with only ONE handling and without marking.

It's a real money-maker on framing work, saving \$75 to \$200 on average homes. Handles every kind of sawing operation, and also does first-class shaping, dadoing, ploughing, grooving, fluting, bevelling, routing, etc.

We make a complete line of machines for every woodworking operation. Write today for full information.

J. D. WALLACE & CO.
136 So. California Ave., Chicago, Ill.

Beaver Caulking Guns



Immediate Delivery

For Cartridge or Bulk Compound

Precision made for longer life and better results. • All working parts accurately machined.

Sold with a LIFETIME GUARANTEE

- Extra heavy gauge barrels.
 - Uses all caulking materials—handles light oils.
 - Positive ratchet drive.
 - Threaded nozzles—no bayonet joints to come loose.
 - Three popular sizes—6 1/2", 10" and 15".
- List prices—\$6.50, \$7.50, \$8.50. Write for discounts.

3708 E. 93rd St.

Cleveland 5, Ohio

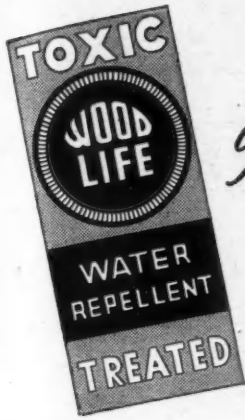

PROTECTS

Beautiful Entrance Doors



The Dignity And Versatility of WOOD

A beautiful wood door that doesn't warp, open at joints, stick — paint doesn't peel and no surface checks.

WOODLIFE — The Original Toxic Water Repellent adds immeasurably to life, serviceability and wood beauty. Ask your dealer.

Protection Products Mfg. Co.

Mfrs. of CHEMICAL PRESERVATIVES Since 1921
Research Laboratory and Plant KALAMAZOO, MICH.

Profit in MANUFACTURING
Start at Low Cost

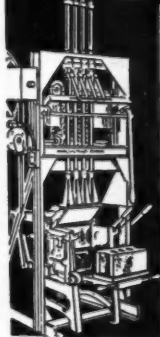

Get into the manufacture of these masonry products. Cut your costs. Make for your own use, also to supply local building trade.

Start on a small investment—use modern machinery—priced low because sold direct from factory to you. Backed by 40 years' dealing with thousands of men like you. Write for new catalog. Describes complete line of equipment with prices plainly marked. Early delivery.

CONCRETE EQUIPMENT COMPANY
514 Ottawa Avenue
Holland, Michigan

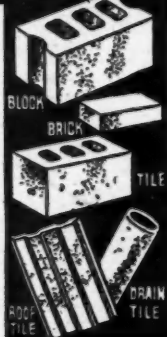

Get a **FIRM GRIP**
IN HOLLOW MATERIALS
with **PAINÉ**
TOGGLE BOLTS

Paine Spring Wing Toggle Bolts take hold in hollow walls and provide sure, permanent support for hanging or securing fixtures. The two-piece toggle springs into place after insertion and will not pull out or work loose. Available in several head styles in standard bolt diameters from 1/4" to 1/2" in standard lengths.

Ask your Dealer or Write for Literature and Prices

THE PAINE CO. 2959 CARROLL AVENUE
CHICAGO 12, ILLINOIS

STOK-RAILS

TRADE MARK

4'-2" 3'-8" 3'-2" 2'-8" 2'-2"

5 POPULAR SIZES
IN 3 ATTRACTIVE DESIGNS

STOK-RAILS are now available in 5 popular sizes as shown above. Also available in ornamental scroll or diamond designs in the same 5 sizes as furnished on the plain design.

These stock size entrance rails assure prompt delivery at savings of nearly 50% compared to special orders. Volume production — no quality sacrifice. Standard height, quality and black paint. Order from your dealer, or write

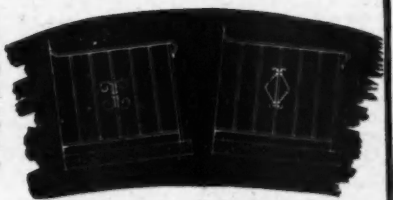

LOGAN CO. INC., 420 BUCHANAN ST., LOUISVILLE 6, KY.

STOK-RAILS

TRADE MARK

—immediate delivery—

ALUMINUM FOIL

for home insulation
.00094" x 26"
Coils of 16000 sq. ft. **87c** per 100 sq. ft.

STRUCTURAL SHAPES

Aluminum Angles, Channels, Tees, Zees, I Beams

ALUMINUM SHEETS

From one of the nation's largest stocks

ASSOCIATED ALUMINUM and METALS CO.

973 Peachtree St., N.E. Atlanta 5, Ga.
VERnon 4723-4

The No. 760 and 1000 Staples Only **\$6.00**

LOOK! A GUARANTEED SCREEN TACKER
FOR MAKING OR REPAIRING SCREENS

Equipped with a set of universal reversible claws, used to either pull or push screen wire tight. A down stroke on the plunger drives a two-prong steel staple into the frame, holding screen wire firmly. A handy TACKER for numerous other applications.

Write today for a 5-day free trial.

J. B. CROFOOT CO.
217 Evergreen Avenue
Mt. Prospect, Ill.

Wire stretching claws. Reversed for use with rabbeted screen frames

We ship postpaid if C. O. D. or when check is sent with order.

ALPHABETICAL INDEX TO ADVERTISERS, FEBRUARY, 1947

A	Adam Electric Company, Frank..... 4	General Controls.....181	Premier Metal Products Corporation..... 93
	Aetna Steel Products Corporation..... 64	Gilman Brothers Company, The..... 82	Prestile Manufacturing Company.....189
	Airtemp Division of Chrysler Corporation..... 8	Grand Rapids Hardware Company.....189	Prima Products, Inc..... 94
	Allmetal Weatherstrip Co.....201	Great Lakes Steel Corporation..... 21	Protection Products Mfg. Co.....207
	Aluminum Company of America..... 26		Pyne & Co., Inc.....190
	Aluminum Window Corporation, The.....191	H	Pyrofax Gas Division.....188
	American Builder.....174-175-186	Harbor Plywood Corporation.....79-192-193	
	American Floor Surfacing Machine, The..... 95	Harnischfeger Corporation..... 72	R
	American Gas Association.....62-63	HomeOla Corporation, The..... 16	R. O. W. Sales Co..... 47
	American Radiator & Standard Sanitary Corp..... 10		Reardon Co., The..... 78
	American Roof Truss Co.....209	I	Red Cedar Shingle Bureau..... 204
	American Saw Mill Machinery Co..... 27	Ideal Brass Wks. Inc.....202	Red Devil Tools..... 209
	Andersen Corporation.....54-55	Ingersoll Steel Division.....17-18-19	Red Star Products, Inc..... 155
	Appley & Son, J. W..... 13	Insul-Cotton Division.....201	Reed Corporation, R. S.....180
	Arkansas Soft Pine Bureau.....86	Institute of Boiler and Radiator Manufac- turers, The.....173	Reel-Line Corporation, The.....168
	Arketex Ceramic Corporation.....171	Insulite Division of Minnesota & Ontario Paper Co..... 5	Reid-Way, Inc.....205
	Armstrong Cork Company..... 80	International Oil Burner Co.....178	Republic Steel Corporation..... 15
	Associated Aluminum & Metals Co.....207	Irrington Form & Tank Corp.....179	Reynolds Metals Company.....25
			Roddis Lumber & Veneer Co..... 84
B	B & T Metals Company, The..... 32	J	Rolscreen Company.....196
	Bar-Brook Mfg. Co., Inc.....162	Jaeger Machine Co., The..... 33	Rowe Manufacturing Company.....147
	Barnes Manufacturing Co.....199	Jones & Laughlin Steel Corporation.....69	Ryerson & Son, Inc., Joseph T.....200
	Barrows Lock Works..... 150	Just Manufacturing Co.....206	
	Bell & Gossett Co.....209		S
	Bennett-Ireland Inc.....195	K	Salter Mfg. Co., H. B..... 87
	Better Homes and Gardens..... 71	Keasbey & Mattison Company..... 92	Samson Cordage Works.....209
	Bilco Company, The.....170	Kelvinator Division.....157	Sargent & Company.....153
	Bituminous Coal Institute..... 52	Kimberly-Clark Corporation..... 50	Sav-u-time Sales Co.....186
	Black & Decker Mfg. Co., The..... 9	Kinnear Manufacturing Co., The.....156	Servel, Inc.....66-67
	Borg-Warner Corporation.....17-18-19-163		Sisalkraft Co., The.....179
	Bradley Lumber Company of Arkansas..... 29	L	Skilsaw, Inc.....161
	Bruce Co., E. L..... 65	Legion Stainless Sink Corp.....184	Smith, Barney & Co.....205
	Butler Manufacturing Company.....30-31	Leslie Welding Co.....209	Smith Company, The T. L.....205
		Libbey-Owens-Ford Glass Company..... 81	Solvay Sales Corporation.....209
C	Carbozite Protective Coatings, Inc..... 24	Lockport Cotton Batting Co.....170	Square D Company.....165
	Carr, Adams & Collier Co.....185	Logan Co.....207	Standard Dry Wall Products, Inc.....198
	Carter Div., R. L.....197	Lucke Inc., William B.....204	Stanley Electric Tool Div.....164
	Ceco Steel Products Corporation..... 59		Stanley Works, The..... 98
	Celotex Corporation, The.....2-45	M	Sterling Tool Products Co.....204
	Coleman Co., Inc., The.....169	Macklanburg-Duncan Co.....176	Stran-Steel Division..... 21
	Columbus Plastic Products, Inc.....202	Majestic Company, The.....206	Strand Building Products Company.....76
	Concrete Equipment Co.....207	Mall Tool Company.....190	Strathmoor Co.....199
	Consolidated Machinery & Supply Co., Ltd.....181	Marco Stairways.....178	Structural Clay Products Institute..... 96
	Construction Machinery Co.....209	Marsh Wall Products, Inc..... 75	Superior Fireplace Company.....177
	Copperweld Steel Company.....187	McKinney Manufacturing Company.....154	Surface Combustion Corporation.....159
	Coroaire Heater Corporation, The.....194	Medusa Portland Cement Co..... 49	
	Crawford Company.....187	Mengel Company, Incorporated, The..... 74	T
	Crofoot Co., J. B.....207	Mesker Brothers..... 61	Tamblin System.....203
	Croft Steel Products, Inc.....208	Metal Building Products, Inc..... 85	Taylor Bedding Mfg. Co.....201
	Curry National Home Shows.....172	Molly Corporation.....205	Texas Company, The..... 28
	Curtis Companies Service Bureau..... 57	Mueller Furnace Co., L. J..... 97	Thrush & Company, H. A..... 88
			Timken-Detroit Axle Company, The.....149
D	Detroit Steel Products Company..... 3	N	Timken Silent Automatic Division.....149
	Donley Bros. Co., The.....188	Nash-Kelvinator Corporation.....157	Truscon Steel Company..... 15
	Duplex, Inc.....197	National Association of Fir Door Manufac- turers..... 51	Tylac Company.....177
		National Brass Company, Mfrs..... 20	
E	Edwards Manufacturing Co., The.....198	National Electrical Manufacturers Associa- tion.....22-23	U
	Electro-Matic Serviceman, Inc..... 46	National Gypsum Company..... 77	United States Plywood Corporation..... 74
	Eljer Co..... 34	National Life Insurance Co.....158	Universal Atlas Cement Co.....210
	Elkay Mfg. Co..... 48	National Lock Company.....201	Universal Form Clamp Co.....208
	Emerson Electric Mfg. Co.....182	National Manufacturing Company.....4th Cover	Universal Zonolite Insulation Co..... 60
	Equipment Engineering Co.....152	National Steel Corporation..... 21	Upson Company, The..... 6
	Eubank and Son, L. H..... 79	New Castle Products.....148	
		Niagara Furnace Division.....180	V
F	Fir Door Institute..... 51	Nordberg Mfg. Co..... 58	Van Nostrand Inc., D.....184
	Firestone..... 12	Norge Division, Borg-Warner Corp.....163	Vent-A-Hood Company.....203
	Ford Cement Block Machine Co.....203	Northwest Tube and Metal Fabricators.....184	Vikre Co., J. N.....182
	Ford Motor Co..... 83		
	Ford Roofing Products Co.....166	O	
	Forest City Foundries Company, The.....180	Overhead Door Corporation.....3rd Cover	
	Franklin Machine Co.....151	Owens-Illinois Glass Company..... 68	
	Frantz Mfg. Co.....183		P
	Fulton Bag & Cotton Mills.....196	Paine Co., The.....207	Pittsburgh Plate Glass Company.....90-91
		Pittsburgh Plate Glass Company.....90-91	Ponderosa Pine Woodwork..... 70
G	Galanot Products Co., The.....186	Portland Cement Association.....185	Pratt & Lambert, Inc..... 56
	General Bronze Corporation.....191		

Remember...

UNI-FORM PANELS HAVE THE LOWEST FORMING COST OF ANY METHOD



Because they are lightweight (one man can handle them) prefabricated, ready-to-use units, which lock together into a rigid, accurately spaced concrete form, UNI-FORM Panels provide faster erection, easier stripping and require alignment on one side only. You can erect, strip, clean and move a set of these forms for less than 4c per square foot of form area. No other method is so economical.

WRITE for the new UNI-FORM Circular UNIVERSAL FORM CLAMP CO.

Founded 1912
Concrete Form Specialists for 35 Years
1246 N. Kostner, Chicago 51

BETTER SERVICE WHEREVER YOU BUILD

STEEL CASEMENT WINDOWS

Immediate Deliveries

Our 30 years of experience and new production methods enable us to offer immediate shipments.

See our catalog in Sweet's or write today for your copy.

CROFT STEEL PRODUCTS, Inc.
370 Lexington Avenue, New York 17, N.Y.





SPOT CORD

REG. U.S. PAT. OFF.

Reg. U.S. PAT. OFF.

—the most durable material for hanging windows

SAMSON CORDAGE WORKS
BOSTON 10, MASS.

For **RAPID-FIRE GLAZING**

Drives 'em in at machine-gun speed



Red Devil

AUTOMATIC DIAMOND POINT DRIVERS

Glaze with one hand. Efficient from EVERY position and angle. Securely hold clips of 100 DIAMOND POINTS which won't bend or corrode. Drive into hardest wood. Diamond Points for No. 1 (1 1/2") package of 50 sticks of 100 each (5,000 points); for No. 2 (1 1/4") package of 40 sticks of 100 each (4,000 points).

RED DEVIL TOOLS, Irvington 11, N. J., U. S. A.

Glaziers and Painters Tools and Machines Since 1872

Use **SOLVAY** **CALCIUM CHLORIDE**



with All Portland Cement Concrete

for **ACCELERATION — CURING — COLD WEATHER PROTECTION**

Solvay Sales Corporation 40 Rector Street New York 6, N. Y.



Hydro-Flo HEAT

Forced hot water heating for radiator, convactor, unit heater, baseboard and radiant panel systems.

Water Heaters for home and industry

BELL & GOSSETT CO.
Morton Grove, Ill.
Dept. S-11



NEW CALIFORNIA DIVISION REPORT

AMERICAN ROOF TRUSSES SPECIFIED FOR 21 WEST COAST BUILDINGS

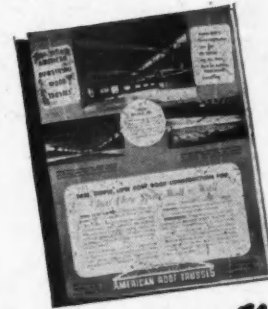

Our new California Division, recently established to better serve the entire West Coast with special earthquake-resistant roof trusses, reports a big demand by West Coast Contractors and Builders for American Roof Trusses.

American serves Contractors and Builders throughout the nation with roof trusses for many types of buildings. Write to our nearest office today for complete information.

Free! Send for New American Roof Truss Catalog Now...

Shows photographs of Factories, Bowling Alleys, Garages, and other buildings constructed with American Roof Trusses.

25th Anniversary 1922-1947

AMERICAN ROOF TRUSS CO.

CHICAGO, 49 6852 Stony Island Ave. Phone PLAZa 1772

LOS ANGELES, 37 232 W. Santa Barbara Ave. Phone ADams 1-4379

WHEN YOU NEED CONSTRUCTION EQUIPMENT

Think First of

CONSTRUCTION MACHINERY CO.

WATERLOO IOWA



MIXERS • PUMPS • HOISTS
BATCHING & PLACING EQUIP.
SAWS • ELECTRIC GENERATORS

LESLIE LOUVERS



SHINGLES
OPENING FOR AIR
BAFFLE
SCREEN
ROOF BOARDS
DRIFF CAP

SLANT ROOFS

VERTICAL WALLS

LESLIE Louvers for every type roof or wall provide ventilation against summer heat and winter condensation. More advanced design, easier installation and exclusive features which avoid leaks and increase efficiency are found in LESLIE Louvers. Roof (Universal) Type Louvers have improved baffle angle which permits condensation to drain off; deeper baffle to create air pocket and separate driven rain from air stream. Addition of a drip cap prevents water from running under the shingles. LESLIE Vertical Wall Louvers are available in Flush Flange Type—4 sizes.

Write for descriptive circular

LESLIE WELDING CO.
2937 W. Carroll Ave., Chicago, Ill.

Chicago Housing Project used Duraplastic in Structural Frames



Second unit, Princeton Park Housing Project, Chicago; Holsman & Holsman & Klekamp, architects, Chicago

ON THIS HOUSING UNIT of 107 buildings, concrete was made with Atlas Duraplastic air-entraining portland cement.

The superintendent reports that concrete "was very plastic and workable... flowed easily, aiding placement... showed no segregation or bleeding... well pleased with final results."

Duraplastic cement complies with ASTM specifications and sells at the same price as regular cement. It pro-

vides the proper amount of entrained air by intergrinding with the cement the precise amount of air-entraining material needed for satisfactory field performance.

Send for further information. Write to Universal Atlas Cement Company (United States Steel Corporation Subsidiary), Chrysler Building, New York 17, New York.

OFFICES: Albany, Birmingham, Boston, Cleveland, Chicago, Dayton, Des Moines, Duluth, Kansas City, Minneapolis, New York, Philadelphia, Pittsburgh, St. Louis, Waco.

AB-D-39

ATLAS DURAPLASTIC

AIR-ENTRAINING PORTLAND CEMENT

MAKES BETTER CONCRETE AT NO EXTRA COST

TRADE MARK REG.
U. S. A. C. CO.



"THE THEATRE GUILD ON THE AIR"—Sponsored by U. S. Steel—Sunday Evenings—ABC Network

A Product of Quality

The "OVERHEAD DOOR" with the Miracle Wedge is the product of sound, experienced engineering applied to finest materials. Instant operation and uninterrupted service are assured year in and year out, in all weathers. The "OVERHEAD DOOR" blends with any style of architecture—which is yet another quality responsible for its selection by millions of users. It is the *all-purpose* door to install for complete satisfaction.

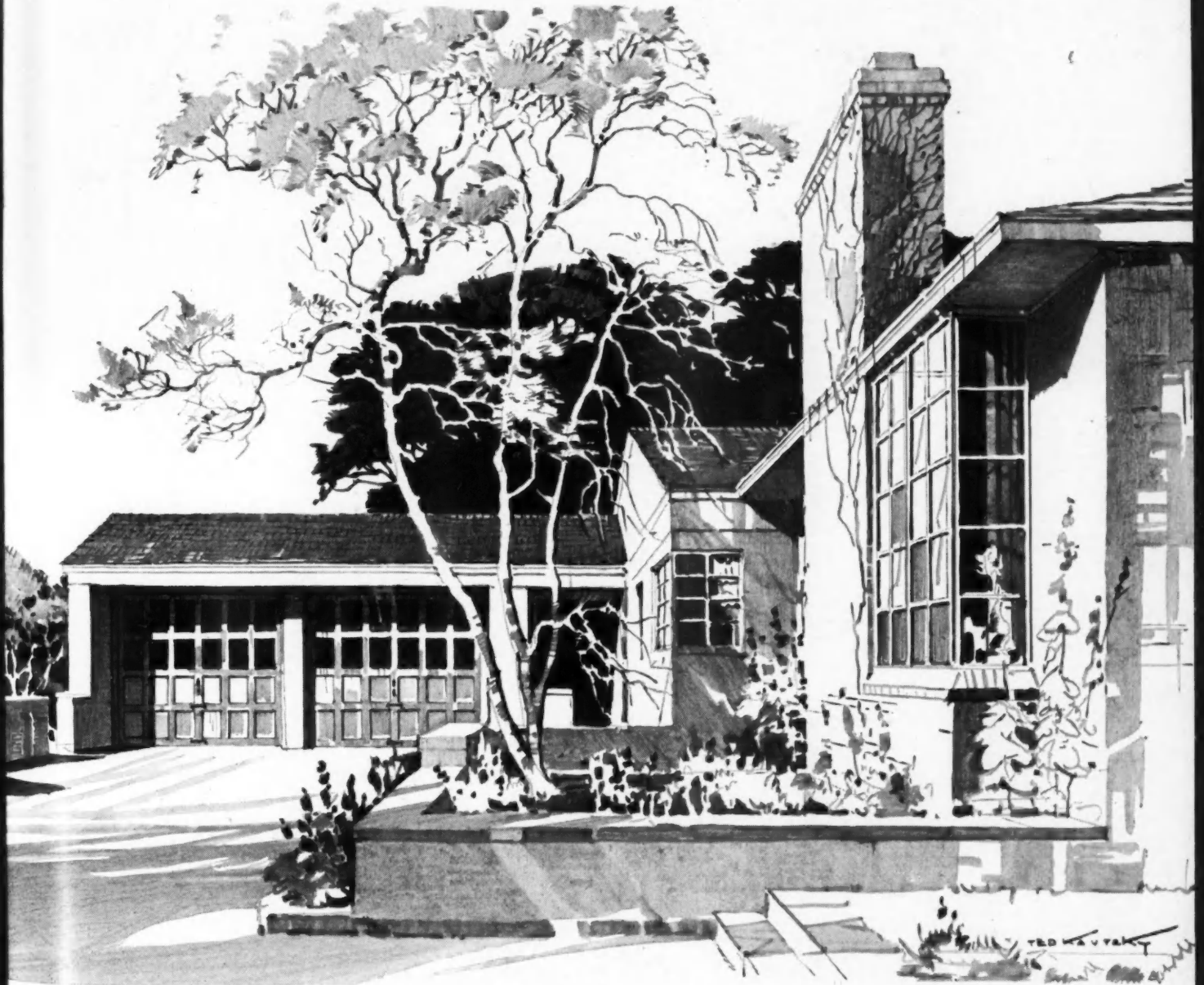

RIGHT, 1947, OVERHEAD DOOR CORPORATION

OVERHEAD DOOR
TRADE MARK
WITH THE
MIRACLE WEDGE

TRACKS AND HARDWARE OF SALT SPRAY STEEL

• Any "OVERHEAD DOOR" may be manually or electrically operated. Sold and installed by Nation-Wide Sales—Installation—Service.

COMING YOUR WAY

EXPERIENCE

QUALITY

National Builders' Hardware
is distinguished by four and a half decades
of experience and established quality.
Greater quantities are on the
way. Keep in touch
with your National dealer.

National

MANUFACTURING CO

STERLING, ILLINOIS

