

48.
186
246
218
259
268
30
264
35
58
173
184
227
208
157
238
48
143
234
210
212
144
60
28
242
40-41
73
51
169
238
154
268
190
232
260
172
47
199
250
236
254
156
188
8
244
168
214
248
218
196
200
191
171
249
216
264
190
54
58
254
49
212
218
263
239
239
153
4
184
182
165
248
247
222
264
205-224
260
202-203
240
254
251
he...262
255
244
149
260
ion...228
196
he...17
250
179

TECHNOLOGY DEPARTMENT

AMERICAN

PUBLIC LIBRARY

MAR 15 1948

DETROIT

MARCH 1948

PRICE 35 CENTS

WORLD'S GREATEST
BUILDING PAPER

BUILDER

AND BUILDING PAGE



**PLANS
MATERIALS
EQUIPMENT
TOOLS AND
KNOW HOW**

To Meet This Year's Building Market

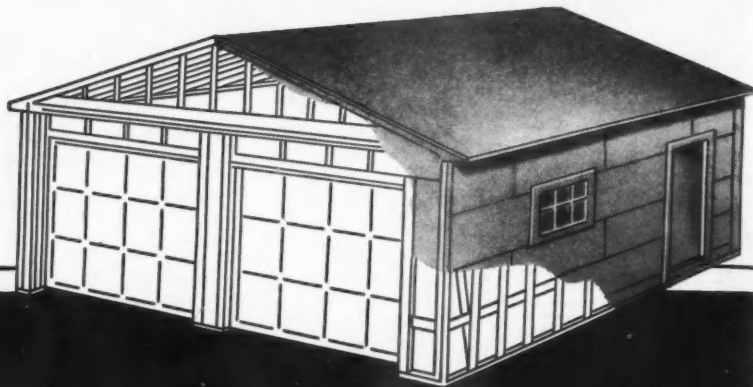

HERE'S THE **ABC** TO
INCREASED PROFITS
 WITH CELO-SIDING GARAGES

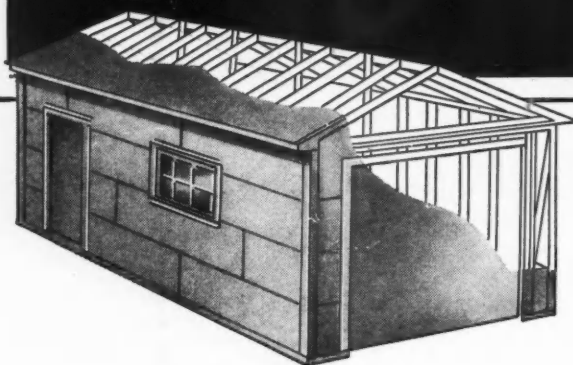

ATRACT the attention of garage hunters by arranging with a nearby lumber yard to lend you space to build a sample Celo-Siding garage.

BUILD your model garage—put a price sign on it—let garage hunters see for themselves the low-cost . . . and the protective advantages of Celo-Siding. Not only will you meet a shortage and make a profit . . . but you'll help your community solve a serious problem.

CUSTOMER satisfaction is certain with the quickly constructed, labor-saving Celo-Siding garage. This well-known Celotex insulating material provides weather-tight garage walls with an exterior mineral-granule surface in pleasing colors. No painting required. A practical, attractive garage that will give many years service.

SEND FOR YOUR **FREE**
 ONE- AND TWO-CAR GARAGE
 PLANS **NOW!**

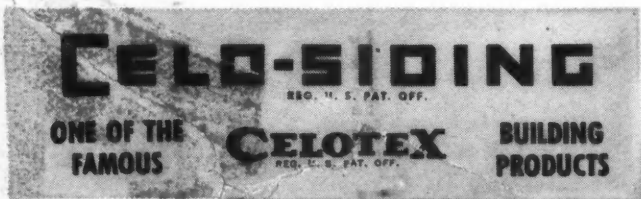

THE CELOTEX CORPORATION
 CHICAGO 3, ILLINOIS

Published monthly by Simons-Boardman Publishing Corporation, 105 W. Adams St., Chicago 3, Ill. Subscription price, United States, Possessions and Canada: \$3.00; 3 years, \$5.00. Foreign countries: 1 year, \$10.00; 3 years, \$20.00. Single copies, 35 cents. Entered as second-class matter Oct. 11, 1930, at the Post Office at Chicago, Ill., under the act of March 3, 1879, with additional entry as second-class matter at Mount Morris, Illinois. Address communications to 105 W. Adams St., Chicago 3, Ill.

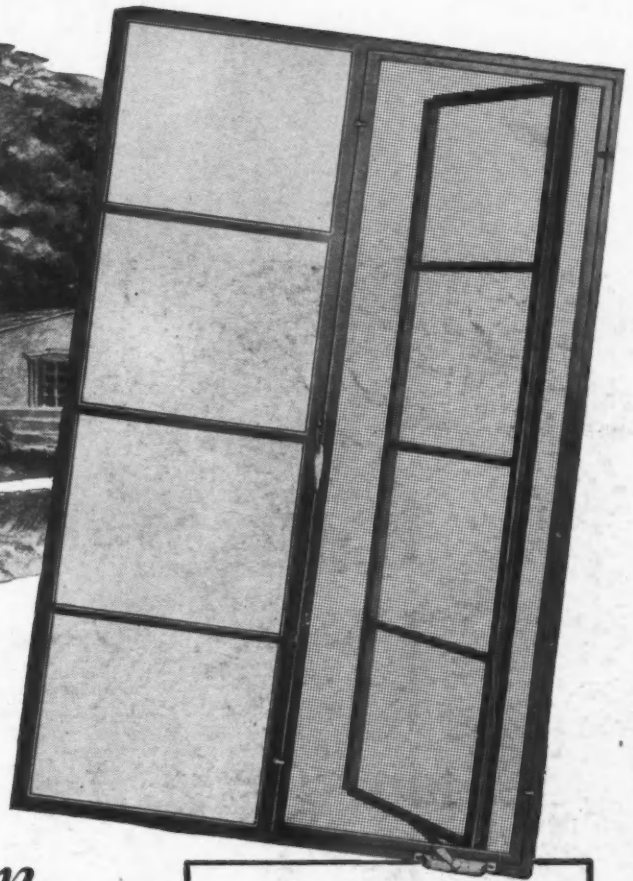
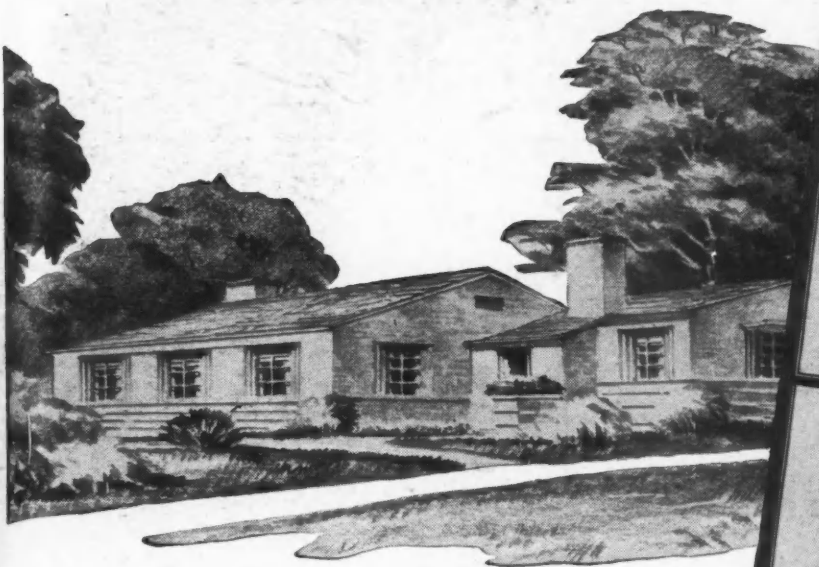

How to keep window costs down...

There *are* ways to save on windows without sacrificing quality or window benefits. It's a matter of choosing the best window at the best price.

Type 2414N, for typical window openings, is an excellent example. Its 50% opening offers controlled ventilation—more than you get with ordinary windows. It provides 16 $\frac{2}{3}$ % more daylight. It's well made, sturdy, good looking, easy opening.

Yet it is definitely a "price" window . . . and we're eager to have you compare it with any window of equal size you can buy.

Type 2414N is standard. That means lower first cost and greater availability. It is sized for use in the popular 2'10" x 4'6" opening—presents no installation difficulties.

Fenestra offers Residence Steel Casements to fit every need. All made to quality standards, they add salability to houses. For full information and prices in your locality, see your Fenestra dealer—or write to Detroit Steel Products Company, Dept. AB-3, 2260 East Grand Blvd., Detroit 11, Michigan.

WHICH IS THE RIGHT WINDOW TO USE?

For maximum economy—Type 2414N. Meets most residential window needs. Use this for all general locations. One swing leaf provides full 50% opening . . . deflects air into the room.



For maximum ventilation—Type 2424. Provides 100% opening. Costs 70% more than Type 2414N because it has two ventilators with Roto-Adjusters.

Obviously, there are places where this extra ventilation makes the additional cost well worth while.

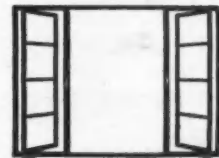

For maximum view—Type 4424: Picture window, plus ventilation . . . many other types and sizes of Fenestra Casements to provide a right window for every need.

Fenestra
RESIDENCE STEEL CASEMENTS

Two of Every Three Homes are good *Prospects!*



Good News! Upson Kuver-Krak Panels are moving to lumber dealers in larger quantities!

Now, you too can join the thousands of carpenters who are starting again to make good money installing Upson Ceilings *every month of the year*. Simple carpentry is all it takes. And it is *your* market.

(1) Plan your paneling for good balance, breaking up the area into three or more parts. (2) Apply furring strips right over unsightly ceilings on 16" centers. Provide backing for all four edges of each panel. (3) Nail Upson Floating Fasteners to furring strips 8" apart. (4) Apply the panels to Fasteners. (5) Apply cornice around outer edges of ceiling. Then apply Upson Duplex moulding strips over joints.

Get started now! Ask your lumber dealer for easy-to-follow Direction Sheets, or write us for them.



Easily Identified By the Famous BLUE Center

THE UPSON COMPANY, Lockport, New York

Pacemaker in Crackproof Panels for 35 years. 6 Ply Strong Bilt—for new construction • 3 Ply Kuver-Krak—for re-covering cracked plaster • 5 ply Dubl-Thik Fibre Tile—for baths and showers • 4 ply Upson Panels—for general use • 3 ply Easy Curve Board—for displays and industrial

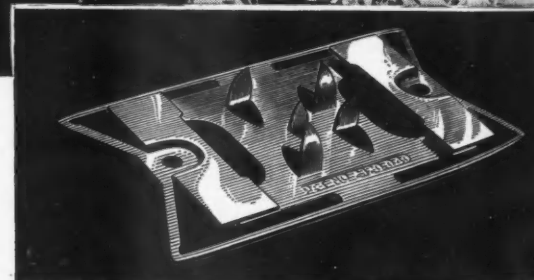

1. The amazing Upson Floating Fastener provides for structural movement of studs and joists—avoids face nail

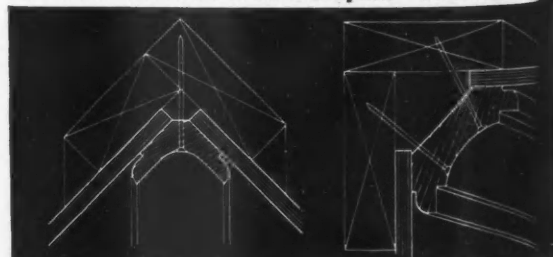

2. Inside corner detail with Upson Shad-O-Line Moulding. 3. Cornice detail with Upson Shad-O-Line Moulding.

Copyright
BOARD
H. Mor
Editor;
rector;
Clark,
tural E
W. C. F
M. Balm
Assistan
Adams
made to
lication
velope)
be resp

Americ
"Carpe
reted M
Builder
register
Istrar o
BOARD
West A
Street,
Chairm
Lyne, E
S. Cran
dents;
John
United
\$3; 3
years,
ers are
ture of
Taylor,
York 7
fifth, C
Whitti

Membr
and o
Printed



AMERICAN BUILDER

Founded—1875

Copyright 1948 with all rights reserved, SIMMONS-BOARDMAN PUBLISHING CORPORATION. Robert H. Morris, Publishing Director; Edward G. Gavin, Editor; Lyn E. Arent, Managing Editor and Art Director; B. H. Wambolt, Associate Editor; Newell L. Clark, Eastern Editor; Arthur V. Hansen, Architectural Editor; Bernard L. Johnson, Western Editor; W. C. Rodd, Contributing Editor, Los Angeles; Ruth M. Balmes, Production Director; Margaret C. Carroll, Assistant to the Editor. Editorial Office, 105 West Adams Street, Chicago 3, Ill. Every effort will be made to return material submitted for possible publication (if accompanied by stamped, addressed envelope), but the editors and the corporation will not be responsible for loss or damage.

American Builder and Building Age (originally "Carpentry and Building") with which are incorporated National Builder, Permanent Builder and the Builder's Journal, was founded Jan. 1, 1879. Names registered in U.S. patent office and Canadian registrar of trade mark. Published by the SIMMONS-BOARDMAN PUBLISHING CORPORATION, 105 West Adams Street, Chicago 3, Illinois; 30 Church Street, New York 7, New York. Samuel O. Dunn, Chairman of the Board and President; James G. Lyne, Executive Vice President; Robert H. Morris, J. S. Crane, C. J. Wageman, F. A. Clark, Vice Presidents; Roy V. Wright, Vice President and Secretary; John T. DeMott, Treasurer. Subscription price: United States and Possessions and Canada, 1 year, \$3; 3 years, \$5; foreign countries, 1 year, \$10; 3 years, \$20. Single copies, 35 cents each. Subscribers are requested to state company connection, nature of business, title or position. Address W. L. Taylor, Circulation Manager, 30 Church St., New York 7, N.Y. Field Staff: C. L. Conley, W. J. Griffith, C. R. Hartung, Joe Sanders, R. J. Schnell, Dick Whittington.

Members of the Associated Business Papers (A.B.P.) and of the Audit Bureau of Circulations (A.B.C.) Printed in U.S.A.

Publisher's Page	5
American Aid to Foreign Socialism	
Monthly Review of NAHB	57
Editorial	67
An Important Announcement	

FEATURES

Building Permanent Real Estate Value	68
Careful Land Planning Insures Property Values	
Two-Bedroom Houses for \$7,825—With Attached Garages ...	74
In Norwalk Manor, 15 miles from the Heart of Los Angeles	
"Tailor Made" Home Has Distinction	77
Outdoor Views—Indoor Comfort	78
Every Room with a Wall of Glass	
Here's One for All Builders	82
Versatile and Economical House with Complete Blueprints	
Good Value Sells Itself	87
Designed to Meet Special Needs	90
An Unusual Country Home	
Engineered House Construction	91
Radiant Baseboard Heating	
The A.B.C.'s of Rental Planning	96
He Who Lives in a Glass House	98
Can Now Throw Stones	
A Store That Speaks for Itself	100
Modern Approach to Displaying and Merchandising Furniture	
Narrow Frontage No Handicap	102
Store Remodeling Introducing New Techniques	
Luxury Apartments for West Coast	103
Every Apartment Is an Individual Home	104
Privacy Preserved in Multiple Housing Units	
Known Property Taxes Help Determine Rental Rates	106
A Solution to the Housing Shortage in Neighboring Cities	
Aluminum As a Building Material	107
Compact Dairy Barn	108
Combines Several New Ideas for Compact Convenience	
Water Supply	110
For Town and Country	
How to Install a Metal Door Frame	112
How to Cut Rafters for Bow String Type Truss	113
Giving Builders Service	116
Builds Big Business for Small Yard in 18 Months	
Supply Lines Are Filling Up	120
R. E. Saberson's Comments on the Lumber Situation	
Asphalt Shingles Outwit Wind and Weather	122
Proper Application Adds Years of Life to Building Material	
New Products	124
The Latest in Equipment	

DEPARTMENTS

Trends	51
On and Off the Record	52
Letters	55
How-to-Do-It and Better Detail Plate	114
Catalogs	134
Dealer News	136
Index to Advertisers	246

FIRST in heating and plumbing
because **AMERICAN-Standard** quality
is second to none!

■ The high quality of American-Standard Heating Equipment and Plumbing Fixtures is a well-proved fact. Your clients see it in the smart styling . . . you recognize it in the sturdy construction and advanced engineering of these famous products . . . home owners enjoy it through the years in fine performance.

Yes, American-Standard products are first in quality! They always have been. That's why more American homes have heating and plumbing by American-Standard than by any other single company. For details of the complete line, contact your Heating and Plumbing Contractor.

American Radiator & Standard Sanitary Corporation, P. O. Box 1226, Pittsburgh 30, Pa.



AMERICAN-Standard
First in Heating and Plumbing

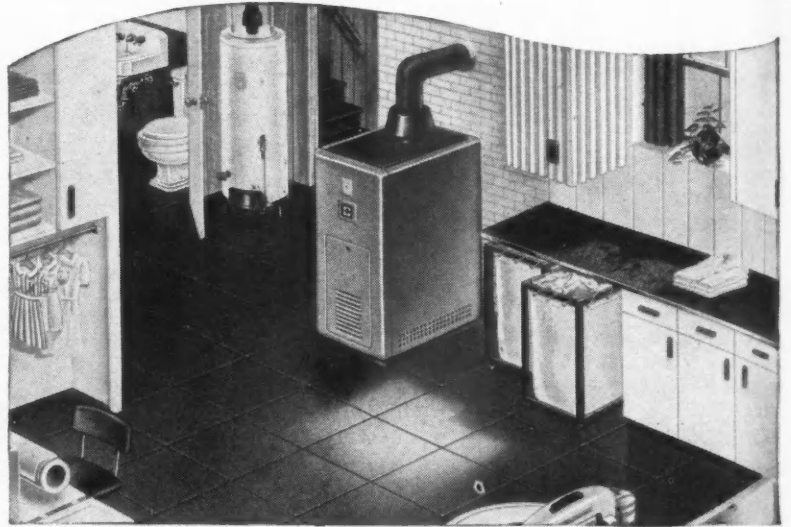

The **EMPIRE** Gas Boiler with its colorful Canyon Two-Tone Red Jacket adds to the appearance of this modern basement utility room. Offering all the sound construction features essential to carefree, automatic performance, it is as efficient as it is attractive. The gleaming white **BUDGET** Gas Fired Automatic Storage Water Heater provides an abundance of instant hot water for the laundry and other household needs.



This novel bath-dressing room arrangement owes much of its functional value to the installation of an additional lavatory—the **MARLEDGE**—with built-in dressing table and storage space. In the bathroom area, separated by a door, are the popular recess model **MASTER PEMBROKE** Bath, shelf-back **COMRADE** Lavatory, and quiet **COMPACT** Water Closet. Fixtures are available in white and a wide variety of lustrous colors.

LOOK FOR THIS MARK OF MERIT—It identifies the world's largest line of Heating and Plumbing Products for every use . . . including Boilers, Warm Air Furnaces, Winter Air Conditioners, for all fuels—Water Heaters—Radiators, Convectors, Enclosures—Gas and Oil Burners—Heating Accessories—Bathtubs, Water Closets, Lavatories, Kitchen Sinks, Laundry Trays, Brass Trim—and specialized products for Hospitals, Hotels, Schools, Ships and Railroads.

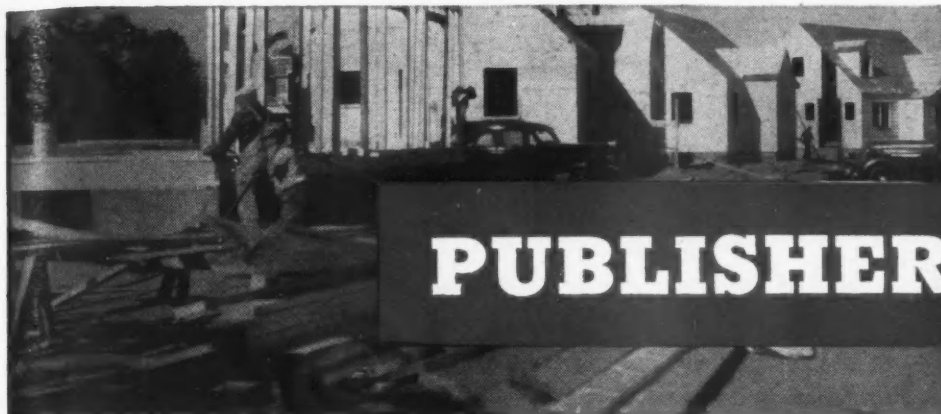

PUBLISHER'S PAGE

American Aid to Foreign Socialism

IT IS a function of a business paper to discuss everything that affects, or may affect, business. This plainly includes the Marshall plan, which proposes that the people of this country shall be taxed to provide perhaps \$20 billion for relief and recovery in other countries and thereby help arrest the advance of communism.

The burden of proving by a preponderance of evidence and arguments that the plan, if adopted, will accomplish its purposes, obviously rests on its advocates. That it will not work, unless the governments and peoples of the nations aided do their utmost to help themselves, is not questioned by anybody. There is one strong reason for believing they will not do their utmost to help themselves. This is, that most of these nations are more or less rapidly adopting socialism, because most of their people favor it.

A vast majority of the American people believe that socialism, by reducing the incentives of all classes to use their brains and hands to produce, would be ruinous to the United States. This belief is supported by reason and the entire experience of mankind. Why should we believe that socialism will promote recovery and prosperity in other countries when we believe it would cause ruin here?

We are told we must not try to dictate the political and economic policies of the nations it is proposed that we aid. Agreed. But certainly we have a right and duty, before giving the aid, to consider what use will be made of it; for the use made of it will determine its value to the nations aided and to ourselves.

Whatever goods and capital we donate will reduce by that much the amount of goods and capital we will have for our own use. We are still confronted with shortages of many kinds. These shortages can be remedied only by investing huge amounts of capital in housing and in expanding the productive and carrying capacity of our factories and means of transportation. If we retained in this country the capital that it is proposed we shall donate to other countries, would we turn most of it over to the bureaucrats of our local, state and federal governments to invest? On the contrary, we would leave it in the possession of its private owners to be invested in private enterprise, knowing that if government bureaucrats "invested" it, it would be largely wasted.

Whether other nations waste their own substance by going socialist is their own affair. Whether we shall let them waste our substance by continuing to go socialist, is very decidedly our affair.

Finally, would the Marshall plan help "contain communism?" Communism is simply *socialism established and maintained by force*. The economic policies and results of communism and of what is called "democratic socialism" are the same. The American people have a right to be told much more definitely than they have been why and how they and the world will benefit if they are taxed billions of dollars to finance socialism, however established and maintained.

Samuel O. Drumm,

HERE'S THE TICKET FOR CABINET LATCHES ON LIPPED DOORS!



I INSTALL THEM
IN 4 MINUTES WITH THE
STANLEY "SPOTTER"

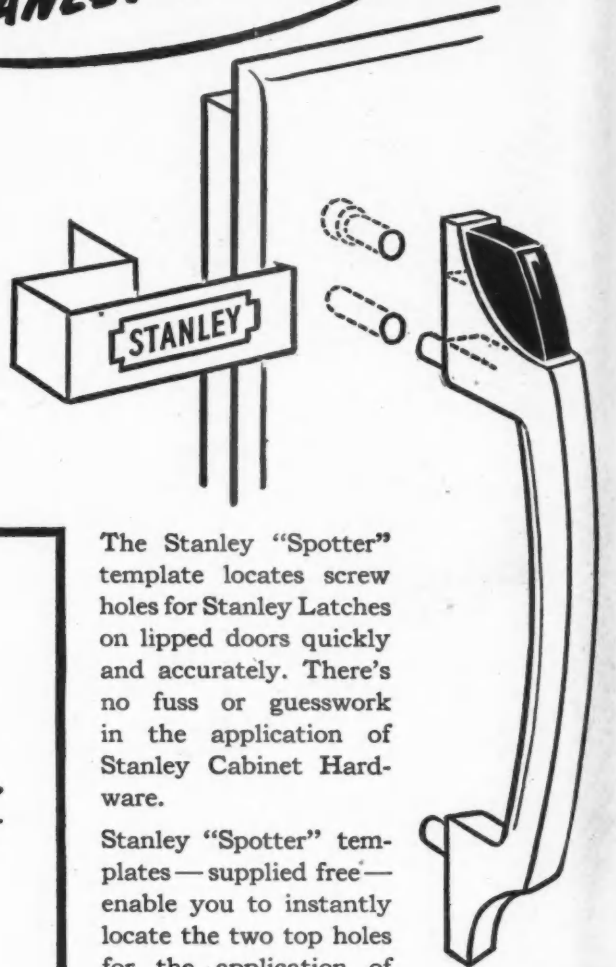

HERE'S HOW EASY IT WORKS

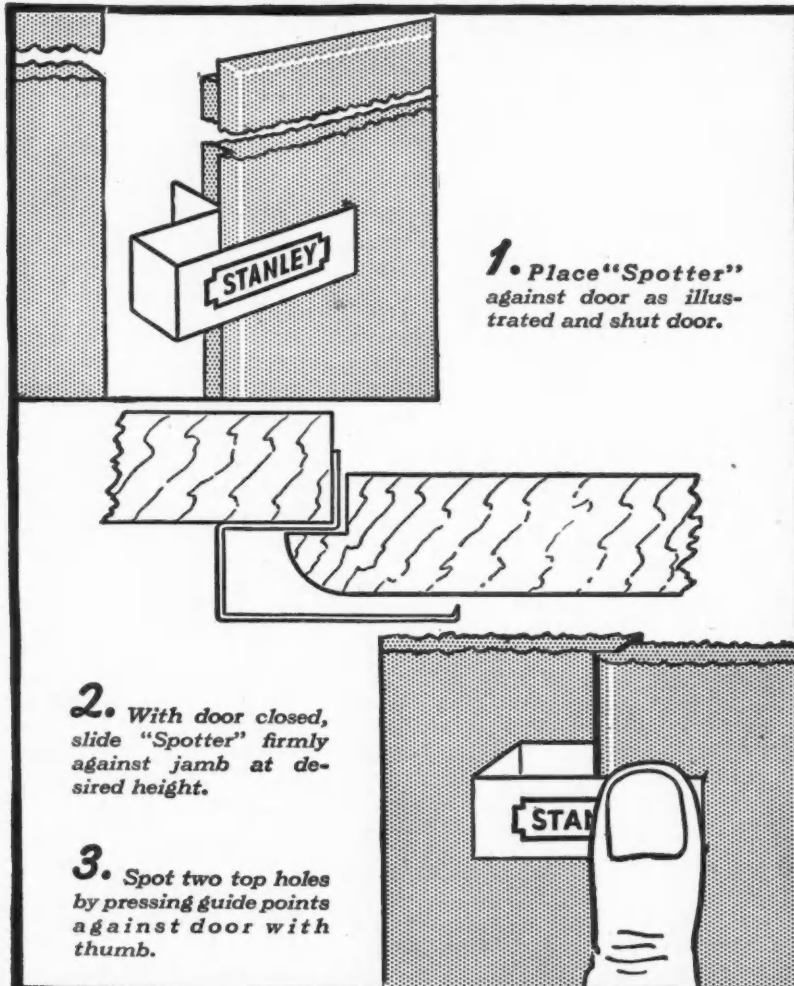

The Stanley "Spotter" template locates screw holes for Stanley Latches on lipped doors quickly and accurately. There's no fuss or guesswork in the application of Stanley Cabinet Hardware.

Stanley "Spotter" templates—supplied free—enable you to instantly locate the two top holes for the application of Stanley cabinet latches the correct distance from the jamb. A simple press of the thumb does it!

After installing the latch the adjustable strike can be quickly applied. The whole assembly is simple and time-saving. Your dealer stocks the Stanley Blue Ribbon line. The Stanley Works, New Britain, Conn.

STANLEY

Reg. U.S. Pat. Off.

HARDWARE · HAND TOOLS · ELECTRIC TOOLS

NEW**REYNOLDS *Lifetime* ALUMINUM****Gutters****Downspouts
and Fittings****Rust-proof, stain-proof, lightweight, needs no painting! In round or Colonial box design**

Aluminum is a "natural" for rain-carrying equipment ... the only comparable rust-proof material used in the past is hard to get at nearly *twice the price!* And Reynolds, biggest name in aluminum building products, now brings you a choice of design ... round or Colonial box type.

Both styles are 5" across top, come in 10' lengths, with slip-joint "S" connectors—no soldering. Weight, less than 3¼ lbs. per length. Conductor pipes are available in 3" plain round, 3" corrugated round and 2" x 3" square corrugated. Fittings include inside and outside mitres, trough section with drop, end caps, hangers, elbows.

It's what your customers will want. See your supplier now. Write for literature. Reynolds Metals Company, Building Products Division, Louisville 1, Kentucky.

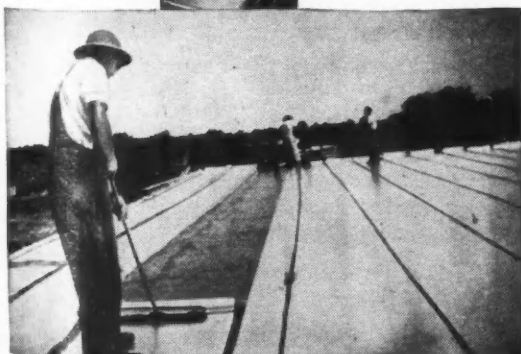
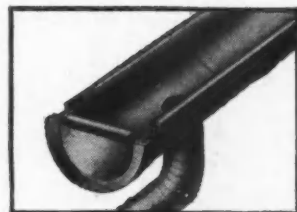
**NEW... for longer roof life, lighter roof
Load, cooler buildings in summer****REYNOLDS *Lifetime* ALUMINUM
BUILT-UP ROOFING**

.004" embossed aluminum that rolls in as easy as felt, bonds firmly, seals in the life of asphalt by sealing out air, light, moisture. Saves 400 to 500 pounds per square compared with slag or gravel dressed roofs. Reflects sun heat—to keep interiors up to 15° cooler. Rolls 36" wide, contain 10 squares, weigh about 60 pounds. *Ideal for re-caps, a world of new business!* Write for specifications on 2- and 3-ply new roofs and re-caps.

**REYNOLDS PIONEERING MADE ALUMINUM COMPETITIVE . . . TAKE ADVANTAGE OF IT!****WORLD'S LARGEST PRODUCER OF ALUMINUM BUILDING PRODUCTS:**

Aluminum Shingles • Clapboard Siding • Sheet Roofing & Siding • Eaves Trough & Conductor Pipe • Ceiling Panels
Wall Tile • Windows • Garage Doors • Reflective Insulation • "Alumi-drome" (Farm and Commercial Utility Bldgs.)



CHOOSE YOUR CEMENT like a carpenter selects his saw — TO FIT THE JOB

*The carpenter saves time and trouble
and gets best results by using the saw
that fits his job.*

Any workman knows that tools and materials must be fitted to the job and that certainly applies to cement. That's why wise contractors carefully select special cements for special work. For example, suppose you have plans calling for the use of stucco. If you want a finer stucco construction, you won't use just any cements, you will select two Medusa Special Cements, Medusa Waterproofed Gray Portland Cement* and Medusa Waterproofed White Portland Cement for the finish coat.

WHY THESE SPECIAL CEMENTS FOR STUCCO?

Medusa Waterproofed Gray Portland Cement in the Mortar coats, and Medusa Waterproofed White Portland Cement in the finish coat are selected because they have a waterproofing material ground in during manufacture to insure uniform distribution throughout the stucco. This material repels water in the surface guarding against moisture penetration and against efflorescence. The Waterproofed White Finish Coat prevents rain-carrying dirt from entering and staining the surface—instead, the dirt is washed off. That's why Medusa stucco made with these two special cements stays beautiful. If you want lasting beauty for your stucco homes, choose wisely—use the cements made especially for finer stucco. Send a coupon for the booklet, "A Guide to Finer Stucco".

*If Medusa Waterproofed Gray Portland Cement is not available, use either Medusa Waterproofing Paste or Powder.

"FIFTY-SIX YEARS OF CONCRETE PROGRESS"



MAIL
THIS
COUPON
NOW!

MEDUSA PORTLAND CEMENT COMPANY

1002-1 Midland Building • Cleveland 15, Ohio

Gentlemen: Please send me a copy of the book, "A Guide to Finer Stucco".

Name

Address

City State

Also made in Canada by Medusa Products Co. of Canada, Ltd., Paris, Ontario

NEW ALL THROUGH! FORD *Bonus Built* TRUCKS

BUILT STRONGER TO LAST LONGER!



Series F-8 illustrated

Bonus* Built—THE AMAZING RESULT OF AN ENGINEERING PRINCIPLE THAT ASSURES WIDER USE, LONGER LIFE . . . and ONLY Ford Trucks have it!

Every one of the new Ford Trucks for '48 is **Bonus Built** . . . built with *extra strength* in every vital part. This extra strength provides **WORK RESERVES** that pay off for you in two important ways:

- **FIRST**, these **WORK RESERVES** give Ford Trucks a greater range of use by permitting them to handle loads beyond the normal call of duty. Ford Trucks are not limited to doing one single, specific job!
- **SECOND**, those same **WORK RESERVES** permit Ford Trucks to relax on the job . . . to do their jobs easier, with less strain and less wear. Thus, Ford Trucks *last longer* because they work easier!

Yes, Ford Trucks are **Bonus Built** . . . built stronger to last longer! That's why they give their owners wider use and longer life! That's why there are more Ford Trucks in use today than any other make!

***BONUS**: "Something given in addition to what is usual or strictly due."
—Webster's Dictionary

NEW FORD BIG JOBS!

F-7 BIG JOB 19,000 LBS. G.V.W.
F-8 BIG JOB 21,500 LBS. G.V.W.

- ★ **NEW** Rouge 337 Truck V-8 engine! 145 horsepower. Hydraulic valve lifters. Cobalt-chrome faced exhaust valves. 4-ring pistons with top ring porous-chrome plated.
- ★ **NEW** Million Dollar cab gives you living room comfort. 3-way air control. Level Action cab suspension.
- ★ **NEW** 5-speed transmission; overdrive-type available in F-8, standard in F-7.
- ★ **NEW** heavy duty Quadrax rear axles. Hypoid-type in F-7, two-speed-type in F-8.
- ★ **NEW** Feather-Foot vacuum-actuated truck brakes. 16-in. by 5-in. double cylinder rear brakes in F-8, 16¼-in. by 3½-in. double action rear brakes in F-7.
- ★ **NEW** roller action steering! 3-tooth roller supported by two rows of needle bearings. Free-moving steering worm rides on two sets of roller bearings.

You'll find these and scores of other outstanding features in the brand new Ford **BIG JOBS** for '48! They're **Bonus Built** for wider use, longer life!

Listen to the Ford Theater over NBC stations
Sunday afternoons 5:00 to 6:00 p. m.,
Eastern Standard Time.

THEY'RE here . . . they're revolutionary!
The finest line of trucks in Ford history!

More than 139 chassis-body combinations!
Three new engines! New Million Dollar Cab!
New frames, axles, brakes, steering!

See the new Ford **Bonus Built** Trucks now.
You'll find the *right* truck for your needs in the new Ford line.

LIFE INSURANCE EXPERTS PROVE . . . FORD TRUCKS LAST UP TO 19.6% LONGER!

THIS IS YOUR AD



This ad appears in American Home for April

how is your stock?

Now—while millions of people have screening on their minds and this *Velon* ad before their eyes—now is the time to be sure you stock plenty of this amazingly durable screening. Make this ad work for you, and pull in thousands of dollars worth of sales in your area. now—ask your jobber or write Firestone, Akron, for full information and free merchandising aids: information folders, window streamers, counter cards, newspaper mats and *Velon* screening samples.



Firestone *Velon**



TRADE MARK.

Take this low-cost Portable Saw-Shop

to your job!



It's a CUT-OFF saw!



It's a MITER saw!

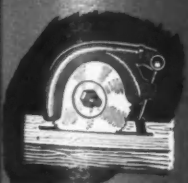

It's a RIP saw!

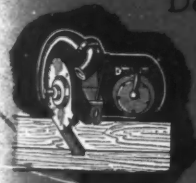

It's a DADO machine!



It's a ROUTER!



It's a VARIETY saw!



It's a SHAPER!

This ever-popular, low-cost DeWalt is easy to carry from job to job. When you put it to work you actually have a "saw-shop" on the job, because every time you change the cutting tool, you have *another* machine!

To build more and better houses faster—builders use this portable, low-cost DeWalt. Because most of its working parts are now of light-weight, heat-treated aluminum, operators find it easier to handle—safer than ever before—and it does the fast, accurate work they want. It's a machine you can get quickly. Write for catalog, DeWalt, Inc., 13 Fountain Avenue, Lancaster, Penna.

ALL THESE AND MORE
IN ONE . . . and for
THE PRICE OF ONE!

DEWALT

HE SAW THAT'S FIRST WITH BUILDERS

The Show Window

For Your Building Products

IF YOU want volume selling for any building product, put your show window on Main Street. That's where the crowds are—that's where the buyers are.

American Builder is the "Main Street" of the nation for the sale of building products. Its readers are the men who select and install these products in the largest segment of the building field—homes and other light load bearing structures.

The advertising pages of American Builder are the show windows for your products. All of the shoppers are the men who buy for this second largest national industry.

Ask any American Builder representative to call and go over our ABC audited statement on circulation—see who and where our more than 80,000 readers are.

We know you will reach the conclusion that "They are the Builders who Buy."

Never leave your show window vacant. Help keep your sales volume up by using adequate sales display space. Start your advertising campaign in the April 1948 issue and use *every* issue throughout the year.

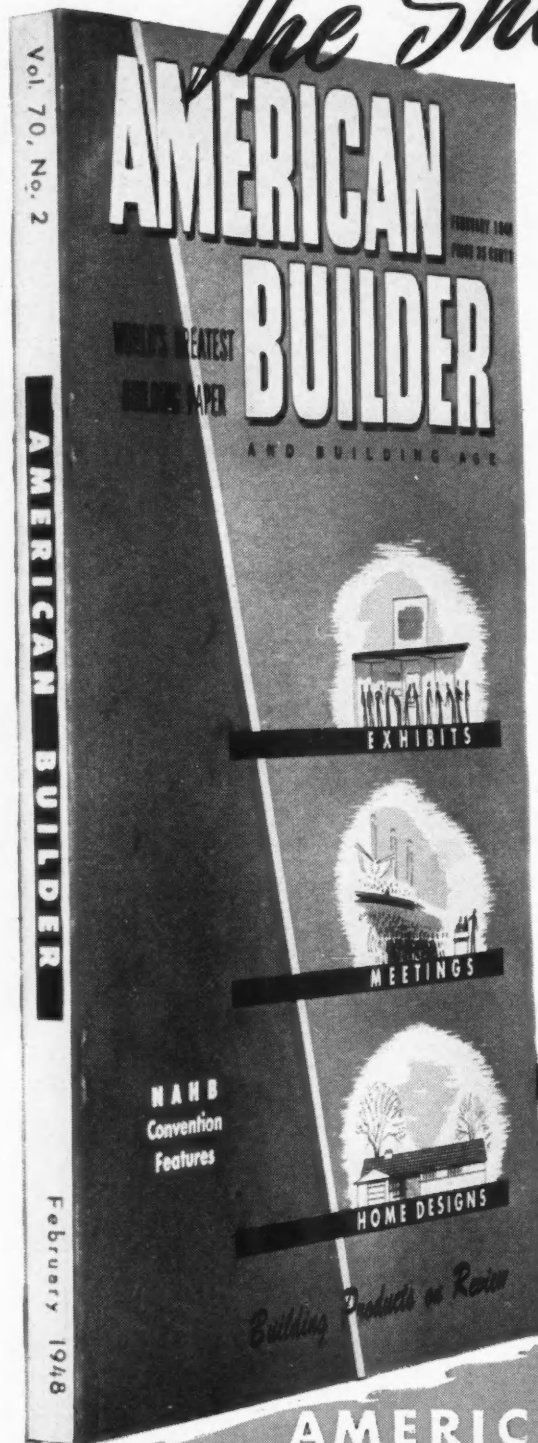

MAIN STREET FOR BUILDING PRODUCTS
MATERIALS - EQUIPMENT - TOOLS - SUPPLIES OF EVERY KIND FOR THE BUILDING INDUSTRY



AMERICAN BUILDER

A Simmons-Boardman Publication

105 West Adams St.
CHICAGO 3, ILL.

30 Church St.
NEW YORK 7, N.Y.

THE PRODUCT

Pittsburgh Steeltex Floor Lath

Gives you both **FORM AND REINFORCEMENT**



Floors are placed *faster* with Pittsburgh Steeltex Floor Lath. Additional reinforcement is not required because Steeltex Floor Lath is a *combination* of form and reinforcement for both concrete and gypsum floors and roofs.

With Steeltex you get high-tensile reinforcement, uniformly spaced and laced to a waterproof cord reinforced backing. It definitely aids curing of concrete because the water cannot run through and must evaporate slowly. This provides maximum strength and reduces cracking in the slab. Also Steeltex minimizes drip and prevents waste of cement and aggregate and the resultant clean-up

expense on joists and floors below. Note that the lacing wires in Steeltex are crimped and permit separation of the backing from the reinforcing fabric which gives you automatic imbedment from the weight of the mix.

You'll like the way your jobs move along—swiftly, smoothly and at a big saving in time and material. You'll like the end result: better finished floors and roofs with Pittsburgh Steeltex Floor Lath. Specify Steeltex on your next job. For your copy of our catalog D. S. 133 write today to Pittsburgh Steel Products Co., 3235 Grant Bldg., Pittsburgh 30, Pennsylvania.

*The background photo shows Steeltex—
one-third actual size.*

Pittsburgh Steel Products Company
Subsidiary of Pittsburgh Steel Company



STOP VAPOR and MOISTURE with revolutionary KAPCO BOARD!

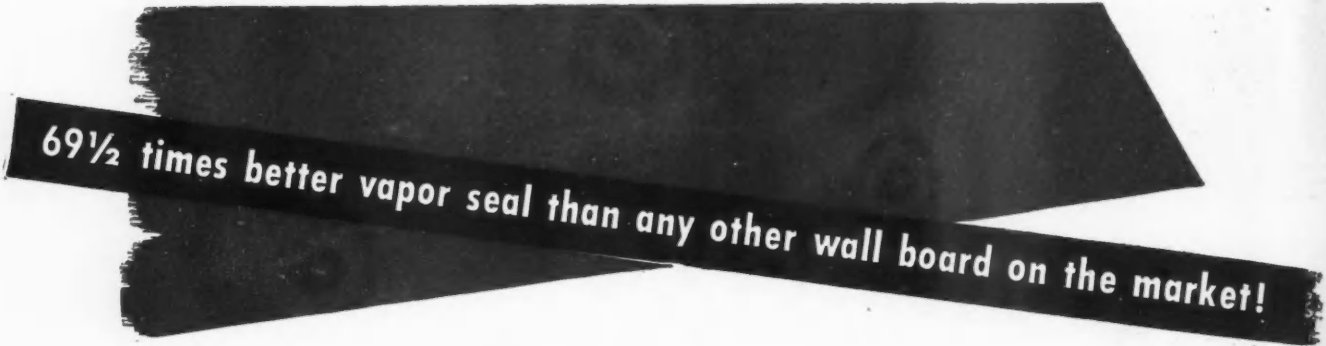

There's absolutely nothing like Kapco Board—resists water, vapor, alkali, acid, brine and alcohol. It's odorless, rigid, vermin-proof and termite-proof. Fire retarding. New superior strength. Stands up where other boards can't—will not rust, rot, mildew, mold, oxidize or de-laminate.

Bureau of Standards report reveals moisture penetration of Kapco Board is practically nil—only 1/25 gram (0.04) per sq. meter per day with quarter-inch board. This is 69 1/2 times better protection than any other board on the market gives. Nothing finer for plaster base or dry wall construction. OK'd by F. H. A.

NOW AVAILABLE—THREE TYPES FOR A THOUSAND USES!

PLASTER BASE—*Monolath*. Prevents vapor and moisture condensation inside of outer walls. 99.92% perfect vapor barrier. No more soggy, packed-down insulation—no more ice formations inside the walls. No chance of walls sweating—the cause of most plaster failures. Gives rigid support. Strong-armed workmen won't push through Kapco Board. Plaster clings better, is stronger—dries slower—from one side only. Comes in standard sizes. Cuts easily, or just score and break off. Priced competitively with ordinary sheet plaster base.

DRY WALL CONSTRUCTION—May be sealed and painted any color, or wallpapered. Filler or tape conceal joints perfectly. Use also as backerboard, as roofing base, as sheathing board, as flooring and linoleum underlayment, as a general utility construction board. Wonderful for basementless houses and concrete slab construction. Waterproof. Use on the farm for lining poultry houses, barns, silos, sheds. Stands all weathering. Easy to cut. Sizes to 4 x 8 ft. Costs less than ordinary building boards.

DECORATIVE WALL BOARD—Kapco Board in knotty pine and light walnut wood-grain finishes on one side now available. Nothing finer for finishing basements, attics, porches. Other decorative finishes available soon.

KAPCO BOARD

KEYSTONE ASPHALT PRODUCTS CO.

A Division of American-Marietta Co.
41 E. Ohio St., Chicago 11, Ill., U. S. A.



Keystone Asphalt Products Co.
41 E. Ohio St., Chicago 11, Ill., U.S.A.
Rush free illustrated booklet on Kapco Board.
I am: JOBBER DEALER
BUILDER ARCHITECT

Name.....
Firm.....
Address.....
City & Zone..... State.....

Precision

FOLDING STAIRWAY

ACCEPTED BY FHA EVERYWHERE
PATENT APPLIED FOR

NO SPRINGS!
No Adjustments Necessary!
RUGGED AND STRONG
SIMPLE AND EASY TO OPERATE

MADE OF HIGHEST QUALITY MATERIALS
SHIPPED IN ONE PACKAGE
REQUIRES VERY LITTLE
INSTALLATION EXPENSE

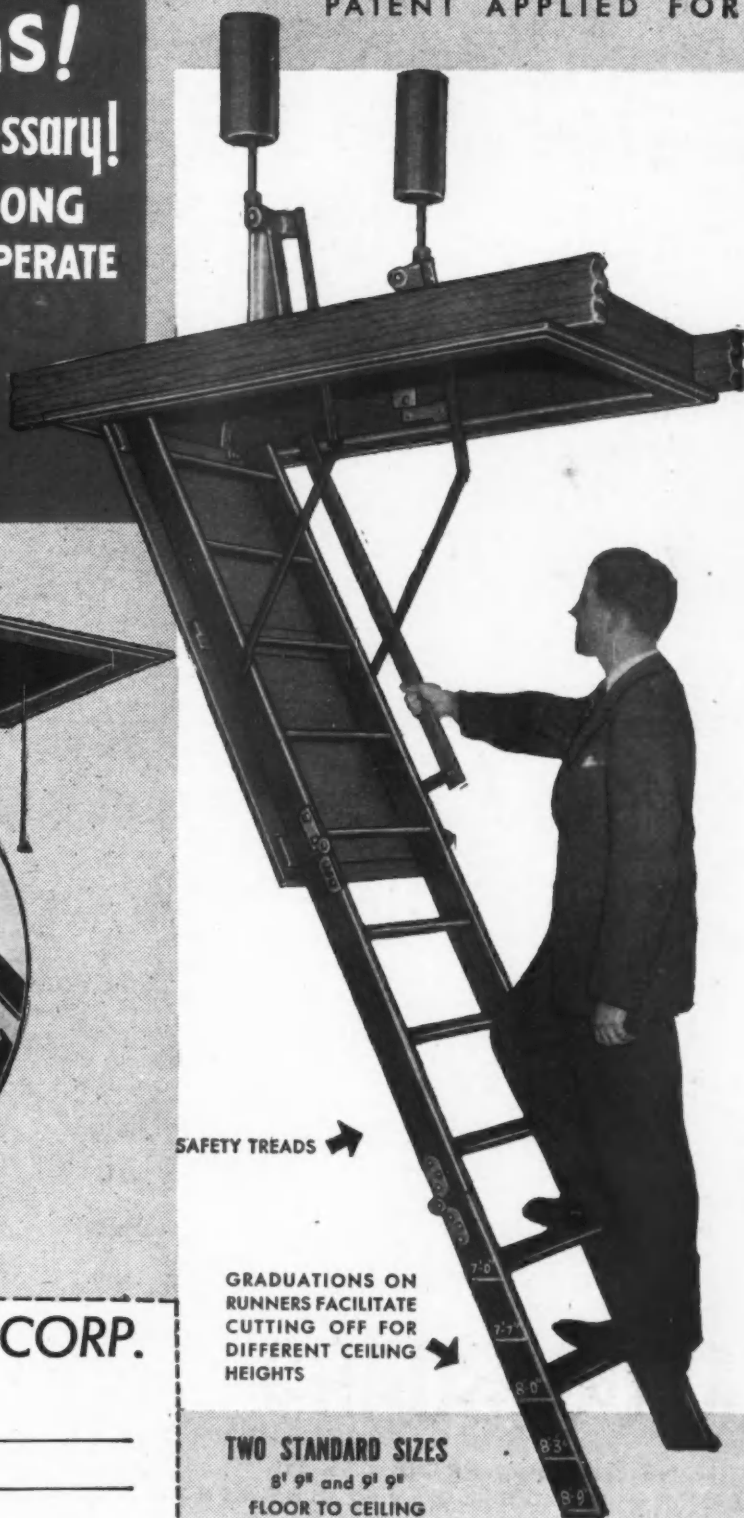
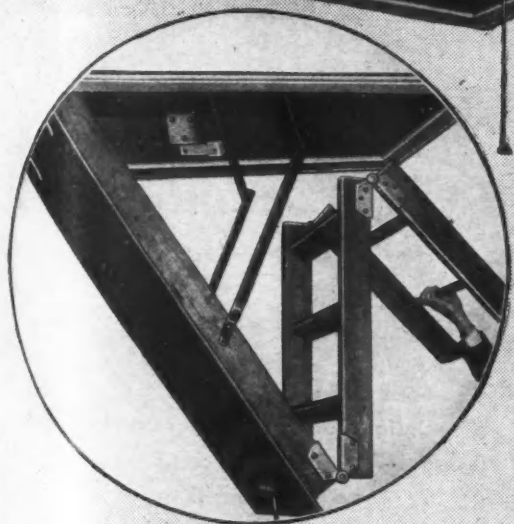

SAFETY TREADS →

GRADUATIONS ON
RUNNERS FACILITATE
CUTTING OFF FOR
DIFFERENT CEILING
HEIGHTS →

TWO STANDARD SIZES
8' 9" and 9' 9"
FLOOR TO CEILING

PRECISION PARTS CORP.
NASHVILLE 7, TENN.

NAME _____

ADDRESS _____

board.
T □

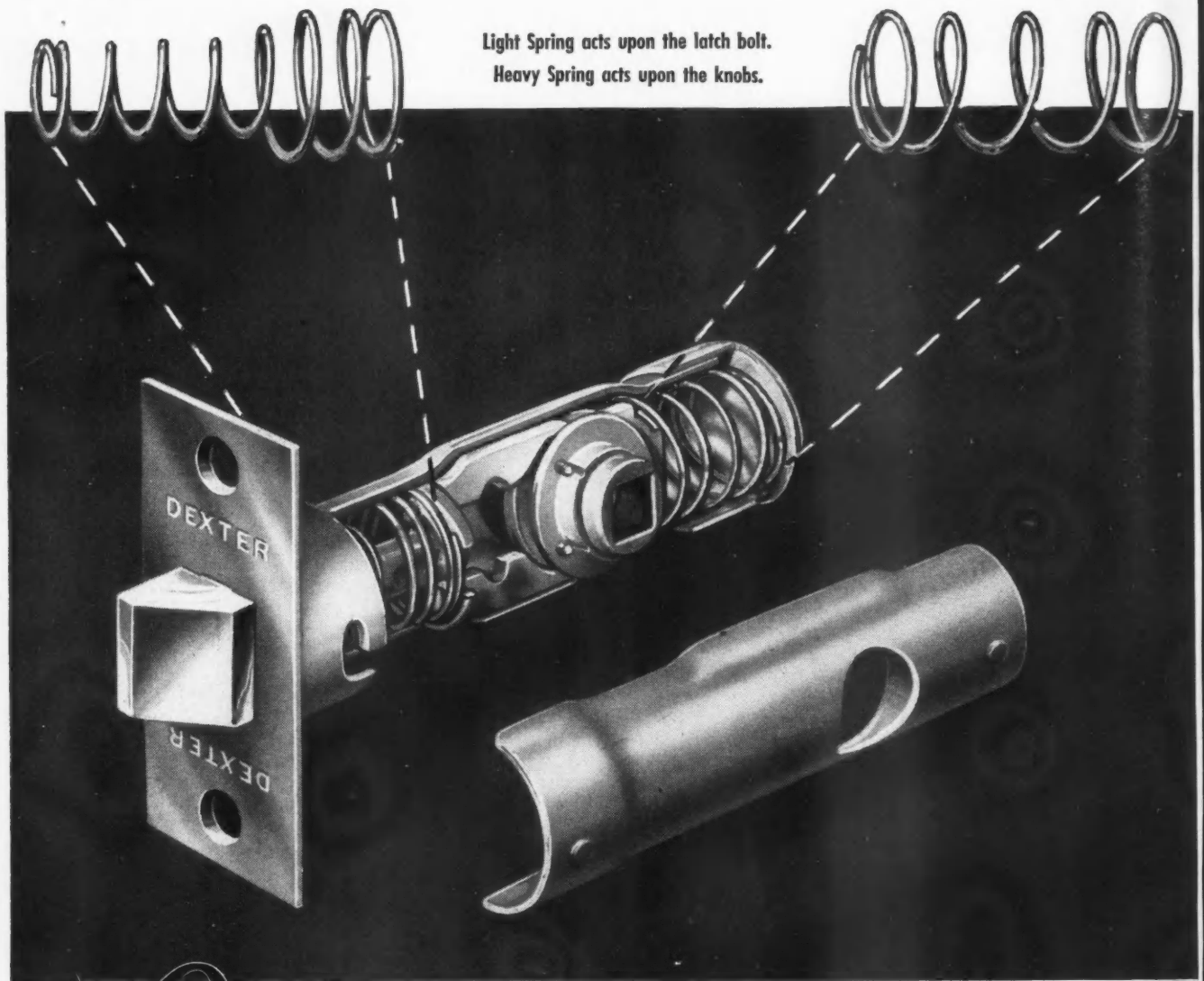

Only DEXTER TUBULARS have all these 9 features of superiority

TAKE a peek inside — you will see what makes a Dexter Latch stand up — *extra large size springs* give an abundance of spring power.

A large, easy action spring in front for the latch bolt.
A heavy spring in back for quick, positive knob action.

This is only one of the nine features which assures you of the very best when you use *Dexter Tubulars*.

- 1 Stay-tite Set Screw
- ② Two Big Coil Springs
- 3 All Steel Interior
- 4 Solid Brass Trim
- 5 Uniform Boring for Locks and Latches
- 6 Self-Adjusting Alignment
- 7 25 Years Specialized Experience
- 8 Shallow Face Plate Mortise
- 9 Lifetime Guarantee

NATIONAL BRASS COMPANY
Grand Rapids, Michigan

MAKERS OF BUILDERS, CABINET, SCREEN DOOR
AND SHELF HARDWARE



Floor layer's favorite for over 30 years

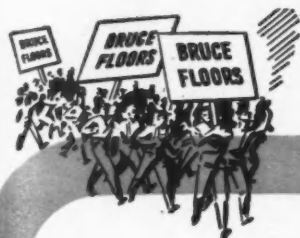

Bruce Flooring is first choice of men who specialize in beautiful hardwood floors



• A floor layer *knows* his hardwood floors. Through years of experience he can judge the quality of the flooring as soon as he breaks open a bundle and lays a few strips. He knows whether it is made from good lumber, whether it is properly kiln dried, whether it is accurately machined, and whether it is graded right.

It has always meant a lot to us at Bruce that so many floor layers have expressed their preference for Bruce Hardwood Flooring. They've been using it and boosting it for the past 20, 25, and even 30 years!

And here's added proof that floor layers *know* their hardwood floors: Survey after survey has shown that architects, dealers, contractors and home owners also prefer Bruce Flooring to all other brands . . . by a wide margin!

E. L. BRUCE CO., MEMPHIS, TENN. • WORLD'S LARGEST MAKER OF HARDWOOD FLOORS

BRUCE HARDWOOD FLOORS

Prefinished and Unfinished

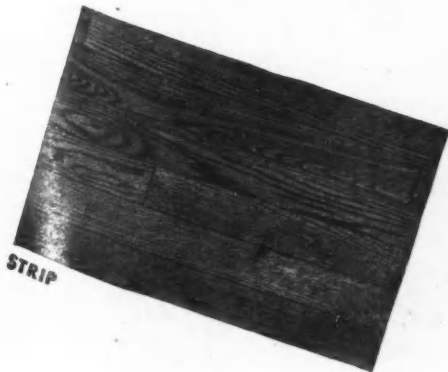

STRIP



BLOCK

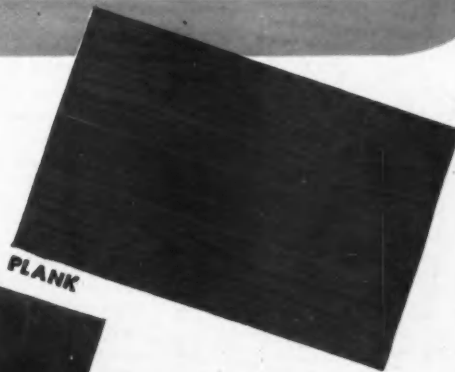

PLANK

Better Homes and Gardens

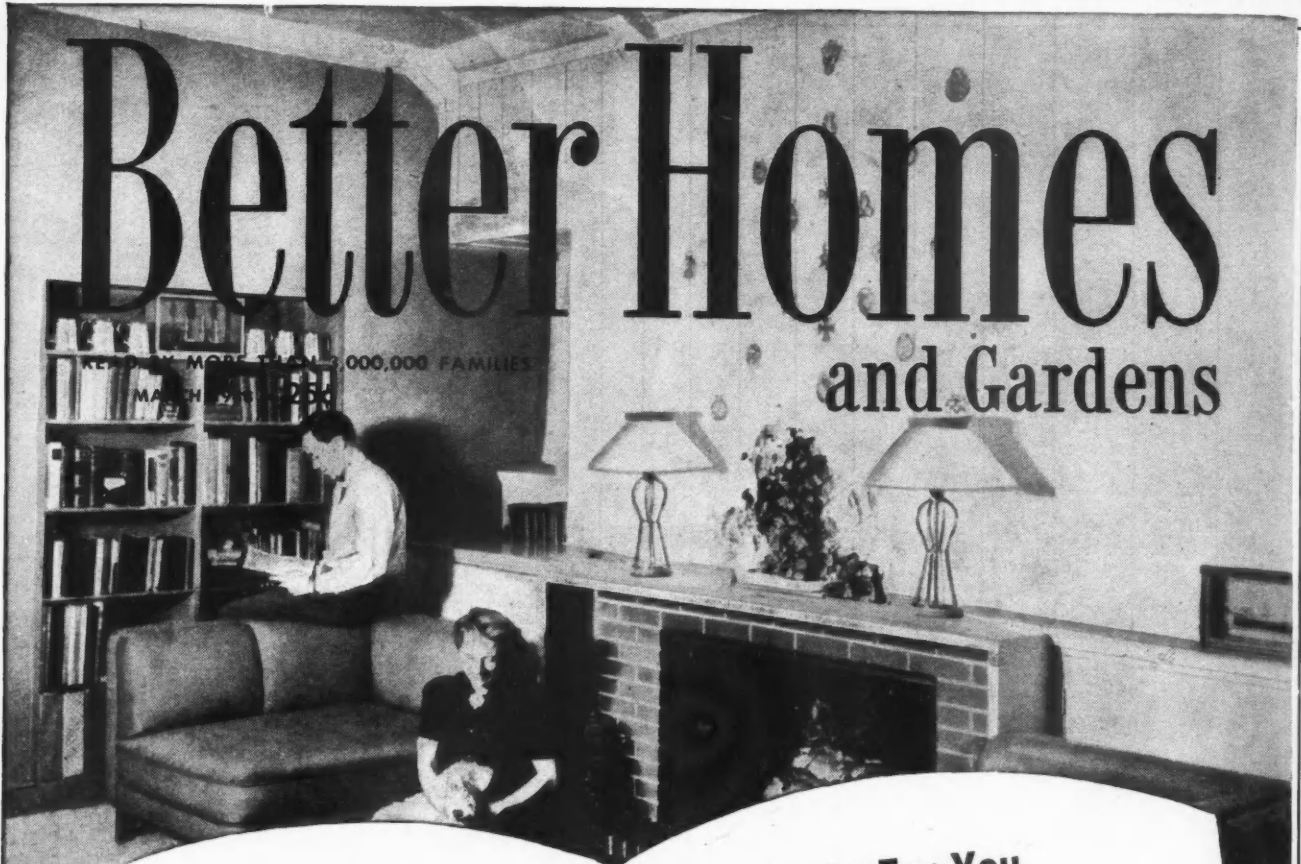

Our Job is To Make Better Clients For You

Better Homes & Gardens' job is to sell families on what's new and good in homes. We help create a demand for better homes — help create a group of clients ready to appreciate and welcome and enjoy the new ideas you build into houses for them. That's why it's a good idea for you to keep an eye on trends as they're

expressed in BH&G; that's why it's such a good idea for manufacturers to catch this trained audience with their ads in BH&G. Take a look at our March issue. There's a rambling house that fits a 50-foot lot, a Five-Star house that requires a minimum of maintenance, and two articles on intelligent remodeling.

These advertisers have found BH&G a top medium for sales:

APPLIANCES

Admiral Refrigerator
Ben-Hur Home Freezer
Boss Oil Ranges
Cadillac Vacuum
Caloric Ranges
CP Gas Ranges
Dexter Washing Machine
Easy Washing Machine
Frigidaire Electric Range
Frigidaire Refrigerator
GE Electric Range
GE Home Freezer
Grand Gas Range
Harvester Home Freezer
Hoover Vacuum
Hotpoint Dishwasher
Hotpoint Matched Kitchens
Hotpoint Refrigerator
Kelvinator Refrigerator
L & H Gas Range
Majestic Home Incinerator
Maytag Dutch Oven Gas Range
Norge Washing Machine
Oriole, Acorn & Vulcan Gas Ranges
Philco Refrigerator
Premier Vacuum
Roper Gas Range
Servel Gas Refrigerator
Voss Washing Machine

ELECTRICAL & WIRING

Amer. T. & T. Bell System
Burgess Batteries
Cutler-Hammer Fuse Boxes
Delta Flashlights
Onan Power Plants

HANDYMAN

Casco Glue
Durham's Rock Hard Putty
Lowell Paint Spray
Plastic Wood
Schalk Handyman's Aids
Smooth-On Cement

HARDWARE

Anaconda Bronze Screen
Anchor Fence
Cyclone Fence
Firestone Velon Screen
Invisibile Sash Balance
Pittsburgh Glass
Yale Trim Hardware

HEATING & AIR CONDITIONING

Aldrich Automatic Hot Water Heat
American Radiator Automatic
Arvin Portable
Bennett-Ireland Fireplace
Burnham Base-Ray Automatic

HEATING & AIR CONDITIONING (Cont'd)

Burnham Portable Electric
Steam Radiators
Chelsea Attic Fans
Crane Automatic
GE Hot Water Automatic
Heatilator Fireplaces
Hydro-Flo Automatic
ILG Kitchen Ventilator
Janitrol Automatic
Minneapolis-Honeywell Controls
Mueller Automatic
Oil-O-Matic
Petro Automatic
Waterbury Automatic

INSULATION

Baldwin-Hill
Balsam-Wool
Gold Bond
Kimsul
Zonolite

LUMBER — MILLWORK & SERVICES

Bennett-Ireland Fireplace Plans
Chamberlin Comb. Storm-Screen Sash
Curtis Silenite Millwork
Masonite
Mesker Steel Windows

LUMBER—MILLWORK & SERVICES (Cont'd)

Orylt Greenhouses
Plan-a-Home Model Kit
Prestile Wallboard
Rusco Comb. Storm-Screen Sash
Southern Shower Doors
Weldwood
Western Pines
Weyerhaeuser Services

PAINTS

Alston-Lucas Paint
Albron Pigments
Bruce Terminix
Cabot Paint
Cuprinol Wood Preservative
Kemtone
Kyanize
Lin-X Clear Gloss
Luminall
Minwax Floor Finish
Nu Enamel
O'Brien
Paratex Paint
Sherwin-Williams

PLUMBING

American Central Kitchen
American Standard Fixtures
Burks Water System
Capitol Toilet Seat
Crane Fixtures

PLUMBING (Cont'd)

Deming Water System
Eljer Fixtures
GE Hot Water Heater
Goulds Water System
Kitchen Maid Kitchen
Kohler Fixtures
Merlland Hot Water Heater
Midwest Kitchens
Myers Water System
Orangeburg Pipe
Roto-Rooter Sewer Cleaner
Salter Fixtures
Sepco Hot Water Heater
Sherman Fixtures
Smithway Hot Water Heater
Toastmaster Hot Water Heater
White Hot Water Heater

WALL COVERING

Imperial Wallpaper
Sanitos Fabric Wall Covering
Trimz Ready-Pasted Wallpaper
United Wallpaper
York Wallpaper

MISCELLANEOUS

Armstrong Linoleum
Barre Guild Monuments
Dunbrik & Dunstone
Johns-Manville Roofing
Perma-Stone Siding
Portland Cement
U. S. Steel

CIRCULATION OVER 3,000,000

America's First Service Magazine

STAINLESS STEEL



and now—
SCREENS

Another outside job has been taken over by the metal that has given permanent beauty to everything from kitchen sinks to building trim. Home owners are installing stainless steel screens for their windows, doors, and porches. They've found that the stainless steel screens do not stain any painted surface beneath them, though many times soaked by rain. And they resist denting and tearing, too. If you would like to keep informed about the many other uses for stainless steel in the home, ask to receive our monthly publication ELECTROMET REVIEW. Write to Department B-3.

ELECTRO METALLURGICAL COMPANY

Unit of Union Carbide and Carbon Corporation
30 East 42nd Street **UCC** New York 17, N. Y.

PRODUCERS OF ALLOYS THAT MAKE STEEL STAINLESS

Beautiful Enduring Strong Tough

First choice
for Title VI in rental housing
MODULAR BRICK and TILE



economical • fire-safe • beautiful

Contractors and builders show great preference for brick and tile for rental housing.

For proof—note the great number of multiple-unit and two-family houses made of these materials. Probably you've built some yourself.

Lower first-cost, less depreciation and repair, assurance of higher resale value are good reasons for building with brick and tile.

Durability, great structural strength, fire-safety and lasting beauty are others.

Now—in modular sizes—brick and tile mean

more savings . . . better housing because of earlier planning and estimating, perfect fit with other modular designed materials, less cutting and fitting, better workmanship, reduced construction time.

NEW SMALL HOMES PLANS BOOK

Our new plan book of 30 small homes, "Your New Brick Home", is now available at 50 cents per copy. Send 25 cents for our new book of 6 Engineered Houses in Brick and Tile. Send your order to Structural Clay Products Institute, Dept. AB-3, 1756 K Street, N.W., Washington 6, D. C.

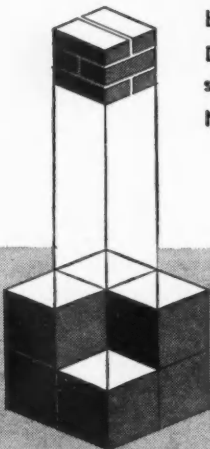

Now it will be built with Modular-Designed
BRICK AND TILE

h 1948.

THIS IS THE NEW 10 in. SKIL[®] SAW YOU NEED . . .

MODEL "107"
10 INCH BLADE



For All Ripping and Cross-cutting in 3 inch Lumber

This new SKIL Saw does just about everything you could expect from a 10-inch power saw. It rips or cross-cuts lumber up to 3 3/8 inch, bevel cuts 2 3/8 inch lumber at 45°. Cuts 3/8 inch copper or aluminum sheets. Cuts 3 inch lead-covered cable. Scores stone, tile, marble, concrete. All this with the customary SKIL Saw speed and efficiency. Ask your distributor today for a demonstration.

SKILSAW, Inc., 3033 Elston Ave., Chicago 30, Ill.
Factory Branches in Principal Cities

In Canada: SKILTOOLS, LTD., 66 Portland St., Toronto, Ont.

*SKIL Saw is made only by SKILSAW, INC.

SKILTOOLS







First Bundle of
Temlok Insulation Board
Produced at New Macon Plant

There's More To Come

The first bundles of the new Temlok® Insulation Board and Temlok Sheathing are coming off of the production line right now at Armstrong's new plant in Macon, Georgia. And the new Temlok is all we had hoped for—light in color, light in weight, yet as strong as any insulation board ever produced. We are anxious for you to have an opportunity to try it for yourself. And you'll get that chance soon, because, now that the wheels have started turning, it won't be long until the great manufacturing capacity of this plant will make material available in your territory. Armstrong Cork Company, Building Materials Division, 1603 Ross St., Lancaster, Pa.

ARMSTRONG'S TEMLOK

Gold Bond is still carrying the ball for you!

Here is the latest ad in the Gold Bond Saturday Evening Post series which is now in its third year. Too many people have the mistaken idea that today's homes are merely "thrown together." Instead they are getting the finest homes ever built—greater comfort with Rock

Wool; fire protection with Gypsum Sheathing; long lasting beauty with Gypsum Lath and Plaster. Of course, the ads feature Gold Bond building products but we think you'll agree they are doing a constructive job for the whole building industry.

NATIONAL GYPSUM COMPANY, BUFFALO 2, N. Y.

(Appearing in full color in the March 20th issue of the Saturday Evening Post)

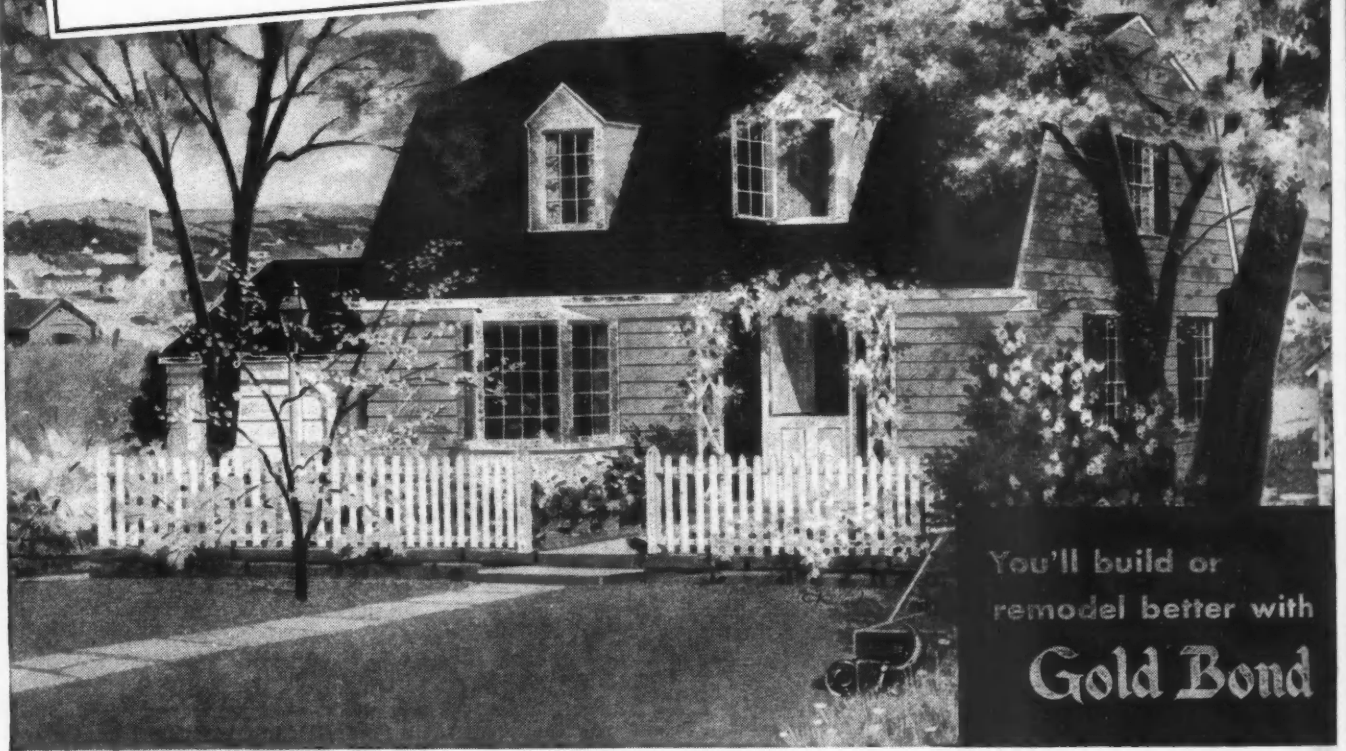

You'll build or remodel better with **Gold Bond**

For the newest in building and remodeling products, see your local Gold Bond dealer first.

What kind of dreams is a house made of?

Our friends really thought we were dreaming when we insisted our new home was going to be fire-safe. "Wait till you figure up what it costs!" they said. But the laugh was on them when our dream came true . . . because our architect showed us how to use fireproof materials without spending an extra penny!

Real fire protection in woodframe houses is no dream today with the modern materials now available. It starts with the sheathing that goes on the outside walls under the clapboards or other finish. Just ask for Gold Bond Gypsum Sheathing. These big, husky panels build a permanent barrier against fire, and a stronger, more weather-tight wall at

less cost than old style inflammable sheathing.

Your insulation should be fireproof too. Yet not all insulation is fireproof and it will pay you to be sure . . . by specifying fireproof Gold Bond Rock Wool. Gives you full insulation value and absolutely cannot burn. (For your present home, call the Gold Bond applicator and have him "blow" Gold Bond Rock Wool into the roof and sidewalls. He is in the phone book under "Insulation").

For walls and ceilings too, you can have fireproof materials at no extra cost. Just be sure the specifications say "Gold Bond Gypsum Lath and Plaster". And for charming painted interiors, with

no fire hazard, there's non-inflammable Gold Bond Sunflex. Comes in many attractive colors and dries in an hour with no "painty" smell.

Fire protection is only one of many sound values that research has put into Gold Bond building materials to help you build or remodel better. Your local Gold Bond lumber and building material dealer can now supply over 150 of these superior Gold Bond Products. He can give you helpful free advice. When you build or remodel, see him first!

NATIONAL GYPSUM COMPANY
BUFFALO 2, NEW YORK

Gold Bond Building Products add greater fire protection, permanency, and beauty at no extra cost. These include fireproof wallboard, lath, plaster, lime, sheathing, wall paint, insulation, metal and sound control products.

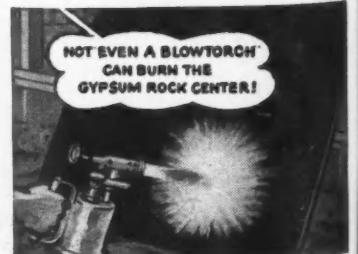

BRIXMENT Makes Good Workmanship EASIER!

The pictures below show an example of good workmanship — and of bad workmanship. They also explain why mortar such as Brixment makes it *easier* for the bricklayer to deliver good workmanship.

No. 2 OF A SERIES—

THE RIGHT WAY AND THE WRONG WAY—IN BED JOINTS

When absorbent brick are used, especially in hot weather, mortar should be spread out over only a few brick at a time. The brick should be placed on this mortar immediately, before it can stiffen.



The mortar should be spread over a few brick only.



So the mortar will still be soft and plastic when the brick are bedded.

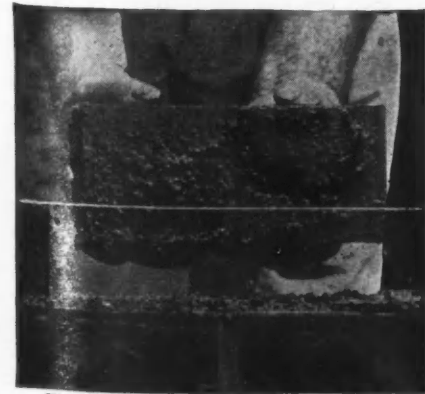

Then the mortar will stick to the brick on top of it as well as to the brick below it.

BRIXMENT makes good workmanship *easier* because it holds its moisture longer than ordinary mortars, when spread out on the wall. This enables the bricklayer to properly bed the brick before the mortar has stiffened too much.

Brixment mortar has greater plasticity, higher water-retaining capacity and bonding quality, greater resistance to freezing and thawing, and freedom from efflorescence. Because of this combination of advantages, Brixment is the leading masonry cement on the market.

LOUISVILLE CEMENT COMPANY
Incorporated
LOUISVILLE, KENTUCKY

If the mortar is spread out too far, or if any delay occurs between spreading the mortar and placing the brick, the mortar will be sucked dry and will not stick to the brick placed on top of it.



Mortar for this bed joint was spread out on the wall too far.



So the mortar dried out too much before the next course of brick was placed on top of it.



Therefore the mortar did not stick to the top brick. A good bond was not secured.

A FAST-MOVING MIXER...



3½—5 Tilting Mixer. Capacity, 3½ cu. ft. plus 10% overload (A. G. C. rating).



Quickly spotted and towed, this half-bag mixer is a cost-cutting combination of strength, lightness and efficiency. Other Ransome Blue Brute Mixers in capacities up to 126 cu. ft.



PLENTY OF RESERVE POWER...



Blue Brute Self-Priming Centrifugal Pump. Built in A.G.C. sizes to A.G.C. standards.



Now! a Contractor's Pump by Worthington, the world's largest pump makers, with fast, dependable pickup that saves time and money. Rust- and abrasion-resistant, with built-in self-priming.

Your nearby Worthington-Ransome Distributor (write us for his name) has the complete line of Compressors, Rock Drills and Air Tools, Contractor's Pumps, Portable Mixers, Truck Mixers and Pavers.

Distributors In All Principal Cities

WORTHINGTON



WORTHINGTON PUMP AND MACHINERY CORPORATION
Worthington-Ransome Construction Equipment Division
262 Canal Street, Holyoke, Massachusetts
IF IT'S A CONSTRUCTION JOB, IT'S A BLUE BRUTE JOB 100-9



priced for modest homes

Expert window engineering and the most modern metal window fabricating equipment are coordinated in the production of these fine, sparkling aluminum windows.

That's why even the most modest, low cost home can have windows that are built for the most luxurious.

Erection is simple, too, and costs much less than for most other types of windows.

PROMPT DELIVERY

Send for full size erection details and "Thorn Products for the Home."

ALUMINUM WINDOWS
J. S. THORN CO.
PHILADELPHIA 32 PENNA.



Bertram Weber—Architect

A TELEPHONE RACEWAY COMES WITH THIS COTTAGE

A raceway for concealing telephone wires is an inexpensive feature which adds a lot of convenience to any new home.

Installed within walls during construction, a few sections of pipe or electrical conduit will carry telephone wires to conveniently located outlets. A raceway eliminates the need for exposed wiring on walls or woodwork and assures modern built-in telephone outlets.

Your Bell Telephone Company will be glad to help you plan telephone wiring facilities scaled to cottage or mansion. Just call your Telephone Business Office and ask for "Architects and Builders Service."

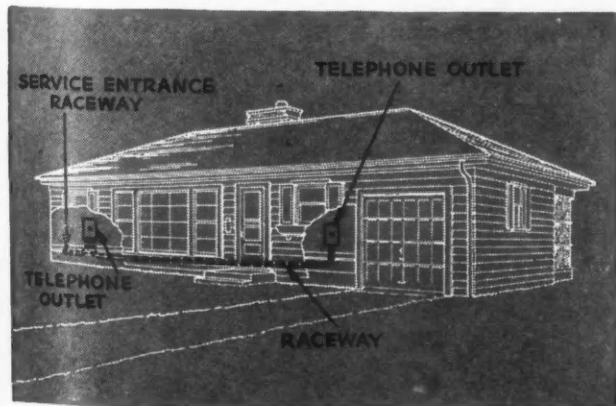

BELL TELEPHONE SYSTEM





IT JUST NATURALLY saves you money. In Pratt & Lambert Paint and Varnish you will find economy, durability and beauty. Easy working, excellent spreading and hiding cut your labor to a minimum.

And the new, authoritative P&L colors will help sell your houses, not only now but also when they may be harder to sell.

If you are not already using Pratt & Lambert Paint and Varnish, write for helpful information. Pratt & Lambert-Inc., 80 Tonawanda Street, Buffalo 7, N. Y.

PRATT & LAMBERT
 paint and varnish

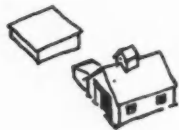

DOUBLE DUTY INSULITE



Far above all other things to remember when buying insulation for your jobs are these two money-saving facts: **INSULITE builds** — **INSULITE insulates** at the same time. Two things for the cost of one! A double-duty building material that helps you build better competitive houses — so you can sell them faster—make more profits —have more satisfied customers.

INSULATES AS IT
BUILDS AS IT

double-duty
INSULITE

BUILDS
INSULATES

The GENUINE

"Insulite" is a registered trade mark, U.S. Pat. Off.

INSULITE DIVISION  MINNESOTA & ONTARIO
PAPER COMPANY
MINNEAPOLIS 2, MINNESOTA

Wherever there's news in building

IDEA HOUSE #2, built by the Walker Art Center in Minneapolis to demonstrate the latest advances in home planning and equipment. Featured in the January issue of McCall's Magazine, the house incorporates split-level planning, solar orientation. One of its main attractions is the "New Freedom Gas Kitchen."

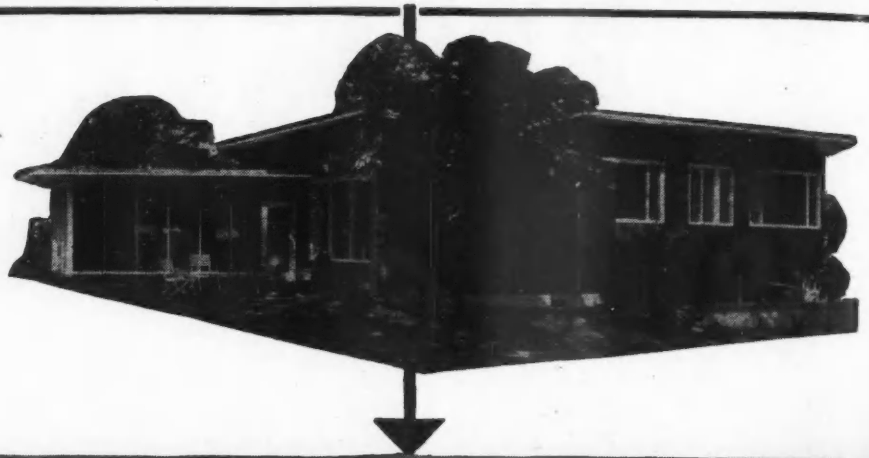

4-IN-1 LIVING AREA gives family of 4 plenty of room for work and play. Note built-in storage units, all-purpose table, "conversation" groups. Automatic Gas air conditioner keeps indoor weather perfect 12 months of the year.

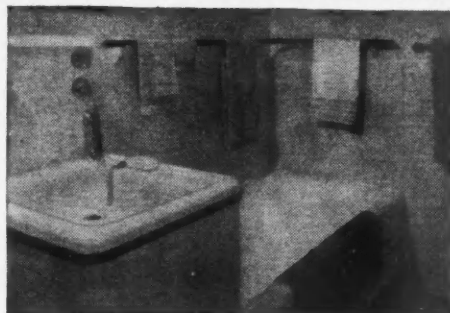

"PACKAGED" BATHROOM. Radically new, all-in-one prefabricated bathroom unit has swing-around washbowl, adjustable shower, handy cabinets. Trouble-free hot water service is supplied by an automatic Gas water heater.

"NEW FREEDOM GAS KITCHEN" planned as part of the living area features up-to-the-minute appliances in a casual, charming setting. Automatic Gas range built to "CP" standards makes light work of cooking. roomy Servel Gas refrigerator operates soundlessly, economically. automatic Gas water heater in stairs supplies abundant hot water.

*Cert. Mark, Amer. Gas Assn.

...there's a

"NEW FREEDOM GAS KITCHEN"

*How you—the architect, the builder—
can use this great new selling tool*

Sweeping national advertising has sold all America on the "New Freedom Gas Kitchen." Buyers know them, want them. All you have to do is give them these kitchens — and you cash in on a tremendous, ready-and-waiting market! It's simple as ABC. For your kitchen qualifies as a "New Freedom Gas Kitchen" if it meets these simple requirements:

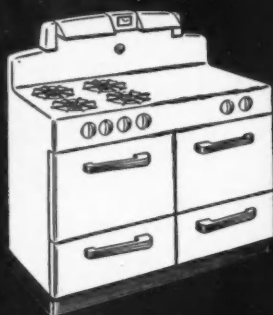

1.

It must have a Gas range built to "CP" standards (Gas is America's favorite cooking fuel . . . it "feeds" 91,000,000 people daily)



2.

It must have an automatic Gas refrigerator (Serval refrigerators stand in the tip-top ranks of America's most-wanted makes)



3.

It must have an automatic quick-recovery Gas water heater (an absolute necessity for dishwashers and the new automatic laundries)

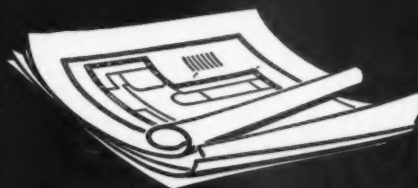

4.

It must be well-planned and efficient (and you'll take care of that, anyway —aren't American kitchens the finest in the world?)

Hear what bankers . . . architects . . . builders . . . and buyers have to say about the "New Freedom Gas Kitchen" Program

THE BANKER SAYS: "The house with a completely equipped Gas kitchen is a better financing risk . . . results in fewer delinquencies."

. . .

THE ARCHITECT SAYS: "I like the flexibility of planning with modern Gas appliances; the combination of mass appeal with individuality of design."

. . .

THE BUILDER SAYS: "A kitchen that's ready to live in, one that bears a 'stamp of approval' everybody knows, is a big help in selling a house."

. . .

THE BUYER SAYS: "A completely equipped kitchen saves us the delay and inconvenience of installation. Our kitchen will stay modern, will give our house a higher re-sale value."



Free: Complete promotional material to help you tie in with this great program. See your local Gas Company or write

AMERICAN GAS ASSOCIATION

420 LEXINGTON AVENUE, NEW YORK 17, N. Y.



**"I Like
Supertreated Pol-mer-ik
because it does a
better job, and saves
brushing time!"**

So says **R. LEE GRAY**, Minneapolis, Minnesota. Like all master painters, he really missed Supertreated Pol-mer-ik. Now it's back with its **EXTRA VALUES** of better leveling, smoother brushing and higher gloss—the qualities that make for a better painting job with **LESS BRUSHING**.

Supertreating does it—that special processing and blending which strengthens Pol-mer-ik's molecular structure . . . making it the finest linseed oil science has produced.

And remember—you get these **EXTRA VALUES** of Supertreated Pol-mer-ik **AT NO EXTRA COST**.

Pol-mer-ik *Supertreated*

100% PURE LINSEED OIL

Available in factory-sealed cans
**EXTRA VALUE
AT NO EXTRA COST**

Product of **ARCHER-DANIELS-MIDLAND CO.**
680 Roanoke Building, Minneapolis, Minnesota

Send additional information on Supertreated Pol-mer-ik Linseed Oil.

Name _____

Firm _____

Address _____

City _____ Zone _____ State _____

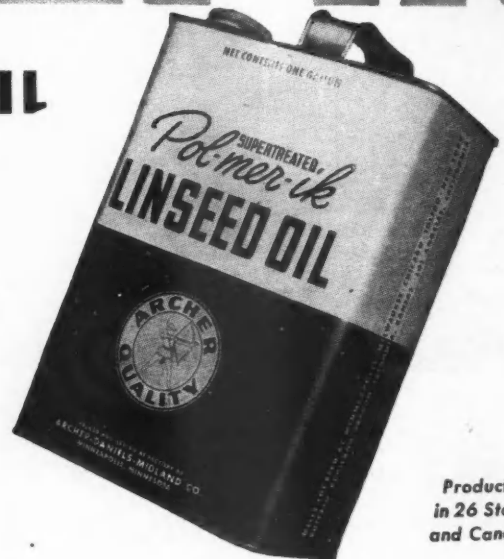

Production
in 26 States
and Canada

Am
write
... of
I can B
trated,
log de
Miami-
you m
design
home,
Institut
bring
mail, A
Miami
Asbes
Aspha
Water

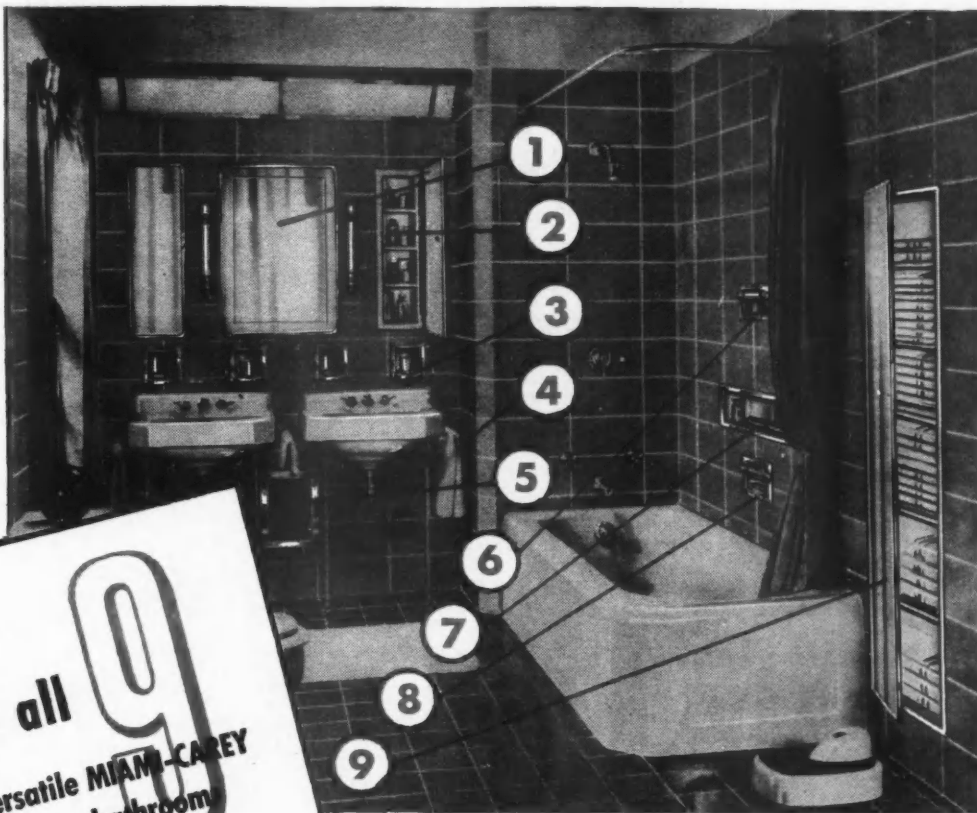

bathroom by Kohler

design with all **9**
 use the complete, versatile MIAMI-CAREY
 line to glorify your bathroom



**CONTRACTORS,
 BUILDERS:**

write for your **FREE** copy
 ... of "Glorifying the Amer-
 ican Bathroom." Fully illus-
 trated, this complete cata-
 log describes the exclusive
 Miami-Carey lines... brings
 you many modern ideas in
 designing bathrooms for the
 home, hotels, hospitals and
 institutions. A postcard will
 bring your copy by return
 mail. Address Dept. AB-3

- 1** **BATHROOM CABINET**... Eye-easy lighting — either tubular or fluorescent. Skillful harmonizing of chromium and mirror. All wiring completed at the factory.
- 2** **EXTRA CABINETS**... May be installed alongside large cabinet over lavatory or on adjacent walls. Door mirror set in chromium-plated frame. *Crystal Snow* inside finish.
- 3** **RECESSED TUMBLER HOLDERS AND SOAP DISHES**... Chromium plated over brass for ever-lasting lustre. Add unmistakable touch of luxury to any bathroom.
- 4** **TOWEL BARS**... Smooth, sparkling chromium finished... complete selection... both detachable and permanently fixed models.
- 5** **MIAMI ELECTRIC BATHROOM HEATER**... Compact, safe, efficient, this fan-driven heater fits snugly into any wall and is easy to install. Carries approval of Underwriters' Laboratories, Incorporated.
- 6** **SHOWER GRAB BAR AND SOAP DISH**... Eliminates bending under shower while searching for soap. Grab bar lends a safety factor, too.
- 7** **RECESSED SHELF**... Another modern Miami-Carey idea! This smart accessory is mirror-lined and available in either the regular silver or rose (flesh) colored mirror.
- 8** **TUB SOAP HOLDER AND GRAB BAR**... All Miami-Carey accessories are easy to install. Their design eliminates open joints. They will not crack or craze.
- 9** **RECESSED TOWEL SUPPLY AND UTILITY CABINET**... The perfect convenience extra for any bathroom. Features a full-length mirror set in chromium-plated frame... and five plate glass shelves.

the **Carey** line

Miami-Carey Bathroom Cabinets and Accessories
 Asbestos Shingles & Sidings • Asphalt Shingles & Roofings
 Asphalt Roll Brick Siding • Rock-Wool Insulation
 Waterproofing Materials • Roof Coatings and Cements
 Asbestos Coverall Wallboard



75
 years serving home and industry

THE PHILIP CAREY MANUFACTURING CO., CINCINNATI 15, OHIO

THE MIAMI CABINET DIVISION, MIDDLETOWN, OHIO In Canada: The Philip Carey Co., Ltd. 1557 MacKay St., Montreal 25, P. Q.

Tenth Edition . . .

The Building Estimator's Reference Book

By Frank R. Walker

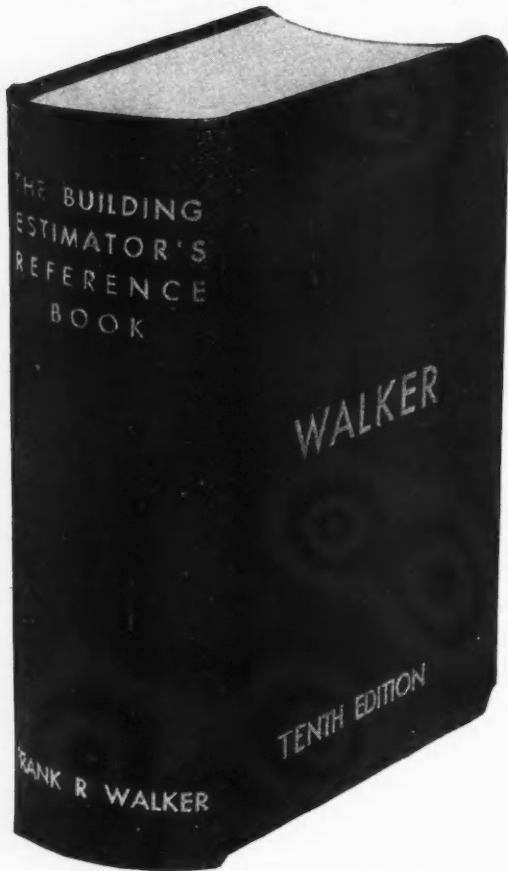

1700 pages, 1000 illus., 1000 tables,
25-page index, 4½ x 6½, flexible

COVERS

Excavating, Foundation Work, Reinforced Concrete, Framing, Millwork, Lathing and Plastering, Painting and Decorating, Glass and Glazing, Structural Steel, Masonry, Sheet Metal, Marble and Tile, Heating and Air Conditioning—and many other building subjects.

The new Tenth Edition contains latest estimating and cost data on everything that goes into house construction, from foundation to finish. It can be used in any locality, regardless of local prices or wage scales. It covers all types of small and large building construction.

For 30 years Walker's handbook has furnished contractors and estimators the most complete compilation of estimating and cost data available. The new edition has been revised and improved in the light of postwar conditions. Thousands of items that enter into construction estimates are logically arranged and tabulated for ready reference. A complete cross-index enables the user to quickly locate any subject.

HELPS PREPARE BETTER ESTIMATES

A copy of this new edition will help any builder, contractor or estimator in figuring and performing work at minimum costs. It will reduce the chance of overlooking an important item in an estimate. New methods of doing various kinds of work are explained and new building materials that have come on the market since wartime restrictions were lifted are fully described.

SEND FOR A COPY TODAY

Send for a copy of the new Tenth Edition of THE BUILDING ESTIMATOR'S REFERENCE BOOK today. Take advantage of the many opportunities it offers for increasing your profits through better estimates. Money back if not entirely satisfactory.

FILL OUT THIS GUARANTEED ORDER FORM

American Builder and Building Age,
Simmons Boardman Publishing Corp.
30 Church Street, New York 7, N. Y.

Enclosed find \$10 remittance for which send me a copy of the New Tenth Edition of THE BUILDING ESTIMATOR'S REFERENCE BOOK and a Free copy of THE VEST POCKET ESTIMATOR. If I do not find the books entirely satisfactory I will return them within five days of receipt and you will refund my \$10.

Name

Address

City..... Zone..... State.....

A.B. 3-48

FREE

With The Building Estimator's Reference Book
The Vest Pocket Estimator

This is one of the most popular little estimating books ever used by contractors. It contains 220 pages, 2½ x 5 inches, and is flexibly bound to fit the vest pocket. Estimating and cost data most frequently referred to is presented in condensed tabular form. It can be instantly referred to on the job or in the office.

ok

and
ion,
ity,
pes

ac-
sti-
een
ns.
tes
ce.
te

S

n-

at

g

g

g

e-

E

.

y

ok

i-

y

at

n-



EVEN
TRADE MARK REGISTERED
TEMP
 OIL FLOOR FURNACE

Ranches \$27,500
 KE
 MADE
 3 rms. and
 bath. Barn
 10ft. chix
 runs, out-
 les. fertile
 4 million
 oss. Lake
 krat wire.
 1er hiway
 town.

BUS. OPPORTUNITIES 130 BUS. O

If you are merchandising minded and are alert to the profit making opportunities of eye appealing quality products, replete with sales making talking points—then by all means get complete information on the Even-Temp line of oil fired Floor Furnaces! Join the ranks of other wide awake dealers all over the country who today feature Even-Temp Floor Furnaces. Drop us a line today for complete information—you'll be glad you did!

CASH AND CARRY—Cor-
 ner location, good district
BUSINESS IS GOOD

ROADS
 possib
 Pimba
 parke
 \$1.2

GROCE
 busy
 \$75
 Good
 price.

FOUNTA
 living
 and
 rent.



NORTHWEST Metal PRODUCTS Inc.
 SEATTLE 4, WASH. D. C. A.

ARKANSAS SOFT PINE
TRADE MARK
REGISTERED

This Symbol

is your guide to lumber products of the finest quality. Arkansas Soft Pine is a wood of extra soft texture, fine grain and freedom from pitch. It works easily, does not gum edged tools or split at nail holes. For interior trim, paneling and cabinet work, it provides matchless, satin-like surfaces that absorb primers evenly and take applied finishes without raised grain. These definitely superior qualities are inherent in trade marked Arkansas Soft Pine . . . the mark that protects your workmanship.



for beautiful floors.

What Arkansas Soft Pine Is

Arkansas Soft Pine is the highest quality of shortleaf pine (*Pinus Echinata*). Uncle Sam himself says this about it in U. S. Forest Bulletin No. 106, "Shortleaf pine in Arkansas is generally considered of a higher grade than the same species grown in other regions. It is soft, of good color and the annual rings show well in the growth."

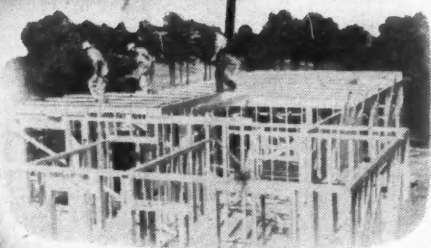

for framing better-built homes.

for light commercial construction.



for satin-like interior woodwork and paneling.

Where To Get It

Trade marked Arkansas Soft Pine is produced exclusively by big, modern mills. It is well manufactured to standard sizes, scientifically kiln dried and seasoned to specified moisture content, and available to you at local lumber dealers and planing mills east of the Rockies. For complete information, data and how to specify, write now for your copy of this useful handbook.

Send for
Your
FREE COPY



ARKANSAS SOFT PINE BUREAU . . .

348 Boyle Building,
Little Rock, Arkansas

WILFAMCO offers builders these DEFINITE ADVANTAGES

✓ **BETTER APPEARANCE—NO WRINKLED FACES.** Newly developed Wilfamco roll grooving treatment keeps face panels flat and rigid—eliminates sags and buckles—improves beauty, increases strength.

✓ **BUILT OF LIGHTWEIGHT ALUMINUM**—the modern, long lasting, feather-light construction material—eliminates heavy lifting—can't rust, can't rot, termite proof—painting not necessary.

✓ **SIMPLE, INEXPENSIVE INSTALLATION** One man can install a Wilfamco Door in less time—it's that easy. No time consumed in assembly on the job. Hardware completely assembled—mechanisms require no tricky adjustments.

✓ **STURDY, ONE PIECE ALL-WELDED CONSTRUCTION.** WILFAMCO DOORS are shipped complete in one 8' x 7' panel. Full length channels at top, bottom, and sides prevent sagging or bowing. Strong diagonal braces keep door rigid.

✓ **SAFE, EFFORTLESS OPERATION** WILFAMCO Doors are quiet in operation and easy to operate. Dual lifting mechanisms are simple, dependable, and safe—give years of trouble-free operation, eliminate costly service calls.

✓ **FAST DELIVERY—ALL TYPES** WILFAMCO produces doors all year 'round—stock piling for better service during the rush months. There's no waiting—WILFAMCO can deliver from stock.

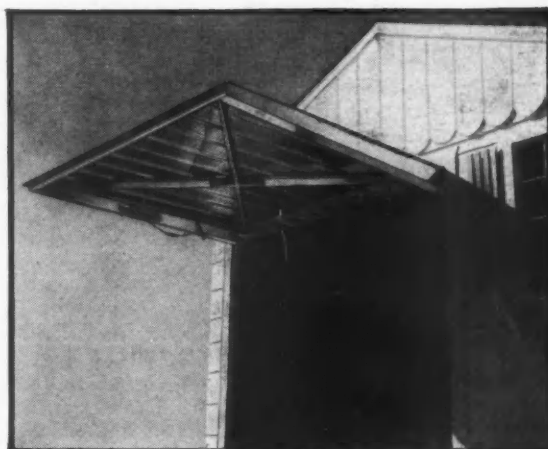
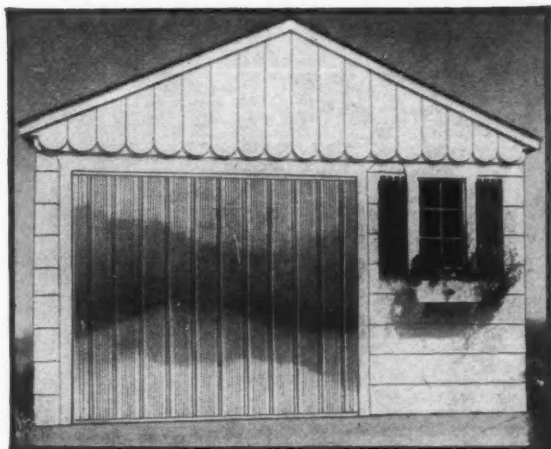

THREE POPULAR MODELS

1 CANOPY—

Swings on ball bearings forming canopy in front of opening. Dual mechanisms are fully enclosed. Requires no headroom—operates entirely within door frame.

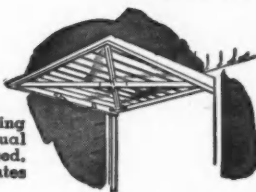

2 TWIN CANOPY—

Requires no center post. Doors suspended from exclusive WILFAMCO center mounting bracket allows doors to operate independently of each other—closes to a weathertight seal.

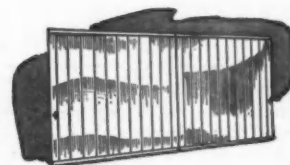

3 TRACK TYPE—

Glides up into the garage, out of the way, on silent rubber rollers turning on oil-less bearings. New, simplified hardware reduces installation time to a minimum.

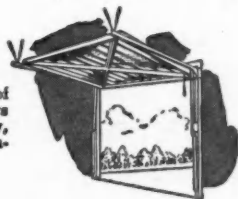

Distributors and Dealers—You'll find the WILFAMCO franchise profitable: Phone, write, or wire for prices and literature.

WILSON FOUNDRY AND MACHINE CO.
301 Wilson Avenue • Pontiac, Michigan

WILFAMCO

Easy Lift

GARAGE DOORS

Get This Blueprint Plan Book NOW!



Use this new **Blueprint Plan Book** as a sales tool. Use it to accurately estimate building costs. Use it for ideas on **Built-Ins** and ideas on **garage styles** that will harmonize with the exterior design treatment of the house.

12 COMPLETE BLUEPRINTS
21 HOUSE DESIGNS
GARAGES — BUILT-INS

\$2.50



Order TODAY

American Builder and Building Age
Simmons-Boardman Publishing Corp.
Book Service Department
30 Church Street, New York 7, N. Y.

Gentlemen:

Enclosed is a check or money order for \$2.50 for which please send a copy of your Blueprint Plan Book to:

Name.....

Street.....

City.....

State..... 3-48

AMERICAN BUILDER'S New Blueprint Plan Book will be a valuable sales aid to you. The blueprints open up to 16½ inches by 11½ inches, suitable for accurately estimating construction costs of these attractive homes and garages. Colorful plastic binding permits it to open and stay flat while in use. You can help you customers visualize the house from all sides, as *all four elevations are shown*. Furthermore, the large size plans assist your customers to obtain a better idea of the relative sizes of rooms than is possible with ordinary "plan books." In addition, important details are shown and each plan is illustrated with a large, clear photograph of the house. In fact, no customer can fail to be impressed with the splendid material in this book. All homes in this book have been designed by nationally famous architects.

America
E
C
On
Y
• Sal
quicke
custom
one sh
Tite-O
• Com
• Prov
perfo
• Outs
• Low
• Fire
When
Dubl-
the cu
D

Everything
your
customers
want
in a
roof!

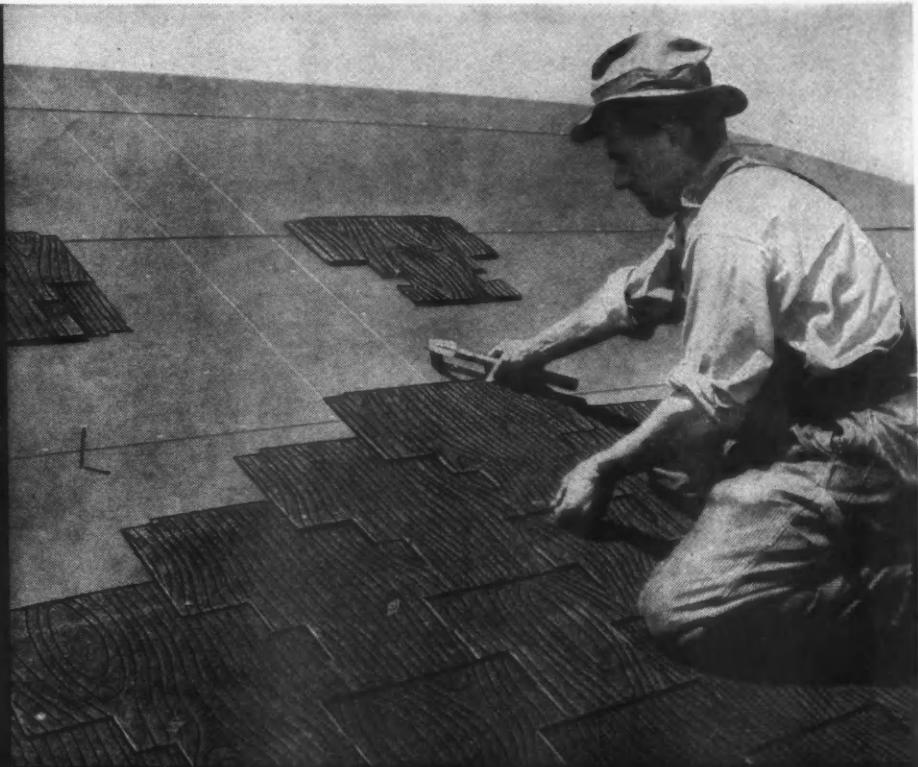

The Secret is in the Design. Concealed interlocking — a patented feature — plus hidden nailing, makes Tite-Ons completely windproof. They can't blow up or come loose!

Only Ruberoid Dubl-Coverage Tite-Ons give you all these Exclusive Selling Features!

• Sales come easier (and quicker) when you give your customers all this . . . all in one shingle! Dubl-Coverage Tite-On Shingles provide:

- Complete double coverage
- Proved windproof performance
- Outstanding good looks
- Low application costs
- Fire resistance

When you sell a Ruberoid Dubl-Coverage Tite-On Roof the customer gets extra years

of trouble-free service . . . you are selling today's outstanding roofing value.

Sell Dubl-Coverage Tite-Ons for maximum protection in both new work and re-roofing. For re-roofing jobs where double coverage is not required, Standard Tite-Ons are available.

You can build bigger, better, and more profitable roofing and re-roofing business with Ruberoid Tite-On Shingles. Remember, only Ruberoid makes Tite-Ons.



Like getting two roofs for the price of one!

Tite-Ons interweave to give 100% double coverage, right over the entire roof area!

The RUBEROID Co., Executive Offices, 500 Fifth Avenue, New York 18, N. Y.

RUBEROID

DUBL-COVERAGE TITE-ON SHINGLES



**YOUR CUSTOMERS
ALWAYS COME BACK**

**... WHEN YOU SELL
WITH A·B·C**



LIKE a good homing pigeon, your ABC customers come back to you. For repeat sales are the rule when you use the instalment note services of Allied Building Credits, Inc. One firm has made TEN ABC "repeat sales" to the same customer, four or five are not unusual.

Why do ABC customers come back to you? Because it's easy to buy from you. "No cash down, monthly payments to suit income."

They like the convenience of buying this way, without going elsewhere to arrange a loan or credit. If after one ABC purchase they apply directly to ABC for credit on another job, what happens? They are politely refused! And sent to you to arrange ABC credit. You make another ABC sale.

Yes, when you sell with ABC, your customers always come back to you.



ALLIED BUILDING CREDITS, INC.
DEPT. B, 3109 WILSHIRE BLVD. LOS ANGELES 5, CALIF.
Complete Instalment Note Services for the Building Industry
NATIONWIDE SERVICES; OFFICES IN PRINCIPAL CITIES.

OW

DO NOT
stainless
or imm
stainless
utter, c
HARON
uckling
now or
stainless
ually im
brasives
HARON
ainting
ttack b
urface
either
ermane
struction
orked a
rememb
ull deta
SH
UCTS OF
ANY, DE
SYLVANI
as Steel T
oxidized
CT SALES

Now Available!

STAINLESS STEEL

FOR GUTTER
DOWNSPOUT
CONDUCTOR PIPE
FLASHING



DO NOT DELAY construction of industrial buildings . . . Sharon Stainless Steel for your roof drainage specifications is available for immediate delivery. Architects and builders agree that stainless steel is the finest, most durable material known for gutter, downspout, conductor pipe and flashing.

SHARON STAINLESS STEEL'S extra strength prevents sagging, buckling or cracking caused by heavy accumulations of ice and snow or by widely varying temperatures. A solid metal, Sharon stainless has a tough, flake-proof, peel-proof surface that is virtually immune to wear from roof gravel, soot or other air-borne abrasives.

SHARON STAINLESS STEEL banishes costs of maintenance, painting and replacement even on structures under constant attack by corrosive industrial atmospheres. Since there is no surface reaction, Sharon Stainless cannot "bleed" . . . there is neither patina nor corrosion to discolor adjoining areas. Its permanent, neutral finish is appropriate for any type of construction. And 28-gage Sharon Stainless can be soldered and worked as easily as 26-gage galvanized sheet.

Remember, Sharon Stainless Steel lives up to its name—forever. Full details upon request to

SHARON STEEL CORPORATION

Sharon, Pennsylvania

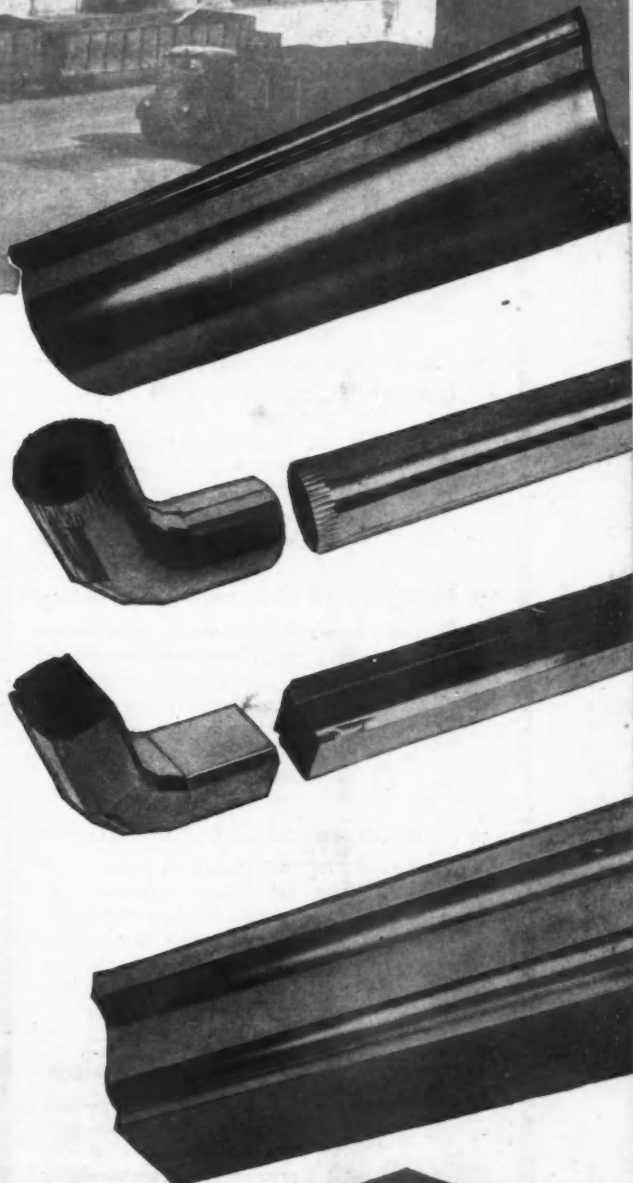

PRODUCTS OF SHARON STEEL CORPORATION AND SUBSIDIARIES: THE NILES ROLLING MILL COMPANY, NILES, OHIO; DETROIT TUBE AND STEEL COMPANY, DETROIT, MICHIGAN; BRAINARD STEEL DIVISION, WARREN, OHIO; SHARONSTEEL PRODUCTS COMPANY, DETROIT, MICHIGAN, AND PARRELL, PENNSYLVANIA. Hot and Cold Rolled Stainless Strip Steel—Alloy Strip Steel—High Carbon Strip Steel—Galvanite Special Coated Products—Cooperage Hoop—Detroit Steel Tubing—Seamless Steel Tubing in Alloy and Carbon Grades for Mechanical, Pressure and Aircraft Applications—Electrical Steel Sheets—Hot Rolled Annealed Oxidized Sheets—Galvanized Sheets—Enameling Grade Steel—Welded Tubing—Galvanized and Fabricated Steel Strip—Steel Strapping, Tools and Accessories.
SALES OFFICES: Chicago, Ill., Cincinnati, O., Cleveland, O., Dayton, O., Detroit, Mich., Indianapolis, Ind., Milwaukee, Wis., New York, N.Y., Philadelphia, Pa., Rochester, N.Y., Los Angeles, Calif., San Francisco, Calif., St. Louis, Mo., Montreal, Que., Toronto, Ont.

NEW CHEVROLET

Advance-Design Trucks for 1948



**Only Advance-Design Trucks for 1948
Have All These New and Finer Features:**

- ★ **New Chevrolet 4-Speed Synchro-Mesh Truck Transmission** Entirely new Chevrolet developed Synchro-Mesh transmission assures truck users of unparalleled new ease and efficiency in truck operation!



- ★ **New Chevrolet Advance-Design Gearshift Control** Unrivaled new convenience and ease of operation in Advance-Design models with 3-speed transmission. Gearshift is mounted on the steering column to provide new efficiency on every hauling job!



- ★ **New Foot-Operated Parking Brake** Here's a revolutionary new feature of Advance-Design Models with 3-speed transmission. The new Chevrolet foot-operated parking brake provides safer, more efficient braking, plus new, clear floor area!



- ★ **New Improved Chevrolet Valve-in-Head Engine** The world's most economical engine for its size—Chevrolet's power-packed valve-in-head engine is now even finer, with vital new features that assure greater durability and operating efficiency



- ★ **New Multiple-Feature Developments** Chevrolet's Advance-Design provides new splined rear axle shaft attachment to wheel hubs for greater strength and durability in heavy-duty models... New heavier, more durable springs... New propeller shaft bearing-seal design...

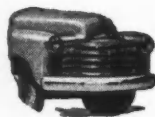

The Newest Line... The Greatest Features... The Biggest Values!

Here are the nation's biggest truck values —with the latest and greatest features of advance-engineering! They're new Advance-Design Chevrolet trucks for 1948 —107 models on eight wheelbases—built to deliver *Transportation Unlimited!* See them at your Chevrolet dealer's.

CHEVROLET MOTOR DIVISION, General Motors Corporation, DETROIT 2, MICHIGAN



... PLUS THESE FAMOUS PROVED ADVANCE-DESIGN FEATURES:

The Cab that "breathes"* • Flexi-Mounted cab • Uniweld all-steel construction • Large, durable, fully adjustable seat • All-round visibility with rear-corner windows* • Extra-durable frames • Full-floating hypoid rear axles • Specially designed hydraulic truck brakes • Thorough cab-sealing insulation • Standard cab-to-axle-length dimensions permitting interchange of bodies... and MANY other fine features.

*Fresh air heating and ventilating system and rear-corner windows optional at extra cost.

CHOOSE CHEVROLET TRUCKS FOR TRANSPORTATION UNLIMITED!

We have a new Baby
And we want the world to know it

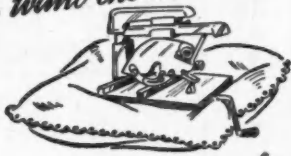

Baby is a *Multiplex*
Named *Model 20A* Weight *101 lbs.*
Parents *Red Star Products, Inc.*

MULTIPLEX

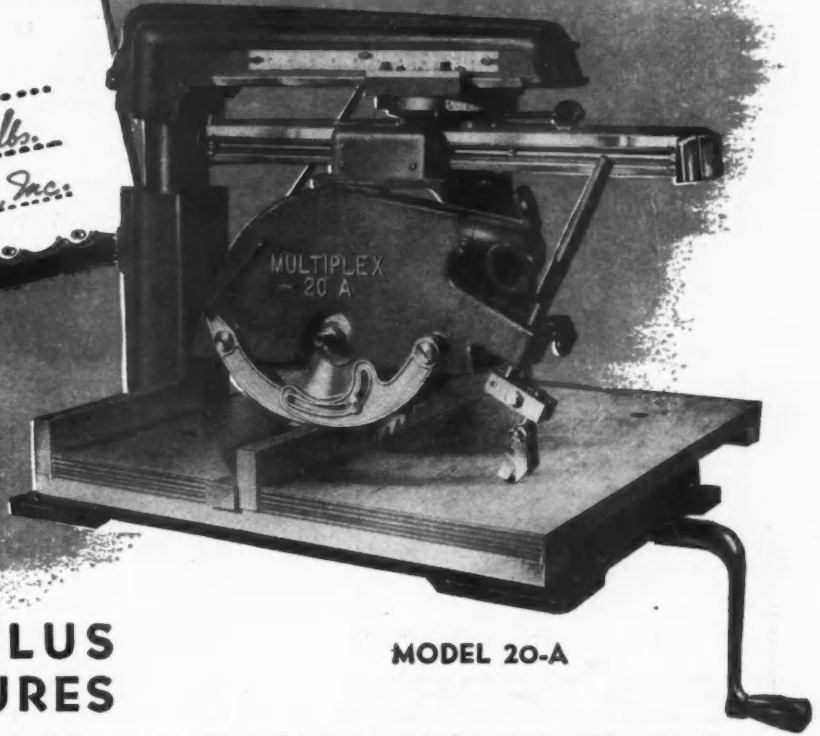

MODEL 20-A

PORTABILITY - PLUS EXCLUSIVE FEATURES

Just in time for the approaching busy building season is the new **MULTIPLEX Model 20A** Radial Arm Saw filling a vital need in many wood-working operations for a portable, smaller capacity, general purpose saw, with big saw performance, and at a popular price.

EASILY PORTABLE - Compact, light, - weighs only 101 pounds. It rides easily in the back of your car.

VERSATILE - contractors and home builders find it exceedingly handy for inside trim and other smaller capacity jobs - valuable for all kinds of work where a large capacity saw is not required.

PLUS EXCLUSIVE FEATURES - Like its larger

brothers, Multiplex Models 30A, 40A and 50A, the smallest Multiplex has the exclusive Versatile Elbow making possible certain operations that cannot be duplicated on any other radial arm saw. For example - only a Multiplex can perform **LEFT** hand as well as conventional right hand miters up to 90 degrees. Unequaled for ease of operation.

Lightness, compactness, versatility, superior engineering and design and low price - put them all together - they spell **MULTIPLEX Model 20A** Radial Arm Saw - the perfect combination to meet the needs of all those requiring brilliant saw performance at low cost.

Write today for literature and name of nearest dealer.

RED STAR PRODUCTS, INC.

3455 VEGA AVENUE,
CLEVELAND 13, OHIO U. S. A.

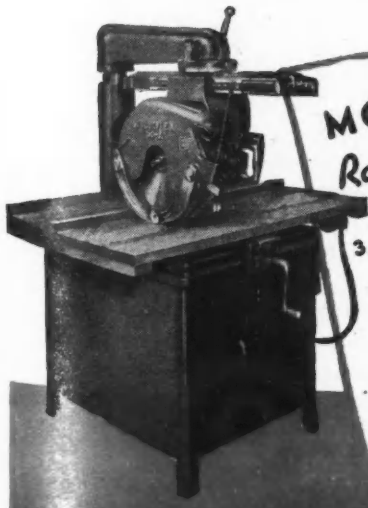

MODEL 50-A
Radial Arm Saw
POWERED BY
3, 5, 7½ or 10 H. P. MOTOR

Designed to handle heavy work in greater capacities. Available with either 22" or 30" travel track. For lighter work investigate Multiplex Models 30A and 40A.

CROSS CUT • RIP • BEVEL CUT OFF • MITER
COMPOUND MITER • DADO • PLOW • RABBIT
SHAPE • TENON • ROUTE • CIRCLE ROUTE • ETC.

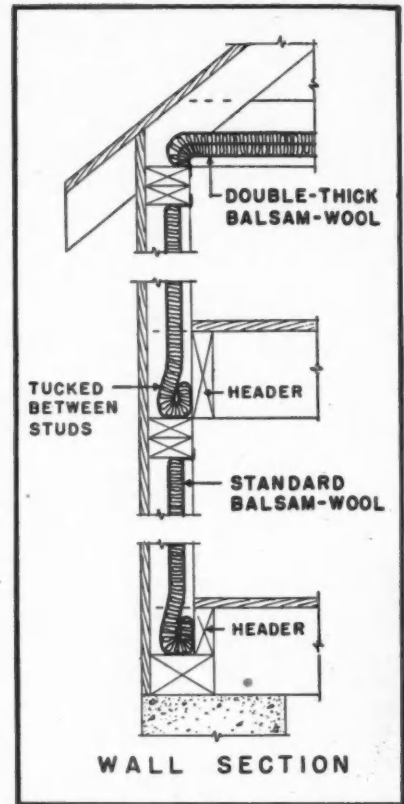
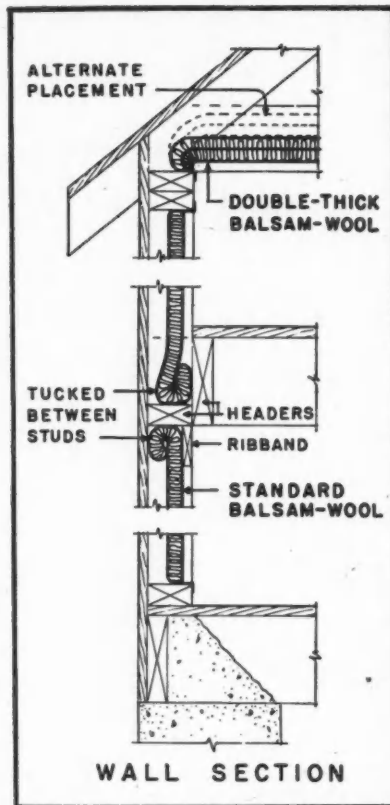
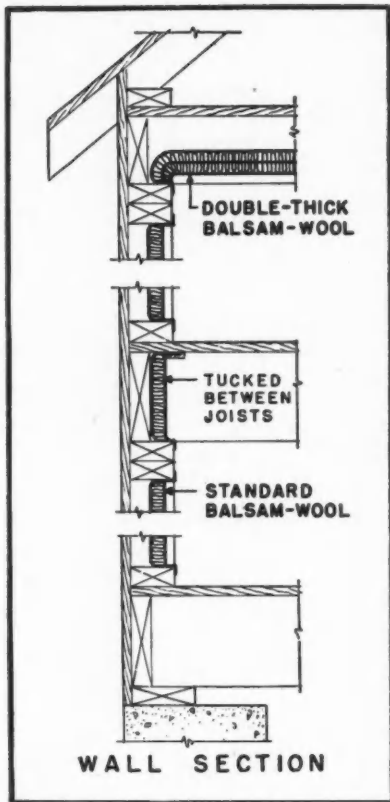

PLATFORM-BALLOON or BRACED *Balsam-Wool* has the Insulation Answers!

• No matter what the type of construction, Balsam-Wool provides the *sure* way to insulate. Its method of application and special features assure a *lasting* insulation job—wind-proof, moistureproof, highly fire retardent and non-settling.

To place insulation application data at your finger tips, Wood Conversion Company has developed a series of 32 Balsam-Wool data sheets, with carefully prepared drawings and explanatory text. You'll want a set of these sheets for your files—and it is yours for the asking. Just mail coupon!

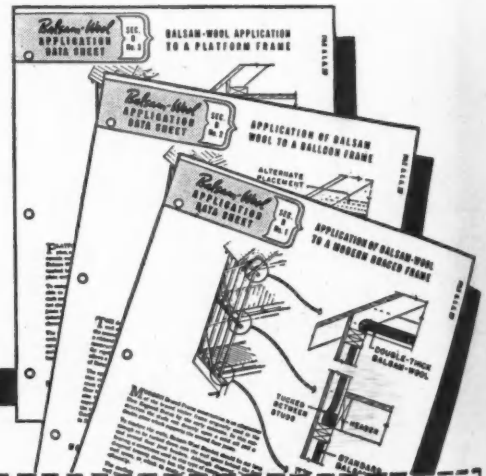

MAIL THE COUPON FOR YOUR SET!

*Balsam-Wool**



SEALED INSULATION

*REG. U.S. PAT. OFF.

BALSAM-WOOL • Products of Weyerhaeuser • NU-WOOD

WOOD CONVERSION COMPANY
Dept. 119-38 First National Bank Building
St. Paul 1, Minnesota

Please send me a set of Balsam-Wool Application Data Sheets.

Name

Address

City State

CHRYSLER AIRTEMP

AUTOMATIC HEATING HELPS SELL HOUSES!

—say leading builders like Gordy & Prang, Inc. (Wilmington, Del.)



“New home buyers are particular about the type of heating they are purchasing,” writes Mr. E. S. Gordy of Gordy & Prang, Inc., Builders and Developers of Wilmington, Delaware. “The neat appearance of Airtemp units, together with the known reputation of the Chrysler Corporation have been of extreme value to us in selling our homes.”

Isn't it wise planning to give your houses this added sales-appeal? Plan *Airtemp* heating for your next house or development project, and open the way to faster sales and continuing customer good will. Your Airtemp dealer will be glad to work with you . . . Call him today.

MORE COMFORT FROM ANY TYPE OF FUEL AUTOMATICALLY!



Winter Air Conditioner.
Gas or Oil.

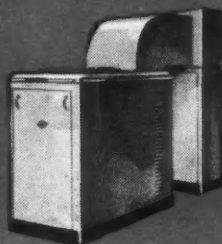

Year-Around Air Conditioner.
Heats and Cools.

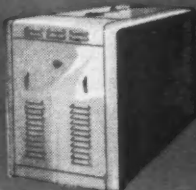

Boilers for Steam
and Hot Water.

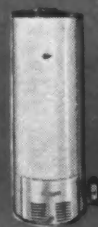

Automatic Oil
Water Heaters.



Winter Air Conditioner for
small homes. Gas or oil.

NATION-WIDE DEALER ORGANIZATION

There is a Chrysler Airtemp installation . . . and for the speedy, dealer nearby to serve you. Depend on him for prompt delivery, expert efficient maintenance service that holds the buyer's good will.

AIRTEMP DIVISION OF CHRYSLER CORPORATION

Dayton 1, Ohio

In Canada: Therm-O-Rite Products, Ltd., Toronto



ANDERSEN

Windowalls

transparent mirrors of outdoor beauty



HOME IN BERLIN, WISCONSIN; PHILIP D. WEST, CHICAGO, ARCHITECT

In the clear, even glass of these WINDOWALLS can be seen the reflection of the lovely trees outside this Wisconsin home. You can be certain the vista opened up by this wide expanse of windows is a stirring one, indeed.

And remember, too, that ANDERSEN WINDOWALLS can be opened in fine weather—to bring in an adequate

amount of fresh air, as well as to invite in the view.

This WINDOWALL shows two standard ANDERSEN Gliding Window units with horizontal bars—also available in one-light glazing. Consult Sweet's Architectural File for complete details. For additional information, write direct to ANDERSEN.

* TRADEMARK OF ANDERSEN CORPORATION

Andersen Corporation

BAYPORT • MINNESOTA

1 P P IN

Im D

The In
engin
appli
Kitch
all bo

Insta
L



Ingersoll Utility Unit Proves Its Economy, Convenience, Adaptability in Small Homes Construction!

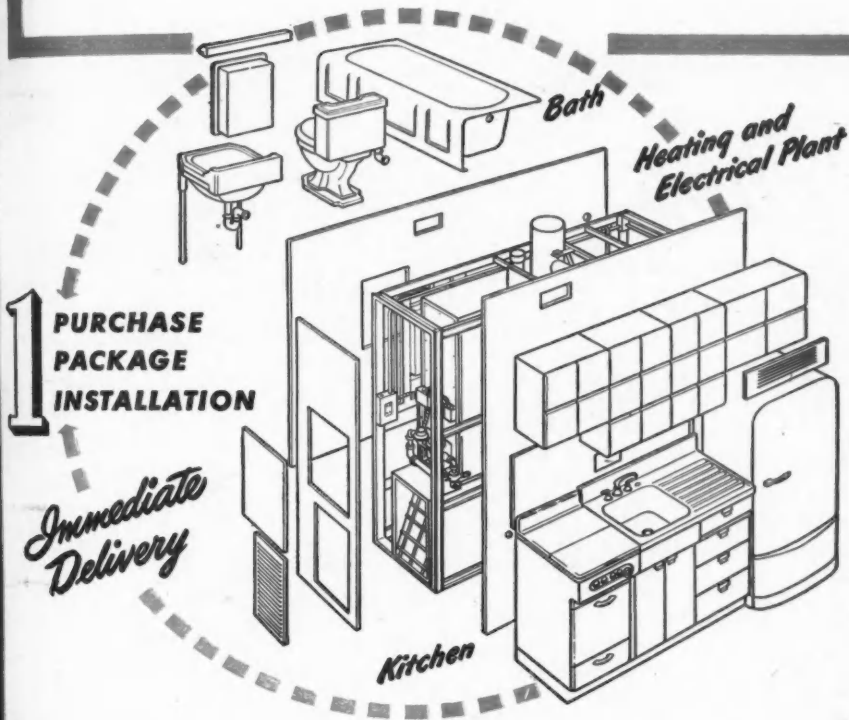

BUILDERS, ARCHITECTS, HOMEOWNERS ENTHUSIASTIC OVER PERFORMANCE UNDER ACTUAL LIVING CONDITIONS!

Proved practical, economical and satisfactory in every way in thousands of installations, the Ingersoll Utility Unit offers architects and builders the means to speed up small home construction and give greater value.

The Ingersoll Utility Unit is compact, requiring less than 80 square feet of floor space. It is complete, simplifies time-consuming specifications—everything comes with one purchase, from one source, right when it's needed. Every part of the Unit is of the finest quality—not a makeshift collection of fixtures—but an engineered assembly of top quality products.

If you haven't learned of all the time and space saving features of the Ingersoll Utility Unit, it will pay you to get the details immediately. Just mail the coupon today—we'll send you complete information explaining how the Ingersoll Utility Unit will help you produce better homes faster, more economically.

The Ingersoll Utility Unit is a single, engineered assembly of the fixtures, appliances, controls and fittings of Kitchen, Bathroom, Heating Plant; plus all basic plumbing and electrical lines.



Installations in 316 Cities Prove That Unit Meets Local Requirements, Fits Individual Plans and Needs

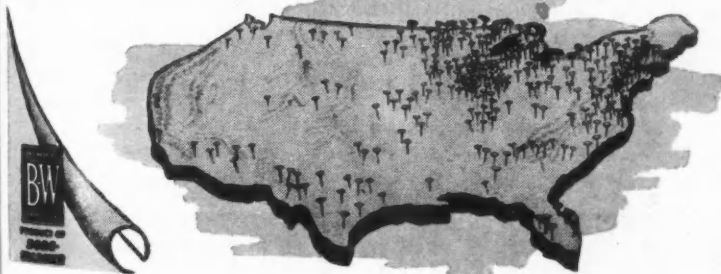

MAIL THIS COUPON TODAY

**INGERSOLL UTILITY UNIT DIVISION
Borg-Warner Corp., Dept. B-3
321 Plymouth Court, Chicago 4, Ill.**

We're interested in learning how the Ingersoll Utility Unit is saving time, money and space. Please send details and illustrated brochure.

Name

Firm

Address.....

City.....State.....

*Available NOW
Economical NOW
Useful NOW*

#2 RED CEDAR SHINGLES

Overlooked by many lumber dealers and builders, the No. 2 CERTIGRADE cedar shingle solves many building problems. The supply of No. 1's is critical but No. 2's, readily available at considerable savings in cost, are ideal for farm buildings, for garage roofs and sidewalls, and for double-coursed residence walls at 10" or 12" exposure. Here is the answer to your demand for exterior building material at low cost.



** Utility with Economy*

The Certigrade No. 2 cedar shingle is especially designed to provide a utility grade for good roofs on secondary buildings, for over-roofing and for excellent sidewalls.

Made of world-famous western red cedar, the 16" and 18" No. 2 Certigrade shingles are clear of all defects 12 inches from the butt. When laid on roofs at recommended exposures, two complete layers of clear shingles are provided at every point.

Certified by Inspection

Ask for the Certigrade label (all grades) and you will get a shingle guaranteed by inspection at mill.

RED CEDAR SHINGLE BUREAU

5510 White Building, Seattle 1, Washington or
Metropolitan Building, Vancouver, B. C., Canada

SPECIFY CERTIGRADE No. 2 GRADE SHINGLES

TWO
were
many
in the
for t
a sub
deliv
cated
prefa
type
the t
Ship
six p
non-
reau
ing
Ship
four
types
out o
of all
fabri
still
80 fi
out o
porte
ducti

L

A
ance
opera
polita
in use
ing a
insura
ment
plann
housi
sons
invest
Michi
move
invest
spoke
Comm
consti
"we c
financ
The
builde
money
of liqu
1946,
saving
amount
the na
20 bi
assets
every
they s
hopefu
rental

TRENDS

BUILDING MATERIAL — EQUIPMENT — APPLIANCES

Prefabricated Homes Industry Continues Production

TWO YEARS ago great expectations were held for prefabricated homes and many millions of dollars were invested in the industry; although the great hopes for the industry have not been fulfilled a substantial number of homes have been delivered. According to the Prefabricated Home Manufacturer's Institute, prefabricators shipped 4,000 permanent-type homes during December bringing the total for last year to 37,000 units. Shipments for December represent about six per cent of the 62,000 permanent non-farm dwelling units which the Bureau of Labor Statistics reported as having been started during that month. Shipments for the year represent about four per cent of the 860,000 starts of all types reported by B.L.S. Thus about one out of twenty-five of the new dwellings of all types produced this year was prefabricated. The future of the industry still remains uncertain. Approximately 80 firms manufactured homes in 1947 out of an estimated 450 who were reported to have been contemplating production in 1946.

LIFE INSURANCE RENTAL INVESTMENTS

A relatively new field for life insurance companies is the construction and operation of large rental units in metropolitan centers. Already completed and in use are 24 housing projects representing an investment of \$138,000,000. Life insurance firms plan an additional investment of \$262,000,000. With all projects planned, under way or completed, rental housing will be provided for 200,000 persons (more than 50,000 families) at an investment in excess of \$400,000,000. Michigan is the latest state making a move to permit insurance companies to invest in long term housing projects. A spokesman for the Detroit City Planning Commission recently stated that if a constitutional amendment is approved "we could tap the biggest reservoir of finance outside of Fort Knox".

The life insurance companies to which builders of all kinds look for mortgage money are indeed the largest reservoir of liquid assets outside of Fort Knox. In 1946, the accumulation of long-term savings in life insurance companies amounted to 41 billion dollars whereas the nation's gold stock amounts to about 20 billions dollars. The fact that the assets of life insurance companies double every ten years makes it imperative that they seek investment outlets; the most hopeful outlet appears to be residential rental developments or home mortgages.

It is, therefore, believed that the spreading strikes of insurance companies against home loans is only temporary.

COMMERCE DEPARTMENT ATTACKS SHORTAGES

If financing is not available in adequate amounts the present record volume of new construction may diminish substantially. Nevertheless the Department of Commerce is preparing to attack building material shortages through their new office of Industry Co-operation.

Lumber heads the list of shortages that will be attacked. Department officials fear this year's lumber supply will fall far below needs and that other industries will be bidding against construction for supplies, sending prices up.

Nails, critically short last year may be even more so in 1948, unless production is stepped up sharply, officials say. Nail producers have the capacity to meet requirements. They demonstrated that early in 1947 when the emergency agencies talked the steel companies into diverting wire into nails. The O.I.C. hopes it can be equally persuasive.

The key to its plans will be voluntary industry-government agreements. If O.I.C. finds that nail makers need, say 100,000 more tons of steel wire this year than they are scheduled to get, it will try to get the steel industry to sign a "contract" to deliver the wire to the nail

companies. It will try to set up similar arrangements with the pig iron suppliers on the one side and the cast iron soil pipe and plumbing fixtures manufacturers on the other.

While O.I.C. plans to allocate the "makings" to the building material producers, it has not decided how it can distribute the materials to builders and contractors. It does not intend to negotiate allocation agreements that will include dealers at first, but it may be necessary.

THE BREAK IN PRICES

Number one news during February was the drop in commodity prices, which if sustained will ultimately affect building material prices. As the chart shows, they have a long way to travel downward before they reach decontrol or pre-war levels. If it develops that this drop in prices is similar to the one in 1920, it may be that building will drop from its present high level for a brief period and will resume peak activity when the price level begins to level off.

The disparity in the price of lumber may be corrected by a general drop in prices. A recent analysis by the Construction Division of the Department of Commerce indicates that lumber costs have increased from an average of 19 per cent of the total selling price of an average house in 1939, to 25 per cent in June 1947 and to 26 per cent in November 1947.

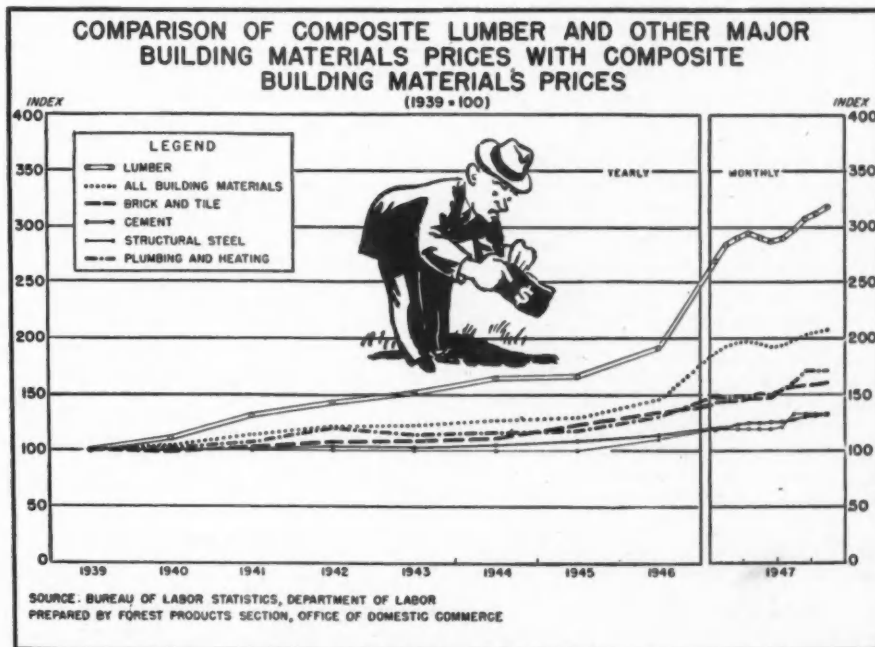



Here — in one handy package — are all the lock and latch sets needed for two average small homes. You can't overlook any item you may need. Think of the convenience, the savings in handling time, the smaller inventories that this Sargent Quality House Unit Package brings to you. Packed as complete house units, each individual lock set and latch set is packed in a separate box, suitably labeled for the opening for which it is intended. The master carton carries a complete listing of its contents. If additional items in this package are required, they are immediately available from your jobber's open stock. It's a quality package, too, including for the front door as desired, the famous Sargent Integralock, cylinder front door knob set or sectional handle set, all sets furnished in solid brass trim — front and rear doors keyed alike. Save yourself time and labor by insisting on the Sargent Quality House Unit Package!

See your Sargent Jobber for prompt deliveries or write or wire us for details.

SARGENT & COMPANY

NEW HAVEN, CONN.

NEW YORK

CHICAGO

News, Views
and Comments

On and Off the Record

OHIO—This state has a state tax on retail sales. It was not set up to build state-owned public housing, but that is what it is doing. Part or all of the accumulated funds collected as sales taxes was pro-rated among the counties for public housing. Many counties accepted the donation. Result is that Ohio is in the housing business with units renting for \$37.50 a month. Some counties refused, the funds, because they had no need for more houses.

JOHN W. SCOVILLE—He says that if there is a public reason why tenants should be subsidized, there is no reason why the subsidy should be paid by taking over part of the property of landlords. Says that government imposition of arbitrarily low rents is confiscation of part of landlords' property. That is sound logic.

UNION HOUSING—Local 770, Retail Clerks Union, Los Angeles, says both industry and government have failed, and union is going into housing as an organizer of buyers. Intend to start digging as soon as 1,000 people sign up. Expect to have 12 designs available at prices from \$5,200 to \$10,000. It's been tried before, and Local 770 is asking for, and no doubt, will get a terrific headache.

ARCHITECTS—The American Institute of Architects adopted a four-point program asking for a two-year program of public housing to meet the needs of low-income families. If A.I.A. is really serious, and actually means that recommendation, there are two fair questions they should be asked to answer. The first is, just how can any program of public housing help anybody, since eventually it throttles all building. The second is, can it be possible that A.I.A. is entirely ignorant of what has happened to building in England, because of public housing.

MODULAR MATERIALS—Producers' Council says that more than 600 manufacturers now are producing or are prepared to produce material in modular sizes. Most of them are manufacturers of brick, tile or concrete masonry units.

ED CARR—The dynamic past president of NAHB scored two more smashing victories for private building in less than two weeks. The first was on "American Forum of the Air," Dec. 30 when he teamed with Morgan L. Fitch in opposition to two noted public housers,

Nathan Straus and Leon Keyserling. Sweeping generalities and dramatic gymnastics from the public housers were no match for facts and logic from Carr and Fitch.

TESTIMONY—Past President Carr's second victory took the form of one of the soundest documents on housing ever written. It was his testimony before the Joint Congressional Committee on Housing in Washington.

MORTGAGE MONEY—Late in November there were indications of tightening. Soon after the first of the year there was no doubt. Speculation is that it is part of a planned slight recession to halt inflation, level prices.

CO-OPS—The tax issue regarding co-operatives can be expected to flare anew before the present session of Congress adjourns. National Tax Equality Association was impressive in Congressional hearings last December.

PUBLIC HOUSING—The National Association of Housing Officials (they are public housing officials) says there are 964,879 dwellings in 5,584 separate developments of the public housing program.

MORE ON WAY—The association adds that local housing authorities and municipalities have filed plans for 360,099 new public housing units in 300 cities in 40 states, at estimated cost of two billion dollars.

WAITING FOR CONGRESS—Most of that program waits for a go-ahead from Congress that the public housers confidently expect.

LOCAL PUBLIC HOUSING—Eight states, say public housers, are not waiting for Congress, but have voted state funds for public housing. Thwarted in attempts to get the T-E-W bill through Congress, public housers apparently are having better success at state and city levels. Builders opposed to all public housing will do well to watch their own back yards as closely as the NAHB watches the Washington scene.

PREFABRICATION—Prefabricated Home Manufacturers' Institute reported the industry sold 70,000 new permanent houses in 1946 and 1947. Eighty prefabricators have a capacity of 100,000 to 120,000 houses a year.



LOOK ON THE *Bright Side*



Kindle a gleam of pride and satisfaction in home-owners' eyes. Use Flintkote Asbestos Cement Sidings... either for new construction or remodeling.

Pride comes with the spic and span appearance this modern siding material gives a home. Satisfaction... with the modest price, the durability, the fire safety that come with it.

Truly, Flintkote Asbestos Cement Siding is the bright side of the siding problem. For, once these sidings are applied they require no periodic painting to maintain their long life. Flintkote Asbestos Cement Sidings keep their beauty for years... and give long years of carefree service.

You can get these popular sidings in either the Straight-Edge Tapertex, or the Waveline Woodgrain pattern. Standard colors are silver gray, white and super white.

Don't fail to get complete specifications and data on this beautiful, durable building material. Your nearest Flintkote Sales Office or Dealer can supply you with full details and samples. Or, write direct to us.

Then... either for new construction or remodeling... look on the *bright side*. Use Flintkote Asbestos Cement Sidings.

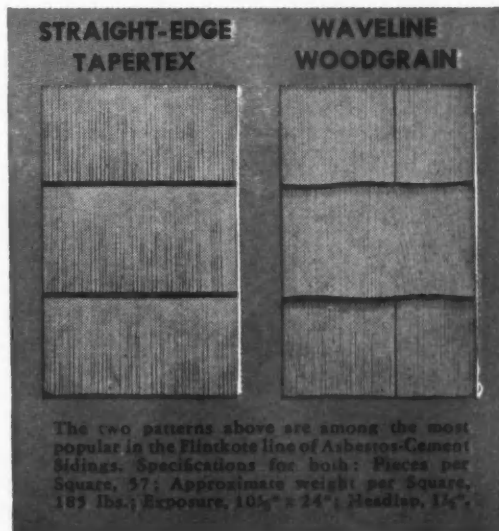

The two patterns above are among the most popular in the Flintkote line of Asbestos-Cement Sidings. Specifications for both: Pieces per Square, 37; Approximate weight per Square, 187 lbs.; Exposure, 10 1/2" x 24"; Thickness, 1 1/4".



THE FLINTKOTE COMPANY, Building Materials Division
30 ROCKEFELLER PLAZA • NEW YORK 20, N. Y.

FLINTKOTE

the extra years of service cost no more!



**Home Buyers are like
elephants —**

they never forget!



To make your customers remember you with pleasure, popular home-buyer trends must be recognized.

Today the trend is to Electric Ranges. Another million American families switched to Electric cooking last year.

Estimates indicate that this year over a million more Electric Ranges will be installed.

This is a definite trend that cannot be ignored. Progressive builders recognize this trend. Electricity is a "must" in any house, and it's simple and economical to include wiring for an Electric

Range leading to a range outlet in the kitchen at the time of construction. This is assurance that the houses you build are not only modern today, but will stay modern for years to come!

Electric Range Section • NATIONAL ELECTRICAL MANUFACTURERS ASSOCIATION • 155 E. 44th Street, New York 17, N. Y.

A-B STOVES • ADMIRAL • CROSLY • ESTATE HEATROLA • FRIGIDAIRE
GENERAL ELECTRIC • GIBSON • HOTPOINT • KELVINATOR • LEDO
MONARCH • NORGE • QUALITY • UNIVERSAL • WESTINGHOUSE

Follow the trend... **wire** YOUR HOUSES **FOR ELECTRIC RANGES**

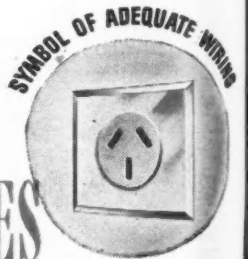

Another 1,000,000 American families switched to Electric Cooking last year

LETTERS

Black markets

To the Editor: On all sides I hear stories about black markets in nails, gypsum board, and sometimes, mill-work. I have been told that some workers in plywood plants ask for part of their pay in plywood panels, and that they sell the panels to black market operators for a profit. Have heard the same thing about doors. A few days ago, I was told that a dealer who gets regular shipments of gypsum board re-consigns some of the cars to another part of the country at a better mark-up than he can get selling the board to builders in his locality. Then, I was told that an advertisement appeared in an eastern newspaper some time offering several hundred kegs of nails, and that the ad had a key address.

Isn't it time that somebody, maybe one of the Congressional committees, shook down these stories, and found out if they are true. If they are, possibly the bootleggers of the dry era are now in the building material business, and if that is true we need some FBI investigating, and some new laws that will let manufacturers control the distribution of their products and the prices they sell for. If the stories are not true, they should be stopped, because they are causing a bad impression in the minds of the public. If there are just a few cases now and then, they should be showed up.—DEALER.

Commends February Issue

To the Editor: I want to congratulate you on the splendid job you have done on the February issue of *American Builder*. I have just gone through my copy from cover to cover, and I believe there will be little chance of any of your readers discarding this issue for some time to come. It is the kind of copy that I am sure builders will want to keep in their files.—E. C. ROBINSON, Advertising Manager, White-Rodgers Electric Co., St. Louis 6, Mo.

On Politics and Inflation

To the Editor: Thanks and congratulations for your excellent Publisher's Page editorial "The Real Cause of Inflation" in *American Builder* by Samuel O. Dunn.

It is hard to understand the mental operations of the authorities who seem blind to the cause of inflation. The extent of the dilution of the value of the dollar seems to indicate a further advance in prices. Perhaps the politicians realize this and are hoping to continue to misinform the public.

It is a satisfaction to many that you point to the source of the trouble.—GEO. DONLEY, President, The Donley Brothers Co., Cleveland, Ohio.



... that
will score
a hit

And it's easy to do—install an Electric Water Heater and profit from the appreciation of the home-buyer. There's a trend toward automatic Electric Water Heaters—they're the home-buyer's preference. But there's no trick to installing them.

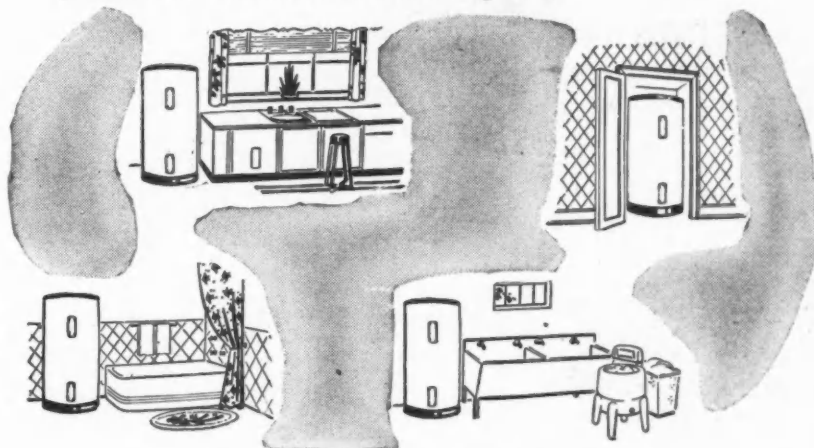

How to reduce construction costs and add customer features

Construction costs can be reduced with Electric Water Heaters because there's no flue or vent, so installation can be made anywhere—in a closet, in the kitchen, in the bathroom, in the utility room. Hot water lines can be short, cutting piping cost.

Customers like Electric Water Heaters because they are: (1) AUTOMATIC (con-

tinuous hot water, no attention); (2) CLEAN (smokeless, sootless); (3) DEPENDABLE (short hot water lines; no flue or vent); (4) TROUBLE-FREE (as electric light); (5) ECONOMICAL (plenty of hot water, fully insulated storage at low cost); (6) SAFE (all-electric); (7) FLEXIBLE INSTALLATION (can be located in living quarters; does not consume oxygen).

Electric Water Heater Section • NATIONAL ELECTRICAL MANUFACTURERS ASSOCIATION
155 East 44th Street, New York 17, N. Y.

B & F • CLARK • FOWLER • FRIGIDAIRE • GENERAL ELECTRIC • HOTPOINT • HOTSTREAM • JUD WHITEHEAD • KELVINATOR • MONARCH • NORGE • PEMCO • REX • RHEEM • SEIDELHUBER • SELECTRIC • SMITHWAY • SUNBEAU • THERMOGRAY • THERMO-WATT • UNIVERSAL • WESIX • WESTINGHOUSE

It's EASY to
INSTALL an electric WATER HEATER

... in a house wired for an Electric Range!

an ELJER Bathroom...



Gives your customers Extra Values

The *extra values* that Eljer fixtures offer come from nearly half a century of continuous research and manufacturing experience. When you recommend Eljer, you specify plumbing fixtures and quality brass trim that is *second to none*.

Eljer's color and design policies are right, too, because constant study of homeowners'

likes means you are furnishing customers what they want.

The Eljer line is complete... fixtures in Vitreous China and Enameled Cast Iron for every purse and purpose. An Eljer bathroom features *extra values* that make your customers strong friends. See your Eljer Distributor or write direct to *Eljer Co., Ford City, Pa.*

ELJER

PLUMBING FIXTURES ARE OUR EXCLUSIVE BUSINESS - 17 ACRES OF IT!

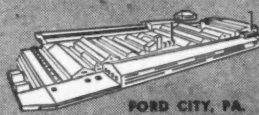

FORD CITY, PA.



LOS ANGELES, CALIF.

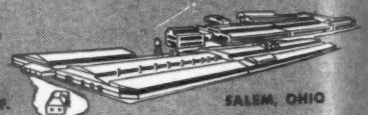

SALEM, OHIO

MANUFACTURERS OF FINE PLUMBING FIXTURES SINCE 1904

Ameri
 NATIONAL ASSO
 of the
 NEWS
 M
 Hom
 form
 prog
 low-
 Clim
 position
 "Milt"
 Associa
 laid th
 this ye
 suffici
 lending
 associa
 buildin
 and pu
 is a se
 mortga
 Befo
 it was
 the tig
 make t
 mortga
 home
 ton's
 Congr
 the sta
 dent th
 ing pla
 with r
 price
 of the
 Mr.
 to the
 prisin
 the in
 public
 home
 Atte
 record
 throug
 staged
 materi
 home
 in its
 aisles
 Steven
 The
 Edwa
 dent,
 by an
 tribut
 birthd
 At
 Frank
 presid
 4,000
 room
 mortg
 ly cri
 exten



MONTHLY REVIEW

NEWS OF THE NATIONAL ASSOCIATION OF HOME BUILDERS AND AFFILIATED ASSOCIATIONS

MILTON J. BROCK NEW PRESIDENT

Home builders pick Californian to lead NAHB in program calling for true low-cost housing in 1948

Climaxing its 1948 Home Show and Exposition with the election of Milton J. "Milt" Brock as president, the National Association of Home Builders in Chicago laid the groundwork for intensive building this year in the low-cost housing field if sufficient mortgage money is available from lending institutions to finance them. The association warned that the million-a-year building rate demanded by the government and public can be reached only if there is a secondary mortgage market to make mortgage securities more liquid.

Before the convention got under way, it was believed that growing concern over the tightening of mortgage funds would make the creation of a secondary market for mortgages the chief concern of the 5,000 home builders who gathered on Washington's Birthday at The Stevens hotel and Congress hotel for the exposition. But with the start of the program, it soon was evident that interest was highest in developing plans to reach the lower income brackets with new homes in the \$4,000 to \$7,000 price range—with emphasis on the bottom of the bracket.

Mr. Brock described reaction of builders to the low-cost home discussions as a "surprising development" and said it reflected the increasing demands on the part of the public, particularly veterans, for cutting home prices.

Attendance on opening day smashed records as some 5,000 builders roamed through the two million dollar exhibit staged by 130 manufacturers of building materials and supplies, power tools, and home appliances. The crowd was non-partial in its attention to the show, crowding the aisles in the exhibit halls in both The Stevens and Congress hotels.

The convention was opened formally by Edward R. "Eddie" Carr, retiring president, in an impressive salute to the colors by an American Legion color guard in tribute to George Washington on whose birthday the program got under way.

At the first general session on Monday, Frank Cortright, NAHB executive vice president, gave his report. He warned the 4,000 builders jammed into the Grand Ballroom of The Stevens that the problem of mortgage finance was becoming increasingly critical and recommended the immediate extension of Title VI mortgage insurance

(Continued to page 58)



MILTON J. BROCK
1948 NAHB President

It was no great surprise to most of the builders when Milton J. "Milt" Brock of Los Angeles was elected president of the National Home Builders Association at the 1948 Home Show and Exposition in Chicago February 25. From the time the show opened until after the election, orange "Brock for President" buttons blossomed on the lapels of loyal California builders and those from other states whom they persuaded to follow suit.

Milt Brock, at 56, has been active in the building field for 30 years. He heads the Los Angeles building firm of M. J. Brock & Sons, currently constructing 350 dwelling units in the San Fernando Valley and 228

additional housing units at Downey, Calif.

A native of St. Louis, Mr. Brock moved to Los Angeles as a boy and was educated in the public schools of that city, later attending La Verne College.

Active in NAHB affairs for several years, he was elected secretary in 1945 and served as treasurer in 1946 and 1947. In past years, he has been president of the Building Contractors Association of California and president of the Southern California Exposition and Home Show. Associated with him in his firm are two of his three sons. One, Milton, Jr., serves as vice president of the firm. Mr. Brock has a daughter in addition to his sons.



RODNEY M. LOCKWOOD
1948 NAHB Vice President

Mr. Lockwood is best known for his outstanding work in behalf of veterans' housing since the end of the war. As chairman of the NAHB Special Committee on Building Materials and Regulations, which acted in advisory capacity to the Housing Expediter, Mr. Lockwood developed a series of comprehensive reports which resulted in the correction of many government regulations and practices impeding construction.

More than two-thirds of the recommendations of Mr. Lockwood's committees were ultimately accepted by the government and brought relief to the building materials supply picture.

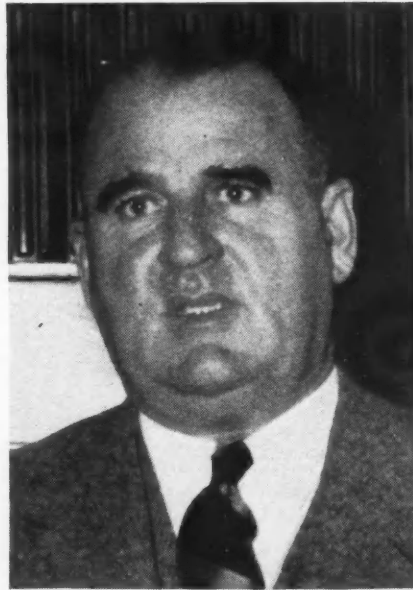

THOMAS P. COOGAN
1948 NAHB Secretary

Thomas P. Coogan of Miami has been a home builder for 20 years in the low-cost field. He is a past president of the Florida Home Builders Association, and for three years has been a national director of NAHB. In 1947, he was a regional NAHB director. He studied engineering at Massachusetts Institute of Technology and is president of the Technology Club of Southern Florida. He is a member of the Town Planning Board of Surfside, Fla. A veteran of World War I, Coogan served as an observer, bomber-gunner in the Naval air force. He currently is building houses to sell from \$6,600 to \$7,800. They include two bedroom and three bedroom designs.



NICHOLAS MOLNAR
1948 NAHB Treasurer

For 26 years, Nicholas Molnar has specialized in low-cost housing construction. He is a graduate in engineering from the Royal Hungarian University of Budapest. Molnar is a past president of the Home Builders Association of Greater Cleveland and in 1947 was treasurer of the Home Builders Association of Ohio. Noted for his interest in Cleveland civic affairs, he has been executive secretary of the Cleveland City Planning Commission and of the Board of Zoning Appeals of Cleveland. He is a member of the Board of Trustees of the Cleveland Real Estate Board. The 40 cultural gardens he laid out in a city park are his hobby.

(Continued from page 57)

and establishment of a secondary mortgage market.

The keynote address was given by Arthur Motley, president of Parade Publications, who indicated that the industry is in bad favor with the public, chiefly because the public does not know the real facts and is confused by misleading propaganda.

"Since your industry is in politics whether it likes it or not," he warned, "as an industry you should begin to organize to make sure that the public is correctly informed of your situation." Present public sentiment, he said, makes this an opportune time to get rid of the malpractices that have raised housing costs.

Taxes Boost Cost of Houses

Retiring President Eddie Carr told newsmen in his final press conference, as top official of NAHB, that the best place to start cutting home prices would be to reduce some of the taxes that go into them. The association's surveys indicate that at the present time, 25 per cent of the cost of a house is in visible and hidden taxes. He stole away for the conference Tuesday while most members of NAHB were attending the minimum house and other clinics. As a personal prediction, he said builders will hold the line on prices in 1948.

Tuesday afternoon, a battery of panel discussion speakers concluded that new

homes will be harder to sell this year, and that a secondary mortgage market will be necessary to insure a steady flow of funds.

Sees Million-a-Year Demand

Past President Robert Gerholz of Flint, Mich., predicted there are buyers for at least a million homes a year for several years, but that the "automatic" market is gone. Miles L. Colean, Washington economist, echoed this view and said that demand pressure for new homes is easing and that the market, therefore, will be more selective.

Convention activity on Wednesday centered about an afternoon session where assembled builders heard an address by Raymond M. Foley, administrator, Housing and Home Finance Agency, and listened to a host of crack construction, veteran and government leaders discuss the need for low cost veterans' housing. Foley said that the 1948 housing task, shared by government and industry, is to achieve a delicate balance of production against material and labor supply, so there is no inflationary bidding for scarce supplies.

Low-Cost House Is Problem

Consensus of speakers on a veterans' housing panel was that the supply of lower priced houses poses a big problem for NAHB members. The discussion evolved recommendations for an overall apprentice training program, increased labor pro-

ductivity and the modernization of antiquated building codes. Builders were urged to adopt short cuts whenever possible to boost the production pace, and to discard any ancient and outmoded construction practices. Thursday's final session was headlined by the appearance of James O'Neil, national commander of the American Legion, and W. G. "Bill" Power of Chevrolet Motors. Outlining his Veterans Homestead Act now before Congress, O'Neil argued that the plan contemplates that established home builders, such as members of NAHB, would implement the program.

"This is not like a public housing program," he declared. "The veterans would buy and pay for their homes. Long-range housing programs are not sufficient for the present emergency."

The builders showed heavy and constant interest in the exhibit of power tools, new building materials, kitchen cabinets, heating and plumbing displays that were included in the largest show NAHB ever has staged. There were 130 manufacturers exhibiting, and their representatives were kept busy continually. Paul Van Auken, manager of the show, received many compliments on the outstanding job he and his staff had accomplished. At the opening session on Sunday, it was estimated that at least 5,000 persons viewed the show—an attendance up 30 per cent over last year.

NAHB
held h
formed
immed
secreta
becomi
tion as
tional
a milli
right a
Lafaye
law at
Univer
he ope
adelph
ganiza

Pre
Wi

COL
colo
tion
oper



FRANK W. CORTRIGHT
NAHB Executive Vice President

NAHB's executive vice president has held his position since the association was formed in 1942. He came to Washington immediately after Pearl Harbor and became secretary of the Home Builders Institute, becoming executive officer of the association as the need became apparent for a national approach to the problem of building a million homes for war workers. Mr. Cortright attended Farnum Preparatory School, Lafayette College, and studied real estate law at Wharton College of Finance at the University of Pennsylvania. For 15 years, he operated a real estate business in Philadelphia and was active in real estate organizations.

Brock Issues Statement Of New NAHB Policies

A pledge to build more low cost homes in 1948 for low income families was a major point in NAHB policies stated by Milton J. Brock, new NAHB president, in the closing general session of the convention, February 26. To accomplish this pledge, Brock stressed the importance of a sustained and dependable source of home building credit.

To fulfill the builders' pledge for 1948, Brock called for the joint effort on the widest possible scale by all segments of our industry—in the provision of adequate financing; in the production and distribution of materials; in high productivity by labor; and in keeping building codes in pace with modern technological progress.

So important has the role of government in the home finance field become, Brock said, that today the government and not the consumer determines the type of house which will be built, and the terms of its financing. Immediate financial steps recommended toward NAHB objectives were that Title VI be extended so that operations might be programmed for 1948 without discrimination against the financing of small homes for sale; that a suitable government agency be designated by Congress to discount or purchase both FHA and VA loans for the term of the Veterans Housing program in such manner that these loans may be eligible for discount by national banks, savings banks, building and loan associations, trust companies, insurance companies, co-operative banks and others without limitation as to the amount dis-countable by any particular institution

in any stated period of time; and that the provisions of Section 203 be amended to increase the maximum loan to 90 per cent on the first \$10,000 and 80 per cent on the next \$10,000 with a maximum loan of \$17,000.

This association, Brock said, demands that local public housing-authorities cease the wide-spread expenditure of federal funds for public housing propaganda. The national office, he said, shall make every effort to bring these prevalent practices to the attention of the Congress and of appropriate government officials.

Brock revealed the recommendation of NAHB to promote slum clearance programs similar to that of the program in Baltimore directed by Robert Bready, president, Home Builders Association of Maryland.

Builders Evince Interest In Community Development

One of the outstanding exhibits of the NAHB convention is the display of community developments especially prepared for the show by a committee, headed by W. P. "Bill" Atkinson of Oklahoma City.

A detailed analysis, graphically illustrated, was made of ten of the nation's outstanding examples of successful community developments. The display covered all phases of this type of planning, from the urban land planning and land use for rental units to complete shopping centers or a combination of both.

It is the purpose of the sponsors to continue and enlarge upon this exhibit during 1948 by conducting a postwar Neighborhood Development contest in each of the twenty NAHB regional areas. This contest will be broken down into six different classifications, with a suitable award in the form of a plaque given to the winners in three of the classifications. The winners of each of the regional groups will then be pitted against each other on a national basis and the winners selected by a committee of experts. These projects will then be on display during the 1949 convention. It is the committee's plan to place the responsibility for the success of the regional contests in the hands of the respective regional vice presidents. This will assure a wholehearted participation on the part of the members. An entry blank for the contest can be obtained from any member of the Community Development Committee.

President Carr Opens NAHB Exhibits With Salute to Washington



COLOR GUARD provided by an American Legion post, plus two couples dressed in colonial attire, lend color and impressiveness to the opening ceremonies at the 1948 National Home Show and Exposition. President Eddie Carr welcomed the builders as he opened the show that was to close four days later with Milt Brock his successor

Britain Views Convention

A. Thomas Gilling, staff correspondent of the Farmers' Weekly, London, England, was enthusiastic over the convention exhibits. Arriving here recently from London, Gilling indicated that Great Britain has "nothing like this." He was particularly interested in the exhibit of the "ideal farm home."

"British farmers and their wives would give anything to have a house like this one. As you know, most English farms are very small and this house adapts itself very well to that sort of farm."



ALFRED GROSS of Long Island was discussion leader of a clinic on "How to make your 608 acceptable." Attending builders said Al Gross really knew the answers on this

FHA Officials Aid Builders In Clinic on Financing

Functions of the FHA from the builder's point of view—FHA requirements of builders seeking mortgage insurance, and the objectives of these requirements—were the main problems discussed in the panel at the Congress hotel, February 24.

The panel, led by Assistant Commissioner of FHA (Underwriting) Curt Mack, included four brief speeches on various FHA requirements. Minimum property requirements, operative builders requirements, architectural requirements, and the various ways FHA may help the builder in competent land planning were discussed. Emphasis was placed on the fact that the FHA objectives of these requirements are to create uniformity and, at the same time, a flexible program to accommodate the needs of each community.

Alfred W. Jarchow, Chief of Mortgage Credit Section, FHA, first speaker on the panel, explained a new form in which builders may file an application for a 603 commitment. Under the old form, he explained, it was necessary for the builder to file a separate commitment application for each property. Now, under the new form, all properties can be described in one application, and any size group can be covered. Descriptions in the one application under the new form would be the same as in the old form, except there is no separate application.

FHA has done away with the old rule-of-thumb method in determining borrower eligibility, Jarchow said. Now, more eligibility qualities are considered (such as reserve savings, size of family, and stability).

Explaining the way in which FHA can help the builder, Byron Hanke, Chief, Land Planning Section, FHA, explained how the association takes preliminary analysis of the builder's proposed constructions; and how, through the accumulated knowledge FHA has from the experience of many builders, much valuable advice can be given.

He emphasized the value of land-planning consultants.

Lancelot Sukert, Chief Architectural Section, FHA, spoke mainly on the value of good designing.

"Good designing is good business," Sukert said. It helps the builder to keep the design sold; helps him to establish a reputation for good looking homes; helps to improve the neighborhood, and is a great personal satisfaction to the builder.

Simplicity, harmony, and refinement must be included in the planning of good design, Sukert said.



NICHOLAS MOLNAR, new NAHB treasurer, presides at the minimum house round table which, originally assigned to a room for 50 persons, attracted over 400 builders

Slums Are Rehabilitated

A top-notch feature of the NAHB convention, which opened Sunday afternoon, was the Baltimore Slum Rehabilitation plan which was presented to the meeting by G. Yates Cook, chief of the Baltimore Health Department Housing Division.

"Under the Baltimore plan," said Mr. Cook, "structurally sound dwellings are

Crowded Meetings Underscore Interest in Minimum House

The determination of the nation's home builders to construct more houses in the low-cost brackets, especially under \$8,000 was graphically illustrated by an overflow attendance at the Minimum House Round Table conducted with Nicholas Molnar of Cleveland as chairman.

Throughout the discussions, emphasis was not only on the low cost house volume scheduled for this year, but also on the fact that these houses must be quality homes, embodying materials, design and livability that will make them sound, long-term financial risks. A number of builders explained their plans to proceed with a minimum house adaptable to expansion. These houses would be located on lots in a well-laid out subdivision planned with the idea that eventually the majority of the homes there would be considerably larger, as a result of periodic expansion, than when they are first erected.

Some builders expressed concern over the reluctance of authorities in some municipalities to accept large groups of houses to sell for less than \$8,000 because of worry over development of possible future slum areas. It was explained that this can be overcome in most instances by builders preparing comprehensive plans of the houses, elevations and subdivision plans with large lots, and make personal appearances before city authorities to adequately present the cases for low-cost house developments.

Out of the discussions came the one inescapable fact—that in 1948 more of the nation's home builders than ever before are determined to build houses to sell for under \$8,000 in large volume.

being repaired and saved by their owners. Unsound structures are being vacated and razed. Ramshackle sheds and rotting fences are being torn down. Rat-infested refuse heaps are being carted away; dwellings rat-proofed. Outside toilets are removed and modern indoor toilets installed."

Eleven thousand slum dwellings have been brought into good sanitary condition under the plan so far.

The t
in new l
of heati
lively di
sided ov

After
clinic
cussed t
relate to

Joseph
Air Co
handled

and equ
subcontr
ternatio
equipme

problem
Robert
nois sur
done the
ress on

Cyril
Americ
ing Eng

program
organiza
systems.

there ar
must be
heating

ous con
efficiency

Contrar
air, ver
operatio
water.

Modern For M

Under
land, ar
sion on
sign go
thusiast

The r
build be
was the

present,
future a
house d
new ho

Mr. E
design
tions. I

today h
units an
tions, st
in units

Walt
phia, p
planning

sons be
proach
a narrow

was ab
tect an
stressed

major r
advanta

stressed
placeme
side, d

large h
house a

Panel Discussion on Heating Rouses Interest of Builders

The tremendous interest of home builders in new heating equipment and new methods of heating homes, was evidenced by the lively discussions at the heating panels presided over by Harry J. Durbin of Detroit.

After hearing the problems outlined by clinic authorities, those in attendance discussed the various angles on heating as they relate to construction techniques and costs.

Joseph C. Fitts, of the Heating, Pipe and Air Conditioning Contractors Association, handled problems of installation techniques and equipment from the standpoint of the subcontractor. H. F. Randolph, of the International Heater Co., dealt with trends in equipment manufacture along with other problems inherent in the subject. Professor Robert W. Roose of the University of Illinois summarized the work that has been done there and research that is still in progress on warm air heating systems.

Cyril Tasker, director of research for the American Society of Heating and Ventilating Engineers, reported on an expanded program of research being launched by that organization on hot water panel heating systems. There is general agreement that there are still a great many questions that must be answered before hot water panel heating systems can be installed under various conditions with assurance of maximum efficiency and comfort for the home owner. Contrary to the situation regarding warm air, very little actual research of panels in operation has been completed with hot water.

Modern House Design Calls For Multiple Use Rooms

Under the leadership of John H. Highland, architect, Buffalo, N. Y., the discussion on the latest innovations in home design got under way in a vigorous and enthusiastic manner.

The need for the industry to design and build better homes in the immediate future was the consensus of opinion of all those present, if the industry is to progress in the future as it has in the past. The time when a house designed in 1937 could be used as a new house is past.

Mr. Highland brought out that the house design in the past was based on unit functions. Due to increased costs the house of today has shrunk in size to the point where units are combined to serve several functions, such as multiple-use rooms and built-in units.

Walter Durham, architect of Philadelphia, presented examples of good and bad planning, and drew some excellent comparisons between the two plans. How to approach the problem of designing a house for a narrow lot, common in the Chicago area, was ably handled by Martin Braun, architect and builder of Oak Park, Ill. He stressed the use of larger glass areas in the major rooms with proper orientation to take advantage of the sun's rays. He further stressed that rear lot planning, with the placement of major rooms on the garden side, does not need to be confined to the large house, but can be adapted to the small house as well.



PAUL HATHAWAY, standing, assistant chief of the Appraisal Division, Loan Guaranty Service, Veterans Administration, answers queries at the VA and GI clinic

Practical Kitchens Needed

The need to take the latest and best ideas for kitchen and laundry layout out of the magazine picture stage and to put them to practical use was stressed by the research experts and advanced designers at the Kitchen-Laundry Planning Clinics.

Headed by Grant Layng, sales manager of the Builder Division, Bendix Home Appliances, who served as moderator, the speakers' table included such authorities as Mrs. Helen W. Kendall of Good Housekeeping magazine; William Schieck of the University of Illinois Small Homes Council; John Thornton of Detroit Edison Co.; J. A. Amerman of the Prudential Life Insurance Co.; Dave Hays, American Washer and Ironer Manufacturers' Association.

Regional Vice Presidents

The following men are regional vice presidents to serve NAHB in 1948 in their respective sections of the country.

John Olson, Worcester, Mass.
Leland T. Pflanz, Rochester, N. Y.
Russell Muth, Philadelphia, Pa.
Robert Bready, Baltimore, Md.
George Goodyear, Charlotte, N. C.
John Malone, Atlanta, Ga.
Joseph B. Haverstick, Dayton, Ohio.
Arthur Fossier, Chicago, Ill.
S. G. Pearson, Minneapolis, Minn.
O. G. (Bill) Powell, Des Moines, Iowa.
W. P. (Bill) Atkinson, Oklahoma City
Alan Brockbank, Salt Lake City, Utah.
Marcus Bogue, Denver, Colo.
Edwin Sandberg, Portland, Ore.
Cedric Roberts, Los Angeles, Calif.
Wm. C. Chandler, Memphis, Tenn.
F. R. Kimbrough, Jackson, Miss.
Charles R. Malowney, Tucson, Ariz.
Maurice G. Read, Berkeley, Calif.
E. M. Spiegel, Dumont, N. J.

National Directors-at-Large

A. J. Alexander, Akron, Ohio.
Luther J. Boggs, Atlanta, Ga.
Cliff May, Los Angeles, Calif.
Wynn Cooper, Port Huron, Mich.
Sidney F. Dwyer, Milwaukee, Wisc.
William B. Dixon, Pittsburgh, Pa.
Wallace E. Johnson, Memphis, Tenn.
W. Hamilton Crawford, Baton Rouge.

Vets Panel Sees Evidence Justifying GI Complaints

Complaints by veterans about inferior construction materials and inferior workmanship in houses financed through the Veterans Administration guaranty were the chief problems discussed in the V.A. and G.I. Loan panel in the Tower ballroom, February 24, in The Stevens hotel.

In the panel, headed by T. B. King, Director, Loan Guaranty Service, V.A. picture slides were shown to point out the various reasons for the veteran's complaints. Some of the slides showed evidence where homes had been constructed with green lumber; where only a 4½-foot head space was allowed over a stairway; where foundations were inferior; where plaster, in some houses had caved in; where siding had been improperly nailed, and was out of line—in one case where siding had been put on upside down; where, as the most outstanding example, a house that cost between \$18,000 and \$20,000 had been constructed out of plumb.

Builders construct the homes; veterans select, and lenders finance them. After that, said Paul Hathaway, Assistant Chief, Appraisal division, Loan Guaranty Service, the Veterans Administration steps in. The V.A. superimposes a guaranty on private homes, he said—the V.A. does not loan. They do, however, send an appraiser to the construction who renders a report.

For several thousand homes that have been constructed in the past through V.A. guaranty loans, there have been inadequate records of who appraised the constructions, what their reports were, or when they made them. Now, Hathaway said, the V.A. is "trying desperately" to establish a closer relation between the builder and the V.A.

To aid in this, Hathaway said, the V.A. is organizing a new group of technicians called "construction analysts," whose job it will be to make closer studies of constructions financed through V.A.

Stressing the importance of the V.A. loan guaranty to veterans, T. B. King said the V.A. has made loans at the rate of 50,000 per month.

Market Outlook Panel Sees Demand For Housing Firm for Five Years



REHEARSING for one of the important panel discussions of the convention, the Market Outlook, are: Arthur Fossier, Chicago; Marshall Mayes, Deputy Chief, Construction Division, U. S. Chamber of Commerce; Miles Colean, Washington economist; James Downs, president of Real Estate Research Corp.; Douglas Whitlock, Producers Council and Robert Whitlock who served as moderator

Two problems discussed in the panel "What's the Market Outlook?", February 24, were the increasing costs in new housing and the tightening up of mortgage finance. In spite of these problems, however, there was general consent that 1948 would be a good building year.

"It is well for us to remember that in relation of the price of other commodities, the price of building materials and labor are not out of balance", Robert P. Gerholz, Flint, Mich., moderator of the panel said. "A builder must see things as they really are: Recognize that the scramble for new houses is over; realize that prices, wages and costs are becoming a day to day problem; and recognize that a large percentage of cost factors are beyond his control."

Speaking on the condition of the real estate market, James C. Downs, Jr., president of the Real Estate Research Corp., Chicago, pointed out that the recent drop in the stock market and grain markets has not in the least affected the current housing shortage. In fact, according to Downs, the drop in commodity prices after World War I set the stage for the greatest building boom in U.S. history.

"The housing demand is likely to continue to be strong for a number of years ahead," Miles L. Colean, economist, Washington, D.C., predicted. The characteristics of the future housing market are certain to be different from those familiar since the end of the war, he added.

Influences that will affect this change, Mr. Colean said, are the increase in the volume of housing, the decline in the rate of family formation, and harder credit.

Optimism was expressed concerning production and distribution by Douglas Whitlock, chairman, Building Products Institute, Washington, D.C., when he said that an analysis of the major factors indicated adequate production and supply of building materials in relation to expected demand in 1948.

The necessity for low priced homes for

1948 was emphasized by Milton J. Brock, treasurer, National Association of Home Builders, Los Angeles, Calif. We, as builders, he said, must face and solve the problem of building low cost housing. FHA Title II will be of little or no help in this part of our program since it points toward the elimination of mass construction—the real key to low cost housing that must be built and delivered to buyers able, ready and willing to own new homes costing between \$6,500 and \$8,500.

Speaking on the ability of the market to absorb homes at our present rate of production, Arthur E. Fossier, Chicago, Ill., said it was unlikely that the market will continue to absorb homes for more than the next five years. While we will still undoubtedly sell a minimum of a million homes this year at present price levels, he continued, future sales will be governed by the ability to adequately finance, and by the ability of the public to buy. Therefore, he said, unless adequate mortgage money is made available, production will decrease.

Foley Suggests Transitional Three-Step Plan for Building

Home builders have a responsibility above and beyond the construction of a maximum number of houses per year in the opinion of Housing and Home Finance Administrator Raymond M. Foley, who addressed the convention Wednesday afternoon, February 25. "Your job is more than to build a maximum number of houses for a year or two," he said, adding, "And HHFA's responsibility is much more than just to help you do that."

Mr. Foley explained that, working together, the home building industry and government must develop solutions to the nation's housing problems in three sections—the immediate steps, transitional steps and long-range steps.

The immediate problem is to satisfy housing requirements of the moment as fast and as economically as possible. Looking back on the last year's accomplishments, Mr. Foley commented, "The number of houses produced is encouraging; their cost is not."

Transitional steps should be taken only as long, as far and in such direction as will help to build into the industry the strength it needs to carry its big job on a sustained level over a period of years, Mr. Foley explained. Major objectives of these transitional steps for a private building program should include:

1. Emphasis on lower price and lower rent;
2. Emphasis on increased production of rental properties;
3. Continuance of sound production finance devices to not only sustain a good level of building but also to prevent its forming an artificial support of unnecessary costs and inflationary prices;
4. Use liberal finance devices only as incentives to production in the lower price brackets, passing savings on to the consumers;
5. Long-range encouragement of better technical practices, greater efficiency, new materials and other means for strengthening the industry;
6. Continuing efforts to produce a better quality product, better planned, constructed and located.



EDDIE CARR'S farewell conference with the press as he concludes his term of office

Ten Million Houses in Ten Years Require Easier Funds, Panel Holds

The need for a secondary mortgage market to make mortgage securities more liquid was underscored at an NAHB convention panel on financing ten million homes. The high interest of builders in suggestions for creating such a secondary market completely filled the Grand Ballroom at The Stevens hotel.

The seriousness of the tightening mortgage money market was indicated by the builder side of the panel—particularly in statements from V. F. Buchek of San Antonio, Texas. Buchek declared that western builders are dependent almost entirely on eastern capital for building loans, and are having a serious lack of demand for 4 per cent mortgages.

On the financial side of the panel, Horace Russell of the U.S. Savings & Loan League of Chicago declared that there appears to be a secondary market available for legitimate home financing from private lending sources, and that government need not provide funds for either primary or secondary mortgage markets. Government financing will lead to government control, not only of the mortgages, but of the houses themselves, he declared.

Russell said six billion dollars a year will be needed to build a million homes a year. He estimated that buyers would provide one billion in cash payments. Savings and loan institutions would provide two billion dollars toward new homes, plus an additional billion for purchasing existing housing. Commercial banks, trust companies and mutual savings banks can be expected to finance another two billion dollars worth of new housing, plus an additional large group of existing houses, from funds provided by a net increase in savings and payments on existing mortgages. From insurance company financing would come another billion dollars for new housing, Russell indicated, with still more money available from individuals and other mortgage institutions.

Joseph E. Merrion, president of the Chicago Metropolitan Home Builders Association, urged extension of FHA Title VI mortgage financing, plus the establishment of a government "safety valve" secondary market for home mortgages. He recommended creation of a government agency, similar to the Reconstruction Finance Corporation, to act as a clearing house for excess mortgages held by financing organizations.

Six Billion a Year Needed

Speaking in the same vein, Joseph Meyerhoff of Baltimore, past president of NAHB, said that we cannot have a working mortgage finance structure without some federal government participation and support.

Indicating a unanimity of thinking among the builders, Thomas P. Coogan of Miami, who later in the day was elected NAHB treasurer, voiced recommendations almost identical with those of Meyerhoff and Merrion.

Franklin D. Richards, FHA commissioner, and a member of the panel, told

builders of steps taken recently to increase the national ratio of rental housing commitments under Title VI and to conserve the authorization so that the maximum amount will be used for new construction that is ready to start. The new measures, he said, are:

1. To encourage the return and cancellation of commitments where construction is not likely to start promptly and to cancel 603 commitments over 30 days old where construction has not started.

2. To use overtime solely for making inspections, closing all types of cases and processing rental housing cases in 608 projects and 2, 3 and 4 family units under 603.

3. To re-emphasize that quality of underwriting decisions must not be sacri-

ficed in the case of quantity production.

4. To stress that FHA directors assign all available personnel to processing rental housing applications.

5. That no further commitments on single family dwellings under Section 603 shall be issued until written assurance has been received from the submitting mortgagee that it actually intends to make the loans if commitments are issued, regardless of any change that may have occurred in the secondary market.

Others who appeared on the financing panel were T. B. King, chief of the Loan Guarantee Service, Veterans Administration; Rollin Bengé, Detroit banker; John C. Thompson, president of the Mortgage Bankers Association and L. Douglas Meredith, executive vice president of the National Life Insurance Co. of Vermont. Alfred Gross, chairman of the NAHB Mortgage Finance Committee, was moderator for the panel.



GATHERED for an informal chat after the directors meeting at the convention are John Dickerman, left, of the NAHB staff; Fritz Burns, mass builder from California; and Robert Bready and George Y. Cooke, both builders from Baltimore

Prefab Trend Slowed by Code Restrictions, Clinic Shows

Problems and trends in the prefabricated home manufacturers field were discussed and illustrated at the clinic meetings Tuesday and Wednesday. Harry Steidle, of the Prefabricated Home Manufacturers Institute, Washington, D. C., introduced the subject with a comprehensive talk illustrated with colored slides. He covered all the various ramifications of the industry today—architecture, materials used, manufacturing methods, problems in codes and public acceptance and site erection of the houses.

The fact that prefabricated home manufacturers have not been able to gear their factories to maximum output has thus far precluded the majority of them from achieving the maximum savings inherent in the system. Reluctance of the public to accept

new materials and construction methods, plus a large number of building codes in various large population centers have thus far retarded the introduction of major savings in materials and labor which could be effected, and will eventually be realized when the public and building code authorities accept new methods of reducing wall thicknesses; low-cost, preassembled plumbing units and similar economies.

Following Mr. Steidle's introduction of the subject, questions from the floor were answered by William A. Shearer of National Homes Corp.; Hart Anderson, of Page and Hill; Peter S. Knox, of Knox Corp., and Richard F. Voell, of the Ingersoll division of Borg-Warner Corp.

Questions put by builders concerned problems of erection crew sizes, costs, transportation methods, acceptance by their local public and building code authorities and means of achieving volume.

Late Bernard Johnson Honored By NAHB Memorial Resolution

Among resolutions adopted by the National Association of Home Builders at the sixth annual convention, was one in recognition of work on behalf of the organization by the late Bernard L. Johnson. Mr. Johnson, western editor of *American Builder* for the last five years and editor of



BERNARD L. JOHNSON

this publication until 1942, passed away in Seattle, Wash., December 22, 1947.

The resolution is as follows:

"Whereas, the late Bernard L. Johnson, western editor of *American Builder* magazine for the past five years, and editor of that magazine from 1907 to 1942, served home builders and the light construction industry with distinction throughout his long editorial career, and

"Whereas, he contributed valuable advice and aid in effecting the organization of the National Association of Home Builders and later worked diligently in Seattle to assist in organizing and developing local home builders associations in Washington and Oregon,

"Therefore, be it resolved that the National Association of Home Builders in annual convention assembled at Chicago, Ill., on this 25th day of February, 1948, does officially and publicly express its sympathy to the bereaved, and its appreciation of the late Bernard L. Johnson's work in behalf of the National Association of Home Builders, and

"Be It Resolved that this resolution be included in the official proceedings of this Sixth Annual Convention and Exposition of the National Association of Home Builders, and

"Be It Further Resolved, that a copy of this resolution be sent to Mrs. Bernard L. Johnson, and to the *American Builder*."

Comes As the Crow Flies

A veteran Boston home builder believes that the shortest distance between two points is a straight air route. He is A. P. Rounds who flew to the annual convention of the NAHB in his private Aerocoupe.

Women Are Making Their Mark in Field Of Building by Practicality of Ideas

Although little is known about the woman operative builder, her influence is being felt more and more throughout the industry, not only because her number is increasing, but because of her practical ideas on home design.

Like her counterpart—the male—she has turned to the building field as a means of support. She is succeeding, as he succeeds, through good building practice, building cost economy, and promotion.

Only in matters of house utility does she seriously differ with him. In this phase of the business, she has the advantage of the viewpoint of a mother in the home. Remembering her own difficulties with poor lighting, wrong placement of doors and closets, small bedrooms and inadequate storage facilities, she is enthusiastic and practical when preparing plans which embody more livability.

While some of her ideas may run counter to what men think women want, hers is the voice of experience.

Group Attend Convention

A group of these women home builders attended the recent NAHB convention. Veteran among them was Mrs. Grace Perego of San Francisco who has been an operative builder since 1913. The only woman licensed to build in the state of California, she specializes in apartment buildings and flats. She originated the first patio duplex in San Francisco, and introduced modern apartments to that city. In 1940, she built her first single-family dwelling and is just completing a project of three-bedroom homes built to sell for \$14,000. Owner of power equipment, she is about to break ground for her first 608 rental unit. In this ultra modern 14-apartment building, every apartment will have a huge picture window in the living room and a modern kitchen, fully equipped, including a garbage disposal unit.

Mrs. R. B. Butler of Tulsa, Okla., is another veteran woman builder who has achieved an enviable reputation and record in the industry. She started building houses during the depression when she saw houses generally were shabby in appearance. Having always held certain ideas about kitchens, she made kitchen planning a specialty. Today her homes feature the "Personality Kitchen." Some of her innovations include picture windows in the kitchen and the elimination of the partition between the kitchen and breakfast nook. This combination of kitchen and breakfast nook is now being developed into a combination kitchen, breakfast and laundry room with all electric or all gas fixtures housed in cabinets to conceal fixtures. As an experiment Mrs. Butler built shoe closets in the bedrooms of several homes which drew a good deal of favorable comment from all who saw them.

"I have never been guilty of building a home without a dining room," Mrs. Butler reported. "Women are sold on the idea of their shiny cut glass display

and they have no other place in which to exhibit it."

Mrs. Butler specializes in the ranch-type home in the \$25,000 and up range. At present she has six such homes under construction and will build an additional 21 as soon as spring building commences.

Gate House Is Inspiration

A gate house on a large New England estate seen years ago contributed to the thinking and planning behind a huge ultra modern housing development being built by Mrs. Lee Stroud of New Mexico.

Mrs. Stroud puts special emphasis on quality in materials, workmanship, and house design. "I pick up a plan that has lots of appeal. Then I pick the plan to pieces and live in every room before the plans take shape," she explained. She is an enthusiastic promoter of the two and three-passenger bathroom, and is currently using them in all her homes. Because she is primarily interested in the family with growing children, she puts special stress on the service end of the house—the kitchen and utility room arrangement. "I want the woman to be able to cook, wash, iron and take care of the kiddies, if necessary," she stated.

Mrs. Stroud is the only woman in the state of New Mexico to hold a general contractor's license. She will shortly stage a home show, featuring houses in all stages of construction.

Among the newer women home builders, Mrs. Henny Mollgaard is probably the best known to NAHB, having served as secretary of her local chapter. Although Mrs. Mollgaard is primarily interested in veteran housing, she recently built a ranch type demonstration home for Good Housekeeping magazine.

Ohio Woman Builds Bungalows

Mrs. Olive McCoy of Canton, Ohio, specializes in the medium price bungalow. She is currently building a project of 12 homes seven blocks outside the city of Canton proper. Her plan for a cottage, entered in a contest held for women realtor-builders at the NAREB meeting in San Francisco, was chosen first for being the most practical and utilizing every bit of space. Bedroom windows spaced so furniture will fit into the room comfortably, and a dinette window placed higher than average so a dinette table will fit under it are important features in her house.

Mrs. Dooley Chalaron of New Orleans is the only woman in her state to hold a general contractor's license. Her specialty is the Crawford three-bedroom prefabs, although she also constructs a number of custom made homes. Youngest member of this woman home builder's group in point of experience, she not only looks forward to accomplishing a great deal but expects to enjoy doing it.

(Continued to page 130)

Every Month Builders Install Thousands of Galvannealed Steel...One Piece...Overhead...

STRAND GARAGE DOORS



Home owners like the strength and lifetime durability of galvannealed steel—and Strand's easy operation.

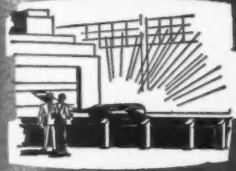

Galvannealed for rust resistance with a heavy galvanized zinc coat, oxidized to provide an excellent base for paint.

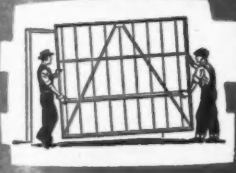

One piece construction — easiest, quickest of all doors to install.

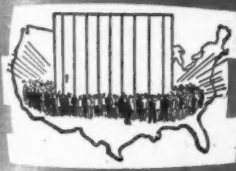

New low price — America's greatest garage door value — result of volume production concentrated in one plant — and standardization on two models.



2 Types . . . Receding and Canopy . . . for 8' x 7' opening

Builders like Strand's easy installation — no field assembly of the door is required. The door leaf is in one piece; hardware is shop-fabricated and acts as an installation templet.

Both canopy and receding (track-type) doors are of welded one-piece construction — no bolts or screws to loosen. Only 2" of headroom required. Heavy rubber weatherstrip across bottom.

Home-buyers, too, are quick to recognize the benefits of this door: the strength of steel — proof against sagging, warping, shrinking, rotting . . . uniform steel sheets are milled to exact specifications — no variation in quality as with some other materials.

This galvannealed steel door is available *now*.

ORDER FROM YOUR DEALER OR WRITE:

Strand Building Products Company
Subsidiary of Detroit Steel Products Company
1710 Buhl Building Detroit 26, Michigan



Here's how I put big kitchen advantages... into small kitchens!

1. SAVES SPACE!

New 6 cu. ft. Kelvinator only 24" wide... takes no more floor area than previous 4's!

Without changing floor-plans, builders and planners can now make small kitchens work like big ones! For today's answer to the problem of limited space is... KELVINATOR'S "SPACE-SAVER PACKAGE"!

It's a family-size refrigerator! Kelvinator's beautiful, new 6 cu. ft. "Space-Saver" holds 50% more than previous models... but takes no greater floor-space! Big, stainless steel freezer, ample room for tall bottles, shelf space galore for daily food storage! Precision built to Kelvinator quality standards.

2. SAVES SPACE!

New Kelvinator Range only 21 inches wide... stars full-sized oven... modern features!

A real workaday Electric Range!... this compact new Kelvinator is only 21" wide—and its new design permits installation flush against wall. Features a full-size, 2-unit oven for baking and broiling. Automatic oven temperature control. 7-heat surface units for electric-fast, safe, cooler cooking. Three units in all—one 8", two 6". Beautiful porcelain exterior... Kelvinator quality throughout!

Kelvinator's

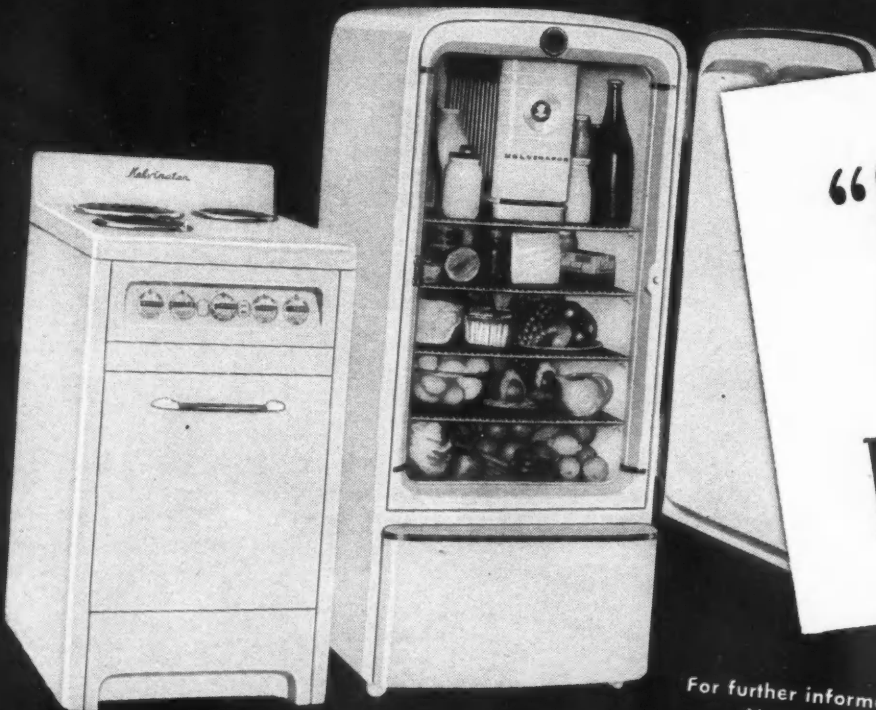

"SPACE-SAVER PACKAGE"

For further information, write Kelvinator Division
Nash-Kelvinator, Detroit 32, Michigan

AMERICAN BUILDER

L D I T O R I A L

Important Announcement

THE publishers of *American Builder* are happy to announce a new editorial policy that has been planned for some time, and that has been urged by many builder and dealer readers.

Beginning with this issue, publication of the Dealer Edition, containing the Dealer Distribution Section, and directed only to subscribers who are retailers and wholesalers, has been discontinued. Henceforth, all subscribers will receive the same edition of *American Builder*. Editorial material formerly published only in the Dealer Distribution Section, now is integrated with the general editorial contents of the magazine as news of interest and importance to everyone connected with light construction.

The new policy reflects *American Builder's* traditional leadership through the ability of its publishers to alter policies and methods of presentation in keeping with changing conditions.

The disruptions of building activities and material supply channels caused by war, and the attacks on all the major segments engaged in light construction have brought about a new and long desired consciousness on the part of all segments that they constitute an industry of inter-dependent groups, rather than a collection of autonomous groups merely doing business with each other. For that reason, news of distribution problems and trends and of supply conditions is just as important to builders and others in the industry as news of design and of building operations and techniques is to distributors. *American Builder's* new policy enables it to render an improved and distinctive service by printing the news of all the segments of the industry in one publication, and thus leading the way to more complete unity of industry purpose and performance.

While the policy was evolved some time ago, putting it into effect required the use of considerably more paper for each issue, and the necessary additional paper supply did not become available until this month. It is with a feeling of achievement in the face of difficulties that the publishers announce the policy effective now.

American Builder's publishers are convinced that the new policy marks another milestone in this magazine's progressive 70-year record as the world's greatest building paper. Now, for the first time, a building paper recognizes each of the elements engaged in light construction as contributing to and dependent on each other; speaks specifically and exclusively to and for all segments of a uniting industry; and provides a powerful medium for aiding the industry in the solution of its problems and the defense of its position.



DAVID SWOPE, County Homes president

Building Permanent Real Estate Value

Careful land planning in advance of building insures top prices for new homes and preserves properties against obsolescence in the future



EARLY postwar construction includes some two-bedroom houses with combination living room and dining area, as shown in the plans for these houses on the facing page. Plan for the left hand house is at left; for the center house, at right. Current demand is for three-bedroom floor plans

TH
Top
Cou
top
ity
bee

S
ing
Yo
are
van
tak
rain
me
you
also
Ho
em
sal
int

C
vel
che
icy
val
ins
nen
bui
pre
Ta
Wh
clu
wh
ma
wa
194
the
Sw
alm

lar
at
bei
pla
80-
and

C
plo

THE rendering at left shows exclusive Tappan Hill, the latest development of County Homes, Inc. Streets conform to the topography. Provision is made for community recreation areas. An old mansion has been remodeled into a club and restaurant

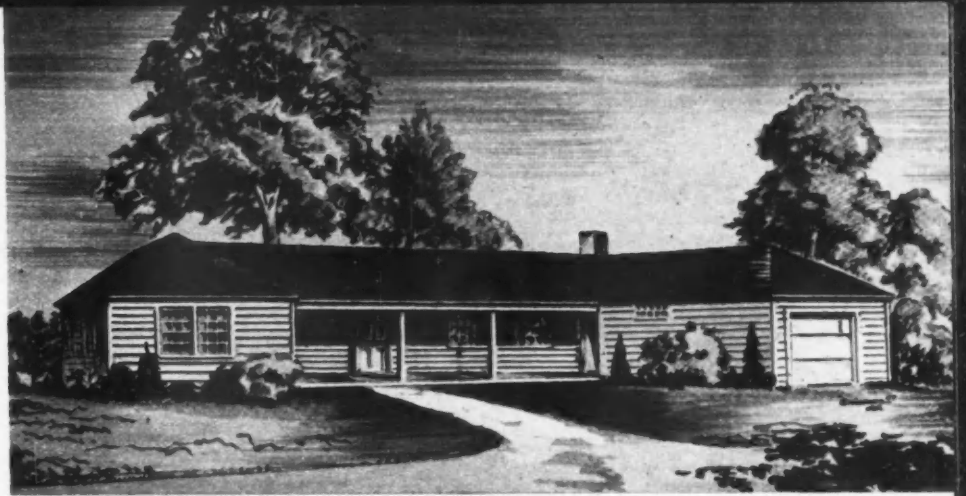

SPECIALIZING in the construction of middle-bracket suburban dwellings, County Homes, Inc., of New York's exclusive Westchester County area, does careful land planning in advance of every building project to take full advantage of the rugged terrain and natural beauty of its developments. Headed by David Swope, young and energetic builder who is also president of the Westchester Home Builders Association, the firm employs its own architect, office and sales manager and construction superintendent to function as a team.

County Homes did considerable development before the war in the Westchester area, and established its policy of land planning to get the most value out of its developments and to insure that the value would be permanent for the owners of the homes it built. Among the most notable of these prewar projects is Tappan Landing at Tarrytown, N.Y., and Fulton Park at White Plains, N.Y. These projects included a lot of two-bedroom houses which were then in considerable demand. No homes were built during the war, but operations were resumed in 1946. The first jobs included more of the two-bedroom homes, but Mr. Swope reports that current demand is almost entirely for three bedrooms.

The latest project, and one of the largest yet undertaken, is Tappan Hill at Tarrytown. The first home is just being erected at this project. Also planned for early construction is an 80-house project at Irvington, N.Y., and 180 homes at Briarcliff Manor.

On each project, the builder employs the landscape architectural firm

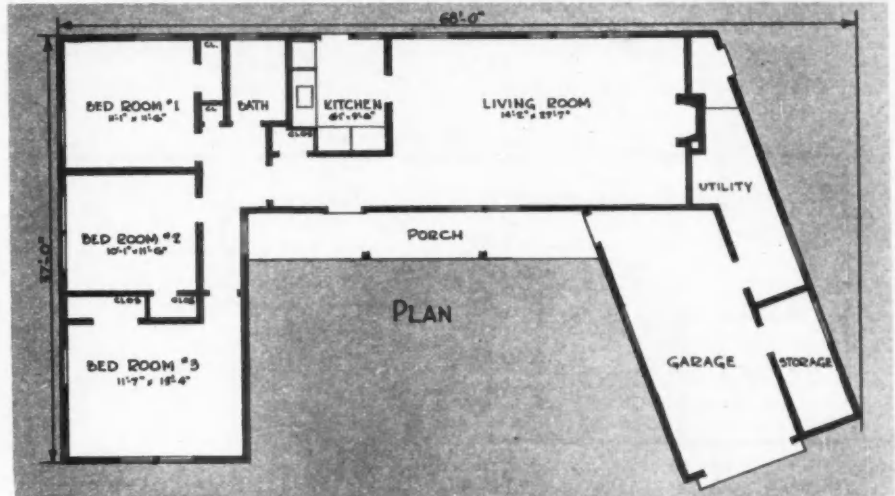

THIS ranch house has been introduced in one of the smaller developments. The plan has three bedrooms. The angle of right wing opens up front, gives space for utilities

of Clarke, Rapuano and Holleran of New York City to make a topographical survey of the site and to plan the subdivision. The survey is very thorough, with all large trees spotted in addition to showing land contours.

The plan is then studied to determine the approximate size of lots. Currently, County Homes aims to provide from a quarter to a half acre of land with every building site. This is in line with their established policy. When other builders in Westchester

were building lots with minimum width of 60 feet, County Homes set a 75 foot minimum. Now the minimum width is 90 feet.

The average depth of lots in a new subdivision is determined from a study of the topographical survey, and streets are then laid out. Care is taken not to run streets around the perimeters. Curves and cul-de-sacs are used to discourage through traffic after the roads are finished. When the development plan is finished, with roadways

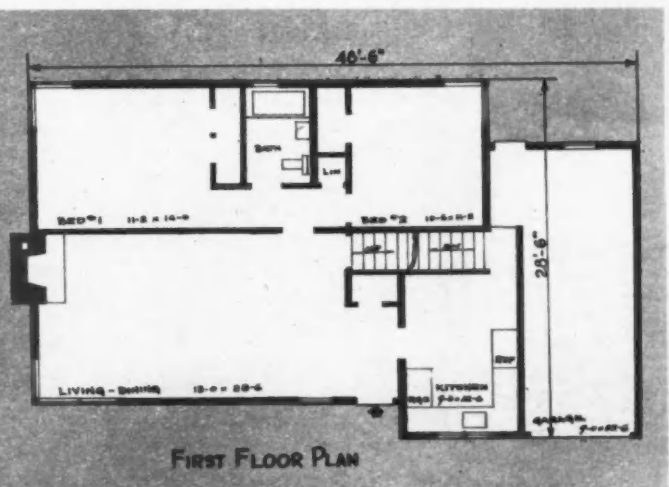
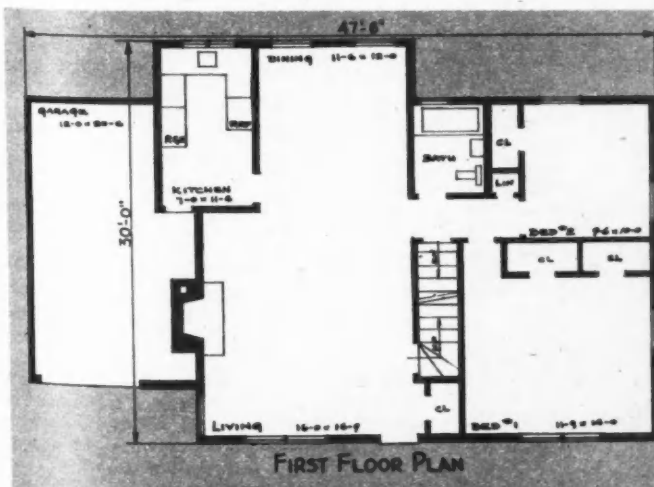

struction
bedroom
on liv-
area, as
these
page.
house
and is
plans

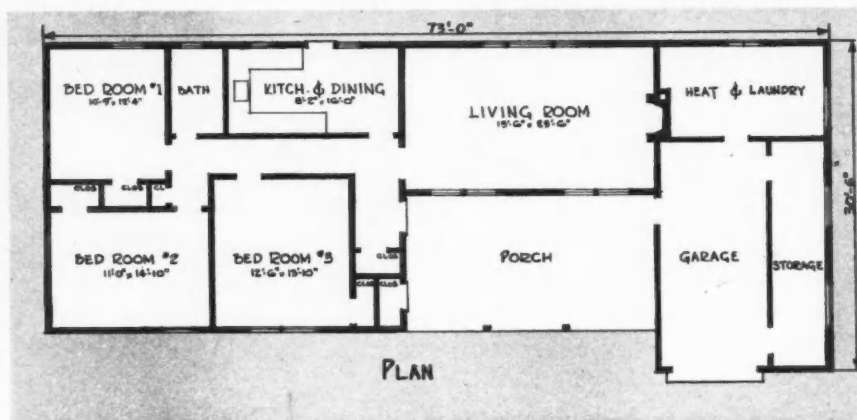
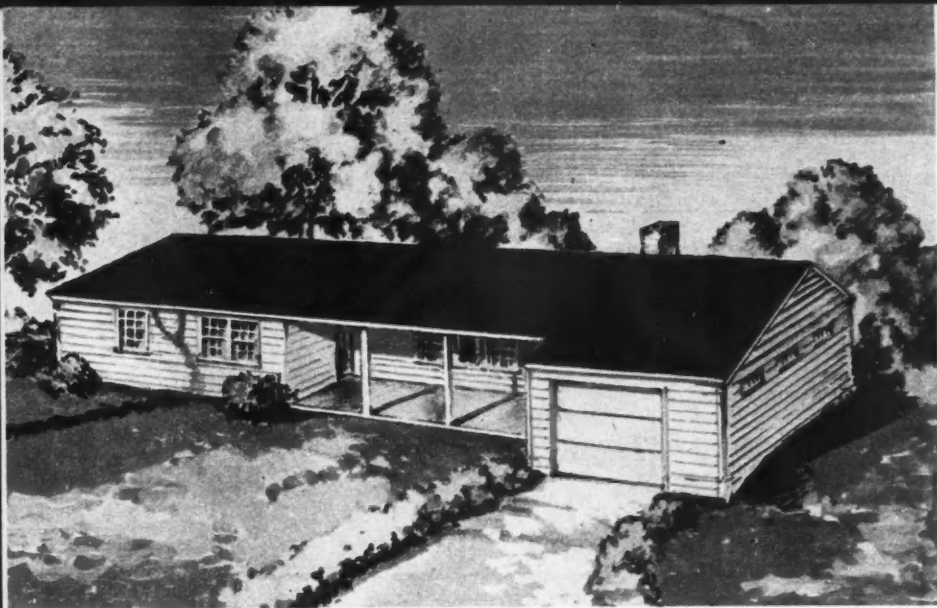

ANOTHER County Homes ranch type design. In the several that have been built, radiant panel heating is employed with copper coils laid in a concrete slab, heated with gas

and lots all designated, the plan is turned over for study to William Vladek, the County Homes architect.

Mr. Vladek makes a rough study of each lot to determine which of the several plans on file is best suited to the topography of individual lots. In this way, when a client is interested in a particular site, several suggested designs can be shown him. Or if he has a preference for a particular design, a site can be selected which will accommodate that design. In making design selections, care is taken to avoid as much tree-felling as possible. Not only does preservation of the trees add to the attractiveness of the site, but considerable expense is saved.

Although most of County Homes construction has been of traditional colonial design, several new ranch type designs have been introduced in a small subdivision. Their acceptance has been very good, indicating that the East is not wedded to colonial if it can find some of the modern designs to buy.

The price of the ranch designs shown is from \$17,500 to \$18,000. The houses have a hot-water radiant heat installation with gas-fired boiler. Walls are of dry-wall construction with 2 inches of cotton insulation. An 80 gallon hot-water heater with automatic sidearm is installed, costing little more than the usual 40 gallon tank and insuring ample hot water supply. The kitchens each have a 6 cubic foot refrigerator, a dishwasher and garbage disposal sink. The concrete floor panel is finished with a rubber base paint. Copper gutters and leaders are used. The garage doors are aluminum, or aluminum over wood, of the upward acting type.

The wide variation of design limits the amount of precutting that can be done, but a small shop has been erected on one development for precutting studs and rafters. Door and window headers are also assembled. Joists are lapped to eliminate cutting. The shop is equipped with a Walker-Turner radial saw and planer. Skilsaws are furnished to carpenters.

County Homes does both speculative building and custom building. Having its own architect, it is a simple matter to make minor changes in plans to suit a client. And with the scope of its operations, workmen can be kept busy on speculative jobs if there is a lull in custom-ordered homes. Of course, at the present time,

(Continued to page 72)

LUMBER is stockpiled on the development and some precutting is done at a shop on the site. However, the wide variation in plans limits the amount of such work. In County Homes developments, the topography of each lot determines the plan to be constructed



n is
liam
tect.
study
of the
d to
s. In
ed in
d de-
e has
gn, a
com-
esign
d as
only
dd to
con-

omes
ional
ranch
ed in
tance
at the
it can
ns to

esigns
. The
t heat
boiler.
action
n. An
auto-
ing lit-
n tank
upply.
c foot
l gar-
e floor
r base
ers are
alumi-
of the

limits
can be
erect-
cutting
window
sts are
e shop
Turner
ws are

pecula-
ilding.
simple
ges in
ith the
en can
jobs if
rdered
t time,

lopment
o on the
n plans
County
of each
ructured



THE natural beauty of site on which this attractive three-bedroom colonial was erected has insured permanent value for its owner for many years in the future

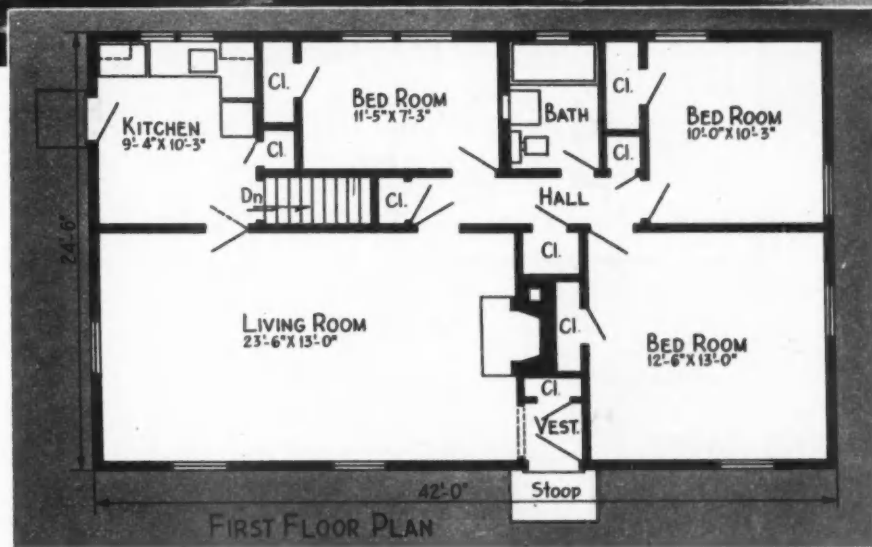

WHEN radiant heating panels are installed, valves control circulation for each room. The builder found that concrete could be poured over coils easier if studs were nailed to plate through the bottom and hung before coils are laid. Plates serve as a guide for leveling the concrete slab

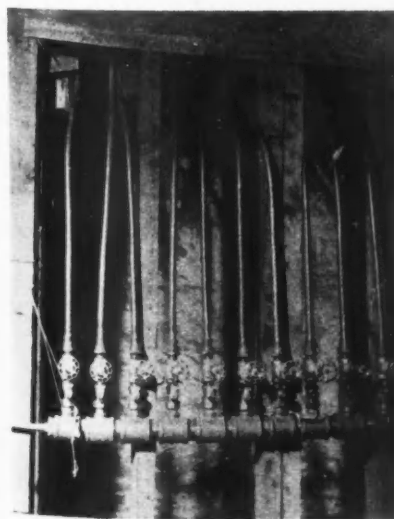

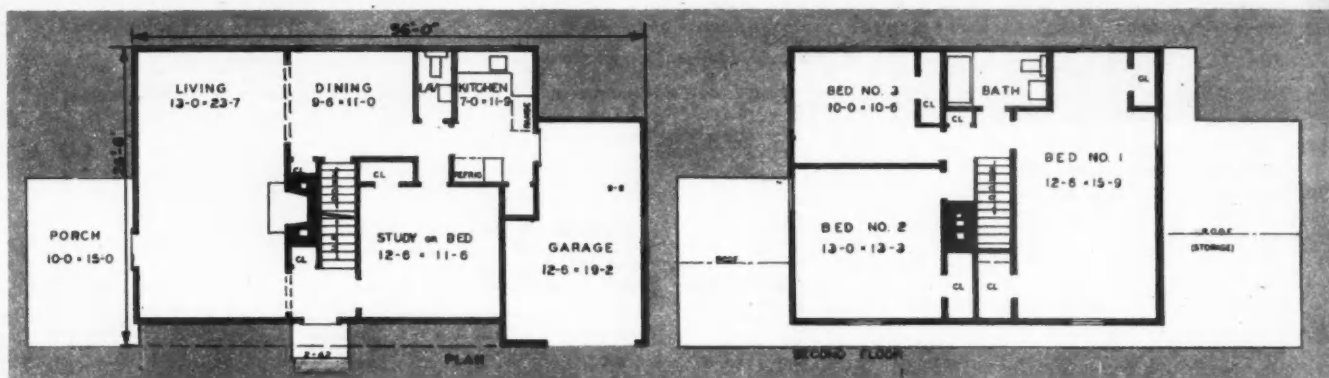
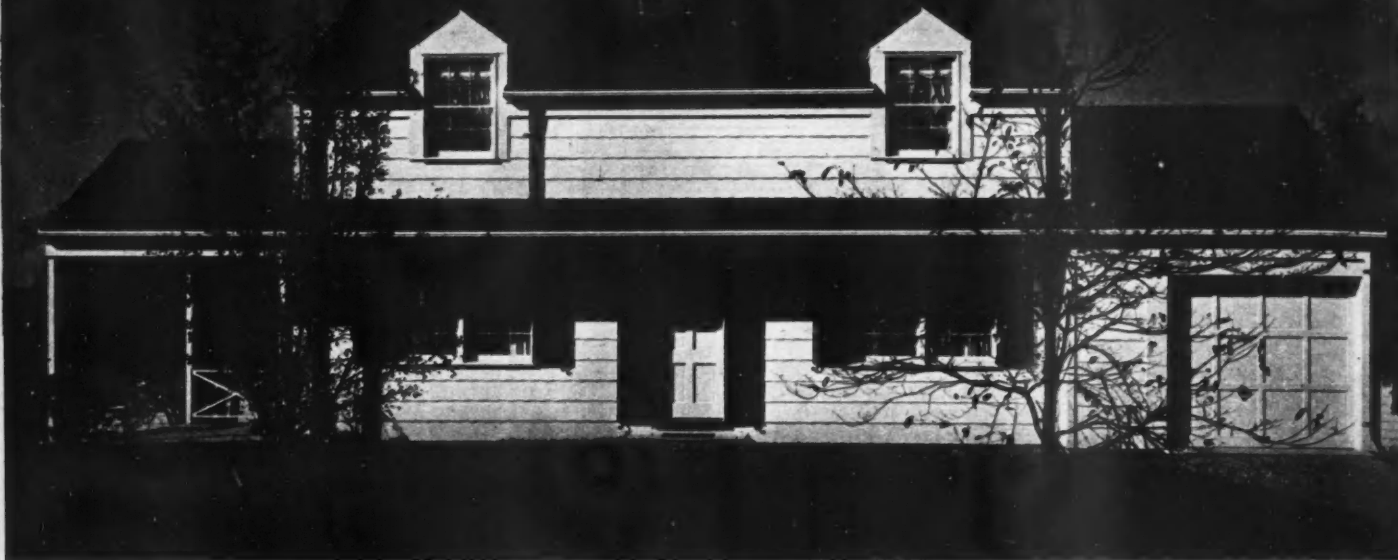

(Continued from page 70)
 nearly every home is sold before it is finished because of the terrific demand for homes in Westchester.

County Homes has acquired much of its land by purchasing estates of wealthy former residents of Westchester. Mansions and large acreages that were maintained by millionaires in the days before high income taxes and high-cost domestic help are now white elephants. The structures themselves are too costly to maintain as residences, even for most millionaires. Usually they have to be torn down to make room for the new homes. In the case of Tappan Hill, however, an old mansion has been preserved and remodeled into a club and restaurant.

County Homes has sufficient land available for several years of large building operations. Not far from the Tappan Hill development, it has a tract overlooking the Hudson River which was formed by the acquisition of three adjacent large estates.

Mr. Swope is president of County

Homes. Sales are in charge of Edward T. Gorman who also is office manager. Frank B. Ginnel is construction superintendent.

SWEEPING colonial plan is popular selection with clients who select hilltop locations in County Homes developments. It has three bedrooms, large dimensions

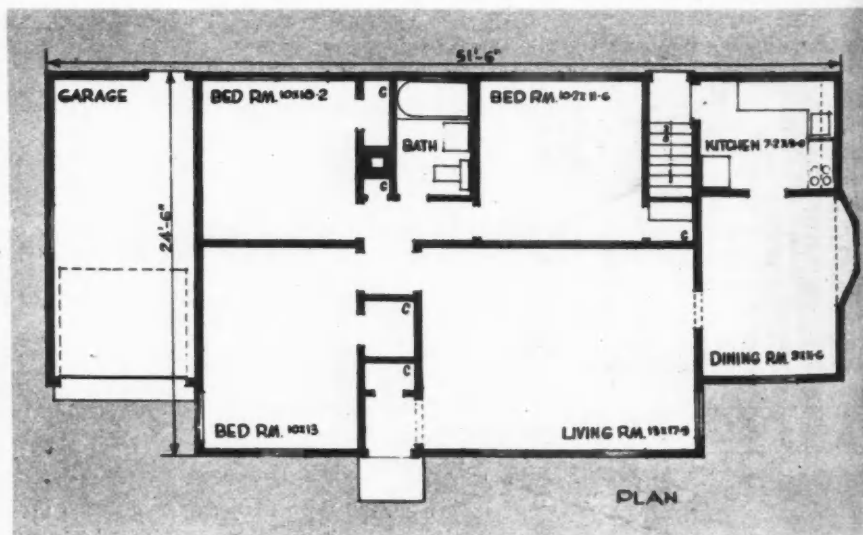

A MOR...
 is dec...
 has fou...
 seven...
 signed...
 Homes

ANOTH...
 the des...
 natural...
 This h...
 stood...
 years

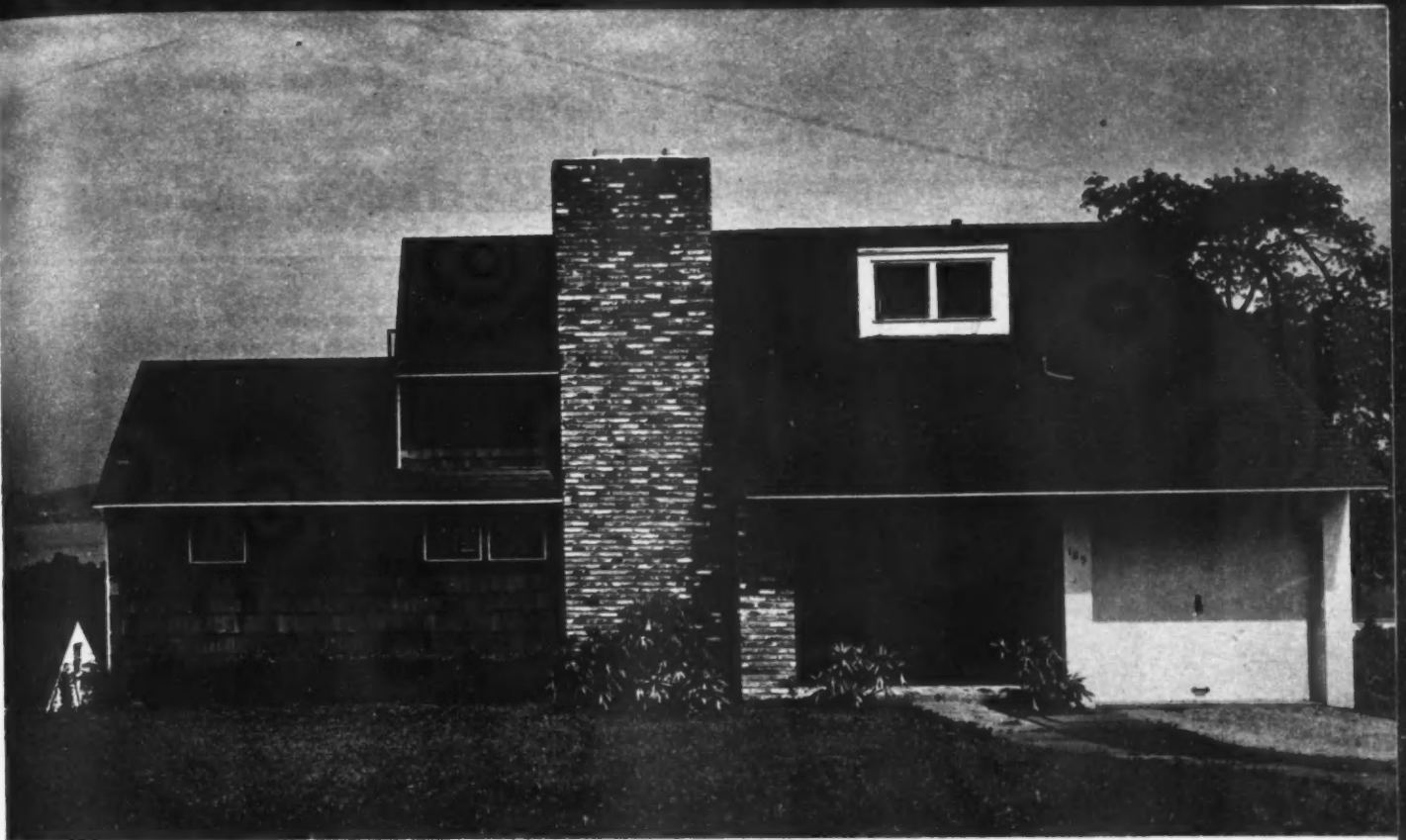

A MORE modern design, this house is deceptive in appearance. It has four bedrooms and a total of seven rooms; was especially designed for a client by County Homes architect. Overlooks river

ANOTHER excellent example where the design fits the site and all natural beauty has been preserved. This home looks as if it had stood in this location for many years instead of a half dozen

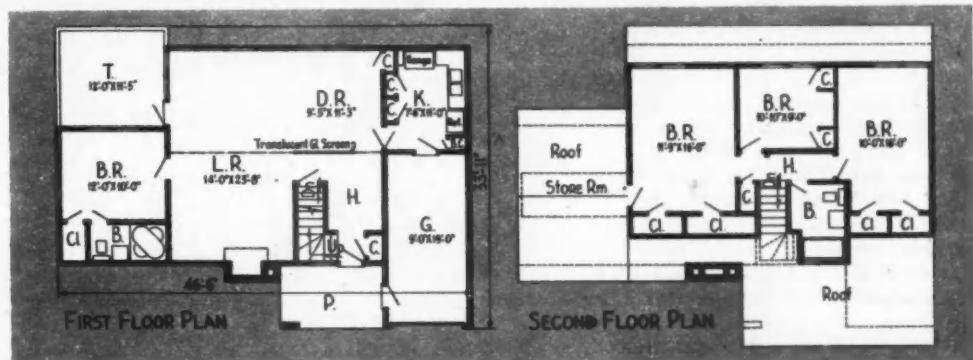

Two-Bedroom Houses



ABOVE are the men responsible for unusual veterans' housing. From left to right: Reno H. Sirrene, Don Wilson, Frank Sheldon, and Milton Kauffman. At right is an air view of the project, located 15 miles from the heart of Los Angeles. Kauffman predicts that Los Angeles industrial area will expand toward the project. Below is a street scene of three typical houses under construction, showing garages, stuccoed exteriors, driveways, and walks. There is a five-foot fence in the rear

Two-bedroom houses on 60x100-foot lots sell for less than \$8,000 in 250-house project, 15 miles from the heart of Los Angeles. This concern achieves low-cost housing by simplifying standard construction methods

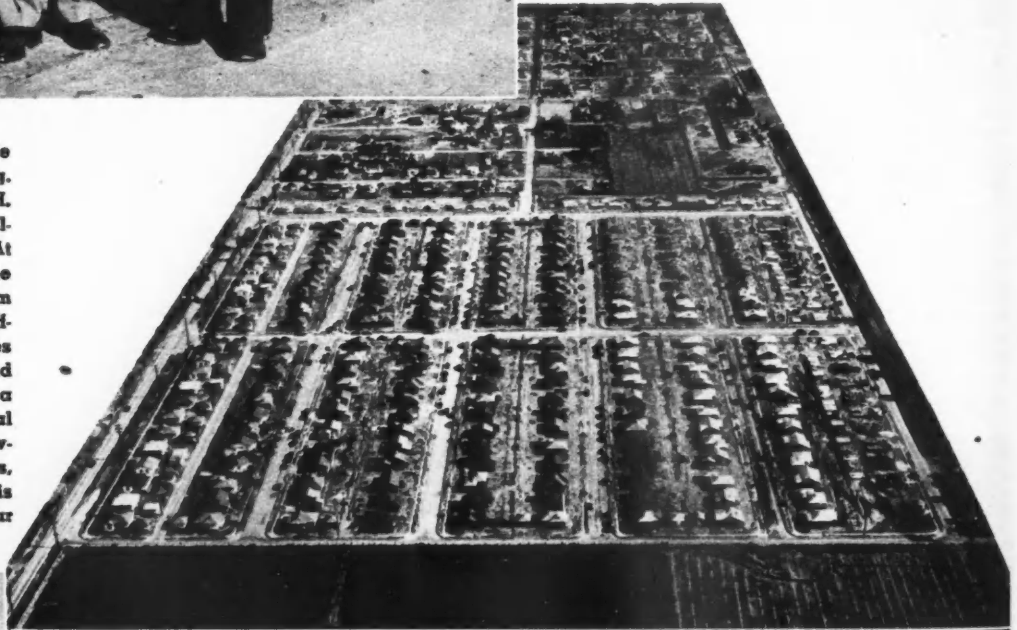

LAST
sing
structi
and bu
around
fast on
ed any
two ye
big op
horns a

It di
to go
250 ho
and F
believ
conside
were h
houses
the 35,
were in
fellow
that m
and S
newspa
wasn't
planned
000—th
them a
did, an
out be
complete

The
room u
of floo
includi
Sixty
voted
20 per
with 1
per ce
units w
The lat
as the
stated
houses
dollar
is that
was a
ones w
pany, t

All h
plaster
and th
walks
The c
shingle
and til
the mo
closet

KITCHE
ing cor
board.

for \$7,825 - With Attached Garages

LAST summer there were 35,000 single-family houses under construction in the Los Angeles area, and buyers were beginning to shop around. Completions were coming so fast on houses which had been started anywhere from three months to two years earlier, that many of the big operators decided to pull in their horns and take it easy.

It didn't seem to be the best time to go ahead with a new project of 250 homes. But Milton Kauffman and Frank Sheldon, his associate, believed they could produce a house considerably under the prices which were being asked for most of the houses on the market. The bulk of the 35,000 houses referred to above were in the \$10,000 price class. The fellow who couldn't afford to pay that much would search the Saturday and Sunday building pages of his newspapers in vain—there just wasn't anything for him. Kauffman planned to sell his houses under \$8,000—that is, if Sheldon could build them at a low enough cost. Sheldon did, and the first 250 homes were sold out before even one of them was completed—and without advertising.

The featured house is a two-bedroom unit containing 830 square feet of floor space and selling for \$7,825 including a one-car attached garage. Sixty per cent of the project is devoted to these two-bedroom units; 20 per cent to three-bedroom units with 1,010 square feet at \$8,875; 20 per cent to deluxe three-bedroom units with 1,070 square feet at \$9,450. The latter two models sold as readily as the smaller unit, although as stated above there is no shortage of houses in the nine and ten thousand dollar bracket. Perhaps the reason is that people felt that the small unit was a good value and since the large ones were produced by the same company, they must be a good value too.

All houses have stuccoed exteriors, plastered interiors, hardwood floors; and the price includes driveways, walks and a 5-foot fence in the rear. The deluxe models have wood-shingled roofs, tile floors in baths and tile wainscot above the bath. All the models have more than adequate closet space.

The Veterans Administration appraised the houses at the selling prices. F.H.A. made a commitment on the two-bedroom house of \$6,700. The terms were \$175 down and \$48.55 per month to a veteran. A non-veteran paid \$250 down. The company took back a second mortgage for the difference between \$6,700 and \$7,825, minus the down payment, when necessary.

Kauffman has been a leading land developer and builder for 40 years. He developed one of the first subdivisions in Los Angeles County records in 1907. He is the owner of the project under consideration. With the aid of Don Wilson, his righthand man, he acquires the land, subdivides it, finances the construction operations and directs the sales. Frank Sheldon is the builder.

The town of Norwalk in which this project is located is 15 miles from the heart of Los Angeles. Several other large operators had passed it up. But Kauffman made more than a superficial study of the area. He looked into the future and saw that the great industrial expansion of Los Angeles would have to be east and south. He believed that here was a

place to get started on a low-cost housing project which would sell at the present time due to the tremendous demand for houses, and a place where he could keep on building for many years to keep pace with the growth of industry toward that section. The cost of the land on the first tract plus the subdividing costs was approximately \$1,200 per lot. That is exactly the figure at which F.H.A. appraised the lots. The streets are paved; there are curbs, sidewalks and sewers. This is more than many subdivisions selling at twice the price can say. The lots are 60 feet wide by 100 feet deep. Kauffman donated seven acres of ground to the local school board for a school and park.

The builder, Frank Sheldon, has had a great deal of experience in the mass production of houses, using both conventional methods and prefabrication in its various forms. Before associating with Kauffman he was in charge of field operations for some of the largest contractors in the West, having directed the construction of some 5,000 homes. He states that perhaps some day someone will invent a system of producing houses

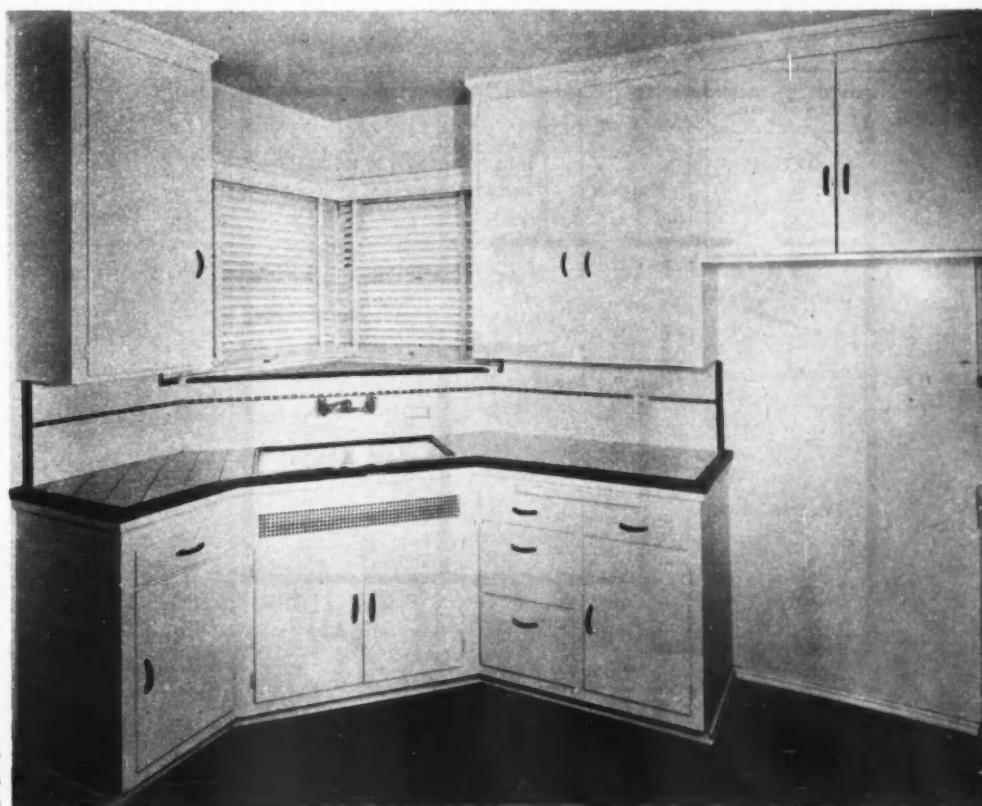

KITCHEN in one house of the project showing corner sink, tile back-splash and drain board, linoleum floor, and paneled cabinets



A TYPICAL house in the project, showing attached garage. Plans are at right

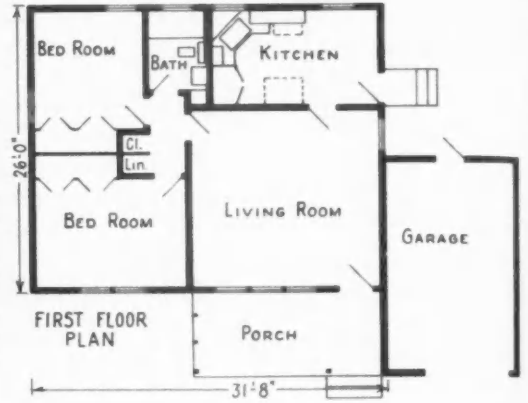

acceptable to both the financing institutions and general public by a prefabricating process at a price below the conventional type, but he has not yet seen such a system.

On this project, Sheldon is achieving exceptionally low costs (lower than the one or two prefabricators who remain in this market) by standard construction methods. The studs are cut to length before reaching the job but all the rest of the lumber is cut on the job. The lumber for each house is stacked at the foundations so it will be handy.

Sheldon handles his own carpentry but subcontracts the balance of the work. In order to obtain the utmost efficiency from his men in these days when it is difficult to get topnotch craftsmen, he simplifies the work to

the largest degree possible, by training crews to do only one job. For example, one crew lays the subfloors, one raises the framing, and another puts on the roof. The men become acquainted with their work and lose no time waiting for someone to tell them what to do next. Sheldon states that he receives fine cooperation from the union officials. He always informs them in advance of his anticipated requirements and they usually take care of him.

Costs on the two-bedroom model went up about \$150 while they were under construction but the company decided to absorb this increase on the first unit. They didn't want to change that magic figure \$7,825 which enabled them to sell 250 houses in 60 days without advertis-

ing or ballyhoo. This figure by the way includes financing charges of almost \$200.

A second tract of 50 homes has since been completed; a third of 565 is well on the way and engineers are now staking a fourth which will take another 500 homes.

During a 120 day period, Kauffman sold 400 houses net, and after deducting the inevitable cancellations, the total amounted to about \$3,500,000.

Kauffman is now planning a business center which will require a \$250,000 investment on his part. He will erect the stores and rent and lease them in accordance with the practice of most subdividers, thus enabling the community to be provided with all essential services.

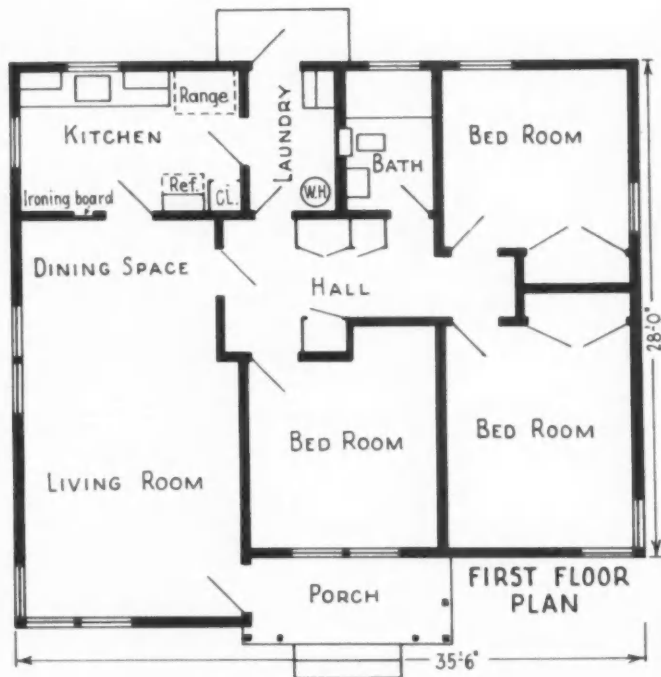

ABOVE is the plan for three-bedroom house in Norwalk Manor. Ample space for kitchen-laundry facilities is included. At right is bathroom, showing medicine cabinet, tiled floor and tile wall around bath

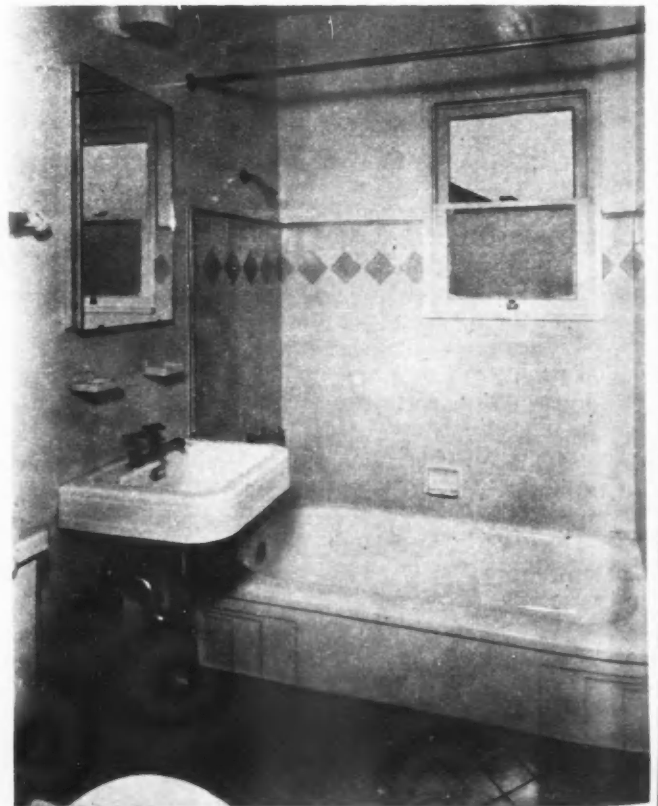

THE
typ
Carl
thoug
long
plus
situa
ness
Such
cause
space
ample
comm
Th
on an
the b
at ab
\$19.0
stucc
in the
with
Ba
clude
fixtur
nace,
Schla
ity-B
heater
show
Th
in Al
Gabri

by the
ges of

es has
of 565
ers are
ill take

Kauff-
d after
ancell-
about

a busi-
quire a
art. He
ent and
with the
s, thus
be pro-
ces.



“Tailor Made” Home Has Distinction

THE house shown on this page is typical of a number constructed by Carl Bryan, Pasadena, Calif. Although the houses are not large, the long, low sweeping lines of the design plus the large lots on which they are situated give an impression of roominess and opportunity for good living. Such an impression is not wrong because there is a surprising amount of space in these small homes providing ample facilities for good average accommodations.

The house shown above is situated on an 85-foot lot, 35 feet back from the building line. With the lot figured at about \$5,000, the house sells for \$19,000. The exterior is finished in stucco, with bevelled redwood siding in the gable ends. The roof is covered with cedar shingles.

Basic materials and equipment include: Standard-Sanitary plumbing fixtures, a Holly gas-fired floor furnace, J-M mineral wool insulation, Schlage hardware, Pomona tile, Quality-Bilt cabinets, Day & Night water heater, select oak floors, and a separate shower stall in the bathroom.

The house featured here was built in Altadena, in the foothills of the San Gabriel mountains.

Specializing in “Made to Measure” houses, Carl Bryan has built a successful homebuilding business—with every owner a satisfied booster

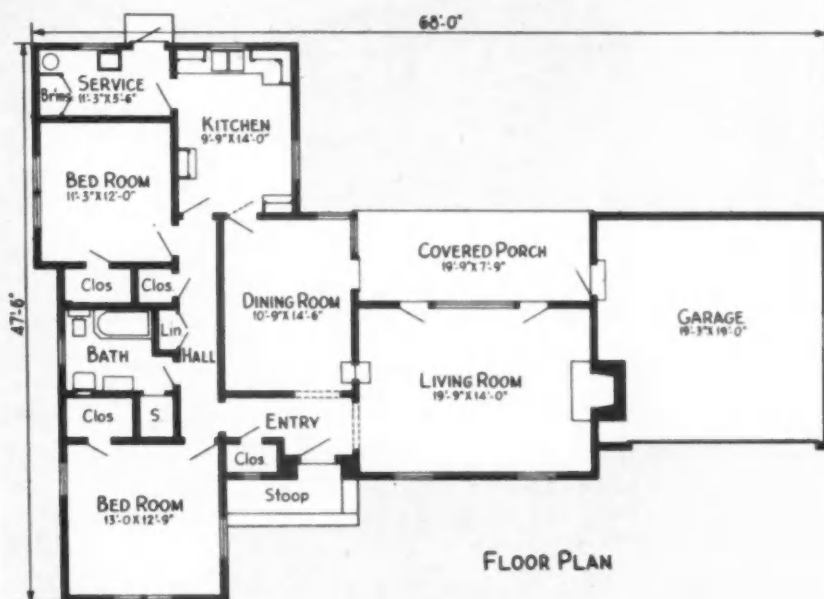

PLAN of Carl Bryan's "tailor made" home, which sells at \$19,000



Outdoor Views—Indoor Comforts

Every room has a wall of fixed and louvered glass panels. Width of roof overhang on all three sides was arranged to cut the summer heat while admitting the longer rays of the winter sun

All Photos by Baskerville Photograph



NORTH wall of house at left consists of window wall of utility, kitchen and living room. Wide redwood fascia board, hiding gutter, trims roof projection all around house. East elevation is shown at left and below. This side of house is children's play yard. Right, dining terrace looking toward bedroom wing. Redwood siding on walls

CASE study house number two is one of a group of houses that is being built on the west coast. Its purpose is to give direction to the creative thinking being done by an ever increasing number of architects, builders and manufacturers. Their joint objective is to stimulate advance thinking in the minds of the building public; in order to produce good, sound and practical housing.

This house was built by Eric Barclay from plans prepared by Sumner Spaulding and John Rex, A.I.A. architects, both of Los Angeles, Calif. The architects had to solve the problem of designing a house that would meet the needs of extensive entertaining. The plan and orientation were developed with consideration given to the site and the social and private life of the occupants. This house, being of a comparatively moderate footage, was given apparent added increase in size through the extensive use of entire walls of glass. This fact provides a movement of space in and around the house and completely through the living area.

The house as seen from the crest of the entrance drive is dramatic in line and form. The long serpentine



wall stemming from a group of trees near the property line, enters the house several feet below the roof overhang. It separates the motor court, car shelter and entry, from the living terrace and grounds. The curving in and out of this wall offers a striking contrast to the straight lines of the house.

The general plan of the house achieves a feeling of spaciousness and flexibility. The plastered ceilings are picked up by the plastered soffit of the overhang and the long glass walls tend to increase room sizes. The living area is not broken by any floor to ceiling partitions. A twelve foot long case, open at both floor and ceiling separates the dining portion from living room. The one solid wall of the living room contains a split brick fireplace capped with a lip of black soapstone. The wall around the fireplace contains book shelves and paneled cupboards.

The kitchen work space is "U" shaped. Cabinets fill the wall above the counter. Bar storage on the kitchen side of the pass-through gives the counter a double function. Two transparent glass panels slide over one another and enlarge both kitchen and utility room. In the utility room there are drawers and shelves in abundance. Space is provided for washing machine and ironer.

PORTION of east wall of living room at left. Open shelves for books extend from fireplace to bedroom door. Solid row of table-height drawers hold gaming equipment. Bins for record albums below. Balance of east wall of living room below. Fireplace is faced with split brick and capped with lip of black soapstone. The wall above the fireplace is birch plywood



MATERIALS AND EQUIPMENT

- Thomas moulding asphalt tile
- Hoegger Inc. bathroom cabinets and accessories
- Thermador Manufacturing Co. bathroom heaters
- Amerok cabinet hardware
- Square D. Co. circuit breaker
- Nu-Tone door chime
- Draft Bloc Draft Seal
- Kirsch Co. drapery hardware
- Red Comet fire extinguishers
- Hammel Engineering Co. furnace
- Kimsul insulation
- Met-L-Top ironing board
- Formica kitchen counter top
- Kinkead Industries metal trim
- American Radiator & Standard Sanitary Corp. plumbing fixtures
- Flintkote roofing materials
- Permalite luminous switch plates
- Frigidaire refrigerators
- Victron ventilating fan
- Laundrall washer
- Continental water heater
- Dalmo window hardware



THE pass-through pantry in kitchen has sliding doors and shelves which open from both sides. Left: Dining room side of pass-through. Divisional case, open above and below, has sliding glass doors and shelves for storage of silver and dishes. Below left: Recessed niche at end wall between kitchen and utility room. Below: Transparent glass sliding panels separate utility room from the kitchen



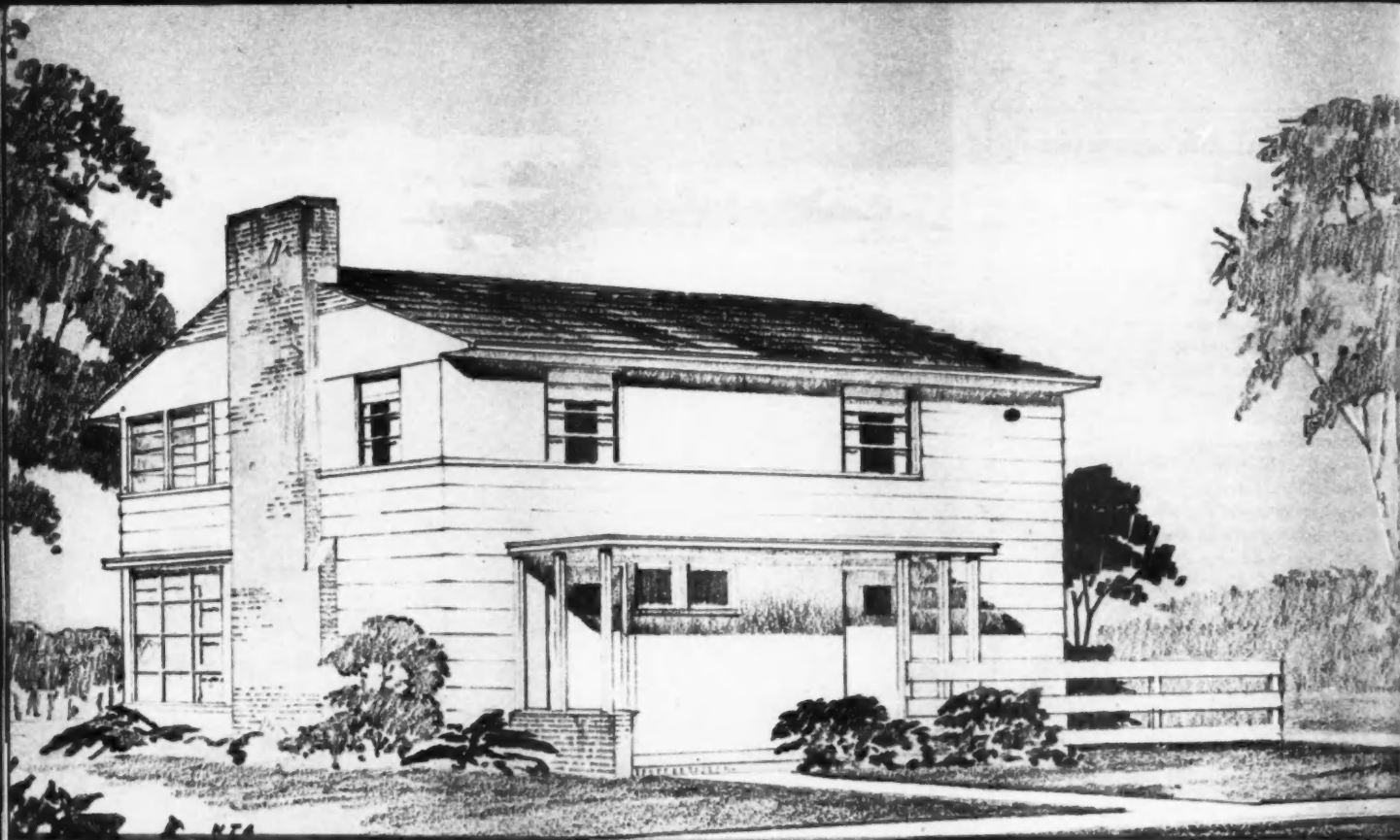

SIMPLE, straightforward lines prevail throughout the exterior, with a contemporary touch in the large windows of the major rooms

Here's One for All Builders

Anicka
**BLUEPRINT
HOUSE No. 14**

THE builder of today is constantly seeking ways and means of keeping the so-called small house in line with mounting costs. In the house shown on this and the accompanying pages, Walter T. Anicka, architect of Ann Arbor, Mich., has produced a design that has been reduced to its simplest form, yet retains that elusive quality of proportion that gives it character and distinction.

This house can be readily adapted to minor changes that may be required to meet the special needs of a builder. The overall dimensions are $22\frac{2}{3}$ feet by 28 feet with the 28-foot width toward the street. The design is so flexible that the $22\frac{2}{3}$ -foot depth or living room end, can be placed to the street without any change in plan. With exterior changes in materials, a number of variations may be obtained. This possibility would be an asset to a builder in the event that a number of houses were to be erected in the same locality.

In the study of the plans, it can be observed that economy of construction, especially in relation to framing and roughing-in of the various utilities, was paramount in the mind of the designer. Bathroom, kitchen and laundry are placed one above the other so that supply and waste stacks are concentrated together. The arrangement of the front and service door, opening on to the same entrance porch is unusual. This increases the efficiency and workability of the plan, and also permits the rear of the lot to be used as a garden and outdoor living area.

A terrace or porch can be easily added to the rear of the living room at some future time. A garage can also be conveniently placed alongside the outside wall of dining room, without resorting to major alterations to the house.

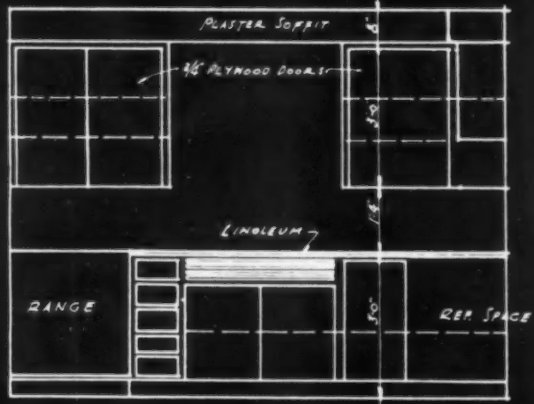

KITCHEN
SCALE 1/4" = 1'-0"

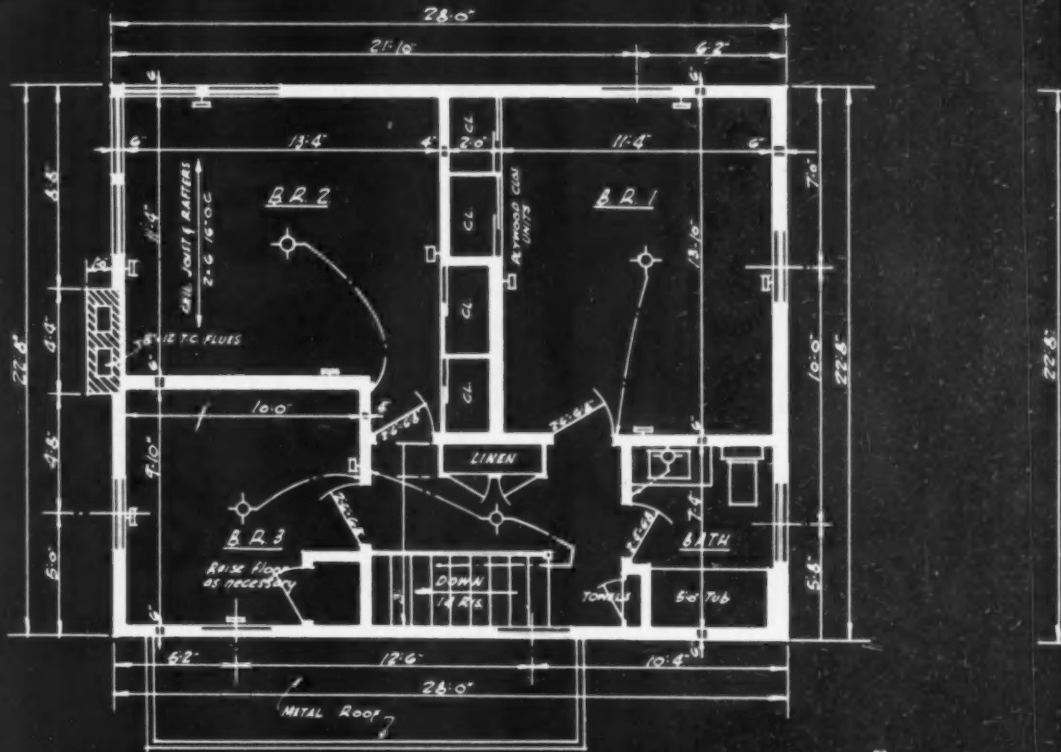

SECOND FLOOR

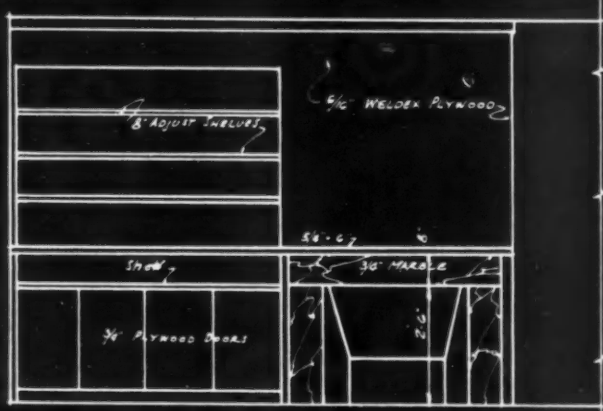

ELEVATION

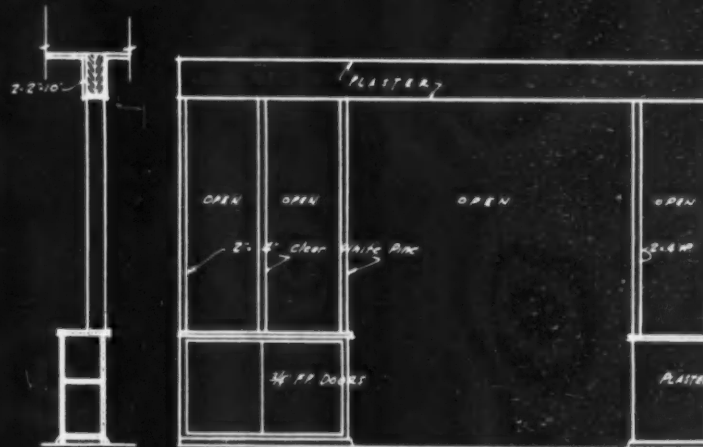

SECTION

ELEVATION

DETAIL P-2
SCALE 1/4" = 1'-0"

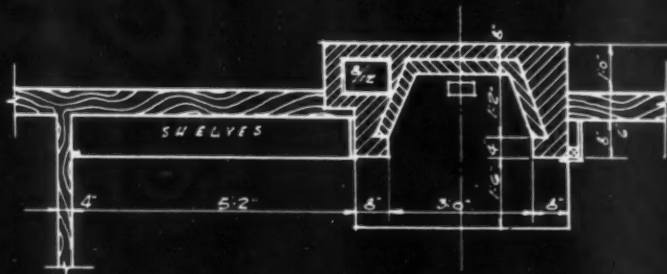

PLAN

DETAIL P-1
SCALE 1/4" = 1'-0"

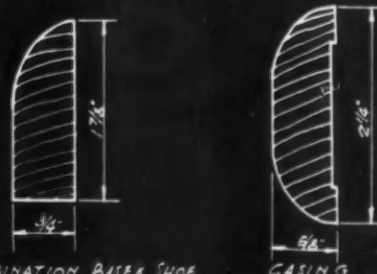

TRIM DETAILS
SCALE 1/2" SIZE

USE 3/4" x 4" S&S
PLINTH AS BASE

BASE

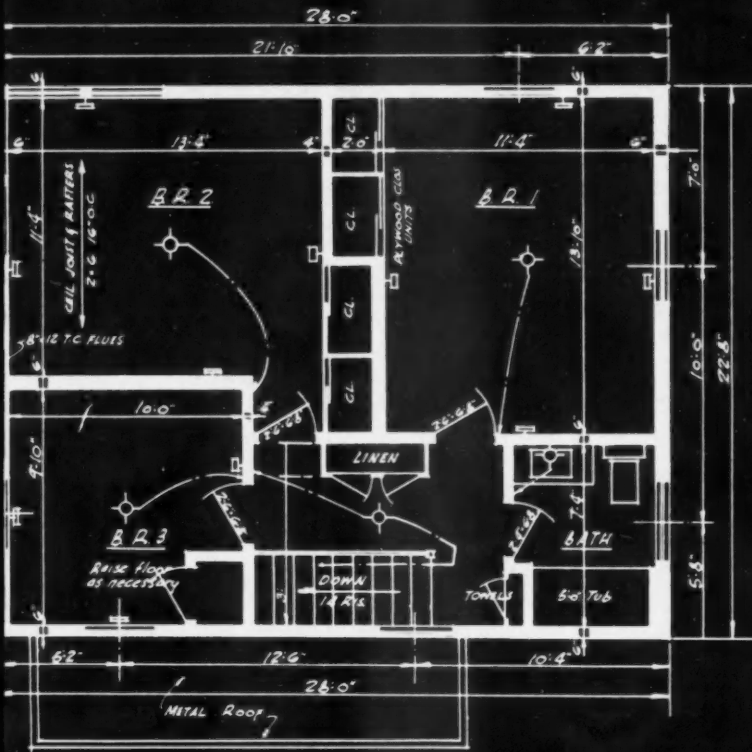

SECOND FLOOR.

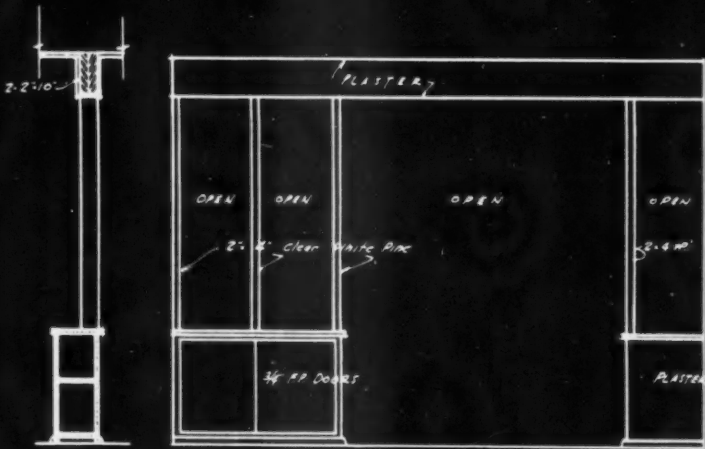
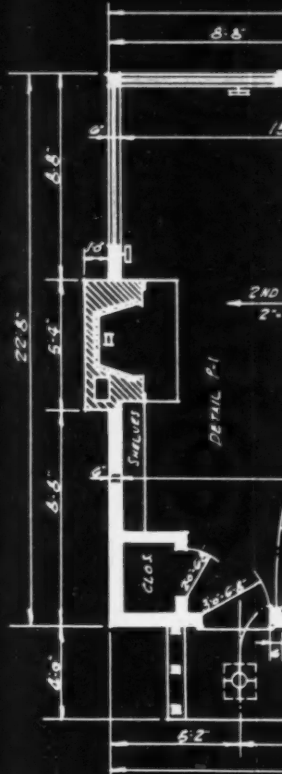

SECTION.

ELEVATION.

DETAIL P-2
SCALE 1/4" = 1'-0"

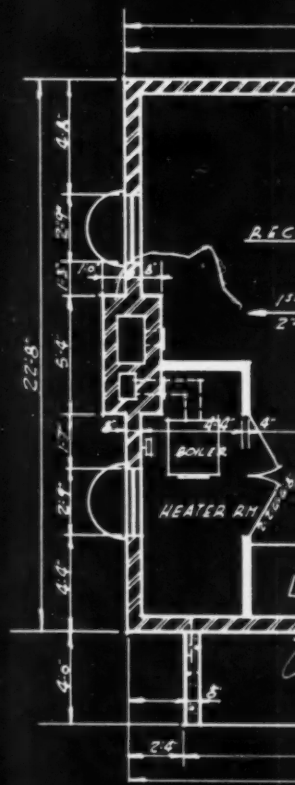

BASEMENT.

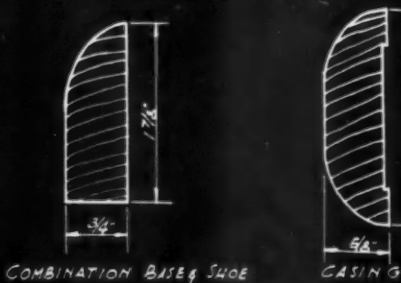

COMBINATION BASE & SHOE

CASING

USE 3/4" x 5/8" PLINTH AS BASE

TRIM DETAILS
SCALE 1/4" = 1'-0"

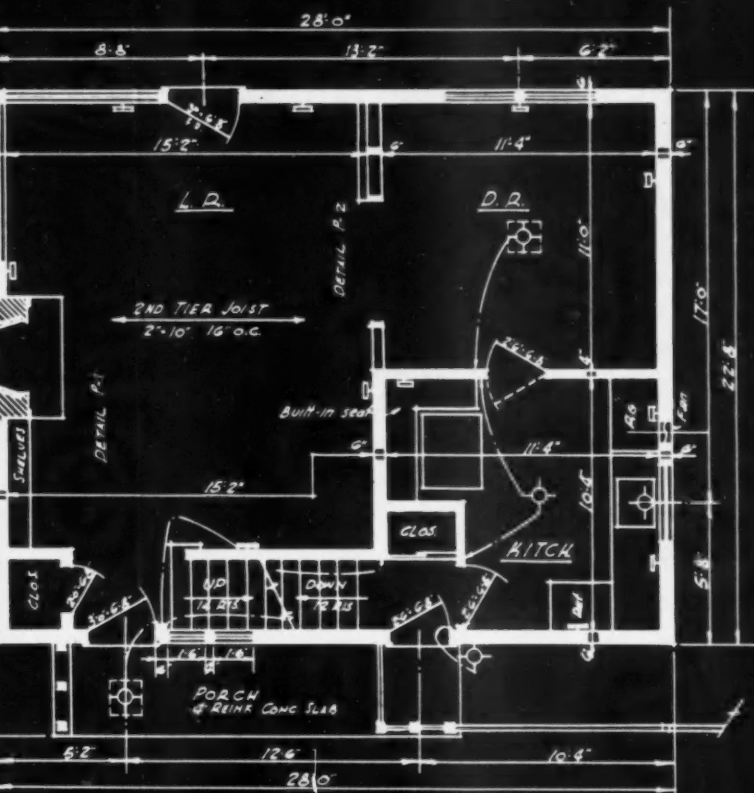

• FIRST FLOOR.

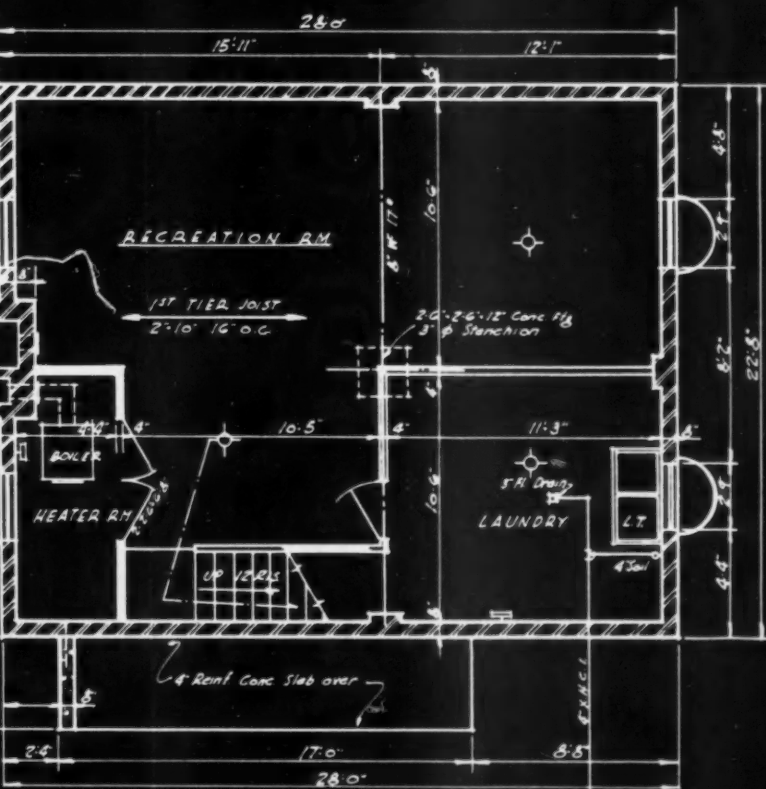

ENT.

DESIGN No. AB 127	
AMERICAN BUILDER BLUE PRINT SERIES	
Designed By	
WALTER T. ANICKA,	ARCHITECT.
Ann Arbor,	Michigan.
Simmons Boardman Pub. Corp. 105 W Adams St. Chicago, Ill.	

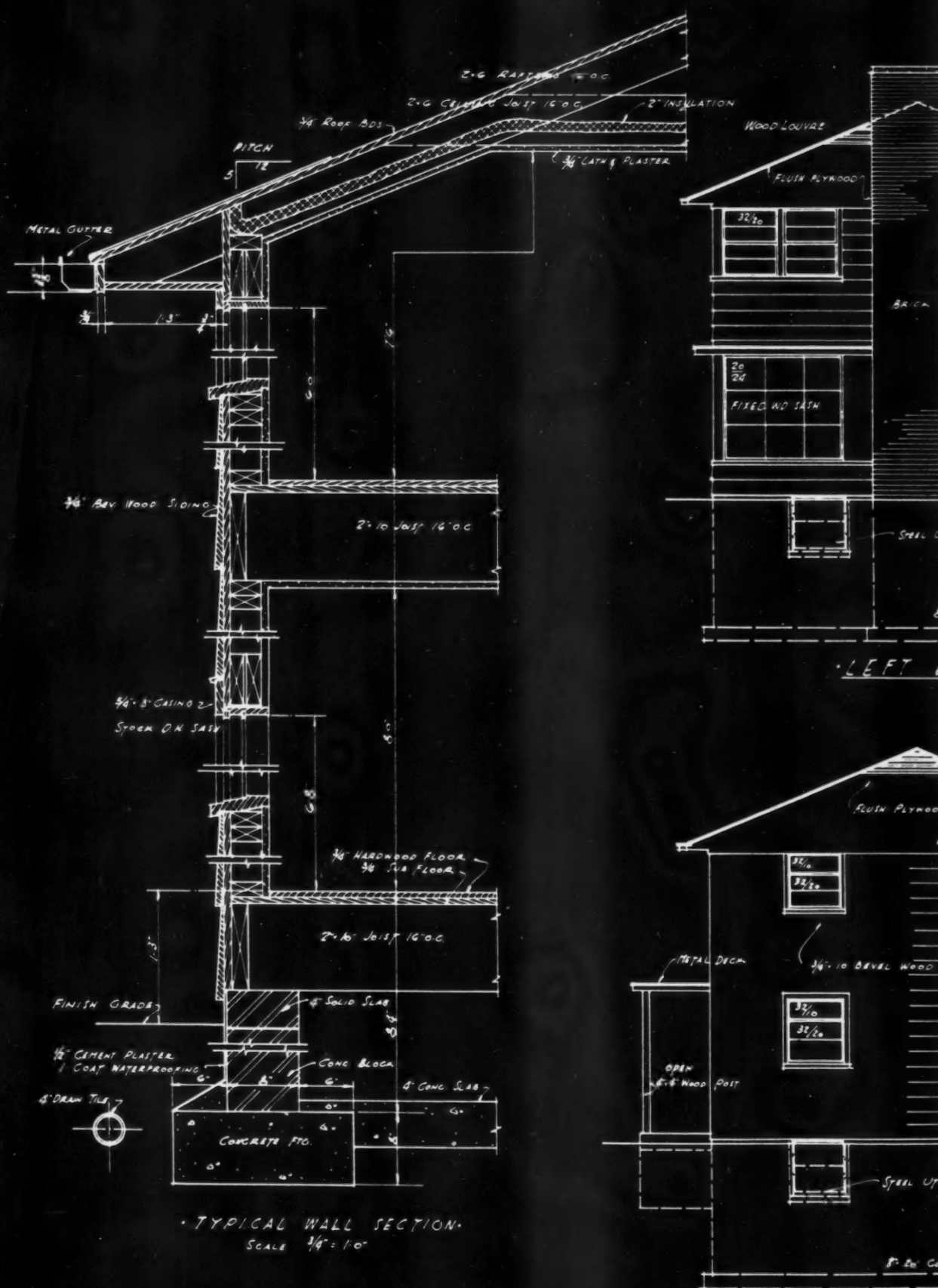

TYPICAL WALL SECTION
 SCALE 3/4" = 1'-0"

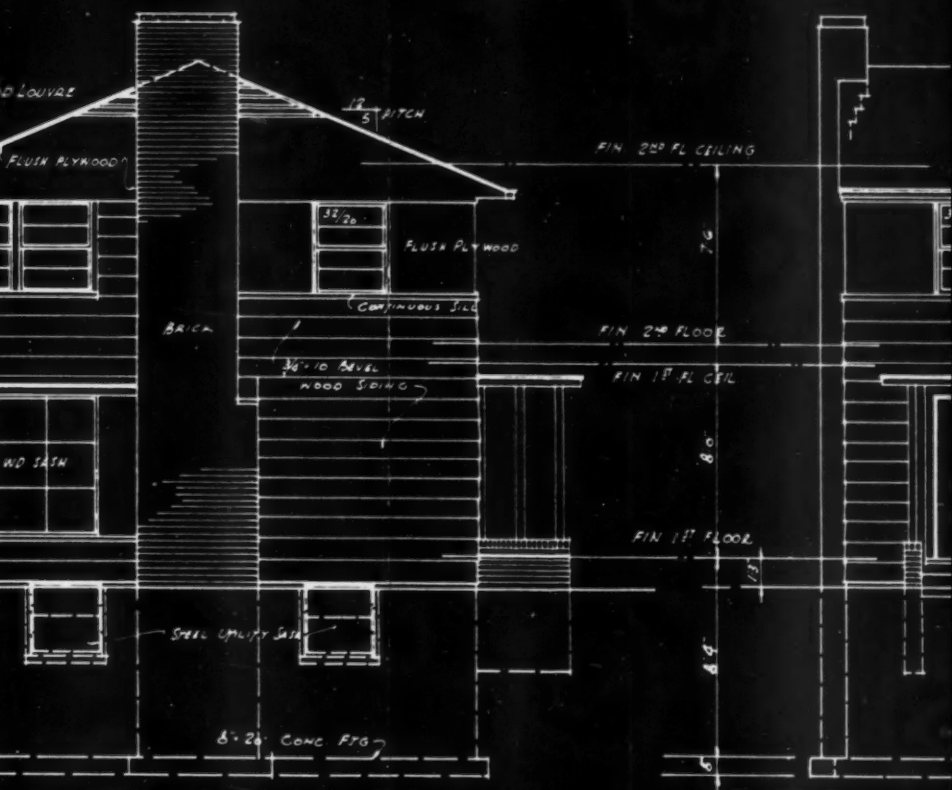

• LEFT ELEVATION •

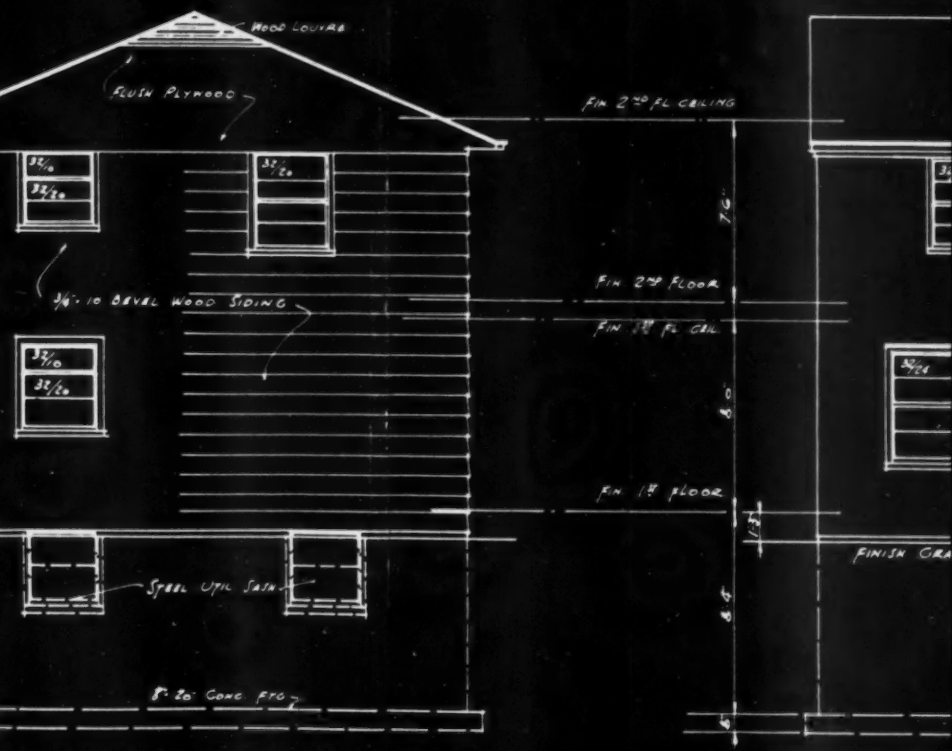

• RIGHT ELEVATION •

• ELEVATIONS •
SCALE: 1/8" = 1'-0"

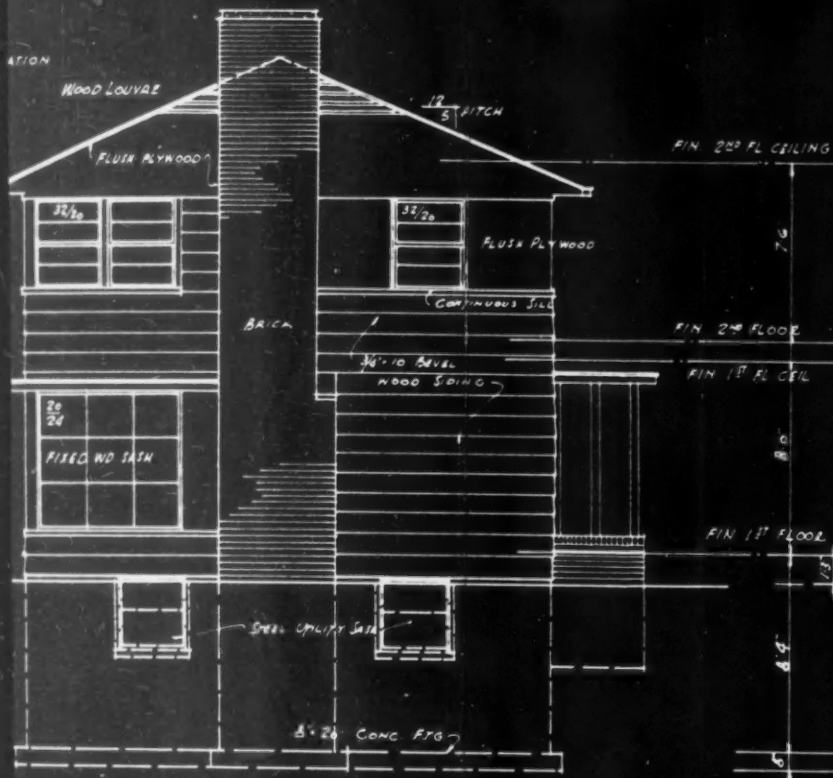

LEFT ELEVATION

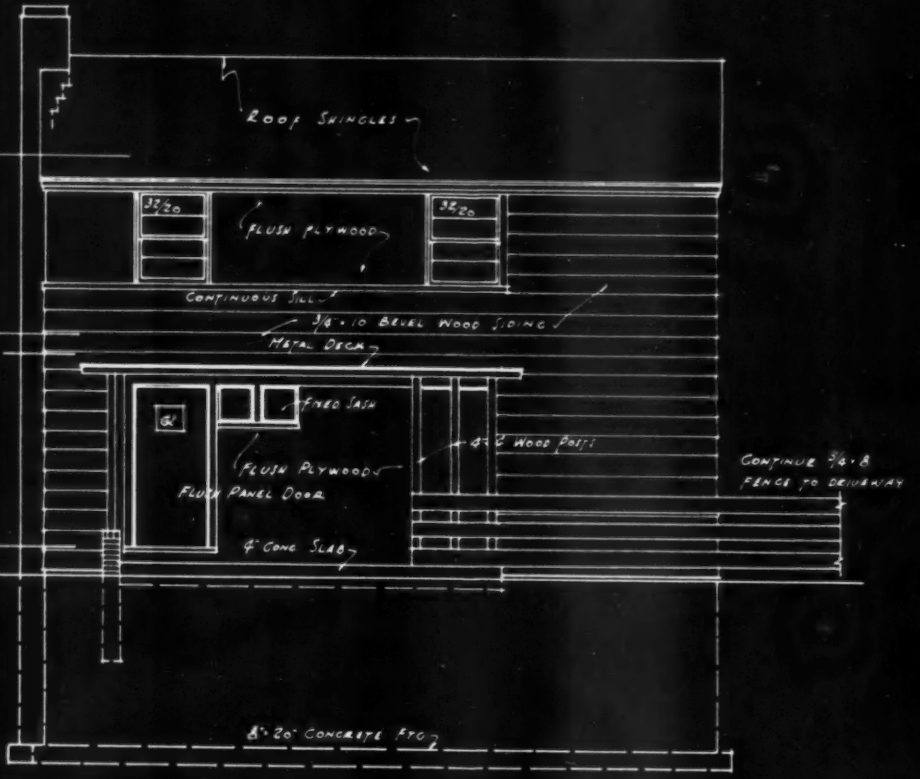

FRONT ELEVATION

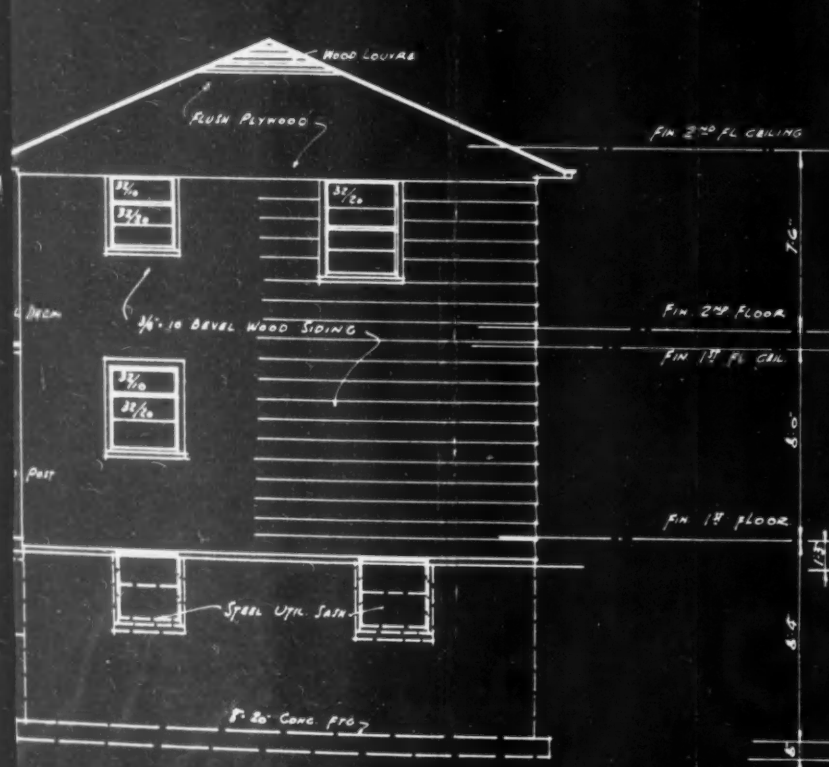

RIGHT ELEVATION

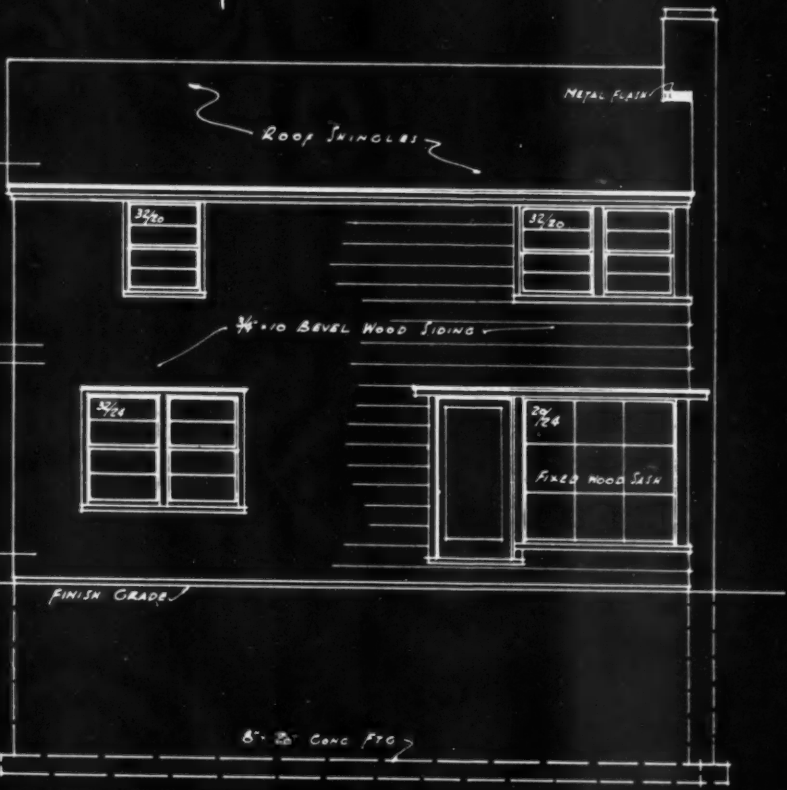

REAR ELEVATION

ELEVATIONS
SCALE 1/8" = 1'-0"

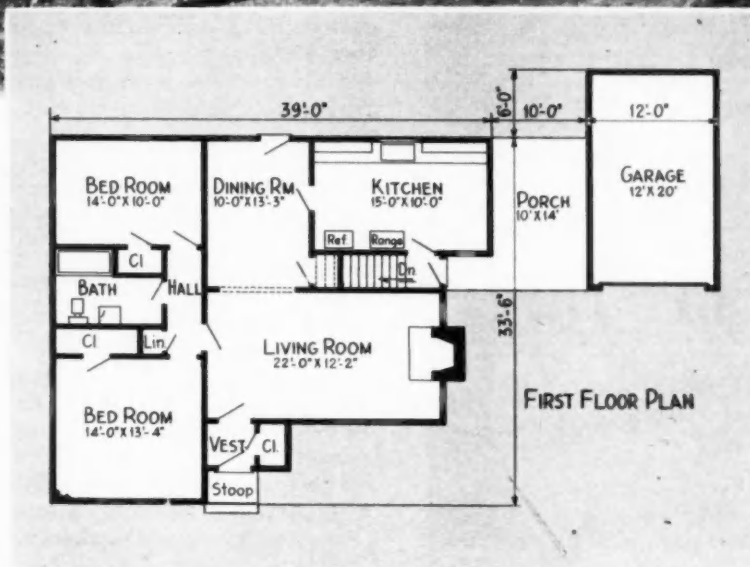

Good Value Sells Itself

WHEN a builder gives plus values in new construction at a time when demand far overshadows supply, his customers know that good building practices are habitual with him. Examples of such plus values are found in a 66-house project built in Springfield, Mass., by Joseph Chapdelaine.

These homes, nearly all three-bedroom plans of which several are illustrated here, sold from \$12,500 to \$12,900. In traditional colonial, for the most part, in keeping with New Eng-

Builder creates future business potential by delivering a lot of value in middle bracket homes during period of high cost

ROOF and sidewall variations, staggered building lines and different materials relieve monotony of 66-house project



A HIP ROOF. Dutch colonial variation and gable roof colonial, each having different exterior sidewall treatment and some window differences, completely change the appearance of a single floor plan. Note that all garage doors are upward acting in four sections for easy articulation

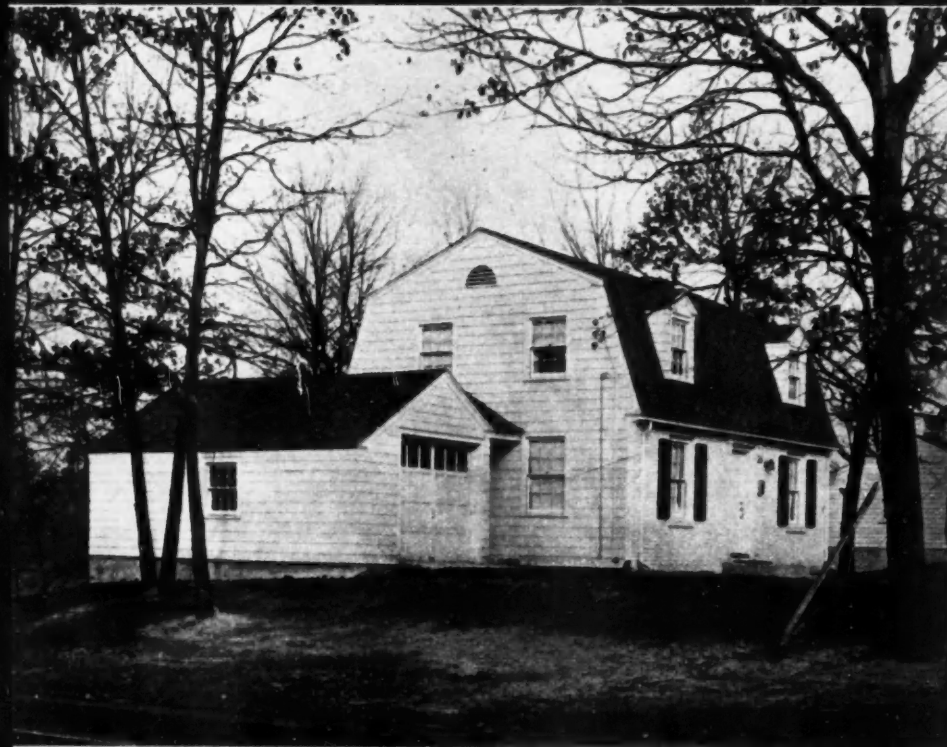

land conservatism, they are modern in their construction features and have first-rate materials, secured at a time when material was difficult to get.

It is natural that Mr. Chapdelaine should be in the habit of using high quality materials, for in prewar years he specialized in expensive, custom-built homes. It was only when rising material prices and supply shortages virtually eliminated such construction that he entered the small home field. Even so, he did not turn out any of the small-dimension, two-bedroom houses of which so many thousand have gone up all over the country. He employs several devices to avoid monotony in appearance, even when most of the floor plans are the same. Changed roof lines, reversed plans, different fenestration, varying door treatments and exterior mouldings all contribute to individuality of appearance.

The result has been that buyers in Springfield have been eager to purchase a Chapdelaine home. That eagerness will be carried over to the time when salesmanship again will be required to move new homes—a time not too far away, according to some predictions.

With the exception of the house shown on the first page of this story, all the homes are three-bedroom type. The exception has five rooms on the first floor with an expansion attic for future finishing of two additional bedrooms.

The framing lumber was either fir or Canadian spruce throughout. Floors are good quality oak hardwood. Baths are ceramic tile, and kitchens are floored with inlaid linoleum. Kitchen cabinets are custom-built of wood. The Chapdelaine houses are insulated fully with 2-inches of mineral wool in the sidewalls and 4-inches for cap insulation. Copper and brass plumbing is used throughout. A gas furnace provides forced hot air heat.

Foundations are of poured concrete with steel beams. Walls are plastered. Asphalt strip shingles are used for roofing. Exterior sidewalls generally are of bevel siding or cedar shingle, although brick veneer facings are used occasionally to vary the appearance of the front of a house.

Steel casement windows are used in the most expensive house. The others have double-hung wood sash except where large fixed windows are used.

ENTR
hous
exter

The
glas

E

feat

usu

bre

wid

lot

hou

size

feet

feet

are

M

by a

shop

alth

tool

Flo

prec

in th

don

teric

kitch



ENTRANCE detail of one of Chapdelaine's houses. Millwork for such entrances and exterior moulding is done in his own shop



These, in some cases, are of plate glass, but usually are small paned.

Each house has a fireplace, central feature of the living room. The garage usually is attached to the house by a breezeway which may be narrow or wide, depending on the width of the lot. Chapdelaine does not crowd his houses too closely together, and lot sizes range from 75 feet up to 100 feet in width and are from 100 to 125 feet deep. Existing trees on the sites are preserved where possible.

Mr. Chapdelaine keeps costs down by a precutting operation in his own shop. This is not an on-site shop, although he plans to use some power tools for site precutting in the future. Floor joists, studs and rafters all are precut. Stairs are made and finished in the shop. Much of the millwork is done in the shop also, including exterior doorways, fireplace mantels and kitchen cabinets.



TWO other exterior variations of the same floor plan used for houses on facing page. Note decorative touch given by exterior mouldings. Floor plans for entire group below

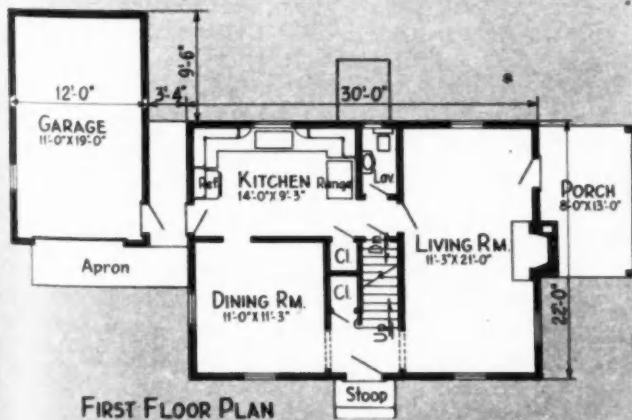

FIRST FLOOR PLAN



SECOND FLOOR PLAN

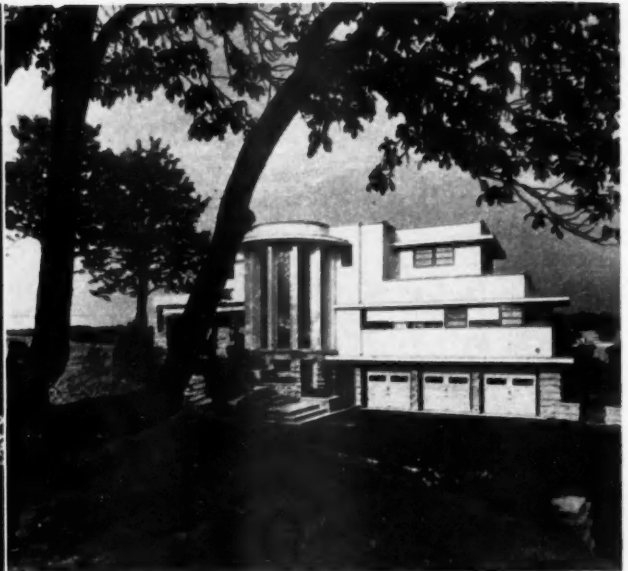

MAIN entrance to house at left. Garage court above

Designed to Meet Special Needs

THE OWNER of "Rancliff," Mr. E. C. Raney, was a farm boy who had lived all his adult life in the city, and at 60 years of age wanted to return to farm life.

When they went to the architects, Tibbals, Crumley and Musson, Columbus, Ohio, they had definite ideas of what they wanted incorporated in a new house. They wanted a place where they would be comfortable living alone. They also wanted to accommodate their children, all married, and quite a collection of grandchildren over week-ends. The solution to this problem was to place all the owner's living quarters on the

first floor with a suite of three guest rooms with two baths on the second floor. The owner's suite can be locked off from the rest of the house.

Another requirement they placed on the design was that the stairway should curve and be placed inside a curving glass block wall.

The third requirement was that the house should be modern. This idea coming from a gray-haired couple is quite understandable when one realizes that Mr. Raney is the inventor of the automatic circuit breaker and a number of thermo-static controls used by air conditioning and refrigerating concerns.

As might be expected, the house of an inventor would have certain mechanical innovations. The heating system is forced air, and for summer, the air is passed over a coil that is cooled by water from a deep well. The water is then pumped to the roof where it stands in a four inch puddle for added insulation. The overflow is collected and used for watering the garden.

The exposed ground floor is built of native limestone with concrete block backup. The walls above are stucco on wood frame, heavily insulated. The flat roofs are of tar and gravel.

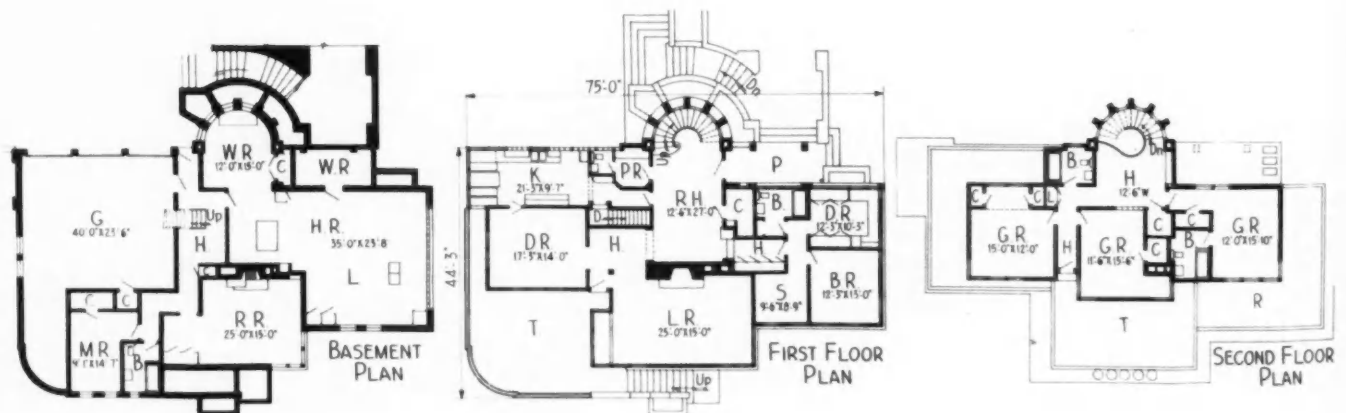

PLANS adequately care for the needs of the Raney's, as well as providing room for children and grandchildren during visits

R A
heat
spic
the
use
drap
men
ing
inst
R
beca
liver
radi
obje
rath
pass
very



"BEFORE" and "after" photographs show replacement of a radiator with radiant baseboards

Engineered House Construction Radiant Baseboard Heating

By J. L. Shank

Consulting Engineer

RADIANT baseboard heating, like radiant panel heating, provides heat from a source that is inconspicuous while leaving almost all of the floor and wall space available for use in the arrangement of furniture, draperies, and other household equipment. It can be installed in an existing structure as readily as it can be installed in a new building.

Radiant baseboard heating is clean because while some of the heat is delivered by convection, most of it is by radiation. Heat by radiation heats the objects which it comes in contact rather than the air through which it passes. Since the air is not heated, very little air circulation will be set

up in the room by warm air rising. This holds deposits of lint and dust on the walls, draperies, and furniture at a minimum.

Radiant baseboard heating provides a curtain of warmth from the floor to the ceiling. Many installations show not more than a three degree temperature difference between floor and ceiling. This uniform temperature is achieved because the heating unit usually covers the entire outside wall, thus preventing cold air, which normally filters in from the outside, from penetrating the room. In addition radiant heat rays are emitted into the room at ankle height and warm everything within their path. Thus

with the cold kept from reaching the occupants of the room, and the floor area blanketed with heat, the overall results are satisfactory.

Radiant baseboard heating is piped in the same manner as conventional heating systems which use radiators or convectors. By having such a piping arrangement, it is possible to reduce the heat in any room immediately by closing the supply valve on the unit within the room.

In some instances it is difficult to get enough baseboard in a room to take care of the heat loss. At times it is necessary to extend the baseboard onto inside walls and other times it is necessary to augment that with radia-

This is the tenth article in the *American Builder* series to acquaint builders with the fundamentals of good home heating system selection and installation. Again the Anicka two-story Blueprint House No. 10 was used for a typical installation

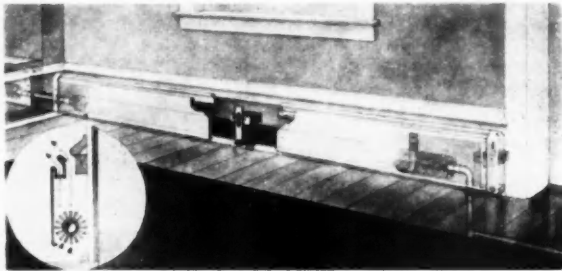

CUTAWAY view of a modern baseboard heating unit

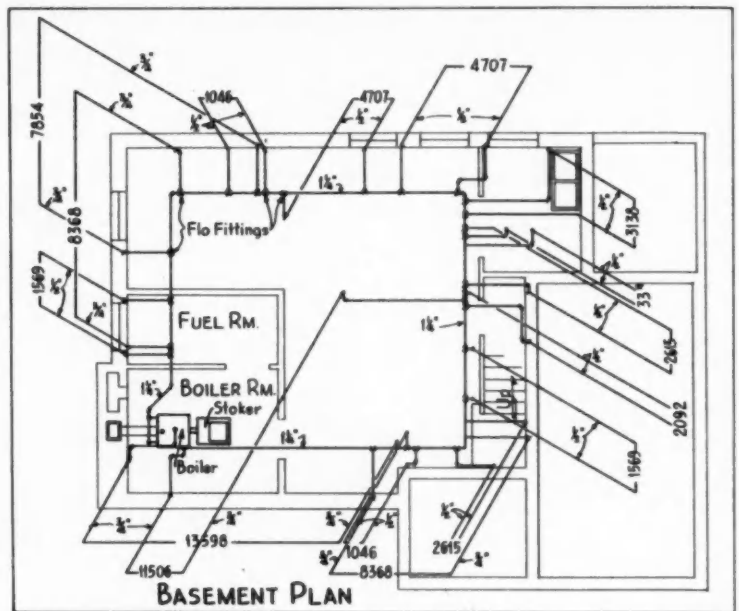

tion of another type. This has been done in the heating plan accompanying this article.

The residence used here is the same standard two-story colonial residence, designed by Walter T. Anicka, architect, Ann Arbor, Mich., around which other articles have been written. The heat loss calculations are based on an inside temperature of 70 degrees Fahrenheit, except the bathroom, which is figured on an inside temperature of 80 degrees Fahrenheit, with the outside temperature of 10 degrees below zero.

The heat losses are based on a first floor wall construction of brick veneer, 25/32 insulating board sheathing, studs and plaster on gypsum lath. The second floor wall construction is wood siding, 25/32 insulating board sheathing, studs and plaster on gypsum lath. The window calculations are based on double hung wood sash without weather stripping or storm sash. The infiltration figures are based on between averages and poorly fitted windows and doors. The coefficient of heat transfer for the second floor ceiling was based on plaster on gypsum lath with a 2½-inch thick mineral wool fill or bat.

HOT WATER IS USED AS THE HEATING MEDIUM

After making the necessary heat loss calculations for the building, it was decided that hot water would be the heating medium. While it is entirely possible to use steam or vapor with radiant baseboard heating, it is a general consensus that hot water is more adaptable. To begin with, the baseboard will not expand or contract as much with hot water as it will with steam or vapor, due to the fact that the temperature of the heating me-

diuum is not as great. Hot water is more easily controlled because only a slight increase or decrease in temperature will affect the entire heating system.

HOW B.T.U. EMISSION RATE WAS DETERMINED

With hot water as the heating medium, the B.T.U. emission rate of the radiant baseboard panels was determined by trying to utilize as much of the outside wall space as possible, and as little of the inside wall space as possible, a B.T.U. emission rate of 200 was decided upon. The use of 200 B.T.U. provides leeway for the system to keep the building warm regardless of whether the outdoor temperature goes below 10 degrees below zero or whether the occupants desire the inside temperature to be above 70 degrees Fahrenheit. All that is required in either instance is to increase the boiler water temperature, thus increasing output of the baseboard panels.

Coal has been selected as the fuel and, inasmuch as it is practical and economical to heat domestic hot water the year round from the heating boiler, a stoker has been specified to maintain a constant boiler water temperature. While a stoker does not provide a completely automatic system, the fire has to be cared for only once or possibly twice a day in extreme weather.

The heating of domestic water the year round from the heating boiler has proved to be economical. Using the same types of fuel in both a direct-fired water heater and in a boiler which heats the water indirectly, the cost of operation during the summer months is greater with the boiler and indirect water heater. During the

heating season, however, it is much cheaper to heat the domestic water with the boiler and indirect water heater. Thus, by taking both methods of heating domestic hot water on a year round basis, it has been proved that less fuel is consumed in the boiler and indirect water heater installation.

In addition to the saving in fuel through the installation of a system of indirect water heating, it has also been found that there is less service on the automatic firing device and less deterioration on the boiler itself. The automatic firing device may be compared to an automobile. If an automobile is run a little each day, less service will be required than if it is run eight months and allowed to stand idle for four months. Likewise if a little heat is kept in a boiler at all times, there will be very little, if any, rust or scale form and, consequently, very little deterioration. For economical maintenance, the heating system should be operated year round.



RADIANT baseboards heat at ankle height

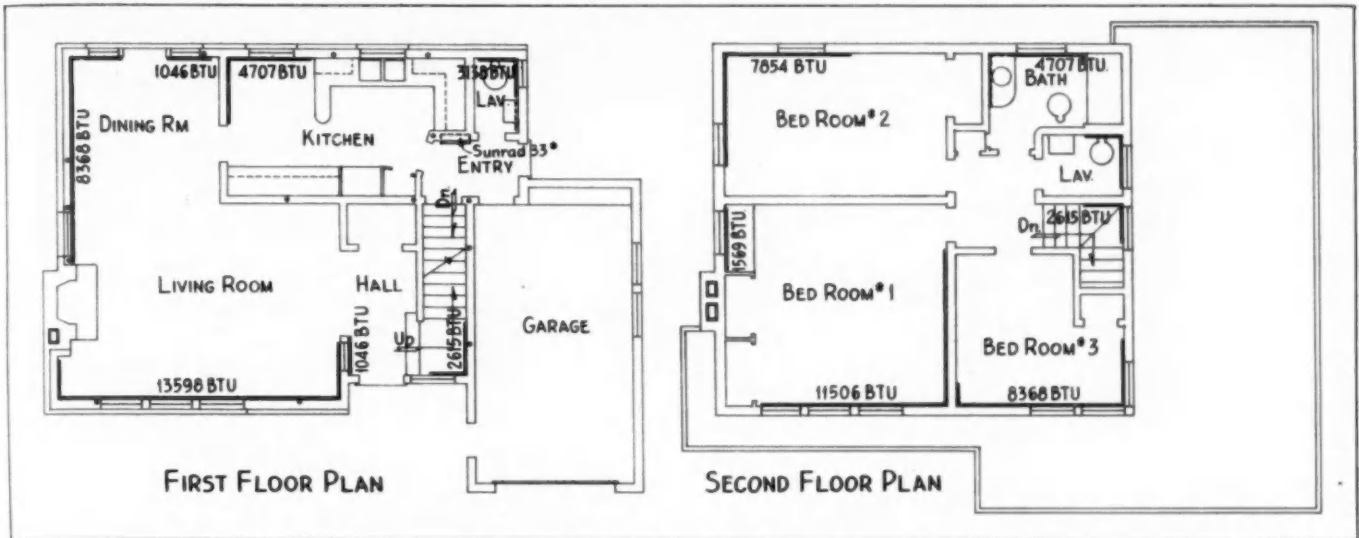

RADIANT baseboard panels are located in all rooms except the entry. Here it became necessary to use a cast iron radiator for reasons explained in the article

Since air in a hot water heating system has always been a source of annoyance, a great deal of concern was given to its elimination when designing this system. It is a known fact that before a radiator, convactor or a radiant baseboard will heat, air must be eliminated. The usual procedure is to provide each radiator, convactor or radiant baseboard with a compression type air valve and to open the valve when the unit ceases to function properly. These comparison aid valves are placed on each of the baseboard panels and on the radiator in this installation. Another provision was also instituted to take care of the elimination of air from the system after the initial eliminating process. This is the installation of an Airtrol boiler fitting. Tests have shown that air in the water in a hot water heating system is released at the point of heat application, which is the boiler. The function of the Airtrol boiler fitting is to project the supply main for the baseboard panels into the boiler approximately two inches. This forms a trap in the top of the boiler at least two inches deep into which the air is pocketed as it is released from the water. By forming this trap, the air does not escape to the baseboard panels where the air would have

to be eliminated before the panels will heat. The air pocketed in the top of the boiler is eliminated through the Airtrol into the compression tank. Compression tanks are used to take care of the expansion of the water in hot water heating systems when the water is heated. The compression tank with the Airtrol system is also put to the same use as well as taking care of the air which is released from the water as it is heated.

HOW THE VENTS WORK WHEN SYSTEM IS FILLED

When the entire system is being filled with water, all the vents on the baseboard panels are opened to permit the release of air in the panels. In addition, the air vent on the Airtrol which is fitted into the compression tank is also opened to permit the flooding of the compression tank. After all of the air within the system has been completely eliminated and the system filled with water, all of the vents are closed. Then, before turning on the booster pump to circulate the water through the system, the temperature on the boiler is built up to 220 or possibly 240 degrees Fahrenheit. In building up the temperature within the boiler, the air in this water is released. Since the only place for it to go is to the high point within the

immediate system, which is the compression tank, it will go there and replace the water which is contained in the compression tank. The only reason that it can go there, however, is because there is an Airtrol installed in the compression tank, and which in reality is a separator fitting. The Airtrol permits the air which is released in the boiler to flow to the top of the compression tank and release the water from the bottom of the compression tank. This then permits the compression tank to be partially charged with air which will form a cushion for the water to expand against as it is heated. After maintaining the 220 to 240 degrees temperature for several minutes, the booster may then be started replacing the cool water in the balance of the system with the heated water. As the cool water returns to the boiler, it is heated and the air released which will further charge the compression tank. With the compression tank properly sized, an ample air cushion will result.

When water in the system cools, it tends to take on air. Thus if there are any air pockets formed in the piping or radiant baseboards, they will eventually be eliminated through absorption.

Since the system is to be used for

ROOMS	CALCULATION SHEET											
	FIRST FLOOR						SECOND FLOOR					
	RECEPTION HALL	LIVING ROOM	DINING ROOM	KITCHEN	LAVATORY	ENTRY	BED ROOM No. 1	BED ROOM No. 2	BATH	LAVATORY	HALL	BED ROOM No. 3
Factors	Exposure S.T.U.	Exposure S.T.U.	Exposure S.T.U.	Exposure S.T.U.	Exposure S.T.U.	Exposure S.T.U.	Exposure S.T.U.	Exposure S.T.U.	Exposure S.T.U.	Exposure S.T.U.	Exposure S.T.U.	Exposure S.T.U.
Infiltration Windows .72 Doors 1.42	29 2270	48 2778	38 1728	34 1980	13 700	29 2270	60 3020	34 1680	17 1100	17 900		91 2940
Total Exposed Wall	194	272	190	129	64	40	219	198	196	30	46	130
Glass 1.13	38 3258	64 5790	39 3520	24 2160	7 1175	21 1900	48 4848	24 2160	12 1220	12 1000	18 1625	34 3210
Net Wall .2	68 1065	230 3230	121 1835	104 1665	57 910	19 305	170 2720	164 2880	93 1765	18 290	27 400	84 1940
Floor .3					15 45	12 36						
Ceiling .3					15 120	12 95	210 1900	100 1200	45 405	24 190	60 480	100 900
Total S.T.U.	9085	11900	9485	5705	3000	9015	12900	7940	4400	2545	2025	8320
Length of Baseboard	13'	23'	18'	11'	8'	33'	35'	15'	9'	5'	5'	18'

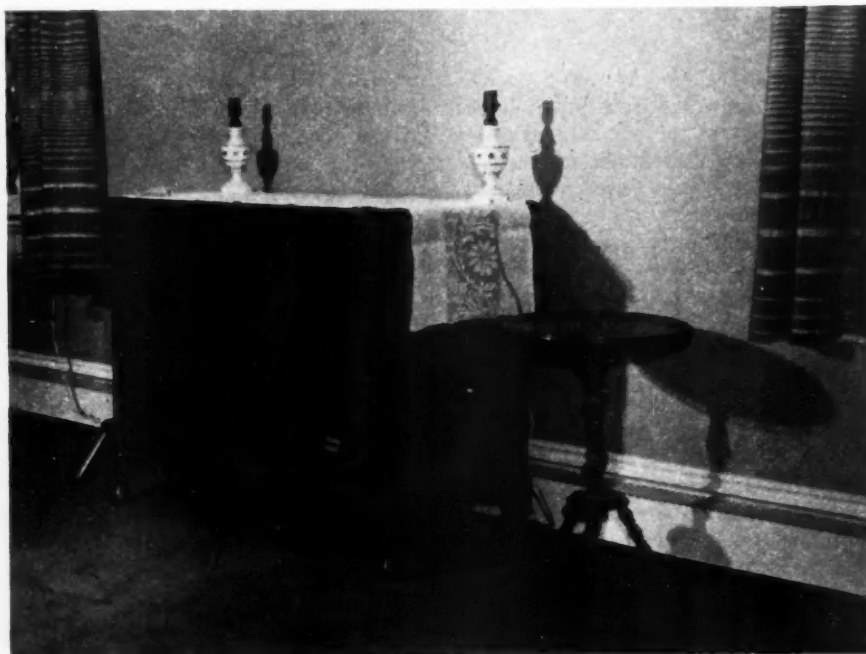
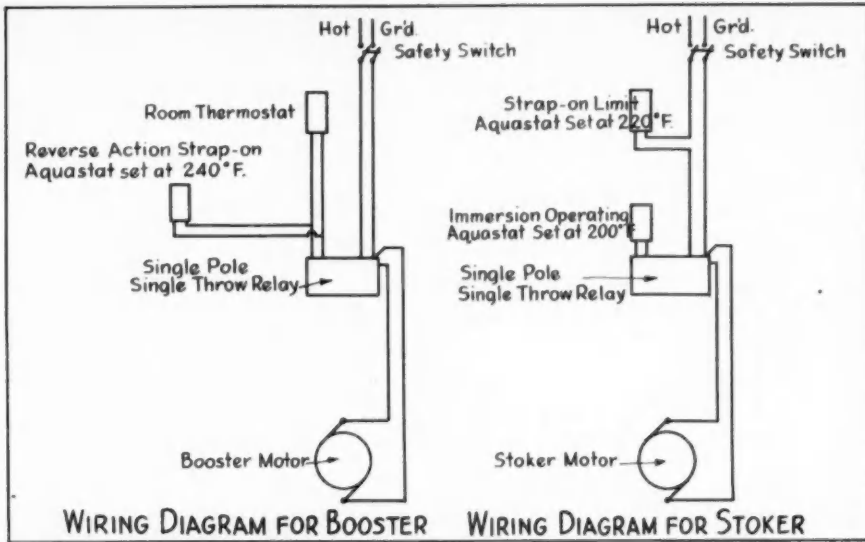

RADIANT baseboards will blend into any decorative scheme in the modern home



MANUFACTURERS are producing baseboard heating panels in a large number of attractive designs

year round domestic hot water, and is stoker-fired, the control problem merits careful study. A flow control valve is installed in the heating main which furnishes heat to the baseboard panels, so that no circulation will be set up to them unless the booster is in operation. The control for the heating of the building is such that when the room thermostat calls for heat, the relay operating the booster is closed, causing the booster to start and warm water to flow to the baseboard panels. When the room thermostat is satisfied, it causes the relay to break the circuit to the booster and stop the flow of warm water to the baseboard panels. Control of the stoker is by an aquastat installed in the boiler. When the aquastat calls for heat, the relay to the stoker is closed, causing the stoker to start. When this immersion aquastat is satisfied, it causes the relay to open and to stop the stoker. Should this immersion aquastat fail in a closed position, there is also a strap-on line voltage aquastat installed, in the hot lead to the relay, which will open the circuit to the relay, causing the stoker to stop. In addition to these two aquastats, there is a third aquastat which is connected in parallel with the room thermostat. This aquastat is of the reverse action type, and will close on temperature rise. The purpose of this aquastat is to start the booster and relieve any excessive temperatures within the boiler after the stoker controls have caused the stoker to stop. The control of the temperature of the domestic hot water is taken care of by the thermocheck installed in the return from the hot water heater to the boiler. As the water in the hot water storage tank becomes warmer, the temperature of the return water from the heater will

also l...
 eleme...
 the b...
 circul...
 ing th...
 water...
 again...
 heat.
 To...
 autom...
 ing v...
 instal...
 reduc...
 pound...
 full c...
 to re...
 shoul...

THE piping arrangement here is the same as that of a one-pipe forced hot water heating system. The coal stoker-fired boiler is used to heat domestic hot water the year round in addition to taking care of the heating requirements of the home

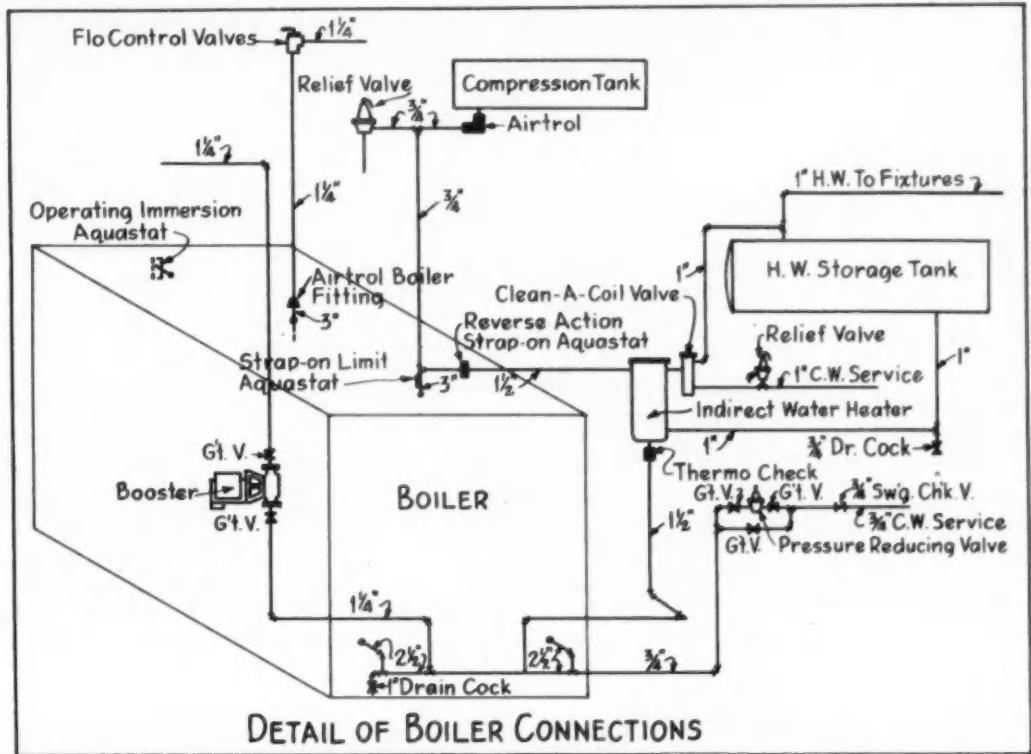

also become warmer. The by-metallic element in the thermocheck will cause the butterfly to close, retarding the circulation of warm boiler water flowing through the heater. As the return water cools, the thermocheck will again open and permit the water to heat.

To make the system completely automatic and safe, a pressure reducing valve and a relief valve are also installed. The pressure reducing valve reduces the city water pressure to 12 pounds and keeps the heating system full of water. The relief valve is set to relieve the system of pressure should it exceed 28 pounds. Perhaps

enough cannot be said about the pressure relief valve, as it is really the safety on the heating system. Without it the system would be dangerous and as explosive as TNT. It is essential to install the best relief valve available, and to test it at regular intervals to be sure that it operates.

Radiant baseboard panels were located in all rooms except the entry. Due to the amount of heat loss in the entry, and the lack of wall space to install a sufficient amount of radiant baseboard, a cast iron radiator was used. Precaution was taken, however, in the selection of the radiator to make sure that the heat which it emitted was

as near as possible the type of heat emitted by the radiant baseboard so a cast iron radiator with a radiant front was installed.

The piping arrangement is that of a one-pipe forced hot water heating system. Special flow fittings were used on both the supply and return connections in the main for the radiant baseboards and the radiator. The flow could have been established with a flow fitting on either the supply or the return connection to the units. However, an additional size pipe would have been necessary in order to accomplish the same rate of flow as is established with two fittings.



ANOTHER type radiant baseboard panel which might use either steam or hot water as the heating medium

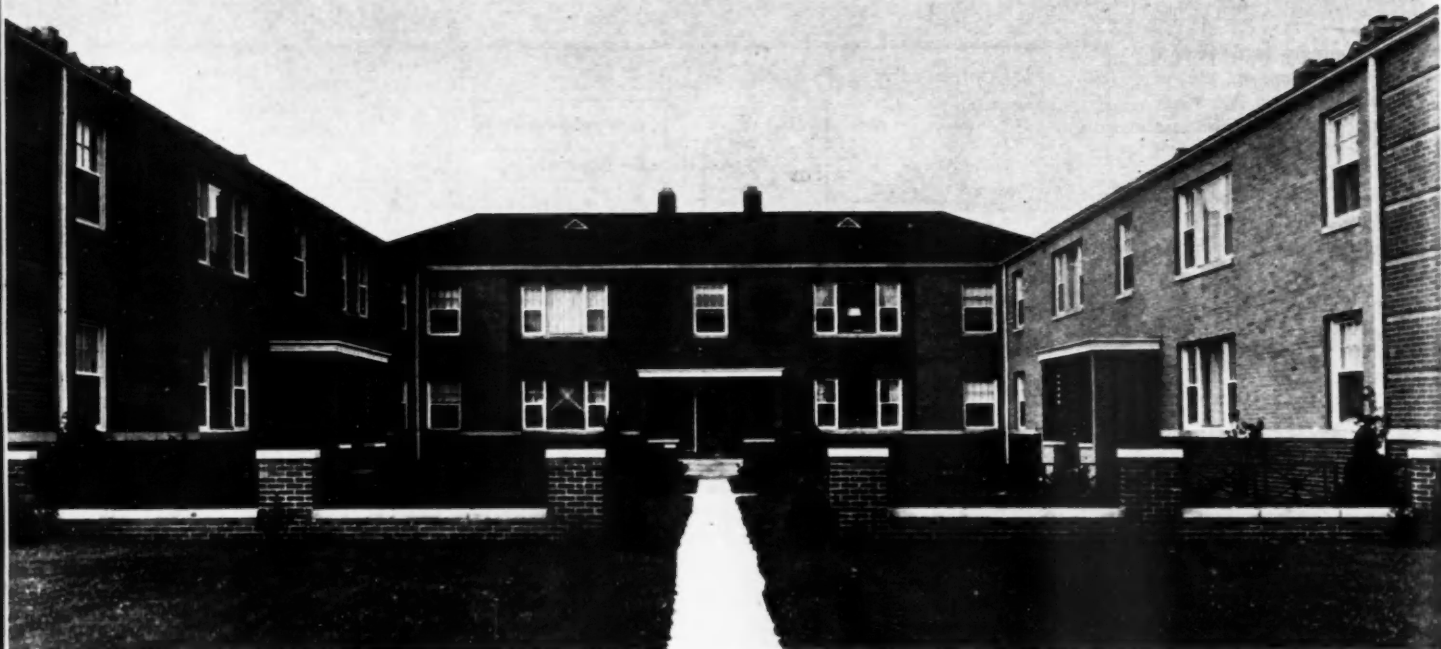

VIEW in one of the three typical courts that are formed by combining separate units, each containing four apartments

The A. B. C.'s of Rental Planning

Apartment planning is based on the comfort obtained by the occupants through a substantial measure of light, air and privacy

INVEST an apartment unit with plenty of light and air, add to it a measure of privacy, and the simplest housing unit becomes an adventure in good living, not just another place to hang one's hat. The apartment will then contribute to the happiness of family life and will have a vital influence on the growing generation.

These basic facts were given prime consideration in the planning of the Broadland Place Apartments, one of the largest projects of its kind in Columbus, Ohio. Ten separate buildings, each complete in itself, yet joined together to make a unified group, contain a total of forty dwelling units. These have recently been completed

by the owner and builder, J. C. Robbins, under the guidance and direction of Harry T. Roderick, architect, Columbus, Ohio.

An additional thirty-two units are now under construction directly to the rear of the present buildings. One hundred and four units are contemplated for immediate future construction in the same general area.

Each building contains four five-room apartments. Each apartment rents for \$88.75 a month including water and garage. Gas, light and heat is paid by the tenant. Each apartment is individually heated with a gas-fired Janitrol unit. These are located in the closet adjoining the kitchen. Thus,

each tenant has complete control of the heating of his apartment.

Each of the ten buildings are connected. They are placed in relation to each other in order to form a large open U-court, as indicated on the plot plan. These courts each measure 55x72-feet, with the front of the foremost building set back 60 feet from the main road.

In the construction of these buildings, Mr. Robbins gave consideration to the importance of site selection. Accessibility to industrial, commercial and shopping areas by convenient transportation was of importance.

STREET view of building group shown below



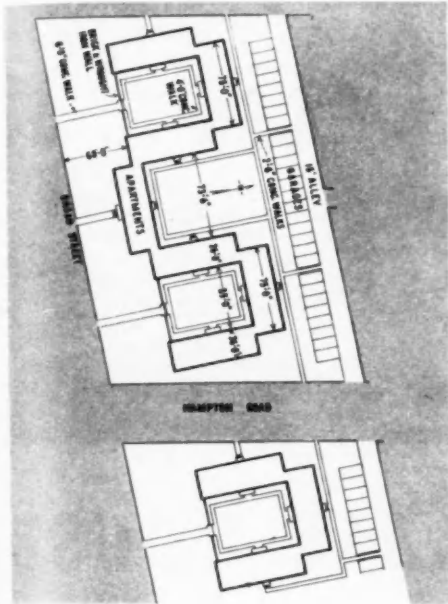

PLOT plan shows garage for each apartment



COMBINATION of patterned brick and glass block produces an effective entrance motif

MATERIALS AND EQUIPMENT

- Ready-Mixed, poured concrete foundation
- Twelve inch thick brick exterior walls —Clay Craft Manufacturing Co.
- Johns-Manville asbestos slate and composition roof
- Kimsul rock wool batt insulation
- Oak and Armstrong linoleum floors
- Corbin, Yale and Slager finished hardware
- D.H. and fixed wood sash and frames
- Fenestra steel sash and frames
- Rezo wood slab doors
- Janitrol forced hot air, gas-fired heating units
- Crane plumbing fixtures
- Stone steel hot water tank with side coil heaters (all in basement)
- Tappan gas ranges
- General Electric refrigerators
- Davis Co. steel kitchen cabinets
- Libbey-Owens-Ford D.S.A. glass Vitrolite and Carrara glass walls
- Copper plumbing
- Rock lath and plaster walls and partitions

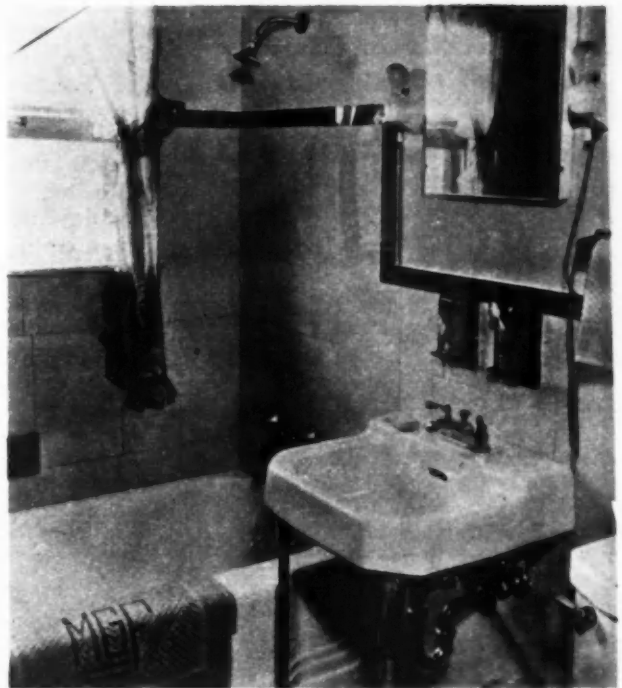

TYPICAL bathroom shown at left. All walls are faced with Vitrolite or Carrara glass from floor to ceiling. Typical apartment, consisting of five rooms, shown below. Ample light and air available to each rental unit

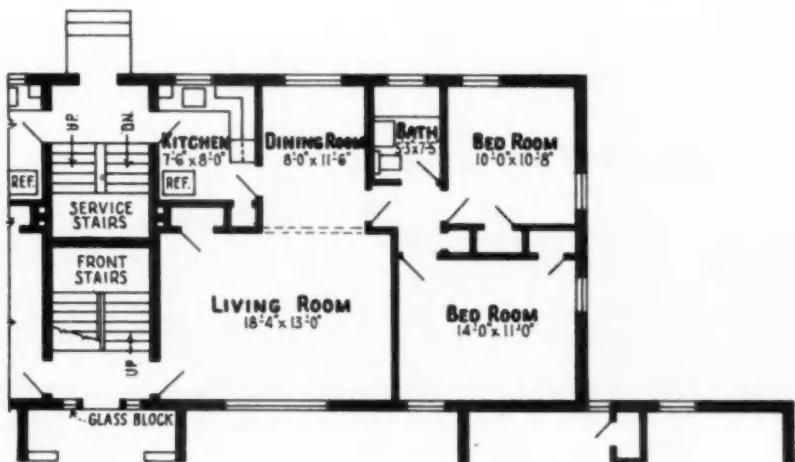

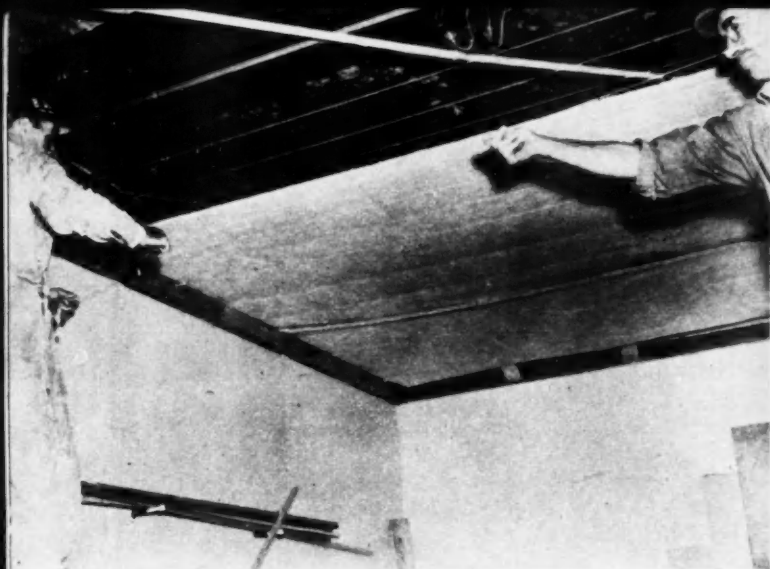

HE WHO LIVES IN A GLASS HOUSE

New offices for New York staff of Owens - Corning Fiberglas Corp. demonstrate that fragile glass of yesterday has become an amazingly versatile and practical building material

INGENIOUS glass manufacturers, backed by intensive research, are well on the way toward disproving the old adage that "People who live in glass houses should not throw stones." The recently completed building to house the New York staff of Owens-Corning Fiberglas Corp. symbolizes the growth of this depression-born industry and serves as a permanent demonstration of the wide range and numerous applications of glass in fiber form.

More than a score of Fiberglas materials, ranging from air filters, thermal insulation batts, acoustical blankets and acoustical tiles, to glass yarns fabricated into curtains, wall coverings and upholstery fabrics, are used in the building, its equipment and its interior decoration. The architects,

Skidmore, Owings and Merrill, were directed to use Fiberglas materials wherever practical, regardless of whether they had ever before been used for similar purposes in an office building, or whether they had ever before been used in any similar application.

A membrane, consisting of a Fiberglas fabric impregnated with asphalt, is installed between the limestone and the brick backing to make the front waterproof. The membrane is also used as a flashing on the roof. The building is completely air conditioned with banks of Fiberglas air filters employed to strain dirt and pollen from the air. Air ducts and piping are Fiberglas insulated, and the product is also installed under all floors and beneath the roof.

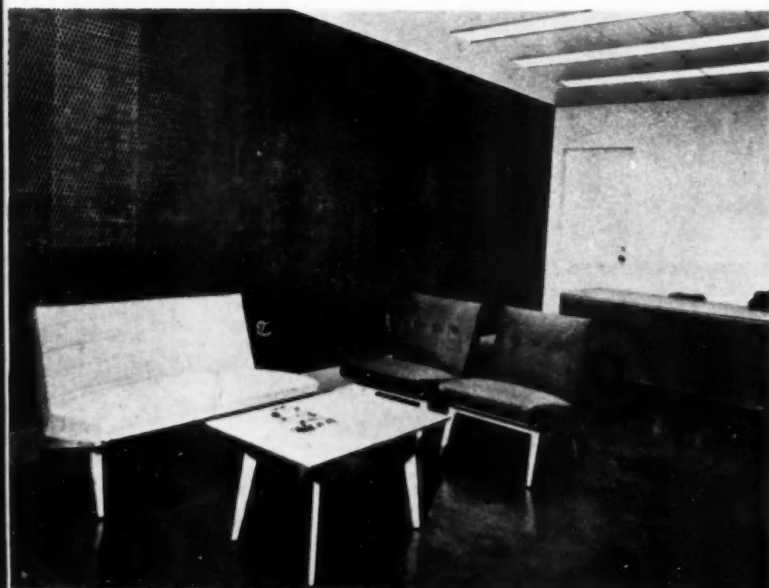

THE left wall is an aluminum grille, backed by brown Fiberglas mat over glass fiber batts installed between the furring strips



ON WALL at right, a black and white fabric of Fiberglas and cotton yarns is mounted over a glass fiber blanket on wood panels

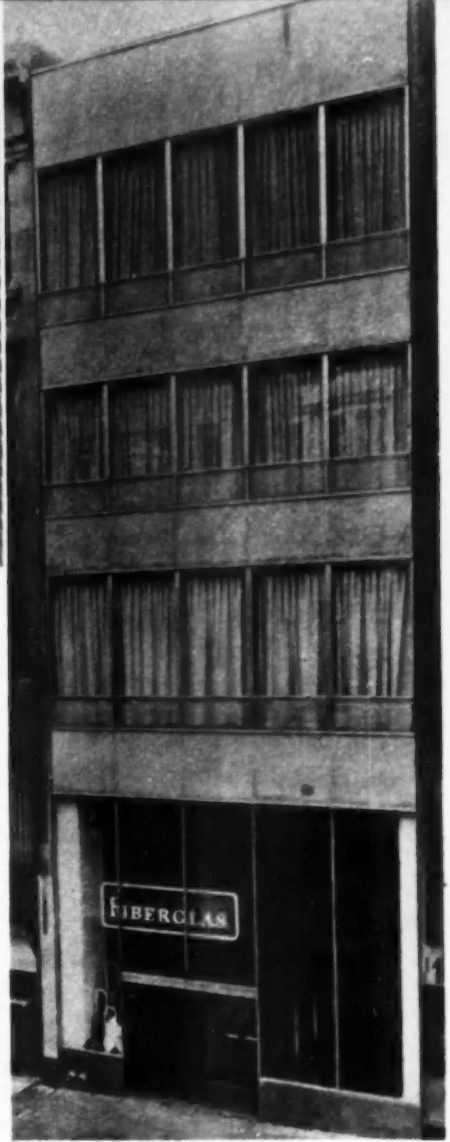

Can Now Throw Stones

A number of acoustical treatments are used in ceilings, all of which are of the suspended type. Fiberglas acoustical tile or acoustical board are in the majority. A treatment employed in individual offices consists of sound-absorbing blankets laid on Fiberglas cord stretched behind a fabric of glass fiber. Still another ceiling acoustical treatment is Fiberglas sound-absorbing batts, faced with a thin, porous Fiberglas mat, installed behind perforated metal. Blankets of Fiberglas are installed between studs of plaster-and-metal-lath walls of washrooms, conference rooms and individual offices. Decorative acoustical wall treatments are provided by natural color Fiberglas board, but the same board faced with fabric woven of glass yarns and by decorative fabrics woven

of glass and other yarns, stretched over wood panels, with an acoustical blanket between the fabric and the panels.

On large wall areas, Fiberglas board or batts are installed between furring strips, then faced with a porous glass mat. Over this, perforated Fiberglas-plastic sheets, perforated aluminum sheets, or metal grilles are placed as finishes. The curtain, wall and upholstery fabrics are made up of a variety of Fiberglas yarns and various combinations of glass and other yarns. The upholstery fabrics used on furnishings throughout the building provide the first comprehensive demonstration of the use of the newly developed plastic-covered Fiberglas is durable and attractive.

FOUR photos at top of this and opposite page show workmen installing Fiberglas in several different forms as ceiling and wall acoustical finishes. Directly above is the front of completely remodeled structure where glass in fiber form was used throughout in every manner for demonstration purposes



WALL on right is covered with a resin-impregnated Fiberglas mat cemented to plasterboard. Ceiling is fabric of glass yarns



CEILING here is Fiberglas board faced with resin-impregnated glass mat. Glass yarns were used in drapes and upholstery fabrics



A Store That Speaks for Itself

The House of Modern Chairs in Detroit provides maximum opportunity for both day and night display of furniture. The distinguished, open front makes the store an outstanding show place



THE front of this store makes both the first and second floors virtual show-cases for display of the furniture. The large, attractive staircase in plain view in the center says "welcome" to shoppers in a silent manner that is both dignified and cordial

Ame
TH
 De
 for
 libra
 two-
 desig
 tect,
 own
 block
 the c
 terio
 huge
 with
 Th
 of th
 throu
 This
 does
 barr
 store
 sales
 interi
 show
 perm
 and t
 shopp
 actual
 plate
 to the
 open
 Th
 with
 plays
 street
 sion
 summ
 night
 front
 Pa
 ond
 where
 daylig
 adds
 the se
 on th
 cious
 keyne

THE House of Modern Chairs in Detroit is an outstanding show place for modern living room, breakfast, library and recreation furniture. The two-story, 90x140-foot building was designed by Louis G. Redstone, architect, Detroit, for Ely Robinson, the owner. Exterior walls are of cinder block construction, waterproofed on the outside and plastered on the interior. Structural members of the huge two-story visual front are faced with marble.

The center section of the interior of the store is exposed to full view through the large plate glass windows. This increases store traffic because it does so much to minimize the visual barrier between the street and the store's interior. Daylight brightens the sales floor, and at night, the lighted interior makes the whole store a showcase. Windows in the "wings" permit excellent model room displays and the low bulkheads make window shoppers feel as though they were actually in the rooms. The tempered plate glass doors lend a modern note to the entire front and accentuate the openness.

The second floor is also "open" with a glass front. Merchandise displays there can be seen from the street, day or night. The roof extension keeps direct rays of the high summer sun out of the store and at night, lights in the canopy flood the front and the sidewalk.

Patterned glass in some of the second floor windows provides privacy where it is wanted, without sacrificing daylight. Day and night, this glass adds a decorative note. Starting with the setback from the sidewalk in front on through the entire structure, spaciousness, dignity and quality are the keynotes.

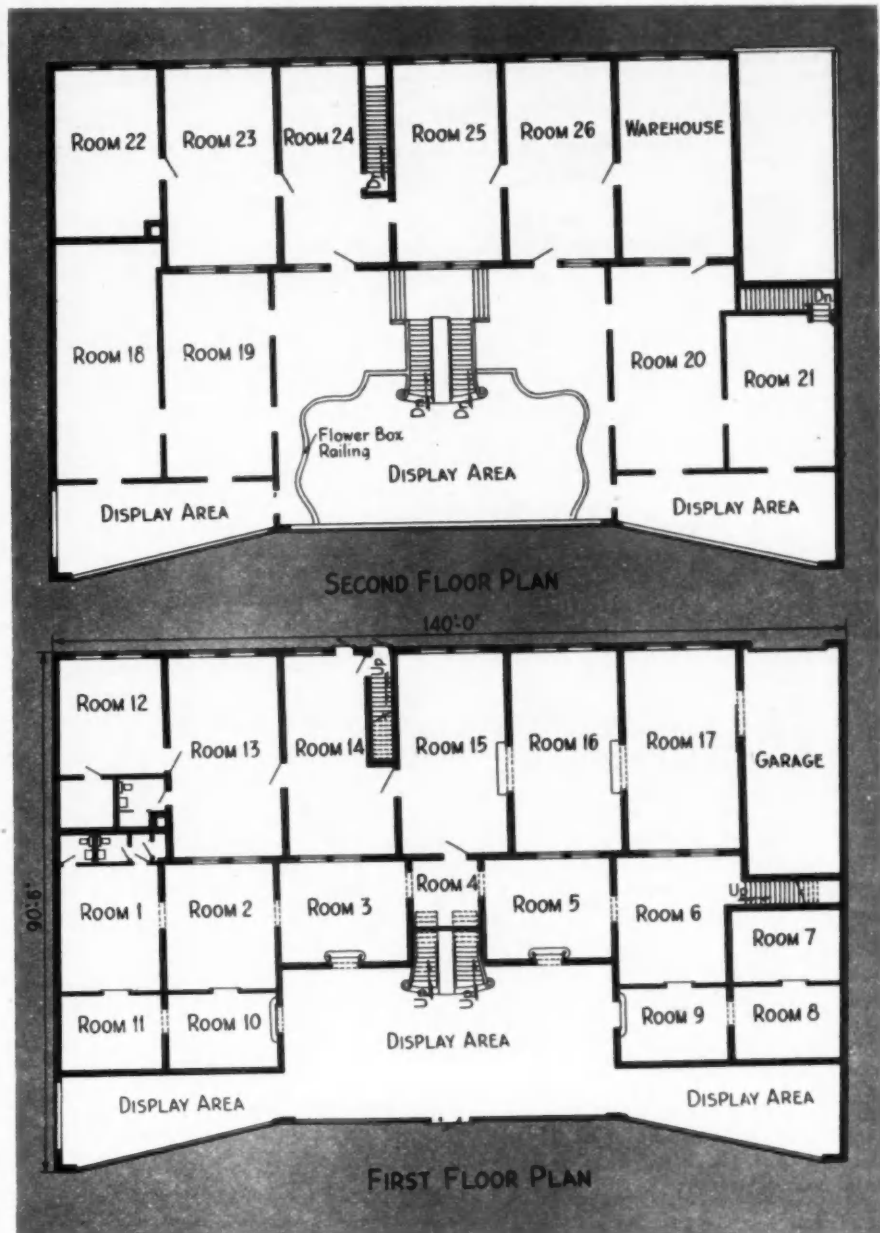

INTERIOR of the store is planned to accommodate a large number of individual room displays on both the first and second floors. Below are two more views of the stairway, which is a strong focal point in presenting the furniture displays for view by the public both day and night



des
ight
pen
lace

store
at and
show-
of the
atrac-
plain
r says
pers in
that is
cordial

NARROW

In the remodeling of this store, the designer made an effort to create an illusion of width and to provide an informal atmosphere for the display of women's apparel



LEFT: General view of remodeled exterior. Introduction of rough stone at corner piers, with extended wood mullions at second floor and wood siding at third floor spandrel, emphasizes informal character of store

BELOW: First and second floor plans show a solution to a modern merchandising problem in a congested area, as applied to a difficult site

ABOVE right: Second floor looking toward store front from just beyond stairway. Bullet-type spotlights dramatize special platform displays

RIGHT: General view of the first floor from a point opposite the stairway. Horizontal wall treatment at the elevator and other areas further emphasizes the illusion of width

Photos by Charles R. Moor, Columbus, Ohio

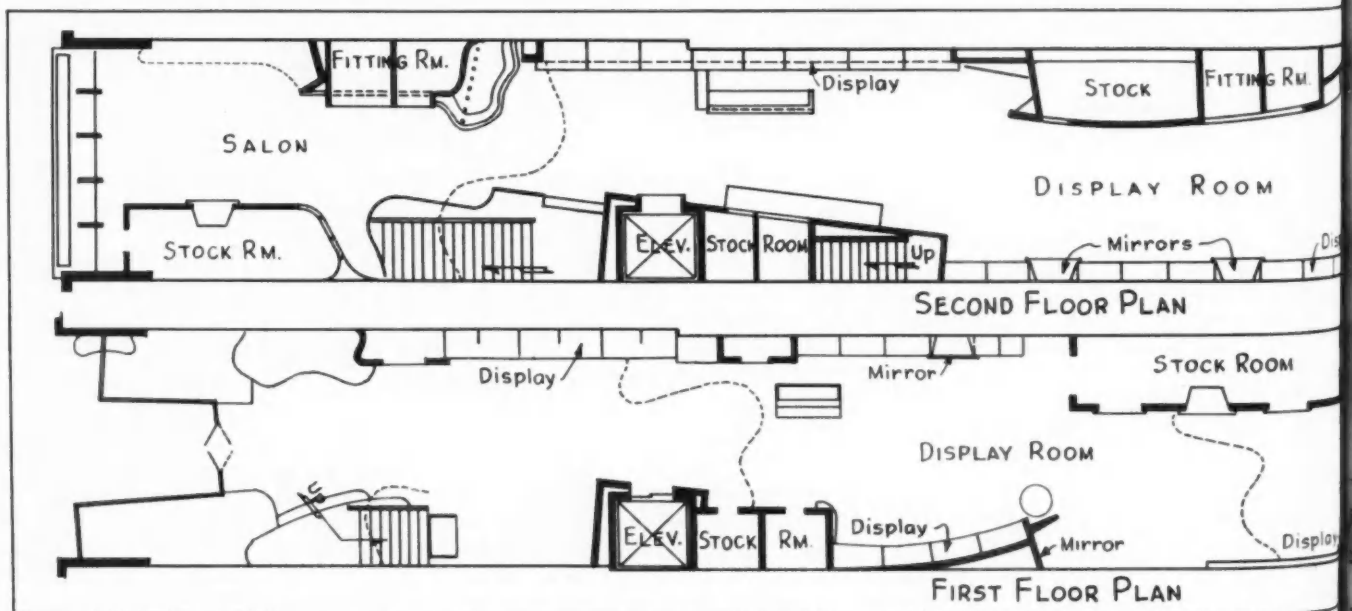

Frontage No Handicap

MODERN design of commercial structures, is created, not only to attract the eye and beguile the customer, but the basic thought is to furnish the proper kind of background for the sale of merchandise.

Gerstenfeld's, Columbus, Ohio, is a store for women. Louis G. Gluskin, designer of New York, took over the task of adjusting the requirements of the new owner to the conditions of the old structure. Aside from the exterior walls and floors of the first two stories, all areas were gutted to accommodate the new status.

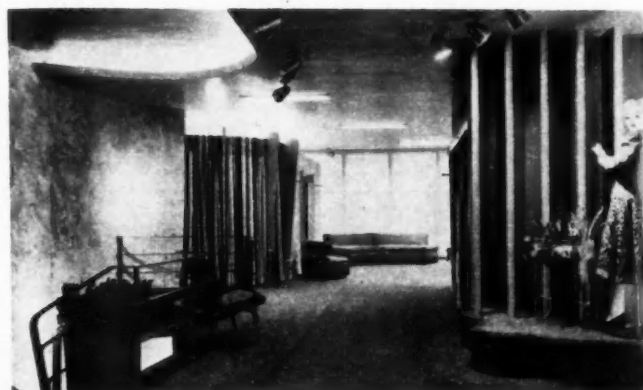

ARCHITECTS rendering of proposed apartment building

Luxury Apartments for West Coast

STAID, conservative Pasadena is apparently going modern. Work on this attractive ten story apartment building is to be started March 30, 1948, according to L. D. Owens, Jr., the owner of the project. The land, building, furnishings, landscaping and other details are estimated to cost approximately \$1,250,000.

The design is particularly noteworthy. Each of the 48 apartments will have a corner location and a private balcony. These balconies will have ample room for a daybed, and bridge table, or can be used for an outdoor dining area. The building will be operated as a co-operative effort with each apartment sold to the occupant at prices ranging from \$15,000 for a single-bedroom apartment, to \$48,500 for a luxurious penthouse apartment containing two bedrooms, two bathrooms, maid's room and powder room.

No money will be required from the purchasers until all the apartments have been sold.

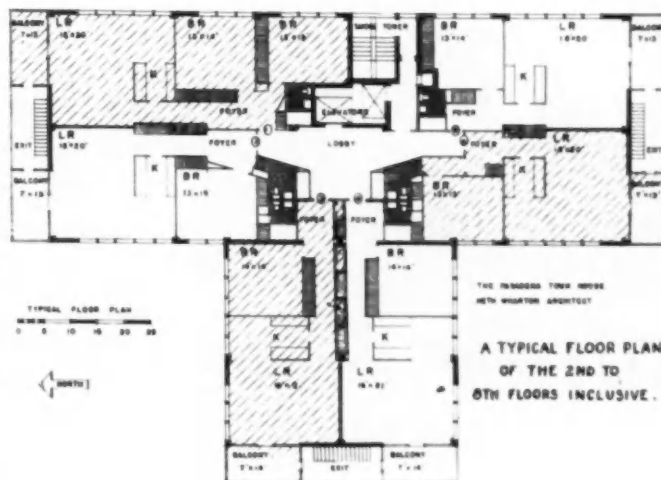

of
n-
to
of
de
s-
ay
el

eled
tone
wood
wood
pha-
store

plans
mer-
ested
site

oking
yond
dram-
plays

first
stair-
ant at
urther
width

Rm.

OM

Display

Every Apartment Is An Individual Home

In this development, which consists of a group of multiple housing units with interesting and varied arrangements, the privacy and flexibility of the individual home has been preserved

PRODUCING sound, permanent rental living units at the lowest possible costs, commensurate with good construction, has been the objective of the Don M. Casto Corporation, builders and realtors of Columbus, Ohio on entering the rental housing field.

The Mayfair Boulevard development, the latest of similar projects completed by this firm, is a group of individual buildings each containing four apartments. The buildings are on both sides of the boulevard, adjacent to the Mayfair Housing Project described in the February issue of *American Builder*. Entrance to the apartments of one group of buildings is from a center hall, two of the apartments being on the first floor and two on the second floor. Individual furnaces and laundry equipment for each tenant is in the large open basement area. The apartments are four rooms each.

In the long rectangular buildings, each of the four apartments in one

unit have a separate front entrance. These apartments contain a total of five rooms, with living, dining room and kitchen on the first floor and two bedrooms and bath on second floor. Each apartment has its own basement area, complete with necessary utilities. A perusal of the plans on the opposite page will indicate clearly the separation of the various units, particularly in the latter buildings, where the lines of a private home are followed.

Because of the ready market for this type of dwelling, the Casto organization has been concentrating most of its efforts on rental units. In spite of high building costs, Mr. Casto states that these apartments can be rented at a price showing a fair return on the investment. In this type of setup, all maintenance and care is reduced to the bare minimum. The architect for the Mayfair boulevard development is J. Edgar Outcalt, an associate member of the Don Casto organization.



MATERIALS AND EQUIPMENT

Concrete block foundation walls
Exterior walls—9 inch brick, 4 inch cinder, blocks, furred, lath and plaster
Bangor slate roof
Kimsul 4-inch ceiling insulation
Gypsum plaster walls
Fenestra and Truscon steel sash
Pease Co. millwork
Bruce Co. prefinished oak floors
Armstrong standard-gauge linoleum
Ceramic tile floor in bathrooms
Corbin, Yale and Skillman hardware
Rybolt Co., and Armstrong gas-fired warm air furnaces
Libby-Owens-Ford Co. glass
Gas ranges
General Electric refrigerators
American Radiator-Standard Sanitary Corp., Kohler Co., and Crane Co. plumbing fixtures
BX and Romex electric wiring
Iron hot water tank with side-arm heater, thermostatically controlled



ARC
with

Up
Fu

Lo
Fu

Stora

BAS



ARCHITECT'S rendering of a group of rental units above. Plan of four-apartment building with center hall and entrance below. Plot plan of Mayfair Boulevard Apartments at right

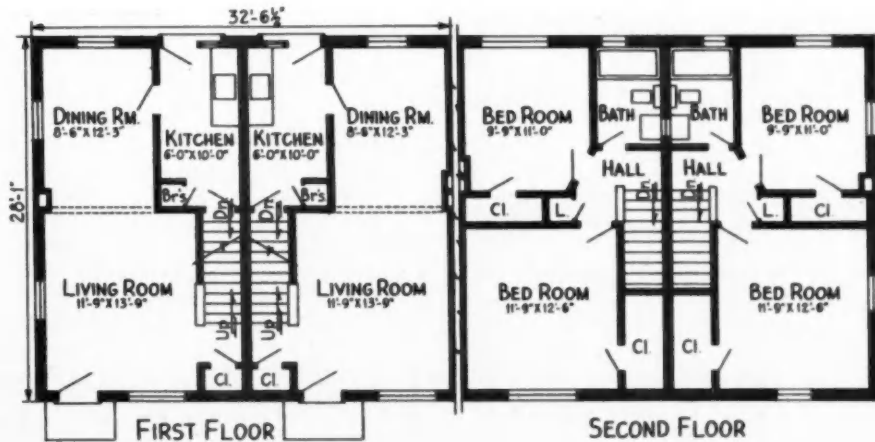
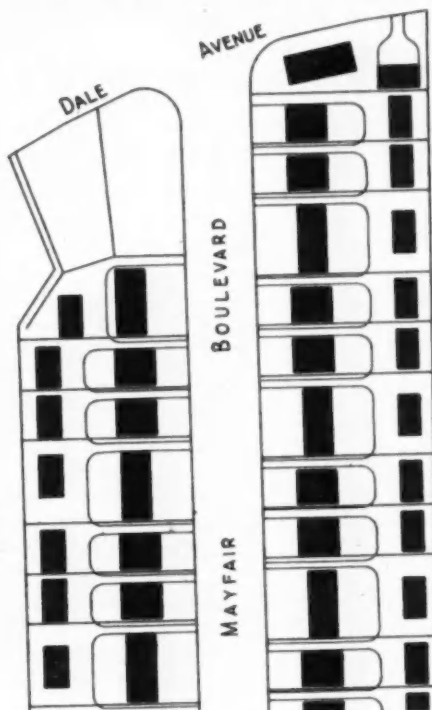
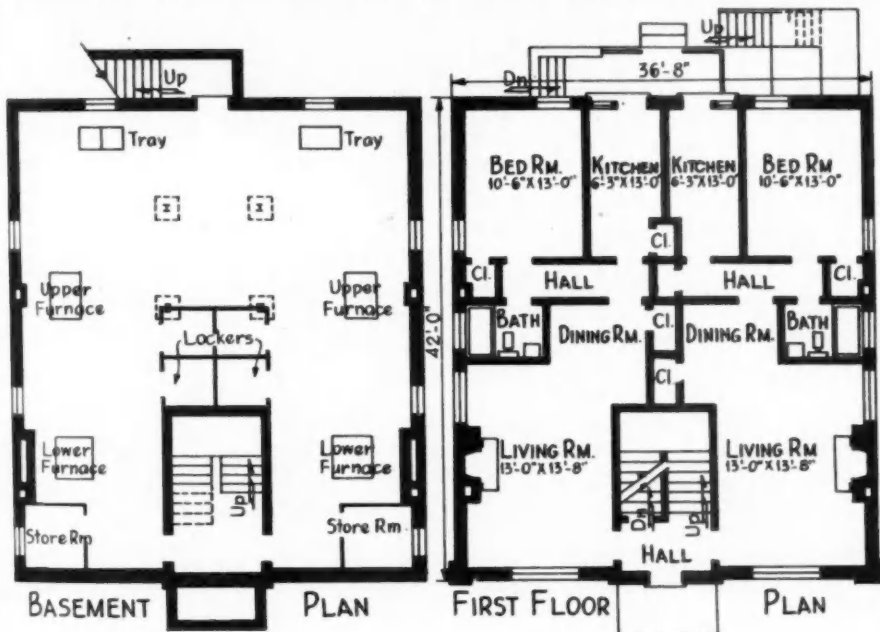

AT left are some of the completed buildings of Mayfair Boulevard project. The different types in their placement to each other establish a staggering building line. Plan of four duplex type building is at right. Each apartment has a separate front entrance

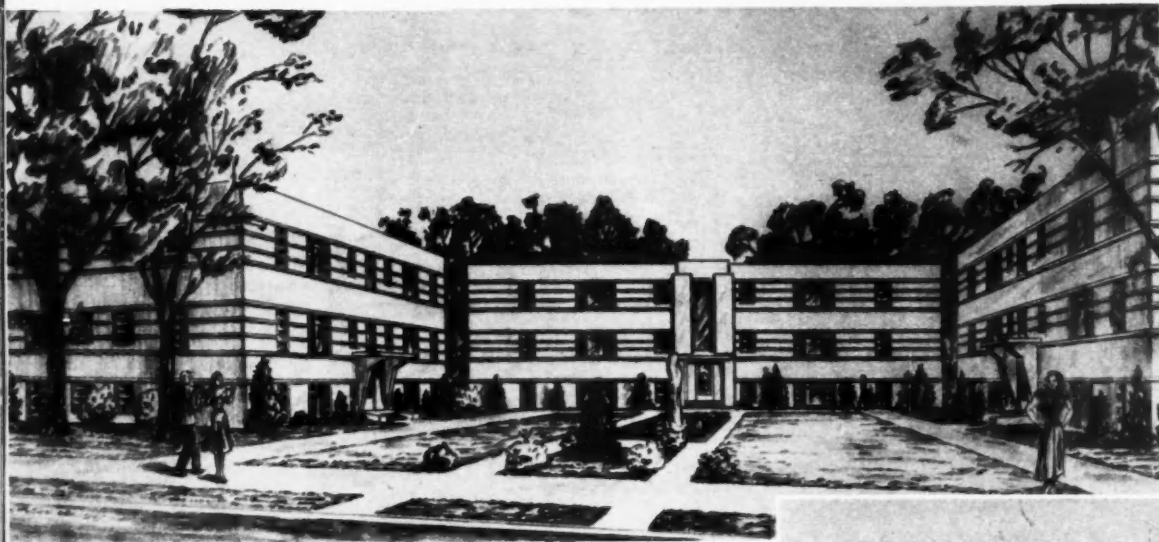

LEFT, view of one apartment court in the Acme Co. project. Below is another one of 18 apartments in the project now underway in Aberdeen, S.D. Each apartment has thermostat heating control, cross ventilation, ample closet space, latest plumbing

KNOWN PROPERTY TAXES

Help Determine Rental Rates

Acme Company plans low cost housing project for veterans by close estimations, shrewd management

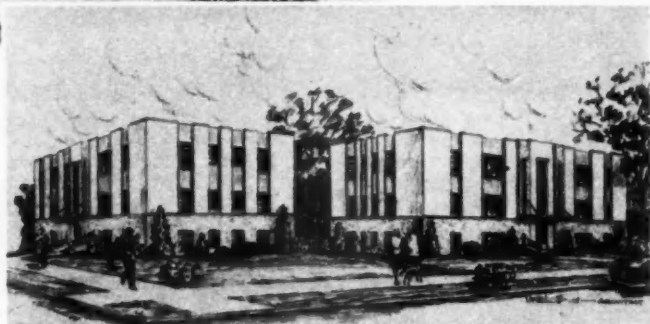

WITH plans to alleviate the Aberdeen, S.D., housing shortage, a special city committee met with Sheldon F. Reese.

As a result, Reese announced plans to erect 18 new apartment buildings in Aberdeen and, later, 10 more in Huron, S.D.

The committee agreed that taxes would be assessed on a value of \$12,882 for each of the 18 structures, a valuation arrived at by comparing the proposed construction to similar constructions in Aberdeen.

With a mill levy of 50.0769, which includes city, county, road, school and the like, the total tax per building each year will be about \$642.84,

depreciated in the normal manner. Broken down still further, the tax for each of the 11 apartments in each building will be about \$58.44 per year, or \$4.87 per month.

Reese said one complete "pilot" structure, the first building in the project started at Aberdeen, would be followed by the other 17 structures on an "assembly line" method of construction.

The Acme Co., of which Reese is president, has its own ready-mix and cement block plants to handle aggregate mechanically and cement in bulk.

Aggregate is handled from hopper cars to an elevator; then into large

storage bins; weighed out over automatic weighing equipment into ready-mix trucks that deliver the concrete directly into steel plywood-lined forms. Neither cement nor aggregate is handled by hand.

Blocks are lifted onto the scaffolding with cranes, so that the only manual labor involved is in placing the blocks.

Light material is brought into the building with electric hoists; heavy materials, with mobile cranes. Excavation is done with bulldozer and caterpillar tractor, and mobile Quick Way crane digs the footings with a trench hoe. All excavation except trimming is done mechanically.

Since the ground floor apartments will be one-half flight down, and the first floor apartments one-half flight up, easy access to them is provided. There will be two two-bedroom and two one-bedroom apartments on the first and second floors of each building, and two one-bedroom and one two-bedroom apartments and utility rooms on the ground floors.

Footings and foundations are reinforced concrete; outside walls are concrete block. Floors are 2½-inch concrete reinforced with Steel-Tex on bar joists.

Acme Company estimates that building costs for the Aberdeen project will be \$1,000,000; and for the project in Huron, almost \$600,000.

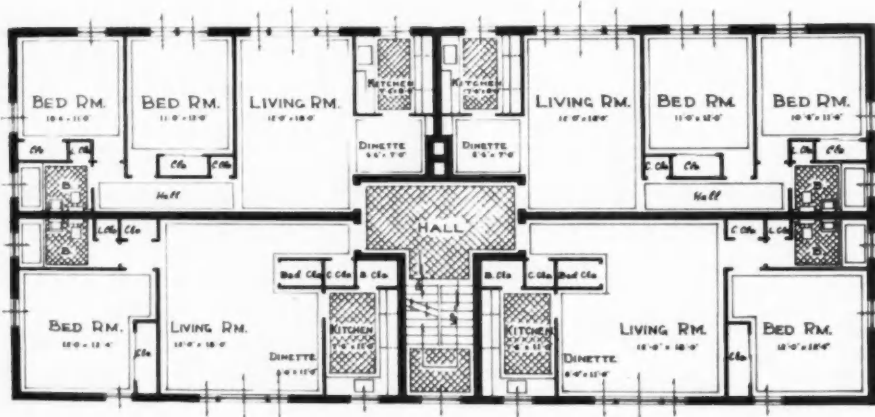

FIRST FLOOR PLAN

BUILDINGS will have solid concrete walls, asphalt tile floor over concrete



THE house at left was especially designed for the use of aluminum clapboard siding and aluminum roofing. The round-roofed building below illustrates one type of an all-aluminum general utility structure



ALUMINUM

As a Building Material

In 1947 aluminum products manufacturers showed tremendous gains in sales of their materials to the construction industry

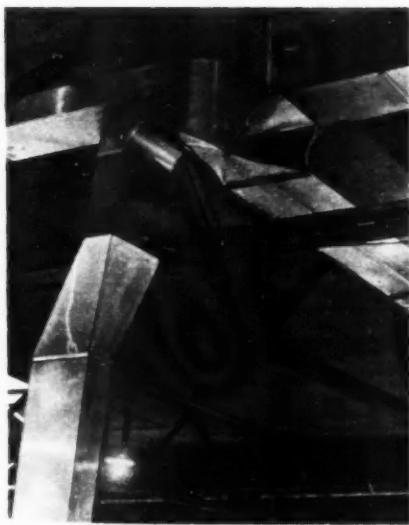

ALUMINUM for heating and air-conditioning ducts is filling an industry need

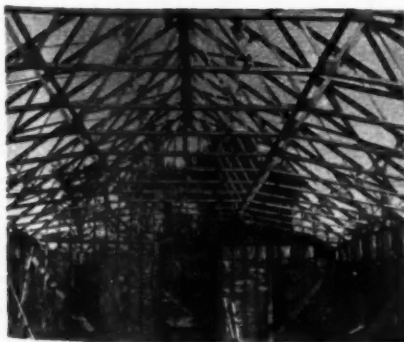

THE building industry is one of the largest markets for aluminum products

SHIPMENTS of aluminum in 1947 indicate that the building industry now constitutes the most attractive market for that product. Aluminum windows have shown a tremendous increase in use since World War II. Prior to the war, only about 25,000 such windows had been made, and to some extent the use of aluminum windows in homes was considered experimental. In 1946, however, more than 500,000 of these windows were fabricated, and estimates for 1947 place this figure well above the 2,000,000 mark, representing approximately 25,000,000 pounds of aluminum.

In recent months there has been an accelerated demand for aluminum for home and commercial building heating and ventilating ducts and fittings. Hundreds of sheet metal contractors are using aluminum for this purpose, and more than 100,000 homes are now equipped with aluminum ducts and fittings. In a domestic heating installation, an average of 150 pounds of aluminum is used on each housing unit.

In 1947, the output and sale of aluminum nails showed a steady increase in volume. At least nine manufacturers are now producing alu-

minum nails from a specially developed Alcoa alloy wire. The most promising use for aluminum for this purpose is in the specialty nail field, particularly where aluminum is used as the base metal to be fastened. Aluminum roofing nails are, and should be, employed for installing aluminum roofing and siding, aluminum shingles, aluminum gutters and downspouts, and aluminum flashing. In addition to roofing nails, common nails, gutterspikes, slatting nails, tacks, other special types now are being manufactured from aluminum.

The use of aluminum screens, thresholds, venetian blinds, awnings, garage doors, gutters and downspouts, and prefabricated house panels showed a marked rise in the last year. Large amounts of aluminum go into the building field now in the form of clapboard siding, corrugated siding and other forms of siding and roofing. The material is also being used extensively in the manufacture of factory-fabricated houses. Aluminum wall facing is becoming increasingly popular in large office and industrial projects. Designers and builders are calling for a large number of aluminum castings in the form of panels, copings and decorative building trim.

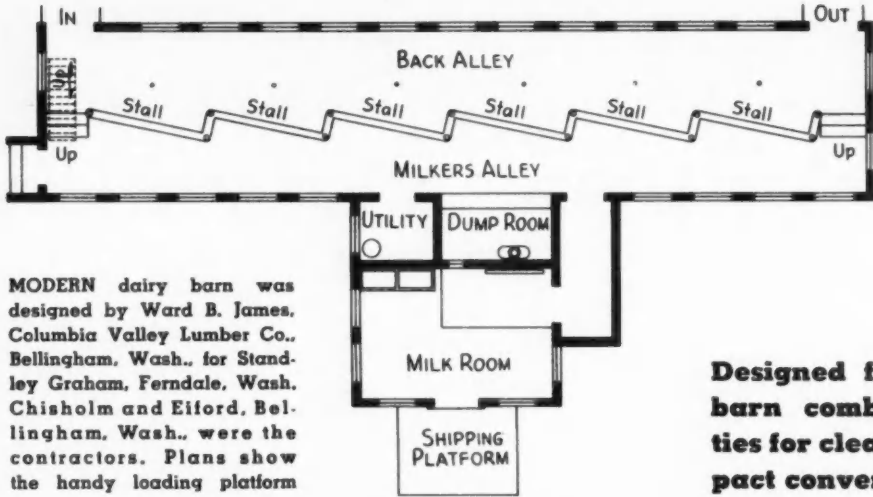

STANDLEY Graham's new compact milking parlor is designed to keep down material costs. End of the parlor is only twelve feet wide. Note the roofed-over walk for three entrances

MODERN dairy barn was designed by Ward B. James, Columbia Valley Lumber Co., Bellingham, Wash., for Standley Graham, Ferndale, Wash. Chisholm and Eiford, Bellingham, Wash., were the contractors. Plans show the handy loading platform

Designed for material cost saving, milk barn combines good ventilation, facilities for cleanliness, and new ideas for compact convenience. Total cost about \$6,500

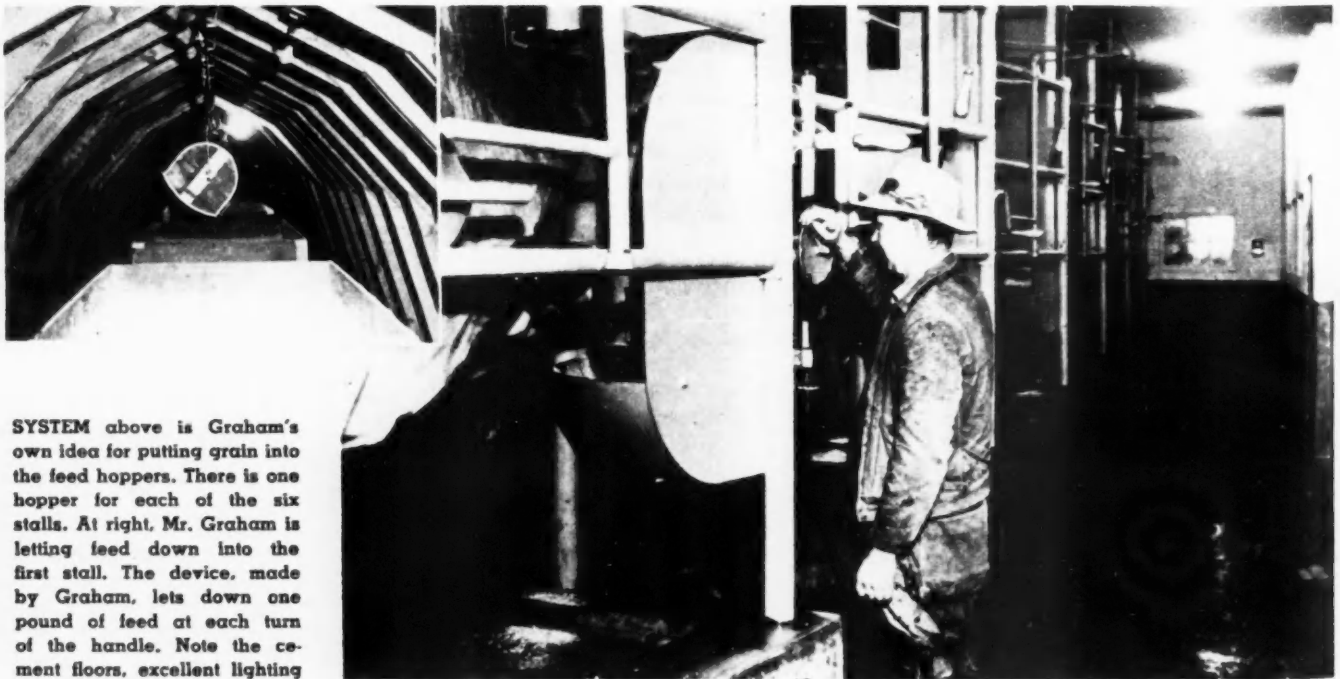

SYSTEM above is Graham's own idea for putting grain into the feed hoppers. There is one hopper for each of the six stalls. At right, Mr. Graham is letting feed down into the first stall. The device, made by Graham, lets down one pound of feed at each turn of the handle. Note the cement floors, excellent lighting

Compact Dairy Barn

BY DOING his own wiring and plumbing and helping out in the construction, Standley Graham, Route 1, Ferndale, Wash., kept the construction cost of a new, compact milking parlor to about \$6,500.

Graham's ideas, incorporated in a design by Ward James, Columbia Valley Lumber Company, produced an over-all compactness in the building with emphasis on utility and convenience. The plans considered everything from feeding procedures to the loading platform for milk.

Grain is raised from a truck or wagon bed to the upper story of the parlors by a carrier system operating on a track. The track carries the grain back to separate feeding hoppers, directly over the milking stalls, where it is automatically dumped.

Wooden feed chutes then carry the grain down from the hoppers to each manger (six in all) where it is let into the mangers by a steel paddle wheel. The wheel, designed with four fins, measures out a pound of grain at each turn of the paddle.

The floor plan of the parlor was taken from a plan recommended by the Seattle Health department.

A counterbalanced stairway that folds upward when not in use makes it easy to reach the upper story from the entrance to the back alley. Another counterbalanced structure is a door that slides up into the milkroom wall through which cans can be put on the shipping platform.

These features—along with a convenient dump room, utility room, elevated stalls for the cows, and the many windows for a maximum of natural lighting—show what can be done with new ideas, a small amount of space, and a minimum expense.

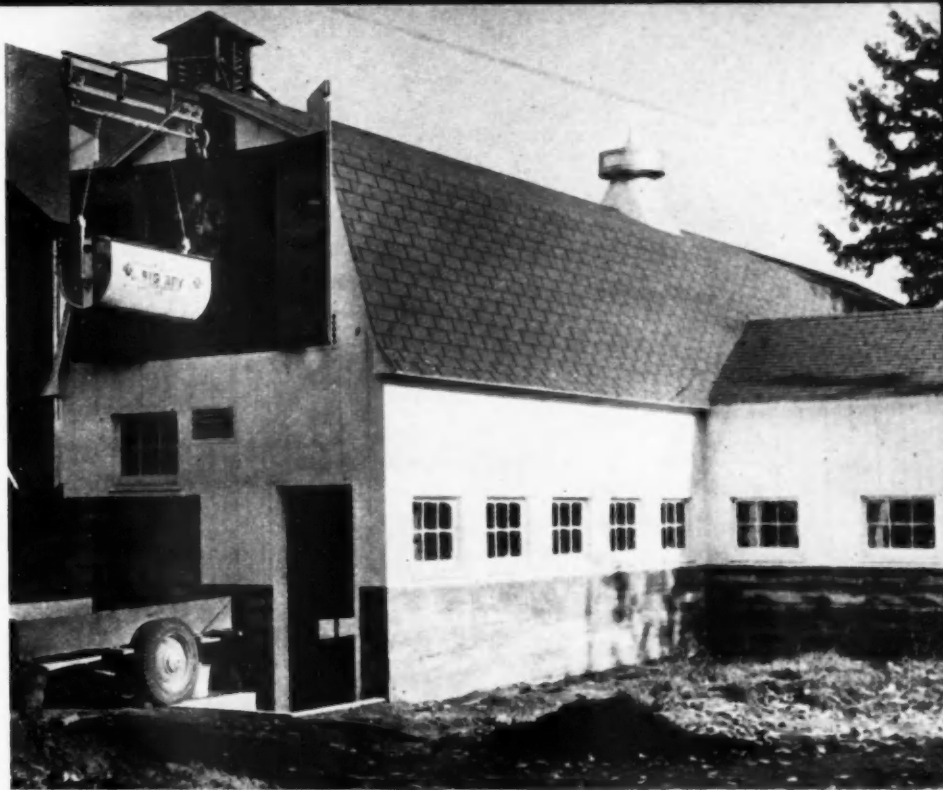

TOP picture shows how feed carrier is lowered to trailer. Above, is shown handy arrangement for loading platform at milk house. Note roof vent. Below left, is stairway to overhead feed storage. Stairs are on counter balance and recede into ceiling when not in use. Below center, shows close-up of roofed-over walk between milkroom, parlor, and shipping platform. Below right, is milk cooler, arranged close to loading platform

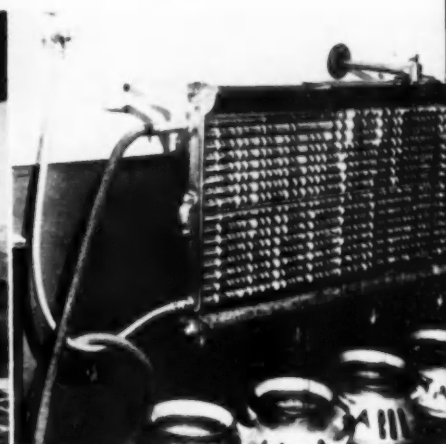
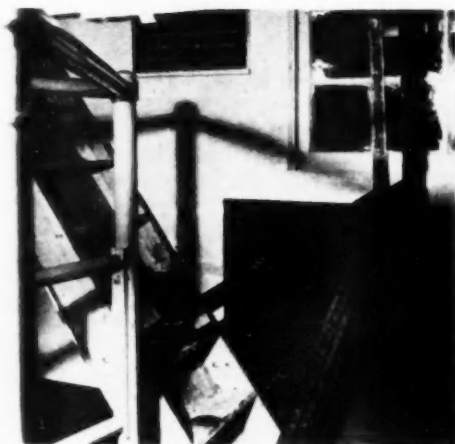



THE FARM MARKET



NON-FARM RESIDENTIAL

WATER SUPPLY

For Town and Country

THE home building and modernization market is rapidly expanding beyond the reaches of city water mains. This expansion is in conformity with a trend which has prevailed for many years, although all the conveniences of urban dwelling were not available to the rural dwellers until recent years. Today, beyond the water mains, all the sanitation facilities and modern techniques of living are being incorporated in houses and light commercial structures adjacent to electric power through installation of electric water systems.

Dealers in electric water systems face a business this year that will be in excess of \$100,000,000. The sale of products and services related to the installation of rural water systems boosts that figure by many more millions, and the market is being expanded systematically by the federal government's rural electrification program, not to mention the rural extensions being constructed by private capital.

All this is of tremendous import to all segments of the building industry. It not only means that better, more modern homes can be built in rural areas, but it presages a tremendous remodeling and modernization market for years to come. Although fewer than 500,000 new houses were actually completed in the United States in 1946, 6,143,968 dwellings were wired for electricity, a large percentage of

these houses were in the rural sections.

Not all of the rural homes wired were equipped immediately with electric water systems, but it is a certainty that every rural home now equipped with electricity constitutes a potential customer for a water system. Wide-awake retailers in areas where rural electrification is being effected are following the electricians with numerous sales of water pumps.

Once a water system is installed in an existing rural home, a whole new program of modernization possibili-

ties of prime interest to builders and dealers is possible. A kitchen modernization job is one of the first projects on the docket. This involves considerable labor as well as sale of materials and kitchen cabinets. The firm which establishes a reputation for being kitchen-modernization specialists in a rural area, where electricity is being made available for the first time, is headed for a steady flow of good business.

Another major project in any home where electricity is available for the first time is a modern bathroom. Again the sale of considerable material as well as labor is involved on each job, and although plumbing fixtures are still in short supply, alert builders and dealers are watching the potential in their trading areas so they can take over when materials and labor are available.

With farm income at an all-time high, and farm savings and cash resources exceeding all previous records, many new farm homes will be built in the years immediately ahead. The coming of electricity and modern water systems will accelerate that trend because in many instances the old farm house is totally unadaptable to modernization incorporating the use of electricity and water.

In other cases where the house is comparatively new and in a good state of repair, it will require a complete remodeling job from basement to



HAVE you considered the farm market lately?



RURAL COMMERCIAL



SUMMER RESORT

A huge market for the building industry is being developed by electrification of rural areas and the resultant demands for conveniences formerly unavailable beyond city water mains

attic, inside and out, to completely renovate the dwelling to adapt it to modern living with electricity and water.

Along with home modernization and new construction on the farm with the coming of electricity and water, comes the huge potential in new construction and modernization of farm service buildings, particularly dairy barns. Again builders and dealers who are equipped to satisfy the requirements of these farmers, and impress their potential customers with that fact, should face the future with a maximum amount of optimism. According to recent reliable figures, there are more than 4,000,000 farms without running water.

The farm market is only one segment of the potential market being created for the sale of electric water systems and the related products and services. The non-farm residential market is now considered as about four-fifths as large as the farm market by manufacturers of electric water systems. Thousands of city dwellers are continuing to move to rural areas, and the trend is being accelerated. Despite the fact that most new houses being built now beyond the reaches of city water mains are being equipped with electric water systems, there are more than 3,000,000 non-farm homes without running water.

A third large potential for builders and dealers to develop for business in

connection with electric water systems is the rural commercial market. Filling stations, tourist courts, taverns, restaurants, airports and other types of establishments beyond the city water mains constitute another huge volume of business that can be developed by the alert dealer and builder.

Still a fourth segment of the market for this type of business is the summer resort and summer home owner. Accumulation of capital and increased earnings have brought this potential sharply into the limelight for the sale of electric water systems along

with the related need for materials and labor to modernize this type structure.

Industry surveys reveal that one of the first major investments made by farmers and others, once electric power is made available, is an electric water system. Predictions by the electrical industry reveal that by the end of 1948 there will be more than 5,000,000 farm homes wired for electricity. Progressive builders and dealers are gearing their operations to take care of this market for their goods and services.

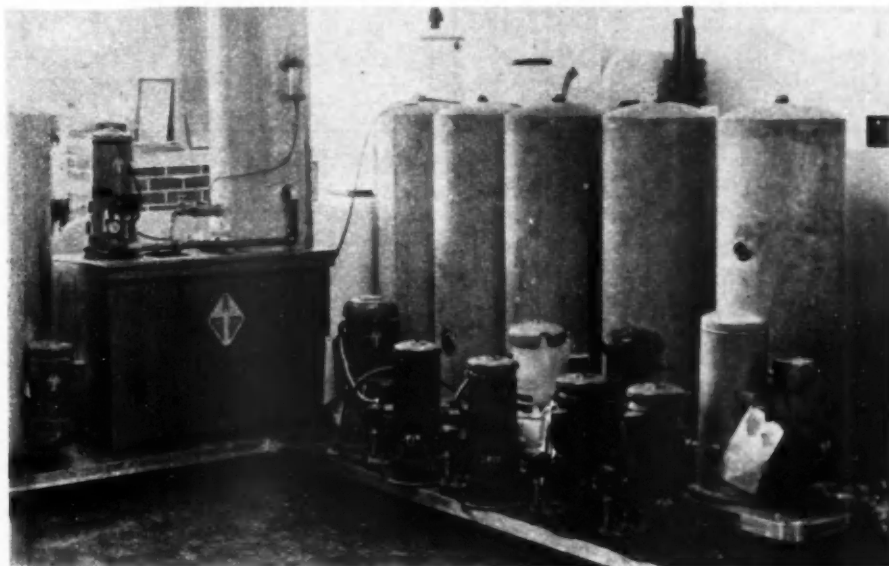

IN 1941 water system sales totaled 347,055 units. In 1946 sales totaled 625,729

How to Install A Metal Door Frame

One-piece assembly produced by Aetna Corp. for home use designed for easy installation

A NEW steel door frame made by Aetna Steel Products Corp., 61 Broadway, New York, arrives on the site assembled in one piece, with head, two sides of trim, anchor clips (or T-anchors, if the frame is to be installed in masonry walls), hinges, steel dust box, and brass strike spot welded to the frame.

The frame is secured to wood stud partitions (plaster or dry wall finish) with metal clips; to masonry partitions with loose T-anchors placed at masonry joints, three per jamb; and is secured to steel stud walls by anchors welded to the frame which may be bolted, welded or securely tied for proper anchorage.

For use in wood stud partitions with plaster finish, these frames can be installed before or after partition studs are placed. In wood stud partitions with dry wall finish, the wall board should fit tightly against the back band of the frame. Where thin boards are used, it may be necessary to place shims between the stud and the board.

Flanges of the anchors for Aetna's frame (for dry wall or plaster finish stud partitions) come flattened against the back band and are bent into position when the frame has been placed in the wall opening.

One of the advantages found in the use of metal frames is the added rigidity to the opening. Aetna has gone a long way toward adding the advantage of simplicity in installation of door frames.



AETNA door frame assembled in one piece

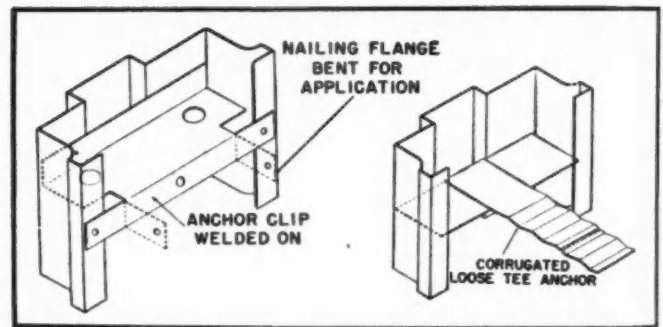

FRAME is secured to the partitions by means of anchors

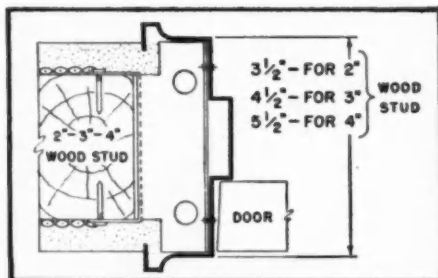

POSITION of metal frame installed in wood stud partition with plaster finish.

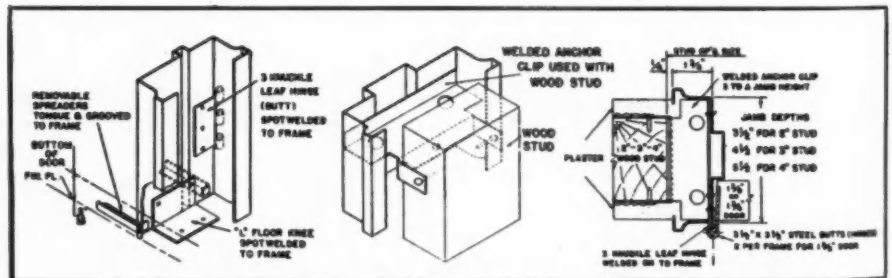

FRAME anchored to floor by knees, left. Center and right, jamb clips secured to studs

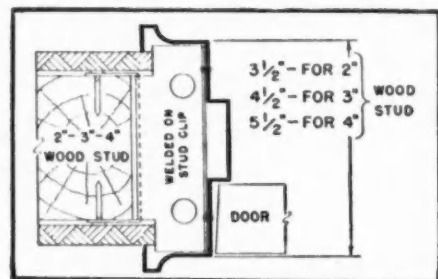

POSITION of frame in wood stud partitions with dry wall finish. Where thin boards are used, it may be necessary to place shims between stud and board

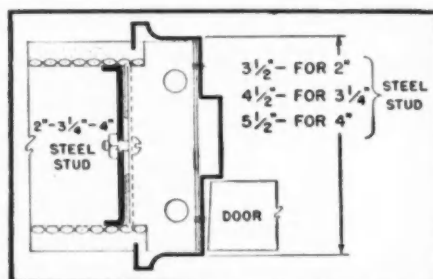

WHEN metal frames are used in steel stud partitions, T-anchors may be bolted, welded or securely tied for proper anchorage. See illustration of anchors, above left

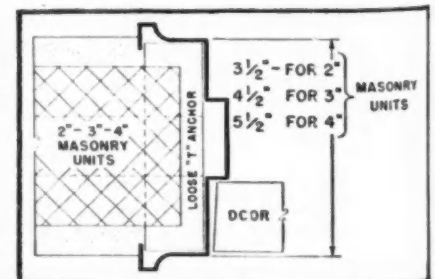

IN masonry partitions, Aetna provides T-anchors for proper bond between frame and partition. T-anchors should be placed at masonry joints, three per jamb

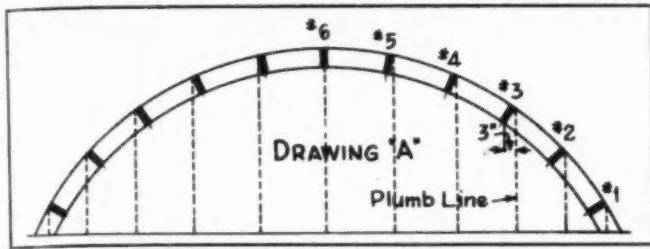

DRAWING A shows typical rafter positions at truss, and plumb lines for measurement. Also, distances above bottom of truss to top of rafters are shown. Note tilt angle from plumb line to rafter



DRAWING B shows typical position of rafters at plate or stirrups

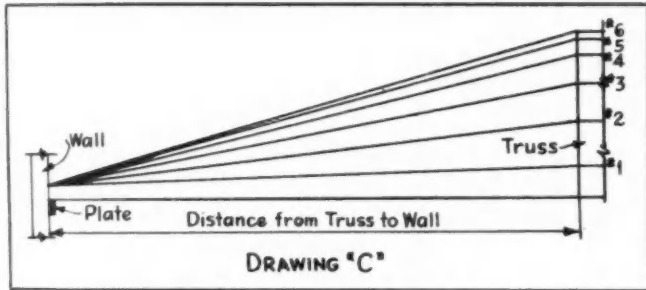

DRAWING C shows top line of rafters, plate, truss, and wall

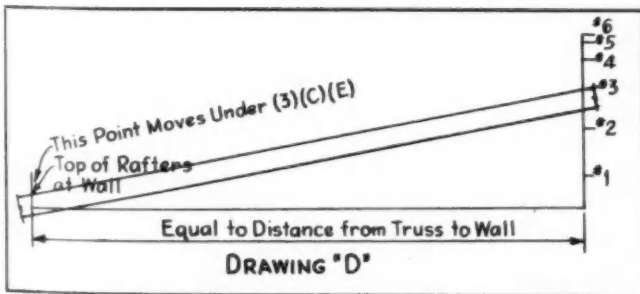

DRAWING D shows line jig laid out on floor with two 90 degree upright lines in place. Rafter heights above bottom of truss are shown, with board in place for number 3 rafter

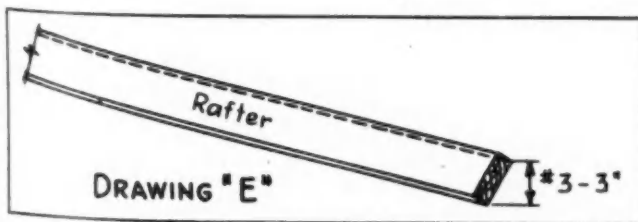

DRAWING E demonstrates how proper tilt angle for cutting is determined by measuring from plumb line to rafter on truss layout

Accurate Method of Cutting Rafters Between Wall and Bow String Type Truss

Simplicity of procedure is sacrificed in order to obtain more accurate results and less waste. Though a bit more complex, it eliminates guesswork

RAYMOND R. NEAL, of Phoenix, Ariz., suggests the following method for cutting rafters between a bow string truss and the end wall where end of rafter rests on a plate or in a stirrup. This method eliminates guesswork and saves on materials.

The method employed by Mr. Neal is of particular advantage where the building is out of square or where the truss and wall are not parallel. All of the rafter cuts will fit accurately if care is used in the layout. The following procedure should be followed:

1. Lay out rafter positions on truss and wall.
 - a. When laying out rafter position on the truss, measure from bottom of truss to top point of rafter on truss for each pair of rafters. (See drawing "A.")
 - b. With a plumb bob or hand level draw a line down from outside top point of rafter layout on truss, and measure from bottom of rafter layout, to this line, for each pair.
 - c. An additional measurement is necessary for each rafter from top of rafter layout on truss, to top point of rafter at the wall, if the building is out of square. (See drawing "C.")
2. Measure the distance from wall to truss. (See drawing "C.")
3. With the above measurements a line jig can now be set up.
 4. Draw or snap line on wood or cement floor, equal in length to distance between truss and wall. (Drawing "D.")
 - a. Draw or snap a 90 degree upright line at one end equal in length to height of truss at center. (Drawing "D.")
 - b. At the opposite end another 90 degree upright line should be drawn, equal in length to desired distance above plate or stirrup for top of rafters. (Drawing "D.")
 - c. On the truss height line the individual distances from bottom of truss to top of rafter layout can now be marked. (Drawing "D.")
 - d. If the building is out of square, the measurements taken under (1c) are now used, and the wall end of jig is shortened or lengthened to this measurement.
 5. Place top of rafter timber to proper points, as shown in drawing "D" for each pair of rafters (or individual rafters if building is out of square).
 6. Raise lower or upper side of timber (depending on which side of truss the rafter fits) to measurement taken from plumb line in drawing "A" as shown in drawing "E." Transfer or scribe along straight edge the lines from the floor jig to timber, while timber remains raised as above.
 7. Cut on lines and rafter will now fit properly.

Mr. Neal is a carpenter foreman who has had charge of a number of large housing projects.



How-To-Do-It Pointers

How to Make a Non-Swelling Threshold

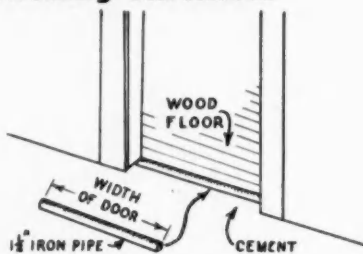

TO make a non-swelling threshold for basement and small factory doors, P. A. Herman, LaCrosse, Kan., suggests imbedding a 1½ inch diameter iron pipe in concrete across the width of door opening, allowing pipe to extend ¾ inch above floor surface.

How to Make a Roof Purlin Plumb

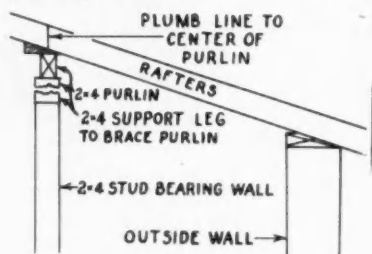

RAYMOND R. NEAL, Phoenix, Ariz., submits the following suggestion. By using scrap wood (plate notch) to shim the purlin, it is easy to make the purlin plumb, thus avoiding the placing of purlins at right angles to the rafters. Some of its advantages are as follows:

1. Simplifies cutting of legs or braces.
2. Eliminates scribing, thus saving time.
3. By adjusting the plate notch, it is easy to raise or lower rafters.
4. Plate notch is secured to purlin and rafter.
5. It is easy to raise a section of roof if necessary.

How to Make a Saw Clamp

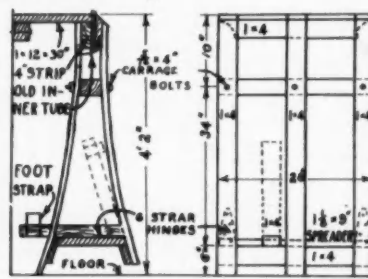

THE saw clamp suggested by J. G. Caldwell, San Mateo, Calif., can easily be made from 1x4 inch lumber. When in use, it will hold the saws tight and prevent any vibration or screeching. It should be secured to the wall near a north window.

How to Install a Glass Block Store Front

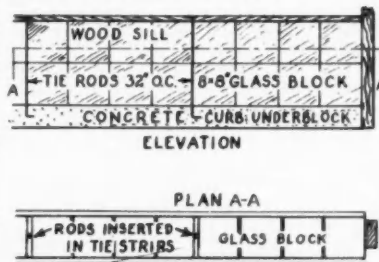

RAYMOND R. NEAL, Phoenix, Ariz., submits the following suggestion: To properly anchor glass blocks to concrete curb, a ¾-inch tie rod is imbedded in the curb every fourth course of the glass blocks. These rods extend through the glass block wall at mortar joints, and are capped with a countersunk nut at top of wood sill. The concrete curb should extend at least 4-inches above the sidewalk line.

How to Remove Dowels

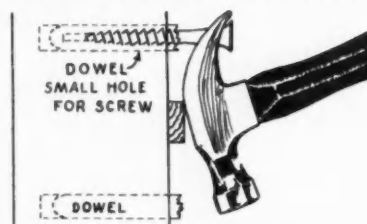

BORE a small hole in center of dowel. Insert a 2-inch screw about 1 inch into hole. Place a block of wood under heel of hammer and use in the same manner when pulling nails. Quick pressure on handle will force old dowel to come out. H. B. MASON, Duncan Falls, Ohio.

AMERICAN

"Built-ins", a Feature Of Dual Bath and Dressing Room

By R. J. Alexander

HOUSES of the better than average class, having three or more bedrooms, are usually planned to contain one master bedroom that has an adjoining bath and dressing room.

The size of the bath and the equipment that it contains will depend upon the space that is available and the ultimate cost of the house. The bathroom may be a single unit used only by the occupants of the master bedroom, or it may be separated into several compartments for dual use, as indicated in the drawing on the opposite page. This permits one portion of the bath to be used by all occupants, reserving the other part exclusively for use with the master bedroom.

There are many ways of planning for the extra bathroom. Family requirements will dictate its size, equipment and location. An opening to bathroom from the hall as well as the master bedroom can make it accessible to children preparing for school. Where two bathrooms are provided, they should be placed adjacent to each other to effect a saving in labor and material costs.

The bathroom today offers a challenge to the designer. Many new and beautiful materials are available. Regular clay tiles, plastic tiles, steel tiles as well as hardboards in tile and other patterns can be obtained. Structural glass, glass blocks, linoleum for walls and floors, together with rubber tile and cork tile also provide opportunities for unusual effects. Metal and plastic trim and bases that form a continuous rounded member between floor and sidewalls can be used in conjunction with these materials.

The planning of the dressing room will also be governed by its size. In addition to regular hanging closets, built-in tray cases are always welcome. By referring to the detail sheet on the opposite page additional information covering the built-in features may be obtained.

The swinging closet doors with mirrors attached may be replaced with sliding wardrobe doors. In that case a full length mirror should be provided in the dressing room. Dressing table may be movable or built-in. In the event that it is a built-in unit then a small lavatory may be placed in the counter top, making it an integral part of the table. The group of closets are indicated as being built up of studs and plaster. They can be made entirely of plywood, extending from floor to ceiling with ¾ inch thick plywood doors.

AN BUILDER'S BETTER DETAIL PLATE

American Builder, March 1948.

115

NO. D-41 DRESSING ROOM & BATH OFF. MASTER BED ROOM.

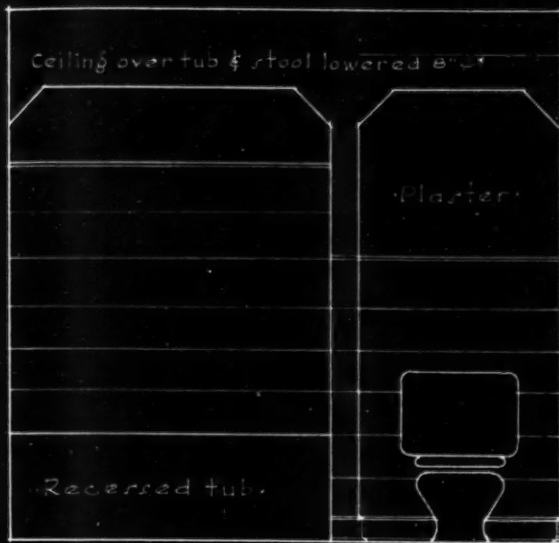

ELEVATION A

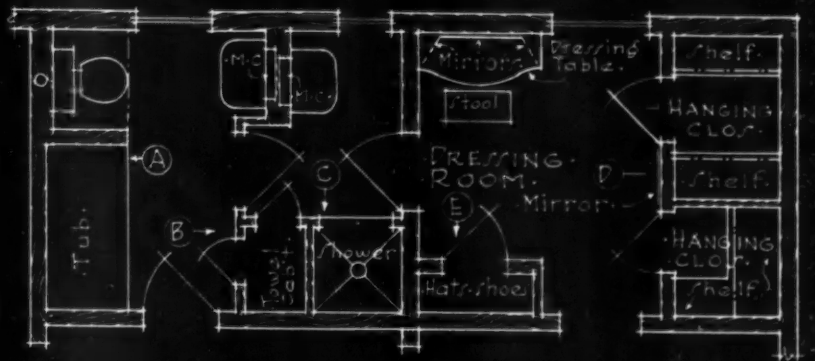

HALL MASTER BED ROOM
PLAN OF DRESSING ROOM & BATH

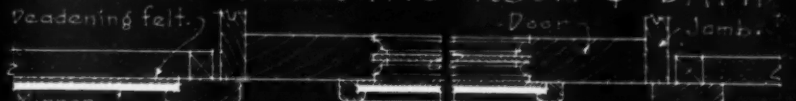

SECTION F-F

SECTION G-G



ELEV. B

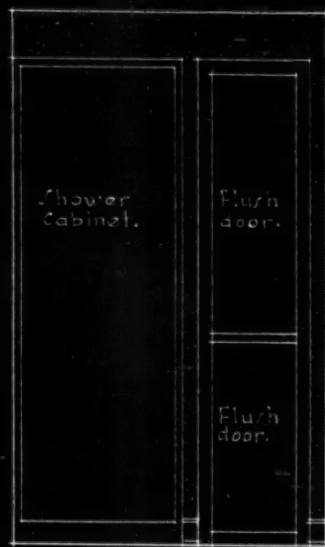

ELEVATION C

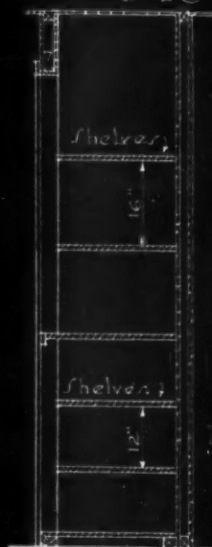

SECTION THRU TOWEL CABINET

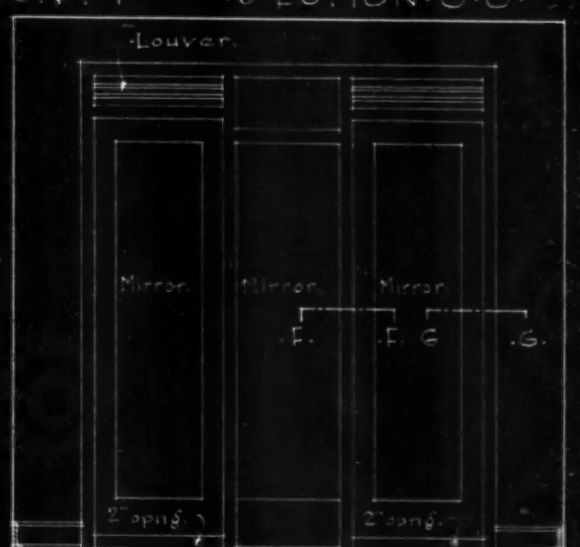

ELEVATION D

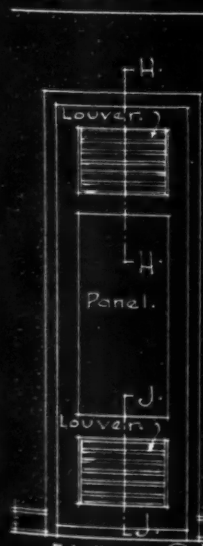

ELEV. E SECT. HANG. CLOS.

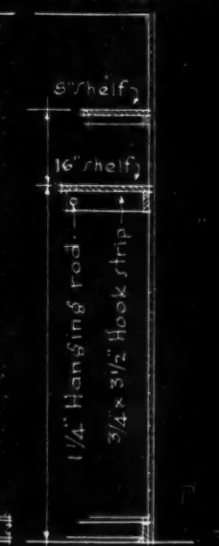

SECTION H-H

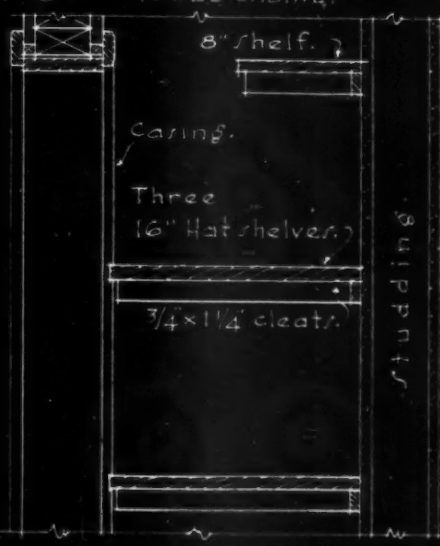

SECTION J-J

verage
bed-
con-
t has
ssing

equip-
pend
e and
The
used
master
d into
l use,
on the
e por-
by all
r part
master

nning
ily re-
size,
pening
well as
ake it
ng for
ns are
ed ad-
a sav-
ts.
a chal-
y new
avail-
c tiles,
ards in
be ob-
blocks,
rs, to-
ork tile
or un-
ic trim
inuous
or and
unction

ressing
by its
hanging
always
e detail
ditional
built-in

rs with
eplaced
In that
ould be
room.
able or
it is a
avatory
ter top,
of the
are indi-
uds and
entirely
floor to
plywood

OO IT

GIVING BUILDERS SERVICE

Builds Big Business for Small Yard in First Eighteen Months



MYRTLE Avenue Lumber Co., Monrovia, Calif., one of most modern yards in San Gabriel Valley, specializes in service

BY CATERING to the builder and small contractor, the Myrtle Avenue Lumber Co. of Monrovia, Calif., has grown from a small business to one of the most modern and progressive yards in the San Gabriel Valley—in just 18 months.

In June, 1946, the business was operated from a temporary office located in an orange grove. Today, on the same site, is an attractive, modern office and yard—proof of growing success.

Although there are many large housing projects in the community, Norbert Bundschuh, general manager, feels that a more permanent business can be established by catering to the smaller builder. He made more than

1,200 separate sales in a recent month. Bundschuh is assisted by Walter H. Henkel and Paul Forman. All three men are young, and determined to make a success of the business.

The design of the office, conceived by C. William Ainley, architect, was intended to make it an actual display room. To do this, the materials used in the construction of the office were those which would be offered for sale.

The interior is panelled with T&G Douglas fir and knotty pine, both used in random widths. Display islands, also, were made of knotty pine.

Lamineer, a plastic material suitable for drainboards, was used for counter tops. The floor of the office is asphalt tile.

Soundproofing was effected by using Acousti-Celotex on the ceilings. Six spot lights, inset flush with the ceiling, light the store. These lights, together with the neon-light sign on the roof, are operated by a time clock which turns them on and off.

The individual displays are well arranged and kept attractive by adding new merchandise as soon as that on display is sold.

Adequate ventilation is provided by transoms arranged at the top of fixed plate glass windows. The windows extend from about a foot above the floor to ceiling height.

On both sides of the windows are expanses of 1x12 T&G red cedar siding, treated with one coat of oil and

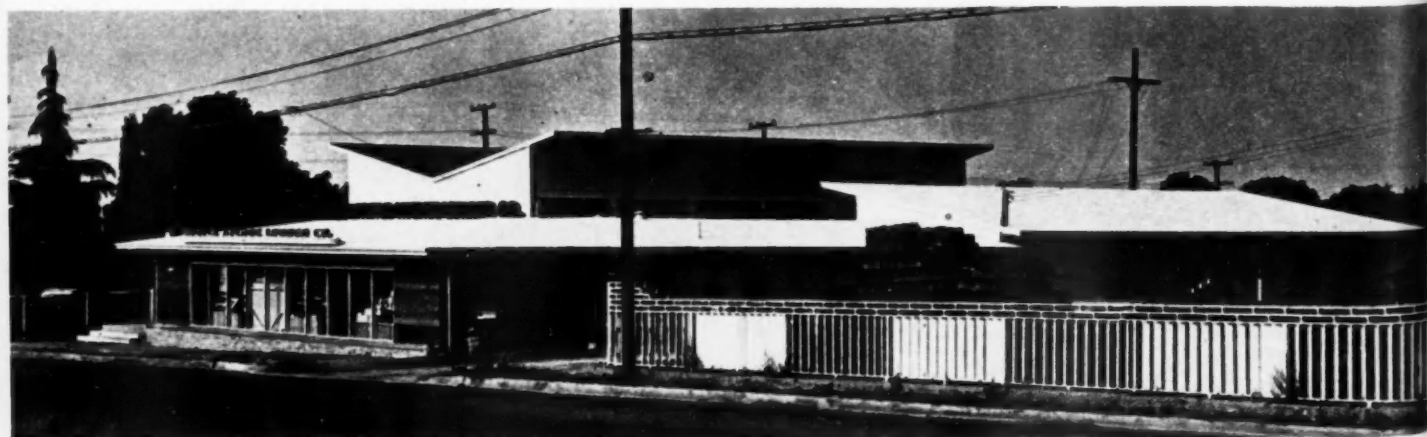

REAR view of yard, showing display fence with different ideas for fence construction, designed by Ainley

Catering to builder and small contractor has paid big dividends for Myrtle Avenue Lumber Co. Maximum effort is made to keep materials on jobs to avoid construction delays



LOADED trucks have steel straps around lumber to prevent breakage, reduce pilferage



NORBERT BUNDSCHUH, 33, manager

two of dull varnish. The area below them is built up with Arizona flagstone.

The sidewalks are wide, extending from the building to the street. Although the yard is located on the main street in Monrovia, plenty of parking is available because the location is away from the crowded business section.

The display fences are constructed of six types of fencing, all designed

by Ainley. They are made from stock lumber in different patterns and are about 4 feet high, painted in cream color. The idea here was to show the builder what could be done with ordinary materials to create a variety of designs for fences.

The yard has been successful in selling merchandise and, also, successful in getting merchandise. Getting materials has been a big job, as one would expect, for a new yard. Many

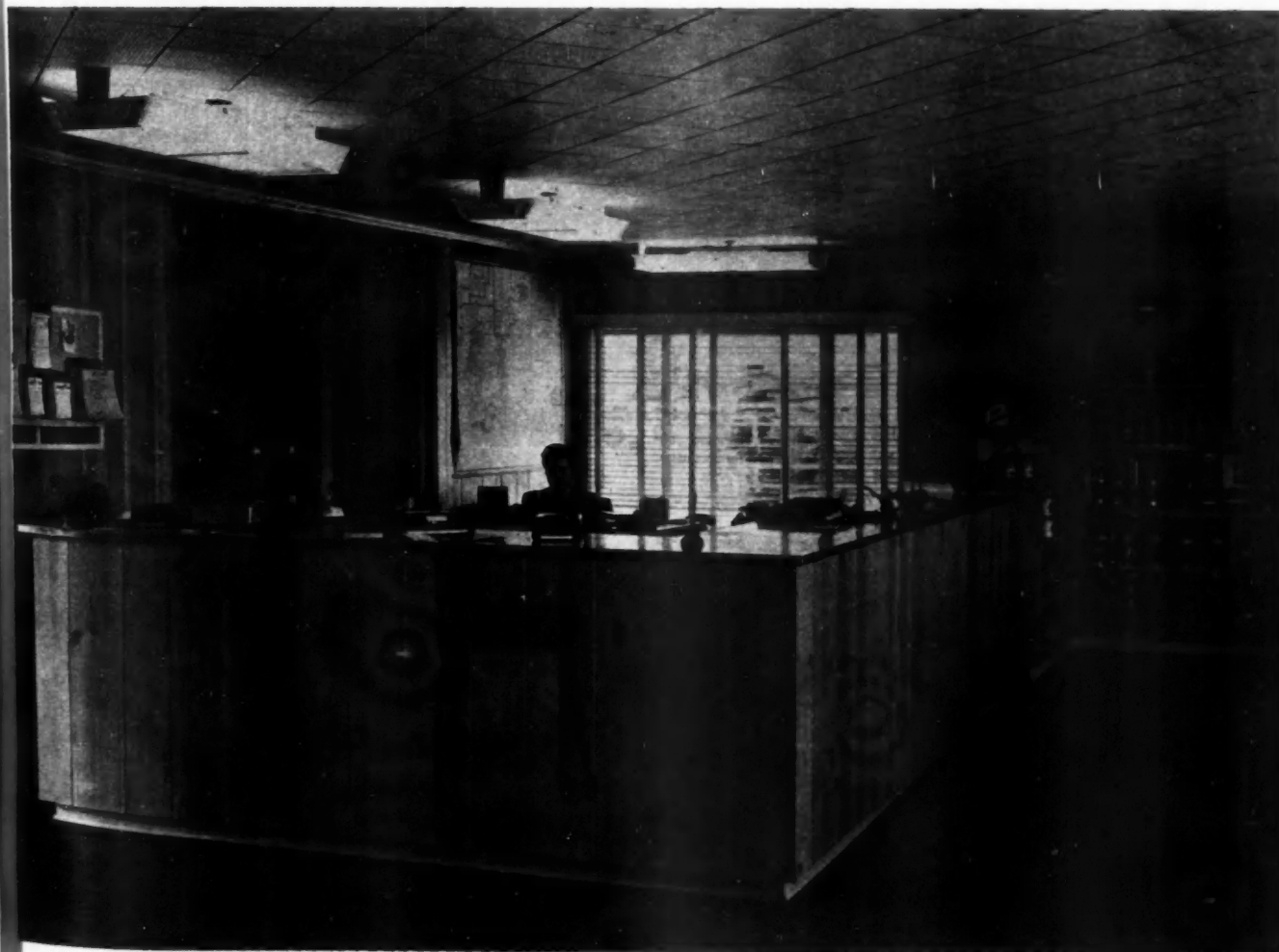

ATTRACTIVE use is made of knotty pine paneling in partition dividing office from sales area



AT Christmas time, Bundschuh erected this unusual display. Six spot lights inside building and neon sign (front) are operated by time clock. Note attractive window display

manufacturers adopted the policy of taking care of their old customers first, but when material salesmen call at this attractive and friendly yard, they are impressed; they believe in its future and have a tendency to do everything possible to take care of its requirements.

The yard carries every conceivable item needed to complete a house except plumbing and electrical materials. If a job requires an item in the build-

ing material field which is not stocked, the firm ascertains where it can be purchased, obtains it, and delivers it to the customer.

An unusual practice of the yard is to put a steel strap around loads of lumber. This tends to prevent breakage when the load is dropped to the ground, and it also helps to reduce the amount of pilferage when the lumber is left on the job site any length of time before being used.

The company has one flat bed Chevrolet truck and an International KB7 with a roller bed. All orders, regardless of size, are delivered promptly in accordance with the policy of working with builders to avoid delays due to lack of materials on the job.

The company does a consistent advertising job, not only in the local papers but in papers in the adjoining territory which is considered as its trade area.

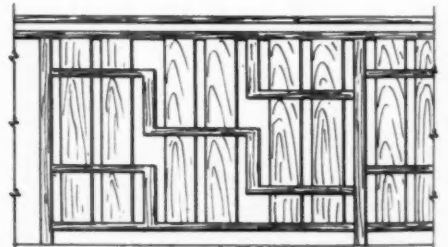
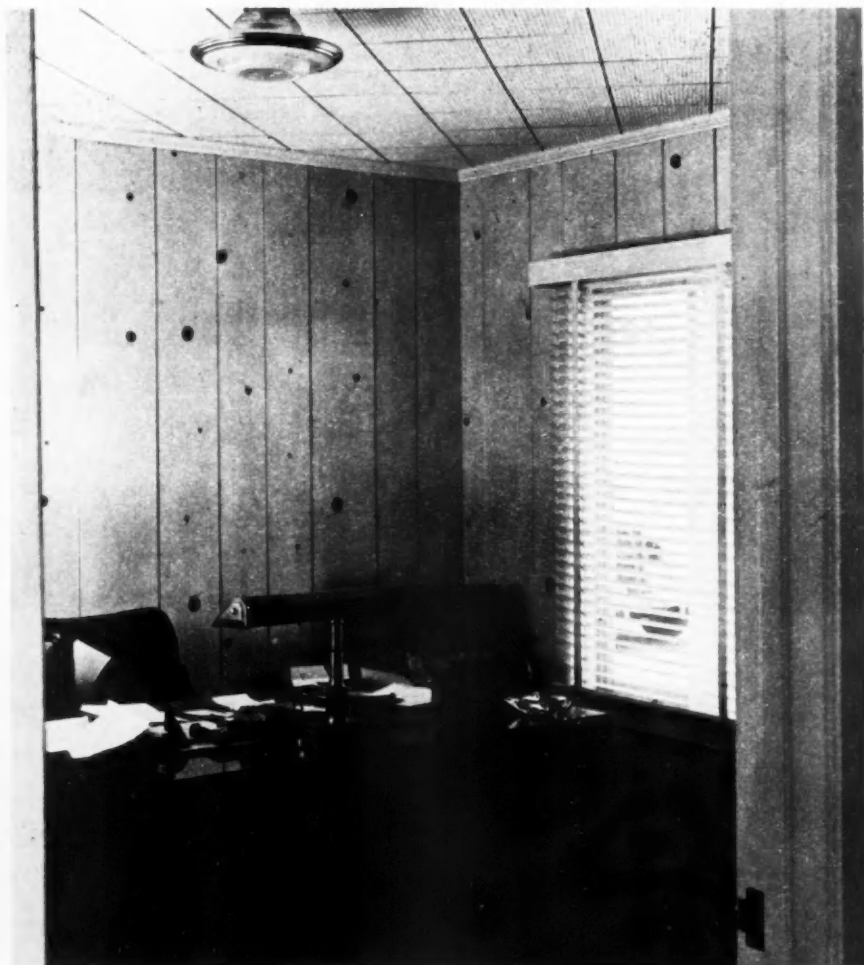

PLAN is one of C. William Ainley's used in the Myrtle Avenue Lumber Co. display fence. Fence at yard has six different designs

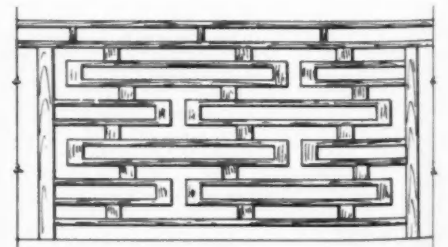

ANOTHER fence design by Ainley. The attractive patterns are made from stock lumber, are about 4 feet high, painted in cream color

LEFT shows interior of Bundschuh's office paneled with T&G Douglas fir and knotty pine. Ceiling is soundproofed with Acousti-Celotex; floors are asphalt tile

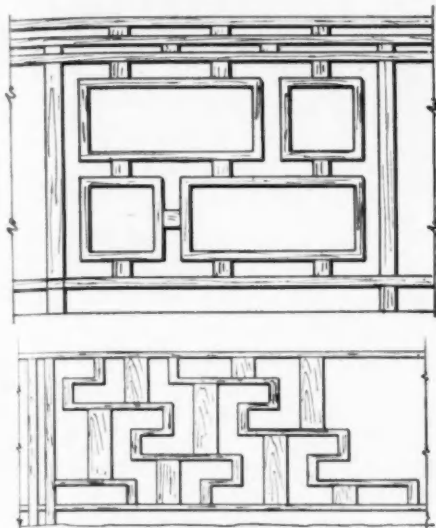

ABOVE are two designs used in display fences. Below is yard plan of company



INDIVIDUAL displays are kept attractive and well arranged

Bund- unusual ghts in- neon operated Note display

t bed ational ers, re- prompt- licy of delays job. ent ad- e local joining as its

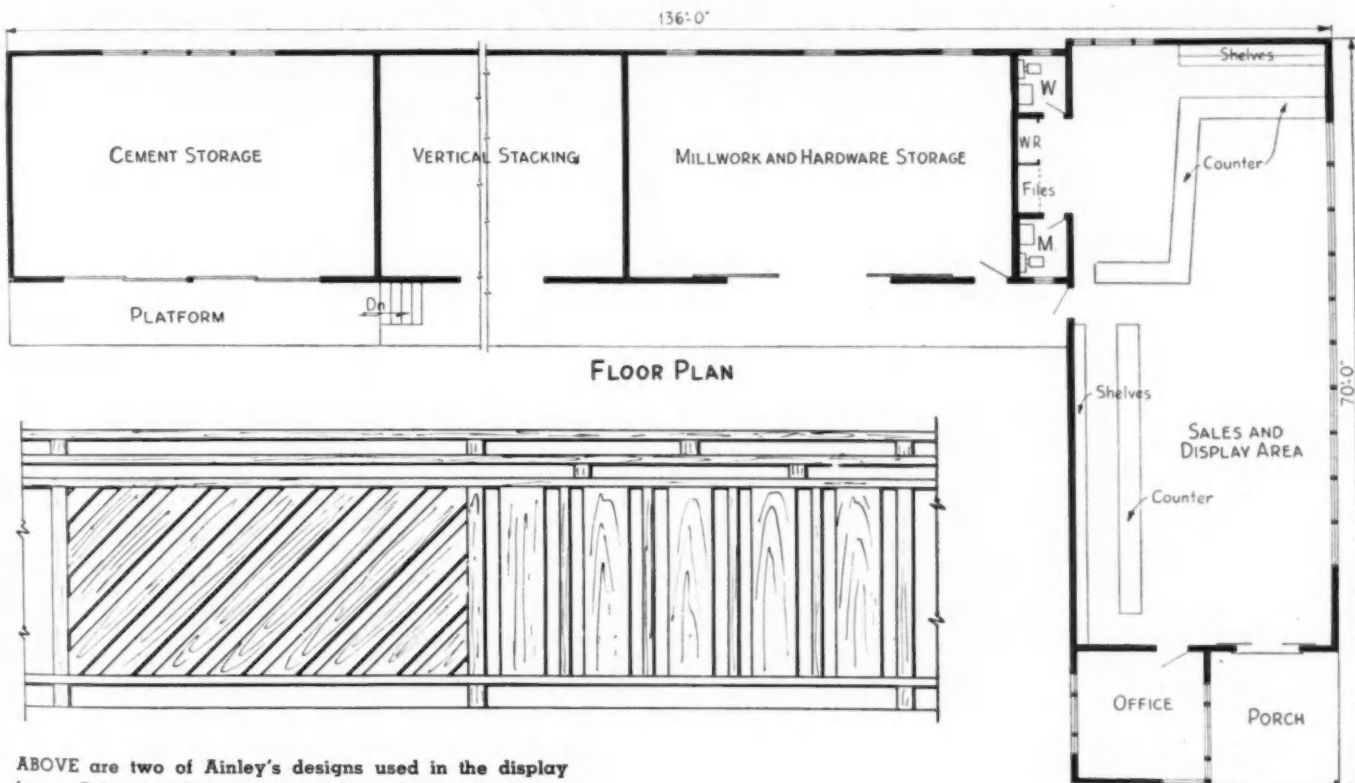

FLOOR PLAN

ABOVE are two of Ainley's designs used in the display fence. Below is a large portion of fence, built around yard



's used display designs

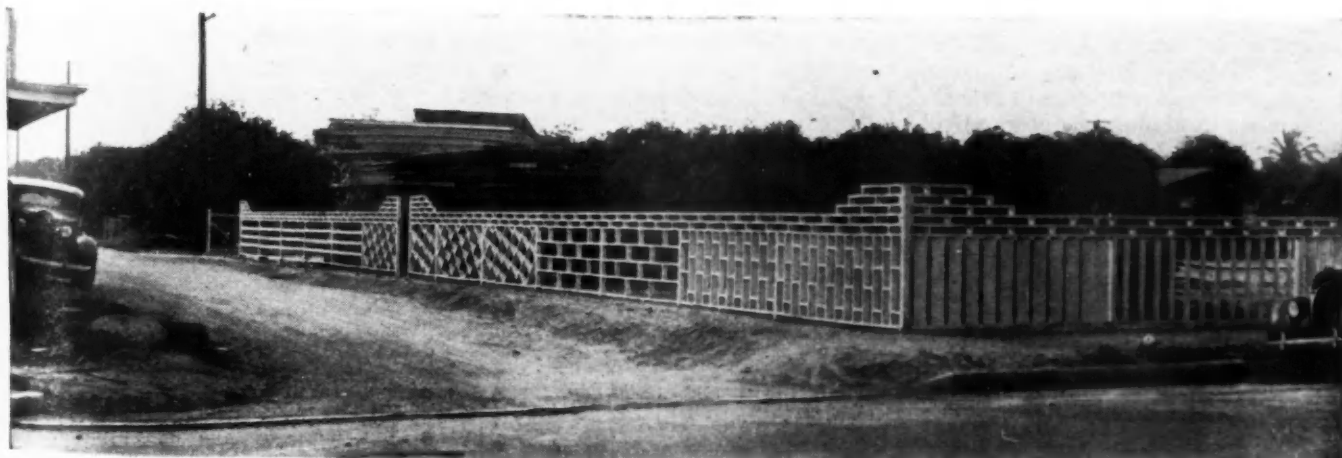

The at- lumber. am color

office motty with tile



LOGGING operations like this are gradually filling the pipe lines of supply

Supply Lines Are Filling Up

By R. E. Saberson

CONTINUED shortages of certain lumber items and other kinds of building materials are apt to obscure the fact that the pipe lines in many cases are beginning to fill up. By slow degrees supply is catching up with demand and when that long-awaited day finally arrives, the retail lumber industry will be confronted with a completely different set of problems.

These problems are not new. As a matter of fact, they are almost as old as the industry itself, for they revolve around the question of how to sell merchandise at a profit when there are more goods than buyers.

Perhaps it may seem a bit early to do any great amount of speculating on what to do and how to do it, come the day when competition will rear its well-known head and the question will be "What price?" instead of "Have you got it?" or "How much can you let me have?"

Take lumber, for example.

Demand continues heavy, and especially for certain hard-to-get items, but already substitutes are popping up to relieve the situation. The substitutes may come from another species, size or kind of lumber or they may be the product of another industry. The fact remains that no single

product has ever proved to be indispensable to our economy. What is no longer to be had invariably is replaced by something that usually is better and more economical.

At the moment we hear much about the continued scarcity of lumber and the high prices which prevail. Often we hear it claimed that lumber, instead of catching up, is losing ground.

In order to get a more comprehensive view of the situation, keep these three figures in mind—14, 5 and 9—which represent the total lumber inventory on hand at three important periods—(1) back in the days when supply was normal, (2) at the low period following the war and (3) at the present time.

Fourteen is the total number of billions of feet of lumber on hand at the end of 1940.

Five billion feet is the amount at the low point . . . the first quarter of 1946.

Nine billion feet is where we stood at the end of the third quarter of 1947.

The actual figures in all cases are the estimates of the United States Chamber of Commerce.

Total lumber stocks at the close of 1940 amounted to 14,447 million feet, divided as follows: Sawmills and con-

centration yard, 8,352 million feet; retail yards, 6,095 million feet.

At that time little was heard of lumber shortages and there seemed to be enough on hand to meet the needs of a busy nation.

Then came war which not only diverted lumber to military purposes but eventually reduced production, due to shortages of manpower and essential mechanical equipment.

The low point brought about by a variety of uncontrollable circumstances was reached at the close of the first quarter of 1946 when the total national inventory amounted to 5,250 million feet. Sawmills and concentration yards, 3,541 million feet; retail yards, 1,709 million feet.

From this unprecedented low point inventories began to creep up gradually despite the fact that demand never was greater and shortages continued to be the order of the day.

At the end of the third quarter of 1947, the national inventory had recovered to the point where it totaled 9,487 million feet. This was 66 per cent of the amount on hand at the end of 1940 and an advance of 81 per cent above the 1946 low.

That's where we get the three figures mentioned at the beginning—14,

Amer

5 and
easy
glance
being

A
retail
1,709
3,779
1947,
cent.

ories
tration

It v
mate
ter of
last q
quarte

Dur
tion
severe
same
duction
more
curren
year a
crease
This

W

plenti
to go
ing to
that t
fill up
deman

Ho

In
let's t
duction
The y
since
were

larges
the hi
was d
all ex
a sing
1925.



Although scarcity of certain lumber items and other materials obscure the facts today, the lumber supply is slowly catching up with demand. When that long-awaited day arrives, the lumber industry will be confronted with new problems



LUMBER flowing into dealer yards by truck and train, shows a supply increase

5 and 9. In round numbers they are easy to remember and show at a glance the substantial progress that is being made.

A further breakdown shows that retail stocks have advanced from 1,709 million feet (the low point) to 3,779 million feet near the end of 1947, which is an increase of 121 per cent. During this same period inventories at the sawmills and in concentration yards went up 61 per cent.

It will be noted that the final estimate was at the end of the third quarter of 1947. It does not include the last quarter of that year or the first quarter of 1948.

During these six months, construction was retarded substantially by severe weather conditions while the same slow-down did not occur in production. This should result in an even more favorable showing, so far as current inventories are concerned. A year ago there was an 8 per cent increase during the comparable period. This year it should be even greater.

We are not claiming that lumber is plentiful or that there now is enough to go around, but merely are attempting to show by government statistics that the pipe lines are beginning to fill up, even in the face of the greatest demand in history.

How come?

In order to answer that question, let's take a quick look at lumber production figures for the past few years. The year 1920 is a good place to start since the years between 1920 and 1930 were ten big lumber years . . . the largest production decade, by far, in the history of the lumber industry. It was during this period that we broke all existing home building records for a single year . . . 937,000 houses in 1925.

It is highly important to note that for these ten years the average annual production was 37 billion feet. Keep that figure well in mind, too, so that you can compare it with what happened in 1947 and what is expected to take place in 1948.

In the decade between 1930 and 1940 lumber production dropped to an annual average of approximately 21 billion feet due to the depression of the early thirties and the slow recovery which encountered another setback in 1937.

Then came the stimulus of war and the all-out effort to supply the prodigious demands created by the worldwide conflict. Lumber soon became the Number 1 critical material and every effort was made to produce the largest possible amount. During these years (1940-1946) the average annual production was 33½ billion feet.

What happened immediately after hostilities ceased is of equal interest, when the industry turned its attention to the colossal job of supplying the pent-up demand which had accumulated not only during war years but also during the depression years of the thirties when little construction work was going on.

In 1947 the lumber industry produced between 35 and 36 million feet of lumber and came close to equalling the high average established during the big lumber-using years of the twenties. Furthermore, the estimate for 1948 is 38 million feet!

What better evidence is needed to prove that the supply lines are gradually filling up, even in lumber.

High prices have no doubt been responsible for this exceedingly satisfactory record . . . prices which made it possible for several thousand small sawmills to go into production that

otherwise would not have been able to do so.

It is an amazing fact that there are now nearly twice as many lumber-producing units in the United States as there are lumber yards—a situation that does not prevail in any other industry. Many of these units may not properly be called sawmills as we know the term today, but the fact remains that each and every one of the estimated 50,000 is producing lumber of some kind and that this output is helping to reduce the pressure of excessive demand.

As long as these marginal mills remain in production, we shall be coming closer to the time when supply and demand are balanced.

Current high prices are, of course, the constant worry of those who can't afford to pay them, and that includes many young people who would like to rent an apartment but, not being able to do so, have turned their attention to the building of an individual home . . . at a time when prices are highest.

The fact that these same young people couldn't afford to buy a home at prewar prices (and didn't want to be bothered with one) has not modified the zeal of politicians with an eye on the ballot box. On the other hand the fact should not be overlooked that the 1947 home-building record comes mighty close to beating 1925 when we built more houses than in any other year. All of which indicates that the pipe lines may likewise be filling up so far as houses are concerned.

Some of these days there will be as much too much of everything as there is now too little, and there are now signs that indicate it may be sooner than we think. Production facilities are being doubled, trebled and even quadrupled in industry after industry. We simply can't keep that up indefinitely without reaching a point where supply eventually exceeds demand.

In the meantime prices will remain high as long as there are buyers who can afford to pay them, for it is the buyer, not the seller, who actually makes the price.



FULL stock piles of lumber are already evident in some localities

BEHIND the SCENES

In a Woodworking Factory

How Men and Machines Speed Production

WINDOWS, doors, cabinets, mantels and exterior trim are all short items in the stock piles of distributors and dealers today.

The above items remain short in spite of the greatest production effort in the history of woodworking companies. The shortages are not because of lack of machines and know-how, nor because of a lack of willingness on the part of the manufacturers to produce, but because scarcity of raw material and skilled labor continue to be obstacles.

Mr. Builder, Mr. Dealer, let's step behind the scenes in any modern woodworking factory. Let us start where the raw material is unloaded from the cars, goes to sorting tables, through the cutoff saws and on into the respective stock piles.

Not a scrap of that precious lumber is wasted—the shorts and blocks go to make up the cores for doors, the clear pieces are sorted and stored by size. The production line is so well organized that materials move in a constant flow to the machines that produce the finished products.

The whirr and buzz of a busy mill is deafening—noise, noise, noise, but no confusion, all permeated with a pleasant aroma of fresh cut white pine.

Look at that battery of seven cutoff saws—note the skill of the operator in his selection of cuts that holds waste to a minimum. See the sawdust flying from that pulley machine. It routs out a pocket and two heads at one time for a window frame.

Over to our left is a monstrous machine. Let's step over and get a closer view. It is turning out sills all in one operation. With four heads cutting, it takes a square piece of $1\frac{3}{4}$ inch material and shapes it into the smooth lines of a finished sill. Now the sill runs through a machine that cuts the lug to fit the side jambs of a window frame. Speed and precision is in every operation.

Let us move on to the sash department. Everyone needs sash and here they come. That double-end tenoner has a pay load on every lug. After the parts have been cut and shaped to size, glued and nailed together, they go to the glaziers. See that lad with the automatic trigger-operated tinner. It drives diamond points into the sash to hold glass in place for the glazier. Did you every try putting the putty around a sash? Watch that glazier—one stroke and a side is finished. Rhythm, speed and know-how combine to make the finished sash.

Doors are manufactured with equal speed and precision. Trim and cabinets are coming off of the production lines in greater volume than ever before. Gradually the pipe lines of production are filling. The manufacturers are doing a marvelous job. Without their know-how and machines the builders of this country could never have attained the high mark made last year in the number of completed homes. Their ability to supply stock woodwork has made better homes possible for the American public. Their production quotas are only limited by the supply of raw materials and skilled labor.

All Photos Courtesy of the Carr, Adams & Collier Co.



1 SEVEN cutoff saws keep conveyor belt filled with clear cuts of Ponderosa Pine. All knots are marked, and cut out

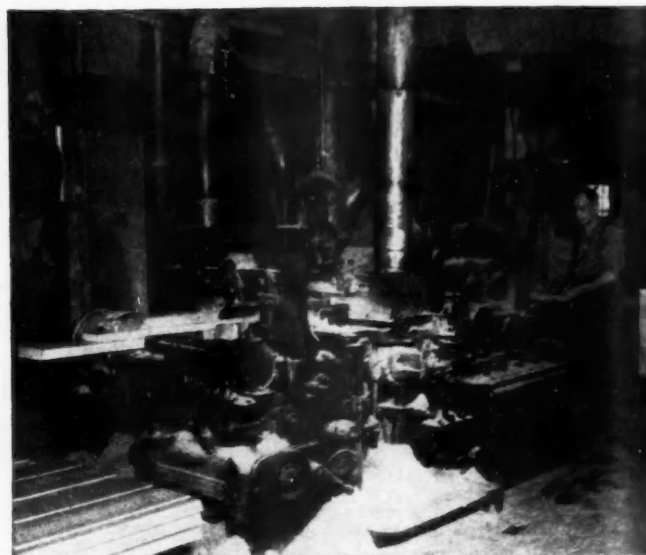

4 WITH four heads of the machine cutting, a square piece of $1\frac{3}{4}$ inch wood is shaped to form smooth lines of a sill



7 AUTOMATIC trigger-operated tinner drives diamond points to fill-in-and-tin glass into the sash before they are glazed

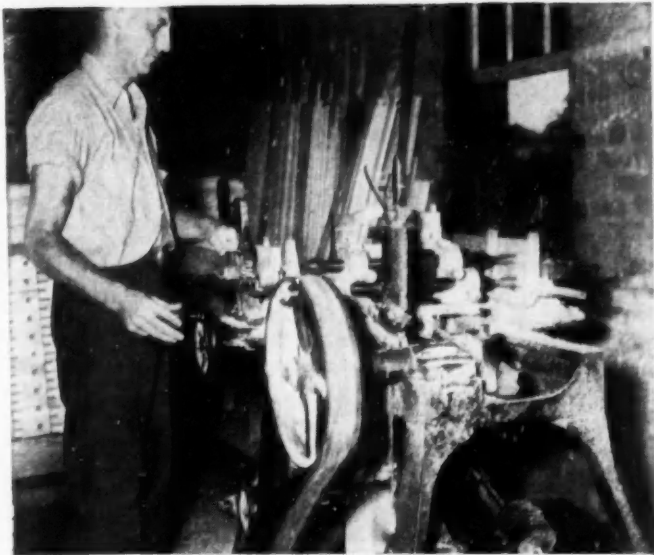

2 SAWDUST flies when this pulley machine routs out a pocket and two heads for a window frame, all at the same time



3 A SILL for a window is born in one operation. Material is fed into a huge cutting machine by a single operator

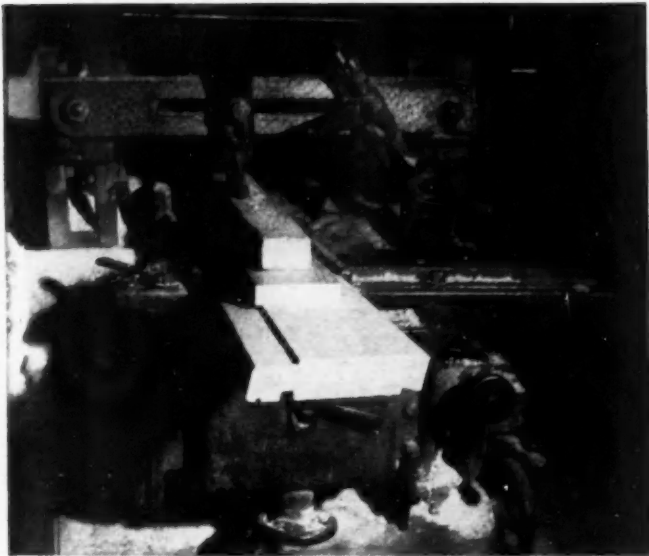

5 A CLOSE-UP of sill emerging from cutting machine. Sill runs through machine that cuts lug to fit side jamb



6 EVERY lug carries pay load of stiles through double end tenoner. Stock sash are being produced in big quantities

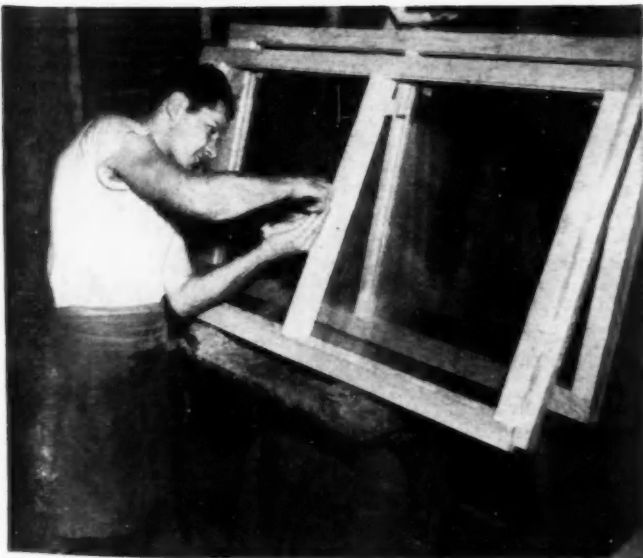

8 A SKILLED operator proves that glazing is an art. Putty is applied to each edge of sash rail with a single stroke



9 POWER CLAMP turning out a combination door. Operator on left is ready to insert an instruction sheet for builders

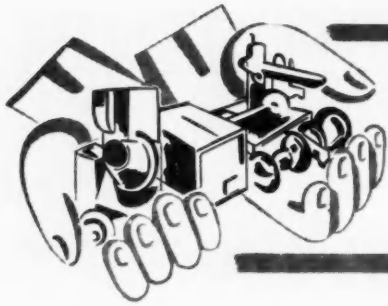

NEW PRODUCTS

Offered by Manufacturers

LINE HOLDER

AB3811

One of the most practical, useful and timely new products to be introduced to the trade is the Jiffy Line Holder devised by the An-Dean Manufacturing Co., Inwood, Ind. Made of cast alumi-



num, this line holder is a time saver. It is easy to use, quickly adjusted, and eliminates driving nails and pointing up. This product is distributed nationally, or may be ordered direct from the manufacturer.

JACKALATOR SCAFFOLDING

AB3809

A convenient scaffold for gabled room buildings or for any building where a hanging scaffold cannot be used is found in the Jackalator Scaffolding Model S-20. This scaffold is fastened by means of key plates nailed to the side of the building and requires no ladder for support. It eliminates the need for ladder brackets, planks hung on jacks or brackets, and the continual shifting of all the supporting paraphernalia and planks for each change in position. Platform supports are raised and lowered by means of pins that fit into holes spaced along the uprights. Thus the operator can work from the top right down to the bottom or vice versa without any other set-up. The Jackalator accommodates up to a 20-inch width of planking and has a guard rail for additional safety. With this equipment, the contractor can meet many diversified scaffolding problems. The manufacturer is the Jackalator Corp., P. O. Box 606, Rochester, N. Y.

ELECTRIC HEATER

AB3812

An electric wall heater has been added to the appliance line of the Westinghouse

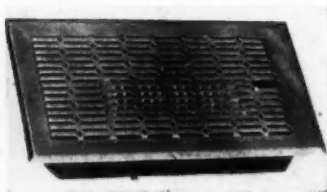

Electric Corp. Designed for all installation to save space, this heater is adapt-

able to any location where the convenience of having extra heat is desired. Equipped with an attractive modern grill of rust-proof satin-finished aluminum, it supplies heat by both radiation and convection. Easily installed, it has a capacity of 1250 watts and operates AC or DC on 115 volts. The Electric Heating Dept., Westinghouse Electric Corp., Emeryville 8, Calif., is the division producing this unit.

BATHROOM ACCESSORIES

AB3808

Beauty of design is combined with quality workmanship in the Gouverneur line of chrome finish bathroom fixtures. Produced by the oldest exclusive manufacturer of bathroom accessories in America, these fixtures affect a custom-made



appearance. They are severely modern, and carry a lifetime guarantee. The line features paper holders, tumblers holders, soap holders, robe hook and towel bars. The manufacturer is the E. C. Smith Manufacturing Corp., 445 North La-Salle St., Chicago 10, Ill.

KITCHEN VENTILATOR

AB3814

A kitchen ventilator that can be located within a wall cabinet above the stove is being made by Trade-Wind Motorfans, Inc., 5725 South Main St., Los Angeles, Calif. A unique feature is an adjustable hood which when drawn out picks up all smoke and grease from the range top. A grille near the ceiling also draws excess heat from the room. Air filters which can be easily removed for cleaning are provided for both inlets and the entire assembly is soundproofed within a metal housing. Known as the Super Clipper Type K, this ventilator comes as a complete package unit, ready for installation. It will fit any wood or metal cabinet that provides a space 18 inches high by 12 inches deep by 21 inches wide. The hood is 42 inches wide.

WOOD SURFACERS

AB3819

A wood dough for surfacing large imperfections and a surfacing putty for filling smaller cavities that bonds tightly to wood, metals, plastics, fabrics and



other commonly used materials, is being produced by the Webb Products Co., 216 South G St., San Bernardino, Calif. Both products are marketed under the trade-name Duratite. Because they dry quickly and have little shrinkage, surfaces up to 1/2-inch deep can be filled in one application. When dry, Duratite dough and putty can be sawed, cut, sanded and polished. They remain tight under drastic weather conditions and are not affected by moisture. Available in seven wood colors, these products can also be stained, lacquered, or painted.

AWNING WINDOW

AB3804

A pre-fabricated awning window which permits ventilation without allowing rain or snow to enter a room is made by the



Gate City Sash & Door Co., Fort Lauderdale, Fla. A handle inconspicuously located below the sill operates the movable sash. In standard units, all sash are movable; if desired, however, fixed sash may be combined with the movable. Units are shipped complete to the job
(Continued to page 126)

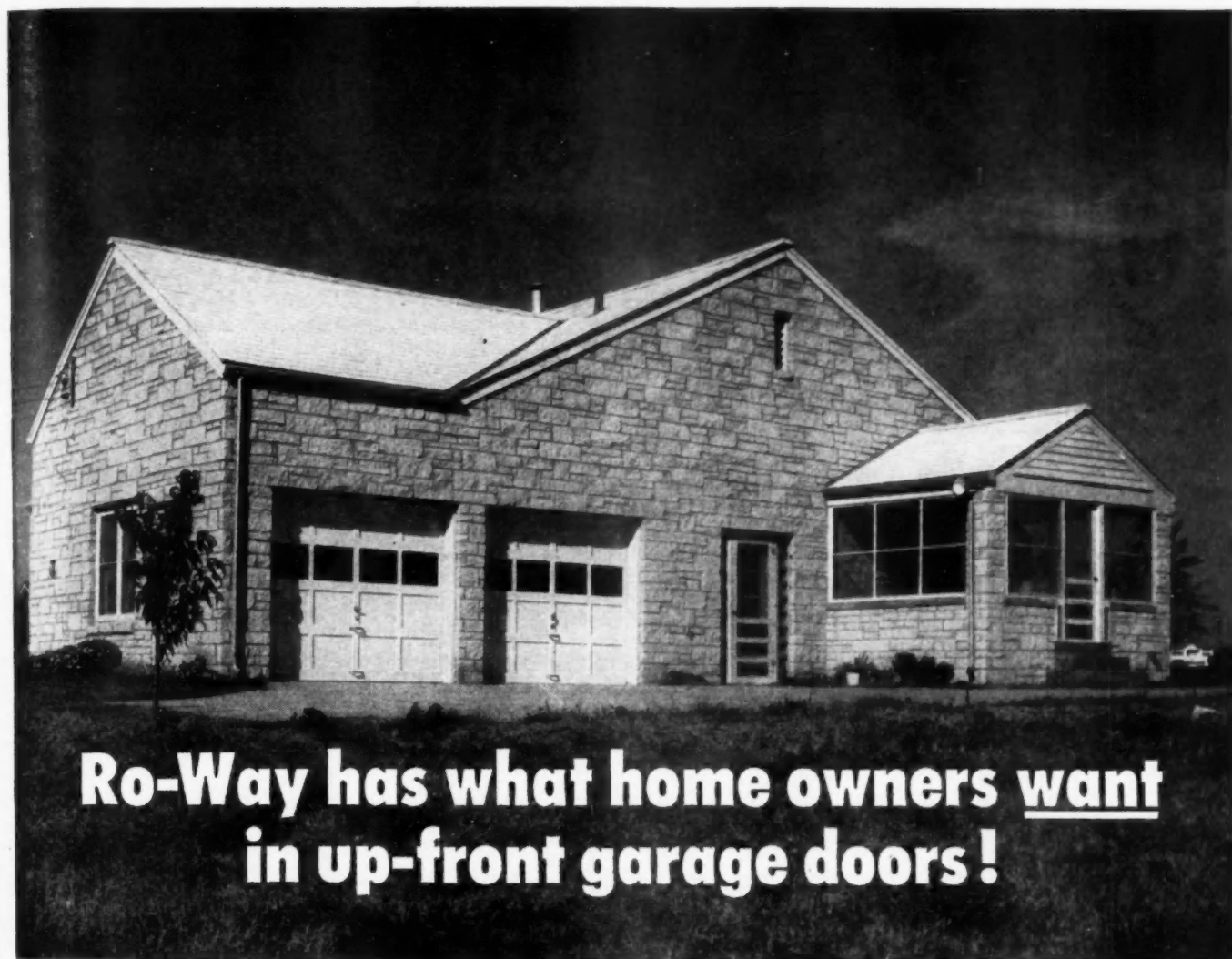

Ro-Way has what home owners want in up-front garage doors!

Even the fussiest home owner would have a tough time finding fault with Ro-Way Overhead Type Doors. For Ro-Ways have what it takes to make home owners happy!

Simple, clean-cut architectural beauty—designed, and engineered to compliment any style of residence. Finest materials—from kiln-dried lumber to selected steels. Proud workmanship in every detail from design to finished door.

Exclusive, extra-value features for smooth, quiet operation and lasting, trouble-free service. .

That's why so many architects, builders and owners look upon Ro-Way as the standard of comparison in overhead type doors. Make your own comparison and see for yourself. **ROWE MANUFACTURING COMPANY, 733 Holton Street, Galesburg, Illinois, U. S. A.**

Ro-Way distributors in all principal cities. Consult your classified telephone directory, or write for distributor's name. See our catalog in Sweet's.

There's a Ro-Way for every Doorway!

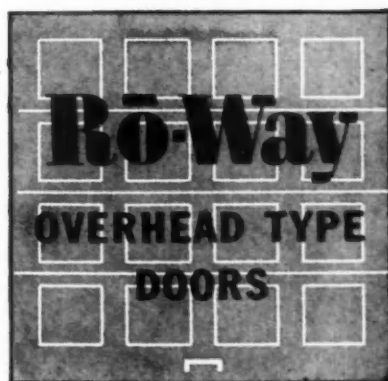

(Continued from page 124)

with hardware and glass installed and including screens. Weather stripping is included on the jamb sections, and is available for the horizontal joints.

PAINT IMPROVER AB3806

A product is now available which added to paint makes it easier to apply, improves its consistency, gives it more elasticity in addition to increasing the quantity. Named Paintmor, it is the new product of the Kay-Tite Co., West Orange, N. J. Paint mixed with this product will not crack or fade under exposure to extreme variations of temperature; neither will the paint separate and dry out while standing. Paintmor is available in one and five-gallon cans, and in 55-pound drums.

WELDWOOD PLYWOOD AB3803

Two important new Weldwood Plywood products are announced by the United States Plywood Corp., 55 West 44th St., New York, N. Y.

The first is the new Weldwood Moldings illustrated. Designed to aid the installation of hardwood plywood for wall use, these moldings are made with genuine wood veneer faces which match the paneling itself. They eliminate face-

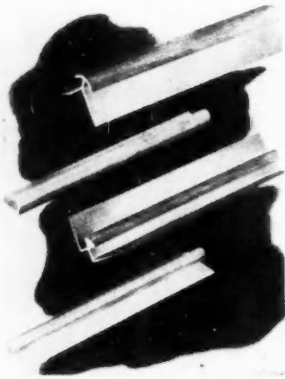

nailing, countersinking and puttying. There are four types: inside corner, outside corner, cap and divider strip. Wood species are: oak, mahogany, walnut, birch, maple and Prima Vera.

The second product is a new light-colored, popular-priced tropical wood, Korina. This Weldwood, it is reported, closely resembles Prima Vera but is superior to it in cleanliness, soundness and width of flitches. It can be used for cabinet work of all kinds, and for paneled walls in homes and offices. It comes in assorted thicknesses and sizes. The beauty of the wood adds to its attractiveness.

HOUSE PLAN TEMPLATE AB3816

A handy versatile tool for anyone who works with building plans is the Timely Planner. A modular spacer, it saves hours of planning and drafting time. It is made of clear sheet plastic, with accurate cut-outs for drawing door-swings, plumbing and electric fixtures, fireplace, stairs, moulding, and roof-pitch. It is available from Timely Products, Box 206-H, Columbus 9, Ohio.

TILEBOARD CEMENT

Prestile Manufacturing Co. has introduced an improved adhesive for use in applying tileboard or other wall coverings. A newly designed label, in attractive colors, carries complete illustrated instructions explaining the easy application for tileboard installation. The material is packed in gallon cans, four to a carton. The manufacturer's address is 2860 Lincoln Ave., Chicago 13, Ill.



CARBIDE TIPPED SAWS

A new standard line of carbide tipped circular saws, to be marketed under the Meyco trademark, is announced by the W. F. Meyers Co. Inc., Bedford, Ind. The line includes both standard and fine tooth saws in six different diameters ranging from 8 to 18 inches. Major advantages claimed for the saws are their resistance to wear and abrasion which reduces the need to sharpen often, and the exceptionally smooth finish obtained through their use. The saws, which were formerly made on special order only, can handle all types of woods, plywoods, composition boards and plastics.

SPINNER TYPE ROOF VENTILATOR AB3823

The Red Cap Spinner Type Ventilators made by the Warner Ventilator Co., LaGrange, Ind., are now equipped with step type ball bearings. The vertical, machined shaft on which the revolving head or blades are mounted is inserted in a tube, filled with weather-resistant lubricant, and rests on this bearing, assuring easy propulsion of the unit from the slightest breath of air. The spinning blades create a vacuum, thereby sucking or drawing hot air, gases, fumes, or other contamination out of barns, garages, foundries, paint shops, restaurants and attics. The blades are shaped and spaced to emit contaminated air without permitting the entrance of rain or snow.

TIME-CHIME AB3813

This attractive Telechron clock is equipped with a two-door Nu-Tone chime. Two notes of the chime indicates front door and one note, the rear door. The self-starting clock operates on 115 volt AC, the door chime on a chime transformer. The clock comes in white only and is trimmed with chrome. It is a product of the Nu-Tone Door Chimes, Merchandise Mart, Chicago 54, Ill.

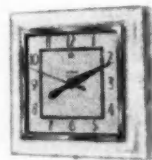

LIGHTING FEATURE AB3805
A streamlined lighting fixture which is

AB3815

equally suitable for exterior as well as interior installation is manufactured by the Steber Manufacturing Co., Broadview, Ill. Designed as a wall bracket, it is made of cast aluminum and finished in Graytone, Coppertone, black or ivory. Each fixture is furnished complete with a cylindrical frosted glass shade, socket and mounting strap. Suggested indoor uses are for bathrooms and halls; exterior uses are on porches and terraces.

WINDOW FOR GLASS BLOCK WALLS

AB3807

An aluminum window tailored to blend into a glass block wall or panel is being marketed by the Valley Metal Products

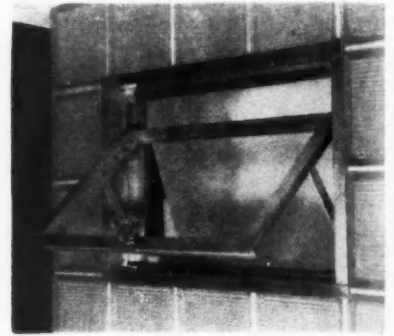

Co., Plainwell, Mich. The window can be had with or without a ventilator; and when ventilator type is used, ventilation can be regulated. The window is shipped open to allow the purchaser to select the type of glass to be used for glazing.

PACKAGED SHINGLES AB3801

To solve the shingle repair problem a packet is now available which contains

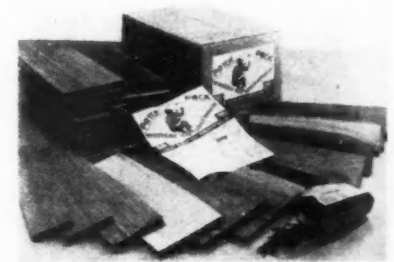

fifty No. 1 grade Western Red Cedar Shingles in assorted widths, one hundred shingle nails, and complete instructions for use. The shingles are made with a new patented tapered-shape which makes it possible to replace worn or broken shingles in a jiffy. No tool other than a hatchet or hammer is needed. This handy maintenance kit is named "Patch Pack." It is the new product of the Patch Pack Co., a division of the Portland Shingle Co., Portland, Ore.

MATCHED METAL WALL TRIM AB3821

The Youngstown Manufacturers Inc., 66-86 South Prospect St., Youngstown, Ohio, offer a matched set of metal wall trim designs that can be applied after the wall covering has been cut and cemented to the wall. The set includes a cap strip. (Continued to page 128)

BRICK & FOUNDATION VENTILATORS

for ventilating unexcavated foundations, flat roofs, fruit cellars, etc.

Built to high standards — at amazingly low prices! Made of galvanized steel with rain deflecting louvered faces — screened for insects.

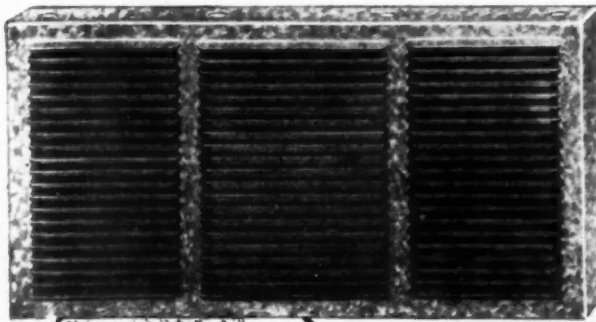

FOUNDATION VENTILATOR for MASONRY WALLS — Style "M"

Style "M" Ventilators are installed in cement block, brick or concrete foundations. The size of a cement block — projecting margins have punched holes for mortar lock — resulting in easy installation. Louvered face provides a maximum of free area and deflects rain. Free area 89 sq. in.

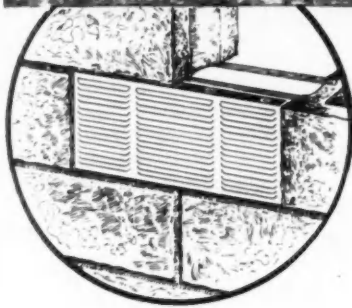

STYLE "M"
Shown cemented in concrete block

BRICK VENTILATOR

The size of a brick — easily laid in any brick wall. Bottom edges flanged to give a positive mortar lock. Built of galvanized steel of rugged construction. Ideal for ventilating flat roofs, fruit cellars, etc.

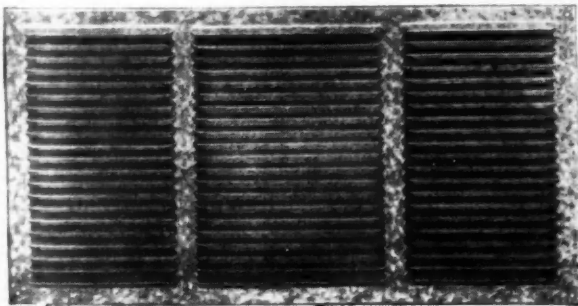
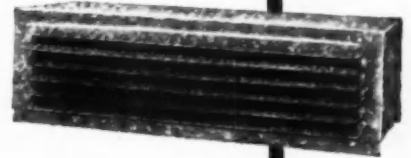

FOUNDATION VENTILATOR for WALL INSTALLATION (above foundation) — Style "W"

Style "W" Ventilators (flush type) are installed in walls, above the foundation. Usually nailed to end of joists. Holes in corners for nailing — similar in size and construction to Style "M" Ventilators. Screened on back to keep out insects. Free area 89 sq. in.

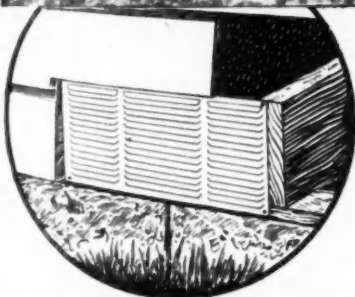

STYLE "W"
Shown installed above foundation covering opening between floor joists

See your LEIGH Building Products Distributor today! Or write for Catalog 47-L describing the complete line of LEIGH Building Products.

Styled and Built by

AIR CONTROL PRODUCTS, Inc.

COOPERSVILLE, MICHIGAN

Manufacturers of AIR CONTROL REGISTERS • GRILLES • DIFFUSERS • ACCESSORIES

(Continued from page 126)
divider strip or panel strip, an outside corner and an inside corner. Because of the continuity of design the cap strip sets on top of the outside and inside corners, hiding any rough ends. The trim is easy to install and requires no special tools; a hack saw and a hammer will do the trick. One of its outstanding features is the ease with which the four metal trims fit together.

GAS-FIRED FURNACE

AB3802

The Palmaire is a gas-fired, forced air furnace, compactly designed for the average home where ducts are used for warm air distribution. It can be installed in a closet, basement or utility room. Outstanding features of this furnace include an all-steel, press-formed streamline cabinet with silent corrugated steel lining, heavy gauge die-formed steel elements, baked enamel steel burners, and automatic controls. All controls are located in the front and are easily accessible for inspection by finger tip front panel removal. It is made by the Palmer Manufacturing Corp., Phoenix, Ariz.

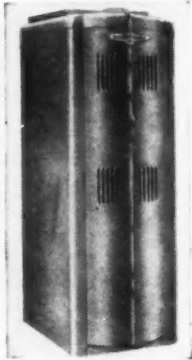

MASONRY COATING

AB3824

A new rubber base masonry coating which is absolutely resistant to the destructive effects of the alkali present in all concrete has been developed by the Truscon Laboratories, Caniff and Grand Trunk, Detroit 11, Mich. This important feature is accomplished through the formulation of the coating with chlorinated rubber, which alkali does not touch. Named Para-StoneTex, the coating is equally resistant to water. In rigid tests, continuous contact of water with the Para-StoneTex film showed substantially no physical or chemical change. This coating works easily, dries quickly, and stays clean. It is available in white and colors.

SHINGLERS BRACKET

AB3818

A safe toe hold for the roofer has been devised by Reimann and Georger, 69 N.

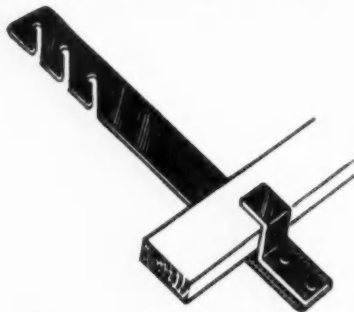

Division St., Buffalo, N. Y. The product is a bracket called Shingler which takes

a 2x4 on edge making a safe toe hold for the roofer without his having to drive nails through the new roofing. It is constructed of two pieces: a thin wide strap with three notches which allows the Shingler to be removed without raising the shingle, and a heavy bent bar which holds the 2x4 and forms a blunt end that can be struck or dropped on concrete without damage. The parts are fastened together with rivets heavy enough to withstand the shock of hammering or dropping.

AWNING-TYPE WINDOW

AB3820

Awning-type windows which provide no-draft ventilation for homes, apartment buildings, and other structures, are available from the Super-Vent Co., 303 W. Monroe St., Chicago 6, Ill. These windows are produced in a range of sizes to include from one to five vents, depending on window height. A small handle at the window base operates the vents which open outward to an approximate 80-degree angle, and lock securely at any desired opening. A unique patented mechanism lowers the upper vent when opened to facilitate cleaning of its exterior glass and permits cleaning of the outside windows from the inside of the home or building.

SUSPENDED HEATER

AB3817

A streamlined body in which are housed all working parts, and an exclusive type of heating element which delivers a balanced heat pattern are the outstanding features of the Pacific Suspended Heater. Product of the Naco Manufacturing Co., Huntington Park,

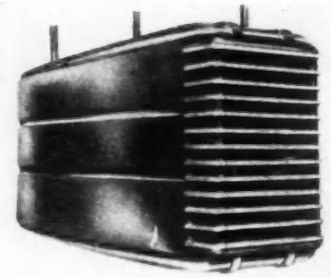

Calif., the unit is designed primarily for commercial structures. It requires no boiler, central heating system or ducts, and saves floor space.

INSIDE STORM SASH

AB3810

A new inside metal storm window that combines with steel casement and screen to make a complete window unit has been introduced by Detroit Steel Products Co., 3101 Griffin St., Detroit 11, Mich. Made of formed steel, bonderized, with a factory-baked-on coat of paint, the storm window is hardly noticeable from inside or outside the house, and

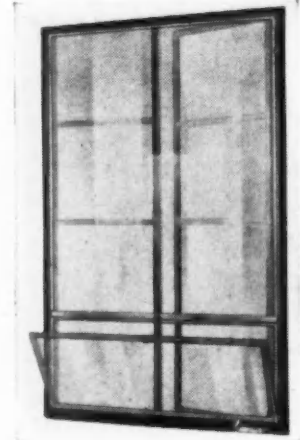

does not interfere with draperies, venetian blinds or curtains. Easily and quickly installed, it fits snugly against the steel casement. If desired, the storm window can be had with a tilt-in vent at bottom to provide draftless ventilation. Besides reducing heat loss, the installation of this storm window prevents fogged or frosted windows.

RUSTPROOF WATER HEATER

AB3822

The Ford Steel Products Corp., Tarrytown, N.Y. produce a completely automatic electric water heater which carries a 20-year guarantee against rust. An exclusive, patented process of applying an inside protective rock-lining enables the manufacturers to make this guarantee. Applied on the inside of the steel tank shell, the rocklining forms a thickness of 1/2-inch which prevents the chemical particles present in water from reaching the metal and forming a rust. Actually there are two tanks, rock inside and steel out. The modern design of the heater makes it a decorative as well as useful installation.

CHECK NUMBERS AND MAIL COUPON FOR INFORMATION

American Builder, 105 West Adams Street, Chicago 3, Illinois

NAME..... ADDRESS.....

CITY..... STATE.....

AB3801	AB3807	AB3813	AB3819
AB3802	AB3808	AB3814	AB3820
AB3803	AB3809	AB3815	AB3821
AB3804	AB3810	AB3816	AB3822
AB3805	AB3811	AB3817	AB3823
AB3806	AB3812	AB3818	AB3825

When you address inquiries direct to manufacturers concerning a new product described here, please mention that you saw it described in American Builder.

B3810
that
green
has
Prod-
t 11,
ized,
paint,
eable
and



From a text of the 1860's...
"A Practical Treatise on Ventilation"
 "Pray, remember: fresh air, pure air gives elasticity to the step, buoyancy to the spirits, secures serenity to the pure of heart, adds a sparkle to the eye of innocence, induces good digestion and sound, refreshing sleep."

We've come a Long way since then!



Whether or not Richmond's new Oil Winter Air Conditioner will "secure serenity to the pure of heart, or induce good digestion . . ." (see text above), we really

couldn't say. But, be sure of this: the Richmond Oil Winter Air Conditioner is specifically designed to meet every requirement in small, low-cost home installations.

B3822
Tarry-
auto-
which
against
process
rock-
ers to
on the
l, the
2-inch
articles
g the
actually
le and
of the
s well

- Only Richmond Offers All These Features**
1. Vaporizing type with unusually low pilot flame—as little heat as a gas pilot. No overheating in mild weather.
 2. Automatic control of oil-air ratio at all stages of fire—keeps pot purged!
 3. Delivered completely assembled and wired—estimated saving \$20 to \$35 on installation costs.
 4. Horizontal design permits quick, easy duct installation on low headroom jobs.
 5. Beautiful finish in durable, heavy white enamel.
 6. Capacity: 75,000 Btu. at bonnet.

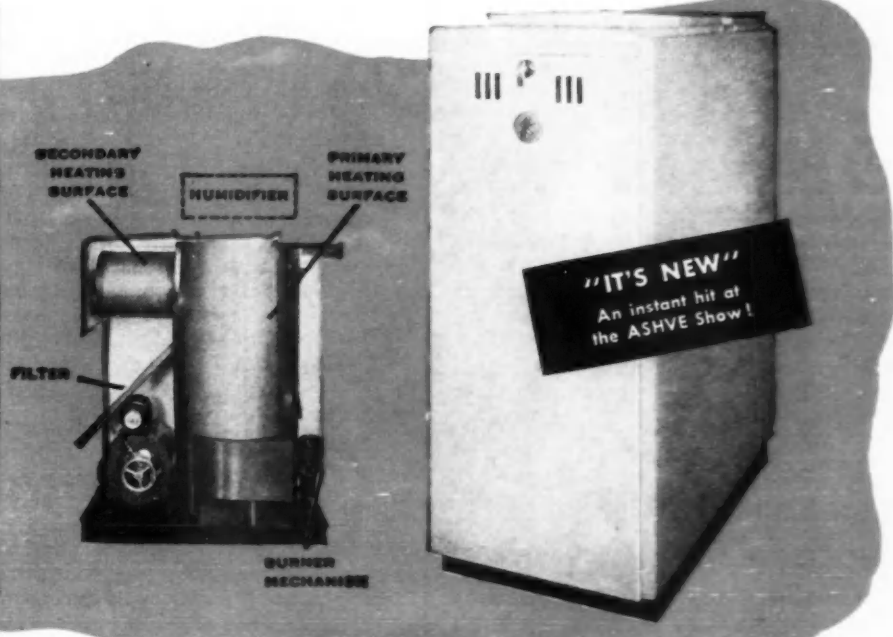

For complete details on the Richmond Oil Winter Air Conditioner, fill out the coupon and mail today.

RICHMOND RADIATOR COMPANY

AFFILIATE OF REYNOLDS METALS COMPANY

- Enameled Cast Iron Ware • Vitreous China • Perma-Gloss • Gas Boilers
 Oil and Gas Winter Air Conditioners • Gas Gravity Furnaces • Radiators

Richmond Radiator Company
 19 East 47th Street, New York 17, N. Y.

Gentlemen:
 I am interested in the new Richmond Oil Winter Air Conditioner. Please send me full details by return mail. No obligation, of course.

Name.....
 Company.....
 Street Address.....
 City.....Zone.....State.....

dis
...
...
duct
der.

MONTHLY REVIEW

(Continued from page 64)

W. P. "Bill" Atkinson Heads Oklahoma Unit

The Oklahoma City Home Builders Association has elected W. P. "Bill" Atkinson, nationally known operative builder, as its new president. Atkinson has been in the building industry since 1939, and before that time worked as a university instructor and in the newspaper and public relations field.

In 1942, Bill Atkinson bought a 320 acre wheat field southeast of Oklahoma City, and built on it his famed Midwest City. He has been currently active in civic affairs and for the last three years has been chairman of the National Association of Community Planning and Shopping Centers Development Committee.

Roger Givens was elected first vice president of the Oklahoma City association; Faye Ferguson, second vice president. Howard Tippin is treasurer and Russell Showalter, secretary. Ben C. Wileman is a national director. N. D. Woods is first alternate and Steve Pennington second alternate director of NAHB.

Philadelphia Sets Dates For Home Show in April

The Home Builders Association of Philadelphia and Suburbs will sponsor a home show in the Commercial Museum in that city April 5-10. There is 113,000 square feet of exhibit space. As a major undertaking for the show, an industry-engineered house will be constructed.

The Philadelphia group is getting some good publicity as a result of the effort of William E. Johnson, its executive vice president. Mr. Johnson put up the necessary cash for a plot of ground on which homes are being constructed for disabled veterans at absolute cost. They will be the equivalent of \$12,000 houses, although they will not cost the veterans that amount. Much of the work is being done by apprentices at the Bok Vocational School in Philadelphia.

Ohio Association Will Aid Vet Co-ops With Advice

Anticipating that there may be many veterans who undertake cooperative building projects under the Homestead Act, the Ohio State Home Builders Association is planning to offer free consultation to such groups in order that they may avoid the pitfalls that can trap those unfamiliar with building problems.

Ivor Jones, newly appointed executive vice president for the association, said that builder members of the organization will be available on call from various parts of the state to consult with veterans who may request the service.

Cortright's Column

By Frank W. Cortright

Executive Vice President, National Association of Home Builders of the United States



The most casual inspection of any issue of the *American Builder* or any other trade journal of the home building industry completely repudiates the propaganda line of public housers, crackpots and Socialists who endlessly proclaim that we are an antiquated industry. Because competition in home-building is so keen, the builder who does not utilize every available new technique and material that is practical does not long survive.

In our entire economy, it is doubtful if there is any other classification of small businessmen with greater courage, imagination and ingenuity than the men who survive in the operative home building field.

Those who have earned sufficient credit facilities to purchase and develop raw acreage; to conceive the best in design and land planning; to deal with and secure a day's work from labor; to purchase and install the most practical and permanent building materials; to put together all of these services and things in such fashion as to secure public acceptance and prompt sale—these men are entrepreneurs deserving of greater commendation than has been accorded them by a public and press accustomed to the wild charges of public housers.

The home builder is called unprogressive because he cannot turn out houses on an assembly line by such comparatively simple methods as are employed in the manufacturing field. Compare the production of a bathtub or a refrigerator with that of a completed house on a desirable piece of land, properly financed and fully acceptable to discriminating purchasers.

Since prefabrication and "industrialized housing" are proclaimed to be the cure-all and solution of our housing problems, statements made recently by Fritz Burns of Los Angeles before the Joint Congressional Committee on Housing are of particular interest. One of the largest producers of houses in this country and probably one of the largest investors in prefabricated housing techniques, Burns sums up his experience as follows:

"1. Prefabrication speeds construction but invariably adds to cost.

"2. Highly mechanized prefabrication plants that are something more than a group of saws and hammers assembled under one roof, are very expensive to build and to maintain and, therefore, add to the cost of housing.

"3. Materials which are prerequisite to prefabrication—high grades of plywood, clear and dry dimensional lumber for precision cutting, and the various metal combinations that have been used in prefabrication—are all expensive materials.

"Therefore—prefabrication, in summary, is quick but costly.

"On the other hand, it has been observed that conventional builders throughout the country are gradually incorporating into their methods of operation many of the tried and tested economical operations of the prefabricator. Hand-saws are largely a thing of the past. Mechanized equipment is more and more prevalent. Preassemblies of certain portions of the house, such as wall cabinets and storage walls, stairways, glazed window sub-assemblies, doors and trim sub-assemblies and garage doors are in common usage. Pre-cutting of dimensional lumber on the site by power saws and the preframing of wall sections on jig tables at the site have become common practices with many builders.

"Therefore, in summary again, it is encouraging to note that all builders, both large and small, without 'going overboard' in the direction of prefabrication, are assimilating the best and most important phases of prefabrication methods."

Such factual statements should be brought to the attention of the uninformed individuals who complain that the industry refuses to adopt "revolutionary" methods which will ensure houses rolling off the assembly line in neat packages. Home builders of America today are adopting and adapting every new method and material just as quickly as it is proved to be practical, economical and acceptable to the American public.

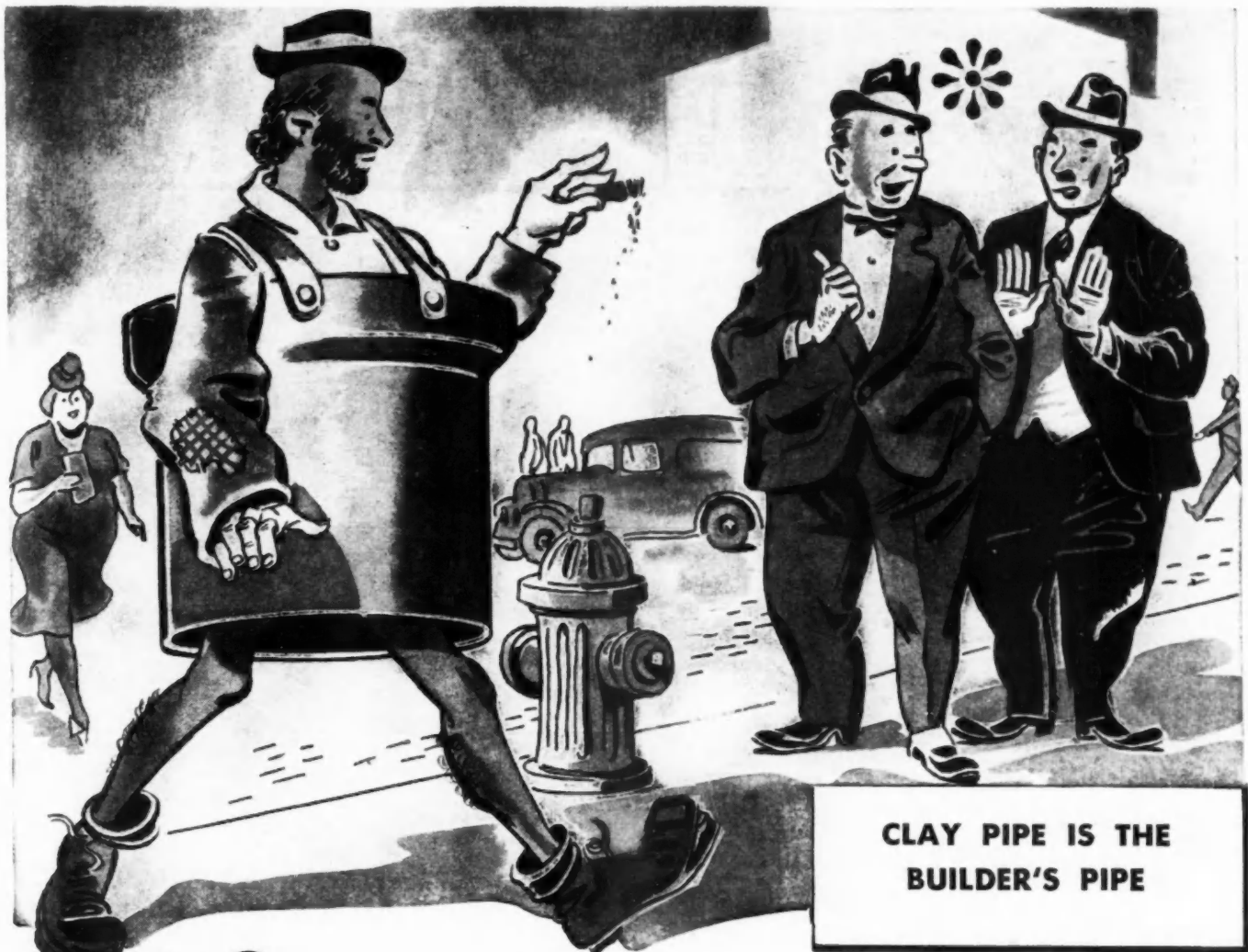

**CLAY PIPE IS THE
BUILDER'S PIPE**

*** SOMEBODY TOLD HIM THAT
CLAY PIPE NEVER WEARS OUT!**

And they're right! Vitrified Clay Pipe is made from nature's own tough material left from millions of years of chemical reduction. Because clay cannot be reduced further, it is corrosion-resistant, acid-proof, chemical-proof, and moisture-proof. Because it has been vitrified, Clay Pipe is abrasion-resistant and has great mechanical strength. Vitrified Clay Pipe has a smooth surface, providing an even flow

with a minimum of friction and wear. These are the reasons Vitrified Clay Pipe *never wears out!*

Everywhere they're using Clay Pipe because they want permanent jobs — because they know that when Clay Pipe is down, *it's down to stay* — because they know Clay Pipe has held the line for lower costs and fair profit.

If you need specific information on a Clay Pipe problem, write the details to the office nearest you

NATIONAL CLAY PIPE MANUFACTURERS, INC.

522 First National Bank Building, Atlanta 3, Ga.
1105 Huntington Bank Bldg., Columbus 15, Ohio

111 West Washington Street, Chicago 2, Illinois
703 Ninth & Hill Bldg., Los Angeles 15, Calif.

C-448-3

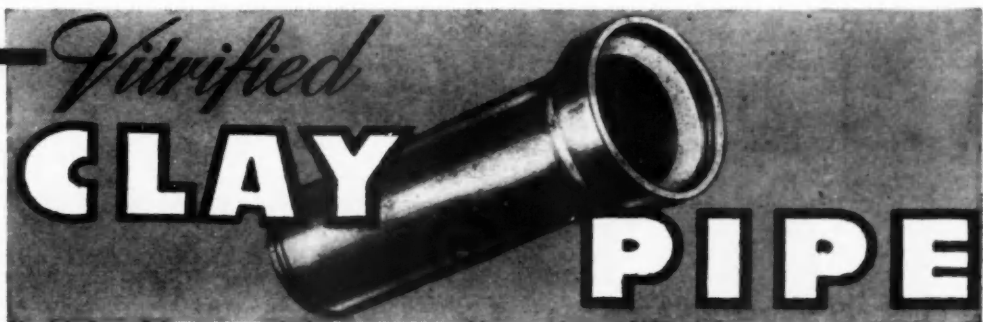
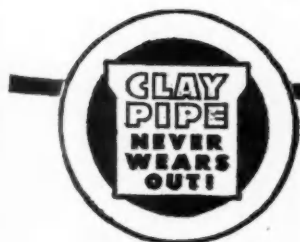

Include **FIBERGLAS***

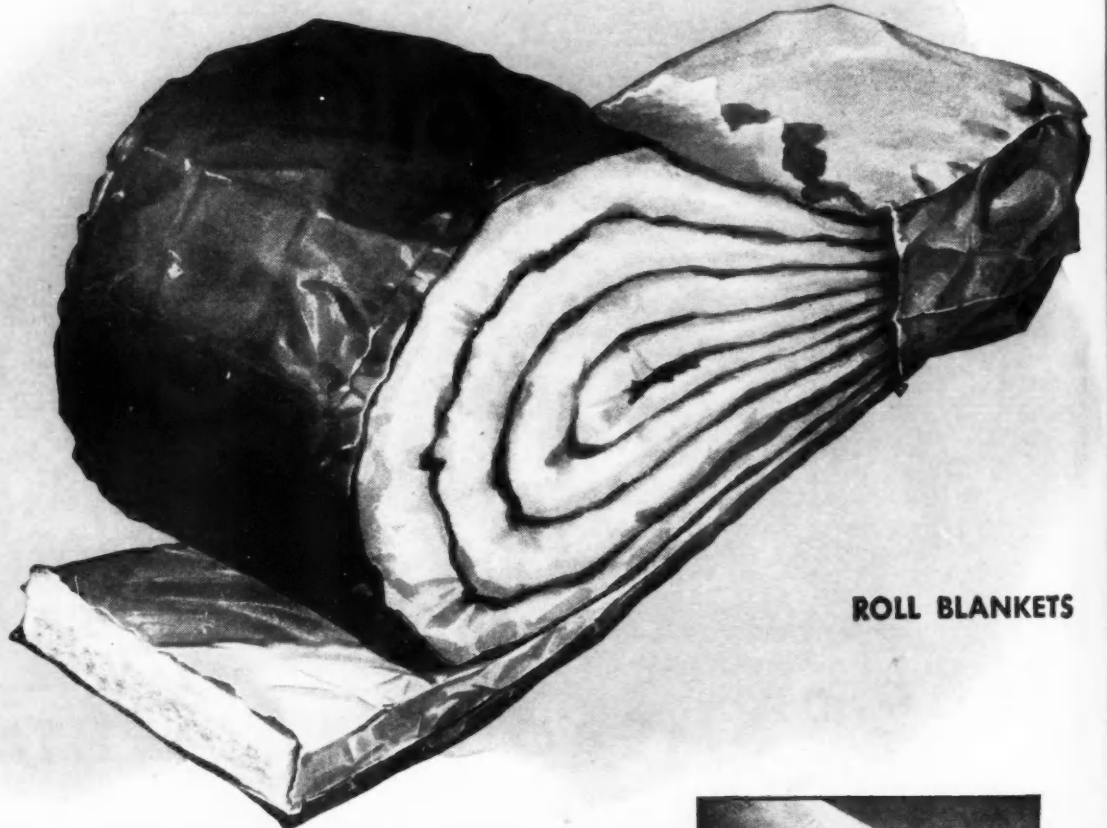

ROLL BLANKETS



BATT BLANKETS

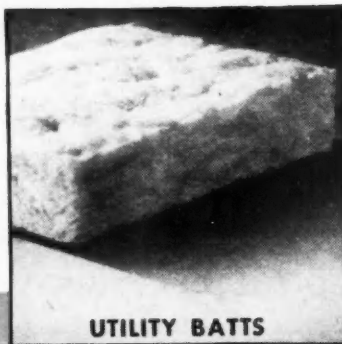

UTILITY BATTS



POURING WOOL

OWENS-CORNING
FIBERGLAS
TM. REG. U.S. PAT. OFF.

**BUILDING
INSULATION**

*FIBERGLAS is the trade-mark (Reg. U.S. Pat. Off.) for a variety of products made of or with glass fibers by Owens-Corning Fiberglas Corporation.

in All Your Plans this year!

1. For top performance. Besides being a highly efficient barrier to the flow of heat, FIBERGLAS Building Insulation provides everything needed for permanent satisfaction. Light in weight and highly resilient, this insulation stays put—doesn't disintegrate or pack down. The ageless glass fibers of which it is made won't rot, won't burn, provide no food for vermin. In any of its forms—roll blankets, batt blankets, utility batts and pouring wool—FIBERGLAS Building Insulation is easy to install.

2. For top buyer acceptance. Consumers, architects, builders and lending agencies all know FIBERGLAS Building Insulation and readily accept it as evidence of quality construction. This acceptance will contribute to the salability of your homes and other buildings.

3. For top service. The various forms of FIBERGLAS Building Insulation are available everywhere from top-flight lumber and building supply dealers who are served by the national distributors listed below. For further information, contact your dealer or one of the four distributors. Order FIBERGLAS in the new compression packages that simplify handling and save space on the job. Owens-Corning Fiberglas Corporation, Dept. 2018, Toledo 1, Ohio.

In Canada: Fiberglas Canada Ltd., Toronto, Ontario

DISTRIBUTED BY

4

INDUSTRY LEADERS



ARMSTRONG CORK COMPANY
Lancaster, Pa.



CERTAIN-TEED PRODUCTS CORP.
Chicago, Ill.



THE FLINTKOTE COMPANY
New York, N. Y.



KELLEY ISLAND LIME & TRANSPORT CO.
Cleveland, Ohio

Save scarce fuel... Insure comfort... Insulate with FIBERGLAS

UNIVERSAL

First choice

in VITREOUS PLUMBING FIXTURES...

UNIVERSAL

UNIVERSAL SANITARY MANUFACTURING COMPANY

Redlands, Calif.

New Castle, Pa.

Camden, N. J.



Catalogs and HOW-TO-DO-IT INFORMATION

409—SUSPENDED CEILING CONSTRUCTION—Using the Nailock Method of mechanical fastening for acoustical ceiling materials is described in a new catalog published by the Nailock Steel Division, The Sanymetal Products Co., Inc., 1705 Urbana Road, Cleveland 12, Ohio. Four basic methods of use of Nailock Nailing Channels, specifications for the architectural writer, and loads tests are features of this 12-page, three-color catalog.

410—MODINE HEATING COILS are fully described and illustrated in Catalog No. 345. Prepared primarily for architects, designing engineers and contractors, the book completely covers in 48 pages performance, selection and installation data on the new Modine coil line. To obtain a copy, write the Modine Manufacturing Co., Racine, Wis., on a letterhead.

411—100 FIREPLACE IDEAS is the title of a 32-page booklet offered free of charge to architects, builders and contractors by the Price Fireplace Heater & Tank Corp., 2 Austin St., Buffalo, N. Y. Largely pictorial, the book covers fireplace design from Colonial America to the present day. The designs shown are in a variety of detail and material construction and all utilize a steel warm air circulating form. Requests for this booklet should be sent early since this is a limited edition.

412—NEW HEATING GUIDES—Specific technical information relative to best applications for various types of heating systems, most suitable arrangements of ducting, furnace locations, etc., is provided in a series of heating guides prepared by the Janitrol Division, Surface Combustion Corp., Toledo 1, Ohio. There will be ten guides in all, three available now.

413—HOME INSULATION BOOKLET—Issued by the Kimberly-Clark Corp., Neenah, Wis., deals with radiant heat loss, air stratification and drafts, variable exposures, and how correct

design avoids trouble with heat lag. Over 40 illustrations, charts, and tables are shown. Other features include architectural specifications and a tabulation by percentages of heat loss stoppage through blanket insulation.

414—KITCHEN PLANNING is emphasized in a new profusely illustrated catalog being distributed by American Kitchens, American Central Division, Avco Manufacturing Corp., Connersville, Ind. In 16 pages, this catalog offers specific suggestions in kitchen design and remodeling. In addition, it advances plans for the adaptation of the factory-built American Kitchen package to needs previously filled only by the custom-made kitchen.

SERVICE COUPON—CLIP and MAIL to CHICAGO

Readers Service Department
American Builder,
105 W. Adams St., Chicago 3, Ill.

(March, 1948)

Please send me additional information on the following product items, or the catalogs, listed in this department:

Numbers.....

Name.....

Street.....

City..... State.....

OCCUPATION*.....

*Please note that occupation must be stated if full service is to be given.



SELLS MORE

... because they ask for it by name

Yes, Inselbric is still the only brick siding consumers ask for by name. First in the field, it has steadily and surely maintained its leadership against a constantly growing stream of competitive items, by sheer built-in quality, beauty and performance. Because we're proud of our product, the name INSELBRIC is stamped on the back of each panel—trade mark protection to insure that consumers get the product they ask for—to insure that YOU click with Inselbric in '48.



MASTIC ASPHALT CORP.
Makers of Inselbric and Inselstone
 SOUTH BEND, IND. • ELIZABETH, N. J.

JONES & BROWN, INC.
National Distributors of Inselbric and Inselstone
 PITTSBURGH, PA.

rations,
 archi-
 of heat

of usely
 itchens.
 D., Con-
 fic sug-
 tion, it
 Amer-
 by the

CAGO

(1948)

oduct

given.

DEALER REVIEW

NEWS OF ACTIVITIES IN THE NATIONAL AND LOCAL FIELDS

New Editorial Policy Implemented By Establishment of This Department

THE editorial on page 67 of this issue announces a new policy regarding the handling of editorial material of interest to distributors of building materials. Material formerly published only in the Dealer Distribution Section now is integrated with the general editorial contents of the magazine as news of interest and importance to everyone connected with light construction.

To implement that new policy, this "Dealer Review" section is being inaugurated as a regular monthly feature. Here we will report activities of the National Retail Lumber Dealers Association and the regional and state dealer associations, as well as other news of prime interest to distributors. In reply to a letter which outlined the new policy and announced the new Dealer Review, H. R. Northup, secretary-manager of the National Retail Lumber Dealers Association, wrote:

"Congratulations!

"With distribution and the availability of material playing such an important part in home construction today, your magazine's decision to cover the whole field of building without departmentalization should result in a greater, stronger editorial appeal.

"This sound approach to the whole building problem should certainly gain you a larger, more earnest, readership among dealers.

"The importance of distribution to both producer and contractor has been spectacularly high-lighted since the end of the war.

"It has definitely been proved, I think, that lumber and building material yard services do save the contractor and builder both time and money. Immediate availability of materials, and delivery upon a synchronized time schedule have assumed a new dollar value.

"Recent moves toward greater coordination and cooperation within the entire building field have certainly been taken to make the task of the contractor and builder financially less hazardous.

"The *American Builder's* move to treat the whole field of construction as an editorial unit is truly in line with current industry development and thinking."

Announcement and reports from sec-

retaries and managers of regional and state dealer associations about the activities of their groups will be welcomed by the editors for inclusion in this new section.

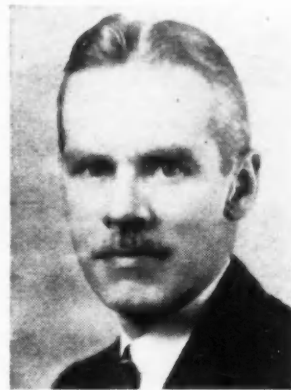

H. R. NORTHUP, secretary-manager National Retail Lumber Dealers Association, congratulates *American Builder* on new editorial policy integrating former Dealer Distribution Section with the general magazine contents

Dealers Conducting State and Regional Association Meetings

MEMBERS of state and regional retail building material dealer associations, with few exceptions, conduct their annual meetings during the first four months of each year. Pertinent facts regarding those conventions which were conducted prior to February 12 are reported here.

NORTHWESTERN

The fifty-eighth annual convention of the Northwestern Lumbermen Association was conducted in the Minneapolis Auditorium, Minneapolis, Minn., January 12, 13 and 14. Total registration was 3,586, including 1,626 dealers, 1,097 exhibitors and 863 guests. Ten states were represented on the registration list. There were 231 exhibits at the convention, which occupied both the main and lower floors of the auditorium.

Ward D. Briggs, of the Crane-Johnson Co., Inc., Fargo, N. D., was re-elected president. Other officials named are: H. A. Albinson, Worthington, Minn., vice president for Minnesota; Gerald A. (Continued to page 138)

Tour of Door Factory Is Part of Training Course



A FEATURE of the 30-day intensive University of Washington course for future and present retail lumbermen is field trips to nearby manufacturing plants which produce much of the nation's lumber and building materials. Typical of that feature was the recent trip to the Wheeler-Osgood Co., door

manufacturing plant at Tacoma, Wash. In the photo above some of the 35 visitors to the factory are shown how clamps help to assemble plywood and lumber parts into a three-panel fir house door. From the clamp, the door is carried to automatic trim saws for factory-fitting to exact dimensions.

With THIS Power Saw . . .

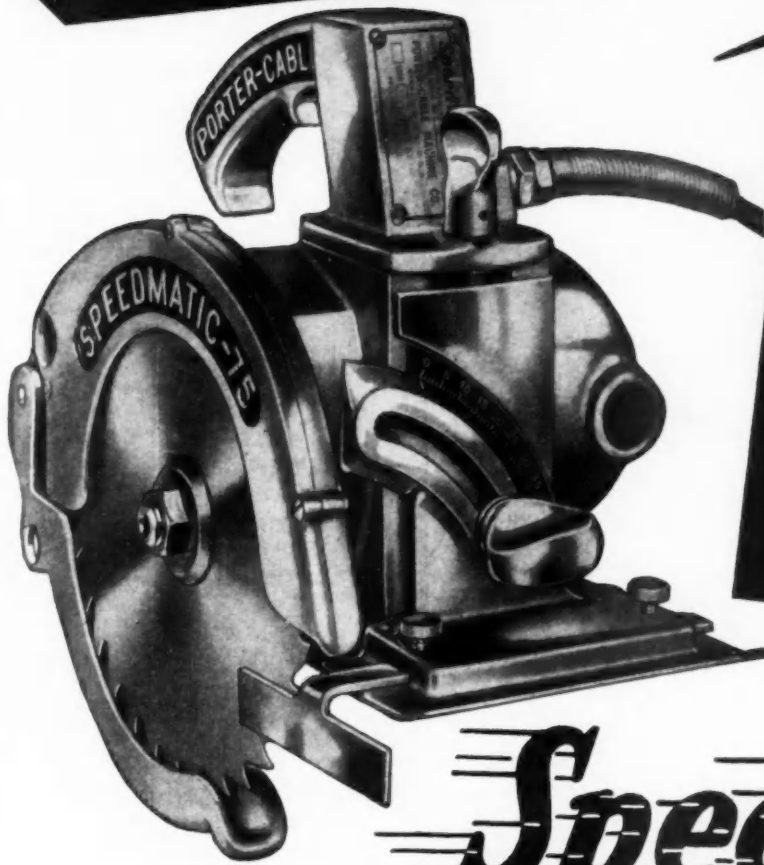

A Carpenter does

10 TIMES

MORE

SAWING

Speedmatic

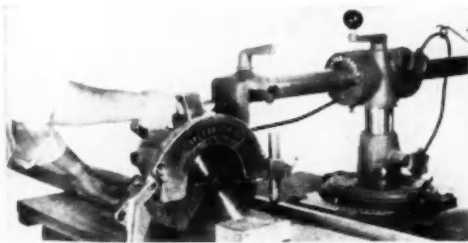

Has Retractable Radial Arm for Extra Utility! Unlike some power saws, the Radial Swing Arm of the Porter-Cable SPEEDmatic does not obstruct the operator's view. When he pushes saw out of the way, the arm moves too, leaving the cut and work in perfect view.

With Radial Arm, SPEEDmatic can be set for high production of identically-cut pieces.



Electric Hedge Shear

Trims and cuts shrubs, hedges, border grass and any garden growth up to 1/2" thick. Bevels. Makes sharp, beautiful curves without practice. Weighs only 3 1/4 lbs. Only \$34.50

That's saying plenty! For longer hours of continuous operation on any kind of cuts . . . Porter-Cable SPEEDmatic actually produces 10 times more sawing than any man you've got. Man! That's meeting high labor and building costs in no uncertain way!

Easier, Faster One-Hand Sawing . . .

Balanced—Broad shoe, correctly placed, permits a steadier, easier cut in any position, at any angle. No veering, no tipping, no twisting.

Faster—Sturdy helical gear delivers 11% more power to the blade which travels at 7000 rpm. Practically feeds itself.

Versatile—Operates on concrete forms, joists, bridging, rafters, siding, trim, cabinets, etc. Requires no premarking for a square cut.

At hardware stores and builders' supply houses. Or write us for literature.

PORTER-CABLE MACHINE CO.

1721-3 N. Salina St.,

Syracuse 8, N. Y.



ZUT... CUT!
and it's
AMERICAN SAW

With an



You'll do the job 10 times faster than hand sawing—with an AMERICAN Power Saw! It's a time-saver on any cut... easy one-hand operation... ideal for construction, maintenance and repair work. Use it to cut wood, metal, stone, tile, composition.

Starts smoothly—no jerk or jar. Develops 1½ H.P. Blade speed 6500 R.P.M. Maintains cutting efficiency in all types of conditions. Exclusive elevating mechanism for accurate depth-of-cut adjustment. Telescoping guard. Will cut a 2" plank at 45° or 2 7/8" straight cut. American-built dependability. Send coupon for details.

A



AMERICAN
PORTABLE TOOLS

THE AMERICAN FLOOR SURFACING MACHINE CO.
511 So. St. Clair St., Toledo 3, Ohio.
Please send latest catalog and price on the American Power Saw. No obligation.

Name

Street

City.....State.....

(Continued from page 136)
Jewett, Des Moines, Iowa, vice president for Iowa; John A. Larson, Bismarck, N. D., vice president for North Dakota; Myrle V. Hilton, Vivian, S. D., vice president for South Dakota; V. E. Stocker, Minneapolis, treasurer, and W. H. Badeaux, Minneapolis, secretary. Directors are Hiram G. Ross, Sioux Falls, S. D.; R. V. Porter, Oskaloosa,



WARD D. BRIGGS

Iowa; L. G. Morley, Morris, Minn.; John Wallace, Minneapolis, Minn.; Charles E. Goessling, Shenandoah, Iowa; D. B. Taylor, Marshall, Minn.; Clem Knecht, Rapid City, S. D.; Max Gray, Hibbing, Minn.; Brooks Baughman, Cedar Falls, Iowa; L. A. Geise, Winona, Minn.; G. B. Patterson, Rugby, N. D.

The 1949 convention will be conducted in Minneapolis January 10, 11 and 12 at the Auditorium.

KENTUCKY

Sam Crump, of the Square Deal Lumber Co., Park City, was elected president of the Kentucky Retail Lumber Dealers Association at the annual meeting conducted in the Brown Hotel, Louisville, January 13, 14 and 15. Blaine Fulton, Newport, Ky., is vice president and Don A. Campbell continues to serve as secretary.

New directors for 1948 and 1949, named at the convention are John Casner, Madisonville; Ben P. Eubank, Lexington; Charles McGinnis, Lawrenceburg; Hobart Reams, Middlesboro, and Lambert Suppinger, Frankfort. Directors re-elected for the 1948-49 term are Tudor Jones, Mayfield; Albert Kittinger, Owensboro; Blaine Fulton, Newport, and Sam Levy, Louisville.

The busy three-day program was highlighted by record attendance and a record number of building material and equipment exhibits.

OHIO

Members of the Ohio Association of Retail Lumber Dealers gathered in the Public Auditorium in Cleveland January 20, 21 and 22 for their sixty-seventh

(Continued to page 142)

ident
marck,
akota;
vice
V. E.
and
retary.
Sioux
loosa,

Minn.;
Minn.;
andoah,
Minn.;
; Max
Baugh-
Geise,
Rugby,
e con-
10, 11

e Deal
elected
il Lum-
annual
n Hotel,
Blaine
resident
to serve

d 1949,
e John
Eubank,
Law-
llesboro,
ankfort.
1948-49
; Albert
Fulton,
ville.
as high-
d a rec-
erial and

ation of
d in the
January
y-seventh
)

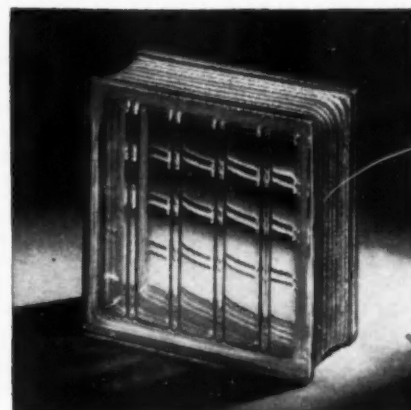

INSULUX

GLASS BLOCK
AMERICAN STRUCTURAL
PRODUCTS COMPANY
Subsidiary of
OWENS-ILLINOIS GLASS COMPANY

American Structural Products Company is a wholly owned subsidiary of the Owens-Illinois Glass Company. It has taken over the manufacture and sale of Insulux Glass Block and other Owens-Illinois structural products.

Daylight + design + privacy = profits for builders

IT DOESN'T take an interior decorator's trained eye to see how the Insulux Glass Block panel adds to the beauty of this bathroom. Nor to see how Insulux brings lots of bright, pleasant daylight without sacrificing privacy.

But there's something else in the picture, too. A story of profits for builders.

You'll discover that Insulux Glass Block has more than one application in homes. Its versatility earns it a place in living rooms, kitchens, beside stairways . . . anywhere extra daylight is desirable. You'd be

surprised how much Insulux does for a building at so small a cost.

Insulux has many qualities which should interest you as a builder. It passes light with privacy, it insulates, and it requires a bare minimum of maintenance. Insulux never requires paint, never rots, rusts or corrodes. It is permanent and durable.

Check into the profit possibilities of Insulux Glass Block. Send now for booklet, "Ideas for Brighter Homes." Write Dept. E-51, American Structural Products Company, P.O. Box 1035, Toledo 1, Ohio.

An Attitude... a Creed behind a company slogan.

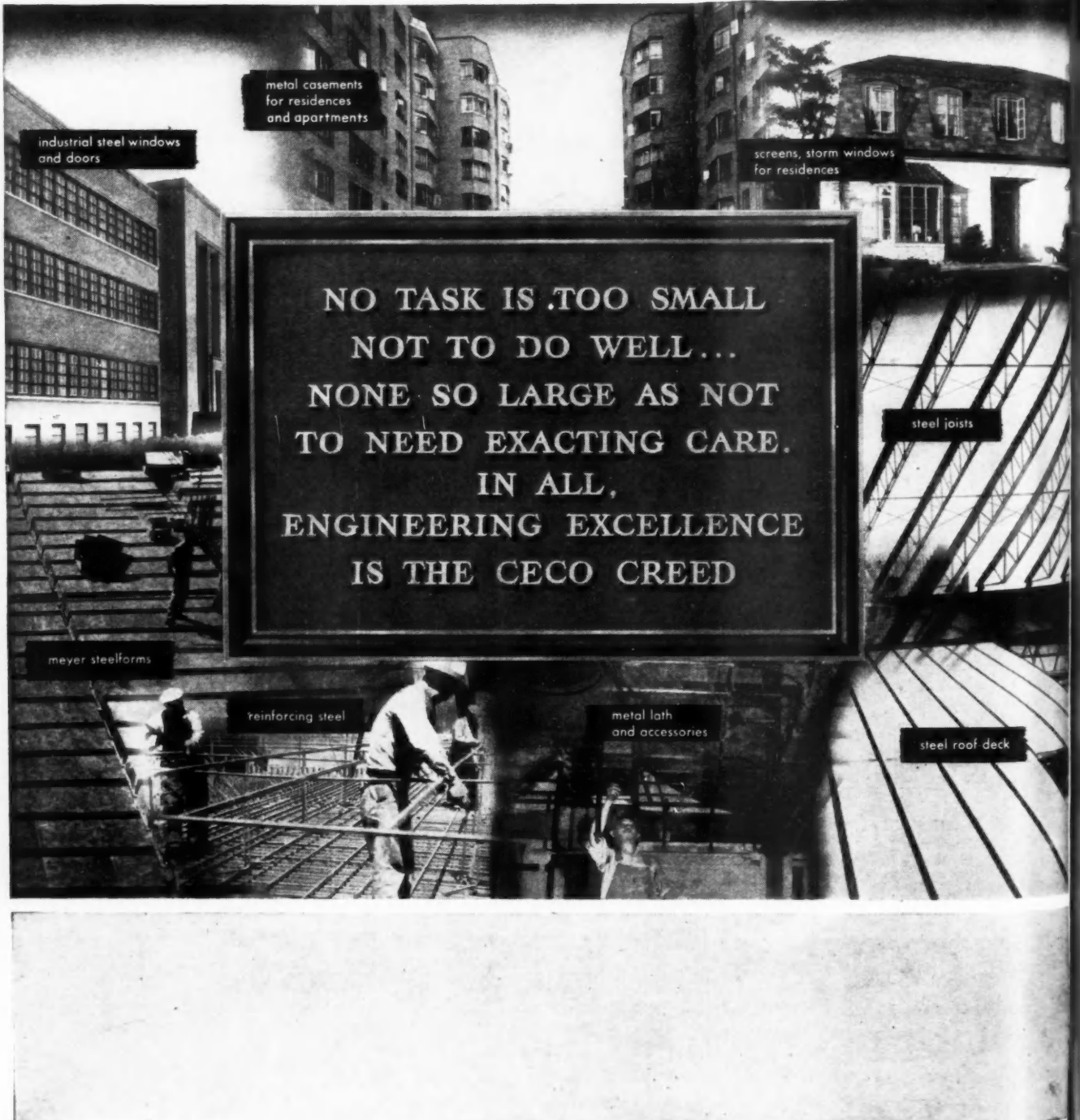

industrial steel windows and doors

metal casements for residences and apartments

screens, storm windows for residences

steel joists

meyer steelforms

reinforcing steel

metal lath and accessories

steel roof deck

"In construction products CECO ENGINEERING makes the big difference"

Thirty-six years ago an attitude, an ideal, started the Ceco Steel Products Corporation. Today, that attitude, that ideal, is summed up in a Creed, which best describes the way Ceco and all its people have worked to build the company. No lofty phrases make up this Creed, just simple, direct language. Here it is:

No task is too small not to do well . . .

None so large as not to need exacting care.

In all, Engineering Excellence is the Ceco Creed.

Today the Ceco Creed puts into words what thirty-six years of practice put into action, to dramatize the company's oft repeated slogan . . . "In Construction Products CECO ENGINEERING Makes the Big Difference." Actually, there are three types of engineering at Ceco:

CREATIVE ENGINEERING. Here there is the ceaseless and endless search for new and better ways to do things, for new and better products to simplify building . . . to provide short-cuts in construction methods so as to reduce building costs.

PRODUCTION ENGINEERING. This type of engineering means the organization of work in manufacturing so that each process flows properly, merging individual jobs into the whole for better manufacturing practices, with savings in time and, consequently, in costs . . . plus the making of better products.

FIELD ENGINEERING. This is where Ceco Engineers test and prove the products they make . . . where product advantages are proved by practice . . . where in-the-field, on-the-job data is developed so that the best way to use a product is discovered.

In all the aspects of Ceco work, meticulous attention to little things is the byword, for we believe no product is better than the perfection of its smallest detail. And here it is that Ceco applies all its engineering skill in seeking excellence. That's why we say that all jobs at Ceco are important . . . every task must be well done because each has a relation to the whole. That's why we say the Ceco Creed makes true the Company Slogan . . . "In Construction Products CECO ENGINEERING Makes the Big Difference."

CECO STEEL PRODUCTS CORPORATION
GENERAL OFFICES: 5701 West 26th Street, Chicago 50, Illinois

**CECO
STEEL**



ORDER A
CHROMTRIM
SILENT SALESMAN
for Your Store NOW!

THESE 8
CHROMTRIM
SHAPES MEET
EVERY HOME
TRIM NEED

Over 10,000 dealers can't be wrong—and they're saying that Chromtrim's "Trim-it-Yourself" floor merchandiser is one of the biggest moneymakers they've ever had in their stores!

Compact, elliptically-shaped — covering only 24" x 16" of floor space — its four full-color illustrations show Chromtrim's many uses. The eye catching appeal of the Chromtrim girl will create extra sales and extra store traffic almost the moment it's installed in your store.

Homemakers from coast-to-coast are getting the Chromtrim habit. Through Chromtrim's powerful advertising and promotion campaign, they've found that modernizing and remodeling is easy and economical too when they do it themselves the Chromtrim way.

Dealers prove there's quicker turnover and easier profit in selling Chromtrim metal mouldings.



Here's the
CHROMTRIM
8/60 DEAL
only \$55.80

- Ten 6 ft. lengths each of 8 different Chromtrim metal mouldings—ready wrapped for quicker purchasing. **PLUS:**
1. The Chromtrim "Silent Salesman" 8 tube stock dispensing unit.
 2. Eight metal snap-on holders with retail price tags.
 3. Metal dispensing tray and supply of nails.
 4. Supply of 100 consumer instruction folders.
 5. Free copy of Chromtrim's "Trim Ideas" and remodeling projects.
 6. Three-color counter display card, 11" x 14".
 7. Full-color life size window display of the "Chromtrim girl."

R. D. WERNER COMPANY, INC.
295 Fifth Avenue, New York City 16, N. Y.

Dept. AB-348

Please rush full information on Chromtrim "Trim-it-Yourself" special 8/60 merchandise deal, including Dealer Mat Service data and your free copy of "Trim Ideas". I understand there's absolutely no obligation on my part.

NAME _____
FIRM _____
ADDRESS _____
CITY _____ STATE _____

R. D. WERNER CO., INC.
295 Fifth Avenue, New York 16, N. Y.

In Canada: R. D. WERNER COMPANY, Ltd. - PORT DALHOUSIE, ONTARIO, CANADA

(Continued from page 138)

annual convention. Don B. Beaumont, of the Cleveland Lumber and Door Company, Cleveland, was elected president to succeed Floyd Pendleton of the F. S. Pendleton Lumber Co., McComb, Ohio.

Other officers elected are J. Irvin Jones of Columbus, first vice president; John M. Horn, Hamilton, second vice



DON B. BEAUMONT

president; Allen H. Brain, Springfield, treasurer. Findley H. Torrence, Xenia, continues to serve as secretary and Charles E. Benson, Columbus, is field secretary.

Total attendance was more than 3,000, the largest in the association's history. Discussion of current lumber costs and their causes was a feature of the meeting. There were 160 exhibits at the exposition of which Ted E. Weil, vice president of the Lumbermens Door and Trim Co., Cleveland, was chairman.

NORTHEASTERN

More than 3,500 attended the fifty-fourth annual convention of the Northeastern Retail Lumbermen's Association at Hotel Pennsylvania in New York January 26, 27 and 28. Exhibits of building materials and equipment totaled 83.

New president of the Northeastern is Chester T. Hubbell, president of the



CHESTER T. HUBBELL

C. T. Hubbell Lumber Corp., Albany, N. Y. He succeeds Frank W. Whitty, of Boston. Elected as vice presidents are Willard F. Terrell, Meriden, Conn.;

(Continued to page 146)

TH

Coas
roofi
of m
As
weat
prote
has p
the r
color
luxur
It
gles
assur
popu



SPONSOR

Choose the roof that sells itself
and the House, too!



THERE'S ACTION IN ASPHALT SHINGLES!

Coast to coast, by an 8 out of 10 margin, America's first choice roofing material is Asphalt! It is first choice for a combination of many reasons.

Asphalt is the roof that has been manufactured to meet weather's specifications. It is the roof that gives the home the protection of a highly fire-resistant surface. It is the roof that has proved its ability to take extra years of hard wear. It is the roof that gives the whole house extra appeal through its color, texture and beauty of line. It is the roof that would be a luxury if it were not for its economy.

It pays to feature the favorite. In the case of Asphalt Shingles it pays two ways. First, Asphalt's acceptance is your assurance of a satisfied customer. Second, Asphalt's great popularity has made possible its current low cost position. **Roof with Asphalt!**



FREE! ... Get this booklet, "Choose Your Roof for rain... AND SHINE". 24 pages in full color. Filled with tips on choosing and combining colors for exterior styling. From members or direct.

**CONSTRUCTION'S BIGGEST
DOLLAR'S WORTH**

ASPHALT SHINGLES

ASPHALT ROOFING INDUSTRY BUREAU
Room 1703 • 2 W. 45th St. • New York 19, N. Y.

SPONSORED BY 28 LEADING MANUFACTURERS OF ASPHALT SHINGLES • ROLL ROOFINGS • SIDINGS • AND BUILT-UP ROOFINGS

Mr. Martin's tenants never stop thanking him

SERVEL GAS



1. Mr. Martin heads a company that owns apartments. During construction of a new one last year, he decided he'd better put in his order for refrigerators. He hadn't given much thought to which make he would choose. He figured that any of the five or six leading makes would be a good buy.



2. All good refrigerators—Mr. Martin and his associates thought—offer pretty much the same modern features. BUT one day they were reminded that there is *one* refrigerator that offers something *more* than all others. Yes, only the *Servel Gas Refrigerator stays silent . . . lasts longer!*

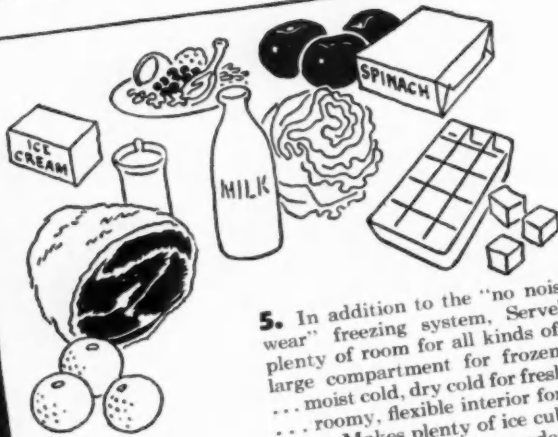

5. In addition to the "no noise, no wear" freezing system, Servel has plenty of room for all kinds of food; large compartment for frozen foods . . . moist cold, dry cold for fresh foods . . . roomy, flexible interior for bulky items. Makes plenty of ice cubes, too . . . and has many other modern cabinet features.



6. Mr. Martin checked Sweet's catalog and mailing pieces from the gas company. Yes, now he was ready to talk to that gas refrigerator salesman who had called on him before. The salesman came, gave the complete Servel story . . . and now Mr. Martin's tenants enjoy the advantages of Gas Refrigeration.



3. Mr. M before . . . lasts long machiner . . . A ti

STA
E
The

g him for their NEW, SILENT GAS REFRIGERATORS

He also thanks himself, for Servel gives
dependable service year after year . . . at low cost



3. Mr. Martin had heard the story of Servel's difference before . . . but now it really struck home: Servel stays silent, lasts longer, because it freezes with no moving parts . . . No machinery in the operating system to wear or break down . . . A tiny, silent gas flame does all the work.

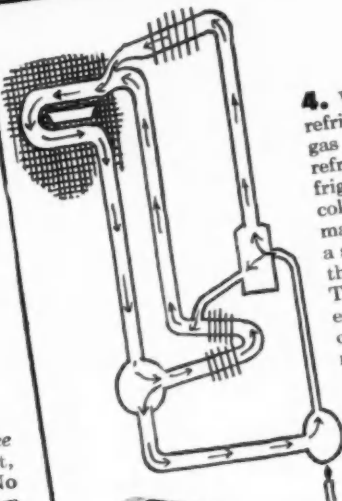

4. Why is Servel the different refrigerator? Because the small gas flame circulates a simple refrigerating liquid. This refrigerant supplies the constant cold that preserves food and makes plenty of ice cubes. Not a single moving part is used in the entire freezing operation. That means there's no machinery (no motor, no pump, no compressor, etc.) to ever need repair or replacement.



STAYS SILENT . . . LASTS LONGER

Servel

The GAS Refrigerator

SERVEL INC., EVANSVILLE 20, INDIANA

mailing
as ready
who had
gave the
Martin's
igeration

**BUILD
NOW**
WITH

Duo-Laps

**DOUBLE COURSE
RED CEDAR
STAINED SHINGLES**

**YOU CAN'T
BEAT GENUINE
RED CEDAR
FOR SIDE WALLS**

The demand's for broad siding. With Duo-Laps, you get the beauty of wide, expensive, Red Cedar siding with deeper horizontal shadows, at a fraction of usual cost. Build for beauty and instant sales with Duo-Laps double-course shingles, laid with full 12" or 14" exposure over solid or spaced sheathing.

FASTER, EASIER TO APPLY

Duo-Laps are dipped and stained by hand, butted, squared and tapered and require no painting. The genuine Red Cedar of Duo-Laps is unexcelled as insulation — keeps homes warm in winter, cool in summer. Selection of eight colors. Get two shingles in one (Stained No. 1 Red Cedar top course and rugged, genuine Red Cedar undercourse) with cost-cutting Duo-Laps.

**WRITE FOR DETAILS
AND THE NAME OF THE
DUO-LAP DEALER NEAREST YOU**

THE American

STAINED SHINGLE CO.

GENERAL OFFICES COR. SPRUCE ST. AND DENNISON AVE.

COLUMBUS 8, OHIO



(Continued from page 142)

John W. Dain, Lake Mahopac, N. Y.; Russell L. Fish, Scituate, Mass., and Frank H. Morin, Fulton, N. Y. Oliver J. Veling, Buffalo, N. Y., was re-elected treasurer and Paul S. Collier, Rochester, N. Y., continues as secretary.

Directors elected for one year are George E. Carr, Norfolk, Conn.; N. P. Clough, Lebanon, N. H.; Karl Norris, Montpelier, Vt.; Hubert C. Elder, Amherst, Mass.; Henry W. Turgeon, Lewiston, Me.; Leon H. Fleming, Providence, R. I.; for two years, W. O. Lindbeck, Jamestown, N. Y.; for three years, F. Caldwell Greene, Utica, N. Y.; Robert K. Ward, Syracuse, N. Y.; Vernon Lamb, Lake Placid, N. Y.; Charles S. Brower, Williamson, N. Y., and Willis F. Atkinson, Newburyport, Mass.

A resolution stating that reinstatement or imposition of any government restrictions or controls would impede the production of lumber, building materials and housing, promote price inflation, and disrupt and retard the entire construction industry, introduced by Willard F. Terrell, of Meriden, Conn., was unanimously adopted at the convention.

SOUTHWESTERN

The Sixtieth Annual Convention of the Southwestern Lumbermen's Association was conducted at the Municipal Auditorium in Kansas City January 28, 29 and 30. Total registration was 3,090 and 135 exhibitors taxed the available exhibit space in the huge arena to capacity.

Paul M. Leird, of the Leird Lumber Co., Little Rock, Ark., was elected president to succeed Walter A. Lambert, of Leavenworth, Kans. Other officers named are Kermit W. Ingham, Stillwater, Okla., first vice president; Charles H. Kemper, Troy, Mo., second vice president; C. D. Burkholder, McPherson, Kans., third vice president; C. W. Baker, Kansas City, Mo., treasurer. Allan T. Flint, Kansas City, is secretary-manager.

Directors elected for three-year terms are E. E. Bonsteel, Harrison, Ark.; Charles P. Cheney, DeWitt, Ark.; D. B. Morgan, England, Ark.; Ralph E. Colvin, Liberal, Kans.; C. Lee Detter, Hutchinson, Kans.; William Fay, Manhattan, Kans.; Herbert W. Meyers, Mission, Kans.; G. A. Neylon, Hays, Kans.; Austin P. Sanborn, Chapman, Kans.; Bert Lewis, Wichita, Kans.; Price Berryman, Parsons, Kans.; Harold Harpster, Hiawatha, Kans.; Sam Arnold, Kirksville, Mo.; W. E. Nance, Stanberry, Mo.; W. T. Nethery, Hayti, Mo.; Edmund F. Speck, Joplin, Mo.; Ralph Williams, Silex, Mo.; Bob Henderson, Jackson, Mo.; Ralph Mayes, Moberly, Mo.; Ned Cowan, Clinton, Mo.; Harry McIntyre, Oregon, Mo.; J. W. Dutton, Ponca City, Okla.; Roy

(Continued to page 148)

**BENNETT
"DEEP-SEAT"
ASH DUMP**

100% Heavier for Permanent, trouble-free service — 9 x 4½ inches. Cat. No. C-203.



**ALL-ALUMINUM
"SCREW-TITE"
CLEANOUT DOOR**

Will not rust or corrode. Air-tight closure with convenient thumb-screw. Crimped masonry wires. Size 8x8. Cat. No. C-212.

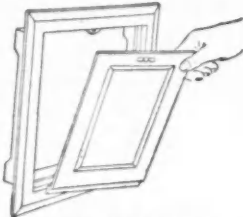

**BENNETT
GRATES & LOG DOGS**



Cat. No. A-501 Heavy Duty. Extra Deep, Removable Ends. Ash dumping trap. For Coal or Wood.



Cat. No. A-503 Cradle Grate. Sturdy Coal or Wood Basket.



Cat. No. A-515 Wood Grate. Use with or without andirons. Good outdoor fireplace grate.



Cat. No. A-1451 Log Dogs. Heavy Logs. Protect valuable andirons. Ideal for camp or outdoor fireplace.

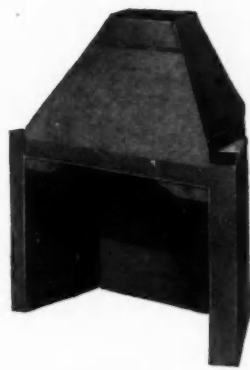

**BENNETT
Warm-Aire
FIREPLACE UNITS**

The post war recirculating Unit. Leak-seal flange around firebox. Tight-seal base. Longer baffles increase heating efficiency. Interchangeable Rotary or Ratchet control on Damper. Cat. No. C-131.

**THE BENNETT LINE
OF SALES PROVEN
FIREPLACE SUPPLIES**

The Bennett Dealer enjoys steady demand for our line through our continuous National Advertising. Bennett Fireplace Supplies are a complete line of profitable quality products. It pays to sell Bennett.



**BENNETT
Fresh-Aire
FIREPLACE UNITS**

The very best for the modern weather-tight house. Draws fresh air from out of doors, heats and circulates it throughout the house. Cat. No. C-121.



**BENNETT
Expanslip
THROAT DAMPERS**

A Better Damper at Low Cost. Steep 60° Front slope gives strong sure draft. Structural Steel with sturdy slip-joint eliminates damage in shipping, handling and in use. Cat. No. C-101.



**BENNETT
CAST-IRON DAMPER**

A quality damper at competitive prices. Superior casting facilities in our own foundry enable us to produce this steep slope 50° Damper, with interchangeable Rotary or Ratchet Control feature. Cat. No. C-103.



Flexscreen
REG. U. S. & CANADA. PAT. OFF.

SAFETY FIREPLACE CURTAINS

The only Nationally Advertised curtain screen. Every fireplace owner is a prospect for Flexscreen. Its own best salesman, a display on your floor will increase your volume on this "quality" product.

BENNETT - IRELAND INC.

Chartered in 1906

NORWICH, NEW YORK

Write now to 348 Market St. for

Catalog and Full Information on the

COMPLETE POST-WAR BENNETT LINE

Recognize a Trend?



More and More People Want Lumite

STAINPROOF!

RUSTPROOF!

NEVER NEEDS PAINTING!

LASTS A LIFETIME!

Day-in and day-out use—all over the country—is proving that LUMITE has qualities never before found in window screening . . . qualities that have started a trend towards this amazingly different plastic screening.

Here is the screen material that absolutely can't rust, rot, stain, or corrode . . . that never needs painting, lasts a lifetime. Made from SARAN. It costs less to own than any other type screening made.

You'll find all the facts about this amazing material in SWEET'S FILE, or, if you want samples and more complete information, write LUMITE DIVISION, Chicopee Mfg. Corp., 47 Worth Street, New York 13, N. Y.

Sold through Hardware and Lumber Dealers and Screen Manufacturers.

SPECIFY BY NAME

LUMITE



(Continued from page 146)

Lundy, Tulsa, Okla.; L. I. Parks, Lawton, Okla.; J. Reniker, Miami, Okla.; Fred Stephenson, Chickasha, Okla.; Barney Stewart, Jr., Oklahoma City; W. P. Kennedy, Jr., Oklahoma City; Louis Stuart, Sapulpa, Okla. Walter A. Lambert, Leavenworth, Kans., was elected to fill an unexpired three-year term. Cliff G. Scruggs and Allan T. Flint are Southwestern representatives on the board of directors of the National Retail Lumber Dealers Association.

TENNESSEE

W. Jay Willingham, Chattanooga, was re-elected president of the Tennessee Lumber, Millwork and Supply Dealers Association at the twenty-third annual



W. JAY WILLINGHAM

meeting conducted at the Hermitage Hotel, Nashville January 28, 29 and 30. New division vice presidents are T. O. Lashlee, Humboldt, west; Fleming Smith, Nashville, middle, and Henderson Horsley, Kingsport, east.

The Tennessee director to the National Retail Lumber Dealers Association, Abner E. Taylor, Jackson; the treasurer, Ralph Cockrum, Knoxville, and the secretary, R. O. Brownlee, Knoxville, were all re-elected.

Revision of the counties in the state to provide a sound pattern for the conduct of district meetings by Secretary Brownlee resulted in election of eight new directors. Elected for three-year terms from the new districts are Clay Rose, Elizabethton; Charles Rhyne, Newport; Sam Hathcock, Lebanon, and W. A. Nailling, Jr., Union City. New directors for two-year terms are J. D. Womack, McMinnville, and H. B. Brink, Lawrenceburg. Harry Molyneaux, Rockwood, will serve a one-year board term for District IV.

Registration at this year's annual was low because the entire state was blanketed with eight to twelve inches of snow and ice just before the sessions were scheduled. Every available exhibit space was occupied and lack of additional facilities forced the convention management to turn away manufacturers who

(Continued to page 150)

Columbia's the name they know...

because of

advertising like this!*

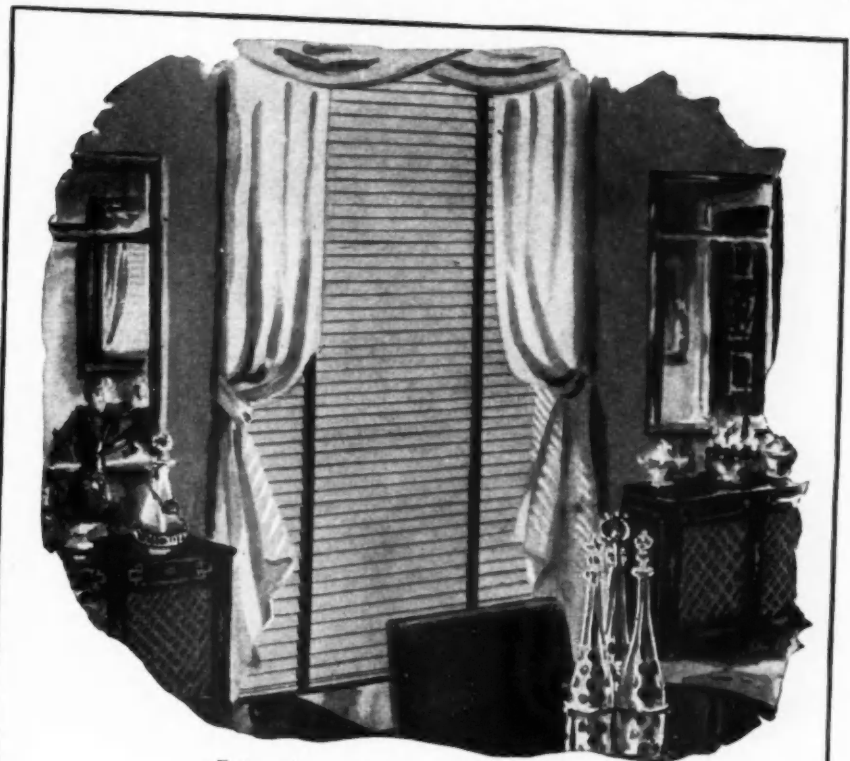

Choose Columbia Venetian Blinds—and at once you're on favorable ground with your prospects. They are conditioned to ready acceptance of Columbia Venetian Blinds because Columbia has been advertising them nationally for 15 years. A bigger schedule than ever for '48 features Columbia's smart styling...emphasizes that "CCC"—Columbia-Controlled-Construction—means a superior blind and perfect performance.

We'll be glad to give you the name of the nearest Columbia dealer. Let him show you the new Columbia styles and colors, give advice and counsel on your problem.

Like fine wine with good food...

Columbia's new Venetian Blinds are the perfect accompanying touch. Do you think "perfect" is too bold a word? Then wait until you see how the new colors (ranging from striking, to soft, to subtle), will fit almost any decorative scheme in your home. Wait until you handle one of the new Columbia Venetian Blinds, a marvel of honey-smooth mechanics. Now, every working part is completely enclosed by the handsome, dustproof headbox. Slats are plastic-coated for easier cleaning and longer wear. Tape removal clips allow you to change tapes quickly and easily. Columbia's "Snap-Stop" won't let blinds away in the breeze; completely automatic stop holds them in place with never a chance of slipping!

See the new Columbia Venetian Blind in steel or aluminum slats at your local Columbia Authorized Dealer.

Columbia
VENETIAN BLINDS
ALSO WINDOW SHADES • LACE
NET CURTAINS • LACE DINNER CLOTHS

Remember "CCC" - Columbia Controlled Construction for perfect performance.

THE COLUMBIA MILLS, INC. • 225 FIFTH AVENUE, NEW YORK 10, N. Y.

Columbia

VENETIAN BLINDS
AND WINDOW SHADES

*Four color ads like this appearing in:
House Beautiful
House and Garden
American Home
Better Homes and Gardens

THE COLUMBIA MILLS, INC. • 225 FIFTH AVENUE, NEW YORK 10, N. Y.



**Neat...Uniform
Rolls that SELL!**

KEYSTONE POULTRY NETTING

Just unroll a few feet of this netting and let your customers examine its beautiful even weave, its freedom from buckling, its easy handling. They can SEE you're showing them a PREMIUM QUALITY netting. And it sells for a price no higher than ordinary netting! In your store, these convincing selling points clinch sales quickly and easily.

Now is the time to display and SELL Keystone poultry netting.

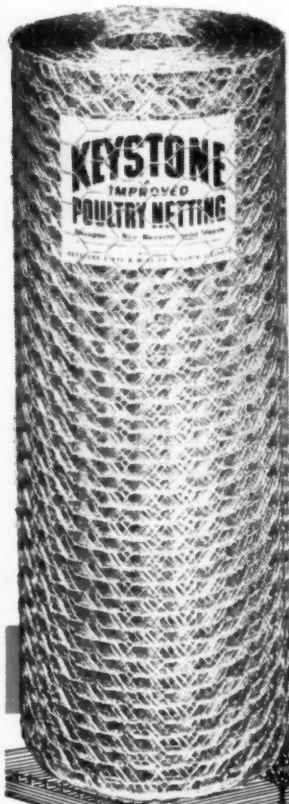

KEYSTONE STEEL & WIRE CO.
PEORIA 7, ILLINOIS

By the Makers of

RED BRAND Fence

RED TOP STEEL POSTS



(Continued from page 148)
desired space to exhibit new products.

MICHIGAN

Michigan Retail Lumber Dealer Association members gathered in the Pantlind Hotel and the Civic Auditorium in Grand Rapids February 3, 4 and 5 for their fifty-ninth annual convention. Registration totaled 1,485 and 103 manufacturers and distributors occupied exhibit space in the Civic Auditorium exhibit hall.

Edwin F. Westover, Westover-Kamm Co., of Bay City, was elected president. Other officers are Axel Becker, Monroe, vice president; Lester Essenburg, Holland, vice president; Norman B. Cove, Lansing, treasurer; Hunter M. Gaines, Lansing, secretary, and Donald J. Moe, East Lansing, assistant secretary.

Directors are Wesley Habermehl, Alpena; F. Gordon Feather, Petoskey; Charles Bracken, Traverse City; A. E. Swanson, New Era; T. P. Peterson, Grayling; Gordon Granger, Big Rapids; Edwin F. Westover, Bay City; John Sheridan, Caro; L. M. Spears, Grand Rapids; Lester Essenburg, Holland; William T. Gates, Lansing; John Hughes, Flint; Walter Peacock, Port Huron; Russell Nowels, Rochester; Axel Becker, Monroe; Joseph Deuel, Marshall; Hilton Nowlen, Benton Harbor. Clyde A. Fulton, Charlotte, is the dealer-director to the National Retail Lumber Dealers Association.

WESTERN PENNSYLVANIA

Six hundred and twenty-three persons registered at the forty-first annual convention of the Lumber Dealers Association.



MARLYN R. FETTEROLF

tion of Western Pennsylvania conducted February 4 and 5 at the Hotel William Penn, Pittsburgh. Forty-nine exhibitors displayed their products and services to visiting delegates.

Marlyn R. Fetterolf, Johnstown, Pa., president of the Thomas-Kinzey Lumber Co., was elected president succeeding James H. Hankins, of the Hankins-Paulson Co., Uniontown. Others elected are George B. King, Tideoute, Pa.

(Continued to page 152)

Americ
E
IN
N
IN
C
1. R
UP TO
Greatest
in 20 y
Silverco
of insur
effective
insulatio
of two v
works b
1. Ce
filler of
that's u
effective
in preven
conduct
2. Ce
two nor
membra
heat wit
nent eff

BIGGEST

INSULATION

NEWS

IN 20 YEARS

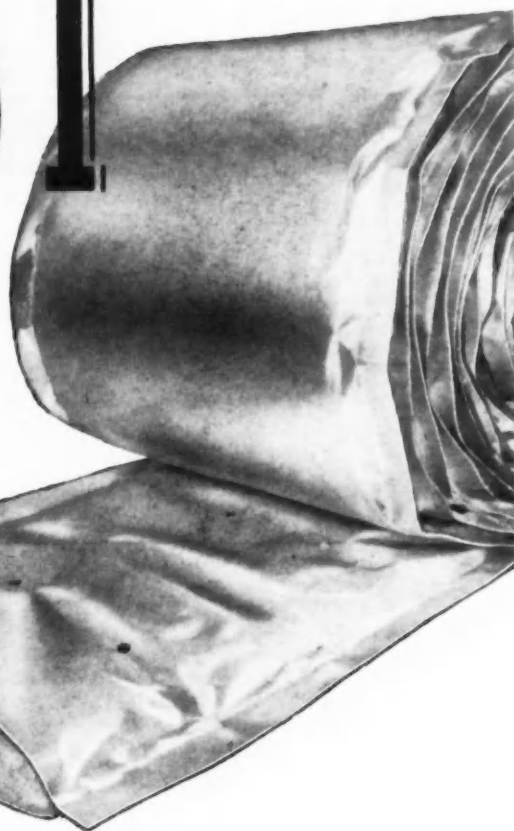

CELLULITE - SILVERCOTE*

- 1. Reflects Radiant Heat**
- 2. Blocks Conduction and Convection**

UP TO 70% MORE EFFICIENT

Greatest insulation development in 20 years, patented Cellulite-Silvercote combines two types of insulation in one new, doubly effective insulation. Unlike other insulations, which work only one of two ways, Cellulite-Silvercote works *both* ways:

1. Cellulite-Silvercote has a filler of fluffy, fibrous Cellulite that's up to 36 per cent more effective than other insulations in preventing heat transfer by conduction and convection.

2. Cellulite-Silvercote has two non-corrosive Silvercote membranes that reflect radiant heat with unsurpassed, permanent efficiency.

This new duplex action means up to 70 per cent greater effectiveness than any other insulation can give... the greatest insulation value on the market... a K-Factor of 0.12.

Sturdy vapor barrier exceeds FHA requirements. Gilmanweld nailing flanges are extra strong to speed and simplify installation. Compact packaging of rolls means easy handling.

Cellulite-Silvercote is flame-proof, moisture resistant, pest repellent; contains no irritating fibers, odors or dust... is permanent — can't sag, settle or pack.

Write today for full information on Cellulite-Silvercote's greater values for you and your

customers. Cellulite sales have tripled in three years. It will pay you to ride the Cellulite-Silvercote bandwagon.

Wholesalers — Distributorships now available in some valuable territories. For details write or phone Main Office in Gilman, Conn., or sales offices in New York, Chicago, Tacoma, San Francisco or Los Angeles.

THE GILMAN BROTHERS COMPANY
52 Richard St., Gilman, Conn.

Please send me, without obligation, full information about Cellulite-Silvercote.

Name _____

Firm _____

Street _____

City _____ Zone _____ State _____

Please Check One:

Wholesaler Dealer (Retail) Builder Architect

*Cellulite is a registered (U.S. Pat. Off.) trademark of The Gilman Brothers Company; T. M. "Silvercote" Reg. U.S. Pat. Off. by Silvercote Products, Inc.

The Barcol OVERdoor

BY **BARBER-COLMAN**

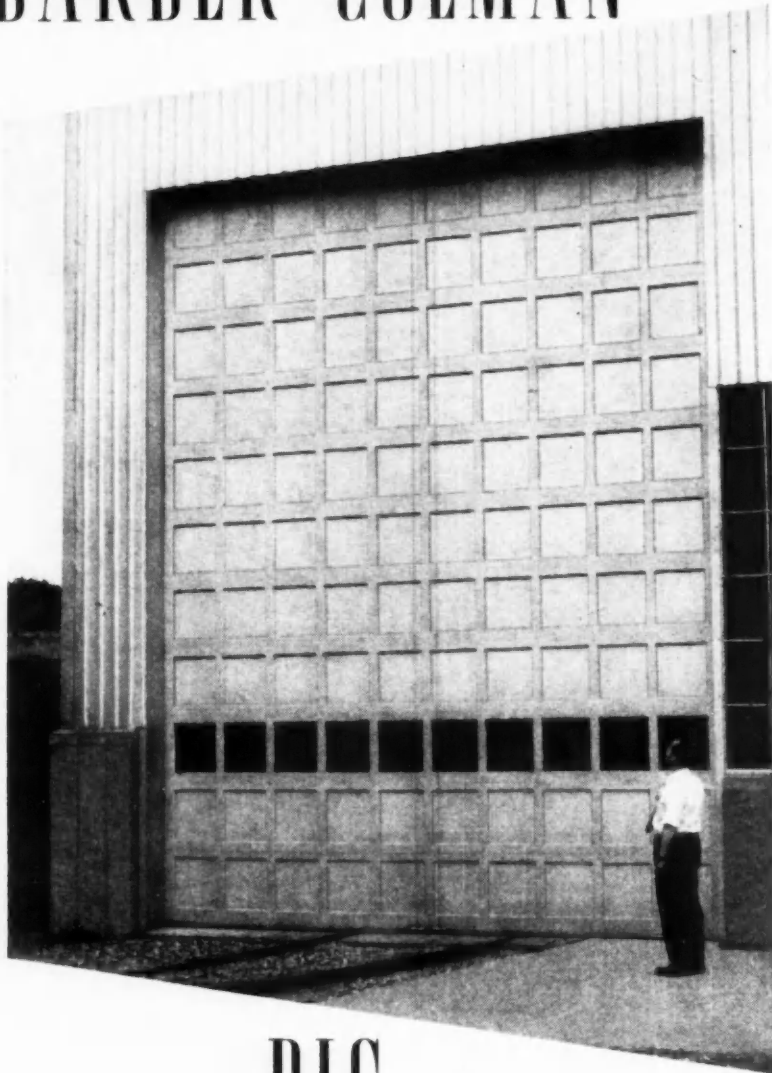

A GOOD SOURCE FOR **BIG** OVERHEAD-TYPE DOORS

It takes *experience*, coupled with engineering and manufacturing know-how, to construct successfully **BIG** overhead-type doors like the 17 by 22-foot example shown in the picture. Barber-Colman can claim this experience because, in the 17 years we have been making Barcol OVERdoors, we have designed and built hundreds of large, non-standard-size doors for industrial plants, commercial buildings,

municipal installations, and other purposes. The specialized knowledge gained in this work is available to you when conditions call for big doors. With wide experience on thousands of "standard" installations as well, we are in excellent position to work with you on *all* your overhead-type door requirements. Write for descriptive literature. *Consult your Barcol representative for details.*

FACTORY-TRAINED SALES and SERVICE REPRESENTATIVES in PRINCIPAL CITIES



BARBER-COLMAN COMPANY

104 MILL ST. • ROCKFORD, ILLINOIS

American Builder, March 1948.

(Continued from page 150)

first vice president: O. E. Eymann, Charleroi, Pa., second vice president: S. W. Means, Pittsburgh, treasurer, R. F. McRea, secretary, and R. P. Greiner, assistant secretary-treasurer, of Pittsburgh, were re-elected. Mr. Hankins, who had completed two terms as president, was elected dealer-director to the National Retail Lumber Dealers Association.

MIDDLE ATLANTIC

The Middle Atlantic Lumbermen's Association three-day fifty-sixth annual convention was conducted at the Claridge Hotel in Atlantic City, N. J., February 4, 5 and 6. This association does not have exhibits as part of its convention program. More than 800 persons registered at this year's meeting.

Officers of the Middle Atlantic group are as follows: President, Watson Malone III, of Watson Malone & Sons, Philadelphia, Pa.; vice president, Claude G. Ryan, Lancaster, Pa.; executive director, Robert A. Jones, Philadelphia; secretary-treasurer, Ray E. Latslaw, Philadelphia, Pa.; dealer-director to



WATSON MALONE III

NRLDA, J. Hammond Geis, Baltimore, Md.; dealer-director to U. S. Chamber of Commerce, Joseph W. Brosius, Wilmington, Del.

Directors are John T. Early, Philadelphia; Louis E. Mullin, Norristown, Pa.; Frank W. Romig, Allentown, Pa.; George F. Peck, Peckville, Pa.; Cephus C. Rosser, Nanticoke, Pa.; John W. Lundy, Williamsport, Pa.; Frank S. Buechley, Pottsville, Pa.; Luther H. Schmoeyer, Boyertown, Pa.; Charles D. Hummer, Chester, Pa.; Claude G. Ryan, Lancaster, Pa.; Gable L. Arnold, Red Lion, Pa.; Robert H. Bogar, Steelton, Pa.; E. A. Lakin, Hagerstown, Md.; G. Hunter Bowers, Frederick, Md.; G. Kessler Livezey, Jr., Aberdeen, Md.; Samuel F. M. Adkins, Salisbury, Md.; Weldon C. Waples, Newark, Del.; Hugh M. Peter, Pleasantville, N. J.; John Collins, Jr., Moorestown, N. J.; Frank Hankins, Jr., Bridgeton, N. J.; William R. Lamar, Washington, D.C.

(Continued to page 154)



TYPE D PANEL—Box beam formed by welding together two steel sections. Side laps interlock to form continuous flat surface. Cover plates available for open cells to provide two flat surfaces. Standardized in 16" width. Depth 1 1/2" to 9". Gages 18 to 12.

NEW METHOD OF FLOOR CONSTRUCTION

Better Floors-Faster!

with Fenestra Building Panels

Fenestra Building Panels come in a range of types, sizes and weights for almost any building need . . . save you time in construction of floors, walls, roofs, ceilings and partitions. For full information, mail the coupon, or call us.

1. WHY IT APPEALS TO HOME BUYERS.

It's a stronger, safer, noncombustible floor of steel. It can't warp or shrink. It provides an attractive ceiling for the basement. It marks your houses as up to date—tells prospective buyers that you have built well.

2. WHY IT SAVES CONSTRUCTION TIME.

Two men, without special skill or special tools lay the 16"-wide panels in standard joist lengths. Since the panels serve as joists, bridging and subflooring, much time is saved. Linoleum, wood or other finished floor material of your choice can be laid quickly on the smooth top surface of the panels.

Fenestra
BUILDING PANELS FOR

ROOFS

W
A
L
L
S

FLOORS

DETROIT STEEL PRODUCTS COMPANY
Building Panels Division
Dept. AB-3, 2260 E. Grand Boulevard
Detroit 11, Michigan

Please send me, without obligation, information on Fenestra Building Panels.

Name _____

Company _____

Address _____

Fiat

**PRECAST
SHOWER
RECEPTOR**

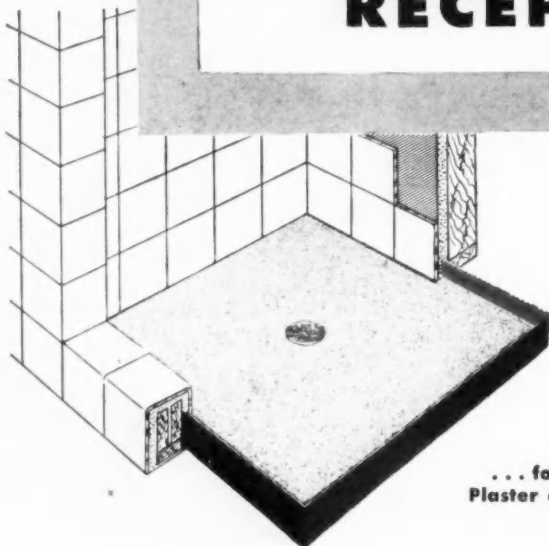

STANDARD SIZES

- 32" x 32"
- 36" x 36"
- 40" x 40"

... for built up showers with Tile, Plaster or Structural Glass Walls

A Fiat Precast Receptor in a built up shower is assurance of a water tight leakproof job at a considerable saving in cost over a hand fabricated floor using the old lead pan method. Walls are easier to handle with a solid one-piece foundation provided by a Fiat Precast Receptor.

A brass drain for 2" waste and the galvanized steel side wall flange is cast integral with the terrazzo forming a complete one-piece floor that is not affected by shrinkage or movement of supporting wood members.

Section through Fiat Precast Receptor showing cast-in drain connection and typical wall and threshold construction.

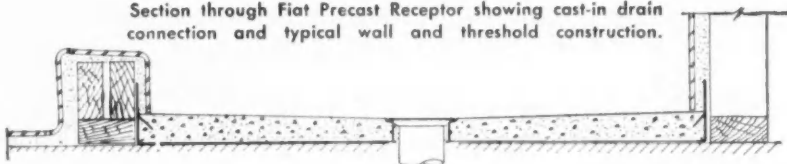

Fiat glass doors make showers more attractive in appearance and have a definite practical value to the user. Three types available: Dolphin, the finest in door construction, solid brass chromium plated frame. Zephyr, a satin finished aluminum frame door in the medium price class. Neptune, a low cost aluminum frame door. All Fiat doors are made for opening 24 inches wide.



Dolphin or Zephyr Door on built-in Fiat Shower.



Metal Manufacturing Company

Chicago 13, Illinois
Long Island City 1, N. Y. Los Angeles 33, Calif.

In Canada—Fiat showers are made by the Porcelain and Metal Products, Ltd., Orillia, Ontario

(Continued from page 152)

Highlights of the convention were addresses by Senator Kenneth S. Wherry of Nebraska, Congressman Samuel K. McConnell, Jr., Pennsylvania, and Lloyd J. Weir, sales and marketing consultant, Philadelphia. Dealer clinics, open to retail dealers only, were conducted on the morning of each session.

ILLINOIS

More than 3,100 registrants crowded the Sherman Hotel in Chicago for the fifty-eighth annual convention of the Illinois Lumber and Material Dealers Association February 10, 11 and 12. The 128 exhibits of building materials, equipment and services for dealers taxed the exhibit hall capacity of the Sherman.

James L. Watson, of the Watson Lumber Co., Troy, Ill., was elected president to succeed Henry L. Krumm, of Elgin. The new vice president is John W. McConnell of the Dacy Lumber Co.,



JAMES L. WATSON

Woodstock, Ill. John D. McCarthy, Springfield, is secretary-treasurer, and J. J. Lavengood, Springfield, is editor of the Illinois Building News, an association publication.

Directors elected are Paul Leach, Joliet; Rodney Ainsworth, Moline, and Robert H. White, Marissa. Other board of director members are Earl Anderson, Litchfield; C. B. Elliott, LaSalle; Jas. P. Flannery, East St. Louis; W. Lindley Huff, Decatur; Charles A. Smith, Rock Falls; Bob Stotlar, Herrin; Otto Wahlfeld, Peoria, and John A. Wheeler, Newton.

C. W. Ingham Heads West Coast Lumbermen

C. W. INGHAM was re-elected president of the West Coast Lumbermen's Association at the thirty-seventh annual meeting in Portland, Ore., January 29 and 30. All other officers of the Association were re-elected along with Mr. Ingham, who is vice president of the Fischer Lumber Co., Marcola, Ore. Approximately 250 members attended the meeting.

LAVISH WITH COMFORT!
A MISER WITH FUEL!

EVERY NIGHT
THIS MIRACLE
THERMOSTAT
SAVES FUEL

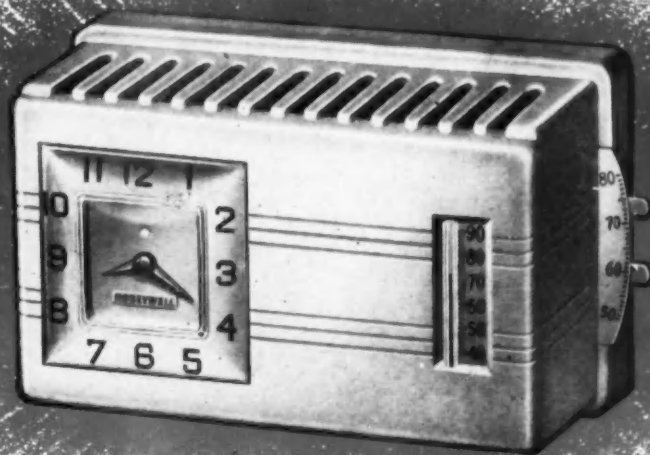

THE NEW *Chronotherm*

WITH Chronotherm, Honeywell's handsome new electric clock thermostat, owners of your homes can enjoy the most carefree heating comfort they have ever known—and at the same time save fuel! Chronotherm keeps homes at just the right comfort temperature from morning to night. Then, when the family retires, it automatically switches to lower fuel-saving temperature, or in mild climates, shuts off the heat. In the morning, the desired daytime temperature is

restored gradually, without overshooting. The result, according to government authorities, is savings of 10 per cent or more of the heating bill—with complete comfort and convenience. Make certain you include Honeywell's new, nationally advertised Chronotherm in every house you build. It is another way to provide your homes with the newest in modern improvements. Minneapolis-Honeywell, Minneapolis 8, Minnesota. In Canada: Toronto 12, Ontario.

MINNEAPOLIS
Honeywell
CONTROL SYSTEMS

The **NEW**

JACKSON

BUILT-IN home DISHWASHER

Especially designed for builder installation

The New Jackson Home Dishwasher is a machine that can be incorporated in the builder's plans and be built in the drainboard, or installed in present drainboards.

The Jackson Dishwasher will wash and rinse a basket of dishes in approximately **one minute**. It is a machine that can wash dishes for two people—or 100 people—since while one basket is being washed, the other can be filled. The Jackson Dishwasher, with features entirely **new** to the home dishwashing field, can be a strong selling point in the houses you build.



For installation, a 19½ inch hole is cut in drainboard. Here, cover—which fits flush with drainboard—has been removed to show dishes in machine.

NEW MACHINE BACKED BY 23 YEARS EXPERIENCE IN DISHWASHING FIELD

The new Jackson Home Model embodies all the highly successful features of the world-famous Jackson Commercial Dishwashers. Dishwashing machines have been the *exclusive* business of the Jackson Dishwasher Company since 1925. At last, here is a machine for the home with *proven* performance and dependability.



Monel metal hood, solid one-piece base casting. Centrifugal pump operated by ¼ H.P. motor maintains constant high water pressure in machine.

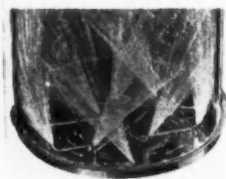

Washing operation. Double revolving wash sprays force water under high pressure over every surface of articles being washed.

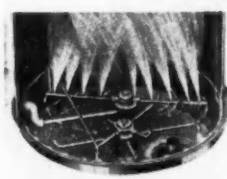

Rinsing operation. Separate revolving rinse spray, using fresh clean water, thoroughly rinses—and the dishes are done.

The Jackson Built-In Home Dishwasher, designated "Model H-1A," is now in production. Your inquiry is invited.

Write today for literature, prices, and complete information.

THE JACKSON DISHWASHER CO.

Dept. AB, 3703 East 93rd St.

Cleveland 5, Ohio

Dishwashing Specialists Since 1925



How-To-Do-It

How to Lay Out Stairs With the Correct Ratio Between Treads and Risers

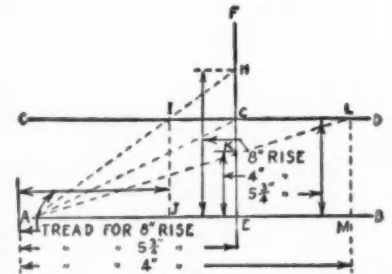

C. C. BOLES, Saginaw, Mich., offers the above suggestion.

A 12 inch tread and 5¾ inch riser is considered the standard for an easy flight by the average stair builder. By using this standard as a guide the above diagram has been prepared.

Draw two horizontal lines about 20 inches long and 5¾ inches apart. These are indicated on diagram by letters A, B, C, and D. The vertical line EF, is then drawn about 10 inches high, starting from line AB, 12 inches to the left of A.

From these three basic lines the rise and tread of any stairs may be correctly determined by the following procedure.

Due to lack of room, it may be necessary to build a steeper stair. Then the builder is forced to change the ratio. For example, an 8 inch riser is determined, requiring a narrower tread. Therefore, establish a point 8 inches high from line AB, marked H. Connect AH, by a straight line, crossing CD, at I. Drop a line from I to J, then AJ, will be the width of tread for the 8 inch riser.

A terraced lawn or a long gradual rise to the approach of a public building, for example, may call for only a 4 inch rise. Therefore, measure up from AB, 4 inches to point K. From A, through point K, extend a line to L, on CD. From L, drop line to M, AM, is then the width of tread for the 4 inch riser.

In practice the treads and risers will figure out in fractional parts of inches, in which case the rule applies just the same.

How to Repair Defective Downspouts, Gutters

TO COVER a hole in a rusted drain pipe, first paint a coat of plastic around or adjacent to the hole. Stretch a burlap or piece of heavy cloth across the hole, with the edges well out in the plastic around the sides. If the builder uses a

(Continued to page 158)



S. Neale

How to clinch more closings on the floor

Wide-awake contractors know this from experience. You gain *two* ways when you standardize on Devoe floor-finishing systems. When customers find you're using materials they recognize as top quality, they gain respect for your workmanship—enthusiasm for your houses. :

Devoe floor-finishing systems give fine results



... CUT OVERHEAD AS WELL. FOR INSTANCE:

Devoe 87 Filler-Sealer Topped with Devoe 87 Spar—Here's a truly postwar quality combination for *fast* work and superb results. Both are made with Devran (Patent applied for) the new Devoe miracle resin, for extra durability. National advertising on 87 Spar is heavy—your prospects will recognize it as a top-quality floor finish.

Devoe Floor & Trim Seal—A one-product finish with real appeal to your most quality-conscious prospects. In a single operation it seals and case-hardens the wood and gives a surface ideal for buffing to a soft, rich finish. Quick and easy to apply by brush, rag, or mop. Ready for re-coating in only *4 hours!*

Get full details on these fine Devoe products from your Devoe Agent or write us direct on your letterhead today.

HOW DEVOE PAINT HELPS WITH CLOSINGS

When it comes to closing contracts, there's real magic in materials bearing known brands these days. Devoe is one of the oldest, most trusted names in the Paint Industry. It pays to use Devoe products—and make sure your prospects know it.

DEVOE & RAYNOLDS COMPANY, INC.

787 First Avenue, New York 17, N. Y.

SCHLAGE LOCKS

for buildings well-built

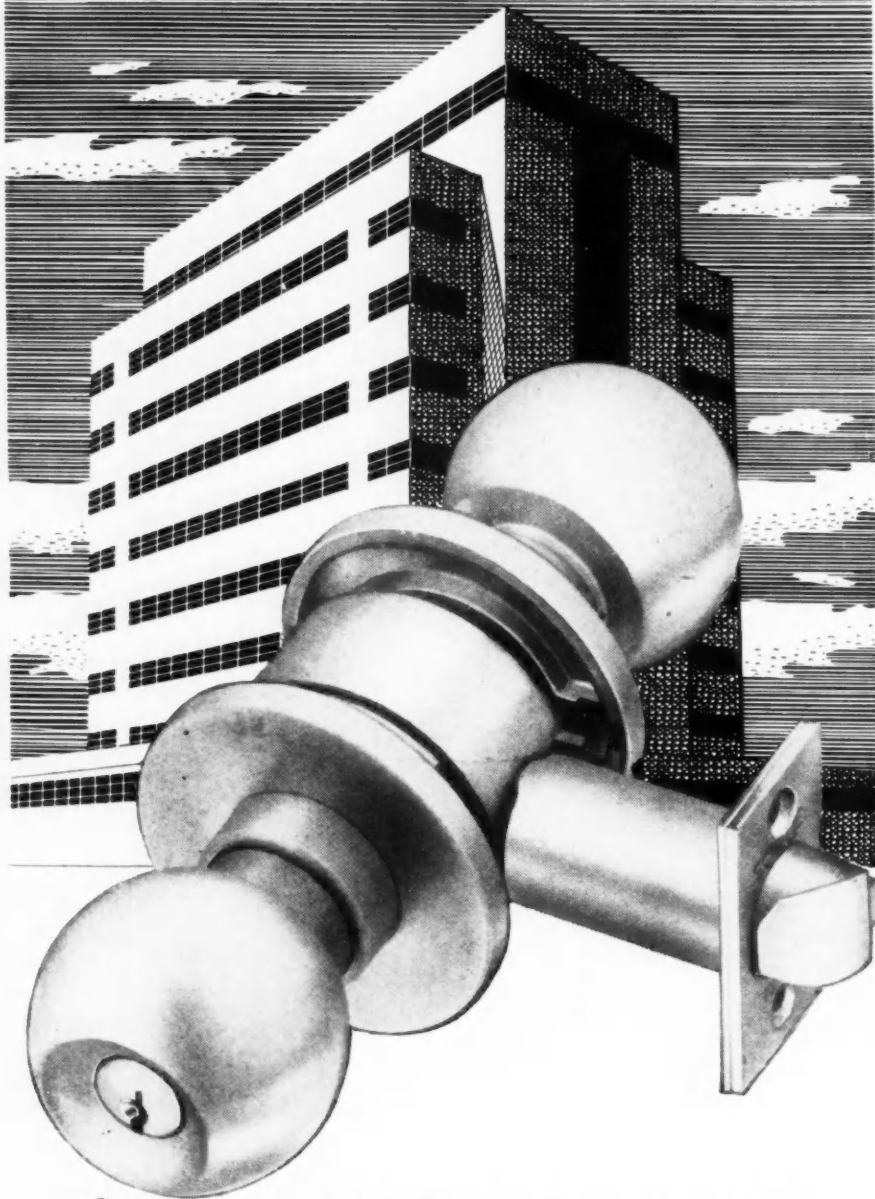

Of course only the finest hardware goes into well-built buildings. That's why so many of the world's outstanding buildings are equipped with Schlage . . . the finest in quality locks.

Write for Illustrated Booklet:
"Locks by Schlage"



SCHLAGE

LOCK COMPANY

SAN FRANCISCO NEW YORK

ORIGINATORS OF THE CYLINDRICAL LOCK



How-To-Do-It

(Continued from page 156)

plastic such as Mix-Tite, it should be spread $\frac{1}{8}$ inch thick.

If the drain pipe, downspout, or gutter is badly rusted—even if it is not rusted



HOW plastic is spread on each side of the defective part of a downspout or gutter before applying burlap or cloth

through—it is a good idea to spread plastic over the entire surface and spread a burlap or piece of cloth over the area.

How to Make a Guide For Marking Center Lines on Boards

USED in the manner shown above, this guide will mark boards of various widths right down the center of the board without any adjustments.

A piece of scrap wood about one foot long is fitted with a handle of either wood, metal or leather. Nails are then driven all the way through the piece of

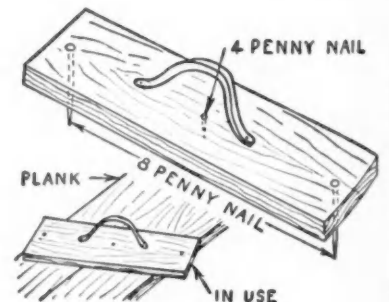

scrap wood, two near the ends and one in the center. The nail in the center is driven through the wood so that it projects no more than $\frac{1}{8}$ inch.

To mark a board, place the guide so that the outside nails touch the edges of the plank. Then draw the guide down the entire length of board as may be required. Submitted by Herbert E. Ferguson, New Braunfels, Texas.

If it's built for rental income . .



Specify windows of
ALCOA ALUMINUM

Will that new building show a profit ten years from now . . . twenty years from now? Not if maintenance costs eat up the income! Before you build, be sure you cut window maintenance costs to the bone. Make sure your specifications call for quality windows made of Alcoa Aluminum.

Non-warping, corrosion-resistant aluminum windows eliminate painting costs; are easy to keep clean and attrac-

tive. Aluminum windows stay snug fitting and weathertight. Alcoa Aluminum can't shrink or swell; will not rot or rust away.

Quality aluminum windows, in all standard types and sizes, are available for every type of building—commercial, industrial and residential. For information on any application of aluminum, write ALUMINUM COMPANY OF AMERICA, 1914 Gulf Building, Pittsburgh 19, Pa.

ALCOA FIRST IN **ALUMINUM**

1888 1948
60 YEARS OF SERVICE

DO YOU KNOW

*the latest trend
in floors for homes?*



Wright Rubber Tile — first choice for Commercial installations — now offers smart new floors for homes!

In a recent national survey, builders and architects picked rubber tile floors as their number one choice for commercial installations. But that's not all — figures from the same survey show the trend is to rubber tile floors for homes.

In Wright Rubber Tile, it's *Wrightex* that's best for homes. A wide variety of warm, rich colors, and different sizes readily lend themselves to any floor design, color scheme or period plan. Equally important — the same outstanding features of unusual walking comfort, wear resistance, and easy low-cost care, that have made Wright Rubber Tile the favorite in commercial installations, now make it number one for home floors too.

Where radiant heat is planned, exhaustive tests and many installations have shown that Wright Rubber Tile has an excellent heat diffusion characteristic. Equally important, it's absolutely unaffected by high temperatures!

NOTE!
Don't forget Wright-On-Top, the new compression base for all type floors. Always beautiful — will not scuff or mar.

Next time you plan a home—remember Wright Rubber Tile. It can make your floor plans have lifetime smartness. See your dealer or write direct to us for detailed information. Taylor Manufacturing Company, 3050 West Meinecke Avenue, Milwaukee 10, Wisconsin.

WRIGHT RUBBER TILE

Floors of Distinction

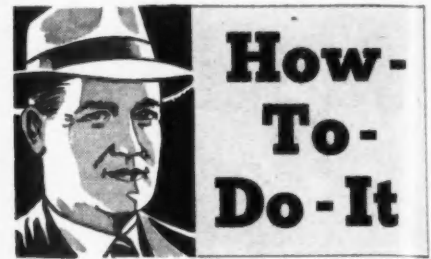

How to Secure Large Pieces of Masonite and Sheet Rock to Ceilings

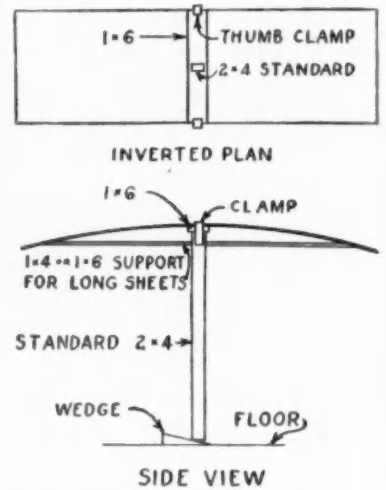

"A PRACTICE that is common with a most mechanics," says C. C. Boles, a builder in Saginaw, Mich., "is to cut a standard from some handy material, such as a 2x4-inch piece, long enough so that it will reach from floor to ceiling, and to nail a 1x4 or 1x6-inch piece on top of it. The sheet of material that is to be placed on the ceiling is then raised, and the standard slipped under until it holds the sheet firmly in the proper position on the ceiling.

"This is easier said than done, as the support slips, and it is hard to control.

"A better way is to cut the 2x4-inch standard about 4 inches shorter than the ceiling height. Then while the sheet of material lies flat on the floor, turn the standard with the 1x6-inch nailed on top, upside down on the sheet, and secure the sheet to the cross piece at each side with small thumb clamps or other temporary fastenings.

"Take hold of standard and place it in an upright position with the sheet of material at the ceiling in position for nailing. Place a wedge under 2x4-inch vertical standard at floor to hold sheet tightly in place at ceiling. After ends of the sheet have been secured to the joists, remove clamps and proceed to permanently nail the entire sheet of material in place.

"In case the sheet is so long that it is liable to break in the center when raising, nail a piece to standard as shown in the drawing. This will support the ends until the entire piece can be secured in place. This is a one man job, but two men can work at it to better advantage and economy."

NEW!

1948 Catalog of Basic Plywood Data

Sixteen pages of specification data, grade description and application suggestions—a basic manual for all who buy, sell, specify and use Douglas fir plywood in construction.

SEND for free copy of this new Basic Plywood Catalog—a reprint of the sixteen pages appearing in the 1948 Sweet's File, Architectural. It covers the full range of Douglas fir plywood data, from panel sizes to finishing procedure. Single copies mailed free to any point in the United States.



Douglas Fir PLYWOOD

LARGE
LIGHT
STRONG

Real Wood



Panels

DOUGLAS FIR PLYWOOD ASSOCIATION— DEPT. 100
Tacoma 2, Washington

GENTLEMEN: Please send me a copy of the 1948 Basic Plywood Catalog

Name _____

Title _____

Firm _____

City _____ Zone _____ State _____

Sell the
PROVEN BRAND



SCREEN WIRE CLOTH

Sell the proven brand . . . sell Cortland Brand. On the market since 1873, Cortland Brand wire cloth brings you responsible manufacturing, dependable service, and customer good-will. All grades of steel, aluminum, and bronze-wire cloth are made by Wickwire to full compliance with Bureau of Standards' specifications.

Simplify your source of supply . . . there is a Cortland Brand screen wire cloth for every use.



Cortland Bronze: Made of special alloy that is absolutely rustless and not affected by salt air, acids, or gases. Bright or antique finish; 18 x 14 mesh.



Cortland Gray Wick: The all-purpose, popular-grade screen wire. Doubly protected against corrosion by electro-zinc coating and enameling with pigmented varnish. "Glare-proofed" finish; 18 x 14 mesh.



Cortland Aluminum: Made from Alclad aluminum wire. Light in weight — approximately one third the weight of steel wire cloth. Cannot rust or stain; 18 x 14 mesh. Packed 100-foot linear rolls; standard widths from 24" to 48".

WB

Cortland BRAND

WIRE • SCREEN WIRE CLOTH • POULTRY NETTING • NAILS

WICKWIRE BROTHERS, INC., CORTLAND, N. Y.



How to Repair Venetian Blinds Quickly

THIS suggestion is submitted to the readers of the *American Builder* by Herbert E. Fey, builder of New Braunfels, Texas. "Here is a simple little trick that I use when broken dowel pins need to be replaced in Venetian blinds.

"I first cut off the defective end of the shutter as shown in the drawing, after which a 3/16-inch hole is drilled through the blind frame and the exact center of

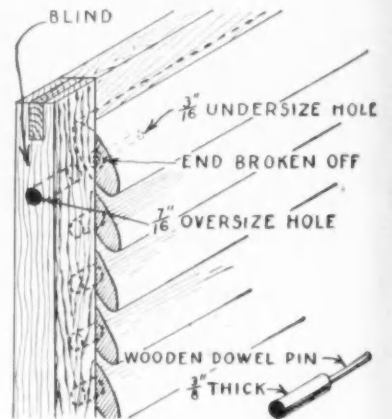

the shutter end. Then a wooden dowel pin is cut to the shape shown, with the largest portion of dowel being 3/8 inch in diameter, and the smaller portion slightly larger than the hole in the shutter. The dowel pin is then driven into the shutter from the outside.

"I have found that this is about the only way that blinds can be repaired without taking them completely apart. When an attempt is made to remove and replace a defective shutter, all the other members fall out of position and it becomes extremely difficult to line them up in their proper order. Needless to say, the hole in the blind frame must be drilled oversize to permit the shutter to move freely".

How to Hang Cabinet Doors Accurately

"WHEN I am faced with the task of hanging cabinet doors accurately," says Herbert E. Fey, builder of New Braunfels, Texas, "I always use the method shown here.

"A large single piece of plywood, from which the doors are to be formed, is cut to the exact size of the total opening of the cabinet. Before putting the hinges in place, take a fine hand saw and make a perfectly straight cut from either side

(Continued to page 164)



**Be sure . . .
make it CRANE!**

1-110 Drexel Lavatory
2-83 Criterion Bath
3-120 Drexel Toilet

● Reason number one—and a *big* one, too—is **PROVED POPULARITY!** Crane is the name your clients know best . . . as proved time and again in nation-wide surveys.

Reason number two is **QUALITY** . . . as reflected in the lasting brilliance and smart styling of every Crane fixture. And don't overlook such Crane extras as finger-tip *Dial-ese* controls—in all Crane bathrooms, kitchens, and laundries.

Reason number three? **COMPLETENESS!**

Crane offers a style for every taste—a price for every budget. Crane quality extends not only to the fixtures, but also to the piping that makes them work. In heating, too, the Crane line is complete, providing for any system, any fuel.

You'll find a representative selection from the Crane line in your Sweet's Builders' File. Naturally, some fixtures are still coming through faster than others—it's well to check your requirements with your Crane Branch or Wholesaler.

CRANE

CRANE CO., GENERAL OFFICES:
836 S. MICHIGAN AVE., CHICAGO 5
PLUMBING AND HEATING
VALVES • FITTINGS • PIPE

NATION-WIDE SERVICE THROUGH BRANCHES, WHOLESALERS, PLUMBING AND HEATING CONTRACTORS

THE A. B. C. of
ATLAS
SAVINGS

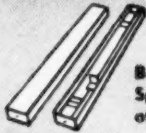

Basic unit, the Speed Panel, made of rugged steel.



Ingenious, quick-action Wedge Bolt. For rapid joining or stripping.



Speed Panels combine into units of two or more for quick handling.



Forms are quickly positioned for easy pouring.

Light and sturdy. Easy wall assembly. Rapid stripping.



Forms assembled into multi-unit panels for rapid crane handling.

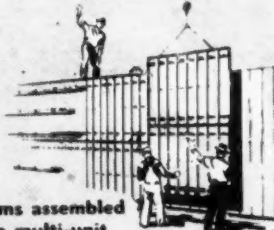

Make us PROVE it!

Atlas Speed Forms Cut to 50% Off Your Poured Concrete Costs BECAUSE

1. They cut Form Costs in half.
2. They cut On-Site Labor in half.
3. They're easy to assemble, strip, store.
4. Forms last indefinitely. Many contractors have had 400 uses, are still going strong.
5. On job after job, for hundreds of contractors, on large and on small operations, Atlas Speed Forms drastically reduced costs.

Let us prove it! At our expense and with no trouble to you. Send in the coupon below, it will bring you a data sheet to be filled out. We will then furnish you with a verified estimate on your form work and you can figure the savings for yourself. Five minutes of your time against a fifty per cent saving—the odds are in your favor! And here's the coupon....

*An average figure. Of course special cases will prove an exception. But we may surprise you!

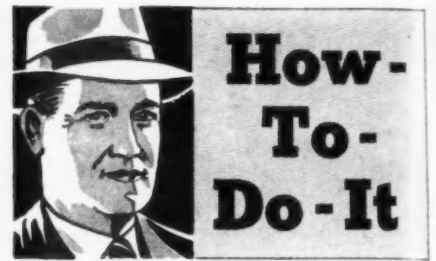

(Continued from page 162)

of the plank. This cut must be in the exact center of the sheet. Be sure that

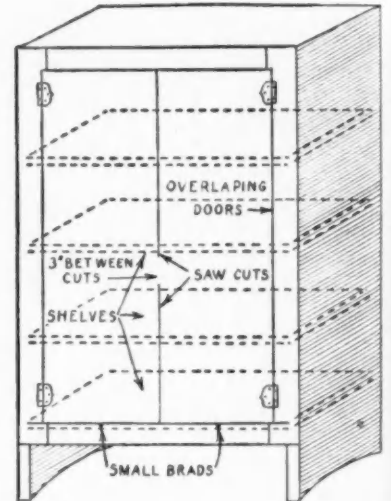

the bottom cut is made a bit farther up than the bottom or second shelf. "Fasten the double doors with small brads so that the hinges can be screwed on tightly. The final step is merely cutting the two doors apart and removing the brads".

How to Make a Wooden Raker Gauge

IN submitting this suggestion, J. G. Caldwell, San Mateo, Calif., says, "When filing a fancy tooth power saw, the crosscut teeth are filed first to a point.

Then place the gauge shown in the

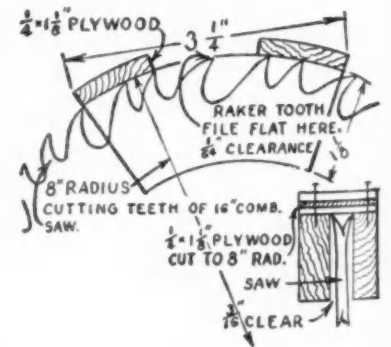

drawing on top of the teeth, and file raker teeth 1/64 inch shorter than the others. If this is done each time the saw is filed, then better and smoother service will be obtained from the saw, and rakers will not get too long".

Address mail inquiries to Irvington Office.

BOSTON, MASS. 294 Washington Street

DENVER 2, COLORADO 1800 West Colfax Ave.

HOUSTON, TEXAS 3815 Garrett Street

MIAMI, FLORIDA 93 N.E. 20th Street

NASHVILLE 3, TENN. Amer. Natl. Bank Bldg.

PHILADELPHIA, PA. Broad St. Station Bldg.

SAN FRANCISCO, CAL. Sixth and Hooper Sts.

TACOMA, WASH. 2412 N. 10th Street

WASHINGTON, D.C. 805 G Street

NEW YORK, N. Y. 43 Cedar Street



IRVINGTON FORM & TANK CORPORATION

IRVINGTON 92, NEW YORK

Please send me information on Atlas forms. I am particularly

interested in forms for Walls Floors Tunnels Bridges

Sewers Columns

NAME

FIRM

ADDRESS

.....

This Improved Construction Assures a Permanent

DRY WALL

at Minimum Material and Labor Cost!



VAPOR SEALS FROM THE INSIDE!

Reflective Sisalation prevents passage through sidewalls of harmful moisture-vapor. Provides adequate insulation at no extra cost!

WEATHER SEALS FROM THE OUTSIDE!

Tough Sisalkraft building paper over sheathing prevents passage of wind-driven rain into walls.

See for Yourself: New wall construction, utilizing the prime features of Sisalkraft and Sisalation, now enables you to stop the passage of harmful moisture into walls, easily and economically. This simple method provides a permanently DRY WALL in homes PLUS all the advantages of effective INSULATION at no extra cost!

Write today for further information about these two products.

The SISALKRAFT Co., Dept. AB, 205 W. Wacker Drive, Chicago 6, Ill.



and file
than the
e the saw
er service
and rak-

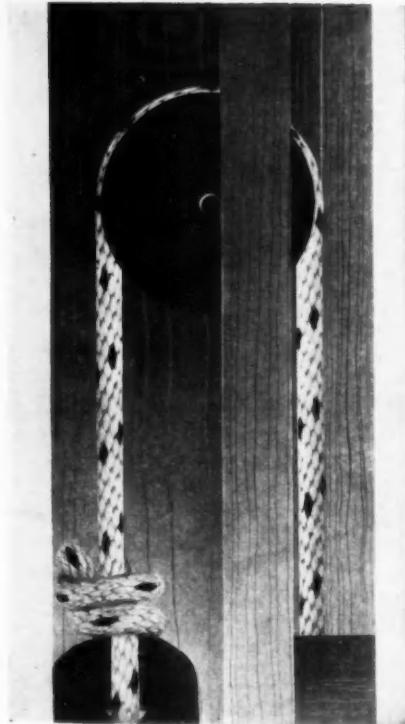

®

SPOT SASH CORD

Simplicity — no other device is as simple or as permanently efficient for balancing double-hung windows as the time-tested combination of Spot Cord, pulleys and weights. Perfect and permanent balance and noiseless operation are assured. There is nothing to get out of order.

The part that takes the wear is the cord — and Spot Sash Cord will last almost indefinitely. It is made of extra quality fine cotton yarn, firmly and smoothly braided, and guaranteed free from imperfections.

Identified by our trade-mark, the Colored Spots (Reg. U.S. Pat. Off.) Send for sample card with table showing right sizes for different weights.



®

SAMSON CORDAGE WORKS

BOSTON 10, MASS.

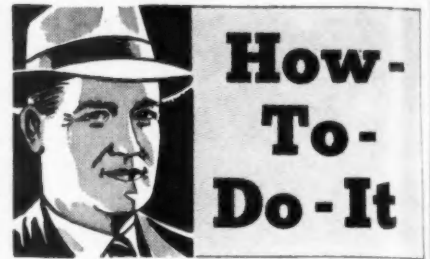

How to Insulate Frame Construction

WHEN an attic is unused and unfloored, Kimsul insulation can be laid between the joists, with the waterproof cover facing down. Attic flooring may be laid over it without trouble or without special preparation.

For unused upstairs rooms, Kimsul is installed between the roof rafters and across collar beams (Figure 2). Water-

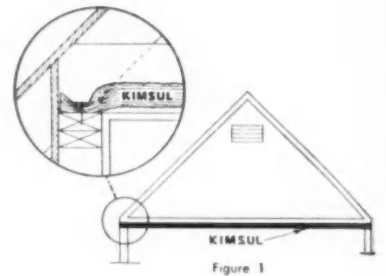

Figure 1

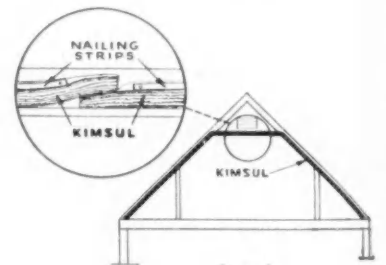

Figure 2

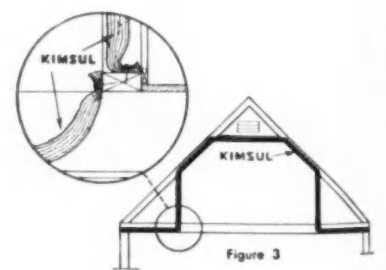

Figure 3

ILLUSTRATIONS show where to install Kimsul insulation in existing frame constructions, leaving ventilation space

proof cover over the insulation should face toward the inside of the house. Attic space above the collar beams should be adequately ventilated for the greatest comfort.

To insulate only living space of an upstairs room, Kimsul is placed between the ceiling joists, wall studs, roof rafters and the collar beams (Figure 3). Waterproof cover of the insulator, in this case, must face inside of the house, and the area above the collar beams should be adequately ventilated.



"Why hasn't anyone thought of this before?"

Wait till you see the new sales promotion plan Rheem has in store for small-home builders.

READ ALL ABOUT IT NEXT MONTH!

Rheem  Home Comfort Appliances

570 Lexington Avenue, New York 22, N. Y.

WATER HEATERS

SOFT WATER APPLIANCES

HEATING APPLIANCES

COOLING APPLIANCES

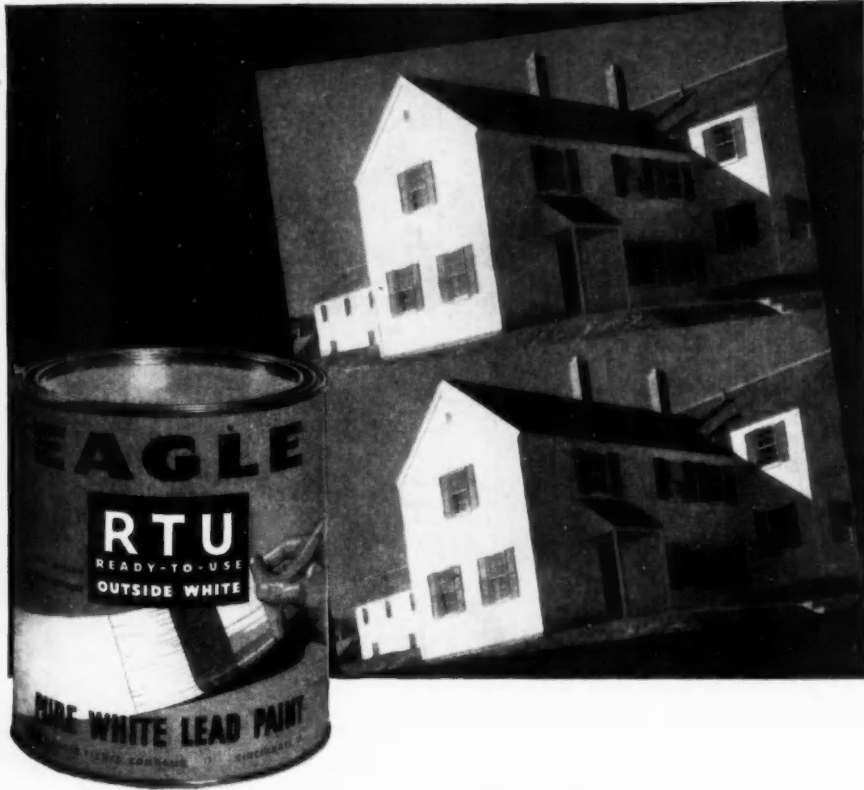

does double duty

1. Being pure white lead, Eagle RTU has traditional beauty and durability.
 2. It's factory-mixed for new efficiency, goes to jobs in original containers.
1. Eagle RTU's fine brushing and hiding qualities make for easy application.
 2. Its smoothly gleaming coat gives lasting distinction to your buildings.
1. Eagle RTU is favored by builders for its time-and-labor-saving convenience.
 2. It's preferred by homeowners for its whiter white that stays white longer.
1. Eagle RTU is pure white lead paint in a modern form.
 2. It is backed by Eagle-Picher's 104-year-old reputation.



Since 1843

THE EAGLE-PICHER COMPANY
CINCINNATI (1), OHIO
Member of the Lead Industries Association

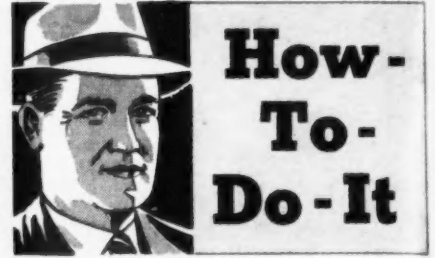

How to Measure Roof Pitches

THE DIAGRAM in Figure 15 shows the principal roof pitches. They are called one-half pitch, one-quarter pitch, as the case may be, because the height from the level of the wall plate to the

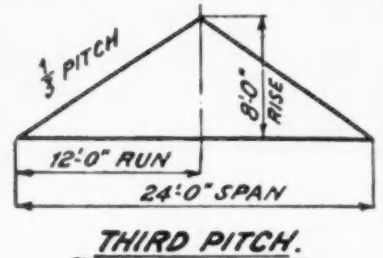

FIG. 13.

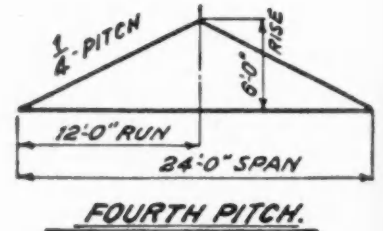
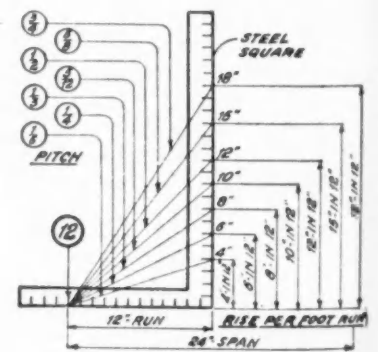

FIG. 14.

EXAMPLES of a one-third and a one-fourth pitch. The pitch is the ratio of the total rise of the roof to the building width



PRINCIPAL ROOF PITCHES

FIG. 15.

EXAMPLES of different pitches. If the height of the steel is 15 inches and width is 12 inches, it is a five-eighths pitch

ridge of the roof is one half or one fourth of the total width of the building. To measure the roof pitch, then, measure the distance from the level of the wall plate to the ridge of the roof and divide this measurement into the width of the building. The fraction, as a result of this division, is the pitch.

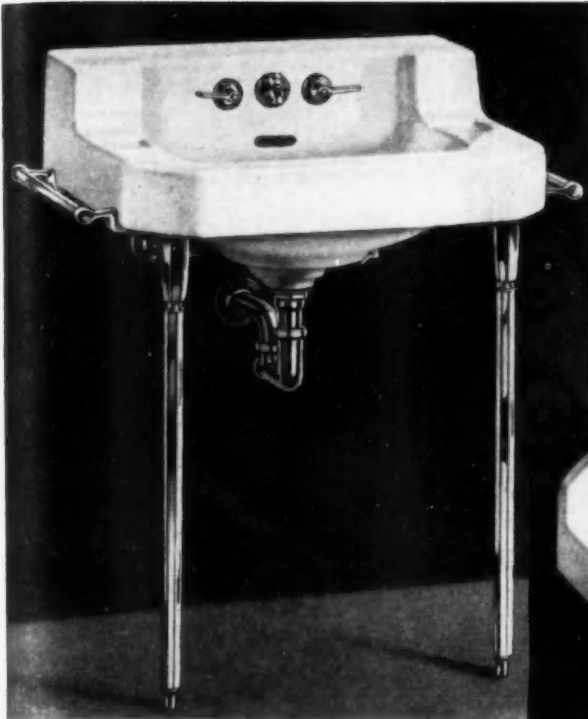

LEFT,
GRAMERCY:
K-1860-BA. Sizes
24 x 20" and 22 x 18".



RIGHT,
STRAND:
K-1870-BA.
Sizes 26 x 15½" and
20 x 14".



LEFT,
GREENWICH:
K-1950-J. Sizes—
24 x 20" and 20 x 18".

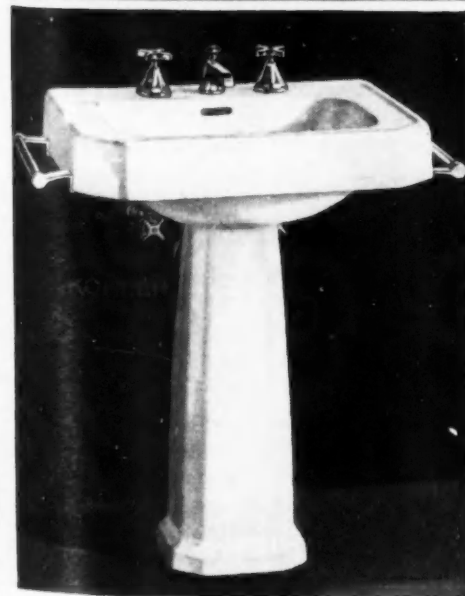
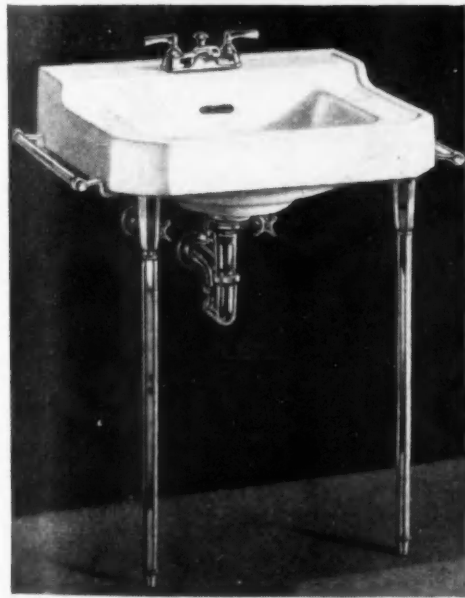

Sell the satisfaction that goes with **KOHLER** Vitreous China Lavatories

IT is a real service to your customers to point out the advantages of Kohler vitreous china lavatories. Among those illustrated the average home owner will find the practical answer to his needs.

Made of fine imported and domestic clays, Kohler vitreous china lavatories are fired under intense heat to give them glass-hard, permanently lustrous, acid resistant surfaces that are easy to clean. The chromium plated fit-

tings with pop-up drain are engineered to Kohler high standards of efficiency.

The Gramercy and Chesapeake, both popular lavatories, are available in two sizes, with or without legs. Both are shelf lavatories, as also is the Strand, designed especially for small, narrow rooms. The Jamestown is available with pedestal as well as with legs. The Greenwich combines smartness and low cost.

LEFT CENTER:
CHESAPEAKE:
K-1910-C. Sizes
24 x 20" and 20 x 18".

LEFT,
JAMESTOWN:
K-1780-F. Sizes
27 x 22", 24 x 20"
and 20 x 18".

Send for free copy of new 16-page color booklet showing Kohler fixtures in attractive settings, with practical floor plans, color suggestions, data on sizes and dimensions and other helpful information. Address Kohler Co., Dept. 17-B, Kohler, Wis.



KOHLER OF KOHLER

PLUMBING FIXTURES • HEATING EQUIPMENT • ELECTRIC PLANTS

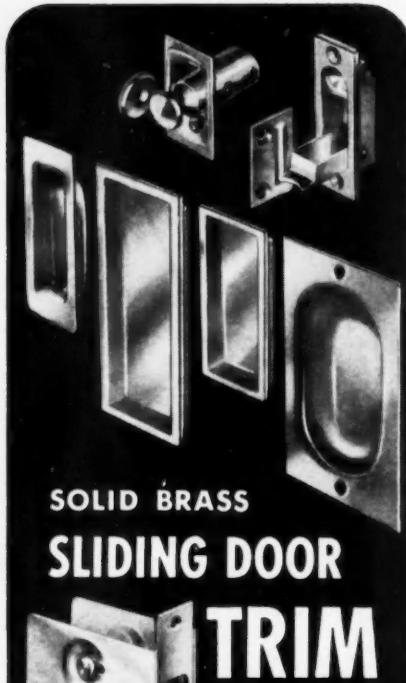

**SOLID BRASS
SLIDING DOOR
TRIM**

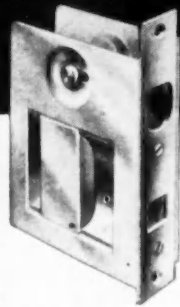

RITE Trim has the look of quality . . . it is high quality, too, yet prices are modest! When you

think of sliding doors remember Adams-Rite can supply the proper trim from a cup pull to a completely modern lock. You'll especially admire our lock . . . it is unit-type, easily installed even in narrow stiles by a simple cut-out, no mortise. Two types fit all doors from $1\frac{1}{8}$ " to $1\frac{3}{4}$ " in thickness. Adaptable to doors of either hand with dead-lock either side and emergency unlocking feature opposite. For maximum security, pin tumbler cylinder operation in the escutcheon is optional. Escutcheon measures $3\frac{3}{4}$ " x $2\frac{7}{8}$ ". A variety of 9 standard finishes available on all Adams-Rite items.



WRITE NOW FOR YOUR CATALOG SHEETS



**ADAMS-RITE
MANUFACTURING CO.**

540 WEST CHEVY CHASE DRIVE, GLENDALE 4, CALIFORNIA, U. S. A.



How-To-Do-It

How to Make a Modern Office Desk

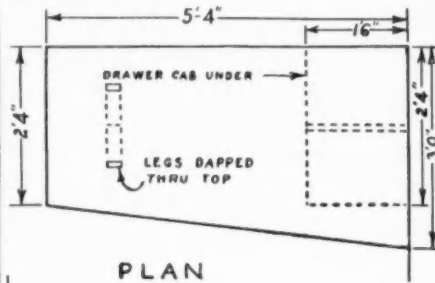

PLAN

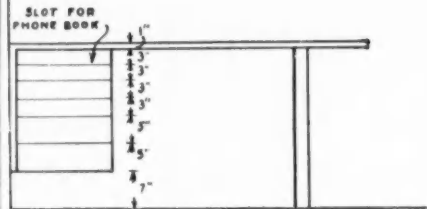

FRONT ELEVATION

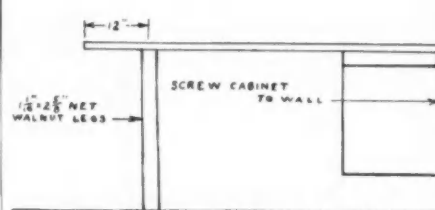

REAR ELEVATION

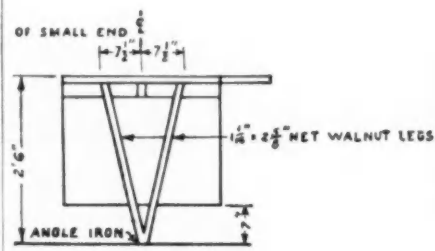

END ELEVATION

DESK DETAILS

THE plans for this modern office desk combine beauty, utility, and ingenuity. Since it is supported at one end by being fastened to the wall, and since the legs are secured to the floor by a small angle iron, the desk is rigid, and at the same time offers ample leg-room around three sides for one to sit comfortably.

Ample leg-room around three sides of the desk was achieved by a V-cut arrangement.

TO OUR KNOWLEDGE:
"THE BEST SURFACE BOLT"

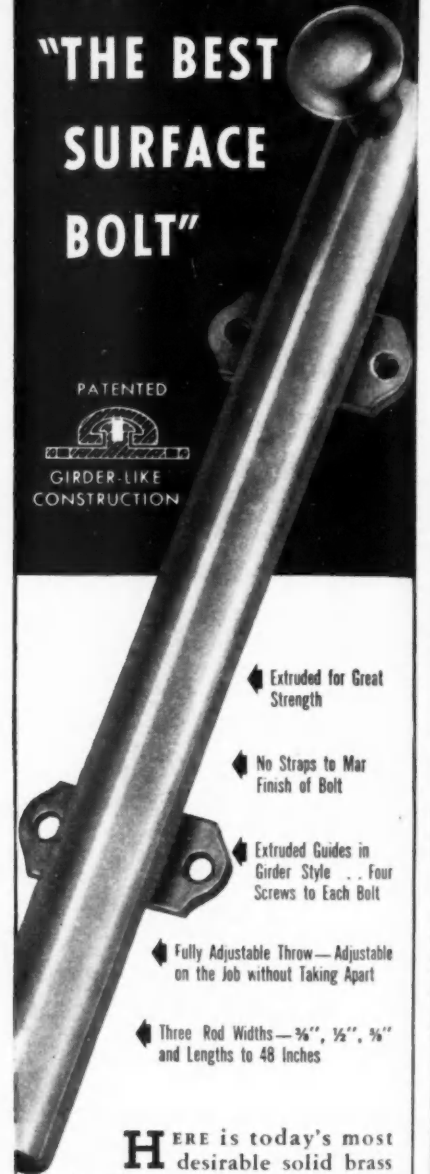
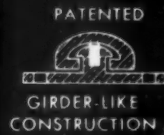

- ◀ Extruded for Great Strength
- ◀ No Straps to Mar Finish of Bolt
- ◀ Extruded Guides in Girder Style . . . Four Screws to Each Bolt
- ◀ Fully Adjustable Throw—Adjustable on the Job without Taking Apart
- ◀ Three Rod Widths— $\frac{3}{8}$ ", $\frac{1}{2}$ ", $\frac{5}{8}$ " and Lengths to 48 Inches

HERE is today's most desirable solid brass bolt. The very simplicity of its design makes this Adams-Rite bolt harmonize with any interior trim. Simple to install too . . . adjust to any throw *on the job* without taking apart. Strong, handsome and durable — completely satisfactory during an entire lifetime. Hidden springs prevent rattle and hold bolt open at any point. Slide bolts of this same design and construction are also available . . . useful on dutch doors, lavatory stall doors, etc. Rod widths $\frac{3}{8}$ " — $\frac{1}{2}$ " — $\frac{5}{8}$ " — solid brass, of course! Be smart — specify Adams-Rite surface bolts for every job.



**ADAMS-RITE
MANUFACTURING CO.**

540 WEST CHEVY CHASE DRIVE, GLENDALE 4, CALIFORNIA, U. S. A.

1 Okay. Electric because duction
2 Gener correct a amperes, tion. Las
3 Pick fit fram stud affor
With a at any po

What's your score?

(A three-minute test on the effective use of wiring materials)



1 Existing service entrance consists of 3/4-inch conduit, containing two No. 8 Type R wires. How can this installation be made suitable for an electric range, without tearing out the conduit?

- A** — Install a second service entrance.
- B** — Run two No. 6 Type T wires and one bare No. 8 conductor in existing conduit.
- C** — Tap into the next door neighbor's circuits.



2 An electric device that can be seen but not heard helps any builder or architect to sell good wiring to clients. What is it?

- A** — Electronic toaster.
- B** — Mercury switch.
- C** — Piped light.



3 Many electricians are saving time in box installations on residential wiring jobs. How are they doing this?

- A** — By using precut wooden spacers.
- B** — Through the use of S-type bar hangers.
- C** — By nailing boxes directly to the plaster.

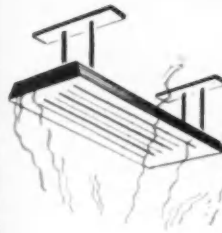

4 Even "cool" fluorescent lighting sometimes must withstand fairly high ambient temperatures. What would you choose to safeguard such installations?

- A** — Air conditioning.
- B** — Cold cathode.
- C** — Deltabeston* fixture wire.

Answers

1 Okay, if you chose **B**. And you'll be wise to make it General Electric thermoplastic every time you choose a building wire, because General Electric has always been a leader in the production and sale of thermoplastic insulated wire.

2 General Electric's silent mercury switch makes **B** the only correct answer for modern planners. It is now T-rated at 10 amperes, 125 volts, and is a beauty to look at in any installation. Lasts a whale of a long time, too.

3 Pick **B** for this one. G-E S-type bar hangers are made to fit framing spaced from 6 to 24 inches. A new, heavy-duty stud affords ample support for any modern fixture.

With a G-E S-type hanger, a box can be located on the bar at any point between studs simply by tightening a single screw.

4 If you picked **C**, and specify it for your "hot" jobs, you won't go wrong. In fact, always say Deltabeston when heat is a problem in wiring installations.

We hope this little quiz was fun. And maybe it will give you a better picture of General Electric Construction Materials—the full line for all wiring needs. Each part of the line is made for ready use with other G-E wiring materials. It's a line that has been designed for convenience—in specifying—in installation—and in maintenance. And it is backed up by experienced men who are always ready to help you with engineering and application counsel on your every project. It's the kind of one source, one complete line service that makes it easy for you and your clients to do a top-notch wiring job. If you want information on any of our products, please write to Section K6-32, General Electric Company, Bridgeport 2, Connecticut.

*Trade-mark Reg. U. S. Pat. Off.

Construction Materials

GENERAL ELECTRIC

• **MORE GARAGE SPACE with**



AMERICAN ROOF TRUSSES

- American Roof Trusses cut costs and eliminate space taking posts. Extra floor space means more parking revenue.
- One example of how American can save you money . . . no matter what you plan to build —warehouse, supermarket, church . . . consult American first. Write for free catalog today.

AMERICAN ROOF TRUSS CO.



Established 1922

6852 Stony Island Ave.
Chicago 49, Illinois
PLAZA 1772

235 West 37th Place
Los Angeles 7, Calif.
ADams 3-4191

Ten or More Houses Now Handled by FHA With One Application

In an effort to simplify operating procedures and improve efficiency of the Federal Housing Administration, Commissioner Franklin D. Richards has announced a new procedure in regard to applications for mortgage insurance on one to four-family houses under the veterans emergency housing provisions of the National Housing Act (Title VI, Section 603).

Under the new procedure only one application form will have to be filled out in applying for mortgage insurance under Section 603 on a group submission of 10 or more properties. Accompanying the application must be plans and specifications for each basic type of house in the group.

The new application forms for group submissions under Section 603 (FHA Forms 2003-G and 2003-S) are now available at FHA field offices, which have been instructed in their use.

Ohio Firm Makes New Aluminum Roofing, Siding



BEFORE aluminum roofing was added to home



AFTER adding aluminum roofing made by National Aluminum Products Co., Canton, Ohio

THE National Aluminum Products Co., Canton, Ohio, is producing aluminum siding and roofing which can be purchased unpainted or with baked enamel finish. The product is being used by several manufacturers of prefabricated houses and also for residing and reroofing existing houses.

At the present time the firm is pre-assembling the exterior shells for small 24 x 24-foot houses. In addition to fabricating the siding and roofing for these small housing units, the company is also making the window sash, frames and sills. Current output is running about 50 houses a week.

FOURTH EDITION SIMPLIFIED CARPENTRY ESTIMATING

By J. DOUGLAS WILSON

Coordinator, Apprentice Education, Carpentry and Cabinet Making Los Angeles City Schools Los Angeles, California

and CLELL M. ROGERS

Mathematics Instructor, Venice High School, Venice, California

A practical text on carpentry estimating, covering rough lumber, finish lumber and hardware, in which the parts of a house are analyzed under six main divisions. Material lists, short cut rules and tables supplement the text and guard against anything being overlooked in making up the final estimate. Valuable information is given for making labor time estimates.

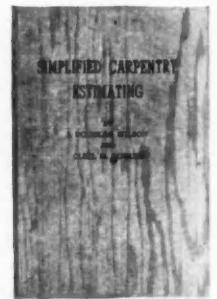

While designed as a beginner's text the Fourth Edition is complete enough for the use of builders and lumber dealers. Simple arithmetical methods for accurate estimating, are given. Helpful tables that save much time in figuring and a full index make the book suitable for quick reference in the shop or on the job.

Contents

Estimating Fundamentals. Foundation Material. Framing. Exterior Finish. Interior Finish. Hardware. Building Information. Estimating Short Cuts. Labor Hours per Unit of Work. Carpentry mensuration. Mathematical Reference Tables. Stair Estimating. Index. 1948. 4th. 288 pages. 123 illustrations, 60 tables, 5x7, \$3.00.

Book Department

AMERICAN BUILDER and BUILDING AGE

Simmons-Boardman Publishing Corporation
30 Church Street New York 7, N. Y.

1. **Extra Width.** KIMSUL blankets provide fully insulated fastening edges.



3. **Many-layer Stitched Construction.** High thermal efficiency. ("k" factor of dependable KIMSUL is 0.27.)



2. **Handy Compressed Package.** Comes in light, compact rolls—reduced to 1/5th installed length. Easy to handle—easy to apply.

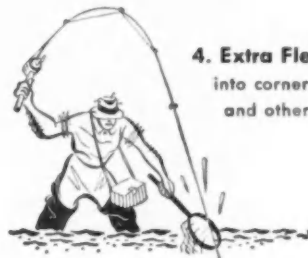

4. **Extra Flexibility.** Fits snugly into corners, behind pipes and other "tight spots".

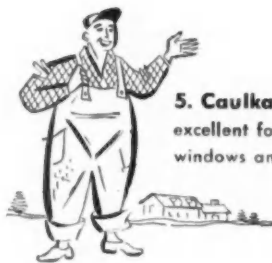

5. **Caulkability.** Cut strips are excellent for caulking around windows and door frames.



6. **PYROGARD† Fire-Resistant Cover.** Even its cover is entirely treated to resist fire and flame. A unique KIMSUL feature.

What's more, KIMSUL* insulation is precut to fit standard spaces between studs and rafters. It's permanent—won't sag or settle. Clean—no sharp particles to irritate workmen's skin. Adds little to structural load. (1,000 sq. ft. of Standard Thick KIMSUL weighs only 115 lbs.) Resists fire, moisture, vermin and fungi—and it's termite-proof. KIMSUL comes in

three thicknesses for the proper balance of efficiency and economy. Specify Commercial Thick (about 1/2 in.) and Standard Thick (about 1 in.) for walls, attics and floors; Double Thick (about 2 in.) for attics.

KIMBERLY-CLARK CORPORATION
KIMSUL Division, Neenah, Wisconsin, U. S. A.

FREE INSULATION BOOKLET



A brand new manual filled with technical data you can use. Prepared by the makers of KIMSUL. Write us for your free copy on your business letterhead.

Insulate when you build.

Over-all insulation

means ready salability.



*T.M. Reg. U. S. & Can. Pat. Off.
†Trademark

This cutaway view shows why the Improved **ACME TWIN** is the most efficient sash balance ever designed

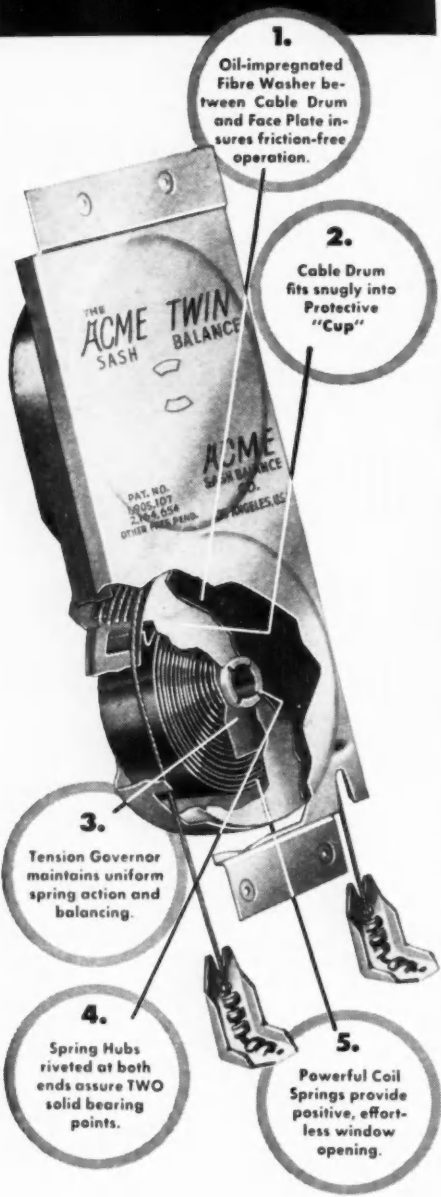

1. Oil-impregnated Fibre Washer between Cable Drum and Face Plate insures friction-free operation.

2. Cable Drum fits snugly into Protective "Cup"

3. Tension Governor maintains uniform spring action and balancing.

4. Spring Hubs riveted at both ends assure TWO solid bearing points.

5. Powerful Coil Springs provide positive, effortless window opening.

Accurately Balanced... Simple to Install... Economical to Use... Easily Weather-stripped... Requires No Adjustment... Finger Tip Lifting... Fully Enclosed... Unconditionally Guaranteed.

See your hardware or building supply dealer or write direct for literature.

ACME
SASH BALANCE COMPANY
1626 Long Beach Ave.
Los Angeles 21, Calif.

New "Integrallock" Designed For Average Small Home

SARGENT & CO., New Haven, Conn., has developed a new lock set for exterior doors, primarily to be used on residential construction. Known as the Sargent Precision-Built Integrallock, it is made with a round rosette and pear-shaped knobs.

A unique feature of the Integrallock is the ease with which a housewife can, by

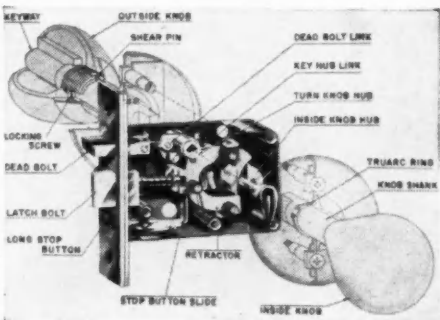

AETNA'S new Integrallock is designed for easy operation, and for ease in installation

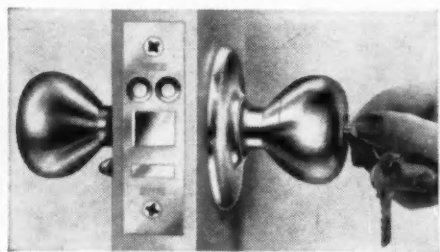

EASY-to-find keyhole; compact working parts

a quarter turn of the key, release both the latch and dead bolt and open the door.

Another important feature is the use of a shear pin in the cylinder knob which gives way when subjected to extreme torsion, allowing the knob to spin harmlessly. Yet the regular key will continue to retract the bolts.

The accompanying pictures bring out the beauty of the lock. The lock set is made of heavy cast brass or bronze, with exposed parts polished to high finish and heavily lacquered to retain the original luster. The Integrallocks are manufactured in six types of finish: Bright Brass, Dull Brass, Bright and Dull Nickel, Bright Chrome, and Dull Chrome.

In designing this lock, the prime factors considered by the manufacturer were strength, simplicity, ease of installation, and smooth, precision operation. The small number of working parts together with ease of alignment make installation simple.

The lock has self-lubricating Oilite bearings. Three of these bearings ride in elongated slots in the lock case cover to ensure smooth functioning of the retractor.

Through mass production methods, Sargent has developed the Integrallock in the price range for the average small home.

REZ

for better...easier...more economical
WOOD FINISHING



REZ Primer and Sealer...The foundation for all wood finishes. Controls dimensions and provides a perfect hard surface for paint, enamel or varnish.



WHITE REZ Intermediate Coat... A superior undercoat to be applied after sealing the wood with REZ. Makes possible beautiful finishes on softwoods, such as Douglas fir plywood and pine.



HI-GLOSS REZ... A clear, transparent, sparkling surface finish for furniture, built-ins, interior woodwork, millwork, panels, toys, paneling, athletic equipment and all kinds of cabinet work.

Ask your dealer or jobber for further information and copies of new folder, "Wood Finishing"—or write direct to **MONSANTO CHEMICAL COMPANY**, Western Division, Seattle 4, Wash. District Sales Offices in Los Angeles, Calif., and Lockport, N. Y. *Rez: Reg. U. S. Pat. Off.*



SERVING INDUSTRY... WHICH SERVES MANKIND

GIVE BASEMENT FLOORS BEAUTY and HARDNESS
 with **ART-ROC** *Built-in* **COLOR**



SEND FOR FOLDER

Add the Eye-Appeal and Sales-Appeal of Beautiful Concrete Floors . . . at Low Cost

Concrete is a grand material—but who would choose an ordinary, uncolored, concrete floor in their basement if they could have a richly colored, super-hard surfaced floor at almost no extra cost! That is exactly what you can give clients with Truscon ART-ROC. Dusted on before finish troweling, ART-ROC will take all kinds of punishment because it is much harder than ordinary concrete. Any basement, terrace, porch, sun room, sales-room, store, restaurant, with such a floor has eye-appeal and sales-appeal which will gratify owners and prospects alike and will give your work colorful distinction. We invite your inquiries. Write Dept. AR-12, Truscon Laboratories, Division of Devco & Reynolds Co., Inc., Detroit 11, Michigan.

TRUSCON
ART-ROC
 AGGREGATE

Supplied Ready-to-Use
 GIVES

Built-in **COLOR**
HARDNESS
DURABILITY
Costs So Little
Adds So Much

TRUSCON *Laboratories*

You can Dip this House in Water

Protected with TRUSCON

Reg. U. S. Pat. Off.

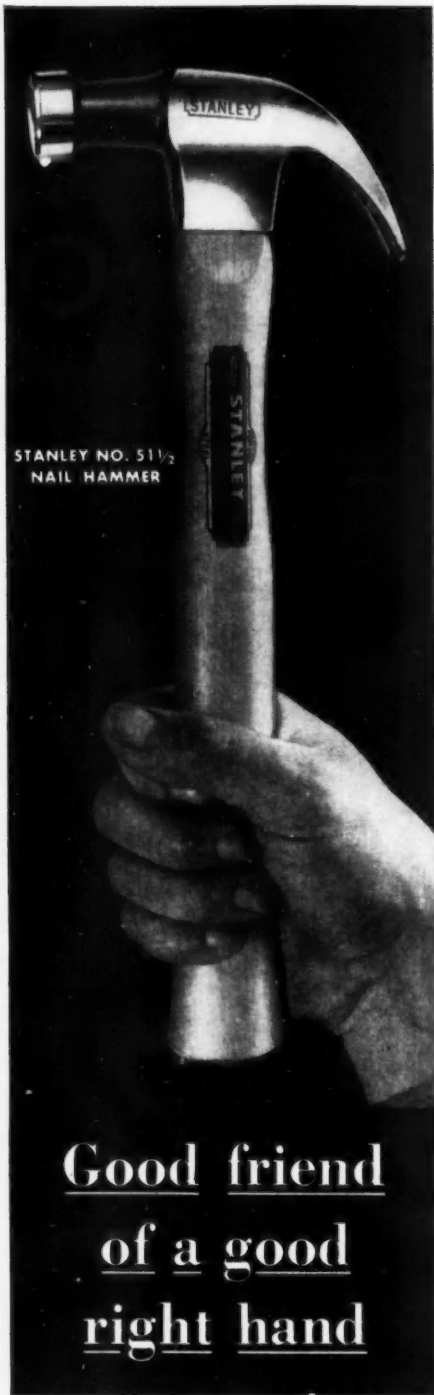

Good friend
of a good
right hand

Picking up a Stanley Hammer is like grasping the hand of an old friend. It feels just right because it's skillfully made to the measure of your own skill. Forged from special analysis steel and given two super heat treatments. Handle is locked in head by "Evertite" process, exclusive with Stanley. Stanley Tools, New Britain, Connecticut.

THE TOOL BOX OF THE WORLD



Reg. U.S. Pat. Off.

HARDWARE HAND TOOLS · ELECTRIC TOOLS

Clark Equipment Studies European Market

THE Export Division of Clark Equipment Co., Battle Creek, Mich., through their sales manager, W. P. Baranowski, is making a first-hand study of sales opportunities for Clark products in more



W. P. BARANOWSKI

than 15 countries from the Scandinavian peninsula to North Africa.

In order to appraise the potential market for Clark fork trucks, towing tractors and special handling attachments, Mr. Baranowski will study in particular methods employed for handling material, in intra-plant movement, packaging and loading, and in stevedoring operations.

Asphalt Tile Industry To Increase Output

DEMAND for asphalt tile flooring has grown to such an extent during the past year that the 12 companies which make this flooring have increased their manufacturing facilities to five times their prewar capacity, it is announced by the Asphalt Tile Institute.

Despite these increased facilities, the continued high level of new construction activity, coupled with millions of dollars' worth of home and business building remodeling planned for the next 12 months, is expected to force production to capacity during 1948.

The use of asphalt tile flooring for almost any installation has become general during recent years by builders and architects. Its long life, low cost of installation and maintenance plus the fact that it is available in a variety of color and sizes are factors which contribute to its increasing popularity throughout the building industry.

The development of basementless homes has also given considerable impetus to the demand for asphalt tile. These homes use a single concrete slab for foundation and floor, and most builders cover the slab with asphalt tile because it is the only smooth-surfaced, resilient flooring recommended for use on concrete resting on the ground. The material is not affected by moisture which is generally present under such conditions.

The material also is used extensively in the conventional home, particularly in kitchens, bathrooms, hallways and basements.

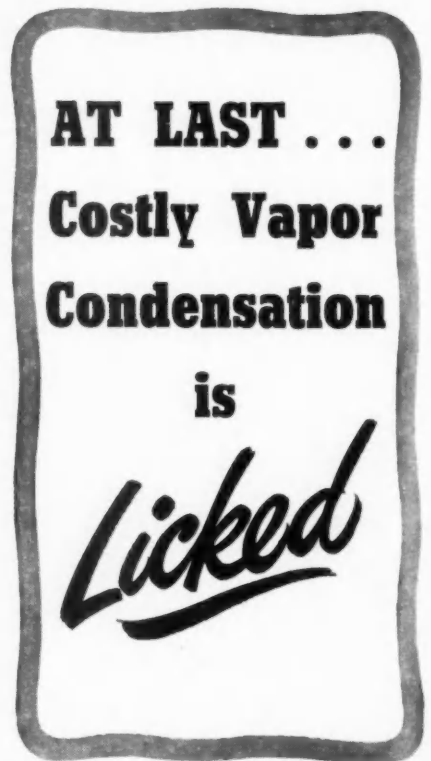

Bird Neponset Black Vapor Barrier is the permanent answer to expensive "in-wall" condensation. Applied on the warm side of insulation, it repels vapor, ends stained walls and peeling paint . . . and it keeps insulation at top efficiency.

A small investment for long-lasting protection, Bird Neponset Black Vapor Barrier costs only about \$20.00 to give a \$10,000 building dry walls that *stay dry*. Consult Sweets Architectural File, 9b-2. For sample, write Bird & Son, inc., 10 Pine Street, East Walpole, Mass.



Specifications — Roll width: 36"; square feet: 500; approximate weight: 50 lbs. Asphalt saturated. Coated both sides with glossy asphalt surface. Meets Federal Specifications UU-P-536 Grade B.

BIRD NEPONSET BLACK VAPOR BARRIER
BIRD & SON, inc., East Walpole, Mass.
Chicago · New York · Shreveport

Won't split, splinter, dent or corrode

Resists moisture permanently

Takes virtually every applied finish

Can be sawed, nailed, beveled, routed

Great structural strength

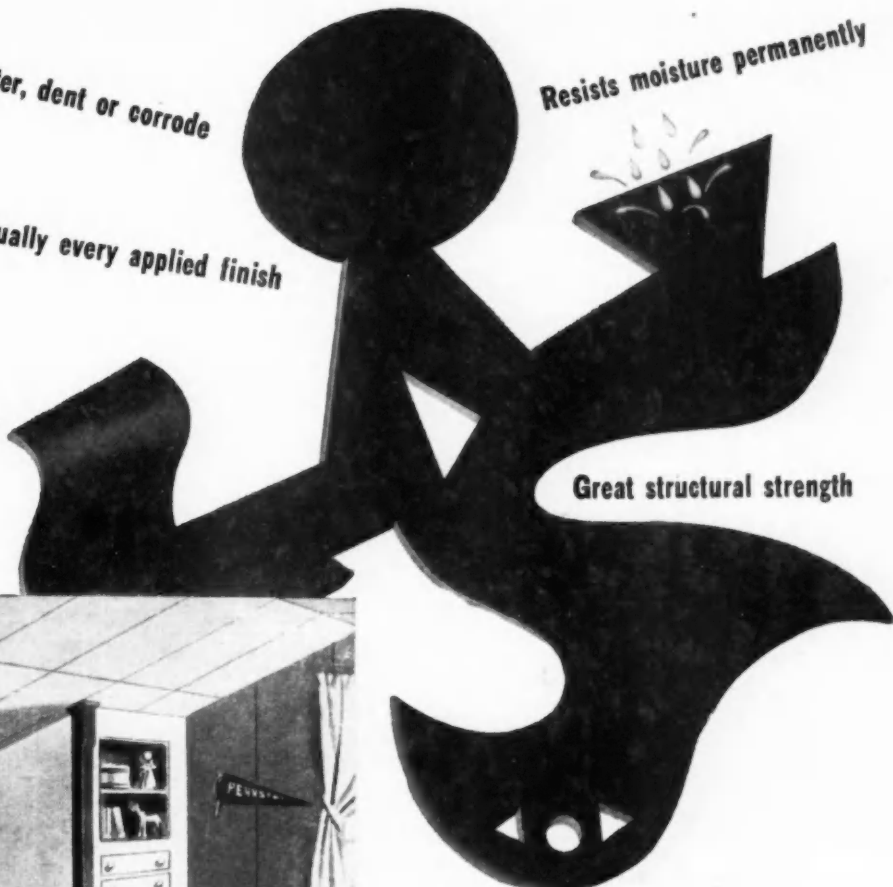

Easily worked with carpenters' tools

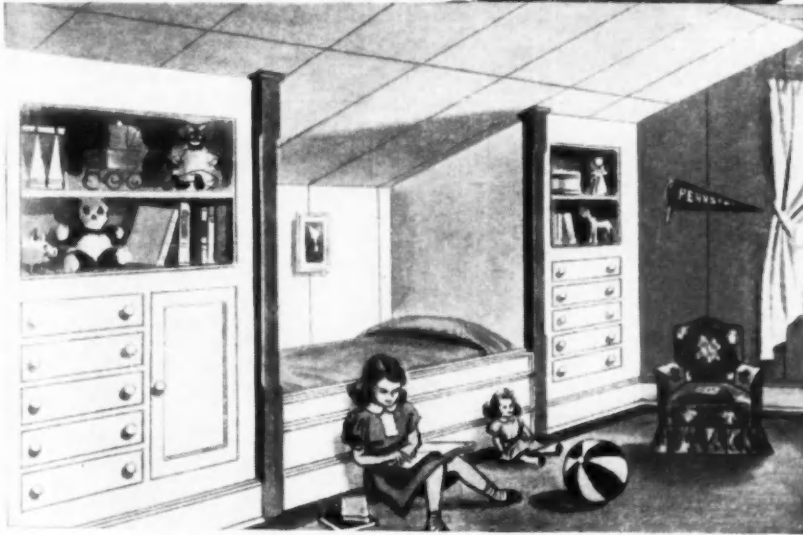

Presdwood quickly transforms an unused attic into this cheery, modern child's room. Presdwood is used for ceiling, walls, built-in cabinets.

THE WONDER WOOD OF 1000 USES • MASONITE PRESWOOD

This durable, time-proved hardboard is the sign of quality construction. And its uses are numbered in the thousands. Because of Masonite* Presdwood's* characteristics, it provides unusual durability and beauty for virtually every kind of construction or remodeling job. It can be bent into curved shapes. It is smooth, grainless, extremely hard and dense. And it goes up easily and quickly. Presdwood is made from natural wood, refined to a better, stronger, wonder wood. Lumber dealers have Presdwood — both Untempered, and Tempered to extra hardness. Write for technical data to Masonite Corp., Dept. AB-3, Chicago 2, Ill.

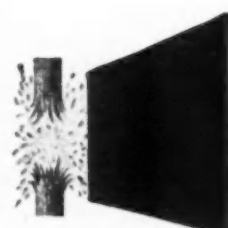

"The best wood is Presdwood" MADE FROM EXPLODED WOOD

THE LEADING HARDBOARD

MASONITE PRESWOOD

Reg. U. S. Pat. Off.

*Trade-marks Reg. U. S. Pat. Off. "Masonite" signifies that Masonite Corporation is the source of the product.

BE INDEPENDENT OF THE MILL!

Save **BIG** money and unnecessary trips to the mill by owning a

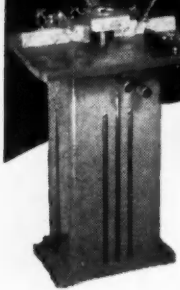

BOICE-CRANE NO. 2120 SPINDLE SHAPER

You can turn out commercial grade sash, fine mouldings, coped joints, stair treads, drawer and cupboard fronts and do other millwork yourself.

Boice-Crane offers a complete line of cutters for this large capacity shaper for producing most commercially used shapes. You can run wide mouldings and raised panels in one cut with our Ogee Sash Cutter sets.

The Boice-Crane is the only shaper having "down-draught" exhaust for chips from the cutters, and $\frac{1}{2}$ " and $\frac{3}{4}$ " cutter-arbors formed on a solid one-piece vanadium-steel spindle—stronger, more accurate and safer than any 2-piece type. Merely invert the quill to change from $\frac{3}{4}$ " to $\frac{1}{2}$ " arbor without special tools.

Large 1" diameter precision ground spindle, carried on two high quality dust and grease sealed ball bearings, stays true even after years of running wide, deep cuts. The bearing-seats in the quill casting, as well as the entire body of quill are all finely ground to precision dimensions.

The 20" x 27 $\frac{1}{2}$ " table features a large opening with provision for nested table rings, with these advantages: (1) All cutters, up to 6 $\frac{1}{4}$ " diameter lower below table to undercut for greater safety. (2) Undercutting lessens danger of springing spindle. (3) Undercutting brings cutters closer to spindle bearings to reduce strain and wear.

SPECIFICATIONS:

Table (has 1 miter-gauge groove): 20" x 27 $\frac{1}{2}$ "
Table with Front Wing: 28" x 27 $\frac{1}{2}$ "
Table-Opening Diameters: 6 $\frac{1}{2}$ ", 3 $\frac{1}{2}$ ", and 2"
Widest Bevel Edge Knife Capacity: 2 $\frac{1}{2}$ "
Widest Wing-Type Cutter Capacity: 3"
Largest Diameter Cutter Capacity: 6 $\frac{1}{4}$ "
Vertical Spindle Travel: 1 $\frac{3}{4}$ "
Spindle Diameter at Ball Bearings: 1"
Height from Floor to Table: 35"
Power: $\frac{1}{2}$ h.p. for Cutters 3 $\frac{1}{2}$ " and less.
1 h.p. for Cutters over 3 $\frac{1}{2}$ "
Two Models: 7,200 or 10,000 r.p.m.

Boice-Crane, with its complete line of power tools, can, at minimum cost, completely equip a contractor's shop that will make you practically independent of the mill.

For a guarantee of satisfactory service specify only the products of established manufacturers who SPECIALIZE in producing power tools, rather than making them a sideline.

Write for free literature

BOICE-CRANE COMPANY

966 Central Avenue • Toledo 6, Ohio

BAND SAWS • JIG SAWS • SAW JOINTERS • BELT SANDERS
SPINDLE SANDERS • LATHES • THICKNESS PLANERS
SPINDLE SHAPERS • DRILL PRESSES • JOINTERS

Williams Oil-O-Matic Starts Fuel Saving Program

A PLAN to help conserve fuel oil and alleviate the threatened national home heating emergency was launched in Champaign, Ill., early this year by engineers and executives of the Williams Oil-O-Matic Divisions of Eureka Williams Corp. The firm, from national studies, is convinced that anywhere from ten to fifty per cent of the fuel oil used in U.S. homes and the heat it produces is wasted, mostly unknowingly. They set out to prove it in Champaign, an average American community.

Led by their chief, W. A. Matheson, executive vice president of Eureka Williams Corp., these men, 75 in all, rang doorbells and called on oil-heated homes to try out their checking formula. Each was equipped with heat loss handbooks and instruments to check heat and oil wastage. They probed from cellar to attic to find the common forms of heat and oil losses.

The researchers concerned themselves with all phases of automatic home heating—insulation, storm sash, weather stripping, caulking and poor heating practices, as well as with oil burners and heating plant performance.

When compiled, the results of the Champaign tests are to be released nationwide, and the national dealer organization of Williams Oil-O-Matic mobilized to make these free surveys of oil-heated homes throughout the country.

Before sending his executives and salesmen out as researchers, W. A. Matheson, executive vice president, told them that the national home-heating emergency was really a very great opportunity for the oil heating industry.

"We are now doing things," he said, "that we should have done long ago. We have concerned ourselves too long with oil burners and furnaces and boilers—rather than complete automatic home heating. That means everything that makes a home comfortable, healthful and heated without waste of money or work and trouble.

"We now are finding that complete automatic oil home heating includes the sale of oil and oil burners, oil-fired furnaces and boilers, heat circulating equipment, controls and clock thermostats, insulation, storm sash, caulking and public education on the best home heating practices.

"This is the business all our dealers—and every other heating dealer in the country who wants to be successful in the future—will be in. We have renamed our dealers to make them conscious of this. They will now be known as Complete Automatic Home Heating Merchants.

"The whole thing boils down to fuel conservation at the point of heating, and heat conservation above this point. The two are Siamese Twins inseparable. From now on, our concern must be not with the price per gallon of oil, but the price of heating the home per year.

"There are 350,000 oil burners in this

(Continued to page 180)

DRY WALLS

Interior or Exterior
Above or Below Grade

Eliminate costly guess work in solving wet wall problems. Seal and beautify porous walls of concrete block, tile, stucco, etc., with Spray-O-Bond Concrete Sealer. It's easy to apply—almost like brushing on paint. Used successfully by contractors for over 20 years. A post card will bring you the name of your nearest dealer.

SPRAY-O-BOND COMPANY

2225 N. Humboldt
Milwaukee 12, Wis.

spray-O-bond

TACK FASTER

with

DUO-FAST

Featuring

FOLLOW-THRU DRIVE

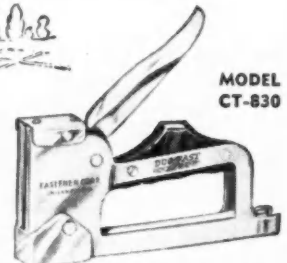

MODEL
CT-830

There's nothing more helpful than an efficient, quality tool. DUO-FAST Tackers have helped builders all over the country accomplish a quick, neat tacking job. For a true test, try a DUO-FAST Tacker the next time you install insulation.

Ask about our free service and parts policy.

FASTENER CORPORATION

888 Fletcher Street
Chicago, Illinois

More and More Home Owners are Demanding New STEELCRAFT STEEL CASEMENTS

*...Proved BETTER by Actual Laboratory Tests!**

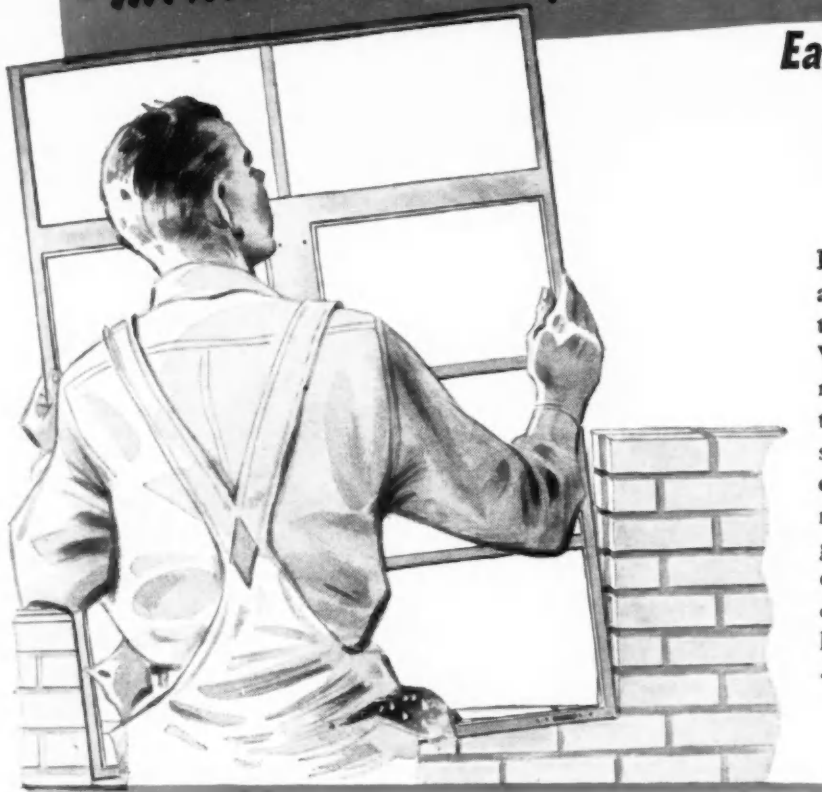

**Easy to Install, Easy to Operate,
Easy to Clean! Steelcraft
Casements Give Complete
Customer Satisfaction!**

In swiftly increasing numbers, home owners are coming to know the many great advantages provided by STEELCRAFT Casement Windows. Added benefits of strength, lightness, beautiful appearance, foolproof operation . . . plus remarkable ease of cleaning and screening—these assets are encouraging more consumers to request, and contractors to recommend, STEELCRAFT Casements. View this growing market potential in the light of finer engineered casement construction and greater durability . . . *and prompt delivery . . .* and you have the solution to all your window problems —with STEELCRAFT Casement Windows!

* STEELCRAFT CASEMENTS PROVED LIGHTER YET STRONGER IN INDEPENDENT LABORATORY TESTS . . .

Here it is . . . vivid, indisputable proof of the superiority of STEELCRAFT Steel Casements! When analyzed with the steel casements of three other leading manufacturers, STEELCRAFT showed 15% less pressure-induced deflection than the next strongest window, 34% less deflection than the weakest window tested. Results testify that STEELCRAFT is built to withstand from six to eight times the normal masonry load on openings of the width tested.

The on-the-scene laboratory photo (right) shows STEELCRAFT Type 2423 steel casement undergoing vertical deflection analysis in load-testing machine. Supports at bottom edges of casement allow deflection measurement at center of bottom as load is applied top center. Loads were up to equivalent of 600 lbs. per lineal foot.



MAIL THIS COUPON TODAY!

STEELCRAFT MFG. CO.
9036 Blue Ash Rd.
Rossmoyne (Cincinnati), Ohio

Please send me, without obligation, complete descriptive literature on STEELCRAFT Casement Windows.

Name

Position

Business Address

City State

STEELCRAFT

MANUFACTURING COMPANY

ROSSMOYNE (CINCINNATI), OHIO



DON'T! BE A BEAVER

The beaver does a good job, but he does it the hard way. Don't wear yourself out on the end of a hand-saw, or struggle with heavy, cumbersome mechanical saws that waste your time and are only half accurate.

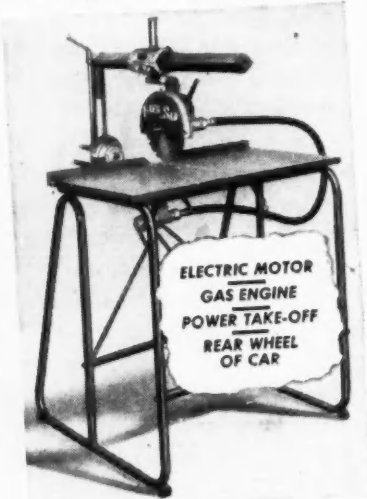

FLEXSAW

MAKES ANY CUT

Use it for Production Work, Construction out on the Job, or in Job Shop or Hobby Shop

A rigid, rugged, accurate, portable saw that makes cuts 3" deep and up to 15" wide. Knocks down into two 55 lb. units for transport in any car. A truly ONE MAN portable saw. Ideal for farm use, builders, hobbyists.

Rapid adjustment for any cut—no wrenches required. Rigid in all positions. Large, easily read dials for setting all cuts, eliminate all guesswork. Lifetime Fafnir ball bearings. Highest quality, flexible drive shaft. Balanced tubular base.

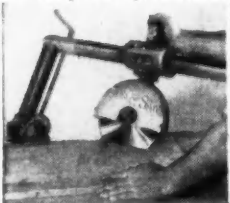

priced so anyone can own it **\$125**

SEE YOUR LOCAL DEALER, OR WRITE DIRECT TO:

Less Motor.
F.O.B.
Factory
GUARANTEED

THE FLEXSAW CO.
PORT AUSTIN, MICHIGAN

(Continued from page 178)
country which should be replaced. Most of them are oil wasters. Many were installed years ago when there was no concern about how much oil was used so long as there was plenty of heat.

"These burners not only waste oil, but they are costing users plenty of money every year. We have done very little about this big replacement market. But now that we are unable to sell new installations in many markets, we are more or less forced to. It looks like the fates are forcing oil burner dealers to be successful."

Robert S. King Elected Director of Diamond Match Company

ELECTION of Robert S. King of Indian Hill, Cincinnati, Ohio, as a director of the Diamond Match Co. is announced by Robert G. Fairburn, president.

Mr. King is president of the Philip Carey Manufacturing Co. of Cincinnati,



ROBERT S. KING

Ohio, manufacturers of building supplies. He joined that company in 1939 and was elected president a year later. He is a former president of the Pennzoil, Refiners' Oil and State Oil companies, and was vice president of Socony Vacuum, in charge of the General Petroleum Co. of California.

Tiletone Company To Expand

A CHICAGO industrial tract one block long has been leased by Tiletone Company, manufacturers of pre-finished tile wallboard panels and steel and aluminum alloy shower cabinets. The new space will be utilized in expansion of the company's shower cabinet operation and development of new products for the building trade.

The new consolidated lease includes the present Tiletone plant at 2323 Wayne Ave., additional corner property at Fullerton and Belden Avenues, and switch track facilities of the Chicago, Milwaukee, St. Paul, and Pacific railroad. The Tiletone Company moved into its present location in August, 1945.

Fred L. Anway, president, stated the term rental for the twelve-year period is \$256,666.27.

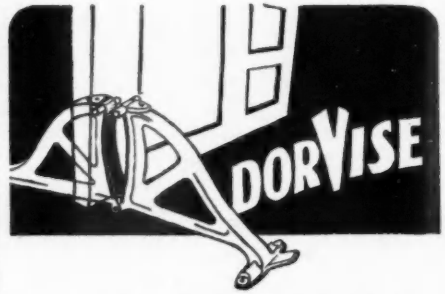

Improve working efficiency with the new Stow Metal dor-V-ise. Made of highest quality materials. Sturdily built to hold any size door firmly. Rubber padded jaws increase grip and prevent damage. Holds door or window sash while planing, drilling and sawing.

- Heavy duty
- Cast aluminum
- Weighs only 2 3-4 lbs.
- 20 inches long
- Easy to operate
- Use any place

Only
\$9.65
EACH

WE PAY POSTAGE

SEND CHECK OR MONEY ORDER
(ALL C.O.D. ORDERS \$9.65 PLUS POSTAGE)

STOW METAL PRODUCTS CO.

758 E. Kent Road Stow, Ohio

'48 IS GOING TO BE A BIG PAINT YEAR!

PA'SO and RUB-X will help you sell more paint . . . keep it sold . . . give better jobs.



Be Sure Your Stock of PA'SO and RUB-X Will Fill the Demand

PA'SO Sells Fast because:

- It is a better paint softener
- Prevents Chipping and Crawling
- Cleans Hard Brushes Quickly
- Makes Old Woodwork Smooth
- and has over 100 other uses

RUB-X Earns Big Profits because:

- Cleans—Polishes—Brightens
- Excellent Metal Polish, Removes water spots, shoe marks

THESE PRODUCTS SELL EASILY

. . . Be Sure Your Stock Is Sufficient

CHARLES PAINT RESEARCH CO
25th & STRONG KANSAS CITY 3, KAN.

MITER • COMPOUND BEVEL • MITER • SAND DRUM • PLANE • CROSS CUT • RIB • DADO • ROUT

Camellia
Colorado
A. Perlm
tor; Man

Truso
forcin
Servo

Camelli
features
at those



strengt
forced c
mercial
warehou
with wi
Screens
Write f
rity Typ

A
Rigidity

TRUSCON PLANNING BOARD

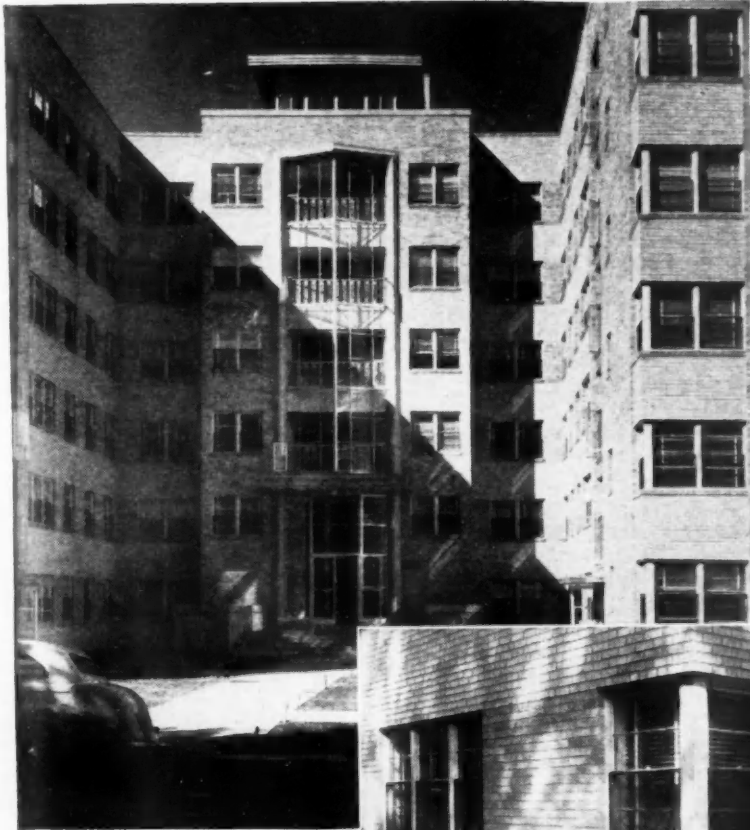

CAMELLIA HOUSE BEAUTY AND SECURITY BUILT WITH TRUSCON STEEL BUILDING PRODUCTS

Handsome New Denver Apartment House Adds Bright Note of Modernism to Mile-High City

The generous use of Truscon Series 138 Double-Hung Steel Windows in Camellia House offers its residents an opportunity to enjoy Colorado's brisk air and bright sunshine as desired. Smart and sparkling, too, is the pleasing window pattern achieved by the ample number of the windows across each facade and around outside corners.

This outstanding window was an original development by Truscon as an answer to the insistent demand for an economically priced steel window in the popular double-hung design. To attain a production volume permitting sale and installation at a price level comparable to that of the conventional type residential window, it was necessary to design and construct special manufacturing equipment capable of high quality fabrication in mass output, with a resulting minimum of manufacturing cost.

Of major importance in the Series 138 Truscon Double-Hung Steel Windows is the fact that the sash members are of welded tubular construction. This adds greatly to the strength, durability and finished appearance. Weights and cords are not used. Operation is controlled by motor type spring balances equipped with tapes of Enduro stainless steel. Quiet, positive action and long trouble-free life are assured.

Each window is completely factory weather-stripped in stainless steel. Screening is easily and attractively accomplished.

The low cost is reflected not only in the window price, but in all accessories. Frames are prepared to receive screens and storm sash of the simplest and most economical type. Shade, drapery, curtain or venetian blind fixtures, of standard types are easily attached to the interior side, in holes provided in all units.

Write for complete information.

New Literature

A 36 page catalog complete with installation details and specifications on Truscon Double-Hung Windows and Casements. Write for your free copy.



TRUSCON
STEEL COMPANY
 YOUNGSTOWN 1, OHIO
Subsidiary of Republic Steel Corporation

Camellia House Apartments, Denver, Colorado. Walter H. Simon, Architect; A. Perlmutter Construction Co., Contractor; Manhattan Builders, Inc., Owners.

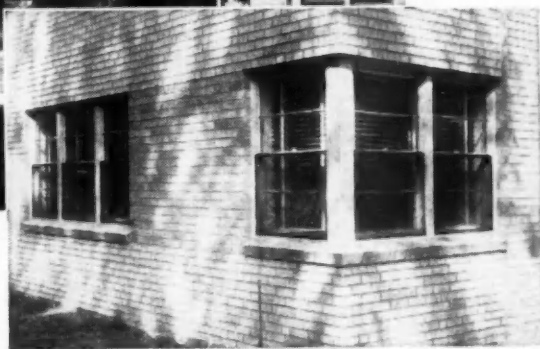

Truscon Security Windows, Reinforcing Bars and Metal Lath Also Serve This Handsome Structure

Camellia House also utilizes the protective features of Truscon Security Steel Windows, at those points where ventilation is desired with extra protection against unauthorized entry. This is a highly desirable safety feature, especially where the property of a large number of people is concentrated in one structure.



Truscon Security Windows are standardized denton windows, built of heavy industrial window sections. Their weight and

strength are adequate to effectively resist forced or illegal entry to apartments, commercial and industrial buildings, stores and warehouses. Glazing is from the interior, with wire clips and putty as standard. Screens may be conveniently installed.

Write for full information on Truscon Security Type Steel Windows.

Adequate Reinforcement

Rigidity of structure in Camellia House is

assured by the use of Truscon Steel Reinforcing Bars.

Truscon Steel Bars for reinforcing are applicable to a wide range of concrete work, such as concrete slabs, beams and girders, columns, walls and footings; in the construction of buildings, bridges, tanks, and all other concrete structures subject to tension and compression stresses. Write for details.

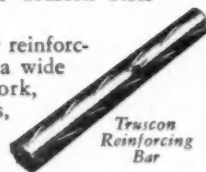

Truscon Metal Lath a Beauty Aid

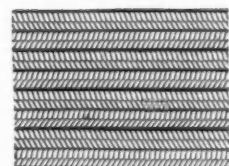

Truscon Doublemesh
 *Herringbone Metal Lath
 Reg. U. S. Pat. Off.

Smooth, straight walls and ceilings, without unsightly cracks, are assured for Camellia House rooms through the use of Truscon Metal Lath.

Truscon has a wide range of types of metal lath, corner beads, stucco mesh, corner reinforcements, hollow partition studs, base screeds, cold rolled channels and other products related to the plastering trades. All Truscon Metal Lath products are manufactured in accordance with U. S. Department of Commerce Simplified Practice Recommendation R-344. Write for free catalog showing the complete line, or refer to SWEET'S.

COMPLETE WEATHER PROTECTION FOR MASONRY

Above Grade

Cabot's Clear Brick Waterproofing

For red brick and dark colored masonry.

Cabot's Clear Cement Waterproofing

For cement, stucco, cast stone and light colored masonry.

Cabot's Clear Waterproofings penetrate deep into voids and pores of masonry walls . . . provide a complete and long lasting moisture-proof seal . . . prevent unsightly efflorescence . . . protect walls from damage caused by freezing and thawing. Walls treated more than twenty years ago with Cabot's Clear Waterproofings are as moisture-proof today as when built.

Below Grade

Cabot's Foundation Coating

A black, bituminous, elastic coating which makes foundation walls completely watertight . . . assures dry basements . . . protects masonry from the weakening effects of water seepage. Cabot's Foundation Coating is an efficient termite and insect repellent. Inexpensive and easy to apply.

Write Today

for free samples of these efficient waterproofings and complete information.

Samuel Cabot, Inc.

2222 Oliver Building, Boston 9, Mass.

- Please send me a free sample of
- Cabot's Clear Brick Waterproofing
 - Cabot's Clear Cement Waterproofing
 - Cabot's Foundation Coating

NAME _____
 ADDRESS _____
 CITY _____
 STATE _____

FROM THE PAGES OF AMERICAN BUILDER 50 YEARS AGO

By Old Timer

"REMEMBER THE MAINE;" "Armed intervention in Cuba;" "Down with Spain"—all were loudly talked about fifty years ago this month; talked about so loudly that before April ended a "splendid little war," as John Hay called it, started.

Hearst's New York Journal had screamed with the headline "THE WHOLE COUNTRY THRILLS WITH WAR FEVER," but he wasn't accurately referring to many people in the building business, for if they had the "fever" they didn't let it interfere with their building, and progress continued about as usual.

Two outstanding exceptions were Philadelphia and Baltimore. Philadelphia was just getting thawed out after a long, severe winter; Baltimore had around 7,000 vacant homes, and some of the builders had submitted a bill to the state legislature in an attempt to do away with cheap, unreliable, and speculative building in the city.

In Newark, N.J., the Master Masons' Association was trying to get 50 cents an hour and a half day Saturdays for journeymen bricklayers and masons; in Cleveland, the painters and decorators were beginning to demand an eight hour day with a minimum wage of 27½ cents per hour, and there were a few similar labor movements in Detroit and in other cities.

Fifty cents an hour was good pay, then, because prices were down accordingly. You could build a ten room house for less than \$7,000—and it would include double floors (the upper one of quartered oak; lower one of white pine); a den finished in poplar; chamber floor of poplar, stained in imitation mahogany; and the whole exterior architecturally designed to the latest styles.

In New York City—right in the midst of this "journalistic warfare"—Columbia university, designed to be the largest college building in the country at the time, was under construction.

In Rome, N.Y., the Wilson Manufacturing Co. were erecting their new plant to turn out bath tubs with a white enamel finish on them. Since most bath tubs in those days were solid copper and copper lined, this new enamel finish was really something to talk about.

Bath tubs were in the news in another town about this time. Mrs. William Shaw, Jr., a socially minded lady in Pittsburgh, Penn., gave that city a new fireproof public bath house — tubs, showers, and all—so that people financially unable to own their own bathing facilities would be provided for. The

(Continued to page 184)

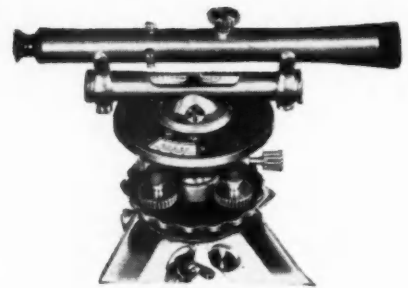

BUILDER'S LEVEL (DUMPY TYPE)

- Needs No Servicing
- Sealed Against Dust
- Ideal for On-the-Job Work
- Longer Lasting Accuracy

Manufactured to the same exact standards as all Brunson Instruments. Write for detailed information and name of nearest distributor.

The BRUNSON INSTRUMENT CO.
 1405 Walnut Street, Kansas City 6, Mo.

AVAILABLE NOW!

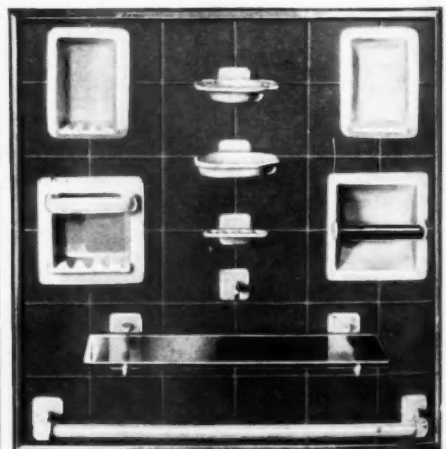

PORCELAIN ENAMELED CAST IRON BATHROOM ACCESSORIES

A complete line of recessed and screw-on type accessories now available in quantities in standard colors—White, Black and Green. Display board, shown above, No. D-995 furnished at net cost of applied fixtures only, with stock order.



Order from your wholesaler. ASK FOR CATALOG NO. 9.

ILLINOIS PORCELAIN ENAMEL CO.
 422 SO. WINCHESTER AVE., CHICAGO 12, ILL.

**SIZED TO
FIT**



YOUR REQUIREMENTS FOR

•Like fitting a gown to a personalized form... you can meet exact requirements on your domestic, commercial or industrial radiation heating job with one of the *thirty-six* automatic gas-fired boilers provided by the Bryant Line. Bryant Boilers are rated from 67,500 to 3,996,000 btu per hour, backed by full automatic operation, long-life, cast-iron sections and high operating efficiency... all proved in thousands of on-the-job successes since 1908. For perfect fit in hot water, steam and vapor systems, or for hot water storage applications, choose your gas-fired boilers from Bryant's *thirty-six* sizes... the *perfect 36* for radiation heating.

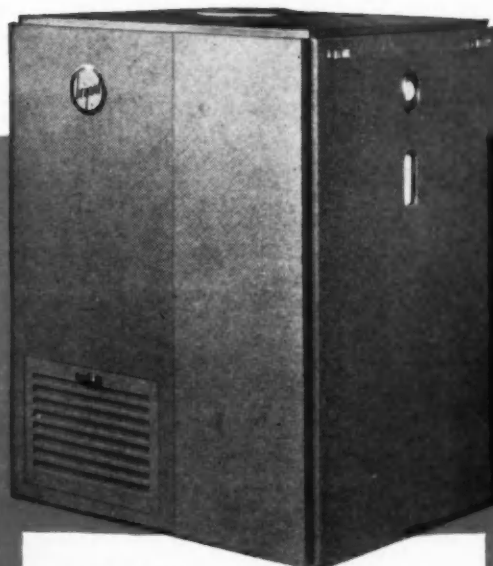

MODEL 455—A. G. A. ratings sq. ft.: Steam 660-2860, Water 1060-4580. Inputs: 198,000 to 858,000 btu per hour. For large homes and other buildings of medium and large size. Water tube design provides maximum brushing action to utilize the most possible heat.

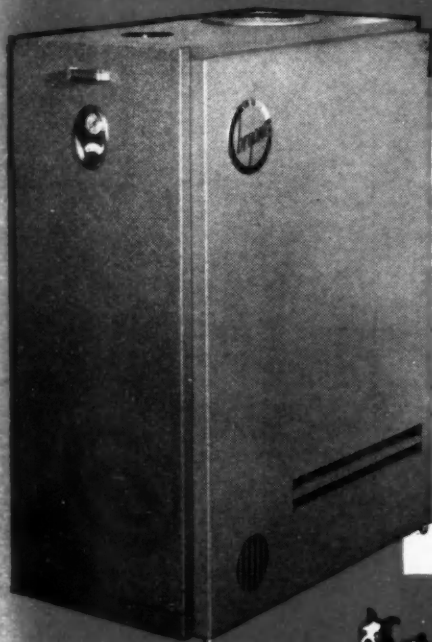

MODEL 26—A. G. A. ratings sq. ft.: Steam 230-600, Water 360-1920. Inputs: 67,500 to 360,000 btu per hour. For moderate size hot water and steam radiation heating systems. Features maximum heating surface, with water tubes surrounding the combustion chamber. Jacket is asbestos-insulated, completely encloses boiler and controls... A favorite for home radiation heating systems.

MODEL 630—A. G. A. ratings sq. ft.: Steam 2960-13,320, Water 4740-21,300. Inputs: 888,000 to 3,996,000 btu per hour. For steam, vapor or hot water systems in large homes, apartments, commercial and industrial buildings. Like all Bryant boilers, operates efficiently on natural, manufactured, LP or mixed gases.

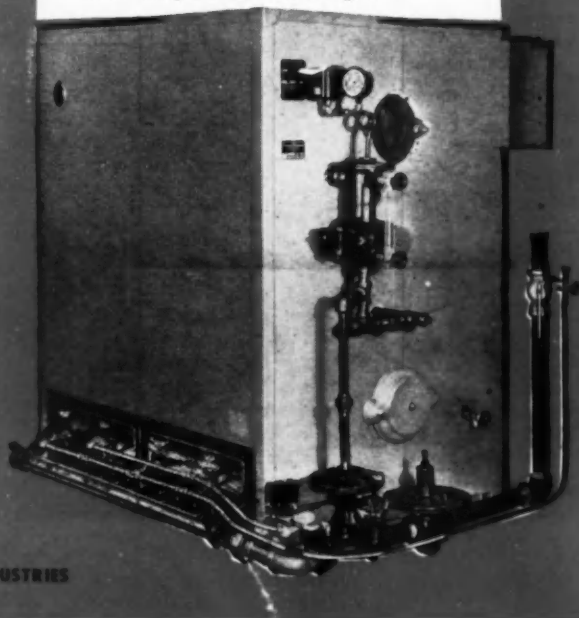



Let the pup be furnace man
bryant
AUTOMATIC HEATING

BRYANT HEATER COMPANY • CLEVELAND, OHIO • ONE OF THE DRESSER INDUSTRIES

Art in Iron

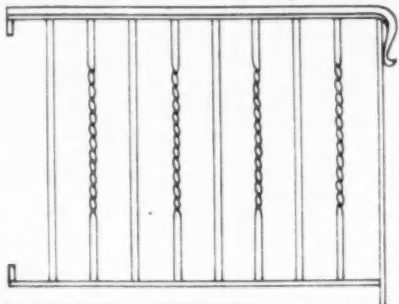
NEW stock sizes at new lower prices



ARTCRAFT newest stock railings No. 395

Note the alternately twisted 1/2" sq. spindles and gracefully forged finials that give added beauty to ARTCRAFT stock rails. 1" sq. terminal posts. Drilled lugs attached. **FOUR LENGTHS** all standard 32" high. **PRICED LOW!**

	per pair		per pair
2' 6" long..	\$12.00	3' 6" long..	\$14.00
3' 0" long..	13.00	4' 0" long..	15.00

STOCK Corner & Single-panel PORCH COLUMNS



No. 20

12" panel	Single
Height	corners 12" panels
7' 0"	\$25.00 ea. \$14.50 ea.
7' 6"	27.00 ea. 15.50 ea.
8' 0"	29.00 ea. 16.50 ea.

IMMEDIATE DELIVERY on all Artcraft stock items. Prices net F.O.B. Columbus, Ohio. Terms: Payment with order or C.O.D. Have ARTCRAFT do your most exacting custom iron work too.

FREE!

ARTCRAFT'S big new 36 page catalogue "ART in IRON" is just off the press. Write for your FREE copy today. Keep your eye on ARTCRAFT for additional new low priced STOCK ornamental iron work.



No. 14

ARTCRAFT Ornamental Iron Co.
724 E. Hudson St. Columbus 11, Ohio

ARTCRAFT Ornamental Iron Co.
724 E. Hudson Street, Columbus 11, Ohio

Send me FREE by return mail my copy of your new 36 page catalogue titled "ART in IRON."

NAME _____
ADDRESS _____
CITY _____ STATE _____
OCCUPATION _____

(Continued from page 182)

outstanding feature, here, was not so much the gift as it was the fact that even bathing structures were fireproofed. Builders had learned a lot from big fires, such as the one in Chicago, and they weren't taking chances.

A small thing, perhaps, but out in Chicago the Warner Lock Co. had just come out with a new type steel door knob—the first of its kind—significant in that the same type knob, with little changes, is still used today.

The "latest" in architecture in those days had a distinct European look about it. Highly ornate balusters, carved wood capitals, freizes, and gables were all the rage, with tall slender chimneys and other characteristics giving an Elizabethian appearance to most houses. Guess it's only fairly recently that we have become architecturally independent enough to let our own ideas dominate our home building styles.

Twenty-five Years Ago

Twenty-five years ago we were still a long way from the independent designs for homes we now have, but there were several trends that indicated we were on the way. The old tall chimneys, for instance, started going out in favor of the shorter, blockier ones you see today; apartment buildings were beginning to come more in style, and some of these—especially out on the West coast—were structures that have yet to be surpassed. In California, around Los Angeles and San Diego, housing was on the boom, and Spanish architecture was still in the lead, with hollow tile and stucco as the main elements used in construction of some of the "more modern" homes.

At this time 25 years ago, housing was on the boom in almost all the states. A statement made by Arthur S. Bent, at the fourth annual convention of the Associated General Contractors of America, could pretty well be applied to nearly every significant town in the United States. Bent, who was president of the Contractors in 1923, said at the convention that when he was a boy, he herded cows on the spot where he then was speaking—that the spot had changed from a cow pasture to a busy part of a thriving metropolis.

All in all, Bent drew a pretty accurate picture of the main changes that were made in American building from April, 1898, to April, 1923.

A new invention that people called the "radio" was receiving a great deal of attention in the building about this time 25 years ago. Some talked about it in mysterious tones; about how they figured the world was really shrinking down to no size at all. Others spoke reverently of the new invention, as though it would be one of the greatest boons to humanity. Builders were discussing the radio in terms of what probable effect it would have on architecture; thought that architectural provisions for good acoustics would now be of prime importance in the construction of any home where a radio might be installed.

Not much was done to change architectural requirements, that month.

GET BEARCATS ON YOUR JOBS

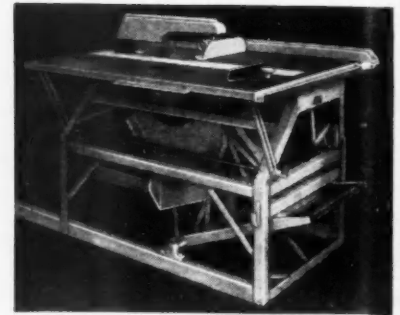

for FASTER SAWING

You'll cut costs *plenty*—with Bearcat! Fast, foot-pedal swing cut-off . . . Rip, cut-off at all angles. Portable from job-to-job . . . Rugged, welded steel frame and top . . . Heavy-duty ball bearings. Two sizes: XCO (above) for heaviest jobs, XJR for home-builders. **QUICK DELIVERY.**

Write **TODAY** for Literature!

DEALERS—
SOME AREAS
STILL OPEN

THE PAXSON CO.
38 "A" Ave., Dowagiac, Michigan

BUILDING BEARCATS FOR 25 YEARS



ALL THE EXCITEMENT of the Old West—against a background of modern luxury at the Last Frontier. Name-band dancing in the Ramona Room . . . carefree hours in the Gay Nineties Bar . . . 21 Club Casino.

The Early West in Modern Splendor

**HOTEL
LAST FRONTIER
LAS VEGAS, NEVADA**

"I put certifi homes beca identifies me I plan to be the present and forgotte Wynne, Jr."

PRO
buildi
—the

What It makes to helps you come. It cause: (1 it assures electrical What It Wiring modeled electrical such thin

ad



"I put certified adequate wiring in my homes because that certificate identifies me as a reputable builder. I plan to be in business long after the present housing shortage is over and forgotten," says Angus G. Wynne, Jr., Prominent Dallas builder.

**The sign
of the
times is...**

"Certified Adequate Wiring"

PROOF ADEQUATE — another home-building project featuring Certified Adequate Wiring — the Wynnewood development in Dallas, Texas.

What It Means To You: Certified Adequate Wiring makes today's home buyers tomorrow's boosters. It helps you build houses that stay modern for years to come. It helps you sell houses easier and quicker because: (1) it overcomes today's buyer resistance; (2) it assures you of promotional support from your local electrical industry.

What It Means To The Home Buyer: Adequate Wiring makes even a moderate-cost house, or a remodeled home, *modern*. It provides not only for today's electrical needs but for those of tomorrow—including such things as kitchen and laundry appliances which

can be covered by a "packaged mortgage."

What "Adequate Wiring" Means: An adequate electric service entrance; enough circuits, enough convenience outlets; permanent lights and switches.

Here's What You Can Do About It:

1. Use the services of your local Adequate Wiring Bureau in preparing complete wiring layout for every floor plan.
2. Install Adequate Wiring in accordance with this layout.
3. Obtain your "Proof Adequate"—a certificate to present with each deed.
4. If there is no Adequate Wiring Bureau in your area, *write us* for details of how to take advantage of "Adequate Wiring" as a sales feature.



**NATIONAL
adequate wiring
BUREAU**

CLIP AND MAIL TODAY for free information and material!
NATIONAL ADEQUATE WIRING BUREAU, Dept. AB-3
155 E. 44th Street, New York 17, N. Y.
Please send me, without charge, information on how to take advantage of Adequate Wiring as a sales feature.

NAME.....
FIRM.....
STREET ADDRESS.....
CITY.....STATE.....

"USE YOUR ATTIC"



For free information, see your building material dealer or write—

MARCO STAIRWAYS
BOX 7A, LUCCA, N. DAK.

Hardwood Flooring Reaches Record Output In 1947

AN all-time annual record of approximately 620,000,000 board feet of hardwood flooring in 1947 was reported by Allen Harris, Jr., president of the National Oak Flooring Manufacturers' Association. The figure, he said, is about double that of 1946 production and some 36,000,000 board feet greater than the previous high, recorded in 1926. It includes unfinished and pre-finished flooring of oak, hard maple, beech, birch and pecan, all of which have been in short supply since 1942.

With demand expected to remain heavy due to increased residential building this year, Mr. Harris said, there is a likelihood that 1948 production may top last year's peak output by as much as 100,000,000 board feet.

"Predictions regarding the volume of housing construction in 1948 vary," he pointed out, "with government sources estimating that 950,000 new non-farm family dwelling units will be started. About 850,000 were started and 830,000 completed during 1947.

"An analysis of the hardwood flooring production chart during the past year indicates that the industry, given the advantage of continued favorable conditions, should be able to keep pace with the expected increase in building activity. Hardwood flooring probably will not be plentiful for some time, but the present gap between supply and demand should be narrowed considerably."

Vermiculite Institute Announces Changes

A CHANGE in both the name and managing directorship of the Vermiculite Research Institute, Evanston, Ill., is announced. Henceforth, this organization will be known as the Vermiculite Institute. Edward R. Murphy has been named managing director and executive secretary of the Institute, to succeed Vilas E. Watts.

As the change in name implies, the Vermiculite Institute will no longer be primarily concerned with research. Its functions will be the promotion of the use of vermiculite products nationally, cooperation with allied industries in the construction field, and the preparation of new literature and publicity. Mr. Murphy, a civil engineer, is well qualified for these duties. He comes to V.I. from the Gypsum Association, where he was assistant chief engineer for over twelve years. Prior to that time, he was with the structural clay products industry code authority during N.R.A., and with the former Metal Lath Manufacturers Association.

The new chemically-treated vermiculite concrete aggregate used in producing lightweight insulating concrete, a treatment which makes vermiculite concrete more uniform and less subject to improper usage on the job, is a discovery of Mr. Watts.

The Vermiculite Institute will continue at its present address, 2540 Eastwood Ave., Evanston, Ill.

GABRIEL SCAFFOLD BRACKETS

*Easy to Handle and Store -
Easy to Sell*

● For more than twenty-five years Gabriel Scaffold Brackets have been reducing builders' costs by providing scaffold supports where they are wanted without waste of time or material.

Gabriel Scaffold Brackets are light-weight, durable, easily handled. They are collapsible, take up little room. They can be erected and removed with equal ease and rapidity. . . . Made of rolled steel sections with brass washers separating all parts to insure easy opening and closing. . . . Patented automatic locking device holds brackets in either rigidly open or closed position. . . . Gabriel Scaffold Brackets can be handled and stored as a unit; there are no loose parts that might become lost. They can be used anywhere from the first floor line to the highest gable. . . . Available in 4' 6" length for use on corner of building, and 3' 6" length for sidewall use.

Write for Catalog showing Complete Line of Home Building Specialties

National Sales Representatives: HARRIS, INC., 1157 Cleveland Ave., Columbus 3, Ohio

GABRIEL STEEL COMPANY, 13700 SHERWOOD, DETROIT 12, MICHIGAN

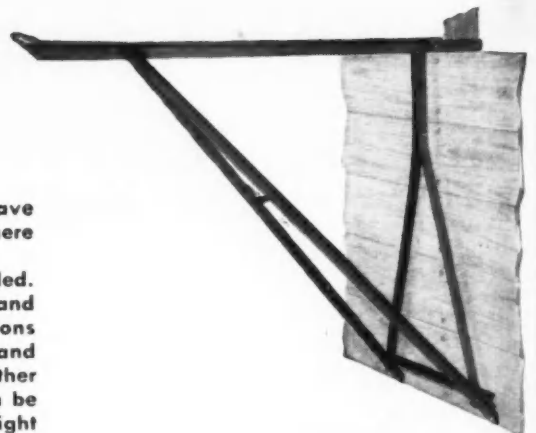

GABRIEL
ROLLED STEEL
PRODUCTS

Pr
The e
is der
Proje
TITLE
tect.
ence
know
casen
provi
Follow
SPEC

14

and
Ver-
ston,
s or-
rmi-
rphy
and
e, to

the
er be
Its
f the
nally,
n the
on of
Mur-
lified
from
e was
welve
with
ustry
with
urers

micu-
odue-
ete, a
e con-
ect to
iscov-

con-
East-



Copco

STEEL WINDOWS

Preferred by LEADING BUILDERS

The effective use of Copco Residential Steel Windows is demonstrated (as pictured above) in the Ewald Circle Project, Detroit, Michigan. F.H.A. APPROVED UNDER TITLE No. 608. Designed by Louis G. Redstone, Architect. Built by Practical Home Builders. These experienced construction experts PREFER Copco because they know that Copco cold roll-formed sections make perfect casements. Copco Steel Windows are always uniform, providing tight, faultless fit . . . and greater strength. Follow the example of leading builders . . . next time SPECIFY COPCO.

●
Write for free illustrated literature and price list on Copco Steel Windows and Building Products.
●



Copco STEEL and ENGINEERING CO.

14035 GRAND RIVER AVE. • DETROIT 27, MICHIGAN

EASTERN WAREHOUSE, 44 LISTER AVENUE, NEWARK 5, N. J.

a fine foursome...

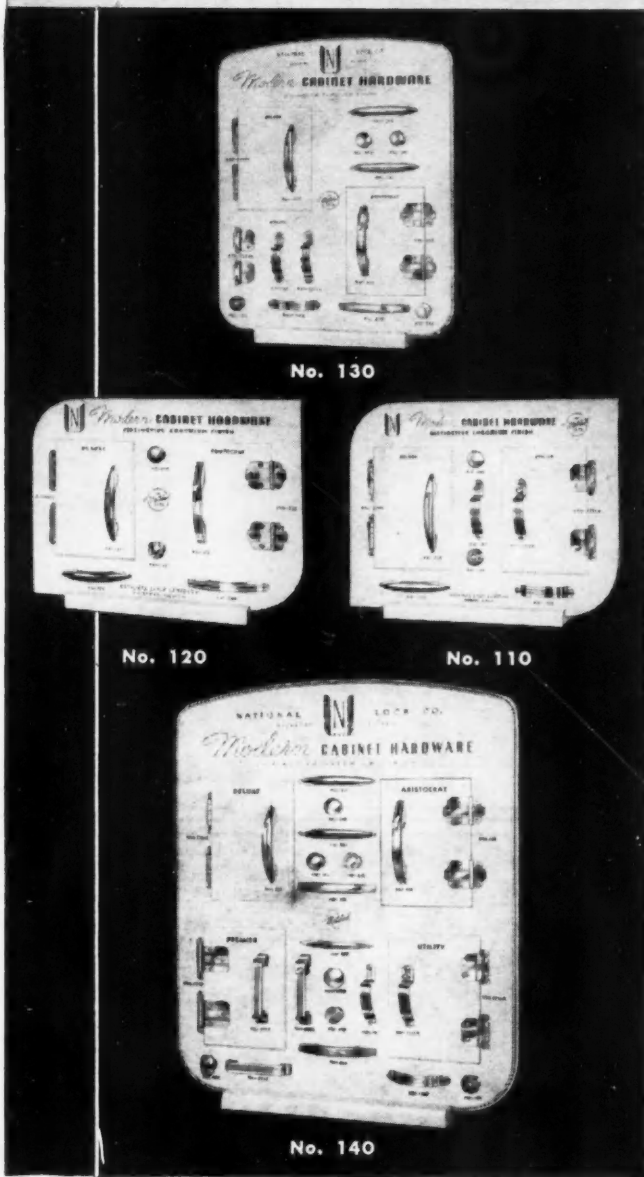

Meaning More Profits!

with kitchen cabinet hardware

● Four fine display boards. Four complete sets of matched cabinet hardware. Four distinctive designs. Four different ways of making *more* money by selling *more* kitchen cabinet hardware at *more* profit. Ask your jobber or write us. You'll be interested in learning about these profitable NATIONAL LOCK "deals" available promptly.



NATIONAL LOCK COMPANY
Rockford • Illinois
merchant sales division



NEW PACKAGE

Now that high quality white patent coated boxboard is again available, Duplex SASH BALANCES step out in brand new packages — beautiful packages for America's finest sash balances — lemon yellow and royal blue for the ADJUSTABLE — yellow and emerald green for the PRE-SET. The first million boxes were delivered to us in January; they'll be on dealer's shelves as fast as we can make shipment.

Inside you'll find...

THE HIGHEST QUALITY IN DUPLEX HISTORY — Guaranteed against mechanical defects for the life of the building... AND AT

LOWER PRICES THAN IN 1938 — Resulting from the mass production methods made possible by overwhelming product preference.

DUPLEX, INC.
628 No. La Peer Dr.
Los Angeles 46, Calif.

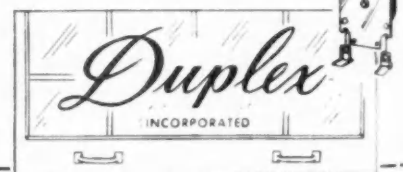

Please send information on Duplex Flat Sash Balances

Type of Business

is th
1
2
3
4
5
6
7
MA

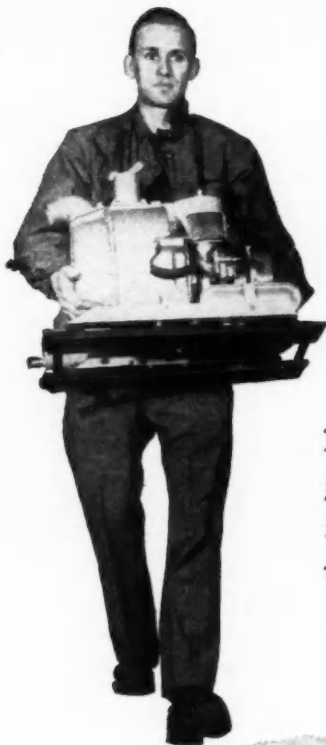

Homelite Carryable Pump ...with 9 Big Features

It weighs only 85 pounds... complete with built-in high-powered gasoline engine... and when it comes to performance, its nine big features are nine big reasons why a Homelite *Carryable Pump* is the best pump for all jobs... *your* jobs.

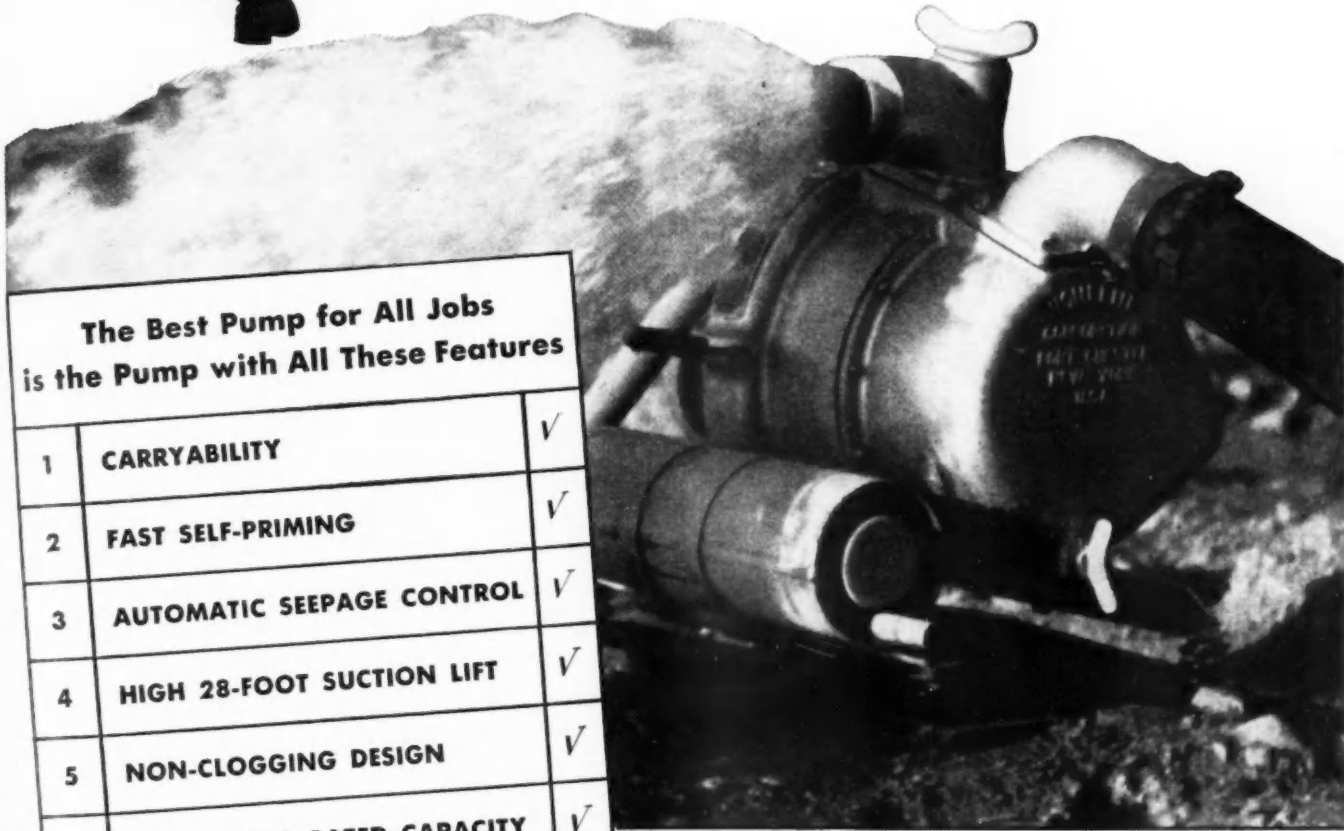

The Best Pump for All Jobs is the Pump with All These Features		
1	CARRYABILITY	✓
2	FAST SELF-PRIMING	✓
3	AUTOMATIC SEEPAGE CONTROL	✓
4	HIGH 28-FOOT SUCTION LIFT	✓
5	NON-CLOGGING DESIGN	✓
6	MAINTAINED RATED CAPACITY	✓
7	DISCHARGE PRESSURE	✓
8	DEPENDABILITY	✓
9	SIMPLE DESIGN AND OPERATION	✓

See for yourself

Write today for our new illustrated bulletin No. L-503 that tells the *complete* story and shows how you can get faster, better pumping with Homelite *Carryable Pumps*.

HOMELITE

CORPORATION

503 RIVERDALE AVENUE, PORT CHESTER, NEW YORK

MANUFACTURERS OF HOMELITE CARRYABLE PUMPS • GENERATORS • BLOWERS • CHAIN SAWS

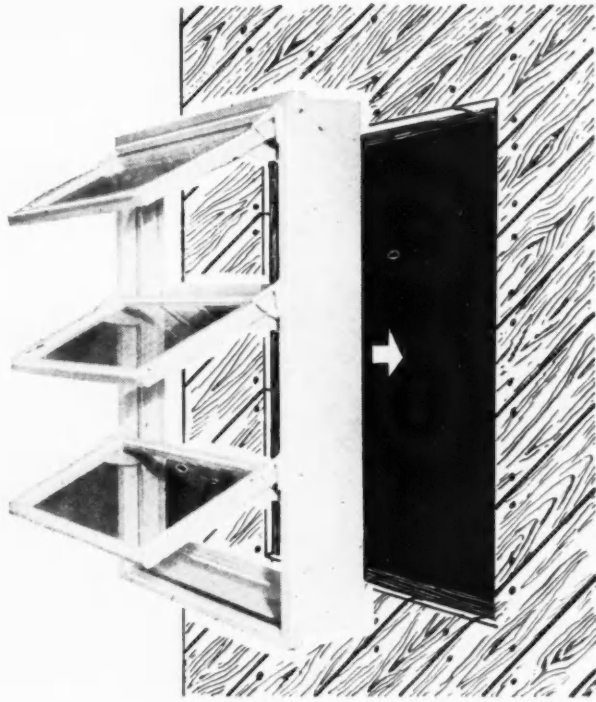

**GOT AN OPENING
FOR A
*Super Salesman?***

Maybe you never thought a window could sell a house. But just install Gate City Awning Windows in a sample house and watch curiosity develop into desire for possession through the irresistible selling power of their advantages:—

- Distinctive architectural design.
- Feather-light worm-and-gear operation by a small handle.
- Draft-free, safe ventilation in all weather.
- No danger of rain damage.
- Natural air circulation promoted by tilt of sash.
- Easy, safe indoor cleaning.
- Child safety.
- Indoor screens and storm sash—no rainstreaks on exterior walls.

Gate City Awning Windows may be just the "plus" to stamp your homes as the best buy in your locality. Their cost is low enough for your smallest home.

Write for full information, sizes, prices, etc. Gate City Sash & Door Co., Dept. B, Fort Lauderdale, Florida.

AWNING WINDOWS
by
Gate City



**To get it faster look in
SWEET'S FILE**

One hundred and ninety-five manufacturers' catalogs—1,336 catalog pages—instantly accessible in the 1948 Sweet's File for Builders.

There, right in your office, you will find up-to-date, useful and comprehensive information on forms, characteristics, performance and use of a wide range of materials, equipments and services.

Manufacturers' catalogs in Sweet's File are indexed by company name, by product and by trade name, so that you can find the information you want instantly—whenever you need it.

**SAVE TIME — SAVE TROUBLE
LOOK IT UP IN SWEET'S....**

Sweet's is always working to build a bigger and better file of manufacturers' catalogs so that buyers and sellers can get together faster and at lower cost. If you would like other manufacturers to include catalogs on their products in your Sweet's File, please send us their names.

If Sweet's File for Builders is not available in your office, please address request for application to:

**Sweet's Catalog Service
Distribution Dept.
119 West 40 St., New York 18, N. Y.**

Free

to qualified organizations and individuals

S

Source of Perpetual Supply

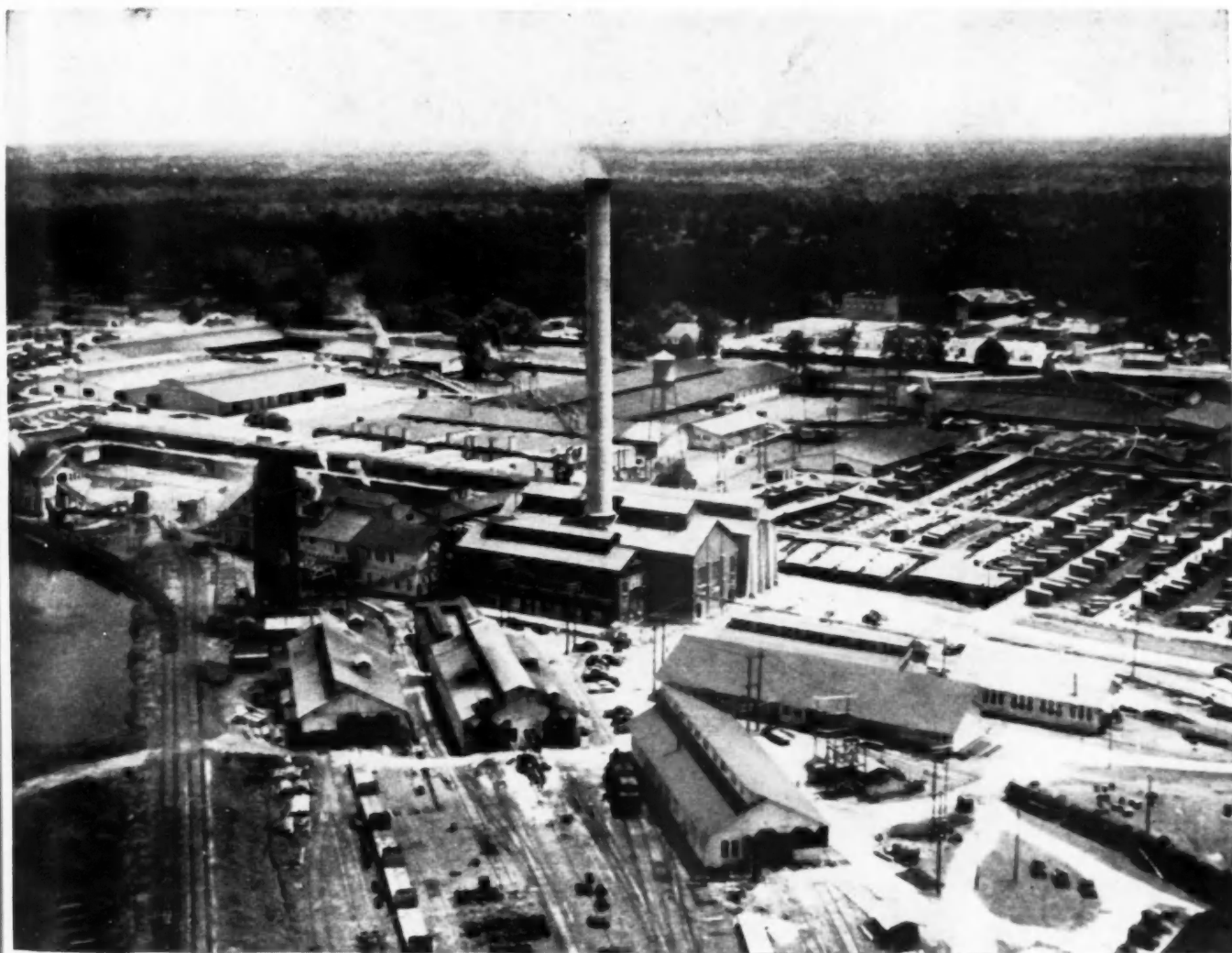

Here yesterday . . . here today . . . here tomorrow. Prevailing standards maintained . . . constant search for better ones . . . old equipment replaced with new at the first hint of obsolescence . . . the Nation's continuing need for good lumber unquestioned . . . the obligation to fill that need honestly, recognized . . . the spirit of confidence between dealer and manufacturer safeguarded . . . a source of perpetual supply paramount to the dealer's best interests . . . timber resources sustained through conservation and reforestation. ***These express Crossett's understanding of service to dealer and consumer . . . these, the principles to which Crossett dedicates its own substantial investment in resources, plant and merchandising organization.

CROSSETT LUMBER COMPANY, CROSSETT, ARKANSAS



Century-Old Doorways helped create these **MODERN** toxic standards

The standards which NDMA has developed for testing the effectiveness of toxic preservatives for millwork did not grow up overnight. Years of research and testing were necessary. Pathologists and non-commercial research technologists studied century-old doorways to learn the secret of the remarkable lasting qualities of wood. The results of extensive laboratory and field tests were carefully tabulated and analyzed.

Today, NDMA Standards for the toxic preservative treatment of woodwork such as doors, screens and windows are accepted as meeting the most rigid requirements of modern home construction. Here are the six steps which NDMA takes to make wood a better building material than ever:

1. An efficient test for measuring effectiveness of toxic preservatives.
2. Minimum standards governing the toxic preservative treating of woodwork products.
3. A seal identifying products treated in conformity with NDMA Toxic Preservative Standards.
4. Mill inspection of treating equipment and practices.
5. Laboratory check-tests of preservative solutions.
6. Educational effort in the public interest.

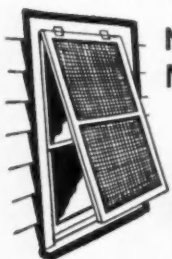

**NATIONAL DOOR
MANUFACTURERS ASSOCIATION**
McCORMICK BUILDING • CHICAGO, ILLINOIS

LICENSE NO. **000** **TOXIC-PRESERVATION
APPROVED**
NATL. DOOR MFRS. ASSN.

UNI-TEX
Reg. U. S. Pat. Off.

**ADDS DOLLARS
TO VALUE...
SAVES DOLLARS
IN COST!**



Walls finished with Uni-Tex, Elliott's famous one coat OIL PAINT, have a rich, luxurious, costly velvet-sheen appearance that adds many dollars to the "eye-appeal" of any job.

Yet—Uni-Tex is actually one of the most economical interior paints you can use—

HERE'S WHY:

- Uni-Tex primes, seals, finishes in one coat.
- Comes ready mixed, ready to use, **saves time.**
- Self-leveling, leaves no brush marks, goes on easy, **saves labor.**
- One coat covers all surfaces, **saves money.**
- Ten beautiful colors and white.

No wonder more and more builders, contractors, painters and decorators are using Uni-Tex. Try it on your next job and let Uni-Tex prove its merit by actual results.



MANUFACTURED EXCLUSIVELY BY

Elliott Paint & Varnish Co.

4525 FIFTH AVENUE, CHICAGO 24, ILLINOIS

Also Manufacturers of Elliott's famous WHITE-VENEER

WHAT IS THE golden touch?

Some people create trends — influence others.

Some stores create trends — influence others.

When the people and stores of influence join forces something important happens,
trends are set... sales are made.

House & Garden

brings together the people and stores of influence...

motivates their buying...

starts the action that multiplies influence *in ever widening circles,*

resulting in store displays and local advertising...

and creates the key buying that leads to multiple sales.



HOUSE & GARDEN

The lowest initial cost in the home service field

© 1948 THE CONDÉ NAST PUBLICATIONS INC.

4-FT. TIDE in Elevator Pit HELD BACK by AQUELLA

The Barnum Garage, Bridgeport, Conn., is located directly over an old river bed. For years, when the tide came in, the pit filled with 4 feet of water, rusting cables and causing frequent breakdowns. Aquella was applied in 1945. Since then, though surrounded by water, the walls and floor of the pit have remained thoroughly dry.

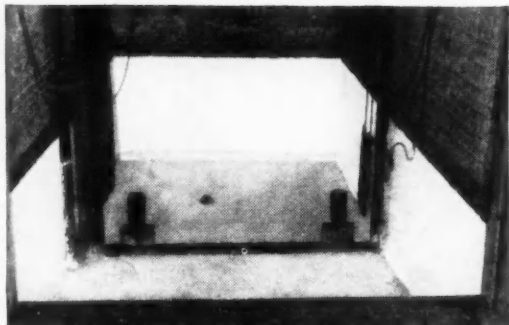

Elevator pit, following treatment with Aquella 3 years ago.

Over and over Aquella does "the impossible." Working on entirely new principle, this amazing mineral surface coating controls seepage above or below grade, interiors or exteriors. Use Aquella for all porous masonry surfaces — brick, concrete, stucco, stone, cement, cement plaster, masonry units. Brilliant white, also buff, rose, green, grey.

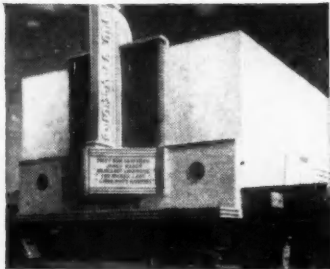

Theatre, Sacramento, Cal., and radio station, Memphis, Tenn., showing beautiful white Aquella finish. Damp, unsightly home (below) now bright and dry after Aquellizing.



Cross section showing how Aquella penetrates tiniest pores, then expands. Continues to harden with age. Will not crack, peel or rub off.

MAIL COUPON TODAY

PRIMA PRODUCTS, INC.
Dept. C, 10 E. 40th St., New York 17, N.Y.

Please rush FREE 16-page booklet, "Aquella and Concrete Masonry Construction."

NAME _____
ADDRESS _____
TOWN _____ STATE _____



\$3.95

per bag
Higher Denver and west.

Mixed with water, according to directions, one bag makes 1 gal. First coat covers approximately 100 to 120 sq. ft.; second coat, 200 to 250 sq. ft. per gal.

Complete



DOOR UNITS with Wood or Aluminum Doors



Give your customers "Over-the-Top" garage door convenience at surprisingly low cost. If your plans call for standard openings 8' wide x 7' high, you'll find the No. 10 "Over-the-Top" Complete Unit . . . wood paneled door, complete with hardware . . . will do the job. Only 2" of headroom are required! Door is prefitted; even the holes are bored for bolts. Has automobile-type Handle-lock (catches engage on both jambs):

Aluminum Door Popular

The No. 17 "Over-the-Top" Aluminum Door Unit combines the lightness and durability of aluminum, the strength and sound-absorbency of a sturdy pine frame and the smooth, effortless operation of "Over-the-Top" Door Equipment. For openings 8' wide x 7' high, 8' wide x 7'-6" high, or 8' wide x 8' high.



You Can Specify "Over-the-Top" Equipment for Any Size Door

For architecturally designed, custom-built doors, or doors heavier than 150 lbs., the ideal solution is "Over-the-Top" Door Equipment. Nineteen sets fit any size or weight door. Write today for free illustrated literature on the complete line of "Over-the-Top" Door Equipment, including Wood and Aluminum Door Units.



FRANTZ MANUFACTURING CO., STERLING, ILLINOIS

Home
eral Ele
ern appl
Custo
so long,
longer,
Until
one that
Show
that's m

• The D
en sink

Genera
1285 B
Please
NAME
ADDRE
CITY

*General E

HOUSES SOLD → HERE!



Home Buyers Are Sold on the General Electric Disposall*—a truly modern appliance.

Customers have waited for new homes so long, they're willing to wait a little longer, until...

Until the right one comes along—the one that's truly modern, inside and out.

Show her *your* house with a kitchen that's modern-designed for convenience,

efficiency and cleanliness and—other things being equal—*yours* is the house a woman will go for.

That's why it's good salesmanship to install General Electric Disposalls in your kitchens. Above all other appliances, the Disposall says—"modern"!

Shredding all food waste and flushing it automatically into sewer or septic tank, the Disposall says "good-by for-

ever" to sloppy garbage. It says "never again" to garbage handling, to unsanitary garbage mess. It insures a cleaner, more healthful home . . . it promises countless footsteps saved each day.

Costing no more to install than the standard sink drain, the Disposall will add greater sales appeal to every home you build! Install this "extra" sell in your very next kitchen!

Installing the Disposall is as easy as it looks!

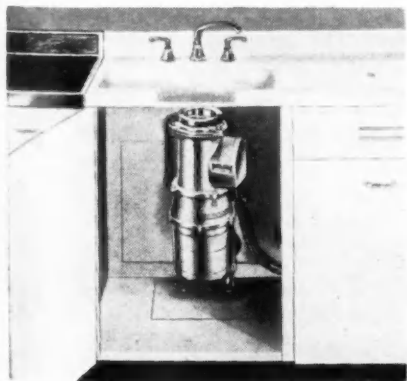

● The Disposall fits snugly under kitchen sink—replacing the standard drain.

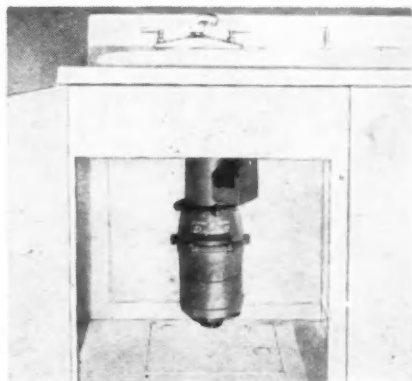

● Installable in any modern sink with 3½ to 4-inch drain opening, this is how the Disposall looks installed in the General Electric Electric Sink.

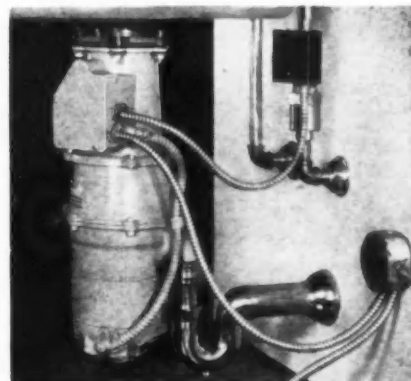

● Close-up, under-the-sink view shows all plumbing and electrical connections.

Mail this coupon for complete information

General Electric Company, Appliance and Merchandise Dept.
1285 Boston Avenue, Bridgeport 2, Conn. Dept. ES-1
Please send me complete information about the G-E Disposall

NAME

ADDRESS

CITY STATE

*General Electric's registered trade-mark for its food-waste disposal appliance.



DISPOSALL

—means good-by to
garbage, automatically!

GENERAL ELECTRIC



Versatile Fred W. Wappat Electric Hand Saws

CUT LUMBER *and over 20 other building materials*
Fast . . . Accurately . . . in any Position . . . at Less Cost!

With a Fred W. Wappat Electric Hand Saw on your job, you have more power than you'll ever need (with thorough operator protection), assuring continuous high-speed cutting . . . you get absolute accuracy, thanks to visible cutting line and rigid, simple angle settings on saw frame . . . top performance is maintained whether saw is trimming sub-flooring, wall sheathing, or hung inverted for ripping operations . . . your operating and maintenance costs are minimized through such features as the Fred W. Wappat lubricating system, and special Fred W. Wappat-designed gears, produced under our rigid shop standards.

In addition to working lumber, you can quickly fit your Fred W. Wappat Saw with special blades and cut over twenty other tough building materials, from insulating board to light metal sheets, *still utilizing the Fred W. Wappat basic advantages!* Write today for full information, or ask for free copy of Bulletin S-10.

High-Speed Portable Electric Tools • Radial Guides • Service and Parts for Wappat and Alta Tools

FRED W. WAPPAT • 135 Valley St. • MAYVILLE, N.Y.

On Chautauqua Lake

CUT JACK-RAFTERS OR WIDE PANELS THE EASY, FAST, ACCURATE WAY, with an improved Fred W. Wappat Radial Guide. Inexpensive, portable, in models from 25" to 120" capacity. Ask for "free" copy of Bulletin S-8, today!

sell your trade the whitest white cement



A whiter white cement that gives greater beauty wherever used . . . widely and consistently advertised to your customers.

Trinity Portland Cement Division,
 General Portland Cement Company
 111 W. Monroe St., Chicago; Republic Bank Bldg.,
 Dallas; 816 West Fifth St., Los Angeles

as white  as snow

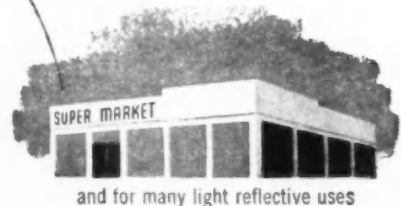



Apac never needs protective painting, but the owner of this attractive service station painted it green and white with outstanding decorative results.

4 BIG
 advantages of
K&M Century
APAC
 ASBESTOS-CEMENT
 SHEETS

1. You'll find "Century" Apac sheathing is easy to use and apply. With Apac you save cutting time—just score it and snap off. You can lay up its 4' x 8' sheets 32 sq. ft. at a time, fasten them with nails or screws.

2. Being made of asbestos and Portland cement. Apac sheets are completely fire-proof, rot-proof, rust-proof, weather-proof. They grow tougher with age.

3. Because of Apac's smooth finish and pleasing light gray color, your finished job will be neat and attractive. And Apac never needs painting, though you *can* paint it when desirable for decorative reasons.

4. Best of all, you make a good profit on an Apac job... thanks to Apac's ready workability and surprisingly low cost.



Why not look further into the possibilities of this versatile asbestos-cement material? See your K&M dealer about Apac, or write direct to us.

Original manufacturers of asbestos-cement roofing shingles in this country.

KEASBEY & MATTISON
 COMPANY • AMBLER • PENNSYLVANIA

Modern Homes deserve the BEST in modern CASEMENT HARDWARE

COMPARE THESE 8 VITAL POINTS

GETTY

No. 4703W

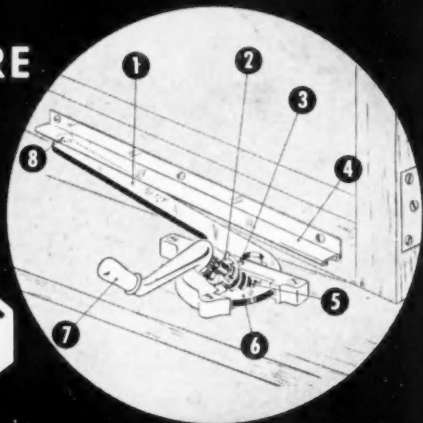

1. Arm, 3/4" wide, of 3/16" thick cold rolled steel, cadmium plated.
2. Shaft bearing made of bronze, threaded and pinned in housing.
3. Arm pivots on 3/8" shoulder of solid bronze bearing-stud.
4. Heavy brass channel guide has 3-point anchorage on window ... cannot bend or bind.
5. 3/8" diameter worm, machine cut of case-hardened, cold-rolled steel, will give long, efficient service. Full length of the worm is engaged at all times with the Internal Gear.
6. Internal Gear is integral with operating arm. Teeth are heavy, strong, and accurately machined at exact operating angle.
7. Revolving swivel (turn-knob) gives easy finger-tip control; cannot be removed.
8. Arm button of solid brass is locked in channel ... cannot come out accidentally; prevents rattling. Button cannot freeze in channel.

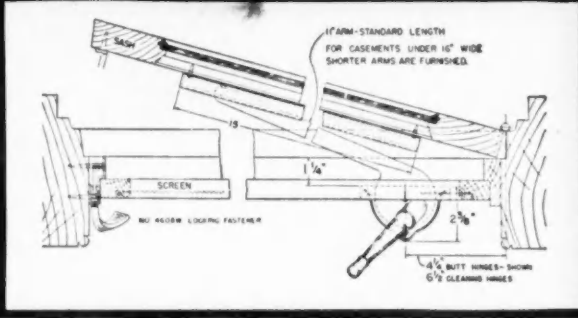

Getty — originator of the Internal Gear — gives you the finest in casement operators

- Internal Gear construction—strongest known in gearing.
- Housing is solid, high-tensile strength bronze.
- Sturdy, sound construction. Will not rust, stick or rattle... operates under severe conditions.
- Completely redesigned for low, graceful contour.
- No. 4608 W Locking Fastener locks and unlocks the casement without disturbing the screen.
- No. 4703 W Operator gives full opening or holds to any fixed degree of opening by operating under the screen and without disturbing it.



More than 25 Years Service to the Hardware Industry

Consult your local Contract Builder's Hardware Dealer, your local Building Materials Dealer, your Wholesale Hardware Jobber, or write:

H. S. GETTY & CO., INC.

3348 N. 10th ST., PHILADELPHIA 40, PA.

TIME

PROVES

Galvanized (ZINC-COATED) Sheets Stay Stronger Longer



34 YEARS . . . Erected in 1913, and covered with heavy gauge galvanized sheets, this Tennessee concentrating plant of the A/Z Company, pictured at left, is still in excellent condition after more than three decades of service. Painted with Gray Metallic Zinc Paint in 1932.



50 YEARS . . . The galvanized metal roof on this old Missouri farm building has outlasted the building itself, and is still in good condition after half a century of service. Industry and the farm have long depended on galvanizing to protect iron and steel against costly rust. Builders know that as long as iron or steel is zinc covered, it *cannot rust*.

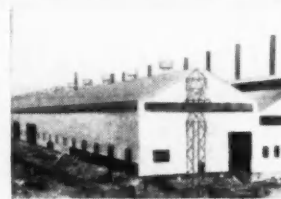

In building for the future, look to the past for proof of a building material's strength . . . durability . . . service. With *galvanized* (zinc-coated) roofing and siding you get the strength of steel . . . the rust protection of Zinc. So for low-cost, long-time service choose the building material that's proved by TIME itself . . . galvanized sheets. Send coupon for information about Zinc and how it helps keep buildings and equipment *stronger longer*.



This "Seal of Quality" is your guide to economy in buying galvanized sheets. Sheets bearing it carry at least 2 oz. Zinc per sq. ft.



American Zinc Institute

ROOM 2601, • 35 E. WACKER DRIVE, CHICAGO 1, ILL.

FREE BOOKLETS!

- Send me without cost or obligation the illustrated booklets I have checked.
- Repair Manual on Galvanized Roofing and Siding
 - Facts about Galvanized Sheets
 - Use of Metallic Zinc Paint to Protect Metal Surfaces

Name _____

Address _____

Town _____ State _____

R Sterling times f surface. sills, st smooth T less, eas Sa distribu

STI



Hey mister, you're losing something!

**... and You — Mr. Builder,
Are Losing Time and Money Too
—if You Sand by Hand**

Reduce sanding time and finishing costs with a Sterling Portable Electric Sander—it does the job 3 times faster and produces a smoother, more uniform surface. Use it to sand cabinets, doors, frames, drawers, sills, stair treads, dry wall construction and to smooth plaster.

The Sterling is lightweight, compact, vibrationless, easy to handle. Sands flat or curved surfaces.

Save man-hours — increase profits. Ask your distributor for a demonstration.



SAND CABINET WORK — EASILY, IN SECONDS!

STERLING¹⁰⁰⁰ SANDER
PORTABLE ELECTRIC

Write for illustrated folder!
STERLING TOOL PRODUCTS CO.
1334-A Milwaukee Ave., Chicago 22, Illinois

Success Formula

FOR BUILDERS, DEALERS, ARCHITECTS



1. WINDOWS THAT OPEN WIDE

Men and women everywhere want windows that open wide at the slightest touch of the hand . . . smoothly . . . silently.

+ Plus 2.

INVIZIBLE SASH BALANCES



The "Grand Rapids Invincible" Sash Balance is always at your service . . . never in your sight. It is completely concealed in and moves with the sash itself.

+ Plus 3.

SAVINGS IN MONEY . . .

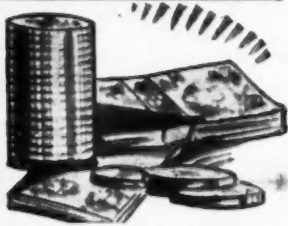

This preferred balance more than pays its cost in the savings on installation alone.

= EQUALS =

SATISFIED HOME OWNERS

Tested in the laboratory and proved in thousands of homes, these preferred spiral sash balances will give you a lifetime of dependable service.



ADVERTISED TO

134,445,000 READERSHIP IN NATIONAL MAGAZINES

BALANCE 100%
concealed in the sash . . . no tapes . . . no cables . . . no corrosion.

EASY TO INSTALL
. . . just drive in two fasteners . . . screw in one screw.

10 SIZES FIT 95%
of all new and old windows . . . completely interchangeable.

GRAND RAPIDS SASH PULLEYS
No. 103 face plate, cone bearing type, and Nos. 175, 109, 110 sawtooth drive type sash pulleys cover 95% of all sash pulley requirements.

SEE OUR CATALOG IN SWEET'S
WRITE
for Illustrated Specifications and Instructions

GRAND RAPIDS HARDWARE COMPANY
GRAND RAPIDS 2, MICHIGAN
Quality Leaders in Sash Hardware for over 50 Years

Structural Reinforcing or other Blding Steel Shipped from Stock

Write for Stock List—your guide to over 10,000 different kinds, shapes and sizes of steel for quick shipment from ten plants.

Joseph T. Ryerson & Son, Inc., Plants at: New York, Boston, Philadelphia, Detroit, Cincinnati, Cleveland, Pittsburgh, Buffalo, Chicago, Milwaukee, St. Louis, Los Angeles.

RYERSON

NORDAHL SLIDING DOOR FRAMES

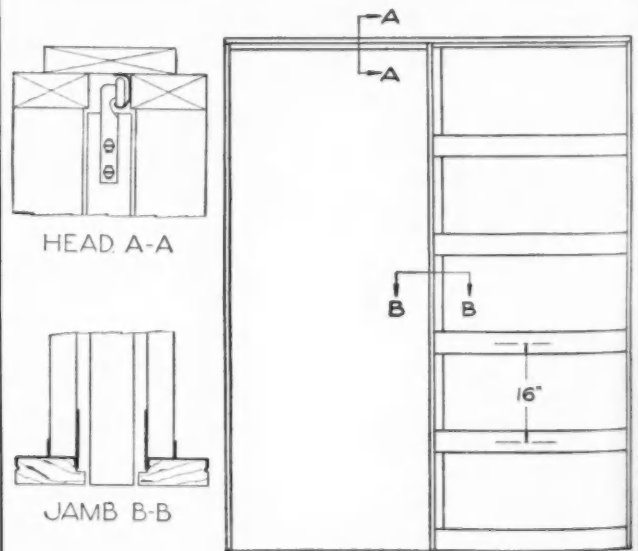

Note the **METAL REINFORCED JAMBS**, exclusive with NORDAHL FRAMES. The pocket opening is held rigid and true. Sturdy metal track in a built-up header makes a smooth running surface for the wear-resisting phenolic fiber rollers. Nothing to go wrong . . . easy to install. See your dealer or write for descriptive folder. Nordahl—180 W. Alameda Ave., Burbank, Calif.

Johns-Manville SUPER-FELT

... the superior Rock Wool Batt for insulating new houses or accessible attic spaces

Easier to install

The J-M Super-Felt Batt is strong and tough. Its superior felted structure makes it easier to handle . . . ensures savings in application. The batt holds its shape . . . fits snugly between framing members.



Will not settle

The Super-Felt Batt is resilient yet so rigid it will actually stand alone. When installed, it stays in place, won't settle.



It's fireproof, too!

You can't burn it even with a blow torch. J-M Super-Felt is rock wool, a mineral. It acts as a fire-retardant . . . prevents spread of flames in wall spaces.

Send for Super-Felt brochure, HI-125A. Johns-Manville, Box 290, New York 16, N. Y.

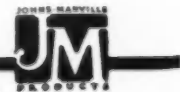

**Keep ahead of concrete crews
with JAEGER 3½-S
AUTO-LOADER**

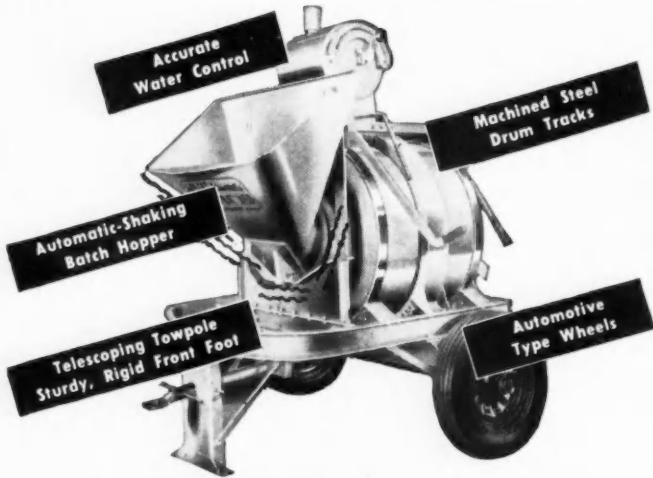

GOOD FOR UP TO 50 CU. YDS. A DAY. Fastest loading, fastest producing non-tilt half-bagger made. That 30% to 40% greater yardage sets a faster pace for your crews, means more production for wages paid. Hopper takes a fresh load while the previous one is mixing and discharging. When hopper gate is opened, hopper automatically *shakes* load into mixing drum — fast and clean. Mixing is practically continuous. Famous Jaeger "Dual-Mix" drum gives thorough mixing and extra fast discharge. Machined steel drum tracks, ¾ hp engine, built for long service.

OR 3½-SPEEDY TILTER
FAST TOWING • FAST SPOTTING • FAST POURING

Latest half-bag end-discharge tilter. Tows with loading end at rear. Just back up to the material pile, unhitch, and start mixing. No feet or legs on discharge side. — fast easy approach and getaway for wheelers. Exclusive Jaeger "V" bottom drum doubles the mixing action of other tilters. Gives cleaner discharge.

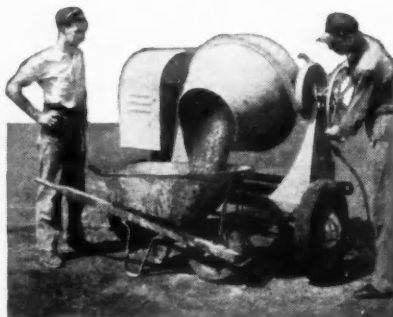

**6-S, 11-S and 16-S Power Loaders in famous
JAEGER SPEEDLINE**

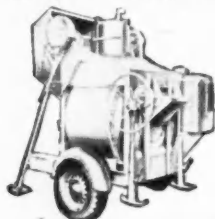

Run like a clock with their machined steel drum tracks and automotive transmissions. "Skip Shaker" loader and "Pressure" discharge produce more batches per day.

Write, or ask your nearest Jaeger dealer for complete catalog M-8.

THE JAEGER MACHINE CO.

Main Office and Factory — Columbus 16, Ohio
REGIONAL OFFICES

1504 Widener Bldg. 226 N. LaSalle St. 235-38 Martin Bldg.
Philadelphia 7, Pa. Chicago 1, Ill. Birmingham 1, Ala.

AIR COMPRESSORS, MIXERS, PUMPS, HOISTS, PAVING MACHINERY, TRUCK MIXERS — DISTRIBUTORS IN 130 CITIES



Homes and buildings now being planned and built with ModernAire Attic fans are investments in "Temperatures For Comfort" that will bring years of satisfaction and contentment to the owners.

ModernAire Attic Fans are famous for their expert engineering, fine construction and smooth, economical performance. Investigate now the advantages and costs of ModernAire Attic fans for builders. Write to . . .

**NATIONAL GAS
EQUIPMENT COMPANY, INC.**
P. O. BOX 443 TERRELL, TEXAS

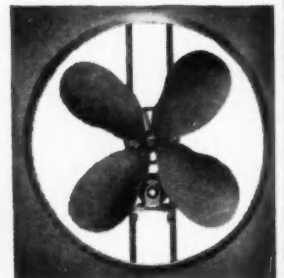

with a
**FORD
CEMENT BLOCK MACHINE**

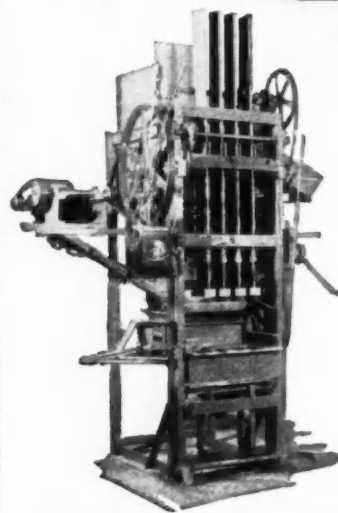

**FORD MACHINES CAN
TURN OUT FOUR - 8 x 8 x 16 -
BLOCKS A MINUTE.**

IT HANDLES SO EASILY,
THREE MEN ALONE, CAN MAKE
1500-1600 BLOCKS A DAY!!
MAKES 30 DIFFERENT TYPES
OF CEMENT BLOCKS!

**FORD MACHINES
MAKE A 37 LB. BLOCK
MEETING A.S.T.M. SPECIFICATIONS -
\$20 TO \$40 MORE PROFIT
PER 1000 BLOCKS!!**

FORD WRITE FOR INFORMATION
CEMENT BLOCK MACHINE CO.
DEPT. 25 CEDAR FALLS, IOWA

ORDER NOW IMMEDIATE DELIVERY!



SPEED LOAD

Streamlined for quick, clean, efficient application

Nu-CALK

"THE WORLD'S FINEST CALKING"

What a selling combination this is! The world's standard of calking quality *plus* the most efficient and practical calking load on the market. Adheres to almost any surface. Standard color is "off-white." Order now. IMMEDIATE DELIVERY guaranteed!

Nu-CALK Calking Compound is furnished in 1/2 pint, pint, quart, gallon, 5-gallon cans. Also 55-gallon drums.

SPEED LOADS packed 10 loads to a carton, 4 cartons to a case. Full freight allowed on 8 cartons or more.



MACKLANBURG-DUNCAN CO.

OKLAHOMA CITY 1, OKLAHOMA

SOLD ONLY THROUGH HARDWARE STORES, BUILDING SUPPLY DEALERS AND LUMBER YARDS

Sell Nu-Glaze instead of putty!



Nu-Glaze sells fast and repeats. It's the perfect material for glazing wood or steel sash, replacing putty, setting plumbing, filling cracks, boatwork of all kinds, and general patching purposes. Sets to a rubber-like consistency. Clean to handle... requires no working up. Cheapest material to use in the long run because it "stays put."

Furnished in 1/2 pint, pint, quart, 5 lb. and 12 1/2 lb. cans. Also in 25, 50, 100 and 880 lb. drums.

COMPARE THE FINISH

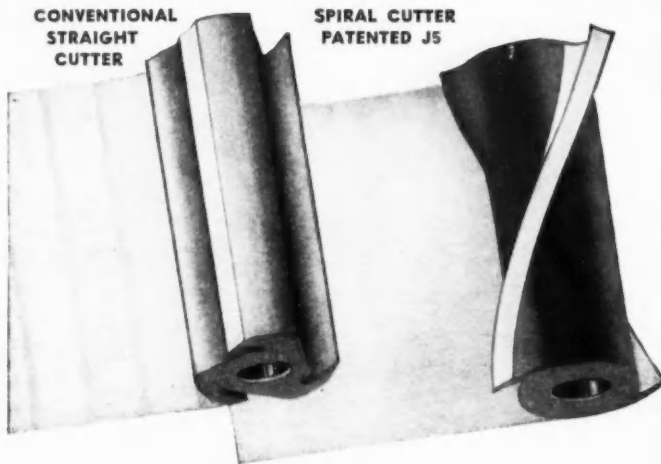

The STANLEY-CARTER J-5 POWER PLANE cuts Smoother and Faster with the Exclusive Spiral Cutter

NO MATTER HOW FAST you "hog off" the wood with a Stanley-Carter J5 Power Plane, you leave a smooth surface that needs no sanding. The patented spiral cutter shears off the wood at 18,000 R.P.M. It has to be smooth.

With a J5, you can handle door, sash, screen and similar work 3 to 5 times faster. Develops a full 1 H.P.—weighs only 16 lbs.—planes surfaces up to 2½" wide, depth to ¾"—takes straight or bevel cuts to 45°.

Write for Catalog, Stanley Electric Tools, Stanley-Carter Sales Dept., 534 Myrtle St., New Britain, Conn.

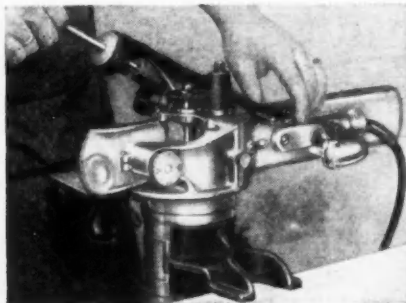

SHARPENS ITS OWN CUTTER—Just set it up in the Bench Bracket and use the simple Grinding Attachment.

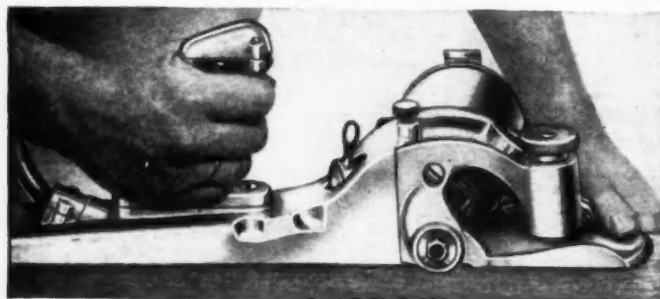

Reg. U. S. Pat. Off.

HARDWARE · HAND TOOLS · ELECTRIC TOOLS

NOW A BOND COAT THAT WILL



1. restore old walls and ceilings
2. bond tight to new dry wall

NU-WALL
PERMANENT bonding plaster

Easily applied NU-WALL tightly bonds to new dry wall, cracked, chipped, or painted walls, smoothest concrete and Spanish plaster.

NU-WALL being applied to rough brick painted surface of old building being readied for office and laboratory space.

wood trim. NU-WALL bonds permanently to any firm surface. No chipping, scratching or roughing required. A 1/8 inch coat will dry in about 24 hours providing a sturdy new wall ready for decorative finish.

On dry wall construction, joints must be properly taped before applying NU-WALL.

One bag of NU-WALL applied about 1/8 inch thick will cover 20 yards or more depending on roughness of surface.

SEND FOR COMPLETE INFORMATION TODAY

NU-WALL Manufacturing Company

923 N. 19th ST.

MILWAUKEE 3, WISC.

WEATHER-BLOC

(TRADE MARK REGISTERED)

INDIVIDUAL UNIT VENTILATORS for all GLASS BLOCK INSTALLATIONS

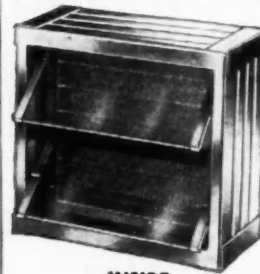

INSIDE

Made of Stainless Steel, WEATHER-BLOC conforms in size to standard glass blocks. Requires no special preparation, and takes no longer to install than a standard glass block.

Glass diffusers on the outside deflect wind, rain, and snow—16 mesh screen protects against insects and dirt. Glass louvres inside control amount of ventilation, and direction of air current.

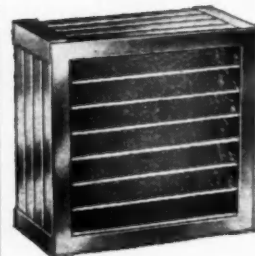

OUTSIDE

Ideal for that "New Look" in homes and offices—can also be readily adapted to industrial and commercial buildings.

Many architects thruout the U. S. and Canada are specifying WEATHER-BLOCs—they function perfectly and are priced right, for both client and contractor.

Give your clients the advantages these Modern Glass Block Ventilators offer.

AIR RECTIFIERS, Inc.

3734 SOUTHPORT AVE.

CHICAGO 13, ILL.

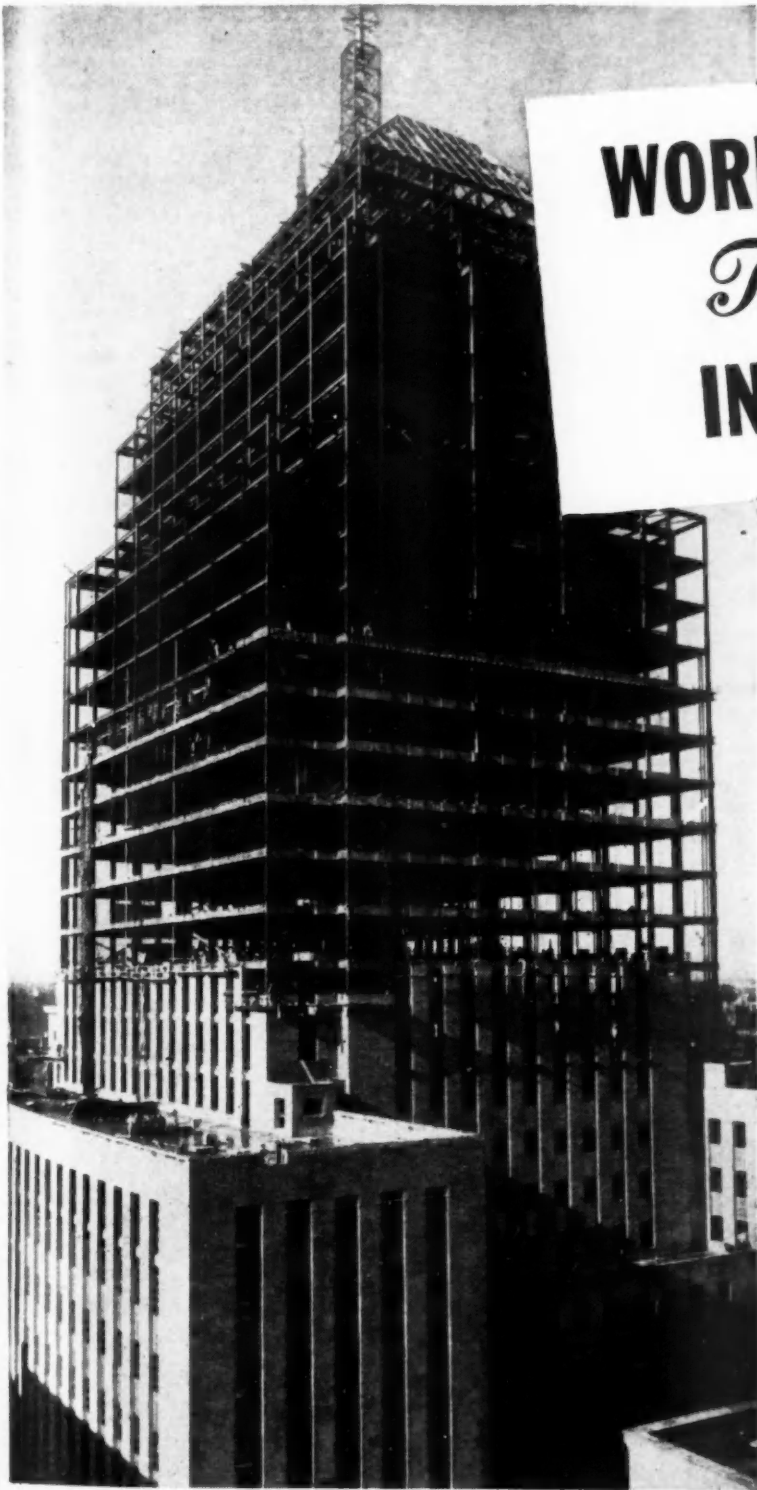

WORLD'S LARGEST *Thermopane* REG. U. S. PAT. OFF. INSTALLATION

John Hancock Mutual Life Building being glazed with 16,205 L-O-F Glass Insulating units for greater comfort, clearer vision. Architects and engineers for Boston's newest skyscraper chose *Thermopane* for all windows because it is the most modern glazing material available.

Providing year-round insulation, *Thermopane* is composed of two or more panes of glass, separated by a hermetically sealed air space. Its advantages include: more accurate and economic control of air conditioning equipment... reduced heat loss through glass... minimization of roomside condensation with controlled humidity and temperature... reduced sound transmission... and, of course, greater comfort. Because of *Thermopane's* metal-to-glass seal, dirt and moisture cannot enter the air space.

Thermopane is available through L-O-F Glass Distributors. Over 60 standard sizes facilitate its use in the windows of both new and old buildings.

Complete information available upon request. Libbey-Owens-Ford Glass Company, 1838 Nicholas Building, Toledo 3, Ohio.



• Every window opening in the 26-story, completely air-conditioned John Hancock Mutual Life Insurance Building in Boston is being glazed with *Thermopane* to provide maximum air conditioning efficiency. Architects: Cram & Ferguson, Boston. General Contractor: Turner Construction Co. Glass furnished by Boston Plate & Window Glass Co.



LIBBEY • OWENS • FORD
a Great Name in **GLASS**

ONLY LIBBEY-OWENS-FORD MAKES *Thermopane*

THE *look* THAT'S
ENJOYED FOR A LIFETIME



From the outside, a home built of Western Pines always "looks good" to its owner. For these fine, durable woods faithfully maintain through the years, the distinctive charm and values of the exterior architectural design.

Within, the home owner enjoys a sense of gracious living imparted by the mellow, paneled walls, fine cabinet work, and interior trim.

In all parts of the country architects are specifying, and builders are using the Western Pines with assurance. They know that these versatile, even-grained, soft textured woods will give any type of home the look that will be enjoyed for a lifetime. Western Pine Association, Yeon Building, Portland 4, Oregon



*These are the Western Pines

*Idaho White Pine *Ponderosa Pine
*Sugar Pine

These are Associated Woods

Larch • Douglas Fir • White Fir
Spruce • Cedar • Lodgepole Pine

Well manufactured—thoroughly
seasoned—carefully graded—
by all Association member mills

IT'S MORE ECONOMICAL
THAN YOU THINK...

... to provide comforting, early morning heat for bathrooms, bedrooms or nurseries. The quick-acting Electric Quikheter adds this touch of heating comfort to your home at a cost of only a few cents per hour of continuous operation... depending upon your local electric rate. Complete information is contained in our Bulletin No. 77.



"ELECTRIC"
FA QUIKHETER

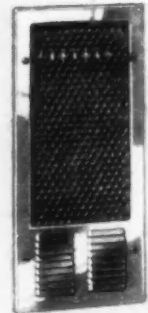

Frank Adam
ELECTRIC COMPANY
ST. LOUIS, MO.

Sedgwick

ELEVATORS AND DUMB WAITERS

ELECTRIC AND HAND POWER
OPERATION

DUMB WAITERS

CORRESPONDENCE LIFTS

UNDER COUNTER
DUMB WAITERS

FREIGHT ELEVATORS

SIDEWALK ELEVATORS

RESIDENCE ELEVATORS

STAIR-TRAVELORS

DUMB WAITER DOORS

PROMPT SHIPMENT

STANDARD SIZES

Write For New Catalog

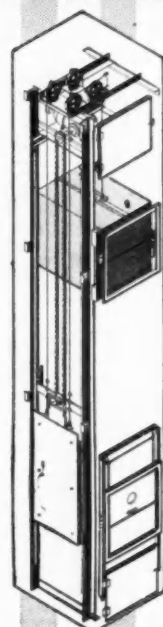

SEDGWICK MACHINE WORKS

Established 1893

154 WEST 15TH STREET NEW YORK 11, N. Y.



\$1200 SAVED in supervisory expenses alone!



The Practical Bible Training School now heats and supplies hot water to dormitories, classrooms and apartments with nine G-E Oil Boiler units.

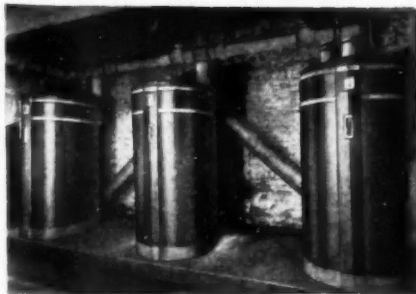

A group of three General Electric Boilers serving the school, linked as a unit gives multiplied economies and lower shut down risk.

A MULTIPLE INSTALLATION of General Electric Oil-Fired Boilers at the Practical Bible Training School, Bible School Park, N. Y., has lopped \$1,200 per year from the school's heating bill.

These G-E Boilers . . . installed in groups of two and three, as well as individually, have eliminated the need for constant operating supervision for heating as well as domestic hot water. The reliable G-E controls and safety features are completely automatic.

Multiple installations of G-E Boilers can mean major fuel savings, too. G-E design which permits many home owners to effect up to 50% fuel savings, helps provide savings when *more than one* unit is used.

There is less risk of complete shut down because part of the system can continue to provide heat while one or more units are being serviced.

Your General Electric Dealer will be glad to indicate how multiple installation economies can be applied to your building. Call him today. *General Electric Company, Air Conditioning Department, Section H8153, Bloomfield, N. J.*

GENERAL ELECTRIC

Automatic Gas and Oil Heat



CUTTING CORNERS?

We need more homes, for more people, more than ever before—and we salute all who put their shoulders to the wheel, to devise the ways and means to help this nation build faster than ever.

But, in the hue and cry of this strenuous period of post-war adjustment there is one grave danger. We must not only build, we must also build durably and well.

In our hurry we should not discard old and proven materials merely for the sake of "cutting corners".

Lime plaster is one of those materials that have served us for centuries. Yet no better material for finishing walls and ceilings has so far been devised. Its monolithic character is without equal. It is durable and fire-resistant. So don't "cut corners" the wrong way. Only a first class plastering job takes care of walls and ceilings, and of all the corners the right way.

When it comes to a choice of finishing lime consider the brands shown here, long known for consistent quality, always uniform, scientifically processed from the world's purest dolomitic limestone. Look for the red zig-zag stripes, your guarantee of quality.

The Ohio Hydrate & Supply Co., Woodville, Ohio



Easy-Lift SASH BALANCES

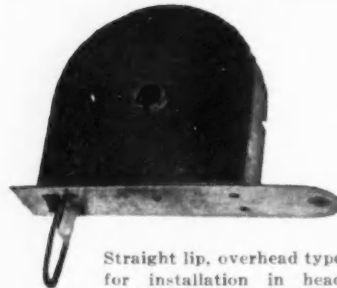



**No Finer
Sash Balances
Made—
Regardless
of Price!**

Straight lip, overhead type for installation in head jambs. Single or double installation. Rust resistant metal.

**Also Made In Side Type
and Turned Down Lip**

**NOTED
for its Uniform
Tension and
Smooth Operation**

Manufactured In the Following Weights:

 4 1/2 - 6 - 8 
10 - 12 - 14 - 16 lbs.

Circular
on Request

Prompt Delivery

DETROIT METAL PRODUCTS, INC.
1600 E. 10-Mile Road Hazel Park, Michigan

Customer Satisfaction Assured with easy-to-install

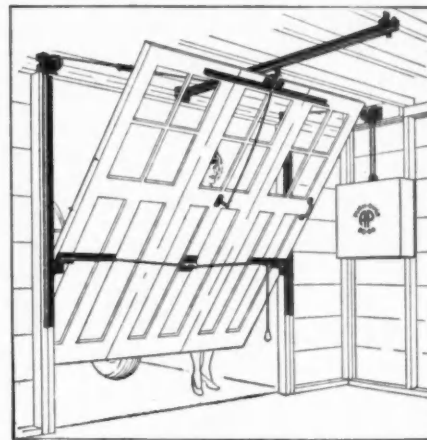

ALLITH

50-50 PUSH-OVER GARAGE DOOR HARDWARE

Heavy duty, well engineered garage door hardware. Result: a quickly installed, easily operated, overhead door. Designed to insure **customer satisfaction.**

ALLITH-PROUTY, INC.
DANVILLE, ILLINOIS

All over the house

Curtis makes it... Home!



SUNNY WELCOME: No matter how small the home or how modest the building budget, you can add the charm of a Curtis entrance. Always in good taste, built to precision standards, Curtis entrances are made in a wide variety of styles. Entrance at left is Curtis No. C-1731, a design by Willis

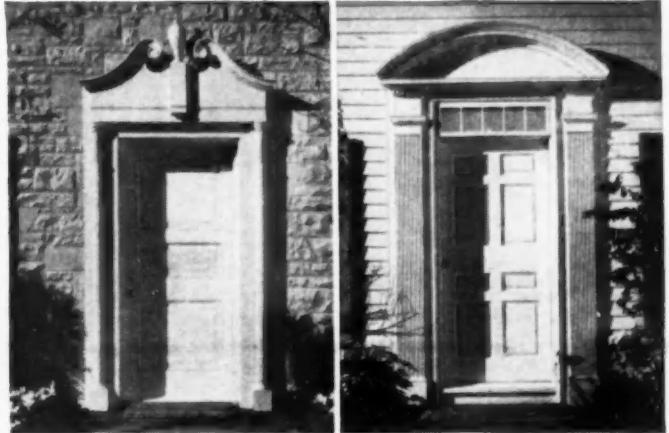

Irvin, architect. Second from the left is C-1730, the work of H. Roy Kelley, architect. Entrance in the stone wall is C-1701, designed for Curtis by architect George W. Stoddard. The fourth design, C-1724, is by Cameron Clark. All Curtis entrances are toxic, water repellent treated.



STORAGE PLUS CHARM! For books, prized china and *objets d'art*, Curtis china cabinets provide ideal storage. Shown here are only two of eighteen styles made by Curtis. Useful for dining rooms, living rooms and bedrooms. At the left is Curtis design C-6505, by Cameron Clark, architect; at right, C-6526, a design by architect H. Roy Kelley.



WARM HOSPITALITY! In today's homes, there's a trend away from the stark and bleak—a trend toward warmth and cheer. A Curtis mantel makes the utility of a fireplace beautiful. Curtis mantels "wear well" because they were soundly designed by leading architects, and have correct proportions and fine detail. At left is mantel C-6059, at right C-6049.

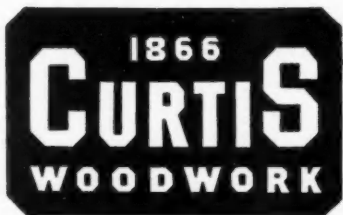

When in New York, visit the Curtis Woodwork Display at Architects' Samples Corporation, 101 Park Avenue

SEND FOR THE CURTIS WOODWORK BOOK!

Curtis Companies Service Bureau
 AB-3W Curtis Building
 Clinton, Iowa
 Gentlemen: Please send me your book on the new Curtis Woodwork line.

Name.....

Address.....

City.....State.....

I am () Architect, () Contractor, () Prospective Home Builder,
 () Student.
 (Please check above)

**THE
Thoro
SYSTEM**

Protects the Earth's Masonry

**Contractors and Builders
THOROSEALING
A
MASONRY SURFACE
KEEPS WATER
OUT OF YOUR WALL
SPRING RAINS
AND
MELTING SNOWS
ARE SURE TO COME**



WHY NOT

Send your men into the basement room during the cold, stormy weather and have it THOROSEALED and ready for the prospective buyer and the wet, stormy days to come.

Write today for Circular No. 17 which instructs, by photographic detail, how to keep water out of a masonry wall.

Request your Lumber or Builders' Supply Dealer in your home city to order for you.

Standard Dry Wall Products, Inc.
BOX X NEW EAGLE, PENNA.

EXCLUSIVE FRANCHISE

**SOME TERRITORIES
STILL AVAILABLE**

Nationally
Advertised

ALUMATIC

All-Aluminum
Combination

**WINDOW
and
COMPANION
DOOR**



Offered To Qualified Organizations
Selling Direct To Home Owners the
best-working aluminum window
with all these good features:

- ★ All aluminum construction with hollow sections for insulation value.
- ★ Complete self-storage and convenient, removable sill.
- ★ Double-Hung Design . . . open in any position.
- ★ Automatic-mechanical weatherstripping.
- ★ Telescoping sill for weather-tightness.

Our companion aluminum combination door embodies exclusive features that have created a tremendous impression wherever shown.

WRITE WIRE
PHONE

ALUMINUM BUILDING PRODUCTS CO.
1229 S. 41st Street Milwaukee 4, Wis.
Telephone EVERgreen 0243

An invaluable book

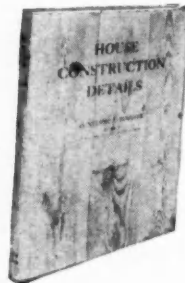

314 p.
1,500 illus.
index, 8½x11
cloth, \$4.00

for builders or others making alterations in a set of stock plans and when drawing up a complete set of plans. All aspects of house construction are clearly explained from the excavation of the foundation to the finished house with the aid of scale drawings and photographs carefully chosen to make each detail easily understood and arranged in logical construction sequence. Ready reference is aided by thorough system of indexing.

Many new building materials are shown and the various systems of pre-fabrication are presented as well as standard methods of carpentry work. The broad usefulness of the book is demonstrated by its wide acceptance by builders, instructors in vocational high schools, working carpenters and contractors.

CONTENTS

Floor Plans; Sets of House Plans—Excavations; Foundation Forms; Foundations—Sills; Girders; Joists; Sub-flooring—Outside Walls—Inside Walls; Wall Sheathing; Ceiling Joists—Roof Construction; Bay Construction; Roofing—Cornices and Porches—Exterior Wall Construction—Interior Wall Coverings; Interior Trim—Stair Construction—Windows—Doors—Hardware—Closets; Shelves; Built-in Equipment—Finished Flooring—Chimneys and Fireplaces—Scaffolds—Garages—Wiring for Modern Homes—Insulation; Sound Proofing—Gates; Garden Furniture—Camps; Cabins; Cottages—Farm Buildings—Painting and Finishing—Modern Homes—Modern Building Materials—Heating; Air Conditioning—Pre-fabrication. Index.

314 p., 1,500 illus., index, 8½ x 11, cloth, \$4.00

Book Service Department

American Builder and Building Age, 30 Church St., New York 7, N. Y.



When you're buying kitchens . . .

Top quality* is important

YOU CAN *always depend* on the top quality of Youngstown Kitchens. In fact, Youngstown quality helps the buyers of your houses to see *greater value in your prices*.

Every rugged Youngstown unit is a glistening, modern beauty . . . built to give years and years of satisfaction.

Youngstown Kitchenaider cabinet sinks, wall and base cabinets are welded, white-enameled steel . . . sound-deadened throughout . . . made to last a lifetime. Sink tops are finest acid-resisting porcelain-enamel.

Top quality . . . to the last letter!

And, Youngstown Kitchens are within your cost estimates, for houses large and small, because they're *mass-produced*. Every Youngstown unit is precision-built according to rigid standards established through more than 75 years of steel-stamping experience.

Sixty Mullins field men and 7500 trained Youngstown Kitchen dealers throughout the country are ready to cooperate with you . . . give you the advantage of Youngstown's great experience and pioneering in the kitchen business. For name of nearest distributor or field man, please write



OTHER YOUNGSTOWN FEATURES

- Easy installation
-
- Sold everywhere
-
- Easy handling
-
- Low cost
-
- Modern styling
-
- Wide selection
-
- National acceptance

MULLINS MANUFACTURING CORPORATION • WARREN, OHIO



Youngstown Kitchens

BY MULLINS

World's largest makers of steel kitchens

18.
as
e
w
ow
nf,
ny
ng.
em-
a
Vis.
era-
men
ans.
are
ion
use
pho-
each
ged
eady
tem
are
pre-
l as
ork.
k is
e by
high
con-
orms;
alls-
ction;
Wall
Con-
ult-in
ffolds
roofing
Build-
ilding
N.Y.

Quality is here in
TILETONE'S
MODERN DESIGN
SHOWER CABINETS
Model 75

Here is quality in shower cabinets that's never been known before. Tiletone has designed new modern machinery to manufacture shower cabinets of MODERN DESIGN! Tiletone's Model 75 is the result of better manufacturing methods. It's unexcelled in quality with improved receptor base—longer lasting finish.

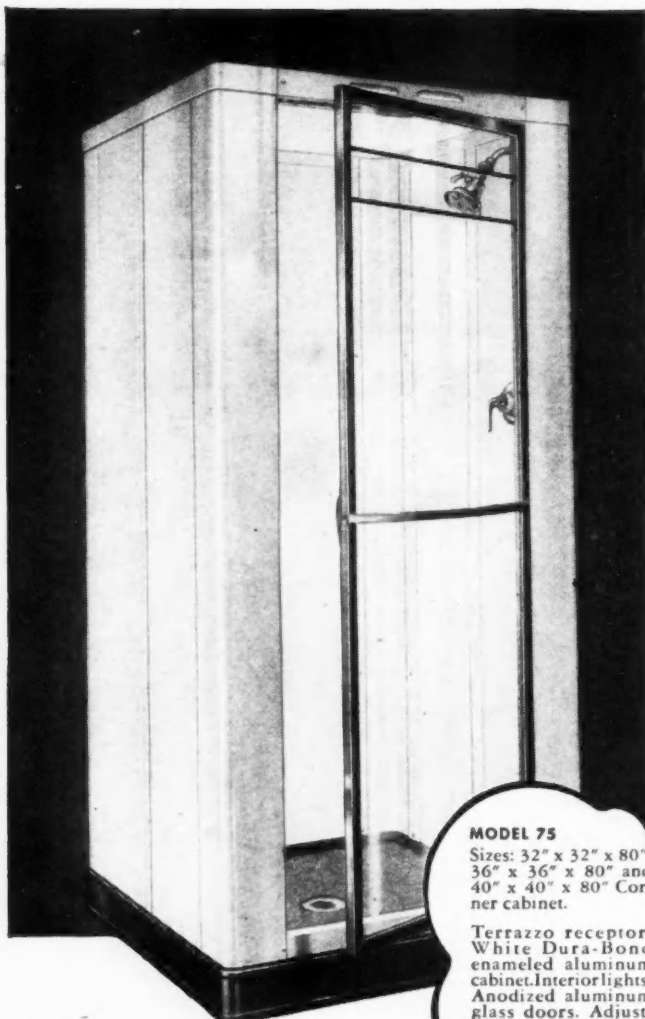

MODEL 75
 Sizes: 32" x 32" x 80",
 36" x 36" x 80" and
 40" x 40" x 80" Corner cabinet.

Terrazzo receptor. White Dura-Bond enameled aluminum cabinet. Interior lights. Anodized aluminum glass doors. Adjustable shower head. Dial type mixing valve.

TILETONE
Shower Cabinets

TILETONE COMPANY
 2323 WAYNE AVENUE • CHICAGO 14, ILLINOIS

FRYING ONIONS
 is a **BUILDER'S PROBLEM**

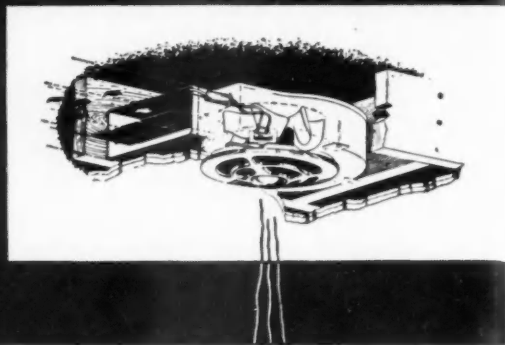

WHISK OUT OFFENSIVE ODORS
 . . . REMOVE THE CAUSE WITH

BLO-FAN builds into the kitchen ceiling...directly over the range—where a fan belongs. Its patented blade expels greasy cooking fumes and odors with astonishing efficiency as they rise—before they spread.

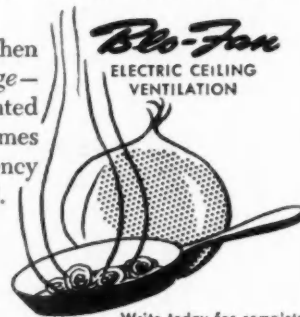

Blo-Fan

more than a fan... more than a blower

PRYNE & CO., INC.

LOS ANGELES 54, CALIFORNIA

CHICAGO

NEW YORK

Write today for complete Blo-Fan information and the address of your nearby distributors.

THE KITCHEN VENTILATING FAN THAT'S DIFFERENT—THE KITCHEN-AIRE!

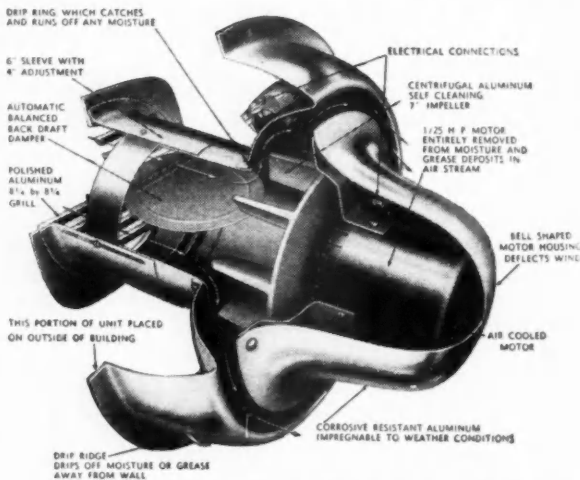

HOW AND WHY KITCHEN-AIRE IS DIFFERENT

- Equipped with CENTRIFUGAL TYPE HEAVY DUTY ALUMINUM IMPELLER.
- Motor is out of air stream—insuring cleanliness.
- Operating unit located exterior building—fully protected in rustproof non-corrosive attractive aluminum housing against all weather conditions.
- Adaptable to a wide diversity of locations—either ceiling or wall.
- Simple inexpensive wall or ceiling installations. Standard 6" duct provides convenient duct connecting intake grill to exhaust unit, no special costly ducts to order. No waiting as 6" pipe is readily available anywhere. Installations on exterior walls require no duct.
- Back draft BALANCED damper automatic in operation—no shutter to open—no chain to pull.
- Handsome small polished aluminum intake grill readily lends itself to any interior kitchen color scheme—easily cleaned. PATENT PENDING.

Contractors, if your Electrical Distributor does not have Kitchen-Aire write us!

STEWART MANUFACTURING COMPANY
 3204 East Washington St., Indianapolis 1, Indiana

"We find Atlas Mortar Cement to be exactly what we like in a masonry cement. It is as smooth as silk and as plastic as butter. The way it spreads with a trowel, it is a real pleasure to handle."



After-the-job comments on

ATLAS MORTAR CEMENT

Contractors and masons praise Atlas Mortar Cement. They like its rich, fat plasticity. They also appreciate its yield, its water retention, strength, durability and color.

Backed by years of research, Atlas Mortar Cement complies with ASTM and Federal specifications for masonry cement.

"In my thirty years' experience as a brick mason, I have never seen a prepared masonry cement that works as well as Atlas Mortar."



"... it has a yield that lays a lot of units per bag. We have never seen anything better."



OFFICES: Albany • Birmingham • Boston • Chicago • Cleveland
Dayton • Des Moines • Duluth • Kansas City • Minneapolis
New York • Philadelphia • Pittsburgh • St. Louis • Waco

For further information, write
Universal Atlas Cement Company
(United States Steel Corporation Subsidiary), Chrysler Building,
New York 17, N. Y.

AB-MC-16

SKILLED HANDS PREFER

ATLAS MORTAR CEMENT

THE SAIN OF MASONRY CEMENTS

"THE THEATRE GUILD ON THE AIR"—Sponsored by U. S. Steel Subsidiaries—Sunday Evenings—ABC Network

Do Precision Sawing...

- ON THE JOB
- IN THE SHOP

with H & A WOODWORKING TOOLS

Wherever exacting performance is required—in the shop or on the job—H & A Woodworking Tools can be used to advantage. Their up-to-date design and high quality workmanship make each tool a long term investment that pays off in increased efficiency . . . lower operating costs . . . and longer service.

Write AT ONCE for further information

NEW H & A MODEL 5 SWING CUT-OFF SAW

Now equipped with latest Fairbanks-Morse 1 H.P. motor. Uses no weights or springs—motor weight balances beam and blade . . . assures free, easy swing . . . automatically returns blade to resting position. Any unskilled worker can operate it safely and successfully. Has 10" blade for 3" x 12" capacity. Other models with capacities up to 4" x 14" and 5" x 16".

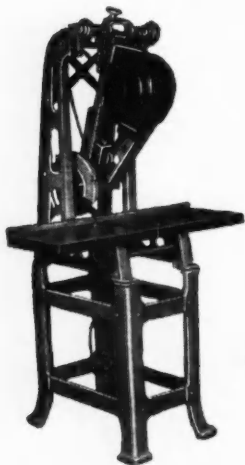

H & A 6" JOINTER

Finest available—makes precision planing, edging, rabbeting, relieving, and chamfering easy. Sturdy, cast iron construction for vibrationless operation. Solid steel cutter head—fitted with 3 high speed steel knives—spins in life-sealed ball bearings at 6000 r.p.m. Extra long 42"x60" tables are stress released to remain level and in perfect alignment with cutter head.

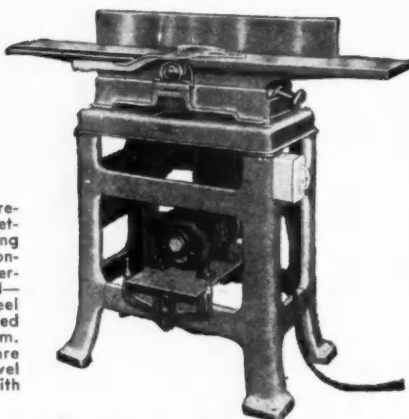

Other H & A Quality Woodworking Tools include the H & A 14" Band Saw and the H & A Woodmaster

Heston & Anderson

Founded in 1921



608 W. Kirkwood St., Fairfield, Iowa

for Easier Installation

for Longer Life!

SPECIFY
Hidalift
THE 100% CONCEALED SASH BALANCE

Plough the sash, attach two screws and Hida-lift is installed . . . as easy as that! The self centering guide bushing maintains perfect balance, prevents jamming and eliminates the need for templates in installation. The tension spring is sealed inside the tubing to prevent wear caused by dust. Home owners appreciate the trim architectural lines made possible by the elimination of bulky, drafty sash weight boxes . . . approve Hida-lifts "100% Concealed" feature.

WRITE for completely descriptive literature which includes installation details and lists sizes and specifications to fit all standard sash.

THE TURNER & SEYMOUR MFG. CO.
TORRINGTON, CONN.

PLASTER AND MORTAR MIXERS

- ★ Low shoveling height.
- ★ Built-in safety grating.
- ★ Triple mixing hoes with adjustable blades.
- ★ Renewable drum liner.

Built in six and ten cubic foot sizes for mixing lime and cement mortars—Patent plaster with hair or fibre—Dry concrete, etc. See your CMC Distributor or write for more details.

CONSTRUCTION MACHINERY CO'S. WATERLOO, IOWA

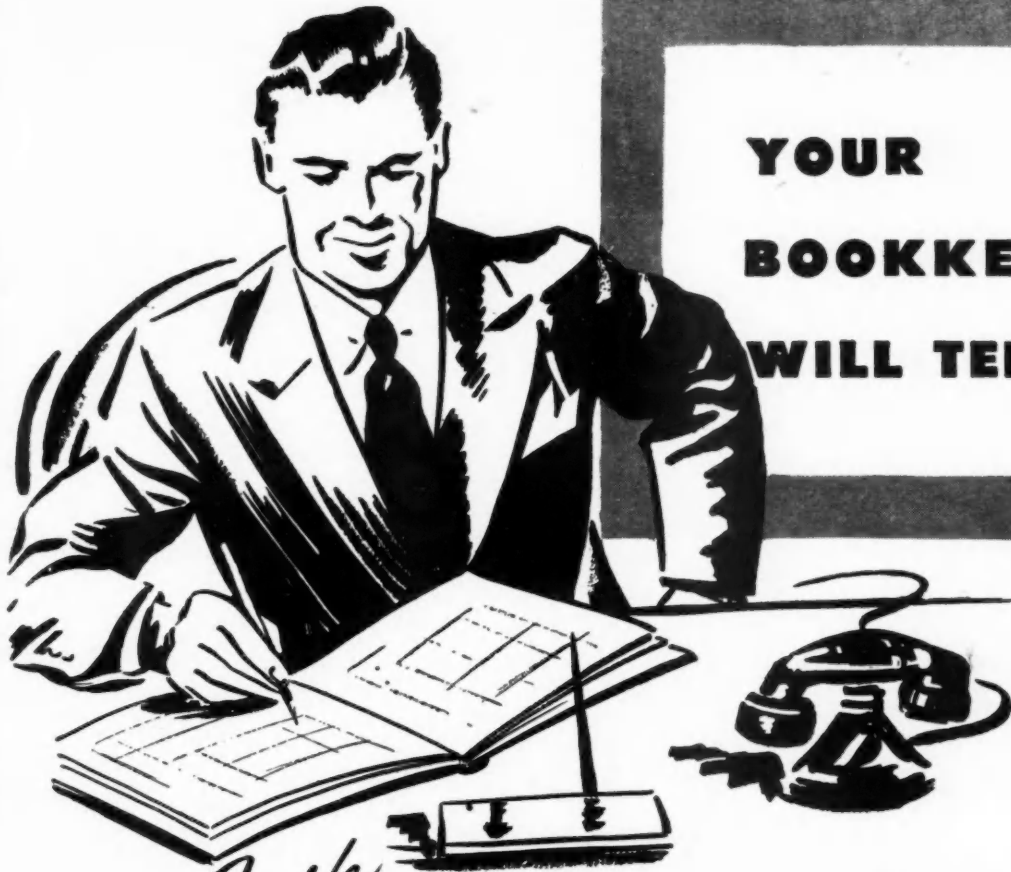

**YOUR
BOOKKEEPER
WILL TELL YOU!**

THE *Inside* STORY OF **Cotton Insulation**

**SELL MORE
INSULATION JOBS
AT MORE PROFIT
PER JOB**

Turn prospects into strong booster-customers — sell rings around competition—learn "The *INSIDE* Story of Cotton Insulation." Pass it on to employees—use it for increasing your insulation sales and profits.

WRITE for
your copy now—
IT'S FREE!



Cotton Insulation jobs show up on the right side of the ledger! Savings in your costs of storing, handling, and installing this featherweight, flameproof insulation swell the total in your profit column.

Cotton Insulation may be compressed in storage to conserve space—it fluffs up again to original thickness when released. Featherweight Cotton Insulation is easy to handle. It comes in one long blanket to the roll. Installation is fast—simple as unrolling a rug.

Get the complete story of the many more *INSIDE* advantages Cotton Insulation offers you and your customers. Send now for your free copy of "The *INSIDE* Story of Cotton Insulation."

**NATIONAL COTTON COUNCIL OF AMERICA
COTTON INSULATION ASSOCIATION**

National Cotton Council, Dept. B
Box 18, Memphis 1, Tennessee

Please send "The *INSIDE* Story of Cotton Insulation."



Name

Address

CityState

Universal LEVEL-TRANSIT



**MOST PRACTICAL
ALL-AROUND BUILDER'S
INSTRUMENT
EVER DESIGNED!**



Highly accurate, amazingly rugged, the Universal Level-Transit does all survey and check-up operations in building and road construction!

Quickly convertible from level to transit, its novel type of design protects parts which were formerly exposed to damage and inaccuracies. Other features include: a patented ball-bearing race, lock and release lever system, and perfect alignment adjustments.

12" Telescope, 25 power, horizontal guarded circle, Verniers to 5 minutes, Vertical arc, 3".

Write today for full details and free booklet "How to lay out building lots."

We repair all makes of instruments



**MANUFACTURERS OF
INSTRUMENTS FOR ENGINEERS,
SURVEYORS AND BUILDERS.**
311 West Court St., Milwaukee 12, Wis.



**A Scott LAWN
is a good sign of
client satisfaction**

It's easy to build a reputation for completing homes and industrial projects with lawns which are everything your clients hoped for. **Especially if you specify Scotts Lawn Seed and Turf Builder.** To help you with your planning, grading and seeding operations, send today for a complete volume of "Lawn Care" bulletins. It's FREE! Our soil experts are also at your service, no obligation of course.

O M Scott & SONS CO., 101 Spring St., Marysville, Ohio
Also Ridgfield, N. J. and Palo Alto, Calif.



**SPECIFY Scott GRASS SEED
AND TURF BUILDER FOR FINE LAWNS**



**NO NAILS • NO BOLTS
needed to make
Safe SCAFFOLDS**

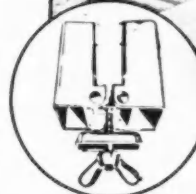
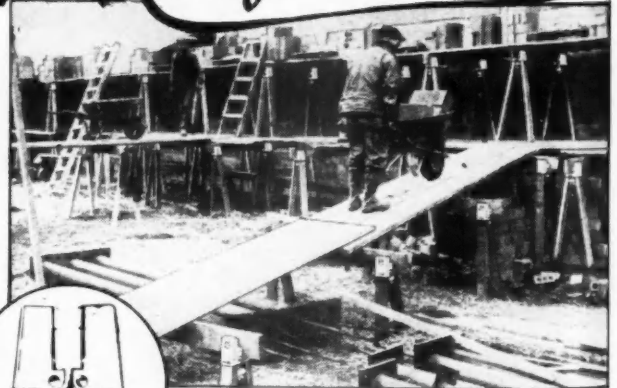

Use **PATENTED
DU-ALL SCAFFOLD
BRACKETS**

TO MAKE SCAFFOLDS ON JOB—ANY HEIGHT

NO STOCK TRESTLES. Save time and money. Use Standard 2" lumber, build safe scaffolds on the job — quick, easy with DU-ALL BRACKETS. No damage to lumber. 12 gauge steel, anti-slip lugs. Used by general contractors, masons, plasterers, etc.

Write for free information on how to cut your costs with DU-ALL. Some excellent territories still available.

DU-ALL SCAFFOLD BRACKET COMPANY
DEPT. M, 44 EAST BROAD STREET COLUMBUS, OHIO

NOW... a prefabricated door-frame assembly

-with a new and ingenious checking floor hinge

The new Pittsburgh Checking Floor Hinge is an engineering triumph. The case and cover are drop-forged. All main working parts are hardened and ground to steel, and all bearings are anti-friction precision-ground. In operation, it has many exclusive advantages, including positive door-speed control; separate checking control; built-in hold-open feature, and many others.

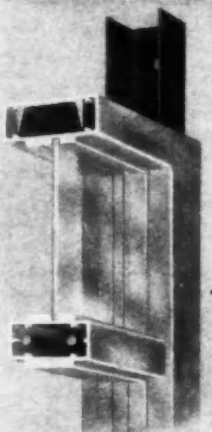
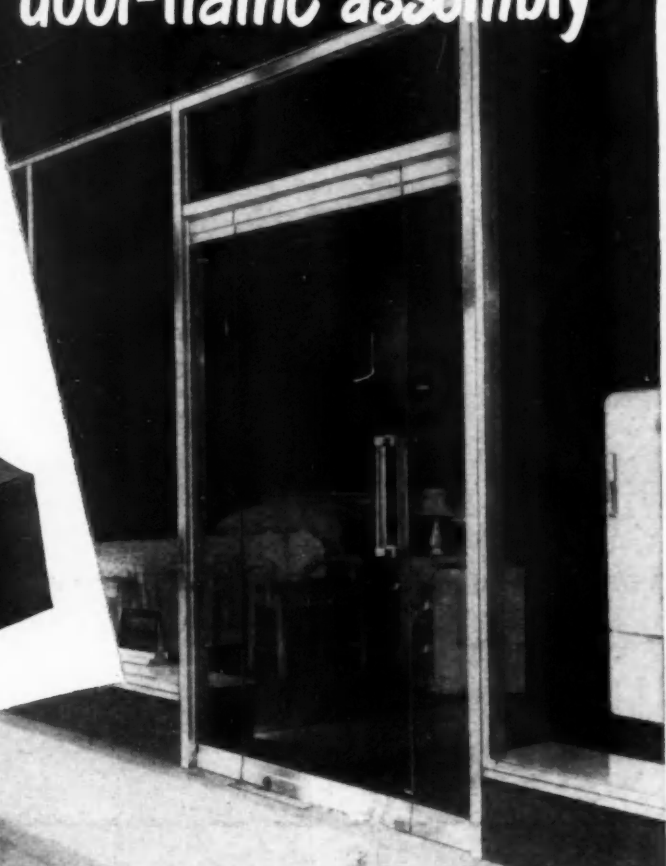
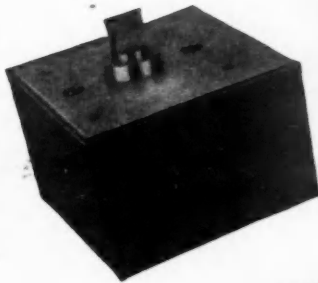

Frame is made of extra-heavy extruded aluminum - highly polished and anodized. Steel channels and tie rods heavily reinforce the frame, as partially shown here.

SPECIFICALLY designed to be used with each other, "Pittsburgh's" revolutionary new Door-Frame Assembly and the equally unique checking floor hinge—are developments of great importance to architects, contractors, chain store executives, and retail merchants.

"Pittsburgh's" new Door-Frame Assembly has beauty, ruggedness. It's a "packaged" construction, affording utmost ease of installation. It's supplied complete with checking floor hinges and top pivots, ready to bolt into the rough building opening. It's constructed to accommodate standard Herculite Tempered Plate Glass doors. All clearances on the frame and doors are controlled by accurate factory gauges.

These features make possible its simplicity of installation: When the building is ready to receive the doors, they are simply set on the hinge pivot, the top pivot is dropped

into the top channel, and the entire structure is complete.

That's all there is to it! No bothersome details of setting and fitting; no time- and labor-consuming details about clearances and other matters; no custom-made frames requiring scores of different materials and trades to install.

Get the full story on "Pittsburgh's" new Herculite Door-Frame Assembly—with all its marvelous design characteristics—simply by filling in and returning the coupon below.

Pittsburgh Plate Glass Company
2075-8 Grant Building, Pittsburgh 19, Pa.
Without obligation on my part, please send me your descriptive literature on "Pittsburgh's" new Herculite Door-Frame Assembly.

Name.....

Address.....

City..... State.....

HERCULITE DOOR-FRAME ASSEMBLY



PAINTS • GLASS • CHEMICALS • BRUSHES • PLASTICS

PITTSBURGH PLATE GLASS COMPANY

That NEW Look



There's a smart Barrows "Modern" for almost any of the many new ideas in interiors and exteriors. And bear this in mind: All Barrows "Moderns" keep that new look after years of use. That's because of the basic metals—brass and bronze—that are used, plus our own special skill in the making. Barrows pleases the builder because it's easy to install, and pleases the owner because good hardware, well installed, always means lasting pride.

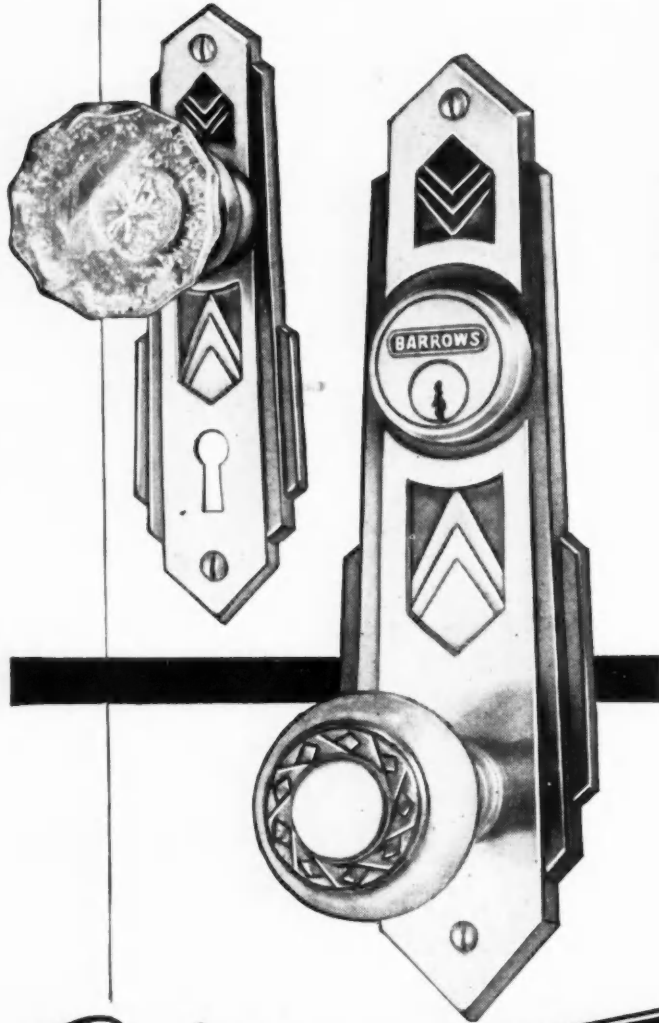

Bank on
BARROWS
 NORTH CHICAGO, ILLINOIS

Majestic

BUILDING NECESSITIES

featuring the smoke-free

CIRCULATOR FIREPLACE

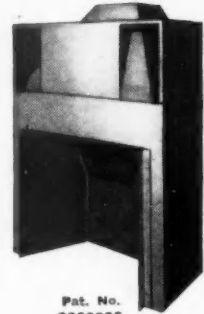

Pat. No. 2363026

Step up your profits with this budget-priced fireplace package. The Majestic Circulator is a strongly built, all-metal core that fits any mantel structure. Sends *smoke-free* heat to all corners of the room. The heat can even be piped to other rooms. Saves high-cost furnace operation in chilly fall or spring. Serves as sole source of heat for small homes in mild climates. The ready-to-install Circulator has all necessary operating parts built in, including dome damper with patented, easy-to-use poker control. Prompt delivery on all sizes. Send for details now.

The Majestic Co.

834 Erie St., Huntington, Ind.

Majestic Building Products—nationally known and advertised for over 40 years.

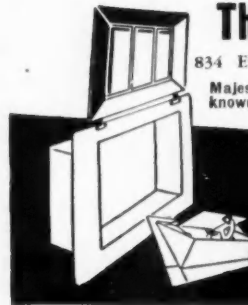

How to be *Sure About Costs*

When You Estimate a Building Job

THE SIMPLE TAMBLYN SYSTEM OF ESTIMATING REDUCES BUILDING MATERIALS and LABOR COSTS TO EASY-TO-USE FACTORS!

Do you get that *creepy feeling* about your estimates? Why take a chance when you can be sure? Just multiply by our simple factors to determine your labor and material costs. The Tamblyn System is simple, fast, accurate, complete and dependable!

YOU MAY SAVE MANY TIMES ITS LOW COST IN ONE USE!

In order to get your share of profitable building contracts, you must be able to figure jobs fast and accurately. You must be sure your estimate is just right—low enough to get the job—high enough to give you a reasonable profit.

USED BY SUCCESSFUL CONTRACTORS FOR OVER 40 YEARS!

Many of the largest and most successful contractors in the United States and Canada—thousands of them—have used the Tamblyn System of estimating. It is tried and tested—it has been used for more than 25 years. Forty years of experience in construction and building is behind it. And you can study the system for 10 days without cost.

TEST THE TAMBLYN SYSTEM IN YOUR OWN OFFICE WITHOUT OBLIGATION

Send the coupon below for your complete Tamblyn System. Examine it in the privacy of your own home or office for 10 days. Try it on new jobs—check it against completed jobs. There is no obligation unless you keep it.

SEND NO MONEY—TRY IT FOR 10 DAYS FREE!
 THE TAMBLYN SYSTEM, JOHNSON BLDG., A15, DENVER, COLO.

THE TAMBLYN SYSTEM, JOHNSON BLDG., A15, DENVER, COLO.
 Send me the complete Tamblyn System on free 10 days trial! If I like it I will pay \$8.75 when 10 days are up and \$7.50 per month until \$38.75 is paid. Otherwise I will return it.

NAME _____
 ADDRESS _____
 CITY _____ STATE _____

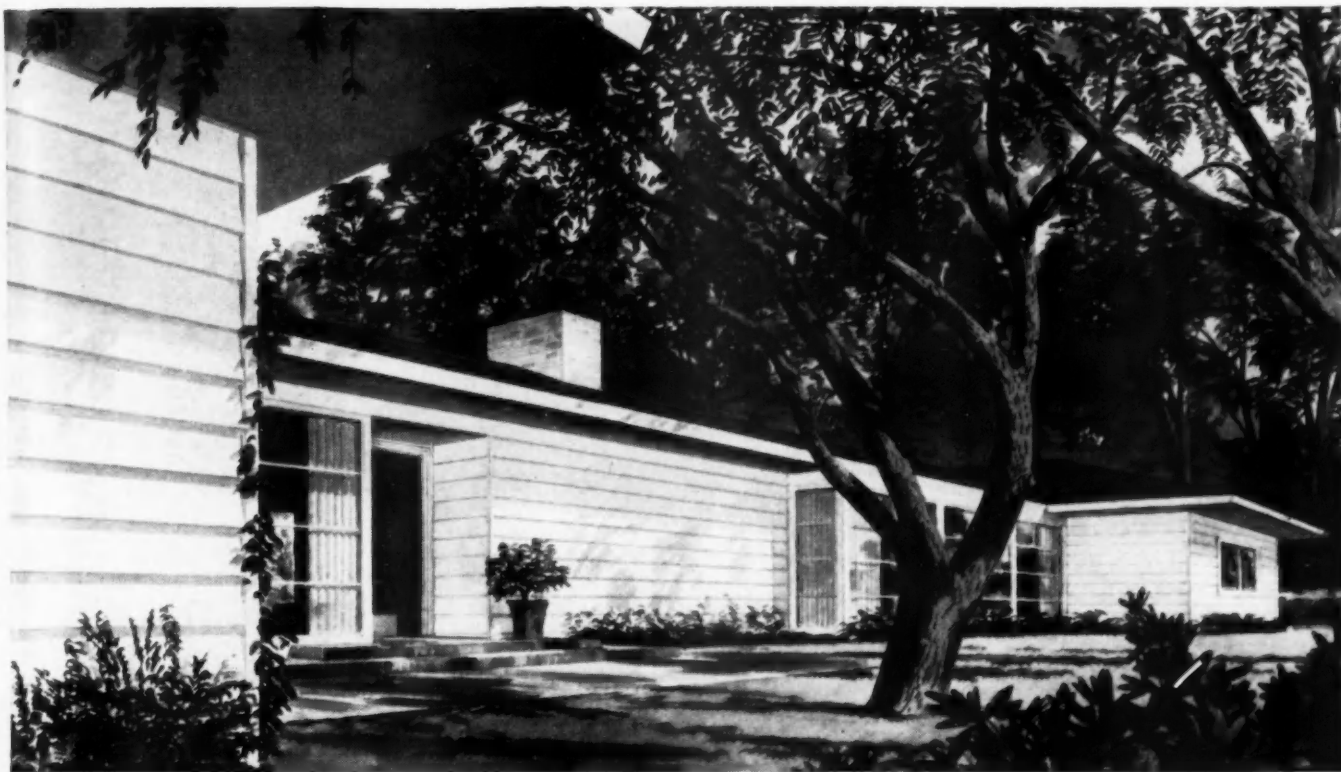

NEW! A better building material at no increase in cost!

One look at this new Kaiser Aluminum clapboard Siding and Roofing and we think you'll agree—

it is better looking, stronger, more weathertight, more durable than any other siding and roofing on the market!

We know that to be a fact, because our

engineers investigated every known design in order to select the one that proved itself superior on every count.

Made of full hard Kaiser Aluminum, each section is absolutely uniform. When nailed down, the curved surface creates a tension which results in a *weatherproof lock!* No other siding has this feature!

Prime-coated for painting, it easily takes finishing coats... in fact, the appearance of paint is enhanced. And you save costs all down the line. On handling, erection, nails, paint, and elimination of waste.

Today—wire, write, or phone any Permanente Products' office below for a free folder giving all the facts!

Kaiser Aluminum

SIDING AND ROOFING

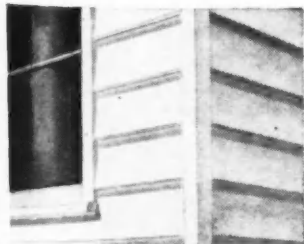

The concave surface gives maximum strength, ultimate rigidity, provides deep shadow lines.



Applied from top to bottom, each section locks with a spring action, assures weather tightness, no rattles.



Gives on-the-job savings in labor, nails, paint, elimination of waste. Can be worked with regular wood tools.



Roofing has all the features of the siding and can be applied at lower cost than shingles.

A Permanente Metals product

SOLD BY PERMANENTE PRODUCTS COMPANY, KAISER BLDG., OAKLAND 12, CALIFORNIA... WITH OFFICES IN:
 Atlanta • Boston • Buffalo • Chicago • Cincinnati • Cleveland • Dallas • Detroit • Kansas City • Los Angeles • Milwaukee
 Minneapolis • New York • Oakland • Philadelphia • Seattle • St. Louis • Wichita

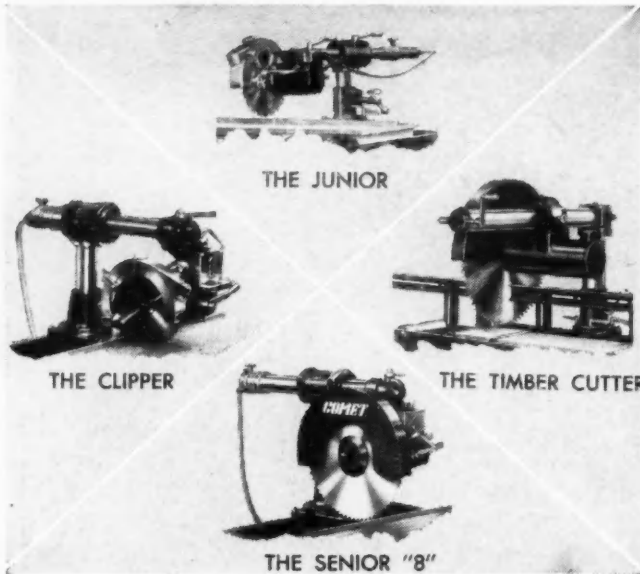

THE JUNIOR

THE CLIPPER

THE TIMBER CUTTER

THE SENIOR "8"

COMET Performance
CAN BE *Duplicated*
only by **COMETS**

The widely heralded, highly praised Comet all around, power cutting performance is the very exclusive feature of these famed machines. Only Comets can perform like Comets. Such excellent superiority has been achieved by years of research and engineering, and from an inestimable period of time in purposely difficult field testing. Indeed, the Comets you buy today, as always, will give you "more cuts per dollar." Order from your dealer, or write direct.

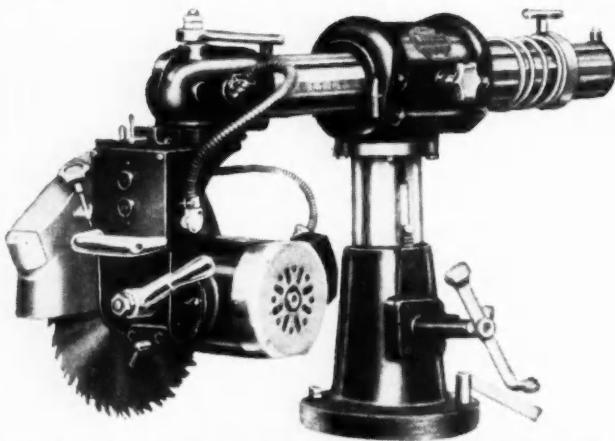

CONSOLIDATED MACHINERY & SUPPLY CO., LTD.
2029-33 Santa Fe Avenue, Los Angeles 21, California

COMETS cut quicker

\$SAVE WITH \$SMITH

3 1/2-S TILTER

The champion of small mixers. Built like the world-famous Big Smith Tilters. Equipped with air-cooled or water-cooled engine, fully enclosed, easily accessible. Other features include: simple rope starter, big wide feed chute, fast "tilt and pour" discharge.

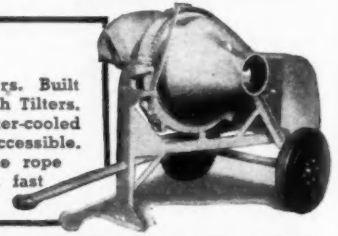

11-S TRAIL-SMITH

Compact, sturdy, trailer-type non-tilt mixer with air-cooled or water-cooled engine, spring-mounted axle, roller bearing automobile wheels, automatic skip vibrator and enclosed gear reduction. Tows behind truck at fast speed. Also available in 11-S, 4 wheel, and 6-S, 2 wheel, end discharge models.

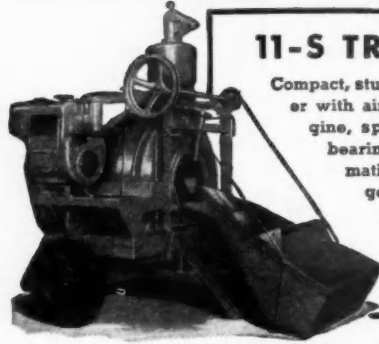

SPECIFY SMITH MIXERS for that next concrete job and save money. All Smiths are backed by 47 years mixer building experience. They last longer . . . cost less to operate.



Write for literature.
THE T. L. SMITH COMPANY
2849 N. 32nd Street • Milwaukee 10, Wisconsin

MIXERS

Famous for Performance on the World's Greatest Projects

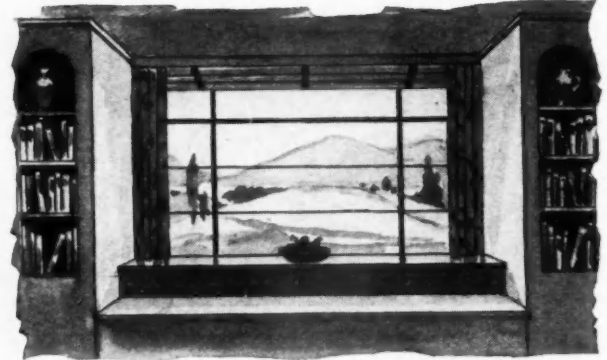

ILLUSTRATED ABOVE IS NEW *Lemo* PANORAMIC VISUALITE CASEMENT WINDOW CAT. TYPE 4423 VMR (Builder's Price) \$19.97 **DELIVERED FROM STOCK**

All Panoramic Visualite Windows are **EXCLUSIVELY Lemo** and cannot be furnished elsewhere.

Write for New 1948 Catalogs or see "Sweets"

AMERICA'S OLDEST CASEMENT WINDOW MANUFACTURER

CROFT STEEL PRODUCTS, INC.
JAMESTOWN, N. Y.

Head Off Headaches in Dry Wall Construction!

Use Reardon's Joint Cement with its "BALANCED FORMULA"



You take the gamble out of dry wall construction when you use Reardon's Joint Cement. The specifications of this joint cement were written on the firing line—by men who knew what they wanted. Reardon chemists filled the bill with a product that does its job without alibis.

A balanced formula is the answer and tests under scorching sun and sweaty humidity prove it. Reardon's Joint Cement puts real satisfaction into dry wall jobs. Try it yourself and see why the balanced formula is winning new friends every day for Reardon's Joint Cement.

4 Advantages of Reardon's "Balanced Formula" Joint Cement..

1 Ease of application

You save time because it works so smoothly.

2 Tight strong joints

Never any loose tape to worry about.

Every Bag Exactly the Same

Because Reardon checks each shipment of raw material—because laboratory technicians sample and analyze each batch that's made — Reardon's Joint Cement never varies. The Balanced Formula stays balanced.

Order From Your
Distributor Of Bondex Cement Paint

3 Ease in sanding

Operation simplified with no sacrifice of quality.

4 Lasting results

Dry wall jobs that last for years to come.

Reardon's **JOINT**

THE REARDON COMPANY



CEMENT

2206 N. SECOND ST. • ST. LOUIS 6, MO.

FREE! SEND FOR REARDON'S "SHORT COURSE ON DRY WALL CONSTRUCTION"

Wal-lite

THE NEW IMPROVED—DECORATIVE WALLBOARD
makes old walls NEW
 and
new walls BETTER

To Be Used Here

RESIDENTIAL ROOMS

Bath, Kitchen, Breakfast Nook, Recreation, Laundry, Utility, Butlers Pantry, Sun Porch, Library, Den, Hallway and many others.

COMMERCIAL

Bath, Kitchen, Washroom, Food Store, Meat Market, Hospitals, Schools, Barber and Beauty Shops, Cafeterias, Restaurants, Offices, Cocktail Lounges, Taverns, Night Clubs, Club Rooms, Church Recreation and Class Rooms and many others.

BEAUTY and DURABILITY . . .

are the excellent qualities accounting for Wal-lite's rapid acceptance by a constantly increasing number of dealers, contractors and builders. Consumers, too, are pleased with Wal-lite. For renewed beauty of old walls and the enrichment of walls in new structures, Wal-lite has all the desired qualities and decorative features.

Installs Easily - Quickly

Wal-lite can be applied to any smooth dry wall or ceiling surface quickly and easily. A fine toothed saw does the cutting easily and application is quick and permanent with Wallace Wallboard Adhesive No. 630. Three standard size panels eliminate much waste and unnecessary cutting on the job.

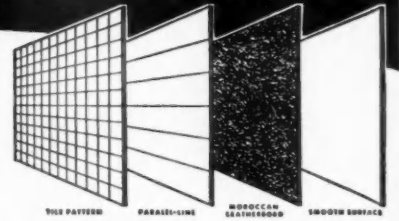

4 Distinctive Patterns
10 Delightful Pastel Colors
and White

DISTRIBUTED Through
LUMBER and BUILDING
MATERIAL DEALERS

Manufactured by . . .

WALLACE MANUFACTURING CO.
 10th and FAYETTE • NORTH KANSAS CITY, MO.

DUNTILE

World's Most Beautiful Roof

Can be Your Outstanding

Manufacturing Opportunity

You can earn big money in the Duntile business—100% to 150% mark-up on basic costs. You can manufacture for a selective market—uncrowded and minus price-competition—because Duntile is exclusive and much-wanted.

Duntile is the world's most beautiful roof. With all the safety, endurance and economy of masonry at its best. Wide range of smart, fused-on colors. French or Spanish type. Truly the roof that every owner wants.

Swing into Duntile production NOW. You may already have some equipment that can be utilized. Manufacturing is easy, interesting, profitable. We supply all machinery necessary. Instruct you fully. Back you with aggressive cooperation. Write for *Manufacturing Analysis* which gives cost and profit data, etc.

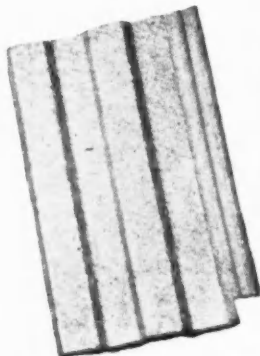

W. E. DUNN MFG. CO.
 430 W. 23rd Street
 Holland, Mich.



- DESIGNED FOR HARD, EVERYDAY USE.
- STURDY
- SMOOTH OPERATION

School Hardware

• A complete dependable line of builder's hardware backed by 70 years of manufacturing experience.

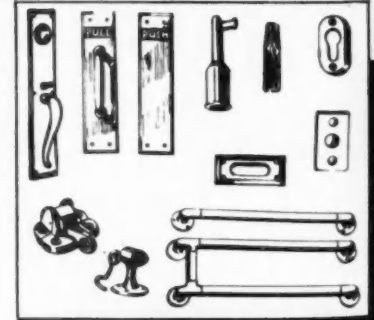

Send for illustrated catalog

SKILLMAN HARDWARE MFG. COMPANY
 TRENTON 4, N. J.

Why The Kitchen Is Today's "Measure Of Value"



Prices Look Lower Through The Windows of Hotpoint All-Electric Kitchens

ALERT ARCHITECTS and builders find there is "magic" in modern electric kitchens. For the tremendous impact of powerful advertising has made Americans thoroughly kitchen conscious. Today, buyers are apt to judge the value of the house on the merit of the kitchen.

Within the past three years Hotpoint has received over 2,000,000 inquiries about All-Electric Kitchens. Pioneer of the modern electric kitchen, Hotpoint has designed new and revolutionary appliances that make the kitchen a real showplace.

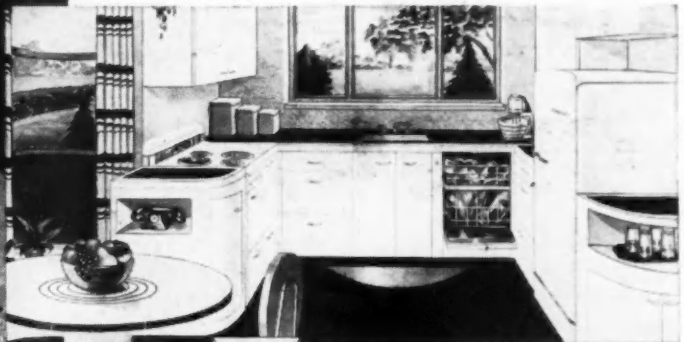

Today the Kitchen is the Measure of Value

Thirty million people know that Hotpoint means the finest, and prospective owners say houses which include All-Electric Kitchens are better buys. Payments are easier, too, because in most states the cost of both the house and the appliances may be included in a "package mortgage." See your *Sweet's Catalog* for details or consult your nearest Hotpoint Distributor. Hotpoint Inc., 5641 W. Taylor Street, Chicago 44, Ill.

Hotpoint has everything for the kitchen and laundry:

- RANGES • REFRIGERATORS • FREEZERS • DISHWASHERS • DISPOSALS*
- CABINETS • SINKS • WATER HEATERS • FLATPLATE IRONERS
- ROTARY IRONERS • WRINGER-TYPE WASHERS • DRYERS

*Reg. U. S. Pat. Off.

Everybody's Pointing to

Hotpoint

Hotpoint Inc. A General Electric Affiliate

PIONEER IN THE ALL-ELECTRIC KITCHEN

THE ANGULATOR DOES IT!

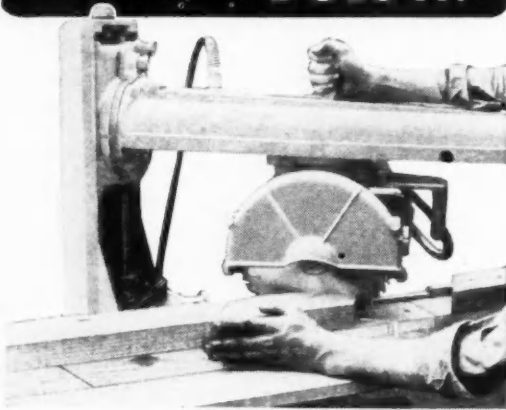

YES, the "angulator" is why so many builders prefer the Wallace No. 1 Radial Saw. This attachment quickly relocates the correct ridge and plate angles in sawing rafters—you swing from one angle to the other, cutting the rafter complete without marking or handling the material twice!

Also this machine provides a 4900 r.p.m. spindle speed for faster, smoother sawing. And an offset spindle, giving extra cutting capacity with small diameter blades.

If you're a careful buyer, you'll want to know more about the superior features of the Wallace No. 1 Radial Saw—also about our Universal Saws, Bandsaws, Jointers, Shapers, Mortisers. Write today for complete bulletins.

J. D. WALLACE & CO.

136 S. California Ave.

Chicago 12, Ill.

EVERYTIME YOU BUY

a roofing adhesive or coating part of the money pays for something you can't see—



SERVICE

ABESTO COLD ROOFING MATERIALS have invisible built-in service qualities that would shine like a pile of gold if you could see them.



Write for descriptive literature and price sheets.



ABESTO
MANUFACTURING CORP.
Michigan City, Dept. B1, Ind.

Modern Architects and Building Contractors Specify and Want
RUBBER-GARD VELVET



... because it is

Modern Paint Contractors Use
RUBBER-GARD VELVET



... because it

Modern Building Supply Dealers Stock
RUBBER-GARD VELVET



... because

**LIME-PROOF
MOISTURE PROOF
SCRUBBABLE AS MOST ENAMELS
FIRE & FUNGUS RESISTANT**

**GOES SAFELY OVER WET PLASTER
DRIES IN ONE HOUR
NO PRIMER NEEDED
COVERS IN ONE COAT
HIGH HIDING
BRUSHES OR SPRAYS BEAUTIFULLY**

THERE'S NOTHING ELSE LIKE IT AT ANY PRICE!



There's a real sales campaign behind it, available to our dealers — electric flashing sign, counter display, return postals, envelope stuffers, etc. We also make a Free Test offer that lets your customers try Velvet without risking a penny.

Write for full details about this modern flat paint that does things never before possible with water or oil-base paints.

"PAINTS THAT ARE DIFFERENT"

Dept. L-43, 43 Leon Street, Boston 15, Mass.



PRINTED
DECIMA



*Smart Businessmen
watch their figures, too...*

... and that's why you find Remington Rand's Printing Calculator producing the figure facts in so many efficiently-run offices.

Only the Printing Calculator does *all* your figure work with printed proof of accuracy. It multiplies and divides automatically, adds and subtracts—and simultaneously prints the factors and answer of each calculation.

It's simple! Fast, touch-method operation is natural on the compact 10-key keyboard. You enter the figures as you read them—there's no searching the keyboard for the correct columns . . . the machine selects them automatically.

See for yourself how "Smart Businessmen watch their figures..." Write to Adding-Bookkeeping-Calculating Machines Div., Dept. ABU-3, 315 Fourth Ave., New York 10.



Remington Rand

MACHINES FOR MANAGEMENT

PRINTED PROOF ON TAPE • ONE-HAND CONTROL • AUTOMATIC DIVISION • ELECTRIFIED MULTIPLICATION • MANY USES • TWO MACHINES IN ONE
DECIMALS LOCATED AND PRINTED • DIVERSIFIED APPLICATIONS • THE ONLY ALL-PURPOSE CALCULATOR PROVIDING A PRINTED RECORD

A Masterpiece*

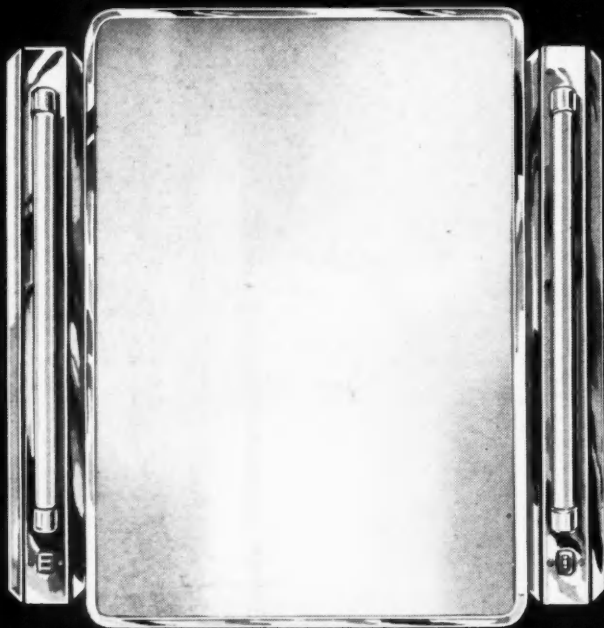

by **MIRRO-GLO**

* Anything done or made with extraordinary skill. (Webster) This certainly describes the new MIRRO-GLO Framed Bathroom Cabinet with fluorescent side fixtures. This bathroom cabinet "masterpiece" combines ultra modern beauty with streamlined efficiency to give today's homeowner the finest in bathroom cabinet quality, and the most for their investment.

Chrome finished fluorescent side fixtures
Polished plate glass mirror
Separate light switch and electrical outlet



For additional information concerning our line write for our New Products folder.

A DIVISION OF STANDARD STAMPING & PERFORATING CO.
3131 WEST 49th PLACE, CHICAGO, ILL.
HEMLOCK 6600

The **MIRRO-GLO** CABINET CO.

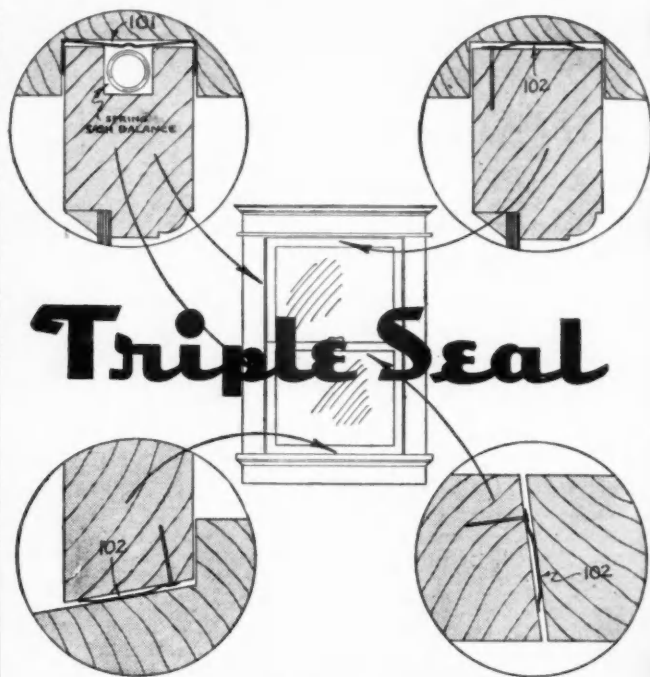

Triple Seal

COMBINATION SASH BALANCES BRONZE WEATHERSTRIPS

Unit PACKAGED, any size opening \$3.25

See your lumber dealer or order direct from us.

THE WEATHERPROOF PRODUCTS CORP.
321 WESTPORT ROAD • KANSAS CITY 2, MO. • WESTPORT 1210

Goldblatt

LONG HANDLE CEMENTERS' and PAVERS' TROWELS

Highest grade spring steel blade.



Steel-mounted ash handle 7 feet long.

Size 18 x 5 inches, Price each..... \$ 8.00
Size 24 x 5 inches, Price each..... 9.00
Size 30 x 5 inches, Price each..... 10.50
Size 36 x 5 inches, Price each..... 12.50

ALUMINUM MOUNTING



Correctly tempered flexible steel, pre-war quality blade. 10 1/2 or 11 inch lengths.

CEMENT FINISHERS' TROWELS
12-in. @ \$3.35; 14-in. @ \$3.60; 16-in. @ \$3.85;
18-in. @ \$4.10, each.
Add 25c per trowel for packing and shipping.

A complete line of Cementers' Sidewalk Edgers, Curb Tools, Sidewalk or Pavers' Groovers.

GOLDBLATT TOOL CO.

1515 Walnut Street, Kansas City 8, Missouri

TROWEL



BRAND

TRADE MARK REGISTERED
Top Quality, Best Known Masons Tools of All Kinds for Over 60 Years.
Send Check With Order. Catalog FREE!

Amer
NE
CO
FO
One of
the Kew
Mellenb
at Berea
by Toft

NEW RADIANT PANEL SYSTEM LOWERS CONSTRUCTION AND HEATING COSTS FOR SINGLE FLOOR-PLAN HOUSES

One of 80 three-bedroom houses of the Kew Garden project designed by Mellenbrook, Foley & Scott and built at Berea, Ohio, suburb of Cleveland, by Taft and Blackman.

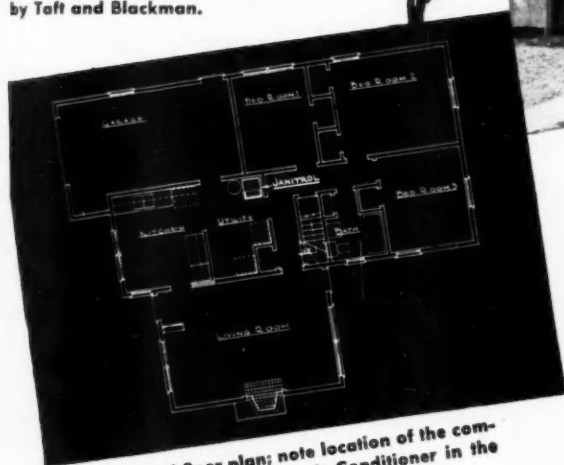
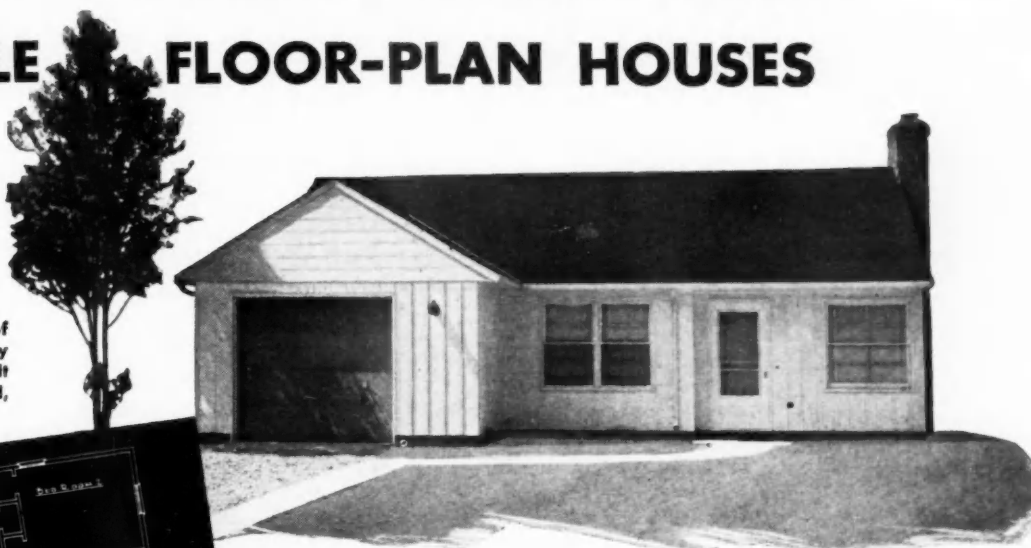

Typical floor plan; note location of the compact Janitrol Winter Air Conditioner in the combination kitchen-utility room.

● There's no guesswork about the results of these 80 warm air radiant heating installations, for many of these homes have been occupied for more than a year.

The system which employs a Janitrol Winter Air Conditioner, works beautifully and the home owners are immensely enthusiastic.

All of the floor area, except the garage, of these one floor type houses is radiant panel heated. The Janitrol gas-fired 105,000 Btu Winter Air Conditioner is located in the combination kitchen-utility room. See floor plan at the left.

In addition to the solid com-

fort supplied by quiet, automatic Janitrol heat, installation of the unit and house construction costs were materially lowered by the unique heat distribution system.

Forced warm air is first conducted upward to the attic and then distributed by stacks located in the walls to the under-floor duct system. Special care was given in the duct design to minimize any resistance to air flow.

A more complete description of the construction and operating details of this money-saving, modern heating system is available upon request. Write for the "Kew Gardens Story" and learn how Janitrol can help you sell better home comfort at lower cost



Beginning of floor construction, two tiers of bricks are laid on concrete slab to form heat distribution ducts 5½" deep.

Pouring concrete over corrugated sheet steel above the duct tiers on which reinforcing bars are supported.

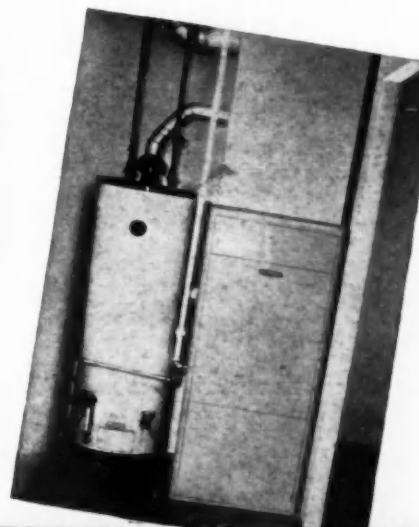
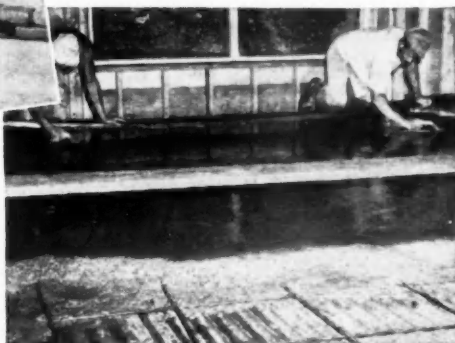

Extremely compact, this 105,000 Btu Janitrol Winter Air Conditioner requires a floor space of less than 22" x 22".

Janitrol

SURFACE COMBUSTION CORPORATION, TOLEDO 1, OHIO



You Mean I Save Money Using
Tru-sized DOOR JAMBS*

Reg. U.S. Pat. Off.

Yes. And You'll
Complete Your Jobs
Quicker and Better!

*Patent applied for

Wise builders the country over are learning that factory-built Tru-sized Door Jambs save time and money. Do a top-quality job faster! No nailing, no squaring, no plumbing with wedges, no stops to install. With only a screwdriver and a level, you can

make a quick, accurate installation. Master builders and carpenters praise them highly. Shock absorber leaf springs assure accurate fit always. Use Tru-sized Jambs for top-quality jobs at less cost. Write today for FREE information, Dept. 7AB.



THE WHEELER, OSGOOD COMPANY

Plants and General Office: Tacoma 1, Washington

NEW YORK OFFICE	1326 Empire State Building, New York 1, New York	Phone: Longacre 4-6520
CHICAGO OFFICE	134 So. LaSalle Street, Chicago 3, Illinois	Phone: State 5335-6-7
SAN FRANCISCO OFFICE	3045 19th Street, San Francisco, California	Phone: Valencia 4-2241
LOS ANGELES OFFICE	416 W. 8th Street, Los Angeles, California	Phone: Vandike 6326
TACOMA OFFICE	1216 St. Paul Avenue, Tacoma 1, Washington	Phone: Broadway 9321

SCRAP-BOY



TRADE MARK

**THE IDEAL
PATENTED
DISPOSAL UNIT**

**Features
All These Big
Advantages**

- Takes 2 minutes to fasten unit in any convenient place.
- Sturdily Built—Designed for a long life of practical service.
- Economical—Priced at only \$1.98 per complete unit including 30 waterproof bags and installation screws.
- Convenient—Just a flip of the wrist and kitchen refuse disappears.
- Sanitary—Tight fitting lid opens easily, and waterproof bag quickly replaced when full.

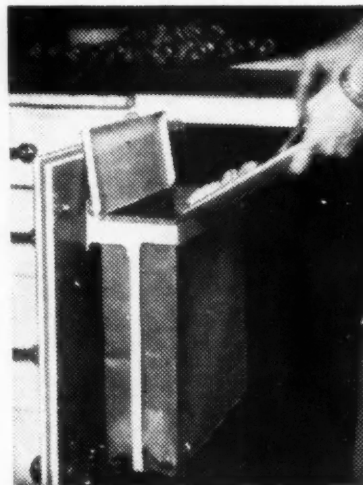

**QUICK SELLING
—NEEDED IN
EVERY KITCHEN
STEADY PROFITS
FROM BAG SALES**

Distributed by

**Sterling-Freeland
Industries, Inc.**

122 S. Michigan Avenue
Chicago 3, Illinois

BUSS

**No.
4L**

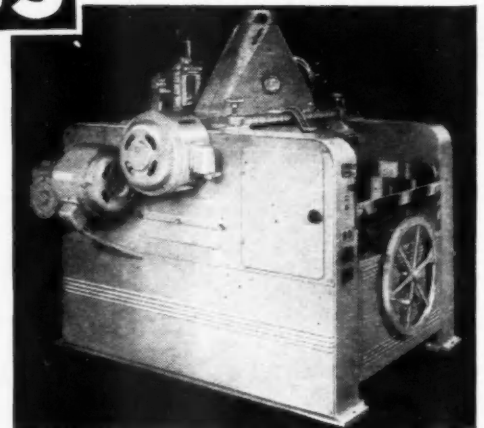

**WAY AHEAD OF ANYTHING
IN THE LOW-COST PLANER FIELD!**

Built for the precision accuracy formerly obtainable only with the larger machines. A husky producer with wedge adjusted bed, and many patented features promoting convenient, time-saving operation and highest quality work. Big enough to meet all the requirements of retail lumber companies and many wood-working establishments. Capacities: 24" x 8" to 30" x 8". Priced way below the larger planers. Every user is a booster. Write for Bulletin No. 54.

BUSS MACHINE WORKS
240 EIGHTH ST. HOLLAND, MICH.

Americ
W
You kn
wood
clean a
Doors
inside
crossba
NA
Camb
Chico
Cine
Dail
Dre
Kun
Loui

Roddiscraft Quality



You know that the faces of Roddiscraft Doors and Hardwood Plywood are smooth as satin — that edges are clean and true — but the quality that gives Roddiscraft Doors and Plywood long life and lasting beauty is an inside job. It's the inside materials — core blocks, glue, crossbandings, plus the care and craftsmanship used in

fabrication that makes it possible for Roddis to unqualifiedly guarantee materials and workmanship.

Yes, — Roddiscraft backs its Doors and Plywood with a guarantee bond. That's your assurance that Roddiscraft beauty is more than veneer-deep.

NATIONWIDE Roddiscraft WAREHOUSE SERVICE

- Cambridge 39, Mass. 229 Vassar St.
- Chicago 8, Ill. 1440 W. Cermak Rd.
- Cincinnati 2, Ohio. 457 E. Sixth St.
- Dallas 10, Texas. 2800 Medill St.
- Detroit, Mich. 11855 E. Jefferson Ave.
- Kansas City 8, Mo. 2729 Southwest Blvd.
- Louisville 10, Ky. 1201-S S. 15th St.
- Long Island City, N. Y., Review & Greenpoint Ave.
- Los Angeles 11, Calif. 2860 E. 54th St.
- Marshfield, Wis. 115 S. Palmetto St.
- Milwaukee 8, Wis. 4601 W. State St.
- New York City, N. Y., 920 E. 149th St.
- San Antonio, Texas. 727 N. Cherry St.

DEALERS IN ALL PRINCIPAL CITIES

Roddiscraft
Roddis Lumber & Veneer Co.

MARSHFIELD, WISCONSIN

Western Red Cedar
PORTLAND
 B R A N D
SHINGLES
SKOOKUM
True-Cut
SHAKES

Shingle
Shake

Double-coursed sidewall

THE PERFECT COMBINATION FOR THE PERFECT SIDEWALL

Double-coursed sidewalls of Skookum True-Cut Shakes with an undercourse of Portland Brand #2 or #3 grade shingles.

- **LOW COST**
- **LONG LASTING**
- **BETTER INSULATION**
- **ALWAYS ATTRACTIVE**

Skookum True-Cut Shakes and Portland Brand #2 and #3 grade shingles are available for immediate shipment.

Write or wire for information and literature

MAIN OFFICE
PORTLAND SHINGLE COMPANY
 9038 N. Denver Avenue, Portland 3, Oregon

MILLS AT
 Portland, Oregon Kelso, Washington
 Ridgefield, Washington Quinalt, Washington

How to design and install

RADIANT HEATING SYSTEMS

HERE IS detailed, up-to-date information on radiant heating for architects, contractors, and home-builders. This new book covers the subject thoroughly—explains the principles of modern radiant heating, describes the equipment available, and gives you step-by-step methods for design and application of radiant heating systems to new and existing commercial buildings and dwellings.

JUST OUT

By **R. W. Shoemaker**
Consulting Engineer on Radiant Heating

306 pages
 242 illustrations, charts and tables

\$4.00 CONTENTS

1. General Considerations
2. Advantages
3. Location in Residences
4. Location in Buildings
5. Control Systems
6. Design
7. Installation
8. Radiant Cooling
9. Method of Design

Appendix includes many valuable tables of design data on heat value of fuels, dimensions of pipe and tubing, standard fittings, etc.

Provides formulas, techniques, engineering data

It offers a wealth of authoritative facts and proven techniques to help you employ radiant heating to best advantage. Numerous diagrams and concise text guide you in planning and specifying proper systems to fill any requirement.



SEND NO MONEY SEE THIS BOOK 10 DAYS FREE

McGraw-Hill Book Co., Inc., 330 W. 42d St., NYC 18
 Send me Shoemaker's **RADIANT HEATING** for 10 days' examination on approval. In 10 days I will remit \$4.00 plus a few cents postage, or return the book postpaid.

Name

Address

City and State

Company

Position

ABB-3-48
 (\$4.80 in Canada; order from McGraw-Hill Co. of Canada, Ltd., 12 Richmond St., E., Toronto 1.)

A Money-Maker for CONTRACTORS!



NEW Book of 150 HOME DESIGNS

only
\$5
 for Design Book with Valuable **CONTRACTOR'S KIT FREE!**

SHOW your customers and prospects this big, NEW "Home-Of-The-Week" Design Book. It helps them select their homes; helps YOU sell your services. Book shows 150 tested designs for attractive, low-cost homes, 4, 5, and 6 rooms. Shows elevations and floor plans. Priced at only \$5.

PLANS and full specs available from us for all homes shown in our Design Book. Plans comply with all FHA, VA and local codes. **SPECIAL PRICE OFFER:** to show you quality and detail of our plans; only \$3 for plans (1 set) for one home (list \$12.50).

Contractor's Kit has all forms needed for Material and Labor specs, Contract, Bid, Change of Contract and Release forms. Makes it easy to figure jobs right. Prevents errors, disputes. Saves time and money.

ORDER NOW
 A postcard will do.

Architects
CO-OPERATIVE PLAN SERVICE

89 Elmgrove Avenue, Providence 6, R. I.

Only \$5 for Design Book with Contractor's Kit FREE. Or \$1 for Kit alone.

BENDIX
 automatic
 Home Laundry Equipment
 is installed in this Home
 TAUXEMONT DEVELOPMENT CORP.

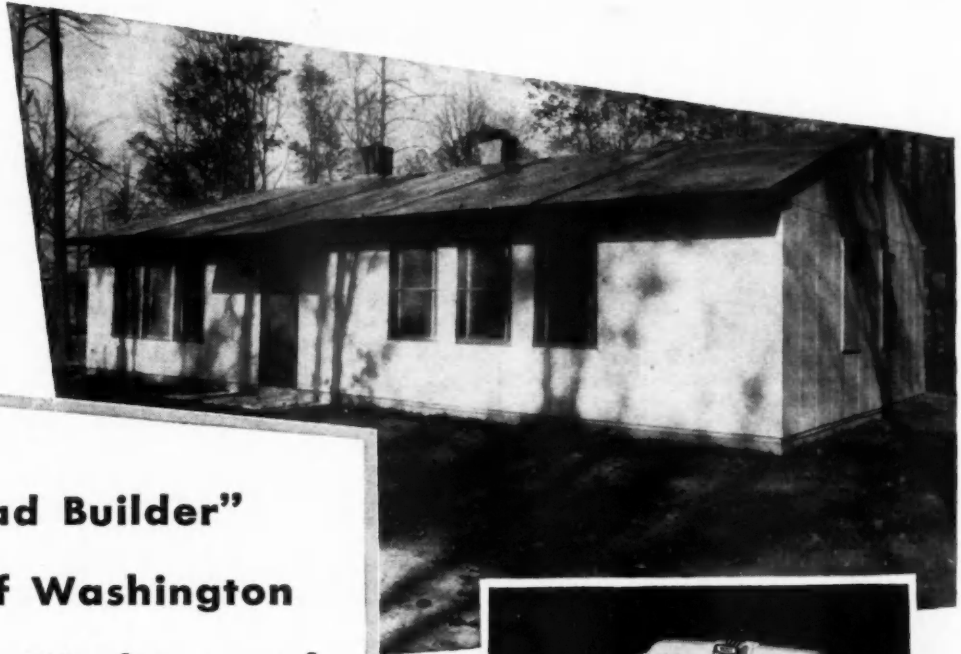

**"Look-Ahead Builder"
 Tauxemont of Washington
 installs Bendix Washers and
 Dryers in every home!**

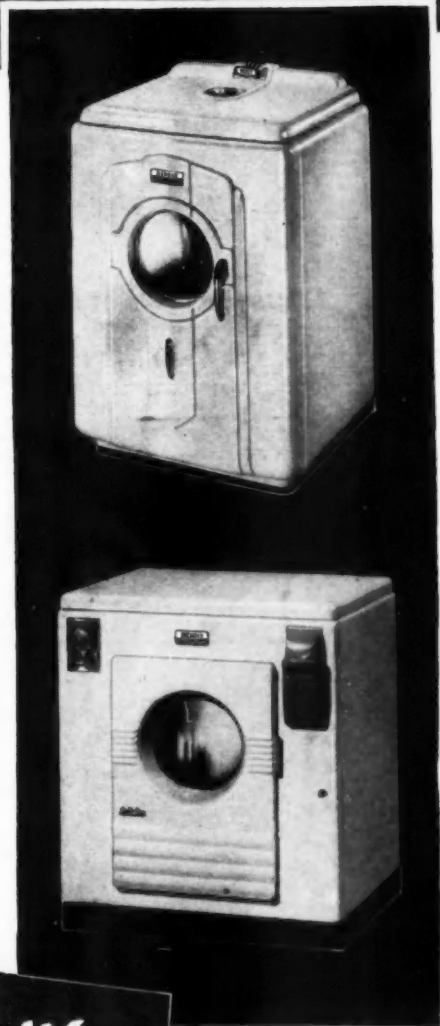

The first group of all-aluminum houses made by General Homes, Inc., Columbus, Ohio and erected by Tauxemont Development Corporation in their development south of Alexandria, Virginia are causing quite a stir in the vicinity of Washington. Unusual, different, they provide another answer to the problem of mass-erected modern housing—and the Bendix automatic Home Washer and Bendix automatic Dryer are right in each blueprint!

Today's emphasis is on better, more leisurely living. Smart builders like Tauxemont, and many, many others, specify Bendix appliances in their plans . . . because they make life so much easier for the housewife who does her own laundry!

Would you like to know more about how easily you, too, can bolster your reputation as a builder . . . how simple it is to install Bendix equipment in your projects . . . how much more livable, more salable, your developments will be? Remember, Bendix appliances can be included in an FHA package mortgage!

Simply write to Bendix Home Appliances, Builder Division, South Bend, Indiana. Find out how you can *keep on* selling your homes faster than you can build them! More and more prospects are looking for the "sign of a Look-Ahead Builder". Display it. It's worth money to you!

Houses range from \$10,500 to \$12,000; including Bendix automatic Washer and Dryer in package mortgage plan

BENDIX
 automatic
Home Laundry

TO LIVE BETTER—LIVE WITH BENDIX!

BENDIX HOME APPLIANCES, INC., SOUTH BEND, INDIANA

LOG STRUCTURES

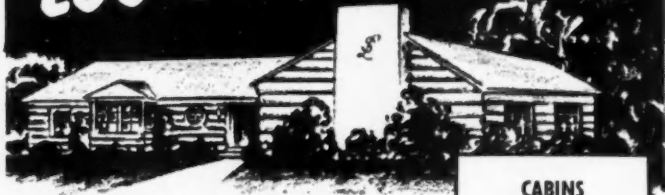

For unusual homes of character and distinction... for typical western homes of rustic beauty. Materials available NOW... not 30 days... not next week... but TODAY!

Effects substantial savings in construction costs. No studding required. Meets FHA construction requirements and is easily financed through FHA loans or your local bank

Conventional or rustic interior finish and modern arrangements adaptable to any floor plan. Solid wood walls provide best insulation against heat and cold. Average home can be completed in 30 days ready to move in! Chemically treated to resist discoloration, dry rot, and termites

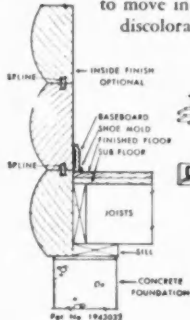

THE Lowe CO.
ENGINEERS
CONSULTANTS
CIVIL MECHANICAL ELECTRICAL

EXCLUSIVE NATIONAL and INTERNATIONAL DISTRIBUTORS
Dept. AB-3, 244 W. Colorado
Glendale 4, California

- CABINS
- COTTAGES
- RUSTIC HOMES
- RANCH HOMES
- RESORT BUILDINGS
- MOTELS
- RESTAURANTS

Planning Consultation Available

Some Choice Exclusive Dealer Territories Still Available

UP GO CEILINGS... and your PROFITS!

Approved by... CONTRACTORS BUILDERS CARPENTERS LUMBER YARDS

Jackflat PNEUMATIC LIFT

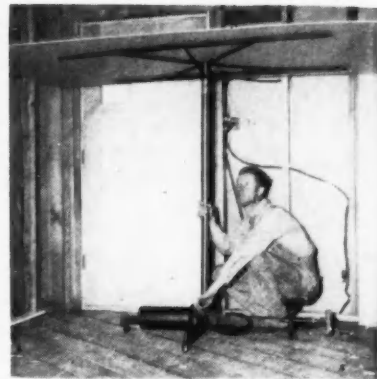

Cuts Installation Time in 1/2

Furnishes 150 lbs. Lift Force from 5' to 9' 8"

Now... two men can hang TWICE as much fabricated ceiling material or metal lath... as three men doing the job the old-fashioned way. Jackflat... lifts and holds while one or more men anchor the material to the ceiling. Simple to use; knocks down in 3 minutes; carry it in any car. Pays for itself in a week. Up go your ceilings and profits with Jackflat.

For Full Information Write, Wire or Call: Sales Office

Jackflat CO. 3406 MAIN STREET DALLAS 1, TEXAS PHONE RIVERSIDE 4747

A Single ANSWER to 2 PROBLEMS!

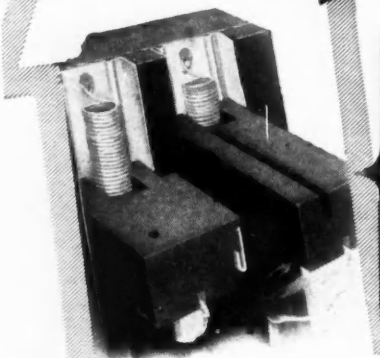

1. Efficiency? *Greater!*
2. Cost? *Less!*

Milwaukee SASH BALANCE WEATHERSTRIP COMBINATION

Write for free FOLDER and PRICE LIST

For new or old building. Easily installed bronze channel strips and rust-proof steel springs. Smooth, quiet, efficient operation. A tried product that builders swear by... used with outstanding results in Milwaukee for 10 years... now available on national market.

DEALER INQUIRIES INVITED

Manufactured by **Milwaukee STRIP SERVICE, Inc.**
Dept. B. - 3808 W. Burleigh Street, Milwaukee, Wisconsin

Two Tools that save You TIME and MONEY

BORD-PRI TRADE MARK **BORD-JAK** TRADE MARK

LUMBER RECLAIMER

Removes siding, roofing, flooring or forms easily and without splitting or damaging lumber. Ideal for packing case salvage. Relieves lumber shortage and saves money.

WORKS FROM EITHER SIDE OF STUDDING

See Your Supplier or Write - DO IT TODAY!

BOARD TIGHTENER

- Easy-to-use lever action forces warped boards in line. Butts square-edged or tongue-and-groove lumber tightly together.
- for FLOORING, SIDING, SHEATHING open joists or sub-floor

THE MACO CORPORATION - HUNTINGTON, INDIANA

Use **SOLVAY** CALCIUM CHLORIDE

with all Portland Cement Concrete

for ACCELERATION—CURING—COLD WEATHER PROTECTION



SOLVAY SALES DIVISION
ALLIED CHEMICAL & DYE CORPORATION
40 RECTOR ST. NEW YORK 6, N. Y.

GOOD HOUSEKEEPING



FROST PINE

A lot of things make Frost Pine quality tick. There's correct seasoning, good manufacture and accurate machine work, of course. But the important thing is to get stock into the hands of you, the dealer, in prime condition so you'll benefit by the full selling appeal of these refinements. That's why Frost Pine products are handled, stored and shipped with the skill and care due fine merchandise. That's why you can depend on Frost Pine to back up your own reputation as a dealer in clean, bright lumber of the finest quality.



FROST LUMBER INDUSTRIES, INC.

St. Louis, Mo.

SHREVEPORT, LOUISIANA

Mt. Vernon, N.Y.

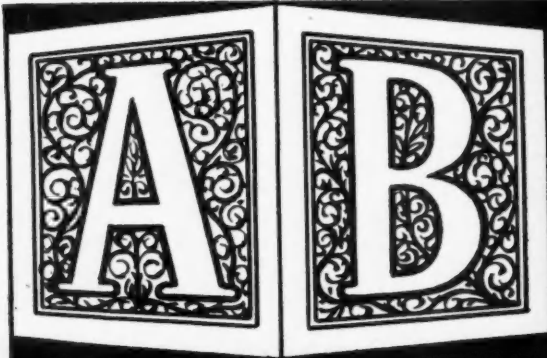

AMERICAN BUILDER

First

AMERICAN BUILDER

— The first building paper — — —
(Founded - 1879)

FIRST in circulation
(More than 80,000 ABC)

FIRST in number of ad pages
(1433 pages in 1947)

FIRST in readership
(Surveyed by Roy Eastman Corp.)

FIRST in selling power
(It's readers are the Builders Who Buy)

AND
*Lowest Advertising Rate
Per Thousand*

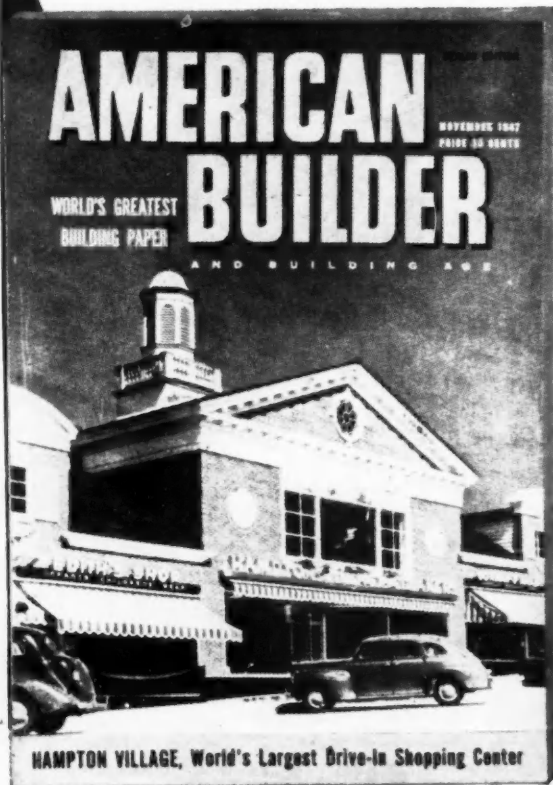

AMERICAN BUILDER

A Simmons-Boardman Publication

105 West Adams Street, Chicago 3

30 Church Street, New York 7



What do your Flooring Specifications call for on jobs like these?

RANCH HOUSE DEVELOPMENT...



Basementless, concrete slab construction. More and more cost-conscious operative builders are turning to Tile-Tex* Asphalt Tile as the all purpose flooring for a one story ranch house. It's low in cost, has an amazing record of long life . . . and is the only type of resilient flooring which can be installed with perfect safety over a non-waterproofed concrete slab. No other sub-flooring required. Can be installed in gay, colorful patterns or solid tones. Appeals to home owners because it can be used with or without rugs or carpeting.

BLOCK OF STORES...



On the main street of town, where store traffic is heavy, and tenants require different decorative effects. With Tile-Tex Asphalt Tile you can offer the commercial user an almost endless variety of designs, patterns and custom accessories around which to plan colorful and functional floors. Yet your client pays no maintenance penalty for high style. Tile-Tex is exceptionally easy to clean and keep clean.

RESIDENCE...

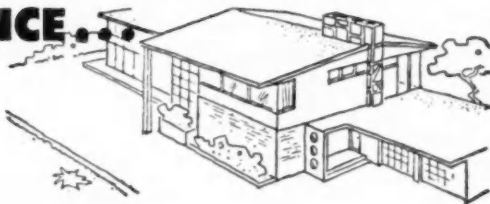

Two stories and a basement, for upper income purchaser. For kitchen, bathroom, basement recreation room, foyer, children's bedrooms . . . specify Tile-Tex Asphalt Tile, by all means. It's the right floor for heavily used areas. It brings bright, spirit-lifting color to many areas of the home. It lightens the cleaning burden. And it helps sell your homes

Tile-Tex Asphalt Tile is installed by expert flooring contractors located in principal cities and towns. Write The Tile-Tex Company, Inc., (subsidiary of The Flintkote Company), Chicago Heights, Illinois for the name of the flooring contractor nearest you. Sales offices in Chicago, New York, Los Angeles and New Orleans.

THE TILE-TEX CO., Inc.
CHICAGO HEIGHTS, ILLINOIS

*REGISTERED TRADEMARK OF THE TILE-TEX COMPANY



every home is
MORE MODERN

and **EASIER TO SELL** with

"Niteair" Cooling

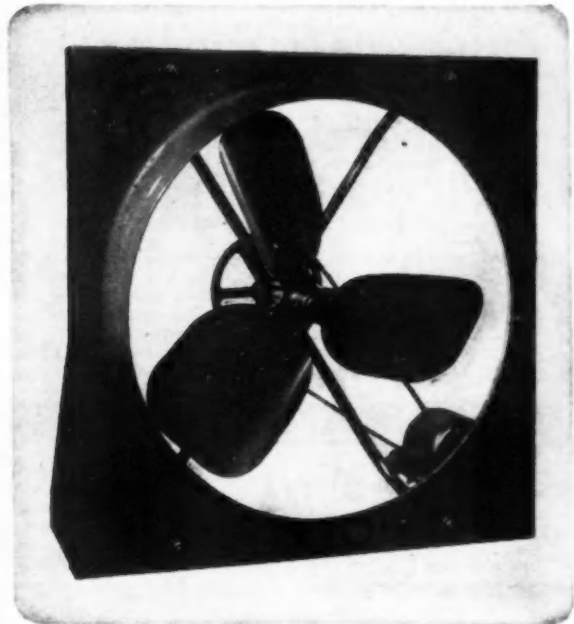

Capitalize upon the demand for new, modern comforts and conveniences . . . the BUILT-IN extras that mean extra sales and extra value for you. Install LAU "Niteair" Fans while buildings are being constructed . . . pave the way for future sales while installation costs are lower . . . create interest and desire in your new homes.

● Thousands of home owners the nation over are using LAU "Niteair" Fans with outstanding results . . . thousands more are seeking homes with this added convenience already built in.

Try this idea in your very next house so that you can actually "demonstrate" the benefits to your prospects. You will see how easy it is . . . how much more revenue it means.

LAU "Niteair" Fans have been engineered and built to exacting specifications. They operate at extremely low cost with a minimum of noise and maximum output of air movement with reduced power consumption. Their light weight means lower shipping costs.

Write us direct to Dept. B for specifications . . . or contact your jobber. Do it now!

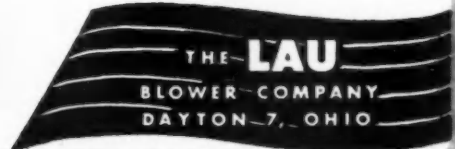

Shevlin-McCloud Lumber Co.

(SUCCESSORS TO SHEVLIN PINE SALES CO.)

SELLING THE PRODUCTS OF

*The McCloud River Lumber Co.
McCloud, California

*The Shevlin-Hixon Company
Bend, Oregon

*Member of the Western Pine Association,
Portland, Oregon.

DISTRIBUTORS OF

SHEVLIN PINE

REG. U. S. PAT. OFF.

EXECUTIVE OFFICE

900 First National Soo Line Building

MINNEAPOLIS 2, MINNESOTA

DISTRICT SALES OFFICES:

NEW YORK 17 CHICAGO 1
1604 Graybar Bldg. 1863 LaSalle-Wacker Bldg.
Mohawk 4-9117 Central 9182

SAN FRANCISCO 5
1030 Monadnock Bldg.
Exbrook 2-7041

SPECIES

PONDEROSA PINE
(PINUS PONDEROSA)

SUGAR (Genuine White) PINE
(PINUS LAMBERTIANA)



TACK UP INSULATION with the HANSEN TACKER

saves
**TIME
STEPS
MATERIAL**

Modern houses—modern insulation—modern Tacking with HANSEN—that's the program!

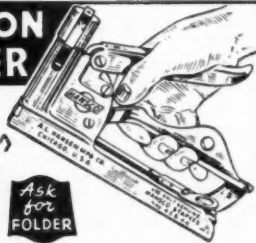

Ask for FOLDER

PROPERLY installed, insulation is much more efficient. Tack it snugly, securely against rafters, studs, beams, with HANSEN—the speedy, one-hand Tacker. Tacks blanket types of insulation, screens, paper, etc.—with zip-zip speed and precision. A saver of time, steps, materials, money.



A.L. HANSEN MFG. 5059 RAVENSWOOD AVE
CO. CHICAGO 40 ILL.

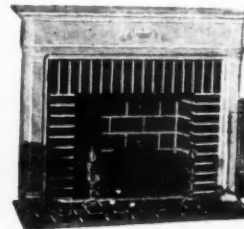

READYBUILT (Reg. U.S. Pat. Off.) FIREPLACES

Lends unsurpassed beauty and charm to homes—old and new. The modern fireplace that fulfills all modern day requirements—used with gas or electricity. Large variety of attractive models in brick, stone, wood, etc., available.

Furnished complete—ready to be installed in hour's time of handy man—shipped anywhere.

DEALERS, BUILDERS and HOMEOWNERS write for catalog and full information.

THE READYBUILT PRODUCTS CO.
1705-23 McHenry St. Baltimore 23, Md.

Get set for PROFITS in building construction

—make every bid count!

PUT this handy Dingman pocketbook to work, in making accurate estimates for building construction, in saving time and error in the job of determining profitable, competitive prices. Based on the most practical experience, it is full of helpful pointers for new or experienced estimators, shows how to determine quantities of labor and amounts of material to produce a unit of completed work in practically every branch of building construction.



ESTIMATING BUILDING COSTS

By CHARLES F. DINGMAN

Architectural Engineer

Third Edition, 401 pages, 4 x 6 1/4, 27 illustrations, \$3.50

THIS practical guide-book of estimating trains the estimator to analyze every construction job into its component parts, to apply cost data, adjusted to living conditions, to the several operations necessary, and to calculate a price that will approach the actual cost of doing the work as closely as is humanly possible.

ESTIMATING BUILDING COSTS tells how to make an estimate on a wood, brick or concrete building construction. Covers every operation from excavating to roofing and waterproofing—with valuable material on such important details as fireproof construction, shingling, steel sash, or cement gun work. Included also are a number of useful data tables, but its primary purpose is to give the step-by-step methods that will train the reader to become a thoroughly competent estimator. Helps you to make sure that no element of the work is overlooked; explains the special factors to watch in dealing with each type of work.

SEND THIS McGRAW-HILL COUPON

McGraw-Hill Book Co., Inc., 330 W. 42nd St., N. Y. 18
Send me Dingman's ESTIMATING BUILDING COSTS for 10 days' examination on approval. In 10 days I will send \$3.50, plus few cents postage, or return book postpaid. (Postage paid on cash orders.)

Name.....

Address.....

City and State.....

Company.....

Position..... ARB-3-48

\$4.20 in Canada; order from: McGraw-Hill Co. of Canada, Ltd., 12 Richmond St., E., Toronto 1,1

Boost Your Sales

Through Established Sales Organization

Our experienced, active sales staff are specialists in selling direct to home owners. They will boost your sales in Buffalo and Western New York. Complete established selling organization including promotional-minded sales executives, large sales staff, warehouse facilities. If you are manufacturing a sales-worthy product to sell - - write today!

Address All Replies to Our Advertising Agency

GASKILL-OERTEL

232 DELAWARE AVE.

BUFFALO 2, N. Y.

Telephone Cleveland 0660

SAW-FILING

Carpenters Make up to \$2 or \$3 an hour in Spare Time

With a Foley Automatic Saw Filer you can file hand, hand and circular saws better than the most expert hand filer. Cash business, no canvassing. No eyestrain, no experience needed. "I bought a Foley, one year later had all debts paid and \$400 on new home. Many days I earn as much as \$16.00"—J. H. Kellogg. Send coupon for FREE Plan, no obligation.

Large Contractors and Builders who have many saws to file can increase production, do better work and reduce filing costs with a Foley Saw Filer. Soon pays its cost. Get the facts.



FOLEY MFG. CO., 324-8 Foley Bldg., Minneapolis 18, Minn.

Send Free Plan on Custom Saw Filing.

I want to file saws for crew of about (10-25-50-100) men (Check No.)

Name.....

Address.....

Here's an unbeatable combination—



Those houses that use the unbeatable combination of an automatic stoker and the plentiful cheaper sizes of smokeless hard coal don't have to worry about the threat of turning down their thermostats to chilly levels.

Stoker heating is the lowest cost automatic heat with savings up to 50% over other fuels. It's convenient because it feeds from the bin, controls temperature and ash removal automatically. Then too, a full winter's supply of hard coal can be stored in the summer which eliminates the necessity of depending on weather hindered winter deliveries.

Anthracite Institute
 Dept. 3-D
 101 Park Avenue
 New York 17, New York

Please send me more information on anthracite and anthracite heating.

Name _____
 Company _____
 Address _____
 City _____ Zone _____ State _____



ANTHRACITE INSTITUTE
 101 Park Avenue • New York 17, New York

How to make a
WARM FRIEND
out of a cold customer



Specify a **KRESKY** oil furnace

You'll give him clean, instantaneous... economical heat he can depend on at all times in that new or remodeled home.

A practical model for small homes. Requires only three feet under floor. A one-man installation job. Fully automatic or manual control. The original and still the leading oil-fired floor furnace with forced air circulation bearing the Underwriters' label. The dual-register model shown at right.

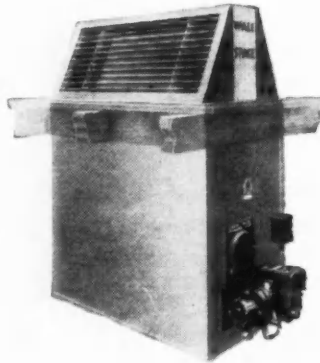

Kresky Oil Burners
There's profit in tying to the most popular name in oil-fired floor furnaces

KRESKY Oil heating equipment has been making American homes cozy and warm for two generations. Today, literally thousands throughout the country swear by the famous KRESKY name.

You see the KRESKY patented burner, basic unit in all models, inducts air into the oil flame in just-right amounts by an electrically operated blower to give fast, high-low, clean heat in all climates or altitudes. This famous unit—pioneer in its field—makes all KRESKY furnaces independent of unpredictable drafts and as dependable as a fine watch.

There's a fully guaranteed model to suit your next job and a nearby dealer to give you excellent service. If you do not know him, write to us for his name. Also write for our 1948 illustrated folder showing our full line of heating equipment.

Dept. AB
KRESKY MFG. CO., INC.
Petaluma, California



The Master
COMBINES
12 MACHINES IN ONE

with Overhead Cross Cut Slide Saw; Underslung Ripsaw and Jointer, operated with only one Power Unit

5 SIZES
1 to
5
H.P.

JOINTING MITERING RIPPER CROSSCUTTING BORING MOULDING DADOING TENONING ROUTING RABBETING

MOST POWERFUL AND STURDY MACHINE ON THE MARKET

ELECTRIC MOTOR OR GASOLINE ENGINE DRIVE

BUILT BY THE OLDEST EXCLUSIVE MANUFACTURER OF UNIVERSAL WOOD WORKERS

THE MASTER WOODWORKER MFG. COMPANY

Fort and Brush

Established 1917

Detroit 26W, Michigan

"Jiffy" LINE HOLDER

EASY TO USE... QUICKLY ADJUSTED... RUST PROOF.

for SIGN PAINTERS! CARPENTERS! BRICK LAYERS!

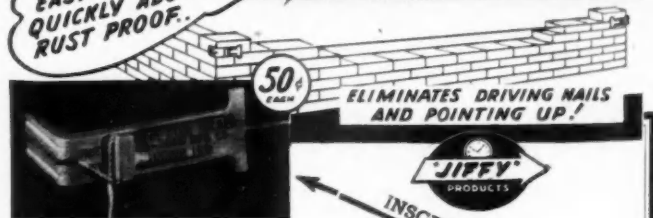

ELIMINATES DRIVING NAILS AND POINTING UP!



INSCRIPTION AREA
2 1/4" LONG, 5/8" WIDE

New!

For Manufacturers and Dealers

• Ask us for literature showing how you can use the new JIFFY LINE HOLDERS to increase your sales. Your customers will ask for it with their re-orders. New business will be attracted through its reputation. Salesmen will demand it to stimulate sales.

Quantities with or without your name or slogan at extremely low prices.

Write for descriptive literature

AN-DEAN MFG. CO.
BOX 5 INWOOD, INDIANA

6 REASONS WHY BUILDERS PREFER

AllianceWare

Porcelain-on-steel Bathtubs

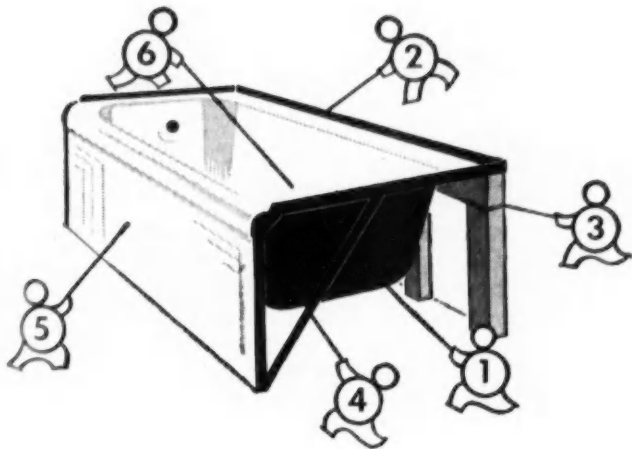
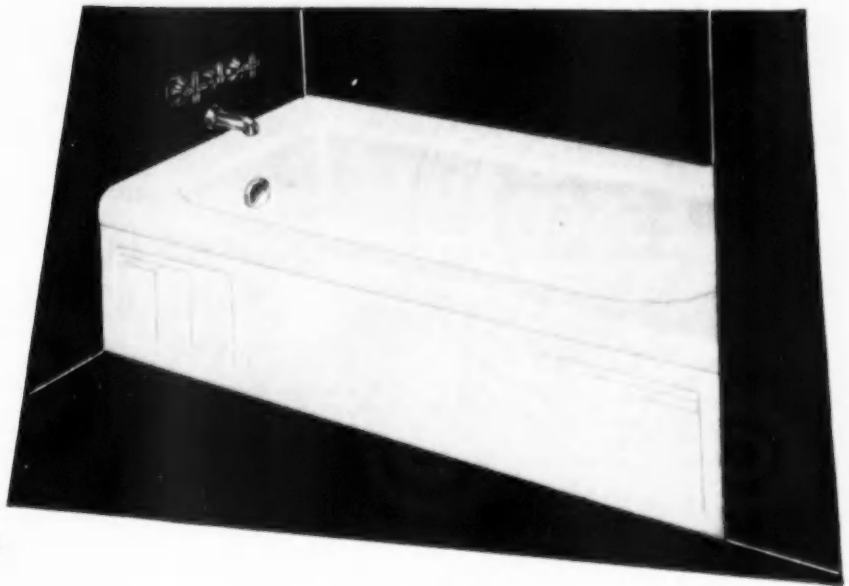

- 1 One-piece construction from heavy-gauge steel—much heavier than the commercial standard.
- 2 Wallguard flange insures an invisible, permanent leak-proof joint when the wall-tile or plaster is applied in front of the flange.
- 3 A horizontal 2 x 4 nailed to studs provides rigid support. Anchor lugs fit over back of 2 x 4, holding the tub securely in position.
- 4 Welded cross-ties reinforce the rigidity of one-piece construction.
- 5 Wet-process porcelain enamel provides smoother lifetime finish.
- 6 Smooth, flat bottom—easy to clean and keep clean.

WHETHER you are building on contract or building on speculation, you can be certain of the satisfaction you will *get* and *give* with AllianceWare bathtubs.

Durability and beauty are two outstanding features of AllianceWare:

The porcelain enamel is fused to the steel by the "wet-process," producing a lifetime surface that resists acids and stains and which is easy to clean. The sleek, modern lines and smooth lustrous finish are a constant delight to the homemaker.

When you install AllianceWare you secure

extra home-selling features of great value. This is why AllianceWare is preferred by an ever-increasing number of building organizations from coast to coast.

If your plumbing contractor does not handle AllianceWare, write us.

ALLIANCEWARE, INC., • Alliance, Ohio
Bathtubs • Lavatories • Sinks

AllianceWare
ALLIANCE OHIO



TWX 484

EXCHANGE SAWMILLS SALES CO.

Since 1879

Manufacturers and Distributors

DOUGLAS FIR • SOUTHERN PINE
YARD AND RAILROAD STOCK
FIR PLYWOOD • OAK FLOORING

1111 R. A. LONG BUILDING

KANSAS CITY 6, MISSOURI

New BEVIL-DEVIL ALL PURPOSE SET for

1 SLICING
2 GROOVING
3 BEVELING & RABBETING

NOW AVAILABLE—the tools you need for insulation board jobs. Sharp, strong, specially ground blades cut through toughest insulation boards leaving clean, smooth edge. Three tools—five blades—attachments. All for . . .

\$585
Sent postage paid anywhere in U.S.A.

Extra Bevil-Devil Blades, of selected steel, ground to cut insulation board. Package of 100 for \$4.00, postage paid.

KIMBALL MANUFACTURING COMPANY, INC.
1629 SYCAMORE ROYAL OAK, MICH.

For RAPID-FIRE GLAZING

Drives 'em in at machine-gun speed

Red Devil AUTOMATIC DIAMOND POINT DRIVERS

Glaze with one hand. Efficient from EVERY position and angle. Securely hold clips of 100 DIAMOND POINTS which won't bend or corrode. Drive into hardest wood. Diamond Points for No. 1 (1/4") package of 50 sticks of 100 each (5,000 points); for No. 2 (1/2") package of 40 sticks of 100 each (4,000 points).

RED DEVIL TOOLS. Irvington 11, N. J., U.S.A.
Glaziers and Painters Tools and Machines Since 1872

For Real Accuracy on the Job



Many mechanics whose jobs call for real accuracy are now using the Master Brite-Blade. This outstanding steel tape rule has a trim, nickel plated, zinc alloy case that will withstand the roughest kind of treatment. The contrasting jet black graduations on the snow white, non-peeling, non-chipping, blade makes reading even in dimly lighted places easy. Brite-Blade can be used for inside measure, too, and blades can quickly be replaced. Comes with 6 or 8 ft. tapes. See your hardware or building supply dealer or use the coupon.



MASTER RULE MFG. COMPANY, INC. F-3
201 Main Street, White Plains, N. Y.

Gentlemen: Please send me 6 ft. Brite-Blade (\$1.75)
 8 ft. Brite-Blade (\$1.90). Check, Money Order is enclosed.

NAME.....
ADDRESS.....
CITY..... STATE.....

Makes DAMP WALLS DRY

Ranetite Damproofer seals walls against penetrating dampness. Absorbs all present moisture in walls and prevents further condensation. Provides lasting protection for decorating. Backed by 33 years of research and development. Fully guaranteed.

Pts. \$1.00 Qts. \$1.50 Gals. \$5.50

DEALERS: Territories open to responsible dealers—write today!

RANETITE MFG. CO.
1917 S. BROADWAY ST. LOUIS 4, MO.

SOLVE ROOF PROBLEMS INSTANTLY - SAVE MATERIALS

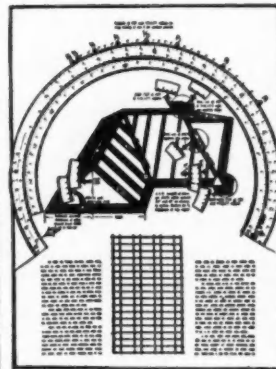

RAFTER DIAL
\$1.95

IN 10 SECONDS!! All 11 lengths and cuts for any size and shape of simple or hip roof. Just set dial to "pitch" and "run," and the figures appear in windows at proper places on diagram of roof. Unlike the usual rafter tables, this instrument enables you to set "run" directly in feet and inches—not just in even feet. Takes thickness of ridge board into account from the start and avoids troublesome adjustments later. Angles are given both in degrees and square readings. Eight standard pitches and all other pitches in degrees from 10° to 57°. Perfect also for estimating lumber needs. Indispensable to the carpenter, builder, architect, draftsman, contractor, and lumberman. Worth many times cost.

Order from: E. Weyer, Dept. F, P.O. Box 153, Planetarium Station, New York 24, N. Y.



WHAT DOES THIS SYMBOL MEAN

**to our readers and
advertisers?**

What it is

The Associated Business Papers is a national association of business publications devoted to increasing their usefulness to their subscribers and helping advertisers get a bigger return on their investment.

How the reader benefits

Through the constant exchange of editorial and publishing ideas with fellow ABP members, each individual editor and publisher is able to give his readers the benefit of the best experience in publishing.

One interesting result of this cooperative affiliation has been a program, sponsored by ABP publishers, wherein they work with advertisers to help them make their messages more informative and useful to business magazine readers. *American Builder*, as an active participant, has interviewed many of its readers to find out from Builders and Dealers themselves what some of their *problems* are that are also *opportunities* for manufacturers who know something that will help.

How the advertiser benefits

The more helpful a business publication is to its readers—the more avid and constant its readership; hence, the more assurance the advertiser has that his message, *if as helpful and informative as the editorial pages*, will be read, understood and acted upon. Advertising can be *more* interesting and useful to readers because it can talk more specifically of *user benefits* than is generally possible in editorial material.

A number of our advertisers have expressed interest in applying specifically to the building field some of the "Tell All"* principles brought out in ABP's crusade to help advertisers get a bigger return on their investment.

To dig up material that might reveal angles of interest to advertisers, we employed a Field Reporter to call on Builders and Dealers. He is specially trained by ABP in the art of "drawing out" readers. His field reports are being passed along to manufacturers with the thought that this first-hand, up-to-the-minute picture of reader problems and viewpoints might reveal opportunities for them to step up the interest and usefulness of their advertising. We believe that those manufacturers of building materials and equipment who do this will get a greater value for their money and, of course, it will make *American Builder* more interesting and valuable to the readers.

And what does American Builder Get out of it?

These benefits of ABP membership help us build a better business publication for our special group of "fan" readers, hence a better vehicle for the messages of manufacturers who have something of interest to say to those same readers. It's a matter of record that fruitful advertising usually means more advertising. And that means more income with which to improve our publishing business.

*Definition of "Tell All" Advertising: Each and every advertisement should be given a specific and sufficient objective and should tell all that the business minded business paper reader must know before the advertisement can attain that objective.



Chicago 3, Illinois: 105 West Adams St.; New York 7, N.Y.: 30 Church St.; Cleveland 13, Ohio: Terminal Tower; Ann Arbor, Mich.: 1080 Stein Road; Washington 4, D.C.: 832 National Press Building; Seattle 1, Wash.: 1038 Henry Building; San Francisco 4, Calif.: 300 Montgomery St.; Los Angeles 14, Calif.: 530 West 9th St.; Dallas, Texas: P. O. Box 1008.

a book to recommend to building-bent customers

the house for you

To Build, Buy or Rent

By CATHARINE & HAROLD SLEEPER

Not only can you safely recommend this excellent book to customers to guide their home-building ideas, but you will find it an invaluable source of reference in giving building help and guidance.

While THE HOUSE FOR YOU also discusses buying and renting, emphasis is on building . . . and the authors advocate building to suit individual tastes and needs wherever feasible.

THE HOUSE FOR YOU is written in a lively easy-to-read manner. It covers the entire field of building . . . selection of a site, details of planning, construction, types and styles of homes, finishes, etc. The book is fully illustrated with many helpful plans, graphs and charts. It is an outstanding book in its field.

1948
313 Pages
\$5.00



ON APPROVAL COUPON

AB-3-48

JOHN WILEY & SONS, INC.
440 Fourth Ave., New York 16, N.Y.

Please send me, on ten days' approval, a copy of Sleeper & Sleeper's THE HOUSE FOR YOU To Build, Buy or Rent. If I decide to keep the book, I will remit \$5.00 plus postage; otherwise I will return the book postpaid.

Name _____
Address _____
City _____ Zone _____ State _____
Employed by _____
(Offer not valid outside U.S.)

ANYONE CAN DO THIS IF THEY HAVE OUR CHART

Blue print 27x36" now printed on both sides showing squares full size. Shows how to find the length of any rafter, find any angle, in degrees, frame any polygon three to sixteen sides, read the board foot and brace-table, octagon scale, rafter tables, many other uses, can be scaled down for model work as well as full scale framing. Also chart changing pitches to degrees. For use with radial saws. About 13 square feet of printed copy sent post paid for \$1.00.

SLIDE CALCULATOR for Rafter

TWO AIDS for SPEED and ACCURACY

Special Offer for Agents

Makes figuring rafters a cinch! Shows the length of any rafter having a run of from 2 to 23 feet; longer lengths are found by doubling. Covers 17 different pitches. Shows lengths of hips and valleys, commons, jacks, and gives the cuts for each pitch, also the angle in degrees and minutes. Fastest method known, eliminates chance of error, so simple anyone who can read numbers can use it. Not a slide rule but a Slide Calculator designed especially for Carpenters, Contractors and Architects. Thousands in use. Price \$2.90 postpaid. Check or M. O., no stamps.

MASON ENGINEERING SERVICE, 2108 N. Burdick St., Dept. 3, Kalamazoo 81, Mich.

Down Hill ALL THE WAY!

Well Balanced FOR EASY WHEELING!

* Sterling barrows wheel so easily, they make it seem like going down hill all the way. Lightweight . . . well-balanced . . . equipped with modern, anti-friction bearings. Sterlings relieve the operator of fully 80% of the load. Delivery of Sterlings will be as prompt as conditions permit.

STERLING WHEELBARROW CO., Milwaukee 14, Wis.

Look for this Mark of STERLING Quality

Sterling WHEELBARROWS

NOW — AS NEVER BEFORE YOU NEED THIS SCREEN TACKER

This No. 760 Tacker and 10,000 Staples Only **\$10.50** Guaranteed

SAVE TIME—MAKING or REPAIRING SCREENS

Drives a flat steel staple securely holding wire. Reversible claws for pulling or pushing wire tight.

Write today for a 5-day free trial.

Wire stretching claws. Reversed for use with rabbeted screen frames

J. B. CROFOOT CO.
217 Evergreen Ave.
Mt. Prospect, Ill.

We ship postpaid if C. O. D. or when check is sent with order.

BRADLEY PRE-FINISHED (STRAIGHT-LINE) HARDWOOD FLOORING IN OAK, BEECH & PECAN

Write for data and specifications.

Bradley Lumber Co. of Arkansas
WARREN, ARKANSAS



SAFE!

CLEAN!

AUTOMATIC!

THAT'S WHY
MORE
HOME OWNERS
WANT

NORGE

**AUTOMATIC
ELECTRIC WATER HEATERS
THAN EVER BEFORE!**

NORGE WATER HEATERS ARE: Fumeless, flameless, smokeless, sootless, automatic. No flue, no vent. Plenty of hot water all the time. Low cost. Modern in every detail. Eight sizes from 12- to 82-gal.

NORGE WATER HEATERS HAVE: Thermostatic control. Sealed "Nichrome" element projected directly into water. Heat trap in outlet. Coldwater baffle at inlet. Three-inch spun glass insulation. Steel jacket finished in baked white enamel. Norge Division, Borg-Warner Corporation, Detroit 26.

A BORG-WARNER INDUSTRY

- REFRIGERATORS
- ELECTRIC RANGES
- WATER COOLERS
- WASHERS
- ELECTRIC WATER HEATERS
- HOME HEATERS
- GAS RANGES
- HOME FREEZERS

SEE
NORGE
BEFORE YOU BUY

NEW versatile FAN PACKAGE

A Complete Easy-to-Install Unit,
for **ATTIC, WALL**
or **BASEMENT**



**The BAR-BROOK
W-36 FAN UNIT**

Here is the answer to the Builders' prayer for a profitable yet economical cooling appliance for small homes and housing projects.

The Bar-Brook W-36 is a complete fan unit, simple and inexpensive to install in ceiling or wall. Rubber cushioned direct drive motor. Quiet two-speed air delivery, High 7000 CFM, Low 4500 CFM. Big 36" blades. Durable ivory white baked enamel finish. Available with or without automatic shutters.

You better write and get the complete details on the Bar-Brook W-36—TODAY!



**THE BAR-BROOK
W-30 Fan** is a smaller model that is also popular for small homes, apartments and offices. Two-speeds, High 4800 CFM, Low 3300 CFM. 30" blades. Ivory baked enamel finish.

BAR-BROOK Breezebuilder* Fans

have been consumer accepted—and preferred—for 16 years. 4 sizes—36", 42", 48", 54". Air deliveries certified by ASHVE Code. UL approved. Designed for ATTIC or BASEMENT installation.

Write for free catalogs.

*Trademark

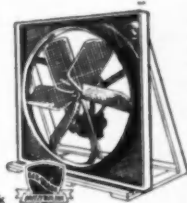

BAR-BROOK FANS
BAR-BROOK MANUFACTURING CO., INC.
SHREVEPORT, LA.

HOUSE CONSTRUCTION DETAILS

By NELSON L. BURBANK

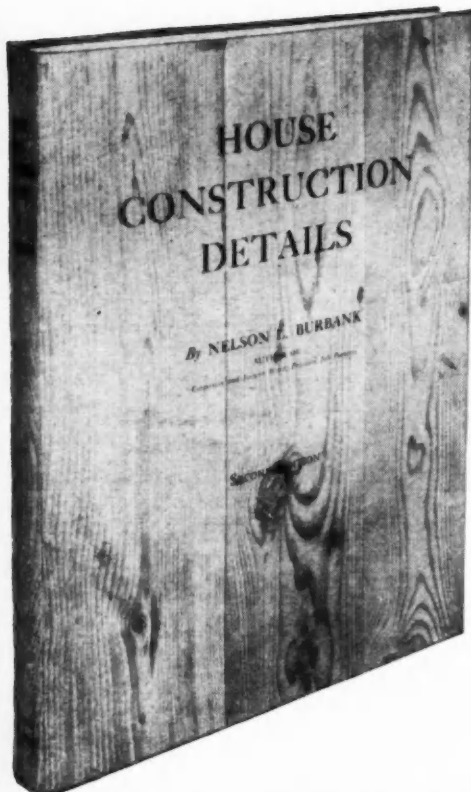

314 pages, 1,500 illustrations, index, 8 1/8 x 11, cloth, \$4.50

Practical builders find this book very helpful when making alterations in a set of stock plans or drawing up a complete set of plans for a house or small building. The details shown in clear line drawings and in photographs conform with standardizations recommended by housing authorities wherever such have been established.

The chapters are in construction sequence and as such serve as a guide in detailing each step in the construction of a dwelling, from foundation to finish. Just enough description is included to explain general principles.

Many of the new materials such as plywood are shown in application. Various systems of pre-fabrication are shown in addition to traditional methods of house carpentry. Chapters on painting, wiring, insulation and sound proofing, and on heating and air conditioning show modern methods. Graphic and factual information from widely scattered sources is brought together and cross-indexed for quick reference.

Look over the table of contents below and see the wide scope of its information. Then send for a copy on our money back guarantee and give it a five days working tryout.

Fill Out This Guaranteed Order Form

American Builder and Building Age
30 Church Street, New York 7, N.Y.

Enclosed find \$4.50 for which send me a copy of the Second Edition of HOUSE CONSTRUCTION DETAILS by Burbank. If I do not find the book satisfactory I will mail it back within five days of receipt and you will refund my \$4.50.

Name

Address

City..... Zone..... State.....

A. B. 3-48

Contents

Floor Plans; Sets of House Plans—Excavations; Foundations Forms; Foundations—Sills; Girders; Joists; Sub-Flooring—Outside Walls—Inside Walls; Wall Sheathing; Ceiling Joists—Roof Construction; Bay Construction; Roofing—Cornices and Porches—Exterior Wall Construction—Interior Wall Coverings; Interior Trim—Stair Construction—Windows—Doors—Hardware—Closets; Shelves; Built-in Equipment—Finished Flooring—Chimneys and Fireplaces—Scaffolds—Garages—Wiring for Modern Homes—Insulation; Sound Proofing—Gates; Garden Furniture—Camps; Cabins; Cottages—Farm Buildings—Painting and Finishing—Modern Homes—Modern Building Materials—Heating; Air Conditioning—Pre-Fabrication.

**AMERICA'S BIGGEST-SELLING
FLOOR FURNACE IS**

Coleman

THE COLEMAN CO., INC., WICHITA, KANSAS

**ANGELINA COUNTY
LUMBER COMPANY**

Southern Pine and Hardwoods

- MIXED CARS A SPECIALTY
- 61 YEARS OF SERVICE
TO RETAIL LUMBER DEALERS

General Sales Office — Keltys, Texas

THE EVERYDAY ESTIMATING KIT

This handy kit contains complete forms for estimating ten repair, maintenance, modernization or other small jobs. Each form consists of a permanent stub on which the contractor makes out his estimate, and a detachable Letter of Proposal which is given to the prospect. On the back of the stub, which is securely stapled to the 4 3/8 x 8 1/2-inch folder cover, is a form for recording the actual costs of the job. The stiff paper will stand erasures and the folder keeps it clean. Does away with messy carbons and facilitates quick estimates on all kinds of small jobs.

Single Kit, \$.35; Four for \$1.00; Dozen for \$3.00

Book Department

AMERICAN BUILDER and BUILDING AGE

30 Church Street

New York 7, N. Y.

CONCRETE MIXERS \$59⁸⁵ up

Gasoline,  or Hand Electric Operated

MULLER MACHINERY CO., Inc.
Metuchen 3, N. J.

Send Prices and Literature ■ Dealer Information ■

Name

Company

City

State



INSL-COTTON

INSULATION'S BEST SALESMEN

are INSL-COTTON owners

Yes, Insl-Cotton owners are so sold on Insl-Cotton they sell their friends! In the winter-time they brag about how low their fuel bills are...in the summer, they keep talking about that up-stairs room that used to be an oven, but now is cool and comfortable.

They tell their friends how easy it is to install Insl-Cotton—that it is light as a feather, doesn't irritate skin, eyes or lungs. They explain that Insl-Cotton is flame-proof and fire-retarding—actually helps protect their homes. They bear down on the fact that Insl-Cotton won't sag or settle, but will last them the lifetime of their homes.

There's a big satisfaction in handling a product that not only creates dollar profits...but creates those greater profits of customer good will!

Contractors—no special equipment needed to install Insl-Cotton...low labor costs. Insl-Cotton exceeds government specifications for 7d, FHA, FPHA and HH-1-528 specifications.



*** Certified** - Insl-Cotton contains no second-hand material. Every lot is tested and certified to the U. S. Government. No other insulation except flame-proof, fire-retarding cotton insulation made under Federal supervision can make this claim. Insl-Cotton will permanently retain its flame-proof qualities—you are certain to get what you buy.

INSL-COTTON DIVISION

TAYLOR BEDDING MFG. CO. TAYLOR, TEXAS

The Originators of Flame-Proof, Fire-Retarding Cotton Insulation

MAIL THIS ORDER COUPON TODAY

DEALERS DISTRIBUTORS

Some territories still open for competitively priced Insl-Cotton. Write for details.



INSL-COTTON DIVISION
Taylor Bedding Mfg. Co., Taylor, Texas

Gentlemen:
Please send specifications and full information on INSL-COTTON.

Name

Address

City and State

Check Here: Distributorship Architect Contractor.

ALPHABETICAL INDEX TO ADVERTISERS, MARCH, 1948

A

Abesto Manufacturing Corp.....224
 Acme Sash Balance Company.....174
 Adam Electric Company, Frank.....206
 Adams-Rite Manufacturing Co.....170
 Air Control Products, Inc.....127
 Air Rectifiers, Inc.....204
 Airtemp Division of Chrysler Corporation.....47
 Allianceware, Inc.....239
 Allied Building Credits, Inc.....42
 Allied Chemical & Dye Corporation.....232
 Allith-Prouty, Inc.....208
 Aluminum Building Products Co.....210
 Aluminum Company of America.....159
 American Builder.....36-40-172-210-234-241-244
 American Floor Surfacing Machine Co., The.....138
 American Gas Association.....32-33
 American-Marietta Co., The.....16
 American Radiator & Standard Sanitary Corporation.....6
 American Roof Truss Co.....172
 American Stained Shingle Co., The.....146
 American Structural Products Company.....139
 American Telephone & Telegraph Co.....29
 American Zinc Institute.....198
 Au-Jean Mfg. Co.....238
 Andersen Corporation.....48
 Angelina County Lumber Company.....245
 Anthracite Institute.....237
 Archer-Daniels-Midland Co.....34
 Architects Cooperative Plan Service.....230
 Arkansas Soft Pine Bureau.....38
 Arkansas Cork Company.....24-25, 132-133
 Artcraft Ornamental Iron Co.....184
 Asphalt Roofing Industry Bureau.....143

B

Barber-Colman Company.....152
 Bar-Brook Mfg. Co., Inc.....243
 Barrows Lock Works.....218
 Bendix Home Appliances, Inc.....231
 Bennett-Ireland, Inc.....147
 Better Homes and Gardens.....20
 Bird & Son, Inc.....176
 Boice-Crane Co.....178
 Borg-Warner Corp.....49-243
 Bradley Lumber Company of Arkansas.....242
 Bruce Co., E. L.....19
 Brunson Instrument Co., The.....182
 Bryant Heater Company.....183
 Buss Machine Works.....228

C

Cabot, Inc., Samuel.....182
 Carey Manufacturing Co., The Philip.....35
 Carter Div., R. L.....204
 Ceco Steel Products Corporation.....140-141
 Celotex Corporation, The.....2
 Certain-tyed Products Corp.....132-133
 Charles Paint Research Co.....180
 Chevrolet Motor Division.....44
 Chicopee Manufacturing Corporation.....148
 Chrysler Corporation.....47
 Coleman Co., Inc., The.....245
 Columbia Mills, Inc., The.....149
 Consolidated Machinery & Supply Co., Ltd.....220
 Construction Machinery Co.....214
 Copco Steel and Engineering Co.....187
 Cotton Insulation Association.....215
 Crane Co.....163
 Crofoot Co., J. B.....242
 Croft Steel Products, Inc.....220
 Crossett Lumber Company.....191
 Curtis Companies Service Bureau.....209

D

Detroit Metal Products, Inc.....208
 Detroit Steel Products Company.....3-153
 Devoe & Reynolds Company, Inc.....157-175
 DeWalt, Inc.....13
 Douglas Fir Plywood Association.....161
 Du-All Scaffold Bracket Company.....216
 Dunn Mfg. Co., W. E.....222
 Duplex, Inc.....188

E

Eagle-Picher Company, The.....168
 Electro Metallurgical Company.....21
 Eljer Co.....56
 Elliott Paint & Varnish Co.....192
 Exchange Sawmills Sales Co.....240

F

Fastener Corporation.....178
 Fiat Metal Manufacturing Company.....154
 Firestone.....12
 Flexsaw Co., The.....180
 Flintkote Company, The.....53, 132-133
 Foley Mfg. Co.....236
 Ford Cement Block Machine Co.....202

Ford Motor Company.....11
 Frantz Manufacturing Co.....194
 Frost Lumber Industries, Inc.....233

G

Gabriel Steel Company.....186
 Gaskill-Oertel.....236
 Gate City Sash & Door Co.....190
 General Electric Company.....171-195-207
 General Motors Corporation.....44
 General Portland Cement Company.....196
 Getty & Co., Inc., H. S.....198
 Gilman Brothers Company, The.....151
 Goldblatt Tool Co.....226
 Grand Rapids Hardware Company.....200

H

Hansen Mfg. Co., A. L.....236
 Harris, Inc.....186
 Heston & Anderson.....214
 Homelite Corporation.....189
 Hotpoint, Inc.....223
 House & Garden.....193

I

Illinois Porcelain Enamel Co.....182
 Ingersoll Utility Unit Division.....49
 Insl-Cotton Division.....245
 Insulate Division Minnesota & Ontario Paper Co.....31
 Irvington Form & Tank Corporation.....164

J

Jackflat Co.....232
 Jackson Dishwasher Co., The.....156
 Jaeger Machine Co., The.....202
 Johns-Manville.....201
 Jones & Brown, Inc.....135

K

Keasbey & Mattison Company.....197
 Kelly Island Lime & Transport Co.....132-133
 Kelvinator Division.....66
 Keystone Asphalt Products Co.....16
 Keystone Steel & Wire Co.....150
 Kimball Manufacturing Company, Inc.....240
 Kimberly-Clark Corporation.....173
 Kohler Co.....169
 Kresky Mfg. Co., Inc.....238

L

Last Frontier Hotel.....184
 Lau Blower Company, The.....235
 Libbey-Owens-Ford Glass Company.....205
 Louisville Cement Company, Incorporated.....27
 Lowe Co., The.....232
 Lumite Division.....148

M

Macklanburg-Duncan Co.....203
 Maco Corporation, The.....232
 Majestic Co., The.....218
 Marco Stairways.....186
 Mason Engineering Service.....242
 Masonite Corp.....177
 Master Rule Mfg. Company, Inc.....240
 Master Woodworker Mfg. Company, The.....238
 Mastic Asphalt Corp.....135
 McGraw-Hill Book Co., Inc.....230-236
 Medusa Portland Cement Co.....10
 Miami Cabinet Division, The.....35
 Milwaukee Strip Service, Inc.....232
 Minneapolis-Honeywell.....155
 Monsanto Chemical Company.....174
 Muller Machinery Co., Inc.....245
 Mullins Manufacturing Corporation.....211

N

Nash-Kelvinator.....66
 National Adequate Wiring Bureau.....185
 National Brass Company.....18
 National Clay Pipe Manufacturers, Inc.....131
 National Cotton Council of America.....215
 National Door Manufacturers Association.....192
 National Electric Products Corporation.....14
 National Electrical Manufacturers Association.....54-55
 National Gas Equipment Company, Inc.....202
 National Gypsum Company.....26
 National Lock Company.....188
 National Manufacturing Company.....4th Cover
 Nordahl.....200
 Norge Division, Borg-Warner Corporation.....243
 Northwest Metal Products, Inc.....37
 Nu-Wall Manufacturing Company.....204

O

Ohio Hydrate & Supply Co., The.....208
 Overhead Door Corporation.....3rd Cover
 Owens-Illinois Glass Company.....139
 Owens-Corning Fiberglas Corporation.....132-133

P

Paxson Co., The.....184
 Permanente Metals Corporation.....219
 Pittsburgh Plate Glass Company.....217
 Pittsburgh Steel Company.....15
 Pittsburgh Steel Products Company.....15
 Porter-Cable Machine Co.....137
 Portland Shingle Company.....230
 Pratt & Lambert, Inc.....30
 Precision Parts Corp.....17
 Prima Products, Inc.....194
 Pryne & Co., Inc.....212

R

Ranetite Mfg. Co.....240
 Readybuilt Products Co., The.....236
 Reardon Company, The.....221
 Red Cedar Shingle Bureau.....50
 Red Devil Tools.....240
 Red Star Products, Inc.....45
 Remington Rand.....225
 Republic Steel Corporation.....181
 Reynolds Metals Company.....9
 Rheem Home Comfort Appliances.....167
 Richmond Radiator Company.....129
 Roddis Lumber & Veneer Co.....229
 Rowe Manufacturing Company.....125
 Ruberoid Co., The.....41
 Ryerson & Son, Inc., Joseph T.....200

S

Samson Cordage Works.....166
 Sargent & Company.....53
 Schlage Lock Company.....158
 Scott & Sons Co., O. M.....216
 Sedgwick Machine Works.....206
 Serval, Inc.....144-145
 Sharon Steel Corporation.....43
 Shevlin-McCloud Lumber Co.....236
 Sisalkraft Co., The.....165
 Skillman Hardware Mfg. Company.....223
 Skilsway, Inc.....23
 Smith Company, The T. L.....220
 Solvay Sales Division.....232
 Spray-O-Bond Company.....178
 Standard Dry Wall Products, Inc.....210
 Standard Stamping & Perforating Co.....226
 Stanley Tools.....176
 Stanley Works, The.....8
 Steelercraft Manufacturing Company.....179
 Sterling-Freeland Industries, Inc.....228
 Sterling Tool Products Co.....199
 Sterling Wheelbarrow Co.....242
 Stewart Manufacturing Company.....211
 Stow Metal Products Co.....180
 Strand Building Products Company.....65
 Structural Clay Products Institute.....22
 Surface Combustion Corporation.....227
 Sweet's Catalog Service.....190

T

Tamblyn System, The.....218
 Taylor Bedding Mfg. Co.....245
 Taylor Manufacturing Company.....160
 Thorn Co., J. S.....28
 Tile-Tex Co., Inc., The.....235
 Tiletone Company.....212
 Trinity Portland Cement Division.....196
 Truscon Laboratories.....175
 Truscon Steel Company.....181
 Turner & Seymour Mfg. Co., The.....214

U

Union Carbide and Carbon Corporation.....21
 United States Steel Corporation Subsidiary.....213
 Universal Atlas Cement Company.....213
 Universal Sanitary Manufacturing Company.....134
 Upson Company, The.....4

W

Wallace & Co., J. D.....224
 Wallace Manufacturing Co.....222
 Wappat, Fred W.....196
 Weatherproof Products Corp., The.....226
 Werner Co., Inc., R. D.....142
 Western Pine Association.....206
 Weyer, E.....240
 Wheeler, Osgood Company, The.....228
 White Company, David.....216
 Wickwire Brothers, Inc.....162
 Wilbur and Williams Paint Corporation, The.....224
 Wiley & Sons, Inc., John.....242
 Wilson Foundry and Machine Co.....39
 Wood Conversion Company.....46
 Worthington Pump and Machinery Corporation.....28