

# AMERICAN ★ BUILDER

DECEMBER 1949  
PRICE 50 CENTS

THE WORLD'S GREATEST BUILDING PAPER



*A Salute to America's Home Builders*  
**For Producing More Than 900,000 New Homes in 1949**

# The Thermostat That Does Everything

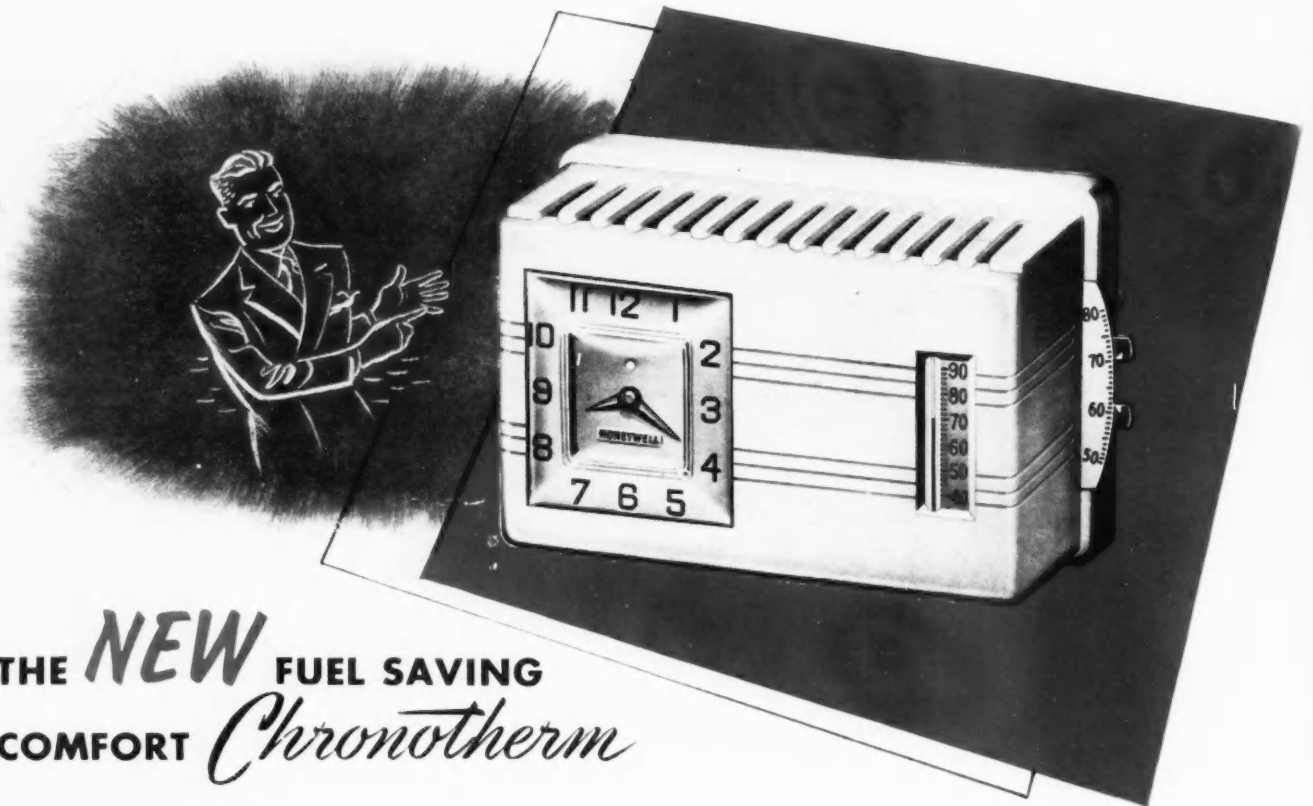

## THE *NEW* FUEL SAVING COMFORT *Chronotherm*

EVERYTHING to bring owners of your homes sensitive, accurate home heating comfort—that's what Chronotherm does, automatically and economically. Right around the clock, seven days a week, this new Honeywell electric clock thermostat helps heating plants perform at their best—helps make every home owner a bigger booster for his heating plant, and for you.

Automatically, Chronotherm saves fuel every night by lowering room temperatures and returning them in the morning to whatever level is wanted for daytime comfort. By this feature, alone, Chronotherm pays for itself.

So, here's reason enough to include Chronotherm in every home you build. It's a nationally advertised product with real consumer acceptance. Use Chronotherm as a sales feature—as a mark of quality as well as convenience. Minneapolis-Honeywell, Minneapolis 8, Minnesota. In Canada: Leaside, Toronto 17, Ontario.

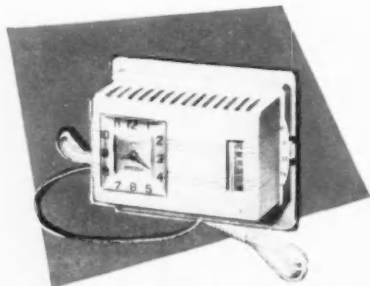

The new Plug In Chronotherm is designed to replace all manual thermostats. All the advantages of the regular Chronotherm. Anyone can install it in a few minutes.

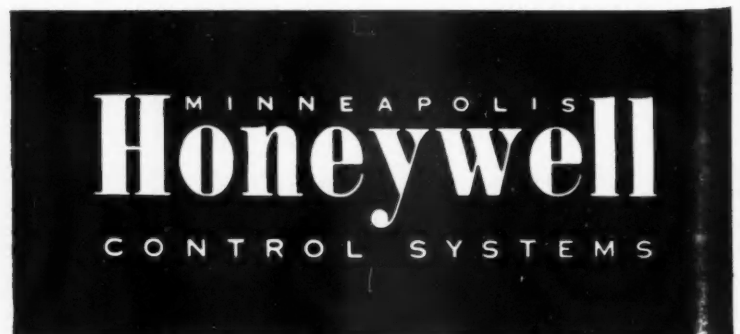

77 BRANCHES FROM COAST TO COAST WITH SUBSIDIARY COMPANIES IN: TORONTO • LONDON • STOCKHOLM • AMSTERDAM • BRUSSELS • ZURICH • MEXICO CITY





Residence in Caldwell, Idaho, equipped with beautiful, standardized Fenestra Residence Steel Casements. Architects: C & A Schreiber—Chicago; Hummel, Hummel & Jones—Boise. Contractor: Hoff Bldg. Supply Co.—Caldwell.

## EXTRA SALES APPEAL that actually costs less

Busy builders are meeting the challenge of today's buyers' market with homes like the one shown above . . . equipped with Standardized Fenestra\* Residence Steel Casements.

They are finding—as Builder O. D. Arnold wrote us recently—that “Fenestra Steel Casement Windows represent an important feature in the sale of our homes” and are “installed at a lower cost than our original estimate for ordinary windows.”

### Some of the sales-appealing features:

1. Fenestra Residence Steel Casements are modern appliances—swing leaves twirl open by geared Roto-Adjusters. They can't warp, swell or stick.
2. They are easy to wash and screen and stormsash . . . all from inside the room.
3. They are graceful casements designed to bring in more light and air.

### Some of the reasons for their low cost:

1. Standardization streamlines Fenestra production, keeping costs down and the quality uniform.
2. Standard types and sizes save on-the-site time and money.
3. Frame and sash are assembled, Bonderized, and prime paint is baked-on—at the factory. Easy-to-attach hardware is supplied with each unit.

There's a right window in Fenestra's Residence line for every spot in the house—even over sink or buffet. Standard units can be combined into whole window walls, picture windows with flanking casements, corner windows.

Build the low cost, high performance sales appeal of Fenestra Windows into *your* homes. See your nearest Fenestra dealer for types and sizes, or write to Detroit Steel Products Company, Dept. AB-12, 2260 East Grand Boulevard, Detroit 11, Mich.

\*®

### WHICH IS THE RIGHT WINDOW TO USE?

For maximum economy—Type 2414N. Meets most residential needs. For all general locations. One swing leaf provides 50% opening.



For maximum ventilation—Type 2424. Provides 100% opening. Costs more than Type 2414N because it has two ventilators with Roto-Adjusters.

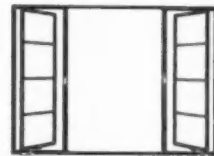

For maximum view—Type 4424. Picture window, plus ventilation. Fenestra's many types and sizes provide a *right* window for every need in the home.



# LET FRED LUDWIG TELL YOU

## how UPSON KUIVER-KRAK PANELS

### solved the cracked ceiling problem in his own home



**FRED H. LUDWIG**, *President Merritt Lumber Yards, Inc., Reading, Pa., former president National Retail Lumber Dealers Association, nationally known merchandiser of quality building materials, writes:*

"The reason that I used Upson Kuiver-Krak Panels in the living room and library of my own residence was brought about by the great difficulty I had with the plaster cracking. In fact some of the white coat separated from the brown coat.

"Having the faith in Upson Panels, developed through the many years that we've handled your products, prompted me to use it and once and for all, get rid of further failures.

"I am glad to report to you that these panels have been very satisfactory and have done everything that we expected them to do."



*Few homes have the charm and character of Mr. Ludwig's living room with an Upson-pannelled ceiling.*

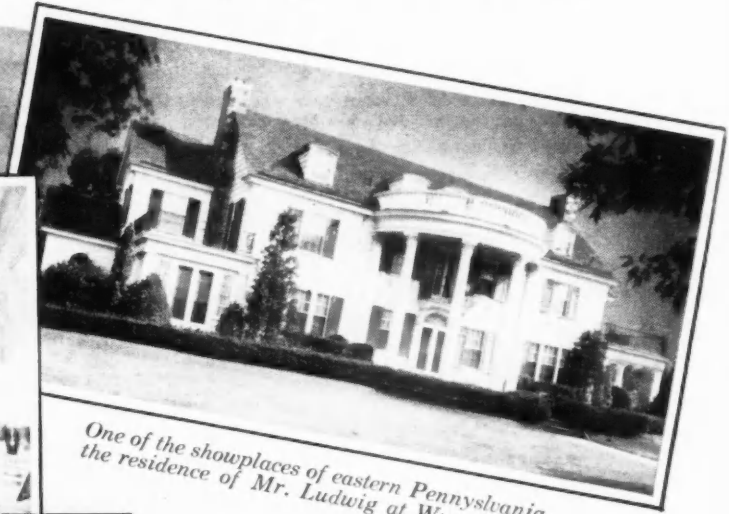

*One of the showplaces of eastern Pennsylvania, the residence of Mr. Ludwig at Wyomissing.*



**mail this coupon today!**

### THE UPSON COMPANY

5112 Upson Point, Lockport, New York.

I am interested in knowing more about Upson Strong-Bilt Panels  Kuiver-Krak Panels  Send me a free copy of your booklet—"New Interiors For Old."

NAME \_\_\_\_\_

TYPE OF BUSINESS \_\_\_\_\_

STREET \_\_\_\_\_

CITY \_\_\_\_\_ STATE \_\_\_\_\_

You mar the beauty of any panel when you face nail. Avoid it with Upson self-clinching Fasteners. Like Fred Ludwig, thousands of lumber dealers and thousands of carpenters too will tell you there's nothing like Upson Panels for re-covering cracked ceilings.

*Upson Strong-Bilt Panels for new construction. Upson Kuiver-Krak Panels for re-covering cracked plaster.*

Cop  
SIM  
POR  
Ill.;  
ican  
Build  
Build  
foun  
U.S.  
of tr

Subs  
sessi  
forei  
Sing  
ques  
of b  
LOR  
Conf  
Simo

Add  
ence  
part  
New

Char  
week  
old  
sible  
will  
extra  
sent.

P  
Ra  
Ra  
M

# AMERICAN BUILDER

Founded - 1879

Copyright 1949 with all rights reserved, SIMMONS-BOARDMAN PUBLISHING CORPORATION, 79 W. Monroe St., Chicago 3, Ill.; 30 Church St., New York 7, N.Y. American Builder (originally "Carpentry and Building") with which are incorporated Building Age, National Builder, Permanent Builder, and the Builder's Journal, was founded Jan. 1, 1879. Names registered in U.S. patent office and Canadian registrar of trade mark.

Subscription price: United States and Possessions and Canada, 1 year, \$3; 3 years, \$5; foreign countries, 1 year, \$10; 3 years, \$20. Single copies, 50c each. Subscribers are requested to state company connection, nature of business, title or position. W. L. TAYLOR, Circulation Manager; Field Staff: C. L. Conley, W. J. Griffith, C. R. Hartung, John Simonson, Dick Whittington.

Address all subscriptions and correspondence concerning them to: Subscription Department, American Builder, 30 Church St., New York 7, N.Y.

Changes of address should reach us three weeks in advance of next issue date. Send old address with the new, enclosing if possible your address label. The Post Office will not forward copies unless you provide extra postage. Duplicate copies cannot be sent.

**SIMMONS BOARDMAN  
PUBLISHING CORPORATION**

**THE HOUSE OF BUILDING  
AND TRANSPORTATION**

*Publisher of*

**American Builder  
Railway Age**

**Railway Engineering & Maintenance  
Railway Mechanical Engineer  
Railway Signaling & Communications**

**Marine Engineering &  
Shipping Review**

**Car Builders Cyclopedia  
Locomotive Cyclopedia  
Railway Engineering &  
Maintenance Cyclopedia**

**Marine Catalog & Buyers Directory  
Books covering Building and  
Transportation**



## In This Issue

**Publisher's Page** ..... 7  
 "Ill Fares the Land . . . Where Men Decay"

**Association News**..... 63

**Editorial**..... 69  
 Socialism in Australia

### FEATURES

**National Home Week**..... 70  
 Building industry's annual promotion mushrooms in second year to include more cities, more builders, keener public interest

**Parade of Homes**..... 71  
 A twenty-five page presentation of homes successfully displayed in various sections of country during National Home Week

**How Color Helps Sell Homes**..... 96  
 The story of a color counsellor who has color-styled more than 25,000 homes in 19 states

**Utility Companies Offer Builders Aid in Kitchen Planning**..... 98  
 Better kitchens result when builders take advantage of "know-how" of planning department of Southern Calif. Gas Co.

**Everyday Building Methods Can Be Used**..... 100  
 Blueprint House of the Month

**Performance of a Typical Baseboard Heating System**..... 105  
 National Bureau of Standards tests baseboard heating in low-cost housing

**How to Plan for Modern Electrical Living**..... 106  
 "Four Degrees of Electric Living" Demonstrated in Indianapolis homes

**Salute to Courage**..... 110  
 R. E. Saberson salutes building industry for its impressive 1949 record

**How Builders Sell**..... 111  
 Third of a series of articles detailing ideas of outstanding builders on public relations

**Cutting Costs through Modern Design**..... 156  
 Specializing in homes of functional design reduces firm's building costs

**Swimming Pools Built Without Use of Concrete Forms**..... 160

### DEPARTMENTS

**Trends** ..... 47

**On and Off the Record**..... 51

**Editors' Round Table**..... 55

**Technical Guide, How-To-Do-It and Better Detail Plate**..... 112

**New Products**..... 118

**Catalogs** ..... 126

**Index to Advertisers**..... 186





# Stock up now...

**Nu-WAY**  
 TM REG. U. S. PAT. OFF.  
**WEATHER STRIP**  
 for doors and windows!



**EASIER TO SELL ...**

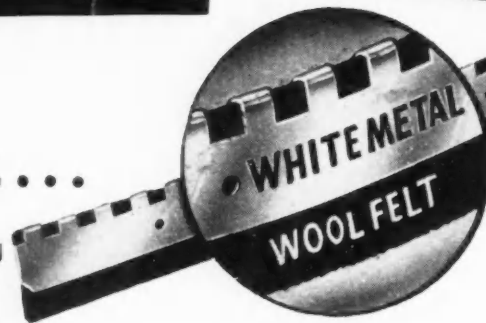

**EASIER TO PUT ON!**



Any clerk, regardless of his experience, can sell Nu-WAY Weather Strip quickly and intelligently. And, any customer, regardless of his inexperience, can install Nu-WAY with perfect results. What could be sweeter? We know that's why you won't want to miss any sales of this all-time favorite. We'll pre-sell it for you in our national advertising. All you have to do is to keep well supplied. Be ready for Fall sales, order your stock of Nu-WAY Weather Strip now!

**THESE BUSINESS-GETTERS MAKE Nu-WAY SALES EASIER!**

*Handy*  
**DISPLAY CARTON**



Attractive display carton holds 12 individual 20-ft. rolls of Nu-WAY, each with sufficient nails and instructions for easy installing.

*National*  
**ADVERTISING**



Consistent advertising in leading national magazines tells your customers to buy Nu-WAY from you. Don't miss any of these sales—keep well supplied.

**KEEPS OUT COLD--SAVES FUEL**

*Brings in sales!*



**ORDER NOW — Your order will be shipped same day received**

# MACKLANBURG-DUNCAN CO.

OKLAHOMA CITY 1, OKLAHOMA

## Publisher's Page



### "Ill Fares the Land . . . Where Men Decay"

"THIS country is going to hell," said an elderly man. "Old men always have said that," replied a younger man. "History shows the old men always have been right," answered the oldster. "Every country in the world excepting ours already has gone to hell, and ours is well on the way." Nobody can survey the ruins of nations throughout the world without admitting that he was largely right. But how about this country? Is it traveling the same road?

A man has to be advanced in years to realize from his own experience the startling change that has occurred in the American people within the last quarter-century.

*"Ill fares the land, to hastening  
ills a prey,  
Where wealth accumulates, and  
men decay."*

The change is indicated by what the people do themselves and by what they tolerate others doing.

Prior to two decades ago almost all, excepting the ill and feeble-minded, took pride in depending on their own efforts and thrift for their current living, for improving their standards of living and positions in life, and for providing for their future. The nation was built to its present greatness by the virtually universal practice of self-help.

It seems that now almost everybody seeks to live largely on the efforts of others and to have his future provided by them. Labor

unions strike rather than agree to having their members participate with industry in providing funds for pensions. Thousands prefer loafing on unemployment compensation to working for good wages. Many farmers favor and accept subsidies from government for not producing and to maintain prices. Many businessmen and industries (such as those providing and using waterway, highway and air transportation) seek and defend subsidies that put the unsubsidized railroads at a competitive disadvantage. We have become largely a nation of panhandlers and burglars preying upon the general taxpayer—in ignorance or disregard of the fact that this taxpayer is ourselves!

And who would have believed a quarter of a century ago that the American people would grow so soft and stupid that they would allow great labor monopolies to exist and use the strike to threaten the people with paralysis of industry and freezing? The Taft-Hartley Act is part of the law of the land which the President has sworn to enforce, and could have been invoked by him to prevent the national emergency caused by the steel and coal strikes. Yet, although President Truman, for his own political reasons, has refused to use this law to protect the people, there has as yet been no great outburst of public sentiment in condemnation of his conduct.

It is almost seventeen years since the New Deal began teaching the economic and social philosophy that it is the government's duty to care for the people instead of the people's duty to care for themselves, that "security" is more important than progress and prosperity, and adopting corresponding policies. Hence, a large part of the adult population knows little or nothing about policies and conditions when the American philosophy of individualism, self-help and control of the government by the whole people, not organized minorities, prevailed.

Is it still possible to re-establish belief of the majority in individualism and self-help and lead it to the destruction of the labor monopolies and to repudiation of the so-called "welfare (i.e., charity) state?" Socialism is like cancer—its growth can be stopped if the attempt is made in time, but to be successful the attempt must be made in the incipient stages of the disease.

Whether it is too late now to destroy labor monopolies and arrest the growth of socialism can be determined only by the beginning immediately of opposition to them in politics by forces as well organized and led as are the labor monopolies and other forces now destroying individualism and private enterprise, which are the only dependable foundation of popular government, freedom and prosperity.

American Builder is published by the SIMMONS-BOARDMAN PUBLISHING CORPORATION, with editorial and executive offices at 79 W. Monroe St., Chicago 3, Ill.; 30 Church St., New York 7, N.Y. Samuel O. Dunn, Chairman of the Board; James G. Lyne, President; Robert H. Morris, C. J. Wageman, F. A. Clark, Vice Presidents; J. S. Crane, Vice President and Secretary; John T. DeMott, Treasurer.

American Builder is a member of Associated Business Publications (A.B.P.) and Audit Bureau of Circulations (A.B.C.). Printed in U.S.A.

*Samuel O. Dunn*

# More Glass means n

Here's additional proof that when you select from "Pittsburgh's" line of glass products and use "Pittsburgh's" experienced crews of workmen, you'll get a good-looking, practical front. And because today's business-wise merchant is familiar with the name "Pittsburgh," you'll find your selling job is made a lot easier simply by mentioning "Pittsburgh."

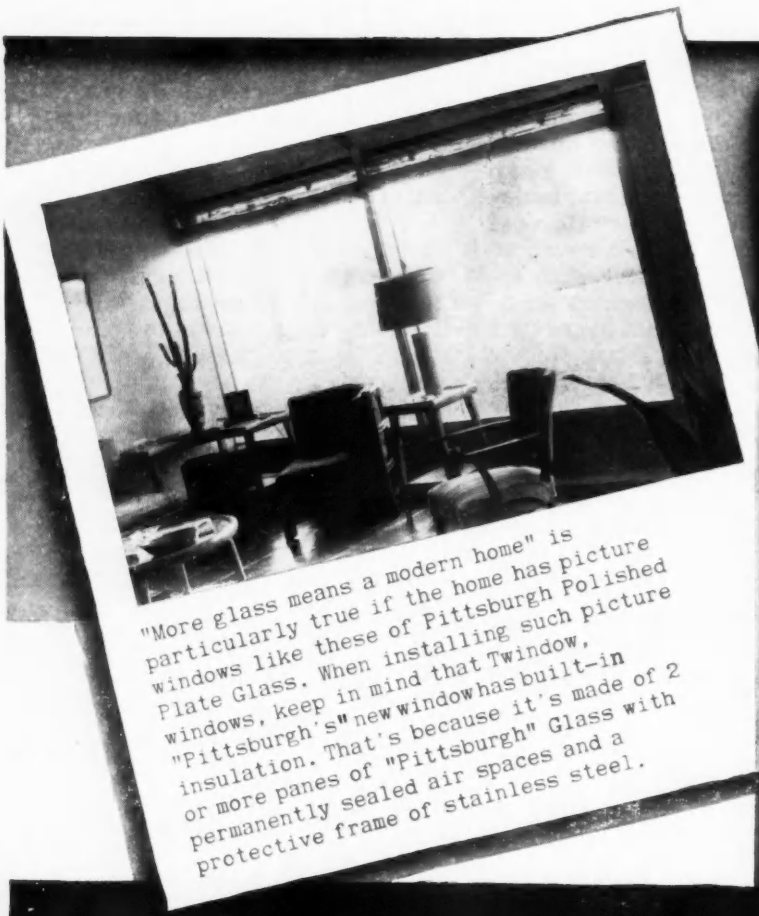

"More glass means a modern home" is particularly true if the home has picture windows like these of Pittsburgh Polished Plate Glass. When installing such picture windows, keep in mind that Twindow, "Pittsburgh's" new window has built-in insulation. That's because it's made of 2 or more panes of "Pittsburgh" Glass with permanently sealed air spaces and a protective frame of stainless steel.



Because it is practical and long-lasting, as well as extremely good looking, Carrara Structural Glass is well-suited for walls and wainscots of kitchens and bathrooms. For splash panels, too...behind stove or lavatory...as a fireplace surround or for corner shelves or window sills—Carrara is certain to please customers. They'll like its pleasing colors (10 to choose from). Its easy cleaning. And the fact that it won't check, craze, fade, or absorb odors.

Pitts  
an in  
the t  
a min  
insur  
This  
of "P  
the c  
"Pit  
that  
produ

Design



PI



# modern buildings

here's proof  
from "Pittsburgh"



Pittsburgh Plate Glass Company has developed an instrument which makes it possible to "read" the thickness of a silver film at any point on a mirror. The remarkable instrument thus insures more uniform mirror silvering quality. This development is another practical result of "Pittsburgh's" energetic program to improve the quality and the performance of all "Pittsburgh" products. And it is another reason that you can always recommend "Pittsburgh" products with confidence.

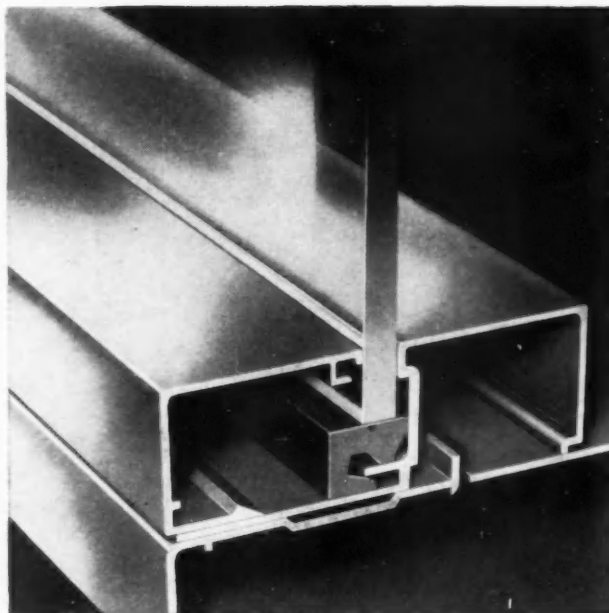

This double-faced rectangular sash (Pittco De Luxe 15C) is for use where store front design calls for a plain surface, rich in tone and gloss. This sash is especially suitable for installations above the first floor level, for the sash can be reversed and necessary replacements can be made easily from inside. It can be used with any Pittco De Luxe moulding. Its strength, and clear, sharp profiles are assured by its extruded method of manufacture.

See the complete listing and descriptions of Pittsburgh Plate Glass Company products in Sweet's Catalog Files.

Design it better with

# Pittsburgh Glass



PAINTS • GLASS • CHEMICALS • BRUSHES • PLASTICS

PITTSBURGH PLATE GLASS COMPANY

# Show your Clients these 3 modern Automatic Anthracite Heating Units

They save up to 52% annually on fuel bills

❏ **I. Automatic Anthracite Stokers—**  
 Installed in an existing boiler or furnace, or in new houses, automatic hard coal stokers deliver *plenty* of heat quickly . . . save up to 52% on fuel bills . . . eliminate fuel worries.



**2. The Revolutionary Anthratube—**saves on fuel bills . . . its proved efficiency is over 80%. This scientifically engineered boiler-burner unit, with "Whirling Heat" and other revolutionary features, produces quicker response, superior performance than units using other types of fuel. Fully automatic.

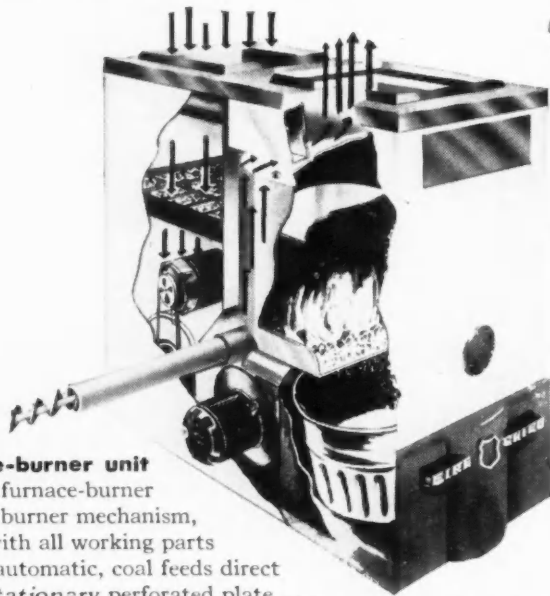
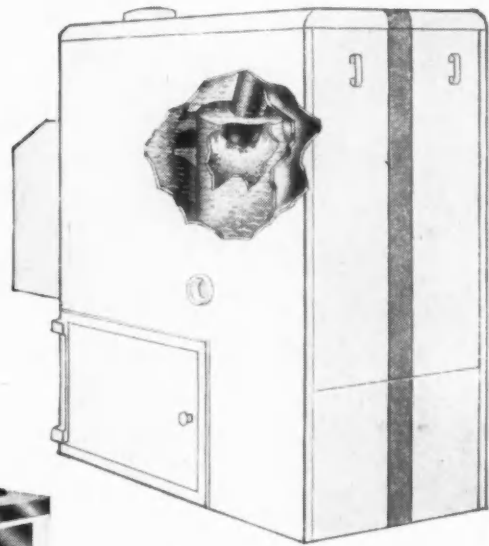

**3. Anthra-Flo furnace-burner unit**  
 —An entirely new type furnace-burner which features a simple burner mechanism, attached by two bolts with all working parts easily accessible. Fully automatic, coal feeds direct from bin across single *stationary* perforated plate . . . ashes discharge by gravity into container within unit. Available for steam, hot-water and warm-air heating systems.

**TODAY YOU CAN OFFER YOUR CLIENTS** modern automatic heat with Anthracite equipment.

You can show your clients how to save money . . . as much as \$100 to \$200 every year and yet have *plenty of heat—clean heat—even heat—*and no worry about future supplies or deliveries.

For complete information about (1) new anthracite stokers (2) revolutionary Anthratube or (3) Anthra-Flo, just fill in and return the coupon below.



**ANTHRACITE INSTITUTE**

101 Park Avenue • New York 17, New York

**ANTHRACITE INSTITUTE**  
 101 Park Ave., Dept. 12-D, New York 17, N. Y.

Please send me more information on

- 1. New Anthracite Stokers
- 2. Revolutionary Anthratube
- 3. Anthra-Flo furnace-burner unit

Name \_\_\_\_\_

Address \_\_\_\_\_

City \_\_\_\_\_ Zone \_\_\_\_\_ State \_\_\_\_\_

PLEASE PRINT

# **BRIXMENT** *makes better* **STUCCO** *and* **PLASTER,** *too!*



**Y**ou yourself know, probably from years of experience, that Brixment has many advantages for masonry — unusual plasticity, strength, bond, water-retention and freedom from efflorescence.

*Brixment is equally superior for stucco and plaster, too.* It can be used in leaner mixes, hence practically eliminates hair-checking and crazing. Its greater plasticity permits faster and smoother application. It also resists moisture. It is mixed and applied exactly like Portland-cement stucco *except that no lime is required.*

Brixment is being widely used with lightweight aggregate for interior plaster, because it is extremely economical, moisture-resistant and durable.

This 119-year-old company manufactures Portland cement and lime as well as Brixment. We ourselves use Brixment for stucco and plaster in our own construction. We recommend it to you. Write to us direct or ask your dealer for a copy of the handbook, "*Brixment for Stucco and Plaster.*"

**LOUISVILLE CEMENT COMPANY, Incorporated, LOUISVILLE, KENTUCKY**



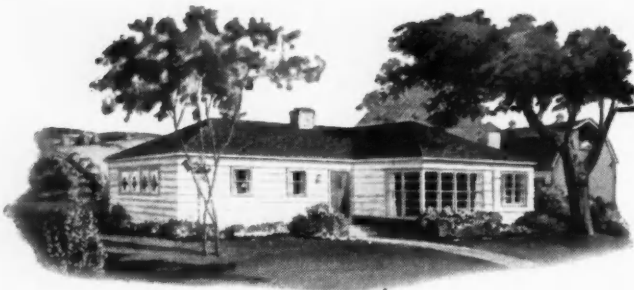

# Modern farm homes

ARE ADDED TO THE  
WEYERHAEUSER 4-SQUARE  
BUILDING SERVICES

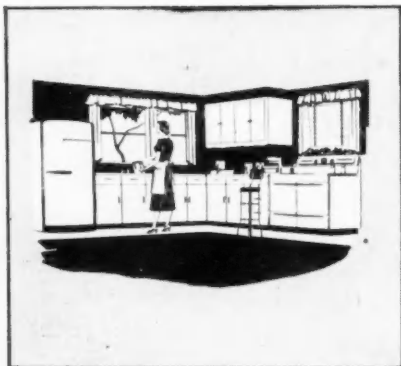

From the kitchens of all the 4-Square Farm Homes, the farm wife has a full view of the farm yard and approaching visitors... a feature women like.



Modern bathrooms, pleasant, airy bedrooms, and generous clothes closets are outstanding features of these farm homes.



A farm home is truly modern when its plans call for a service room that provides the space and equipment for laundering and other activities.

# HELPING BUILDERS SERVE another profitable field

More and more builders see in the farm market a rich field for the sale of farm homes . . . because farmers today have the buying power to satisfy the needs of their families for better farm living.

For years, Weyerhaeuser, through the 4-Square Home Building Service, has made available to builders the best in urban small homes . . . scores of practical, smart homes designed for the popularly priced market.

Now . . . at a time when interest in farm homes is accelerating at a lively pace, Weyerhaeuser offers six designs of modern farm homes, including floor plans and condensed material lists. Each home has been specially designed to meet farm needs.

Every design includes a service room for such chores as canning, laundering, rough processing . . . a room that serves as a buffer between the farm yard and spotless

kitchen . . . a room providing space for the men to clean up and store work clothes.

Rear entries open into the service room . . . halls lead from this room to bedrooms and bath so that traffic is kept away from the rest of the house.

Sparkling kitchens, as compact and efficient as those of city homes, are included, as well as modern bathrooms and light, airy bedrooms.

These homes are designed for comfortable country living . . . for full size farms or suburban plots . . . and many a town family would prefer them, for a properly equipped service room is a real adjunct to efficient, convenient housekeeping.

Weyerhaeuser helps builders serve the rich and profitable farm market with specially designed farm homes. See your 4-Square Lumber Dealer for complete details.

---

**NOW BEING ADVERTISED TO 3<sup>1</sup>/<sub>4</sub> MILLION FARM FAMILIES**



Modern Farm Homes are the liveliest topic with farm families today . . . and these Six New Designs are being featured in page dominating advertisements in the current issues of leading state farm papers from coast to coast to focus interest on the new designs available through your 4-Square Lumber Dealer.

# Weyerhaeuser

**SALES COMPANY**

ST. PAUL 1, MINNESOTA

WEYERHAEUSER 4-SQUARE LUMBER & SERVICES



## Leader in Value . . . Leader in Registrations CHEVROLET ADVANCE-DESIGN TRUCKS



American truck owners recognize the superiority of Chevrolet Advance-Design trucks . . . and buy more Chevrolets than the next two makes combined! They turn to Chevrolet for extra value—for stamina, economy and long-life dependability. They know Chevrolet trucks are easy to handle . . . speedy and high-powered on the highway. Moreover, Chevrolets alone give unsurpassed 3-WAY THRIFT—lower cost of operation, lower cost of upkeep, and the lowest list prices in the entire truck field. Chevrolet trucks are *right* on the job . . . leaders in value—leaders in registrations all over America. See your Chevrolet dealer—for full details.

CHEVROLET MOTOR DIVISION, General Motors Corporation,  
DETROIT 2, MICHIGAN

### TOP-VOLUME PRODUCTION BRINGS YOU TOP-VALUE FEATURES!

Chevrolet's new 4-SPEED SYNCHRO-MESH TRANSMISSION offers quicker, quieter and easier operation. Double clutching is eliminated. Faster shifting maintains speed and momentum on grades. In Series 3800 and heavier duty models.

Chevrolet's power-packed VALVE-IN-HEAD ENGINES provide improved durability and efficiency as well as their world-famous economy.

Chevrolet trucks have the famous CAB THAT "BREATHES"! Outside air is drawn in and used air forced out! Heated in cold weather.

Chevrolet Advance-Design brings you the FLEXI-MOUNTED CAB, cushioned on rubber against road shocks, torsion and vibration.

Chevrolet's SPLINED REAR AXLE HUB CONNECTION adds greater strength and durability to heavy-duty models.

Uniweld, all-steel Cab Construction • Large, Durable, Fully-Adjustable Seat • All-Round Visibility with Rear-Corner Windows\* • Heavier Springs • Super-Strength Frames • Full-Floating Hypoid Rear Axle in the 3600 Series and Heavier Duty Models • Double-Articulated Brake Shoe Linkage • Hydrovac Power Brakes in Series 5000 and 6000 Models • Many Color Options.

\*Heating and ventilating system and rear-corner windows with de luxe equipment optional at extra cost.

**CHOOSE CHEVROLET TRUCKS FOR TRANSPORTATION UNLIMITED!**



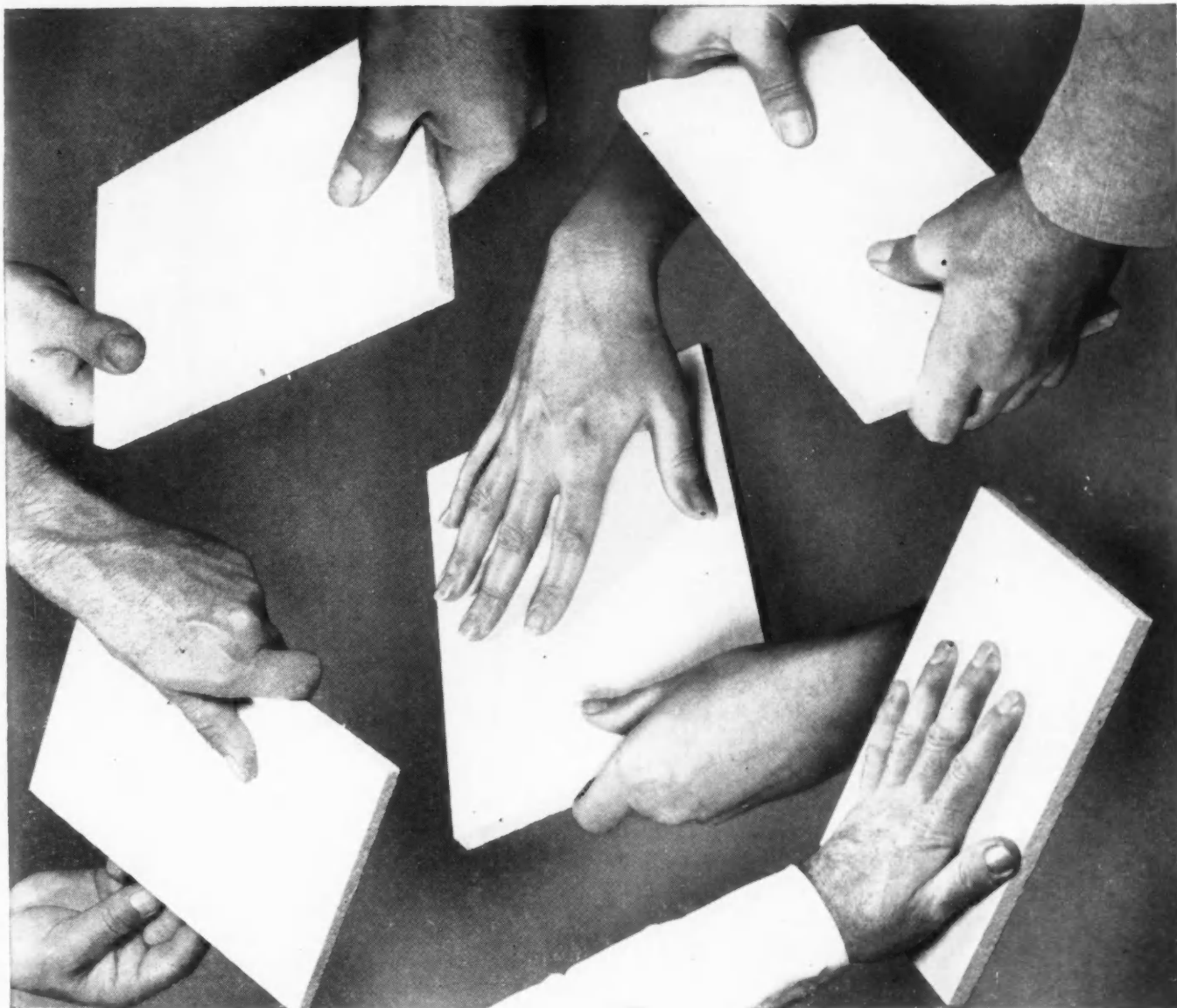

## New smoothness you can feel

You can feel the newest advantage of Armstrong's Temlok Insulation Board. That's because Temlok<sup>®</sup> now has an "ironed-on" paint finish—a finish that's satiny smooth.

This smoothness makes walls and ceilings of Temlok easy to keep clean and new looking. Temlok's new color—a pleasing "warm white"—is an attractive background for any decorative scheme.

You'll like the way Temlok handles on the job, too. This sturdy fiberboard is firm and rigid. It won't crumble or separate into

layers. The big sheets are light in weight and quick to install. This makes work go faster and cuts labor costs.

Compare Temlok Insulation Board yourself for appearance, smoothness, strength, and handleability. Here's a real general-purpose board you can use profitably in farm, commercial, and residential construction. Ask your local lumber dealer for samples and full details or write Armstrong Cork Company, 1612 Ross Street, Lancaster, Pennsylvania.



# Armstrong's Temlok

# Which house will sell first?

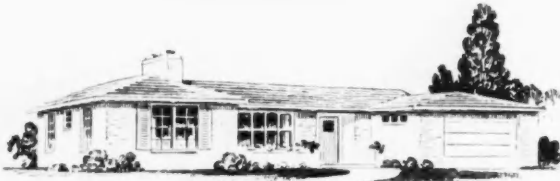

The only difference between these two houses is that one has ordinary floors and one has floors of **WRIGHT RUBBER TILE**. The house with floors of **WRIGHT RUBBER TILE** will sell first!

Time after time, builders have proved that **WRIGHT RUBBER TILE** improves floor beauty so much that prospects *want* the house for their home. Prospects sell themselves easier . . . *sign up to buy quicker*.

**And remember—no other floor covering is "as good as" WRIGHT RUBBER TILE!**

No other floor covering has the naturally glossy surface of **WRIGHT RUBBER TILE**. No other floor covering resists stains and scuffing so well. And none can match the permanently built-in *newness*—or the long life—of **WRIGHT RUBBER TILE**. 27 years of proof are behind these statements!

#### TRY THIS YOURSELF!

Specify **WRIGHT RUBBER TILE** for the kitchen, bath . . . all the rooms . . . in the next house you build.

Ask your salesman to tell you how the prospects react when they are shown the house.

#### AND JUDGE FOR YOURSELF!

Listen to the comments . . . watch the sales . . . you will see the difference **WRIGHT RUBBER TILE** can make.

For easier sales and more satisfied home-buyers, *always* specify **WRIGHT RUBBER TILE** for the floors in your houses.

#### THERE'S 27 YEARS OF PROOF BEHIND WRIGHT RUBBER TILE

No other materials offer as much proof of superiority as these famous *Wright* products.

**WRIGHTEX** Soft Rubber Tile

**WRIGHTFLOR** Hard Surface Rubber Tile

**WRIGHT-ON-TOP** Compression Cove Base

Write for full information on **WRIGHT RUBBER TILE** today. You will be starting on the road to even greater success as a builder. Wright Manufacturing Co., 5203 Post Oak Road, Houston 5, Texas.

# WRIGHT RUBBER TILE

FLOORS OF DISTINCTION

# AMERICAN-Standard

First in heating . . . first in plumbing



This "family kitchen" is planned to lighten household tasks—and so is the **ROYAL HOSTESS Sink**. The beautiful sink comes in models and sizes to fit virtually any kitchen plan. Fits easily into continuous cabinet arrangements, and the new **UNION STRIP** forms a watertight seal between sink and adjoining countertops.

## Important step in designing a home . . .

Heating equipment and plumbing fixtures are of prime importance in designing a smart home. The modern sink in the kitchen; the comfortable warmth from an efficient heating unit; the sparkling cleanliness of a beautiful bathroom . . . these are essentials that add to the livability of any home. *The better their quality, the more desirable becomes the home.*

How can you be sure of the finest quality? By saying, "Make it American-Standard all the way." American-Standard quality is second to none. Yes . . . and that famous name also assures lasting client satisfaction. For no line enjoys greater public acceptance.

For information about the complete American-Standard line, contact your Heating and Plumbing Contractor. **American Radiator & Standard Sanitary Corporation, P. O. Box 1226, Pittsburgh 30, Pa.**

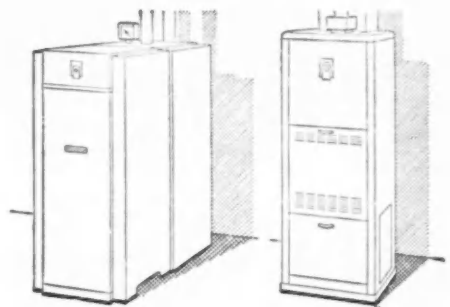

Two heating units by American-Standard designed for small homes, with or without basements. (Left) the oil fired **ARCOLINER** Wet Base Boiler. (Right) the gas fired **CHIPPEWA** Winter Air Conditioner.

Look for this  Mark of Merit

Serving home and industry

AMERICAN-STANDARD • AMERICAN BLOWER • CHURCH SEATS • DETROIT LUBRICATOR • KEWANEE BOILER • ROSS HEATER • TONAWANDA IRON



*of course you'll choose*  
**MILCOR**  
*Super-Ex*



*Greatest Achievement in Corner Bead*

**For easy installation and lasting plaster beauty**

- ▶ Straight, true nose — reinforced by solid flanges
- ▶ Extra rigidity — strengthened by corrugations
- ▶ Perfect plaster bond — provided by staggered perforations, and expansion flange.

**INLAND** **STEEL PRODUCTS COMPANY**

*Formerly Milcor Steel Company*

4025 WEST BURNHAM STREET • MILWAUKEE 1, WISCONSIN

Baltimore 24, Md. • Buffalo 11, N.Y. • Chicago 9, Ill. • Cincinnati 25, Ohio  
 Cleveland 14, Ohio • Detroit 2, Mich. • Kansas City 8, Mo. • Los Angeles 23, Calif.  
 New York 22, N.Y. • Rochester 9, N.Y. • St. Louis 10, Mo.



CONTROLLED  
RADIANT  
WARMTH

Plus

YEAR  
'ROUND  
HOT WATER



# B&G Hydro-Flo Heating

*offers the features most appealing to both men and women*



This is the *forced hot water* system that provides radiant sunny warmth at its best . . . accurately controlled . . . easy on fuel. You can have its modern, comfort-economy benefits with your choice of radiant panels, baseboards, radiators or convectors.

The B&G *Hydro-Flo* System adjusts itself to weather changes so smoothly that indoor temperature is uniformly constant . . . even in Spring and Fall when overheating is usual. And as a plus feature, an all-year supply of hot water for kitchen, laundry and bath, furnished by the same boiler that warms the house. Always plenty for showers and automatic washers and at minimum cost.

Hundreds of thousands of B&G *Hydro-Flo* Systems are in operation today. *For greater salability, add this feature to your own homes!*

B&G Hydro-Flo Heating Equipment—Booster Pump, Flo-Control Valve, Relief Valve and Water Heater—can be installed on any hot water boiler.



Send today for the interesting booklet, "Capture the Sun," for the full story of B&G Hydro-Flo Heating.



## BELL & GOSSETT

*Company*

Dept. 16-11, Morton Grove, Illinois

©Reg. U.S. Pat. Off.



# Radiant Heat

FOR LOW COST HOUSING!

## Thrush Flow Control System OF HOT WATER HEAT

**EVERYBODY** wants Radiant Heating! Give them Forced Circulating Hot Water Heat, of course, because it's mild, steady, economical, and ideally suited to radiant panel, baseboard, or radiator heating. Thrush Flow Control System not only offers the best control for Radiant Heating, but costs much less to install. The controls are simple, inexpensive, highly efficient . . . and assure a continuous flow of sunny warmth throughout the entire heating season without thought on the part of the owner.

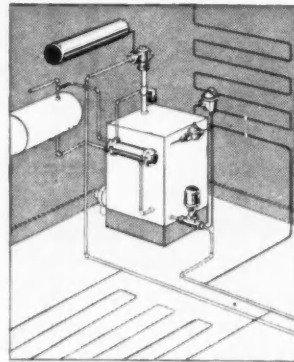

RADIANT PANEL HEAT

### FORCED CIRCULATING

Thrush System provides completely automatic forced circulation for new homes or conversion jobs. The Thrush Radiant Heat Control anticipates outdoor weather changes and maintains room temperature without noticeable fluctuation.

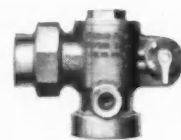
FLOW CONTROL  
VALVETHRUSH WATER  
CIRCULATOR

### LOW OPERATING COSTS, TOO!

Not only is Thrush System lower in cost because of the simpler and more efficient controls used, but it is also more economical of fuel. There is no overheating, never any chilly feeling, no drafts . . . and no fuel is ever wasted. A plentiful supply of domestic hot water is supplied all the year around by the same heating boiler, making further reductions in both installation and operating costs. It is ideal for zoning which may also effect installation and operating economies. For more information, see our catalog in Sweet's or address Dept. G-12.

# H. A. THRUSH & COMPANY

PERU, INDIANA

IF INTERESTED SEND TODAY FOR THIS FREE BOOKLET

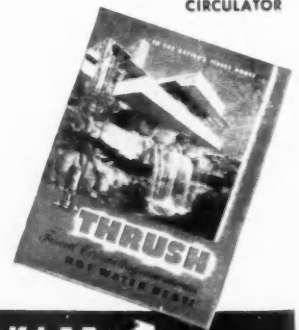





**1070 MORE  
REASONS  
WHY...**

**Again RUBEROID  
Shingles and  
Siding are chosen**

**to protect homes in huge building development!**

When the above air photo was taken, the St. Louis development of Charles Vatterott numbered 1070 completed homes . . . all of them roofed with Ruberoid Asphalt Shingles and more than 700 boasting exterior walls of Ruberoid Asbestos Siding.

Huge developments like this must be their own "salesmen." They succeed to the extent that *every* home owner receives thorough, lasting satisfaction.

Hence, the choice of Ruberoid Shingles and Siding . . . products reflecting over 60 years spent in developing better building materials. Products offering home owners more *service-free* years for their dollar. Products that smart builders are finding mighty profitable to stake their reputation on these days.

**RUBEROID**

**asphalt & asbestos building materials**

The RUBEROID Co., Executive Offices: 500 Fifth Ave., New York 18, N. Y.

# KEEP YOURSELF INFORMED ON

**KNOW**

latest in Home Designs

**KNOW**

about new and improved products

**KNOW**

the most recent building techniques

**KNOW**

the best in plumbing and heating

**KNOW**

how to sell your finished product, **THE HOME**

**KNOW**

the new developments in small commercial and industrial structures

**KNOW**

best methods for farm building

**YOU GET worthwhile information in every**



## 12 Big Issues - One Every Month

OR BETTER STILL

## 36 Big Issues - 3 Full Years

# BUILDING THROUGHOUT 1950

## EXTRA VALUE Every Month

Every month besides all the know-how material you get a blueprint plan of a selected home, drawn to 1/8-inch scale, complete with elevations, details and plans. This feature alone is worth more than the subscription price.

You also get all the news of the National Association of Home Builders and Retail Lumber Dealer Associations, plus spirited columns and editorials by leaders of the Building Industry.

Don't miss a single issue. Be prepared to meet competition in 1950.

**American Builder will help you as it is helping thousands of active building men all over our nation.**

### issue of AMERICAN BUILDER

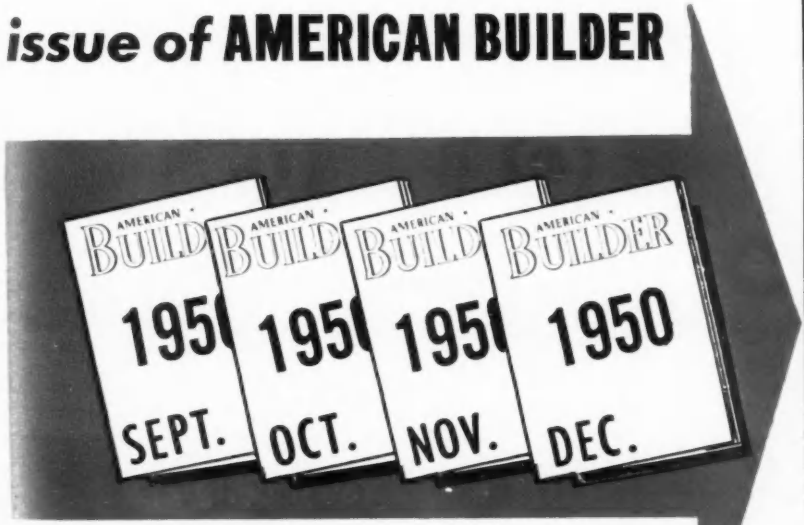

for **ONLY \$3<sup>00</sup>**

for **ONLY \$5<sup>00</sup>**

**Mail This Coupon TODAY**  
**For the Biggest Value**  
**IN THE BUILDING FIELD**

#### Subscription or Renewal Order

AMERICAN BUILDER,  
30 CHURCH STREET, NEW YORK 7, N. Y.

- Enter my subscription to American Builder for **THREE YEARS (36 issues)** at your money-saving rate of \$5. My remittance of \$5 is enclosed.
- Enter my subscription to American Builder for **ONE YEAR** at your regular price of \$3. My remittance for \$3 is enclosed.

Your Name.....  
 Street.....  
 City..... Postal.....  
 State.....

NAME OF YOUR FIRM.....

Please indicate your position in the above named firm:

If Owner of Business, please state.....

If not, give Title or Position.....

*Subscriptions accepted only from those directly connected with the building industry.  
(Good only in United States, Possessions and Canada)*  
AB-12-49

#### PLEASE NOTE—

Kindly check your principal activity  
Builders and Contractors:

- Builders and Contractors specializing in Residential or Light Commercial or Light Industrial Building.
- Contractors specializing in Heavy Building Construction.
- Builders and Contractors engaged in both Residential or Light Commercial or Light Industrial Building and Heavy Building Construction, *not specializing in either.*
- Contractors specializing in all types of Heavy Construction *other than Buildings.*
- General Contractors engaged in Heavy Construction of both Buildings and other than Buildings, *not specializing in either.*
- Special Trade Contractors, contracting for only such parts of Building Construction as carpentry, masonry, plumbing, roofing, heating, ventilating, electrical, painting, concreting and excavating.

#### Distributors:

- Retail Dealers—lumber, building materials and installed equipment.
- Wholesalers, Jobbers and Manufacturers' Agents of lumber, building materials and installed equipment.
- Distributors of Construction Equipment.

If none of the foregoing applies, please advise the type of business with which you are affiliated:  
Type of Business.....



*It's a cinch to clinch good-paying jobs*  
*with* **NEW GOLD BOND**  
**INSULATION BOARD!**

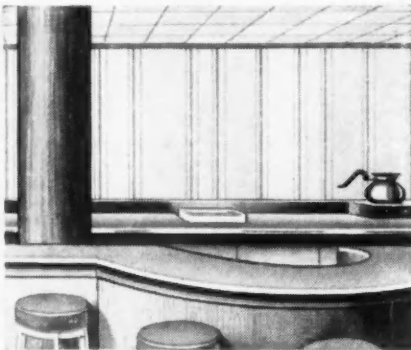

**EVERY REMODELING JOB** you do with Gold Bond Insulation Board, Plank and Tile advertises your building "know-how" because every job means a satisfied customer.

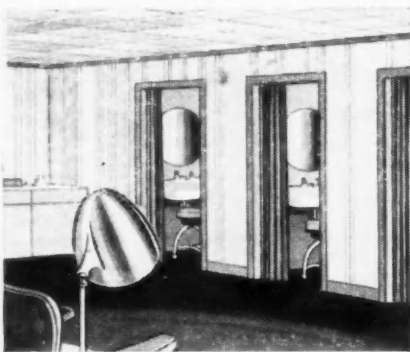

**COMBINES BEAUTY AND ECONOMY.** Variegated color blends give a pleasing modern effect. No additional decoration is needed—a big saving for your customers.

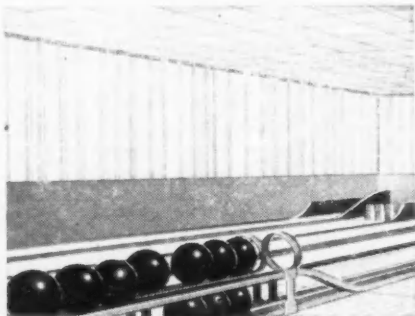

**APPLIES FASTER.** New interlocking edges permit rapid stapler application . . . completely hides staples. Cuts installation time about half, increases your profits.



**COLORFUL FULL-PAGE GOLD BOND ADS** in the Saturday Evening Post feature smart remodeling ideas like this month after month. Save these ads and use them with your prospective customers. They will help you sell more jobs.

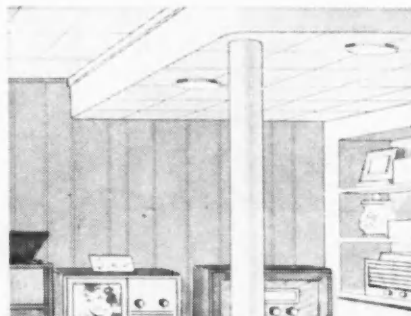

**FOR HOME OR COMMERCIAL JOBS.** Ideal for stores, bowling alleys, attic apartments, etc. Your local Gold Bond Dealer has this new improved Insulation Board.

You'll build or  
 remodel better with  
**Gold Bond**

**NATIONAL GYPSUM COMPANY**  
 Buffalo 2, New York

*Over 150 Gold Bond Products including gypsum lath, plaster, lime, wallboards, gypsum sheathing, rock wool insulation, metal lath products and partition systems, wall paint and acoustical materials.*

# How to cut costs installing CECO CASEMENTS with STEEL CASINGS



**1** Lay casement out flat, inside up. Then attach sill member to sill of casement with nuts and bolts provided. Do not take up tension of nuts and bolts. Leave nuts and bolts loose enough to move sill member.

Steel Casings have been added to Ceco's casement line . . . speeding your installations, saving money for you. Casings bring you extra profits in finishing window openings because they eliminate the time and expense of plaster returns. Casings are carried in warehouse stocks in 4½" and 5¼" depths (measured from inside face of casement to inside face of Casing).

**2**

Next, move one of the jamb members up to the attached sill member. Let the tab ends of jamb member slip into slots in sill member. Then bolt jamb member to casement. Repeat with second jamb member.

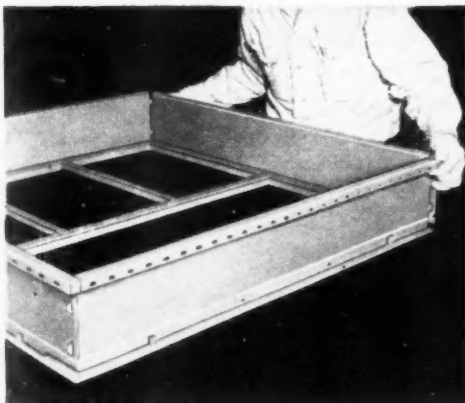
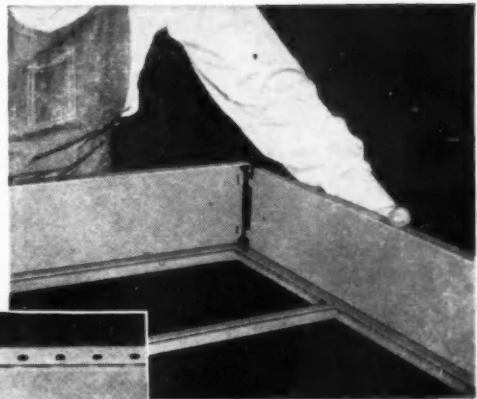

**3** The head member should then be attached as illustrated above, with the slots slipped over the tab ends of both jamb members. Then attach to casement with nuts and bolts but leave them loose.

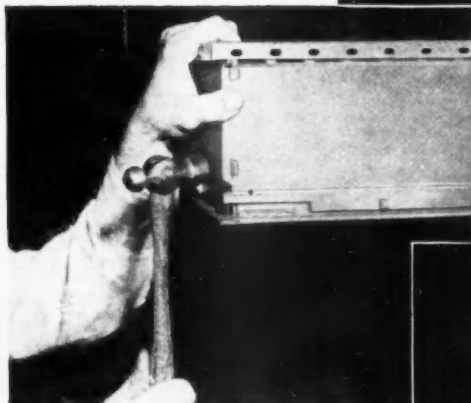

**4** Clinch over all tab ends by carefully pounding ends with hammer. Portion of sill member extending beyond jamb member may be clinched over jamb if desired. All nuts and bolts are then to be securely tightened.

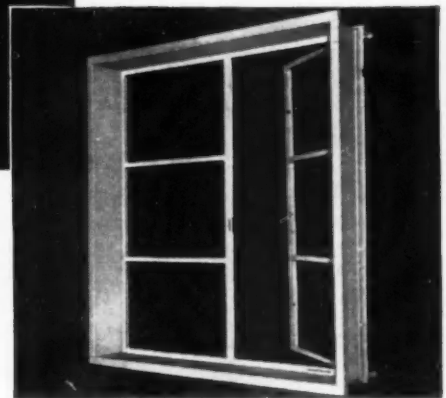

**5** Casement with the casing attached as shown in above illustration is now ready for installation. Casement hardware should be attached to casement after the unit is installed.

## CECO STEEL PRODUCTS CORPORATION

General Offices: 5601 West 26th Street, Chicago 50, Illinois  
Offices, warehouses and fabricating plants in principal cities



In construction products **CECO ENGINEERING** makes the big difference

# BUNGALOW OR MANSION . . . INSIDE OR OUTSIDE . . .

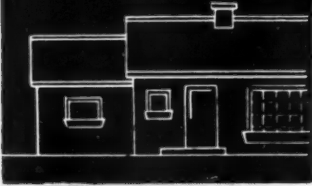

## *Vitrified* CLAY PIPE IS THE BUILDERS' PIPE



Vitrified Clay Pipe is the finest pipe available for any and all home and apartment construction. Whether your project is large or small, Clay Pipe helps you fight rising costs—yet gives you the only pipelines that do not corrode, rust, crumble or disintegrate!

When you use Vitrified Clay Pipe you save on *any* sewerage or drainage installation. Labor costs are reduced, because one man can lay the handy lengths easily, quickly and accurately. A wide variety of fittings are available to handle any inside or outside installation. *And Clay Pipe is as close to your project as your nearest building supplies dealer!*

Send your specific questions to the office nearest you.

#### NATIONAL CLAY PIPE MANUFACTURERS, INC.

100 N. LaSalle St., Rm. 2100, Chicago 2, Ill.

206 Connally Bldg., Atlanta 3, Ga.

703 Ninth and Hill Bldg., Los Angeles 15, Calif.

1105 Huntington Bank Bldg., Columbus 15, Ohio

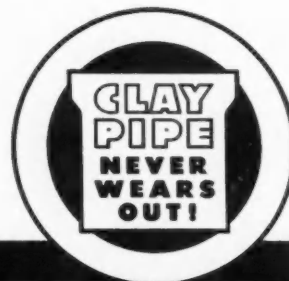

C-1249-1

*Vitrified*

# CLAY PIPE



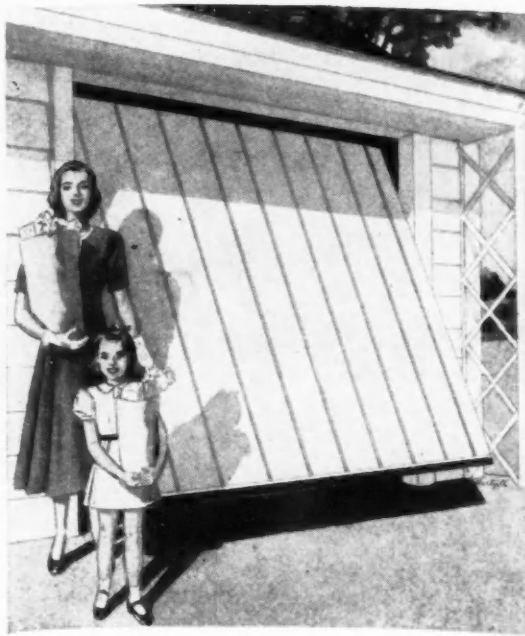

**4 Features Make  
STRAND  
"BEST SELLER"  
Among  
GARAGE  
DOORS**

**1 EASIER TO INSTALL**—no "factory-trained expert" is needed because Strand one-piece construction and factory-assembled hardware make installation so simple and easy.

**2 MORE DURABLE**—Strand doors have the strength and durability of steel—can't sag, warp, shrink or rot. Welded construction—no screws or bolts to work loose. Rugged—to withstand shipping, delivery and handling. Galvanized—for rust resistance and can be painted without special priming coat.

**3 EASY TO OPERATE**—for life. Strand doors are built for trouble-free performance. Dependable hardware. Uniform steel sheets mean no absorption of moisture (as with some other materials); the weight remains the same in all weather, for uniformly easy operation.

**4 LOW COST**—the result of standardization on 3 models—and large scale production concentrated in one plant. Strand is America's biggest garage door value!

Strand Doors are available in Canopy and Receding (track) types for 8' x 7' opening; there's a double-garage door (Receding type only) for 16' x 7' opening, unobstructed by center post. Order from your dealer, or



Easier to install



Easier to paint

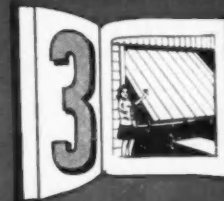

Easy-operating—always



Low first cost and upkeep cost



**MAIL COUPON FOR INFORMATION AND DEALER'S NAME**

ALL-STEEL • GALVANNEALED • OVERHEAD

**STRAND**

**GARAGE DOORS**

FOR SINGLE AND DOUBLE GARAGES

STRAND GARAGE DOOR DIVISION  
Detroit Steel Products Company  
Dept. AB-12, 2250 E. Grand Blvd.  
Detroit 11, Michigan

Please rush detailed description of Strand all-steel Garage Doors, for 8' x 7' and 16' x 7' garage openings.

I am a  Builder  Dealer  Prospective Owner  Other

Name \_\_\_\_\_

Address \_\_\_\_\_

City \_\_\_\_\_

State \_\_\_\_\_

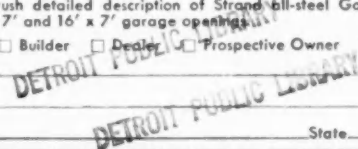



# HOME is where the buying's done

HOME is where your merchandise is used—where decisions to buy are made—where brand preferences are born and bred.

That's why Better Homes & Gardens is "America's 1st Point of Sale"—and why advertising for building products is so much more effective here.

For BH&G has a unique standing with readers in more than 3,000,000 select homes. They read it only for the 100% service content\* on better living—which includes more edi-

torial lineage in the building classification than any other major magazine.

In this way, their pores are opened to the buying impulse. And since their incomes are above average, they do something about the things they like.

See for yourself by checking the brands in your store. You'll notice that the fastest movers are the ones that are advertised in Better Homes & Gardens.

*\*Articles reproduced above are from the October, November and December issues of BH&G.*

## America's **1<sup>ST</sup>** Point of Sale

**A SCREENED MARKET OF MORE THAN 3,000,000 BETTER HOMES**

Am  
M  
W  
in  
APP  
Adm  
Adm  
Amc  
Arvi  
Arvi  
Biss  
Bruc  
Cadi  
Calo  
Cory  
Cros  
Drep  
Eaxy  
Erig  
Erig  
Gene  
Gene  
At  
Gene  
Gillb  
Gran  
Ham  
Ham  
Hau  
Hau  
Hoo  
Hot  
Hot  
Hot  
In-Si  
John  
Kitel  
Knap  
Knap  
Knap  
Lew  
May  
Mirr  
Mot  
Nese  
Norg  
Oste  
Oste  
Oste  
Rexa  
Riva  
Riva  
Rop  
Serv  
Seth  
Spee  
Sun  
Tapp  
Thon  
Toas  
Toas  
Toas

# More than 3,000,000 select homes will buy these brands — pre-sold

## in Better Homes & Gardens *October, November and December Issues*

### APPLIANCES

Admiral Range  
Admiral Refrigerator  
Admiral Television  
American Gas Assn.  
American Kitchens Disposer  
Arvin Electric Cook  
Arvin Toaster  
Arvin Waffle  
Bissell Sweeper  
Bruce Doozit  
Cadillac Vacuum  
Caloric Range  
Cory Knife Sharpener  
Crosley Shelvador Refrigerator  
Deepfreeze Home Freezer  
Easy Washer  
Frigidaire Range  
Frigidaire Refrigerator  
Frigidaire Washer  
General Electric Television  
General Mills Iron  
General Mills Steam Ironing Attachment  
General Mills Toaster  
Gilbert Mixer  
Grand Range  
Hamilton Beach Mixer  
Hamilton Drier  
Handyhot Ice Cream Freezer  
Handyhot Juicer  
Hardwick Range  
Hoover Vacuum  
Hotpoint Dishwasher  
Hotpoint Range  
Hotpoint Refrigerator  
Hotpoint Washer  
In-Sink-Erator Disposer  
Johnson's Floor Polisher  
Kitchen-Aid Mixer  
Knapp-Monarch Corn Popper  
Knapp-Monarch Liquidizer  
Knapp-Monarch Toaster  
Knapp-Monarch Waffle Baker  
Lewyt Vacuum  
Maytag Washer  
Miro-Matic Percolator  
Motorola Television  
Nesco Roaster  
Norge Range  
Oster Hair Dryer  
Oster Liquidizer  
Oster Mixer  
Oster Stim-U-Lax  
Rexair Vacuum  
Rival Broil-O-Mat  
Rival Iron-O-Mat Iron  
Rival Steam-O-Matic Iron  
Roper Range  
Serval Refrigerator  
Seth Thomas Clocks  
Speed Queen Washer  
Sunbeam Mixmaster  
Tappan Range  
Thor Automatic Washer  
Toast-O-Lator Toaster  
Toastmaster Toaster  
Toastwell Toaster

Tyler Harder-Freezer Home Freezer  
Universal Coffee Maker  
Universal Electric Blanket  
Universal Toaster  
West Bend Coffee Maker  
Westinghouse Coffee Maker  
Westinghouse Disposer  
Westinghouse Drier  
Westinghouse Home Freezer  
Westinghouse Iron  
Westinghouse Mixer  
Westinghouse Range  
Westinghouse Refrigerator  
Westinghouse Roaster Oven  
Westinghouse Toaster  
Westinghouse Vacuum  
Westinghouse Washer  
Whirlpool Drier  
Whirlpool Ironer  
Whirlpool Washer  
Zenith Television

### AWNINGS, BLINDS & SHADES

Columbia Shades & Blinds  
Flexalum Blinds  
Kirsch Blinds  
Marvalon Shades  
Rusco Awnings  
Sunchek Blinds  
Zephyr Awnings

### FLOORS

Bruce Hardwood Floors  
Nat'l Oak Flooring Mfrs. Assn.

### FLOOR COVERINGS, HARD

Armstrong's Asphalt Tile  
Armstrong's Linoleum  
Delaware Flor-Ever  
Kentile  
Mattico Asphalt Tile  
Pabeo Linoleum  
Sandran  
Sloane Linoleum  
Wright Rubber Tile

### GLASS

L.O.F. Plate Glass  
L.O.F. Thermopane  
Pittsburgh Plate Glass

### HANDYMAN

Atlas Press Tools  
Burgess Vibra-Sprayer  
Dic-A-Doo Paint Brush Bath  
Duco Cement  
Ermick Tools  
Home Utility Tools by Black & Decker  
Plastic Wood  
Smooth-On Cement  
Synco Hone Sharpener  
3-In-One Oil  
Zephyr Spraymaster

### HARDWARE

Alcoa Aluminum Screening  
Badger Traverse Rods  
Eddy E-Z-Y Ash Scoop  
Gerity-Michigan Fixtures  
Hall-Mack Fixtures  
Inner-Seal Weather Stripping  
Kintrim Metal Molding  
Knape & Vogt Closet K-Veniences  
M-Q Sewer Cartridge  
Moore Push-Pins  
Mortite Weather Stripping  
Nat'l Retail Hardware Assn.  
Nu-Way Weather Stripping  
Reddylite Lantern  
Stewart Fence  
Tel-O-Post  
Weed-American Tire Chains  
Weisway Shower Cabinets  
Yale Trim Hardware

### FANS

Acropel Kitchen Fan  
American Kitchens Ventilator  
Torrington  
Vent-A-Hood Ventilator  
Westinghouse

### HEATING, MAJOR

American-Standard  
Arvin Portables  
Bell & Gossett  
Burnham Portables  
Coleman  
Crane  
Dearborn Space Heaters  
Deleo  
Electresteen Portables  
Institute of Boiler & Radiator Mfrs.  
Nu-Way Oil Burner  
Oil-O-Matic  
South Wind  
Trane  
Waterman-Waterbury

### HEATING, MISCELLANEOUS

Bennett-Ireland Flexscreen  
Carlo Radiator Covers  
Dust-Stop Air Filters  
Hancock Outdoor Fireplace  
Heatform Fireplace  
Heattilator Fireplace  
Honeywell Controls  
Price Fireplace Form  
Robertsshaw-Fulton Controls  
Van-Packer Chimneys

### INSULATION

Armstrong's Temlok  
Balsam-Wool  
Eagle-Picher  
Gold Bond  
Homasote  
Ins-Cotton  
Johns-Manville

Kinsul  
Nat'l Cotton Council  
Zonolite Vermiculite

### KITCHENS

American  
American-Standard  
Crane  
Kitchen-Kraft  
M and M Woodworking  
Morton  
Shirley  
Youngstown Kitchens by Mullins

### LUMBER

Arkansas Soft Pine  
Douglas Fir Plywood  
Weldwood Plywood  
West Coast Woods  
Western Pines  
Weyerhaeuser

### MASONRY

Portland Cement  
Structural Clay Products  
Van-Packer Chimneys

### PLASTICS & MATERIALS

Boltalex  
Consoweld  
Duran  
Koylon  
Marvalon  
Naugahyde  
Styron  
Velon  
Vinylite

### MILLWORK

Crawford "Marvel-Lift" Doors  
Curtis Silentite Windows  
Frantz Garage Doors  
M and M Doors  
Pella Casement Windows  
Ponderosa Pine Woodwork  
Rusco Doors & Windows  
Rusco Porch Enclosures  
Stoaco Storm Windows & Doors  
Thermoseal Screen & Storm Sash  
Weisway Shower Cabinets

### PAINT & RELATED PRODUCTS

Armor Coat  
BPS Flatlux  
BPS Glos-Lux  
BPS Satin-Lux  
Caprinol  
Dow Penta  
Gum Turpentine  
Kyanize  
Minwax  
Nat'l Paint, Varnish & Lacquer Assn.  
Pittsburgh

Reynolds Metals Aluminum Pigment  
Woodlife

### PLUMBING

Alcoa Anodes  
American Home Root Eliminator  
Briggs Beautyware  
Burks Water Systems  
CE Heatmaster Water Heater  
Coleman Water Heater  
Crane Fixtures  
Deming Water Pumps  
Deming Water Systems  
Eljer Fixtures  
Flint & Walling Water Systems  
Frigidaire Water Heater  
Morton Cabinet Sinks  
Orangeburg Pipe  
Penberthy Sump Pump  
Roto-Rooter Service  
Smithway Water Heater  
Westinghouse Water Heater  
Youngstown Kitchenaid Cabinet Sink

### PREFABS & PLANS

Cleveland House Plans  
Int'l Mill & Timber  
Lustron Homes  
National Homes  
Orlyt Greenhouse

### WALLBOARDS

Armstrong's Temlok Interior  
Consoweld Laminates  
Marlite Panels  
Upson Panels  
Weldwood Plywood

### WALLCOVERING

Imperial Wallpaper  
Marvalon  
Sandran  
United Wallpaper, Inc.  
Varlar, Division of United Wallpaper, Inc.  
Wall-Tex

### WIRING, LIGHTING & TELEPHONE

Bell System  
Cutler-Hammer Multi-Breaker  
Delta Lantern  
Doubt-Glo Christmas Decorations  
Edwards Door Chimes  
Farady Kitchen Cord  
General Electric Lamps  
Nutone Door Chimes  
Reddylite Lantern  
Rittenhouse Door Chimes

### MISCELLANEOUS

Federal Savings & Loan Assn.  
Majestic Garbage Receiver  
Majestic Incinerator  
Rexair Humidifier  
Ruberoid Roofing & Siding  
U. S. Steel

**POINT OUT** to your customers the brands "seen in BH&G." For your supply of free display cards, check the list above for the brands you stock—then mail, with your name and address, to:

**MERCHANDISING DIVISION,  
BETTER HOMES & GARDENS,  
DES MOINES 3, IOWA**





# Johns-Manville PANELS and PLANK

are better because they have these unique advantages:



*Improved Glazecoat finish...*

For years the Glazecoat finish on Johns-Manville Ceiling Panels and Wall Plank has helped to make these Insulating Board products pre-eminent in their field. Now, through research and development, J-M Panels and Plank are available with a new and improved Glazecoat finish that is smoother, harder, and more beautiful than ever. Accidental smudges easily removed with an ordinary art gum eraser.

*Pre-decorated in soft pastel colors...*

Beautifully finished at the factory in a variety of soft pastel colors, the materials require no further decoration. They are ready-to-use when installed, but may be painted if desired, with either oil or water paint. The Glazecoat finish eliminates the need of a primer.



*Lightning Joint conceals all nails!*

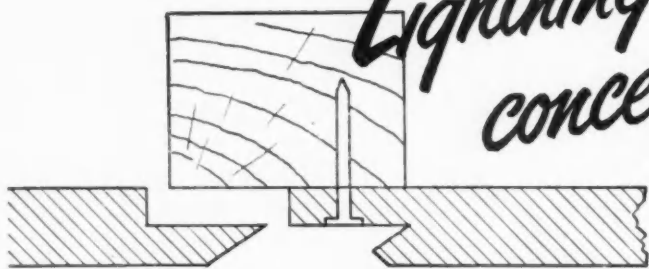

This J-M feature speeds alignment and offers the important advantage of concealed nailing. No exposed nailheads to mar the beauty of wall or ceiling. Beveled edges provide a neat "V" groove at the joints. Write for new brochure on J-M Decorative Insulating Board. Johns-Manville, Box 290, N. Y. 16, N.Y.

JOHNS-MANVILLE  
**JM**  
PRODUCTS

**IT'S SO "HOT" IT SIZZLES!**

**THE  
AMAZING NEW  
ALSCO  
ALUMINUM**

**Thrifty  
for '50**

**CONVERTIBLE STORM WINDOW**

**FANTASTIC LOW PRICE**

**TERRIFIC ENGINEERING TRIUMPH**

**HIGH PROFIT MARGIN**

It's got everything! Eye appeal Price appeal Profit appeal  
ALSCO THRIFTY is by far the lowest priced aluminum convertible storm window ever offered.

**WIRE, PHONE or WRITE for details, TODAY!**

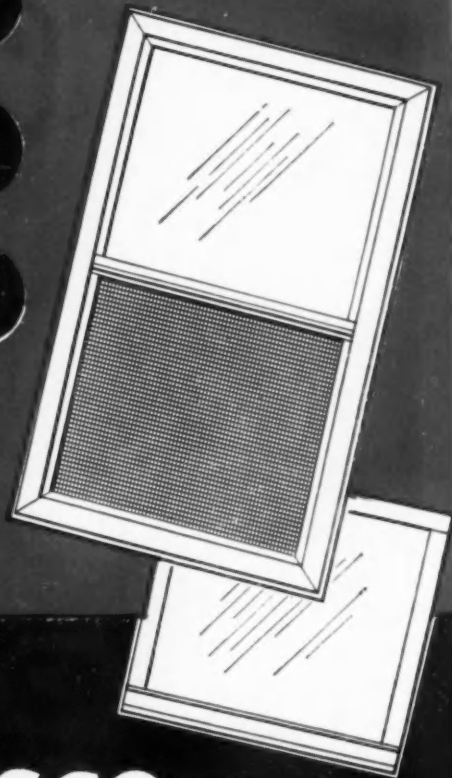

**ALSCO, Inc.**  
260 S. FORGE STREET  
AKRON 8, OHIO

You bet I want to strike it rich with the new ALSCO Thrifty Storm Window. Please rush dealership details to:

Name \_\_\_\_\_

Address \_\_\_\_\_

City \_\_\_\_\_ State \_\_\_\_\_

**ALSCO, INC.**

AKRON 8, OHIO • JEFFERSON 6113

DETROIT PUBLIC LIBRARY

DETROIT PUBLIC LIBRARY

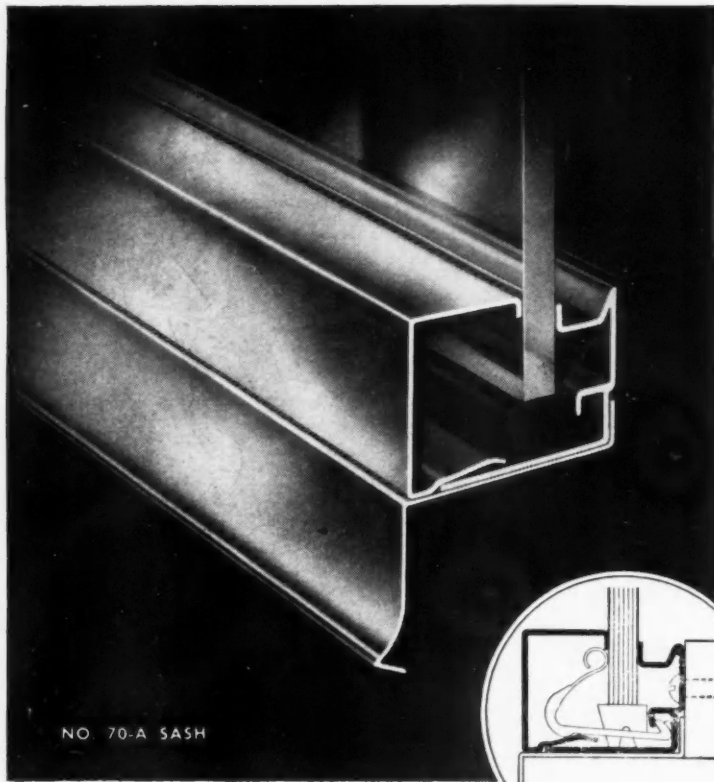

NO. 70-A SASH

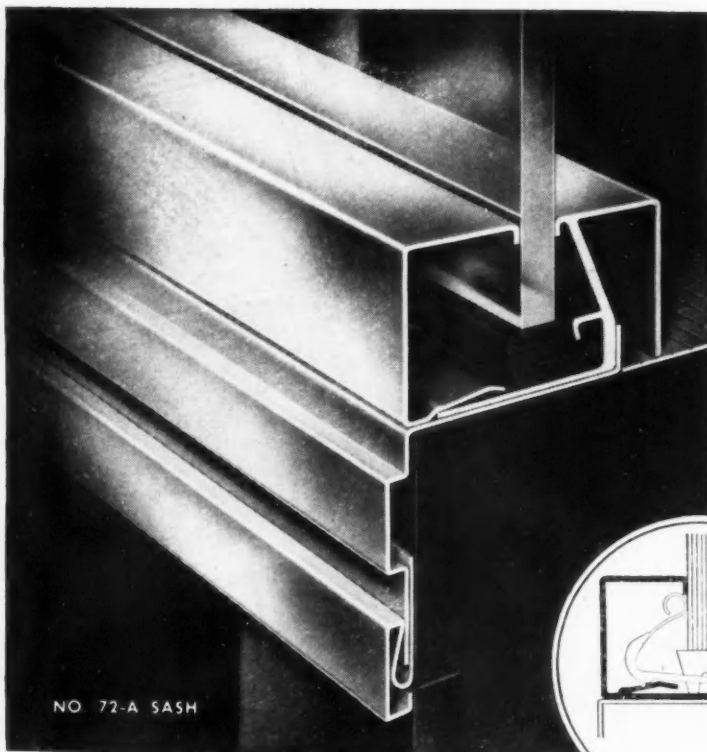
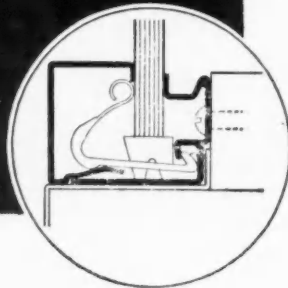

NO. 72-A SASH



## TWO NEW SASHES

in the  
Premier line of

Pittco

## Store Front Metal

● These single and double-faced sashes (70-A and 72-A) have been added to the Premier line of Pittco Store Front Metal to satisfy requests for a plain rectangular sash for certain modern store fronts. Both sashes can be used with all Premier mouldings, thus offering a multitude of design possibilities.

These additions to the Premier line help to realize Pittsburgh's aim of providing architects and builders with the most complete and most modern selection of store front materials available.

Two complete lines of Pittco Store Front Metal permit you to create a wide range of impressive, sales-winning store fronts. Pittco Premier is light in weight, its sashes provide a shallow reveal for show windows, and are easy and economical to install. Pittco De Luxe is extruded for rugged strength, sharp profiles and a rich, smooth finish. It is ideal for top quality installations.



# PITTCO STORE FRONT METAL

PAINTS • GLASS • CHEMICALS • BRUSHES • PLASTICS

PITTSBURGH PLATE GLASS COMPANY



IT'S A CASE OF  
*Quality...*



View of Drexelbrook, Drexel Hill, Pa. Architect: James G. Ludwig, West Chester, Pa. Builders: Daniel G. Kelly and Fred P. Meagher, both of Upper Darby, Pa.

# with 1,223 Personalized heating systems

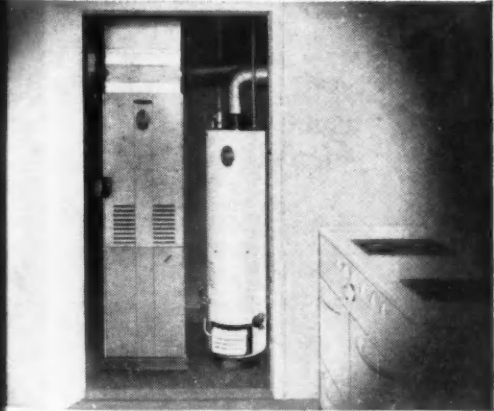

23 APARTMENTS at Drexelbrook are equipped with Bryant Personalized Heating. Shown are the Bryant Modet VS-304 Water Air Conditioner and Bryant Red Seal Automatic Gas Water Heater in closet installation. 50 community laundries are equipped with Bryant Water Heaters.

New evidence of the ever-increasing acceptance of *Personalized Heating* for apartments comes from *Drexelbrook*, where the Bryant name plate appears more than two thousand times.

This 137-acre wonderland of garden-style apartments is one of the largest and most modern developments of its kind in the world. It is a product of far-sighted planning that provides unsurpassed comforts and conveniences for its occupants.

Bryant *Personalized Heating* stands high on the list of tenant advantages at *Drexelbrook*. Each family enjoys *independent, automatic control* of all heating in its own home. Living areas are never overheated, never underheated. There is always plenty of hot water on tap—at the temperature desired by the user; for each family has

its own *individual* hot water service.

Aside from its advantages for occupants of multi-family housing, Bryant *Personalized Heating* also provides these advantages for *management*:

*Personalized Heating* is maintained at *low cost*; large staffs of janitor-firemen or heating maintenance men are unnecessary and, in most cases, a single custodian is master of *all* equipment. Service or repair, if necessary, is entirely local, handled within a period of minutes and at *minimum* cost. Waste heat is virtually eliminated, and there are few, if any, tenant complaints.

These advantages of Bryant *Personalized Heating* benefit *all* who finance, invest in, build or manage multi-family housing. Ask the Bryant Distributor nearest you to tell you the complete story.



Let the pup be furnace man  
... and water boy, too!

# bryant

AUTOMATIC HEATING

**BRYANT HEATER DIVISION**  
AFFILIATED GAS EQUIPMENT, INC.  
Cleveland, Ohio • Tyler, Texas

### "AN AID TO CONSTRUCTION"

says the Drexelbrook construction team, DANIEL G. KELLY, Realtor, and FRED P. MEAGHER, Builder

"Bryant *Personalized Heating* aids construction by affording tremendous space savings. This outstanding equipment provides the same advantages in heating for apartment dwellers as those enjoyed by occupants of individual homes."





TOM HENDERSON  
 TOM HENDERSON  
 FAMOUS COLLIER'S CARTOONIST

Santa's gonna have it easier *this year...*  
 now that —

*"Everything Hinges on Hager!"*



**C. HAGER & SONS HINGE MFG. CO. • St. Louis, Mo.**

FOUNDED 1849 — EVERY HAGER HINGE SWINGS ON 100 YEARS OF EXPERIENCE

© 1949

The T  
 Janua  
 inform  
 to spe  
 design  
 file in

**WAYS** *Easy to clean...* **ALWAYS GOOD LOOKING**

**BECAUSE WALLS AND FLOORS ARE**

GENUINE CLAY  
*tile*

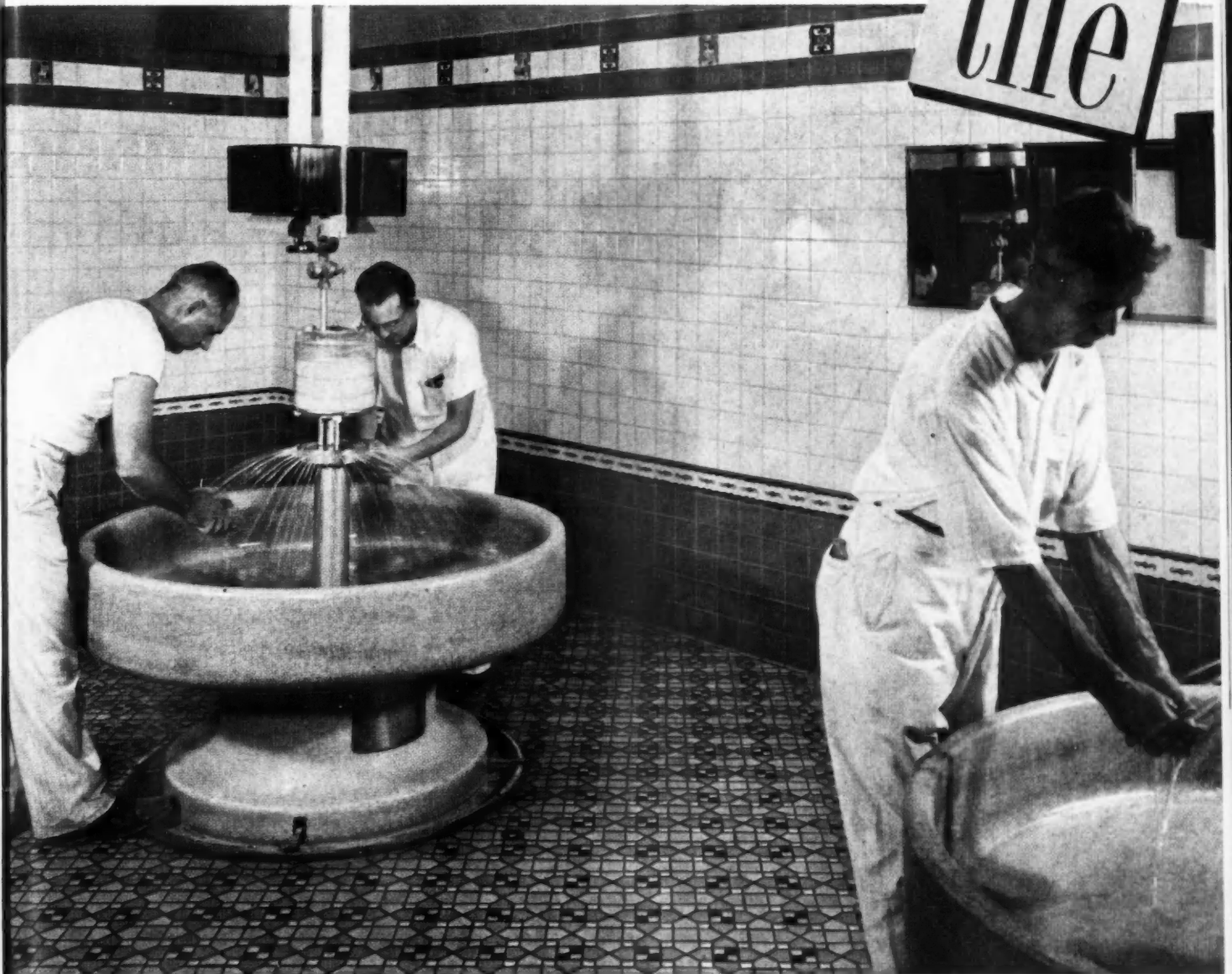

"There's no better surface!" That's what one manufacturer says about the genuine clay tile used on the walls and floors of this carefully planned, modern industrial washroom.

He particularly likes the sharp drop in maintenance cost that always goes hand-in-hand with a clay tile installation. For genuine clay tile shrugs off water, soaps, acids and grease, leaving no fade marks, streaks or scars. Moreover, the handsome colors are good for a lifetime—they're fired-in!

You'll find that clients appreciate specification of genuine clay tile. They know that costly replacement, painting and refinishing are unheard of wherever tile is used. It's in to stay—it stays good-looking!

Today, genuine clay tile is available—there is no need to accept substitutes. For specific information, see Sweets Architectural or A-E-C File. THE TILE COUNCIL OF AMERICA, Room 3401: 10 East 40th Street, New York 16, New York. Room 433: 727 West Seventh Street, Los Angeles, California.

The Tile Council of America was formed in January, 1945, to provide a central source of information about clay floor and wall tile, and to sponsor research and development projects designed to increase the usefulness of clay tile in all types of private and public building.

**PARTICIPATING COMPANIES:** American Encaustic Tiling Company, Inc. • Architectural Tiling Company, Inc. • Atlantic Tile Manufacturing Company • B. Millin Hood Company • Cambridge Tile Manufacturing Company • Carlyle Tile Company • General Tile Corp. • Gladding, McBean & Company • Mosaic Tile Co. • Murray Tile Company, Inc. • National Tile & Manufacturing Company • Olean Tile Company • Pacific Clay Products • Pacific Tile and Porcelain Co. • Pomona Tile Manufacturing Company • Robertson Manufacturing Company • The Sparta Ceramic Company • Summitville Face Brick Company • United States Quarry Tile Company

**THE MODERN STYLE IS CLAY TILE**



# THANK YOU Mr. Creden

*Edward Hines Lumber Co.*

ESTABLISHED 1892

2431 SOUTH WOLCOTT AVE  
(FORMERLY LINCOLN ST.)  
PHONE CANAL 0349

ADVERTISING DEPARTMENT

Oct. 18, 1949

*Chicago 8, Ill.*

Mr. E. G. Gavin, Editor  
American Builder  
77 West Monroe St.  
Chicago, Ill.

Dear Ed:

When I was reading over the astounding record of National Home Week in the October American Builder, I could not help but recall the days in early 1948 when you were selling a brilliant idea to an industry that didn't want to think they'd ever need any sales promotion help. I know how hard it was to put our deal together here in Chicago -- the inertia, apathy and half-heartedness we had to overcome.

But put it over we did -- what you like to call, "The greatest industry show ever staged", but what I like to think as the greatest demonstration of free enterprise this country has ever seen.

The results of the first National Home Week celebration which we, in Chicago, stretched into a month long Festival were gratifying. This year, the record is astounding -- over 1,200,000 people visiting our Demonstration Homes, some 3,300 houses sold and the building business stimulated to boom proportions.

The American Builder is to be congratulated for initiating, engineering and putting over National Home Week; but to me this National Demonstration, that is both the greatest sales promotion and public relations idea ever conceived, will always be the lengthened shadow of a man -- one Ed Gavin, who has always been overly generous with his time and his energy in guiding an industry to help the American people gain the greatest of all goals -- homes of their own.

Yours truly,

*Phil Creden*  
Phil Creden  
Advertising Manager

AMERICAN ★  
**BUILDER**

79 W. MONROE ST. CHICAGO 3, ILLINOIS - 30 CHURCH ST. NEW YORK 7, NEW YORK

# MASTER MIXERS

Frank Borri and Mike Dvorchack are the Richmond craftsmen who control the precise mixing of ceramic stains and enamel powders—and the careful matching of the finished ware. To assure color matches between china and enamelware—constant checks are made against master color control panels, by Borri in Metuchen and Dvorchack at Uniontown. The painstaking care and teamwork of these two men, tho miles apart, make Richmond one of the tops in the industry for colorware.

*Mike Dvorchack, 25 years with Richmond, is supervisor of the Mill & Mix Department at their Uniontown, Pa., enamelware plant.*

*Frank Borri, 20 years in the Metuchen, N. J. pottery plant, is chief color ceramist for Richmond Vitreous China products.*

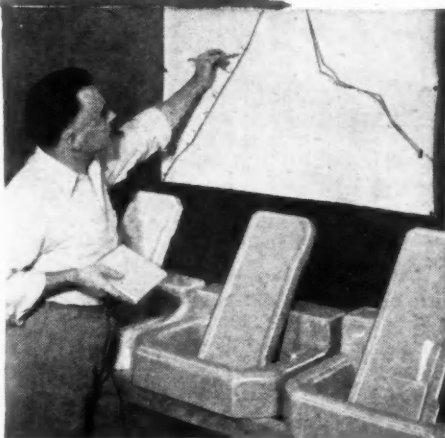

Borri thoroughly tests each new batch of color glaze against his present run—side by side—in the same scientifically controlled kiln. These ceramic test tiles are then checked against the master color patterns and with Dvorchack's matching enamelware. Borri is shown checking a graph of the temperature in his color kiln—an important phase in matching colorware. Also shown are the master color guides and samples of the matching enamelware.

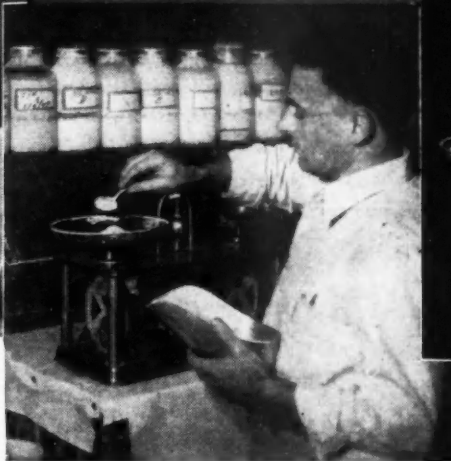

Computing, mixing and testing each new lot of Richmond color glaze is a delicate, detailed job—a job that calls for an experienced ceramist such as Borri.



Dvorchack, a master craftsman, carefully controls the preparation of his color enamel powders from the initial mixing, smelting and milling to their ultimate use. Mike precisely measures out the ingredients for his color powder, makes sample castings in his electric oven and then matches the color casting against his control panels. When his enamel sample matches, the powder lot gets his final OK for use.



## RICHMOND

RICHMOND RADIATOR CO.—AFFILIATE OF REYNOLDS METALS CO.



Vitreous China

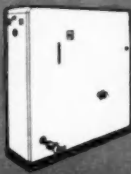

Gas Boilers

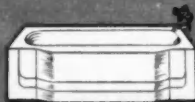

Enameled Cast Iron Ware

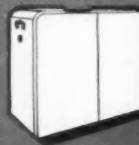

Winter Air Conditioners  
Gas—Cast Iron or steel  
Oil—Steel

See your wholesaler or Mail Coupon Today:

Richmond Radiator Company  
19 East 47th Street,  
New York 17, N. Y.

AB-12

Please send me the latest literature and information on the Richmond line of fine plumbing fixtures. No obligation, of course.

Name.....  
Company.....  
Address.....

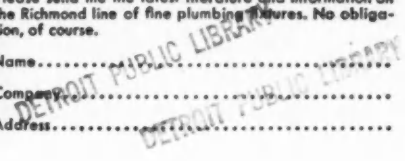

# Plaster Beauty IS ONLY LATH DEEP



**Truscon Metal Lath**  **and accessories help you do a Quicker, More Beautiful Job!**

To help you do a better, quicker, more profitable job of plastering, Truscon has developed a *complete* line of metal lath and accessories that will please the most exacting artisan! The representative group of materials shown here is only a small part of the BIG line of Truscon products—but it

shows the correctness of design, the attention to detail, the quality of the lath and accessories that Truscon manufactures. To learn the complete story of Truscon's "materials of art," see the Truscon catalog in "Sweet's," or write direct to us for separately bound catalogs.

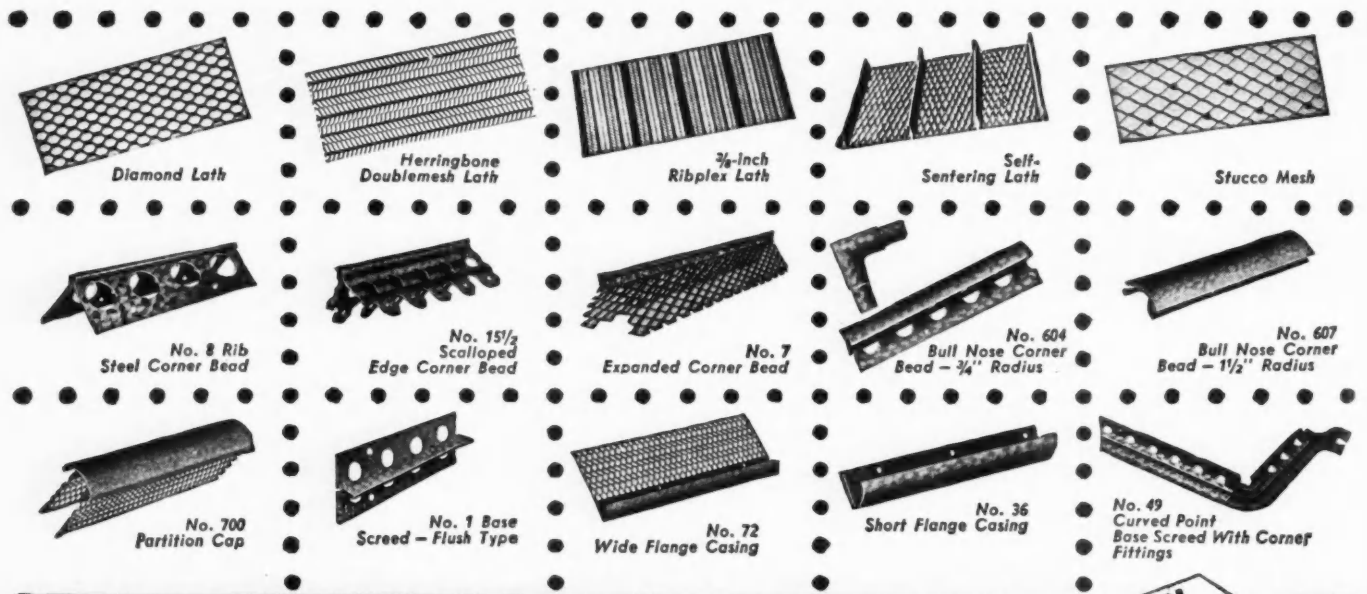

**TRUSCON STEEL COMPANY**

YOUNGSTOWN 1, OHIO

SALES OFFICES AND WAREHOUSES IN PRINCIPAL CITIES

Subsidiary of Republic Steel Corporation

**TRUSCON  
SERVES  
THE PLASTERING  
INDUSTRY**



Builders across the country are using **CHASE® COPPER TUBE** for soil, waste and vent lines!



**HERE'S WHY...**

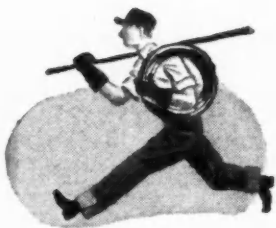

**FAST DELIVERY!**

No need to wait for material for soil, waste and vent lines. Just ask for Chase Copper Tube—you'll get it right away, in all the sizes you need.

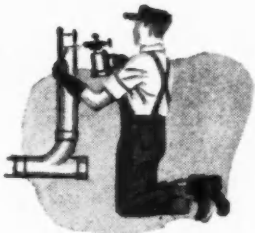

**FAST INSTALLATION!**

Fewer connections — tube comes in 20-foot lengths. Joints quickly made with solder-type fittings. You can pre-assemble into sturdy units that stand rough handling.



**SUPERIOR MATERIAL!**

Smooth tube surface does not hamper flow of wastes. Pockets at joints eliminated by solder-type fittings. Excellent resistance to corrosive action.

• Write for literature on Chase Copper Tube for drainage lines. Address Dept. AB129.

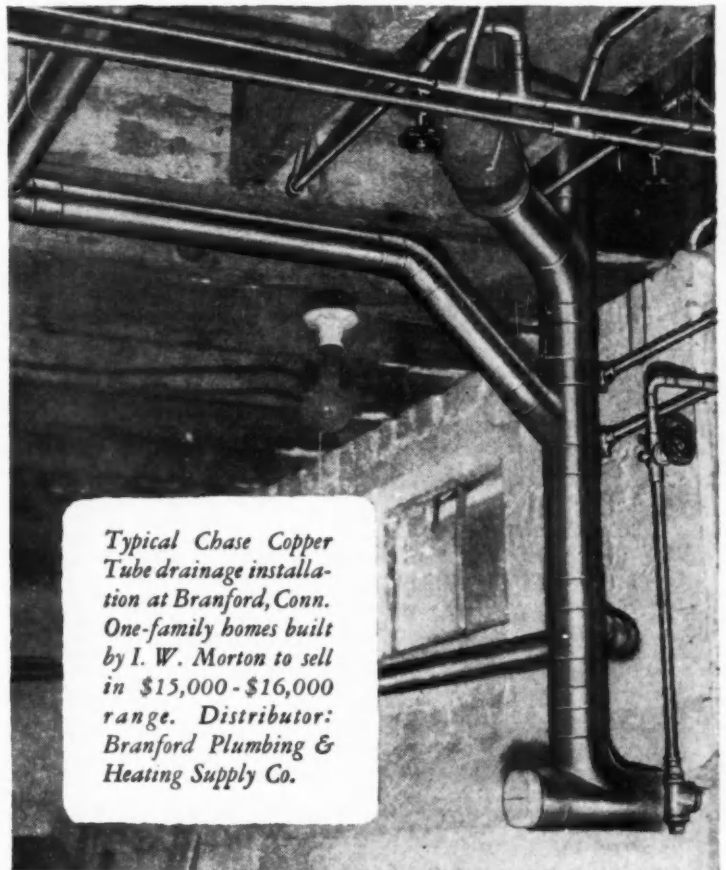

*Typical Chase Copper Tube drainage installation at Branford, Conn. One-family homes built by I. W. Morton to sell in \$15,000 - \$16,000 range. Distributor: Branford Plumbing & Heating Supply Co.*

# Chase



*the Nation's Headquarters for*  
**BRASS & COPPER**

WATERBURY 20 CONNECTICUT

SUBSIDIARY OF KENNECOTT COPPER CORPORATION

THIS IS THE CHASE NETWORK . . . handiest way to buy brass

ALBANY† ATLANTA BALTIMORE BOSTON CHICAGO CINCINNATI CLEVELAND DALLAS DETROIT INDIANAPOLIS KANSAS CITY, MO. LOS ANGELES MILWAUKEE MINNEAPOLIS  
NEWARK NEW ORLEANS NEW YORK PHILADELPHIA PITTSBURGH PROVIDENCE ROCHESTER‡ ST. LOUIS SAN FRANCISCO SEATTLE WATERBURY (Sales Office Only)



## For Christmas Giving

Your business associates and friends will appreciate your gift of books on trade subjects. Make your selections from the list below, and send the Gift Order Coupon today.

## Take Your Pick

of these useful, authoritative books on building and allied subjects. Any book you choose from this list is appropriate as a gift to a builder, contractor, engineer, mason, painter, electrician, or other professional man of your acquaintance. For this Christmas, give the priceless gift of knowledge! Mail coupon below.

- 1 **THE BUILDING ESTIMATOR'S REFERENCE BOOK** and **Vest Pocket Estimator** (not sold separately). By Frank R. Walker. Contains latest estimating and cost data on everything that goes into house construction. Can be used in any locality. Most complete compilation of estimating and cost data available. New Tenth Edition, 1687 pages, 800 illustrations, \$10.00.
- 2 **THE BUILDING TRADES HANDBOOK**. Ready reference on building subjects—mathematics, architectural drawing, structural design, materials and methods. \$1.75.
- 3 **CONTRACTOR'S MATERIAL LIST**. A 10-column take-off form for complete listing of materials and labor costs. \$1.00.
- 4 **HOUSE CONSTRUCTION DETAILS**. Compiled by Nelson L. Burbank. Exact working guide on every detail of house construction from foundation to finish. Tells dimensions, materials, processes, step-by-step working methods. \$4.50.
- 5 **ARCHITECTURAL GRAPHIC STANDARDS**. By C. G. Ramsey and H. R. Sleeper, A.I.A. Structural detail drawings for all types of small and large buildings. \$6.50.
- 6 **PRACTICAL ACCOUNTING AND COST KEEPING FOR CONTRACTORS**. Complete instructions and examples showing proper methods of keeping time and compiling costs on all classes of construction work. \$3.00.
- 7 **MODERN METHODS OF HOME HEATING**. Standard heating systems illustrated with 17 floor plans showing heating outlets, 40 photos of equipment and installations, 25 boiler and piping connection diagrams, and 11 heat loss calculating tables. \$5.00.
- 8 **HOME BUILDERS MANUAL FOR CONTRACTORS**. Provides convenient data and check lists to follow all operations connected with construction of a home. Looseleaf binder permits additions of special material pertaining to project being constructed. \$5.00.
- 9 **CABINS, COTTAGES AND SUMMER HOMES**. By B. S. Mason and F. H. Kock. Full instructions for building vacation homes. \$3.50.
- 10 **DUPLEX AND APARTMENT HOUSES**. By J. W. Lindstrom. Floor plan sketches and brief descriptions of 35 duplexes, 11 4-apartment buildings, and 5 larger ones ranging from 6 to 12 apartments. Cubic footage given. \$1.00.
- 11 **HANDBOOK OF BRICK MASONRY CONSTRUCTION**. By John A. Mulligan. For mason contractors, estimators and construction engineers. \$5.50.
- 12 **INTERIOR ELECTRIC WIRING AND ESTIMATING**. By Albert Uhl, A. L. Nelson and C. H. Dunlap. How-to-do-it book on interior wiring and cost estimating. \$2.75.
- 13 **PAINTING AND DECORATING CRAFTSMAN'S MANUAL**. Sponsored by the Painting and Decorating Contractors of America. \$2.00.
- 14 **PRICE GUIDE FOR PAINTERS AND DECORATORS**. Tables covering practically every type of work done by the painter and decorator, with suggested prices based on various wage scales. \$1.25.
- 15 **SIMPLIFIED ROOF FRAMING**. By J. Douglas Wilson and S. O. Werner. Tells how to frame gable, hip and unequal pitch intersecting roofs. Contains short-cut methods, clear and practical explanations. \$2.00.
- 16 **STAIR BUILDING**. By Gilbert Townsend, S.B. Fully illustrated explanation of every problem in design and construction of stairs. \$2.50.
- 17 **PRACTICAL JOB POINTERS**. More than 850 "tricks of the trade," short cuts, kinks and modern methods of doing all kinds of carpentry and building repair jobs. Cross-indexed for quick reference. Fully illustrated. \$4.00.
- 18 **SIMPLIFIED CARPENTRY ESTIMATING**. By J. W. Wilson and Clell M. Rogers. Everything needed to "take-off" a bill of materials from set of plans and specifications for a frame house—with many helpful quick-reference tables and short-cut methods that simplify the work. \$3.00.
- 19 **HOUSE CARPENTRY AND JOINERY**. By Nelson L. Burbank. Every step of carpentry in and around a house, clearly explained and illustrated. Covers every job from foundation forms to interior trim. \$3.98.

### GIFT ORDER COUPON—MAIL NOW!

Book Service Department, American Builder  
Simmons-Boardman Publishing Corporation  
30 Church Street, New York 7, N. Y.

Please send me at once the books indicated by the numbers circled below.  
 Remittance in full payment enclosed for \$.....  
 Send bill, and I will remit in 10 days—shipping charges added. Any book not satisfactory may be returned within 10 days for full credit or refund.

1 2 3 4 5 6 7 8 9 10 \*No. 20 sent FREE if  
11 12 13 14 15 16 17 18 19 20\* order totals \$5 or more

Name .....  
Address .....  
City .....  
Zone ..... State .....  
A.B. 12-49



*This Book FREE*  
with your order



20 **BLUEPRINT PLANS**. Contains 12 complete blueprints of modern small homes designed by leading architects. Also descriptions and floor plans of 9 other houses, 7 garages; sketches of built-in equipment. \$1.00  
Your copy sent FREE if your Christmas Gift Order totals \$5.00 or more. Use coupon at left—mail today.

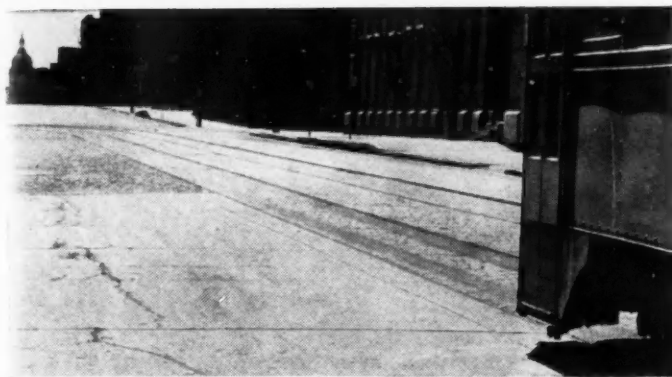

# Ten Years Ago...

in August, 1939, this concrete test paving was laid in Second Avenue North, Minneapolis. The badly scaled section of roadway in the background was made with regular portland cement. The foreground section, laid at the same time, was made with Atlas Duraplastic—the first commercial use of the air-entraining portland cement originated and developed by Universal Atlas.



Both sections, subjected to the severity of ten Minneapolis winters and to heavy applications of de-icing salts, are shown just as they appeared in July, 1949—convincing proof of the characteristic durability of Duraplastic concrete, of its high resistance to freezing-thawing weather and the scaling action of de-icing salts. Longitudinal structural crack shows some ravelling. Note perfect transverse joint.

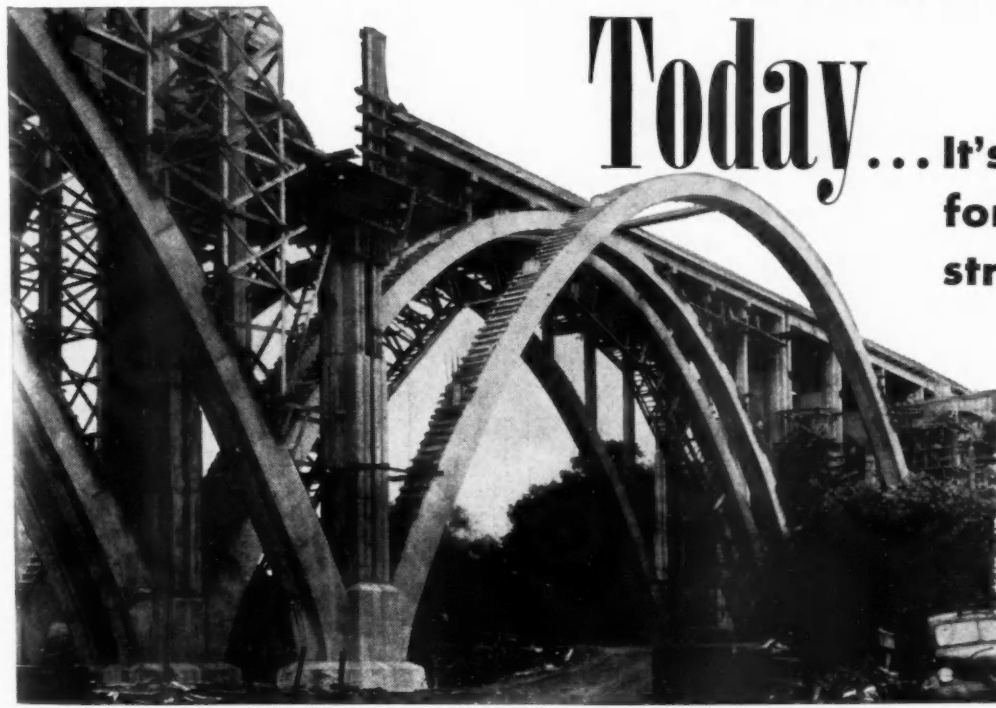

# Today... It's DURAPLASTIC\* for more durable structures

Photo taken during construction of three-span bridge on Penn-Lincoln Highway. Spans for bridge and paving and underpasses made with Atlas Duraplastic. Designed by Pennsylvania Dept. of Highways. Contractor: Dinardo, Inc., Pittsburgh, Pa.

From the first paving test installation to this tremendous three-span bridge, Atlas Duraplastic air-entraining portland cement has demonstrated both its added durability in countless paving jobs and its improved appearance in structural uses. In its rapid ten-year growth, Duraplastic's advantages have been applied to all types of mass and structural concrete — for foundations, walls, columns, and floors. It's ideal for slip-form, gunite, stucco and similar uses.

With Duraplastic, less mixing water is needed for a given slump. The resulting mix is more plastic, more uniform and more cohesive. It's easy to place and finish. Water-gain and segregation are reduced. Surface appearance is improved and the concrete has higher resistance to effects of weather-exposure. For structural concrete needs of today and tomorrow, Duraplastic offers better concrete at no extra cost. It provides the precise amount of air-entraining agent interground with

the cement for satisfactory field performance. It complies with ASTM and Federal Specifications, sells at the same price as regular cement and calls for no unusual changes in procedure. For further information write to Universal Atlas Cement Company (United States Steel Corporation Subsidiary), Chrysler Building, New York 17, N. Y.

OFFICES: Albany, Birmingham, Boston, Chicago, Dayton, Kansas City, Minneapolis, New York, Philadelphia, Pittsburgh, St. Louis, Waco.

\*"Duraplastic" is the registered trade mark of the air-entraining portland cement manufactured by Universal Atlas Cement Company.

AB-D-97

**ATLAS DURAPLASTIC**  
 AIR-ENTRAINING PORTLAND CEMENT  
 MAKES BETTER CONCRETE AT NO EXTRA COST

"THE THEATRE GUILD ON THE AIR"—Sponsored by U. S. Steel Subsidiaries—Sunday Evenings—NBC Network



# Now... Two Great Names to Serve You



## It's Tops for Tops

Now Roddiscraft quality lives up to its name again. General Electric Textolite is part of the Roddiscraft line. It's available through all Roddiscraft warehouses.

Textolite—the ideal plastics surfacing material—has a durable, lasting beauty that will please your clients now . . . and for years to come. Here is a decorative material that wears like iron, cleans like glass.

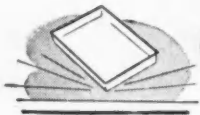

**TEXTOLITE is scratch-resistant**, beautiful but tough. It resists scratching better than low-carbon steel!

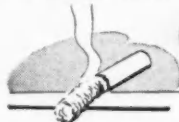

**TEXTOLITE is heat-resistant**, not easily charred, blistered or discolored by heat. A special cigarette-proof grade is also available.



**TEXTOLITE is stainproof**—food acids, alcohol and household chemicals won't discolor it.

And besides that, G.E. Textolite is easy on the eye. Easy to clean, too, with its smooth, lustrous finish.

A wide variety of colors and patterns to fit hundreds of surfacing jobs — restaurants, cocktail lounges, kitchens, soda fountains, institutions — make long-lasting Textolite your best buy in decorative plastic laminates. Wherever you require a surfacing material that combines beauty with durability, specify General Electric Textolite. You'll be sure it's right with Textolite.

Write to Advertising Department for free color chart and folder describing best bonding techniques.

*\*Reg. U. S. Pat. Off.*

## Roddiscraft

RODDIS PLYWOOD CORPORATION  
MARSHFIELD, WISCONSIN

### NATIONWIDE Roddiscraft WAREHOUSE SERVICE

Cambridge 39, Mass. . . . . 229 Vassar St.	Los Angeles 11, Calif. . . . . 2860 E. 54th St.
Charlotte, N. C. . . . . 123 E. 27th St.	Louisville 10, Ky. . . . . 1201-5 S. 15th St.
Chicago 32, Ill. . . . . 3865 W. 41st St.	Marshfield, Wis. . . . . 115 S. Palmetto St.
Cincinnati 2, Ohio. . . . . 457 E. Sixth St.	Milwaukee 8, Wis. . . . . 4601 W. State St.
Dallas 10, Texas. . . . . 2800 Medill St.	New York 55, N. Y. . . . . 920 E. 149th St.
Detroit 14, Mich. . . . . 11855 E. Jefferson St.	Port Newark 5, N. J. . . . . 103 Marsh St.
Houston 10, Texas. . . . . 2425 Sabine St.	Philadelphia, Pa. . . . . 5 N. Delaware Ave.
Kansas City 3, Kan. . . . . 35-53 Southwest Blvd.	St. Louis, Mo. . . . . 4453 Duncan Ave.
L. I. City, N. Y. Review & Greenpoint Ave.	San Antonio, Texas. . . . . 727 N. Cherry St.
San Francisco 24, Cal. . . . . 345 Williams Ave.	

Trim  
sheathing  
fast with  
easy-to-handle  
**SKIL Saw**

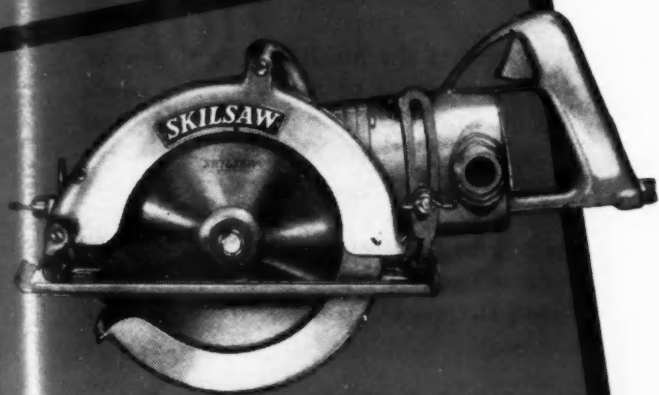

• SKIL Saw is easier to handle on any cut . . . and easiest of them all on the really tough cuts like overhead trimming of sheathing or siding. With SKIL Saw you get perfect one-hand or two-hand operation for fastest, easiest sawing everywhere.

• A perfect combination of balance and power gives you "built-in" ease-of-handling in SKIL Saw. That means faster sawing with less effort on all cutting. And, of course, you know about SKIL Saw dependability that keeps it out of the shop and on the job. Ask your SKIL Tool Distributor to demonstrate cost-cutting SKIL Saw today!

SKIL Tools are made only by  
**SKILSAW, INC.**

5033 Elston Ave., Chicago 30, Ill.

Factory Branches in Principal Cities

In Canada: SKILTOOLS, LTD., 66 Portland St., Toronto, Ont.

**SKIL** ELECTRIC  
**Tools**  
PNEUMATIC

VICE  
54th St.  
15th St.  
netto St.  
State St.  
49th St.  
Marsh St.  
rare Ave.  
can Ave.  
erry St.

# Door Installation as easy as...

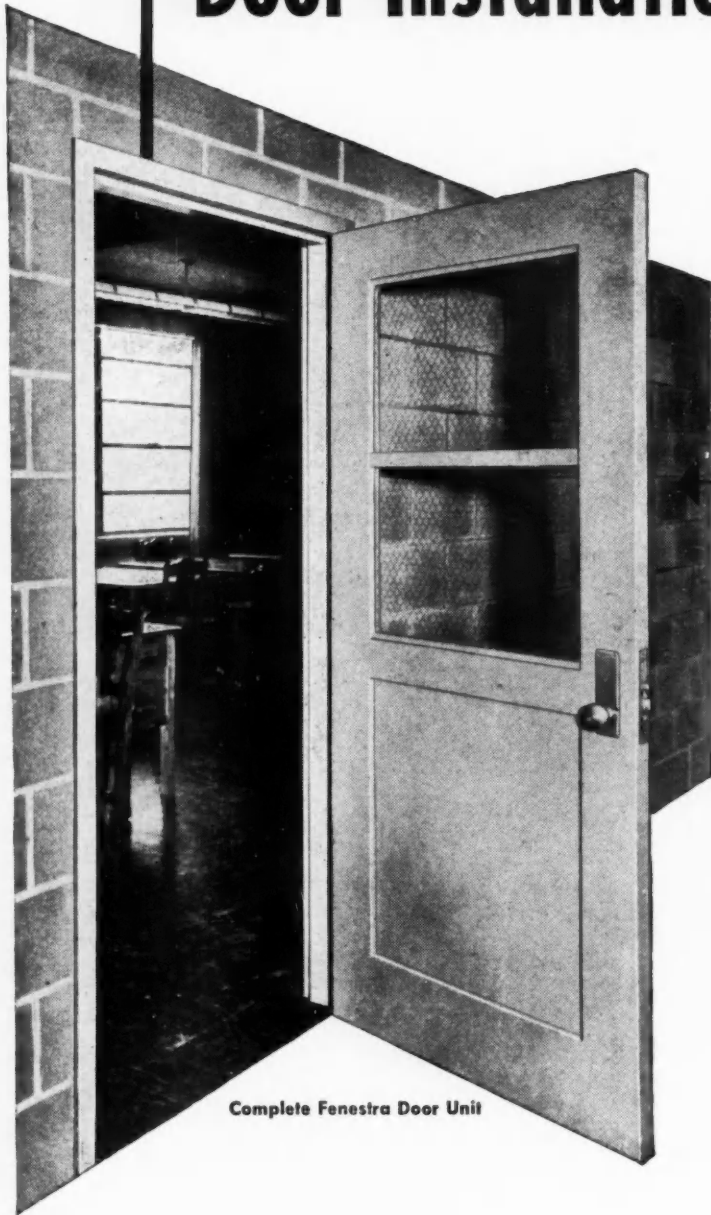

Complete Fenestra Door Unit

- 1** bolt the strong steel frame together.
- 2** attach frame to floor and anchor to walls.
- 3** screw on template locks and hinges.
- 4** hang the door.

## Avoid all this Monkey business...

1. Cutting and fitting jams.
2. Cutting and fitting stops.
3. Cutting and fitting trims.
4. Mortising frame and door for hinges.
5. Mortising frame and door for locks and strikes.
6. Cutting and fitting door.
7. Countersinking holes.
8. Puttying holes.
9. Prime-painting.

With Fenestra\* Standard Hollow Metal Doors, all the expensive, time-taking steps in installation are done for you *at the factory*. Skilled, experienced craftsmen do the mortising, drilling, the tapping and prime-painting. Each door comes complete with frame and hardware.

*These high-quality doors cost less* because they are made in great quantities . . . in standard sizes. *Each is packed with insulation . . . and carefully*

*wrapped to protect the finish during shipment.*

*Order now and quick shipment will be made within 2-3 weeks*, wherever you're located. And most Fenestra Doors, including those with the Underwriters' B Label, are *immediately* available from local stocks.

Call the nearest Fenestra office or write Detroit Steel Products Company, Dept. AB-12, 2260 E. Grand Blvd., Detroit 11, Michigan. \*Trademark

*Fenestra* **STANDARD HOLLOW METAL  
SWING AND SLIDE DOORS**





For quality features, style,  
performance...specify the

## Case Wilmington Lavatory

**N**ew and remodeled homes for which bathroom equipment must be carefully budgeted can have the style, beauty and utility of this handsome Case lavatory.

Made of the finest quality vitreous china, the *Wilmington* has a raised back with recessed fittings and *dry* shelf space that give it a distinctive character of luxury.

Its square basin conceals a front overflow, and there is a soap dish for added usefulness. The metal spout has a special stream regulator that prevents splashing.

Renewable valve seats, swivel discs and encased long-wearing washers are among the features that value-conscious home owners are sure to appreciate. The *Wilmington* lavatory comes in the popular 22" x 18" size — it is available wall hung or with chrome-plated legs, with or without towel bars. In white and colors. Now is a good time to renew your acquaintance with

Case plumbing fixtures. See the *Wilmington* and other leading Case designs at your Case distributor's showroom. His name is listed in Classified Telephone Directories of major cities; or write W.A. Case & Son Mfg. Co., Buffalo 3, N. Y. Founded 1853.



**Vitreous China Plumbing Fixtures**

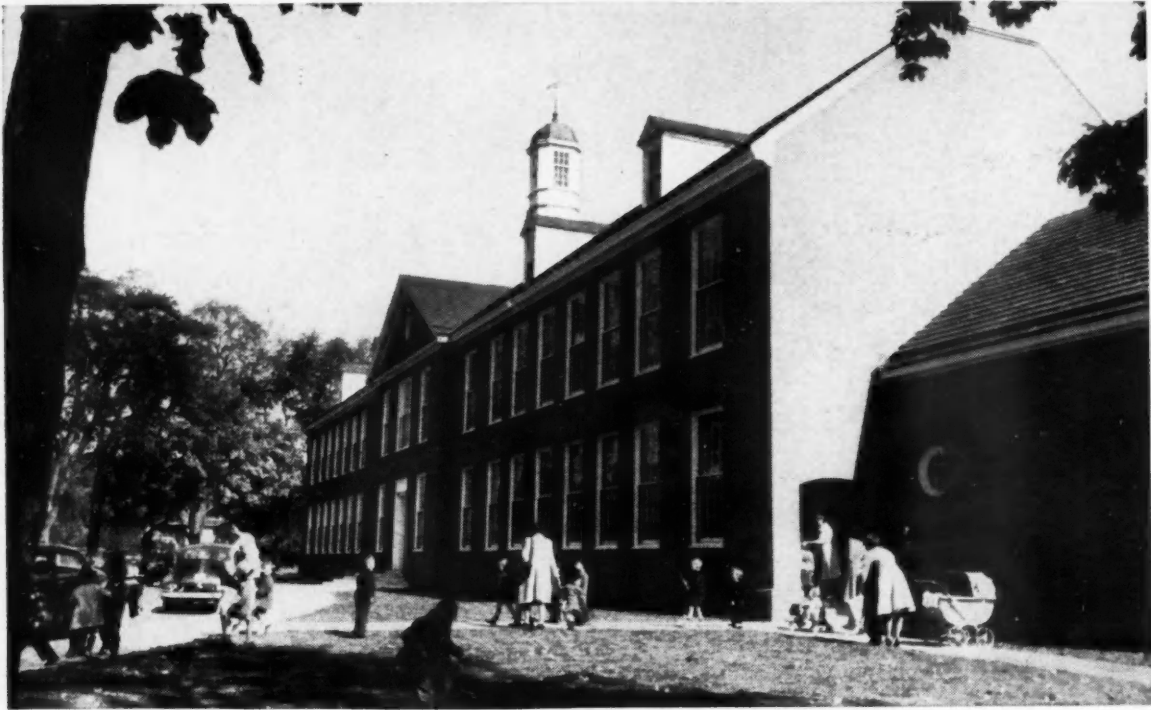

## THE BIG RED SCHOOLHOUSE WITH THE 3 FRIENDLY R's

**E**ACH year sees the quality of school construction average higher and higher, as well-designed, fire-safe structures steadily replace the fire-traps of the little-red-school-house era. Today's Big Red Schoolhouse, like Julian Curtiss School, in Greenwich, Conn., is a far pleasanter place in which to grapple with the eternal three R's. This school, built by WILLIAM A. BERBUSSE, JR., INC., NEW YORK combines every modern educational need with the utmost in construction know-how. Brick work is laid up with Lone Star Masonry Cement, . . . the Masonry Cement which passes with highest grades the three R's of good mortar:

### THE 3 R's OF MASONRY MORTAR



**Rich, extra-fat, buttery mortar, obtained with the wide variety of sands encountered under today's job conditions . . . uniform texture, easy-spreading quality, sustained high yield;**

**Retains water . . . keeps thirsty brick or block from sucking water from the mortar . . . remains plastic, units are firmly bedded . . . assures better bond;**

**Resists penetration of driving rains and frost action . . . provides strength more than ample for any type of brick or block structure . . . assures watertight, weather-resistant walls.**

**There's a Lone Star Cement for every construction need: LONE STAR MASONRY CEMENT for quality masonry . . . LONE STAR PORTLAND CEMENT for strong, durable concrete in all types of work . . . 'INCOR'\* 24-HOUR CEMENT for top-speed construction with 50% less forms and important winter economies . . . LONE STAR AIR-ENTRAINING PORTLAND CEMENT for highway work and other uses. The name LONE STAR on cement assures the utmost in quality and uniformity.**

\*Reg. U. S. Pat. Off.



## LONE STAR CEMENT CORPORATION

Offices: ALBANY • BETHLEHEM, PA. • BIRMINGHAM • BOSTON • CHICAGO • DALLAS • HOUSTON • INDIANAPOLIS • JACKSON, MISS. • KANSAS CITY, MO. • NEW ORLEANS • NEW YORK • NORFOLK • PHILADELPHIA • ST. LOUIS • WASHINGTON, D. C.

LONE STAR CEMENT, WITH ITS SUBSIDIARIES, IS ONE OF THE WORLD'S LARGEST CEMENT PRODUCERS: 15 MODERN MILLS, 27,000,000 BARRELS ANNUAL CAPACITY

# TRENDS in the Building Field

## Banner Residential Building Year

IT IS now certain that 1949 has been one of the three biggest residential building years in history and will probably exceed the all-time record of 1925 when 937,000 dwelling units were started. Last year the total was 931,000; the total for 1949 will probably be close to 950,000. Starts for this summer and fall were the highest on record. In September the Bureau of Labor Statistics estimates that 100,000 new permanent non-farm dwelling units were started, 17,800 or 22 per cent over September, 1948.

This upward trend is contrary to the predictions of most experts early this year. They foresaw a continuation of the slump which started in the fall a year ago and through May 1949. Then in June home building became the bright spot in a widening recession. This was not entirely a surprise to the staff of *American Builder*. A survey made among subscribers in March showed that there would be an increase of four per cent in new homes over last year. At the time our enthusiasm for polls was tempered by the upset of the pollsters in the November election last year. However, it now appears that this was an accurate prediction of the record homebuilding activity that would take place this summer and fall.

Starts for the four years since the end of World War II will total 3,400,000, of which 2,800,000 (82%) comprise one-family dwelling units. This is by far the largest number of one-family dwelling units ever constructed in a similar period in the nation's history. When housing production was high in the 1920's, 40 per cent of the new dwelling units were rental type units. Most of these were in large cities.

The collapse of home building activity in the 1930's can be attributed to three factors.

(1) The number of new dwelling units provided exceeded the in-

crease in number of families. During the 1920's there was an increase of 5,500,000 families and 7,000,000 dwelling units were constructed.

(2) Financing of both apartment buildings and single family houses was unrealistic. The new home owner was usually burdened with two or three mortgages with interest rates as high as 8 per cent.

(3) The depression, believed by some economists to have been largely caused by the decline in residential building from 1925 onwards, effected wage cuts which made it impossible for people to pay the high rentals required for apartments or to meet mortgage payments on single-family houses.

A handicap to the continuation of homebuilding at the rate of approximately 1,000,000 units a year during the 1950's exists in the fact that the increase in family formation as estimated by the Bureau of Census will be less than 400,000 families per year. If production of 1,000,000 units a year is continued, about 500,000 older dwelling units a year in the course of time will have to be destroyed.

Operative builders, in particular, need to watch very carefully the population trends of their com-

munities in making their future plans, and to stimulate large scale remodeling projects when and if the market for new houses begins to slacken.

Government estimates of housing needs differ considerably from the requirements outlined above. Raymond A. Foley, Housing Administrator, appearing before the Senate Banking Subcommittee a few months ago stated in effect that we would need approximately 1,400,000 dwelling units a year during the 1950's; a total of 600,000 for the increase in families each year; 100,000 for the replacement of houses destroyed; 500,000 for substandard units to be replaced and 200,000 for farm homes to be built or remodeled.

Whatever the fallacies behind these estimates, a sustaining influence in the market is the fact that builders in many communities are able to offer to the mass market in the lower middle income group houses at \$8,000 to \$9,000 which require little or no down payment and monthly payments commensurate with weekly wages. This can cause the evacuation and subsequent demolition of hundreds of thousands of sub-standard rental dwelling units.

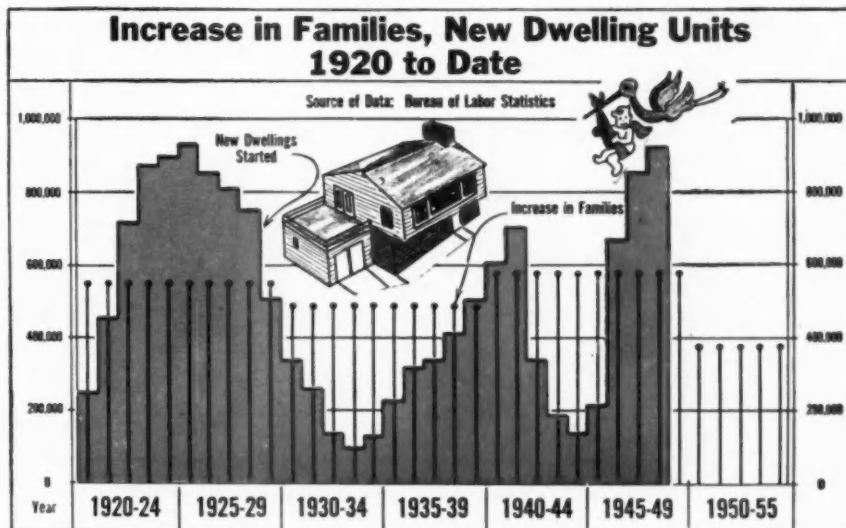



# How even modest bathrooms can have MORE SALES APPEAL with Miami-Carey cabinets and accessories

Your clients see themselves in a new light that's wonderfully bright, yet easy on the eyes, when you install these handsome fluorescent wall light fixtures alongside the bathroom mirror!

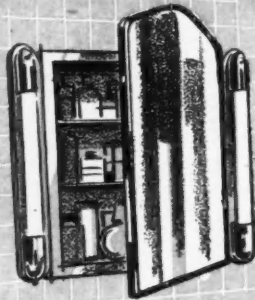

Just 4 of 44 ideas from Miami-Carey's bathroom planning booklet... to make your homes more salable... to help you build-in extra convenience and beauty... give bathrooms that "custom designed" appearance for very little cost.

Families with children save on laundry bills when you install this gleaming chrome roll paper towel holder right in the bathroom. Low, handy, saves work!



Bring the bathroom to life with this added touch! Sparkling crystal glass shelves on either side of the medicine chest. A pair for her toilet articles, a pair for his. Leaves the medicine chest for first-aid and drug items.

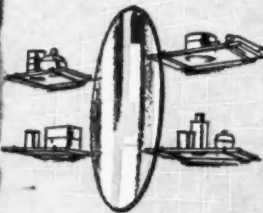

Here's a deluxe touch that costs very little. Individual soap holders for everyone—to each his own favorite kind of soap. Far more sanitary than piling all the soap in just one holder.

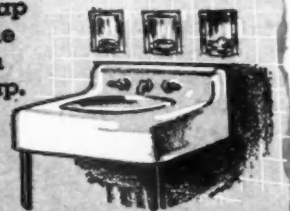

NO BUILDER SHOULD BE WITHOUT THIS HELPFUL BOOKLET



"44 Ideas for Your Bathroom." Jam-packed with helpful suggestions to aid you in planning new bathroom convenience for new homes and old. Use it to assist owners in selecting their appointments. For your free copy, see your Miami-Carey dealer, or fill in and mail the coupon below.

For a look at the latest in Miami-Carey's complete line of bathroom cabinets and accessories—made in a wide range of styles and prices to fit your design and building needs, visit your Miami-Carey dealer—pronto!

MIAMI-CABINET DIVISION  
THE PHILIP CAREY MANUFACTURING CO.  
MIDDLETOWN, OHIO

AB-12

Please rush me your big new FREE booklet that shows how to plan new bathrooms for old homes and new.

FIRM NAME \_\_\_\_\_  
YOUR NAME \_\_\_\_\_  
ADDRESS \_\_\_\_\_  
CITY \_\_\_\_\_ ZONE \_\_\_\_\_ STATE \_\_\_\_\_



MIAMI-CABINET DIVISION  
THE PHILIP CAREY MFG. CO. MIDDLETOWN, OHIO

"National Guard Defends America... Join Now"



# The RUSCO PRIME WINDOW

VERTICAL SLIDE

the only ready-to-install window unit that provides year 'round, all-weather window conditioning

**RUSCO** gives you the most complete

unit ever offered . . . glass, screen, weather stripping, wood surround . . . with or without insulating sash . . . all in one factory-assembled unit . . . ready for quick installation . . . costs no more than you're paying today

Now . . . for the first time, you can specify and use a factory-assembled window unit that is extremely practical, durable and trouble-free . . . is simple to install . . . that reduces field painting and installation costs . . . that provides for year 'round safety, convenience, comfort and economy.

The Rusco Prime Window is the result of over 12 years of field experience . . . it is an adaptation of the basic engineering principles that have made Rusco all-metal, self-storing combination windows today's most widely accepted unit of its kind.

## RUSCO LEADS IN DESIGN, CONSTRUCTION

**AND ADVANTAGES** . . . All working parts of tubular, Armco Steel, hot-dipped galvanized Ingot Iron Zincgrip—Bonderized and finished with baked-on outdoor enamel . . . All installation members of toxic-treated wood . . . Waterproof felt weather stripping assures weather-tight closure . . . Requires no field painting . . . All glass and screen panels removable from inside . . .

No weights, balances or cords . . . Smooth, trouble-free operation . . . Automatic positive locking in closed or ventilation positions . . . Easier window cleaning . . . Available with or without self-contained insulating sash . . . Complete unit offers the combined, year 'round advantages of . . . windows, screens, storm sash and weather stripping.

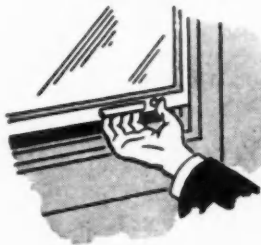
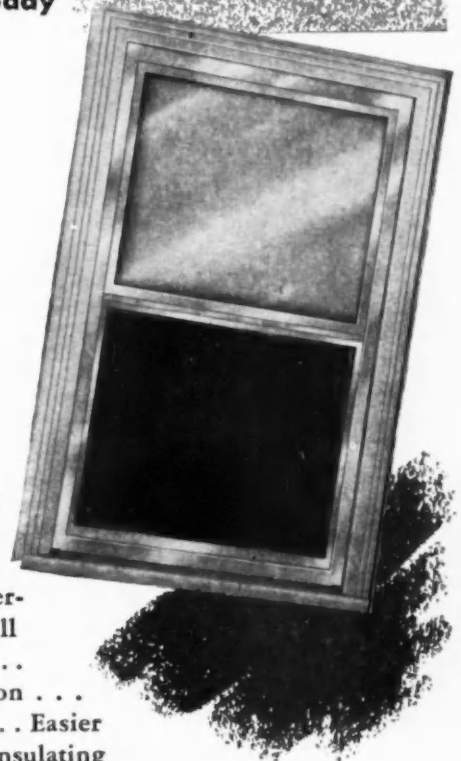

## THE F. C. RUSSELL CO.

DEPARTMENT 7-AB129 • CLEVELAND 1, OHIO

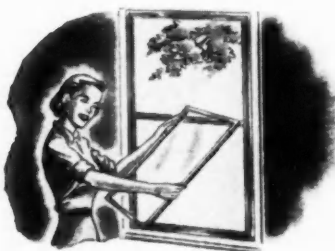

**SEND COUPON FOR COMPLETE INFORMATION-- SPECIFICATIONS**

© TFCRC

THE F. C. RUSSELL COMPANY  
Dept. 7-AB129, Cleveland 1, Ohio

Gentlemen: Please send me catalog of informative data and specifications on Rusco Prime Windows.  
(please check) I am \_\_\_\_\_ Architect \_\_\_\_\_ Building Contractor  
\_\_\_\_\_ Building Supply Dealer

Name \_\_\_\_\_  
Company \_\_\_\_\_ Title \_\_\_\_\_  
Address \_\_\_\_\_  
City \_\_\_\_\_ Zone \_\_\_\_\_ State \_\_\_\_\_



Openings for distributors are available in select territories

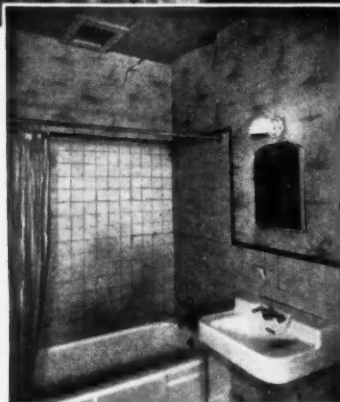

**AFTER**—The same area smartly modernized with versatile Marlite. Note that ceiling, too, features beautiful Plain-Color Deluxe Marlite panels. Now dirt, stains and moisture are permanently sealed out. The room is easy to clean and to keep clean—mighty important to budget-wise hotel operators.

**BEFORE**—In the Reeves Hotel, New Philadelphia, O., the wall covering in this tub area was peeling away from the walls of this outmoded room, before remodeling.

## Here's how *Easy* it is to modernize bathrooms with Marlite!

**HOW MARLITE IS APPLIED**—Old walls or new are easily modernized with Marlite. Walls should be reasonably clean, dry and smooth. The applicator establishes plumb and level lines, measures for the panels and mouldings, works with ordinary carpenters' tools. Mouldings are cut, trimmed and fitted. Waterproof caulking is applied to moulding channels and fixture openings. Waterproof Marsh adhesive is applied, and panels are pressed firmly into position.

**MARSH MATCHING MOULDINGS COMPLETE THE JOB**—The complete line of Marsh Mouldings (Aluminum Alloy, Colored Presdwood and Plastic) is especially designed for Marlite installations, with wide flanges for easy nailing and adequate room in the channels for expansion. Faces of various shapes are matched to make perfect joints easy.

**WIDE RANGE OF PATTERNS, COLORS, SIZES**—Marlite comes in large, wall-size panels, 4' wide, 5/32" thick, and in 5, 6, 8 and 12' lengths. There are gay, colorful, decorator colors in tile-pattern, horizontal and plain-color patterns (as well as in new Wood and Marble patterns). Marlite never needs painting or redecorating, withstands the abuse of daily public usage, remains sparkling clean with only an occasional wiping with a damp cloth.

**CATALOG FOR BUILDERS**—Send for your free copy of fully illustrated catalog showing complete installation details, typical Marlite installations in all kinds of interiors, and information on the complete line. Address Dept. 1203 Marsh Wall Products, Inc., Subsidiary of Masonite Corporation, Dover, Ohio.



*Marlite*  
good for home modernization, too

See our catalog in  
Sweet's Builders File

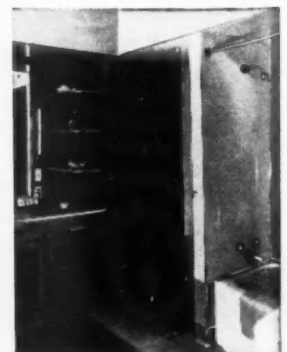
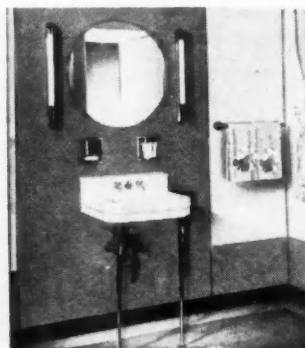

ST...  
app...  
the...  
and...  
ene...  
ning...  
hav...  
  
DO...  
to b...  
stat...  
indu...  
pub...  
evid...  
may...  
way...  
wha...  
  
RA...  
mun...  
noth...  
figh...  
port...  
side...  
  
A &...  
groc...  
sole...  
foun...  
they...  
name...  
Atla...  
to lo...  
eithe...  
whet...  
publi...  
  
TAC...  
gove...  
of ar...  
made...  
so m...  
and...  
coale...  
being...  
A &...  
the h...  
could...  
pendi...  
guard...  
  
PUB...  
hard...  
heard...  
builde...  
Briefl...  
ing n...  
fact o...  
the pu...





**STATEISM**—It is a word that is appearing with more regularity in the press. Reason is that industries and professions immediately threatened by big government are beginning to awake to the fact that they have a common fight to wage.

**DOCTORS**—They are beginning to believe that they cannot ward off state medicine alone. The building industry knows it cannot fend off public housing alone. There are evidences that doctors and builders may pool their resources in some way to acquaint the public with what impends if both go socialistic.

**RAILROADS**—They're not immune, by any means. And there is nothing to indicate that they can fight government control of transportation without help from outside the industry.

**A & P**—Here is an isolated retail grocery concern being attacked solely because it is big. Perhaps the founding fathers, unsuspecting as they were, blundered when they named the company, The GREAT Atlantic & Pacific Tea Co. Begins to look like it may be a sin to be either great or big, regardless of whether or not a service to the public is being rendered.

**TACTICAL ERROR**—Maybe big government, apparently resentful of anything else that is big, has made a bad mistake in attacking on so many fronts at once. It could, and possibly will, mean a strong coalescence of forces opposed to being regimented. The attack on A & P, which, if successful, hurts the little man in the pocketbook, could be the Pearl Harbor in the impending war to protect and safeguard private enterprise.

**PUBLIC RELATIONS**—It's a hard term to define, but it is being heard more and more every day in builders' and dealers' councils. Briefly, the term amounts to nothing more than assembling either fact or fancy, and dispensing it to the public. So much fancy has been

dealt to the public by the forces of socialism that industry for the first time is concerning itself with the need to tell a few truths to the public.

**NOT EASY**—That definition is an over-simplification, because the multitude of facts—all of them axioms to most business men engaged in home building—must first be assembled, and then placed before the public in terms that are easily understandable. Both operations cost money, and require specialists in the art of writing for public consumption.

**1950**—It is a year that will see a multitude of public relations programs launched. The only ones likely to be successful will be those instituted and implemented at the grass roots level. Passage of the public housing act last summer reduced public relations for home builders, their suppliers and sub-contractors from the national to the local level.

**UNITED FRONTS**—All branches of the home building industry pooling their resources and information, and using them to inform all economic and social brackets at home of the immediate effect of socialism or stateism on their lives, is the answer to effective public relations.

**SUMNER D. HERSEY**—A good example of public relations by a lone crusader is the continuous series of messages that Hersey publishes in the Natick (Mass.) Herald. With Hersey to spearhead a movement in Natick, public housing could be knocked cold in a hurry in that community.

**CHICAGO**—Chicago Metropolitan Home Builders Association is engaged in developing a public relations plan that has every promise of establishing a pattern for use in every city in the nation. More about it next month. CMHBA is not ready to release information at this time.



for a **UNIVERSAL ALL-PURPOSE FLOORING**

**FIRST CHOICE** among architects, builders, contractors and property managers as the *universal, all-purpose flooring* is asphalt tile and the finest asphalt tile made is AZPHLEX!

*Here's why AZPHLEX ranks as "the best of the best":*

**HIGHEST GREASE RESISTANCE**—will not soften or stain in contact with animal, mineral or vegetable greases, alkalis, alcohol or mild acid solutions.

**TOUGH**—virtually immune to scarring and scuffing; very resistant to indentation by rolling or standing loads. Surface will take very high polish—and keep it.

**COLORFUL**—sharp, clear marbleized colors go all the way through; wide range of colors makes possible many color and pattern combinations.

**MODERATELY PRICED**—far below the luxury classification despite its premium qualities. Installed cost is only slightly higher than that of standard asphalt tile—an important factor in today's low-cost housing program.



AZPHLEX is the asphalt tile that has everything—that comes closest to being the universal, all-purpose flooring!

For complete information see your AZROCK-AZPHLEX dealer, or refer to Sweet's Architectural File—or, if you prefer, write directly to Department "B"—Please classify your business as builder, contractor, dealer, etc.

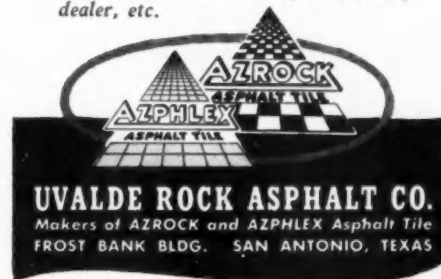



FOR BEAUTY

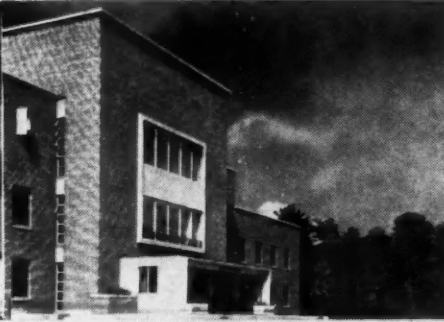

FOR GREATEST VALUE



FOR PERMANENCE



FOR CUSTOMER PREFERENCE



FOR LOW MAINTENANCE COST



FOR PRIDE OF OWNERSHIP



FOR FIRE SAFETY



FOR MOST TROUBLE-FREE



FOR HIGH RE-SALE

**YOU SAID IT! time after time**

*"Brick first"*

You builders are the men who know—so, in a recent survey, we asked you, What material do you prefer for beauty, strength, lasting value — for almost every quality that makes a material valuable to you as a builder? Time after time your answer was, "Brick."

*In most cases the preference for brick was greater than for all other materials combined!*

Actually, surveys and statistics aren't necessary to prove this overwhelming endorsement of brick. *You can see it*—all about you, in all types of buildings. *That* is the strongest endorsement of any material. That is also a sure sign that it pays to remember, "Brick first."

#### HOW TO BUILD IN BRICK AT LESS COST!

Send today for MODERN BRICK HOMES, a 56-page planbook full of labor-saving, cost-reducing information for home builders. Economy engineered plans for 20 houses, discussions on location of site, choice of plans, financing, interior arrangements, exteriors. Only 50¢! Send with your name and address to the address below, Dept. AB-12.

#### STRUCTURAL CLAY PRODUCTS INSTITUTE

1520 18th Street, N. W., Washington 6, D. C.

Like Having a  
Portable Millwork Shop...

New  
**PORTER-CABLE**  
**Guild**  
**ROUTER**



...Right  
on  
the Job!

MODEL 100  
**ONLY**  
**\$47.50**  
f.o.b. factory



*Now...* Routes for Hinge  
Butts on 20 DOORS A DAY!

Here's an outstanding example of how the Guild Router makes itself useful on home construction—pays for itself many times over. Used with the Porter-Cable Hinge Butt Templet, it enables *one man* easily to rout for hinge butts while fitting and hanging 20 doors a day. Think of the hand work it saves—how it helps speed door hanging on a real production basis.

**PORTER-CABLE**  
**HINGE BUTT TEMPLET . . . . . \$70.00**  
Adjustable to any door or jamb up to 8' high.

Next job, take along one of these handy Guild Routers. You'll cut down—perhaps eliminate entirely—costly, time-wasting trips to the millwork shop. That's because this versatile router is designed to do many fancy cuts without any special skill—quickly, accurately, inexpensively. With it you can do expert trimwork on cabinets, corner cupboards, bookshelves, valances. You can do edging, carving, and other types of decorative work. More, it's the speedy accurate way to groove for weatherstrips and sash hardware.

The new Guild Router is way out front in performance, quality, value—with features you'd expect to find only in the most expensive routers. There's nothing like it on the market at the price. See it—try it—at your Porter-Cable GUILD Tool dealer's, today.

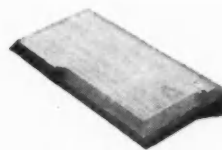

Ideal for chamfering, beveling, rounding corners, etc.



Makes ogee cuts, coving, beads and fluting.



Tongues, grooves, rabbets, dovetails, dados, ploughs.



Routes relief work, veins for recesses and inlays.



Shapes edges of all types; makes ornamental cuts.



Carves and contours cut-out work in display panels.

**PORTER-CABLE Machine Co., 1612 N. Salina St., Syracuse, N. Y.**  
Manufacturers of **SPEEDMATIC** and **GUILD** Electric Tools

In Canada: Write Strongridge Ltd., St. Catharines, Ont.



Don't give them anything to "Grouse" about!



... of course, it's Electric!

Customers being people, they'll "grouse" unless you give them what they want in the new homes you build. Include the kind of cooking equipment more people want—modern Electric Ranges!

The trend to Electric Cooking is proved by the fact that another million American families switched to it last year.

So build houses that are modern today and will stay modern for years to come. During construction, include wiring for an Electric Range, leading to a range outlet in the kitchen. An Electric Range, like electricity itself, is now a "must" in every modern home!

ELECTRIC RANGE SECTION, National Electrical Manufacturers Association, 155 East 44th Street, New York 17, N. Y.

ADMIRAL • COOLERATOR • CROSLY • FRIGIDAIRE • GENERAL ELECTRIC • GIBSON • HOTPOINT  
KELVINATOR • LEDO • MONARCH • NORGE • QUALITY • UNIVERSAL • WESTINGHOUSE

Follow the trend...

**wire** YOUR HOUSES FOR ELECTRIC RANGES

Another 1,000,000 American families switched to Electric Cooking last year

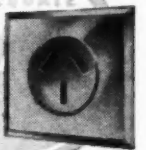

**EDITORS'**  
**Round Table**

**ELSEWHERE** in this issue there is a roundup of the results of National Home Week. It reveals a spurt in sales unparalleled by any other merchandising program ever engaged in by home builders.

**AT LEAST** one local newspaper found itself confounded by National Home Week. Nothing could be gained by revealing the name of the city here. What happened is that the real estate editor received a release from Associated Press telling about the plans and magnitude of National Home Week over the country as a whole.

**INTRIGUED**, the real estate editor phoned a number of local builders and retail lumber dealers only to be greeted by the astounding information that they had never heard of such a thing. Instead of writing a story about the participation of the local building industry in NHW, he wrote a short two-paragraph item mildly asking who was asleep.

**IF THAT REAL ESTATE** editor is as alert as his telephone survey indicates, it is almost a safe bet that his paper will see to it that NHW is celebrated in his city next year, and that the seekers for new homes among his readers enjoy the same advantages as the citizens of several score of other cities where NHW was feature news for something between a week and a month.

**NEW ORLEANS** gave NHW a Mardi Gras flavor with a parade and floats, bands and snappy drum majorettes down Canal Street.

**PITTSBURGH** did what might be called a one-week take-off on the Railroad Show or a World's Fair, when it took over a large tract of ground for the demonstration of modern homes and the materials and equipment that go into them.

**LONG ISLAND** had what amounts to almost a fabulous number of homes open throughout the week.

**CHICAGO** again cooperated with the retail furniture dealers, and operated throughout an entire month, focusing on week ends. The estimate of visitors was well over 1,000,000, and sales jumped 40 per cent.

(Continued on page 57)

**"MOST POWERFUL  
SAW I EVER USED"**

**"BEATS 'EM ALL  
FOR FAST CUTTING"**

**"EASY HANDLING  
... ANY POSITION"**

**"BEST FOR  
ALL-AROUND USE!"**



**New  
AMERICAN 8 1/2" SAW**

SINCE 1903

**AMERICAN  
PORTABLE TOOLS**

Here's the sweetest handling Saw you've ever used—the sensational new American! See it—try it—compare! Big capacity—8 1/2" blade. Develops 2 1/4 H.P. Top speed cutting, any position . . . for wood, stone, tile, sheet metal, compositions. No jolt—no twist when starting—balanced torque principle. *Saves time, saves labor, cuts costs!* Send coupon for details and FREE demonstration.

The American Floor Surfacing Machine Co.  
511 So. St. Clair Sr., Toledo 3, Ohio

- Please send illustrated bulletin and price on new American Power Saw. No obligation.
- Please arrange a FREE demonstration of the new American Power Saw. No obligation.

Name \_\_\_\_\_  
City \_\_\_\_\_ State \_\_\_\_\_

**SEND COUPON TODAY!**

DETROIT PUBLIC LIBRARY  
DETROIT PUBLIC LIBRARY



Attractive store front modernized with  
 $\frac{3}{8}$ " thick "Century" APAC.  
 White & Prinz, Dallas, Texas, Architects.

**Good looks and good service**

**... you can give both with**

**K&M "Century" APAC**

Many merchants in your town would like to have an attractive store front like this. They know it would create prestige . . . bring in business. Yet they put off modernizing. Why? Because some think it costs "big money" . . . musses up the place . . . takes a lot of time. They're wrong on all three counts so far as "Century" APAC is concerned.

Explain to your customers how economical "Century" APAC is . . . how quickly it can be applied . . . how well and how long it stands up in service. You'll find that it will help to bring you many extra jobs . . . not only remodeling, but new construction as well.

Being made of asbestos and cement, "Century" APAC is fire resistant and proof against weather, rot, rust, corrosion, rodents, termites. It requires no protective paint, and maintenance is at a minimum. Use APAC for interior and exterior walls, ceilings, partitions, almost all flat surfaces.

Get full information about "Century" APAC from your K&M Dealer, or write direct to us. We'll attend to your inquiry promptly.



Original manufacturers of  
 Asbestos-Cement Roofing  
 Shingles in this country

**KEASBEY & MATTISON  
 COMPANY • AMBLER • PENNSYLVANIA**



## EDITORS' Round Table

(Continued from page 55)

**RACE AGAINST TIME** is a slogan adopted in Chicago in support of better merchandising. The point of the slogan is that every family to whom a new home is sold adds two more potential votes for free enterprise, if the purchasers are told what public housing will do to their taxes, and possibly to their equities. The 900,000 new homes sold this year, most of them to new home owners, can mean 1,800,000 votes against stateism. If future elections go the way of the recent ones, that 1,800,000 is enough to halt socialism.

**A READER** whose identity will not be divulged here, because his permission to use his letter was not asked, writes as follows: "The main objection I have to *American Builder* is that the houses planned by your architect and incorporated in your publication by showing blueprints, are too large and expensive to build. Why could you not give more attention to a house of three or four bedrooms, living room, kitchen and dinette, or a breakfast nook in the kitchen, and use part of the living room as a dining room when wanted, if the living room is large enough? This kind of house could be about 24 feet by 40 or 42 feet. It could be so planned that an extra room or two could be added, and make the house not only well planned but practical. A little higher roof, a dormer and a stairway is always good for more rooms if wanted. If the stairway is at one end of the house the upper part can easily be rented if desired. A good selling point when selling property, and a mighty good idea, too. Just as well have a good planned house as a box car. No good reason why one should have to pay \$15,000 to \$20,000 to build a good house. Too many of the houses that are being built for around \$10,000 are eye sores, not only poor design, but poor construction."

**WELL, THAT'S** certainly an inclusive objection. Looking over the Blueprint Houses that are a regular feature of *American Builder*, there is no question that few of them meet the design and dimensional requirements specified by the reader. The objection seems to be that

(Continued on page 59)



8-FT.  
LENGTHS

## MORE DOLLARS AND SENSE!

### More Facts that Prove Bermico Cuts Building Costs

Bermico's convenient 8-foot lengths store more safely with far less breakage... are easier to handle on the truck or job. Bermico weighs only  $\frac{1}{3}$  as much as other types of pipe. A cinch to lay, too. No joining compound needed. A few hammer blows and Bermico joints are tight... and stay tight even when the ground shifts underneath!

Small wonder builders find that Bermico saves money, time, effort all along the line. Bermico is a hit with customers, too. It's rootproof, leakproof, watertight... unaffected by temperature extremes... Bermico assures a smooth, dependable high capacity water flow.

That's why, today, millions of feet of Bermico are in use in house-to-sewer connections, septic tank disposal and drainage systems.

Bermico can cut your costs for time and labor and increase your profit as well. Drop us a line and get the whole story of why it pays to insist on

Bermico Sewer Pipe.

Dept. A-112, Brown Co., 500 Fifth Ave., N.Y.

# BERMICO®

## SEWER PIPE

A PRODUCT OF BROWN COMPANY



WEIGHS  
 $\frac{2}{3}$  LESS

ROOT-PROOF  
JOINTS

# It's as easy as



To Pick the Right  
Advertising Medium  
for the Building Market

**A** is for *American*  
**B** is for *Builder*  
**C** is for *Coverage*

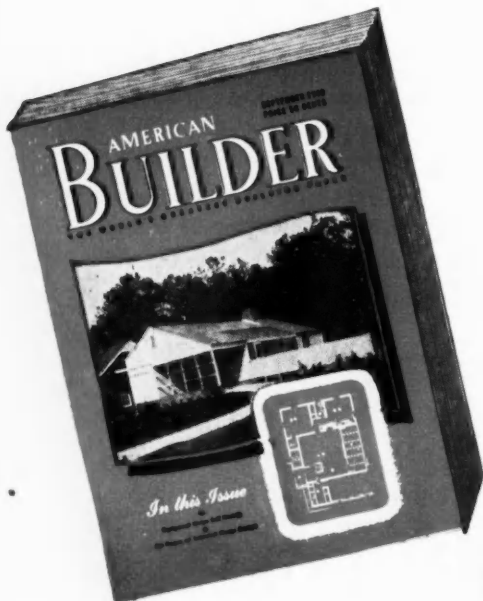

When buying advertising space to reach the building market American Builder is first choice because American Builder is

1. *First in Circulation*
2. *First in Reader Interest*
3. *First in Number of Advertisers*
4. *First in the Building Field*  
(Established 1879)

Plan your selling campaign to the light construction market for 1950 around your advertising space in American Builder. Our sales representative will be glad to help you in planning your advertising program. Your interests are his interests.

Drop us a line today asking for the complete sales analysis of the Building Industry. There's no obligation. Let us help you.

AMERICAN  
**BUILDER**

79 W. MONROE ST.  
CHICAGO, ILL.  
30 CHURCH ST.  
NEW YORK, N. Y.



A SIMMONS BOARDMAN PUBLICATION



EDITORS'

**Round Table**

(Continued from page 57)

the Blueprint Houses offer too little house for too much money. That, we question, and in doing it, suggest to the reader that the size and type of house he desires to see in plan can be built in few if any sections of the country for \$10,000.

**THERE CAN BE NO** argument with his desire for good design, and aside from the Blueprint Houses, a study of recent issues of *American Builder* will reveal that many houses of the kind the reader wants to see have been presented in other parts of each issue.

**FOR INSTANCE,** to select one of several in the August issue, take the one on page 95. The outside dimensions are 26x44.

**ANOTHER EXAMPLE** is on page 72 of the September issue. This is a three-bedroom house 26 feet 8 inches by 42 feet 11 inches.

**ANOTHER READER** who builds houses ranging from \$25,000 to \$45,000 reported that while his sales have been nil for months, and his inquiries almost static, National Home Week brought out people who proved to be more than just sight-seers. The builder sold most of his inventory, and took orders for these high-priced ready-builts to deliver next year.

**REPORTS** from many sections of the country indicate that the erstwhile dormant market for houses costing \$25,000 and up suddenly has become active.

**ONE BUILDER,** however, complained quite emphatically about the reactions of what he calls the "limousine trade", the prospects who drive up in six or seven thousand dollars worth of automobile, and expect to get a large new house with a down payment of \$100 and monthly payments of \$75.

**THEY ARE,** he said, indignant when they learn that the down payment is almost as much as the cost of the automobile, and that the monthly payments are several times what they apparently expected. It doesn't occur to them that the automobile will be worth only a few hundred dollars in several years, while the house will be worth its purchase price for a long time.

**A BRAND-NEW \$SALES\$ MAKER FOR YOU!**

**Forged Iron**  
by McKINNEY

**McKINNEY Forged Iron Cabinet Hardware KIT #77**

—to tie in with the current trend of "more color in the home"—this board displayed in your paint department is a sure sales stimulator!

**SPECIAL OFFER \$51.00 Complete**  
IMMEDIATE DELIVERY

**YOUR PROFIT-60%**

**YOU GET—** 1/2 dozen of 18 different items of McKINNEY Genuine Forged Iron Cabinet Hardware—

- |                 |                          |                              |
|-----------------|--------------------------|------------------------------|
| Small knob      | <b>FOR FLUSH DOORS</b>   | <b>FOR 3/4" OFFSET DOORS</b> |
| Large knob      | Throw Over Latch         | Throw Over Latch             |
| Drawer pull     | Plate Latch              | Plate Latch                  |
| Heart Door Pull | H Hinge                  | H Hinge                      |
| Butterfly Hinge | H and L Hinge            | H and L Hinge                |
| Thumb Latch     | 6 1/2" Heart Strap Hinge | 6 1/2" Heart Strap Hinge     |
|                 | 8 3/4" Heart Strap Hinge | 8 3/4" Heart Strap Hinge     |

(Regular price through Jobber of these items would be \$54.50.)

- 12 additional items mounted (as shown above) on an attractive green Display Board.
- Also—a supply of consumer sales literature for counter or mail use.
- And—National Advertising to help build demand for McKINNEY Forged Iron Hardware.

A timely, practical merchandising idea for quick, easy, profitable sales of the authentic McKINNEY Forged Iron Cabinet Hardware.

Order from your Jobber—or send this coupon

**McKINNEY**

MANUFACTURING COMPANY

1400 Metropolitan St., Pittsburgh 12, Pa.

Please ship through jobber indicated below McKINNEY Hardware kit or kits as checked:  
#77 with Pastel Green Board at \$51.00  #78 with Knotty Pine Board at \$51.00

Firm Name \_\_\_\_\_

Address \_\_\_\_\_ City \_\_\_\_\_ State \_\_\_\_\_

Name (individual) \_\_\_\_\_ Title \_\_\_\_\_

Jobbers \_\_\_\_\_ (To assure prompt delivery, please list two jobbers.)

the  
950  
e in  
rep-  
you  
pro-  
in-  
for  
the  
ob-





# WHAT MAKES

# Kwikset

LOCKSETS

# SELL?



What makes anything sell . . . demand! KWIKSET locksets continue to fill a long desired need in the building industry. They provide a high quality, low cost lock of infinite beauty that is simple to install. Little wonder then that in less than 4 years more than 5 million KWIKSET locksets have been sold throughout the nation.



MANUFACTURED BY  
**Kwikset**  
LOCKSETS INC.  
ANAHEIM CALIF.

## ● BEAUTY

Simple beauty and clean modern design make KWIKSET locks adaptable for installation on both traditional and modern homes. And, there's a KWIKSET lockset for every door in the house.

## ● TOP QUALITY

KWIKSET locksets are precision built to give years of trouble-free service. Individual lock parts are made of wrought brass, bronze, steel, and tough durable Zamak No. 5. Materials and workmanship are *unconditionally guaranteed!*

## ● PRICED TO SELL

Builders know that KWIKSET locks mean great savings on initial cost and installation time. Quick, easy, 2-hole installation cuts time and labor on the job to a minimum.

## ● CUSTOMER ACCEPTANCE...

Is best evidenced by the fact that there are today millions of KWIKSET locksets in use . . . giving day-in, day-out service as well as enhancing the beauty of hundreds of thousands of homes.

*Write for complete information.*

DISTRIBUTORS

**Petko**  
INDUSTRIES, INC.  
1107 East Eighth Street  
Los Angeles 21, California

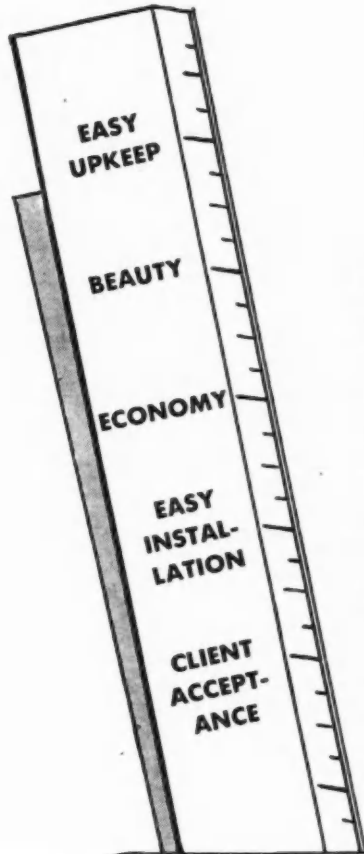

## Measures up to YOUR High Standards

FLOR-EVER's smoother, non-porous surface doesn't absorb dirt. It's spot-, stain- and alkali-resistant, grease- and water-proof. The mere swish of a mop leaves it sparkling clean.

FLOR-EVER adds charm to every home. Quiet and resilient to the step, it comes in a wide range of bright, fade-resistant colors that go right through to the backing—blend well with all decors.

FLOR-EVER outwears other floor coverings in its price range.

FLOR-EVER comes by the yard or in tile form for quick inexpensive installation. Feature strips and borders create individual patterns.

FLOR-EVER is made of Vinylite Brand Plastics—a famous trademark that represents quality the country over. FLOR-EVER is nationally advertised. Prospective home-owners see FLOR-EVER's full color campaign in Better Homes and Gardens, American Home, House Beautiful, House & Garden, Living for Young Home-makers, McCall's, Good Housekeeping and the Saturday Evening Post. It bears the Good House-

keeping Guarantee Seal.



**DELAWARE FLOOR PRODUCTS, INC., Wilmington 99, Delaware**  
 Also manufacturers of Del-Ware Kolorflor (plastic surfaced) and "Duralin" Enamel Floor Covering

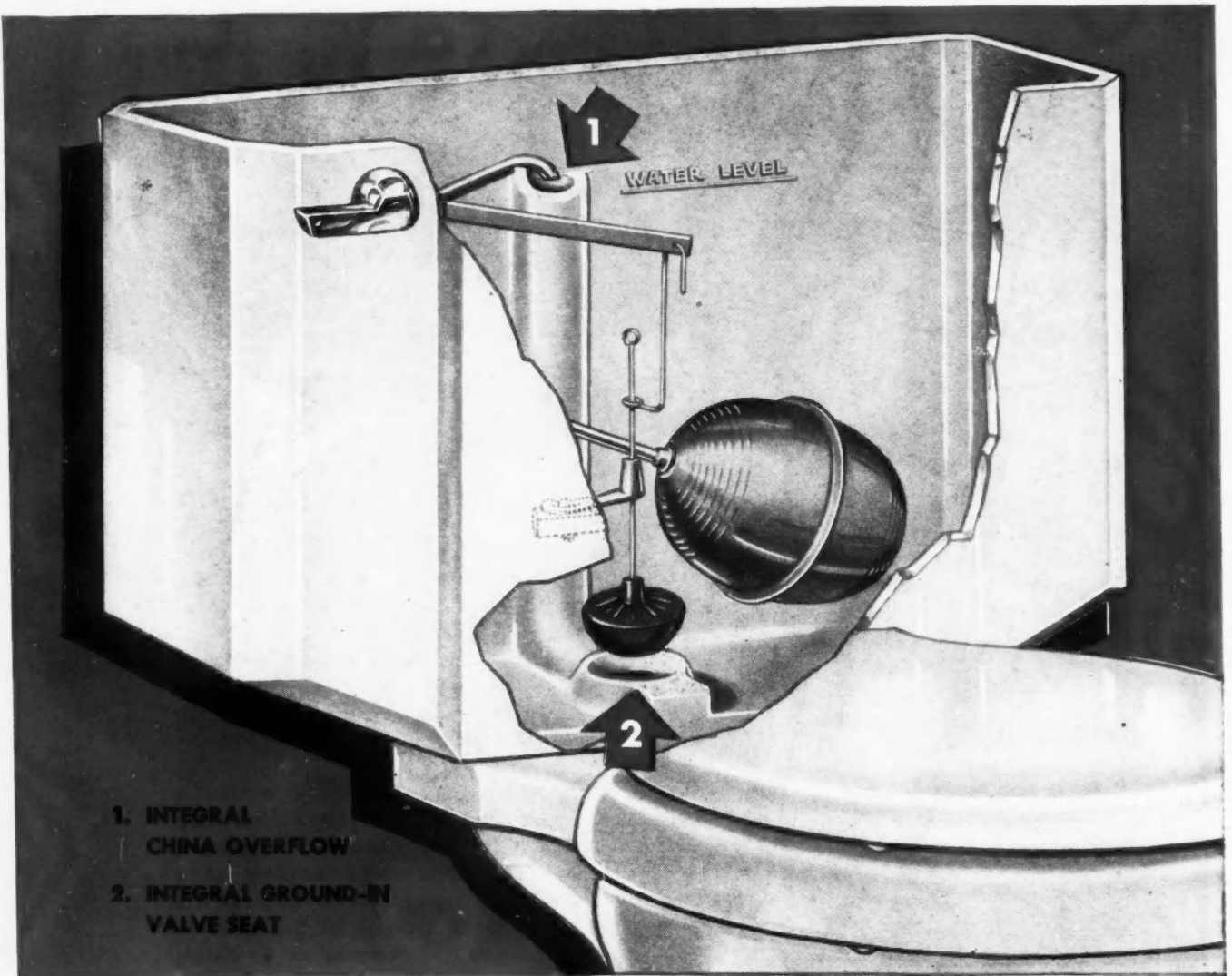

## SELL THESE FEATURES...WIN CUSTOMER SATISFACTION

Your customers can easily see *why* the construction of Eljer Water Closet Tanks is the finest available.

The Eljer *integral china overflow* and *ground-in valve seat* are made of real vitreous china . . . a part of the tank itself. This eliminates thin metal tubes and metal seats that wear and corrode. The construction is *foolproof* . . . built to last the life of the closet. Vitreous china cannot corrode. An Eljer Fixture with

this extra quality costs no more than an *ordinary* fixture . . . even less, considering the resulting savings in maintenance expense.

Any plumber who points out these extra values to homeowners will make extra sales . . . and have satisfied customers. To have quality customers, sell quality plumbing fixtures. Sell Eljer . . . see your Eljer Distributor or write Eljer Co., Box 192, Ford City, Pa.

*It pays you, it pays us*—because we specialize in Plumbing Fixtures and Brass







# ASSOCIATIONS - *Their Plans and Activities*

## Record Materials, Equipment Exhibit Assured for 1950 NAHB Convention

Exhibit space for the 1950 NAHB Convention and Exposition, to be held in Chicago Feb. 19-23, is already a sell-out, according to an announcement by Paul S. Van Auken, convention and exposition director. Van Auken said that the exposition, with a 25 per cent increase in space over the 1949 show, will be the largest and most diversified display of home building equipment and materials ever presented.

A special section devoted exclusively to new and unusual building products will be a new feature of the Exposition. A committee headed by Joseph Schulte of Los Angeles is working with Van Auken in arranging details of the display, which will include 25 or 30 products shown for the first time. Space in the new products section (as distinguished from general exhibit space, which is sold out) is being held open as long as possible in order that the maximum number of eligible products may be included. Approximately one-half of this space was allocated before Nov. 15.

Plans for the convention program were discussed at a meeting of the program committee which was held in conjunction with fall meeting of NAHB directors at Miami Beach. While details of the agenda are not yet available, Committee Chairman E. M. Spiegel of Passaic, N.J. said that the program would stress activities which would be of value to individual members, including discussion and demonstration of new construction techniques and applications of new equipment.

A special session will be conducted by women builders, under the direction of Mrs. Henny Mollgaard, well-known Milwaukee realtor and builder. This feature proved highly popular last year and will cover topics of interest to men builders as well as women.

A new attendance record is predicted for the 1950 show, with an intensive attendance promotion campaign already under way among NAHB members. In addition, allied groups such as architects, financial representatives and lumber and building material dealers and distributors are expected to attend in larger numbers than heretofore.

Persons planning to attend the convention have been urged by NAHB officials to register and make hotel reservations as soon as possible, in order to insure accommodations. This may be

done through local NAHB chapter secretaries or by communicating with Convention Headquarters, National Association of Home Builders, 111 W. Jackson Blvd., Chicago 4, Ill.

## Lowering of Construction Costs Heads Discussion At Annual NRLDA Meeting

Leading discussion topic at the annual three-day NRLDA meeting in San Francisco Nov. 9-11 was "What can be done to lower construction costs?"

The effects of national and international trends and scientific and economic developments were pointed out by a number of nationally prominent speakers. They included Senators Kenneth S. Wherry of Nebraska and Harry P. Cain of Washington; Emmett J. Leahy, member of the Hoover Commission; William H. Scheick, executive director, Building Research Advisory Board of the National Research Council; Arthur S. Goldman, marketing and research di-

rector of Architectural Forum magazine; and Public Relations Counsellors Ted Baldwin of New York and Russell F. Bjorn of Stockton, Calif. The problem of how to lower current costs of construction was featured by leaders of several discussion groups.

Addresses of welcome were made by E. E. Robinson, mayor of San Francisco, and George Adams, president of the host association, the Lumber Merchants Association of Northern California. NRLDA President C. B. Sweet made the official report.

One of the features of the program was the presentation of plaques and awards to lumber dealers whose public relations work in their own communities has merited national recognition. Awards will be made by Stanley F. Horn, Nashville, Tenn., editor of the Southern Lumberman magazine.

## Delegates Traveled By Special Trains

A special train from Chicago took almost 300 delegates to San Francisco, including contingents from Pennsylvania, Delaware, Ohio, Tennessee, Michigan, Indiana, Illinois, Wisconsin, Iowa and Missouri. About 80 of

(Continued on next page)



FROM left to right: R. A. Schaub, Indiana delegation; J. T. Holmstrom, Illinois delegation; Arthur A. Hood, editor of *American Lumberman*; Edward G. Gavin, editor of *American Builder*, and Roy Winters, of the National Plan Service, leave Chicago to join Lumber Dealers in San Francisco, Nov. 9-11. Convention delegations from ten states were entertained at the Sherman hotel, Chicago, by the Illinois delegation before the special train left for San Francisco. Acting as host at the Sherman was John D. McCarthy, Springfield, Ill., head of the Illinois NRLDA delegation



## Cy Sweet Says -

**C. B. SWEET, President, National  
Retail Lumber Dealers Association**

The average American believes that the government can produce low-cost housing more cheaply than private enterprise. This erroneous belief had its origin with the essential and low rental housing supplied in the war emergency by the government, which served a vital need and which could not have been handled otherwise. Propaganda has kept it alive and flowering.

At present, however, there is no necessity for government housing. We lumber dealers and building contractors know that we can furnish better built and lower cost dwellings than the proponents of Federalized housing claim can be produced by their so-called more efficient and less costly methods. The old methods are sound, and the local contractor is better equipped to fill the need in his community. Through every channel, we of the National have tried to educate the public to the facts stated above, and to convince people that our methods are not out-moded, antiquated, old-fogyish, or expensive, and we are going to keep on trying.

It is scandalous that at this time, and in spite of our protests, the "planners," who want government control of every industry, have backed the now famous Lustron Company that entered the housing field in 1947. Of course the president of the company had only \$1000 of his own money to risk in the venture, but he had a friend in the person of Wilson Wyatt, and through this friend was able to get a small loan of \$15,000,000 from RFC to start showing all of us "old fogies" how to produce homes the modern way. The Lustron production schedule was set for 17,000 nice, shiny,

enamel-coated houses by December 31, 1948. As could be expected, they encountered some "unforeseen" difficulties such as, and I quote their own words, "training of labor, tooling up, learning how to pack the 3,000 parts that go into the house, developing ways to transport the pieces to the house site, overcoming building codes," . . . all of which the old "moss backed" builders already know. To Lustron this was no drawback, they merely went to RFC for more millions. As this is being written, the fair-haired boy of the "planners" has already spent \$37.5 millions of YOUR money to produce approximately 18,000 houses, at a cost of a measly \$20,000 per unit; the same unit that the backward builder could sell at a price of \$7,500 to \$8,500. Lustron is now asking RFC for 10 or 12 more millions of your money to further prove how much better it can do the job of furnishing low-cost housing for the American people.

When the whole story on this unsavory situation is told it will make the "five percenters" and the "deep freeze" deals seem very insignificant. Undoubtedly it will never be told unless you, and every other honest individual, insist that our Congressmen stop countenancing such expenditures. Each one of us should make this his first order of business; and each one of us who wants the citizens in his community to believe that their lumber dealers and their local contractors are better able than some government agency to fulfill their housing requirements, should make it his second order of business to persuade them to believe it.

### Speakers for Ohio State Convention Announced

A number of nationally prominent speakers, including Senator Robert A. Taft of Ohio, will address the members of the Ohio Association of Home Builders at the group's sixth annual convention Dec. 5-7 at the Biltmore Hotel, Dayton.

Other speakers on the three-day program will be Rodney M. Lockwood, Frank W. Cortright and Edward R. Carr, NAHB president, executive vice president and past president, respec-

tively; Franklin D. Richards, FHA commissioner; Edward G. Gavin, *American Builder* editor; and James C. Downs, Jr., president of the Real Estate Research Corp., Chicago.

Convention Chairman Joseph B. Haverstick and Executive Secretary Thomas R. Johnson are responsible for obtaining guest speakers and for arranging the program of panel discussions.

The Women's Auxiliary of the Montgomery County Builders Association, Dayton, is arranging a special program for wives of delegates.

### NRLDA Meeting

(Continued from page 63)

these delegates were entertained upon their arrival in Chicago by John D. McCarthy, Springfield, Ill., head of the Illinois delegation, who acted as host with headquarters in the Sherman hotel.

The New England contingent traveled via the CB&Q railroad, and stopped over one day in Salt Lake City. The Carolina delegates, both North and South, went via the Missouri Pacific line, with a one-day stop in Denver. Both delegations joined the special train at Ogden, Utah.

### E. Clarke King, Dayton Executive Secretary, Dies of Heart Attack

E. Clarke King, executive secretary of the Montgomery County Builders Association, Dayton, Ohio, for the past two and one-half years died Oct. 9 at the Miami Valley Hospital, Dayton, following a heart attack suffered the previous day. He was 55.



**E. CLARKE KING**

Mr. King was born in Albany, N.Y., and came to Ohio in 1916, joining the staff of the Springfield Daily News. He was later associated with the Dayton Daily News and the Dayton Herald and was manager of the Safety Council of the Dayton Chamber of Commerce. In 1943 he started his own public relations business. In addition to service with newspapers in Dayton and Springfield, he was also associated with a number of other organizations in Dayton and other cities in a public relations capacity.

Much of the progress of the Montgomery County Association took place while Mr. King was secretary. He played a large part in the establishment and success of the Association's annual home show and was given a large share of the credit for promoting interest in the regular meetings.

Mr. King was a member of a number of Masonic orders, the Lions Club, Dayton Advertising Club, Miami Valley Association of Editors, the Chamber of Commerce and Christ Episcopal Church.

### Texas Legislator Honored

The Home Builders Association of Dallas held a luncheon honoring Rep. J. Frank Wilson of Texas Nov. 4 at the Baker Hotel, Dallas.

### John P. McCollum Named Chicago Association Executive Secretary

Appointment of John P. McCollum as executive secretary of the Chicago Metropolitan Home Builders Association has been announced by Martin C. Huggett, executive vice president.



JOHN P. MCCOLLUM

McCollum, who has had many years experience in the real estate and building field, served from 1937 to 1942 as property management representative for the Home Owners Loan Corp. He liquidated all properties in Southern Illinois for this agency.

He joined the National Housing Agency shortly after its organization and became deputy regional representative in Kansas City and later in Chicago. He resigned from NHA in 1947 and recently has been president of the L. B. Harris Co., Inc., Chicago subdividers and developers.

McCollum has worked very closely with builders during his career, particularly those in the Chicago area. As executive secretary of the Chicago Association, he will act as public relations and liaison representative with governmental and other agencies.

### Erie, Pa. Builders Name Robert Fortune Director

Appointment of Robert V. Fortune as executive director of the Home Builders Association of Erie County, Pa., has been announced by the Association's president, Floyd S. Andrus.

Organizer in Erie County of the Blue Cross hospitalization service, Fortune served as local director of the service until 1942, when he entered the Army Air Forces. He held the rank of captain at the time of his relief from active duty.

### Glen Simon Joins Staff Of Middle Atlantic Group

Glen Simon of Glenside, Pa. has joined the staff of the Middle Atlantic Lumbermen's Association as assistant to the executive director. He succeeds Robert Boston, who left the association some time ago.

Simon is a recent graduate of Temple University's school of business administration, with a major in journalism.

## Cortright's Column



FRANK W. CORTRIGHT, Executive  
Vice President, National Association of  
Home Builders of the United States

Before long your income tax man will give you the bad news. The average United States citizen pays Uncle Sam his earnings for one day of every four he has worked. Even this and other taxes fall \$5 billion short of meeting our current \$40 billion Federal budget.

The cost of the Truman Fair Deal program, if enacted by the Congress next year, will require working one day of every three to support government. In other words the average family now paying \$1300 per year will be required to pay \$1900 yearly taxes (source—Hoover Report).

Twenty years ago there was one government employee to about forty of the population—today there is one to every twenty-two of the population. In terms of our *working* population there is one government employee today to about every eight of the *working* population.

As a home builder operating under current favorable conditions, you are probably working for the government at least three days out of five and in many cases more than this. In so doing you are paying the salaries of millions of government employees, you are bolstering up the economies of Europe, you are supporting Socialism in England and maintaining a powerful military establishment in this country.

Because of the terrific direct and indirect tax load the smartest home builders in the country are building more and more income-bearing property for their own account. They have learned the futility of building only sale property for profit and paying very high percentages of this to the Federal government. High gross earnings resulting from current high volume end up in a pitifully small net return.

Recognizing the advantage of monthly income over an extended period of years, as contrasted with immediate profit, more and more builders are putting up commercial structures or moderately priced apartments for rent.

Ownership of commercial property, of course, requires freezing capital which the average builder needs for his housing projects. Still, such investment can be made on a small scale each year and in time an assured income can be built up. The depression of the thirties proved that such holdings can carry builders through hard times.

On the other hand, every builder with imagination, good judgment and patience can construct apartments for rent under FHA Section 608. Applications so far this year total 183,552 units involving \$1,456,108,811. Congress recently increased this authorization by one-half billion dollars—convincing evidence of the desire for still more rental accommodations.

Although FHA is becoming increasingly selective in approving 608's, it is still possible for most builders to locate reasonably priced land and solve the various problems involved in building such income-bearing properties for their own account.

Home builders in England, faced with frighteningly heavy tax levies placed upon them as early as 1919, learned the value of making some investment in income property each year. As a result many of the men we met there recently are now living comfortably on this income—even though the Socialist government has put them out of business as builders.

Current favorable conditions in the home building industry in this country will continue for some time. No one is wise enough to know when things will change but change they will and now is the time to prepare for less prosperous days.

If you are unhappy when you see your net profit from sales after taxes, we suggest that you put more money, time and effort into building for future monthly income and less into earning tax dollars to be poured in ever increasing amounts into Uncle Sam's bottomless collection coffers.



## Detroit Group Awards Lockwood Plaque



**WILLIAM P. ATKINSON**, Oklahoma City, NAHB second vice president, presents Oklahoma Indian chief's headdress to NAHB President **Rodney M. Lockwood** at Detroit dinner. Looking on is Toastmaster **A. W. King**. Dinner, honoring Mr. and Mrs. Lockwood, was sponsored by Home Builders Association of Metropolitan Detroit. The NAHB head is a Detroit association member

Rodney M. Lockwood, NAHB president, was presented a testimonial plaque by members of the Home Builders Association of Metropolitan Detroit at a dinner in honor of Mr. and Mrs. Lockwood at the Birmingham Club, Detroit, Oct. 26. Lockwood is a member of the Detroit Association.

The presentation address was made by Nicholas Molnar of Cleveland, NAHB secretary. Other out-of-town guests included W. P. Atkinson, NAHB second

vice president; Frank W. Cortright, NAHB executive vice president; Hugh G. Selby, NAHB director and John Dickerman.

In the presentation speech Lockwood was lauded for his work since being elected to the presidential post in February, and especially for his leadership of the National Association's fight against the public housing act.

Atkinson, of Oklahoma City, also made a talk congratulating Lockwood.

## Attendance Mark of 1,700 Set at 1949 Convention Of Oklahoma Lumbermen

Previous attendance records were broken when more than 1,700 lumbermen gathered for the third annual convention of the Oklahoma Lumbermen's Association at the Oklahoma City municipal auditorium Oct. 18-19. A new mark was also set in exhibition space, with 133 exhibitors using 165 booths.

Keynote of the meeting was set by the principal speaker, NRLDA President C. B. Sweet, who in an address called "Let's Look at the Record" warned all lumbermen to continue an aggressive campaign against Socialism. Sweet cited the records of France, England and Russia where he pointed out that state-controlled programs had shown discouraging results.

The convention was opened by Oklahoma Lumbermen's Association President Walter B. Kelly, Tulsa, who made the annual report. Other convention speakers included Gates Ferguson, advertising director for The Celotex Corp.; C. W. Cameron, North American Accident Insurance Co.; and Dr. Hilton M. Briggs, Oklahoma A. and M. College.

In the annual election of association officers, Walter H. Hinton, Altus, was named president, succeeding Kelly. Paul Leonhard, Oklahoma City was elected treasurer, succeeding Ralph T. Currell, Lawton; and Alfred E. Leonhardt, Oklahoma City, was re-elected treasurer.

Albert Mason, Oklahoma City, convention director, and Association Secretary W. M. Morgan supervised the program arrangements.

The closing banquet at the Skirvin Tower Hotel honored President Sweet.

(Continued on page 180)

## Boston Group Sponsors Home Show February 27-March 5

The New England Home Exposition for 1950 is scheduled for the Mechanics Building in Boston next February 27 through March 5 under sponsorship of the Home Builders Association of Greater Boston. Campbell-Fairbanks Expositions, Inc., which is handling promotion and space sales for the show, expect to have more than 200 local and national firms displaying products to the public. A three-color four-page brochure announcing the show and space application forms were mailed to prospects late in October by George Alexander, secretary of the Boston association.

## Cortright Visits Milwaukee

Frank W. Cortright, NAHB executive vice president, was the guest of the Milwaukee Builders Association at a dinner-dance Nov. 2 in the Plankinton Hotel, Milwaukee.

Also reported by the Milwaukee group was the launching of a new membership campaign. The association now has approximately 450 members and is one of NAHB's largest affiliates.



**MEMBERS** of the Kiowa Indian Tribe of Oklahoma perform a war dance for their new honorary chief, NRLDA President C. B. Sweet, at the annual convention of the Oklahoma Lumbermen's Association. Watching (left to right) are Albert Mason, convention director, "Chief" Sweet and Chief Frank Bosin of the Kiowa Tribe. The NRLDA leader was given the name "Chief Tigh-Da-Ugh," meaning "Topman of Everything." More than 1,700 attended the convention

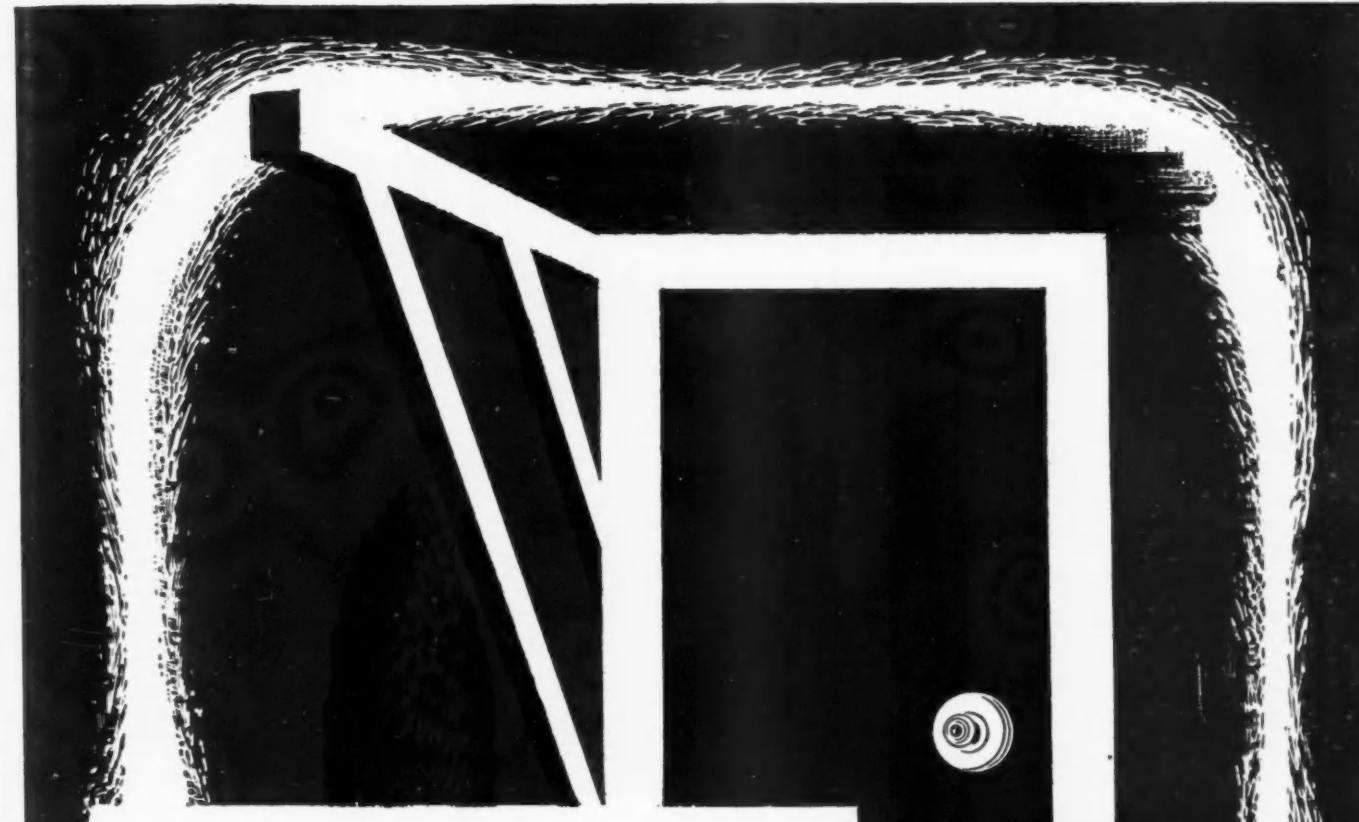

**Your buyers can see  
the difference at a glance  
the SCHLAGE "Long Backset"\***

First impressions—acceptance—sales for your houses start at the front door, even before the prospect sees the interior.

The Schlage "long backset" is different—individual—exclusive. It permits placing the lock 5" away from the door edge—allows the use of large, eye-catching escutcheons—gives distinction to the entrance of any house.

Would you like to see the *lift* the "long backset" can give your homes? An attractive brochure illustrates new designs and entrance doors. Write Schlage Lock Company, 2201 Bayshore, San Francisco 19, California.

**SCHLAGE®**

**SCHLAGE LOCK COMPANY**

SAN FRANCISCO • NEW YORK

**\* "Long Backset"**—formerly used only in luxury homes—now available in Schlage's standard residential locks—competitively priced. The same proven Schlage mechanism—the same simple Schlage installation.



MR. MONTY H. TYSON  
Builder



MR. A. P. ORLEANS  
Builder



MR. A. H. WEISS  
Builder



Lynnewood Gardens, rising on the beautiful grounds of the former Widener Estate in the Elkins Park suburb of Philadelphia, will have 129 buildings over 126 acres. All of the buildings will be in the charming style of the two sketched here. Architect James G. Ludwig has brilliantly merged gracious living and far-sighted convenience in this giant project. Significantly, each one of the 1798 Lynnewood Gardens' units will be equipped with a Kelvinator refrigerator.

## 1798 Garden Apartments . . . 1798 Kelvinators . . . Largest F.H.A. Project of its Kind!

Prominent Philadelphia builders, Monty H. Tyson, A. P. Orleans and A. H. Weiss say, "We chose Kelvinators for all Lynnewood Gardens' dwellings because we know, through experience, that Kelvinator beauty and long-term dependability will give the residents complete satisfaction."

More than ever, top builders are choosing Kelvinators to assure user-satisfaction in their developments. In your next building,

call on Kelvinator for beauty . . . space-saving . . . economy . . . and easier planning. Six different models . . . all one width . . . fitting the identical floor-plan. You simplify —and save!

For further information, write to Apartment House and Home Builder Sales Department, Kelvinator, Division Nash-Kelvinator Corporation, 14250 Plymouth Road, Detroit 32, Michigan.

Easier planning! Flexible Combinations! Choose from new, ONE-WIDTH KELVINATORS!

3 of the 5 Kelvinator Electric Ranges all 39 1/4" wide—and the Kelvinator FR6 Freezer.

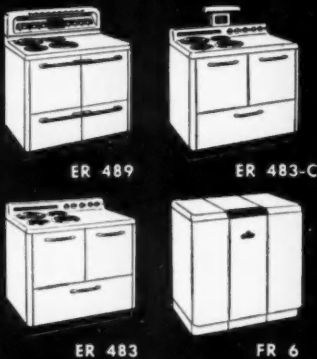

4 of 6 Great Kelvinator Refrigerators that are all 31 1/4" wide.

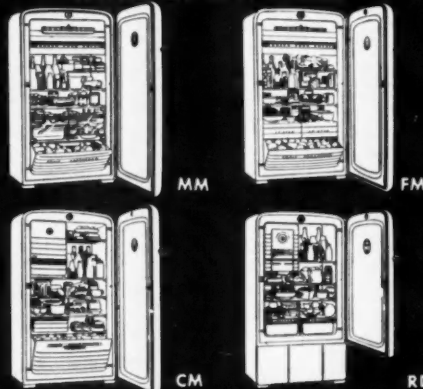

Here's Kelvinator's Space Saver Package—Refrigerator 6 cu. ft., 24" wide; range 21" wide.

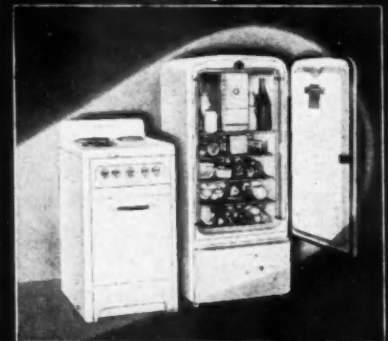

GET MORE *Get* Kelvinator



# AMERICAN BUILDER

---



---

E D I T O R I A L

## Socialism in Australia

**M**ANY Americans, aware of the advance of socialism in Australia, have written that country off the list of free enterprise nations. It appears now that such action was premature. At least, that is the considered judgment of E. S. Elliott, managing editor, *The Australian Builder*, a publication launched only a few months ago.

In a letter to the *American Builder*, Mr. Elliott says in part, "Free enterprise is not dead or even dying in Australia, but it has a strong fight on its hands. The socialist planners, aided by a clever communistic element, have been using every means in their power to socialize the country; but fortunately our forefathers were wise in their years, and the Australian Constitution is so well drawn that the two big enactments aimed firstly at the control of banking and secondly at the control of the medical services have been declared as invalid by the High Court of Australia and in the case of banking, by the Privy Council.

"Our federal election is to be held on the 10th December, and we are extremely hopeful that the socialist-minded government at present in control will be removed. It should also be of interest to you to know that our large country with its small population has state governments which are in themselves sovereign states, and the powers of the Commonwealth government are severely limited at the will of the state governments."

That is a heartening statement from the editor of a new magazine which boldly proclaims on its cover that it is dedicated to free enterprise in a country in which socialism has made deep inroads. It should be an encouraging statement to those in this country who view the public housing law passed last summer as the beginning of an inevitable end of free enterprise in the United States. The public housing law certainly is the first tangible and important wedge driven in the bulwark of free enterprise in the United States. But it need be no more conclusive than Pearl Harbor was in the final outcome of World War II, unless that historic military debacle is viewed as the tragedy that was needed to awaken a sleeping nation to the dangers that threatened it.

Socialism has penetrated far deeper into Australia than it has here, but strong forces are coming together in the island nation to wage war against its further advancement. The question in the United States is how much farther will socialistic doctrines be permitted to penetrate here before strong, enlightened resistance forms.

With the holiday season and its emotional upsurge just ahead, it would be well for all Americans to appraise their situation and compare it with the living conditions and the opportunities for individuals in the countries where government controls are increasing. It would be well for them to inform themselves of the bitter truths that are becoming evident to men of all classes in the socialistically inclined nations, and then ask themselves if 1950 is not the time to dedicate themselves to preserving their freedom and its blessings. If Australia, farther down the hill of socialism than we are, can begin to fight with a hope of winning, its action should spur Americans to begin their fight against stateism at once.

PUBLISHING DIRECTOR  
Robert H. Morris  
EDITOR  
Edward G. Gavin  
MANAGING EDITOR  
Lyn E. Arent  
SENIOR ASSOCIATE and  
EASTERN EDITOR  
B. H. Wambolt

ARCHITECTURAL EDITOR  
Arthur V. Hansen  
WESTERN EDITOR  
William C. Rodd  
FIELD EDITOR  
Robert Charles  
ASSISTANT EDITORS  
Richard Gavey  
Raymond Stein

PRODUCTION EDITOR  
Margaret C. Carroll  
ART EDITOR  
George M. Clark  
CHIEF DRAFTSMAN  
J. T. Froh  
CONSULTING ARCHITECT  
Walter T. Anicka

Editorial Office, 79 W. Monroe St., Chicago 3, Ill.

Every effort will be made to return material submitted for possible publication (if accompanied by stamped, addressed envelope), but the editors and the corporation will not be responsible for loss or damage.

at homes has been step  
y the builders.  
e of the many features hon  
rs seem to like about  
homes in Northridge Vill  
he real fireplaces included  
models,  
disclose.

# NATIONAL HOME WEEK

## Parade of Selected Homes

**Building industry's annual promotion mush-rooms in second year to include more cities, more builders, keener public interest**

PREVIOUS reports on 1949 National Home Week have demonstrated the over-all success of the event. At this time it is possible to present a review of the actual houses that were on display; and the *American Builder* devotes the pages that follow to photographs, floor plans and brief descriptions of demonstration homes in all sections of the country.

The designs and construction details of the homes varied, of course, with their geographic location but followed a general characteristic—that of being planned to deliver good quality at a price which would meet the needs of specific income groups. Some builders exhibited in a number of price levels, tailoring their houses to fit the known tastes and requirements of purchasers in those ranges. While there was a predominance of low- and medium-cost homes, all classes were well represented.

In this presentation, emphasis has been placed on country-wide coverage and variety of homes, rather than complete treatment of individual units. This is done in order to show as completely as possible the types of planning that have gone into houses in the various areas. Because the large number of exhibit homes precludes their publication at one time, the *American Builder* plans to present additional material in future issues.

The builders who displayed houses during the week and cooperated in the public relations campaign were virtually unanimous in their reports of large crowds and good sales. Most of the homes shown were sold shortly after they were opened for inspection. At the same time, large numbers of buyer-prospects were added to builders' lists.

Aside from being instrumental in selling a large volume of houses, the Week was invaluable in pointing out to the American public that the free enterprise builder is eager to provide as great a housing value as possible, that his continued prosperity depends on his ability to do this—and that he is currently doing an excellent job of it.

cannot obtain  
governor urged builders to find  
re economical methods of  
struction and of merchandis-  
g homes so that this great  
oup of home-hungry familie  
lived well through pri  
ate enterprise.  
housing programs, suc  
dortakin

### Bowles Appeals For Building Of Private Homes

Hartford, Sept. 15. (AP)—Gov

### Home Builders Emblem Denotes High Standard

Code of Ethics Is Designed to Protect Worker and Owner

### Homes Hold Open House

Home builders and real e  
bro offering a large r  
be  
tid  
er

### LONG ISLAND HOMES OVER A WIDE AREA FIND READY BUYERS

Upsurge in Sales in Cent

### Builders Set Open House for Projects

Some fifty builders in Dalla  
and hold open house at their cor  
and projects beginning Sun  
Nation

### MODEL HOMES GO ON PARADE

NEW YORK (AP)—The world's  
ggest home show opens today.  
More than 2,500 new  
mes

### Build a Model You May Win Valuable Prize

Here's your chance to be architect, builder and landscaper

ders to Take  
e of National  
me Week Here

coming week will be cel  
throughout the country

ear Offers Tip  
Low Budget  
hrood Planner

mes Open  
Public During  
e Week Here

20 new homes will be open  
the public in con-  
Week.

Northridge  
Model homes  
be shown

model homes will  
on display today by Tho

ILDERS SHO  
OO NEW HOME

uses on Display i  
OO Communities

DAVID G. BAREUTHER  
IP Real Estate Reporter  
YORK, Sept. 10.—The world  
home show

Is Marking  
me Week

HE JOINED the nation y  
ty in opening the observ  
National Home Week.  
re week-long observance is  
nd for this city, according  
Thompson, chairman of  
Assn.

OMES WEEK  
OPENS TODA

Building Techniques  
Worth \$2 Million  
to Be Displayed

est in home building tech-  
l be exhibited to Tulsans  
local builders begin the  
of National Home Week, fi  
n 150 homes representing  
nt of over \$2,000,000 will  
o the public.

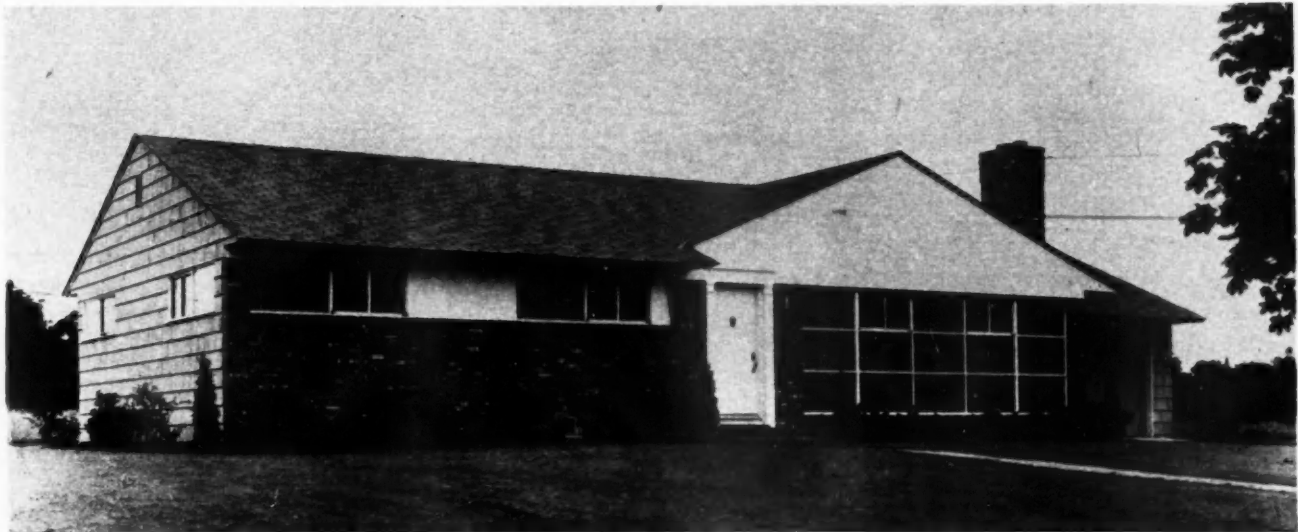

FIRST of 100 large ranch homes announced by G. A. Mezger, Long Island builder, on opening of 1949 National Home Week

## Modern Fenestration Adds Character

G. A. MEZGER, developer of Norgate-at-Roslyn on Long Island, N. Y., observed 1949 National Home Week by opening the first of 100 three-bedroom ranch houses to be built in East Hills, Long Island, with a price tag of \$21,500. The houses will be a continuation of Norgate-at-Roslyn which has been under development since 1938. The low price for this type of house was made possible because but one basic plan will be used, with seven elevations, varied further by uses of different materials and colors. The houses are being built on one-fourth-acre plots and no two houses of the same elevation will be permitted adjacent to each other. The 26x52-foot foundations are poured concrete. Brick will be the major exterior material for fronts, with rear and side wood shingles stained in various colors. Particularly outstand-

ing in these houses are the two 20-foot-wide floor-to-ceiling windows in the front and rear walls of each unit. These are each seven feet high and are made up of 15 panes of double-glazed insulating glass each about 2x4-feet in size. Two sections at the top of each window are mounted in aluminum swinging sash so they may be opened. These openings are screened.

The unusual floor plan, developed by Architects Philip Resnyk and Edward Tyler, of the Mezger organization, features an open area for the living-dining-kitchen area. There is no wall between the kitchen and dining area, although the kitchen is separated from the living room with a wall.

Some of the materials and equipment in these houses are: sliding doors on all closets; a 5-foot high 20-

inch wide medicine chest with full length mirrored door in master bath; plastic wall tile in both bathrooms; ultra-violet and infra red lamps in bath; stainless steel kitchen sink; electric range; 10-foot refrigerator; ventilating fan in kitchen; sliding opaque glass doors on kitchen cabinets; glass shower-stall door; colored bathroom fixtures; venetian blinds in bedrooms and bathrooms; pickled pine wood trim; oak floors; automatic laundry; forced warm air heat oil-fired; 52-gallon electric hot water heater; 4-inch mineral wool insulation in side-walls and ceilings.

Veterans can purchase this \$21,500 house with as little as \$1,500 down and monthly payments of \$147.45 for principal, interest, taxes, insurance and water on a 20-year mortgage. Non-veterans pay \$5,500 down and \$127.48 a month on 20-year mortgage.



KITCHEN with snack bar. Drapes separate kitchen, dining area



FIRST FLOOR PLAN



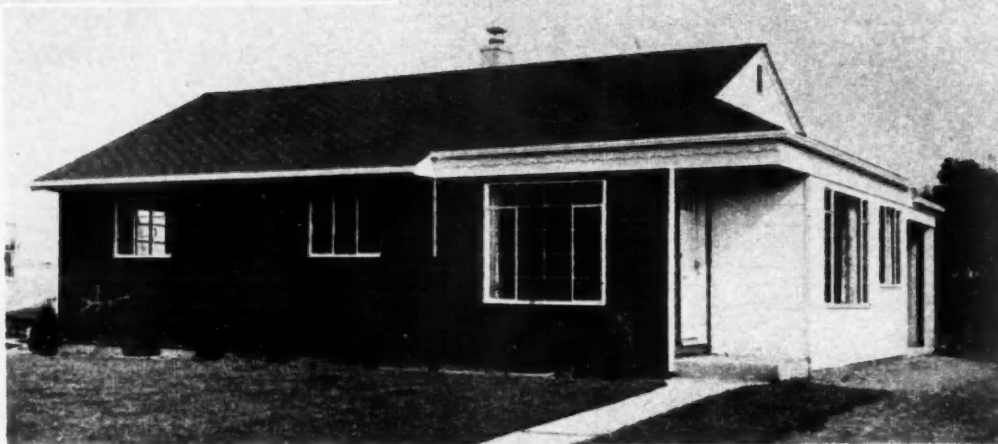

**NATIONAL HOME WEEK** offering of David Stein, Long Island builder, was this three-bedroom house without a basement at \$10,300 or with a full basement for an extra \$1,000

**VARIETY through combination of materials**

**A** THREE-BEDROOM house without a basement, priced at \$10,300, or virtually the same house with a basement at \$11,300, was the offering made to National Home Week house hunters by David Stein, Lakeview, Long Island, N. Y., builder. He had eight houses in various stages of construction on display so visitors could inspect all details. The basementless model, built on a concrete slab, employs the new warm air perimeter heating system which has been under study by the Small Homes Council of the University of Illinois and which was first described in the March, 1949, *American Builder*. The houses with basements are built on 10-inch

poured concrete foundations. Floor plans for the two are identical except that the space occupied by the utility room and furnace closet in the basementless house is converted in the house with basement to closets, basement stairway and additional kitchen space.

Included in the price is an automatic laundry, electric range, seven-cubic-foot refrigerator, 30-gallon electric water heater, kitchen ventilating fan, laminated plastic kitchen counter tops and wall tile in the bath. Outside side walls are insulated with aluminum foil and ceilings with two inches of mineral wool.

Stein is well along on the 80 houses

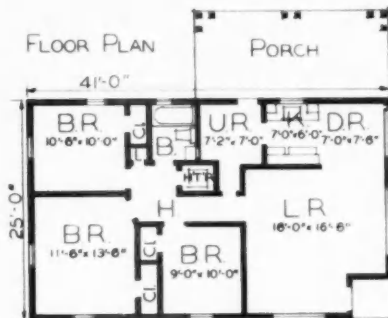

planned for his current project known as Loch Haven Park Estates. Karl Bloch designed the houses to be built from one basic floor plan with six different roof treatments plus a good variety of front elevation colors and materials to lessen the danger of monotony in the 80-house project.

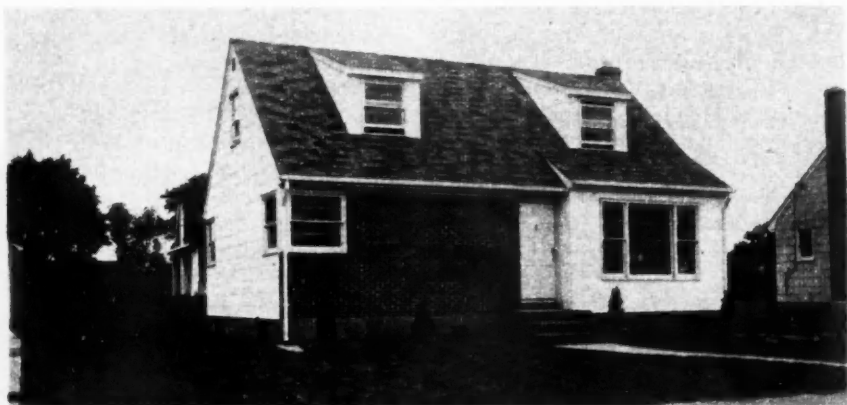

**EMIL KEEN, East Hempstead, N. Y.,** displayed this house priced at \$9,990 during NHW

**P**LENTY of interest was shown in these \$9,990 houses placed on display during National Home Week by Emil Keen at East Hempstead, Long Island, N. Y. Karl Bloch, the architect, developed the basic plan, shown, with four principal exterior elevations for a 300-house development. To avoid monotonous appearance on any of the streets, exteriors will be

changed through the use of various materials and colors, in addition to reversing elevations. The houses are erected on poured concrete foundations which enclose full basements. A built-in stairway leads to an unfinished attic where two additional bedrooms may be completed. Interior walls are 1/2-inch gypsum board. Knotty pine is used in some of the

**EXPANSIBLE two-bedroom house**



dinettes. Floors are oak except in the bathrooms where asphalt tile is used and in the kitchens where linoleum is the finish. Sidewalls and ceilings are insulated with mineral wool. Heat is supplied with a hot water system. Standard equipment includes an electric range and venetian blinds.

## LARGE ROOMS a feature of this low-cost house

A HOUSE in the low price range featuring larger than average rooms in its class was displayed during National Home Week by Gerome Gordon and Goskill Cox at Valley Stream, Long Island, N. Y. In addition to the roomy downstairs in the modified Cape Cod, the unfinished second floor, with a built-in stairway, offers room for expansion for the growing family. A poured concrete foundation encloses the full basement. Exteriors of these houses are varied with changes in roof lines, location and size of dormers along with a wide choice in materials and colors used. Mattern & York, the architects, use many small but significant architectural devices to add individuality and distinctiveness to their houses. Gordon & Cox, the builders of these units, offer them at \$13,200. Interior walls are finished with three coats of plaster. Floors are oak. Bathrooms are finished with ceramic tile and

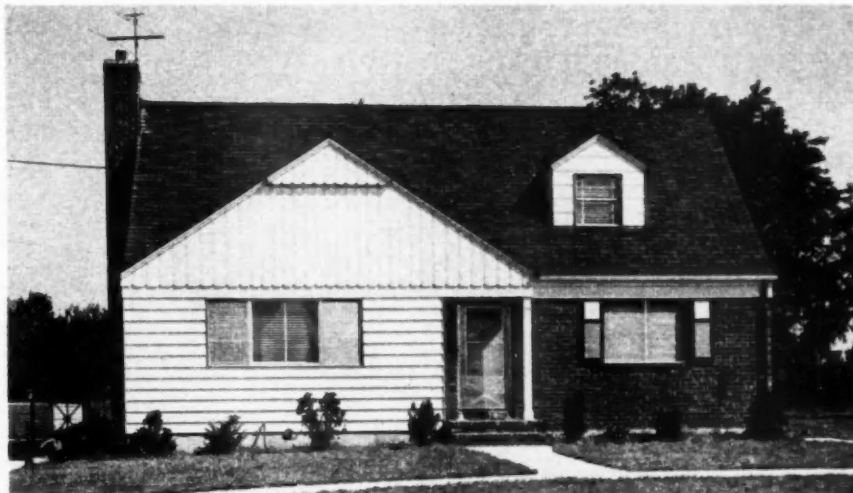

THE \$13,200 price on this unit includes large first floor rooms and unfinished second floor with built-in stairway. Equipment includes range, tiled bath and colored fixtures

equipped with colored fixtures. Along with adequate cabinet and counter space in the kitchens, an electric range is included as standard equipment. Windows are double-hung aluminum, with extra large units in the front living room and bedroom. Heat is supplied by an oil-fired hot water boiler with recessed convectors.

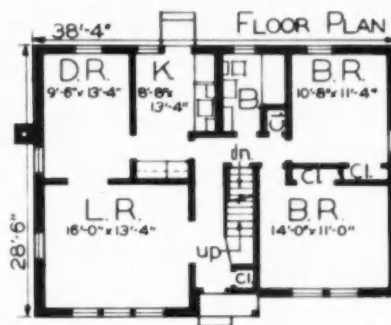

## PICTURE WINDOW adds appeal to this small home

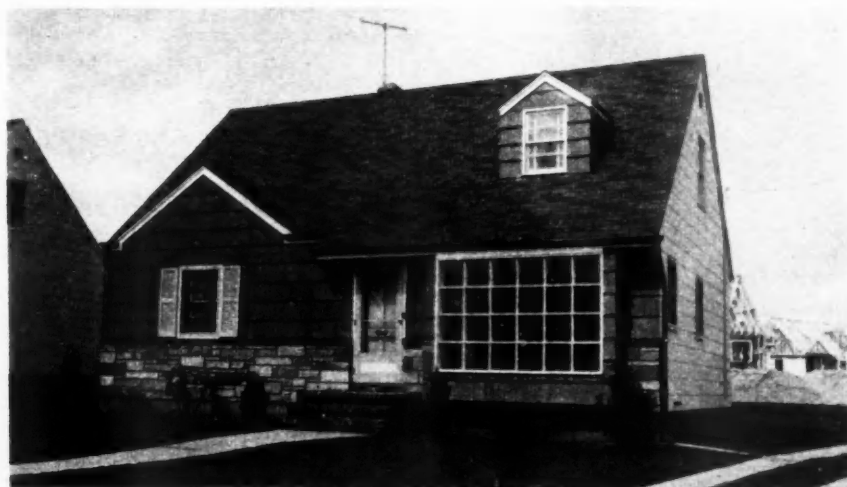

ONE of ten exteriors used with two basic floor plans in 200-house Long Island project



VISITORS who inspected this model during National Home Week were offered a choice of ten different elevations and two basic floor plans at prices of \$10,990 to \$11,450. The builders, Carillo, Wanes & Levin, are erecting 200 of the units in a project at New Hyde Park, Long Island, N. Y. The designer, William La Valle, not only varies roof lines and window treatment to remove monotony, but makes good use of stone, brick and various wood sidings to achieve further variety. The houses, built on poured concrete foundations, have full basements and built-in stairways to unfinished attics which can be completed to add two more bedrooms. Interior walls are 1/2-inch gypsum board. Floors are hardwood except in the bathroom where asphalt tile is used and in the kitchen where the flooring is linoleum. Walls and ceilings are insulated with mineral wool. Standard equipment includes a kitchen range, ventilating fan, and a built-in dressing table in the bathroom. The furnace is an oil-fired forced warm air unit. The houses are sold to veterans with no money down and payments of about \$81 monthly. Other buyers pay \$1,500 down with monthly payments of about \$73.

**Demonstration Homes  
NATIONAL HOME WEEK**



THREE bedrooms and a garage on a 60x100-foot lot for \$9,890 featured by Miller Homes

**ROOF LINES varied to avoid monotony**

THE OFFER of three bedrooms and a garage for \$9,890 on lots 60x100 or larger, attracted crowds to models erected by Miller Homes at Bethpage, Long Island, N. Y. during NHW. The houses are being sold to veterans with no money down and payments about \$68 per month. They are of frame construction with dry wall interior finish, gypsum board, papered, and with striated plywood used in some living rooms. The price includes a kitchen equipped with an electric refrigerator and range, automatic washer, colored cabinets and an exhaust fan. Baths are tiled and equipped with heat ray lamps. Other standard equipment includes venetian blinds, colored bathroom fixtures and sliding doors on clothes closets. Houses are erected on concrete slabs, well-insulated, which are piped for heating with an oil-fired hot water boiler. Side-walls and ceilings are insulated with mineral wool. Lighting in all rooms is recessed except in the kitchen where a fluorescent unit is installed. Leon Miller is the designer.

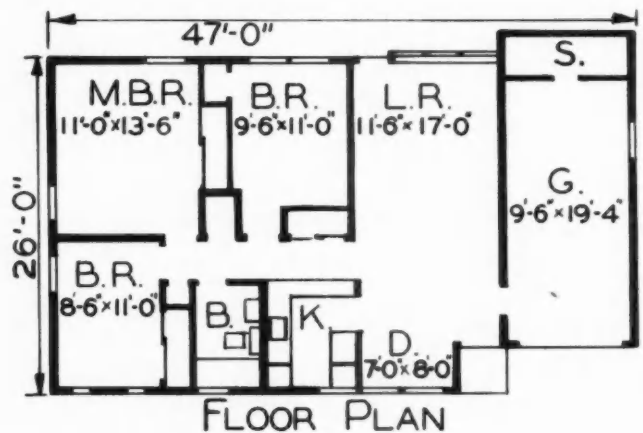

TWO-STORY, 3 bedroom house on 75x120-foot lot. Price: \$13,200

A TWO-STORY three-bedroom house proved popular in the Stratford, Conn., area. Priced at \$13,200, it was designed by the builders, McNeil & Blaney. The bedrooms are large for a house in this price range. The plan includes a lavatory on the first floor in addition to the full bath on the second floor. The laundry room is on the first floor, adjacent to the rear exit, although there is a basement under all of the house except the garage, laundry and

**THREE-BEDROOM HOUSE  
including lot for \$13,200**



lavatory. Foundation is poured concrete. Exterior wall surfacing is wood shingle siding and the roof is covered with asphalt shingles. Interior walls are plaster over gypsum lath. All windows are double-hung wood sash, except where picture windows are used. Sidewalls and ceilings are insulated with wood fiber blankets and heat is supplied by an oil-fired forced warm air unit. This style home provides ample floor space at moderate cost.



## POPULAR DESIGN of model home sells all houses in project

**T**HOUGH only a sample house was fully completed for the opening of National Home Week by this builder, two others were shown in various stages of construction, and the builder reports that the entire project of 125 houses was sold out in ten days.

Built by Arthur Oman and Sons, Inc., in the Brook Hill development, Weymouth, Mass., these three-bedroom homes, 888 square feet in area, sell for \$9,900. Sales price includes the lot and a fully equipped electric kitchen.

The Oman homes are of frame construction, with plywood exterior sheathing and wood shingle roofs. Dry-wall construction is used throughout, with aluminum foil insulation in sidewalls and two-inch waterproof blanket insulation in ceilings. Heat is supplied by an oil-fired, warm air furnace. Flooring is of asphalt tile. Ceramic tile is used on walls in bathroom; and a built-in shower is installed over tub.



**FEATURES** of Oman home include asphalt tile floors throughout, ceramic tile walls in bathroom, built-in shower over tub, completely equipped electric kitchen. Homes sold to veterans on G.I. 25 year loan; to non-veterans on 20 year loan at 4 per cent. Monthly payments average approximately \$65



## FRONT ENTRANCES featured by contrasting color

**H**UGE crowds viewed the two model houses displayed by Milton Zerman on his 600-house Continental Ridge development at River Edge, N. J. By the middle of October more than 300 of the houses had been sold. The attractive front entrances, flanked by louvered shutters and painted a color which contrasted with the sidewalls of the house, were the cause of much favorable comment.

One basic floor plan with eight different elevations is used for both the two and three-bedroom models. The third bedroom is added at the rear in the corner formed by the bathroom and the larger of the other two bedrooms. Situated on 75x100-foot lots, the houses are being sold for \$10,990 for two bedrooms and \$11,990 for three bedrooms. Veterans may purchase them without any down payment and \$78 per month. Foundations are concrete block with a basement under the center part of the house. Interior walls are plastered, three coats over gypsum lath. Bathroom floor and walls are ceramic tile, with fixtures in matching colors. Linoleum is used on the kitchen floor and oak flooring is used in the balance of the house. Windows are metal casements except for the large picture window in the living room and the high win-

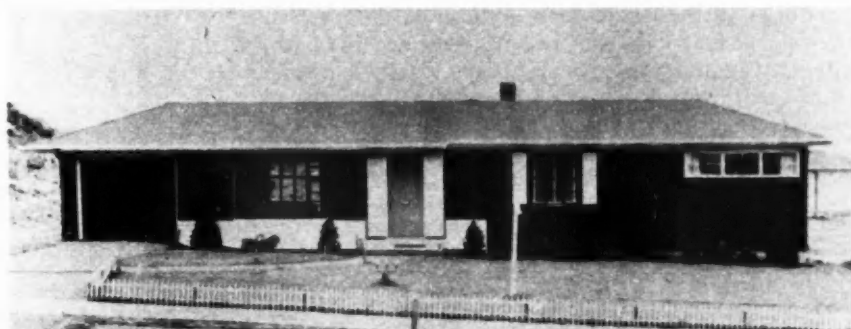

**MODEL** and typical floor plan of the two- and three-bedroom ranch houses being erected at River Edge, N.J., on 75x100-foot lots and selling for \$10,990 to \$11,990

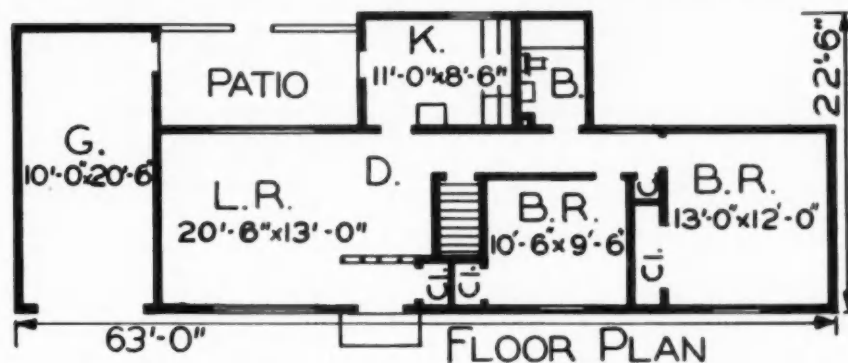

dows in bedrooms. Ceilings are insulated with two inches of mineral wool. A forced warm air, oil-fired furnace supplies heat. Standard equipment includes sliding doors on all

closets, kitchen ventilating fan, silent mercury switches and automatic hot water heater. Fred Harsen, Tenafly, N. J., is the architect for Zerman in his Continental Ridge development.

**Demonstration Homes  
NATIONAL HOME WEEK**

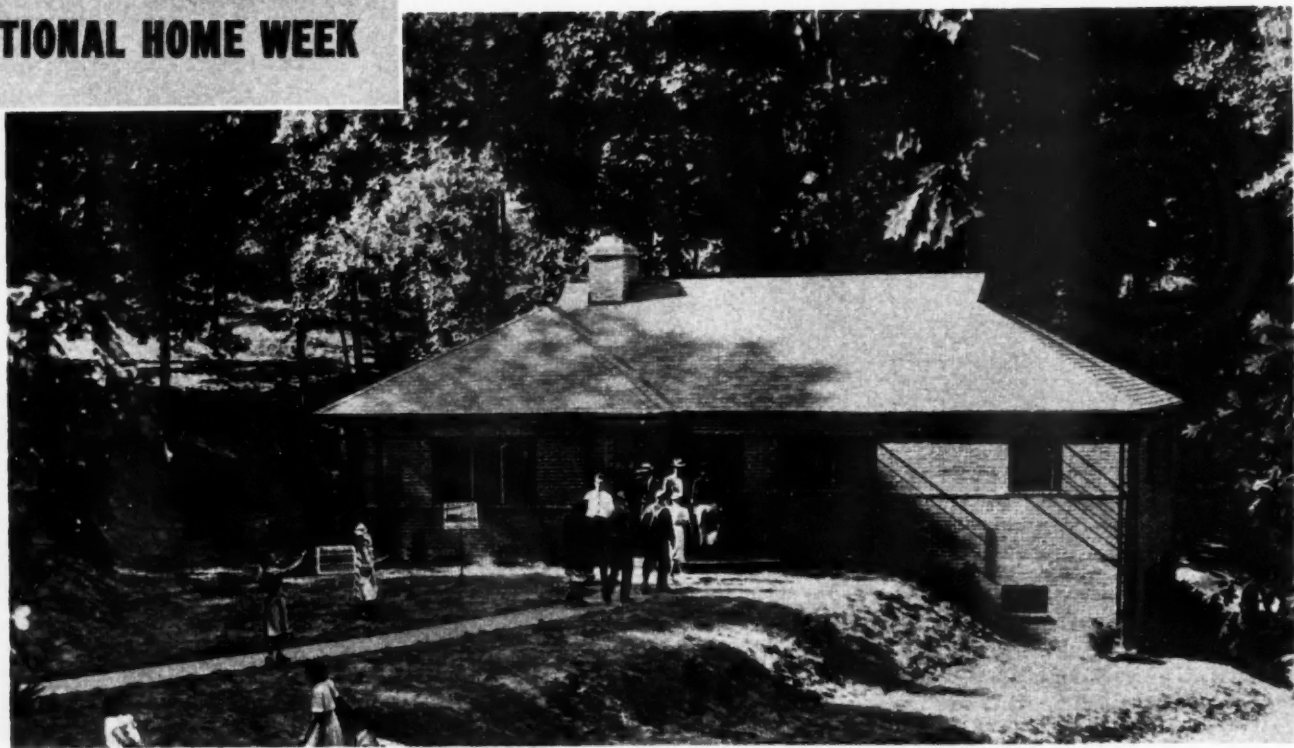

THIS display model led to sale of 75 similar houses in three weeks at \$20,000 each

**GOOD PLAN aids sales**

**M.** T. BROYHILL and Sons, Arlington, Va., set an enviable sales record with this one-story brick veneer home during National Home Week. So popular was the house that 75 were sold in three weeks. One of the features that attracted attention was the spacious outdoor living area in the rear, where a spreading porch overlooks the lawn. The living-dining area opens onto the rear porch. The plan permits easy access from the kitchen to the dining area, laundry, yard, delivery entrance and front door. The plan of the house, together with its somewhat unusual orientation on a corner lot creates maximum privacy for occupants. During National Home Week, this house was also featured in the Washington Post's "Homes of '49." The house was designed by Horace W. Peaslee, architect, and sells for \$20,000.

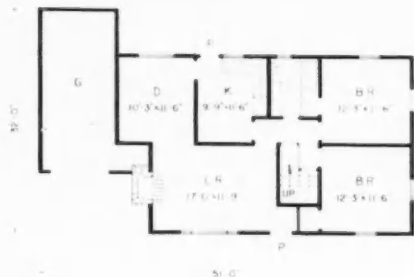

**CAPE COD** with garage in Fairfield, Conn., on 75x125-ft. lot sold for \$13,500

**TRIM LINES of this small house proved popular**

**A** BASEMENTLESS Cape Cod design, including a garage, developed by Clifford E. Anderson, has proved popular in the Fairfield, Conn., area, where Anderson builds from 15 to 18 houses a year. The foundation is concrete block with a conventional frame floor above the crawl space. The exterior wall is finished with double-coursed wood shingles and wood siding in combination. Asphalt shingles cover the roof. One-half-inch gypsum board was used as interior wall and ceiling finish. Floors are oak except in the kitchen where linoleum is used and in the bathroom where the floor, as well as the walls, are ceramic tile. A sliding door is used between the kitchen and dining room but all other doors are the conventional swinging type. The house is insulated throughout with aluminum foil. Heat is supplied by a hot water boiler with concealed convectors. The kitchen is equipped with a combination sink and cabinets. Counter top is linoleum.

## TRADITIONAL is still in demand

**T**HE J. S. Mozino & Co., Inc., three-bedroom, two-story house with garage priced from \$13,495 to \$14,350 was the center of much attention during National Home Week in their Springfield, Pa., project of 300 single-family detached units. With one basic plan and four elevations, all priced a little differently, the firm has found sales of this unit unusually fast-moving. Foundations are 18-inch stone, finished on the inside with concrete to form the basement walls. Exteriors are finished with a variety of materials including brick, stone, asbestos cement shingles and wood siding in a variety of colors and combinations. Interior walls are plaster over gypsum lath and floors are hardwood except in the bathroom where ceramic tile is used and in the kitchen where linoleum is the finish. Bathroom walls are tiled to three-quarter height. Ceilings are insulated with two inches of cotton. Heat is supplied by a forced warm air unit, gas-fired. The price includes a kitchen range, ventilating fan and ceramic tile counter top. Ceramic tile is also used on the wall above the range to ceiling height. The houses are designed by the Mozino organization.



THREE-BEDROOM, 2-story house and garage on 60 x 120-foot lot, priced at \$14,300



## CAPE COD designed for expansion

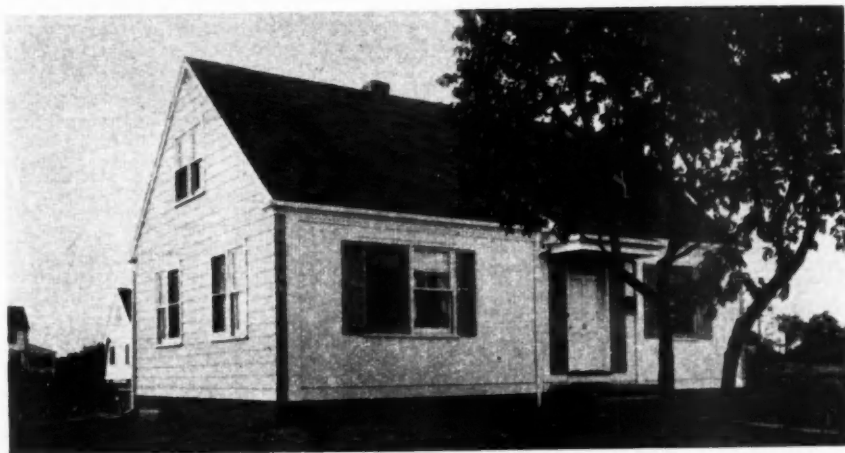

CAPE COD with expansible second floor priced at \$10,875, without lot, in Stratford, Conn.

**H**EALING & WARDMAN, Stratford, Conn., have found this a popular model Cape Cod. The large shed dormer on the rear makes an unusually roomy unfinished second floor with sufficient area for two bedrooms and a lavatory to be completed by the purchaser. The house is priced at \$10,875, without the lot.

The model shown here was built on a \$1,600 lot, 80x120 feet. The foundation, enclosing a full basement, is poured concrete. Exterior walls are finished with red cedar shingles and the roof is covered with asphalt shingles. Interior walls are 1/2-inch gypsum board, painted or papered to suit the purchaser. Kitchen and

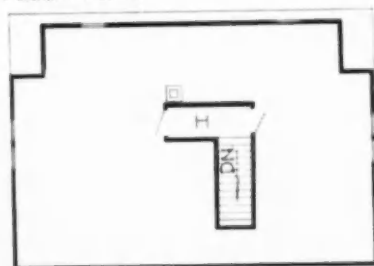

SECOND FLOOR PLAN

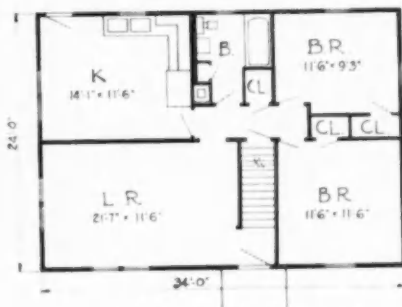

FIRST FLOOR PLAN

bathroom floors are covered with linoleum and the balance of the floors are red oak. Bathroom walls are finished with ceramic tile. Heat is supplied by a forced warm air oil-fired unit. This is one of Healing & Wardman's own designs.



**Demonstration Homes  
NATIONAL HOME WEEK**

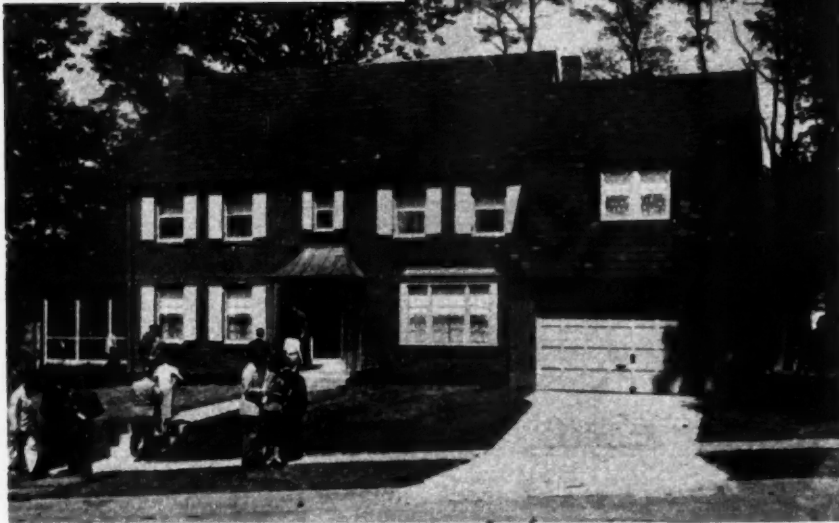

THREE-STORY, six-bedroom house opened for NHW in Washington, D. C., area

**CONVENTIONAL DESIGN—quality construction**

ONE of the largest houses to be exhibited during National Home Week was this \$46,000 three-story six-bedroom home in Spring Valley, adjacent to Washington, D. C. The exterior is brick veneer over frame with slate on the roof.

Unusually large rooms, with large window areas, and numerous closets characterize this well-planned luxury home, which has three fireplaces and four and one-half baths. Built by W. C. and A. N. Miller Development Co., it was included in the Washing-

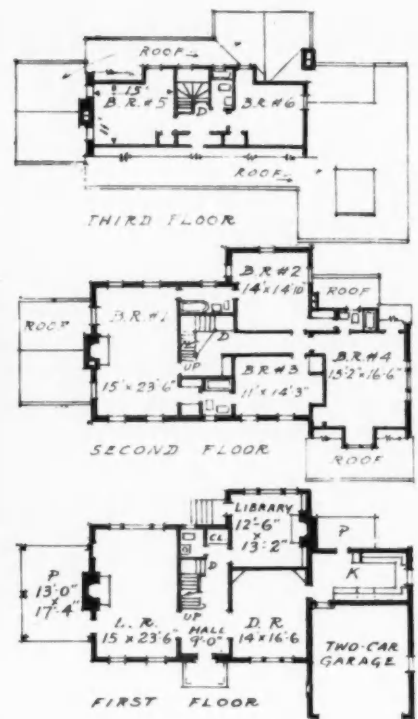

ton Post's "Home of '49" display promotion, and attracted several thousand visitors during the opening. It was designed by the W. C. and A. N. Miller organization.



SEVERAL different elevations of \$11,500 house which proved popular in Fairlawn, N. J.

**FORTY HOUSES—from one plan**

A MODEL of these two-bedroom houses with a built-in stairway to an unfinished second floor, plus a breezeway and garage was displayed in Fairlawn, N. J., by Harold Hartstein and Monroe Koggan. The price, on a 55x119-foot lot, is \$11,500. The model was one of 40 erected from the same floor plan with three different front elevations. Exterior walls were covered with wood shingle siding and the roof was finished with asphalt

shingles. Interior walls were of gypsum board. The bathroom walls were tiled with aluminum tile to three-quarter height. Kitchen equipment included in the price consists of a gas range and a ventilating fan. Ceilings were insulated with two inches of cotton. A forced warm air furnace supplied the heat.

These Hartstein and Koggan houses were designed by Percy S. Simon, architect, of Teaneck, N.J.



## THREE-LEVEL RAMBLER has eye-appeal

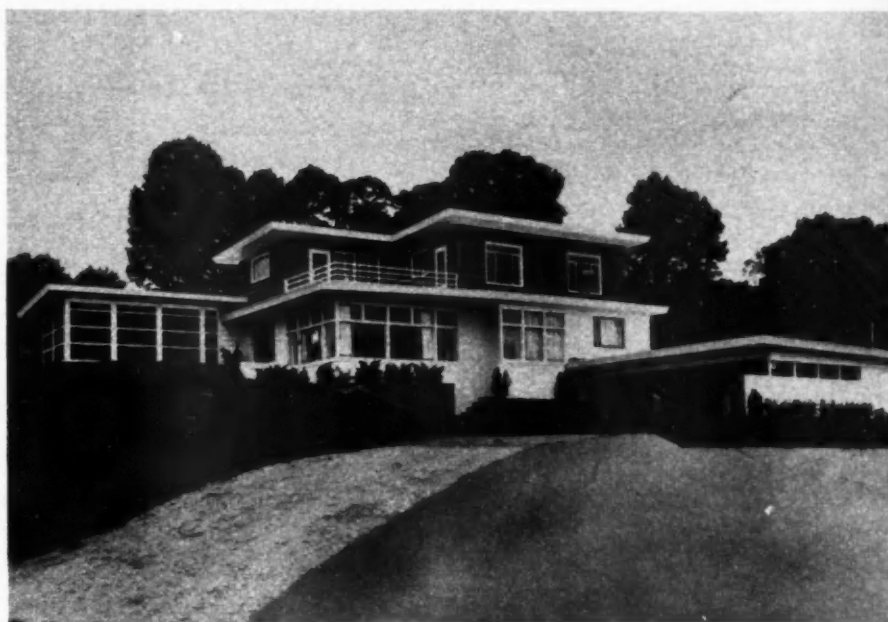

FOUR-BEDROOM, two-story modern in Fairfax County, Va., sold furnished for \$60,000

THE unusual lines and large glass areas of this house created much interest and discussion during the time it was on display as a feature of National Home Week observance in Malbrook, Va., adjacent to Washing-

ton, D. C. It was sold completely furnished for \$60,000. Brick veneer, painted white, is used as the exterior finish for the first floor walls and redwood siding, finished naturally, covers the second floor exterior walls.

Large overhangs at both floor levels, plus the flat roof, give the house a pleasingly modern appearance. The house was designed by Spector & Montgomery and erected by Malice & Brooks.



PENNSYLVANIA firm offered this model and lot for \$25,750

THIS Moss NHW house was priced, with lot, at \$29,750

## NATIVE STONE used for luxury homes in Pennsylvania

J. FRANKLIN MOSS & CO., J. Merion, Pa., is building and selling about 15 houses a year in the \$25,000 to \$30,000 price range in their development adjacent to Philadelphia, Pa. The two houses shown here were opened in time for display during National Home Week. Stone is used for the foundations and as the principal exterior wall finish along with concrete block. Roofs are covered with asbestos cement shingles. Bathrooms are finished with ceramic tile floors and walls. Interior walls and ceilings are plaster over gypsum lath and floors are clear red oak. Standard kitchen equipment includes stainless steel sink, metal cabinets, laminated plastic counter tops, and an electric

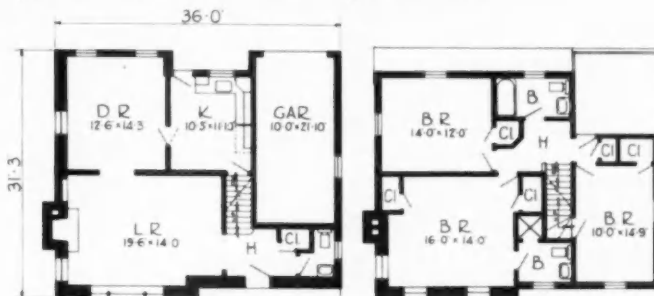

range. Also standard in these houses is a second floor sun deck, a first floor open terrace with a concrete floor, fireplace in the living room with marble facing and Colonial mantel. The second floor ceiling is insulated with

four inches of mineral wool and all exposed frame walls are insulated with mineral wool. Heat is supplied by a forced warm air unit, oil-fired. The houses were designed by Ralph F. Moss.

**Demonstration Homes  
NATIONAL HOME WEEK**



**SMALL** but adequate for an expanding family, this model with unfinished second floor on a 60x100-foot lot proved popular with home seekers at \$11,500. Included in the price was kitchen equipment

**VARIED EXTERIORS add interest**

**I**N the five weeks after this model house was opened to the public, 53 of the units were sold by Wenshaw Builders at North Merrick, Long Island, N. Y. Although this house was featured for NHW, there are six other models being built in the 200-house planned community. Prices on the models vary with the style and size which the buyer selects. All units have full basements with poured concrete foundations. Exteriors are varied with brick, stone, shingles, pin paneling and bevel siding. Roofs are covered with asphalt shingles. Interior walls are plastered with three

coats and floors are select oak. Ceramic tile is used for the bathroom floors and linoleum is standard in all kitchens. Bathroom walls are tiled and have matching fixtures. Equipment in the Wenshaw houses includes an electric range, refrigerator, ventilating fan, laminated plastic counter tops, automatic laundry, recessed bathroom scale, electric bathroom heater and glass shower enclosure. Heat is supplied by an oil-fired hot water unit with recessed convectors. Standard lot size is 60x100 feet. This home building firm does all its own house designing.

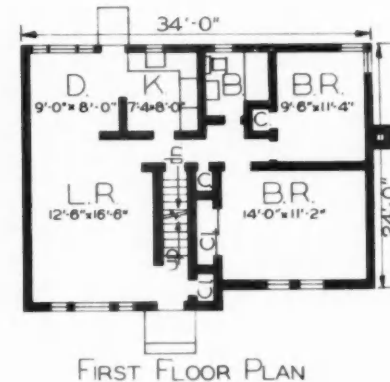
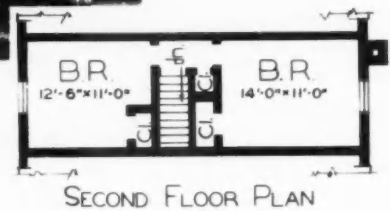

**THREE-BEDROOM HOUSE for \$10,500**



**VISITORS** to East Meadow, Long Island, N. Y., viewed this three-bedroom Colonial priced at \$10,500. Project of 70 houses was entirely sold out by late October

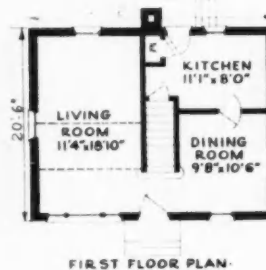
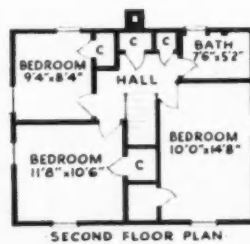

**A** THREE-BEDROOM two-story Colonial on a 60x100-foot lot, priced at \$10,500, was displayed during National Home Week by Housing Associates, Inc., in their East Hempstead Estates project at East Meadow, Long Island, N. Y. The basic plan is the same for the 70 houses in the project, but Architect Stanley Klein, of Jamaica, N. Y., varied front elevations with a choice of different materials, window and roof treatment. Foundations are poured around a full basement. Interior floors are oak except in the kitchen where linoleum is used and in the bathroom where the floor as well as the walls are ceramic tile. The kitchen is equipped with a gas range, included in the sale price. Ceilings are insulated with mineral wool. A forced warm air furnace, oil- or gas-fired, supplies the heat.



## PACKAGED KITCHEN sparks buyer interest

"NATIONAL Home Week brings a lot of people to a project who aren't buyers—but these people indirectly help sales through the good publicity they give the homes," according to C. E. Blomgren, Northbrook, Ill., who estimates that more than 1,000 people visited his model home during NHW.

The demonstration home located in the Blomgren 35-house project, is priced at \$20,000. This price includes a kitchen equipped with automatic washing machine, waste disposer, range and refrigerator, and a ventilating fan. Prices of other homes in the project range from \$12,500 to \$20,000.

Built on a concrete slab floor, the home is heated by hot water circulated through 5/8- to 1-inch copper pipes embedded in the slab. Hot water is supplied from a gas-fired boiler.

Blomgren believes that while many visitors were "merely observing" during NHW, later—in about five months—"we can expect some of them back, and then they will be definite sales prospects."



FLOOR PLAN

## LANDSCAPING adds a finishing touch

GRASS and shrubbery, planted well in advance of National Home Week, accented the interesting facade of this model home visited by about 10,000 people during the Week.

Displayed by William Joern & Sons, LaGrange Park, Ill., the home represents the typical "Joern system" of construction. Exterior walls are solid masonry, placed on a 10-inch thick, poured concrete foundation. The first floor is composed of a con-

crete slab supported by junior steel beams. Flooring is of pre-finished hardwood set in mastic. In the kitchen and bathroom rubber tile flooring was laid. Interior walls, ceiling joists and roof are conventionally built, with 2x8 joists and 2x4 studs 16 inches on center. Roof is covered with 210-pound asphalt shingles. Ceilings are insulated with mineral wool.

The home, priced at \$28,500, is equipped with an automatic clothes

washer and dryer, a range, a refrigerator, and door chimneys. Two fireplaces are provided; one in the living room and one in the basement. A coat closet, 2'6" x 4'8", situated near the front entrance, forms a partial separation between the dining and living rooms. A handy clothes chute is provided at the entrance to the bathroom. Two clothes closets, one a walk-in type, are situated in the master bedroom.



FIRST FLOOR PLAN

LANDSCAPING, carefully done well in advance of National Home Week, did much to enhance the appearance of this home visited by 10,000 people during NHW. Features include two large closets in the master bedroom, clothes chute at entrance of bathroom, and two attractive fireplaces

**Demonstration Homes  
NATIONAL HOME WEEK**

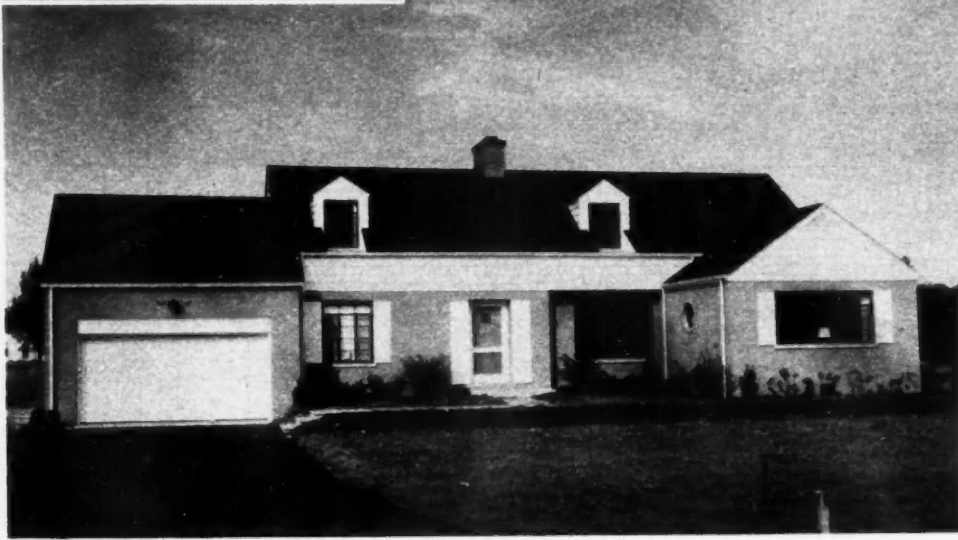

**C. A. HEMPHILL** model home in Winnetka, Ill., drew about 2,500 visitors during NHW. Sales price of \$45,000 included gas-fired, warm air furnace, hot water heater, complete electric kitchen appliances and steel cabinets.

**POPULAR LARGE HOME meets ready sale**

**T**HE sales record of this building firm immediately before and during National Home Week indicates there is still a good market for deluxe dwellings in the Chicago area. Two out of three of their model homes, priced at \$28,500 and \$59,500, were sold before the Week opened, and the third, priced at \$45,000, sold during NHW. The \$28,500 and \$59,500 houses were built on contract; the latter was kept open for the Chicagoland Home and Home Furnishings Festival which opened in conjunction with NHW.

The building firm, C. A. Hemphill and Associates, Skokie, Ill., reports that about 2,500 people visited the \$45,000 model home built in Winnetka, Ill., and that about the same

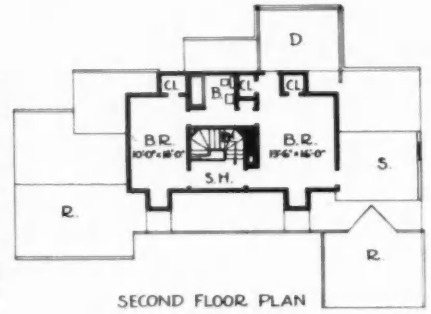
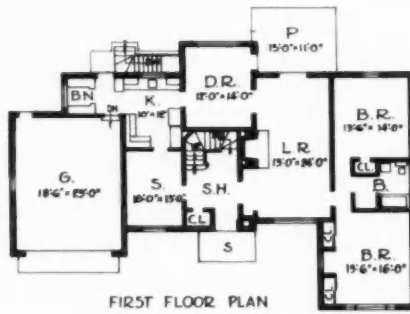

number visited each of the other two demonstration homes. The Winnetka home was equipped with range, refrigerator, steel kitchen cabinets, door chimes, ventilating fan, and steel case-

ment windows. It is situated on a half-acre lot, included in the sales price. Estimated value of lot is \$8,500. About 95 per cent of the homes built by this firm are on contract.

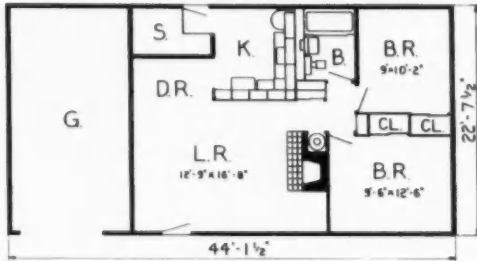

**PACKAGED HOME a success**

**\$12,500** home in Wheaton, Ill., provided builder with 50 sales of similar homes on construction contract. Completely furnished, this home is on 105x134-foot lot. Homes to be built will be on smaller lots, will not include furnishings.

**O**NE of the most popular demonstration homes in the Chicago area during the Chicagoland Home and Home Furnishings Festival and National Home Week was the one built by Richard Smykal, Inc., in Wheaton, Ill. Priced to sell for \$12,500, the home is situated on a 105x134-foot lot. Included in this price were a complete set of modern furniture, and the carpeting and draperies, interior decorating, a wood burning fireplace, and a kitchen range. A gas-fired, forced warm air furnace is installed in the attic.



During, and two weeks following NHW, Smykal sold on construction contract 50 homes similar to the one shown here. He will use two floor plans and six elevations for these homes.

## VARIED SIDING adds interest to model home

VARIED exterior siding adds interest to the front and side elevations of this National Home Week demonstration home in Lombard, Ill. Lower portion of the side walls is covered with 8-inch-wide horizontal siding, and the upper portion is covered with 3/4-inch-thick waterproof plywood. The vertical siding and horizontal siding are combined to make an attractive gable end on the front.

The home, built by Prudential Builders, is priced at \$16,900. During NHW, about 4,000 people visited the model house and the building firm signed contracts to build four homes similar to it.

Included in the demonstration home were wood kitchen cabinets, kitchen ventilating fan, steel windows, and a domestic hot water heater. Hardwood flooring was used throughout, except in the kitchen and bath where linoleum floor covering was laid.



COMBINATION of horizontal and vertical siding adds interest to exterior of this NHW model home priced at \$16,900. It was built by Prudential Builders, Lombard, Ill., a firm headed by Viktor Hoyer

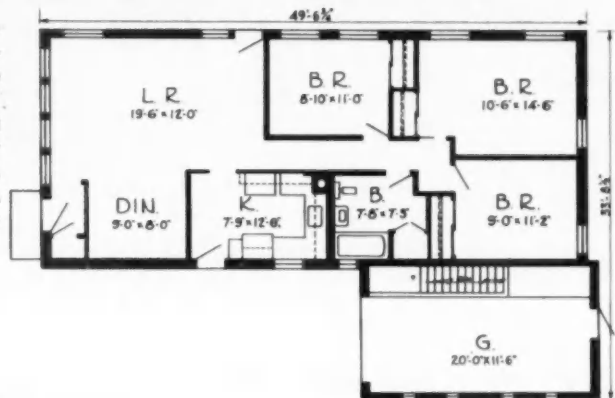

## GOOD PLANNING makes a practical home

AVERAGE number of visitors to this home for each of two weeks preceding and during National Home Week totaled about 1,000. That visitors were favorably impressed is evidenced by the builder's accelerated sales. During this approximate three-week period, he got commitments to build 95 homes similar to the one demonstrated—to be completed in February and March, 1950.

The well-planned home, built by Paul E. Schleicher & Sons, Inc., Gary, Ind., sold for \$9,250, complete with automatic clothes washer, automatic hot water heater, shower, tile bath, kitchen sink and cabinets. Built on a concrete slab, the home incorporates a radiant baseboard heating system that will be discussed at length in a future issue of *American Builder*. Plenty of closet space is provided, each with sliding doors. A folding door separates the living-dining area from a studio bedroom. When this door is open, the studio becomes a part of the living room. A small storage room abutting the rear of the house provides ample space for garden tools, and a large storage area is provided near the kitchen.

Other features include full landscaping, trees and grass seed; a 50x63-foot lot; rubber tile in the bathroom; silent type electric switches; flush rift oak doors; oak parquet flooring; aluminum windows.

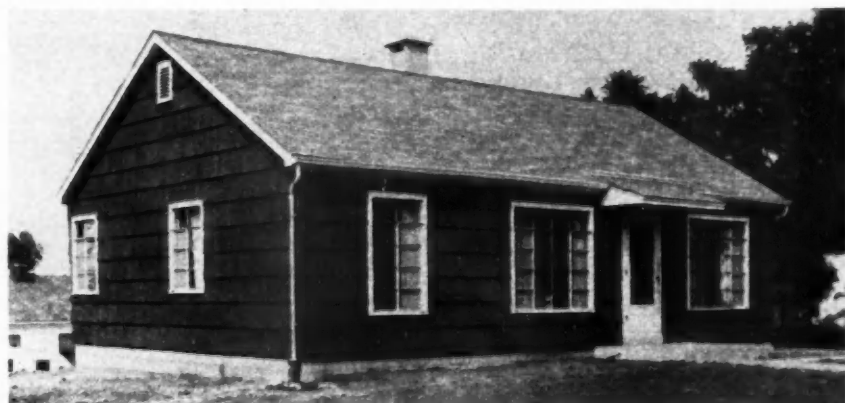

PLEASING variation of exterior materials helped to make this NHW model home in Gary, Ind., popular.

FLOOR plan of Gary home, built by Paul E. Schleicher & Sons, Inc., shows handy storage room adjacent to kitchen, and garden tool storage area at rear of house. Closets have modern sliding doors

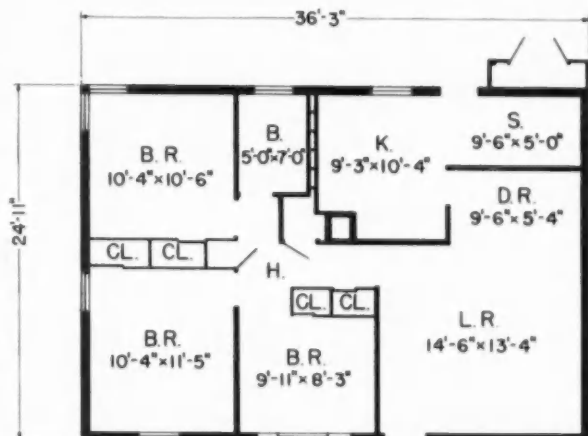



**Demonstration Homes  
NATIONAL HOME WEEK**



**"WORK-FREE" home**

**D**ESIGNATED by the builder as a "work free" home, this modern six-room residence, priced at \$37,500, has a complete electric kitchen, well-arranged to save steps and work. Appliances include a dishwasher, waste disposer, range, and oversized refrigerator. Metal cabinets are a soft gray, contrasting with the coral rose ceiling.

A basement recreation room has a fireplace, oversized built-in bar, two-tone asphalt tile floor and window wells. Labor saving laundry equipment includes washer, dryer, ironer, and porcelain laundry tubs. A deep freeze unit is included in the price of the home.

The home, in Chicago, is situated on a 62x132-foot lot. It was built by James C. Moreland & Son, and designed by Carl J. Kastrup, AIA, of Forest Park, Ill.

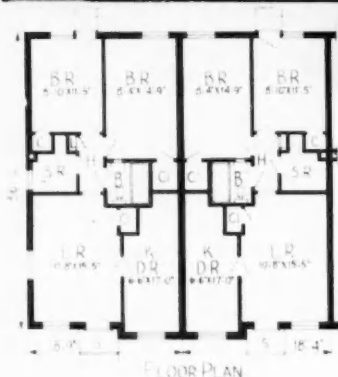

**BRICK veneer two-bedroom row houses in Philadelphia are popular with veterans**

**ROW HOUSING fills a need**

**R**OW HOUSING is popular in a number of eastern cities and especially so in Philadelphia. No showing of new houses in that area would be complete without models of row housing. In Philadelphia Russel Muth this year completed 191 of the row houses, and practically all of them have been sold at \$6,950 on lots 18 feet 4 inches by 67 feet 6 inches, without a garage. Veterans bought them with no money down and are paying \$48.59 per month. They are one-story bungalow type houses built on concrete foundations without basements. Floors are conventional frame, finished in parquet oak. Interior walls are plastered; bathrooms are tiled. Four inches of mineral wool is used for insulation. Each unit has its individual heating plant—a gas-fired forced warm air system. Kitchens are equipped with factory-finished cabinets, a gas range, and a combination sink and laundry tray. The houses were designed by Muth.

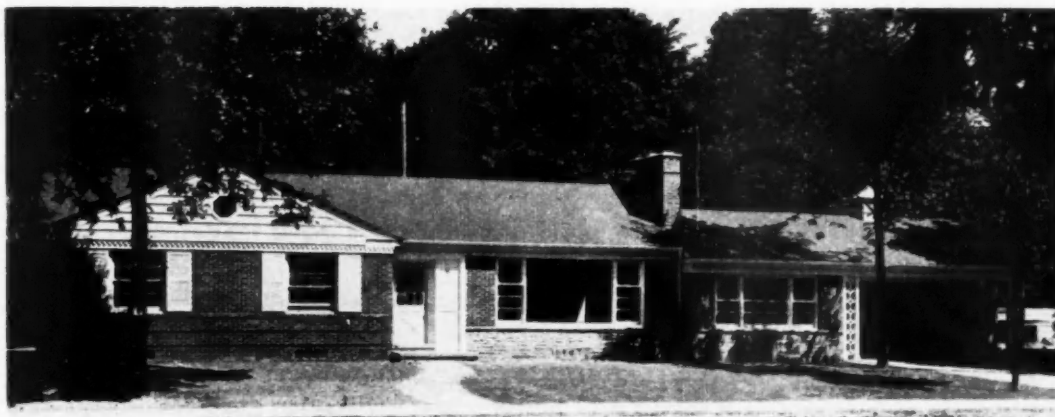

HOST of attractive features offered in this home built by Michael R. Rublin in Detroit drew about 600 visitors during National Home Week. Priced at \$32,000, the home is situated on a 100x120-foot lot. The use of large window areas and a combination of brick, stone and horizontal wood siding on the front exterior wall and gable end produces a distinctive front elevation. Blanket-type insulation is used in the ceiling, and heat is supplied by a gas-fired furnace. Electrical appliances in kitchen include range, refrigerator, dishwasher and disposer. Picture window is double glazed.



## Home Show Accelerates Local Business

IT IS conservatively estimated that at least 250,000 persons inspected demonstration homes of the 100 participating builders in Detroit during National Home Week this year. Participating suppliers, manufacturers, appliance and specialty shops report sharply accelerated business as the result of the Week, and these results have generated enthusiasm for a greatly expanded 1950 program.

The activity this year was the first formally organized Detroit observance of National Home Week. Consequently, the local participants had neither precedent nor experience to guide them when they planned their program. As was the case in other cities, the success of their project far exceeded expectations.

Association member John Baker was program chairman.

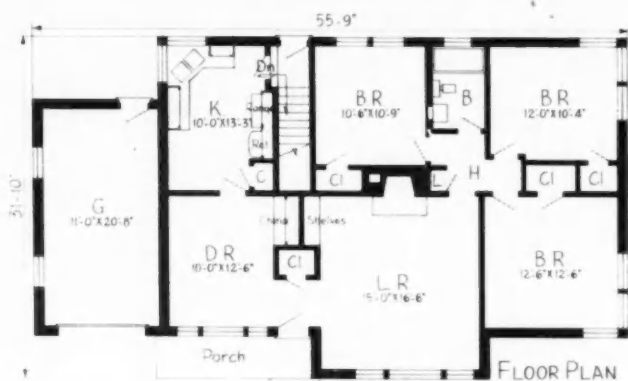

MORE than 12,000 persons a week for a three-month period visited this Detroit NHW model home built by Norman J. O'Neill. On an 80x125-foot lot, it is priced at \$15,500. The home has a full basement; is insulated in ceiling with mineral wool. Range, refrigerator and ventilating fan are provided in kitchen. Heat is supplied by oil-fired winter air conditioning unit. Storm windows and screens are offered. Large picture window in living room is double glazed. While the trend in modern ranch style homes has been toward large window areas facing the rear of the house, this residence represents an effective reversal of that orientation. An advantage in using this floor plan is the elimination of space consuming hallways. Living room, at front of house, becomes the focal point of activity

## 100,000 View 18 Homes in Midwestern City

**Builders, materials manufacturers, local business  
and home buyers profit in Milwaukee NHW observance**

**A**N ESTIMATED 100,000 persons viewed the 18 dwellings shown in Milwaukee's third annual "Parade of Homes." The 18 participating builder-members of the Milwaukee Builders Association threw open the doors of their model houses at 2 p.m. each day during the Week, and kept the homes open under floodlights until 9 p.m. The homes, located in three different sections of the city, were estimated to value \$216,000. Furnishings were valued at about \$54,000.

Much emphasis is placed on kitchens and basements in the Milwaukee area, where home buyers demand plenty of square footage in each. During the "Parade

of Homes" kitchens and basements became the central points of interest in most of the houses displayed. Kitchens offered a variety of excellent arrangements, large cabinet areas, and were equipped with appliances of leading manufacturers. Basements, in many cases, provided space for recreation rooms.

Booth space was made available in most of the demonstration homes, and rented to manufacturers of building materials, the local gas company, electric appliance manufacturers, and to other suppliers. Those who rented space reported "very satisfactory" results.

An excellent promotion carried out in conjunction

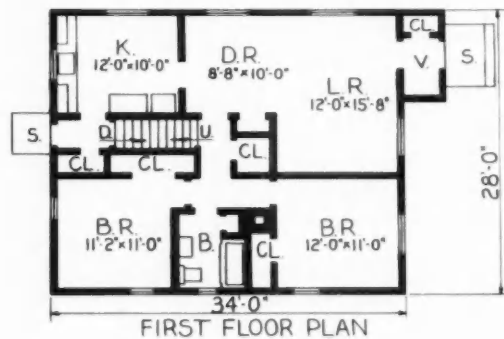
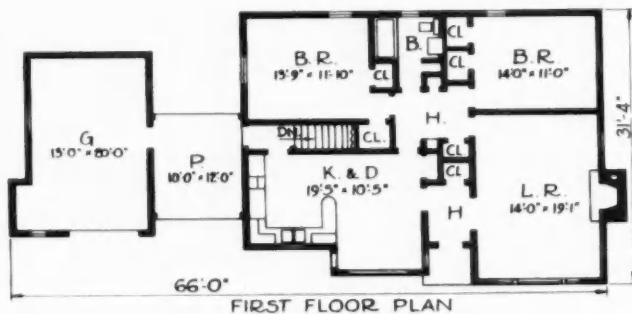

**KITCHEN-DINETTE** areas are partially separated by a convenient counter in this NHW demonstration home built by Joe Linke Building Co., Milwaukee. Priced at \$18,000, with 52x150-foot lot, the house has an exceptional amount of closet space and a well-planned kitchen work area. Heat is supplied by an oil-fired, forced warm air furnace. Bedrooms are at rear for greater privacy and quiet from street noise. Breezeway adds an appearance of greater width to the house.



**DINETTE**, forming an L off the living room, creates an illusion of greater size in this home. Kitchen is large and has a rear entry hall where a spacious closet and convenient entrance to the basement are located. Bedrooms and bathroom are well isolated from the living quarters. Equipped with storm windows, screens and combination doors, the dwelling sold for \$13,900. Tile is used on bathroom floor and walls, kitchen floor is linoleum. The Mollgaard Co. were the builders.



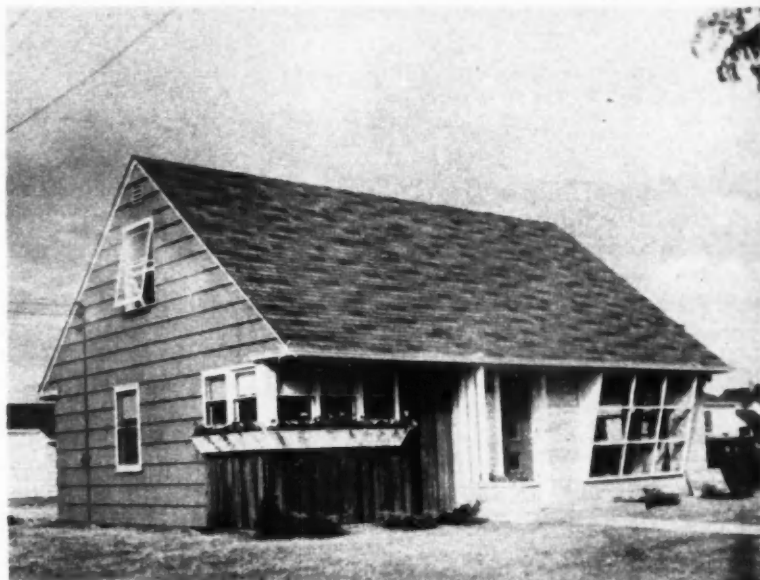
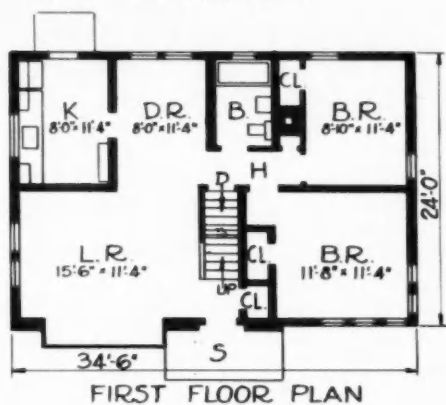

**WINDOW** treatment of this home gives it an air of distinction. Features that attract attention are the unusual living room window set at a slight angle, the corner windows in the bedroom at the opposite side and the masonry flower box by the front door. Two finished rooms upstairs are conveniently reached by a centrally located stairway. Heat is supplied by an oil-fired, forced warm air furnace. With 55x113-foot lot and garage, the Milwaukee NHW demonstration home, built by Van Dyke Builders, was priced at \$15,900. Floor plan, left above.

with the Week by the Milwaukee Builders Association was the publication of a 64-page plan book. The book carried plans, renderings, and data of 25 dwellings, including the 18 demonstrated during the Week. Copies were sold to visitors for 25 cents each. The fact that "A dollar paid on a home is a dollar saved" was stressed. The book carried advertising from local distributors.

Builders reported many direct inquiries from potential home owners, and many definite prospects during NHW in Milwaukee. Most of the demonstration homes were sold during the Week.

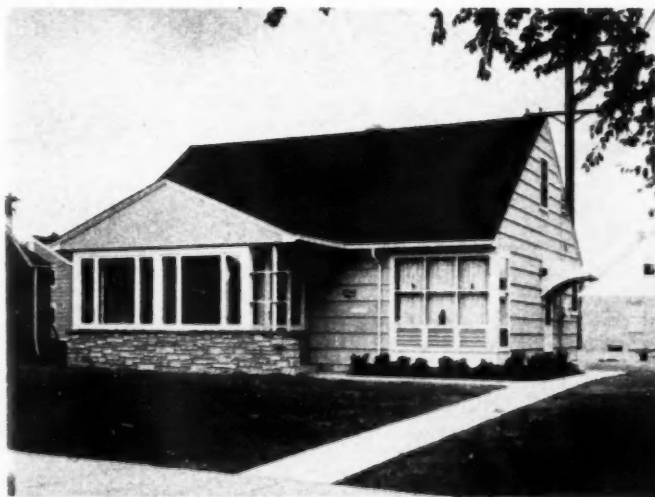
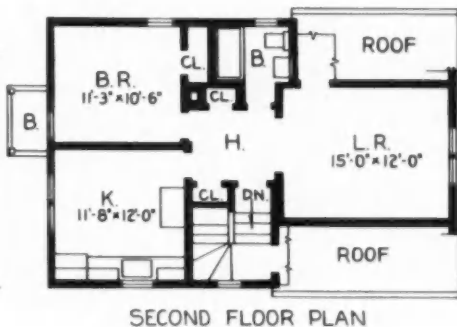
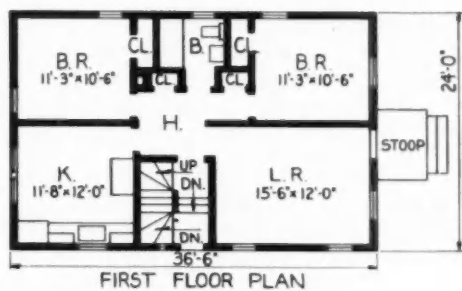
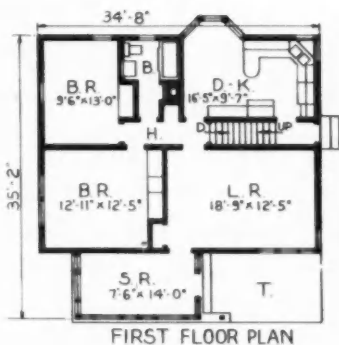

**ATTRACTIVE** sunroom, which serves also as a front vestibule, is a feature of this NHW demonstration home built by Goelzer & Schults Co., Milwaukee. On 58x108-foot lot, home sold for \$15,500, including carpeting, storm windows and screens. Heat is supplied by oil-fired, forced warm air furnace. Bathroom is well planned, with a linen closet off the hallway between the kitchen and bedrooms. Bay, with three windows, makes a bright and cheerful dining space in the kitchen. Closets are ample.



**DUPLEX**, built for NHW demonstration in Milwaukee by Alfred J. Weter, has the appearance of a single family home. It has two separate gas-fired furnaces. Front door serves the first floor occupants, while side entry serves the second floor. Each bedroom has an ample closet and there are two smaller closets in the hallway next to the bathroom. Second floor kitchen is directly above first floor kitchen and bathrooms are similarly placed to economize on plumbing and piping. Sold for \$16,500

**Demonstration Homes**  
**NATIONAL HOME WEEK**



THIS house of Colonial characteristics and proportion has five rooms on the first floor with space for two additional rooms in the large unfinished second floor. Floor plan, below, indicates rooms are spacious



**A favorite with many**

THIS house located in Bay Village, Ohio is a good example of what one member of the building industry in this area exhibited to the public for their approval during National Home Week.

Built by the Selby Construction Co., of Cleveland, from the plans of Erwin O. Lauffer, architect, the house caused a great deal of favorable comment from its hundreds of visitors because of its simple yet effective exterior and plan, which follow

the Colonial style of architecture.

The house contains the equivalent of five rooms on the first floor with a potential of two additional rooms in the unfinished attic. A full basement is provided where heating and laundering facilities are installed, with ample space allowed for recreation. A porch connects the one-car garage with the house. Selling price for this home including a 60-foot lot is \$16,500.

Construction details follow the nor-

mal with emphasis placed on the use of branded products. Concrete foundation walls extend to grade with face brick from grade to first floor joists. Walls above and framing are of wood with batt insulation in sidewalls and ceiling. Asphalt shingles cover the roof.

Reminiscent of Colonial days are the wood quoins at corners of main gabled wing with flush boards on wall surface, the restrained cornice and the ornament on pediment

**Preferred by the thrifty**

APPLICABLE to a narrow lot is this 24-foot 8-inch wide house containing 850 square feet of livable area, which is offered for \$11,250 by James A. McFarland, builder, Dayton, Ohio. This dwelling was placed on exhibition without furnishings during National Home Week. Approximately 400 people trekked through its rooms and examined its design and construction at their leisure.

The 45 degree pitch of the roof, unbroken except for protruding chimney and vent pipe, adds a note of interest to the exterior by conforming to the new trend, which is a reversal from the popular low-pitched type. This roof creates an extensive area in the attic, which if left unfinished as was the case with this house is always available for future expansion. This area is accessible from living room by means of a normal stair.

The exterior is a clear-cut expression of the plan with the first floor raised above grade to permit windows in the basement. Brick veneer facing on exterior walls is placed on concrete foundation at floor line, with exposed concrete trowel smooth above grade. Gable ends are finished in beveled siding and 210-pound asphalt shingles are used on roof. House contains four rooms on first floor including two bedrooms and combination kitchen and dining room, bath, and living room; basement extends under entire house.

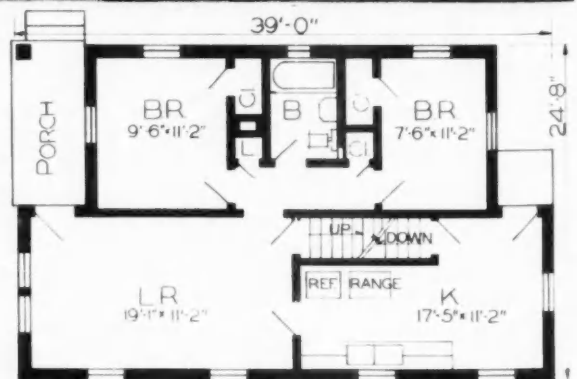
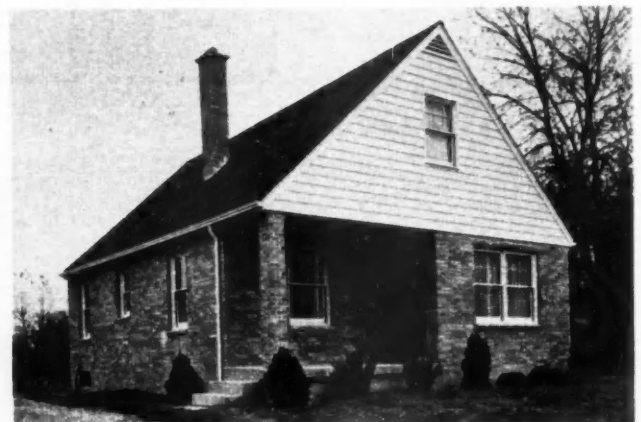

FLOOR PLAN

**PAINTED** brick walls broken at intervals with large windows, and a wide-spreading 5-12 pitched roof, accentuate the excellent proportions of house at right. Plan right, below



## Homelike and Modern

**WITH** 100x200-foot lots in one of Cincinnati's finest subdivisions at their disposal, the Arcose Company, builders, patterned their houses to fit the site and erected low, wide-spreading ranch houses that fit perfectly into the surrounding terrain.

The company had two houses on display during National Home Week: the ranch house shown above, which sold for \$32,500, and a one-and-one-half story house that was priced at \$12,600. An extensive advertising program in three local newspapers brought more than 3,000 people out to see these houses. The company reported that 25 per cent or better of their recent sales can be attributed directly to NHW.

This ranch house contains five large rooms, a ground level activity room adjoining garage, and two baths. A basement under the entire house provides abundant room for all types of activity in addition to heating and laundering facilities. A normal stair provides access to large attic space.



**COMPACT** arrangement of rooms with ample closet space is feature of both first and second floor plans. Basement is under center area

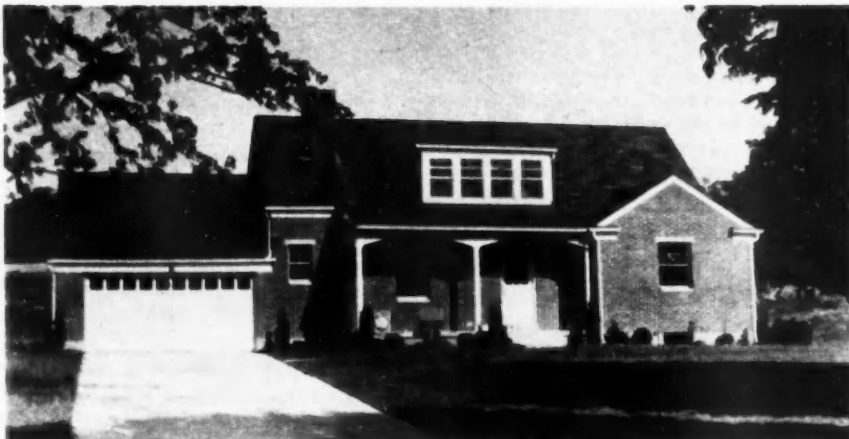

## Patterned from Cape Cod

**THIS** medium-sized house, built from a typical floor plan with living room as center core, shows how traditional architecture, in the right hands, can foster friendly, comfortable living. With a straightforward design, the architects Lorenz & Williams, produced a model house for Paul E. Lapp, builder of Dayton, Ohio, that was one of the show places of National Home Week. Over 500 interested persons visited the home during the week. Placed on a 93x175-foot lot the house sold for \$29,500.

Exterior walls are of frame finished with face brick veneer in a dark red shade. All trim is painted a contrasting white with roof of variegated colored asphalt shingles. First floor contains five rooms with two bedrooms and bath; three additional rooms and bath are on second floor.



**Demonstration Homes  
NATIONAL HOME WEEK**



**ROCK-FACED** Indiana stone veneer is used on all exterior walls of this large one-story ranch-type house, detailed in the Colonial manner. Floor plan provides for three sleeping rooms and two baths, in addition to generous living quarters.

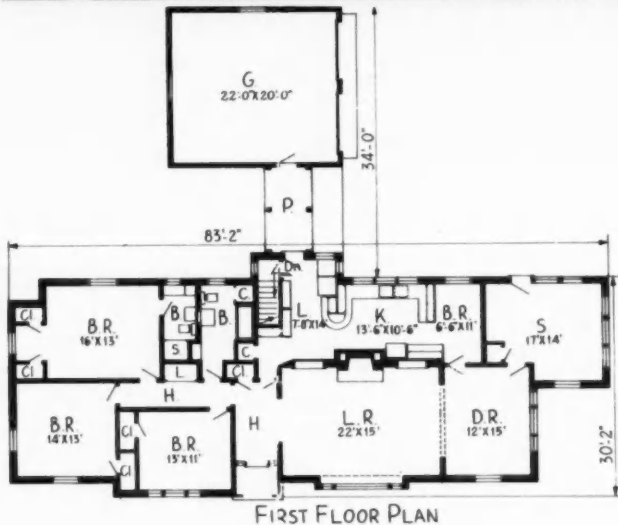

**Impressive in Size**

**PARTICIPATING** in the display of homes during National Home Week were builders with model houses priced as low as \$7,000, and ranging up to approximately \$50,000.

The house displayed by A. H. M. Graves, Inc., Indianapolis, Ind., offered for sale at \$47,900 is impressive in its size and setting. Between 600 and 700 people visited the house during the time it was open to the public. The details of the exterior are distinctly Colonial in their aspect. Coupled with the severe stone walls they add up to an extremely successful design. The park-like surroundings lend character to the setting. The house contains seven rooms with two full baths, including combination kitchen, breakfast room and laundry. Basement is provided under entire house except study. Garage at rear is approached by a covered service walk.

**Compact and Practical**

**EFFECTIVE** in its simplicity is this small four room house of 816 square foot capacity which was designated as a model house by W. D. Jennison & Sons, builders of Memphis, Tenn. House was opened to the public during the National Home Week when 5,000 home-hungry people visited the premises.

This house is part of a subdivision of 29 homes now under construction. The homes range in price from \$7,300 to \$7,700 and are placed on 60x150-foot lots. Plans were prepared under the supervision of Faires & Sanford, architects, Memphis, Tenn.

The builder has found that the simple oblong type plan used in this house is the most economical to build. In masonry and wood it eliminates excessive labor costs in forming bays that are often used to break up long wall surfaces. Conventional framing is adhered to in walls and roof. Ac-



**STRONG** horizontal lines of this house are relieved by the slab-type shutters on each side of the windows and entrance porch. Bearing partition in center of plan separates the living-service and quiet zones

cess to large attic space is obtained by way of a scuttle in the ceiling.

House is placed on a 4-inch-thick reinforced concrete slab with pre-finished block hardwood floors. Asphalt tile was used in kitchen and bath.



ROMAN brick and machine-raked wood shakes on walls capped with variegated colored asphalt shingles on roof combine to produce an exterior of pleasing proportions. Plan provides for complete separation of sleeping rooms from living and service zones

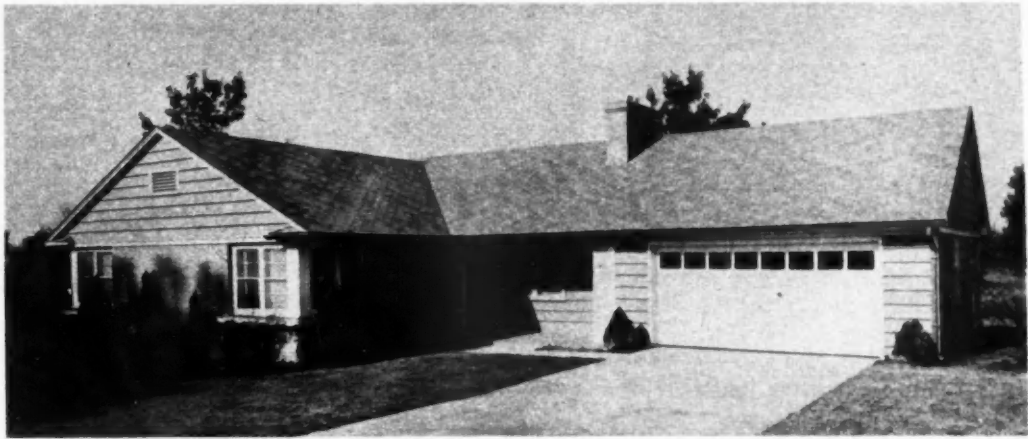

**PLUS FEATURES—good exterior—excellent plan**

TWO models from two different subdivisions being developed by John B. Goodwin, builder of Memphis, Tenn., were opened for inspection to the public during National Home Week.

One of the houses shown (above) contains 1600 square feet and is priced at \$23,800. Built on a solid concrete reinforced slab the house contains many special features, including a complete electric kitchen.

All rooms are large and well ventilated with double window exposure in each. Room arrangement is excellent with a distinct separation between the quiet, living and service zones of house. Built-in cupboards and drawers, in addition to normal type closets, are made a part of every room. Space for a breakfast set is allowed at one end of kitchen. Additional storage space is provided in attic.

Faires and Sanford, architects, designed home.

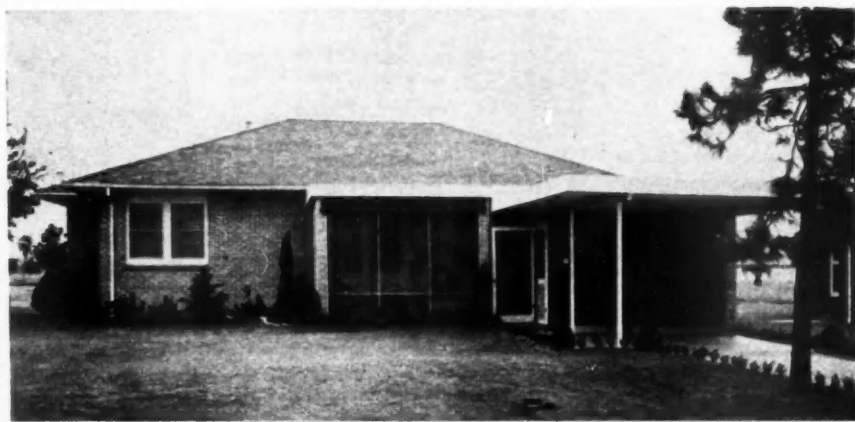

**Exposure on Two Fronts**

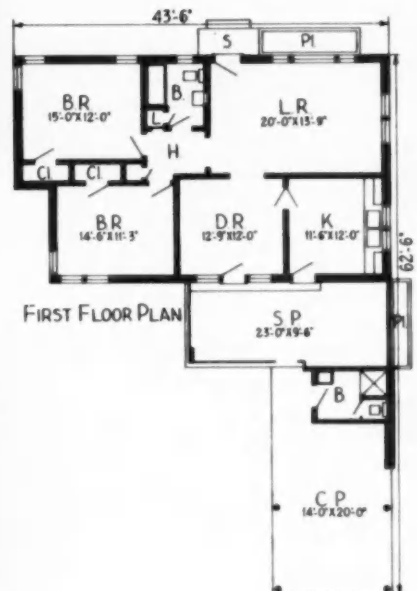

THE house placed on display for National Home Week by Lionel S. Boulmay Jr., builder of New Orleans, La., is somewhat unusual, in that plan layout conforms to an 83x30x104 foot "pie-shaped" site. With a two-front public exposure, the carport is made an extension of screened terrace and utility room which is placed at wide end of lot. This arrangement partially screens the terrace from public view. Without benefit of furniture during display, the house nevertheless attracted approximately 2,000 people during the week. Price of home is \$20,000.

AN unusual shaped lot with public exposure on two sides, dictated plan arrangement and exterior treatment of this house.



## Demonstration Homes NATIONAL HOME WEEK

### GOOD DETAILS add livability

**B**OTH interior and exterior of this home offer details that add interest and utility. Design of the series of gables blends well with the broad roof area, and ornamental iron adds distinction to the front entrance. Exterior walls are Roman brick veneer. Windows are metal. Each room in the house is accessible from L-shaped hallway. Partial separation between dining and living rooms is achieved through use of translucent, corrugated glass, placed as indicated in floor plan. Abundant clothes closets and cabinets are provided.

The home, demonstrated during National Home Week by the Star Lumber Co., Amarillo, Texas, sold for \$24,500. It was built by Floyd Richard, contractor, and designed by Architect John L. Hannon.

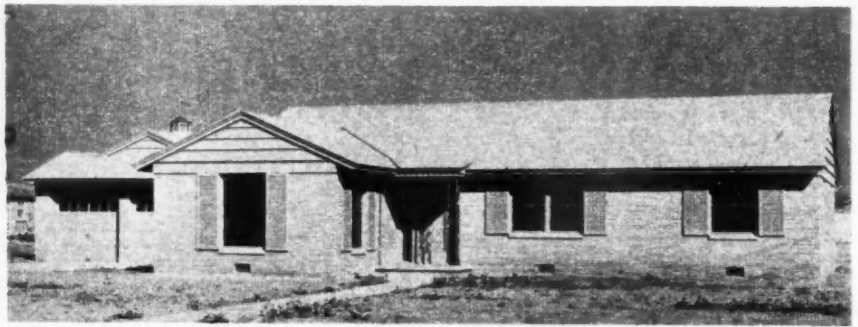

### FIVE-ROOM HOUSE for \$5,850

**A** \$5,850 home demonstrated by the Seale Company, builders, during National Home Week in Amarillo, Texas, sells to G.I.'s for less than \$150 down. Monthly payments are \$40. It is one of 500 low-cost homes completed by this firm since 1946, and currently the Seale Company is completing them at a rate of more than two a day.

The house rests on concrete piers, 5 feet 10 inches apart, placed 36 inches below grade. The piers are 16 inches square at the base and 10 inches square at the top. Foundation walls are 6 inches thick, topped with metal termite shields. Floor joists are 2x6's; studs, 2x4's, placed 16 inches on center. Sub-flooring is 1x7, laid diagonally, and finished floors are oak in all rooms except kitchen and bath where linoleum is used. Oak floors are sanded, finished with shellac and one coat of varnish. Dry wall construction is used. Roof trusses are of 2x4's and 2x6's. The ceiling is insulated with three inches of blown mineral wool. Heat is supplied by a centrally located wall heater.

Owners of the homes are permitted to select wall paper and linoleum from the builder's varied stock.

Before a home is turned over to a buyer it is landscaped with shrubs, and shade and fruit trees. Free grass seed is given to anyone who will plant it. Paint is sold at wholesale prices, with free brushes and instructions by Seale Company's master painter. Fences are sold on easy terms with no down payments. A service certificate is given to the owner when he moves into his new home. It covers repairs and adjustments without cost to him for the first month.

Says Fred Seale, head of the firm and an active proponent of free enterprise, "National Home Week gives builders an army of co-workers who are willing to fight for private enterprise but who lack leadership."



SEALE Co. in Amarillo, Tex., demonstrated home similar to this one during NHW, in their project of 500 houses





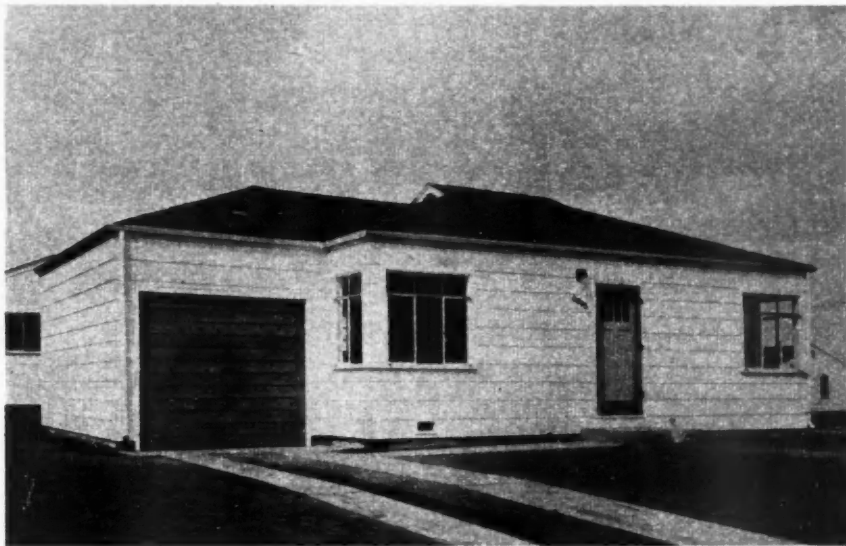

### FOR MAXIMUM ECONOMY

THE current Fran-Brent house placed on display by the Burns Realty Co., builders, during the National Home Week, follows the economy trend that is consistently emphasized in the extension of their Brentwood addition in Denver, Colo. Burns has made a concerted effort to meet the needs of the veteran in this small economy

house that contains four rooms including two bedrooms, and an enclosed garage. House is placed on concrete foundation extending below frost line, with wood framing and walls above. Exterior walls are covered with asbestos shingles and roof with asphalt shingles. House has 725 square feet without garage.



FLOOR PLAN

FITTING into the economy picture is this one-story house with attached garage. To facilitate the work of the various craftsmen, this builder has all cement drives, walks, stoops and finished grading put in at the same time foundation is done

### GOOD DESIGN stressed in a Seattle home

THIS house, which sold at \$9,500 without lot, was built by Fairbanks-Owen, Inc., in Seattle as a part of the economy house program of the Small House Plans Bureau. Jesse M. Warren of Seattle was the architect.

The Bureau is jointly sponsored by the Seattle Master Builders Association and the Washington chapter of A.I.A. Its purpose is the planning, design and construction of better homes for the lower- and middle-income groups.

The Fairbanks-Owen house contains 1,060 feet of floor area, including two bedrooms and full dining room. Lot size is 60x100 feet. Construction is of pumice block masonry. Other features are a patio, fireplace and aluminum sash windows. Flooring is of select oak; and cedar shingles are used for roofing.



FLOOR plan shows utility of design; good use of hall space; convenient dining room-kitchen-utility room grouping. Feature of carport is handy 9 x 10-foot furnace room with storage facilities



FLOOR PLAN

**Demonstration Homes  
NATIONAL HOME WEEK**



SHERMAN-GRAY, Inc., does contract building in San Diego area. Firm has a number of designs, ranging from the very low-cost home to costly luxury mansion

**Putting the BEST FRONT FORWARD**

WITH slight variations, Sherman-Gray, Inc. of San Diego, Calif. has built more than 1,000 homes of this model within the last ten years. Current price of the house shown is \$8,150 without lot; floor area is 926 square feet. A smaller home of the same model sells for \$6,995.

The floor plan of the two homes is the same; the \$8,150 house has slightly larger rooms and a stall shower.

Exterior of the home shown is stucco over concrete block and stucco over metal lath on frame up to window sill, with drip-cap separating the two sections. Finish above stucco is of cedar shakes. Interior is plaster, with paneled ceilings. Kitchen and bath are tiled. The roof is of composition shingles.

The firm has a number of stock designs to offer customers.



**Typical  
WEST COAST  
Value**

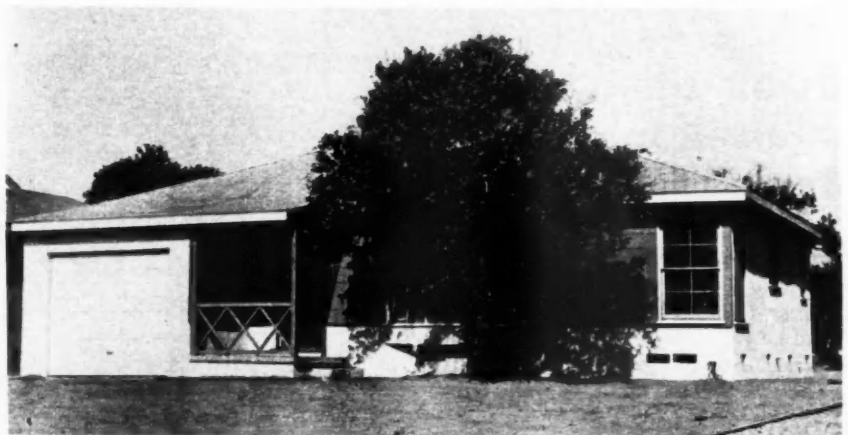

MIDLAND Manor home exhibited in Los Angeles area during National Home Week by Whiting Construction Co. Compact and well-planned, it is a good example of the type of low-cost home popular in the West

THE Whiting Construction Co. of Los Angeles recently completed and sold 72 homes in the first unit of its Midland Manor development near Whittier, Calif. A second unit, consisting of 60 homes, has been begun.

The house shown here is one of the 59 two-bedroom homes included in the first group. Built on a 50x120-foot lot and containing 800 feet of floor space, it sold for \$7,950. In the same unit there were 13 three-bedroom homes with 1,087 square feet of floor area in the \$9,350 class. The homes typify the values currently being offered on the West Coast.

The exterior of this demonstration

home is of stucco and horizontal boards and the roof is composition shingle. Interior plaster walls are painted. The house has hardwood floors, tile in kitchen and bathroom and ample closet and kitchen cabinet space.

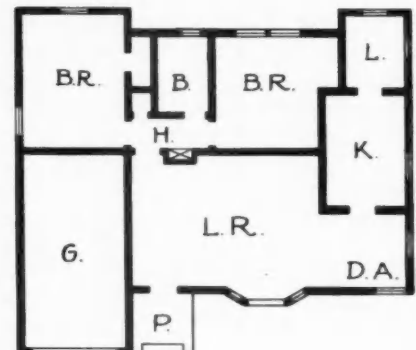



INDOOR living-dining area is closely connected with outdoors. Exterior is a straightforward expression of plan

## OUTDOOR LIVING in low-priced homes

THIS three-bedroom home is one of 53 built by the Thomas Companies, Inc. in their Rancho Whittier project in Whittier, Calif. It sold for \$8,800, including the 60-foot lot. Forty per cent of the homes in the subdivision were in this price range; the remainder were \$8,100 and \$7,800 models.

A feature of all homes in the proj-

ect is a rear patio, separated from the living room by a 6-foot picture window. All houses also have two-car garages.

Exterior finishes are cedar shingles, redwood boards and redwood siding. Side and rear walls are stucco. Some houses in this subdivision are all stucco.

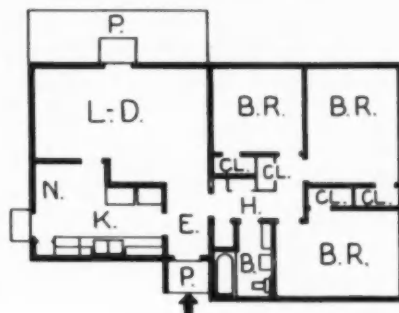

## Designed for A SETTING

THIS attractive, modern home in Will Rogers Estates, Pacific Palisades, Calif., was designed by Lawrence Cuneo and built by Burke and White, both of Los Angeles. The first of several models planned for the development, it is located on a 130-foot ocean-view lot. The price is \$35,000.

The house has been well-adapted, both in design and choice of materials, to a rugged background of mountains and forest. The exterior finish is of redwood and stucco. Redwood has also been used to a considerable extent on the interior.

Features of the house include a large service porch which connects with the garage, a large breakfast nook and a corner fireplace in the living room.



PICTURESQUE setting is exploited to full advantage by rambling, open design of this home in rugged Los Angeles area. Interesting details of floor plan include convenient grouping of garage, service area and kitchen; unusual bath and dressing room arrangement between bedrooms; and location of living and dining rooms for maximum use of patios





## How Color Helps Sell Homes

**N**O ONE questions the ability of Levitt & Sons, Inc., Long Island home builders, to build and sell homes. As salesmen and merchandisers, they are acknowledged to have few peers.

So it was news of the man-bite-dog variety when Alfred Levitt, the architect and designer, said recently, "Bea, after twenty years of building, I have to admit to you I don't know enough about color."

"Bea," is Beatrice West, an attractive and persuasive young lady, now associated with the Rahr Color Clinic of New York City. She is director of interior design and color co-ordination of an organization that has previously color-planned 156 projects totaling more than 30,000 homes. She believes, and can prove, that color styling of homes should be undertaken with the same care that is

given to design, site planning, landscaping, production, and financing.

She documents her case by referring to 108 builders in nineteen states with whom she has worked in the past three years, and for whom she alone has color-styled more than 25,000 homes. Included are such "blue bloods" as J. C. Nichols, the Texas Housing Company, New Mexico Housing Co., American Home Realty Company, and United States Vanadium Corp.

It was only natural, then, for the Levitts to ask Beatrice West to come to New York from her native Dallas just a year ago. The Levitts were in need of the best color advice obtainable to plan the exterior and interior color co-ordination of the 4500 homes being built this year at Levittown; the 4000 houses projected for 1950, as well as the recreation area

and shopping center, and the 750 ranch-type homes and Roslyn Country Club at Roslyn, Long Island.

Shortly after the war, Miss West had an opportunity to prove her theories about the sales power of color. The Texas Housing Company of Dallas was having trouble selling its homes, despite the housing shortage. The floor plan was good. The construction was sound. The price was right. But the houses wouldn't sell. The builder called in Beatrice West, and she immediately saw the trouble. The houses lacked eye appeal. All of the houses were painted the same monotonous color. Interiors lacked harmonious color treatment. The entire development suffered from a complete lack of integrated color planning.

Repainted inside and out in accordance with Miss West's specifications,

the  
R  
the  
hom  
sell  
der  
cou  
bui  
T  
bui  
vel  
tion  
the  
ext  
clap  
stu  
pos  
one  
pre  
sel  
the  
and  
rou  
gio  
sch  
ave  
and  
ha

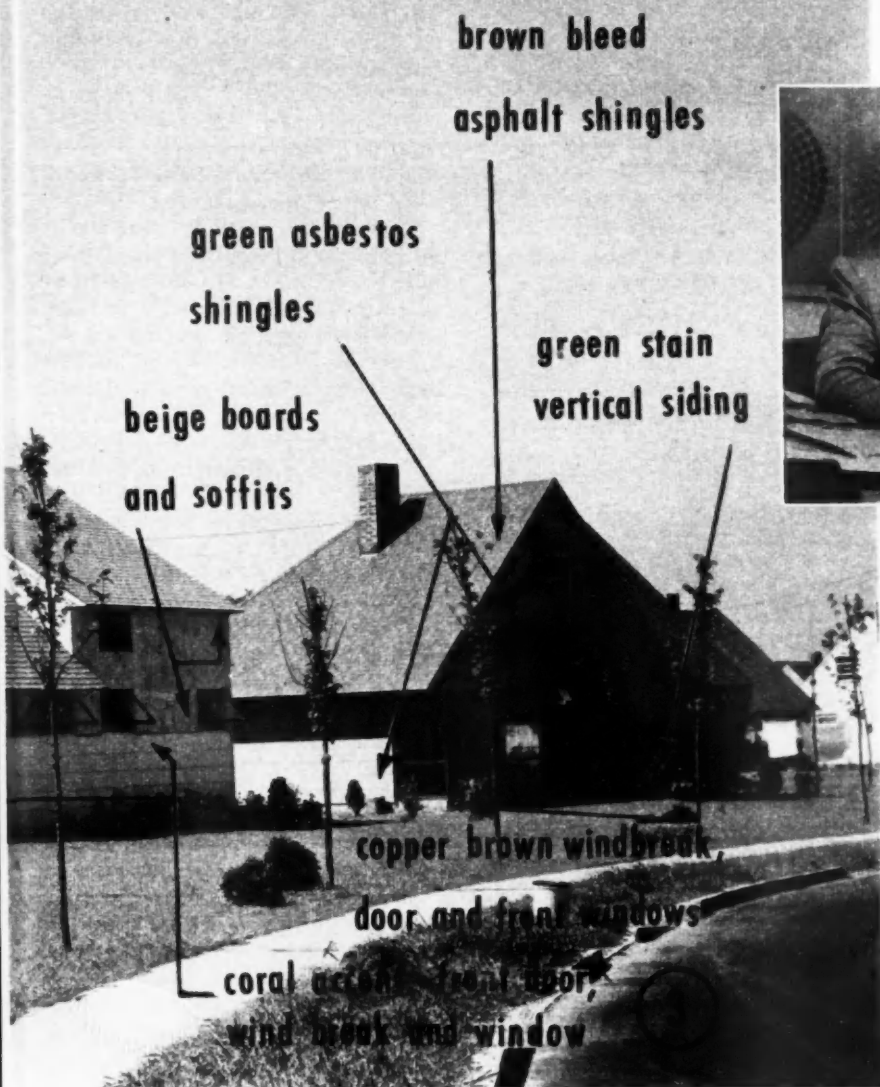

**BEATRICE WEST**, who has color-styled more than 25,000 homes for 108 builders in 19 states in three years discusses the plans for still another project with **Fred Rahr**, head of the Rahr Color Clinic

**A MAJOR** problem at Levittown, where 4500 houses are being built this year to a single floor plan with but five varying exteriors, was how to give individuality to a standardized product while creating a community with an integrated, harmonious appearance. How this end was achieved economically is indicated by three houses pictured at left

the houses sold, and sold quickly.

Reinforced in her conviction as to the importance of color in selling homes, Miss West then set about selling her color service by "mail order" to permit her to serve as color counsellor for a large number of builders at low cost.

The plan is basically simple. The builder sends a plot plan of the development, a set of plans and elevations for each house, and indicates the materials he plans to use on the exterior—brick, stone, shingles or clapboard. Every factor is then studied—orientation of the house, exposure of each room, the relation of one house to another, and the color preferences which the builder himself may have expressed. In addition, the over-all harmony of the project, and its relation to climate and surrounding buildings, terrain and regional preferences are considered.

In planning the exterior color scheme, particular care is taken to avoid an appearance of monotony, and to suggest colors which combine harmoniously with those in adjacent

homes. Her objective, she says, "is to suggest a minimum of different colors with a maximum of color combinations in order to provide diversity of appearance without running up costs."

Color planning begins from the roof down, and "quite naturally," says Miss West. "The roof is the largest single unbroken area normally visible to the eye, so if the roof colors are not right to begin with, not only does the color scheme of a single house fail, but that of the entire community as well."

Asphalt roofing offers the best colors in her opinion. "Asphalt shingle blends give the designer a wide latitude in selecting colors for side-walls and trim material. Any strong, solid color immediately limits the variety of colors which the designer may wish to use. A blend is exactly what the word 'blend' implies—a mixing of colored granules which readily harmonize with a range of colors."

As to interiors, a detailed color scheme is planned for each room based upon exposure, but always with

an eye to variety with harmony.

The color schemes for both interiors and exteriors are sent to the builder in a folder containing:

- 1) Actual samples of asphalt roofing recommended for each house;
- 2) Paint samples with the paint formulae and with specific directions where each color is to be used;
- 3) Plan and elevation drawings which help to clarify still further where the colors are to be used;
- 4) Suggestions and drawings for adding such variables to the plan as window boxes, changes in siding, wainscoting, fences, cornices, and valances;
- 5) Wallpaper samples for each room of each house, again with paint sample;
- 6) Samples of kitchen and bathroom colors for linoleum and tile.

A variegated color schedule is pro-  
(Continued on page 164)

## Utility companies offer builders aid in **KITCHEN PLANNING**

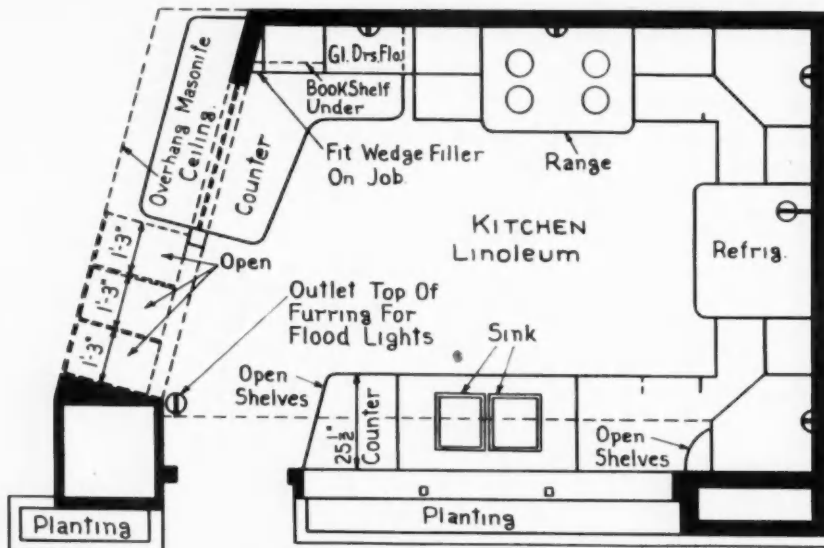

**MODIFIED U-shaped kitchen has liberal amount of counter space and ample cabinets for storage. Central location of refrigerator makes it handy to both stove and sink. Return counter at open end of kitchen simplifies serving meals in the dining room**

**H**UNDREDS of builders in the Los Angeles area have built and are building better kitchens as a result of the kitchen planning service inaugurated in 1930 by the Southern California Gas Company under the direction of Frank Moon, head of the department.

In analyzing thousands of kitchen plans submitted by owners and builders Moon has found that most of them can be improved at little or no extra cost by the application of the basic principles of kitchen design which he and other kitchen designers throughout the country have evolved.

Considering the amount of time housewives spend in the kitchen and the importance most women attach to it, it is surprising that more builders do not take advantage of this "know-how" which is available in most large cities through the utility companies. Proper design not only improves the kitchen functionally but improves its appearance, gives it an inviting look which poorly designed kitchens do not have, and thus adds to the sales features of the house.

Since the kitchen is primarily a work-shop, whenever possible it should be designed to fit the specific needs and preferences of the housewife who is to use it. How big is the family? Will the housewife do any canning? Any baking? Washing and ironing? Does she want a breakfast nook? Has she any hobbies? These are some of the questions which are asked when Moon's men are called upon to design kitchens for individual houses. However, on houses built for sale, the best that can be done is to fit the kitchens to the average needs of the particular type of families expected to buy the houses.

Many errors of omission and commission are made by the uninitiated in kitchen planning, sometimes even by architects. In one group of houses an architect erroneously allowed space only large enough for a five cubic foot refrigerator although the houses were adequate for large families. Kitchen experts find that a common error is to make kitchens either much too large which means unnecessary footwork for the housewife or too small or the wrong shape which makes it difficult to get the work done. Many times the square footage of cabinet space is adequate but the placement is such that some of it is inaccessible without getting on a step-ladder. Lights are frequently placed so that the housewife is constantly in her own shadow.

Amer

The  
which  
ment  
Gas C  
ing th  
most  
ciple  
flow  
stor  
tion  
the c  
may  
appre  
design  
friger  
the w  
house  
time  
That  
dustr  
kitch  
Kitch  
to ge  
Con  
kitch  
kitch  
throu  
with  
tions  
and t  
which  
house  
Th  
effici  
tages  
may  
appli

We  
incre  
plan.  
work  
impa  
waste  
space  
a wa  
ter s  
corn  
back  
struc  
shou  
ters  
areas  
The  
how  
weig  
wall

W  
for  
exha  
wall  
cause  
pulle  
posit  
befor  
small  
over  
cook  
and



There are certain basic principles which the kitchen planning department of the Southern California Gas Company utilize in approaching the design of any kitchen. Foremost among them is the 1-2-3 principle of triangulation, the natural flow of food from refrigeration and storage space, through the preparation center at the sink, and on to the cooking and serving centers. It may be difficult for a mere man to appreciate it but actually a poorly designed kitchen with range, refrigerator, storage and counters in the wrong places can mean that the housewife has to spend *twice as much time and effort* to get her work done. That's why the American Gas Industry calls the well-planned kitchen "The New Freedom Gas Kitchen"—it enables the housewife to get things done easily.

Considering first the shape of the kitchen we find that the U-shaped kitchen is the most efficient because through traffic does not interfere with preparing and cooking operations and because all appliances and their work centers are adjacent which means greater ease for the housewife during meal preparation. The L-shaped kitchen is next in efficiency, the principal disadvantages being that through traffic may interfere and that the major appliances may be too far apart.

#### Doors and Windows

Well located doors and windows increase efficiency of the complete plan. Valuable storage space and working centers may otherwise be impaired. Doors near corners waste space. If practical, a door space should be near the center of a wall to permit a cabinet or counter surface to be installed in the corner. A door should not swing back against a counter if it obstructs a working center. Windows should be located over work centers wherever practicable. Eating areas should also be near windows. The advantage of large glass areas, however, should be carefully weighed against the loss of needed wall cabinets.

#### Kitchen Ventilation

Windows alone are not adequate for ideal ventilation nor will an exhaust fan placed on an opposite wall from the range do the job because the greasy vapors will be pulled across the room and deposited on the walls and ceiling before they can be exhausted. A small blower placed in a cabinet over the range will provide the cooking area with ample fresh air and whisk away heat, odors and

vapors before they can be spread into the room. The air control cabinet, as it is usually referred to, should be designed to include removable, cleanable filters to remove the grease particles before the air stream enters the ducts which carry the air outdoors.

#### Storage and Preparation Center

The flow of food starts from the service porch or entrance to the refrigerator and this latter appliance should therefore be located near the service entrance. Adequate counter space and both base and wall cabinets should be provided in this area for storing supplies and utensils used in mixing foods. Either a large drawer or a cabinet at counter level should be provided for the electric mixer. Cabinet space above the refrigerator provides additional storage space, ideal for cereals and soda-crackers which will be kept crisp.

#### Washing and Cleaning Center

If possible the sink should be placed on an outside wall under a window where there is a nice view and where light is abundant. The sink is the washing and cleaning center and should have ample work space on both sides.

#### Cooking and Serving Center

The gas range should be placed close to the other two centers and near the dining room or other principal eating area. Counter space should be provided at each end of the range to simplify cooking and service operations. The length of a base cabinet between the range

and a corner of the room should not be less than 15 inches. If this cabinet adjoins a counter at right angles, the space in the corner is of little value, unless revolving shelves are installed or some access to the space at the back of the counter is provided. A cabinet or decorative unit above the range improves the appearance of the center and may be used to conceal a blower, as previously mentioned. Compartments may be provided within easy reach of the range to store all utensils and supplies used at the cooking and serving center.

#### Counters

A continuous counter should combine the work center and serving center into one unit wherever possible. A special installation may be made with the range and end counters as a single unit, or a sink unit may be used to form part of a continuous surface. Counters recessing the range should be made 25 to 25¼ inches deep to approach as nearly as possible a straight line with the face of the range.

A return counter will simplify serving to the kitchen eating area and will provide space for dishes returned from the dining room. The counter may be designed as a breakfast bar either 30 or 36 inches from the floor; a cabinet over the return counter may be built for the storage of china.

#### Cabinets

Few housewives ever have enough storage space so the more cabinets you can install the better  
(Continued on page 148)



**TWO-WALL** or corridor type kitchen situated between laundry area and breakfast area. This arrangement is mandatory for a small kitchen that is accessible at opposite ends.

# AMERICAN BUILDER

## Blueprint House

### Number 36

Walter T. Anicka, Architect

## *Everyday Building Methods Can Be Used*

**A** DETAILED analysis of the current Anicka blueprint house, together with an analysis of previous Anicka designs submitted for use in this section, brought out the fact that this designer adheres to a definite set of sound principles or patterns during the embryo or formative stage of the design. These principles are considered in the light of a group of "must's."

First: the house must be practical in its design. This is accomplished in the selection and application of exterior materials sympathetic with its character. The arrangement of the fenestration and orientation of principal features together with simple and effective roof lines complete the exterior assembly.

Second: the planning must be sound. Rooms should be compactly

arranged with ample closet space, a minimum of halls, and good circulation. The elimination of excess external corners in the over-all plan profile is a measure that promotes economy in construction.

Third: framing should be simple and straightforward. This can be done by having windows and doors built and spaced in the walls on a modular basis, thus avoiding unnecessary cutting. Partitions and room dimensions are arranged to conform to standard size framing members, with roof lines kept simple so that framing can be either by conventional methods, or by truss fabrication and assembly.

Anicka finds that when he holds sharply to this type pattern, he develops a house that can be reproduced in permanent materials by any builder at minimum cost.

He applied these principles in their entirety to the house shown below. A refreshing note is indicated in the large window divided with heavy muntins located in the front wall of living room. This window together with the vertical plywood panels and battens on wall surface within the limits of the covered terrace and entrance door create a central motif that can be made interesting through the application of a dark shade of paint that contrasts with the sidewalls.

Protection from the sun's rays during the summer is provided by the extension of roof line over the large center window. Diagonal 2x6-inch vertical supports are placed on each side of the overhang. This pattern is repeated in roof line of the garage which when extended provides shelter from house to garage.

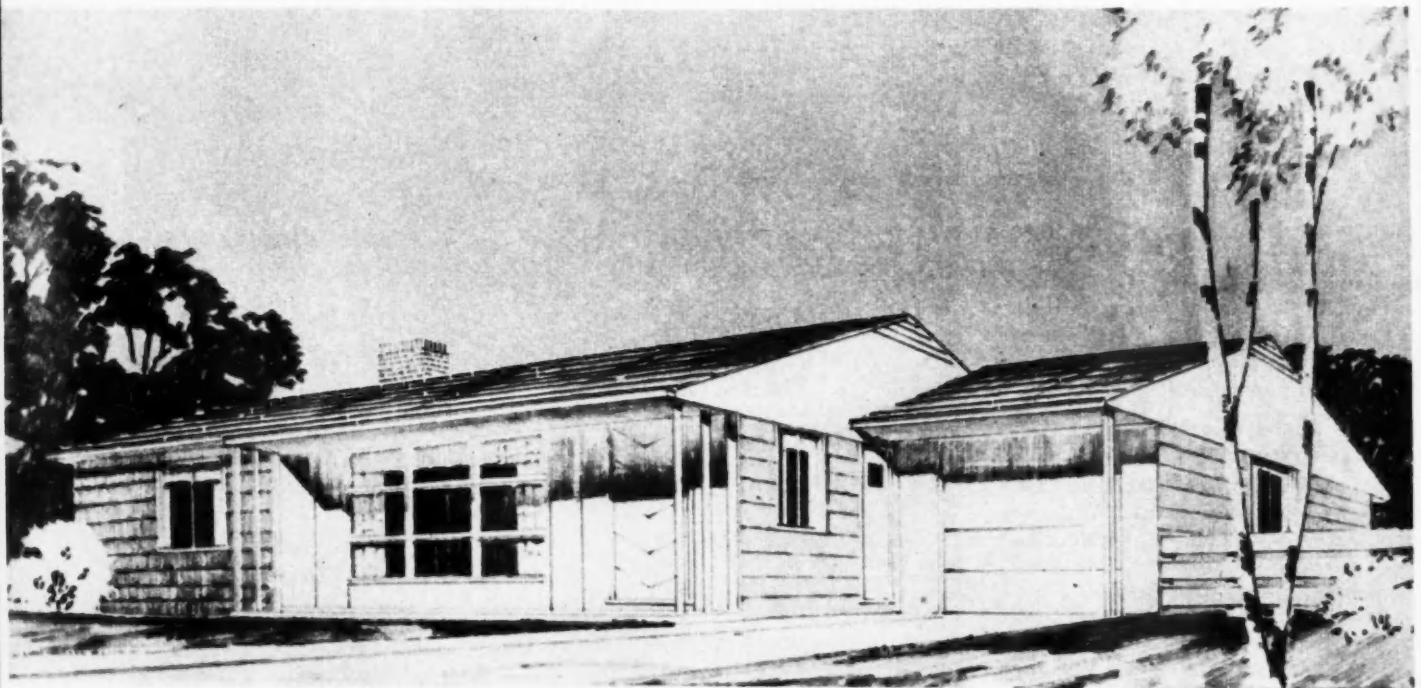

AM  
WAL  
Ann  
Simmo



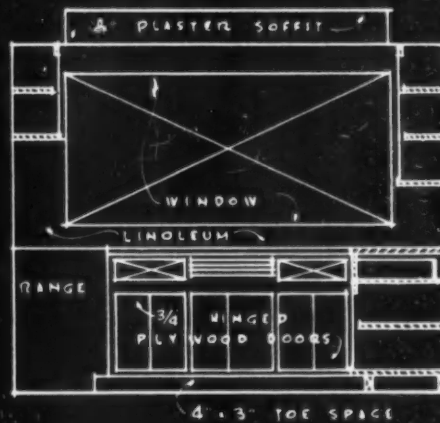
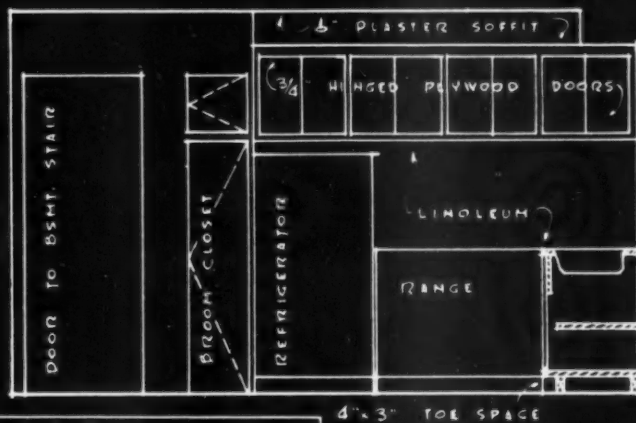

DESIGN NO. A.B. 149  
 AMERICAN BUILDER BLUE PRINT SERIES  
 Designed By  
 WALTER T. ANICKA ARCHITECT.  
 Ann Arbor Michigan.  
 Simmons Boardman Pub. Corp. 79 W. Monroe St. Chicago, ILL

KITCHEN DETAILS

SCALE: 1/4" = 1'-0"

NOTE: VERIFY S.I.

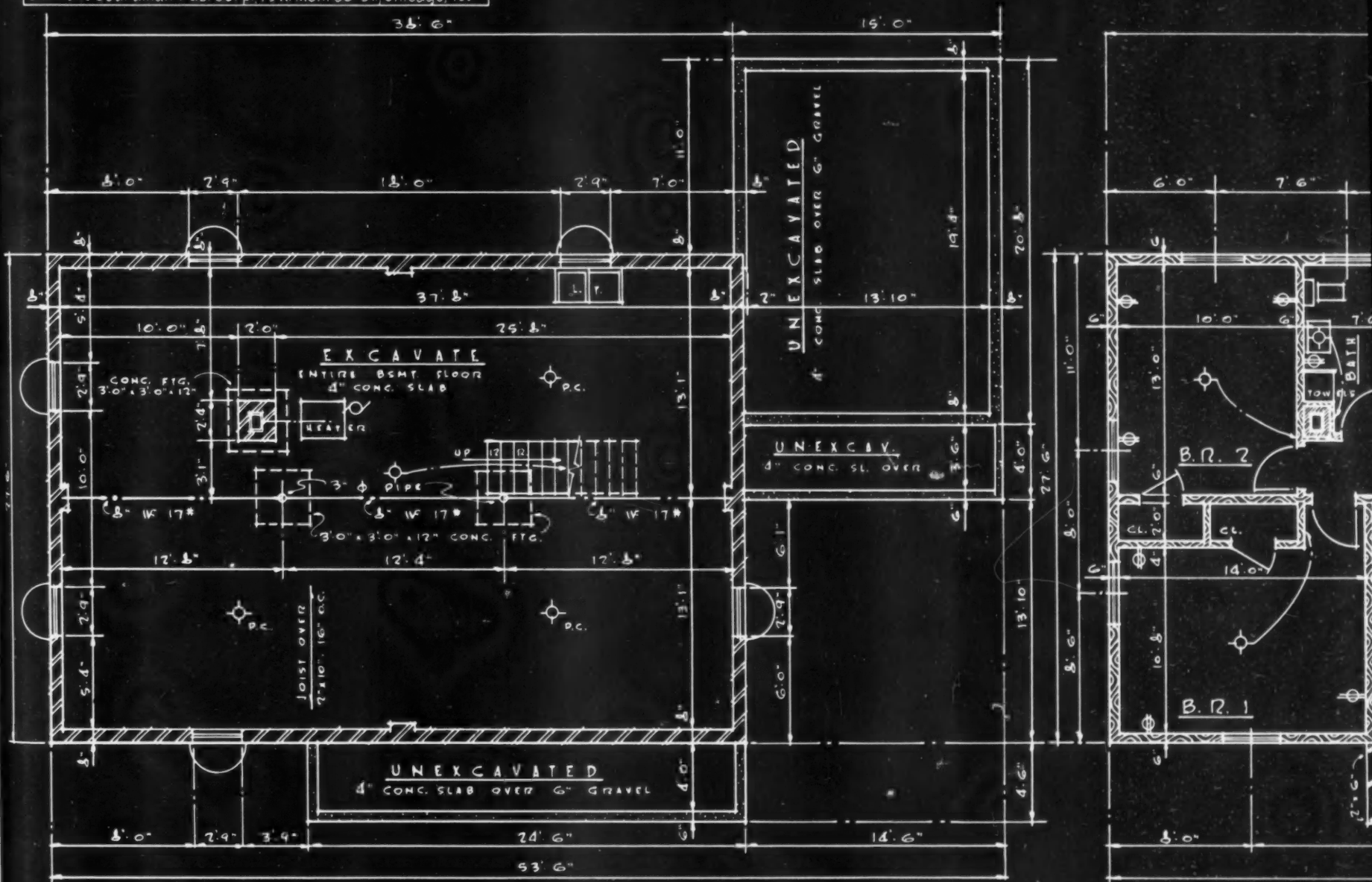

BASEMENT PLAN

SCALE: 1/4" = 1'-0"

FIRS



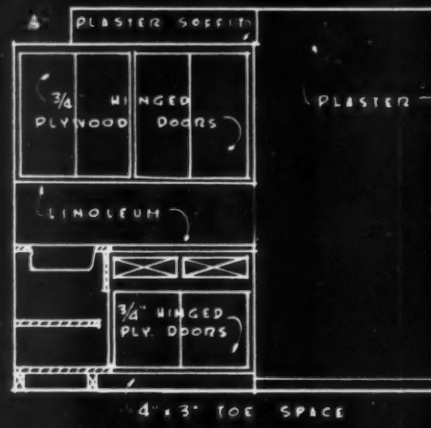
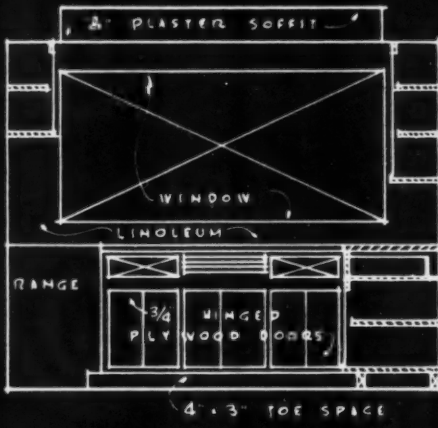

# KITCHEN DETAILS

SCALE: 1/4" = 1'-0"

NOTE: VERIFY SIZES OF ALL APPLIANCES

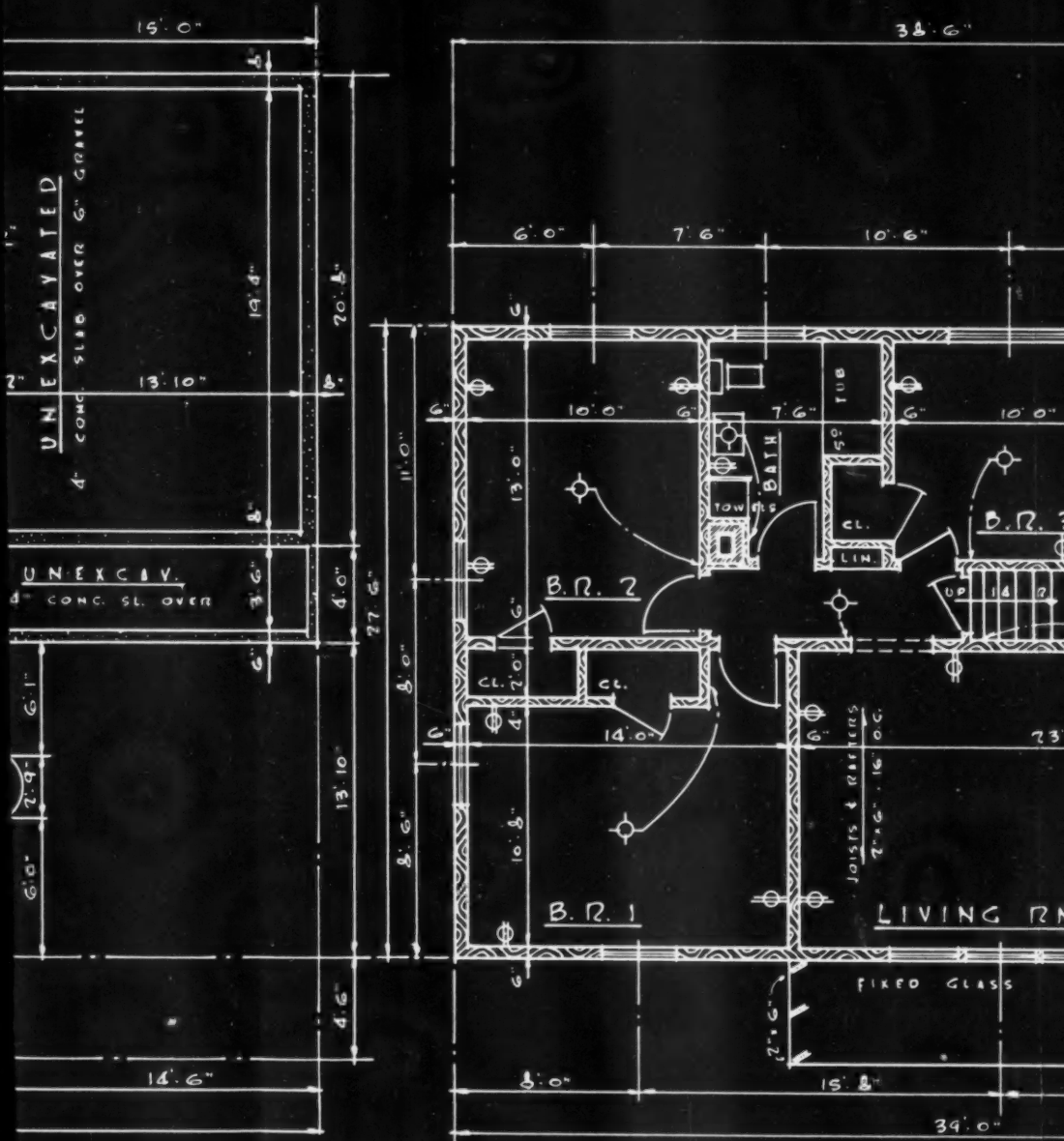

# FIRST FLOOR

SCALE: 1/4" = 1'-0"



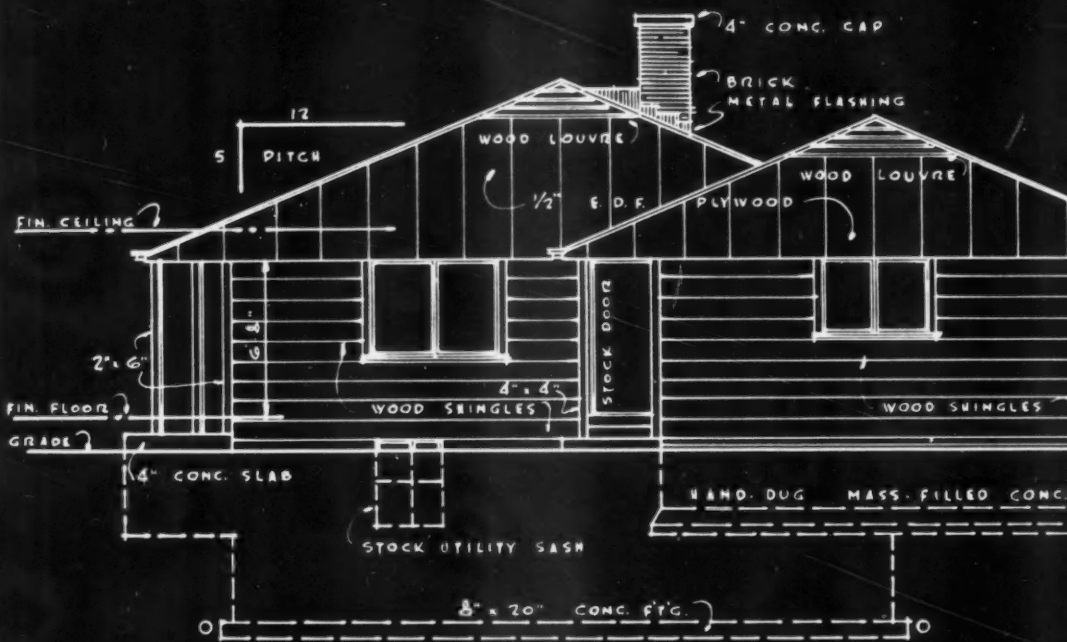

RIGHT ELEVATION.

NOTE

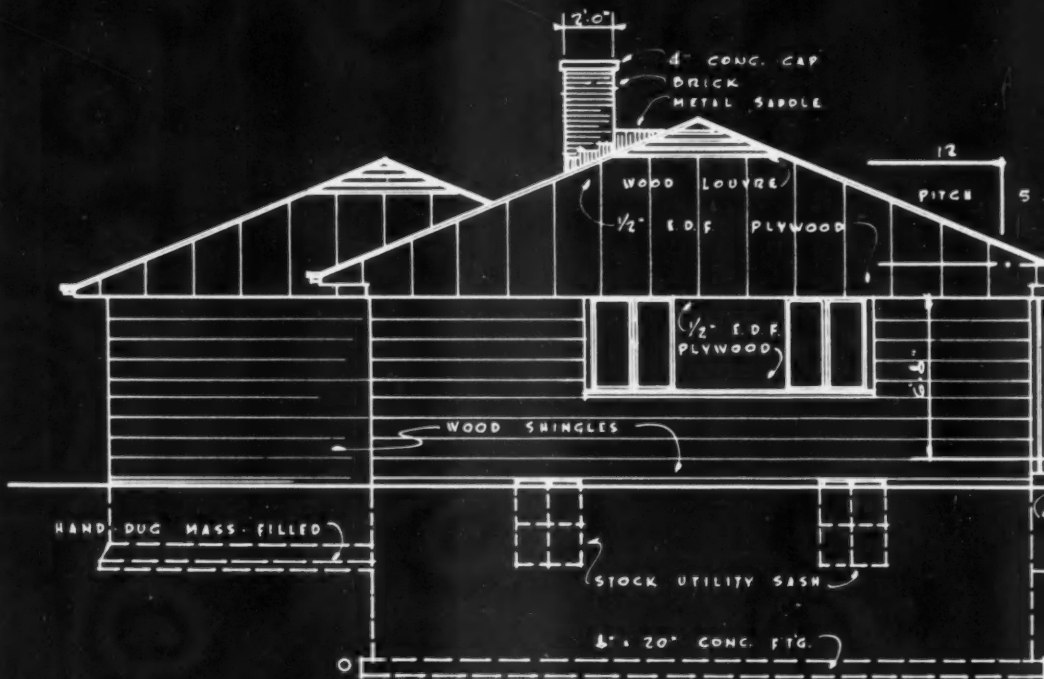

LEFT ELEVATION.



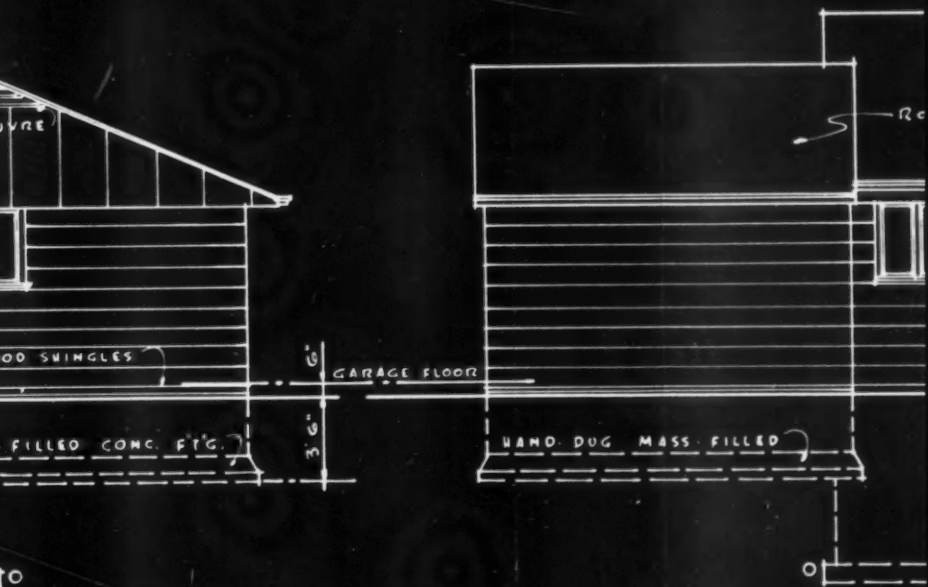

NOTE ELEVATIONS SCALE  $\frac{1}{8}'' = 1'-0''$

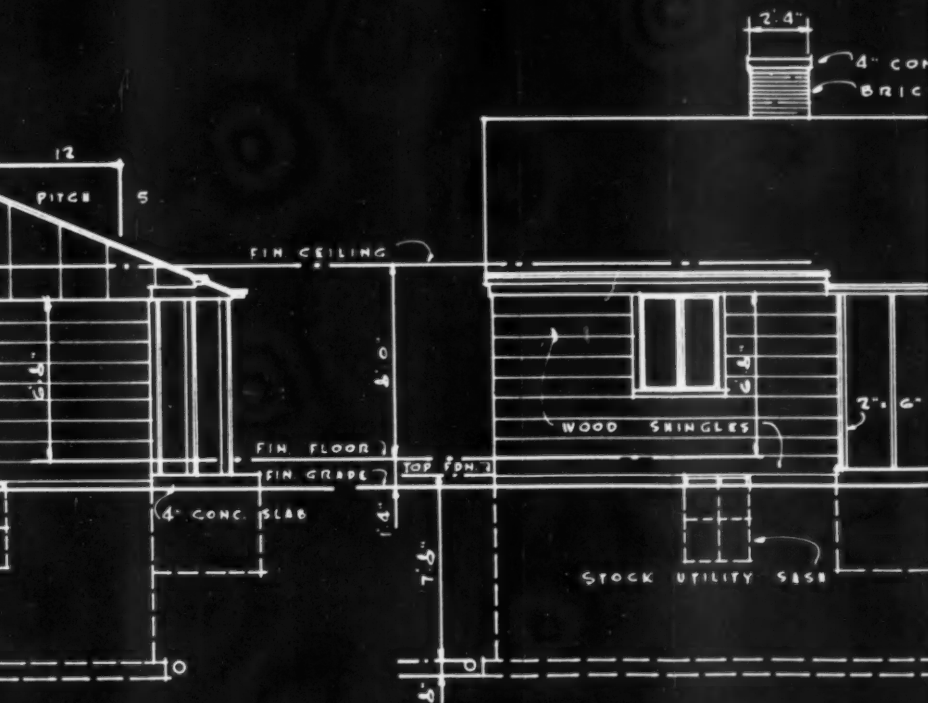

F 12

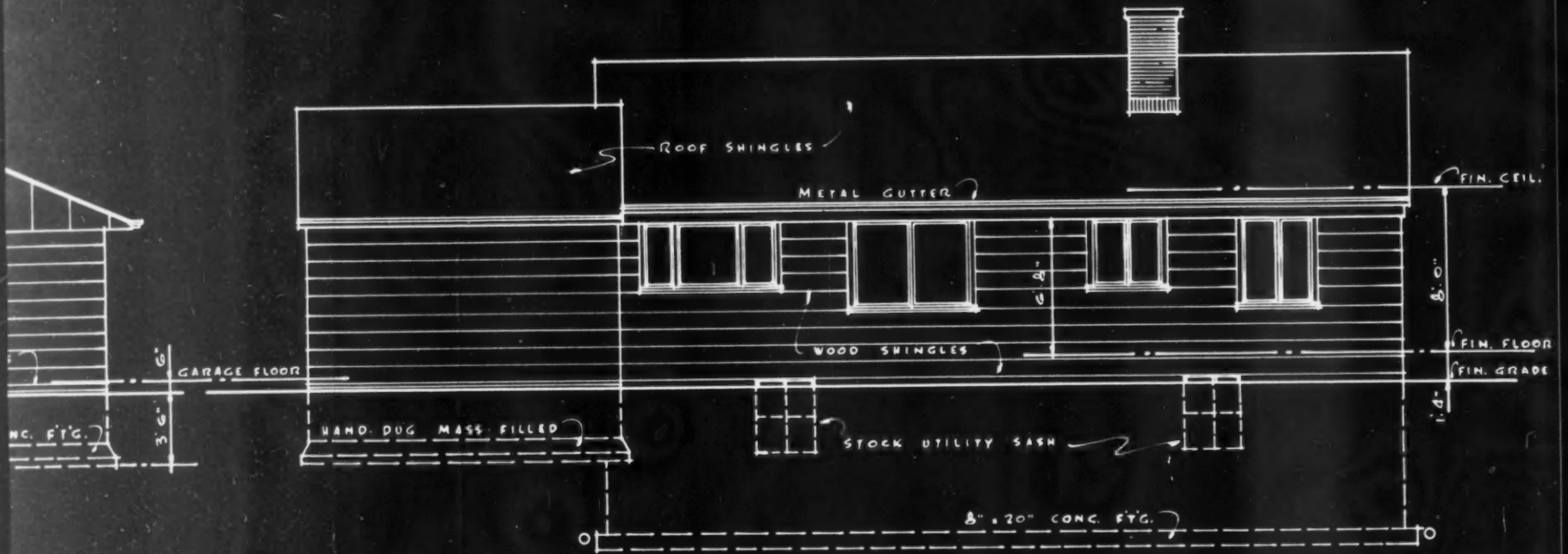

REAR ELEVATION.

ELEVATIONS SCALE 1/8" = 1'-0"

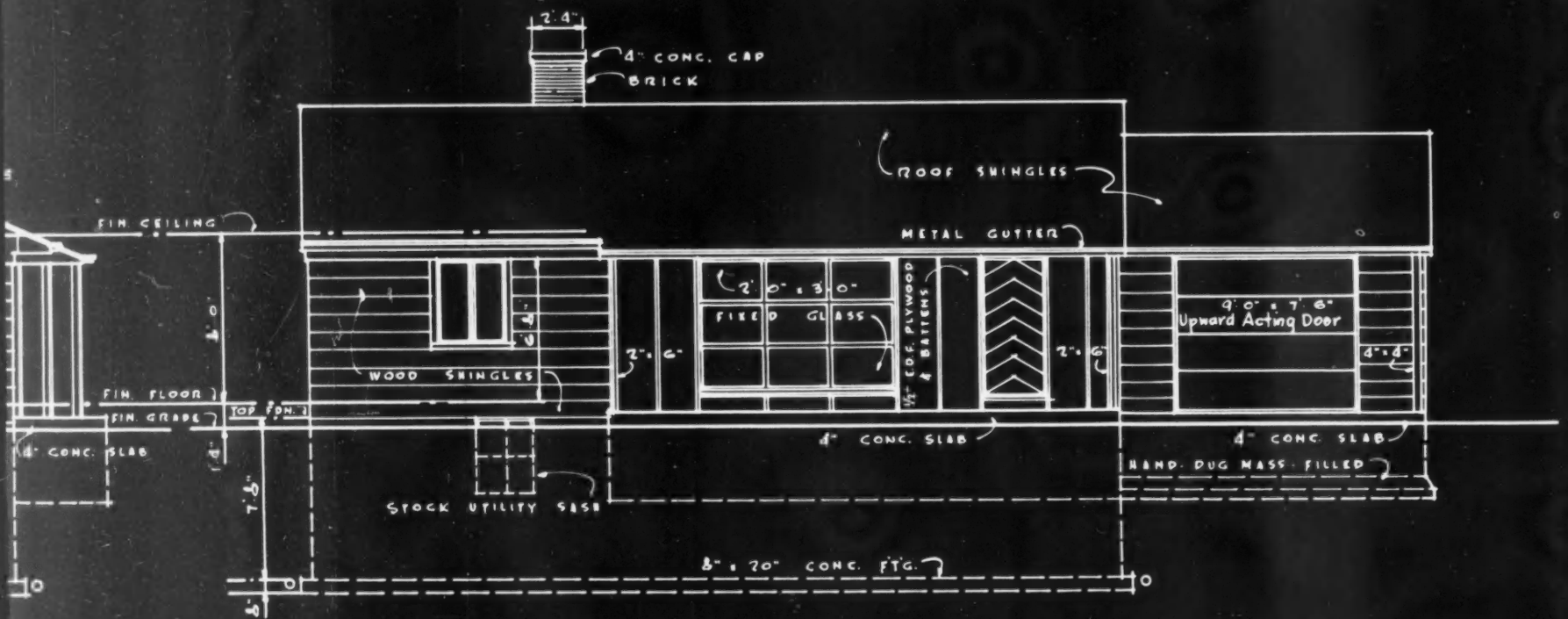

FRONT ELEVATION.

## Performance of A Typical Baseboard Heating System

National Bureau of Standards  
U. S. Department of Commerce



**TEST** bungalow constructed at National Bureau of Standards for research in heat transfer in small houses. All rooms except bath have movable ceilings that can be adjusted to any height between 7 and 9 feet by overhead screw jacks. (Right) Bungalow is completely enclosed within an insulated enclosure so outside temperature can be maintained at any temperature condition encountered throughout the U. S. Floor plan shows piping circuit and location and size of baseboard convector elements as installed for performance study

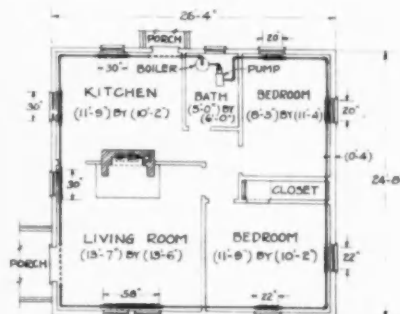
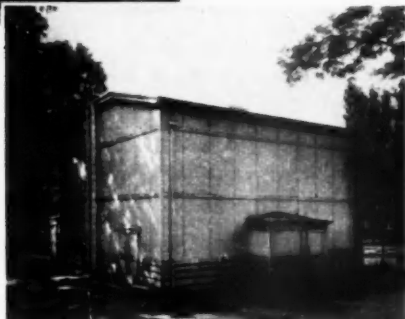

**T**HE use of baseboard heating systems in low-cost housing has increased in recent months, particularly in basementless houses where a first-floor heating system is necessary. In order to acquire adequate technical data on systems of this type, the National Bureau of Standards included an investigation of a typical baseboard heating system as part of its broad program on heat transfer phenomena in small houses. The tests covered the temperature distribution in a four-room test bungalow under various outside temperature conditions, in addition to the installation and operational problems involved. A study of the characteristics of two types of room-temperature controls with such a system was also made. In spite of certain inherent disadvantages—mainly the difficulty of fitting the system to the variable dimensions of conventional houses and the inability to control the heat output to individual rooms—the Bureau's results indicate that the baseboard heating system provides more comfortable environments in homes than many of the systems used in the past.

The various combinations of dry-bulb temperature, relative humidity, and air motion necessary to provide comfortable conditions in homes in the United States have been established by the American Society of Heating and Ventilating Engineers for convection heating. In practice, however, many heating systems provide regulation of the

dry-bulb temperature only accompanied by a partial, indirect control of relative humidity and air motion in the living space.

The temperature differences from the floor to head level and from room to room are also important in judging the comfort provided by a heating system. Satisfactory uniformity is often difficult to attain with inexpensive heating systems. A great many small houses have been built in recent years with concrete floors laid on the ground or with floors laid over shallow crawl spaces. This construction has necessitated placing the heating plant on the first floor in most cases and has eliminated any direct warming of the under side of the floor.

Several types of baseboard heating systems have been developed recently; some use hollow cast-iron elements, either finned or unfinned, and others have finned steel pipe or finned copper tubing with shields or covers partially enclosing the heating elements. These systems use elements not much thicker or higher than a baseboard around the entire perimeter of the living space. An additional advantage claimed for this type system is that the heating elements are almost entirely removed from the useful living space.

The baseboard heating system installed in the test bungalow at the National Bureau of Standards consisted of lengths of finned 1¼-inch iron pipe under the windows connected by unfinned 1-inch

standard pipe and partially enclosed by a perforated sheet-metal cover. The fins were 3½ inches square and were spaced ¼ inch apart on the pipe. Heat was transferred primarily by convection of air through the enclosure and over the finned surface. Hence the system has been termed a baseboard convector heating system.

Two types of controls were used for the tests: (1) a conventional wall-type electric thermostat and (2) a modulating control employing an outside thermostat and a three-way valve that mixed the boiler supply and return water to vary the temperature of the water entering the system.

The Bureau's test bungalow, which conforms to FHA specifications for a low-cost house, is completely enclosed by an insulated outer shell so that the temperature may be varied to simulate any condition throughout the United States. It is of frame construction and has four rooms and a bath, which are connected by a hallway near the center of the house. There is a full basement under the living quarters, although this feature was not a consideration in the present tests. The outside walls of the structure are of conventional frame construction and consist of 2- by 4-inch studding with sheathing and lap siding on the outside separated by a layer of building paper. The inside wall finish consists of ½-inch plasterboard nailed directly to the

(Continued on page 130)





**THRIFT HOUSE**, constructed by W. L. Bridges and Son Co., embodies maximum electric utility and beauty for minimum price

HERE is proof that electrical planning can enhance the value of a home in any price range. The Indianapolis Power and Light Company, in conjunction with the Better Homes Bureau of the Westinghouse Electric Corp., sponsored the construction of four houses in Indianapolis to demonstrate the part electricity plays in modern living. The exhibition called "The Four Degrees of Electric Living,"

revealed that the modern mode of electrical living is available, in varying degrees, to every family building or remodeling a home. Each "degree" represented a particular price range.

The builders of these four houses are all prominent in Indianapolis building circles: Thrift House—W. L. Bridges and Son, Inc.; Budget House—Albert E. Thompson Co.; Ideal House—Meridian Construction Co.; Deluxe House—Robert L. Mason.

The electrical equipment that has gone into these homes is not sensational. The distinction is in steps saved, in comfort felt, and in the safety and charm of balanced electrical utilities. Fixtures and appli-

ances are those available at the neighborhood electric shop.

The construction companies furnished their own plans for the undertaking. These are not "model homes"; they are traditional and practical in construction and design. Westinghouse Electric Corporation's planning experts, and the Home Service Division of the Indianapolis Power and Light Co. aided the builders with their knowledge of home electrical requirements.

Three essential tasks and needs in the home are fulfilled by electrical power. They are: laundering and cleaning, preservation and preparation of food, and lighting. The problem of planning to meet these three requirements is qualified by the degree of luxury expected and by the necessity for providing for future additions to these needs. This is the point of departure that governed the distinctive planning for these four homes.

Fundamental, however, in all four is the basic wiring system. In quality, this system is the same in all. Conventional wiring methods are used with metallic and non-metallic sheathed cable, number twelve. But, where the average house is provided with only four

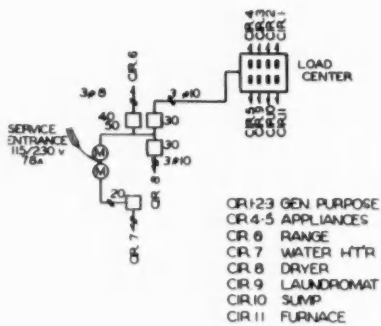

WIRING DIAGRAM

**LEFT: Thrift house wiring harness provides ample power for this degree of electric living. Below: Floor plan of the Thrift house. Kitchen has complete electric package, and parallel work areas**



FLOOR PLAN

**Appliances by Westinghouse Electric Corp. installed in the Thrift house.**

Refrigerator	D-7
Range	E-64
Water Heater	4952-5G2
Laundromat	RL-1
Clothes Dryer	D-1
Ventilating Fan	10 PHV

# for Modern Electrical Living

**"Four Degrees of Electric Living" demonstrated by actual installation of electrical conveniences and utilities in four Indianapolis homes shown during National Home Week**

Circuits to meet minimum specifications for "wiring for safety," these buildings are equipped with from eleven to seventeen circuits to meet fully the need for electrical energy within the four "degrees." In these homes, the wiring costs ranged from one to 3.5 per cent compared with two per cent for the usual house.

Although the use of fuseless load centers is not an innovation, the treatment here is interesting since all four homes have fuseless centers. All except the Thrift house have fuseless distribution centers on the first floors. Separate circuit breakers control segments of the electrical power so that only part of the household need be without electricity in an emergency. The use of the Quicklag Loadcenter, manufactured by the Westinghouse Electric Corp., in strategic locations eventually saves the household time, effort, and inconvenience. (See floor plans.)

Central ceiling fixtures are employed in the kitchens of all four of these houses to meet the requirements of general illumination in this work area. Incandescent bulbs furnish the general light in the Thrift and Budget homes. In the Ideal house fluorescent fixtures are used in the kitchen and in the adjacent laundry. Both fluorescent and incandescent sources are utilized in the Deluxe house.

Local lighting in the four kitchens meets the most stringent demands, but a somewhat more resplendent treatment is accorded the local areas in the Ideal and Deluxe houses. Where incandescent bulbs are used in the Thrift and Budget kitchens, fluorescent tubes furnish lighting in the more expensive versions of electrical living—the Ideal and Deluxe degree.

The modern tendency is to eliminate the central ceiling fixture in the living room. These homes, of course, are without that ceiling device. Fluorescent



**BUDGET HOUSE**, by Albert E. Thompson Co., features Waste-Away unit and bathroom heater

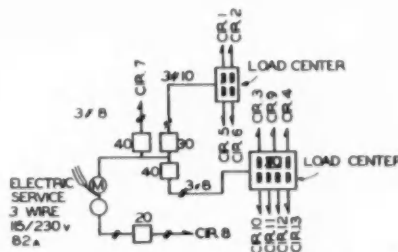

- CR12-34 GEN PUR
- CR 5-6 APPLIANCES
- CR 7 RANGE
- CR B WATER HTR
- CR 9 DRYER
- CR 10 LAUNDROMAT
- CR 11 SUMP
- CR 12 FURNACE
- CR C BATHROOM HEATER

WIRING DIAGRAM

RIGHT: Two load centers are used in Budget house, one is on the first floor. Below: Budget house floor plan shows broken L-type kitchen with breakfast bar

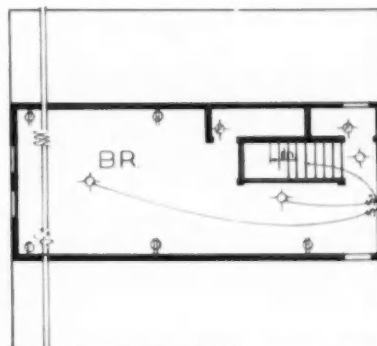

SECOND FLOOR PLAN

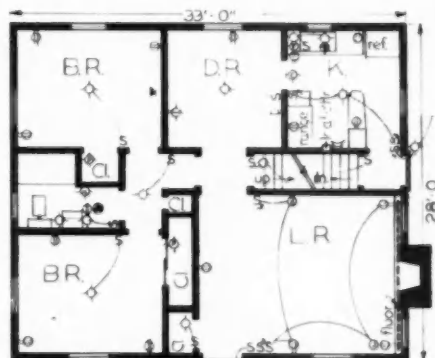

FIRST FLOOR PLAN

**Appliances by Westinghouse Electric Corp. installed in the Budget house.**

Refrigerator	D-9
Range	D-74
Water Heater	4966-SG2
Laundromat	RL-1
Clothes Dryer	D-1
Ventilating Fan	10 PHV
Waste-Away	G-4
Bathroom Heater	B-1.25





**IDEAL HOUSE**, of Meridian Construction Co., contains added conveniences such as three-way switches and dishwasher. Fluorescent lighting supplements interior decor

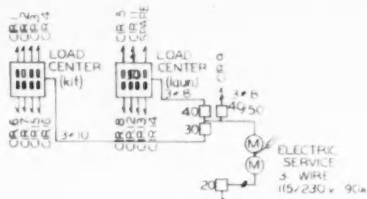

- OR 12 345 GEN PUR
- OR 6 7 8 APPLIANCES
- OR 9 RANGE
- OR 10 WATER HTR
- OR 11 DRYER
- OR 12 LAUNDROMAT
- OR 13 ELECT. SINK
- OR 14 BATH HTR
- OR 15 PUMP
- OR 16 FURNACE

**LEFT: Wiring harness of Ideal house includes expansion provisions at center. Below: Practical and spacious floor plan provides for extensive electric living**

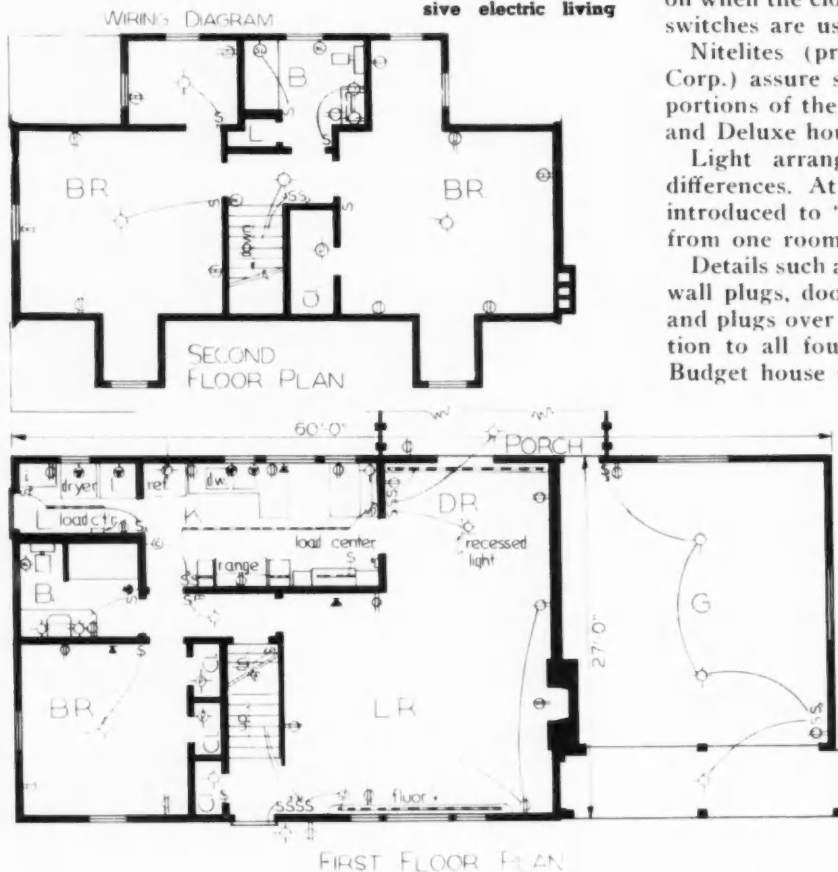

tubes in valances provide both useful and decorative lighting in all four living rooms. The use is more extensive in the Ideal and Deluxe houses where valance lighting is also generously employed in the dining rooms. These dining rooms are given an added touch by recessed ceiling spotlights designed to heighten dining room table decor. Transformers for the fluorescent equipment are installed in the basements.

Silver bowl bulbs furnish light in all major closets. One closet in the Thrift, Budget, and Ideal houses is equipped with an automatic switch that turns the light on when the closet door is opened. Five such automatic switches are used in the Deluxe house.

Nitelites (product of the Westinghouse Electric Corp.) assure safe nighttime illumination in strategic portions of the homes. Two are installed in the Ideal and Deluxe houses.

Light arrangements exemplify these degrees of differences. At the Ideal level, three-way switches are introduced to "light the way ahead" as one advances from one room to another.

Details such as telephone outlets, exterior all-weather wall plugs, door chimes, kitchen fans, garage outlets, and plugs over work space in the kitchens add distinction to all four levels. The bathroom heater in the Budget house reflects somewhat more extensive elec-

Appliances by Westinghouse Electric Corp. installed in the Ideal House.	
Refrigerator	D-11
Range	B-74
Water Heater	4980-DG2
Laundromat	L-4
Clothes Dryer	D-1
Ventilating Fan	10-PHV
Waste-Away	G-4
Bathroom Heater	B-1.25
Ironer (Ironrite)	
48" Dishwasher	
Home Freezer	F-6





**DELUXE HOUSE**, built by Robert L. Mason, epitomizes the maximum in electric living. Appliances have full complement of convenience features. Sunlamp, night lights, automatic closet switches add to household happiness

trical plans, as does the sunlamp, directed over the tub-shower, in the Deluxe. The common room of the Deluxe house is illuminated by flush fluorescent ceiling fixtures that add a notable decorative effect.

The appliances used reflect the relations of the four houses and the four corresponding "degrees." All four groups meet the basic household needs in a more-than-adequate fashion. Variations in tastes, demands, and incomes are reflected in the size of the electrical package. The equipment is listed below.

The three functions mentioned above (i.e., cooking, cleaning, light) are variable, not only with the size of the family, but with the general pattern of family life. All four of these houses are equipped to meet these demands completely, but beyond the utilitarian aspect, aesthetic considerations promote differences.

A general summary of the wiring systems follows:

House	Price	List price of electrical package	Number of circuits	Number of Duplex outlets
Thrifty	\$12,750	\$1,059	11	25
Budget	15,500	1,374	13	28
Ideal	27,500	2,360	16	37
Deluxe	37,500	2,724	17	40

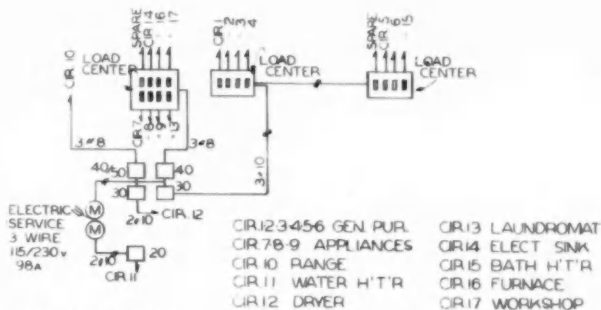

WIRING DIAGRAM

ABOVE: Circuit diagram for Deluxe house. Right: U-type kitchen of house combines utility and beauty effectively



BELOW: A "commons" distinguishes the Deluxe plan

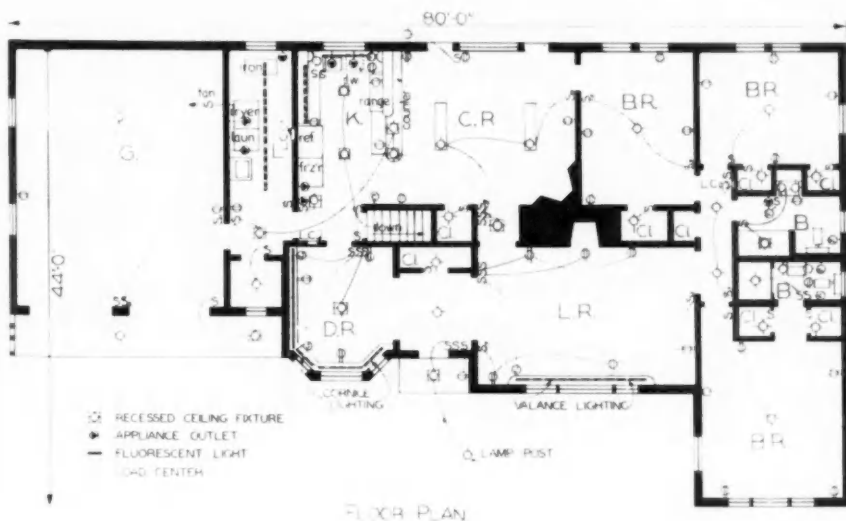

Appliances by Westinghouse Electric Corp. installed in the Deluxe house.

Refrigerator	A-10
Range	A-774
Water Heater	4980-DG2
Laundromat	L-4
Clothes Dryer	D-1
Ventilating Fan	10 PHV
Waste-Away	G-4
Bathroom Heater	B-1.25
Ironer (Ironrite)	
48" Dishwasher	
Home Freezer	F-6

# Salute to Courage

By R. E. Saberson



**L**AST year when the residential construction curve began to dip downward at times, it frequently was heralded as a bad sign by those who study trends and come up with the answers.

Nevertheless, 1948 finished in a blaze of glory, so to speak, and went down in the records as one of the biggest home building years in history.

Came 1949 with its early uncertainties and fears. There was much talk of an impending depression. Only question in the minds of many was how long it would last . . . and the degree of its severity. Fear began to feed on fear. Many businessmen, certain that this was "it," ran to cover. Inventories of building materials were reduced drastically. Replacements were held to a minimum. Something was just around the corner . . . and it was not prosperity.

Once again the home building industry took the bit in its teeth and decided to go its own way. Beginning in June, each month showed a substantial increase in starts with the result that '49 promises to break all existing home building records for a single year.

Of a certainty it can now be pointed out that the home building industry exhibited a brand of courage in 1949 that was conspicuous by its absence in other industries.

But that isn't all there is to the story.

Not only did the industry roll up an impressive record as far as the number of residential units was concerned,

it likewise produced homes which promptly began to dispel the erroneous idea that houses again would never be within reach of the average family and that if such were the case no one would want to live in them.

Thus an industry that was called upon to do the impossible, at the close of the war, has already found a way to do it in a manner that entitles it to a hearty salute.

Naturally, today's homes are not the final answer. No one claims this to be the case. On the other hand, such vast progress has been made in a remarkably short time that little is heard these days about the housing emergency that was the subject of nation-wide discussion not long ago.

Remember when the bureaucrats discovered to their great consternation that the building industry was wholly inadequate to meet the pentup demand for homes? Remember, too, how the "expeditors" were rushed to Washington to lead the homeless nation out of the land of the wilderness and cause millions of houses to grow where none grew before? Remember the grave concern of the Congressmen who pledged their hopeful constituents that laws would be passed pronto which would solve the housing problem once and for all? Remember the promises that were made by the promoters of new methods of construction which would turn out luxurious homes at fantastically low prices in streamlined factories that would surpass all previous efforts of the automobile industry?

It v  
Mater  
with  
But  
buildi  
men  
great  
when  
Howe  
was

Du  
despi  
a "he  
strate  
repre  
been  
have

W  
tom-t  
it w  
pro  
build  
clined  
and c

By  
even  
began  
took  
it di  
press  
deale  
hesita  
migh  
Marl  
reaso  
popp

As  
the  
every  
to ta  
keep  
gran

De  
buil  
And

No  
That  
the

To  
mon  
the  
in r  
whic  
and  
Ame

Re  
stan  
gues  
buil  
buil

St  
wher  
Nev  
shor  
cour  
of w  
of it  
has  
give

A  
salu

It was a tough period for the home building industry. Material shortages were the order of the day. Same way with mechanics. It was hard to get going.

But the industry took what it could get in the way of building materials and had them put together with such men as were available. True, the results often were no great shakes in the way of homes and the prices were high when compared with what they had been in the past. However, this situation did not apply to homes alone. It was true of everything else.

During it all, the home building industry kept operating despite the blundering efforts of the bureaucrats to lend a "helping" hand. By this time it has been well demonstrated that if the political aspects of the situation (as represented in the OPAs, rent controls and such) had been abolished earlier, the great housing shortage would have been on its way to a solution much sooner.

With Government do-gooders beating their political tom-toms and with shortages of all kinds to contend with, it would have been easy to wait for conditions to improve, before tackling the job. But the many thousand builders who make up the vast industry were not so inclined. There was a job to be done and they sailed right in and did it under exceedingly difficult circumstances.

By 1949, the home building industry was faced with an even more difficult problem. Fear of an economic setback began to rear its ugly head. But once again the industry took a hitch in its belt and demonstrated conclusively that it didn't believe all it heard about an approaching depression despite the fact that many building material dealers were striving valiantly to empty their bins and hesitating to refill them. Declining prices conceivably might cause home prospects to wait for further drops. Markets might suddenly dry up. Dozens of perfectly good reasons for not doing anything for the time being were popping up on every side.

Assuredly, it took plenty of courage to try and run with the ball when the boys at Washington were throwing every conceivable block in order to gain an opportunity to take over the play. But it required even more faith to keep headed for the goal when those in the well-filled grandstand began to shout warnings and run for the exits.

Despite all this, the home building industry kept on building houses . . . better, cheaper, more efficient homes. And it is still doing it.

Nor was the industry content merely to erect them. That perhaps was the easier part of the job. Until sold, the structures were merely a liability.

To plan, finance, erect and sell a home takes brains, money, mechanical skill and plenty of selling ability. When the industry did the kind of a job it did in '48 and then, in the face of the discouraging psychological situation which prevailed in the spring of '49, turned right around and repeated the performance, it has what it takes to keep America the greatest home-owning nation in the world.

Regardless of the political gyrations which go on constantly in Washington . . . and irrespective of the bad guesses of business and studious economists, the home building industry in a confident sort of way keeps right on building and selling homes.

Since the war ended there has not been a single moment when all factors were favorable to home construction. Nevertheless and notwithstanding, the great housing shortage has been melting away under the impact of a courageous industry. It is a bright and shining example of what American competitive enterprise can do in spite of its many handicaps and without benefit of subsidies. It has demonstrated its ability to well take care of itself if given half a chance.

At the close of another great home building year we salute it!

## How Builders SELL HOMES

**This is the third article in a series being published exclusively in American Builder detailing the ideas of outstanding home builders on successful public relations, promotion and sale of houses in all price classes.**

**T**HE selling of homes starts a long time before you have gotten to that point," says a St. Louis, Mo., builder. "Your subdivision location with reference to transportation, schools, churches, shopping centers—all these things are important.

"Homes that you are going to offer have to be a real product, they have to be salable and just as complete as the price will allow. To merchandise successfully on a volume basis, your homes have to be priced in a bracket where there is a volume demand.

"Right now we have two salesmen working on commission, and they're *selling* houses. We have a frame house subdivision where every house is priced at less than \$10,000. I have one salesman on a straight salary and he is taking orders for houses . . . Where you have a sales problem, you have to have more than one salesman so there is competition between the salesmen . . . and the subdivision has to be of such size that the commission to the salesman gives him a pretty good annual return."

**A LARGE DISPLAY ADVERTISEMENT** is used by this firm in opening a new subdivision. "We attempt to enumerate not only features of the house, but the subdivision as well," the builder says. "Every Sunday we follow up with a display ad attempting to key it either to the number of homes sold or to some particular phase of the subdivision or else to current events, pointing out that monthly payments are lower than rent on comparable living quarters. We also run small daily classified ads on the subdivision."

**DEMONSTRATION HOME IN EVERY SUBDIVISION.** "In every subdivision we have a demonstration home," the builder continues. "In these houses we have cards printed and attached to the various features of the home. For instance, on the walls, we place a card saying that we use dry-wall construction and a sand finish oil paint. A card with a streamer runs up to the scuttle hole in the attic indicating that the walls are furred out. One in the kitchen runs to the ventilating fan, another to the sink cabinet pointing out that it's an American Central All Steel sink."

**"PEOPLE ARE BEING CONSERVATIVE** in their spending," the builder continued. "We are going to have to work a little harder to separate them from their cash.

"Under normal circumstances every year there are families who want to move out of rented quarters and buy a home. Incidentally, I'm not referring to G.I.'s. The average age of the buyer is thirty-five—and that's the group I'm talking about. During the war years, there was nothing built for them. For several years after the war, because of stringent regulations we were limited in selling only to veterans. I feel, therefore,

(Continued on page 138)



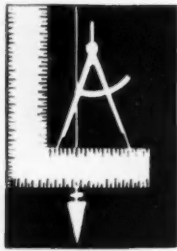

# TECHNICAL GUIDE for Builders and Craftsmen

## A New System Of Panel Heating



TILE blocks which are finished on top surface form panels for radiant heating system. No additional flooring or floor covering is required

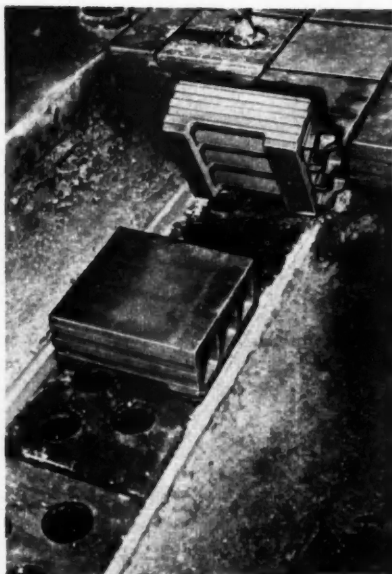

LEFT: Connection between perforated ducts and channels in floor blocks is made with open-bottom block as shown above. Right: By tilting block slightly, sleeves slip easily into preceding block. Ordinary mortar is used to bring blocks to exact alignment



**A** FORCED warm air radiant heating system which uses specially designed tile flooring blocks as panels has proved satisfactory in tests made over a period of several winters. The system, called RadianTile Panel Heating, was developed by engineers of the Clay Products Association.

### How a RadianTile System Works

With RadianTile panel heating the entire floor area of the house is a radiator. Four simple units are used in the RadianTile system—two types of floor block and two types of clay duct. Each block has three channels through it. When laid end to end, the blocks are aligned to form a continuous channel for the full length or width of the room. When the block is laid, a space of about  $\frac{5}{8}$ -inch is left between each unit. This space is later filled with cement mortar. Special sleeves connect the ducts between each block to prevent mortar from entering the channels. When floor is finished, channels form a "closed type" system, with no air entering the room.

Forced warm air from the heating unit is carried to the floor ducts through larger clap supply ducts laid beneath the floor. This warm air flows through the channels in the floor blocks and enters return ducts which carry it back to furnace for re-circulation.

### Design Factors

Since the heat panel in the RadianTile system is the floor, the temperature of the surface is limited to the degree most comfortable to persons using the room. Experience shows that a floor temperature of 90 degrees is possible with optimum comfort. A floor temperature of less than 85 degrees is not recommended.

The low temperature of the floor automatically determines three elements of the heating system: (1) Room Temperature. (2) Maximum

Heat Output. (3) Insulation Needed. These fundamental facts must be kept clearly in mind in RadianTile panel heating.

There will be four heat losses of consequence—to the ground by direct heat flow downward; through the masonry at edges of floor to the ground and outside air; through walls and ceilings; and by air leakage from the house. Limitation of the first three may be accomplished by use of suitable insulating materials, such as the use of lightweight concrete and other structural insulating materials under the floor, and filling of open spaces around edges of floor with insulating material to intercept heat flow.

**Construction Details**

Because of the small number of units involved, installation of the block flooring panel heating system is relatively simple. All supply and return ducts are laid in trenches, the bottoms of which are excavated to exact grade and thoroughly tamped to provide a uniform, firm foundation. All supply and return ducts are laid with the 12-inch dimension horizontal. The top surface of these ducts should be about six inches below the desired level of the finished floor.

Corners, angles and other "fittings" for the supply and return ducts are made by cutting straight lengths of ducts. Each block is one foot square, including mortar joints, and when laid should be placed to avoid the need for fractional or cut blocks. The joints between the sections of supply and return ducts should be sealed with four to six inch wide strips of heavy building paper cemented to the pipe with an asphalt compound. After the ducts have been completed, care should be taken to tamp the backfill around them firmly.

The concrete slab is laid flush with the top surfaces of supply and return ducts. The slab will vary in thickness according to the type of foundation under it and should be held to a minimum thickness both for cost and for heating efficiency. Where heavy loads are to be carried by the floor blocks, it is good practice to increase the thickness of the slab under the supporting area to six or eight inches.

RadianTile blocks are designed to withstand a minimum crushing strength of 700 pounds per square inch when imbedded uniformly in mortar on top of concrete slab. The universal strength of blocks makes it feasible to lay the floor surface of the entire house as an unobstructed slab placing partitions and other structural elements on finished floor.

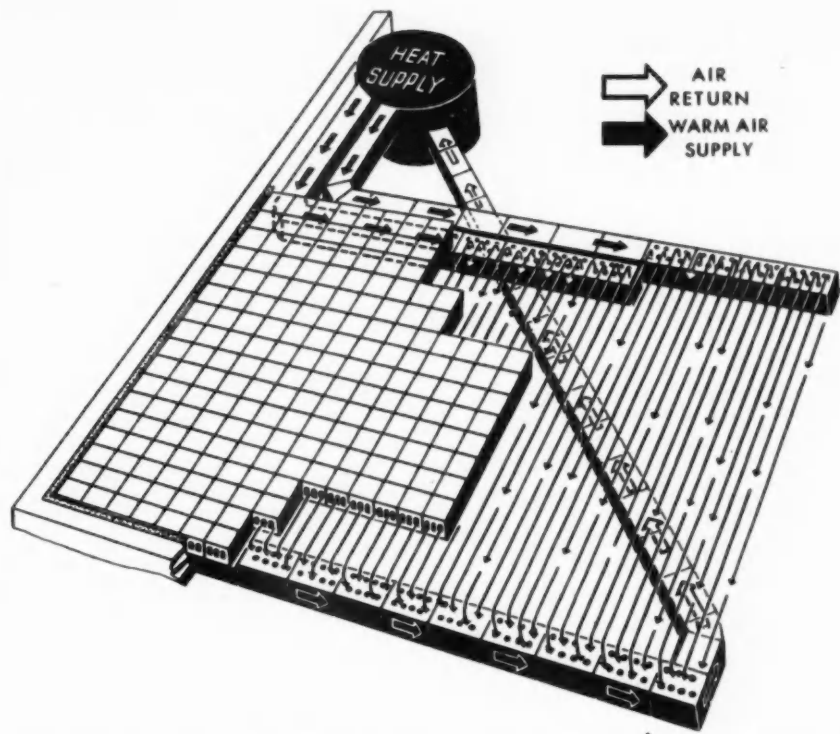
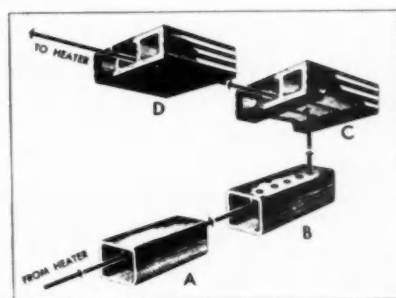
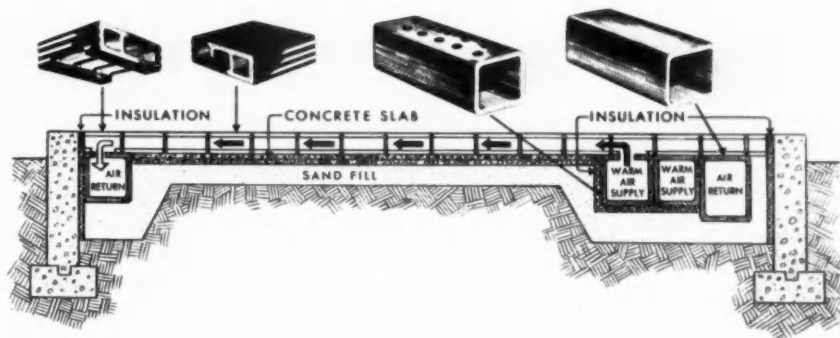
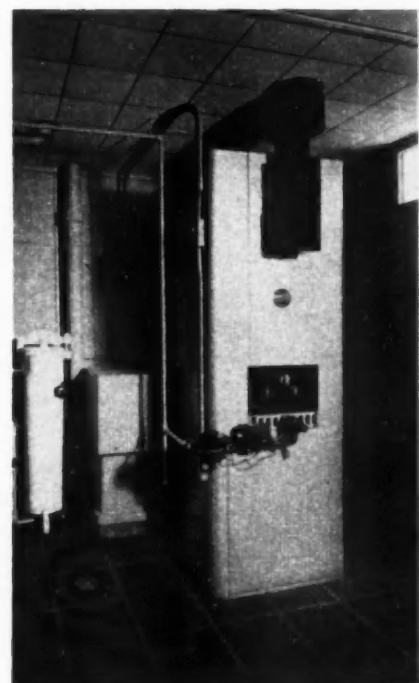

DIAGRAM above shows air flow through a simplified RadianTile panel heating system, tracing warm air supply and air return. Below is cross section of typical installation



TYPES of ducts and blocks are illustrated above: closed type duct (A), perforated duct (B), open-bottom block (C) and closed-bottom block (D). Right: finished heater installation. Return air enters heater from below and after being heated, re-enters floor ducts through ducts to left of heater



## TECHNICAL GUIDE for Builders and Craftsmen

### How to Carry Shingling Axe

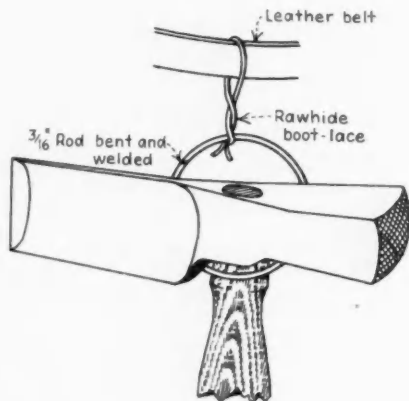

**T**HE method indicated in the sketch above shows a safe way to carry a sharp shingling axe with safety.

A 3/16-inch diameter rod is formed into a circle and welded where ends come together. A rawhide lace is wrapped around the metal ring, extended up and tied securely to workman's belt. In this manner the axe is held in place and is always handy when needed.—Submitted by J. G. Caldwell, San Mateo, Calif.

### How to Keep a Rule Handy

**T**O avoid misplacing or covering over the rule when working at a bench mark off the front edge of work bench in inches and feet with India ink and then apply a coat of varnish over same. An alternate to the above would be to insert a yardstick into the counter, similar to a counter in a dry goods store.—Submitted by Geo. A. Hefelfinger, Lehighton, Pa.

### How to Hang Corner Shelves

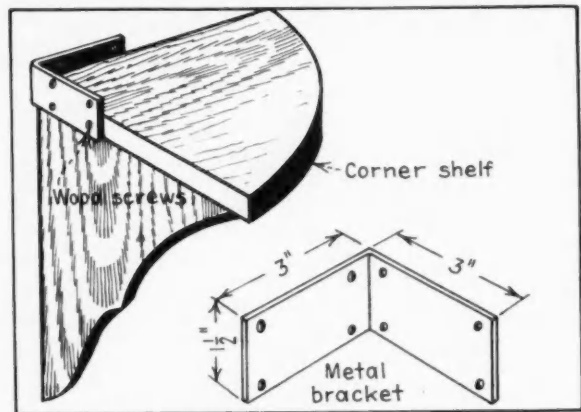

**A**N easy and simple way to attach corner shelves to the wall is by using a bracket made of thin metal.

A strip that is wider than the thickness of the wood shelf is bent to form a 90 degree angle and then eight small holes are drilled in the approximate locations shown in the illustration. The bracket is fastened to the shelf by means of wood screws placed in the holes at bottom of metal strip while the top holes which extend above the shelf are used to attach the shelf to wall.—Submitted by Herbert E. Fey, New Braunfels, Texas.

### How to Keep Blueprints on the Job

**A**BRIGHT sun or sudden rain showers either fade or destroy blueprints that are left in the open during the time building is in the process of construction. To avoid this happening attach blueprints to a piece of cardboard or preferably plywood by sealing the edges with scotch tape on all sides. Then cover the blueprint with a good coat of shellac. The sun will not fade nor will showers destroy a print so mounted.—Submitted by W. L. Dodds, Branson, Mo.

HOW TO DO IT · HOW TO DO IT · HOW TO DO IT · HOW TO DO IT · HOW TO DO IT

## Interior Styling Reflected in New Front

By Louis J. Gluskin

**T**HE complete separation of show windows from the sales area of the store—a method employed in the planning of store buildings during the late thirties—has been entirely swept away through the new concept of store designs now rolling off the drafting boards of architects in an ever increasing volume. The modern trend is to unify the exterior and interior through design.

The National Shoe Store of New York City, (see opposite page) designed by Louis J. Gluskin is representative of this new type of thinking and designing. A view of the store's interior is visible from almost any place on the sidewalk. The general pattern of the interior design is reflected in the area devoted to the exterior show window display. An interesting fact to note is how the show windows appear to be enlarged replicas of the show cases used within the store. This is done by creating the illusion of a free standing case with glass sides and top. This illusion is further enhanced by the receding and undercut profile of the terrazzo base.

No crowding is evident in the placing of the architectural features. Ample height and width for a generous display front is obtained through the curved profile of

the plaster soffit. This soffit is a continuation of the store's ceiling and the narrow pylons and pilasters on each side which form the framework of the design.

Only long-lasting materials that will withstand the ravages of time were used in constructing this new front. The outside pilasters and top trim are of white marble. Top trim is flashed with copper back to the face of old wall above. Background for the display sign is porcelain enamel designed to simulate stained wood siding. Side walls in the vestibule and curved pylons at front on each side are laid up in one-inch-square glazed ceramic tile in grey-green and gold colors. Windows above porcelain enameled siding are steel sash glazed with Louvrex glass. Floor of vestibule and front of receding bulkheads are laid up in terrazzo with ceiling above of Keenes cement plaster over metal lath. The two rows of recessed lights in ceiling of vestibule are adjustable so that they may be lowered or raised as occasion demands. The Hercules doors in store entrance are placed in a floating steel frame. The porcelain enamel letters of the sign are of channel construction. They were designed as an integral part of the store front.



# AMERICAN BUILDER'S STORE FRONT DETAILS

## Nº G-2 · DETAILS OF REMODELED STORE FRONT.

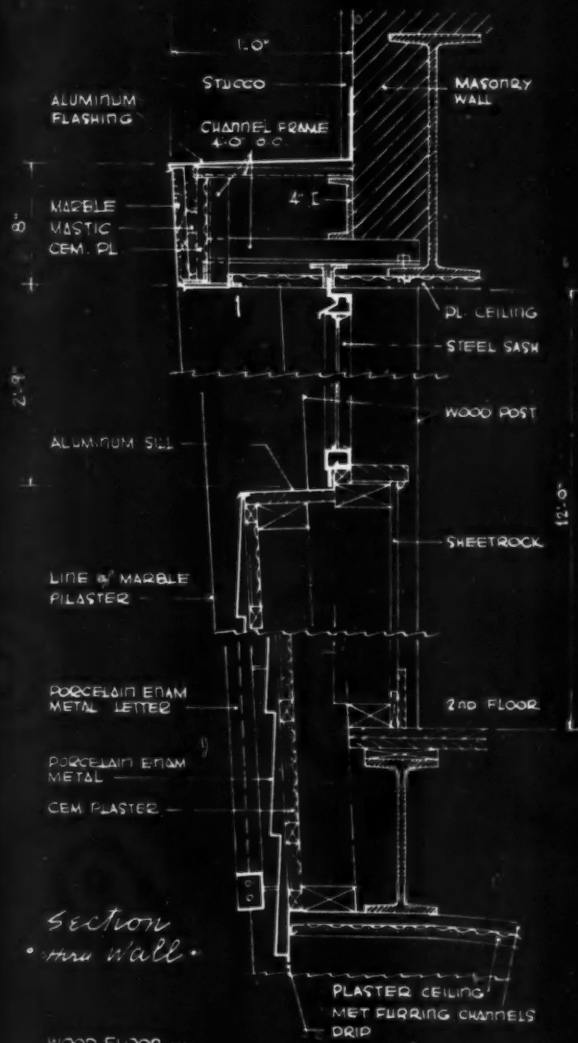
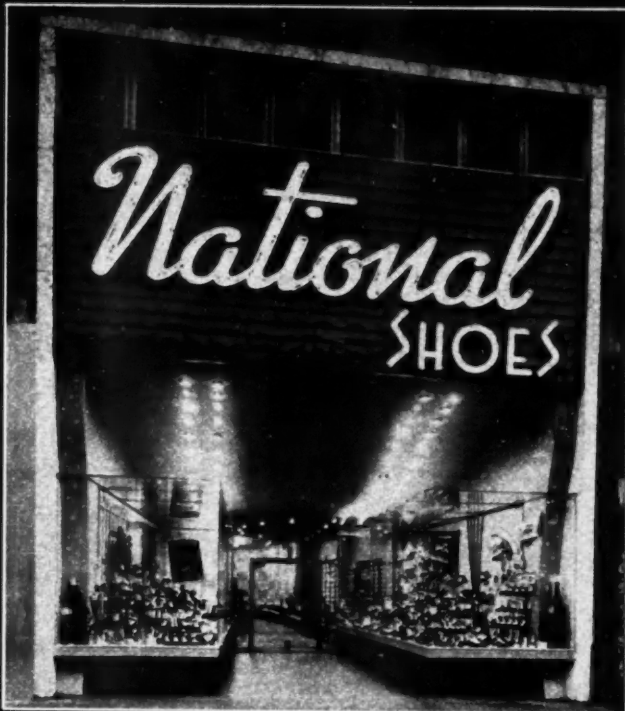

*Section  
· thru wall ·*



*· Section ·*

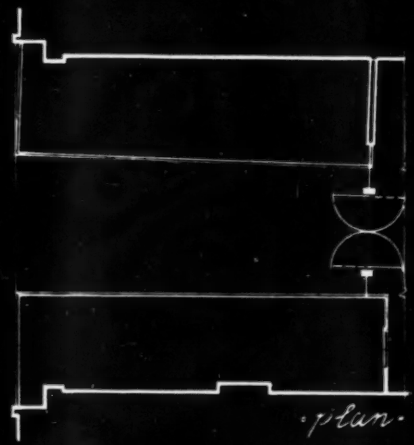

*· plan ·*

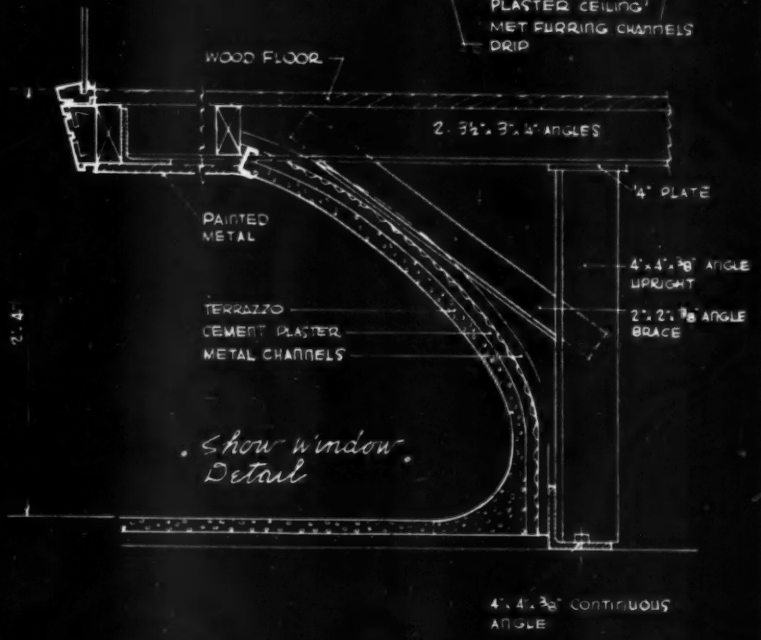

*· Show Window  
Detail ·*

## TECHNICAL GUIDE for Builders and Craftsmen

### How to Cut Discs with a Jig-Saw

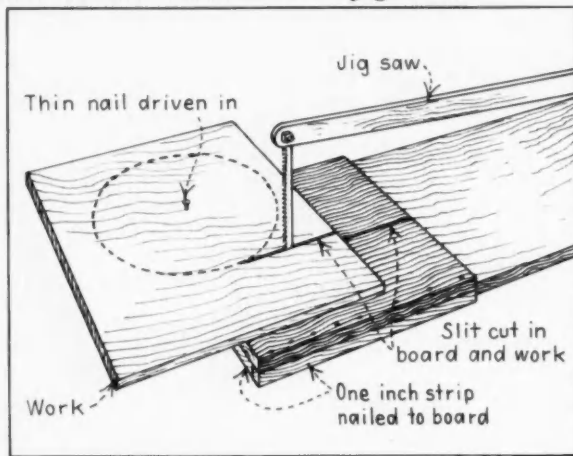

**C**UTTING perfectly round wooden discs or wheels with a jig-saw is no trick if the following method is used.

Three strips of wood are secured to the underside of a one inch thick board which fits snugly over the jig-saw table as shown in the illustration. Two of the three strips of wood are secured to the sides and one on the front. With an ordinary saw make a cut in the one inch board so that the saw blade of jig-saw will slip in easily. A six to eight inch cut is also made in the piece that is in work.

In use, the piece in work is tacked on the board with a thin nail. When the saw is in operation all that need be done is to push the piece in work up against the blade and the result will be a perfectly round disc. The size of the disc is determined by the distance the nail is placed from the blade.—Submitted by Herbert E. Fey, New Braunfels, Texas.

### How to Lengthen Wide Boards

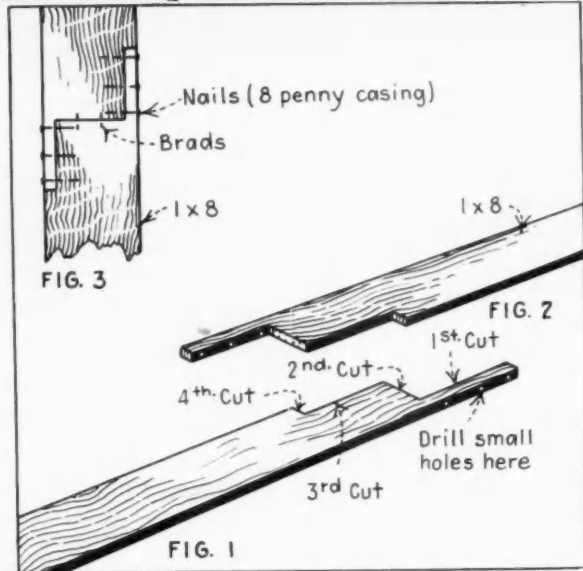

**T**HE following method is suggested for use where short pieces of 1x8, 1x10, or 1x12 inch boards are joined together to make one long piece of lumber.

First make a lengthwise cut through the board about 12 inches long, cut to occur one inch from edge. Second, make a cross cut through the plank so the inch wide strip will remain. Third, make another lengthwise cut 12 inches long and one inch away from edge. The fourth cut will make the board look like Fig. 1. Lay this piece over the other board, mark off with pencil and cut out. Drill three or four small holes through each of the two one-inch wide strips so that the casing nails will not split the boards.

Join the two boards together as shown in Fig. 3, driving in a few extra brads along the joint. A board butted together in this manner is exceptionally strong and can be subjected to a great deal of strain without buckling when placed in an upright position.—Submitted by Herbert E. Fey, New Braunfels, Texas.

HOW TO DO IT • HOW TO DO IT • HOW TO DO IT • HOW TO DO IT • HOW TO DO IT

## New Ideas in Kitchen Planning

By R. J. Alexander

**D**ESIGNERS and builders are aware of the fact that an attractive and well-planned kitchen is the finest sales tool that can be developed in the merchandising of new homes. This room, like the bathroom, receives the greatest amount of attention in the application of new materials, planning, styling and coloring. Most of the items in the kitchen, including floor covering, wall finish, cabinets, counter tops, refrigerator, range, and lighting have undergone drastic improvements in the past few years. All this has been done to please the housewife upon whom the burden of decision is usually placed in the selection of a new home.

The photograph and details on the opposite page illustrate a number of ideas that are entirely different from the normal type of packaged kitchen. Opaque sliding glass panels forming cupboard doors are placed in metal frames with a roller bearing track. An outline of the shelves and vertical members, as well as contents of cupboards may be seen through the glass panels. This creates an interesting pattern of light and shade on face of glass.

An unusual feature is the novel manner in which ceiling lighting and exhaust fan are combined in a single unit. The sloping ceiling of kitchen follows contour of roof. This posed a difficult problem for lighting. It proved, however, to be a case where a liability was turned into an asset. This was done by introducing a free standing unit across the width of this room at door height. Bottom of unit is covered with light transusion glass with fluorescent lights above. Exhaust fan placed at one end is directly over the stove. The position of vent duct for fan is optional. It can extend over fluorescent lights to outside wall, or to partition on opposite side of fan and then upward in partition to roof.

Open shelves at each end of kitchen above counter line provide a place for the display of plants and ornaments. They also act as a finishing motif for counter extension. The exterior of top and bottom cupboards, including trim and wood facing, is allowed to remain in a natural finish. Interiors of cupboards, ceiling and ceiling beams are painted in contrasting colors.

# AMERICAN BUILDER'S BETTER DETAIL PLATE

NO D-61. DETAILS MAKE DISTINCTIVE KITCHEN.

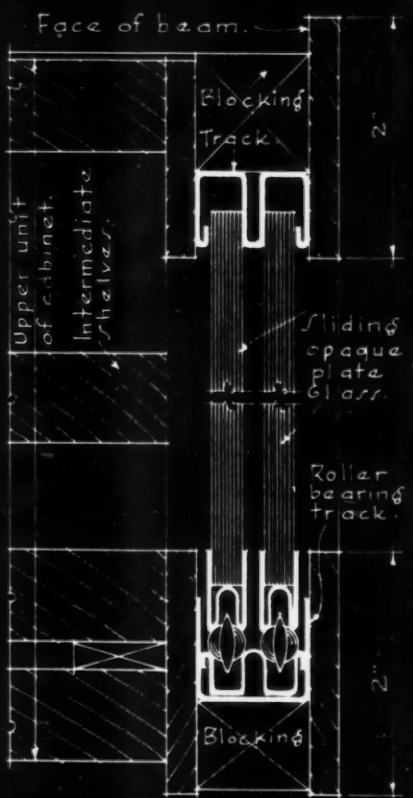
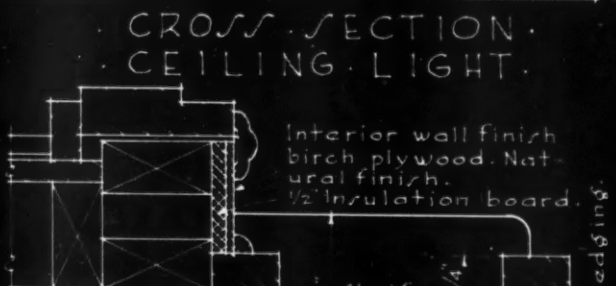
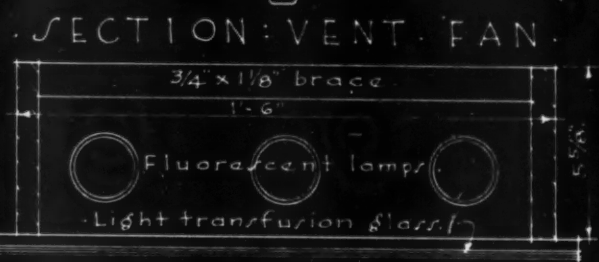
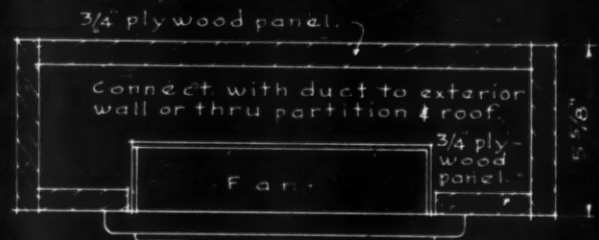

PLAN: UPPER CASE: OPEN SHELVES

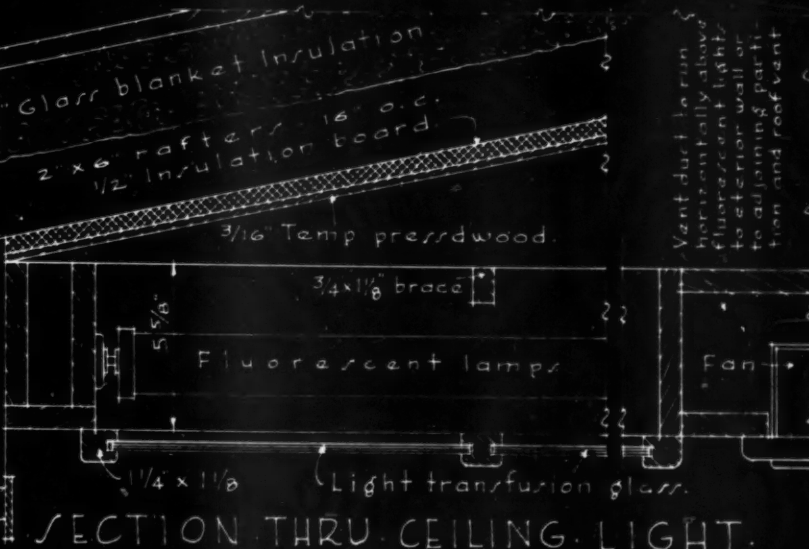

DETAIL OF TRACK

SECTION THRU CEILING LIGHT





# NEW PRODUCTS

## Offered by Manufacturers

**HIGH OUTLET TRAP AB12903**  
New high outlet trap to be used in conjunction with FA3-JR Disposall, permits installation of appliance without major plumbing change in most existing homes having sinks with a 3/2 to 4-inch drain

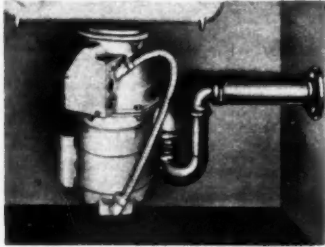

opening. Permits economical installation even if distance between bottom of sink bowl and center line of drain is only seven inches. Trap may also be used with standard FA3-ER Disposall if the distance between bottom of the sink and top of drain is 10 1/2 inches. Trap designed for General Electric Disposall by M. S. Little Manufacturing Co. For information write General Electric Co., Appliance and Merchandise Dept., Bridgeport 2, Conn.

**CONVECTOR-RADIATOR AB12908**  
Convector-radiator units fit under picture windows to provide blanket of warmth over the expanse of glass, and neutralize drafts at their source. There are three basic models: free standing, semi-recessed, or fully recessed, in lengths up to 88 inches. Units are 12 inches high, in 4, 6, 8 or 10-inch depths. Suitable for either steam or hot water heating systems. Model numbers are RKL, recessed type, and FKL, free standing. The Trane Co., La Crosse, Wis.

**FORK-LIFT TRUCK AB12902**  
"Clipper" Model, 2,000-pound capacity fork-lift truck has wheelbase of 36 inches. Grades of as much as 15 per cent can be climbed without difficulty. Frame has been widened slightly to provide more protec-

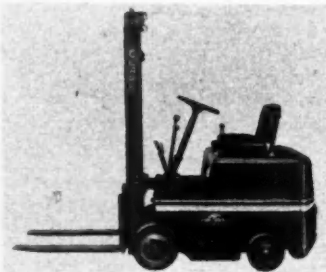

tion for wheels and to allow more space for servicing, but over-all width is only one inch larger than previous model. With longer wheelbase, additional weight is put on drive wheels to provide increased traction and improved performance. Clark Equipment Co., Industrial Truck Div., Battle Creek, Mich.

**PANEL GARAGE DOORS AB12907**  
In Raynor Raised Panel doors, panels are made of attractive grained white pine, raised 11/16-inches. Figured panels may be used throughout or may be combined with plain raised panels to create various



panels. Doors come in one-car and two-car standard residential door sizes ranging in width from 8 to 16 feet. They can be constructed to fit in any odd size garage door opening. The doors are sectional, residential models. Doors swing upward when open, and are spring balanced. Raynor Manufacturing Co., Dixon, Ill.

**BASEBOARD HEATING UNIT AB12926**  
Panel of Brown Bayce-Heat, an aluminum fin baseboard, extends out from wall 1 1/8 inches. Panel has open lattice work and closed top to prevent wall smudges; can

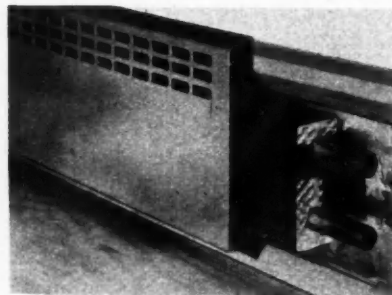

be removed for cleaning. Fins are beaded for stiffening, to provide greater heat area and for more air turbulence. Rated at 4 1/2 square feet per linear foot at 215 degrees F., based on 240 B.T.U.'s being the equivalent of one square foot of steam radiation. Made in standard five-foot units weighing 12 pounds. Brown Products Co., 96-08 72nd Ave., Forest Hills, N. Y.

**NEW FURNACE LINE AB12905**  
New complete line of oil, gas and coal furnaces range in capacity from 75,000 to 400,000 B.T.U.'s. Firm also supplies other kindred heating accessories such as blowers, conversion oil burners, filters, controls and repair parts. Inquiries are invited from interested dealers and manufacturers' representatives. Homer Furnace & Foundry Corp., Coldwater, Mich.

**SEMI-RECESSED BASEBOARD AB12914**  
National Art Baseboard, when installed, extends 1 1/2 inches into the room from plaster, wood, brick, or building board wall. Manufacturer does not recommend that product be installed in a gravity hot water

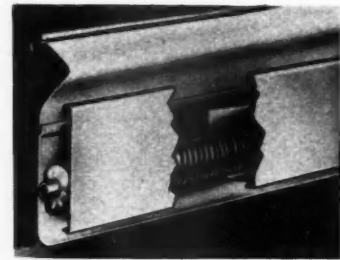

system when lengths exceed eight feet, but it can be economically installed to replace standing radiation, as well as in an entirely new heating system. Hot water ratings range from 370 B.T.U. per hour, per lineal foot at a water temperature averaging 170 degrees F., up to 730 B.T.U. per hour, per lineal foot with water temperature averaging 230 degrees F. The National Radiator Co., Johnstown, Pa.

**GASOLINE CHAIN SAW AB12925**  
Weight of new line of Homelite gasoline engine chain saws ranges from 33 to 42 pounds. Engine is two-cycle, air-cooled single cylinder. Size is kept to minimum by compact design, location of cylinder, magneto and drive housing directly on crankcase. Ball and roller bearings are used throughout the engine. Manufacturer states that chrome-plated chain cuts through 18-inch softwood tree in 18 seconds, through 18-inch hardwood in 35 seconds. Line includes straight blade saws in 14, 20, 27 and 30-inch sizes and a non-binding bow saw. Homelite Corp., Port Chester, N. Y.

**CLOTHES DRYER AB12915**  
Rotite hanging type clothes dryer is made from sturdy channel iron sections with adjustable support legs. Dryer is attached with wood screws to ceiling joists of the base-

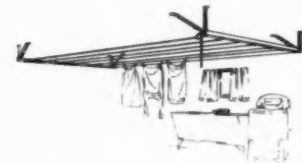

ment or utility room. Installation can be accomplished in 15 minutes. Up to 150 feet of clothes line is strung on steel hooks located between metal side frames. Quick-acting, ratchet type line tightener is provided for taking up line sag or stretch. Rotite Manufacturing Div., 863 E. 140 St., Cleveland, Ohio.

Am  
CABI  
"Tut  
the g  
When  
curely  
nets.  
are o  
tional  
AUTO  
Gray  
tive p  
to op  
balan  
and  
windo  
lock i  
windo  
drop  
Inc.,  
BASE  
Plasti  
gon v  
corros  
easily  
partic  
the w  
black  
tan,  
color  
by gr  
is fou  
come  
Plasti  
Brimf  
FOR  
MAC  
Azor  
design

**CABINET LATCH**

**AB12921**



"Tutch Latch" opens cabinet doors with the gentle touch of finger, wrist or elbow. When door is closed, latch holds it securely. Applied to interior of wood cabinets. Beauty, convenience and low cost are outstanding features of the unit. National Lock Co., Rockford, Ill.

**AUTOMATIC WINDOW LOCK AB12912**

Gray automatic window lock offers positive protection against prowlers. Designed to operate as a combination lock and sash balancer on any standard 28-inch window and as an automatic lock on any size window. Inexpensive and easy to install, lock is inserted flush into the sash. Keeps windows in position so that they will not drop or sag. Gray Automatic Lock Co., Inc., Mitchell, S. D.

**BASE COVE MOULDING AB12901**

Plastic Top Set Cove Base is made of Tygon vinyl plastic, a material that is tough, corrosion resistant and durable. Can be easily installed in or around corners. Dust particles can not get between the base and

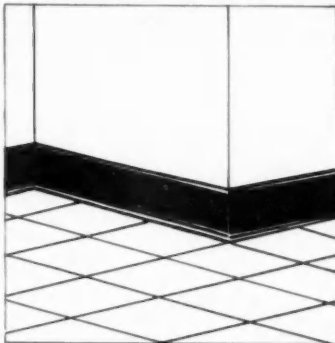

the wall. Available in seven solid colors: black, brown, gray, green, blue, red, and tan, made to harmonize with marbelized colors of Plastile floor covering. Unaffected by grease, oil, acids and alcohol. Material is four inches high and 1/8 inch thick and comes in 4-foot lengths. Installed with Plastile Cement. The U. S. Stoneware Co., Brimfield Rd., Akron 9, Ohio.

**PORTABLE NAILING MACHINE**

**AB12917**

Azor portable pneumatic nailing tool is designed to nail sheathing or sub-flooring



at the rate of 40 to 50 nails a minute consistently. Nail goes in straight or at an angle as desired, and depth of nail

set can be adjusted. Due to the power drive, nail head can be driven below the wood surface, if desired, without the usual hammer marring of the surface. Tool automatically stops driving at any pre-determined depth. Weight, approximately 22 pounds. Nail hopper has capacity of from 400 to 600 nails. Model 1A handles numbers 7d, 8d or 10d box of common nails. Azor Products Co., 683 Santa Fe Ave., Los Angeles 21, Calif.

**NEW TYPE GARAGE DOOR AB12919**

Installation of this upward-acting aluminum garage door is greatly simplified because the spring operator is mounted on the door panel. Because it is mounted on the door itself, it is adjusted at the factory and needs no field adjustment. The door is made of two rectangular panels, joined at the factory by a continuous piano-type hinge. The panel frames are aluminum

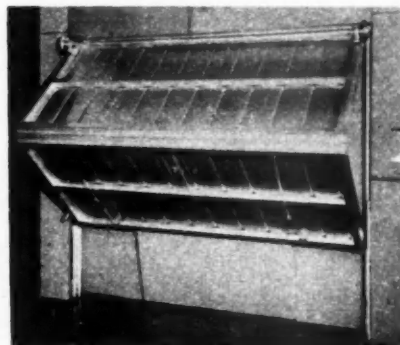

structural angles, 1/8x1 1/2x1 1/2 inches, to which are attached the covers of heavy aluminum sheet, corrugated on eight-inch centers for rigidity. The piano-type hinge is made of aluminum strip, with galvanized steel wire hinge pin. The hinge is weather-stripped inside. The door is delivered, assembled, ready for installation, which takes about 30 minutes. All that needs to be done on the site is to attach the two rails to side jambs and place the door in the hangers. Operation is smooth and quiet. L. S. Taylor Manufacturing Co. 851 Marietta St., Atlanta, Ga.

**OIL-FIRED FLOOR FURNACE AB12918**

Model 0-70 Super, oil-fired Oran Shallow floor furnace is 34 inches high. Underwriters' approved and rated at 70,000 B.T.U., unit embodies Armco aluminized

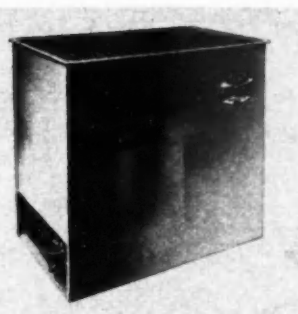

steel combustion assembly and stainless steel in the burner. Auxiliary cold air return draws cold air from bedrooms and other hard-to-heat areas, providing uniform comfort. Unnecessary to remove furnace from floor for servicing. Automatic, with forced draft fan. Finished in attractive baked enamel. Oran Co., 2232 S. Third St., Columbus 7, Ohio.

**WATER CLOSET**

**AB12911**

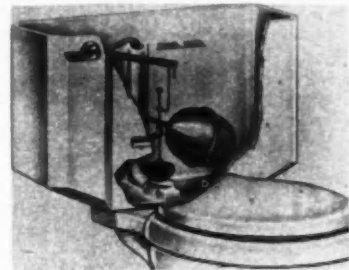

Eljer water closets incorporate integral china overflow and ground-in valve seat made of real vitreous china. This eliminates thin metal tubes and metal seats. Overflow and valve seat construction is foolproof. They are built to last the life of the closets. The Eljer Co., Ford City, Pa.

**SMOOTH OPERATING FINISHER**

**AB12904**

Detroit "Easy Finisher," with straight-line, reciprocating action, duplicates the back-and-forth motion of hand-block finishing. It permits working up to moldings and right angles without marring or scratching. It

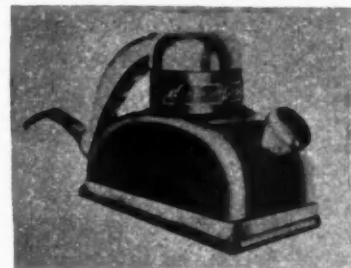

does not sand cross grain, cut swirls, or other hard-to-cover abrasive patterns. New mechanism provides smooth, fast operation. Finishes flat or curved, wet or dry surfaces. Dust filtered cooling is provided by locating air intake at top of motor and use of special designed fan. Easy maintenance. Detroit Surfacing Machine Co., 7461 W. Davison Ave., Detroit 4, Mich.

**PORTABLE ELECTRIC SAW AB12920**

American portable electric saw for all-around use by builders has an 8 1/2-inch blade and special General Electric motor which develops 2 1/8 H. P., providing power to cut wood, sheet metal, stone, tile or compositions. Saw will cut 2 1/2-inch plank

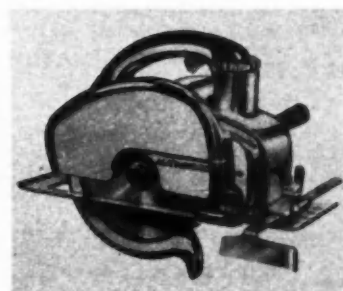

at 45 degrees, or will take a straight cut of three inches. Balanced for one-hand operation, operating on torque principle in which motor and saw blade turn in opposite directions, keeping saw from jolting or twisting when starting. Accurately calibrated ripping guide. Front base calibrated in inches. Saw may be quickly set for cutting angles from 0 to 50 degrees. American Floor Surfacing Machine Co., Toledo, Ohio.

**COPPER FLASHING SYSTEM AB12922**

A complete system of solid copper flashing for masonry construction consists of Revere-Keystone Thru Wall flashing, Revere Simplex Reglet Insert flashing, and Revere-Keystone Vertical Rib siding. Thru Wall flashing provides for positive mechanical bond in every direction in the mortar bed, assuring protection against seepage and leaks at copings, parapets, belt courses, sills, spandrel facings and other masonry units. Soldering at end joints not required. Economical and easy to install. Revere Copper and Brass, Incorporated, 230 Park Ave., New York 17, N. Y.

**DIAPHRAGM PUMP AB12910**

Rex 4-inch single diaphragm pump is designed to meet de-watering requirements in which large amounts of solid materials are present. Efficient where there is considerable debris, such as leaves and straw. Unit weighs 440 pounds, and has a capacity

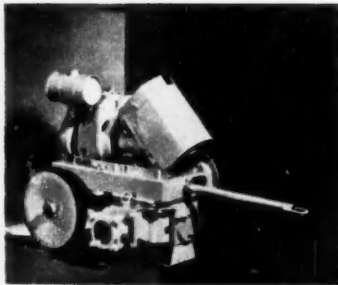

of 6,000 gallons per hour suction lift of 10 feet. Twenty-foot suction lift is 3,000 gallons per hour. Height is 36 inches, and width is 30 inches. Handy cleanout opening is provided for quick cleanout inspection. Diaphragm may be quickly changed. Incorporates Helical-type cut gears, precision machined, mounted on ball bearings running in oil in enclosed gear case. Chain Belt Co., 1600 W. Bruce St., Milwaukee 4, Wis.

**ALL-PURPOSE SIGNS AB12913**

"Nu-Lume" all-purpose signs consist of weather-proof, dull black mounting boards, L-shaped brackets made of rust-proof Alacrome, and Nu-Lume reflecting letters and numbers which will not rust or tarnish. Designed for use on lawn signs, mail boxes, hallway signs and house numbers, the signs have many other handy uses for identification purposes of all types. A novel mail box display case is furnished to dealers. Dept. AB, Macklanburg-Duncan Co., Oklahoma City 1, Okla.

**FLEXIBLE WINDOW FRAME AB12916**

Balance-Seal unit for double hung windows combines sash balance, weather seal, parting strip and inside stop. No grooving of sash or jambs necessary, and four wood

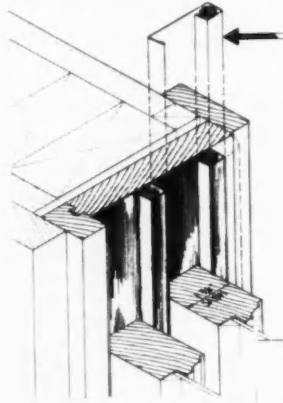

members are eliminated. Unit covers full height of jamb, and sash balance is completely concealed. Double weather seal on each stile. Flexible flanges give and take when sash swells or shrinks. Can be used on standard or simplified frames. Balance-Seal Co., 312 W. Lakeside St., Madison 5, Wis.

**MULTI-PURPOSE TOOL AB12909**

New multi-purpose, portable electric tool, especially valuable to maintenance men, may be used for drilling, sawing, filing, sanding, polishing, buffing and other specialized applications. Three separate spindles project from motor housing. The first provides for 1/4-inch capacity heavy-duty drilling in metal or 1/2-inch capacity



in hardwood. The second provides a reciprocating stroke of 3/8-inch length for hack sawing, filing and key hole cutting, and may be adapted to jig sawing, reciprocating sanders, or hammers. The third and bottom spindle can be used for right angle drilling, for sanding and buffing with discs. Smilan Tool Co., 2848 W. Pico Blvd., Los Angeles, Calif.

**INSULATED SIDING AB12924**

Flintkote Ashlar Stone Insulated Siding is applied directly over old sidewalls. Design includes small, narrow stone-like surfaces with fire-resistant mineral granules of various colors. Surface does not require paint or stain. Other Flintkote insulated sidings are brick, stone, shake and shingle design. The Flintkote Co., 30 Rockefeller Plaza, New York 20, N. Y.

**SUBMERSIBLE UTILITY PUMP AB12923**

"Enpo" utility pump was designed to run under water to eliminate possibility of becoming inoperative due to flooding out. The 1/4 H. P. single phase, 115 volt, 60 cycle motor is hermetically sealed and is constructed of non-corrosive materials. Pump

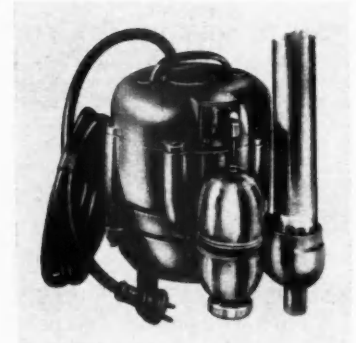

is produced with either manual or automatic float control. It is the centrifugal type and delivers 3,000 gallons per hour. Pump is non-clogging, life-time lubricated, light weight, easily portable and features quiet operation and non-corrosive construction throughout. Piqua Machine & Manufacturing Co., Piqua, Ohio.

**PACKAGED FLOORING AB12927**

This Laytite Packaged short length flooring, introduced by The Connor Lumber and Land Company, is put up in attractive cardboard cartons and sealed to protect its contents from dust and moisture. Designed in size to make easy handling, the



carton contains sufficient material to cover 10 square feet of floor, thus eliminating all figuring of additions for match, and also protecting the dealer against loss through errors in tallying. The manufacturer says this method of selling hardwood floors by the carton instead of the thousand board feet method, eliminates the price per M and easily brings the unit price to the buyer's understanding. Write The Connor Lumber and Land Co., Marshfield, Wis.

**BRICKLAYING MACHINE AB12906**

With "Brick-Lay-R," any type worker can lay brick properly and at high rate of speed, and efficiency of skilled masons is stepped up many times. Average day's work on 12-inch walls is 3,000 brick. Walls are automatically aligned vertically and horizontally and leads are not required. Each brick is jiggled into place and mechanically aligned. Solid walls are assured because joints are automatically filled with mortar. Hodgson-Sommers Incorporated, Montgomery, Ala.

**CHECK NUMBERS AND MAIL COUPON FOR INFORMATION**

American Builder, 79 W. Monroe Street, Chicago 3, Illinois

NAME..... ADDRESS.....  
 CITY..... STATE.....

AB12901	AB12906	AB12911	AB12916	AB12922
AB12902	AB12907	AB12912	AB12917	AB12923
AB12903	AB12908	AB12913	AB12918	AB12924
AB12904	AB12909	AB12914	AB12919	AB12925
AB12905	AB12910	AB12915	AB12920	AB12926
			AB12921	AB12927

When you address inquiries direct to manufacturers concerning a new product described here, please mention that you saw it described in American Builder



# EXTRA VALUES by the dozen

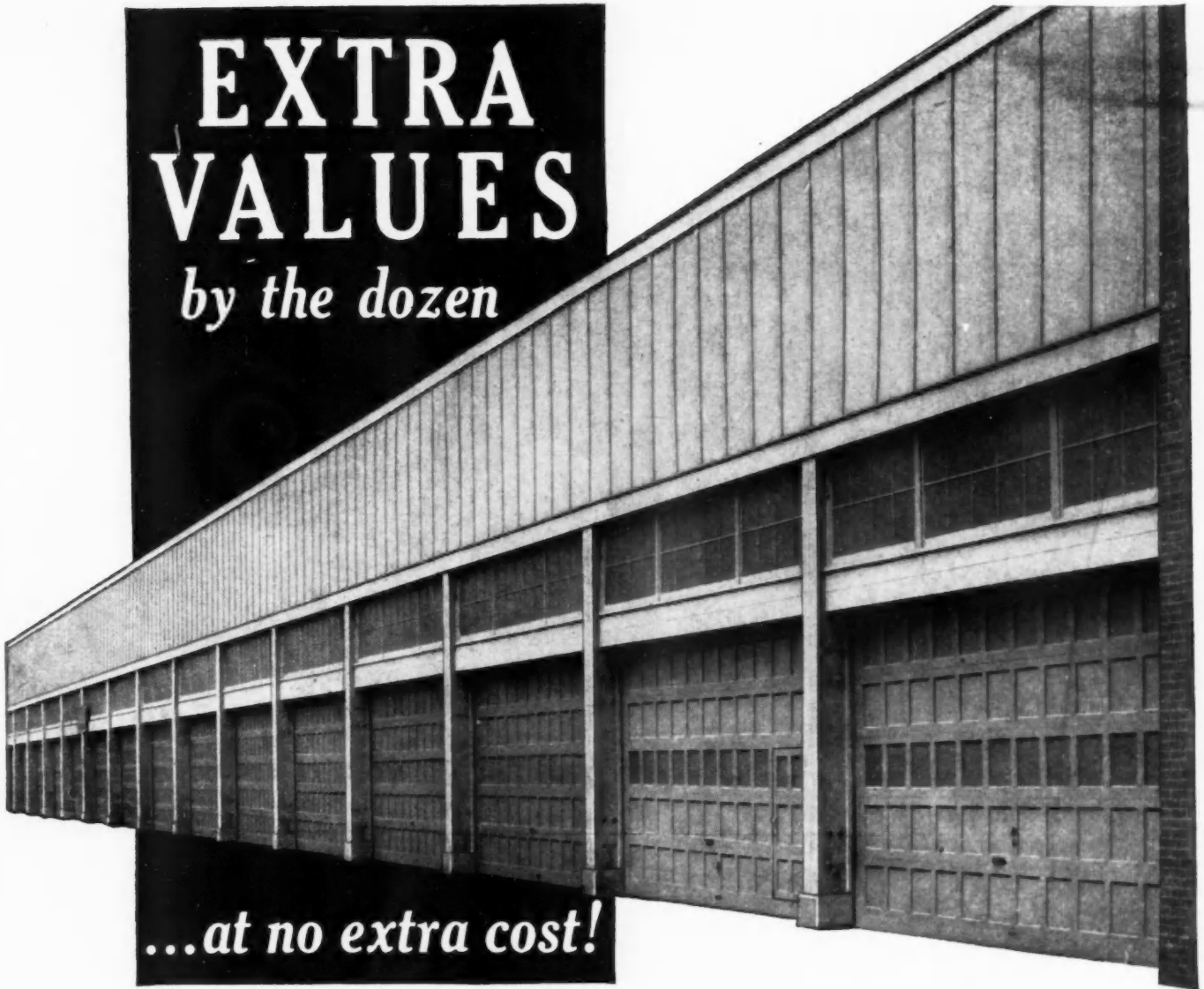

...at no extra cost!

Not one or two . . . not five or ten . . . but a round dozen "Extra Value" reasons why Ro-Way Overhead Type Doors are better built, better finished, better all around. Twelve reasons why . . . and here they are:

1. Only high quality lumber is used. Personally selected by our own buyer at west coast mills.
2. Panels are made of 3-ply, exterior grade Douglas Fir plywood for maximum resistance to moisture.
3. Multiple mortisers are used to assure accuracy, uniformity and good fit.
4. Tenons are cut on both ends in one operation for efficient construction.
5. Muntins, rails and stiles are accurately squared up.
6. Sections are drum-sanded to a fine preliminary finish.
7. Ro-Way's own workmen then do the final finishing with hand sanders.
8. All sections are rabbeted carefully to assure weather-tight joints.
9. All mortise and tenon joints are glued and then steel doweled for strength.
10. Ro-Way springs are made in our own plant, and power-metered to the weight of the door on which they're used.
11. Special machines make Ro-Way track rollers with a double-thick tread that wears twice as long.
12. After all Ro-Way hardware has been fabricated, it is Parkerized and painted for extra protection against rust and streaks that spoil the looks of a door.

Ro-Way Overhead Type Doors are better built—last longer—look better and cost no more. Insist that your commercial, industrial and residential doors be Ro-Way. ROWE MANUFACTURING CO., 758 Holton St., Galesburg, Ill., U. S. A.

*There's a Ro-Way for every Doorway!*

*Nationwide sales and installation service. Standard sizes available for prompt delivery. Good delivery on special sizes for commercial and industrial use.*

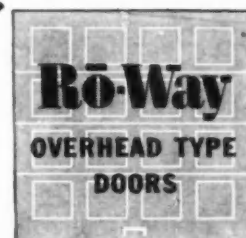

See your classified telephone directory for names and addresses of Ro-Way Distributors

Save with  
Individual\*  
**VIKON METAL TILES**  
buy only the number you need!



Here is the metal tile that is easily installed on existing walls or ceilings without expensive alterations or disconnection of fixtures. On new construction VIKON TILE permits economically erected walls or wall boards to be used as a satisfactory base. Can be applied over any smooth surface. Recommend *Individual* Vikon Metal Tiles, your guarantee of client satisfaction.

- 27 fade-resistant decorator colors and stainless steel
- will not warp, crack or craze
- resists heat and household chemicals
- fire-resistant, waterproof, seals out insects
- particularly adaptable to remodeling

\*"The Original Individual Metal Tile" Established 1926:  
See our catalog in Sweet's Files

STEEL • ALUMINUM • STAINLESS STEEL

**VIKON TILE**  
BEAUTY • ECONOMY **COLOR FUSED ON METAL** DURABILITY

MAIL THIS COUPON TODAY

**VIKON TILE CORPORATION** Dept. 5C  
Washington, New Jersey

Please send me, without obligation or cost, a full-color descriptive brochure and sample of Vikon Metal Tile. I am interested in tile for:

My home  As a dealer  As a contractor

NAME \_\_\_\_\_ (Please Print)  
ADDRESS \_\_\_\_\_  
CITY \_\_\_\_\_ ZONE \_\_\_\_\_ STATE \_\_\_\_\_

**Specify Rustproof**



**LUMITE\***  
WOVEN SARAN SCREENING

\*Registered Trade-mark

LUMITE is long lasting . . . guaranteed rustproof and stainproof . . . is unaffected by humidity, salt air or acid smoke. Yet LUMITE costs only 11½ to 12¢ per square foot, retail . . . gives maximum efficiency at a big saving on every type of job!

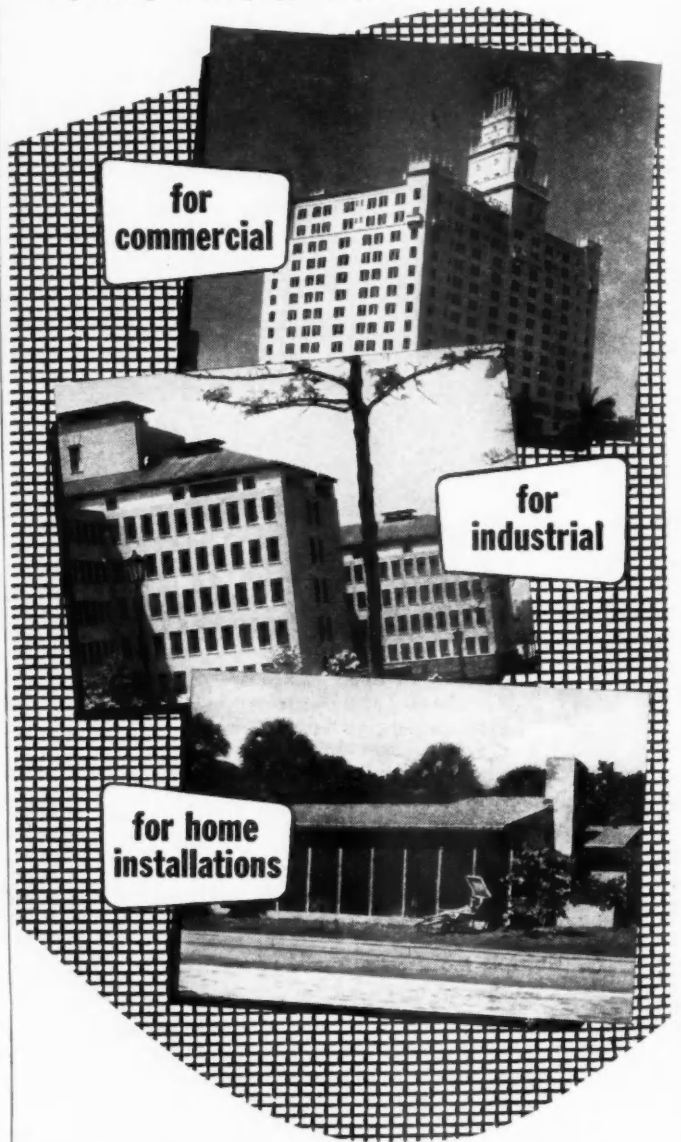

**FACTS FOR ARCHITECTS AND BUILDERS**

- Effects of Acids, Alkalies and Solvents** —Essentially none.
- Non-inflammable** — Lumite will not support combustion . . . is self-extinguishing. Softening point 240°F.
- Tensile Strength, Ultimate** (of filament) —Up to 40,000 lbs. per square inch.
- Impact Strength**—Greater than conventional screening.
- Installation**—Cut with scissors. Fold edges under ½". Tack or staple the screening smoothly and evenly every 1½". Because of inherent characteristics LUMITE will gradually draw itself into a snug, firm fit.

LUMITE DIVISION, Chicopee Manufacturing Corporation of Georgia  
47 WORTH STREET, NEW YORK 13, N. Y.

# BIG SHEETS

up to 8' x 14'

## FEWER PIECES — mean Lower Handling Costs

An 8' x 14' wall requires:

HORIZONTAL WOOD SHEATHING



16 Pieces

FIBRE BUILDING BOARD SHEATHING



4 Pieces

HOMASOTE SHEATHING



1 Piece

THE FEWER  
THE PIECES  
THE GREATER  
THE STRENGTH

HOMASOTE  
SHEATHING  
**272%**  
STRONGER  
THAN HORIZONTAL  
WOOD SHEATHING

Fewer PIECES TO UNLOAD • Fewer PIECES TO PICK UP  
Fewer PIECES TO PILE • Fewer PIECES TO PUT INTO PLACE

## WARMTH

The BTU rating tells only 1/4 of the story

TRUE INSULATING VALUE UNDER ACTUAL OPERATING CONDITIONS DEPENDS ON 4 FACTORS

- 1 BTU rating—heat loss thru board
- 2 Water absorption
- 3 Water that passes thru board
- 4 Air that passes thru board

THE WILSON INSULATING EFFICIENCY FACTOR SHOWS THE RELATIVE EFFICIENCY OF 12 FIBRE BUILDING BOARDS

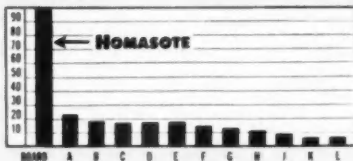

• We invite architects and builders to send for illustrated booklet—giving physical characteristics, performance charts, specification data and application instructions.

## HOMASOTE COMPANY

Trenton 3, New Jersey



## COMPARE THE TENSILE STRENGTH — of HOMASOTE and other FIBRE INSULATING BOARDS

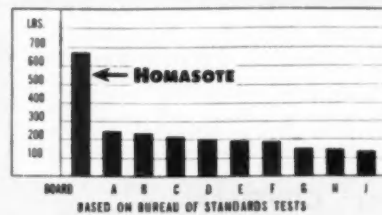

Only HOMASOTE gives you maximum strength and maximum insulating value in one board

mean  
**BIG SAVINGS**



..... oldest and strongest insulating and building board on the market





**Picture of a Man Installing a Window—the Hard Way!**

Naturally, builders use stock size windows, building them into the construction as the wall goes up. Coffman stock railings are as practical and economical as stock windows—or any other building item. They enable you to build forms to stock sizes, stand the railing in place, pour the masonry, and have a quality job at greatly reduced cost. Imagine a 2-step rail section for \$8.65, FOB factory!

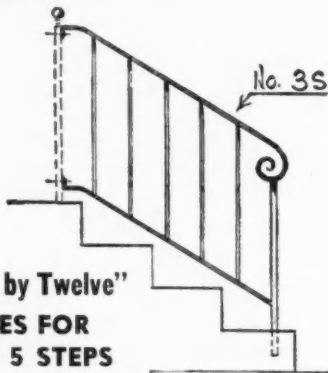

**“Seven by Twelve”  
SIZES FOR  
2 TO 5 STEPS**

Coffman Stock Step Sections are standardized for 7 inch riser, 12 inch tread. Perfect alignment assured by Coffman precision craftsmanship, giving a finished job of great beauty.

**EASY TO INSTALL**

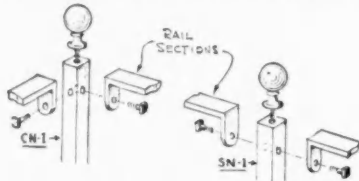

Installation of Coffman Ornamental Iron is simplicity itself. All components FIT easily, perfectly together. Various combinations of railings and newel posts can be adapted for almost any installation.

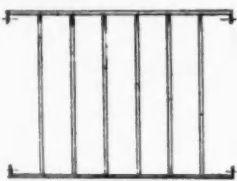

**COFFMAN  
HORIZONTAL  
RAILING**

Made in six different lengths. 2'8" to 5'2" for any need.

Write for Form 712 AB TODAY! P.O. Box 1113 GIVES YOU COMPLETE details and interesting "how to use" ideas.

Manufacturers of the Original "Complete Builders' Line" of Hand-Wrought Ornamental Iron Sold by Lumber and Building Supply Dealers

**The R. J. Coffman Co. Inc.**  
ORLANDO, FLORIDA  
ESTABLISHED 1925



**TECHNICAL GUIDE  
for Builders and Craftsmen**

**How to Substitute Shiplap for Siding**

ORDINARY shiplap sheathing, because of its economy in material and application, makes an acceptable substitute for weatherboarding. By nailing the shiplap on the sheathing in the manner shown an interesting effect is obtained through the heavy shadow cast by the overhang. If the material is left in its unfinished state and stain applied to the surface, a modern effect is obtained that can be used equally well with a sloping or flat roof house. —Submitted by Herbert E. Fey, New Braunfels, Texas.

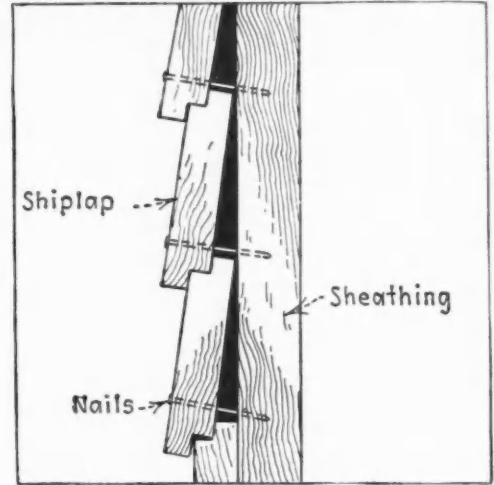

**HOW TO DO IT · HOW TO DO IT · HOW TO DO IT**

**How to Drain Surface for Concrete**

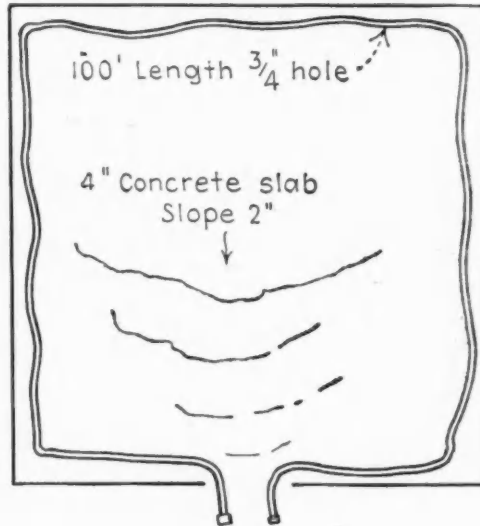

TO remove water that has accumulated in an area where concrete slab is poured on wet ground is a laborious and time consuming job. This idea will save the workmen many valuable moments when they prepare to place concrete on wet ground in winter.

To remove this excess water place a rubber hose around the inside walls of the building. Hold both ends of hose and then slowly drag hose out through the door. Squeegee action of hose will scrape water in front of door and out through opening. Slab may then be carefully trowelled.—Submitted by J. G. Caldwell, San Mateo, Calif.

**HOW TO DO IT · HOW TO DO IT · HOW TO DO IT**

Let your suggestion pay you five dollars (\$5.00) in cash. This sum is paid by American Builder for each short cut or job pointer that is accepted for publication. Send all material to Architectural Editor, American Builder, 79 W. Monroe St., Chicago 3, Ill.

# YOU GET THE MOST FOR YOUR MONEY

# IN Johnson RUBBER TILE



## MOST ECONOMICAL

Lasts a lifetime, resists scuffing, denting. Takes a beating other floors could not withstand. From the standpoint of wear it gives you more value per dollar than any other floor.

## MOST BEAUTIFUL

15 fade-resistant, plain and marbled colors—new decorator colors—the most brilliant afforded in any type floor covering. Squares, diagonals and custom inserts—tiles with die cut centers, polka dots and stars which may be readily removed and other colors inserted. Affords an unlimited choice of patterns.

## MOST COMFORTABLE—MOST QUIET

Cushions and silences footsteps. Slip-resistant.

## EASY TO KEEP CLEAN

Resists stains, has no pores to catch dirt and grit. Even burning cigarettes leave no permanent blemish.

## EASY TO APPLY

### JOHNSON GREASE-PROOF TILE

Unaffected by ordinary grease, fats, oil, citrus juice, acids and alkalis. Ideal for commercial kitchens, restaurants, industry, auto showrooms, bakeries, filling stations, etc.

Readily available from dealers  
throughout America

### DISTRIBUTORS!

Choice territory still open. Write for details.

### OTHER JOHNSON PRODUCTS

RUG CUSHION  
STAIR TREADS  
VINYL PLASTIC SET-ON-BASE COVING

# Johnson Industries, Inc.

359 McPherson Highway • Fremont, Ohio

Please send literature on Johnson Rubber Tile.

I am a distributor.  I am a dealer.

NAME \_\_\_\_\_

FIRM \_\_\_\_\_

STREET \_\_\_\_\_

CITY & STATE \_\_\_\_\_

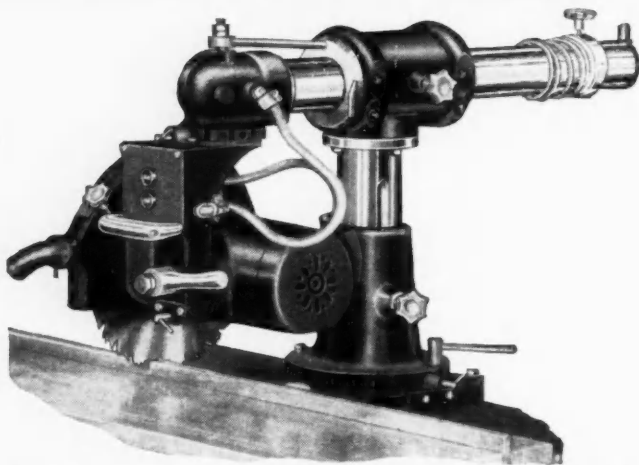

## The Powerful SENIOR Model

All the reasons why you should buy a radial power saw show clearly in the brilliant performance of this new model Comet Senior. Rugged, powerful, long-lasting, more efficient, it is the only saw to purchase. For quick proof ask any Comet owner. For full information see your nearest Comet dealer or write direct.

### Many New Features

1. Maximum portability. Easy to move Comets to lumber.
2. The Senior features new, easy raising and lowering mechanism at front of machine.
3. Exclusive safety return spring assembly. Increases cutting by 20%.
4. All controls located at right and front of machine.
5. Comet motors are rated to provide 100% overload capacity.
6. All exposed parts weather-proofed.
7. Enclosed, easy to change, felt wipers keep retractable arm dust free.
8. Newly designed adjustable saw guard and saw dust chute. Offers highest safety factor.
9. Self-Aligning Column. The column is always in perfect alignment when locked into position. Assures extreme accuracy.
10. Makes all cuts with great speed and accuracy.

CONSOLIDATED MACHINERY & SUPPLY CO., LTD.  
2029-33 Santa Fe Avenue, Los Angeles 21, California



## Catalogs and HOW-TO-DO-IT INFORMATION

**663—CUSTOM-BUILT ORNAMENTAL IRON—** Illustrated catalog available from Belson Manufacturing Co., Aurora 3, Ill., enables builders to determine custom-built prices on the job, without submitting sketches for quotations. Includes simplified dimensioning procedure and "Fill-In" dimension sketches.

**664—MACHINE TOOLS FOR METAL AND WOODWORKING—** New 16-page catalog offered by the Walker-Turner Div., Kearney & Trecker Corp., illustrates line of smaller tools made by this company. Four new models, a 12-inch hand saw, a 6-inch jointer, 8-inch tilting table saw and a 9-inch tilting arbor saw are included in descriptions. Complete specifications.

**665—LIGHTING FIXTURES—** Three bulletins illustrate and describe Lennox-2 fixtures, the new Luvex Slimline fixtures, and a complete listing of the firm's 85-watt fixtures with one piece, closed end reflectors for industrial use. Basic channel listed with couplings. Day-Brite Lighting, Inc., St. Louis 7, Mo.

**666—"HOW TO USE SHELLAC"—** New edition of the 18-page booklet has been made available by the Shellac Information Bureau, 65 Pine St., New York 5, N.Y. Information on how to employ shellac to get best results in finishing new and old floors, walls and woodwork, in addition to general facts about shellac are given.

**667—NEW PORTABLE HAND TOOL—** which uses special .38 or .22 caliber cartridge as source of power to safely anchor steel to concrete, wood furring strips to concrete, and for many other anchoring uses, is described in well-illustrated catalog issued by Powder-Power Tool Corp., 0719 S. W. Woods St., Portland 1, Ore. New tool is called "Drive-It."

**668—OIL-FIRED WINTER AIR CONDITIONER—** Colorful 4-page booklet illustrates and describes new Thatcher 492 Series oil-fired winter air conditioner. Cutaway and full view illustrations of unit are included, as well as engineering data and specifications. Thatcher Furnace Co., Garwood, N.J.

**669—"HOW TO MAKE BASEMENTS DRY AND BEAUTIFUL"—** is title of catalog available from Medusa Products Division of Medusa Portland Cement Co., 1000 Midland Bldg., Cleveland 15, Ohio. Basements are classified as to degree of dampness, and corrective measures are outlined in detail for making each type basement dry.

**670—"INVISIBLE WARMTH"—** How the installation in residential rooms of cast-iron convectors concealed by sheet steel enclosures produces both convected and radiant heat is explained and illustrated in new 8-page Bulletin No. 540, now available from The National Radiator Co., Johnstown, Pa.

**671—SIXTEEN IDEAS FOR NEW KITCHENS—** Promotion piece published by M and M Wood Working Co., 2301 N. Columbia Blvd., Portland 3, Ore., offers 16 sure-fire ideas for well-planned kitchens, telling how to build them with Malarkey plywood and patented flush cupboard door stock. Folder carries bill of materials for each of the 16 ideas.

(Continued on page 128)





Beautiful Oak Flooring as Seen with Contemporary.

## How to make home-owners sell your services

We all know that a satisfied customer is your best salesman. But home-owners, happy with the oak floors you advised, can be made into a special kind of salesmen—and here's how to do it:

Point out to them one quality of oak possessed by no other flooring material and one they will come to appreciate as their home decoration progresses: the versatility of oak grain.

Then as they discover how perfectly oak grain

combines with other materials—with other woods, glass, metals and fabrics—and with any motif from Provincial to Modern, they will gratefully remember your advice.

The realization that you have given them not only the utmost in beauty, durability, and economy, but also flooring that blends with and enhances any decorative scheme they may ever choose—that realization turns happy home-owners into salesmen for you.

**MEMO TO: Builders and Contractors**  
**SUBJECT: Flooring FOR LOW COST HOUSING**

You can now overcome the increasing sales resistance created by substitute flooring materials in low cost homes. Oak flooring, preferred by 85% of prospective home-owners, is now available in lower-priced, common grades.

Give the low cost homes you build the plus values of oak, and, at the same time, keep building costs down.

To help home-owners visualize the style and color adaptability possessed only by oak flooring, show them the new free 16-page booklet, "Planning and Decorating the most important side of a room." Send for your copies today.



**NATIONAL OAK FLOORING MANUFACTURERS' ASSOCIATION**  
 814 STERICK BUILDING • MEMPHIS 3, TENNESSEE

OUR SELECTIVE LOGGING ASSURES YOUR FUTURE SUPPLY OF FINE NORTHERN HARDWOODS  
**Connor FOREST PRODUCTS— Since 1872**

**First Again With  
 "LAYTITE"  
 MAPLE and BIRCH  
 FLOORING**

*The World's Finest—Bar None  
 in*

**CARTONS**  
 (or Long Lengths in Bundles)

1. Have retail sales appeal.
2. Keep flooring clean and dry.
3. Keep the moisture content more uniform.
4. Make inventory easy—the contents are plainly marked for grade and scale.
5. Give buyers the exact cost of 10 sq. ft.
6. Save contractors time in laying mixed lengths without breaking several bundles.



**CONNOR "LAYTITE"  
 PACKAGED FLOORING**

*Cartons keep flooring dry and clean.*



*Assorted lengths save time in laying.*



*Each  
 carton labeled  
 for easy inventory.*

**Telephone No. 3 or 418**

**P. O. Box 112-D**

**Teletype—Marshfield No. 26**

**The CONNOR LUMBER and LAND CO.** Sales Office  
 MARSHFIELD, WISCONSIN  
*Send for Illustrated 75th Anniversary Book*

## Catalogs

(Continued from page 126)

**672—COST DATA ON USE OF CONCRETE FORMS**—Brochure issued by Irvington Form & Tank Corp., 43 Cedar St., New York 5, N.Y., offers cost data on specific construction jobs where Atlas Speed forms are used. Publication is first of series to be issued by firm giving recent labor costs on various types of concrete construction.

**673—PAINT SELECTION CHECK CHART**—describes paint products having important performance requirements, including cost, for each paint job. Chart is valuable tool in determining which coating to use for specific applications. The Wilbur & Williams Co., 43 Leon St., Boston 15, Mass.

**674—END-GLUING WOOD WITH ELECTRONIC WAVES**—a new process developed by Bilt-Well research engineers is described in small brochure issued by Carr, Adams & Collier Co., Dubuque, Iowa. Illustrations of several typical joints glued by the process are shown.

**675—"HOW TO RECESS TYPE A CONVECTORS"**—Booklet 1865, available from The Trane Co., La Crosse, Wis., describes the ease with which convectors can be recessed. To show installation details completely, a wall section was built and a series of photographs were taken in a step-by-step sequence as the plaster, woodwork, finished flooring and draperies were added.

**676—ANTI-BACTERIAL CEMENT**—New literature presents information about a cement to use in making

concrete that kills bacteria and fungi on contact. The anti-bacterial cement is sanitary and safe when used as directed. North American Cement Corp., 41 E. 42nd St., New York 17, N.Y.

**677—SPECIFICATIONS FOR STUCCO AND OVERCOATING**—Adaptations of stucco reinforced with Keymesh, and specifications for both stucco and overcoating are presented in A.I.A. File No. 20-B-1 issued by the Keystone Steel & Wire Co., Peoria 7, Ill. Popular home designs to which reinforced stucco is adaptable are featured.

### SERVICE COUPON—CLIP and MAIL to CHICAGO

Readers Service Department  
 American Builder,  
 79 W. Monroe St., Chicago 3, Ill.

(December, 1949)

Please send me additional information on the following product items, or the catalogs, listed in this department:

Numbers.....

Name.....

Street.....

City..... State.....

OCCUPATION\*.....

\*Please note that occupation must be stated if full service is to be given.

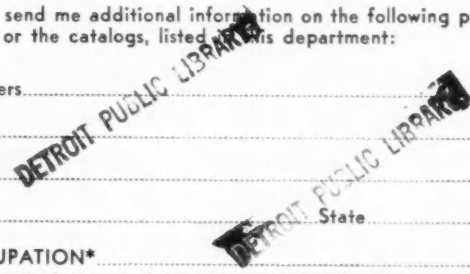

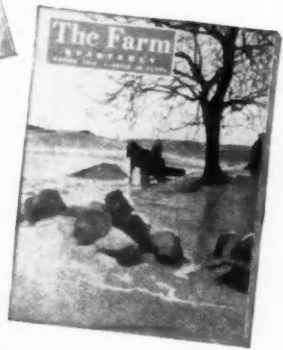

*build  
with  
lumber  
that's*



this year

53,000,000

readers are

learning the

advantages of

building with

**penta-**treated lumber  
chlorophenol

Today you can offer your customers a plus building value—one that will increase your prestige as a quality builder. It's "PENTA"-protected wood—lumber that's protected from termites, decay and mold.

Water repellent toxic solutions containing PENTA are now available which not only protect wood, but also increase its resistance to warping and checking. Costly annoyances such as sticking windows, peeling paint and ill-fitting trim are practically eliminated.

Lay a sound foundation for repeat business—build with PENTA-PROTECTED wood! Write to Dow about where to obtain PENTA-treated lumber. Address Dept. PE 60A.

THE DOW CHEMICAL COMPANY  
MIDLAND, MICHIGAN





# QUALITY LOCKS

from ADAMS-RITE

## THE ORIGINAL RITE-LOCK for SLIDING DOORS

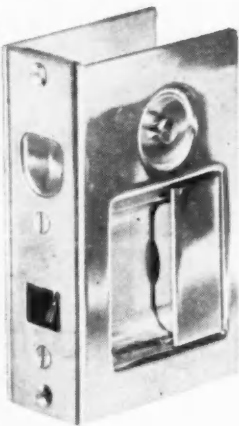

Single assembly easily installed by simple cut-out, even in narrow stiles. No mortising. 3 types fit doors 1 1/8" - 2" thickness, with a 3/4" wardrobe type. Thumb button, emergency, 5-pin tumbler cylinder or latch type may be had interchangeably. Exterior parts solid brass. Escutcheons measure 4 1/2" x 2 7/8".

## MINIMUM BACKSET DEADLOCKS FOR STANDARD CYLINDERS

Can Be Keyed to Any Job

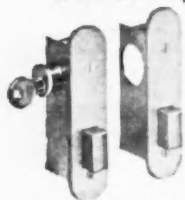

For narrowest extruded aluminum, structural steel and wood stiles. Series 970 Deadlocks for standard cylinders have 1/16" backset, 1 1/8" depth. Fifteen other standard backsets to 1 3/4". Series 980 identical

except for 3/4" dia. pin tumbler cylinder and 1/8" backset. Rugged steel and brass construction, armored bolt with 3/8" throw, bronze or aluminum face and strike. Radius, flat and bevelled faces interchangeable.

## TEMPERED GLASS DOOR DEADLOCK



Takes the place of 2 locks. Has single or double bolts and 1 or 2 cylinders. Handle operates bolts in sequence, cylinder locks handle. Designed for and can be installed in any tempered glass door top or bottom channel. 4 sizes: 1-15/16" High x 1-13/32" Wide.

## CYLINDER SLIDING DOOR LOCK



Operates by cylinder from one or both sides. Fits all standard cylinders with adapter cams furnished, (specify when using Yale or Sargent cylinder). Solid bronze face, strike & bolt. Heat treated aluminum alloy case. Use your own cylinders and trim. Also used as jimmy-proof lock.

Also—Adams-Rite Solid Brass Sliding Door Flush and Edge Pulls, Surface and Jamb Bolts and Ball Latches



## Baseboard Heating

(Continued from page 105)

studding. A double-wood floor is used with 1-inch rigid insulation nailed directly to the underside of the floor joists. The ceiling of the living quarters is 1/4-inch plywood supported by frameworks of 2- by 4-inch members and covered by 3 5/8 inch of rock wool insulation.

Temperatures were measured in the test bungalow by means of thermocouples supported by strings attached to the ceiling. Five strings of five thermocouples each were located in the kitchen, living room, and the two bedrooms with one

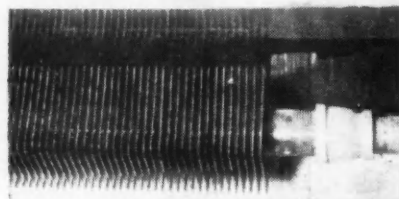
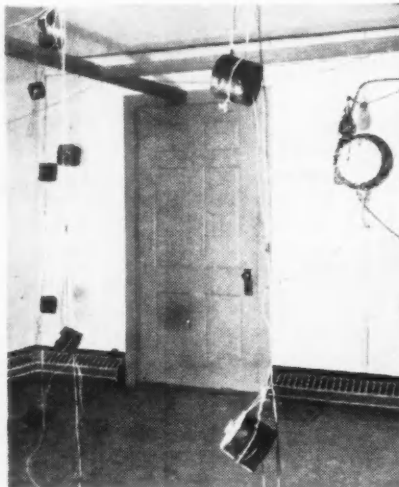

**BASEBOARD convector (top) in living room of test bungalow with perforated metal housing in place. Strings suspended from ceiling support five thermocouples each at 2, 30, 60, 78, and 94 inches above floor. A close-up view of a finned convector element without sheet metal enclosure is shown at bottom**

string suspended at the center of each room and one midway between the center and each corner of these rooms. Three strings of five thermocouples each were used in the bathroom. The five thermocouples on each string were permanently installed at distances of 2, 30, 60, 78, and 94 inches above the floor.

Other thermocouples were used to measure the temperatures outside of the bungalow, on the inside and outside surfaces of the exterior walls, on the floor surfaces, in the basement, in the attic, and at sev-

(Continued on page 132)



## There's only ONE—

Various limes come from Ohio . . .  
they're OHIO limes.

When more or less white . . .  
they're called WHITE limes.

When sold for finished plaster . . .  
they're FINISH limes.

Some may even come from Ohio, be white, and be meant for finishing limes . . .

Yet, there's only one OHIO WHITE FINISH (our trade mark), that through its consistent quality has gained favor everywhere with architects and builders, and is preferred by plasterers for its good working qualities.

You too may rely on our twin brands: OHIO WHITE FINISH and HAWK SPREAD WHITE FINISH. Scientifically processed from hand picked, kiln burned dolomitic limestone, they are always of uniform good quality, 99 1/2% pure.

They are easily recognized by the Zig-zag Bags.

The OHIO HYDRATE & SUPPLY Co.  
WOODVILLE, OHIO



**A New Species Book**

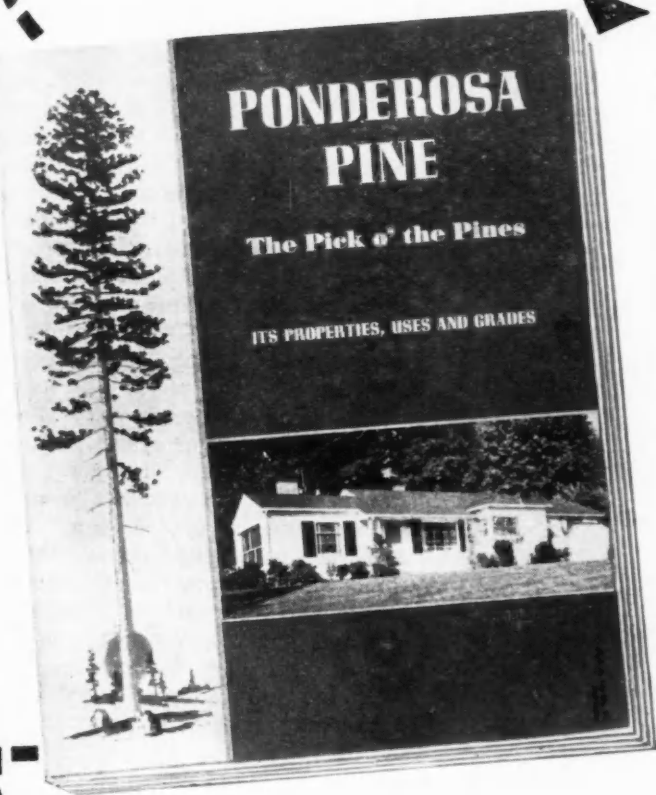

**For Lumber Dealers, Builders, Architects, and Wood Users**

Factual, complete and profusely illustrated data on its properties and uses, including photographs of typical pieces of each grade with illustrated recommendations for their use and details of popular paneling patterns.

A free copy will reach you quickly when requested on your business letterhead.

**WESTERN PINE ASSOCIATION**  
510 Yeon Building Dept. 141B Portland 4, Oregon



*\*These are the Western Pines*

\*Idaho White Pine \*Ponderosa Pine  
\*Sugar Pine

*These are Associated Woods*

Larch • Douglas Fir • White Fir  
Spruce • Cedar • Lodgepole Pine

*Well manufactured—thoroughly seasoned—carefully graded—by all Association member mills*

**10 POWER MACHINES IN ONE!**

FOR "FINISHING" YOUR HOUSES

**DE WALT**

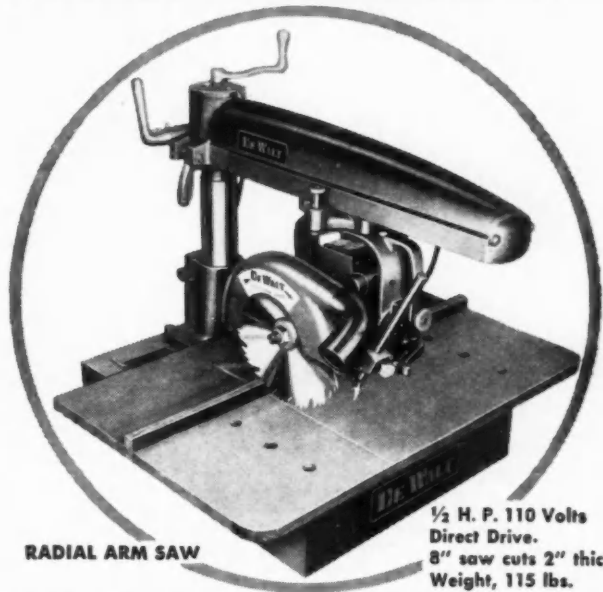

**RADIAL ARM SAW**

1/2 H. P. 110 Volts Direct Drive. 8" saw cuts 2" thick. Weight, 115 lbs.

<b>TENONER</b>	<b>DADO</b>	<b>HORIZONTAL DRILL</b>
<b>METAL CUTTER</b>	<b>SHAPER</b>	<b>DISC SANDER</b>
<b>VARIETY SAW</b>		
<b>GRINDER</b>		
<b>ROUTER</b>		

Every time you change the cutting tool on a DeWalt, you have another machine! All ten of these, and more! This low-cost, easy-to-operate DeWalt will cut all your interior trim more accurately and give you a better fitting job. You can use DeWalt to cut material any length and to rip to center of 40" panel.

DeWalt is safe and accurate. It costs so little—and pays for itself quickly. Order now. Write DeWalt Inc., 112 Fountain Avenue, Lancaster, Penna.

**DE WALT**

There's a world of  
experience behind the  
 $1\frac{3}{4}$ " standard  
**PAINE**  
**REZO**  
T. M. REGISTERED  
**Door**

It guarantees  
your customers  
satisfaction  
— and your own

There is nothing arbitrary about  
the standard  $1\frac{3}{4}$ " thickness of Paine  
Rezo doors.

Over the years, all over the world,  
the global, patented Rezo door con-  
struction has proved to be most stable, most free from dimensional change. That's  
why Paine specifically recommends this thickness — because it's right.

Why accept a lesser doubt when you get a fact that's GUARANTEED . . .  
for every Rezo door carries an unconditional warranty of satisfactory service  
by the world's largest exclusive producer of air cell flush doors. These time-tried  
and time-proved doors are now obtainable at all dealers. Specify them. See  
Sweet's catalog for an informative data bulletin, or a copy will gladly be  
mailed to you for the asking.

Manufactured by the  
**PAINE LUMBER CO., LTD.** Oshkosh  
Wisconsin  
ESTABLISHED 1853

### Baseboard Heating

(Continued from page 130)

eral places on the hot water pipe encircling the house.

The temperature distribution was observed in the bungalow while a temperature of 70°F. was maintained at the 30-inch level for outside air temperatures of 50°F., 32°F., 20°F., and as near 0°F. as could be attained. In addition to the investigation of the temperature distribution in the four rooms with a steady outside temperature, the characteristics of the modulating valve and outdoor-thermostat control system were observed when the outdoor temperature was varied between 0°F. and 40°F. as rapidly as the refrigerating system permitted.

The pickup characteristics of the baseboard convector system, when controlled by the outdoor thermostat, were also observed. The two bedrooms were cooled down to 50°F. by opening the windows, thus simulating the practice of many people who sleep with the bedroom windows opened. When the bedrooms reached a temperature of 50°F., the windows were closed and the recovery of the temperature in the bedrooms was observed while the interior doors remained closed. The temperatures in the kitchen and living room and the supply water temperature were also recorded during this transient condition.

The test results showed that comparatively small temperature differences existed between rooms and between different levels in the same room with this type heating system for the range of outside temperature from 50°F. to 0°F. However, the temperature differences increased in magnitude both horizontally and vertically as the outside temperature decreased. The vertical temperature gradient ranged from 0.3°F. per foot above the floor for an outside temperature of 50°F. to 0.8°F. per foot for an outside temperature of 0°F. The maximum temperature difference between any two rooms in the living zone ranged from 0.7°F. to 1.4°F. with the interior doors open and from 1.4°F. to 3.6°F. with the interior doors closed for an outside temperature range 50°F. to 0°F.

The heat loss of the test bungalow observed at the different outside temperatures was shown to be directly proportional to the differ-

(Continued on page 134)





**EXCLUSIVE LONG-SHAFT TRANSVERSE MOTOR MOUNTING** transmits as much as 25% extra power, supports blade on oversize ball bearings from one side of the tool clear to the other.

**EXCLUSIVE SAFETY-LOCK SWITCH**—positive protection against accidental starting.

**EXCLUSIVE SHOCK-ABSORBER GEARING** harnesses the added power of these great new saws, gives extra life to motor, gears, spindle and blade.

**EXCLUSIVE PROTECTED DEPTH AND BEVEL SCALES** are in plain sight when you use them—out of the way when you don't. Always accurate.

**EXCLUSIVE EXTRA-WIDE REENFORCED STEEL SAFETY BASE** for better balance—easier to handle, far safer to use.

**PLUS** powerful, built-in sawdust blower . . . over-size ball bearing construction . . . automatic ball bearing blade-guard . . . die-cast aluminum housings . . . steel inserts for bearings and threads . . . fingertip depth and bevel control . . . convenient handles . . . steel rip guide . . . extra-capacity switches . . . most powerful motors ever used in electric saws.

*Silver Line* means "new design"—from

rip guide to switch—to give you the safest, easiest handling, most powerful saws on the market today. 15 new features . . . many of them exclusive . . . each of them thoroughly field tested and approved for economical, trouble-free operation. Six sizes to meet every demand from the lightweight "6" to the sturdy "12". Try these great new Silver Line Saws now available at your Thor distributor. Independent Pneumatic Tool Co., Aurora, Illinois.

**Thor** PORTABLE POWER  
**TOOLS**  
ELECTRIC • PNEUMATIC

# TIME IS MONEY!

SAVE BOTH WITH **KEYSTONE**  
*Frameless Tension* **SCREENS**

(PATENT APPLIED FOR)

**NO SCREEN FRAMES**  
to Make or Fit.  
**NO PAINTING**  
**NO OUTSIDE Hardware**

Install screens this new modern frameless way and eliminate making and fitting screen frames, painting and outside hardware. You will not only save money, but will cut screen installation time to a minimum this modern Keystone way.

**ALL ALUMINUM**... no stains, rust, or painting, and you in addition offer beauty, easy storage, long life and satisfaction to your clientele.

**EASY TO INSTALL**... Simple round headed screws and small sill fixtures are all you install. A removable bar attaches screen to top of window and is held under slight tension by a bottom bar fixture. In reality you make the blind stops serve a double purpose as part of the tension screen frame. Now available for both wood and metal windows.

New projects or remodeling of homes, apartments, hospitals, hotels and other structures can be quickly and economically screened with the completely new Keystone Frameless Tension Screens.

Send in coupon today for complete descriptive literature and prices.

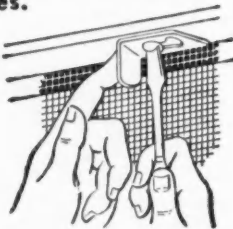

Round headed screw installed in top blind stop holds removable top bar bracket.

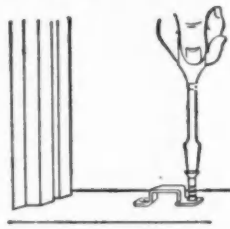

No bulky hardware on sill... just a neat, small, permanent bracket.

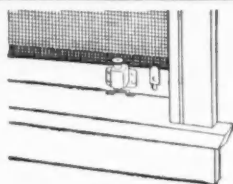

Catch at sill engages sill fixture. Note that fixture is easily adjusted for proper tension.

**KEYSTONE**  
**WIRE CLOTH CO.**  
HANOVER, PENN.

KEYSTONE WIRE CLOTH CO.  
Hanover, Pennsylvania

Please send complete details and specifications.

Name.....

Att'n of.....

Street.....

City.....State.....



AB-31

## Baseboard Heating

(Continued from page 132)

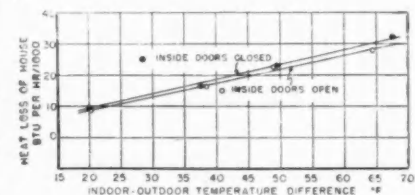
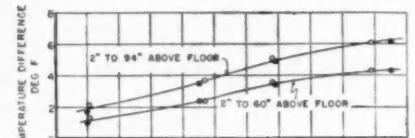
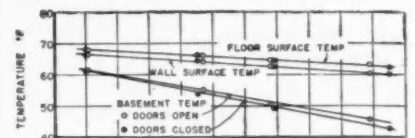

GRAPHS showing relation of heat loss, vertical temperature differences, basement temperature, wall-surface temperature, and floor surface temperature to the indoor-outdoor temperature difference for the baseboard convector system with room-thermostat control

ence in temperature between the inside air and the outside air, although the heat loss averaged about 5 per cent greater when the interior doors were closed. This greater heat loss when the doors were closed was due primarily to the overheating of the bathroom (used as a utility room).

The control of room temperature by the outdoor thermostat and modulating valve for rapidly changing outdoor temperature was observed. The results show that some over-heating of the house occurred during periods of rapidly falling outdoor temperature and that some under-heating occurred during periods of rapidly rising outdoor temperatures. This phenomenon was to be expected because the temperature of the supply water was changed immediately in response to counter changes in outdoor temperature whereas the inside air temperatures did not feel the effect of the outdoor temperature change for an hour or more because of the thermal lag of the exterior walls.

The pick-up of the bedroom temperature after night cooling was measured with the outdoor thermostat control because consideration of the operating principle of this control suggested that it would provide slower pick-up than conventional room thermostat control. It was noted that seven hours elapsed before the temperature in the north bedroom reached 70°F.

(Continued on page 136)

# HERE ARE THE 25 MOST POPULAR modular size

## WOOD WINDOWS THAT SAVE BUILDING TIME AND COSTS!

Less cutting and trimming on the job . . . less waste . . . lower building cost! These are the reasons why it pays to insist on modular-size windows, sash and frames!

The 25 most popular sizes of 5 of the most popular designs shown on this page are manufactured on the 4-inch "module" or unit of measurement. All are available promptly. See your lumber dealer.

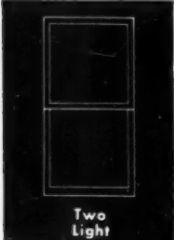
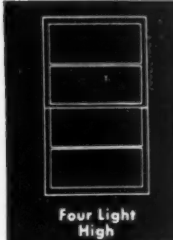
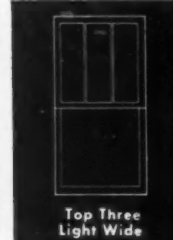
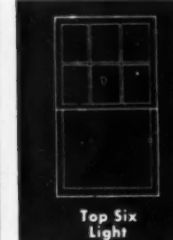
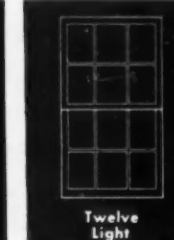
OPENING SIZES	GLASS SIZES—1 <sup>3</sup> / <sub>8</sub> " CHECK RAIL WINDOWS										
(Note: Windows are made 1/8" narrower and 1/8" shorter than window opening sizes shown below)											
	Two Light		Four Light High		Top Three Light Wide		Top Six Light		Twelve Light		
	2-0x3-2	20x16	20x18	20x20	20x24	20x28	6 <sup>1</sup> / <sub>2</sub> x16	6 <sup>1</sup> / <sub>2</sub> x18	6 <sup>1</sup> / <sub>2</sub> x20	6 <sup>1</sup> / <sub>2</sub> x24	6 <sup>1</sup> / <sub>2</sub> x28
	2-0x3-6	20x18	20x20	20x24	20x28		6 <sup>1</sup> / <sub>2</sub> x18	6 <sup>1</sup> / <sub>2</sub> x20	6 <sup>1</sup> / <sub>2</sub> x24	6 <sup>1</sup> / <sub>2</sub> x28	
	2-0x3-10	20x20	20x24	20x28			6 <sup>1</sup> / <sub>2</sub> x20	6 <sup>1</sup> / <sub>2</sub> x24	6 <sup>1</sup> / <sub>2</sub> x28		
2-0x4-6	20x24	20x28				6 <sup>1</sup> / <sub>2</sub> x24	6 <sup>1</sup> / <sub>2</sub> x28				
2-0x5-2	20x28					6 <sup>1</sup> / <sub>2</sub> x28					
2-4x3-2	24x16	24x18	24x20	24x24	24x28	7 <sup>2</sup> / <sub>2</sub> x16	7 <sup>2</sup> / <sub>2</sub> x18	7 <sup>2</sup> / <sub>2</sub> x20	7 <sup>2</sup> / <sub>2</sub> x24	7 <sup>2</sup> / <sub>2</sub> x28	
2-4x3-6	24x18	24x20	24x24	24x28		7 <sup>2</sup> / <sub>2</sub> x18	7 <sup>2</sup> / <sub>2</sub> x20	7 <sup>2</sup> / <sub>2</sub> x24	7 <sup>2</sup> / <sub>2</sub> x28		
2-4x3-10	24x20	24x24	24x28			7 <sup>2</sup> / <sub>2</sub> x20	7 <sup>2</sup> / <sub>2</sub> x24	7 <sup>2</sup> / <sub>2</sub> x28			
2-4x4-2	24x22	24x24	24x26	24x28		7 <sup>2</sup> / <sub>2</sub> x22	7 <sup>2</sup> / <sub>2</sub> x24	7 <sup>2</sup> / <sub>2</sub> x26	7 <sup>2</sup> / <sub>2</sub> x28		
2-4x4-6	24x24	24x26	24x28			7 <sup>2</sup> / <sub>2</sub> x24	7 <sup>2</sup> / <sub>2</sub> x26	7 <sup>2</sup> / <sub>2</sub> x28			
2-4x4-10	24x24	24x26	24x28			7 <sup>2</sup> / <sub>2</sub> x24	7 <sup>2</sup> / <sub>2</sub> x26	7 <sup>2</sup> / <sub>2</sub> x28			
2-4x5-2	24x28	24x28				7 <sup>2</sup> / <sub>2</sub> x28					
2-8x3-2	28x16	28x18	28x20	28x24	28x28	9 <sup>3</sup> / <sub>2</sub> x16	9 <sup>3</sup> / <sub>2</sub> x18	9 <sup>3</sup> / <sub>2</sub> x20	9 <sup>3</sup> / <sub>2</sub> x24	9 <sup>3</sup> / <sub>2</sub> x28	
2-8x3-6	28x18	28x20	28x24	28x28		9 <sup>3</sup> / <sub>2</sub> x18	9 <sup>3</sup> / <sub>2</sub> x20	9 <sup>3</sup> / <sub>2</sub> x24	9 <sup>3</sup> / <sub>2</sub> x28		
2-8x3-10	28x20	28x24	28x28			9 <sup>3</sup> / <sub>2</sub> x20	9 <sup>3</sup> / <sub>2</sub> x24	9 <sup>3</sup> / <sub>2</sub> x28			
2-8x4-2	28x22	28x24	28x26	28x28		9 <sup>3</sup> / <sub>2</sub> x22	9 <sup>3</sup> / <sub>2</sub> x24	9 <sup>3</sup> / <sub>2</sub> x26	9 <sup>3</sup> / <sub>2</sub> x28		
2-8x4-6	28x24	28x26	28x28			9 <sup>3</sup> / <sub>2</sub> x24	9 <sup>3</sup> / <sub>2</sub> x26	9 <sup>3</sup> / <sub>2</sub> x28			
2-8x4-10	28x24	28x26	28x28			9 <sup>3</sup> / <sub>2</sub> x24	9 <sup>3</sup> / <sub>2</sub> x26	9 <sup>3</sup> / <sub>2</sub> x28			
2-8x5-2	28x28	28x28				9 <sup>3</sup> / <sub>2</sub> x28					
3-0x3-2	32x16	32x18	32x20	32x24		7 <sup>1</sup> / <sub>2</sub> x16	7 <sup>1</sup> / <sub>2</sub> x18	7 <sup>1</sup> / <sub>2</sub> x20	7 <sup>1</sup> / <sub>2</sub> x24		
3-0x3-6	32x18	32x20	32x24			7 <sup>1</sup> / <sub>2</sub> x18	7 <sup>1</sup> / <sub>2</sub> x20	7 <sup>1</sup> / <sub>2</sub> x24			
3-0x3-10	32x20	32x24				7 <sup>1</sup> / <sub>2</sub> x20	7 <sup>1</sup> / <sub>2</sub> x24				
3-0x4-6	32x24					7 <sup>1</sup> / <sub>2</sub> x24					
3-4x3-10	36x20	36x24				8 <sup>1</sup> / <sub>2</sub> x20	8 <sup>1</sup> / <sub>2</sub> x24				
3-4x4-6	36x24					8 <sup>1</sup> / <sub>2</sub> x24					
						Top Four Light Wide	Top Eight Light Four Wide	Sixteen Light			
						7 <sup>1</sup> / <sub>2</sub> x16	7 <sup>1</sup> / <sub>2</sub> x18	7 <sup>1</sup> / <sub>2</sub> x20	7 <sup>1</sup> / <sub>2</sub> x24		
						7 <sup>1</sup> / <sub>2</sub> x18	7 <sup>1</sup> / <sub>2</sub> x20	7 <sup>1</sup> / <sub>2</sub> x24			
						7 <sup>1</sup> / <sub>2</sub> x20	7 <sup>1</sup> / <sub>2</sub> x24				
						7 <sup>1</sup> / <sub>2</sub> x24					
						8 <sup>1</sup> / <sub>2</sub> x20	8 <sup>1</sup> / <sub>2</sub> x24				
						8 <sup>1</sup> / <sub>2</sub> x24					

For additional data, see our catalog in Sweet's Builders' File

### POPULAR DESIGNS OF MODULAR-SIZE WOOD WINDOWS

Made of ponderosa pine, these modular-size windows have the natural insulating advantages that wood so handsomely provides. They hold paint or other finishes lastingly . . . discour-

age condensation. They are available toxic preservative treated at the factory for extra resistance where staining, decay, insect attack or humidity are factors. Ask your dealer for them.

### NATIONAL WOODWORK MANUFACTURERS ASSOCIATION

332 SOUTH MICHIGAN AVENUE CHICAGO 4, ILLINOIS

This seal of approval identifies woodwork products which meet N.W.M.A. minimum standards of toxic preservative treatment.



National Woodwork Manufacturers Assn.  
332 South Michigan Avenue  
Chicago 4, Illinois

Gentlemen: I want to know more about modular design woodwork. Please send me your folder, "New Savings for Builders."

Name.....

Address.....

City..... Zone..... State.....

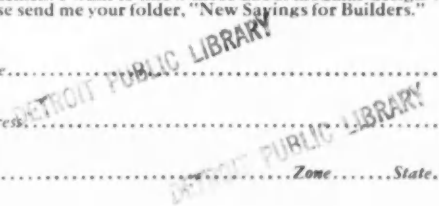



# Standardize on Stanley JOB-PROVED electric tools

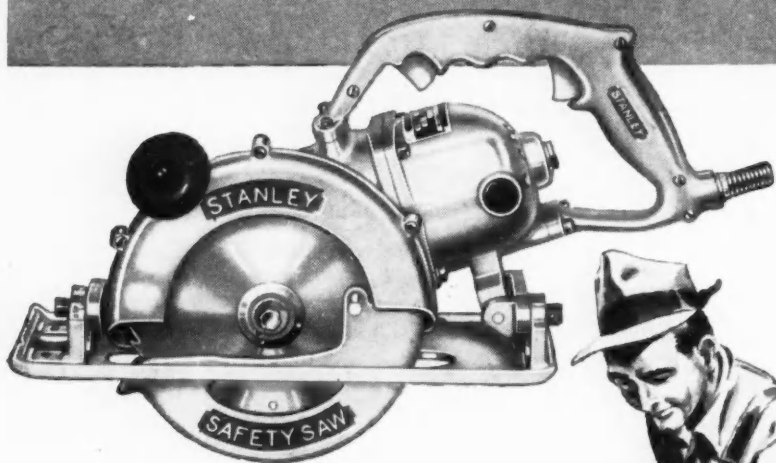

Model W8 Safety Saw  
cuts 0 to 2 3/4"

Stanley W8 is a heavy-duty power saw that handles as easily as a hand saw. Gives machine-perfect accuracy on all kinds of tough jobs... compound angles, stair stringers, floor joists, flooring.

Duplex handle with two switch triggers for convenient handling in any position. Simple wing nut adjustment for depth of cut. Safety guard covers cutting edge at all times. Motor and arbor mounted on sealed ball bearings. Tilting base permits bevel cuts up to 2 1/16" at 45°. Capacity on straight cuts, 0 to 2 3/4". Operates on AC or DC.

See these Stanley Electric Tools at your industrial distributor's. Stanley Electric Tools, New Britain, Conn.

## STANLEY

Reg. U.S. Pat. Off.

HARDWARE • HAND TOOLS • ELECTRIC TOOLS • STEEL STRAPPING

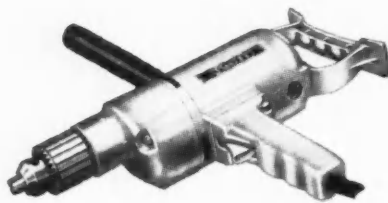

No. 112 Electric Drill, 1/2" . . . Compact, lightweight, general purpose drill for wood and metal. Chuck spindle offset to allow drilling in close quarters without removing either pipe or spade handle. Fast hole saw work. Drill stands available.

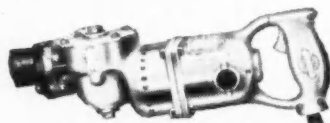

Stanley No. 310A Electric Hammer  
Powerful but lightweight for drilling, chipping, channeling, vibrating, tamping, scaling rust . . . all kinds of hammer work. Plugs into any lighting circuit, AC or DC.

## Baseboard Heating . . .

(Continued from page 134)

and the temperature in the south bedroom did not approach a steady value of 68°F. for at least nine hours after closing the windows. The temperature of the water supplied to the baseboard convactor did not change appreciably when the windows were opened or during the pick-up period. A change in supply water temperature was not to be expected with the outdoor thermostat control system, however, since the outdoor temperature remained constant.

The results of the Bureau's investigation showed that the specimen baseboard convactor system produced lower vertical temperature gradients in the test bungalow than any other system or device that had been tested heretofore. Whereas a temperature difference of 8°F. was observed between the 2-inch and 60-inch levels for a gravity hot water heating system with conventional thin tube radiators and the boiler in the basement, a temperature difference of 3.5°F. was observed between the same levels with the baseboard convactor for an outside temperature of 20°F. in both cases.

The baseboard heating system is well suited for application to basementless houses because it is installed above the floor level and because it provides better comfort than most other systems at the floor level. However, this type system can also be used in houses with basements with the boiler located below the floor.

## Owens-Corning Conducts Fiberglas Demonstrations

With 40-mock-ups and more than a hundred samples and exhibits, Owens-Corning Fiberglas Corp. recently demonstrated the characteristics and uses of Fiberglas to Chicago business men who met at the Chicago Stock Yards Inn. Attending the mobile exhibit were architects, engineers, builders, contractors, manufacturers and industrial technologists.

The touring demonstrations' personnel showed how Fiberglas products have found their way into building construction, cold storage uses, electrical equipment, homes, office buildings and in many other fields.

The exhibit, to be shown in several other cities, is directed by Edward C. Ames, public relations director of the firm.

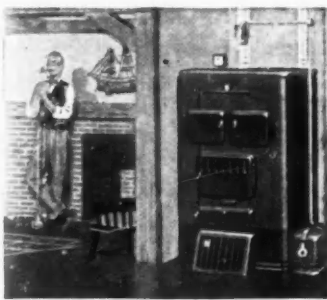

**WALL-FLAME OIL BURNERS**, ready for immediate installation in existing boilers and furnaces, save up to 25% or more on ordinary fuel oil costs.

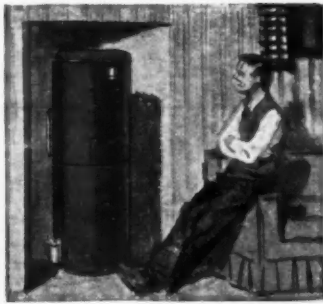

**"DUTY-DESIGNED" HI-BOILERS** are built specifically to give small homes all the benefits of modern oil heat—plus automatic domestic hot water.



**SUPER-COMPACT HI-FURNACES**—for finest automatic warm air heating—combine Wall-Flame oil burner, blower and air filter in one fully-integrated unit.

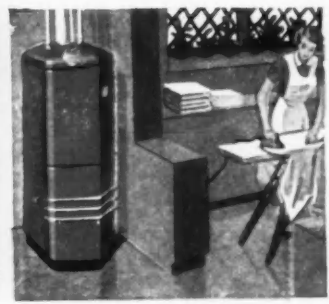

**OIL BURNING WATER HEATERS**, both coil and tank type, are fired by the Wall-Flame Burner—supply oceans of hot water for a few cents a day.

**Clients Expect More—Get More**  
*when you specify*

# TIMKEN

## *Silent Automatic*

### HOME HEATING EQUIPMENT for OIL, GAS and COAL

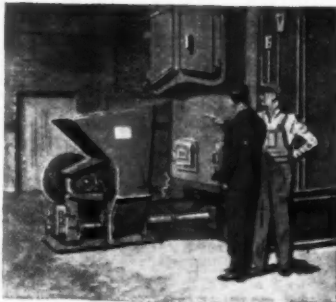

**POWER-FLEX STOKERS** are ruggedly built for heavy-duty dependability—give major savings on steam costs. Capacities up to 15 tons a day.



**RESIDENTIAL COAL BURNERS**, quality-built by Timken Silent Automatic, offer a wealth of features to give you modern automatic coal heat at its finest.

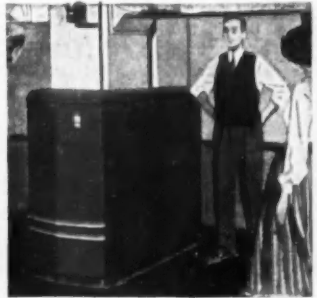

**NEW GAS FURNACES**, fired by efficient mono-port burners, are unsurpassed for clean, quiet heat. Timken Silent Automatic gas boilers, too.



**ALL-NEW GAS BOILERS**, especially designed for small homes, are also recommended for tandem installation in larger houses. Mono-port burner.

Over a period of the last 20 years, prospective builders and purchasers of new homes have learned to expect more from Timken Silent Automatic heating equipment, principally because their friends have gotten more from this efficient and dependable equipment installed in *their* homes. Today, public awareness of the *plus value* offered by Timken Silent Automatic heating equipment is at an all-time high, speeding acceptance of both the heating system and the entire home and adding to the profits enjoyed by architects and builders alike.

Among the several new types of heating equipment recently introduced by Timken Silent Automatic are the new advance-designed Gas Furnaces, equipped with wall-flame type burners and built to last as long as the homes in which they are installed. Complete information will be gladly supplied upon request.

Write today for free literature on Timken Silent Automatic heating equipment for all three fuels—oil, gas and coal.

## TIMKEN

# *Silent Automatic*

## HEAT

**OIL • GAS • COAL**

TIMKEN SILENT AUTOMATIC DIVISION

The Timken-Detroit Axle Company • Jackson, Michigan

TRADE MARK REGISTERED

PLANTS AT: DETROIT, MICH. • OSHKOSH, WIS. • JACKSON, MICH. • UTICA, N. Y. • ASHTABULA, OHIO • KENTON, OHIO • NEW CASTLE, PA.

# WALLS UP! in 3 DAYS with SPEED-WALL



## AMAZING EVIDENCE

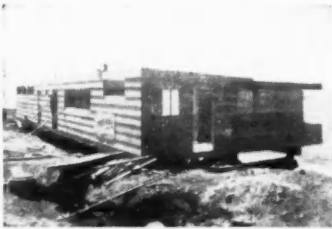

**3rd Day**  
4 men—3 days—Ready  
for Plates and Roof

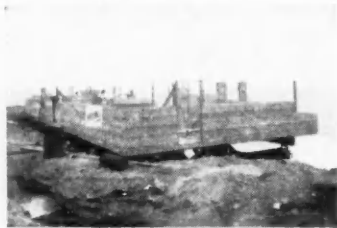

**2nd Day**  
Walls Half Up—52 Man  
Hours



**1st Day**  
2100 Sq. Feet Floor  
Space

Study these pictures. They make eye-popping evidence in support of Speed-Wall advantages. They reveal the swiftness with which floor, walls and roof, all Speed-Wall, were erected on the new Marinos Restaurant, Topanga Canyon Beach, California... Speed-Wall's greatest virtue is its sound engineering principle which results in great strength and ability to absorb vertical and horizontal stresses. Not a pre-fabricating method, exterior and partition Speed-Wall may be pre-cut, or cut on the job. Speed-Wall construction saves from one to two dollars per sq. ft. of floor space. Eliminates fire-blocking, studding, diagonal bracing, insulation, plaster and stucco. It is amazingly fire-resistant, has very high insulation and acoustical values. May be stained, varnished, calcimined or paneled... Speed-Wall is versatile in application—May be effectively integrated with other elements. Opens wide new field in architectural adaptation. Offers larger profits to builders! Write for free information!

### Available Kiln Dried if Desired

It's New! It's Practical! It's Economical!  
It's Amazingly Fast Construction! For  
tract development or single homes.  
Arrange now to handle this type of  
construction exclusively in your area.



FOR FASTER AND BETTER BUILDING

# SPEED-WALL

INC.

General Offices: 332 SO. BEVERLY DRIVE - BEVERLY HILLS, CALIF.

### How Builders Sell . . .

(Continued from page 111)

that there is a tremendous market and that the buyers are those we had before the war, who are making a little more money, and want to enjoy the amenities of home ownership. . . . We've got to convince them that they're getting a dollar's worth of house for the dollar they spend. We are, therefore, going to have to convince them that there will not be any great drop in the foreseeable future, and sell them on the idea once again that real estate is a good investment."

★ ★ ★

"SUCCESS IN SELLING a new home project should date back to the very beginning," says another builder, from Battle Creek, Mich. "First, the decision should be made as to the price bracket or selling range of the homes; then use caution in choosing the lots or building sites.

"I am really sold on obtaining the services of a good architect to help work out all plans and specifications and of impressing upon him that the exterior design of every house should be different, thereby eliminating the appearance of row houses. Further, retain the architect's services in selecting the color schemes, as they should be very attractive and properly worked out."

★ ★ ★

### NEVER FORGET QUALITY.

"A builder should never forget quality," this builder stresses. "It is important that he sell the general public as well as the buying public, the lending institutions, and the local chamber of commerce, on the quality of his houses, thereby establishing a reputation for quality in the community. It helps sell homes.

"A salesman has to be vigorous, energetic and ambitious. He must thoroughly understand and have all of the knowledge necessary to explain in detail everything about the home from start to finish and be sold on the bargain this home represents, so that he is able to tell the prospect the truth in making the sale.

"It is also necessary for the salesman to be able to judge and understand his prospect instantly. The first thing to do is to sell the prospect on yourself. Do all of the talking necessary to sell your prospect, but do not talk too much. You may do quite a lot of talking to some

(Continued on page 140)



# Plywood Paneled Walls

## Achieve the "Modern Look"—Easily

It's no trick to achieve attractive, modern interior walls with Douglas fir plywood. Many design treatments are easy to plan—by following these simple, fundamental principles of application.

### Work "From the Openings"

For the most pleasing effect when joints are to be visible, always work from the openings in a wall. Line up vertical joints with the openings, then divide the plain wall spaces into orderly patterns. One typical design treatment is shown below, with PlyPanel (the paneling grade of Douglas fir plywood) placed horizontally. Note that vertical

joints are placed at each side of top of door and at top and bottom of window openings. (Detail A, C, E and G.) For economy, cover large areas first.

### Joint Treatment Varied

Joints between panels offer no problem. Frank recognition of the joints themselves add to the architectural effect. They may be "veed," an inset moulding used, or any one of several types of mouldings may be placed over the joint itself.

Special design layouts, or patterns made up of small panels, are best applied by first sheathing with 5/16" PlyScord (the sheathing grade of Douglas fir plywood) and then applying the finish panels as desired.

### Finishing Plywood Walls

The room design shown would be ideal for finishing with any of the new light stain finishes (some selection of panels for attractive grain pattern is desirable when a light finish is used). Such finish affords a variety of soft tones yet retains natural beauty of real wood paneling. Paneled walls, of course, can be painted as well, or plywood interiors may be

papered when joints are filled and smooth felt or blank stock applied first.

### Other Treatments Possible

The detailed design shown here is only one of many possible. However, it illustrates the basic principles of plywood application. Paneling arrangement may be planned for either vertical or horizontal placement of plywood. Combinations may be used successfully in the same room.

Ceilings of plywood, too, may be applied in many patterns and given almost any finish.

Data on plywood wall and ceiling application and finishing may be secured from Douglas Fir Plywood Association, Tacoma 2, Washington.

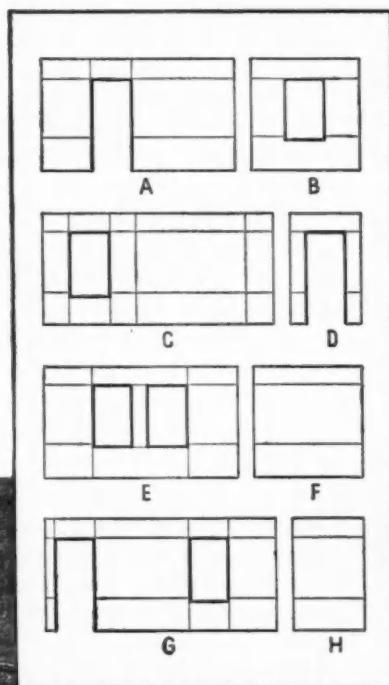

Shown is one typical design treatment—a modern living room. Note how attractive the joint treatment can be with proper—though simple—planning of panel placement.

## Douglas Fir PLYWOOD

LARGE, LIGHT, STRONG

Real Wood Panels

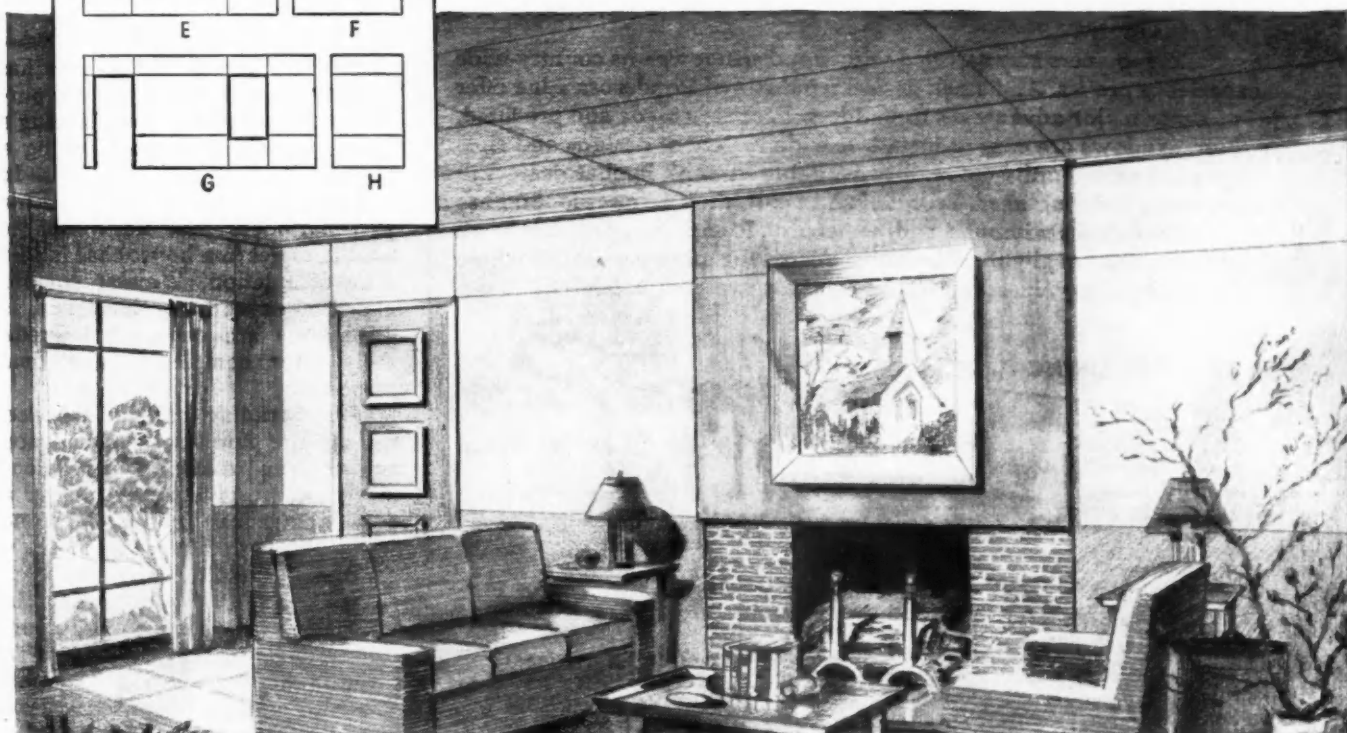



why owners **STAY** satisfied  
with Wood windows



Mrs. Smith loves comfort—and chooses wood windows because they help insulate her home against winter's cold and summer's heat. The Joneses like wood windows because moisture does not readily condense on them to cause annoying water spots. The Browns prefer wood because it decorates so beautifully—holding paint or other finishes lastingly . . .

Yes, owners stay satisfied with wood windows—as country-wide experience proves. And stock design windows of Ponderosa Pine offer other major advantages to builders. Precision made and pre-fitted, these windows are easy to install. A wide variety of designs and sizes in pre-assembled units are readily available from all lumber dealers to meet every building need. Economical in cost, they permit plentiful use of windows without a budget penalty. Remember, too, that these windows are available chemically treated for extra protection where stain, decay, insect attack or humidity are problems.

FOR FRIENDLY LIVING . . .

*Ponderosa Pine*  
**WOODWORK**

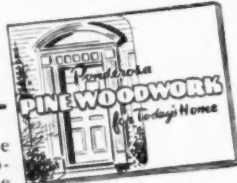

Mail the coupon today for the new Ponderosa Pine Booklet "Ponderosa Pine Woodwork for Today's Home." Full of illustrations—many in natural colors—it shows how you can use Ponderosa Pine windows, doors, cabinets and other woodwork to give any home greater convenience and livability. Send for your copy now!

Ponderosa Pine Woodwork  
Dept. SAB-12, 38 S. Dearborn St.  
Chicago 3, Illinois

Please send me a copy of "Ponderosa Pine Woodwork for Today's Home."

Name.....

Address.....

City.....Zone.....State.....

**How Builders Sell . . .**

(Continued from page 138)

prospects; with others, let them do the talking. You have to do some pretty good guessing and be cagey yourself with a prospect who doesn't talk at all. Do your best to make him know you are trying to help him. First find out if he qualifies; if he does, give him all the time necessary to do a good job of selling. Never mind the weather—they'll buy if it is snowing, raining or storming—as quickly as if the sun is shining. When the customer is sold, don't procrastinate on closing."

★ ★ ★

**COUNTRY ATMOSPHERE—CITY CONVENIENCE.** About the utilization of hilly land, this Pittsburgh builder says, "We attempt to purchase ground where the prospective buyer will have full use of his lot, without going into a hobby of raising goats. In every instance, we attempt to put in curved roads, thus giving the plan character. We hold our profits to a minimum, enabling us to offer value. Selling from blueprints helps to cut our overhead. In every instance, we pass these benefits along to the prospective buyer. Water and sewage is quite a problem in the urban area around Pittsburgh. Rather than use septic tanks, we use a sewage disposal plant and pipe public water three-quarters of a mile to reach our present development. This gives the prospective buyer a country atmosphere with city conveniences.

"I have started to sell from drawings, and might add that this has been very helpful. It gives the purchaser a feeling that he is having a house built, rather than buying a package unit in a row of houses. In this way, he is able to include little personal ideas that he would be unable to get in a house that is sold after completion. We also cut our overhead on construction loans, as all houses are occupied immediately after completion and final inspection.

"After grading land for a house, we give the purchaser sufficient top soil to plant his lawn. During construction, we give the purchaser a stone entrance and a flagstone walk, although our plan shows a concrete walk and a plain brick front. We find this very helpful in winning the confidence of the purchaser, as he feels that he has been given more than he has bought. We also allow the purchaser to

(Continued on page 142)

# NEW INSULATING ROOF DECK

## — EFFICIENT ... LONG-LASTING ... EASY TO CONSTRUCT



Village Hall, Twin Lakes, Wisc. Derald M. West, Architect

The photograph above tells you important facts about the modern deck material, Kaylo Roof Tile—**EASY TO CONSTRUCT**—One man handles the lightweight (23-lb.) tile, which means fast, easy laying. Tile can be nailed to wood joists or laid on steel sub-purlins. If necessary, tile can be sawed on the job to fit.

**STRUCTURALLY STRONG**—Kaylo Tile has great supporting strength—more than many heavier roof deck materials. Tile and conven-

tional roof covering form the entire roof.

Kaylo Roof Tile has other advantages that make it ideal for small or large jobs. It has insulating value equal to 1½-in. insulation board. It is made of materials which are non-combustible and permanent.

When you see Kaylo Roof Tile specified, or recommend it to owners, you can be sure of a roof deck that will be easy to construct and give lasting satisfaction.

### Send NOW for FREE Sample



Mail the coupon below for a free sample of Kaylo Roof Tile and 12-page illustrated book showing construction details and giving complete information about this modern, tested roof-deck material.

# KAYLO<sup>®</sup>

## INSULATING ROOF TILE

**OWENS-ILLINOIS GLASS COMPANY**  
 Kaylo Division Toledo 1, Ohio

SALES OFFICES: ATLANTA • BOSTON • BUFFALO • CHICAGO • CINCINNATI • DALLAS  
 MINNEAPOLIS • NEW YORK • PHILADELPHIA • ST. LOUIS • TOLEDO • WASHINGTON

**OWENS-ILLINOIS GLASS COMPANY**

Dept. F-446, Kaylo Division Toledo 1, Ohio

Gentlemen: Please send me sample of Kaylo Insulating Roof Tile and descriptive book, without obligation.

NAME.....

FIRM NAME.....

STREET ADDRESS.....

CITY..... STATE.....



# Get the Facts

## About the NEWEST STEEL DOOR and FRAME on the market!

**FREE**

Selected for 6 of the nation's largest, newest multiple dwelling projects!

- STUYVESANT TOWN  
New York City
- PETER COOPER VILLAGE  
New York City
- RIVERTON  
New York City
- FORDHAM HILL  
New York City
- PARKLABREA  
Los Angeles, Cal.
- PARKMERCED  
San Francisco, Cal.

**USF** HOLLOW STEEL DOORS and FRAMES  
for multiple dwellings • office buildings • institutions

USF UNITED STEEL FABRICATORS, INC.  
WOOSTER, OHIO



# HOLLOW STEEL DOORS and FRAMES

were selected for

- |  |  |
|--|--|
| <b>STUYVESANT TOWN</b><br>New York City      | <b>FORDHAM HILL</b><br>New York City     |
| <b>PETER COOPER VILLAGE</b><br>New York City | <b>PARKLABREA</b><br>Los Angeles, Cal.   |
| <b>RIVERTON</b><br>New York City             | <b>PARKMERCED</b><br>San Francisco, Cal. |

Sliding Closet Doors • Elevator Doors • Elevator Enclosures

**U N I T E D S T E E L F A B R I C A T O R S , I N C .**

WOOSTER, OHIO

### How Builders Sell . . .

(Continued from page 140)

choose the color of the linoleum, inside and outside paint, brick and roofing."

\*\*\*

**JACKSONVILLE, FLORIDA BUILDER** says: "We have used many ideas to help sell homes, but the following are the most important and have been most successful:

"(1) As we start a construction program, we have colored sketches made of the houses we intend to build, and with these to help them our salesmen are able to sell many of the houses before they are finished or upon completion. The purchasers seem to like the sketches, even though they wait until the house is completed before buying it.

"(2) After the first house is completed in a new development, we go on the air with the new owner and his family as the principal stars. We ask them questions about the house and, of course, they are happy with it. This sort of thing, together with a little humor on the part of the one who asks the questions, makes a pretty good program.

"(3) We have found that being open for inspection on Sunday afternoons is very good, coupled with a display ad in the Saturday and Sunday papers.

"(4) On one or two occasions we have had houses completely furnished, and once we had an all-electric house with complete General Electric equipment, including range, refrigerator, hot water heater, and washing machine."

\*\*\*

**DALLAS, TEXAS, BUILDER** tells of his experience:

"In my experience in building houses, I have found that proper planning of a subdivision is one of the outstanding features of selling houses.

"I have also found that a salesman or agent should familiarize himself with the construction methods used in building. He should be able to carry on an intelligent conversation about the type of framing and type of materials used. Therefore, I suggest that he be trained first and be armed with all information regarding same.

"Advertising can be a great aid in the selling field. Planned advertising is as essential as a well-planned house. Running the same ad continuously is important, as it becomes a landmark to the buyer.



**WESLOCK**

CYLINDRICAL LOCKS

*Melody* design

large escutcheon No. 256 shown  
with WESLOCK No. 240 five-  
pin tumbler entry lock set.



## *New heights in style*

Accepted by Architects and Builders as one of the most modern lock set accessories, the WESLOCK Melody escutcheon is the only design of its type available in any line. Although budget-priced, WESLOCKS are of the highest quality and unconditionally guaranteed. Send for a catalog of the complete WESLOCK line which is the best at *any* price.

**WESTWOOD**

**MANUFACTURING CO.**  
1420 South Evergreen Avenue  
Los Angeles 23, California



Another WESLOCK installation,  
Richlee Gardens, Mineola, New York,  
204 apartment units—FHA insured.

Architects: Samuel Paul Associates,  
Jamaica, New York

Builder: Silbert Construction Co.,  
Great Neck, New York

Hardware Contractor: Samuel  
Golden, Brooklyn, New York

THIS JOB SURE CALLS FOR  
**CHROMTRIM**  
METAL MOULDINGS

"In the building business we face this one every day: 'Keep costs down—but maintain quality!' (A challenge we invariably meet.) That's why we always specify CHROMTRIM. We know that CHROMTRIM metal mouldings are available in all popular shapes . . . easy to install . . . perpetually beautiful. Best of all their low cost is matched by their high quality. Yes, that's all we need to put the finishing touch to any job!"

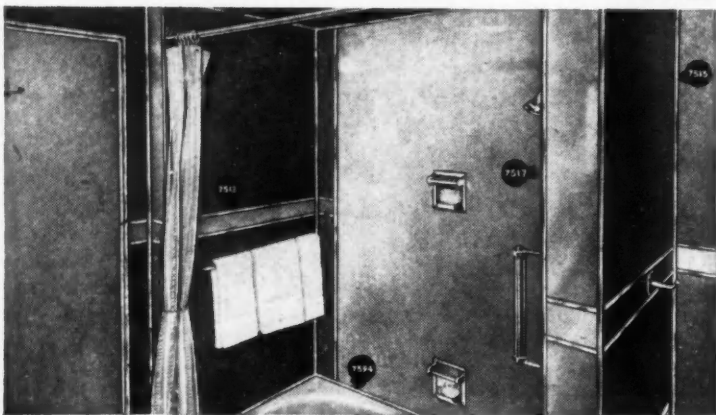

**METAL MOULDINGS  
ARE MONEY-MAKERS!**

Just watch YOUR sales soar and profits pile up with CHROMTRIM metal mouldings. Here's the ECONOMY LINE, completely fabricated and produced under one roof, using modern assembly line methods. Cut to convenient lengths and individually wrapped to preserve its lustrous finish, easy to handle—easy to sell . . . here's complete, lasting satisfaction for you and your customers. No wonder CHROMTRIM is the first choice with contractor, dealers and mechanics from coast to coast!

Sold through a nation-wide distribution organization.



**R. D. Werner Co., Inc.**

295 FIFTH AVE.

NEW YORK 16, N. Y.

In Canada: R. D. WERNER COMPANY LTD.  
PORT DALHOUSIE, ONT.

Write Dept. AB-12

Please send me a copy of the CHROMTRIM Price List.

NAME \_\_\_\_\_  
ADDRESS \_\_\_\_\_  
CITY \_\_\_\_\_ STATE \_\_\_\_\_

**Ceco Steel Celebrates  
Thirtieth Year**

Ceco Steel Products Corporation celebrated its thirtieth year in Chicago at a community open house, October 15, in the firm's general offices and plant. Approximately 3,500 people were on hand, including members of Ceco families, their neighbors and friends, as well as the company's first-shift plant employees.

The affair commemorated the opening of the Chicago district plant in



VISITORS to Ceco Steel Products Corp. open house totaled about 3,500

Cicero (suburb of Chicago) in 1919, seven years after the firm originated in Omaha, Neb.

Functional displays were viewed in each general office department before the tour into the main plant, where visitors saw the manufacture of steel residence casements and other steel sash, steel casings, aluminum storm windows, combination windows, metal frame screens, steelforms, steel joists, steel roof deck, metal lath, metal roofing and siding and many related products.

Among the displays were visual charts showing the firm's operations in 14 other plants and 24 sales offices throughout the country.

**Harold R. Linebaugh Joins  
F. C. Russell Company**

The appointment of Harold R. Linebaugh as assistant to the president of the F. C. Russell Company has been announced by Frank C. Russell, president of the Cleveland company. Linebaugh will be concerned primarily with sales management for the company.

Prior to his association, Linebaugh was appliance merchandising buyer of the B. F. Goodrich Co. During the recent war, he served in the Air Corps with the rank of Lt. Colonel.



# DURALL SCREENS

in your houses  
help you sell

*faster!*



**These new type, low-cost screens  
can be installed in a few minutes!**

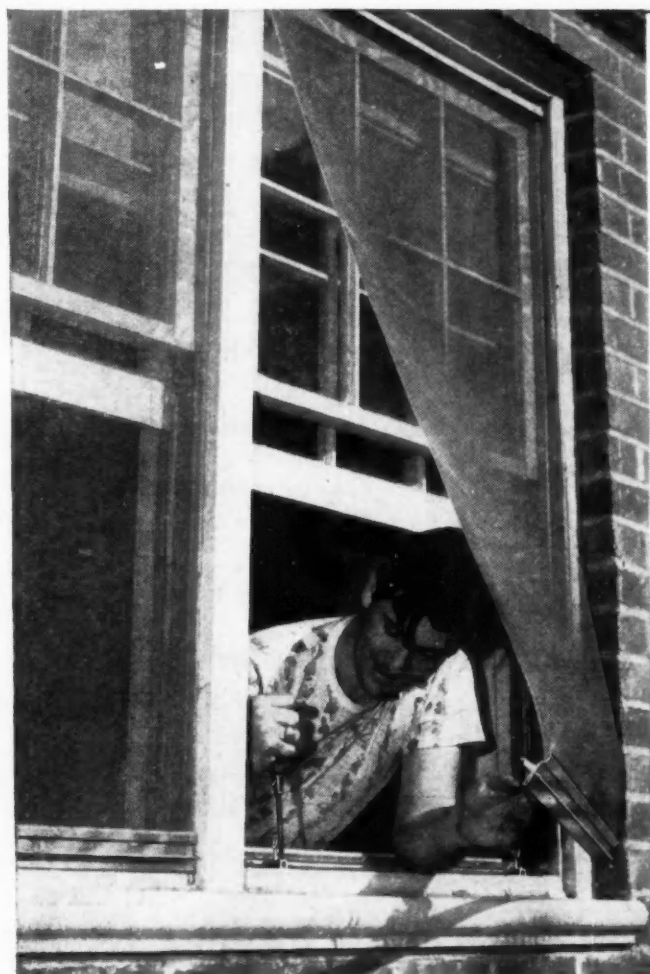

"I have them on my own home, recommend them heartily and install them wherever possible", says Chester L. Siska, River Bend Associates, Inc., Builders, Stamford, Conn.

Durall is a NEW kind of window screen that gives your houses an eye-catching, sales-making "plus". It's light, flexible, easy to put up, take down, or store. It never rusts or stains.

*Installation is a "snap"* with Durall. A few minutes man time is your total installation cost. Durall goes up from inside. There are no side frames to cut, fit and refit. There is no ladder climbing, and no painting, ever.

*The cost is low*, amazingly low for a full length, all metal screen. The screening is the famous Aldura aluminum with the non-fraying Multi-Strand edge. Present price, at retail, is only \$3.75 for an average size!

**FREE BOOKLET!** Write today to the address below, Desk AB-12, for complete information about DURALL. Or ask your building supply or sash and door jobber about Durall Aluminum Tension Screens.

West of the Rockies ask for Ry-Lock



**NEW YORK WIRE CLOTH COMPANY  
445 PARK AVENUE, NEW YORK 22, N. Y.**

Tenth Edition . . .

# The Building Estimator's Reference Book

By Frank R. Walker

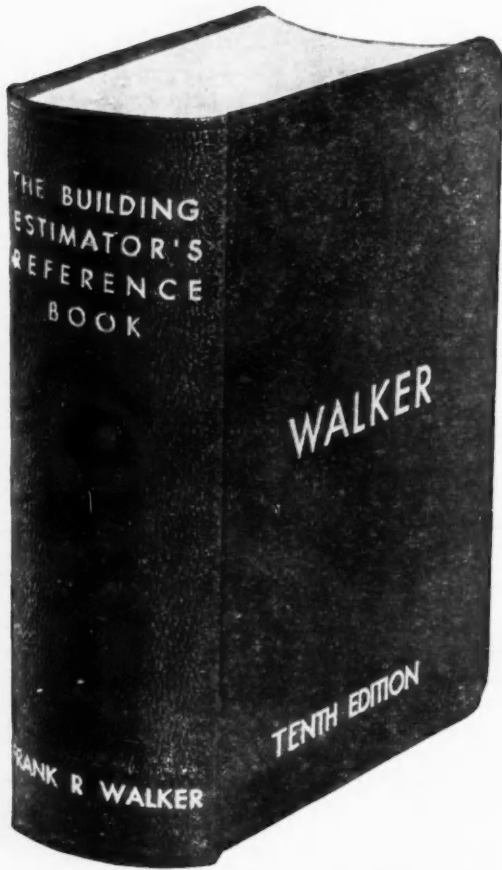

1700 pages, 1000 illus., 1000 tables,  
25-page index, 4½ x 6½, flexible

### COVERS

Excavating, Foundation Work, Reinforced Concrete, Framing, Millwork, Lathing and Plastering, Painting and Decorating, Glass and Glazing, Structural Steel, Masonry, Sheet Metal, Marble and Tile, Heating and Air Conditioning—and many other building subjects.

The new Tenth Edition contains latest estimating and cost data on everything that goes into house construction, from foundation to finish. It can be used in any locality, regardless of local prices or wage scales. It covers all types of small and large building construction.

For 30 years Walker's handbook has furnished contractors and estimators the most complete compilation of estimating and cost data available. The new edition has been revised and improved in the light of postwar conditions. Thousands of items that enter into construction estimates are logically arranged and tabulated for ready reference. A complete cross-index enables the user to quickly locate any subject.

### HELPS PREPARE BETTER ESTIMATES

A copy of this new edition will help any builder, contractor or estimator in figuring and performing work at minimum costs. It will reduce the chance of overlooking an important item in an estimate. New methods of doing various kinds of work are explained and new building materials that have come on the market since wartime restrictions were lifted are fully described.

### SEND FOR A COPY TODAY

Send for a copy of the new Tenth Edition of THE BUILDING ESTIMATOR'S REFERENCE BOOK today. Take advantage of the many opportunities it offers for increasing your profits through better estimates. Money back if not entirely satisfactory.

### FILL OUT THIS GUARANTEED ORDER FORM

American Builder Book Department,  
Simmons Boardman Publishing Corp.  
30 Church Street, New York 7, N. Y.

Enclosed find \$10 remittance for which send me a copy of the New Tenth Edition of THE BUILDING ESTIMATOR'S REFERENCE BOOK and a Free copy of THE VEST POCKET ESTIMATOR. If I do not find the books entirely satisfactory, you will return them within five days of receipt and you will refund my \$10.

Name .....

Address .....

City..... Zone..... State.....

AB. 12-49

## FREE

With The Building Estimator's Reference Book  
**The Vest Pocket Estimator**

This is one of the most popular little estimating books ever used by contractors. It contains 220 pages, 2½ x 5 inches, and is flexibly bound to fit the vest pocket. Estimating and cost data most frequently referred to is presented in condensed tabular form. It can be instantly referred to on the job or in the office.

# Winter Time IS THE RIGHT Time FOR KITCHEN REMODELING

## NU-STYLE SECTIONAL CABINETS Fit any size or shape kitchen



BEFORE



AFTER

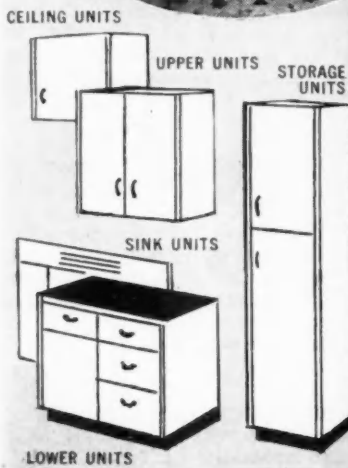

The method of outfitting a kitchen in Nu-Style Sectional Cabinets has two decided advantages

First, it affords you unusual flexibility in arranging kitchens for the greatest utility, convenience and efficiency

Second, it makes the installation economical without involving extensive expensive remodeling of partitions or walls.

Put profits in your pockets this winter by "talking kitchen remodeling." Thousands of housewives will greet you with open arms . . . they want new kitchens! You can satisfy the "want" with Nu-Style Cabinets because Nu-Style is styled to harmonize perfectly with the latest ranges and refrigerators . . .

Because Nu-Style Cabinets are supplied in graduated sizes . . . Because they are made of kiln-dried Ponderosa Pine and can be cut, sawed or scribed. Because, they can be painted any color or finished natural.

Nu-Style Cabinets are shipped semi-assembled in dust proofed cartons.

**CARR, ADAMS & COLLIER CO.** Dubuque, Iowa.



*The Bilt-Well Line:* Superior Unit Wood Windows • Exterior & Interior Doors • Entrances and Shutters • Clos-tite Casements • Carr-dor Garage Doors • Basement Unit Windows • Louvers & Gable Sash • Breakfast Nooks • Combination Doors • Screens & Storm Sash • Corner (China) Cabinets • Gli-dor Cabinets • Ironing Board Cabinets • Mantels & Telephone Cabinets • Multiple-Use & Linen Cabinets • Stair Parts.



Automatic  
**REZNOR**  
gas fired unit heaters

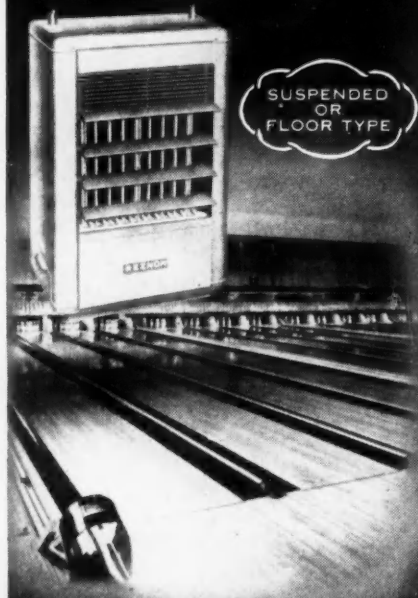

SUSPENDED  
OR  
FLOOR TYPE

**TIME TO PLAN  
IS "NOW"**

Every heating season comes sooner than you expected. The rush exceeds the demand for heaters and men to install them . . . people are cold. Don't put off your selection when you can do it now and save. Do it now and have a summer ventilating system. Write for Catalog U-45 today. We'll see that you are taken care of.

- FULLY AUTOMATIC
- EXTRA LARGE FAN
- SPECIAL HEAT EXCHANGER
- STRONGER CONSTRUCTION
- MORE ECONOMICAL
- LOW COST INSTALLATION
- ALUMINIZED STEEL INTERIOR UNIT

**REZNOR MANUFACTURING CO.**

17 UNION ST. • MERCER, PENNA.

*Gas Heaters Since 1888*

**Kitchen Planning**

(Continued from page 99)

your kitchen will be liked. After you locate the refrigerator, range and sink, fill in the areas between them with the type of base cabinets most suited to the owner's needs and liking. Start by placing cabinets at corners and work toward the center of each wall. Locate wall cabinets in the same way, i.e., by starting in the corner and working to the centers.

On mass housing you can do little more than install adequate general storage space but on a custom-built house for an owner with imagination and who is willing to spend a little more money you can work out dozens of ideas which will endear the kitchen to her forever afterwards and which will cause her to boost you to her friends. Such things as a revolving shelf for the mix master, a Lazy Susan arrangement for cooking utensils, special drawers and files for "hard-to-store" items; special bins for flour, sugar; spice racks; and special places for pots and pans.

Soffits always give an interesting appearance to kitchens and of course pull the cabinets down so that the top shelves are within reach. Shelving higher than 6 feet 6 inches from the floor is not generally considered as usable shelf space except for dead storage. Shelf space should be approximately 11 inches deep for dishes and miscellaneous storage. One-bedroom houses should have at least 18 lineal feet of such space; two-bedroom houses, 24 lineal feet and three-bedroom houses need 30 feet. A good space for a handy cabinet is over the gas refrigerator but keep in mind that the refrigerator protrudes out about 24 inches and is set 5¼ inches from the wall so that the cabinet above it will have to be provided with a back and will be set at least 7 inches from the wall; this provides an air passage to the vent for the dissipation of the heat extracted from the food compartment and the setting forward also makes the shelves easier to reach.

**Miscellaneous**

While on the subject of gas refrigerators, do not forget to allow sufficient space for the larger boxes. The trend is more and more toward the bigger refrigerators with the frozen food compartments. In addition, as a family grows in size their needs increase and a refrigerator which was suitable when there were just two in the family be-

(Continued on page 150)

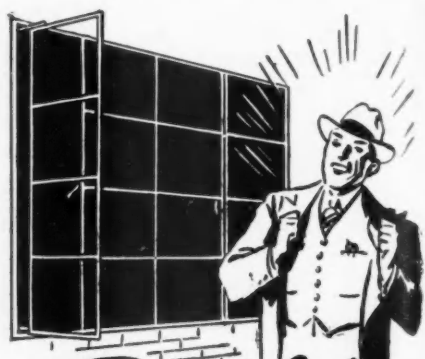

**Build Economically WITH VENTO STEEL WINDOWS**

**BUILDERS** and home owners both appreciate VENTO quality. It's a line of steel casement windows that will bring you satisfied customers . . . and business-building prestige . . . for the years to come.



**THE BUILDER** likes to buy windows that are completely assembled, ready to install . . . that are sturdily constructed of heavy section steel to stand rigidly in position during construction, and finally operate smoothly.

**THE HOME OWNER** likes the moderate price and enduring beauty of VENTO Windows . . . less costly than wood construction, better in quality than most steel windows. Fine quality workmanship down to the smallest detail has real significance to the man making a "life-time" decision.

Other VENTO features are: heavier construction than other steel windows of comparable price; electrically welded throughout; easily installed screening or storm sash; roto hardware, and locking device.

Write for price list and catalog . . . today!



**VENTO STEEL PRODUCTS**

**COMPANY, INC.**

247 Colorado Avenue  
Buffalo 15 N. Y.



# Take a complete low-cost shop *right to the job* in this portable

## DELTA MILWAUKEE

# Multiplex

### Exclusive with Double Radial Action

2 radial movements do more work than the usual 3!

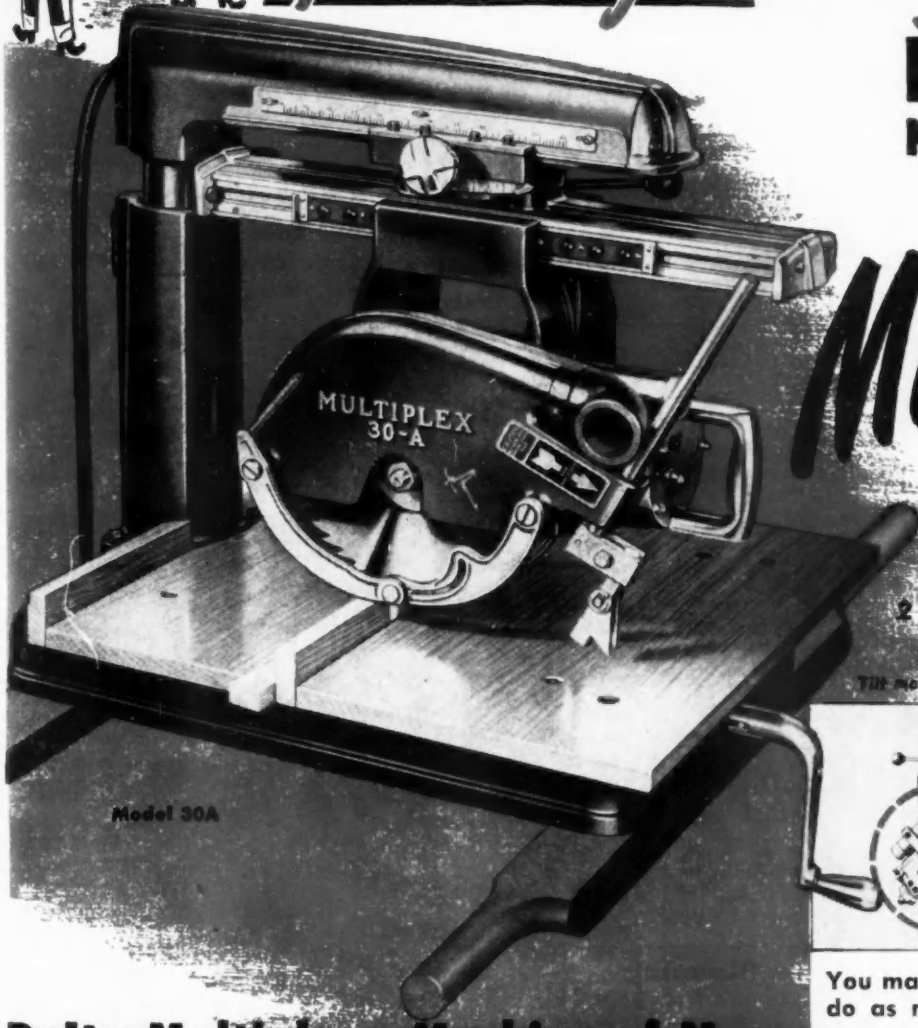

Model 30A

Tilt motor for bevel

Swing track for miter or rip

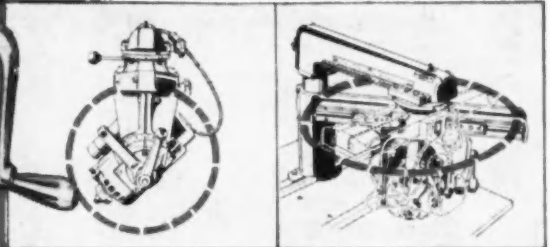

## Delta Multiplex - Machine of Many Uses! Does all this - and more:

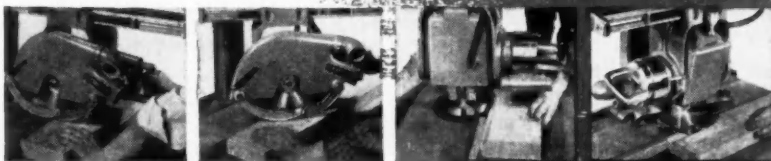

It Cross Cuts

It Miters

It Shapes

It Rabbets



It Rips

It Bevel Rips

It Compound Miters

It Rout



It Ploughs

It Tenons

It Cuts Dados

It Drills

You make only 2 simple adjustments — to do as many as 125 different operations!

Exclusive double radial action uses only two instead of the usual three radial movements. This reduces set-up time, provides greater safety, and speeds up production. You get more flexibility to do more jobs, easier operation, fewer adjustments, front control of all moving parts, and full use of the saw travel.

Delta Multiplex has unequalled capacity . . . for low-pitch rafters cuts, for difficult left-hand miter cuts, for-all-around pre-cut work on the job!

Delta Multiplex is the outstanding value for your work today. Send for descriptive literature. Many models available. Easy time payments. Prices start at \$195 f. o. b. Norwalk, Ohio.

POWER TOOL DIVISION

**Rockwell**  
Manufacturing Company  
MILWAUKEE 1, WISCONSIN

TEAR OUT COUPON AND MAIL TODAY!

Power Tool Division  
ROCKWELL MFG. CO.  
7148 N. Pierce St., Milwaukee 1, Wis.

Send me descriptive literature on the complete line of Delta Multiplex machines.

Name \_\_\_\_\_  
Title \_\_\_\_\_  
Company \_\_\_\_\_  
Address \_\_\_\_\_  
City \_\_\_\_\_ State \_\_\_\_\_

Look for the name of your Delta distributor under "Tools" in the classified section of your telephone directory.

## This new siding keeps homes beautiful!

Low cost, precision produced Kaiser Aluminum Siding is *flawless* in beauty and quality... free of splits, knots, sawing scars. Its beauty will last generations!

Its baked-on finish can't chip, crack or peel. Available in cream, gray and white.

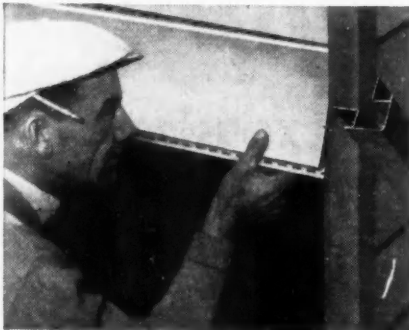

**STRONG, DENT-RESISTANT.** Can't rot, warp, crack or rust. Made of highest grade aluminum. Fire-resistant. Can't be damaged by termites.

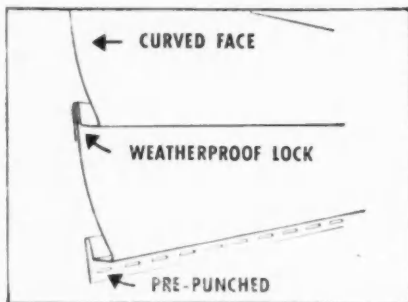

**CURVED SURFACE**, installed under tension, makes rigid, sound-resistant, insulating siding with weatherproof joints, beautiful shadow lines without wrinkles. Easy to apply. Low construction costs!

Meets FHA requirements for new construction. See Kaiser Aluminum Siding at the NAHB Show in Chicago, February 19 through 23. Write today for free AIA File.

# Kaiser Aluminum SIDING

Kaiser Aluminum & Chemical Sales, Inc.  
Kaiser Bldg., Oakland 12, California

### Low Voltage Conditions Corrected by Booster

A new voltage booster, designed to correct low voltage conditions in floor sanding machines, radial arm saws and other portable equipment up to five HP, has been developed by the American Floor Surfacing Machine Co., Toledo, Ohio.

The new voltage transformer is used when power at the meter or long



**VOLTAGE booster made by American Floor Surfacing Machine Co., Toledo, Ohio**

lead-ins indicates that low voltage conditions exist. Its use boosts power to a full 115 or 230 volts for more efficient operation of the machines. The machine is operated simply by hooking it to a regular power source or meter and checking the power input.

The voltage booster has no moving parts and is attractively cased with a carrying handle. Over-all dimensions are  $7\frac{1}{4} \times 8 \times 11$  inches.

The machine is made in two capacities—the Standard Model, weighing 55 pounds and the Special Heavy Duty Model, 65 pounds.

### Kitchen Planning

(Continued from page 148)

comes inadequate when two or three children arrive.

Adequate space should also be provided for larger ranges; gas outlets for the refrigerator should be installed; provision should be made if possible for the later installation of disposal units and automatic dish washers. Be sure the water heater is adequate in capacity not only for the present needs but for anticipated needs over the first few years; if two or three children have to be given baths every day the demand for hot water is great, and an adequately sized heater will not need to be overworked and will last longer.

★ ★ ★ ★

Material for this article was furnished by Frank Moon and other members of the service and sales department of the Southern California Gas Company. Similar valuable information may be available to you in your own community. Take advantage of this invaluable know-how in kitchen planning.

## Low cost screening keeps homes cooler!

Kaiser Aluminum Shade Screening has thin, one-inch wide louvers set close together at an angle against the sun. They deflect sun's rays and heat without blocking the view!

Thus, sunniest rooms are as much as  $15^\circ$  cooler, yet light and airy.

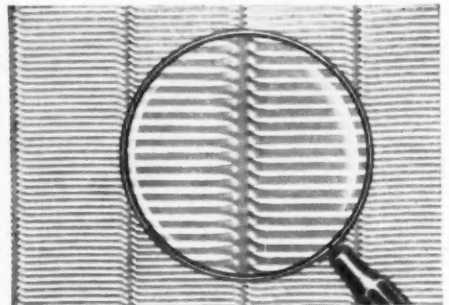

**MADE OF TOUGH**, high grade aluminum. Can't rust or stain. Never needs paint. Adds extra beauty to any window.



**PROTECTS INTERIORS** against sun. Keeps out insects. Easily installed. Low in cost. Available from sash and screen manufacturers and building material jobbers.

See Kaiser Aluminum Shade Screening at the NAHB Show in Chicago, February 19 through 23. Write for free AIA File!

# Kaiser Aluminum SHADE SCREENING

Sold by  
Kaiser Aluminum & Chemical Sales, Inc.  
Kaiser Building, Oakland 12, California



N A T I O N W I D E S E R V I C E

# Straight Cars OR Mixed Cars



## PACIFIC MUTUAL DOOR CO.

TACOMA BUILDING • TACOMA 2, WASHINGTON  
MILLS—OREGON, WASHINGTON, CALIFORNIA

WAREHOUSES FIVE PRINCIPAL CITIES

Garwood, N. J.                      Baltimore 31, Md.  
Chicago 8, Ill.  
Kansas City 3, Kansas      St. Paul 4, Minn.



**DOUGLAS FIR  
and  
WESTERN PINE**

Plywood • Doors • Mouldings • Frame  
Stock • Sash • Industrial plywood cut  
to size for customers' specifications.

### CASE HISTORY NO. 2283

This distributor had a car of plywood on file with us when he picked up a nice order which included some moulding patterns that more than depleted his stock. He needed approximately 30,000 lineal—about 1/10 of a car—to fill the order and keep his inventory balanced. His problem explained to us by a phone call resulted in stopping his plywood car at the moulding mill and having the mouldings included. He got his mouldings priced right with quality and prompt service conserving his working capital and still maintaining a well balanced inventory.

Could this distributor's mixed car  
experience make a profit for you?

## Lemco LIFT-OUT BASEMENT WINDOW

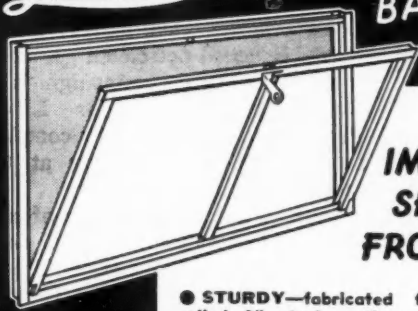

**IMMEDIATE  
SHIPMENT  
FROM STOCK**



UTILITY WINDOW



SECURITY WINDOW

- **STURDY**—fabricated from solid, hot-rolled 1" steel sections to give life-time satisfaction
  - **LOW COST**—priced no more than ordinary windows
  - **SIMPLE OPERATION**—no sheet metal side arms or tricky opening devices
  - **ECONOMICAL INSTALLATION**—completely prefabricated, hardware factory applied; installed in one-third less time than ordinary windows
  - **COMPLETE LINE**—available in three sizes, plus utility and security windows; especially adaptable to concrete block construction. Basement and utility windows also available in aluminum
- Write today for our 1949 Catalog or see Sweet's for further information on casement windows, awning windows and other LEMCO building products.

**CROFT STEEL PRODUCTS, INC.**  
14 MARKET STREET • JAMESTOWN, N. Y.

## New AMERICAN VOLTAGE BOOSTER

**assures FULL POWER  
on Every Job!**



Saves TIME  
Saves LABOR  
Saves MOTORS

### SOON PAYS FOR ITSELF!

This new American Voltage Booster helps contractors avoid damage to equipment and lost time caused by low voltage conditions! This Booster transforms weak voltages of 95 or 105 volts to a full 115 or 230 volts. Also, boosts 115 or 208 to 230 volts... or will reduce 208 volts to 115 volts. Will operate all portable electric equipment up to 5 H.P.

Full power with this Booster enables you to get full efficiency out of equipment by supplying voltage recommended by motor manufacturer's specifications. You can save time and labor and save money! Write for details and prices.

- BOOSTS** {
- 95 volts to 115 and 230 volts
  - 105 volts to 115 and 230 volts
  - 115 volts to 230 volts (also direct 115 tap)
  - 208 volts to 230 volts

Reduces 208 volts to 115 volts

**AMERICAN FLOOR SURFACING MACHINE CO.**  
511 So. St. Clair St., Toledo, Ohio

# SAFE . . . SAFER . . . SAFEST

## for sidewall and ladder work



### SCAFFOLD BRACKETS

Simplify the installation of safe working platforms for many types of sidewall work. "TroubleSavers" are light, easy to handle and extra strong. Made of rail steel in nail-attached, studing and bolt-attached types. They do not bend.

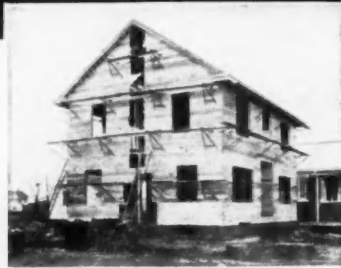

Builders and contractors are quick to see the time and money-saving advantages of "Trouble Saver" Equipment... and the extra safety provided. Use of "Trouble Saver" Scaffold brackets and ladder jacks speeds work and eliminates many working hazards that cause costly accidents. Safe working platforms help your men do more and better work.

Write for catalog "M" on "Trouble Saver" Scaffolding Accessories



### LADDER JACKS

ONE-MAN Ladder Jacks (top) adjust to any pitch on either side of the ladder. Weight is distributed on three rungs. New rail type jack (bottom) provides added safety by using side rails of ladder for support.

**THE STEEL SCAFFOLDING COMPANY, INC.**  
Dept. AB, 856 HUMBOLDT STREET      BROOKLYN 22, NEW YORK  
Telephone EVergreen 3-5510

HETTINGER'S

# Triple Seal

PATENT NO. 2172580  
WINDOW COMBINATION

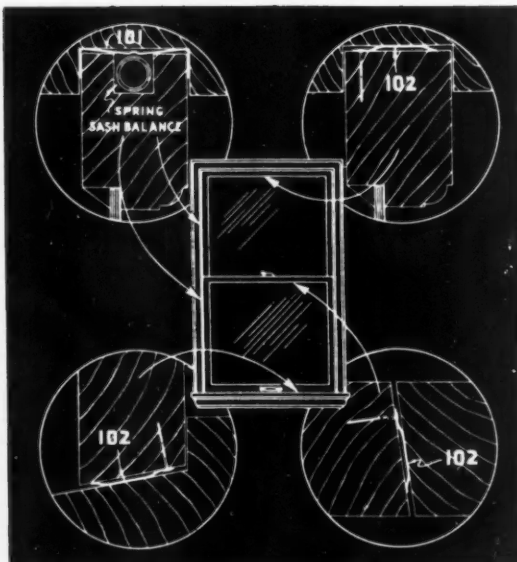

Thousands of dealers are now getting their TRIPLE SEAL requirements from these jobbers and many others:

American Sash & Door Co.  
Kansas City, Mo.  
E. E. Bach Millwork Co.  
Minneapolis, Minn.  
Bardwell-Robinson Co.  
Fargo, N. D.  
Builders Wholesale Supply Co.  
Sioux City, Iowa  
Carr & Moehl Co.  
Des Moines, Iowa  
W. P. Fuller Co.  
Portland, Oregon  
Houston Sash & Door Co.  
Houston, Texas  
Indiana Wholesalers, Inc.  
Evansville, Ind.  
Rock Island Lumber Co.  
Buffalo, N. Y.  
Scott Graff Co.  
Duluth, Minn.  
Texas Sash & Door Co.  
Fort Worth, Texas  
Whitmer-Jackson Co.  
Rochester, N. Y.

Many profitable trade areas still open. We welcome dealer and jobber inquiries.

**SASH BALANCES AND SPRING BRONZE METAL WEATHERSTRIPPING**

Complete Unit Carton Packaged - Any Size \$3.50

**SEE YOUR LUMBER DEALER**

**THE WEATHERPROOF PRODUCTS CORPORATION**

329 Westport Road

Kansas City 2, Missouri

Jefferson 3133

## 'Plastering Teamwork' Theme Of U.S. Gypsum Display

One of the outstanding displays at the 32nd annual Contracting Plasterers' International Association, held recently at the Statler Hotel in Washington, D.C., was a pictorial review of the United States Gypsum



UNITED States Gypsum Co.'s 36-foot photo-mural panel display at Contracting Plasterers' International Association meeting

Co.'s plastering activities. Central theme of the exhibit, which contained photo-mural panels on a 36-foot background, was "50 Years of Plastering Teamwork."

Subject matter of the panels included the firm's plastering developments in the last ten years, advertisements on plastering which appeared in trade and consumer magazines in 1948 and 1949 and those planned for 1950, pictures of quarries, plants and machinery, and pictures of some of the representative salesmen over a number of years.

## LP-Gas Industry Plans Promotional Program

Plans for a nation-wide promotional program have been announced by the liquefied petroleum gas industry. Directing the campaign is the National Committee for LP-Gas Promotion, which recently completed an organizational meeting at Chicago's Palmer House.

John C. Pankow, director of sales, Detroit-Michigan Stove Co., is chairman of the group and M. L. Trotter, president, Carolina Butane Gas Co., Columbia, So. Carolina, is vice chairman. Robert E. Borden, Chicago, is secretary.

Embracing advertising, publicity, employee training and special public relations, the projected program will be financed by voluntary contributions from all elements of the industry, including marketers, producers, appliance and equipment manufacturers, Pankow pointed out. It is co-sponsored by three national trade organizations—Liquefied Petroleum Gas Association, Natural Gasoline Association of America and Gas Appliance Manufacturers Association.

The committee expects to raise between \$500,000 and \$1,000,000 for the first year of the activity.

MERRY CHRISTMAS AND A HAPPY NEW YEAR...

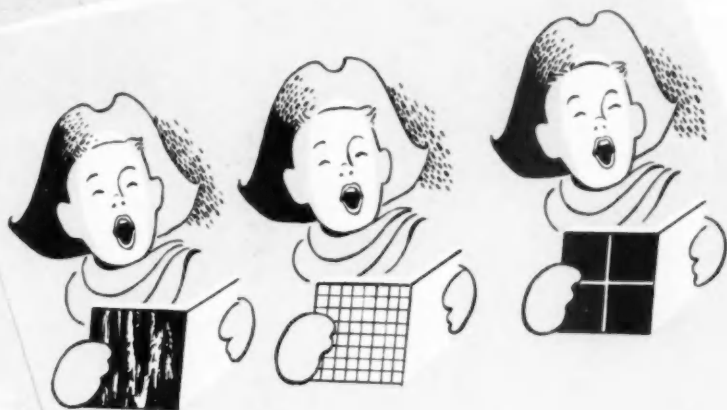

FROM THE **HAKO** TRIPLETS

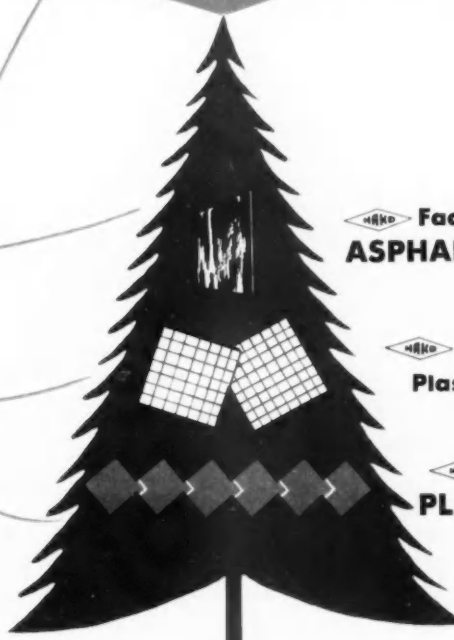

**HAKO** Factory Waxed ASPHALT TILE FLOORING

**HAKO** BLOXOLITE Plastic Partition Blocks

**HAKO** Styled in Beauty PLASTIC WALL TILE

Since 1903

**HACHMEISTER**

PITTSBURGH, PENNA.

*Inc.*

MANUFACTURERS OF

**HAKO** Factory Waxed ASPHALT TILE FLOORING  
**BLOXOLITE**—Plastic Partition Blocks  
 Styled in Beauty PLASTIC WALL TILE



*When your plans say "Heating"...*



This lovely residence, the home of Mr. and Mrs. Forrest Beyer at Red Hill, Pennsylvania, is equipped with a dependable Spencer Heater. Architect: Charles M. Talley, Telford, Pennsylvania. Heating Contractor: Paul Schlicher, East Greenville, Pennsylvania.

**EXPERIENCE SAYS . . .  
"SPENCER"!**



Constructed in accordance with ASME requirements. Fully approved by the Steel Boiler Institute.



- Whatever your heating needs—residential or commercial—there's a dependable Spencer of the right type and capacity to meet your most exacting specifications, to solve your most difficult problem.

The Spencer Boiler pictured here is typical of the wide range of models. Its many fine features make it especially adaptable for residential uses.

**THERE IS A SPENCER  
FOR EVERY BUILDING, FOR EVERY FUEL**

- For homes, small buildings . . . . . 29 models
- For light industrial uses . . . . . 13 models
- For heavy industrial uses . . . . . 34 models

**76 MODELS**  
—ranging in capacities from 290 to 42,500 net load, steam—

- Take any type of customary fuel—oil, gas, coke, and anthracite or bituminous coal
- Fit various methods of firing—oil burner, automatic stoker, or hand firing
- Adaptable to difficult locations—permitting either front, rear, or side installation of oil burner or stoker unit
- Quick-heating—staggered, divided tubes speed water circulation, provide fast steaming
- Economical—exclusive peaked firebox aids in complete combustion, conserves fuel
- Beauty jacketed—on many models optional steel jacket provides extra insulation, handsome appearance for basement game rooms or workshops

**WRITE FOR COMPLETE CATALOG**



**TRADEMARKED**  
as well as grademarked  
... your double guarantee  
of plywood quality.



Something has been added in the labeling of plywood produced at Associated Plywood Mills, Inc. It is the APMI trademark, and you'll find it together with the DFPA grademark on both exterior-type and interior-type panels manufactured by this company.

This combination of trademark and grademark is your assurance that regardless of where you buy APMI plywood, you get the guaranteed products of a pioneer mill in the industry... And you can purchase APMI plywood at any one of 14 centrally located sales warehouses from coast to coast, from experienced plywood men who are eager to serve you.

APMI Stock | Lengths: 60"- 72"- 84"- 96"- 108"- 120"- 144"  
Panel Sizes | Widths: 24"- 30"- 36"- 42"- 48"

## ASSOCIATED PLYWOOD MILLS, INC.

MILLS: Eugene, Oregon, and Willamina, Oregon

BRANCH SALES WAREHOUSES: Eugene and Willamina, Oregon; 925 Toland St., San Francisco 24, Calif.; 4814 Bengal St., Dallas 9, Tex.; 4268 Utah St., St. Louis 16, Mo.

SALES WAREHOUSES: Bessonette & Eckstrom, 2719 S. Compton, Los Angeles 11, Calif.; Pacific Mutual Door Co., 626 Tacoma Bldg. (Home Office), Tacoma, Wn.; 1407 Fleet St., Baltimore 31, Md.; 2141 Throop St., Chicago 8, Ill.; 516 South Ave., Garwood, N. J.; Adams and Shawnee Sfs., Kansas City; 2235 Territorial Road, St. Paul 4, Minn.

## IN A GAS WATER HEATER



### Beauty

modern design, beautifully finished.

### Safety

100% automatic

### Performance

finest controls, modern burner design, heavy insulation, sealed combustion—double doors.

### Long Life

tanks 350 lb. test, thoroughly galvanized by hot-dipped process.

ARE  
**BIG**  
SELLING  
FEATURES

## KOVEN AUTOMATIC GAS WATER HEATERS HAVE THEM ALL!

Satisfy your customers completely by recommending or installing the KOVEN Automatic Gas Water Heater. Precision engineering by KOVEN insures fully automatic, trouble-free performance. Backed by liberal guarantees.

CUT-AWAY SECTION ►

L. O. KOVEN & BRO., INC.  
154 OGDEN AVENUE,  
JERSEY CITY 7, N. J.

PLANTS:  
Jersey City, N. J.    Dover, N. J.





## Cutting Costs Through Modern Design

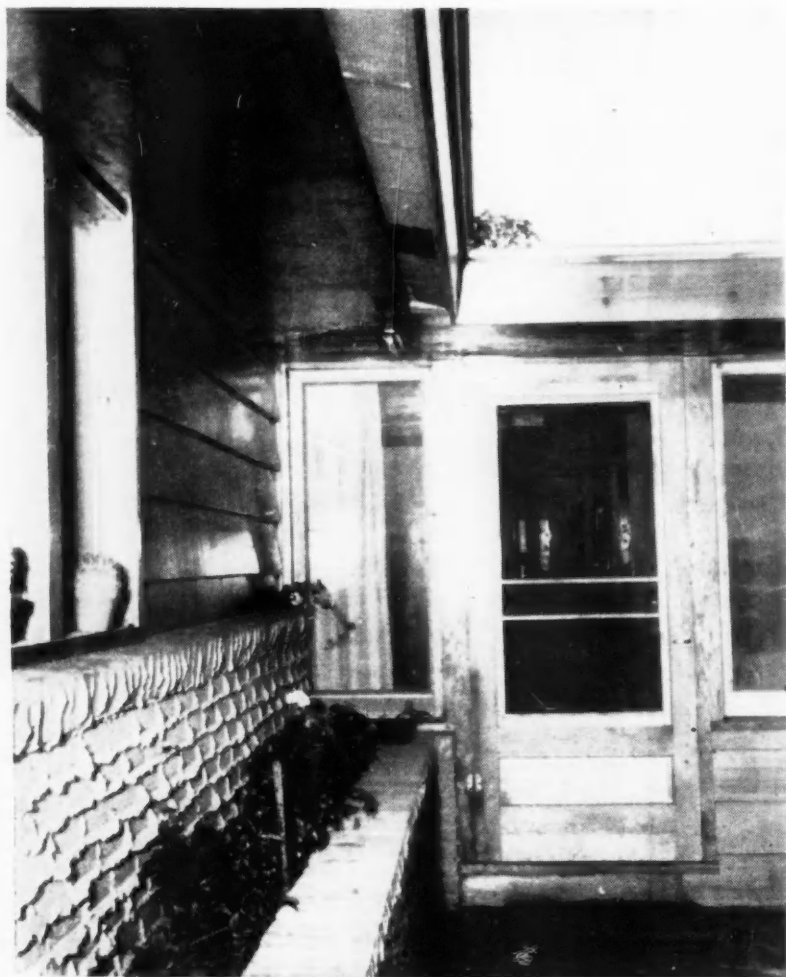

**FARM HOME** of Mr. and Mrs. M. W. Malkow cost \$14,500. It has large basement, is heated by forced warm air. Over entrance, double 2x6's rest on top of studs

**"I**T'S A LUXURY to own a home that isn't purely functional," says Architect John W. Steinmann of the Karlen and Steinmann Lumber Co., a builder-dealer firm in Monticello, Wis. By producing homes of modern, functional design at a cost below that of conventionally-designed homes in the area, the 50-year-old firm has demonstrated the soundness of the architect's assertion.

"We do everything we can to sell modern architecture for these reasons," says Architect Steinmann, partner in the firm: "First, it simplifies construction methods and eliminates structural materials that do not have a use; second, more attention can be given to new materials that eliminate the need of those which no longer solve the problems as well." Steinmann stresses the fact that materials are constantly being improved. "Builders and buyers should take advantage of them," he insists.

Specifically, Steinmann lists four instances in which his design and construction save money: In the elimination of basements and stairways whenever possible; the use of low-pitched roofs, where ceiling joists and roof rafters become one and the same; the elimination of baseboards, window casings and door casings; and by the use of a system of warm air radiant heating. The firm has conducted extensive research in this type of heating.

Of 45 homes completed by this firm in the last four years, 38 were built



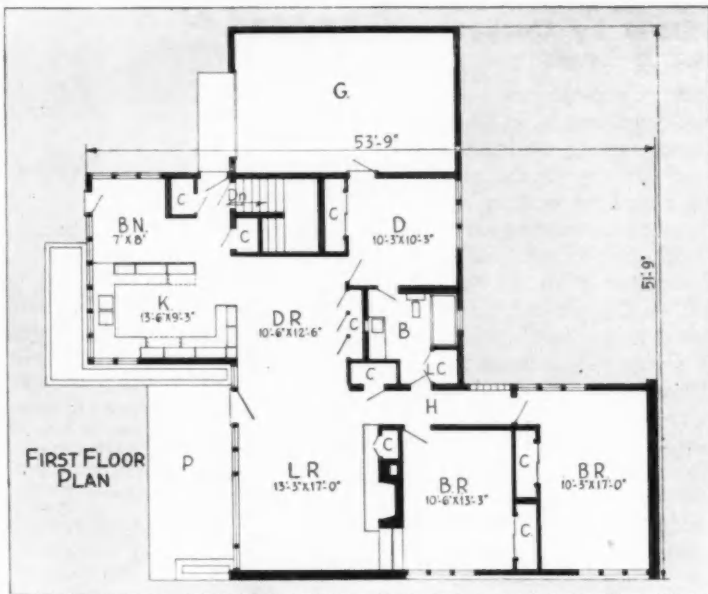

BOTH double glazed picture windows and casements were used in Malkow home. Trim over windows and door is plywood. Mullions were cut from 4x6 timbers

**By simplifying construction methods and eliminating structural materials that "do not have a use," an architect has cut his firm's building costs**

for less than their preliminary estimates. The remaining seven cost more than the estimates because of additions requested by the owners during construction. Average prices range from \$9,600 to \$17,500.

A typical example of the type of home built by Karlen & Steinmann is one completed for Mr. and Mrs. M. W. Malkow of Brodhead, Wis. The home is situated on a farm, and abundant storage space was needed. The owners desired a basement. Complete with a large basement, the home, illustrated here, was built for \$14,500.

Unexcavated portion of this home rests on poured 12-inch-thick concrete footings, placed four feet below grade. Manufactured plywood forms were used for forming concrete foundation walls. Over the top of the foundation wall, a 2 x 6-inch sill is bolted. Floor joists are 2 x 10's. Exterior walls are frame and brick veneer. Studs are 2 x 4's, 16 inches on center. Double 2 x 6's run continuously along the top of exterior walls, and eliminate the need for flashing over windows.

Rafters and ceiling joists are one and the same in this house, except over the kitchen, dinette and bathroom. Pitch of the roof is 2 1/2-12. Roof covering is 110-pound, 36-inch half and half roll roofing, over 15-pound felt and 3/4-inch sheathing. The asphalt shingles were cemented down, and were rolled with a 100-pound roller. Between 2 x 6 joists and rafters, 3 5/8 inches of Fiberglas insula-

tion is placed, and the ceiling consists of 3/8-inch gypsum board nailed to the under side of the joists, with 3/8 inches of plaster forming the finished surface. Both joists and rafters are placed 16 inches on center.

John Steinmann, partner in the

firm with his brother, Howard, believes that their firm saves as much as 20 per cent on cost of a home by using modern design. John is in charge of design and construction, while Howard shares responsibility with R. W. Karlen in purchasing materials. Karlen, who also handles finances for the firm, is senior partner and general manager. The company does contract building in Illinois, Wisconsin and Iowa, besides running a lumber and building firm.



STORAGE walls are plywood. The clothes closet and china closet are framed with 2x2 members. Karlen and Steinmann rarely permit cross walls to be load-bearing



## CABOT'S Waterproofings

Cabot's Clear Brick and Clear Cement Waterproofings add years to the beauty and life of above-grade masonry — add dollars to the value of your buildings! Cabot's Waterproofings penetrate deeply . . . fill pores with water resistant material . . . retard unsightly efflorescence . . . protect walls, terraces and steps from the damaging effects of freezing and thawing.

*Cabot's Waterproofings do not affect color or texture.*

**Cabot's Waterproofings are**

**INEXPENSIVE!**

**EFFECTIVE!**

**QUICK AND EASY TO APPLY!**

*Cabot's Clear Brick Waterproofing* — for bricks and dark-colored masonry surfaces.

*Cabot's Clear Cement Waterproofing* — for cement, concrete, stucco, stone and all other light-colored masonry.

**WRITE TODAY** for samples and complete information.

**Samuel Cabot, Inc.**  
1224 Oliver Building, Boston 9, Mass.



### New Trends in House, Lot Design Stifled by Current Zoning Laws

Conventional provisions for setbacks and yard requirements of present and proposed zoning ordinances are standing in the way of the new trends in house and lot design, according to a recent statement on architectural trends by Frank Sohn, architectural consultant for Libbey-Owens-Ford Glass Co., Toledo, Ohio. Sohn said that the new trends, based on more open design of the house interior, on planned use and relationship of the house and lot, and on greater privacy and better use of daylight and solar heat, are being advanced by leading architects, featured in building magazines, and taught in architectural schools.

The text of Sohn's statement follows:

"The provisions that block the realization of these new trends are the usual requirements that houses have minimum uniform setback lines of 25 feet from the street line regardless of the direction of the street and lot, and that back yards be a minimum of one-quarter of the lot depth up to 25 feet, coupled with the ban on fences and high hedges on walls at the front of the lot, past the setback lines.

"These requirements have brought about many fine residential areas in the past. Their effect is to give homes, individually and collectively, a setting that makes a fine appearance to the passer-by.

"But there has come a realization that the front yard, with its wide expanse of lawn, has little use otherwise. What is left for a lot at the back, especially if there is a garage and driveway, is generally not enough to do much with. So that, also, is usually given to lawn with a border of shrubbery.

"The houses on such lots usually face the street but could be turned in any direction without making much difference. That they give little privacy is generally recognized.

"The new approach, as exemplified in the solar house toward which the so-called "ranch house" is a transition stage, calls for wider lots, 60-feet being the minimum. The main rooms of the house are turned toward the south, the south wall being largely of glass, looking out upon the yard which is landscaped to provide a beautiful view and planned for the use of the family, just as the house is planned. Thus the lot might provide for a flower garden, vegetable garden, drying yard, play area and terrace.

(Continued on page 168)

## Brown's SUPERCEDAR



### Red Cedar Closet Lining

**Guaranteed 90% Red Heart or Better**

Only SUPERCEDAR is of the same uniform high quality standard that guarantees every package to contain 90% Red Heart or better, and 100% oil content which produces the pleasing aroma.

**100% oil content**  
Suggest Cedar Lined Closets to Every Home Builder. There is Nothing Better than



SEALED  
PACKAGED  
LABELED



More home builders are specifying cedar lined closets today than ever — and Brown's SUPERCEDAR is nationally advertised to thousands of new home prospects, architects and builders. SUPERCEDAR closet lining is surfaced, tongue and grooved, ready to put on with no waste. Packaged and sealed with the Geo. C. Brown label and guarantee, famous since 1886.

Product of  
**GEO. C. BROWN & CO.**  
GREENSBORO, N. C. ESTABLISHED 1886

LARGEST MANUFACTURERS OF  
AROMATIC RED CEDAR IN THE WORLD

### ACOUSTICAL TILE NAILS ... designed for the job

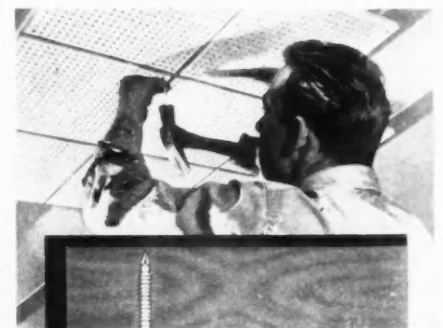

When installing acoustical tile choose a job-designed nail that combines ease of application with these special features: a head end which allows the nail to be driven home without damaging the tiles ... a collar which holds the tiles firmly in place...annular threading which gives superior holding power. The nails are furnished with a plated finish to prevent rust streaks where moisture is present. Send for free samples and descriptive literature.



**JOHN HASSALL, INC.**

182 Clay Street  
Brooklyn 22, N. Y.

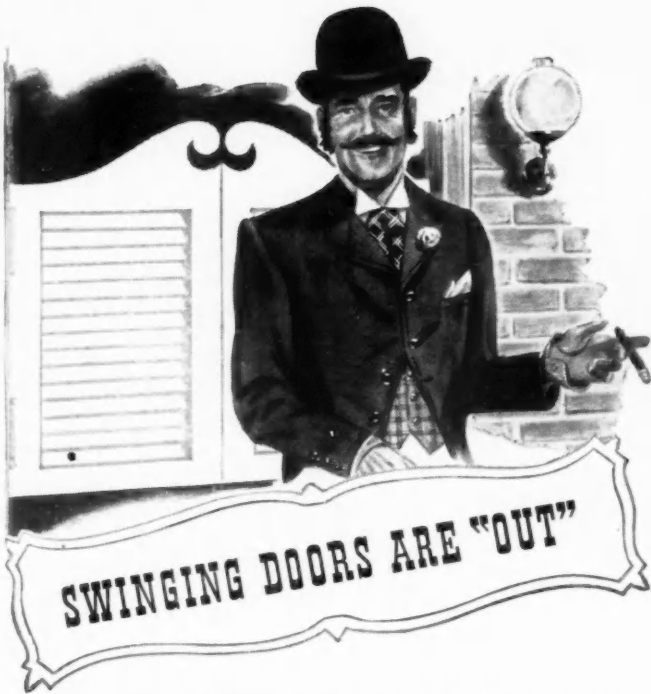

For garage doors that give trouble-free service... specify RICHARDS-WILCOX 999 Garage Door Hardware

For many years, leading architects and builders have agreed that Richards-Wilcox Door Hardware is the world's finest. Now, with the new line of R-W 999 Garage Door Hardware, out-dated, troublesome swinging garage doors can be converted quickly and easily into the modern, overhead type.

Overhead garage doors hung with R-W 999 Hardware are weathertight, the easiest to operate, and they "stay put." And R-W 999 Hardware comes *complete*—in one convenient kit—with everything needed for installation and operation.

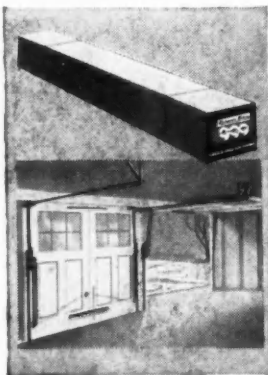

For further information, simply call or write the nearest Richards-Wilcox office. Ask for free folder with complete facts about R-W 999 Hardware—your surest cure for garage door grief.

1880 LEADERS IN DOOR HARDWARE OVER 69 YEARS 1949

**Richards-Wilcox Mfg. Co.**

"A HANGER FOR ANY DOOR THAT SLIDES"  
AURORA, ILLINOIS, U.S.A.

Branches: New York Chicago Boston Philadelphia Cleveland Cincinnati Washington, D.C.  
Indianapolis St. Louis New Orleans Des Moines Minneapolis Kansas City  
Los Angeles San Francisco Denver Seattle Detroit Atlanta Pittsburgh



Reg. U. S. Pat. Off.

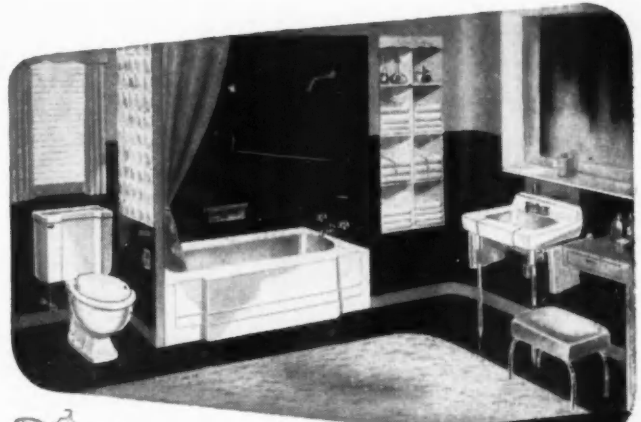

**YOUR CUSTOMERS CAN SAY**

*Merry Christmas* WITH  
**UNIVERSAL-RUNDLE BATHROOM  
AND KITCHEN FIXTURES**

★ Beautiful bathrooms and kitchens, too, can bear the Christmas tag of good wishes. Now, with the Universal line complete, you can package-merchandise a full U-R installation.

1949 has been an eventful year in our relationship. The merger brought a combined line of china and cast iron, followed by colorware, then Luxury-Trim chrome-brass fittings... a wide range of quality products in pace-setting styles. It has been a year of success.

May we wish you a Merry Christmas and a prosperous New Year.

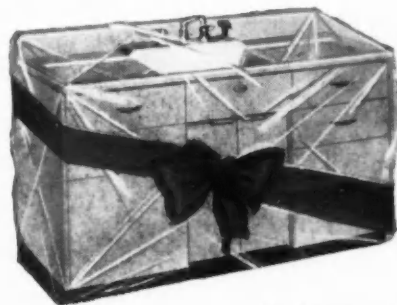

★ A Universal cabinet sink is a gift of lasting appreciation. Let it head your Holiday promotional list.



**UNIVERSAL-RUNDLE CORPORATION**  
NEW CASTLE, PENNSYLVANIA

PLANTS IN New Castle, Pa.; Camden, N. J.; Milwaukee, Wis.; Redlands, Calif.



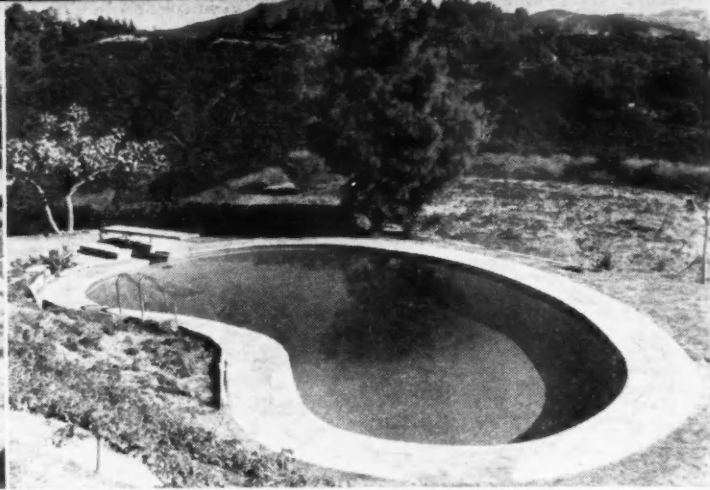

VARYING shapes of Paddock pools are illustrated by two above. Materials used for walks are brick, flagstone and concrete

## SWIMMING POOLS

### *Built without the Use of Concrete Forms*

**I**N THE Los Angeles area a firm with long experience in the building of swimming pools, Paddock Engineering Co., has developed a technique which brings private swimming facilities within the reach of moderate-income groups. The Paddock pool has a rounded bottom and is built by a method called Gunitite, in which concrete is poured with a pneumatic hose directly onto steel-wire mesh. This process eliminates the expense of the forms and supports required for a flat-bottomed pool with straight sides. Price of the pool is as low as \$1,995.

The Gunitite construction method, perfected by Philip Ilsley, president and general manager of the company, has reduced construction time by as much as two-thirds, and costs by one-third. Practically all pools currently erected on the West Coast are based

on the Ilsley system, which permits great flexibility of design and economical maintenance.

Construction time for Gunitite pools ranges from two to six weeks. The Paddock company also builds poured-concrete pools, which are completed in from eight to 12 weeks. The price differential between the two types is greater for smaller pools. In the 20 x 60-foot size, form-poured concrete pools cost approximately 50 per cent more than the Gunitite type; in the 75 x 165-foot class, Gunitite is about 10 per cent cheaper. In larger pools the construction costs of the two are about equal but construction time for form-poured pools doubles or triples that of Gunitite.

Approximately 1,400 pool installations using the Gunitite method have been made by the company during the last eight years.

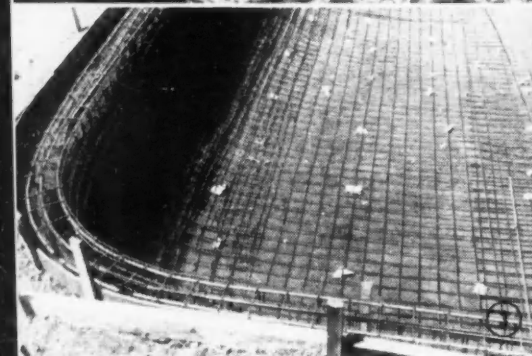

INITIAL digging of pool sites (1) is done with bulldozers whenever practicable. (2) Hand digging is needed to smooth final contours. (3) Steel mesh is set in place, ready for application of concrete. (4) Gunitite method of applying concrete. Man with hook pulls out steel in order that concrete may be distributed under it. (5) Silicite, manufactured by Paddock and consisting of silica sand and cement, is final plaster coat. Color is white, surface is smooth, and it gives the water a brilliant turquoise blue appearance

# Your Houses Will Sell Faster with *American* Kitchens



INSTALL NATIONALLY ADVERTISED EQUIPMENT LIKE AMERICAN KITCHENS AND PROSPECTS WILL HAVE FAR MORE CONFIDENCE THAT THE HIDDEN MATERIALS YOU USE ARE TOP QUALITY, TOO!

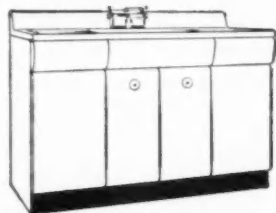

**NEW ECONOMY SINKS**  
Now—especially for builders—new American Kitchens economy sinks in 42", 54" and 66" sizes—at the country's lowest prices for this high quality.

## American Kitchens Save You Money Besides!

A good reputation is seldom enough to convince prospects that your houses are really soundly built. But it's easy to convince them with American Kitchens, because they know you wouldn't put top-quality kitchens in "jerry-built" homes.

American Kitchens are good busi-

ness from a cost standpoint too—actually cost *less* per running foot than quality wood cabinets. Take advantage of the new line of Economy Sinks and you can afford to equip even your lowest-priced houses with the most advanced, most convenient of all kitchens!

# *American*

**KITCHENS**  
STYLED IN STEEL

AMERICAN CENTRAL DIVISION



CONNERSVILLE, INDIANA

### FREE — SPECIAL BUILDERS FILE

American Central Division, Dept. AB-12  
AVCO Manufacturing Corporation  
Connerville, Indiana



Please have my nearest American Kitchens supplier furnish me—without charge or obligation—your new Builders File, complete with specifications and roughing-in diagrams.

Name \_\_\_\_\_

Address \_\_\_\_\_

City \_\_\_\_\_

County \_\_\_\_\_

State \_\_\_\_\_

DETROIT PUBLIC LIBRARY

DETROIT PUBLIC LIBRARY

# CUSTOM BUILT SINKS



Help You Plan  
**Tomorrow's Kitchen  
TODAY**

Whether you are planning a new building project or the modernization of an old one, we will build a "JUST LINE" Stainless Steel

## Radiiluxe Sink

to meet your most exacting specifications. Now you can exercise your creative ability to the fullest extent in the planning of the modern kitchen.

**JUST LINE Radiiluxe Sinks** are precision built of No. 16 U. S. standard gauge Stainless Steel. Reinforcing U-shaped steel channels extend the full length of the drainboards and prevent warping, bulging and sagging. Die drawn raised edges and electric welding throughout eliminate all joints, seams and overlapping flanges and assure the greatest degree of sanitation.



Write today for illustrated Literature B12 and send us your specifications. Our engineers will gladly cooperate with you in submitting blue prints and estimates.

### TWO EXCLUSIVE FEATURES

Built-in Anti-Splash Rims in bowls prevent the splashing of water on the floors.

Smooth, Double-Pitch Drainboards without grooves reduce to a minimum the danger of breakage of glassware and dishes and assure positive drainage and the utmost in sanitation.

**JUST Manufacturing Co.**  
4610-20 W. 21st Street, Chicago 50, Illinois



**FREE**

10 day examination offer  
SEND FOR THE TAMBLYN SYSTEM OF ESTIMATING ON FREE 10 DAY OFFER

● Let me show you how you can cut guesswork out of building estimating

Hazards of competitive bidding have been reduced to a minimum for thousands of contractors now successfully using my simple factors in preparing their cost estimates on materials and labor. I want to become your "silent consultant" by placing at your elbow, for immediate reference, the boiled-down essence of my 40 years' experience—expressed in simple factors that require only the application of your local wage and material rates to arrive at a competitive, yet safe cost, as a basis for contracts. Mail the coupon to me today.

*Gordon M. Tamblin*

**MY GUARANTEE**

Send no money—just mail this coupon.

As a reader of this publication we are warranted in sending you a copy of the complete Tamblin System for 10 days free inspection. At the end of inspection period, you may mail it back or pay \$38.75 in easy monthly payments.

GORDON TAMBLYN, THE TAMBLYN SYSTEM  
1115 So. Pearl St. A-36 Denver, Colorado

Send me the complete Tamblin System on free 10 days trial! If I like it, I will pay \$8.75 when 10 days are up and \$7.50 per month until \$38.75 is paid. Otherwise I will return it.

Name \_\_\_\_\_  
Address \_\_\_\_\_  
City \_\_\_\_\_ State \_\_\_\_\_

## SAVE YOUR AMERICAN BUILDERS For Ready Reference

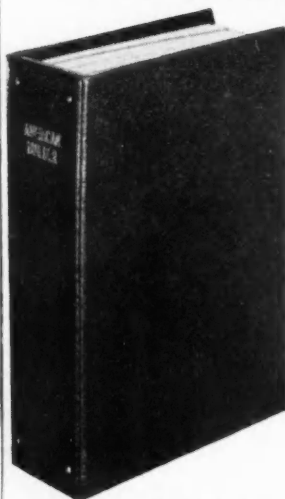

BINDERS NOW AVAILABLE. These new binders are smart in appearance, easy to handle, made of extra heavy cardboard covered with dark blue fabrikoid which is washable and exceptionally tough and wear-resistant. AMERICAN BUILDER is embossed in gold letters on the back for ready identification.

Holds six big issues—issues are easily inserted. No punch holes required. A strong, flexible steel rod holds each issue in position. . . . A handsome addition to any library or office desk.

ORDER NOW—ONLY  
**\$2.50**

Send Check or Money Order Direct to AMERICAN BUILDER

**AMERICAN BUILDER**  
30 Church St. New York



You'll Find Widespread Acceptance  
For These Quality Hardware Items  
**BY NATIONAL LOCK**

**IN  
DEMAND**

GET THEM  
FROM YOUR JOBBER

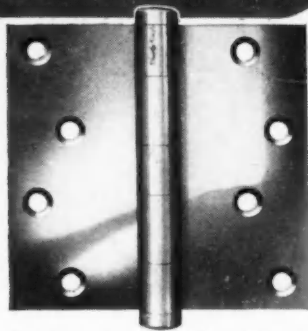

Butts and Hinges  
Sash Hardware  
Shelf Hardware  
Screws and Bolts  
Cabinet Hardware  
Furniture Trim  
Casters and Other  
Profit Makers

Consumers and builders alike respect the broad line of NATIONAL LOCK hardware. Here's hardware that's in demand... that moves fast at a profit. Ask your jobber or building material wholesaler.

Distinctive Hardware All From 1 Source



**NATIONAL LOCK COMPANY**

Rockford, Illinois • Merchant Sales Division

**For Rain  
Insurance**



USE

**THOROSEAL**

**and make lifelong friends**

Applications of THOROSEAL may be made over exterior surfaces of foundation walls as work progresses.

THOROSEAL, to seal the surface, and QUICKSEAL Finish Coats are substantial and beautiful.

Our NEW 20-page brochure has four pages of specifications. WRITE FOR IT TODAY. NO. 127.

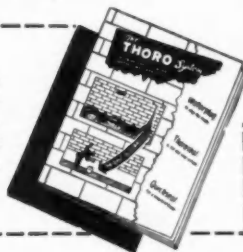

**STANDARD DRY WALL PRODUCTS**  
BOX X NEW EAGLE, PENNSYLVANIA

# Crossett Siding Holds Paint

That's because it's produced from soft textured Arkansas Soft Pine which is free from pitch, absorbs primer and finish coats uniformly and does not bleed through.

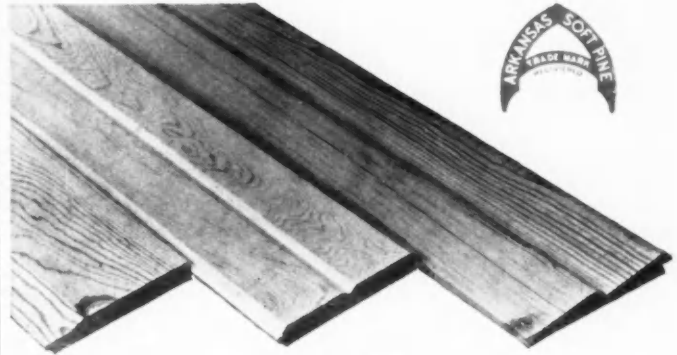

NO. 106

NO. 116

NO. 117

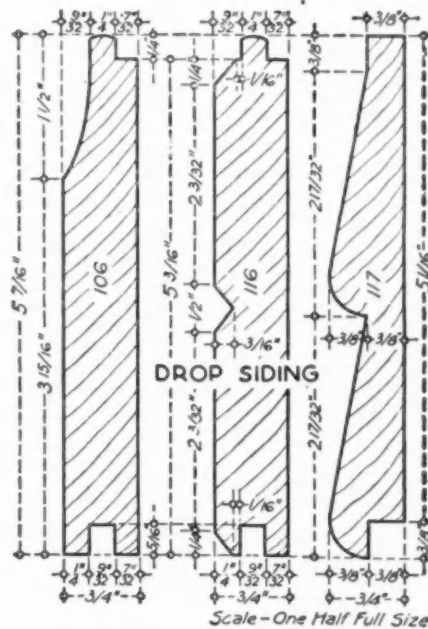

These are the most generally used patterns of drop siding. Other standard patterns are available.

## CENTER & END-MATCHED SHEATHING

Goes on 1/3 faster. Disregards stud centers. Kiln-dried, holds nails, stays put. A superior, flush base for siding. Widths: 3/4", 5/4", 7/4".



Crossett siding and sheathing bear the Arkansas Soft Pine trade-mark. Ask your lumber dealer.

**CROSSETT LUMBER COMPANY**  
CROSSETT, ARKANSAS

*The Milwaukee Combination*  
**SASH BALANCE**  
*and*  
**WEATHERSTRIP**

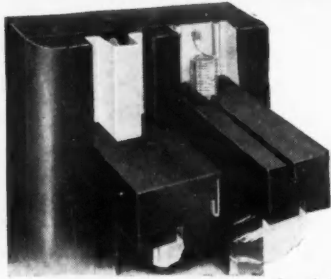

Available with or without bronze covers that completely hide spring, as shown above.

**PERMITS REMOVAL OF SASH WEIGHTS, INSULATION OF MULLIONS.**

*Slash Labor Costs'*

Simple installation allows one man to easily install 30 or more windows in 8 hours. No high-priced skilled labor needed. This means you can get more satisfied customers at lower cost . . . higher profit!

*Tops in Operation!*

Smooth, positive action; accurate balance; finger-tip control plus the perfect seal against draft, dust, moisture. No wood-to-wood contact. Prevents sticking windows and window rattle.

**EFFICIENT  
 LOW  
 COST**



**FOR OLD  
 OR NEW  
 BUILDING**

**ATTENTION MILLS AND LUMBER YARDS  
 IDEAL FOR PRE-FIT WINDOWS**

Can Also Be Sold in Single Unit Packages

**Mail this coupon today!**

Milwaukee Strip Service, Inc.  
 4621-23 W. Lisbon Ave.  
 Milwaukee 8, Wisconsin

Please rush me folder A-12 and price list of Milwaukee Combination Sash Balance Weatherstrip.

Name .....

Address .....

City..... Zone..... State.....

DETROIT PUBLIC LIBRARY

**Color Helps Sales**

(Continued from page 97)

duced with complete color specifications which includes the sources of materials in the exact colors suggested.

The cost of the service is moderate. On a project basis, the charge is approximately \$5.00 per house.

**The Psychology of Color**

"Today's home buyer is highly color conscious," says Miss West. "A recent survey by the Rahr Color Clinic in the home furnishing field revealed that 50 per cent of the consumers gave first consideration to color, and then to design. Since color is important to the consumer, doesn't it appear that skilled color planning is as important to the builder as efficient production and sound finance?"

"It is the woman who buys the home, even though the man must pay for it," says Miss West.

It was with knowledge of the work she was doing for other builders, but nevertheless with a "show-me" attitude, that the Levitts asked Miss West to come to Levittown to demonstrate what she could contribute economically toward making the community they had planned more distinctive and appealing. The color plan and the decoration of one model home convinced the Levitts that Miss West "had it."

The next assignment was to spend a week with a plot plan in one hand and a steering wheel in another, slowly driving up and down 10 miles of streets lined with 6000 homes rented to vets.

Her job was to advise the Levitts the color to use in a "face-lifting" job by re-painting the trim of the houses in the rental section of Levittown.

The trim on the houses had been painted white but the Levitts were quick to realize it was necessary to help maintain the tone of the community and to give the houses some individuality. Fresh paint in stimulating colors would help to keep tenants happy. It was Miss West's job to decide on the colors to use on each house. Her work was not complete until she had worked with the painter, giving him the paint formulae and making sure he would use the exact hues she specified on the right house in the proper sequence.

Her major job, of course, was color planning the 4500 houses selling for \$7990 which will have been built in Levittown this year, as well as the recreation areas and shopping center.

(Continued on page 166)

**NOW!**  
**IMPROVED KORK-PAK JOINT FILLER**  
 Insulates against HEAT LOSS!

Specify KORK-PAK Joint Filler for use between floor slabs and footings in basementless houses and structures on grade and get the extra KORK-PAK insulating feature as well as a waterproof, resilient, non-extruding filler that will keep the joint effectively filled at all times.

KORK-PAK is composed of cork granules bonded together with asphalt between two sheets of asphalt-saturated paper—it's waterproof and insect proof to assure positive joint filling for the life of the building.

KORK-PAK is the least expensive non-extruding joint filler made—low cost, coupled with its high insulation coefficient, makes KORK-PAK the ideal joint filler for any type of construction.



Write for complete details on KORK-PAK. See our Catalog in SWEET'S.

**SERVICISED PRODUCTS CORP.**  
 6051 W. 65th ST., CHICAGO 38, ILL.

when the call is for  
**CONTROLS**  
 you'll find the answer



**HERE**  
 Bigger, Better,  
 General Controls  
 Catalog now ready  
 -reserve your copy!

104 pages covering the complete General Controls line of Automatic Pressure, Temperature, Level and Flow controls. It charts, tabulates and details, capacities, pressures, dimensions and specifications of hundreds of controls. Whatever the product or process—in heating, refrigeration, aircraft or industry, there's a better General Control for the job. General Controls do more and cost less. The new Catalog tells how and why. Send for your copy today.

**GENERAL CONTROLS**  
 818 Allen Ave., Glendale 1, Calif.

**GENERAL CONTROLS**  
 Automatic Pressure, Temperature, Level and Flow Controls

FACTORY BRANCHES: Baltimore (5), Birmingham (3), Boston (16), Buffalo (3), Chicago (5), Cincinnati (2), Cleveland (15), Dallas (1), Denver (4), Detroit (8), Glendale (1), Houston (6), Kansas City (2), New York (17), Minneapolis (2), Philadelphia (40), Pittsburgh (22), San Francisco (7), Seattle (1), St. Louis (12), Tulsa (6). DISTRIBUTORS IN PRINCIPAL CITIES.

The Sensationally **NEW** Low-Priced

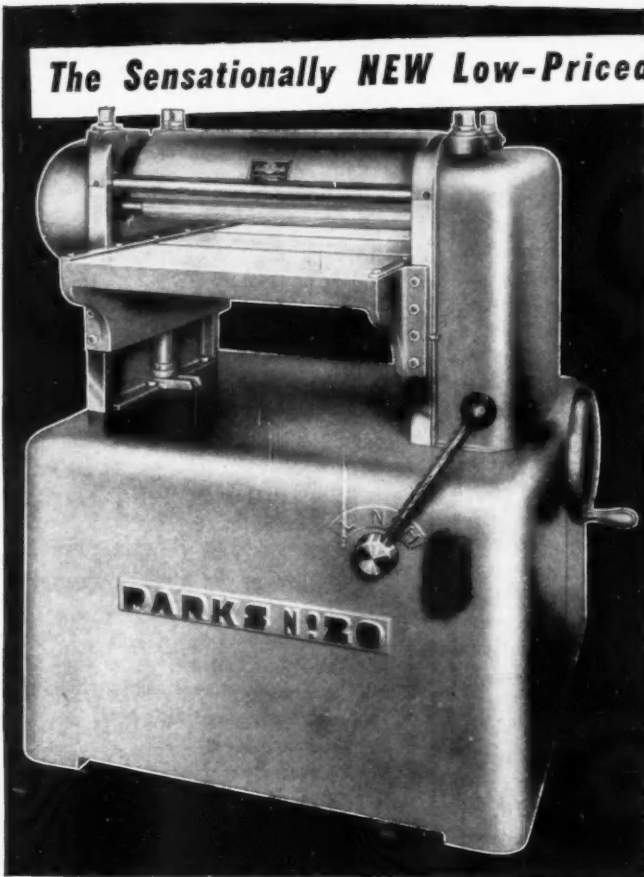

# PARKS No. 20 20" PLANER

Here is a modernly designed, rugged, high-speed, low-priced planer that is ideally suited for every shop and industrial plant requiring a quality sur-facer. The Parks No. 20 Planer has a four-knife cutterhead with a speed of 3600 R.P.M. and offers two feed speeds — 20 and 40 F.P.M., and 40 and 80 F.P.M. Write for complete descriptive literature.



## The PARKS Heavy-Duty 12" x 4" Planer

A compact, sturdy, thickness planer that offers mill planer precision and ruggedness at a sensationally low price. Write for descriptive catalog sheet.

The PARKS WOODWORKING MACHINE CO., Dept. 30-JJ, 1546 Knowlton St., Cincinnati 23, O.

# Majestic INDOOR INCINERATOR

disposes of all burnable home refuse

A profitable seller  
the year 'round

Every housewife is quick to see that this handy appliance saves steps, time, and trouble. The Majestic Incinerator gets rid of wastebasket trash plus wet and dry garbage by burning it all indoors. Waste itself serves as fuel. Unique downdraft does the trick! Dries the refuse and hastens complete burning. *Guaranteed.* Taps to furnace flue in basement or utility room. Tips more profits your way. Write today.

Costs  
nothing  
to use!

No. 2  
Economy  
Model



The Majestic Co.  
100-A Erie St., Huntington, Ind.

TYPICAL MAJESTIC PRODUCTS EVERY HOME NEEDS



Nationally Known and Advertised for Over 40 Years

YOU CAN BE SURE... IF IT'S Westinghouse

## FREE Valuable Planning Help



Packed with simple, practical data to help you develop the most effective applications of electricity and electrical equipment, regardless of size or type of house. Explains the Four Degrees of Electrical Living, summarizes them to make it easy to apply the principle to your houses to make them sell faster. Gives kitchen planning data for "Economy Kitchen" that is minimum in space and equipment requirements, and an "Ideal Kitchen" that offers an arrangement of equipment, counter and storage space for the homemaker who wants the best. Contains suggestions for laundries designed for maximum use of space and convenience. Shows wiring and construction details for lighting, with many examples illustrated. Gives data on lighting and wiring; also sizes and installation requirements of electric appliances and equipment for the home.

G-10065

SEND FOR  
Free  
Booklet

Better Homes Bureau  
Westinghouse Electric Corporation  
P. O. Box 868, Pittsburgh 30, Pa.

Gentlemen: Please send me a copy of your new book, Planning Homes for Electrical Living—B-4326.

Name .....  
Street .....  
City ..... Zone ..... State .....

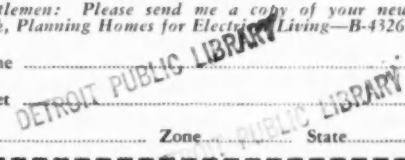





**HERE'S  
THE NEWEST  
INSULATION**

**TYPE 6**

**INFRA ACCORDION INSULATION**

*Three thick sheets  
of permanently sep-  
arated aluminum*

**PLEASE LOOK AT THE THERMAL VALUES**

*4" to 7 1/2" Insulation Value in a 2 1/2" Depth*

There are SIX, 97% effective, radiant-heat-repelling surfaces, EACH of ONLY 3% emissivity (against ordinary insulation's 90%). There are SIX non-conductive, reflective air spaces. FIVE barriers to convection consist of THREE EXTRA-THICK aluminum sheets, IMPERVIOUS to warm or cold air, WATER VAPOR, or any gas; and TWO Fiber Separators, flame, mold and verminproof, which also block inner convection. For 16" and 24" centers.

**\* THERMAL FACTORS, TYPE 6  
AND DRY ROCKWOOL EQUIVALENTS**

Down-Heat	C.044, R 22.72 = 7 1/2"
Up-Heat	C.08, R 12.50 = 4"
Wall-Heat	C.073, R 13.69 = 4 1/2"

*Infra — Light, Strong, Easily  
Installed, Competitive in Price*

**WRITE** Infra for details and FREE COPY of "Insulating Effect of Successive Air Spaces Bounded by Bright Metallic Surfaces," by L. W. Schad, research engineer of Westinghouse Electric & Mfg. Co., issued by the Amer. Society of Heating & Ventilating Engineers. Address Dept. AMB.

Multiple Accordion Aluminum  
Triangular Reflective Air Cells

**Infra** 10 MURRAY ST.  
NEW YORK, N. Y.  
**INSULATION, INC.**

### Color Helps Sales

(Continued from page 164)

In fact, so complete was Miss West's assignment, it included the design and color to be used on signs for bus stops.

The houses have one basic floor plan with five varying exteriors. Built to a price, it was necessary to plan carefully to achieve individuality economically. And it was here that the idea of providing a minimum of color selections with a maximum of color combinations paid dividends.

Consideration first was given to the colors in the asphalt shingle roofs. As the roofs are pitched, not flat, they are highly visible. And the Levitts agreed with Miss West that it would not be possible to be assured of color harmony and of a community with an integrated appearance if the roof colors were allowed to run rampant. She finally selected two basic colors—a brown asphalt blend and a gray asphalt blend. There are several tones of browns and greys, but all tend to be on the dark side.

Asbestos siding used on the side-walls is in any of four colors—green, cedar, white or grey.

Rough hewn pine, used as trim, is stained in any of four colors—brown, white, green or beige.

The front door and front window trim is limited to six colors—blue, brown, jade, yellow, copper-brown or red.

This limited color selection is combined into nine exterior color schemes, and with five variable exteriors, only one house in 46 has a twin. But Miss West reminds builders that "It is not just a blue, a green or a brown that's important. It's exactly the right tone that whets a woman's appetite to buy. And in a house, as in a woman's dress, it's the complete ensemble that counts. Color has rhythm, and color, even a shade off 'pitch', destroys the feeling of rhythm and the entire concept."

As proof that it is possible to high-style a community of low-cost homes as well as homes selling at higher prices, exactly the same colors were used in color styling the 750 houses being built in the Roslyn Country Club development by the Levitts. These homes sell in a price range from \$17,500 to \$19,500. Again, all of the houses have a common floor plan, but with 12 variable exteriors. Again, brown and grey blend asphalt roofs set the color pattern, but due to the greater diversity of materials used on the exterior, it was found possible to give the houses individuality and to integrate the community by actually reducing the number of color schemes from nine to seven; thus, only one house in 86 has a "twin."



## RANGE-VENTOR

**Provides Modern  
Kitchen Ventilation**

- Built-in electric blower eliminates heat and odors
  - Shadowless illumination
  - Brilliant enamel-chrome trim
  - Reduces redecorating costs
  - Protects cabinets
  - Easily installed; Moderately priced
- Write for Bulletin No. 509

**Universal Blower Co.**  
Birmingham 1, Mich.

Only **TRADE-WIND**  
MAKES THE

### CLIPPER CEILING VENTILATOR

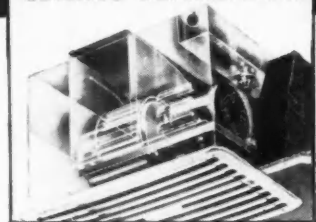

... better 5 ways because —

1. Mounts in ceiling directly above stove — instantly catches heat, grease and odors as they rise.
2. Only an inconspicuous "dripless" ceiling grille is visible, yet unit easily installed.
3. Powerful squirrel-cage blower (not a fan!) creates fast-moving stream of air to do job efficiently.
4. Because of patented construction which isolates motor from greasy air stream, unit guaranteed 5 years.
5. Available everywhere. Stocked by dealers coast to coast.

Ask your Electrical Dealer or mail coupon.

Trade-Wind Motorfans, Inc.  
5705 S. Main St., Los Angeles 37, Calif.

Name \_\_\_\_\_

Address \_\_\_\_\_

# How to use this Oil Floor Furnace to help sell houses!



The H. C. Little OIL FLOOR FURNACE is more than a heating unit...

it is a powerful sales tool for builders



**IT LIGHTS ITSELF!**  
**IT BURNS CATALYTIC OILS!**  
**IDEAL FOR SMALL HOMES!**  
**PROVED IN USE!**

- It looks after the home owner's comfort with 24 hour electric control ... the ONLY oil floor furnace with electric ignition and NO PILOT LIGHT.
- It burns the new catalytic oils that are high in heat value, low in cost.
- It's big enough for supreme comfort, small enough to operate at peak efficiency.
- 160,000 H. C. Little installations in 22 years spell reliability. Factory guaranteed. Underwriters listed.

Learn how to use it to help sell YOUR houses

Factory Representatives:

- |                       |                      |
|-----------------------|----------------------|
| Baltimore, Md.        | Larned, Kansas       |
| Belmont, Mass.        | Newark, N. J.        |
| Boise, Idaho          | Portland, Oregon     |
| Chicago, Ill.         | Prescott, Ariz.      |
| Columbus, Ga.         | Reno, Nevada         |
| Detroit Lakes, Minn.  | Salt Lake City, Utah |
| Fayetteville, N. Car. | Seattle, Wash.       |
| Kansas City, Mo.      | St. Louis, Mo.       |
|                       | St. Petersburg, Fla. |

Write Dept. A-12



SAN RAFAEL, CALIF.

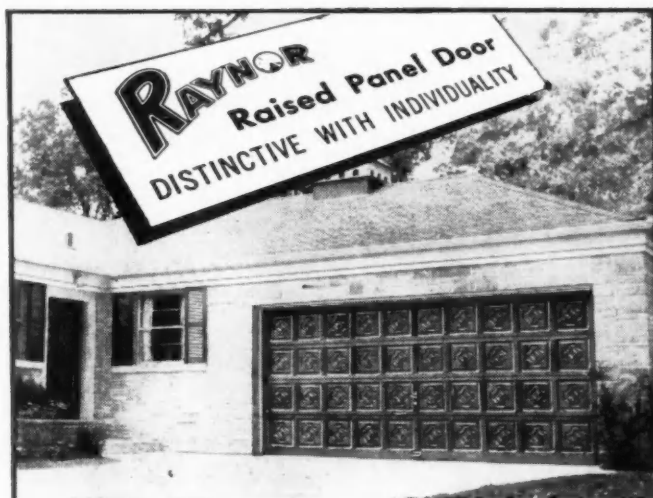

**RAYNOR**  
 Raised Panel Door  
 DISTINCTIVE WITH INDIVIDUALITY

**Creates Demand... MEANS GREATER PROFIT!**

PANELS machine-routed from solid 1 inch stock. A complete selection of panel designs available. All doors equipped with Graduated Seal.



Raynor offers a complete line of wood sectional overhead type doors. Write for dealer and franchise information.



**RAYNOR MANUFACTURING CO.**

River Street

DIXON, ILLINOIS

## save up to \$59 a day JAEGER SELF-RAISING TOWER

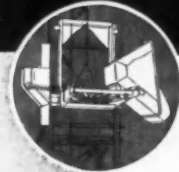

with MATERIAL CAGE and CONCRETE BUCKET



Contractors everywhere are profiting with it! Saves scaffold erecting time — saves repeated loss and cost of scaffold material — handles and places materials faster and surer. Take the dis-assembled tower and 17-hp hoist to your jobs on a truck. Two men assemble it on the ground in two hours. Then the Jaeger "Hoister" raises it to 37' standard height — 67' with extra sections. Material cage accommodates two wheelbarrows or largest concrete cart — handles 1 ton loads with absolute safety. And, there's a Concrete Bucket available — easily interchangeable with the cage, on the job — water level capacity, 14 cu ft — working capacity, 11 cu ft (the full batch of an 11-S mixer!)

Write for bulletin and complete information

**THE JAEGER MACHINE CO., Columbus 16, Ohio**  
 Distributors sales and service in 130 principal cities

Pumps • Mixers • Compressors • Paving Equipment



**YOUR DISTRIBUTOR HAS THIS PERFECT TEAM**

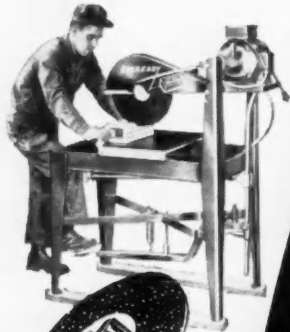

**YOU CAN SAVE TIME AND MONEY WITH EVEREADY BRIKSAW**

**The PERFECT TEAM**

EVEREADY BRIKSAW and EVEREADY BRIKSAW Blades give you lowest masonry cutting costs... you can actually save the cost of your EVEREADY BRIKSAW on one job and you can do better work faster.

**THE SAW THAT HAS THESE EXCLUSIVE FEATURES**

Adjusts to hardness of material.

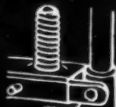

**PRESSURE EQUALIZER**

**CUT WET OR DRY**

Take your choice... change in a second from dry cutting to dustless wet cutting. Can be bought originally for dry cutting. Later inexpensive wet cutting kit can be installed in a few minutes.

21 seconds to remove cutting head.

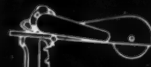

**PORTABLE**

4 seconds to adjust cutting head height.



**"ADJUSTA-HEIGHT"**

"Toe-Matic" provides instant head angularity control.



**"TOE-MATIC"**

**CUT ANY MATERIAL IN 4 TO 21 SECONDS**



Abrasive blades for dry or wet cutting. Diamond blades for wet cutting. A blade for any job.

**EVEREADY BRIKSAW CO.**

1505 S. Michigan Blvd., Chicago 5, Ill.

Without obligation send information on EVEREADY BRIKSAW and blades for cutting...

NAME \_\_\_\_\_  
 CITY \_\_\_\_\_ STATE \_\_\_\_\_  
 DETROIT PUBLIC LIBRARY

**Zoning Laws Stifle Design**

(Continued from page 158)

"The house itself is planned to give more efficient, attractive and spacious appearing interiors and to bring in ample daylight, utilizing the sun for part of the heating in winter. Window walls make up most of the south walls and part of the east walls, while they are more restricted on the west and north. South windows are shaded by roof overhangs or other devices which let in the winter sun but cut down the summer heat.

"But these desirable houses will not fit into conventional lots with present zoning restrictions.

"Take, for example, houses on an east-west street. Houses on the south side of this street should be set reasonably close to the street line, leaving room for a little planting on the north or street side. The south or window-wall side would then face toward the back of the lot which would be landscaped for both appearance and utility.

"Houses on the north side of an east-west street would be more advantageously placed if set close to the north or back end of the lot, so that the south window wall would again face the major part of the lot. Since it would face the street as well, it should be permissible to plant a high hedge or build a wall along the street side, thus assuring privacy for the owners. Most zoning laws prohibit this.

"For houses on a north-south street, it follows that they should be located as near the north line as possible, permitting the south side to look out on a more spacious, planned lot area.

"It is a decided change from the present regulations but it would have a new type of beauty related to the appearance of a country estate district.

"Such orientation should also be applied to groups of homes, housing developments and garden-type row houses.

"The point is that present zoning laws with their setback and yard requirements do not allow such orientation. There is, however, a dawning recognition of the need for more latitude in zoning provisions to permit desirable new developments in house and lot planning to be used, but still to protect the older areas laid out under the old rules.

"This will come about through specifying the desirable objectives of adequate light, air and space. It would leave freedom for ingenuity and greater usefulness instead of holding new houses and developments to the straightjacket of the old regulations."

**Red Devil FLOOR POLISHERS**

**For Fast Sales . . . Easy Rental . . . or Your Own Use**

Light and fast, or heavy duty—there is a complete line of RED DEVIL Floor Polishers with accessories to fill your demands. Order thru your jobber or write for facts.



**RED DEVIL FP11" BRUSH UNIVERSAL MOTOR**

**RED DEVIL FP1 11" BRUSH A. C. MOTOR**

Products of

**Red Devil Tools.**  
 IRVINGTON 11, NEW JERSEY, U. S. A.

**ASBESTOS SIDING NAILS**

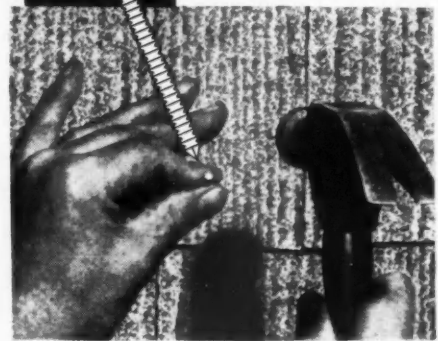

Hassall threaded asbestos siding nails are the choice of contractors throughout the country. Made of bronze and steel with plated finish. Note threaded shank which guarantees maximum holding power. Made of #14 gauge wire (.082) in 1", 1 1/4", 1 1/2", 1 3/4" lengths. Advise quantities. Prompt shipment.

**JOHN HASSALL, INC.**

182 Clay Street  
 Brooklyn 22, N. Y.  
 Established 1850





1818  
1949

# HOPE'S

The Name  
Guarantees



HOPE'S STANDARD  
STEEL CASINGS

● HOPE'S STANDARD STEEL CASINGS, made from 18-gauge steel bonderized and primed, are fire-resistant and vermin-proof. Their hard, smooth surfaces form reveals and stools which are neat in appearance and easy to keep clean. They provide a key and a template for plaster and are suitable for all types of home construction... frame, masonry or brick veneer.

Sizes carried in stock are available in two depths, 4½" and 5¼" and fit all types of Hope's Residence (Holford) casements.

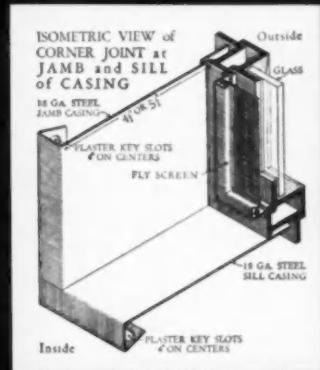

For complete information,  
send for leaflets 102F  
and 118.

Hope's Windows, Inc., Dept. A. B., Jamestown, N. Y.

Please send leaflets 102F and 118 featuring  
HOPE'S STANDARD STEEL CASINGS.

Name \_\_\_\_\_

Address \_\_\_\_\_

## SPEED CONSTRUCTION, REDUCE COST WITH ZONOLITE\* VERMICULITE PLASTER



**LIGHTWEIGHT**  
sticks better,  
fewer droppings



**NOT BRITTLE**  
absorbs shock  
and impact



**LESS SETTLEMENT**  
eliminates source  
of many cracks

### Only ZONOLITE Plaster Gives ALL These Extra Advantages:

- Three times lighter than ordinary plaster.
- Four times more fire resistant than ordinary plaster.
- Resists chipping and cracking.
- Fireproofs steel columns, beams, etc.
- Applies easier—less tiring to workmen.
- Ends plasterer's biggest headache—the frozen sand pile.

For FREE information about Zonolite Plaster, write to Dept. AB-129.

**ZONOLITE COMPANY**  
135 South LaSalle Street  
Chicago 3, Ill.



\*Zonolite is a registered trademark of Zonolite Company

## WAGNER ELECTRIC Automatic DOORMAN



Easily Installed  
ON ANY TYPE OF  
OVERHEAD DOOR

Here's a low-cost electric push-button garage door operating unit that has proved itself by compiling a record of more than 100,000 opening and closing operations without requiring service. It can be furnished to operate your present doors by (1)—Radio control button in car (2)—Magnetic control button in car or (3)—Key control button on driveway. Write for Bulletin AB-49—and, if you are interested in new doors, ask for information on "Glideover" and "Rollezy."

Dealer franchises for several excellent territories are still available.

**WAGNER MANUFACTURING CO.**  
CEDAR FALLS, IOWA



WESTINGHOUSE NEW, IMPROVED

**Poweraire\***  
*Home Ventilator*

*Clean, cool kitchens  
sell homes Faster*

A clean, attractive, well-ventilated home is easier to sell. The new Westinghouse Home Ventilator Fan, with the amazing *Injector Grille*, can completely change the air in an average kitchen every **TWO MINUTES**. Now, alert builders everywhere are including the Westinghouse Home Ventilator in construction and remodeling plans.

\*T. M. Reg. U. S. Pat. Off.

**LOOK AT THESE FEATURES**

- Modern Streamline Design
- Insulated Outside Door
- Easily Installed in Practically Any Wall Thickness
- White, Snap-on Air Injector Grille
- Easy to Clean
- Single Pull-chain Control
- Economical to Operate

FOR  
ADDITIONAL  
INFORMATION  
CLIP AND MAIL  
THIS COUPON

**REQUEST FOR  
HOME VENTILATOR INFORMATION**

Name \_\_\_\_\_

Address \_\_\_\_\_

WESTINGHOUSE ELECTRIC CORPORATION  
Fan Department • Springfield 2, Mass.  
12AB

**Westinghouse Fans**

WESTINGHOUSE ELECTRIC CORPORATION  
Appliance Division • Springfield 2, Mass.

**A Method for  
Finding Jobs**

**Daily reports provide over-all view of construction activities by areas, trades, values, and types in addition to leading builders, subcontractors, dealers to new customers**

**B**EFORE a contractor can bid on a job, he must know about it; he must know the facts of construction and the name of the possible customer. This is the crucial problem. Two alternatives present themselves to the contractor. One is to draw the customer to him by employing mass advertising and promotional schemes. Newspaper advertisements, radio commercials, billboards, broadsides, and other media are used in hopes that the potential customer will be induced to call the contractor. The second method is to seek out the individual customer specifically. The first method is more frequently employed, since seek-

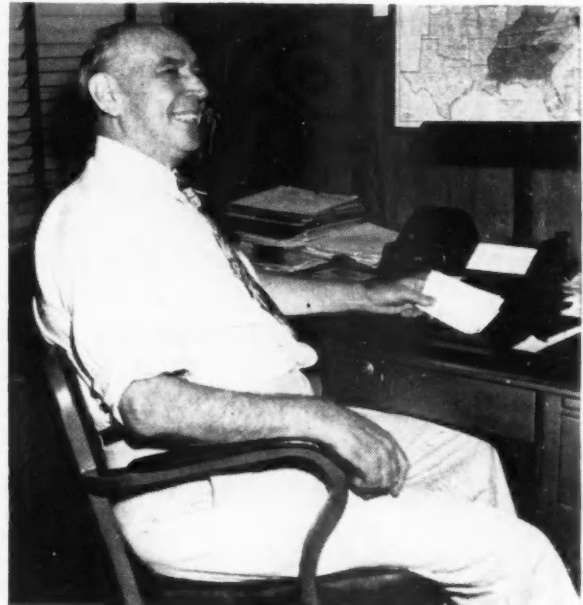

**E. CLYDE HOGE** checks reports daily for prospects

ing out the customer is an imposing task. However, it is becoming an imperative one in an era of increasing competition.

The method utilized by the Hoge-Warren-Zimmermann Company of Cincinnati, Ohio, is one answer to this problem of customer identification. This is an asphalt roofing subcontracting firm, but the method which it uses is applicable to all phases of building construction marketing. E. Clyde Hoge, partner of this company, explained that their technique is based on the use of Dodge Reports prepared daily by the Dodge Reports Division of the F. W. Dodge Corporation, whose home offices are located in New York.

Dodge Reports are daily construction news releases issued from fifteen central offices. They give timely and reliable facts on the progress of individual construction projects in the 37 states east of the Rocky Mountains from the earliest moment that information is available until the projects are completed. A large percentage of the projects reported are only in the contemplated stage.

Regularly, sometimes daily, trained Dodge reporters gather accurate information on construction in their areas from owners, architects, contractors, subcontractors, build-

## Work-saving Appliances Help Builders Sell Houses

Careful selection of house designs is not always enough to assure fast house turnover. A feature which prompts one couple to buy may have no appeal to the next, points out a recently released Westinghouse Builder Booklet.

One way to increase the sales appeal of a house, the booklet explains, is to add time and work-saving household appliances, especially those which require installation services of plumbers, electricians or other building craftsmen.

Trade-marks or labels which the prospect sees have a tremendous influence on his decision, too. But, rarely does he see the trade-marks of the quality building materials used. They are so often covered over with plaster, paint or wallpaper. Recognized brand appliances are assurance of quality throughout the house.

Making provision for installation of automatic washers, dryers, ranges, refrigerators, garbage disposers, electric water heaters or ventilating fans seldom increases building costs but it does save the house buyer added expense and quite often space. For instance, an electric water heater eliminates need for an expensive flue and can be installed in a closet to save space.

Some builders feel that increasing the cost of a house by adding appliances narrows their field of prospective buyers. This is contrary to the experience of successful builders throughout the country. The Westinghouse booklet shows that, actually, appliances add little to the monthly installments when appliances are included in a packaged mortgage plan.

Suppose, for example, a house prospect wanted a ventilating fan, garbage disposer, automatic washer, clothes dryer and electric water heater. The list price would total approximately \$840. That's a considerable extra burden for a new home purchaser to carry on a separate installment arrangement. But when these appliances are included in a packaged mortgage they would add only \$4.59 to the monthly installments on a 15-year, 4½% mortgage.

The Westinghouse booklet, entitled "Mr. Builder", goes further into the subject. It is available at no cost upon request. The coupon below is provided for your convenience.

**Westinghouse Electric Corporation**  
**Appliance Division—Mansfield, Ohio**  
 Gentlemen: Please send me your booklet, "Mr. Builder".

Name \_\_\_\_\_  
 Address \_\_\_\_\_  
 City & State \_\_\_\_\_

12 AB

**YOU CAN BE SURE ..IF IT'S  
Westinghouse**



## Woo the Lady with a Lifetime Supply of Hot Water

Modern living demands more hot water. Mrs. House-Hunter has probably been struggling along with an inadequate supply. Show her a Westinghouse Automatic Electric Water Heater in your house. Tell her how clean, efficient and dependable it is. Explain that the exclusive Booster Button (on De Luxe models) gives her an additional supply of hot water, over and above normal tank capacity, and that her heater will last years longer because of the Tank-Guard. Tell her all these things and, Mister, you're well on your way to closing another house sale.

**Round and Table-Top Models in Sizes for Every Home**  
 ... of course, they're Electric

# Westinghouse

**ELECTRIC CORPORATION**  
 Plants in 25 Cities • Offices Everywhere  
**APPLIANCE DIVISION • MANSFIELD, OHIO**



ing departments, government agencies, realtors, financial firms, administrative boards, and engineers. Approximately 750 news-gatherers call upon 138,000 sources of authoritative news for a total of 1,845,000 personal calls per year. Further, trained readers search practically all newspapers and trade journals for construction news leads.

The news material is dispatched speedily to the central offices where it is consolidated and prepared for use on standardized Dodge Report forms. These forms utilize abbreviations and special codes, the meanings of which are explained to the subscribers, to facilitate communication. As a consequence, the forms are brief without impairment of their value. A typical report lists this data: Date of report, stage of construction activity, serial number, date of first report, condition of project, type of project and construction cost, location, owner, architect, general description of project, general contractors and subcontractors (if bids have been let), and corrections.

After preparation, the reports are forwarded to individual subscribers according to the type of news requested by each. In order to avoid unnecessary reading and sorting of many irrelevant reports, Dodge Reports are issued selectively to subscribers according to their instructions and requirements. Following are the important points of selectivity: Area, kind of construction, valuation, stage of planning, and trades.

The reports are used by contractors, subcontractors, manufacturers, banks, and dealers to keep abreast of their fields of interest within the building industry. These reports save time and effort, for they bring relevant information right to one's desk. They cover projects that might otherwise go unnoticed.

The information garnered from the Dodge Reports enables the subscriber to acquire a better perspective of construction activity in his own area. Furthermore, the



HOGE-WARREN-ZIMMERMANN engineer estimates job at Dodge's

subscribing contractor or other sales person knows what a prospect needs so that he can intelligently approach the customer with the offer of his services.

Plan rooms are another service offered by the F. W. Dodge Corporation. This company maintains plan rooms in 48 principal cities. Here plans for projects reported are available to subscribers for cost estimation. A plan room attendant assists contractors with their estimates. A special notice is forwarded to all subscribers concerned whenever plans are filed in these central offices.

The Hoge-Warren-Zimmermann Company receives reports covering Ohio, Kentucky, W. Pennsylvania, N. Illinois, Georgia, Mississippi, Alabama, and western



You'll find many a job for this

## WELDWOOD LUMBER STAVED CORE DOOR!

There are many applications  
 . . . Residential, Commercial, Institutional  
 . . . for this new Flush Veneer Door

Many of your customers are looking for just exactly the door you can offer them with this newest addition to the Weldwood line.

The solid lumber core provides a satisfyingly "solid" feel. It also means you can hang the door from either side, and it's especially adaptable to custom-cut lights and louvres. Hardware goes in quickly, easily, permanently.

All bonding is done with 100% waterproof phenolic glue, so that you can safely recommend this door for either exterior or interior use.

These new all hardwood Weldwood Doors are furnished with faces of

richly figured hardwood veneers in all the popular species. Made in a wide variety of standard sizes; thicknesses: 1 3/4" and 1 3/8" from stock, also available in 2" and 2 1/4".

In short, the Weldwood Lumber Staved Core Door gives you an opportunity to offer customers a quality product that combines convenience and easy working with versatile, durable, trouble-free beauty.

Your lumber dealer or nearest Weldwood branch or distributing unit has complete information on this new Weldwood product. Get complete details today.

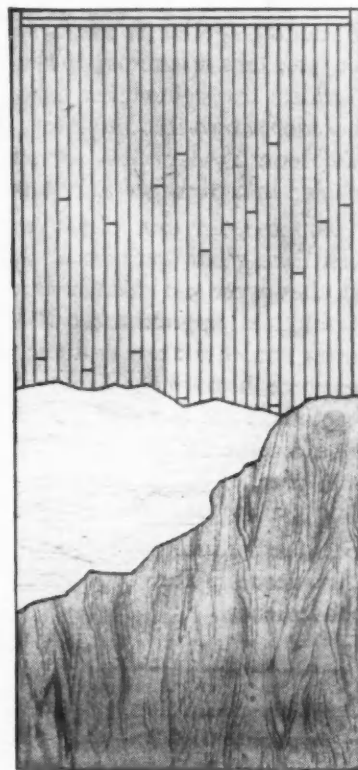

## UNITED STATES PLYWOOD CORPORATION

55 West 44th Street, New York 18, N. Y.

Distributing units in Albany, Baltimore, Boston, Brooklyn, Buffalo, Chicago, Cincinnati, Cleveland, Detroit, Fresno, Glendale, Hartford, High Point, Indianapolis, New Hyde Park (L. I., N. Y.), Los Angeles, Milwaukee, Newark, New York, Oakland, Philadelphia, Pittsburgh, Portland, Ore., Richmond, Rochester, San Francisco, Seattle, Spokane, St. Paul, Washington, D. C. Also U. S. - Mengel Plywoods, Inc., distributing units in Atlanta, Birmingham, Dallas, Houston, Jacksonville, Kansas City, Kans., Louisville, Memphis, New Orleans, San Antonio, St. Louis, Tampa. In Canada: United States Plywood of Canada, Limited, Toronto. Send inquiries to nearest point.

- A beautiful evenness of tone
- A harder, more protective finish



Builders everywhere are enthusiastic about the New Infra-Red Dried Shingles.

They find Dua-Laps are always thoroughly dry, and easier, more economical to apply over solid or spaced sheathing, because of the wide 12" or 14" exposure. Double coursing gives double insulation value.

Write for free literature and name of your nearest dealer.

**THE American**  
**STAINED SHINGLE COMPANY**  
SPRUCE ST. & DENNISON COLUMBUS 8, OHIO

**BESSLER**  
THE QUALITY DISAPPEARING STAIRWAY



Extensively used throughout the United States

Adds sales appeal and extra value to any home.

The panel is the only part visible when the stairway is closed.

The metal parts are all made of pressed steel.

Each stairway is packed with complete installation instructions.

Our 35 years of experience in the disappearing stairway field are at your service.

Made In Seven Models

Write today for literature and details.

**THE BESSLER DISAPPEARING STAIRWAY CO.**  
1900 E. Market St. Akron 5, Ohio



*Avoid WINTER SHUT-DOWNS with Clean, Safe Heat!*

**The HERMAN NELSON DeLuxe Model Portable Heater**

- Provides Quick, Clean, Safe Heat — without smoke, soot or open flame
- Abundant, Fresh Heated Air — forced to areas where most needed!

Full 250,000 BTU per hour capacity — enough to heat three ordinary five-room houses!

Kerosene-burning, electric motor powered. 115/230 volt, 60 cycle, single phase.

Has auxiliary connection for external fuel supply.

Automatic, constant spark ignition!

Two 12" dia. x 12' long, extendable hot air ducts.

**Also Available!**

Popular Herman Nelson Gasoline-Burning Portable Heater (completely self-contained unit). Self-powered for areas lacking electric power. Easily portable by one man.

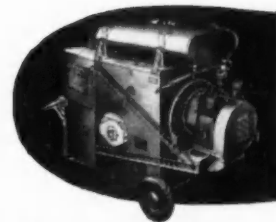

Write for information about temporary heating.

**THE HERMAN NELSON CORPORATION**  
MOLINE ILLINOIS

Since 1906 Manufacturers of Quality Heating and Ventilating Products



**Bostitch T5 Tackers**  
**DRIVE STAPLES IN WITHIN 1/16" OF INSIDE CORNERS**

When a Bostitch T5 Tacker sticks its tiny nose into your business, you save time, money and work. It simplifies back-breaking ceiling jobs and close, difficult corner work. You just place the tacker, squeeze the handle and the staple shoots all the way in. No missed shots, no marred surfaces, no bruised fingers! One hand free for faster, more accurate positioning. Try Bostitch T5 Tackers on your next paneling, insulating or metal lath job. You'll notice a big cost-cutting difference.

**Quick, easy way to attach cornerite**

Attaching cornerite becomes an easy one-handed job with Bostitch H2 Self-Feeding Hammers. The just-right-length staples fasten the metal lath securely to the plaster base without going through to the studs. This floating "tie-down" guards against cracked plaster due to settling of the structure.



**Application time cut in half**

More and more roofers are shifting to Bostitch H4 Self-Feeding Hammers. No wonder! A flick of the wrist drives home a sturdy 3/4" staple like a two-pointed nail. No smashed fingers, no infected mouths. Long, one-arm reach cuts down staking needs. Cuts hours off new roofing jobs.



**INVESTIGATE BOSTITCH** — For installing insulation, attaching building paper or roofing, metal laths, etc., you'll find that Bostitch fastens it better and faster at lower cost. Fill in coupon below for more facts.

**BOSTITCH**, 550 Mechanic Street, Westerly, Rhode Island

I'm interested in more information about time-saving, cost-cutting Bostitch machines for applying:

- Insulation
- Roofing
- Paneling
- Metal Lath and Cornerite
- Building Paper

List other applications: .....

Name ..... Title .....

Firm .....

Address .....

City ..... State .....

**BOSTITCH**  
*AND FASTER*  
 fastens it better with wire

ALL TYPES OF MACHINES  
 FOR APPLYING STAPLES  
 ALL TYPES OF STAPLES  
 APPLIED BY MACHINES

Trademark "Bostitch" Registered U. S. Pat. Off. and Foreign Countries.

South Carolina, the extent of its sales territory. Each day reports covering these areas are examined by a member of the firm to isolate information likely to lead to new customers and new jobs. When a notice is received that plans for a specific job are on file at the local Dodge Corporation office, a representative of the company visits the plan room and estimates the costs based upon the approved plans. A bid is then submitted to the appropriate party as indicated in the Dodge Report.

To cite a specific example, on December 10, 1948, Mr. Hoge received a Dodge Report which stated that the Hull-Dobbs Company, a large distributor of automobiles, planned to build a new showroom and office. This report was segregated for action. When a "plans-on-file" notice

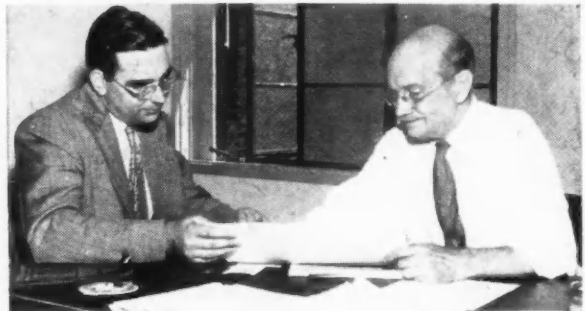

**BIDS** are directed to successful contractor noted in Dodge Report

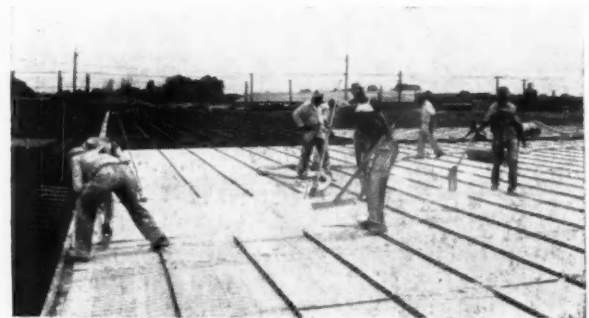

**ROOFING** firm followed Dodge Report lead, won contract

appeared, an estimator from the subcontracting firm examined the plans (by Harold Herman and Associates, architects) and prepared an estimate. The bid was then submitted to the successful general contractor, Penker Construction Company, which had been listed on a report for this project. The Penker Construction Company, in turn, awarded the roofing contract to the Hoge-Warren-Zimmermann Company.

Dealers find use for such services as these since the information given leads salesmen to owners, architects, and contractors interested in materials for specific jobs. Direct mail literature campaigns for sales promotion can be based upon the information obtained from these Dodge Reports.

Two other services are furnished by the Dodge Reports Division. A special Inquiry Section is maintained at the central offices to answer questions from subscribers related to construction projects. Another service is the Home Owners Catalog which is mailed to each confirmed home builder who plans to spend \$5,000 or more and to each confirmed owner who plans to remodel and to spend \$2500 or more. These catalogs contain descriptive literature of leading firms whose materials, equipment, furnishings, and services are used in home building. Salesmen are represented in the catalogs by their own supplementary remarks including telephone numbers, names, addresses, and other marginalia on the sections devoted to their products.



**MORE APPEAL IN YOUR HOMES**  
with MODERNFOLD DOORS

WHERE CLOSURE PROBLEMS ARE TRICKY, employ Modernfold magic. It simplifies closing off Pullman kitchens, bedrooms, alcoves, etc.

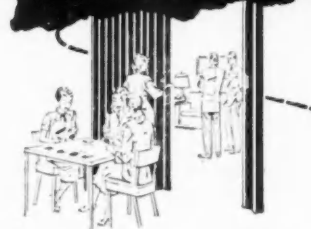

AS A "MOVABLE" WALL Modernfold can be used to divide a large room into small private rooms.



TO SAVE SPACE for all types of interior openings - approximately 8 sq. ft. of space - space swinging doors waste.



Modernfold Doors are accordion-like in opening and closing... add sparkle with their beautiful, washable fabric covering... are rigid and strong—thanks to a sturdy metal frame. Write for full details.

**modernfold**  
DOORS

**NEW CASTLE PRODUCTS**  
New Castle Indiana  
In Canada: Raymond Mfg. Co., Ltd., Montreal  
Consult your local telephone book for the names of our Installing Distributors

**Now! THE NEW**  
**CAPITOL STREAMLINE**  
**FLUSH-PANEL**

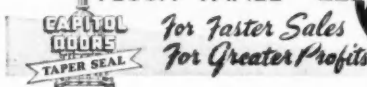

For Faster Sales  
For Greater Profits

Here's a new and beautiful Sectional garage door that has every superior feature of design and workmanship. Streamline, flush panels electrically bonded to frames. (Not nailed) Insures rigidity which prevents warping and distortion.

Dialectric heating, under tremendous pressure, in a High Frequency Heating Unit forms a complete fusion, or bond — impervious to rain, snow or ice. Equalized "pull" or "strain" at all points of the section. A stronger, longer lasting, super-quality door combining beauty and long life with economy.

Same easy-to-install hardware is used on all Capitol Taper Seal doors.

Ruggedly and more substantially constructed — and they're priced to sell — but fast.

**NOTE THESE MANY SUPERIOR FEATURES**

- Modern Beauty - Streamline - Flush Panels - Dialectric Bonding - Equalized "Pull" or "Strain" - Balanced Action - Ball Bearing Rollers - "Feather Touch" Operation - Taper Seal Weather Protection - Rugged Construction - Easy Installation - Long Life - Reasonably Priced.

Sizes Available	
8'0" x 7'0" x 1 3/4"	
8'0" x 7'6" x 1 3/4"	
8'0" x 8'0" x 1 3/4"	
9'0" x 7'0" x 1 3/4"	

See Your Lumber Dealer or Write Us For Full Information and Prices.

**CAPITOL PRODUCTS**  
118 South Third St. Springfield, Ill.  
Telephone 7838

**Whatever the job...**

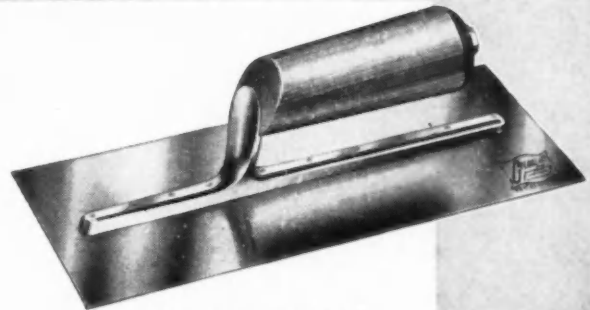

See bottom of ad for description and prices

**Ask your mechanics about**

- LIGHTER**
- FASTER**
- LONGER WEARING**

**Goldblatt MASONRY TOOLS**

Goldblatt masonry tools save time, work, money. For 64 years, skilled craftsmen have chosen Goldblatt, because Goldblatt tools are forged stronger, balanced better, more comfortable, non-corrosive, more flexible. Every Goldblatt tool is guaranteed for materials and workmanship.

WRITE FOR **FREE CATALOG**

Send today for 64-page illustrated catalog describing largest line of tools for your trade, including Steel Mortar Boxes and Transit Levels. Goldblatt offers a complete line of bricklayer, mason, and plasterer tools and supplies for every masonry need—and for Road Paving and General Building Contractors, Trade Schools, Institutions, and Municipalities. Goldblatt can re-blade plastering trowels; can make up special tools to your specifications.

**PLASTERING TROWEL**  
NO. 2S — aluminum mounting; 10 1/2 or 11 inch lengths. Each \$3.35

**CEMENTERS' TROWEL**  
NO. 4S — aluminum mounting; 10, 11, 12-inch, each \$3.35 — 14-inch \$3.60 — 16-inch \$3.85 — 18-inch \$4.10.

**Goldblatt Tool Co.**  
1515 Walnut St. Kansas City 8, Mo.

**GOLDBLATT**  
TOOL

FIRST CHOICE OF THE TRADE FOR 64 YEARS

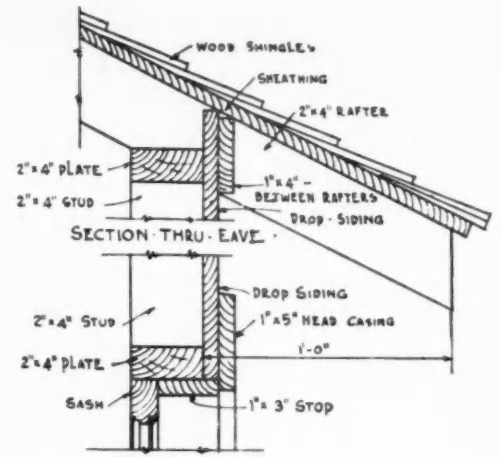
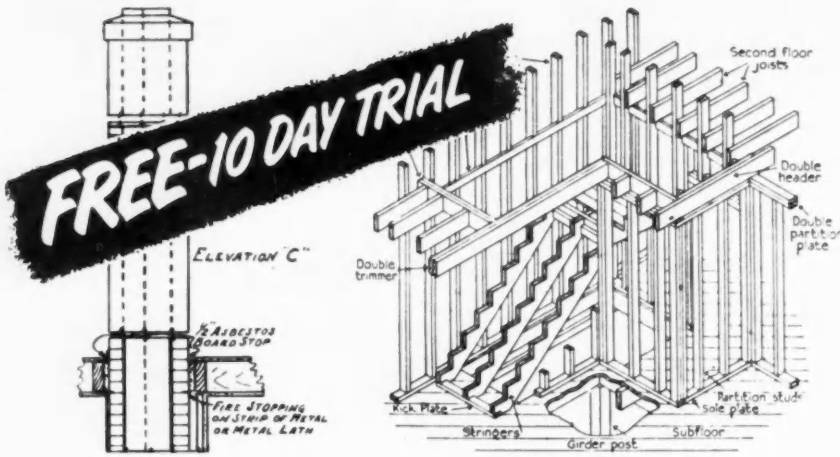

# NOW—Add to your "know-how" of HOUSE CONSTRUCTION DETAILS

Save Money and Time with these Latest Professional Methods

Here is an exact working guide on every detail of house construction from foundation to finish. Tells you dimensions, materials, processes, step-by-step working methods. Hundreds of scale drawings and photographs make every step easy to follow. Quick-reference index enables you to find instantly any construction detail on which you want modern, authoritative guidance. Can be used for alterations in a set of stock plans, for making additions or changes in a building,

or for complete construction of a dwelling. Conforms with modern practice and building regulations in all parts of the country. Gives you helpful ideas on how to build in accordance with latest developments in painting, wiring, heating and air conditioning, insulation and sound-proofing.

The guidance you get on even a single house construction detail can repay you a hundred times the small cost of this remarkable volume. Send for free-examination copy today. Mail coupon below.

## Every Step in House Construction Explained and Illustrated:

Excavations • Footings and drainage • Foundation forms • Sills • Girders • Joists • Sub-flooring • Exterior wall framing • Interior wall framing • Ceiling joists • Gable roof • Hip roof • Gambrel roof • Dormers • Siding and shingling • Cornices • Porches • Exterior walls of wood • Exterior walls of brick • Interior walls finished in plaster, in plywood • Wall panels • Mouldings for interior trim • Stair construction • Windows • Sash details • Window framing details • Doors and door trim • Hardware used in dwellings • Closets, shelves, built-in equipment • Breakfast alcove • Sewing room • Flooring • Chimneys and fireplaces • Mantels and seats • Outdoor fireplaces • Scaffolds • Garages • Electric wiring • Insulation • Arches and gates • Lattice porch, lattice trellis • Garden benches, tables • Swings and other garden furniture • Picket fences • Log cabins, camps, cottages • Barns • Feeders and nests • Rabbit hutch • Septic tank • Painting and finishing • Heating systems • Air conditioning systems • Prefabricated houses • Useful information for home builders including architectural styles and data on modern building materials.

313 PAGES, SIZE 8 1/2 x 11. FULLY INDEXED. 1500 ILLUSTRATIONS.

### High Praise! Read What Reviewers say---

"Best one-volume work on house building we have ever seen."—*Walker's Library Service, Toronto*

"All the elements of house construction are considered in an orderly manner and are illustrated with great clarity."—*The Architectural Forum*

"An amazing number of illustrations, photographs, working drawings and cut-away sections fill this complete book for architects, contractors and builders."—*Scientific American*

**More than 41,000 satisfied users!**

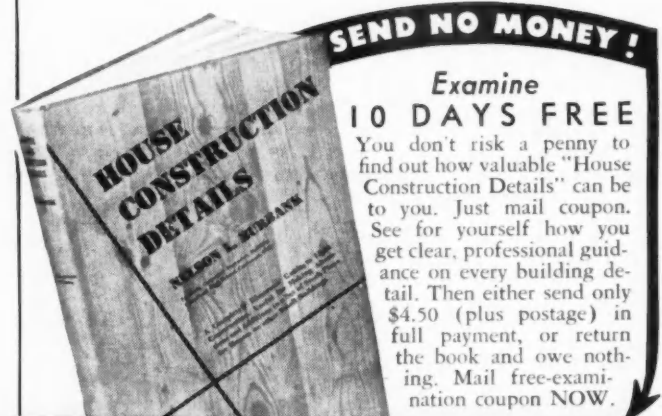

**SEND NO MONEY!**

**Examine 10 DAYS FREE**  
You don't risk a penny to find out how valuable "House Construction Details" can be to you. Just mail coupon. See for yourself how you get clear, professional guidance on every building detail. Then either send only \$4.50 (plus postage) in full payment, or return the book and owe nothing. Mail free-examination coupon NOW.

## MAIL THIS COUPON

Simmons-Boardman Publishing Corp., 36 Church Street, New York 7, N. Y. AB 12-49

Send for 10 DAYS' FREE EXAMINATION, "House Construction Details." I will either return in 10 days and owe nothing, or send only \$4.50 (plus shipping charges) in full payment.

Name \_\_\_\_\_

Address \_\_\_\_\_

City & State \_\_\_\_\_

SAVE! Send \$4.50 with this coupon and we will pay postage. Same return and refund privilege.

DETROIT PUBLIC LIBRARY  
DETROIT F -16 LIBRARY

# WATERPROOF IN FREEZING WEATHER!

with **CRYSTAL**  
Silicone Water Repellent  
Non-Freezing!  
Lastingly Effective!

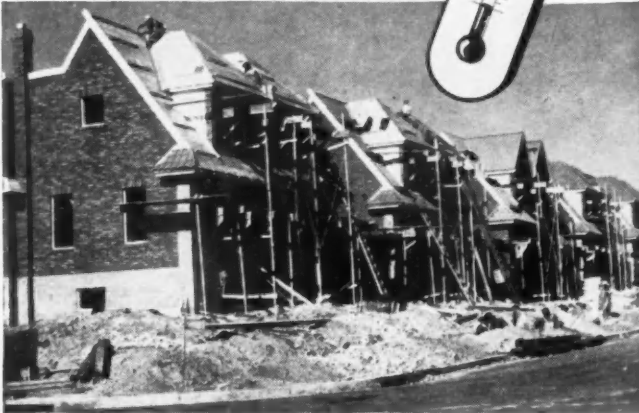

Construction jobs are speeded up in cold weather with **CRYSTAL** exterior waterproofing . . . applied quickly by brush or spray on dry brick, stucco, concrete block —AT TEMPERATURES BELOW FREEZING!

Only **CRYSTAL** has all these advantages:  
**ONE COAT.** Crystal penetrates, waterproofs entire depth. One gallon covers 100 to 200 sq. ft. of surface.  
**TRANSPARENT.** Invisible after application. Will not change surface color, texture.  
**STAINPROOFS.** Makes surfaces self-cleaning.

Send for detailed information and literature

**WURDACK CHEMICAL COMPANY**  
4956 Fyler Ave. St. Louis 9, Mo.

## Home Builders and Allied Interests

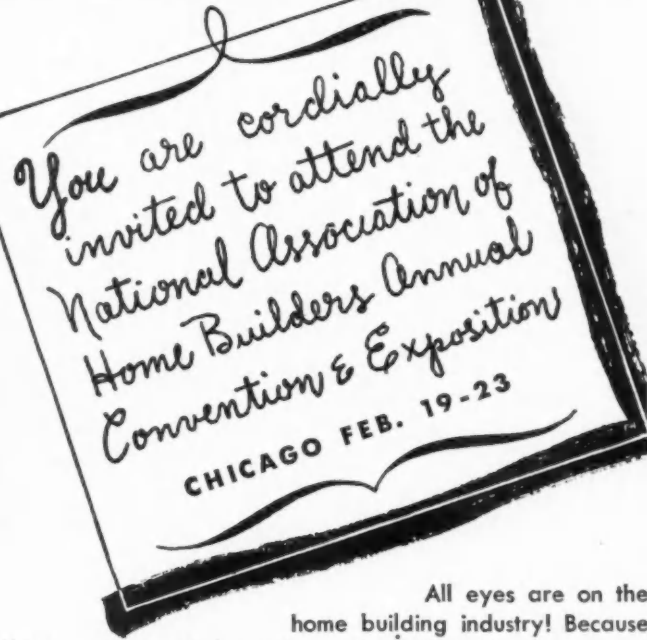

All eyes are on the home building industry! Because of its nation-wide importance, the 1950 Convention and Exposition will raise the curtain on the homes of tomorrow and set standards of home building practices from coast to coast. It is designed to meet the issues of the industry as a whole—also deliver a full measure of benefits useful to you personally. Here at the Convention assemble the most progressive minds, the most vigorous figures in America's home building industry. Come—hear their ideas—make your voice heard. See the biggest and best exposition of home building materials and equipment ever assembled. In it you will see the newest and best the country's manufacturers have to offer. A special section will be devoted to new and revolutionary products.

Use the coupon below to make hotel reservation. Advance Registration of \$12.50 for the men and \$7.50 for the ladies must accompany Hotel Reservation request. Reservations will be confirmed and registration certificate mailed immediately. Make checks payable to National Association of Home Builders. If registration is for more than one person, please give, on a separate sheet, names, addresses, business classifications and dates of arrival.



**REGISTER BY MAIL**  
National Association of Home Builders  
Convention & Exposition Headquarters  
111 W. Jackson Blvd., Chicago 4, Ill.

Enclosed find my check for \$ \_\_\_\_\_ Dept. D  
Please make hotel reservations for arrival February \_\_\_\_\_

NAME \_\_\_\_\_  
STREET \_\_\_\_\_  
TOWN OR CITY \_\_\_\_\_ STATE \_\_\_\_\_  
BUSINESS \_\_\_\_\_

## EASY INSTALLATION

*Metalart*

### ALUMINUM TENSION SCREEN

*Lifetime Service at Common Sense Cost!*

Heavy, rust-proof, corrosion-resistant aluminum frames and wire—stainless steel hardware. Simplest to install of all screens made—only 4 screws necessary. Greatest variance for adjustment. Maximum tension from two stainless steel handles, engaged at bottom of screen. Full range of sizes.

#### OTHER ALUMINUM BUILDING PRODUCTS

Aluminum double-hung windows, two types, 51 sizes, 8 styles with trim. Packaged, glazed and screened.  
CUSTOM FRAMED SCREENS—ALUMINUM SHUTTERS—ATTIC VENTILATORS—STORM WINDOWS

*Exclusive areas available to Agents and Distributors*

METAL ARTS MFG. CO., P. O. BOX 4144, ATLANTA, GA.  
Please send me detailed information on your Aluminum Building Products

I am a Distributor  Dealer  Builder  Architect

NAME \_\_\_\_\_  
ST. & NO. \_\_\_\_\_  
CITY \_\_\_\_\_ ZONE \_\_\_\_\_ STATE \_\_\_\_\_



# Attract Buyers with this "BUILT-IN" Comfort Feature!



**S**SOLID COMFORT at low cost. That's what you offer when you equip your homes with Gate City Awning Windows. Here's the window that has taken Florida by storm . . . that cools off hot, stuffy rooms.

But that's not all! This window ventilates without draft . . . sheds rain . . . protects against prowlers . . . may be cleaned from the floor . . . has screens and storm sash indoors . . . can be weatherstripped . . . operates without interfering with shades, Venetian blinds or drapes.

Of course, these windows cost a little more. *But* — they more than repay that extra cost the first time the rain-deflecting sash saves a redecorating bill!

15 standard and 36 special sizes available. Toxic treated for *extra* durability and low maintenance. Precision-fabricated for unit installation. Glass and hardware installed. Lumite screen included.

Give your homes the edge over competition. Write for prices, name of nearest distributor, etc. to Gate City Sash & Door Co., Dept. B-12, Fort Lauderdale, Fla.

*We are in Sweet's Architectural and  
Builder Files*

AWNING WINDOWS BY  
**Gate City**

USE THE

*finest!*

UNIVERSAL  
LEVEL-TRANSIT



**RUGGED**

**ACCURATE**

**DEPENDABLE**

Truly the finest in accuracy and dependability, the Universal Level-Transit is smoothly converted from a precision level to a highly accurate transit in 2 easy motions. A practical all-around builders' instrument.

Patented ball-bearing race assures perfect adjustment under the severest conditions. Telescope 12" long, 25 power, horizontal circle 4 1/2" with Vernier to 5 minutes. Price \$165.00



Manufacturers of  
Instruments for  
Engineers, Surveyors  
and Builders.

**EXTRAS — MODEL 3000**

Detachable compass.....\$13.75

Stadia wires..... 5.50

Extension leg tripod..... 15.00

Write today for full information on Model No. 3000 . . . Also FREE booklet "How to Lay Out Building Lots."

311 West Court St., Milwaukee 12, Wis.



## An entirely New Conception of Effortless Hoisting

Whenever material is to be hoisted in a hurry, visualize how nicely you could use a Hoist like this on your job! No expensive rigging necessary . . . easy to set up in just the spot where the material is stacked. Every contractor can use one . . . Brick and Stone Mason, Carpenter, Lather, Plasterer, Roofer, Sheet-metal Man, etc. in models to suit your work for lifting from 200 to 1,000 lbs.

KING Hoists are portable . . . they handle like a bag or barrel truck . . . easy to load and unload onto your motor trucks. Powered by air-cooled engine—won't freeze in cold weather or over-heat in summer. Rugged construction . . . long dependable service with lowest maintenance.

Write for free literature.

**KING MFG. CORP.**

3146 W. Chicago Ave.  
Chicago 22, Ill.



Available in 6 sizes—  
2 to 6 Horse Power

# SYMONS FORMING SYSTEM



"Seven men set-up the forms for a 26' x 27' basement in one hour and fifteen minutes."—Harry G. Dehring, Carpenter Foreman, Taylor Brothers, South Bend, Indiana.

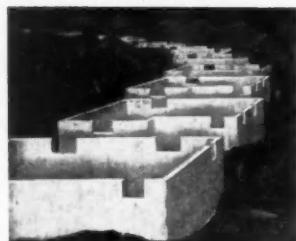

"We have used these forms 60 times without appreciable wear. We expect to get at least 60 more reuses."—Homer L. Short, Supt. Reed Construction Company, Mishawaka, Indiana.

## SAVES TIME

There are only three essential pieces of hardware . . . bolt, wedge and form tie. The tie remains in the concrete . . . bolt and wedge are used again and again.

Bolt holds forms together and also holds tie both ways. No nails or spreaders are used.

To remove forms, tap out wedges, remove bolts, then easily pull forms up or out without tools. The ties will break back inside the wall, 1" from the surface by twisting loop 1/2 turn.

## SAVES LABOR

The Symons System speeds erection and stripping of forms. Forming labor is cut 50%.

## SAVES COSTS

With Time and Labor cut in two . . . Plus savings in nails, spreaders, wafers and bracing . . . Plus for greater reuse of forms . . . Costs drop to new low.

Symons Forms can be rented with purchase option or you may purchase the hardware with free blueprints to make your own forms.

WRITE TODAY for your free copy of our 36 page catalog. If you will enclose dimensions of your next form job you will receive a free form layout and estimate.

# SYMONS CLAMP & MFG. CO.

4261 DIVERSEY AVE. CHICAGO 39, ILLINOIS



LIKE A TEETER-TOTTER...



**Tilt-a-Door**  
ALL METAL ALUMINUM

operates with

- NO SPRINGS
- NO TRACKS
- NO NOISE

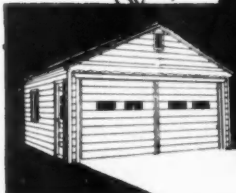

... JUST A SIMPLE TILTING ACTION Aluminum construction is unaffected by weather. No sticking, warping or freezing. Nothing to get "out-of-order"... Nothing to wear out. Noiseless, sturdy and smart. Simple installation.

Exclusive areas available to Dealers and Distributors

TILT-A-DOOR CORP., DEPT. "A"—468 EAST NINE MILE ROAD—DETROIT 20, MICHIGAN  
Please send me detailed information on your Aluminum Garage Door.

I am a Distributor  Dealer  Builder  Architect  Home Owner

NAME \_\_\_\_\_

ST. & NO. \_\_\_\_\_

CITY \_\_\_\_\_

ZONE \_\_\_\_\_ STATE \_\_\_\_\_

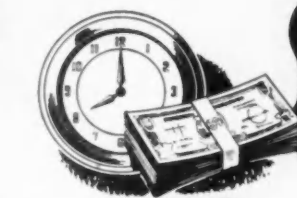

Save Time and Money  
on the  
**HARD JOBS**

WITH  
**FULLY ENCLOSED**

**INSL-COTTON**

**INSULATION**

- **Faster Installation**
- **Lower Labor Costs**
- **Greater Protection**



WHEN there's a

hard job ahead that presents difficult installation problems, let fully enclosed INSL-COTTON save you time and money—get the job done right! Fully protected because it is fully enclosed, it has a heavy vapor-proof, wax-treated and asphalt coated barrier with tacking flaps on one side and tough paper on the other. It can be jerked, pulled and handled roughly with no danger of the insulation coming loose. Flexible and easy to handle, it goes up fast at low labor cost — gives exceptional efficiency — licks the tough jobs!

FULLY ENCLOSED OR OPEN TYPE,  
INSL-COTTON IS

*Certified*

Insl-Cotton contains no second-hand material. Every lot is tested and certified to the U. S. Government. No other insulation except flame-proof, fire-retarding cotton insulation made under Federal control can make this claim. Meets 7d, FHA, FPMA and HHI-1-528 specifications.

Efficient—K factor 0.24  
Permanently Flame-proofed  
Moisture and Insect Repellent  
Won't Sag or Settle  
Exceptionally Light Weight  
Uniformly Thick  
An Excellent Sound Deadener  
Harmless to Handle



You'll like Insl-Cotton because it saves you time and money . . . your workmen will like it because it is easy to install, harmless to handle . . . your customers will like it because it is exceptionally efficient.

## INSL-COTTON DIVISION

TAYLOR BEDDING MFG. CO.  
TAYLOR, TEXAS + BELTON, TEXAS

ALL COTTON INSULATION IS NOT  
INSL-COTTON . . . INSIST ON THE  
ORIGINAL AND GENUINE  
INSL-COTTON

Originators of Flame-Proof, Fire Retarding  
Cotton Insulation

## MAIL THIS COUPON TODAY!

INSL-COTTON DIVISION  
TAYLOR BEDDING MFG. CO., Taylor, Texas

Gentlemen:  
Please send specifications and full information on Insl-Cotton

Name \_\_\_\_\_

Address \_\_\_\_\_

City and State \_\_\_\_\_

Check Here:

Distributor

Architect

Contractor

**SELL YOUR  
HOMES  
EASIER...  
EVERY WOMAN  
WANTS ONE!**



**FASCO**  
**AUTOMATIC  
KITCHEN  
VENTILATOR**

- PROFIT from the big sales appeal of clean, cool, comfortable kitchens.
- AMAZING LOW PRICE . . . quick, easy installation . . . helps keep your building costs down . . .

LIST PRICE **\$24.95** Plus Attractive Discount to Builders!

- Changes air in average kitchen every three minutes!
- Quiet operation, without drafts . . . no radio interference
- Four models for all size kitchens . . . all wall thicknesses . . . all types of construction.
- America's largest builders use FASCO Ventilators as standard equipment.

WRITE, WIRE or PHONE for complete information to FASCO Industries, Inc., 100 Davis Street, Rochester 2, N.Y. (Phone HAmilton 1800)



**ROCHESTER 2, N. Y.**

## ASSOCIATIONS - Their Plans and Activities

### High Demand for New Homes Continues in N. California

The demand for new homes, which increased sharply in July, continues at a high level throughout Northern California, according to a survey made recently by the Home Builders Council of California. More than 450 builder-members of the Council were polled.

In announcing the results of the survey, Robert B. Johnson, Council chairman, said that the increasing demand for new homes first became apparent in greater volume of home sales for July, with a further rise being noted in August. He added that incomplete figures for new home construction in September indicated a full ten per cent increase over the preceding month.

Johnson attributed the new expansion to two main factors—conviction on the part of prospective home buyers that there will be no important change of prices within the foreseeable future; and increased development in the field of lower-priced homes.

Associations affiliated with the Council which took part in the survey are: Associated Home Builders of San Francisco, Associated Home Builders of Alameda County, Associated Home Builders of Sacramento, Peninsula General Contractors and Builders Association, General Contractors Association of Contra Costa County, Marin Builders Association and Home Builders Association of San Joaquin County.

### Hold 72nd Pennsylvania Savings and Loan Meeting

The 72nd annual convention of the Pennsylvania Savings and Loan League was held at Reading Oct. 19-21, with representatives present from most of the state's 569 local savings and loan associations.

Housing problems were a major discussion topic in the three-day program. Speakers at the meeting included: Curt C. Mack, assistant FHA commissioner (underwriting); Howard E. Reed, Pennsylvania director, banking and investment section, Treasury Savings Bond Division; Dr. Raymond Kistler, president of Beaver College, Jenkintown, Pa.; B. H. Wambolt, *American Builder* senior associate and eastern editor.

Raymond Trigger, savings and loan editor of *Investment Dealers' Digest*, New York; H. Merle Smith, director of field service, U. S. Savings and Loan League, Chicago; Oscar R. Kreutz, executive manager of the National Savings and Loan League; and William S. Livengood, state secretary of internal affairs.

### Convention Dates Announced

The Michigan Builders Supply Association will hold its 23rd annual convention at the Pantlind Hotel, Grand Rapids, Feb. 6-7.

(Continued from page 66)

The NRLDA head was inducted into the Kiowa Indian tribe as an honorary chief by Chief Frank Bosin, one of the few full-blooded Indian chiefs of the aboriginal tribes still living.

Other entertainment features included a stag party for the men in the Skirvin Hotel, honoring the Hoo-Hoo organization. A party for women guests was held at the Oklahoma Club with Mrs. Alene Beckford, operator of the Independent Lumber Co. in charge.

The winners of top awards in the NRLDA nation-wide public relations contest featuring women's interests were recently announced, following their selection by a panel of women radio and news feature editors in Washington, D.C. The winning dealers are: L. Grossman and Sons, Inc., Quincy, Mass.; William P. Proctor Co., North Chelmsford, Mass.; and the A. W. Burritt Co., Bridgeport, Conn.

The three awards, which consisted of identical bronze statuettes on mahogany bases, were presented specifically for "Community and Industry Public Relations Service of Significant Interest to American Women."

Primary purpose of the NRLDA contest, of which the women's section was a part, was to focus the attention of lumber and building material dealers on the necessity of developing a good public relations program locally.

### Metal Lath Commissioner Post Resumed by D. R. Wadle

Donald R. Wadle has resumed the position of commissioner of the Metal Lath Manufacturers Association, following a year's leave of absence, according to a recent announcement by the association at its Cleveland headquarters.

W. B. Turner, who was manager of the fireproof building materials department of Inland Steel Products Co. when he retired in 1948, served as commissioner during Wadle's absence.

Wadle has been associated with the lathing and plastering industry since 1927 and joined the Metal Lath Manufacturers Association in 1939 as Pacific Coast representative. He was elected commissioner in 1946.

### Taxes, Insurance Discussed At Northern Jersey Meet

An enlightening discussion on how the intelligent use of ordinary tax knowledge can mean substantial savings was presented to the Home Builders Association of Northern New Jersey at the November 1 meeting at Teaneck. Peter Mazarella led the discussion on tax matters. R. P. O'Connor explained the life insurance plan now available for members of the New Jersey Association. Insurance may be obtained up to age 65, with no physical examination, at a very low rate.





**READYBUILT**  
(Reg. U. S. Pat. Off.)  
**FIREPLACES**

Lends unsurpassed beauty and charm to homes—old and new. The modern fireplace that fulfills all modern day requirements — used with gas or electricity.

Large variety of attractive models in brick, stone, wood, etc., available.

Furnished complete—ready to be installed in hour's time of handy man—shipped anywhere.

DEALERS, BUILDERS and HOMEOWNERS write for catalog and full information.

**THE READYBUILT PRODUCTS CO.**

1705-23 McHenry St.

Baltimore 23, Md.

**METAL TILE PRODUCTS, INC.**

Manufacturers of

**HASTINGS alumitile**

and

**alumi-SHIELD AWNINGS**

wishes its thousands of dealers and distributors throughout the United States,  
*A Merry Christmas and A Happy New Year*

**HOMEBUYERS EVERYWHERE PREFER R-O-W REMOVABLE WOOD WINDOWS**

Can be delivered to the job completely assembled and pre-fit. See your building materials dealer or write:



**R-O-W SALES COMPANY**  
FERNDALE 20, MICHIGAN

For construction details see our catalog in Sweet's File.

**E-Z MARK BUTT GAUGE**

**HANG THAT DOOR THE PROFESSIONAL WAY!**



Makes a clean-cut deeply etched profile. Remove chips. Repeat on jamb. Hang door!

Comes in 3", 3 1/2" and 4" (Std.) sizes. If dealer can't supply, send only \$1.00 with order, pay postman balance plus postage C.O.D. In Canada, 25c higher per order. No C.O.D. State sizes wanted.

Comes with Leatherette Case

**E-Z MARK TOOLS**

P. O. Box 8377 Los Angeles 16, Calif.  
Dept. A



**It's Easy... It's Economical!**



**Eliminate Your CHIMNEY PROBLEMS WITH A PHONE CALL**

**Here's How:**

Be free of delays when the building is ready for the chimney . . . get fast action, just phone your Van-Packer dealer and ask him for the

**VAN-PACKER PACKAGED CHIMNEY**

Easily installed in 3 man hours by a sheet metal man or carpenter. Light weight. Needs no foundation. Suspends from floor or ceiling joists.

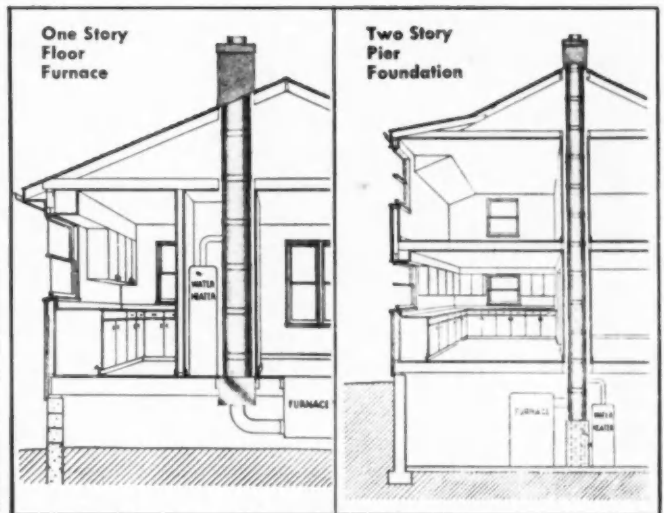

**ENTIRE CHIMNEY SHIPPED COMPLETE**

(Convenient 2-foot sections: base, housing, roof flashing, chimney cap.) Nothing else needed.

**SAFER . . .**

Underwriters' Laboratory accepted for any fuel: gas, oil, coal or wood for any type space heater or floor or basement furnace. Meets FHA Requirements.

**ECONOMICAL . . .**

Save up to 50% over brick. A lifetime chimney, more efficient . . . better draft.

**IMMEDIATE SHIPMENTS**

made direct to project.

**LIBERAL DISCOUNTS**

to project builders.

**WIRE** us name of your lumber or heating dealer for immediate quotation.

**VAN-PACKER CORPORATION**

136 South Clark St., Chicago 3

Phone: Randolph 6-1840

It pays  
to push  
**PRESTILE**



There's a big profit in tileboard! And for new or old homes Prestile is your best bet! It's easy to sell because your customers know the Prestile name. They see Prestile advertised in their favorite magazines . . . know it is a colorful, smart wall paneling that costs less to install . . . keeps its bright beauty for years and years. And remember, Prestile supplies you with many important merchandising aids. Yes, in every way Prestile means more profits for you.

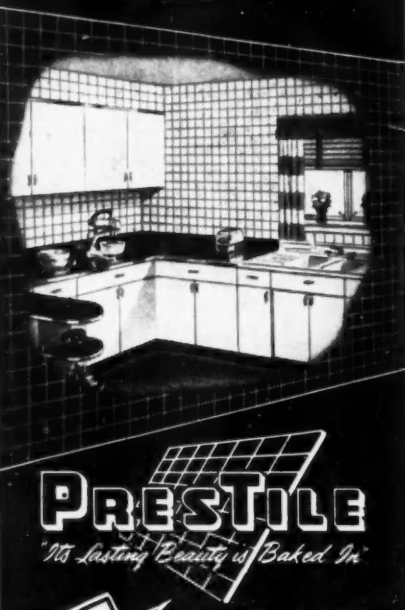

**PRESTILE**  
*"Its lasting beauty is Baked In"*

Free

Clip this handy memo to your letterhead and mail today!

Prestile Mfg. Co. • 5850 Ogden Ave. • Chicago 50

Please send me free samples and Dealer's Merchandising Kit—"How to Make More Profits from Tileboard." B

Your Name.....

**Connellan Named Strand Garage Door Manager**

Thomas K. Connellan has been appointed manager of the Strand Garage Door Division of Detroit Steel Products Co., E. C. Hodges, firm vice president, announced recently.

Connellan has been affiliated with the Strand Garage Door Division since it was organized in 1945. He was assistant to Carl A. Strand, president of the Strand Building Products Co., for several years prior to December, 1947, when that firm was purchased by Detroit Steel Products Co. Since that time Connellan has been in charge of sales and promotional work for the garage door division.

**C. C. Sheppard, Prominent Southern Lumberman, Dies**

C. C. Sheppard, whose service in the Southern Pine industry had covered almost his entire lifetime, died Oct. 13 at his home in Clarks, La. He was 72.

Mr. Sheppard was born on a farm near Lee Summit, Mo., was graduated from Central High School, Kansas City, Mo. and attended the University of Missouri. He was associated with lumber firms in Missouri until 1914 when he took a post in Oakdale, La.

In his wide career, Mr. Sheppard had served as general manager, Ouachita and Northwestern Railroad Co., Clarks, La.; president, Louisiana Sawmill Co., Glenmora, La.; vice president, Forest Lumber Co., Kansas City, Mo.; director, White-Grandin Lumber Co., Slagle, La.; and director, Exchange Sawmills Sales Co., Kansas City, Mo. All of these companies were associated with the White-Grandin interests. He had also been vice president of the Washington Lumber Co., Washington C.H., Ohio. At the time of his death he was president and general manager of the Louisiana Central Lumber Co., Clarks, La.

Among high industry posts which Mr. Sheppard had occupied were: president, Southern Pine Association; chairman, Central Committee on Lumber Standards; president, National Lumber Manufacturers Association; president, Southern Hardwood Producers, Inc.; and, most recently, chairman of the Southern Pine Industry Committee. He had acted as spokesman and witness for the lumber industry before the Interstate Commerce Commission, legislative bodies and other groups.

Surviving are his widow, two brothers, Grover A. of New Orleans and Ernest, Washington C.H., Ohio.

**metal weather strip NAILS**



Preferred everywhere by the trade for many years. Made with barbed shanks and suitably plated for maximum resistance to elements. Available in one, two or five pound packages and in bulk. Immediate delivery.

**JOHN HASSALL, INC.**

182 Clay Street  
Brooklyn 22, N. Y.  
Established 1850



**Jiffy SAWHORSE BRACKETS**



**BUILT STRONG FOR HEAVY JOBS!**

- Set 'em up or
- Take 'em down in a Jiffy

**NO NAILS—NO BOLTS—A strong, simple, bracket for making up Sawhorses! Use ordinary 2" x 4" for legs and 2" x 4"-6"-8"-10" or 12" for the crossbar.**

Boxed, one pair in counter display.

Price . \$1.50  
West of the Rockies \$1.60



**ORDER FROM YOUR JOBBER OR WRITE TO US: GRAND HAVEN STAMPED PRODUCTS CO. GRAND HAVEN, MICH.**

# NOW YOU CAN BID ON...

**CHURCHES... GYMNASIUMS... THEATRES... GARAGES**

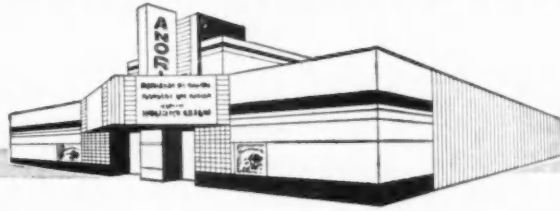
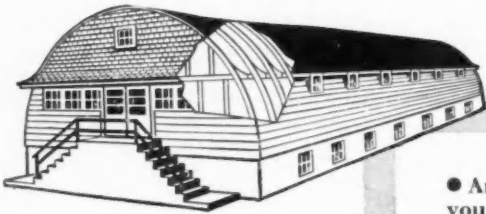

● And that's only the beginning. With Rilco Arches, Trusses and Rafters you can handle almost any commercial construction . . . bowling alleys, auditoriums, super markets, airplane hangars, factories . . . buildings you never tackled before!

You can keep your bids low—and your profits up—because Rilco Framing Members are engineered, factory-built, arrive at the building site ready to swing into position. They save on-the-job building time, reduce labor and material costs, make stronger, better-looking, permanent buildings.

Rilco engineers design framing members for all types of buildings . . . graceful, massive Church Arches . . . long, clear-span Type 74 Arches for armories, fieldhouses and auditoriums . . . Type 59 Arches for smaller gymnasiums, theatres and warehouses . . . Type 54 Arches for roomy, wind-resistant hangars . . . Type 62 Bowstring Trusses for post-free buildings up to 200 feet . . . Type 70 Tied Arches for stores and garages.

Want to find out how Rilco Framing Members can help you handle more jobs, get more profits? If you haven't already received Rilco's new 12 page Commercial Catalog AIA File No. 19B-3 write for a copy.



# RILCO

**WORKS  
WONDERS  
WITH WOOD**

**Laminated PRODUCTS, INC.**  
1667 First National Bank Building  
St. Paul 1, Minnesota

*Custom Built!*

**IRON RAILINGS**

COMPARE . . .

STYLE, QUALITY, PRICE  
WEATHERIZED RAILING ECONOMY RAILING

\$375 per Ft.      \$3.00 per Ft.

LESS TRADE DISCOUNT

All Types of Architectural Iron  
Send us your requirements

**FREE**

CATALOG,  
DIMENSION SHEET  
PRICE LIST, ETC.



**BELSON Mfg. Co.** 111 FRANKLIN ST. AURORA 3, ILL.

## YOUR CLIENTS KNOW

The name Kohler has stood for plumbing products of high excellence for more than three quarters of a century. When you specify Kohler fixtures and fittings your clients will know their plumbing will have beauty and harmony of appearance . . . and that from the lustrous surfaces to the smallest detail of each working part it will be durable, practical and serviceable.

**KOHLER OF KOHLER**

Plumbing Fixtures • Heating Equipment • Electric Plants

**NEW HOLLY "25"**

**SINGLE WALL HEATER  
25,000 BTU**

**ABSOLUTELY SAFE . . .** Smartly designed panel hides internal parts — furniture, fingers and clothing can't be damaged!  
**EXTRA SMALL . . .** Rough-in dimensions only 14" x 50 1/2" in standard 4" wall.  
**ECONOMICAL . . .** The Holly "25" meets higher A.G.A. standards than those required for heaters at 20,000 BTU or less. Burns natural, manufactured or liquefied petroleum gas.

HOLLY MANUFACTURING CO., 883 S. Arroyo Parkway, Pasadena 2, Calif.

## WE SET YOU UP IN BUSINESS

Here's A Real Opportunity

Read what Elmer L. Warn wrote us: "I have operated a Foley Saw Filer and a Retoother for over two years. I am a carpenter. When it will be hard for me to throw a hammer and push a saw, I will have a shop that will make me an easy living. I call these machines my old age insurance, and they are paying for themselves as we go along."

**FREE BOOK "Independence After 40"**

shows how you can start at home, make up to \$2 or \$3 an hour in spare time. Send coupon today. No salesmen will call.



FOLEY MFG. CO., 1224-9 Foley Blvd., Minneapolis 18, Minn.

Send FREE BOOK—"Independence After 40"

Name \_\_\_\_\_

Address \_\_\_\_\_



DETROIT PUBLIC LIBRARY



# Latest Word on MASONRY CUTTING



**GUARANTEES...**

**... To Provide the Fastest  
Cuts... at the Lowest Cost  
... with the Greatest Ease  
Anytime... Anywhere**

and you can have  
a New Clipper on  
**FREE  
TRIAL**



## 9 NEW 1949 CLIPPER MASONRY SAWS

Yes, nine NEW models to choose from and each with outstanding features for smooth, fast and economical Clipper Cutting Action. See the 1949 DUSTLESS Model HD—cuts wet or dry—the 100% Answer to All Masonry Cutting. Contact your nearest Clipper Factory Branch for a FREE TRIAL on any of the nine Clipper models. See the "ADJUST-A-CUT" Control; "PRESSURE EQUALIZER" Spring; and the STREAMLINED Conveyor Cart... you'll know why Clipper is more outstanding than ever before!

Write for illustrated literature



**2808 WARWICK • KANSAS CITY 8, MO.**  
Factory Branches  
Philadelphia • St. Louis • Cleveland • Austin, Tex. • San Francisco

## ASSOCIATIONS—Their Plans and Activities

### Warm Air Heating Association To Hold Convention Dec. 14

The National Warm Air Heating and Air Conditioning Association will hold its 36th annual convention Dec. 14-15 at the Cleveland Hotel, Cleveland, Ohio. Members of the program committee are Atlee Wise, association president; John E. Peterson, American Artisan magazine editor; and H. C. Gurney, of the Surface Combustion Corp.

Wise, president of the Wise Furnace Co., Akron, Ohio, will make the opening address. One of the featured speakers will be Senator Robert A. Taft, of Ohio.

Other speakers will include Charles E. Price, general manager of American Artisan; M. I. Levy, president of the Viking Air Conditioning Corp.; Howard Hartman, L. J. Mueller Furnace Co.; and Elizabeth Gordon, editor of House Beautiful magazine.

Plans for the new two-day 1950 Indoor Comfort Conferences will be outlined by Guy A. Voorhees, application engineering director of the association. Social activities will include a luncheon and cocktail party.

### Philadelphia Association Uses Newspapers to Tell Story of Its Home Builder Members



**PHILADELPHIA** Association's full page advertisements stressed value of home ownership and told the advantages of buying now

### Northern New Jersey Group Active in Housing Fight

The Home Builders Association of Northern New Jersey sparked a vigorous, state-wide fight against a New Jersey public housing law which was voted on at the Nov. 8 election. Clarence J. Von Drehle, secretary of the Northern New Jersey Association, served as secretary of the New Jersey Council for Home Protection, which was composed of the home builders, mortgage bankers, savings and loan people, chambers of commerce and retail lumber dealers. The Council, with Von Drehle as secretary, raised funds to finance the campaign and ran a speakers bureau which arranged dates and scheduled speakers at all types of public meetings where they spoke in opposition to the public housing law. In addition to these activities, huge volumes of literature were prepared and distributed to voters pointing out the dangers of such legislation.

This fall the Home Builders Association of Philadelphia and suburbs ran a series of three full page advertisements in the Philadelphia newspapers pointing out to the public the advantages of home ownership and why now is a good time to buy. One of the advertisements was scheduled as part of the National Home Week promotion. All insertions carried the emblem of the Philadelphia Association in large size and in a prominent position. At the bottom of each a complete list of the active builder members was included with office addresses. William E. Johnson is the executive vice president of this very active local NAHB chapter.

### Long Island President Lectures in Short Course For Real Estate Men

Leonard L. Frank, president of the Long Island Home Builders Institute and president of Frank Homes, Inc., delivered a two-hour lecture on "Construction—Basic Fundamentals" before the Long Island Real Estate Board Monday evening, Oct. 24. His talk covered architecture, the general types of construction, prefabricated houses, and details on construction such as roof types, foundations, good and bad construction, plumbing, heating, floor and wall finishes. He also discussed painting, various types of windows now popular and other components of today's houses. He also went into detail concerning problems of today's home builders in dealing with municipalities, federal agencies, financial institutions and the public.

### Join Long Island Group

A series of organizational meetings sponsored by the Long Island Home Builders Institute has resulted in the enrollment of a large percentage of the Suffolk County home builders as members of the Institute. Prior to this fall the Suffolk County builders did not, as a group, have many problems similar to those of the bulk of the members of the Long Island Institute. The rapid and healthy growth of home building in Suffolk now has confronted home builders there with many situations in which the help of the Institute is valuable.

## YOU SAVE MONEY



with American-bowstrings!

You Save Money, Speed Construction Time with these unusually fine roof trusses. Durable, safe, approved by engineers everywhere. Used on the nation's buildings for over 27 years. Deliveries Quickly Made. Shipments sent fully assembled . . . immediately ready for fast, easy erection.



**AMERICAN Roof Truss Co.**  
6856 Stony Island Ave., Chicago 49, Illinois . . . PLaza 2-1772  
Established 1922

## KIMBALL

Light Electric Elevator

Send for free circular and prices

SINCE 1883

**KIMBALL**

HAS MADE  
GOOD ELEVATORS

PASSENGER ELEVATORS FREIGHTS  
Hand Power Electric Hydraulic

**KIMBALL BROTHERS  
COMPANY**

1883 BOX 301 COUNCIL BLUFFS, IOWA

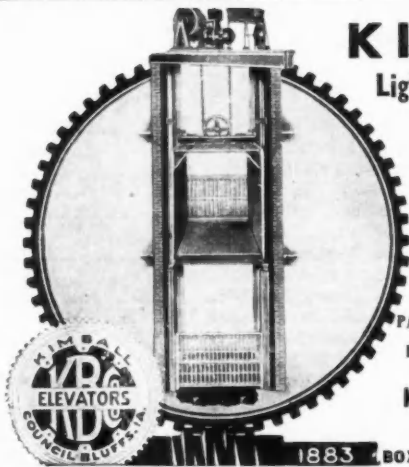

# ABC

YOU SHOULD LEARN HOW

ALLIED BUILDING CREDITS, INC. CAN HELP YOU TO . . .

- A . . . make more money
- B . . . give greater service to your customers
- C . . . increase your sales

Write for information and a copy of  
"THE ABC'S OF MAKING MONEY"



**ALLIED BUILDING CREDITS, INC.**  
3109 WILSHIRE BLVD., LOS ANGELES, CALIF.

## INCREASE PRODUCTION 100%

### with KEN Corner LEVEL

In 15 minutes you can determine the amazing savings in time and effort constructing corners, window openings, and doors, in all building. The NEW KEN CORNER LEVEL is the greatest improvement since the original invention of the level. It will double present production during any 15 minute period of working time. Multiply that saving by the number of 15 minute periods in a working day then you will know what kind of production increase you can expect with more accuracy and less effort. With the KEN CORNER LEVEL the mechanic working at the same speed will install twice as much material over the old fashioned, wood, level; because, it plumbs and squares TWO sides of a corner at ONE time. The "Z" bars form a "jig" that fits each corner brick in place, plumbing and leveling all sides, corner, and top, with a single movement.

The bubble is adjustable for plumbing a batter, incline, or tapering surface. Level sizes 18", 24", 36", and 48". KEN CORNER LEVELS are being successfully used by builders, masons, and carpenters, everywhere. DROP Post Card for information:

A KEN CORNER LEVEL with your Xmas Greetings pasted thereon will help sales.

**SINGER-KENNEDY CORP.**

Dept. L—21 E. Van Buren St., Chicago 5, Ill.

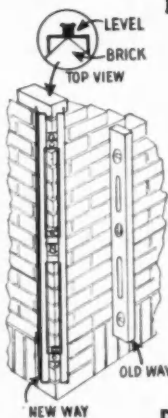

## Where Wood Needs Protection from DECAY and TERMITES

# WOLMANIZED PRESSURE TREATED LUMBER

Makes Lasting Customers for You

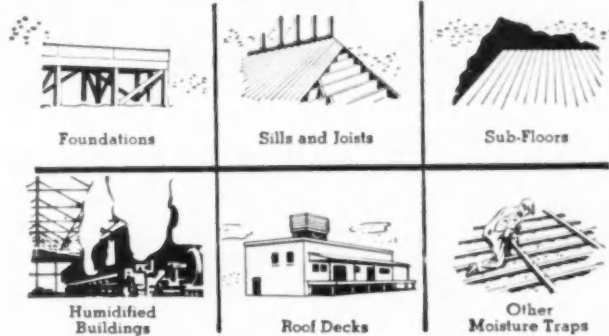

Here are six common, unsafe conditions where WOLMANIZED\* Pressure-Treated Lumber provides protection from wood decay and termites:

1. Where excessive ground moisture, rain or thaws cause early decay failures.
2. Where wood near the ground is open to termite attacks.
3. Where wood is in contact with concrete or masonry.
4. Where steam and vapor from industrial processes promote wood decay.
5. Where walls, floors, ceilings are subject to condensation from refrigeration.
6. Where wood is exposed to moisture in humidified buildings or farm buildings.

Investigations by qualified technologists prove that on installations where decay and termites ordinarily shorten lumber life, WOLMANIZED Pressure-Treated Lumber lasts THREE TO FIVE TIMES LONGER than untreated wood.

Such lasting protection is assured because penetrating preservative solutions are forced, by vacuum-pressure treatment, deeply into the wood fibres of WOLMANIZED Lumber. And, WOLMANIZED Lumber is clean, odorless, paintable, non-corrosive, non-leaching and glueable. Only WOLMANIZED Lumber offers all these extra advantages.

### For Better Building— Read This Booklet

Get all the facts on how WOLMANIZED Pressure-Treated Lumber stops wood decay and termites. See how it can help you and your business. Write today for this valuable booklet.

\*Reg. U.S. Pat. Off.

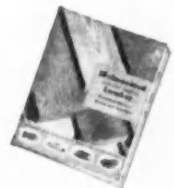

## AMERICAN LUMBER & TREATING COMPANY



General Offices: 332 South Michigan Avenue, Chicago 4, Illinois  
Branch Offices: Baltimore, Boston, Jacksonville, Fla., Los Angeles, New York, Philadelphia, Portland, Ore., San Francisco, Washington, D. C.

## ALPHABETICAL INDEX TO ADVERTISERS, DECEMBER, 1949

<b>A</b>		Holly Manufacturing Co. .... 183	Pomona Tile Manufacturing Company..... 35	
Adams-Rite Manufacturing Company..... 130		Homasote Company ..... 123	Ponderosa Pine Woodwork..... 140	
Affiliated Gas Equipment, Inc. .... 33		Hope's Windows, Inc. .... 169	Porter-Cable Machine Co. .... 53	
Allied Building Credits, Inc. .... 185			Prestile Mfg. Co. .... 182	
Also, Inc. .... 31		<b>I</b>		
American Builder ..... 36-40-58-146-162-166-167-176		Independent Pneumatic Tool Co. .... 133	<b>R</b>	
American Central Division ..... 161		Infra Insulation, Inc. .... 166	R-O-W Sales Company..... 181	
American Encaustic Tiling Company, Inc. .... 35		Inland Steel Products Company..... 18	Raynor Manufacturing Co. .... 167	
American Floor Surfacing Machine Co., The. 55-151		Insl-Cotton Division ..... 179	Readybuilt Products Co., The..... 181	
American Lumber & Treating Company ..... 185			Red Devil Tools ..... 168	
American Radiator & Standard Sanitary Corporation ..... 17		<b>J</b>		
American Roof Truss Co. .... 185		Jaeger Machine Co., The ..... 167	Republic Steel Corporation ..... 38	
American Stained Shingle Company, The ..... 173		Johns-Manville ..... 30	Reznor Manufacturing Co. .... 148	
Anthracite Institute ..... 10		Johnson Industries, Inc. .... 125	Richards-Wilcox Mfg. Co. .... 159	
Architectural Tiling Company, Inc. .... 35		Just Manufacturing Co. .... 162	Richmond Radiator Company ..... 37	
Armstrong Cork Company ..... 15			Rileo Laminated Products, Inc. .... 183	
Associated Plywood Mills, Inc. .... 155		<b>K</b>		
Atlantic Tile Manufacturing Company..... 35		Kaiser Aluminum & Chemical Sales, Inc. .... 150	Robertson Manufacturing Company ..... 35	
Avco Manufacturing Corporation ..... 154-161		Keasbey & Mattison Company ..... 56	Rockwell Manufacturing Company..... 149	
<b>B</b>		Kelvinator Division ..... 68	Roddis Plywood Corporation ..... 42	
B. Mifflin Hood Company ..... 35		Keystone Wire Cloth Co. .... 134	Rowe Manufacturing Company..... 121	
Bell & Gossett Company ..... 19		Kimball Brothers Company ..... 185	Ruberoid Co., The ..... 21	
Belson Mfg. Co. .... 183		King Manufacturing Corp. .... 178	Russell Company, The F. C. .... 49	
Bessler Disappearing Stairway Co., The. .... 173		Kohler Co. .... 183		
Better Homes and Gardens ..... 28-29		Koyn & Bro., Inc., L. O. .... 155	<b>S</b>	
Bostitch ..... 174		Kwikset Locks, Inc. .... 60	Schlage Lock Company..... 67	
Brown Company ..... 57			Serviceis Products Corp. .... 164	
Brown & Co., Geo. C. .... 158		<b>L</b>		Singer-Kennedy Corp. .... 185
Bryant Heater Division ..... 33		Little Burner Company, H. C. .... 167	Skil-saw, Inc. .... 43	
<b>C</b>		Lone Star Cement Corporation ..... 46	Sparta Ceramic Company ..... 35	
Cabot, Inc., Samuel ..... 158		Louisville Cement Company, Incorporated..... 11	Speed-Wall Inc. .... 138	
Cambridge Tile Manufacturing Company..... 35		Lumite Division ..... 122	Spencer Heater Division..... 154	
Capitol Products ..... 175			Standard Dry Wall Products, Inc. .... 163	
Carey Manufacturing Company, The Philip ..... 48		<b>M</b>		Stanley Electric Tool Div. .... 136
Carlyle Tile Company ..... 35		Macklanburg-Duncan Co. .... 6	Steel Scaffolding Company, Inc., The ..... 152	
Carr, Adams & Collier Co. .... 147		Majestic Co., The ..... 165	Strand Garage Door Division ..... 27	
Case & Son Mfg. Co., W. A. .... 45		Marsh Wall Products, Inc. .... 50	Structural Clay Products Institute ..... 52	
Ceco Steel Products Corporation ..... 25		McKinney Manufacturing Company ..... 59	Summitville Face Brick Company ..... 35	
Chase Brass and Copper Co. .... 39		Metal Arts Mfg. Co. .... 177	Symons Clamp & Mfg. Co. .... 179	
Chevrolet Motor Division ..... 14		Metal Tile Products, Inc. .... 181		
Chicopee Manufacturing Corporation of Georgia 122		Miami Cabinet Division ..... 48	<b>T</b>	
Clipper Manufacturing Co. .... 184		Milwaukee Strip Service, Inc. .... 164	Tamblyn System, The ..... 162	
Coffman Co., Inc., The R. G. .... 124		Minneapolis-Honeywell ..... 2	Taylor Bedding Mfg. Co. .... 179	
Connor Lumber and Land Company..... 128		Mosaic Tile Co. .... 35	Thrush & Company, H. A. .... 20	
Consolidated Machinery & Supply Co., Ltd. 126		Murray Tile Company, Inc. .... 35	Tile Council of America, The ..... 35	
Croft Steel Products, Inc. .... 151			Tilt-A-Door Corp. .... 179	
Crossett Lumber Company ..... 163		<b>N</b>		Timken-Detroit Axle Company, The ..... 137
<b>D</b>		Nash-Kelvinator Corporation ..... 68	Trade-Wind Motorfans, Inc. .... 166	
Delaware Floor Products, Inc. .... 61		National Association of Home Builders ..... 177	Truscon Steel Company ..... 38	
Detroit Steel Products Company ..... 3-27-44		National Clay Pipe Manufacturers, Inc. .... 26		
DeWalt, Inc. .... 131		National Electrical Manufacturers Association. 54	<b>U</b>	
Douglas Fir Plywood Association ..... 139		National Gypsum Company ..... 24	United States Plywood Corporation..... 172	
Dow Chemical Company, The ..... 129		National Lock Company ..... 163	United States Quarry Tile Company..... 35	
<b>E</b>		National Manufacturing Company ..... 4th Cover	United States Steel Corporation Subsidiary ..... 41	
E-Z Mark Tools ..... 181		National Oak Flooring Manufacturers' Association ..... 127	United Steel Fabricators, Inc. .... 142	
Eljer Co. .... 62		National Tile & Manufacturing Company..... 35	Universal Atlas Cement Company ..... 41	
Eveready BrikSaw Co. .... 168		National Woodwork Manufacturers Association 135	Universal Blower Co. .... 166	
<b>F</b>		Nelson Corporation, The Herman ..... 173	Universal-Rundle Corporation ..... 159	
Fasco Industries, Inc. .... 180		New Castle Products ..... 175	Upson Company, The ..... 4	
Foley Mfg. Co. .... 183		New York Wire Cloth Company ..... 145	Uvalde Rock Asphalt Co. .... 51	
<b>G</b>		<b>O</b>		
Gate City Sash & Door Co. .... 178		Ohio Hydrate & Supply Co., The ..... 130	<b>V</b>	
General Controls ..... 164		Olean Tile Company ..... 35	Van-Packer Corporation ..... 181	
General Motors Corporation ..... 14		Overhead Door Corporation ..... 3rd Cover	Vento Steel Products Company, Inc. .... 148	
General Tile Corp. .... 35		Owens-Illinois Glass Company ..... 141	Vikon Tile Corporation ..... 122	
Gladding, McBean & Company ..... 35			<b>W</b>	
Goldblatt Tool Co. .... 175		<b>P</b>		Wagner Manufacturing Co. .... 169
Grand Haven Stamped Products Co. .... 182		Pacific Clay Products ..... 35	Weatherproof Products Corporation, The ..... 152	
<b>H</b>		Pacific Tile and Porcelain Co. .... 35	Werner Co., Inc., R. D. .... 144	
Hachmeister, Inc. .... 153		Pacific Mutual Door Company ..... 151	Western Pine Association ..... 131	
Hager & Sons Hinge Mfg. Co., C. .... 34		Paine Lumber Co., Ltd. .... 132	Westinghouse Electric Corporation ..... 165-170-171	
Hassall, Inc., John ..... 158-168-182		Parks Woodworking Machine Co., The ..... 165	Westwood Manufacturing Co. .... 143	
		Petko Industries, Inc. .... 60	Weyerhaeuser Sales Company ..... 12-13	
		Pittsburgh Plate Glass Company ..... 8-9-32	White Company, David ..... 178	
			Wright Manufacturing Co. .... 16	
			Wurdack Chemical Company ..... 177	
			<b>Z</b>	
			Zonolite Company ..... 169	



THE

# OVERHEAD DOOR

TRADE MARK

## WITH THE MIRACLE WEDGE

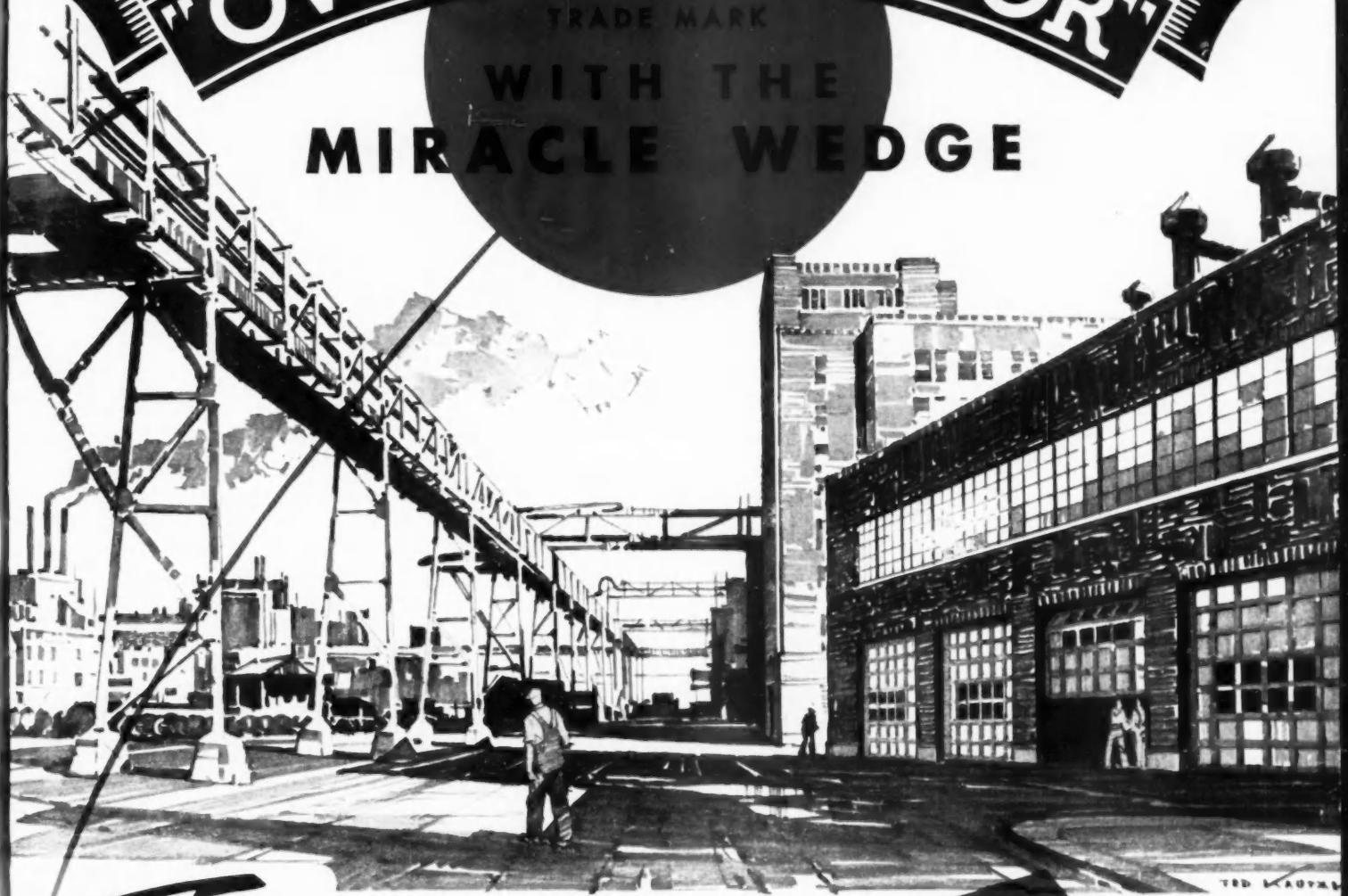

TED KAUFMAN

© 1949, OVERHEAD DOOR CORPORATION

*Specify* the **BEST** door for the **BIG** jobs!

● Structures housing equipment and goods of large quantity or heavy weight must be built from best materials throughout in order to have a long and useful life. The door which has proved eminently satisfactory in such structures is The "OVERHEAD DOOR" with the Miracle Wedge. This door combines great strength with light weight and unparalleled ease of operation. It is equipped with durable hardware, is always ready for instant opening, and it provides a weathertight closure. That is why so many builders specify it for every structure. The "OVERHEAD DOOR" is built for industrial, commercial, residential and rural use, and may be manually or electrically operated.

TRACKS AND HARDWARE OF SALT SPRAY STEEL

*Nation-Wide Sales-Installation-Service*

**OVERHEAD DOOR CORPORATION • Hartford City, Indiana, U.S.A.**

MANUFACTURING DIVISIONS

CLEDALE, CALIFORNIA  
OKLAHOMA CITY, OKLAHOMA

DETROIT, MICHIGAN  
PORTLAND, OREGON

HILLSIDE, NEW JERSEY  
LEWISTOWN, PENNSYLVANIA

CORTLAND, NEW YORK  
DALLAS, TEXAS

# Quality performance

## in the NEW NATIONAL No. 900 Door Set

The modern upward-acting doors with easy finger-tip lifting. Available in a number of styles and sizes for one-car and two-car garages.

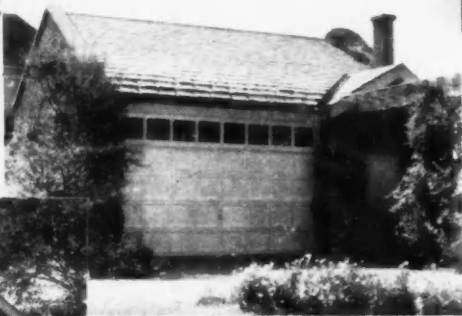

The highest standards of appearance and performance are built into the new National No. 900 Upward-Acting Garage Door Sets. These doors are admirably suited to all types of homes owing to the variety of combinations of heights, widths and sections permitted.

Snug-fitting rabbeted joints and a special cam closing feature which pushes doors firmly against the stops make a completely weather-tight installation. Doors are toxic treated to make them fungus and insect resistant.

All hardware and fittings are of the highest quality and always give the utmost in service and satisfaction.

Quickly and easily installed as hardware is attached to door before shipping. Instructions for installation come with every door set.

**NATIONAL MANUFACTURING CO.**  
Sterling Illinois

● SEE YOUR NATIONAL DEALER FOR  
FURTHER DATA ON SIZES AVAILABLE



per-  
. 900  
doors  
owing  
widths

l cam  
gainst  
ht in-  
them

ighest  
ervice

are is  
ctions

FOR  
ABLE