

# AMERICAN BUILDER

THE WORLD'S GREATEST BUILDING PAPER

FEBRUARY 1953

PRICE 75 CENTS



**CONCRETING YEAR AROUND**



**SUBURBAN LOW COST HOMES**

The case for residential  
**AIR CONDITIONING**

**BLUEPRINT HOUSE IN COLOR**



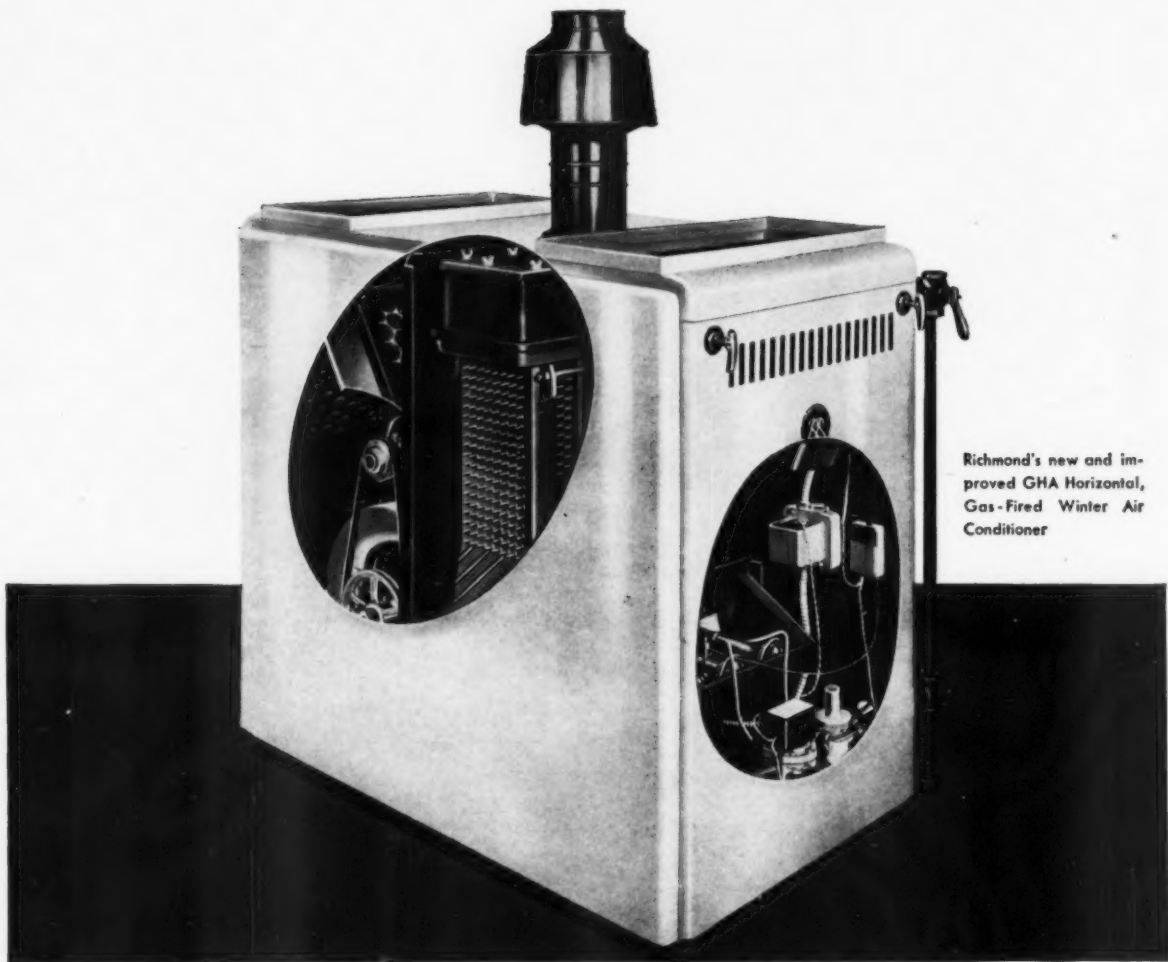

Richmond's new and improved GHA Horizontal, Gas-Fired Winter Air Conditioner

## A Fine Unit Now Made Even Finer!

Now the popular Richmond GHA will deliver more heat more efficiently than ever before. Thanks to a new sectionalized heating element, with easily removable individual burners for each replaceable section . . . all designed to produce maximum heating performance.

Other GHA features include: cast-iron heat exchanger for longer life and greater re-

sistance to corrosion . . . new single-unit design for installation on combustible floors . . . handsome white enamel jacket . . . full range of sizes (single: 75,000 to 175,000 input BTU/hr.; twin: 200,000 to 300,000 input BTU/hr.) . . . fully approved by the AGA.

For small, medium and large homes where quality is desired, use this new and improved GHA unit.



Richmond Radiator Company AB-2  
19 East 47th Street, New York 17, New York  
Please send me more information and literature on the Richmond GHA Unit. No obligation, of course.

NAME.....

COMPANY.....

ADDRESS.....

CITY..... ZONE..... STATE.....

We are  plumbing wholesalers  plumbing contractors  building contractors.

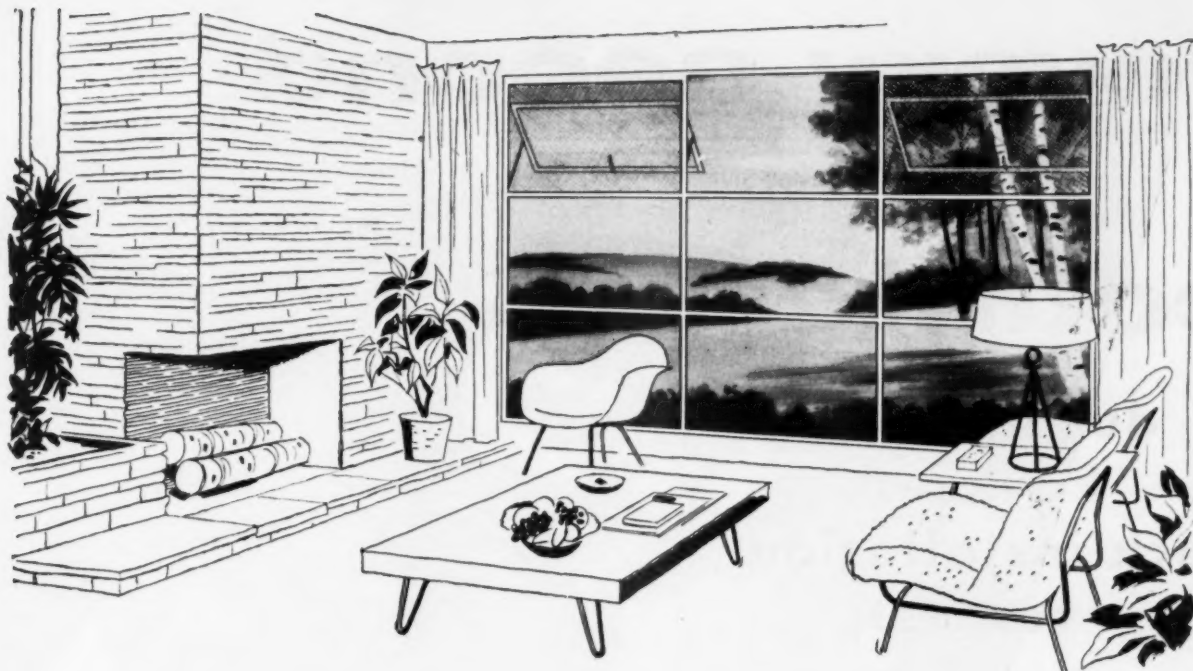

## HERE'S THE WINDOW YOU ASKED FOR! ...The New Fenestra WindoWall\* Unit!

### IT'S MADE OF STEEL

Made of solid hot-rolled Intermediate Window sections a full 1¼" deep with interior bars continuous and rigidly interlocked . . . ample strength for large window openings. Available from local stocks in two sizes—6'-3⅜" wide by 6'-4⅛" high (six lights) and 9'-4⅛" wide by 6'-4⅛" high (nine lights).

### AWNING-TYPE VENTILATORS

WindoWall Units feature the projected-type open out vents which provide ventilation even in down-pouring rain. Ventilators may be installed in any or all lights, or may be eliminated, as desired. Specify the number and location of ventilators on your order.

### INSIDE METAL SCREENS

Fenestra all-metal screens go on easily and quickly from inside the room where they are protected from the weather. They are top hinged to provide convenient access to ventilator hardware.

### IDEAL FOR INSULATING GLASS

Depth of window sections permits the use of ½" insulating (double-paned) glass in stock sizes for all-season comfort . . . no need for storm windows.

Units may also be glazed with single lights of plate or double-strength glass. Glass size for fixed lights is 36" x 24" . . . for ventilators, 34" x 21⅞".

\*Trademark

Call your Fenestra Representative, or write today to Detroit Steel Products Company, Dept. AB-2, 3411 Griffin Street, Detroit 11, Michigan.

# *Fenestra*<sup>®</sup> STEEL RESIDENCE WINDOWS

...everything in windows for the home



**every second  
counted**  
during  
kwikset's  
lock installation  
contest

held at the  
National Association  
of Home Builders  
Convention in Chicago  
January 18 through 22



and other prizes  
totalling \$7,000 were  
awarded to contestants

First prize winner and his time  
will be announced next month.  
Installations\* were made in record  
time with Kwikset Installation Aids  
featuring the new three-hole jig  
used with power drills.

\*Installation did not include strike.

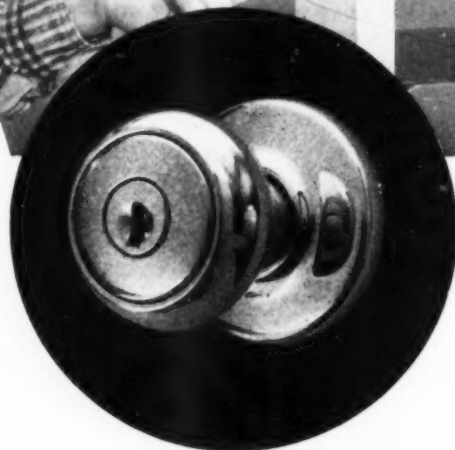



American Builder is published by the SIMMONS-BOARDMAN PUBLISHING CORPORATION, Emmett St., Bristol, Conn., with editorial and executive offices at 79 W. Monroe St., Chicago 3, Ill.; 30 Church St., New York 7, N.Y. James G. Lyne, President and Publisher; Samuel O. Dunn, Chairman Emeritus; C. J. Wageman, Vice President and Publishing Director; J. S. Crane, Vice President and Secretary; Fred A. Clark, Vice President and Business Manager; A. J. McGinnis, Treasurer.

American Builder (originally "Carpentry and Building") with which are incorporated Building Age, National Builder, Permanent Builder, and the Builder's Journal, was founded Jan. 1, 1879. Names registered in U.S. patent office and Canadian registrar of trade mark.

Copyright 1953 with all rights reserved, SIMMONS-BOARDMAN PUBLISHING CORPORATION.

Advertising Sales Offices: 79 W. Monroe St., Chicago 3, Ill.; Terminal Tower, Cleveland 13, Ohio; 2909 Maple Avenue, Dallas 4, Texas; 1127 Wilshire Blvd., Los Angeles 17, Calif.; 30 Church Street, New York 7, N.Y.; 514 Terminal Sales Bldg., Portland 5, Ore.; 244 California St., San Francisco 4, Calif.

Address all subscriptions and correspondence concerning them to: Subscription Department, American Builder, Emmett St., Bristol, Conn. Changes of address should reach us three weeks in advance of next issue date. Send old address with the new, enclosing if possible your address label. The Post Office will not forward copies unless you provide extra postage. Duplicate copies cannot be sent.

Circulation Department: W. L. Taylor, Manager; Field Staff: C. L. Conley, Guy Hill, John Simonson, M. A. Spector, Earl Spohn, Dick Whittington.

Published monthly by Simmons-Boardman Publishing Corporation, Emmett St., Bristol, Connecticut. Editorial and Executive Offices, 79 W. Monroe St., Chicago 3, Illinois, and 30 Church Street, New York 7, New York. Subscriptions to individuals or firms (and their employees) engaged in building construction, design and engineering; material distribution; teachers and students of the trades and trade associations connected with the building industry: United States, Possessions and Canada, 1 year, \$3.50; 3 years, \$7.00. Foreign countries: 1 year, \$10.00; 3 years, \$20.00. Single copies, 75 cents; April issue, \$2.00. Entered as second-class matter July 20, 1950, at the Post Office of Bristol, Connecticut, under the act of March 3, 1879.



American Builder is a member of Associated Business Publications (A.B.P.) and Audit Bureau of Circulations (A.B.C.). Printed in U.S.A.

**Editorial** ..... 13

**Washington Newsletter for Light Construction Industry** ..... 14

**Trends** ..... 16

**Association News** ..... 37

**FEATURES**

**This Portable Cover Speeds Concrete Work** ..... 83  
Not even inclement weather stops work with this portable shelter

**Builder Know-How Plus Owner Labor Equals Low Cost Package** ..... 86  
How one builder offers a 768 square foot house for \$6,995

**Wide Variety and Packaged Financing Sell Homes** ..... 88  
Eight floor plans and 23 elevations attract wide range of buyers

**The Case for Home Air Conditioning**  
**What It is** ..... 92

**What It Does for the Builder** ..... 95

**What It Does for the Architect** ..... 96

**What It Does for the Home Owner** ..... 97

**Problems, and How They Are Being Solved** ..... 98

**Let the Heart of the House be a Rectangle** ..... 99  
*American Builder's Blueprint House of the Month in four colors*

**Material List for Blueprint House** ..... 105

**Idea of the Month: Built-in Entertainment Center** ..... 106

**Do You Know How to Organize Your Business?** ..... 116  
The first of a series on how to systematize operations as your business grows

**Assisting 'Build-Your-Owners' Can Be Profitable** ..... 118  
A Spokane builder finds 90 per cent of the owner-builders need professional aid to complete their houses

**Here Is An Effective Community Library** ..... 120  
Modern in design, functional in plan

**Modular Principles in Roof Framing** ..... 122  
Chapter 14—Hip and valley rafter calculations

**New Method of Construction Combines Steel and Cemesto Board** ..... 132

**This Corn Crib Costs a Dollar a Bushel** ..... 134  
An \$11,000, 11,000 capacity corn crib

**How Merchandising on Local and National Level Builds Volume** ..... 137

**Simplification of Construction Cuts Cost of Swimming Pool** ..... 140  
By Hugh M. McClure, Architect

**DEPARTMENTS**

**"Ask the Experts"** ..... 32

**Better Detail Plates** ..... 154-157

**Letters to the Editor** ..... 42

**New Products** ..... 158

**On and Off the Record** ..... 46

**Catalogs** ..... 168

**Technical Guide, How-to-do-it** ..... 52

**Index to Advertisers** ..... 256

# you can lift it out entirely

## IF IT'S AN R·O·W

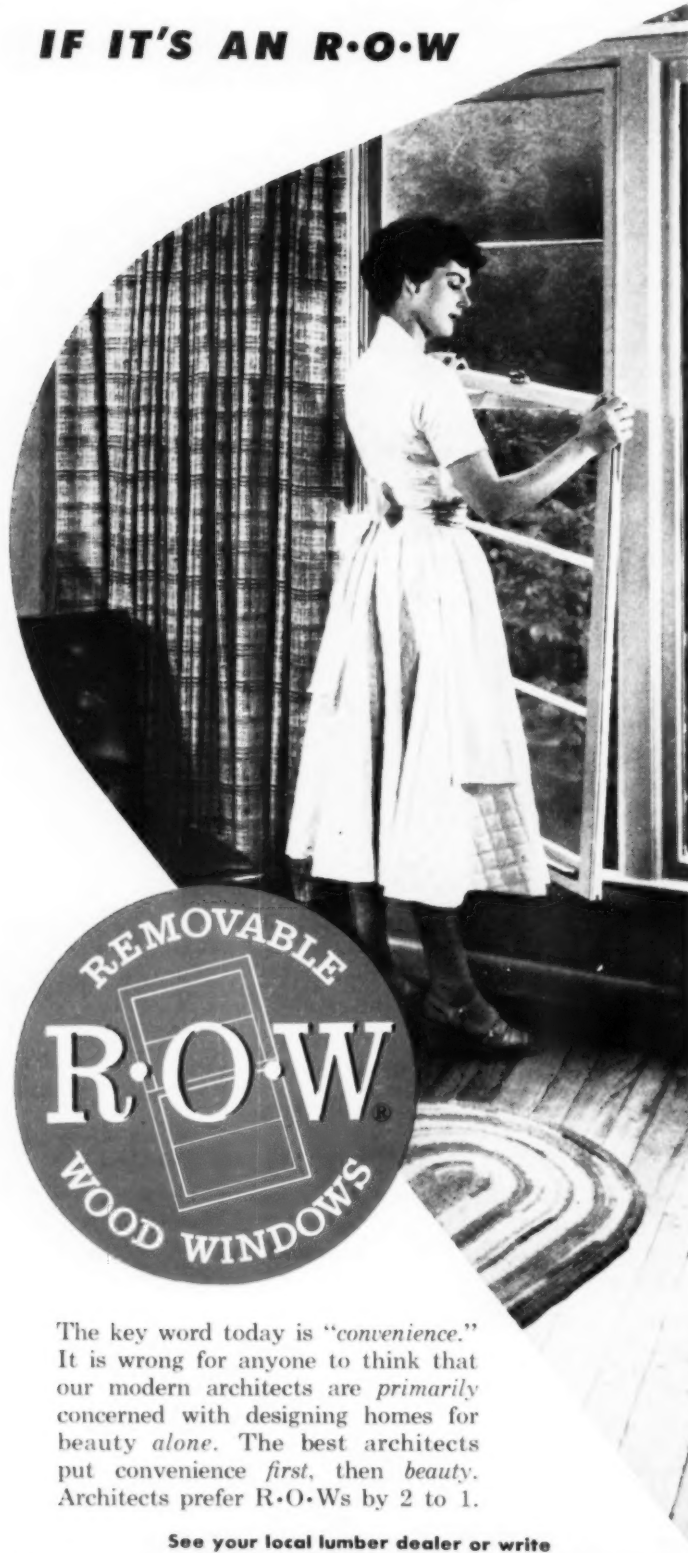

The key word today is "convenience." It is wrong for anyone to think that our modern architects are *primarily* concerned with designing homes for beauty *alone*. The best architects put convenience *first*, then *beauty*. Architects prefer R·O·Ws by 2 to 1.

See your local lumber dealer or write

R·O·W SALES COMPANY 1324••66 ACADEMY AVENUE • FERNDALE 20, MICHIGAN

### YOUR R·O·W MANUFACTURER IS...

- ALABAMA**  
R·O·W DISTRIBUTORS  
Rocky Mount, Virginia
- ARKANSAS**  
CENTRAL R·O·W DISTRIBUTORS OF ARKANSAS  
North Little Rock, Arkansas
- CALIFORNIA**  
CALIFORNIA BUILDERS SUPPLY CO.  
Richmond, Fresno, Oakland, Sacramento  
T. M. COBB CO.  
Los Angeles, San Diego, California
- COLORADO**  
LUMBER DEALERS, INC.  
Denver 17, Colorado
- CONNECTICUT**  
GENERAL WOODCRAFT CO., INC.  
North Bergen, New Jersey
- DELAWARE**  
DEALERS WAREHOUSE SUPPLY CO., INC.  
Baltimore, Maryland
- DISTRICT OF COLUMBIA**  
JOHNSON & WIMSATT, INC.  
Washington, D. C.
- FLORIDA**  
V. E. ANDERSON MFG. CO.  
Bradenton, Fla.
- GEORGIA**  
R·O·W DISTRIBUTORS  
Rocky Mount, Virginia
- IDAHO**  
BOISE SASH & DOOR, INC.  
Boise, Idaho  
R·O·W SALES AGENCY  
Spokane, Washington
- ILLINOIS**  
R·O·W WINDOW CO.  
Joliet, Illinois  
IMSE-SCHILLING SASH & DOOR CO.  
St. Louis 16, Missouri  
V. E. ANDERSON MFG. CO.  
Owensboro, Kentucky
- INDIANA**  
V. E. ANDERSON MFG. CO.  
Owensboro, Kentucky  
ROYAL OAK WHOLESALE CO.  
Royal Oak, Michigan
- IOWA**  
HERRICK REFRIGERATOR CO.  
Waterloo, Iowa
- KANSAS**  
MARTIN MATERIAL CO.  
Kansas City, Missouri  
WHELAN LUMBER CO.  
Topeka, Kansas
- KENTUCKY**  
V. E. ANDERSON MFG. CO.  
Owensboro, Kentucky  
R·O·W WHOLESALE DIST., INC.  
Norwood, Ohio
- MAINE**  
GENERAL WOODCRAFT CO., INC.  
North Bergen, New Jersey
- MARYLAND**  
DEALERS WAREHOUSE SUPPLY CO., INC.  
Baltimore, Maryland  
JOHNSON & WIMSATT, INC.  
Washington, D. C.
- MASSACHUSETTS**  
GENERAL WOODCRAFT CO., INC.  
North Bergen, New Jersey
- MICHIGAN**  
PORTER-HADLEY CO.  
Grand Rapids, Michigan  
ROYAL OAK WHOLESALE CO.  
Royal Oak, Michigan  
FLINT SASH & DOOR CO.  
Flint & Saginaw
- MINNESOTA**  
ANDREW A. KINDER & SONS, INC.  
Minneapolis 2, Minnesota
- MISSOURI**  
IMSE-SCHILLING SASH & DOOR CO.  
St. Louis 16, Missouri  
MARTIN MATERIAL CO.  
Kansas City, Missouri
- MONTANA**  
INTERSTATE LUMBER CO.  
Missoula, Montana  
WESTERN BUILDERS  
Billings, Montana  
LUMBER YARDS SUPPLY CO.  
Great Falls, Montana  
R·O·W SALES AGENCY  
Spokane, Washington
- NEBRASKA**  
THE SOTHMAN CO.  
Grand Island, Nebraska
- NEW HAMPSHIRE**  
GENERAL WOODCRAFT CO., INC.  
North Bergen, New Jersey
- NEW JERSEY**  
GENERAL WOODCRAFT CO., INC.  
North Bergen, New Jersey  
JOHNSON & WIMSATT, INC.  
Westville, New Jersey
- NEW YORK**  
THE WHITMER-JACKSON CO., INC.  
Buffalo & Rochester

YOUR R-O-W MANUFACTURER IS...

**NEW YORK—Contd.**

A. ROBERSON & SON, INC.  
Binghamton, New York  
GENERAL WOODCRAFT CO., INC.  
North Bergen, New Jersey

**NORTH CAROLINA**

MILLER MILLWORK CORP.  
Charlotte, North Carolina  
R-O-W DISTRIBUTORS  
Rocky Mount, Virginia  
DALTON-BUNDY LUMBER CO., INC.  
Norfolk, Virginia

**NORTH DAKOTA**

JACK R. KINNARD & CO.  
Minot, North Dakota  
R-O-W SALES AGENCY  
Spokane, Washington

**OHIO**

THE MAHONEY SASH & DOOR CO.  
Canton, Youngstown, Ohio  
R-O-W WHOLESALE DISTRIBUTORS, INC.  
Newwood, Ohio  
FABROW MFG., INC.  
Toledo, Ohio

**OKLAHOMA**

LUMBERMEN'S SUPPLY CO.  
Oklahoma City, Oklahoma

**OREGON**

OREGON PULP & PAPER CO.  
Salem, Oregon  
R-O-W SALES AGENCY  
Spokane, Washington

**PENNSYLVANIA**

ADELMAN LUMBER CO.  
Pittsburgh, Pennsylvania  
JOHNSON & WIMSATT, INC.  
Westville, New Jersey  
A. ROBERSON & SON, INC.  
Binghamton, New York

**RHODE ISLAND**

GENERAL WOODCRAFT CO., INC.  
North Bergen, New Jersey

**SOUTH CAROLINA**

R-O-W DISTRIBUTORS  
Rocky Mount, Virginia

**SOUTH DAKOTA**

WATERTOWN SASH & DOOR CO.  
Watertown, South Dakota  
R-O-W SALES AGENCY  
Spokane, Washington

**TENNESSEE**

V. E. ANDERSON MFG. CO.  
Owensboro, Kentucky  
R-O-W DISTRIBUTORS  
Rocky Mount, Virginia

**TEXAS**

CHUPIK WOOD MFG. CO., INC.  
Temple, Texas  
B. I. BARFIELD & SONS, INC.  
Amarillo, Texas  
H. E. WOODRUFF CO.  
Corpus Christi, Texas  
LUMBERMEN'S SASH & DOOR CO.  
Dallas, Texas  
SOUTHWEST SASH & DOOR CO.  
Houston, Texas

**UTAH**

R. W. FRANK & CO.  
Salt Lake City, Utah

**VERMONT**

GENERAL WOODCRAFT CO., INC.  
North Bergen, New Jersey

**VIRGINIA**

DALTON-BUNDY LUMBER CO., INC.  
Norfolk, Virginia  
JOHNSON & WIMSATT, INC.  
Washington, D. C.  
R-O-W DISTRIBUTORS  
Rocky Mount, Virginia

**WASHINGTON**

ACME MILLWORK, INC.  
Kirkland, Washington  
R-O-W SALES AGENCY  
Spokane, Washington  
SPOKANE SASH & DOOR CO.  
Spokane, Washington

**WEST VIRGINIA**

R-O-W DISTRIBUTORS  
Rocky Mount, Virginia

**WISCONSIN**

WISCONSIN WINDOW UNIT CO.  
Merrill, Wisconsin

**WYOMING**

FOWLER & PETH  
Cheyenne, Wyoming  
R-O-W SALES AGENCY  
Spokane, Washington

**CANADA**

W. H. CLARK LUMBER CO., LTD.  
Edmonton, Alberta  
D. PORTER & SON  
Stellarton, Nova Scotia  
M-P PRODUCTS, LTD.  
Vancouver, B. C.

wash both sides indoors

IF IT'S AN R-O-W



Eliminate the annoyance and hazard of climbing ladders to wash windows. R-O-W patented construction permits removal of the window from inside the house for easy washing, painting, or glazing indoors. And—*snug-glide* construction is an R-O-W exclusive.

See your local lumber dealer or write

R-O-W SALES COMPANY 1324••66 ACADEMY AVENUE • FERNDALE 20, MICHIGAN

# Everybody Benefits

WITH

# Permalite



## IN PLASTERING, FOR INSTANCE

**PLASTERER**—The *light weight* of Permalite/plaster — about  $\frac{1}{3}$  the weight of sand/plaster — lifts a heavy load off the plasterer's shoulders . . . makes plastering easier, faster, better, because Permalite/plaster has *excellent workability*.

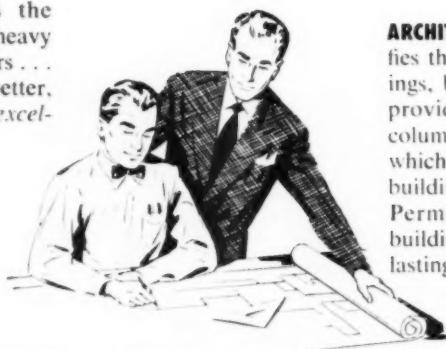

**ARCHITECT**—Permalite/plaster simplifies the architect's job on large buildings, because it reduces dead weight, provides *easier fireproofing* of steel columns and ceilings — saves money which can be better applied to other building features. Architects specify Permalite/plaster in many home-building jobs because it provides more lasting satisfaction to the home owner.



**BUILDER**—Builders like Permalite/plaster for three reasons. *Light weight* means the job goes quicker—easier to mix and handle on multi-story structures. *Light weight*, saving as much as one ton of dead weight per 100 sq. yd., also means less settling, less chance of cracks. (Permalite/plaster gives up to 42% *greater crack resistance*.) And Permalite/plaster also gives *increased fire resistance*.

**BUILDING OWNER**—This man gets all the benefits shown above, and, in addition, gets greater comfort, because Permalite/plaster provides him with *extra insulation*, for more even room temperature.



To get the full story on Permalite's many advantages, send today for your free bulletin on Permalite, the largest-selling perlite aggregate in the world. Write Great Lakes Carbon Corporation, Dept. H-412-612 So. Flower St., Los Angeles 17.

Dependable GREAT LAKES  
**Permalite**  
 THE LARGEST-SELLING PERLITE AGGREGATE IN THE WORLD

PROCESSED FROM SOCORRO PERLITE ONLY BY THESE EXCLUSIVE PERMALITE LICENSEES OF GREAT LAKES CARBON CORPORATION

Indoken Perlite Company  
Cincinnati 17, Ohio

William J. McCormack Sand Co., Inc.  
New York, New York

Airlite Processing Corp. of Fla.  
Scottsburg, Indiana

MacArthur Company  
St. Paul 4, Minn.

Perma-Rock Products, Inc.  
Baltimore 30, Maryland

The Whittemore Company  
Rosindale 31, Mass.

Perlite Products Corp.  
Dallas, Texas

Pennsylvania Perlite Corp.  
Allentown, Pennsylvania

New Jersey Perlite Corp.  
Newark, New Jersey

McClure & Erickson Corp.  
Los Angeles, California

West Indies Perlite Mfg. Co., Inc.  
Havana, Cuba

Virginia Perlite Corp.  
Hopewell, Virginia





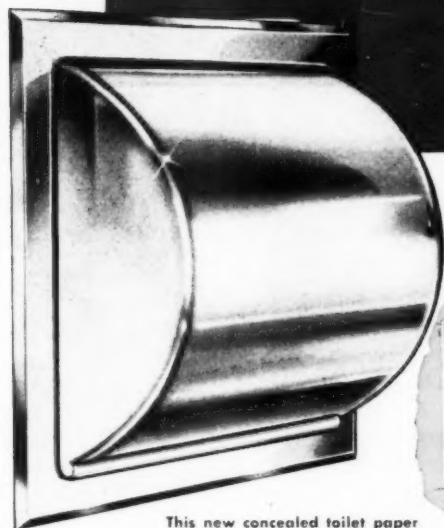

# BATHROOM PLANNING is important!

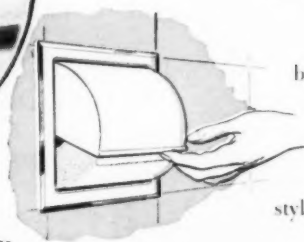

This new concealed toilet paper holder originated by Hall-Mack strikes a note of quiet refinement in any modern bathroom.

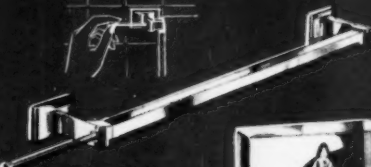

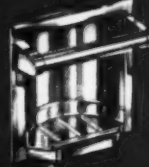
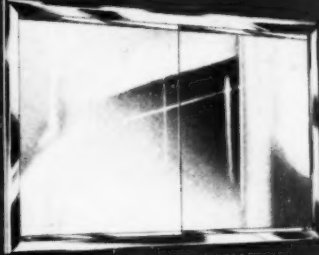
**A CHEERFUL BATHROOM** — accented with the refreshing, gleaming beauty of Hall-Mack accessories — has a way of making busy households run smoother. Every member of the family seems to enjoy the unique combination of convenience and smart styling which has made Hall-Mack the consistent choice of discriminating home-builders down through the years.

 <p>Concealed magic for soap ... tumbler ... toothbrush</p>	 <p>Towel bar with pull-outs for extra drying space</p>	 <p>Handy Kleenex holder for wall or table top</p>	 <p>Clear Lucite stirrup-type towel ring</p>
 <p>Recessed soap and grab</p>	 <p>Mirror doors slide open... one of many fine Hall-Mack cabinets</p>	 <p>Tumbler and toothbrush holder</p>	 <p><b>HALL-MACK</b> <i>the BEST</i> <i>answer to</i> QUALITY ACCESSORIES FOR EVERY BATHROOM STYLE AND BUDGET!</p>

You'll use your bathroom accessories for many years to come — so make sure you get Hall-Mack's lifetime quality and permanent beauty.

SOLED BY LEADING PLUMBING, TILE AND HARDWARE DEALERS EVERYWHERE

## HALL-MACK COMPANY

1344 West Washington Blvd., Los Angeles 7, California • 7455 Exchange Avenue, Chicago 49, Illinois

# Surround your prospect



**WEDGEWOOD is easy to install and finish**

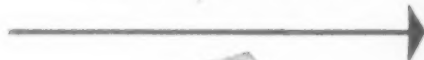

Sturdy cartons protect WedgeWood from breakage in storage and handling . . . assure you of clean undamaged panels from factory to job-site.

**Just Nail It Up**



WedgeWood genuine wood wall paneling comes in 4 x 8 ft. panels that nail right to studs or furring strips.

**Covers with First Coat**



WedgeWood panels are factory-sealed . . . need no primer . . . before painting or staining.

**Wipe Second Color**



Wipe off second coat of contrasting color. Result—a dramatic, two-tone harmony of color and texture.

*No other wall paneling offers such beauty at such savings*

**with beauty that sells and sells!**

# WEDGEWOOD

**Georgia-Pacific's new textured wood wall paneling gives you powerful new sales appeal at low cost**

With WedgeWood you can turn prospects into customers: give them style, beauty, texture, give them color . . . give them new decorative ideas . . . AND reduce your costs. WedgeWood adds distinction and charm to any home design or style . . . raises them far above the ordinary in the eyes of your prospects. WedgeWood can be used in full-room or one-wall treatments . . . gives you an important edge over

competitive builders in your area.

The swirling grain and rich, sculptured texture of WedgeWood lend themselves to dramatic two-tone color effects that are in complete accord with the sweeping trend to texture in decorating.

Let WedgeWood help you sell the next homes you build.



WedgeWood blends harmoniously with modern furniture, fabrics and accessories.

**WedgeWood brings you limitless new styling and color possibilities**



WedgeWood fits with timeless ease into traditional decor. Your customers will find their favorite style fits right with WedgeWood.

**How builders use WEDGEWOOD in occasional or full-room treatments to create exciting effects and dramatic interiors**

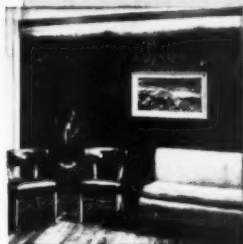

In an entrance hallway, WedgeWood paneling provides a warm welcome.

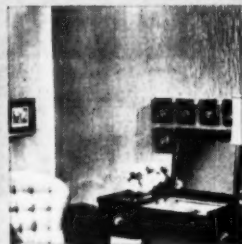

In a bedroom, WedgeWood creates a restful, relaxing atmosphere . . . hospitality and comfort in a guest room.



In a living room, WedgeWood's natural grain pattern adds style and beauty.

*Use this Background of Beauty as a Cost-Cutting Sales Feature. See your Georgia-Pacific Representative or write to*



**GEORGIA-PACIFIC  
PLYWOOD COMPANY**

617-A2 North Capitol Way, Olympia, Washington

OFFICES OR WAREHOUSES IN: Augusta, Baltimore, Birmingham, Boston, Chicago, Cleveland, Columbia, Detroit, Fort Worth, Lancaster, Los Angeles, Louisville, Memphis, Nashville, Newark, New Castle, New Hyde Park, New Orleans, Olympia, Orlando, Philadelphia, Pittsburgh, Providence, Raleigh, Richmond, Savannah, Vineland.

# A BATHROOM THAT GROWS WITH THE FAMILY

Another of 46 room plans from new Crane Sketchbook of Ideas that make houses easier to sell



Raising money to buy a home and raising a family are two things that usually go together. That's why you'll find that many of your customers are favorably influenced by ideas like this—a bathroom that grows with the family.

As the picture shows, there's a section at the rear that starts out as a nursery bath and includes a small Crane Lahoma tub that may be used later as a bath and shower combination. As the children grow up, another lavatory is set in the counter-top space already provided, a water closet goes where you now see the bathinette—then a simple partition, and there are two complete bathrooms instead of one!

This is just one of the 46 easily adaptable room plans illustrated and described in Crane's new Sketchbook of Ideas. The Sketchbook is part of Crane's new service to builders—affords an easy practical way of helping your customers visualize and approve new room arrangements. Also available are specific suggestions for arrangement and decoration of any room in the book. Ask your Crane Branch or Crane Wholesaler for full details.

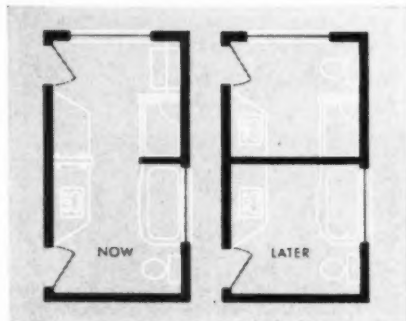

**NOW**—The bathroom as it looks when the family moves in.

**LATER**—How it becomes two bathrooms as the children grow up.

## CRANE CO.

GENERAL OFFICES: 836 SOUTH MICHIGAN AVE., CHICAGO 5  
VALVES • FITTINGS • PIPE  
PLUMBING AND HEATING  
AMERICAN BUILDER

# TYPHOON

HANDS YOU THE KEY TO A

# new billion-dollar market



MODEL S-W  
2-3-5  
TON  
SIZES

## WITH Cooling-Heating Units FOR THE HOME

The boom in home air conditioning is on—and you can get in on the ground floor with Typhoon. One compact unit that gives complete indoor control of temperature, humidity, circulation. It means year-round comfort for your customers and easier selling for you. Give the next homes you build the sales magic of year-round air conditioning.

### 44 YEARS OF COMFORT ENGINEERING IN THESE EXCLUSIVE TYPHOON FEATURES!

**ONLY TYPHOON** has one-button control—summer or winter, a touch of a button brings cool air or warm... automatically!

**ONLY TYPHOON** has an all-copper condenser—it defies rust and corrosion, gives trouble-free service.

**ONLY TYPHOON** is a miracle of compactness—takes up less space than any other unit, can even fit into a standard closet!

**ONLY TYPHOON** has completely automatic changeover design—for

switching from heating to cooling; no dampers to manipulate!

**SIMPLE TO INSTALL**—Just a few quick connections and within hours your Typhoon unit is ready to function.

**INEXPENSIVE TO OPERATE**—Engineered to the point of greatest economy consistent with dependable performance.

**QUIET**—Completely insulated heavy-gauge steel cabinet and floating spring base assure whisper-quiet operation.

**A.G.A. APPROVED.** Perfected, Tested and Factory-Guaranteed by Typhoon.

Year-Round Air Conditioning  
With ONE CENTRAL UNIT  
Fully Automatic

**TYPHOON  
HAS THE KEY**  
to this great  
new home market  
— write, wire, phone  
for information today.



**TYPHOON** AIR CONDITIONING CO. INC., 794 Union Street, Brooklyn 15, N. Y.

Specialists in Air Conditioning Since 1909.

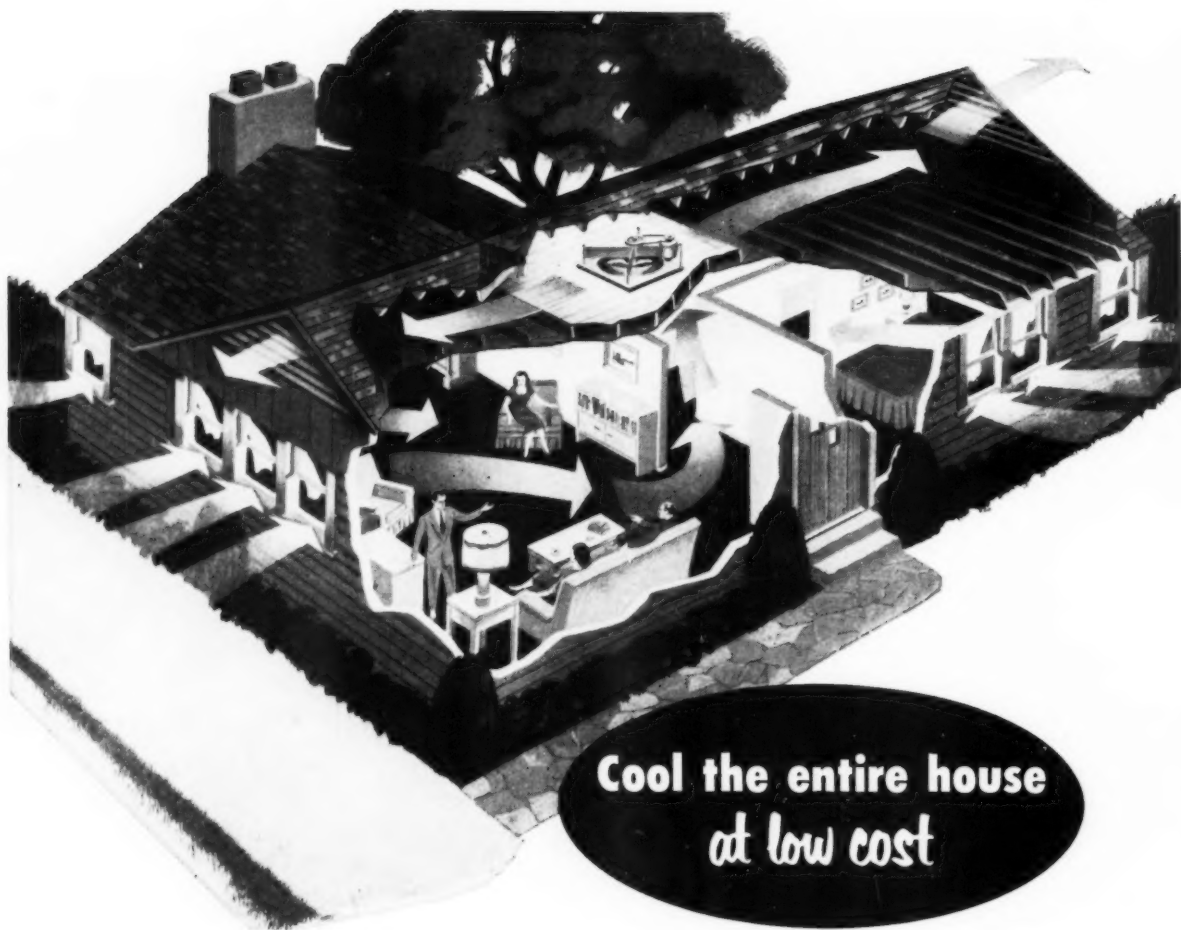

**Cool the entire house  
at low cost**

**Hunter home cooling is one of the most  
popular features of modern homes**



*Installation is easy and inexpensive. Fan rests on attic floor—no suction box or other extras. Automatic ceiling shutter screw-fastens over ceiling opening—no replastering or repainting.*

For home owners who want cool comfort at lowest cost during hot summer months, Hunter Attic Ventilation is the perfect answer. Both initial cost and operating expense are very low.

The attic fan's method of cooling a house is simple (see drawing above). It drives out stagnant air through the attic and creates a strong suction which pulls in fresh, cool air from outdoors.

The new Hunter Attic Fan is a compact unit that is easily in-

stalled in any home. It requires only 18" attic clearance . . . ideal for low-pitched roofs. Certified air deliveries range from 5000 to 15500—to fit any home size and climate.

This improved attic fan is priced substantially lower than previous models. Yet it has the same smooth, quiet operation and dependability that have made Hunter Fans famous for over 65 years.

Write for free copy of "How to Cool for Comfort." See our catalog in Sweet's Files.



**HUNTER FAN AND VENTILATING CO.**  
381 S. Front St., Memphis 2, Tenn.

**Hunter Package Attic Fans**

## ***Are we over-building?***

**W**ITH another year of more than one million starts behind us, and most predictions for 1953 indicating a similar figure, the question of whether or not we are getting over-built is beginning to be voiced. No one has raised the question loudly or boldly. It is being heard as a half-audible timid suggestion.

The time has come to bring it out in the open and answer it. It is these timid half-audible suggestions, based on unreasoned fear, that become rumors, which in turn bring on panic stoppages of production.

The answer to whether or not we are about to become over-built can be yes or no, whichever the home building industry wants it to be. If the need market, based on net new family formations predicted by statisticians for the next several years, is going to be the accepted measuring stick, we are going to become over-built if we continue to build a million or more new dwelling units a year.

On the other hand, if the industry chooses to gauge its annual production of housing units on a realistic potential that can be developed through modern merchandising methods, we are not within ten or twenty years of becoming over-built with an annual volume of one million or more units a year. And by that time, the birth rate of the forties will have produced a net new family formation ratio of more than a million for a long period of years.

It must not be forgotten that until now, there has never been an organized home

building industry, a force capable of marshalling the merchandising tools available on a nation-wide basis, and fortified with statistical information. Until 1941 and indeed until now, home builders produced as the need market absorbed new houses.

There is a difference between need and demand. A part of the difference is non-stimulated. That part consists of those families who are housed, but who desire better housing, and who of their own volition order a new house built. Of far greater importance, however, is a potential demand that has to be stimulated by merchandising the benefits of modern houses.

It is this potential demand that has never been developed. And it is this potential demand that can be developed by an organized industry, using the successful selling tools that have created demand in other industries. NATIONAL HOME WEEK has been the most successful industry-wide merchandising program thus far. From this highly successful selling program, and the experience gained from it, together with the fact that there is an articulate organized industry, for the first time, there is no reason why production cannot be sustained at one million or more during the period in which net new family formations is only three-quarters of that figure.

The answer to whether we are becoming over-built can and should be no. If it is anything else, home builders will have demonstrated that they are incompetent designers and salesmen of the world's second most necessary and desired commodity.

---

*Publisher, James G. Lyne*

*Publishing Director, C. J. Wageman*

*Editor, Edward G. Gavin*

*Managing Editor, Lyn E. Arent*

*Feature Editor, Welden Reynolds. Architectural Editor, Arthur V. Hansen. Eastern Editor, Garrett Winter.*

*Assistant Editors, H. Louis Purdy, J. L. Zar. Assistant to the Editor, Margaret C. Carroll.*

*Western Editor, W. C. Rodd. Washington Editor, J. W. Kizzia. Production Editor, Dorothy Milchrist.*

*Research Director, W. S. Gaskill. Assistant Research Director, Constance Nicolai.*

*Catalog Directory Editor, Edmund Mottershead. Architectural Consultant, W. T. Anicka.*

*Art Editor, George M. Clark. Chief Draftsman, J. T. Froh.*

*Editorial Office, 79 W. Monroe St., Chicago 3, Ill.*

*Every effort will be made to return material submitted for possible publication (if accompanied by stamped, addressed envelope), but the editors and the corporation will not be responsible for loss or damage.*

# AB Washington News Letter

## For the Light Construction Industry

A special service for American Builder readers. The latest Washington developments affecting the light construction industry assembled by special Washington correspondent and sent by wire to be printed and bound in your American Builder at the last minute before it is mailed. A regular monthly feature.

Washington, January 21, 1953

- ▶ BUILDERS ENTERED 1953 with fewer government restrictions than at any time since 1950. As the year got under way it appeared the few remaining strings would soon be removed.
- ▶ A JANUARY 1 REPORT on the mobilization program contained these words: "Our present calculations indicate that, during 1953, the Controlled Materials Plan — under which steel, copper and aluminum are allocated — can be progressively relaxed."
- ▶ THIS ESTIMATE appears conservative. Individuals in Congress already are calling for the removal of steel from CMP control. Similar action on copper and aluminum is urged "at the earliest possible date."
- ▶ WHETHER TO EXTEND the Defense Production Act is a big question facing the new Congress. It is still too early to tell, but it looks like wage and price controls will be dropped, even if parts of the law are extended. Homebuilding should be free of these restrictions by mid-year.
- ▶ TAX REDUCTIONS could stimulate new business. Significantly perhaps, the first bill introduced in the Congress this month was one to reduce individual income taxes. Its sponsor: Representative Reed (R.-N.Y.), chairman of the Ways and Means Committee, the group which writes tax laws.
- ▶ PHA HAS TAKEN what may be the first step toward a higher interest rate. The agency has circulated a letter to lending institutions authorizing a 1/2 per cent "service charge" on Title 1, Sec. 8 loans. This section relates to housing in suburban or outlying areas.
- ▶ LENDERS HAVE BEEN RELUCTANT to go into this market because of high servicing costs. Allowing this new "service charge" is FHA'S way of encouraging lenders to go after this business. The agency reports it has insured only 11,000 mortgages since this section was added to the Housing Act in 1950.
- ▶ INTEREST RATE to the borrower, with the new "service charge" included, will be 5-1/4 per cent. The basic FHA rate remains 4-1/4 per cent with an additional 1/2 per cent going to FHA and the new "service charge" going to the lender.
- ▶ PRESIDENT TRUMAN submitted his last budget message to Congress on January 9. Among other things, he asked that "major provisions" of the Defense Housing and Community Facilities Act be extended beyond June 30, its present expiration date.
- ▶ APPLICATIONS for FHA insurance in non-defense areas have been "rising steadily" since Regulation X was relaxed last summer, the President reported. If the present trend continues, FHA will need to insure mortgages on 300,000 new housing units in the fiscal year beginning July 1. It will need to insure mortgages on more than 200,000 existing homes purchased during the year. These estimates reflect thinking that government-insured mortgages will gain in favor later this year.
- ▶ TO MEET FHA REQUIREMENTS next year, the President said, it will be necessary to increase the agency's mortgage insurance authority by \$1.5 billion. He said it will be necessary also to make a \$500 million increase in FHA authority to insure property-improvement loans.



- ▶ THE NEW BUDGET, which may become a target for the new Administration, contains a request for 75,000 public housing units. This is the same number requested last year, when Congress cut the number back to 35,000.
- ▶ ALL FORECASTS FOR 1953 continue optimistic. One of the most favorable was issued early this month by the staff of a congressional committee — the Joint Committee on the Economic Report.
- ▶ DURING THE DECADE of the 1950's our total housing construction job should average close to 1,400,000 nonfarm units a year, the report said. What has seemed like boom years of the recent past "may well become the normal construction pattern," the report added.
- ▶ "TO THE DEGREE that actual home building falls below this figure in any year or years — as it did, for example, in 1951 because of material shortages and credit restrictions — the need for housing construction is merely postponed and the job compressed into fewer and fewer years."
- ▶ TOTAL HOUSING NEED in this decade is influenced by four factors: Added housing for our expanding population, normal replacement, rehabilitation of some substantial housing and the offsetting of miscellaneous losses arising through fire and disaster.
- ▶ POPULATION GROWTH between 1950 and 1960 will total around 24 million. The report estimated it will take almost 7,000,000 new housing units to house and shelter this additional population.
- ▶ IF WE ACCEPT 75 years as an approximate over-all service life for all kinds of housing units, replacement needs during the next few years would appear to run around 175,000 units per year. Something like 700,000 additional units will have to be provided during the 1950-1960 decade to replace losses through fire and other disaster and the removal of temporary war and veteran housing.
- ▶ IF ONLY ONE-HALF of the unsafe, dilapidated units and one-half of the unsanitary, urban units are replaced in the next eight years, it will still call for construction of over 3,000,000 units by 1960, the report said.
- ▶ SUMMARIZING these estimates, it seems to be a "reasonable estimate" that 9,700,000 housing units will need to be constructed or rehabilitated between now and 1960, the committee staff concluded.
- ▶ TO HELP MEET these housing needs the report predicted that government aids in the form of guarantees and loans would be "continued or liberalized" if necessary to avoid a decline in housing standards.
- ▶ A MOVE TO CONTINUE one existing program already is under way. A bill has been introduced in Congress to extend until mid-1955 the direct home loan program for veterans. This program is presently due to expire next June 30.
- ▶ DEFENSE HOUSING in critical areas continues to make slow progress. At the beginning of 1953 a total of 220 areas had been declared "critical." HHFA had 98,029 housing units programmed in 204 of these areas. A mid-December survey showed that 41,983 programmed units were then beyond the starting point, of which 24,697 had been completed.
- ▶ RECREATIONAL CONSTRUCTION, recently released from a two-year ban, will be an important factor in 1953 construction. NPA is predicting as much as \$250 million in recreational, amusement and entertainment construction this year. The agency relaxed its controls on this type of construction as of January 1.
- ▶ DOLLAR OUTLAYS for new construction reached a new high in 1952, the bureau of Labor Statistics and Department of Commerce reported. Expenditures for private residential construction were estimated at more than \$11 billion in 1952, compared with \$10.9 billion in 1951. The unusually high volume of private dwellings begun last fall helped make 1952 a record year.

# AB Washington News Letter

## For the Light Construction Industry

A special service for American Builder readers. The latest Washington developments affecting the light construction industry assembled by special Washington correspondent and sent by wire to be printed and bound in your American Builder at the last minute before it is mailed. A regular monthly feature.

Washington, January 21, 1953

- ▶ BUILDERS ENTERED 1953 with fewer government restrictions than at any time since 1950. As the year got under way it appeared the few remaining strings would soon be removed.
- ▶ A JANUARY 1 REPORT on the mobilization program contained these words: "Our present calculations indicate that, during 1953, the Controlled Materials Plan — under which steel, copper and aluminum are allocated — can be progressively relaxed."
- ▶ THIS ESTIMATE appears conservative. Individuals in Congress already are calling for the removal of steel from CMP control. Similar action on copper and aluminum is urged "at the earliest possible date."
- ▶ WHETHER TO EXTEND the Defense Production Act is a big question facing the new Congress. It is still too early to tell, but it looks like wage and price controls will be dropped, even if parts of the law are extended. Homebuilding should be free of these restrictions by mid-year.
- ▶ TAX REDUCTIONS could stimulate new business. Significantly perhaps, the first bill introduced in the Congress this month was one to reduce individual income taxes. Its sponsor: Representative Reed (R.-N.Y.), chairman of the Ways and Means Committee, the group which writes tax laws.
- ▶ PHA HAS TAKEN what may be the first step toward a higher interest rate. The agency has circulated a letter to lending institutions authorizing a 1/2 per cent "service charge" on Title 1, Sec. 8 loans. This section relates to housing in suburban or outlying areas.
- ▶ LENDERS HAVE BEEN RELUCTANT to go into this market because of high servicing costs. Allowing this new "service charge" is FHA'S way of encouraging lenders to go after this business. The agency reports it has insured only 11,000 mortgages since this section was added to the Housing Act in 1950.
- ▶ INTEREST RATE to the borrower, with the new "service charge" included, will be 5-1/4 per cent. The basic FHA rate remains 4-1/4 per cent with an additional 1/2 per cent going to FHA and the new "service charge" going to the lender.
- ▶ PRESIDENT TRUMAN submitted his last budget message to Congress on January 9. Among other things, he asked that "major provisions" of the Defense Housing and Community Facilities Act be extended beyond June 30, its present expiration date.
- ▶ APPLICATIONS for FHA insurance in non-defense areas have been "rising steadily" since Regulation X was relaxed last summer, the President reported. If the present trend continues, FHA will need to insure mortgages on 300,000 new housing units in the fiscal year beginning July 1. It will need to insure mortgages on more than 200,000 existing homes purchased during the year. These estimates reflect thinking that government-insured mortgages will gain in favor later this year.
- ▶ TO MEET FHA REQUIREMENTS next year, the President said, it will be necessary to increase the agency's mortgage insurance authority by \$1.5 billion. He said it will be necessary also to make a \$500 million increase in FHA authority to insure property-improvement loans.

- ▶ THE NEW BUDGET, which may become a target for the new Administration, contains a request for 75,000 public housing units. This is the same number requested last year, when Congress cut the number back to 35,000.
- ▶ ALL FORECASTS FOR 1953 continue optimistic. One of the most favorable was issued early this month by the staff of a congressional committee — the Joint Committee on the Economic Report.
- ▶ DURING THE DECADE of the 1950's our total housing construction job should average close to 1,400,000 nonfarm units a year, the report said. What has seemed like boom years of the recent past "may well become the normal construction pattern," the report added.
- ▶ "TO THE DEGREE that actual home building falls below this figure in any year or years — as it did, for example, in 1951 because of material shortages and credit restrictions — the need for housing construction is merely postponed and the job compressed into fewer and fewer years."
- ▶ TOTAL HOUSING NEED in this decade is influenced by four factors: Added housing for our expanding population, normal replacement, rehabilitation of some substantial housing and the offsetting of miscellaneous losses arising through fire and disaster.
- ▶ POPULATION GROWTH between 1950 and 1960 will total around 24 million. The report estimated it will take almost 7,000,000 new housing units to house and shelter this additional population.
- ▶ IF WE ACCEPT 75 years as an approximate over-all service life for all kinds of housing units, replacement needs during the next few years would appear to run around 175,000 units per year. Something like 700,000 additional units will have to be provided during the 1950-1960 decade to replace losses through fire and other disaster and the removal of temporary war and veteran housing.
- ▶ IF ONLY ONE-HALF of the unsafe, dilapidated units and one-half of the unsanitary, urban units are replaced in the next eight years, it will still call for construction of over 3,000,000 units by 1960, the report said.
- ▶ SUMMARIZING these estimates, it seems to be a "reasonable estimate" that 9,700,000 housing units will need to be constructed or rehabilitated between now and 1960, the committee staff concluded.
- ▶ TO HELP MEET these housing needs the report predicted that government aids in the form of guarantees and loans would be "continued or liberalized" if necessary to avoid a decline in housing standards.
- ▶ A MOVE TO CONTINUE one existing program already is under way. A bill has been introduced in Congress to extend until mid-1955 the direct home loan program for veterans. This program is presently due to expire next June 30.
- ▶ DEFENSE HOUSING in critical areas continues to make slow progress. At the beginning of 1953 a total of 220 areas had been declared "critical." HHFA had 98,029 housing units programmed in 204 of these areas. A mid-December survey showed that 41,983 programmed units were then beyond the starting point, of which 24,697 had been completed.
- ▶ RECREATIONAL CONSTRUCTION, recently released from a two-year ban, will be an important factor in 1953 construction. NPA is predicting as much as \$250 million in recreational, amusement and entertainment construction this year. The agency relaxed its controls on this type of construction as of January 1.
- ▶ DOLLAR OUTLAYS for new construction reached a new high in 1952, the bureau of Labor Statistics and Department of Commerce reported. Expenditures for private residential construction were estimated at more than \$11 billion in 1952, compared with \$10.9 billion in 1951. The unusually high volume of private dwellings begun last fall helped make 1952 a record year.

# TRENDS in the Building Field

## why people buy the houses they do

The Housing and Home Finance Agency in 1950 engaged the University of Michigan to make a sample study of the considerations that have influenced recent purchases of single-family homes, using a sample which might be expected to be representative of buyers throughout the United States. The results show who bought the houses that have recently changed hands. Why those buyers were in the market. What kind of houses they wanted. What they got. What prices they paid. How well they are satisfied.

Many builders no longer are certain that "because people buy their houses, they must like them!" Increasingly, they are coming to believe they must have some fundamental knowledge of the particular requirements and desires of people who are expected to buy their houses. Some even have become convinced that in the reasonably early future the only way a builder can stay in business will be by offering a continuously improved and specifically appropriate product.

The survey is the result of personal interviews with 1,000 house-buyers throughout the country. The interviewing was done in nine of the 15 largest metropolitan areas and in 30 counties in the United States, outside metropolitan areas.

**Who were the buyers?** Nearly half (47 per cent) of the buyers were veterans of World War II. These veterans, however, bought 63 per cent of the new houses that were purchased. A large proportion of the buyers were young: 37 per cent less than 35 years of age; 31 per cent, between 35 and 44; 17 per cent, between 45 and 54. However, one buyer out of every seven was 55 years of age or older.

Two-sevenths of the buyers had no children. Of each seven families, two were one-child families; an-

other two had two children each; and one-seventh of the families numbered three children or more.

Half of the buyers (48 per cent) had 1950 family incomes of \$3,000 to \$5,000. One-third had larger; one-sixth had smaller. Incomes of \$7,500 or over were reported for 13 per cent of the buyers, largely concentrated among those aged 40 and over.

A third of the buyers had owned other houses just before making their purchases, and in every such case the proceeds realized from the sale were an important factor in financing the new purchase. Six buyers out of every ten had been renters just prior to their purchases and five out of the six (half of all the buyers) had never previously owned a home. Nearly a tenth of the buyers were newly formed families, people who had previously lived "doubled up" with other families and others who had neither owned or rented houses of their own.

**Why were these people in the market?** A third of buyers were in the market previously because the quarters in which they had been living were physically inadequate. A closely related incentive mentioned by one buyer in six was a recent or prospective increase in the size of the family. In 20 per cent of the purchases the primary cause was a move from one city or town to another, usually for business reasons.

Desire to change location within the same city or town was a factor, but not often the primary factor, in one purchase out of eight. Other considerations were the desire (mentioned by 17 per cent) to own a house and to "make a home for the family"; the desire for independence or privacy (9 per cent); the security in owning a home (11 per cent); providing shelter for relatives (10 per cent). The percentages add to considerably more than 100

because many buyers cited two or more reasons.

**What did they want and what did they get?** Typically, Mr. and Mrs. Home Buyer wanted a one-story house with a basement. A large number desired brick construction probably because of the belief that upkeep would be less expensive.

The buyers definitely did not appear to be style-conscious in matters of architecture. Few expressed any preference on that score, and the preference boiled down to the desire for a one-story house.

Five and six-room houses accounted for 57 per cent of the purchases; four-room houses for 17 per cent; seven and eight-room houses 19 per cent. Eighty per cent of the houses bought had one bathroom each; 13 per cent had two; a few had more than two; a small number had none.

Most of the purchasers paid between \$5,000 and \$15,000 for the houses they bought. Only 12 per cent paid less than \$5,000 and 16 per cent paid \$15,000 or more. The middle-most purchaser paid \$9,500.

**Were the buyers satisfied?** The survey disclosed dissatisfaction prevailing among a substantial number of buyers regarding number and size of rooms, lack of separate dining space and inadequate storage facilities. Nearly 30 per cent of the buyers were dissatisfied with the size of the lot, many complaining in particular that the lot was too narrow.

Nearly a fourth of all buyers said they wanted more bedrooms, and these included a majority of the purchasers of three- and four-room houses.

Half of the buyers were dissatisfied with the size of their rooms; 23 per cent of the buyers complained about the bedrooms; 19 per cent complained about the kitchen, and

(Continued on page 188)

# Your BEST ASSURANCE

OF UNIFORMLY  
HIGH QUALITY MORTAR



5,293 barrels of LONE STAR MASONRY CEMENT were used on \$9.5-million, 10-story, 500-bed Veterans Administration Hospital, New Orleans, in laying up all brick, block and stone—typical of widespread use of this high-quality mortar in structures, large and small.

## VETERANS ADMINISTRATION HOSPITAL New Orleans

Supervision:

U. S. CORPS OF ENGINEERS, NEW ORLEANS DISTRICT

General Contractor:

ROBERT E. MCKEE, Dallas, Texas

Architects & Engineers:

FAVROT, REED, MATHIS & BERGMAN, New Orleans

FAULKNER, KINGSBURY & STENHOUSE,  
Washington, D. C.



← Write for this New Book

Write for this new illustrated Masonry Booklet, full of timely, useful information. Address Lone Star Cement Corporation, 100 Park Ave., New York 17—or nearest office, listed below.

On Large Structures or Small,  
Lone Star Masonry Cement  
Assures Quality plus Economy

● Produced to exacting Lone Star Standards, under rigid laboratory control throughout the manufacturing process, LONE STAR MASONRY CEMENT greatly simplifies the problem of obtaining uniformly high quality mortar:

One ready-to-use cementing material instead of two means greater uniformity from batch to batch;

One less cementing material to handle . . . no lime or Portland cement to add . . . no soaking or slaking;

Extra workability and plasticity due to exceptional water retention . . . brick and block bed easier, minimum droppage, smoother work schedules;

Soundness, low absorption, high water repellency . . . durable, weather-resistant performance.



LONE STAR CEMENTS COVER  
THE ENTIRE CONSTRUCTION FIELD

## LONE STAR CEMENT CORPORATION

Offices: ABILENE, TEX. • ALBANY, N. Y. • BETHLEHEM, PA. • BIRMINGHAM  
BOSTON • CHICAGO • DALLAS • HOUSTON • INDIANAPOLIS  
KANSAS CITY, MO. • NEW ORLEANS • NEW YORK • NORFOLK  
PHILADELPHIA • RICHMOND • ST. LOUIS • WASHINGTON, D. C.

LONE STAR CEMENT, WITH ITS SUBSIDIARIES, IS ONE OF THE WORLD'S LARGEST CEMENT PRODUCERS: 17 MODERN MILLS, 125,600,000 SACKS ANNUAL CAPACITY

# For 30 Years America's



An old friend, and a leader in weather strip sales for 30 years. Conveniently packaged in sets for windows or doors in individual cartons. A perfect over-the-counter sales item. Place your order now for a supply of Numetal and be ready to make those weather strip sales.

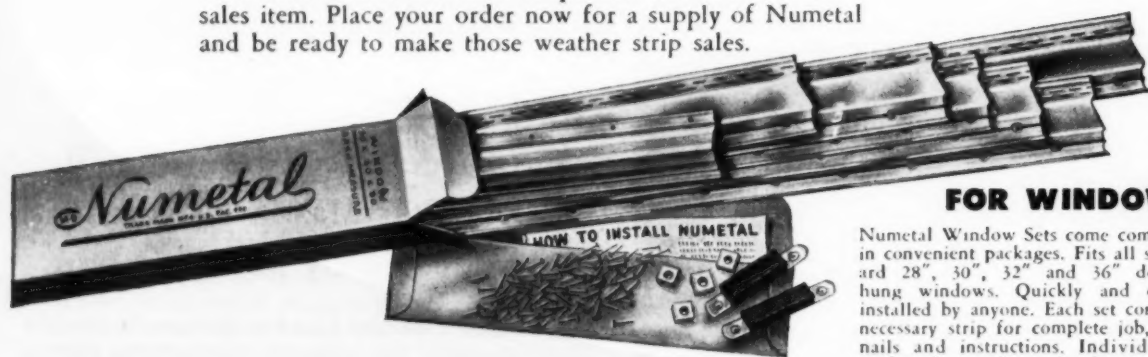

## FOR WINDOWS

Numetal Window Sets come complete in convenient packages. Fits all standard 28", 30", 32" and 36" double hung windows. Quickly and easily installed by anyone. Each set contains necessary strip for complete job, plus nails and instructions. Individually packaged — ready to hand customer!

## Nu-WAY WEATHER STRIP

### Easiest in the world to put on

Any clerk, regardless of experience, can sell Nu-Way Weather Strip! That's because any customer can put it on quickly and easily.

Nu-Way works perfectly on most any type window, storm-sash or door. Made of moth-proof, pre-shrunk, color-fast wool felt and white metal.

Yes, Nu-Way keeps out cold — saves fuel. And sells at a low price that really brings in sales!



This colorful, attractive display carton really sells the goods! Contains one individual 18 ft. roll of Nu-WAY, with sufficient nails and instructions for easy installing. Stock up today!



Mac says "Be prepared for **COLD WEATHER SALES!**"

**ORDER NOW** — your order will be shipped same day received

# Leading WEATHER STRIPS!

## FOR DOORS

Numetal Weather Strip comes in handy sets for almost all standard doors. Available with regular stainless steel and felt door bottom strip, or with threshold and exposed hook. Easily installed — no special skill or tools needed. Comes complete. All ready to install.



## Nu GARD Automatic DOOR BOTTOM & DRAFT ELIMINATOR

Show customers how it works, and this automatic door bottom sells itself. It's the perfect answer for all drafty doors — inside or outside! Completely solves the old problem of clearing rug or carpet every time door opens. Nu-GARD is beautifully designed with smart, silvery-satin finish and easily installed. Will not rust or tarnish. Furnished in 28", 32", 36", 42" and 48" lengths. May be shortened approximately 2". Packed in individual cartons.

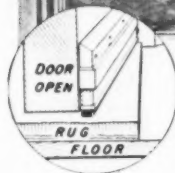
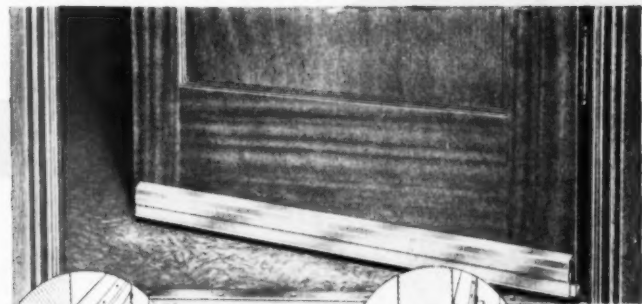

**UP**  
automatically  
when door  
opens  
Felt bottom  
raises to clear  
carpets and rugs.

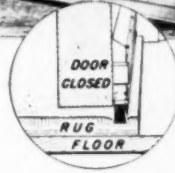

**DOWN**  
snugly when  
door closes  
Thick felt  
bottom now  
hugs floor to  
seal out drafts,  
noises, odors.

## Numetal DOOR BOTTOM STRIP



Here's a fast-selling weatherproof item that is tops in the field! Made of thick, wool felt and heavy gauge stainless steel. Furnished in standard lengths — 28", 30", 32", 36", 42" and 48" — packed 1/2 dozen same length to carton. Also furnished in special lengths.

# MACKLANBURG DUNCAN CO.

OKLAHOMA CITY, OKLAHOMA

**MACKLANBURG DUNCAN CO.**  
MANUFACTURERS OF  
**QUALITY**  
BUILDING SPECIALTIES

THIS HOME, built by L. I. Combs & Sons, typifies the successful use of *Thermopane* by builders in northern Indiana. It is an \$18,000, three-bedroom house with full base-

ment, garage and perimeter gas heat. It's all set for the cold Lake Michigan winds coming over the dunes. It has *Thermopane* insulating glass in every window.



## "This sign packs a wallop for builders"

—says HENRY J. BULZA  
of GARY, INDIANA

"This is *Thermopane*\* insulating glass." Those words in the window of a new house—or spoken to a home-buying prospect—are powerful selling. *Thermopane* is known—and wanted.

Henry J. Bulza of the Ambridge Lumber and Supply Company, Inc., Gary, Indiana, can tell you from experience that it works! Builders have bought from him over 1,000 lights of *Thermopane* in two panel window sizes. They're offering *Thermopane* in every window of houses ranging from \$18,000 to \$25,000. They give home buyers insulated windows right at the start, included in the mortgage package. There's no extra selling job for storm sash.



The use of *Thermopane* in panel windows gives builders an economical way to add the extra value and the sales appeal of *Thermopane*. Mr. Bulza says: "The panel window eliminates storm sash and cuts the builder's cost. Also, it gives the home owner more glass for less money. We can give him 82 sq. ft. of glass for about \$200. The same wall area with conventional windows would cost a lot more."

Write for full information. We'll send you full data on *Thermopane* sizes, types of windows for *Thermopane* and details on panel windows. Libbey-Owens-Ford Glass Co., 323 Nicholas Building, Toledo 3, Ohio.



# Thermopane

INSULATING GLASS

LOOK FOR THE NAME ON THE SEAL BETWEEN THE PANES

For better vision, specify *Thermopane* made with Polished Plate Glass

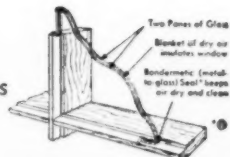

AMERICAN BUILDER





About 200 more Knox Homes have been added to this attractive Fleming Heights subdivision in Augusta, Ga., in the past year. All are roofed with *Certain-teed* Thick Butt Asphalt Shingles.

## EVERY HOME IN THIS MODERN DEVELOPMENT ROOFED WITH CERTAIN-TEED THICK BUTT SHINGLES

*"We use Certain-teed Thick Butt Asphalt Shingles exclusively on all our homes and find them very satisfactory."*

—Says E. Knox Withers,  
Knox Corporation,  
Thomson, Ga.

When builders like the Knox Corporation use *Certain-teed* Thick Butt Asphalt Shingles exclusively in an important development like this, it's first-

rate evidence for you to consider before your next roofing job.

*Certain-teed* Thick Butt Shingles can do 3 important jobs on any roof:

1. They're tough, strong, highly weather resistant. That means longer life for your roof.
2. They're *fire resistant*—made of asphalt. That means a greater margin of safety.

3. They're made in a beautiful range of colors—from the new Silver and other pastel blends through the popular Blues, Greens, Reds, Blacks—in plain or decorative grained surfaces. That means a roof that adds charm and distinction to almost any style house, one that sells on sight.

Write today for the new 32 page full-color roofing book illustrating the complete line of *Certain-teed* asphalt shingles.



# Certain-teed

REG. U.S. PAT. OFF.

Quality made *Certain*... Satisfaction Guaranteed

**CERTAIN-TEED PRODUCTS CORPORATION**

124 E. LANCASTER AVE., ARDMORE, PENNSYLVANIA

EXPORT DEPARTMENT: 100 East 42nd Street, New York 17, N.Y.

ASPHALT ROOFING • SHINGLES • SIDINGS  
ASBESTOS CEMENT ROOFING AND SIDING SHINGLES  
GYPSUM PLASTER • LATH • WALLBOARD • ROOF DECKS  
ACOUSTICAL TILE INSULATION FIBERBOARD

where  
the  
elements  

---

are  
at  
their  
worst



The dome of the Terminal Tower, Cleveland, Ohio, 614 feet above the sidewalk, takes a beating from wind, rain, boiling sun and subzero temperatures. The exposure to elements, beyond the endurance of most building materials, is protected with Thoroseal, as shown in above photograph.



Photograph on left shows how Bob Reynolds, of H. Reynolds Company, of Cleveland, Ohio, stands on extreme edge of hanging scaffold, 614 feet above sidewalk.

<p><b>WATERPLUG</b> To Stop Leaks</p>	<p><b>THOROSEAL</b> To Seal Surface</p>	<p><b>QUICKSEAL</b> For Beautiful Finish</p>
---	---	--

Get our new 20-PAGE BROCHURE, with designer's guide. Pictorially described, in detail... "HOW TO DO IT."



*Standard Dry Wall Products*

**BOX X, NEW EAGLE, PENNSYLVANIA**

*Architects, Builders—  
Strong, Durable, Lightweight*  
**J&L Junior Beams**



*Save Time, Save Costs, and  
Help Solve Design Problems*

Modern building needs stress the importance of saving construction time, holding down over-all costs *without* sacrificing permanence, safety or beauty in design.

Because of their versatility and adaptability, J&L Junior Beams go far toward meeting the demands of today's builders. They cost less to buy and less to erect. Lightweight Junior beams may be easily raised, placed and bolted directly into position with a minimum of labor and manpower. This fast, economical construction helps hold building costs low.

In addition to their EASE OF INSTALLATION, you'll be interested in other important design

and construction features of J&L Junior Beams. They are RIGID, VIBRATION RESISTANT, SHRINK PROOF, FIREPROOF, VERMIN PROOF, and have the LOWEST DEFLECTION FACTOR OF ANY STRUCTURAL SECTION OF EQUIVALENT WEIGHT.

Why not write today for our new booklet covering J&L Junior Beams and Channels? It shows how Junior Beams are used as floor joists and roof purlins, with loading and spacing tables for various spans.

**J&L  
STEEL**

Jones & Laughlin Steel Corporation  
492 Gateway Center  
Pittsburgh, Pennsylvania  
Please send me a copy of the booklet  
covering J&L Junior Beams and  
Channels.

NAME \_\_\_\_\_

COMPANY \_\_\_\_\_

ADDRESS \_\_\_\_\_

**JONES & LAUGHLIN STEEL CORPORATION**  
**PITTSBURGH, PENNSYLVANIA**

# 10

# Reasons Why

**Sterling**  
HARDWARE

IS PREFERRED  
FOR  
SLIDING  
DOORS



Plan sliding doors in your homes. They are quick and easy to install and save space

Wardrobes and cabinets are better lighted and contents are more accessible.

No crowded passageways with sliding doors on Sterling Hardware.

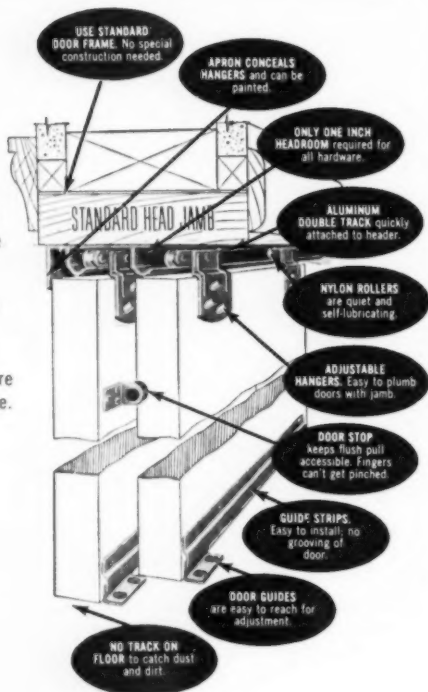

USE STANDARD DOOR FRAME. No special construction needed.

APRON CONCEALS HANGERS and can be painted.

ONLY ONE INCH HEADROOM required for all hardware.

ALUMINUM DOUBLE TRACK quickly attached to header.

NYLON ROLLERS are quiet and self-lubricating.

ADJUSTABLE HANGERS. Easy to plumb doors with jamb.

DOOR STOP keeps flush pull accessible. Fingers can't get pinched.

GUIDE STRIPS. Easy to install; no grooving of door.

DOOR GUIDES are easy to reach for adjustment.

NO TRACK ON FLOOR to catch dust and dirt.

GET FULL  
DETAILS  
Today!

**STERLING HARDWARE MFG. CO.**  
2345 W. Nelson Street • Chicago 18, Illinois  
Send Catalog and more information to:

NAME \_\_\_\_\_

ADDRESS \_\_\_\_\_

CITY \_\_\_\_\_

Builder  Architect  Dealer

# Now you can Choose AIR-KING Ventilating Fans...

for every purpose  
— in any size  
and price range

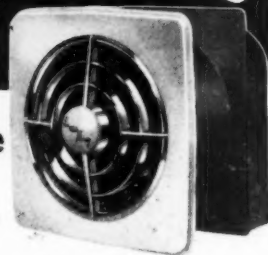

wall switch controlled

low cost model **AUTOMATIC SIDEWALL**

Now available at the same price as pull chain models! Weatherproof outside hood protects against ice, snow, wind and rain—encloses scientifically counter-balanced, exclusive "Flutter-Free" shutter that automatically opens and closes when fan starts and stops. **Wall Switch controlled**—single or three speed (extra). Unscrewing of center grill knob removes grill for easy cleaning. Motor and blade completely removable by merely loosening two wing nuts. In 8-inch and 10-inch models for walls 4 1/2" to 28" thick. Sparkling white or chrome finish. **Full 5 year guarantee.** WF8C, WF10 and WF10C...priced as low as **\$27.55**



FOR CEILING OR SIDEWALL

- Only 3 1/2" deep over-all
- Blower-type blades

Most attractive, powerful, versatile kitchen fan available. New blower-type pressure blade maintains high air exhaust volume in long ducts. Mounts in ceiling or sidewall. Grill removes by merely unscrewing center grill knob. Outside frame will never warp or rust. Model CF8C especially recommended where low cost is a deciding factor. In White Enamel or Chrome finish. Available with 3-Speed Control switch (extra). **Full 5 year guarantee.** CF8C, CF10N and CF10NC...priced as low as **\$27.95** complete with Wall Cap.



**ECONOMICAL PULL CHAIN MODELS**

Where wall switch is not desired, this powerful, economical pull chain model is highly efficient. Eliminates wall switch installation cost. Outer frame will never rust or warp fan housing. Grill easily removed by merely unscrewing center knob. Motor mounted on one bracket—motor and blade completely removable by loosening just two wing nuts. Available in 8" and 10" models, white enamel or chrome finish for walls 5 1/2" to 16" thick. **Full 5 year guarantee.** KF8N and KF10N...priced as low as **\$27.55**



Listed in Sweet's Catalog or ask your Wholesaler.

Complete catalog available by writing to

**BERNS MFG. CORP.** 3050 N. ROCKWELL ST., CHICAGO 18, ILL.

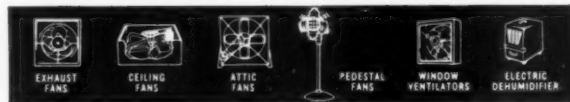

AMERICAN BUILDER

**rolling door hardware that breathes...**

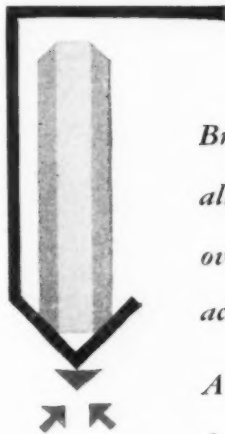

*Breathing space shown by arrows  
allows WASHINGTON wheels to ride  
over the years of dust and dirt  
accumulating in any track.*

*A bumpy track may be all right  
for a freight train, but not in  
a lady's wardrobe... better  
use WASHINGTON.*



**WASHINGTON LINE**

*Three types of bearings available  
Ask your dealer for more information or write to:*

**WASHINGTON STEEL PRODUCTS, INC.**  
Dept. AB-2, 1940 East 11th Street, Tacoma 2, Washington

# HERE NOW! NEW

**No joints to conceal...**

**No nails to treat**

*Goes up as fast as wallpaper:* using special U.S.G. spreader apply PERF-A-TAPE\* Cement on back of panels, press into place, and *presto*—they're up to stay... on old plastered walls, or over regular SHEETROCK Wallboard in new construction.



# PANEL SHEETROCK\*

FIREPROOF GYPSUM WALLBOARD



#### Plain Panel SHEETROCK

Can be finished in dozens of ways: paint, wallpaper, textures, grass cloth are just a few exciting ideas.



#### Prefinished Knotty Pine Panel

When walls are up the decorating's done, too—providing the interest and beauty of real wood paneling.



#### Neutraltone Striated Panel

Subtle surface scorings help create the effect of straight-grain wood paneling—at only a fraction of the cost.

## The greatest advance in Gypsum Dry-Wall since U.S.G. invented SHEETROCK in 1917!

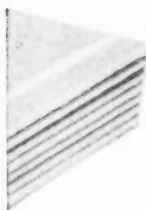

All the famous SHEETROCK advantages, plus: light weight, easy handling, fast erection, smart modern effects.

Only 16" wide, an 8' panel weighs but 16 lbs. Easy to maneuver around corners, in narrow places—simplifies finishing hard-to-get-at

\*T. M. Reg. U. S. Pat. Off.

attic and basement spaces. Available in 8', 9' and 10' lengths; 3/8" thick; 4 pieces per bundle.

Ask your building supplies dealer about this revolutionary gypsum dry-wall development. Another first from U.S.G. research, it's sure to be a big business builder for you!

*Another sensational first from U.S.G. research*



## UNITED STATES GYPSUM

The Greatest Name in Building

\*T. M. Reg. U. S. Pat. Off.

# In 5 Weeks, Labor

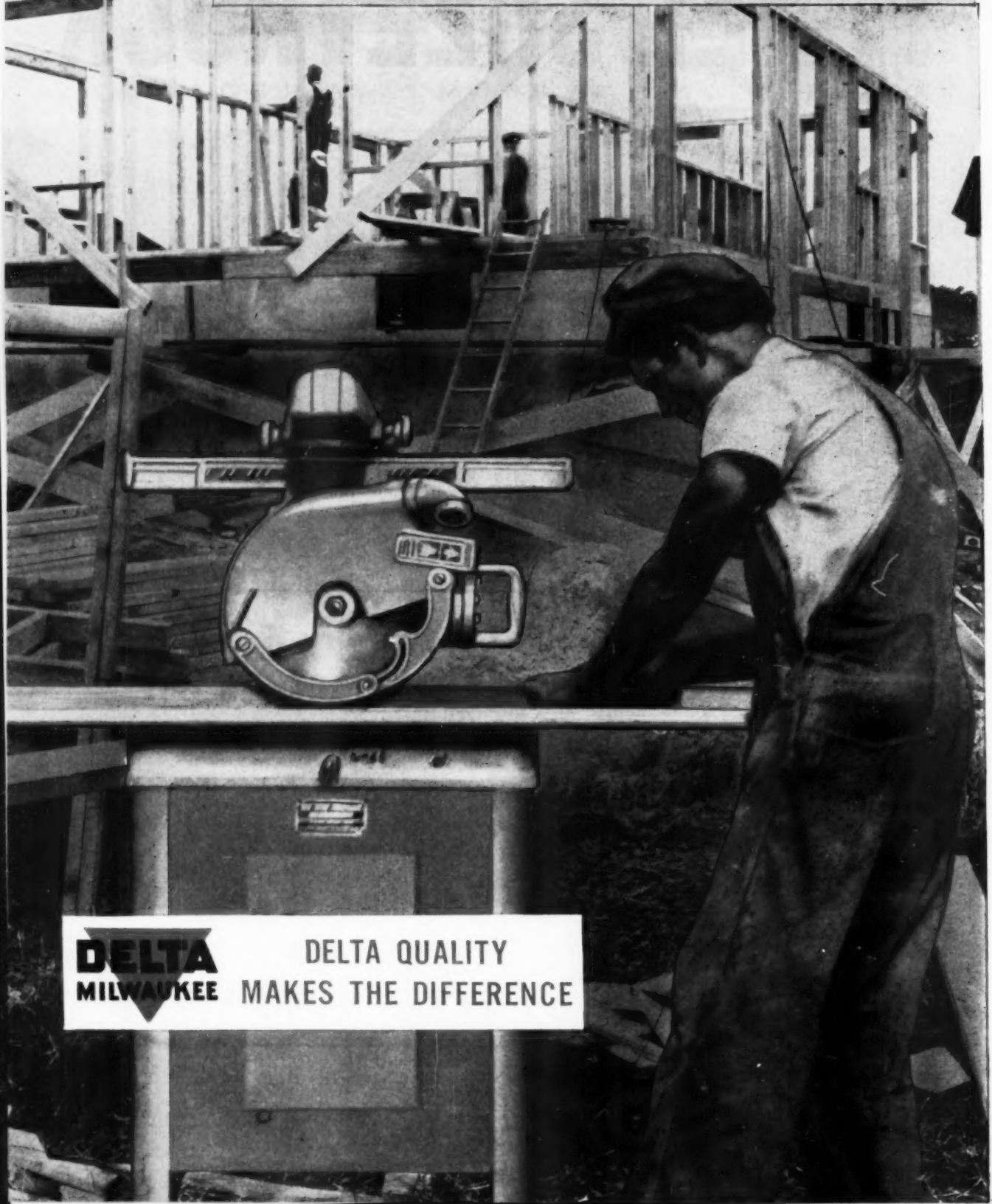

**DELTA**  
**MILWAUKEE**

DELTA QUALITY  
MAKES THE DIFFERENCE



# Savings Paid for my first DELTA Radial Saw

**SAYS Allen Chambers, Kansas City, Mo., General Contractor**

... "That job—where I paid for my first Delta saw in five weeks was in Salina, Kansas. On another one—a 6-month job in Kansas City, I saved enough to pay for the machine 10 times over."

Listen to what his partner, Lawrence A. Chambers, Jr., says about putting a Delta Radial Saw on the job:

### Only 16½ cents per hour for Delta Saw on School Job

Here are Allen Chambers' actual operating costs for operating a Delta Radial Saw on the Brookwood School Job in Kansas City. These itemized costs were averages for 1050 hours in six months and include \$20 for yearly maintenance, although, reports Lawrence A. Chambers, Jr., "we spent only \$2.25 for repairs in a year."

	Per Hour	Per Year
Depreciation 8% and average interest 2% on investment in Delta radial saw	\$ .04	\$ 42.50
Installation at job site	.024	25.00
Maintenance allowance	.010	20.00
Risk of breakage	.024	25.00
Saw blade depreciation	.023	24.00
Sharpening	.015	15.75
Electric power	.020	21.00
<b>Total Machine Operating Cost</b>	<b>.165</b>	<b>173.25</b>
Labor, per hour	2.15	
<b>Total, including Labor</b>	<b>2.315</b>	

Says Mr. Chambers: "We consider these figures proof of the economy of setting up one of these saws on the job."

"We've made many studies of the money-saving capacity of Delta radial saws in the field. We figure that \$1500 worth of labor was performed on Delta saws at a cost of only \$350. In general, we know that the Delta radial saw saves 65% over hand labor, and on ripping it saves 90% to 95%.

"Formerly we had experience with portable power hand saws, but a Delta radial saw does the work better and faster, because it is a mass production piece of equipment.

"With the Delta radial saw it's easy to make chamfer cuts for column forms and beveled strips and cant strips for roof construction. We set up a regular mill on the job and do all kinds of work—trim, jambs, casement, moulding and even doors. If it weren't for the Delta saws, we would have to spend thousands of dollars for additional labor."

You, too, can make these labor savings with the new Delta radial saw. Its many exclusive features—such as complete 360° "turret" action, up front controls, etc., allow you to do more jobs—faster—than with any other radial saw.

Use the coupon below for more information on the complete line of Delta radial saws—built in 8", 10", 12", 14" and 16" sizes.

## Hear What Other Builders Say About Delta:

**Finley-O'Shea Construction Co., Oklahoma City**—"The Delta radial saw is truly universal. Nothing seems impossible with it. It takes only 100 hours of operation to save two men's wages at \$2.00 per hour and this practically repays the saw's first cost."

**Hunkin-Conkey Construction Co., Cleveland**—"This saw does it easier, better, and quicker. It's a safe saw to use."

**Woodbine Mill and Lumber Co., Nashville, Tenn.**—"It is the best saw I ever ran."

**Metcalfe-Hamilton Construction Co., Kansas City**—"For performance, ease of operation, and economy the Delta radial saw can't be beat."

**Arthur Weeast, Florence, N. J.**—"I can think of no other power tool to compare with Delta."

**E. H. Moldenhauer & Sons, Cedarburg, Wis.**—"Using the Delta radial saw in our shop we pre-cut all structural members for a complete house in a few hours."

Delta Power Tool Division  
Rockwell Manufacturing Company  
646B N. Lexington Ave., Pittsburgh 8, Pa.

Please send me full catalog data on Delta radial saws.

Name \_\_\_\_\_

Company \_\_\_\_\_

Street \_\_\_\_\_

City \_\_\_\_\_ Zone \_\_\_\_\_ State \_\_\_\_\_

**DELTA** QUALITY POWER TOOLS  
Another Product of **Rockwell**



The **SOLD** sign goes up quicker...

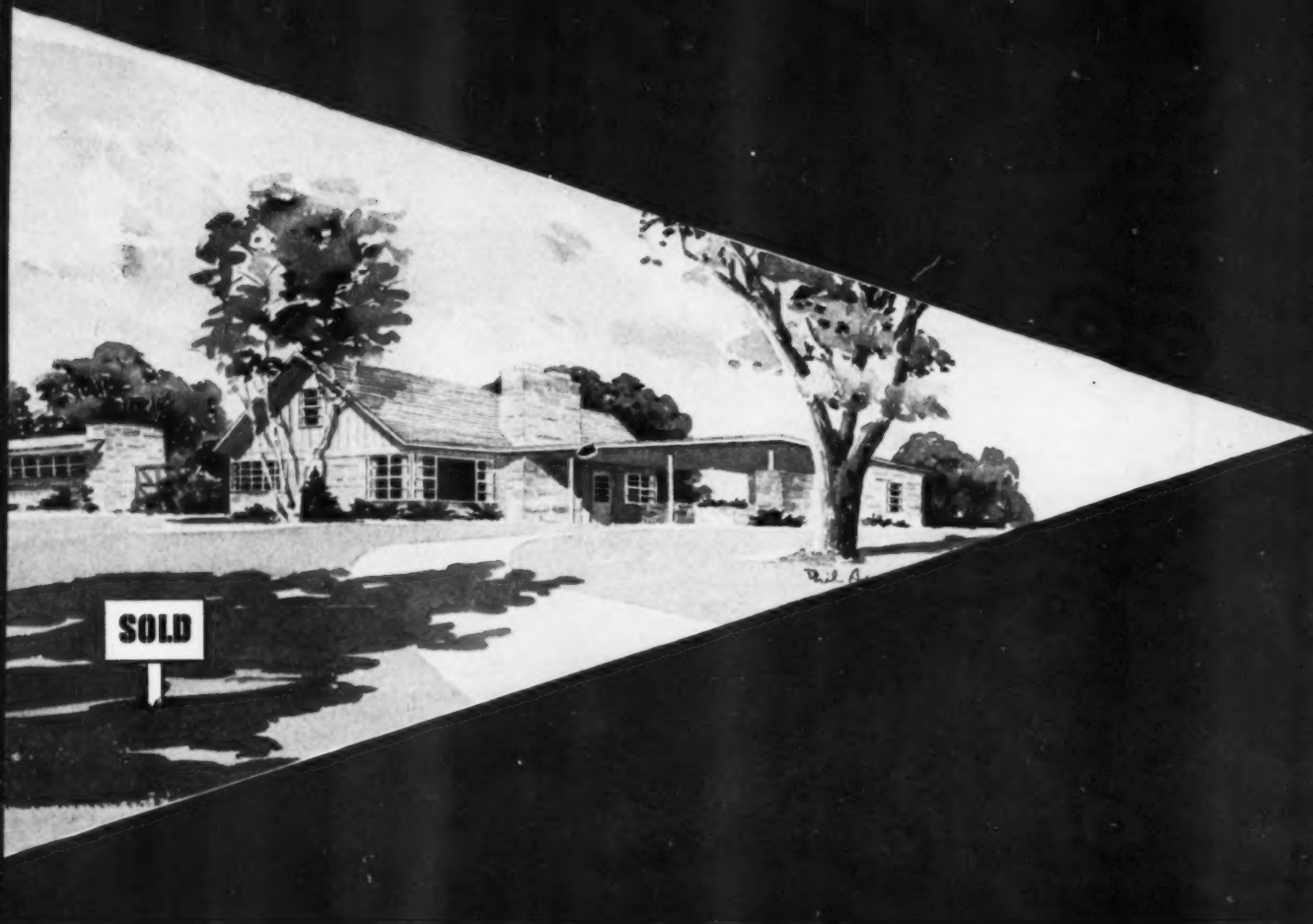

One of the **easiest** ways to sell a home **quicker** is to give the buyer what he wants... Builders everywhere say homes with metal windows sell faster because home-owners prefer metal windows over any other type... A recent study here at Ceco substantiates what builders believe... what they know to be true of customer preference. Both builder and buyer said they prefer Ceco

metal windows, because they are easy to clean and maintain, won't rust, warp, stick or swell and are truly better looking... Slender muntins mean more light gets in... more view, too... We believe it is significant that our study showed twice as many home-owners selected metal windows in the planning stage as chose a competing product... Yes, it's evident the swing is to metal

# on homes with metal windows



Ceco Steel Residence Casements and Picture Window

Ceco-Sterling **Double-Hung** Aluminum Window  
Series 60-B for residences

windows . . . that is why we feature Ceco-Sterling Double-Hung Aluminum Windows and Ceco Metal Casements. If you are a builder who hasn't featured metal windows in your homes, let us tell you more about how you can sell more homes by giving people what they want . . . Ceco-Sterling Double-Hung Aluminum Windows and Ceco Metal Casements.



*In construction products*  
**CECO ENGINEERING**  
*makes the big difference*

**CECO STEEL PRODUCTS CORPORATION**

General offices: 5601 West 26th St., Chicago 50, Illinois

Offices, warehouses and fabricating plants in principal cities

# "Ask The Experts"

Got a problem you haven't solved? Can't solve? Haven't the time to solve?

Have you solved a problem with an answer you aren't sure of?

Are you doing some particular job—big or little—in a way that you think might be improved?

Then "ASK THE EXPERTS"—a group of industry authorities—experts in their fields. They'll give you the answer.

Address your questions to: "Ask The Experts," *American Builder*, 79 West Monroe St., Chicago 3, Ill.

As many questions and answers as space permits will be published monthly in *American Builder*, under the head—"Ask The Experts."

## A Waterproofing Problem

Please advise the kind of waterproofing compound which I may apply to my cellar walls. The walls have damp spots and a small amount of water settles at the base on two sides of the cellar. I want to waterproof these walls before installing knotty pine walls.

A. H. B., Rockville Center, Long Island, N. Y.

To solve your problem we suggest that you refer to the section on waterproofing "Building Watertight Masonry Walls" in the booklet sent you entitled, "Concrete Masonry Handbook."

Portland Cement Association

## Correct Framing

I would like to know if I could receive information on the proper framing of homes, giving the exact details on how all the wood structures are installed and the proper measurements on such data.

F. P., Washington, Pennsylvania

We are sending you a copy of a reprint on our Construction Lumber series in reply to your question.

## Framing a Basement Entry

I had my basement completely remodeled and modernized this past summer. The outside entry steps are of concrete. I expected to put an aluminum Bilco Door at the outside entry and found the company had discontinued the doors in aluminum. I wrote the company and found they have an accessory known as "Feather Action" door operators for use with their steel-copper doors.

Now I find that the horizontal length of the opening at the top of the steps is about 12 to 18 inches longer than the horizontal length of the longest Bilco Door which is six feet. The

height of the door at the foot of the steps is about six to eight inches above the ground level and there is a fall of about three feet in the ground to the front part of the house. The builder and I talked of building an extension at the top next to the house. I would appreciate any suggestions you may give for a suitable solution such as style or plan for building an extension so that it might not look too "patched up."

A. W., Virginia, Minn.

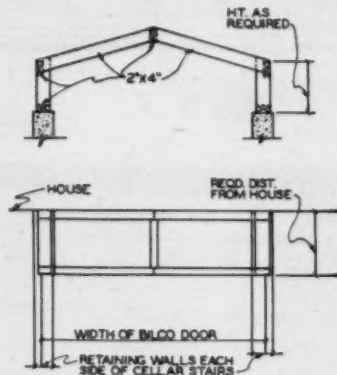

The drawing indicates the basic frame that is to be placed over the stairs leading to the basement opening. No attempt has been made to show the finish for the shelter. This, we feel, can be supplied by yourself or the builder according to your own tastes.

## Gas Furnace Problem

We are in need of help on a problem which has caused us much expense, trouble and suffering. In August, 1951 we moved into a home which at that time was about two years old. There are four rooms and a bath. The basement runs under the entire house except for an area of about 10x14 feet under one bedroom which is not excavated.

Last winter when we started the gas furnace there seemed to be fumes in the house. Our eyes burned, we became nauseated to a degree and became quite drowsy. We had the gas furnace checked but none of the furnace men could find anything wrong. Nevertheless we couldn't imagine what it could be other than the furnace and continued to work from this angle the entire winter and in desperation even had a new furnace installed, although the old one was only a couple of years old. But we still had the fumes when spring came.

To give you an idea as to how thorough we have been here are a few of the things we have done in regards to the furnace.

1. We raised the Transite chimney to a higher level on the roof.

2. We had draft tests made on the flue action.

3. We had the gas lines checked and tested for leaks.

4. We had the gas pressure checked.

5. We tried operating without the humidifier. We tried operating with excess moisture in the air.

6. We tested for leaks in the Transite.

7. We tested for down drafts.

8. We had the furnace body tested and the furnace torn down.

9. We rigged up a method for bringing outside air into the blower system.

10. We devised a means of making sure there was no puff of raw gas when the thermostat kicked the furnace on.

11. We had tests made as to the carbon monoxide, etc. produced by the flame.

We operated for several weeks without the automatic hot water tank being on. We removed the electric refrigerator from the kitchen and stored it outside. We disconnected the gas kitchen stove. We plugged the two drains in the basement. We thought perhaps sewer gas might be the source of our trouble. We searched the house high and low for any foreign material which might cause an allergy. Still we couldn't solve the problem. Could any sort of fumes emanate from the ground in the unexcavated area under the bedroom? Is it possible that a certain type of earth here could cause our trouble? We have poured lime on this ground but it caused no change.

Could there have been any building material used in the construction of the house which might cause this trouble? How could we cover the unexcavated area so no gases or fumes

(Continued on page 35)

**SELL YOUR HOMES FASTER IN '53 with ..**

# All 3 NuTone Products



NuTone Ventilating Fans for  
**Fresh Clean Air**

**YOU SELL HOMES FASTER ..**  
with **NUTONE DOOR CHIMES**

..for a cheery musical welcome at the front door. So pleasing to the ears .. attractive to the eyes .. easy on the nerves.



**"Toasty-Warm" Bathroom**  
with a NuTone electric CEILING heater.

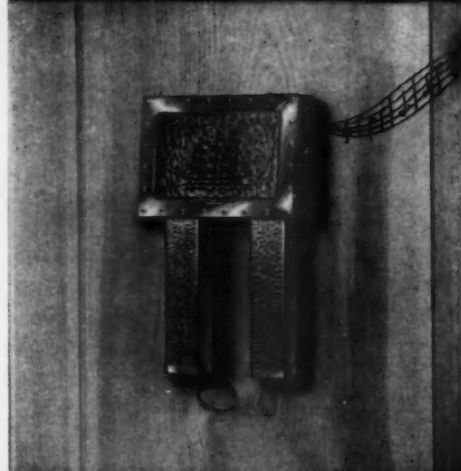

These 3 NuTone Products "dress-up" your new low cost homes .. make them **MORE ATTRACTIVE** .. **MORE SALEABLE** .. especially to women.

**YOU SELL HOMES FASTER ..**  
with **NUTONE VENTILATING FANS**

..to get rid of kitchen odors .. to keep greasy film from settling on walls and woodwork.

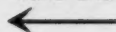

NuTone Door Chimes for a  
**Cheerful Earful**

**YOU SELL HOMES FASTER ..**  
with **NUTONE ELECTRIC CEILING HEATERS**

.. to make bathrooms "Toasty-Warm." Built into the ceiling for safety. Saves valuable wall space.



**Free**

NuTone, Inc.  
Dept. AB-2, Cincinnati 27, Ohio  
Gentlemen: Please send illustrated literature to

Name \_\_\_\_\_  
Firm \_\_\_\_\_ Title \_\_\_\_\_  
Address \_\_\_\_\_  
City \_\_\_\_\_ State \_\_\_\_\_

VENTILATING FANS DOOR CHIMES

**NUTONE**  
ELECTRIC CEILING HEATERS

PLEASE TURN PAGE



# NU TONE

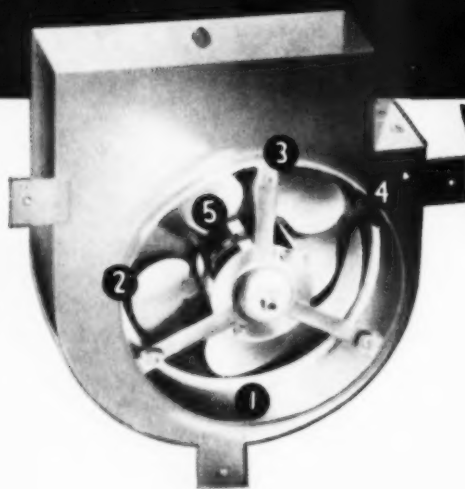
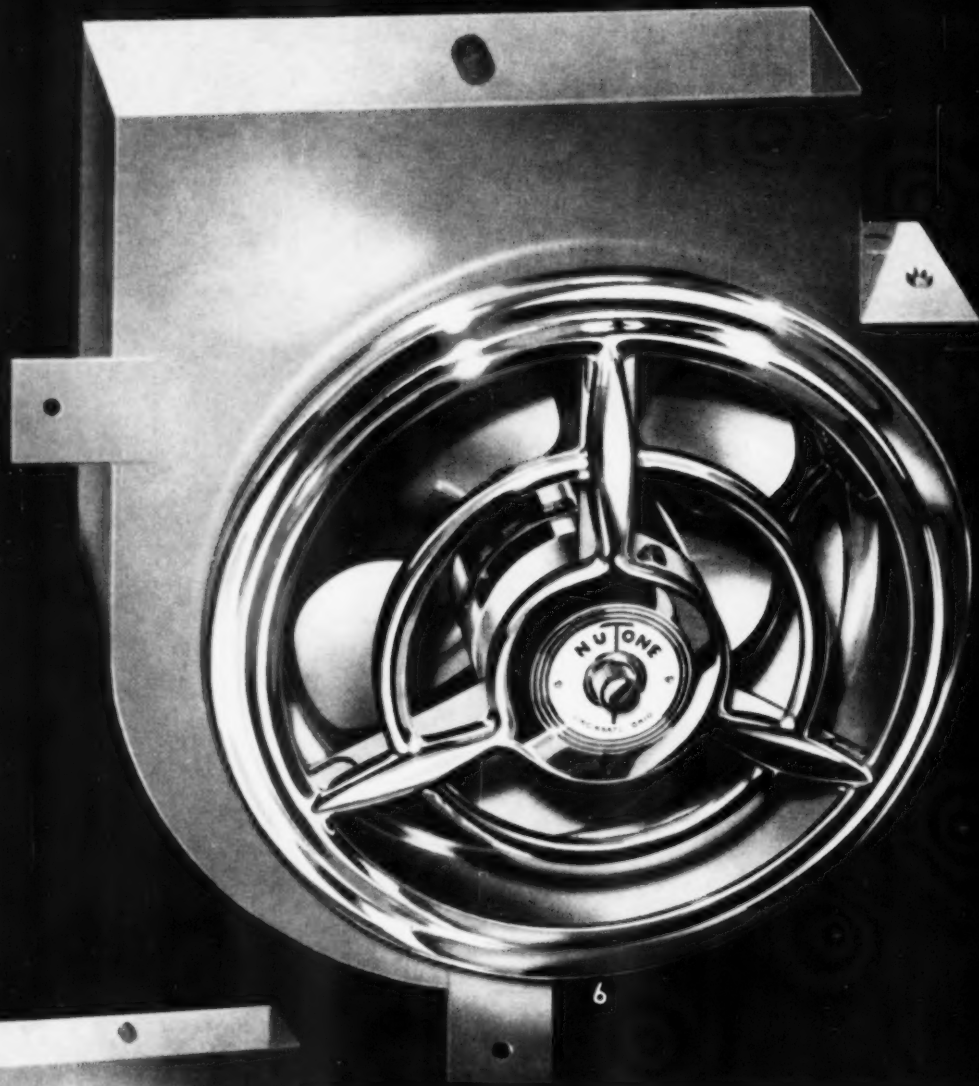

**NU TONE**

## VENTILATING FANS

All leading builders agree . . . NuTone Ventilating Fans offer greater air delivery, more quiet, at lower cost than any other ventilating fan.

LOOK INSIDE the fan housing and see for yourself why NuTone is the choice of Leaders in the Building Industry. Here are just a few of the outstanding features found in NuTone Ventilating Fans:

- ① EXCLUSIVE VENTURI HOUSING . . . keeps exhaust air from "bouncing back." This means NuTone is a quiet fan!
- ② PRESSURE BLADE . . . removes kitchen odors and grease faster!
- ③ SNAP-IN INSTALLATION . . . saves installation time and money.
- ④ PLUG-IN MOTOR . . . for safer, easier cleaning. Easier to install.
- ⑤ MOTOR . . . fully guaranteed for 5 years. No service problems.
- ⑥ GRILLE . . . removed by thumbscrew — can be washed like a dish.

FOR ODOR-FREE AIR . . . 8 BASIC MODELS IN CHOICE OF WHITE OR CHROME.

# NUTONE

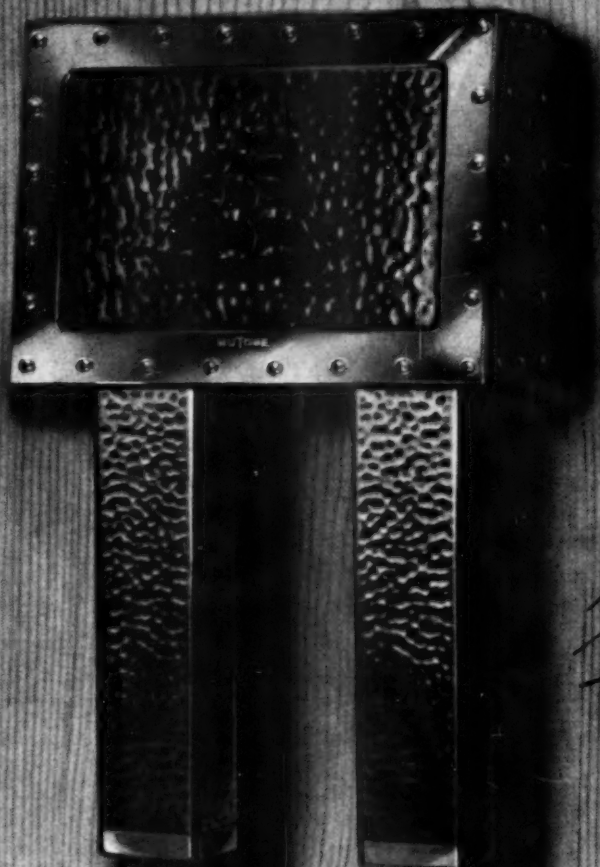

**NUTONE**

## DOOR CHIMES

Why does NuTone sell more Door Chimes than all other chime manufacturers combined? . . . Because NuTone Door Chimes are designed for beauty . . . engineered for better tone — and most heavily advertised.

LOOK INSIDE OR OUTSIDE and you'll see the smarter styling and the durable construction of NuTone Chimes:

- ① ENCLOSED POWER UNIT . . . avoids maintenance trouble.
- ② SPECIAL ALLOY TONE BARS . . . for louder chime tone.
- ③ FLOATING TONE BAR SUSPENSION . . . for clearer chime tone.
- ④ SOLID BRASS TUBES . . . for more musical chime tone.
- ⑤ OUTSTANDING DESIGNS . . . blend with Modern, Ranch type, or Colonial interiors.
- ⑥ DURABLE CHIME COVERS . . . in plastic, stamped and die cast metal.

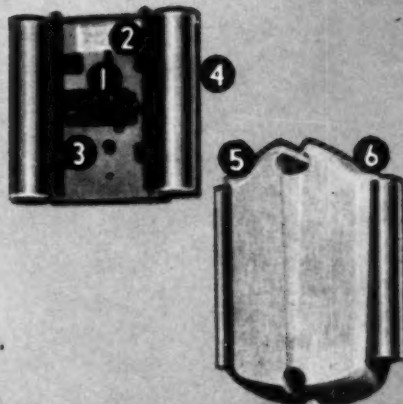

FOR A "CHEERFUL EARFUL" . . . 15 SHORT AND LONG TUBE NUTONE CHIME MODELS

PLEASE TURN PAGE

**NU TONE**

# ELECTRIC CEILING HEATERS

## THE WORLD'S SAFEST HEATERS. . . BUILT INTO THE CEILING

No danger of burns with the revolutionary NuTone electric CEILING heater. Quick, gentle, uniform heat — to make the entire bathroom "Toasty Warm" in a few minutes. No hot blasts — no chilly drafts — no fumes . . .

Economical because a ceiling heater is more efficient! NuTone Electric Ceiling Heaters save valuable wall space. Quick and easy to install — no pipes — no ducts.

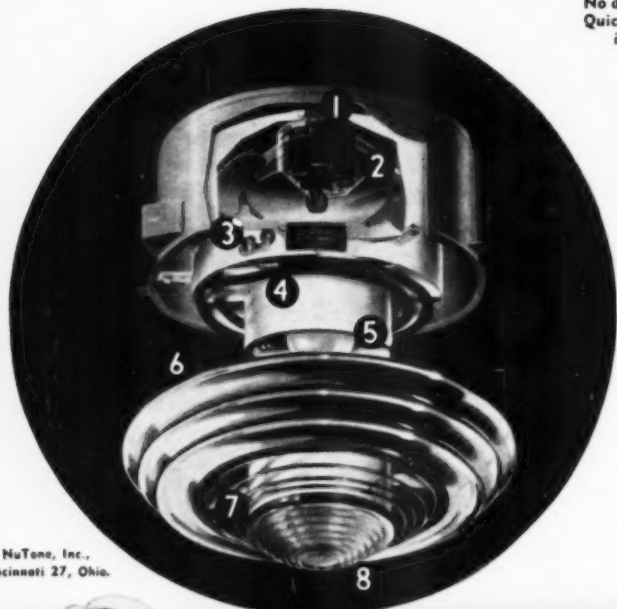

- ① MOTOR . . . guaranteed for 5 years against mechanical and electrical defects.
- ② FAN BLADE . . . forces downward a gentle stream of warm air throughout the entire room. No heat loss into the ceiling.
- ③ THERMAL-PROTECTOR . . . automatic circuit breaker . . . no overheating — therefore safer.
- ④ HEATING ELEMENT . . . chromalox heating unit entirely concealed — safe from children's fingers.
- ⑤ LIGHT BULB . . . independently controlled by wall switch. If desired, use light without the heater.
- ⑥ INTAKE GRILLE . . . draws in warm air trapped near ceiling . . . forces it down into the room.
- ⑦ DISCHARGE GRILLE . . . conceals the heating elements . . . no exposed electrical coils or wires.
- ⑧ PRISMATIC LENS . . . casts diffused lighting over entire room.

8 CEILING MODELS — FOR "TOASTY-WARM" BATHROOMS — AND OTHER "HARD-TO-HEAT" AREAS.

NuTone, Inc.  
Cincinnati 27, Ohio.



# NU TONE



(Continued from page 32)

could escape from it if this should be our trouble? We prefer not to provide ventilation here unless absolutely necessary as it would entail breaking into the brick concrete block.

There is an attached garage and we thought it might be possible gasoline fumes from the car might have been the source of our trouble. So we parked the car outside for several weeks. This did not help.

I. L. M., Mansfield, Ohio

It is possible that one of the three points mentioned below may help to solve your problem.

1. It may be possible that your home is constructed too tightly. If you are getting condensation in any part of your home, that is, on the windows or walls, this would be a further indication of the lack of necessary ventilation during the heating season.

2. In the event the products of combustion from your gas furnace do not have sufficient natural draft, we recommend a fan for induced draft purposes. It would force all products up the chimney rather than depend upon a natural draft operation.

3. Take a sample of the air in the rooms affected and have this air tested by the testing department of your local gas company. This should tell you where the trouble is.

### Computing Costs

In your August issue of the American Builder, you advise the cubic foot method of computing cost of ranch type house with cellar. Does that include plumbing, painting and electric?

We find that 75 cents per cubic foot barely covers carpentry, material and labor. As a matter of fact, \$1.00 per cubic foot is nearer the cost in this vicinity. We compute square footage by eight feet high. Are we correct in this method?

C.P.H., Monticello, New York

When a cubic foot cost is set up it should include all of the trades involved in the building of a home except grading, landscaping, sidewalks, screens and storm sash. In computing cubic foot contents the area is taken from six inches below the finish basement floor up to one-half of the height of the roof.

### Whitewashing the Fence

Several years ago we built a fence around our ranch. We spray it with lime, but every year when it rains the whitewash disappears. The fence is almost a mile long and we cannot afford to paint. If you can solve this problem for me it would be a great help.

M.C., Gonzales, Calif.

How about trying a stain formulated for use on exterior wood? It would be cheaper than paint, but not so cheap as whitewash. Or, if you don't care about color, you might try using creosote oil. This will protect the wood against rot, but will dry to a dull finish. Nothing, however, will give the protection and durability that proper painting will provide. Don't expect it.

### Pitch for a Hip Roof

I received your booklet in reference to the calculation of the number pertaining to the carpenter's framing square but that does not quite answer my question.

Here is my problem: We take a pitch of a hip roof 8x12 inches or 1/3 pitch. The jack rafter end cut is 10x12 inches. Hip rafter end cut is 10 $\frac{7}{8}$ x12 inches. I would appreciate it if you can show me mathematically how you would arrive at the above figures.

F. P., Philadelphia, Pa.

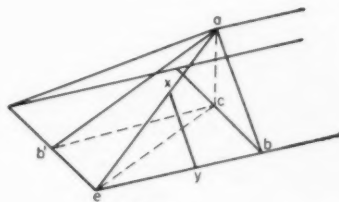

FIG. 1

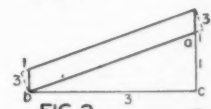

FIG. 2

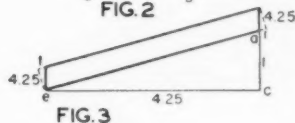

FIG. 3

The diagram in Fig. 1 represents a hip roof with a 1x3 slope. A, b and a, b' are rafters whose slopes are, of course, 1x3 also. The end cut on such rafters is, therefore, 1x3 as shown in Fig. 2. Likewise, the end cut on any jack rafter x,y, is also 1x3 since it has the same slope as a,b. The slope on a hip rafter a, e, is a.e. or 1x4.25.

c.e.

C.e. is simply the hypotenuse of the triangle b.c.e. The end cut therefore on a hip rafter is 1x4.25 as seen in Fig. 3.

### A Settling Foundation

I have a 25 year old frame house. Recently I discovered that the foundation on one side of the house is settling. Upon investigation I found heavy water seepage under the footing.

In lieu of replacing the entire side

of the foundation would it be practical to pour substantial piers against the inside of the foundation wall and use Perma-jacks and a girder to provide a new support. This support would be approximately 10 inches inside of the outer wall line. The floor joists are 2x8 on 16-inch centers. I have a five foot head clearance thus making the work accessible.

R.J.C., Tulsa, Oklahoma

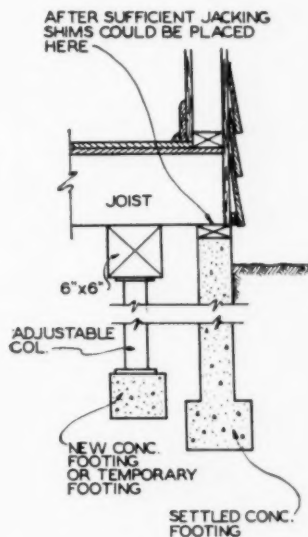

The drawing submitted is self-explanatory and carries out in general the thought expressed by yourself in providing supports for the defective foundation.

The concrete piers should be spaced not more than six to eight feet on centers which will form the basis for the adjustable column or Perma-jack, which in turn supports 6x6-inch girders which support the center of the floor joist and the area above.

### Steam Pipe Insulation

Can you tell me the relative heat conductivity between paper and asbestos? If I wrap my steam pipes (residence) with newspapers can the heat of the pipes set the paper on fire?

E.M.P., Scranton, Pa.

It is not recommended to wrap steam pipe with newspaper for many reasons. The steam pipes develop a temperature of 220 degrees, and this will have a tendency to turn the paper brown and cause it to be brittle. This parched newspaper would then be very easy to ignite.

Asbestos paper is recommended for all steam pipes. The best type of pipe insulation is the corrugated cell type of pipe wrapping. This provides an air space which better insulates the pipe and cuts heat loss.

# NEW ELJER BALANCED-CONSTRUCTION Ballcock

long-wearing  
cup washer

plunger

plunger bore

plunger bore  
clearing pin

heavy-duty  
encased seat washer

high-copper  
alloy body

slotted stem for  
adjusting quietness

oversize packing

leather washer

stainless steel  
screen

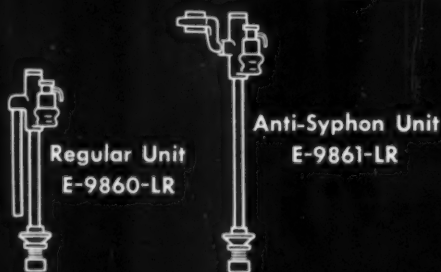

Regular Unit  
E-9860-LR

Anti-Syphon Unit  
E-9861-LR

## HERE'S HOW IT WORKS . . .

**Snap-Action Shutoff**—Water passing upward through plunger bore, as float rises, builds up pressure above cup washer. This creates an overbalance of downward force that snaps the plunger shut at correct water level setting.

### Integral Stop and Volume Control Permits . . .

- A. Positive and easy adjustment for quiet operation under high pressure.
- B. Complete shutoff for repair without disturbing main water supply.

### Why you should know about this ballcock:

This new ballcock is typical of the *extra quality* you get in Eljer Fixtures and Fittings. It was designed and perfected to operate quietly and efficiently under extremes of high or low pressure . . . and it does just that . . . in assuring trouble-free performance. No other ballcock has so many desirable features.

Snap-action shutoff provides instantaneous closing without water hammer . . . assures longer seat life . . . maintains constant water level, even after years of service.

Extra quality is built into all Eljer Fixtures and Fittings. That's why it's good business to install Eljer. You don't lose time and profits handling complaints. You *add* to the good reputation of your business.

For complete information, see your Eljer Distributor or write Eljer Co., Box 192, Ford City, Pa.



# .....NEWS OF ASSOCIATIONS

## Frank Cortright's Resignation Accepted with Regret by NAHB

After eleven years of painstaking and devoted service as executive vice president of the National Association of Home Builders, Frank W. Cortright has tendered his resignation to the executive committee, effective March 1, 1953. The step was taken by Cortright upon the advice of his physicians, inasmuch as he has for nearly a year been undergoing treatment for polyneuritis.



Frank W. Cortright, retiring executive vice president of the National Association of Home Builders, Washington, D. C.

The committee has accepted the resignation with reluctance and deep regret. For the time being, the assistant executive vice president, John Dickerman, with the aid of his staff, will carry on the functions of the organization on an interim basis.

Since January, 1942, Frank Cortright, as one of the original founders of the National Association of Home Builders, has overseen the growth and prosperity of this influential organization of the building industry. At that time, Cortright, a Philadelphia lawyer, went to Washington to accept the position of secretary of the then Home Builders Institute, an offshoot of the National Association of Real Estate Boards. The NAHB, at its inception, consisted of approximately 250 members, and had a total budget of \$18,000; the staff consisted solely of

Cortright and one stenographer. This is a far cry from the present status of the group which in January, 1952 accepted its 25,000th member and has 319 directors.

Cortright stated, in part, in his memorandum of December 1, 1952 to NAHB president Alan E. Brockbank and the members of the executive committee: "... As I think back upon the eleven years that I have served this Association and all that has been accomplished, and as I see the leaders and staff which have been developed in that time, I know that I can relax my efforts on behalf of the Association with complete confidence that it will continue to grow in power, prestige and industrial statesmanship to the end that the home building industry will provide a strong foundation for a strong American economy."

Two days later, President Brockbank issued a resolution which was unanimously approved by the executive committee; this statement accepted Cortright's resignation upon the conditions that the retiring officer be appointed an Honorary Life Member of the executive committee, and that for a period of three years commencing March 1, 1953, the association retain Cortright in an advisory capacity, to render such services to the group that his time might allow.

## Pacific Northwest Builder Officers Meet in Seattle

The presidents and executive officers of the four Northwest chapters of the NAHB, which include Portland Home Builders Association, Spokane Home Builders Association, Tacoma Master Builders and Seattle Master Builders, met recently in Seattle.



John LaPorte, regional vice president of Pacific Northwest chapters, NAHB, addresses joint session of chapter presidents at Seattle Master Builders' meeting

John LaPorte, regional vice president; John Richardson, executive vice president, Portland; Wayne Garceau, president and Robert Twigg, executive secretary, both of Spokane; Norman Jardeen, president, and Phil Garland, executive secretary, both of

(Continued on page 38)



## Spratt Heads Producers' Council

Newly elected officers of the Producers Council, l. to r.: R. S. Hammond, Johns-Manville Sales Corp., New York, first vice president; William Gillett, Detroit Steel Products Co., Detroit, second vice president; A. Naughton Lane, Monarch Metal Weatherstrip Corp., St. Louis, immediate past president; Elliott C. Spratt, The Hill-yard Chemical Co., St. Joseph, Mo., newly elected president; F. J. Close, Aluminum Co. of America, Pittsburgh, treasurer, and Fred M. Hauserman, E. F. Hauserman Co., Cleveland, secretary

## NAHB '53 Convention and Exhibition Draws Record Attendance

Advance interest in the 1953 Convention and Exposition held by the National Association of Home Builders in Chicago, January 18-22 was so intense that an attendance of over 18,000 was anticipated, setting a new record. The pre-convention enthusiasm was attributed in part to the increased number of "how-to-do-it" clinics, business management forums, and the record number of nearly 250 exhibiting firms showing a variety of home building materials and allied equipment.

Typical of the character of the entire convention program was the "How-To-Do It" demonstration that took place on January 21 in the Grand Ballroom. Seven presentations of outstanding subjects developed through the Operation Trade Secrets program were given.

Because of increasing interest in the big annual affair on the part of companies who continued to apply for exhibition space, it was found necessary to open two new exhibit areas on the sixth floor and on the lower level of the hotel. The enlarged facilities provided over 100 extra spaces to take care of the tremendous demand on the part of manufacturers who were anxious to present

their new products to builders.

One of the outstanding features of the 1953 affair was the series of displays where manufacturers showed and explained the latest developments in home air conditioning. The success of the world's biggest building show was manifestly a foregone conclusion as could be forecast weeks before its opening. In its March 1953 issue, *American Builder* will devote considerable space to a summation of the NAHB Convention and Exposition.

### Rhode Islanders Receive Insurance Dividend

A check for \$6,552, representing the total dividends of its members participating in a workmen's compensation insurance plan, was received recently by the Home Builders Association of Rhode Island.

The dividend represented a return of about 35 per cent of premiums to approximately 40 builder and associate members, according to Anthony Viola, president. Charles Reed of the American Motorists Insurance Co. presented the check to Viola at the association's October dinner meeting.



### St. Louis Builder Receives Best Citizenship Award

His hobby of studying building codes paid off handsomely for Erwin Schneider, St. Louis builder. A past president of the Home Builders Association of Greater St. Louis, Schneider received the second annual award of the Bildor Best Citizenship trophy in recognition of his work in promoting the adoption of the BOCA Codes. His reputation as an authority on codes became so well known that he was automatically appointed a commissioner when St. Louis County set up a new Building Commission. Shown with Schneider, at left, is C. S. Upson, new president of the Home Builders of St. Louis, and at right, Builder Norman R. Scheurmann, the donor of the trophy

### Pacific Northwest Builders

(Continued from page 25)

Tacoma; and A. C. Goodwin, president and V. H. Dent, executive vice president both of Seattle, discussed the various problems confronting the Pacific Northwest associations.

A brief report was made on prospective new chapters, particularly at Yakima and Long View, Wash. Visiting delegates attended a general dinner meeting of the Seattle Master Builders. Regional Vice President John LaPorte was the principal speaker of the evening.

### McWilliams New Head Of Pittsburgh Home Builders

C. F. McWilliams, Jr., has been elected president of the Home Builders Association of Metropolitan Pittsburgh. He has been active in the builders' group for the past eight years, and has just completed a term as vice president of the association. He served as chairman of the ethics committee which was responsible for the bonded builder program now in effect for builder members of the association. McWilliams is vice president of Park Builders, Inc., and a council member of Pleasant Hills Borough.

Other officers elected were: A. M. Rearick, first vice president; T. A. Rauch, second vice president; Franklin Wimer, treasurer, and Calvin D. Crawford, secretary.

### NAHB Essay Contest Causes Widespread Interest

Considerable interest throughout the country has been evidenced by the announcement of the first NAHB Annual Essay Contest. One aggressive builder, John Bonoforte, of Pueblo, Colorado, NAHB director, has taken the initiative in his town to get the contest rolling in high gear. He sent a letter to the local superintendent of schools stating his interest in sponsoring the essay program in Pueblo. Bonoforte is offering \$120 in prizes to the winners of the local essay contest, giving a first prize of \$50, a second prize of \$25, third prize of \$10.00 and seven additional prizes of \$5.00 each.

The Essay Contest consists of the submission by high school students of a 600-word theme on the subject "Why Home Ownership Builds Good Citizenship." National awards will range from \$500 to \$25, with the teachers of winning students also receiving cash awards equal to the amount paid each winner. The contest closes April 1, 1953.

## Schorling Honored at Hoo Hoo Christmas Party

The International Concatenated Order of Hoo Hoo held its annual Christmas party on December 13, 1952, at Kansas City. Eight clubs in Jurisdiction 7, consisting of Corpus Christi, Dallas, Gurdon, Houston, Kansas City, Pan Handle, St. Louis and San Angelo, paid particular tribute to Clifford Schorling for his services to the order. During the past two years, Schorling has visited at least 24 cities throughout Texas, the Pacific Northwest and as far east as St. Louis for the benefit of the organization. The Jurisdiction 7 clubs contributed toward the donation of a Hallicrafter Television set which was presented to Mr. and Mrs. Schorling following the banquet.



John F. Miller, Jr. congratulates Mr. and Mrs. Clifford Schorling on the occasion of "Cliff Schorling Night" at the Hoo Hoo Christmas Party held in Kansas City

## California Home Builders Council Chooses 1953 Officers

Alec McKenzie, San Mateo builder, has been named to succeed A. F. Oddstead, Jr., as chairman of the Home Builders Council of California, it was announced by Harry E. Smith, secretary of the Council.

Others elected were Fred F. Chopin, Oakland, vice-chairman; Frank Ohman, San Francisco, secretary-treasurer, and John I. Hennessy, Oakland, executive secretary.

The Home Builders Council is the coordinating agency for statewide legislative and public relations problems. Members include the Associated Home Builders of San Francisco, Associated Home Builders of Sacramento, General Contractors and Builders Association of Contra Costa, Peninsula General Contractors Association, Marin Builders Association, Home Builders Institute of Los Angeles, and the Associated Home Builders of the Greater Eastbay.

## Dealer's Viewpoint

H. R. NORTHUP, Executive Vice President,  
National Retail Lumber Dealers Association



### Increased Domestic Housing Selling Opportunities Ahead

It is rather disturbing at first glance, to read that the average American now spends only 15 per cent of his income for shelter, whereas he formerly spent 25 per cent for that purpose. The fact is that these statistics, like so many others, are extremely misleading.

The figures present a challenge, but they aren't a cause for alarm.

The percentage in question unquestionably has dropped but there are at least three explanations, none of which shows any lessening of public appreciation of the desirability and value of good housing.

For one thing, rent control, which still is in effect in a good many communities, automatically limits consumer expenditures for shelter. Secondly, a large segment of the public is living in older homes which were built and contracted for before inflation set in. Mortgage and interest payments are based on pre-inflation costs.

In the third place, the average worker today is taking home more dollars than he did in 1939, after taxes and after allowing for inflation. In some cases, those extra dollars are being spent for more or better housing but, in large part, they are being spent for luxury and non-luxury items that the family couldn't afford in 1939.

Since almost everyone admits that American housing standards are higher than they ever have been and that the American public is better housed, on the average, than ever before, there are no grounds for concluding that spendable income is being diverted from housing to

something else. Housing hasn't lost ground. It simply has failed to run up as large a gain as some other industries have registered.

That is where the challenge comes in. The figures in question show unmistakably that the public can be persuaded to spend for better housing some of those extra dollars now being spent for non-housing purposes. Far too many families have a tendency to be content with modest and sometimes inadequate housing so that there will be more money for TV sets, fur coats, vacations, and other wholly desirable but, nevertheless, competitive purposes.

The whole point is that the light construction industry has by no means reached the limit of its selling opportunities. Even though 1952 probably saw the largest expenditure of all time for housing and residential modernization combined, there is no reason why 1953 and 1954 can not be even larger.

I have a hunch that is exactly what will happen. If retail lumber dealers and builders find their profit percentage starting to slip a little, they can be counted on to go out after the extra volume needed to hold up their profits. In other words, they will go after their full share of those extra dollars which are now being spent elsewhere.

Dealers who decide to attract some of those dollars will find some practical, helpful suggestions in the Merchandising chapter of the Dealer Operating Guide which NRLDA is distributing to its members.

## Prefab Home Industry Survey

The ability of the prefabricated homes industry to meet the nation's long-range housing needs is described in a 16-page pamphlet issued by the Prefabricated Home Manufacturers' Institute. The report, representing the first comprehensive study of its kind made of the prefabrication industry, is based upon a survey conducted by the Housing and Home Finance Agency, Washington, D.C.

The survey findings cover the business experience of 53 leading manufacturers of factory-made homes, their plant facilities and production capacity. The report also includes data on marketing practices, and manpower requirements for site erec-

tion and completion of prefabricated homes. A section is devoted to estimates on the quantities of building materials and equipment used by the prefabricated homes industry.

The report was published so that information may be available to home manufacturers as well as to builders, suppliers and other interested persons. Although the survey covered operations in 1950, the industry enjoyed a steady expansion since that time. Production and material requirements are now at a higher level, although all new housing activity is considerably below the 1950 rate. Individual copies of the report are available from the Institute.



### Ohio Home Builders Greet President C. R. Miller

Retiring president of the Ohio Home Builders Association, Joseph J. Roberts, Cincinnati, (third from left) congratulates his successor, Clinton R. Miller, Akron. Other OHBA officers for 1953 include: (l. to r.): A. B. Stanbery, Toledo, first vice president; Melvin E. Kimmey, Dayton, second vice president; Charles L. Prior, Columbus, secretary; Lowell T. Blackman, Cleveland, secretary; and A. H. Falace, Columbus, executive vice president



### St. Louis Builders Plan '53 Home Show

Ideas and features for the St. Louis "Bildors" Home Show, to take place May 2-10, 1953 at Kiel Auditorium, are being planned by the above committee, Chairman is Ed Cassilly, Jr., seated, left. Other committee members include (standing, l. to r.): Marion R. Evett, Clayshire Electric Co., Elmer L. Daab, Kluthe Daab, Inc., J. C. Radcliffe, Overhead Door Co., and Gerald F. Borgschulte, builder. Seated with Cassilly is Clinton R. Schattgen, Schattgen Company, chairman of the 1953 Home Show

### Hardboard Association Founded in Chicago

The Hardboard Association was formally organized in Chicago on November 13, 1952. Its major objectives are to promote the uses of hardboard and to deal with technical and trade promotional problems pertaining to the hardboard industry.

Representatives of the following hardboard manufacturers were present: Superior Wood Products Co., Duluth, Minn.; Oregon Lumber Co., Dee, Ore.; United States Gypsum Co., Chicago; Masonite Corporation, Chicago; Chapman Manufacturing Co., Corvallis, Ore., and Forest Fiber Products Co., Forest Grove, Ore.

Officers of the new organization

### California Builders Issue 1-Year New Home Warranty

Associated Home Builders of Greater Eastbay (Calif.) have announced that all homes built by members of their association will henceforth carry a full year's warranty against defective materials or workmanship. Under the plan, known as the "certified construction" system, Association member builders will issue to all buyers a "Home Owner's Service Warranty" which certifies that any deficiencies in workmanship or material will be adjusted or repaired without cost to the buyer during the year after purchase.

As explained by John I. Hennessy, executive vice president of the Association, each warranty certificate carries a detachable coupon which the buyer fills out and mails to the Association office where it is registered for the full year's service period.

To assist the home buyer in identifying builder members of the Association, each builder will display on his homes an insignia carrying the membership seal in red.

### L. J. Rothfus Elected to Head Des Moines Home Builders

L. J. Rothfus was elected 1953 president of the Home Builders Association of Des Moines at the organization's annual business meeting on Dec. 16, 1952. He succeeds T. R. McNeal.

Other officers elected include William Witter, vice president; O. C. Grandquist, secretary-treasurer, Ernest Canine, national director, and W. Reed Davidson, alternate national director.

McNeal, as retiring president, reviewed major activities of the past year. He emphasized sponsorship of National Home Week and the Better Homes Exposition; establishment of a public service and information department; and adoption of a service policy for member builders to give to home buyers.

Chairman O. C. Powell and Executive Secretary William Weesner reported "good progress" in preparations for the 1953 Home Show, set for March 21-28. Exhibit space commitments were reported to be well ahead of those signed up at this time in 1952.

are Harold A. Miller, Forest Fiber Products Co., president; K. V. Hafner, Superior Wood Products Co., vice president; Paul B. Shoemaker, Masonite Corporation, secretary-treasurer. Chicago will serve as headquarters for the new association.



# Bucks flying by WHILE YOU HUNT RABBITS?



Still wasting shots on small game during deer season? Aim at the buck. Equip your homes with AUTO-LOK Windows and bag quick sales at quality prices... for higher net profit.

**Auto-Lok alone may change "FOR SALE" TO "SOLD"...  
be safe — choose the window women want most!**



**TIGHTEST CLOSING WINDOWS EVER MADE!**

**When competitive chips are down,  
windows often make the difference.**

Why select any other window when AUTO-LOK gives women all the advantages of every window with none of the disadvantages they've put up with in the past?

Auto-Lok windows save you installation time and costs. They're easy to handle because they're delivered on the job completely assembled with no parts to lose and no adjustments to make. They are the tightest closing windows ever made — suitable for any style of architecture in any climate. Your choice of the widest possible variety of sizes and combinations — continuous heads and sills up to 156", in 6" increments.

Check Auto-Lok's performance-proven features at your dealer's today! You'll quickly see why you can't afford to build with any other window!

For name of dealer nearest you, write-

**LUDMAN Corporation**

Box 4541, Dept. AB-2, Miami, Florida

**LUDMAN LEADS THE WORLD IN WINDOW ENGINEERING**

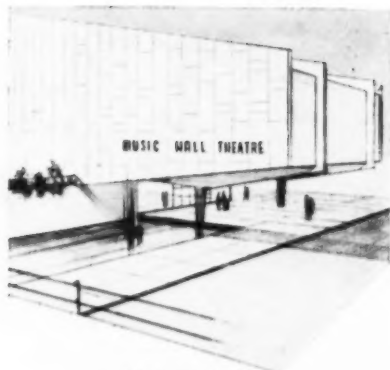

Here's a  
**DOUBLE FEATURE**  
for BUILDERS  
using



Concrete and Gypsum . . . reinforce both with Clinton Welded Wire Fabric. It is available in weights suitable for concrete floors, walls and sidewalks; and light weight aggregate roof-decking.

Another double feature of Clinton Welded Wire Fabric is its ease and economy of installation. It's no wonder that Clinton Fabric is a favorite with builders everywhere...and here's why:

**Simple to Form and Shape.** Clinton Welded Wire Fabric possesses the proper ductility to make it easy to bend, form or shape right on the job. It is sufficiently rigid, however, to hold its shape after forming.

**Easy to Handle and Place.** Both the heavy and light gauges of Clinton Welded Wire Fabric flatten quickly and easily from the roll.

Investigate the savings of Clinton Welded Wire Fabric for your next concrete or roof-decking job. Get full information from your building supply dealer or jobber or write the office nearest you.

THE CALIFORNIA WIRE CLOTH CORPORATION • Oakland  
THE COLORADO FUEL AND IRON CORPORATION • Denver  
WICKWIRE SPENCER STEEL DIVISION • New York 22, N. Y.



1072

## LETTERS

### send 50 copies

Sir: The November issue of the *American Builder* has just arrived and I am glad to see that we are gaining prestige with your organization. Did you make a reprint of the article on "Here Are Some Useful Tips On Winter Building" on pages 123-127? If so, we would like to get about fifty copies of the same. In the event that no reprint of this article has been made, will you please advise the approximate cost of fifty copies of the November issue.

Roy F. Healy,  
Executive Vice President,  
Milwaukee Builders Assn.,  
Milwaukee, Wis.

### very informative

Sir: . . . As a carpenter, I have found your publication very informative. My firm uses a great many new products in its construction work and through your publication I have been able to keep up with methods of installation and ways of using new equipment. This has been invaluable to me in my work.

Clarence R. Kuhn,  
Chicago, Ill.

### co-operation

Sir: The writer who has for a long time been reading your magazine with great interest, hereby would like to ask for your kind co-operation in the following matter.

I am planning to visit the United States in a few months and intend to stay for some time in order to increase the exchange of business between our two countries. I am representing various firms in the interior decorating and house fitting branches, and plan to introduce some of our products on the American market.

In the first place, we have an entirely new method of making lead-mounted window panes for which I am seeking a suitable manufacturer. I am co-operating with the famous Swedish artist and sculptor, Arvid Kullstrom, about this product. He has specialized in decorat-

ing church exteriors with his sculpture works, as well as in lead-mounted glass paintings.

I also represent a furniture company manufacturing "Gustavian Style" furniture. A household grill and other important fittings for the home are also represented by me.

Ivar Nordh,  
Ingenjorsfirma Ivar Nordh,  
Reginavagen 29,  
Saltsjo-Durnas,  
Sweden

### very fine story

Sir: Thank you for the fine story which appears on page 233 of the September issue of the *American Builder*. It is a very accurate presentation of our recently completed testing program for fireproofing steel columns. This story should prove very effective in informing builders in the United States of this latest development in fireproofing.

We would like to purchase fifteen additional copies of this issue of the *American Builder* for distribution to our member companies. Please invoice us.

Victor G. Pignolet,  
Technical Director,  
Metal Lath Mfrs. Assn.,  
Cleveland, Ohio

### it was a shocker

Sir: For the many months that my subscription has been in effect I've enjoyed *American Builder* thoroughly. However, the article "Here's How A Seattle Plan Was Adapted For Florida" was a shocker.

The predominant factor in Florida living is our climate. When an individual transposes a residence that was designed for the cold climate to this climate, he has automatically sacrificed the most fundamental feature for better living in this area. A "must" in a Florida-designed home is the careful consideration of outdoor living as well as indoor living, i.e., screened terraces, porches, or patios, the opening of large wall areas onto such private or semi-private screened

(Continued on page 44)





# **BRIXMENT**

## **ASSURES A GOOD BOND**

After all is said and done, the first function of a mortar is to form a good, tight *bond* with the brick. Upon this characteristic depend both the strength and the water-tightness of the wall. A good bond is particularly important in securing water-tight walls, because most cases of leakage are caused by the passage of water *between* the brick and the mortar.

Brixment mortar assures a good, strong, *thorough* bond because: (1) Its great plasticity permits a more complete bedding of the brick, and an increased area of contact between the

brick and mortar.

(2) Its high water-retaining capacity keeps the brick from sucking the water out of the mortar too fast, and prevents the mortar from congealing before the brick is thoroughly bedded and bonded.

(3) It hardens slowly enough to permit deeper penetration and more thorough keying into the pores of the brick.

Because of these characteristics, Brixment mortar makes a *better bond*. Isn't this what you want in *your* brickwork?

**LOUISVILLE CEMENT COMPANY, Incorporated, LOUISVILLE 2, KY.**

IN THIS TEMPLE  
AS IN THE HEARTS OF THE PEOPLE  
FOR WHOM HE SAVED THE UNION  
THE MEMORY OF ABRAHAM LINCOLN  
IS ENSHRINED FOREVER



## Everybody knows where the Lincoln Memorial can be found...but

how many newcomers, transients and other prospects in your community know what products and services you sell?

Tell them easily and economically through the 'yellow pages' of your telephone directory. Nationwide surveys prove 9 out of 10 shoppers use the 'yellow pages' to find buying information they need.

The 'yellow pages' introduce your business and sales story in homes, shops and offices all over town. They lead new prospects to you and serve as a constant reminder to old customers.

Why not let 'yellow pages' advertising tell everybody where you are located and what merchandise you offer?

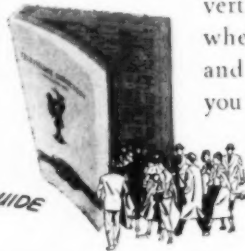

AMERICA'S BUYING GUIDE

FOR OVER 60 YEARS

CALL YOUR LOCAL TELEPHONE

BUSINESS OFFICE FOR MORE DETAILS



## letters . . .

(Continued from page 42)

areas, careful planning of cross ventilation, complete insulation (in the attic at least), attic fans, and sometimes air conditioning to mention a few.

I do not attempt to criticize the plan as being adaptable to the Seattle regions. It is probably well planned for that locale. However, surrounding it with a few palm trees and sand burrs definitely would not justify calling it a Florida home.

This condition of improperly designed homes being constructed in this area is neither new nor rare. We've had to contend with this blight upon our landscapes for many years in the past. However, through the education and the enlightenment of the public, the more aggressive people of the state hope to lessen this stigma in the future.

It is primarily with publications such as the *American Builder* that we have placed our hopes in such a transition. If articles such as this one continue to be printed, we can only feel that you are condoning instead of combating such poor practices.

I feel certain that any reputable architect in the Daytona Beach area could have handled the situation in a more suitable manner.

Richard G. Smith,  
General Contractor,  
St. Petersburg, Fla.

### greatly pleased

Sir: Our organization was greatly pleased with your excellent story of our Expansible House in the October issue of your magazine. As I intimated at the time, the house has only been moderately successful due to financial problems primarily. I shall be interested in knowing if you have much comment from your readers on it. I have to date received one inquiry, that being from Harry Frey of Michigan City, Ind.

C. A. Thompson,  
Champaign, Ill.

• Letters to the Editor should be sent to 79 W. Monroe St., Chicago 3, Ill. Your comments are invited.

AMERICAN BUILDER

*Bonded for beauty and strength*

with **ATLAS MORTAR**

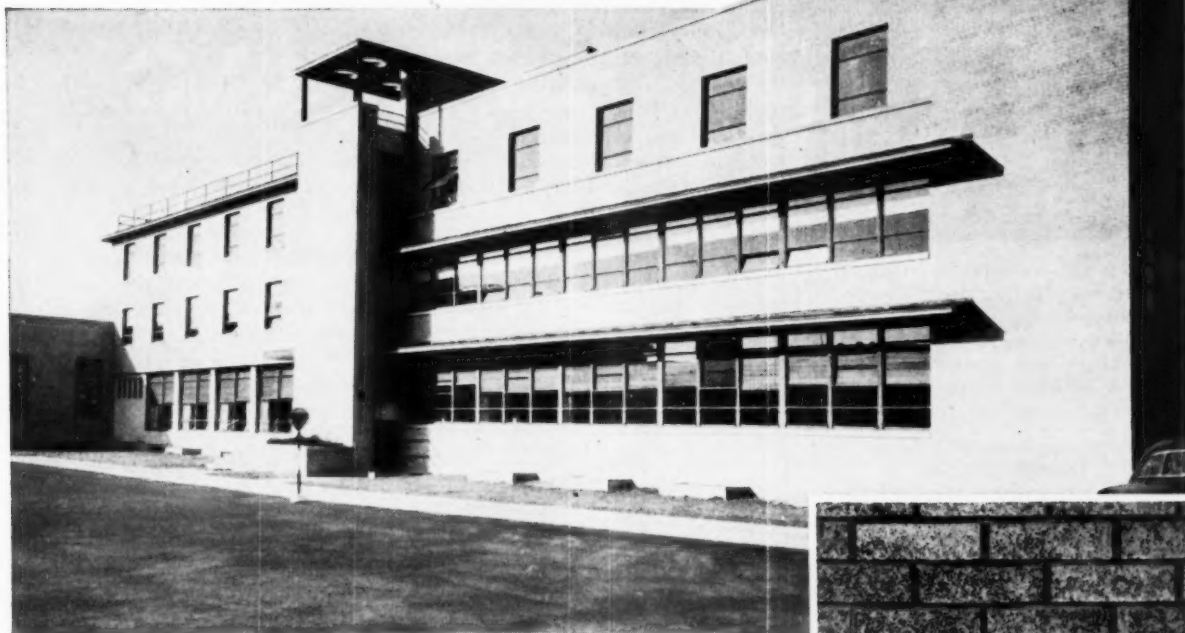

Hebrew Home for Orphans and Aged, Jersey City, N. J.

### CONTRACTOR TELLS WHY IT'S PREFERRED

The uniformly good color of Atlas Mortar can be seen readily on this job. But what you can't see is even more important. It's *the way* Atlas Mortar helped give a better job. The Geo. Siegler Co., Contractors, Jersey City, N. J., report they used Atlas Mortar because its mixes are smoother, work more easily, and the color is uniformly good.

**HOW IT HELPS CONTROL OF MIX**—Atlas Mortar is such a well-balanced masonry cement that mixes get too short to "work" if *too much* sand is added. Thus, in effect, Atlas Mortar becomes its own "job inspector"—and contractors agree that it can be used with minimum supervision.

**ATLAS MORTAR** has proved itself on large jobs and small. Complies with ASTM and Federal Specifications for masonry cement. For further information, write Universal Atlas Cement Company (United States Steel Corporation Subsidiary), 100 Park Ave., New York 17, N. Y.

OFFICES: Albany • Birmingham • Boston • Chicago • Dayton • Kansas City  
Minneapolis • New York • Philadelphia • Pittsburgh • St. Louis • Waco



**TRUE, TIGHT JOINTS**—Experience proves that masonry units are strongly bonded with Atlas Mortar. Strong walls and tight joints are obtained.

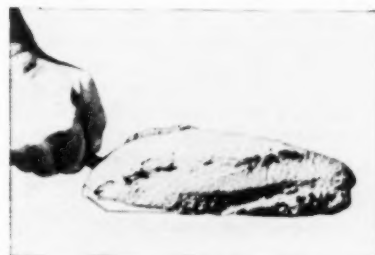

**MASONS LIKE** the smooth, rich plasticity of Atlas Mortar. It's buttery smooth to use. And it hardens satisfactorily with uniformly good color.

AB-M-40

SKILLED HANDS PREFER

# ATLAS MORTAR CEMENT

THE SATIN OF MASONRY CEMENTS



"THE THEATRE GUILD ON THE AIR"—Sponsored by U. S. Steel Subsidiaries—Sunday Evenings—NBC Network

**METAL  
WEATHERSTRIPPED  
WINDOWS**  
show infiltration ratio

**6**  
TIMES LESS

... than non-weatherstripped windows by actual test. (University of Minnesota Institute of Technology Testing Laboratory.) Metal Weatherstrip effectiveness is actually greater than 6 for average or poorly fitted windows.

**Reduction in Air Infiltration  
Through Windows  
Due to Weatherstripping  
(Unlocked—no storm sash)**

Type of Fit	Par Infiltration* cfh/ft. of Crack		
	Weather- stripped	Non- Weather- stripped	Weatherstrip Effectiveness†
Well	14.2	61	4.30
Average	16.7	104	6.24
Poorly	23.8	163	6.85

\*At a pressure of 0.20 inch of water (20.4 mph wind velocity).

†Ratio of non-weatherstripped to weatherstripped par-infiltration.

The above facts, plus the complete story on weatherstripping is presented in Bulletin No. 35—"Air Infiltration Through Weatherstripped and Non-Weatherstripped Windows," published by the University of Minnesota, Institute of Technology. The facts showing the economic value of weatherstrip are based on over-all research of climatic conditions in 12 selected cities in the U.S. covering a full range of weather conditions.

THE SYMBOL OF  
INSTITUTE MEMBERS



**WEATHERSTRIP Research  
INSTITUTE**  
OFFICE OF THE SECRETARY  
BOX 101 - RIVERSIDE, ILLINOIS  
DEPT. AB-23

Please send my FREE Copy of the 47 page,  
illustrated Bulletin No. 35.

NAME \_\_\_\_\_

ADDRESS \_\_\_\_\_

CITY \_\_\_\_\_ ZONE \_\_\_\_\_ STATE \_\_\_\_\_

## ON and OFF the RECORD

**THE LONG AND SHORT** of it this month has to do with two gentlemen who have never heard of each other. The two are C. N. Dalrymple, Shamrock, Texas contractor, and C. F. Geyer, Elmwood Park, Illinois, C. N., reports Guy Hill, *American Builder's* circulation salesman in the southwest, is the long of it. He's 31 years old, still an active contractor, and is now reading his *American Builder* for the fifty-first consecutive year.

**SAYS MR. DALRYMPLE**, "In 1902 my partner and I received a mail solicitation from *American Builder*, and we decided to subscribe. We made a pretty good investment that day fifty years ago."

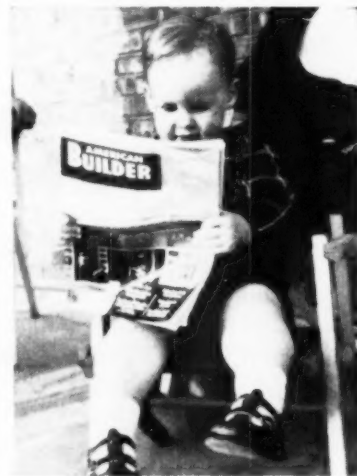

**THE SHORT OF IT** is C. F. (Mr. Geyer) age two, who probably is the youngest reader we have. If there is any doubt about his being a reader, just study the intent look of interest and understanding with which he is studying the back cover of his *A.B.*

**WE KNOW**, of course, that the back cover carries the perennial advertisement of the National Manufacturing Co. of Sterling, Ill.

**WELL, WE ALWAYS** maintained that *A.B.*, now in its 75th year, is new every month, and here's the proof that we start them young, and keep them as long as they live.

**WE HAVEN'T ASKED** C. F. whether he read the entire issue

from cover to cover or whether he is just a natural born hardware man. Anyway, when he is 31 he will have been a reader for 79 years, and that is likely to be a new long.

**MILES COLEAN**, nationally known building economist, has issued a new study in which he challenges the general belief that construction is subject to 13 to 20-year boom and bust cycles.

**POST WAR DECLINES**, such as those that followed the Civil War and World War I, are held by Colean to be not inevitable. He says that a high volume of building can be maintained throughout the foreseeable future.

**IT'S A BUBBLE-BREAKING** report, and deserves close study. It could clear away a lot of the haze of uncertainty that frequently clouds the thinking of the home building industry.

**WHEN A ROTTERDAM** ship builder got an order from a San Francisco man for a 135-foot Diesel yacht recently he couldn't find the buyer's name in Who's Who or any other listing of people who can afford \$750,000 yachts. Says the San Francisco Chronicle, in reporting the incident, the Dutch ship builder would not have been surprised had he known the customer, Henry Doelger.

**WE AGREE**. Heinie doesn't make newspaper headlines or "how I done it" popular magazine copy for the simple reason that he doesn't want to.

**HE JUST PARLAYED** a hot dog stand into a home building enterprise pushing two hundred million dollars, and thinks nothing of it.

**HE LIVES** unimpressively and locally, but very fully. He's a big (physically and mentally) bundle of dynamite. According to Dean Jennings in the Chronicle, his doctor told him at the age of 57 that he had better stop playing handball. When Heinie remonstrated, Jennings says the doctor told him that it was all right for him to have solid con-  
(Continued on page 43)

another **NATIONAL LOCK** first...



the *new*



# "Select-a-Pak" screw assortment No. 24

for fast, profitable wood screw sales

Handy "PAK" has clear acetate cover

Merchandise in full view at all times

Attractive eye-appealing display

Slide cover provides new customer convenience



retail price 15c

*A Complete Wood Screw Department  
Using Only 15½ x 12 Inches of Counter Space*



compact, metal "Select-a-Pak"  
screw dispenser included

this sturdy metal dispenser  
included with the No. 24 screw  
assortment at no additional  
cost (you pay only for the  
merchandise)

"Select-a-Pak" is the perfect answer to  
consistent wood screw profits. It's easy for  
you to service... easy for your customers to  
use. Assortment consists of 24 proven-popular  
wood screws... all those most frequently  
requested. Dispenser is a hard-hitting silent  
salesman. Everything is ready for prompt  
delivery NOW! Order your assortment today.

order from your jobber... open stock when desired



distinctive hardware... all from 1 source

**NATIONAL LOCK COMPANY**

Merchant Sales Division • Rockford, Illinois

# Build better HOUSES

## Keep them priced to move



# PREFABRICATION will help you do it!

Today more than ever, as costs squeeze both builder and buyer, Prefabrication deserves your attention. Through the economies and efficiency of Prefabrication you can do three things: deliver your customer a better house, sell it to him at a price that gives him more for his money, protect yourself on your

own profit. Get the facts about today's big swing to Prefabrication. Write for the free book, "Build Better, Build Sooner."

- ✓ **START SOONER!**
- ✓ **COMPLETE QUICKER!**
- ✓ **SELL FASTER!**



**PREFABRICATED HOME  
MANUFACTURERS' INSTITUTE**

929 20th St. N.W. • Washington 6, D.C.

## On and Off the Record

(Continued from page 46)

crete in his houses but not in his head.

**MARK A. THORESON**, president of the Home Builders Institute, reported that 3,000 houses, with a sales price of \$54,000,000 were shown in southern California during National Home Week. Nine hundred and ninety were sold during the Week for \$10,000,000. Just another bit of evidence that NHW is the industry's greatest merchandising program.

**NAMES IN THE NEWS** include these recent appointments by Hotpoint. **CLIFFORD C. CRAMER**, merchandising manager; **GORDON C. HURT**, advertising manager; **JOHN F. MCDANIEL**, vice president in charge of marketing.



**HERE IS THE** handsome and personable, not to mention highly efficient and popular mayor of Amarillo, Texas formally opening the holiday season in his city. He's Gene Klein, whose full time and principal occupation is running the Star Lumber Co. He's not just a public speaking and public appearance mayor. He works at the job, and is a major factor in the rapid growth and development of the Texas Panhandle metropolis. We'd like to greet him as Governor Klein someday. He's big enough in every way even for Texas.

**ALEX BRUSCINO**, Cleveland builder and originator of Bruscino-Built Expan-Homes, has been spotlighted by NBC television. Fifty-four stations joined in telecasting the construction of Expan-Home from excavation to occupancy.

(Continued on page 50)

Attractive, low-priced

# Hazelwood Plankweld<sup>®</sup>

Sells new houses **like hot cakes!**

...and it's **perfect**  
for remodeling jobs



Mister Builder . . . here's what you've been waiting for! Something your clients can't resist!

A low, low-cost paneling that looks like a *million dollars* . . . that helps close the sale of a house just about as fast as you open its doors to the public.

And it's a paneling that is a cinch to sell to those "I-can't-make-up-my-mind" prospects for remodeling jobs.

It's the sensationally new Weldwood development, Hazelwood Plankweld . . . pre-finished *honey-colored* panel with great uniformity of color . . . made of beautifully grained, genuine hardwood veneers throughout.

**Easy, Economical To Install**—You can panel a 13½-foot wall with one package of Hazelwood costing you only \$47.50.

Like all Plankweld Panels, Hazelwood Plankweld is easy and quick to install. It goes right over old or new walls . . . right over shabby or cracked plaster. Without furring or framing.

Panels are ¼" thick, 16¼" wide . . . 6', 7', and

8' long. They are edge-grooved to provide a neat lap joint . . . designed with a simple, concealed metal clip that holds Hazelwood Plankweld to the wall.

Hazelwood is also available in 4' x 8' panels.

**Durable, Factory-Applied Finish**—Hazelwood Plankweld comes already finished. Once erected, there is nothing more to do. The factory-applied finish will retain all of its original rich lustre . . . with only occasional waxing. No paint, no stain, no redecorating will ever be needed.

**Nationally Advertised!**—Already new, Hazelwood Plankweld has been introduced to hundreds of families in your community through eye-catching full-page, full-color advertisements in the largest and best-read homemaker magazines.

Take advantage of all that Hazelwood Plankweld offers! See this truly wonderful new low-cost panel and other Weldwood<sup>®</sup> products at your Weldwood dealer or any of our 60 distributing units from coast to coast.



## WELDWOOD<sup>®</sup> Plywood

Manufactured and distributed by

**UNITED STATES PLYWOOD CORPORATION** New York 36, N. Y.

World's Largest Plywood Organization

and **U. S.-MENGEL PLYWOODS, INC., Louisville 1, Ky.**

Branches in Principal Cities • Distributing Units in Chief Trading Areas • Dealers Everywhere

# TRY IT FREE!

**New interior door catch**

**Installs in 2 minutes**

**No mortising, no boring**

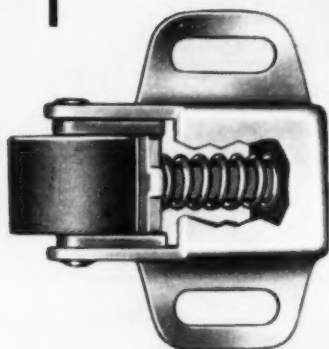
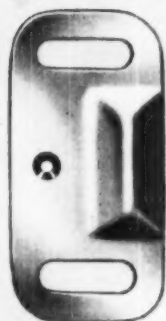

**E9745 Actual size  
only 50¢ RETAIL**



**For closet and interior doors,  
try this BIG BROTHER of Amerock's E9710  
cabinet-size Rubber Roller Spring Catch**

Send for free sample—find out for yourself how easily this door catch can be installed in two minutes, how smoothly and quietly it operates. Sturdy rubber roller and shock absorber coil spring action are guaranteed for ten years. Packed one dozen in carton, retail value \$6.00 dozen. Order by number from your favorite hardware supplier.

**E9745 "Perma-Brite" Finish  
E9845-3 Bright Brass Finish**

**—TRY ONE FREE! SEND COUPON TODAY —**



**AMERICAN CABINET HARDWARE CORP.  
DEPT. AB-2, ROCKFORD, ILLINOIS**

I'd like to see and try your No. E9745 Rubber Roller Door Catch.  
Please send one to:

NAME \_\_\_\_\_

ADDRESS \_\_\_\_\_

MY HARDWARE SUPPLIER IS \_\_\_\_\_

## On and Off the Record

(Continued from page 48)

**THE TELECAST** was a feature of the National Association of Manufacturers popular "Industry on Parade" program.

**TAX FACTS**, produced by the Chamber of Commerce of the United States, says that "Uncle Sam's tax take is 21 times what it was in 1939."

**PERSONAL INCOME**, says the study, has risen from \$73 billion to \$254 in the past 12 years. But personal taxes have jumped from \$1.2 to \$26.1. The figures are from the United States Department of Commerce.

**SELLING THE SIZE** and importance of the home building industry to the public and to government is the industry's biggest job for next year, said Hon. D. D. Watson, real estate commissioner of California, in a speech before the California Real Estate Association in San Francisco recently.

**THE FIVE GREAT LAKES**, arranged out of their geographic order, are Huron, Ontario, Michigan, Erie, Superior. In that order, the initial letters spell, "Homes" appropriately enough, since the lakes region embraces one of the nation's largest areas of home ownership. Contribution by Dick Hughes.

**SHINJUTAKU**, Japanese magazine published in Kitaku, Osaka, is packed with photographs of recently built houses that indicate Japanese architecture to be as modern as tomorrow afternoon. Low roof lines and large glass areas predominate.

**FOR THE FIRST TIME**, construction now leads agriculture in dollar volume, and thus becomes the nation's leading industry. It used to be in order of importance, food, shelter and raiment.

**THE ROW HOUSE** in Philadelphia is up for careful scrutiny. Long accepted in that city as the best buy for the money, the Philadelphia Housing Association is reported as seeking ways to preserve claimed advantages and at the same time avoid obvious disadvantages.



"For Cold Air Return Ducts  
**THAT MUST BE PERMANENT,**  
 I specify **CLAY PIPE**"

— says HENRY C. R. GRIEME, R. A. of Chagrin Falls, Ohio

Clay Pipe cold air return ducts are a quality feature of this home and many other custom-built basementless homes designed by Mr. Grieme.

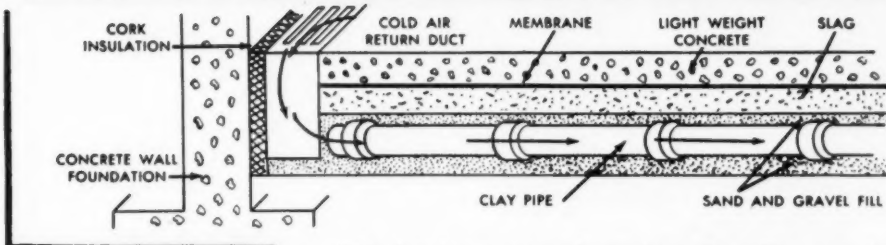

"Cold air return ducts buried under a concrete floor slab must be permanent," says Mr. Grieme. "That's why we specify Clay Pipe. The cost is the lowest we have been able to find for a permanent material."

There's no safe substitute for Vitrified Clay Pipe when you install heating or ventilating ducts under a concrete floor slab. Clay Pipe doesn't squash out of round or float when the concrete is poured. Clay Pipe can't corrode or disintegrate to block up the duct system. Every section is guaranteed for 50 years. Why take chances on substitute materials? Use Clay Pipe and be sure the job is right.

This heating system shows how Clay Pipe can be used effectively for cold air return ducts as well as for warm air. Ducts made of 8, 10 and 12-inch Clay Pipe, depending upon the size of the rooms, are covered with a layer of pea gravel or coarse slag, and a moisture membrane. Then the concrete floor slab is poured. Light-weight aggregate used in the slab makes it an insulator, insuring warm, dry floors.

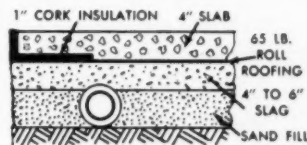

**NATIONAL CLAY PIPE MANUFACTURERS, INC.**

1520 18th St. N. W., Washington 6, D. C.  
 206 Connally Bldg., Atlanta 3, Ga.  
 100 N. LaSalle St., Rm. 2100, Chicago 2, Ill.  
 703 Ninth & Hill Bldg., Los Angeles 15, Calif.  
 311 High Long Bldg., 5 E. Long St., Columbus 15, Ohio

**ESSENTIAL • ECONOMICAL • EVERLASTING**



# technical guide

for builders and craftsmen

## how to install the attic fan

The attic fan takes advantage of nature's own cooling method—the fact that evening temperatures drop from 10 to 25 degrees. The attic fan pumps this cool outdoor air into all the open windows and through the house in quantities adequate to carry away the day's stored up heat, quickly bringing the temperature down within a degree or two of the outdoor temperature.

There are three important elements in a fan system. They are: (1) adequate inlet openings; (2) a large powerful fan; and (3) adequate discharge openings for exhaust air. The cooling system will lose efficiency if the capacity is cut on any of the three elements especially the discharge opening.

Be sure the discharge opening is

adequate and that it is in the right location. Several openings at different points of the compass insure efficiency in spite of head winds from any single direction. If possible, when a single opening is used, place it on the side of the house away from the prevailing wind.

The operating principle of the fan is to draw cool, fresh air into the home by exhausting accumulated hot air into the attic and thence outdoors. The fan should be centrally located so that the in-flow of air through windows on all sides of the living area will be even. This usually means locating the fan in a central hall, on which most of the living quarters open.

A practical and economical method of venting the attic fan is

through the eaves of a house. Where the rafters project downward past the sidewall, the vent area is limited by the narrow distance between the underside of the roof and the top of the sidewall. This distance multiplied by the width of the openings between joists and rafters, multiplied by the number of openings gives the total vent area. In houses where the overhang is closed off with a soffit, the soffit must be opened to provide vent area equal to that of the eave openings. The size of the openings depends on the manner in which the vents are to be protected. The usual protection is one-half inch wire mesh known as hardware cloth; since it adds 20 per cent resistance to the openings, the vent area must be increased.



### 1. MARK CEILING OPENING

Mark out the position of opening in ceiling, using dimensions of model to be installed. Check attic above for interference. Clear space for the fan should measure about 20 inches from top of ceiling joists.



### 2. DRIVE NAILS AT CORNERS

Drive nails up through ceiling at the four corners of opening marked off on ceiling. If a nail hits a joist, move opening slightly either way so nail will clear. Check attic space for any other interference.

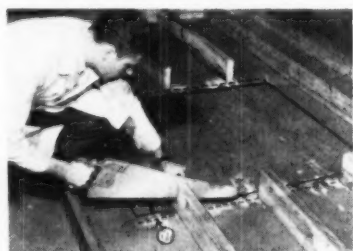

### 3. CUT OUT JOISTS

With nails in the ceiling as a guide, cut joists  $1\frac{3}{8}$  inches back from line of the opening. This is to provide room for new framing for the opening. Cut joists down to ceiling only. Do not cut through the ceiling.



### 4. CUT CEILING OPENING

Tack plaster or board to frame above. Using keyhole saw to start, cut lath or plaster board along line flush with inside of framing. After start, use hand saw. Do not break plaster.



### 5. FRAME TOP OF JOISTS

Provide a 1x4-inch frame on top of joists with flat side down and inside edges flush with joists and headers. Top framing is used to set the cone sections of fan. Nail to joists and headers.

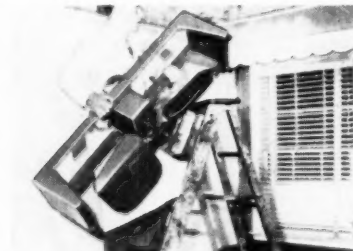

### 6. TAKE FAN BRIDGE UP

Take the fan bridge, with blades still folded, up into the attic. This is done at the discretion of the installer, with or without the motor attached. Set the bridge to one side until cone is placed.

# How to Stop CONDENSATION!

**Prevent Damage to Wood,  
Plaster, Paint, etc.**

As air grows colder, it can hold less vapor. Saturation increases until a dew point is reached, and condensation occurs. The surface of a material colder than the contacting air it faces, and continuously losing heat on the other side, will continuously extract heat from the air by direct conduction. The denser and bulkier the material, the more heat will it extract and store before attaining room temperature, if it ever does.

For example, if ordinary insulation is installed with air spaces on both surfaces, it continuously absorbs and emits heat rays at a rate of over 90%. If installed without air spaces, there is even more heat flow continuously by direct conduction through solids. Each square foot contains about 363,314 fibers, with surfaces aggregating approximately 46 sq. ft. for possible condensation formation.

With multiple sheets of accordion aluminum, the sheet nearest the warm room weighs only  $\frac{1}{4}$  oz. per sq. ft., absorbs and radiates only 3% heat; thus extracts and stores practically no heat from the air, only enough to attain and remain at room temperature. The additional reflective air spaces on the other side are insignificant heat conductors. The other sheets of aluminum and fiber block convection heat losses to the "cold" side.

No condensation forms on the aluminum surface next to the warm room, for a dew point is never reached. The sheet's other surface faces a space which is a *little* colder than the aluminum. Since warmth flows to cold in radiation and conduction, the aluminum will *give off a slight* amount of *heat* to the colder space, thereby slightly *increasing* its vapor retaining capacity; which prevents condensation.

The next reflective space has almost the same temperature as the next aluminum surface, with its slight mass,  $\frac{1}{5}$  oz. per sq. ft. The aluminum absorbs and emits little heat. Its other surface is slightly warmer than the air it faces; again there is no extraction of heat (the REVERSE), so no dew point.

With 4 or 6 reflective spaces, there can be no dew point anywhere on or in such aluminum insulation. Should rain leak in, it will be slowly expelled as vapor, since exterior walls, in comparison to aluminum have a far greater permeability than the required minimum 1 to 5 ratio. Because aluminum is impervious to vapor flow, condensation on under surfaces of roofs and inner surfaces of outer walls is minimized.

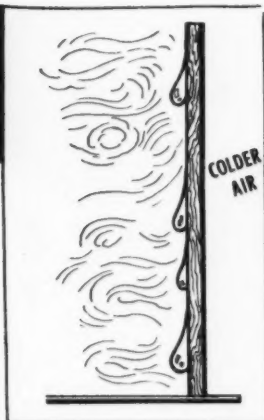

Condensation forms when temperature of contacting air is reduced below dew-point by a cold surface.

Condensation forms when the capacity of an air space at a given temperature is too small for the amount of vapor present.



## THERMAL FACTORS, TYPE 6 INFRA

Up-Heat C.089, R11.23 equals 4 $\frac{3}{8}$ " DRY Rockwool  
Wall-Heat C.073, R13.69 equals 5 $\frac{5}{8}$ " DRY Rockwool  
Down Heat C.044, R22.72 equals 9" DRY Rockwool

## INFRA INSULATION, INC.,

525 Broadway, New York, N. Y. — WORTH 4-2241

INFRA INSULATION, INC.  
525 Broadway, N.Y., N.Y. Dept. B-2  
Please send me FREE, U.S. Bur. of Standards booklet:  
"Moisture Condensation in Building Walls."

Name \_\_\_\_\_

Firm \_\_\_\_\_

Address \_\_\_\_\_

Send Prices of Infra Insulations  Send Sample

# technical guide

for builders and craftsmen

# how to install the attic fan

(Continued from page 52)



## 7. NAIL CONE IN PLACE

With the cone and bridge assembly in position, center the entire assembly over the opening and nail in place on top of the top frame. Holes are provided in the cone for nailing. Tighten the cone joining the strips.

### Types of eave discharge

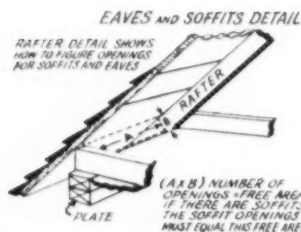
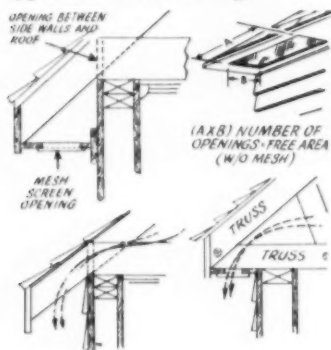

### How to figure louver outlets

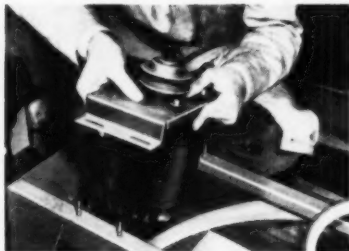
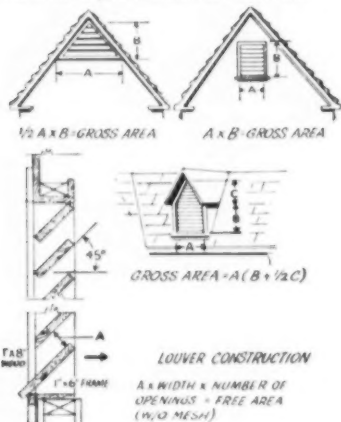

## 8. REMOUNT MOTOR

Set the motor back on the bridge so that the studs on the bridge slip through the slots in the motor mount. The motor base is slotted so that it may be moved to adjust belt tension. Attach with wing nuts and washers.

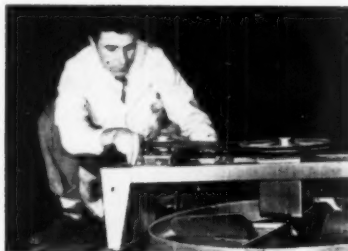

## 9. ADJUST BELT

Attach belt over two pulleys and adjust belt tension by sliding motor base on the bridge. Belt should be tight enough so there will be no slippage and yet loose enough so there may be an inch or two flexing at center.

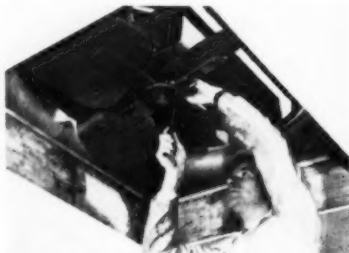

## 10. BOLT BLADES

After the blades have been spread by rotating the upper pair, insert the four bolts and nuts through the hub plate and tighten them securely. Insert the bolts from below so that the nuts are on the top of the hub.

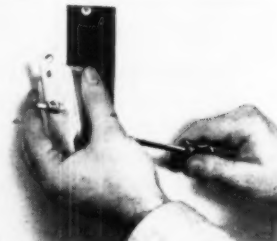

## 11. INSTALL WALL SWITCH

If timer is used, install it according to instructions accompanying the timer. Otherwise install a standard light switch. Wire for 115 volt, 60 cycle, single phase AC current. All switches wired in series.



## 12. MOUNT SHUTTERS

Fit shutters into position in the ceiling opening and nail. Attach shutter trim. Then demonstrate the fan to the homeowner so that he fully understands its operation.

Photographs, drawings and data courtesy Viking Fan Conditioning Corp.

## Minimum Outlet Areas for Discharge Opening

As recommended by Propeller Fan Manufacturers' Association and U. S. Department of Commerce Commercial Standard

### ALL OUTLET OPENINGS GIVEN IN SQUARE INCHES

Type of Opening	SIZE OF FAN					
	22"	24"	30"	36"	42"	
1 {	Free Opening	407	525	920	1310	1710
	W/1/2" Wire Mesh	508	655	1150	1640	2130
2 {	Wood Louvers	810	1050	1830	2620	3400
	W/1/2" Wire Mesh	1010	1310	2290	3270	4250
3 {	Metal Louvers	648	840	1470	2100	2720
	W/1/2" Wire Mesh	810	1050	1835	2620	3400



Mr. William A. Zeh, builder of this house at Los Angeles, Cal., says, "No builder nowadays would think of installing anything but automatic heat and electric refrigerators in his new houses. And just as people take those things for granted, they're looking for automatic electric cooking equipment."



"'Modern' is the theme of our development," says Mr. Noble S. Clay, builder of this house at Shaler Township in Pennsylvania—"and we find that most home buyers go for contemporary design. The *Electric Range* is a definite part of it. It's *really* modern cooking equipment. *Everybody* wants the electric convenience features."

**EAST OR WEST—**



these houses have one thing in common

*they have electric ranges!*



This is a kitchen of a Shafer Township house. Builder Clay practiced electrical engineering for 16 years before entering the building field. His background helped him to choose what home buyers want, so the range—of course, it's **ELECTRIC!**

Home buyers may differ on the size of house they want, or on its construction features. But from one end of the country to the other they want *Electric Ranges* in the kitchen. They've learned that cooking with an *Electric Range* is both economical and easy, and assures a clean, cool kitchen. No matter what the size or price bracket of *your* houses, one item of equipment that will really help you sell them is the *Electric Range!*

More builders every day

are installing

**ELECTRIC  
RANGES**



**ELECTRIC RANGE SECTION**

**National Electrical Manufacturers Association**  
155 East 44th Street, New York 17, N. Y.

ADMIRAL • COOLERATOR • CROSLY • DEEPFREEZE • FRIGIDAIRE  
GENERAL ELECTRIC • GIBSON • HOTPOINT • KELVINATOR • MONARCH  
NORGE • PHILCO • WESTINGHOUSE

**Top Profit Item**

**Coffman "Standardized" ORNAMENTAL IRON**



**Easy to Handle  
Easy to Install**

**"BIG PROFIT,"** says N. J. Dealer

"I used to be afraid to handle ornamental iron, so I sent my business to local iron shops. A year ago, I investigated Coffman 'Standardized' ornamental iron. When I discovered how easy it is to stock, the profit I had been missing, I started to include it on the material estimate sheets for our builders and contractors. We all learned that Coffman standardized ornamental iron is easier to install than a door or a window. Now all of us are making profit we previously overlooked! Now all of us are Coffman boosters!"

—R.H.J., Newark, N. J.

If you are not stocking Coffman porch posts or rails, you are missing easy profit! Investigate today! Remember there is a stock size Coffman post or rail to fit any porch or entrance.

**FREE:** Write for descriptive catalogue on all Coffman products and complete information on our amazing free air mail blueprint service.

America's Largest Manufacturer  
of Ornamental Iron

*The R. S. Coffman Co. Inc.*

© R. S. COFFMAN CO.

Dept. AB-2 ORLANDO, FLORIDA

## how would you do it?

*ideas for the man on the job*

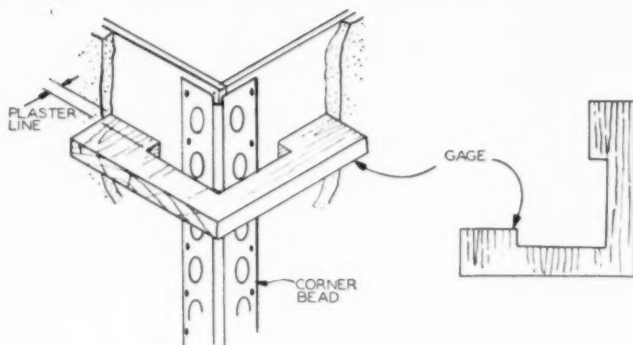

### keep corner beads even

This simple gauge for use in placing corner metal bead for a plastered wall can be made of  $\frac{3}{4}$ -inch plywood. The opening is cut for the required depth of the plaster. In using, keep the corner of the bead in the corner of the gauge. There will be no chance of having an uneven thickness of plaster at the corner.—George A. Heffelfinger, Lehighton, Pa.

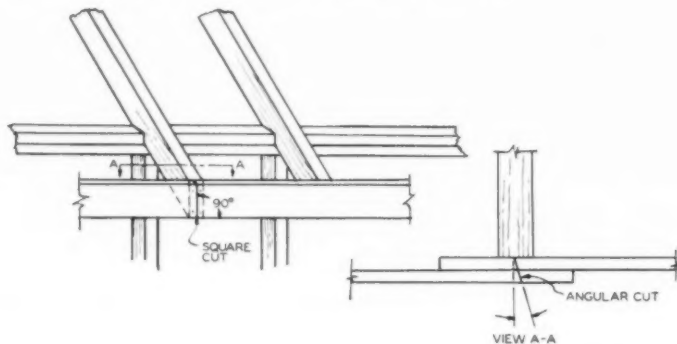

### perfect fascia joints

Lap ends of the fascia on the rafter or lookout and cut on a square mark made with a knife or nail. Saw at a slight angle. The outside board will then slip tightly in place.—David Reck, Long Beach, Calif.

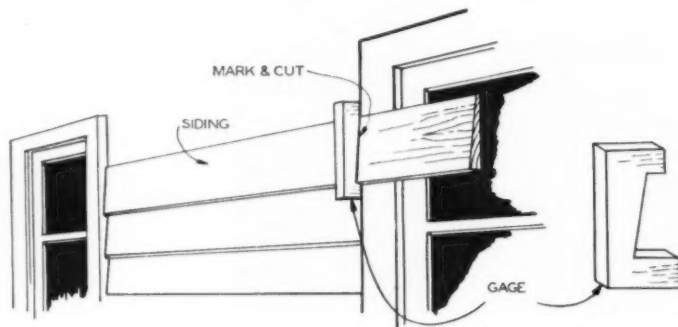

### bevel siding marker

A notched gauge made from a piece of  $\frac{3}{4}$ -inch plywood will permit correct cuts for beveled siding around outside trim of doors and windows. The gauge will have to fit the type of siding that you are using.—Walter E. Croll, Slipping Rock, Pa.

THE NEW **LOW COST**  
**REMINGTON**  
*Office-riter*



## The Complete.... Compact Typewriter For Professional and Small Business Use

Here it is—a typewriter that's just right for the professional or small business office. And its low price is just right, too! The new Remington Office-riter has every needed, practical typing feature for general correspondence, invoicing, carbon copies and stencil cutting. Accurate columnar typing is easy with the exclusive Miracle Tab that sets and clears tabulator stops from the keyboard.

The fast, responsive action and crystal clear printwork that are the hallmarks of a fine office typewriter are yours with the Office-riter. So, if you have been thinking of getting a new typewriter for your office—and if you want to make a *substantial saving*—call your local office equipment dealer and ask to see the Office-riter today!

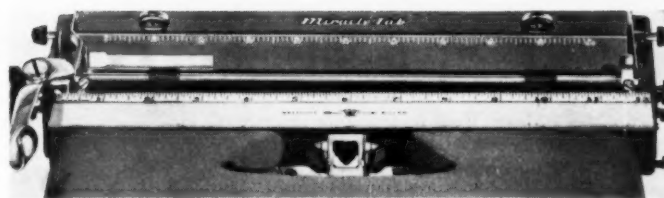

*Standard 11-inch carriage with a full 10 3/10-inch writing line*

—The Office-riter's 11-inch paper capacity is large enough for all general office typing, and the writing line is the longest of any 11-inch carriage machine now manufactured. The Office-riter easily takes paper, carbon packs

or forms up to 11 inches wide. *Plus all these other office typewriter features:*

- Exclusive Miracle Tab
- New direct-set visible margins
- Standard keyboard with 42 keys, 84 characters
- Pat. simplified ribbon changer
- Super-strength frame construction

**THE ONLY COMPLETE COMPACT LOW COST OFFICE TYPEWRITER • A PRODUCT OF *Remington Rand***

FEBRUARY 1953

57

# PAINE REZO DOORS

T. M. REGISTERED

*coreway*  
the doorway to trouble-free service

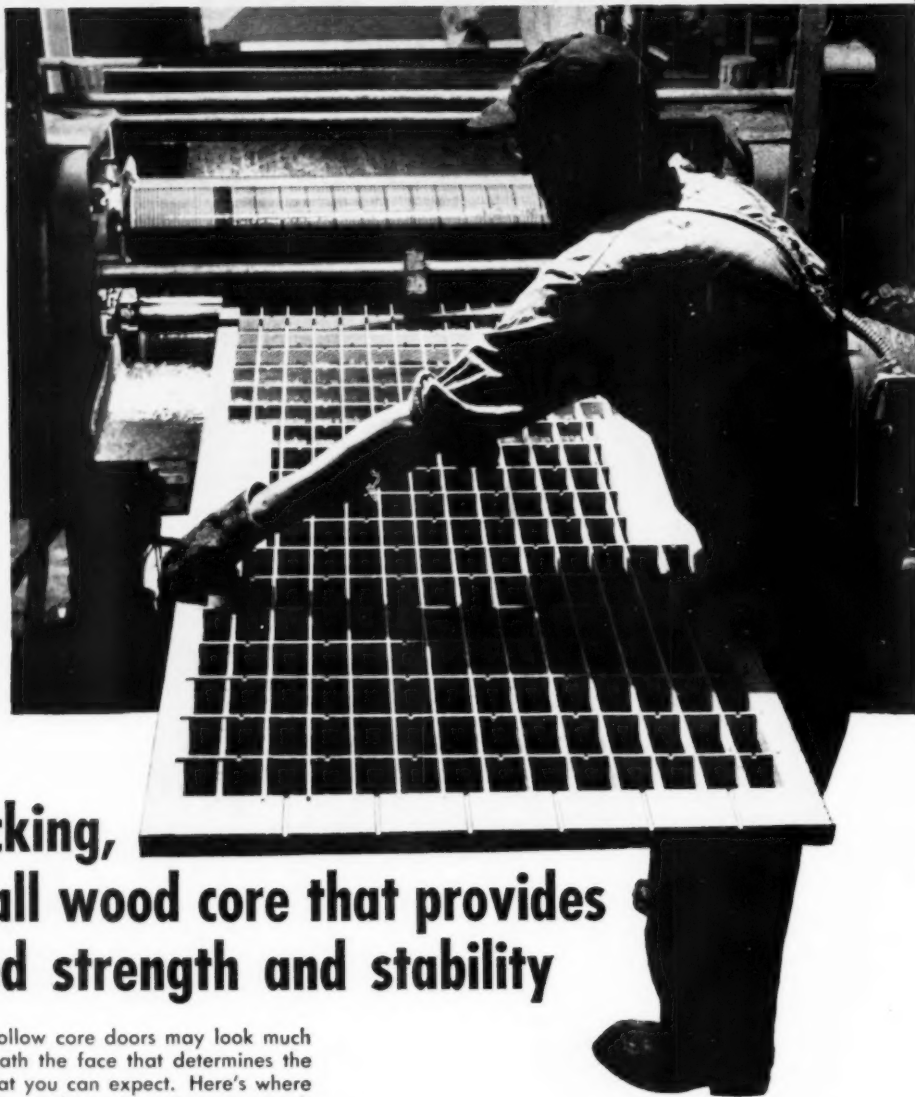

Here's  
the interlocking,  
ventilated all wood core that provides  
unduplicated strength and stability

On the surface, flush hollow core doors may look much alike, but it's what's beneath the face that determines the service and satisfaction that you can expect. Here's where the superiority of Paine Rezo doors is most pronounced; for nowhere else will you find equal dimensional stability, nor such lightness in weight combined with great structural strength.

For these reasons architects and contractors everywhere have installed more than five million Paine Rezo doors in

buildings of every type. No other hollow core door has been so widely endorsed, so thoroughly time-proved. Remember, when you decide on Paine Rezo doors, you specify a door that not only looks good, but is good all the way through.

Write for an illustrated data bulletin.

Manufactured by the

**PAINE LUMBER CO., LTD.** *Oshkosh  
Wisconsin*

ESTABLISHED 1853

1953 is the  
**PAINE**  
Centennial Year



AMERICAN BUILDER





Lightweight, extra-strong coils of Bundyweld Tubing can be mounted easily onto ceilings by just two men. Coils lie flat and straight, are quickly plastered over with little chance of damage from rough handling or accidental hammer blows.

## Want to put your houses ahead of all others? Do it with Bundyweld Ceiling Radiant Heating



SIZES UP TO 1/4" O.D.

### Key to Low Cost

Bundyweld is the only tubing double-walled from a single strip, copper-brazed through 360° of wall contact. It's leakproof, thinner walled, yet stronger. It transmits heat quickly, has high bursting strength. It saves on material costs and installation time.

Standard 20' lengths of Bundyweld are easily formed into coils in shop or on job site. Expanded ends (furnished when specified) are quickly soldered into leakproof union. Joined, lightweight coils are easily mounted onto ceiling, quickly plastered over.

Here's a distinctive, exciting new sales feature to put you out ahead of competition — to make your houses stand out as streamlined kitchens and bathrooms once did.

With Bundyweld Ceiling Radiant Heating, you can put your houses years ahead of others. For here's heating so comfortable, convenient, and economical it's making other types obsolete.

It's today's big heating news — already drawing heavy interest and growing every day. Thousands of people now living with Bundyweld Ceiling Radiant Heating are spreading the good news to friends. Too,

our full-page ads in *Better Homes & Gardens*, *House Beautiful*, and *American Home* are going to millions of prospective home owners. They, in turn, are bombarding us with coupons, requesting literature.

More important to you, they're asking for the names of builders and architects handling Bundyweld Ceiling Radiant Heating. Why not send for free information today?

**Radiant Heating Division**  
**BUNDY TUBING COMPANY**  
 Detroit 14, Michigan

SEND FOR  
**FREE** →  
**LITERATURE!**



Bundyweld  
 Ceiling Radiant Heating

Radiant Heating Division, Dept. AB-253  
 Bundy Tubing Company, Detroit 14, Michigan

- Send free 20-page nontechnical brochure explaining Bundyweld Ceiling Radiant Heating.
- Send Bundy technical radiant heating pamphlet.

Name \_\_\_\_\_ Title \_\_\_\_\_

Company \_\_\_\_\_

Address \_\_\_\_\_

City \_\_\_\_\_ Zone \_\_\_\_\_ State \_\_\_\_\_

# Delco Water Systems are Really Built—

to **SELL EASIER**  
and to **STAY SOLD!**



When you sell a Delco Water System you're dollars and dollars ahead. Spend less time selling because Delco features sell themselves. Build a reputation for delivering a "baker's dozen," because Delco pumps are designed to deliver every gallon promised or more, now and years from now.

**General Motors Engineered**

Years ahead engineering, an assurance of continuous top performance

Delco Convertible Jet Pump.  $\frac{1}{2}$  to 1 hp. Up to 1,620 gph at 20 feet. Easily converts from shallow to deep well.

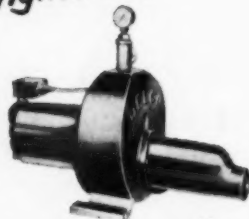

**The complete line for every domestic need**

Every type, every capacity, to meet every problem

Delco Deep Well Reciprocating Pump. 100 to 410 gph for lifts up to 325 feet.  $\frac{1}{4}$ ,  $\frac{1}{2}$ ,  $\frac{3}{4}$  and 1 hp models.

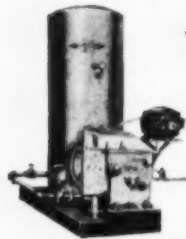

**Competitive Pricing**

Quality at low, low prices—assurance you'll be hard to underbid

Delco Model C12 Shallow Well Pump with 225 gph capacity. For small farms, suburban homes, or as booster for present system.

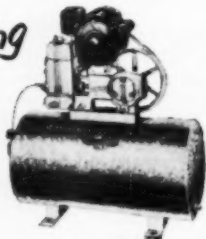

**Choice new Franchises Available Now!**

**WRITE OR WIRE TODAY!**

For information about DELCO and franchise opportunities contact Dept. ABW, Delco Appliance Division, General Motors Corp., Rochester 1, N. Y.

**GENERAL MOTORS  
DELCO WATER SYSTEMS**

For a good deal **DEAL WITH DELCO**

Manufacturers of famous Delco-Heat oil- and gas-fired burners, Conditionairs, boilers, and water heaters

## how would you do it? ideas for the man on the job

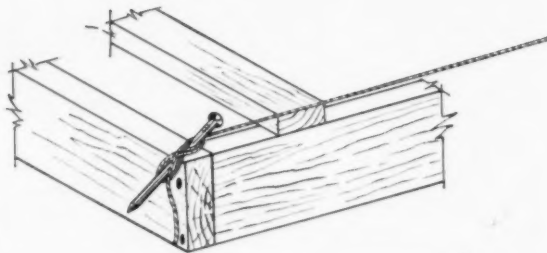
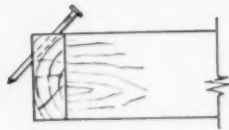

### an easy way to tie a line

An easy and efficient way to tie a line is to drive a nail into the edge of a stake or stick of lumber at an angle so that the nail comes out the side. Then stretch the line and wind it around both ends of the nail, using the same principal found in rope fasteners on sail boats.—Dick Sogge, Sioux Falls, So. Dak.

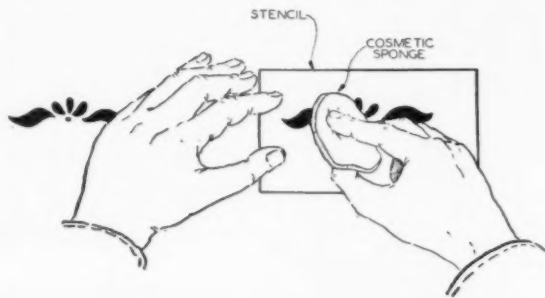

### pointers on stenciling

Use a woman's cosmetic sponge in connection with the stencil pattern. The sponge is easier to control and the pattern will last longer because it eliminates the pounding of the brush across the thin strap sections of the pattern.—Fred B. Chott, Cicero, Ill.



PLASTER CHECKING



DRILL HOLE SIZE OF SCREW BODY PREVENTS CHECKING

### screwing into plaster

When putting a screw into a plastered wall, a drilled hole the size of the screw body will eliminate the checking of the plaster when the screw is driven into position.—Myron G. Miller, So. Williamsport, Pa.

*Schlage creates a jewel  
for modern homes*

**SCHLAGE**

*Capri* design

Like the sparkle of a  
diamond, refracted lights  
from these jewel-like  
glass knobs add life to any room  
from colonial to contemporary.

See the new Schlage Capri design  
at your Schlage dealer's.

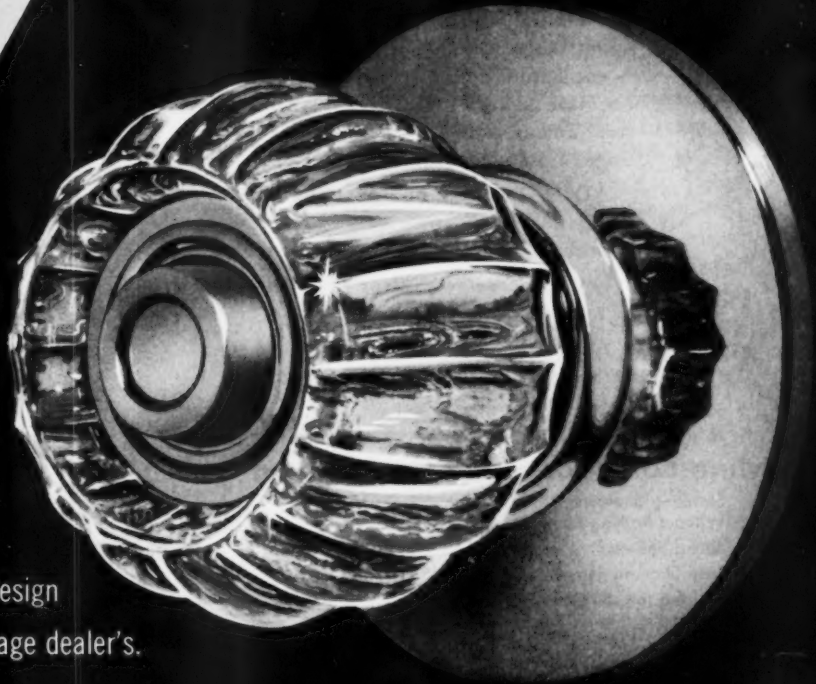

**SCHLAGE®**

**SCHLAGE LOCK COMPANY**

2201 Bayshore Boulevard, San Francisco  
Schlage Lock Company of Canada, Ltd., Vancouver, B. C.

## SWING-DOWN

with  
**ADJUSTO**  
COMBINATION  
TUB AND SHOWER  
FIXTURE

IT'S A SHOWER!



IT'S A  
TUB FILLER!





## for modern bathrooms



ADJUSTO does the same thing for the modern bath that the swinging spout faucet does for the kitchen sink—one fixture mixes hot and cold water for full stream or fine spray. Saves time and money in installation! Adds finger-tip convenience!

ADJUSTO can be installed after tiling and decorating is completed—eliminating danger of theft or damage.

Only one set of valves—no danger of back siphonage.

ADJUSTO gives a modern look to bathrooms—definitely helps sell houses.

### SWING-DOWN FOR:

Standing Showers  
Without Bathing Cap  
Sitting Showers  
Easy Shampooing  
... and the children  
love it

See  
your Plumbing  
Contractor  
Plumbers: See  
your Jobber  
or write  
direct

Manufacturers of Famous  
MILWAUKEE Fixtures and Brass Goods

**MILWAUKEE FLUSH VALVE CO.**

323 E. Reservoir Avenue

Milwaukee 12, Wisconsin

## how would you do it? *ideas for the man on the job*

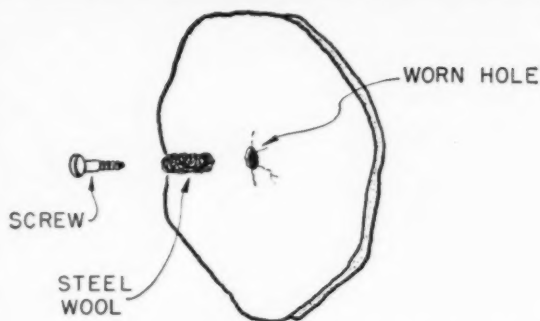

### reducing opening by packing

When a screw hole is worn too large for the original screw to be tightly held in place, take a small wad of steel wool and pack it in the hole. Use the original screw and it will fit as tight as before. This will also work for a screw hole in plaster.—John Menkveld, Grand Rapids, Mich.

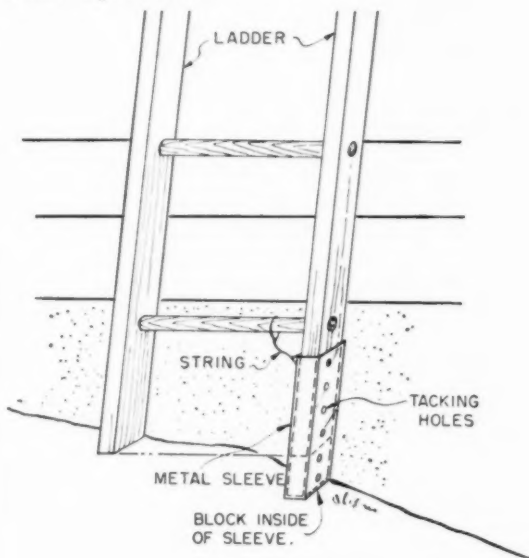

### adjust ladder to uneven ground

With this easily made attachment, ladders can be quickly leveled for uneven ground. Make a metal sleeve to fit snugly over the bottom strut of ladder. Sides of sleeve are perforated to receive a large nail or metal pin. This metal sleeve can be cut from a downspout or a square tin can with top and bottom cut out.

A wood member, the same dimension as the bottom strut of the ladder, is cut into a series of graduated lengths from 1½ to 6 inches. The block of proper size to meet the slope of the ground is placed under the strut and the metal sleeve is slipped over the block. This is held in place by a nail or pin placed in a perforated hole. For minor adjustments, the metal sleeve can be nailed to ladder strut without the block insert.—Werner Kraatz, Santa Cruz, Calif.

# HOW

## KAUSTINE'S "JERSEY 75" DELIVERS MORE HEAT PER FUEL DOLLAR

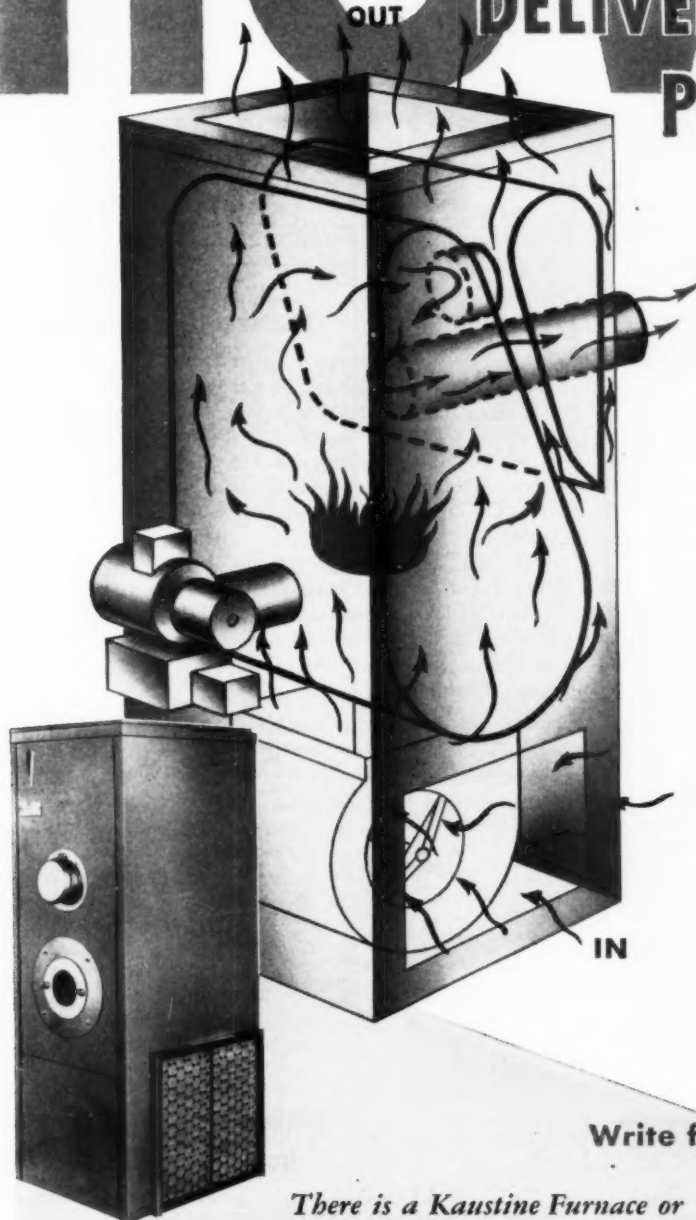

**T**HE unique air flow of the Kaustine Heat Exchanger System shown in the phantom illustration is the reason for the "Jersey 75's" ability to produce maximum heat at lowest cost

The controlled course of the air around the all steel welded tear drop Heat Exchanger and Economizer Unit, which utilizes the heat from stack gasses, enables the "Jersey 75" to develop a maximum of quick, even heat.

This is not the only feature that makes this Oil Fired Automatic Forced Warm Air Furnace such an ideal unit for small homes. It requires a minimum of installation time and takes only 3½ square feet of space. It is shipped from the factory completely assembled and ready for installation. A separate compartment is available to encase the burner.

The "Jersey 75" is also available as a "Counter-Flow" model for installation in slab or crawl space type homes. Weight 324 lbs.

Write for full information to Dept. AB-2

*There is a Kaustine Furnace or  
Winter Air Conditioner for every type of home.*



# Kaustine

COMPANY, INC.  
PERRY, NEW YORK

# FOR SAVINGS

Modulated Warm Air Furnaces from 65,000 to 270,000 B. T. U.  
Septic Tanks ... Pressure Vessels ... Oil and Gasoline Storage  
Tanks ... Truck Tanks ... Custom Built Fabricated Equipment

# DOUGLAS FIR

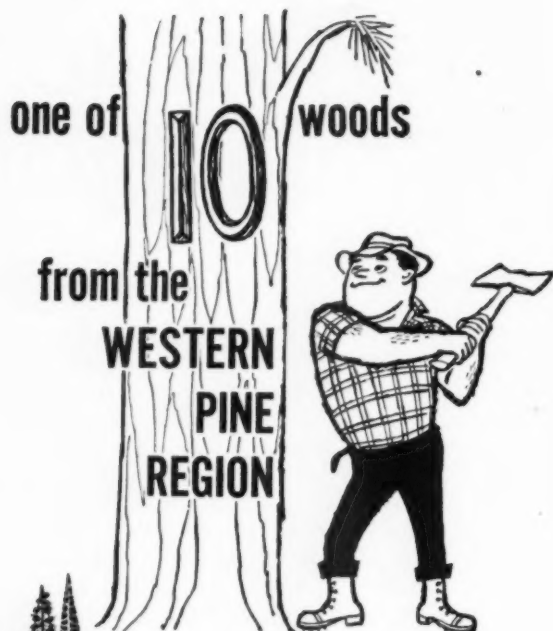

This strong, tough, straight-grained softwood is a first choice for any lumber use where unusual strength, stiffness, load-bearing capacity and nail-holding power are important. Popular, too, for paneling and interior trim and cabinetwork.

One of ten fine softwoods from member mills of the Western Pine Association. All are manufactured, seasoned and graded to exacting Association standards. Lumber dealers, builders, architects and wood users have found them dependable and best for many construction uses.

#### THESE ARE THE WESTERN PINES

IDAHO WHITE PINE  
PONDEROSA PINE • SUGAR PINE

#### THESE ARE THE ASSOCIATED WOODS

LARCH • DOUGLAS FIR  
WHITE FIR • ENGELMANN SPRUCE  
INCENSE CEDAR • RED CEDAR  
LODGEPOLE PINE



Write for free illustrated book about Douglas Fir.  
Address:  
Western Pine Association,  
Yeon Building,  
Portland 4, Oregon.

## how would you do it? ideas for the man on the job

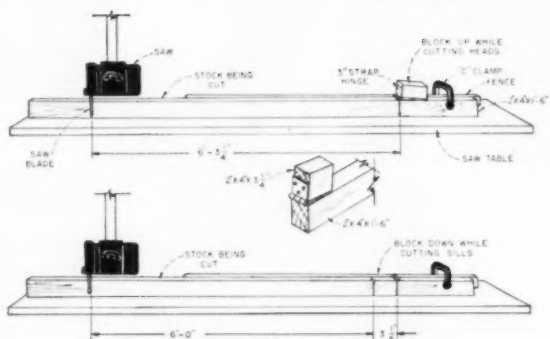

### framing for metal windows

An easy way to frame for metal windows is to cut the heads the same width as the windows, and the sills  $3\frac{1}{4}$  inches shorter. For instance a 6 foot by 5 foot 3 inch window requires a header cut 6 feet  $3\frac{1}{4}$  inches and a sill 6 feet even. The cripples, one on each side, are cut 6 feet  $3\frac{3}{8}$  inches and extend from bottom of plate to header. This makes all windows 6 feet 10 inches above subfloor.

Take a 3-inch strap hinge and hinge a  $3\frac{1}{4}$ -inch block to a 2x4 as shown. Clamp this stop to the saw table and cut all 6 foot window heads for the job. Fold block down and cut all sills. Nail sills to heads and mark out stud marks on both head and sill at once.—J. G. Caldwell, San Mateo, Calif.

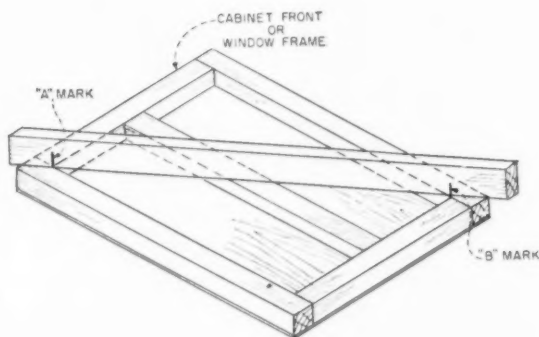

### method of squaring cabinet fronts or window frames

To square the cabinet front or window frame take a 1x2 and mark A and B. Using the same markings, measure the opposite diagonal. If the frame is square, both diagonals will be the same size. If they are not, push the frame to the correct size and nail braces to it.—M. J. Hiland, Lansing, Mich.

**CASH FOR JOB SHORTCUTS**—American Builder will pay five dollars (\$5) in cash for each shortcut or job pointer accepted for publication. Send all material to the Architectural Editor, American Builder, 79 W. Monroe St., Chicago 3, Ill.

Products Designed to Cut the Cost of Building... FROM CELLAR TO ROOF!

Every product designed and built to meet 3 basic yardsticks

ARCHITECT, BUILDER, INTERIOR DESIGNER and home owner agree that three yardsticks are paramount in the selection of building materials and products... (1) the installed cost; (2) the basic value added to the house—for sale or mortgage purposes; (3) the increased beauty of the house. Each product or material on this page was designed and engineered to be measured and appraised by these three standards.

43 years of service to architects and builders are typified in these products. In one 12-year period we spent more than \$500,000 on pure research—covering many problems the average builder and architect have never had the time to explore.

Through our representatives, you draw upon tested methods for exterior and interior design, for scheduling operations, for setting up site or factory fabrication, for the coordination of operations. You profit further by buying many products and materials from one dependable source. The coupon below will bring details and specification material on all these products.



● Nova-Vita Horizontal-Sliding Windows are revolutionary — offer new advantages for every room.

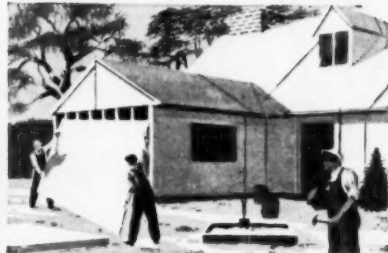

● Homasote Big Sheets (up to 8' x 14') save time and labor in the sheathing of roofs and exterior walls.



● Nova Wall and Furniture Units — of many types — give more usable space in less total space.

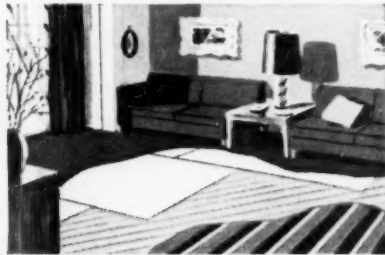

● Homasote Underlayment is nailed directly to the rough flooring. No felt or pad is needed.



● Nova Roller Doors — for closets and passageways — are installed in less than 30 minutes.



● Striated Homasote offers infinite variety of design for attractive interior finishes.



● Sheathe and shingle in one operation with Nova Side-walls and Roofs. Top quality; maximum economy.



● Wherever you want to keep water in or out, time-tested Novaproofing methods afford lasting protection.

**HOMASOTE COMPANY**

**NOVA SALES**

Co. Trenton 3, N. J.



HOMASOTE COMPANY, Trenton 3, N. J., Department 50C

- Send detailed, illustrated literature on all Homasote-Nova products
- Have representative contact us

Name.....

Address.....

City & Zone..... State.....

My lumber dealer is.....

By boat...  
by rail...

FROM ALL PARTS

OF THE WORLD...

Come Rare and Rugged Woods  
TO PRODUCE



FAYETTEVILLE, NORTH CAROLINA

# Thomason FLUSH DOORS

**THERE ARE THOMASON HOLLOW  
AND SOLID CORE FLUSH DOORS  
FOR**

*Residences, Apartments, Office Buildings,  
Hotels, Schools, Hospitals, Institutions and  
Public Buildings*

**AVAILABLE IN THESE  
FACE VENEERS**

- ✓ PHILIPPINE MAHOGANY
- ✓ GENUINE HONDURAS MAHOGANY
- ✓ WALNUT
- ✓ OAK
- ✓ BIRCH
- ✓ KNOTTY PINE
- ✓ GUM
- ✓ OR IN ANY FACE VENEER DESIRED.

**PLEASE NOTE**

THOMASON plastic-faced flush doors are now available in all domestic and foreign wood grain plastics, as well as in decorative plastics.

It takes the best to make the best. That's why THOMASON Flush Doors are produced from the finest quality of foreign and domestic woods. By boat . . . by rail . . . from Africa, the Philippine Islands, Panama, Honduras, Canada, and from America's own Northern and Appalachian forests come the rare and rugged woods that go into the production of THOMASON Flush Doors.

**SOLD ONLY THROUGH DISTRIBUTORS**

**WRITE TODAY FOR NAME OF  
YOUR NEAREST DISTRIBUTOR**

**THOMASON  
PLYWOOD CORPORATION**

FAYETTEVILLE • NORTH CAROLINA

AMERICAN BUILDER



Choose the floor that's **NATURALLY** beautiful!

# BRUCE RANCH PLANK

*Hardwood Floor*

**Everybody likes this pegged oak floor**

Alternate widths, walnut pegs and beveled edges give a Bruce Ranch Plank Floor a luxury look far beyond its moderate cost.

This popular oak floor provides the beautiful decorative effect of an expensive random-width plank floor . . . the same informal charm and enduring style . . . for about one-half the cost. That's because Ranch Plank is pegged and finished at the factory and is installed just like prefinished strip flooring.

Architects and interior designers alike praise Bruce Ranch Plank's versatile appeal and its beautiful "Decorator" Finish that harmonizes with all color schemes. Write us for booklet with full color photos. See our catalog in Sweet's File.



**E. L. BRUCE CO., MEMPHIS 1, TENN.**

Hedrich-Blessing Photo

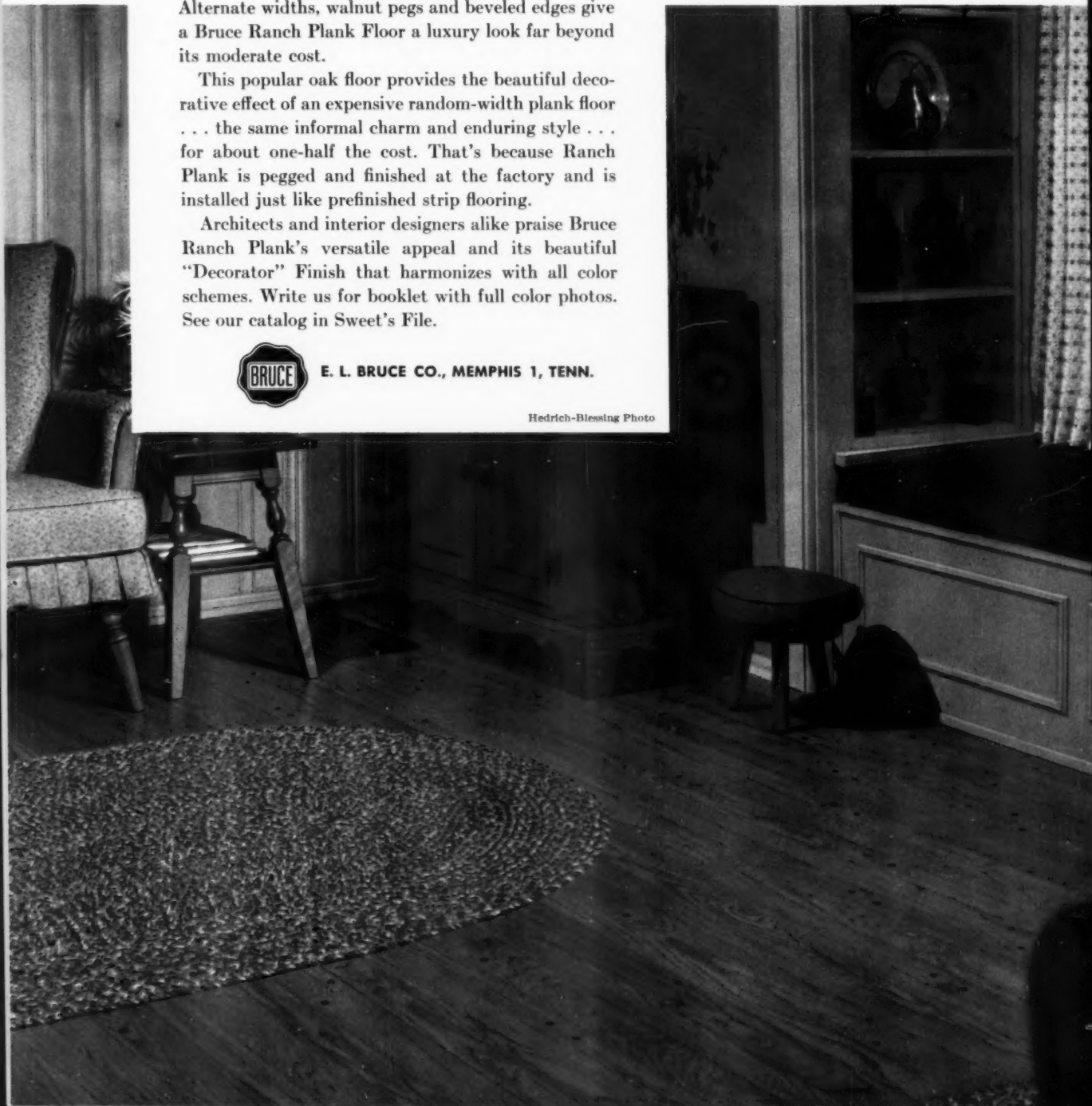



Here's how Milcor Casing Bead creates interior beauty: Note how trim, narrow face is all that is exposed — for smart simplicity, easy cleaning. Construction-wise, note how expanded wing provides perfect plaster ground, and how casing acts as a screed to separate plaster from other material.

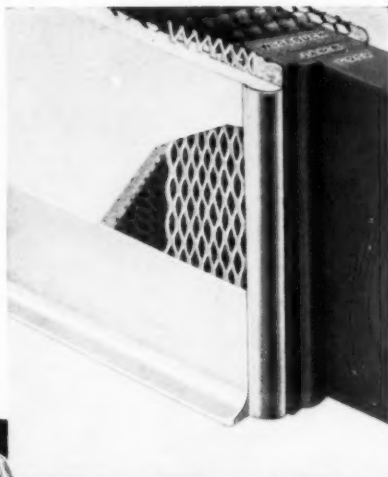

Create  
Smart,  
Appealing Interiors

with **MILCOR**<sup>\*</sup>  
Window and Door Casing Bead

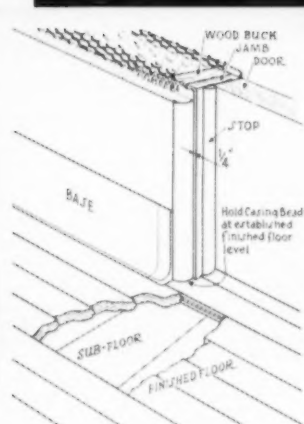

**Use of Milcor Casing Bead around door openings**—Finished door frames (the same width as the partition or wall) are to be erected before lathing and plastering. Casing should be held back from the edge of the jamb a minimum of  $\frac{1}{4}$ " to provide sufficient space for door hinges. Since the finished floor is laid after plastering, casing bead on sides of the opening should be held at established finished floor level.

MILCOR Casing Bead, when installed, creates the clean, modern beauty and spacious simplicity that today's buyer demands. This is because the smooth attractive face of the steel bead blends so perfectly with surrounding walls, permitting flush door and window openings. Milcor Casing Bead is made of steel for a lifetime of beauty and extra plaster protection. It is easily installed and finished.

Either solid or expansion wing-

types can be obtained to meet all ordinary requirements, and to meet many special and difficult needs as well. A variety of styles is available. All are straight and uniform to permit perfectly fitted mitres and neat, flush joints.

Since Milcor Casing Bead and other Milcor Metal Lath products are in great demand, it pays to let your supplier know your needs as early as possible for satisfactory delivery. Write for literature, today.

<sup>®</sup>Reg. U. S. Pat. Off.

**INLAND STEEL PRODUCTS COMPANY**

Formerly Milcor Steel Company

4025 WEST BURNHAM STREET • MILWAUKEE 1, WISCONSIN  
BALTIMORE 24, MD.—5300 Pulaski Highway • BUFFALO 11, N. Y.—64 Rapin St. • CHICAGO 9, ILL.—4301 S. Western Avenue Blvd. • CINCINNATI 25, OHIO—3240 Spring Grove Ave. • CLEVELAND 14, OHIO—1541 E. 38th St. • DETROIT 2, MICH.—490 Amsterdam Ave. • KANSAS CITY 8, MO.—South West Blvd. and State Line • LOS ANGELES 58, CALIF.—4807 E. 49th St. • NEW YORK 17, N. Y.—230 Park Ave. • ST. LOUIS 10, MO.—4215 Clayton Ave.

P-383A

# Owners' pride . . . Operators' delight the **NEW OLIVER "OC-18"**



**OWNERS** can't say enough good things about the new Oliver "OC-18." They keep telling us how it does more work . . . how that full 135\* drawbar horsepower gives it plenty of power for the really tough jobs . . . about its low operating and maintenance costs . . . and how the operators and mechanics like it.

**OPERATORS** are even more enthusiastic. It's the first big tractor they've found that is designed to make life easier for them. They tell us that toward the end of a long day on the "OC-18," they are much less fatigued, much more fit to continue giving top performance. The illustration shows clearly the 9 important "easy operating" features of the "OC-18." No other tractor boasts all these. They make the "OC-18" "the operators' dream come true."

Ask your Oliver Industrial Distributor to arrange a demonstration. Or if you prefer, write to The Oliver Corporation, 400 W. Madison St., Chicago, Illinois.

\*OFFICIAL NEBRASKA TEST NO. 489

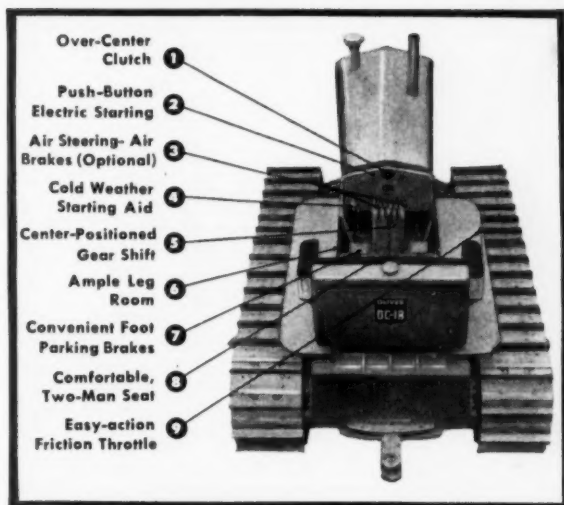

## THE OLIVER CORPORATION

400 West Madison Street, Chicago 6, Ill.



A complete line of industrial wheel and crawler tractors

# More insulation



COMPARE THESE  
BIG ADVANTAGES



- 1. More Insulation**—yet cost less than some ordinary blankets. Won't settle or sag, leaving thin spots that leak heat. A single length gives uniform, uninterrupted insulation from ceiling to floor.
- 2. Cleaner, Easier to Handle**—thanks to the neat, durable paper casing which also assures more secure installation.
- 3. Faster Application**—less cutting and fitting means less waste and thriftier, speedier application. Flanged for quick, easy stapling or nailing.
- 4. Unbroken Vapor Barrier**—continuous from ceiling to floor, provides more effective protection from condensation within wall, ceiling and roof structures.
- 5. Permanent**—rock wool cannot rot, is fireproof, insulates efficiently for the life of the building.

# *value for less money*

WITH THE POPULAR

# CELOTEX

REG. U. S. PAT. OFF.

## 8-FOOT, SEMI-THICK ROCK WOOL BLANKETS

You can make your homes *more* comfortable, *more* salable at *less* cost . . . with the new, improved 8-ft. Semi-Thick Celotex Rock Wool Blankets!

Compare insulating efficiency. Compare ease and speed of installation. Compare cost with the insulation you are now using. You'll see then

why more and more builders all over the country are changing to Celotex 8-ft. Semi-Thick Rock Wool Blankets!

Celotex Rock Wool Blankets come in 4 and 2-ft. lengths, as well as the new 8-ft. length. Semi-thick or full-thick. See samples at your Celotex Dealer's today!



★ ★ ★

### **Celotex Hand-Pouring Rock Wool**

Where *rock-bottom* cost is a "must," insulate attics with Celotex Hand-Pouring Rock Wool! One 40-lb. bag covers 25 sq. ft. to a depth of 3". Specially processed into pellets just the right size for *easy* pouring directly from the bag into open attic joist spaces and other areas.



Remember, over a quarter century of consistently effective advertising in *The Saturday Evening Post* and other popular national magazines, has created *nation-wide acceptance* for Celotex Products. That's another important reason why homes insulated with Celotex Rock Wool Products are *easier to sell!*

*To make your home easier to sell...*

BUILD WITH GENUINE

# CELOTEX

REG. U. S. PAT. OFF.

**BUILDING PRODUCTS**

THE CELOTEX CORPORATION • 120 S. LA SALLE ST.  
CHICAGO 3, ILLINOIS

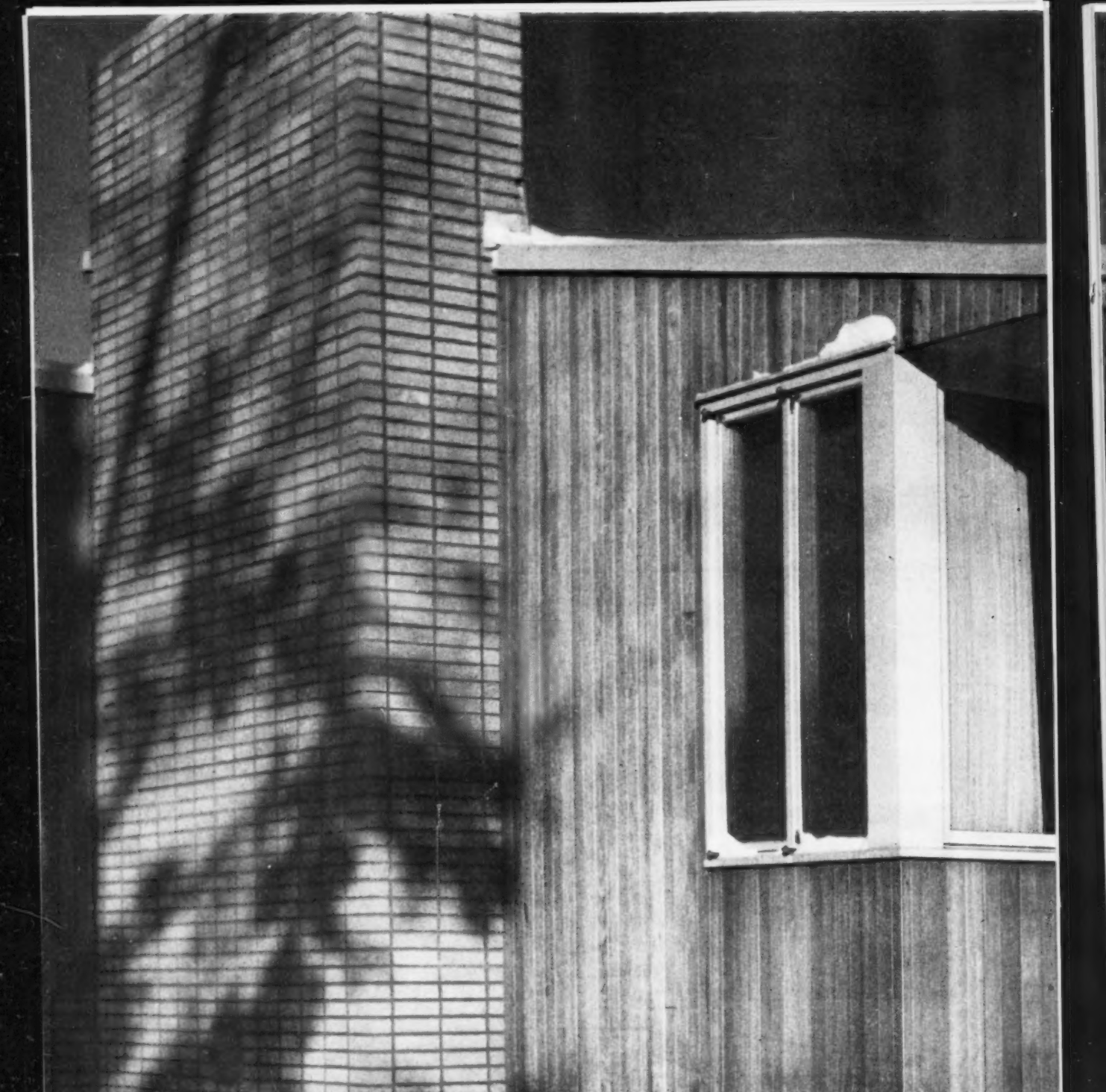

*Thorshov & Cerny, Inc., Architects*

**TAKE THE STING**  
**OUT OF WINTER with**

**ANDERSEN**  
*Windowalls*\*

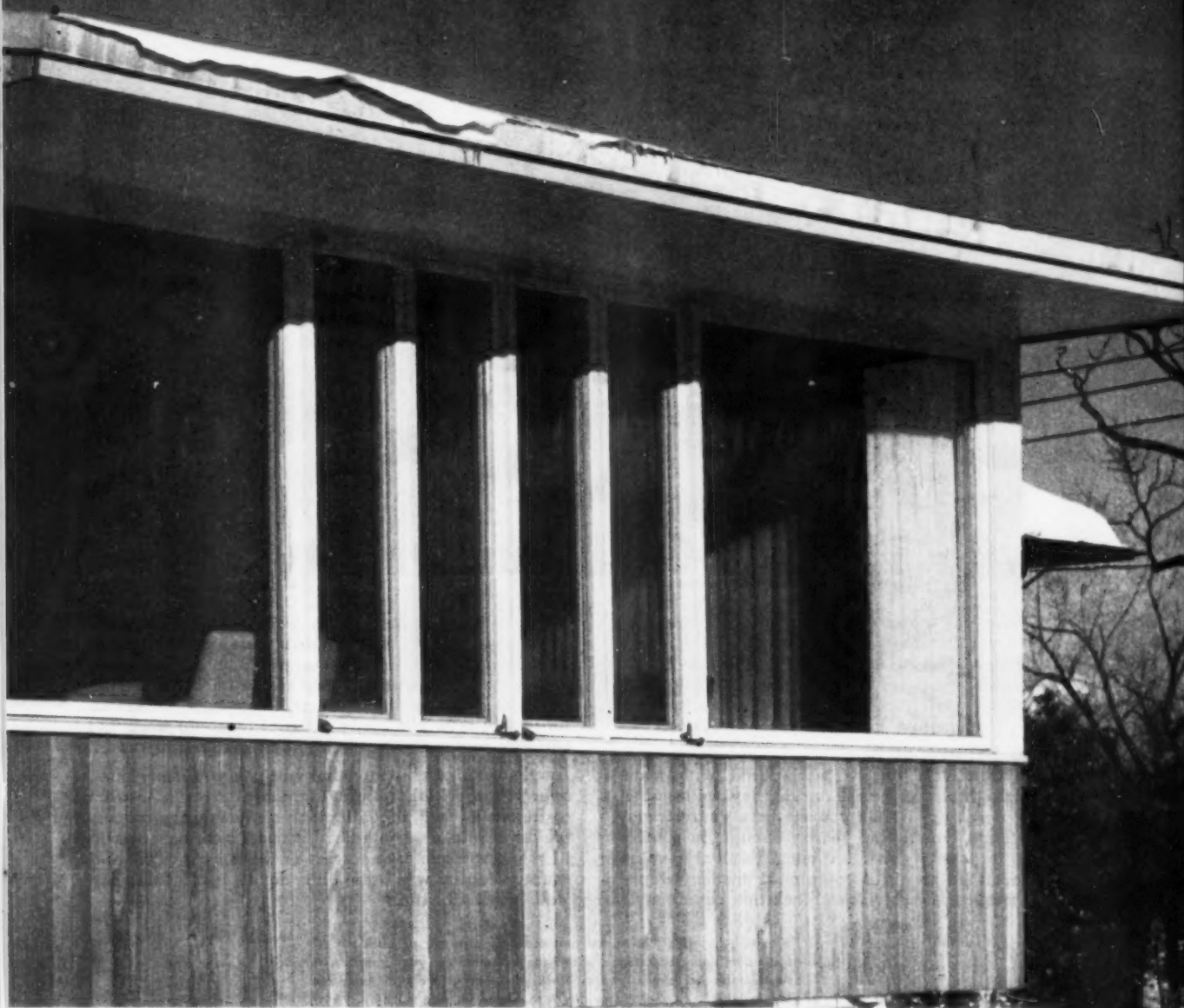

SUNSHINE FLOODS into this living room with a warmth that belies the zero temperature outside. Highly weathertight WINDOWALLS of Andersen Casement Window Units protect the owner's perfect

comfort. These same WINDOWALLS frame a scene of wintry beauty, and in warmer days, admit every cooling breeze. These are Andersen WINDOWALLS, efficient both as windows and as walls.

\*TRADEMARK OF ANDERSEN CORPORATION

- • **Sell Andersen WINDOWALLS**  
• **For Remodeling Profits**  
• Use WINDOWALLS for porch enclosures. For extra rooms.  
• For attic dormers. For modernizing kitchens.  
•••••

*Andersen Corporation* BAYPORT • MINNESOTA

WINDOW SPECIALISTS FOR 50 YEARS

*For more information see your local millwork dealer or write Andersen Corporation.*



your dollars stretch farther  
and give better building results

## with LITHIBLOCK Bonus Quality

When you're fighting costs every step of the way, the best friend you can have on any masonry job is Bonus Quality Lithiblock. At each turn, this Prince-among-block squeezes out those extra pennies that make such a big difference by giving you full measure for your dollar . . . then paying quality dividends beside.

Known far and wide for its unerring dimensional accuracy, Lithiblock lets masons work faster with much better results . . . and you'll notice they smile when they're laying it up. When you measure your savings on labor alone, you'll find reason enough to specify Lithiblock for every job . . . but Lithiblock's value doesn't stop there! It gives you almost uncanny duplication of texture from block to block that combines to

make the most eye-catching wall you've ever seen, anywhere . . . a real beauty that warrants a craftsman's best efforts and pays a bonus of client satisfaction to help your business grow. And in the trend toward exposed masonry in all buildings, this special Lithiblock finish will save you costly hours of touch-up work that eats into profits and never seems to come out just right.

Another Lithiblock bonus that will pay you many times over is its rock-like internal strength. No matter what aggregate is used, the Lithiblock manufacturing process breaks it into a smooth-flowing mass before it gets to the mold so there are no voids or weak spots to fail and cause you grief when the job is done . . . your Lithiblock wall is there for life.



*To avail yourself of the speed and economy that are so much a part of all Lithiblock construction, write for the name of your nearby Lithiblock supplier. He has every type of block you need at the right price for your locality . . . and the quality is a bonus for you to enjoy.*

### FREE BLOCK CALCULATOR

Figures the block you need . . . easily, quickly!  
Send the coupon today.

NAME \_\_\_\_\_

ADDRESS \_\_\_\_\_

CITY \_\_\_\_\_ STATE \_\_\_\_\_

# LITHIBLOCK

Lithiblock is produced to rigid standards on machines manufactured by the Lithiblock Division of the Lithibar Company, Holland, Michigan.



# EXPERIENCED BUILDER REPORTS:



Vane R. Howard

## "SCR brick<sup>\*</sup> builds warm, dry walls at minimum cost"

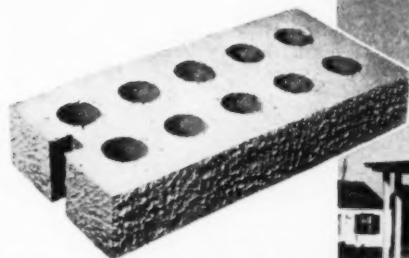

"SCR brick"—the THRU-THE-WALL unit that builds solid brick homes for the cost of frame. Developed by the Structural Clay Products Research Foundation.



One of builder Howard's "SCR brick" homes in the middle-price range. Architect: H. J. McComb

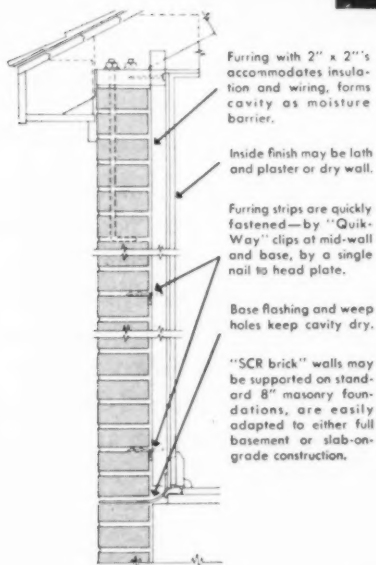

That's one reason why the demand for "SCR brick" is booming from coast-to-coast. Here are some others—reported by home-builder Vane R. Howard:

"I like the flexibility of 'SCR brick' construction—it gives you plenty of design freedom.

"There's only one unit to handle—the wall goes up faster.

"We didn't have to worry about on-site delays—"SCR brick" is readily available—and we could choose from a wide range of colors and textures."

\*Reg. TM, SCPRF, Patents Pending

Free booklet "HOW TO BUILD BRICK HOMES THAT SELL WITH THE SCR BRICK" gives full construction details. To get one, just write us on your own letterhead. Address: Dept. AB-2.



**STRUCTURAL CLAY PRODUCTS INSTITUTE**

1520 18th Street, N. W., Washington 6, D. C.



**your dollars stretch farther  
and give better building results**

## with LITHIBLOCK Bonus Quality

When you're fighting costs every step of the way, the best friend you can have on any masonry job is Bonus Quality Lithiblock. At each turn, this Prince-among-block squeezes out those extra pennies that make such a big difference by giving you full measure for your dollar . . . then paying quality dividends beside.

Known far and wide for its unerring dimensional accuracy, Lithiblock lets masons work faster with much better results . . . and you'll notice they smile when they're laying it up. When you measure your savings on labor alone, you'll find reason enough to specify Lithiblock for every job . . . but Lithiblock's value doesn't stop there! It gives you almost uncanny duplication of texture from block to block that combines to

make the most eye-catching wall you've ever seen, anywhere . . . a real beauty that warrants a craftsman's best efforts and pays a bonus of client satisfaction to help your business grow. And in the trend toward exposed masonry in all buildings, this special Lithiblock finish will save you costly hours of touch-up work that eats into profits and never seems to come out just right.

Another Lithiblock bonus that will pay you many times over is its rock-like internal strength. No matter what aggregate is used, the Lithiblock manufacturing process breaks it into a smooth-flowing mass before it gets to the mold so there are no voids or weak spots to fail and cause you grief when the job is done . . . your Lithiblock wall is there for life.



*To avail yourself of the speed and economy that are so much a part of all Lithiblock construction, write for the name of your nearby Lithiblock supplier. He has every type of block you need at the right price for your locality . . . and the quality is a bonus for you to enjoy.*

### **FREE** BLOCK CALCULATOR

Figures the block you need . . . easily, quickly!  
Send the coupon today.

NAME \_\_\_\_\_

ADDRESS \_\_\_\_\_

CITY \_\_\_\_\_ STATE \_\_\_\_\_

# LITHIBLOCK

Lithiblock is produced to rigid standards on machines manufactured by the Lithiblock Division of the Lithibar Company, Holland, Michigan.

# EXPERIENCED BUILDER REPORTS:



Vane R. Howard

## "SCR brick\* builds warm, dry walls at minimum cost"

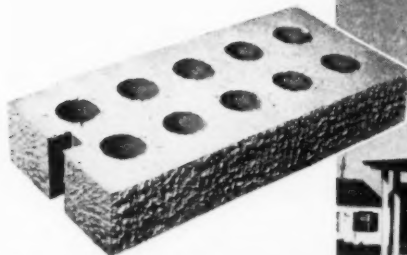

"SCR brick"—the THRU-THE-WALL unit that builds solid brick homes for the cost of frame. Developed by the Structural Clay Products Research Foundation.



One of builder Howard's "SCR brick" homes in the middle-price range. Architect: H. J. McComb

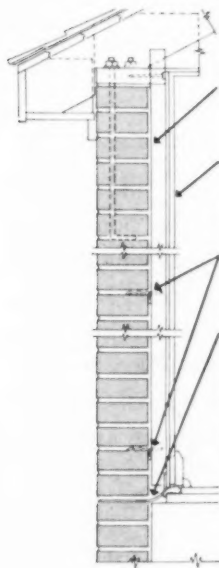

Furring with 2" x 2"s accommodates insulation and wiring, forms cavity as moisture barrier.

Inside finish may be lath and plaster or dry wall.

Furring strips are quickly fastened—by "Quik-Way" clips at mid-wall and base, by a single nail to head plate.

Base flashing and weep holes keep cavity dry.

"SCR brick" walls may be supported on standard 8" masonry foundations, are easily adapted to either full basement or slab-on-grade construction.

That's one reason why the demand for "SCR brick" is booming from coast-to-coast. Here are some others—reported by home-builder Vane R. Howard:

"I like the flexibility of 'SCR brick' construction—it gives you plenty of design freedom.

"There's only one unit to handle—the wall goes up faster.

"We didn't have to worry about on-site delays—"SCR brick" is readily available—and we could choose from a wide range of colors and textures."

\*Reg. TM, SCPRF, Patents Pending

Free booklet "HOW TO BUILD BRICK HOMES THAT SELL WITH THE SCR BRICK" gives full construction details. To get one, just write us on your own letterhead. Address: Dept. AB-2.



### STRUCTURAL CLAY PRODUCTS INSTITUTE

1520 18th Street, N. W., Washington 6, D. C.

# FLORIDA BUILDER GIVES HOMES "BACK-DOOR" SALES-APPEAL!



One of 147 Crosley-equipped homes built by Mr. Vaughn Dekle in the Rodney Sub-Division of Jacksonville, Florida. Average price—\$9,000.

**Mr. Vaughn Dekle, one of Florida's leading contractors, has been building houses in the vicinity of Jacksonville, Florida, for 12 years.**

Here's another builder who really knows what makes homes sell. Mr. Dekle has equipped 147 houses in the Rodney Sub-Division to take advantage of the "back-door" sales approach.

Taking prospects into new homes through the back door really pays off. People are mighty interested in the kitchens that go into their new homes. The proper appliances can put them in a buying mood right from the start.

That's why many architects and builders—like Vaughn Dekle—are giving their homes real "back-door" sales-appeal by specifying and installing beautiful, work-saving Crosley Kitchens. Crosley products adapt so easily to any floor plan. And when planning your kitchen, you can depend upon Crosley for real help. All Crosley's years of kitchen planning experience are yours to draw upon.



**Shelvador®  
Refrigerators**

**Shelvador®  
Freezers**

**Electric  
Ranges**

**Electric  
Water Heaters**

**Automatic  
Dishwashers**

**Steel  
Kitchen Cabinets**

**Sinks and Food  
Waste Disposers**

**Radio  
Receivers**

**Television  
Receivers**

**Room  
Air Conditioners**

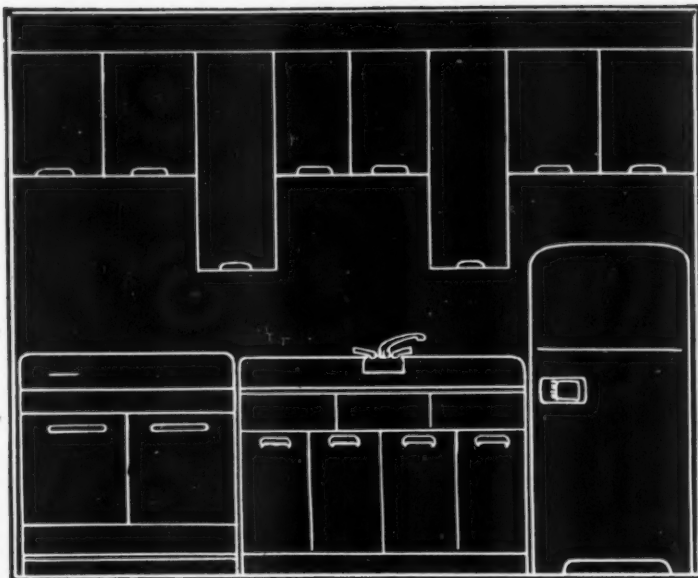

Here is one of the kitchen plans and a photo of the actual kitchen installed in Mr. Dekle's newest homes. Notice how this convenient Crosley Kitchen equipment provides so many big kitchen advantages in a small space.

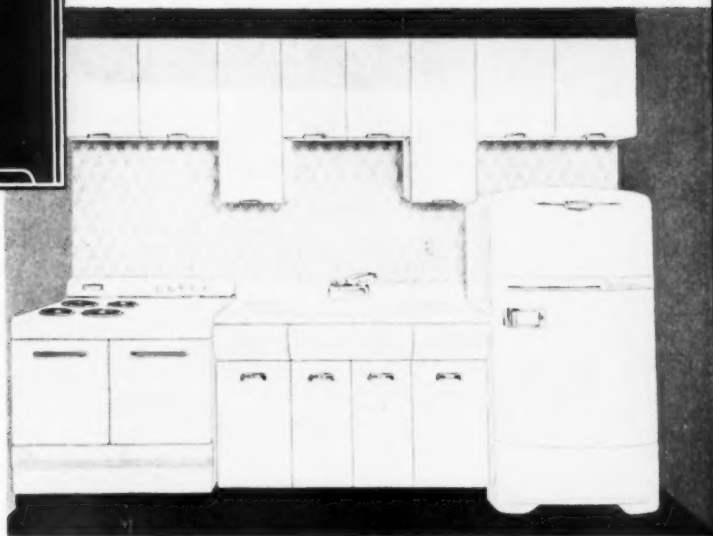

## CROSLY KITCHENS HELP SELL PROSPECTS

A step-saving, work-saving kitchen filled with Crosley products can help put your prospects in a buying mood . . . help convince them that your house is their best buy.

Roomy Crosley Wall Cabinets—like those shown above—provide Mrs. Prospect with the convenient and compact storage space. Crosley Sinks make beautiful and practical companion pieces for other Crosley products. They're available in 42-, 48-, 54- and 66-inch widths.

The Crosley Shelvador® Refrigerator is a first-rate "salesman," too. It features across-the-top freezer with real freezer-locker convenience, plus shelves in the door for lots of "easy-to-get-at" space. Crosley Electric Ranges, available in 20" and 40" widths, provide "modern" cooking.

And don't forget, all Crosley products can be included right in a package mortgage. That's a strong point when making a sale.

### **FREE INFORMATION FOR BUILDERS AND ARCHITECTS!**

#### **CLIP AND MAIL TO:**

**Builder Sales, Dept. AB 23, Crosley  
Division, AVCO Manufacturing Corporation  
1329 Arlington Street, Cincinnati 25, Ohio**

Please send complete information on all Crosley products to:

Name \_\_\_\_\_

Company \_\_\_\_\_

Address \_\_\_\_\_

City \_\_\_\_\_ Zone \_\_\_\_\_ State \_\_\_\_\_

# CROSLY



Cincinnati 25, Ohio

**BETTER PRODUCTS FOR  
HAPPIER LIVING**

# Not just "thinking" of building

these 3¾-million families with  
Buy on their minds  
have spent \$81,000,000 in construction  
on one new BH&G home plan!

Lots of families spend years just "thinking" of building. But the 3¾-million families who read Better Homes & Gardens are not merely "thinkers," they are BUY-ers!

They have spent \$81,000,000 in construction costs alone on *one* set of BH&G house plans. They undertake over 1¾-million home improvement jobs a year. And 7 out of 10 families who are building new homes read BH&G!

It's all because BH&G itself always combines theory with practice. Every page of every issue is chock-full of practical ideas on what to try, what to BUY, to make home life richer and better. In this way, BH&G screens the nation for families who are do-ers and BUY-ers—and now there are 3¾-million of them—a new, all-time high!

## BH&G BUYOLOGICAL BRIEFS

- 1,298 SETS OF PLANS sold for BH&G Five Star Home 2204, within 30 days after being featured in BH&G.
- BUILDING PRODUCTS ad pulled 47% more in BH&G in less than a month than next-best-producing magazine.
- BUILDING MATERIAL DEALER PROGRAM, offering vast collection of sales helps, now going to 5,000 dealers.

MEREDITH PUBLISHING COMPANY,  
Des Moines, Iowa





Unwelcomed eyes can't see what's stored in the garage when a panel of glass block is used instead of windows.

## A better way to make garages lighter and private

**O**UTSIDERS CAN NEVER TELL what's inside a garage that has panels of Insulux Glass Block<sup>®</sup> instead of windows. That's just one of the benefits that Insulux panels bring to any building, new or old.

Insulux blocks sight . . . lets in all the daylight. Insulux protects valuables stored inside . . . a panel is exceptionally hard to break; makes a difficult entry for thieves. Insulux is maintenance-free . . . because it can't rust, rot or corrode,

you can be sure it will give a lifetime of trouble-free service. Insulux insulates . . . cleans with an easy wipe.

Glass blocks are noncritical and immediately available in quantity. Installation is simple and quick . . . in new homes or old . . . requires only ordinary mason's tools.

One glass block installation often points the way to other jobs. Home applications are practically limitless.

Kitchen, bathroom, basement—to name just a few places—offer excellent opportunities for the installation of panels of glass block.

Get all the information about the many profitable glass block applications you can find in the average home . . . don't overlook this method for keeping your volume up in the face of increased competition. Write Insulux Glass Block Division, Kimble Glass Company, Dept. AB2, Box 1035, Toledo 1, Ohio.



**KIMBLE GLASS COMPANY**

Toledo 1, Ohio—*Subsidiary of Owens-Illinois Glass Company*

the  
**SPOTLIGHT**  
 for 1953  
 is on the

**Curv-TITE**  
 glass jalousie

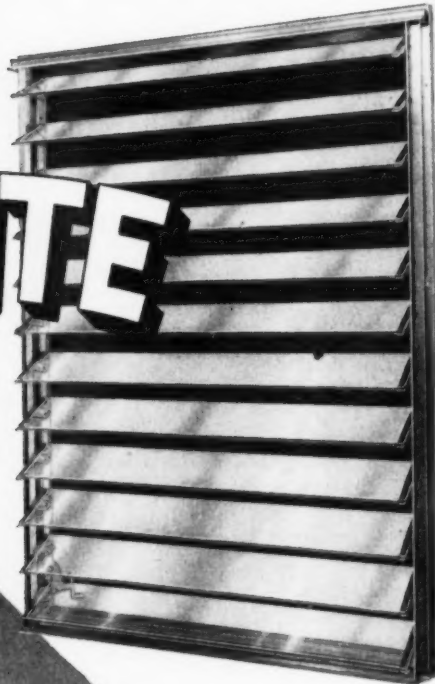

The ultimate in consumer demand has been incorporated in the CURV-TITE glass jalousie. Positive weather protection and trouble free service assure you of a quality product. Adaptable to every type of installation, its ease of setting makes it the builder's dream. Flexibility of sizes and symmetry of lines allow its use in any type of architecture.

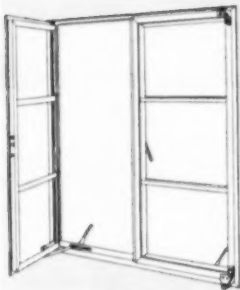

**Casement**

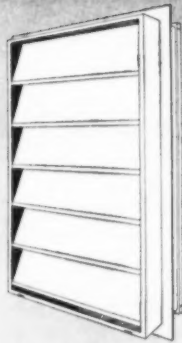

**Aluminum Louver**



**Storm Sash**

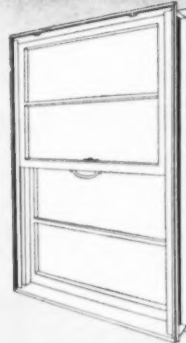

**Double Hung**

Metal Arts Manufacturing Co., Inc.

P. O. Box 4144 Atlanta, Ga.

Att'n: Dept. AW

Please forward full information on your complete aluminum window line.

Name: \_\_\_\_\_  
 Co. Name: \_\_\_\_\_  
 St. Address: \_\_\_\_\_  
 City: \_\_\_\_\_ State: \_\_\_\_\_

Precision engineered aluminum windows close completely, yet open with little effort. The low initial cost, plus NO maintenance cost, will amaze you. Metalart Aluminum Windows carry the Aluminum Window Manufacturers' Seal of Approval, personification of quality standards of the highest order.

**METAL ARTS MFG. CO., INC.**

P. O. BOX 4144

ATLANTA, GEORGIA

AMERICAN BUILDER



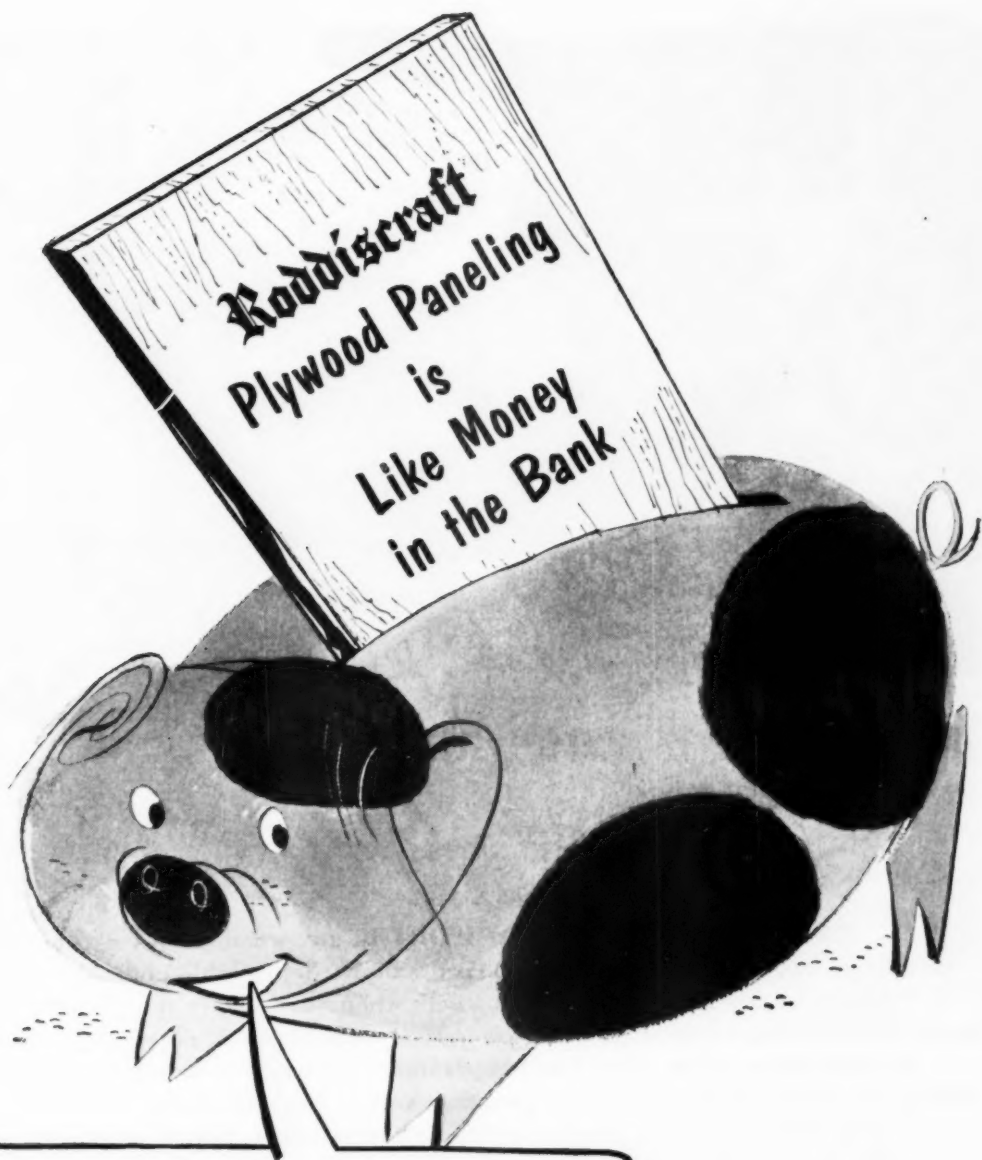

Money in the bank never asks anything of the owner — and neither does Roddiscraft plywood.

**H**ERE'S a sales story that will help sell quality homes. Roddiscraft plywood gives — instead of taking. It gives a permanent wall that pays continuing dividends in lasting beauty. It never takes more and more money for painting, papering, patching, scrubbing. A Roddiscraft plywood paneling installation is a one cost job — it's a

built-in part of the building — a background of beauty.

Roddiscraft is preferred 2 to 1 by architects for doors. The same quality that has made Roddiscraft doors first choice of architects for over half a century is built into Roddiscraft plywood. It's beauty with brawn—built to last and last and last.

#### NATIONWIDE Roddiscraft WAREHOUSE SERVICE

Cambridge 39, Mass. • Charlotte 6, N. C. • Chicago 32, Ill. • Cincinnati 4, Ohio • Cleveland 4, Ohio • Dallas 10, Texas • Detroit 14, Mich. • Houston 10, Texas • Kansas City 3, Kan. • Los Angeles 58, Calif. • Louisville 10, Ky. • Marshfield, Wis. • Miami 38, Fla. • Milwaukee 8, Wis. • New Hyde Park, L. I., N. Y. • New York 55, N. Y. • Port Newark 5, N. J. • Philadelphia 34, Pa. • St. Louis 16, Mo. • San Antonio 6, Texas • San Francisco 24, Calif. • San Leandro, Calif.

# Roddiscraft

RODDIS PLYWOOD CORPORATION  
Marshfield, Wisconsin



please home owners with Thrush

No. 201  
RADIANT HEAT  
CONTROL

## *Radiant Hot Water Heat*

**AUTOMATIC HEATING COMFORT** in any weather . . . a constant flow of radiant heat . . . with one inexpensive, simple, dependable control.

That's what you provide home owners when you specify the No. 201 Thrush Radiant Heat Control for Hot Water Heating Systems. It completely ends the ups and downs of heating. The temperature remains constant at the desired setting, no matter how the outdoor weather varies. It compensates automatically for even the widest outdoor temperature changes. When combined with the complete forced circulating Thrush Flow Control System, the Radiant Heat Control assures the finest home heating at lowest cost.

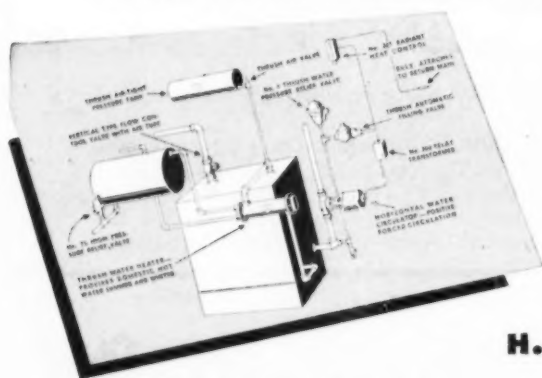

**THE COMPLETE THRUSH SYSTEM** of Hot Water Heat shown here assures automatic control of temperature from beginning to end of the heating season.

**Radiant coils, Baseboards, Convector or Radiators** -- Thrush Radiant Heat Control ends overheating and underheating . . . no matter what type of radiation may be used. Find out more about it now.

See our catalog in Sweet's or write Dept.G-2.

**H. A. THRUSH & COMPANY**  
PERU • INDIANA

This man ***KNOWS***

where he's

going...



in 1953

He's a contractor who uses Dodge Reports. They keep him posted *daily* on every phase of the new construction market in his territory. Dodge Reports tell him *who* and *where* his best prospects are—*what* and *when* they're going to build and when action should be taken to get the business.

Most of the leading firms in new construction have long relied on Dodge Reports. This 62-year-old business service pinpoints active prospects—gives you the names and addresses of people who definitely need your services. Dodge Reports cover any territory you name—local or wide-spread anywhere east of the Rockies—to bring you complete and detailed information every day on your part of the rich construction market.

Let Dodge Reports help *you* get the contracts you want. They'll keep you ahead of competition . . . keep you alert to golden opportunities that might otherwise be missed—among old customers and new—stand you in good stead during the days ahead. More than 900 Dodge field men constantly comb the new construction market to report what's going on and what's coming up—being planned—out for bids—who gets the contracts. Put these men to work discovering business leads for *you!*

Write today for free book on "Dodge Reports — How to Use Them Effectively." It explains in detail how Dodge Reports can take the all-important *first* step to business for you.

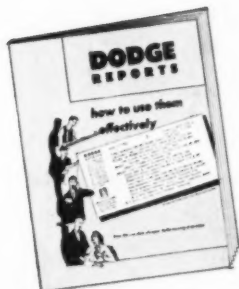

Send for this free book on how to use Dodge Reports. No obligation.

## DODGE REPORTS

Dept. AB253, 119 W. 40th St., New York 18, N. Y.

*Timely, accurate, comprehensive construction news service*

THE FIRST STEP IN EVERY SALE





*SHE has her eye on beauty...*

*HE has his mind on durability*



Here's a kitchen that sparkles with good living. It's a pleasure to see the lovely colors and patterns of G-E Textolite plastics surfacing. It's a comfort to know that the fine finish can really take it.

**YOU'LL PLEASE THEM BOTH**  
**WITH G-E *Textolite* \***  
**PLASTICS SURFACING**

Architects and builders are setting the pace by specifying G-E Textolite plastics surfacing in other places, too. Plan on its heat-, stain-, and scratch-resistant surface for linen closet shelves, radiator covers, window sills—wherever you want beauty plus extra durability.

**FOR FULL INFORMATION** and pattern sheet, write: Section 351-2B, Chemical Division, General Electric Co., Pittsfield, Mass.

\*Reg. U.S. Pat. Off.



Just the swish of a damp cloth keeps this bathroom vanity spotless and lustrous. Why it's actually easier to clean the G-E Textolite plastics surfacing than it is to clean the mirror!

*You can put your confidence in—*

**GENERAL  ELECTRIC**

**BUILDER:**  
Nathan Manilow,  
Chicago, Illinois

**ARCHITECT:**  
A. J. Del Bianco  
Chicago, Illinois

A 32x60 foot tent protects slab during rainy and extreme hot weather. Tent enables contractor to pour two slabs a day or 50 per cent normal production. Tent costs \$1,000 and is used on about 10 per cent of work



## this portable cover **SPEEDS** concrete work



A 32x60 foot tent shelter designed by a concrete subcontractor and made by a local welding concern has proved instrumental in setting a fast construction pace. The portable shelter covers the concrete slab so production can continue in hot or rainy weather. With this rig the subcontractor will pare six months off the two year production estimate for Nathan Manilow's

latest Chicagoland development, Des Plaines Villas.

During the first seven months of production the subcontractor, De Graf Brothers of Chicago, were 60 to 70 slabs ahead. This accomplishment is noteworthy considering that this is the firm's first venture into project work. Heretofore, they concentrated on custom work.

In their planning for the project



the brothers designed the shelter for bad weather concreting. They wanted production to roll ahead regardless of the elements. The 32-foot rig which they designed carries a 32x60 foot piece of canvas. The canvas rolls on the top of the frame in its portable state. Four men can push the rig into place when bad weather threatens. Before unfurling the canvas they erect a 4-foot high 2x4 frame at the ends of the slab. The canvas is unrolled and stretched across the 2x4 framework. The ends are fastened to stakes much the same as a tent.

Workmen have just enough head-room under the canvas enclosure. Concerning their rainy weather concreting, De Graf stated, "We order



Concreting was the key to a production schedule that saw a two-year estimate for 475 houses reduced to 1½ years



Trenches are cut wide so that men can work in them. Footing is 10x20 inches

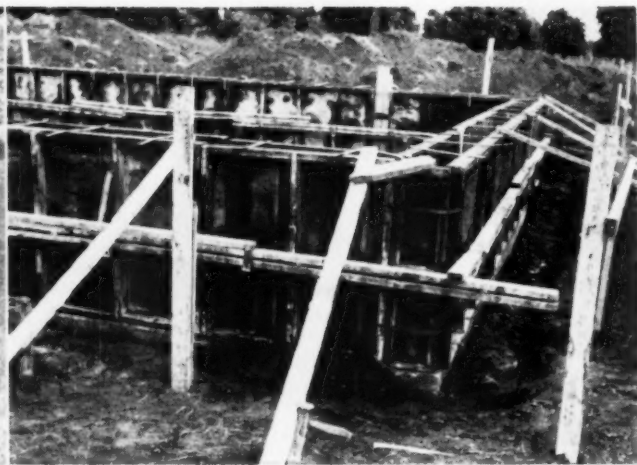

Foundation forms await pouring. Wall is 10 inches thick to satisfy local code

the day before so we must make provisions in all kinds of weather. We cover one slab with the tent and the other with waterproof paper. When the tent covered slab has set up enough, we finish it. When we can put down waterproof paper without marring the finish we move the tent to the other slab and finish it."

The tent has been used in 10 per cent of the slabs produced by the subcontractor. In bad concreting weather they pour two slabs a day, maintaining 50 per cent production.

In good weather the De Grafs pour four slabs a day. They use ready mixed concrete. A five bag mix was found best for slab finishing when no topping was used. A "jitterbug" forces the heavier ag-

gregates to the bottom of the slab, giving the finishers good topping for a float finish.

Costs approximate \$23 a yard

in place for the 10-inch foundation wall and the 10x20-inch footing. Slab costs amount to forty cents a square foot.



Screed levels off half of slab. Copper pipes seen in the slab are hot water heating pipes for baseboard heat. Pipes are one piece copper tubing. ends are closed to keep concrete out of them



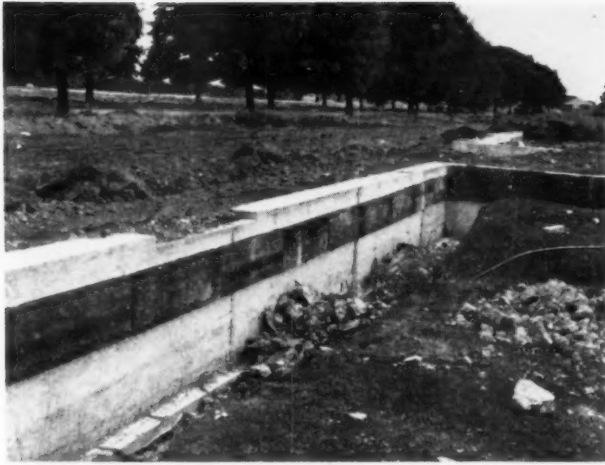

Glass wool perimeter insulation is fastened to the foundation wall prior to interior filling. Sand fill is used under the slab. Note how insulation stops below top of slab. This enables trucks to pour the fill without breaking the insulation. It is put back in place after the fill has been put into place

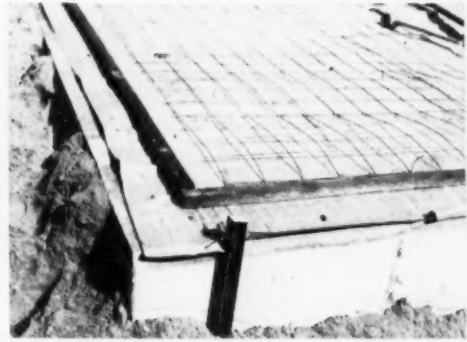

Waterproof paper, creosoted 2x2's and mesh are prepared on top of the slab prior to slab pouring. Under-slab fill is two inches below foundation wall—slab is four inches thick



The brick, ranch type design houses of Des Plaines Villas are in the \$14,900 to the \$19,500 bracket. Homes include two or three bedrooms, all purpose room and heating closet



FEBRUARY 1953



"Jitterbug" used to agitate concrete for float finish

The \$6,995 price tab for the 24x32 foot house is under the prevailing Chicago area price. Site, decoration, wall board seaming, and finished floor are additional cost items

**BUILDER:**  
N. H. Engle and Sons  
Chicago, Ill.



Kitchen has automatic washer included in the low price. Partition at left of stove is removable for servicing hot water heater and water pump



The kitchen area is 11½x15 feet. It provides plenty of space for dining



Furnace closet centralizes the heating system for short duct runs. Cold air return is through the louvered door

## builder know how + owner labor =LOW COST PACKAGE

The bogey of high construction costs is being met successfully by N. H. Engle and Sons of Lake Villa, Ill., with a low-cost house package. This builder is delivering a house for \$6,995 plus the site. The low-cost 763 square foot house features two bedrooms, automatic oil fired heat, and an automatic clothes washer. Owners must complete decorating, wall board seaming, and flooring. These owner labor devices reduce costs and improve the mortgage picture. Five hundred dollars plus site is the down payment for the 15 year conventional loan.

The development is located about 35 miles northwest of Chicago. It is near commuting service to the metropolitan area. Lots sell for \$300 and up; however, most deals average \$800 to \$1,000.

As the development is outside of any corporate limits, wells and septic systems must be provided. The \$6,995 price includes these utilities. Wells in the area average \$500.

The builder allows this figure. His sales contract protects him from conditions beyond his control. If the well cost runs above the contract figure, the buyer stands the additional cost. If, on the other hand, the well is less the buyer receives a credit.

The \$6,995 house is not a shell. It is ready for occupancy. Buyers receive the complete house except for wall board finishing, decorating, and the finished floor. Buyers can take their choice of finishing these items themselves or having the builder do it. The additional cost can be included in the mortgage with an additional down payment. The advantage of the owner's labor according to the builder is the reduced down payment.

Wall board seaming if done by the builder costs the buyer \$150. Painting and decorating for both the exterior and interior costs \$375 to \$400. Asphalt tile in "B" colors can be installed for \$300. The



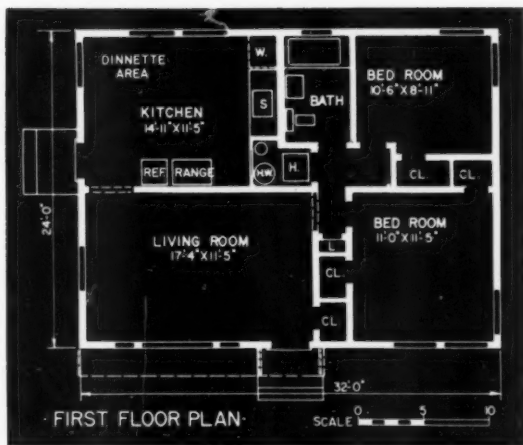

The small plan is compact and affords plenty of livability. Exceptional idea is removable panel to service the water pump and water heater

BUILDER'S OTHER DESIGNS—



Two bedroom with utility room and garage for \$8,200



Three bedroom with utility room for \$8,650. Site and owner labor are extra



Wall board is applied to large areas. Then partitions are set in place



Finish carpenter can trim house as wallboard is being installed. Owners do the seam finishing

builder finds that about 25 per cent of the buyers choose the wall board seaming. Very few choose any of the other operations.

The house is of crawl space construction. Framing includes precut members power-cut on the job. These are assembled on the deck and tilted into position. The structure is standard framing. The wall section includes number 101 drop siding, 1/2-inch insulated sheathing, 2-inch blanket insulation, and wall board.

Speed and economy is achieved by the builder in his construction method. He first completes the deck, then assembles and tilts his side-walls and bearing partition. Next the ceiling joists and rafters are installed and the roof boards nailed in place. When the house is under roof all electrical work is completed. The interior carpenter crew then installs all the wallboard in the two rooms (both halves of the house). Next the interior partitions

are assembled and tilted into position and the wall board applied. Because the home will be turned over to the buyer with the seams unfinished a finish carpenter can work the wall board crew.

Heat is supplied by an oil-fired furnace. A manufactured chimney is used. Economies are achieved through a central location which provides short duct runs (see heating plan). The central closet also houses the electric hot water heater and water pump. Easy access to these appliances is through a removable hardboard wall in the kitchen (see floor plan).

The builder also offers buyers other house designs at additional cost. A two bedroom model with utility room sells for \$7,200, a two bedroom with utility room and garage is priced at \$8,200. The largest, a three bedroom with utility room, is sold for \$8,650. All models feature the same owner labor and land cost figures.

**NOW \$6995**  
plus site

**only \$500 DOWN**  
plus site  
for 2-bedroom, year 'round home—completely finished—ready to move into

Now you and your family can enjoy country living with all the conveniences of the city. Here in the ideal setting hundreds of families are enjoying bathing beaches, parks, fishing, boating and hunting... plus all these extra features. Completely finished home with:

- Automatic Bendix Washers
- Kohler Plumbing Fixtures
- Cabinet Kitchens
- 5 Closets
- Automatic 50 Gallon Electric Hot Water Heater
- Double Wall Construction
- Double Insulation
- Large Picture Window
- Conco Removable Forced Hot Air Oil Furnace, automatically thermostat controlled.

**N. H. ENGLE & SONS**  
4200 Milwaukee Avenue  
Chicago 41, Illinois

**VENETIAN VILLAGE**

**COME UP ANY DAY**

Model Home Open 10 A.M. to Dark

HOW TO GO: Venetian Village is located one hour northwest from Chicago, 100 miles west on Milwaukee Ave. Highway 211 northwest from Chicago, only 20 miles to the entrance. Just follow Venetian Village road sign. Good camping area, too, if you choose.

Display advertising makes play on coming out to the country. Builder includes \$50 to \$60 for advertising each house



This type costs \$12,900, is available under both FHA and VA financing. There are four elevations, three using a Colonial-type roof. Low parapet wall at entrance is in reality a planter box lined with waterproof cement and provided with a drain pipe

## wide variety and packaged financing are selling these houses

CARL JACOBSON AND LLOYD LOVITT, builders in the Memphis area, are well along in a job of constructing 76 brick houses on 32 acres of farm land along the eastern limits of the city. They bought the land at \$2,100 an acre, cleaned off the cotton to start a project of moderate-priced homes. Their over-all plan stresses wide variation in floor plans and elevations, "packaged financing" and volume concentration at the \$12,650-\$13,450 level. All of the eight basic house types are being offered



Colonial elevation in the lowest-priced type—\$12,650. No bedroom in Princeton Park is less than 10 feet 6 inches by 11 feet 6 inches. All houses make a definite point of dining room space



**Eight basic floor plans have 23 elevations in Jacobson & Lovitt's "Princeton Park" in the East Memphis countryside. Prices range from \$12,650 for 1,100 square feet to \$20,000 for 1,400 square feet. The minimum lot is 75 feet wide**



under FHA financing. The four most important of these types may also be purchased under VA financing at prices of from \$12,650 to \$13,450.

The builders' advertising sells effectively on a simple three-front basis: (1) architect's rendering of an elevation; (2) a simplified floor plan; (3) financial chart showing price, downpayment and monthly notes if bought under FHA, downpayment and monthly notes if bought under VA.

\$15,200 for this type, in four elevations, under FHA financing only. Pitch of roof in all the houses is unusual—7 to 12. This provides plenty of attic storage space, and permits placement of furnace and hot water heater there. The former is U. S. Radiator's Capitolaire, an 80,000 B.T.U. gas-fired warm air plant. Water heater is a 30-gallon Mission-Crenshaw



Most expensive house—\$20,000—has one elevation, two bathrooms, fireplace of Los Rancho brick



Roof sheathing is 1x8-inch pine boards. Barrett shingles are used, in three pastel shades, one black, one red blend, one slate and one white. Every house has a built-in ventilating fan installed in the attic, with exhaust vents in eave soffits

Typical wall section. Interior finish is gypsum lath and plaster. The lath is backed with foil

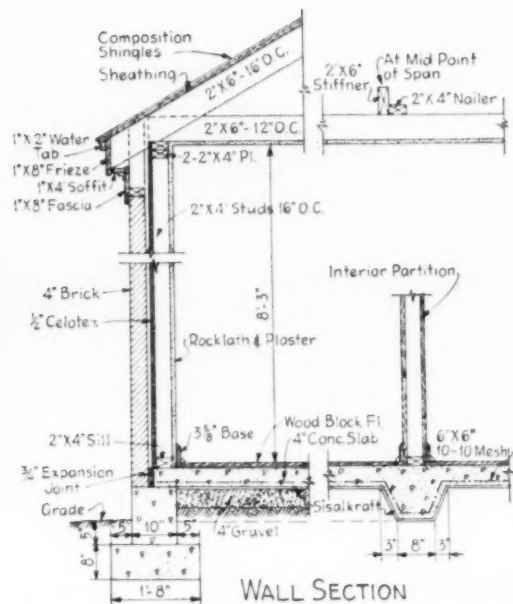

About half the Princeton Park elevations use the ranch-type roof, and half are in a Colonial style. Variety is also achieved by using nine different types of brick and seven different tones and combinations in roof shingles.

Employing a crew of 15 carpenters and 20 laborers under a field superintendent, Lovitt and Jacobson directly control the whole operation.

Except for painting, plumbing, heating and electrical work, they handle all the jobs themselves, even doing the advertising and publicity.

This direct supervision keeps down overhead, makes for greater day-to-day efficiency on the job.

Jacobson has been at it since 1923. He built the first FHA house in Memphis. That was back in 1936, and he well remembers how it took

six months to get the loan, which finally had to be arranged through the Reconstruction Finance Corporation.

The plans for the Princeton Park houses were worked out by architects George F. Mahoney and Berneice M. Burnette, and are based on tested ideas the builders have been collecting in over 30 years of land development.

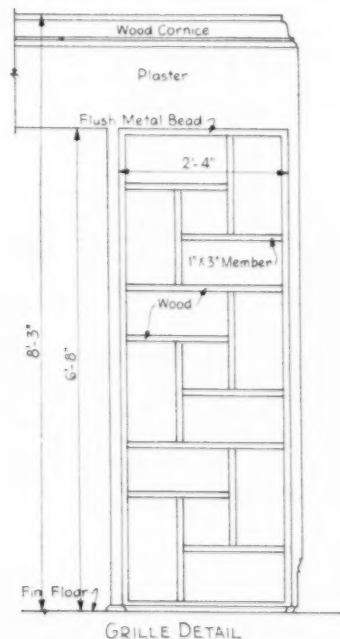
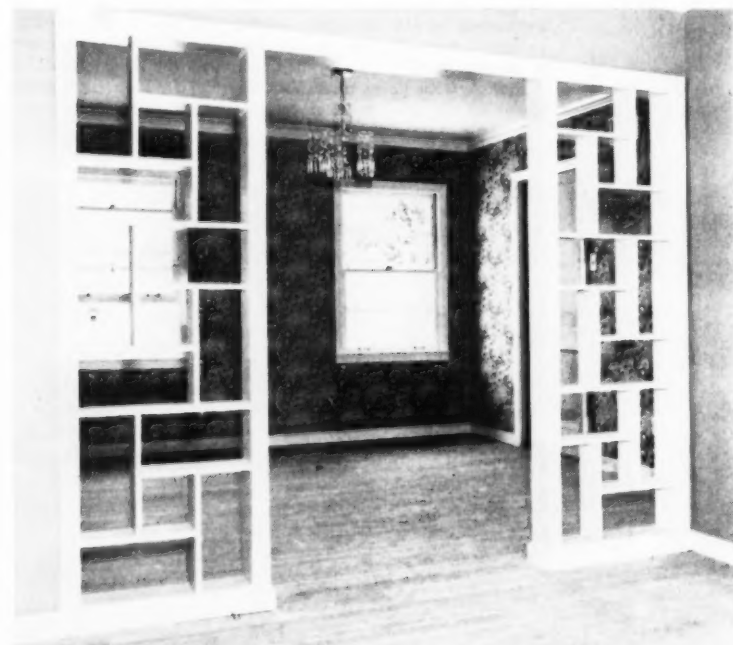

Grilles are a favorite device for dividing rooms. This one helps to separate living room and dining room. In most of the houses, flooring is parquet block by E. L. Bruce

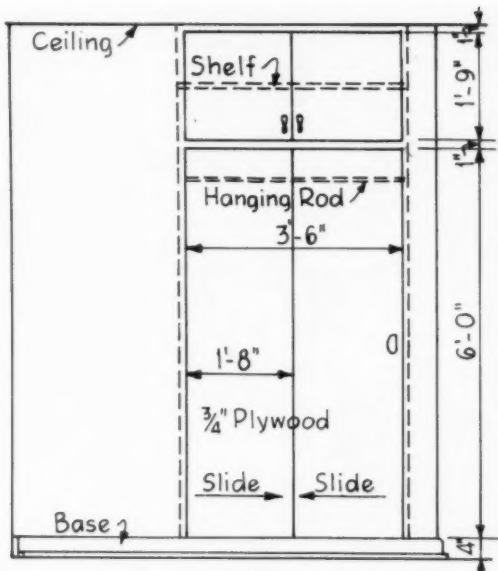

Sliding doors for closets are made by the builder. Closets are plastered. Ceramic tile is used for walls and floors of bathrooms. Plumbing fixtures are American Standard

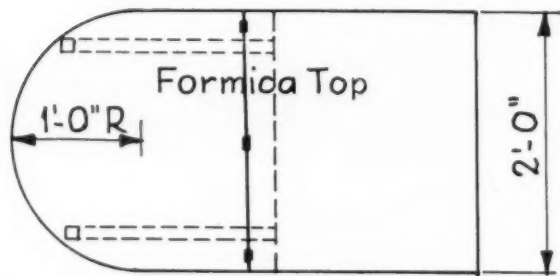

PLAN

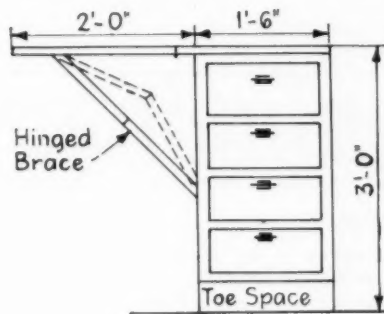

SIDE VIEW

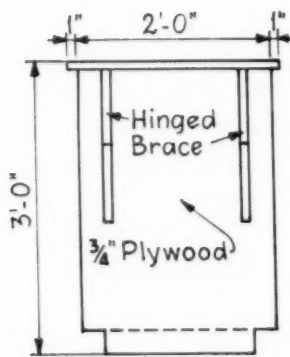

FRONT VIEW

Kitchens have Crosley cabinets and sink, include bar with folding top. Kitchen floors are plastic asbestos tile made by Mastic Tile Corporation





Typical booths (above and right) at the Long Island Home Builders Institute's precedent-shattering air conditioning exhibition

● **what is it?**

Air conditioning in its complete form must meet the following six conditions:

- 1 Heat the home in winter
- 2 Add moisture to dry air in cold weather (humidification)
- 3 Cool the house in summer
- 4 Remove moisture from air in hot weather (dehumidification)

- 5 Clean the air of dust, soot, dirt and pollen by filtering

- 6 Circulate this clean air throughout the house, using some outside air constantly to freshen the inside air
- Steps 1, 2, 5 and 6 are the elements provided in a winter air conditioning system.

Steps 3 and 4 are the summer cooling elements which must be added to any system designated for year-round air conditioning.

● **what does it do for the builder?**

Air conditioning creates a new desire for ownership; thus becomes a major stimulant for home sales *(see page 95)*

● **what does it do for the architect?**

Air conditioning opens up new areas of expression in design *(see page 96)*

● **what does it do for the home owner?**

Air conditioning insures a comfortable temperature at all times—regardless of the weather—and widens the scope of decorative possibilities *(see page 97)*

● **what problems face manufacturers?**

Air conditioning operating as well as installation cost factors limit the market—water supply is limited in many areas—too much space is needed for equipment *(see page 98)*

● **what are they doing about it?**

Air conditioning is being made available in compact package units, combining heating and cooling in less space and at lower cost, while increasing efficiency—Cooling towers and other methods are recommended where water must be conserved *(see page 98)*

## the case

Air conditioning for the home is coming of age. Unmistakable signs are cropping up all over the United States. A year ago, the trend to year-round air conditioning struck noticeably in Texas, extended to Florida and many other Southern areas. Then it spread north to Washington, D. C., Philadelphia and Cincinnati.

A few installations were completed in Long Island and in Connecticut cities, despite the often repeated expression that "we don't need air conditioning in homes this far north. The few uncomfortably hot days we have each year would hardly be worth the great expense involved."

But a prolonged hot spell last summer weakened some of the doubters. New projects in the Long Island, Westchester County and northern New Jersey areas of metro-



Minutes after these pictures were taken, the floor was filled with builders seeking first-hand knowledge from factory experts

## for HOME air conditioning

politan New York began to offer air conditioning as standard or optional equipment. Sales came quickly to these pioneers. By late fall, nearly one-fourth of the new projects announced for New York suburbs were making air conditioning available to buyers who wanted it.

Then rapidly growing Long Island, long recognized as a "wet heat" stronghold, took the bull by the horns. The Long Island Home Builders Institute invited several major manufacturers to participate in a two-day air conditioning exhibition at the scene of its regular meetings: the Stewart Manor Country Club, Stewart Manor, N. Y. The association emphasized that it held no brief for the use of year-round air conditioning or any other type of equipment but that it sponsored the exhibit as a vehicle to organize the air conditioning story and present it

on a proper plane to the Long Island home building industry.

Builders want to know, said Clifton W. Rand, Institute meeting program chairman, at the start of the Nov. 17-18 show, "that the equipment installed will spare them cus-



Clifton W. Rand, who arranged the show as chairman of the LIHB's meeting program committee

tomers complaints, and that they can get the best possible price and terms, with a minimum chance of delivery delays or annoyance with construction details."

Twelve manufacturers took part, including American-Standard, Bryant, Carrier, Clime-Matic, Chrysler Airtemp, General Electric, Lipman, Servel, Typhoon, U. S. Air Conditioning, Westinghouse and York. Factory men joined with local distributors to answer questions. It was the first time so many manufacturers of year-round air conditioning equipment had gathered together anywhere to display their units and explain the technicalities of summer cooling. They had the golden opportunity to "talk up" the advantages of their own particular systems, yet their task was mainly educational—to describe the advantages of air conditioning to the builders

and try to convince them that they could profit by installing it in their homes.

More than 400 builders, engineers, architects and others connected with the home building industry milled about the exhibits. Several were admittedly curious and "just looking." Others sought installation and operating costs and indicated they were considering a swing to air conditioning in their next projects.

Many of the older builders were skeptical and frankly predicted that the installation price plus operating costs would scare off most buyers. They said they would wait and see how the builders who offered year-round air conditioning as optional equipment made out in their sales.

But early reports made it quite apparent that there are buyers in the New York metropolitan area willing to pay plenty for comfort (See examples on next page).

To some, the Long Island show brought on a strange feeling. Here was new equipment and yet some of the exhibitors were privately describing it as already obsolete. They talked of the still newer models to be introduced by several manufacturers at the National Association of Home Builders annual convention and exposition in Chicago late last month. Though they could not then reveal specific changes, they plainly inferred that a new standard of compactness and efficiency was in the offing.

The 1953 goal of manufacturers, according to one informed observer, will be to develop year-round air conditioning equipment (heating and cooling) which will represent no more than 10 to 12 per cent of the cost of a new house, even though that cost may be as low as \$11,000.

## features stressed by manufacturers

Some of the features stressed by each manufacturer at the Long Island exhibition were:

**American Standard:** Two-step thermostatic control assuring flexible capacity plus greater operating economy by cutting out operating circuits automatically when less cooling is required.

**Bryant:** Special control device pro-

### FUTURE TREND?

"Some builders have gone so far as to predict that in three years no speculative house will be built to sell for over \$15,000 without air conditioning. That may be on the optimistic side, but we do believe it's only a matter of time before air conditioning is universal in new homes."

—S. J. Levine, General Manager, Home Heating and Cooling Dept., General Electric Company

"Builders cannot afford to pass up air conditioning if they are to move homes built in the next few years."

—John A. Gilbreath, Vice President (in charge of air conditioning), Servel, Inc.

viding for fully automatic temperature and humidity control in conditioned spaces as well as a handy switching means to obtain either constant or intermittent circulating air blower operation.

**Carrier:** Heating and cooling combined in single "package" unit shipped in two sections, both small enough to go through a 30-inch door; single control switch.

**Clime-Matic:** Seven sizes from 2-ton to 16.52-ton to insure proper size for each installation; accessible hermetic compressor.

**Chrysler Airtemp:** Sealed radial compressor suspended from rubber mounting to insure quiet operation; automatic high pressure control.

**General Electric:** Two-stage cooling thermostat; finger-tip control to change from heating to cooling; "Air-Wall" registers.

**Lipman:** Basic units of 2-ton or 3-

ton capacity are convertible; use duct top for home installation or plenum top for commercial job.

**Servel:** Needs no compressor or other moving parts due to absorption principle in refrigeration unit. Five-year warranty on both heating and cooling equipment.

**Typhoon:** Package heating-cooling unit operated from one-button control on living room thermostat; all-copper condenser.

**U. S. Air Conditioning:** Continuous fluted-fin type cooling coil, with staggered seamless tube construction. Bonderized cabinet.

**Westinghouse:** All components company-made. Cooling unit hermetically sealed with oversized coil for extra dehumidification.

**York:** Twin refrigerating circuits, each with entire cooling unit hermetically sealed. One circuit automatically cuts out whenever less cooling is required.



This tri-level house in a Virginia suburb of Washington, D. C., was designed to take advantage of year-round air conditioning, rather than as a conventional home with air conditioning installed. See the March issue of *American Builder* for the complete story of its special design features



# air conditioning: SALES BUILDER

Will home buyers be willing to pay for year-round air conditioning?

For buyers able to pay, the answer is already known—a resounding yes! Builders who last year pioneered its use on an optional basis in homes priced around \$20,000 and up are reporting sharp increases in their sales activity. Most of the new owners were specifying air conditioning despite an additional charge averaging \$1,000, knowing that they could add little or none of that extra cost to their mortgages.

More than 30 per cent of the buyers wanted General Electric air conditioning in Haworth Manor, Hawthorn, N. J., where James D'Agostino is erecting homes at \$23,000 and up. The same type of summer cooling equipment is used by Irwin Chess and Nat Siegel in one of Long Island's newest and largest projects, the 700-unit Bar Harbour at Massapequa. Three models at \$19,900 to \$26,500 were opened Nov. 16 with the G.E. air conditioning equipment standard in the most expensive model and hot water heat in the others. Irving Kern, whose Kern Realty Co. is handling the sales, reports that of the 40 buyers obtained the first month, few wanted the big house, but 15 wanted air conditioning and most of these were willing to pay \$1,200 additional to have it installed in one of the lower-cost models.

William Morrison, offering \$19,900 homes in Bonnie Crest Estates



One of three models in Bar Harbour, new project at Massapequa, Long Island, N. Y. Irwin Chess and Nat Siegel, builders offer air conditioning as standard in this home, optional in the other two. Matern & York are the architects



at New Rochelle, N. Y., with Chrysler Airtemp air conditioning for \$1,000 more, finds three-fourths of his more than 50 buyers to date taking up the option. Also in New Rochelle, S. Solon Cohen has just opened the 150-unit Monterey Homes with York three-ton air conditioning as standard equipment for \$19,900. He started the first 42 homes, all under contract, within a month of opening day.

Oman-Neal, Inc., has sold more than 20 of its planned 30 units at Valley Brook, Va., especially planned for Servel three-ton units and priced at \$26,750.

The Coleman Company's nationwide survey of new owner preferences, compiled from returns to 4,000 questionnaires, disclosed in the December *American Builder* that 45.3 per cent of the people wanted summer cooling in their homes; 43.6 per cent of those polled in northern states agreed.

Signs of this intense interest are expected to appear this spring in the form of additional builders turning to air conditioning, and joining with manufacturers offering smaller and more compact units to reach a larger segment of the mass \$10,000 to \$15,000 market.

## GLOSSARY OF SOME COMMONLY-USED TERMS

**BTU**—British thermal unit: amount of heat needed to raise the temperature of one pound of water one degree Fahrenheit.

**BTUH**—B.T.U. per hour.

**TON**—Refrigeration obtained by melting 2,000 pounds of ice, or its equivalent, in 24 hours, which is heat removal at the rate of 12,000 B.T.U.H. This capacity is usually obtained from a one-horsepower compressor. Thus, a two-ton unit is operated by a two h.p. compressor (or two one h.p. compressors) to remove 24,000 B.T.U.H.

**COMFORT COOLING**—Maintenance of a comfortable condition in the home by cooling its living area to approximately 15 degrees, or less, below the outdoor temperature. For instance, it is desirable to have an in-

side temperature of about 85 degrees when outside temperature is 100 degrees, or 75 degrees when it is 90 degrees outside. Where the inside-outside differential becomes greater, one may experience discomfort or a shock-effect when entering or leaving the air conditioned space.

**DESIGN COOLING**—Maintenance of a pre-determined temperature, such as 70 degrees, regardless of outside temperature.

**HUMIDIFICATION**—Increase of humidity or water vapor in a given air space.

**DEHUMIDIFICATION**—Reduction of water vapor.

**SENSIBLE HEAT**—That part of heat which changes temperature only, such as the sun's rays, and not the physical properties of air.

**LATENT HEAT**—That part of the cooling load produced by water vapor coming from human bodies, the outside air, cooking, bathing, clothes washing and drying.

**TOTAL HEAT**—Sensible plus latent heat.

**COOLING LOAD**—Total of all heat which must be absorbed and dissipated to maintain desired temperature and humidity in a building. It includes heat gain from without, heat generated within and allowances for duct transmission and distribution.

**HEATING LOAD**—Total of all heat required to maintain a desired temperature in a building.

**THERMAL LAG**—Delay in temperature change caused by conductivity of heat through materials used in the building construction.

# air conditioning: REVOLUTION IN DESIGN

Air conditioning gives the architect a new freedom for expression, in that he is no longer restricted by ventilation or temperature control problems. He can put windows, doors and partitions wherever he feels they will function best, without regard for cross ventilation or prevailing winds.

He must, however, pay more attention to outside wall length and oversized window groupings, for they supply the house with most of its heat gain in summer. This can mean the difference between two-ton and three-ton cooling equipment.

Where low price is paramount, the designer can return to the square or rectangular floor plan to get more interior space for the dollar. He can dispense with a costly wing to increase exposure.

Windows can be grouped to create a spacious feeling; can go high on a wall to improve natural light and facilitate furniture arrangement; run from floor to ceiling to expand a view or be omitted completely from a wall if the view is poor or privacy is desired. Picture windows require neither ventilating louvers or movable windows on each side.

Among traditional features made unnecessary are outside wall bathrooms, breezeways, porches, screens, awnings and fans.

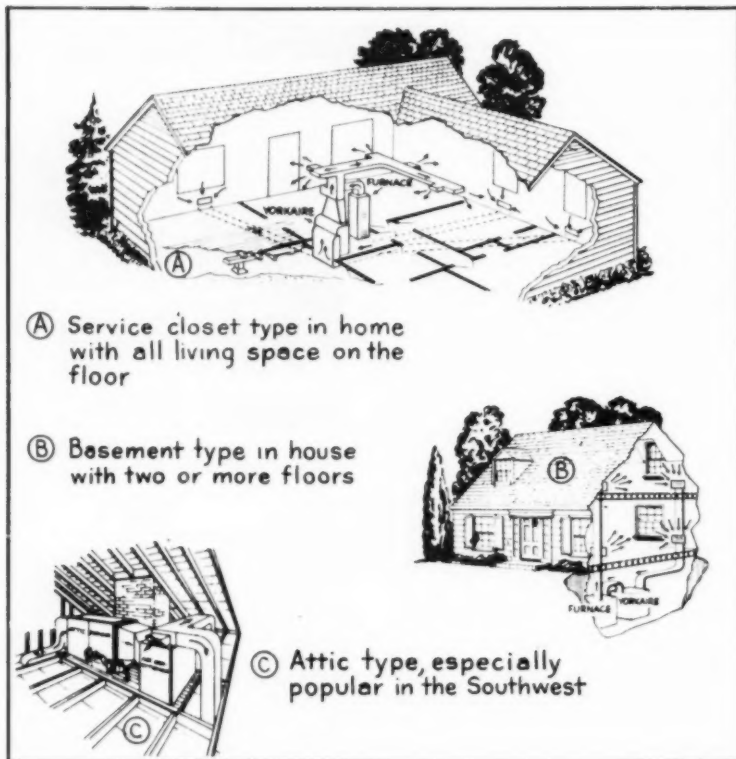

Three varieties of air conditioning installations

Sketch by York Corp.

## how refrigeration cycles work

When house air is circulated by the blower in an air conditioning system, warm and humid room air is blown over the cooling coils or evaporator to be cooled. It is then

recirculated through the rooms to pick up more heat and moisture, completing the forced air cycle.

Cooling of house air by the evaporator depends on four physical changes in a refrigerant, brought about by compression, condensation, expansion and evaporation.

As the house air passes over the evaporator, the refrigerant in the cooling system picks up the heat, which causes it to become a low-pressure gas. This moves along the cycle to the compressor, which sends it as a high-pressure gas to the condenser. Water circulates through here whenever the compressor motor is running and condenses the refrigerant gas to a high-pressure liquid. Then it enters a small diameter tube called a capillary, which connects with the cooling coil. The larger diameter of the coil causes the refrigerant to expand into a low-pressure liquid. As this absorbs heat while passing through the coil, it gradually changes into a heat-laden, low-pressure gas, completing the refrigerant cycle.

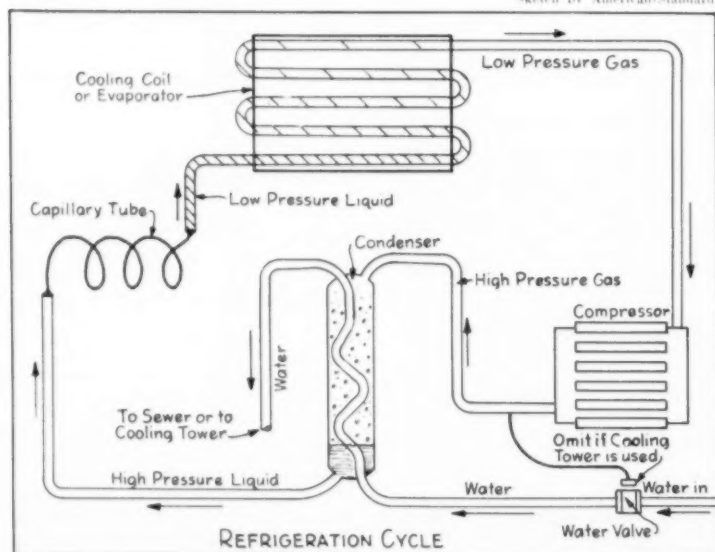



"Emancipation House" at Deerfield Park, Short Hills, N. J., so named to highlight the advantages of air conditioning to the housewife. It is the pilot model of 44 custom-built homes, \$28,000 up, by F. H. Mulcahy, Inc.

## air conditioning: A NEW WAY OF LIVING

Talk of year-round air conditioning and one immediately thinks of bodily comfort. But a properly installed and maintained system offers many additional advantages, which not only reflect better living standards but also in large part tend to offset much of the operating cost of the equipment.

Many of these "plus values" are aptly described in the "emancipation proclamation" appearing on this page, but there are still others:

More security in the home is provided with windows closed and locked at all times. Street noises and outside odors are shut out; so are nocturnal prowlers and sudden thunder showers.

Closets and the basement area become safe for storage use, with danger of mildew and dampness virtually removed.

Packaged foods stored in cabinets or on pantry shelves remain fresh longer.

Plants grow better.

Smoke clears away immediately.

The piano won't need as frequent tuning.

Screens are unnecessary with closed windows. Their maintenance plus the nuisance of putting them up

and taking them down is eliminated.

Less redecorating is required, as paint, wallpaper, etc., remain clean for longer periods.

All these advantages, in the eyes of manufacturers, provide a strong appeal to families buying a home for the first time.

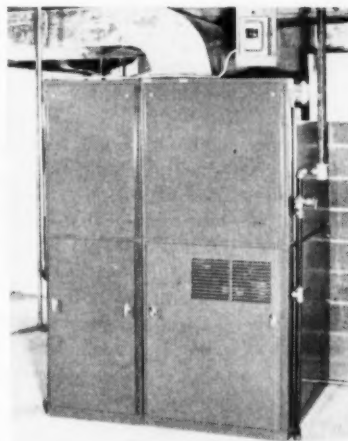

Carrier's packaged unit for year-round air conditioning in basement of "Emancipation House"

### EMANCIPATION PROCLAMATION FOR HOMEMAKERS

Be it now published and ordained, with the opening of the doors of this abode, that woman is freed henceforth and forever, to wit, from:

1. The rigors of daily dusting, cleaning and sweeping.
2. The onslaught of ailments arising from the pestilent humors of houses of uneven temperatures, and air over-laden with dampness and dirt.
3. Limitations upon her God-given inclination to use light colors of wide and varying hues in the decoration of her abode, and her choice of fabrics in the furnishing thereof.
4. The grievances of the creaking chair and the bureau drawer that refuses to open, due to the lack of humidity control.
5. Insects and all manner of creeping and flying things which seek out open windows and enter to make their residences and wreak their destruction.
6. The wading-pool basement with its clothesline of drying garments which won't.
7. The abomination of the paint that peels and the wallpaper that buckles and sags, resulting from extreme moisture.
8. The bills for too frequent cleaning and pressing of clothing, slip covers, drapes and furnishings which throw out of balance her household budget.
9. The jittery nerves and bad disposition, to the everlasting benefit of her beloved family, through diminishment of noise from the street, yes, even to that of the all outdoors.

Proclamation posted in Short Hills, N. J., House by Carrier Corp.

# air conditioning: problems facing the industry

Industry recognizes it has two big problems in dealing with residential air conditioning:

1. Costs to the owner; operating as well as installation.
2. Availability of a constant water supply.

## First Cost

Initial cost varies greatly, depending directly on house, size, amount of glass, outside wall area, type of construction, insulation, duct lengths, geographic location, labor costs and number of units contracted for by the builder.

Addition of proper summer cooling equipment as an optional feature to a new home with forced warm air heat adds about \$1,000 to the sales price. Pioneering builders say this is close to actual cost.

As a step in cutting installing cost, more packaged units are being turned out. Heating and cooling sections come separately to pass through average width doors but fit together in about the same space needed for a furnace alone. This not only lowers the cost somewhat, but simplifies installation.

Manufacturers realize that many builders will want to offer equipment on an optional basis until sure they have enough of a market for air conditioning. However, they point out that if a home is intended for this from the beginning, much of the installation cost can be absorbed by special attention to design.

Offering summer cooling as an extra also means the cost will not usually go on the mortgage but must be met at the time of purchase by the buyer. Some developers specifically designing their homes for air conditioning report they are getting a full share of the cost accepted for FHA mortgage insurance. The first such job to gain FHA approval will be described fully in the March *American Builder*.

## Operating Costs

The first wave of optimism over air conditioning in some areas is sometimes followed by a resistance, blamed on operating costs. Distributors at the Long Island exhibition

pointed out that during the period the summer cooling unit was operating, such cost might average \$1 per day. This they felt was not too much to pay for comfort.

They pointed out that the conditioners use about 1½ gallons of water per minute for each ton of refrigeration, when compressors are operating, and estimated that during peak loads, the equipment would run about 10 hours daily. Under local conditions, the water rate was figured about 50-60 cents per day, along with an additional 50 cents for electricity to run the compressor motors.

The General Electric Co. cites an estimate of \$93 a year to cool a six-room house in Dallas, Texas, which has a long cooling season, and \$65 to cool a similar house in New Jersey. Servel, Inc., has obtained an estimate from local utility companies that a specially built seven-room split-level house with 1,300 square feet of floor area in the Washington, D. C., area would cost around \$300 a year for heating and cooling. The latter, intended for parts of five months during the year, totaled \$140.

Given the estimated annual use of the air conditioner, its tonnage, water temperature factor and local utility costs, General Electric has evolved the following formula to arrive at an approximate annual operative cost:

Annual cost = tonnage installed x hours of operation

$$\left( \frac{1.2 \times \text{cost per K.W.H.} + \text{cost per 1,000 gals. water}}{\text{temperature factor}} \right)$$

K.W.H. stands for kilowatt hours.

Average hours of annual operation in various areas where installations have been made are listed as follows by G.E.:

Baltimore	700	Fort Wayne	600
Boston	200	Grand Rapids	500
Buffalo	125	Houston	1,450
Chicago	400	Indianapolis	800
Cincinnati	850	Milwaukee	300
Columbus	650	New Orleans	1,650
Cleveland	300	New York	300
Dallas	1,200	Pittsburgh	500
Detroit	500	St. Louis	1,150
Duluth	100	Washington	700

Water temperature factors are given as 15 when the mean summer water temperature is 70 degrees

Fahrenheit; 12 at 75 degrees, eight and one-half at 80 degrees and five at 85 degrees.

As an example to operate this equation, G.E. selected a three-ton conditioner in Montclair, N. J., a New York suburb. Given were mean summer water temperature, 70 degrees; electric rate at the "follow-on" step of 2 cents per K.W.H. and water rate at 35 cents per 1,000 gallons.

The formula then becomes:

$$3 \times 300 \left( \frac{1.2 \times \$0.2 + \$3.5}{15} \right)$$

$$\text{Cost} = 900 (\$0.24 + \$0.23)$$

$$\text{Cost} = \$42.30$$

## What about water?

The cost of water is one thing but its availability is another matter. In Long Island, for instance, rapid growth of the population since the war has taxed the capacities of the utility companies to such extent that during protracted hot spells in summer, residents have been urged not to water their lawns during daytime periods. What will happen if large numbers of air conditioned homes start tapping the supply at the rate of 2,000 to 2,500 gallons each per day?

The industry has long-range and short-range answers for this. At least one manufacturer has an air-cooled unit available now and most others are known to be working on this principle. In the meantime, use of a cooling tower or well is recommended where water is high in cost or limited in quantity.

Generally, a cooling tower sized to serve a three-ton unit stands about 6 or 7 feet high and measures about a yard in width and depth. Installation cost in most areas is said to run around \$400 for a type made of material which will ward off corrosion and give many years of trouble-free service. The material, usually an asbestos cement board, is used for packing sheets, exterior panels and sump. Such towers may be installed in the basement or outdoors. Their recirculating process saves about 95 per cent of the water.

Wells are feasible as a water supply in certain areas. If too much digging does not have to be done, this can be cheaper than the cooling tower method. Still more economical ways to obtain the water supply are under experimentation and expected to be announced soon.



Detail view of main entrance. Entire house is sparked through the concentration of bright color in this area

**AMERICAN BUILDER  
BLUEPRINT HOUSE**

DESIGNER AND BUILDER:

*John D. Harrison, Detroit, Mich.*

**let the heart  
of the house  
be a RECTANGLE  
for ECONOMY**

**MORE**

## BLUEPRINT HOUSE

**practical design and  
sound construction methods  
feature this house**



View of house from garage wing. Excellent proportions and soft colors produce a pleasing exterior

**I**n the planning of this house the principle of a rectangle, which produces economy in framing, has been rigidly adhered to by the designer and builder.

The extensions to the basic rectangular perimeter occur on the rear of kitchen and utility room and also the front bedroom. These extensions are "T'ed on top of the truss roof using conventional rafters and ceiling joists. The ends of trusses are carried on built-up beams at points where the extensions occur. The extension for the dining room is framed in a similar manner, with the roof continuing its normal slope for the extended distance. In some cases the ceiling is furred down to the bottom of the beam and in others the beam is enclosed with plaster board.

A feature of the interior finish is

the manner in which the birch plywood paneling is applied to the walls of the activity room. Panels are mounted over two-inch wide strips of the same material and spaced approximately  $\frac{1}{2}$ -inch apart on all four sides. Exposed portion of strips is then finished the same as the panels. This provides a reveal that creates a nice shadow line. Casing and base are formed of the same strips to maintain a uniform effect.

The plan introduces a number of innovations in room layout. Activity room is given the spot usually devoted to the breezeway. Fireplace is taken out of its accustomed position and given a prominent place in this area.

The small bathroom is located in a logical position in the midst of the service and preparation areas. It

is convenient to the service door leading from the utility room to the rear yard. This is practical where small children are involved. The balance of the layout conforms to the modern ranch type style with rooms extending in orderly sequence across the front of the property.

This house, which contains 1,720 square feet of living area exclusive of the garage, is placed on a half acre of ground, with a minimum width of 115 feet. It is currently selling for \$21,400 in the Detroit area. The price includes rough grading but not landscaping or seeding.

For complete one-quarter inch working plans of this house write American Builder Home Plan Service, 30 Church St., New York 7, N. Y.

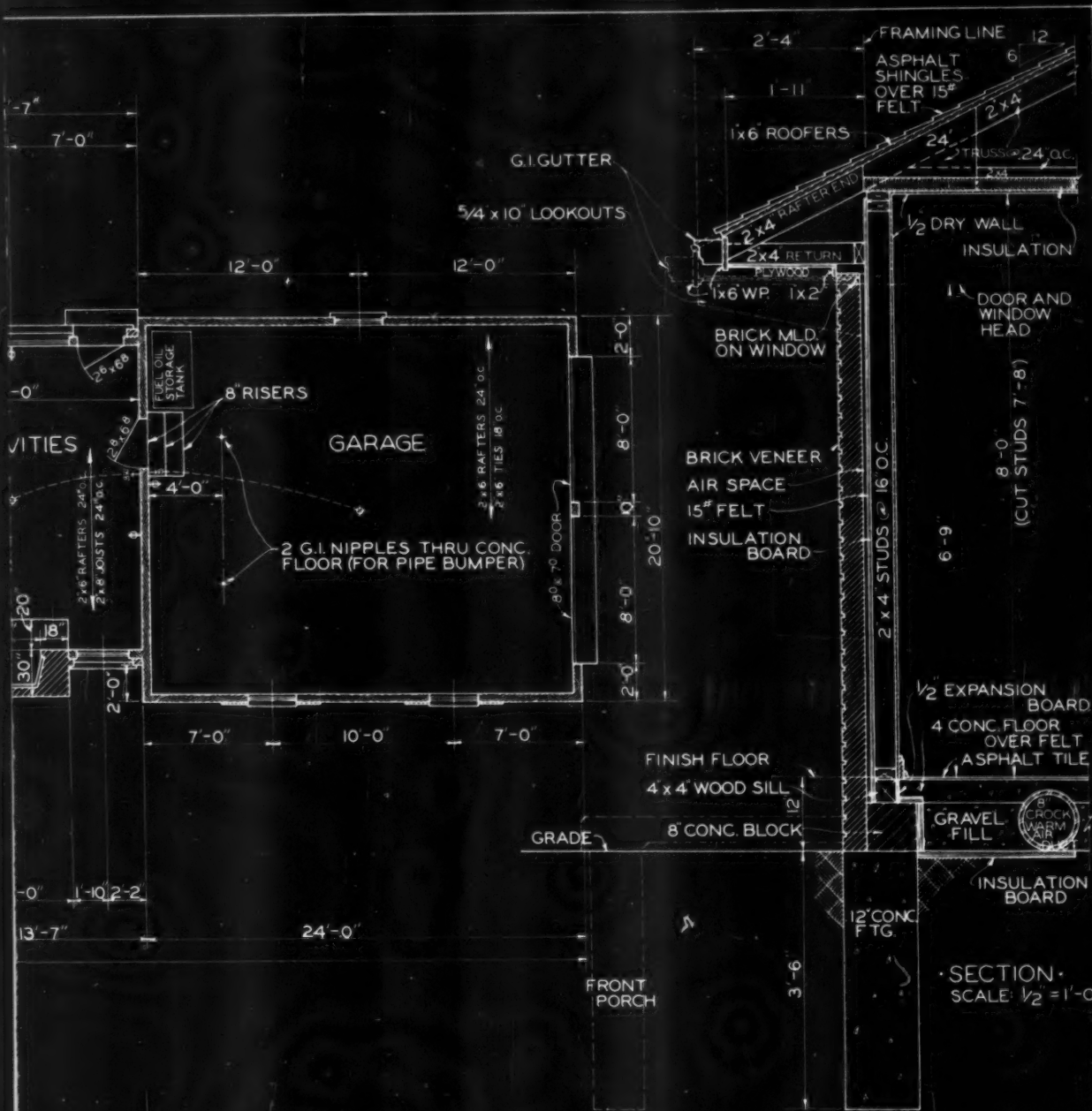

SECTION  
SCALE: 1/2" = 1'-0"

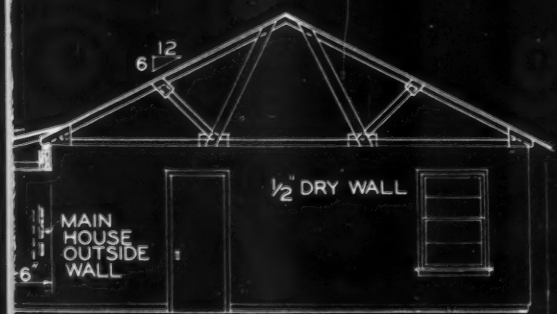

SECTION THROUGH DINING AND LIVING ROOM.  
SCALE: 1/8" = 1'-0"

**DESIGN NO. A.B. 188**

**AMERICAN BUILDER BLUE PRINT SERIES**

DESIGNED BY

JOHN D. HARRISON  
14 ENGLEWOOD

DESIGNER  
DETROIT, 2, MICH.

SIMMONS-BOARDMAN PUB. CORP., 79 W. MONROE ST., CHICAGO 3, ILL.

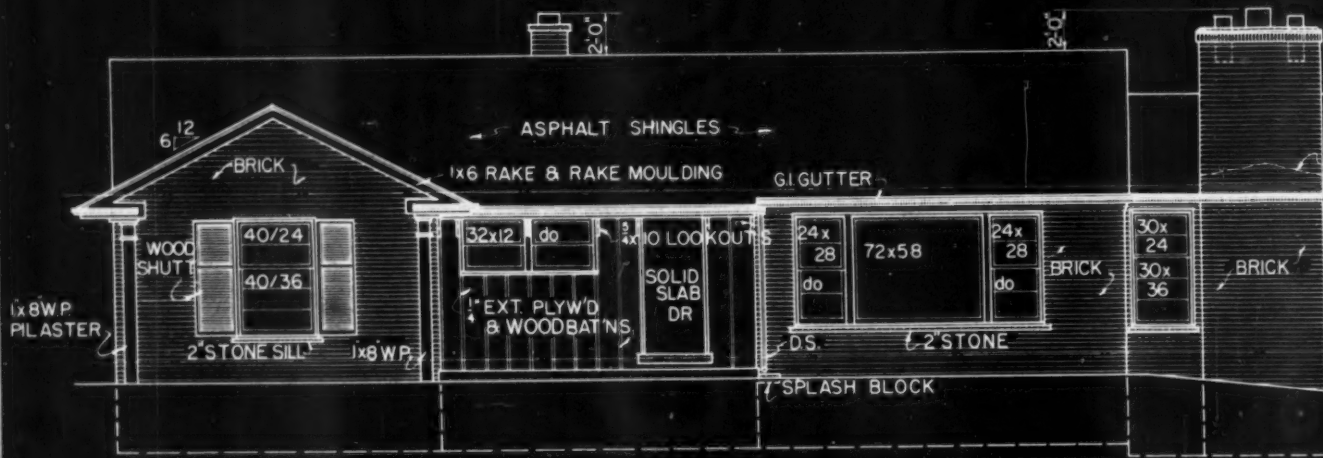

FRONT ELEVATION.

SCALE  $\frac{1}{8}'' = 1'-0''$

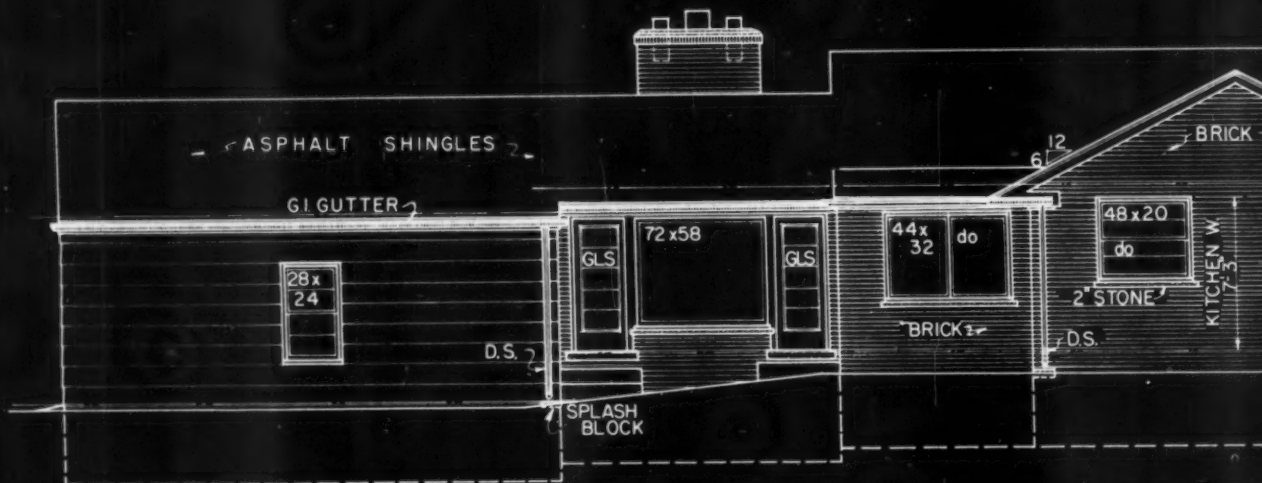

REAR ELEVATION.

SCALE  $\frac{1}{8}'' = 1'-0''$

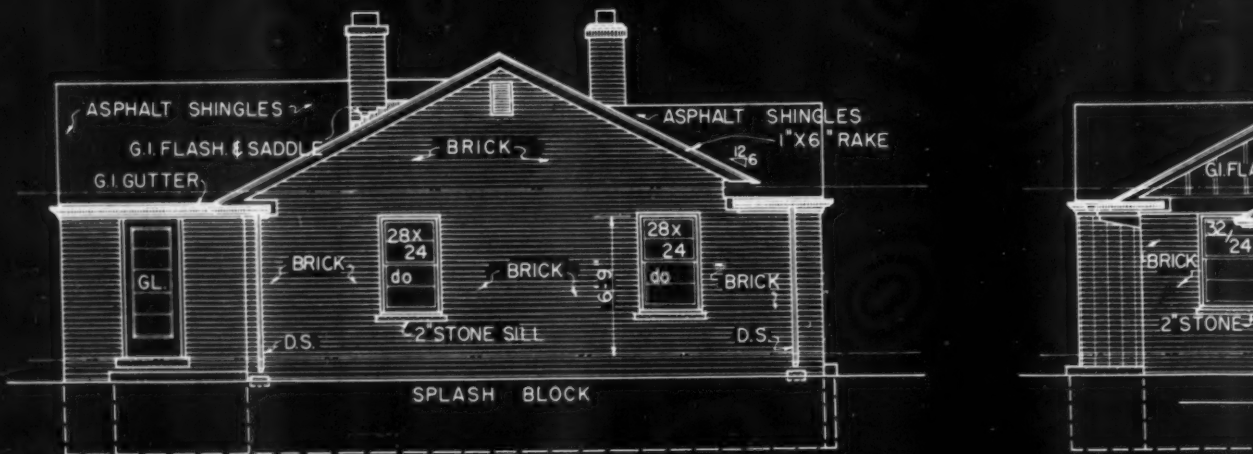

LEFT SIDE ELEVATION.

SCALE  $\frac{1}{8}'' = 1'-0''$



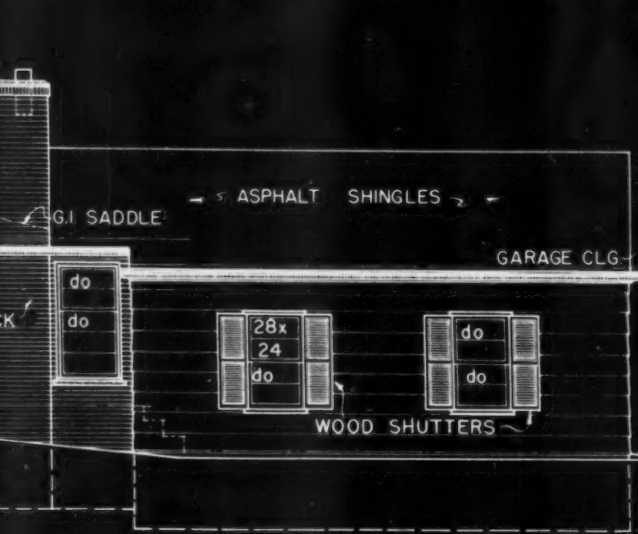

REAR ELEVATION.

SCALE  $\frac{1}{8}'' = 1'-0''$

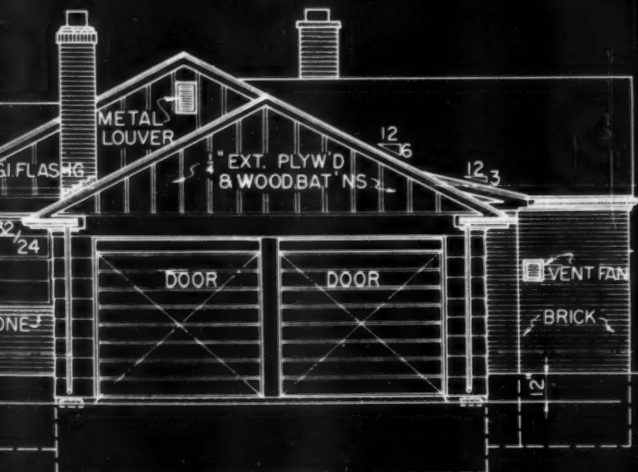

RIGHT SIDE ELEVATION.

SCALE  $\frac{1}{8}'' = 1'-0''$



GARAGE SECTION.

SCALE  $\frac{1}{2}'' = 1'-0''$



RAKE SECTION.

SCALE  $\frac{1}{2}'' = 1'-0''$

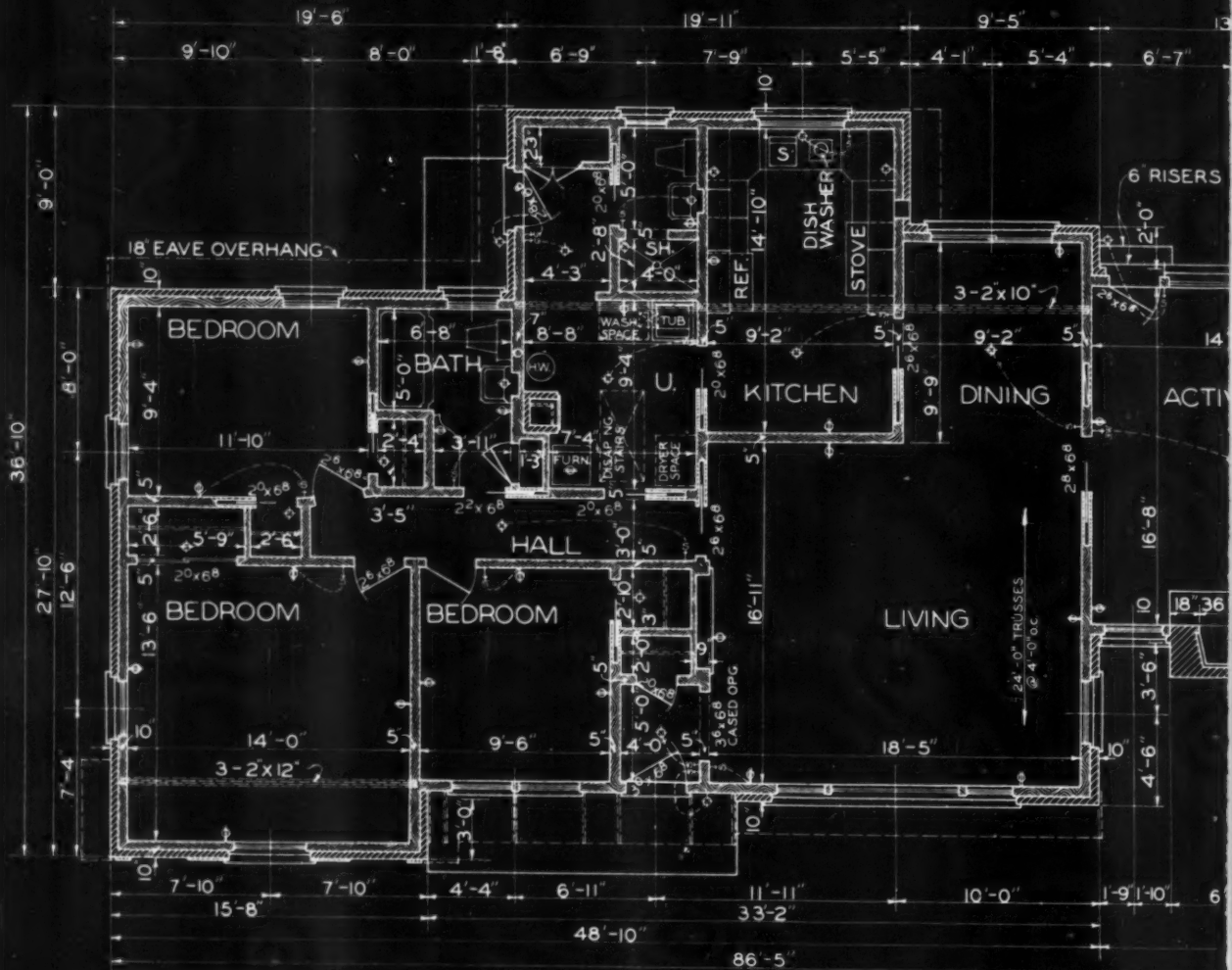

**FLOOR PLAN**  
SCALE 1/8" = 1'-0"

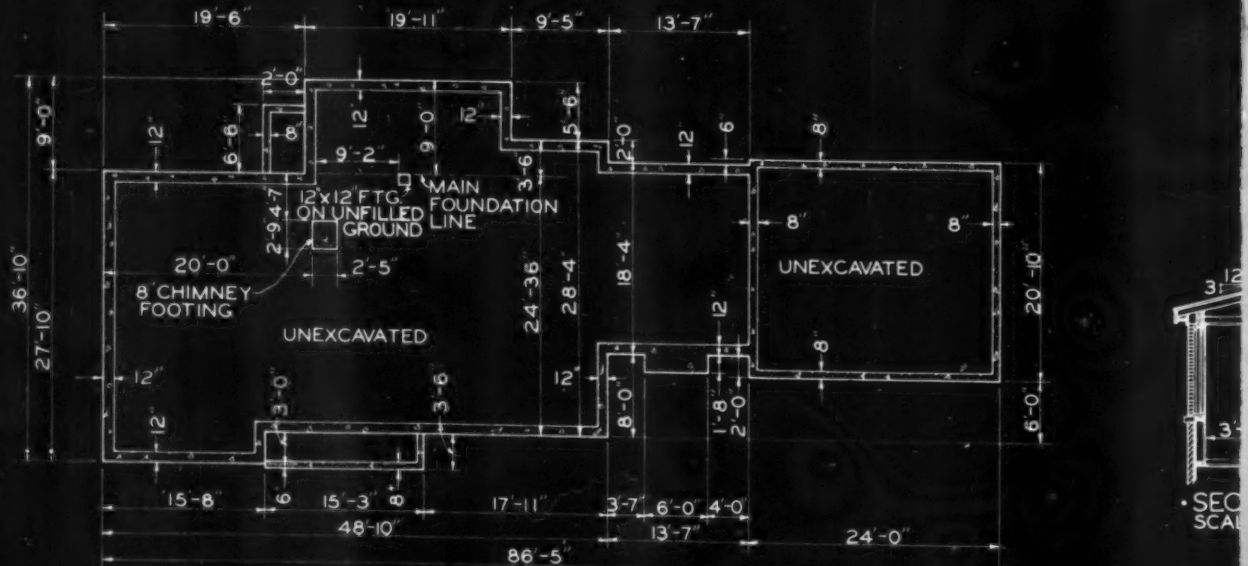

**FOUNDATION PLAN**  
SCALE 1/16" = 1'-0"

TURN AND UNFOLD FOR ELEVATIONS, DETAILS AND QUANTITY LIST OF MATERIALS ▶

# Quantity List of Materials

## For American Builder Blueprint House No. AB 188

John D. Harrison, Architect

### General Information

House — Type	combination
Area	1,501 sq. ft.
Cube	20,143 cu. ft.
Height taken for cube was 13.5 feet	
Garage — Area	499 sq. ft.
Cube	5,988 cu. ft.
Height taken for cube was 12 feet	
Porch — Area	53 sq. ft. concrete slab

1 — 2'0" x 6'8"
2 — 1'2" x 6'8"
sliding 1 — 2'8" x 6'8"
2 — 2'6" x 6'8"
1 — 2'2" x 6'8"
8 — 2'0" x 6'8"

Special Interior Millwork	kitchen cases, bookcase in living room — 4'6" x 9" 1 disappearing staircase, 1 bathroom case
---------------------------	---

### Excavating

Trench for foundation	292 lin. ft.
Chimney and column footings	1 1/2 cu. yds. chimney and fireplace

### Cement Work

Foundations	890 cu. ft.
Concrete Work	2,060 sq. ft.
Thickness	4" over gravel fill 500 sq. ft. insulation board under gravel fill
Steps	32 cu. ft.
Anchor Bolts	65 1/2" x 10"

### Masonry

Type	vener
Walls	1,100 sq. ft. 4" brick veneer
Window sills	stone
Chimney	2 — brick
Flue Lining	64' — 12" x 12"
Cap	4"
Fireplace	226 cu. ft.
Throat and Damper	1
Lintels	1
Miscellaneous	145 concrete blocks

### Iron Work

Structural	5 lintels
------------	-----------

### Millwork

Windows — Type	fixed, sliding, double hung
Material	wood
Windows Glazed including trim	fixed 2 — 72" x 58" sliding 2 — 44" x 32" 1 — 2 lt. 32" x 24" 6 — 2 lt. 28" x 24" 1 — 2 lt. 48" x 20" 1 — 2 lt. 20" x 16" 1 — 2 lt. 24" x 20" 2 — 2 lt. 24" x 28" 2 — 2 lt. 32" x 12" 2 — 2 lt. 30" x 24" 1 — 40" x 24" over 1 — 40" x 36"
Exterior Doors — Material	wood
	solid slab 1 — 3'0" x 6'8" French doors 2 — 5 lt. 2'6" x 6'8" 1 — 5 lt. 2'8" x 6'8"
Garage Doors	2 — 8'0" x 7'0"
Exterior Millwork	
Shutters	3 pair wood
Louvers	2 metal
Exterior Pilasters	2
Lookouts	7 — 5/4" x 10"
Interior Doors — including jams and trim	
	flush panel 1 — 2'8" x 6'8" 3 — 2'6" x 6'8"

### Carpentry

Beams	1 — 3'2" x 10" x 30'0" 1 — 3'2" x 12" x 16'0"
Foundation Plates	180 lin. ft. 4" x 4" 280 lin. ft. 2" x 4"
Studding and Plates	66 — 2" x 4" — 16'0" 215 — 2" x 4" — 8'0" 100 — 2" x 4" — 12'0"
Ceiling Joist	8 — 2" x 6" — 18'0" 7 — 2" x 6" — 22'0" 6 — 2" x 6" — 20'0" 2 — 2" x 6" — 16'0"
Roof Rafters	8 — 2" x 8" — 14'0" 8 — 2" x 8" — 12'0" 40 — 2" x 6" — 14'0" 8 — 2" x 6" — 12'0"
Framing Lintels	2 — 2" x 8" — 20'0" 4 — 2" x 10" — 14'0" 2 — 2" x 8" — 8'0" 2 — 2" x 6" — 8'0"
Roof Sheathing	3,500 b.f.m.
Side Wall Sheathing	670 sq. ft. wood 1,300 insulation board 143 lin. ft. 1" x 2" wood battens
Side Wall Materials	166 sq. ft. 1/4" plywood 420 sq. ft. 1" x 8" beveled W.P. siding
Trusses — 25 Required	25 — 2" x 4" — 24'0" 50 — 2" x 4" — 16'0" 50 — 2" x 4" — 12'0" 100 sq. ft. plywood gusset
Flooring — Material	asphalt tile
Area to cover	1,400 sq. ft.

Exterior Material —	
Soffits	52 lin. ft. 1" x 10" — 125 sq. ft. plywood
Eaves	310 lin. ft. 1" x 6" 130 lin. ft. rake moulding 76 lin. ft. 1" x 2" trim moulding 70 lin. ft. 1" x 8" fascia
Insulation	blanket — 1,500 sq. ft. ceiling

### Sheet Metal

Gutters	175 ft. G.I.
Downspouts	56 ft. G.I.
Flashing	18 ft. G.I.
Miscellaneous	G.I. saddle at chimney

### Roofing

Type	asphalt shingles
Area	29 squares

### Interior Walls

Area to be covered	1/2" drywall 5,800 sq. ft walls and ceiling
--------------------	--

Quantity list prepared by Edward Hines Lumber Co., Chicago

# IDEA of the Month —

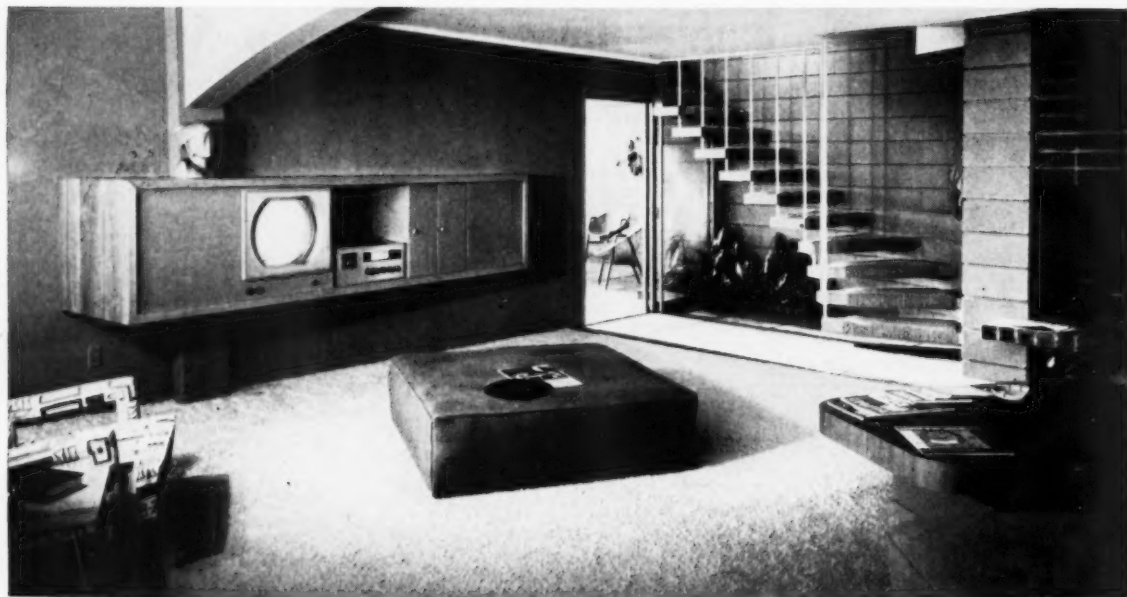

## BUILT-IN entertainment center

Mrs. Prospect looks thoughtfully around the bare expanse of the new living room. "Where would we put the television set?" is one big question she asks herself. It is a question which certainly gets more and more important to today's new home buyer. Why not turn it into a point of sales advantage by definitely providing for television placement in the house design?

Here's one easy and economical way to do it. This cabinet is sus-

pended from one wall of the living room, and groups television, radio-phonograph and record albums in one logical unit. Handsome to look at, simple to build, it "sells" the room. It was designed by Richard O. Spencer for a house in California. Doors and facing for speaker compartment are in  $\frac{1}{8}$ -inch perforated Presdwood.

In this particular case, a remote control unit for the television set was rigged up in the coffee table.

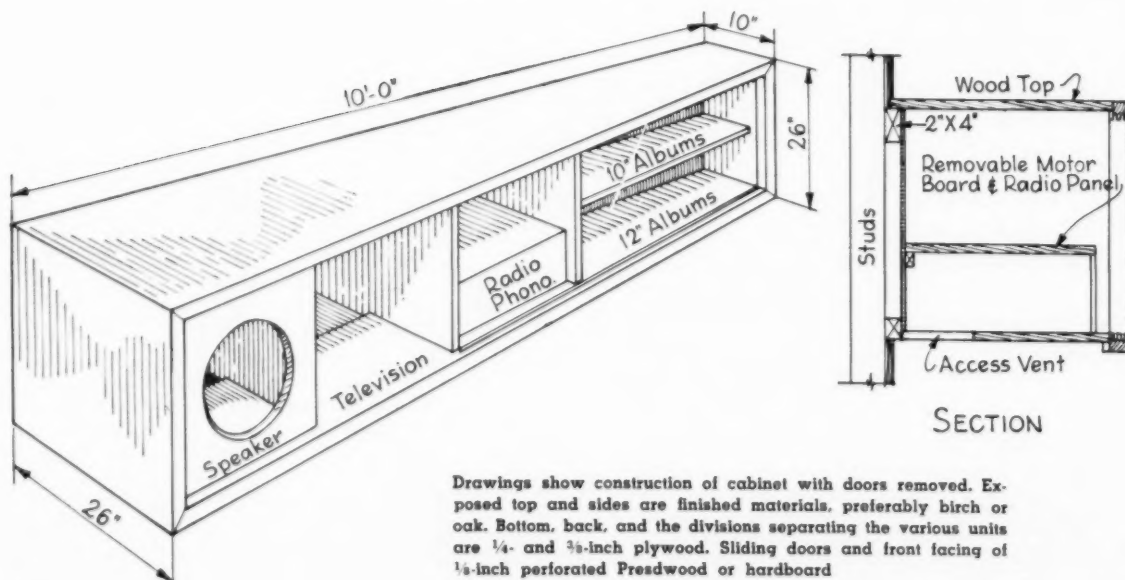

Drawings show construction of cabinet with doors removed. Exposed top and sides are finished materials, preferably birch or oak. Bottom, back, and the divisions separating the various units are  $\frac{1}{4}$ - and  $\frac{3}{8}$ -inch plywood. Sliding doors and front facing of  $\frac{1}{8}$ -inch perforated Presdwood or hardboard

# Car Housing at its best—



that's what

## RO-WAY

offers you

### with the finest garage doors in its history

Modern car housing is a far cry from the "back yard" garage of the past. *Today's* garage has moved "up front" and become part of the house—a complement and compliment to new ideas in architecture.

To keep pace with these changes, Ro-Way now brings you Taper-Tite Tracks and Seal-A-Matic Hinges, in addition to such famous features as Power-Metered springs, Friction-Reducing track, and Double-Thick Tread rollers.

● **TAPER-TITE TRACK.** Vertical tracks taper away from the jambs at a pitch of  $\frac{1}{4}$ " per door section. In "down" position, door is snug-tight against the weather, providing positive protection.

● **SEAL-A-MATIC HINGES.** Ro-Way design, Ro-Way made. Graduated to guide the closing door tightly against jambs and to hold it there snugly. On opening, hinges instantly free the door to provide smooth, easy, almost frictionless operation.

This is car housing at its best—with Ro-Way overhead type doors. Specify Ro-Way.

**ROWE MANUFACTURING CO., 710 Holton St., Galesburg, Ill.**

*there's a Ro-Way for every Doorway!*

Nationwide sales and installation service. See your classified telephone directory for nearest Ro-Way distributor.





# All set to save dollars on every door-hanging job

with the convenient

**HANDYMAN**

**BUILDERS KIT**

Now in one compact carrying case are all the power tools you need for hanging doors quickly and expertly right on the job.

Look at what you can do — the time and money you can save — with the Stanley Handyman Builders Kit:

With the motor unit in the plane attachment, you can fit doors and sash in a jiffy — also fit storm sash, screens, shutters, inside trim, drawers.

Then, using the templet and router, you can mortise for door hinges *six times faster* than by hand — and every mortise will be perfect.

Put the Stanley Builders Kit to work for you. It will pay off in extra speed and economy on every building job. Ask your Stanley dealer for a demonstration. Or write for descriptive literature to: Stanley Electric Tools, 400 Myrtle Street, New Britain, Connecticut.

On the job  
from East to West  
... Made by  
men who make  
tools **BEST**



For Production-Line Efficiency  
Investigate These Companion Tools



Lock Mortiser, LM1. Does a complete mortising job in about 30 seconds. Easily adjustable.



Safety Saw, W65. Light-weight 6" saw, full 2" cut. High speed, sturdy construction. Easy to handle in any position.

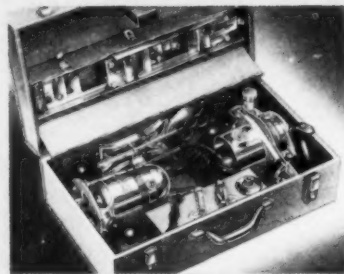

Stanley Builders Kit includes: 3/4 h.p. motor, straight and circular gauge, router base, plane attachment, arbor, plane cutter, mortising bits, templet guide, door and jamb butt templet, carrying case.

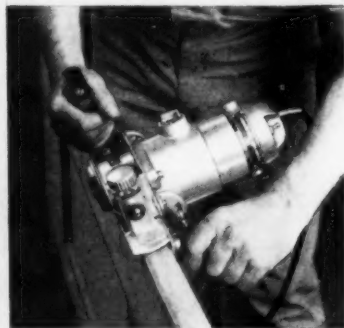

Plane cutter used in plane attachment. Will handle doors up to 1 1/16" in width. Leaves smooth, waveless surface that requires no sanding. Blows chips entirely free.



Router base and motor used with templet for cutting mortises. Provide perfect fit for round or square corner hinges. Accurate, micrometer depth adjustment.

**STANLEY**

Reg. U.S. Pat. Off.

HARDWARE • TOOLS • ELECTRIC TOOLS • STEEL STRAPPING • STEEL

# FASCO Revolutionizes the Home Ventilating Industry!

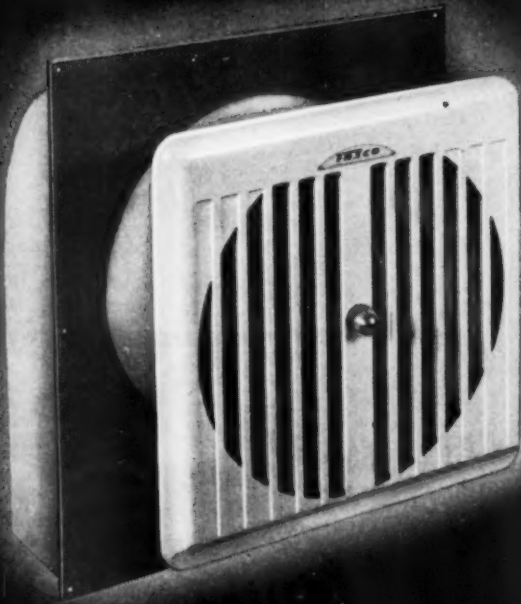

## WITH COMPLETELY *Automatic* OUTSIDE WALL VENTILATING FANS

Now . . . Fasco introduces the greatest combination of features in any outside wall ventilator. Style, simplicity, installation ease and *completely automatic* performance make the new Fasco 882 and 1082 first choice with leading architects, builders and contractors everywhere.



Four-pole **TOTALLY** enclosed motor in both 8 and 10-inch ventilators. **FIVE** petal deep pitch blades in 8-inch model. Provides for greater air exhaust with whisper-quiet performance.



Incomparable installation ease. Outside Junction Box accessible for quick wiring. Electrician's job completed at time of rough wiring.

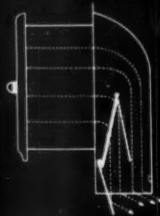

Flip switch on . . . quiet, extra-powerful Fasco fan *automatically* opens louvre. Exhaust air is forced away from exterior walls. Flip switch off . . . louvre closes automatically by perfectly balanced spring action, keeping out dust, cold wind and rain. Positively stops backdraft. A Fasco exclusive!

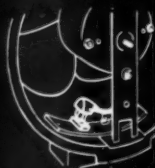

New separable plug allows final installation or removal of fan and motor unit without tools. Wiring is never disturbed.

**FREE** complete details on this and all Fasco ventilators. Write today!

SPECIFY FASCO FOR EVERY VENTILATOR INSTALLATION

**FASCO**  
INDUSTRIES, INC.



223 AUGUSTA STREET • ROCHESTER 2, NEW YORK

**JOHNS-MANVILLE**

# Asbestos Flexboard

**offers advantages  
never before combined  
in one building  
material.**



One man can handle the big sheets



Easy to nail

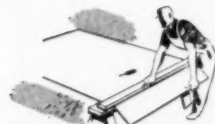

Easy to handle



Strong and tough

**Asbestos Flexboard** answers a thousand building needs  
for the home, for the factory, for the farm!

IT'S DIFFICULT to appreciate the many advantages of Asbestos Flexboard until you have used it. It wears like stone, it's light in weight, and it can be flexed to fit curved surfaces. On the job, ordinary hand tools are used to work Flexboard and customary construction methods are followed.

It can be applied horizontally or vertically, and can be nailed close to the edge without drilling.

Made of asbestos and cement, Flexboard is fireproof, won't rot, rust or corrode, resists rats and termites. Large 4' x 8' Flexboard sheets come in 3 thicknesses— $\frac{1}{8}$ ",  $\frac{3}{16}$ ", and  $\frac{1}{4}$ ".

Flexboard has an attractive stone-grey color with a smooth hard surface that needs no other finish. As soon as it is in place, it is ready for years of maintenance-free service.

For more information about Asbestos Flexboard, write Johns-Manville, Box 60, New York 16, N.Y.



**Johns-Manville**



Could you offer such features  
in an \$8,950 home?



WINDOW WALL



BUILT-IN  
WARDROBE

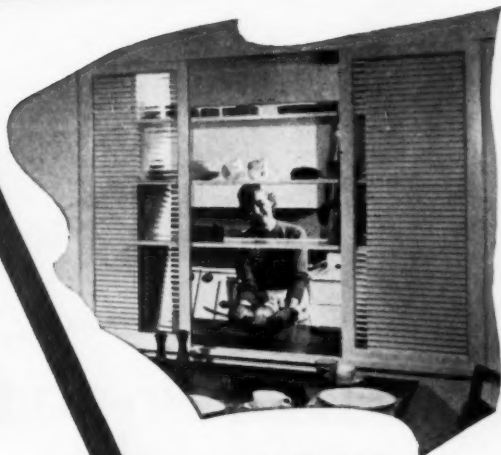

PASS-THRU



CARPORT

## You can, if you build P & H Homes

Build P & H Homes, and you offer these luxury features and top quality construction for as little as \$8,950—practically anywhere. No question you'll sell more homes. And, with the P & H near-complete prefab home package, your site costs are shaved to the bone. So you'll profit more, too.

To Help You Sell—P & H Homes are nationally advertised in *Better Homes & Gardens*, *Living for Young Homemakers* and *Household*.

Start your own building boom this year with P & H Homes. Send for details today. . . . Or learn about the P & H Builder Profit Plan at the NAHB Show, P & H Booth No. 13, Hilton Hotel, Chicago.

**P & H HOMES** DIVISION OF HARNISCHFEGER CORPORATION



12 Spring Street, Port Washington, Wis.

the **P & H** Line



TRUCK CRANES



DIESEL ENGINES



POWER SHOVELS



PRE-FABRICATED HOMES



ELECTRIC HOISTS



SOIL STABILIZERS



WELDING EQUIPMENT

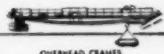

OVERHEAD CRANES

FEBRUARY 1953

111

# Figure it BOTH ways

1. cost-in-place  
of lumber  
roof sheathing

2. cost-in-place  
of PlyScord  
roof sheathing



HERE's paper and pencil proof that you can cut costs with PlyScord—and get a far better job, too. Remember, the full story of construction costs isn't shown on the bill of materials. It's the *applied cost* that counts. That's why you can save up to \$2.50—and more—per square with PlyScord. Prove it yourself. Figure it *both* ways on the chart below.

### Estimating Chart to Cover 1,000 Sq. Ft. of Roof Area

Data Developed from Walker's "The Building Estimators' Reference Book"

PLYSCORD*	RATE	TOTAL	LUMBER	RATE	TOTAL
1,056 sq. ft. 3/8" or 5/16"			1,200 ft. b.m. 1x8 shiplap		
Nails 6d-12 lbs.			Nails 8d-20 lbs.		
Carpenter 6 Hours			Carpenter 11 Hours		
Helper 3 Hours			Helper 5 Hours		

TOTAL COST IN PLACE..... TOTAL COST IN PLACE.....

\*FHA now accepts 3/8" PlyScord over rafters 24" o.c., 5/16" PlyScord over rafters 16" o.c. Write Douglas Fir Plywood Association, Tacoma, Wash. for application data.

# PLYSCORD®

## GRADE FIR PLYWOOD

This registered trademark identifies PlyScord—the economical construction grade of Interior fir plywood bonded with highly moisture resistant glue. This stamp on panel is your assurance of tested quality.

© Douglas Fir Plywood Assn., (DFPA)



In test above 3/8" PlyScord on 24" span easily withstands 500 lb. concentrated load. Plywood's great two-way strength means economy because relatively thin panels can be used—3/8" PlyScord on rafters 24" o.c. easily withstands uniform load of 30 lbs. p.s.f., 5/16" on 16" span takes uniform load of 40 lbs. p.s.f. Both constructions now FHA accepted.



PlyScord holds nails well. Tests on roofs exposed 2 years show minimum force of 85 lbs. required to pull cedar shingle from 5/16" PlyScord. In case of asphalt shingles, roofing is invariably torn from PlyScord without loosening nails. Other tests and actual experience shows 5/16" PlyScord holds nails as well or better than 1" soft pine boards.

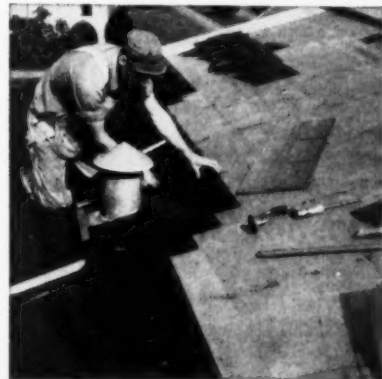

Roofing materials go down faster over solid PlyScord sheathing. Factory seasoning assures dimensional stability. PlyScord won't shrink or swell like boards to damage roofing. Roofing lays flat, stays flat. PlyScord roof sheathing adds strength and rigidity, acts as a structural diaphragm in resisting loads caused by high winds, earthquakes.

# Stop plaster cracks —before they start

**KEYMESH GALVANIZED REINFORCING ASSURES EXTRA DURABLE, CRACK-RESISTANT, SMOOTH PLASTER INTERIORS BY OVER-ALL UNIT REINFORCING.** Unit reinforcing is accomplished by applying Key-mesh over an entire room area so that the finished plaster becomes a complete, unbroken, strongly reinforced unit. This *Unit* reinforcing with Key-mesh distributes stresses and strains evenly, prevents plaster cracks, and permits a wider variety of interior design and construction possibilities for commercial and residential buildings, and private homes.

Keymesh goes into place flat and laps without bulges. The open-mesh design permits quick, easy troweling. Keymesh has no jagged edges to tear the hands. It's flexible, too. It forms easily around corners and arched, curved or rectangular surfaces. It cuts quickly to shape around windows or other openings. Keymesh is available in 150' by 3' or 4' rolls, 18 or 20 gauge, galvanized hexagon 1" mesh steel wire fabric. Other widths and gauges available.

The "Keystone System" outlines a fast, practical method for unit reinforcing over-all interior plaster with Keymesh. Write for your copy of the "Keystone System," today.

## **KEYSTONE STEEL & WIRE COMPANY**

Peoria 7, Illinois

KEYMESH • KEYMESH-KORNER • KEYSTONE TIE WIRE  
NON-CLIMBABLE FENCE • KEYSTONE ORNAMENTAL FENCE



NAILS  
WELDED FABRIC



# "G-E Remote-Control Wiring helped me contract for 500 homes in one month"

says W. W. PRAVER

One of America's foremost builders reports  
from Kansas City on G-E remote-control wiring.



"It's remarkable how much sales appeal G-E remote-control wiring gives for only \$30 more than a conventional installation," says W. W. Praver.



Master selector switch that first attracts a home-buyer's attention.

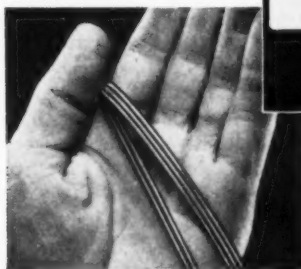

Small, lightweight wire used to connect switches with relays at fixtures or outlets.

Remote-control relay operates on 24 volts—is located in or near the outlet box—does the actual switching of the 120-volt power.

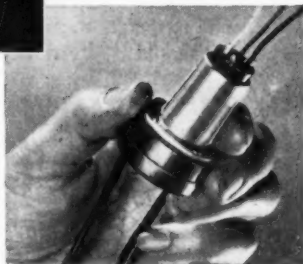

"Every item for our 1750 house Ruskin Heights project had to offer great value," says Kansas City builder, W. W. Praver, president, Praver and Sons. "Our plan was to use quality materials and they had to offer an obvious plus value.

"This approach worked perfectly for the wiring," Mr. Praver said. "We chose the G-E low-voltage remote-control wiring system because it is a quality system which can be demonstrated on the spot. The master selector switch in this G-E system controls 9 circuits from one location—we located ours in the bedroom. Prospects are fascinated with the extra convenience that G-E remote-control wiring offers and it helps carry their interest throughout the house. One month after announcing that our \$10,000 and \$10,500 model homes were open for inspection, we had orders to build more than 500. I am convinced that the G-E remote-control wiring system was an important factor in this record sales volume."

## Get the facts— write for these informative booklets

- 1. CONTRACTOR'S MANUAL**—Thirty-six-page manual gives you all the facts—layout, wiring diagrams, and important installation hints. Let this booklet bring you up to date on G-E remote control.
- 2. CONSUMER BOOKLET**—To explain the advantages of G-E remote-control wiring to your prospects, General Electric offers an informative, 8-page booklet. Write for a copy of the Remote-Control Consumer booklet, and ask for information on obtaining it in quantity.
- 3. LOCAL ADVERTISING MATERIAL**—A complete package of advertising material has been prepared for use with your remote-control program. Ask for this important selling aid.

For any of these aids, see your G-E Construction Materials distributor or write Section D67-22, Construction Materials Division, General Electric Company, Bridgeport 2, Connecticut.

*You can put your confidence in—*

**GENERAL  ELECTRIC**

# do you know how to organize YOUR BUSINESS?

**forms that help the  
custom builder grow  
into a larger busi-  
ness without going  
broke**

Any successful builder of houses on order has plenty of know-how "under his hat," so to speak. So long as he can personally control every phase of a job, he doesn't feel much need to try to put down his system on paper.

But let him once begin to grow out of the "little black book" stage of interviewing clients, estimating, specifying, etc., and he finds himself in a different position. Say his volume is beginning to expand from 10 or 15 houses a year up toward 50. Now he finds that his system must cease to be "private" and be made instead into a "public" outline for job procedure which can be easily grasped and followed by the augmented staff which he will now have to assemble around him. Now he is faced with the absolute need to communicate his knowledge to others, and to systematize things in such a way that the business as a whole can function successfully without dependence on any one or two persons.

To do this is not as easy or as simple as it may sound. And while any expansion and organization of a small-volume custom business

into a larger one will always to a large extent be an individual matter, nevertheless there is a real need today for a manual of sample forms, tested by experience, which will help a custom business grow in the orderly way which is basic to success.

The Larger Homes Council of the National Association of Home Builders has recognized this need and is in the midst of doing something about it. In preparation is just such a manual. Sparked by John R. Worthman of Fort Wayne, Indiana, the Council is gathering a collection of suggested procedures, contract and operating forms which can be used to cover almost every situation attaching to the various steps of the building process. Over 50 forms now make up this collection, most of them having evolved from John Worthman's own early experience as a one-man operator who did a good deal of the carpentry, cement, masonry and painting work himself.

While arranged chiefly with the custom builder in mind, many of these forms are equally useful to the builder of houses for sale. It should

also be emphasized that this proposed manual is *not* a bookkeeping system, but consists of supplementary forms and procedures which support and feed into the actual bookkeeping end of the business.

Eventually this valuable new tool will be available in published form. In the meanwhile, the *American Builder* is privileged to present a few of the forms which will stand as foundation stones in building the manual. We have picked four as being of outstanding interest: (1) an Initial Building Questionnaire; (2) Preliminary Agreement between builder and client; (3) a Home Trade-In Guarantee; (4) a long form which functions three ways, as Comprehensive Estimate Summary, Outline Specification, and Progress and Supply Check list.

We will publish these forms one at a time with brief comments on their design and use. We urge any reader who may have questions about the forms—or who believes he has something similar to offer which does the job even better—to write us. Or better yet, contact John R. Worthman, 215 W. Leith Street, Fort Wayne 6, Indiana.

## initial building questionnaire

THIS FORM can be used by the builder or salesman as the initial step in getting down to an actual case. It fills in the background of the client and records those main points with which the builder will later have to deal in full. It determines immediately the feasibility of fulfilling the client's needs and desires. Thus if the questionnaire re-

veals negative points, such as unrealistic financing, overbuilding the location, improper site for type of home desired, poor credit risk, etc., much time is saved which otherwise would have been wasted in trying to work out an impractical deal. This form is also a helpful record and guide to the salesman or designer in preparing preliminary sketches.

It usually results in a free-hand sketch done on 1/8-inch layout pad. It is attached to the inside of the client's file cover. If the sale is postponed, this form serves as a good future reference. Also, it often proves to be invaluable when mortgage matters come up later on—and for this reason alone it should not be skipped in the first dealings.

## INITIAL BUILDING QUESTIONNAIRE

Name ..... Wife ..... Date .....  
 Address ..... Phone—Res. .... Bus. ....  
 Children—Boys ..... Girls ..... Others ..... Referred to us by .....  
 Profession or employment ..... How long? .....  
 Position ..... Superior's name .....

**FINANCING** (If needed)      **FHA** ..... **Veteran's** ..... **Other** .....  
     Annual Regular      \$ ..... Available cash      \$ .....  
     Income Bonus, etc.    \$ ..... Owners lot equity      \$ .....  
     TOTAL                    \$ ..... **TOTAL DOWNPAYMENT**    \$ .....

Payment limit (determined by above info) \$ ..... Cost limit of house & lot \$ .....

(Note: If FHA or Veteran's Loan is desired, review credit application.)

Establish approx. limits of:

Proposed house cost	\$ .....	Proposed financing:	Equity value in lot	\$ .....
Proposed lot cost	\$ .....		Plus cash available	\$ .....
Total cost	\$ .....		Other	\$ .....
Less Downpayment	\$ .....		Total Downpayment	\$ .....
Mtg. Required				

Is proposed financing feasible? ..... Checked with .....

**SITE INFORMATION:**

Lot: Own one now? ..... if not, where preferred? .....  
 Legal description ..... Street address .....  
 FHA approved location? ..... School preferred .....  
 Lot size ..... Set back ..... Corner lot ..... Inside lot .....  
 Topography ..... Direction ..... Wooded .....  
 Drive (front) ..... (rear) ..... (alley) .....  
 Sewer ..... Water ..... Gas ..... Light .....

**HOUSE DESIGN—Plan Info:**

Describe Floor Plan with approx. sq. ft.

Design preferred      No. Stories

Basement ..... Attic ..... Frame ..... Masonry .....

Prospects furniture analysis .....

Special planning objectives or problems .....

Vestibule ..... Porch: Size ..... x ..... Screened in? ..... or glassed & screened .....

Where garden ..... Any special views? .....

**Number of rooms & sizes:**

**Built-ins & special furniture**

Living	x	Piano	.....
Dining Room	x	Plus dining space	.....
Kitchen	x	Showers	.....
Bath #1	x	Showers	.....
Bath #2	x	Showers	.....
Bath #3	x	Showers	.....
Bedroom #1	x	Twin or Std.	.....
Bedroom #2	x	Twin or Std.	.....
Bedroom #3	x	Twin or Std.	.....
Bedroom #4	x	Twin or Std.	.....
Study	x	Where	.....

Activities Rm ..... x ..... Ceiling ..... Sidewalls .....

Garage: (1 car) (2 car) (attached) (detached) .....

Fireplaces: How many and where ..... Inside ..... Outside .....

Heating plant (Type:) Forced air ..... Hot water ..... Fuel .....

Wall finish: Plaster ..... Drywall ..... Other .....

(Special remarks and rough plot plan on reverse side) .....

Salesman .....

**next month — PRELIMINARY AGREEMENT FORM**



Owner-built home erected by Dave Ek with assistance of the H. L. Ring Company, Spokane, Wash. The lot was valued at \$2,000 and an \$11,000 loan was secured. Completed house of 1,160 square feet cost Ek about \$14.50 per square foot, compared with best contract price secured of \$17.50. Ek worked from 10 A.M. to 2 P.M. daily, did part of the carpentry, most of the finish, all painting and also laid the floors

## assisting 'BUILD-YOUR-OWNERS' can

**Spokane builders find help is required in 90 per cent of cases**

The man who has made up his mind to construct his own home will hardly stir enthusiasm among professional builders, yet one West Coast firm has found it good business to help him in every possible way, rather than buck the movement.

Recognizing that glowing success stories in home and women's magazines about owner-building are influencing many families that this is the way to save "thousands of dollars," the H. L. Ring company of Spokane, Wash., has adopted a widespread service policy tailored to fit their needs. In the opinion of Harvey L. Ring, president, 90 per

cent of the families desiring to do all or part of the work with their own hands actually need considerable assistance, and this can be a very fertile field for the alert builder.

For its part in this novel alliance, the Ring company is geared to:

1. Furnish plans or work with the client's plans;
2. Supply any or all materials;
3. Provide subcontractors for any work the client does not want to do;
4. Arrange easy-term financing including the value of the owner's labor;
5. Make periodic inspections;
6. Give expert advice when necessary;

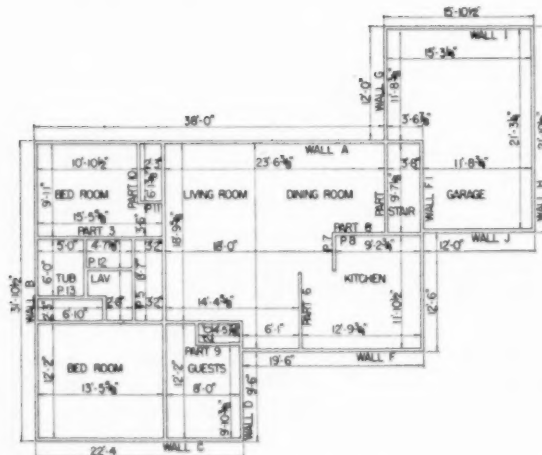

Floor plan of Ek home indicates position of each exterior wall and interior partition by number. The same idea is followed in wall and partition elevations, as well as in roof layout, with each piece of pre-cut lumber numbered. Top and bottom plates are cut to length and marked for studs. Headers and cripples are also marked

COMPLETE BREAKDOWN SHEET	
Name _____	Plan No. _____
Address _____	Floor Area _____
City _____	Construction _____
	Contract Buyer
Plans and Specifications.....	
Survey and Clearing Lot.....	
Building Permit and House Number.....	
Excavating, Backfilling and Grade.....	
Footings and Foundations.....	
Basement Windows.....	
Concrete Floors, Step, Slab and Patio.....	
Water Proofing (Labor and Material).....	
Water Connection - Septic Tank <input type="checkbox"/> Sewer <input type="checkbox"/>	
Water Connection, Tap and Meter.....	
Rough Plumbing (Labor).....	
Rough Plumbing (Materials).....	
Finish Plumbing (Labor).....	
Finish Plumbing (Materials).....	
Heating (Materials).....	
Heating (Labor).....	
Fuel Storage.....	
Wiring (Materials).....	
Wiring (Labor).....	
Wiring Fixtures.....	

Excerpt from breakdown sheet listing every item going into house. Total of two columns helps determine amount of loan



7. *Be prepared to take over construction at any stage. the client may decide he has bitten off more than he could chew.*

Ring believes his activities will not interfere with sales of conventional builders, because such customers are those who have made up their minds to build in this manner and would not patronize the contractor or builder operating in the usual way.

To date, about half of the firm's clients are farmers, while the other half are residents of Spokane and smaller areas located up to 800 miles away. Most of the volume comes from small towns and rural areas.

## be profitable

Contrary to common belief, according to Ring, the bulk of his homes are in middle- and upper-price brackets. In one small town, for example, his customers erected homes costing \$10,000, \$18,000, \$25,000 and \$30,000. They did this, he believes, because they wanted a better home than they could buy with the amount of cash available for a down payment; they had spare time and wanted to put it to use, and, in many cases, they actually like to work with their hands. Many farmers with spare time in winter, he noted, will have the excavation made and shell erected, then do the balance of the work themselves or by day labor.

On a client's first visit, Ring discusses the work in detail with him; finds out his special aptitudes, how much time he has to work on the house, in order to counsel him as to his best procedure. Plumbing, wiring and electrical work are almost always sublet, but most owners do all or part of the carpentry and painting.

If the client decides to do certain work and later finds he cannot do it, Ring subcontractors pick up where he left off. This happens frequently.

### Determining Loan Amount

Once the owner-builder is ready to negotiate a contract, a breakdown sheet is filled out in his presence. The cost of every item—labor and materials—to be used in building the house is entered in one of two columns at the right. Anything to be furnished by the owner is listed under "buyer," while all other items are marked down under "contract."

Total of the two columns is the basis for the loan to be arranged by the company.

Later, Ring and a mortgage company representative go over the whole plan in detail. The loan is based upon their joint judgment as to whether or not the buyer can perform the work specified for himself. If there is any question over this, an amount is set up in the first column (contract) to cover the labor which is in doubt. After six years' experience in doing this, Ring reports few mistakes are made and practically all jobs go forward as scheduled or with a little additional assistance where the owner has overestimated his time or energy.

One stipulation in the loan is that the house must be completed within nine months; if construction lags, the owner is urged to push his work or employ a subcontractor to avoid penalty.

Most buyers have from \$1,000 to \$4,000 in cash, but many have all the cash needed. A buyer needs about \$1,000 in cash, plus his lot, Ring points out, the cash being needed to carry the building to the point where he can begin to draw mortgage money to continue the construction. "Draws" are allowed on this type of work according to a "percentages of completion" table, on which 33 steps are listed. Usually, only six or seven "draws" are made and it is a rarity when any one is for less than 10 per cent.

The Ring company furnishes detailed plans through its own architectural department and makes at least five supervisory inspections during construction, at which time the client is coached. Operation of the plan is intended to have the client always feel that he is safe—he knows no item of cost has been overlooked in computing his loan; he knows he can get expert advice on any point where necessary, and he knows that if he cannot or does not want to go through with his own work that he can have it completed without delay.

### Lumber Furnished

Ring usually furnishes all lumber and millwork. The lumber is cut to size, each piece marked to indicate where it goes, and is delivered to the job in accordance with the agreed plan. When the subfloor is completed, the client can make a 12½ per cent draw, which generally goes to Ring to apply on the first package of lumber delivered (this includes lumber to roof the house). This draw, plus cash originally deposited, is usually sufficient to cover excavation and foundation costs and

a payment on the lumber. A second package, comprising the balance of the material supplied by Ring, is delivered when the house is enclosed.

Floor joists, shiplap and portions of the dimension lumber which do not require cutting are delivered directly from the mill to the job. Studs, plates and rafters which are cut and marked come from Ring's plant. His five-ton truck can haul lumber for a 1,000 square foot house in two loads. On long hauls, he finds it cheaper to use a trucking service.

Ring sells heating equipment and appliances in a store adjoining his offices and home buyers securing appliances from him get a special price. Precut packages usually include birch doors, cedar shakes, select oak flooring, weatherstripped windows, roofing and mineral wool insulation, and framing lumber.

### Low-Cost Unit Planned

The firm is preparing a program to market a low-cost unit with an expandable plan. Completely precut and packaged, this will have to be accepted by the buyer without major change if he wants the low package price: \$4,860 for a one-bedroom unit to \$6,860 for four-bedrooms.

PERCENTAGE OF COMPLETION		
	% Draw	Total %
Excavation . . . . .	2	2
Forms Set . . . . .	3	5
Foundations Poured . . . . .	3	8
Floor Joists Set . . . . .	2	10
Subfloor Laid . . . . .	2½	12½
House Framed . . . . .	6	18½
Walls Sheathed . . . . .	4½	23
Roof Ready to Shingle . . . . .	2	25
Roof Shingled . . . . .	3½	28½
Chimney and Fireplace in . . . . .	5	33½
Plumbing Roughed in . . . . .	6	39½
Wiring Roughed in . . . . .	2½	42
Sheetrock or Rock Lath in Place . . . . .	6	44
Plastered or Sheetrock Sealed . . . . .	2	50
Siding on . . . . .	5	55
Basement Floor Poured . . . . .	2	57
Furnace Set . . . . .	6	63
Furnace Connected . . . . .	2	65
Interior Carpentry and Trim . . . . .	8	73
Windows Set . . . . .	2	75
Exterior Cement Work . . . . .	2	77
Interior Decoration . . . . .	5	82
Siding Primed . . . . .	1	83
Siding Second Coat . . . . .	1	84
Siding Third Coat . . . . .	1	85
Sewer Connected . . . . .	3	88
Linoleum Laid . . . . .	2	90
Plumbing Fixtures in . . . . .	3½	93½
Light Fixtures in . . . . .	1	94½
Finish Hardware in Place . . . . .	1	95½
Insulation in Place . . . . .	½	96
Floors Laid . . . . .	3	99
Floors Finished . . . . .	1	100

Table indicating percentage of mortgage loan money which can be drawn at any given stage of the work

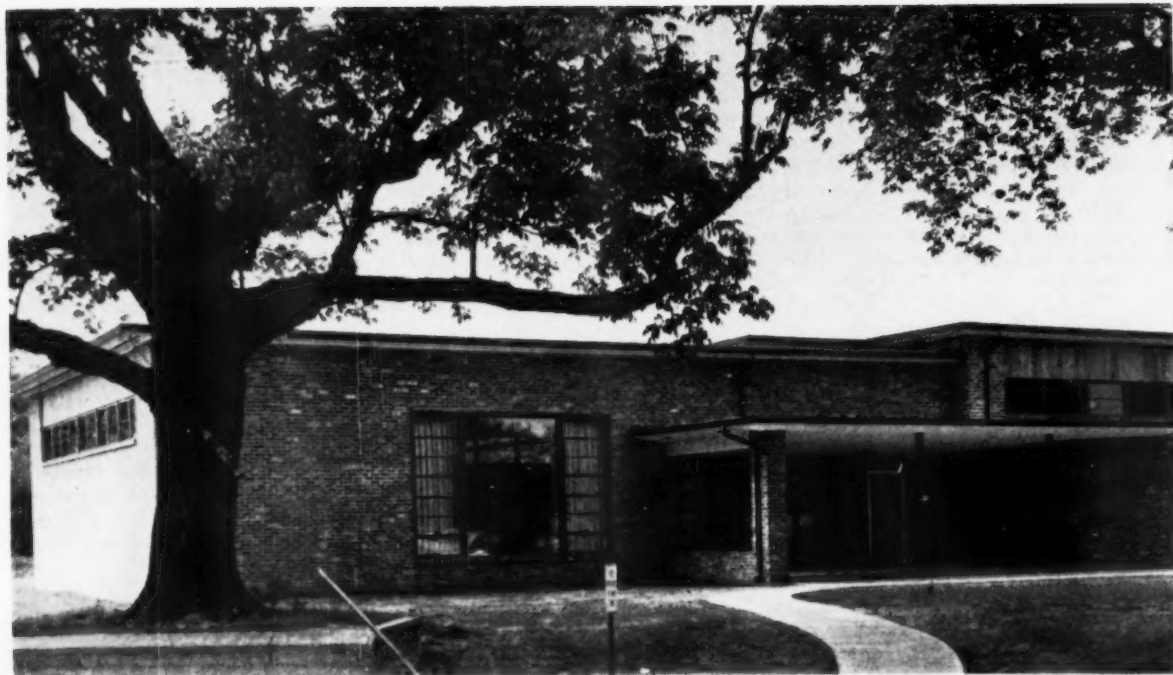

## here is an effective community library

**D**edicated last year, when an exhibit on it was also presented in Chicago before the annual conference of the American Library Association, this outstanding public library building for a small community is in Rossford, Ohio. It was built with a \$50,000 gift from the Libbey-Owens-Ford Glass Company,

which has large plate glass and Thermopane plants at Rossford. Total cost of the building was \$75,000. The design, by Karl B. Hoke of Toledo, provides 6,157 square feet of space.

Entrance doors are of  $\frac{3}{4}$ -inch Tufflex glass, heat treated to make them resistant to shock and break-

age. Window sills, counter tops, and receiving desk top are of Vitrolite structural glass in a green tone to match the walls. Thermopane picture windows are used in both reading rooms.

The penthouse-type second floor is given over to a stack room. Heating is by gas fired forced air



◀ Inside the Juvenile Department

Top of receiving desk is Vitrolite. Juvenile department (to right) can be separated from rest of library by Modernfold door

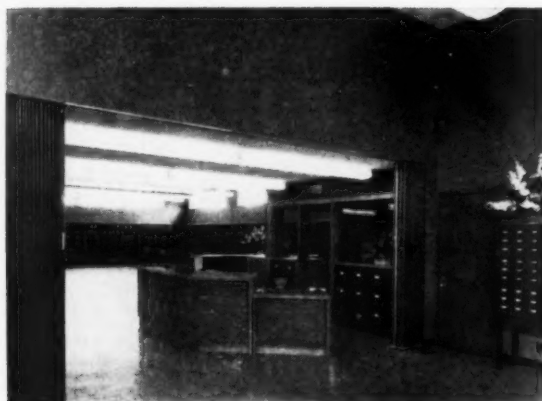

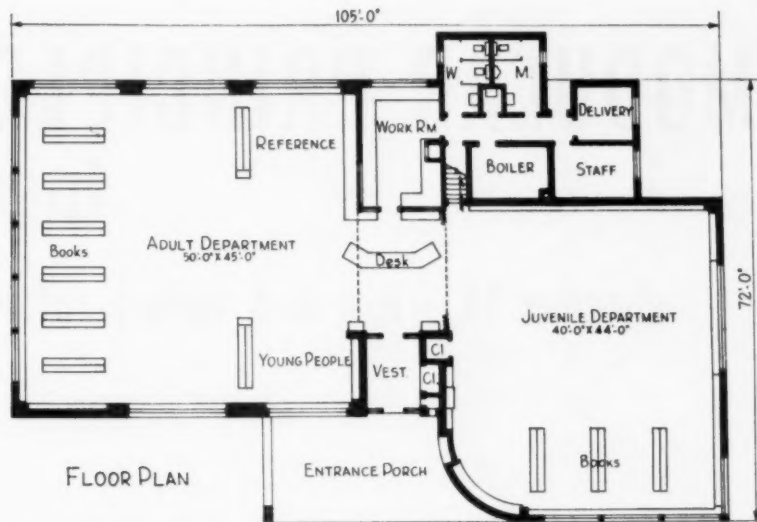

FLOOR PLAN

Fenestration effectively combines two picture windows, clerestory and small, high windows in the Juvenile Department (at right). Note curved section in brick wall under entrance porch. Drawing shows construction of this section

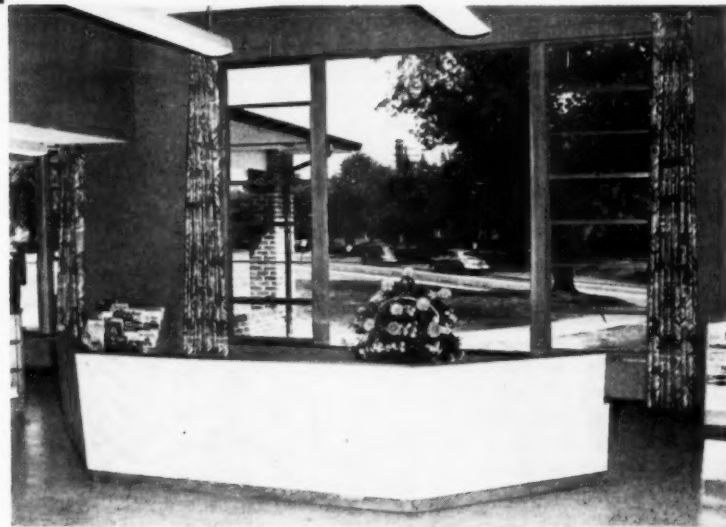

Picture window in adult reading room looks out on Rossford's main street

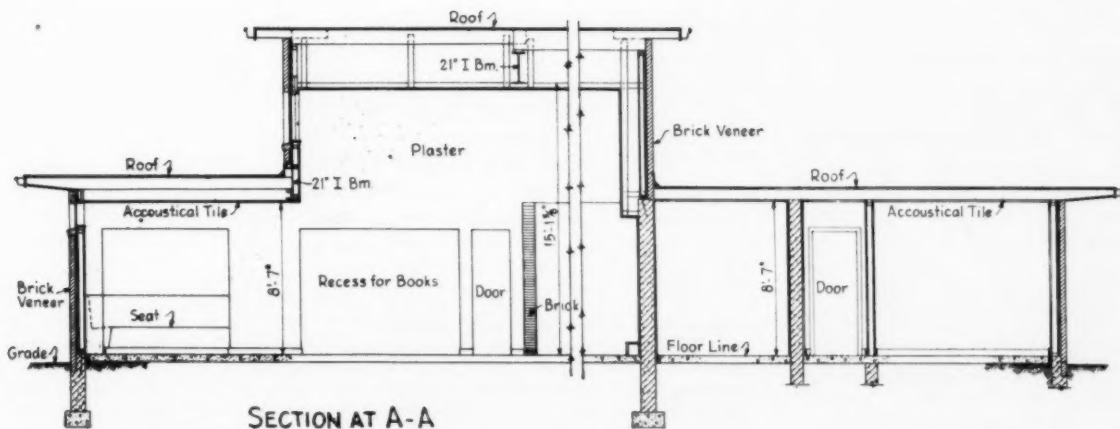

SECTION AT A-A

# MODULAR PRINCIPLES

## in roof framing

### chapter 14—hip and valley rafter calculations

By Griffith S. Clark

There is no short cut to theory in the treatment of conditions relating to roof framing. Simple publication of the Wilson Rafter Table, which was presented and extensively described in last month's article of the modular series, with an example worked out would suffice in demonstrating the ease of calculation. However, the subject requires more than examples.

Results of hip and valley rafter problems encountered by many builders will be detailed here. It is hoped that the field condition will be explained with such clarity that any similar condition which may arise will present no problem to the contractor who understands the functions of these members.

Hip and valley rafters, as previously stated, should have a 2-inch greater depth of stock than common and jack rafters. Hip and valley rafters are always laid out in plan so that they bisect a right angle equally. In every instance, they are located at a 45 degree angle in plan from the ridge. They become the

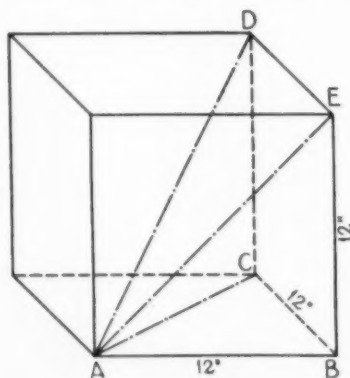
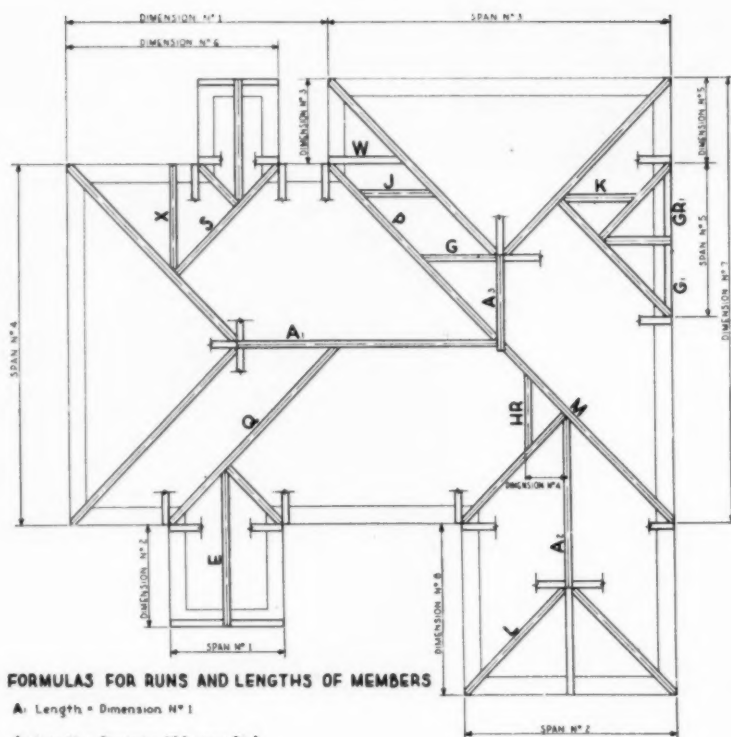

FIG. 1—Difference in rafters



#### FORMULAS FOR RUNS AND LENGTHS OF MEMBERS

- A: Length = Dimension N° 1
- A2 Length = Dimension N° 6 minus 5/16"
- A3 Length = Dimension N° 7 minus Spans N° 3 plus 2 1/4"
- E Length = Dimension N° 2 plus  $\frac{\text{Span N° 1}}{2}$  minus 1 1/4"
- G Run = Dimension N° 3 minus 1 1/8"
- G1 Run =  $\frac{\text{Span N° 5}}{2}$  minus 2 1/8"
- HR Run = 2 (Dimension N° 4) minus 2 1/4"
- J Run = Dimension N° 3 minus 1 1/8"
- K Run = Dimension N° 5 minus 1 1/4"
- L Run =  $\frac{\text{Span N° 2}}{2}$  minus 1"
- M Run =  $\frac{\text{Span N° 3}}{2}$  minus 1"

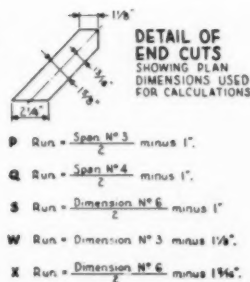

FIG. 2—Diagrammatic roof plan showing end relationships of framing members on which calculations are based. Letters refer to typical details in Figure 3. Members indicated by GR, HR, etc., are opposite hand to members G, H, etc. Dimensions and spans in this drawing are nominal; therefore in 4-inch multiples. Calculations of runs and lengths are based on 1 1/8 inches actual dimension for 2-inch stock. Ridge lengths A1, A2, A3 and E represent details given in Figure 3 of last December's installment

backbone member for the intermediate supporting rafters, known as jacks. Therefore, it is necessary to increase their depth in order to support the greater demand for strength.

To understand the difference in performance of a hip or valley rafter from a common rafter, examine carefully the detail in Figure 1. Suppose this figure represents a 12-inch cube. To determine the length of the common rafter, it will be equal to the length AC or AE. In order to obtain this measurement geometrically, the square root of the sum of the squares of the base and altitude must be found. Since AB equals 12 inches and BC equals 12 inches, the sum of the squares of these lengths would be 144 plus 144 equals 288. Square root of 288 is 16.9706 inches.

### Two Unit Measurements

In the discussion of rafters, one hears two unit measurements. The common rafter is calculated on a unit measurement of 12 inches. This is because the architect assigns pitches on the basis of inches of rise per foot. The hip or valley rafter is calculated on a unit rise of "approximately 17 inches." This 17 inches actually refers to the 16.9706 inches above. If the sum total of the squares had been 289 instead of 288, the actual unit measurement would have been 17 inches.

The common rafter is actually the longest side or hypotenuse of a right triangle. The base is the distance from the edge of the ridge to the exterior wall face in a horizontal plane. The altitude is the distance from the plate to the top of the ridge in a vertical plane. The hip or valley rafter represents the diagonal of the cube or rectangle AD. The base of this triangle is the diagonal distance through the cube, which is also the length of the common rafter. The sum of the square of this distance and the square of the distance of elevation from which the square root has been extracted, represents the length of the hip or valley rafter.

The numerous detail drawings in Figure 3 show the points of dimension for calculating the length of hip and valley members. They also show the details of the end cuts in plan. Length of these members is clearly designated.

Care must be used in laying out

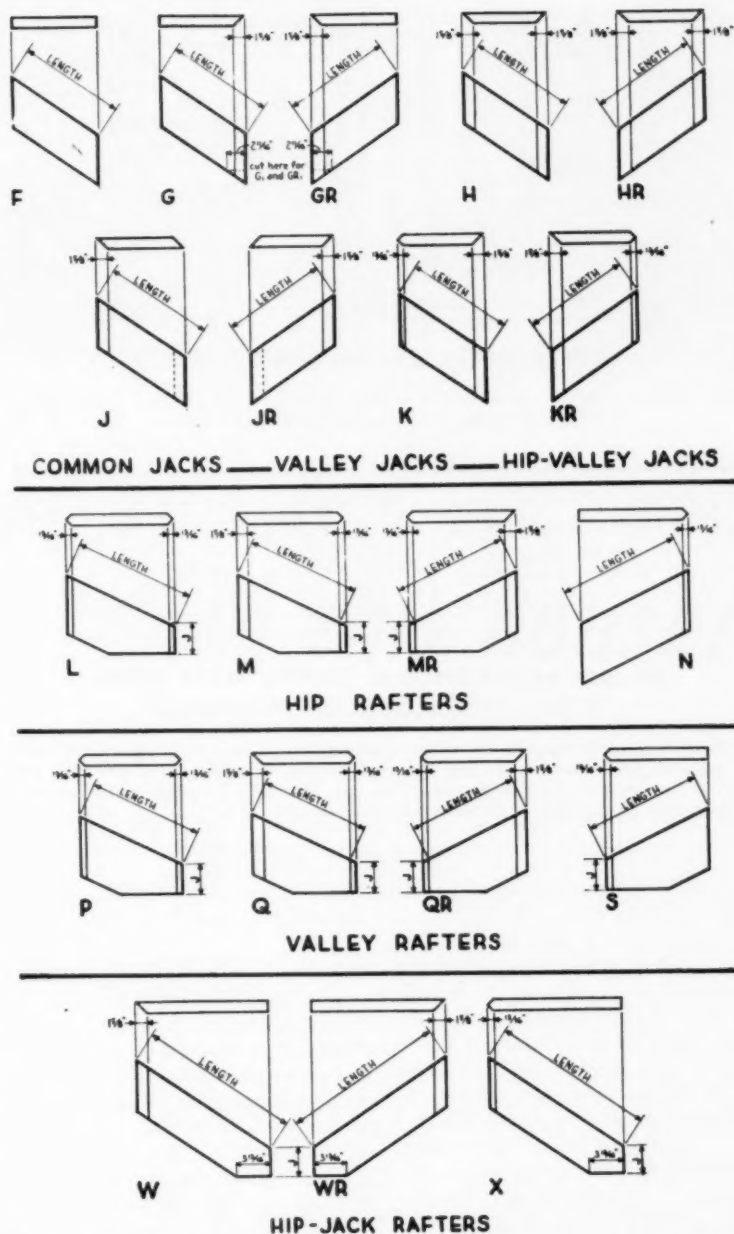

FIG. 3—Typical rafter details, most of which appear in the roof plan in Fig. 2. Detail N is shown in Fig. 4 of the December, 1952, installment

these members for cutting; otherwise the rafter will be short. A case in point would be detail MR. The length terminates at the base of the end cut, so that from this point two lines laid out on a 45 degree angle from either face of the rafter, intersecting at the center, would give the entire length of the rafter.

### Heaviest Roof Load

The cut abutting the ridge will always be made with the horizontal

vernier of the saw set on a 45 degree angle. The plumb cut will be the designated rise, but in 17 inches. The Wilson Rafter Table gives the angle setting for each cut. Improper cutting of these jack rafters can cause endless delays in erection. Their importance cannot be minimized, because they form vital support for the hip or valley, which bears the heaviest proportional roof load per square foot of roof surface of any member forming the roof framing. Their functions are best

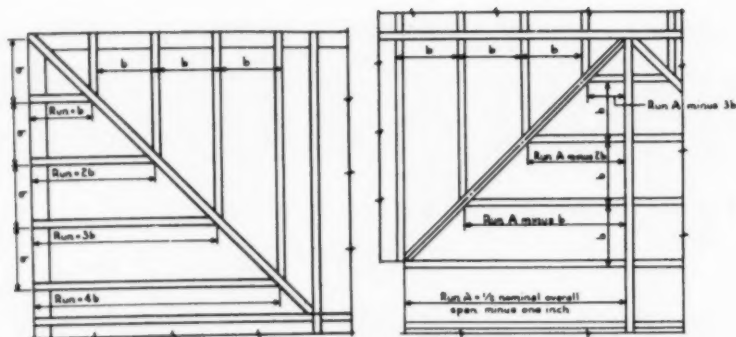

**HIP-JACK RAFTER SPACING, RAISED PLATE DETAIL**

NOTE: "b" should be in some even 2" or 4" multiple to facilitate length computation from tables.

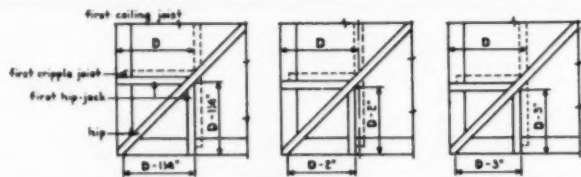

**HIP-JACK RAFTER SPACING, DROPPED PLATE DETAIL**

SHOWING THE THREE POSSIBLE LOCATIONS OF FIRST CEILING JOIST BELOW AND RESULTANT LOCATION AND RUN OF THE FIRST HIP JACK RAFTER.

FIG. 4—Spacing for hip-jack and valley-jack rafters. It is important to note that when a dropped plate condition is used, the roof framing plan must be traced over the ceiling framing plan so that the rafters will not interfere with ceiling joists but are framed against the sides of the joists wherever possible

described in the diagrammatic roof plan shown in Figure 2.

Particular care must be given to the detail of end cuts as these calculations are based on an actual width of  $1\frac{5}{8}$  inches for nominal 2-inch stock. In the "Table for Runs and Lengths of Members" in Figure 2, certain fractions occur which are standard. These refer to details published in Figure 3 of the December installment of this series, which described end conditions occurring in the termination of ridge members. To facilitate their use, these fractions become axiomatic and need no further reference detail.

### Figuring Hip Rafter Length

Dimensions needed here would be clearly shown by the architect in order to insure proper construction. Take a case in point. Assume that Span 3 in Figure 2 is 24 feet 4 inches and we wish to determine the length of M. The detail of M appears in the above designated hip rafter M and the points of measurement are clearly indicated. Assume the pitch assigned is an  $8\frac{1}{2}$ -inch

rise per foot. The formula for the run is expressed as  $\frac{\text{Span No. 3 minus 2}}{2}$

2 inches.

Span 3 is 24 feet 4 inches. Therefore, this amount divided by 2 leaves 12 feet 2 inches and that less 1 inch equals 12 feet 1 inch. Refer to the Wilson Rafter Table (in last month's *American Builder*) under the column "hip and valley rafters" for an  $8\frac{1}{2}$ -inch rise and the following figures will be found: 303.7 under feet and 25.3 under inches. Thus

$$\begin{array}{r} 303.7 \times 12 \text{ is } 3644.4 \\ 25.3 \times 1 \text{ is } 25.3 \\ \hline \text{Total } 3669.7 \end{array}$$

Converting from Column E we have

$$\begin{array}{r} 3670 \\ 3648 \text{ equals } 19 \text{ feet} \\ \hline 22 \\ 16 \text{ equals } 1 \text{ inch} \\ \hline 6 \text{ equals } 6/16\text{ths inch} \end{array}$$

Accordingly, by adding these results, the length of hip from control points is 19 feet  $1\frac{3}{8}$  inches.

However, examine detail M again

and a  $13/16$ -inch peak will be noticed. This is cut by scribing a 45 degree angle across the rafter in plan from either side. Where they intersect is  $13/16$  inch beyond the length in plan. This means the stock must be 19 feet  $1\frac{3}{8}$  inches plus  $1\frac{5}{8}$  inches or 19 feet 3 inches. Since the other common rafters would be 2x6 stock, the K dimension discussed in last month's article would be 27/16 inches which must also be available in the stock length. Thus, the minimum length of a 2x8 from which this could be cut would be 19 feet  $5\frac{7}{16}$  inches.

### Hip and Valley Jack Rafters

Figure 4 illustrates how hip and valley jack rafters are laid out. To facilitate calculations on raised plate details, start at the eaves end and progress toward the ridge. The small "b" in Detail No. 9 of this illustration indicates the unit of spacing.

Suppose, for example, the unit of spacing is 16 inches and the pitch assigned is  $6\frac{1}{2}$  inches rise per foot. The note at the foot of the Wilson Rafter Table explains that the increments of increase for each jack will be equivalent to the factors in the 16th column under the heading, "Common and Jack Rafters," multiplied by the spacing for that particular rise. Therefore,  $1.14 \times 16$  equals 18.24 or  $18\frac{1}{4}$  inches. Since the first jack will be  $18\frac{1}{4}$  inches and each subsequent spacing is 16 inches, the amount of each increase in length to be added to the previous cut will be  $18\frac{1}{4}$  inches.

In the details presented in Figure 3, those with a single letter denote the left-hand cut and addition of the letter R denotes the opposite hand to match the position. In other words, all jacks are cut in a right and left hand manner. Common jacks differ from hip and valley jacks in that they connect a ridge member with a valley or hip rafter, or a hip and valley member. Since they do not rest on the plate, they therefore have no level cut.

### NEXT MONTH'S ARTICLE

will coordinate the theory of modular control with its practical application in the use of the saw.



**LESS HOUSEWORK • BETTER HEALTH • MORE COMFORT**

## *Sold this house!*

When you install Chrysler Airtemp in your homes, you're selling *modern living* to your prospects! You're selling health, comfort, and less housework . . . all potent selling points. But that's not all. Here are just a few of the unique advantages only Chrysler Airtemp Air Conditioning can offer:

- The Chrysler Airtemp name is *known!* Your selling job is easier because your customers have complete confidence in the Chrysler Airtemp name.
- 15 years of residential installation experience! Chrysler Airtemp offers a time-tested package.
- Chrysler Airtemp stands behind its product! A complete Chrysler Airtemp authorized dealer network helps eliminate service "callbacks" for you.
- An optional 5-year warranty creates confidence . . . and is a strong sales feature.
- Consistent national advertising aids in selling your prospects.

Why not get all the facts today. Write The Airtemp Division of Chrysler Corporation, Dayton 1, Ohio.

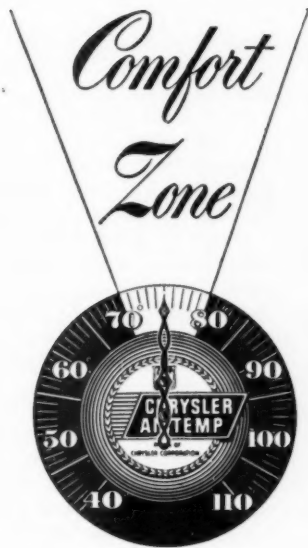

# *Chrysler Airtemp*

**HEATING • AIR CONDITIONING**

for **HOMES, BUSINESS, INDUSTRY**

Airtemp Division, Chrysler Corporation, Dayton 1, Ohio

See your Chrysler Airtemp dealer  
or write **AIRTEMP DIVISION,  
CHRYSLER CORPORATION,  
DAYTON 1, OHIO.**



Airtemp Division, Chrysler Corporation  
P.O. Box 1037, Dayton 1, Ohio

AB-2-53

Please send full details on Chrysler Airtemp Comfort Zone Air Conditioning.

Name \_\_\_\_\_

Address \_\_\_\_\_ Phone \_\_\_\_\_

City \_\_\_\_\_ Zone \_\_\_\_\_ State \_\_\_\_\_



## 4 powerful reasons why you get more of what you want in 1953 CHEVROLET Advance-Design Trucks

**MORE TRUCK FOR LESS MONEY!** Chevrolet trucks list for less than any others of comparable specifications. Yet they bring you features and advantages found in few other trucks. For example, the advanced Loadmaster engine—standard in 5000 and 6000 Series heavy-duty and forward-control models (optional on 4000 Series heavy-duty trucks)—now has a new high-compression ratio of 7.1 to 1, and delivers even more horsepower than before.

**FACTORY MATCHED TO YOUR JOB!** Every unit of the Chevrolet truck you buy is balanced to the job. Tires, axles, springs, engine, frame, body and brakes form a team carefully engineered for the greatest efficiency—and the lowest cost.

**GREATER VALUE IN FEATURE AFTER FEATURE!** Two great valve-in-head engines—the Thriftmaster and the Loadmaster—provide greater gasoline economy. Hypoid Rear Axle, Unit-Designed Bodies, Flexi-Mounted Cabs and many other Advance-Design features offer value unmatched by any other truck at such low cost.

**MORE RUGGED THAN EVER!** In 1953, Chevrolet trucks are even sturdier. Bigger, more durable brakes on many models; heavier, more rigid frames and stronger construction lengthens truck life and lowers your hauling costs. See your Chevrolet dealer. Chevrolet Division of General Motors, Detroit 2, Michigan.

### CHEVROLET ADVANCE-DESIGN TRUCK FEATURES

**TWO GREAT VALVE-IN-HEAD ENGINES**—the Loadmaster or the Thriftmaster—for give you greater power per gallon, lower cost per load. **POWER-JET CARBURETOR**—for smooth, quick acceleration response. **DIAPHRAGM SPRING CLUTCH**—for easy-action engagement. **SYNCHRO-MESH TRANSMISSION**—for fast, smooth shifting. **HYPOID REAR AXLE**—for dependability and long life. **TORQUE-ACTION BRAKES**—on light-duty and medium-duty models and on front of heavy-duty models. **TWIN-ACTION REAR BRAKES**—on heavy-duty models. **DUAL-SHOE PARKING BRAKE**—for greater holding ability on heavy-duty models. **CAB SEAT**—with double deck springs for complete riding comfort. **VENTI-PANES**—for improved cab ventilation. **WIDE-BASE WHEELS**—for increased tire mileage. **BALL-GEAR STEERING**—for easier handling. **UNIT-DESIGNED BODIES**—for greater load protection. **ADVANCE-DESIGN STYLING**—for increased comfort and modern appearance.



AMERICAN BUILDER



There is a difference in hinges

# Here's why most builders specify **STANLEY No.242\***

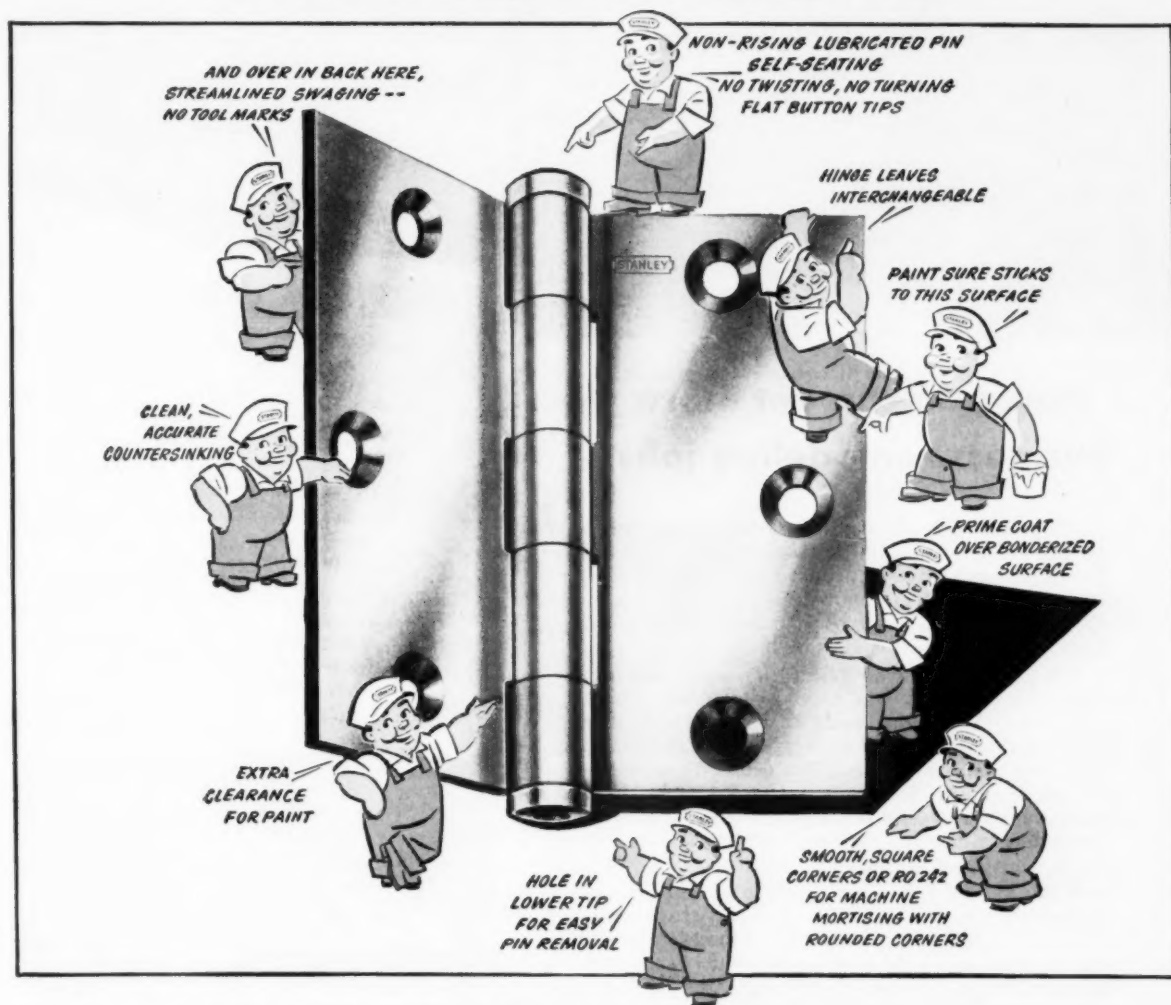

When you specify Stanley No. 241 or 242 Butt Hinges for doors of residences, apartment houses and other medium weight low frequency wood doors, you *know* the hinges will endure for the life of the building. Generations of architects and builders have made the Stanley 241 Hinge the Standard of the World.

\*No. 242, Flat Button Tip prime coated for painting.

No. 241, regularly furnished with ball tip in plated finishes, flat button tip on order (FBT).

**REMEMBER . . . THREE HINGES TO A DOOR**

The Stanley Works, New Britain, Conn.

# STANLEY

Reg. U.S. Pat. Off.

**HARDWARE • TOOLS • ELECTRIC TOOLS  
STEEL STRAPPING • STEEL**



✓ Butcher shops and dozens of other businesses are potential M-67 Monowall customers. One commercial installation like this is equal in profit to several residential jobs.

## How you can get more business remodeling jobs

You'll get a bigger share of the commercial remodeling business when you install Armstrong's M-67 Monowall. Every job can lead to many more. There are dozens of stores and shops near you that have need for this practical wall material. And it's easy to show the "business man" customer how the job saves him money.

Although a Monowall job costs a little more at first than many ordinary wall treatments, it soon starts to pay back that additional cost. That's because it's so long wearing that it saves the cost of repainting and remodeling every few years. You can demonstrate how the M-67 plastic finish resists hard knocks, fading, stains, and even solvents. You'll find that Monowall's smart decorator colors will practically sell themselves.

You'll like working with Monowall, too. One or two men can complete an installation quickly because Monowall is easy to handle. The big size sheets—4' wide and up to 12' long—mean fewer joints. Monowall can be cemented right over the old walls or directly to gypsum lath.

Every time you remodel a store with Armstrong's Monowall, you'll find that other merchants around town will call on you for the same kind of job. For samples and other information, see your Armstrong lumber dealer or write to the Armstrong Cork Company, 1602 Lincoln Street, Lancaster, Pa.

\* T.M. applied for



Here's your checklist of commercial markets for Armstrong's M-67 Monowall

- |                     |                   |
|---------------------|-------------------|
| — AMUSEMENT CENTERS | — FLORIST SHOPS   |
| — BAKERIES          | — GROCERIES       |
| — BARBER SHOPS      | — GYMNASIUMS      |
| — BEAUTY PARLORS    | — LOCKER ROOMS    |
| — BOWLING ALLEYS    | — HOSPITALS       |
| — BUS TERMINALS     | — CORRIDORS       |
| — TICKET COUNTERS   | — KITCHENS        |
| — REST ROOMS        | — LABORATORIES    |
| ✓ BUTCHER SHOPS     | — THERAPY ROOM    |
| — CAFETERIAS        | — HOTELS          |
| — FOOD COUNTERS     | — BATHROOMS       |
| — DINING AREAS      | — COFFEE SHOPS    |
| — CANDY STORES      | — KITCHENS        |
| — CLINICS           | — LAUNDRIES       |
| — CLUBS             | — LAUNDRIES       |
| — LOCKER ROOMS      | — LUNCH COUNTERS  |
| — BARS              | — MOTELS          |
| — DAIRIES           | — RAILWAY STATION |
| — DELICATESSENS     | — RESEARCH LAB    |
| — DENTISTS' OFFICES | — RESTAURANTS     |
| — DINERS            | — SCHOOLS         |
| — DOCTORS' OFFICES  | — SERVICE STATION |
| — DRUG STORES       | — SUPERMARKETS    |
| — DRY CLEANERS      | — TAVERNS         |
| — FISH MARKETS      | — THEATERS        |

# Armstrong's Building Materials

M-67\* Monowall® • Cushiontone® • Temlok® • Hardboards • Insulating Wool

# now **value** takes the spotlight

Today, perhaps more than ever before, home owners are value-conscious. They want to know what they are getting—respond quickly to product names which are "old friends."

Here Curtis Silentite Windows are a definite help. These wood windows put real meaning into that over-worked word "quality."

They are precision-built, pre-fit and pre-assembled units for quick, economical installation. Materials and workmanship are *guaranteed*. Silentite weather-tightness and easy operation are attested by millions of installations. And the name "Curtis"... known for 87 years—has become almost a household word in fine woodwork.

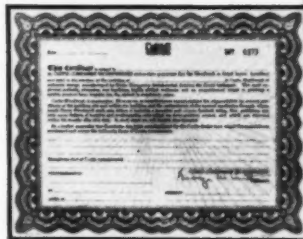

◀ This Curtis guarantee of materials and workmanship is available with every installation of Silentite windows and other Curtis Woodwork. Your dealer will give you complete information.

Curtis makes picture windows in a variety of sizes. Here, a picture window is flanked by the famous Curtis Silentite double hung units with their exclusive "floating" weather-strips, which lower heating costs.



◀ The new Curtis panel windows offer a highly flexible means of providing for any desired number of window openings. Simple, yet rugged in construction, they are available for standard Thermopane or Twindow glazing. Ventilating units and louvres are furnished when desired.

Curtis Silentite wood casements are known as the most weather-tight casements made today. They come in several sash styles and sizes. Their patented operating mechanism provides easy operation—locks casements in any open position.



Curtis makes every practical type of window for every style of home. Complete information is yours for the asking—mail the coupon.

Curtis Companies Service Bureau, AB-2 Curtis Building  
Clinton, Iowa  
Please send me booklet on the Curtis line of Silentite Windows.

Name.....

Address.....

City.....State.....

Curtis offers a complete line of architectural woodwork and kitchen cabinets for homes of all types and sizes. Make your next home "all Curtis."

# NEW

## EMPIRE GAS FLOOR FURNACE

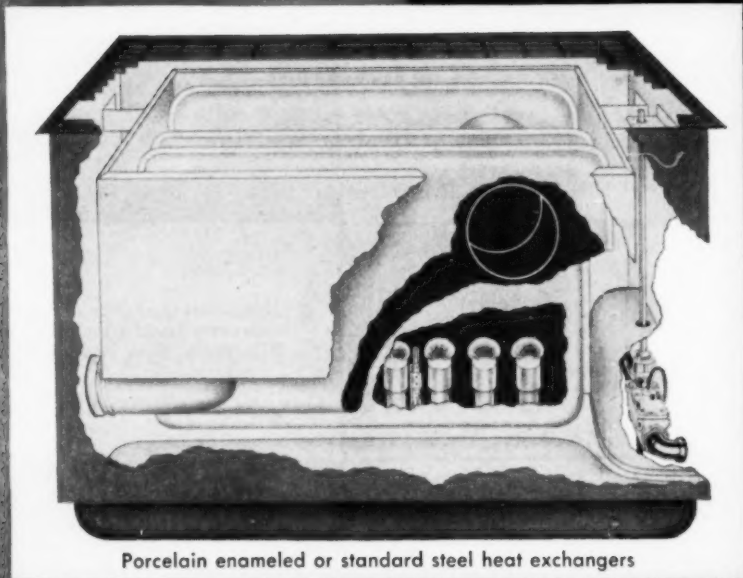

Porcelain enameled or standard steel heat exchangers

With  
the  
FAMED

VERTICAL  
*"Thriftmatic"*  
GAS BURNER

EXCLUSIVE  
with Empire

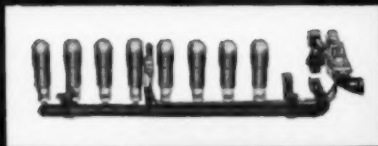

Designed and patented by Empire to provide top efficiency and economy. Engineered for all types of gases... Mixed, Natural or L-P.

**No Noisy Ticking,  
No Boom, No Bang!**

Heat exchangers engineered to reduce expansion and contraction noises! New Vertical "Thriftmatic" Burner is as silent as a kitten with extra foot pads. No service calls. Precision-machined for even flow of gas and air!

# EMPIRE

see your local  
Empire Representative  
or write direct to EMPIRE

**STOVE COMPANY**  
BELLEVILLE, ILLINOIS



WORLD'S LARGEST MANUFACTURER OF GAS FLOOR FURNACES



*"Got snowbound every winter till I found out . . .*

**EVERYTHING HINGES ON HAGER!\***

C. Hager & Sons Hinge Mfg. Co. • St. Louis, Mo.  
Founded 1849—Every Hager Hinge Swings on 100 Years of Experience



# new method of construction

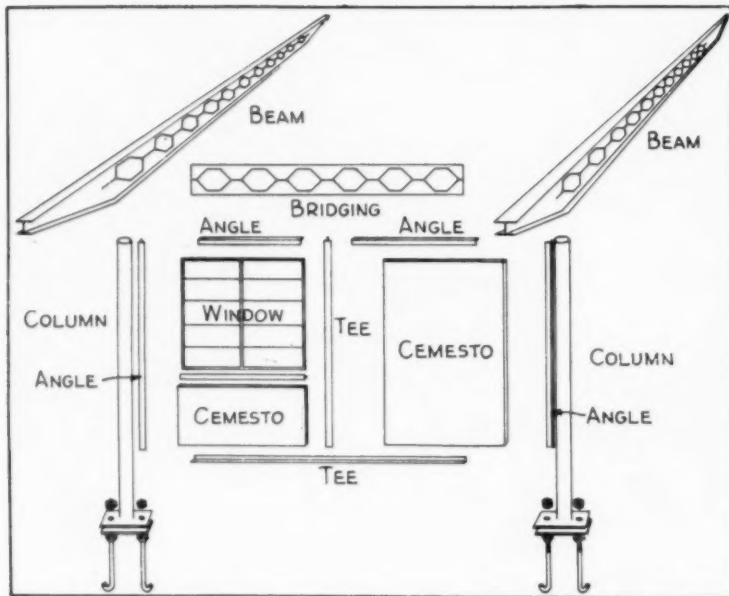

A Moduplan house is built with these structural elements (steel roof deck and foundation in addition). The columns are 3-inch ordinary water pipe, 10-feet long, with plates at the bottom for anchoring to concrete supports. Junior I-beams are placed on tops of the columns and the pipes are welded to the lower flanges. Shorter steel beams are used for some of the spans

The building is held in plumb by guy wires. When the roof is on, an additional 12x12-inch pier, 24 inches high, is poured around the columns, and a wall 6 inches wide and 24 inches high is poured around the entire building, to connect the columns. A hollow rib steel deck is used, with insulation, then a roof is built up

Eugene Memmler of Glendale, Calif., and Frederic Barrenborck, architect, have worked out a system of construction called Moduplan. Instead of studs, steel posts are used, and steel beams for ceiling joints and bridging. Celotex Cemesto board is used for exterior walls. One of the big advantages of the system is that all basic materials are standard stock items.

The 3-inch standard pipe which forms the supporting skeleton is buried 24 inches in concrete. Footings on exterior walls go 32 inches below the slab floor. In the first pour, a concrete ribbon 14 inches wide and eight inches deep is stretched around the perimeter of the house (larger pads are located where the columns occur). Plates 6x6 inches are anchored to the top of this ribbon, according to the 3.5-foot dimension on which the modular system is based. Spans can be in combination of 3 feet 5 inches, 4 feet 2½ inches, or 2 feet 1¼ inches.

Any conventional windows or plate glass can be used which conform to the module. An interesting feature is that the closure materials are entirely separate from the framing and can be removed and exchanged.

Cost depends on how the building is finished. A house of 1,000 square feet takes approximately 175 man hours to complete the footings and all steel work. The exterior walls of Cemesto board cost about 55 cents per square foot in place, Memmler states.

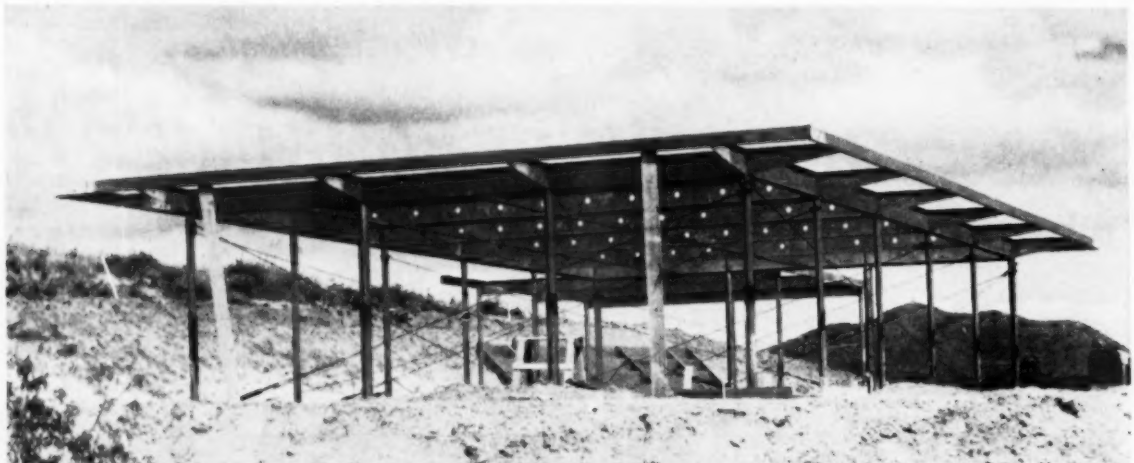

# combines steel and cemesto board



Exterior walls are of 1 9/16-inch Celotex Cemesto board, which has a core of insulating board surfaced on both sides with waterproof and fire-resistant asbestos

cement. One surface is the exterior finish, the other the interior finish. These boards are fitted into flanges welded to the 3-inch columns. Joints are covered with metal caps

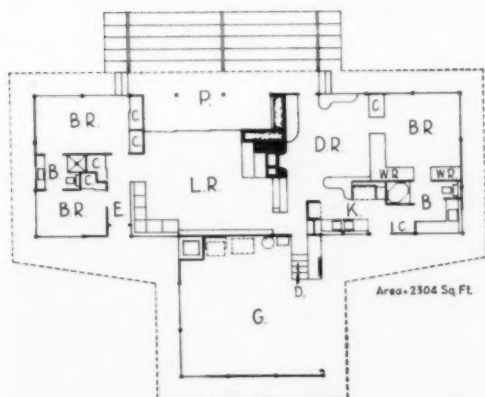

Partition walls are non-load bearing, can be moved around to suit. They too are Cemesto board. The asbestos cement surface may be decorated

Ceilings are panels of Fiberglas, 7/8-inch thick, and 2 feet by 4 feet. They are sprayed with a coat of USG water paint and give a sound-absorbing surface. Panels are placed on lower flanges of the I-beams. Additional flanges are welded to the beams as needed to give support for the panels and to conceal joints. These flanges are exposed in pattern. The 12-inch space between top and bottom of I-beams gives room for wiring, heating, and plumbing



**this corn crib costs —**

**A DOLLAR  
A BUSHEL**

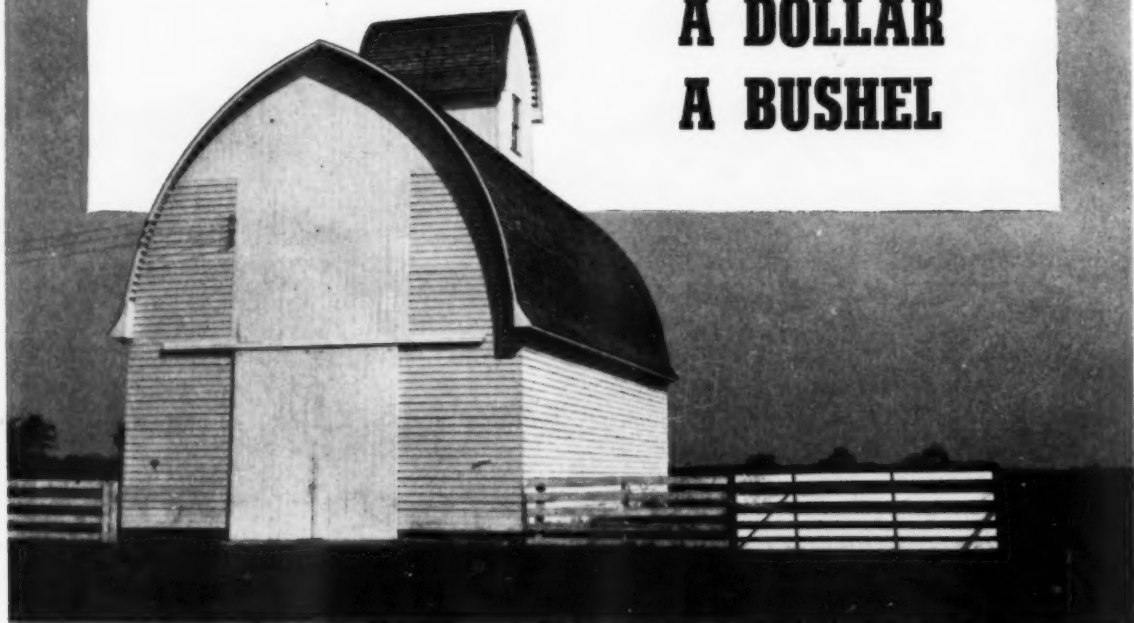

Innovations to a standard corn crib include spaced sheathing above the plate, laminated truss reinforcing on the end walls, and ventilation where the corn would normally lay against the roof boards

Remember when "Dollar A Bushel Corn" was the main topic of rural discussions? Well . . . today, the crib goes for a dollar a bushel. An \$11,000, 11,000 bushel capacity crib has been built for Mrs. H. H. Crossman of Tuscola, Illinois by the local builder, M. Deem.

Deem has taken a standard corn crib plan and added to its construction many features that insure proper drying. Today's farmer now holds his corn for higher spring and summer prices. He must be satisfied that his crib will dry the corn with little or no spoilage.

Normally, spaced sheathing is applied plate high. Yet the storage capacity is 12 feet higher. The builder carried the sheathing 12 feet over the plate on the gable ends. The spaced sheathing is cut back on the under side, forming a drip cap, to lessen the tendency of water to run into the crib.

Greater structural stability for the end walls was another problem tackled by the builder. He claimed that farmers left the dump head in one place when loading the crib. This practice had a tendency to weaken or push out the end walls. These walls were reinforced by nailing a laminated truss to the center stud of the crib.

Another construction innovation was nailing 6 inch sheathing spaced 1½ inches to the roof rafter. Normally, corn would lay against the roof boards without the proper ventilation. Now, air can circulate around the corn between the rafters. Rilco laminated rafters were used in the construction of the crib. The builder cut poultry house arches for use on the cupola. Both the crib roof and the cupola roof lines were of the same gothic design. The cupola allows a space for the dump head as well as ventilation.



Laminated truss nailed to the center stud of the crib reinforces the end wall. Truss is 24 feet in length



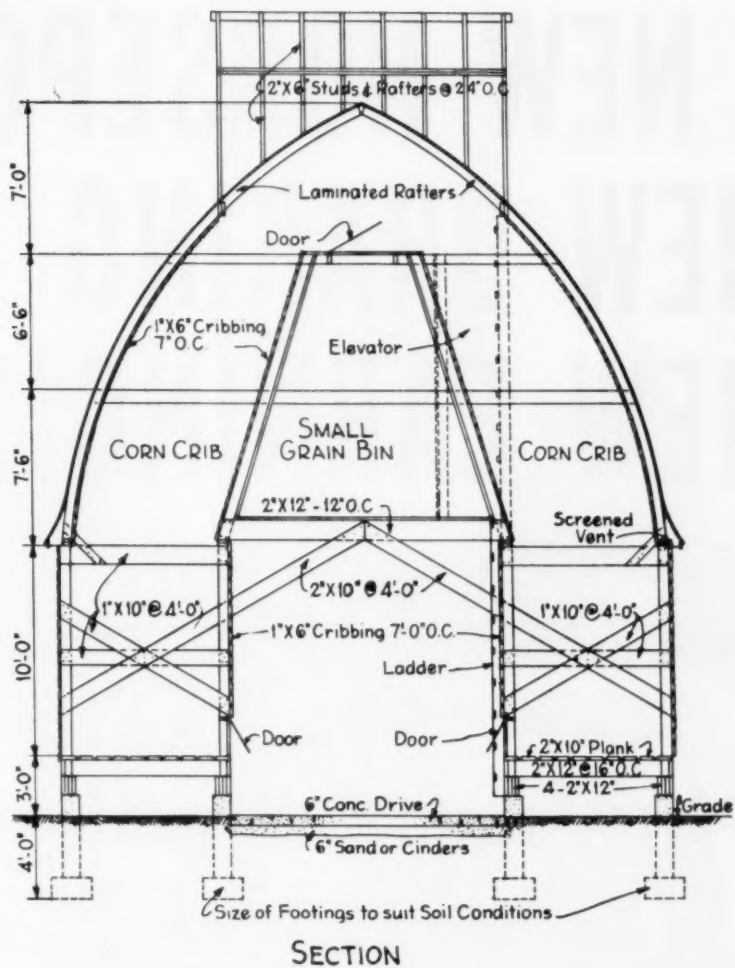
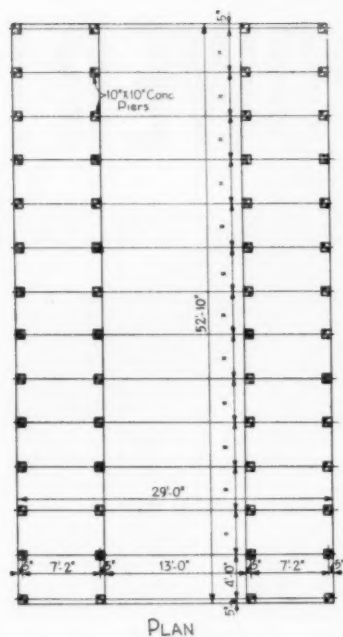

1x6 sheathing spaced 1 1/2 inches nailed to the rafter assures ventilation above the plate where corn would normally lay against the roof board. Air can circulate between the rafters



Thirteen foot drive has plenty of room for a truck. Overhead is a 3,800 bushel capacity storage bin for small grain. Elevator on the right carries grain up to bin. Capacity of the two 8x54 foot cribs is 7,200 bushel

# NEW HORSEPOWER! NEW BRAKING POWER! NEW EARNING POWER!



Biggest truck values of the year!  
New, just-announced Dodge trucks  
with features like . . .

7 high-compression engines, with 100 to 171 horsepower, give you more ton-miles per hour, more deliveries per day! New styling inside and out, tough new floors in pick-up and panel bodies, new tighter-than-ever tailgates on pickups and expresses! A total of more than 50 brand-new features to boost truck earning power!

More, you get such famous Dodge extra values as lightweight aluminum-alloy pistons, rivetless Cycle-bond brake linings on all hydraulic brakes, moistureproof ignition, shot-peened rear axle shafts! Get more truck for your money . . . see your neighborly Dodge dealer!



## NEW! MORE POWERFUL ENGINES!

7 high-horsepower engines! 3 brand-new, with increased displacement, greater cooling capacity, twin carburetion available on larger trucks!



## NEW! BETTER BRAKING!

Super-safe brakes stop smoothly, easily, with less pedal pressure! New increased stopping ability on 1- thru 2½-ton trucks!

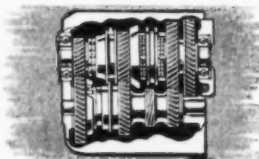

## NEW! NO GEAR- SHIFTING!

Truck-o-matic transmission with gýrol Fluid Drive available on ½- and ¾-ton models! Saves shifting, yet lets you rock out of snow, mud!



## NEW! OVER 50 FEATURES!

Reinforced cab construction, larger exhaust system, new 116" wheelbase ½-ton pick-up! Dodge-Tint glass, higher output heaters available!

There's one to fit your job . . . ½-ton through 4-ton. See your friendly Dodge dealer.

# DODGE "Job-Rated" TRUCKS

**Rheem Automatic Storage Water Heaters** make up the most complete line in the field—come in all sizes, all types—gas, electric and oil.

**Rheem Winter Air Conditioners** provide safe, care-free, economical heating—automatically.



*Tips on Selling Homes...  
remember—Men Are Lazy!*

Show him comfort—and the man is yours. Show him the automatic Rheem Gas Furnace and Rheem Water Heater—and you can prove he'll have all the comfort he wants—with none of the work.

He'll be convinced when you tell him how Rheem Furnaces are Fire-Tested at the factory—how

Rheem Water Heaters are Pressure-Proved—how this scientific pre-testing assures him of the best, most trouble-free service possible.

Let Rheem help you keep the lazy male in your homes. See your Rheem contractors today. They can prove to you that Rheem is the best buy for builders.



© 1953 RHEEM MFG. CO

# RHEEM

**MANUFACTURING COMPANY**

Manufacturing Plants in 22 Cities Around the World

# Buy Your Houses...



## NATIONAL HOMES *Monterey*

"Open planning" in the modern manner is expressed in this distinctive new home. It has rear living room and all-purpose room that flows into the living-dining area or can be shut off with sliding doors. Dozens of other sales advantages including dual-use carport; dishwasher sink; laundry alcove with Bendix automatic washer and dryer. An outstanding example of the kind of "packaged homes" you get from National Homes!

More Builders make More Profits the **NATIONAL**

# in One Pre-sold, Complete Package from NATIONAL HOMES

## ONLY QUALITY "BRAND-NAME" PRODUCTS USED THROUGHOUT

National Homes builders get all structural and component parts, all top quality "brand-name" materials, in one complete package . . . eliminating the problems of inventory, warehousing and purchasing . . . reducing site work to the minimum . . . lowering administrative, overhead and operating costs.

They are able to offer smartly styled, livable homes at up to 20% below the local market. No wonder National Homes builders sell more houses, make more profit!

Moreover, National homes are *pre-sold* through full-color ads in leading magazines, newspapers, other media—the *greatest promotion program in building history*. Your own community has hundreds of pre-sold prospects for National homes. Send for details. See what it can mean to you in profits to become a National Homes builder!

All National Homes prefabricated panels and structural parts, as they leave the assembly plant, carry the Good Housekeeping guarantee seal and Parents' Magazine seal of commendation as advertised therein.



© 1953, N.H.C.



## A Builder of 1,000 National Homes

Achille C. Colpaert, South Bend, Indiana, long-time successful builder of homes in all price ranges, says: "We have erected over 1,000 National homes, which is three times as many houses as we could have built conventionally with the same field organization and the same working capital. At the same time we greatly reduced our operating and administrative overhead per house. Your method is ideal for the conventional builder."



# HOMES Way than by Any Other Method. INVESTIGATE!

# DE WALT meets the needs of "Volume Demand" Cutting!

says Kristian Samuelsen, Pre-Cutting Contractor for the  
Levittown Housing Development near Morrisville, Pa.



"I have nine DeWalt model GE machines set up in an assembly line to cut rough lumber.

"This makes mass production possible, and solves the "volume demand" cutting problem quickly and cheaply.

"The DeWalt is such a fast, versatile machine, it's ideal either for mass production methods or the construction of a single house. Each one of our nine DeWalts is set up to make a different cut. A piece of lumber is processed in seconds—and ready to cart away to be used for framing.

"Our nine DeWalts have a tremendous daily output. We cut...  
27,000 lineal feet of 2 x 6 rafters  
30,000 lineal feet of 2 x 4 studs  
24,000 lineal feet of 2 x 4 ceiling beams.

"We've already cut lumber for over 20,000 homes with these nine DeWalts. They really stand up. I have great confidence in them, and the next time we get a new power saw, you can be sure it will be a DeWalt."

Why don't you investigate DeWalt's unmatched speed, versatility, precision and safety. See your DeWalt dealer or mail coupon below.

DeWalt Inc., Lancaster, Pa.



**POWER SAWS**

Subsidiary of AMERICAN MACHINE & FOUNDRY COMPANY, New York

**MAIL THIS COUPON TODAY!**

DeWalt Inc., Dept. AB-2, Lancaster, Pa.

I am interested in finding out how DeWalt can benefit my building operation. Also please send full details on the DeWalt Radial Power Saw line.

Name \_\_\_\_\_

Address \_\_\_\_\_

City \_\_\_\_\_ Zone \_\_\_\_\_ State \_\_\_\_\_



The 1953 model complete with carport and outside storage

## how merchandising on local and national level builds volume

The National Homes Corp., Lafayette, Indiana, is embarking on a plan of merchandising to acquaint the public with the latest model home, the Monterey.

Under this plan it is arranged to have builders in 150 widely scattered cities open model houses, decorated and

furnished identically, on the same day, starting Saturday, Feb. 21, 1953. The model is a departure from the usual styling in prefabricated houses, and offers a new concept of open, modern living.

Furnishings for all homes are selected by independent field men through manufacturers chosen in advance. The field men arrange for the handling of all furnishings and stay in touch with the builders to keep them informed.

A comprehensive book is supplied builders. It contains pictures of all furnishings and how they are to be placed. Necessary drawings are included. The book also includes the names of participating manufacturers, stock numbers of each item, suggested newspaper advertising, layouts, interior in window display for stores, radio and TV spot announcements and publicity stories.

National Homes has prepared and sent to participating builders three smaller ads which the dealer is to run on the three week ends following the opening. The backbone of this promotion, as set up, is local tie-in advertising.

National Homes has also devised a "front door hand-out," which lists the features of the Monterey, sale price



Floor plan shows a practical distribution of space



Rear view of model house;  
outdoor terrace adjoining  
living room



View in living room toward all  
purpose room and hall. Note fold-  
ing doors dividing all purpose  
room from living room

and terms. This gives dealers a list of interested persons.

The Monterey design contains many of the features found in the above average 1953 conventionally built houses. Floor construction can be slab on grade or over a basement. Where slab is used, compensating storage space is provided adjoining the carport. Window walls are used in living areas with strip windows in bedrooms and kitchen. A modern look has been given to the exterior through the use of horizontal siding, vertical boards and striated plywood in addition to the closely cropped gable ends, overhanging eaves and flat roof treatment of the carport and storage.

No attempt is made to cover the joints of the drywall material on ceilings. Instead a V-cut is made in the board which is exposed. All openings to closets and space divisions are provided with sliding bamboo curtains. The kitchen is the corridor type with ample space for storage of utensils and equipment.

The house is heated with a warm air furnace located in the approximate center of the area with ducts in the slab leading to the various centers.

Floor plan is an excellent arrangement for effective space use. Through the use of sliding doors and curtains, areas may be opened to accommodate large groups, or closed for more intimate living.

National Homes Corp. is currently producing 14 different floor plans and models. Sixty-four different types of panel, which include floor, wall, ceiling and roof, are required for the erection of these 14 different models. Many of the panels are interchangeable. In this manner they can be used in a number of different models. Prices for these houses range from \$7,000 to \$17,000 including foundations, plumbing, heating, electric wiring and fixtures, kitchen cabinets, washer and dryer. The Monterey model shown on these pages sells for \$11,250 without lot.

Successful application of mass production to work previously considered unadaptable to such methods has increased the company's production greatly within the past few years. Production for the fiscal year ending June 30, 1952 ran close to 10,000 units. Aggressive merchandising and promotional tactics, together with advanced design have built this volume.



*Tracy*  
KITCHENS

BUILDER'S  
TACK BOARD

SCOOPED  
the '53 market!

new  
super-series

*Value-line*

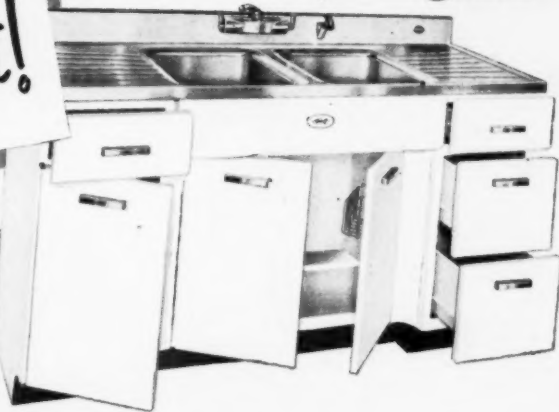

*Tracy* QUALITY  
stainless steel  
SINKS  
PRICED LIKE  
PORCELAIN

original **TRACY** *Value-line*



that rocked the kitchen industry  
like an earthquake!

GET IN  
TOUCH  
↙

NOW even  
stronger  
as a  
SALES-MAKER  
for  
HOUSES

*Tracy*  
KITCHENS

EDGEWATER STEEL CO.  
P.O. BOX 1137 - PITTSBURGH 20, PA.

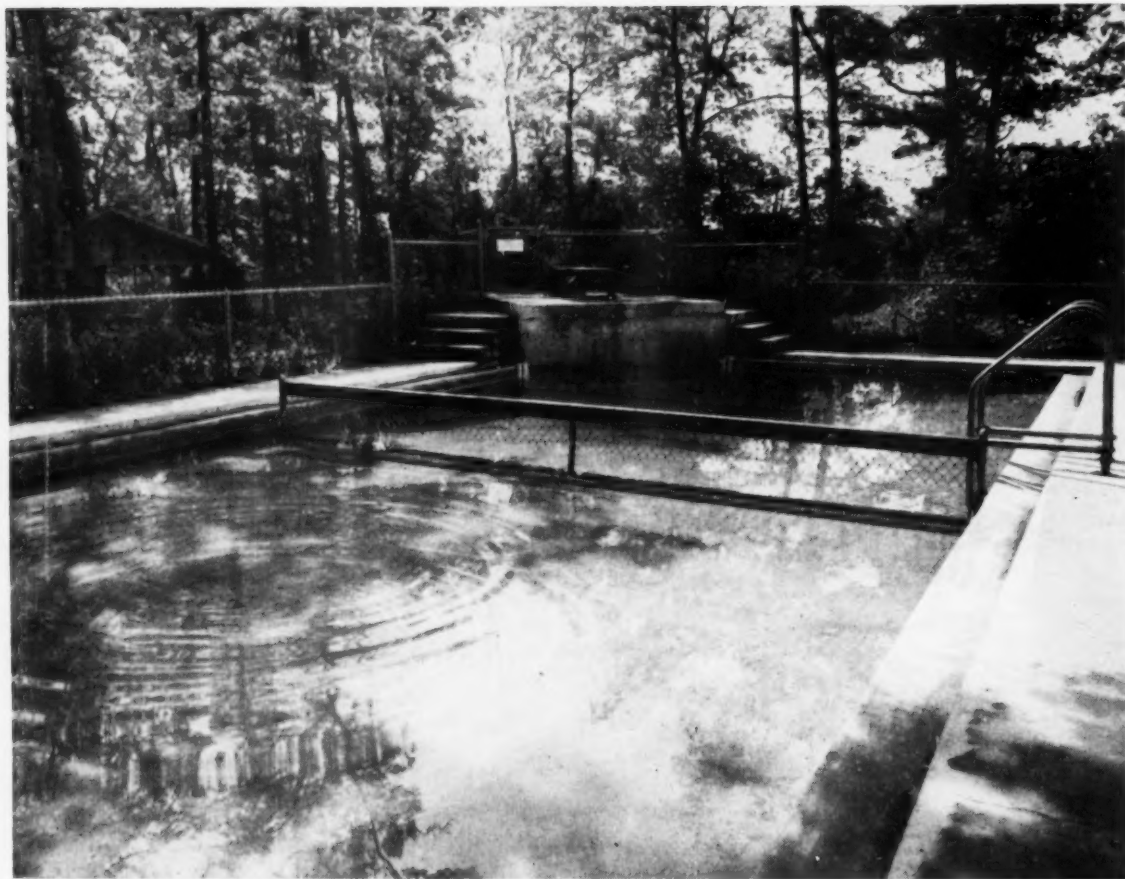

Day camp training pool 20x40 feet of water surface. Filtration and water treatment plant at far corner. The fence dividing the pool lengthwise is readily removable

## simplification of construction CUTS COST of swimming pool

*by Hugh M. McClure, Architect*

Outdoor swimming pools located in our northern states must be so designed and built that their structure will successfully withstand the powerful upward thrust in early winter of the freezing and "heaving" soil bearing upon which are rested the footings and the floor.

There must also be built into the pool's walls a successful defense against the crushing inward pressure of the freezing soil surrounding the pool.

If this is not done, the original cost of the pool can well be doubled within a few years by the accumulation of heavy annual expenses for repairing damage to the structure and piping.

In northern climates the number one problem is not to construct a reservoir which will "hold water." This is

a simple problem in itself. The basic problem is how to build an outdoor pool which will not be crushed and broken by the compression forces exerted by frost and freezing, which are many times greater than the force of the water pressure acting outward and downward.

A broken reservoir will not hold water, of course, even water under the comparatively mild pressures which exist in swimming pools.

In northern areas the general practice in building outdoor pools is to employ a "retaining wall" structural design for the pool walls. This comprises a massive footing as the stabilizing base for the wall, with a proportionately heavy wall cantilevered vertically from the approximate middle line of the footing.

Utilizing this type of construction it is necessary to

**this scheme combines walls  
and surrounding walks into  
an unyielding frame sur-  
rounding the water reservoir**

make four setups for pourings. The footings are poured at the first setup, the walls second, the floor the third, and the walks are poured at fourth setup. The cost of getting set and ready for mixing and pouring concrete is not a small item of expense.

Using the structural design illustrated in the drawing "Section Thru Wall and Walk," there is no need for a massive footing to stabilize the wall. The wall is locked into the floor-footing slab at the bottom, and at its top it is cast integral with the inward edge of the walk.

The walks become structural members; reinforced concrete beams, lying on their sides. These flat-lying beams are supported along their outer edges on a line of pre-poured concrete piles having expanded bases.

(Continued on page 142)

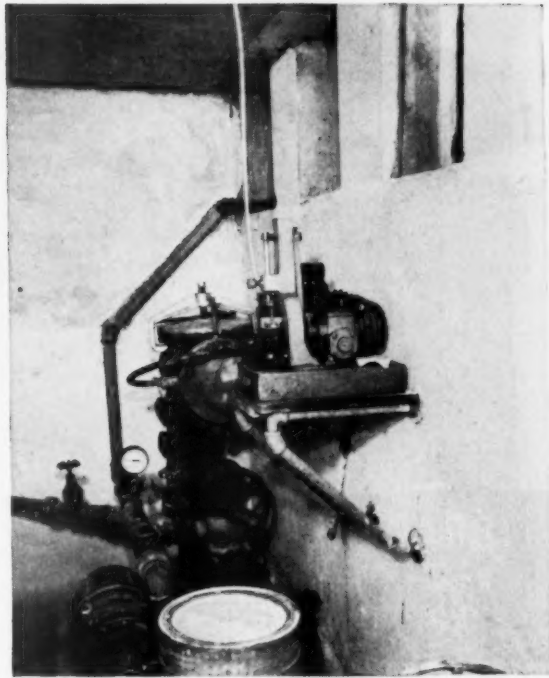

View in filtration plant under diving platform. Pump and motor, apparatus and piping compactly arranged, requiring little space. Openings into filter compartments seen at upper part of photo

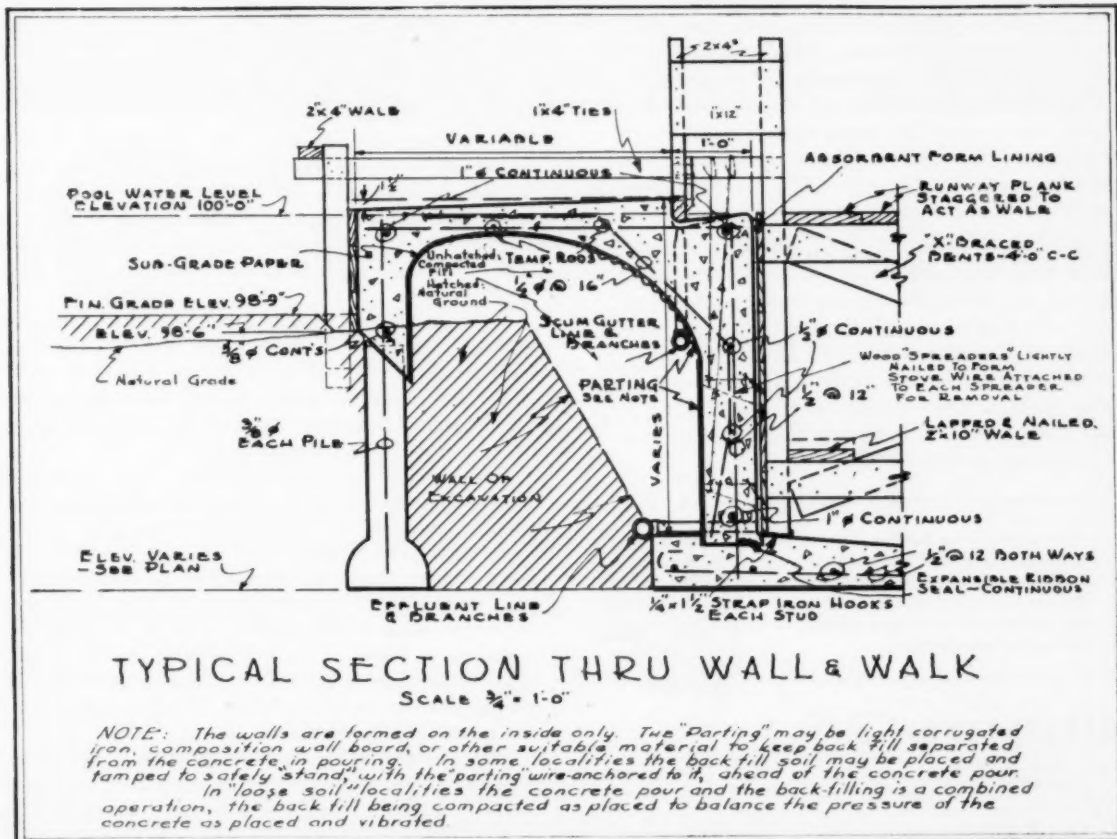

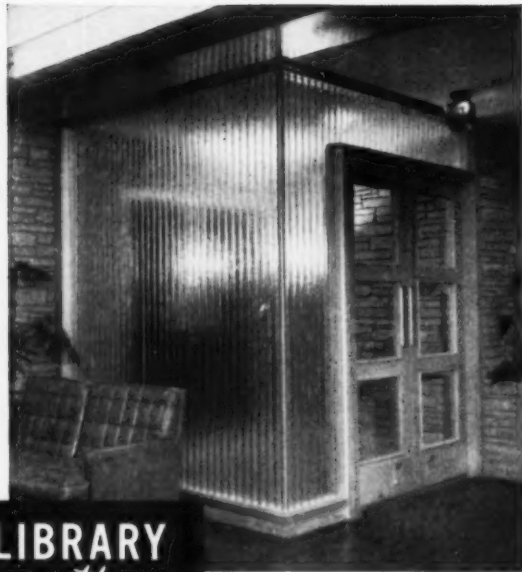

**LIBRARY**  
*with*  
**EYE APPEAL**

Hutchinson Public Library, Hutchinson, Kansas  
Architect, English, Miller & Hockett

## Structural Corrugated Glass by Mississippi Gives Modern Look to Well-Designed Structure

This library took a page from one of its own books. Carefully planned treatment of entrance and exterior walls to take fullest advantage of the properties of translucent glass achieves an atmosphere that invites the reader. The entire room is flooded with soft, natural light by day . . . glows a warm welcome to patrons at night. The effect is that of clean, crisp, modern efficiency that still retains a friendly feeling.

Structural Corrugated Glass by Mississippi is being used by builders and contractors everywhere for its beauty and utility. This modern material offers new scope for talents, suggests numerous ways to handle design problems. Manufactured in a wide variety of patterns and surface treatments, Mississippi Figured glass is available wherever quality glass is sold. Select glass by Mississippi for your plans and add sparkle to your ideas.

Write today for free booklets, "Figured Glass by Mississippi" and "Modernize Your Home With Decorative Glass." Contain many ideas on ways to utilize this dramatic material in modernization or new construction.



**MISSISSIPPI** *Glass* **COMPANY**

88 ANGELICA ST. SAINT LOUIS 7, MO.  
NEW YORK • CHICAGO • FULLERTON, CALIF.

WORLD'S LARGEST MANUFACTURER OF ROLLED, FIGURED AND WIRED GLASS

## swimming pool

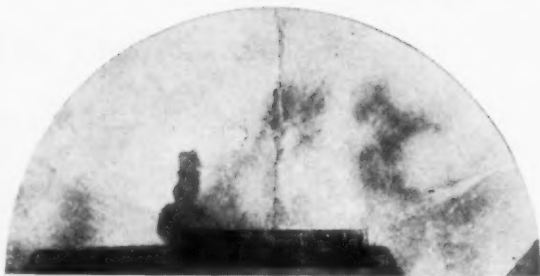

Picture of gratings over the main drain taken through eight foot depth of water

(Continued from page 141)

and on their inner edges they are supported by the pool walls.

The pool walls are also developed as beams, standing vertically.

The combination of the walls with the walks forms an immense reinforced concrete structural "angle," which functions as an unyielding "frame" surrounding the water reservoir.

Since both the top and the bottom of the pool's walls are rigidly fixed, and since the span between the top and bottom fixed anchors is short, the walls can now be developed as steel reinforced "simple slab" with assurance of safety, and the volume of the concrete required for them is greatly reduced. The saving in the volume of concrete required for this construction amounts to 30 per cent and more as compared with typical footing and wall design.

The pool illustrated is 20x40 feet. This pool was designed for the special purpose of teaching swimming to the children enrolled in a day camp and school located near Chicago. The boys and girls enrolled for the summer term range in age from six to twelve years.

In this special purpose pool the depth of the water begins at two feet, increases to three feet at the removable fence, and extends to eight feet under the diving platform.

Simplification is further exemplified by limiting expansion joints to one only in the pool floor, and two only in the walls; all being in the line of a vertical plane separating the pool structure from the structure which houses the open bed sand filters, the pump and the chemical feeding apparatus.

The slight movement which takes place at these expansion joints is absorbed by a specially designed expansion and contraction joint structure, which remains water-tight at all times.

Further cost-reducing simplicities are represented by the fact that the roof slab over the filtration and water treatment plant is adapted to serve as a diving platform, upon which a low springboard can be mounted when desired, and by a very compact and simplified piping system for recirculating, filtering and treating the water for repurification.

Although the piping and apparatus is at rock bottom minimum, it includes everything necessary to filter the water to a state of clarity which makes it appear when

(Continued on page 144)

*Your Customers* are seeing  
**beautiful U/R bathrooms like this!**



*The World's Finest Bathroom Fixtures*

by **Universal-Rundle**

Your best prospects and customers will be seeing these lovely bathrooms in full color—in the Saturday Evening Post, Better Homes and Gardens, and other leading magazines. They'll be reading about the famous quality features that make Universal-Rundle fixtures the world's finest bathroom fixtures:

**Whitest White**, by actual scientific test!

**Matched Colors**, made by Universal-Rundle, maker of the first colored bathroom fixtures.

**Lifetime Bond** between surface glaze and fixture body, to give highest resistance to chipping!

**"Harder than Steel"** surfaces that resist scratches, stay bright for year after year!

Universal-Rundle's national advertising gives you ready customer acceptance when you recommend Universal-Rundle fixtures!



**GET UNIVERSAL-RUNDLE'S  
 NEW CATALOG!**

Shows bathroom and kitchen fixtures, trim and fittings . . . gives plans, specifications, drawings, full-color baths . . . helpful information for plumber, architect, and builder. Write for your copy today!

**UNIVERSAL-RUNDLE CORPORATION**  
 119 Caruthers St., New Castle, Pa.

Please send me your new catalog.

NAME \_\_\_\_\_

COMPANY \_\_\_\_\_

ADDRESS \_\_\_\_\_

CITY \_\_\_\_\_ ZONE \_\_\_\_\_ STATE \_\_\_\_\_

Plants in Camden, N. J.; Milwaukee, Wisc.; New Castle, Pa.; Redlands, Calif.; San Antonio and Hondo, Texas

# SPECIAL DOORS

By RAYNOR MFG. CO.

MODEL T-17

● Torsion spring door for warehouses, factories and other commercial and industrial buildings.

MODEL 6

● Torsion spring Hy-Lift door for service stations and lubricatoriums where clearance is needed above the door.

MODEL VL-22

● Torsion spring door for buildings with high ceilings where it is desirable for the door to follow the face of the wall.

MODEL L-30

● Extension spring low headroom single car residential door—for installation in 3" minimum headroom.

MODEL L-65

● Extension spring low headroom, two car residential, commercial and industrial door—for installation in 6½" minimum headroom.

See our Catalog in Sweets. Write for colored illustrated literature on Raynor Carved Raised Panel Doors.

**RAYNOR MFG. CO.**

DIXON, ILLINOIS

Builders of a complete line of wood sectional overhead doors.

## swimming pool

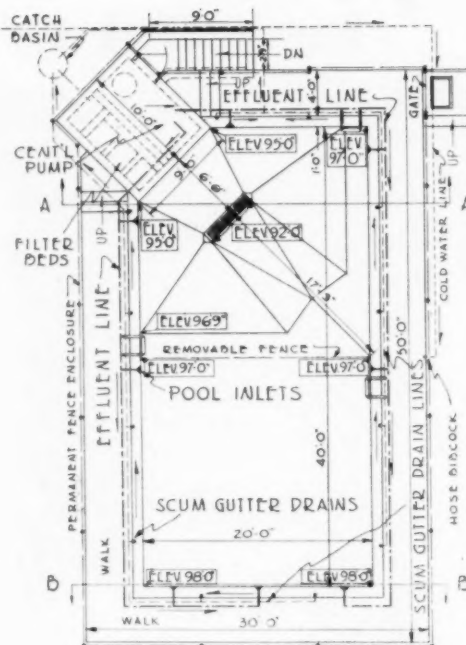

PLAN

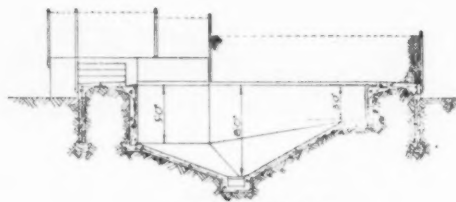

SECTION A-A

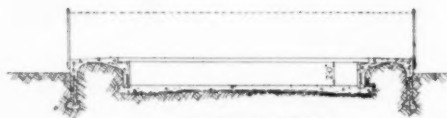

SECTION B-B

(Continued from page 142)

the surface of the water is quiet almost as if there were no water in the pool. Tests for bacteria count affirm that the water is "fit to drink."

Good outdoor swimming pools do not need to cost so much as they oftentimes cost. The relative cost of one pool, as compared with the cost of other pools of like size, is no sensible criterion of appraising either the permanence of their construction or the degree of perfection at which the water is maintained.

A good pool can be low in its cost, and a bad pool can be high-priced. The approach to building a good swimming pool at low cost is to make everything about it as simple as possible without in any way impairing the ability of any part to satisfactorily perform its function.

Georgian...Ranch...any style

TRUSCON DOUBLE-HUNG  
STEEL WINDOWS

*Blend Perfectly*



**Go In Fast!..At Low Cost!..Give Lifetime Service!**



TRUSCON® a name you can build on

It's the window with the wonderful, time-tested features. And, it is available in an unusually wide range of standard styles and sizes that harmonize with and beautify all home styles. Trim, slim lines produce clean-cut modern beauty. The cost is amazingly low.

Truscon Double-Hung Steel Windows require the absolute minimum of expensive field labor. They're completely factory assembled with all hardware attached. No cutting, no planing, no fitting. Just position and attach to studs or masonry. Even stainless steel weatherstripping is built-in.

Being STEEL, these windows can't warp, swell, shrink or rot. They're galvanized and Bonderized, then given a baked-on prime coat of paint. That means long life, low upkeep.

No wonder Truscon Series 138 Double-Hung Steel Windows are the largest selling windows of this type in the world! See them at Truscon dealers. If stocks are low, dealers get you fast delivery from Truscon warehouses.

**TRUSCON STEEL DIVISION**  
REPUBLIC STEEL CORPORATION  
1050 ALBERT STREET • YOUNGSTOWN 1, OHIO

# **New! Insulite announces asbestos-cement shingles**

**New,  
tested system  
developed  
by Insulite  
gives you:**

## **1. Savings on every job**

- Low applied costs
- Use less shingles per square
- No building paper required

## **2. Greater sales appeal**

- Deep shadow-line beauty
- Quieter walls
- Increased insulation

## **3. Better construction**

- "Cushioned" shingles give less chance of breakage
- Stronger, tighter walls

**1. Yes, this is an asbestos-cement shingle sidewall!** Insulite's new Shingle-Backer System gives it that attractive shadow-line that makes it look richer, more

expensive. Yet this better-built, better-looking sidewall can cost \$2.53 a square *less* to build than asbestos-cement shingles directly over wood sheathing!





# system for applying to Insulite Sheathing!

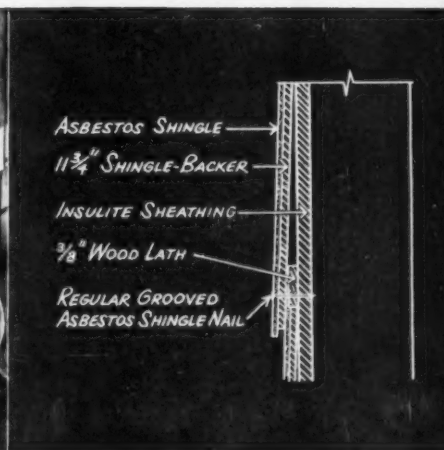

**2. Here's how it works. First, apply Insulite Sheathing.** One carpenter can sheath 1,000 sq. ft. in 8 hours or less . . . cuts sheathing time as much as 43%. Eliminates need for building paper because it's waterproofed throughout with asphalt.

**3. Next, apply 1 3/4" Shingle-Backer** and the asbestos-cement shingles. This system goes on quickly and easily. Increases shingle exposure from customary 10 1/2" to 11". Provides a cushioned base for asbestos-cement shingles to reduce impact breakage.

**4. System is self-aligning.** Line up each shingle with top of Shingle-Backer and it's ready for nailing. No special nails or tabs needed. Extra insulation value provided by Shingle-Backer over Insulite Sheathing makes your homes warmer. Quieter, too.

## These builders found big savings!



"We've tried this new Insulite System."  
"You might think that this new system would cost considerably more than asbestos-cement shingles applied directly over wood sheathing. Actually you can do it for about \$2.50 per square less!"

**ED JUNCKER**  
Edward Juncker, Inc.  
Overland, Missouri

SEND COUPON TODAY FOR DETAILS AND INSULITE COST-COMPARISON FOLDER. SEE HOW YOU CAN BUILD BETTER FOR LESS ON YOUR NEXT ASBESTOS-CEMENT SHINGLE JOB!

"I can save \$42.00 on every job."  
"Besides the savings that we can realize, I'm getting beautiful well-insulated walls, too. As soon as the first house using this new system was completed, I got an order for another just like it!"

**EZRA OSTERHUS**  
General Contractor  
Robbinsdale, Minnesota



INSULITE DIVISION, Minnesota and Ontario Paper Company  
Minneapolis 2, Minnesota

INSULITE IS A REG. T.M., U.S. PAT. OFF.

Build and insulate with double-duty

# INSULITE



Made of hardy Northern wood

INSULITE, Minneapolis 2, Minnesota

Please rush data on your new Insulite Shingle-Backer System for Asbestos-Cement Siding Shingles.

Name \_\_\_\_\_

Firm \_\_\_\_\_

Address \_\_\_\_\_

\_\_\_\_\_

# Now . . . you can give home buyers bryant's new "Command-Aire" Twins

## practical, attainable

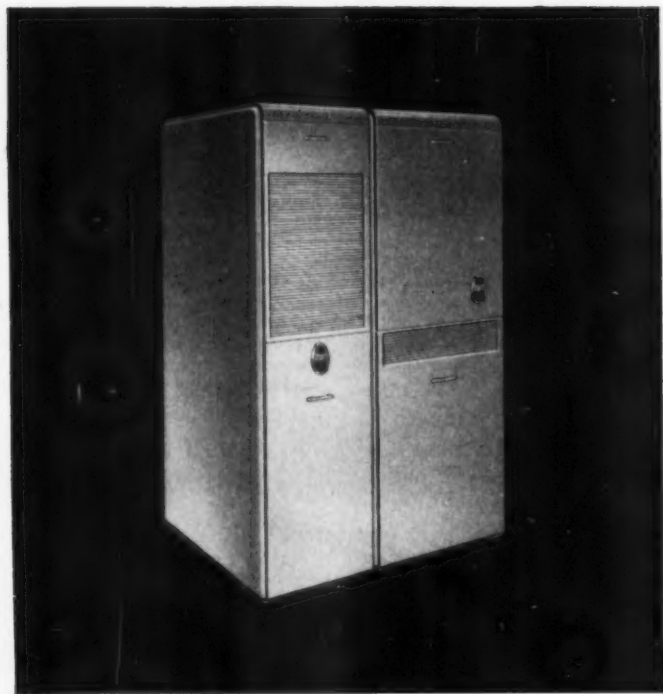

*Year 'round comfort . . . or the early "prospect" of it . . . is going to sell a lot of new homes this coming season. It's a feature home buyers want, and for two reasons: First, for the added enjoyment it provides; second, for the extra value it adds to the home should the owner have to sell in the next few years.*

Now, with the introduction of Bryant's "Command-Aire" Twins, you can offer this sales-clinching feature in *all* of your homes. Thanks to Bryant's mass-production techniques, you can offer summer cooling for 30% to 50% less than heretofore . . . or, let the purchaser add cooling later. Either way the buyer gets a big "plus" and think what this can mean in the profitable selling of your homes.

**bryant**® *means business...*

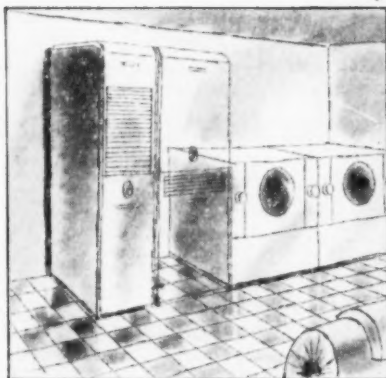

**Unusually compact design** permits hide-away installations of the "Command-Aire" Twins—in closets or alcoves . . . in utility rooms . . . in basements. Requires a minimum of 7 $\frac{1}{2}$  sq. ft. of floor space (actually less than twin sanitary tubs).

**Use one cooling unit . . . sell 100!** By installing the "Command-Aire" Twins in your model home and leaving space for the cooling unit in the others, you can offer "year 'round conditioning" in *all* your houses without additional investment.

**Air conditioner is independent unit** with its own blower, air filter and controls. This eliminates need for air to pass through both units, improving both heating and cooling efficiency—and making for hushed operation. A Bryant "exclusive" in low-cost equipment.

"the home of the future" today!

# make year 'round conditioning

## by average-income families

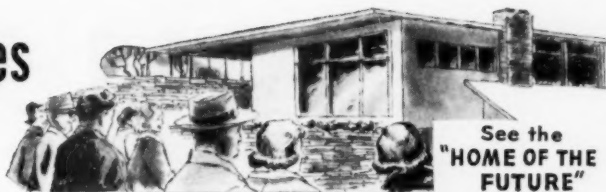

Bryant's "Command-Aire" Twins, as you might guess, are *matched* heating and cooling units. Each operates separately, or they may be used together. And you can use *gas* or *oil* for heating, as both types of forced air furnaces are available. You also have a wide range of furnace sizes to choose from . . . as well as 2, 3 and 5-ton capacities in the summer conditioning units.

You will want to get all the facts on this new Bryant equipment before you firm up plans for your 1953 homes. You'll be interested also in Bryant's supporting program to help you sell your houses. Ask your Bryant Distributor to give you the details . . . or write Bryant Heater Division, 17825 St. Clair Avenue, Cleveland, Ohio.

**Sales magic!** Year 'round comfort conditioning at prices even "GI home buyers" can afford, can be real sales magic for you in '53. You'll get bigger crowds, more interested prospects, easier-to-sell customers . . . and make more money on your houses.



National advertising will pre-sell Bryant "Command-Aire" year 'round conditioning to millions this spring and summer, also carry the names of leading builders who are featuring "Command-Aire" installations in their homes this year.

Local promotion and publicity can tie you into the big national advertising program. We'll help you prepare your material and get it into your local papers. The "Command-Aire" Twins are "news"—news you can use to your advantage.

### *better business for builders*



**Five-year warranty** on the hermetically sealed compressors of the 2 and 3-ton "Command-Aire" Cooling Units has tremendous appeal to home buyers. They will also appreciate the fact that factory-trained experts are close at hand.



**"On-the-site" selling** helps, especially developed for use by builders, will point up the extra comfort—extra value—of year 'round conditioning, also the many advantages of a "Command-Aire" installation to home buyers, both today and tomorrow.

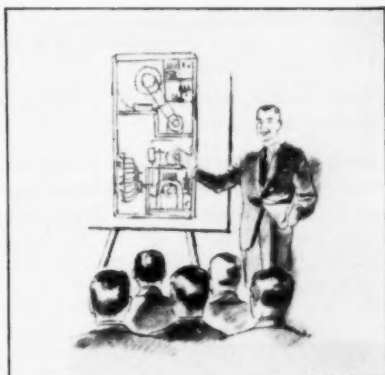

**Sales Training** is another important feature of Bryant's new "Command-Aire" program. Qualified representatives are available to aid your salesmen in selling summer cooling most effectively. This can add substantially to your profits.

# You'll sell houses faster with



**I**NSULATE with Gold Bond Rock Wool Blankets and you can offer prospects wintertime fuel savings... summertime comfort! You'll save insulation money and cut installation time, too. Here's how:

1. The fireproof rock wool adheres to casing, both front and back. It won't slip or sag.
2. Exclusive rugged construction reduces tear and damage. These sturdy Blankets are built to take punishment!
3. They're easier to handle, go up faster... save time and labor on the job.

Drawing (right) shows breather strips and the built-in vapor barrier and nailing flange on the opposite side. A type to meet every FHA and Building Code requirement. These extra-value features are available in all sizes and thicknesses—Mat-Thick, Semi-Thick and Full-Thick. At your Gold Bond lumber and building materials dealer now!

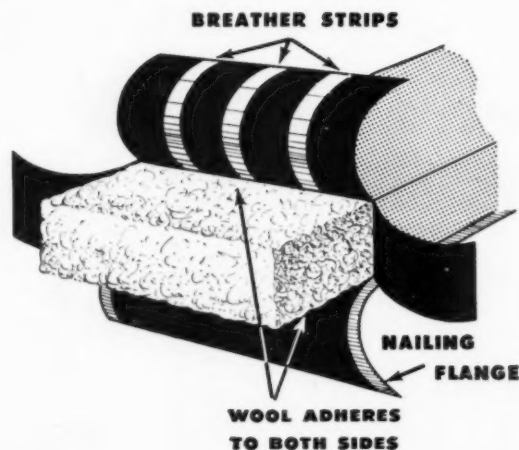

You'll build or  
remodel better with

**Gold Bond**

**NATIONAL GYPSUM COMPANY • BUFFALO 2, N. Y.**

*Fireproof Wallboards, Decorative Insulation Boards, Lath, Plaster, Lime, Sheathing, Wall Paint, Textures, Rock Wool Insulation, Metal Lath and Sound Control Products.*

RICHMOND HOMES

prefabricated to your plans



Now . . . for project builders . . . a new and unusual opportunity in prefabrication! Now . . . you can have completely prefabricated homes expertly adapted to your own tried and proven plans. Now . . . you can have the well-established economy of prefabrication, with new exclusive features, more advanced construction techniques plus an entirely new concept of exterior variations that express the same

individuality as custom-built homes. As a manufacturer of pace-setting, quality homes for over seven years, it is with a deep sense of pride that we offer Richmond Homes to qualified builders under this unique plan.

---

*Our program, naturally, has certain requirements relative to the financial status and experience of the builder. If you feel that you can qualify, we would like to hear from you. Write, wire, or phone for complete information.*

**RICHMOND**  
homes

RICHMOND BUILDERS, INC.

524RB Northwest "K" Street, Richmond, Indiana

# Pittsburgh Glass

*can help you get handshakes*

*instead of  
headaches*



A TRIPLE-MIRROR arrangement is sure to please prospective new-home buyers or persons interested in modernizing their present houses. Two doors in the bedroom—fairly close together—equipped with full-length Pittsburgh door mirrors, with a third full-length mirror placed on the wall between, will do the trick. But make sure you supply Pittsburgh door mirrors. They're made from Polished Plate Glass . . . are really full-length—68 inches high. Sizes are available to fit more than 90% of all interior millwork doors—16, 18, 20, 22, or 24 inches wide.

Every Nickel you spend on glass shows. And the results always far outweigh the cost.



CARRARA GLASS on the walls and ceiling of a bathroom gives a home an exciting, glamorous look. Builders put up more "sold" signs on homes having this high quality, beautiful veneer material. And on renovating jobs, they please home owners no end. Where the advantages of Carrara Glass are wanted at minimum cost, Pittsburgh has available Ready-Built Carrara Panels for use as tub recesses in bathrooms, as well as for stove backings in kitchens. Carrara lasts a lifetime, is easy to keep clean and sparkling. It's not affected by water, chemicals, grease or pencil marks. Ten attractive colors to choose from.

AMERICAN BUILDER

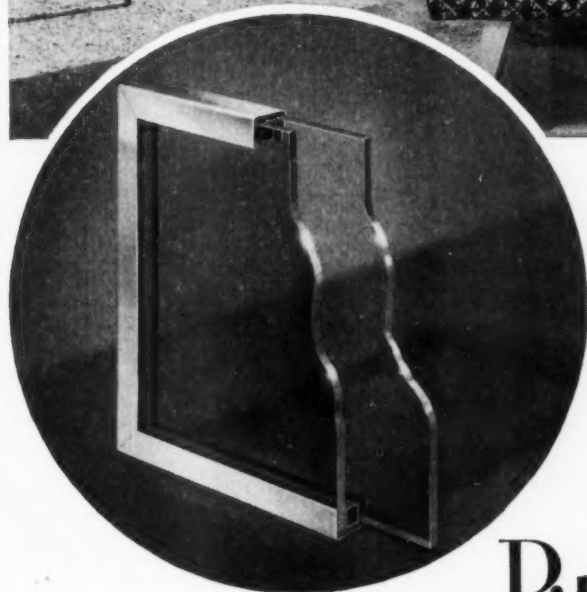

**TWINDOW** multi-units create a window wall which admits an abundance of natural daylight, while keeping interiors more comfortable. Occupants have a clear view of the outside from inside the home. In new building or remodeling, you can't offer a more-appreciated feature than Twindow—"the window with built-in insulation." And this is possible even in average-size homes, like the one shown here. Photo, courtesy of National Homes Corporation, Lafayette, Indiana.

**SOLEX-TWINDOW.** Where protection against solar heat and sun glare is required, there's nothing like Solex-Twindow. The inside light is regular Plate Glass . . . the outside pane is green-tint Solex, "the best glass under the sun!" This combination gives the double advantages of Twindow's high insulating properties, plus the solar-heat-absorbing, sun-glare-reducing advantages of Solex. The entire unit is enclosed by a stainless steel frame—to protect the seal and glass edges and to make handling easy, quick and safe.

*Build it better with* **Pittsburgh Glass**



See Sweet's Builders Catalog for detailed information on Pittsburgh Plate Glass Company products.

PAINTS • GLASS • CHEMICALS • BRUSHES • PLASTICS • FIBER GLASS

**PITTSBURGH PLATE GLASS COMPANY**

FEBRUARY 1953

153



panels transform any wall  
into a **WORKING WALL**



decorative, functional, versatile!



"PEG-BOARD" presents a brand new concept in wall paneling—a combination of perforated hardboard matched with over 60 hanging fixtures (magazine racks, towel bars, shelf brackets, hooks, etc.) all instantly interchangeable without screws, nails or tools of any kind. Take a new look at those plans you're working on now—you'll find dozens of places to save space and add beauty and efficiency with "PEG-BOARD" panels and metal hangers.

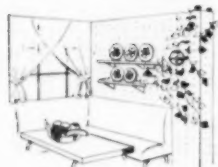

Ideal for tools—in garage or workshop



Gives new utility to closet space

A perfect room divider

Copyright 1953 B. B. Butler Mfg. Co., Inc.

**NEW YORK** • PEG-BOARD OF NEW YORK, 131 E. 64th St., New York 21, N. Y.  
**CLEVELAND** • DAVIS PLYWOOD CORP., 12555 Berea Rd., Cleveland 11, Ohio  
**MIAMI** • A. H. RAMSEY & SONS, INC., 71 N.W. 11th Terrace, Miami, Fla.  
**LOS ANGELES** • PEG-BOARD OF CALIF., 717 E. Gage Ave., Los Angeles 1, Cal.  
**MINNEAPOLIS** • L. E. HIER DISPLAY EQUIP. CO., 23 N. 6th St., Minneapolis, Minn.  
**CHICAGO** • Mfg. by B. B. BUTLER MFG. CO., INC., 3146 Randolph, Bellwood, Ill.

## No. D-99 window and door details

Fixed windows or a combination of fixed units and hinged sash are today used in greater number as the trend toward contemporary styling in homes increases.

The frames detailed on the opposite page are selected from a group of houses that constitute Norwood Village in Factoria, Washington. Designers are Chiarelli and Kirk and Bassetti and Morse, architects.

The frames used in the houses do not follow a stock pattern but are designed to conform to the nature of the wall construction and the character of the materials used in the rooms in which they occur.

A minimum number of members are used in the construction of the fixed glass frame. The frame for the bearing mullion consists of two members: a rabbeted blind stop and exterior casing. The adjoining supporting post is considered as a finished unit in the room. In the partition mullion the interior jamb member and exterior casing are placed in position to form the rabbet for glass. Metal grounds provide the finish for plaster. Dotted lines shown at the head, and partition mullions indicate the position of the hinged steel sash unit which adjoins the fixed frame.

In the assembly of these windows, accuracy in the placing of adjoining rough framing is of utmost importance due to the fact that this framing becomes an actual part of the window structure. Assembly of the units is done on the job.

Door frames follow in general the pattern of the windows except that they can be assembled in the mill and placed in position.

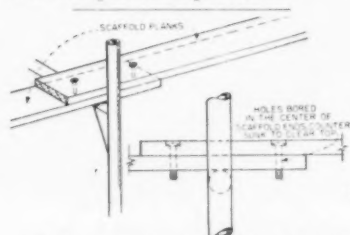

Holes may be bored in the ends of the scaffolds so that bolts several inches long can be placed in them. These holes should be counter-sunk so that the bolt heads will be below the surface of the plank.—Arthur N. Nelson, Kansas City, Mo.



# AMERICAN BUILDER'S BETTER DETAIL PLATE

Detailed by K. Roderick O'Neal A.I.A. for American Builder

## NO. D-99 WINDOW & DOOR DETAILS . . .

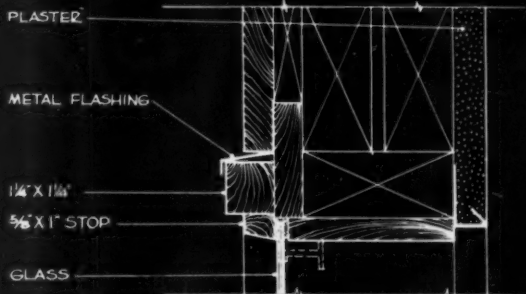

WINDOW HEAD

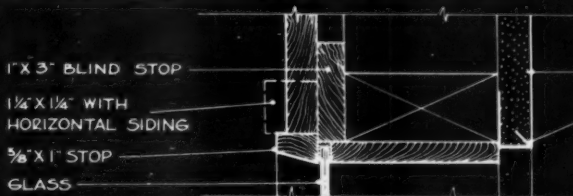

WINDOW JAMB

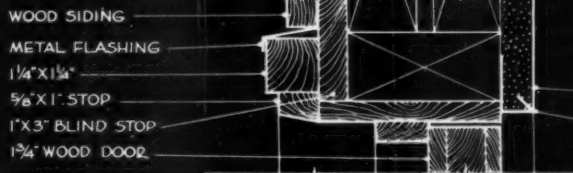

DOOR HEAD

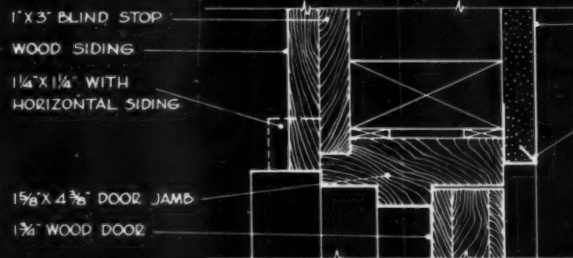

EXTERIOR DOOR JAMB

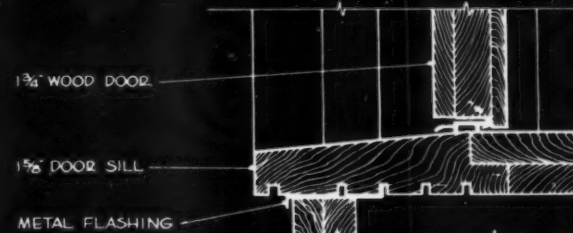

DOOR SILL

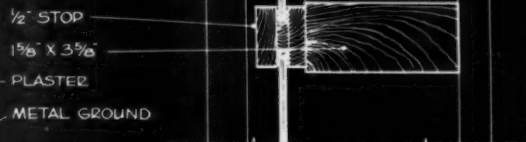

MULLION & TRANSOM

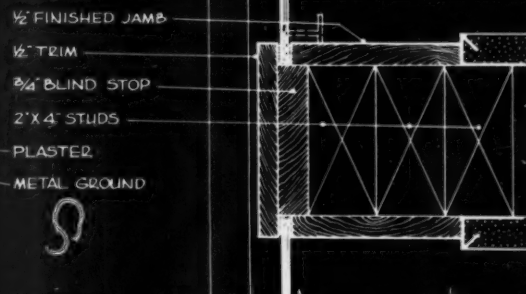

PARTITION MULLION

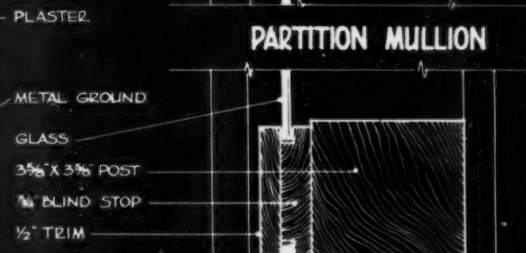

BEARING MULLION

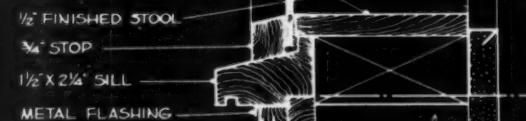

WINDOW SILL

# Smooth and Sure ...

that's  
*Hydrocrane*  
**PRECISION  
CONTROL**

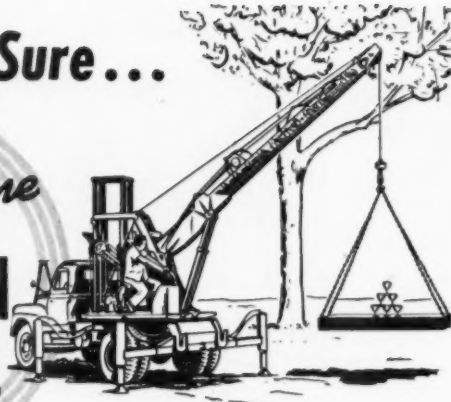

HERE the Hydrocrane with crane hook hoists a heavy stone slab to an upper story. Crane is available with additional money-making attachments — four hydraulically operated buckets, magnet and grapple plus the HYDRO-HOE — A DRAGSHOVEL FRONT-END THAT IS QUICKLY, EASILY ATTACHED IN THE FIELD. Ideal for trenching and foundation work.

No matter how carefully you must handle certain building materials — concrete slabs, brittle stone, plate glass windows, concrete buckets — you can handle them with confidence the smooth Hydrocrane way. With every crane function actuated by a liquid-smooth, cushion-action hydraulic system, Hydrocrane control is so precise loads can be moved a fraction of an inch if necessary. In actual tests this machine lifted, swung and set down a pyramid of six full drinking goblets (on a 1-ton steel test slab) without spilling a drop.

And to make this precision control pay off to the fullest extent, the Hydrocrane is equipped with four outriggers that extend in seconds, providing a rock-solid crane foundation. Truck springs are locked out through a semi-automatic spring lock-out assembly.

Simple hand controls, no hand-foot coordination required . . . 50 mph top highway speed . . . telescoping boom for reaching into hard-to-get-at places — these are just a few of the many additional reasons why your best buy is Hydrocrane. Send coupon now.



South Milwaukee, Wisconsin

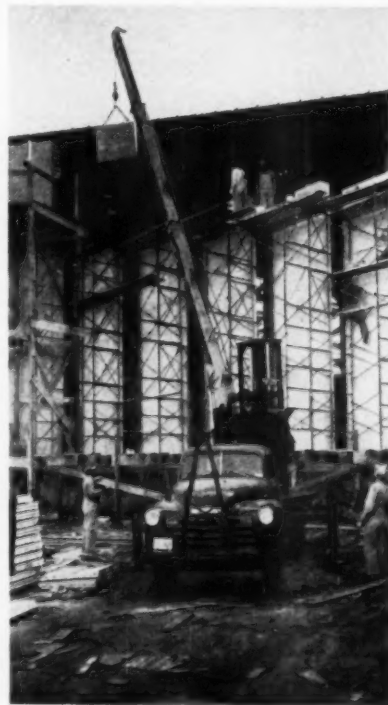

## BUYRUS-ERIE HYDROCRANE DIV.

South Milwaukee, Wisconsin

Gentlemen:

- Please send Hydrocrane literature.  
 I am interested in a demonstration.

Name.....

Company.....

Address.....

City..... State.....

183H52

No. G-40

this store front and canopy  
designed for a store

The drawing on the opposite page details the entrance feature and the front of a store building which has sufficient square foot area to attract chain store occupancy. Designed with that idea in mind, the front has been kept rather simple with the emphasis placed on the large corner pylon which flanks the entrance doors.

The entrance placed at the corner of the building, which is located on an inside lot, is unusual. With a parking area adjoining, which is part of the store setup, this type of entrance permits guide rails alongside of the doors without infringing on the public walk. It also facilitates the movement of shoppers from parking area to store.

Standard store front construction is used throughout with awning hood, fascia and mouldings of aluminum. A furred beam just inside the head of the window openings accommodates a series of recessed lights along the entire front. An extended canopy built up of wood framing with an aluminum face and plaster soffit provides shelter for the entrance. The bulkhead and corner pylon is faced with limestone with face brick above the awning line.

### how to cut tile pipe

To cut ceramic tile pipe, fill the pipe with sand and then cut with a bricklayer's hammer.—Fred B. Chott, Cicero, Ill.

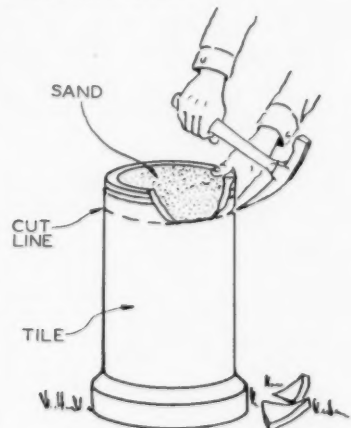

AMERICAN BUILDER

# AMERICAN BUILDER'S STORE FRONT DETAILS

Designed by Sidney C. Finck, A.I.A., Chicago, Ill.

Detailed by K. Roderick O'Neal, A.I.A. for American Builder

## NO. G-40 STORE FRONT & CANOPY . . .

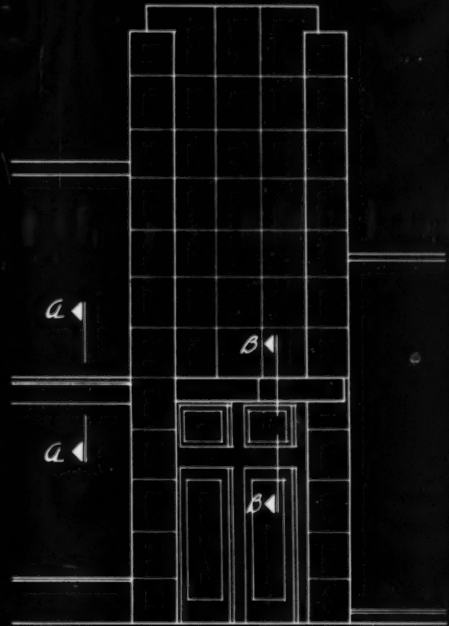

*Elevation . . .*

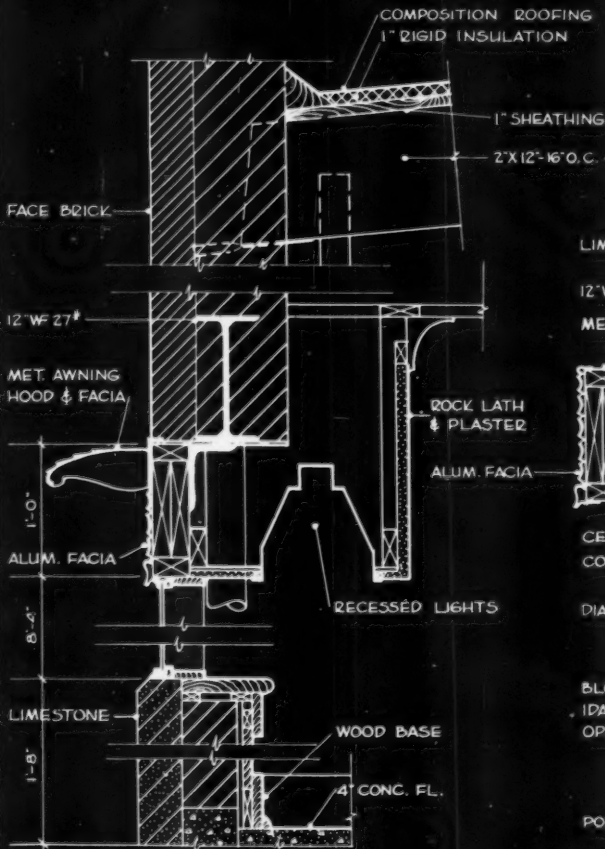

*Section a-a . . .*

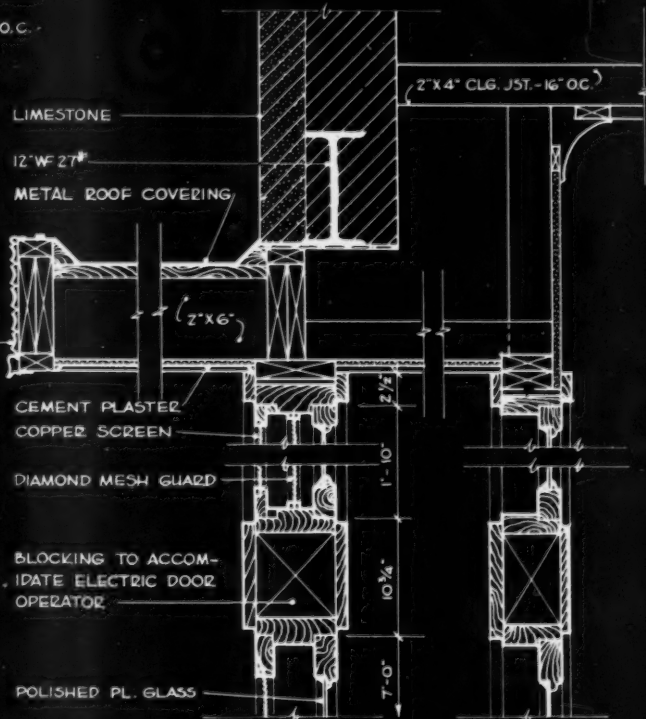

*Section b-b . . .*

# new products

## offered by manufacturers

### Attractive Interiors with Mahogany Plywood Squares

AB25314

Precision cut, beveled edge Philippine mahogany plywood squares are an effective answer to a growing demand for beautiful interior paneling with virtually no waste. Called "Tropicblox," these 16x16 inch square panels are sanded at the factory after cutting to size and beveling of edges; this process assures accurate easy-to-finish bevels and eliminates possible splintering at the edges or corners. The panels being square and all of the same pattern do away with any saw-kerf loss.

The "Tropicblox" panels are 1/4-inch thick. They are supplied rotary cut in slash grain, or slice cut in ribbon stripe grain. They are particularly adaptable to original architectural uses, yet due to their accurately cut bevels, can be installed by the home craftsman.

Uses include installation for new walls, over existing walls, for wainscoting and ceilings; in commercial establishments, they can be used effectively to cover store windows and for counters.

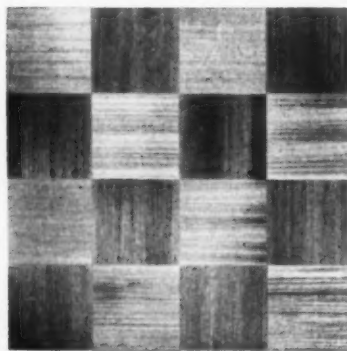

The ribbon stripe grain of these Philippine mahogany panels improves interior design

The panels are packaged in sturdy Fiberboard cartons, 28 pieces in each, assuring ease of handling, as well as protecting the color brightness from exposure to light, while minimizing losses by damage in transit or from dust and moisture. Elliott Bay Lumber Co., Dept. AB, 600 W. Spokane St., Seattle 4, Wash.

### GRINDING ATTACHMENT AB25305

A new grinding attachment for use with an all-purpose floor maintenance machine converts the unit to a powerful portable floor grinder, capable of refinishing, grinding, polishing or resurfacing terrazzo floors. It is also efficient for smoothing

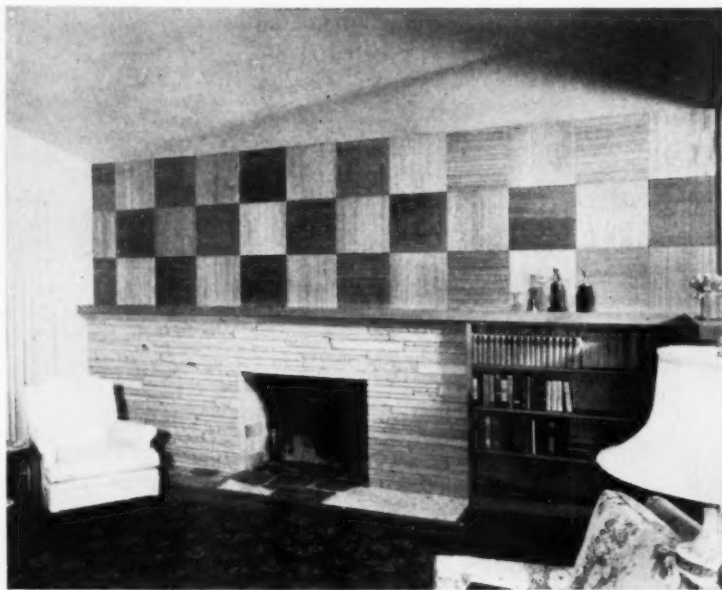

Applied in "parque" design. "Tropicblox" panels enhance the appearance of this fireplace wall. The 16-inch squares reflect light to create the above attractive effect

out rough, uneven concrete or brick surfaces, jobs formerly requiring heavy-duty equipment.

The grinding attachment is designed with three carborundum grinding stones which are equally spaced and fastened to rotate individually on planetary discs which are a part of a cast iron frame. The attachment can be put on or taken off in seconds without the use of tools.



Several grits are available, including 24, 60, 80 and 100, with others furnished upon request. Special wood wedges of the proper taper to hold stones firmly in place are also available in any quantity. American Floor Surfacing Machine Co., Dept. AB, 515 S. St. Clair St., Toledo 3, Ohio.

### METAL PORCHES AND STEPS AB25309

The combination metal porch and steps is shipped as a package unit, ready for installation. The porch and steps are neat in appearance and constitute a new home feature which is a lifetime installation, providing safety without maintenance or replacement. The non-skid deck and steps with metal railing offer protection and security both to children and adults. The metal porches and steps are available in 15 stock sizes in a choice of steel or aluminum. Sturdee Metal Porch Co., Dept. AB, P. O. Box 671, Baltimore 3 Md.

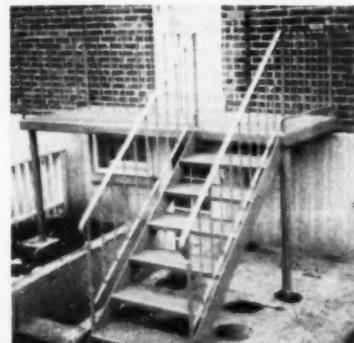

(New Products continued on page 160)

# THE BIGGEST BOON TO THE BUILDING TRADES

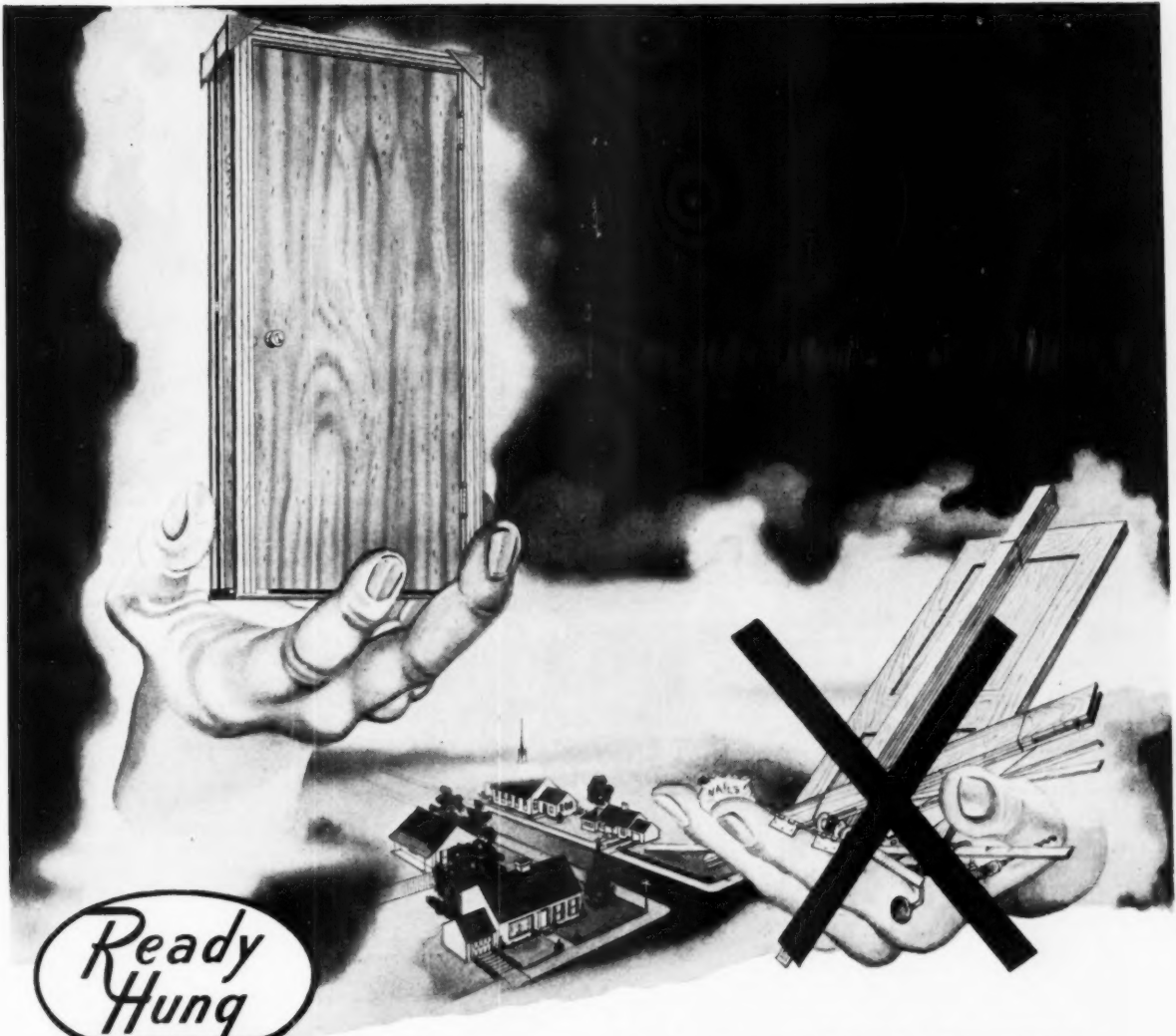

PATENT NO. 2489029

## The Door and Frame PACKAGED UNIT

### IT'S NO LONGER NECESSARY TO CASE AND HANG A DOOR ON THE JOB

Truly a Boon to the Building Trades! The **READY HUNG DOOR**, a door and frame packaged unit, is delivered to the job with all the hard and accurate work done for you—as it should be—on precision machinery and jig assembled on an assembly line. All you do is separate the halves of the two piece jamb, slip them together in the opening and nail it to the wall—**IN JUST 20 MINUTES!**

With **READY HUNG DOORS** you don't have to mark and saw one or both ends of 12 pieces of lumber per opening and nail them in the opening a piece at a time—you don't have to layoff and hand chisel hinge mortises, plane and fit cumbersome doors, and bore and mortise for the lock.

**SAVE TIME, LABOR, MONEY, WASTE, WORRY, SKILL AND DO A BETTER JOB.**

#### SOLD THROUGH LUMBER DEALERS

For further information write the mill nearest you.

**BIRMINGHAM, ALA.**  
National Woodworks, Inc.  
2201 29th Ave. North

**BURBANK, CALIF.**  
Ready Hung Door Mfg. Co.  
200 South Victory Blvd.

**DALLAS, TEXAS**  
Ready Hung Door Mfg. Corp.  
1113 Dragon

**DENVER, COLORADO**  
Prefabricators, Incorporated  
P. O. Box 5222

**GRAND RAPIDS, MICH.**  
Haskelite Manufacturing Corp.  
701 Ann St., NW

**HOUSTON, TEXAS**  
Ready Hung Door Mfg. Co.  
P. O. Box 124

**MEMPHIS, TENN.**  
Ready Hung Door Mfg. Corp.  
911 Rayner

**NEW YORK, N. Y.**  
Bailey-Whalen Company  
17 Park Ave., W. Orange, N. J.

**SAN ANTONIO, TEXAS**  
Ready Hung Door Mfg. Corp.  
200 Seguin Street

**SIoux FALLS, S. DAK.**  
Jordan Millwork Co.

**TORONTO, CANADA**  
C. Lloyd & Son Limited  
1214 Lawrence St., N. Park P. O., Ont.

**READY HUNG DOOR CORP.,**  
Fort Worth 2, Texas



PAT. NO. 2489029  
\*TD. MK. REG. U. S. PAT. OFF.

## new products

(Continued from page 158)

### MAGNESIUM LEVEL AB25322

A 24-inch die cast magnesium carpenter's level, utilizing magnesium's light weight, dimensional stability and strength, is equipped with permanently set vials which are moisture, dust and dirt free.



The tool is guaranteed as to accuracy, workmanship and materials by the manufacturer. The level incorporates a new vial fluid which is capable of withstanding greater extremes of temperature. It is finished in gold bronze with royal blue putty sealing the vials. Mayes Brothers Tool Manufacturing Co., Dept. AB, Port Austin, Mich.

### RADIANT FRONT RADIATOR AB25301

A radiant front radiator said to include developments not available in any other makes is designed with a low silhouette that blends into any decorating scheme. The unit combines both radiant and convected heat. It is provided with an additional front air inlet to assure higher efficiency in any type of installation. Only

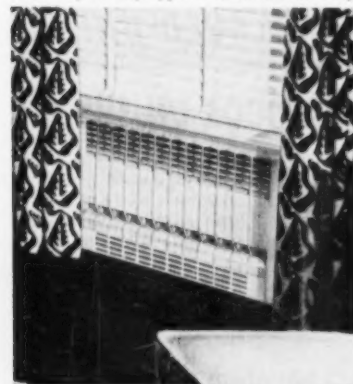

20 inches high, the radiator can be used as a free-standing unit, or recessed in the wall. It forms its own cabinet and requires no separate enclosure. Matching snap-on grilles provide complete concealment of piping. U. S. Radiator Corp., Dept. AB, 300 Buhl Bldg., Detroit 26, Mich.

### WHITE ROOFING MATERIALS AB25336

Roofing that is true white, without any gray shades has been introduced, including No. 210 Thick Butt shingles and No. 90 Lastile roofing. A wide range of colors is also available for selection by architects and builders. Roll roofing offers Tile Red, Royal Red, Velvet Black, Midnight Black, Dixie Green, Atlantic Green and Slate Green, as well as the new pure white shade. Thick butt roof blends which harmonize with a home's natural surroundings are available in Forest Green, Red Blend, Canyon Blend, New Harvest Blend, Graytone, Greentone, and White. The Philip Carey Mfg. Co., Dept. WR, 316 S. Wayne St., Cincinnati 15, Ohio.

### ASME APPROVED BOILER AB25316

Design changes and engineering improvements have been made in the manufacturer's round boiler. The unit is ASME approved and recommended for FHA construction. Available either as a boiler or as a packaged unit, the product provides domestic hot water and is furnished with a built-in expansion tank. It is made in four models, for steam or hot water, with B.T.U. ratings of 99,600, 115,200, 144,000 and 196,000. All models are available with flush or extended enamel jacket.

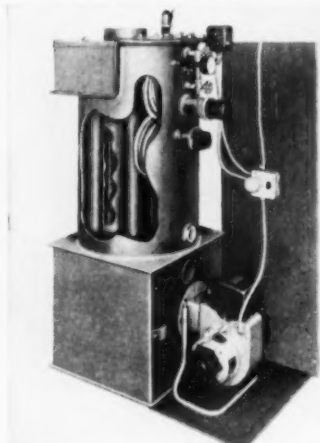

The cover plate is removable to permit cleaning. An accessible peephole allows flame observation without disturbing combustion. Replaceable high pressure steel tubes are submerged for tube protection and faster heat transfer. The unit occupies a floor space less than 4 square feet, with all controls mounted on the front of the boiler. The flush jacket can be installed after installation. Penn Boiler and Burner Manufacturing Corp., Dept. AB, Lancaster, Pa.

### 4-PURPOSE BATHROOM UNIT AB25315

A new product which combines the facilities of a vanity, lavatory, linen closet and medicine cabinet is called the "Vallette." It is stated to meet FHA requirements for a linen closet, yet requires only  $\frac{3}{4}$  of a square yard of floor space. The unit's versatility offers architects and builders a ready-made solution to many design and cost problems. It fits easily into even small size bathrooms.

An exclusive feature of the unit is the "Hideaway Beauty Bar" on the top vanity surface, which gives instant accessibility for beauty aids, soaps, etc. When the Bar cover is closed, the usual lavatory disorder is concealed. The top has 2½ square feet of working area.



The "Val-ette" has a porcelain-enamelled lavatory, chromium finish brass fixtures and a bonded Formica top. It is made in a range of three colors—Pearl Blue, Pearl Gray and Pearl Pink, with the base finished in durable matching pastel colors. Majestic Mfg. Co., Dept. AB, 4550 Gustine Ave., St. Louis, Mo.

### AUTOMATIC CLOTHES DRYER AB25311

The new Sun-Aire automatic gas and automatic electric clothes dryers are provided with a top-lint trap, for easy access and maintenance. A "Turbo-Vent" device permits the dryer to be vented either in or outdoors; fast moving air takes the moisture out of the clothes. Both heat and drying cycles are fully automatic. A signal bell indicates when clothes are ready for ironing or folding. A germicidal lamp gives clothes a fresh-air fragrance. The interior is illuminated so that one can watch clothes drying. Five minutes before the drying cycle is completed, the heating unit turns off so that the clothes are cool when finished and can be handled with ease. No heat is wasted.



Safety is stressed in the new unit. The electricity or gas turn off automatically when the dryer is opened; the cycle resumes when the door is closed. The use of thermostats and gas controls assures maximum safety. The Stiglitz Corp., Dept. AB, 2007 Portland Ave., Louisville, Ky.

(New Products continued on page 162)

# PRODUCT NEWS from AMERICAN-Standard

*A review of products in the news and important features worth remembering*



**RESTAL RECEPTOR BATH.** Here is complete bathing convenience in shower stall space. The 12" high Restal, with integral corner seat, fits a finished compartment approximately 36" x 38". In modernization, a closet or similar space often can be turned into an extra bathroom with the Restal. It's made of rigid cast iron with a thick enamel coating in white and five colors.



**AMERICAN-STANDARD KITCHEN CABINETS.** The maker of the world's finest cast iron kitchen sinks now offers a complete line of all-steel kitchen cabinets . . . base, wall, utility and undersink cabinets. Convertibility feature permits changing shelf and drawer arrangements to meet individual storage needs. Finished in smooth, white, baked enamel.

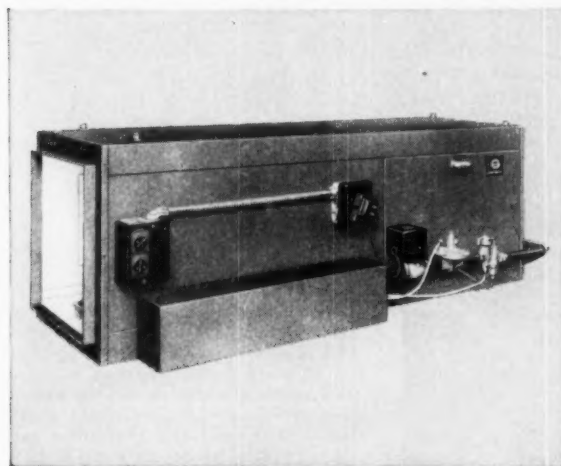

**PAWNEE WINTER AIR CONDITIONER.** This gas fired horizontal type unit is a space-saver in small homes, can be installed in out-of-the-way places. In attic installations, in suspended installations or installed in the crawl space under a basementless house, the Pawnee allows complete freedom of duct layout. It can be used for perimeter heating jobs, too.

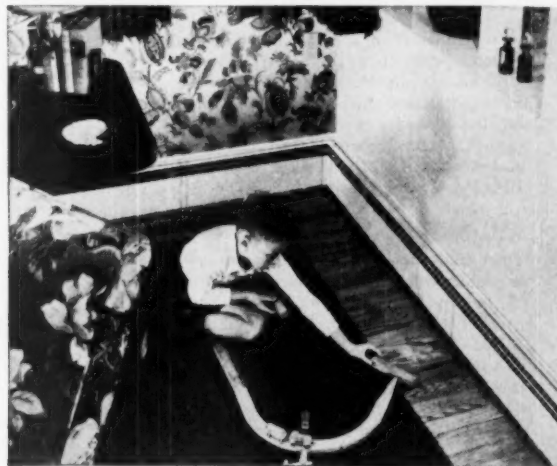

**HEATRIM PANELS.** Specifically designed for forced circulation hot water heating, these baseboard heating panels provide convected warmth throughout each room. The panels take the place of regular wood baseboards, allow use of virtually all the floor area. Panels can be installed free standing or recessed . . . are ideal for use under picture windows.



American Radiator & Standard Sanitary Corporation  
Dept. AB-23  
Pittsburgh 30, Pa.

Without obligation on my part, please send me your free literature on:

- Restal receptor bath       Kitchen cabinets  
 Pawnee winter air conditioner       Heatrim panels

Name.....

Address.....

City.....State.....

American Radiator & Standard Sanitary Corporation, Dept. AB-23, Pittsburgh 30, Pa.

*Serving home and industry*

## new products

(Continued from page 160)

### PORTABLE ELECTRIC SAW AB25317

A heavy-duty 6-inch portable electric saw, designated as Model 686, introduces the manufacturers' new line of heavy-duty, portable electric tools. This saw is designed for carpenters, builders, and others who require a hard-working tool. It is provided with a universal motor, ball and needle bearings throughout, aluminum alloy housing, safety trigger switch, automatic blade guard with retracting handle, built-in bevel and depth of cut adjustments, and an indexed rip guide for either right or left hand use. The depth of cut

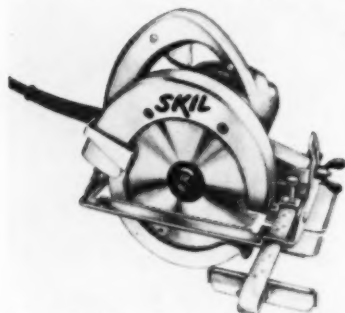

is regulated from zero to  $1\frac{5}{16}$  inches. Speed is 6,000 r.p.m. The saw weighs only  $10\frac{1}{2}$  pounds; its overall length is just ten inches. Standard equipment includes combination blade for general purpose cutting, wrench, rip fence, guard retracting handle, and cord. Skilsaw, Inc., Dept. AB, 5033 Elston Ave., Chicago 30, Ill.

### STEEL BASEMENT WINDOW AB25302

Steel frame basement windows are now available with a heavy galvanized coating applied by the continuous Hot-Dip process, after manufacture. The galvanizing is done in a Detroit plant specially built to handle the complete process of cleaning, bonderizing and galvanizing of steel windows under careful controls. Special tanks permit dipping of the entire steel window, after assembly, so that all exposed metal receives a protective coating.

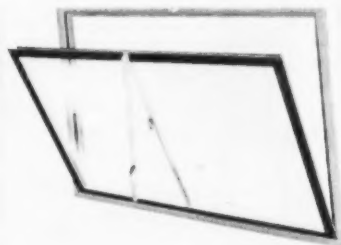

Experience has shown that windows which have been properly galvanized can withstand weather, even salt spray, for more than 30 years without deteriorating. Protective maintenance is no longer a problem, nor is painting necessary, except for decorative purposes. Detroit Steel Products Co., Dept. AB, 3101 Griffin St., Detroit 11, Mich.

### GAS FURNACES

AB25304

Two new model gas furnaces approved by the A. G. A. have been added to the company line, which now includes oil-fired Hiboy's, Loboy's, a Counterflo and hanging models. The gas furnace has similar construction to that featured in the oil-fired unit, with the same efficiency and speed in heat production; 80 per cent of the fuel input goes for actual heat; within three minutes after being turned on, heat is coming from the registers.



The compact, light weight unit is constructed of heavy-gauge steel, with a double-walled metal construction, asphalt sealed joints; it comes ready for installation and is available in 70,000 and 90,000 B.T.U. capacities. Turb-O-Tube Furnace Co., Dept. AB, 204 Rhode Island Ave., Buffalo, N. Y.

### RANDOM PATTERN FIBERBOARD AB25321

A distinctive new design for Cushiontone, No. 302 S/R, a low density perforated fiberboard acoustical material, has the perforations arranged in a "skip random" pattern. The established straight row de-

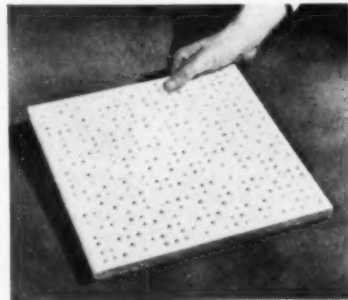

sign will also be continued in the line. The staggered arrangement of perforations produces a new textured appearance and a contrast to the regularity of the straight row design. It presents a smooth monolithic appearance and eliminates the tile design and straight line perforation effect of the established pattern. The new pattern has a minimum border between the random perforations and the beveled edge. It has a  $3/32$ -inch ironed and painted bevel and a washable paint finish. The design is available in  $12 \times 12 \times \frac{1}{2}$ -inch and  $12 \times 12 \times \frac{3}{4}$ -inch tile. Armstrong Cork Co., Building Materials Div., Dept. AB, 1010 Concord St., Lancaster, Pa.

### KNOCKED-DOWN STEEL DOOR AB25306

A one-piece packaged, knocked-down steel garage door has all its parts precision punched so that assembly consists only in bolting the various parts together.

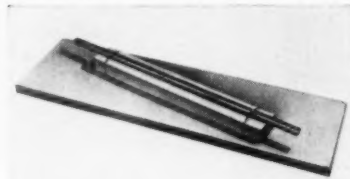

According to the manufacturer, a problem in merchandising one-piece metal doors heretofore has been the difficulty encountered in handling, storing and shipping a package eight by seven feet. The knock-down feature of this product eliminates this problem. K-D Garage Door Sales, Dept. AB, 12482 Evergreen Road, Detroit 23, Mich.

### ELECTRIC WATER SYSTEM AB25325

A "package" electric water system designated as the "Torrent" is designed for domestic well installations at depths down to 70 feet. The unit incorporates a new deep-lift jet assembly. Inside surfaces of the jet body are coated with corrosion-

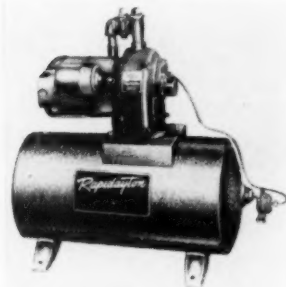

resistant plastic. The venturi is precision made of micro-smooth brass. The assembly said to provide greater pressure from greater depths. The unit will also be available as a shallow well jet system. Both systems are equipped with a standard  $\frac{1}{3}$  h.p. motor and a 12-gallon galvanized tank. The Dayton Pump & Mfg. Co., Dept. AB, 500 N. Webster St., Dayton, Ohio.

### WATERPROOF, FLEXIBLE SANDPAPER

AB25331

A waterproof sandpaper developed for the automotive, hardware, floor and paint industries is called "Tufbak" Speed-Wet Durite Paper. The product has the ability to keep the initial edge necessary in wet sanding primer coats and fillers on both wood and metal, according to its maker. A tough backing material permits adequate flexibility. The sandpaper's increased body strength is stated to resist creasing, cracking and curling. It maintains high resistance to skidding and peeling of grit whether it is soaked in the usual liquids for a few minutes or for hours. Behr-Manning Corporation, Dept. AB, 933 Sidford St., Troy, N. Y.

(New Products continued on page 164)

AMERICAN BUILDER



**Keep your customers satisfied**

**with**

**BRIGGS**  
*Beautyware*

**acid-resistant fixtures!**

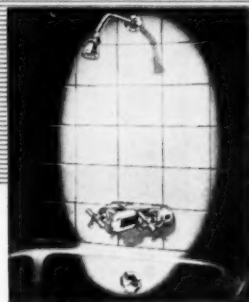

Because all Briggs Beautyware is thoroughly acid-resistant at no extra cost, you deal with satisfied home owners when you specify and install Briggs fixtures at every opportunity. Besides uniform acid-resistance, the Briggs Beautyware bathtub features a wide rim seat, leak-proof tiling-in flange and patented Safety Bottom. Briggs lavatories and closets meet highest plumbing ware specifications, too. Every closet is carefully *flush-tested* before it leaves the plant. You can virtually forget annoying call-backs if you install Briggs Beautyware, whether of porcelain enameled

formed steel or quality vitreous china.

You'll find that any house sells faster after the prospective buyer has seen sparkling Briggs fixtures in the bathroom. And home owners *stay sold* on Briggs Beautyware! After long service, Briggs fixtures are still a source of pride—because they *look new longer!*

For so many reasons, you—and your customers—profit every time you specify Briggs fixtures in Sea Green, Sandstone, Sky Blue, Ivory or White. For all your residential plumbing ware needs, select the very finest—Briggs Beautyware!

©1953

**WALL SURFACE TUB AND SHOWER FITTING** for copper tube solder-joint use. Designed for fast, efficient installation on finished surface of wall. All working parts readily accessible from the front for easy maintenance. No leaks behind wall. Attractive modern appearance. See your Briggs Distributor for full details on complete line of quality brass fittings.

**See our new 28-page catalog in Sweet's Architectural and Light Construction Files**

**BRIGGS MANUFACTURING COMPANY • 3001 MILLER AVENUE • DETROIT 11, MICHIGAN**

FEBRUARY 1953

163

# new products

(Continued from page 162)

## FOOD WASTE DISPOSER AB25340

A telescoping mechanism permits adjustment of this waste disposer to any rough-in dimension between six and 11 inches without special fittings. The unit is also



equipped with a simpler mounting that permits installation under any sink with a standard 3½ to 4½-inch drain opening. The toggle switch may be placed at any convenient point. The only moving part in the entire unit is the rotor-shredder. In-Sink Erator Mfg. Co., Dept. AB, 1201-14th St., Racine, Wis.

## PENDANT TYPE LUMINAIRE AB25335

This luminous indirect luminaire is adaptable to a variety of applications which require a unit of low surface brightness. The fixture has a high lumen output with over-all efficiency of 76.5 per cent and exceeds the rigid low surface brightness specifications of 0.5 foot-candles p.s.i. below 90 degrees. Combined side and bot-

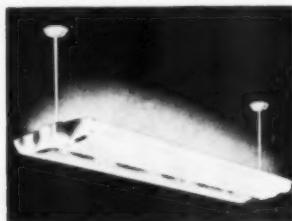

tom panels of white polystyrene give high reflectivity and low surface brightness. The unit is available in 4-foot lengths, 16 5/16 inches wide and 4 inches deep. Pittsburgh Reflector Co., Dept. AB, 484 Oliver Bldg., Pittsburgh 22, Pa.

## FLOOR RESURFACER AB25326

A flooring material, known as Latex-O-Crete, has been designed purposely to resist the destructive action of chemicals, many acids, oils, food fats and acids, fruit juices, solvents and other items which normally cause floor deterioration. The product can be applied directly over the old surface at an average depth of only one quarter inch. No special floor preparation is necessary other than thorough cleaning. The substance is shipped ready for application; all ingredients are pro-

portioned at the factory and no other materials need to be added. The product contains no asphalt or other bituminous substance. It can be applied either on inside or outdoor flooring. United Laboratories, Inc., Dept. AB, 16801 Euclid Ave., Cleveland 12, Ohio.

## ENGINE-GENERATOR AB25337

A contractor's model of an engine-generator set is designed for full output at 115 volts, 60 cycles, a.c. It has a motor starting capacity of 4,500 watts—sufficient to start and run motors up to 1½ h.p. The unit has 3,000 watts intermittent and 2,500 watts continuous rating. The set will operate many portable tools such as cut-off saws, electric chain saws, concrete vibrators or lights. Thermostatic cut-out switches with a manual reset protect the generator from overload and overheating.

The outlet box on top of the generator provides a volt meter, and one 20-amp and two 15-amp capacity twist-lock type outlets wired in parallel. The unit—Model 4500—is available with either standard

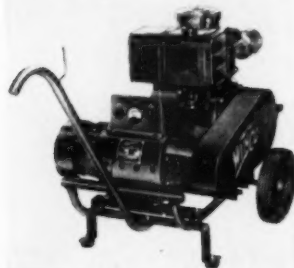

tubular cradle base or a portable base attachment with semi-pneumatic rubber tired wheels, located to provide practical tip-proof mounting. Wincharger Corp., Dept. AB, E. 7th and Division Sts., Sioux City 2, Iowa.

## FREE-LIFT TRUCK UPRIGHTS AB25320

A free-lift upright for the Hyster Model 20 lift truck is now available for delivery. The upright has the feature of being able to elevate the load without an increase in the overall height of the lift truck. It is designed for applications where a minimum overhead clearance exists, and where the inner upright of a standard

model would strike obstructions before the load could be elevated to the desired stacking height. Typical applications include loading and unloading freight cars and van trucks, and working under low ceilings and balconies. Free-lift upright assemblies are available in 7 feet 8 inches and 9 feet 8 inches lift heights. Uprights

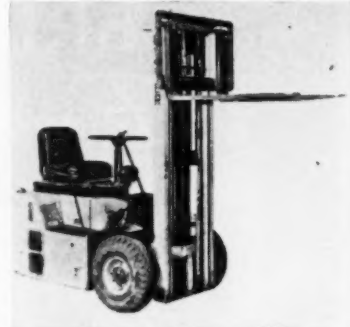

are also available on special order in lifts higher than 9 feet 8 inches. Hyster Co., Dept. AB, 2902 N.E. Clackamas St., Portland 8, Ore.

## TILE COVE BASE PIECES AB25319

Three new cove base pieces have been added to the Miraplas wall tile line. The cove is furnished in tile-and-one-half lengths, with matching inside and outside corners. Addition of these accessories introduces several new color possibilities. The home owner can have a complete one-color tile installation, or a multi-color room with the choice of 19 trim colors.

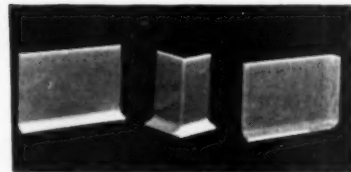

The overall appearance of the kitchen, bathroom, or nook is enhanced by selection of a tile color scheme to blend with the floor, walls, or drapes. Shown are the new plastic tile cove base (left) with matching outside corner (center) and inside corner (right). S. & W. Moulding Co., Dept. AB, 990 Parsons Ave., Columbus 6, Ohio.

**USE THIS COUPON FOR MORE INFORMATION  
ON NEW PRODUCTS IN THIS ISSUE**  
**Save Time—Just Insert Key Numbers and Mail To:**  
**American Builder, 79 W. Monroe Street, Chicago 3, Illinois**

Name .....

Address .....

City ..... State .....

No. .... No. .... No. .... No. ....

No. .... No. .... No. .... No. ....

No. .... No. .... No. .... No. ....

No. .... No. .... No. .... No. ....

When you address inquiries direct to manufacturers concerning a new product described here, please mention that you saw it described in American Builder

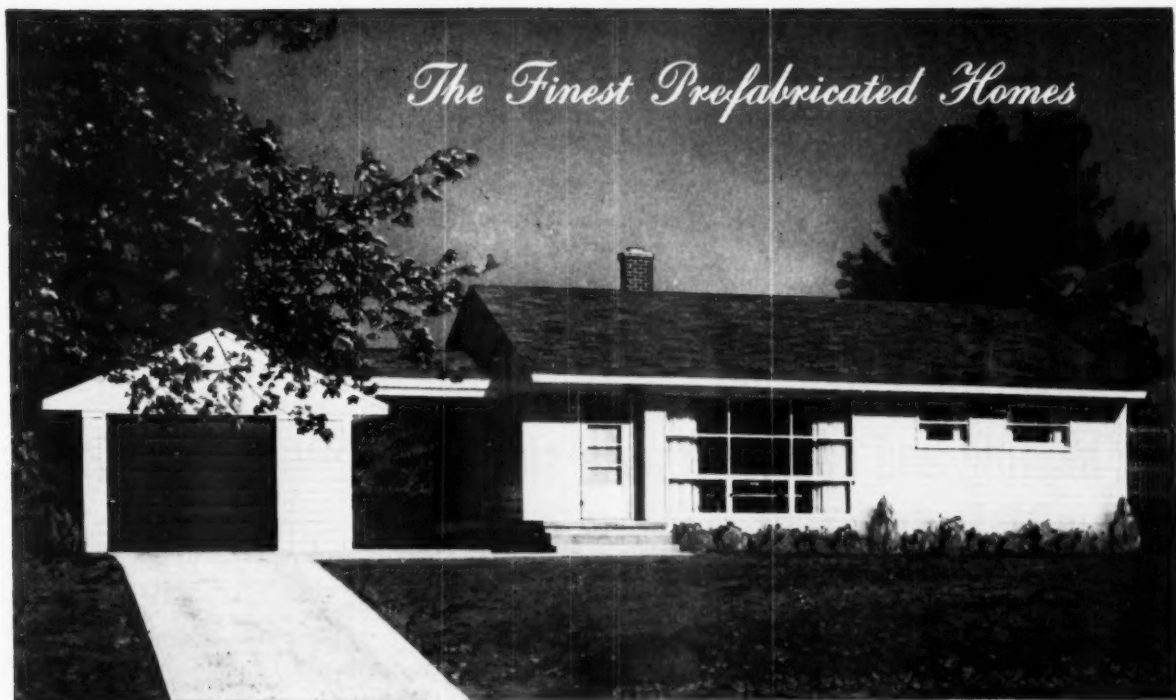

## Where Else Can You Get This Outstanding Combination?

Exceptional Quality • Conventional Construction  
and Appearance • Architect Designed Homes  
• Nationally Advertised Materials and Equipment  
• Budget Prices • Fast Completion on the Site  
• Fourteen Models • Five Front Elevations for  
Every Model • Assistance in Site Planning—  
Financing — Decorating • Nationally Advertised  
Homes—FHA and GI Acceptable

### *Attention Builders*

We have openings in a number of localities for qualified builders. If you have sound financial resources and an established reputation for building well-designed, high quality homes, this is an exceptional opportunity for you. Write today on your letterhead.



7744 GREENFIELD ROAD • DEARBORN, MICHIGAN

# Announcing New G-E Year-Round For Every Size Home

Dramatic sales appeal for homes is provided by heating and cooling from a single factory-packaged unit! Uses as little as 8.2 sq. ft. of floor space

## New System is flexible

The new G-E Year-Round Air Conditioner comes in over 190 different combinations! You pick the heating and cooling capacities you want, depending on home design and climate...pick gas or oil for heating...choose the type of power supply—single or 3 phase. G. E. offers a unit to fit *your* needs, with selectivity of sizes, fuel and power.

## Many outstanding features

Compare the unusually compact size of this new G-E air conditioner with any other! All models are only 55" high, 30" deep, and width varies from 39" to 74" depending on capacity. Locate the unit anywhere—basement, utility room, closet, attic, crawl space, garage. Handsome two-tone color makes a smart appearance. Dependability is assured by the new factory-sealed hermetic cooling system—backed by the most famous name in refrigeration.

## Extra benefits with G-E Air-Wall System

It's a complete system...from the new G-E Year-Round Air Conditioner and the special easy-to-install small ducts, to the unique G-E Air-Wall Registers. The same blower and ducts are used for heating and cooling. The G-E Air-Wall Registers, located low on

outside walls, perform ideally for both heating and cooling. No unsightly high-wall outlets; no carpet cutting necessary, as with floor-type registers.

## Make home sales boom!

G-E year-round air conditioning is *big news* wherever it's offered! You give your prospects comfort benefits that are hard to resist: no cold walls or drafts in winter...no hot spots in summer...quiet, clean comfort because windows are kept closed even in summer, and air is filtered all year!

## Merchandising helps for you!

General Electric offers hard-hitting promotional help to builders using G-E home heating and cooling. National advertising to create demand for G-E air conditioned homes, cooperation with you in your local advertising, help on model home promotions are only a few of the many aids available.



**AIR WALL**  
HOME HEATING and COOLING



**DECORATOR'S DELIGHT**—Air-Wall Registers blend into any setting...allow freedom in arranging furniture and draperies because they spread a protective wall of warm or cool air upward—don't blast it straight out. No carpet-cutting required.

Over 190 combinations from which to choose! Cooling from 2 to 5 tons. Gas heating from 48,000 to 168,000 BTUH output. (Types of gas: natural, mixed, mfd., LP and LP-air). Oil heating from 60,000 to 155,000 BTUH output.

\*Reg. trademark of General Electric Co.



# Round AIR CONDITIONERS And Every Climate

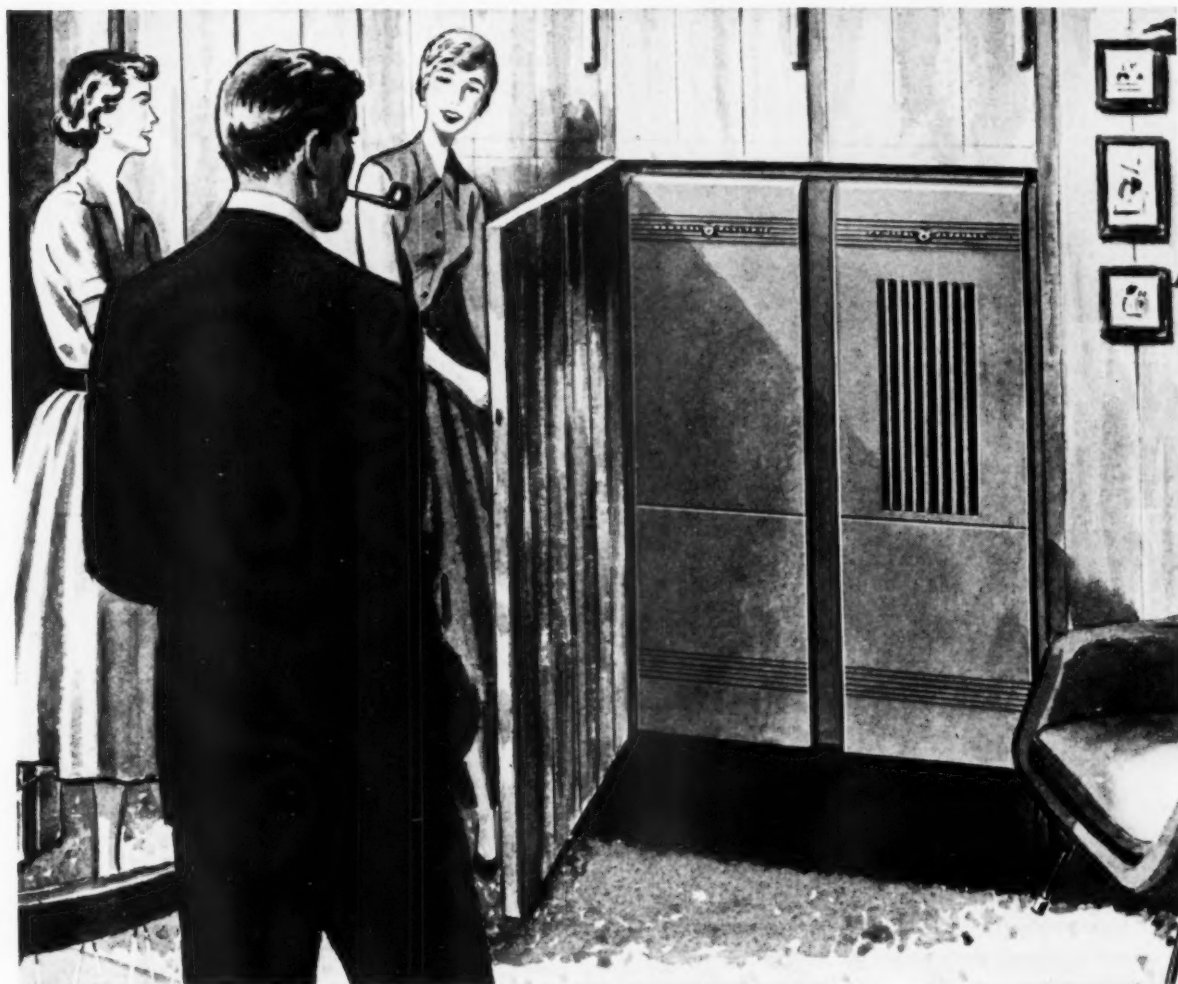

Here is the attractive, compact G-E Year-Round Air Conditioner, which you saw at the recent National Association of Home Builders Exposition in Chicago. Only 8.2 square feet are needed for the smallest unit and only 15 sq. ft. for the largest. In-

stallation with the G-E Air-Wall system is easy. The air conditioner has no exposed parts to mar its streamlined appearance.

You can put your confidence in—

**GENERAL**  **ELECTRIC**

**General Electric Company  
Air Conditioning Div., Sec. AB-10, Bloomfield, N.J.**

Please send me free folder on new G-E Year-Round Air Conditioner . Please have my G-E dealer tell me the G-E Year-Round Air Conditioning story .

NAME .....  
TYPE OF BUSINESS .....  
ADDRESS .....  
CITY ..... STATE .....



**FREE**

**"thrifty  
third"**  
the economy  
grade

**TOP HALF LOWER HALF**

Third Grade MFMA Northern Hard Maple finished with natural penetrating seal, for full effect of interesting grain pattern.

Some strips finished with combination stain and sealer—note how the varied tones are blended beautifully in the one operation.



**NORTHERN  
HARD  
MAPLE** finished bright  
or subdued, its charm far  
outshines its thrifty price!

These are *modernization times* . . . and you'll find it'll pay you well to stock Northern Hard Maple, Beech and Birch Flooring—available now in all grades. "Thrifty" Third Grade (pictured above) is an especially good proposition for home floor replacements—for defense housing—for industrial, commercial and military construction. MFMA strict grading rules assure sound, long-lasting flooring in this fine-looking *economy* grade, at prices that will bring you a good volume of profitable business. Special MFMA leaflets, with full facts about Second and Third Grades. Write—

**MAPLE FLOORING MANUFACTURERS ASSOCIATION**  
Suite 596, Pure Oil Bldg., 35 East Wacker Drive  
CHICAGO 1, ILLINOIS

**FLOOR WITH NORTHERN HARD MAPLE**  
BEECH AND BIRCH

**Catalogs —  
and Manufacturers Literature**

**327—PLYWOODS AND DOORS**—A 60 page catalog in full color delineates in attractive and useful detail the various patterns of the company's line of fir, redwood, mahogany and other decorative and utilitarian plywoods, with physical properties and specific examples of the uses and applications of each. Several pages are devoted to the line of panel and flush doors, with standard designs and specifications. M and M Wood Working Co., Dept. AB, 2301 N. Columbia Blvd., Portland, Ore.



**328—VINYL CORK TILE**

—This revised eight page catalog describes in detail the features of this floor tile and indicates in a color chart the 16 available patterns. A comparison table gives the results of numerous tests made by an independent laboratory on the manufacturer's and other hard surface floor coverings. Design data, installation specifications and directions for the tile's care and maintenance are included. Dodge Cork Co., Inc. Dept. AB, 664 Manor St., Lancaster, Pa.



**329—CONCRETE HOMES**

—A 32 page brochure in full color describes the various advantages of comfort, security and cost to be gained by building homes of concrete masonry. Photographs of over 30 homes from coast to coast, with floor plans of many are included. Different architectural styles, varieties of landscaping are shown, aiding prospective builders in selection. Portland Cement Association, Dept. AB, 33 W. Grand Ave., Chicago 10, Ill.



**330—WATER REPELLENT SILICONE**—A clear transparent fluid, named Crystal, is described in a six page folder. Descriptive information concerning where the product can be used is contained in the folder. The manufacturer claims the product protects mortar joints, stops seepage through grade brick stucco, concrete block, and other masonry materials, and thus prevents efflorescence, staining and spalling. Wurdack Chemical Co., Dept. AB, 4977 Fyler St., St. Louis 9, Mo.

(Continued on page 170)

# Announcing the new HEATILATOR SERVICE-WAY



**No need to clutter** the garage with lawnmowers, tools, baby carriages when Service-way makes it so convenient to keep them in the basement. Every new home-builder will want a Service-way as soon as he sees one in operation!



**Functional design...** Blends with any style of architecture, becomes an integral part of the house. Comes fully assembled ready to install.



**Finger-tip control...** Specially-designed spring suspension counterbalances the weight of the door. Automatically locks in full-open position.



**Saves work on washday...** Clothes can be carried direct from laundry to clothes line with fewer steps—fewer stairs to climb. A real help to busy housewives.

## The Service-entry for Modern Basements

**Here's good news** for today's home builders. The new Heatilator Service-way is the long-sought answer to the problem of providing easy access to the basement from outdoors. It's one of the most desirable convenience features that can be included in the modern home.

**The Service-way solves** the basement storage problem. Bicycles, lawn mowers, garden tools can be kept in the basement instead of cluttering up the garage. Home freezers, hobby tools, ping pong tables and other bulky equipment can easily be moved in through the wide Service-way opening. Storing screens and storm windows is twice as easy.

**The Service-way saves** hundreds of steps—simplifies dozens of household jobs—saves tracking dirt through the house. Repair men, meter readers and children with muddy feet can go direct to the basement from outdoors.

**Service-way is made** of heavy-gauge steel structurally reinforced. The single door is counterbalanced for easy operation. Overlapping flanges assure snug fit—keep out rain, snow and wind. Slide bolts lock door securely inside. Worth many times its moderate cost—adds to property value too. Made by the makers of the famous Heatilator Fireplace. Mail coupon today for full information.

## HEATILATOR SERVICE-WAY



HEATILATOR, INC.  
582 E. Brighton Avenue  
SYRACUSE 5, N. Y.

Please send me your free illustrated booklet and specifications on new Service-way.

Name \_\_\_\_\_

Address \_\_\_\_\_

City \_\_\_\_\_ State \_\_\_\_\_

Keep your jobs moving this winter...  
regardless of weather



## HERMAN NELSON PORTABLE HEATERS

There's no reason why your winter schedules should be upset by bad weather this year. You can keep your jobs moving and your workers more comfortable if you put Herman Nelson Portable Heaters to work for you. These furnaces on wheels provide clean, pure, hot air to warm your workers, protect concrete pours, thaw machinery, dry plaster—do scores of other heating and drying jobs.

*The only completely safe portable heater that uses flexible ducts to spot heat where most needed—and remember, only uncontaminated air heaters are absolutely safe!*

Contractors all over the country are investing in Herman Nelson Portable Heaters. Many find that these units pay for themselves during the first winter. Investigate how you can beat winter weather on your job. Mail the coupon below for full information.



### HERMAN NELSON

Herman Nelson Division, Dept. 56  
American Air Filter Company, Inc., Moline, Illinois

Gentlemen: Please send me complete information about Herman Nelson Portable Heaters and your free Cost Control Booklet.

Name \_\_\_\_\_

Title \_\_\_\_\_

Company \_\_\_\_\_

Address \_\_\_\_\_

City \_\_\_\_\_ State \_\_\_\_\_

170

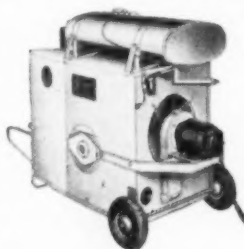

**HERMAN NELSON ECONOMY MODEL**  
Priced lower for the smaller jobs. Capacity 125,000-190,000 BTU/hr. Oil fired, electric powered. Costs only 19¢ per hour to operate. Other models available—electric or gasoline powered with capacities to 450,000 BTU/hr.

## Catalogs

(Continued from page 168)

**331—HOME KITCHENS—**a new 24 page consumer catalog for dealer's use presents kitchen photographs in full color, and illustrates all the cabinet sinks, wall, base and utility cabinets in the manufacturer's line. Sections are devoted to the electric sink, automatic dishwasher and the food waste disposer. Kitchen planning is discussed and basic kitchen arrangements are shown. Eight approved methods of financing a kitchen purchase are given. Mullins Manufacturing Corp., Dept. AB, Warren, Ohio.



**332—CLAY TILE—**a 20 page comprehensive reference manual describing the "Thin-Set" method of setting genuine clay tile contains facts and illustrations showing how to install tile quickly, permanently and at minimum expense. Detailed isometric drawings show how to install tile on new projects or for modernization of existing buildings; installation of tile over old plaster, gypsum wallboard, and how to set tile on floors, walls, and ceilings. Book is organized into sections for instant reference. Miracle Adhesives Corp., Dept. AB, 214 E. 53rd St., New York 22, N. Y.



**333—BATHROOM FIXTURES-KITCHEN EQUIPMENT—**A 20 page, two color catalog delineates the manufacturer's full line of bathtubs, lavatories, water closets, chrome brass lavatory and kitchen fittings, commercial and institutional bathroom equipment, and vitreous-enameled cast iron and steel kitchen sinks and cabinets. Complete specifications and information are included. Universal-Rundle Corp., Dept. AB, Aaruthers St., New Castle, Pa.



**334—CLOTH WALL COVERINGS—**Made of Fab-Rik-O-Na, for use in recreation rooms in homes, in hotels, public buildings and institutions, are illustrated and described in a four page folder. The material's decorative texture, durability, application, and other features are given; specifications, the preparation of surfaces upon which it is to be applied are included. H. B. Wiggin's Sons Co., Dept. AB, Bloomfield, N. J.

(Continued on page 172)

AMERICAN BUILDER





*Left: Showing how Fedders Convector-Radiator conforms to modern decor of smart living room.*

*Below: Arrangement of furniture, draperies and wall-to-wall carpeting presents no problem when Fedders non-streak Baseboard Radiators are specified.*

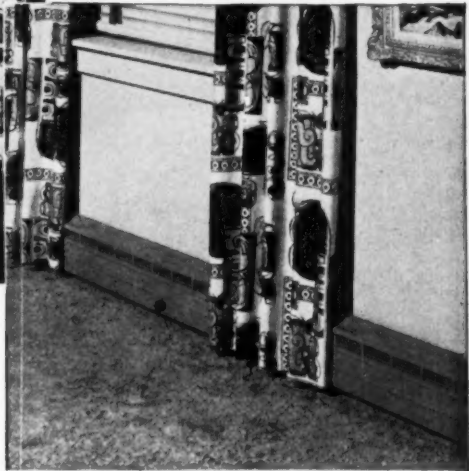

*Why* BUILDERS SPECIFY

## F E D D E R S CONVECTOR-RADIATORS

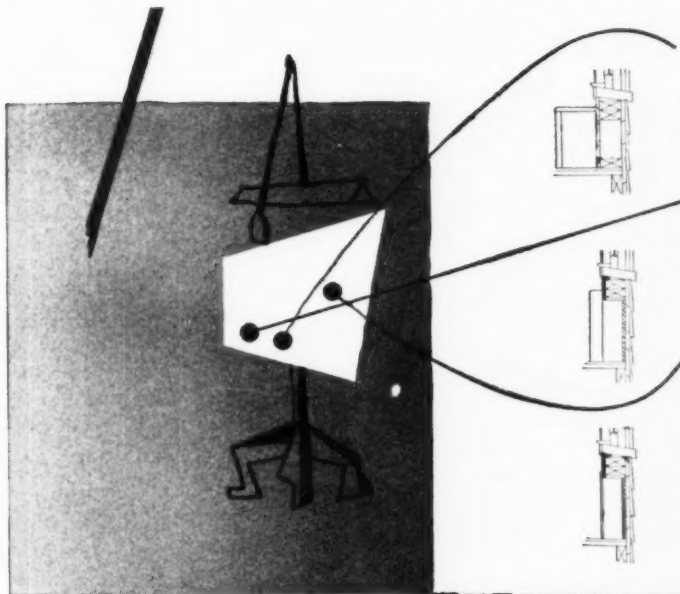

**beauty** . . . begins on the drafting board and ends up in the home. Fedders Convector and Baseboard Radiators are being written into the specifications of modern homes because of their efficiency and smart decor.

**economy** . . . The profession and the trade are discovering that they no longer think of steam or hot water heat as expensive. Fedders radiation combines uniform floor-to-ceiling comfort, compact size, and easy installation.

**standard specifications** . . . They are made in a wide range of sizes and types and can be used in combination to provide a well balanced system.

*Fedders catalogs are working tools for men who design and install heating systems. Information is complete and accurate. Write for your copies.*



For cool, cool comfort specify Fedders Room Air Conditioners.

### FEDDERS-QUIGAN CORPORATION

57 TONAWANDA STREET, DEPT. AB-2, BUFFALO 7, N. Y.

Please send me information on:

- Fedders Baseboard and Convector-Radiators
- Fedders Room Air Conditioners

Name \_\_\_\_\_

Street \_\_\_\_\_

City \_\_\_\_\_ State \_\_\_\_\_



for  
**SECURE  
BONDING of**

- WALL TILE
- GLASS
- METAL
- WOOD
- CORK
- INSULATION
- WALLBOARD
- ACOUSTICAL TILE
- FABRIC
- GEMCO HANGERS

ALSO FOR MANY  
GENERAL PURPOSE USES

**Y**es, Tuff-Bond sticks almost anything to anything! Perfected and produced especially for the building industry, these fine adhesives are tenacious, flexible, waterproof, easily applied, and assure exceptionally strong bonds. Available in different types for specific uses. Highly recommended by enthusiastic users the world over. Use Tuff-Bond adhesives on the next job and you'll agree that they are TOPS. Write, phone, wire . . .

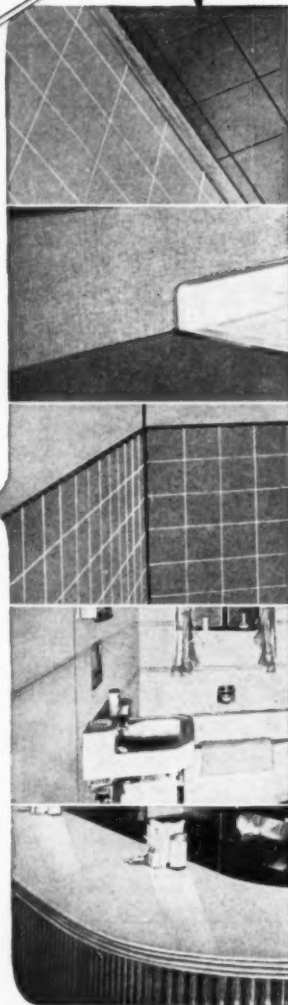

**GOODLOE E. MOORE**

INCORPORATED  
**DANVILLE 8, ILLINOIS**

In Canada: W. D. ELMSLIE, Ltd.  
409 Notre Dame St., West, Montreal 11, Quebec

## Catalogs

(Continued from page 170)

**335—SMALL HOME REMODELING**—An eight page booklet planned to encourage remodeling projects among the thousands of families considering home enlargement. The 31 basic ideas contained have been selected for their ability to stimulate home owners' plans for remodeling and to hasten their decision to carry out these plans. Practical tips suggest how to arrange for more sleeping rooms, larger living areas, extra storage space. Ponderosa Pine Woodwork, Dept. AB, 38 S. Dearborn St., Chicago 3, Ill.

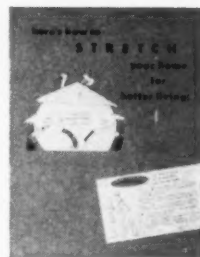

**336—PLASTIC STRUCTURAL PANELS**—The 12 page catalog describes translucent structural panels of Fiberglass reinforced plastic, manufactured in eight colors and tints. Specifications, loading light transmission values, and other physical characteristics are given. Pictured are suggested applications with detailed drawings for home, office partition, patio coverings, building facings, industrial skylighting, toilet and shower stalls, and other practical uses. A complete range of sizes and accessories are also included. Resolite Corp., Dept. AB, Zelienople, Pa.



**337—FURRING CLIPS**—A four page folder which explains how builders and construction firms can cut furring costs and labor through the use of furring clips which are placed in the brick wall between the mortar joints. The clips are three inches wide, with a groove on the face to permit the insertion of a staple to secure the furring strip to the wall. Illustrations clarify the use of the device. Peterson Products Co., Dept. AB, 929 Milton Ave., Janesville, Wis.

### SERVICE COUPON—CLIP and MAIL to CHICAGO

Readers Service Department  
American Builder  
79 W. Monroe St., Chicago 3, Ill.

February, 1953

Please send me additional information on the following product items, or catalogs, listed in this department:

Numbers .....

Name .....

Street .....

City ..... State .....

OCCUPATION\* .....

\*Please note that occupation must be stated if full service is given.

**AMERICAN BUILDER**



*Your present metal window supplier may not always have just the style or size you need . . . but you can bet your bottom dollar your nearest **THORN** dealer does! That's because **THORN** makes the most complete line of **aluminum and steel windows** in the industry!*



Write today for the complete THORN catalog—packed full of How-to-Do-It information for faster, more efficient, and more economical installation of every kind of metal windows.

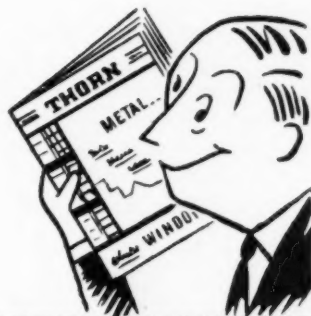

**J. S. THORN** Company

Founded 1877 ★ PHILADELPHIA 32, PA.

Precision-Built Steel and Aluminum Windows

J. S. THORN COMPANY,  
Philadelphia 32, Pa.

- Please send THORN 1953 Catalog.  
 Please send name of nearest THORN dealer.

Name \_\_\_\_\_

Address \_\_\_\_\_

City \_\_\_\_\_ State \_\_\_\_\_

# VENTO



THE STEEL  
WINDOWS  
OF  
**EXTRA VALUE**

The extra value in Vento Residence Casement Windows includes: all casements drilled and tapped to receive storm sash and screens, operator arm guide channels attached with screws for easy removal and replacement, if necessary; ventilator frames constructed from the same heavy sections as the outside frame. This provides greater rigidity and stronger ventilators.

Also ask about the extra value in:  
**NEW IMPROVED VENTO "CHAMPION" BASEMENT WINDOWS**  
**VENTO "THRIFTY" BASEMENT WINDOWS**  
**VENTO FORMED STEEL LINTELS (FOR BLOCK AND BRICK CONSTRUCTION)**  
Vento "Champion" Barred Basement Windows  
Vento "Champion" Utility and Barn Windows  
Vento Thrifty Utility and Special Type Windows  
*Write us for latest catalog and full information*

**VENTO** STEEL PRODUCTS  
CO., Inc.

247 Colorado Ave., Buffalo 15, N. Y.

## here's how to get the most



Plymouth Cordage Co. photo

Here's one of the first steps in making the rope you use. Fiber slivers (lower left) are drawn into this machine where they are twisted, first into yarns and then yarns into strands (far right). Three or more strands are then twisted to form the rope

By R. C. Weaver\*

Rope is one of the handiest tools of the trade around any building project, but an understanding of how to use it and how to care for it can bring you dividends in longer rope life and safer, more dependable service.

Satisfactory rope service begins with selection of the proper rope for the specific job you want it to do. To guide you in that selection, it is necessary to first understand something about the nature of rope itself.

### HOW TO SELECT ROPE

#### Materials—

The material from which the rope is made is a big factor in its performance. These materials can be broken down into two categories—natural or vegetable fibers such as manila or sisal, and synthetic fibers such as nylon, Fiberglas, etc. Generally, natural fiber rope made from manila is more suited for work around construction projects. It has 25 per cent more

strength than sisal. Nylon is even stronger than manila, one and one-half to two times stronger, but it has four times manila's working elasticity, which is an advantage for some uses, a disadvantage for others.

#### Construction—

Rope is manufactured by twisting these fibers into yarns, the yarns into a strand and three or more strands into a rope. By controlling the amount of twist, a rope can be classified as either hard, standard, medium-soft, soft or extra soft. Each of these has different characteristics in such matters as abrasion resistance, flexibility and strength.

For most uses a standard-lay rope is best. Hard rope has less strength, more abrasion resistance; soft rope handles more easily but abrades more readily. Standard is a good combination of all characteristics, but your supplier is well qualified to advise you on your specific needs.

## out of ROPE

### PART 1—how to select it

—how to pick  
its accessories

—how to reeve a  
tackle

*\* The author, mill superintendent of the Plymouth Cordage Company in Plymouth, Mass., has long been recognized as an authority on rope usage.*

#### Size—

When ordering rope, you specify its size according to circumference or diameter. Actually, however, you are not interested in size but in strength. To determine which size rope you want, consult the manufacturer's size and strength chart; select the rope with the guaranteed strength you want and then look under the size column to see what size you must order to get that strength.

#### Strength—

What strength do you want? Here is a rule of thumb: good practice dictates a 5 to 1 ratio between the rope and the load it is to lift. In other words, if you intend to use the rope to lift a load of 1,000 pounds, you should have a rope with a minimum breaking strength of 5,000 pounds when new.

#### Summary—

To select the rope that best suits your purposes you will then want to determine:

1. What material it should contain (probably manila).
2. Its construction characteristics (probably standard-lay).
3. The strength required (five times the amount it will lift).

For specialized purposes, your supplier will gladly provide assistance.

#### PICKING ROPE ACCESSORIES

Your rope will often be used in conjunction with other accessories.  
*(Continued on page 176)*

a growing

# PAINE



## helps you



EXPANSION  
SCREW ANCHOR

### SPEED CONSTRUCTION, CUT COSTS!

Your continued demand for more and more Paine products was a clear call for us to expand. So, in our fortieth year in business, we built a big new plant at Addison, Illinois, just west of Chicago.

This enables us to match your orders for Paine hanging and fastening devices, and still maintain that famous Paine quality.

Paine Expansion Screw Anchors will hold in any solid material. They are stamped with the bolt or screw size and thread, have a convenient arrow indicating the hole end. A setting tool in each box makes fast installation easy.

For the holes, use a time-saving Paine "Sudden Depth" Drill.

THE PAINE COMPANY, 7 Westgate Road, Addison, Illinois

the best craftsmen always take

# PAINE'S

Spring Wing Toggle Bolts  
Expansion Anchors  
"Sudden Depth" Drills  
Wood Screw Anchors

Conduit Clamps  
Pipe Hooks and Straps  
Hanger Iron, perforated  
Expansion Shells

Star Drills  
Malleable Shields  
Special Hanging and  
Fastening Devices

**How to CUT Blade Costs  
in Masonry Cutting!  
EVEREADY BRIKSAW  
FREE BOOKLET**

**Tells How  
Cut any Masonry  
Material in  
4 to 21  
Seconds**

**WET and  
DRY  
CUTTING**

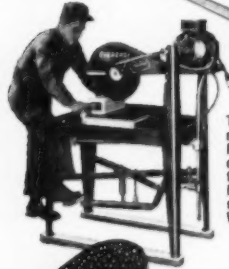

The fastest,  
most modern  
Masonry Saw  
on the market  
today! Cuts any  
Masonry material,  
or Stone—  
WET or DRY.

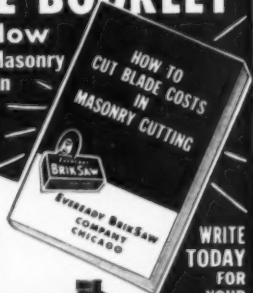

**WRITE  
TODAY  
FOR  
YOUR  
FREE  
COPY**

**EVEREADY**

**Abrasive and  
Diamond Blades**

Fit every make and model  
of Masonry Saw. An exactly  
right EVEREADY Blade for every  
cutting operation.



Zip in seconds through any Masonry material  
or stone—No matter how hard—No matter  
how complicated the cut.

**Exclusive EVEREADY FEATURES**

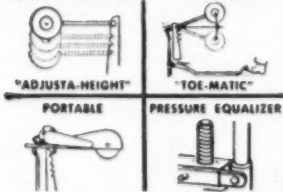

These exclusive Patented features make  
BRIKSAW the most efficient, most accurate,  
rate, most easily portable Saw money  
can buy.



**EVEREADY BRIKSAW COMPANY**

1505 S. Michigan Blvd., Chicago 5, Ill.

Send without obligation of any kind FREE  
Booklet on "HOW TO CUT BLADE COSTS  
IN MASONRY CUTTING"

NAME \_\_\_\_\_  
ADDRESS \_\_\_\_\_  
CITY \_\_\_\_\_ STATE \_\_\_\_\_

**ROPE.....**

**Parts of a  
Typical Block**

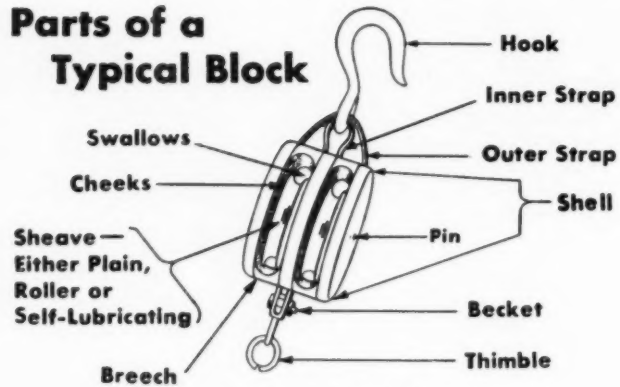

Parts of a typical block

such as various types of pulley blocks. Some knowledge of these accessories is helpful in increasing rope life and service.

**Pulley blocks—**

Generally the strength of the block, not the strength of the rope, determines the load. In other words, a good rope is usually stronger than a commercial block

for a given size of pulley or sheave.

If the pulley will take the load, the rope for that size pulley is certain to.

Always use the largest diameter sheave practicable. The larger the diameter, the less internal friction on the rope. Two main causes of rope wear are too sharp a bend and a block with too little clearance. Your supplier will furnish you with

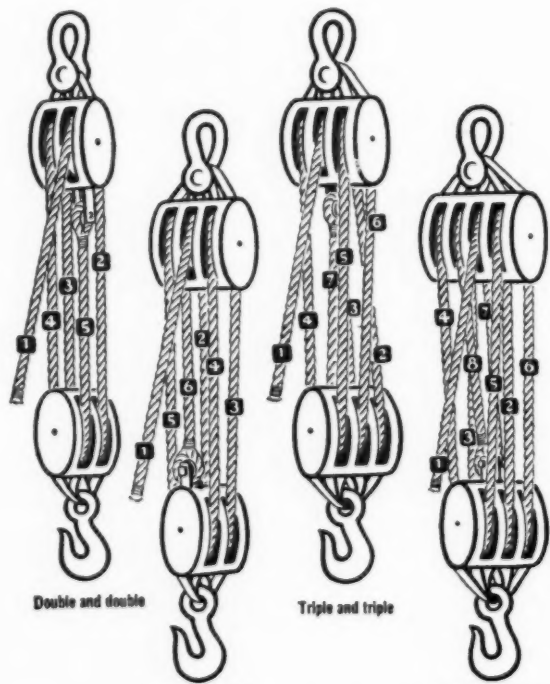

Double and double

Triple and triple

Triple and double

Quadruple and triple

Proper reeving procedure

.....

a chart from which you can readily determine the proper size of block to be used with any given size of rope.

### REEVING A TACKLE

The ordinary tackle consists of two blocks and a rope. The proper threading of the rope through the blocks is known as reeving. Diagrams of proper reeving techniques are shown on opposite page.



Determining rope size

There are several points to keep in mind when reeving a tackle. When the number of sheaves in the blocks differ, the block having the smaller number carries the becket; when both blocks have the same number of sheaves, the becket is always on the fall-block. Another thing to bear in mind is that the hoisting rope or fall (number 1 in the diagrams of reeving procedure) should always lead from one of the center sheaves when a pair of blocks has more than two sheaves. This keeps hoisting strain on the center of the blocks and also insures that the upper and lower blocks will be at right angles to each other. This prevents toppling and possible injury to the rope.

A good hint to make reeving easier is to always start from the fall rope (number 1 in diagram) and

(Continued on page 178)

## BIRDS BAFFLED



Nixalite installed flush with the outside edges of ledges on buildings, signs, cables and other places pigeons, starlings or other birds land or roost

## ENDS BIRD SPATTER

Birds can not land on Nixalite nor do they fly over it for a distance of 18 inches.

**Easy to Apply - Lasts 25 Years - Inconspicuous**

Write for illustrated "Know How"

Manufactured by  
**NIXALITE COMPANY OF AMERICA**  
115-119 W. 3rd St., Davenport, Iowa, U.S.A.

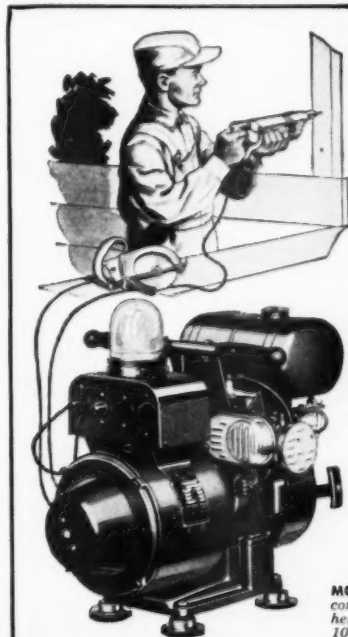

## KOHLER ELECTRIC PLANTS

*Independent Source  
of Electricity*

### Take Electricity to the Job

Jobs move faster with portable electricity for saws, drills, grinders, pipe threaders and cutters, other tools. Low-cost model saves bother and expense of temporary power line hook-ups. Develops 1500 watts AC. Engineered throughout by Kohler. Two-wheel rubber-tired hand truck available. Other sizes 500 watts to 30 KW. Write for folder 12-K.

**MODEL 1.5M25**, 1500 watts, 115 volts AC. Manual control. Handles for carrying. Length 20", width 16", height 20", weight 130 lbs. Also 115 volt DC weighing 101 lbs.

Kohler Co., Kohler, Wisconsin. Established 1873

## KOHLER OF KOHLER

PLUMBING FIXTURES • HEATING EQUIPMENT • ELECTRIC PLANTS  
AIR-COOLED ENGINES • PRECISION CONTROLS

**5 YEAR**  
*written*  
**GUARANTEE**  
furnished with  
each unit



**PRECISION**  
folding stairway

**No other stairway offers so much**

**EASY TO OPERATE** — The cleverly engineered counterweights operate on LIFE-TIME ROLLER BEARINGS and silently raise or lower the stairway with practically no effort.

**RUGGED & STRONG** — Construction of No. 1 kiln dried lumber throughout. Brackets, rocker arms and hinges cast of special aluminum alloy. Trim furnished on door panel only. All parts are numbered and interchangeable. Frame is made to fit 26" x 54" opening in ceiling.

**INSULATED PANEL** — Panel is insulated with Cellufoam and protected with tough chip board.

**SAFETY TREAD** — Each step is covered with full-width composition safety treads. Adds to appearance as well as safety.

**FITS ALL CEILINGS** — The stairway fits any ceiling from 7 feet to 9 feet, 9 inches figured from finished floor to finished ceiling. Runners are graduated to facilitate cutting off at different heights. Two standard sizes: 8'9" fits from 7' to 8'9" ceiling, 9'9" fits from 8'9" to 9'9" ceiling.

**EASY TO HANDLE** — Shipped in 1 package assembled. Precision Stairways are packed completely in one heavy carton, assembled complete with jamb and ready for installation, which offers a considerable savings over other attic stairways. Shipping weight 130 pounds.

**EASY TO INSTALL** — No adjustments — No springs — Requires no attic space. Full height above attic floor is only 36". Folds completely into 26" x 54" opening in ceiling.

Accepted by F. H. A. Listed in Sweets. Specified by leading architects. Sold by more than 12,000 dealers in U. S. A. and Canada.

*Manufactured by*

**PRECISION PARTS CORPORATION**

400 NORTH FIRST STREET — NASHVILLE 7, TENNESSEE

**ROPE**

work through the sheaves toward the becket. If you begin at the becket and work out you'll have to pull the entire length of rope through each sheave.

**What size to use? —**

To determine what size rope is needed to lift any given weight with a tackle, you have to find out the actual pull that will be put on the fall rope. This is done by dividing the weight of the object to be lifted by the number of ropes running from the movable (lower) block. However, you must also take into account a friction loss of about 10 per cent for each sheave in both the fall and movable block.

If you wanted to lift 5,000 pounds with the tackle shown in the above diagram, assuming you have selected two blocks of sufficient capacity, your formula would run like this:

Load to be lifted is 5,000 pounds; tackle has 4 rope parts at the movable block to give it a mechanical advantage of 4; tackle has 4 sheaves in both blocks for a friction loss of 40 per cent (4 x 10 per cent). Therefore

$$5,000 \text{ lbs.} \div 4 = 1,250 \text{ lbs.}$$

$$1,250 \text{ lbs.} \times 1.40 = 1,750 \text{ lbs.}$$

Pull on fall rope is 1,750 pounds.

Assuming that the rope is in comparatively new condition, a safety factor of 5 to 1 is desirable. As the rope gets older that factor should be increased. So 1,750 by 5 equals 8,750 pounds rope strength required. The rope tables which can be had from your supplier will show you what diameter rope you need to guarantee this strength.

**NEXT MONTH**

The second part of this series of four articles will describe the use of rope without accessories. Subjects to be covered include how to make rope slings and lashings, how to splice and how to tie time-saving, efficient knots.



*"It's easier to sell our houses because  
buyers trust General Motors Delco-Heat,"*

*says GAYLORD M. CROTHERS, Washington, Pa.,  
well-known Pittsburgh area project developer*

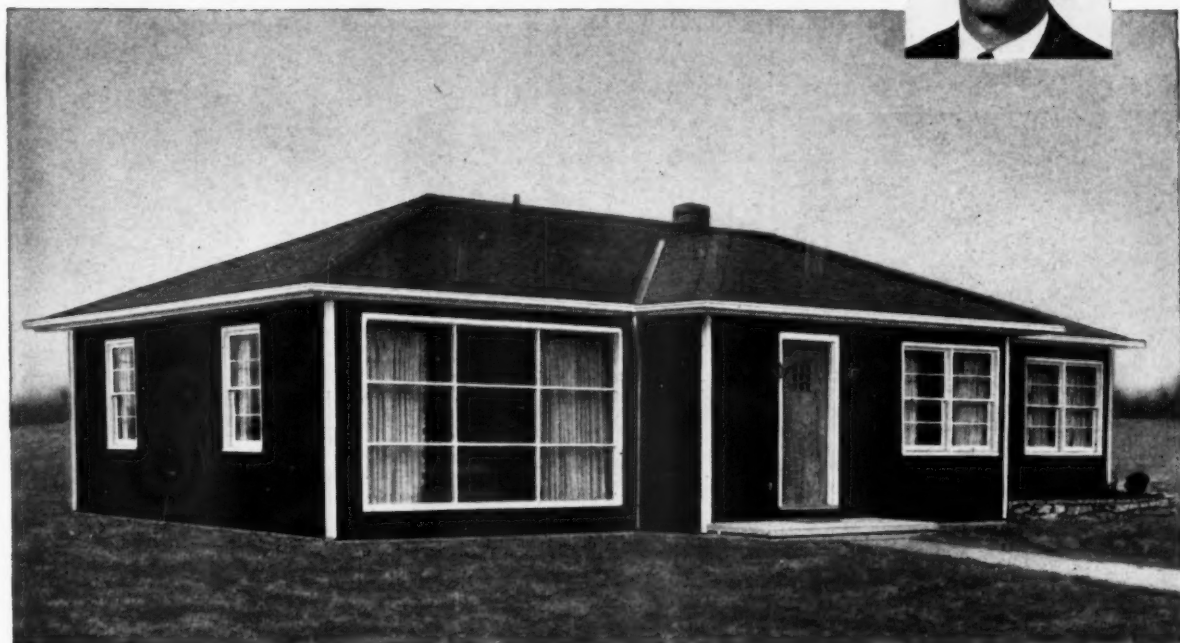
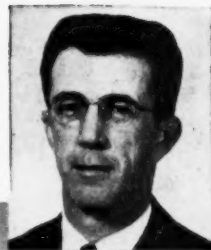

## *Pittsburgh area builder builds sales-winning buyer confidence with **DELCO-HEAT***

### **DELCO-HEAT GA-120 GAS CONDITIONAIR**

Delco-Heat ribbon type burners give cleaner, quieter flame. Multi-Rad Heat Transfer Unit delivers more heat to home, less up chimney. Delco built Rigidframe Blower Motor. For natural, mixed, manufactured or LP gas.

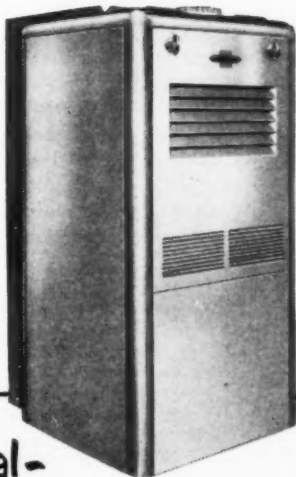

TYPICAL of this project is this three-bedroom precut home supplied by Lumber Fabricators, Inc., Alabama, with a Delco-Heat installation made by Piatt Heating and Roofing Co., Washington, Pa. Mr. Crothers goes on to say, "A home buyer considers with confidence the house that's complete with well-known and accepted equipment. That's why we're building our houses at Franklin Farms with nationally advertised Delco-Heat, a product of General Motors. The Delco-Heat Conditionairs are doing an outstanding job of dependable and economical heating."

Warm air, hot water, or steam—gas or oil-fired—your Delco-Heat distributor has the answer. See him or write: Dept. ABH, Delco Appliance Division, General Motors Corporation, Rochester 1, N. Y.

For a good deal—

# DEAL WITH DELCO

**GENERAL MOTORS  
DELCO-HEAT**



*... your keys to sales success*

# SOLVED!

BY STERLING...

Another  
Weatherproofing  
Problem



**KORD** is the prefabricated caulking compound designed to reduce waste and labor costs. One of its many uses is to permanently seal sills.

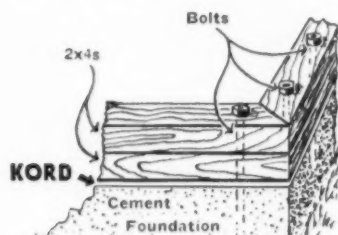

The sketch shows how **KORD** is used by the builders of the famous Levittown homes to weatherproof the sills.



**STERLING** — the nation's most complete caulking and sealing service.

**KORD** is produced by the makers of the well-known Sterling Elastic Glazing Compound.

Send for full information today.

**STERLING PAINT  
& VARNISH CO.**

151 Commercial St. Malden, Mass.

## Bendix introduces market's first ALL-IN-ONE home laundry

The revolutionary new Bendix "Duomatic" dries as well as washes clothes in one continuous operation. It occupies only 6½ square feet of floor space, is 36 inches wide



**B**endix Home Appliances of South Bend, Ind., pioneer manufacturer of automatic washing machines, has combined automatic washing and drying of clothes in a machine which is only 39 inches high and occupies only 6½ square feet of floor space, as compared with the 12½ square feet required by individual Bendix washer and dryer when placed side by side. Price of this revolutionary new appliance will be about \$500. It is now in production.

The result of 7 years of experiment and prolonged testing, the new Bendix "Duomatic" will dry as well as wash an average mixed load in one continuous operation lasting 68 minutes. The operation is completely automatic except for putting in the clothes and soap, and setting the control dials.

Only slightly larger than an individual washer or dryer, the Duo-

matic can be placed as conveniently in bathroom or kitchen as in utility room or basement. Only plumbing requirements for installation are hot and cold water lines and a drain pipe. The machine has two simple controls—a washer timer and dryer timer—and a water temperature selector. It can be operated either as washer or dryer.

Both in washing and drying, the Duomatic uses tumbling action in a horizontal cylinder that revolves inside a tub. In drying, a new principle is used—cooling the warm air by forcing it through a water-cooled condensing system that washes heat, lint and moisture down the drain. The air is then used again and there is no lint trap to clean. The diagram shows the Duomatic's essential working parts.

Bendix also makes news for 1953 by adding its first line of electric refrigerators, freezers and ranges.

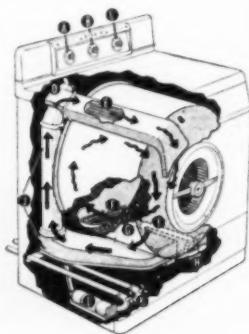

*Working principle of the market's first washer-dryer:*

**A**—washer timer control; **B**—water temperature selector; **C**—dryer timer control; **D**—drying system high velocity blower; **E**—cooled air is heated as it passes over this 220-volt heating coil and then it moves into drying cylinder; **F**—220-volt Magic Heater, beneath the water level between tub and cylinder; **G**—heated air, laden with lint and moisture, enters dehumidifying system; **H**—drain pump; **I**—drain outlet connected with house's drain system; **J**—dehumidifying or condensing chamber in which cold water running down chamber's sides pulls heat, lint and moisture from air and washes them out the drain; **K**—conveniently located water shut-off valves; **L**—water-mixing valve, which sends hot water into unit for washing, prepares lukewarm mixture for soaking or rinsing



Placing nails to show correct height for concrete in forms. A level line is established by liquid, then location of nails is referred to this line by measuring with ruler

## how to use new LEVELING DEVICE

An ingenious and useful device for determining levelness of stakes, uprights and concrete forms, as well as for grading, building foundations and other construction work, is known as the Levelall. Its usefulness to builders and contractors is practically unlimited, since its application lends it to a wide variety of uses. It is manufactured by Levelall, 31 Webster St., Rockland, Mass.

Basically, the standard model consists of a 50-foot clear plastic tube filled with a special red liquid called Level-Flo that finds its own level. Its operation is so simple that one man can determine level points without assistance.

A typical application consists of marking a series of stakes, all to be checked at the same level, as in laying out grade stakes. The operator marks on the first stake the desired height for all the rest. To this stake he fastens the Levelall; steel clamps affixed to the tube ends hold them upright on stakes or other locations where leveling is required. The T-bracket's point is driven in at any convenient height so that the tube

passes near the mark. Next, the loose end of the tube is carried to the second stake and fastened with the T-bracket. The tops of the liquid will then be level with each other.

Thus, if at the first stake, the  
(Continued on page 184)



Board is placed in a spot correct in height, and a mark indicated at liquid level; as board is moved, difference between liquid and mark will show when fill is to be added or removed.

Add SALES  
APPEAL yet  
they cost so  
little...



## VENTILATING Exhaust FANS For Kitchens and other Rooms

No other exhaust fans have so much utility, eye-appeal and built-in quality at such little cost. Is it any wonder "RADIA" is specified by so many architects, builders and home owners for new construction as well as for modernization jobs? Use them once and you'll use them always!

Easy to Install . . .  
"Tailored" Fit!

IN ALL  
STYLES  
& SIZES



AUTOMATIC CEILING EXHAUST FANS. Require minimum joint space. No wall space needed.

WALL Invisi-Grille EXHAUST FANS. Automatic bead chain control. Chrome or white Durenamel finish.

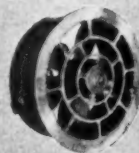
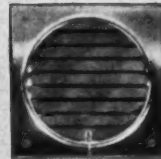

DUCT, FLUE AND CHIMNEY FANS. With or without shutters. Automatic operation by wall switch.

SEND FOR COMPLETE CATALOG

• DISTRIBUTORS ATTENTION

For PROFITABLE additions to your present lines get the facts on Shepler Ventilating Fans and Heaters. Write for full information today.

**SHEPLER**  
*Manufacturing Company*

1229 GOEBEL STREET  
PITTSBURGH 33, PA.

QUALITY FANS AND HEATERS SINCE 1921

*Sparking a revolution in small-home*

# Servel presents an all-new

*...the perfect*

## It's a genuine Servel ... ready to install!

Here is a top-quality, low-cost packaged unit by the world's foremost maker of *All-Year* home air conditioning that provides *all seven* true air-conditioning advantages:

1. Heats in winter.
2. Cools by refrigeration in summer.
3. Cleans the air.
4. Removes excess moisture on hot days.
5. Adds needed moisture on cold days (optional).
6. Circulates the air.
7. Ventilates with outside air.

### A new low-priced "Big Home Size" 3-ton Servel Unit

For larger homes, Servel now offers a new, improved "Big Home Size" 3-ton unit at a record-breaking low price! It provides every advantage of complete *All-Year* air conditioning for

the entire house... Operates on gas or oil... full 3 tons of refrigeration capacity... heating output, 96,000 b.t.u./hour. 5-year guarantee.



building



# All-Year Air Conditioner

*packaged unit for low-cost houses!*

ON THE WAY—soon—ready to become your next great sales attraction! It's today's most amazing development in small-home air conditioning—a revolutionary achievement in design and price by world-famous Servel!

This remarkable new 2-ton Servel unit simplifies space and air-distribution problems . . . permits building plans that can actually save money even when compared to the cost of heating alone. What's more, it's a package job, ready to install speedily, easily!

Just look at these advantages: runs on dependable low-cost gas . . . has *no moving parts* in heating or cooling systems . . . is quiet and vibration-free . . . requires practically no service . . . carries a full five-year factory warranty.

Think of what this new Servel 2-ton unit can do to sell home-buyers on *your* next project! See your Servel distributor about this revolutionary, new, sales-winning Servel package—or return the coupon below today.

# Servel

*the name to watch for great advances in*  
**AIR CONDITIONING—  
REFRIGERATION**

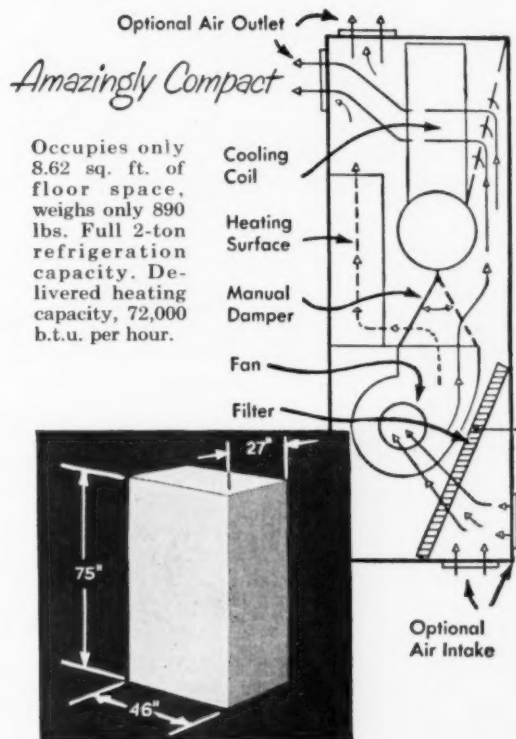

## MAIL TODAY!

SERVEL, INC., Dept. AB-2, Evansville, Indiana

Please send me at once complete information about the new 2-ton Servel All-Year Air Conditioner.

Name \_\_\_\_\_

Street \_\_\_\_\_

City \_\_\_\_\_ Zone \_\_\_\_\_ State \_\_\_\_\_

**ALLITH**  
**50-50**  
**PUSH-OVER**

**Easy to Install . . .  
Lasting Satisfaction**

**GARAGE  
DOOR  
HARDWARE**

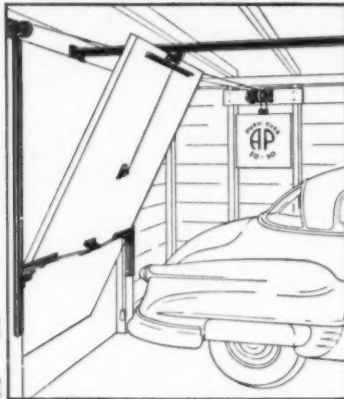

Combine the expertly-designed Allith garage door hardware with your own or any standard door. Result . . . a rugged, easily-operated overhead door that gives full and lasting customer satisfaction.

Quickly installed, standard set fits any opening up to 9' wide x 7'6" high when doors do not exceed 275 lbs. Other sets available for openings up to 10' wide x 10' high.

**ALLITH**  
**-PROUTY, INC**  
DANVILLE, ILLINOIS  
IN AMERICAN BUILDER for Forty-Five Years

## BURKS Pumps

and water systems



**Patented  
Kam-Action  
Feature**

Gives you Larger Capacity • Greater Efficiency • Velvet Smooth Operation

A Deep Well Pump that can be used either horizontally or vertically—without any mechanical changes.

**Write for Catalog Folder**

**DECATUR PUMP CO. 78 Elk St., Decatur 70, Ill.**

## new leveling device

(Continued from page 181)

liquid is 30 inches above the original point marked, the liquid is also 30 inches above the level point at the second stake. Therefore, on the second stake, the operator simply measures down 30 inches from the liquid, and he has determined the next level point.

On this type of work, one man can use the Levelall with speed and accuracy. This same procedure is recommended for making level points at inconveniently high or low

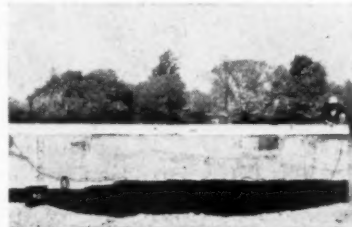

Checking sill for a perfect level: marks are placed on cement, sills then checked from marks with ruler

spots, such as in ditches or on high concrete forms. By "leapfrogging," i.e., using the last determined point as the next departure point, the operator can, by the same procedure, find level points on more distant stakes.

Another use of the device is in marking a level line on concrete forms before pouring.

A slightly different procedure may be followed when level marks are to be placed at eye or waist level. It is then quicker to use two men. At the starting place, the desired level is marked on a stake or wall. While the helper stands at the second stake, the operator holds the tube end so that the liquid is exactly even with the marked point. The helper marks on his stake or wall point exactly where the liquid indicates.

*Kitchen Flooring—A recent American Builder survey revealed that 68 per cent of the builders prefer linoleum, 12 per cent rubber tile; 11 per cent asphalt tile, and 5 per cent vinyl. For basement playrooms, asphalt tile was preferred.*

**AMERICAN BUILDER**

# KNOCK-OUT DOOR CLOSING HOLD-UPS

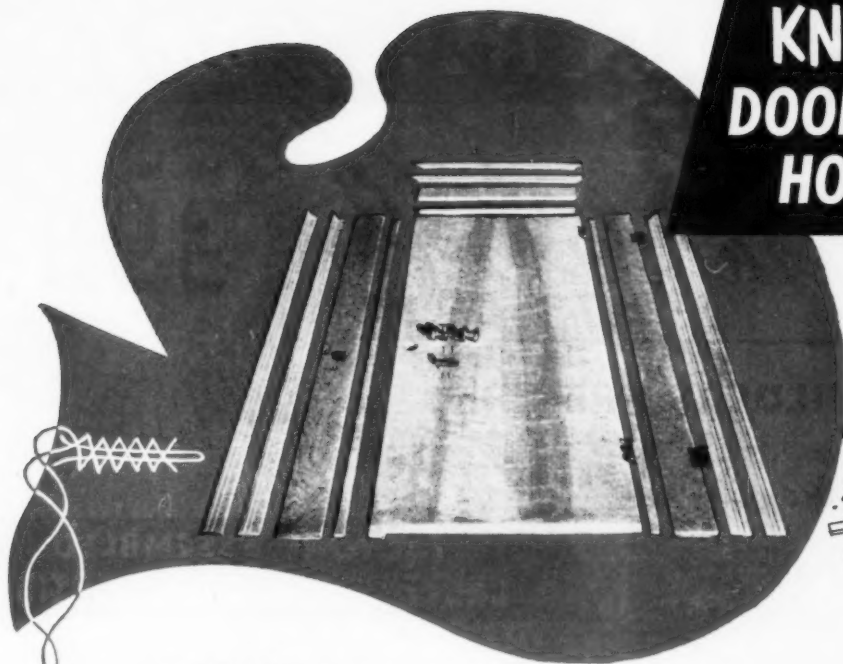

## WITH THE NEW HASKO PACKAGED K-D UNIT

**SAVE TIME**—From rough opening to finished door in 40 minutes or less — it's possible with the new packaged Hasko K-D Door Unit. Everything — door drilled for lock, frame notched for header, stop cut exactly to size, trim mitered and cut to size, hinges installed on frame and door, lock set, shingles for shimming, and nails — is included in the Hasko Package. With no sawing, chiseling, planing or boring to do, the carpenter merely takes a hammer, level, and nail set to case and hang the door. Instead of four hours skilled labor cost on each door you have less than three-quarters of an hour.

**SAVE MONEY AND WASTE**—Skilled craftsmen using mass production methods get factory cut precision into these units. Quality trim and that mill-made look are part of the Hasko K-D advantages. All waste lumber is absorbed in the reasonable cost of the units. Skilled workmen don't waste time running to the lumber pile, sawing, chiseling, boring and fitting. Their time can be used on more important tasks requiring their experience and know-how. The labor cost saved lowers the estimate and speeds construction time.

**GET BEAUTY AND DURABILITY PROVED BY TEST** —Over a million Hasko flush doors have been made and installed. Time and weather have proved their dependability. Strict factory tests maintain their quality. All Hasko doors are made of select, kiln-dried lumber and beautiful veneers permanently bonded to one another to produce the finest in quality and strength.

**See Your Supplier or write Haskelite for More Information on the New K-D Unit**

*There's a trouble-free Hasko Door for every opening*

**HASKO**  
HASKELITE MFG. CORP.  
Grand Rapids, Mich.

# MR. BUILDER... *you too*

## The *International*

# SUN

**MORE BUILDERS PREFER**

*International's ...*

**FACTORY ASSEMBLED  
CONVENTIONAL CONSTRUCTION**



2 BEDROOM with CAR PORT



3 BEDROOM with CAR PORT Low Pitch Roof



2 FAMILY DUPLEX

*Because it--*

- Returns Greater Profit
- Assures Rapid Turnover
- Stabilizes Costs
- Improves Financing
- Speeds Construction

**THE INTERNATIONAL HOME** was designed with both the builder and home owner in mind. The use of latest engineering techniques, and on-site construction methods, has produced one of the fastest built and fastest selling homes in the residential sales market.

**THE INTERNATIONAL HOME PACKAGE**, truck delivered to your foundation, includes:

1. Exterior Wall Panels, with all windows, insulation board, siding, door frames, painted.
2. Gable Ends, sided, prime painted; windows and vents installed.
3. Roof Panels, with rafters, sheathing, assembled. Shingles and paper supplied.
4. Partitions, completely assembled.
5. Interior: Doors completely finished and assembled into finished jambs. All trim finished in syntho blonde enamel; Youngstown Kitchens by Mullins; assembled, disappearing stairway; pre-cut utility room closet and shelving.

*"Everything, including the Kitchen Sink"*

## 18 MODELS 2 *and* 3 BEDROOMS



**CAN BUILD THE HOME** *that sells itself!*

*Home*



**EVERY FEATURE** *Designed* **FOR SALES APPEAL**

Kitchen Exhaust Fan; Insulated Ceilings, Outside Walls and Floors; Storm Doors for front and rear doors; Garbage Disposal; Westinghouse Washer and Dryer; New Gas Furnace with counterflow heat, controlled by thermostat; large, spacious closets and storage space.

Asphalt Tile Floors, easy to clean; Hollywood Flush Doors, easy to dust; Youngstown Kitchens with new Lazy Daisy Corner Base; Beautifully Painted Interior Walls and Ceilings; Expansible Attic, can add 2 bedrooms; All Aluminum Windows, fully weatherstripped; Thermopane Picture Window.



**INTERNATIONAL HOMES INCLUDE  
THESE NATIONALLY ADVERTISED PRODUCTS**

Alwintite Aluminum Windows • Libbey-Owens-Ford Thermopane  
Celotex Roofing, Insulating and Gypsum Board  
Berger Inversaire Furnace • Waste King Garbage Disposer  
Certainteed Roofing; Gypsum Board  
Mullins Youngstown Kitchens • Miami-Carey Ventilating Fans  
Westinghouse Washers and Dryers  
Philip Carey Roofing • Owens-Corning Insulation

*International Homes*  
MINERAL RIDGE, OHIO

For complete information on these homes,  
plus help in planning lower cost, high appeal  
home, write us on your business stationery.

**Full Expansible Attic: 5 TO 7 ROOMS OVERNIGHT**

## TRENDS — why people buy the houses they do

(Continued from page 16)

12 per cent, the living room. Bedrooms were charged with being too small to move around in after furniture was installed. Kitchens were criticized for not providing space for eating, and in some cases for inadequate work space or cupboard room. Living rooms were complained of for not accommodating furniture or permitting entertaining. A third of the buyers were not satisfied with the eating arrangements their houses provided, and a third were dissatisfied with the laundry arrangements.

About one buyer in four criticized the arrangement of rooms, with these changes most frequently desired: (1) relocation of living room or kitchen to allow easier access between those rooms or to improve the view from the living room windows; (2) relocation of bedrooms, to afford greater privacy or to lighten housework; (3) relocation of the bathroom, to give greater

privacy, especially with respect to the living room, or to improve access from bedrooms and kitchen.

Most frequent of all were the complaints about storage space, which only 55 per cent of the buyers said was fully satisfactory. A big majority of the 45 per cent who were dissatisfied said they had inadequate space for storing clothing, food, or large articles that were seldom used.

Satisfaction with storage space depended largely upon whether the house was provided with basement or garage. Eighty-five per cent of the buyers owned automobiles. About two-thirds of the houses they bought had garages; and two-thirds of the garages were used for storage in addition to or to the exclusion of the automobile. Best satisfied with their storage space were the buyers who had acquired both a basement and a garage; while those who had neither a basement nor a garage

were the least satisfied.

**In Summary:** the majority of home-buyers show these general characteristics, gleaned from the information which the survey provides:

The head of the family was, in most cases, a veteran of World War II. He was under 40, either a skilled or semi-skilled worker, a managerial employee or a self-employed person. His 1950 income was between \$3,000 and \$5,000.

Five-sevenths of the families had children, an important consideration.

The majority decided to buy because they thought owning would be cheaper than renting and they regarded buying a home as an investment. A one-story house was preferred because of its convenience and because the buyer and his wife believed a one-story dwelling would

(Continued on page 191)

Featured in the International Homes  
200 and 300 Series—



### THE EZ-WAY folding stairway

easy, convenient access  
to 384 square feet  
of extra space

#### A Real Sales Feature

The International Home owner receives the extra convenience of 384 sq. feet of additional attic storage space, made possible with an EZ-Way Folding Stairway. It's the practical, effective solution to customer demand for convenient access to usable attic space.

#### Customer Satisfaction

The EZ-Way Folding Stairway offers extra advantages. Touch-controlled, balanced spring action . . . Sturdy attractive styling . . . constructed of premium materials . . . disappears into ceiling when not in use. These features give customer satisfaction—supply "bonus" sales appeal

#### EZ-WAY FOLDING STAIRWAY

the stairway to easier sales, customer appreciation

## EZ-WAY SALES, INC.

Box 300-2, St. Paul Park, Minn.

**PREFERRED** FOR EVERY TYPE  
OF INSTALLATION

**Mouflex**  
IMPROVED VINYL-PLASTIC  
TILE FLOORING

- Available in both low-cost standard gauge and 1/8" heavy-duty thickness.
- Vinyl-Plastic throughout—no felt backing.
- Lasts for years!
- Can be installed on, above or below grade.
- Resists dirt, grease, acid, alkali and fire.
- 13 striking color combinations.

Write today for full details!

DEPT. M5-2

**Moultile**  
FLOORING  
SINCE 1929

## MOULTILE, INC.

89

Joliet, Ill. • Long Beach, Calif. • Newburgh, N. Y.

**TWO QUICK DEPTH  
ADJUSTMENTS--FRONT  
AND REAR--MEAN THAT  
HANDLE CAN BE KEPT  
AT COMFORTABLE WRIST  
POSITION EVEN IN  
VERY SHALLOW CUTS**

**FAST-OPERATING BEVEL  
ADJUSTMENT PERMITS  
BEVELS AT ANY ANGLE  
FROM 0° TO 45°;  
EASILY READ ON  
CALIBRATED QUADRANT**

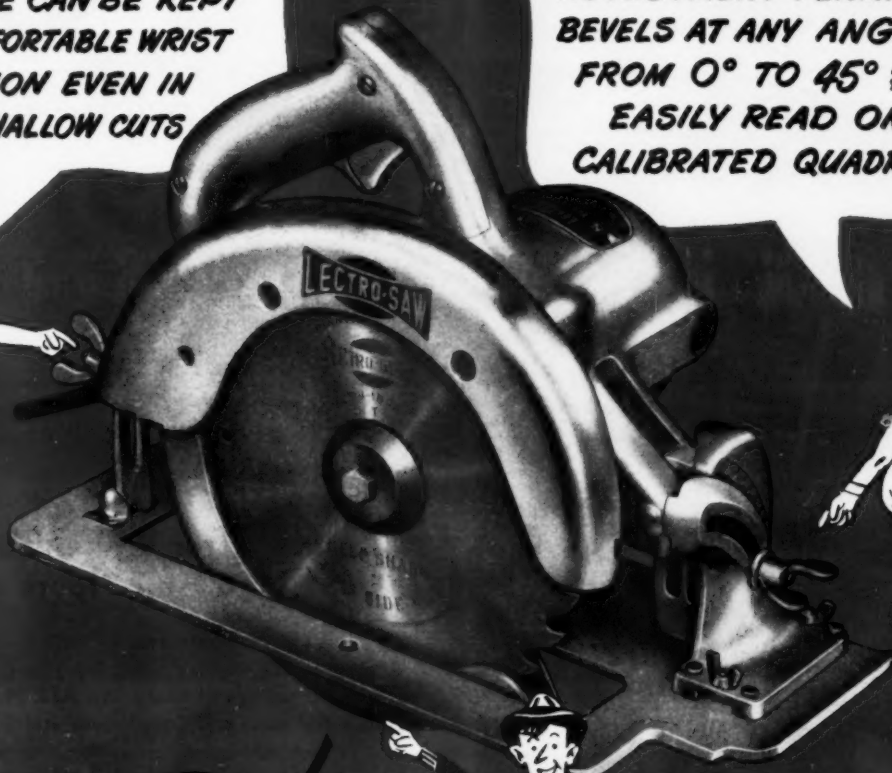

**Black & Decker**  
ELECTRIC  
**UTILITY TOOLS**  
PORTABLE  
ELECTRIC  
TOOLS

The Black & Decker Mfg. Co.,  
Dept. H-662 Towson 4, Md.



**BEVEL CUTS CAN  
BE MADE AT  
ANY DEPTH  
ADJUSTMENT**

## **Talk about FAST ADJUSTMENT Look what Black & Decker Saws give you!**

### **PLUS**

- Abundant Power
- Easy Handling
- Maximum Safety
- Job Versatility

### **PLUS**

#### **POPULAR PRICES!**

- 6" Heavy-Duty ... \$56.50
- 6" Deluxe Heavy-Duty ... \$76.50
- 8" Heavy-Duty ... \$92.50

See Your Building Supply Dealer for a convincing demonstration of Black & Decker Saws and Blades and handy, new Protractor. Learn how they pay for themselves in a few jobs! WRITE FOR FREE CATALOG.

# By All Means, Our New Home Must be a **FIRE-SAFE** All-Masonry Home!



**VIBRAPAC  
BLOCK**



**SOFFIT  
BLOCK**

## **VIBRAPAC BLOCK for Walls and Foundations . . . . . SOFFIT BLOCK for Floors and Ceilings!**

When you build a new home, you naturally want to make it FIRE-SAFE. You never can tell when fire will strike, erasing in a matter of minutes, the dreaming, planning and savings of years. An ALL-MASONRY home . . . with Vibrapac Block for walls and foundations and Soffit Block for floors and ceilings . . . assures maximum fire-safety and performance, without sacrificing charm and architectural beauty.

Vibrapac Block are available in a variety of attractive styles for sturdy, fire-resistant walls. The quality of these block can be controlled and varied in both texture and density as required for sound-proofing, acoustical correction or attractive appearance of wall.

Soffit Block give you fire-safe concrete floors . . . warm and dry . . . rigid floors that won't sag or shrink . . . floors that are especially adapted for radiant heating. Soffit Block ceilings produce a surface of acoustical and insulation value that can be left exposed or painted.

### ● BOTH Made on a Besser VIBRAPAC

Vibrapac Block and Soffit Block are both produced on Besser Super Vibrapac machines. Every block can be made of uniform texture. You can make your selections from a wide variety of block designs and sizes . . . units that will exactly meet your individual requirements. Write on your letterhead for sample pages from new "Block Masonry Homes Plan Book" featuring 116 residential plans . . . also names of Vibrapac-equipped Products Plants in your area.

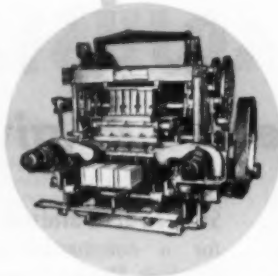

# **BESSER**

Complete Equipment for Concrete Products Plants

**BESSER MANUFACTURING COMPANY • ALPENA, MICHIGAN, U. S. A.**

# TRENDS

(Continued from page 188)

save housework. The type of construction material was not important as long as the quality of material and workmanship were good; but a basement was a majority choice.

On the average, the house purchased was a newly built one-story house with five or six rooms (two-bedrooms) and one bath, of frame construction with wood siding. It had a basement and a garage. The price was between \$9,000 and \$9,500—less in the towns and smaller cities, more in some of the big metropolitan areas, with prices tending generally to run lower in the South than in the North.

Having acquired a dining room, a basement and a garage, the new owner and his wife are reasonably well satisfied with the facilities their new home affords for eating and for doing the laundry, and in general for storage; though his wife says there isn't adequate space for keeping clothing and food.

## how to pull wires in completed wall

To install a convenient outlet in an old house proceed in the following manner: Bore a 1-inch hole in upper plate from attic. Then locate stud in room and bore a  $\frac{7}{8}$ -inch hole close to stud. Take an old 6-foot tape type rule, double it and slide through the hole. It will completely fill the space between the studs. Drop weighted string down from hole above. Pull rule out with the end of string attached. Tie #12 wires to string and pull up.—J. G. Caldwell, San Mateo, Calif.

## how to do a good caulking job

A good caulking job cannot be depended on by just squeezing the material on with a gun. It requires a follow-up by manual pressure. The best procedure to follow is to wrap a rag around the working finger of right hand, (to protect from cuts) soak with kerosene or gasoline and press and glide evenly along caulked joint. This will complete the caulking and feather out the edge. Kerosene is preferable on old work because it is easier to work, but where a painting job will soon follow, gasoline or paint thinner should be used because these materials will not affect the paint. On extremely dry surfaces caulking material should be primed with linseed oil before proceeding with the work.—Werner Kraatz, Santa Cruz, Calif.



**SAVES YOU MORE TIME, RIGHT ON THE JOB, THAN ANY OTHER TOOL IN YOUR KIT!**

A Journeyman's tool, built to stand up under constant, on-the-job Contractor or industrial use. Needs no starting hole—has built-in blower — fits any heavy duty  $\frac{1}{4}$ " or  $\frac{3}{8}$ " drill — blades to cut all materials — listed on Federal Supply Schedules, Class 40 Materials.



**SEND THE COUPON FOR FULL FACTS**

**R. C. S. TOOL SALES CORPORATION**  
JOLIET, ILLINOIS

Please send literature to: Bulletin L-2

Name \_\_\_\_\_

Address \_\_\_\_\_

City \_\_\_\_\_ State \_\_\_\_\_

## IDEA for a living room angled window wall with planter

Living room of this small house in St. Petersburg, Fla., is given character by making one end a slanting window wall with planter built across. There is a matching planter outside the window. Side sections of the window are jalousies by E. L. March. Sill of window and ledge of planter are both ceramic tile. The house was built by Northeast Homes, Inc., and sold for \$15,000 during National Home Week.



Triangular shape of the planter fills in the rectangular line needed to keep floor dimensions practical



Outside planter becomes part of entrance detail



House is of cement stucco on concrete slab, has oak flooring in most rooms, plaster walls and ceilings, full tile in bathroom. Farwest Homes' designs are copyrighted by W. A. Wollander, Tacoma, Wash.

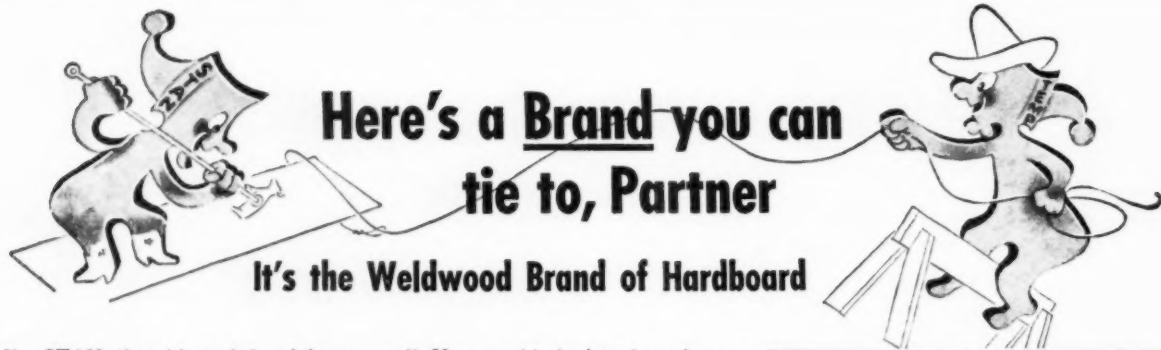

I'm STAN, the old stock hand from Weldwood STANdard Hardboard.

My sidekick is TEMP, from Weldwood TEMPered Hardboard. Temp is oil-treated, plastic-treated and water resistant.

And, partner, we rustle up a lot of stock of this pedigreed Weldwood Hardboard.

We keep builders and mechanics happy because we both "work" so

well. Use any kind of tools and see how neat, clean and sharp every edge shows up.

And another thing, look at our nice light color. We take paint, even pastel shades, without any fuss or trouble.

Whatever you build, however you use Hardboard, look for the Weldwood brand. And place an order with your Weldwood supplier.

## WELDWOOD® Hardboard

Manufactured by Abitibi Power and Paper Company  
Distributed Exclusively By

UNITED STATES PLYWOOD CORPORATION

55 West 44th Street, New York 36, N. Y.

World's Largest Plywood Organization

Branches in Principal Cities • Distributing Units in Chief Trading Areas

To meet all your requirements: both Standard and Tempered Grades of Weldwood Hardboard come in three popular thicknesses: 1/8", 3/16", and 1/4". In sizes: 4'x6', 4'x8', 4'x10', 4'x12' and 4'x16'. Panels up to 4'x12' are wrapped six to a package. Weldwood Tempered Tile Board is available only in 1/8" thickness and sizes 4'x4', 4'x8', 4'x12'.

Call your Weldwood salesman for Weldwood Hardboard or Tile Board today.

United States Plywood Corporation is the world's largest plywood organization, producing a complete line of decorative hardwood plywood, fir plywood, Novoply®, Weldtex® and other specialty items — as well as the most complete line of wood-faced flush doors on the market.

\*Trade Mark registered  
Patented: other patents pending

# MATICO PRESENTS

# Confetti

a great new style  
in asphalt tile

MATICO *Confetti*

## SETS PACE IN SMARTER ASPHALT TILE STYLING

It's gay, it's new, it's colorful! It's festive MATICO CONFETTI Asphalt Tile — the striking multi-color pattern that meets the demands of decorators and homeowners alike for smarter floor styling. Western builders have already found this distinctive, low-cost floor covering a valuable aid to home sales. And remember, Confetti, like all MATICO Asphalt Tile, is fortified with polystyrene plastic for bright, enduring colors . . . extra toughness and resiliency . . . long-lasting wear. And it's adaptable to many different decorative schemes — in homes, offices, commercial buildings and institutions. Available in 9" x 9", 1/8" tiles.

MAIL COUPON TODAY  
FOR FULL DETAILS



**MASTIC TILE CORPORATION OF AMERICA**

Member: Asphalt Tile Institute

JOLIET, ILLINOIS • LONG BEACH, CALIFORNIA • NEWBURGH, NEW YORK

MASTIC TILE CORPORATION OF AMERICA  
Dept. 5-1, P.O. Box 986  
Newburgh, N.Y.

Please send me free sample kit and complete installation data on MATICO Confetti.

Name.....  
Address.....  
City..... Zone..... State.....

THE NEW DAY HAS DAWNED...

*Announcing*

**REPUBLIC**

REPUBLIC STEEL

*Kitchens*

*Find out what this new big*





# STEEL KITCHENS

*Planned and built by one of the world's largest steel companies.*

Here's a completely *new* line—newest and most complete on the market—with new features, new styling, new accessories.

With it come new policies and programs that definitely will interest every home builder.

The wealth of styles and sizes in this big new line allows you to apply the very real economies of steel construction to every home you build . . . to use standardized units and create kitchens with a "custom" look . . . to cash in on the growing public preference for easy-to-maintain steel kitchens.

The new day has dawned for builders.

**Berger Manufacturing Division, Republic Steel Corporation, Canton 5, Ohio**

*name in Steel Kitchens offers you..*

**Republic  
Steel Kitchens  
Sales Department  
1022 Belden Avenue,  
Canton 5, Ohio**

**Mail Coupon TODAY!**

I'm interested in details about your new line and new programs. Please send me more information.

Name \_\_\_\_\_ Title \_\_\_\_\_

Firm \_\_\_\_\_

Address \_\_\_\_\_

City \_\_\_\_\_ Zone \_\_\_\_\_ State \_\_\_\_\_

ADDS *Beauty* AND VALUE TO NEW AND OLD HOMES



*Fawesco* ALUMINUM AWNINGS, CANOPIES, SHUTTERS

Saves "On the job" construction costs...

Builders and contractors everywhere are raving about these economical all-aluminum FAWSCO home beautifiers that are installed so easily and quickly. All aluminum, with a baked enamel finish, FAWSCO canopies are unconditionally guaranteed . . . never rust . . . never rot. They give all-weather protection summer and winter. Select FAWSCO canopies from a variety of styles in any one of these colors: Green, Red, Blue, or White. Write for catalog illustrating the canopies, and other FAWSCO building products.



WESTWIND Door Canopy



SLANT Door Canopy

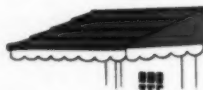

WEATHER GUARD Door Canopy

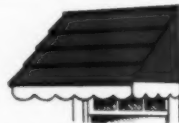

WEATHER GUARD Awning



Full Louvre Shutters

*Write for free Colored Catalog*



FAWSCO Manufacturing Company  
Cuyahoga Falls, Ohio AB-253  
Please mail me illustrated 4-color FAWSCO catalog.

NAME \_\_\_\_\_

ADDRESS \_\_\_\_\_

CITY \_\_\_\_\_ STATE \_\_\_\_\_

Print name and address plainly, clip, and mail today.

a picture window that disappears and screens itself

This double-glazed picture window can be raised or lowered to any level simply by touching an electric wall switch which controls a motor assembly attached to the top framing member. A 16 mesh bronze screen is built into the unit at the top and is attached to the top of the glass. As the window lowers, it pulls the screen down with it. When the window is closing, the screen lifts the glass into position and rolls out of sight.

The double glass used is Pittsburgh Plate Glass Co.'s "Twindow." The window is also available in single 1/4-inch plate glass. Weatherstripping is part of the unit. Frame

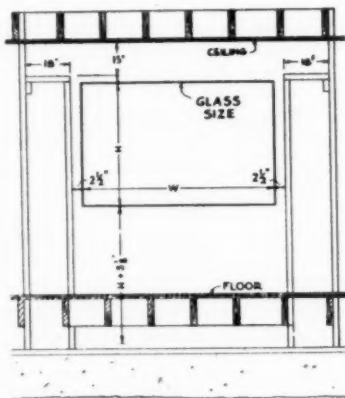

Showing installation in wood framework. 2x8-inch studs are recommended for easy construction, but Vita Windows are designed to fit all wall widths

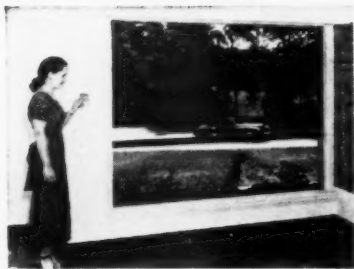

and sills are 1/16-inch steel. Motor and gear box assembly includes a Westinghouse 1/4 h.p. instantly reversible motor with limit switch and safety control.

Known as Vita Automatic Windows, these units are made to accommodate the following "Twindow" sizes: 66x42, 84x42, 84x66, 96x72, and 96x80 inches. The last of these is a glass window-door which disappears beneath floor level, without screen.

Vita Windows are sold as packaged units, with all parts including glass. The manufacturer is Vita Automatic Windows, Inc., 65-30 Queens Blvd., Woodside, L.I., N.Y.

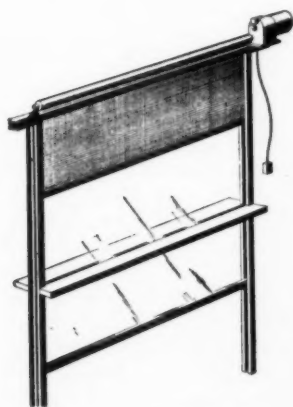

Showing window sinking beneath sill level, pulling screen down with it. For basementless houses special recess pits or space in foundation must be provided

## MARLITE WOODPANEL



**for the beauty of fine, fully-finished woods at far less cost!**

Dens, recreation rooms, libraries, living rooms, offices, corridors, waiting rooms, bars, lounges, and hundreds of other interiors quickly respond to the *practical beauty* of Marlite Woodpanel.

The high-heat-baked finish is unharmed by alcohol, fruit juices, and boiling water . . . cleans with a damp cloth . . . never requires painting or redecorating . . . cuts maintenance costs to the bone. Seven beautiful patterns, authentic reproductions of fine woods, are priced well within the modest budget.

Plan on Marlite Woodpanel. It's a sure client pleaser for beauty, permanence, and economy. See genuine Marlite at your lumber and building materials dealer. MARSH WALL PRODUCTS, INC., Dept. 203 Dover, Ohio. Subsidiary of Masonite Corporation.

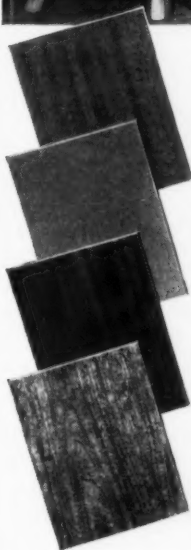

for creating beautiful interiors



# Marlite®

PLASTIC-FINISHED  
WALL AND CEILING PANELS

**SAVE MONEY  
on PAYROLL  
without stinting  
on quality**



... with  
**"PACKAGED PROFITS"**  
in these fully assembled  
**AWNING WINDOWS**



Alert builders welcome the sound economies in saving labor time with these quality windows, delivered to the job fully assembled and ready for quick, easy installation in any type of construction.

- Stock sizes and styles for every requirement
- Clerestory, picture windows and window walls
- Weatherstripped, with inside screens semi-prefit
- Thermopane or storm sash at slight extra cost
- Design and climate control features help sell houses

# Gate City

PERMA-TREATED FOR LONG LIFE

## WOOD AWNING WINDOWS

Write today for name of nearest GATE CITY dealer, list of stock sizes and literature.

### GATE CITY SASH & DOOR CO.

P.O. Box 901, Fort Lauderdale, Florida

AB-2

Gentlemen: Please send me complete information on GATE CITY Awning Windows.

NAME \_\_\_\_\_

ADDRESS \_\_\_\_\_

CITY \_\_\_\_\_

STATE \_\_\_\_\_

## lighting will sell your living rooms



These two living rooms, from houses built in Columbus, Ohio, by E. J. Cahill and Homer Friend, show the trend to special lighting effects for well-designed houses. Valance lighting is used in both rooms to provide general illumination and for decorative effect.

A valance placed over a window or an inner wall surface spreads the light both downward and upward. In the Cahill living room (below) a wide wash of light over drapery folds dramatizes texture and color. In the Friend living room, the valance lighting over the scenic wall paper helps create the illusion of distance.

Valance lighting may be purchased in packaged units to be used with shields made by the builder. Shields may be painted or papered to blend with walls, or upholstered to match draperies or other furnishings.

Remember: in decorating with light, complete shielding of the light source is essential, so that what one sees is the effect but not the source.

Lighting for these rooms was designed by the Home Lighting Department of the Columbus and Southern Ohio Electric Company.



AMERICAN BUILDER



...builders like it...owners want it!

## "Century" NU-GRAIN

asbestos-cement siding...

looks like split wood...  
lasts like stone!

**This colored shingle for re-siding old homes and for new construction** enables you to offer all the architectural appeal of the old-fashioned split wood shingle together with the economical, lasting toughness of stone! The well-defined vertical texture of "Century" NU-GRAIN Shingles is obtained with colored slate granules which are permanently embedded into the shingles under hydraulic pressure. The result is a smooth even surface with no grooves to hold dirt.

**Three non-fading colors give a choice to suit any taste:** NU-GRAIN Green, NU-GRAIN Gray, NU-GRAIN Brown. When the shingles are applied, the vertical joints are all but lost in the unique design, and even the exposed nail heads are not easily seen. Added distinction is gained by the straight-butt shadow lines. And these beautiful shingles can't burn, can't get rain-soaked, won't rot, and haven't a thing to offer that a termite likes!

To help you sell your prospects, "Century" NU-GRAIN Shingles are featured in their attractive colors in *Better Homes & Gardens*—a magazine read by more than 7,000,000 home-conscious men and women. Ask your K&M Distributor to show you the complete line of "Century" NU-GRAIN Shingles—or write to us direct.



Illustrated—"Century" No. 58 NU-GRAIN  
Asbestos-Cement Siding Shingles, NU-GRAIN  
Green. 57 shingles per square, 1½" head lap.

America's first maker of Asbestos-Cement Shingles

**KEASBEY & MATTISON**  
COMPANY • AMBLER • PENNSYLVANIA

**SAVE TIME, SAVE PAINT, SAVE MONEY**  
**On Every House You Build With**

..... *New* .....

# **GPX GREEN**

..... **PLASTIC-FACED PLYWOOD** .....

**ENGINEERED FOR PAINTING**

**IT'S EXCLUSIVE! GPX GREEN**

.....

is made by an exclusive formula of the Georgia-Pacific Plywood Company. Years of research make it the material that meets all the requirements of paint. It combines the miracle of modern plastics with the structural strength of plywood. It offers an improved interior and exterior surface in one grade. It's exclusive in color and surface. So insist on green—GPX GREEN . . . if you want the surface that's engineered for painting.

.....



## IN EXTERIOR SIDING—GPX GREEN

paint grade plywood is weatherproof and waterproof when painted. Paint lasts up to three times longer on GPX GREEN than on other materials. And it's easy to apply. No priming is needed and the smooth surface can be covered with one coat. GPX GREEN sidewalls will not check or crack and grain raise is reduced to a minimum. Use the panels in their full 4 x 8 ft. size or cut in strips and lap. Either way, you save time, paint and money and give your customers the finest paint surface obtainable.



## IN INTERIOR WALLS—GPX GREEN

is made from top-grade Douglas Fir Plywood and surfaced with a plastic overlay fused to both sides of the plywood. The large panels are nailed right to the studs and produce a complete wall in minutes. Checks and cracks won't mar the smooth surface—ever! Your painters will be amazed to see how GPX GREEN can be covered with one coat without any primer. Walls of GPX GREEN seldom require re-painting. For you and your customers—GPX GREEN is the best buy by far.



## IN CABINETS AND BUILT-INS—GPX GREEN

is easy to work. Solid cores produce a smooth, clean edge when cut. The smooth plastic surface eliminates feathering and chipping. GPX GREEN is flexible . . . bends to the same short radius as regular plywood and is ideal for curved counter bases. This "engineered for painting" material saves you money in every application. To cut costs and speed completion time, use GPX GREEN in the next house you build.



# GEORGIA—PACIFIC PLYWOOD COMPANY

617-A2 North Capitol Way, Olympia, Washington

OFFICES OR WAREHOUSES IN: Augusta, Baltimore, Birmingham, Boston, Chicago, Cleveland, Columbia, Detroit, Fort Worth, Lancaster, Los Angeles, Louisville, Memphis, Nashville, Newark, New Castle, New Hyde Park, New Orleans, Olympia, Orlando, Philadelphia, Pittsburgh, Providence, Raleigh, Richmond, Savannah, Vineland.

**MAIL COUPON TODAY!**

Please send me FREE Technical Data Manual on GPX GREEN.

Name .....

Title .....

Company .....

Address .....

City ..... State .....

# TWO SEATTLE CONTRACTORS SPEAK ABOUT KAY-TITE

*Alco Waterproofing Co.*  
 212 NORTH 7TH ST. - SEATTLE 2, WASHINGTON  
 PHONE 424-2828

February 27th, 1952

Gentlemen:  
 After many years of specializing in masonry water proofing, using various products we found Kay-Tite by far the most outstanding. Results on every job where it has been used have been very satisfactory.

Our contracts cover all kinds of buildings, residential, government and commercial. We do work on all types of masonry, inside, out, side and above and below grade. All work is covered by bond and guaranteed.

We always recommend Kay-Tite and are most happy to attest to the dependable quality of your product as it has enabled us to give a long term guarantee on all jobs.

Very sincerely yours,  
 Alco Waterproofing Co.

SEATTLE WATERPROOFING CO.  
 ALL TYPES OF WATERPROOFING  
 4121 ALBUQUERQUE  
 SEATTLE 4, WASH.

February 20, 1952

Gentlemen:  
 We have been using Kay-Tite for over five (5) years now with the utmost success. We have used it in conditions of extreme hydrostatic pressure and we find that it does a better job than any other product of its type that we know of.

We guarantee and stand behind our work so the choice of the proper material is quite important to us.

The pleasant experience we have had with Kay-Tite the past five years enables us to highly recommend its use either below or above grade and under any type of climatic conditions.

Yours truly,  
 R. W. Lyman

**KAY-TITE**  
 PROTECTS MASONRY  
 AGAINST  
 WATER SEEPAGE  
 FOR  
 BRICK  
 STUCCO  
 CINDER BLOCK  
 ROUGH MASONRY  
 UNGLAZED TILE

WHITE  
 and  
 9  
 COLORS

CREAM  
 BUFF  
 YELLOW  
 SPANISH BUFF

GREEN  
 BLUE  
 GRAY  
 ROSE  
 BRICK RED

**KAY-TITE COMPANY**  
 WEST ORANGE NEW JERSEY

ELEVEN FAR WESTERN STATE contact KAY-TITE COMPANY  
 1717 WESTLAKE AVENUE, NORTH SEATTLE 9, WASHINGTON  
 FOR FLORIDA contact KAY-TITE COMPANY OF FLORIDA  
 P. O. Box 995 Mountain Lake, Lake Wales, Fla.  
 More than 20 years of satisfactory performance

## builder shows house

The "open house" has long been standard operating procedure for builders in selling their houses. However, a Minot, N. Dak., builder recently reversed the idea instead of asking the people to come to the house, he took the house to the people. It was done by exhibiting a model house at the 1952 North Dakota State Fair at Minot. During the six-day period of the fair, an estimated 12,000 people passed through the model home. The total fair attendance was 85,000, so approximately one in every seven fairgoers viewed the house.

The builder is John Norton of the Norton Construction Co. In looking



The model house exhibited at the 1952 North Dakota State Fair

back at his model home exhibited at the fair, which produced five actual sales and several hundred good leads, he stated, "I'll do it again next year. We build about 25 houses a year, so in one week we sold one-fifth of the houses we'll build next year. And I honestly expect to get enough sales from the 'interested leads' to take care of our complete next year's operation."

To make certain that the public could see what materials he used between the exterior and interior finish, Norton utilized the principle of the cutaway house. Although this idea is not a recent promotion device, it has proved a sure-fire method of stimulating the public's interest in home building and home buying. Briefly, the cutaway house exposes construction details. One wall in the living room of the house was purposely left unfinished, showing the various stages of construction, from



## at state fair

the wall board to the empty stud spaces. Over other studs, the visitors could see the blanket insulation. The same procedure was followed for a section of ceiling and the

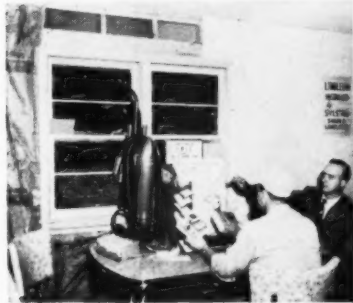

Inside the model house, visitors were able to see what lies behind the interior finish of a home

floor. On the exterior, the siding was left off so that the insulating sheathing was exposed.

To estimate the number of people passing through the model house, visitors were asked to register for a drawing on a new vacuum cleaner held at the close of the fair. The registration card also asked whether the individual was interested in learning more about owning a Norton-built home. This method furnished many leads for the firm. One salesman or a member of the Norton firm remained available at all times to answer questions and to help direct visitors through the house.

### the "trade-in" house — a new potential

Since many potential purchasers must first dispose of existing property before acquiring a new home, increasing numbers are incorporating in their sales programs methods for "trading in" older houses. NAHB officials have recommended to FHA and HHFA that current FHA legislation be adapted to handling this involved transaction. Builders are cautioned to examine carefully tax aspects of the "trade-in" house.

—from NAHB Washington Letter

FEBRUARY 1953



Only straight-line action sands with-the-grain—produces a satin-smooth finish free from cross-grain scratches and swirl marks. That's why contractors and builders find Dremel Sanders best for finishing wood panelling, cabinets, flush doors, woodwork, dry wall joints, stairways, custom furniture, etc. Light weight (only 5 lbs.) and convenient one hand operation eliminate fatigue on vertical and overhead sanding. Has a production-sized (21-sq. in.) sanding pad—develops 14,400 sanding strokes per minute. Fully guaranteed. Approved by Underwriter's Laboratory.

THE WORLD'S FINEST FINISH SANDER



MODEL 2000 PRICE INCLUDES—

This all-steel case for easy portability to and from jobs. Also 25 assorted abrasive sheets and a sheepskin polishing pad.

**\$24.50**

If your Dealer cannot supply, order direct from factory.



110-120 V., A.C.

DREMEL MFG. CO., 2414-18th St., Racine, Wis.

Write for FREE Dremel Power Tool Catalog.

# 100 FIREPLACE IDEAS FREE

32 PAGE BOOK OF FIREPLACE DESIGNS AND MATERIALS

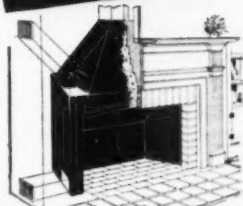

### FOR HOMES, PLAYROOMS, SUMMER COTTAGES, CABINS

You'll get more fireplace business when you show your customers this beautiful book of over 100 fireplace ideas. It helps please customers because they can choose from a wide selection of designs. It aids you because it helps get a decision quickly.

### FYRO-PLACE Heat Circulating Form

Book also describes FYRO-PLACE—the only heat circulating steel form designed to make the mason's work easier. The finished fireplace will give more abundant heat and more satisfaction through the years.

Gentlemen:

Please send me your free book of "100 Fireplace Ideas"

I am a Builder  Architect  Dealer

Name \_\_\_\_\_

Address \_\_\_\_\_

City \_\_\_\_\_

## PRICE

FIREPLACE HEATER &  
TANK CORPORATION

195 W. Austin Street  
Buffalo, 7, N. Y.

# You can get ideal light construction levels made by David White

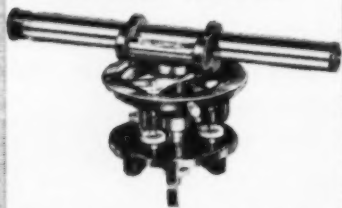

This low-priced, reliable David White Improved Light Construction Level No. 8020 is simple and easy to use. Telescope 10" long, 10 power. Graduated spirit level, 4 1/2" dia. circle graduated in degrees in quadrants. Has leveling screws and clamp screws. Complete with instruction book, carrying case, plumb bob, hinged leg tripod, rod and target. List price: \$35.00\*.



The David White Improved Light Construction Level Transit No. 8022 is a low-priced, simple, complete combination instrument. Levels and plumbs from same set-up. Has same features of instruments costing \$100.00 or more. 2 1/2" graduated spirit level. Vertical arc 2 1/2" graduated. Horizontal circle — 4 1/2" graduated in degrees in quadrants. Base has 4 leveling screws and shifting center. Clamp and tangent screws for vertical arc and horizontal circle. Complete with instruction book, carrying case, hinged tripod, plumb bob and rod with target. List Price: \$75.00\*.

How many times have you wished for easy-to-use, low-cost levels and transits? Instruments ideally suited to light or rough construction work — basement excavating, landscape grading, trenching, tiling, concrete work, laying out building lots, etc. Here's your answer. These instruments are fully guaranteed. Small contractors have successfully used them for years. Big contractors often supply their individual crews for on-the-job service. See them at your nearest David White dealer or write direct for literature.

DAVID WHITE COMPANY, 311 W. Court Street, Milwaukee 12, Wis.

We offer complete, prompt repair service on all makes of instruments—levels, transits, theodolites, etc.



\*Prices subject to change without notice.

## metal forms used for casting concrete steps

The Adapto Corporation, Milwaukee, is a manufacturer of metal forms for casting concrete steps on an embankment.

The forms are adjustable and will make any width step from one foot to eight feet wide, at six-inch increments. Only minor changes are required to make the forms adaptable to any embankment slope. The forms can be used to pour one or 100 steps. When the number exceeds the quantity of forms the contractor has available, he can set up the forms to

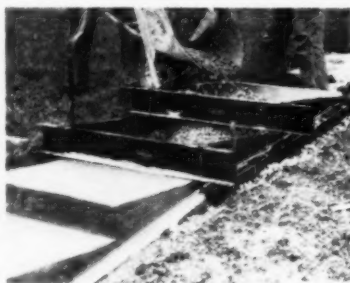

Side rails and plates are in position, as are the front risers, ground stakes have been driven through frame loops, and the concrete steps continue upward

make the bottom step, cast them, then remove the forms when the concrete has set sufficiently to retain its shape without the aid of the forms. The forms are then reset further up the slope, with the bottom step of the forms set at the top of the previously set steps.

"The actual labor in setting up and casting steps with the embankment forms is a simple, direct, one-two-three process," says A. F. Pollman, president of the company. First, the side rails of the forms are set in their approximate position. The side plates which form the sides of the steps are then attached to the side rails. The front risers come next and are held in place by drop pins. Time for this process should not exceed ten minutes. The forms are then shifted until they are squared in the proper position. The four stakes which will hold the forms in place are next driven in the ground; they are positioned according to the loops attached to the forms.

Leveling is accomplished by the

## The Milwaukee Combination SASH BALANCE and WEATHERSTRIP

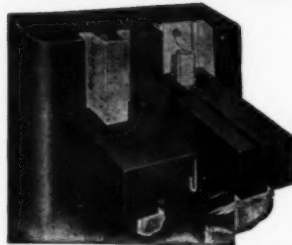

Available with or without bronze covers that completely hide spring, as shown above.

PERMITS REMOVAL OF SASH WEIGHTS, INSULATION OF MULLIONS.

### Slash Labor Costs

Simple installation allows one man to easily install 30 or more windows in 8 hours. No high-priced skilled labor needed. This means you can get more satisfied customers at lower cost . . . higher profit!

### Tops in Operation!

Smooth, positive action; accurate balance; finger-tip control plus the perfect seal against draft, dust, moisture. No wood-to-wood contact. Prevents sticking windows and window rattle.

EFFICIENT  
LOW  
COST



FOR OLD  
OR NEW  
BUILDING

ATTENTION MILLS AND LUMBER YARDS  
IDEAL FOR PRE-FIT WINDOWS

Can Also Be Sold in Single Unit Packages

Mail this coupon today!

Milwaukee Strip Service, Inc.  
4621-23 W. Lisbon Ave.  
Milwaukee 8, Wisconsin

Please rush me folder A-2 and price list of Milwaukee Combination Sash Balance Weatherstrip.

Name .....

Address .....

City ..... Zone .... State .....

I am (please check) Building Contractor   
Lumber Yard  Installer

AMERICAN BUILDER

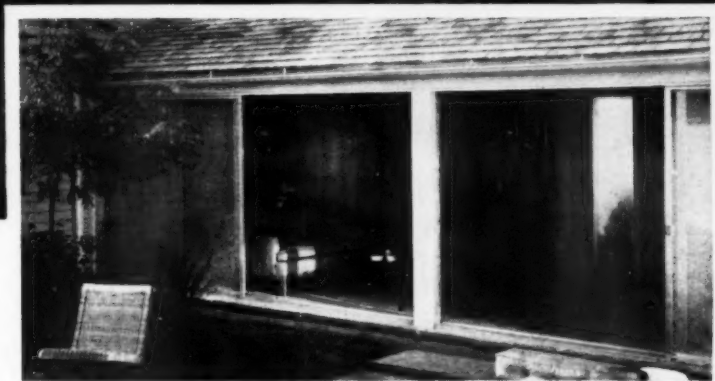
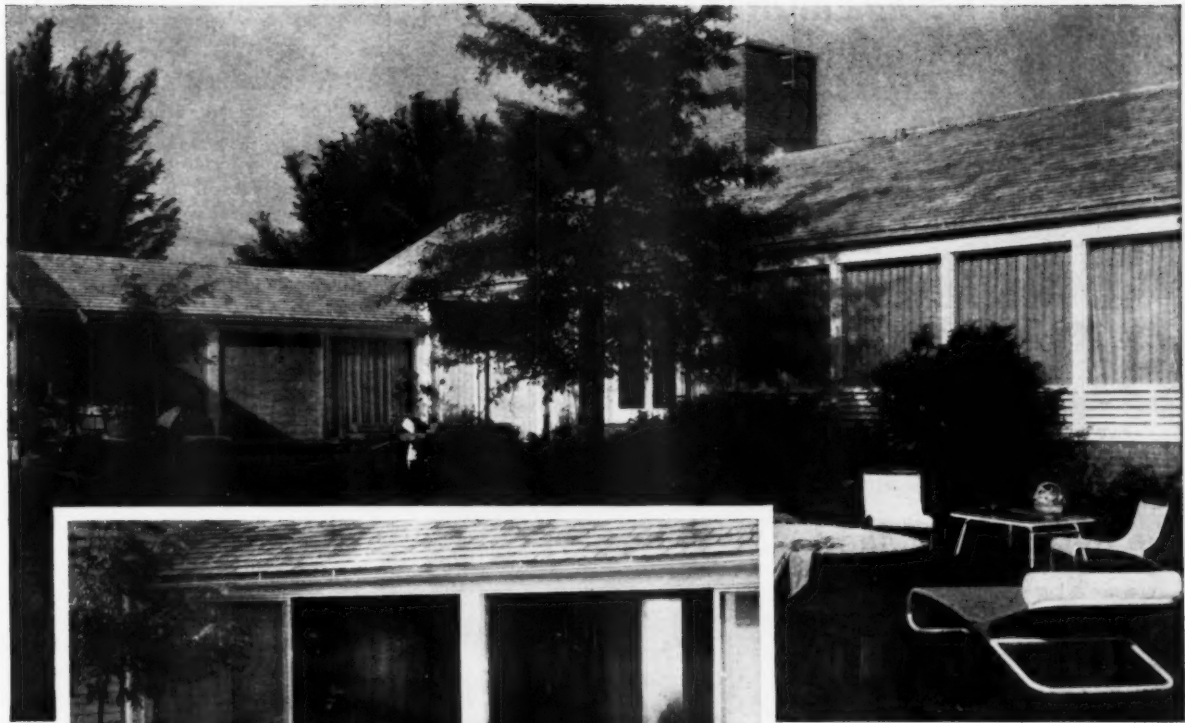

Architect: George W. W. Brewster  
 Associate: James C. Schnur  
 Builder: O & O Construction Company

## 1952 "House of Ideas" selects **B & G Hydro-Flo Heating**

Here is a striking example of the way in which B & G *Hydro-Flo* Forced Hot Water Heating solves the problem of heating homes with large glass areas.

In the "House of Ideas," sponsored by House and Garden, a 3-zone B & G *Hydro-Flo* System with radiant floor panels makes every inch livable space. B & G Comfort Controls (outdoor type) assure close control of temperature and provide compensation for wind effect.

This installation is indicative of the sweeping trend to forced hot water heating. Today you'll find B & G *Hydro-Flo* Systems in buildings twenty stories high . . . in garden apartments covering acres . . . in low-cost housing developments. The comforts of radiant warmth, *plus* positive heat control which keeps indoor temperature uniform and prevents fuel waste, are ample reasons for this preference.

For the complete story of this modern heating method, send for free booklet, "Capture the Sun with B & G *Hydro-Flo* Heating."

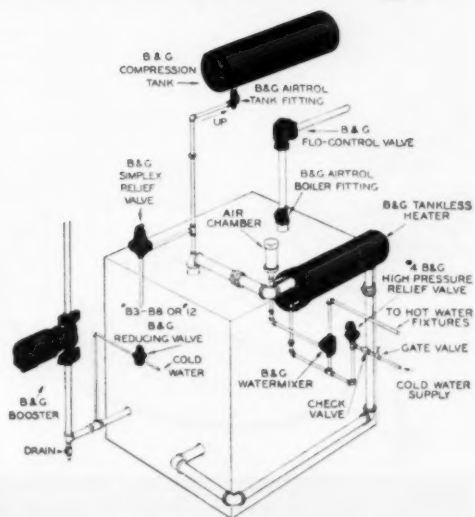

Typical B & G *Hydro-Flo* Hot Water Heating installation with tankless domestic water heater.



**BELL & GOSSETT**  
 COMPANY

Dept. CV-11, Morton Grove, Ill.

Canadian License: S. A. Armstrong Ltd., 1400 O'Connor Drive, Toronto, Canada

**Save TIME! Save MONEY! Save LABOR!**

When  
Installing

**PERIMETER  
HEATING  
SYSTEMS**

USE

**SONOAIRDUCT**

PAT. APP. FOR  
**LAMINATED  
FIBRE DUCT**

*The Improved Method*



Sonoairduct—so easy to handle, easy to level and easy to store—and LOWER COST, tool Designed specifically for use in loop, lateral or radial slab-on-ground perimeter heat installations. Important savings over clay or galvanized pipe! Available in sizes 2" to 24" I.D., up to 24' long. Can be sawed on job to exact lengths! Be sure you get the facts on this widely job-tested and approved method.

**WRITE TODAY**  
for complete information  
and prices!

**SONOCO PRODUCTS COMPANY**

Construction Products Division  
GARWOOD, N. J.      HARTSVILLE, S. C.      MYSTIC, CONN.  
LOS ANGELES, CAL.      BRANTFORD, ONT.

DISTRIBUTORS WANTED—Write for full details!



*(Continued from page 204)*

use of a spirit level and adjustment of the wing bolts which tighten the loops to the ground stakes. With a light coat of oil on the faces, the forms are ready for pouring the concrete in the conventional manner. As soon as the concrete has set sufficiently, the forms are stripped. The pins are removed and the front risers are worked away from the concrete. The side plates and side rails are removed in a similar manner and the final hand finishing is completed. There are no strains created in the removal of the drop pins and metal forms.

The height of the rise is determined by the type of riser being used, varying from 5½ to 7 inches. The change in forms necessary to adapt them to any slope is accomplished by varying the length of the tread. The risers are tipped inboard at the bottom to allow toe room, of particular importance where the incline is steep, and the tread becomes quite short. The side rails are formed to make a concrete lawn mower path at the sides of the steps, minimizing the amount of hand trimming of grass on each side of the steps.

**new edition of standard text  
on house construction**

"House Construction Details" by Nelson L. Burbank has recently been issued in a third edition, comprising 386 pages, with 2,100 illustrations. This standard work on how to build a house has been completely modernized. The new edition is a working guide on every detail of house construction from start to finish. Dimensions, materials, processes and step-by-step working methods are given. Scale drawings and photographs facilitate following every construction step.

The book's new features include a large section of specially drawn detail blue print plates, pictures and descriptions of new building materials, methods of erecting prefabricated houses, and recent information on painting, heating, insulation and other important construction subjects. Complete scale plans for two modern homes also appear in the book.



**LOOK JOE!... FREE TRIAL**

**GUARANTEES Your... WILL PAY FOR ITSELF!**

**Clipper**  
MASONRY SAW



LOOK for the BRIGHT ORANGE COLOR and the TRADEMARK CLIPPER

MODEL HD  
15 MODELS PRICED FROM \$265

**CUT Any MASONRY MATERIAL**  
*Easier - Faster*  
**WITH A NEW CLIPPER MASONRY SAW**

HERE'S WHY! . . . The DUSTLESS Clipper operates right beside your bricklayers because the Clipper is PORTABLE . . . easily moved from basement to roof. One Clipper Model HD with a Clipper Diamond Blade will do the cutting of 3 ordinary abrasive saws! This is possible ONLY with such Patented Clipper features as . . . the Pressure Equalizer Spring, the Famous Select-A-Notch, Water Application System, and Adjust-A-Cut which makes possible One-Spot Operation.

**INCREASE YOUR PROFITS . . .**  
**Saw Concrete Before Breaking**  
**for Patches and Trenches**



Save up to 50% in labor and material. Saw repair patches—gas, water, sewer and air line trenches in floors, streets, walks, runways and highways. Save, too, by sawing contraction joints—eliminate costly hand forming and spalling.

5 MODELS, GAS OR ELECTRIC POWERED

MODEL C-130

**CLIPPER "CONSAWS"**

**SAME DAY SERVICE FROM YOUR NEAREST FACTORY BRANCH—**



MR. CLIPPER

- PHILADELPHIA
- ST. LOUIS
- CLEVELAND
- DETROIT
- AUSTIN, TEX.
- CHICAGO
- LOS ANGELES

- BOSTON
- HOUSTON
- MILWAUKEE
- ST. PAUL
- INDIANAPOLIS
- NEW YORK
- PITTSBURGH

- SAN FRANCISCO
- CINCINNATI
- ATLANTA
- WASHINGTON, D.C.
- BIRMINGHAM
- CHARLOTTE, N.C.
- DALLAS
- KANSAS CITY

IN CANADA — P.O. BOX 476, WINDSOR, ONTARIO

**SOLD ONLY DIRECT FROM FACTORY BRANCHES**

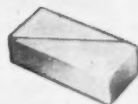

PORCELAIN  
Cut in  
**22 SECONDS**

VITREOUS BRICK TILE  
Cut in  
**21 SECONDS**

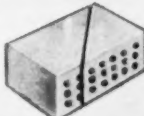

VITRIFIED PIPE  
Cut in  
**18 SECONDS**

KILN BLOCK  
Cut in  
**21 SECONDS**

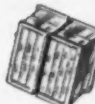
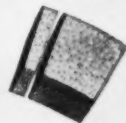

GLASS BLOCK  
Cut in  
**8 SECONDS**

CONCRETE BLOCK  
Cut in  
**19 SECONDS**

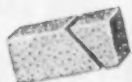

FIRE BRICK  
Cut in  
**4 SECONDS**

ROOFING TILE  
Cut in  
**14 SECONDS**

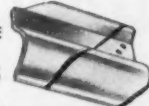

NATURAL STONE  
Cut in  
**12 SECONDS**

CHROME-MAGNESITE  
Cut in  
**15 SECONDS**

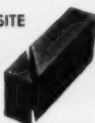

**OUR ONLY BUSINESS FOR NEARLY 20 YEARS . . . MASONRY AND CONCRETE SAWING!**

The unqualified Clipper guarantee of satisfaction is backed by world-wide experience, the ability to select the finest materials, and the "know-how" to put them together.

**. . . and Still Delivered to You on FREE TRIAL**

ORDER TODAY . . . on FREE TRIAL. Discover for yourself how CLIPPER . . . will increase your profits by increasing your production at reduced costs. CLIPPER'S "On the Job" FREE TRIAL guarantees you satisfaction at no obligation!



**DON'T GAMBLE**  
Depend on  
*Genuine*  
**CLIPPER**

"CBR" DIAMOND ABRASIVE SUPERIOR BLADES

. . . guaranteed to "Consistently Provide the fastest cut . . . at the lowest cost . . . with the greatest ease!" Clipper alone can supply all specifications of Abrasive, Diamond and "CBR" (Break Resistant) Blades to accurately meet your requirements. INVEST IN CLIPPER and YOU'LL GET RESULTS!



KANSAS CITY 8, MISSOURI

**COAST TO COAST**

MAIL COUPON NOW

**CLIPPER MANUFACTURING CO.**

2808 S. WARWICK • KANSAS CITY 8, MO.

Send FREE Literature and Prices on:

- |   |   |
|---|---|
| <input type="checkbox"/> CLIPPER MASONRY SAWS | <input type="checkbox"/> CLIPPER ABRASIVE BLADES          |
| <input type="checkbox"/> DUSTLESS MODELS      | <input type="checkbox"/> WET <input type="checkbox"/> DRY |
| <input type="checkbox"/> DRY ONLY MODELS      | <input type="checkbox"/> CLIPPER DIAMOND BLADES           |
| <input type="checkbox"/> CLIPPER CONSAWS      |   |

95

COMPANY \_\_\_\_\_  
ADDRESS \_\_\_\_\_  
CITY \_\_\_\_\_ STATE \_\_\_\_\_

# JAEGER'S shorter mixing cycle increases daily yardage

Jaeger's shorter mixing cycle means more batches-per-day with no increase in crew and payroll. Here's how it's done — charge and discharge have both been cut to only 5 to 7 seconds. The original Skip Shaker throws its load

into the drum in one swift slide. Extra big bucket and flight blades and specially designed "catch-all" spoon discharge it with equal speed.

What's more, Jaeger's rugged design stands up to the pace. Heavy drum with high carbon machined tracks, Timken bearing rollers, engines with power to spare, automotive transmission — all require minimum upkeep, give years of service free from breakdowns.

Available in 6, 11, and 16S sizes. Ask for Catalog M-10.



3 1/2 Auto-Loader, with Power-Shaker Hopper, loads while mixing, produces 12 to 15 more yds. daily.

**THE JAEGER MACHINE COMPANY**

521 Dublin Avenue  
Columbus 16, Ohio

PUMPS • COMPRESSORS • HOISTS • PAVING EQUIPMENT • TRUCK MIXERS



Texture and color tone of walls were improved by sandblast treatment

## sandblasting concrete block gives pleasing texture

In the course of building an addition to a factory building, the MacIsaac & Menke Co., general contractors of Los Angeles, accidentally discovered that sandblasting the

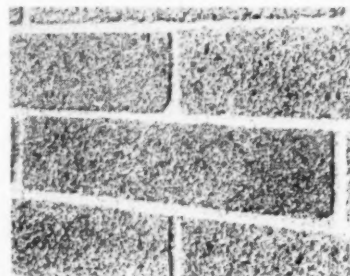

Close-up showing new texture after concrete block has been sandblasted

concrete block used for walls not only gave a pleasing new texture to the block but also deepened the color. The block used was made from a volcanic lava aggregate with a slightly reddish cast.

On this particular job, the grout between the blocks was so hard that it posed no problem, but a good operator can leave grout intact even though it is not hard. After sandblasting, a transparent waterproofing was applied. Cost of the sandblasting for the job was \$75. Both sides of the walls were treated.

**GUARDS AGAINST RUST**—A coat of paint applied when outdoor iron is new and renewed regularly will keep the metal from rusting. Should rust gain a foothold, be sure to remove it entirely with steel wool or a wire brush before refinishing.

**IMPERIAL**  
*Lux-Right*<sup>®</sup>  
The Nation's Best

**HEAVY, CORRUGATED STEEL AREAWALLS**

We **PAY** the **FREIGHT** Anywhere (12 units or more)



**IMPERIAL LUX-RIGHT**, the pace-setter since first offered in 1938. The **ONLY** steel areawall **COMPLETELY** Hot-Dipped Galvanized **AFTER** forming. Two types; Streamlined Straight for restricted areas. Round type where you have more space. Complete range of sizes. Each unit (one-piece, no attachments), has Hug-Tite Flanges for tight fit to foundation wall.

**LUX-RIGHT** Areawalls outlast the house. Need no paint. Speed of installation saves time, labor, money. **FREE** illustrated folder shows sizes and proper installation. See your distributor, materials dealer, or write us.

**EASY TO INSTALL**



**BUY RIGHT—BUY Lux-Right**

**SAINT PAUL CORRUGATING CO.**  
Expert Sheet Metal Manufacturers for 68 Years  
SOUTH END WABASHA BRIDGE • SAINT PAUL 1, MINN.

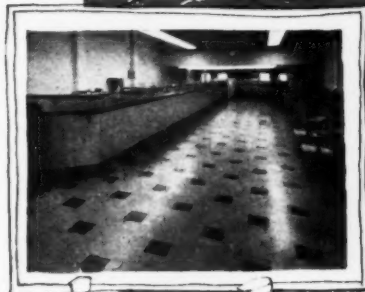
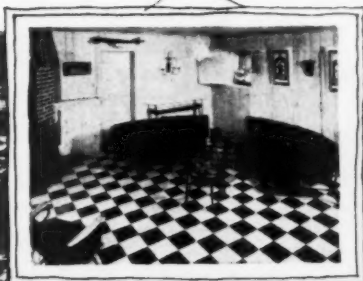

# REMEMBER

*Rubber*

## FLEXI-FLOOR and WALL-FLEX



### FLEXI-FLOOR

—for time proven satisfaction. The ideal material for resilience, long wear and easy maintenance. 28 colors in rolls or tile. 3 standard gauges.

### WALL-FLEX

—the exclusive wall covering of its kind. 1/16" gauge fabric back, provides absolute dimensional stability. All 28 colors completely homogeneous. For economy, sanitation, durability and ease of installation, specify Wall-Flex.

### ACCESSORIES

—the most complete line of related products. 28 colors in cove base, corners, safety tread runners. Residential and heavy duty stair treads—all in the same dependable R.C.A. rubber.

## FLEXI-FLOOR

FLOORS of RUBBER

## WALL-FLEX

WALLS of RUBBER

*"the more we're together*

*.. the happier you'll be"*

CONSULT SWEET'S Architectural File—  
or write for color brochure and full details.

**THE R. C. A. RUBBER COMPANY**  
1843 E. Market St., Akron 5, Ohio



These spring bronze or aluminum alloy weatherstrips make a perfect seal for ALL types of HINGED METAL windows . . . steel and aluminum casements . . . awning style windows . . . projected windows . . . metal ventilators in picture windows.

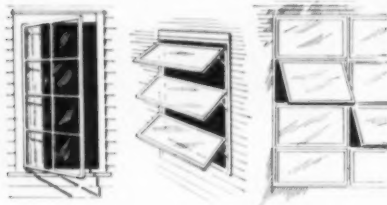

Countless thousands of installations have proved the effectiveness of MASTER Weatherstrips in keeping out those enemies of the home: dirt, dust, rain, and cold. Strips are fastened to the frame and sash is sealed tight under tension when closed. Many territories still available for competent dealers. Write today for full information and catalog of all MASTER products.

**MASTER METAL STRIP SERVICE, INC.**  
1720 N. Kilbourn Ave., Chicago 39, Ill.

**METAL WEATHERSTRIPS—THRESHOLDS  
MASTER NO-DRAFT SASH BALANCES**

MASTER METAL STRIP SERVICE, INC.  
1720 N. Kilbourn Ave., Chicago 39, Ill.

Please send free information and catalog of Master products.

Name \_\_\_\_\_

Address \_\_\_\_\_

City \_\_\_\_\_

State \_\_\_\_\_

## Cleveland HomExpo — builders' idea center

An "idea center" for Cleveland builders is the HomExpo, a continuous building materials exhibit which is also an impartial building advice center. It distributes information about all phases of building materials and equipment to architects and builders, home owners and prospective home buyers.

About 65,000 persons visit the exhibits annually to get latest ideas



Display of sliding closet door units



Typical modern heating display

on home building. They see the construction of the foundation, showing proper placing of footings, fill, basement floor and walls, first floor and side walls above grade. Exhibits of various building materials are displayed.

Different construction items are also shown, following much the same order as they would in the actual building. Displays of wiring show proper placing of switches and wiring installations. Doors, windows, heating equipment, interior finishes, bathroom fixtures, complete kitchens and bathrooms, with decorative schemes, are displayed.

The HomExpo is made possible by space rentals paid by 35 Ohio manufacturers and other concerns. Each has a display, changed frequently, to keep it up to date.

THE NEW

**calder**

**OVERHEAD  
GARAGE DOOR  
LINE**

*has a style and size  
for every need*



**CALDER "STURDY" DOOR**



**CALDER "LEVELINE" DOOR**



**CALDER "FLUSH" DOOR**



**CALDER COMMERCIAL DOOR**

Here's a brand new line of doors that has *everything*. Made by a manufacturer with over half a century of designing and engineering experience, the new Calder doors are available in every conceivable size and style for every conceivable need. Special designs and sizes to order and for extra appeal to the customer and extra profit for you—all Calder doors can be equipped with radio controlled electric operators.

Send for complete information and our new, free, illustrated catalog.

SEE OUR CATALOG IN  
**SWEETS**

**calder**  
**MANUFACTURING CO.**  
LANCASTER 12, PENNA.



**TRADEMARKED**  
as well as grademarked  
...your double guarantee  
of plywood quality

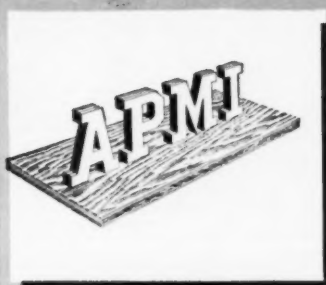
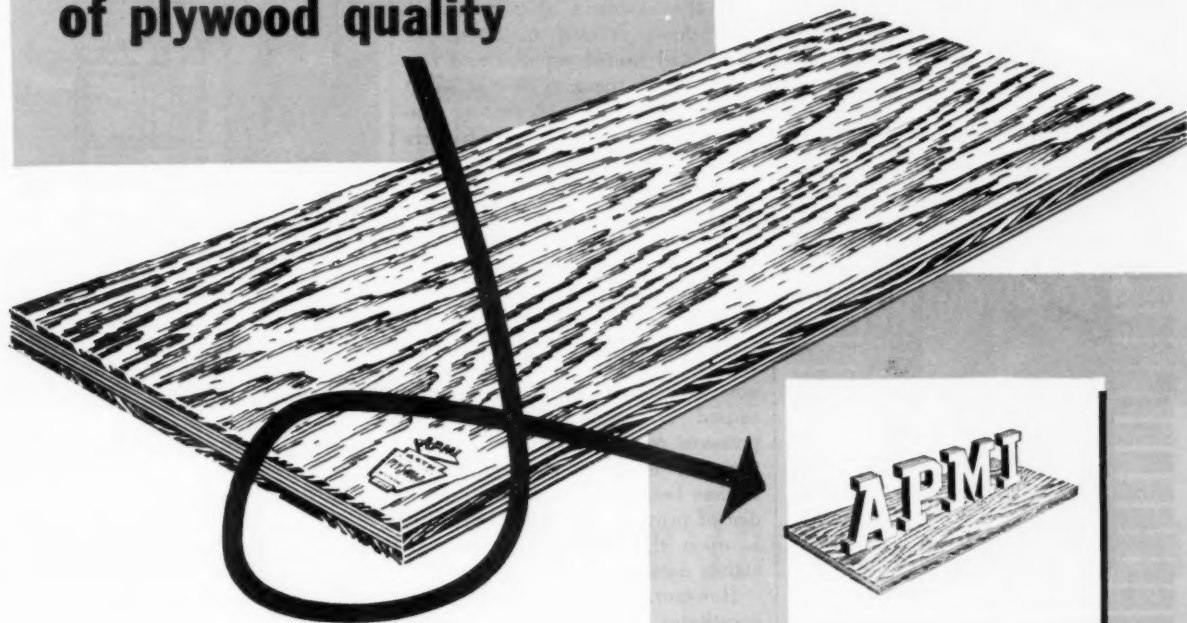

**T**he combination of APMI trademark and DFPA grademark is your assurance that regardless of where you buy Associated plywood, you get the guaranteed products of a pioneer mill in the industry.

There is a type, size and grade of APMI plywood (exterior and interior) for every building need:

Douglas fir plywood; *Sea Swirl* decorative plywood; Philippine mahogany faced plywood; birch faced plywood; vertical grain fir plywood.

APMI products are sold from centrally located sales warehouses, sold by experienced plywood men. Your inquiries are invited.

**BRANCH SALES WAREHOUSES:**

4268 Utah St., St. Louis, Mo.  
4814 Bengal St., Dallas, Texas  
4003 Coyle St., Houston, Texas  
1026 Jay St., Charlotte, N. C.  
111 Welborn St., Greenville, S. C.  
925 Toland St., San Francisco, Cal.  
Eugene, Oregon  
Willamina, Oregon

**SALES OFFICES:**

31 State Street, Boston, Mass.  
595 E. Colorado St., Pasadena, Cal.

**ASSOCIATED**  
**PLYWOOD MILLS, INC.**  
General Offices: Eugene, Oregon  
PLYWOOD MILLS AT EUGENE AND WILLAMINA, OREGON

Announcing  
the  
New

**RITE-PULL**

**NO. 100**

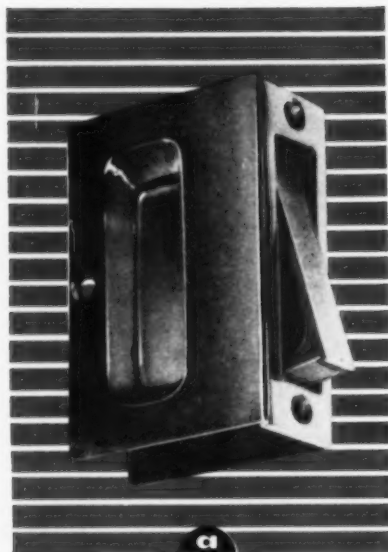

*The mark of excellence*

This fine new Adams-Rite No. 100 combination pull incorporates two flush pulls and an edge pull for use on sliding doors. The flush pulls are deeply recessed and the edge pull is equipped with a spring return.

The pull is easily installed by merely notching the door and is adjustable to fit doors from 1<sup>1</sup>/<sub>8</sub>" to 1<sup>3</sup>/<sub>8</sub>" in thickness. The escutcheons measure 3<sup>5</sup>/<sub>16</sub>" x 2<sup>5</sup>/<sub>16</sub>". A cutout template is packed with each unit.

Like all Adams-Rite quality products, the pull is made of solid brass... is available in seven standard finishes... and is hand polished.

WRITE FOR COMPLETE INFORMATION

QUALITY HARDWARE FOR  NEARLY HALF A CENTURY

**ADAMS-RITE MANUFACTURING CO.**

140 WEST CHEVY CHASE DRIVE, GLENDALE 4, CALIFORNIA, U.S.A.

SPECIALIZED LOCKS AND BUILDERS' HARDWARE

212

## percolating water can cost YOU money

By Francis George

Last January, a flash flood filled a basement excavation in Howe, Oregon. The water seeped through into the basement of a restaurant next door, flooded it, broke the floor, and ruined supplies and records stored there. The restaurant owners sued the excavating contractor. The contractor's lawyers argued that he didn't bring the water there, didn't want it, and that nothing he had done caused the damage. The excavation was properly and carefully dug and in fact could have been done in no other manner. The judge agreed but made the contractor pay anyway. He said that a contractor is not liable for water seepage or damage caused by increased hydrostatic pressure resulting from an excavation. He is not responsible unless he has been careless, and the burden of proving that he was careless is upon the abutting owner who claims damage.

However, a judge's idea of what constitutes carelessness is sometimes a pretty broad thing. In this case, he ruled that starting an excavation in the winter in the Willamette Valley is careless because January is the rainy month and the soil there always becomes saturated with water in the winter.

A South Dakota contractor, however, got out of a similar situation when water from the street gutter flowed into his excavation and undermined an abutting wall and caused it to settle. That judge followed the rule that a contractor must not undermine his neighbor's wall, but is entitled to dig on the property where he is working as long as his work is properly done. He need not shore up an abutting wall, but will be held liable if the neighbor can prove any carelessness in the way he dug. An unusual rain or flood pouring into the excavation by a broken street sewer is not his fault unless, as happened

(Continued on page 214)



## A MONEY-SAVING TIP ON

### *light duty* SCAFFOLDING

**IT'S TRUE**—SAFWAY'S "4 x 4" carbon steel tubular scaffolding is the lowest cost steel scaffold you can buy—for loads up to 50 lbs. per square foot and heights up to 40 feet

The light-weight tubular steel frame is perfectly balanced. It's easy to dismantle and assemble. Wing-nuts join frames to cross braces for rigidity. Safway's "4 x 4" scaffolds are approved by Underwriters' Laboratories, Inc.

An extra working convenience is a provision for locating work platforms at 16-inch intervals. This permits placing materials at waist level.

Write for this Free Bulletin

RENTED and SOLD  
by distributors everywhere



**SAFWAY**  
STEEL PRODUCTS, Inc.

6221 West State St.  
MILWAUKEE 13, WISCONSIN

Tubular Steel Scaffolding and Equipment

AMERICAN BUILDER



Modular homes in Burton W. Duenke Subdivision, St. Louis County, Mo.

## They Sell Better When They Look Better

When a prospect is looking at a house, the first thing he sees is the outside. Naturally! That's why the outside is so important—it forms the first impression that leads to the inside, and, to a sale!

Because architects, contractors and builders know this, many of them are coming more and more to color-toned Rez, as the outside finish for siding, panels, doors, fences, trellises.

Rez itself is a clear resin primer and sealer developed on the Pacific Coast 15 years ago—sold and used expandingly with the development of ranch-type architecture—"growing up" with the trend to modern living and contemporary design.

Now comes color-toned Rez—a series of nature's own tones that offers the simple, easy means of capturing colors from the desert, the seashore, the prairies, the Northwest forests.

In addition, this new color-toned Rez series becomes part of the wood, due to its penetrating and sealing action. This means that wood not only retains its natural beauty but is protected for years against sun, rain, discoloration.

The 5 beautiful tones: **CEDAR REZ**—warm cedar brown, colored like sherry aged in the cask . . . **DRIFTWOOD REZ**—smoky gray, with the color of bleached driftwood . . . **REDWOOD REZ**—the rugged, ruddy color of the California redwoods

. . . **SAGE REZ**—a soft, dry green that captures the color of desert sagebrush . . . **MAHOGANY REZ**—a rich wine red, with the deep tone of saddle leather.

Visit your paint, hardware or lumber dealer—ask for actual "on-the-wood" color samples . . . Or write **MONSANTO CHEMICAL COMPANY**, Merchandising Division, 1700 South Second St., St. Louis 4, Mo. In Canada, Monsanto Canada Limited, Montreal, Toronto, Vancouver.

Trade-mark: Reg. U. S. Pat. Off.





**1 ANCHOR WINDOW** — Pella Windows are completely assembled when they arrive. Just set the unit in the opening and anchor it firmly at the head and sill. Flange screws are furnished for this purpose.



**2 ATTACH OUTSIDE FINS** — Next, attach metal fins at jambs. The grooved edge of the fin fits over the edge of the steel frame. The flat surface of the fin is nailed to the sheathing. Exterior trim can now be applied.

**FOR QUICKER, EASIER  
INSTALLATION  
USE**

*Pella*

**CASEMENT WINDOWS**

Installation costs are cut to a minimum because Pella Casement Windows are completely assembled and pre-fitted at the factory. Pella Casements, in modular dimensions, fit right into specified rough openings. Welded, rust-resistant, wood-lined steel inner frame is fitted with 1-3/4" wood sash. All Pella Casements are equipped with inconspicuous, convenient Rol-screens (that roll up and down like window shades), Dual Glazing and weatherstripping. All hardware included. More Thermopane sizes available for Pella than any other wood casement window.



**3 ATTACH INSIDE FINS** — To complete the installation, apply the inside metal fins at head, sill and jambs. Fins fit under the lip of the steel frame and are nailed to the studding. This insures a tight weatherseal all the way around the window.

**Write Today** for the Pella Installation Instructions and full size Casement Details.

**ROLSCREEN COMPANY, Dept. E-8, Pella, Iowa**

Without obligation, send me "PELLA CASEMENT Installation Instructions in Full Size Casement Details No. 1050M."

NAME \_\_\_\_\_

FIRM \_\_\_\_\_

ADDRESS \_\_\_\_\_

CITY \_\_\_\_\_ STATE \_\_\_\_\_

WINDOWS • ROLSCREENS • VENETIAN BLINDS • FOLDING DOORS

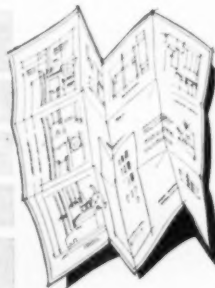

(Continued from page 212)

in Illinois a few years back, the excavation was left open for three years. The judge said that taking that long to do a job is negligence and even though the flood was unusual and couldn't be helped, the contractor or owner should not have left the hole open that long and he held them both liable.

A Missouri contractor got hooked months after he had finished laying a sewer pipe along a St. Louis street. Water collected in two open cellar holes near the line, ran out along the old sewer pipe connection and worked into other basements. The owners sued the contractor and the judge decided that the trenches had not been properly filled. The dirt was not packed tight enough so the water had percolated along beside the pipes and been drained into various basements. He said that the contractor was just as liable as if he had not filled the tunnels at all.

While the law books say that a builder is not responsible for percolating water unless he has been negligent, most judges will find negligence upon pretty slight evidence, so it is wise to take all possible extra precautions against water, even though technically they may not seem required.

*Brown vs. Saxler, 230 P 2nd, 541*  
*Ulrich vs. Dakota Loan & Trust, 51 NW 1023*  
*Garey vs. Coughlan, 92 Ill. App. 582*  
*Martin vs. Benoist, 20 Mo. App. 262*

**30-day lumber employees' training course a success**

The Retail Lumber Training Institute, a development of the Educational Department of the NRLDA, has already trained more than 5,500 employees from over 3,000 separate lumber and building materials dealers in various institutions throughout the country. The course consists of a 30-day term of practical, inexpensive training at one of 17 colleges and universities located from New England to the Pacific Northwest. Each employee who signs up for the course receives a minimum of 144 hours of training, covering every major phase of the retail lumber business. Dealers can enroll employees at any of the institutions.

## FOR RADIANT HEATING

*choose easy-to-join*

## CHASE® COPPER TUBE

Architects and builders know that any radiant heating job is better with Chase Copper Tube. And Chase Solder-Joint Fittings make every joint leakproof. Easy-bending Chase Copper Tube comes in long lengths so fewer fittings are required. It's light in weight, corrosion-resistant, ideal for ceiling and wall installations, too. Write for FREE 50-page Radiant Heating Book today.



# Chase



## BRASS & COPPER

WATERBURY 20, CONNECTICUT • SUBSIDIARY OF KENNECOTT COPPER CORPORATION

*The Nation's Headquarters for Brass & Copper*

Albany †	Cleveland	Kansas City, Mo.	New York	San Francisco
Atlanta	Dallas	Los Angeles	Philadelphia	Seattle
Baltimore	Denver †	Milwaukee	Pittsburgh	Waterbury
Boston	Detroit	Minneapolis	Providence	
Chicago	Houston †	Newark	Rochester †	( † sales office only)
Cincinnati	Indianapolis	New Orleans	St. Louis	

FEBRUARY 1953

215

watch prospects  
nod approval when they see



NEW micarta®  
PLASTIC SURFACE

★  
MARDI GRAS  
★

Designed by Decorating Experts to Combine Beauty with Utility

MICARTA is Easy to Work With  
Available in Economical Sizes

Easily installed MICARTA panels are available in four sizes to eliminate almost all waste. For your convenience, they are pre-bonded to 3/4" Weldwood® Plywood; 24" x 96" . . . 48" x 96" . . . 30" x 60" . . . 30" x 96" all 7/8" thick. Ask your lumber dealer about MICARTA. For more information, fill out and mail the coupon below.

Builders are becoming increasingly conscious of the *new importance* taken on by kitchens, breakfast bars, dinettes, and bathrooms. That's why they are seeking new, efficient, economical and convenient ways to impress new home prospects with these rooms.

New MICARTA® "Mardi Gras" adds a gay, colorful, festive spirit to whatever surface it covers. What's more, its beauty is protected for years and years against normal household abuse. Long after other surfacing materials have been replaced, MICARTA continues to resist scuffs, scratches, chipping, cracking and burning. In line with its bright, cheerful appearance, "Mardi Gras" leaves housewives carefree and workfree . . . with plenty of time to praise the intelligent long-range planning of their builders. J-06506

.....  
UNITED STATES PLYWOOD CORPORATION  
55 West 44th Street, New York 36, N. Y.

Please send color guidebook and full application information on MICARTA.

NAME \_\_\_\_\_

ADDRESS \_\_\_\_\_

CITY \_\_\_\_\_ ZONE \_\_\_\_\_ STATE \_\_\_\_\_

AB-2-53



Westinghouse  
micarta®

distributed by UNITED STATES PLYWOOD CORPORATION  
largest plywood organization in the world  
and U.S.-MENGEL PLYWOODS-INC.

## providing adequate suburban disposal systems

Most contractors and builders have been concentrating their construction in areas which are served by public sewer and water facilities. They are usually unaware of the difficulties into which they could run if the regular local facilities were not available. These hazards could include underground springs, streams or swampy soil. Occasionally, the opposite condition exists, and a solid, non-porous soil, or even rock, is present. In other areas, the water table is found to be just below the surface of the ground, creating a serious problem to the builder.

Among the precautions which the builder should take is making a preliminary investigation of an intended building site. This is done by making soil borings and percolation tests. The purpose of the tests is to determine the absorbent quality of the soil, in order to learn what type of disposal system would be the most suitable under the circumstances.

The sewage disposal method most widely used in areas where no public facilities exist is the underground leaching system, which consists either of tile fields, leaching pits or an underground lagoon. Some local health department regulations prohibit certain types of leaching systems, making this method an unsatisfactory solution.

Some builders overlook the fact that by proper planning of disposal system, a more efficient and less expensive system may be set up. This will save both the builder and the future home owner considerable future grief.

Included among the factors involved in setting up a domestic disposal system to fit the individual home site are, besides the above-mentioned soil tests: obtaining the required permits in accordance with local sanitary regulations; actual installation of the systems from the plumbers stub out, including sinking of the septic tank; arranging for local health department inspection; filling in trenches, the tank pit and other backfill, and removing excess earth, if necessary.

FEBRUARY 1953

★ Let this New Star brighten your building picture!

# Malt-a-Master

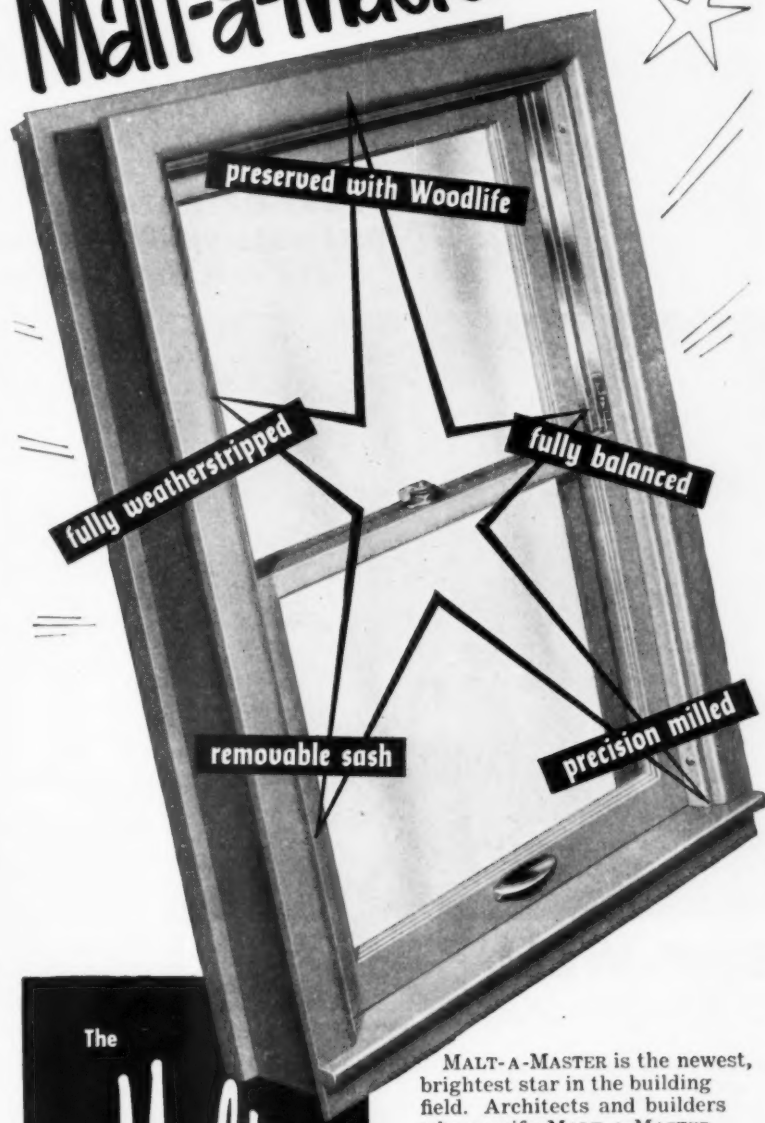

The

# Malta

Manufacturing Company

MALTA, OHIO

Supreme Quality Since 1901

MEMBER PONDEROSA PINE  
WOODWORK ASSN., AND N.W.M.A.

MALT-A-MASTER is the newest, brightest star in the building field. Architects and builders who specify MALT-A-MASTER window units find they have a new star salesman . . . for home buyers want the many new advantages that the MALT-A-MASTER now offers.

Remember, the great, new MALT-A-MASTER window unit is fully balanced . . . fully weatherstripped . . . and has removable sash. So hitch your 1953 building plans to this star performer—the MALT-A-MASTER.

# BILT-WELL

## Twin Features:



**WEATHERTIGHTNESS to save fuel  
and EASY OPERATION to save irritation make both  
BILTWELL SUPERIOR and BILTWELL CLOS-TITE  
the outstanding windows of each type**



### BILT-WELL Superior Windows

Superior Jamb-liner

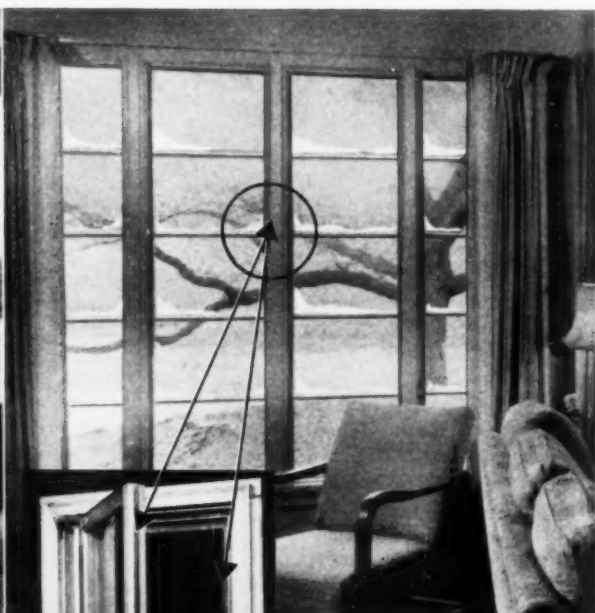

### BILT-WELL Clos-tite Casements

Double Weather Stripping

give you TWICE the protection against air infiltration as required by American Wood Window Institute's Specifications by Actual Tests. And, Superiors require only 1/10th the lifting effort of most other effectively weatherstripped windows. Yes,—Superior's patented Jamb-liner is the secret. This exclusive feature provides flexibility which insures both finger-tip lift and snug-fitting windows. And "Superiors" are counter-balanced with guaranteed overhead spring balances. These fine features are permanent, no adjusting or servicing. NO OTHER WINDOW IS COMPARABLE!

are double weatherstripped to provide the twin features—weather-tightness and ease of operation. Full  $\frac{3}{16}$ -inch clearance between beveled edge of sash and frame insures bind-free operation. Both sash and frame are weather-stripped, plus the additional insulating feature of twin glass on all sash. Cadmium finish (weatherproofed) hardware includes Extension Hinges (for easy cleaning) and a quiet, smooth Crank-type Operator. Locking handle is bronze plated.

The Bilt-Well Line of Building Woodwork (everything for the home) is made of clear, kiln-dried Ponderosa Pine. Essentially all exterior products are toxic, water-repellent treated in accordance with National Woodwork Manufacturers Association Standards.

**HERE'S A LIST OF THE BILT-WELL LINE**

- Superior Unit • Wood Windows • Nu-Style & Multiple-Use Cabinets • Carr-dor Garage Doors • Combination Doors • Screens & Storm Sash
- Basement Unit Windows • Shutters • Exterior Doors • Interior Doors • Entrances • Louvers & Gable Sash • Corner China Cabinets • Ironing Board Cabinets • Mantels • Telephone Cabinets • Stair Parts

manufactured by

**CARR, ADAMS & COLLIER CO.**

Dubuque, Iowa







This house has  
an **ELECTRIC**  
Water Heater!

These Rhodes houses were priced at \$8,900. This builder credits a large part of his success to the electric appliances he includes—not only the electric range, dishwasher and refrigerator, but the *Electric Water Heater*. In houses of any size, anywhere, builders find the *Electric Water Heater* a real selling feature.

Your houses need  
this Selling Feature, too!

“When I sold 45 houses without any effort,” said Mr. Samuel M. Rhodes, Jr., of Media, Pa., “I realized that I must be including some features that were star salesmen. One of them was the *Electric Water Heater*. Customers just naturally take to it.”

Here's why: *Automatic* hot water. Cleanness of operation. Economy of operation, due to short hot water lines and fully insulated tank. Easy installation, because there's no flue or vent . . . the modern water heater for the modern house—of course, it's *Electric!*

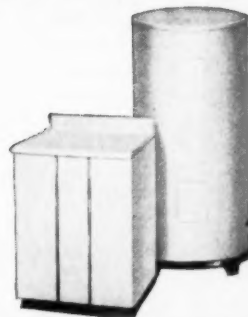

Equip your  
homes  
with

**electric water heaters**

THEY'RE WHAT  
PEOPLE WANT!

ELECTRIC WATER HEATER SECTION  
National Electrical Manufacturers Association  
155 East 44th Street, New York 17, N. Y.

ALLCRAFT • BAUER • CRANE-LINE SELECTRIC • CROSLY • DEEPFREEZE • FAIRBANKS-MORSE  
FRIGIDAIRE • GENERAL ELECTRIC • HOTPOINT • HOTSTREAM • JOHN WOOD  
KELVINATOR • LAWSON • MERTLAND • MONARCH • NORGE • PEMCO • REX • RHEEM  
SEPCO • A. O. SMITH • THERMOGRAY • TOASTMASTER • WESIX • WESTINGHOUSE

FEBRUARY 1953

219

# Place Homes

assure **positive profits** from conventional construction for all builders!



**5 FLOOR PLANS  
17 ELEVATIONS**

More and more builders are turning to Place Homes for *positive profits* with lower overhead . . . lower inventories . . . lower investments. Designed by top architects, Place Homes are planned for contemporary living and modest budgets. Such features as Thermopane Windows throughout, Kitchen Maid Kitchens and Radair Heating plus a selection of two, three and four bedroom plans assure you of distinctive *homes that sell*.

Place Homes are shipped factory-cut with some vital pre-assembly to permit fast on-site construction by proved project methods.

Start saving through Place Homes' volume buying . . . factory-cutting . . . and labor specialization. Start taking advantage of Place Homes' complete program that includes sales and financial assistance. Thousands of homes already built and sold are proof of this fool-proof plan! Send coupon today for full details!

*Place Homes Inc.*

1212 South Walnut Street, South Bend, Indiana

Place Homes, Inc., 1212 S. Walnut St., South Bend, Indiana  
Rush full details on your positive Profit Plan for conventionally built Place Homes.

Name \_\_\_\_\_

Address \_\_\_\_\_

## builders sponsor EXTENSION COURSES

Trade schools teach the mechanics of construction and colleges teach engineering and architecture, but there still remains a big need for a program of instruction designed to help the businessman-builder bridge the gap between trained brains and trained skills.

That's the quick answer Morris L. Blucher, coordinator of building industry courses at City College, New York, gives when asked why his intensified extension courses have proved so popular.

During this time when several colleges and universities have been turning to long-term degree programs in home building, City College's evening and extension divi-



Left to right, Morris Blucher, instructor, Alwin Cassens, Jr., L.I. architect, Walter G. Stackler, president, LIHBI

sion, headed by Dr. Robert A. Love, has conducted four 150-hour classes with capacity enrollment, aided by local home builder co-operation. Evening sessions of three and one-half hours duration were held twice weekly.

What's behind the interest in such a course, considering each student must pay a \$150 tuition in advance plus \$20 or so for books?

Primary value of the course, in Blucher's opinion, lies in its operation at the local level. The class that ended last fall, for example, met in the Hempstead, L.I., high school under the sole sponsorship of the Long Island Home Builders Institute. Local problems as they would be solved by local authorities were presented by the authorities themselves.

Such intensive study is impossible in the usual college building course, Blucher contends, because students there are beginners drawn from sections of the country where local conditions differ, and also because they

must depend more upon regular college instructors rather than leaders in the industry who can instill in the class the exact conditions to be found in the field where they will work.

Blucher estimates that the extension course students, all of whom are engaged in some phase of building or allied industries, are moved three to four years ahead in their work from the point where they would be had they not taken up the study. Employers have come to appreciate the value of the work to

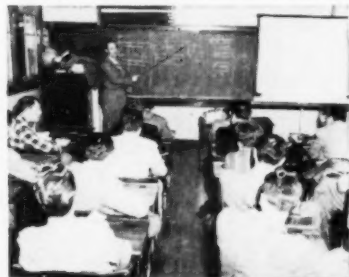

Alwin Cassens, Jr., prominent L.I. architect lecturing on blueprint reading

such an extent, he points out, that they themselves enrolled 75 per cent of the students and paid their tuition in the last class. This class included 22 persons employed by builders, 3 by real estate firms, 4 by engineers and architects, and 3 each by subcontractors, utility contractors, home improvement organizations and financial institutions, plus a few others in related fields.

The course included 26 hours devoted to construction techniques in charge of Emil Keen, Long Island builder who illustrated his lectures with models and conducted his class on a field trip through his own houses during construction and after occupancy. Among other institute members devoting considerable time as lecturers on their specialties were Walter Stackler, job management; Charles M. Jaeger, job estimating; Alwyn Cassens, blueprint reading; Herman H. York, design and layout, and William Clair, law and real estate.

Still other subjects discussed were lumber, building finance, insurance, accounting and taxes, labor relations, heating, plumbing, electricity, land planning and sales promotion.

The course is now being repeated at Hempstead high school under the same conditions, with a capacity enrollment. Earlier classes were sponsored by the New Jersey Home Builders Association, the Home Builders Association of Westchester (N.Y.) and the Long Island group. The Jersey organization is collaborating with Rutgers University in sponsoring another class at Newark.

FEBRUARY 1953



# odor-free air

increases home sales

## specify EMERSON-ELECTRIC KITCHEN VENTILATORS

In this "odor-conscious" age, home buyers look for the equipment that puts kitchen odors in their place . . . outside the home! It's an Emerson-Electric Kitchen Ventilator . . . dependable, economical, easily installed. Specify these ventilators to give your buyers "Odor-free Air" . . . cool, clean air that increases home sales! For complete data, write for Bulletin No. T-118.

The Emerson Electric Mfg. Co., St. Louis 21, Mo.

### Wall Model . . .

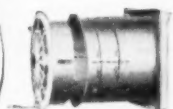

- Telescoping adjustable sleeve fits walls 5 1/4" to 13"
- Square outside frame, easy to brick or frame around
- Special outer door seal gives weather protection
- Induction motor, 10" blade moves 470 c.f.m.

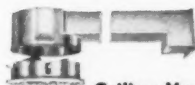

### Ceiling Model . . .

- Adjustable sleeve joint fits standard 3 1/4" x 10" duct
- Outside grille has angle baffles for weather protection
- Automatic shutter closes duct when fan is not operating
- Dependable Emerson-Electric motor equipped with special thrust bearing.

### SPECIFY EMERSON-ELECTRIC ATTIC FANS

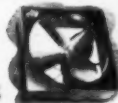

Build cool, summer comfort right into your homes by installing Emerson-Electric Attic Fans! Here is another sales-clincher . . . available in four sizes from 24" to 48". Note: you'll save **half** on installation by installing during original construction.



# Will '53 be like



## New '53 General Electric Builders' Line—

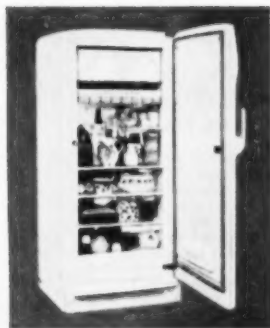

**G-E REFRIGERATORS**

New models provide 20% to 58% more food-storage space per square foot of floor space than comparable older models.



**G-E RANGES**

The new full-sized "Beacon" supplements other low-priced G-E models—a model with special appeal to builders.

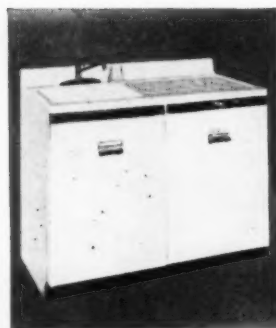

**G-E ELECTRIC SINK-DISHWASHER**

Builders' models basically same as de luxe models, but modified to make them more attractive price-wise.

### New G-E Laundry Equipment, too!

New Automatic Washer and new Automatic Clothes Dryer. Also: Wringer Washers and Toe-Touch Automatic Ironer.

# this for you?

The photograph at the left was snapped one fine Sunday afternoon last Spring, when hundreds of cars swarmed about a model home equipped with a complete G-E Kitchen-Laundry. Within the next few days the development of 47 houses was completely sold.

'53 can be like that for you. And we don't think we're painting an over-optimistic picture, either!

Why? Because all during 1952, and 1951, and 1950—and before that—builders who have installed General Electric Kitchen and Laundry equipment in their houses have reported just such phenom-

enal results as indicated at right.

## Did you know this?

A G-E Kitchen-Laundry can be built right into your \$10,000 or \$12,000 houses—and the monthly cost to the homeowner may be no more than a regular telephone bill because under modern home-financing the cost of these dependable appliances can usually be included right in the regular mortgage.

Start selling your houses faster, just as many other builders are doing from coast to coast. See your local G-E distributor or write to General Electric Company, Louisville 2, Kentucky.



**Sold 114.** Messrs. Rosenberg and Beneson erected 114 houses in Bethel, Conn. and sold the entire development before it was completed.



**Sold 47.** Mr. R. O. Smithson Jr. developed Conant Village near Boston, Mass. and sold 47 General Electric equipped houses within a few days.



**Sold 1,000.** Mr. J. T. Broyhill's firm sold 1,000 houses in the \$10,000 to \$13,905 price class in the Wash., D. C. area within the last few years.

You can put your confidence in—

# GENERAL ELECTRIC

## all matched, all dependable appliances!



**G-E DISPOSALL®**

General Electric is first in the industry with 5-year protection plan. A real sales point in helping to sell houses.

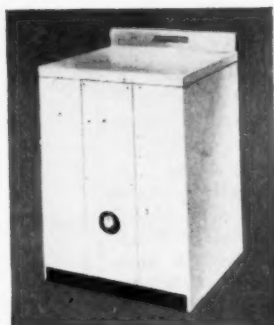

**G-E WATER HEATERS**

All connections located at top of tank to save time and installation costs. Other models up to 82-gal. capacity.

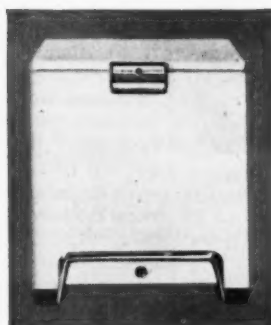

**G-E FOOD FREEZERS**

New 7-cu-ft freezer above occupies only slightly more floor space than 4-cu-ft models. Also: new 14-cu-ft upright.

### New G-E Steel Base and Wall Cabinets

Designed to blend with new matched line of G-E appliances. White baked-on enamel. Rust-resistant steel.

**saw, nail  
and save**

with original

**Alsynite**<sup>®</sup>

TRANSLUCENT FIBER GLASS PANELS

• Alsynite is the ideal translucent architectural material. Shatterproof, feather-light. Can be sawed and nailed, installs like corrugated metal. Economical. Seven colors, corrugated or flat. Use Alsynite anywhere and everywhere for brilliant new effects. See our brochure in Sweet's catalog.



**homes...** for skylights, window walls, patio roofs, awnings, shower stalls, etc. Ideal indoors and out.



**commercial...** for store fronts, office partitions, luminous ceilings, decorative effects, signs.



**industrial...** for unlimited daylighting... skylights, side walls, etc. No framing needed.

**ALSYNITE COMPANY OF AMERICA**

Dept. AB-1, 4670 DeSoto St., San Diego 9, Calif.

Please send me complete information on Alsynite and name of nearest distributor.

Name \_\_\_\_\_

Company \_\_\_\_\_

Address \_\_\_\_\_

City \_\_\_\_\_ State \_\_\_\_\_

Plants in California and Ohio  
Distributors in Principal Cities

**Foresees Free Enterprise  
Backing by New Administration**

Predicting that the new administration will go all out to maintain prosperity and full employment by a "free enterprise" attack on the nation's economic problems Emanuel M. Spiegel, first vice president of the National Association of Home Builders, speaking before the Congress of the Building Contractors Association



**C. J. Wm. Millerburg, retiring president of the Building Contractors Association of California, Inc., and Emanuel M. Spiegel, 1952 first vice president of NAHB**

of California, Inc., challenged the contention of some pessimistic prophets that the recent tremendous expansion of our industrial plant capacity will lead to a recession.

"It seems to me that the new administration will come into power determined that there will be no economic letdown," Spiegel said. "Every sign indicates that Eisenhower and his aides will try every means at their disposal to maintain a high level of prosperity."

In commenting on the business outlook, the speaker predicted that the home building industry will play a major role in maintaining prosperity, as it has done since World War II. He said that construction of 1,000,000 new homes annually is only a "minimum supply," and that "under favorable economic and mortgage conditions" the industry can build and sell 1,500,000 homes a year.

Spiegel's address closely followed remarks made by C. J. Wm. Millerburg, retiring president of BCA during the observance of the 29th Anniversary Congress of the California builders group. Millerburg stated that the need for adequate housing for those now living in substandard units will be met by measures already taken in Los Angeles and the Pasadena plan, proving that private enterprise can do the job better.

NO MAGIC — "WITH THE ABC PROGRAM"

**YOU'LL  
MAKE  
MORE in '53"**

**USE THIS HARD-SELLING WALLOP IN YOUR BUSINESS**  
Why do business the hard way? With the **NEW ABC PLAN** you can sell at nothing down and give 36 months to pay. You add this hard-selling wallop, yet you receive your cash from ABC immediately. Call for complete details.

**BRANCH OFFICES**

- BALTIMORE
- BIRMINGHAM
- BOSTON
- BUFFALO
- CHARLOTTE
- CHICAGO
- CINCINNATI
- CLEVELAND
- COLUMBUS
- CORPUS CHRISTI
- DALLAS
- DAVENPORT
- DENVER
- DES MOINES
- DETROIT
- HOUSTON
- INDIANAPOLIS
- KANSAS CITY
- LOS ANGELES
- MILWAUKEE
- MINNEAPOLIS
- NEW ORLEANS
- OKLAHOMA CITY
- OMAHA
- PHILADELPHIA
- PHOENIX
- PITTSBURGH
- PORTLAND
- ST. LOUIS
- SALT LAKE CITY
- SAN FRANCISCO
- SEATTLE
- SOUTH BEND
- TAMPA
- TOLEDO



Your best sales tool — the ABC Time Sales Program. Ask us today.

**ALLIED  
BUILDING CREDITS  
INC.**

Specialists in Property Improvement and Modernization Sales Financing

General Office: Box 3426 Terminal Annex, Los Angeles 54



WITH **Jiffy**

**SAWHORSE BRACKETS**

- NO NAILS
- NO BOLTS
- NO SCREWS



At Work



At Home



At Church

All welded construction. Use any 2x4s for legs and crossbar.

Set up or knocked down instantly. Easy to move from job to job, and easy to store.

For sale in most hardware and lumber stores. If your dealer cannot supply you, write us direct.

**GRAND HAVEN STAMPED PRODUCTS CO.**  
GRAND HAVEN, MICH.

AMERICAN BUILDER



# Hoe-Boy

**3-4 CUBIC FOOT  
PLASTER-MORTAR  
MIXER**

**MIGHTY  
MIDGET**

OF



**HOE TYPE  
MIXERS**



**CHECK ON MY BIG  
BROTHERS, TOO!**

**6 CU FT  
WONDER DELUXE  
AND SUPER SIX**

**10 CU FT  
MECHANICAL  
HOEMAN**

**LOOK AT THESE  
*Extras* YOU GET  
WITH HOE-BOY!**

- 1** ADJUSTABLE TRIPLE ACTION MIXING HOES
  - 2** SAFETY GRATING AND BAG SPLITTER
  - 3** SELF-ALIGNING-SELF LUBRICATING SHAFT BEARINGS
  - 4** HEAVY-DUTY ELECTRIC WELDED FRAME
  - 5** MACHINE-CUT SPROCKETS-ROLLER CHAIN DRIVE
  - 6** ONLY 29" WIDE-TO GO THROUGH NARROW DOORWAYS
- GAS OR ELECTRIC POWER**

**CONSTRUCTION MACHINERY COMPANIES**

**WATERLOO, IOWA**

**Now... Thermopane FOR ANY PRICED HOME WITH**



## **THERM-O-PANEL\*** *Window System*

**ONE** of the most wanted features in home construction is now available for homes in *any* price range—"Thermopane" glass windows! THERM-O-PANEL Window System makes it possible—and profitable—to incorporate genuine "Thermopane" throughout, even in homes selling for \$10,000 and less!

**9 BASIC UNITS** of standard 45" x 25" glass provide unlimited combinations of fenestration—from shoulder-high horizontal bedroom windows of one, two, three or more panels, to big, modern window walls that are so popular today.

**ANY PANEL VENTILATED.** As many panels as desired may be ventilated by top-hung sash equipped with quality hardware, including roto operators and sill lock. Aluminum frame screens available.

**THERM-O-PANEL** will provide one of your strongest selling points. Write for full details.

## **THERM-O-PANEL**

**BOX 496 • TOLEDO 4, OHIO**

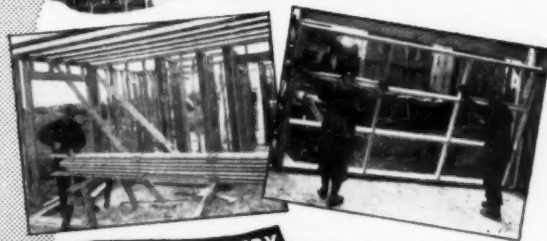

**"PACKAGE" DELIVERY THERM-O-PANEL**

offers all the advantages of prefabrication. Sash of selected kiln dried Ponderosa pine, cut to exact size, all milling operations completed, bundled and shipped in the various units. Wood toxic treated after milling. Easily assembled on the job without cutting or fitting. Saves time, saves labor.

\*TRADE MARK



## Save Valuable Time



Here's how to use your Catalog-Directory

**FIRST**—Leaf through the book from cover to cover and get the general layout in mind. This will enable you to use it sufficiently later on. The 5 Directory Sections are printed on colored stock for easy identification. If you are looking for the answer to a specific building problem, consult the index for the particular Product Reference Section you want. These sections tell you who makes it and how to use it.

### 1. Building Products and Equipment Manufacturers

An alphabetical list of products and equipment listed under appropriate titles. No cross references to delay or confuse you.

### 2. Brand Names

If you know the brand name but not the maker, you can find the name of the manufacturer here.

### 3. Names and Addresses of Manufacturers

This section completes your Buying Guide by listing the principal manufacturers in alphabetical order.

### 4. Industry and Allied Professional Trade Assns.

A valuable addition that saves you a lot of time when you want the name and address, and principal officers of local or national associations.

### 5. List of Participating Communities in 1951 National Home Week

An alphabetical list by states of communities that have taken part and cashed in on the promotional value of National Home Week. Look and see if your community is listed.



If you have a special building problem—write us. Our editors have the knowledge and experience to be of real help to you. Don't hesitate to write. No obligation, of course.

## AMERICAN BUILDER

79 W. MONROE ST.

CHICAGO 3, ILL.

## how to build



The Lake Hotel cabins in various stages of completion. Note how the exterior plan of exposed studding and cross-supports

Yellowstone Park Company recently completed 34 low-cost cabins at Lake Hotel, Yellowstone National Park. They are among 81 planned for this area and Old Faithful Lodge. All are sided with Masonite  $\frac{5}{16}$  inch Tempered Presdwood, applied inside the 2x6 studs, with the smooth side out and the textured side in.

Designed by Fred F. Willson, architect, in collaboration with the construction department of the Yellowstone Park Company, the 13 double units cost \$3,450 each; the 21 cabins, \$2,175 each, including furnishings.

Because of the uniform design, the construction department was able to apply mass production methods to the job. Frame members, plates, studs, rafters and other parts were pre-cut in a centrally-located area at the construction site.



Carpenter is shown nailing a panel into place on a Lake Hotel cabin in Yellowstone National Park. He is nailing to the inside of the framework, so that the smooth side of the Masonite  $\frac{5}{16}$  inch Tempered Presdwood will be exposed. After painting, the textured side of the panel presents the appearance of canvas



## LOW COST cabins



becomes architecturally attractive as well as functional. The cabins are roofed with cedar shingles over wood sheathing

Sheeting for sub-floors was cut on the job. There were no sub-assemblies, and the pre-cut parts were delivered to the cabin sites for fabrication there. The wooden floors were covered with Masonite Underlayment and asphalt tile.

Unusual in exterior appearance because of the exposed framework, the cabins are expected to last for many years due to their sturdy construction. Specified were 4x4 corner posts, 4x6 girders, 2x6 studs and 4x6 door frames. Eight-inch footings were used, 24 inches deep.

In the construction of the single units accommodating three persons, 350 man-hours were required. On the double units for six, the labor time was 725 hours. Respective sizes are 14 feet by 15 feet and 16 feet by 35 feet.

Ceilings and closet walls are Masonite 1/4-inch Panelwood.

Cedar shingles were used over wood sheathing for the roof, with a 4 1/2 inch exposure and every fifth course double.



This view of a double unit cabin shows workmen installing the ceiling—Masonite 1/4" Panelwood, which is reported to be ideal from wearing and economy stand-points for drywall construction

FEBRUARY 1953

## Exclusive *KICK-PROOF* Clutch ...Eliminates Kick-Back 100%

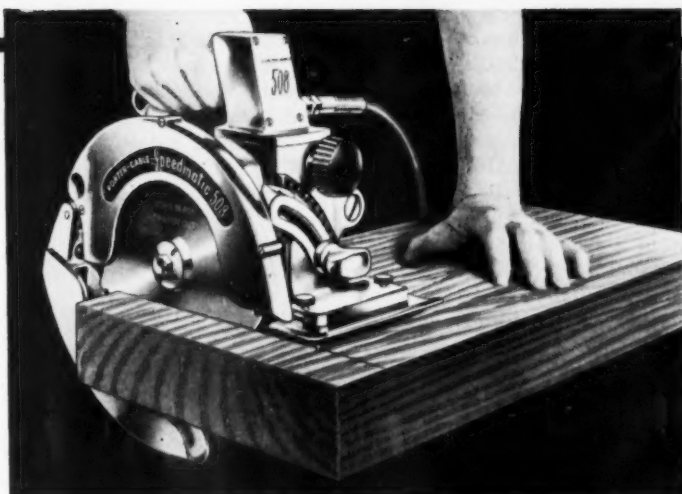

## PORTER-CABLE Electric Saws

No other saw performs like a Porter-Cable! Now—for the first time—you can whiz through lumber, through knots and hard spots, without the slightest danger of the saw kicking back.

This latest "first" by Porter-Cable means easier, safer sawing when you're on a roof, ladder or scaffold. It means longer saw life, less maintenance cost, no more burned-out motors or stripped gears—because the kickproof clutch allows the motor to turn, even though the blade remains stationary. You'll get better work, less scrap—no more gouging caused by bucking.

Visit your Porter-Cable Dealer and get a demonstration of the world's best 100% Kick-Proof Saws. Let him show you how Porter-Cable's exclusive patented Kick-Proof Clutch protects you—your saw—your work.

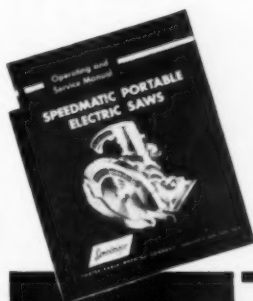

SEND FOR  
*Free*  
OPERATING  
MANUAL

Porter-Cable Machine Co.  
1002 N. Salina Street, Syracuse 8, N. Y.

Please send me your free "Saw Operating and Service Manual" . . . also name and address of nearest Porter-Cable Dealer.

Name

Address

City  State

Manufacturers of Quality Portable Electric Tools  
In Canada write: Strongridge, Ltd., London, Ont.

## New Jersey HBA adopts statewide certification plan

By December 1, 1952, every builder member of the New Jersey Home Builders Association must have applied for certification or his name was to be dropped from the membership rolls.

This startling advance in self-policing of the building industry was announced by Raymond E. Hanly, president of the state organization, at its first fall conference held recently in the Military Park Hotel, Newark. It marked the first time such a radical step had been taken by a statewide building association. According to Hanly, the National Association of Home Builders is "looking over" the program with the possibility that it might consider the movement on a nationwide basis.

At the same time, it was revealed that every certified builder will be bonded, unless he indicates he does not wish to be so covered. Issued by Lloyds of London in the amount of \$100,000 per year, the bond will

serve as an indemnity against "the wrongful misapplication of earnest money or monies that have been given to the builder-member or his agent as a deposit toward the purchase of a home."

The bonding procedure, similar to that introduced last spring by the Chicago Metropolitan Home Builders Association, was recently adopted by the Home Builders Association of Metropolitan New Jersey, one of the eight local associations comprising the state group.

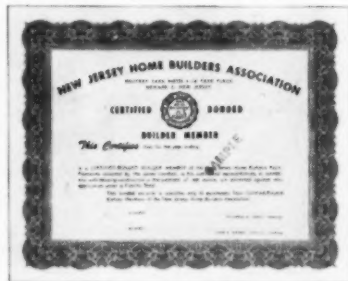

The sign of a certified and bonded New Jersey home builder

The certified builder program is the outgrowth of a convention session last spring, when the state association felt it was compelled to initiate a realistic plan to give home buyers the confidence they deserve in the dependability of its builder members, who number about 475.

Every existing builder member or new applicant for builder membership must fill out an application for certification, giving pertinent information so that he can be judged whether or not he is technically capable and morally satisfactory to represent himself as a New Jersey home builder.

All questions must be answered and an affidavit signed before the application will be submitted to a certification committee of a local association. If found acceptable, after examination and possibly further investigation, the application is passed along to the State Certification Board of the New Jersey Home Builders Association. If approved, the state board will issue to the member a document which

(Continued on page 229)

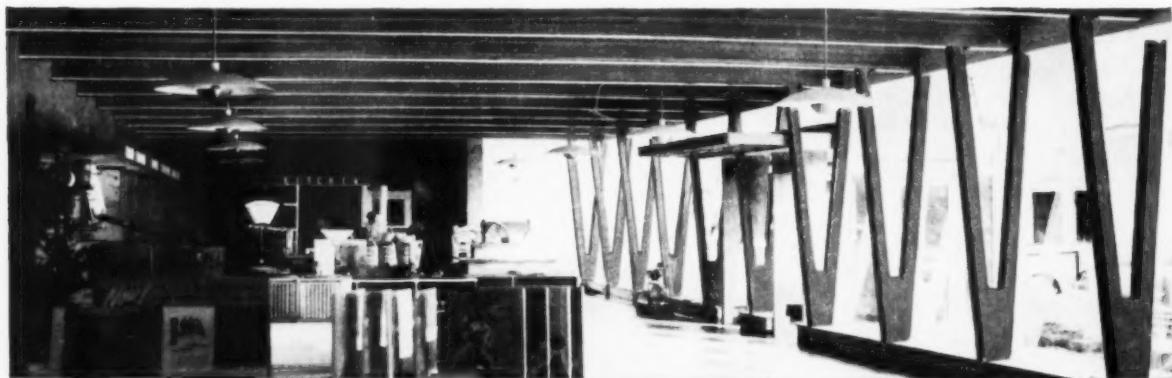

One Job Like This

## Can Bring You Six New Contracts

**THEY'LL** be coming to you for "a building like that" when you finish your first structure with Rilco laminated wood Beams and Columns. Contractors report up to six new jobs resulting from their first Rilco building—in the first two years alone.

Businessmen want Rilco buildings like the one above because the laminated columns are dramatic eye-catchers—inviting because the rich warmth of Rilco beams attract new business. Delighted owners send prospects to you.

Best of all, this goes on for years, since Rilco engineering provides tremendous strength and durability.

See your lumber dealer, or write for full information. Check, too, on Rilco laminated wood trusses, arches and rafters for commercial, industrial and farm building at remarkable savings. They're available *now*—no costly delays.

WORKS WONDERS WITH WOOD

# RILCO

RILCO Laminated PRODUCTS, INC.

2511 First National Bank Building, St. Paul 1, Minn.

**FREE BOOK!**

**LIFE-TIME SECURITY**  
**IN YOUR OWN BUSINESS**



Andy Phillips says: "My BELSAW CIRCULAR SAW SHOP gives me BIG PROFITS

at LOW expense . . . I can run 35 to 40 saws in an 8-hour day . . . That make's me \$40 cash."

You can start this REPEAT CASH business in your own home or garage, while you are working at your regular job. Easy to operate, no experience needed. "Pays for itself from just 65 saw jobs."—Harvey Jensen.

For as little as \$15 down payment, you can get your BELSAW CIRCULAR SAW SHOP rushed to you.

You can make \$4 to \$5 an hour in your SPARE TIME sharpening and setting CIRCULAR SAWS for builders, lumber yards, factories . . . No Extra Equipment needed, no canvassing . . . send postcard for your Free Copy of "Life Time Security" today.

**BELSAW MACHINERY CO**

4503 Field Building Kansas City 11, Mo.

**CASH IN**

on

**RED CEDAR CLOSET LINING**

SEAL-  
 PACKAGED  
 FAST-MOVING

*Nationally  
 Advertised*

**BROWN'S**

**SUPERCEDAR**

Guaranteed 90% Red Heart—100% Oil Content

Our national advertising annually produces thousands of customer inquiries which are turned over to our dealers for follow-up. Here is an active market for cedar closet lining. Brown's SUPERCEDAR is a fast-moving, profitable item and is produced by the largest and oldest experts in the business. Sold only through leading jobbers and millwork distributors.



Write for Builders Folder and Consumer Booklet

PRODUCT OF  
**GEO. C. BROWN & CO., Inc.**  
 GREENSBORO, N. C. Established 1896

LARGEST MANUFACTURERS OF  
 AROMATIC RED CEDAR IN THE WORLD

(Continued from page 228)

certifies to the public that he is:

1. A qualified builder.
2. A builder of moral responsibility and integrity.
3. A member with proven experience in the home building business.
4. A member who has qualified to be certified and bonded.

In cases where an application is rejected by a local committee, the applicant has the right of appeal to the state board. Its decision shall be final.

The local certification committee will accept in writing a complaint from any interested person. Such

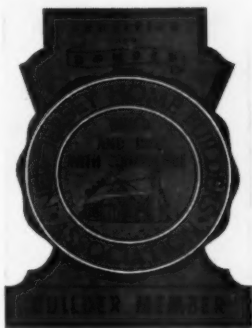

Specimen copy of certificate which the New Jersey Home Builders Association will issue to all certified and bonded builder members

complaints will be investigated and the builder member given a hearing in order that he may have the privilege of defending his position. If a builder member is found to be guilty in a matter of his conduct, business practices or lack of ability, his membership and his certification will be terminated.

Verification of any certified member is available to the public at local or state offices.

This is an annual program. Members must apply each year for renewal of their certificates.

Rep. William B. Widnall of New Jersey, a member of the House Rains Committee which spent considerable time in the state earlier this year investigating construction complaints received by the Veterans Administration, was a guest at the conference banquet where he complimented the builders for "attacking your own problem and trying to solve it."

Pointing out that the job at hand is to create in the minds of prospective purchasers what a builder means

(Continued on page 231)

**Serious strain?**



Yes, it's quite a strain on the cord that weights windows. That's why, in the long run, it pays to use and recommend the best!

**SPOT SASH CORD**



**TOUGH  
 SOLID  
 BRAIDED  
 COTTON**

**WEAR  
 RESISTANT**

**PLIABLE FOR  
 EASY  
 INSTALLATION**

Look for the colored spots, our registered trade-mark, your guarantee of quality. For new installations or replacements, use and recommend wear-resistant, long-lasting Spot Sash Cord.



**Samson**

**CORDAGE WORKS**

BOSTON 10, MASSACHUSETTS

**Which driveway is one year old...  
Which one is five years old?**



**B**OTH driveways are located in the same city, and subject to the same climate conditions. You would expect that the cracked and broken driveway had been built five years ago, and that the one with unbroken paving had been built recently. Actually the reverse is true. The one on the left was constructed five years ago *with American Welded Wire Fabric* reinforcement; the one on the right was built a year ago *without* reinforcement.

Here is dramatic proof in pictures of the value of welded wire fabric. In driveways, foundations, sidewalks, terraces—in any concrete construction which goes into building a house—the proportionately small cost of American Welded Wire Fabric reinforcement pays off big dividends in *long-lasting* service and good looks. American Welded Wire Fabric's small, evenly-spaced steel members bind foundations, walls and floors into a solid unit . . . eliminate the common causes of cracked plaster,

warped floors, sagging baseboards and other damages which detract from the dollar value of a home.

Now, more than ever, prospective home-buyers are demanding real value for their money. That's why the use of American Welded Wire Fabric can do much to assure quicker sales and satisfied buyers. It is easily handled, quickly laid. You can get U·S·S American Welded Wire Fabric in every locality from jobbers' and dealers' stocks.

If you'd like to receive illustrated folders, just drop a line to American Steel & Wire Division, Room 842, Rockefeller Building, Cleveland 13, Ohio.

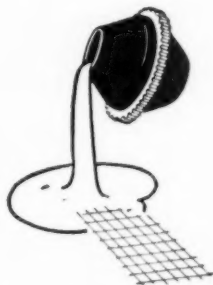

AMERICAN STEEL & WIRE DIVISION, UNITED STATES STEEL CORPORATION, GENERAL OFFICES: CLEVELAND, OHIO  
COLUMBIA-GENEVA STEEL DIVISION, SAN FRANCISCO, PACIFIC COAST DISTRIBUTORS  
TENNESSEE COAL & IRON DIVISION, FAIRFIELD, ALA., SOUTHERN DISTRIBUTORS  
UNITED STATES STEEL EXPORT COMPANY, NEW YORK

**EVERY TYPE OF REINFORCED CONCRETE CONSTRUCTION NEEDS**

**U·S·S AMERICAN WELDED WIRE FABRIC**

**UNITED STATES STEEL**



(Continued from page 229)

to them, he said: "some people think all builders are crooks. We all know this isn't so. But there are exceptions." He urged the builders to continue the program they have launched because, "it will be a fine thing for you as individuals and your organization, ultimately reacting to your own good."

Hanly disclosed the state association is planning an institutional advertising program to tell the story of certification to the public. He predicted the conference date would some day be regarded as a milestone marking a period of steady association growth.

"With what we have done here today," he concluded, "the time is coming when the builder who is not certified is the man who is going to be looked upon askance by the public."

Members of the state association's new certification board include Carl T. Mitnick, NAHB regional vice president; Harold Goodley, Russell Willis, Leo Chmil, Joseph Scullin, John Mahoney, Joseph Fratantonio, Richard Hudson, Edward Crot and John Wright. Hanly and Alex Feinberg, association counsel, are ex officio members.

**TOURIST COURT PLAN BOOK.** 132 pages, 9 inches by 12 inches, Tourist Court Journal. \$17.50

Not once, but several times during the past year the *American Builder* has received requests for information about the planning and building of tourist courts, or as they are frequently called, motels. In answer to those inquiries and as useful information for builders generally, we are glad to be able to recommend a well prepared volume entitled *Tourist Court Plan Book*, published by Tourist Court Journal of Temple, Texas.

By no means, however, is this work just a plan book. True, it contains 52 double-sized pages of tourist court block plans and renderings together with 15 pages of illustrated plan reference sheets, but it also gives the reader much more. Here are clearly written chapters on financing a tourist court, location for a tourist court, heating and cooling, plumbing, lighting, furnishing, landscaping, advertising, tourist court service stations and coffee rooms, tourist court operating averages and information on AAA inspection for listing in guides. All of this data may seem to be aside from the point as far as a builder is concerned, but then it is always helpful to know something about a client's business operation when considering a special project of this kind. The plan ideas alone are worth the price of the book if a building job of this sort is in the offing. The book is well indexed.

FEBRUARY 1953

## GET THE FACTS on the Amazing *Fleettlite* Aluminum WINDOWS



*Beautifully Modern  
Reduces Building Time  
Comes Packaged in Carton*

*Offers NEW LIVING COMFORT  
EASY HOUSEKEEPING*

● Here's the revolutionary new window you've been hearing so much about... the window that builders are applauding... the window home owners are specifying—FLEETLITE Aluminum Windows. They come, packaged and ready for installation, these complete year-round units combine interior and exterior double hung windows in a four-channel extruded aluminum frame. Keep homes warmer in winter and cooler in summer.

When you build—plan for the future, insist on FLEETLITE Windows for the home owners comfort—for the added sales advantage—for protection of resale value. It costs no more to have the best.

FLEETLITE Windows are the most handsome, most practical windows in America. Get the facts for yourself—today.

WRITE TODAY for complete literature on



MADE BY ...

FLEETLITE Windows

TERRITORIES OPEN  
FOR FULL TIME  
FACTORY REPRESENTATIVES

*Fleettlite*  
AMERICA'S finest WINDOW

As advertised in *House Beautiful*, *House and Garden*, *Small Homes Guide*, *American Builder*, *Practical Builder* and *Magazine of Building*.

FLEET OF AMERICA, INC., 112 Pearl Street, Buffalo 2, New York

FLEETLITE double hung windows on each side of FLEETLITE matching picture window.



Double windows weather stripped with pile mohair give most complete protection against winter cold, summer heat or dust storms.



Block rain, adjust air flow for inside pleasure by centering the two middle sash.



Sash easily and quickly removed for washing.

# Serve YOUR CUSTOMERS BEST with...

Thirty years of satisfactory use in homes all over America, plus national advertising in sixteen consumer magazines and plan books have made **HEATFORM** the choice of discriminating home owners as well as leading architects, engineers and builders.

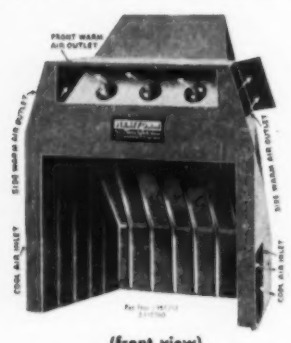

(front view)

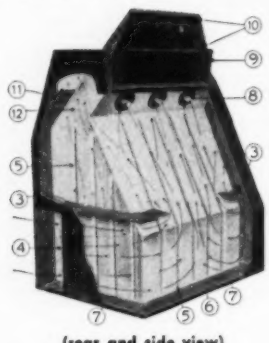

(rear and side view)

### HEATFORM Model "A"

**HEATFORM** is a double-walled, metal unit (hearth to flue) around which anyone can easily build the masonry to complete a fireplace of any design.

**HEATFORM** air chambers, which surround the firebox, front and side walls of the dome, and round air passages across the throat, capture and circulate through the home heat lost up the chimney by the ordinary fireplace.

**HEATFORM** adds but little to the cost of the finished fireplace. It consists of the firebox, throat, smoke dome and properly located damper; thus saving some labor and material.

#### HEATFORM HAS ALL THE GOOD QUALITIES OF OTHER HEAT CIRCULATING UNITS, PLUS ... these exclusive features

- Corrugated reinforced firebox.
- Heating chambers around firebox; also upper front and sides of throat.
- Round air passages across the throat.
- Larger cool-air inlets and warm-air outlets.
- Sloping rear outer lining permitting masonry downdraft shelf to protect the metal from rust.

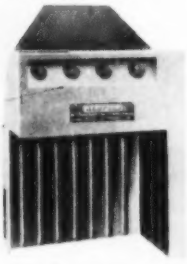

Photo above shows outer lining removed. Arrows demonstrate air circulation through heating chambers and contact of air to all heating surfaces; thus eliminating dead-air pockets. NOTE key below to numbers on photo above:

- (3) Baffle plates direct air to the rear heating chamber over the hottest metal.
- (4) Large air inlets at floor level.
- (5) Corrugated ribs in boiler-plate firebox provide much greater strength than flat metal.
- (6) Location of rear cool-air inlet.
- (7) Bottom view of air heating chambers.
- (8) Superheating air passages through the throat.
- (9) Underslung poker friction control damper.
- (10) Smoke dome guides construction.
- (11) Side air passage to upper heating chamber.
- (12) Inner lining of the throat.

#### HEATFORM Model "S" (at left)

for the modern corner fireplace with right or left side open has all the features of Model "A" plus view of the fire from front and either side. Model "M" (not shown) has front and both sides open for greater view of the fire, otherwise the same as Model "S".

Special fabricated lintel angle bars and corner posts available for Models "S" and "M". Custom-built drap screens and fuel grates are available for all models and sizes of **HEATFORM**.

Write for Complete Information identifying your trade or profession.

OUR EAST AND WEST COAST FACTORIES MAKE HEATFORMS QUICKLY AVAILABLE THROUGH BUILDING SUPPLY AND LUMBER DEALERS EVERYWHERE.

**SUPERIOR FIREPLACE CO.**  
 Dept. AB 531                      Dept. AB 531  
 1708 E. 15th St.                  601 North Point Rd.  
 Los Angeles 21, Calif.          Baltimore 6, Maryland

# report on

## a new building material makes



Plexolite

Daylight brought into a house through a reinforced plastic skylight, in color

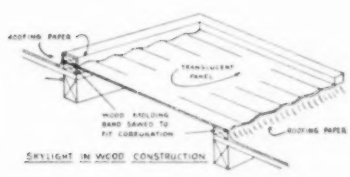

It has been said that the development of "a skylight that can be nailed in place" is one of the wonders of the postwar chemical era. While this judgment may be a little on the side of over-enthusiasm, nevertheless, remarkable progress has been made since the war in the manufacture and use of reinforced plastic material suitable for residential and industrial building.

Often called "glass fiber panels," this important new building material is made of fibrous glass imbedded in polyester resins. Fibrous glass in the proper form has shown strengths in excess of 200,000

# TRANSLUCENT STRUCTURAL PANELS

a strong bid for a big future

pounds per square inch. The polyester resins have high strength at very low temperatures, maintain their properties at temperatures of 250 degrees or higher, and show extreme chemical resistance to nearly all acids, alkalis and organic solvents.

The material produced by combining these resins with fibrous glass is translucent, shatterproof and will stand a lot of beating from wind, snow, hail and other weather conditions. Light in weight, it has the virtue of being easily handled on the job. It can be sawed, drilled,

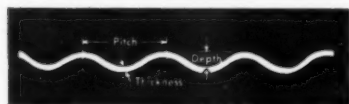

and nailed or bolted in place, and is worked with ordinary tools. It is easily maintained.

Generally made in a thickness of  $\frac{1}{16}$  inch, these panels are available in widths up to 42 inches and lengths up to 12 feet, in corrugated, flat or curved form. The corrugated panels (the most common form) are usually made to correspond with corrugated iron, aluminum and asbestos. Hence, they can be made to nest perfectly with these other materials and do not require framing, flashing or closure strips other than

(Continued on page 234)

# R-W Garage Door Operators

- Convenient
- Practical
- Efficient

For every need—two R-W controls, designed and engineered for smooth sure performance



**No. 1251  
Standard control**  
—operates from drive-side key-switch

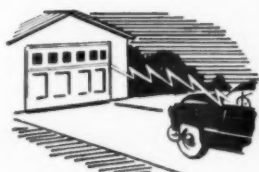

**No. 1504 Radio control**  
—battery operated radio with dash control button opens and closes doors within 75 feet.

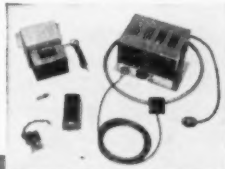

**And . . . R-W 999  
Garage Door Hardware**

Complete overhead garage door hardware conveniently packed in one box! For single doors up to 200 lbs.; double doors up to 375 lbs. Write for folder giving full details.

## Check these important R-W features!



- ✓ **Easy to install**—Completely assembled, including track, in a single carton at the factory.
- ✓ **Easy to service**—Simple adjustments, requiring no special tools, keep the doors working smoothly.
- ✓ **Safe**—A large friction clutch prevents operational failures with resulting damage to property. In power failure, doors may be operated manually.

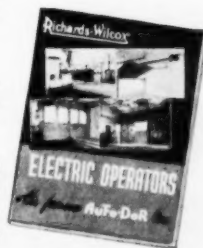

For complete information on R-W AuT-o-DoR line see your nearest dealer or write for catalog number A-87

1880  
RICHARDS  
WILCOX  
Mfg. Co.  
1953  
OVER 73 YEARS

**Richards-Wilcox Mfg. Co.**  
"A HANGER FOR ANY DOOR THAT SLIDES"  
AURORA, ILLINOIS, U. S. A. • Branches in all principal cities

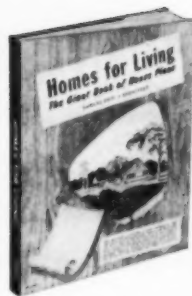

# How This New Book Helps You Build And Sell More Houses

*Homes For Living* makes you a handy, powerful sales tool. Use it as a deluxe illustrated catalog to excite and guide your prospects. With this big book of tested house plans you can show any home-seeker just what he needs to make him decide to start building.

## Homes For Every Income

Here is a wide range of home types for every income:

- 30 Homes for families earning \$3,000-\$5,000
- 25 Homes for families earning \$5,000-\$7,000
- 25 Homes for families earning \$7,000 up

You'll find illustrations and floor plans for homes of all sizes and styles. Dimensions of each room are shown in the floor-plan layouts. Special features of each home are described so that you can readily point out how a particular plan meets your customer's special requirements.

## Homes Of All Types And Sizes

Whether you are asked for a ONE-FLOOR LAYOUT—a SPLIT-LEVEL home—a RANCH STYLE home—or a TWO-STORY home . . . whether the house must have 2 bedrooms or 5 bedrooms . . . a COMPACT design or a plan of GENEROUS room sizes and open living areas . . . you'll find what your customer wants in *Homes For Living*.

## 1/4-inch Blueprints Are Available

All plans are the designs of Samuel Paul, A.I.A., who has designed over 25,000 family units in the past few years. Over \$300,000,000 worth of dwellings ranging from efficiency apartments to luxury mansions have brought to his designs a reputation for maximum livability per construction dollar. The 80 plans in *Homes For Living* have proved by actual sales to be among the most popular of all Mr. Paul's designs. Working blueprints (1/4-inch scale) and outline specifications are available for all 80 plans.

## 5 Days Free Examination

Suppose that in a year's time *Homes For Living* produces just one extra construction job for you. The book will have earned its price and a good deal more besides. \$3.95 is a very modest investment toward the selling of a house. And that minimum of one sale may be next week. Why pass it up? Order your copy of *Homes For Living* right now from the handy coupon below. 5-day Free Trial, if you prefer.

## FREE EXAMINATION ORDER

Simmons-Boardman Books, Dept. 253  
30 Church St., New York 7, N. Y.

I'd like to see if *Homes For Living* can help me sell homes. Send me a copy today. After 5 days trial I'll return it and owe nothing. Or, if I think it's worth having, I'll keep the book and pay just \$3.95 plus a few cents for postage and handling.

Name .....  
Company .....  
Street .....  
City, State .....

**SAVE!** Send \$3.95 with your order and we pay postage and handling. Same 5-day trial privilege.

## translucent structural



Asbestosite

The corrugated panel-windows on either side of the front door (A) let in daylight yet keep the entrance hall private. Trans-

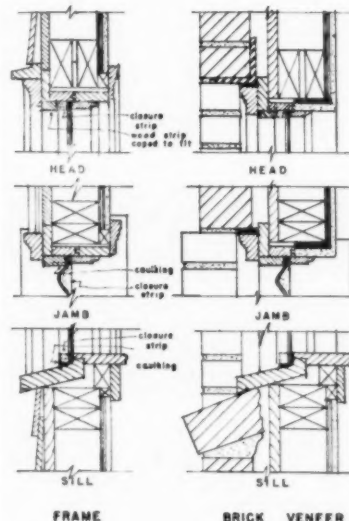

Structoglas

Typical details for installation of the material as windowing

those used normally with metal or asbestos. They also come in corrugations of special pitch, and are complete with various accessories for easy installation.

The important structural feature of the material is, of course, the large loading capacity. Some manufacturers claim loading capacities in excess of 100 pounds per square foot on a 4-foot span. Tensile strengths of 10,000 P.S.I. or more are common and flexural strengths exceed 20,000 P.S.I.

AMERICAN BUILDER



**panels** (Continued from page 233)

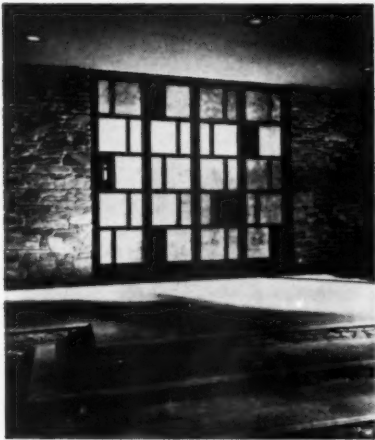

Absynite

lucent plastic panels in flat form (B) replace wooden panels in a front door, dramatize the approach to the house

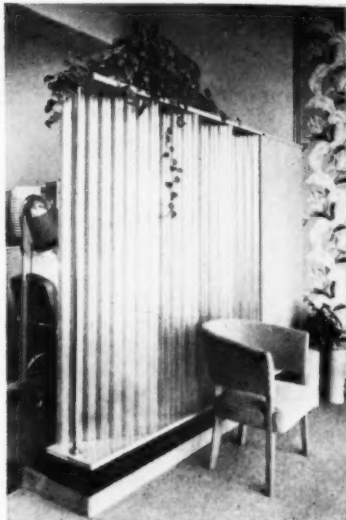

Absynite

Corrugated panel partition blends well with modern decor of beauty salon

The panels' translucent character (some have as much as 90 per cent light transmission) added to the wide range of colors available give the material unusual decorative value.

A quick look at the history of one of the manufacturers of this material—The Corrulux Corp. of Houston, Texas—gives an indication of what is happening. Begun only in 1948, Corrulux is now producing over 3,000,000 square feet of the material annually. A large

(Continued on page 236)

# IMMEDIATE DELIVERY!



See Sweet's



## FREE! New Catalog!

Illustrates and describes complete line of seven Bessler Disappearing Stairway Models to meet all your needs. This new catalog should be in your files for ready reference—write for your copy now!

## Build More Saleable Area into Homes with BESSLER Disappearing Stairways

1. The ORIGINAL disappearing stairway—made for over 40 years.
2. A real stairway—not a ladder.
3. Seven well-engineered models—for every need.
4. Safety-designed in every detail for your protection.
5. Suitable for the finest homes—old and new.
6. Operates from above and below.
7. Full width treads—SAFE for everyone.
8. ALL steps are of equal height.
9. Treads and stringers are made of Sitka Spruce.
10. Full door width provides ample access for large objects.
11. Full length SAFE hand rail.
12. Accurate architectural design assures easy and SAFE ascending and descending.
13. All metal parts are made of strong, SAFE pressed steel.
14. Repairs always available on quick notice for all models—no "orphans."
15. Doors made of White Pine and Fir in two-panel type: flush doors in hardwood only.
16. Tailor-made for all heights—no short or long steps.
17. Proved in performance—hundreds of thousands in constant daily use.
18. IMMEDIATE DELIVERY!
19. Meets all building codes.

The Bessler Disappearing Stairway Co.  
1900 East Market St., Akron 5, Ohio  
**BESSLER—best for over 40 years!**

## WEATHER-BLOC *The Original* Single Unit VENTILATOR For GLASS BLOCK SMALL PANELS



### LOUVER TYPE - ALLWEATHER VENTILATION

- NO SACRIFICE OF BEAUTY OR PRIVACY
- CONTROLLED VENTILATION
- STAINLESS STEEL BODY

WEATHER-BLOC on the outside presents a series of horizontal louvers which blend with glass block and permit ventilation regardless of outside weather and assures absolute privacy no matter where the Weather-Bloc is located. The inside offers finger tip control of ventilation with adjustable louvers. Aluminum screen.

### 3 WEATHER-BLOC MODELS IN STANDARD GLASS BLOCK SIZES

- STANDARD—glass louvers outside and inside
- UTILITY—stainless steel louvers outside, glass louvers inside
- ECONOMY—stainless steel louvers outside and inside. 6 and 8 inch sizes only

#### Purchase through

Your Glass Block Dealer or Distributor  
Also Nationally Distributed By  
**WINCO DISTRIBUTING & MFG. CO., INC.**  
533 Bittner Street, St. Louis 15, Missouri

Patented  
U.S.A.—2565122  
Canada—478095  
Other Patents  
Pending



**GLASS BLOCK DISTRIBUTORS**  
Write and ask about your attractive discounts.

WEATHER-BLOC can be used in existing glass block panels, or can be built into new panel construction as easily as a single glass block.

A Product of AIR RECTIFIERS, Inc. **WEATHER-BLOC**  
3734 NORTH SOUTHPORT AVENUE • CHICAGO 13, ILLINOIS

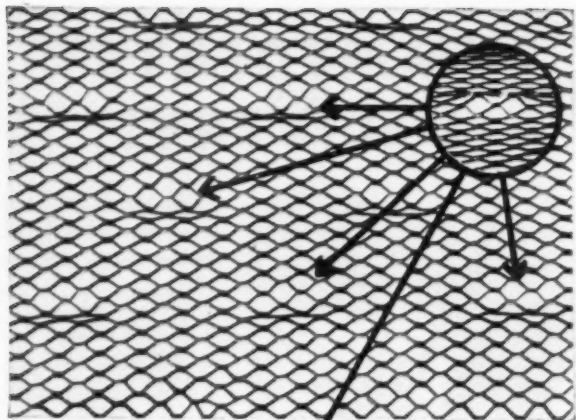

**Bostwick GIVES YOU A DIMPLED (SELF-FURRING) DIAMOND MESH METAL LATH**

ON FLAT SURFACES of brick, wood or steel, Dimpled Lath eliminates furring strips. The dimples placed against a flat surface give good plaster key. The diamond mesh grips all mortar, allowing no waste. The entire operation is quicker—cuts time, labor and material costs.

Before tackling your next job call your dealer for information on Bostwick Dimpled Metal Lath.

**Bostwick** THE BOSTWICK STEEL LATH CO.  
103 HEATON AVE. • NILES, OHIO

**BUILT-IN RADIOS help sell your homes!**

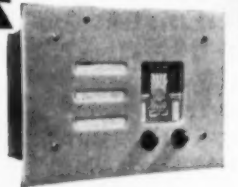

FLUSH-WALL appeals to prospective home buyers—it's novel and saves valuable space.

Easy for builders and electricians to install—fits in standard 4" partition. As easy to install as any electrical receptacle outlet.

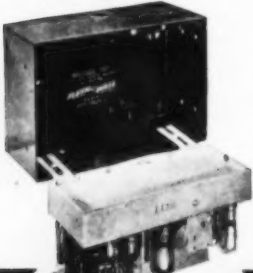

Radio is 5-tube AC-DC Superhetrodyne. Panels to match color scheme of room.

**LOW COST!** Retail price only \$34.95 plus installation. Special trade prices on request. Panels extra: Masonite \$2.45. Plastic colors \$4.45.

Write for descriptive folder and specifications.

Territory franchises available to qualified jobbers and dealers.

**FLUSH WALL RADIO COMPANY**  
Dept. AF3, 1012 Cleveland Street, Clearwater, Florida

**translucent structural**

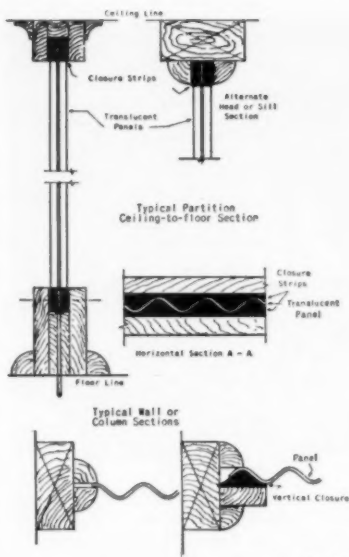

Typical partition details

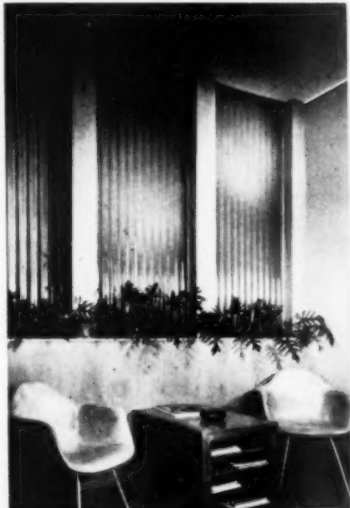

Alsynite and Plexolite

Partition possibilities are endless. The corrugated panels are even suitable for shower walls and doors. Contour moldings for interior installations are available from the manufacturers

portion of it goes into industrial use for skylights in factories, Quonset-type structures, barns and warehouses. But there is a rapidly growing demand for these panels in house construction, where their decorative value comes into its own. Awnings are a big field. Movable screens and partitions of all kinds are now important markets. With an

AMERICAN BUILDER

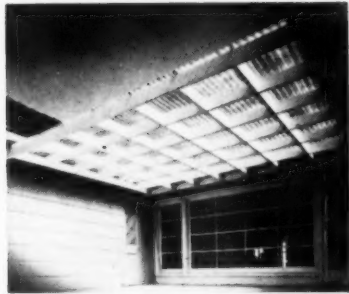

Plexolite

Translucent panels used as roofing to enclose a patio. The material is also much used as a permanent awning for terraces

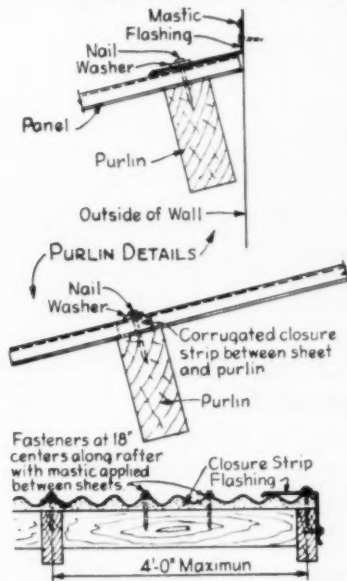

Alsynite  
Details on installation of panels as roofing

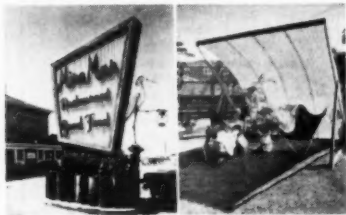

Alsynite

Lighted background for a sign is made of two maize-colored sheets. Lights are placed between them. The material also is useful as a movable sun and wind shelter, and as windbreak strip added to top of fence (in background of photo) alert eye to future trends, Libbey-Owens-Ford Glass Co. recently purchased the Corrulux Corp., made it a division of the company.

(Continued on page 238)

# BIG Money-Maker!

## Atlas 10" SAW

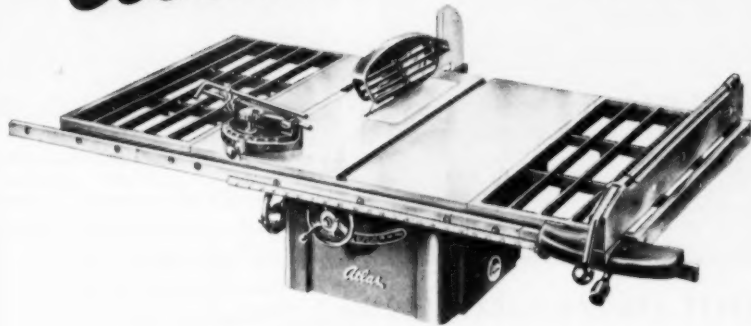

**Saves Costly Minutes Every Day!**

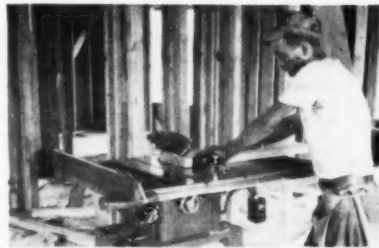

For all around sawing—roughing in *and* outside and inside finishing—you can't beat an Atlas 10" saw. It saves time, money and material on ripping, cross-cutting, dadoing, shaping, and moulding operations.

### 2 Men Can Carry It!

The Atlas is *big*—to handle large boards and panels—yet it's extremely portable. Two men can easily take it into the job.

Every feature for years of dependable accuracy is built into the Atlas—rugged construction throughout, big sealed-for-life ball bearings, tilting arbor, dual V-belt drive, and exclusive patented Atlas rip fence.

### Exclusive ATLAS Features Really Pay Off!

Features like the exclusive patented Atlas fence are great time savers in your work! The fence *lifts off instantly* to change from rip to cross-cutting . . . *slides* to new positions . . . *extends clear across* the table . . . *locks rigidly at both ends*. Has *Vernier control* for fine adjustment!

See all the extra features of this unusual low-cost saw. Send for latest catalog.

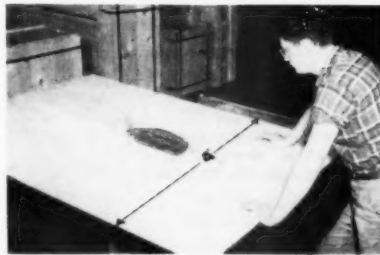

No other saw of comparable price has as big work capacity! Precision-ground table and extensions measure 45½" x 25"! There's 12¾" ahead of the blade, and 24½" between the blade and fence.

**ATLAS PRESS COMPANY**  
201 N. PITCHER ST. • KALAMAZOO, MICH.

*Atlas*

DEPENDABLE QUALITY TOOLS SINCE 1911

**\*Frames set faster—  
Cost of houses reduced**



**SPLIT-SECOND FASTENING  
INTO CONCRETE OR STEEL  
WITH  
*Ramset* JOBMASTER  
SAVES TIME, CUTS COSTS**

Anchoring prefabricated wood frames to concrete sills with RAMSET JOBMASTER saves this builder substantial time on every house, with worthwhile cost reductions. Layout work is faster, and the RAMSET operator can easily locate his anchors exactly where desired.

Just as thousands of users have been saving for six years, you can slash costs and time with RAMSET SYSTEM, pioneer in powder-actuated fastening.

Let us show you, on your own work, the new ease, speed, economy and utility of the JOBMASTER. See the easy loading, one-hand operation, lightning speed, accuracy of positioning and straight, firm penetration which only JOBMASTER can give you. Call your local dealer for demonstration or mail coupon for time-saving, money-saving details.

***Ramset Fasteners, Inc.***  
Ramset Division, Olin Industries, Inc.

12117 BEREA ROAD • CLEVELAND 11, OHIO

RAMSET FASTENERS, INC.,  
12117 Berea Road, Cleveland 11, Ohio  
Please send details and arrange demonstration of JOBMASTER.  
Name \_\_\_\_\_  
Address \_\_\_\_\_  
City \_\_\_\_\_

**translucent structural panels**

(Continued from page 237)

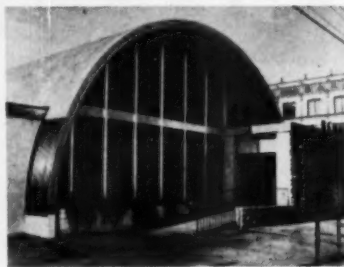

Corrulux

A sidewall of translucent structural panels combined with Texas shellstone and aluminum in an institutional building

**A List of Manufacturers of Translucent Structural Panels**

Alsynite Company of America,  
4654 DeSoto St.,  
San Diego 9, Calif.

Depew Manufacturing Corp.,  
Duffy Ave.,  
Hicksville, Long Island, N. Y.

Fiberlite Corp.,  
604 N. San Vicente Blvd.,  
Los Angeles, Calif.

Fiberpane Corp.,  
Route 1, Box 68,  
Bellevue, Wash.

Hoffman Products, Inc.,  
3788 N. W. 52nd St.,  
Miami, Fla.

International Glass Fibers,  
1870 N. Gay St.,  
Baltimore 13, Maryland

International Molded Plastics, Inc.,  
"Structoglas,"  
4387 W. 35th St.,  
Cleveland 9, Ohio

Alex. H. Kerr & Co., Inc.,  
"Rippolite,"  
3440 Wilshire Blvd.,  
Los Angeles 5, Calif.

Libbey-Owens-Ford Glass Co.,  
Corrulux Division,  
410 Holmes Road,  
Houston 25, Texas

Modern Air Moldings, Inc.,  
220 W. Henrietta St.,  
Baltimore 30, Maryland

Pacific Plastics Co.,  
Renton, Washington

Parker Manufacturing Co.,  
1577 F St.,  
San Diego, Calif.

Plexolite Corporation,  
4223 W. Jefferson Blvd.,  
Los Angeles 16, Calif.

Plymold Company,  
2707 Tulare,  
Burbank, Calif.

Resolite Corporation,  
U. S. Route 19,  
Zellenople, Pa.

Tucker Industries,  
1900 Euclid Ave.  
Cleveland, Ohio



MOISTURE RESISTANCE

**CUPRINOL**  
WOOD PRESERVATIVE

**"The Wood Preservative Plus"**

- Minimizes swelling and Shrinking of doors and floors
- Reduces Grain Raising and Separation Checks in Plywood
- Dries quickly and takes Paint or varnish perfectly
- Non-toxic to handle for On-the-job Application
- Stops Rot and Termites
- Carried by Lumber Dealers

CUPRINOL Division, Darworth Inc.  
56 Maple Street • Simsbury, Conn.

**GET HIGH EARLY  
STRENGTH  
WINTER CONCRETE  
with Standard Cement plus  
Solvay Calcium Chloride**

- Provides Additional Cold Weather Protection
- Permits Positive Control of All Temperatures
- Assures High Ultimate Strength
- Avoids the Need for Special Cement
- Includes "Built-in" Curing
- Lowers Your Costs

To speed up operations and permit use of concrete in shorter time—especially in cold weather—add Solvay Calcium Chloride to your Portland Cement concrete mixes. Works equally well with all Portland Cements, including standard, high early, air entrained and low heat cements. It helps lengthen the pouring day and cuts costly protection time in half. For full details, write to Dept. 34-2 for free book, "The Effects of Calcium Chloride on Portland Cement."

**SOLVAY PROCESS DIVISION**  
ALLIED CHEMICAL & DYE CORPORATION  
61 Broadway, New York 6, N. Y.

When Ordering  
**READY MIXED CONCRETE  
IN COLD WEATHER—**  
Be Sure to Specify  
Concrete with



DEALER  
INQUIRY INVITED

**CALCIUM CHLORIDE**

**EXAMINE  
FREE . . .**

# **Greatest Handbook of Building Facts & Methods Ever Published!**

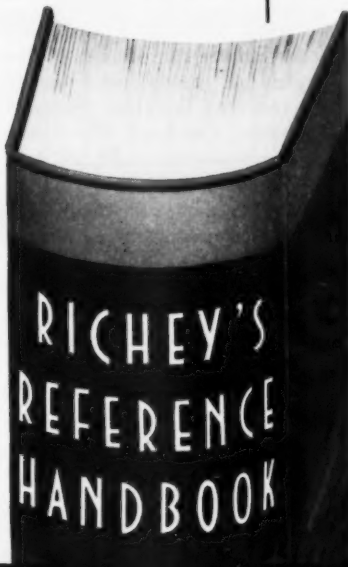

**1,640 Facts • 400  
Tables • 544 Drawings  
500,000 Words!**

**SAVE TIME • SAVE MONEY • AVOID MISTAKES**

**Richey's Reference Handbook**

**for Builders • Carpenters • Architects**

**Engineers • Contractors • Etcetera**

**H**ERE is the greatest collection of drawings, tables, and practical building and construction data ever assembled! You have never seen a book like this before. It is a giant, 1,640 page volume packed with thousands upon thousands of facts, figures, statistics, procedures and illustrations covering the **ENTIRE CONSTRUCTION FIELD!**

No matter what branch of the building profession you're in, this great new book tells you what to use and how to do it. It gives you, not building theory, but up-to-date building **FACTS**. On every kind of construction operation, **RICHEY** tells you in plain language the method or methods that years of experience have proved sound and efficient. **RICHEY** warns you of costly pitfalls you must be careful to avoid . . . guides you in safe, fast, economical building methods . . . helps you select the latest qualities, grades, types, sizes, etc. of building materials for best results.

Whether you're working with wood, concrete, tile, brick, metal or plastic, pipe, glass, wire, etc., or any combination of such materials, you can consult **RICHEY** and—in a matter of minutes—you'll have the facts about which materials will be most economical and best to use along with step-by-step methods for using them. Every page of **RICHEY** is packed with crystal-clear information . . . the book is crammed with thousands of clear detailed drawings and time-saving informative tables and charts.

H. G. Richey, the man who assembled this extraordinary new building guide, has drawn on the experience of 60 years in construction—as carpenter, contractor and builder, architect, including thirty-eight years in the Government service as superintendent of construction, construction engineer, and district engineer, supervising the construction of Federal public buildings, and other works.

We invite you to examine this great handbook at our expense. The coupon below will bring you a copy of **RICHEY'S REFERENCE HANDBOOK** for 10 days' **FREE TRIAL**. Mail it today.

**Packed with Up-to-date  
Building Know-How on:**

Carpentry — Woodworking — Hardware — Wood Fastenings — Timber — Strength of Timber — Life of Timber — Inspection of Lumber — Preservation of Timber — Concrete Forms — Excavating — Testing the Carrying Power of Soil — Natural Foundations — Concrete Piles — Sheet Piling — Driving Piles — Footing Courses — Foundation Walls — Waterproofing — Dampproofing — Selection of Building Stones — Testing Stones for Building Purposes — Stone Masonry — Cut Stonework — Stone Setting — Marble Work — Structural Slate and Glass — Terrazzo — Tile Work — Composition Floors — Bricklaying — Estimating Brickwork — Mortar — Cement — Sand and Aggregate — Superintending Concrete Construction — Fireproofing and Fire Prevention — Curbs and Copings — Cast Iron — Structural Iron and Steel — Tin and Sheet Metal Work — Painting — Plastering — Plumbing — Sewers and Drains — Heating and Ventilation — Hydraulics — Strength and Weight of Materials — Orders of Architecture — Drawing — Laying out Rafters, Hoppers, Curves for Walks, Arches, Circles, etc. — Squares, Cubes, Roots, Mensuration — Engineering Formulas — Electric Wiring — Conduit Systems — Bell Wiring — Elevator Installation — Glass and Glazing — Etc. Etc.

**FREE 10 DAY TRIAL**

Send No Money Now! Simply fill in and mail the coupon at right to get a copy of **RICHEY'S REFERENCE HANDBOOK** for free Examination. Use it for 10 days. If you don't agree it's the greatest construction handbook ever published, return it without cost or obligation.

**MAIL COUPON TODAY!**

**MAIL TODAY**

Simmons-Boardman Books Dept. AB353  
30 Church Street, New York 7, N. Y.

Please send me a copy of **RICHEY'S REFERENCE HANDBOOK** for 10 days' **FREE EXAMINATION**. Within 10 days I will either remit \$9.95 plus postage, or return the book and owe nothing.

Name .....

Address .....

City ..... Zone ..... State .....

**SAVE!** Send \$9.95 with this coupon and we will pay postage. Same return and refund privileges.

only **ONE** easy Adjustment to  
put Men at the Right Height **QUICKLY!**

**"TROUBLE SAVER"  
ADJUSTABLE  
STEEL TRESTLES**

- Your men can do more work because they will spend less time in erecting and moving "Trouble Saver" Steel Trestles.
- Only one, easy, positive adjustment—no tools, triggers or gadgets required.
- "Trouble Savers" are made of carbon steel . . . in eight handy sizes.



Write for literature—giving complete information on all "Trouble Saver" scaffolding accessories.

Manufacturers of  
**"Trouble Savers"® since 1912**

**The Steel Scaffolding Company, Inc.**

856 Humboldt Street Dept. AB Brooklyn 22, New York  
Telephone: EVERgreen 3-5510

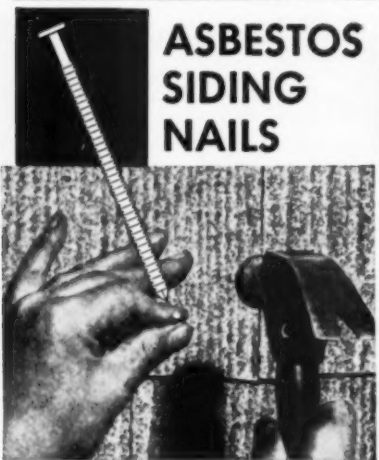

**ASBESTOS  
SIDING  
NAILS**

Hassall threaded asbestos siding nails are the choice of contractors throughout the country. Made of bronze and steel with plated finish. Note threaded shank which guarantees maximum holding power. Made of #14 gauge wire (.082) in 1", 1 1/4", 1 1/2", 1 3/4" lengths. Advise quantities. Prompt shipment.

**JOHN HASSALL, INC.**  
188 Clay Street  
Brooklyn 22, N. Y.  
Established 1850



For faster . . .  
easier . . . better  
tacking . . .

**DUO-FAST** One Hand  
**Automatic Tackers**

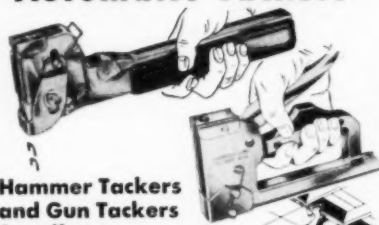

**Hammer Tackers  
and Gun Tackers  
for all your  
Tacking Jobs**

DUO-FAST AUTOMATIC TACKERS are widely used in home construction work, for tacking insulation, building papers, ceiling tile, metal lath. They provide the fastest, easiest, and best way to do the work.

FREE SERVICE—Duo-Fast Tackers are serviced without charge. An important money-saving feature.

Write today for complete information.

**FASTENER CORP.**  
860 FLETCHER ST., CHICAGO 14, ILL.



**how to apply NEW  
GYPSUM PANELS**

New drywall opportunities for the builder can be seen in the new, plain or pre-decorated panels just introduced by The United States Gypsum Company. The material is 16 inches wide, and 8 feet long and is applied over a gypsum board base in new construction. In remodeled construction it can be applied to the existing wall.

For new work a base layer of 3/8-inch gypsum board is nailed to the studs and the panels are applied over it as in double drywall construction. The vertical joints give a panel effect.

In remodeled construction the panels can be installed over existing walls of plaster or wallboard if the walls are in good condition. However, in remodeling care must be taken in the removing of all calcimine, loose paint and wall paper.

The panels are available in plain or pre-decorated knotty pine or neutraltone striated effects. The units are manufactured from standard 3/8 inch thick gypsum board material with a round edge 16 inches wide; 8, 9 and 10 feet long. The pre-decorated types have the knotty pine or striated paper face with a lacquer coating.

The material can reduce costs for the builder as no seam work is needed. Material costs approximate 7 cents per square foot for the plain, 12 cents per square foot for the knotty pine, and 15 cents for the striated panel. The material is intended primarily for sidewalls.

**the following pictures give  
you step-by-step procedure**

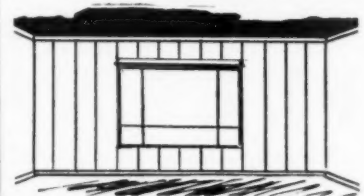

**1 JOB LAYOUT**—Before starting application, plan the layout of the panels. In all cases, joints in the face layer must occur between underlying supports. If a large window, door or fireplace is a wall feature, center the panels or the joints so that as balanced an effect as possible is achieved.

(Continued on page 241)

## how to apply gypsum panels

(Continued from page 240)

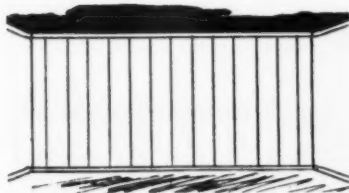

**2 JOB LAYOUT**—If the wall does not have an opening to feature, arrange the panels so that the two end panels are approximately the same width.



**3 ARRANGING YOUR WORK**—Remove all wrappings from the gypsum panel bundles. Place each piece face down in a neat pile. Saw horses are suggested for convenience. The material may, however, be piled on the floor. Material should be assembled in the center of the room to permit easy access to all wall areas.



**4 MIXING CEMENT**—Use a clean metal container such as a five gallon paint pail. Pour the exact amount of water required into the pail—approximately 22 pints for 25 pounds of cement. Stir vigorously until contents are thoroughly mixed and relatively lump free. Additional cement or water may be added to give a smooth, flowing material. Mix only enough material for one day's usage. Estimate 60 pounds of Perf-A-Tape cement per thousand square feet of wall.

(Continued on page 243)

FEBRUARY 1953



## "MODERNFOLD" doors really make houses more salable

—SAYS BUILDER CLARENCE E. FLETCHER

Clarence E. Fletcher of La Habra, California, built his Hacienda La Habra development with a family's future in mind. For instance, as shown here, he uses a large "Modernfold" door to build a nursery right into the large Master Bedroom.

"People like the good looks, the smart colors and easy sliding action of the doors," he writes. "But they are much impressed by the added convenience, privacy and double utility which the doors impart to any room in which they are installed."

You'll be impressed, too—by the way these steel-framed, vinyl-coated folding doors save both labor and materials. They go up in a hurry—complete. No fitting, painting, hardware or cornices needed.

For full details check our distributor—listed under "doors" in your classified directory. Or clip coupon.

Many builders use "Modernfold" rolling post doors to provide roomy, easily accessible closets without sacrificing valuable floor and wall space to door swing—a big sales feature in small homes.

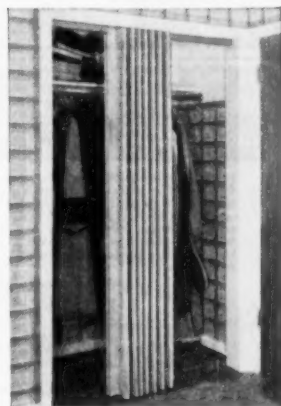

### SOLD AND SERVICED NATIONALLY

NEW CASTLE PRODUCTS  
NEW CASTLE, INDIANA

In Canada: Modernfold Doors  
1315 Greene Avenue, Montreal

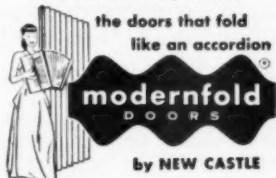

COPYRIGHTED NEW CASTLE PRODUCTS 1953

New Castle Products  
P. O. Box 500  
New Castle, Indiana

Please send me full details on "Modernfold" doors.

Name.....

Address.....

City.....County.....State.....

THE WORLD'S FINEST  
**"LAYTITE" Maple Birch FLOORING**

Blocks, Continuous or Regular Strip, and Slats

Forest Products Since 1872

**CONNOR LUMBER AND LAND COMPANY**

P. O. BOX 112-D, MARSHFIELD, WIS. — PHONE No. 3 — TELETYPE No. 26

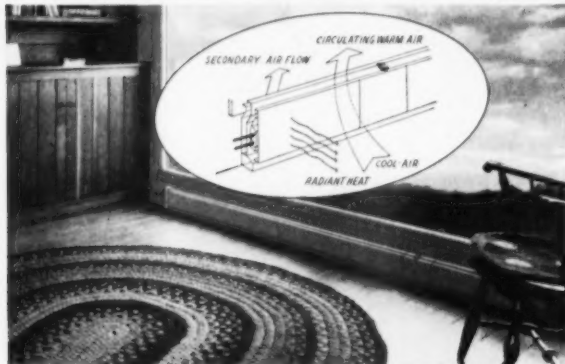

**NEW LUXURY HEATING NOW COSTS LESS**

New lower cost of Wesix Automatic Electric Baseboard Panels plus new simplified installations means you can equip your homes with perfect, modern perimeter heating at a fraction of former cost.

Ideal for homes with "picture" windows or rambling style, Wesix Baseboard Panels can be installed as total house heating (economical, too, wherever electric power "end rate" is 2c per KWH or below) alone or combined with famous Wesix Wall Furnaces or as auxiliary aid to central furnace systems.

Send your next set of plans and insulation specifications to your nearest Wesix office for free engineering recommendations and operating cost data.



**WESIX ELECTRIC HEATER CO.** Dept. AB-2  
 390 FIRST STREET, SAN FRANCISCO, CALIF.  
 Seattle · Portland · Los Angeles · Detroit  
 Chicago · Dallas · Huntsville, Ala.

**\*2 Quik-Way FURRING CLIPS**

*Cut your FURRING COSTS 30 to 50%*

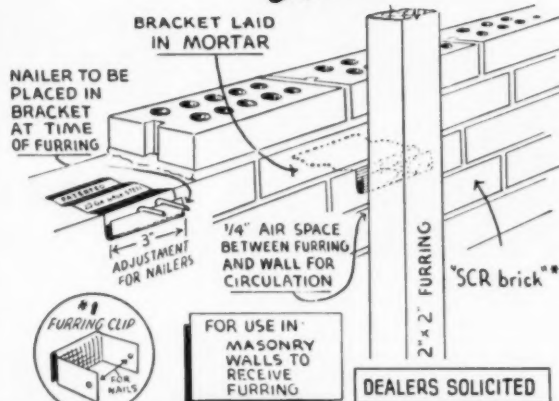

Available from your "SCR Brick" manufacturer, building material dealers or write:

**PETERSON PRODUCTS COMPANY**

P.O. BOX 462 JAMESVILLE, WISCONSIN

\* BLDG. STRUCTURAL CLAY PRODUCTS RESEARCH FOUNDATION PAT. PEND.

3/4 INCH WIDE WHITE BLADE  
**MEASURES 10 FEET UP**  
*without buckling!*

Handy for all your measuring, the new **BIG CHIEF** is especially designed for extended overhead and reach-in measurements. The extra rigid 3/4-inch wide blade extends farther horizontally, and a full 10 feet overhead without buckling. Easy-to-read white blade is graduated in feet and inches.



**EXTRA RIGIDITY**

- with these famous CARLSSON features
- Double graduations feet and inches
  - Ten second blade change
  - Easy-action swing-tip
  - Easy-to-read crackproof white face
  - Built-in automatic brake

**AT YOUR HARDWARE DEALER TODAY**

Produced under patents 2089209, 2510939

**CARLSSON & SULLIVAN, INC.**  
 MONROVIA, CALIFORNIA



**78" Aluminum LEVEL \$14<sup>85</sup>**

For setting door jambs and window frames! No other like it. 4 Plumbs, 2 LEVELS. Use either end or edge up. Weighs only 4 1/4 lbs. I-Beam type—non-warp. Direct from factory. Patented.

**NO FACTORY REPAIRS NEEDED**

Spirit tube-holder (50¢) replaced in a minute with an ordinary screw-driver. New design has double-grip—locks positively in position. 72" Level—\$14.35. Levels express paid—Cash with order.

**SIMPLEX LEVEL CO., INC.**  
 4919 Cadillac Blvd. Detroit 14, Michigan

**Spread - Easy CEMENT and TAPE APPLICATOR**

**FOR TAPING WALLBOARD SEAMS**

Needs only to be loaded with cement and tape, threaded, and it's ready to save hours of time. Applies cement and tape both at the same time. Complete with fittings for

inside and outside vertical corners, vertical wall seams and horizontal ceiling seams. Light in weight. Made of galvanized iron. \$26.50 each, postpaid.

**DEBS DECORATORS Old Middleton Road, Madison 5, Wis.**



## how to apply gypsum panels

(Continued from page 241)

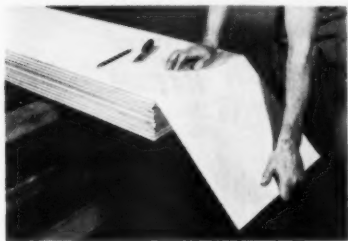

**5 CUTTING**—Using a sharp knife, cut the face paper and edges, and snap the boards as shown, breaking the core. From the reverse side, cut the back paper and snap forward for a clean break. Extra pressure on the knife is necessary in cutting the paper on knotty pine and striated gypsum panel wallboard.



**6 SPREADING CEMENT**—Full panel—Place the USG three notch spreader at the end of the top piece of gypsum panels. Fill about half full of mixed Perfa-Tape cement. Using the little finger for a guide on the edges, draw the spreader blade to within 12 inches of the other end of the panel, leaving three sharp, firm ridges of cement.

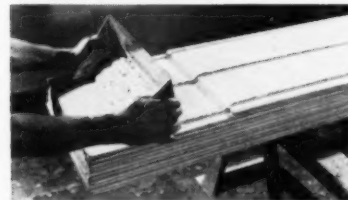

**7 CARRYING CEMENT** from Panel to Panel—Without moving the spreader, shove the top board forward approximately 10 inches. Then continue spreading cement on the top board over the end onto the underlying board as shown. The top panel is now ready to apply. To spread cement on next panel, reverse the direction of the spreader and continue.



**8 SPREADING CEMENT**—Narrow Panel—the USG one-notch spreader is used in a similar manner for gypsum panels narrower than 16 inches. One ribbon of cement is sufficient on sizes up to six inches, but two ribbons should be applied on all gypsum wallboard panels from seven inches up to 10 inches in width.

(Continued on page 245)

## This Shower Cabinet was Caught with its Paint Down...



and the man who specified, sold and installed it is seriously embarrassed. Now, *only eighteen months after installation*, it's a rusty hulk. A dangerous, unsanitary eyesore that no longer is fit for the purpose intended.

Sooner or later this *always* happens to black steel cabinets, those called "bonderized" or those that merely get a temporary "flash" coating of zinc. They cannot stand up in service because they are not protected against rust... every nick or scratch becomes a rust spot.

Specifying or installing a sub-standard shower cabinet is as dangerous a gamble as installing *black iron pipe and valves in a water system*. No reputable contractor would knowingly do either. Assuming that the piping and installation cost is double the cost of the shower, it is easy to see that slight savings on the shower cost are unimportant in the total sale... and a bad gamble when you may be requested to replace a sub-standard shower.

**DON'T BE FOOLED**—"bonderized" alone is not enough... for your own protection, insist that the Shower Cabinets you sell and install have walls of bonderized, galvanized steel. *There is no substitute!* **Unlike most low-priced Shower Cabinets—even Fiat's lowest priced cabinets meet these minimum standards.**

### Minimum standards for satisfactory shower cabinet service:

- 1** WALLS of bonderized, galvanized steel of adequate thickness finished with an alkali-resistant two-coat synthetic enamel baked-on.
- 2** RECEPTOR must provide an absolute rust-proofed surface such as pre-cast concrete, terrazzo or rigid porcelain enameled steel.
- 3** CABINET engineered to be permanently leakproof, sturdy and precision built to assure quick and easy assembly.
- 4** BRASS goods of recognized high quality manufacture with quality finish.

## FIAT METAL MANUFACTURING COMPANY

THREE COMPLETE PLANTS—ECONOMY • CONVENIENCE • SERVICE



Long Island City 1,  
New York



Franklin Park, Ill.  
(Chicago suburb)



Los Angeles 63,  
California

In Canada: Fiat Products are made by Porcelain and Metal Products, Ltd., Orillia, Ontario



GENERAL L-K MODEL R-520



GENERAL MODEL RS-1004

**SAVE DOLLARS... SAVE SPACE with the NEW General Kitchens**

**A COMPLETE KITCHEN: REFRIGERATOR, COOKING-TOP, SINK**  
Has horizontal freezer, 9 ice-cube trays, inner door shelf. In 27½" combines refrigerator, sink, storage drawer and 3 gas burners adjustable to natural or bottled gas. Also available with electric burners for 220 v. or 110 v.

**COOK ON YOUR REFRIGERATOR.** General Chef—now is standard 36" height. Requires only 4.1 sq. ft. of space.

These units advertised in **LIFE**



**5 YR. GUARANTEE**

Distributors — Dealers — Builders — write:

4526-A E. Dunham St. • Los Angeles 23, Calif.  
New York: Dept. 3, Suite 543, 11 W. 42nd St.  
Chicago Office: Dept. 15, 323 W. Polk St.



for the **extra beauty**  
of the whitest white cement  
Use—  
**Trinity White**

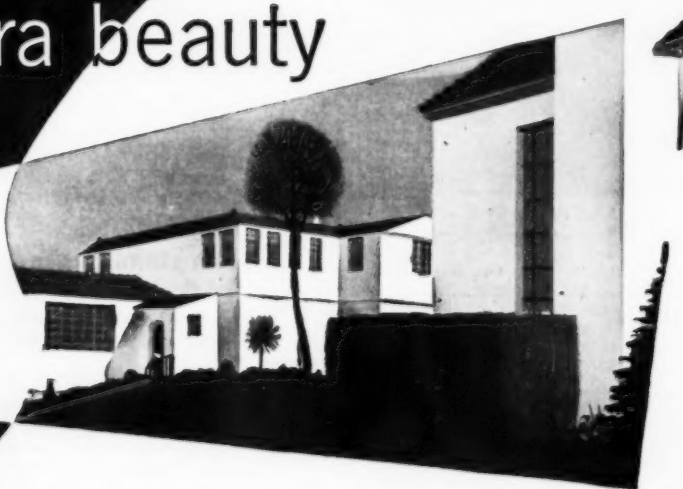

For the *whitest* white cement ask for Trinity White. It is a true portland cement made from selected raw materials. You'll get fine results with it. General Portland Cement Co., 111 W. Monroe St., Chicago; Republic Bank Bldg., Dallas; 816 W. 5th St., Los Angeles; 305 Morgan St., Tampa; Volunteer Bldg., Chattanooga.

as white  as snow

## how to apply gypsum panels

(Continued from page 243)



**9 SPREADING CEMENT**—Panels with Cutouts—Above is shown how cement is spread on a full size panel cut for fitting around a window opening. The board has been cut to fit, the cut-out piece replaced, the cement spread and then the cut out removed as shown. Electrical outlets are handled similarly.



**10 APPLYING FIRST BOARD**—Having determined the layout and corresponding width of first panel, start the wall application by placing the first panel at a corner. Plumb the first board with a carpenter's level as shown. Press the board *lightly* against the surface to assure even adhesion.



**11 HOLDING PANELS TIGHT** to Ceiling—Where it is necessary to hold the top edge of the panel tightly against the ceiling, a 4d common nail can be used as shown. It should be driven as close to the ceiling as necessary, and is later covered by trim.



**12 TIGHTENING JOINTS**—It is important that the panels are in close contact with each other to assure tight  
(Continued on page 247)

FEBRUARY 1953



Architect: Roche & Roche, New York

## This wall decorates two rooms

Instead of wondering how to decorate a wall, what about this . . .

Let the wall itself decorate the room. Build it with a few panes of patterned glass and a simple wood frame.

There you are—a translucent partition that decorates *two* rooms. It ap-

peals to people's desire to be different. That means a quick nod of approval when they see this idea in your houses.

Blue Ridge Patterned Glass lets light pass from room to room. That helps brighten rooms with windows on one or two sides. A wonderful answer to the dark hall problem.

The beautiful Blue Ridge patterns give light, but with privacy. You can suit your decorating scheme by choosing from linear, checkered or over-all patterns—in plain, textured or *Satinol*\* finish. Your L·O·F Distributor or Dealer can show you samples. And mail the coupon for our book of decorating ideas. ®

**BOOK OF 42 DECORATING IDEAS.** "New Adventures in Decorating" shows how leading architects and decorators have used this lovely glass to add light and distinction to home interiors. Send coupon for free copy.



Libbey-Owens-Ford Glass Company  
Patterned & Wire Glass Sales  
B-123 Nicholas Building, Toledo 3, Ohio

Please send me my free copy of "New Adventures in Decorating".

Name (please print) \_\_\_\_\_

Address \_\_\_\_\_

City \_\_\_\_\_ State \_\_\_\_\_



**BLUE RIDGE**  
**Patterned GLASS**



Save Time and Money . . . Avoid Mistakes . . . Use

# SIMPLIFIED CARPENTRY ESTIMATING

HERE IS EVERYTHING YOU NEED to know to "take off" a bill of materials from set of plans and specifications for a frame house. Saves you time figuring jobs, protects you against oversights or mistakes that waste materials and cost money. Nothing complicated—just use simple arithmetic to do house carpentry estimating with this easy-to-use ready reference handbook.

**CONTENTS:** Estimating Fundamentals. Foundation Material. Framing. Exterior Finish. Hardware. Building Information. Estimating Short Cuts. Labor Hours per Unit of Work. Carpentry Mensuration. Mathematical Reference Tables. Stair Estimating. How to Plan a House.

1950. 5th Ed. 304 p. 123 illus. 60 tables. 5x8. \$3.75

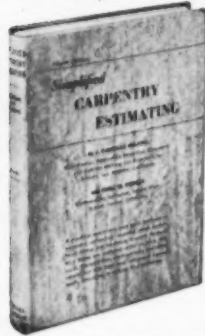

**FREE EXAMINATION COUPON**  
 Simmons-Boardman Books, Dept. AB353  
 30 Church St., New York 7, N.Y.

Please send me a copy of *Simplified Carpentry Estimating*. If after 5 days trial I am not fully satisfied, I'll return it and owe nothing. Otherwise I'll keep the book and send \$3.75 plus a few cents for postage and handling in full payment.

Name .....

Street .....

City ..... State .....

**SAVE.** Send \$3.75 with your order. We pay postage, handling. Same trial terms.



FASTER THAN \$100 ENGINEER INSTRUMENTS!  
 Packed in husky carrying case 12 x 11 3/4 x 3 1/4"



**UP TO 30 FEET OR MORE**  
**LEVELALL**

THE NEW, IMPROVED WATER LEVEL  
 FOR SIMPLEST ONE-MAN OPERATION

LEVELALL, 83C Webster St., Rockland, Mass.  
 Mail me ..... Levelall instruments at \$ 8.95  
 Mail me ..... DeLuxe Levelall at \$12.95  
 you guarantee satisfaction or money back upon return of Levelall within ten days.

Name .....

Address .....

City ..... Zone ..... State .....

Send C.O.D. I will pay postman full purchase price plus delivery charge on arrival.  
 Full purchase price is enclosed. Send postpaid. (Postage prepaid on orders in U.S.A. only).

**FOOTINGS FOUNDATIONS GRADINGS**  
 Anything you need level LEVELALL does it

**LEVELALL**  
 83C Webster Street  
 Rockland, Mass.  
 Dealer inquiries invited



## Make \$20 to \$30 a Week Extra FILING SAWS

Turn your spare time into CASH—sharpening saws with a Foley Automatic Saw Filer pays up to \$3 or \$4 an hour. Start in your basement or garage—no experience necessary. "The first saw I sharpened with my Foley Filer came out 100%," writes Clarence E. Parsons. No canvassing—"I advertised in our local paper and got in '98 saws"—says M. L. Thompson. With a Foley you can file all hand saws, also hand and cross-cut circular saws.

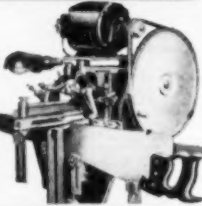

**FREE BOOK—"Money Making Facts"** shows how you can get business from home-owners, farmers, carpenters, schools, factories, etc. Send coupon for Free Book—no salesman will call.

**FOLEY MFG. CO., 236-3 Foley Bldg., Minneapolis 18, Minn.**  
 Send **FREE BOOK "Money Making Facts"**

Name .....

Address .....

# Let us send you this book of HOME BUILDERS SHORT-CUTS

for **FREE** five-day trial

More than 800 "practical job pointers" that save time, expense and labor on building jobs.

Now! Carpentry, building construction and building repair jobs are made easier with the practical methods shown in this big 211-page book. Every one of these methods has been **TESTED** in actual use; every one saves time, saves work, saves money.

**Contents include:** 68 handy ways to use tools; 37 ideas for work benches and attachments; 62 work-saving ways to use portable equipment; 39 suggestions on excavations, foundations and forms; 32 methods for making sills, girders, joists and sub-flooring; 49 hints on exterior and interior wall construction; 36 short-cuts in roof and bay construction; 19 tips on making cornices and porches; 54 ideas for interior wall covering and trim; 27 helps on stair construction; 37 window suggestions; 54 ideas for installing doors; 29 tips on closets, shelves and built-in equipment; 24 flooring pointers; 35 aids in installing sanitary equipment; 44 short-cuts in laying out work; etc., etc. More than 700 illustrations show you exactly "how-to-do-it." All items indexed so that any particular idea or short-cut you want can be located instantly.



### DO YOU KNOW HOW TO

- Raise a sagging beam without using a jack?
  - Repair a sunken floor board without ripping out the entire floor?
  - Scribe and fit boards to an irregular surface?
  - Replace broken asbestos shingles?
  - Repair worn door hinges?
  - Lay a wood floor over a concrete base?
  - Fit door casing to a wall surface out of plumb?
  - Make sagless garage door?
  - Make a septic tank grease trap?
  - Put pipe into a partition already plastered?
  - Apply corner moulding to wallboard?
  - Quick answers on these and HUNDREDS OF OTHER building problems are at your fingertips in "Practical Job Pointers."
- Mail coupon below for your copy today.**

### SEND NO MONEY

Examine 5 Days **FREE**  
 Just fill in and mail coupon below to get practical Job Pointers" for 5 **DAYS FREE TRIAL.** If not fully satisfied, return the book and owe nothing. If you keep it, send only \$4.50 plus few cents postage in full payment. You take no risk, Mail coupon below, now.

### FREE TRIAL COUPON MAIL TODAY

Simmons-Boardman Publishing Corp., 1-53  
 30 Church St., New York 7, N. Y.

Send me for 5 **DAYS FREE TRIAL**, "Practical Job Pointers." I will either return it in 5 days and owe nothing, or send only \$4.50 (plus shipping charges) in full payment.

Name .....

Address .....

City ..... State .....

## how to apply gypsum panels

(Continued from page 245)

joints. This may be assured by using a 2x4 to impact the leading edge as shown above. The leading edges should be checked with a carpenter's level every three panels to be sure they are plumb.

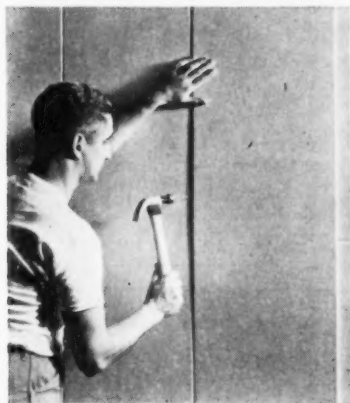

**13 LEVELING UP the Surface**—Within 15 minutes after panels have been applied, surfaces of all adjoining panels except the last two applied should be leveled by impacting the joints gently with the width of a 2x4. Over uneven surfaces it may be necessary to temporarily nail an edge in position with a 4d finishing nail as shown above.

### SURFACE PREPARATION

**Suitable Surfaces**—Gypsum panels are designed to be applied over new or old surfaces of gypsum wallboard or plaster, not for direct attachment to studs.

**New Construction**—Gypsum panels are applied over a base layer of regular 3/8-inch gypsum board erected horizontally. Base layer is applied directly over wood studs or wood furring strips 16 inches o.c. Framing must be in true alignment before base layer is applied.

Erect base layer using 4d common nails located not less than 3/8 inch from edges and ends of boards and spaced eight inches apart along the supports. Top wall panel is applied first and butted against ceiling. Over openings, end joints should be centered on studs. End joints should be staggered.

**Refinishing**—Trim at ceiling, base, doors, windows, etc. must generally be removed. Where panels are to be applied over existing gypsum wallboard or plastered surfaces, all wall paper, calcimine and loose paint must be removed. Where surfaces are textured in a medium to coarse pattern, high points must be taken off.

Use of gypsum panels is not recommended over textured areas having patterns so coarse as to prevent reasonable continuity of contact between the adhesive ribbons and the wall surface. Plastered surfaces must be reasonably sound and true.

Photos and data courtesy of United States Gypsum

FEBRUARY 1953

*One American Super 8  
does work of Two  
Standard Sanders!*



American Sustaining Device provides variable control of drum pressure to meet all conditions in floors.



Single adjustment quickly changes drum speed . . . range 1600 to 2800 r.p.m.



Powerful 2 P.H. motor starts under a "no load" condition due to automatic take-up of motor pulley.



### SAVE LABOR . . . INCREASE PROFITS!

Working side by side on a job—this great American Super 8 walks right away from standard sanders! It cuts nearly *twice as fast*—and that means nearly *double your production!*

Figure your savings in *time and labor* when you switch to the American Super 8. One Super 8 instead of *two* standard machines. *One* worker instead of *two*. More speed . . . more profit on every job for you! Compare the many "plus" features of American Super 8. You'll find it "tops" for high production . . . low upkeep . . . and long-life dependability.

### NATION-WIDE SERVICE

Your nearby American Distributor—in principal cities—has factory-trained men to make repairs *pronto* when needed! This keeps your sanders producing maximum profits for you. R. E. Shuler, Memphis area distributor, serves floormen from this modern headquarters.

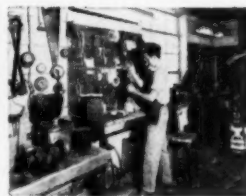

## AMERICAN

FLOOR MACHINES • PORTABLE TOOLS

The American Floor Surfacing Machine Co.  
511 So. St. Clair St., Toledo 3, Ohio.

Please send latest catalog on the following, without obligation:

- Floor Sanders       Floor Edgers  
 Floor Finishes     Abrasive Paper  
 Floor Maintenance Machines

Name.....  
Street.....  
City.....State.....



**50 YEARS OF PROGRESS**  
Famous American Machines are all engineered, manufactured, sold and serviced by American!

SEND COUPON TODAY!

## bought in a package

This attractive design is making life lively for builder S. J. Langoe of Portland, Ore. Langoe built houses in the conventional way for years, recently switched to project work using packaged materials and designs from West Coast Mills in Chehalis, Wash. Langoe is building 35 of these houses on a tract in Oswego, Ore.

He states that packaged materials save him from \$500 to \$700 a house (on a three-bedroom, 855 square foot model). He estimates his carpenter labor at about \$500 to \$550 a house. Eight carpenters and two laborers carried 13 houses from foundation to completion in 60 days.

Foundations, floor joists and subfloors are installed in the usual way. The package contains all framing lumber. Exterior walls come in sections 12 to 24 feet in length completely framed and sheathed with exterior finish applied. They weigh from 300 to 900 pounds and Langoe uses a small crane to put them in place, rental of which costs him \$9.75 an hour.

Sash and windows come installed in frames, all window and door frames being set in mastic and flashed to prevent leakage. Glass is furnished, ready for installation. Rafters for the truss roof are cut, numbered and packaged for each house. Roof sheathing and fascia board are provided in random lengths.

(Continued on next page)

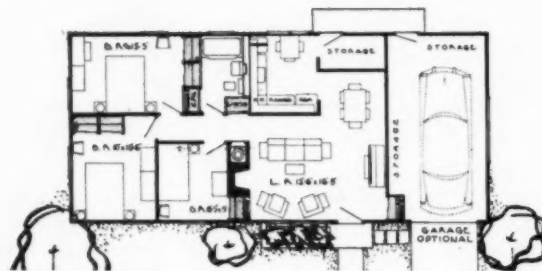

Farwest Homes' designs are copyrighted by W. A. Wollander, Tacoma, Wash.

We've got your *Number* in locks

... the "4500" Line!

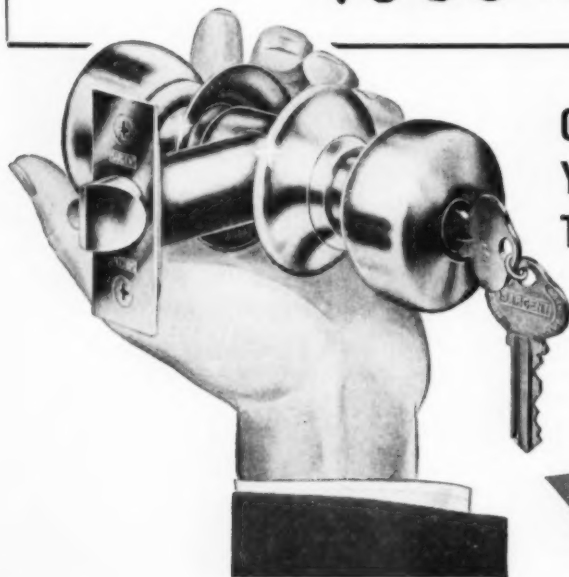

**ORDER  
YOURS  
TODAY!**

**Remember that number: "4500"!**

*It stands for a Sargent lock that has more features for home-owners and you than any other lock in its price range.*

And it's really a *cinch* to install... a real time-saver! Needs only a 1 1/4" crossbore. Just 2 holes to make.

And it's a *beauty!* Home-owners say, "Orchids" to the neat roses of this tulip-shaped lock. They admire its smart brass or bright, clean-looking Alumilited aluminum finish.

In addition to its convenient key-in-knob action, the Sargent "4500" Line also includes locks with a variety of other operations... such as those required for bathroom, passage and bedroom doors.

Yes, we've got your number—"4500"—for complete customer satisfaction and quick, easy installations.

Ask your building supply dealer for a "house lot" of Sargent "4500" locks today.

Write your supplier or us. Department 5B.



**SARGENT AND COMPANY**

New York • NEW HAVEN, CONN. • Chicago

Builders Hardware and Fine Tools since 1864

AMERICAN BUILDER

## new way to lay up a concrete block wall

The advantages of the new mortarless interlocking concrete block is its self-aligning principle which enables a fair workman to lay a masonry wall with a speed exceeding that of an able mechanic. Another point in favor of the new block is its economy of mortar mix for wall units. It is possible to effect savings in materials up to 30 per cent.

In experimental cases the walls were laid dry up to

Data and photograph courtesy of Interlock Block Co.



On the job demonstration of mortarless block

heights of seven feet or more with no mortar between the joints. A sealer was then applied on the inside and the exterior face of the wall, resulting in a plaster smooth wall that for three years has resisted the rigors of the northern climate without cracking or peeling.

It is claimed that the new interlock, mortarless block will be able to reduce the ever increasing labor and material costs in home and commercial construction. The units (manufactured under patents pending) cost little more than the conventional block, but the inventor claims that savings in high labor and material costs more than offset this fractional difference.

### bought in a package *(Continued from page 248)*

For interior partitions, 2x4 studs are furnished cut to size and bundled, and top and bottom plates are provided in random lengths. Interior millwork is furnished in mitre-cut sets and bundled for each opening. The only use for a power saw on the job is for the roof sheathing. Doors are pre-fit for exact sizes, bored for locks.

## These NEW MULLER PLASTER and MORTAR MIXERS "have everything"!

These new Muller Mixers, with new money-saving features, live up to the well known Muller tradition for high quality with low price and low upkeep. All sizes now have the Muller Paddle Shaft Seal (Pat. Pdg.) for positive bearing protection, guaranteed for the life of the mixer!

### THE 3½' MODEL—

A new larger drum for light materials . . . choice of electric motor or either of the two best air-cooled engines, large enough to stand plenty of overload . . . power throw-out . . . hinged engine housing . . . self-lubricating self-aligning bearings . . . ball thrust on paddle shaft . . . new safety grid.

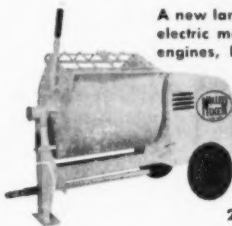

#### PRICES F.O.B. FACTORY

1 H.P. Electric Motor	\$312.00
2.7 H.P. Briggs & Stratton Engine	330.00
3.1 H.P. Wisconsin Engine	360.00

### THE 6' MODEL—

Large heavy duty drum . . . double V belt drive from engine to countershaft with simple power throw-out (on gasoline models), avoiding all need for clutch adjustments . . . drive from countershaft to paddle shaft through machine cut gears . . . narrow trucks optional for indoor use.



#### PRICES F.O.B. FACTORY

3 H.P. Electric Motor	220/440 3 Ph.	\$580.00	4.6 H.P. Wisconsin Engine	530.00
			7.7 H.P. Briggs & Stratton Engine	540.00

### THE 6' TO 8' HEAVY DUTY MODEL—

This size for large jobs requiring extra capacity, or where mixer encounters extra severe service . . . regularly equipped with 7 H.P. Wisconsin Air-Cooled Engine with built-in disc type clutch running in oil . . . drive from engine to countershaft is heavy duty roller chain and machine cut gears to paddle shaft.

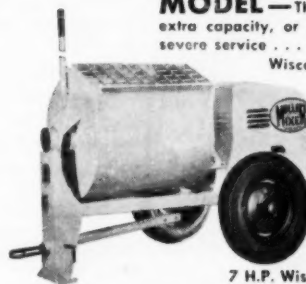

#### PRICES F.O.B. FACTORY

7 H.P. Wisconsin Engine	\$650.00
5 H.P. Electric Motor 220/440 V	680.00

(Standard 9 Cubic Foot 3 Bagger also available)



## MULLER MACHINERY COMPANY, Inc.

Mail coupon for descriptive folders

Muller Machinery Co., Inc., Metuchen 4, New Jersey

Please send me descriptive folder(s) checked below:

- 3½' Plaster and Mortar Mixer  
 6' Plaster and Mortar Mixer  
 6'-8' Plaster and Mortar Mixer

NAME.....TITLE.....

COMPANY.....

STREET.....

CITY.....STATE.....

# Lightsteel

Low Cost, Lightweight  
Structural Steel

**BRINGS THE BENEFITS  
OF STEEL FRAMES TO  
SMALLER BUILDINGS**

PENMETAL has developed a system of strong double-trussed studs, joists, rafters, plates, sills and accessories in a complete range of standard widths and pre-cut lengths. These PENMETAL LIGHT-STEEL Structural Sections are fabricated to exacting specifications, cold-rolled to keep initial costs down.

Proved, practical design reduces installation costs, too. A high strength-to-weight ratio makes for easy handling and quick erection, without need for cranes or special skills. Open webbing simplifies the installation of pipe and conduit, speeds up the fastening of wire or clips for metal lath or any other surfacing material.

PENMETAL LIGHTSTEEL sections pay off with straighter, safer, stronger jobs, plus generous savings in both time and costs.

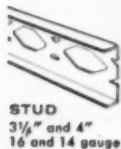

**STUD**  
3 1/2" and 4"  
16 and 14 gauge



**DOUBLE  
STUD**  
3 1/2" and 4"  
16 and 14 gauge



**JOIST**  
6" and 8"  
16 and 14 gauge

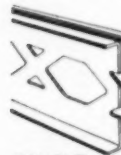

**DOUBLE  
JOIST**  
6" and 8"  
16 and 14 gauge



## Lightsteel SECTIONS

provide structural stability . . . complete protection against warping, shrinkage, rot, termites. Fire safe—they cut insurance costs with ratings up to a full four hours. Catalog 55-30 tells the whole story, gives all facts, specifications and data. Write for your free copy.

**PENN METAL COMPANY, INC.**

205 EAST 42nd STREET • NEW YORK 17, NEW YORK

## Long Island Builders Elect Stackler President

Approximately 350 members of the Long Island Home Builders Institute attended the 11th anniversary meeting of the group on December 10, at the Stewart Manor County Club, Stewart Manor, N.Y., and elected Walter G. Stackler as its 1953 president. Frederick E. Gibson, retiring president, was named chairman of the board.

The new leader is a member of Stackler & Frank, one of Long Island's largest development firms. His partner, Leonard L. Frank, is chairman of the NAHB Construction and Design Committee, a member of its executive committee, and a former Long Island president.

"Speechless Visualization," a novel method of presenting the president's annual report which proved so popular last year, was repeated. The association's progress through the year was pictured in vivid color illustrations which were reproduced on an 8x10 foot screen.

Other officers elected include Emil Keen, Leon Edelstein and Anthony Zummo, vice presidents; Samuel Levin, secretary and Charles M. Jaeger, treasurer.

## Plywood Manufacturers Issue Inspection Certificates

Beginning January 1, 1953, the Southern Plywood Manufacturers Association will issue Certificates of Inspection for Glue Bond Quality to those hardwood plywood mills which can qualify for them and maintain the high quality standards required for their continued use. These certificates, designed for use with invoices, will cover hardwood plywood manufactured in accordance with the Inspection and Testing Standards of the Southern Plywood Manufacturers Association and the specifications as established by the U. S. Department of Commerce. Complete information concerning these standards is available from the Association, 65 Peachtree Place, N.E., Atlanta, Ga.

The formal announcement of these Inspection Certificates for Glue Bond Quality was made at the fall meeting of the association, held recently at St. Simons Island, Ga. The one and one-half day program was devoted to a variety of subjects pertaining to the interests of the delegates.



## Alderman Finds Chicago Lax in Slum Clearance

Suggesting the appointment of a single agency to deal with the problem of run-down buildings in Chicago, rather than relying upon the results produced by the nine different overlapping agencies now existent, was the crux of the address made by Alderman Robert E. Merriam, chairman of the Chicago Housing Committee, speaking before a forum luncheon of the Chicago Metropolitan Home Builders Association.

Alderman Merriam discussed the need for tearing down condemned and unsafe buildings. However, the problem of cleaning out dilapidated buildings which constitute "pockets of blight" from the rest of the neighborhood is not a simple one, due to the legal barriers which arise. Some owners of unsightly buildings refuse to allow their buildings to be removed. Some houses have been altered and made into rooming houses, increasing the already crowded condition of the neighborhood.

Merriam suggested that existing ordinances be backed up with more stringent rulings, punishing flagrant violations of the housing code. He further suggested that more specific legislation be enacted to counteract the seeming laxness in fining those who persist in disregarding the present housing ordinances. By naming two or three "conservation areas" as pilot areas, the present situation could be attacked successfully over a period of time, Merriam stated.

## Plans Under Way for Rochester 1953 Home Show

Rochester Home Builders' Association has set the wheels in motion for its big Spring Festival and Home Show, which will take place at Edgerton Park, April 25 through May 2, 1953. This annual event is designed to present the home building, planning and buying story to home owners and prospective home owners throughout the Rochester metropolitan area. A total of 130 exhibit spaces are being reserved, providing booth dimensions up to 30x20 feet.

As a pre-show publicity scheme, the Rochester Home Builders' Association is sponsoring an \$1,800 Model Home prize contest, open to high school students throughout the Rochester area.

# New silent selling power for every home

Majestic's  
Gas-Fired  
Indoor  
Incinerator



Approved by the American Gas Association



## Burns all garbage — wet and dry — plus all "trash-burner waste" with accelerated *Jet-Air* action

Here's powerful buyer-appeal for every home! An improved, low cost answer to the *most neglected chores in modern housekeeping*. Majestic's complete disposal unit does away with grinding mechanisms or messy outdoor garbage containers... eliminates backyard trash burners with their hazardous fire, smoke nuisance, and flying ashes that irritate neighbors... avoids endless "emptying" trips outdoors in all kinds of weather. *Look at some of the advantages this complete Indoor Incinerator offers!*

- Fully modern cabinet beauty with white baked enamel finish.

- Simplest operation. Just turn burner control (or light a match) when waste is to be burned.
- Takes all wet and dry garbage plus all kinds of trash-burner waste.
- Uses same flue as furnace... easily connected... ideal in kitchen, utility room, or basement.
- Exclusive *Jet-Air* action, with patented downdraft feature, accelerates air flow... dries moist contents faster... speeds combustion... reduces waste to powder-ash.
- Easy 3-way fuel convertibility — gas-fired, automatic gas-fired, or fuelless.

— And for many other reasons, Majestic's new Indoor Incinerator is

## Today's Most-talked-about Chore-Saver!

Get the full story on Majestic's all-new home disposal unit — by the makers of Majestic Incinerators since the '20s. See your nearest distributor.

The **Majestic** Co., Inc.  
300-A Erie Street  
Huntington, Indiana

# FRANTZ

THE OVERHEAD  
GARAGE DOOR  
THAT OPENS WITH

## "GLIDE-O-MATIC" ACTION!



### FRANTZ

NO. 200 SERIES  
SECTIONAL-TYPE

Available in a variety  
of sizes for residential  
and light commercial  
openings

### TURN THE LATCH... THE DOOR DOES THE REST

More builders than ever before specify FRANTZ Doors . . . because FRANTZ Doors are easy and fast to install and because they have more features! You will like the "Glide-O-Matic" self-opening action of the 200 series—so smooth and effortless you almost think it is motor driven. You'll like the easy closing action, friction brakes which prevent rebound, weather-tight construction, ball bearing rollers, and the low headroom needed (only 13½ inches). Take a look at the 200 Series in the smart new panelled design, and check the many other features. See your FRANTZ dealer . . . today!

INSTALL FRANTZ·AMERICA'S BEST ENGINEERED OVERHEAD DOOR

# FRANTZ

GARAGE DOORS AND HARDWARE

© FRANTZ MANUFACTURING CO.

FRANTZ MANUFACTURING CO., STERLING, ILL.

## how would you do it? ideas for the man on the job

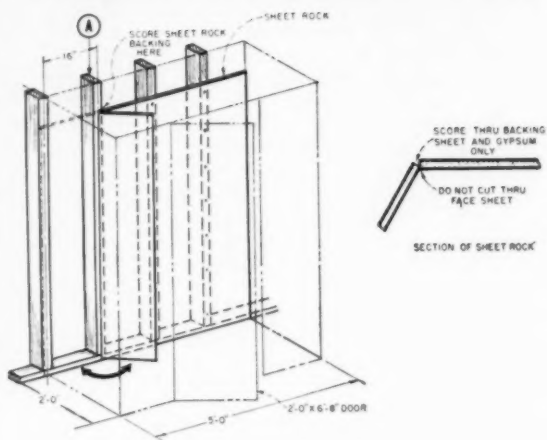

### cutting sheetrock for closets

This idea is for use when cutting Sheetrock for closets. If door is centered as shown, then the back piece of Sheetrock will not go into the closet. Measure to center of stud (A) approximately 1 foot 4 inches, then lay this distance off on the back of a piece of sheetrock. Score this material with knife, fold Sheetrock and slide through door easily. Unfold Sheetrock and nail. No taping required.—J. G. Caldwell, San Mateo, Calif.

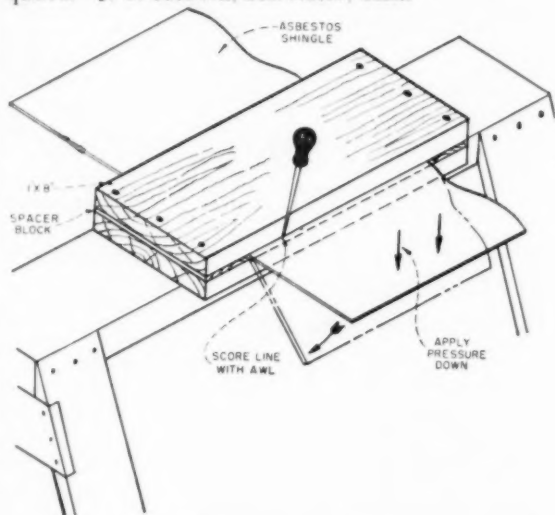

### cutting shingles in an emergency

To make an asbestos shingle cutter, take two short lengths of 1x8 boards and nail together after placing two spacer blocks between them as shown; tack the boards to sawhorse. To cut the shingle, score it on one side with a sharp awl or similar tool. Place shingle between the boards, making sure that the score is on the upper side and flush with edges of the boards. Press the shingle down and finish off with a rough rasp or file.—Herbert E. Fey, New Braunfels, Texas.

## Mountain States Lumber Dealers Hold '53 Convention

The year 1953 marks the 60th anniversary of the founding of the Mountain States Lumber Dealers Association, with headquarters in Denver. The organization will hold its annual convention in that city on February 4-5-6.

Three top men in the lumber industry have been booked as speakers

at the annual affair; names had not been released at press time. This year's convention is stressing *Management and Merchandising*, and the three business sessions will be devoted to practical suggestions of interest and value to all attending delegates and firms. Latest reports issued prior to the convention listed a total of 64 companies who will exhibit their products concurrent with the convention.

## Epstein Succeeds Dudiak As North Jersey Leader

Lewis Epstein, Clifton, N. J., builder, was elected president of the Home Builders Association of Northern New Jersey for 1953 at the organization's recent annual meeting in Teaneck, N.J. He succeeds Stephen Dudiak, also of Clifton, who headed the association for the past two years.



Lewis Epstein

Other officers elected were Russell H. Willis, Closter, first vice president; Alan D. Allen, Hillsdale, second vice president; Fred R. Brunetti, Maywood, treasurer, and Michael Petruska, Clifton, secretary.



**Here's  
QUICK  
HEAT**

to lick  
**High Humidity  
in Fall  
Building  
Simplex  
PORTABLE  
HOT BLAST HEATERS**

This handy heater will more than save its cost in speeding up construction for you! Licks humidity and condensation in Fall construction—for faster drying of plaster, paint, varnish . . . prevents freeze-ups and aids worker comfort, too, for Winter work. Saves both time and labor.

The Portable, HOT BLAST generates an intense blue flame, smokeless, sootless, on a mixture of kerosene and compressed air—like a blow torch. Completely safe. Automatic Shut-Off Control stops fuel supply if flame goes out. Lightweight, sturdy, easily portable. Also available with wheels.

See your Builders' Supply Dealer, or write for details and prices.

**WESTERN METAL SPECIALTY CO.**  
Dept. AB-2, 1211 N. 62nd St.,  
Milwaukee 13, Wis.



**TRY THE LOW-PRICE WAY  
TO HIGH QUALITY TRUSSES!**

Our trusses can save you money . . . Low first cost . . . no maintenance required . . . trusses will last the lifetime of the building. Trusses are shipped direct to your job site. Why wait? Write for information today!

**AMERICAN Roof Truss**  
1038 East 87th Chicago



Est. 1922

**"The BARCO  
RAMMER  
Pays for  
ITSELF!"**



*Says* **PAUL SCHLEICHER & SONS**  
GARY, INDIANA, HOUSING CONTRACTOR

**"SOIL COMPACTION** with the Barco Rammer has been the key to *earlier completions* and *lower costs* for us," says Paul Schleicher & Sons, Gary, Indiana, housing contractor.

The Barco Rammer is a new tool with many uses! No longer is it necessary to wait for loose earth fill, or backfill, to settle — tamp it immediately to **HIGH DEGREE COMPACTION** under slabs . . . around foundations and footings . . . on grades . . . in trenches — **SAVE TIME! CUT COSTS!**

### ASK FOR DEMONSTRATION

See for yourself — ask for our nearest distributor to give you a demonstration.

• Send for  
CATALOG No. 621



**BARCO  
MANUFACTURING  
COMPANY**

1823C Winnemac Ave.,  
Chicago 40, Illinois

**Builders of Portable Gasoline  
HAMMERS and RAMMERS**



# BUILDING BOOK ORDER SERVICE:

Here's an easy way to get new essential information that will help you increase your income. Every volume a standard work by leading authority. Remember—it's the informed builder who is the successful builder.

## ESTIMATING

1. **THE BUILDING ESTIMATOR'S REFERENCE BOOK** and Vest Pocket Estimator (not sold separately). By Frank R. Walker. Contains latest estimating and cost data on everything that goes into house construction. Most complete compilation of estimating and cost data available. \$12.00.
2. **SIMPLIFIED CARPENTRY ESTIMATING**. By J. W. Wilson and Clell M. Rogers. Everything needed to take-off a bill of materials from set of plans and specifications for a frame house—with many helpful quick-reference tables and short-cut methods that simplify the work. \$3.75.
3. **CONTRACTOR'S MATERIAL LIST**. A 10-column take-off form for complete listing of materials and labor costs. \$1.00.
4. **SPECIFICATIONS**. Full set of detailed house specifications (and item index), with spaces for inserting the pertinent description data. \$.50.

## CARPENTRY AND BUILDING

5. **HOUSE CONSTRUCTION DETAILS**. Compiled by Nelson L. Burbank. Exact working guide on every detail of house construction from foundation to finish. Tells dimensions, materials, processes, step-by-step working methods. \$4.75.
6. **HOUSE CARPENTRY AND JOINERY**. By Nelson L. Burbank. Every step of carpentry in and around a house, clearly explained and illustrated. Covers every job from foundation forms to interior trim. \$4.75.
7. **PRACTICAL JOB POINTERS**. More than 850 "tricks of the trade," short cuts, kinks and modern methods of doing all kinds of carpentry and building repair jobs. Cross-indexed for quick reference. Fully illustrated. \$4.50.
8. **FUNDAMENTALS OF CARPENTRY**. By Walter E. Durbahn. Complete house carpentry course in two volumes. Outstanding value. \$7.50.
9. **STEEL SQUARE**. By Gilbert Townsend. This how-to-do-it steel square instruction book provides fundamentals plus step-by-step house construction problems solved by proper steel square use. \$2.25.
10. **STAIR BUILDING**. By Gilbert Townsend. Fully illustrated explanation of every problem in design and construction of stairs. \$2.50.

## PLAN BOOKS

11. **SUNSET WESTERN RANCH HOUSES**. Authoritative book on the California ranch house, with thorough pictorial descriptions and ground floor and site drawings. \$3.00.
12. **DUPLEX AND APARTMENT HOUSES**. By J. W. Lindstrom. Floor plan sketches and brief descriptions of 35 duplexes, 11 4-apartment buildings, and 5 larger ones ranging from 6 to 12 apartments. Cubic footage given. \$1.50.

## PAINTING AND DECORATING

13. **PAINTING AND DECORATING CRAFTSMAN'S MANUAL**. Sponsored by the Painting and Decorating Contractors of America. \$2.00.

## HEATING AND PLUMBING

14. **HEATING, COOLING AND AIR CONDITIONING HANDBOOK**. A handy reference manual and practical instruction book. 706 pages. 351 illustrations. \$4.00.
15. **HOW TO DESIGN AND INSTALL PLUMBING**. By A. J. Matthias, Jr. Every step in the design and installation of

the plumbing system, to fulfill requirements indicated in blueprints and specifications, explained and illustrated. \$3.50.

## BRICKWORK AND MASONRY

16. **THE ART OF BRICKLAYING**. By J. Edgar Ray. Basic brick-laying job instruction, many illustrations, glossary, special scaffolding and cement block chapters. \$4.00.
17. **MASONRY SIMPLIFIED**. Vol. II. Practical masonry procedures in the various phases of construction, from building forms for concrete to constructing fireplaces and septic tank systems. Includes discussion of handling new products such as glass blocks, waterproofing mixtures and insulating blocks. \$5.00.

## ELECTRIC WIRING

18. **INTERIOR ELECTRIC WIRING AND ESTIMATING**. By Albert Uhl, A. L. Nelson and C. H. Dunlap. How-to-do-it book on interior wiring and cost estimating. \$2.75.
19. **WESTINGHOUSE HOME WIRING HANDBOOK**. By A. Carl Bredahl. A guide for planning the wiring of moderate-price homes, with emphasis on safety, effectiveness and efficiency. \$1.00.

## MISCELLANEOUS

20. **ARCHITECTURAL DRAWING FOR THE BUILDING TRADES**. By J. E. Kenney and John P. McGrail. A practical book of drawing instruction for builders and contractors as well as for students and draftsmen. Excellent show-how illustrations. \$4.00.
21. **A REFERENCE HANDBOOK for Construction Engineers, Architects, Builders, Superintendents of Construction and Building Construction Foremen**. By H. G. Richey. A basic reference and data book covering all building trades. 1600 pages. \$10.00.
22. **PRACTICAL ACCOUNTING AND COST KEEPING FOR CONTRACTORS**. Complete instructions and examples showing proper methods of keeping time and compiling costs on all classes of construction work. \$3.50.

## FREE with Your Order

23. **MODERN METHODS OF HOME HEATING**. Standard heating systems illustrated with 17 floor plans showing heating outlets, 40 photos of equipment and installations, 25 boiler and piping connection diagrams, and 11 heat loss calculating tables. \$0.50. Your copy sent FREE if your Order totals \$5.00 or more. Use coupon below—mail today!

Book Service Dept., American Builder  
30 Church St., New York 7, N. Y.

Please send me at once the books indicated by the numbers circled below. Remittance (plus 10c per book to cover mailing costs) enclosed for .....

1 2 3 4 5 6 7 8 9 10 11 12 13  
14 15 16 17 18 19 20 21 22 23\*

\*No. 23 sent FREE if order totals \$5 or more

Name .....

Street .....

City, State .....

AB 2-53

# GET ALDRICH *Gulf Stream*

**C-SERIES  
BOILER-BURNERS**



**GULF STREAM PACKAGE.** Fully erected, pre-wired, accessory-equipped package. Ready to set in place and connect.

**P** **PERFORMANCE** — With Lasting Economy. Fast, quiet hot water heating . . . instant hot water.

**D** **DESIGN** — For Today's Market. Quick and easy to install, Aldrich saves money, space, installation time.

**Q** **QUALITY** — At Quantity Prices. Engineered for instant response to heating needs . . . peak fuel efficiency.

**EASIER TO SELL . . .  
EASIER TO INSTALL . . .  
EASIER TO SERVICE . . .**



**GULF STREAM STANDARD**  
Shipped fully erected with complete automatic controls: stack switch, thermostat and limit control.



**HOT WATER HEATER**  
Internally galvanized; 100 to 255 GPH at 100° rise. Instant, directly heated hot water.

## ALDRICH *Gulf Stream* OFFERS VALUE . . .

- that's profitable to sell, practical to buy.
- Five sizes with SBI ratings from 440 to 1120 square feet of water radiation.
- Multiple flue tubes baffled for maximum heat extraction.
- Aldrich burners coordinated to Gulf Stream boilers.
- For inspection and maintenance, readily removable top jacket and large opening to combustion chamber.
- Minimum temperature change regardless of firing conditions.
- Designed for standardized production; to meet ASME code.
- Burners U.L. listed.

**THE  
ALDRICH  
COMPANY**  
WYOMING, ILLINOIS

A Subsidiary of Breeze Corporations, Inc.



FEBRUARY 1953



**Yours  
for the  
asking**



**. . . this new, authoritative handbook — based on the latest research in gas appliance venting**

When you install gas burning appliances, you'll want this useful handbook containing complete, up-to-date information on gas venting practices plus many helpful installation tips. The findings presented are based on extensive engineering research recently completed by the Metalbestos Division, William Wallace Company, with the assistance of Stanford Research Institute.

Here are some of the subjects covered:

- **Fundamental Rules of Venting** — Amply illustrated throughout — and indexed for convenient reference — this handy pocket-size booklet will be an invaluable aid to anyone who specifies, sells, installs or services gas burning installations.
- **Determining Correct Vent Sizes and Capacities**
- **Choosing the Location of Vertical Vents**
- **Rules for Venting Various Types of Appliances**
- **Vent Installation Tips**

**Send for your free copy today! No obligation.**



**METALBESTOS** DIVISION  
WILLIAM WALLACE COMPANY · BELMONT, CALIF.

DEPT. D

Please send me with-

out cost, \_\_\_\_\_ copies of VENT INSTALLATION HANDBOOK.

NAME \_\_\_\_\_ TITLE \_\_\_\_\_

COMPANY \_\_\_\_\_

ADDRESS \_\_\_\_\_

CITY \_\_\_\_\_ ZONE \_\_\_\_\_ STATE \_\_\_\_\_

## ADVERTISERS IN THIS ISSUE

<p>Adams Rite Manufacturing Co. .... 212            Air Rectifiers Inc. .... 235            Airtemp Divn. of Chrysler Corporation ..... 125            Aldrich Company, The ..... 255            Allied Bldg. Credits Inc. .... 224            Allith Protuy Inc. .... 184            Alsynite Co. .... 224            American Builder ..... 234, 239, 246, 254            American Cabinet Hardware Corp. .... 50            American Floor Surfacing Machine Co. The ..... 247            American Radiator &amp; Standard Sanitary Corp. 161            American Roof Truss ..... 253            American Steel &amp; Wire Division ..... 230            American Telephone &amp; Telegraph Co. .... 44            Anderson Corp. .... 70, 71            Armstrong Cork Company ..... 128            Associated Plywood Mills, Inc. .... 211            Atlas Press Co. .... 237            Avco Manufacturing Corporation (Crosley Division) ..... 74, 75</p> <p>Barco Mfg. Co. .... 253            Bell &amp; Gossett ..... 205            Belsaw Machinery Co. .... 229            Berger Manufacturing Div. (Republic Steel Corporation) ..... 194, 195            Berns Mfg. Corp. .... 24            Besser Mfg. Co. .... 190            Bessler Disappearing Stairway Co., The ..... 235            Better Homes &amp; Gardens ..... 76            Black &amp; Decker Co. (The) ..... 189            Bostwick Steel Lath Co. .... 236            Briggs Manufacturing Co. .... 163            Brown &amp; Co., Inc. Geo. C. .... 229            Bruce Co., E. L. .... 66a            Bryant Heater Division ..... 148, 156            Bucyrus-Erie Hydrocrane Div. .... 59            Bundy Tubing Co. .... 154            Butler Mfg. Co. B. B. .... 154</p> <p>Caldor Manufacturing Co. .... 210            Carlson &amp; Sullivan, Inc. .... 242            Carr, Adams &amp; Collier Co. .... 218            Cece Steel Products Corporation ..... 30, 31            Celotex Corp., The ..... 68, 69            Certain-Teed Products Corporation ..... 21            Chase Brass &amp; Copper ..... 215            Chevrolet Division ..... 126            Clipper Manufacturing Co. .... 207            Coffman Co., Inc. R. G. .... 56            Colorado Fuel &amp; Iron Corp. (Wickwire Spencer Steel Div.) ..... 42            Connor Lumber &amp; Land Co. .... 242            Construction Machinery Companies ..... 225            Crane Co. .... 10            Crosley Division of the (Avco Manufacturing Corporation) ..... 74, 75            Cuprinol Division ..... 238            Curtis Companies Service Bureau ..... 129</p> <p>Debs Decorators ..... 242            Decatur Pump Co. .... 184            Delco Appliance Division (General Motors Corp.) ..... 60, 179            Detroit Steel Products Co. .... 1            DeWalt Inc. .... 136D            Dodge Div. of Chrysler ..... 156            Dodge Corporation, F. W. .... 81            Douglas Fir Plywood Association ..... 112, 113            Dremel Mfg. Co. .... 203</p> <p>Edgewater Steel Co. (Tracy Mfg. Co.) ..... 139            Elier Co. .... 36            Emerson Electric Mfg. Co. .... 221            Empire Stove Company ..... 130            Eveready Briksaw Co. .... 176            EZ-Way Sales, Inc. .... 188</p> <p>Fasco Industries Inc. .... 109            Fastener Corp. .... 240            Fawcso Manufacturing Company ..... 196            Fedders-Quigan Corporation ..... 171            Fiat Metal Mfg. Co. .... 243            Fleet of America, Inc. .... 231</p>	<p>Flush Wall Radio Company ..... 236            Foley Mfg. Co. .... 246            Frantz Manufacturing Company ..... 252</p> <p>Gate City Sash &amp; Door Co. .... 198            General Air Conditioning Corp. .... 244            General Electric Company ..... 82, 115, 166, 167, 222, 223            General Motors Corp. (Delco Appliance Div.) 60, 179            General Portland Cement Co. .... 244            Georgia-Pacific Plywood Company ..... 8, 9, 200, 201            Grand Haven Stamped Products Co. .... 234            Great Lakes Carbon Corp. .... 6</p> <p>Hager &amp; Sons Hinge Mfg. Co. C. .... 131            Hall-Mack Co. .... 7            Harnishfeger Corporation ..... 111            Haskeite Manufacturing Corp. .... 185            Hassall Inc. John ..... 240            Heatilator Inc. .... 169            Homasote Company ..... 65            Hunter Fan &amp; Ventilating Co. .... 12</p> <p>Infra Insulation Inc. .... 53            Inland Steel Products Company ..... 66B            Insultite Division (Minnesota &amp; Ontario Paper Co.) ..... 146, 147            International Homes ..... 186, 187</p> <p>Jaeger Machine Company, The ..... 208            Johns-Manville ..... 110            Jones &amp; Laughlin Steel Corporation ..... 23</p> <p>Kaustine Company Inc. .... 63            Kay-Tite Company ..... 202            Keasbey &amp; Mattison Co. .... 199            Keystone Steel &amp; Wire Company ..... 114            Kimble Glass Co. .... 77            Kohler Co. .... 177            Kwikset Sales &amp; Service Co. .... 2</p> <p>Levelall ..... 246            Libbey-Owens-Ford Glass Company ..... 20, 245            Lithibar Company ..... 72            Lone Star Cement Corp. .... 43            Louisville Cement Company, Inc. .... 41            Ludman Corp. .... 18, 19</p> <p>Macklanburg Duncan Co. .... 251            Majestic Co. Inc. .... 217            Malta Manufacturing Company ..... 168            Maple Flooring Mfgs. Ass'n ..... 197            Marsh Wall Prod. Inc. .... 210            Master Metal Strip Service, Inc. .... 193            Mastic Tile Corporation Of America ..... 78            Metal Arts Mfg. Co., Inc. .... 255            Metal Bestos Division (Wm. Wallace) ..... 62            Milwaukee Flush Valve Co. .... 204            Milwaukee Strip Service, Inc. .... 142            Minnesota &amp; Ontario Paper Co. (Insultite Division) ..... 146, 147            Mississippi Glass Company ..... 142            Modern Homes Corp. .... 165            Monsanto Chemical Company ..... 213            Moore, Goodloe E., Inc. .... 172            Moutile, Inc. .... 188            Muller Machinery Company, Inc. .... 249</p> <p>National Clay Pipe Manufacturers, Inc. .... 51            National Electrical Manufacturers Association 55, 219            National Gypsum Company ..... 150            National Homes Corporation ..... 136B, 136C            National-Lock Company ..... 47            National Manufacturing Company ..... 4th Cover            Nelson Div., Herman ..... 170            New Castle Products ..... 241            Nixalite Company of America ..... 177            NuTone Inc. .... 32a, 32b, 32c, 32d,</p>	<p>Ohio Plate Glass Co. .... 225            Oliver Corp. .... 67            Overhead Door Corporation ..... 3rd Cover</p> <p>Paine Company, The ..... 175            Paine Lumber Co. Ltd. .... 58            Penn Metal Co., Inc. .... 250            Peterson Products Co. .... 242            Pittsburgh Plate Glass Co. .... 152, 153            Place Homes, Inc. .... 220            Porter-Cable Machine Co. .... 227            Precision Parts Corporation ..... 178            Prefabricated Home Manufacturers' Institute ..... 48            Price Fireplace Heater &amp; Tank Corp. .... 203</p> <p>Ramset Fasteners, Inc. .... 238            Raynor Mfg. Co. .... 144            R.C.A. Rubber Company ..... 209            R.C.S. Tool Sales, Corporation ..... 191            Ready Hung Door Corp. .... 159            Remington Rand ..... 57            Republic Steel Corporation ..... 145, 194, 195            Rheem Manufacturing Company ..... 136A            Richards-Wilcox Mfg. Co. .... 233            Richmond Builders, Inc. .... 151            Richmond Radiator Company ..... Cover 2            Riley Laminated Products Inc. .... 228            Rockwell Manufacturing Co. .... 28, 29            Roddis Plywood Corporation ..... 79            Rolscreen Company ..... 214            Rowe Manufacturing Co. .... 107            R-O-W Sales Company ..... 4, 5</p> <p>Safway Steel Products, Inc. .... 212            Saint Paul Corrugating ..... 208            Samson Cordage ..... 229            Sargent &amp; Co. .... 248            Scharf Mfg. Co., J. H. .... 256            Schlage Lock Co. .... 61            Serval, Inc. .... 182, 183            Shepler Manufacturing Company ..... 181            Simplex Level Co., Inc. .... 242            Solvay Process Division ..... 238            Sonoco Products Co. .... 206            Standard Dry Wall Products ..... 22            Stanley Works, The ..... 108, 127            Steel Scaffolding Company, Inc., The ..... 240            Sterling Hardware Mfg. Co. .... 24            Sterling Paint &amp; Varnish Co. .... 180            Structural Clay Products Institute ..... 73            Superior Fireplace Co. .... 232</p> <p>Therm-O-Panel ..... 225            Thomason Plywood Corporation ..... 66            Thorn Company, J. S. .... 173            Thrush &amp; Company, H. A. .... 80            Tracy Manufacturing Co. (Edgewater Steel Co.) 139            Truscon Steel Div. (Republic Steel Corp.) ..... 145            Typhoon Air Conditioning Co. Inc. .... 11</p> <p>United States Plywood Corp. .... 49, 192            United States Gypsum ..... 26, 27            United States Steel Corporation (American Steel &amp; Wire Div.) ..... 230            Universal Atlas Cement Company ..... 45            Universal Rundle Corporation ..... 143</p> <p>Vento Steel Products Co. .... 174</p> <p>Wallace, Wm. (Metal Bestos Division) ..... 255            Washington Steel Products, Inc. .... 25            Weather Strip Research Institute ..... 46            Wesix Electric Heater Co. .... 242            Western Metal Specialties Co. .... 253            Western Pine Association ..... 64            Westinghouse Electric Corporation ..... 216            White Company, David ..... 204            Wickwire Spencer Steel Division (Colo. Fuel &amp; Iron Corp.) ..... 42</p>
--	---	---



# Scharf

## LEVELS



**PROTRACTOR LEVELS**

Eliminates "guessing" at difficult angles. Makes Work Easier for all tradesmen! Just one simple turn of the dial and you have the angle or drop per foot you want — quickly, easily, accurately!

Pat APPLIED FOR

If your dealer can't supply you Write Dept. 5

J. H. SCHARF MFG. CO.

Omaha, Nebraska

**MAGNELITE LEVELS**

Unbreakable frame of extruded magnesium—1/3 lighter than aluminum. Replaceable Vial Units. Available in 9 sizes — 12, 18, 24, 28, 30, 42, 48, 60 and 72 inches.



to build a **five-section**  
door with wide  
horizontal panels  
—1951



Rapid advancements in residential architecture called for a new and modern design of The "OVERHEAD DOOR"—to complement the ranch-type home, yet blend with every style of architecture.

True to tradition, our engineers produced a door with narrow sections and wide horizontal panels . . . with the same structural strength and the same blue-ribbon performance, always!

*Only* **OVERHEAD DOOR CORPORATION**  
and its manufacturing divisions make



**OVERHEAD DOOR CORPORATION** • Hartford City, Indiana  
Manufacturing Divisions  
Hillside, New Jersey    Cortland, New York    Lewistown, Pennsylvania  
Nashua, New Hampshire    Dallas, Texas    Oklahoma City, Oklahoma  
Portland, Oregon    Glendale, California

Copyright 1953—O. D. C.



The new design has been adapted to large doors for commercial and industrial structures, blending perfectly with modern architecture.

Look for this trade mark in the yellow pages of your telephone directory. It stands for—  
**More Than 30 Years of Quality and Leadership!**



*Easier* to install  
and maintain—



*National*

**Screen and Storm Door  
HARDWARE**

This is but one of the many reasons why leading contractors and builders specify this popular brand of hardware.

Simple, clear instructions are packed with the hardware along with all of the necessary screws and component parts for a first class installation—smooth, friction-free working coordination accounts for a longer service life.

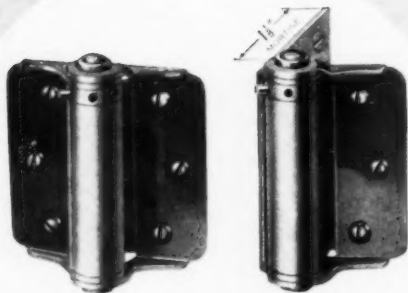

No. 125 Adjustable  
Full Surface Spring  
Hinge

No. 126 Adjustable  
Half Surface Spring  
Hinge



A symbol  
of quality  
for over  
50 years.

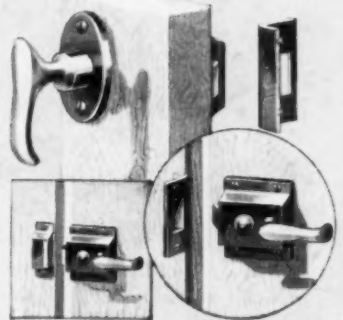

No. 95 Rim Latch

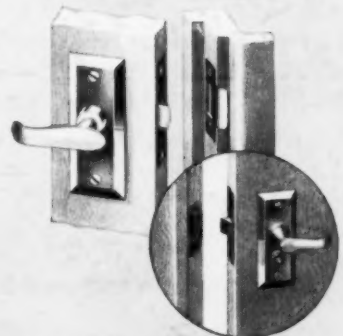

No. 96 Mortise Latch

*National*

**MANUFACTURING  
COMPANY**

*Sterling, Illinois*