

AMERICAN BUILDER

THE WORLD'S GREATEST BUILDING PAPER

NOVEMBER 1954

75 CENTS

Air-Conditioned
Village

•
Basement
Remodeling

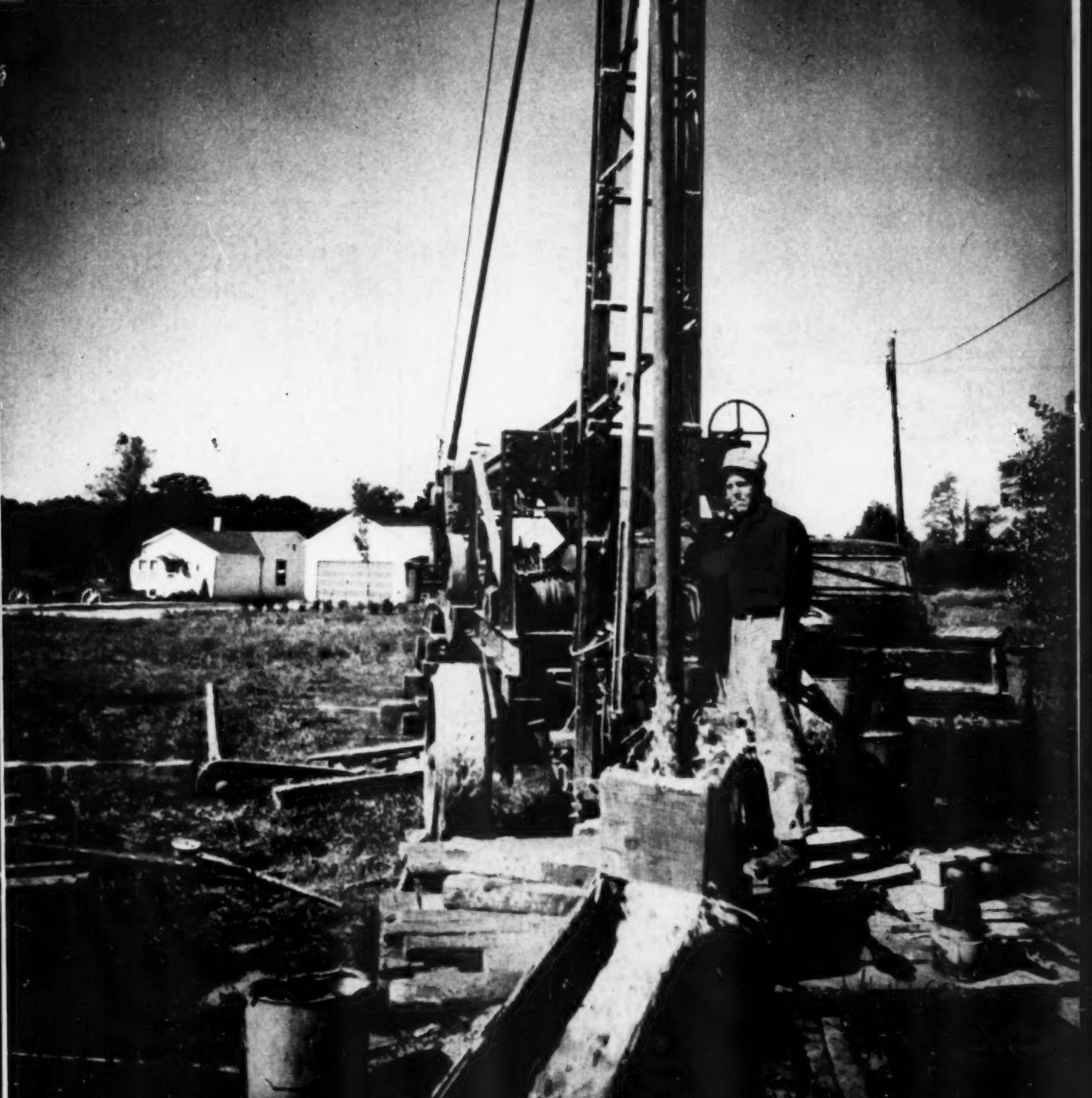

Building Beyond The Mains

NEW NUTONE Hood • Fan

"U. S. & Foreign Pat. Pend."



NEVER BEFORE at SUCH LOW PRICES!

SPARKLING BEAUTY . . . COPPER or STAINLESS anodized Aluminum . . . WHITE Steel and STAINLESS Steel . . . in new, graceful, flowing design.

ENGINEERED FOR EFFICIENCY . . . The powerful, compact NuTone No. 870 Twin Blower Fan is easy to install in steel or wood cabinet. Installation Kit Free.

LOWEST PRICES . . . NuTone has built a completely new factory in order to MASS PRODUCE NuTone Hoods at prices even the lowest cost homes can afford!

FREE . . . Get all the exciting news by writing for installation data, catalog, and low prices.

NUTONE, INC., Dept. AB-11, Cincinnati 27, Ohio

NUTONE

**The HOOD Traps
Hot, Greasy Odors**

**..The FAN Exhausts
Them Fast!**

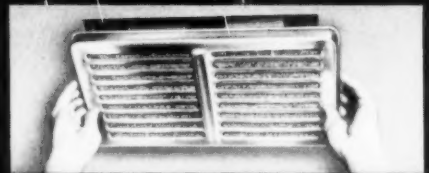

EXCLUSIVE FILTER GRILLE . . . No screws — Just snap it down and wash like a dish — in 30 seconds. Keeps inside fan and ducts grease-free. Walls stay clean and bright.

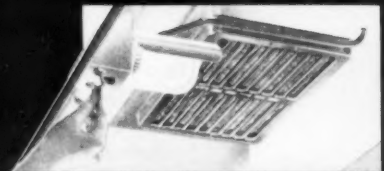

IN-BUILT SWITCHES UNDER HOOD . . . Control light and fan. Concealed "NON-GLARE" lighting. Removable Metal Reflector. . . . No special bulbs. No extra lenses to clean.

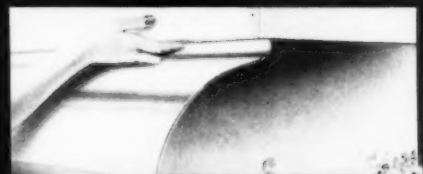

GRACEFUL FLOWING LINES . . . Recessed to fit all metal or wood cabinets—1 1/2" to 1 3/4" deep. Extra depth extends to front burner of range—Traps all greasy vapors.

the new *kwikset* "600" line

with *feather touch* knob action



**THE ONLY LOCK WITH
ALL THESE FEATURES:**

- Six pin tumbler security
- Exclusive adjustable strike
- Two-way locking action
- All steel and brass construction
- Full 1/2" latch bolt throw
- Equi-distant knob projection
- Elimination of cylinder reversing
- Unconditional guarantee

You can feel the QUALITY

More and more home buyers are looking for QUALITY. With the KWIKSET "600" line you provide quality they can *feel*. Just a feather-touch of the fingers produces a smooth, quiet turn of the knob. This soft, sure action is eloquent proof of the precision construction and superior quality built into the KWIKSET "600" line. Here are locksets that help sell homes.

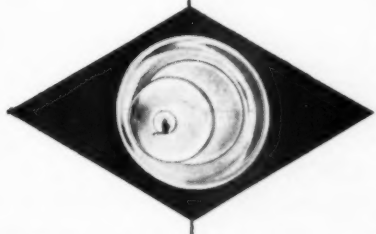

A finer lock for finer homes

KWIKSET SALES AND SERVICE COMPANY • ANAHEIM, CALIFORNIA

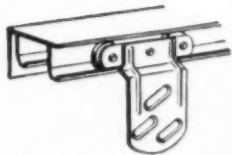

SATIN FINISH ANODIZED ALUMINUM TRACK WITH APRON . . . ADJUSTABLE HANGERS WITH NYLON ROLLERS

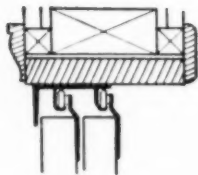

STANDARD DOOR FRAME . . . TRACK APRON SERVES AS TRIM . . . ONLY 1" HEADROOM

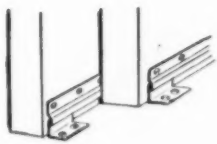

No. 876 GUIDE STRIPS SAVE TIME, CUT COSTS . . . ELIMINATE GROOVING DOORS

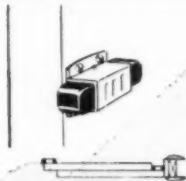

No. 885 DOOR CUSHIONS PROTECT FINGERS AND PREVENT SLAM

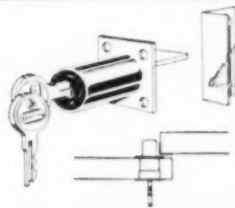

No. 1058 SLIDING DOOR LOCK FOR BY-PASSING DOORS

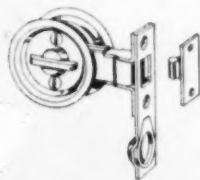

No. 1036 SLIDING DOOR LOCK FOR POCKET DOORS



No. 1100 SERIES POCKET DOOR T-FRAME . . . ALL STEEL . . . WARP PROOF

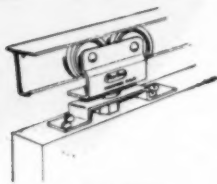

No. 700 SERIES TRACK AND HANGERS DESIGNED FOR POCKET DOORS



SLIDING DOOR SET FOR SIDE ENTRANCE DOOR IN HOME GARAGES



ALUMINUM GUIDE STRIP ATTACHES TO BOTTOM OF DOOR . . . GUIDES DOOR INTO POCKET

Sterling®

sets the standard in sliding door hardware

Through extensive research and engineering, Sterling has pioneered and perfected many new ideas which simplify and improve sliding door installations.

Sterling is the most imitated sliding door hardware.

Pictured on this page are a few of the products recently introduced by Sterling. The new locks for by-passing and pocket doors and the new T-Frame and hardware for pocket doors embody many basically new ideas.

Builders everywhere depend on Sterling Hardware for advanced design and trouble-free operation.

Specify Sterling Hardware for your sliding door installations.



STERLING HARDWARE MFG. CO.
CHICAGO 18, ILL.

SEE OUR CATALOG IN SWEET'S:
Architectural File • Light Construction File

VISIT OUR DISPLAYS:
Architects Samples Corporation, N. Y. C.
Chicagoland Home Building Center, 130 W. Randolph St.

Sterling means **Quality**

EDITORIAL

- 5 Let's get tie-in advertising straightened out

TRENDS

- 7 National housing starts soar, but—how's business in your home town?

ON AND OFF THE RECORD

- 58 A commentary on persons, places, problems and events

NEWS

- 11 Buildercast of regional trends, forecasts
13 News of note from your area
39 News from the national scene
41 Dickerman's column
42 Northup's column

WEATHER

- 17 A 30-day weather forecast for your area by Dr. Irving P. Krick

HOME DESIGNS

- 20 Six pages of popular house designs from your area

BLUEPRINT HOUSE IN COLOR

- 70 How to make a tri-level fit on a flat lot
73 An 1/8-inch scale blueprint
77 Materials list for blueprint house

REMODELING

- 64 Watch this basement turn into the liveliest room in the house

LAND DEVELOPMENT

- 78 How to build beyond the mains
126 How a land-buying pool in Milwaukee is helping small builders acquire raw land

AIR CONDITIONING

- 98 How design can help or hinder the effectiveness of air conditioning equipment

BUSINESS MANAGEMENT

- 104 This simple form gives you cost control over a job in progress

TAXES AND MORTGAGES

- 123 How the new income tax law affects builders
124 What you should know about construction and permanent loans

DETAIL PLATE

- 128 Why not dress up that outside stairway?

TECHNICAL GUIDE

- 136 Is crackproof concrete possible?

ASK THE EXPERTS

- 140 Technical problems from our readers analyzed by a group of industry authorities—experts in their fields

HOW-TO-DO-IT

- 148 Job shortcuts for the man on-the-job

NEW PRODUCTS

- 153 New and improved products and equipment offered by manufacturers

CATALOGS

- 182 Review of literature offered by manufacturers

LEGAL

- 192 New FHA-VA regulation on performance requires warranty



American Builder is published by the SIMMONS-BOARDMAN PUBLISHING CORPORATION, Emmett St., Bristol, Conn., with editorial and executive offices at 79 W. Monroe St., Chicago 3, Ill.; 30 Church St., New York 7, N.Y. James G. Lyne, President; A. J. McGinnis, Executive Vice President and Treasurer; Samuel O. Dunn, Chairman Emeritus; C. J. Wageman, Vice President and Publisher; J. S. Crane, Vice President and Secretary; Fred A. Clark, Vice President and Business Manager; E. G. Gavin, Vice President and Editor; Bayne Sparks, Vice President; Robert G. Lewis, Vice President.

American Builder (originally "Carpentry and Building"), with which are incorporated Building Age, National Builder, Permanent Builder, and

the Builder's Journal, was founded Jan. 1, 1879. Names registered in U.S. patent office and Canadian registrar of trade mark.

Address all subscriptions and correspondence concerning them to: Subscription Department, American Builder, Emmett St., Bristol, Conn. Changes of address should reach us three weeks in advance of next issue date. Send old address with the new enclosing if possible your address label. The Post Office will not forward copies unless you provide extra postage. Duplicate copies cannot be sent. Circulation Department: Robert G. Lewis, Director of Circulation; Lawrence L. Cone, Circulation Manager; Field Staff: C. L. Conley, John Simonson, M. A. Spector, Earl Spohn, Dick

Whittington, Guy Hill, George Heinrich, John B. Heinrich.

Published monthly by Simmons-Boardman Publishing Corporation, Emmett St., Bristol, Connecticut; Editorial and Executive Offices, 79 W. Monroe St., Chicago 3, Illinois, and 30 Church Street, New York 7, New York. Subscription price: United States, Possessions and Canada, 1 year, \$3.50; 3 years, \$7.00. Foreign countries: 1 year, \$12.00; 3 years, \$25.00. Single copies, 75 cents. April issue, \$2.00. 75th Anniversary issue, August 1954, \$1.00. Entered as second-class matter July 20, 1950, at the Post Office of Bristol, Connecticut, under the act of March 3, 1879. Copyright 1954 with all rights reserved. SIMMONS-BOARDMAN PUBLISHING CORP.

Fred A. Clark, Vice Pres., Bus. Mgr., 79 W. Monroe St., Chicago 3, Ill.

Advertising Sales Representatives

New York 7, N.Y., 30 Church, Worth 4-3060
Bayne Sparks, D. S. Clark, W. J. Kane

Chicago 3, Ill., 79 W. Monroe, Ra 6-0794
George Hutchings, Harold Mann, Herb Willson

Cleveland 13, O., Terminal Tower, Ma. 1-4455
D. T. Brickner, D. J. Casey

Coral Gables, Fla., 1810 Ponce deLeon Blvd.
Joe Halzer Co. 48-1786

Dallas 4, Tex., 2909 Maple, Randolph 3833
Joe Sanders

Los Angeles 17, Cal., 1127 Wilshire, Ma. 6-0553
Fred Klaner, Jr.

Portland 5, Ore., Terminal Bldg., Br. 4993
L. B. Conaway

San Francisco 5, Cal., 244 Calif., Ga. 1-7004
Lewis Vogler

SIMPLE in operation
RUGGED in construction
DEPENDABLE in performance

SAVE TIME - SAVE MATERIAL SAW MASONRY or CONCRETE with

Clipper

"SAILS RIGHT THRU"

SAWS & BLADES

... known the world over as the "Finest" in Masonry and Concrete cutting equipment. Clipper's nearly twenty years of experience and consistent quality assure you of the fastest, most economical masonry and concrete cutting. Try a CLIPPER on **FREE TRIAL**. See Why 4 Out of 5 Buy Clipper!



Model HD
15 MODELS
PRICED FROM
\$265



LOOK for the BRIGHT ORANGE COLOR and the TRADE MARK CLIPPER

Mr. Clipper

ABRASIVE

The consistent quality of Clipper WET and DRY cutting Abrasive Blades guarantees you of the fastest cut... at the lowest cost... with the greatest ease. Only Clipper gives you a complete selection of specifications for any cutting job.

"CBR"

Favorite blade of thousands of masonry saw and hand power saw owners. A Clipper "CBR" Break-Resistant Abrasive Blade is virtually unbreakable... bend it—twist it—drop it! For difficult grinding cuts impossible to make with standard abrasive blades.

DIAMOND

Amazing cutting speed and performance are yours with a genuine Clipper Diamond Blade. Rigid quality control, manufacturing "know-how", and the ability to select and use the best materials make Clipper Diamond Blades the World's Finest... Use one on your next job!

Clipper Blades Fit Every Make and Model Masonry, Concrete, or Hand Power Saw.

Genuine Clipper Blades are available in sizes and with arbor shapes to fit any make masonry, concrete, or hand power saw. Buy Clipper Blades by the case for Greater Savings!



The World's Finest Masonry Saw. Simple in operation—Rugged in construction—Dependable in performance. Clipper's patented-exclusive features give you unmatched cutting action. "Select-A-Notches" give instant, positive height adjustments... "Pressure Equalizer" automatically adjusts blade pressure. Clipper's **FREE TRIAL** guarantees you satisfaction at no obligation.



Self-propelled—and powered for heaviest duty—Clipper's new "ConSawMatic" Saws get better results from EVERY Blade—for lowest cutting cost per foot. Contraction Joints in highways and airport runways—Trenches for conduits, sewers, gas and water lines—Warehouse Floors of monolithic concrete—ALL use genuine Clipper Saws and Blades—the Perfect Combination for Quality Results!



MODEL C-250
25 H.P.
ONE OF 7 MODELS
FROM \$395



FREE TRIAL

YOUR ONLY GUARANTEE OF COMPLETE SATISFACTION
ACTUAL ON-THE-JOB TEST!

No. 103

2808 WS WARWICK • KANSAS CITY 8, MO.

SAME-DAY SERVICE—WRITE OR SEE YOUR PHONE BOOK

- ATLANTA
- AUSTIN, TEX.
- BIRMINGHAM
- BOSTON
- CHARLOTTE, N. C.
- CHICAGO
- CINCINNATI
- CLEVELAND
- DALLAS
- DENVER
- DETROIT
- HARTFORD
- HOUSTON
- INDIANAPOLIS
- LOS ANGELES
- MILWAUKEE
- NEW ORLEANS
- NEW YORK
- PHILADELPHIA
- PITTSBURGH
- SAN FRANCISCO
- SEATTLE
- ST. LOUIS
- ST. PAUL
- WASHINGTON, D.C.

FACTORIES IN ENGLAND AND FRANCE

SOLD ONLY DIRECT FROM CLIPPER FACTORY BRANCHES

Let's get tie-in advertising straightened out

THE PROBLEM of local tie-in advertising paid for by manufacturers has reached a point of decision. Pressure on the manufacturers to contribute fifty dollars here and a hundred dollars there for tie-in advertising to support a local distributor's newspaper advertising campaign, or a builder's local advertising to promote his National Home Week or other demonstration offering, has become so great that a breaking point is imminent.

There is a popular belief that producers of building products can easily afford to dish out a few dollars here and there to support laudable sales efforts at local levels. That would be true if it were only a few dollars here and there. But, where does the producer draw the line? And draw the line he must if he is to continue his primary advertising and exhibition program, and continue to make a profit. If he breaks in one area, how does he refuse his district sales manager in another area? How does he justify refusing a customer in one town and playing ball with a customer in an adjacent town? And what does he get out of such advertising, anyway?

Let's take a fictitious X Company, national advertisers, national distributors of several products, or only one product. Now, let's assume the company sells one-fourth of 26,000 lumber yards, one-fourth of an assumed 70,000 builders who advertise locally, and a couple thousand distributors other than lumber yards. That is 26,000 customers. Let each of them request a modest 50 dollars a year for local tie-in advertising. That figures *one million, three hundred thousand dollars*. That is on top of a well rounded and primarily necessary national advertising program. There isn't that kind of money in the production of building products. It's a highly competitive field in which sales costs are much higher than in most industries. And advertising is a carefully calculated part of that sales cost.

If the local point-of-sale factors—distributors and builders—really believe that cash from the manufacturers for local tie-in-advertising is an economic necessity to all concerned, including the home owner, they must be prepared for an across-the-board rise in costs to themselves. It has to be paid for, and in the end, added to the builders' costs.

We do not believe that such expenditures are properly part of the manufacturer's sales costs. We believe the manufacturer should advertise first to distributors and builders, the people who stock and actually use the products. They must be reached first. Second, if he wishes to appeal to consumers, and many building products manufacturers believe they should, his consumer advertising dollars should be spent in nationally or regionally circulated media directed to consumers.

LOCAL ADVERTISING to the consumer is the responsibility of the distributor and the builder. Every builder, of course, should use nationally advertised brands, or in some cases regionally advertised products and promote the advantage to himself and his customers. The responsibility for that promotion is the builder's. The manufacturer is doing his job at the national or regional level. His advertising makes the name known, and creates ready acceptance.

Branded name products attract the buyer, but few sales are ever either killed or consummated by the presence or absence of any particular branded product. It is the package and its livability and appeal plus the responsibility of the builder that sells a prospect. The package is the builder's, and so is the choice of products that make it a good package. So, likewise, is it the builder's responsibility to promote and sell the package and its components.

The manufacturer's responsibility ends with creating national acceptance for the products stocked by the distributors and used by the builders. He should be under no compulsion to finance local tie-in advertising of the package in which his products are used, or the retail sales of those products for maintenance and repair.

The matter has now reached a point for industry-wide decision. We believe that if manufacturers, distributors and builders will stick to their respective national and local advertising responsibilities, maximum economy and efficiency will accrue to all concerned. If, however, the factors involved disagree with this conclusion all will have to become reconciled to stepping up price structures to meet heavily increased advertising appropriations.

Publisher, C. J. Wageman

Editor, Edward G. Gavin

Managing Editor, Lyn E. Arent

Associate Editor, Donald F. Coenen. Feature Editor, Welden Reynolds. Architectural Editor, Arthur V. Hansen. News Editor, Garrett Winter.

Field Editor, J. L. Zar. Associate Architectural Editor, W. F. Koelling. Assistant to the Editor, Margaret C. Carroll.

Assistant Editor, H. Louis Purdy. Western Editor, W. C. Radd. Eastern Editor, Joseph B. Mason.

Washington Editor, Walter J. Taft. Research Director, W. S. Gaskill. Assistant Research Director, Constance Nicolai.

Director, Home Plan Service, Ralph E. Westerman. Legal and Tax Consultant, John F. McCarthy.

Art Editor, George M. Clark. Chief Draftsman, J. T. Froh.

Editorial Office, 79 W. Monroe St., Chicago 3, Ill.

Every effort will be made to return material submitted for possible publication (if accompanied by stamped, addressed envelope), but the editors and the corporation will not be responsible for loss or damage.

JOHN B. GOODWIN, Prominent Memphis Builder

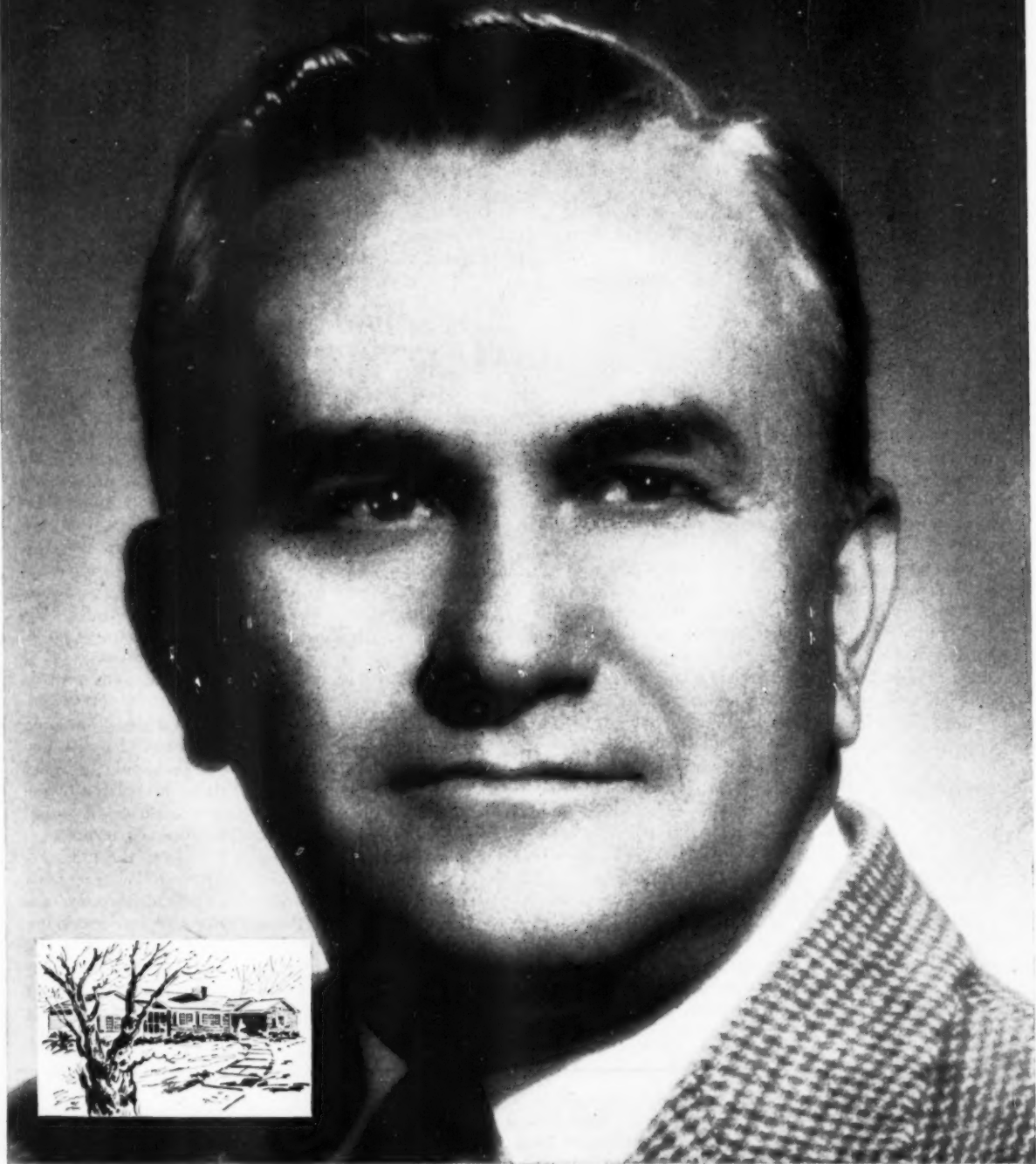

"THERE'S NO SUBSTITUTE for quality products in a home. Whether the home sells for \$15,000 or \$200,000 — and I've been building both types since 1924 — my customers expect and demand top-grade, name-brand materials. And that's just the kind they get. I make sure of it by using 127 of the fine products advertised in *The Saturday Evening Post*." *(Manufacturers of building materials, equipment and fixtures place more advertising dollars in the Post than in any other consumer magazine.)*

The Saturday Evening
POST

—gets to the heart of America

AMERICAN BUILDER

National housing starts soar, but— how's business in your home town?

- Housing industry needs more market data at the local level
- Several cities successfully operate housing fact-finding committees

The housing industry has made news this summer as national housing starts increased about 17 per cent over a year ago. The Wall Street Journal reports that "Home building, a big prop in today's economy, is passing from summer to fall at a pell mell pace."

Dallas, Boston, Chicago and other cities are expecting to break all home building records this year. A Dallas builder says, "Housing starts are going crazy around here. So many hit all at once, it's causing a shortage of Sheetrock, cement and plumbing supplies. We're absorbing a three per cent increase in building costs as a result of these materials going up in price."

Cities seldom conform to national projection

But what's the situation in your home town? Past experience has shown that a projection of the prospects in the home building and real estate markets on a national basis does not necessarily foreshadow the trend of events in local markets.

The Housing and Home Finance Agency has studied this subject and issued a report entitled "Housing Research." In 1952, for example, the total value of home building undertaken in non-farm areas was about four per cent higher than it had been in the previous year. Among individual cities with populations of 100,000 or more, however, there were only a handful where the national performance could have been at all helpful in predicting local market trends.

650 per cent increase—78 per cent drop

At the one extreme, we find communities like Reading, Pennsylvania with its 650 per cent increase in home building; Bridgeport, Connecticut, with 424 per cent; Camden, New Jersey, with 366 per cent; or Jersey City, New Jersey, with 243 per cent. At the other end of the scale there was Fall River, Massachusetts, with a 78 per cent drop in housing starts; and Trenton, New Jersey, Providence, Rhode Island, and Lowell, Massachusetts, with a decline of 75 per cent.

Clearly, the national picture, which showed no significant change from the previous year, was valueless as a guide to the building prospects in these eight areas. It happens that some of these areas were unfortunately hit by hurricanes this fall, and that's another unpredictable factor.

Some other examples of extreme changes during last year in home building volume in an otherwise stable material market were Peoria, Illinois, up 162 per cent, and Scranton, Pennsylvania, up 44 per cent. During the same period there was a decline of nine per cent in housing starts in Indianapolis, Indiana, 15 per cent in Toledo, and 35 per cent in Wichita.

Need for local data

The builders aren't the only ones who need data in their local building market. The questions of what lies ahead for next year are asked by lenders, real estate brokers

and building suppliers in practically every city and town across the length of the land. Yet in only a handful of places can satisfactory answers be given. In the absence of good usable local figures, too many businessmen fall back upon one or another of the many national forecasts to provide them the answers as to what to expect in their local community.

Yet there are a number of communities where committees make detailed studies of the residential market on a cooperative basis, including the Los Angeles Research Committee which was started in 1939, and similar committees in Memphis, Miami, San Francisco, Seattle, Baltimore, Denver, and San Diego.

Strong leadership sparks these committees

Looking at the communities in which housing fact-finding groups are now in operation, it is apparent that the one common denominator is the presence of one or more individuals or organizations who get the undertaking off to a good start with their staunch support and leadership. The experience of every single one of the fact-finding groups has been that once they got underway, area support gradually broadened, with more and more businessmen seeking to get access to the findings.

This kind of local information is just as necessary in smaller communities as it is in the large metropolitan areas mentioned. Rochester, New York, is an example of this.

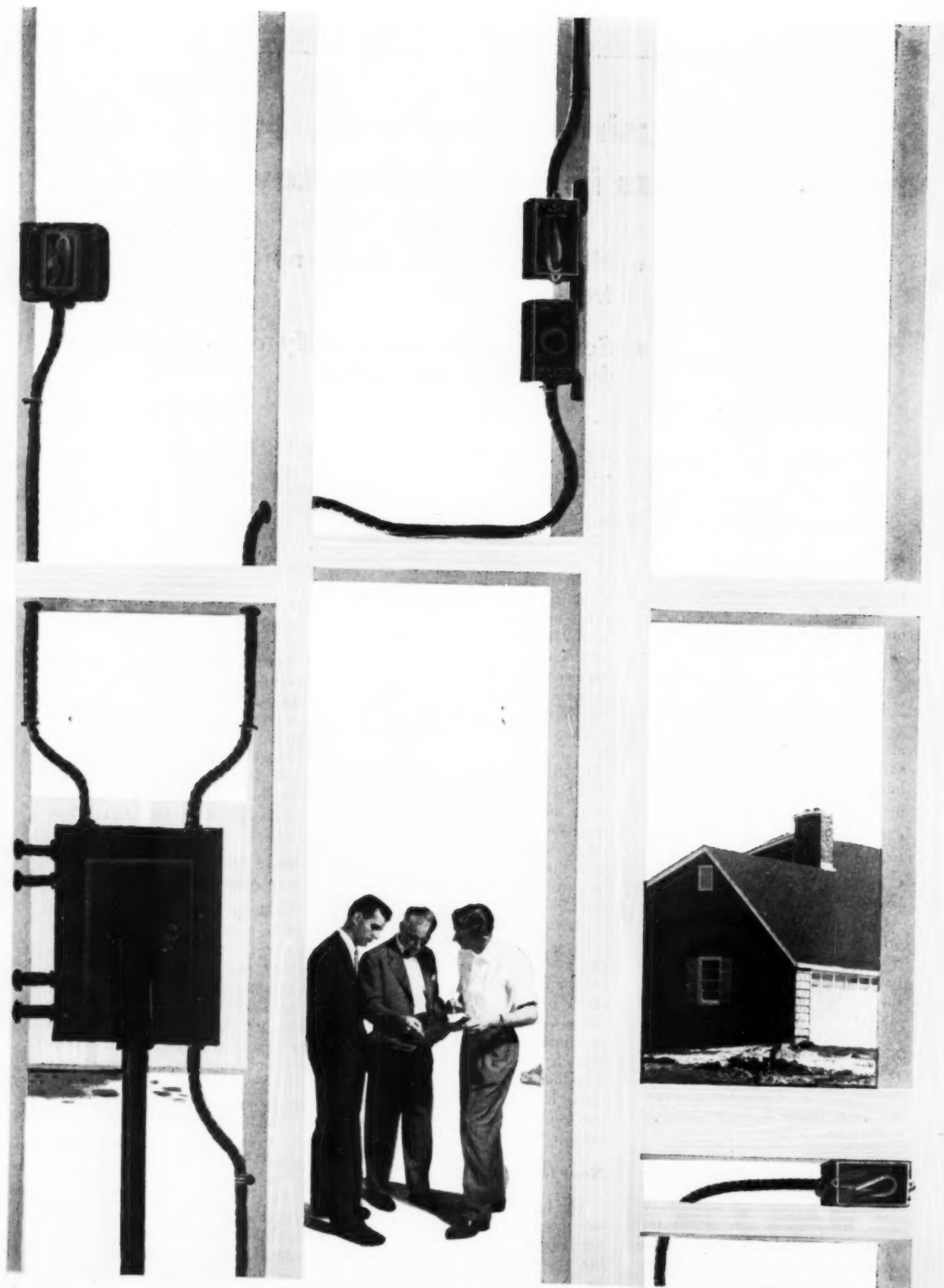

Today's best reputation builder...

SOUND WIRING!

No one knows better than a builder how the building business has developed since 1930!

Today, you'll find better materials, simplified techniques, improved construction methods — things a builder of 20 years ago might never have even *dreamed* of! But there's *one* factor that some builders overlook...

Since 1930, the number of household appliances has almost *tripled*. Today there are nearly *60* different kinds of home electrical appliances in general use. *But more than*

20,000,000 homes in the United States just aren't built to stand this extra work load!

What's needed is more adequate wiring — large wires...the right circuits and plenty of them...handier, more numerous outlets.

Today's electrically-minded home owners *demand* the convenience of this adequate wiring. That's why it's so important to incorporate this feature in the homes *you* build. It boosts your reputation as a builder of quality homes...makes your houses easier to sell.

Important note: Watch for the national Kennecott adequate wiring advertisements now appearing in *The Saturday Evening Post* and *This Week* national magazines. They *pre-sell* what *you* are building and selling — fine homes, adequately wired...fully powered for modern living!



Kennecott
COPPER CORPORATION

Fabricating Subsidiaries: Chase Brass & Copper Co., Kennecott Wire & Cable Co.



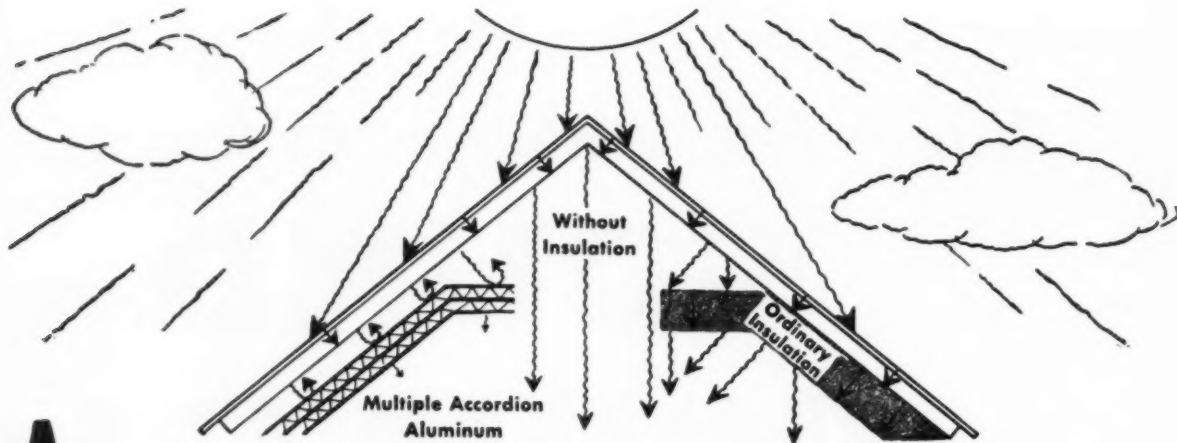

An Empty Roof Space Would Be The Best Insulation Against Summer Sun, Were It Not For Radiation

But substantially the only summer heat flow through empty roof space is RADIATION. There is slight CONDUCTION. Heat flow by CONDUCTION through any building space is about 7% of the total. CONVECTION is not a problem—there is NO CONVECTION downward.

Ordinary insulation may retard heat for a time, but stores a large amount of heat as compared to empty space. More dense, it is a much better conductor of heat than just air and so more heat passes through it by conduction. Its surfaces have a heat ray absorptivity and emissivity of over 90% and radiate heat into the building through the day, and sometimes into the night.

The solution is to use a material which has little substance and whose surfaces will absorb and emit little radiation. Gold or silver foil would be excellent, but tough multiple accordion aluminum, which weighs but ¼ oz. per sq. ft., is inexpensive and almost as good, with a heat ray absorptivity and emissivity of only 3%.

The metal sheets of multiple accordion aluminum are almost impervious to water vapor and are continuous, 500 ft. to 750 ft. long. Infiltration under their flat stapled flanges is slight. The scientific construction of multiple layers of aluminum, fiber, and air spaces minimizes condensation formation on or within this type of insulation. Its slight mass is capable of little heat storage.

The National Bureau of Standards Booklet BMS52, "Effect of Ceiling Insulation Upon Summer Comfort" lists on Page 10 the relative effectiveness of the insulations tested in protecting ceilings against summer heat. First in effectiveness was two layers of aluminum foil (both sides of each layer reflecting). Second was full thick (3½-inch) ordinary insulation. (Use coupon to get the booklet FREE!)

Try this test: Tack or scotch-tape 3 sq. ft. of multiple accordion aluminum (we will send it free on request) to the underside of a hot roof or ceiling, whether uninsulated, or insulated with ordinary material. Step in and out of the protected area beneath. The difference will be so marked you will need no thermometer.

To obtain MAXIMUM, uniform-depth protection against heat loss and condensation formation, it is necessary to use the new edge-to-edge multiple aluminum*, each sheet of which stretches from joist to joist, and also all through the flanges for further vapor protection as well as permanent attachment of each sheet.

*Patent applied for.

**COST OF EDGE-TO-EDGE INFRA
Multiple Aluminum Insulation
installed in new construction between
wood joists, material with labor**

Type 6-5 under 9½¢ sq. ft.

Type 4-5 under 7½¢ sq. ft.

INFRA INSULATION INC.
525 Broadway, N.Y.C., Dept. B11

Please send FREE:

- Bureau of Standards Booklet, BMS 52, "Effect of Ceiling Insulation upon Summer Comfort."
- 3 Ft. Square of Multiple Accordion Aluminum for Test.

Name _____

Firm _____

Address _____

INFRA INSULATION, INC., 525 BROADWAY, NEW YORK, N. Y.

AMERICAN BUILDER



DEMAND FOR NEW HOMES will not be satisfied for at least a year or two in the Detroit area, Robert A. Taggart, president of the Detroit Mortgage Bankers Association, said recently. While his remarks were aimed locally, the reasoning behind them applies generally throughout the nation. He said:

"When newspaper advertising of both small and large projects, or of a home with exceptional features, brings lines of scores and hundreds of people to view them, it requires no special vision to see a great potential demand. Naturally, many of these people are what is known in the trade as 'lookers' only, or people whose hopes are in the future, but a **basic buying urge is evident.**"

Continued **high level of savings** was seen as another important factor. "This creates a **steady supply of mortgage money** on the one hand," he said, "and a **residue of buying power**" on the other."

SINCE THE HOUSING ACT WAS PASSED three months ago, starts have increased about 20 per cent. Coupled with the first half of the year, which ran neck and neck with 1953 figures, this late drive will help 1954 wind up with an over-all improvement of at least 10 per cent.

Two of the nation's largest home centers help bear this out. New York's Long Island area, growing by nearly 40,000 homes annually for the past five years, has experienced a late surge in starts which will probably raise the 1954 total more than 10 per cent, according to a Long Island Home Builders Institute spokesman.

Chicago area is running 12 per cent ahead of 1953 in starts, 16 per cent in dollar volume, at the nine-month mark, according to a Bell Savings & Loan survey. September figures were the brightest of the year in a month-to-month comparison. With 35,674 starts credited through September, last year's total of nearly 40,000 should be exceeded by at least 5,000 home units.

Canada, with a more liberal housing act of its own, is expected to break its all-time record set last year. A spurt in July boosted starts for the first seven months to 60,589, a 3 per cent in-

crease over the comparable 1953 period. Completions numbered 49,955, 8 per cent higher.

FOUR MANUFACTURERS AND A UTILITY

have joined Fred Garling Custom Builders Inc. as co-sponsors of some of the most completely equipped homes seen to date, starting at \$25,000. To mark the opening of the 323-acre Westchester Village in Bloomfield Township, near Detroit, General Electric "premiered" its **built-in refrigerator and freezer units,** the new Ford Thunderbird **sports car was in each two-car garage,** Carrier Weathermaker air conditioning units were installed and, in one model, several new uses of Reynolds aluminum were featured. Advanced lighting methods and appliances were demonstrated in another model by Detroit Edison.

Garling, working with Sullivan-Smith, Inc., builders, plans over 600 houses, each on half-acre plots, but expects to take six years to do the job. It's understood each house will have, in addition to the built-in refrigerator and freezer, plus a sports car or a station wagon, a built-in "hi-fi" record-player with capacity to play 100 long-playing records automatically, two 60-gallon electric water heaters connected in tandem, electric outlet strips, dishwasher and disposal unit.

CONTROL SHOPPING CENTER DESIGN was the plea of Hugh Pomeroy, Westchester County, N. Y., planning director, at Philadelphia conference of American Society of Planning Officials. Such centers spring up so fast, he said, that old zoning laws can't cope with them.

Often a developer will appear before a zoning commission with beautiful pictures of what he proposes to build, Pomeroy charged, "but too often any resemblance of what he does to what he says he will do is wholly accidental."

Developers of new suburban store centers, he urged, should be required to submit a layout plan as part of their request for a zone change, and no permit should be given unless the building actually conforms to an over-all approved plan, insuring that neighbors will not be unduly hurt.



Plymouth Design
Sectional
Handle set



Montgomery Design
Sectional
Handle set

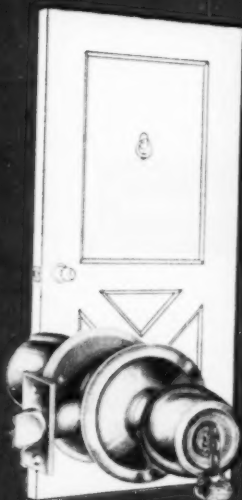

New Windsor
"Crestwood" Design



New Windsor
"Windsor" Design



How Corbin Hardware
Helps You

AVOID "LOOK-ALIKE" STYLING

Of all the good ways to make homes look different, few are more important than front door styling. A distinctive front door can create a good first impression. It can dramatize your workmanship. It can help close a sale!

So, don't let "look-alike" styling slow your sales! Give each door its own individual look. With Corbin locks and trim hardware, it's both easy and economical.

For example, use a Plymouth Sectional Mortise Type lock set on one front door . . . a Montgomery on another. On other front doors you can use Windsor Design *Defenders* or *Crestwood Design Defenders*. For greatest economy and good performance, use Corbin *Defender* or *Guardian* cylindrical locks on the back doors and interior doors.

King size roses in FIVE designs and THREE sizes allow further interesting variations. All cylinders for any one home can be keyed into ONE convenient keying system . . . keyed alike or master keyed.

CORBIN

The World's
most widely used
BUILDERS'
HARDWARE

P. & F. CORBIN
Division
The American Hardware
Corporation
New Britain, Conn.



Guardian Lock set
with
Auxiliary Handle



Defender Lock set
with King Size rose

MISCELLANEOUS FRONT DOOR TRIM HARDWARE

1 2 3

House Numbers

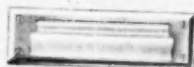

Letter Drop Plates



Door Knockers



Push
Buttons

NEWS

**Eleven Northern Builders Win
Top Awards in Acapulco Derby**

Eleven northern builders were among the 25 Acapulco Derby grand prize winners announced at the recent National Association of Home Builders directors' meetings in New York. The group will meet at Dallas Nov. 27 to start a 10-day "fisherman's holiday" in Mexico as the guest of the Minneapolis-Honeywell Regulator Company, which sponsored the contest with NAHB cooperation.

Eight builders adjudged to have conducted outstanding merchandising programs, climaxed by a National Home Week showing, were Louis Beckenstein, West Hartford, Conn.; Fred P. DeBlase, Rochester, N. Y.; Leon N. Weiner, Franklin Builder Homes, Wilmington, Del.; Fred C. Garling, Dearborn, Mich.; Bruce S. Blietz, Wilmette, Ill.; James H. Furney, Minneapolis; Richard Moseley, Kansas City, Mo., and Joseph Scullin, Trenton, N. J.

Three successful entrants in the trade-in and new-conditioning contest were Allen K. Davidheiser, Pottstown, Pa.; John R. Worthman, Fort Wayne, Ind., and Edward Rose, Detroit.



Offer Student Awards

James J. Byrne, president, Detroit Hoo Hoo Club and Fred B. Lowrie, president, Detroit Lumbermen's Association, presenting their organizations' annual lumber merchandising scholarships to William B. Lloyd, associate professor, Michigan State College

Other winners in the merchandising contest were Henry J. Rolfs, Washington, D. C.; Charles C. Lucas, Carolina Construction Co., Charlotte, N. C.; Vincent J. DeMeo, Miami Shores, Fla.; N. O. Simmons, Corpus Christi, Texas; Melvin H. Jensen, Salt Lake City; Russell Udovick, M. O. Bogue & Co., Denver; Donald J. MacGillvray, Spokane, Wash.; John Boswell, South Pasadena, Calif.; Stanley Trezevant, Trezevant & Kelly, Memphis; L. P. Smith, New Orleans; Dale J. Bellamah, Albuquerque, N. M., and Chris Finson, Finson & Oddstad, San Mateo, Calif.

Trade-conditioning winners also included Albert Balch, Seattle, and Lee Construction Co., Dallas, Texas.

Roamin' the North—

After five years as exec. director of the HBA of Metropolitan Pittsburgh, **H. William Hanna Jr.** has resigned to become exec. V.P. of HBA of Greater Cleveland. Hanna heads NAHB's Executive Officers Council. . . Newly formed HBA of Illinois established headquarters Oct. 1 in Abraham Lincoln Hotel, Springfield, Ill. **Charles F. Kervin**, former chief



Hanna



Kervin

clerk of the house in the state legislature, has been appointed exec. V.P. He drew a big assignment quickly: first annual convention under official auspices, to be held Dec. 3-4 at Hotel Pere Marquette, Peoria. . .

Clarence J. Von Drehle has left the ranks of the executive officers to become a full-fledged home builder at Hillsdale, N. J., his home town. His place as exec. director, HBA of Northern New Jersey was taken by



Head New Chapter

Officers of the new Home Builders Assn. of Springfield, Mo.: (from left) **Gerry Doran**, secretary-treasurer; **John Blazona**, assistant secretary-treasurer; **J. D. Gillenwaters**, president; (seated) **Fred Riebold**, vice-pres.

Thaddeus C. Borek, formerly with Cincinnati and Long Island builder groups. . . **Ralph Smykal**, vice president of Richard Smykal Inc. of Wheaton, Ill., has succeeded **Larry**



Borek



Smykal

Lawrence as president, Junior Home Builders of Chicagoland. . . "Today's demand for good homes is almost limitless—if they can be purchased on terms that buyers can pay," declared **John A. Rader**, after his Land & Development Co. sold 200 houses in two weeks at Sheffield Lake, Ohio. . .



John A. Rader

Joseph Rader

ARE YOU

BLIND TO

NEW IDEAS?

LABOR INFORMATION, new building techniques, new materials; financing trends, selling suggestions, tax planning . . . few activities escape the all-encompassing home-building industry. To stay on top of them all is a full-time job in itself.

NAHB experts do just that—and pass on their findings to members. Technical services alone more than repay the cost of membership in your local Home Builders Association (which automatically includes membership in the national Association).

An important extra is the Annual Convention-Exposition—one of the largest, most complete and educational events of its kind in this country. Open only to NAHB members, the exhibition presents new products and new methods to builders and representatives of related industries. Some of the subjects covered: How to Sell a House; Land Planning; Remodeling; Tax Planning and Saving for Small and Large Builders; FHA-VA Questions and Answers; Year-Round Residential Air Conditioning; Uses of Lumber; Correct Masonry; Dry Wall; Insulating Board and Good Concrete; Better Merchandising; Financing—all presented by experts. The annual Convention-Exposition is held in Chicago on January 16-20.

Plan to attend if you can—as a member or associate. To join, contact your local HBA. If none has been formed in your area, write to the Membership Department for complete details.

NATIONAL ASSOCIATION OF HOME BUILDERS
1028 Connecticut Avenue, N.W., Washington 6, D.C.

WHAT'S NAHB? An aggressive group of more than 29,000 home builders, contractors and sub-contractors, material suppliers, mortgage lenders, realtors, architects, building material manufacturers, all dedicated to a strong industry, free from unnecessary controls. Organized on national, state and community levels, it provides an effective means of voicing collective opinions on local and national matters. *Through membership in your local Association, you automatically become a member of the National group.*

ACTIVITIES OF NAHB. It represents you on Capitol Hill and before federal legislative groups; provides data on up-to-date design and construction techniques, mortgage finance information; engages in housing research; promotes National Home Week and the Parade of Homes; informs the public of industry activities through press, magazine, radio and TV; sponsors slum clearance programs, "trade secrets" meetings, annual conventions and expositions; your local association speaks for you at City Hall, at local FHA and VA offices.

NAHB provides these information services:

- *Washington Letter*—keeps NAHB members posted on trends that will influence operations; issued about three times monthly in concise, factual form.
- *Correlator*—monthly publication for members only, packed with Association news and information.
- *Housing . . . U. S. A.*—NAHB and Simmons-Boardman Publishing Co., publishers of American Builder magazine, combined forces to produce this interesting, informative, profusely illustrated volume on the merchant builder and the housing industry
- *Special Bulletins* on new developments issued as circumstances warrant.
- *Technical Services Department* conducts continuing research to "build a better house with less money and fewer headaches"; examines new materials, construction techniques, land-planning methods. The Trade Secrets House was a product of this service available only to NAHB members.



AFFILIATED LOCAL ASSOCIATIONS
(Northern)

CONNECTICUT

GREATER BRIDGEPORT BUILDERS ASSOCIATION
37 Bolin Circle, Trumbull 19, Conn.
HOME BUILDERS ASSOCIATION OF HARTFORD COUNTY, INC.
62 LSAille Rd., West Hartford, Conn.
Telephone # Adams 3-4495
HOME BUILDERS ASSOC. OF GREATER NEW HAVEN
122 Welba St., Milford, Conn.
Telephone # Locust 2-1607

DELAWARE

HOME BUILDERS ASSOCIATION OF DELAWARE
503 South Maryland Ave., Wilmington 4, Delaware

DISTRICT OF COLUMBIA

HOME BUILDERS ASSOCIATION OF METROPOLITAN WASHINGTON
Suite 303, 1757 K St., N.W., Washington, D. C.
Telephone # Republic 7-1171

ILLINOIS

CHICAGO METROPOLITAN HOME BUILDERS ASSOC.
130 W. Randolph St., Chicago 1, Ill.
Telephone # Franklin 2-9740
HOME BUILDERS ASSOCIATION OF DECATUR
1812 W. Forest, Decatur, Ill.
Telephone # 3-4451
PEORIA AREA HOME BUILDERS ASSOCIATION
3505 Prospect Rd., Peoria, Ill.
SPRINGFIELD HOME BUILDERS ASSOCIATION
229 E. Jefferson St., Springfield, Ill.

INDIANA

ANDERSON HOME BUILDERS ASSOCIATION
Rm. # 15 Liberal Life Bldg., Anderson, Ind.
HOME BUILDERS ASSOCIATION OF MONTGOMERY COUNTY
606 E. Main, Crawfordsville, Ind.
ELKHART HOME BUILDERS ASSOCIATION
320 S. Highland Ave., Elkhart, Ind.
HOME BUILDERS ASSOCIATION OF FORT WAYNE
4338 Drury Lane, Ft. Wayne, Ind.
EVANSVILLE HOME BUILDERS ASSOCIATION, INC.
1427 E. Division St., Evansville, Ind.
Telephone # 4-1520
MARION COUNTY RESIDENTIAL BUILDERS, INC.
206 Evans Bldg., 136 No. Delaware St., Indianapolis, Ind.
Telephone # MA-1387
MUNCIE HOME BUILDERS ASSOCIATION
221 Hutchinson, Muncie, Ind.
Telephone # 2-1264
HOME BUILDERS ASSOCIATION OF NORTHERN INDIANA
2801-9th Ave., Gary, Ind.
SOUTH BEND-NISHAWAKA HOME BUILDERS ASSOCIATION
Box 61-B, RR #6, Ireland Road, South Bend, Ind.
Telephone # AM 3-5108
HOME BUILDERS ASSOC. OF INDIANA, INC. (State)
310 K. of P. Building, Indianapolis, Ind.
Telephone # Market 3281

IOWA

HOME BUILDERS ASSOCIATION OF OTTUMWA (Iowa)
411 N. Milner St., Ottumwa, Iowa
HOME BUILDERS ASSOCIATION OF CEDAR RAPIDS
1628 Park Ave., S. E., Cedar Rapids, Iowa
Telephone # 3-9495
HOME BUILDERS ASSOCIATION OF DES MOINES
600 Mulberry St., Des Moines, Iowa
Telephone # 2-8519
HOME BUILDERS ASSOCIATION OF FORT DODGE
720-12th Ave., No. Fort Dodge, Iowa
Telephone # Austin 4-642
HOME BUILDERS ASSOCIATION OF MASON CITY
109 East State, Mason City, Iowa
QUAD CITY ASSOCIATION OF HOME BUILDERS
2434 Degan Court, Davenport, Iowa
Telephone # 3-5054
HOME BUILDERS ASSOCIATION OF SIOUX CITY
434 Commerce Bldg., Sioux City, Iowa
Telephone # 5-9730

KANSAS

TOPEKA HOME BUILDERS ASSOCIATION
121 E. 8th St. Topeka, Kansas
WICHITA ASSOCIATION OF HOME BUILDERS
620 S. Minnesota, Wichita 2, Kansas
Telephone # AM 5-6273

MARYLAND

HOME BUILDERS ASSOCIATION OF MARYLAND
7 E. Lexington St., Baltimore 3, Md.
Telephone # PL 8-532

MAINE

HOME BUILDERS ASSOCIATION OF MAINE
119 Exchange St., Portland, Maine
Telephone # 3-1786

MASSACHUSETTS

HOME BUILDERS ASSOC. OF GREATER BOSTON
7 Water St., Boston 8, Mass.
Telephone # LA 3-2910
HOME BUILDERS ASSOCIATION OF SOUTHEASTERN MASSACHUSETTS
92 Wood St., Somerset, Mass.
FRANKLIN COUNTY BUILDERS ASSOCIATION
12 Holland Ave., Greenfield, Mass.
HOME BUILDERS ASSOCIATION OF BRISTOL & PLYMOUTH COUNTIES
766 County St., New Bedford, Mass.
SPRINGFIELD HOME BUILDERS AND CONTRACTORS, INC.
134 Chestnut St., Springfield, Mass.
MASTER HOME BUILDERS ASSOC. OF WORCESTER
151 Main St., Worcester 8, Mass.
Telephone # 2-7392

MICHIGAN

MICHIGAN ASSOC. OF HOME BUILDERS (State)
307 American State Bank Bldg., Lansing, Mich.

BATTLE CREEK ASSOCIATION OF HOME BUILDERS

717 Upton Ave., Battle Creek, Mich.
BUILDERS ASSOC. OF METROPOLITAN DETROIT
2316 Dime Bldg., Detroit 26, Mich.
Telephone # WO 3-1454

FLINT ASSOCIATION OF HOME BUILDERS

1813 Bennett Ave., Flint 6, Mich.
GRAND RAPIDS HOME BUILDERS ASSOCIATION
800 Association of Commerce Bldg., Grand Rapids, Mich.

HOME BUILDERS ASSOCIATION OF KALAMAZOO
609 So. Bardick St., Kalamazoo, Mich.
Telephone # 5-1965

LANSING HOME BUILDERS ASSOCIATION
2012 Turner St., Lansing, Mich.

SAGINAW VALLEY BUILDERS ASSOCIATION

222 North Bates, Saginaw, Michigan
WASHTENAW COUNTY GENERAL CONTRACTORS,

823 Arlington Blvd., Ann Arbor, Mich.

MINNESOTA

DULUTH HOME BUILDERS ASSOCIATION
411 Builders Exchange, Duluth 2, Minn.
MINNEAPOLIS HOME BUILDERS ASSOCIATION
1750 Hennepin Ave., Room B-15, Minneapolis, Minn.
Telephone # Lincoln-0531
ROCHESTER CHAPTER OF NAHB
625-10th Ave., S.E., Rochester, Minn.
ST. PAUL HOME BUILDERS ASSOCIATION
79 Western Ave., Commodore Hotel, St. Paul 2, Minn.
Telephone # Elkhardt 1-004
WILLMAR CHAPTER OF NAHB
725 E. 4th St., Willmar, Minn.

MISSOURI

HOME BUILDERS ASSOCIATION OF GREATER KANSAS CITY
4638 J. C. Nichols Parkway, Kansas City 12, Mo.
Telephone # Jefferson 6-366
HOME BUILDERS ASSOC. OF GREATER ST. LOUIS
7 No. Brentwood Blvd., Clayton 5, Mo.
HOME BUILDERS ASSOCIATION OF SPRINGFIELD
I.M.O.
1433 So. Pickwick, Springfield, Mo.

NEBRASKA

HOME BUILDERS ASSOCIATION OF LINCOLN
2263 "Y" St., Lincoln, Nebr.
Telephone # 2-3395
OMAHA HOME BUILDERS ASSOCIATION
4807 Military Ave., Omaha, Nebr.
Telephone # Atlantic 3-240

NEW HAMPSHIRE

BUILDERS ASSOCIATION OF NEW HAMPSHIRE
71 Bruce Road, Manchester, N. H.

NEW JERSEY

NEW JERSEY HOME BUILDERS ASSOC. (State)
16 Park Place, Military Park Hotel, Suite 733, Newark 1, N. J.
ATLANTIC HOME BUILDERS ASSOC. OF NEW JERSEY
Brighton Hotel, Atlantic City, N. J.
Telephone # 5-7493
HOME BUILDERS ASSOC. OF METROPOLITAN N. J.
Military Park Hotel, Suite 733, 16 Park Place, Newark 1, N. J.
Telephone # Market 3-0114
HOME BUILDERS OF NORTHERN N. J.
25 Essex St., Hackensack, N. J.
Telephone # Hubbard 7-2733
NEW JERSEY SHORE BUILDERS ASSOCIATION
37 Atlantic Ave., Manasquan, N. J.
Telephone # Manasquan 7-0502
HOME BUILDERS ASSOC. OF JARITAN VALLEY
46 Bayard St., New Brunswick, N. J.
HOME BUILDERS ASSOCIATION OF SOMERSET & MORRIS COUNTIES
47 Oakland Place, Summit, N. J.
HOME BUILDERS LEAGUE OF SOUTH JERSEY
622 Cooper St., Camden, N. J.
HOME BUILDERS ASSOC. OF MERCER COUNTY
146 Hanover St., Trenton, N. J.
Telephone # Trenton 9-2555
NORTHWEST N. J. CHAPTER OF NAHB
P. O. Box 131, Clinton, N. J.

NEW YORK

HOME BUILDERS ASSOCIATION OF ALBANY, INC.
105 Colvin Ave., Albany, N. Y.
BRONX HOME BUILDERS ASSOCIATION, INC.
1280 East Can Hill Rd., Bronx, N. Y.
Telephone # Kingsbridge 7-8181
CHEMUNG VALLEY HOME BUILDERS ASSOCIATION
57 East Market St., Corning, N. Y.
Telephone # Corning 2-1551
GENESSEE COUNTY BUILDERS ASSOCIATION
Box 364, Batavia, N. Y.
LONG ISLAND HOME BUILDERS INSTITUTE, INC.
570 Fulton Ave., Hempstead, L. I., N. Y.
Telephone # Ivanhoe 1-8400
NIAGARA FALLS HOME BUILDERS, INC.
210 Hancock Bldg., Niagara Falls, N. Y.
Telephone # 5711
THE NIAGARA FRONTIER BUILDERS ASSOC., INC.
4 Erie St., Buffalo 2, N. Y.
Telephone # Cleveland 1850
HOME BUILDERS ASSOCIATION OF GREATER SYRACUSE, INC.
220 East Washington St., Syracuse 2, N. Y.
Telephone # 76-6212
ROCHESTER HOME BUILDERS ASSOCIATION
240 Powers Bldg., Rochester 14, N. Y.
Telephone # Baker 5-487
ROCKLAND COUNTY HOME BUILDERS ASSOCIATION
6 Elish Parkway, Spring Valley, N. Y.
HOME BUILDERS ASSOCIATION OF SCHENECTADY
2048 Coolidge Place, Schenectady, N. Y.

NEW YORK HOME BUILDERS ASSOCIATION (State)

64 Metropolitan Oval, Parkchester, Bronx, N. Y.
Telephone # Talmadge 3-5300
SOUTHERN TIER HOME BUILDERS ASSOCIATION
102 Kelly Ave., Endicott, N. Y.
DUSO HOME BUILDERS ASSOCIATION
158 Grand St., Newburgh, N. Y.
STATEN ISLAND HOME BUILDERS ASSOCIATION
150 Bay St., Staten Island, N. Y.
Telephone # SA 7-4600
HOME BUILDERS ASSOC. OF WESTCHESTER, INC.
151 East Post Rd., White Plains, N. Y.
Telephone # Bronxville 2-3908

OHIO

HOME BUILDERS ASSOCIATION OF GREATER AKRON
Rm. 634, Second National Bldg., Akron 8, Ohio
Telephone # PO 2-2013
HOME BUILDERS ASSOCIATION OF STARK CO., INC.
243 Montrose Ave., N.W., Canton, Ohio
Telephone # 5-0207
HOME BUILDERS ASSOC. OF GREATER CINCINNATI
907 Union Trust Bldg., Cincinnati 2, Ohio
Telephone # GA-1212
HOME BUILDERS ASSOC. OF GREATER CLEVELAND
Allerton Hotel, E. 13th & Chester Ave., Cleveland 11, Ohio
Telephone # Cherry 1-2920
COLUMBUS HOME BUILDERS ASSOCIATION
16 E. Broad St., Suite 1300, Columbus, Ohio
Telephone # MA 1-397
HOME BUILDERS ASSOCIATION OF BUTLER COUNTY
1st National Bank Bldg., Hamilton, Ohio
Telephone # 4-7079
HOME BUILDERS ASSOCIATION OF LAKE COUNTY
3150 Lakeland Blvd., Wickliffe, Ohio
LORAIN HOME BUILDERS ASSOCIATION
824 Highland Park Blvd., Lorain, Ohio
HOME BUILDERS ASSOCIATION OF NEWARK
Box 28, Newark, Ohio
HOME BUILDERS ASSOCIATION OF PORTSMOUTH
930 10th St., Portsmouth, Ohio
HOME BUILDERS ASSOC. OF WAHNING VALLEY
3119 Market St., Suite 200, Youngstown 7, Ohio
Telephone # Sterling 8-8222
HOME BUILDERS ASSOCIATION OF MANSFIELD
648 Coleman Rd., Mansfield, Ohio
MONTGOMERY COUNTY BUILDERS ASSOCIATION
132 N. Main St., Dayton 1, Ohio
Telephone # Michigan-0323
NORTHWESTERN OHIO CONTRACTORS AND BUILDERS ASSOCIATION
793 Sereff Rd., Lima, Ohio
OHIO HOME BUILDERS ASSOCIATION (State)
111 East Gay St., Columbus 15, Ohio
Telephone # Fletcher-3112
HOME BUILDERS ASSOCIATION OF SANDUSKY
111 East Gay St., Columbus 15, Ohio
Telephone # 3932
CLARK COUNTY HOME BUILDERS ASSOCIATION
Ohio Fuel Gas Co., 101 W. High St., Springfield, Ohio
TOLEDO ASSOCIATION OF HOME BUILDERS, INC.
564 Spitzer Bldg., Toledo, Ohio
HOME BUILDERS ASSOCIATION OF MARION
R. R. #1, Marion, Ohio
Telephone # 2-6660

PENNSYLVANIA

PENNSYLVANIA HOME BUILDERS (State)
345 Fourth Ave., Pittsburgh, Pa.
THE HOME BUILDERS ASSOCIATION OF METROPOLITAN PITTSBURGH
345 Fourth Ave., Pittsburgh, Pa.
Telephone # AT 1-9534
HOME BUILDERS ASSOC. OF FAYETTE COUNTY
62 E. Main St., Uniontown, Pa.
HOME BUILDERS ASSOC. OF GREATER JOHNSTOWN
701 Belmont Ave., Johnstown, Pa.
HOME BUILDERS ASSOC. OF NORTHWESTERN PENN.
Suite 311, Security Peoples Bank Bldg., Erie, Pa.
Telephone # 2-2712
LEHIGH VALLEY HOME BUILDERS ASSOCIATION
2816 Crest Ave., N. Allentown, Pa.
MONROE COUNTY BUILDERS AND CONTRACTORS ASSOCIATION
R. D. #1, East Stroudsburg, Pa.
HOME BUILDERS ASSOCIATION OF PHILADELPHIA & SUBURBS
Robinson Bldg., 42 So. 15th St., Philadelphia, Pa.
Telephone # RI 6-6588
SHENANGO VALLEY HOME BUILDERS ASSOC., INC.
P. O. Box 303, Sharon, Pa.

RHODE ISLAND

HOME BUILDERS ASSOCIATION OF RHODE ISLAND
Rm. 211, 433 Westminster St., Providence, R. I.

WEST VIRGINIA

HOME BUILDERS ASSOCIATION OF CHARLESTON
2411 E. Washington St., Charleston 2, W. Va.

WISCONSIN

MADISON BUILDERS ASSOCIATION
206 E. Main St., Madison 3, Wis.
Telephone # 5-6579
HOME BUILDERS ASSOCIATION OF LACROSSE
1322 Market St., La Crosse, Wis.
WILWAUKEE BUILDERS ASSOCIATION
6511 W. Blue Moond, Milwaukee, Wis.
Telephone # Blaesmond 8-9850
ROCK COUNTY BUILDERS ASSOCIATION
2652 Riverside Dr., Beloit, Wis.
WISCONSIN BUILDERS ASSOCIATION (State)
206 E. Main St., Madison, Wis.
RACINE-KENOSHA HOME BUILDERS ASSOCIATION
610 Main St., Racine, Wis.
Telephone # 4-1713

NOTE: Only Telephone Numbers listed that were available.

They're coming January 1955

TRACY steel kitchens

with sensational new

PIC-A-DOR

cabinets



color!
warmth!
texture!
flexibility!



Women will love them

Whatever they want, you have it with the combination of lastingly lovely Tracy stainless steel sinks and glamorous new Pic-A-Dor cabinets. Let us show you how you can satisfy any prospective buyer's taste easily and economically. We'll show you steel cabinets with sliding doors that can be made from any material you or the buyer prefers — glass, pegboard, birch, plywood, knotty pine. There is no end to the color possibilities. Here are the kitchens women have been wanting for years. Don't keep the ladies waiting!

See for yourself what Pic-A-Dor will do for your kitchen! Send for free perspective drawing!

To show you what Tracy's Pic-A-Dor can do for the kitchens in the homes you're building, we'll send you, absolutely free, a perspective drawing of a Pic-A-Dor kitchen on your plan.

Tracy
KITCHENS

MAIL THIS COUPON RIGHT AWAY

Dept. AB, Tracy Kitchens, P. O. Box 1137, Pittsburgh 30, Pennsylvania

Yes, I am interested in the Tracy Pic-A-Dor, stainless steel kitchen combination. I am enclosing a floor plan of my kitchen. Please return it with your FREE perspective drawing of a Pic-A-Dor kitchen.

NAME _____

ADDRESS _____

CITY _____ ZONE _____ STATE _____

NAME OF PROJECT _____

NUMBER OF UNITS _____ DATE TO BE STARTED _____

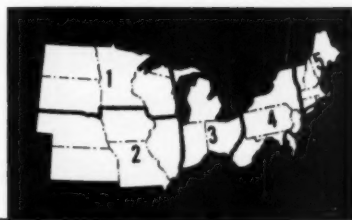

Weather for November

An exclusive American Builder service prepared by Irving P. Krick, Ph.D., and Staff

NORTH: With the exception of Area 5, the north portion of the United States may expect less than the usual number of operational days this November.

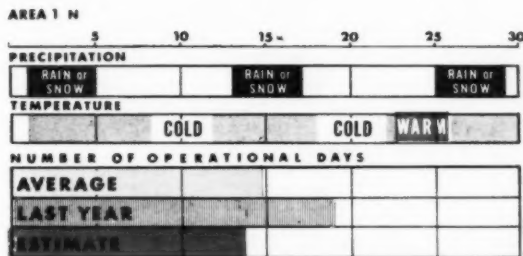

Contractors should expect unfavorable construction weather this month. While temperatures are expected to average normal to slightly above, several sharp cold spells are in prospect. Minimum temperatures well below the freezing level should be anticipated at these times. The chief weather restriction will be rain and snow. Amounts in excess of the critical value will occur during each of the stormy and unsettled periods indicated. Last November, very warm temperatures were observed resulting in a better than average accumulation of operational days.

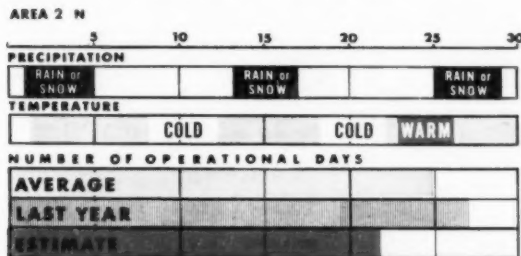

Rainfall and snowfall totals will be above normal during November, 1954. With three periods of storminess in prospect, Area 2 builders should expect less than the usual number of operational days. Wet soil will hamper foundation workers and locally may restrict their movement of heavy machinery. Low temperatures during the two cold spells also will delay outdoor construction. For the month, temperatures will average slightly above normal, however. Better than average working weather was recorded in Area 2 last November.

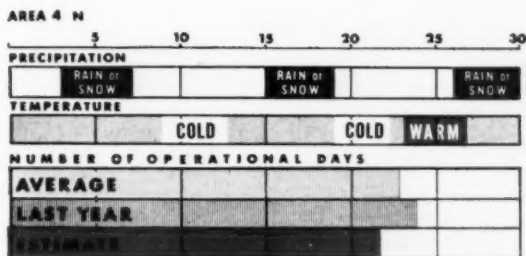
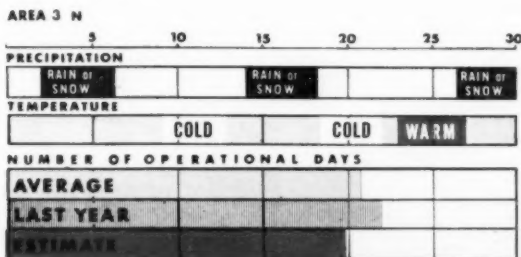

Construction workers should expect less than the average number of operational days to be recorded this month. Precipitation totals will range from slightly above normal in the south to slightly less than normal in northern New York state. Two short cold snaps are in prospect and minimum temperatures below the freezing level should be anticipated during each. A warming trend after the latter cold spell will provide several days of open weather. The better than usual working weather observed last November featured temperatures averaging well above the normal.

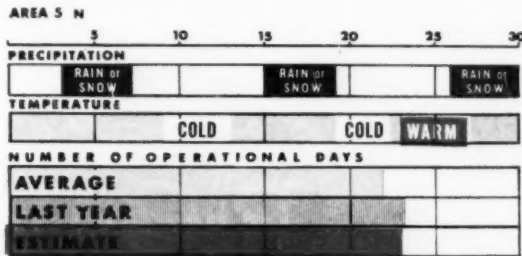

Less than normal precipitation and slightly warmer than normal temperatures should combine this November to provide better than average construction weather. Precipitation amounts in excess of the critical value will account for most of the days lost during the month. One or two days also will be classified non-operational during the indicated cold spells, when below freezing temperatures will be recorded. In November of last year, somewhat similar weather was observed in Area 5.

Warmer than usual weather is expected to prevail this month. Nevertheless, contractors will be faced with more restrictive conditions than normally experienced in November. The principal limiting factor will be precipitation as rainfall and snowfall amounts occurring during the periods indicated on the accompanying calendar bar will exceed the usual November totals. Workers involved in trenching and foundation activities will find wet soil conditions delaying their progress. Last November, slightly better than average working weather was experienced here.

SALES IMPROVE!



Builders know that *only* the homes with extra features are selling, today. Few *plus* values are as easily demonstrated as R·O·W windows. Homes with R·O·W windows sell faster.

See your local lumber dealer or write

R.O.W. SALES CO. 1342-66 ACADEMY AVENUE • FERDALE 20, MICHIGAN

R·O·W is the registered trade mark of the R.O.W. Sales Co.

AUTHORIZED R·O·W DISTRIBUTORS:

CONNECTICUT

GENERAL WOODCRAFT COMPANY, INC.
North Bergen, New Jersey and Lowell, Mass.

DISTRICT OF COLUMBIA

DEALERS WAREHOUSE SUPPLY CO., INC.
Arlington, Virginia

ILLINOIS

V. E. ANDERSON MFG. CO., INC.
Owensboro, Kentucky
IMSE-SCHILLING SASH & DOOR CO.
St. Louis, Missouri
R·O·W WINDOW COMPANY
Joliet, Illinois

INDIANA

V. E. ANDERSON MFG. CO., INC.
Owensboro, Kentucky
R·O·W WHOLESALE DISTRIBUTORS, INC.
Norwood, Ohio
R·O·W WINDOW COMPANY
Joliet, Illinois

IOWA

ANDREW A. KINDEM & SONS, INC.
Minneapolis, Minnesota
WISCONSIN WINDOW UNIT COMPANY
Merrill, Wisconsin

KANSAS

MARTIN MATERIAL COMPANY
Kansas City, Missouri

MAINE

GENERAL WOODCRAFT COMPANY, INC.
Lowell, Massachusetts

MARYLAND

DEALERS WAREHOUSE SUPPLY CO., INC.
Baltimore, Maryland

MASSACHUSETTS

GENERAL WOODCRAFT COMPANY, INC.
Lowell, Massachusetts and Schenectady, N. Y.

MICHIGAN

FLINT SASH & DOOR CO., INC.
Flint, Saginaw, Michigan
PORTER-HADLEY COMPANY
Grand Rapids, Michigan
ROYAL OAK WHOLESALE COMPANY
Royal Oak, Michigan

MINNESOTA

ANDREW A. KINDEM & SONS, INC.
Minneapolis, Minnesota

MISSOURI

IMSE-SCHILLING SASH & DOOR CO.
St. Louis, Missouri
MARTIN MATERIAL COMPANY
Kansas City, Missouri

WINDOWS REMOVE!

AUTHORIZED R-O-W DISTRIBUTORS:

NEBRASKA

THE SOTHMAN COMPANY
Grand Island, Nebraska

NEW HAMPSHIRE

GENERAL WOODCRAFT COMPANY, INC.
Lowell, Massachusetts

NEW JERSEY

GENERAL WOODCRAFT COMPANY, INC.
North Bergen, New Jersey
R-O-W DISTRIBUTORS
Rocky Mount, Virginia

NEW YORK

GENERAL WOODCRAFT COMPANY, INC.
North Bergen, New Jersey and Schenectady, N.Y.
A. ROBERSON & SON, INC.
Binghamton, New York
THE WHITMER-JACKSON CO., INC.
Buffalo, Rochester, New York

NORTH DAKOTA

JACK R. KINNARD & COMPANY
Minot, North Dakota

OHIO

FABROW MFG., INC.
Toledo, Ohio
THE MAHONEY SASH & DOOR COMPANY
Canton, Youngstown, Ohio
R-O-W WHOLESALE DISTRIBUTORS, INC.
Norwood, Ohio

PENNSYLVANIA

ADELMAN LUMBER COMPANY
Pittsburgh, Pennsylvania
R-O-W DISTRIBUTORS
Rocky Mount, Virginia
A. ROBERSON & SON, INC.
Binghamton, New York

RHODE ISLAND

GENERAL WOODCRAFT COMPANY, INC.
Lowell, Massachusetts

SOUTH DAKOTA

WATERTOWN SASH & DOOR COMPANY
Watertown, South Dakota

VERMONT

GENERAL WOODCRAFT COMPANY, INC.
Schenectady, New York

WISCONSIN

WISCONSIN WINDOW UNIT COMPANY
Merrill, Wisconsin

CANADA

D. PORTER & SON
Stellarton, Nova Scotia, Canada
BELTON LUMBER COMPANY
Sarnia, Ontario, Canada
OSHAWA BOX & LUMBER, LTD.
Oshawa, Ontario, Canada

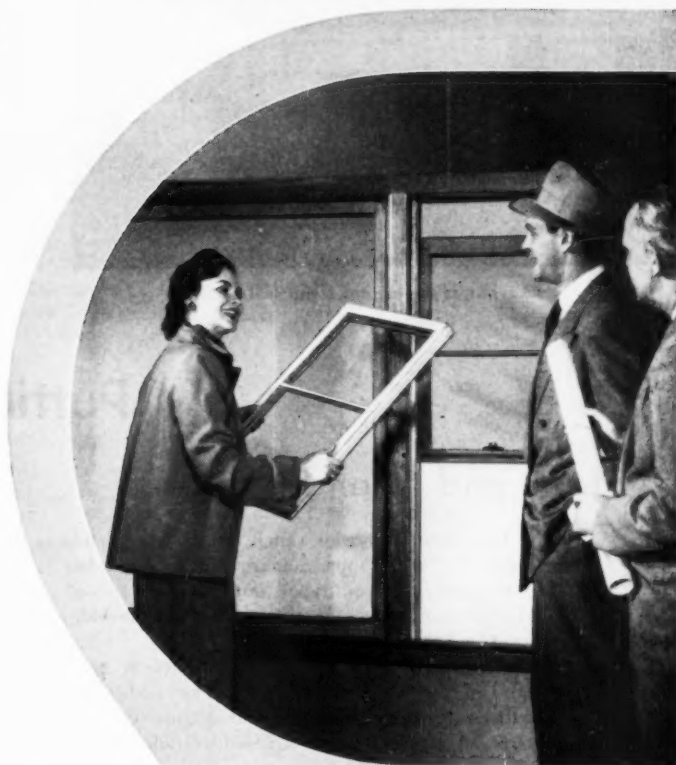

R-O-W windows outsell all competitors. This leadership has been built on the public demand for windows with the patented R-O-W lift-out feature—plus quality construction and fair price.

See your local lumber dealer or write

R.O.W. SALES CO. 1342-66, ACADEMY AVENUE • FERNDALE 20, MICHIGAN

R-O-W is the registered trade mark of the R.O.W. Sales Co.

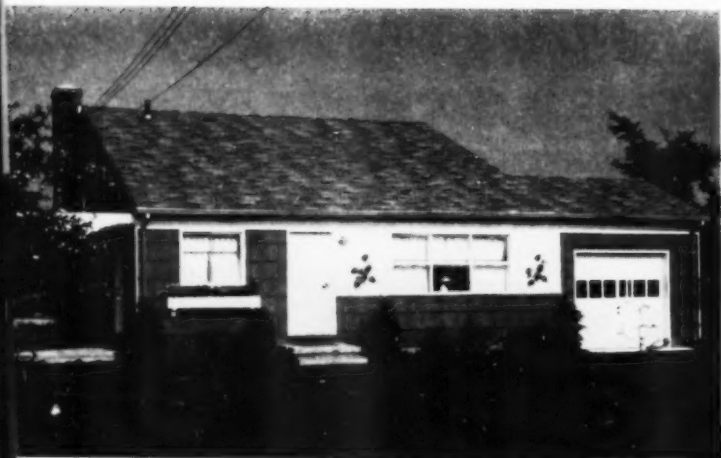

In front, it appears as a ranch design



Rear shapes up as a two-story colonial

IDEAS IN ACTION

Yorktown Heights, N. Y.

Putting that 'ranch look'

... from end to end

This new split-level ranch, which completely hides the "split" appearance from the street, has been outselling "old-type" models three to one at Mohansic Estates, the Busen Brothers development in Yorktown Heights, New York.

Designed by Seymour A. Mitteldorf, it manages to disguise its identity as an end-to-end split-level, with New England saltbox colonial lines on one side and trellised terrace on the other.

Priced at \$16,490, with half-acre plot, this northern Westchester County house is offered to veterans for \$825 down and \$99.50 a month. Separate dining room, entry hall and living room extend open-plan style across the front of the house, unbroken but for a short wood and

glass screen divider adjoining the door. Though built in hilly, wooded country, the house can be built on level ground because the garage is attached alongside and not an integral part of the building.

Among materials used are Ruberoid asphalt shingles, American-Standard colored bath fixtures, Armstrong linoleum and Formica worktops.



Selector board shows the colors and patterns available in many materials, helps buyers decide what they want



Broken line in lower level plan indicates how large multi-purpose room can be created



IDEAS IN ACTION

Babylon, N. Y.

Setback and roof line arrangement effectively hide the "split"

into the split-level . . .

. . . from front to back

This model demonstrates how to hide a split-level look even though the split is from front to back. Edmund Hecht built many units of this type this year in Babylon, Long Island, for \$11,990 on 60x100 landscaped plots.

Roof overhang over higher bedroom wing is carried to same level as that over the lower living room. Wide window plus planter box also appears to "line up" with living room windows. While front door enters higher bedroom wing section, it does so at living room level.

Bevel siding, parallel roof lines extending over carport add to the ranch-like appearance.

Decorative octagon window in front is in a half-bath attached to the master bedroom. Only a louvered partition separates kitchen from dining room.



Recreation room has two wide window groups



Stairs set at angle aid compact plan

BRAND NAME PRODUCTS USED

- Aero ventilating fan
- Barrett roofing
- Briggs bathroom fixtures
- Darby kitchen cabinets
- Dutch Boy paints
- Fiberglas insulation
- General Bronze windows
- Gibraltar tankless water heater
- Hardwick range
- National hardware
- Supradur shingles
- U. S. sliding doors

When Kiln Dried
Sub-Flooring of
Specified Moisture
Content is a **MUST**



CROSSETT HAS IT..

... in Grade-Marked center-and-end-matched or standard lengths of even textured Arkansas Soft Pine. It holds nails and stays put. (Just the answer to F. H. A. and V. A. insured loan requirements.)

Sold by your lumber dealer who can also supply Crossett kiln-dried sheathing, roof-decking, dimension, WOLMANIZED* treated lumber and Royal Oak Flooring.



CROSSETT LUMBER
COMPANY

A DIVISION OF THE CROSSETT COMPANY
CROSSETT, ARKANSAS

*Reg. U. S. Pat. Off.

**HOW TO BUILD MORE
SALEABLE SPACE INTO HOMES**

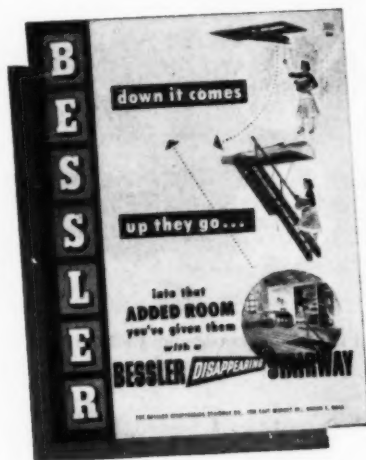

Write today for
FREE
BESSLER
CATALOG
showing how
easily and
economically
you can use
BESSLER
DISAPPEARING
STAIRWAYS
(7 Models)
to assure more
cubic feet per
building dollar!

**IMMEDIATE
DELIVERY**

assured on all models!

THE BESSLER DISAPPEARING STAIRWAY CO.

1900-A East Market Street, Akron 5, Ohio



with *Plus* sales value in homes
**KRITZER "LINE" RADIANT
BASEBOARD**

**EXCLUSIVE
FEATURE!**



Coil Support
Bracket and
Cradle

CLEAN, quiet gentle warmth provides care-free comfort throughout the home.

ECONOMY from low installation cost and high operating efficiency.

FUNCTIONAL DESIGN permits complete decorating and furniture arranging freedom.

BUILT TO LAST like all Kritzer products*. For further information write to: Kritzer Radiant Coils, Inc., 2903 Lawrence Avenue, Chicago 25.

*Kritzer Baseboard Heating • *Kritzer Fin-Pipe Coils

*Kritzer Radiant Panel Heating

KRITZER

**"IF IT'S KRITZER,
IT'S RIGHT, SIR!"**

50% MORE POWER for your jobs...

with the new **AMF DE WALT**
"Power Saw"



Still only
\$395 delivered!

(custom-built 1 1/2 H. P. motor, 10" saw blade, 4 detachable steel legs included)

Here it is—the new model GW-1—specially designed and specially powered for builders in the 10" saw field. Look for the extra value you get at no extra cost!

50% Greater Horsepower to cut more,
cut faster than outdated 10" 1 h.p. saws!

Greatest Capacity—10" saw cuts 3" deep,
cross-cuts 16" x 1" stock, rips 26" wide.

Powerful 1 1/2 H.P. Motor • Safety Lock Key Switch
Built-In Voltage Change Switch • Welded-On Carrying Handles
New Power Safety Brake • Life-Time Accuracy

Plus Many, Many More operating features all fully illustrated and explained in FREE 20-PAGE COLOR BOOKLET "The Greatest Invention Since The Hand Saw."

AMF Product
DE WALT
POWER TOOLS

Lancaster, Penna., U.S.A.
100 CANADIAN De Walt Company Ltd.
Guelph, Ontario

EXCLUSIVE! Welded-on carrying handles conveniently positioned for portable use. Unit weighs only 164 lbs.



EXCLUSIVE! New, powerful 1 1/2 H.P. single phase AC motor delivers full power direct... no belts, pulleys, inserts.

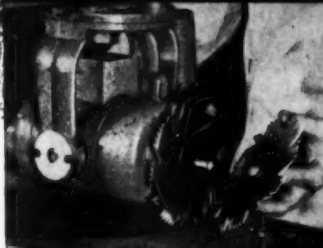

EXCLUSIVE! Approved safety lock key switch on model GW-1 means added job safety... just take the key with you.



EXCLUSIVE! New power safety brake stops blade without using sticks etc... most-wanted feature for over 30 years. (Optional extra.)

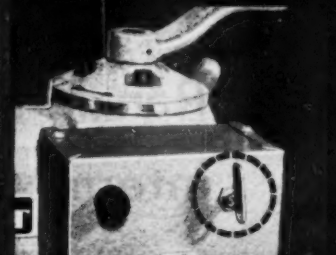

EXCLUSIVE! New 12" saw and guard available to cut 4" deep when needed... big saw capacity at small saw prices.

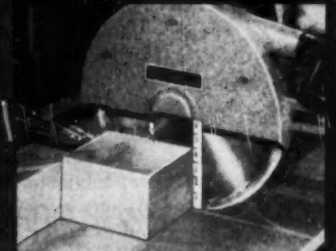

EXCLUSIVE! Built-in 1 1/2 H.P. motor voltage change switch flicks from 110 to 220 volts... no wire changing needed.

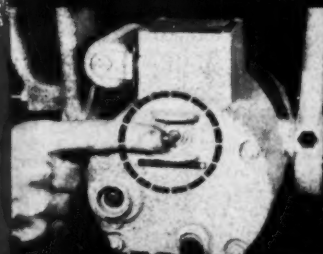

AMF De Walt,
Dept. AB-54-11, Lancaster, Penna.
Please send me free illustrated booklet "The Greatest Invention Since The Hand Saw."

NAME _____

ADDRESS _____

CITY _____ ZONE _____ STATE _____



Buyers choose one or two levels

Ranch, split-level units intermixed in project

These two basic models, offered with or without full basements, are being mixed throughout the 207-unit West Hill Park development of the Newington Heights Company at Newington, Connecticut, near Hartford.

Builders Aaron Schneider and Jack Cooper found sales favored the Bel-Air ranch model because it was 20 per cent cheaper. It was offered for \$13,500 with minimum lot of 10,000 square feet, or \$14,750 with full basement. The larger house was priced at \$16,750, or \$1,000 more for full basement and living room fireplace. Oscar Silverstone was the architect.

Among sales points were panorama windows in living room to take advantage of hilltop site overlooking Connecticut Valley, twin basins with twin mirrored medicine cabinets in bathroom, a 220-volt service.

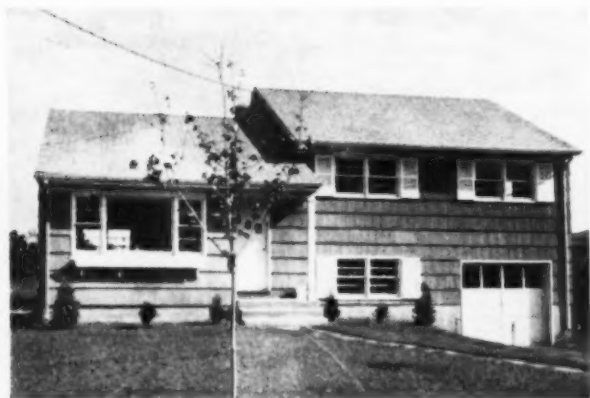

Fourth level is optional feature



Extra dining closet is in basementless plan

IDEAS IN ACTION

Newington, Conn.

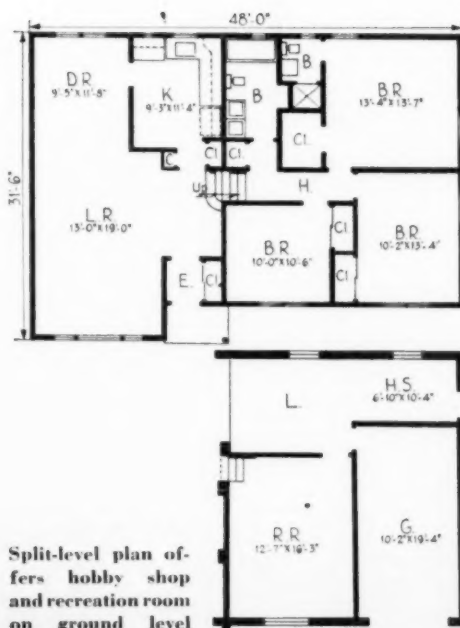

Split-level plan offers hobby shop and recreation room on ground level

AMERICAN BUILDER



Nearly all buyers were veterans using the no-down-payment feature

200 contracts received in first 3 weeks

Three weeks after the Land & Development Company introduced two- to four-bedroom homes in Early American style at Sheffield Lake, near Lorain, Ohio, more than 200 contracts were obtained from buyers. Three model houses representing a range of \$14,500 to \$17,285 drew 25,240 visitors the first two Sundays, according to a mechanical counting machine.

Development of the 96-acre Knickerbocker Knolls subdivision is planned at the rate of 10 completions a week with all 361 homes ready by next September. Two homes completely furnished and decorated at a cost of \$7,000 and a third X-ray model were a great influence on sales, believes John A. Rader, president of the building company. Another leading factor was a no-down-payment plan with \$475 closing costs, used by approximately 185 veteran buyers.

The house illustrated was priced at \$17,172 including plastered garage, entrance fence with lamppost, extra half-bath and \$60 certificate to help the new owner offset his landscaping expense.

BRAND NAME PRODUCTS USED

Alside Lifetime aluminum siding
 American-Standard plumbing fixtures
 Frigidaire washer and dryer
 K & M overhead garage door
 Johns-Manville asphalt shingles
 Ma-Ti-Co asphalt tile
 Miami-Caray bathroom accessories
 Perfection Stove Co. forced warm air furnace
 Waste King Pulverator garbage disposer
 Yale keyed-alike locks

IDEAS IN ACTION

Sheffield Lake, Ohio

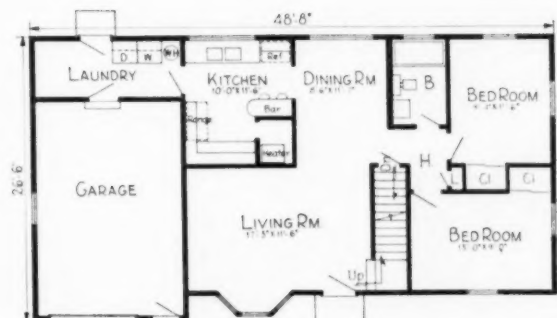

FIRST FLOOR PLAN

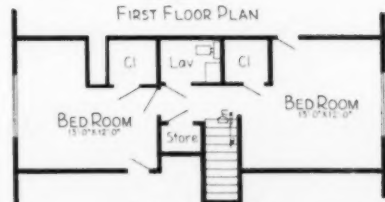

SECOND FLOOR PLAN

In two-bedroom house, second floor is left unfinished

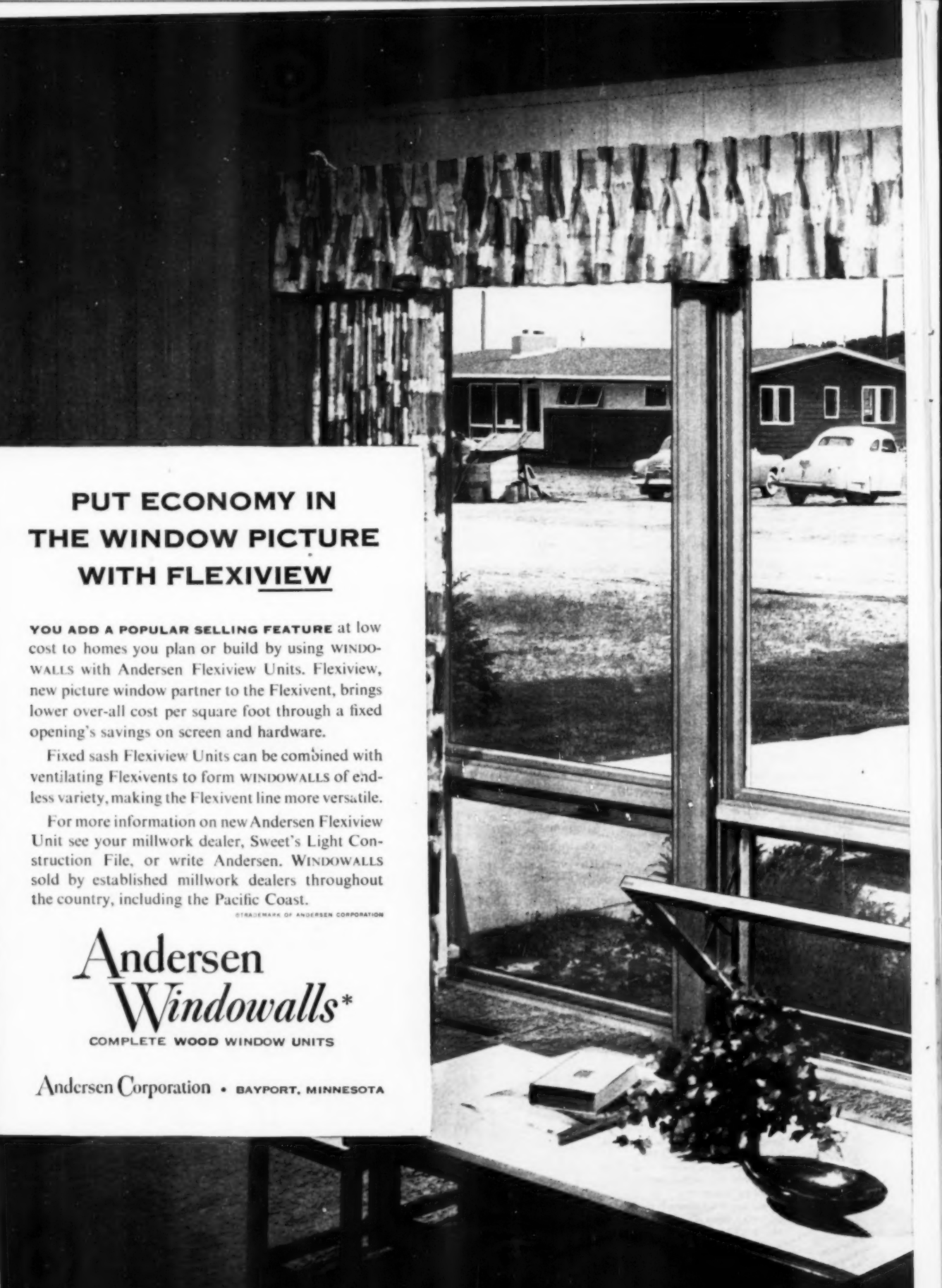

**PUT ECONOMY IN
THE WINDOW PICTURE
WITH FLEXIVIEW**

YOU ADD A POPULAR SELLING FEATURE at low cost to homes you plan or build by using WINDOWWALLS with Andersen Flexiview Units. Flexiview, new picture window partner to the Flexivent, brings lower over-all cost per square foot through a fixed opening's savings on screen and hardware.

Fixed sash Flexiview Units can be combined with ventilating Flexivents to form WINDOWWALLS of endless variety, making the Flexivent line more versatile.

For more information on new Andersen Flexiview Unit see your millwork dealer, Sweet's Light Construction File, or write Andersen. WINDOWWALLS sold by established millwork dealers throughout the country, including the Pacific Coast.

®TRADEMARK OF ANDERSEN CORPORATION

**Andersen
Windowalls***

COMPLETE WOOD WINDOW UNITS

Andersen Corporation • BAYPORT, MINNESOTA

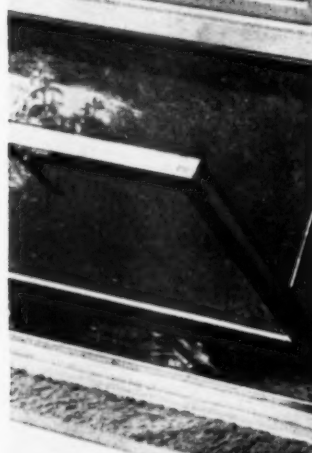



Upper level units have direct exit to street, while lower level exits lead to parking area for 12 cars

Two-story suites designed for a hillside

Clem Casey recently completed this 12-family apartment house in Bismarck, North Dakota, at a cost of \$140,000. The four two-bedroom suites rented for \$130 a month; eight one-bedroom units for \$90 a month. He plans to build five similar buildings, one of which is scheduled to start this fall.

The upper story is at ground level on a hillside so that the building

appears as an elongated ranch house. Nearly all lower level space is utilized as a utility-laundry-storage area. Exterior walls combine Masonite siding, applied vertically in 16-inch widths with battens, and paneled areas made up of tempered Presdwood cut into 4-foot beveled squares.

Foss & Company of Moorhead, Minnesota, was the architect.

IDEAS IN ACTION

Bismarck, N. D.

BRAND NAME PRODUCTS USED

- American-Standard plumbing fixtures
- Hotpoint ranges, refrigerators, washers
- Masonite siding
- Mueller Climatrol forced air furnace
- Nelson shingles
- Paine doors
- Pres-co-lite and Virden lighting fixtures
- Roper clothes dryer
- A. O. Smith water heater
- U. S. Gypsum Sheetrock
- Weyerhaeuser lumber



Four two-bedroom units are placed in wings. Utility room has private storage space for each tenant



IDEAS IN ACTION Montclair, N. J.

Shake shingles blend with brick



Floor to ceiling windows around corner of dinette brighten whole kitchen area

A Mount Vernon-like portico with columns 14 feet high imparts a colonial touch to this luxury split-level home which served as a model for the 30-unit Windermere Estates project of Leonard Kohl, opened last summer at Montclair, New Jersey.

Large size of the home is emphasized by the brick exterior framed in white trim on the two-story section, adjoining the one-story wing with heavy hand-split shakes.

Designed by Derick B. Kipp, the homes range from \$31,500 upward, have a two-story garage with rear entrances, large recreation room, two baths and air conditioning. Floor-to-ceiling window wall extends length of 30-foot living room up to corner fireplace.



FIRST FLOOR PLAN

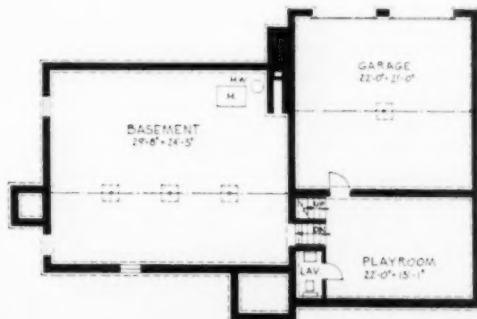

BASEMENT PLAN

Fire bricks (used in test because of low density) here demonstrate water repellency of LINDE Silicones. Treated brick, unchanged in appearance, floats indefinitely. Untreated brick soaks up water and sinks.



How buildings can keep their heads above water

You can keep water out of your above-grade brick and masonry walls just as it's kept out of that floating brick, above.

Above-grade masonry water repellents made with LINDE Silicones do the job. Tests already indicate they last ten years and up.

Damage to interiors from seepage is eliminated. Repair and maintenance costs really drop.

Fully protect new buildings. Fix up old buildings. These silicone-based water repellents prevent even 100-mile-an-hour wind-driven rain from penetrating brick and concrete. They do not change surface appearance.

Yet they *do* keep building surfaces clean, since water simply rolls down the sides, carrying dirt with it. Streaking and efflorescence are stopped. They are easily applied by spray or brush.

These silicone masonry water repellents end spalling and cracking caused by freezing moisture. They even prevent seepage where exhaust fans reduce indoor air pressure. They let no outdoor water in, yet the pores of the masonry can still "breathe."

For full details on above-grade masonry water repellents made with LINDE Silicones, and a list of representative suppliers, write Dept. E-11.



General Offices: 30 East 42nd Street, New York 17, N. Y.

In Canada: Dominion Oxygen Company, Division of Union Carbide Canada Limited

The term "Linde" is a registered trade-mark of Union Carbide and Carbon Corporation.

Include this SELLING feature in your plans

SCHLAGE 5" BACKSET

GREATER Convenience

Sales point No. 1. Use the Schlage 5" backset feature on every flush door in your homes—inside and out. It will add custom-built convenience and has a lot of extra sales appeal. Prospective home buyers will be interested to know this unusual idea has been incorporated in your homes and the old knuckle busting days are gone forever.



Standard lock installation—Note the lack of knuckle clearance.

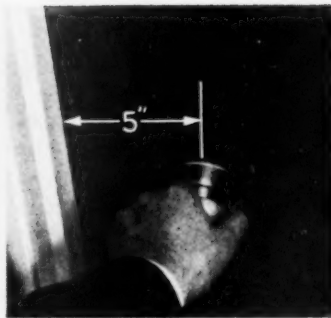

5" backset installation—Setting lock back gives more hand freedom.

DISTINCTIVE Designs

Sales point No. 2. Today's home buyer wants something different—and you can give it to him. Use the Schlage 5" backset and striking ornamental escutcheons to add sales appeal to your entrance doors. Dramatic escutcheons in combination with a wide variety of lock stylings and finishes will help individualize the appearance of your homes' entrance ways.

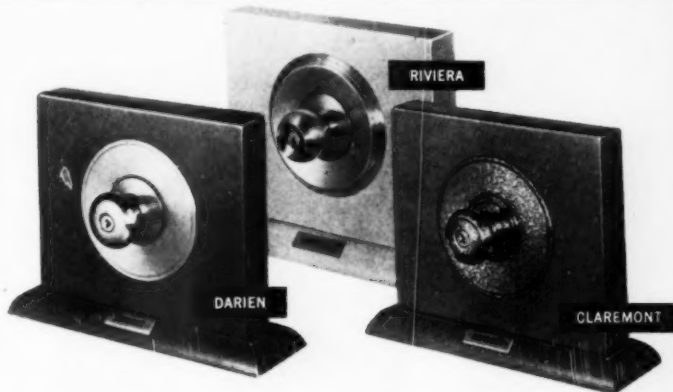

QUICK AND EASY Installation

The new Schlage 5" backset guide, used with the Schlage boring jig and hole saw makes it possible to bore hollow-core doors easily, quickly and accurately regardless of size or positioning of lock block.

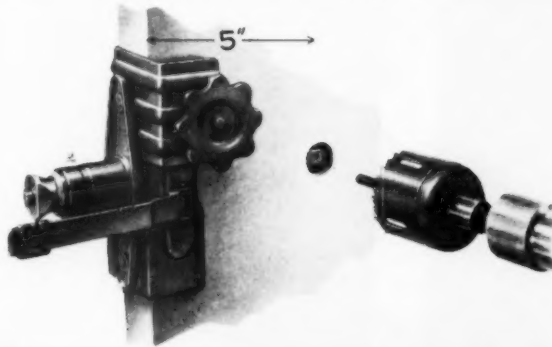

SCHLAGE®

THE WORLD'S MOST IMITATED LOCK

SCHLAGE LOCK COMPANY

SAN FRANCISCO

NEW YORK

VANCOUVER, B.C.

2x8 FACIA
6'-0"
OPEN SHELVES ABOVE
SHELF & POLE
40 GAL. W.H. 10 YR. GUARANTEE 4" TRANSITE
F.N. F.Z.
TAB
37
1'-4 1/2" x 5'-2 3/8"
4" W
3'-7

OD LIGHT

There is a fine
MENGEL FLUSH DOOR
FOR EVERY DOOR OPENING—
Palace or Project!

What is the RIGHT door for any particular job? Is it the BEST door you can buy, or the CHEAPEST, or *what?*

Mengel makes *three* distinct types of flush doors. Each is exactly RIGHT for its purpose. Each is the *best possible* value in its field. *All* are built by the makers of world-famous Mengel Furniture, and to the same standards of quality.

This MEANS SOMETHING to you, your clients and your customers—this, and the fact that every Mengel Door is guaranteed by all the resources of this company, the *world's largest manufacturer* of hardwood products. All Mengel Flush Doors are described in Sweet's (Architectural and Light Construction) Catalog, are available everywhere.

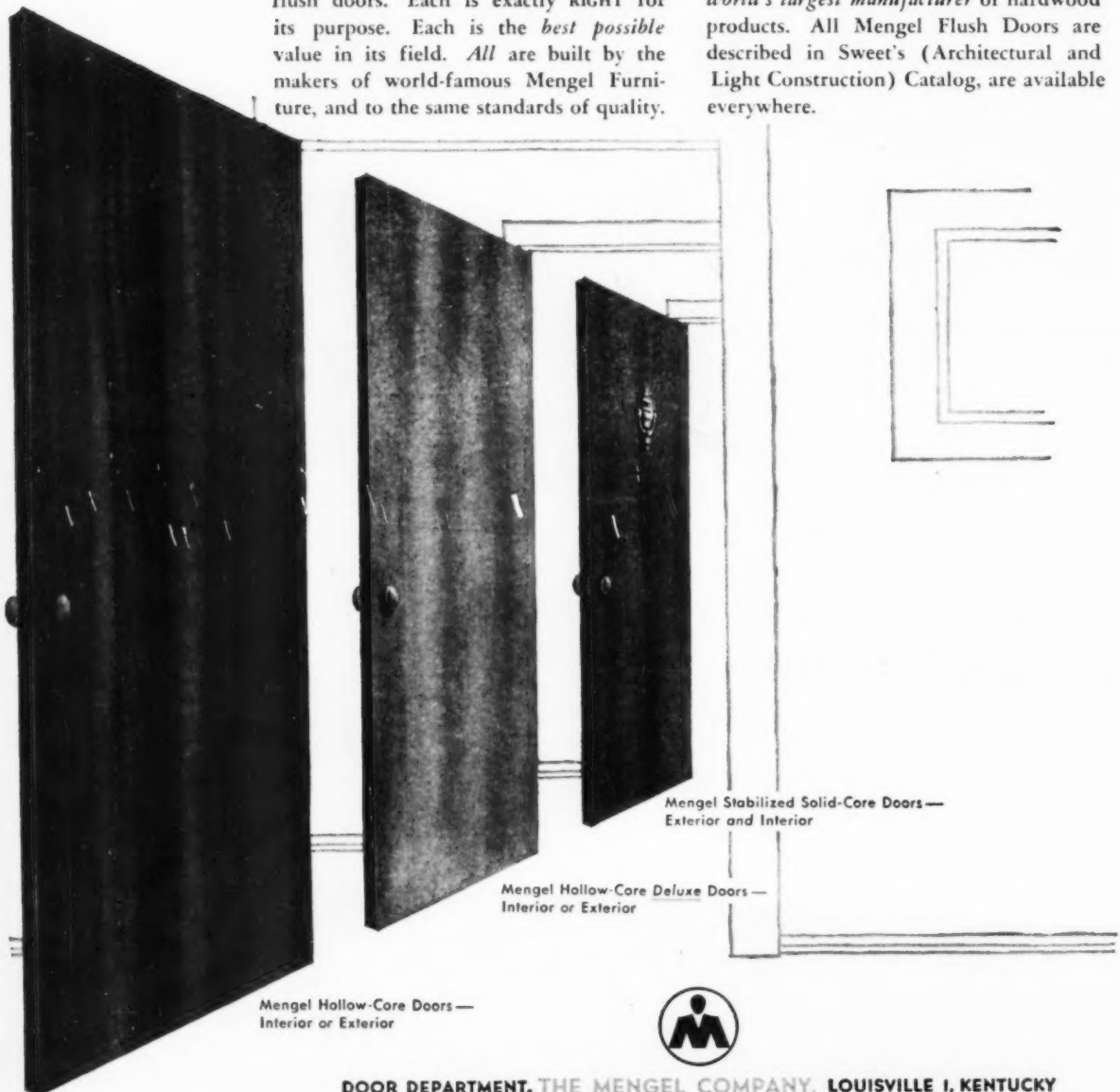

Mengel Hollow-Core Doors —
Interior or Exterior

Mengel Hollow-Core Deluxe Doors —
Interior or Exterior

Mengel Stabilized Solid-Core Doors —
Exterior and Interior



DOOR DEPARTMENT, THE MENGEL COMPANY, LOUISVILLE 1, KENTUCKY

AMERICAN BUILDER

FULL WEIGHT

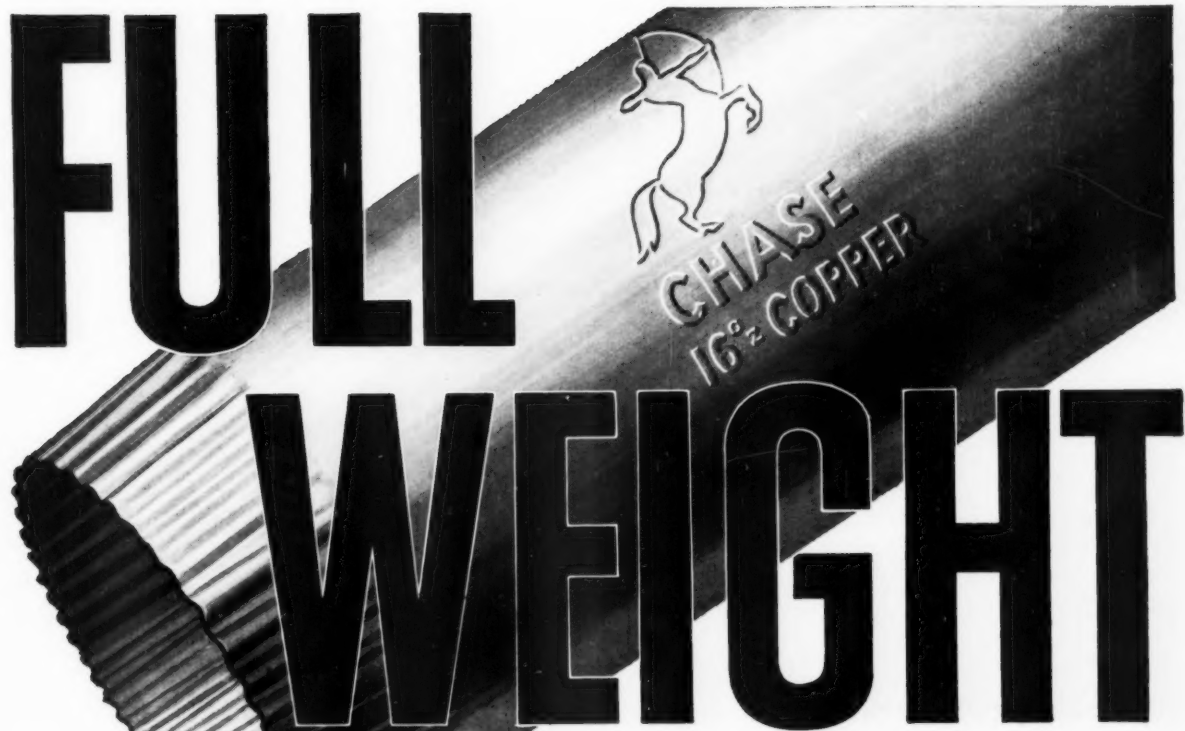
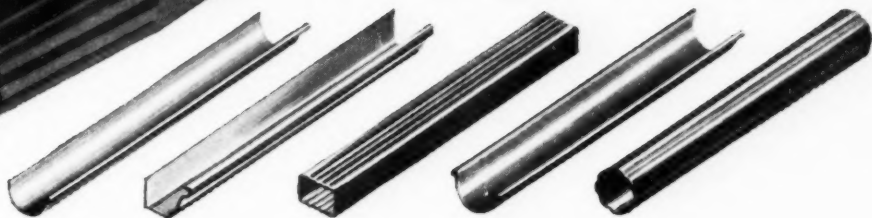
**Chase® copper roofing products are
16 ounce copper or heavier—last years longer!**

When you choose roofing products, look for the die-stamped Chase Trade Mark and Weight Stamp—your assurance of quality, stability and permanence.

To withstand the weight of snow and ice, Chase copper downspouts, gutters, elbows and shoes are all 16 ounce copper or heavier. All corrugations are deep and generous... ample for temperature changes in any climate.

Chase copper leaders are formed from full-width strips, to assure strong, expansion-proof seams. And, since Chase copper roofing products can be joined with standard soldering techniques, the installation will stay water-tight and leak-proof for good.

Chase copper roofing products simply *can't* rust, will resist atmospheric and weather conditions that ruin less durable materials. So insist on Chase copper roofing products.

For more information on copper roofing products and flashing, send for the free Chase Copper Roofing Products Booklet.

Chase

BRASS & COPPER CO.

WATERBURY 20, CONNECTICUT • SUBSIDIARY OF KENNECOTT COPPER CORPORATION

The Nation's Headquarters for Brass & Copper

Albany†	Chicago	Denver†	Kansas City, Mo.	Newark	Pittsburgh	San Francisco
Atlanta	Cincinnati	Detroit	Los Angeles	New Orleans	Providence	Seattle
Baltimore	Cleveland	Houston	Milwaukee	New York	Rochester†	Waterbury
Boston	Dallas	Indianapolis	Minneapolis	Philadelphia	St. Louis	(†sales office only)



*Oak is preferred by
8 out of 10 home owners*

The complete satisfaction that Oak gives homeowners makes this flooring the overwhelming choice in homes of all types and prices. Oak leads in beauty... economy... durability... style adaptability. No other flooring combines all these advantages so attractively as naturally beautiful Oak.

You know you're



**No other floor has
ALL the advantages of**



Oak makes decorating easier

Oak is always in style. Its deep, rich beauty harmonizes with all furniture, fabrics, colors and building materials . . . and is appropriate with contemporary or traditional architecture. For home buyers this ease and economy of decoration is an important plus value; for builders it's a strong sales feature.



Oak won't fade nor wear out

There's no skin-deep beauty here! Nature gave Oak its mellow coloring and rich grain that go all the way through the wood. This beauty, which never fades out nor wears away, is combined with exceptional strength. Oak floors form an interior foundation that adds to the structural rigidity of the building.



Oak is warm and comfortable

The warm coloring of Oak floors reflects the real warmth they bring to a home. Oak's high insulating quality is an effective barrier to cold. It protects health and prevents costly heat loss. Buyers appreciate, too, the comforting foot-ease that the lasting resiliency of Oak floors gives to a home.



right when you specify OAK FLOORS



NATIONAL OAK FLOORING MANUFACTURERS' ASSOCIATION
Sterick Building, Memphis 3, Tenn.



NEW CHEVROLET TRUCKS

have what it takes to boost efficiency and bring down costs!

In the next three paragraphs you'll find a few good reasons why you can get more work out of a Chevrolet truck and save money doing it.

INCREASED POWER IS THE FIRST BIG REASON

With Chevrolet's higher compression ratio you've got more power under the hood. Power that results in greater acceleration and hill-climbing ability. Faster starts and acceleration over the day's work save valuable time and increase over-all efficiency. Check the gas mileage, too. With this higher compression ratio, your Chevrolet truck registers *more miles on the job* for each tankful of gas. That's where you start to save money.

BUILT-IN RUGGEDNESS SAVES EVEN MORE

The strength and stamina of more rigid frames, and the special chassis features that pertain to each model—these combine to add extra ruggedness to your Chevrolet truck. Push it hard on the rough jobs; keep it going over long schedules—you'll still find your upkeep costs lower and your Chevrolet trucks lasting a lot longer.

ONE LAST POINT—and maybe the most important to you—you'll find Chevrolet's line of trucks priced the lowest of all! Talk over your needs with your Chevrolet dealer. He'll be glad to give you the facts about the best model for your job. . . . Chevrolet Division of General Motors, Detroit 2, Michigan.

**MOST TRUSTWORTHY TRUCKS
ON ANY JOB!**



CHEVROLET ADVANCE-DESIGN TRUCK FEATURES

THREE GREAT ENGINES—The new "Jobmaster 261" engine* for extra heavy hauling. The "Thriftmaster 235" or "Loadmaster 235" for light-, medium- and heavy-duty hauling. **NEW TRUCK HYDRA-MATIC TRANSMISSION***—offered on 1/2-, 3/4- and 1-ton models. Heavy-Duty **SYNCHRO-MESH TRANSMISSION**—for fast, smooth shifting. **DIAPHRAGM SPRING CLUTCH**—improved-action engagement. **HYPOID REAR AXLE**—for longer life on all models. **TORQUE-ACTION BRAKES**—on all wheels on light- and medium-duty models. **TWIN-ACTION REAR WHEEL BRAKES**—on heavy-duty models. **DUAL-SHOE PARKING BRAKE**—greater holding ability on heavy-duty models. **NEW RIDE CONTROL SEAT***—eliminates back-rubbing. **NEW, LARGER UNIT-DESIGNED PICKUP AND PLATFORM STAKE BODIES**—give increased load space. **COMFORTMASTER CAB**—offers greater comfort, convenience and safety. **PANORAMIC WINDSHIELD**—for increased driver vision. **WIDE-BASE WHEELS**—for increased tire mileage. **BALL-GEAR STEERING**—easier, safer handling. **ADVANCE-DESIGN STYLING**—rugged, handsome appearance.

*Optional at extra cost. Ride Control Seat is available on all cabs of 1 1/2- and 2-ton models, standard cabs only in other models. "Jobmaster 261" engine available on 2-ton models, truck Hydra-Matic transmission on 1/2-, 3/4- and 1-ton models.

TAKE A GOOD LOOK AT

THE THRIFTY FOUR-FIFTY

series
"450"

NATIONAL LOCK *set*

Pat. Applied for

NOTHING
LIKE IT
FOR CUTTING
INSTALLATION
TIME!

LOCK IS INSTALLED
AFTER LATCH BOLT
IS APPLIED TO DOOR



- Factory Pre-Set for standard 1-3/8" or 1-3/4" doors
- Quality-Built for dependable security and troublefree service.
- Selected Materials . . . Wrought Brass, Wrought Bronze or Aluminum trim . . . cold rolled steel mechanism . . . no zinc die cast parts.

A Superior Cylindrical Lock at a Real Budget Price

WRITE FOR CATALOG "450"

Originator of "Select-a-Pak" . . . Leader in Merchandising



NATIONAL LOCK COMPANY

Rockford, Illinois • Merchant Sales Division



CABINET
HARDWARE



NATIONAL
LOCKSETS



BUILDERS
HARDWARE



SASH
HARDWARE



CABINET
LOCKS



FURNITURE
CASTERS



SCREWS
AND BOLTS

Homes sell faster with **ELJER** Steel Cabinet Sinks

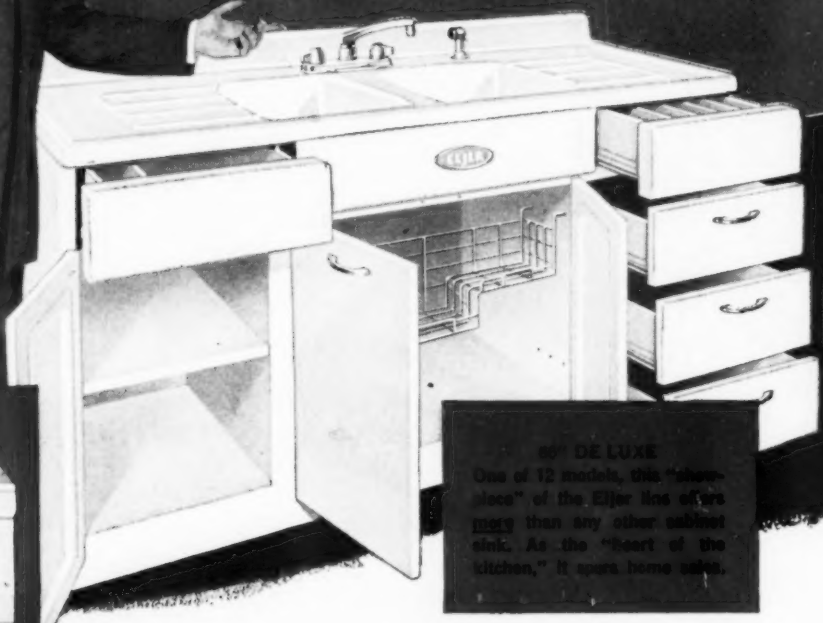
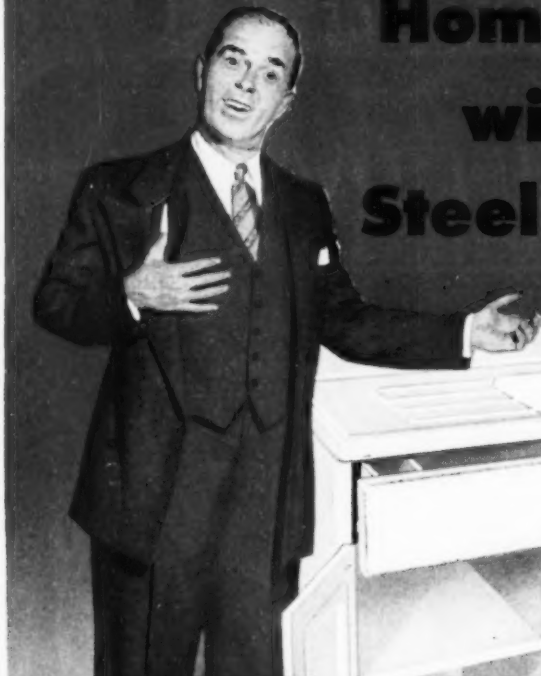

60" DE LUXE
One of 12 models, this "show-stopper" of the Eljer line offers more than any other cabinet sink. As the "heart of the kitchen," it opens home sales.



48" STANDARD



42" DE LUXE



42" SINK AND TRAY COMBINATION

Now! A quality builders' line from a quality plumbing firm!

No matter what make or kind of cabinet sinks you now install in your homes, you'll find the new Eljer line offers extra profit advantages.

Here's why:

- 1 It is a complete line of many styles and sizes, each packed with exclusive features to help home sales.
- 2 Pricing is *right*. Quality the best.
- 3 You can now get *all* plumbing features from a single source that you know and trust.

- 4 Rugged, integral base construction means money saved on installation time.

You will find that Eljer has designed and built these new steel cabinet sinks to *true plumbing standards*. That means immediate customer appeal and long-term customer satisfaction.

The Eljer distributor in your area invites you to inspect these new steel cabinet sinks, and carefully check their special advantages. Call him or write for details to Eljer Co., Box 192, Ford City, Pa.

THE ONLY NAME YOU NEED TO KNOW
IN PLUMBING FIXTURES

ELJER

A SUBSIDIARY OF THE **MURRAY** CORPORATION OF AMERICA

Builder Warranty Now Required for All Insured Loans

Since October 1, FHA and VA have required a builder's warranty before either will insure or guarantee a mortgage on a new home, plus later evidence that it has been delivered to the buyer.

This provision, called for by the new housing act, affects all one- to four-family houses approved for FHA mortgage insurance before construction starts. Builder or seller, Commissioner Norman P. Mason points out, must warrant to owner or purchaser that the dwelling is constructed in substantial conformity with plans and specifications on which the FHA valuation was based. Similar procedure governs issuance of all new VA-guaranteed loans.

Warranty Good for Year

Form 2544, just issued by the FHA, provides:

1. This warranty shall apply only to such instances of substantial non-conformity as to which a purchaser, or a later owner, "shall have given written notice to the warrantor (builder or seller) at any time or times within one year from the date of the original conveyance of title to such purchaser . . . or the date of the initial occupancy of the dwelling, whichever first occurs."

2. If buyer acquired title prior to completion, warranty is good for one year from date of completion or initial occupancy, whichever occurs first. Date of the last day the warranty is effective, must be inserted in the form by the builder or seller.

Binding Contract

3. Warranty is issued in addition to "all other rights and privileges which such purchaser may have under any other law or instrument, and shall survive the conveyance of title, delivery of possession of the property or other final settlement made by the purchaser, and shall be binding on the warrantor notwithstanding any provision to the contrary contained in the contract of purchase or other



Mason Applies the Personal Touch

Symbolic of the interest generated by FHA Commissioner Mason's swing around the nation's home building and financing circuits to explain the workings of the new housing act is this overflow crowd of more than 1100 persons at a Builders Association of Metropolitan Detroit meeting in the Motor City's Sheraton-Cadillac Hotel

writing executed by the purchaser . . ."

4. Space for signature and address of builder or seller and for the dated signature of purchaser acknowledging that he has received the warranty.

FHA officials point out the warranty is not self-executing; that an owner, after giving written notice of nonconformity within the year time limit, must proceed under the state in which the property is located to obtain indemnity.

Preliminary Form Required

Before the buyer appears, the operative builder applying for a commitment must fill out FHA form 2560 stating over his signature that he "will deliver to the purchaser, prior to the execution of a contract for the sale of the property a written statement setting forth the amount of the FHA's appraised value of the property."

On the same form, the builder (or seller) also agrees that upon any sale within a year from date of initial occupancy, he will give that purchaser a warranty, satisfactory to FHA, that the dwelling is constructed in substantial conformity with plans and specifications.

See Low-income Units Challenge To Industry

The new housing act "offers private enterprise a magnificent opportunity to demonstrate that needed new housing can be built and older homes rehabilitated. It also offers a challenge to builders and lenders to assist low-income families at less than a maximum profit. Failure to meet this challenge could open the door to unwelcome alternate solutions."

This warning has been issued several times recently by FHA Commissioner Norman P. Mason in talks before building, financing and lumber dealer groups interested in learning first-hand his interpretations of the Housing Act of 1954. Concurrently, the agency was issuing regulations covering all programs modified by the new legislation.

Noting complaints about processing delays, Mason conceded that the backlog "has us over a barrel in some spots" but gave assurances that addi-

(Continued on page 41)

Clinic Discussions Major Attraction At Dealers' Show

Retail lumber and building material dealers from every part of the country assembled in New York on October 2 for the opening of the first exposition and convention of the National Retail Lumber Dealers Association. Exposition and program headquarters was the Kingsbridge Armory.

The program featured clinic discussions of three subjects of major interest to dealers. These were materials handling, retail store merchandising and the recently developed Lu-Re-Co system for home building.

Materials handling clinics, held during the morning sessions from Monday through Thursday, October 4-7, were supplemented by demonstrations inside and outside of the armory.

The model store program included workshops and was held Tuesday through Friday.

Lu-Re-Co home clinics, held concurrently with the other two, were highlighted by a completely finished and landscaped house designed by National Plan Service, and open for inspection inside the Armory; the construction of another house on the armory floor, and the partial construction of a third Lu-Re-Co house adjacent to the second. The latter house was left incomplete purposely to permit close inspection of structural details.

A new slate of officers was elected by the association, with Watson Malone III of Philadelphia succeeding Henry J. Munnerlyn as president. Ray A. Schaub of Whiting, Ind., general chairman of the exposition committee, was named first vice president.



New Leaders Chosen by NRLDA

Officers elected by the National Retail Lumber Dealers Association at convention in New York are (from left): E. H. Libbey, Washington office, secretary; H. W. Blackstock, Seattle, treasurer; R. A. Schaub, Whiting, Ind., first vice president; Watson Malone III, Philadelphia, president; Paul Ely, North Platte, N. D., second vice president; H. R. Northup, Washington office, executive vice president

Other selections were Paul Ely of North Platte, N. D., second vice president; H. W. Blackstock of Seattle, treasurer, and E. H. Libbey of the Washington office, secretary. H. R. Northup was renamed to another term as executive vice president.

The novel convention program proved to be a bell-ringer with the dealers, who displayed a continuing interest throughout the four clinic days.

Outstanding feature of the numerous manufacturers' exhibits was an aisle of modern rooms supplied by publishers of consumer magazines.

Plan Concrete Sessions

The American Concrete Institute will hold its 51st annual convention February 21-24, 1955, at the Hotel Schroeder, Milwaukee.

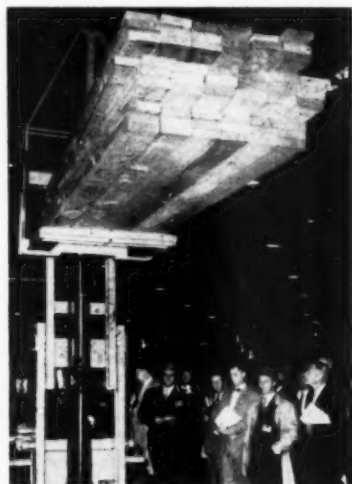

Materials handling was popular

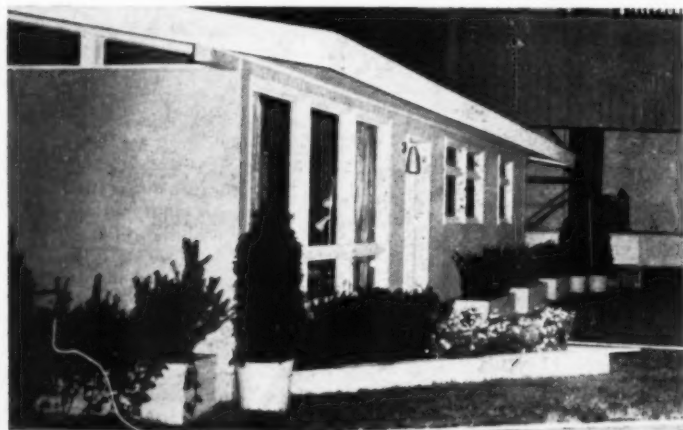

Finished Lu-Re-Co house built on floor of Kingsbridge Armory



Workmen locating Lu-Re-Co wall panel

SCPI to Locate Research Center In Chicago Area

The brick and tile industry has selected the Chicago area as the location for a national research center to house its development efforts. Robert B. Taylor, director of the Structural Clay Products Research Foundation, reports the group has voted to construct the building and is now seeking a suburban site for it.

Among the foundation's research findings have been the development of SCR brick, the SCR insulated cavity wall and the evaluation and development of equipment to facilitate the use of clay products in masonry walls.

Last year the industry unanimously approved extending its original five-year research program into a permanent organization, pledged over \$400,000 a year to its support. Current projects include studies of a new clay-veneer covering for existing structures, lightweight products, clay tile partition panels, clay acoustical tile and fundamental research into properties of clay products and their raw materials. Principal research has been carried on at Armour Research Foundation and Howard T. Fisher & Associates, Inc., in Chicago.

See Low-income Units Challenge to Industry

(Continued from page 39)

tional inspectors and appraisers were being hired "where the need is greatest." At the same time, he said, "I'm determined not to relax our newly framed standards of architectural quality just to get out of this jam."

Cost-Certification Defended

Mason defended Section 207's cost-certification requirement, pointing out that records "need not be more extensive than the normal cost accounting methods used in efficient construction operations. He indicated that where contracts of the cost-plus-fixed-fee variety are involved, allowable fees "may vary in different sections of the country."

The rental housing section (207) recognizes, he added, that "the critical post-war shortage no longer exists and the need for new rental housing arises principally from the increasing concentration of population in large urban centers and the obsolescence of existing structures." He pointed out that leaseholds and fee simple cases will get the same treatment.

By John M. Dickerman, Executive Director, National Assn. of Home Builders

President's Faith in FHA Sets Stage For New Rules to Encourage Housing

President Eisenhower has vindicated the basic integrity of the Federal Housing Administration and reaffirmed his faith in the future of this great agency. By his statement, the President has done much to dispel the atmosphere of fear and suspicion in which FHA's many thousands of loyal and conscientious employees have labored for much of the past year.

In a letter to the annual convention of the Mortgage Bankers Association on Sept. 26, Mr. Eisenhower declared that FHA's mortgage insurance operations are "essential to the successful attainment of our objective to help the American people to acquire good homes of their own."

The President went on to say:

"The integrity of the FHA has been restored. We recognize the great contributions which the agency has made in the past years, and we are determined to develop it into a stronger and better organization. Thus the American people can have real confidence in the agency and its operations. We have made real progress in this direction.

"I shall look to those now in charge of FHA to administer the affairs of that agency in a way which will help our great private home building and financing industry to make real strides in the task which lies ahead. I know I can count on the members of your organization to lend your full support to this endeavor."

Need Workable Procedures

It is now time for all of us, in and out of Government, who are concerned with housing to get on with the job of providing more and better homes for all segments of the American people. One of the first things that must be done is adopt clear, practical and workable administrative procedures to carry out the high purposes of the new National Housing Act. This act will fail of its objectives if it is handicapped at the very outset by overly-restrictive regulations which by their nature will tend to

limit rather than encourage the production of housing.

Ultra-conservatism Blamed

In the light of the uncertainty and confusion created by the attacks that have been made on their agency, it is not surprising that FHA employees charged with administering the new housing law should take an ultra-conservative attitude in its application. Unfortunately, theoretical protective measures applied under such conditions do not in all cases fit the practical operating requirements of the vast and complicated home building industry. Nor do they always achieve their purpose of providing the proper protection to which the home buying public is entitled.

Now that the President has settled affirmatively the future of FHA, we in the home building industry believe that these unnecessary restrictions can and should be modified within the meaning and intent of the new law so that needed housing can be built without sacrificing a single iota of public protection.

There is much to be done. Vast slum areas of our cities must be rehabilitated or cleared away to make room for urban redevelopment. Good housing must be provided at reasonable cost for minority families and low-income groups. And the opportunity for home ownership must be broadened for the many millions of families of modest means who represent the nation's mass market and who form the solid core of America.

\$3 Billion in 5 Months Spent for Improvements

Home owners spent an estimated three billion dollars to fix up their properties during the first five months of this year, according to preliminary results of a sample survey by the Bureau of the Census, Department of Commerce.

The five-months total of \$3,006 million included \$1,260 million spent for repairs and replacements, \$1,407 million for alterations and improvement, \$331 million for additions, and \$8 million not identified.

The total for May alone was \$832 million. That compared with a monthly average of about \$600 million for the five months.



Dickerman

Cole Finds Fresh FHA Interest in Minority Housing

Urban renewal, slum clearance and minority housing have been emphasized in public pronouncements of HHA Administrator Albert M. Cole since enactment of the new housing act. He has complained that only a few cities are really moving forward on the urban renewal program and he has headed into the "minority housing" situation with this statement:

"I think you will find a new, fresh, and more alert interest and concern in minority housing in our FHA offices from now on. But not just as 'minority housing.' You will find that the Eisenhower administration does not make a distinction between the provision of homes for one group of citizens and another. The President has seen integration come into the services; it is coming now into the schools; and both industry and credit institutions are now leading the way into a mature and evenly-spaced growth of credit in housing. The new attitude of government comes as an opportunity that the housing industry welcomes—the same basis of extension of credit on individual merit as applies to any other American consumer of capital goods."

Starts Hold Rapid Pace: 114,000 in September

The 20 per cent increase in building activity of the past two months continued through September, when housing starts totaled 114,000, according to the Bureau of Labor Statistics. The amount was 3,000 units higher than that of August, 18,900 more than that of September, 1953.

The more-than-seasonal gain placed the total for the first nine months of the year at 906,000, compared with 866,400 for the same period of 1953. Seasonally adjusted rate for September was set at 1,232,000, a gain of 56,000 over the August estimate, which indicated that 1954 new home construction will far exceed the activity of all other years except 1950 with its record of 1,396,000 starts.

In September, 111,900 starts were credited to private builders, only 2,100 to public housing, while for the nine-month period, 889,000 starts were private, 17,000 public. The latter figure compares with 32,600 public housing starts recorded during the first nine months of 1953.

42

DEALER'S VIEWPOINT

By H. R. Northup, Executive Vice Pres., National Retail Lumber Dealers Assn.

Publicity, Open-end Mortgages Seen as Start of Big Surge in Title I Loans

FHA's Title I repair and modernization program now is better known and understood by the public than at any past time, as a result of the attention devoted to that program by Congress and the press.

Moreover, those home owners who may be timid about utilizing Title I financing because of the irregularities which have been publicized so widely undoubtedly are greatly outnumbered by others who have learned about the Title I program for the first time and will want to take advantage of it.



Northup

Retail lumber dealers who are well known in their communities as thoroughly reliable and substantial merchants will have little difficulty in allaying the fears of home owners who hesitate to proceed when Title I is mentioned. Thus, the net result of the publicity which Title I has received is bound to be an upsurge in home improvement business for dealers who use Title I aggressively as a sales tool.

The fact that the FHA, for the first time, is specifically authorized by Congress to finance modernization and expansion jobs by open-ending the mortgages it insured, including mortgages written in the past, gives both dealers and home owners another important advantage.

Many Were Unaware of Program

In addition, the benefits arising from all the talk about home improvement loans are not confined to FHA-insured loans. There is good evidence that a large segment of the public had not been aware that it was possible to arrange for any kind of time-payment financing, with no down payment, or a modest one, for home improvements.

We have believed right along, and still do, that there is a tremendous potential market for dealers in the modernization and repair field.

In recent years, many dealers were too busy keeping up with the demand for materials to spend much time cultivating this type of business among home owners. But there now is a steadily growing number who are going after this profitable volume more

aggressively and are making wider use of time-payment financing to help complete the transactions.

Greater Service Expected

Restrictions which FHA has placed on the kinds of loans that can be insured place relatively little handicap on the retail lumber dealer because materials for the construction of swimming pools, installation of burglar alarms, etc., ordinarily were handled by other types of dealers.

FHA's Title I program on the whole has served the public well and promises to perform an even greater service in the future.

Hennessy Named to Head NAHB Executive Officers

John I. Hennessy, executive vice president of the Associated Home Builders of the Greater Eastbay at Oakland, Calif., was elected president of the NAHB Executive Officers Council last month at its annual meeting held in Garden City, Long Island, just before the fall directors' meetings of the parent group began in New York. He will be installed at the January convention, succeeding William B.



John I. Hennessy

Hanna Jr., former Pittsburgh executive officer who has just taken over a similar position at Cleveland.

Gus Fields, executive vice president of the Oklahoma state and Oklahoma City associations, was chosen as vice president; Clayton W. Johnson, Hartford, Conn., as secretary and Charles McKinney of Tulsa, Okla., as delegate-at-large.

AMERICAN BUILDER

Custom heating for custom homes from General Motors DELCO-HEAT!



PLUS:

- 1 GM assembly line methods that cut heating unit costs to save on every home you build!
- 2 GM backing that gives you a name you can merchandise to prospects!
- 3 GM engineering that has designed units to fit all today's modern building needs!



OPC-H



GSA-LD

Here's the top of the Delco-Heat line—designed specifically for the fine installations you need in custom homes. Simple and compact, these sensational oil and gas units deliver the luxury of perfect automatic forced warm air comfort. Both are available in "H" models for basement, alcove and closet installation and in "LD" models for basement installation. The six gas-fired GSA units range in size from 100,000 to 190,000 Btu input. The six oil-fired OPC units from 80,000 to 150,000 Btu output. All units except the OPC 150 LD and GSA 190 LD are shipped assembled for fast installation.

Your nearest Delco-Heat Dealer is listed in the Yellow Pages of your phone book. Or write: Delco Appliance Div., Dept. ABH, General Motors Corp., Rochester 1, N. Y.



DELCO-HEAT

... a complete line of automatic oil and gas-fired conversion burners. Conditionair forced warm air furnaces and heating and cooling units, boilers, water heaters and electric water systems.

GOOD-LOOKING CONCRETE stays good looking and lasts longer when it is reinforced with American Welded Wire Fabric. American Fabric strengthens concrete, prevents destructive cracking. And it is easy to install.

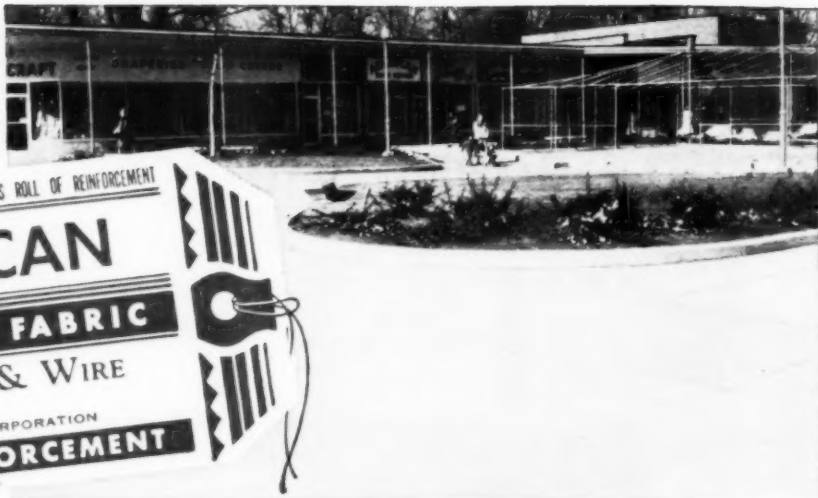

THIS TAG MUST ACCOMPANY CORRESPONDENCE REGARDING THIS ROLL OF REINFORCEMENT

AMERICAN

WELDED WIRE FABRIC

AMERICAN STEEL & WIRE
DIVISION

UNITED STATES STEEL CORPORATION

CONCRETE REINFORCEMENT

MADE IN U. S. A.

This tag is your guide for durable concrete



PEOPLE ARE PROUD of smooth, crack-free driveways; and the driveways you build will stay that way, if you reinforce them with American Welded Wire Fabric. Not only driveways, but sidewalks, patios, porches, floor slabs, walls, and curbs last longer when you give them the extra strength of American Wire Fabric Reinforcement.

FOR concrete that stays smooth and attractive, that resists cracking, that lasts long, reinforce it with American Welded Wire Fabric: the brand with the red and white tag.

You're sure of good results from American Fabric because it is carefully tested before it leaves our factory. The wire size, wire spacing and welding are checked to insure that

every shipment is as good as we can make it.

This extra care pays off: American Welded Wire Fabric *exceeds* the new ASTM Spec. A185-53T; it gives you an extra factor of safety at no increase in cost. Ask your local distributor for the fabric with the red and white tag: high quality American Welded Wire Fabric.

PREFABRICATED ROLLS of American Welded Wire Fabric wound on large mandrels are available in a wide range of styles and sizes. There's a type for every concrete job you have.

AMERICAN STEEL & WIRE DIVISION, UNITED STATES STEEL CORPORATION, GENERAL OFFICES: CLEVELAND, OHIO
COLUMBIA-GENEVA STEEL DIVISION, SAN FRANCISCO, PACIFIC COAST DISTRIBUTORS
TENNESSEE COAL & IRON DIVISION, FAIRFIELD, ALA., SOUTHERN DISTRIBUTORS • UNITED STATES STEEL EXPORT COMPANY, NEW YORK

EVERY TYPE OF REINFORCED CONCRETE CONSTRUCTION NEEDS

USS AMERICAN WELDED WIRE FABRIC

UNITED STATES STEEL





NEW from Black & Decker

A compact, lightweight
3/8" Utility Drill ... only \$38⁹⁵

Here's a brand-new drill from Black & Decker . . . powered and geared to the correct torque and speed for drilling with all types of bits . . . priced far lower than you'd expect for a tool like this!

It's the perfect, compact drill you need for drilling in cement block, wood, metal . . . for all types of installation and construction work—even between joists and in rafters, where the going gets tight. Check these specs: Drives up to 3/4" wood bits, 3/8" twist drills, 1/2" masonry bits, and 1/4" Hole Saws. Weight only 3 1/4 lbs. Overall length: just 8". Speed: 1000 rpm. Motor: B&D-built, 115 v., AC-DC. And it's designed for use with the B&D Screw Driving Attachment!

It's a good bet *you* can use this new 3/8" Utility Drill in *your* work. Find out by getting a free demonstration at your nearby B&D outlet. For more information, write: THE BLACK & DECKER MFG. Co., Dept. H663, Pennsylvania Avenue, Towson 4, Maryland.



For nearest outlet, look under "Tools-Electric".



Available in a complete kit . . . only **\$64⁹⁵**

Includes the 3/8" Utility Drill, plus bits and Hole Saws to cut holes in all types of materials: 3 Hole Saws, 3 masonry bits, 3 wood bits and 8 twist drills. Steel box has ample space for carrying additional items.

LEADING OUTLETS EVERYWHERE SELL



Black & Decker
 PORTABLE ELECTRIC TOOLS



BUILDER: M. J. PETERSON
LOCATION: BUFFALO, N. Y.

Roly-Doors are real "sale-closers"

Victor L. Peterson, Buffalo, N. Y. builder

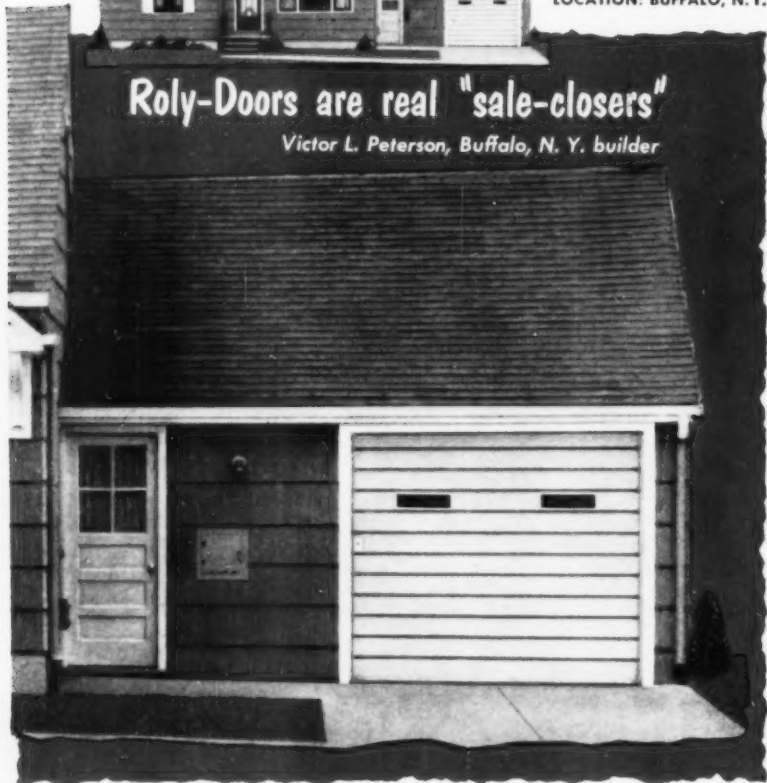

Here's Why M. J. Peterson, Successful New York Builders Are Using Roly-Doors:

"In selling our new homes, we've found that Roly-Door's modern appearance, all-steel construction and easy operation are real 'sale-closers'..." Victor L. Peterson.

MORRISON

Roly-Door

STEEL SECTIONAL GARAGE DOORS



Mail Coupon FOR COMPLETE INFORMATION AND NEW LITERATURE

Prove to yourself that Roly-Door's "plus" sales features will help you put "SOLD" on more of *your* new homes. Write for the new, full-color Roly-Door literature and complete details on Roly-Door's 112 standard sizes and competitively low prices.

Your Roly-Door Distributor also has a complete line of Roly-Doors for all commercial and industrial applications. Ask about them today.

Roly-Door Division, MORRISON STEEL PRODUCTS, INC.
644 Amherst Street, Buffalo 7, New York

Send us the new Roly-Door catalog and all the facts about Roly-Doors.

Name Title

Firm

City Zone State

In Canada, Roly-Door Distributors, Ltd., 1330 Bloor, W., Toronto 4

Also Manufacturers of MOR-SUN WARM AIR FURNACES and CARRY-ALL TRUCK BODIES.



what can we do to remodel this house?

I am enclosing a photograph of a house which is located in the country. What can be done to remodel it? We have thought of removing the old porch at the front and have thought of building a new one that would be more suitable. Is there any possible way of removing the front door and putting in a window? The front door is rarely used although it does face the main highway. The window at the left of the door is the living room, the window on the right is a bedroom.

S. S., Oxford, Mich.

When considering elimination of the front door because of non-usage, bear in mind that it is always well to have at least two exits from the first floor in any house, in the event of fire or other hazard.

Because your house is constructed in a way that gives an essentially colonial or Georgian appearance, the best method to use in



remodeling the house, without a great deal of expense, would be to keep the lines simple.

Remove the porch. Take out the window in the living room and also

(Continued on page 60)

AMERICAN BUILDER

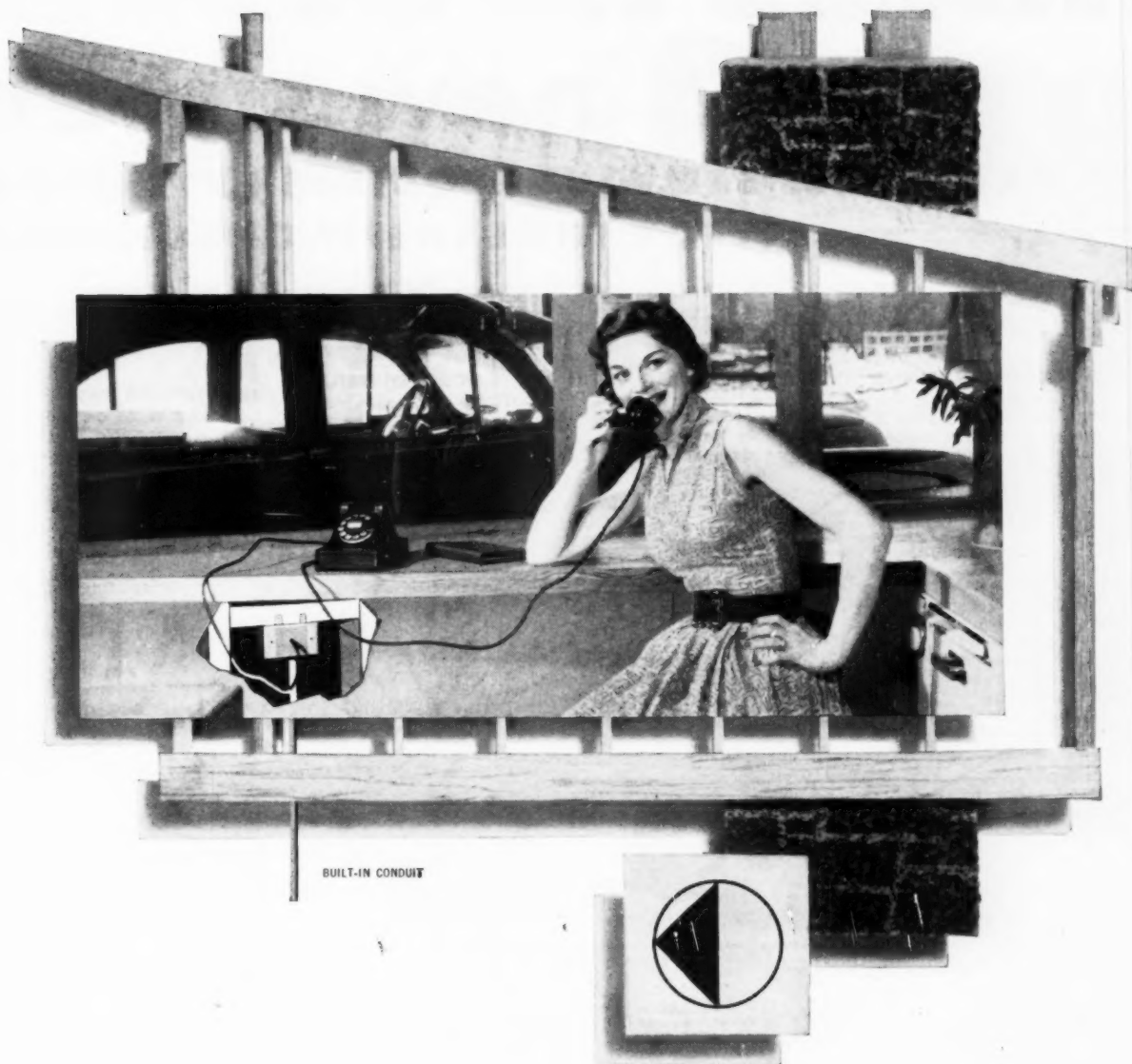

Telephone service is so much a part of modern living.

To make sure that it is available in the right places
(bedroom, kitchen, den and hall) — and that

the telephone wires are concealed —
have telephone conduits built in during construction.

Your Bell Telephone Company will be glad to help you work out economical
conduit installations. Just call your nearest Business Office.

BELL TELEPHONE SYSTEM



TRADE-IN OFFER

on 2 new super

**COMPLETE SELL-OUT REQUIRES EXTENSION
... FOR THE BENEFIT OF BUILDERS**

QUICK-LOCK CLAMPING LEVERS—No more lost wing nuts. One quick motion is enough to lock or release. Saves time on every job.

NEW VENTILATING FAN—Unique turbine design assures cool operation, with consequent lower maintenance and repair costs.

NEW, MORE POWERFUL MOTORS—Power output increased 100% in Model 77 and 107% in Model 825. Higher maintained blade speed gives cuts in lumber, stone and sheet metal an average of 85% faster.

NEW TRIGGER SWITCH—Contoured to fit the index finger. Comfortable for the operator even when used all day.

HIGHER STANDARD BLADE SPEEDS—Mean greater cutting efficiency than ever before. Model 77 speed has been boosted 40% to 4500 r.p.m.; Model 825 increased 34% to 4000 r.p.m.

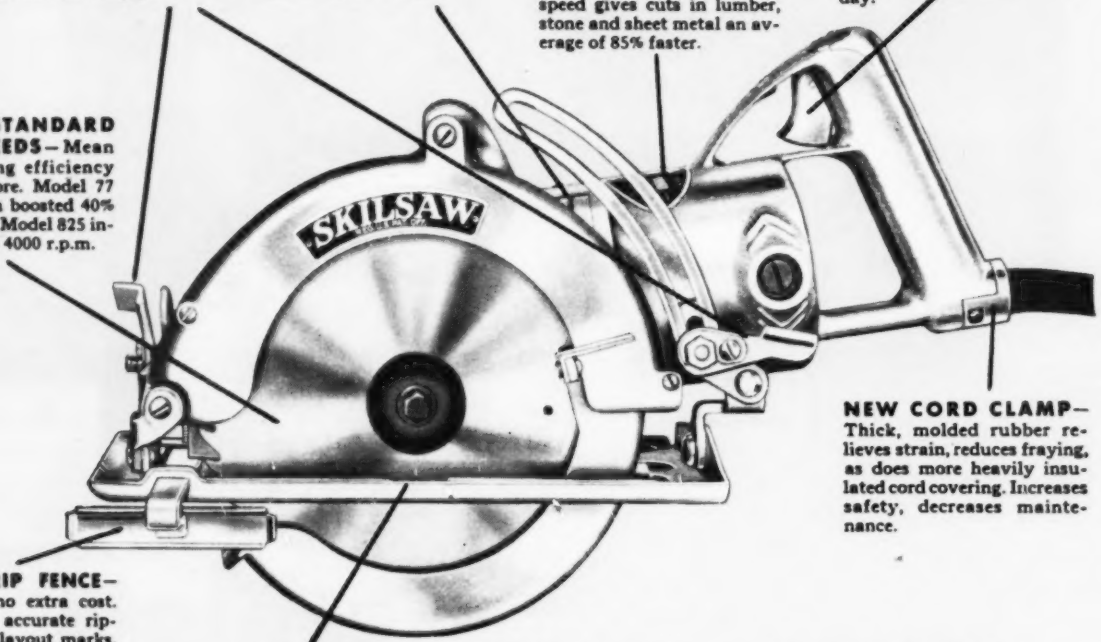

BUILT-IN RIP FENCE—Standard at no extra cost. Permits fast, accurate ripping, without layout marks. Adjustable right or left; indexed by eighths.

NEW, IMPROVED FOOT—Heavy gauge ribbed aluminum provides great strength. Polished and deep-anodized for minimum sliding friction.

REDUCED WEIGHT—New, improved models have more power per pound than any competitive tools. Substantial weight reduction makes for easier handling.

NEW CORD CLAMP—Thick, molded rubber relieves strain, reduces fraying, as does more heavily insulated cord covering. Increases safety, decreases maintenance.

OPTIONAL SPEED GEARS—Exclusive with SKIL! Low speed gears for metals or extra high speed gears for stone or other special cutting jobs are furnished at nominal extra cost.

SEE HOW SKIL OUTPERFORMS OTHER MAKES!

In actual tests,
more power
per pound than
any comparable tool.

**ON
CROSSCUTTING
2 x 12's**



SKIL IS:

117% faster than saw A
95% faster than saw B
164% faster than saw C
35% faster than saw D

**ON
RIP CUTTING
2" LUMBER**



SKIL IS:

100% faster than saw A
44% faster than saw B
83% faster than saw C
71% faster than saw D

**ON SCORING
STONE TO
3/4" DEPTH**



SKIL IS:

78% faster than saw A
78% faster than saw B
67% faster than saw C
100% faster than saw D

EXTENDED! duty SKIL Saws!

**OF THIS TRADE-IN OFFER THRU DECEMBER 15th
WHO MISSED IT!**

**Trade in your
old saw for
\$22.50!**

Your old portable electric saw is worth \$22.50 to you—regardless of its age, make or condition! Here's your chance to own the newest and finest in high-speed, high-power SKIL Saw equipment—through the greatest deal ever!

Offer extended through December 15th! See your SKIL distributor or mail coupon.

NEW SKIL SAW 77 (7¼" Blade)—Speed increased 40% to 4500 r.p.m. and weight cut to 15¼ lbs. Power output boosted 100%. Depth of cut 2½ inches—Bevel cuts 2" dressed lumber at 45°. Most popular SKIL Saw for all-around carpentry—the standard for general construction. Power to cut wet lumber or tough materials such as metal, stone, compositions.

Price, New Model 77 less case \$112.50
Trade-in credit 22.50

YOUR COST, ONLY \$90.00

NEW SKIL SAW 825 (8¼" Blade)—Speed boosted 34% to 4000 r.p.m. and weight reduced to 17¼ lbs. Power output increased 107%. Depth of cut 2½ inches. Bevel cuts 2" rough lumber at 45°. A powerful, heavy duty saw, ideal for use on either residential or commercial construction. Powered to easily cut 2" rough lumber—wet or dry—as well as many other tough and resistant materials.

Price, New Model 825 less case \$134.00
Trade-in credit 22.50

YOUR COST, ONLY \$111.50

Up to 107% greater power!... up to 40% higher blade speed! Lightest weight... lowest price in SKIL Saw history! Better act now!

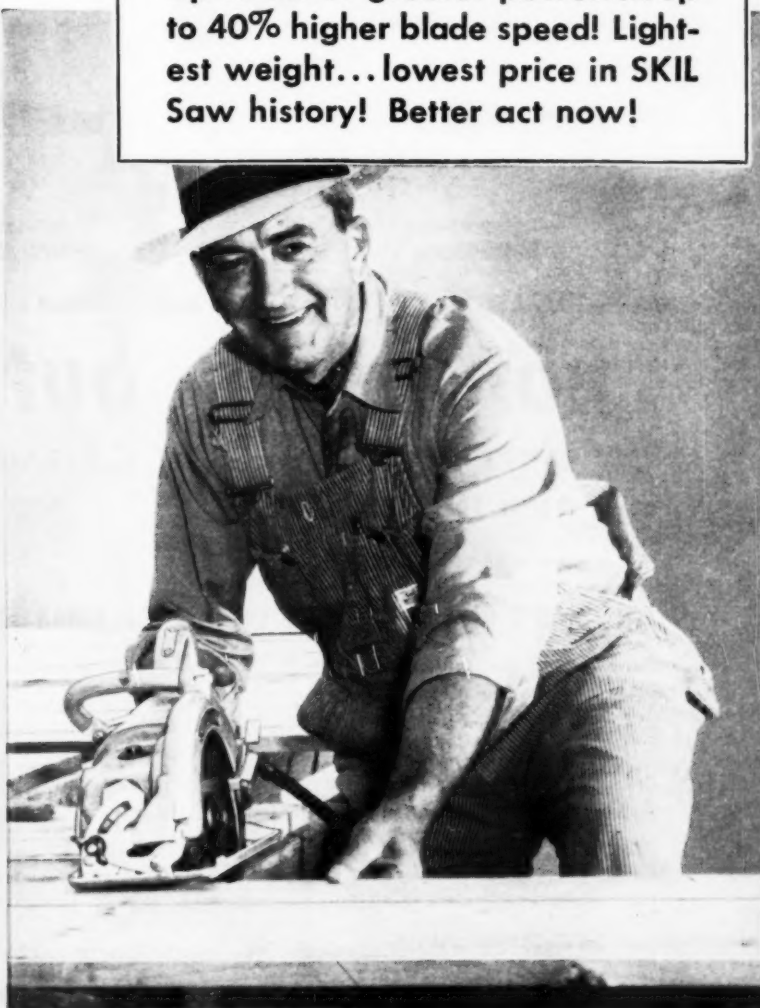

**ON CUTTING
CORRUGATED
STEEL**

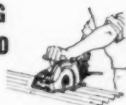

SKIL IS:

78% faster than saw A

78% faster than saw B

*Saws C & D not recommended
for cutting corrugated steel.*

SKIL
PORTABLE TOOLS

Made only by SKIL Corporation,
formerly SKILSAW, Inc.
5033 Elston Avenue, Chicago 30, Illinois
Factory Branches in All Leading Cities

FREE! MAIL COUPON NOW!

SKIL Corporation, Dept. AB-114
5033 Elston Ave., Chicago 30, Ill.

- We want further information on the new SKIL saw trade-in offer.
 Have a salesman call to make a demonstration.
 Let us have a free 15-day trial.

Your name _____ Title _____

Company name _____

Street _____

City _____ Zone _____ State _____

Greatest improvement

Coleman VIT-ROCK



not this...

**DIRTY RED WATER
RUST INSIDE TANK**

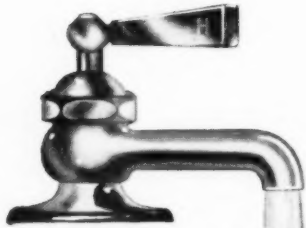

but this...

**CLEAN HOT WATER
NO RUST EVER**

**HERE'S
THE
SECRET**

Flexible rock lining
"rolls with the punches"
to prevent cracking
or chipping. It means
longer heater life and
clean, trouble-free hot
water service.

WHY IT'S A SMART MOVE TO INSTALL COLEMAN VIT-ROCK WATER HEATERS

Now that home buyers are shopping around, it's just plain common sense not to overlook a single plus you can offer them. That's why it pays to install Coleman Vit-Rock Water Heaters. They're definite assets, because they deliver what your prospects want most in a water heater. That's an always plentiful supply of rust-free hot water for every home use and trouble-free hot water regardless of local water conditions. And you can guarantee this

—because they're backed by a 10-year warranty!

Six models: In the Coleman Vit-Rock Water Heater line, you have a range of six models to meet your requirements. It's the outstanding line with the revolutionary Vit-Rock lining* that gives longer lasting life plus other exclusive Coleman-engineered features. Ask your distributor or send the coupon at the right for full information. The Coleman Company, Inc., Wichita, Kansas.



Sheldon Coleman, President of The Coleman Company, Inc., says:

**"IT'S ENGINEERED TO EXCEL ANY
GAS WATER HEATER ON THE MARKET"**

"We've designed the Coleman Vit-Rock Water Heater to be better! We've compared it with other gas heaters, and we know it will *outperform* and *outlast* them. What's more, its advantages are what home buyers want most—clean, clear, rust-free hot water and plenty of it. Its 10-year warranty is a big selling point, too. You'll find it a real sales asset to install Coleman Vit-Rock Water Heaters."

Also made under the name SHELDON VIT-ROCK.
Coleman Water Heaters also available with galvanized tanks.

in water heater history...

WATER HEATER **10 yr. Warranty** †

GAS LP-GAS

VIT-ROCK COSTS NO MORE!



1



It's brand-new. Known by only a few in the trade, the Vit-Rock process is the most revolutionary development in years. It gives the heater advantages found in no other gas unit.

2



Vit-Rock coating is applied to tank walls by centrifugal force. So great is the force that the surface is *completely* covered; not even a pinhole is left exposed. Vit-Rock cannot be "eaten away" by hard water.

3



Special attention is paid to details. Flue connections at top and outer lip of tank bottom are specially coated so no metal is exposed to water.

4

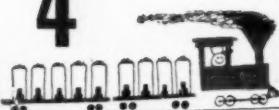

"Safer" to ship and install. Coleman's Vit-Rock lining stands up better because it's tough. This same quality reduces possibility of breakage or damage during installation.

5



The water heater that "breathes." The flexible Vit-Rock lining "gives" with fluctuating pressures; doesn't crack as brittle glass sometimes does. Protects better, lasts longer.

6

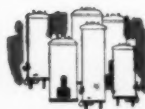

Six models to choose from, each a streamlined beauty with gleaming white plastic enamel outside finish. Fiberglass insulated. Temperature controls readily accessible. 100% safety Shut-Off Valve available on all models for all gases.

Vit-Rock Water Heaters are sold by leading plumbing and heating dealers and gas utilities.

Comfort costs so little
with a

Coleman®

EQUIPMENT AGA APPROVED

†Full unconditional 5-year tank warranty plus 5 additional years pro rata

*Manufactured under the Burwell process

THE COLEMAN COMPANY, INC.
Dept. 851-1-AB, Wichita 1, Kansas

Please send me complete information on the revolutionary new Coleman Vit-Rock Gas Water Heaters.

Name _____

Address _____

City _____ State _____



Quality Building

Preferred **by builders**

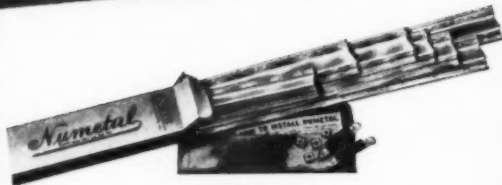

Numetal
**WEATHER STRIP
SETS FOR WINDOWS**

Completely packaged for all standard 28", 30", 32" and 36" double hung windows. Each set contains necessary strip for complete job, plus nails and instructions. Ready to use! Also available in special lengths.

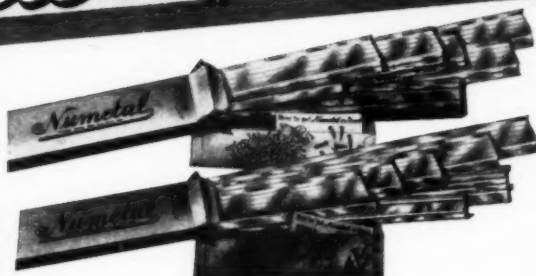

Numetal
WEATHER STRIP SETS FOR DOORS

Completely packaged for standard doors. Available 2 ways— with regular door bottom strip of felt and stainless steel, brass or Alacrome, or with extruded threshold and exposed hook. (When ordering, please specify preference.) Each set contains necessary strip for complete job, plus nails and instructions. Ready to use—easy to install!

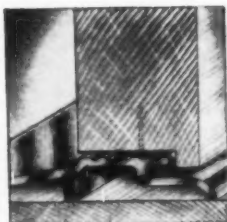

Nu-ART
**THRESHOLDS
in Brass or
Alacrome**

For every type door—residential, as well as commercial and industrial. Individually packed, holes drilled, screws and hooks furnished. Concealed hooks furnished unless exposed type specified!

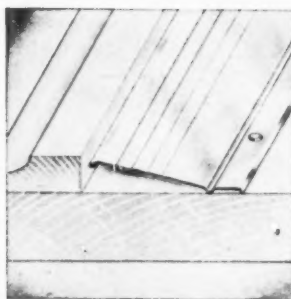

On-GARD COIL WEATHER STRIP

The perfect coil strip in stainless steel or bronze. Packed 2 ways—Six 18 ft. rolls in free display carton, or in 100 ft. and 200 ft. individual cartons with free wall or counter rack. All rolls come complete with nails and holes punched.



BUILDERS! DEALERS!

Look to Macklanburg-Duncan for products of quality—always dependable. Sold at all Hardware, Lumber and Building Supply Dealers!

Order now! Your order will be shipped the same day it is received. Macklanburg-Duncan products are fast sellers, nationally advertised.

Specialties and homeowners alike!

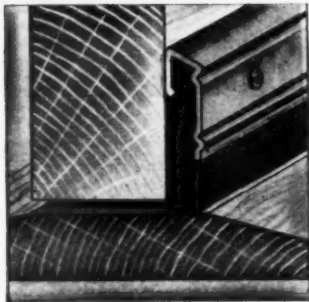

*Nu*metal

DOOR BOTTOM STRIPS

A must for every door in the house! Made of extra thick wool felt and heavy gauge stainless steel, brass or aluminum. Furnished in standard lengths—28", 30", 32", 36", 42" and 48"—packed 1/2 dozen same length to carton. Also available in special lengths.



Nu-WAY WEATHER STRIP

A popular, fast-selling strip because it's the easiest in the world to put on! Works perfectly on windows, storm sash or doors. Made of moth-proof, pre-shrunk, color-fast wool felt and white metal. Package contains one 18 ft. roll with nails and instructions. Packed 12 cartons in handy display case.

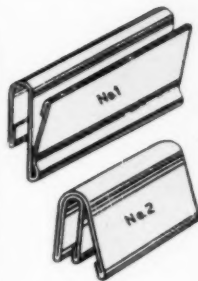
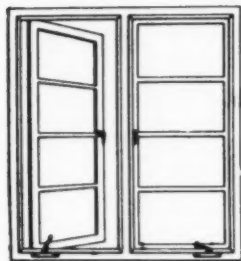

M-D WEATHER STRIP FOR METAL CASEMENT WINDOWS

Available in Alacrome or bronze for all metal casements. Just slips on—no screws or fasteners needed! Furnished in bulk or in packaged sets for standard windows—18" x 26", 18" x 38" and 18" x 50". Only tool needed is pair of scissors or snips to miter corners.

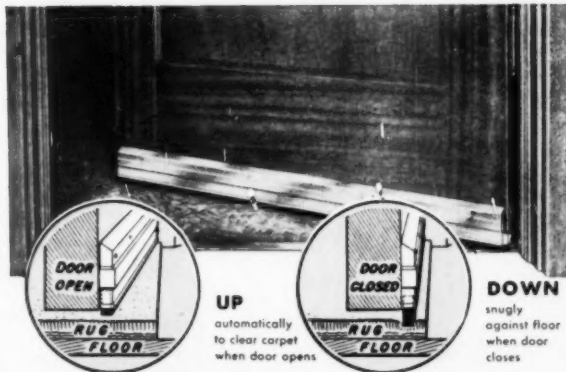

Nu GARD Automatic DOOR BOTTOMS

The perfect answer for all drafty doors. Automatic feature raises felt to clear rug or carpet every time. Smart, silvery-satin finish that will not rust or tarnish. Finished in standard lengths—28", 32", 36", 42" and 48". May be shortened approximately 2". Packed in individual cartons.

MACKLANBURG DUNCAN CO.

OKLAHOMA CITY 1, OKLAHOMA

Leaders in the Building Specialty Field for over 30 years!





Ripplewood

TEXTURED WOOD WALL PANELING



Brilliant settings in G-P Ripplewood Knotty are the feature attraction in model homes from coast to coast.



GEORGIA — PACIFIC

PLYWOOD COMPANY

DEPT. AB-11, 270 PARK AVENUE, NEW YORK 17, N. Y.

BUYERS LOVE ITS LUXURY LOOK BUILDERS CHEER ITS LOW COST

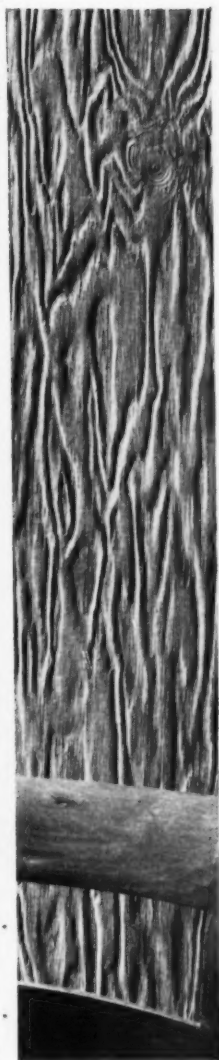

Here's a bargain in buy-appeal! It's G-P Ripplewood, genuine wood wall paneling with beauty that is excitingly different . . . a rich sculptured texture and swirling grain pattern that makes prospects say, "That's for me!" Ripplewood's low cost and ease of installation and finishing have won new friends among economy-minded builders everywhere.

A prominent New Jersey builder found G-P Ripplewood so helpful in selling 170 homes that he plans to use it in 400 additional dwellings. A Con-

necticut project builder is featuring G-P Ripplewood in a large home development. Not only was his material cost surprisingly low, but he estimates his one-coat stain finishing cost to be as little as \$20 per room. That's the kind of record G-P Ripplewood is making all over the country. That's why more builders every day are discovering that G-P Ripplewood helps turn prospects into buyers . . . helps sell homes faster. See your local Georgia-Pacific dealer or mail coupon for complete data.

ONLY G-P Ripplewood Gives You All These Features!

Genuine Wood • Rich Texture • Distinctive Style • Low Cost • Carton Packed for Extra Protection • Easy Installation • Factory Primed for Easy Finishing • Available in 4' x 8' panels and 12" and 16" squares.



G-P RIPPLEWOOD SCORES WITH NEW YORK BUILDERS

Irvin Wanderman and Louis Schiff say, "G-P Ripplewood created a wonderful sales reaction for us. We finished it with one coat of stain. The recreation room in Ripplewood has caused much comment and been a real asset in our community of homes, Bonnie Meadows at Scarsdale, New York."

Free! Builders Fact File—
Send for handy kit of G-P
Ripplewood literature—speci-
fications, sales features and
other useful data.



Georgia-Pacific Plywood Company
Dept. AB-11, 270 Park Ave., New York 17, N. Y.
Please send me the G-P Ripplewood Builders Fact File

NAME _____
COMPANY _____
ADDRESS _____
CITY _____ STATE _____

LATH and

plaster and

"Saved Time and Money"

● Mr. H. E. Rumpel, Superintendent of Schools, Richfield, Minnesota, says: "We selected lath and plaster for our new school because we wanted the fire safety and low maintenance it provides. And we have found that its intelligent use can save a worthwhile sum of money. For example, pre-colored, acoustical plaster eliminated the need for painting, and cost substantially less.

"In addition, plastering considerably shortened construction time. And it gave us a lower insurance rate—a worthwhile yearly saving throughout the life of the school."



A. M. Hede and L. G. Peterson of Peterson & Hede Co., plastering contractors, present Certified Craftmanship Certificate on Richfield High School to Mr. H. E. Rumpel, Superintendent of Schools, Richfield, Minnesota, and Mr. R. N. Thorshov, Senior Partner, Thorshov & Cerny, Architects and Engineers. Richfield is a suburb of Minneapolis.

Certified Craftsmanship in action in Minneapolis

• As in scores of cities across the country, contractors and craftsmen in Minneapolis have formed a local chapter of the National Bureau for Lathing and Plastering. They have subscribed to the Bureau's recently adopted Code of Standard Practices for Lathing and Plastering and are offering Certified Craftsmanship Certificates.

The *Certified Craftsmanship Certificate* is a written pledge of adherence to work schedules, job cooperation, work of craftsmanship caliber and nationally recognized standards of quality. A certificate is yours for the asking from lathing and plastering contractors adhering to the Code of Standard Practices for Lathing and Plastering.

We suggest a thorough reading of the Code of Standard Practices which appears on the back of every certificate. Ask your lathing and plastering contractor for a copy, or write National Bureau for Lathing and Plastering, 1401 K Street, N. W., Washington 5, D. C.

A finish plaster which provides an exceptionally rock-hard surface was used in all corridors. Over 63,000 square feet of acoustic plaster provide sound absorption necessary in classrooms and other areas.

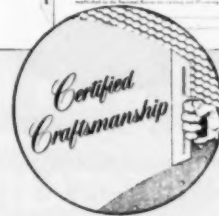

This is the emblem of the National Bureau for Lathing and Plastering. It symbolizes high standards of job performance and responsibility.

**Associated Manufacturers
of Lathing and Plastering Materials
520 N. Michigan Avenue, Chicago 11, Illinois**

FINISHING LIME ASSOCIATION OF OHIO • GYPSUM ASSOCIATION
METAL LATH MANUFACTURERS ASSOCIATION
PERLITE INSTITUTE • VERMICULITE INSTITUTE



A STERLING NEW PRODUCT RELEASE

announcing
A-LUMI-GLAZE



STERLING A-Lumi-Glaze designed for aluminum windows... withstands indefinite exposure on sash without painting... will not dry out or deteriorate!... Metallic reinforced film reflects destructive rays and protects binder. Remains perfect match with aluminum frames, after years of exposure.

A - LUMI - GLAZE
Passes the test of time

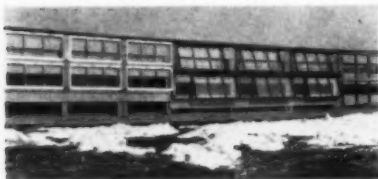

Withstanding the rigors of sun wind and freezing temperatures A-lumi-glaze remains stable on the Sterling test fence.



See our catalog in
or write for copy

See Sweet's File 6c
or send for full information today.

**STERLING PAINT
& VARNISH CO.**

315 Commercial St. Malden, Mass.

ON THE RECORD and OFF THE RECORD

HELIPORT was a new word to me until Joe Dillon, Saint Paul's affable and able mayor, my dinner partner at a recent meeting of the Saint Paul Home Builders Association, remarked that the city had just received its first application for one.

ABOUT THE SAME TIME word was received from New York that the city was on the verge of getting a new heliport less than a minute's flying time from Times Square.

NOW I learn that a number of European cities have had heliports for some time, using them to land and launch helicopters on regular schedules with passengers in and out of the cities.

RIGHT ON THE HEELS of these revelations came an announcement that there soon will appear on the American market a mass-produced helicopter to sell for about the price of a high-cost automobile.

APPARENTLY, about all that is needed now are more heliports to begin a revolution in both city and rural living.

WIDE USE of individually owned helicopters, with a heliport on every apartment building roof places the city dweller within minutes instead of hours from recreation centers or summer or week-end houses.

CONVERSELY, with a heliport on every metropolitan office building roof, Joe Whitecollar can live a hundred or more miles away from his place of employment, and easily commute every day.

OF COURSE, there will be a lag between the modest start already made and popularization of helicopter travel.

FIRST, there must be more heliports, then someone will have to come up with a helicopter counterpart of Henry Ford's teen era Model T.

BUT the time is closer than many of us want to believe.

AND IT PRESAGES the development of suburban communities located several scores of miles away

from down town instead of within the current fifty or sixty mile radius.

SUBURBIA today is limited only by travel time via automobile, bus or suburban railroad train.

SUBURBIA tomorrow will be limited only by air travel time, air traffic conditions, and to some extent by weather.

GLOOM CASTERS, as might be expected are already predicting the end of the big city, because of the new air age.

BUT, THEIR PROTOTYPES of 40 years ago were predicting the same thing because of the new inaugurated steam railroad and electric railway suburban service.

AND IN BETWEEN, another school of havoc criers, predicted the dissolution of big cities with the advent of paved automobile highways.

HOW WRONG all of them were is attested by the fact that every American city of whatever size is bursting at the seams, and has for its major problem how to get increasing throngs of people in and out every day.

THE BIG CITY will stay as long as people have a gregarious instinct.

FOR THE BUILDER, the new air age problem involves pushing suburbia farther and farther out, and rebuilding the decaying cores of the cities.

AND WHERE WILL the people come from to live in all these places? Ask any public school official. At the moment the public school system of the nation is short 370,000 classrooms below what it needs to adequately house the school population.

THAT'S NO SMALL market in itself for the light construction industry. At an average of 10 classrooms per school, it means that we are actually short 37,000 school buildings.

THE HELICOPTER broadens the horizon of places on which to build. May even set the radius up to 500 miles before long.

take a good look at **WESTERN RED CEDAR**

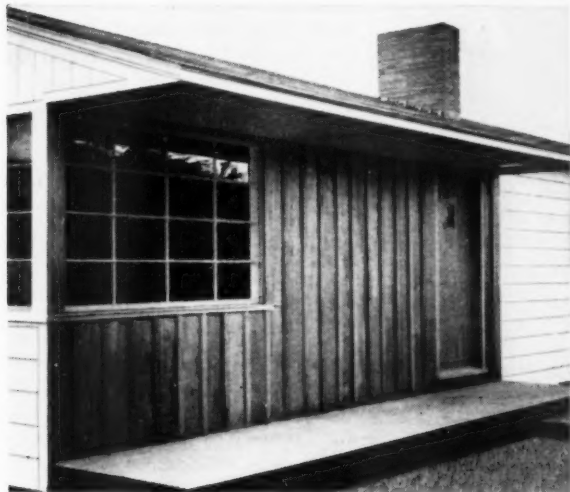

one of 10 woods from the
WESTERN PINE region

Great resistance to decay, dimensional stability, high insulating qualities, workability, nailability, light weight make Western Red Cedar an excellent and economical wood for all residential construction—and preferred for weather-exposed usage such as poles, greenhouses, boats and floats.

Western Red Cedar comes in 3 select and 5 common grades. You can order it in mixed cars—together with other woods from the Western Pine region—from most Western Pine Association member mills!

the Western Pines

IDAHO WHITE PINE
PONDEROSA PINE
SUGAR PINE

the Associated Woods

RED CEDAR
LARCH
DOUGLAS FIR
WHITE FIR
ENGELMANN SPRUCE
INCENSE CEDAR
LOGSPOLE PINE



get the facts to help you sell **WESTERN RED CEDAR**
write for the FREE illustrated booklet to
WESTERN PINE ASSOCIATION
Yeon Bldg., Portland 4, Oregon

NOVEMBER 1954

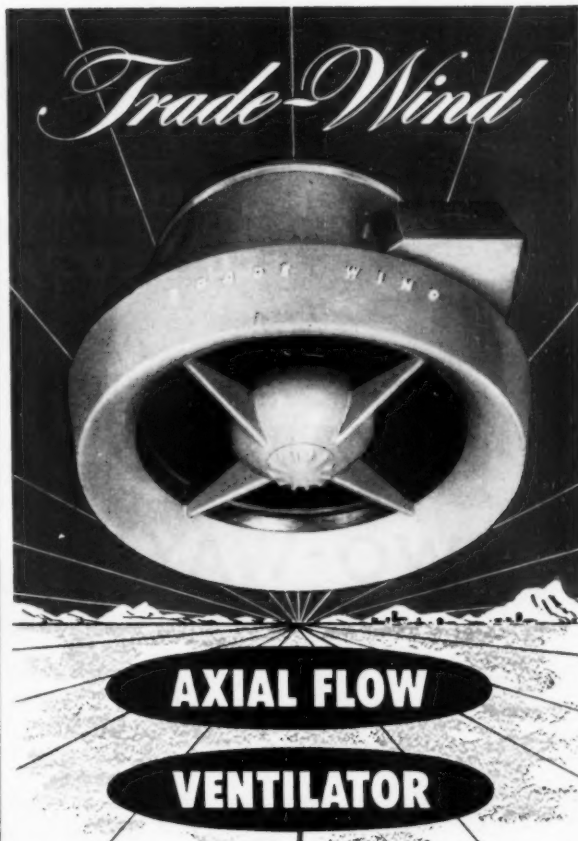

AXIAL FLOW

VENTILATOR

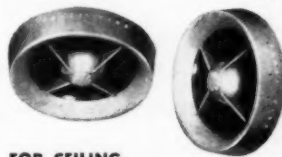

FOR CEILING OR WALL INSTALLATION

Low Price

Outstanding New Styling

Surprising New Quietness

Easiest Installation In Old Or New Construction

Performance Beats Expensive Units

1
2
3
4
5

The new low-cost Trade-Wind Axial Flow Ventilator now makes it possible to use either wall or ceiling installation with the same unit. The ventilator can be installed between joists in the ceiling or between studs in the side wall. Note that no elbows are required for vertical discharge.

The Trade-Wind gives you straight-through axial flow plus super-powered suction. And it sells at a low price which makes kitchen ventilation a must even in the most economically designed house. And it's so good looking! Styled by a top industrial designer, the Axial Flow adds a new distinctiveness to every kitchen.

WHAT IS AXIAL FLOW?

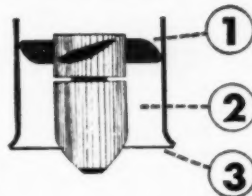

Aerodynamic impellers, shaped like airplane wings, give smooth powerful push to air, almost without noise.

Limited space between hub and tube concentrates straight through pressure drive.

Venturi-shaped tube, "hurries" the air flow by increasing the velocity.

Trade-Wind Motorsfans, Inc.

7755 PARAMOUNT BLVD., DEPT. AB, RIVERA, CALIFORNIA

NEW
BLADE DEVELOPMENT
CUTS COSTS!

SKIL TWO-WAY Saw Blade



REVERSIBLE! Unique tooth design cuts either way, gives twice the cutting edges! May be reversed again and again!



SELF-HONING! Trailing tooth-edges are honed while leading edges cut. Always a sharp cutting edge ready for instant use!



DISPOSABLE! Four times longer life! Saves on needless resharp-ening! Low cost makes disposal practical when worn out!

SKIL
 PORTABLE TOOLS

Made only by SKIL Corporation,
 formerly SKILSAW, Inc.
 5033 Elston Avenue, Chicago 30, Illinois
 3601 Dundas Street West, Toronto 9, Ontario
 Factory Branches in All Leading Cities



...Lasts four times longer than ordinary blades... yet never needs resharp-ening!

Here is the first real cost-cutting development yet made in circular saw blades! The new SKIL Two-Way Blade... lets you save *three ways*: (1) Gives you *four times* as many cuts! (2) Eliminates three to four costly resharp-ening! (3) Reduces *down-time!*

SKIL Two-Way Blade is top quality throughout: Specially-treated alloy steel, 50% harder than ordinary blades. Precision-ground, uniformly-set teeth of patented design. Special no-glare, rust-resistant finish. Constant diameter for uniform cut-depth. All insure controlled cutting performance under toughest job conditions! Give it an on-the-job test *today!*

SKIL Corporation, Dept. AB-114
 5033 Elston Avenue, Chicago 30, Illinois

I would like a demonstration and free trial of the SKIL Two-Way Saw Blade.

Please send me literature on the New SKIL Two-Way Saw Blade.

Name _____

Company _____

Street _____

City _____ Zone _____ State _____

how to remodel house

(Continued from page 46)

the door. In their places, install a large picture window with a door adjoining. In other words, the door and the window would be one large unit. Then provide a protective canopy over the door and the window. This can be composed of either square wood posts or round cast-iron posts at each end of the entrance porch.

Then place a very flat-type roof arrangement with a projecting cornice line so that the window and the door will be amply shaded and protected.

The house lends itself well to the use of shutters on the remaining windows. Their use will help to create the feeling of horizontal lines to make the house appear to hug the ground.

How about adding a terrace that runs the length of the new living-room window and door? Color and planting will also help to make the house attractive and inviting. Either a white house with green shutters or a light grey house with white trim, dark blue shutters, dark blue door and blue-black roof would be very striking.

New clay pipe joint speeds sewer installation

A mechanical joint on vitrified clay pipe is designed to give the contractor a simple sewer pipe installation at minimum cost. It embodies a push-type joint based on the ball-and-socket principle, consisting of a plastic ring die-cast into the bell of the pipe and a second plastic ring also die-cast on the spigot. Diameter of the spigot ring is somewhat larger than the largest diameter of the bell ring, so that when the two are pushed together, the rings are in constant compression, making the joint root- and infiltration-proof.

To lay a standard sewer pipe line requires no preparations, since there is nothing to do but push the pipes together. For average sewage lines, joint is greased with plain water, bell and spigot lined up, the pipe pushed together, and the job is done.

Called the Amvit Joint, it is designed for four-through eight-inch pipe sizes. Product of American Vitrified Products Co., Cleveland.

AMERICAN BUILDER



These Manilow-built homes—Des Plaines Villas at Des Plaines, Illinois—are not only carefully planned to have an "individual look," but they're *complete*. The kitchens include an electric refrigerator, automatic washer, automatic dryer, and an *Electric Range* so the homemaker can be modern . . . cook **ELECTRICALLY!**

Houses like this really sell!

When a builder sells hundreds of houses in just a few months, there are a number of reasons why. But you'll notice one feature again and again that helps to make houses really sell. It's the *Electric Range* in the kitchen.

Women know that an *Electric Range* means economy and ease of operation, a clean kitchen as well as a cool one. That's why builders of homes in all price ranges, in all parts of the country, install *Electric Ranges*.

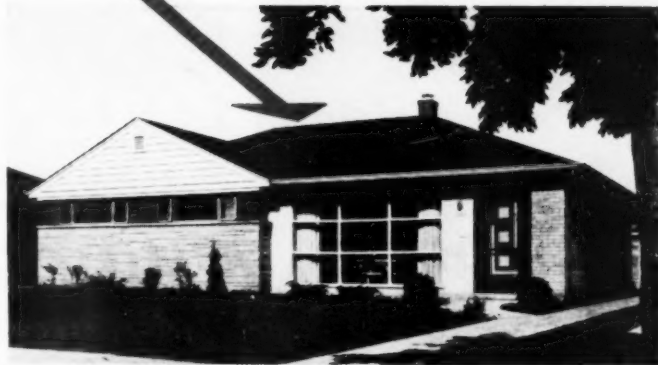

Builder Nathan Manilow says: "We recently completed one of the most outstanding sales achievements ever accomplished by the Manilow Construction Company, by selling 500 moderately priced homes in Des Plaines Villas in nine months. The sale price included four electric appliances, one of the most important being the *Electric Range*."

More builders every day are installing

ELECTRIC RANGES



ELECTRIC RANGE SECTION

National Electrical Manufacturers Association
155 East 44th Street, New York 17, N. Y.

ADMIRAL • BENDIX • CROSLY • DEEPFREEZE • FRIGIDAIRE • GENERAL ELECTRIC • HOTPOINT • NORGE
KELVINATOR • MAGIC CHEF • MONARCH • PHILCO • STIGLITZ INFRA-AIRE • TAPPAN • WESTINGHOUSE



"EVERYTHING HINGES ON HAGER!*"

FREE! If you enjoyed laughing at Virgil Partch's mirth-making cartoon this month, send for Hager's new book containing 28 full-size popular "Everything Hinges on Hager" cartoons! It's FREE! Just address



C. Hager & Sons Hinge Mfg. Co. • 139 Victor Street • St. Louis 4, Mo.
 Founded 1849 — Every Hager Hinge Swings on 100 Years of Experience

AMERICAN BUILDER



← Mr. King's newly-completed big, spacious home in Texarkana, Texas. Architect: Reinheimer and Cox.



Proof of the Pudding! Prominent Builder uses Flintkote Skyline roofing for his own new home!

Mr. Frank King . . . a Southern builder with an unusually successful record of achievements, knows his building methods and materials.

So, when Mr. King personally selected the Skytab specifications of Flintkote's Skyline Roofing System to top off the beautiful new home he is building for *himself*—isn't that proof of the pudding? Isn't that proof of this system's *great value*?

Why did Mr. King single out the Skytab method of Skyline Roofing?

Because Skytab is engineered *especially* for modern low-pitched roofs.

It employs the use of Flintkote Mist Gray Shado-Kool Thikbut Strip Shingles insuring long-range economy and better protection against all kinds of weather.

And Thikbut Shingles provide so many harmonious colors to choose from . . . you are able to use the one that *exactly* fills the bill.

So take a tip from Mr. King. Recommend and use Flintkote Skyline Roofing. Write for complete details today.

Here is Mr. King (center) "supervising" the installation of his 75 squares of Flintkote Skytab roofing. Skytab is ideal for all types of contemporary structures, when roof slopes are within a range of 2" to 4" per foot. In addition to Skytab, the Skyline System consists of two other specifications: Skytex and Skykote . . . to answer most of your modern-day roofing problems.



Shingle tabs are quickly, easily and *surely* cemented down with Flintkote's Stik-Tab Cement.

THE FLINTKOTE COMPANY, Building Materials Division, 30 Rockefeller Plaza, New York 20, N. Y.

FLINTKOTE ... *the extra years of service cost no more!*



watch this basement turn into the Liveliest

◀ **FIRST MAJOR PROBLEM** was a partition
Removal of part of partition opened up unused space of former coal bin

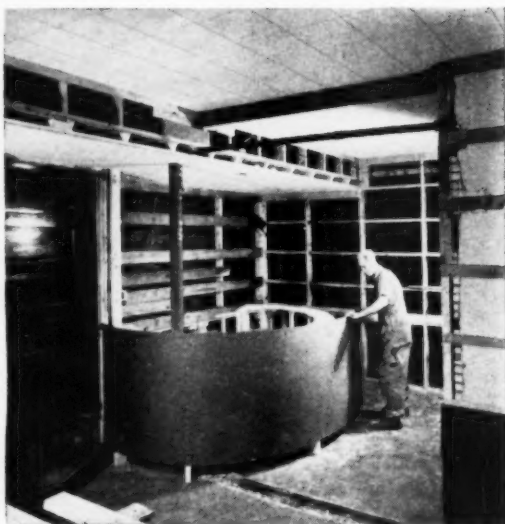

A semi-circular bar was built in coal-bin space, at entrance to basement. Steel lally column was allowed to remain outside furring members

Regular untempered hardboard was used for bar front. Note dropped ceiling effect, important to lighting scheme

▼ **SECOND MAJOR PROBLEM** was a storage area and the usual collection of pipes and meters



Furring strips were applied in the conventional way, but placed behind certain pipes selected to be part of decorative scheme

Room in the House



Formica was added to the top, and a 1x3-inch strip attached around the bottom



Finished room has recessed spotlights and reflected ceiling lighting, makes a bright setting for games and music

● Adding livability to older houses is a wide-open opportunity for builders with smart ideas . . . Test your wits on this basement job by Harold Pawlan in Evanston, Illinois, home

Photos courtesy Insulation Board Institute



Wainscot is hardboard installed with adjacent edges flared out



Insulation board plank was used for the walls, tile for the ceiling



Storage area and meters are now blocked off by Hough split bamboo shades

FOR PLANS AND OTHER DETAILS, please turn to page 68 →

THE BRIGHTEST **STAR** IN THE WALL TILE FIELD

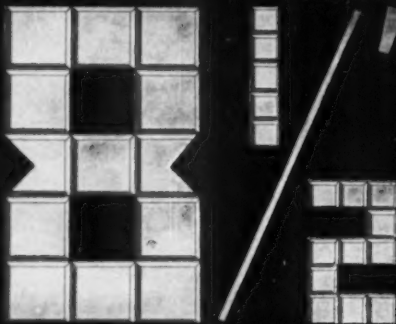

HAKO
Coronet

CARRARA PLASTIC TILE

11 BEAUTIFUL COLORS

Whether you're building or remodeling, the most critical home-owner will be delighted with this magnificent new Tile beauty! Gleaming, cheerful weatherproof walls of permanent color. HAKO CORONET CARRARA is ideal for kitchen, baths, utility rooms and dinettes. Time-tested and performance-proved, and HAKO CORONET CARRARA makes your home worth more at a lower cost. For information and specifications, send the convenient coupon TODAY!



Also available in 4 1/4" x 4 1/4" size



MADE OF
STYRON
A DOW PLASTIC

CHECK THESE OUTSTANDING FEATURES...

- Newly designed face and soft contour bevel edge
- Perfect waterproof protection featuring CORONET'S gleaming beauty is permanently locked to the wall
- All tile is uniformly square—Saves time
- Matching inside and outside Corners and Trim
- Guaranteed color control from shipment to shipment
- New 8 1/2" size saves installation time
- Conforms to the S.P. Commercial Standard Specifications

HACHMEISTER-INC., Pittsburgh 30, Pa. AB-11-54

Please send me complete information and specifications on 8 1/2" HAKO CORONET CARRARA Plastic Tile.

Dealer Distributor Contractor

Name _____

Firm Name _____

Address _____

City _____ Zone _____ State _____

SINCE 1903

HACHMEISTER-INC.
PITTSBURGH 30, PA.



ANOTHER

BUILDER

SEES THE

LIGHT!

YOU'RE LOOKING AT SPACED SHEATHING

This is the practical, *profitable* way to deck a roof. By spacing your sheathing, you save up to 50% on lumber, on labor, on nails. Or an average of \$200 a home.

Only with cedar shingles is this residential roofing economy possible. Because only with cedar shingles do you gain the strength and rigidity that enable you to apply your roof in a bridging application over spaced sheathing.

If you've been searching for a way to add quality to your homes — *without adding cost*, begin using genuine CERTIGRADE shingles applied over spaced sheathing. Take a good look at spaced sheathing. You'll soon see the light.

Write for your free copies of a handy roof estimating sheet and the 100-page Certigrade Handbook.



RED CEDAR SHINGLE BUREAU

5510 WHITE BUILDING, SEATTLE 1, WASHINGTON • 550 BURRARD STREET, VANCOUVER 1, B. C.

NOVEMBER 1954

67

In basement remodeling . . .

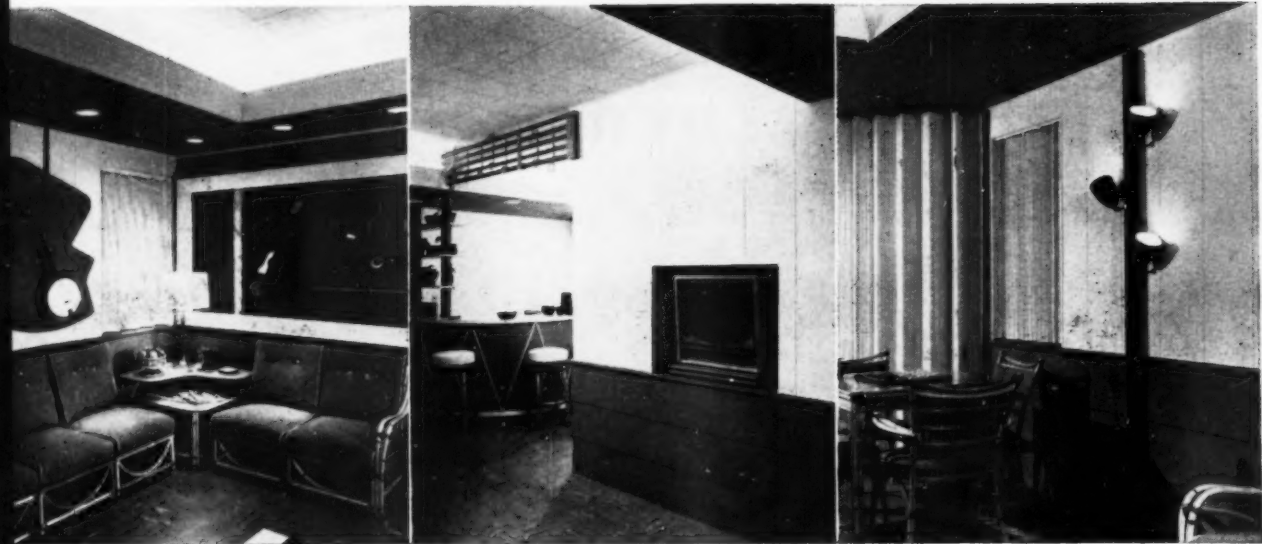

don't be afraid to let certain pipes show . . .

The three photographs above show how various pipes were left exposed and used as a part of the room's decorative scheme. Hot water pipe in photo at left was made a feature of the open storage panel above new built-in cabinets. This pipe was wrapped with photostats of enlarged music sheets permanently secured and then coated with clear shellac. In same photo, banjo is hung on a free-form design cut from perforated hardboard and applied to a cold water pipe. In middle photo, bottom bar of the line of music is a hot water pipe left exposed. Four wood dowels of the same diameter complete staff. Photo right shows pipemade into a lamp tree.

and make the most of ceiling lighting . . .

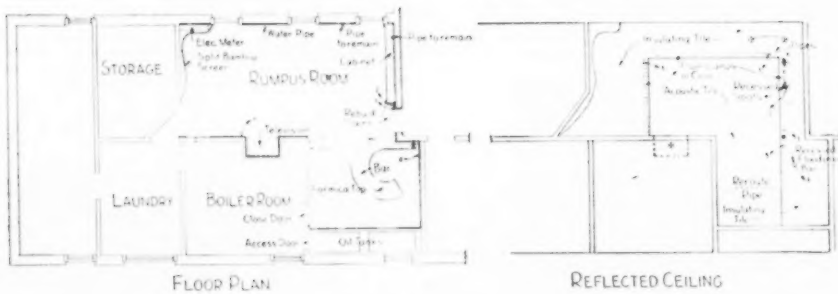

Lighting for this new room was carefully studied, became one of its most attractive features. Plan for the ceiling lighting is shown here, in combination with floor plan for the room

Details for the new wall cabinet unit, shown behind chairs in photo at left, above

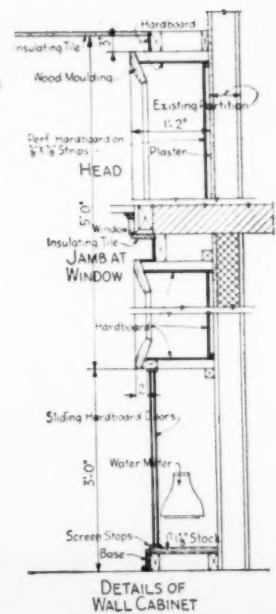

AMERICAN BUILDER

Announcing . . .

New Gold Seal CORK TILE

...an improved, super soil-resistant tile at no extra cost!



Idea: Random shades of Gold Seal Cork Tile go on both floors and walls to give an expensive, custom look to this space-saving den-guestroom.

To get anywhere in today's custom home market you need plenty of "extras" . . . like new Gold Seal Cork Tile! Check all these Gold Seal Cork Tile advantages. See how they add value and salability to your homes . . . give more pleasant living to your customers.

- Gold Seal Cork Tile is closely knit, tightly bonded . . . with a special factory finish that gives it a built-in *soil resistance unsurpassed by any other cork tile* on the market . . . plus longer wear, exceptional resilience, outstanding stain resistance.
- Gold Seal Cork Tile gives you warmer, more luxurious cork colors. Random pack of three shades (light, medium, dark) stimulates hundreds of ideas for dens, entrance halls, living rooms, libraries.
- Gold Seal Cork Tile makes a perfect basic floor. And it is ready to live with. Its soft beauty and luxurious appearance eliminate need for expensive carpeting . . . a big saving for prospective buyers.
- Gold Seal Cork Tile is produced by a modern manufacturing process that minimizes burnt odor found in other cork tiles.

- Gold Seal Cork Tile is amazingly quiet and comfortable underfoot . . . absorbs floor noise . . . reduces foot fatigue. The natural insulating properties of this product make it warm in winter . . . cool in summer.

Specifications:

Gold Seal Cork Tile goes over wood, concrete or any other type of suspended sub-floor . . . can also be installed on any dry wall of sound, even construction. Tiles are die-cut . . . precisely uniform in size. Beveled edges help hide irregularities in sub-floors. 6" x 6", 9" x 9", 6" x 12", 12" x 12", 12" x 24" tiles. 1/8" and 3/16" gauges. Standard packing (all light) or random packing (mixed, light-medium-dark). For detailed information write: Builders' Service Dept.



GOLD SEAL®
Floors and Walls

CONGOLEUM-NAIRN INC., Kearny, New Jersey

BLUEPRINT HOUSE

BUILDER:
*Missner and Passman,
Glencoe, Illinois*

ARCHITECT:
*Robert A. Hirsch,
Highland Park, Illinois*

SQUARE FOOT AREAS

House, full area	1,260
Second floor of house, 1/2 of area	344
Garage, full area	240
Front entry, 1/3 area	20
Patio, 1/3 area	42
Total square foot area	1,906
Cost per square foot	\$13.20

For computation purposes front entry, patio and second floor of the house are fractional, so that their cost per square foot will be in ratio with that of the house.

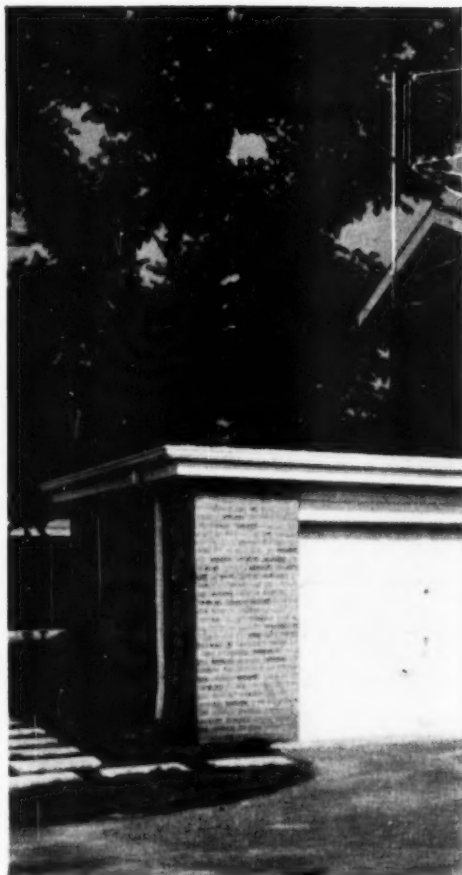

How to make a tri-level

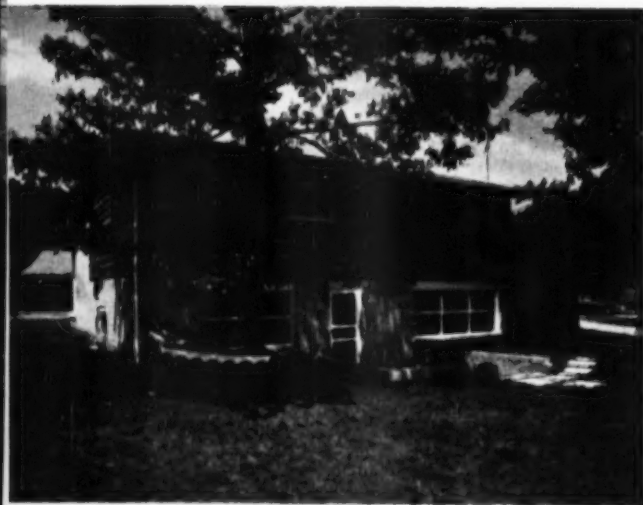

Depressed patio meets level of the door sill



Studio-type living room . . . a big house feature

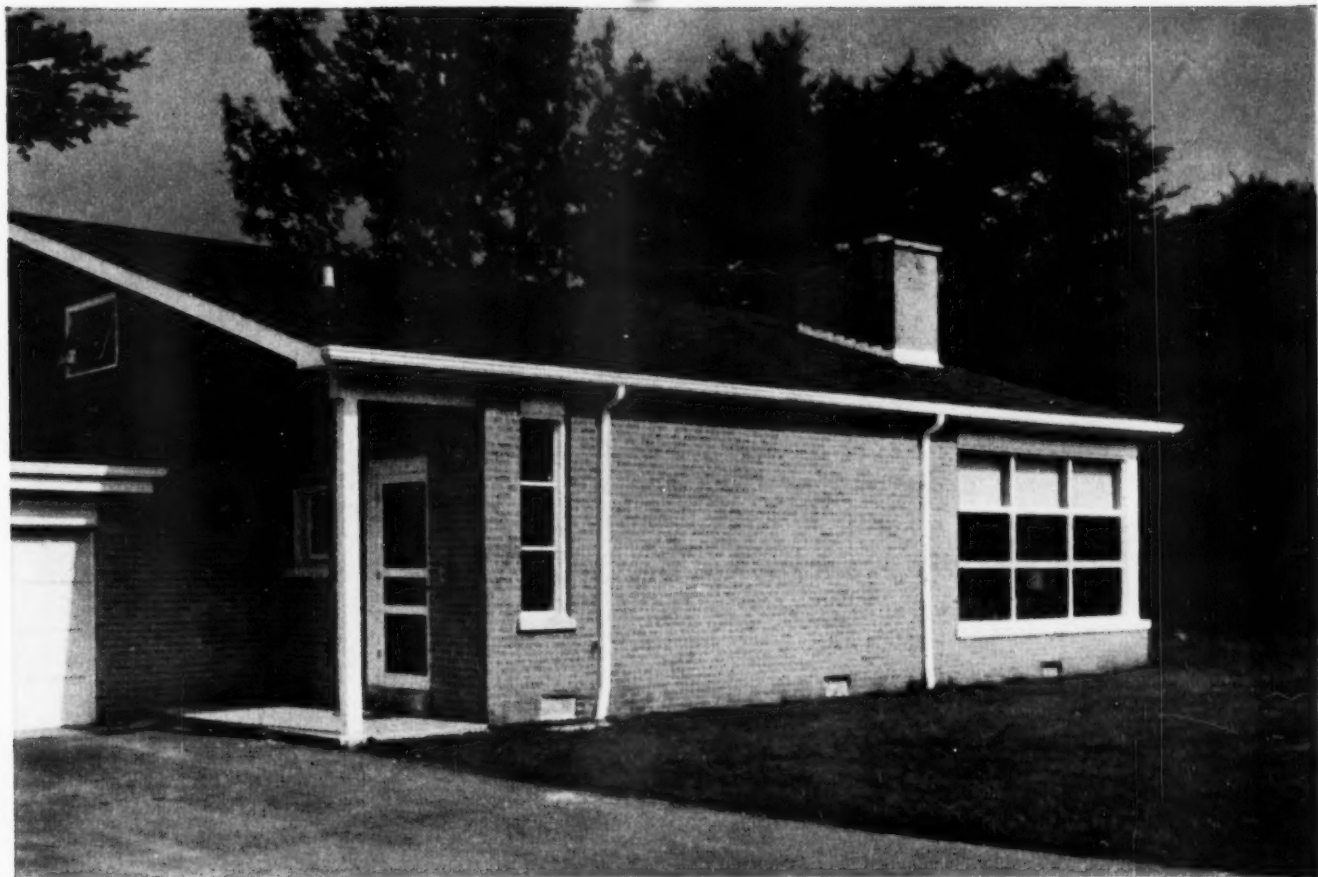

Balanced and conventional three-level living on a flat site

fit on a flat lot

Here is a house that looks at home on level ground, yet has an orderly sequence of three levels on the inside. How was it done?

By splitting front to back—front entrance and living room are one-third flight above the family room and kitchen, two-thirds flight below the bedroom level.

By depressing patio at rear to maintain a level grade line around the house. Brick floor of patio is six inches below the lower level.

By subordinating the garage to the rest of the house, thus achieving a balanced and well-proportioned appearance for the front elevation.

By employing an unbalanced roof with the long sweep to the front and the short slope to the rear. This permits a battery of awning-type windows in the bedrooms. The same pitch is maintained for both roof slopes.

By using the underside of the roof to serve as the ceiling for the studio-type living room.

By creating the illusion of more space with a bedroom level gallery that overlooks the living room.

By locating the fireplace in the corner of the living room opposite the entrance, and by extending the exposed masonry to the sloped ceiling.

Still other design advantages are a close relationship

MORE



Kitchen units are grouped in an orderly and functional manner

between the front entrance and garage door; the large family room adjoining the kitchen for formal and informal dining; a built-in TV set in the family room with book shelves on each side; the economy of an L-type kitchen with heater and utility room adjoining—a concentration of mechanical units in one area.

The house is placed on concrete walls and footings which extend 3 feet 6 inches below the established grade or below the floor of the patio. The entire area of the

house is excavated to the depth required for the kitchen and the family room. The living room floor is up 2 feet 6 inches with the area below used as crawl space.

Exterior walls are brick veneer up to the cornice line on the front, and up to the ceiling line of the kitchen and family room. Walls of the attached garage, including the adjoining wall of house, are of brick nine inches thick. Walls above are faced with horizontal redwood siding. Roof is asphalt shingles.



Convenience and adaptability are assets of family room

BRAND NAME PRODUCTS USED

A.B.C. aluminum awning windows	Nutone fan and heater
Bill-rite sheathing	Pxylite light fixtures
Crane plumbing fixtures	Robbins vinyl tile
Crane hot water heater	Robbins rubber tile
Formica counters	Schlage hardware
Hotpoint dishwasher	Thermopane glass
Minneapolis-Honeywell controls	U.S. Plywood
Mueller Climatrol furnace	U.S. Gypsum lath

For information about complete one-quarter inch working plans of this house write *American Builder Home Plans Service*, 79 W. Monroe St., Chicago 3, Ill.

SEE GATEFOLD BLUEPRINT FOR COMPLETE WORKING DRAWINGS ►

AMERICAN BUILDER

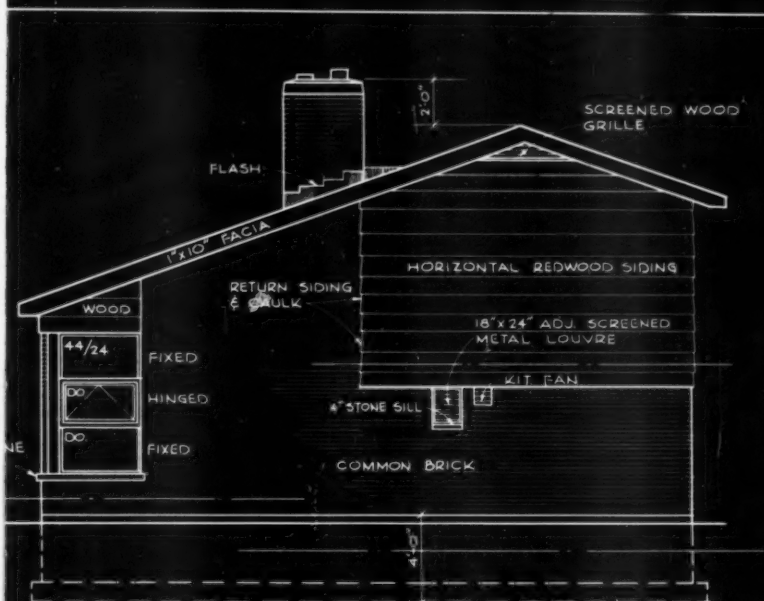

LEFT SIDE ELEVATION
SCALE: 1/8" = 1'-0"

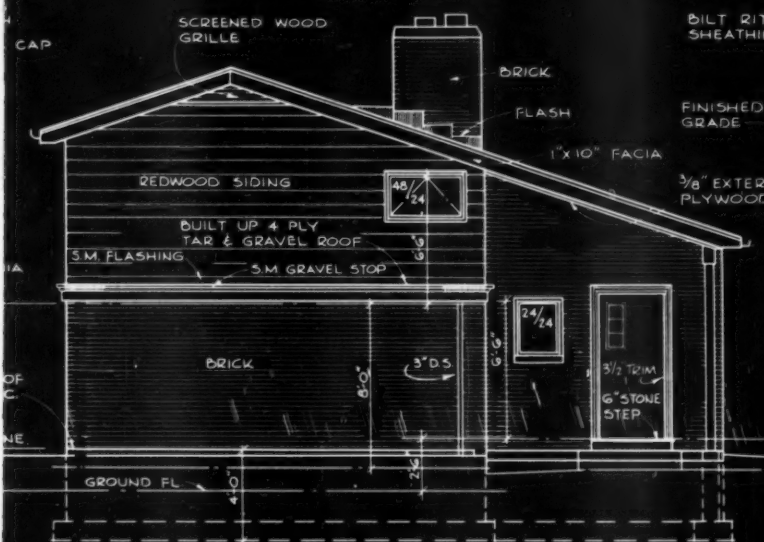

RIGHT SIDE ELEVATION
SCALE: 1/8" = 1'-0"

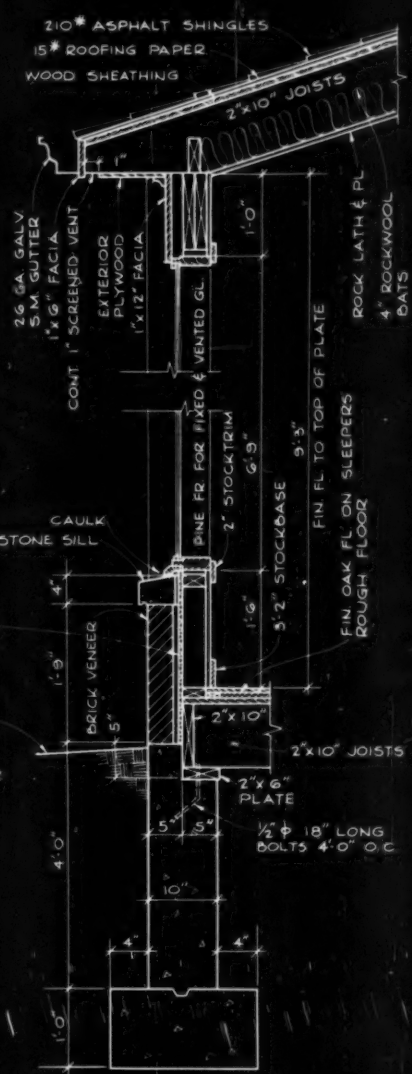

SECTION THRU FRONT WALL
SCALE: 1/2" = 1'-0"

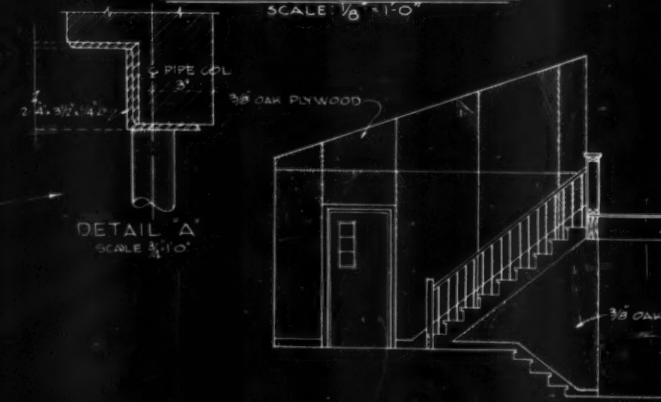

DETAIL 'A'
SCALE: 3/4" = 1'-0"

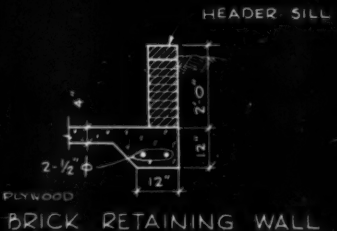

BRICK RETAINING WALL

ELEVATION - STAIR & STAIR WALL
SCALE: 1/4" = 1'-0"

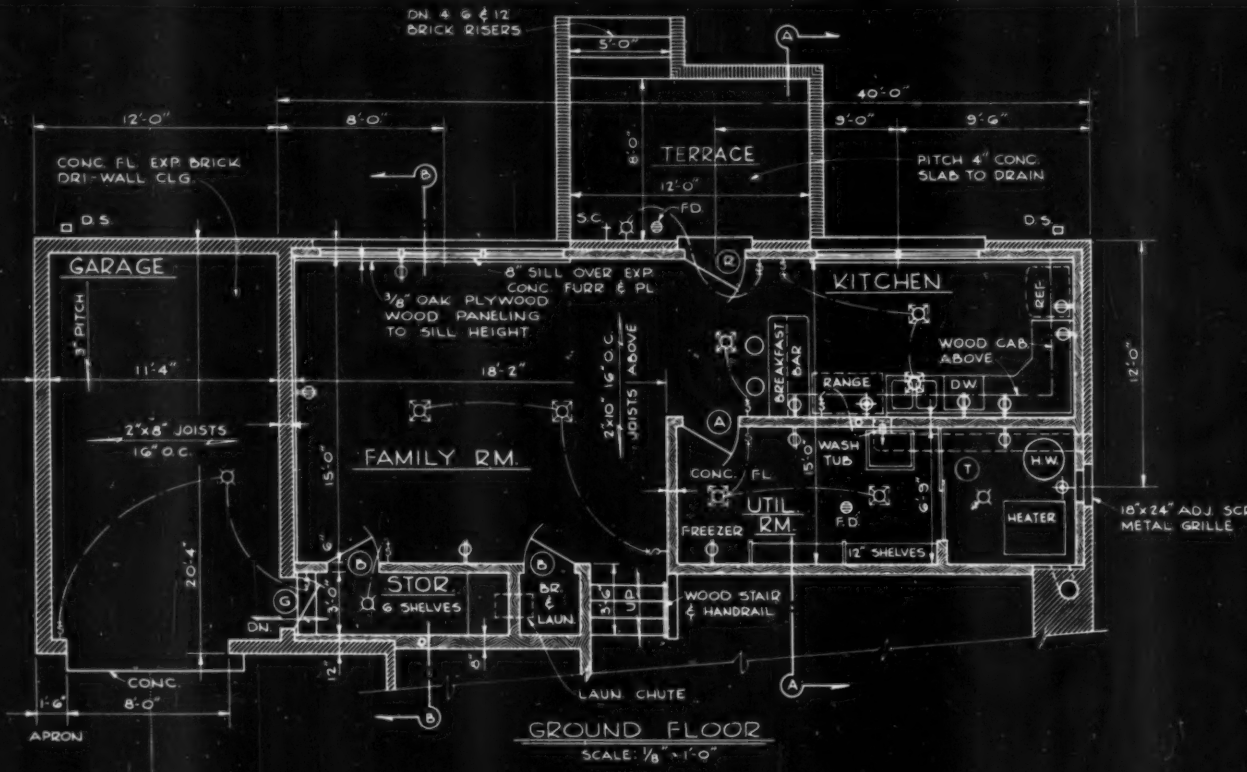

GROUND FLOOR
SCALE: 1/8" = 1'-0"

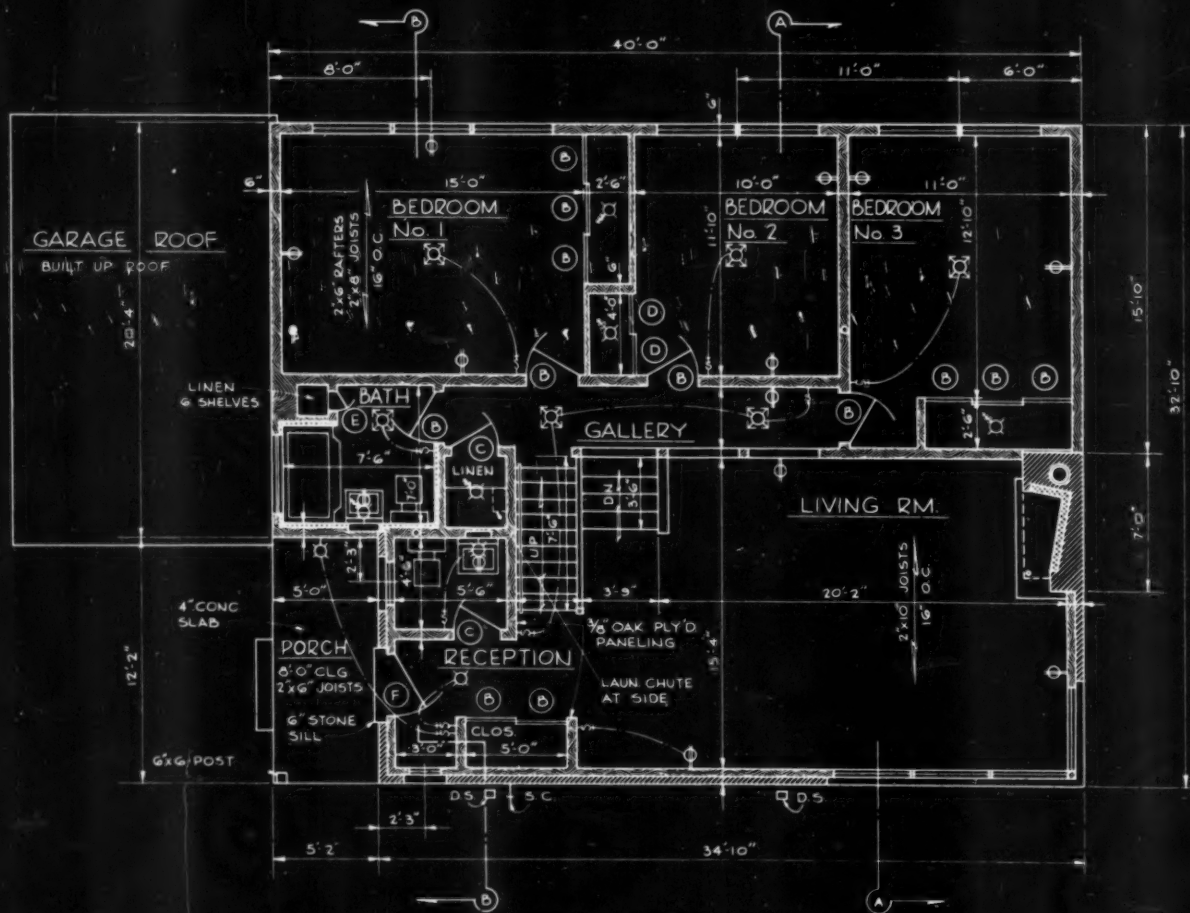

FIRST FLOOR & MEZZANINE PLAN
SCALE: 1/8" = 1'-0"

DOOR SCHEDULE

MARK	SIZE	DESCRIPTION	REQ
A	2'-8" x 6'-8" x 1 3/8"	FLUSH BIRCH HOLLOW CORE	1
B	2'-6" x 6'-8" x 1 3/8"	" " " " " " " "	15
C	2'-4" x 6'-8" x 1 3/8"	" " " " " " " "	1
D	2'-0" x 6'-8" x 1 3/8"	" " " " " " " "	2
E	1'-0" x 6'-8" x 1 3/8"	" " " " " " " "	2
F	3'-0" x 6'-8" x 1 3/8"	FLUSH BIRCH SOLID GLASS PANELS	1
G	2'-6" x 6'-8" x 1 3/8"	CLASS B FIRE DOOR	1
R	3'-0" x 6'-8" x 1 3/8"	FLUSH PINE (STOCK) SOLID, GL PAN.	1
T	2 - SLIDING DOORS	OVER HEATING UNIT	

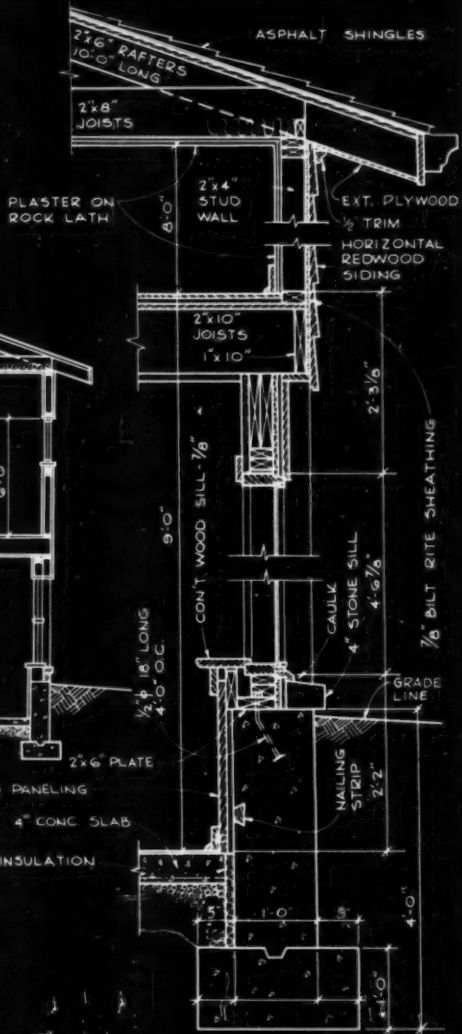

SECTION THRU REAR WALL
SCALE: 1/2" = 1'-0"

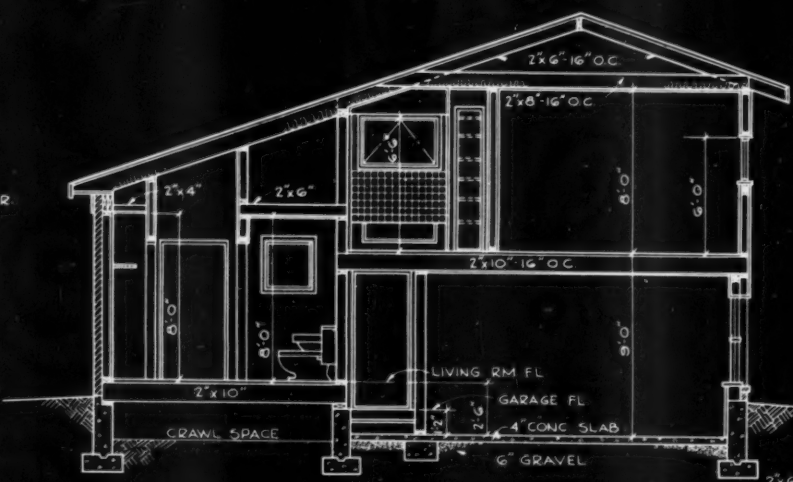

SECTION "B-B"
SCALE: 1/8" = 1'-0"

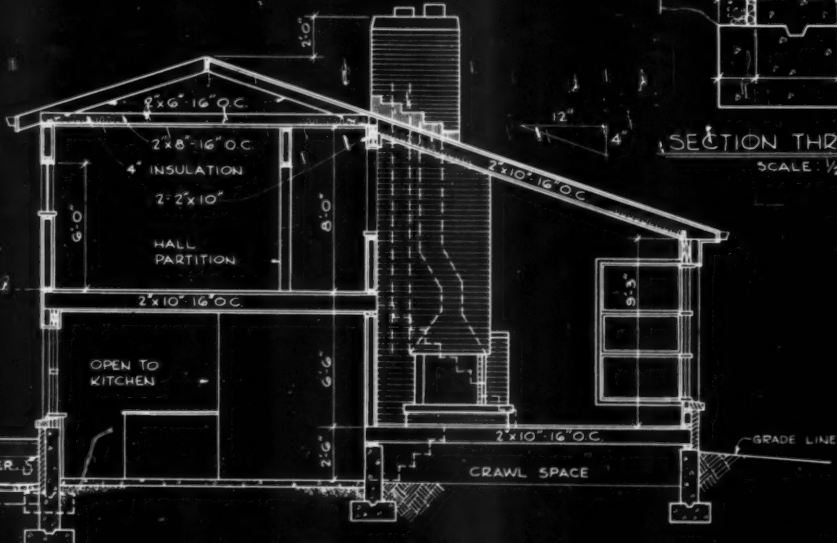

SECTION "A-A"
SCALE: 1/8" = 1'-0"

NOTES:
 STEEL ANGLES OVER ALL WINDOWS & DOOR OPENINGS IN SOLID MASONRY WALLS SHALL BE 2-3/2" x 3-1/2" x 1/4" L.S.
 A SINGLE ANGLE IN VENEER WALLS.
 PLASTER WALLS & CEILINGS IN ALL ROOMS.
 OAK FLOORS IN ALL ROOMS EXCEPT POWDER RM, BATH, KITCHEN, FAMILY RM & UTILITY RM. CERAMIC TILE FLOOR & WAINSCOT IN BATH. RUBBER TILE IN POWDER RM & ASPHALT TILE IN FAMILY RM. & KITCHEN.

DESIGN NO. A.B. 213
 AMERICAN BUILDER BLUE PRINT SERIES
 DESIGNED BY
 ROBERT A. HIRSCH - ARCHITECT
 HIGHLAND PARK, ILLINOIS
 Simmons-Boardman Publ. Corp. 79 W. Monroe St. Chicago 3, Ill.

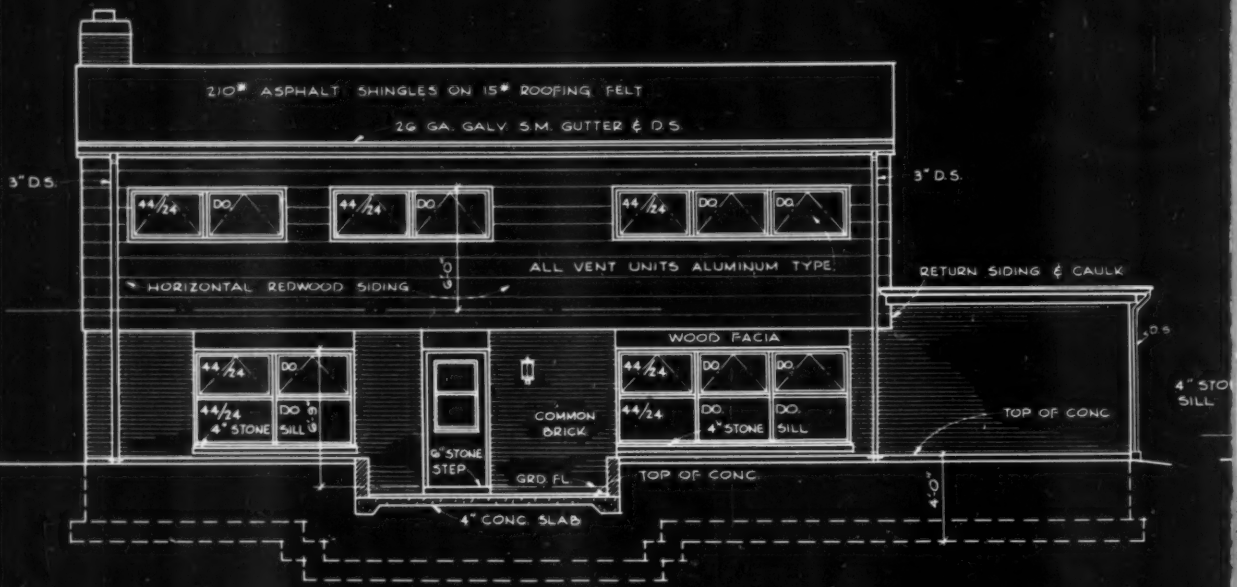

REAR ELEVATION

SCALE: 1/8" = 1'-0"



FRONT ELEVATION

SCALE: 1/8" = 1'-0"

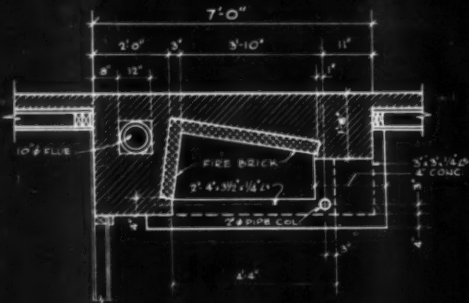

FIREPLACE PLAN

SCALE: 1/2" = 1'-0"

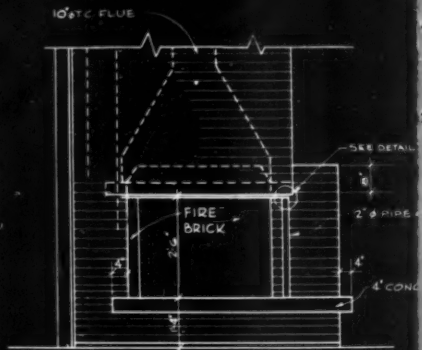

FIREPLACE ELEVATION

SCALE: 1/2" = 1'-0"

PULL OUT FOR FLOOR PLAN

Quantity List of Materials

For American Builder Blueprint House No. 213

Robert A. Hirsch, Architect

General Information

House—Type	frame and masonry
Area	1,260 sq. ft.
Cube	22,680 cu. ft.
Average height taken for cube was 18 ft.	
Garage—Area	240 sq. ft.
Cube	2,160 cu. ft.
Average height taken for cube was 9 ft.	
Porch and Terrace—	
Area	190 sq. ft.

Excavating

Trench for foundation	218 lin. ft.
Chimney and column footings	2
Excavation for basement and crawl space	100 yds.

Cement Work

Foundations	1,090 cu. ft.
Concrete work	1,040 sq. ft.
Thickness	4 in.
(Varies—reinforced at edges including 4 steps for terrace)	
Anchor Bolts	50 — 1/2" x 18"
Waterproofing	432 sq. ft.
Foundation vents—aluminum	3
Miscellaneous	4" concrete shelf at fireplace

Masonry

Type	brick
Walls	480 sq. ft. of 8" wall 730 sq. ft. of 4" veneer
Window sills	stone in brick veneer
Chimney	160 cu. ft.
Flue lining	1 — 10" Vit. Tile — 18' 1 — 12" x 12" — 18'
Cap	concrete
Fireplace	1
Throat and damper	1
Lintels and post	per details
Miscellaneous—Metal Grille	18" x 24"

Iron Work

Miscellaneous	4 lintels for door and window openings
---------------	--

Millwork

Windows—Type	awning and fixed
Windows glazed including trim	29 — 44" x 24" 1 — 48" x 24" 1 — 24" x 24" 3 — 18" x 24"
Exterior doors	2 — 3'0" x 6'8" per detail
Garage doors	1 — 8'0" x 6'8"
Exterior millwork	
Entrance fascias	1 — 3 1/2" trim
Louvers	2 peak head
Interior doors—including jambs and trim	1 — 2'8" x 6'8" 14 — 2'6" x 6'8" 2 — 2'4" x 6'8" 2 — 2'0" x 6'8" 1 — 1'0" x 6'8"
Special interior doors:	
Class B fire door	1 — 2'6" x 6'8"
Sliding doors at heating unit	2
Special interior millwork	
Stairs	4 risers family room to living room 10 risers living room to gallery
Kitchen cases	1 set

Carpentry

Beams and girders	1 — 6" x 6" — 10'0" 3 — 4" x 4" — 8'0"
Foundation plates	150 lin. ft. 2" x 6"
Joists	8 — 2" x 10" — 12'0" 55 — 2" x 10" — 16'0" 14 — 2" x 10" — 20'0"
Bridging	300 lin. ft. 1" x 4"
Studding and plates	175 — 2" x 4" — 8'0" 50 — 2" x 4" — 14'0" 30 — 2" x 4" — 10'0" 22 — 2" x 4" — 16'0" 72 — 2" x 4" — 12'0"
Ceiling joists and roof rafters	22 — 2" x 10" — 18'0" 12 — 2" x 8" — 14'0" 22 — 2" x 8" — 16'0" 13 — 2" x 8" — 18'0" 32 — 2" x 6" — 12'0" 22 — 2" x 6" — 10'0" 10 — 2" x 6" — 14'0" 17 — 2" x 8" — 14'0" 3 — 2" x 8" — 16'0" 2 — 2" x 10" — 16'0" 3 — 2" x 10" — 10'0" 4 — 2" x 10" — 14'0"
Framing lintels	2 — 2" x 10" — 16'0" 3 — 2" x 10" — 10'0" 4 — 2" x 10" — 14'0"
Subfloor	1,500 b.f.
Roof sheathing	2,300 b.f.
Side wall sheathing	1,675 b.f.
Side wall materials	620 sq. ft. redwood siding
Carpenter stairs	all finished mill stairs included in millwork
Flooring—Hardwood	1,000 sq. ft.
Softwood	24 sq. ft.
Exterior material—Soffits	155 sq. ft. exterior plywood
Eaves	2 — 1" x 10" — 10'0" 6 — 1" x 10" — 14'0" 2 — 1" x 10" — 12'0" 3 — 1" x 6" — 14'0" 3 — 1" x 8" — 14'0"
Insulation	1,280 sq. ft. ceiling insulation

Note: No sidewall insulation shown

Sheet Metal

Gutters	95 lin. ft. — 36 lin. ft. gravel stop
Downspouts	60 lin. ft.
Flashing	22 lin. ft. — 1 chimney
Miscellaneous	1 laundry chute

Roofing

Type	composition shingles tar and gravel
Area	15.6 squares plus ridge 2.75 squares

Interior Walls

Area to be covered	5,800 sq. ft. including garage ceiling
--------------------	--

(Note: Some of the above is 3/8" oak plywood. Balance lath and plaster and drywall.)

● This quantity list will be subject to variation depending on the common practices in various sections and municipalities of the country, the techniques of individual builders, the types of materials available locally and cost factors. The list published here is a suggested one, complete enough so that it can be used in arriving at a reasonably accurate estimate of the quantities and cost of materials that will be required to complete the structure. It was prepared by experts at the Edward Hines Lumber Co., Chicago.

To build beyond the mains . . .

get the answers to these . . .

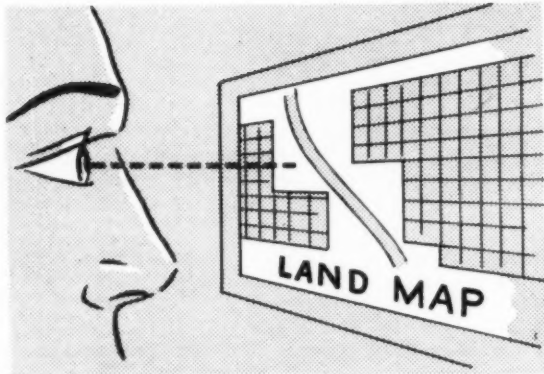

A. Site adaptability



B. Approval requirements

... before you decide to . . .

Builders today face a future of building beyond the mains for, almost universally, developed land is a scarce item. Some builders will purchase land and will seemingly develop it with few problems, while others not familiar with the maze of pitfalls will wish they had never seen raw acreage.

Hard fact dollars and cents economics must be investigated even before the land is purchased. Such dollar-cating development expenses as water and sewer main extensions must be thoroughly figured. For ultimately

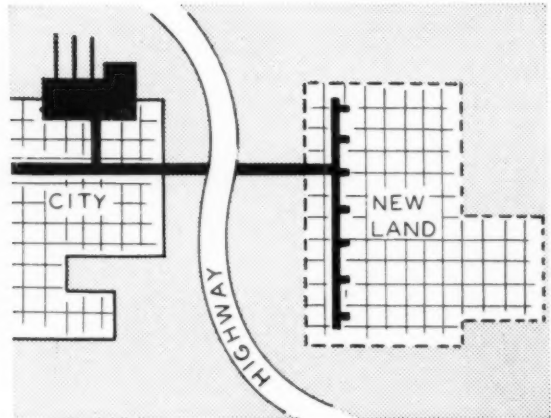

1. Hook to city

the developer must know if it is cheaper to drill a well or run a water main, use septic systems, hook to a community sewage disposal plant or build a disposal plant.

It is necessary to juggle the various economic factors to arrive at a *per lot development cost*. Builders in this first investigation stage should spend all the time required to find the many answers needed.

Basically there are four major factors to consider before buying a piece of acreage: (1) site adaptability; (2) approval requirements; (3) financing needs; and

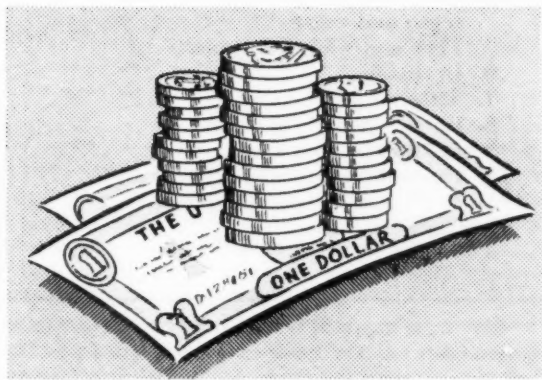

C. Financing needs

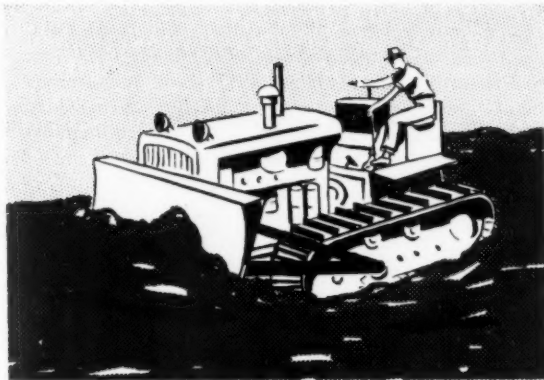

D. Land manufacturing elements

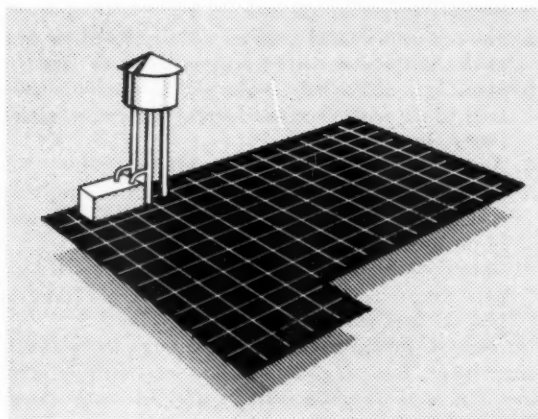

2. Hook to one utility

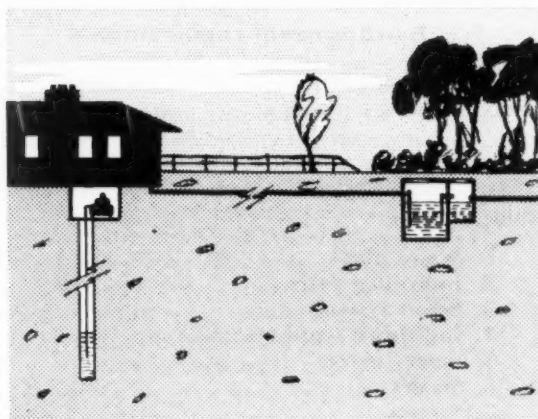

3. Hook to well and septic tank

(4) land manufacturing costs. Full investigation of these factors will lead the builder to conclude there are three types of subdivision possibilities. These are: (1) adjacent to a city where sewer and water main extensions bring the major services; (2) outlying, with one utility, usually a central water system; and (3) outlying, where each house has a well and septic system.

The cost, weighed against the builder's available capital, will determine which of the three subdivision types will be used.

Attaching to the existing mains will have the lowest per lot cost, though it will have the highest capital requirement. A project with one utility (usually a central water plant) will require more capital prior to construction than large lot rural developments that have individual well and septic systems. The large lot rural type of development has the lowest capital outlay requirement prior to construction and also has the highest finished lot cost after the well and septic system costs are added.

(Continued on page 80)

To Build Beyond the Mains

(Continued from page 79)

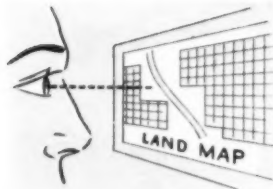

A—Site adaptability

To determine the adaptability of the land there are 14 considerations. These are:

1. Land cost
2. Salability of location
3. Zoning applicable to site and adjacent properties
4. Soil characteristics for bearing, septic systems, and water
5. FHA and VA requirements
6. Drainage
7. Title
8. Easements
9. Utilities
10. Restrictions other than zoning
11. Schools, churches and shopping
12. Transportation



B—Approval requirements

The builder needs approval no matter what size or type of development he contemplates. If he is located in or adjacent to an incorporated area or out in the country, he still will have to get approval for some or all of the following:

1. Water plant
2. Individual wells
3. Sewer system
4. Individual septic systems
5. Storm sewers
6. Swales
7. Streets
8. Roads
9. Sidewalks
10. Drainage
11. Public utilities

Approval must come from (a) town; (b) county; (c) state; (d) FHA; (e) VA; (f) mortgage lender.

Many times approval is hard to get from community governments for they think on a status quo basis. The builder must meet the situation with positive thinking. His subdivision is an asset to the town. Here are some of the reasons why:

1. If the town has outstanding bonds or a sewage disposal plant or water system which is only partially working to capacity, builder can sell the town that his proposed development will use X per cent more capacity, help pay off some of the indebtedness, and reduce the rate for the existing users.
2. Show how increased families add increased revenue to the business section of town—also more jobs.
3. Show how additional people will increase the work level of the post office and increase its rating, giving better service.
4. Additional people mean greater tax revenue.
5. Additional people make town's search for industry easier. Now they will have available labor housed in the area.
6. Objections by school boards can be eliminated by a payment per house for school purposes that helps defray the first year's non-taxable expense.

County approval usually flows through the planning commission. Rezoning, however, presents another problem. The local populace must be sold before the rezoning hearing. A program must be made well in advance to sell the county, local populace, and nearby town on a rezoning petition.

Developments where one utility, such as a water system, is installed, must have local, county, nearby town, and state approval. Usually a rezoning takes place in this type of development. Large (20,000 square feet)



C—Financing needs

Land development costs have reached staggering proportions. Builders in most cases cannot pay these costs before construction and still have working capital. Methods of financing are not clearly defined nor are they generally available to all builders. The individual builder's credit standing is his most important financial aid in obtaining financing for underground improvements.

Eight financing methods can be utilized by builder.

13. Future land use by city or county planning program for area

14. Approximate number of lots

Not knowing what to look for has kept many builders from entering the land development field. Sure, it's a technical subject but one that can be mastered with good economic, legal and planning advice.

There are three stages to preparing a piece of land for development. Each requires different investigations to be sure that it is wise to go ahead with the ultimate plan.

Finding answers to the above 14 considerations is the first stage in determining the adaptability of the site. Each consideration must have definite answers. Never assume or guess at the probable answers. Stage one takes about 30 days to complete.

lots are rezoned to 10,000 square feet. The water system comes under the scrutiny of the State Commerce Commission as a public utility and the State Board of Health as an approved water system. Both have certain requirements the builders must meet in order to gain acceptance.

Check with your State Commerce Commission and Board of Health for their requirements.

Large lot, rural developments where septic systems and individual wells are used require county or town approval. Most have specific requirements concerning the type, size, distance to wells, and layout of septic system; also, the type, size, protection, and distance from septic systems of a well installation.

These are covered in the building code and usually outlined on permit petitions.

FHA SUGGESTS THESE STEPS

Initial conference

A conference between the sponsor and FHA representatives in the local FHA office determines what the next steps are to be; also, what information and exhibits will be needed.

Preliminary analysis

FHA makes a preliminary analysis for two purposes:

1. To reach a tentative development program for the proposed site. This includes advice to the sponsor regarding market demand and suitability of the site for development.
2. To find the most advantageous general plan or layout of the proposed development.

If the 14 points check out to the builder's satisfaction, then he is ready for stage two. In stage two, the builder, after signing an option, will sit down with local or county authorities and also the FHA or other insuring or lending agencies and make tentative plans concerning the proposed development. This is the bargaining session and takes 60 to 90 days to complete.

After the builder understands what he must do to qualify for local and FHA approval, he will have a topographic survey made. Then the final planning starts. The final planning and final approval is the third stage. Final approval must be had from many local and county offices as well as insuring, such as FHA, or lending institutions. After these offices have approved the project the plat is then recorded.

Development program

The program includes such planning features as dwelling type, typical lot size, price range, approximate size, and location of any areas for non-residential uses such as business or parks. Streets are also considered.

Exhibits needed in duplicate

1. Subdivision Information FHA Form 2084
2. Location map
3. Topographic map
4. Photographs of the property and its immediate surrounding area. These should be keyed to the map
5. Protective covenants or deed restrictions
6. Subdivision regulations of local authorities
7. Zoning ordinance and map
8. Other information:
 - A. Subdivision sewerage disposal report FHA Form 2084C—if individual septic tanks and sub-surface disposal fields are proposed
 - B. General development plan in sketch form including topographic data
 - C. Typical house and lot plans
 - D. Other information indicated by FHA

Complete analysis is made by FHA of the above exhibits. The sponsor receives the following from FHA:

1. Definite FHA conclusions
 2. Requirements of the development for FHA approval
 3. Other advice or suggestions
- FHA recommends the above procedure so that it can save the sponsor time and money in the preparation of the exhibits needed by them.

-
1. Land can be financed as a so-called partnership with the owner, where owner carries the mortgage and releases sections—the builder pays for them as he uses them. In many cases the release clause is as small as one lot. Underground improvement financing, such as sewer and water mains, many times is carried by the subcontractor and paid for per lot share when the house is sold. The same holds true for street improvements. In many cases,

however, the builder might have to pay a certain percentage when the contracts are completed and balance when lot is used or house is sold.

2. Sell utility to people who are in business of operating and owning private utility companies.
3. Special assessment bond issues—builder today must find source that will take the bonds for the city. There has been little of this since 1929.

(Continued on page 82)

To Build Beyond the Mains

(Continued from page 81)

4. The town itself might put in underground improvements through special revenue bonds using the additional water and sewer tax to pay for such bonds. This is hard to sell to a local town.
5. The builder puts in the improvements and pays for them.
6. Bank finances a builder by putting land in trust. Builder must have good line of credit and be well known by trust department of bank. The bank finances all underground improvements. The builder pays an agreed upon price per lot or front foot to get a portion of the land released so clear title can be had.
7. Savings and loan institutions cannot make loans

on a vacant piece of property. However, it has been known that large loans have been made on raw acreage with a model house under construction. The builder puts in his underground improvements against payouts of the large mortgage. Some release clause or mortgage transfer is agreed upon by the builder and savings and loan.

8. Today, mortgage companies are doing most of the financing of land improvements. They, of course, assure themselves of loans. Many times they even go in a partnership with a builder and split the profits.

This table is based on the current operating experience of three different types of subdivision builders whose identifications for obvious reasons are not disclosed.

BUILDER'S CAPITAL REQUIREMENTS

Type of Subdivision	\$ needed	No. of acres	No. of houses	Land cost	Cost per lot
Attach to city	\$500,000	72	254	\$1,500	\$2,000
One utility subdivision	\$105,000	33	66	\$1,000	\$2,100*
Large lot, individual well and septic tank	\$ 45,000	40	80	\$ 500	\$2,200**

* Septic system cost was added to development cost to get true picture.

** Individual well and septic tank cost were added to get true picture.

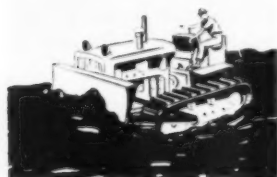

D—Land manufacturing elements

Builders contemplating building beyond the mains must investigate the numerous land manufacturing elements before going ahead. Major items to be investigated are:

1. Water
2. Sewage disposal
3. Streets
4. Drainage
5. Utilities

Water

Builders must deliver drinkable water to their houses. Is it cheaper for them to run a short water extension from an adjoining community or build a community water system? Most developers agree that they would rather run the extension. The highest cost water service per individual lot is the individual deep well. Yet it is the easiest to finance. The individual well can be paid for out of construction pay-outs of the loan. The main extensions or community system must be installed and paid for many times before construction begins.

Sewage disposal

The problems are much the same as with water. As in the case of water it is cheaper to run a short extension than to build an individual septic system or a community disposal plant. Like the water system the most expensive on a per lot basis (the septic system) is the easiest to finance. It can be paid out of construction pay-outs.

Streets

Street costs can vary considerably. In certain type FHA approved urban developments where street, curb and gutter, storm sewers, and sidewalks are required, they are considerably more expensive than rural type streets where seeded swales and simple asphalt coatings suffice. In this situation builders must weigh the development costs against land costs to see if they will come out best with larger rural type subdivisions rather than urban types.

Drainage

Drainage is a consideration in rural type subdivisions, since the surface water must have an outlet. It is best, if possible, to keep the land undisturbed and use the natural drainage. Poor planning can run grading for proper drainage up to heavy costs.

Utilities

Utilities such as electricity, gas and telephone must be planned before construction of the development by

the builder. In many areas the utility companies require deposits from the developer before they will extend the services. As houses are built and the services are used the builder is refunded a part of the deposit. It is most important that the builder make allowances in his capital requirements to pay for the initial running of the services.

Individual well

Builders should design individual wells to produce five to eight gallons per minute for a one-bath house. FHA requires five gallons per minute capacity for a well and pump and will allow less in some areas if a large storage tank is used.

Costwise wells vary greatly. In some areas with a high water table a builder can use a driven well 12 to 22 feet deep. This well will cost less than \$50 (Northern Illinois), pumping equipment about \$100.

In areas where deep wells must be drilled to get to the water-bearing layer, costs can vary considerably. Four types of pumps in general use are:

1. Shallow well reciprocating pumps for depths to 25 feet. Pumps in this category have capacities of 340 to 3,960 gallons per hour.
2. Jet type pumps for either shallow well or deep well have capacities from 215 to 1,100 gallons per hour.
3. Deep well pumps have a capacity 180 to 2,160 gallons per hour.
4. Submersible pumps are for very deep well installations. This type is the latest development of the industry. The motor and impellers are lowered into the well casing. Pump capacities for home use in 4-inch casings are up to 2,950 gallons per minute.

Stringent controls are set on wells by State Health Boards and FHA. The governmental insuring office requires state approval against contamination which comes from ground water seeping back into the well. Usually an improperly constructed well pit or a non-graded casing invites contamination.

Chlorination equipment to purify water is available for individual wells.

The important factors that must be considered when selecting a water system are:

First—Type of well. Diameter, depth, yield, low water level.

Second—Arrive at the daily requirement of water.

Third—Divide the daily requirement by two. Select a pump that will have enough capacity to supply the daily requirement in two hours, if well yield will permit.

For non-farm homes, and other installations for special uses, arrive at peak hourly requirement for water, and select a pump large enough to supply abundant capacity.

Entirely too many prospective water system users do not realize the importance of selecting a pump that will supply adequate capacity. When they think of a 3 or 4 GPM pump, that will supply 180 or 240 GPH or 1800 to 2400 gallons in ten hours, they are under the impression that the pump will supply more water than they will use. They lose sight of the fact that the 3 or 4 GPM

pump will only supply one outlet. When the second outlet is opened both will supply only a trickling stream.

When an adequate capacity water system is installed—a pump that will supply the daily demand in two hours—the owner not only has water when and where it is required at satisfactory pressure, he also has longer service and less maintenance. The water system that does its daily task in two hours will require less service and last longer than the small pump that must operate four hours or longer to supply the same amount of water.

Size of pressure tank

The pressure tank is a very necessary part of the complete water system. Since water is not compressible, the useful capacity of a pressure tank depends upon the proportion of air in the tank. As the air expands, it drives the water out of the tank.

Frequently the question arises as to what size tank to use with a large capacity pump, not listed as a complete water system. A safe rule to follow is: The tank should be approximately ten times the pump capacity in gallons per minute. For example: A 28 gallon per minute pump can use either 220 or 325 gallon tank for sufficient capacity ($28 \text{ GPM} \times 10 = 280$). Standard tank sizes are as follows: 12 - 42 - 82 - 120 - 220 - 315 - 525 Gallons Capacity.

The only time that larger tanks are recommended, other than the sizes regularly furnished with water systems, is on a low yield well.

Information courtesy F. E. Myers & Bro. Co.

Water systems

Where 30 or more houses are to be built the community central water plant is cheapest on a per lot basis. This type of water system must be designed to produce at least 15 gallons per minute and one gallon additional for each house over 15. A 75-house project would require a well which produces 75 gallons of water per minute.

Many states require that the drilling of a well for a municipal system be under the direction of a licensed engineer. He must design and supervise construction. Final approval is given by the State Board of Health. FHA requires such approval.

In many developments with central water systems an additional standby well is required so there will be continuous supply of water.

Approximate water system costs for a development in Northern Illinois are:

1. 25 houses—\$20 to \$30,000
2. 50 houses—\$30 to \$40,000
3. 100 houses—\$50 to \$60,000

Latest legal device for builders who do not want to operate water systems under State Commerce Commission surveillance is to set them up as mutual water trusts. This device is recorded with the restrictions on the property and allows all home buyers an equal share in the water company. They can assess any amount they need to operate without going through Commerce Commission. It frees the builder from Commerce Commission red tape.

(Continued on page 84)

To Build Beyond the Mains

(Continued from page 33)

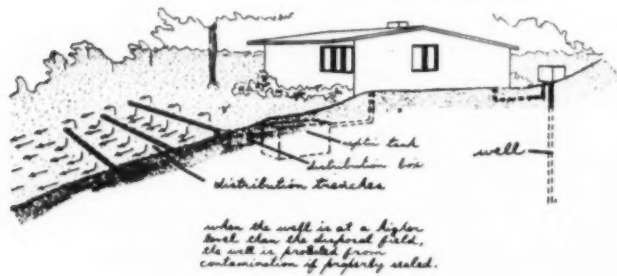

Here is the case for the individual septic system

There isn't any doubt that a sewage treatment plant and sewer system is best. However, the installations are very expensive and "out of the question" for small projects. For these, individual septic systems must be installed.

Local, county, state and FHA have requirements which insure a well operating system which insures health standards.

Biggest problem of septic system is dissipating of the liquid discharge.

Open jointed or perforated pipe is laid in wide (up to 36 inches) trench from 18 to 36 inches deep partially filled with gravel. The effluent from the septic tank is spread over a wide area for absorption into the soil.

Size of tank and absorption field

Tank size suggested for a 2-bedroom house is 500 gallon, and 750 if the house has a garbage grinder. A 3-bedroom house should have a 600-gallon septic tank and 900 with garbage grinder. A 4-bedroom house should have a 750-gallon septic tank and 1,125 gallon

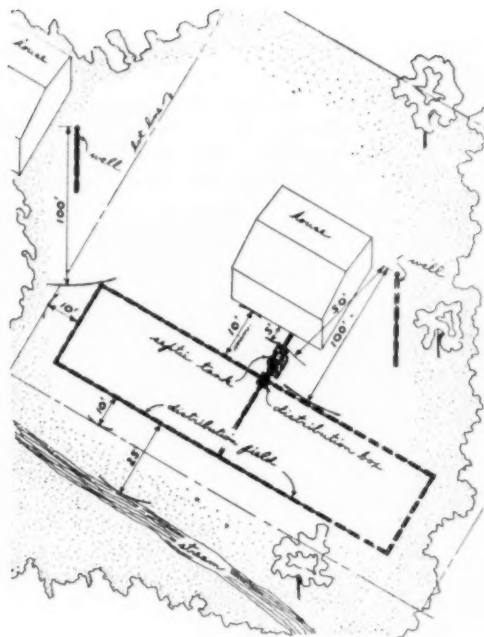

if garbage grinder. For each additional bedroom add 10 gallons and 270 for garbage grinder.

Disposal field sizes are determined by percolation tests, or the average time it takes one inch of water to fall in a test hole. See chart below

Average time for water to fall 1 inch (minutes)	Absorption area required (square feet in bottom of distribution trench per bedroom)			
	Without garbage grinder or automatic washer	With garbage grinder	With automatic washer	With both garbage grinder and automatic washer
2 or less	50	65	75	85
Between 2 and 3	60	75	85	100
Between 3 and 4	70	85	95	115
Between 4 and 5	75	90	105	125
Between 5 and 10	100	120	135	165
Between 10 and 15	115	140	160	190
Between 15 and 30	150	180	205	250
Between 30 and 45	180	215	245	300
Between 45 and 60	200	240	275	330
Over 60	Unsuitable for shallow absorption system. Investigate for seepage pit or subsurface filter arrangement.			

NOTES:

1. In no case should less than 150 square feet of absorption area per residence be provided.

2. In conjunction with the percolation test, a subsoil investigation should also be made. If rock, hardpan, or any other impermeable stratum is found at a depth less than 4 feet, results of the percolation test must be interpreted with caution. The case also warrants special consideration if the ground water table is less than 4 feet deep during any prolonged period. The water table is closest to the ground surface during late winter or early spring. In the above instances, advice and guidance of local or state health authorities should be sought.

3. The above procedure for percolation tests is fundamental. It may be applied to any soil, and is essential in clay-type soils to obtain reliable results. The procedure can be modified as experience is gained in testing typical local soils.

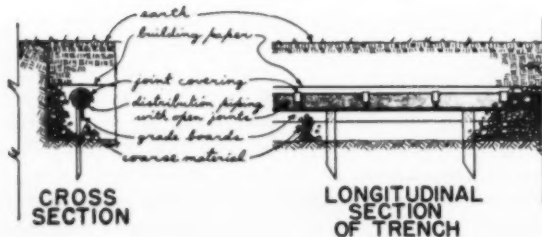

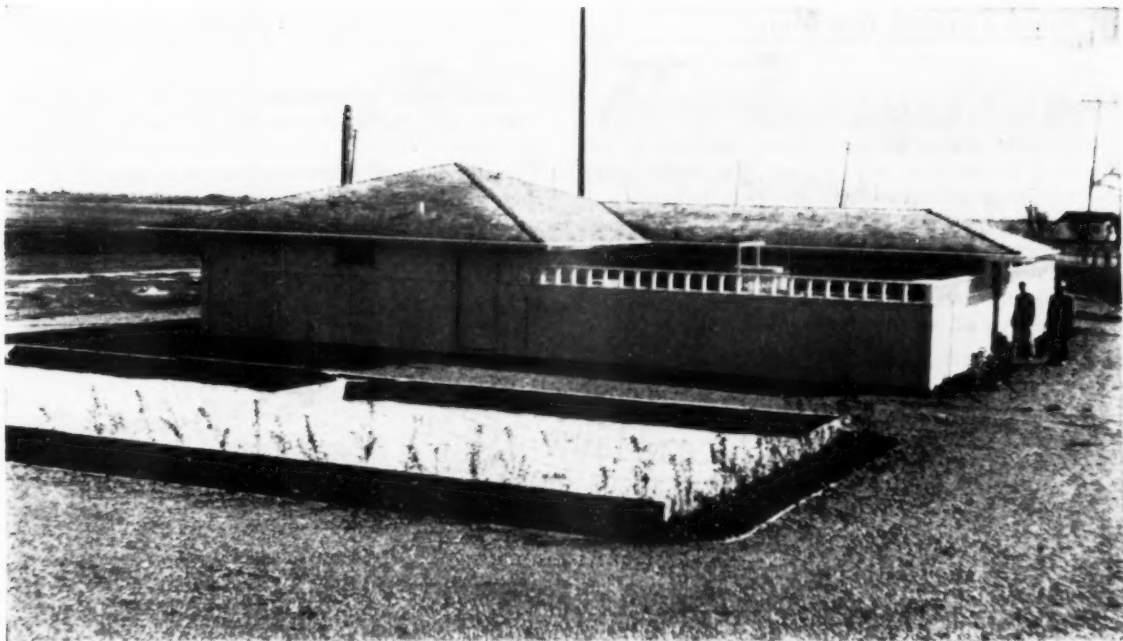

Here is the case for the sewage disposal plant

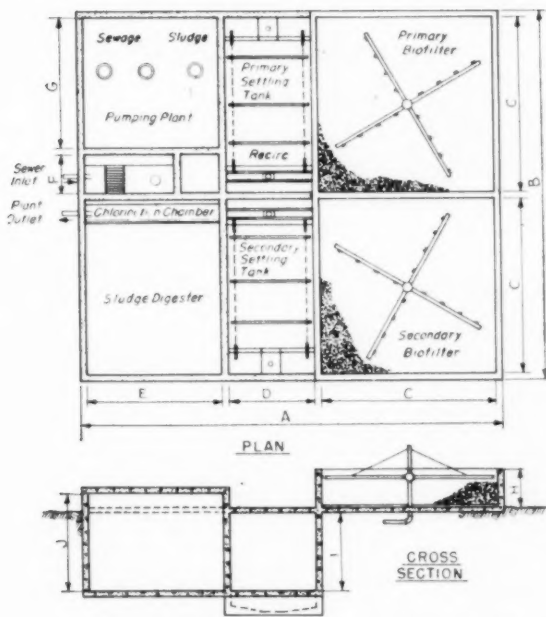

Complete Sewage Treatment for Real Estate Subdivisions, Motels, and Camps, having Populations Ranging from 100 to 750 Persons.

Plant Size	Population Capacity			
	100	250	500	750
A	25'-9"	33'-11"	41'-11"	46'-0"
B	18'-6"	29'-0"	38'-0"	48'-0"
C	8'-6"	13'-6"	18'-0"	23'-0"
D	3'-3"	4'-9"	7'-3"	9'-6"
E	12'-0"	12'-0"	14'-0"	14'-0"
F	4'-0"	4'-0"	4'-0"	4'-0"
G	4'-6"	9'-6"	14'-0"	19'-0"
H	4'-0"	4'-0"	4'-0"	4'-0"
I	8'-0"	8'-0"	8'-0"	8'-0"
J	6'-0"	8'-0"	10'-0"	12'-0"

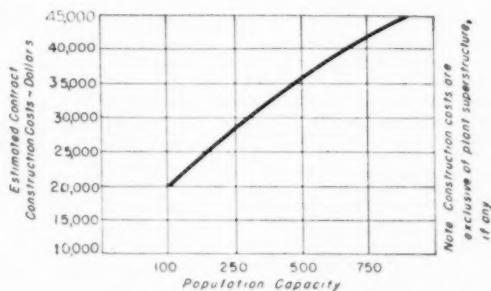

The "Biofilter Junior" sewage disposal plant can be built to accommodate 750 people or approximately 250 houses. The system was designed by Harry N. Jenks, Palo Alto, California, consulting sanitary engineer.

The population capacity chart shows the sizes of filters, etc. required to service 100, 250, 500 or 750 people.

The treatment plant has been designed to look as

much like a home as possible so that it fits into the residential areas.

The plant is automatic in operation and requires a part time operator about two hours a day.

The effluent in the final stage of the sewerage disposal process is discharged as a pure liquid into a nearby stream. The chart right, above, shows the estimated cost to build such a system in California.

To Build Beyond the Mains

(Continued from page 85)

Roads

City street extensions for projects attached to the city have certain local requirements. The builder can obtain these specifications from the local authorities.

Rural-type roads on the other hand are controlled in many cases by the county and the FHA. Rights of way are usually 40 to 50 feet. Important for rural-type roads are the street gradients and swales to handle surface water run off.

To hold down dust and prevent erosion, the swales should be seeded. The road should have a light bituminous surfacing.

Latest street construction method is "soil-cement" system. After the street is graded, cement is spread over the surface. The soil and cement are uniformly mixed. Then the soil and cement mixture is compacted with a sheeps foot roller and finished, graded. A water truck wets the base course. After curing, a 3/4 inch bituminous topping is placed over the soil-cement base.

This system is finding greater use each year. Wearing surface is acclaimed to be the best for low cost installation and maintenance.

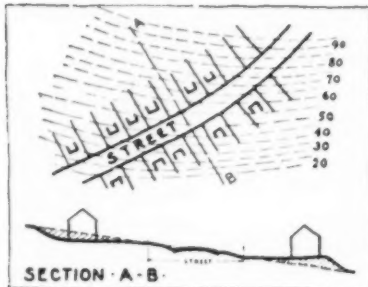

Where grades are steep, streets should be built diagonally across contours.

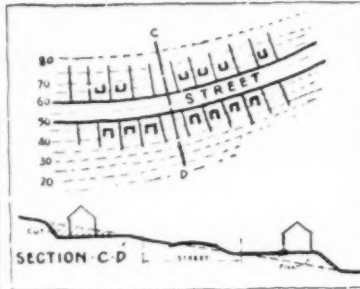

Undesirable conditions are created by streets parallel with contours.

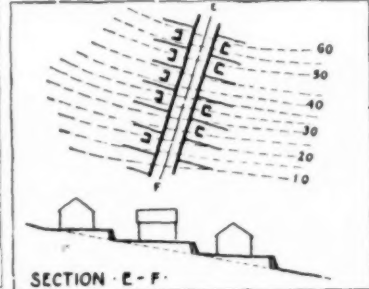

Streets built at right angles to contours are of excessive grade; costly retaining walls are required.

Gcs

The L. P. gas industry is bringing the convenience of gas to rural beyond the main subdivisions. This service gives builders a selling point in today's market, where gas heating seems to be a buyer's demand.

The L.P. gas is stored in various sized cylinders and is piped to the appliance. Many L.P. gas companies are now installing gas meters and have a metered service. They send the customer gas bills each month and keep the storage cylinder filled at all times.

There is even undercurrent in the L.P. gas industry to expand the metered gas service to where beyond the main subdivision will have a central storage tank. Gas mains will be run and each house metered.

Financing of storage tanks, so that users will pay for them a few cents above the gallon cost, is another industry trend.

The L.P. gas is composed mostly of butane and propane hydrocarbons. The gas has an unusually high BTU rating (2,500 to 3,200 per cu. ft.) compared to city gas of 450 to 1100 BTU's. The higher BTU rating which increases the efficiency of the L.P. gas goes a long way in leveling out the higher shipping costs. Local L.P. gas distributors state that L.P. gas heating runs about 10 per cent higher.

All gas operated appliances can be equipped to burn L.P. gas.

REFERENCE MATERIAL—Recommended supplementary reading on various phases and operations involved in building beyond the mains follows. This list of books and pamphlets was compiled from the industry's only complete technical bibliography published in *American Builders*, April, 1954, *Catalog Directory for the Light Construction Industry*.

AMERICAN HOUSING PROBLEMS AND PROSPECTS
by Miles L. Colson, Twentieth Century Fund, New York

REAL ESTATE SUBDIVISIONS
by McMichael, Prentice-Hall, Inc., New York
THE COMMUNITY BUILDERS HANDBOOK
by Urban Land Institute, Washington, D.C.

HOME BUILDERS MANUAL FOR LAND DEVELOPMENT
NAHB Land Planning Committee, Urban Land Institute

LOCAL LAND PLANNING ADMINISTRATION
International City Managers Association, Chicago, Ill.

NEIGHBORHOOD STANDARDS

Local FHA office

PLANNING THE NEIGHBORHOOD

American Public Health Association, Chicago, Ill.

INDIVIDUAL SEWAGE DISPOSAL SYSTEMS

HMFA Technical Bulletin #7, Supt. of Documents, Washington, D.C.

INDIVIDUAL SEWAGE DISPOSAL SYSTEMS

Federal Security Agency, Public Health Service, Washington, D.C.

STUDIES ON HOUSEHOLD SEWAGE DISPOSAL SYSTEMS

Weibel & Straub, Public Health Service, Washington, D.C.

SEPTIC TANKS—THEIR USE IN SEWAGE DISPOSAL

HMFA, Supt. of Documents, Washington, D.C.

SEPTIC TANK STUDIES

by Shuman & McGhan, HMFA Technical Paper #14, Supt. of Documents, Washington, D.C.

SEPTIC TANK SYSTEMS & GARBAGE GRINDERS

by McGhan, HMFA Technical Bulletin #17, Supt. of Documents, Washington, D.C.

TYPES & USES OF REAL ESTATE FINANCING.

CHAPTER OF REAL ESTATE HANDBOOK

by Holmes & Jones, Prentice-Hall, Inc., New York

NATIONAL & LOCAL MORTGAGE MARKET STRUCTURES.

CHAPTER IN HOUSING RESEARCH

by Schachter, HMFA, Supt. of Documents, Washington, D.C.

REAL ESTATE FINANCING AND RISKS.

CHAPTER OF REAL ESTATE ANALYSIS

by Husband & Anderson, Richard D. Irwin, Inc., Chicago, Ill.

URBAN LAND ECONOMIES

by Ratcliff, McGraw-Hill Co., Inc., New York

FINANCING PROBLEMS.

CHAPTER OF REAL ESTATE SUBDIVISIONS

by McMichael, Prentice-Hall, Inc., New York

TRACTION

by Barnhart, HMFA, Supt. of Documents, Washington, D.C.

BUILDING CODE REQUIREMENTS FOR NEW DWELLING CONSTRUCTION

National Bureau of Standards, Washington, D.C. See Librarian, pamphlet out of print.

PLANNING AND ZONING.

CHAPTER OF REAL ESTATE ANALYSIS

by Husband & Anderson, Richard D. Irwin, Inc., Chicago, Ill.

URBAN LAND CREDIT.

CHAPTER OF URBAN LAND ECONOMICS

by Ratcliff, McGraw-Hill, New York

SUGGESTED LAND SUBDIVISION REGULATIONS

HMFA, Supt. of Documents, Washington, D.C.

SUBDIVISION REGULATIONS—AN ANALYSIS OF LAND SUBDIVISION CONTROL PRACTICES

by Laitner, Public Administration Service, Chicago, Ill.

FHA LAND PLANNING BULLETIN #3, LOT & BLOCK GRADING

Local FHA office

STREET IMPROVEMENTS, DATA SHEET 60-C

Local FHA office

FHA'S STREET IMPROVEMENT PROGRAM

FHA local office

SEPTIC TANK SOIL ABSORPTION, SYSTEMS FOR DWELLINGS

HMFA, Supt. of Documents, Washington, D.C.

GENERAL ADVICE REGARDING SUBDIVISION EXHIBITS, DATA SHEET 100

Local FHA office

NEIGHBORHOOD STANDARDS, LAND PLANNING BULLETIN #3

Local FHA office

ECONOMICALLY PLANNED SUBDIVISION, DATA SHEET #6

Local FHA office



More than meets the eye

in every **RO-WAY** overhead type door

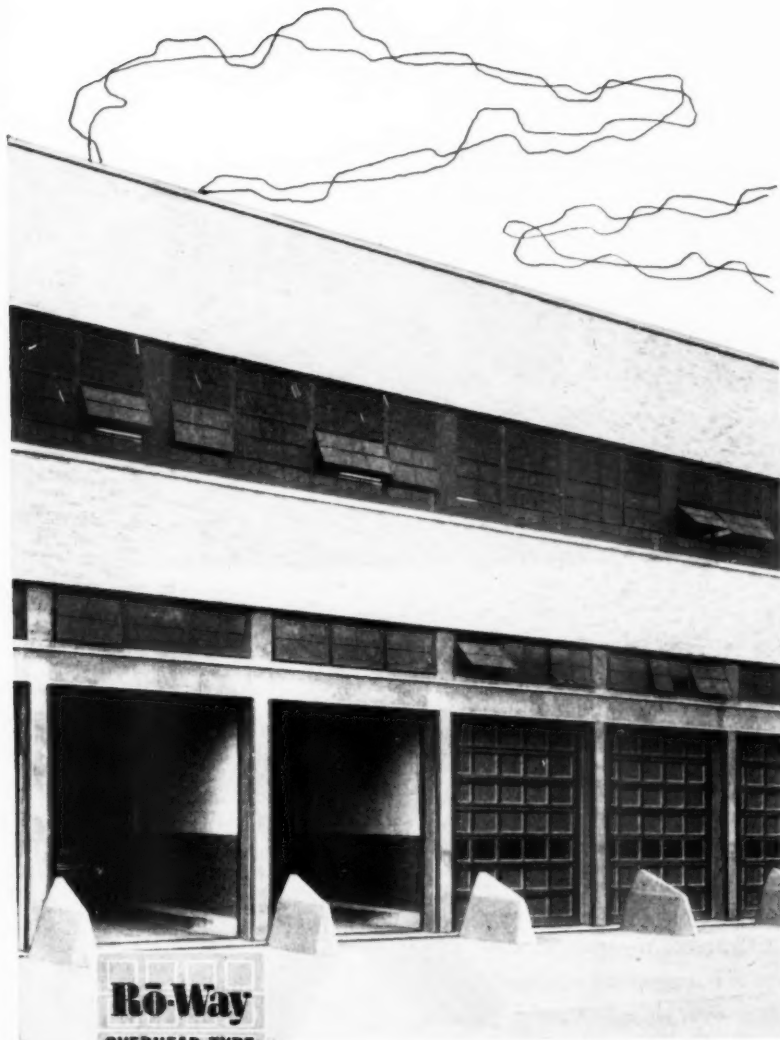

Ro-Way
OVERHEAD TYPE
DOORS

there's a Ro-Way for every Doorway!



Nationwide sales and installation service. See your classified telephone directory for nearest Ro-Way distributor.

What do you see when you look at a Ro-Way overhead type door? Clean, simple, attractive design that blends with any style of architecture. Advanced engineering, husky construction, skilled workmanship, fine quality materials. Outstanding features like Taper-Tite track, Seal-A-Matic hinges, Power-Metered springs, Double-Thick tread rollers.

All this you see at a glance—but there's more to a Ro-Way than meets the eye!

There's your client's deep-down, long-lasting satisfaction and pleasure—result of smooth, quiet, easy operation, trouble-free service and long life.

And your own sure feeling of confidence whenever you specify Ro-Way—confidence born of the knowledge that Ro-Way is your own best "standard of comparison" in overhead type doors.

To be sure of the best for your clients—for any residential, commercial or industrial application—always specify Ro-Way—the overhead type doors that offer so much more than meets the eye.

ROWE MANUFACTURING COMPANY

731 Holton Street • Galesburg, Illinois

“feature for feature...cost for cost
Ceco Windows are the best buy...”

ARCHITECT MICHAEL G. BOCCIA



Michael G. Boccia/architect • Fairlawn Construction Company/builders

One half of the story... the page you are now reading... tells why an architect preferred Ceco metal casements. The other half of the story... the opposite page... answers questions on how Ceco windows add value to homes. But first let's hear from Architect Michael G. Boccia. He says—"After comparing costs and features, we found Ceco Steel and Aluminum Casements our best buy for the Fairlawn Commons Apartment Project in suburban Cleveland. Here's why: 1. Ceco Steel Casements are bonderized and prime painted, which we consider excellent under-coat protection. Therefore we had no prime painting expense on the job. We expect minimum maintenance expense. 2. When Ceco Casements became available in aluminum, we also specified them because of their beauty and sales appeal. They carry the same graceful sight lines as the steel casements, giving unity to our window treatment throughout the project." Ceco casements offered other values to Architect Boccia, such as stronger sections—1-1/16" depth in steel, 5/32" web in aluminum... high quality hardware... full-lapping two-point weather baffles. Now look to the next page for answers to Ceco's window quiz.



CECO STEEL PRODUCTS CORPORATION

Offices, warehouses and fabricating plants in principal cities
General Offices: 5601 W. 26th St., Chicago 50, Illinois

In construction products
CECO ENGINEERING
makes the big difference



**This is a 50-50 story
about Ceco
metal casements and
the advantages
they offer
America's
builders...**

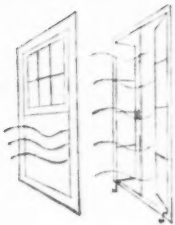

1. Which window assures controlled ventilation? More of it, too.

- Old Type Window
 Ceco Casement

Here's an easy one to start.

Answer: The Ceco Casement, because ventilators scoop in air... open 100%.



2. Which window is easiest to open and close?

- Old Type Window
 Ceco Casement

This is a little harder—but you ought to guess it.

Answer: Again the Ceco Casement, because the sash swings away from the frame... no sticking or tugging.

Score
 yourself
 in the Ceco
 Window
 Quiz



3. How much more daylight is available with casements?

- 10% more
 20% more
 30% more

Easy does it... just look at the pictures at the left.

Answer: Ceco Casements let in 30% more light because of slender muntins and frames.



4. Which window is easiest to clean?

- Old Type Window
 Ceco Casement

If you've ever washed a window, you'll have this answer.

Answer: The one that can be washed while standing inside the home. The Ceco Casement.



5. Which window gets the male vote?

- Old Type Window
 Ceco Casement

Ever wrestle with storm windows or screens? Then you know.

Answer: Yes, you're right! If you marked the Ceco Casement. It permits easy inside screening and stormproofing.

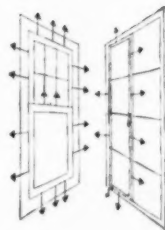

6. Which window will cut fuel bills?

- Old Type Window
 Ceco Casement

Remember last winter's fuel bill? That's a clue for you.

Answer: The Ceco 1-Vent Casement gives the same amount of ventilation as the old type window—but has two-fifths less crack perimeter. This means less air infiltration, thus saves fuel.



7. Which window affords a better view?

- Old Type Window
 Ceco Casement

Who can see through a heavy wooden frame? Another clue for you.

Answer: Once again the Ceco Casement wins, because 10% to 30% more clear glass is provided. Slender muntins and frames do the trick.



8. Which window is least expensive?

- Old Type Window
 Ceco Casement

If you've used Ceco Casements you know.

Answer: Installed, the Ceco Casement costs less. No costly fitting necessary. All hardware included in the window price.

If you scored less than 5, you are under average. 6 to 7 means fairly good. If you checked Ceco on all 8, you are a window expert.

you get stronger plaster with

KEYCORNER

- Pre-formed to fit snug in corners
- Gives multi-directional reinforcement
- Quick and easy to lath
- Lays tight against flat surfaces
- Trowels over smoothly and easily
- Provides a minimum of waste material
- Galvanized to prevent rust streaks
- Comes in easy to handle, easy to store 150 ft. rolls.

Easy to handle... Easy to store 150-foot rolls, 4", 5", 6", 12" and other widths. Ask your dealer for details.

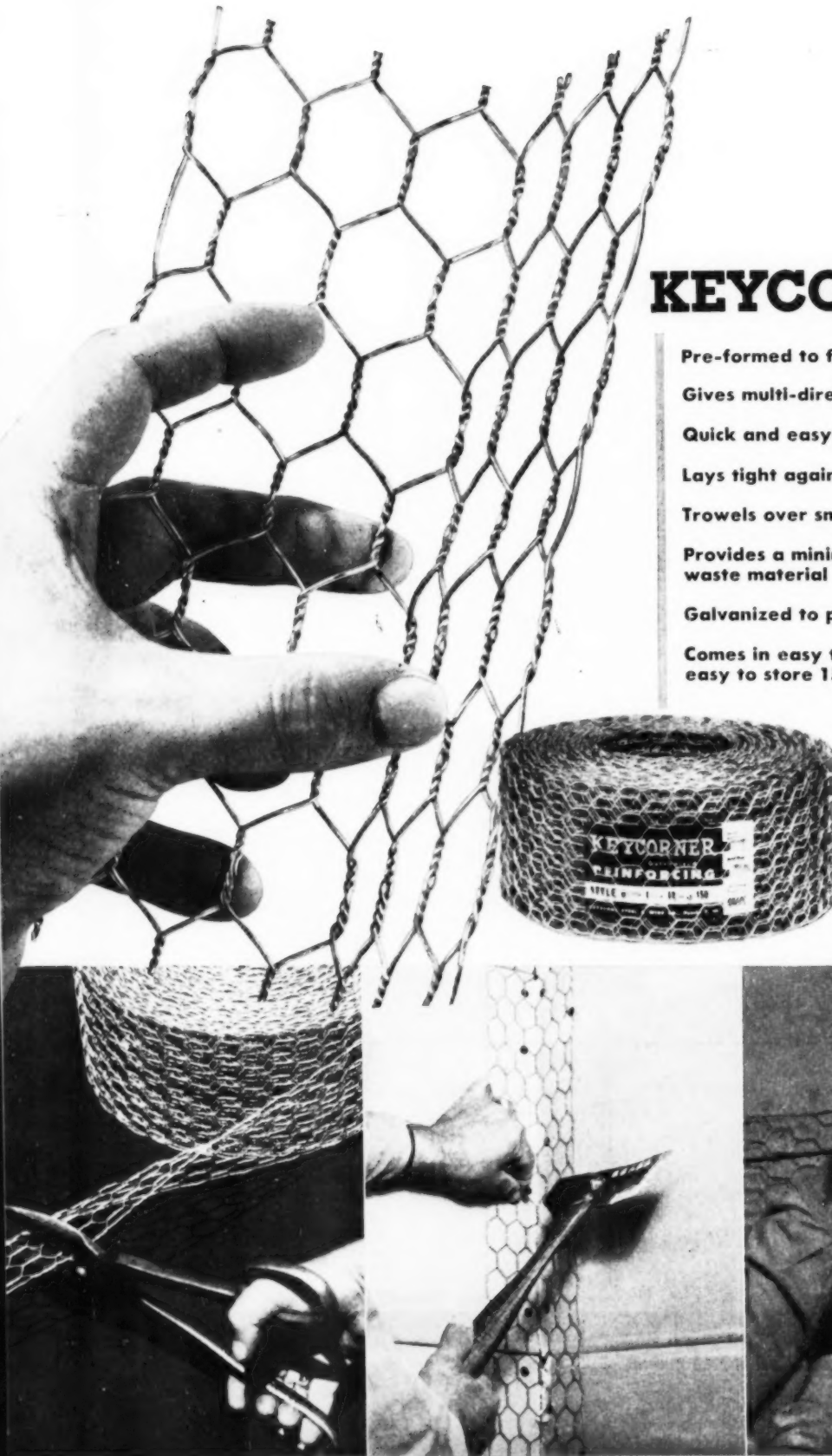

KEYCORNER

GALVANIZED REINFORCING LATH

at joints, corners and ceiling-wall junctures

It's so easy and inexpensive to reinforce plaster with Keycorner strip lath. Yet it gives extra strength where stresses are most severe. The vast network of strong, multidirectional reinforcing wires become fully embedded in plaster. The galvanized surface of Keycorner provides a strong bond with plaster. Plaster fills in completely to assure a full bond with the lath and give solid, reinforced plaster surfaces and corners. No wonder lathers and plasterers everywhere are recommending this improved type of strip lath. Be sure to include it on your next job.

For highest quality at lowest cost, use the 3 Keys to Stronger Plaster.

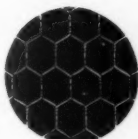

Keymesh has been proved through the years as a superior reinforcement for stucco. Now plasterers are recommending it for ceilings to increase strength and protect against cracking.



Keycorner is preformed to fit accurately and snugly in corners and at wall and ceiling junctures. It also is ideal where strip lath is required... doesn't rust...eliminates waste.



Keybead combines open-mesh reinforcement with a precision-formed bead. It assures a solid plaster corner, reinforced with a network of galvanized wire, preventing rust streaks.

KEYSTONE STEEL & WIRE COMPANY

Peoria 7, Illinois



KEYMESH • KEYBEAD • KEYCORNER • KEYSTONE WELDED WIRE FABRIC • KEYSTONE NAILS • TIE WIRE • KEYSTONE NON-CLIMBABLE AND ORNAMENTAL FENCE

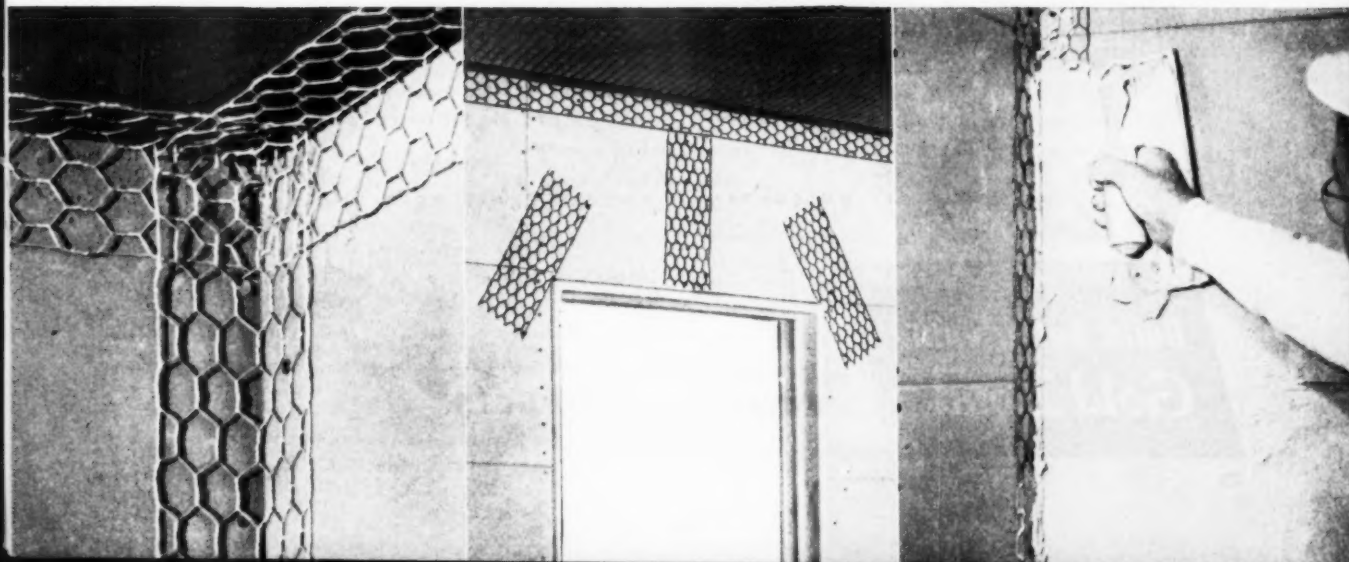



Sun Valley, Lexington, Mass. — Architect: John G. Danielson, Medford, Mass.
 Builders: DeVries Construction Company, Wakefield, Mass.

**"Gold Bond Building Products
 help us turn
 'lookers' into buyers"**



says **GEORGE DeVRIES**, *President, DeVries Construction Company, Wakefield, Mass.; member, National Association of Home Builders.*

"We call our Sun Valley development, 'New England's modern Vacation-at-Home Community.' It's a 200-home project and it's attracting buyers because we've found a selling combination...good workmanship and top-notch building materials. For example, we use Gold Bond Lath and Plaster,

and Gold Bond Rock Wool Insulation. We know how well these products perform and we know, too, that prospects associate the Gold Bond name with the finest in building products. Not only that, but we find added benefits in the undivided responsibility that comes with buying from one manufacturer—National Gypsum Company.

"That's why we can't recommend any better materials than Gold Bond to help build—and sell—homes."

NATIONAL GYPSUM COMPANY • BUFFALO 2, NEW YORK



Gypsum Board Products



Plaster and Lime



Insulation Plank and Tile



Rock Wool



Paint Products



Acoustical Tile



Asbestos-Cement Products

... BUILDING PRODUCTS

This New Freedom Gas Laundry* features a **TEMCO** automatic Gas dryer and a **RHEEM COPPERMATIC** automatic Gas water-heater. Cabinet by **REPUBLIC STEEL**.

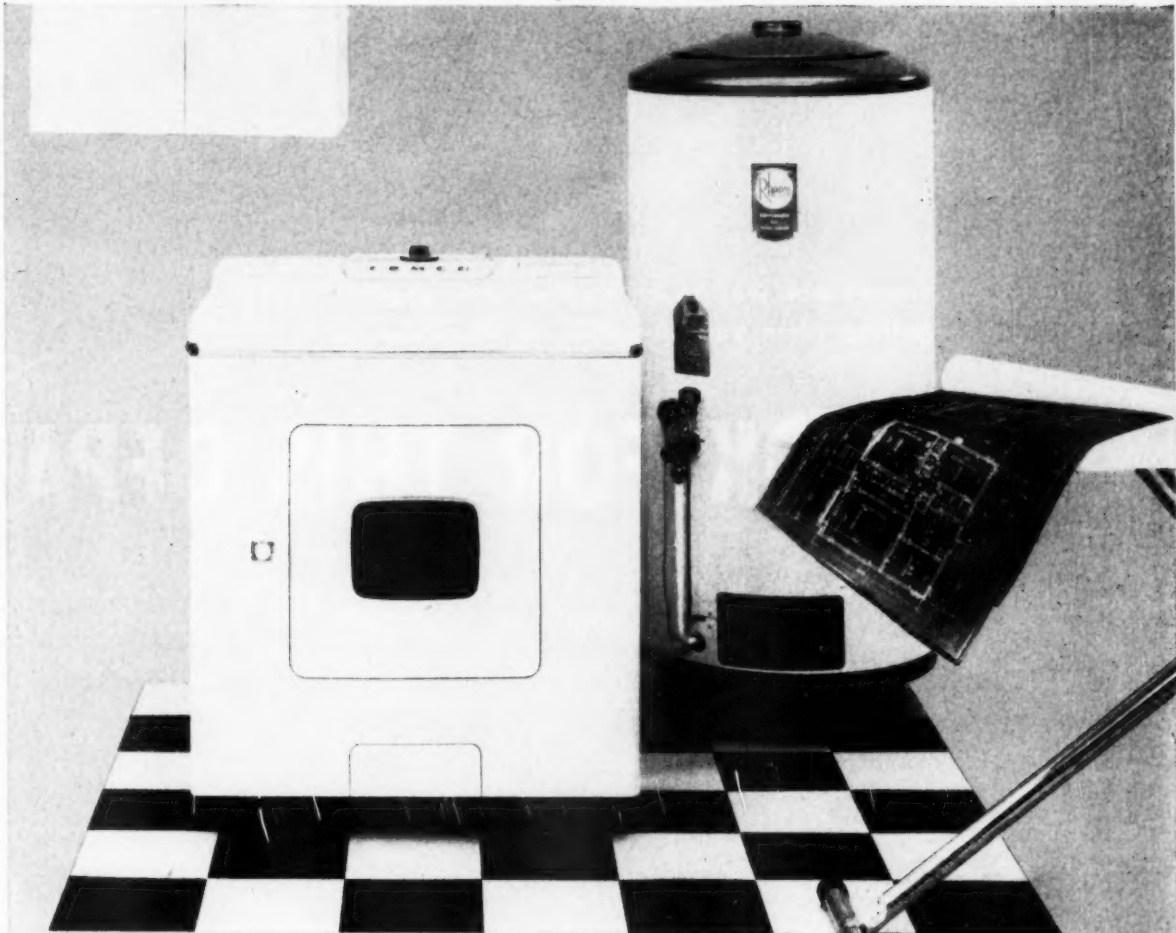

Here's why GAS is your
smartest buy to sell houses

*Reg. A. G. A.

- Sales records give **Automatic Gas Water-Heaters** a 2.8 edge over any other heater run by an all-automatic fuel. Gas does a better job — actually replaces hot water 3 times faster.

- Gas water-heaters offer every product advantage you can think of. For example, the one shown is particularly strong and long-lived. It features a rust-proof copper tank inside a "pressure-proved" steel tank.

- An automatic clothes washer (and what modern home doesn't have one?) definitely needs the speedy recovery rate of a Gas heater.

- Yet automatic Gas water-heaters cost less to buy, install and use.

- **Automatic Gas Clothes Dryers** are preferred 30-1 by professional laundrettes because of speed and economy of operation.

- No warm-up period means that Gas dryers are twice as economical per load.

- Good choice of brands gives chance to select individual features.

- Dryer in home as standard equipment eliminates need for drying yard, allows for smaller lots and neater-looking developments.

AMERICAN GAS ASSOCIATION

Your local Gas company will be happy to work with you on any problem.

Only
Gas 
 is so fast...
 so thrifty

GAS — the modern fuel for automatic cooking, refrigeration, water-heating, house-heating, air-conditioning, clothes-drying, incineration.

There's one way to be sure of what you're
getting when you buy plywood sheathing . . .



LOOK FOR THIS DFPA

Be safe—be sure! Insist on genuine DFPA trademarked sheathing,
engineered to meet exacting structural requirements.

When you buy grademarked, trademarked PLYSCORD, you're getting
strong, durable Douglas Fir plywood sheathing that's quality-tested by
DFPA* to protect the buyer.

* **DFPA:** Douglas Fir Plywood Association is a
non-profit industry organization devoted to product
research, promotion, and quality maintenance.

NEW: A handy slide rule giving thickness
and nailing recommendations for Plyscord sheathing
on various stud, joist and rafter spacings. Free.
Write DFPA, Tacoma 2, Washington.

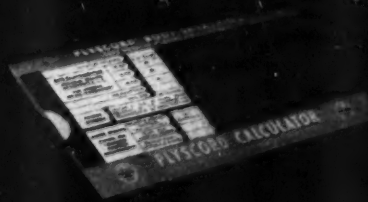

TRADEMARK!

GENUINE
DOUGLAS FIR PLYWOOD

PLYSCORD[®]

INTERIOR TYPE GRADE C-D

SHEATHING



In Every Home

the trend is

to *Quiette*

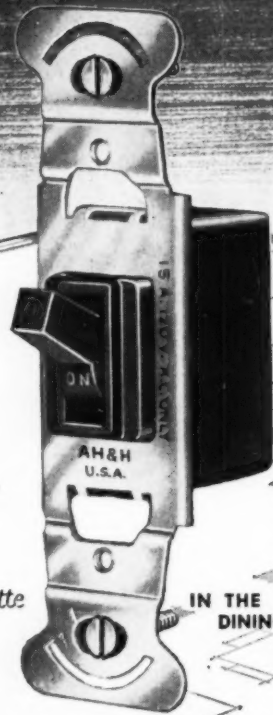

Quiette
IN THE HALLS

Quiette
FOR RELAXING

Quiette
FOR THE BEDROOM

Quiette

IN THE
DINING ROOM

and the
NEW



Junior

Quiette

LIGHT SWITCH

Don't follow the trend toward quiet and QUIETTE SWITCHES . . . LEAD THE WAY!

Recommend that home owners and prospective home owners select the ARROW-HART JUNIOR QUIETTE SWITCH for every room of the homes they own or plan to own.

Here's a light switch that whispers *quality* so quietly you'll have to tell your customers and prospects about it . . . they won't hear it! But they'll appreciate the quiet and the quality and be *completely* satisfied. This will mean *no* unprofitable call-backs but plenty of profitable

new installations through favorable word-of-mouth advertising. Recommendations pave the way to profits!

The desire for quiet . . . and QUIETTE SWITCHES . . . in the home is there. Cash in on it! Sell *quiet*. Sell *quality*. Install ARROW-HART JUNIOR QUIETTE SWITCHES because they . . . along with the other A-H QUIETTE Switches, Lifetime and Interchangeable . . . offer the most perfect combination of quiet and quality available in the electrical industry!

SPECIAL FEATURES OF THE *Junior* *Quiette*

LIGHT SWITCH HAVE WIDE APPEAL



FOR THE USER

- Quiet, safe mechanical operation of incandescent and fluorescent lights and appliances without mercury.
- Special new PLATEAU HANDLE DESIGN that keeps out dust, permits the switch to fit snugly, neatly into any Uniline or metal wallplate.
- Continuous operation in any position.
- Brown or Ivorylite operating handle that complements any decorative scheme.

FOR THE INSTALLER

- Screwless WIRE-LOCK Terminals that make installation easier, faster.
- Ground Feed Thru Shunt (in single pole models) eliminates splicing, taping or soldering jobs . . . and extra wires.
- Positive electrical connection and strong mechanical connection.
- Release Slot that permits release of wires simply by insertion of blade of small screw driver or "Key to Profit."

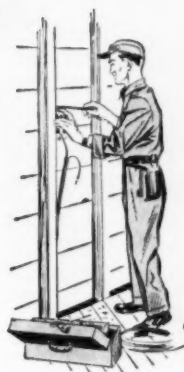

SINGLE POLE SWITCH
CATALOG NO. Q-1
only 80¢ LIST

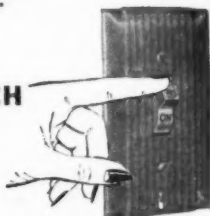

SINGLE OR DOUBLE POLE,
3-WAY OR 4-WAY . . . 15
AMPERES, 120 VOLTS A C ONLY
. . . LISTED AS STANDARD BY
UNDERWRITERS' LABORATORIES.

**Provide YOUR CUSTOMERS WITH MORE THAN ADEQUATE WIRING . . .
 MORE THAN ADEQUATE WIRING DEVICES.**

It's not enough to provide your customers with a sufficient quantity of wiring devices. Quality's a "must" tool. Assure them of all the benefits of modern electrical living . . . comfort . . . convenience . . . safety . . . for years to come through the wiring devices you install today, by installing ARROW-HART.

Arrow-Hart's record of 335 outstanding new developments during the past 24 months is your guarantee that TODAY'S INSTALLATIONS will provide for TOMORROW'S NEEDS!

Buying ARROW-HART means getting prompt delivery from a nearby source . . . because Arrow-Hart serves you through leading electrical distributors of wiring devices.

Send for FREE FOLDERS THAT GIVE SPECIFICATION, INSTALLATION AND ORDERING INFORMATION

Mail the coupon below for two free folders (one a pocket-size folder for handy on-the-job reference) that give full specification, installation and ordering information on the complete A-H line of quality QUIETTE SWITCHES.



ARROW-HART

SINCE 1890

Quality Wiring Devices

MOTOR CONTROLS

ENCLOSED SWITCHES • APPLIANCE SWITCHES

THE ARROW-HART & HEGEMAN ELECTRIC CO.
 HARTFORD 6, CONNECTICUT



WIRING DEVICE DIVISION
 THE ARROW-HART & HEGEMAN ELECTRIC CO.
 103 Hawthorn Street, Hartford 6, Connecticut

Please send me QUIETTE Switch Folders.

NAME _____

POSITION _____

CO. NAME _____

CO. ADDRESS _____

CITY _____ ZONE _____ STATE _____

AB

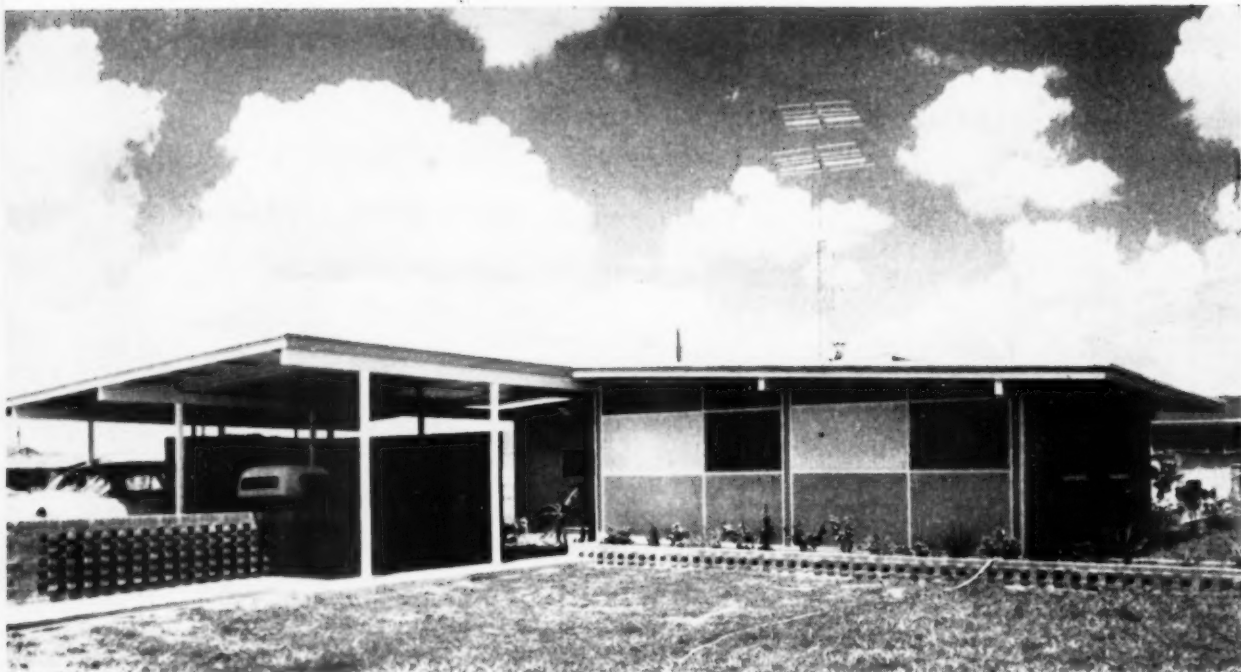

A good example of shading for all walls, well proportioned windows, and the use of light colors where effective

How to design to beat the sun

Make air conditioning equipment
work more efficiently with
these 12 ideas:

1. No windows or doors on the east wall
2. If openings are required on east wall, provide shading
3. Use hip roofs whenever possible
4. Limit the use of sweep-back type gable
5. Place garage or carport on west wall
6. Extend roof over entrance porch
7. Use light colored roofs
8. Ventilate roof and rafter space
9. Use shading devices to check sun's rays
10. Adapt shading methods used for commercial structures
11. Enclose the equipment
12. Make the most of trees



1. No windows or doors on the east wall

Plan the house so that windows can be eliminated on the east wall, especially where a gable treatment is used. It is now recognized that a tremendous heat load is built up on the east wall in the late hours of the morning. With windows, this can place an additional burden on the cooling unit that is difficult to overcome for the balance of the day.

This is *American Builder's* second comprehensive coverage of NAHB's Air Conditioned "Research Village" in Austin, Texas.

Twenty of the 22 houses comprising the National Association of Home Builders' research project were illustrated and described in the June, 1954, issue of *American Builder*. The June report also included purpose and objectives of the long-range project, specifications for each house, names of the builders and manufacturers of air conditioning equipment who are co-operating with NAHB. Houses range in size from 1,100 to 1,300 square feet, each cooled with a two-ton capacity unit.

A walk down the Park View, Twin Oaks or Nasco Drives of NAHB's air conditioned research village in Austin, Texas, on a hot August afternoon proved well the value of air conditioning homes. With their windows closed, the houses on both sides of the drives were in sharp contrast to the non-airconditioned houses adjoining the village where windows were thrown open to the hot blasts from the street in the hope they would catch a breeze.

However, not all of the air conditioned houses in the village were enjoying the maximum benefits to be derived from this type of equipment. Lack of proper shading devices on some windows exposed to the direct rays of the sun made it necessary to draw the shades and draperies despite the cooling units, and thus denied the occupants the benefit of a view of the outdoors.

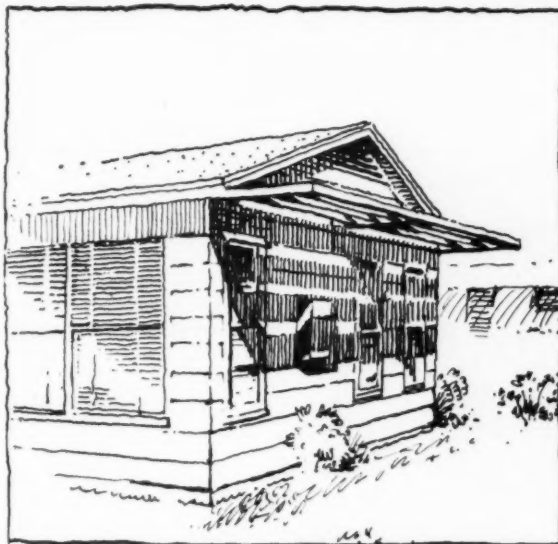

2. If openings are required on east wall, provide shading

If windows on the east wall are a plan necessity, and the design is arranged for a gable roof, provide a projecting horizontal overhang with diagonal intermediate boards to block the sun, as indicated in sketch above. This should be placed along the end wall on a line with the front cornice and gutter.

Shading devices are necessary for window and door openings exposed directly to the sun's rays even where air conditioning equipment is to be installed. The radiating energy of the sun adds heat within a room if it is allowed to enter. External shading devices help reduce the cooling load placed upon the equipment which, in turn, will reduce operating costs. Unprotected glass areas create an uncomfortable condition for

the occupant, even though the load of cool air is sufficient.

The structure of the house is important, too; particularly the walls and ceiling. If a house is well insulated, the cost of cooling can be reduced by installing a unit sized to handle the load efficiently and to maintain proper temperature. Insulation will keep operating costs within reason, as well as increase comfort within the space or room.

Good shading makes for good living



3. Use hip roofs whenever possible

Where shading is of major concern, then a gable roof arrangement for the end walls should be avoided. It is impossible to project the roof line far enough out to be of any shading value for the windows below. A hip type roof,

as shown in the sketch above, is preferred. An adequate overhang directly above window openings can be provided with a hip type roof



4. Limit the use of sweep-back type gable

The sweep-back type of gable adds glamour to the design, but defeats the shading possibility for the fixed windows in the gable end. This objection can be overcome by providing a greater projection at the eave line



5. Place garage or carport on west wall

Carports and garages when placed on the west side of the house act as a buffer against the elements. Positioning the garage or carport to act as a buffer is necessary in all

areas. Extending the front wall of the carport beyond the front wall of the house permits the roof line to continue over the entrance door, thus forming a covered passage

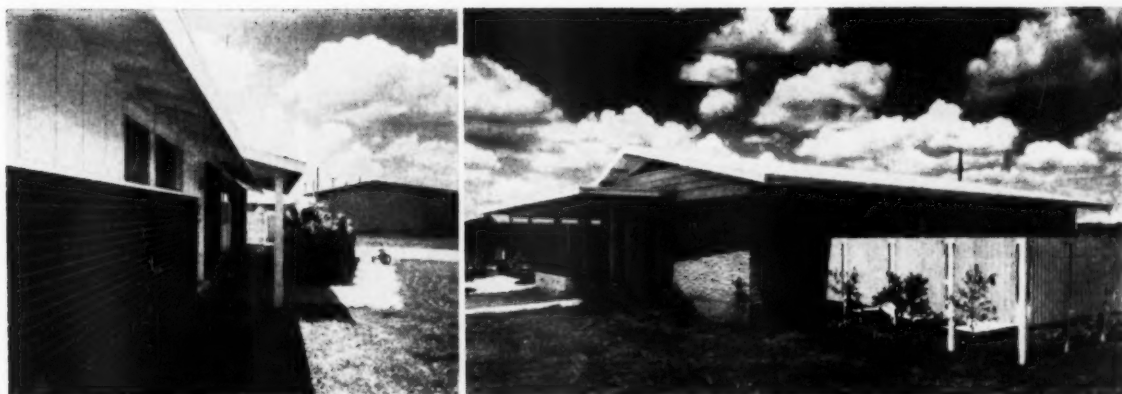

6. Extend roof over entrance porch

Shown above are two more examples of extended garage roof lines which form passages to entrance doors. Projection of the roof at eave should never be less than three

feet. Height of windows and angle of sunlight should determine overhang beyond this minimum

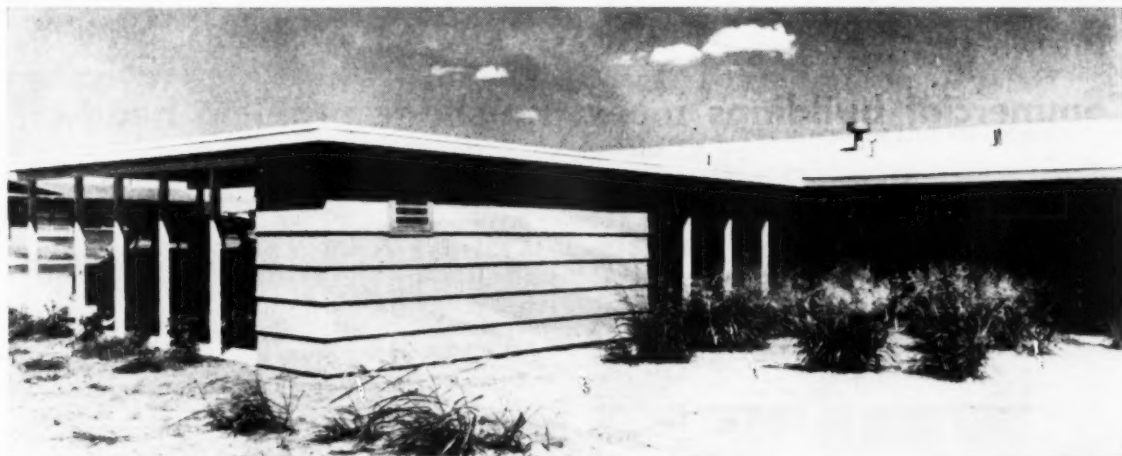

7. Use light colored roofs

Light colored shingles or aggregates should be used for roof surfaces because light colors have a tendency to reflect heat from roof surface



8. Ventilate roof and rafter space

Ventilating the attic space or rafter area is important. In the gable end shown above there are air spaces between vertical overlapping members. The other photograph

shows a simple but orderly arrangement of holes in the fascia under the soffit to ventilate the upper portion of the rafter space

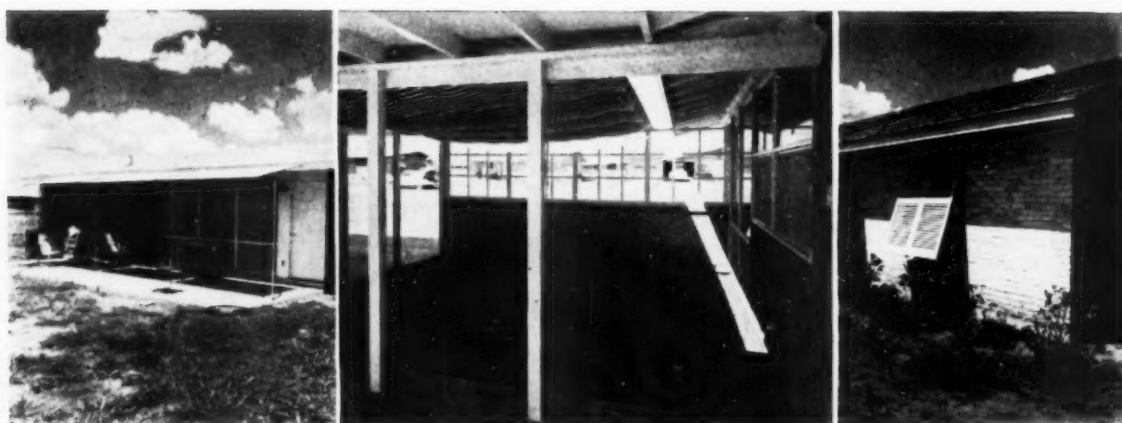

9. Use shading devices to check sun's rays

Ideally, the design of the house should provide all necessary shade. However, when the roof overhang or other structural elements of the house do not provide enough

shade, then manufactured awnings or shutters of various types should be used. Illustrated above are three ways to use shading devices

Commercial buildings meet the shade problem head-on

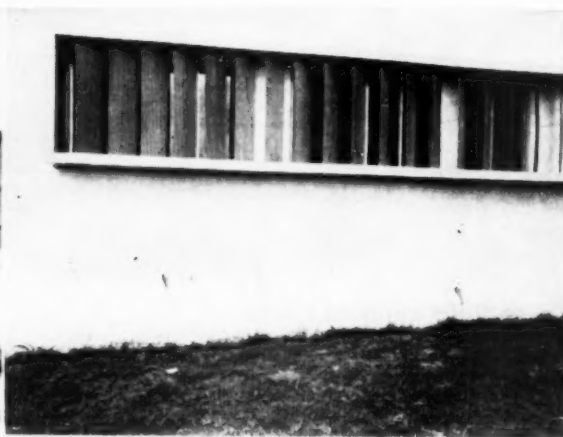

10. Adapt shading methods used for commercial structures

Above are examples of how a battery of windows in commercial buildings can be tied together with a continuous projecting frame. Horizontal and vertical translucent panels, pivoted top and bottom, or sides, are installed in the frame. Panels can be quickly adjusted to the required angle. Also shown is a projecting lightweight concrete overhang

Cooling units can be made design happy

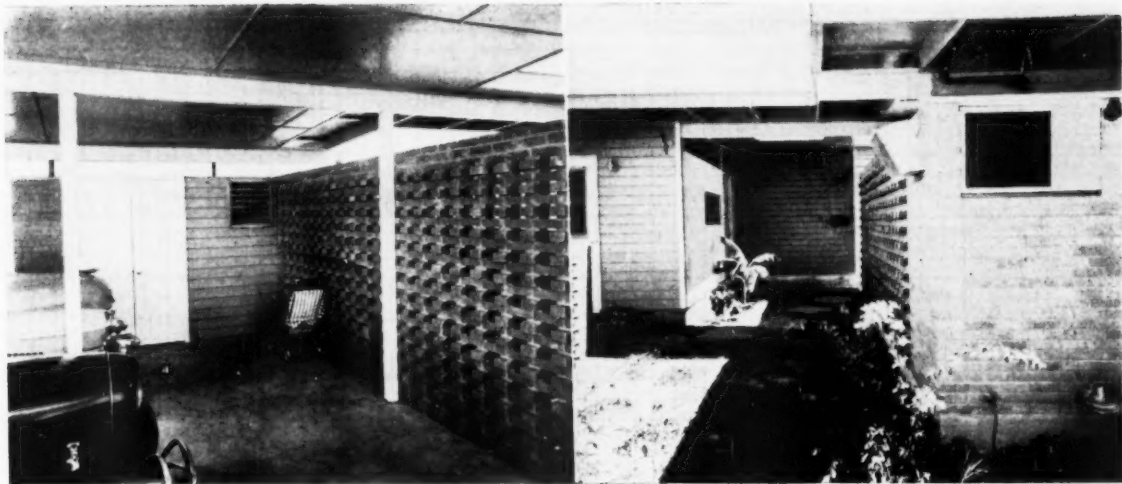

11. Enclosing the equipment

The preferred position for the water cooling tower or the air cooler condenser is outside the house in close proximity to or adjoining the walls. Having established the location outside the house, give it some eye appeal by integrating it with the design, as three of these photographs illustrate. Provide metal grilles for air intake and exhaust



12. Make the most of trees

Trees are particularly good as shade for east and west walls and the roof. Wide branching trees should be used close to the house. When planting, consider their ultimate size and height and the shade pattern desired. Use deciduous trees as they lose their leaves and allow the sun to reach

the house in winter. Trellises with vines, which are located near the east and west walls will diminish the impact of sun heat in one story houses. A sun break of shrubs and a good expanse of turf, in addition to trees, will help in cooling and in glare prevention



ADDRESS 1407 MADISON AVE.

JOB No 104

CONTRACT	ESTIMATED	ACTUAL	1ST DRAW	BALANCE	2ND DRAW	BALANCE	3RD DRAW	BALANCE	JANUARY	FEBRUARY	MARCH	APRIL
ARCHITECT	50 -	50 -	50 -	-0-								
SURVEY	21 -	21 -	21 -	-0-								21 -
PERMITS	85 -	58.40 -	58.40 -	-0-							58.40 -	
EXCAVATION	134 -	120 -	120 -	88 -	88 -	88 -	-0-					
WATER SEWER AND GAS LINES	475 -	425 -	400 -	25 -	25 -	25 -	-0-					400 -
CONCRETE WORK	200 -	1,000 -	55.0 -	405 -	405 -	405 -	-0-				55.0 -	
WATERPROOFING	15 -	15 -	15 -	-0-							15 -	
MASONRY	2,000 -	2,000 -	1,800 -	200 -	200 -	200 -	-0-					1,800 -
STEEL-STRUCTURAL	-	-	-	-0-								
MILLWORK	525 -	525 -	300 -	225 -	225 -	225 -	-0-					300 -
ROOFING	150 -	150 -	150 -	-0-								150 -
FINISHED HARDWARE	60 -	60 -	60 -	-0-								60 -
PLUMBING	1,200 -	1,200 -	600 -	600 -	600 -	600 -	-0-					600 -
HEATING	560 -	500 -	560 -	-0-								
ELECTRICAL	865 -	865 -	865 -	-0-								
INSULATION	49 -	49 -	49 -	-0-								49 -
PLASTER	1,050 -	1,050 -	525 -	525 -	525 -	525 -	-0-					525 -
GLAZING	80 -	80 -	80 -	-0-								80 -
CABINETS-KITCHEN	150 -	150 -	150 -	-0-								
MEDICINE CABINETS	22 -	22 -	22 -	-0-								22 -
LINOLEUM OR FLOOR COVERING	-	-	-	-0-								
WEATHERSTRIP	90 -	90 -	90 -	-0-								
SCREENS OR COMB STORMS	-	-	-	-0-								
FLOOR TILE	81 -	81 -	81 -	-0-								
WALL TILE	130 -	130 -	130 -	-0-								130 -
PAINTING	340 -	340 -	300 -	40 -	CLOSED UNPAID							
SANDING	25 -	25 -	25 -	-0-								
SHADES OR BLINDS	-	-	-	-0-								
OUTSIDE DOWNPOUTS FLASHINGS	90 -	90 -	90 -	-0-								90 -
ORNAMENTAL IRON	75 -	75 -	50 -	25 -	25 -	25 -	-0-					50 -
STEEL SETTING	-	-	-	-0-								
TOTAL CONTRACTS	8765 -	8785.40 -										
LABOR	1400 -	1527.25 -										62.24.40
MATERIALS	1050 -	1055.25 -										6.97.50
FLOORING-FINISH	200 -	187.50 -										
ROUGH HARDWARE	40 -	36.50 -										36.50
MISCELLANEOUS	50 -	47.75 -								10 -		12.50
LOAN EXPENSE	550 -	527.45 -										
TOTAL CONSTRUCTION COSTS	11450 -	11965.60 -										
EXTRAS												
LAND	1500 -	1458.75 -						1400 -	58.75 -			
COMMISSION	200 -	200 -										
TOTAL COST OF JOB	13550 -	13624.35 -						1400 -	58.75 -	70.50 -	58.75 -	

This simple form gives you

cost control over a job in progress

By ALEX G. FLAX

of Flax, Ziegler, Shifris & Co.,
Chicago CPA firm and experts on builders'
bookkeeping problems

● Permits quick closing of the job on the
books, without tedious account checking



1400
houses paneled with
philippine mahogany

*available in plywood or solid lumber -
 write for literature*



PHILIPPINE MAHOGANY ASSOCIATION, INC.
 Dept. AB, 111 West Seventh St., Los Angeles 14, Calif.
 Philippine Lumber Producers' Association, Inc., Manila



JOSEPH L. EICHLER,
*Prominent California
 Contractor and Developer*

"I have used Philippine Mahogany for interior woodwork in all of my tract houses for the past 5 years. It is my firm conviction that the use of this beautiful hardwood in the homes which I have built has increased their value and saleability, and resulted in buyer satisfaction."



Cost control (Continued from page 105)

head factor is applied). This record also functions as a subsidiary ledger, as detailed below, enabling the builder to close a job out of his accounts at the time when it is turned over to the buyer, even though certain unpaid construction costs may still be on the books.

This is how the form is organized:

Begin with payments to subs

Spaces are provided (beginning with the fourth column) for up to three draws on a subcontractor's contract. These are the columns labeled 1st Draw—Balance, 2nd Draw—Balance, and 3rd Draw—Balance. Most contracts will be paid out in two draws, but frequently there will be an exception which will require a third draw. The cement man, for instance, may have to go back and re-do the front entrance steps, which have cracked.

Twelve successive columns are then provided for entering the amount paid in the month of payment. These disbursements are totaled monthly and are accumulated in the two columns at the extreme right, called Job Cost Control, for quick determination of the progress of the job.

Now look at

"Estimates" and "Actual"

For accounting and audit control, the record provides a positive control of costs by simple comparison of aggregate costs in any work classification with the original estimates and contracts. All this takes place within the scope of the first three columns of this record. Note that spaces for the builder's own estimates and costs for his part of the work are provided below the costs fixed by contracts.

How to close the job

As a general rule, most builders will want to close each job out of

their accounts as it is physically completed and the buyer in possession. But at this point there may be certain unpaid construction costs — payments held back for one reason or another.

To satisfy this condition and still permit closing the books, four columns are set up as "Unpaid Contracts and Completion Costs." Any unpaid items at the time of completion are taken into the job costs, but they are also posted to these special columns, which function as a ledger in themselves. Then this whole record of the job can simply be lifted to a subsidiary ledger for use in posting payments which are made after the job has been closed out to cost of sales. This time-saving procedure avoids rewriting and transferring journal entries and helps to simplify the accounting system.

For example, note the entries under Painting and Commission. There were unpaid items attaching to both of these classifications when the job was closed on July 31, but the closing of the books was not held up thereby. These hold-backs were taken into the costs of the job and at the same time were posted to the "Unpaid" columns, where their payment on August 16 and August 21 was duly recorded.

Source of the entries

The sources of the entries in this job-cost ledger, in any well-organized management program, would be three in number: (1) a Cash Disbursements Journal designed to provide for disbursement of job costs by individual job or by group, and by pay-order, if that method is used for settlement with the subcontractors. (2) Payroll records and (3) materials purchases records would also be used by the builder who does part of the work himself, in posting to this over-all record of costs of the job.

IN LATER ISSUES Mr. Flax will discuss

- **HOW TO HANDLE CASH RECORDS and**
- **KEEPING THE ACCOUNT OF THE BUYER**

NOVEMBER 1954

Precision-built for the man behind the gun...



Model 3000 \$195.00* complete with tripod.

White gives you the most practical Universal Level-Transit on the market

HERE'S a Universal Level-Transit specially developed to handle all survey and checking operations. It's sturdy, accurate and exceptionally easy to use. And — a new single truss standard frame design replaces old-style cross bars and wyes. What's more, it has a silvered 4¼" horizontal circle and an easy to read 5 minute vernier.

Other advantages of this outstanding instrument include coated optics, internal focusing and a ball-bearing race for smooth operation even in sub-zero weather. Check out a White on your next trip and discover how much easier your work can be. Write for DAVID WHITE Bulletin 1053 and name of nearest dealer, 311 W. Court St., Milwaukee 12, Wis.



We offer expert
REPAIR SERVICE
on all makes,
all types of
instruments

*Prices subject to change without notice.

First Aid

to **SLIDING DOORS** from **LOCKWOOD**



No. 720 $\frac{1}{4}$
(Latch set — No. 720)

Here at last is hardware for sliding doors you can depend on . . . and it looks as good as it works.

LOCKWOOD sliding door hardware is made to the same quality and performance standards as LOCKWOOD cylindrical locks. In your new homes and your home modernization jobs, install LOCKWOOD and be sure.

- Complete line of locksets and latch sets . . . each set available for metal or wood doors — 1 $\frac{1}{8}$ " or 1 $\frac{3}{4}$ " thick

- Adaptable to any type of sliding door, including cabinets, storage compartments, etc.
- Chrome finish inside, brass outside for bathroom doors; brass finish both sides for bedroom and other doors
- Latching device also serves as pull
- Ingenious design of catch eliminates bounce-back
- Adjustable strike accommodates minor positional changes of doors
- Cup escutcheons available as pulls (No. 700)



LOCKWOOD HARDWARE MANUFACTURING CO.
Fitchburg, Massachusetts

Simple, fool-proof installation with **LOCKWOOD SPEEDRIL**



SPEEDRIL makes light work of hard labor . . . assures accuracy. After boring two holes with **SPEEDRIL** and preparing shallow mortise (same as for LOCKWOOD cylindrical locks), insert latch in hole in edge of door and attach with screws.

Assemble outside cup with cam engaging tailpiece of latch.

Assemble inside cup with machine screws.



ONLY

Pella[®]

**OFFERS THE
NATURAL BEAUTY OF
WOOD FOLDING
DOORS**

**PINE
OAK
MAHOGANY
BIRCH**

You will be delighted at the many different ways Pella *Natural Wood Folding Doors* can be installed to give privacy and maximum utility of space. Use them as folding partitions between living room and dining room, bedroom and living room, dining room and kitchen. Install for regular door openings. Adapt them to closet fronts, kitchen cupboards, snack bars — wherever space is at a premium. Individual panels, joined by continuous spring hinging, fold to about 6" in the average door openings.

Pella *Natural Wood Folding Doors* are solidly built in pine, oak, mahogany or birch (stock doors in pine, finished or unfinished; custom doors in pine, oak, mahogany or birch, clear varnished or unfinished). They are packaged, complete with all hardware and concealing track mould, ready for quick, easy installation. Laminated construction assures straight, true panels. See Pella catalog in Sweet's Files or mail coupon below.



CLIP AND MAIL FOR DETAILED INFORMATION

MAKERS OF
Pella[®] **WOOD CASEMENTS**
MULTI-PURPOSE WINDOWS
ROLSCREENS • VENETIAN BLINDS

ROLSCREEN COMPANY, Dept. F-90, Pella, Iowa

GENTLEMEN:

Please send **FREE** literature on Pella Wood Folding Doors.

NAME _____

ADDRESS _____

TEL. NO. _____

CITY & ZONE _____

STATE _____

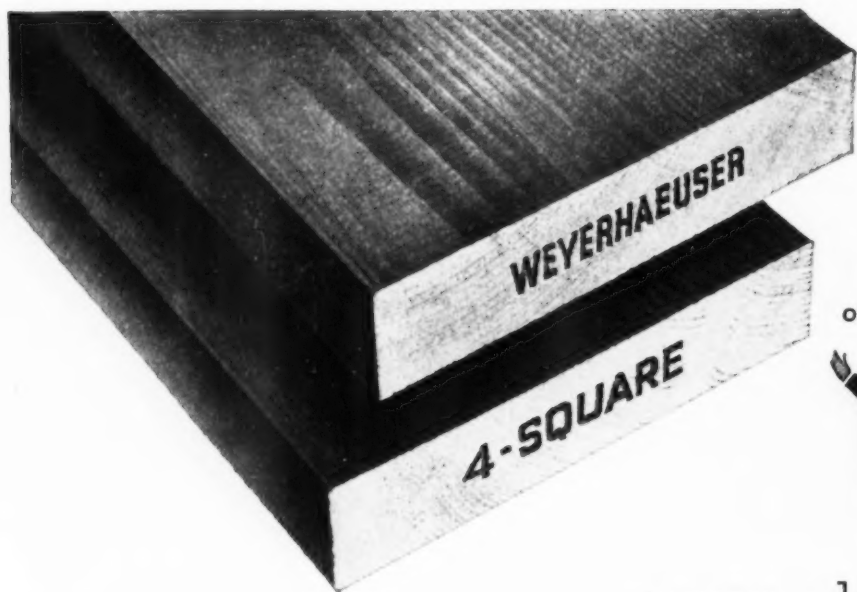

This brand name
on lumber
also brings
you...



your choice of

Beautiful

HERE ARE EXAMPLES of wood sidings with the rugged informality of western forests . . . or the classic simplicity of elegant city homes. To give your customers exactly what they want, the Weyerhaeuser 4-Square line includes sidings of 11 softwood species, milled to a variety of patterns.

These sidings offer many features not found in other materials. Horizontal sidings, for example, can be used to emphasize the length of a home. Vertical sidings add height. Natural finish suggests an informal hospitality, while painted surfaces provide almost unlimited opportunities for individual expression.

Other important features include the fact that all 4-Square sidings offer the warmth and beauty that only wood can give. Wood sidings also are outstanding for their durability and ease of application. Economy is important, too . . . long life means low yearly cost.

Precision manufactured, uniformly graded, shipped and handled with care, Weyerhaeuser

4-Square sidings offer outstanding values for your discriminating home owners.

Ask your 4-Square Lumber Dealer to give you full details of these popular wall coverings, or write for descriptive literature.



The deep shadow lines of bevel siding emphasize the length of this home and enhance the simplicity of the design.



Natural finish Red Cedar siding gives this lovely contemporary home a pleasant informality.

Sidings

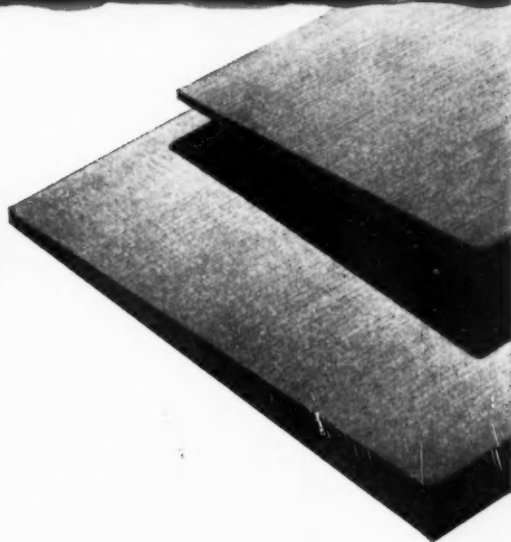

**Weyerhaeuser 4-Square
Lumber and Services**

WEYERHAEUSER SALES COMPANY
St. Paul 1, Minnesota

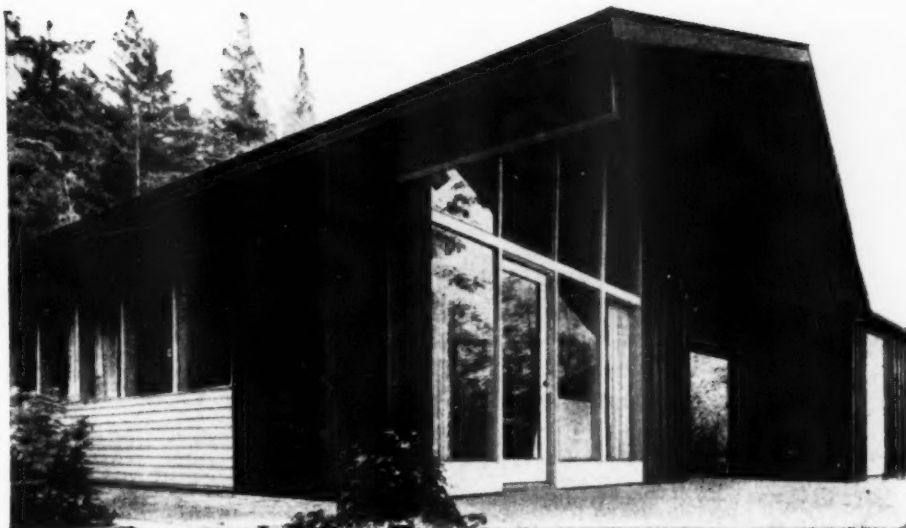

Vertical boards and battens add a rustic touch to this home.

To get more for the sale...give more for with **WELDWOOD**

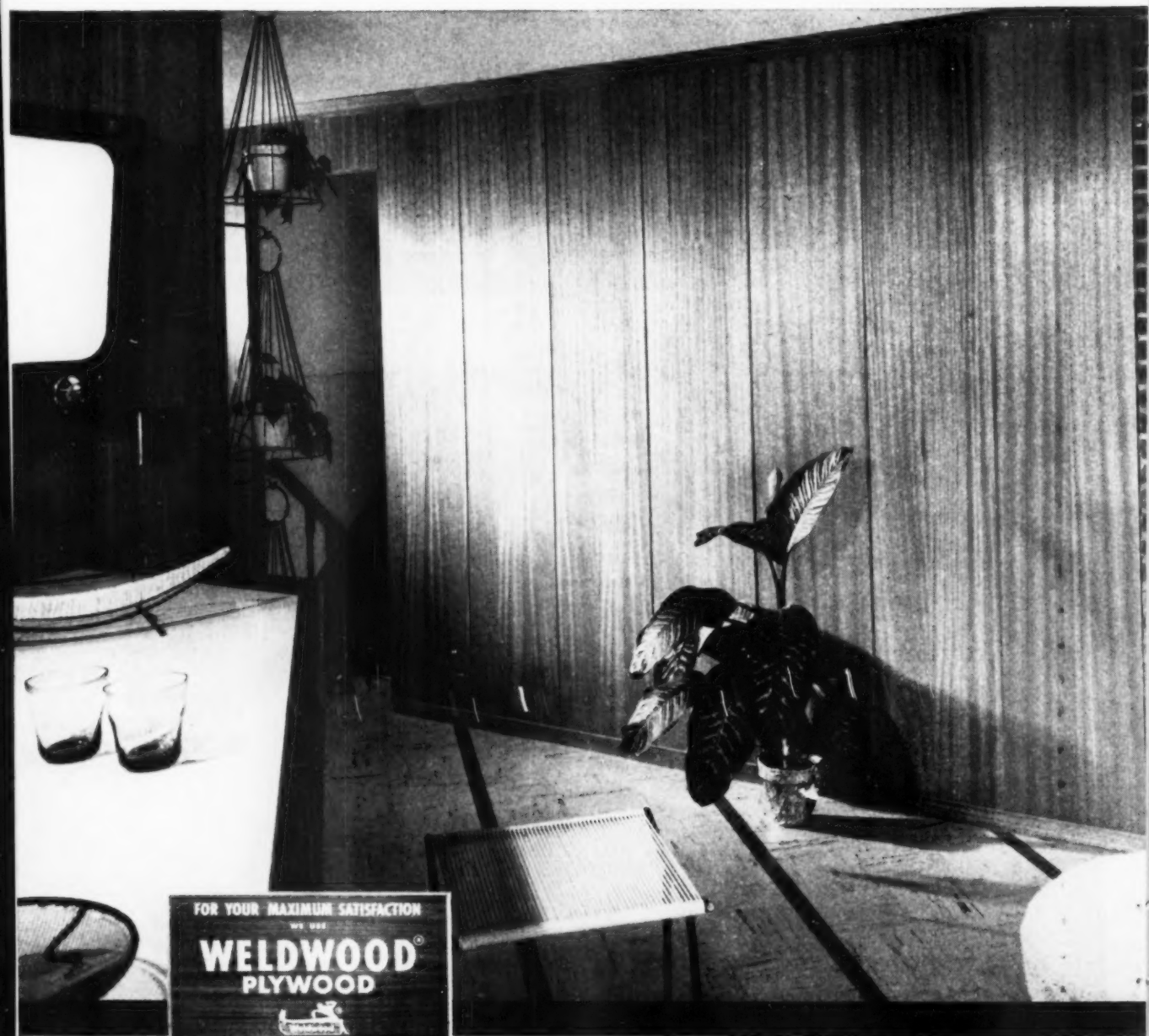

This Weldwood Guarantee display plaque in genuine walnut, 11 $\frac{3}{4}$ " x 7 $\frac{1}{2}$ ", is available free for builders featuring Weldwood paneling. Ideal for model homes.

Plankweld installed in model home, Saddle Harbor Estates, Long Island, N. Y. Builder: Irving Warfield. Architect: A. H. Salkowitz.

PHILIPPINE MAHOGANY PLANKWELD tunes in a permanently happy note for this all-purpose recreation room. A room like this can sell a home without taking the prospect any farther, yet material for an 8' high x 12' long wall area costs you only about \$54.

the mortgage PLANKWELD®

Trend to more liberal and longer mortgages points way for builders to give buyers better value with beautiful lifetime Plankweld paneled interiors. Better value means better price, better profit per sale!

Government agencies and private lending institutions are doing everything in their power to encourage private home ownership. Down payments are becoming lower, mortgage amounts higher, with sufficient funds being available for the builder to build more value into a home.

It's great for everyone concerned, including the builder, but it does give him plenty of competition. That is why more and more successful builders are installing beautiful Plankweld interiors. They know that no other solid wall covering material even comes close to matching the natural beauty, value and *sales appeal* of real wood paneling!

HOLDS COSTS DOWN. Plankweld is completely pre-finished at the factory. It eliminates expensive, on-the-job finishing costs. Plankweld is quickly and easily installed directly to studs or furring with special metal clips which hide nailheads. You are in for a pleasant surprise when you discover for yourself how little the 16 1/4" wide x 8' long Plankweld panels actually cost. *Installed costs* are usually little more than for walls using conventional wall covering materials.

CHOICE OF FINE WOODS. Plankweld is available in a wide variety of luxurious woods: Korina®, Honduras Mahogany, Oak, Walnut, Birch and Philippine Mahogany. It's pre-packaged for safe on-the-job storage.

BIG SALES FEATURE IN LIFE-OF-HOME GUARANTEE. Prospects will be favorably impressed when they learn that your Plankweld paneled walls are *guaranteed for the life of the home!*

SEE YOUR LUMBER DEALER. See Plankweld and other fine Weldwood paneling at your lumber dealer's today! See the complete line, including Weldwood Stay-Strate® Doors and superior Douglas Fir Weldwood at any of the 73 United States Plywood or U.S.-Mengel Plywoods distributing units in principal cities, or mail coupon.



CHEERFUL BIRCH PLANKWELD was used to brighten up this dining area wall. Material for doing the same in the homes you are building costs only about \$54 for an 8' high x 12' long wall area.



HONDURAS MAHOGANY PLANKWELD creates a strikingly handsome fireplace wall that sets a house apart. Materials cost you only about \$61 for an 8' high x 12' long wall area.



Weldwood®

UNITED STATES PLYWOOD CORPORATION

World's Largest Plywood Organization

U. S.-MENDEL PLYWOODS, INC., Louisville, Kentucky

In Canada, Weldwood Plywood Ltd., Montreal and Toronto

UNITED STATES PLYWOOD CORPORATION

55 West 44th Street, New York 36, N. Y.

AB-11-54

- FREE** Please send me information on Plankweld.
 Send me 24-page Contractors and Builders Book packed full of Weldwood data and specifications.

NAME.....

ADDRESS.....

CITY.....STATE.....

Their house drew 10,000

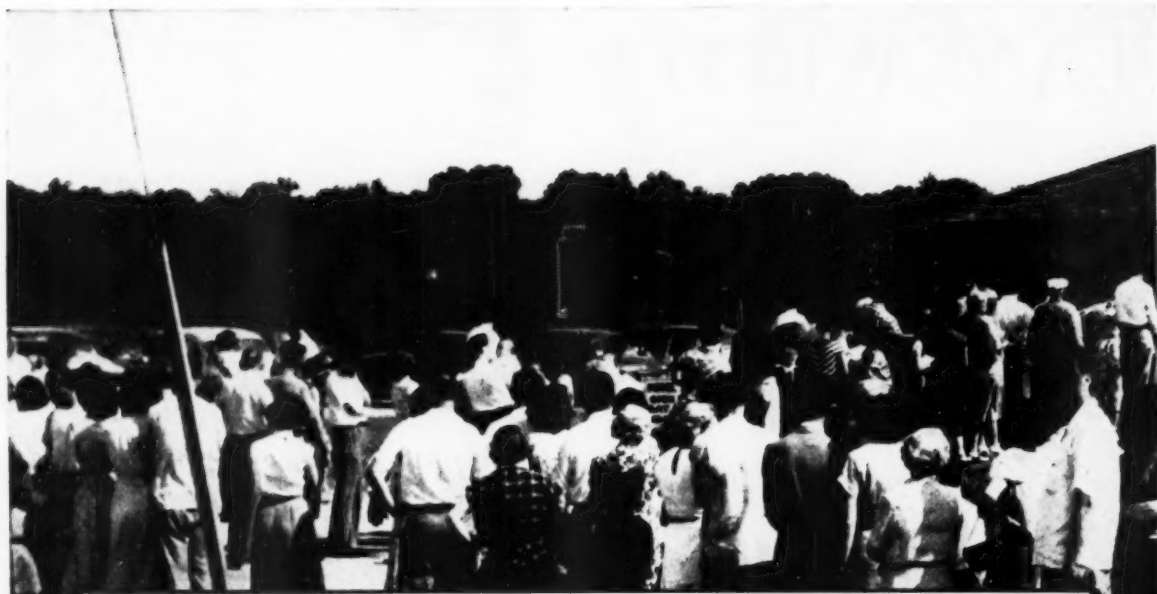

What made Westfield at Natick, Mass. pay off for Campanelli Bros., Inc.?

Let Mr. Nicholas Campanelli, president, tell you in his own words.

"We expected many people at our Westfield opening . . . but nothing like *this* huge crowd that descended on us! They inspected the whole house . . . but spent *most* of their time *in the kitchen*.

"It was the G-E Kitchen-Laundry that held them there. Folks were *amazed* to learn that payments for these appliances are no more than the average monthly phone bill, when included in the regular home mortgage!

"It sold many of them right on the spot . . . and *sold us for good* on G. E. We're planning 600 more houses in the next two years, and we're

relying on the G-E Kitchen-Laundry to do a lot of selling for us."

It can work for you, too. You can put General Electric to work just as Campanelli Bros. have done so successfully.

Install sales-appealing General Electric Kitchen-Laundry appliances in *your* homes . . . include their price in the regular home mortgage . . . and make available to the prospect these worksaving wonders at a price he can *easily* afford!

If you're not selling all you *should* . . . all you want to sell . . . why not get in touch with your G-E distributor right away! General Electric Company, Appliance Park, Louisville 1, Ky.



This is the G-E Kitchen-Laundry that delighted so many househunters on opening day. Included are the G-E Refrigerator, G-E Range, G-E Dishwasher, G-E Cabinets and G-E Automatic Washer.



These are the Campanelli brothers (left to right: Nicholas, president; Joseph, treasurer; Alfred, vice-president; Michael, secretary). Within the past two years, Campanelli Bros., Inc. has completed 629 G-E equipped homes and has 406 under construction . . . all to be G-E equipped, as well. For *them*, G. E. pays solid dividends in faster home sales.

on opening day! *will yours?*



G. E. has a Kitchen-Laundry for your homes—regardless of price range!
(See your G-E distributor for answers to your kitchen problems.)



IN YOUR \$9,995 HOUSES

Include G-E Refrigerator, G-E Range, G-E Dishwasher, G-E Disposall,® G-E Cabinets. Add as little as \$3.26 monthly to mortgage payments.



IN YOUR \$12,500 HOUSES

Include G-E Refrigerator, G-E Range, G-E Disposall, G-E Dishwasher, G-E Automatic Washer, G-E Cabinets. Add as little as \$5.31 monthly to payments.



IN YOUR \$16,000 HOUSES

Include G-E Refrigerator, G-E Range, G-E Dishwasher, G-E Disposall, G-E Automatic Washer, G-E Dryer, G-E Cabinets. Add as little as \$6.31 monthly to payments.

HOME BUREAU

GENERAL  **ELECTRIC**

How Floyd saves \$89 on with Bildrite!



The reason Kimbrough Homes, Inc. switched to Bildrite was to provide extra insulation for their new, completely air conditioned homes. They got it. They also wound up with a sheathing saving of \$89 on homes like this. That's the nice thing about Bildrite. It helps you build a better home—more bracing strength, greater insulation value, tighter sidewalls—yet it cuts your costs, too. Pictures on these pages show how.

Floyd R. Kimbrough, Jackson, Miss.;
Pres. Kimbrough Homes, Inc.;
Past-Pres. Home Builders Assn. of Jackson;
Nat'l Dir. NAHB; Reg. V.P. NAHB;
Reg. Chmn. NAHB Bus. Mgt. Comm.;
Reg. Chmn. NAHB Legislative Comm.



Kimbrough homes like this



1. Bildrite goes up faster, easier.

One carpenter can sheath 1,000 square feet in 8 hours or less with Bildrite. Cuts application time as much as 43% compared with wood. Adds strength. 4' Bildrite has more than twice the bracing strength of horizontal wood sheathing. Eliminates need for corner bracing (F.H.A. accepted).

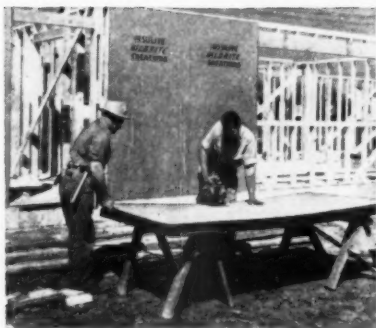

2. Easy to cut, reduces waste.

Bildrite cuts cleanly, quickly, easily with power saw or handsaw. Practically eliminates matching loss and waste. Compare 4' Bildrite's full coverage with the minimum 12% waste figured on horizontal wood sheathing jobs. What's more, carpenters like to work with Bildrite. It's clean.



3. Eliminates building paper.

Since Bildrite is water-proofed throughout with asphalt, there is no need for felt. It protects against moisture, yet is highly permeable to allow vapor to escape from inner wall areas. It's the ideal wet weather sheathing. Eliminates shrinkage problems. Use it, store it, anywhere in any weather.

INSULITE DIVISION, Minnesota and Ontario Paper Company, Minneapolis 2, Minnesota

INSULITE AND BILDRITE ARE REGISTERED TRADE MARKS.

Build and insulate with double-duty

INSULITE

the original structural insulation board



Save \$80 or more on your next job. Write today for Insulite's cost-comparison forms, product data and "case histories" of other builders and how they have built better for less with Insulite. Write Insulite, Minneapolis 2, Minnesota.



Ponderosa Pine Ads like this
are reaching 20,000,000
Readers of The Saturday
Evening Post



Companion of the good life ...Ponderosa Pine Woodwork

The good things of life are best enjoyed in the right setting. Small wonder, then, that Ponderosa Pine Woodwork forms a friendly background in so many homes where living is rich and full. Warm to the touch, appealing to the eye, Ponderosa Pine

windows, doors and cabinets express the spirit of comfort and open-hearted hospitality. Let your lumber dealer show you the many beautiful designs which Ponderosa Pine woodwork offers for your choice today. *Watch the Modern Trend in Wood.*

These are members of and contributors to Ponderosa Pine Woodwork

LUMBER: Alexander Stewart Lumber Co. • Anacosta Copper Mining Company • Associated Lumber & Box Company • Blagen Lumber Company • Brooks-Scanton, Inc. • Cascade Lumber Company • Collins Pine Company • Crane Mills • Crawford Lumber Company • Gibson Lumber Company • Hayfork Lumber Company • Edward Hines Lumber Co. • Industrial Wholesale Lumber Co. • Long Lake Lumber Company • McClellan Lumber Company • Michigan-California Lumber Company • J. Helt Lumber Company • Okeoka Lumber Company • Oregon Lumber Company • Paulsen Lumber & Box, Inc. • Pickering Lumber Corporation • Sarsor Forest Products • Ralph I. Smith Lumber Co. • Torter, Webster & Johnson, Inc. • Weyerhaeuser Sales Company • Wisconsin Lumber Company • WOODWORK: Anderson Corporation • Anson & Gilkey Company • Wm.



Cameron & Co. • Carr, Adams & Estler Company • Cole Manufacturing Co. • Continental Screen Company • Curtis Companies Incorporated • Farley & Loetscher Mfg. Co. • Great Lakes Millwork Corp. • The Hutchins Brothers Co. • Hurd Millwork Corp. • Hurst Manufacturing Co. • Ideal Co. • The Lang-Bell Lumber Company • The Maple Manufacturing Co. • Minnoda White Pine Sash Co. • Morgan Company • Northern Sash & Door Company • Philadelphia Screen Mfg. Company • Beach & Husser Company • Back Island Millwork Company • Buckwell of Randolph, Inc. • Sealing-Heaska Company • The Silver Company • The Watsook Screen Door Company • White Pine Sash Company • ASSOCIATE MEMBERS: Chapman Chemical Company • The Derris Lumber & Moulding Company • McKuen Moulding Company • Protection Products Manufacturing Co.

• WESTERN PINE ASSOCIATION

How Ponderosa Pine puts you ahead in the shift to quality building

The shackles are off! Now the new housing legislation opens a vast new market for better homes. No longer are builders forced to choose the cheaper, less durable and less beautiful materials that can cause owner "come-backs."

Already, wide-awake builders are moving into this new market. And more than ever, they are finding Ponderosa Pine windows, doors and cabinets a big aid in selling the better class of homes. Outstanding in beauty—easily cared for and lastingly durable—Ponderosa Pine is today the mark of superior home *value*. For information, write Ponderosa Pine Woodwork, 105 W. Monroe Street, Chicago 3, Illinois.

It's new—different—this revolving display that puts miniature Ponderosa Pine doors right out on the dealer's counter—helps you to quickly select the *right* doors for any home.



These are members of and contributors to Ponderosa Pine Woodwork

LUMBER:

Alexander-Stewart Lumber Co.
Anaconda Copper Mining Company
Associated Lumber & Box Company
Blagen Lumber Company
Brooks-Scanlon, Inc.
Cascade Lumber Company
Collins Pine Company
Crane Mills
Crawford Lumber Company
Gilchrist Timber Company
Hayfork Lumber Company
Edward Hines Lumber Co.
Industrial Wholesale Lumber Co.
Long Lake Lumber Company
McCloud Lumber Company
Michigan-California Lumber Co.
J. Neils Lumber Company
Ochoco Lumber Company
Oregon Lumber Company
Peshastin Lumber & Box, Inc.
Pickering Lumber Corporation
Setzer Forest Products
Ralph L. Smith Lumber Co.
Tarter, Webster & Johnson, Inc.
Weyerhaeuser Sales Company
Winton Lumber Company

WOODWORK:

Andersen Corporation
Anson & Gilkey Company

Wm. Cameron & Co.
Carr, Adams & Collier Company
Cole Manufacturing Co.
Continental Screen Company
Curtis Companies Incorporated
Farley & Loetscher Mfg. Co.
Great Lakes Millwork Corp.
The Hatchkiss Brothers Co.
Hurd Millwork Corp.
Huttig Manufacturing Co.
Ideal Co.
The Long-Bell Lumber Company
The Malta Manufacturing Co.
Missoula White Pine Sash Co.
Morgan Company
Northern Sash & Door Company
Philadelphia Screen Mfg. Co.
Roach & Musser Company
Rock Island Millwork Company
Rockwell of Randolph, Inc.
Semling-Menke Company
The Silcrest Company
The Wabash Screen Door Company
White Pine Sash Company

ASSOCIATE MEMBERS:

Chapman Chemical Company
The Dorris Lumber & Moulding Co.
McKuen Moulding Company
Protection Products Mfg. Co.

and WESTERN PINE ASSOCIATION



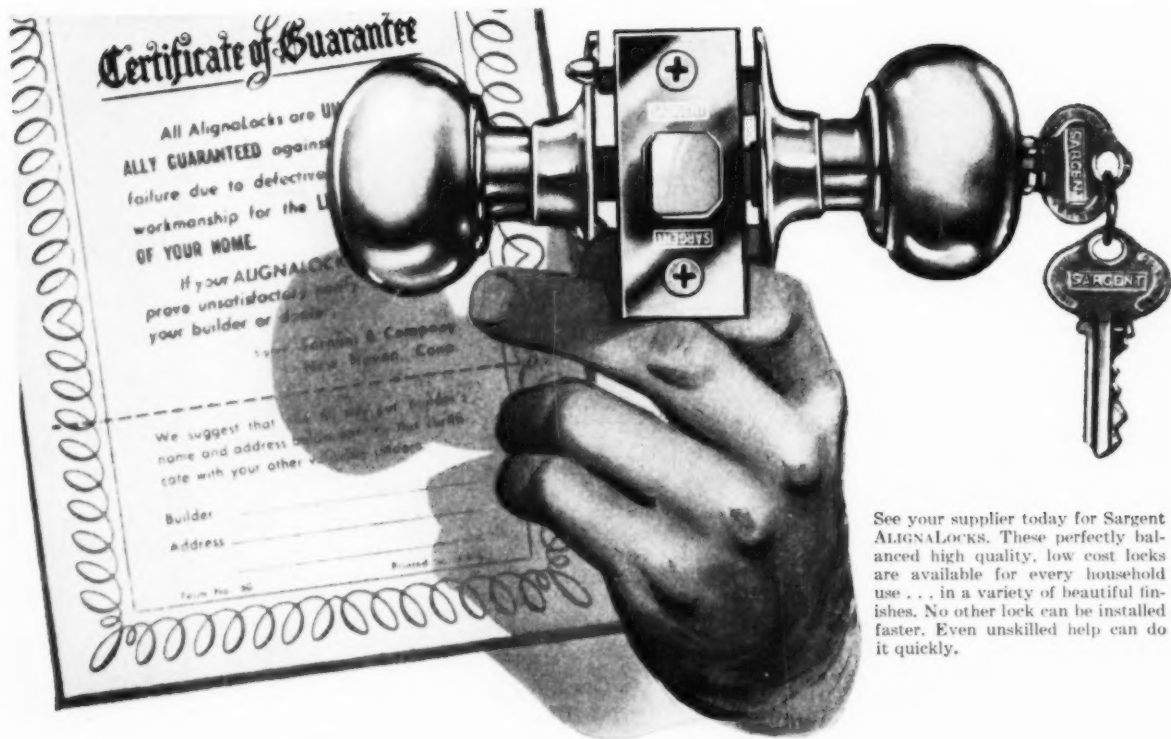

See your supplier today for Sargent ALIGNALOCKS. These perfectly balanced high quality, low cost locks are available for every household use . . . in a variety of beautiful finishes. No other lock can be installed faster. Even unskilled help can do it quickly.

Here's a *Guarantee Certificate* that really works for you!

The beautiful new high quality, low cost ALIGNALOCK is *fully guaranteed* by Sargent of New Haven . . . a name home buyers know and respect.

But the value of this guarantee to you does not stop *there!* There is a plan behind it that helps to sell your homes more easily and quickly! Here's how it works:

Sargent will send you *free* our kit of "Home Selling Aids." This kit consists of 3 different kinds of sales aids . . . each of which impresses the prospective home buyers with the value of the ALIGNALOCK Guarantee to *him* . . . and *her*.

You get 4 free ALIGNALOCK Guarantee Certificates.

You get 4 free ALIGNALOCK signs which say, "ALIGNALOCK—the Sign of a Well Built House. Guaranteed by Sargent of New Haven."

You get 200 copies of a colorful folder, which, in addition to pointing out all of the ALIGNALOCK features, also emphasizes the Guarantee.

So write, phone or wire us for this kit of ALIGNALOCK sales aids today. You'll find that the ALIGNALOCK Guarantee *really works* for you!

Sargent & Company
New York • NEW HAVEN, CONN. • Chicago



Hardware of Character



This Sargent Guarantee Certificate, displayed in new homes, indicates *quality* throughout.



Put this Sargent Sign on window sills and other convenient spots around your houses.

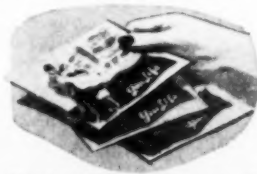

Hand out these folders . . . mail them to prospects . . . and leave them where they can be picked up.



Use West Coast lumber—the building material with an outstanding record of performance—for sub-flooring. Wood's natural qualities give it high strength, great nail-holding ability, and the important advantages of resiliency and insulation. West Coast lumber is time-tested in conventional construction. And, as always, it remains the natural choice of the day's most creative designers. Specify the West Coast species for dependability... Douglas Fir, West Coast Hemlock, Western Red Cedar and Sitka Spruce.

Send for folder describing free literature available for your reference files.
West Coast Lumbermen's Assn.,
1410 S. W. Morrison St., Portland 5, Ore.

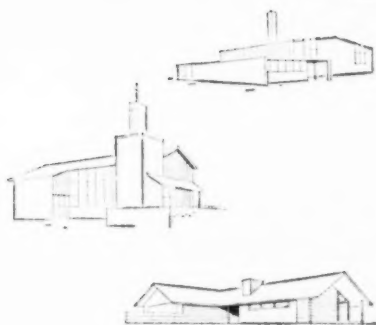

Douglas Fir • West Coast Hemlock
Western Red Cedar • Sitka Spruce

WEST COAST LUMBER

whatever the job, consider WOOD FIRST!

COMPARE *only STEEL kitchens can offer so much!*



HERE'S WHY STEEL IS BEST FOR KITCHENS:

- ★ Labor savings on installation.
- ★ No painting or repainting.
- ★ Mass-production savings.
- ★ Bugproof, fireproof, termiteproof.
- ★ Greatest strength, most beautiful.
- ★ Better finish (porcelain enamel or Hi-Bake enamel).
- ★ Will not warp, rot, swell, stick or splinter.
- ★ Precision-built, consistent quality.

Now check and compare the completely installed (ready to use) cost of any kitchen you are planning or using . . . and you, too, will choose steel Youngstown Kitchens.

HERE'S WHY YOUNGSTOWN KITCHENS ARE USED by more builders than any other steel kitchen:

FAST, EASY INSTALLATION

TIMED DELIVERY

LOW INSTALLED COST

COMPLETE COLOR COORDINATION PLAN

MORE PROSPECT-WANTED FEATURES

PUBLIC PREFERENCE BY 5 TO 1

Steel Youngstown Kitchens with planned color decoration make a sure-fire sales combination you can't afford to miss. For complete details, contact your Youngstown Kitchens distributor, or write: *Builder Sales Department, Mullins Manufacturing Corporation, Warren, Ohio.*

 **STEEL**
Youngstown Kitchens

MULLINS MANUFACTURING CORPORATION • WARREN, OHIO

Sold in United States, Canada and most parts of the world

CABINETS OF STEEL FOR LASTING APPEAL

How the new income tax law affects builders

By John F. McCarthy

Attorney at Law

Last month's article, the first of this special series (see *American Builder*, October, p. 70) dealt with changes made by the new Federal Internal Revenue Code of 1954 which are of general interest to all taxpayers. The new Code also directly affects all business, including construction and home building, in many particulars. This and subsequent articles will consider some of the changes affecting the construction and home building fields.

Under previous laws and regulations, a builder who kept books and filed income tax returns on an accrual basis might use, among others, the completed contract method or the percentage of completion method in computing gross income and deductions on building or construction contracts performance of which covered a period of more than a year. The first or completed contract basis deferred any accounting for any gain or loss until the particular job was completed. The second or percentage of completion basis permitted gain or loss to be computed at various intervals as the particular job progressed. Section 446 of the new Code throws some doubt on whether either of these methods hereafter may be used.

While Section 446(a) of the new Code permits a taxpayer to compute income on the basis which he regularly uses in keeping his books, Section 446(c) enumerates certain methods which he may use. These include the cash receipts and disbursements basis, the accrual basis, any combination of methods authorized by regulations and, in the language of the Act, "any other method permitted by this chapter." The argument may be made that neither the completed contract nor the percentage of completion basis hereafter will be available, because the enumeration of permissible methods in the Statute is exclusive and neither of these methods is mentioned there. Subsequent regulations of the Commissioner of Internal Revenue may clear up this possible difficulty.

Builders often receive so-called prepaid income. This generally is a payment received in one year for services to be rendered or goods to be delivered over a period of time extending beyond the year of the receipt of the money. One example of this is an owner of property who leases the same and receives rentals in advance. Under previous laws and regulations the whole of such payments was treated as income earned during the year of the receipt of the money. It was not spread over the period during which liability existed to render services or deliver goods.

Under the new Code, taxpayers who keep their books and file their returns on a cash basis still must regard the whole of such payments as income earned at the time of receipt. However, Section 452 of the new Code gives taxpayers on an accrual basis an option to defer such income.

The election to defer such income may be made, without the consent of the Commissioner of Internal Revenue, during the first taxable year after December 31, 1953, in which the taxpayer has prepaid income. It may be made at another time with the consent of the Commissioner. Such option, once exercised, applies to all prepaid income of the particular business of the taxpayer in which the income, the subject matter of the option, exists.

Prepaid income, where it may be deferred, must be allocated to the time or over the periods for which it is earned. However, it may not be spread further than the taxable year of its receipt and the five taxable years subsequent thereto. It must be confined to those six years even if it covers a liability over a greater period of time or over an indefinite period of time. Other allocations are permissible, however, with the consent of the Commissioner of Internal Revenue.

Sales of realty on an installment basis have permitted taxpayers to report income arising from such transactions on that basis—or, in other words, as the installments were received. That privilege is continued by the new Code. However, under previous laws and regulations, some payment must have been made during the year of sale and not more than 30 per cent of the selling price could have been received during any one year. Section 453(b) of the new Code eliminates the first requirement of a payment during the year of sale.

The new Code involves so many changes that each taxpayer should seek the professional advice of his own tax counsel to determine to what extent he may take advantage of the new Code's benefits. We continue to urge that action on each reader.

What you should know about construction and permanent loans

Next article—"How to secure loan commitment"

Lack of adequate financing can seriously hamper the builder's sales program and, consequently, his ability to continue his building operation. Therefore, this article will deal primarily with construction loans and permanent loans, as they influence prospective purchasers, and will give a brief description of the various types of loans available. Knowledge of financing methods is almost as important to the builder as knowing how to efficiently produce a house.

Very few contractors would be able to produce a home and find ultimate home buyers were it not possible to secure (1) adequate construction financing and (2) adequate permanent financing. Easy methods of financing stimulate the demand for new homes and home construction. Having available a variety of loan plans is comparable to having a full stock of merchandise on the shelf from which the purchaser can choose.

Construction loans

A construction loan is one where either a short-term or permanent loan is made and recorded before construction begins, and the proceeds are paid out as construction progresses and as periodical inspection of the work justifies.

A short-term construction loan usually is made for a period of one or two years to enable the builder to complete construction of the house. Simultaneously with such a loan, the builder usually secures a commitment for a permanent loan to a prospective purchaser.

The long-term or permanent construction loan is most popular and allows the builder to secure the maximum amount for the longest time allowable (exclusive of FHA or VA which have certain restrictions). This type of loan can be easily transferred to a purchaser at a minimum of cost with provision for release of the builder's liability.

Many institutions promote the use of construction loans for further business development and offer a variety of services to both builders and prospective home owners. These vary from home planning centers, plan services, construction methods and exhibits, construction libraries, architectural services and even accounting assistance. In subsequent articles, we will elaborate on what the lender expects from the builder.

So much for construction loans. Now let's discuss the types of loans available.

Essentially, there are three basic types of loans available for the construction or purchase of a home. The conventional loan, the Federal Housing insured loan and the Veterans Administration guaranteed or insured loan. However, only two of these can be made direct to a builder—the conventional and the FHA. The VA loan can be made to a veteran only. Let's explore the differences between these various types.

The "conventional" loan

This includes all loan plans in which the federal government does not directly participate either by guaranteeing or insuring the loan. The lending institution advances its own money to the borrower and assumes all the risk in case of a default. This type of loan is usually more restricted as to the amount and term. However, it is a more flexible mortgage contract and offers many features not found in loans guaranteed or insured by the government. These features are:

1. Shorter processing time—a definite commitment can be secured from a period of 24 hours to a few days, depending on problems encountered.
2. "Package mortgage" clause to cover the improvements and

By Joseph Nowicki

Loan Officer,
Chicago Federal Savings and
Loan Association

facilities the home buyer intends to mortgage as part of the real estate, including such things as blinds, storm windows and screens, refrigerators, stoves, laundry equipment, and even carpeting.

3. An "open end" clause to permit the borrower to obtain additional advances on the mortgage for use in improving the house, or other purposes.
4. A prepayment privilege to allow borrowers to prepay on their loan in any amount and at any time. A surprising number of families will prepay on their loans to insure against the foreclosure of the loan in event income should stop for six months or a year.
5. Some provision for a grace period, such as 90 days, for a loan paid according to the mortgage contract for three or more years.
6. A "loan modification agreement" may be used to take a loan out of default, to change the monthly payments and extend the loan, to adjust the interest rate, or for other purposes.

Fully 73 per cent of all mortgage loans made are conventional loans and of this figure 46 per cent are by savings and loan associations.

Most lending institutions are subject to state or federal laws which limit the amount of loan they can make on the conventional loan plan. The following table shows the prevailing statutory limitations. These percentages may vary in the different states.

Type of Institution	Statutory Limitations
Federal Savings & Loan Associations	75 or 80 per cent
State Savings and Loan Associations	66 2/3 to 80 per cent
Mutual Savings Bank	60 to 80 per cent
Life Insurance	66 2/3 to 75 per cent
State Banks	60 per cent
National Banks	60 per cent

The FHA loan

The FHA (Federal Housing Administration) does not make mortgage loans. It insures loans made by approved lending institutions previously mentioned. The lending institution advances the funds to the borrower and the FHA insures that the lender will not suffer a loss on the loan. The borrower pays a 1/2 per cent insurance premium to the FHA for this protection. So, in effect, the true rate to the borrower is 1/2 per cent higher than the stated rate of 4 1/2 per cent.

Within recent weeks we have seen the passage of the Housing Act of 1954. The most significant portions of this new act are: the increase in the loan amount; the extension of the terms to 30 years; and the provision for open end advances. The new terms as compiled by FHA are shown below.

Attention is called to the fact that the FHA value does not necessarily correspond to the sales price; therefore, the downpayment may differ

depending on the spread between the FHA valuation and sales price.

FHA is not too concerned about the sales price on any property. The loan is based entirely upon their appraised value and within the limits prescribed by law.

The GI loan

The principal activity of the VA (Veterans Administration) in the mortgage lending field is to guarantee or insure loans to eligible World War II and Korean veterans. Only veterans who qualify can secure this type of loan and then only for the purpose of purchase, construction, repair, alteration or improvement of residential property. The important feature of this type loan, compared to both the conventional and FHA, is that for the loan to be eligible for guarantee or insurance, the price paid or to be paid by the veteran cannot exceed the "reasonable value" thereof as established by the VA.

It is possible to secure loans up to 100 per cent of the purchase price and terms up to 30 years. The long term, low interest rate (4 1/2) and no or low down payments make this loan attractive to veterans. Consequently, many operative builders obtain certificates of Reasonable Value prior to beginning construction so they can offer a VA loan.

HOUSING ACT OF 1954—NEW HOMES

Maximum Mortgage Amounts, Minimum Down Payments, and Monthly Mortgage Payments¹ for FHA Program and Comparison with Previous Legislation
Owner-Occupant Mortgagor for NEW One- or Two-Family Structures

Housing Act of 1954				Previous Legislation ²				
FHA Value	Maximum Mortgage	Loan-Value Ratio	Down Payment	Monthly Payment ³	Maximum Mortgage	Loan-Value Ratio	Down Payment	Monthly Payment ⁴
\$ 6,000	\$ 5,700	95.0%	\$ 300	\$ 31.22	\$ 5,700	95.0%	\$ 300	\$31.22
7,000	6,650	95.0	350	36.42	6,650	95.0	350	36.42
8,000	7,600	95.0	400	41.62	7,350	91.9	650	43.83
9,000	8,550	95.0	450	46.83	8,050	89.4	950	48.00
10,000	9,300	93.0	700	50.93	8,750	87.5	1,250	52.18
11,000	10,050	91.4	950	55.04	9,450	85.9	1,550	56.35
12,000	10,800	90.0	1,200	59.15	9,600	80.0	2,400	57.25
13,000	11,550	88.8	1,450	63.26	10,400	80.0	2,600	62.01
14,000	12,300	87.9	1,700	67.36	11,200	80.0	2,800	66.78
15,000	13,050	87.0	1,950	71.47	12,000	80.0	3,000	71.56
16,000	13,800	86.2	2,200	75.58	12,800	80.0	3,200	76.33
17,000	14,550	85.6	2,450	79.69	13,600	80.0	3,400	81.10
18,000	15,300	85.0	2,700	83.79	14,400	80.0	3,600	85.86
19,000	16,050	84.5	2,950	87.90	15,200	80.0	3,800	90.64
20,000	16,800	84.0	3,200	92.01	16,000	80.0	4,000	95.41
21,000	17,550	83.6	3,450	96.12	16,000	76.2	5,000	95.41
22,000	18,300	83.2	3,700	100.22	16,000	72.7	6,000	95.41
23,000	19,050	82.8	3,950	104.33	16,000	69.6	7,000	95.41
24,000	19,800	82.5	4,200	108.44	16,000	66.7	8,000	95.41
25,000	20,000	80.0	5,000	109.53	16,000	64.0	9,000	95.41
30,000	20,000	66.7	10,000	109.53	16,000	53.3	14,000	95.41

¹ Monthly payments include principal, interest at 4 1/2 per cent per annum, and 1/12 the second annual mortgage insurance premium at 1/2 per cent per annum.

² For a two-bedroom house.

³ For a term of 30 years.

⁴ For a term of 25 years except for mortgage amounts of \$5,700 and \$6,650 for which the monthly payments are computed for the maximum term of 30 years. (Compiled by FHA)

A Customer For Redwood... Is A Prospect For



That's right... everytime you have a customer for Redwood or Red Cedar — and they're growing in numbers every day — you'll have a customer for P.A.R. after you've shown him how P.A.R. gives woods of this type that beautiful natural, glossless finish, plus added protection against...

- ... Discoloration — weathering
- ... Grain Raising
- ... Checking — warping
- ... Swelling — shrinking

Don't overlook this lucrative business! Make P.A.R. available — in quarts, gallons and 5-gallon pails — to Redwood users in your area! Send the coupon or ask your jobber for full information.

New! **WOODLIFE**
The Original WATER REPELLENT PRESERVATIVE
FOR YOUR "DO IT YOURSELF" MARKET!

This new folder, "101 Tips" has been prepared for customers and prospects of dealers stocking WOODLIFE, the leading water repellent wood preservative. It tells as it tells how WOODLIFE can and should be used around the home. Available in quantity, FREE OF CHARGE, for your distribution.



Send today to:

Protection Products MANUFACTURING COMPANY

PROTECTION PRODUCTS MFG. CO.
DEPT. A, KALAMAZOO, MICH.

Send information on P.A.R.

Send () copies of the "101 Tips" folder.

NAME _____

ADDRESS _____

CITY _____ STATE _____

OUR JOBBER IS _____

Builders get land for less by pooling

- Improved lots are at a premium, so small builders must seek new ways to acquire land.
- In Milwaukee, a realtor-developer has worked out a plan for cooperating builders.
- Outlook now may be for builders in other areas to form their own land-developing corporations.



Subdivision for small builders

Plenty of lots for 20 cooperating builders

As builder operations move into the suburbs, improved land becomes more scarce. Big builders have the facilities and the finances to develop raw land on their own. Small builders have a much tougher time. They can't find developed lots that are cheap enough to give them a chance to compete.

In Milwaukee, an enterprising realtor-developer offers a cooperating group of builders a chance to solve their problem. Builders there, who have joined the pool, get improved lots when they want them. They get these lots cheaper too, because subcontract rates are cheaper. As a result, the cooperating builder's costs go down. This year, 20 builders in Milwaukee had the chance of participating in this land pool. Their experience points to the way builders may well consider cooperating among themselves in the future.

How builder fits into plan

August Urbanek of Rite Realty Company, Milwaukee, offers this idea to builders in his area: "You need improved lots on which to build. Join together in an agreement to buy lots that I will develop for you and here is what Rite Realty will do for you."

1. *Buys all land.* Land costs in the vicinity of Milwaukee are about \$2,000 an acre for desirable, unimproved land near sewer and water outlets, transportation and schools.

2. *Develops land,* puts in streets, water, sewers. A typical tract was one of 130 acres planned to contain 400 lots. To put in sewer and water cost \$225,000. Rite Realty paid \$25,000. Bank loaned \$100,000. Sewer and water contractor put up \$100,000 for six months period. All builders who bought these lots agreed to pay that assessment within the six months period.

At the time the builder signed the construction mortgage, the lending institution, from the proceeds of the mortgage, paid off the sewer and water lien before recording their first mortgage of record.

3. *Sells land* to builders according to builder's esti-

mated need for a specified period. Average price of lots is \$2,000 each. Buyer could buy another similar lot for same price elsewhere, but probably could neither buy a sufficient number for his needs nor buy them conveniently enough within the same immediate area.

If the builder bought these lots elsewhere, he would probably have to pay cash. Under cooperative system, builder does not have to tie up so much of his money. A speculative builder signs a 30-year mortgage, can buy lots from Rite Realty for \$100 to \$500 down. The balance of the purchase price is due upon sale of house. For example: the cost of a lot is \$2,000. The down payment is \$500 upon delivery of the deed. The second mortgage of \$1,500 is due and payable upon completion and sale of property by the realty company.

On the other hand, some builders may want to buy only one lot, build a model house on it and use it as a basis for selling others. Rite Realty sells houses from this model to buyers in any one of 13 subdivisions owned by the realty firm. Here, builder has little money involved except for the lot and the model home. Whether a speculative builder or a conservative one, each needs only a limited amount of capital.

4. *Handles all sales* of homes built. Handles radio, TV, and newspaper advertising for all builders cooperating. To offset costs of real estate broker's commission to Rite Realty, reduced costs are achieved by pooling advertising, cost of brochures, by getting cheaper subcontracting rates. For a builder who builds a \$14,900 house, for example, and builds 10 or more of them, Rite asks for a four per cent broker's commission.

5. *Offers lower subcontractor costs* because subcontractors, virtually assured of many jobs within one area, can reduce their bids to builders. The builder can use this service or his own subcontractor—whichever he finds costs the least.

Take the builder mentioned above who cooperates in the plan and builds a \$14,900 house. Under ordinary conditions, he would have to pay another broker five

per cent commission. The cost of his house would go up like this:

Basic cost of house	\$14,900
Five per cent commission	745
Resultant cost of house	\$15,645

But under the cooperative system:

Basic cost of house	\$14,900
Four per cent commission	596
Resultant cost of house	\$15,496

However, this builder's pooled savings, because he used cooperative subcontracts, gave him these additional savings:

\$300 saved for plumbing
75 saved for heating
50 saved for electrical work
100 saved for miscellaneous items.

\$525 Total sum saved

When this figure of \$525 is subtracted from the \$15,496 figure, it means that the builder in question was able to sell his house for \$14,971—almost the amount the house cost the builder before he paid the broker's commission to the Rite Realty Company.

6. *Processes all FHA and VA forms* for builders. This saves the builder valuable time, frees him from red tape.

7. *Offers advice to builder* as to floor plans, design. Builder may build as he chooses, but he can receive benefit of Rite's past experience with prospects and buyers as to what they have wanted in a house.

8. *Offers builders a chance* to increase their production because lots are available when builder wants them. Bill Johnson, builder from Malwaukee, used to build about 10 houses a year. Now that he has joined the plan he builds 150 houses a year.

Carl Stessl built 15 houses the first year he joined the pool; now has increased his production to 60 or 70 houses a year.

9. *Chooses applicant builders* on the basis of past record for honesty, integrity, reputation of building a quality product.

10. *Asks that builders cooperate* by placing all compensation and liability insurance with subsidiary of Rite Realty. (Milwaukee Insurance Center is owned by Rite Realty Company.) However, the possibility of being an insurance broker as well as a realty land corporation means added business and profits. One insurance policy leads to another. Buyers of houses are prospects for future property insurance policies.

How builder benefits

1. Builder's land worries are over, has land when he wants it.
2. Builder saves money by pooling because of subcontracting, and the pooling of advertising.
3. Builder is freed from being in model home on Saturdays and Sundays, because selling is done for him.
4. Builder can sell his house at his original basic price because pooled subcontracting for volume building means lower prices.
5. Saves time and money because he does not have to process FHA and VA papers.
6. Builder is assured of desirable land because land is chosen carefully, land is set aside for shopping

(Continued on page 200)

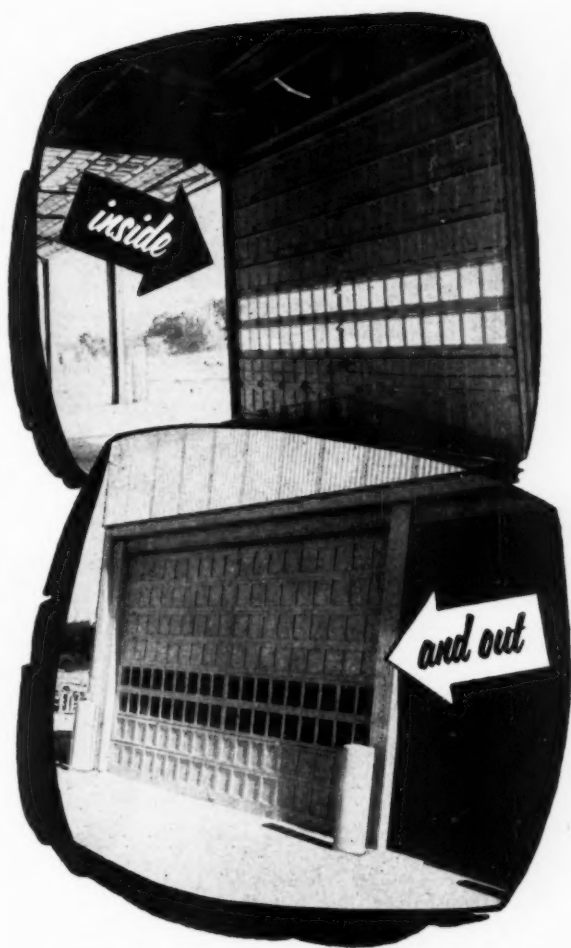

Raynor Commercial & Industrial Doors are **TAILOR MADE** TO FIT THE OPENING!

Designed by Raynor engineers and built complete in Raynor Manufacturing Company's factories... a Raynor Wood Sectional Overhead Door embodies the special door engineering and specialized door construction that assures a full dollar value in trouble free performance, lasting beauty and satisfaction of ownership.

All Raynor residential, commercial and industrial doors contain three-way stress construction and exclusive Raynor Graduated Seal.

Check your telephone directory or write direct for the name of your nearest Raynor representative.



RAYNOR

MANUFACTURING COMPANY, DIXON, ILL.

Builders of a Complete Line of Wood Sectional Overhead Doors



THE MULTI-LAYER REFLECTIVE INSULATION USED IN THE NAHB AIR CONDITIONED VILLAGE

ALFOL BUILDING BLANKET INSULATION

Yes, ALFOL was the multi-layer reflective insulation used on this great NAHB project. And no wonder. ALFOL is an air conditioning "natural."

As proven by the U. S. Bureau of Standards (BMS 52), *nothing*—not even full-thick bulk material—provides the summer value of two-ply reflective insulation in a ceiling. And ALFOL is "First in Reflective Insulation." The result:

ALFOL CUTS INSULATION COSTS, LOWERS OPERATING ESTIMATES, OFTEN PROMOTES THE USE OF A SMALLER SIZE CONDITIONING UNIT!

These cost-slashing, sales-promoting benefits result largely from ALFOL's low heat-storage capacity. Made of multi-ply aluminum foil, ALFOL reflects heat . . . instantly and continuously. Moreover, it attacks all 3 forms of heat transfer; delivers a year-'round average efficiency that is unsurpassed.

ALFOL provides another major feature—a positive, continuous vapor barrier . . . the best obtainable! As a result, vapor condensation (a year-'round problem in air conditioned homes) is permanently, effectively banished.

Yet for all these advantages, ALFOL usually costs less. Rapidly applied because its heavy duplex backing resists ripping. Packaged in handy 500 or 250 sq. ft. rolls, its remarkable compactness makes handling and storage a breeze . . . particularly on project work. ALFOL is available in 5 Types, 4 widths.

For your Air Conditioned project, why not investigate ALFOL?

ALFOL
BUILDING BLANKET INSULATION
"FIRST IN REFLECTIVE INSULATION"

We'll send full details plus Report BMS 52.
Address your letterhead to Dept. AB-11.

REFLECTAL CORPORATION
A Subsidiary of
310 So. Michigan Ave.  Borg Warner
CHICAGO 4, ILL.

Why not dress up that outside stairway?



A single, free-standing concrete stringer supports the stairs leading from an open court to second floor offices in the David Barry Shopping Center in West Los Angeles.

The six-inch-wide stringer has a 1 foot 3 inch high by 3 foot wide continuous concrete footing, the top of which is three inches below the finished grade line. Top portion of the stringer also is free standing. It cantilevers out 4 feet from a vertical strut to within five inches of the second floor balcony line.

The stairway, which is built at a 25 foot radius from a given point on the face of the balcony to the center of the six-inch wide stringer, is 4 foot 6 inches wide with 20—11½-inch wide treads. These stair treads are formed from 5/16-inch steel plates turned up at the back for anchoring to the angle riser, and bent at the front to form the nosing for treads.

Treads are filled with cement 1¾ inches thick. All treads are supported by 6x4x3/8x6-inch long angles secured to the concrete stringer. Bottom leg of these angles are bent to the slant of the top face of the stringer and set to conform to the stringer's radius. The top of the vertical leg of the steel angle is welded to the bottom of the steel pan of the treads.

To cover the gap between the face of the balcony and the upright portion of the bent plate of the top tread, 2½-inch wood nosing is secured flush with the upper edge of the balcony.

The 1½-inch diameter vertical pipe standards and 1½-inch diameter top and intermediate rails that follow the rake of the stairs are welded in place. Standards are welded to an 8x16x¾-inch steel plate which is secured to the underside of the steel pan of the tread. Rails are welded to the vertical standards.

AMERICAN BUILDER'S BETTER DETAIL PLATE

Designed by Caughey & Ternstrom, Architects

Detailed by Carl Zintl, Architect for American Builder

NO. D-117 EXTERIOR STAIR

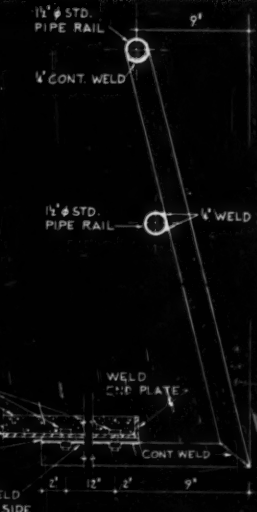
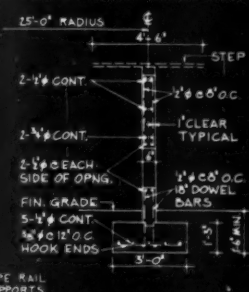
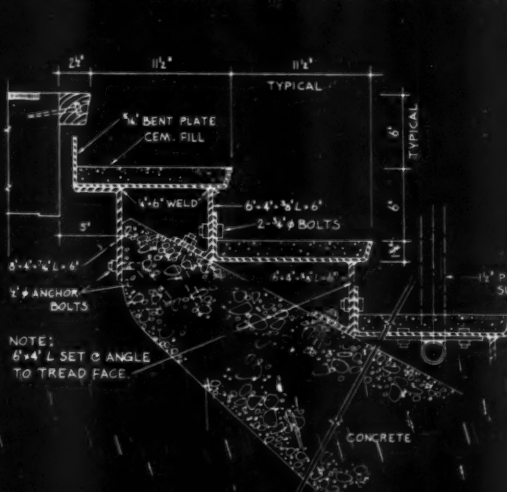

NOTE:
8'-4" L SET @ ANGLE
TO TREAD FACE

SECTION 'A' AT CL OF STAIR

SECTION

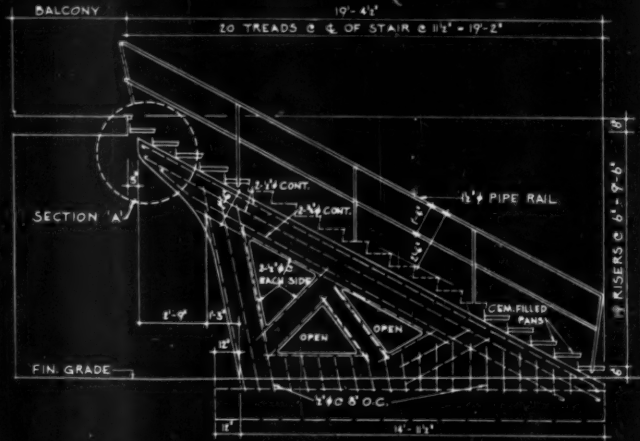
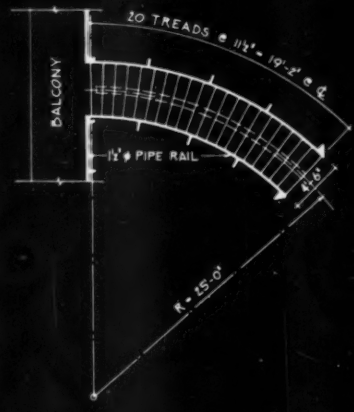

PLAN

ELEVATION DEVELOPED

Houses sell faster

...when you use plenty of

Pittsburgh Glass



YOU GIVE YOUR HOMES real value when you install a Pittsburgh Plate Glass mantel mirror like this one. Buyers know that they are getting quality workmanship in the rest of the house, when Pittsburgh Glass products are supplied. Besides, a large mirror of this kind gives any room in which it is installed a more elegant and spacious look. With the new brackets, even large Pittsburgh structural mirrors can be installed easily and quickly. And they take care of wall irregularities. Decorations by Marie Stosskopf, A.I.D., Chicago. Furniture by Heywood-Wakefield.



AS ANY HOMEMAKER will tell you, a full-length door mirror—in the bedroom, bathroom, entrance hall—is one of the most-wanted features. Full-Length Door Mirrors by Pittsburgh are noted for their true and brilliant reflections; people demand them. They're simple to install, too . . . take just a few minutes to put up. And they're really full-length—68" high. They come in five standard widths—16, 18, 20, 22, and 24 inches, which means that they fit more than 90% of all interior millwork doors. Here's a lot of added value at a low price!

Every nickel you spend on glass shows. And the results far outweigh the cost.



A **PICTURE WINDOW** is a feature that buyers have come to expect. Pittsburgh offers Twindow®, the window with built-in insulation, Solex® Heat-Absorbing Glass, as well as quality Polished Plate Glass, to help you meet any problem in connection with large glass openings. Decorations by Marian Quinlan, A.I.D., Chicago.

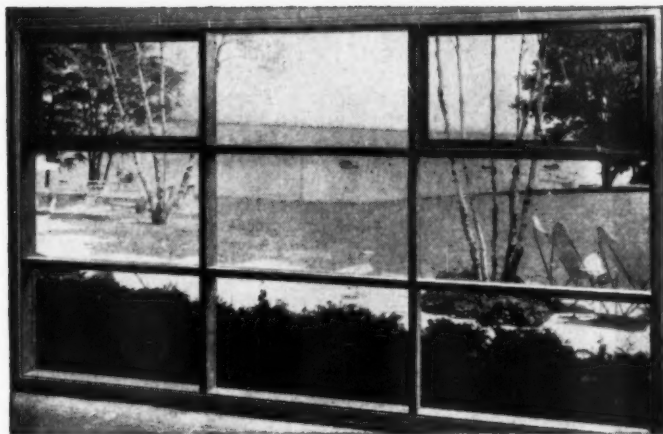

FOR SMALLER OPENINGS, Pennvernon®, because of its high quality, is recognized as the ideal window glass. TwindoWeld® - the all-glass insulating window with electrically-welded, all-glass edge—utilizes two panes of 1/4" thick Pennvernon, with a 3/16" air space between. TwindoWeld is the *de luxe* unit for smaller openings, offering long life, excellent insulating properties and extreme simplicity of installation.

Build it better with **Pittsburgh Glass**

See Sweet's Builders Catalog for detailed information on Pittsburgh Plate Glass products.

PAINTS • GLASS • CHEMICALS • BRUSHES • PLASTICS • FIBER GLASS



PITTSBURGH PLATE GLASS COMPANY

IN CANADA: CANADIAN PITTSBURGH INDUSTRIES LIMITED

Build extra value into your construction



Aluminum duct, for heating and ventilating adds value by cutting heat costs as much as 10 per cent. Can't rust or streak, need never be painted. Permanently attractive. Its lightness makes it easy to install.



Aluminum awnings add value because they beautify homes and at the same time reflect sun's heat. They're strong yet light, easy to install. Can't rust, can't burn, need little upkeep.



Aluminum windows add value because they won't warp, shrink, crack, rattle or leak. They won't mar building exteriors with ugly red rust stains. And they'll keep their silvery beauty for years.



Aluminum insulation adds value because it gives the homes you build extra protection against the weather. It keeps houses warmer in winter, thus cuts fuel bills. And it reflects summer heat, thus gives year-round comfort.

with ALUMINUM PRODUCTS!



Aluminum shingle roofing adds value because it can't rust or rot, keeps its modern good looks for a "housetime." Needs no paint or maintenance. Provides weathertight insulation against heat and cold.



Aluminum nails add value because they can never deface building exteriors with ugly rust stains, can never "rot out" ... thus help assure *permanent* beauty.

WHEN YOU SPECIFY aluminum products for your customers, your construction will have *greater sales appeal* — because aluminum provides a combination of advantages that no other material can match.

Among these advantages are light weight, strength, corrosion resistance, economy, and modern beauty.

Today, there is a plentiful supply of building products ... due in great part to our vast expansion. We now have the capacity to produce 30% of all the primary aluminum made in this country.

If you are using a standard building product you think would be better in aluminum, or if you have in mind any new product not now being manufactured, we will be glad to help you obtain the finished product you need.

Engineering assistance is available from our qualified aluminum engineers. Or for name of building products manufacturers who will be glad to work with you, contact any Kaiser Aluminum office listed in your telephone directory. Kaiser Aluminum & Chemical Sales, Inc., General Sales Office, Palmolive Bldg., Chicago 11, Ill.; Executive Office, Kaiser Bldg., Oakland 12, Calif.

Kaiser Aluminum

setting the pace—in growth, quality and service

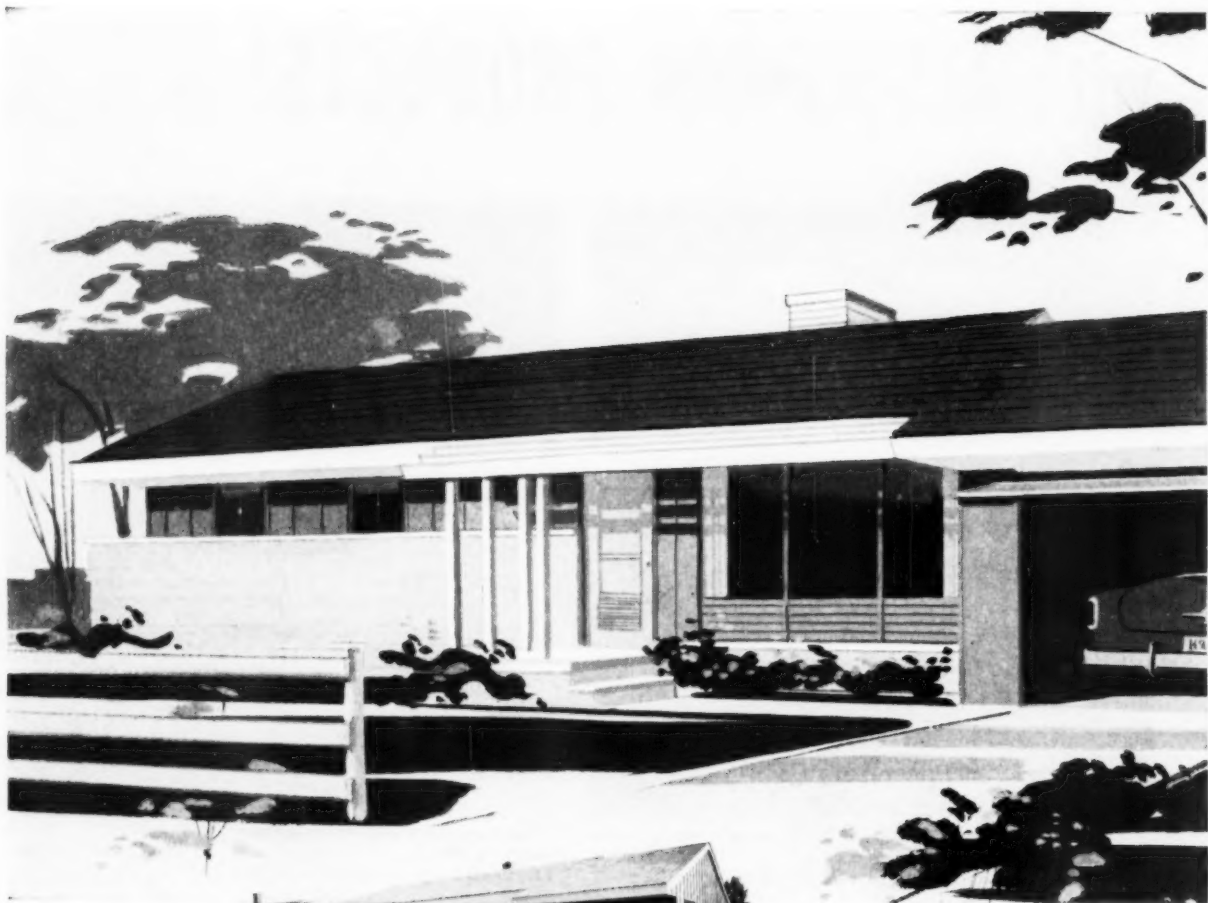

This is the new, 1955 "Windsor," pictured above, as it will appear with full landscaping. All Modern Home models are built and tested before production. This long, low, 3-bedroom home fea-

Precision-built of the finest materials . . . with such exclusive luxury features as



1. Unusually flexible interiors permit Modern Homes builder-dealers to meet local preferences in all degrees of luxury. Thermopane windows; dry-wall or plaster; open floor planning; sliding bedroom windows—your choice. Your customers' preferences are available in all twelve models.

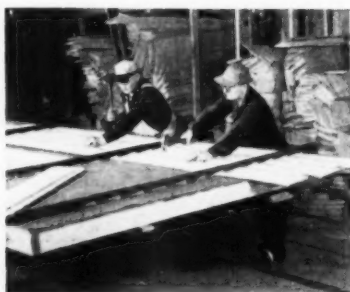

2. Precision machinery that can't make mistakes provides *precision workmanship* that can't be duplicated on the site at practical cost. Higher grade lumber; back-painted siding; and unique Klear-Span steel floor construction are standard due to mass production and volume purchasing.



3. Smaller models can be roofed, locked up within 6 hours of delivery to site. Savings: labor, vandalism, waste, cleanup. Higher unit profit is possible than on "customs." Most dealers pass on unit savings to customers; gain a price advantage—and multiply their total profits through *volume sales*.



Announcing the 1955 MODERN HOMES LINE!

*The builder
with the most discriminating buyers
can multiply his profits with this new line
of handsome homes*

The more value you place on your reputation for excellent craftsmanship and design, the more reasons there are for you to examine carefully the facts behind the new, 1955 Moderns.

These are truly *fine* homes. Precision methods offer a great potential for high quality; and this quality is achieved in every model—whether 2, 3, or 4 bedrooms. Modern Homes has made it possible for the *quality* builder to enjoy the savings, and the multiplied volume and profits, of factory-manufactured homes.

Modern Homes are built and sold through exclusively franchised builders whose special reputation and interest are in quality. If you are such a builder, read the facts and write for details before making final plans for next year. *Modern Homes Corporation, Dearborn, Michigan.*

tures power-operated windows, sound conditioning, big Thermopane windows, 1½ baths, birch kitchens, unique Klear-Span steel floor system, full garage and open, roomy planning.

power-operated windows!

modern  **homes**

CORPORATION



4. Exclusive features that add unique sales appeal include power-operated windows. Modern Homes helps you train erection crews; gives valuable assistance with site-planning, financing, color styling and merchandising. All models meet the building code requirements for *all* areas.



5. As Modern Homes builder-dealer, your reputation is reinforced by high standards of other franchised dealers . . . and by advertising in *LIVING for Young Homemakers*, *Better Homes* and *Small Homes Guide*, *Parents*, *Woman's Day*—aimed at your most promising prospects.

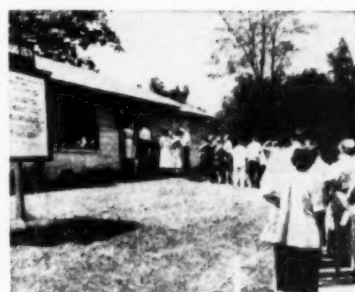

6. Proved "Open House" promotions (signs, photos, literature, displays) help franchised Modern Homes builder-dealers draw crowds, make sales. The factory provides local promotion and advertising; supplies radio and TV scripts, newspaper mats. Write for details today! Sell Moderns!

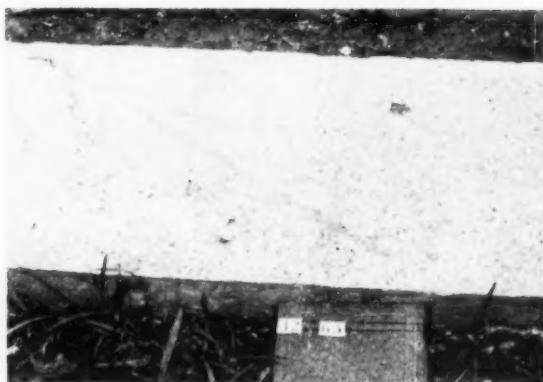
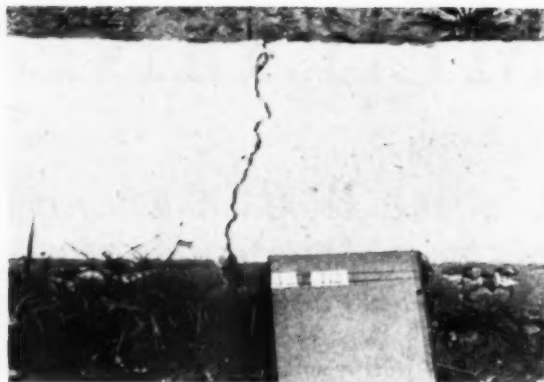

These two slabs are the same thickness, mix, and age, and have been exposed to the same climatic and sub-grade conditions at the Arlington (Va.) Experimental Laboratory of the United States Bureau of Public Roads. The

slab at left contains no reinforcement and the crack is noticeably open. The other is reinforced with welded wire fabric and the crack is barely visible

Photos courtesy Wire Reinforcement Institute, Inc.

Is crackproof concrete possible?

The answer is no. A concrete slab without cracks, even with the use of steel reinforcing, is not possible.

But is reinforcing necessary?

The answer is yes. Steel reinforcing should be placed in every slab. Without it, a soft area in the fill, or in the undisturbed ground below the fill, could result in a positive break in the concrete and a drop in the floor level. Reinforcing is found to be an excellent, low-cost "insurance" against destructive cracking and deterioration in concrete ground slabs.

With reinforcing, this condition is not possible. The reason for metal fabric or rods in concrete is not to prevent the formation of cracks, but to control and

minimize them. By reinforcing, cracks which form in concrete ground slabs as a result of shrinkage, loads, changes in temperature and the moisture content of the air, are kept closed. Because the small cracks are closed, water and dirt are denied entry from above and below the slab, loads are transferred from one crack edge to the other without shearing and failure, and deterioration of the slab is checked.

How should concrete be reinforced?

Where economy and speed of operation is essential, welded wire fabric is recommended. This is a prefabricated rectangular reinforcement consisting of a series

(Continued on page 138)

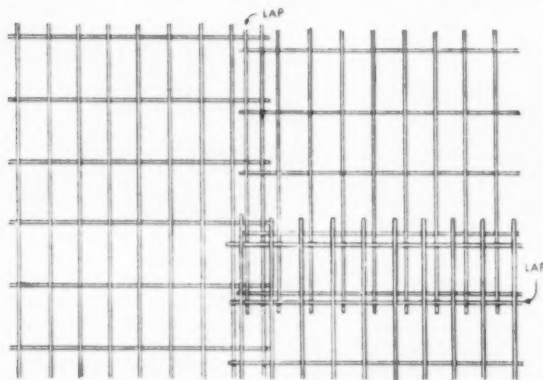

Welded wire fabric should be lapped as indicated to secure maximum reinforcing



Before pouring concrete for the reinforced concrete slab of a small home, fabric has been placed on blanket insulation over a prepared subgrade. Man with rake is working the concrete into and under the reinforcement, lifting it when necessary to a position approximately two inches down from the slab surface

MILCOR* Casing Bead

**Provides clean, protective separation
between plaster and other materials**

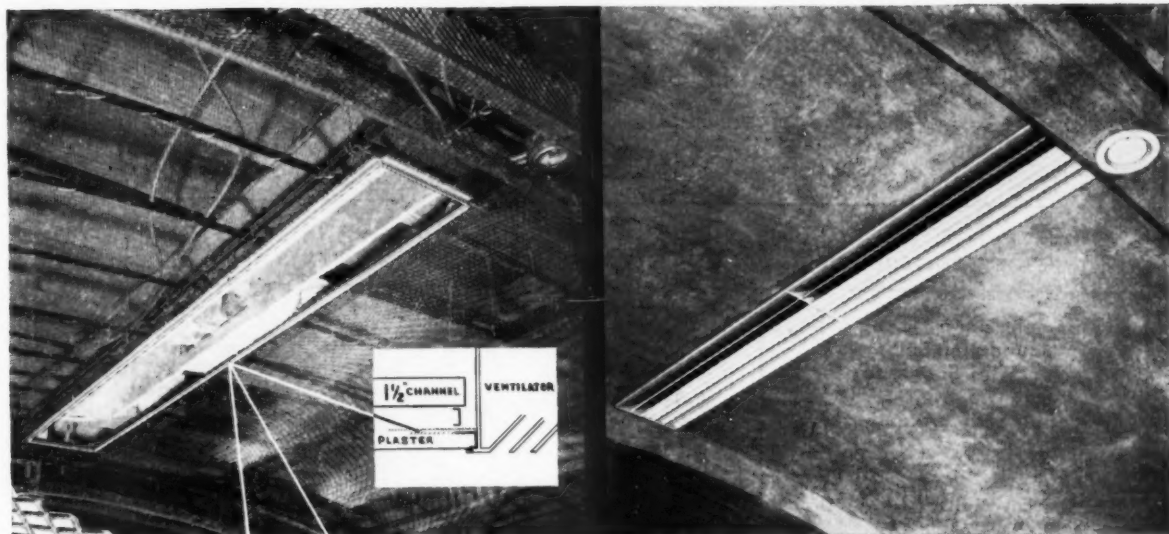

Milcor No. 66
Expansion Casing Bead

**Get a better all-around job
on door and window openings with
MILCOR Casing Bead**

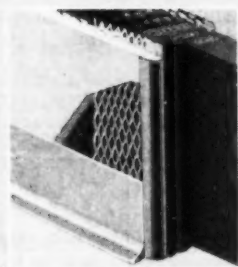

A variety of Milcor Casings is available in solid- and expansion-wing types to suit many requirements. Type No. 4 is used in the illustration at left — in combination with Milcor No. 657 Applied Metal Base and Milcor Smalmesh Metal Lath.

Note that a trim, narrow face is all that is exposed. The expanded wing provides a flush-tight junction of wall and casing. The casing bead acts as a screed to separate plaster from other material.

M-128A

Often eliminates the need for covering trim, batten strip, or cove mould over the joint

When they remodeled Mader's Famous Restaurant in Milwaukee, Wis., the architects called for plaster to abut a metal air-conditioning grill in the ceiling. Different co-efficients of expansion and contraction had to be accommodated. And that's where Milcor No. 66 Casing Bead filled the bill.

Milcor Casing Bead provided a sharp, permanent line of separation between the metal-lath and plaster ceiling and the grill covering duct-work.

Many architects specify Milcor Casing Bead to do a job like this — and for other advantages, also: (1) The permanence of steel. (2) Ease of installation. (3) Perfect mitres and neat joints flush with the plaster surface. (4) Resistance to fire and impact.

For full information on Milcor Casing Bead and other products in the complete line of Milcor Metal Lath and accessories, turn to the Milcor Manual in Sweet's. Write for catalog

*Reg. U. S. Pat. Off.

INLAND STEEL PRODUCTS COMPANY

4025 WEST BURNHAM ST. • MILWAUKEE 1, WISCONSIN

BALTIMORE 5, MD., 5300 Pulaski Highway — BUFFALO 11, N. Y., 64 Rapin St. — CHICAGO 9, ILL., 4301 S. Western Blvd. — CINCINNATI 25, OHIO, 3240 Spring Grove Ave. — CLEVELAND 14, OHIO, 1541 E. 38th St. — DETROIT 2, MICH., 690 Amsterdam Ave. — KANSAS CITY 41, MO., P. O. Box 918 — LOS ANGELES 58, CALIF., 4807 E. 49th St. — NEW YORK 17, N. Y., 230 Park Ave. — ST. LOUIS 10, MO., 4215 Clayton Ave.

of wires welded at regular intervals, and where the intersecting wires are fused into a permanent section by the application of an electric current. The use of this material is adaptable to concrete floors, slabs on grade, and structural concrete such as basement and retaining walls, steps and areaways.

Welded wire fabric is easy to use on the job. Since

all members are welded in position they cannot become displaced. By unrolling the wire fabric over the slab area, an automatically spaced distribution of steel reinforcing is obtained. It also permits other trades to continue working in and around before concrete is poured. This dove-tailing effort results in further economy through cutting down the waiting time by others.

**Recommended Styles Of Welded Wire Fabric
For Various Types Of Building Construction**

TYPE OF CONSTRUCTION	RECOMMENDED STYLE	REMARKS
Basement Floors & Foundation Slabs a. Solid Subgrade	6x6-8/8 or 6x6-10/10	Generally, the poorer the subgrade and the larger the floor area, the heavier the gauge of fabric. Place the fabric 1 1/2 to 2 inches below the top of the slab.
	b. Poorly drained subgrade	
Basement Walls	6x6-6/6 or heavier	Pour walls and floor monolithically for a tighter job. Position fabric with spacers and then construct inside form.
Driveways	6x6-6/6	Position 2 inches from top of 5 or 6 inch thick slab on a well compacted base course. Pour in slabs 30 to 35 feet long, 12 to 15 feet wide. Fabric should not pass from slab to slab. Form contraction joint by butting slabs up against each other.
Porches a. 6" thick slab up to 6' free span	6x6-6/6	Position inch from bottom of slab to take tensile stresses.
	b. 6" thick slab up to 8' free span	
Sidewalks	6x6-8/8 or 6x6-10/10	Position fabric as for driveways.
Steps	6x6-6/6	Use heavier style if more than five risers planned. Position fabric 1 inch from bottom form.
Stub Foundation Walls	6x6-6/6	Center fabric in form and drop vertically. Hold in place with wire spacers.

NOTE 1: The recommendations above have been developed by using standard types of welded wire fabric available in local dealers' stores. These recommendations are based on recognized engineering practice. They are not intended to supplant local building codes or restrictions. Where a complete detailed structural design is required, it is recommended that competent engineering service be employed

NOTE 2: In style designations, the first pair of figures refer in proper order to center-to-center spacing of longitudinal and traverse wires; the second pair of figures to respective gauges

NOTE 3: There are many more styles manufactured and stocked by local building supply dealers than are indicated above. The versatility of welded wire fabric provides styles to meet every requirement



Tailored TO THE BUILDERS' NEEDS

Permabilt quality construction is the kind you can stand back of. We build by conventional proven methods using quality materials and follow the standard practice that builders have used for years. Permabilt Homes are shipped as a package with wall panels and roof trusses assembled at the factory. Windows and doors are glazed, weather-stripped and installed. To protect the home from exterior wall dampness, we provide a full 3½ inch inter-wall air space.

FULL FLEXIBILITY IN DESIGN

Over 50 standard designs and floor plans will meet most buyer needs, however, plans can be altered by re-arranging wall panels. Interior partitions can be moved to suit individual buyers. Numerous front style modifications are possible with several choices of picture windows.

ACCEPTED FOR FHA
AND VA FINANCING

YOU BUY ONLY WHAT YOU WANT

Permabilt's method of selling gives you a choice of packages and you buy only what you want. Select the packages to your own best advantage.

BASIC HOME PACKAGE

Complete shell, everything furnished, including interior partition studs.

INTERIOR TRIM PACKAGE

All interior wood trim, flush doors and hardware. Either dry wall or rock lath to cover. Your choice.

FLOOR PACKAGE

Oak flooring or asphalt tile as required.

CEILING INSULATION

Fibreglas or Rock Wool in rolls or bats.

KITCHEN PACKAGE

Youngstown steel kitchen, cabinet sink with dishwasher or garbage disposer as desired.

Manufactured
HOMES
MARSHALL, MICH. *Inc.*
223 S. KALAMAZOO AVE.

SOME TERRITORIES
OPEN FOR FRAN-
CHISE TO RESPON-
SIBLE BUILDERS

ask the EXPERTS about

- Planning
- Concrete Work
- Framing
- Roofing
- Heating and Plumbing
- Air Conditioning
- Wiring
- Insulation
- Interior Finish
- Power Equipment

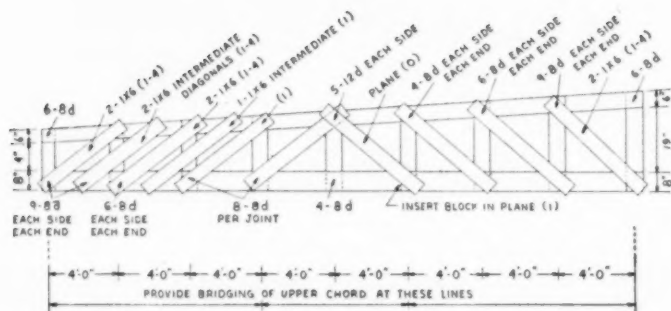

Will a truss like this carry the load?

I would like some advice on an idea I have for a truss spanning 24 feet. Would it be possible to have ceiling joists of 2x8's and roof rafters of 2x6's bridged together using 1x6 diagonals for the purpose?

J. W. O., Welch, Okla.

Yes, a truss such as you outline would carry the load if it is designed as shown in the illustration

and if you use the number and size of nails as shown. Notice that all vertical bridging is of 1x6's, all diagonals are also 1x6's. Lower chord is a 2x8, upper chord is a 2x6. Use stress grade lumber (fiber stress equals 1,100 pounds per square inch. Space trusses 16 inches on center.

Wilbur Tuggle,
Structural Engineer

Expansion joints in concrete lintel?

We are to build a concrete block and concrete reinforced building. The size of the building is to be 100x200 feet. Pilasters of reinforced concrete will be placed about every 11 feet. Between the pilasters, walls are to be built of concrete block having a minimum compressive strength of 1,000 pounds.

Around the top of this wall, an 8x14-inch cast-in-place, reinforced concrete lintel will be placed. Roof will be built-up over wood deck supported by steel I-beam framing. Should this concrete lintel be broken with expansion joints to allow for movement on the bearing or should the lintel be continuous and unbroken and bonded to the bearing?

J. D. G., Dothan, Ala.

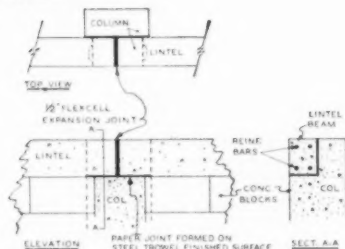

Effective concrete expansion joints are difficult to design, form and maintain. In this case, however, the need for expansion joints is a necessity.

In the 200-foot dimension of the building, assuming the center point of the building remains fixed, and expansion of the concrete lintel beam occurs in both directions from this fixed point, we can expect about 1/2-inch movement in

each direction with each 50-degree change in temperature. Therefore, this results in a bending stress in the end column of approximately 240 foot-kips. (This neglects the effect of shrinkage, which would be subtractive for a temperature rise, and additive for a temperature fall.)

Clearly, normal column design would be significantly changed in order to contain such high stresses. The illustration shown represents a suggested solution to the problem with expansion joints placed at about 50-foot intervals in the lintel.

Wilbur Tuggle,
Structural Engineer

How can I finish cedar to keep natural color?

How can I finish cedar plywood in a way that will not alter the natural finish or appearance of the natural wood?

W. R. M., Moncton, N. B., Canada

Any clear finish will have the effect of darkening the cedar plywood. However, the less absorption of the finish into the wood, the less will be the effect of this darkening.

The best recommendation to make is to seal the surface with white shellac (reduced with alcohol) and finish with a clear, synthetic varnish.

Pabco Products Inc.

Got a problem you can't solve? "ASK THE EXPERTS"—a group of industry authorities—experts in their fields. They'll give you the answer.

Write to "Ask the Experts," American Builder, 79 West Monroe St., Chicago 3, Ill. We'll publish as many questions and answers as we can.

BUILDERS!

Meet customer heating demands

PROFITABLY!

**KAUSTINE QUALITY FURNACES
DO COST LESS!**



**FOR FULL INFORMATION
WRITE TO DEPT. AB-11**

● The answer to customer demands for **RECOGNIZED QUALITY HEATING** *without* increased costs and lower profits is **KAUSTINE OIL-FIRED FURNACES.**

Kaustine engineering enables you to offer an economical and efficient *top quality* heating plant at the very *lowest cost.*

Kaustine compact design provides *more living space . . .* factory assembly *reduces installation costs.*



Kaustine

QUALITY COSTS LESS

There is a Kaustine Furnace or Winter

Air Conditioner for every type of home

BUILT-IN RADIOS

... Only 3 7/8" Deep!

- Fits in standard 4" partition
- Excellent tone and selectivity
- Installed as easily as any electric outlet
- For kitchen, bath, bedroom, etc.
- Colored plastic panels
- Approved by Underwriters'
- Retail for **\$43.50** less panels



Write today for specifications and low builder prices.
(Dealer inquiries invited)

FLUSH-WALL
RADIO COMPANY

1012AB2 Cleveland St., Clearwater, Fla.

Hold the heads of axes
hammers, sledges
mallets, hatchets,
and other handle-
type tools.
Available in a
complete
range of
sizes.

Red Devil
GRADY WEDGES



Red Devil GRADY WEDGES
"Barbed to stay wedged"

Counter-salesman holds
36 No. 5 and 24 No. 10 Wedges for fast
service and impulse sales.

Rust-resistant, chip-proof - pound
these patented steel wedges into the
head of any handle-type tool - they'll
never come out.

8008

A PRODUCT OF
Red Devil Tools.
IRVINGTON 11, N. J., U.S.A.



ask the EXPERTS

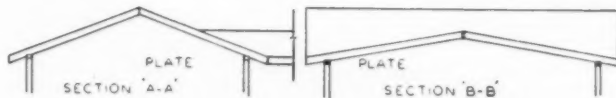
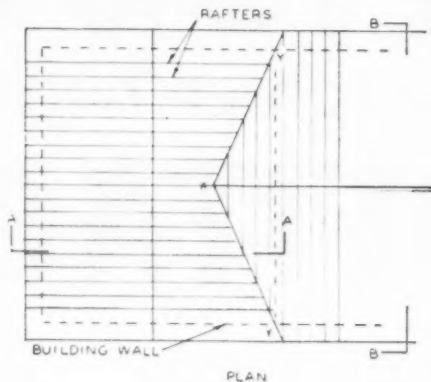

One roof—two gables—different pitches!

I am to build a house with a gabled roof. The roof will be in two parts—one gable placed with ridge running from front to back—the other part with a ridge running from side to side and at right angles to the first, forming valleys.

The two gables will be of different pitches and different spans. One gable will be at a $4\frac{1}{4}=12$ pitch and a run of 12 feet. The other will be at a $2\frac{1}{2}=12$ pitch and a run of 17 feet. The $4\frac{1}{4}$ pitch gable, with a 24-inch soffit will be $8\frac{1}{2}$ inches below plate line. The $2\frac{1}{2}$ pitch will be 5 inches below plate line. How can the framing of the roofs be accomplished so that the eave lines will be even with one another? How can I frame the valleys so that they will be strong enough?

B. V. F., Butte, Nebr.

The most desirable way to frame the roof is shown in the illustration. Carry the roof rafters through to the valley line, Y-X-Y. A valley rafter of 2x8 or 2x10 is desirable. The rafters shown in section A-A can be carried through to the line Y-Y, provided there is a wall beneath this line on which a plate can be carried.

The plates in section A-A and B-B will, of necessity, be at different

levels if the eave line is to remain level. Set the eave line level, first letting the plate height come where it is necessary. Section A-A and B-B show the eave at the same level, but plate levels are different.

Wilbur Tuggle,
Structural Engineer

Should subfloors be laid diagonally?

Should a subfloor be laid diagonally or horizontally? Will a subfloor that is laid horizontally make the finished floor buckle in time?

L. J., Trenton, N. J.

There is very little difference in laying floors horizontally or diagonally. The advantage of the diagonally laid floor is that it produces an area of greater strength. Buckling can occur to either type and is due primarily to inadequate nailing.

In a horizontally laid subfloor consisting of 1x6 sheathing, place nails in every joist spacing. Use nails of a coated type to prevent any possibility of popping. If 1x8 sheathing is used, then three nails should be used in every joist spacing. This would apply also to diagonally laid floors. If this is done, buckling should not occur.



WINTER



or

SUMMER



lay VISQUEEN® film as a waterproof barrier under concrete

You can lay VISQUEEN film—seamless widths up to 16 feet—in coldest winter or hottest summer without damaging your moisture barrier. VISQUEEN is flexible at temperatures as low as 72° below zero—won't get brittle; won't crack or split. VISQUEEN withstands tropical weather. Because it has no plasticizer, nothing can bleed out, even under the hottest sun.

VISQUEEN film is the most effective moisture barrier for side walls. Eliminates moisture leakage from interior into stud walls—does away with outside paint peeling, staining, blistering, rotting, stops plaster cracks from warped studs.

IMPORTANT: VISQUEEN film is all polyethylene, but not all polyethylene is VISQUEEN. Only VISQUEEN, produced by process of U. S. Patents No. 2461975 and 2632206, has the benefit of research and resources of The VISKING Corporation.

VisQueen® film . . . a product of

THE VISKING CORPORATION

World's largest producers of polyethylene sheeting and tubing
Plastics Division, Terre Haute, Indiana
In Canada: VISKING Limited, Lindsay, Ontario
In England: British VISQUEEN Limited, London

NOVEMBER 1954

So light! 1,000 square feet of 4 mil film weighs less than 20 pounds. So wide! Up to 16-foot seamless widths drastically cut laying time. **That means lower labor costs with VISQUEEN.**

VISQUEEN is SHRINK-PROOF. So tough it won't tear, split, shatter or run. **That means complete unbroken protection for every square inch of slab with VISQUEEN.**

So stable, neither acids nor alkalis, bacteria nor moulds affect it. **That means protection forever with VISQUEEN.**

For detailed information, mail the coupon today!

.....

• The VISKING Corporation, Box AB11-1140
• Plastics Division, Terre Haute, Indiana

• Furnish me with complete details about VISQUEEN film.

• under concrete slabs, basement floors, and crawl spaces

• as a moisture vapor barrier in home construction

• Name _____

• Address _____

• City _____ Zone _____ State _____

• My supplier is _____

the eyes buy...

sell the preferred Visible Feature!

ALL NEW

WASTE KING PULVERATOR

AMERICA'S FINEST GARBAGE DISPOSER

WASTE KING, like this young home buyer, is a strong influence in the sale and rental of homes and apartments. Homemakers LOOK for this modern convenience that saves time, saves steps, saves work—that eliminates garbage electrically.

Sell quicker, rent quicker. Show buyers WASTE KING Pulverator. It's the lowest budget, highest quality feature that upgrades the value of the home or apartment.

SUPERIOR WASTE KING FEATURES

SUPER "HUSH-CUSHIONS"—an exclusive WASTE KING feature. Noise and vibration absorbed at sink connector and drain outlet.

LIFETIME GRIND CONTROL—exclusive design controls size of waste particles. Plumbing Lines Protected. Longer Life! Clogproof!

UNBEATABLE SERVICE RECORD—less than 1% service callbacks. Customer satisfaction assured! WASTE KING quality is unsurpassed!

SELL UP THE
PREFERRED VISIBLE FEATURE



Over 500,000 in Daily Use!



MODEL SH7000 SHOWN

ask the EXPERTS

How can a new builder reduce financial risk?

I have recently become a builder. If I build a house on my customer's lot and use my money, I would be stuck if they refused to pay or could not get their G. I. loan. I would like to know some ways that I could protect myself in case a buyer decided against going through with the purchase.

L. F. Hominy, Okla.

Builders in Chicagoland usually enter into a contract to construct a home for a certain specified price, according to plans and specifications. In this contract they provide that as the house is constructed, they are to receive payment as the construction progresses. For instance, the payouts might be made at the following stages of the job:

1. When the basement is completed.
2. When the building is under roof.
3. When the building is roughed-in and ready for plaster.
4. Final payment is made upon completion of the building.

If you want more protection, you might want to have these funds escrowed at a local bank with instructions that they are to be paid at these various stages upon the presentation of proper waivers of lien and affidavits or whatever is customary for the builder to furnish in your local area.

Bell Savings and Loan Assn.

How to insulate SCR brick

I am ready to insulate a house built of SCR brick. I have been told that I cannot use blanket or foil insulation with this building material. Is this true?

R. R., Youngstown, Ohio

They are wrong. SCR brick with 2x2 furring held to brick with an anchor clip system affords ideal space for standard thick insulation stapled to the 2x2's. Use insulation with a vapor seal, or rocklath with a vapor seal. Keep vapor seal on warm side of the insulation.

Harry J. Quinn, architect

AMERICAN BUILDER

second story operator

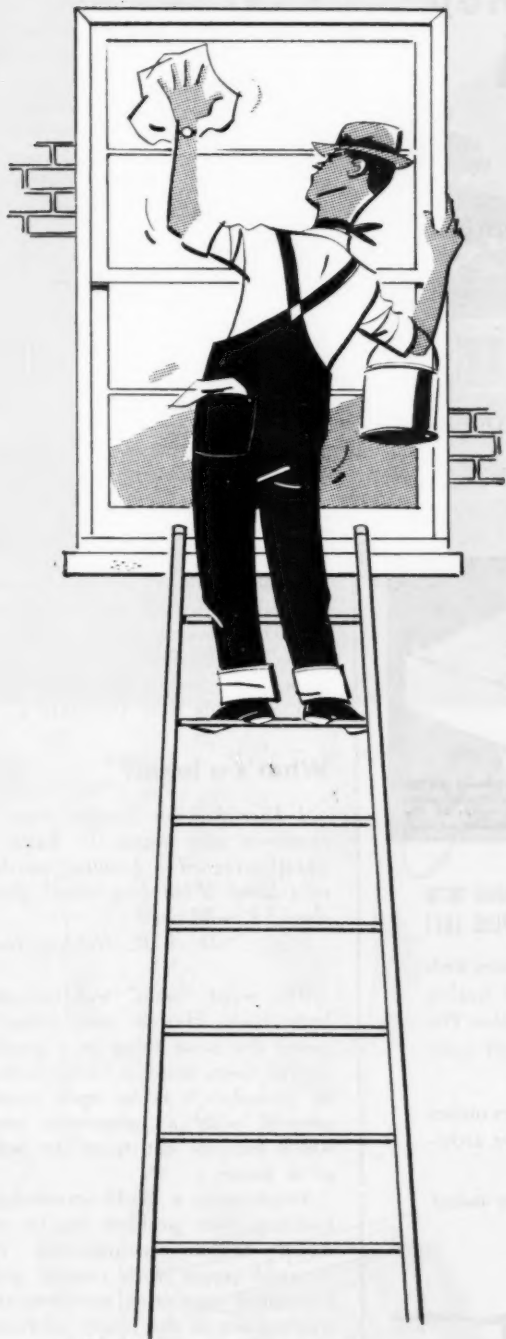

No! He's not breaking in. He's just disgusted that he didn't get windows that snap out — for easy cleaning *inside* the house.

People who are having homes built deserve modern, removable A.R.B. wood windows with the famous, patented "400" metal sash guides.

The Heart of the A.R.B. "400"

Patented metal sash guides and spring tension units make A.R.B. wood windows easily adjustable, removable and weather tight. It requires no more time or effort to install A.R.B. windows than any other type of prime windows.

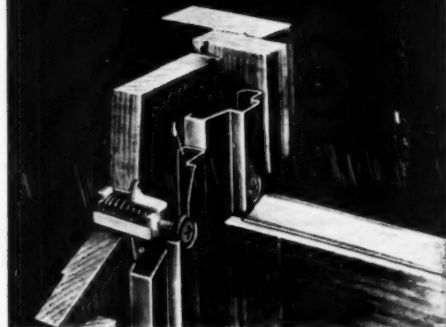

400

METALS BY A. R. B.

for
**ADJUSTABLE
REMOVABLE
WOOD WINDOWS**

A.R.B. WINDOW SALES COMPANY • 19433 John R Street, Detroit 3, Michigan

BUILD AND SELL

"More Home for the Money"

...with Colpaert Homes!



EXTRA
864 FEET
OF RECREATION,
STORAGE AND
LAUNDRY
SPACE

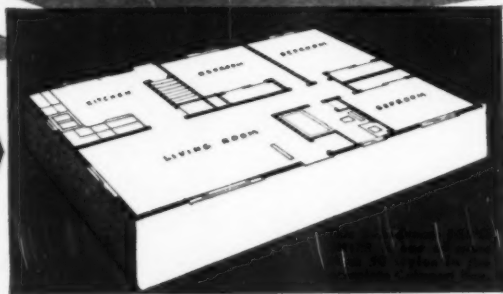

YOU CAN BUILD AND SELL THIS 3-BEDROOM RANCH HOME WITH FULL SPACE-GIVING BASEMENT FOR ABOUT \$9300 PLUS LOT!

COMPLETE FINANCING makes it possible to sell Colpaert Homes with lowest down payments... best possible terms. A full line of quality factory-assembled homes are available in the \$6,000 to \$15,000 class. The Colpaert organization gives you a complete service based on their more than 30 years of successful building experience.

SELL INCOME-MINDED BUYERS, too, for now Colpaert Homes makes available a factory-assembled two-story duplex unit... distinctive architectural lines, outstanding features, competitively priced!

Be the Colpaert dealer-builder in your area... write, wire or phone today!

Colpaert

HOMES INC.



SOUTH BEND • INDIANA

ask the EXPERTS

More about roof framing

My problem concerns a question of framing long valley rafters. Would it be advisable to carry through to bearing partition plate, some doubled common rafters to shorten the span of valley rafters?

Would it be best to carry valley rafters to bearing partition and an auxiliary valley rafter to bear on first? What size of lumber is needed for these valley rafters?

E. L., Brooklyn, N. Y.

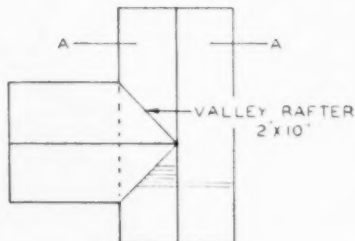

It is not necessary to carry the rafters through in Section A-A (see illustration) to the bearing plate shown in a dotted line unless there is a bearing wall beneath the dotted line. The valley rafters should run from ridge to bearing at the outside wall. Use 2x10's.

What's a lanai?

I have had an inquiry from a customer who wants to build a 24x40 screened-in building similar to a lanai. What is a lanai? How should I build one?

D. A. R., Hebron, Ind.

The word "lanai" was brought here from Hawaii and literally means the same thing as a porch, garden room, tropical room, shelter or veranda. It is an open porch covered with a permanent roof which extends out from the wall of a house.

In planning a 24x40 screened-in building, your problem can be reduced to an arrangement of screened panels with vertical and horizontal supporting members extending across the length of room or building you are designing.

Renew your subscription today!



Cheers FOR THIS GREAT, NEW STYLE
IN TILE!

MATICO *Confetti!*

Pat. Pend.

HURRAHS—from America's value-wise buyers. They really go for gay, festive, colorful Confetti. It's high-style flooring at low asphalt tile prices . . . easy to clean . . . lasts for years!

APPLAUSE—from leading decorators. They welcome the fresh, new styling that gives them wide freedom in creating exciting decorative schemes.

A ROUSING HAND—from builders everywhere. Confetti is a brand new aid to home sales. Builders can now "trade up" their homes, "trade down" their budgets . . . save on installation costs. And Confetti is ideal for on-grade, slab construction homes. Fortified with polystyrene plastic for bright, enduring colors . . . extra toughness and resiliency.

Confetti is available in 10 high-spirited colors, in 9" x 9" tiles of 1/8" thickness. Write department 5-11 today for full details and specification data.

MASTIC TILE CORPORATION OF AMERICA

Manufacturers of: Aristoflex • Confetti • Parquetry • Asphalt Tile • Cork Tile • Plastic Wall Tile

Joliet, Ill. • Long Beach, Calif. • Newburgh, N. Y.



OWENS-ILLINOIS GLASS BLOCK*

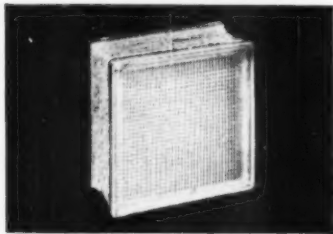

PRACTICAL

Here are two uses of glass block that will appeal to every homeowner...two ways that give your homes visible evidence of quality. Glass Block are easy to handle and easy to install. They can be made to fit any size opening...no frame necessary. They never need to be painted or puttied.



BEAUTIFUL

This attractive panel of Owens-Illinois Glass Block No. 365 allows in plenty of light, keeps out sight. An easy wipe keeps the panel bright and sparkling. A panel keeps the room warmer, too. Glass Block provide better insulation than a window and storm sash.

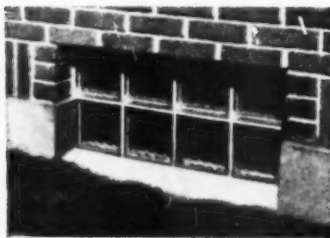

PROFITABLE

Home applications are practically limitless. Bathroom, basement, kitchen, garage, offer excellent opportunities for the use of Owens-Illinois Glass Block. Let Owens-Illinois Glass Block help you sell your homes faster by adding visible evidence of extra value. For information or help with a specific problem, write Kimble Glass Company, subsidiary of Owens-Illinois, Dept. AB-11, Toledo 1, Ohio.

*Formerly known as INSULUX.

OWENS-ILLINOIS
GENERAL OFFICES  TOLEDO 1, OHIO

how would you do it?

Ideas for the man on the job

Two ideas to build a stronger garage gable—

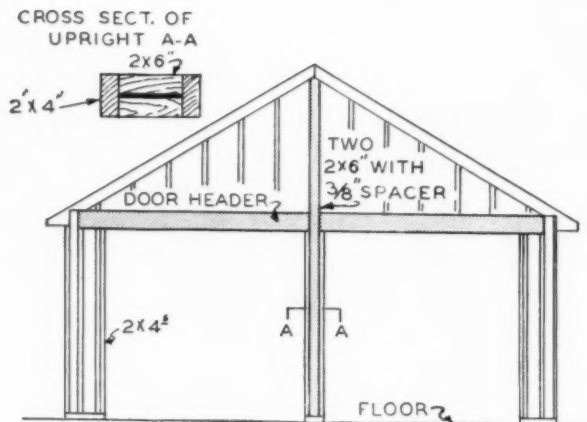

Frame it like this—

Butt two 2x6's together, with a 3/8-inch spacer between, as an upright member between the two garage doors. Use 2x6's that are long enough to reach from sill to ridge of roof in one continuous piece. For greater strength, use 2x8's instead

of the 2x6's for the upright member. Make door headers in the same way with two 2x6's butted together with a 3/8-inch spacer between. Then frame the gable end in the usual way.

—A. J. Clefish, Janesville, Wis.

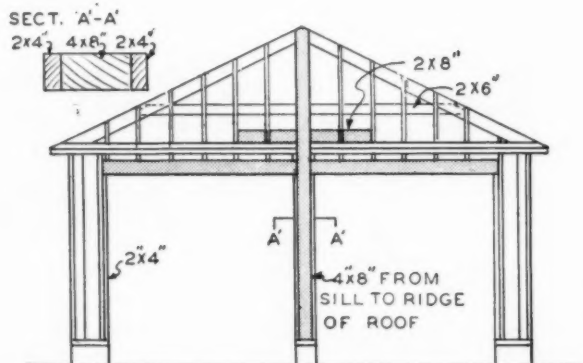

3/8" PLYWOOD APPLIED DOUBLE THICKNESS TO GABLE END GIVES BRACING AGAINST SIDE STRAIN

Or frame it this way—

Run a 4x8 in one piece from sill to ridge of roof on the gable end. This means that the double plate above the doors must be cut at the center. Compensate for this, however, by using a 2x8, eight feet long applied to the inside face of the studs and plate. Use long sections of

3/8-inch plywood in two layers as sheathing. This will tie the entire gable and the 4x8 together into one solid unit which will offer sufficient bracing so wall sections at each side of doors will stay plumb.

—A. N. Nelson, Kansas City, Mo.

PRODUCT NEWS from AMERICAN-Standard

A review of products in the news and important features worth remembering



AMERICAN-STANDARD GAS-FIRED WATER HEATER

This new water heater has really got what it takes to build customer confidence . . . to help you sell more houses. Available in three popular sizes—20, 30 and 40 gallons—it combines quality construction and precision engineering with moderate price and operating economy. Among its customer-pleasing features are a new fuel-saving burner which burns any type of gas efficiently . . . fully automatic controls . . . heavy gauge steel jacket insulated with fiberglass . . . glistening white baked enamel finish with gray trim. The A.G.A. approved American-Standard Water Heater undergoes rigid factory inspection and the tank, burner, safety pilot and thermostat are factory tested to assure dependable operation.

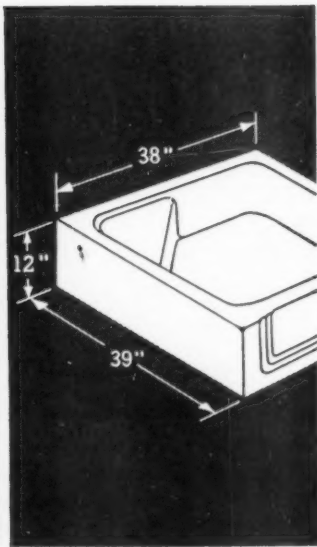

RESTAL RECEPTOR BATH

Here is complete bathing convenience in shower stall space. The 12" high Restal fits a finished stall space approximately 36" x 38". It's an ideal way to add a second bath to the homes you build, and in modernizing, a closet or similar space often can be turned into an extra bathroom with this compact yet roomy fixture. Its low sides, flat bottom and built-in corner seat make the Restal convenient to use. It's made of rigid cast iron smoothly finished with a thick coating of acid-resisting or regular enamel. Long lasting, easy to clean, handsome. And its cost is comparable to that of a properly installed shower stall!

For further information on American-Standard products see Sweet's Light Construction File.



AMERICAN-Standard

American-Standard
Dept. AB-114, Pittsburgh 30, Pa.
Without obligation on my part, please send me literature on:

- American-Standard Water Heater
 Restal Receptor Bath

Name.....
Firm.....
Address.....
City..... State.....

American Radiator & Standard Sanitary Corporation, Dept. AB-114, Pittsburgh 30, Pa.

Serving home and industry: AMERICAN-STANDARD • AMERICAN BLOWER • CHURCH SEATS & WALL TILE • DETROIT CONTROLS • KEWANEE BOILERS • BOSS EXCHANGERS • SUNBEAM AIR CONDITIONERS



Bigger . . . Better . . . Busier! That's the story of the 1955 NAHB Convention-Exposition, where you'll see more exhibits . . . examine more new products . . . exchange more new ideas that you can use to boost your business next year.

NAHB's 11th annual Convention and Exposition will be the building industry's biggest show, offering money-making ideas for everyone. Whether you're a builder, architect, contractor, jobber, dealer, manufacturer, mortgage man or engineer—whether you're a member of NAHB or not—you belong at this great show for builders!

OVER 500 EXHIBITS . . .

everything in building materials and home equipment . . . scores of brand new products, hundreds of improved "standards" will be displayed by leading manufacturers.

TALKS . . . DISCUSSIONS . . . DEMONSTRATIONS

by experts in every field—financing, merchandising, building methods, taxes, market analysis, management and dozens of others.

GET BUSY—REGISTER NOW!

Hotel reservations must be in by December 15! If you are an NAHB member, register through your local chapter. If you're not a member, register in advance and make hotel reservations through Convention Headquarters. Advance registration (\$15 for men, \$10 for women) must be sent with hotel reservation request. Make checks payable to National Association of Home Builders.

Please show name, address, business classification and date of arrival for each person included in your request. Do it today!



NATIONAL ASSOCIATION OF HOME BUILDERS
Convention & Exposition Headquarters
 111 W. Jackson Blvd., Chicago 4, Ill.

how would you do it?

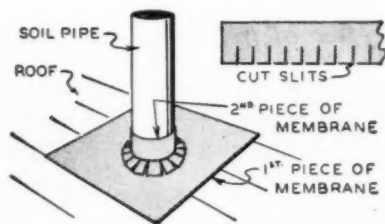

How to prevent leaks around soil pipe vent

Use two pieces of saturated roofing membrane. Cut the first piece about 1 foot or 1½ feet square. Cut a hole in the center to fit around the soil pipe vent. Cement this piece to the roof.

Cut a second piece of membrane in a strip about four to five inches wide and long enough to fit around the body of the vent. Cut a series of slits into one edge of this strip. Wrap and cement the second piece of membrane around the base of the soil pipe vent and to the surface of first piece of membrane. Mop the surfaces of both pieces with bituminous waterproofing material.—

L. F. Hewitt, Willoughby, Ohio.

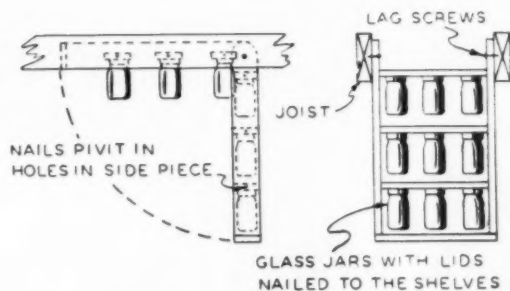

Why not make a small parts rack like this?

Use 1x3-inch stock and make a framework about 14 or 15 inches wide—wide enough to fit between the joists of the basement or garage over your workbench.

Cut three or four pieces of 1x3 to form the shelving. Cut them wide enough to fit between the two vertical portions of the framework. On each of these pieces, fasten two or three caps for jars.

Drill one hole on each side of the framework for each shelf. Fasten each shelf to framework with a nail at either end so that the nail secures the shelf, but pivots it in the holes that were drilled.

Attach upper portion of framework between joists by means of lag screws. When not in use, swing this small parts rack out of the way between joists. Shelves will pivot on the nails allowing jars to hang. To make shelves more free-swinging, bevel corners of each shelf. Use a barrel bolt or a screen door hook to hold the rack in the up position.—

D. McGeady, Chincoteague, Va.

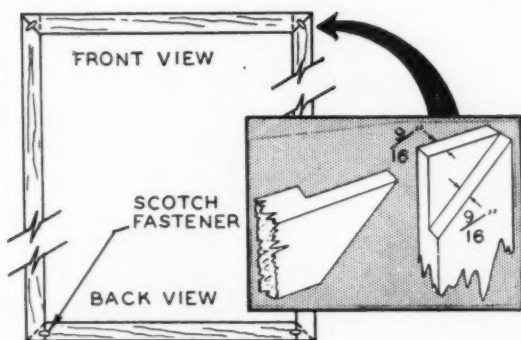

Want an easy way to make screens?

All the materials you will need to make screen frames the easy way are $1\frac{1}{8} \times 1\frac{3}{4}$ inch pine strips and some scotch fasteners. As for tools, use a rip saw, cross-cut saw and a miter box to cut the strips at the joints. Cut strips to desired length and miter the corners so that they are end-lap jointed. See the illustration. Assemble the frame and tie each joint together with scotch fasteners.—

K. A. Corcoran, West St. Paul, Minn.

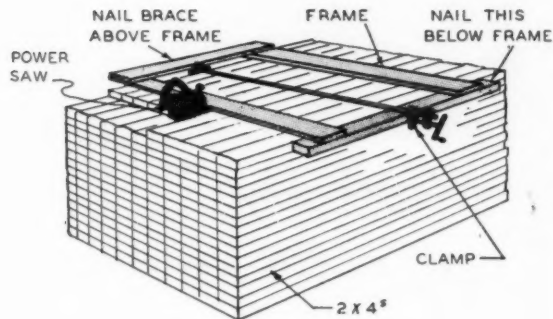

Cut lumber this way—

Use available lumber to make this jig with which you can cut lumber to identical sizes very quickly. It is especially useful when cutting studs to the same length. Make the jig of 1x4's, 1x6's or 2x4's. Be sure that the jig is perfectly square.

Stack lumber to be cut as neatly as possible. Place jig at top of pile and clamp jig and lumber pile together. Use long side of jig as a straightedge or guide for the power saw. When finished cutting, unclamp jig from lumber pile. Slide material that has been cut out from pile and jig is ready for next layer. Clamp jig and lumber together again and cut second layer and so on.—

F. J. Fafejta, West Hurley, N. Y.

CASH FOR JOB SHORTCUTS—American Builder will pay five dollars (\$5) in cash for each shortcut or job pointer accepted for publication. Send all material to the Architectural Editor, American Builder, 79 W. Monroe St., Chicago 3, Ill.

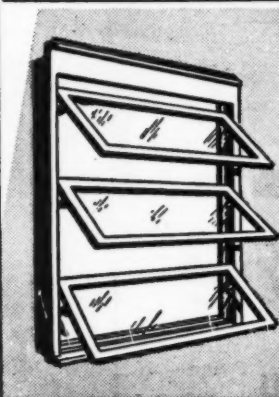
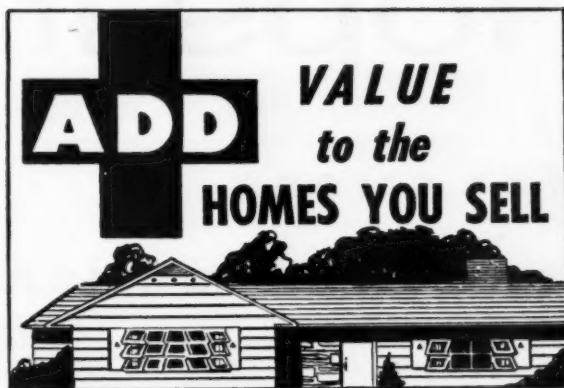

**NOTHING to ADJUST
— NOTHING to GET
OUT of ADJUSTMENT**

WOODCO's 35 years of fine window manufacturing experience has now produced a window that adds Prestige and Profit to any Home you sell. The added value of the WOODCO name makes selling easier.



WOOD WINDOWS WOMEN WANT

Architects, Dealers and Satisfied Homeowners recognize the WOODCO E-ZEE LOC Wood Awning Window as the Finest Awning Window Made; their fine design, ease of operation and long service life make them a MUST for today's builder who erects and sells a quality home.

Complete Unit on the Job — Save on Installation

- All Factory-Assembled of Selected Kiln-Dried Ponderosa Pine Toxic and Water-Repellent Treated
- Double (Pat. Pend.) Vinyl Weatherstripping
- All Glass Bedded in Glazing Compound
- EASY TO LOCK

Use Them On Your Next Project And Notice The Difference!

SEE YOUR LUMBER DEALER

WRITE or CALL FOR COMPLETE INFORMATION
— Permanently Displayed at —

WOODCO CORPORATION

A DIVISION OF GENERAL WOODCRAFT CO., Inc. — NORTH BERGEN, N. J.

3590 N. W. 71st STREET

MIAMI 47, FLORIDA

Phones: 64-3219, 64-3417

Tops in Locks

For screen
and combination
doors

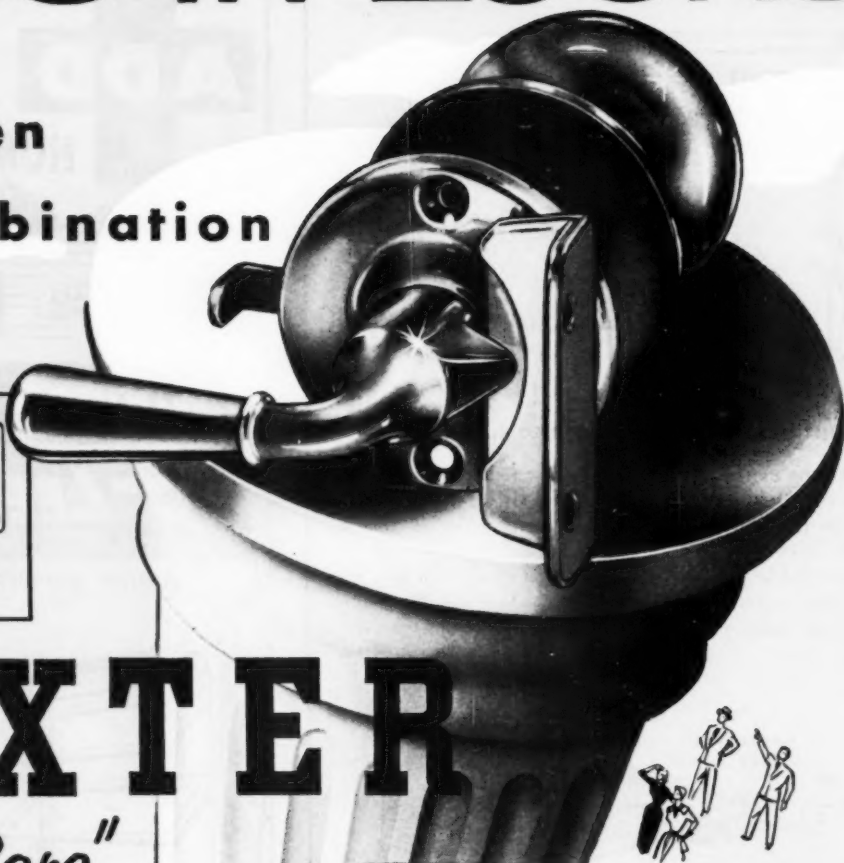
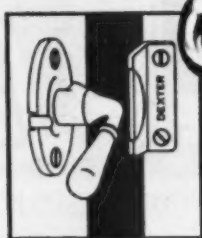

DEXTER

"Single Bore"

easy to install
easy on your pocketbook



CAT. No. 1100
WITH STRAIGHT
SHANK
SEAMLESS
KNOB

CAT. No. 1101
WITH FRENCH SHANK KNOB—
ALSO AVAILABLE IN
ANODIZED ALUMINUM



Here's why:

- Installs in minutes—there's only one hole to bore.
- Strike mounts on surface of door jamb—no mortise required.
- Door edge easily planed after installation because there is no protruding latch bolt.
- "Soft touch" yielding strike, locks door securely.
- Specially suited for use with door closer.
- Exterior parts are solid brass.
- Interior parts steel—no die castings.
- Locks securely from inside at touch of a fingertip.
- Fits doors $\frac{5}{8}$ " to $1\frac{3}{8}$ " thick with no adjustment.
- Dexter Single Bore is *Lifetime Guaranteed*.

DEXTER LOCK COMPANY

GRAND RAPIDS • MICHIGAN

A SUBSIDIARY OF NATIONAL BRASS COMPANY

In Canada: Dexter Lock Canada Ltd., Guelph, Ontario

In Mexico: Dexter Locks, Plata Elegante, S. A. de C. V., Monterrey, Nuevo Leon

MANUFACTURERS OF AMERICA'S ORIGINAL TUBULAR LOCKS

Your Guide to NEW PRODUCTS Information



**mobile power shovel
useful in narrow aisles**

With a capacity of 11 cubic feet or 1,200 pounds, this unit is suitable for handling bulk materials in close quarters. It has outside turning radius of only 73 inches suitable for working in tight corners; has dumping angle of 60 degrees, two forward and two reverse speeds. Competitively priced, sold by nation-wide dealer organization, Industrial Truck Division, Clark Equipment Co., Dept. AB, Attn. J. L. Frost, Battle Creek, Mich.

Circle No. 1 on Coupon, page 154

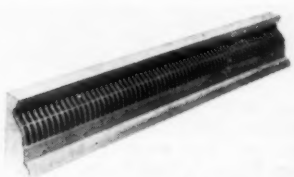

**low-cost baseboard diffuser
can double for register**

This 30-inch unit was designed for perimeter heating and cooling but can be used in place of any standard register; it makes useful return air register since it eliminates cutting into plaster, stud plate and header. Capacity is up to 12,000 Btu for heating. Easy installation is stressed. List price is \$2 at wholesalers. Gerwin Industries, Inc., Dept. AB, Attn. Louis C. Cotts, 200 Spring St., Michigan City, Ind.

Circle No. 2 on Coupon, page 154

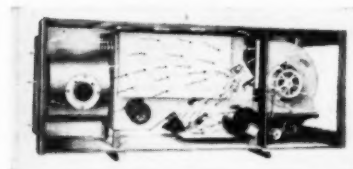

**suspended unit heater is
oil or gas fired**

Available in six models, these suspended units have capacities of from 90,000 to 450,000 Btu's. Triple pass

**How to Use This
New Products Information Service**

AMERICAN BUILDER editors have just spent considerable time, money and effort to find out from you, the reader, exactly what information service you would like for New Products.

As a result of your help, this New Products Service Department has been revised and improved to bring you information about more new products each month, earlier than ever before, and to make it easier for you to get additional information.

You are invited to use the reader service coupon appearing on page 154. Simply draw a circle around the key number of each product that interests you, write in your company name and address, tear out and mail the card. You then will receive literature and detailed information direct from manufacturers.

Each new product and catalog item also carries complete data so that you can write direct to the manufacturer for more information.

heat exchanger gives maximum flue travel, assures minimum fuel consumption, low stack temperature, highest efficiency, makers say. Prices with burner and controls range from \$315 to \$976; distributed through furnace dealers and jobbers. Universal Products Mfg. Corp., Dept. AB, Attn. Wm. C. Schaab, Auburn, Ind.

Circle No. 3 on Coupon, page 154

Wall primer for gypsum wallboard, plaster, masonry, etc., can be recoated after one hour with other paints. Retails at \$5.60 per gallon through lumber dealers. National Gypsum Co., Dept. AB, Attn. J. G. Hagans, 325 Delaware Ave., Buffalo 2, N. Y.

Circle No. 4 on Coupon, page 154

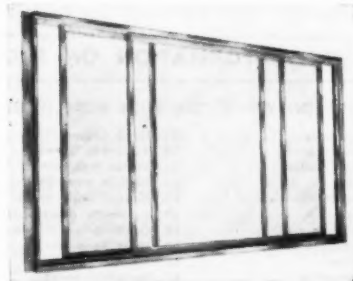

**horizontal slider window
priced for \$6,000 houses**

Aluminum horizontal sliding window has glass panels removable from inside. Unit shipped knocked down, but can be assembled with screwdriver. Available in size range up to 8x4 feet. Unit's price is low enough to use it economically in houses \$6,000 and up. Sold through franchised distributors. Copco Steel & Engineering Co., Dept. AB, Attn. Sam Rich, 14035 Grand River Ave., Detroit 27, Mich.

Circle No. 5 on Coupon, page 154



**aluminum carport doubles as
porch or utility area**

"AlumaPorte" is a self-contained unit with a 20x10-foot roof made of interlocking aluminum slats in choice of nine colors; understructure is of steel in matching baked enamel. Designed as carport, it can be used for porch, play area or extra room. Sells at \$299 from home improvement product dealers. Orchard Brothers, Inc., Dept. AB, Attn. of Luis Midence, 63 Meadow Road, Rutherford, N. J.

Circle No. 6 on Coupon, page 154



**cartridges for grouting gun
simplify mastic application**

Pre-packed mastic cartridges for manufacturer's metal grout gun are said to simplify application of grout lines. Clean-up is reduced to minimum. Method is stated to save two-thirds of mastic formerly wasted. Available in five colors and white, at \$.85 to \$.90 apiece through manufacturer's distributors S. & W Moulding Co., Dept. AB, Attn. E. M. Reynolds, 980 Parsons Ave., Columbus 6, Ohio.

Circle No. 7 on Coupon, page 154

Your Guide to NEW PRODUCTS Information

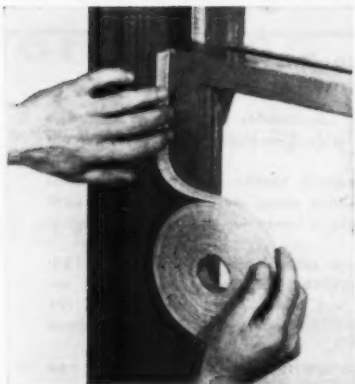

adhesive weatherstrip makes useful baseboard, window seal

"Zip Strip," made of 95 per cent wool felt encased in plasticized, water-repellent paper, has a pressure-sensitive adhesive backing. Product can be applied without tools, and can be painted over, stained or varnished. Furnished in 18-foot rolls, it enables builders to weatherstrip homes at approximate cost of \$1.50 per window or door. Available through sales representatives, Charles Ayres Co., Dept. AB, Attn. B. T. Powers, 698 Minnesota St., San Francisco 7, Calif.

Circle No. 8 on Coupon below

Glass-lined gas water heaters made in 20-, 30- and 40-gallon sizes carry ten-year guarantee; units have heavy Fiberglas insulation. Sold through authorized dealers. Crane Co., Dept. AB, Attn. John T. Benedict, 836 S. Michigan Ave., Chicago 5, Ill.

Circle No. 9 on Coupon below



plastic cutting tool works like circular table saw

This portable electric plastic cutter works like a circular table saw but is self-contained in its own tool box. It can cut large plastic sheets, pearlescent tile cutting and diagonals, as well as inside corners or square holes. Tool sells for \$38.95, subject to dealer-contractor discounts; it is available through flooring industry distributors. Steelgrip Plastics, Dept. AB, Attn. Zorro D. Ruben, 336 N. Central Ave., Chicago 44, Ill.

Circle No. 10 on Coupon below

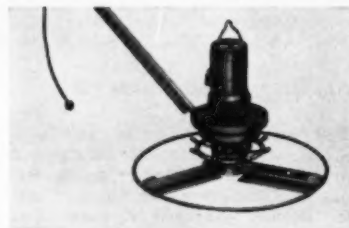

powered concrete trowel does floating and finishing

Equipped with 14-inch wide steel finishing trowels set in 38-inch diameter ring, this "Pow'r Trow'l" can do fast

efficient troweling in both floating and finishing work, makers say. Also available with 18-inch wide floating trowels to drive out air pockets, provide uniform surface. Machine sells at \$375 through construction equipment dealers. Mall Tool Co., Dept. AB, Attn. Mel Rehnquist, 7740 South Chicago Ave., Chicago 19, Ill.

Circle No. 11 on Coupon below

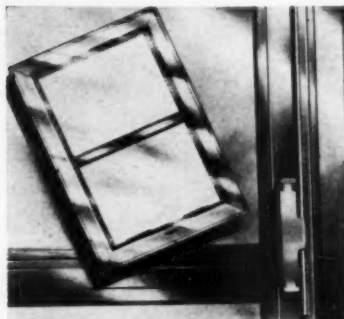

aluminum combination window has retaining clip feature

All-aluminum storm combination window features window panel retaining clip which provides continuous dry lubrication to panels by a tenite guide, assures easy operation in all kinds of weather. Clip is featured on complete company line of aluminum storm combinations. Sold at building supply dealers and specialty houses. Security Sash and Screen Co., Dept. AB, Attn. Robert Johnson, 387 Midland Ave., Detroit 3, Mich.

Circle No. 12 on Coupon below

Steel pliers, Model 506-10, are made with full-forged rib joints for heavy-duty use. List price is \$3.20. Utica Drop Forge & Tool Corp., Dept. AB, Attn. of H. F. Hale, 2415 Whitesboro St., Utica 4, N. Y.

Circle No. 13 on Coupon below

USE THIS COUPON FOR FREE INFORMATION ON PRODUCTS AND EQUIPMENT

CIRCLE ITEMS ON WHICH YOU WISH MORE INFORMATION

1. Power shovel
2. Baseboard heater
3. Unit heater
4. Wall primer
5. Slider window
6. Aluminum carpent
7. Grouting cartridges
8. Adhesive weatherstrip
9. Water heater
10. Plastic cutter
11. Concrete power trowel
12. Aluminum window
13. Steel pliers
14. Steel scaffolding
15. Space heater
16. Exhaust fan
17. Ceramic veneer
18. Plywood concrete forms
19. Door chimes
20. Long table jointer
21. Garage door
22. Adjustable concrete forms
23. Plaster-mortar mixer
24. Reversible metal tape
25. Power trowel
26. Bulk material loader
27. Metal sheet pattern
28. Sliding glass doors
29. Ventilating fan
30. Tub enclosure
31. Brush softener
32. Soldering gun
33. Insulating panel
34. Gas-fired incinerator

35. Folding stairway
36. Wire gripping chuck
37. Light control switch
38. Pocket tapes
39. Window protection device
40. Heating panel
41. Concrete cutting machine
42. Bathroom accessories
43. Electric plane
44. Brad driver-setter
45. Light control unit
46. Copper wall tile
47. Saw safety guard
48. Glass blocks
49. Double-bowl sinks
50. Telescoping door
51. Two-bowl sinks
52. Water circulator
53. Hard glazed tile
54. Residence elevator
55. Water repellent
56. Built-in oven-broiler
57. Electric wall heater
58. Bathroom accessories
59. Combination window
60. Shelf hardware
61. Electric saw
62. Porcelain bathtub
63. Platform hoist
64. Metal tubing connector
65. Air conditioners
66. Caulking gun
67. Automatic washer
68. Wall-ceiling panels
69. Attic stairway
70. Sink bowls

CATALOGS

71. Air filters
72. Entrance doors
73. Masonry paint
74. Builders' hardware
75. Perimeter diffusers
76. Welding electrodes
77. Plastic wall tile
78. Drive svents
79. Aluminum window wall
80. Gas heaters
81. Mastic waterstop
82. Decorator window guide
83. Ceiling air diffuser
84. Prefinished panels
85. Gas-fired furnaces
86. Decorative plywood
87. Aluminum windows
88. Store front details
89. Prefabricated homes
90. Masonry drills

SERVICE ON THIS COUPON EXPIRES IN 90 DAYS—ACT NOW!

NAME
 FIRM TITLE
 STREET
 CITY ZONE STATE.....

Please print name

The **OUTSIDE** of this home attracted crowds of potential buyers...

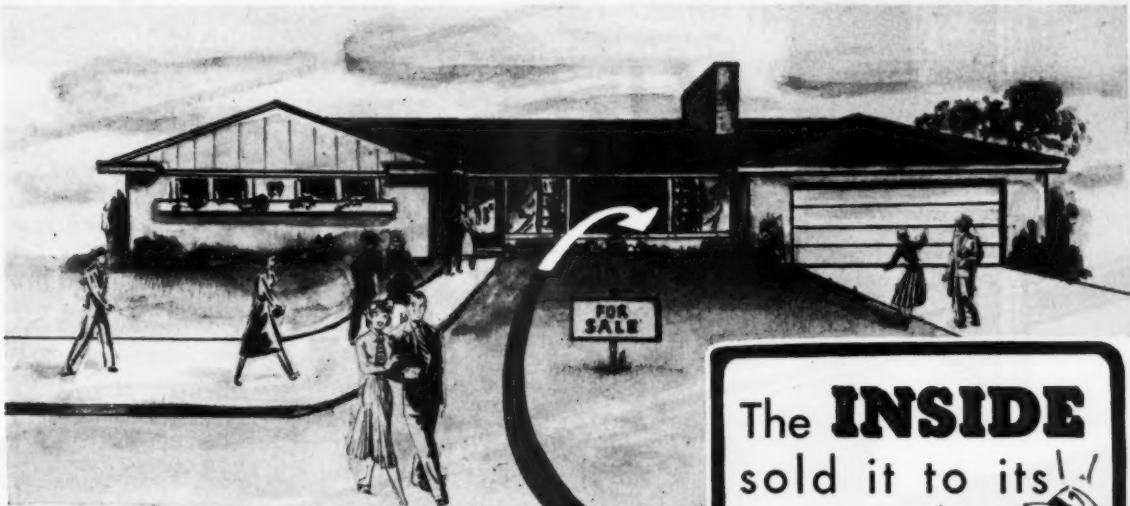

The **INSIDE** sold it to its happy new **owners**



MOUNTAIN-GROWN
Lockwood
Tempered OAK FLOORING

... is so often the feature that determines the selection of a house as *their home* by a family which values the gracious warmth and inviting hospitality of beautiful oak floors!

Not by accident, but by design, is Lockwood America's most desirable Oak Flooring.

Every improvement that can be added to modern manufacturing has been applied in the making of Cloud's Lockwood Oak Flooring.

The Kiln-Drying, for example, is the same type used by manufacturers of fine furniture, where gluing is employed.

The makers of Lockwood have thought of the Builder's problems, too, and this Oak Flooring has the famous Nail Groove Feature and is so perfectly Tempered and Precision-Milled, that Contractors report savings up to 35% in laying and finishing costs!



When you build homes to sell, give them the utmost in "salability" ... give them Lockwood Oak Floors!



CLOUD OAK FLOORING COMPANY
 SPRINGFIELD, MISSOURI

FOR THE MODERN BATHROOM...

HALL-MACK®

THE NEW...

TOWLESCOPE

RECESSED OR SURFACE UTILITY BARS

ONE OF A SERIES ON



Here's a bright new idea in bathroom convenience... a space-saving utility bar that actually telescopes into the wall when not in use! For extra drying space... for nylons, lingerie or guest towels... this modern bathroom accessory adds a full 14" bar with a minimum of wall space! Its clean, modern appearance fits into any bathroom, adds to its beauty and usefulness.

It's another of Hall-Mack's original ideas—*extra touches* that help you design distinctive bathrooms! Be sure to specify Hall-Mack—and Hall-Mack quality—always!

HALL-MACK COMPANY

1380 West Washington Boulevard, Los Angeles 7, California
7455 Exchange Avenue, Chicago 49, Illinois
1000 Main Avenue, Clifton, New Jersey

SOLD BY LEADING PLUMBING, TILE AND
HARDWARE DEALERS EVERYWHERE

AMERICAN BUILDER



would you trade \$7.00
for a \$1,000 IDEA ...

or for the floor plans of the outstanding houses built and sold in your region each month for the next three years?

36 Profit-Packed Issues
only \$7.00

Couldn't you use an up-to-the-minute picture of the building industry as it affects you—the latest builder news, forecasts, trends, designs, weather, mortgage conditions, prices, housing starts, market facts of your area?

Your regional edition of AMERICAN BUILDER gives you this vital information—plus hundreds of “job-tested” ideas for cutting costs, saving time and labor. Moreover, it shows you new ways to

**Build Better Houses For Less
Sell More Effectively
Remodel**

**Arrange Kitchens and Bathrooms
Use New Materials and Equipment
Streamline Management Methods**

and many other procedures that will put more money in your pocket.

Start profiting from AMERICAN BUILDER right away. Just fill out the handy postcard order form (be sure to indicate your title or position, company name and type of construction) and send it to us today.

AMERICAN BUILDER IS THE PERFECT CHRISTMAS GIFT

For as little as \$3.50 you can give your builder friends the Christmas gift that will show them how to do a better job of construction easier and more profitably—a gift that will remind them of your good wishes each month throughout the year.

Moreover, a handsome card announcing your gift will be sent to each person on your list.

Yes, when it comes to Christmas gifts, AMERICAN BUILDER is the greatest value you can find for your builder friends. And it's easy to order, too. Just fill in the handy order form at right and send to us. You can list additional names on a separate sheet. However, be sure to indicate the title or position, company name and type of construction for each person on your gift list.

Solve your builder gift problem today with AMERICAN BUILDER.

PLEASE ENTER MY SUBSCRIPTION TO AMERICAN BUILDER

one year \$3.50* three years \$7.00*

*U.S., its possessions and Canada only

NAME _____
 TITLE or POSITION _____
 COMPANY _____
 TYPE OF CONSTRUCTION _____
 STREET _____
 CITY _____ ZONE _____ STATE _____

• AMERICAN BUILDER is edited exclusively for individuals and firms (and their employees) engaged professionally in the building field
 AB114

PLEASE ENTER MY SUBSCRIPTION TO AMERICAN BUILDER

one year \$3.50* three years \$7.00*

*U.S., its possessions and Canada only

NAME _____
 TITLE or POSITION _____
 COMPANY _____
 TYPE OF CONSTRUCTION _____
 STREET _____
 CITY _____ ZONE _____ STATE _____

• AMERICAN BUILDER is edited exclusively for individuals and firms (and their employees) engaged professionally in the building field
 AB114

Please send AMERICAN BUILDER as my Christmas gift to

NAME _____
 TITLE or POSITION _____
 COMPANY _____
 TYPE OF CONSTRUCTION _____
 STREET _____
 CITY _____ ZONE _____ STATE _____

three years \$7.00* FROM NAME _____
 one year \$3.50* STREET _____
 *U.S., its possessions & Canada CITY _____ ZONE _____ STATE _____
 GIFT CARD TO READ FROM SIGNATURE _____

AB114

• AMERICAN BUILDER is edited exclusively for individuals and firms (and their employees) engaged professionally in the building field

No matter WHERE YOU LIVE *
AMERICAN BUILDER
 will show you the outstanding designs built and sold in your area—your city — or cities near you!

*In the United States

THREE FULL
 YEARS, 36
 Profit-Packed
 Issues only

\$7.00

SEND
 YOUR
 ORDER
 TODAY

THREE
 Great Editions
**SOUTHERN
 WESTERN
 NORTHERN**
 give you
 the builder
 news of
YOUR AREA

FIRST CLASS
 Permit No. 210
 (Sec. 34.9 P. L. & R.)
 BRISTOL, CONN.

BUSINESS REPLY CARD

NO POSTAGE STAMP NECESSARY IF MAILED IN THE UNITED STATES

POSTAGE WILL BE PAID BY

AMERICAN BUILDER

EMMETT STREET
 BRISTOL, CONN.



**AMERICAN BUILDER's
 exclusive Weather
 Forecast**

Each issue of your regional edition of AMERICAN BUILDER contains a month-long Weather Forecast for your area that enables you to estimate the number of working days you can count on for the coming month.

FIRST CLASS
 Permit No. 210
 (Sec. 34.9 P. L. & R.)
 BRISTOL, CONN.

BUSINESS REPLY CARD

NO POSTAGE STAMP NECESSARY IF MAILED IN THE UNITED STATES

POSTAGE WILL BE PAID BY

AMERICAN BUILDER

EMMETT STREET
 BRISTOL, CONN.



**HERE IS WHAT YOU GET
 IN YOUR THREE YEAR
 SUBSCRIPTION**

- 36 accurately drawn 1/8" scale BLUEPRINTS, one in each issue, of easy-to-build houses with proved customer acceptance. Included with each is a Quantity List of Materials.
- 3 Directory Issues (the April issue) with complete listings of Building Products and Equipment Manufacturers, Brand Names and many others.
- 216 or more pages of Photographs and Floor Plans of the outstanding designs built and sold in your area.
- Use of AMERICAN BUILDER'S Consulting Service "Ask the Experts."
- New Product Information, Technical Help and On-The-Job Advice.
- News and Trends of the Industry including Market Conditions, Mortgage Situation, Labor and Materials Supply and other vital Information.

FIRST CLASS
 Permit No. 210
 (Sec. 34.9 P. L. & R.)
 BRISTOL, CONN.

BUSINESS REPLY CARD

NO POSTAGE STAMP NECESSARY IF MAILED IN THE UNITED STATES

POSTAGE WILL BE PAID BY

AMERICAN BUILDER

EMMETT STREET
 BRISTOL, CONN.



**36 Profit-Packed Issues
 only \$7.00**

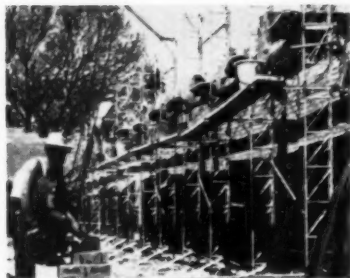

adjustable steel scaffolding is self-elevating

Easy to assemble and set in place, self-elevating triple-platform steel scaffolding affords continuous story-high building without re-scaffolding. Cantilever carriages ride up steel towers carrying three platforms for masons, helpers and materials. Easily assembled, meets safety code requirements. Sold by construction equipment dealers; each unit priced individually. Morgen Mfg. Co., Dept. AB, Attn. James L. Cope, Yankton, S. D.

Circle No. 14 on Coupon, page 154

Oil space heater of 48,000 Btu can be installed in areas where space for rear venting is inadequate. It retails at \$74.95 from company distributors and franchised outlets. **The Coleman Co.**, Dept. AB, Attn. J. F. Warren, Box 1762, Wichita, Kans.

Circle No. 15 on Coupon, page 154

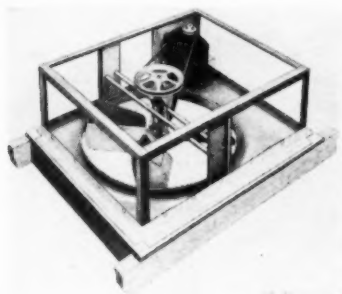

22-inch residential fan moves air at 3,800 c.f.m.

Residential exhaust cooling fan using 1/3 h.p. motor is designed for small homes with truss roof construction. Fan will fit between joists on 24-inch centers by moving one truss brace. Unit has all-welded construction; can be used for vertical or horizontal placement. Sold through builders supply, electrical distributors and dealers at \$98.17 list price. Lau Blower Co., Dept. AB, Attn. E. V. Sullivan, 2001 Home Ave., Dayton 7, Ohio.

Circle No. 16 on Coupon, page 154

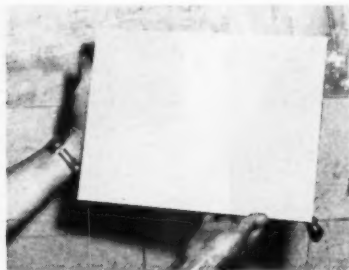

lightweight ceramic veneer has multiple interior/exterior use

Flexible "3/8 Vitrineer" comes in 12x16- and 16x24-inch sheets, can be cut or sawed at job sites with carboboy cutting tool or masonry saw. The veneer weighs four pounds per square foot and can be put on by using mastics or cement grout; now produced in glazed or unglazed, plain or pattern finishes. May be used on exterior or interior walls, flooring, counter tops, etc. Robinson Brick and Tile Co., Dept. AB, Attn. Sam Lusky, 500 S. Santa Fe Drive, Denver 19, Colo.

Circle No. 17 on Coupon, page 154



plywood concrete forms reduce foundation costs

Contractors can now finish a complete foundation in less than 24 man-hours with these Simplex forms, their manufacturer states. Forms can be removed from poured foundation, set up for new foundation and footings laid for third foundation in eight-hour period, due to simplicity and speed of these units. Their cost is approximately \$22.50 per lineal foot, including hardware mounted to 1 1/4-inch plywood; sold through equipment supply houses, lumber dealers. Simplex Forms System, Inc., Dept. AB, Attn. G. A. Markuson, 2500 N. Main, Rockford, Ill.

Circle No. 18 on Coupon, page 154

Door chimes in two-door model in copper or hammered brass and a chime and clock in two finishes are available at \$12.95 and \$19.95 from hardware dealers. **NuTone, Inc.**, Dept. AB, Attn. Paul Venezia, Madison & Red Bank Roads, Cincinnati 27, Ohio.

Circle No. 19 on Coupon, page 154

**less cost
less space
less labor
MORE PROFITS**

with compact
nationally advertised

WILLIAMSON
HEATING & COOLING UNITS



WILLIAMSON Assembled Furnaces

- Units occupying less than 2 feet square floor area
- Pre-wired and pre-assembled... 10 minute installation
- Gas or oil convertible... just change burner package
- 20 gas models, 12 oil models... 4 distinct types... 60,000 to 145,000 BTU

Designed, built, proved, priced for the new housing market. Each unit displays the famous WILLIAMSON symbol, gives you extra merchandising value. Matching cooling units for year 'round air conditioning.

WILLIAMSON Cooling Units

- Water or air-cooled... 2 or 3-ton units
- Sectionally designed to save space
- Need as little as 2.7 sq. ft. floor area, 43" height.

Plus the most comprehensive line of die-cut pre-fabricated Duct, Pipe and Fittings for Heating and Cooling.



- Pipe and fittings for ANY system
- No shopwork, small inventory needed
- Save time and cost... install fast

112 FURNACES - 5 TYPES - 8 LINES

Get ALL from ONE Source... WILLIAMSON, the most complete furnace line, ever!

Regardless of size or type home you build, WILLIAMSON can supply you with everything you need for complete warm air heating and summer cooling.

THE WILLIAMSON
HEATER COMPANY

3535 MADISON ROAD, CINCINNATI 9, OHIO

Please send me complete information on:

Assembled Furnaces Gas Oil

Summer Cooling Units

Water-Cooled Air-Cooled

Pipe & Fittings

Complete Line of Furnaces

Name.....

Address.....

City.....Zone...State.....

Looking IN or OUT



LOOKING IN through the Parallel-O-Plate Glass in a store window, you hardly know the glass is there, so perfect is its parallelism.



LOOKING OUT of a window wall of Parallel-O-Plate Glass, you see the scene as it actually *is*, in all its beauty. Parallelism is doubly important when your windows are *Thermopane*®—the double-paned insulating glass.



or AT New L·O·F Parallel-O-Plate Glass is Amazing!

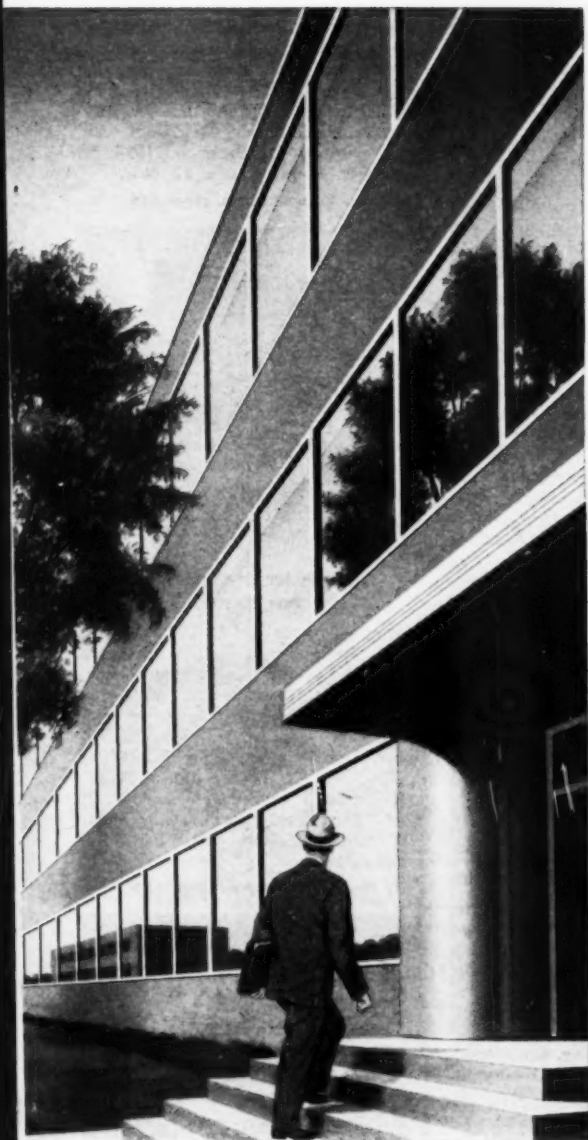

LOOKING AT windows of Parallel-O-Plate you see how important glass of true parallelism is to the architectural beauty of modern buildings.

It's the finest plate glass ever made in America . . . yet it costs no more than ordinary plate!

Parallel-O-Plate is the *first and only twin-ground* plate glass made in America.

For 12 months this L·O·F glass has been reserved solely for fine mirrors and military optical instruments.

Now it has been made available for *general use*.

It sets a whole new standard of performance for windows in stores, homes and offices.

New Libbey·Owens·Ford *twin-grinding* is the most advanced method of perfecting plate glass! At L·O·F, a ribbon of plate glass 127" wide and a fifth of a mile long moves continuously through ingenious machines which grind both sides *simultaneously!*

What does this mean to you?

Most distortion in glass is caused by a *lack of parallelism*.

Twin-ground plate glass is the most perfectly parallel plate glass in the world!

Yet L·O·F Parallel-O-Plate costs *not one cent more!*



LOOK AT THIS COMPARISON between the reflections of the upside-down signs in the mirror of conventional plate glass (left) and the mirror of Parallel-O-Plate (right).

Parallel-O-Plate Glass

the finest plate glass in America...made only by LIBBEY·OWENS·FORD
a Great Name in Glass

SYMONS STEEL FRAME FORMS

Symons lightweight steel frame forms with plastic plywood panels are easy to



handle, easy to set-up, easy to strip. The width of the steel frame is only 2½" wide compared to 4½" for wood frame forms. The forms are so constructed that, when necessary, panels can be easily replaced right on the job.

Send in the plans for your next job. Our Engineering Staff will furnish complete form layouts and job cost sheets on your form work—at no charge to you. This service enables you to get a clear picture of your job (its cost, bill of materials and labor saving methods). Literature on Symons Steel Frame Forms is also available upon request. Symons Clamp & Mfg. Co., 4261 Diversey Ave., Dept. K-4, Chicago 39, Illinois.



CONTRACTORS!
Finish Your
Cold-Weather
Jobs **ON TIME**
... with
Handy
SIMPLEX
PORTABLE

HOT BLAST HEATERS

You'll save the price of a SIMPLEX the first year . . . Speeding up drying of plaster, paint and varnish, keeping workers more comfortable, preventing freeze-ups—keeping work moving in coldest weather.

Smokeless, sootless, the HOT BLAST generates an intense blue flame on a mixture of kerosene and compressed air like a blow torch. Highly efficient, lightweight, sturdy, easily portable, it is also available with wheels. Completely safe. Automatic Shut-Off control stops fuel supply if flame goes out.

See your Builder's Supply Dealer, or write for details and prices.

WESTERN METAL SPECIALTY CO.

Dept. A, 1211 N. 62nd St.,
Milwaukee 13, Wis.

AMERICAN BUILDER

Your Guide to NEW PRODUCTS Information

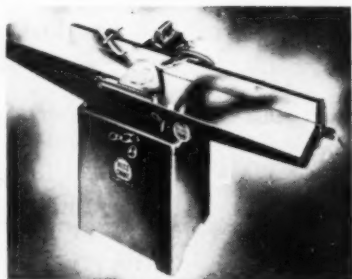

long table jointers permit increased operator control

Fence control handle speeds up angular fence settings on 8x84- and 6x60-inch long table jointers, gives operator better control of fence, avoids interference when feeding stock through machine. Speeds of 14,400 and 10,800 cuts per minute, respectively, are provided for the 8- and 6-inch units. Boice-Crane Co., Dept. AB Attn. M. H. Buehrer, 930 W. Central Ave., Toledo 6, Ohio.

Circle No. 20 on Coupon, page 154

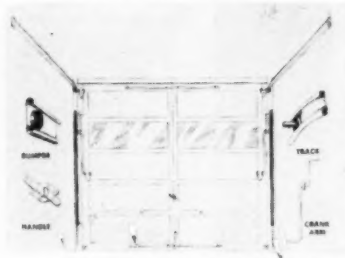

one-piece garage door requires little head room

"Mon-O-Dor" has heavy-duty hardware and patented crankshaft arm that eliminates sway, assures balance and weather-tightness. Unit is said to be easy to install, requires only 1½ inches of headroom. Made in 8x7-foot size. Door is sold through distributors, lumber yards. Howell Mfg. Co., Dept. AB, Attn. John J. Brennan, Hasbrook & Cottman Sts., Philadelphia, Pa.

Circle No. 21 on Coupon, page 154



adjustable concrete forms offer wide adaptability

Made of waterproof plywood attached with split rivets, use of these forms speeds concrete construction of foot-

ings, basements, retaining walls, etc. Simple to set up and strip from any starting point. Outside corners are adjustable to wall thickness, requiring fewer filler sizes. Available in most standard sizes; sold to dealers. Biersach & Niedermeyer Co., Dept. AB, Attn. Norton D. Biersach, 1938 N. Hubbard St., Milwaukee 12, Wis.

Circle No. 22 on Coupon, page 154

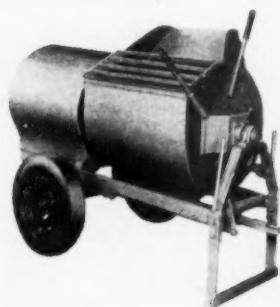

plaster and mortar mixer has increased capacity

Master-Mixer takes a full two-bag batch. Mixing shaft and bearings are protected by labyrinth packing glands. Axle extends to 46½-inch width for stability in travel but telescopes to 35½ inches for passage through 36-inch doors. Unit is powered by 7 h.p. gas engine or 3 h.p. electric motor. Available through equipment dealers at \$725. The Knickerbocker Co., Dept. AB, Attn. E. Sisson, 610 Liberty St., Jackson, Mich.

Circle No. 23 on Coupon, page 154



reversible metal tape can be used on caps and corners

"Flex-Corner" reversible metal tape requires no nailing, and is claimed to save from two to three hours application time. Worker covers corner with wallboard joint cement, presses on tape with hawk, removes excess cement and covers tape with one coat of joint cement. Available in 100-foot rolls. Steel Corner Tape Corp., Dept. AB, Attn. John Dooley, 106-09 Rockaway Blvd., Ozone Park 17, N. Y.

Circle No. 24 on Coupon, page 154



"A salute to those who made it possible" *

How to save money coming and going

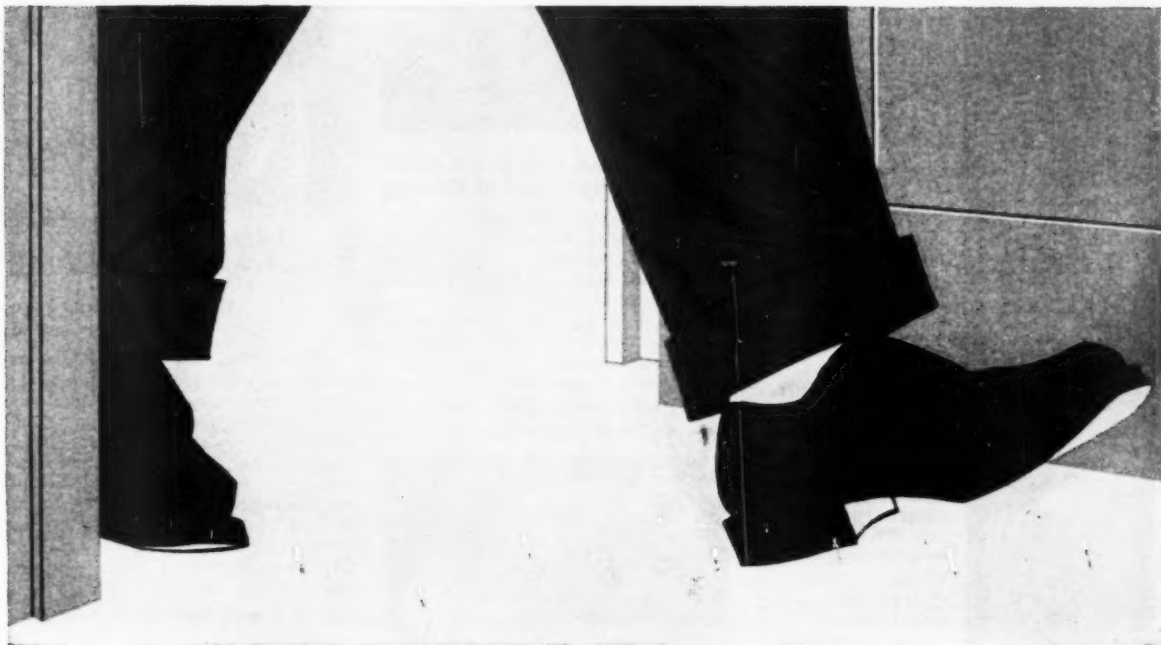

Count the doors in your building. Like to save up to \$100 apiece on each door you put in your *next* building? Compare the installed cost of Fenestra* Hollow Metal Door-Frame-Hardware Units with the cost of other hollow metal doors!

Here are three sound reasons why Fenestra Door Units can bring you such important savings:

1. *They cost less to buy* because you get production line economy—not custom job costs. They are mass produced on special jigs that avoid expensive time and labor.

2. *They come to your job complete* with pre-fitted frame, door and hardware specifically made for each other. You save time because there's no need for planning, ordering and assembling special elements.

3. *You save on installation costs* because these complete units need no cutting, no fitting, no mortising or tapping. Each door is installed and in use in minutes.

And you save year after year on maintenance because Fenestra Hollow Metal Doors can't warp, swell, stick or splinter. They always open easily . . . smoothly. They close quietly because inside surfaces are covered with sound-deadening material.

For strong, solid quality at low cost, check on Fenestra Doors. There's a door for every purpose in the Fenestra line: Entrance Doors, Flush or Regular Interior Doors with glass or metal panels. Doors with the Underwriters' B Label. For pictures and details, write the Detroit Steel Products Company, Department AB-11, 2260 East Grand Blvd., Detroit 11, Michigan. *®

* Your need for lower building costs encouraged us to develop a quality door unit that would save initial cost and installation cost—Fenestra Hollow Metal Door-Frame-Hardware Units . . . a great advancement in building products.

Fenestra | DOOR • FRAME •
HARDWARE UNITS

holly leads again with a New NarrowWall

(PAT. NO. 2,526,613)

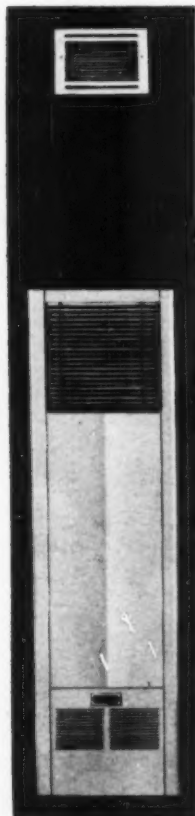

AGA
APPROVED
UNDER
LATEST
1954
CENTRAL
HEATING
REQUIRE
MENTS

Only Holly NarrowWall has the S-H-E (Secondary Heat Exchanger) which generates and circulates extra warmed air without fans. MR. CONTRACTOR, check these Holly advantages:

- ☆ New Design—quieter operation.
- ☆ Each burner factory tested under full operating conditions.
- ☆ All heaters fully guaranteed.

☆ Saves flue material.

☆ Fits any standard wall, even between staggered joists.

On all the essential points which determine heater performance—comfort, safety, low operating cost—the new NarrowWall sets a new standard.

Get the facts about Holly superiority.
Phone your nearest Holly dealer in yellow book, or mail coupon to

HOLLY MANUFACTURING CO.
885 S. Arroyo Pkwy., Pasadena 2, California
Please send me without obligation, complete information about the Holly NarrowWall Heater with S-H-E.

Name _____
Address _____
City _____ State _____

AMERICAN BUILDER

Your Guide to **NEW PRODUCTS** Information



one-man power trowel does rapid concrete finishing

Designed for one-man operation, this 24-inch "Master Midget" power trowel is stated to give skilled sweeping action of an expert finisher and finish concrete much faster than by hand. Unit has three steel blades, with snap-in adjustments for floating, sweep, smooth or hard trowel finishes. Master Vibrator Co., Dept. AB Attn. Mrs. L. DeCamp, 1752 Stanley Ave., Dayton, Ohio.

Circle No. 25 on Coupon, page 154



¾ cubic yard loader has automatic transmission

Model LH-75 Loadster has direct drive from engine, through torque converter coupling to transmission. Four working speeds provided, plus fifth for traveling; reversing mechanism provides full gear range forward or reverse. Unit has ¾ cubic yard capacity. It sells at \$6,350, f.o.b., Batavia, N.Y., through construction equipment dealers. Contractors Machinery Co., Inc., Dept. AB, Attn. Hoyle C. Burt, P.O. Box 191, Batavia, N. Y.

Circle No. 26 on Coupon, page 154

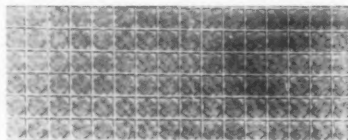

fabricated metal pattern reduces glare, distortion

Rigidity, tensile strength and mar-resistance, plus decorative appeal are fea-

tures of new C-i-S pattern, furnished in sheet, strip and coil and in solid or perforated metals, with variety of finishes. Sold through metal warehouses and factory representatives. Rigidized Metals Corp., Dept. AB, Attn. R. G. Leary, 687 Ohio St., Buffalo 3, N.Y.

Circle No. 27 on Coupon, page 154

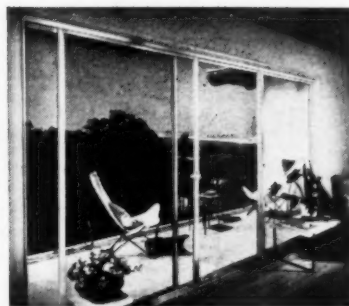

sliding glass doors are weather sealed

"Ador" all-aluminum sliding glass doors feature sealed, box-type aluminum extrusions for added strength; four-way mohair stripping which keeps out sand, moisture and wind; and stainless steel bearings for easy action. Alumilite finish gives smooth appearance, corrosion resistance. Price range from \$132 to \$305, covering 28 sizes; sold by distributors and agents. Ador Sales, Inc., Dept. AB, Attn. C. E. Munson, 1631 Beverly Blvd., Los Angeles 26, Calif.

Circle No. 28 on Coupon, page 154

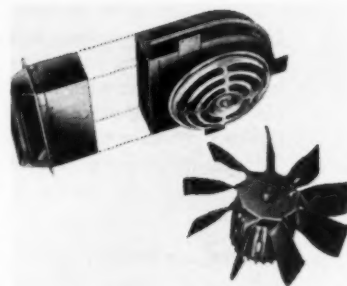

ventilating fan reduces noise, offers high air capacity

Stated to move air with quietness of a blower and capacity of a propeller, 10-inch fan delivers 530 c.f.m. through ten feet of duct. Air-moving surfaces of impeller increased by 50 per cent, take more, but smaller "bites" of air, reducing turbulence and noise. List price for chrome grille model is \$48.95 from electrical contractors, building material dealers. Fasco Industries, Inc., Dept. AB, Attn. J. L. Newman, 255 W. Union St., Rochester 2, N. Y.

Circle No. 29 on Coupon, page 154



The name on the door means a lot

A door tells a lot about its owner's taste and judgment. And when the name on the door you start with is Atlas Plywood, you can be sure the owner has bought beauty plus guaranteed satisfaction.

Atlas Plywood birch doors, in particular, win praise in homes, offices, public institutions. Like all Atlas Plywood flush doors, they are easy to finish, easy to hang and stand up under years of service. They're trued, trimmed and glued right

— no chance of rejects from inferior adhesives. Quality-controlled every step of the way — from American forest to finished product.

Choose from three grades: (1) book matched, "Estate" for natural finishing;

(2) "Suburban" for high grade staining; (3) all-purpose "Metropolitan", suitable for staining. For complete details, send for free color folder on Atlas Plywood flush doors. Write Dept. AB-3, 1432 Statler Bldg., Boston 16, Mass.

Atlas Plywood

CORPORATION

FROM AMERICAN FOREST TO FINISHED PRODUCT

Boston 16, Mass. Distributors in all principal cities



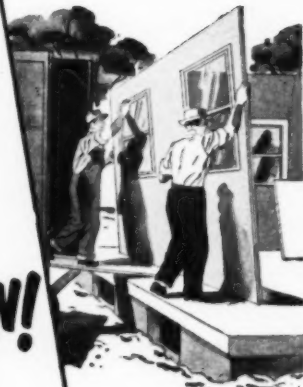

Construction of prefabricated homes continues to show increases as compared with total home building. In the first half of 1954 the gain was 22 per cent over the previous year. The reason is clear. Only with prefabrication's modern methods can builders meet all of today's demands for speed, economy and quality—meet them on time, every time. That's why it's high time to switch to prefabrication.

HIGH TIME FOR FASTER STARTS. All structural materials delivered in one package . . . from one responsible source.

HIGH TIME FOR SHORTER ERECTION TIME. No costly delays of having work held up by a shortage of materials.

HIGH TIME FOR QUICKER COMPLETIONS. Buyers get their homes faster, and you get your money out of the job faster.

HIGH TIME FOR PREDETERMINED COSTS. Prefabrication is the sure way to nail down costs, to make sure of your profits.

Determine for yourself the advantages of prefabrication's modern methods. Write for a list of home prefabricators and learn the advantages of a dealership.

Subscribe now to "PF", the official monthly journal of PHMI. Keeps you fully informed of new opportunities in this fast growing field. \$3 a year.

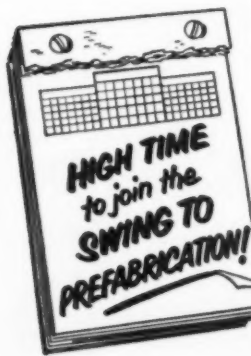

PREFABRICATED HOME MANUFACTURERS' INSTITUTE



923 - 20th Street, N.W.
Washington 6, D.C.

AMERICAN
BUILDER

NEW PRODUCTS



aluminum-glass unit converts tub to shower enclosure

Easily installed, this tub enclosure is factory-assembled, ready to screw side jambs to walls, secure bottom rail to tub rim with mastic. Heavy aluminum parts, translucent 7/32-inch glass mounted in rubber gaskets. Enclosure retails at \$74.95, sold through franchise holders, plumbing supply houses. Glamour Show-R-Door Co., Ltd., Dept. AB, Attn. S. Jacobs, 6459 N. Sheridan Road, Chicago 40, Ill.

Circle No. 30 on Coupon, page 154

Paint brush softener called "Miracle Brush Bath" cleans brushes and rollers; can be used over again. It sells at \$1.69 per quart at paint dealers. Glamorene, Inc., Attn. John B. Howey, 10 E. 44th St., New York 17, N. Y.

Circle No. 31 on Coupon, page 154



lightweight soldering gun furnishes instant heat

With ample power for all types of general soldering, unit has shock-resistant plastic housing. Instant heat in excess of 100 watts is available. Trigger control switches on heat; dual spotlights illuminate work area. Gun sells at \$7.95 list from hardware and electrical dealers. Weller Electric Corp., Dept. AB, Attn. Joseph F. Whitaker, 808 Packer St., Easton, Pa.

Circle No. 32 on Coupon, page 154

Asphalt insulating panel has a textured wood design finish, is fire retardant and weatherproof. Available through building specialty firms. Jones & Brown Inc., Dept. AB, Attn. William J. Sauer, 439 Sixth Ave., Pittsburgh 19, Pa.

Circle No. 33 on Coupon, page 154

Truscon Series 138 is the largest selling window of its type in the world. Especially popular in residential, light commercial and institutional, and apartment construction, with or without sill vent.

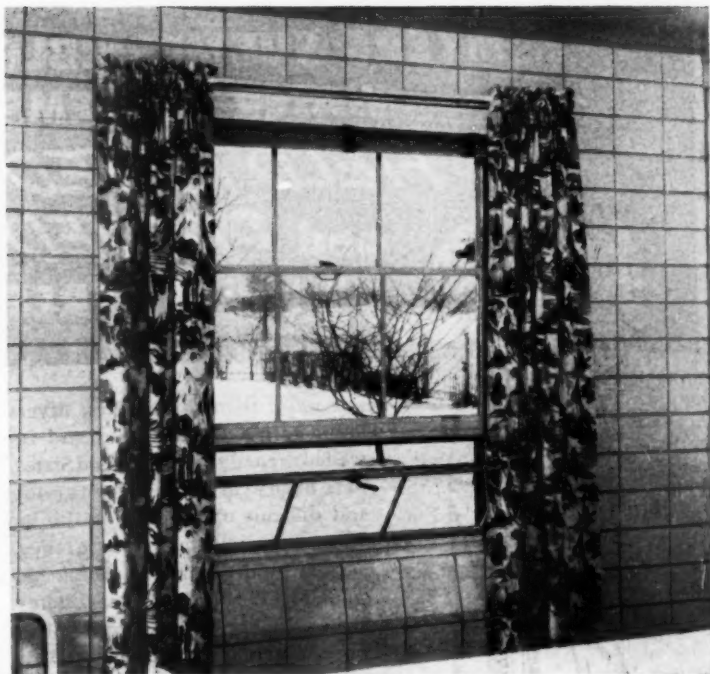

Truscon Series 138 Double-Hung Steel Windows with sill vent are used throughout Barney Convalescent Hospital, Dayton, Ohio. Lorenz and Williams, architects; Maxon Construction Co., contractor.

In Truscon Series 138 Windows... STEEL'S STRUCTURAL STRENGTH KEEPS SASH SECTIONS SLIM

All-steel construction is the big reason why Truscon Series 138 Double-Hung Windows offer you so many advantages.

Steel is structurally strong. Stronger than other window materials. Steel sash members can be attractively slim, trim, graceful, free from bulk.

Steel is dimensionally stable. Steel windows can't shrink, warp, swell. Temperature and humidity conditions have virtually no effect upon them. They fit right, stay right, whatever the weather.

Steel is durable. It can't rot, resists damage. Steel windows can be expected to serve for the life of a building.

Steel is easy to fabricate. This means mass production economies and standards.

In Truscon Series 138 Double-Hung Windows you get all these advantages. And more. Factory-installed stainless steel weatherstripping. Stainless steel motor tape balances. Electro-galvanized, Bond-erized surfaces with baked enamel coat. Wide choice of sizes and styles, including sill vents, picture window units. Finest hardware. Public confidence and acceptance.

You want to look *through* windows, not *at* them. You want Truscon Series 138 Steel Windows, with slim sash section. More facts, details, and specifications in Sweet's; or write Truscon.

TRUSCON®



TRUSCON STEEL DIVISION
REPUBLIC STEEL



1050 ALBERT STREET • YOUNGSTOWN 1, OHIO
EXPORT DEPT.: CHRYSLER BLDG., NEW YORK 17, N.Y.

A NAME YOU CAN BUILD ON

MYERS SUBMERSIBLE WATER SYSTEMS *FIELD TESTED* and *PROVED* TROUBLE FREE

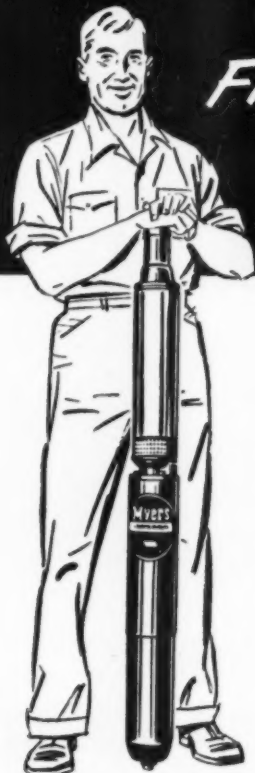

For more than three years, Myers Submersible Pumps, sold and installed throughout the United States, have been field tested under varying and difficult operating conditions. We can now tell you with assurance, backed by the warranty which has made Myers famous, that this pump makes the finest, most trouble-free water system you can sell any customer.

So sell the submersible you can install with complete confidence. Sell the Myers Submersible where high pressure, high-capacity, quiet, automatic water service is desired.

EFFICIENT PERFORMANCE

A submersible pump is the most efficient means of pumping water known today. And a Myers Submersible pumps more per horsepower than any other known submersible.

EASY TO INSTALL

Requires only one pipe in the well. Has tough, light-weight 3 wire electrical cable. Special wire connectors eliminate need for tape or vulcanizing. All electrical controls, including overload protection, installed at surface for easy accessibility.

PURE OIL IN MOTOR

Ball thrust bearings are oil lubricated; Absolutely no parts of the motor come in contact with water.

OTHER FEATURES

High Reserve Electrical Power
Balanced-Pressure Design
Corrosion Resistance
Air Charging System

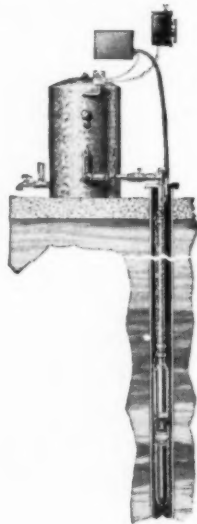

MYERS WATER SYSTEMS



THE F. E. MYERS & BRO. CO.
Ashland, Ohio

AMERICAN
BUILDER

NEW PRODUCTS



automatic, gas-fired incinerator has all-weather protection

Outdoor, gas-fired unit has automatic dial which turns on gas and lights device, turning it off at end of burning cycle. Burner is rated at 20,000 Btu per hour. Unit should be placed on solid masonry base. It is distributed through gas appliance dealers; sells at \$137.50, f.o.b., Cairo, Ill. Bowser, Inc., Incineration Div., Dept. AB, Attn. Clifford E. Hall, Cairo, Ill.

Circle No. 34 on Coupon, page 154

packaging folding stairway installs in 45 minutes

Unit has all parts in one package ready to install; holes are bored. Estimated assembly-installation time is 45 minutes. Furnished frame fits 26x54-inch ceiling opening. Two stair sizes are furnished to fit different ceiling heights. Kits sell for \$24 and \$26 from manufacturer. Precision Parts Corp., Dept. AB, Attn. Paul Harmon, 400 N. First St., Nashville 7, Tenn.

Circle No. 35 on Coupon, page 154



wire gripping chuck used in concrete construction

Reusable gripping chuck for end-anchoring wire in prestressed concrete construction consists of a heavy steel casing with internal taper; three-jaw chuck has wedge-shaped teeth which engage wire automatically. Chuck will hold wire under tensions as low as 300 pounds and anchors wires at from 4,000 to 20,000 pounds tension. Six standard sizes sell at \$.95 to \$2. each, available through electrical supply wholesalers. Reliable Electric Co., Dept. AB, Attn. F. A. Leach, 3145 Carroll Ave., Chicago 12, Ill.

Circle No. 36 on Coupon, page 154

AMERICAN BUILDER

No more
of this

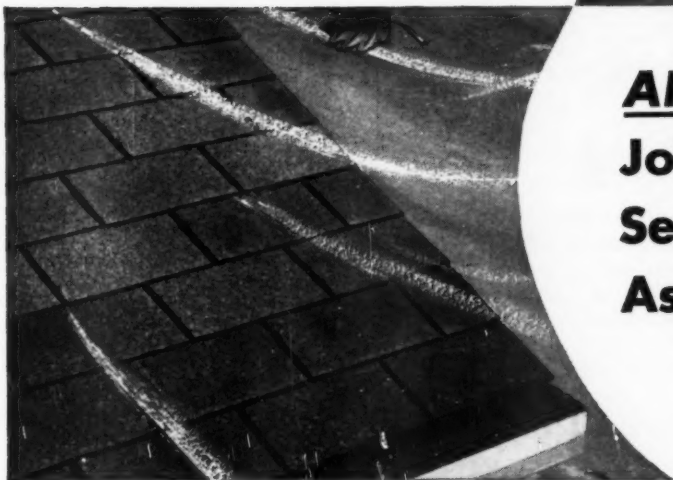
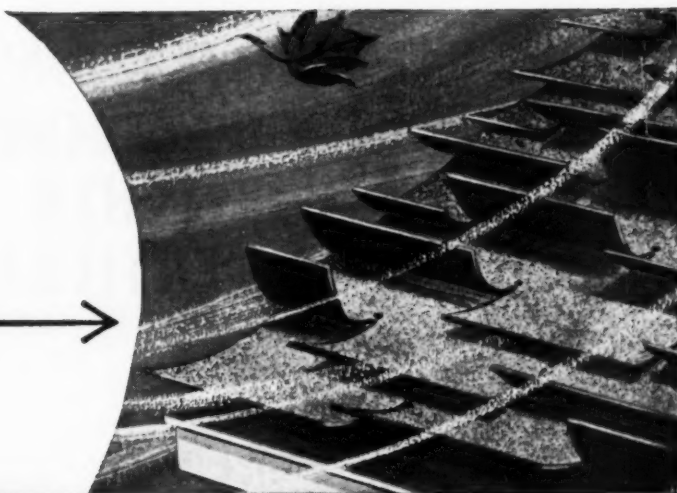
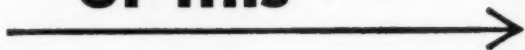

ANNOUNCING
Johns-Manville
Seal-O-Matic
Asphalt Shingles!

**They hold tight when it blows
because they are self-sealing!**



Here's the secret!

The sun's heat seals the tabs automatically because of this strip of special petroleum resin cement on the underside of each shingle.

THIS NEW PATENTED exclusive Johns-Manville Seal-O-Matic shingle is a revolutionary development in asphalt roofing. It provides a roof of traditional shingle design that eliminates fear of wind damage. It has been tested and proved in the high wind areas of the Middle West.

J-M research has developed a special petroleum resin cement with extraordinary bonding qualities. A ribbon of this cement is factory applied on the underside of each strip along the entire butt edge. The sun's heat causes the cement strip to grip the underlying shingle with bulldog tenacity. Every tab is securely cemented. Wind and rain simply can't drive up under the shingles!

Johns-Manville Seal-O-Matic Asphalt Shingles are available in the popular thick butt style in many attractive colors and blends. For complete information write Johns-Manville, Dept. AB, Box 111, New York 16, New York.



Johns-Manville

SOLD

... another modern home
with an
**EMERSON-ELECTRIC
KITCHEN
VENTILATOR**



Many a sale is closed in the kitchen . . . it's there you've got to please that all-important *Mrs. Home Buyer*. A cool, clean odor-free kitchen is a powerful selling point, and one which you can build right into your homes if you specify low-cost, dependable Emerson-Electric Kitchen Ventilators. Get complete specifications and performance data by writing for Bulletin No. 619.

Your choice of 2 easy-to-install models:

WALL MODEL . . .

- Telescoping adjustable sleeve fits walls 5 1/4" to 13"
- Square outside frame, easy to brick or frame around
- Special outer door seal gives weather protection
- Induction motor, 10" blade moves 470 c.f.m.

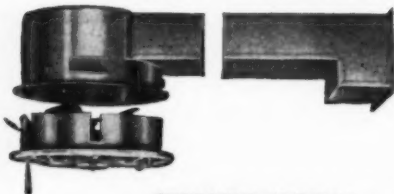
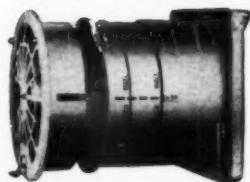

CEILING MODEL . . .

- Adjustable sleeve joint fits standard 3 1/4" x 10" duct
- Outside grille has angle baffles for weather protection
- Automatic shutter closes duct when fan is not operating
- Dependable Emerson-Electric motor equipped with special thrust bearings
- 10" blade moves 470 c.f.m.



**Specify
Emerson-
Electric
Attic Fans**

Build cool summer comfort right into your homes by installing Emerson-Electric Attic Fans! Here is another salesclinger . . . available in five sizes from 24" to 48". **Note:** you'll save *half* on installation by installing during original construction.

THE EMERSON ELECTRIC MFG. CO.
St. Louis 21, Mo.

EMERSON  **ELECTRIC**
FANS • MOTORS APPLIANCES

**AMERICAN
BUILDER**

NEW PRODUCTS

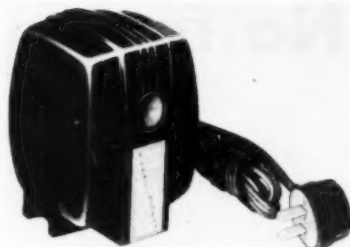

**switch turns on house lights
when darkness begins**

Light control switch called "Nite-lighter" automatically turns on desired indoor lights as dark comes. Switch may be wall mounted, with photoelectric eye pointed toward window; lamp to be controlled is plugged into switch fixture. Switch turns on light which will stay on until daylight. Unit sells for \$15.95. The Fisher-Pierce Co., Inc., Dept. AB, Attn. Alex Stohn, 63 Pearl St., S. Braintree, Boston 85, Mass.

Circle No. 37 on Coupon, page 154

Pocket tapes with inch graduations on one side have normal feet-inches markings on reverse; 72-, 96-, 120- and 144-inch models available; 144-inch tape sells at \$1.89. **Evans & Co.**, Dept. AB, Attn. D. W. Goldman, 400 Trumbull St., Elizabeth, N.J.

Circle No. 38 on Coupon, page 154

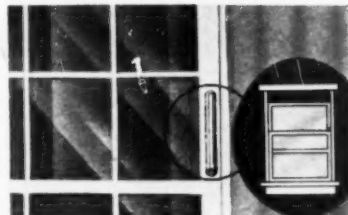

**window device provides
ventilation and protection**

Safe ventilation for double-hung windows and protection against prowlers is provided by Safe-Vent window unit, a stainless steel bolt that slides in a slotted stainless steel plate fastened to either side rail of upper sash. When lower sash is raised, bolt stops it at seven inches; upper sash may be lowered equal distance. Unit retails at 79 cents, is available at hardware, builders' supply dealers. The Brittain Products Co., Dept. AB, Attn. P. W. Brittain, Cuyahoga Falls, Ohio.

Circle No. 39 on Coupon, page 154

Wall-type electric **heating panel** combines radiant and convection heating principles; automatic model has built-in thermostat. Retails for \$62 at electrical appliance dealers. **Electromode Corp.**, Dept. AB, Attn. Paul Hawkins, Rochester 3, N. Y.

Circle No. 40 on Coupon, page 154



**700-proof testimonial
that those who build
with the best
specify**

REYNOLDS ALUMINUM WINDOWS

This letter is just one of hundreds testifying to the faith experienced builders have in Reynolds Aluminum Windows. In every form, Awning, Double-hung, Casement or Traverse, they cut down installation costs, add beauty... never need maintenance. Immune to weather, these windows never warp... give trouble-free performance for the life of the house. Write for literature. **Reynolds Metals Company,** Building Products Division, 2003 South Ninth St., Louisville 1, Kentucky.

FAUSETT & COMPANY

Arkansas' Largest Realtors
REALTORS • INSURORS
Mortgage Loans

An Institution
to serve your Real Estate and Insurance Needs



PHONE 4-6161 • 215-217 LOUISIANA STREET
Little Rock, Arkansas

December 3, 1953

Reynolds Metals Company
1527 Union Avenue
Memphis, Tennessee

Attention: Mr. A. Peter Kilburn, District Manager
Gentlemen:

My desire to give credit where credit is due prompts me to tell you of a few reasons why we selected Reynolds Aluminum windows for installation in our 700 home Broadmoor Subdivision.

Certainly our choice was not a hasty one. You may recall that we have used your windows in several other of our residence developments, and even in our own properties constructed only for investment purposes.

We, as well as the purchasers of our homes, are sold on your windows because of their overall economy, their durability, their immunity to rust, fire resistance, the fact they do not require painting, or other maintenance.

Further, selection of your windows is in keeping with our sincere desire that only the best of planning, materials, and equipment are used in Broadmoor Addition homes.

Proof that we are succeeding in this desire is the terrific enthusiasm expressed by the buying public, and the more than 20,000 people who inspected the first completion of Broadmoor homes during the recent Parade of Homes held in conjunction with the National Association of Home Builders.

Last, but not least, we are proud to be a volume user of aluminum, the wonderful product of Arkansas Bauxite Ore.

Cordially yours,
FAUSETT & COMPANY, INC..

E. L. Fausett
E. L. Fausett, President

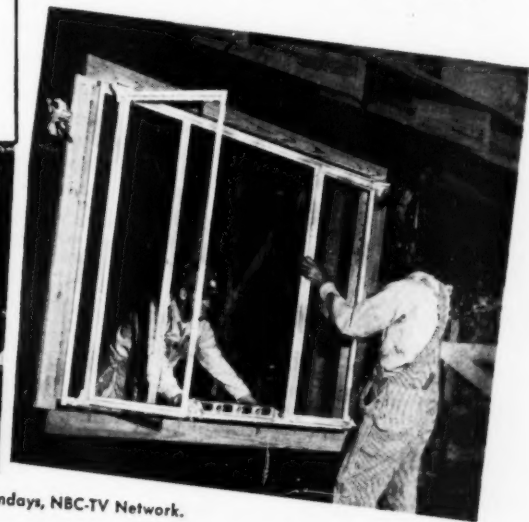

SEE "MISTER PEEPERS," starring Wally Cox, Sundays, NBC-TV Network.

REYNOLDS  **ALUMINUM**
BUILDING PRODUCTS

NOVEMBER 1954



Novafold

SOLID CORE PLASTIC DOORS

—space- and money-saving doors and room dividers

By saving the space a swinging door wastes, you increase the useable area of any room! The Novafold Solid Core Plastic Door provides this attractive sales feature—at a price 25 to 50% less than comparable Vinyl-covered doors.

Novafold folds to 16% of its expanded width in a flush-with-the-wall 4½" stack. 4" leaves, in individual, full-length pockets in the Vinyl Plastic cover, give you a solid core door—room-to-room privacy—true accordion folding.

Smooth, silent operation is assured by self-lubricating Nylon slides. An exclusive Novafold feature is the linkage chain that gives even pleating when the unit is drawn.

Novafold is available in six colors—a wide range of sizes—affording unlimited application possibilities.

In Novafold, you have a top-quality product that is guaranteed for one year by the manufacturer against defects. This unit folds into the smallest space possible, thus increasing the useable floor and wall space.

Novafold affords the latest design features—in a wide range of size and color combinations—at a price 25 to 50% less than for doors of comparable quality.

Novafold is installed in 4 to 7 minutes. In new construction—no furring, trim or roughing is needed. There are no floor guides. With special track, Novafold is available for curved openings.

Colors: Beige, Dark Green, Chartreuse, Eggshell, Gray and Red.

May we send you color samples and specification data suggesting many applications of Novafold in the home? Please address your inquiry to Department 15A.

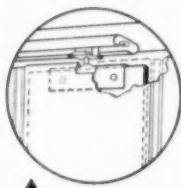

Heavy-duty enameled steel track, fixed to the top of the opening. Self-lubricating Nylon swivel slide, fixed to metal plate riveted to leaf.

4" leaves, in individual pockets, assure perfect accordion-folding.

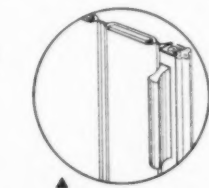
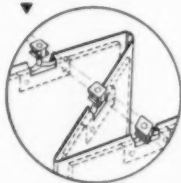

Easy-grip handle. Soft, Plastic beading affords silent closing and tight fit—door-to-door and jamb-to-jamb.

NOVA SALES

Co. TRENTON 3, N. J.

A wholly-owned subsidiary of Homasote Company—manufacturers of the oldest and strongest insulating-building board; wood-textured and striated panels.

AMERICAN
BUILDER

NEW PRODUCTS



portable machine cuts holes in reinforced concrete

"Mechanized Mole," using diamond bits, can cut through aggregate and steel reinforcing bars without loss of drilling speed. It will cut one- to six-inch diameter holes in a foot of concrete in less than two minutes. Electric-powered unit is portable and lightweight. Bits are carried in stock in standard sizes. Two models, in one and two h.p. sell at \$385 and \$485 through manufacturer's distributors. Molco Drilling Machines, Inc., Dept. AB, Attn. Leonard Cecil, 1100 20th St., N.W., Washington, D. C.

Circle No. 41 on Coupon, page 154

Bathroom accessories line is chromium plated on solid brass; units sell at from \$2.00 to \$6.00 each, retail, from plumbing and hardware dealers. **Hall-Mack Co.**, Dept. AB, Attn. DeWald McDonauld, 1380 W. Washington Blvd., Los Angeles 7, Calif.

Circle No. 42 on Coupon, page 154

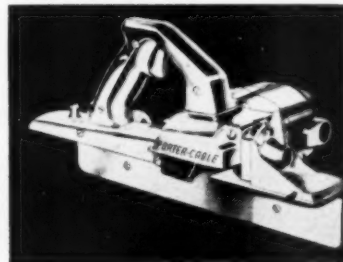

electric plane permits high speed door hanging

Heavy-duty aluminum alloy electric plane has spiral-type cutter that operates at 25,000 r.p.m. Tool removes 3/32-inch of wood at each stroke, producing square, smooth surface that needs no sanding. Plane is 16 inches long, weighs 9¼ pounds. Bevel adjustment allows plane to cut any angle from -15 to 45 degrees. Price is \$95. Porter-Cable Machine Co., Dept. AB, Attn. E. F. Wheeler, 1714 N. Salina St., Syracuse 8, N. Y.

Circle No. 43 on Coupon, page 154

AMERICAN BUILDER



Read how the REMINGTON STUD DRIVER cuts fastening costs!

Free booklets show where powder-actuated
tool can be profitably used

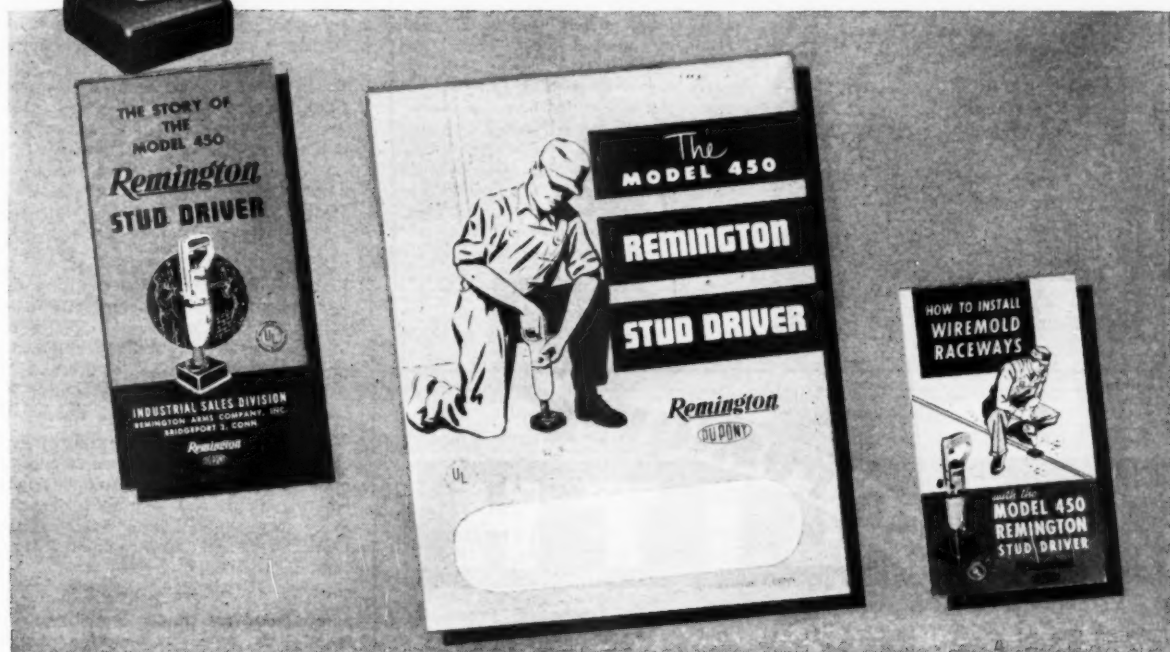

THE STORY OF THE REMINGTON STUD DRIVER. Here's an easy-to-read illustrated booklet that shows you how the tool operates and points out its important features. You'll see close-ups of the Stud Driver in use, securing structural channels, furring strips and many other fittings to steel and concrete surfaces.

THE REMINGTON STUD DRIVER. A complete catalog—it shows actual-size drawings of the Remington Studs available. Another section deals with the special guards for the tool used to fit over lathing sections, flexible framing sections, wood sills and other sections and fittings.

THE WIREMOLD SYSTEM. It's a specially prepared booklet that describes anchoring Wiremold channels with a Stud Driver. A special Remington guard is available for this application. This booklet takes you step by step through the entire Wiremold Raceway & Wireway installation system.

MAIL THIS COUPON FOR YOUR FREE COPIES

"If It's Remington—It's Right!"

Remington

DU PONT



Listed & Approved by Underwriters' Laboratories, Inc.

Industrial Sales Division, Dept. AB-11
Remington Arms Company, Inc., Bridgeport 2, Conn.

Please send me the booklets checked.

- The Story of the Remington Stud Driver
 The Remington Stud Driver
 How to Install Wiremold Sections

Name _____
Position _____
Firm _____
Address _____
City _____
State _____



Balanced design — easy operation

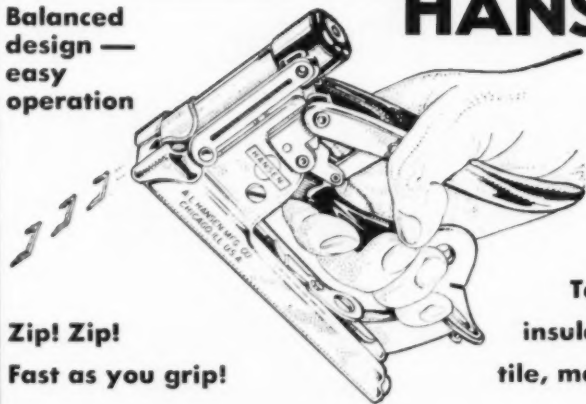

Zip! Zip!
Fast as you grip!

HANSEN

the Tacker
with 1001
uses —

Tacks screens,
insulation, ceiling
tile, metal lath, etc.



INSULATION of all types quickly and properly installed with Hansen, the Tacker you hold and operate with one hand — securely holding material and bracing self with other. Flanges on insulation are easily tacked securely in place. Reflective insulation looks and holds better when tacked with Hansen. Building paper, screens, ceiling tile, metal lath, cornerite, are among other time-saving uses of this modern tacking method.

REQUEST BOOKLET T-40

A. L. HANSEN MFG. CO.
5059 Ravenswood Ave.
CHICAGO 40, ILL.

AMERICAN
BUILDER

NEW PRODUCTS



brad driver and setter
reaches inaccessible spots

This tool simplifies insertion of 1/2-inch-long brads into hard-to-get-at places. It has a 3/16-inch nickel plated brass barrel with a magnetic steel core which picks up head of brad. Point of brad can then be directed in any angle desired and inserted into most woods and soft metals by pressure with palm on hard-wood handle. Tool retails at \$1.69; available through wholesalers. Philip Unsinger & Son, Dept. AB, Attn. R. P. Unsinger, Fremont, Ohio.

Circle No. 44 on Coupon, page 154

Light control unit permits setting of light intensity of home lamps to any value or combination up to 360-watt load. Sold at \$32.50 by electrical wholesalers. Superior Electric Co., Dept. AB, Attn. R. F. Greene, Bristol, Conn.

Circle No. 45 on Coupon, page 154

All-copper wall tile has transparent enamel protective finish, bevelled edges; made in 4 1/4-inch squares. Sold through building supply and flooring dealers at \$1.50 per square foot. Vikon Tile Corp., Dept. AB, Attn. Kenneth Riley, Washington, N. J.

Circle No. 46 on Coupon, page 154

Safety guard for "Power Shop" line of radial arm type woodworking saws, consists of two rings which completely enclose cutting member. \$15.75 to \$34.75 through retail lumber dealers. DeWalt, Inc., Dept. AB, Attn. A. E. Richardson, Jr., Lancaster, Pa.

Circle No. 47 on Coupon, page 154

Glass blocks made in three 12-inch functional patterns reduce glare and solar heat gain. Sold through lumber yards, builders' suppliers. Pittsburgh Corning Corp., Dept. AB, Attn. S. J. Kail, Jr., Pittsburgh 22, Pa.

Circle No. 48 on Coupon, page 154

double-bowl sinks
use any style tops

Stainless steel standard back ledge sinks are available in 21x32- and 21x42-inch sizes. Hudee frames are available for all sizes and styles. Sinks can be used with Formica, tile, linoleum, plastic or stainless steel tops. Legion Utensils Co., Dept. AB, Attn. John Jensen, Long Island City 1, N.Y.

Circle No. 49 on Coupon, page 154

50-50 PUSHOVER ALLITH GARAGE DOOR HARDWARE

USE YOUR OWN OR
ANY STANDARD DOOR

NO MAINTENANCE COSTS

SIMPLIFIED INSTALLATION

ADAPTABLE FOR ANY
TYPE GARAGE

ALLITH hardware works with equal efficiency on either custom or mill-made doors. All working parts simple and sturdy—no springs to stretch or loosen. All hardware parts inside and protected from weather.

Unit shipped complete to the last screw. Quickly and easily installed. Standard set fits any opening up to 9' wide x 7'6" high when doors do not exceed 275 lbs. Other sets available for openings up to 10' wide x 10' high. Write for details.

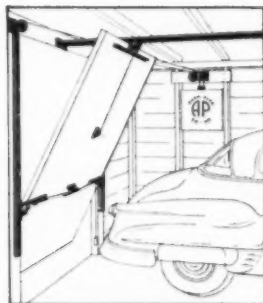

MANUFACTURED BY

ALLITH

PROUTY, INC.

DANVILLE,
ILLINOIS

7 OUT OF 10

WANT A FIRE-CHEX ROOF

SAY VETERAN CINCINNATI BUILDERS DUGAN AND MEYERS



BUILD BETTER FOR BIGGER PROFITS WITH CAREY FIRE-CHEX!

**No Other Roofing Material
Offers All These Advantages.**

Greater Fire Safety—Actual U. L. tests proved that Carey Fire-Chex will resist a blazing wood brand 108 times larger than the size used to test Class C shingles . . . qualified these great new shingles for the highest possible fire safety rating—Class A by Underwriters' Laboratories, Inc.

Beautiful Copyrighted Roof Designs—Only Fire-Chex Shadow-Blend shingles can be laid in exclusive copyrighted shadow blend roof designs that cannot be duplicated! Available in shadow blends of green, gray, red, brown and Shasta Snow—also rich solid shades in Velvet Black and Chocolate Brown.

Please refer to Sweets Catalog for further information or write Dept. AB-11

Years and Years More Protection—Tests under the roughest weather conditions dished up by nature—from sub-frigid cold to sizzling heat—prove that Carey Fire-Chex resist blistering, hail and wind damage far better than ordinary roofing materials.

What an array of "extras" to help you build better for bigger profits! See your Carey Dealer for samples and prices!

Fire-Chex Specifications:
12x36 inches—Square Butt 3-Tab
—Headlap 2 inches—Exposure 5 inches—Weight: approx. 325 lbs. per sq.—Colors: Green, Red, Gray, Brown and Shasta Snow Shadow Blends. In solid colors, Velvet Black and Chocolate Brown.

"You'll be pleased to know that Carey Fire-Chex asbestos-plastic shingles are the preferred roofing on the great majority of new homes we build. Once we tell folks the facts about Fire-Chex, and show samples of those beautiful blends and colors, no shingles but Fire-Chex will do. That's true even on jobs where it means spending a little more to get Fire-Chex, than for ordinary asphalt shingles. Naturally, we're sold on Fire-Chex. They run true to size—go on faster, give us more profit per job and provide greater satisfaction for our customers."

Thomas E. Meyer

Carey

The Philip Carey Mfg. Co.
Cincinnati 15, Ohio
In Canada: The Philip Carey Co., Ltd.
Montreal 3, P.Q.

A Complete SLAB-FLOOR Duct System



PHOTOS—Hathaway Meadows 600-unit Sub-Division, St. Louis, Mo. All 300 of the units with slab-floor heating systems used SONOAIRDUCT in an especially engineered perimeter installation without metal fittings. Milton Construction & Supply Co., St. Louis, contractors. Melvin C. Hendricks, Supt.

Through the Installation of

SONOAIRDUCT[®] PAT. APP. FOR FIBRE DUCT

SEE OUR
CATALOG
IN
SWEET'S

Economical, lightweight SONOAIRDUCT Fibre Duct saves installation cost in gas and oil fired loop, radial and lateral slab-floor perimeter warm air heating systems. Permitted by F.H.A. and widely used by builders everywhere. Sizes 2" to 36" I.D., up to 50 ft., or can be sawed to exact lengths on the job. Aluminum foil lined and wrapped outside with weather-resistant asphalt duplex kraft.

Write for Complete Information and Prices—



SONOCO PRODUCTS COMPANY
Construction Products Division

LOS ANGELES, CAL. HARTSVILLE, S. C. — MAIN PLANT MONTCLAIR, N. J.
5805 SOUTH WESTERN AVE. 14 SOUTH PARK STREET

AKRON, IND. BRANTFORD, ONT.

AMERICAN
BUILDER

NEW PRODUCTS

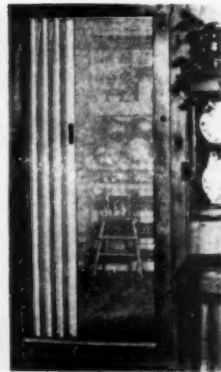

telescoping door has vinyl cover and hardwood core

"Magic-Fold" telescoping door has durable vinyl cover and solid core of hardwood is stated not to stretch; it is fire-resistant and mildew proof and is available in variety of sizes and cover colors. Door retails for \$19.95 to \$40.75 from lumber and building material dealers. Walter E. Selck & Co., Inc., Dept. AB, Attn. R. W. Johnson, 225 W. Hubbard St., Chicago, Ill.

Circle No. 50 on Coupon, page 154

Two-bowl sink for narrow front-to-back dimension is 32x20 inches and is designed for counter top installation. Retail for \$46.50 in white, \$51.50 in color. **Universal-Rundle Corp.**, Dept. AB, Attn. Quentin B. Garman, New Castle, Pa.

Circle No. 51 on Coupon, page 154

Horizontal water circulator has interchangeable flanges for four standard pipe tappings, simplifying stocking. Available from plumbing and heating suppliers. **H. A. Thrush & Co.**, Dept. AB, Attn. D. F. Cypherd, Peru, Ind.

Circle No. 52 on Coupon, page 154

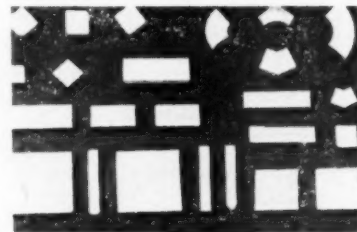

hard glaze tile now has matching trim

Matching hard glaze floor and drain-board trim is now available in Perma-glaze tile. Product is stocked in a variety of shapes, sizes and colors for decorating purposes and for use on floors, counters, etc. All trim stock available in identically matched colors. **Pomona Tile Mfg. Co.**, Dept. AB, Attn. Robert Rexroad, 629 N. LaBrea Ave., Hollywood 38, Calif.

Circle No. 53 on Coupon, page 154

CABINET HARDWARE NEWS!

by

STANLEY

NEW

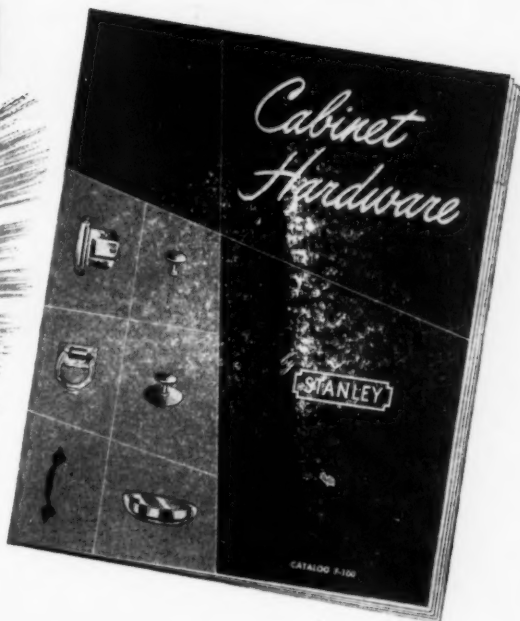

NO. 333 applied on horizontal stile — no vertical mullion necessary.



NO. 334 applied on vertical mullion. Easy to install.

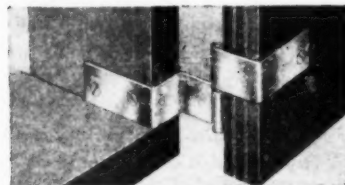

NO. 337 No mortising necessary. Completely reversible.

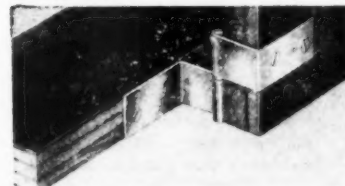

NO. 339 applied on horizontal stile. Easy to install.

Full-Line Catalog New Items . . . New Lines

For the past month you may have heard rumblings about Stanley's big, new, cabinet hardware program for 1954. Now's your chance to get in on the know! Get in early and with all facts! A brand new, fully illustrated catalog is rolling off the presses right now. Use the coupon below to order your copy.

We can't do justice to the completeness of this line in this space . . . you'll just have to get the catalog and then see the actual pieces at your supplier's.

But, for a starter, take a look at these new hinges for overlapping doors — available for the first time in the *new, complete*, Stanley Cabinet Line:

This is only a small sample of the new items shown and described in the new Stanley Cabinet Hardware Catalog. Get yours now. Use the handy coupon.

STANLEY *Hardware*

A Division of The Stanley Works
HARDWARE • TOOLS • ELECTRIC TOOLS • STEEL • STEEL STRAPPING

Stanley Cabinet Hardware
105 Lake St., New Britain, Conn.

Gentlemen:

Yes, I would like a copy of your new Cabinet Hardware Catalog F-100. Rush mine out today.

NAME _____
ADDRESS _____
CITY _____ ZONE _____ STATE _____



Easy to care for...

Architects know that maintenance cost is one of the major considerations in specifying a floor covering.

Dense, yet resilient, floors of Wright Rubber Tile bring savings in maintenance that quickly offset the initial savings of a "cheaper" floor. Dirt won't penetrate Wright's non-porous surface. Mopping and occasional waxing will retain its new-look luster indefinitely.

Because of these characteristics, Wright Rubber Tile is particularly appropriate in large, heavy-traffic jobs, where maintenance costs might otherwise become excessive.

Pictured above is Battelstein's fashionable River Oaks Store in Houston. Wright Rubber Tile was used in all principal sales floor areas.

Architect: Burke, Kober & Nicolais, Los Angeles
WRIGHT MANUFACTURING CO.
 5205 Post Oak Road, Houston, Texas

**WRIGHTEX
 WRIGHTFLOR
 VINYL TILE
 ECONOTILE**

See our catalog in
**ARCHITECTURAL
 FILE**
 or write for copy

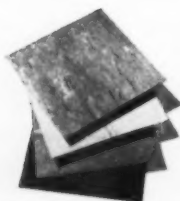

WRIGHT RUBBER TILE

The 100-Year Floor!

4708

176

**AMERICAN
 BUILDER**

NEW PRODUCTS



automatic residence elevator inexpensive to install

Operated by push-button control from car or landing levels, the "Lectro-Lift" may be installed in existing homes without costly alterations. Unit is safe, dependable, operates on standard light circuit, 220 volt preferred. Standard car sizes 30x30-, 36x36-, 42x42- and 48x48-inches. Sedgwick Machine Works, Dept. AB, Attn. R. Gelber, 80 Eighth Ave., New York 11, N.Y.

Circle No. 54 on Coupon, page 154

Water repellent for exterior masonry surfaces is stated to achieve maximum penetration and full water repellence within one hour after application. **Speco Inc.**, Dept. AB, Attn. J. O. Vinney, 7308 Associate Ave., Cleveland 9, Ohio.

Circle No. 55 on Coupon, page 154

Built-in gas oven-broiler and counter top burner units with automatic timer and oven clock control offer wide possibilities for custom kitchen planning. **Caloric Stove Corp.**, Dept. AB, Attn. Victor Klein, 12 S. 12th St., Philadelphia, Pa.

Circle No. 56 on Coupon, page 154

Radiant electric **wall heaters** with integral thermostat are designed for surface mounting; 1,250 and 750 watt ratings. Sold by distributors. **Thermo-Ray Corp.**, Dept. AB, Attn. H. J. Harris, 141 E. 44th St., New York 17, N.Y.

Circle No. 57 on Coupon, page 154

Bathroom accessories in matched five-piece set made in chrome-plated brass or polished aluminum. Sold to jobbers and retailers at customary discounts. **D & P Molded Products Co.**, Dept. AB, Attn. W. E. Daniel, 932 E. 108th St., Los Angeles 59, Calif.

Circle No. 58 on Coupon, page 154

Combination window has Ponderosa pine frame, aluminum track and glass and screen inserts. Retail at \$16.95 for 24x24-inch glass pane, at retail lumber yards. **Gregg & Son Inc.**, Dept. AB, Blandin Ave., Framingham, Mass.

Circle No. 59 on Coupon, page 154

AMERICAN BUILDER



1 **TWO-BOLT CLOSET** can cut your costs. Bolts are precisely positioned to assure rigid anchorage of the closet **WITHOUT CLOSET SCREWS**. This can save time, especially on concrete slab construction.



2 **QUICK FITTING LEGS AND TOWEL BARS** incorporate a unique key-slot design which allows easy "slip-in" installation. No cumbersome, time-consuming wall brackets or special bolt-on devices are needed.

Here are two more
BRIGGS ENGINEERING FEATURES
 designed to speed your installations!

BRIGGS PLUMBING WARE IS DESIGNED TO IMPROVE INSTALLATION. The two features shown above, along with those listed at the right, can eliminate those installation bottlenecks—speed up production! Needless parts have been removed at no sacrifice in quality. Assemblies have been engineered to make installations simpler. And you can be sure of long service and lasting customer satisfaction, too!

Always insist on dependable Briggs Beautyware. You'll save time, trouble and money.

© 1954

CHECK THESE OTHER ENGINEERING ADVANTAGES

- Rigid-frame tub construction makes it free standing . . . needs no wall support.
- Wall-surface tub and shower fitting really fits . . . solders quickly.
- Jiffy pop-up lavatory drain is installed in 4 simple steps.
- Tub drains require no cutting to fit any regular-sized tub.

BRIGGS MANUFACTURING COMPANY • DETROIT 26, MICHIGAN



ALWAYS SAFE and Easy-to-Use

"TROUBLE SAVER" SCAFFOLDING ACCESSORIES

LADDER JACKS



● **RAIL-TYPE JACK** (left) is extra safe. Side rails of ladder are used for support.



● **ONE MAN JACK** (right) is sturdy, convenient. Adjusts to any pitch on either side of the ladder.



ADJUSTABLE ROOFING BRACKET



Simple, durable—for all kinds of jobs and any type roofing. Provides a safe staging at any pitch. Proved in use for many years.

"TROUBLE SAVER" SHINGLERS



Can be removed without raising the shingle. Made in two sizes: "Regular" holds a 2 x 4 staging edgewise. "Wide" holds it sideways. Held by two nails.

LADDER HOOKS

Once you use it, you'll never be without it. Pivot allows ladder to be placed along the valley with complete safety and convenience. Plate protects roof. Weighs only 6 pounds.

● **WRITE** for complete information on all "Trouble Saver" Scaffolding accessories.

THE STEEL SCAFFOLDING COMPANY, Inc.

Manufacturers of "Trouble Savers" Since 1912

356 Humboldt Street Dept. AB Brooklyn 22, New York
Telephone: EVergreen 3-5510

AMERICAN
BUILDER

NEW PRODUCTS

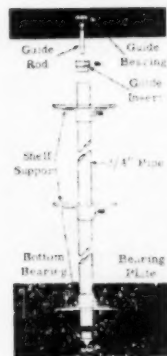

revolving shelf hardware helps utilize waste space

Hardware set is designed to make circular revolving corner shelves; contains all necessary hardware except 3/4-inch pipe. It is made of cast aluminum with steel bottom bearing. Kit sells for \$6. through jobbers. Lake Drive Products Co., Dept. AB, Attn. H. R. Hoopes, P.O. Box 22, Edgerton, Wis.

Circle No. 60 on Coupon, page 154

Portable electric saw has 3 1/4-inch depth of cut, quick bevel and depth adjustment; has 2 1/4-inch cut depth at 45 degrees. Retail for \$79.50. Ram Tool Corp., Dept. AB, Attn. Herbert Singer, 411 Claremont Ave., Chicago 12, Ill.

Circle No. 61 on Coupon, page 154

Porcelain enamel bathtub has paneled apron, five-inch-wide seat along entire length of 60 inches and grab rail along outer edge. Competitively priced, sold through plumbing supply jobbers. AllianceWare, Inc., Dept. AB, Attn. Yost C. Smith, Alliance, Ohio.

Circle No. 62 on Coupon, page 154

Electric platform hoist now has a platform for use within one floor, with cab for mounting in hoistway for between-floors use, or to carry materials between levels. Sells for \$350-\$750, depending upon unit length. The Rapids-Standard Co., Inc., Dept. AB, Attn. Alan D. Turner, Grand Rapids 2, Mich.

Circle No. 63 on Coupon, page 154

insulated throat connectors developed for metallic tubing

Thin wall electrical metallic conduit now can be installed with this all-steel insulated throat connector which has smoothly rounded insulating surfaces at raceway terminations to protect wires inside. It is made in sizes to accommodate conduit from 1/2 to 2 inches diameter, and has a built-in plastic insulating bushing. The Thomas & Betts Co., Inc., Dept. AB, Attn. Lois M. Dussler, Elizabeth, N. J.

Circle No. 64 on Coupon, page 154

A New HEAVY DUTY Tape Rule with 16" centers indicated — makes your work easier

NOW IN 12 FOOT LENGTHS

Graduated in feet and inches on this edge. Adjustable End Hook. Magic Metal Case. The lightest, yet toughest and strongest die cast case made.

1-3 15 1-4 16 1-5 17

WIDE 3/4" LINE

Long wearing snow-white line with bold jet-black figures. Every 16" clearly marked with diamond for quickly determining 16" centers. Graduated in consecutive inches on this edge. Rugged, heavy-duty 3/4" steel line is flexible yet will stand by itself.

LUFKIN WHITE CLAD SUPER MEZURAL

AVAILABLE IN 12 AND 10 FOOT LENGTHS, BLADES REPLACEABLE.

FREE "SEE THRU" PLASTIC BOX

A handy 2-color re-usable plastic box with hinged cover and snap fastener is free with each White Clad.

BUY **LUFKIN** TAPES • RULES • PRECISION TOOLS FROM YOUR HARDWARE OR SUPPLY STORE

THE LUFKIN RULE CO., Saginaw, Mich. • Barrie, Ont.

National Homes' House Package*
for Builder-Dealers sold
13,854 houses from
this one promotion alone!

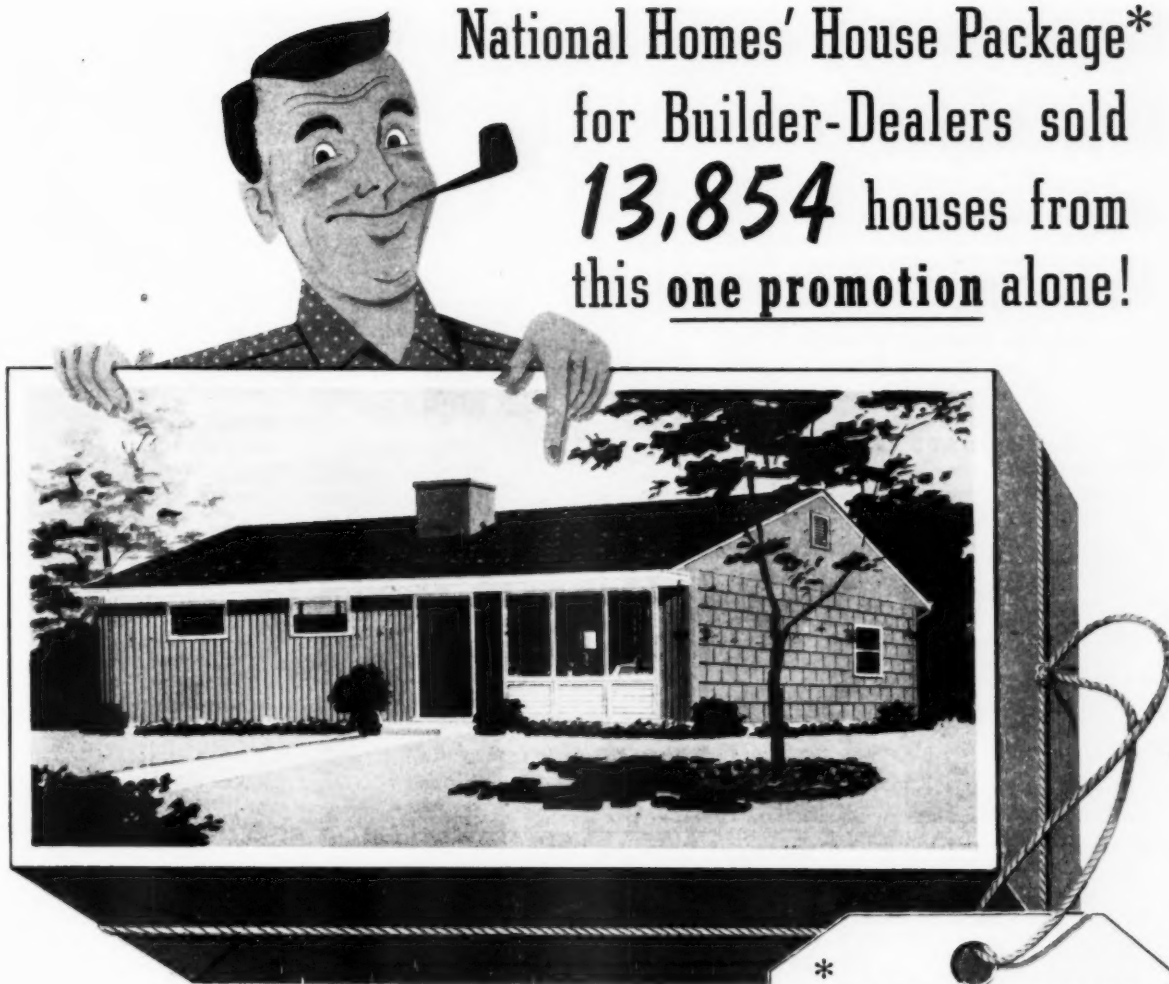

"Pacemaker" Open House SMASHES ALL RECORDS

13,854 Nationals! An almost unbelievable number of new homes is now being erected by our authorized builder-dealers as the result of this one nationwide promotion alone!

Many dealers sold two or three times as many houses as they had anticipated. You too can increase your volume when you buy the complete, pre-sold National Homes package.* Check the list herewith—then write, wire or phone for franchise details. Get on the National Homes bandwagon for a great 1955!

*

Here's what this **PACKAGE** contains for **YOU** as a **NATIONAL** Builder-Dealer!

National Homes offers you more than just a house . . . it's an entirely new, streamlined method of operation! You get a publicly accepted prestige product backed by the leader in the industry, with all these plus benefits:

- Land acquisition and land planning by experts.
- FHA and VA financing available anywhere in the country through National Homes Acceptance Corporation.
- Beauty and variety unlimited—widest range of plans and exteriors, designed by a world-famous architect.
- Newest, smartest color styling, by a noted authority.
- Sell every prospect! Nation's most complete line of homes, from \$6,000 to \$60,000.
- Buy your complete house package from a single source—no warehousing, no inventory, less invested capital required.
- Entire package **PRE-SOLD** by powerful national advertising and unmatched local advertising and promotion.



© N. H. C. 1954

MORE CLOSET SPACE AT LESS COST

with RA-TOX
Fashionfold® Doors

Everyone wants ample storage space. Build large, convenient closets at less cost with beautiful Fashionfold Doors. No fitting, trimming or finishing. Doors supplied complete . . . nothing more to buy. Installation takes 10 to 15 minutes. Woven of Northern Basswood in all sizes . . . choice of colors or natural wood. Write today for Bulletin 706B.

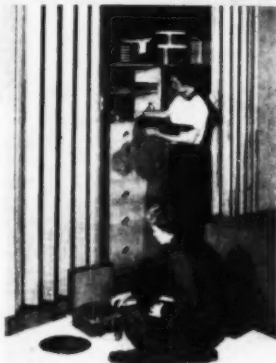

THE HOUGH SHADE CORPORATION

1044 Jackson Street • Janesville, Wisconsin

IN CANADA: Canadian Ventilating Shades, Ltd.
481 Reid Street • Peterborough, Ontario



Exclusive patented wide and intermediate narrow slot pattern available only in Fashionfold Doors.

AMERICAN
BUILDER

NEW PRODUCTS

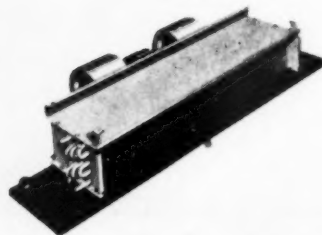

'Airditioner' units operate with hot water heating systems

Four "AIRDitioner" models are designed for operation with new or existing hot water heating systems. Overhead type, shown, is designed for concealed installation, can be mounted in drop ceiling, similar furred space or in a closet. All units heat, cool, ventilate, filter, dehumidify and circulate room air and fresh air in individual rooms, manufacturer states. Modine Mfg. Co., Dept. AB, Attn. M. J. Druse, 1808 Junction Ave., Racine, Wis.

Circle No. 65 on Coupon, page 154

Caulking gun features positive action ratchet rod, plastic nozzle, requires no after-cleaning. Retail at \$1.78 from building supply dealers. Calbar Paint & Varnish Co., Dept. AB, Attn. V. E. Dewees, 2612 N. Martha St., Philadelphia 25, Pa.

Circle No. 66 on Coupon, page 154

Automatic washer has one cycle for regular loads and a second cycle for washing fine fabrics, using less water, briefer agitation. Unit sells for \$319.95 from appliance stores, dealers. Kelvinator Division, American Motors Corp., Dept. AB, Attn. John J. Masimi, Detroit 32, Mich.

Circle No. 67 on Coupon, page 154

Wall and ceiling panels of Marlite now available in birch grain pattern in 4x6- and 4x8-foot sizes, are widely adaptable. Sell at \$.39 per square foot from building material dealers. Marsh Wall Products, Inc., Dept. AB, Attn. R. A. Huff, Dover, Ohio.

Circle No. 68 on Coupon, page 154

Sliding attic stairway stresses installation ease, dual purpose use, natural counterbalance; panel 24x36 included. Sells for \$25 through retail lumber dealers. EZ-Way Sales, Inc., Dept. AB, Attn. James E. Hansen, Box 300, St. Paul Park, Minn.

Circle No. 69 on Coupon, page 154

Stainless steel sink bowls are made in single and double models, are sound deadened and have Lustertone finish. Economically priced for volume builders. Elkay Mfg. Co., Dept. AB, Attn. W. M. Voight, 1874 S. 54th Ave., Chicago 50, Ill

Circle No. 70 on Coupon, page 154

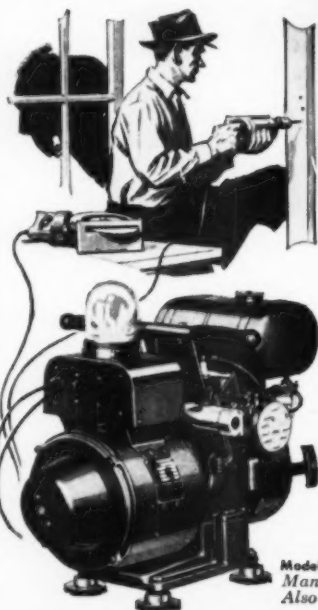

KOHLER ELECTRIC PLANTS

*Portable Power Anywhere,
Any Time*

Take your own electricity to the job

Save expense and bother of temporary power line hook-ups—use a low-cost, portable Kohler plant. Operates saws, drills, planers, grinders, pipe threaders and cutters, other tools. Develops 1500 watts AC. Engineered throughout by Kohler. Two-wheel, rubber-tired hand truck available. Other sizes 500 watts to 30 KW. Write for folder 4S.

Model 1.5M2S, 1500 watts, 115 volt AC.
Manual control. Weight 130 lbs.
Also 115 volt DC weighing 101 lbs.

Kohler Co., Kohler, Wisconsin. Established 1873

KOHLER OF KOHLER

PLUMBING FIXTURES • HEATING EQUIPMENT • ELECTRIC PLANTS
AIR-COOLED ENGINES • PRECISION CONTROLS

**IMPROVED DESIGN!
WIDER RANGE!**



SPENCER "C" BOILERS

For Larger Homes, Motels, Schools, Churches, Apartments
Commercial and Industrial Buildings



Capacity Range: 1100 to 5000 sq. ft. steam net rating
1760 to 8000 sq. ft. water-net rating

SPENCER'S

POPULAR "C" BOILERS

NOW OFFER NEW FEATURES

... NEW SIZES ...

MORE ATTRACTIVE PRICES!

Now, the most popular series in Spencer's quality line of boilers is available for a wider range of jobs... and at more attractive prices.

Improved design now makes this outstanding boiler available with standard 15" base or extra base heights, at nominal charge, for special fuel-burning installations. Four new larger models, with heavy 3" fire tubes, have been added to the line, providing greater range in application.

Here are some of the outstanding features of the Spencer "C" Boilers: water-cooled, precision-ground flue and fire-door frames, equipped with heavy cast-iron insulated doors; extra-heavy steel-plate smokeboxes; staggered boiler tubes for rapid heat transfer; service water-heating coils in many capacities.

Entire boiler line available with attractive standard jackets, insulated with glass wool, with beautiful blue-gray hammerloft finish.

Any fuel can be fired in the Spencer "C" Boilers. Easily and quickly converted from hand to automatic firing.

For any job—residential, industrial or commercial—requiring 1100 to 5000-sq.-ft. net load steam, low pressure, specify one of Spencer's "C" Series. *Save dollars and provide the highest quality heating plant available.*



Spencer Heaters—Dept. AB-114
Lycoming Division
AVCO Manufacturing Corp.
Williamsport, Pennsylvania

Dear Sirs:

Please send additional information and specifications on the new Spencer "C" Series Boilers to:

Name _____

Position _____

Company _____

Address _____

City _____ Zone _____ State _____

5 Contractors tell why they make higher profits with

American



NEW YORK. "My 12 men demand American machines," says Alfred Dumaresq, of Lindenhurst, Long Island, in business 19 years. "With American Machines the sandpaper seems to last longer. I just purchased my 9th American Machine as I want only American Machines and supplies. Super 8 is tops!"



American Super 8, 8" drum, super high production.



RHODE ISLAND. "Three generations of my family have continuously used American machines," says Robert Lamoureux of Woonsocket. "A good measure of our success is due to dependability and efficiency of American machines, to American Floor Finishes and to American's prompt service."

TENNESSEE. "I prefer American to any other equipment," says J. Kirby Carter of Nashville. Mr. Carter started his own flooring company nine years ago. From a one-man operation, he now owns 31 pieces of American equipment, has 7 trucks and employs 25 workmen. He sands floors and also installs floor coverings.



FLORIDA. "American Machines are toughest and fastest sanding machines I have ever run," says Ralph Coleman of Jacksonville, who has used American machines 18 years. "Any floor contractor can get more dollar value out of the operation of American equipment than any other machines."

PENNSYLVANIA. "Using American Machines from start to finish for five years," says Howard B. Snyder, of Hanover. "With the speed and efficiency and precision of American Standard 9 and 12, I accomplish finest quality work with minimum effort."



You, too, will find your *best buy* is American—to do *finest work, faster*, and earn *maximum dollars* per job! Let us demonstrate these great machines on your next job. Of course, no obligation.

AMERICAN

Performance Proved MACHINES... Nation-wide SERVICE



Floor Sanders Floor Edgers Maintenance Machines Abrasives Seal, Finishes Saws Wet or Dry Vacuum

The American Floor Surfacing Machine Co., 511 So. St. Clair St., Toledo 3, Ohio
Send latest catalog on the above.

Name _____

Street _____

City _____ State _____

CATALOGS

AIR FILTERS, made entirely of aluminum, are described in four-page bulletin. Designed for commercial and industrial installations, in heating, ventilating and air conditioning systems. The George Evans Corp., Dept. AB, Moline, Ill.

Circle No. 71 on Coupon, page 154

ENTRANCE DOORS in 11 new available panel door designs are shown in 24x32-inch selection sheet in full color with complete dimensional and construction data. M & M Wood Working Co., Dept. AB, 2310 N. Columbia Blvd., Portland, Ore.

Circle No. 72 on Coupon, page 154

MASONRY PAINT for use on exterior surfaces or uncoated interior walls is a decorative coating of high alkali resistance available in nine colors and white. Catalog page includes color chart. The Arco Co., Dept. AB, 7301 Bessemer Ave., Cleveland 27, Ohio.

Circle No. 73 on Coupon, page 154

BUILDERS' HARDWARE catalog contains complete listings of company line of door hardware with sizes, dimensions, packing, weights and Federal specification numbers if available. Baldwin Mfg. Corp., Dept. AB, 1290 Central Ave., Hillside, N. J.

Circle No. 74 on Coupon, page 154

BASEBOARD PERIMETER diffusers are described in four-page folder giving full information and drawings for heating and cooling use. Step-by-step installation procedure, performance data included. The Lima Register Co., Dept. AB, Lima, Ohio.

Circle No. 75 on Coupon, page 154

ELECTRODES for mild steel and low alloy arc welding are described in 30 page catalog, with formulae for estimating costs, hardness conversion tables, etc. Metal & Thermit Corp., Dept. AB, 100 E. 42nd St., New York 17, N. Y.

Circle No. 76 on Coupon, page 154

PLASTIC WALL TILE booklet contains decorator ideas and detailed installation instructions; 16 pages of full color photographs show room arrangements, color combinations. Tilemaster Corp., Dept. AB, 1415 W. Diversey Pkway., Chicago, Ill.

Circle No. 77 on Coupon, page 154

DRIVE RIVETS introduced in four-page folder are stated to speed building construction; rivets facilitate nailing metal sheets and fixtures to concrete, cinder block or plaster, Southco Div., South Chester Corp., Dept. AB, Lester, Pa.

Circle No. 78 on Coupon, page 154

AMERICAN BUILDER

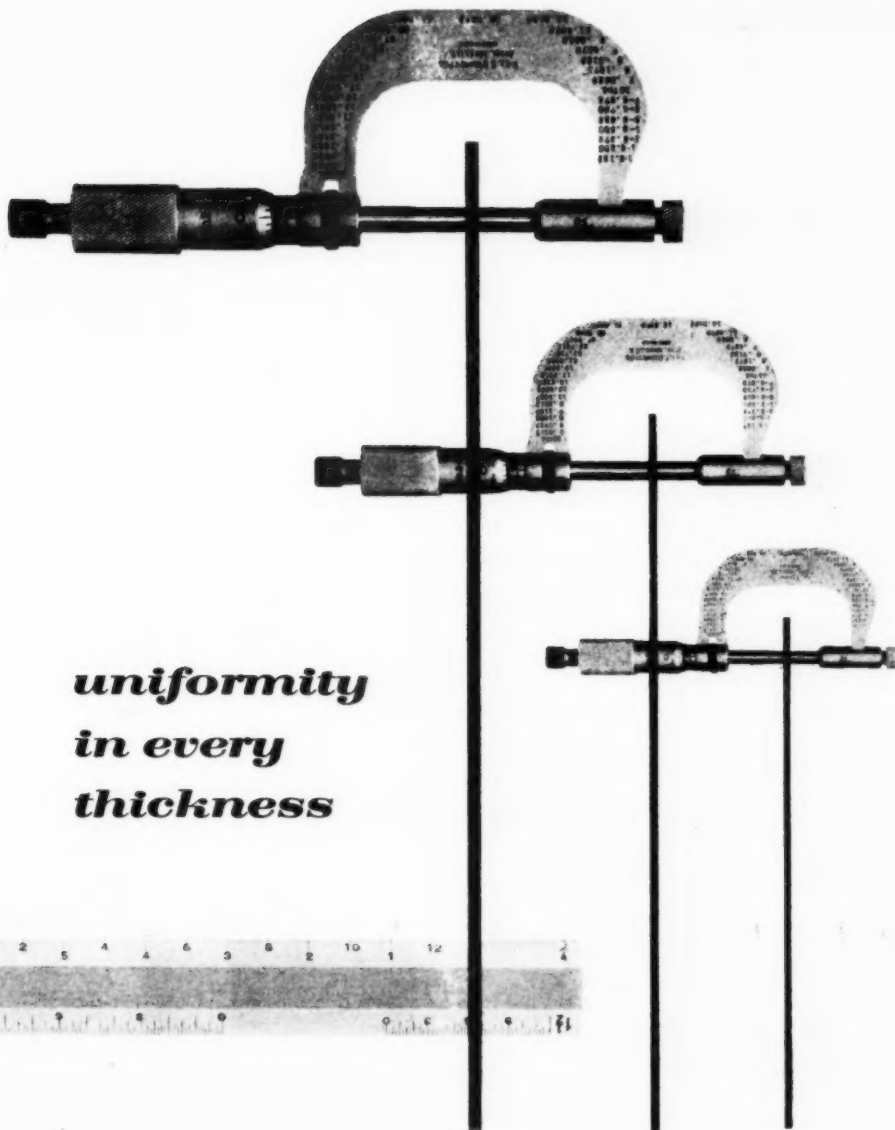

***uniformity
in every
thickness***

Careful checking and control throughout the entire manufacturing process keeps our resilient tiles completely uniform in thickness. This control begins with the analysis of raw materials, and continues through mixing, proportioning, and rolling. Accurate micrometer records are kept for each run, while

laboratory technicians regularly chart viscometer flow rates during calendering. Uniform thickness, accuracy of cutting, trueness and clarity of color, surface smoothness, built-in durability and ease of cleaning and maintenance—all these qualities make this the world's most popular line of resilient tiles.

KENTILE, INC.

America's largest manufacturer of resilient floor tiles

KENTILE: Asphalt Tile • KENCORK: Cork Tile for Floors and Walls • KENRUBBER: Rubber Tile • KENFLEX: Vinyl Asbestos Tile • KENFLOR: Vinyl Tile...also available by the yard • SPECIAL KENTILE: Grease-proof Asphalt Tile • THEMETILE, KENSERTS: Decorative Inserts • KENCOVE: Vinyl Wall Base • KENBASE: Wall Base

CATALOGS

ALUMINUM WINDOW WALL called "Superwall" makes possible any combination of widths and heights or stationary lights and operating vents. Brochure gives complete information. Superior Window Co., Dept. AB, 5300 N.W. 37th Ave., Miami, Fla.

Circle No. 79 on Coupon, page 154

GAS HEATERS are offered in 16-page catalog, showing 37 units in vented and unvented classifications. Decorator finishes and advanced combustion improvements are presented. The Ohio Foundry & Mfg. Co., Dept. AB, Steubenville, Ohio.

Circle No. 80 on Coupon, page 154

MASTIC WATERSTOP installed after concrete is placed, is presented in booklet "Igas Joint Sealer." Product can seal joints subject to severe movement and pressure between structural materials. Sika Chemical Corp., Dept. AB, 35 Gregory Ave., Passaic, N. J.

Circle No. 81 on Coupon, page 154

WINDOW SHUTTERS and louver doors are shown in illustrated Decorator's Guide with suggestions as to how shutters can be used with all window types for dividing, ventilating and light

control. Louvercraft, Dept. AB, 425 Austin Pl., New York 55, N. Y.

Circle No. 82 on Coupon, page 154

CEILING AIR DIFFUSERS are shown in 16-page catalog presenting units for residential heating and cooling. Suggested systems, duct layouts and installation details included. Connor Engineering Corp., Dept. AB, Danbury, Conn.

Circle No. 83 on Coupon, page 154

PREFINISHED PANELS, planks and blocks for walls and ceilings are presented in new eight-page bulletin, showing many uses of "Marlite," with typical room interiors. Marsh Wall Products, Inc., Dept. AB, Dover Ohio.

Circle No. 84 on Coupon, page 154

GAS-FIRED FURNACES with built-in heat exchanger said to triple furnace life are described in six-page folder; cutaway, keyed drawings pin-point salient features. Herber Products Co., Dept. AB, 877 Addison Road, Cleveland 3, O.

Circle No. 85 on Coupon, page 154

DECORATIVE PLYWOODS booklet contains color photographs of home interiors, show use of fir plywoods, veneer faced plywoods in birch, knotty pine and Philippine Mahogany. Associated Plywood Mills, Inc., Dept. AB, P.O. Box 672, Eugene, Ore.

Circle No. 86 on Coupon, page 154

ALUMINUM WINDOWS featuring new horizontal sliding units are presented in eight-page catalog with cut-away illustrations. Information on stacking and transom arrangements included. Peterson Window Corp., Dept. AB, 1377 E. 8-Mile Road, Ferndale 20, Mich.

Circle No. 87 on Coupon, page 154

STORE FRONT DETAILS are shown in 102-page manual containing information on all products normally included in store front design. Available free upon request to company branches. Pittsburgh Plate Glass Co., Dept. AB, 632 Fort Duquesne Blvd., Pittsburgh 22, Pa.

Circle No. 88 on Coupon, page 154

PREFABRICATED HOMES in 18 models both two- and three-bedroom types are shown in "Builders' Guide," presenting latest design techniques, interiors and exteriors. International Homes, Dept. AB, 3896 Mahoning Ave., Youngstown, Ohio.

Circle No. 89 on Coupon, page 154

MASONRY DRILLS and accessories shown in four-page folder stress such features as more carbide cutters, extension shanks, extra drilling speed. Specifications and prices. Tilden Tool Mfg. Co., Dept. AB, 6657 N. Clark St., Chicago 26, Ill.

Circle No. 90 on Coupon, page 154

How You Can Build Quicker Sales with MOUNT AIRY GRANITE ASHLAR

Here's the building stone that adds to your reputation as a better builder and makes quicker home and remodeling sales for you. Exterior facing of entire home with Mount Airy Granite Ashlar actually enhances its value as much as 20%—at no more than 8% above average cost to build.

What's more—Mount Airy Granite Ashlar offers you additional construction savings. It is cut to brick thickness in multiples of brick rises which means less skilled labor can easily knap the sticks into required lengths and set in the wall.

Prospective home buyers are sold at first sight on the dramatic beauty of this distinctively different, light-in-color granite which adapts itself to so many designs . . . and are more than pleased with its



Dramatic application of Mount Airy Granite Ashlar . . . 3-way inside fireplace and outside baywindow on terrace of Mount Airy granite blended with pink and red granite. Home of Mr. and Mrs. William L. Walker, Statesville, North Carolina. Contractor: James C. Walker, Jr., Hollywood, Florida.

durable, maintenance-free characteristics. Mount Airy Granite Ashlar is most attractive, too, when used with brick homes for sills, lintels, steps and copings.

Before you build—Why not check the quick-sale advantages of Mount Airy Granite Ashlar? Write us for complete details.

NORTH CAROLINA GRANITE CORPORATION
Mount Airy, North Carolina

DO YOU KNOW WARE'S REGIONAL WAREHOUSING SYSTEM MEANS OVERNIGHT SERVICE TO MOST CITIES?

WARE ALUMINUM WINDOWS

offer you 3 big bonuses that save you time and assure customer satisfaction—

1. DEPENDABLE DELIVERY

through the Ware system of strategically located warehouses in Houston, Atlanta, Chicago, and Newark—providing overnight service to most cities!

2. A FULL LINE

to meet all your needs. Whether your next requirement is for a ten thousand window project or a single residence, there's surely a Ware Window that's exactly what you want.

3. VALUE THAT'S PROVEN

in thousands of installations from coast to coast . . . quality that's backed by years of successful experience and maintained by the highest standards of manufacturing.

Get *all* the profit-building details. Write Dept. AB-11

Aluminum **WARE** Windows



Jalousie



Econ O Wall



Econ O Ware
Awning



Intermediate
Awning



Projected



Casements

Ware Laboratories, Inc., 3700 N.W. 25th St., Miami, Florida

Member of the Aluminum Window Manufacturers' Association

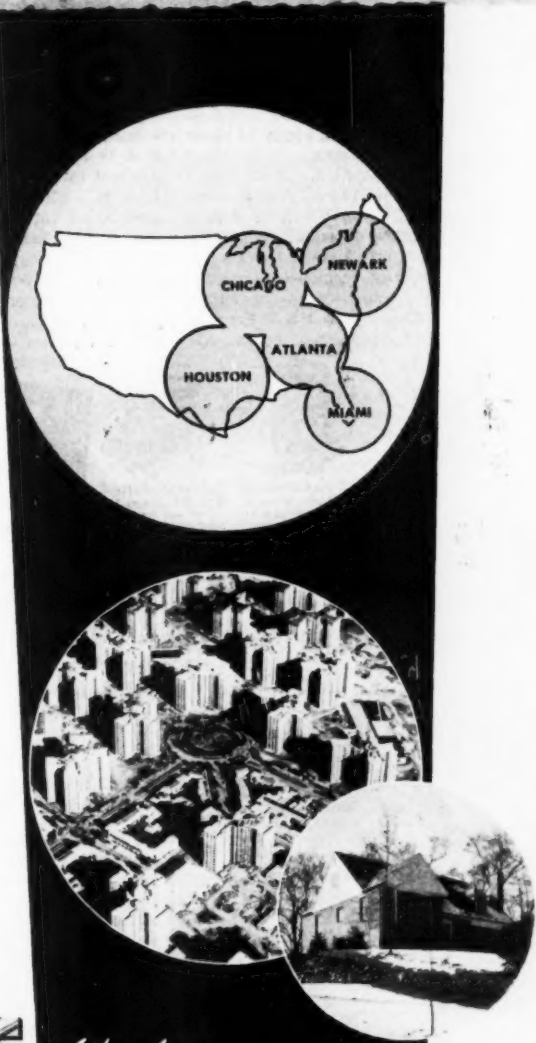



... for homes beyond the water mains

F & W PUMPS OFFER 4 BIG ADVANTAGES!

► You're sure to have plenty of water with an F & W Pump . . . for these important reasons: *First*, the line's complete, with a model to fill your requirements exactly! *Second*, F & W Pumps have proven their dependability in farm and home use for 88 years. *Third*, long-life and low-cost maintenance are assured by corrosion-resistant materials and sturdy design. Every F & W Pump is individually factory-tested! *Fourth*, ad-

vanced design and engineering make F & W Pumps most efficient and economical to operate. For example, the F & W VARIJET pumps 40 to 70% more water, yet use less electricity than any other shallow-well jet pump, thanks to its exclusive variable ejector! Send for FREE booklet, or see your F & W dealer today!

F & W Means Flowing Water by
FLINT & WALLING MFG. CO., INC.

1116 Oak St., Kendallville, Indiana



F & W 2 STAGE DEEP-WELL JET—Delivers extra capacity. New automatic control valve assures top performance.



F & W MULTI-PURPOSE JET—Change from shallow to deep well by moving jet off pump down into well at no extra cost!



THE VARIJET SHALLOW-WELL JET—The most efficient and economical pump ever built for shallow wells.



Log section of Klinkii, cut to plywood length, being placed in barker



Sheets of veneer, still damp with sap, coming from clipper

Process New Plywood Panels from New Guinea "Klinkii"

Plywood processed on location from wood of the Klinkii tree which grows in the sub-tropical jungles of New Guinea is now available in 4x8-foot panels in all standard thicknesses. Because of the strength and uniformity claimed for the wood, it has extremely high grading specifications.

Each Klinkii plypanel of A face is one piece, without joints or defects: the "No. 1" face may contain no more than three matched-joints and patches. Core and back specifications are stated to be appropriately clean. The pattern ranges from straight grain to a bird's-eye pattern. Klinkii's natural light tan color permits panels of the same pattern to blend.

The wood, as it comes from the tree, is said to be a "natural" for plywood, since it is structurally strong, holds nails firmly, yet works easily. Its mean density is 30 pounds per cubic foot at 12 per cent moisture content. It can be peeled continuously 1/64-inch thin without tearing, according to recent tests.

The future supply problem has been considered; there is no seasonal shortage, due to the climate, and a reforestation program, already in operation, assures perpetual log supply.

Avoid Tool Damage And Loss With KARYALL COMPARTMENTS

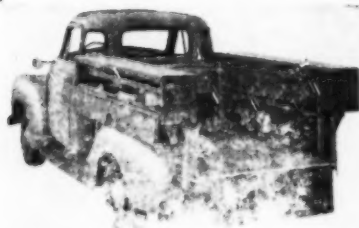

KEEP YOUR TOOLS AND MATERIALS ORGANIZED — SAVE TIME AND INCREASE YOUR PROFITS

- KARYALL COMPARTMENTS convert any 1/2, 3/4 or 1 ton pick-up truck into a handy mobile workshop.
- KARYALL COMPARTMENTS give you more strength for less money. They are built in 78", 88", 95" and 108" sizes to fit full length of truck bed. Shipped complete with mounting brackets for easy installation.
- Immediate delivery from our stock.

—Call Atlantic 1-0470—
or write for prices today

Name
Company
Address
City State

KARYALL BODY, INC.
8221 Clinton Road Cleveland 9, Ohio
Department B

CLASSIFIED ADVERTISING

The Market Place for buying and selling used merchandise, help wanted, positions wanted, and other classified listings.

Rates—\$1.50 minimum for 10 words or less. 15c for each additional word.

Display Classified—\$15.00 per inch. Reverse plates not accepted. No illustrations. No agency commission or cash discount. One column only—2 1/4 inches wide, 2 inches maximum. Signature cuts and trade names allowed.

DISHWASHER FRANCHISE DISTRIBUTORS

A few very desirable territories available. Fast selling, low cost Dishwasher. Write advising states and counties your organization can intensively cover. Give credit references.

Reply Box 104 AMERICAN BUILDER, 79 W. Monroe St., Chicago 3, Ill.

Situation Wanted—Construction superintendent, age 41, wants to locate in Texas. Full knowledge of field. Can handle all type work, light to heavy. Box 105, American Builder, 79 W. Monroe St., Chicago 3, Ill.

How to Join INTERSECTING Concrete Masonry Walls

Building codes require good joining of intersecting walls to provide lateral stability. Proper joining gives concrete masonry construction great sturdiness. Concrete masonry walls should be joined as illustrated here.

LOAD-BEARING AND NON-LOAD BEARING WALLS

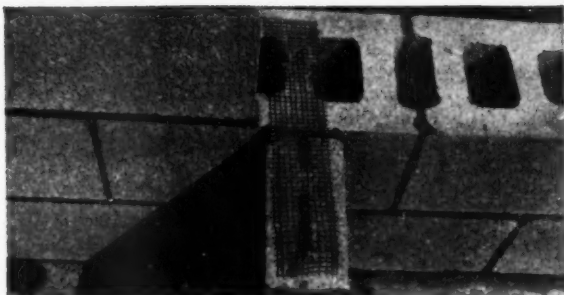

- 1** Cut a strip of ¼-in. galvanized hardware cloth about 1 inch narrower than width of block to be used in partition wall. Lay strip of hardware cloth across the joint between the two walls.



- 2** Apply properly proportioned and thoroughly mixed mortar for the joint over the hardware cloth and block as shown. Use face shell mortar bedding on the inner and outer edges of the block.

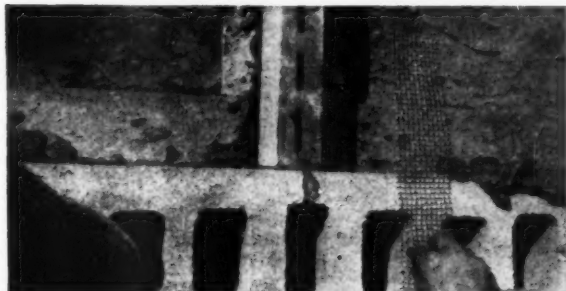

- 3** Bearing wall usually is constructed first. Hardware cloth is positioned in every third joint. Let a portion of each strip hang free until it is imbedded in the mortar joints of the partition wall.

TWO LOAD-BEARING WALLS



- 1** Cut and place ¾-in. metal lath over core in block one course below which metal anchor is used (usually at one-third points in masonry walls up to 12 ft. high but never more than 4 ft. apart).

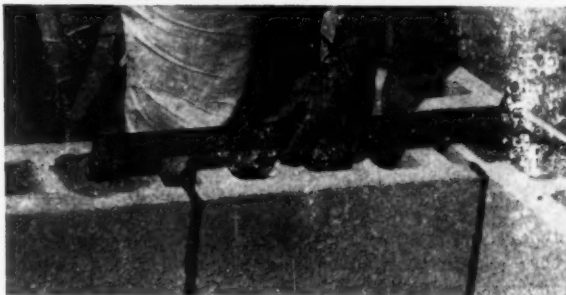

- 2** Place next course of block. Fill core over metal lath with mortar. Insert one end of metal anchor in mortar. Place another piece of ¾-in. metal lath under the upturned end of metal anchor.

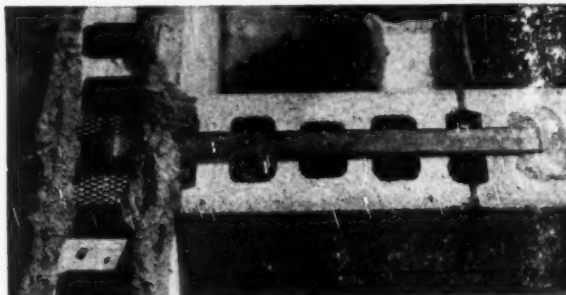

- 3** Apply mortar in normal way over anchor and block. Anchors measure ¼ in. by 1½ in. by at least 2 ft., with at least 2 in. at each end being bent in opposite directions at right angles.



- 4** Now lay the next course of block over the upturned end of the metal anchor. Then fill the core of the block over the end of the anchor with mortar as shown in the photo to complete the joining.

Write today for free copy of "Concrete Masonry Handbook." Distributed only in the U. S. and Canada. Address Dept. 11-3.

PORTLAND CEMENT ASSOCIATION
33 W. Grand Ave. } A national organization to improve and extend the uses of portland cement
Chicago 10, Ill. } and concrete through scientific research and engineering field work

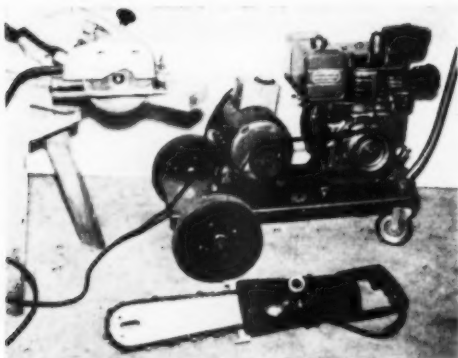

Used as electric generator, unit runs power and chain saw simultaneously

Called the Power Slave, this new convertible unit is an electric generator, air compressor, high capacity pump or spraying unit. Each is interchangeable in less than one minute without the use of tools.

Two models—a 2½ and a 6 h.p.—are made; both operate the same types of equipment, but in each case, equipment is sized to model's capacity.

The generator furnished with the Model 60, or 6 h.p. unit, has a

capacity of 2,500 watts, ample for operating any two power tools at once. It also has adequate capacity to handle one portable radial saw.

Operation of the generator unit is entirely automatic; it snaps into place by means of a "lock and line-up" mounting base. The engine is started and the load is plugged in; there are no adjustments required, since voltage and speed are regulated according to factory setting.

The Model 25, or 2½ h.p. unit, has a similar generator, but with a capacity of 1,200 watts, sufficient to operate one heavy duty tool.

Convertible unit generates, compresses, sprays and pumps

Water pumps furnished with the Power Slave snap into place on their own mounting base and are ready for immediate operation. All pumps have pipe fittings and union couplings in place, which fit couplings on suction and discharge hoses, of which 10 feet of each are furnished.

Two types of pumps are available; the A unit on the Model 60 is a centrifugal with a neoprene impeller, and has a capacity of 3,000 g.p.h.; a similar pump for the Model 25 has an 1,800 g.p.h. capacity.

(Continued on page 190)

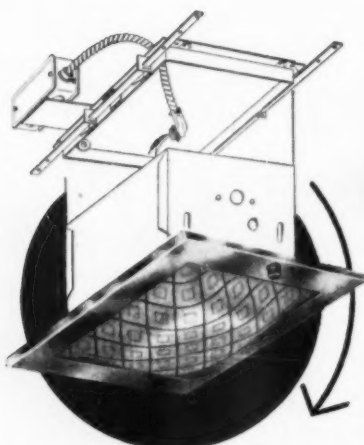

install
it faster
easier...

**ATLITE'S
NEW**

**PRE-WIRED
ASSEMBLY**

Drive four nails
... turn the screws!
It's up—without
framing out
or boxing out.

More Money and Time Saving Features...

Pull "R", "T" or "TW" wire directly into J-box.
No asbestos or slow burning wire required
No additional pull boxes needed
J-box always accessible

NOW! ATLITE'S pre-wired assembly is available for 60 watt fixtures as well as for 100, 150, 200-300 watts.

ORDER FROM YOUR JOBBER—or WRITE FOR LITERATURE and COMPETITIVE PRICE LIST.



ATLAS ELECTRIC PRODUCTS CO.
319 Ten Eyck Street, Brooklyn 6, New York

CARLSON

Super Chief

16 FEET LONG—¾" Wide White Blade

Here's big news—in a compact, pocket-size package. The all-new Carlson SUPER-CHIEF Steel Tape Rule has 16 feet of wider, more rigid steel blade—designed into a pocket-fitting 2½" case that weighs only 6½ oz. Best of all... with the SUPER CHIEF, you alone can now make accurate extended vertical and horizontal measurements quicker... easier.

for one-man measuring

Handy Re-wind Crank moves 16 ft. on snow-white blade won't surface crack or peel.

Easy-to-Read—jet black numerals

Quick Blade-Change—

Patented Swing-Tip

Do-It-Alone—and do it better—
with a Carlson SUPER CHIEF!
See it at your Hardware Dealer!

Carlson & Sullivan, Inc.
MONROVIA, CALIFORNIA

Produced under Patents #2089209, #2510939, #2629180 & Pat. Pend.

IT'S EASIER TO DO A BETTER JOB WITH NICHOLLS QUALITY TOOLS



**NICHOLLS
CARPENTER
SQUARE**

For over 57 years recognized as the finest obtainable.

Balanced design, and superior workmanship of Nicholls TROWELS, FLOATS, CEMENT TOOLS, DARBIES and HAWKS make them the "quality tools" of the trade.

ASK YOUR DEALER FOR

**NICHOLLS
TOOLS**

You Can't Buy a Better Tool!

NICHOLLS MANUFACTURING COMPANY
OTTUMWA, IOWA

GREAT NEW SELLING FEATURE FOR BUILDERS!



Freedom From Fear of Fire

Builders in every price range report the new Edwards Home Fire Alarm is a powerful sales persuader! Here's a \$20 feature — easy to install and demonstrate — that gives every new home what every new home buyer wants: *fire protection!* Add this feature to your new homes.



Complete, integral signal unit mounts behind smartly styled, modern aluminum plate that fits flush into wall. System can be tested anytime simply by pushing button.

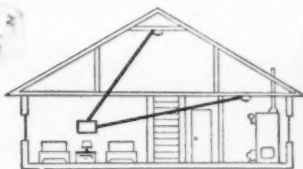

Two automatic, foolproof detectors — ceiling-installed in furnace room, storage area — operate at 140°F., safe coverage for 4-0 sq. ft. each. Additional detectors easily added to system. UL listed.

- ★ COMPLETELY AUTOMATIC, ELECTRIC!
- ★ PERMANENT DETECTORS — NEED NEVER BE REPLACED!
- ★ USES LOW-COST BELL WIRE!
- ★ NEEDS NO SERVICING OR ADJUSTING!

Rings the bell with your prospects! Light a match. Hold it under a detector. In seconds, alarm bell sounds off. Dramatic proof that your prospects are protected! Edwards adds *freedom from fear of fire* to your homes' other selling points!



Home Fire Alarm

Edwards Home Fire Alarm, Catalog #F-100. Two detectors plus complete signal unit. \$19.95. Cash in! See your electrical supplier, wire or phone Edwards for full details NOW!

EDWARDS NORWALK, CONNECTICUT
In Canada: Owen Sound, Ontario

AMAZING Low Prices!

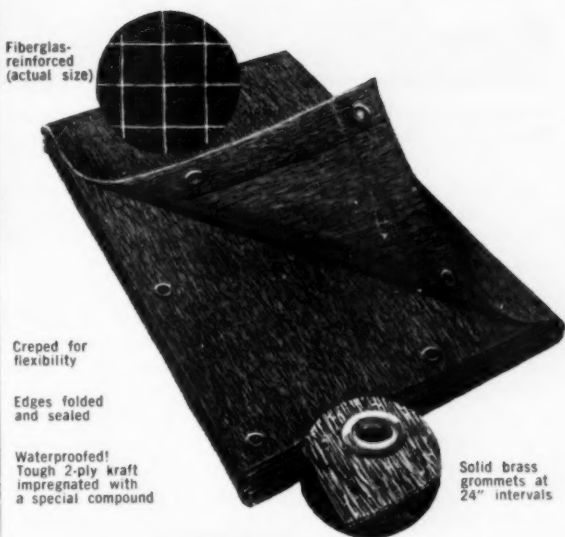

Fiberglass-reinforced (actual size)

Creped for flexibility

Edges folded and sealed

Waterproofed! Tough 2-ply kraft impregnated with a special compound

Solid brass grommets at 24" intervals



For protecting materials at low cost

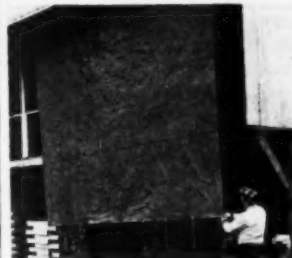

For windbreaks and many other uses

NEW Brownskin Tarps

New, lasting materials used in Brownskin Tarps make possible amazing low prices.

Sizes 8 x 10, 10 x 12, 12 x 16, 15 x 20 at HALF the price you'd expect. Also, these widths in lengths up to 75' at one-third the price of other tarps.

Send now for dealer's name, low prices and . . .

Free sample

ANGIER CORPORATION
Framingham 24, Mass.



Other Quality Building and Construction Papers • Copper-skin • Vaporseal Brownskin • Lumaskin • RFD Brownskin • Glass-mat

Convertible unit—

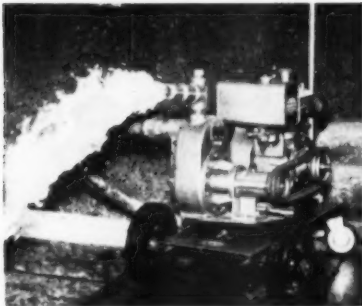

Pumping with self-priming pump on Model 60, at 15,000 gallons per hour

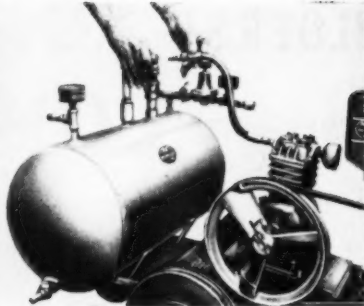

Compressor being attached to Power Slave unit with quick-coupling device

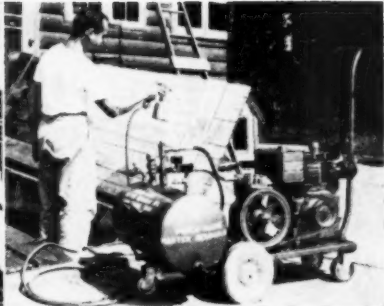

Paint spraying, using compressor tank; pressure reducer is on top

(Continued from page 188)

The other, or Type B pump, is a centrifugal self-priming pump with bronze impeller. Furnished with the Model 60 Power Slave, this pump has capacity of 15,000 g.p.h. The Type B pump for the Model 25 has a 6,000 g.p.h. capacity.

The air compressor also mounts on an individual base. The compressor for Model 60 is a twin-cylinder unit with a capacity of 10 c.f.m. at 900 r.p.m., sufficient for operation of two spray guns simultaneously,

sand blasting and operating air tools. A single-cylinder compressor comes with the Model 25. It is sufficient for one spray gun or above kinds of operation.

The spraying tank on the Power Slave is attached only when compressor is being used and can be readily engaged or disengaged. Tank is mounted on its own carrier which telescopes inside the main carrier of the Power Slave. Compressors are connected to tank with quick-coupling fittings so that entire unit may

be put in operation in less than one minute.

The tank has a built-in agitation system so contents are constantly agitated. Tank is equipped with both high- and low-pressure air outlets, each controlled by shut-off valve.

It is also equipped with high- and low-pressure gauges and pressure relief valve. It can be readily drained through liquid discharge line and any liquid contents can be blown out under air pressure to insure complete drainage.

BUILDERS:

Even for low-cost housing... the "sell" of paneled walls! Now it's practical, thanks to this new no-nail discovery.



Imagine! Put up Without a Single Nail—
this plywood paneled wall!

Made possible by a revolutionary new Weldwood Wizard
Weldwood® CONTACT CEMENT

Now! Plywood wall panels erected without nails, nail holes, puttying or extra finishing. Weldwood Contact Cement makes it possible. It's a revolutionary new concept in adhesives. Bonds *instantly and permanently* on contact. No clamps or presses! Simply install direct to studs or furring.

With Weldwood Contact Cement, pre-finished plywood paneling is practical as never before. Even a single paneled wall is a sales magnet to a buyer.

For applying *Micarta* and other *laminates*; new Weldwood Contact Cement is easier to use—bonds equally sure to any base!

Investigate this easily added "plus" sell today!—write for full information.

UNITED STATES PLYWOOD CORP., Dept. 244, 55 West 44th St., New York 36, N.Y.



*Trademark

And for Finishing Plywood Panels, use these Wizards with Wood.

FIRZITE—White for "woody" pickled or blond finishes on any wood, and for undercoating fir plywood paint jobs; **Clear** for taming wild grain on fir plywood. **SATINLAC**—for a rich, modern natural wood finish that also preserves the wood.

See Sweets Catalog for specifications. Write for details NOW!

He NEVER misses bidding the jobs he wants



This man knows his business. He knows he can't afford to miss out on jobs because he heard about them too late, or not at all.

He makes it a point to know all about who is building what and where . . . to know who to see and when to take action. In short, he *knows in time* about the jobs, selects the ones he wants . . . and then goes out to get them.

How does he do it? Easy: DODGE REPORTS.

Yes . . . the one sure way to know at the right time . . . the way proven for over 60 years for most of the leading firms in new construction, is to use Dodge Reports. You will have the inside track on all the business you want if you know where the jobs are at the right time.

It is Dodge Reports' business to find the jobs and tell you where they are so that you can figure, bid and sell them. There is just no other way to make the most of all the opportunities coming up every day in new construction. There are just too many people to see, too many miles to cover, too little time.

More than 1,000 Dodge field men are constantly investigating new business developments in the construction industry. Their daily reports, backed by the nationwide facilities of the Dodge Organization, make it possible for you to know—wherever you operate in the 37 Eastern States—what's coming up and when—so that you can bid on the jobs you want.

Why not take a look at some typical Dodge Reports covering work right in your territory? We'll gladly let you see them and send along our informative book telling how others use Dodge Reports. Write today, to—



Write today
for book.
No obligation.

DODGE REPORTS

TAKE THE FIRST STEP IN EVERY SALE

Dept. AB-1154, 119 W. 40th St., New York 18, N.Y.

Timely, accurate construction news service East of the Rockies

F.W. DODGE



CORPORATION

ONE COAT PLASTERING

It's easy with... **PLASTER-WELD**

Plaster-Weld is the remarkable job-improved bonding agent which enables you to *permanently* bond gypsum, lime-putty and acoustical plaster **DIRECTLY** to themselves... or to most any other structurally sound surface... even glass! For complete details see your building materials supply dealer, or write us. Address Larsen Products Corp., Box 5756-F, Bethesda, Md.

TYPICAL PLASTER-WELD APPLICATION



Brandywine Apts., Washington, D. C.

One of hundreds of Plaster-Weld installations. In this case Plaster-Weld was used to bond white finish coat of plaster *directly* to all exposed concrete ceilings, columns, beams. *Archt.:* Corning and Moore; *Genl. Contr.:* Charles E. Smith; *Plstg. Contr.:* James Kane & Co.

A PLASTER-WELD BOND NEVER LETS GO!

ASBESTOS SIDING NAILS



Hassall threaded asbestos siding nails are the choice of contractors throughout the country. Made of bronze and steel with plated finish. Note threaded shank which guarantees maximum holding power. Made of #14 gauge wire (.082) in 1", 1 1/4", 1 1/2", 1 3/4" lengths. Advise quantities. Prompt shipment.

JOHN HASSALL, INC.

P.O. Box 2152
Westbury, N. Y.
Established 1850



New FHA-VA regulation on performance requires warranty

By **John F. McCarthy**
Attorney at Law



Title VIII Section 108(a) of the new Housing Act of 1954 directs the Federal Housing Commissioner and the Administrator of Veterans' Affairs to require a warranty in connection with a dwelling designed principally for not more than a four-family residence, and approved for mortgage insurance or guaranty prior to the beginning of construction pursuant to a commitment made on and after October 1, 1954. The warranty is from the seller or builder to the purchaser or owner of the residence and is to the effect that the dwelling is constructed in substantial conformity with the plans and specifications, including any changes approved in writing by the Federal Housing Commissioner or the Administrator of Veterans' Affairs, on which his valuation of the dwelling was based.

The Section also requires that the purchaser or owner give written notice to the seller or builder within one year of the date of conveyance or initial occupancy, whichever first occurs, of all instances of substantial nonconformity to the plans and specifications. The Commissioner and the Administrator are directed to permit copies of the plans and specifications to be made available for inspection or copying by the purchaser or owner. Section 221.13 of the Regulations of the Federal Housing Commissioner issued pursuant to the Act provides that the seller or builder must furnish the Commissioner with a conformed copy of the warranty, with a receipt thereon by the purchaser or owner that the original warranty has been delivered to him. The Administrator of Veterans' Affairs has similar regulations.

It will be noted that the warranty which is required is one to the effect

that the dwelling is in substantial conformity with the plans and specifications. The question naturally arises as to the meaning of the phrase "substantial conformity." Here the legislative history of the Act and the decisions of the courts relative to a similar concept in the law involving building contracts are most helpful.

The language of the Act as originally passed by the House was similar to that found in the final version. In other words, it required a warranty of substantial conformity with plans and specifications. The Senate, in its consideration of the statute, struck out the word "substantial." However, a conference committee of the House and the Senate re-inserted the word and in that form the Act was passed by Congress and approved by the President. This legislative history makes it abundantly clear that the word "substantial" is used to emphasize that the conformity required is something less than complete and exact performance.

It long has been the law that a builder may recover his contract price if he has substantially conformed to his construction contract. There are many decisions by the courts concerning this concept of the law. The courts have repeatedly pointed out that a home is a man-made article, is not machine tooled and cannot be expected to be perfect. They therefore have said that substantial conformity is not full or exact performance of every slight or unimportant detail, but is completion of all important particulars. This reasoning undoubtedly is applicable to the requirement of substantial conformity to plans and specifications imposed by the new Housing Act.

IVES
BUILDERS' HARDWARE



Weather-Tite SASH LOCK



Does Everything!

- Stops wind — drafts
- Draws meeting rails tightly together
- Locks sash securely

Has Everything!

- Beauty of design
- Low smooth silhouette
- Complements today's architectural styling
- Ease of positive operation

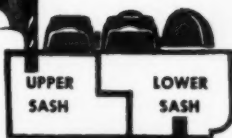

An Exclusive!

Unique design of strike makes it necessary to completely unlock IVES Weather-Tite before window can be opened. No projecting parts to gouge and damage upper sash!

Made in Cast Brass —
Bronze — Permanent
Molded Aluminum

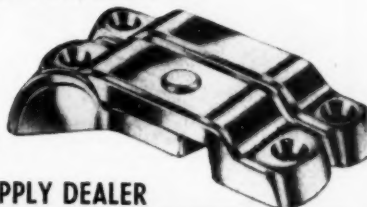

ASK YOUR BUILDING SUPPLY DEALER

THE H. B. IVES COMPANY . . . NEW HAVEN, CONN.

**HOW TO PROTECT
THE HOMES YOU BUILD
FOR LIFE . . .
against the
DESTRUCTIVE DANGERS
of CONDENSATION
and DAMPNESS!**

In just a few minutes, at negligible cost, you can install Midget Louvers on soffits, gable ends, dormers, eaves or you face the menace of moisture. These inexpensive all-aluminum ventilating units are your fastest, cheapest, surest permanent protection. They will prevent the accumulation of heat and condensation . . . virtually eliminate paint blistering . . . combat rot . . . maintain the efficiency of insulation. Made in 7 sizes (1" to 6") and 2 styles (with and without rain deflectors — both with insect screens).

WRITE for full information.

"A House That Breathes is a Better House"
The aluminum louver is the original louver.
Don't accept "second best" substitutes!

MIDGET LOUVER CO.

6 WALL STREET • NORWALK, CONN.

Quick and easy to install. Just drill a hole and push in place. No nails or screws needed.



To Build Modern . . . without Price Penalty . . . Build of Cavitetex

Among today's home builders the swing is to masonry. And the ultra-modern masonry is Cavitetex. With eye-appeal and price appeal, Cavitetex has unusual interest for building contractors and owners alert to modern trends.



Cavitetex is new—in size, proportion, design and color range. Cored-out design provides insulation values and saves weight. Easily the most practicable unit for cavity-type wall construction. Ideal also, as veneer over frame, or as facing over 4" concrete block. Available in pastel tones for exposed masonry interior walls.

Expensive? Just the reverse! Material for material, Cavitetex costs less than frame. This low price made possible by manufacturing economies. Local plants convert local raw materials into units for local builders. Usual high costs of freight and distribution are practically eliminated. Write today for 4-color brochure and name of nearest plant.

W. E. Dunn Mfg. Co., 418 W. 24th St., Holland, Mich.
CANADA: Dunn Masonry Machinery, Ltd. 854 Dundas H'way, Cooksville, Ont.

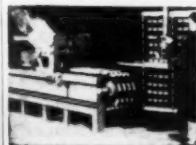

Local Manufacturing Opportunity

Many choice locations are open for the local manufacturing of Cavitetex. Excellent opportunity for building contractors. Each plant operates under franchise in protected territories. Cavitetex machine available on lease or sale. If interested, ask for important book "Opportunity Unlimited."

X-1

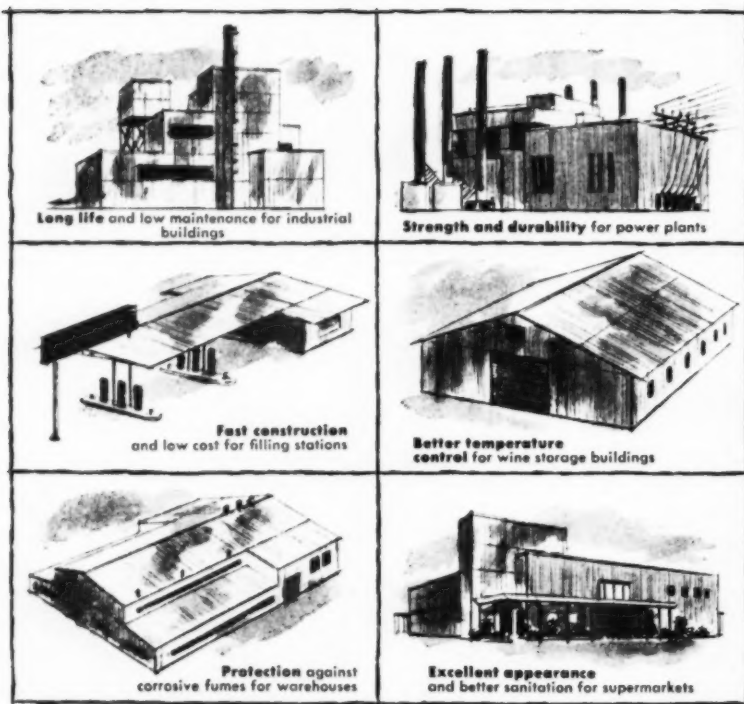

For more value at low cost— figure first in Kaiser Aluminum!

The structures above are only a few of scores that have demonstrated this fact to architects and builders . . .

No other building material offers as many advantages as Kaiser Aluminum corrugated industrial sheet—at such a low cost!

Kaiser Aluminum sheet gives extra value because it's strong and durable, lasts for generations without painting or costly maintenance. It provides its own insulation, keeping structures warmer in winter, cooler in summer. It resists corrosive fumes and gases.

Kaiser Aluminum sheet cuts costs because its light weight makes possible savings on transportation, handling and

erection. You can also use a lighter, less expensive understructure to support aluminum sheet. *This means you can offer lower bids against competing materials!*

So, whatever you're building—figure first in Kaiser Aluminum Industrial Roofing and Siding—for better value at low cost!

For A.I.A. File and complete information, contact any Kaiser Aluminum sales office listed in your telephone directory. Or write Kaiser Aluminum & Chemical Sales, Inc. *General Sales Office*, Palmolive Bldg., Chicago 11, Ill.; *Executive Office*, Kaiser Building, Oakland 12, California.

Kaiser Aluminum

Industrial Roofing and Siding

Low Cost—Provides a combination of advantages not available in other materials at any price.

Light weight—Reduces transportation costs. So easy to handle that construction is faster, lower in cost. Often permits the use of lighter, less expensive framing.

Strong—The increased depth (7/8") of the corrugations of Kaiser Aluminum sheet provides greater load carrying capacities over the longer spans required in modern industrial construction.

Corrosion resistance—High resistance to most industrial fumes. Can't streak with red rust stains. Maintains its attractive appearance indefinitely.

Low maintenance—Never needs painting. Resists heavy winds and hail.

Cooler, Brighter Interiors—By reflecting hot sun rays, aluminum keeps interiors as much as 15° cooler. Aluminum's high reflectivity insures extra interior light.

Letters

favors NHW editorial in September issue

Sir: One part of your September editorial, *National Home Week Needs Face Lifting*, I believe cannot receive too much attention and that is when you mention the carnival or circus atmosphere with admission charges and side shows, which degenerate the Week and decrease its stature. To my mind, it detracts from the dignity of the whole operation and instead of making it . . . solid in the public mind, tends to create a circus.

John C. Reuter,
Executive Secretary,
Seattle Master Builders,
Seattle 1, Wash.

Jubilee issue bouquets

. . . "it's **TERRIFIC**" . . .

Sir: All I can say about your 75th Anniversary issue is . . . it's **TER-RIFIC**. It is a great story and a brave one . . . congratulations to you and your people.

E. C. Anderson, Adv. Mgr.,
P & F Corbin Division,
American Hardware Corp.,
New Britain, Conn.

our forecasts "within the realm of possibility"

Sir: You did a very outstanding job on the 75th Anniversary issue . . . In view of the progress that has been made, I think that the forecasts are all within the realm of possibility. An issue of this kind is particularly inspiring because it takes us away from today, thoughtwise, and projects our thinking far into the future. There is not one thing that I can criticize.

Allen E. Stoltz, Adv. Mgr.,
Carr, Adams & Collier Co.,
Dubuque, Iowa

. . . "unique and outstanding" . . .

Sir: Your 75th Anniversary issue certainly is a unique and outstanding book. While you may have "stuck your neck out" in predictions of things to come, if you are as successful with these as you were with those made in the past, your batting

(Continued on page 196)



*“...business helps itself
by promoting thrift
among its own people.”*

EDWARD C. BALTZ

*President
Perpetual Building Association
Washington, D. C.*

“Expanding the regular sales of U. S. Savings Bonds is essential to the continued success of our Government’s sound money policy. Savings Bonds help people build security for themselves and stability for the nation’s economy. A reserve in Bonds gives them the assurance to spend current income on homes, cars and other substantial purchases. Meanwhile, regular Bond buying goes on adding to their future buying power. Thus business helps itself by promoting thrift among its own people. The surest way to encourage an employee to save regularly right where he works is to sign him up on the Payroll Savings Plan.”

Let’s point up this statement by Mr. Baltz, head of one of the nation’s outstanding thrift institutions and volunteer chairman of the District of Columbia Savings Bond Committee, with a few facts and figures:

- currently, more than 45,000 companies, large and small, representing every classification of industry and business, are encouraging national thrift through the Payroll Savings Plan.
- every month, 8,500,000 Payroll Savers in these 45,000 companies invest more than \$160,000,000 in Savings Bonds.
- largely as the result of employer-encouraged thrift the cash value of Savings Bonds held by individuals on July 31, 1954, totaled more than 37.5 billion dollars.

● never before has America had such a reserve of future purchasing power.

● invested in America, these 37.5 billion dollars in Savings Bonds Dollars are a most effective check on inflation and a very important contribution to economic stability and a sound dollar.

A million new Payroll Savers by the end of 1954! That’s the goal of those who believe that what is good for Americans is good for business. To do your part in reaching this objective, phone, wire or write today to Savings Bonds Division, U. S. Treasury Department, Washington, D. C. Your State Director, U. S. Treasury Department, will show you how easy it is to build a successful Payroll Savings Plan.

The United States Government does not pay for this advertising. The Treasury Department thanks, for their patriotic donation, the Advertising Council and

AMERICAN BUILDER



specify...Cabot's

lasting protection



for exterior walls

Cabot's CLEAR WATERPROOFINGS

Cabot's Clear Brick Waterproofing

For dark-colored BRICKS and Masonry
Fills the pores, seals the surface, provides protection against moisture for as long as 20 years. Prevents efflorescence of white salts on bricks. Will not discolor red brick or dark stone.

Cabot's Clear Cement Silicone Waterproofing

For CEMENT, light-colored Bricks and Masonry.
Fills and seals all voids and pores, without darkening or staining. Protects up to 20 years or more. Will also waterproof asbestos shingles.

A quality product from Cabot Laboratories
...manufacturing chemists since 1877

Samuel Cabot

SAMUEL CABOT INC.
1124 Oliver Bldg., Boston 9, Mass.
Please send me catalog of Cabot's Waterproofings.

Letters.....

(Continued from page 194)

average will continue to be tops.

We are happy to have been associated with you in your climb to first place in shelter publications.

Lou M. Dexter, President,
Dexter Lock Co.,
Grand Rapids 2, Mich.

see you in 2029, Mr. Wood!

Sir: Congratulations! You might be interested in a realization which came to me as I turned the pages of your Anniversary issue: If we are to keep abreast of developments in our industry we must not only read the editorial content, but we must also give careful attention to the advertisements. . . . The right kind of advertising does much to add interest and information to a publication.

I shall be interested in receiving a copy of your issue celebrating your 150th Anniversary.

Walter J. Wood, Vice President,
E. L. Bruce Co.,
Memphis 1, Tenn.

Jubilee Issue also of interest to electrical industry

Sir: Congratulations on your Diamond Jubilee issue. The entire electrical industry must get great satisfaction in knowing that it has such a powerful ally as *American Builder*.

C. Dudley Foster,
Lamp Division,
General Electric Co.,
Cleveland 12, Ohio

Not easy to look ahead

Sir: I enjoyed very much reading your August anniversary issue. I think you did an outstanding job with it. It is easy for all of us to look back at the past—but it is not at all easy to look toward the future. I think insofar as is possible you did a fine job in your prediction for the house of the future.

E. J. Welsh,
Curtis Companies Service Bureau,
Clinton, Iowa

"... a definitive issue"

Sir: We should like to extend to the *American Builder* staff our sincere congratulations on your remarkable Diamond Jubilee issue.

This is not only enormously in-

(Continued on page 198)

a palm is not an oak!

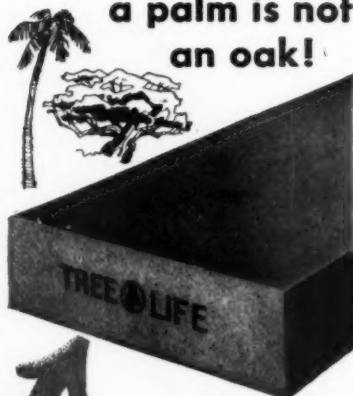

...and kiln-dried
TREE LIFE HEMLOCK
is not ordinary hemlock

West Coast Hemlock (*Tsuga heterophylla*) is an entirely *different* species. TREE LIFE West Coast Upland Hemlock, grown only on the upper western slope of the Cascade Mountains, is the very finest type of Hemlock. TREE LIFE Hemlock gives you all these advantages:

- Strong. Fewer, smaller knots.
- Fine texture, straight grain, relatively hard.
- Dimensionally stable. Easy to work. Takes paint smoothly. NO pitch pockets.
- Durable. Not brashy.
- Expert kiln-drying and controlled manufacturing assure uniform, stable dimensions.
- Carefully graded by experienced graders.
- End-stamped for positive identification.

WRITE for "TREE LIFE HEMLOCK," a 20-page catalog on properties and uses. St. Paul & Tacoma Lumber Co., Dept. AB, Tacoma 2, Washington.

Specify with Confidence

TREE LIFE WEST COAST UPLAND HEMLOCK

ANOTHER MEMBER OF THE FAMOUS TREE LIFE FOREST PRODUCTS FAMILY



AMERICAN BUILDER

Insure your profits by using new 1954 estimating guide...

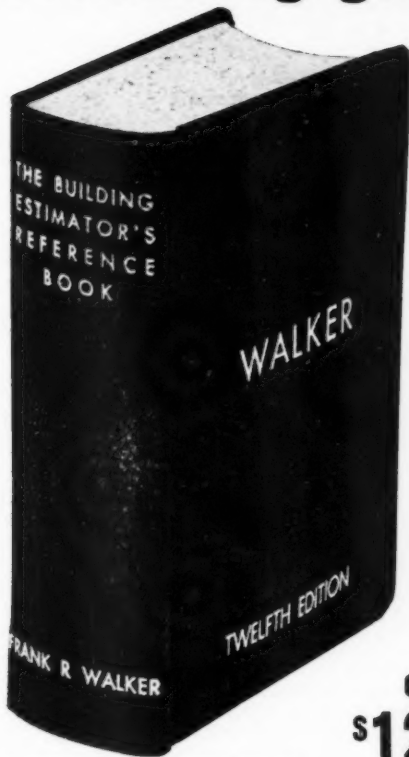

1755 pages
•
Good for any locality
•

only \$12.00 postpaid

at NO EXTRA CHARGE get Companion Vest Pocket Estimator

The standard help for contractors and estimators. During 40 years, over 130,000 copies have been sold in its many editions. This new edition was revised

from cover to cover and includes information on new and modern materials, tools and methods. No builder can afford to be without it if he wants to compete in today's price battles, yet protect his profits.

AMERICAN BUILDER BOOKS

30 Church St., New York 7, N.Y.

I enclose \$..... Send copies of Building Estimators Reference Book with a Vest Pocket Estimator for each copy ordered.

Name
Address
Town, Zone, State

NOVEMBER 1954

FIRST!

- .. because it's designed for today's homes
- .. because it's engineered for safe, easy operation
- .. because it's Precision-built for quality



HYDRAULIC SAFETY CHECKS prevent slamming of stairway on opening and closing.

ACTUATED BY COUNTERWEIGHTS—stairway closes tightly every time. No springs to weaken; no adjustments necessary.

LIFETIME ROLLER BEARINGS insure virtually effortless operation.

RUGGED AND STRONG—all parts secured by bolts and screws. Made for long life, dependable service under constant use.

INSULATED DOOR PANEL keeps out summer heat from room below; prevents loss of heat to attic in winter.

FULL WIDTH SAFETY TREADS protect steps, add to appearance, assure safe footing.

FITS ANY CEILING HEIGHT—graduations on runners facilitate cutting off for different ceiling heights; saves installation time and cost.

TWO STANDARD SIZES—8'0" and 9'9". For ceiling heights 7'0" to 8'9", use 8'9". For ceiling heights 8'9" to 9'9", use 9'9". Figure from finished floor to finished ceiling.

- PRECISION STAIRWAYS ARE SOLD BY MORE THAN 30,000 DEALERS IN U. S., CANADA, AND ALASKA

PRECISION PARTS CORPORATION
400-AB NORTH FIRST STREET NASHVILLE 7, TENNESSEE

Accurate, Easy LEVELING



LEVEL EASY IS A SIMPLE WATER LEVEL COMBINED WITH RESERVOIR FOR EASIER—MORE DEPENDABLE OPERATION

One-man operation speeds job of setting batters for foundations, and flexibility cuts costs on inside floors, ceilings and excavations. With the accuracy of a high priced instrument, LEVEL EASY is compact and durable and can be kept in a kit close to the job always handy. It can be easily adapted to level for contour plowing.

LEVEL EASY consists of 50 ft. clear tough vinyl tube in a special aluminum container. It can extend a level line almost 100 ft. in each set-up. Also complete instructions.

Check coupon now and learn more about this age-old method of leveling, or order LEVEL EASY on our unconditional money-back guarantee. Don't depend on others for grade.

HYDROLEVEL 69 DeSoto Ave. Ocean Springs, Miss.

Please send Descriptive Folder. Mail LEVEL EASY postpaid, \$7.95 enclosed. Mail LEVEL EASY C.O.D. \$7.95 plus postal charges.

Name
Street
City Zone State

197



Pour faster with a Jaeger

Look how this mixer puts out stiff concrete as fast as you can take it. You charge in only 5 to 7 seconds with Jaeger's "Skip Shaker" loader. You mix and remix more thoroughly with Jaeger's criss-cross action, then discharge in another 5 to 7 seconds with Jaeger's big bucket and flight blades and special "catch all" spoon.

With that speed you can really turn out yardage with a mixer that's as rugged as it is fast. Your Jaeger has a bigger engine, automotive transmission, Timken bearing drum rollers and heavy duty drum with machined steel tracks — all to give you years of service with low upkeep and without costly breakdowns on your jobs.

Available in 3 1/2, 6, 11, and 165 sizes. Ask for Catalog M-10.

THE JAEGER MACHINE COMPANY 521 Dublin Avenue
Columbus 16, Ohio

PUMPS • COMPRESSORS • HOISTS • TRUCK MIXERS • PAVING MACHINES

BEST for BUILDERS

**NEW IMPROVED
TRI-SAW**
All-Purpose Portable Power Hacksaw
only **\$37⁵⁰**



**makes any cutting job quick
... easy ... economical**

Zips through wood, sheet metal, lath, plaster, pipe, nails, etc. in seconds! Attaches to any heavy duty 1/4" or 5/16" drill.

Use this sensational time and work-saving tool. You'll say it is the best portable, all-purpose hacksaw on the market.

See Tri-Saw at your jobber or write us for descriptive literature.

TRI-SAW CORPORATION
2207 HANLEY INDUSTRIAL COURT
ST. LOUIS 17, MISSOURI



WITH **Jiffy**

SAWHORSE BRACKETS

- NO NAILS
- NO BOLTS
- NO SCREWS

All welded construction. Use any 2x4s for legs and crossbar.

Set up or knocked down instantly. Easy to move from job to job, and easy to store.

For sale in most hardware and lumber stores. If your dealer cannot supply you, write us direct.



At Work



At Home



At Church



GRAND HAVEN STAMPED PRODUCTS CO.
GRAND HAVEN, MICH.

Letters

(Continued from page 196)

interesting reading. It is a definitive work that will be invaluable as a reference for future generations of builders, students and writers.

Lillian A. Castell,
Vermiculite Institute,
Minneapolis, Minn.

We are proud

Sir: I have had an opportunity to look through (your) 75th Anniversary issue. It is certainly (one) in which you can take a great deal of pride.

C. N. Painter, Vice President
and General Manager,
Armstrong Cork Co.,
Lancaster, Pa.

Fine piece of journalism

Sir: Your August issue was just about the finest piece of journalism in the home building field I have ever read. Your personal enthusiasm finds its way through each page of the magazine. Keep up the good work!

Harold D. Sarshik,
20th Century Construction Co., Inc.,
Haddonfield, N. J.

likes recap of gay 'nineties houses

Sir: Your 75th Anniversary issue is a peach. Where did you dig up the pictures of exteriors and interiors of homes from the Gay 90's and the turn of the century? They show that we have learned a lot about how to build.

We, at Masonite, think highly of *American Builder*, both as a powerful advertising medium and a source of current trends of best building practice.

Keep up the good work and high standard you have set for yourself.

B. P. Williams, Manager,
Masonite Corporation,
Chicago 2, Ill.

sees Jubilee Issue as important reference work

Sir: I think you have turned out an excellent anniversary issue and I can well imagine it will be kept in many libraries for years to come.

C. B. Mills,
O. M. Scott & Sons Co.,
Marysville, Ohio

AMERICAN BUILDER

**Most
Practical
FIREPLACE
for
Air-Conditioned
Homes**

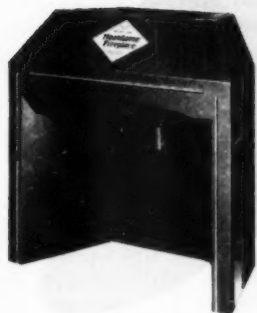

The new improved 3-Star Heatilator Fireplace with exclusive Pressure-Seal Damper is right in step with today's trend to modern air-conditioned homes.

**Here's
why...**

In summer when the fireplace is not in use, the Pressure-Seal Damper effectively prevents loss of cooled air up the chimney. In winter, it stops the waste of costly house heat into the flue. And it blocks, once and for all, the chimney downdrafts that chill the room and scatter ashes.

**But
that's
not
all...**

This fireplace circulates warm air to all parts of the room — even to adjoining rooms. That's a feature home buyers appreciate. They also appreciate the fact that a Heatilator Fireplace will not smoke . . . that you build, and they get a perfectly operating fireplace every time.

**Get
the
facts...**

The 3-Star Heatilator Fireplace carries weight with prospective home owners . . . adds sales appeal to your new houses. It's your best assurance that the finished fireplace will satisfy home buyers.

Ask your dealer or write for free folder giving complete information and specifications. Heatilator Inc., 9211 E. Brighton Avenue, Syracuse 5, N. Y.



**Get WINTER CONCRETE
with HIGH
EARLY STRENGTH
by using**

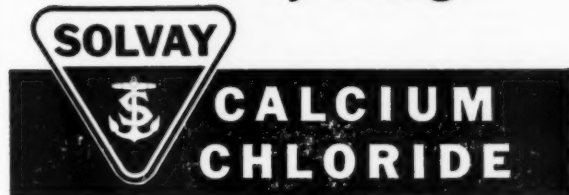

- Lowers Costs!
- Saves Time Between Operations!
- Permits Quicker Finishing!
- Cuts Protection Time!
- Assures Full Ultimate Strength!

Today—with SOLVAY Calcium Chloride, it is both possible and practical to carry on concreting operations during the winter months. The addition of SOLVAY Calcium Chloride assures fast setting to permit quick finishing, full ultimate strength and a short protection period—even in freezing weather.

Whether you do your own mixing or use ready-mix concrete, you will be sure of quality work, minimum cost and a faster operation if you are sure that your specifications include: 1. The use of heated water and materials. 2. The use of SOLVAY Calcium Chloride in the mix. 3. The use of proper covering or protection against anticipated temperatures.



Send for **FREE BOOK**
Containing Full Details!

"The Effects of Calcium Chloride on Portland Cement" is filled with important information and answers to your questions about the use of calcium chloride in concrete. Mail coupon below for your free copy.

**When ordering
READY MIXED CONCRETE
IN COLD WEATHER
—Be sure to Specify
SOLVAY
Calcium Chloride**



SOLVAY PROCESS DIVISION
Allied Chemical & Dye Corporation
61 Broadway, New York 6, N. Y.

Please send me without obligation your book, "The Effects of Calcium Chloride on Portland Cement."

Name

Company Position

Address

City Zone State 34-11

Suggestion for BUILDERS

You find, when selling a house, that its special features help you make the sale. You know, too, that a lot of sales are closed in the kitchen—because that room is the focal point of interest for the homemaker.

A few years ago, the progressive builder could sell his houses if the kitchen had space for an electric range and electric refrigerator. Then he found that his kitchens must accommodate several more electric appliances. In fact, it usually was difficult to make the sale without them.

Now there's one more appliance that customers demand—a modern home freezer. The reason? They want to be **modern—live electrically!**

More and more home buyers every year want this appliance that saves them time, money and labor, allows them to serve better meals, at lower cost. Last year, more than 1,000,000 freezers were installed in American homes.

That's why you should design your kitchens with space for a freezer—allowing, too, for the weight of this appliance and its contents, in figuring the load-bearing strength of the floor.

Don't miss out on this important selling feature. If you need more information, write to any of the manufacturers listed below—or see their dealers in your community.

FARM & HOME FREEZER SECTION
National Electrical Manufacturers Association
155 East 44th Street, New York 17, N. Y.

ADMIRAL • BENDIX • CROSLY • DEEFPREEZE
FRIGIDAIRE • GENERAL ELECTRIC • HOTPOINT
INTERNATIONAL HARVESTER • KELVINATOR • NORGE • PHILCO
QUICFREEZ • REVCO • SEEGER • WESTINGHOUSE

Announcing

THE MULLER POWER TROWEL

-- a sure
money-
maker



One man with a Muller Power Trowel does more and better work than several men troweling by hand. Two sizes—29" diameter, 1 1/4 HP; and 34", 2 1/4 HP Briggs & Stratton Engines. Stationary guide ring eliminates hand troweling when finishing along a base-board. Unique V-Belt Clutch allows operator to control blade movement. Engine speed regulated by governor control on handle. Main spindle shaft Timken Bearing equipped to resist thrust—double seals preventing oil leakage. Blades quickly interchangeable for float or finishing. Reduction from engine through steel heat-treated and ground worm and bronze worm wheel running in oil.

Send for information folder, prices,
and name of local dealer.



MULLER MACHINERY COMPANY, Inc.

Metuchen 4, N. J.

Cable Address MULMIX

200

LAND POOL (Continued from page 127)

centers, apartments and duplexes. These areas are always placed near important thoroughfares, increase the value of the lots and increase the likelihood of sales and future land developments in the area.

What builders can learn from this plan

The idea of cooperating to acquire and develop land is not new. As early as 1946, a group of ten builders made over a million dollars bonus by banding together to develop a 160-acre tract in the Oklahoma City area. The objective was to enable the small home builder to enjoy many of the benefits and advantages that normally accrue only to the nation's largest home builder-developers.

They set up a corporation with each builder allowed to buy stock in the corporation in relation to his financial ability and desires. At the same time he signed the stock subscription contract, he entered into a contract to buy lots from the corporation in the same proportion to the amount of stock he could own.

The corporation built a shopping center whose value was set at \$1,220,000. In 1954, they showed a balance of \$219,507 leaving a net value of \$1,000,493. They not only received lots for less money than they had been able to buy them previously, but they also received a shopping center as a bonus.

Whether or not you find a man like Urbanek in your area, cooperation among builders looks like a good way for the small builder to get land for less and have it when he wants it.

REVOLUTIONARY NEW HEATING



A thermostat in every room

IRON FIREMAN® SelectTemp

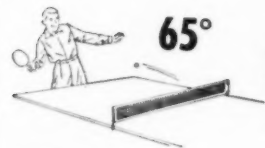

This ultra-modern heating system, which provides a thermostat in every room, can be economically installed in homes and in any type or size of building, new or old.

Look at these advantages: Filtered warm air, continuously circulated by steam turbine-driven fans from individual room heaters recessed into walls. Both temperature and volume of air automatically modulated. No wiring or electricity required for fans or thermostats. Low pressure steam is carried to room units through small, easily installed, (3/4" I.D.) flexible copper tubing. It will pay you to get the facts before deciding on any heating system.

WRITE FOR FULL INFORMATION . . .

IRON FIREMAN MFG. CO.

3279 West 106th Street, Cleveland 11, Ohio

AMERICAN BUILDER

FREE-10 DAY TRIAL

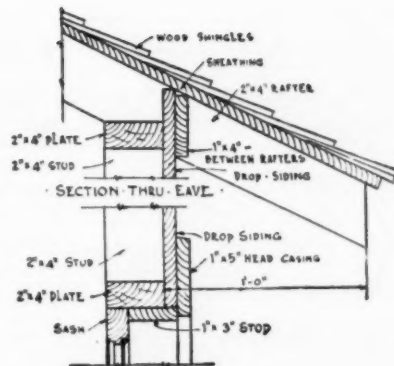
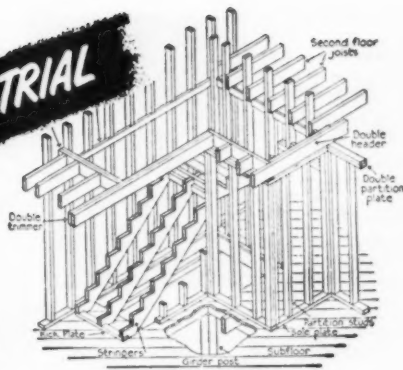

NOW Get the INSIDE TRADE FACTS on
HOUSE CONSTRUCTION DETAILS
 Save Money and Time—Get Better Construction—
 with these Professional Methods

Here, at last, is an exact working guide on every detail of house construction from foundation to finish. Tells you dimensions, materials, processes, step-by-step working methods. Hundreds of scale drawings and photographs make every step easy to follow. Can be used for alterations in a set of stock plans, for making additions or changes in a building, or for complete construction of a dwelling.

Conforms with modern practice and building regulations in all parts of the country. A book you will refer to for years! The professional guidance you get on even a single house construction detail can *repay you a hundred times the small cost* of this wonderful volume! Send for free-examination copy today. Mail coupon below.

Every Step in House Construction Explained and Illustrated

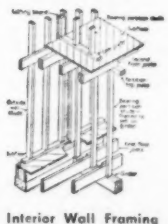
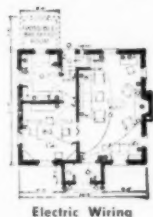

- Excavations • Footings and drainage • Foundation forms • Sills • Girders • Joists • Sub-flooring • Exterior wall framing • Interior wall framing • Ceiling joists • Gable roof • Hip roof • Gambrel roof • Dormers • Siding and shingling • Cornices • Porches • Exterior walls of wood • Exterior walls of brick • Interior walls finished in plaster, in plywood • Wall panels • mouldings for interior trim • Stair construction • Windows • Sash details • Window framing details • Doors and door trim • Hardware used in dwellings • Closets, shelves, built-in equipment • Breakfast alcove • Sewing room • Flooring • Chimneys and fireplaces • Mantels and seats • Outdoor fireplaces • Scaffolds • Garages • Electric wiring • Insulation • Arches and gates • Lattice porch, lattice trellis • Garden benches, tables • Swings and other garden furniture • Picket fences • Log cabins, camps, cottages • Barns • Feeders and nests • Rabbit hutch • Septic tank • Painting and finishing • Heating systems • Air conditioning systems • Prefabricated houses •

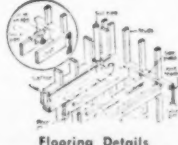

Quick reference index enables you to find instantly any construction detail on which you want Modern, Authoritative Guidance.
 385 Pages. Size 8 1/2" x 11. Fully Indexed. 2100 Illustrations.

The "How" Book of House Construction

Nothing else like it! Other books may show you *what* to build, but this is the book that shows you *HOW* to build! Every detail in the construction of a house is clearly described—illustrated with large, easy-to-follow drawings—indexed for ready reference. Send coupon below to get your free-trial copy.

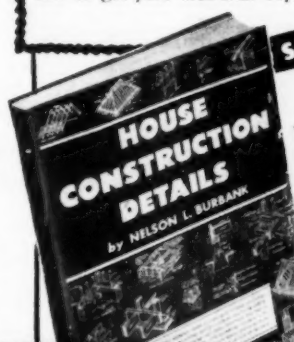

SEND NO MONEY
 NEW, ENLARGED EDITION JUST PUBLISHED
Examine 10 DAYS FREE
 You don't risk a penny to find out how valuable "House Construction Details" can be to you. Just mail coupon. See for yourself how you get clear, professional guidance on every building detail. Then either send only \$4.95 (plus postage) in full payment, or return the book and owe nothing. Mail free-examination coupon NOW.

MAIL THIS COUPON

Simmons-Boardman Books, Dept. AB 11-54
 30 Church Street, New York 7, N. Y.
 Send me for 10 DAYS' FREE EXAMINATION, "House Construction Details." I will either return it in 10 days and owe nothing, or send only \$4.95 (plus shipping charges) in full payment.
 Name
 Address
 City & State
 SAVE! Send \$4.95 with this coupon and we will pay postage. Same return and refund privileges.

ARROW



Automatic NAILING MACHINES

SAVE TIME, LABOR, MONEY For Applying Insulation

Roofing, Siding, Underdecking, Lathing, Cornerite, Building paper and many other nailing operations in Building Industry.

GUN TACKERS

No. T-32 uses staples up to 5/16" leg, .032 wire.

No. T-50 uses staples up to 9/16" leg, .050 wire.



HAMMER TACKER

No. HT-50 uses staples up to 1/2" leg, .050 wire.



SEND FOR COMPLETE INFORMATION . . . and please list supplier.

ARROW FASTENER CO., INC.

1 Junius Street

Brooklyn 12, N. Y.

STATEMENT OF THE OWNERSHIP, MANAGEMENT, AND CIRCULATION REQUIRED BY THE ACT OF CONGRESS OF AUGUST 24, 1912, AS AMENDED BY THE ACTS OF MARCH 3, 1933, AND JULY 2, 1946 (Title 39, United States Code, Section 233)

Of American Builder published monthly at Bristol, Connecticut for November, 1954

1. The names and addresses of the publisher, editor, managing editor, and business managers are: Publisher, C. J. Wageman-Simmons-Boardman Publishing Corp., 79 West Monroe St., Chicago 3, Ill.; Editor, E. G. Gavin, 79 West Monroe St., Chicago 3, Ill.; Managing editor, L. E. Arent, 79 West Monroe St., Chicago 3, Ill.; Business manager, F. A. Clark, 79 West Monroe St., Chicago 3, Ill.

2. The owners are: Simmons-Boardman Publishing Corp., 30 Church St., New York 7, N.Y. Stockholders of one percent or more, James G. and Louise Lyne, 30 Church St., New York 7, N. Y.; Arthur J. McGinnis, 30 Church St., New York 7, N. Y.; Conrad J. and Florence Wageman, 79 West Monroe St., Chicago 3, Ill.; Joseph S. and Clarice Crane, 30 Church St., New York 7, New York, Frederick A. and Artimese B. Clark, 79 West Monroe St., Chicago 3, Ill.; Samuel O. and Carrie E. Dunn, 79 West Monroe St., Chicago 3, Ill.; Edward G. and Elizabeth Gavin, 79 West Monroe St., Chicago 3, Ill.; Joseph or Katherine Sanders, 2909 Maple Ave., Dallas 4, Texas; Mae E. Howson, 6922 Paxton Ave., Chicago, Ill.; Ella L. Mills and Catherine S. Mills, Westfield, N. J.; Ruth Wheaton Johnson, 1615 Ravenna Blvd., Seattle 5, Wash.; William E. Russell as Trustee L/W/T of Ida B. Simmons F/B/O, Mrs. E. S. Fenton, c/o Russell and Russell, 41 East 42nd St., New York 17, N. Y.; J. Streicher & Co., 2 Rector St., New York, N. Y.; Partners of J. Streicher & Co., are: Joseph Streicher, Jack L. Streicher, Ethel Streicher, Judson Streicher all of 2 Rector St., New York, N. Y.; J. V. McManus, 39 Broadway, New York, N. Y.

3. The known bondholders, mortgagees, and other security holders owning or holding 1 per cent or more of total amount of bonds, mortgages, or other securities are: None.

4. Paragraphs 2 and 3 include, in cases where the stockholder or security holder appears upon the books of the company as trustee or in any other fiduciary relation, the name of the person or corporation for whom such trustee is acting; also the statements in the two paragraphs show the affiant's full knowledge and belief as to the circumstances and conditions under which stockholders and security holders who do not appear upon the books of the company as trustees, hold stock and securities in a capacity other than that of a bona fide owner.

FRED A. CLARK, Business Manager

Sworn to and subscribed before me this 29th day of September, 1954.

(SEAL)

RALPH E. WESTERMAN, Notary Public
(My commission expires February 3, 1957.)

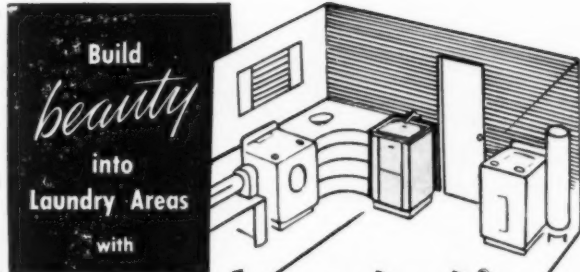

Build beauty into Laundry Areas with

duratub[®] Stationary Tub

that Matches Modern Home Laundry Equipment



There's new beauty in laundry area installations with duratub, the modern stationary tub. Appliance-styled duratub has:

- Gleaming white baked enamel cabinet, stainless steel trim
- Fiberglas* tub—won't crack, chip, stain, mar or dent
- Large storage compartment
- Vinyl-edged top cover

Triple purpose Handidrain eliminates need for double tubs. duratub (the original, fastest-selling Fiberglas* tub) is ideal for small space, easy to install, a money-saver for the builder.

Nationally Advertised

E. L. MUSTEE and SONS, Inc.

6911 LORAIN AVE. • CLEVELAND 2, OHIO

*Reg. T. M.

Save Time and Money . . . Avoid Mistakes . . . Use

SIMPLIFIED CARPENTRY ESTIMATING

HERE IS EVERYTHING YOU NEED to know to "take off" a bill of materials from set of plans and specifications for a frame house. Saves you time figuring jobs, protects you against oversights or mistakes that waste materials and cost money. Nothing complicated—just use simple arithmetic to do house carpentry estimating with this easy-to-use ready reference handbook. CONTENTS: Estimating Fundamentals. Foundation Material. Framing. Exterior Finish. Hardware. Building Information. Estimating Short Cuts. Labor Hours per Unit of Work. Carpentry Mensuration. Mathematical Reference Tables. Stair Estimating. How to Plan a House.

1950, 5th Ed. 304 p. 123 illus. 60 tables. 5x8. \$3.75



FREE EXAMINATION COUPON

Simmons-Boardman Books, Dept. AB1154
30 Church St., New York 7, N.Y.

Please send me a copy of *Simplified Carpentry Estimating*. If after 5 days trial I am not fully satisfied, I'll return it and owe nothing. Otherwise I'll keep the book and send \$3.75 plus a few cents for postage and handling in full payment.

Name

Street

City

State

SAVE. Send \$3.75 with your order. We pay postage, handling. Same trial terms.

Increase your know-how

with these practical books covering
all phases **LIGHT CONSTRUCTION**

ESTIMATING

2. SIMPLIFIED CARPENTRY ESTIMATING*

By J. W. Wilson and C. M. Rogers

Everything needed to take off a bill of materials from a set of plans and specifications for a frame house. Many helpful tables and short cuts that simplify the work. \$3.75

3. BUILDING ESTIMATOR'S REFERENCE BOOK VEST POCKET ESTIMATOR

By Frank R. Walker

Two companion books containing latest estimating and cost data on everything that goes into a house. Most complete available. \$12.00

4. CONTRACTOR'S MATERIAL LIST

A 10-column take off form for complete listing of materials and labor costs. \$1.00

5. SPECIFICATIONS

Full set of detailed house specifications (and item index) with spaces for inserting pertinent descriptive data. \$5.00

BRICKWORK & MASONRY

6. ART OF BRICKLAYING

By J. E. Ray

Basic bricklaying job instruction. Many illustrations, glossary, special scaffolding and cement block chapters. \$4.00

7. MASONRY SIMPLIFIED VOL. I (Tools-Materials-Practice)

8. MASONRY SIMPLIFIED VOL. II (Practical Construction)

By Dulzell and Townsend

Practical masonry procedures in the various phases of construction from concrete forms to fireplaces and septic tanks. Includes discussions of new products such as glass blocks, waterproofing mixtures and insulating blocks. Each vol. \$5.00; \$10.00 for both.

HEATING & PLUMBING

9. HEATING, COOLING AND AIR CONDITIONING HANDBOOK

Handy reference manual and practical instruction book. 706 pages; 351 illustrations. \$4.00

10. HOW TO DESIGN AND INSTALL PLUMBING

By A. J. Matthias, Jr.

Every step in the design and installation of the plumbing system to fulfill blueprint requirements and specifications. \$3.95

ELECTRIC WIRING

11. INTERIOR ELECTRIC WIRING AND ESTIMATING

By Uhl, Nelson & Dunlap

How-to-do-it book of wiring and estimating. \$3.95

12. WESTINGHOUSE HOME WIRING HANDBOOK

By A. C. Bredahl

Guide for planning wiring of moderate-priced homes. With emphasis on safety, effectiveness and efficiency. \$1.00

1. RICHEY'S REFERENCE HANDBOOK*

By H. G. Richey

For construction engineers, architects and builders. Here in one handy volume, is a whole library of information covering all the building trades. Twenty-three chapters, over 400 tables, 544 drawings and a 20-page index. A completely new kind of handbook stressing actual building practice and what-to-use and how-to-do-it instructions. An American Builder publication sold on a ten-day inspection privilege (see coupon).

1600 pages—\$9.95

CARPENTRY & BUILDING

16. HOUSE CONSTRUCTION DETAILS*

By Nelson L. Burbank

Exact working guide for every detail of house construction from foundation to finish. Tells dimensions, materials, processes and step-by-step working methods. \$4.95

17. HOUSE CARPENTRY AND JOINERY*

By Nelson L. Burbank

Every step in carpentry in and around the house, clearly explained and illustrated. Covers every job from foundation to interior trim. \$4.75

18. HOME BUILDING AND REPAIR SHORT CUTS*

By E. W. Shimmons

Almost 200 pages of short cuts, "kinks" etc. from the American Builder which you probably meant to clip but didn't. Illustrated and cross-indexed. \$4.50

19. FUNDAMENTALS OF CARPENTRY

By W. E. Durbahn

Complete house carpentry in two volumes. An outstanding value. \$7.50

20. THE STEEL SQUARE

By Gilbert Townsend

Instructions in fundamentals plus step-by-step house construction problems solved by proper steel square use. \$2.25

21. STAIR BUILDING

By Gilbert Townsend

Fully-illustrated explanation of every problem in design and construction of stairs. \$2.50

PLAN BOOKS

13. HOMES FOR LIVING*

By Samuel Paul, Architect

While designed for prospective homeowners in the "dreaming" stage, builders find this book useful as a source of ideas and suggestions to customers. Sketches and detailed floor plans for 80 houses in a wide variety of popular styles, divided into three general price brackets according to family income. Complete plans and specifications for these houses are also available. \$3.95

14. SUNSET WESTERN RANCH HOUSES

Authoritative book on the California ranch house, with thorough pictorial descriptions, ground floor and site drawings. \$3.00

15. DUPLEX AND APARTMENT HOUSES

By J. W. Lindstrom

Floor plan sketches and brief descriptions of 35 duplexes, 11 four-apartment buildings, and five larger ones ranging from six to twelve apartments. \$1.50

MISCELLANEOUS

22. PRACTICAL ACCOUNTING AND COST KEEPING FOR CONTRACTORS

By Frank R. Walker

Complete instructions and examples showing proper methods of keeping time and compiling costs on all classes of construction work. \$3.50

23. PAINTING AND DECORATING CRAFTSMAN'S MANUAL

Sponsored by the Painting and Decorating Contractors of America. \$2.00

24. ARCHITECTURAL DRAWING FOR THE BUILDING TRADES

By Kenny & McGrail

Practical drawing instruction for builders, contractors, students and draftsmen. Excellent show-how illustrations. \$4.00

FREE with orders of \$5.00 or more

25. Modern Methods of Home Heating*—J. L. Shank

Standard heating systems illustrated with 17 floor plans with heating outlets, 40 photos of equipment and installations; 25 boiler and piping diagrams; 11 heat loss calculating tables. \$5.00

*Starred books are our publications sold with 10-day inspection privilege with full refund.

AMERICAN BUILDER BOOK SERVICE, 30 Church St., New York 7, N. Y.

Send books indicated by circled numerals. I enclose \$....., including 10¢ per book postage.

1 2 3 4 5 6 7 8 9 10 11 12 13 14 15 16 17 18 19 20 21 22 23 24 25

Name

Address

Town, Zone, State

ADVERTISERS IN THIS ISSUE

Allied Chemical & Dye Corporation, Solvay Process Division	199	General Electric Company	114, 115	Owens-Illinois	148
Allith Prouty, Inc.	172	General Motors Corp., Delco Appliance Division	43	Philippine Mahogany Association, Inc.	106
American Builder	197, 201, 202, 203	Georgia-Pacific Plywood Company	54, 55	Pittsburgh Plate Glass Company	130, 131
American Floor Surfacing Machine Co., The	182	Given Mfg. Co.	144	Portland Cement Association	118, 119
American Gas Association	93	Grand Haven Stamped Products Co.	198	Precision Parts Corporation	187
American Machine & Foundry Company, The DeWalt, Inc.	23	Hachmeister, Inc.	66	Prefabricated Home Manufacturers' Institute	164
American Radiator & Standard Sanitary Corporation (Plumbing & Radiator Heating Division)	149	Hager & Sons Hinge Mfg. Co., C.	62	Protection Products Manufacturing Company	125
American Steel & Wire Division, United States Steel Corporation	44	Hall-Mack Company	156	Raynor Manufacturing Company	127
American Telephone & Telegraph Co.	47	Hansen Mfg. Co., A. L.	172	Red Cedar Shingle Bureau	67
Anderson Corporation	26, 27	Hassall, Inc., John	192	Red Devil Tools	142
Angier Corporation	180	Heatilator Inc.	199	Reflectal Corporation	128
A. R. B. Window Sales Company	145	Holly Manufacturing Co.	145	Remington Arms Company, Inc.	171
Arrow Fastener Co., Inc.	202	Homasote Company, Nova Sales Co.	170	Republic Steel, Truscon Steel Division	169
Arrow-Hart & Hegeman Electric Co., The	96, 97	Hough Shade Corporation, The	180	Reynolds Metals Company	169
Associated Manufacturers of Lathing and Plastering Materials	56, 57	Hydrolevel	197	Rolscreen Company	109
Atlas Electric Products Co.	188	Infra Insulation Inc.	10	Rowe Manufacturing Company	87
Atlas Plywood Corporation	163	Inland Steel Products Company	137	R. O. W. Sales Co.	18, 19
Bessler Disappearing Stairway Co., The	22	Insulite Division, Minnesota and Ontario Paper Co.	116, 117	St. Paul & Tacoma Lumber Co.	196
Black & Decker Mfg. Co., The	45	Iron Fireman Mfg. Co., SelecTemp	200	Sargent & Company	120
Briggs Manufacturing Company	177	Ives Company, H. B., The	193	Saturday Evening Post, The	6
Cabot Inc., Samuel	196	Jaeger Machine Company, The	198	Scharf Mfg. Co., J. H.	204
Carcy Philip Mfg. Co., The	173	Johns-Manville	167	Schlage Lock Company	31
Carlson & Sullivan, Inc.	188	Kaiser Aluminum & Chemical Sales, Inc.	132, 133, 194	SelecTemp, Iron Fireman Mfg. Co.	200
Ceco Steel Products Corporation	89	Karyall Body, Inc.	186	Skill Corporation	48, 49, 60
Chase Brass & Copper Co.	33	Kaustine Furnace & Tank Corp.	141	Solvay Process Division, Allied Chemical & Dye Corporation	199
Chevrolet Division of General Motors	56	Kennecott Copper Corporation	8, 9	Sonoco Products Company	174
Classified Advertising	186	Kentile, Inc.	183	Spencer Heater, Lycoming Division	175
Clippier Manufacturing Co.	4	Keystone Steel & Wire Company	90, 91	Stanley Works, The	202
Cloud Oak Flooring Company	155	Kimble Glass Company, Subsidiary of Owens-Illinois	148	Steel Scaffolding Company, Inc., The	178
Coleman Company, Inc., The	50, 51	Kohler Co.	180	Sterling Hardware Mfg. Co.	2
Colpaert Homes Inc.	146	Kritzer Radiant Coils, Inc.	22	Sterling Paint & Varnish Co.	58
Congleum-Nairn Inc.	69	Kwikset Sales and Service Company	1	Symons Clamp & Mfg. Co.	160
Corbin Division, P. & F., The American Hardware Corporation	12	Larsen Products Corp.	192	Tracy Kitchens	16
Crossett Lumber Company	22	Libbey Owens Ford Glass Co.	158, 159	Trade-Wind Motorfans, Inc.	59
Delco Appliance Division, General Motors Corp.	43	Linde Air Products Company, A Division of Union Carbide and Carbon Corporation	30	Tri-Saw Corporation	198
Detroit Steel Products Company	161	Lockwood Hardware Manufacturing Company	108	Truscon Steel Division, Republic Steel	165
Dexter Lock Company, a Subsidiary of National Brass Company	152	Lufkin Rule Co., The	178	United Metal Box Company	Cover 3
De Walt, Inc., American Machine & Foundry Company, The	23	Macklanburg-Duncan Co.	52, 53	United States Plywood Corporation	112, 113, 190
Dodge Corporation, F. W.	191	Manufactured Homes, Inc.	139	United States Steel Corporation, American Steel & Wire Div.	44
Douglas Fir Plywood Association	94, 95	Mastic Tile Corporation of America	147	Visking Corporation, The	143
Dunn Mfg. Co., W. E.	193	Mengel Company, The	32	Ware Laboratories, Inc.	185
Edwards	189	Midget Louver Co.	193	West Coast Lumbermen's Association	121
Eljer Co.	38	Minnesota and Ontario Paper Company, Insulite Division	116, 117	Western Metal Specialty Co.	160
Emerson Electric Mfg. Co., The	168	Modern Homes Corporation	134, 135	Western Pine Association	59
Flint & Walling Mfg. Co., Inc.	186	Morrison Steel Products, Inc.	46	Weyerhaeuser Sales Company	110, 111
Flinkente Company, The	63	Muller Machinery Company, Inc.	200	White Company, David	107
Flush Wall Radio Company	142	Mullins Manufacturing Corporation, Youngstown Steel Kitchens	122	Williamson Heater Company, The	157
		Mustee and Sons, Inc., E. L.	202	Woodco Corporation, General Woodcraft Co., Inc.	151
		Myers & Bro. Co., F. E., The	166	Wright Manufacturing Co.	176
		National Association of Home Builders	14, 15, 150		
		National Brass Company, Dexter Lock Company	152		
		National Electrical Manufacturers Association	61, 200		
		National Gypsum Co.	92		
		National Homes Corporation	179		
		National Oak Company	37		
		National Manufacturing Company	Cover 4		
		National Oak Flooring Manufacturers' Association	34, 35		
		Nicholls Manufacturing Company	188		
		North Carolina Granite Corporation	184		
		Nova Sales Co., Homasote Company	170		
		NuTone, Inc.	Cover 2		

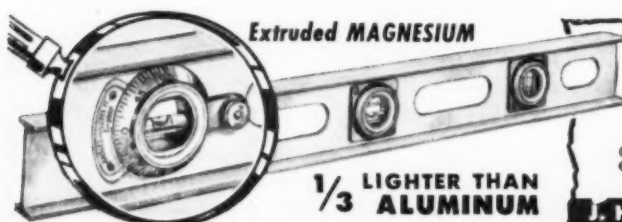

Scharf PROTRACTOR LEVELS

Eliminate "GUESSING" at Difficult Angles
One simple turn of dial gives you angle or drop-per-foot wanted...
Quickly, easily, accurately. Replaceable vial units.

If your dealer can't supply you, Write Dept. A-11

J. H. SCHARF MFG. CO. - OMAHA, NEBRASKA

UNITED ANNOUNCES...
**The Greatest Achievement In
 Kitchen Cabinet Tops Ever!**

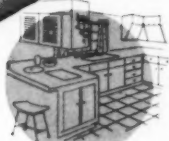
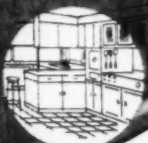
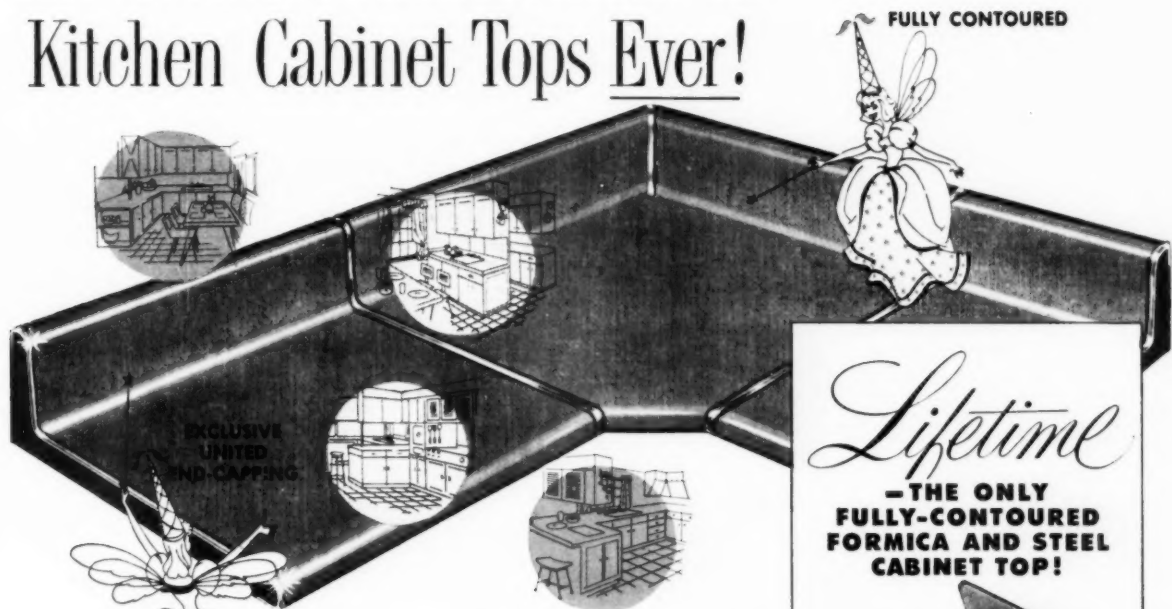

FULLY CONTOURED

Lifetime
 - THE ONLY
 FULLY-CONTOURED
 FORMICA AND STEEL
 CABINET TOP!

FORMICA

STEEL



Now, see United LIFETIME! For the first time, steel and Formica are bonded and contour-formed for life in one piece from rounded front to swing-up backsplash. Only United could do it!

Bonded steel and Formica eliminate metal seams from front to back, eliminate all the disadvantages of plastic and wood surfaces. LIFETIME cannot warp, cannot absorb odors, cannot stain, buckle, crack or separate. Liquids and grease cannot seep in anywhere because United LIFETIME features the most effective end-capping ever! Ends and edges are sealed by an exclusive, patented process. Stainless steel keeps out dirt, dust, water - for a LIFETIME!

Efficient, seam-free LIFETIME costs less to buy, less to install. Big, open work areas are all one piece up to ten feet long. Corner units in L-shapes and U-shapes make possible any kitchen style. Versatile, economical LIFETIME can be blanked to receive sinks and fittings, and with United's exclusive end-capping, you can enlarge assemblies after installation.

HOME-PLANNER ENDORSED



Renowned architect William Hamby says, "I recommend United LIFETIME for modern homes because I'm convinced there's no more durable or serviceable surfacing on the market. LIFETIME is inexpensive, attractive, and particularly versatile."

William Hamby

*As Good as it Looks
 and nothing Looks better!*

LIFETIME matches any decor, too, with four standard and 20 decorator colors, selected for popularity by a panel of America's foremost color consultants.

UNITED

Lifetime

KITCHEN CABINET TOPS



THERE ARE STILL A FEW LOCAL FRANCHISES AVAILABLE TO QUALIFIED DISTRIBUTORS. WRITE TODAY TO UNITED METAL BOX COMPANY
 168 SEVENTH STREET
 BROOKLYN 15, NEW YORK

They're new — They're smart — and made by National

Sh-hhh!
*"They slide with
a whisper"*
on wheels
of real Nylon



National

SLIDING DOOR HARDWARE

Exclusively for interiors

In the home, when precious slumber should be undisturbed, you can be assured of hushed quiet in the operation of sliding closet doors equipped with this hardware. This innovation in swift, quiet and efficient sliding door action is the most advanced step in modern hardware design for the office or factory as well as the home.

Your trade will appreciate the many exclusive features of these new products. Hangers are made in single and tandem wheel styles with special adjustment features and fit every thickness of door.

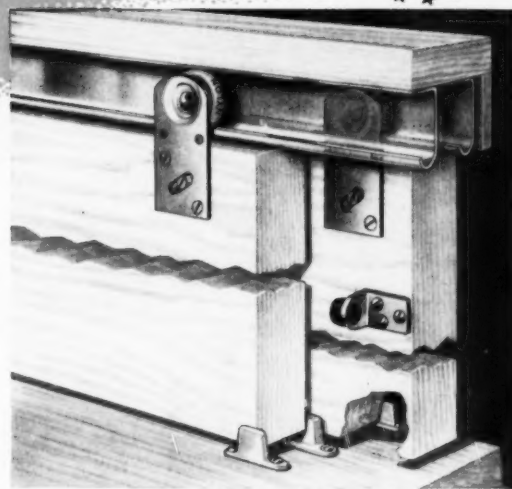

View showing complete assembly



No. 182 Sliding Door Hanger

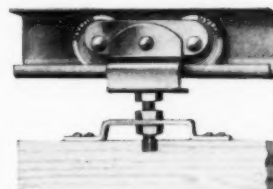

No. 185 Sliding Door Hanger

Large Nylon wheels $1\frac{3}{8}$ inches in diameter carry the door-load with ease and fewer revolutions in operation. Wheels have solid rivet axle and all hardware is zinc plated. Track is 16-gauge Steel Hot Galvanized and fits all doors, regardless of thickness. Furnished in 44, 56, 60 and 68 inch lengths.

ORDER YOUR SUPPLY NOW—THE DEMAND IS SENSATIONAL!

National

MANUFACTURING COMPANY

Sterling
Illinois

SEND TODAY FOR ATTRACTIVE, ILLUSTRATED FOLDER