

# AMERICAN BUILDER

THE WORLD'S GREATEST BUILDING PAPER  
75 CENTS

Solving to-day's  
land problem

•  
**Bright-as-day  
basement**



**SPACEMAKER** ▲ see how it gives you

**a new building pattern**

July . 1955

Four Kitchens

# Put COLOR in Your Kitchens with **NuTone HOOD-FAN**



## Only NUTONE Hood-Fan offers all these features...

- **NEW COLORS** . . 4 finishes blend with any kitchen cabinet.
- **NEW DESIGN** . . Recessed "Concave Curve" Doors can't rub.
- **GREATER EFFICIENCY** . Gets rid of all hot, greasy odors
- **CAN'T RUST OR TARNISH** . Anodized Copper and Mirror finishes.
- **BUILT-IN SWITCHES** . Control light and fan under hood.
- **EASIER TO INSTALL** . Installation kit **FREE** with blower fan.
- **NEW LOW PRICES** . made possible by mass production methods.

**FREE** . . Installation Data, Catalogs. Write to . .  
**NUTONE, INC., Dept. AB-7, Cincinnati 27, Ohio**

**VENTILATING FANS • RANGE-HOODS • DOOR CHIMES • CEILING HEATERS**



# **NEW *Kwikset* SECURE - ALL SAFE**

*safety-deposit box security for the home*

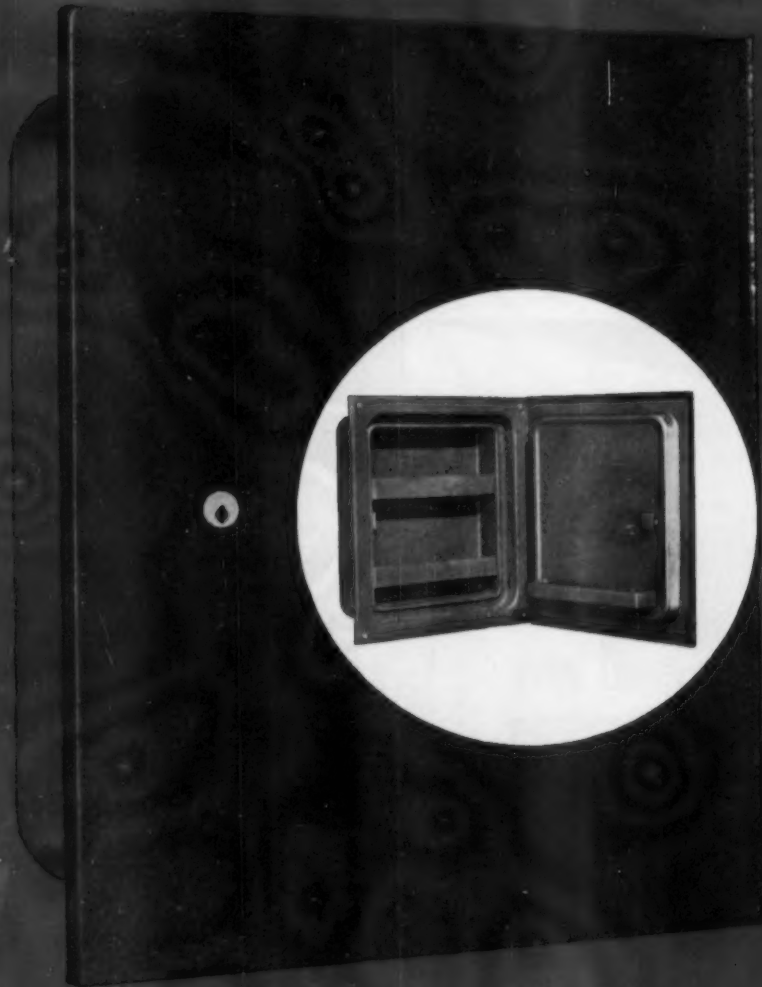

Newest addition to the built-in trend is the KWIKSET SECURE-ALL residential wall safe. Built to fit conveniently in any standard 4" wall, between 16" studs, the KWIKSET SECURE-ALL SAFE offers builders an outstanding low-cost sales feature for protecting home owners' papers and valuables against fire, water and theft. The KWIKSET SECURE-ALL SAFE is made from heavy gauge steel, with thick high-temperature thermal insulation on all sides. It locks securely with a flush pin tumbler locking mechanism and can be easily installed in closets, behind pictures or drapes.

For further information, write  
KWIKSET SALES AND SERVICE CO.  
Anaheim, California



EASY TO INSTALL

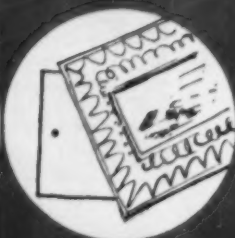

EASY TO CONCEAL



FIRE RESISTANT



WATER RESISTANT



THEFT RESISTANT

manufactured by ***Kwikset*** anaheim, california  
LOCKS, INC.



**Sterling**  
HARDWARE

*Quality you can put your finger on . . .*

**NEW 883 POCKET DOOR PULL**

This new 3-in-1 Pocket Door Pull is another exclusive Sterling product. It takes the place of an edge pull and two flush pulls and requires only one simple cutout in door. It prevents pinched fingers by keeping door edge always accessible when door is in pocket. Available in all popular finishes. Be sure to use Sterling sliding door track, hangers and accessories wherever quality counts.

**STERLING HARDWARE MANUFACTURING COMPANY**  
2345 WEST NELSON STREET • CHICAGO 18, ILLINOIS

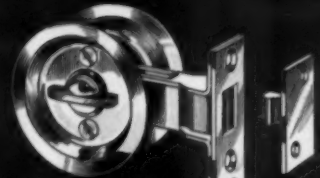

**Pocket Door Lock**

For bathroom and bedroom doors where privacy is desired. Simple installation with standard boring jig.



**Pocket Door T-Frame**

All steel T-Frame prevents warpage, makes pocket sturdier. Includes aluminum track, hangers and door guide.



**EDITORIAL**

- 5 Keep building commissions in their place

**TRENDS**

- 7 The building industry's two-way opportunity  
106 Look what's happening to carpents

**NEWS**

- 13 Buildercast of regional trends, forecasts  
15 News  
16 Dickerman's column  
18 Northup's column  
70 American Builder enlarges staff

**ON AND OFF THE RECORD**

- 68 A commentary on persons, places, problems and events

**HOME DESIGNS**

- 20 Six pages of house designs

**BLUEPRINT HOUSE IN COLOR**

- 72 Arresting to look at, easy to build  
75 An 1/8-inch scale blueprint  
79 Materials list for blueprint house

**HOUSE CONSTRUCTION**

- 80 Try this clever approach to a cool, cool house  
83 Will steel for framing give wood a run for the money?  
114 Test your building know-how

**COMMERCIAL CONSTRUCTION**

- 86 Fresh ideas that paid in the commercial market

**LAND PLANNING**

- 108 Cooperative land purchase and development

**KITCHEN PLANNING**

- 172 Something different for a new kitchen

**REMODELING**

- 176 Try these new planning ideas on your remodeling customers

**BUSINESS MANAGEMENT**

- 116 Smart but simple record keeping

**LIGHT CONDITIONING**

- 118 Bright-as-day basement

**NEW PRODUCTS**

- 95 14 doors to better closets  
125 New and improved products and equipment offered by manufacturers are reviewed

**CATALOGS**

- 142 Review of literature offered by manufacturers

**BETTER DETAIL PLATES**

- 148 New design ideas for corner fireplace construction, circular style

**TECHNICAL GUIDE**

- 152 Steel door standards

**ASK THE EXPERTS**

- 156 Reader queries on technical problems are analyzed

**HOW TO DO IT BETTER**

- 164 Ideas for the man on the job

**LEGAL**

- 170 Milwaukee ordinance tackles problem of prices for condemned properties

**ADVERTISING INDEX**

- 186 Your guide to advertisers in this issue



American Builder is published by the SIMMONS-BOARDMAN PUBLISHING CORPORATION, Emmett St., Bristol, Conn., with editorial and executive offices at 79 W. Monroe St., Chicago 3, Ill.; 30 Church St., New York 7, N.Y. James G. Lyne, President; A. J. McGinnis, Executive Vice President and Treasurer; Samuel O. Dunn, Chairman Emeritus; J. S. Crane, Vice President and Secretary; Fred A. Clark, Vice President and Business Manager; E. G. Gavin, Vice President and Editor; Bayne Sparks, Vice President; Robert G. Lewis, Vice President.

American Builder, originally "Carpentry and Building" with which are incorporated Building Age, National Builder, Permanent Builder, and

the Builder's Journal, was founded Jan. 1, 1879. Names registered in U.S. patent office and Canadian registrar of trade mark.

Address all subscriptions and correspondence concerning them to: Subscription Department, American Builder, Emmett St., Bristol, Conn. Changes of address should reach us three weeks in advance of next issue date. Send old address with the new enclosing if possible your address label. The Post Office will not forward copies unless you provide extra postage. Duplicate copies cannot be sent. Circulation Department: Robert G. Lewis, Director of Circulation; Lawrence L. Code, Circulation Manager; Field Staff: John Simonson, M. A. Spector, Earl Spohn, Guy Hill, George

Heinrich, James F. Whelan, Gerald Blackley, Ash P. Huse.

Published monthly by Simmons-Boardman Publishing Corporation, Emmett St., Bristol, Connecticut. Editorial and Executive Offices, 79 W. Monroe St., Chicago 3, Illinois, and 30 Church Street, New York 7, New York. Subscription price: United States, Possessions and Canada, 1 year, \$3.50; 3 years, \$7.00. Foreign countries, 1 year, \$12.00; 3 years, \$25.00. Single copies, 75 cents; April issue, \$2.00. Entered as second-class matter July 20, 1950, at the Post Office of Bristol, Connecticut, under the act of March 3, 1879. Copyright 1955 with all rights reserved. SIMMONS-BOARDMAN PUBLISHING CORP.

Fred A. Clark, Vice Pres., Bus. Mgr., 79 W. Monroe St., Chicago 3, Ill.

M. J. Figo, Jr., Director of Production, 30 Church St., New York 7, N. Y.

Lyman M. Forbes, Sales Promotion, 79 W. Monroe St., Chicago 3, Ill.

**Advertising Sales Representatives**

New York 7, N.Y., 30 Church, Worth 4-3060  
Bayne Sparks, W. J. Kane, Benks Wanamaker.

Chicago 3, Ill., 79 W. Monroe, Ra 6-0794  
George Hutchings, Harold Mann, Herb Willson

Cleveland 13, O., Terminal Tower, Ma. 1-4455  
D. T. Brickner, D. J. Casey

Carol Gables, Fla., 1810 Ponce deLeon Blvd.  
Joe Helzer Co. 48-1786

Dallas 4, Tex., 3908 Lemmon Ave., Lakeside 2322  
Joe Sanders

Los Angeles 17, Cal., 1127 Wilshire, Ma. 6-0553  
Fred Kloner, Jr.

Portland 5, Ore., 1220 S. W. Morrison, Br. 4993  
L. S. Conaway

San Francisco 5, Cal., 244 Calif., Go. 1-7004  
Lewis Vogler

**THYER  
HOMES**

New!  
Deluxe Models

Available with  
Garage  
or Carpport

● Looking for something different—some extra appeal for today's "harder-to-sell" home buyer—a way to add more variety to a subdivision or street of homes? The new line of Thyer Homes featuring attached garages or carports are just the answer. Factory-assembled and conventionally built, they are erected as a single unit with the house. The cost of this additional space is low—yet receives liberal valuations from lenders.

If you would like more information about Thyer Homes, with or without garages or carports, write today. We will be glad to send literature or have a representative call.

**THYER'S  
"SILVER PLATTER" PROFIT SYSTEM**



● **FINANCING SERVICE**

Your local Thyer Factory Representative will be glad to help you arrange construction and permanent financing for FHA, VA or conventional loans.

● **LOCAL FIELD SERVICE**

Thyer factory representatives located in 28 states are ready to assist you in erecting, land development, arranging financing, and planning local advertising and model home showings.

● **TURN-KEY CONTRACTING SERVICE**

For developers who wish to build 100 or more houses at a time, Thyer can provide a turn-key building service that delivers houses at a bonded contract price. (At present this service is available in all Southern and in most Northern states.)

● **NATIONAL ADVERTISING SUPPORT**

A hard hitting program in national consumer magazines pre-sells your prospects—helps create buyer interest in Thyer Homes.



● **PARENTS' SEAL**

Thyer fabricated units have been awarded Parents' Magazine Commendation Seal.



**Model 2289-B with Carport**

One of several (3 bedroom) Thyer Homes available in Northern States only, featuring garage or carport. For information about Thyer Homes designed for Southern and Gulf coast states, write to Jackson, Mississippi.

**THE THYER MANUFACTURING  
CORPORATION**

2854 Wayne Street  
Toledo, Ohio

515 East Yazoo Street  
Dept. 5, Jackson, Mississippi

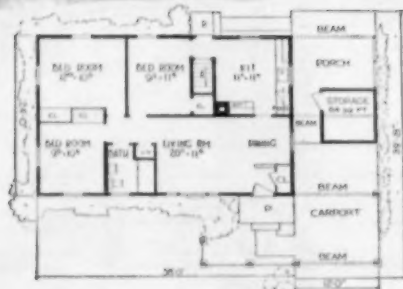

## Keep building commissions in their place

**T**HERE is a growing tendency on the part of local governing bodies to set arbitrary minimum housing standards that go far beyond the traditionally accepted rights of these bodies to exercise authority in this field only to protect public health and safety. Local regulations demanding lots of 100 to 200 feet minimum widths for one residential unit are beginning to crop up. A few building commissions are reported to have concerned themselves with such matters as exterior color styling before granting permits.

Few people will quarrel with the right of groups of individuals to isolate themselves in communities the character of which they protect with arbitrary building and other regulations. This is an inherent right of any group of citizens. It is not unlike the recognized right of labor unions, college fraternities, veterans' societies, lodges, service clubs and trade associations to set and maintain arbitrary standards of membership.

But the right of an entire political subdivision to rule out economic classes with building regulations that automatically place costs on a plane out of reach of middle or lower income groups is neither implied nor stated in the Bill of Rights or anywhere else. Nor is the unwarranted assumption of such a right socially or economically sound.

**T**HE WIDTH of a lot or the cost or color styling of a house, granted that health and safety standards are met and the net result is not an eye-sore, have nothing to do with the desirability of the owner as a citizen. Indeed, the fact that builders who construct houses for middle

and lower income groups gamble their money, time and reputations on their ability to produce houses that are livable and saleable, is the best guarantee of quality and styling a political subdivision can have. People in these income groups, like their more economically favored neighbors, also have inherent rights to establish communities within their economic means, and in any political subdivision they choose.

There need be no clash between the rights of both classes provided local commissions make provisions for both. A corollary to this is the pressing and growing need of builders to find land for housing the middle and lower income groups, which constitute an overwhelming percentage of the total market for new houses.

Economically, attempts to place whole political subdivisions in the high-price housing bracket is short sighted, and very likely will kick back disastrously. Every political subdivision is faced with high and probably higher taxes. It is economic folly to rule arbitrarily that with no exceptions only one house shall be built where two or more could be built and sold to people of economic and social stability. Even the favored will reach a point where the tax load is prohibitive, and the alternative at that time, as has been amply demonstrated, is degeneration of such political subdivisions into hodge-podges and slums.

The time has come to call a halt to activities of building commissions that go beyond constitutional limits, social equity and economic sense.

*Ed Gavin*

Publisher, Arthur J. McGinnis  
Editor, Edward G. Gavin

Executive Editor, Joseph B. Mason

Managing Editor, Lyn E. Arent

Feature Editor, Welden Reynolds. Technical Editor, Charles H. Goodall. News Editor, Garrett Winter. Architectural Editor, Arthur V. Hansen.

Field Editor, J. L. Zar. Associate Architectural Editor, W. F. Koelling. Associate Editors, Margaret C. Carroll, John Novak.

Western Editor, W. C. Rodd. Washington Editor, Walter J. Taft.

Research Director, W. S. Gaskill. Assistant Research Director, Constance Nicolai. Director, Home Plan Service, Ralph E. Westerman.

Legal and Tax Consultant, John F. McCarthy. Art Editor, George M. Clark. Chief Draftsman, J. T. Froh.

Editorial Assistant, Gertrude M. Pelnar.

Editorial Office, 79 W. Monroe St., Chicago 3, Ill.

Every effort will be made to return material submitted for possible publication (if accompanied by stamped, addressed envelope), but the editors and the corporation will not be responsible for loss or damage.

HENRY J. ROLFS, Prominent Washington, D. C., Builder



"SECOND-BEST isn't good enough for a family making their most important investment—a home. Design and construction have to be tops. Also materials and appliances. We find the best way to build a 'best seller' is to build in brand names. That's why 23 products in our new homes are well-known Post-advertised brands. These 'silent salesmen' work for us 365 days of the year." (*Manufacturers of building materials, equipment and fixtures place more advertising in the Post than in any other consumer magazine.*)

The Saturday Evening  
**POST**  
—gets to the heart of America

AMERICAN BUILDER



# The building industry's two-way opportunity

In a letter published in the June issue of *American Builder*, Alan Brockbank, former president of the National Association of Home Builders, writes: "The one point I think you should make . . . and I don't think we can say it often enough—is that there are millions of people in America living in slum conditions, and that if the government of the United States would see to it that worn-out housing was eliminated from the scene as fast as new housing is built, we would not have over-production."

Brockbank's suggestions are very timely. There is widespread apprehension in the building industry and elsewhere that there may be a sharp drop in home building in the next five years due to a decrease in the number of new families that will be formed. There is doubt that there will be sufficient demand for the million or more new house starts that have obtained during the last six years.

Instead of government action to clear slums, there is the alternative of intensified action on the part of the private building industry, which even now is providing low-cost dwelling units. Low-income families are buying such dwellings by the hundreds of thousands each year.

### The low-price factor

A recent Bureau of Labor Statistics survey shows that the median selling price of a new one-family house in 1954 was \$12,300 including land. Eleven per cent, according to the survey, sold at less than \$7,000. 15 per cent at \$7,000-\$9,999 and 20 per cent at \$10,000-\$11,999.

Since more than 1,200,000 dwelling units were produced in 1954, there were therefore about 600,000 new dwelling units sold in 1954 at prices under \$12,000. The low-price side of the market is undoubtedly the factor that has caused the mar-

ket to absorb 10 million dwelling units in the last ten years.

### Why slums, and where?

Internal migration from state to state in the United States is largely responsible for changing neighborhoods. Slums are not confined to large cities, but include derelict dwelling units in small towns and villages and even on farms.

Almost four out of ten dwelling units in the United States were classified as substandard dwellings in the 1950 census. This ratio probably still prevails. These dwelling units were either dilapidated or lacked a private toilet and bath.

The table opposite shows the percentage of substandard dwelling units in each state.

One of the prime reasons for the appearance of slum areas is too high a density. About one out of six dwelling units in the United States is overcrowded. In Mississippi, one out of three dwelling units is overcrowded. In New York and Illinois, the ratio is 12 per cent. Dwelling units are overcrowded, according to definition, when they are occupied by more than one person per room. Example: five, six, seven or more people in a four-room dwelling unit.

### For builders, it works two ways

Builders are today demonstrating that they can produce new housing to accommodate low-income families, on an economic basis. This is creating an opportunity for a part of the slum population to move to new dwelling units, which would relieve the overcrowding. Those substandard dwelling units that are structurally sound can then be rehabilitated. This forms a two-way opportunity for the building industry, which will enable it to maintain a high level of activity and employment, even though the normal high-level demand slackens.

## SUBSTANDARD DWELLING UNITS

Region and State	Percent of Total
<b>North East</b>	
Maine . . . . .	48 %
New Hampshire . . . . .	36
Vermont . . . . .	35
Massachusetts . . . . .	21
Rhode Island . . . . .	28
Connecticut . . . . .	18
New York . . . . .	17
New Jersey . . . . .	17
Pennsylvania . . . . .	28
<b>North Central</b>	
Ohio . . . . .	30 %
Indiana . . . . .	44
Illinois . . . . .	33
Michigan . . . . .	30
Wisconsin . . . . .	42
Minnesota . . . . .	48
Iowa . . . . .	49
Missouri . . . . .	52
North Dakota . . . . .	66
South Dakota . . . . .	62
Nebraska . . . . .	44
Kansas . . . . .	42
<b>South</b>	
Delaware . . . . .	30 %
Maryland . . . . .	29
Dist. of Col. . . . .	13
Virginia . . . . .	50
West Virginia . . . . .	55
North Carolina . . . . .	65
South Carolina . . . . .	66
Georgia . . . . .	64
Florida . . . . .	40
Kentucky . . . . .	65
Tennessee . . . . .	64
Alabama . . . . .	68
Mississippi . . . . .	75
Arkansas . . . . .	71
Louisiana . . . . .	60
Oklahoma . . . . .	48
Texas . . . . .	47
<b>West</b>	
Montana . . . . .	44 %
Idaho . . . . .	38
Wyoming . . . . .	40
Colorado . . . . .	39
New Mexico . . . . .	49
Arizona . . . . .	38
Utah . . . . .	20
Nevada . . . . .	26
Washington . . . . .	21
Oregon . . . . .	26
California . . . . .	14
Total U. S. . . . .	37 %



*Norman Johnson, architect*

**MODERN  
BEAUTY  
FOR THE  
TRADITIONAL  
HOME**

**Andersen  
Windowalls\***

COMPLETE WOOD WINDOW UNITS

THE RICH CHARM of traditional furnishings blends perfectly with the lovely view of this Minnesota home. Key to this happy marriage is strictly up-to-the-minute design—a wide WINDOWALL of Andersen Casement and Picture Window Units.

WINDOWALLS add to the beauty and livability of any architectural style. They provide fresh air, sunshine and a view as windows. They also provide exceptional comfort as walls. They'll fit beautifully into the next home you plan or build.

For complete detail information see your lumber dealer, Sweet's Light Construction File, or write Andersen. WINDOWALLS are sold by established lumber dealers throughout the country including the Pacific Coast.

TRADEMARK OF ANDERSEN CORPORATION

MADE BY Andersen Corporation  
BAYPORT, MINNESOTA





In these days of competitive selling, builder profits often come from savings in labor. Here Ceco Steel Casings helped Builder Richard A. McClatchy in his Row House Project at Folcroft, Pennsylvania. Ceco Steel Casements were ordered with Inside Casings attached at the warehouse. Installation was simplified because the entire window unit was placed in the opening in one operation. That eliminated finishing the inside of the opening, with resultant labor and material savings of \$3.50 per window, compared to older, time-consuming methods. Architect Erling Wenge said, "Ceco Casements are easy to open and close—and are giving fine performance." Ceco Casements offer these additional advantages: 1—Principal sections are 1½" deep, heavier and stronger than other casements; 2—Two-point parallel contact lapping full ¾" provides tight window with minimum air infiltration; 3—100% ventilation available—vents can be arranged to bring in air from any direction. See Sweet's Files for details of Ceco Steel and Aluminum Windows.



In construction products CECO ENGINEERING makes the big difference

# HOW CECO STEEL CASINGS SAVE \$3.50 PER WINDOW OPENING



Row House Project, Folcroft, Pennsylvania  
Richard A. McClatchy, Builder/Erling Wenge, Architect

## CECO STEEL PRODUCTS CORPORATION

Offices, warehouses and fabricating plants in principal cities  
General Offices: 5601 West 26th Street, Chicago 50, Illinois

Ceco Steel Casement and attached Inside Casing are combined as one unit for fast, easy, money-saving installation.



"ALL FROM **1** SOURCE"

*National  
Lock*

"Select-a-Pak" HARDWARE

BUILDERS HARDWARE

LOCKSETS

CABINET HARDWARE

FURNITURE TRIM

CASTERS

CABINET LOCKS

SHELF HARDWARE

SCREWS AND BOLTS

NATIONAL TUTCH LATCH

ORDER FROM YOUR SUPPLIER

Ask for complete catalog

Originator of "Select-a-Pak"...Leader in Merchandising



**NATIONAL LOCK COMPANY**

Rockford, Illinois • Merchant Sales Division



CABINET  
HARDWARE



NATIONAL  
LOCKSETS



BUILDERS  
HARDWARE



SASH  
HARDWARE



CABINET  
LOCKS



FURNITURE  
CASTERS



SCREWS  
AND BOLTS

# A FIRE Started in this School....

## Its Path was Barred by Multiple Accordion Aluminum!



**T**his is the New Bridge Elementary School in New Milford, N. J. When it was built, Arthur Rigolo, the architect, had specified Infra multiple accordion aluminum insulation, Type 6, and it was installed in the ceilings.

In July 1953, the roof of this school was set on fire from the outside. Most of the roof area ABOVE four classrooms was destroyed, but Infra Insulation protected their ceilings. The fire did not penetrate below the insulation.

The ceiling beams were found to have been charred by the fire ABOVE the insulation; but the SAME ceiling beams were NOT charred below it.

When the roof area was renovated in August 1953, Infra multiple accordion aluminum insulation was again installed between the roof beams.

Fires sometimes spread more rapidly when aggravated by Heat-Rays or Radiation; or because of flow of super-heated air. The surfaces of multiple accordion aluminum have a Heat Ray or Radiation absorptivity and emissivity of only 3%, with 97% reflectivity, whether the heat rays originate in the sun, a furnace, a warmed surface or a burning area in a building. Aluminum will not burn. It has a melting point of 1220° F. Even the fiber separators of standard Infra are flame-resistant.

Charred portion of beam shows where fire was retarded at the level of the aluminum sheets of Infra Insulation.

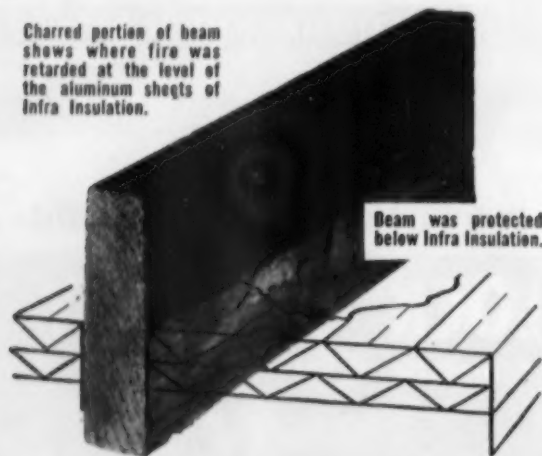

Beam was protected below Infra Insulation.

Photograph of section of ceiling beam removed from New Bridge School when fire damage was repaired.

To obtain maximum, uniform-depth protection against heat loss and condensation formation, it is necessary to use the new edge-to-edge multiple aluminum,\* each sheet of which stretches from joist to joist, and also all through the flanges for further vapor protection as well as permanent attachment of each sheet of aluminum.

In addition to reflecting heat by Radiation, which represents 50% to 93% of all heat transferred through building spaces depending on direction of heat-flow, the layers of aluminum and fiber retard convection, or movement of warm air. The alternating air spaces have low density, therefore Conduction through them is slight. The solid aluminum sheets, long and continuous, are almost completely impervious to water vapor. Infiltration under the flat, stapled flanges is slight.

Condensation on or within this type of insulation is minimized by the scientific construction of multiple layers of aluminum, fiber and air spaces.

A very useful and interesting "Radiation Table" listing the Emissivity, Absorptivity and Reflectivity of the Surfaces of a long list of materials has been prepared by Alexander Schwartz, president of Infra Insulation, Inc. It is yours for the asking.

Also yours for the asking is an illuminating discussion of why and how aluminum insulates, even under extreme conditions. It will be found in the booklet "Thermal Test Coefficients of Aluminum Insulation for Buildings," published by the American Society of Heating & Air-Conditioning Engineers. A free copy, and samples of the new insulation sent by us on request.

\*Patent applied for

### COST OF EDGE-TO-EDGE INFRA

Multiple Aluminum Insulation installed in new construction between wood joists, material and labor Type 6-PS about 10¢ sq. ft. Type 4-PS about 8¢ sq. ft.

Infra Insulation, Inc., 525 Broadway, N. Y., N. Y., Dept. B-7  
 Please send FREE A.S.H.A.C.E. Booklet, "Thermal Test Coefficients of Aluminum Insulation for Buildings."

Name \_\_\_\_\_

Firm \_\_\_\_\_

Address \_\_\_\_\_



**Small volume builders got a break** when a Bay City, Mich., savings and loan association turned land developer. Mutual S&L acquired 55 foreclosed acres of raw land from the city, put in all utilities and improvements. When subdivided into 241 lots, total cost per 60-foot lot averaged \$740. It offered lots ready to build at \$875 up to \$1,500, said to be about half the going price for comparable sites in this city of 50,000 population.

**Builder purchases were limited to 10 lots at a time**—five on definite commitment, five on option. Only after a builder had completed and sold all ten houses could he get more land.

**Sales were subject to approval of house plans and loan terms**, plus a condition that the house be completed within eight months. Most lots were sold to builders; the rest to individuals.

**Helping the small builder proved to be big business for the lender.** Of the first 115 houses built and occupied, 12 were sold in straight cash deals. Mutual holds mortgages totaling over \$1.4 million on the other 103. Another 30 units are under construction and all remaining land is sold or optioned.

**Detroit FHA has declared war on "gray market" in vacant land**, following reports that a parcel of remaining land in a suburban subdivision was sold for \$10,000 an acre.

**"FHA does not have to do business,"** said Wendell O. Edwards, director, "with the man who buys land, already approved by us, at a price of \$1,000 or more an acre over the price when the land was first submitted to us. Our subdivision report is not transferable."

**New York's anti-segregation law now affects FHA-VA class A multiple housing.** Effective July 1, it covers such dwellings, in addition to public housing and state-aided projects, where FHA or VA loans finance wholly or in part the acquisition, construction, rehabilitation, repair or maintenance. Discrimination is prohibited during the life of the loan.

**Two-story houses may be staging a comeback at Columbus, Ohio.** One of the many models in the Lincoln Village model "city" built by the Peoples Development Company is a two-story colonial house on a slab, and with a New England "salt-box" roof. Three bedrooms and bath were moved upstairs, leaving space for large family room. Several of the houses were ordered last year.

**Four times as many two-story units are planned for this year.** Looking ahead, Carl R. Frye, manager, says: "In 1956, we are betting that 20 per cent of our customers will sign on the dotted line for the home with two stories."

**New building labor pacts are expected to lift housing prices another notch.** Many contracts recently enacted will run two years, call for 7½ cents an hour increase now, 5 to 7½ cents more starting May, 1956.

**Some of the higher gains:** Bricklayers, masons, plasterers in Westchester county, N. Y., up 15 cents to \$3.75 an hour. Plumbers in Elgin, Aurora, Lake and DuPage counties, Ill., up 20 cents to \$3.45.

**Prolonged strikes have set back builders in St. Louis and Rochester, N. Y.** Early in June, St. Louis truck drivers entered a fourth week in a strike against building material dealers, causing most construction workers to be laid off. They had refused 7½ cents now, 7½ cents more next May; demanded 10 cents now, 10 cents more next January. Carpenters in Rochester, on strike five weeks, turned down a 15-cent offer, held out for 25-cent boost.

**Picketing kept estimated 9,000 building workers off job in Rochester.** Bricklayers, unhappy over the situation, reminded public in press statement that "when the masons staged their six-week strike in 1950, they didn't picket a single job. They didn't throw 8,000 more men out of work to gain their ends."



**LONG On Beauty . . .**

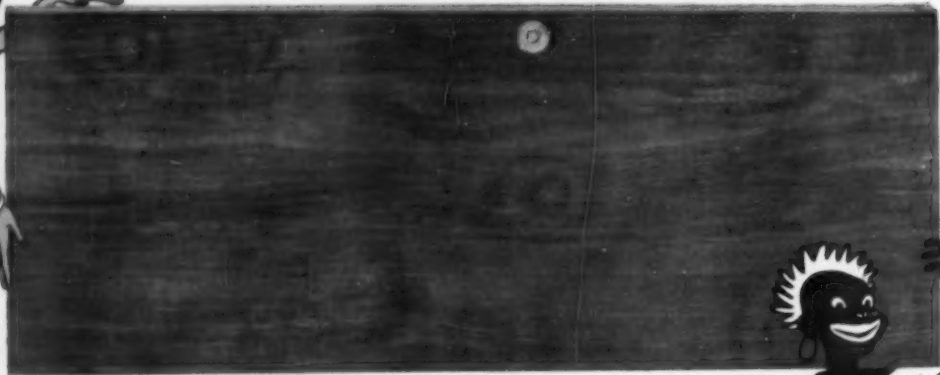

**SHORT On Price!**

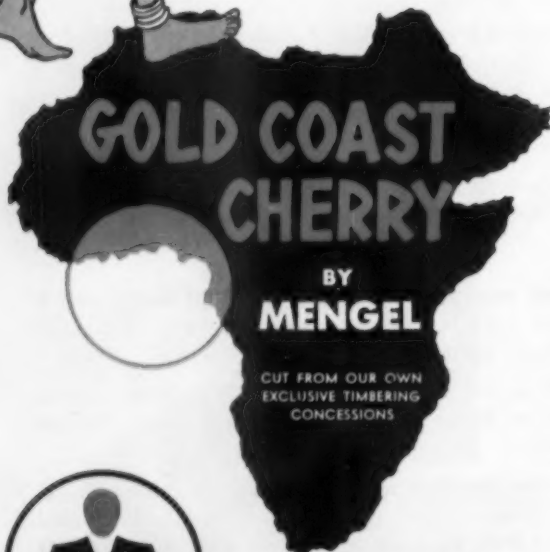

**MENGEL**

*Flush*

**DOORS**

Now Mengel has done it again with Gold Coast Cherry — the newest addition to our extensive line. In a few short months, Mengel Doors in rotary-cut Gold Coast Cherry have bounded to *sensational* popularity!

The price? Strictly competitive! And when you consider the economies of finishing, doors of Gold Coast Cherry are actual *money-savers*: One finish-coat on their smooth, close-textured surfaces is better than two coats on many other woods.

Traditional Mengel quality *and Guarantee* — greater beauty — low cost! Don't take our word for it. Order an inspection lot from your distributor, and see for yourself *how beautiful* rotary-cut Gold Coast Cherry is!

Door Department, THE MENGEL CO., Louisville 1, Ky.  
World's Largest Manufacturer of Hardwood Products  
(Mengel Permanized Furniture, Doors,  
Kitchen Cabinets, Wall Closets)



## Starts Maintain 20,000-a-month Increase

Housing starts in May amounted to 132,000, continuing for the fifth straight month an unprecedented average monthly increase of 20,000 more new units than were started in comparable months last year.

The five-month total of 553,500 starts is 100,500 ahead of 1954 at the end of May. The rate has persisted despite tightening of mortgage money, local shortages in cement and other building materials, and rising costs. If it continues, the experts who have been adjusting their 1955 forecasts of starts downward to 1,300,000 or less, may have to take one eye off the seasonally adjusted annual rate (1,306,000 in May) and pay more attention to comparisons with 1954.

Starts maintaining a 20,000-more-per-month pace would establish a new annual record around 1,450,000. Should the remaining monthly increase be cut in half, total starts for the year would approximately equal 1950's all-time high. If starts fall back to the 1954 level, the total will still be about 1,320,000.

May figures included 129,500 new units by private builders, 2,500 for public housing. The Commerce-Labor Departments reported the February total has been revised downward 100 units to 89,900.

Value of all new construction put in place expanded seasonally in May to \$3.5 billion to set a record high of nearly \$15.3 billion for the first five months. Residential building hit a peak of \$1.4 billion for the month; \$6 billion for five months.

### NAHB Voices Optimism

The National Association of Home Builders anticipates satisfactory business conditions throughout 1955, with ample mortgage money available for an expected volume of 1¼ to 1½ million new building units. Its optimism was reflected at its annual spring directors' meeting in Washington where industry leaders and government officials agreed that present and prospective volume of home building is healthy and that the mortgage debt is on a sound footing.



### Cole Addresses U. S. Chamber Building Session

HHFA Administrator Albert M. Cole (second from right) discusses housing amendments at Chamber of Commerce of the U. S. luncheon with Charles G. Nichols, vice president; Martin W. Watson, chamber's construction chairman and a Topeka, Kans., contractor, and Maynard A. Bebee, principal civil engineer, New York State Department of Public Works

"There is no foundation to recent assertions that the housing market is overbuilt," said Earl W. Smith, president. "The next two or three years will be good for building and the economy generally."

#### No Bubble Prosperity

HHFA Administrator Albert M. Cole told the builders: "We've reviewed actual local conditions throughout the country. We've found housing demand generally strong in the great bulk of our urban markets. Only in a few localities, usually because of special circumstances, have we found any evidence of a significant general housing surplus. We are dealing with these local situations in a local manner. FHA and VA have taken appropriate actions to cut back liberal-term financing in these areas until that particular market adjusts itself. They are continuing to watch for and act on any other such situations that may develop.

"But one swallow doesn't make a summer." And a small number of local surplus situations don't constitute a housing glut throughout the country.

"The housing market as a whole is strong. There is good reason why it should be. This is no bubble prosperity. This is sound production of housing that people want and that people can afford. It would be a grave mistake to tell lenders to stop lending, builders to stop building and buying on the basis of the slide-rule theories of some pessimistic statistician."

#### Specific Shortages and Surpluses

FHA Commissioner Norman P. Mason reported that most surplus situations are in localities which have had substantial cutbacks in defense or Atomic Energy Commission activities. He added:

"There are nearly always some spots where, for purely localized reasons, the supply of housing temporarily exceeds the demand. Too many houses in New Haven won't help a housing shortage in Philadelphia. Shortages and surpluses are even more specific. Too many \$18,000 houses won't help people who can only afford \$8,500 houses. Too many houses of stultified design won't tempt pros-



### Woodwork Group Expands

Ponderosa Pine Woodwork officials, following announcement that the association had absorbed the American Wood Window Institute. From left: Earl C. Thuresson, jobbers' chairman; Robert H. Morris, general manager; F. A. Hoerner, manufacturers' chairman

pects who are thinking of up-to-date comforts . . . This country will swallow all that we're building and come back for more."

As to mortgage debt, the economic policies committee of the National Savings & Loan League has reported that the American income can meet

the commitments involved. Total mortgage debt outstanding as of the end of 1954, it said, was \$75 billion, only one-quarter of estimated national income for the year. In 1940, the proportion was 22.7 per cent.

### Senate Boosts Public Housing

Meanwhile, in mid-June Congress was whipping the housing amendments of 1955 into shape for passage by the end of the month. The Senate exploded a bombshell on June 7 by passing a bill authorizing 135,000 public housing units to be built in each of the next four years, four times as much as that asked by President Eisenhower.

HHFA Administrator Cole said he would "go along with" any additional public housing measure approved. He declared the Administration program was an "absolute minimum" to meet community needs and added: "Public housing is not just

## DICKERMAN'S COLUMN

By John M. Dickerman, Executive Director, National Assn. of Home Builders

# Proposed Increase of FHA Insurance 'Too Close for Operating Convenience'

Contrary to a year ago when the 1954 housing act was being written, Congressional activity in the housing field this year has been limited almost entirely to technical amendments, extensions or enlargements of existing programs.

It is the view of the National Association of Home Builders that the most important of the several housing questions now being discussed on Capitol Hill is that increasing the general mortgage insurance limit of the Federal Housing Administration. An increase of \$4 billion has been proposed in both the Senate and House. While this sounds formidable, it actually is too close for operating convenience. As a practical matter it means that FHA's operations will come to a quick halt if its insured loans during this fiscal year or next come within 200-500 units of its estimates.

### From Crisis to Crisis

There is no reason why FHA should exist from crisis to crisis, or why the Congress should be required to hurry through a supplemental authorization merely because of an inadequate increase at this time. This increase in authorization in no way affects either the national debt or the

budget. Certainly it should be in a larger and more adequate amount.

NAHB also:

- Opposes fragmentation of the Housing and Home Finance Agency at this time. Specifically, we are opposed to the passage of the House measure (H. R. 5945) which would permit the Home Loan Bank Board, including the Federal Savings and Loan Insurance Corporation, to operate as an independent agency. Any action on this proposal should be postponed until the administration has had a complete opportunity to study and form conclusions on a thorough reorganization of the housing agency.
- Supports the five-year extension of FHA's Title I home repair and modernization loan insurance program and recommends that the maximum insurance limit be increased from \$2,500 to \$3,000 and the term be lengthened from three to five years.
- Considers that changes should be made in the charter of the Federal National Mortgage Association to make it more useful as a secondary market. NAHB believes that the requirement of at least a three per cent stock investment to use FNMA is too high. A reduction to two per cent has been recommended. The association further believes that on the basis of the past several months' experience FNMA purchase prices for mortgages depress rather than aid the general mortgage market. It is felt



Dickerman

that FNMA should be authorized to buy loans at a reasonable price level determined by it from time to time rather than at "market price."

### No More Public Housing Needed

- Views more public housing as unnecessary in view of the current high levels of production and income. Certainly, if properly administered, the existing public housing should be more than adequate for the neediest cases for which some kind of public assistance is required. In view of the vast increase in housing supply, coupled with a very sharp decline in the number of low income families, and the excellent prospect for continuation of both trends, NAHB believes there is no longer a need for continuing to build public housing.
- Recommended that the programming of housing under Section 221 of the 1954 housing act should not be confined solely to families displaced by slum clearance of rehabilitation or redevelopment projects.

NAHB also has informed the Congress that unless both law and agency interpretations recognize the highly speculative risk involved in equity investment in the construction of rental housing, investors will undoubtedly continue to choose less hazardous avenues of investment. Lack of recognition of the realities of rental investment has, among other things, acted to prevent the effective use of Section 220 of the 1954 housing act which was designed to provide a workable financing vehicle for the redevelopment and rehabilitation of cities through private enterprise.

## Wichita Builders Rush Aid to Tornado-levelled Udall, Kans.



36 hours after the tragedy: complete destruction



Within 48 hours, new 40x80 city hall was in use

something we would like to have; it is something we have to have."

NAHB President Smith expressed strong opposition to more public housing. He cited increases in consumer income, home ownership and supply of new and used homes as having "drastically diminished, if not eliminated entirely, the problem at which the original public housing program was aimed . . . An increasing number of public housing projects are unable to obtain tenants except by substantially increasing their limits on family income for eligible occupants."

Strong opposition in the House to the Senate bill was a foregone conclusion and it was believed probable that the end result would be somewhere near the original Administration request.

### From Denver to Washington

NAHB's October directors' meeting has been shifted from Denver to Washington. It will thus coincide with the official opening of the National Housing Center, originally scheduled for August 15. W. Hamilton Crawford, Baton Rouge, La., has been named chairman of the \$2.5 million Center, a wholly-owned NAHB subsidiary. He succeeds Nathan Manilow of Chicago who had announced his retirement from the position at the spring board meeting.

### FHA's Typical Buyer

Who's the typical buyer of a new home with an FHA-insured mortgage?

Based on an average of the new homes so financed last year, which involved 55 per cent of the 222,665 mortgages insured by the agency, this borrower:

- Had an annual income of \$5,139,



No time for formal rites, Udall Mayor Earl B. Rowe (left) thanks ex-WAHB President James Gardner

a new high and 5 per cent above 1953.

- Bought a 5½-room single-family house with three bedrooms and floor area of 961 square feet, valued by FHA at \$10,678 including land with market price of \$1,456.

- Obtained a 75 per cent loan of \$8,862 for about 23 years, with monthly installment of \$68.62 including taxes, hazard and mortgage insurance premiums, and debt service. This was slightly more than 15 per cent of his income.

Average mortgage on a new home was highest in Connecticut, lowest in New Hampshire, while monthly payments ranged from \$59.39 in Florida to \$88.28 in Colorado. Monthly income of new home borrowers ranged from \$362 in Vermont to \$619.47 in Nevada.

### Used Home Larger, Loan Lower

Typical existing home was valued by FHA at \$11,549, including lot at \$1,607, 5½-room house with three bedrooms and floor area of 1,035 square feet. The \$9,030 typical mortgage was 78 per cent of property value, provided for monthly payments of \$74.34 over 20 years.

Garage facilities were included in

two-thirds of new homes, four-fifths of existing homes.

### 1,500,000 Title I Loans

The 1954 borrowers under FHA's Title I totaled 1½ million, got nearly \$891 million. Home insulation was the most popular project thus financed, one out of five Title I loans paying for an insulation job, with average cost at \$362. Additions and alterations comprised 14 per cent of the loans, which averaged \$917.

### Friend in Need

Within 48 hours after a tornado destroyed the little town of Udall, Kansas, and killed 79 of its residents, some 50 members of the Wichita Association of Home Builders had constructed a new city hall on the site of the old one.

The tragic blow struck Udall (pop. 610) at 10:29 P.M. Wednesday, May 25. Next afternoon, the Wichita



Crawford: 'Center' Chairman



### Leaders in 'Homes for Korea' Drive

Retired General James A. Van Fleet (center), honorary chairman of the building industries committee, American Korean Foundation, and William Zeckendorf (next right), president of Webb & Knapp and committee co-chairman, show model of new Korean housing to Robert A. Durk, executive vice president, and Charles M. Jaeger, president, New York State Home Builders Assn. (left), and Charles M. Haring Jr. (right), president, Home Builders Assn. of Westchester, New York

builders decided to make some contribution and settled on donation of manpower and materials for a new 40x80-foot building.

Next morning, 50 builders and laborers arrived with lumber and electric generators. In 5½ hours, they were finished. Even before the roof was completed town officials and relief agencies had taken occupancy. On Saturday, the crew returned to erect an adjacent canteen for the Red Cross.

Much of the material and supplies were donated. The remainder were purchased at cost for \$1,200, and that was paid off by contributions from builder and associate members to a Udall building fund.

### Rebuilding Korea

Pilot housing projects in Korea to show residents "how to meet their critical housing needs through mass production" make up an ambitious program of the American Korean Foundation which seeks the aid of the United States building industry.

General James A. Van Fleet (Ret.), former United Nations commander in Korea, is honorary chairman of the foundation's building industry committee. William Zeckendorf, president of Webb & Knapp, New York, and Earl W. Smith, NAHB president, have been named co-chairmen.

Plans called for building pilot projects of about 100 units each, accord-

ing to Brigadier General Richard S. Whitcomb (Ret.), executive director. He said the program would require about \$1,500,000 in materials and money donations.

### SCPI Expanding Market

The brick and clay industry is ready "to sell and service a residential market of over a million new homes annually for at least the next five years."

The statement was made by Douglas Whitlock, board chairman of the structural Clay Products Institute, at a meeting of New York banking executives. This decision of the industry, he said, was based on an analysis of the country's economy by Robinson Newcomb, Washington economic consultant.

Newcomb predicted a 1.3 million or more potential market, based on new households formed and a big increase in income of families in the \$4,000 to \$10,000 class. He added that although the ratio of debt to income is 20 per cent higher than in 1939, interest rates have declined as much as 3 per cent since that time.

### Dealer Show Changed

National Retail Lumber Dealers Association reports that attendance at its 1955 Building Products Exposition will be restricted to invited members of trade groups sharing an interest in the new construction, modernization and home repair markets. The show will be in Cleveland Oct. 11-14.

## DEALER'S VIEWPOINT

By H. R. Northup, Executive Vice Pres., National Retail Lumber Dealers Assn.

### VHMCP Program Seen Influencing Private Lenders to Improve Service

It looks as though another example of the way government initiative sometimes helps to change the thinking and the business patterns of private industry is being developed by the Voluntary Home Mortgage Credit Program.

This new program, established by the Housing and Home Finance Agency to facilitate the flow of mortgage funds to outlying communities and to assist minority groups in arranging home financing, has been making rapid progress, nearly \$3,000,000 being loaned in three months.



Northup

Just as favorable experience with FHA-insured loans led to lower down payments and long-term amortization for conventional loans, and just as FHA's Title I program has been imitated by the banks, so may the VHMCP program lead the larger private lenders to giving better service to that part of the market which they have tended to neglect.

The soundness of Title I has been demonstrated so convincingly that it probably cannot keep up with its competition. In some parts of the country, bankers have been urging each other to finance modernization work on their own terms outside Title I. This may tend to hold down the volume of improvements carried out

with the aid of Title I but, even so, that program will be serving its intended purpose well by stimulating private enterprise to give home owners the assistance they seek.

#### Program May Not Be Needed

Lumber dealers have served enthusiastically on the regional committees set up to make VHMCP work because they know from first-hand experience how difficult it has been for many of their customers to arrange mortgage loans in communities removed from the metropolitan areas where lending has seemed more attractive to those with funds to lend.

When lenders have learned that these loans to outlying areas and minority groups are neither as risky nor as costly to service as they might appear, the need for this special program may well disappear.



**Big Key Opened Big Show**

Michigan's Lieutenant Governor Hart using "gold" key to open home show doors for Builders Association of Metropolitan Detroit. Others, from left, are James Schwerin, Detroit VA loan guaranty chief; Wendell O. Edwards, Detroit FHA director; Finlay Allan, secretary, Detroit Building and Construction Trades Council; Webb H. Coe, association president



**Charter for Mohawk Valley Builders**

Frank P. Tufaro, (center), NAHB regional vice president, presenting charter to C. H. Love, president, Home Builders Association of Mohawk Valley, Utica, N. Y. At left are A. H. Pearsall, secretary; Albert E. Bartlett, former regional vice president and Mayor Boyce E. Golder. At right is Charles M. Jaeger, president, New York State Home Builders Association

**Chicago Scholarships**

An extensive scholarship program for students taking courses in residential building or light construction at accredited colleges has been announced by the Chicago Metropolitan HBA. George Arquilla, president, reports the program is designed to establish a better understanding of the home building industry and its problems and to enable members to obtain better personnel. Awards are to include grants of \$1,000, distributed in amounts of \$250 each year, and \$250 to \$500 to be paid within one year. Residents under 21 years of age and living in the association's territory are eligible. . .

Sales records are rolling in. Orrin Thompson listed 315 sales of three-bedroom ramblers at Coon Rapids, north of Minneapolis in 20 weeks. Waxman Brothers 2,000-home Seaview Village in Brooklyn, with prices ranging from \$16,990 to \$23,490, attracted 327 buyers in three months. Security Construction Corp., Mil-

waukee, offered its "Challenger" model at \$13,475 including five appliances, and sold 74 units in three weeks. . .

If you want to build a basementless house in East Cleveland, new ordinance requires plans to be approved by board of building code appeals before permit can be issued. Reason: drainage difficulties. . . Looking for a gimmick to sell a live prospect? Just before such a buyer returned for another look, Hudson J. Force of Akron had his initial painted on the garage door in a foot-high old English style. The sale was made pronto. . . You don't have to go to Florida, Texas or Arizona to build retirement houses. Paul Bundy built three-room brick unit in suburban St. Louis, found a quick buyer. . .

**Omaha Starts Doubled**

Off to its best start, Omaha metropolitan area has in five months increased its housing pace 100 per cent. Up to May 31, starts totaled 1,599 this year; 795 last year. . . By May 1, permit values in Wichita, Kans., were running \$9,000,000 ahead of last year, reported S. B. Maples, chief building inspector. Housing prospects looked bright, with 65 new plats registered in five months. Chicago metropolitan area listed five-month total of 19,086 new home permits, up to 19 per cent; total construction value of \$413.3 million, up 29 per cent. . .

Charles R. Bragg, executive secretary of HBA of Rhode Island since 1951, has moved north to the post of managing director, HBA of Greater Boston. He fills the vacancy created by the death of Robert W. Heard last April. . . Illinois HBA president Cecil Madaus is meeting with builders to form a new NAHB chapter at Bloomington, Ill. . . Long Island

Home Builders Institute has a new staff position, executive secretary. Robert S. Hunt, who fills it, held similar posts with the Carolina Lumber & Building Supply Assn. and North Carolina Assn. of Plumbing & Heating Contractors. He will be first assistant to Otto J. Hartwig, executive vice president. . .

Blase A. Ravikio of Moorestown, N. J., is the new president of the Home Builders League of South Jersey. Max Odlen and Robert Budd,



Hunt



Ravikio

are vice presidents. . . New executive director of Atlantic HBA, Atlantic City, is Joe R. Riggs. Some time ago, he was an active member of Birmingham (Ala.) HBA. . .

**21st Canadian HBA**

Niagara Peninsula HBA was organized in May at meeting of 50 builders in Niagara Falls, Ont. The 21st chapter of the National Home Builders Assn., Canada, it is headed by C. J. Bartlett of St. Catharines, president, C. W. Bartlett and Robert Johnston, vice presidents. NHBA is planning big promotion of National Home Week throughout the country. . . New York State HBA has approved holding 1956 exposition next spring in the giant New York City Coliseum, but recent collapse of part of the building while under construction may force change of plans.



**Jersey Spikes**

Three new "16-penny" members of the Spike Club honored by the New Jersey Shore Builders Association for their membership activities (from left): Joseph Scalise, Ray Daniels and William F. Russell

## American Builder selected HOUSE OF THE MONTH

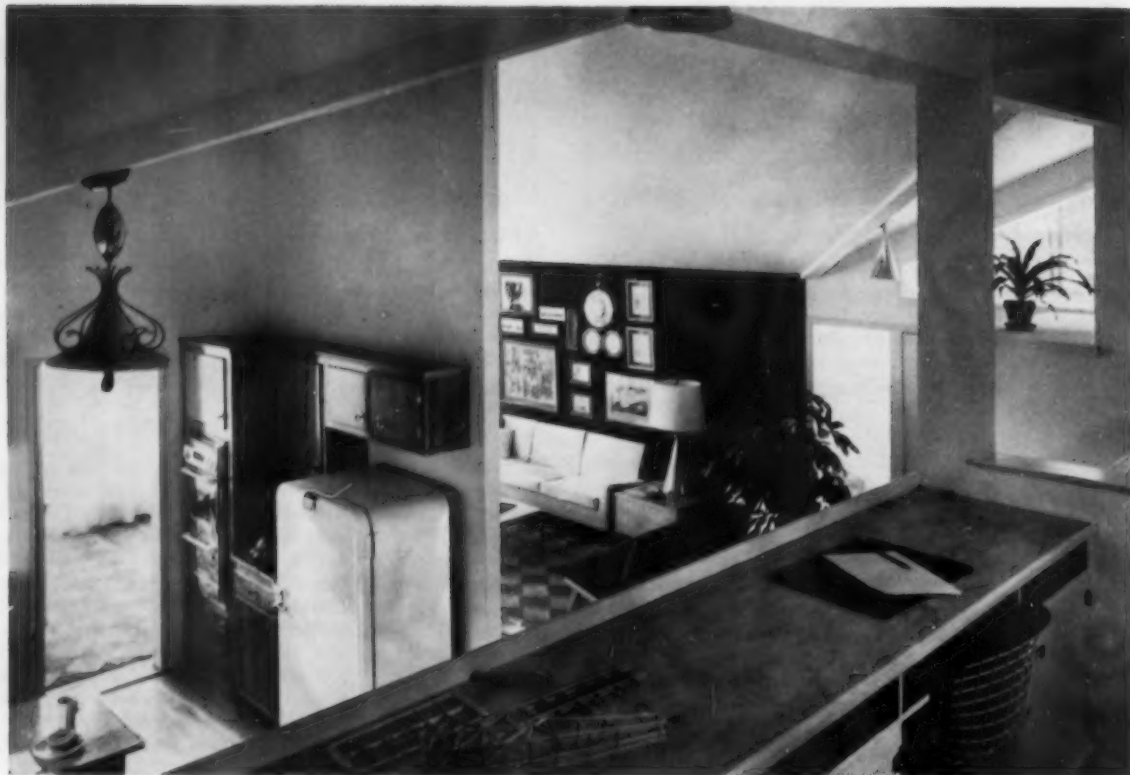

### Split-level kitchen looks up to bedrooms

#### Huntington, N. Y.

From this "look-up, look-down" kitchen, a busy housewife can supervise her children whether they are in their own bedrooms above, in the living-dining area adjoining, in the recreation room below or in the rear yard.

The unusual split-level arrangement appears in the "Melior" model built by Lee Schonfield and Harold Liebman in their Knickerbocker Knolls tract at Huntington, Long Island. It was made possible by grouping all the areas around a family-size kitchen, of which one wall is built along the "split."

Wire-reinforced glass windows extend the full 12½-foot length of this wall—near kitchen floor on one side, at ceiling height of the playroom on the other. Top of the wall



Front porch with overhead trellis is 25 feet long, abuts board and batten walls

from the NORTH



... looks down to recreation room

is flush with the top of built-in cabinets and desk which line the upper hall off the second and third bedrooms. At this point, the vaulted ceiling is at its peak—14 feet above kitchen floor—and the open plan converts the hall to a balcony overlooking all the main floor area.

Living level grouping emphasizes a floor-to-ceiling brick fireplace set in a 25-foot window wall, with clerestory windows overhead in the gable end. The recreation room is planned as an extension of the living level, aided by the wide fixed glass panels off the kitchen.

Schonfield and Liebman offered the Melior for \$19,900 with a 75x100 plot. It was designed by Katz, Waisman, Blumenkranz, Stein & Weber, Architects Associated.



Two lower levels include side entrance, two-car garage and large basement section

Two upper levels. Note position of cabinet wall divider between bedrooms and kitchen

## American Builder Selected IDEAS IN ACTION



Long work center of kitchen is flanked on each end by tall, side-opening cabinets—the one shown, for the dining room. The other opens on family room



Three rooms across rear do not have dividing partitions



## In-a-line kitchen joins dining, hobby areas

### Portland, Oregon

Two popular ideas—open kitchen and family kitchen—have been combined here to merge family room, kitchen and dining room into one complete across-the-house unit 32 feet long.

Except for the refrigerator and its surrounding cabinets, all kitchen facilities are built into a cabinet-

worktop center 15½ feet long. End cabinets help tie in adjoining sections, with hobby storage for family room and china closet-linen chest for dining area.

Leo L. Hall, who designed and built the 1,130 square-foot home for his own occupancy, estimates it cost \$13,000, excluding lot. He used Douglas fir board and batten siding, hemlock on ceiling, Noble fir panel-

ing and radiant heating coils in the concrete slab. Laundry tubs were installed at the far end of the family room, off which furnace and water heater were located in separate closets.

Kitchen is cut off from the living room by a stacked brick open fireplace and a built-in music center which includes from the top down, speakers, record storage, radio, phonograph, telephone and desk-shelf.

Carport and covered porch are built as a 12-foot-wide unit alongside the full depth of the house. An outside storage closet separates them.



Island-type fireplace and adjoining built-in music center facing kitchen-dining area



Other side has radio-phonograph speaker, book shelves, 12-foot light ledge with obscure glass

#### BRAND NAME PRODUCTS USED

American-Standard bath fixtures  
Cobalt stain  
Firtex insulation  
Hall-Mack bath accessories  
Kitchen-Handy hardware  
L-O-W glass  
Pacific furnace  
Schlage locks  
Victrol fan





Slight ramp from driveway eliminates step at entrance, has rough finish

## Cleveland's '1955 home of safety' designed to reduce accidents

### Lyndhurst, Ohio

Elimination of many common accidents in the home was the goal behind the 1955 Home of Safety, on exhibition last month in Lyndhurst, Ohio. It was sponsored by the Cleveland *Press* in cooperation with the Cleveland, Ohio and National Safety Councils.

Peter J. Negrelli, president of DiCarlo Mason & Building Company, the builder estimates that extras directly pertaining to safety added slightly over \$800 to the \$35,000 price. The house was sold before it was completed for a month-long exhibition.

Among the extras were radio-controlled garage door which stops im-

mediately upon striking any object, \$320; five one-handle mixing valves for sink, washbowl, lavatory, shower and washtubs installed at \$125 extra; water heater supplying 180-degree water to washer and dishwasher, 125-degree water elsewhere for \$60 extra; two safety fire hoses installed, \$40; fireproof shingles, \$250 extra; extra handrail to basement, \$30.

Among other safety features: stair treads, bathroom ceramic tile floor and bathtub are all treated with non-skid materials; locks on all bedroom and bath doors may be released from either side to prevent children from locking themselves in; special lock-up cabinets are provided for medicines in the bathroom, for lye, etc., in kitchen; swing doors have door clips to hold them fully open when desired; basement has a locked storage compartment; all gas and water shut-off valves are clearly tagged.



Turnaround drive is sloped to eliminate puddles of water or icy spots

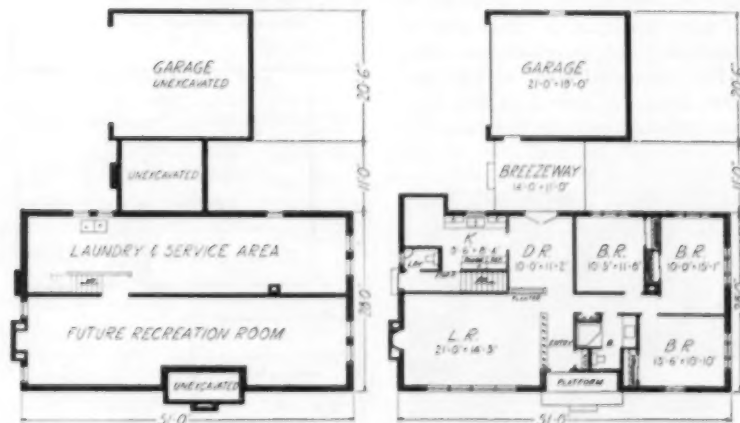

Door to basement opens onto platform, not over the stairs

#### BRAND NAME PRODUCTS USED

- American-Standard fixtures
- Arnold jalousie windows
- Bendis Duomatic washer-dryer
- Corcy Fire-Ches asphalt shingles
- Graham garage door
- Gyro one-handle mixing faucets
- Kwikset and Schlage hardware
- Minneapolis-Honeywell controls
- Roper built-in oven, table-top range
- Rusco combination windows
- Ruud two-temperature water heater
- Servel refrigerator, air conditioning
- Signal ceiling exhaust fan
- Warm Morning gas incinerator

## American Builder Selected IDEAS IN ACTION



Board 1½-inch thick interlocks in 2x8-foot sections over 4x4-inch rafters

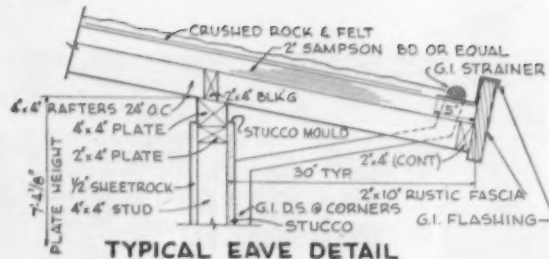

**TYPICAL EAVE DETAIL**  
Roof planks are carried out to eaves. Fascia board on end of rafters forms a natural gutter



## Insulation board doubles as ceiling and roof

### Glendora, Calif.

Builders at The Glendora Gardens development planned for an eventual 1,000 houses, are banking on the acceptability of three cost-saving features to help sell their first 128 units quickly. They are:

- Insulating board panels, sized 2x8 feet and 1½ inches thick, which interlock to act as both roof and ceiling. They are topped only by crushed rock and felt. The underside rests on 4x4 rafters and becomes the exposed ceiling in all major rooms.

- Natural gutters formed by nailing a 2x4 strip on the rafter ends

and over that a 2x10 fascia board, after which metal flashing is fitted into the roof and over the top of the fascia.

- Window frames with flanges on all sides, which are nailed directly to the outside of 4x4 posts in the framing. Stucco keyed under the flanges makes the fit tight.

In addition, developers W. I. Wilkie and Everett Davis & Sons, have installed oak block flooring in place of less expensive asphalt tile to give a "quality atmosphere" which they say increases salability.

The three-bedroom model pictured here was priced at \$12,445; four-bedroom units at \$13,720.

#### BRAND NAMES PRODUCTS USED

Biltrite windows  
Chase copper tubing  
Firtex insulation board  
Formica counter tops  
Higgins bonded floors  
Jenstrol medicine cabinets  
Kaiser gypsum board  
Kohler fixtures  
Kwikset locks  
Minneapolis-Honeywell controls  
Payne forced air furnace  
Stanthony range hood  
Thermador heater  
USG Rocklath  
Whirlaway disposer



Garage and breezeway form an L with the house, adding to impression of size

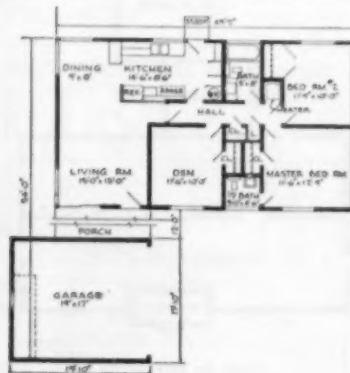



Plan of the Pomponio "mansionette." Carport at right shields a handy, screened dining terrace

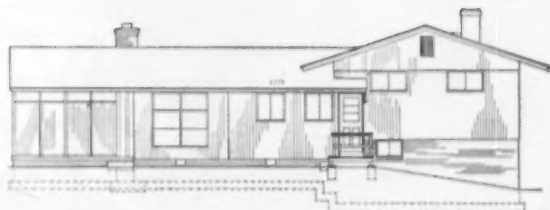

Garden elevation, in rear. Ground slopes down to permit use of full-size windows on side of basement level

## Built to exploit a 'country club' setting

### North Arlington, Va.

When M. Pomponio & Sons, Inc., planned the Janet Knoll development in North Arlington, Va., they determined to "build in" an atmosphere of comfortable living to match the scenic locale.

Split-levels and ramblers are all placed for good views of well-forested hills. Luxury features are designed to take further advantage of the setting.

The "mansionette" here, for example, offers a dining terrace, large

indoor recreation space, wall-high fireplace with tiled hearth, two and one-half baths. Its price: \$26,950.

Larger than its adjoining dining room, the dining terrace is separated from the carport by a vertical louver wall made up of 4x4 redwood posts and 1x6 slats.

Contributing to the kitchen's utility are a dishwasher, disposer, built-in oven and nook and natural birch cabinets.

Edward M. Pitt, Arlington archi-

tect, designed this split-level house so that its bedroom wing is but four risers, or 2½ feet, above the living level. Basement area below the bedrooms offers large recreation space, with private entrance, three wide casement windows.

Siding is mainly brick, with sections of random-width V-joint redwood and of Douglas fir exterior plywood. Teco truss rafters on 24-inch centers support the 4/12-pitch roof.

**INSTALL  
THESE DOORS  
IN MINUTES...  
with only a  
screwdriver!**

It's that easy! For these handsome Fenestra® 1½" Flush Metal Interior Doors come to you as *complete units*—with pre-fitted door, frame and hardware, all specifically made for each other. There's no time-consuming planning, ordering and assembling of special elements...no cutting, no fitting, no mortising or tapping.

You save *dollars*, too! Installation costs are slashed, and because Fenestra Door Units are mass produced on special jigs, you get production-line economy from the very start.

Yet with all this economy of time and money, you'll be delivering a top-quality product that's bound to build satisfied customers. For these attractive steel doors can't warp or swell, stick or rot. They close quietly because inside surfaces are covered with sound-deadening material. For the complete story, call your Fenestra Representative. He's listed in the Yellow Pages of your phone book. Or write the Detroit Steel Products Co., Dept. AB-7, 2260 East Grand Blvd., Detroit 11, Michigan. \*®

## *Fenestra*

**INTERIOR DOOR • FRAME • HARDWARE UNITS**  
ARCHITECTURAL, RESIDENTIAL AND INDUSTRIAL WINDOWS • METAL BUILDING  
PANELS • ELECTRIFLOOR® • ROOF DECK • HOLLOW METAL SWING AND SLIDE DOORS



# NOW!

## Kaustline Quality

# GAS-FIRED

# FURNACES

**NOW** a line of Kaustline GAS-fired Furnaces that were well worth waiting for. The result of many years of engineering research, these furnaces are *exclusively* designed for efficient, economical gas operation . . . however, they do incorporate many of the famous time-tested features of Kaustline oil-fired units.

These furnaces rely on one of Kaustline's most unique developments, the "Tear-Drop" Designed Heat Exchanger System, unsurpassed in its ability to develop quick, even heat with a minimum of fuel consumption.

With these GAS-fired Units you can offer your prospects the same top quality so long synonymous with Kaustline OIL-fired furnaces. The same efficient, quiet operation . . . the same economy and long life. Then too, they embody the same compactness of design and assembly features that save valuable floor space and reduce installation costs.

Approved by A. G. A. for use with natural, manufactured or mixed gases these units are factory assembled with the burner mounted, ready for quick installation.

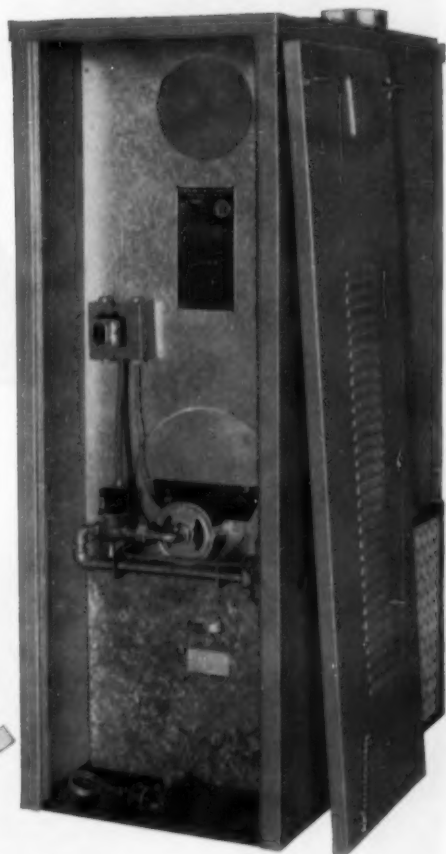

### NEW! GAS-fired COUNTERFLO

Fully automatic Counterflo Units designed for perimeter heating in cellarless homes. Two models delivering 64,000 B. T. U. 's and 90,000 B. T. U. 's at the bonnet.

### NEW! GAS-fired LOW BOY

The fully automatic Low Boys are designed for cellar installation. There are two models delivering 72,000 B. T. U. 's and 90,000 B. T. U. 's at the bonnet.

### NEW! GAS-fired HIGH BOY

The fully automatic High Boys require a minimum of floor space. There are two models delivering 64,000 B. T. U. 's and 90,000 B. T. U. 's at the bonnet.

**GET THE FACTS . . . WRITE DEPT. AB-5**



## Kaustline

FURNACE & TANK CORP.  
PERKY, NEW YORK

## TOPS IN QUALITY

There is a Kaustline Furnace or Winter

Air Conditioner for every type of home

# THESE TWO STYLED FOR YOU



PRIVACY



SAVES SPACE



REMOVABLE FOR CLEANING



EASY TO CHANGE  
SCREENS AND STORM SASH

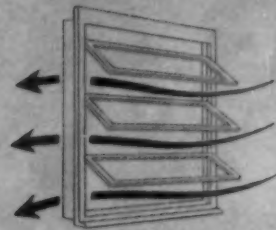

FULL-FLOW VENTILATION  
RAIN OR SHINE



See your local lumber dealer or write

R. O. W. SALES COMPANY, 1373 ACADEMY AVE. • FERNDALE 20, MICHIGAN

AMERICAN BUILDER



EASY OPERATION



WEATHER-SNUG



EASY INSTALLATION

# DOUBLE HUNG FOR DOUBLE VALUE

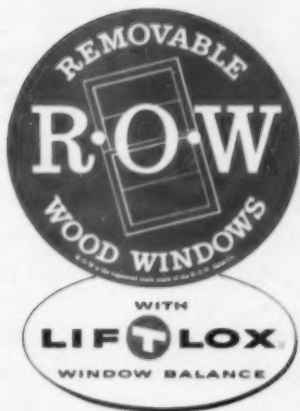

LIFT OUT FROM INSIDE THE HOUSE



WOOD FOR BEAUTY AND WARMTH



EASE OF DRAPING



See your local lumber dealer or write

R. O. W. SALES COMPANY, 1373 ACADEMY AVE. • FERNDALE 20, MICHIGAN

JULY 1955

# EMPIRE



MAKES THE BEST *Gas* HEATING APPLIANCES IN THE WORLD

*There's NO DOUBT about it!*

**MOST EFFICIENT**  
*Gas*  
**BURNER**



**FOR THE SMALL SPACE**

**EMPIRE** HORIZONTAL WINTER AIR CONDITIONERS ARE PARTICULARLY ADAPTABLE WHERE SPACE IS AT A PREMIUM. *Less than 20"* HIGH.

**SILENT**  
**IN**  
**OPERATION**

*Compactly Built* TO GIVE YOU MORE VALUABLE SPACE THAN EVER BEFORE POSSIBLE *and Specially Engineered* TO MEET ANY PARTICULAR HEATING REQUIREMENTS!

- HANDSOME CASING • PRECISION RIBBON STAINLESS STEEL BURNERS • QUIET BLOWER
- AUTOMATIC CONTROLS • LONG-LIFE HEAT EXCHANGER

**MINIMUM FIELD SERVICE**

**DEALERS ACCEPTANCE**



THE **EMPIRE** WINTER AIR CONDITIONER OFFERS YOU THE LAST WORD IN MODERN HEATING LUXURY. THE COMPACT DESIGN PROVIDES MORE LIVING SPACE, AND THE STYLE AND FINISH FITS ANY DECORATIVE SCHEME.

AVAILABLE IN 6 SIZES, THE **EMPIRE** WINTER AIR CONDITIONER IS EVERYTHING YOU NEED IN HOME HEATING.

**USER SATISFACTION**

WINTER AIR CONDITIONER

**EMPIRE MAKES YOUR JOB EASIER**



*Gas*  
**FLOOR FURNACE**

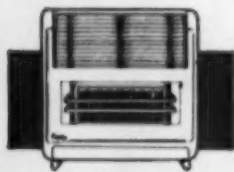

*Gas*  
**CIRCULATOR HEATER**

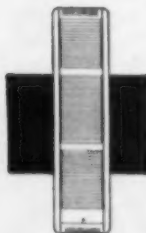

**ZONE CONTROL RECESSED HEATER**



**COUNTER FLOW AIR CONDITIONER**

# EMPIRE

**STOVE COMPANY**

BELLEVILLE, ILLINOIS

WORLD'S LARGEST MANUFACTURER OF *Gas* FLOOR FURNACES





Architect: Merlen T. Ironmenger  
Builder: Gold Coast Construction Co.,  
Fort Lauderdale, Fla.

## **LUSTRACRYSTAL** is the Economical Glass for Large Openings

Now you can use plenty of glass and still keep your cost down. This home in Fort Lauderdale was glazed with LUSTRACRYSTAL—the economical glass for large openings and doors. By using 7/32" LUSTRACRYSTAL the builder realized considerable savings over 1/4" plate. When you buy LUSTRACRYSTAL, you

are buying the sheet glass with extraordinary flatness, clarity and brilliance. It has the highest transparency obtainable without a fraction of distortion. In your next home, add glass—add beauty and still keep your costs down with LUSTRACRYSTAL, a product of the American Window Glass Company.



# **AMERICAN**

WINDOW *Glass* COMPANY

Specialists in the manufacture of flat glass since 1899.

9 West Park Way • Pittsburgh, Pa.



*Just look! You'll see why homeowners prefer*  
**MATICO ASPHALT TILE FLOORING**

The clarity and richness of MATICO fashion-styled colors are winning the acclaim of decorators, homeowners and builders everywhere. But MATICO's beauty is more than "skin deep." Fortified with polystyrene plastic for greater strength and resiliency, economical MATICO Asphalt Tile Flooring gives years and years of wear... is easy to maintain... and performs equally well on, above or below grade. Design possibilities are virtually unlimited because

MATICO is available in 28 striking colors. Be sure to consider the many advantages of plastic-fortified MATICO Asphalt tile flooring for your next project.

*MATICO Tile for floors you'll be proud of!*



**MASTIC TILE CORPORATION OF AMERICA**

Houston, Texas • Joliet, Ill. • Long Beach, Calif. • Newburgh, N. Y.

ARISTOFLEX • CONFETTI • PARQUETRY • MATICORK • ASPHALT TILE • RUBBER TILE • VINYL TILE • CORK TILE • PLASTIC WALL TILE



Photo by Hedrich-Blessing, Furniture by Kroehler

## It's Modern! It's Distinctive! It's Hardwood!



There's high style in this Bruce Block Floor to complement the most modern interior. The parquetry design is beautiful everywhere . . . giving full play to the delicate coloring and interesting grain of durable oak. Installation is simple . . . blind-nailed over wood sub-

floor or laid in mastic over concrete. Famous Bruce factory-applied "Scratch Test" Finish saves time and money. Bruce Blocks are also available for on-the-job finishing. Write for color booklet. See our catalog in Sweet's.

E. L. BRUCE CO., MEMPHIS 1, TENN.

**BRUCE BLOCK Hardwood Floors**  
Naturally Beautiful!

# HOW ORANGEBURG® PIPE SAVES TIME, CUTS COST FOR BUILDERS

## 1. ORANGEBURG IS EASY TO INSTALL

Orangeburg's Taperweld Joints seal *root-proof* with a few hammer taps. No cement, no compounds, no calking required. Readily cut with coarse-toothed saw. Complete line of exclusive matching fittings simplifies installation.



## 2. ORANGEBURG IS EASY TO HANDLE

Orangeburg's ease of handling cuts installation time. Long 8-foot lengths mean less handling from truck to trench. Only 1/6 to 1/3 the weight of other types of pipes. One man can carry several lengths.



### ORANGEBURG DELIVERS A QUALITY JOB

Install it and forget it. Orangeburg is tough and resilient . . . lasts for years. Pipelines installed 49 years ago are still operating like new.

Use Orangeburg Root-Proof Pipe for house-to-sewer and septic tank connec-

tions, conductor lines from downspouts, storm drains . . . other non-pressure outside lines. Made in 2", 3", 4", 5" and 6" sizes.

*Orangeburg Pipe also comes Perforated for septic tank disposal fields, foundation drains, and draining wet spots.*

### BE SURE TO GET GENUINE ORANGEBURG

LOOK FOR THE NAME



Write Dept. AB-75 for Circular SA-11 covering recommended installation practices.

ORANGEBURG MANUFACTURING CO., INC. • Orangeburg, N. Y. • West Coast Plant: Newark, Calif.

Use these Exclusive Fittings with Orangeburg Pipe



*This  
could be  
you!*

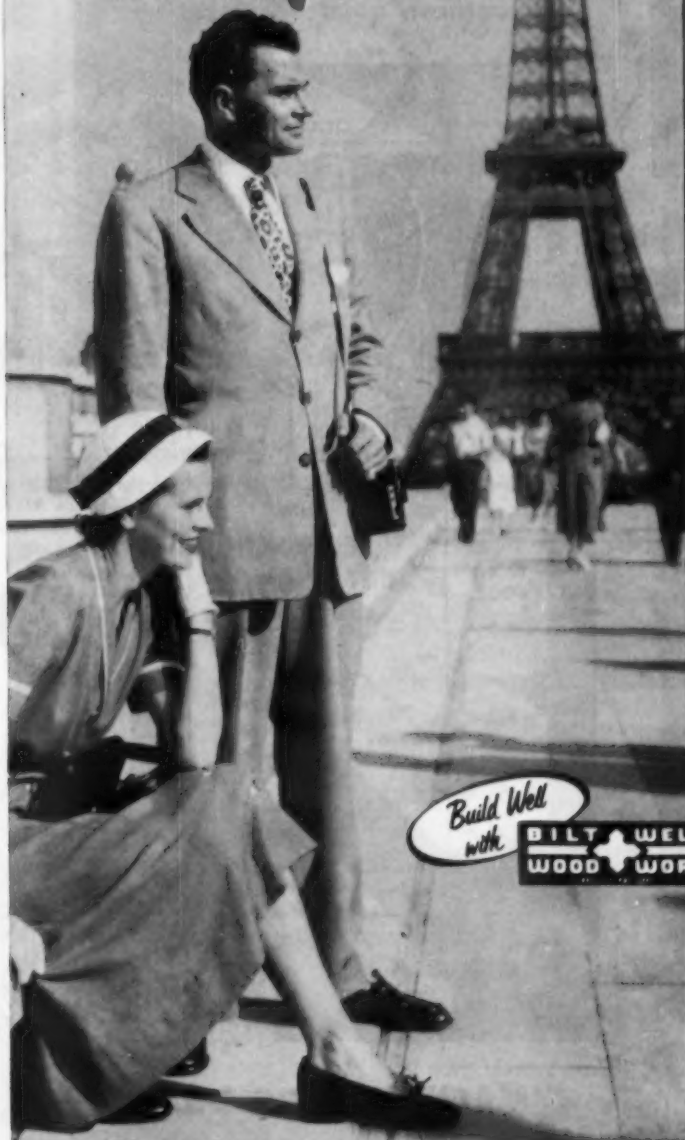

Some lucky builder and his wife are going to spend 26 glorious days in Europe next year as the guests of Carr, Adams & Collier Company. Another couple will enjoy a wonderful vacation in Bermuda . . . another, a delightful holiday in Hawaii . . . and still another will journey to romantic Mexico!

*There's no reason why it  
can't be you!*

All you have to do is increase the "saleability" of your homes by using popular BILT-WELL Windows and Cabinets!

**If you haven't yet sent for your  
BILT-WELL CONTEST KIT . . .**

Send for one today! There's still time. You have until November 30th to complete your contest entry and mail it in.

**If you're one of the many who  
has already received a kit**

- 1 Complete your BILT-WELL job as soon as possible.
- 2 Photograph it! (If you need help, let us know)
- 3 Mail in your completed Entry Blank and photo! Remember, the deadline is midnight, November 30th.

**WINNERS OF GRAND TRIP AWARDS  
WILL BE ANNOUNCED AT THE  
BUILDERS' SHOW IN JANUARY, 1956**

Every builder who submits an entry will receive a valuable prize, a beautiful Parker 21 Fountain Pen.

The BILT-WELL Line of Outstanding Woodwork . . . BILT-WELL WINDOW UNITS—Awning, Double Hung, Casement, Basement, Storm and Screen, Gable, Sash & Louvers . . . BILT-WELL CABINET UNITS—Kitchen, Wardrobe, Multi-Purpose, Corner China, Mantels . . . BILT-WELL DOORS—Interior, Exterior, Combination, Garage, Screen, Flush, Entrances.

**BILT-WELL**  
Since 1866  
**WOODWORK**

Box 658

Dubuque, Iowa

Manufactured by  
**CARR, ADAMS & COLLIER COMPANY**

HERE IT IS . . .

**M-D**  
MACKLANBURG-DUNCAN CO.

**NOISELESS  
Sliding Door  
HARDWARE**

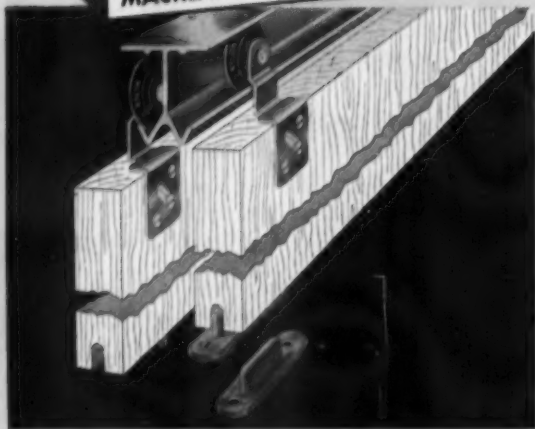

- ★ Extra-heavy extruded aluminum track
- ★ Heavy-gauge cadmium steel hangers with adjustable slot
- ★ Noiseless, lifetime Nylon wheels
- ★ Silent, solid brass wheel bearings
- ★ Positive, no-jump track feature
- ★ Smoothest, quietest operating



**BUILT-IN PROTECTION  
AGAINST TRACK JUMPING**

At last—sliding door hardware with built-in, positive protection against track jumping! No extra work, nothing for you to do—because this exclusive M-D design stops track jumping with a built-in bumper ridge that makes it impossible for the wheel to lift out of the track once the door is in place over the floor guide. Simple, sure, foolproof!

**ATTENTION DEALERS**  
**STOCK-DISPLAY CASE AND**  
**ACTUAL WORKING MODEL**  
**FREE with this assortment!**

<b>TRACK</b>	40 Boxes of
10 PIECES-4' EACH	Complete Hardware
10 PIECES-5' EACH	for 3/4" Doors
10 PIECES-6' EACH	★ ★ ★
10 PIECES-8' EACH	10 Boxes of
TOTAL TRACK-230'	Complete Hardware
	for 1 1/8" Doors

- ★ Attractively Displayed
- ★ Increases Impulse Purchases
- ★ Takes Small Space



**COMPLETE HARDWARE FOR  
DOORS 3/8" to 3/4" or 1" to 1 1/8"**

Hardware comes completely packaged for pair of 3/4" doors, or pair of 1 1/8" doors. Each package contains 2 front door and 2 rear door hangers, 2 door guides and sufficient screws for hangers, guides and track. Cartons clearly marked for 3/4" or 1 1/8" doors.

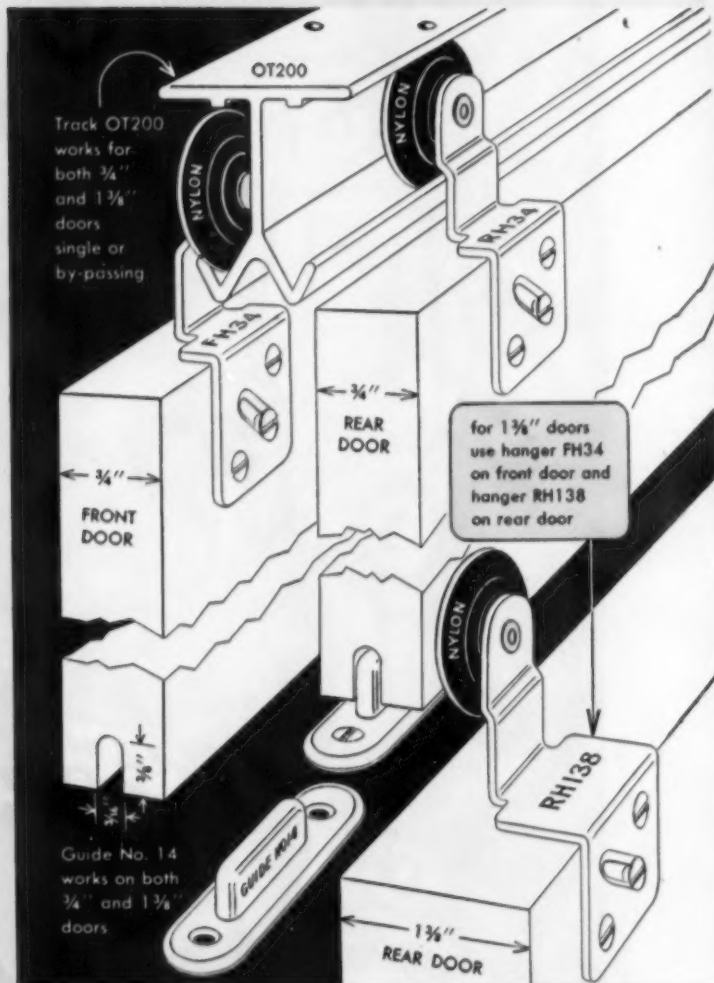
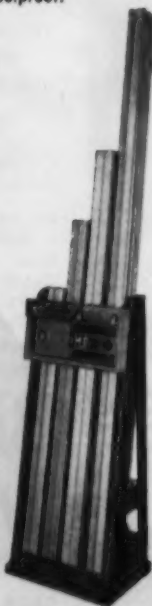

**DEALERS-ORDER TODAY!** your order will be shipped same day received



**MACKLANBURG-DUNCAN CO.**  
OKLAHOMA CITY, OKLAHOMA

# **ANOTHER**

**MACKLANBURG-DUNCAN**  
**Quality Building Product!**



## ***Nu-ART* ALUMINUM LEVEL**

- ✓ Light, Sturdy Extruded Aluminum for Long, Rugged Wear!**
- ✓ Glossy Red Interior with Silvery-Satin Edges**
- ✓ Tough, Non-Breakable Pyrex Vials—Replaceable!**
- ✓ Individually Packed in Polyethylene Tubing to Display Product, Protect Finish!**

***Look at these amazing prices!***

18" .....	\$3.95 LIST
24" .....	\$4.25 LIST
28" .....	\$4.50 LIST
30" .....	\$4.75 LIST
36" .....	\$5.50 LIST
48" .....	\$7.75 LIST
72" .....	\$14.50 LIST
78" .....	\$15.50 LIST



**Long lengths for plumbing doors and windows –  
Shorter lengths for carpenters, masons, home-handymen!**

**Sold by Hardware, Lumber and Building Supply Dealers!**

**DEALERS ORDER TODAY!**

**Your Order will receive prompt shipment!**

*Leaders in the Building Specialty Field for 35 Years*



# **MACKLANBURG-DUNCAN CO.**

BOX 1197 OKLAHOMA CITY 1, OKLAHOMA



## We can *DOUBLE* the value of a *BUILDER'S CAPITAL*

**B**ASED ON OUR EXPERIENCE, it is conservative to say that we can at least double the value of any builder's capital.

If you have capital enough to build 10 houses a year by conventional methods, then you can build *and sell* at least 20 National homes. If you have capital enough for 20 or 50 or 100 conventional houses, you can build *and sell* 40 or 100 or 200 National homes.

The first big advantage National Homes offers you is turnover of invested capital. You can build *and sell* a home in a matter of weeks instead of months. Each time you build and sell you make another profit on your capital. A smart builder-dealer who follows our recommendations can probably do much better than double his sales and his earnings. And if he keeps plowing some of his *extra* profits back into the business he can grow in volume and earnings over the years, beyond anything he can expect if he builds the slow, conventional way.

Why should any builder tie up his money in slow building operations on the site, with all the delays of weather and delivery, and all the handicaps of hand operations, when he can get all the advantages of fast, quality-controlled, indoor, volume production? Why should he tie up his money in inventories and his time in purchasing operations?

National Homes Corporation has been plowing back its own earnings and has grown from a business producing 1230 homes in 1946 to a company that produced over 20,000 in 1954 and had sales of more than \$50,000,000. Today we are far and away the biggest in

the field. Our volume permits us to get all the advantages of large-scale buying and to invest in high-cost, special-purpose machines for our assembly lines. We can retain outstanding architectural, design and style advisers. We advertise nationally and create a national pre-sold market for our builder-dealers.

A major advantage enjoyed by every National Homes builder-dealer is the services of National Homes Acceptance Corporation which has created a nation-wide market for National home mortgages and provides construction money quickly for all authorized builder-dealers.

To meet the increasing demand for our tested homes (already owned by 75,000 families) we are in the midst of a \$4,000,000 plant expansion program. We are increasing our capacity at our plants in Lafayette, Indiana and near Elmira, New York, and we will have a new plant by the end of this year in Tyler, Texas. National Homes is going places!

We invite inquiries from the best and most successful builders in any community east of the Rockies (within reach of our 250 trailers or economically accessible by railroad). Because we are building an organization which we expect will one day do a very large part of the home building in this country, we are equally interested in smaller builders who want to grow. Money is important to us but so is character. Many of our builder-dealers have not had direct building experience but are simply good businessmen.

Write to me personally. JAMES R. PRICE, *President*, NATIONAL HOMES CORPORATION, Lafayette, Indiana.

**ONE OUT OF EVERY 48 HOMES BEING BUILT  
IN AMERICA TODAY IS PRODUCED BY...**







# Gerholz uses Hotpoint Customline kitchens

## to put extra "Buy Appeal" in his Flint, Michigan, Westgate Park Homes!

When Gerholz Community Homes, Inc. decided to develop their Westgate Park community of 800 homes in Flint, Michigan, they enlisted the help of architect William K. Davis.

Davis' drawing board solution: Design each house from inside-out. Give the customer, not what he thinks he can buy, but what he dreams of owning!

The new 3-bedroom contemporary-styled homes now offered by Gerholz prove the value of this solution. They feature sales-winning, all-electric show-place kitchens equipped with the new Hotpoint Customline built-in appliances. And Gerholz's desire to incorporate into general specifications as many luxury features as possible, and still keep the price within reach of the average new home buyer, is being rewarded in heavy buyer demand!

The fact that you can now offer families of modest incomes the luxury and convenience of Hotpoint Customline built-in kitchens... plus the widest choice of installation designs... gives you today's most outstanding sales advantage! Because these kitchens are built in... they can be covered by FHA mortgages and included in regular monthly home payments!

Remember, the Hotpoint name on appliances in homes you build is the sign that gives credence to your desire to offer the best. Join the builders who stand out above and beyond the rest... whose homes sell faster... whose reputations for quality are the finest... because they offer the finest—Hotpoint All-Electric Customline Built-In Kitchens and Home Laundries.



"We selected Hotpoint Customline Appliances for our 1955 Pacemaker Homes because they best expressed the Advanced Design For Living in Westgate Park, our new 800 home community."

R. P. Gerholz

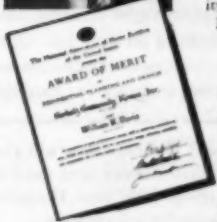

Holder of the most coveted NAHB Awards, Robert P. Gerholz has gained a national reputation for outstanding quality, excellence in design, and lasting value in his homes.



The fabulous new Customline Ensemble by Hotpoint gives you a kitchen that's beautiful and functional—built-in cooking top and oven, built-in refrigerator-freezer, undercounter dishwasher, garbage disposer unit... plus the famous pushbutton Hotpoint Laundry.



Hotpoint Customline Super Oven



Hotpoint Customline Cooking Top Ensemble



Hotpoint Customline Refrigerator-Freezer



Hotpoint Customline Dishwasher



Hotpoint Disposall®



Hotpoint Super De Luxe Laundry

Have your Hotpoint Distributor show you how leading builders are using Hotpoint Customline Built-In Appliances to make their homes the most modern in their area.



## Hotpoint... Our Golden Anniversary—Your Golden Opportunity!

- RANGES • REFRIGERATORS • DISHWASHERS • DISPOSALLS® • WATER HEATERS
- FOOD FREEZERS • AUTOMATIC WASHERS • CLOTHES DRYERS • AIR CONDITIONERS

HOTPOINT CO. (A Division of General Electric Company) 5600 West Taylor Street, Chicago 44, Illinois

# Now! Do All Three Clearing Jobs with One **HOMELITE** Chain Saw



■  
**New Versatile Attachments for  
Model 17 Chain Saw Will  
Clear Everything from Brush  
and Brambles to Four-Foot  
Trees. Save Money on Equip-  
ment and Job Time by Follow-  
ing These Three Steps:**

**1 Clean Out Underbrush** — Attach the new Homelite Brush Cutter to your Model 17 Chain Saw . . . in minutes. Perfect balance makes it a cinch to operate. Clears dense undergrowth, brush and small saplings four times faster than hand-clearing methods. Friction-free flexible shaft delivers full 3.5 horsepower to 10-inch circular saw.



**2 Clear Small Trees and Saplings** — In a jiffy the new Homelite Clearing Attachment converts your Homelite Model 17 Chain Saw to a fast-cutting, light-weight clearing tool. Plunge cuts or plunge bucks and makes limbing an easy job. Open guide rail prevents pinching and binding . . . takes the backache out of knocking the small ones down and cutting them up for haulage.



**3 Now For The Big Stuff** — With the standard guide bar you can bring down trees over four feet in diameter. The Homelite Model 17 is light in weight, easy to handle and packed with more horsepower per pound than any other one-man chain saw ever developed. (3.5 hp — 22 lbs.)

With its new attachments the Homelite Model 17 Chain Saw will give you the versatile, fast-cutting, dependable performance you need to save time and make real profits from clearing. Ask your Homelite Representative for a free demonstration or write for information.

PERFORMANCE • DEPENDABILITY  
SERVICE

**HOMELITE**  
CORPORATION

507 RIVERDALE AVENUE • PORT CHESTER, N. Y.  
Carryable Pumps • Generators • Blowers • Chain Saws

AMERICAN BUILDER



**How To "Storm-Sash" the walls of a 5-Room House for \*30.**

Here's a big sales feature . . . for little added cost. Sisalation, a positive vapor barrier, prevents paint peeling, wood rotting, plaster cracking. Insulation value equal to about 1" of bulk insulation. Keeps your houses cooler in summer . . . warmer in winter. Reinforced for fast application without tearing. In rolls, 36 and 48 inches wide. Send coupon for sample.

**Copper Armored Sisalkraft**—For concealed flashing at 1/5th cost of heavy gauge copper.

**Sisalkraft** — Rugged, waterproof building paper for slab waterproofing...curing concrete.

*Send Coupon for Samples . . .*

**SISALATION**  
POSITIVE VAPOR BARRIER . . . REFLECTIVE INSULATION

**AMERICAN SISALKRAFT CORPORATION**  
 Attleboro, Mass. • Chicago 6 • New York 17 • San Francisco 5

**AMERICAN SISALKRAFT CORPORATION**  
 Dept. AB-7, Attleboro, Massachusetts

Please send samples and more facts on Sisalation — Copper Armored Sisalkraft — Sisalkraft —

Name.....  
 Company.....  
 Address.....  
 City.....Zone.....State.....

OUTSTANDING STYLE AND VALUE—

# WINTER SEAL ALUMINUM PRIME WINDOWS!



## Jalousies

Winter Seal Jalousies are outstanding for life-long ruggedness and smooth operation, smart design and intrinsic value. Look at these typical features!

- The one Jalousie designed for northern and western use.
- Power-riveted bridge-type actuator bar for full opening, complete closure!
- Companion screens and storms available.
- Headers and sills designed for simple, straight cut-off—easiest installation!

## Sliding Windows

Winter Seal Slide-Tite horizontal prime windows are beautifully styled, modern-smooth aluminum! See why you can't go wrong with Slide-Tite:

- A complete unit—just set it, square it, nail it!
- Completely weathertipped with stainless steel—for smooth glide and full protection!
- Top quality at surprisingly low cost!

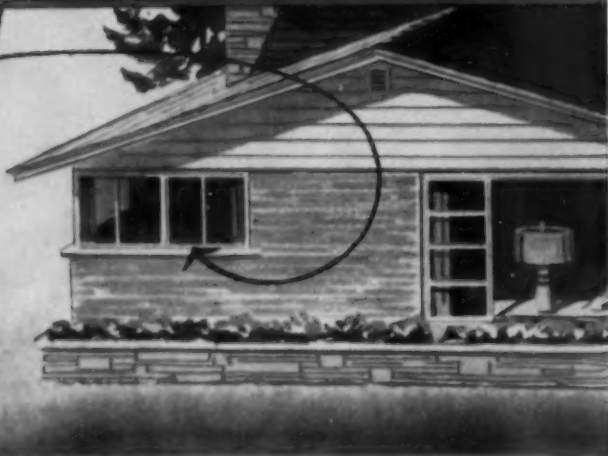

Winter Seal products are unmatched in value and ease of installation; in tailored fit and smooth convenience of operation; make houses look better, sell faster! (Imagine, for instance, the modern appeal of jalousie porches.) If your jobber doesn't yet handle both of these products, write us *today*.

**NOTE:** Winter Seal products can be shipped KD for easy local assembly. Write to learn how this saves time for jobbers, dealers, builders. Distributor franchises available.

**WINTER SEAL**

EXTRUDERS—MANUFACTURERS—  
Aluminum combination storms and screens for all window types—Conventional and Round Top Combination Doors—Separate Screen and Storm Panels—Prime Slide-Tite Gliding Windows—Jalousies—Windows and Doors.



Winter Seal Corporation • 14575 Meyers Road • Detroit 27, Michigan • Winter Seal of Canada, Toronto 15



out of the West...

### Stirrup-shaped to spur sales

—dramatic new towel rings

*by*



Sparkling with excitement, these new Towel Rings crackle with sales appeal. Available in a wide range of styles, they can be featured throughout a bathroom, or used individually to supplement towel bars. These versatile rings require just a few inches of wall space to provide extra towel space in this important room.

Hall-Mack has four lucite rings... crystal clear, ebony black, and crystal flecked with "stardust"... mounted on a heavy cast base finished in gleaming chromium. The fourth ring, a member of Hall-Mack's distinctive Aristocrome 400 line, features a round base, chromium-plated on solid brass.

Put these new Towel Rings where home-owners can get a good look at them... and let them do the rest. They are designed *simply* to spur sales.

Home-owners — everyone will love these rings around the bathroom



- • • • •
- Hall-Mack's stirrup-shaped Towel Rings have this Western touch for two reasons —
- 1. this clean design accentuates their smart appearance — and
- 2. it holds towels neatly — prevents slipping off.
- • • • •

*Sold by leading plumbing, tile & hardware dealers everywhere*

**HALL-MACK COMPANY**

LOS ANGELES 7, CALIFORNIA • 1280 West Washington Blvd  
CHICAGO 48, ILLINOIS • 7488 Exchange Avenue  
CLIFTON, NEW JERSEY • 1000 Main Avenue

more than **7,000,000** installations  
 and over **100** years of  
 woodworking experience  
 are back of every



**PAINÉ**  
**REZO**®  
 air-vented all-wood grid core  
**FLUSH DOOR**

*America's Finest*

Here's the one flush door you can count on to *stay sold* after it's installed! And there's more to REZO's beauty than meets the eye because, hidden inside the richly grained, hand-matched faces is REZO's exclusive, all-wood grid core—mortised into stiles and rails—that assures light weight, strength and rigidity for a lifetime of trouble-free service. You can't sell a better door at any price . . . a door that's backed by more than 7,000,000 installations and over 100 years of woodworking experience.



Flush doors may look alike but only the Paine REZO door has a fully ventilated all-wood grid core to allow rapid stabilization of moisture content throughout the entire door.



No other door on the market is made like REZO with its air-vented all-wood grid core mortised into rails and stiles for strength, rigidity and light weight.



Designs are limited only by the imagination . . . one of many reasons why architects and builders specify REZO flush doors.

**PAINÉ**  
**LUMBER COMPANY, LTD.**  
 ESTABLISHED 1853 • OSHKOSH, WIS.



**Cheapest**  
**EXTRA VALUE**  
 you can put in a house

You're building quality homes that are going to last a long time. You're putting in extra value everywhere you can. The cheapest extra value you can buy is American Welded Wire Fabric concrete reinforcement. A Welded Wire Fabric reinforced concrete ground slab is approximately 30% stronger than an unreinforced concrete slab of equal thickness. Therefore, it costs less to build with reinforced concrete. Since a reinforced slab is 30% stronger than an equal thickness of unreinforced concrete, Welded Wire Fabric adds many years of extra service to floors, foundation slabs, driveways, patios, sidewalks, and porches.

How? By preventing destructive cracking. American Welded Wire Fabric Reinforcement binds concrete tightly together, stops tiny hairline cracks from opening up, gives concrete the added strength of steel.

American Fabric is manufactured in every style and size you need. Ask for it by name.

**AMERICAN STEEL & WIRE DIVISION**

UNITED STATES STEEL, GENERAL OFFICES: CLEVELAND, OHIO  
 COLUMBIA-GENEVA STEEL DIVISION, SAN FRANCISCO, PACIFIC COAST DISTRIBUTORS  
 TENNESSEE COAL & IRON DIVISION, FAIRFIELD, ALA., SOUTHERN DISTRIBUTORS  
 UNITED STATES STEEL EXPORT COMPANY, NEW YORK

EVERY TYPE OF REINFORCED CONCRETE CONSTRUCTION NEEDS

**USS AMERICAN WELDED WIRE FABRIC**

**UNITED STATES STEEL**



COMMERCIAL PROPERTIES, where traffic is heavy and frequent, need the extra strength and durability of American Welded Wire Fabric Reinforcement.

*BUYERS WILL ASK  
 "is it Reinforced?"*



# BOSTITCH Builder's Tools put speed in scores of jobs!

*You'll save what they cost the first week you use the Bostitch Hammer and Tacker*

## BOSTITCH H2B STAPLING HAMMER



Here's the fastest way to apply batt and reflective insulation, metal lath, felt underlayment, light flashing. One-hand, one-blow operation speeds tacking and light nailing jobs as much as 50%. One man using the H2B can put up almost as much material as two experienced hammer-and-nail men. Easy-fill magazine holds staples with leg lengths of 1/4" or 3/8". Model H2B 1/2 takes 1/2" leg lengths.

## BOSTITCH T5-8 STAPLING TACKER



It does jobs where accuracy is important—like putting up ceiling tile and fastening screening to frames. Like the H2B, it's good for applying batt and reflective insulation and almost any light nailing or tacking job. Just spot it and squeeze. Powerful action drives staples with leg lengths up to 9/16" all the way home. Thin nose fits into tight places, lets you place staples within 1/16" of an inside corner. Three models available for three wire sizes. Five leg lengths, 5/32" to 9/16".

**WANT TO TRY THEM?** See your building supply dealer. He has the H2B Hammer and T5-8 Tacker on display. If he doesn't, call your local Bostitch representative or write us directly.

*Fasten it better and faster with*



BOSTITCH, 827 Mechanic Street, Westerly, R. I.

Send me information about the following Bostitch Builder's Tools:

- Bostitch H2B Hammer
- Bostitch T5-8 Tacker

Name \_\_\_\_\_

Address \_\_\_\_\_

City \_\_\_\_\_ Zone \_\_\_\_\_ State \_\_\_\_\_



# for that custom look, at no extra cost...



## NEW USG® SHADOW-ACCENT ASPHALT SHINGLES

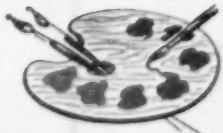

**FOUR PASTEL COLORS.**  
Navajo red, Palisade gray,  
Shasta green, and Mojave brown.



**WEATHER PROTECTION** that  
today's homeowner demands.  
Thick tabs at weather end fight  
wind, wear, water.

### Premium Beauty without Premium Cost

These custom-designed, color-toned, fire-resistant shingles have instant appeal to even the most discriminating prospect. Deep shadow lines separate the courses, creating a roof that brings out the beauty of any home—provides a *plus feature* that helps sell homes. For full details, fill out the coupon below, mail today!



**STANDARD APPLICATION.**  
Conventional pattern; applied  
with normal five-inch exposure.



**QUALITY CONTROLLED.**  
Made to the strict manufactur-  
ing standards you recognize in  
all U.S.G. building products.



**UNITED STATES GYPSUM**

The Greatest Name in Building

United States Gypsum  
Dept. AB-4  
300 W. Adams Street, Chicago 6, Illinois

- Please have U.S.G. representative call.  
 Send me literature on new SHADOW-ACCENT Shingles.  
I understand there is no cost or obligation.

NAME \_\_\_\_\_

ADDRESS \_\_\_\_\_

CITY \_\_\_\_\_ ZONE \_\_\_\_\_ STATE \_\_\_\_\_

FIRM NAME \_\_\_\_\_



TOM  
HENDERSON  
TOM HENDERSON

"EVERYTHING HINGES ON HAGER!"\*



C. Hager & Sons Hinge Mfg. Co. • 139 Victor Street • St. Louis 4, Mo.  
Founded 1849 — Every Hager Hinge Swings on 100 Years of Experience

AMERICAN BUILDER

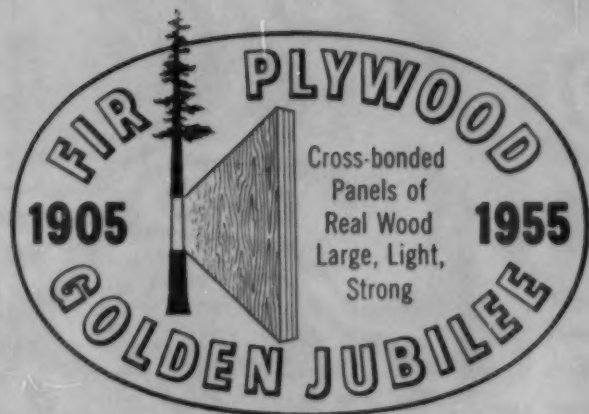

**FIR PLYWOOD  
GOLDEN JUBILEE  
PROMOTION  
BUILDS CUSTOMER  
ACCEPTANCE**

Turn page to see the  
smashing 2-page ad that is helping sell  
26 million LIFE readers on the advantages  
of fir plywood construction



ADVERTISED IN  
**LIFE**



## YOU CAN BUILD ANYTHING WITH



1. Storage wall 2. Ceiling 3. Mobile 4. Texture 1-11 plywood paneling 5. Frame 6. Chest 7. Platform 8. 12' Boat 9. Subfloor & underlay 10. Roof deck 11. Wall sheathing 12. Overlaid plywood siding 13. Fence 14. Building toy 15. Hog house 16. Traffic sign

ANYTHING you can build with wood you can build better, faster, more economically, with fir plywood.

And fir plywood does many jobs that ordinary wood can't do! Pictured here are a few of the million-and-one things built with this modern miracle material. It has set new standards of performance and value, revolutionized construction methods everywhere. It's the *engineered* wood—pound for pound stronger than steel. Light, splitproof, virtually puncture-proof. Easy to handle, easy to work with everyday tools.

In addition to standard 4 x 8 foot sheets, fir plywood is available



# FIR PLYWOOD

in extra-long panels for big construction jobs . . . in convenient Handy Panels. There are new textured panels and surfaced panels that are extra-smooth, doubly durable.

Every lumber yard can supply you with fir plywood. Ask too, about helpful plans and idea booklets\* for scores of building and remodeling jobs.

**See Your Lumber Dealer!**

*\*Just published—book of 52 new home storage plans. If not available at your dealer's, send 50c (USA only) to Douglas Fir Plywood Assn., Tacoma 2, Wn.*

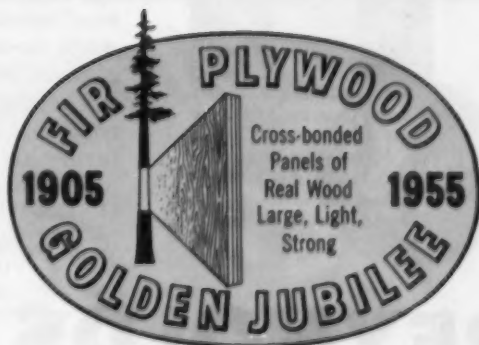

More Homes "ENGINEERED FOR YEAR-ROUND  
AIR CONDITIONING"

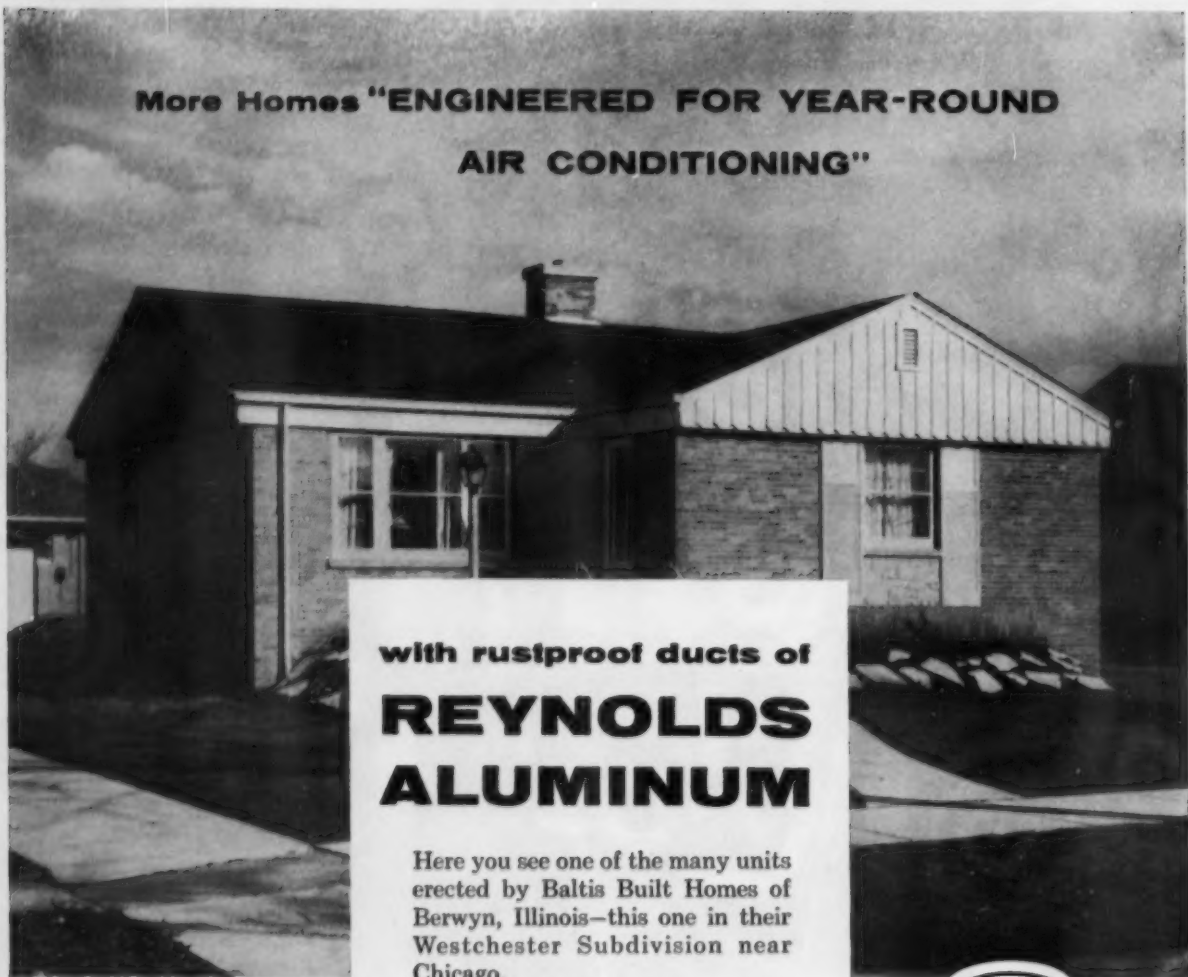

with rustproof ducts of  
**REYNOLDS  
ALUMINUM**

Here you see one of the many units erected by Baltis Built Homes of Berwyn, Illinois—this one in their Westchester Subdivision near Chicago.

It is a lot of house for the modest price. It is not now air conditioned. But it is *engineered for year-round air conditioning*, with a duct system of Reynolds Aluminum. Whenever it is decided to use these ducts for cooled air, the moisture condensation cannot damage them.

More and more builders are now selling air conditioning as a "future" like add-on rooms. And this "future" requires rustproof aluminum ducts. Reynolds is telling the story, strongly, in national magazine ads and important TV advertising. Take advantage of this promotion...sell future air conditioning in your homes. And identify your ducts as aluminum...Reynolds Aluminum.



Heating Contractor for these Baltis Built Homes is Robinson Furnace Company, Chicago. This is the Robinson installed duct system of rustproof Reynolds Aluminum.



SIGNS FOR YOUR BUILDING SITES  
AVAILABLE... CONSUMER LITERATURE  
FOR DISTRIBUTION... ALSO

"Designed in Aluminum" SEALS FOR IDENTIFICATION. Write to REYNOLDS METALS COMPANY, General Sales Office, Louisville 1, Kentucky.



**REYNOLDS**  **ALUMINUM**

# Presenting the new Rheem "IMPERIAL" multipurpose window air conditioner

Here's a revolutionary Rheem "first" which provides multiple space air conditioning from a single window unit. The Rheem "Imperial" unit is designed for duct work applications as well as conventional single room air conditioning. All "Imperial" units are available with either the *Rheem-Air* or *Rheem-Duct* interchangeable front panels.

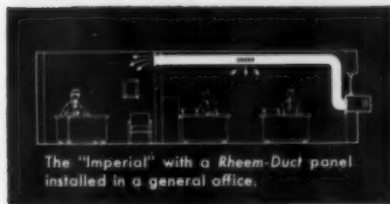

The "Imperial" with a *Rheem-Duct* panel installed in a general office.

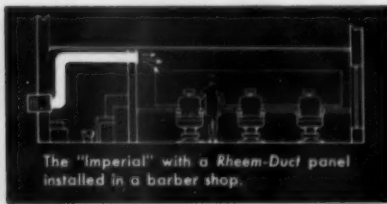

The "Imperial" with a *Rheem-Duct* panel installed in a barber shop.



The "Imperial" with a *Rheem-Duct* panel installed on the roof of a small store.

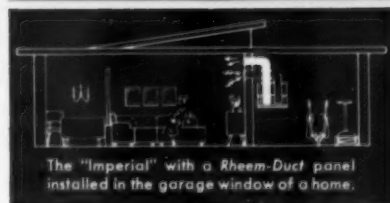

The "Imperial" with a *Rheem-Duct* panel installed in the garage window of a home.

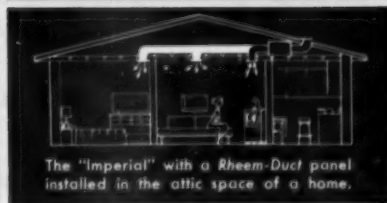

The "Imperial" with a *Rheem-Duct* panel installed in the attic space of a home.

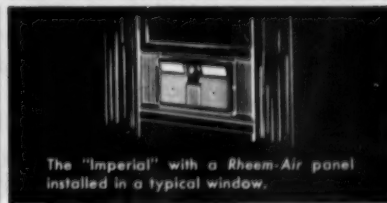

The "Imperial" with a *Rheem-Air* panel installed in a typical window.

All of these typical installations and many more are possible because of the following Rheem "Imperial" features:

- ★ Large, powerful centrifugal supply air blowers
- ★ Die-formed aluminum steel front panel
- ★ Oversize cooling and condenser coils
- ★ Design based on 120° outside temperature
- ★ Electric heating for cool weather use

AVAILABLE IN

¾ HP

Up to 500 sq. ft.

1 HP

Up to 700 sq. ft.

1½ HP

Up to 900 sq. ft.

2 HP

Up to 1200 sq. ft.

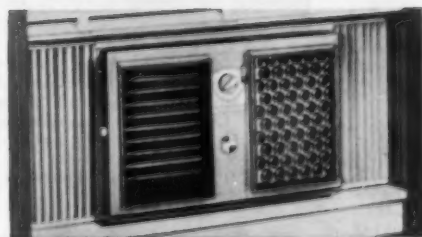

This "Imperial" unit has the functional *Rheem-Duct* front panel for multiple space air conditioning with duct work.



This "Imperial" unit has the beautiful *Rheem-Air* front panel for premium performance in room air conditioning.



**THERE'S A NEED FOR QUIET.** Today larger families, more appliances, and faster-paced living have made people more noise conscious . . . and they'll be impressed by a home that promises the new comfort of quiet. When you announce that your homes have Armstrong Cushiontone ceilings, you give your houses a competitive edge.



**BEAUTIFIES AS IT QUIETS.** Cushiontone absorbs noise and provides an attractive ceiling finish in one material. Its distinctive appearance and white finish add smartness to any room. Prospects will be impressed by its modern Full Random design.



## Why home sound conditioning is the coming feature in new construction

*Increased noise in homes—plus nationwide advertising on Cushiontone tile—puts more prospects in the market for sound-conditioned houses*



**ADVERTISED IN LEADING HOME MAGAZINES.** Armstrong Cushiontone gives you another nationally known brand name to help you sell. Each month, full-page Cushiontone ads in *The American Home* and *Better Homes & Gardens* are read by millions of the nation's most home-minded families.



**EASY TO INSTALL.** A carpenter simply nails furring to joists, then fastens Cushiontone to the furring with collar nails or staples, and the job is done. The new T & G joint on Armstrong Cushiontone speeds and simplifies application, assures a professional-looking installation.



**LOW IN COST.** Cushiontone provides a finished ceiling plus sound conditioning in one fast application. For full information on how Cushiontone can help you sell homes, see your Armstrong building supply dealer or write Armstrong Cork Company, 4297 Rider Avenue, Lancaster, Pa.

**Armstrong  
CEILINGS**

Cushiontone® • Temlok® Tile  
... to quiet and beautify homes

AMERICAN BUILDER



# PROBLEM: To fit your associate's widow into your business

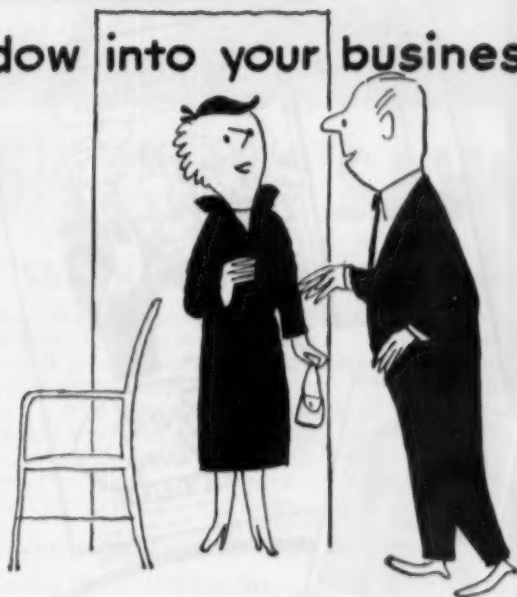

**H**ERE'S something to think about carefully if yours is a closely held corporation or a partnership. If one of your associates should die, would his widow have experience enough to join in running the business? Would your own wife be able to take your place in the business if anything happened to you?

Business life insurance with Connecticut Mutual protects you and your associates from having suddenly to face problems like these unprepared... provides the financing needed so that you and your associates can make a workable "buy-and-sell" agreement NOW!

Remaining owners will then have money on hand to buy the share of an associate who dies, money to insure the continuity of the business. Your best customers and suppliers won't have to wonder whether or not you can hold the business together.

When the problem arises of buying such a share in

the business, or finding a man to replace the one who died, it will be too late to buy life insurance and draw up a buy-and-sell agreement. By then lawyers, executors, a court and tax authorities will be on the scene.

If you and your associates live until retirement, your business life insurance can be used to provide pensions for the owners. The increasing cash value also provides an emergency fund to use if necessary. Your banker will tell you that those who grant credit look with greater favor on companies with substantial investments in business life insurance!

Connecticut Mutual — now over a hundred years old — has established a special department and has trained hundreds of its representatives in business life insurance. Connecticut Mutual will work with you to set up a business life insurance program that's the right one for your individual firm.



## The Connecticut Mutual

LIFE INSURANCE COMPANY · HARTFORD

THE COMPANY OF BUSINESS LIFE INSURANCE SPECIALISTS

### VALUABLE FREE BOOKLETS

One set of problems is faced by partnerships, another by closely held corporations. You may have, without the slightest cost or obligation, a booklet that fits *your* situation. These booklets deal not only with the use of life insurance to fund buy-and-sell agreements but also discuss various business, legal, accounting and tax problems involved in such situations as yours, and give examples of how these have been solved. Write for one of them *today* — or simply complete the coupon.



CONNECTICUT MUTUAL LIFE INSURANCE COMPANY  
Department AB-3, Hartford, Connecticut

Please send me, without cost or obligation, your booklet for the purpose checked below.

Partnerships     Close Corporations

Name \_\_\_\_\_ (please print)  
 Firm \_\_\_\_\_  
 Street \_\_\_\_\_  
 City \_\_\_\_\_ State \_\_\_\_\_

OUR DOORS ARE HUNG IN A FACTORY BY EXPERTS

**Ready Hung DOORS**  
PAT. NO. 2,857,033  
TO. NO. REG. U.S. PAT. OFF.

**DON RUSH**  
Owner  
Don Rush Contractor  
Sioux Falls, S. D.

".....That "factory-finished" or "mill-made" look sure attracts the womenfolk who do most of the deciding about which house to buy. Ready Hung Doors make my houses sell faster so that my sales cost is less."

Sincerely  
*Don Rush*  
Don Rush, Owner

**ASK YOUR LUMBER DEALER READY HUNG DOORS MADE BY:**

**BALTIMORE, MD.**  
Central Building Supply, Inc.  
210 E. Monument St.

**BIRMINGHAM, ALA.**  
National Woodwork, Inc.  
1021 20th Ave. North

**BOSTON, MASSACHUSETTS**  
A. W. Hastings & Co., Inc.  
273 Highland Avenue  
Somerville 44, Massachusetts

**BUFFALO, N. Y.**  
The Blumenthal-Jackson Co., Inc.  
347 Hamburg St.

**BURBANK, CALIF.**  
Ready Hung Door Mfg. Co.  
200 South Victory Blvd.

**CLEVELAND, OHIO**  
The Blumenthal-Jackson Co.  
1950 W. 3rd St.

**DAYTON, OHIO**  
Dayton Sash & Door Co.  
6 Newwood Ave.

**DENVER, COLORADO**  
Profabricators Incorporated  
P. O. Box 4686

**GRAND RAPIDS, MICH.**  
Haskette Mfg. Corp.  
701 Ave. St. 100

**HOUSTON, TEXAS**  
Ready Hung Door Mfg. Co.  
P. O. Box 124

**MARION, INDIANA**  
General Millwork Corp.  
319 E. 3rd St.

**NEW YORK, N. Y.**  
Bakley Whelan Company  
17 Park Ave.  
W. Orange, N. J.

**PITTSBURGH, PENN.**  
Iron City Sash & Door Co.  
3rd Street and 84th St.

**SAN ANTONIO, TEXAS**  
Ready Hung Door Mfg. Co.  
300 Siquin Street

**SAN FRANCISCO, CALIF.**  
Ready Hung Door Mfg. Co.  
180 MacArthur Blvd.  
Oakland, California

**SEATTLE, WASH.**  
Acme Millwork, Inc.  
P. O. Box 668  
Rialto, Wash.

**SHOUF FALLS, A. DAN.**  
Jordan Millwork Co.

**ST. PAUL, MINNESOTA**  
Minnesota Wood Specialists, Inc.  
P. O. Box 21  
5000 Paul Park, Minnesota

**TORONTO, CANADA**  
C. Lloyd & Son Limited  
1214 Lawrence St.  
N. Park, P. O. Ont.

**WACO, TEXAS**  
Frank Stevens Sash & Door Co.  
P. O. Box 1490

A door and frame packaged unit complete with the door hung and locked and the frame trimmed both sides, ready to install in any rough opening in 20 MINUTES.

**FITS ANY WALL FROM 4" to 3"**

**READY HUNG DOOR CORP., FORT WORTH, TEXAS**

# Make your houses Easier to Sell with these CONCRETE MASONRY features

When a customer decides to use concrete block for the foundation and exterior walls of his new house don't overlook opportunities for extra business. Many builders boost profits by promoting block for additional uses in the home.

One architectural trend, for example, is the use of concrete masonry for interior walls and partitions. Showing customers how such walls add real beauty and charm to houses can add to your profits.



The growing popularity of concrete block joist floors affords another opportunity to build better houses. Your customers want floors that can't squeak, sag, rot or burn.

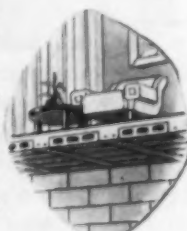

There's rustic charm in a concrete masonry fireplace. Like all block construction it can be painted any of a variety of attractive colors with portland cement paint.

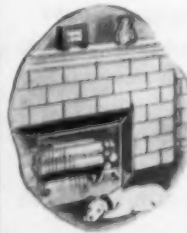

Concrete masonry garages are another source of additional jobs. They are weather-resistant yet economical to build and often provide space for a workshop or storage room.



Also, extra sales await the builder who points out the many advantages of concrete block for:

- Garden Walls • Outdoor Barbecues • Terrace Walls
- Remodeling • Basement Walls • Foundations

Write for free literature on these or other uses for concrete masonry, sent only in U.S. and Canada.

**PORTLAND CEMENT ASSOCIATION**  
Dept. A7-3, 33 West Grand Avenue, Chicago 10, Illinois  
A national organization to improve and extend the uses of portland cement and concrete... through scientific research and engineering field work

AN UNBEATABLE COMBINATION FOR *Profits!*



MODEL 650  
6800 RPM  
BLADE SPEED

**6 1/2" \* High Speed HEAVY-DUTY SAW**

**The Only POWER SAW Needed To Build A Home**



FULL  
1 1/2 HP  
MOTOR

For a real thrill in performance and handling ease, check the 6 1/2" MILWAUKEE Model 650 before you buy your next saw. It's the ONE saw that makes every cut necessary to build a house . . . even to the compound miter cuts. It's the kind of *light-weight . . . big capacity* saw you have long wanted . . . a saw that makes more cuts, faster, more accurately and with less effort . . . A saw that's fully versatile . . . that will handle all special purpose blades and abrasive cutting wheels and that can stand the gaff of all-day heavy duty use.

... with So Many Outstanding Features  
... including EXCLUSIVE Free-Wheeling Clutch Drive

- Grease sealed ball and roller bearings throughout
- Helical cut heat-treated gears and drives for greater power efficiency, quieter running
- Built-in quick setting depth and miter and rip adjustment, fully lockable
- Telescopic and automatic retractable blade guard
- Instant release safety trigger switch
- Light weight, only 12 1/2 pounds
- Perfectly balanced.

\*For bigger capacity High Speed saw ask to see the Model 700 with 7" blade or the Model 825 with 8 1/4" blade.

Still Only

**\$66<sup>50</sup>**

(with handy Steel Carrying Case — \$74.50)

... and the *Famous* **MODEL 414 SAWZALL**

*Compact* Electric Powered **HACKSAW**

A rugged dependable heavy-duty saw that fills perfectly every special sawing need. Zips easily through any sawable material, such as wood, metal, plaster, transite, embedded nails, wire, etc.

**NEEDS NO STARTING HOLE** in plaster  
... In Wood or Comparable Materials

- NOT AN ATTACHMENT . . . but a complete HEAVY-DUTY sawing tool . . . Easily maneuverable with one hand.
- RUGGEDLY BUILT . . . powered by famous MILWAUKEE-Built 115 volt ac-dc motor . . . can also be operated from portable electric generating equipment.
- POWERFUL . . . 3/4" cutting stroke . . . 2250 strokes per minute.
- BALL and ROLLER BEARINGS . . . lifetime lubricated.
- WEIGHS only 6 3/4 lbs. . . . Just 14 1/2" long.
- SAWZALL Blades . . . available in types and lengths to suit every sawing need.

\*Furnished complete with handy steel carrying case and full complement set of Sawzall blades.



Only **\$84<sup>50</sup>\***



• The perfect tool in remodeling work — Breezes right through plaster, wood and nails.

*For Demonstration ... SEE YOUR DEALER... Or Write Today To...*

**MILWAUKEE ELECTRIC TOOL CORP.**

5356 W. State St.

Milwaukee 8, Wis.

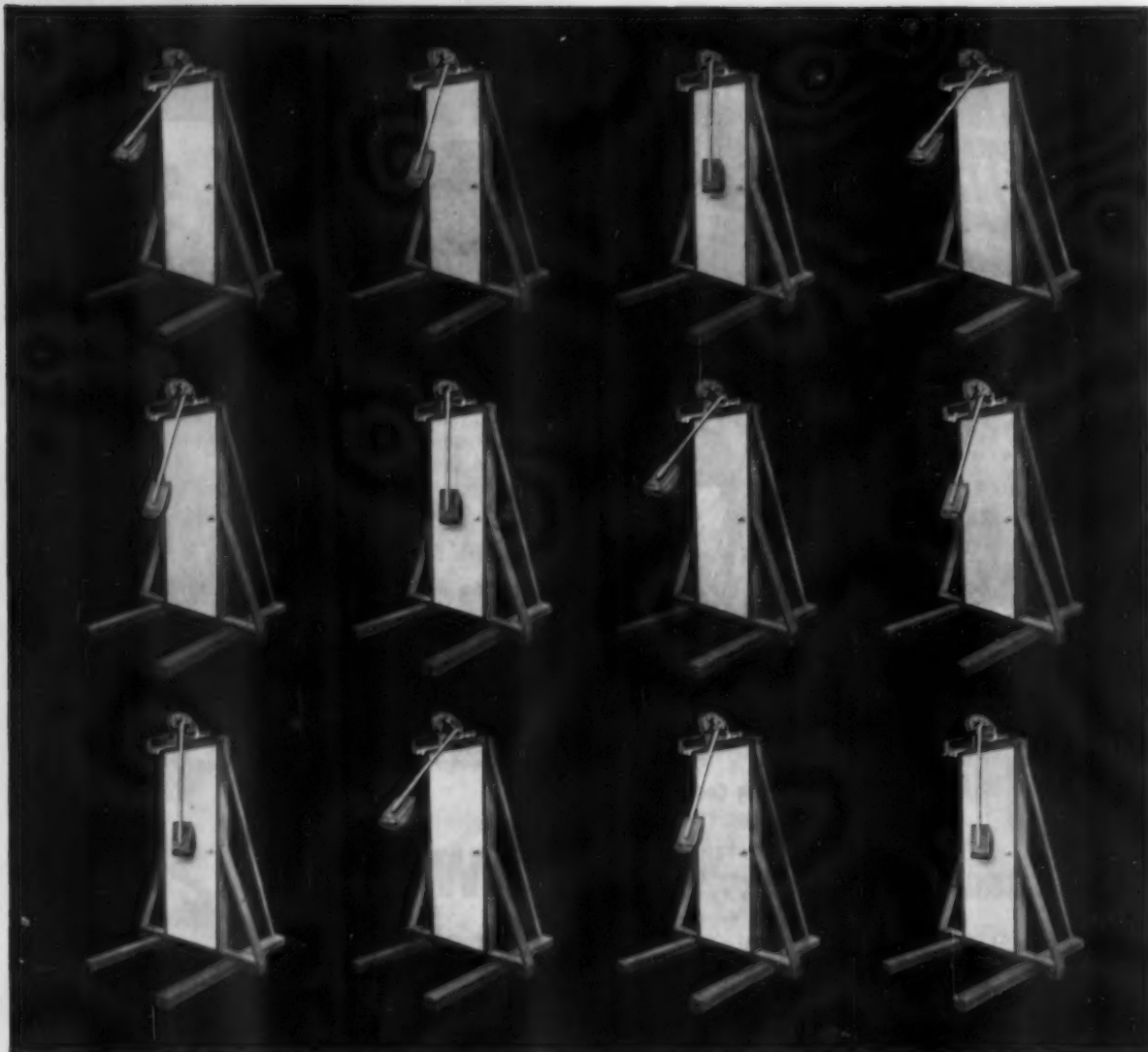

## 529,879 bangs in impact "torture test" prove superior stamina of New Londoner Doors

How much abuse can a Curtis New Londoner hollow-core flush door stand? Curtis engineers wanted to find out. So they rigged up a pendulum which banged a 35-lb. weight against the door 38 times per minute.

After 529,879 bangs—when the engineers gave up—the door was still good as new!

Curtis New Londoner hollow-core flush doors give lifetime service because they are *all wood*—with the grid core locked into the frame to form one completely

joined unit. There are no floating parts—nothing to get out of place in a Curtis New Londoner door.

Many architects and builders consider these superior doors first choice for homes, schools and wherever fine doors are needed. Curtis New Londoner doors and all Curtis Woodwork are sold by retail lumber and building-material dealers everywhere. For complete information, write Curtis Companies Service Bureau, Clinton, Iowa.



CURTIS WOODWORK  
Heart of the Home

Cut Built-In Installation Costs ... Use

# American Kitchens

**NEW SET-IN OVENS AND RANGES  
TO SELL YOUR HOMES FASTER!**



**WOOD** For Warmth

**COPPER** For Charm

**STEEL** For Strength

**COMPLETE UNITS... GAS AND ELECTRIC  
Just Set-In Place . . . Harmonize Perfectly!**

Nothing else clinches a home sale faster than a beautiful custom-built kitchen. And now, you can dazzle your potential home customers with built-in kitchens that require no costly installation!

It's the American Kitchens line of set-in ovens and ranges that makes possible this cost-cutting magic. You just set them in place without expensive custom built installation costs!

Come in a choice of white or copper finishes . . . gas or electric models . . . complete flexibility of arrangement. Ovens can be built into the wall, too.

Let these dramatic new American Kitchens ovens and ranges cut your kitchen installation costs—and sell your homes faster. Send coupon today!



**BASE CABINETS OFFER GIANT STORAGE**

Here is an American Kitchens oven and range in gleaming white. Note the giant storage space in the base cabinets. Bake and broil units are recessed for greater oven capacity . . . can accommodate a 25 lb. turkey. These are the kind of American Kitchens work-saving features that sell your customers!

**American Kitchens** Sell Your Homes Faster!

AMERICAN KITCHENS DIVISION  CORNERSVILLE, INDIANA



Dishwashers



Disposers



Ventilators



Brunch Bars

American Kitchens  
AVCO Manufacturing Corp.  
Cornersville, Ind.

I'd like to have "no obligation" quotation on my next kitchen.

Please send your new Architects' and Builders' File.

Name \_\_\_\_\_

Address \_\_\_\_\_

City \_\_\_\_\_ Zone \_\_\_\_\_ State \_\_\_\_\_

talk about

# COLOR\*



\* Scheme for easier selling with Carey Fire-Chex Shingles and Ceramo Siding in striking combinations!

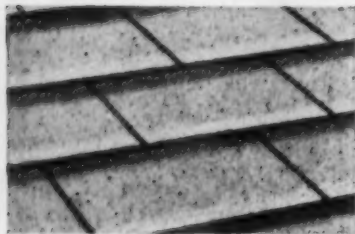

New shadow-blend colors in the Fire-Chex line—Silver Rain (illustrated), Garland Green, Wineberry Red, Moonmist Buff. Other colors include: Tropic Green, Venetian Red, Dusk Gray, Delta Brown, Charcoal Black, Walnut Brown and Crystal White.



New Ceramo Colonial Yellow illustrated. Other Ceramo colors include: Sage Green, Granite Gray, Salem Red, Congo Brown and Brilliant Ceramo White.

## FIRE-CHEX SHINGLES

In beautiful new shadow-blends!

Colorful Fire-Chex on your homes mean there'll be a salesman on duty 24 hours a day! In sunlight or moonlight, there's nothing to match their beauty and buyer appeal. They blend so harmoniously, too, with the new siding colors! Fire-Chex are famous not only for beauty,

but for ruggedness and long life as well. Tests by a foremost authority prove Fire-Chex outlast ordinary shingles several times over. And even hurricanes won't budge them, a fact "Carol" and "Edna" recently discovered. Put Fire-Chex on *your* sales force!

## CERAMO SIDING

In dramatic new colors!

Colonial Yellow is a striking new "cheer up" color that chases gloom, looks smart with any home design! And it's *especially* handsome in combination with a Fire-Chex *Silver Rain* shadow blend roof (as shown). *All* Ceramo colors are an integral part of Ceramo's glazed

ceramic surface. Won't fade, resist stains, are 100% washable with detergent and water! Made of asbestos and cement, two virtually indestructible materials, Ceramo is truly ageless, won't burn, crack, warp or curl. You can't beat it for new homes, or for re-siding jobs.

### Free FOLDER!

Be sure to see beautiful Fire-Chex Shingles and Ceramo Siding at your Carey dealer's now. Also, mail coupon for catalog picturing these and other fine Carey products in full color!

THE PHILIP CAREY MFG. COMPANY Dept. AB-7  
Lockland, Cincinnati 15, Ohio

- Please send my free copy of catalog and complete information on FIRE-CHEX SHINGLES and CERAMO SIDING.
- Also give address of the nearest Carey dealer in my area.

NAME.....

FIRM.....

ADDRESS.....

CITY.....ZONE.....STATE.....

# Carey

THE PHILIP CAREY MFG. COMPANY  
Lockland, Cincinnati 15, Ohio

In Canada: The Philip Carey Co., Ltd., Montreal 3, P. Q.

Bathroom Cabinets and Accessories • Access Doors • Ventilating Fans  
Ceramo Asbestos Siding • Shado-Crest Shingles • Reflective Fire-Guard  
Blanket Insulation • Fire-Chex Asbestos-Plastic Shingles • Other  
quality products for home, farm and industry since 1873.

## HOW NEW ORLEANS HOMES

*sell before completion*



A view of the typical 3-bedroom brick Airline Park homes. Offered at \$15,000 to \$16,500, every home is completely air

cooled with a Hunter Package Attic Fan. *Builder:* A. L. Sizeler Construction Co., Inc. *Architect:* Robert Cummins.

## Low-cost Hunter Attic Fan cooling helps Builder Sizeler close sales



Selling homes before they are completed is a builder's dream come true for A. L. Sizeler of New Orleans.

He has now completed 183 of the 1500 homes planned for his new Airline Park community. All of these have sold while under construction.

His secret? A reputation for quality construction, coupled with such selling "extras" as cooling comfort with a Hunter Package Attic Fan.

### Hunter Fans Are Easy To Install

Easy installation and quiet and economical operation are just a few of the many reasons why Sizeler-built homes are equipped with Hunter Attic Fans.

Equally important, the dependable Hunter requires less service, provides maximum performance with minimum care. As Mr. Sizeler says, "since we started using the Hunter Fan exclusively, we have eliminated

the necessity for expensive call-backs to adjust or service fans."

### Four Sizes Available To Suit Every Need

There's a Hunter model to suit *your* needs, too. Four sizes available, from 5000 to 16000 CFM, with certified air deliveries. Every model is complete with automatic shutter—no extras to build or buy.

Next time, include a Hunter in your plans. You'll see why, in city after city, builders prove that *any* home is a *better* home with a Hunter Attic Fan.

# HUNTER

 *Package Attic Fans*

HUNTER FAN AND VENTILATING COMPANY

381 S. Front St., Memphis 2, Tenn.

**GUARANTEED PERFORMANCE:** Fan unit guaranteed 5 years; motor and shutter, 1 year.

**why  
build to  
BURN?**





# KEYMESH

GALVANIZED REINFORCING LATH

*with gypsum lath and plaster  
multiplies fire resistance of buildings*

Fire safety costs so little.

Actually, walls and ceilings of gypsum lath and plaster, reinforced with Keymesh, cost less than most substitutes. Just see how they *multiply* fire safety.

Take open-web steel joist floors and concrete slabs with gypsum ceilings, for example. With  $\frac{1}{2}$  inch of lightweight aggregate plaster, reinforced with Keymesh-like lath, a fire endurance limit of 3 hours and 28 minutes was obtained.\*

Without reinforcement, the limit was 55 minutes. *Keymesh* adds 2 hours and 33 minutes to the fire endurance limit because it holds the plaster in place. When lath and plaster were omitted,

the fire endurance limit was only 7 minutes.

You'll find equally important protection when simple columns and beams of buildings are protected in this same way. It's so good that insurance companies cut their rates because of the greater fire safety. Actually, these lower rates quickly pay the cost of the lath and plaster.

Think of it. Greater fire safety. Acoustical properties, if you wish. Durability. Low maintenance. Beauty. Takes any decoration. Yet... this fire safe construction costs less than most substitutes. And it can slash insurance rates enough to quickly pay for the plastering.

## *Actual Fire Test Shows Amazing Value of Keymesh-Type Plaster Reinforcement\**

Ceiling of gypsum lath — KEYMESH-type reinforcement and  $\frac{1}{2}$ " gypsum plaster with lightweight aggregate

Fire endurance limit

**3 hrs. 28 min.**

Ceiling of gypsum lath and  $\frac{1}{2}$ " lightweight aggregate gypsum plaster

**55 min.**

Ceiling unprotected

**7 min.**

\*See Building Materials and Structures Report 141, National Bureau of Standards: "Fire Endurance of Open-Web Steel-Joist Floors with Concrete Slabs and Gypsum Ceilings"

## KEYSTONE STEEL & WIRE COMPANY

PEORIA 7, ILLINOIS

makers of Keymesh • Keybead • Keycorner • Keystone Welded Wire Fabric  
Keystone Nails • Tie Wire • Keystone Non-Climbable and Ornamental Fence

Use these three keys to stronger plaster

3 KEYS TO  
STRONGER PLASTER

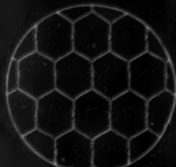

**KEYMESH** lath for over-all reinforcement. Made of galvanized woven wire. Especially recommended for ceiling construction.



**KEYCORNER** strip lath, pre-formed to fit snugly in corners. Lies flat when applied to joints. Galvanized to prevent rust streaks.



**KEYBEAD** corner lath for outside corners. Open mesh fills solid with plaster. Galvanized nose, or solid zinc nose (Key Z Bead).

**LATH and**

# plaster

**Saves Nearly  
\$60,000  
and 30 days**



## on New Wanamaker Store

Mr. A. O. Leighton, Partner of Irwin and Leighton, General Contractors, says: "In the new Wanamaker store in Wynnewood, Pa., a lath and plaster ceiling, serving as membrane fireproofing for the floor beams, eliminated the need for individual encasement of structural members with heavy concrete.

"This construction substantially reduced the dead load weight of the building, thereby cutting framing costs, and reducing the construction time by 30 days. An over-all saving

of approximately \$60,000.00 was effected!"

The technique of using lath and plaster ceilings to fire protect structural floor beams and "shell" or perimeter fireproofing to protect columns, has advanced sharply in recent years. Fire resistive ratings up to 4 hours for beams and columns are provided with lath and plaster that weighs as little as 12 pounds per square foot. These constructions permit a reduction in dead weight of as much as 50%, thereby reducing the cost of steel framing.



Wallpaper "best sellers" — powerful salesman for your model homes

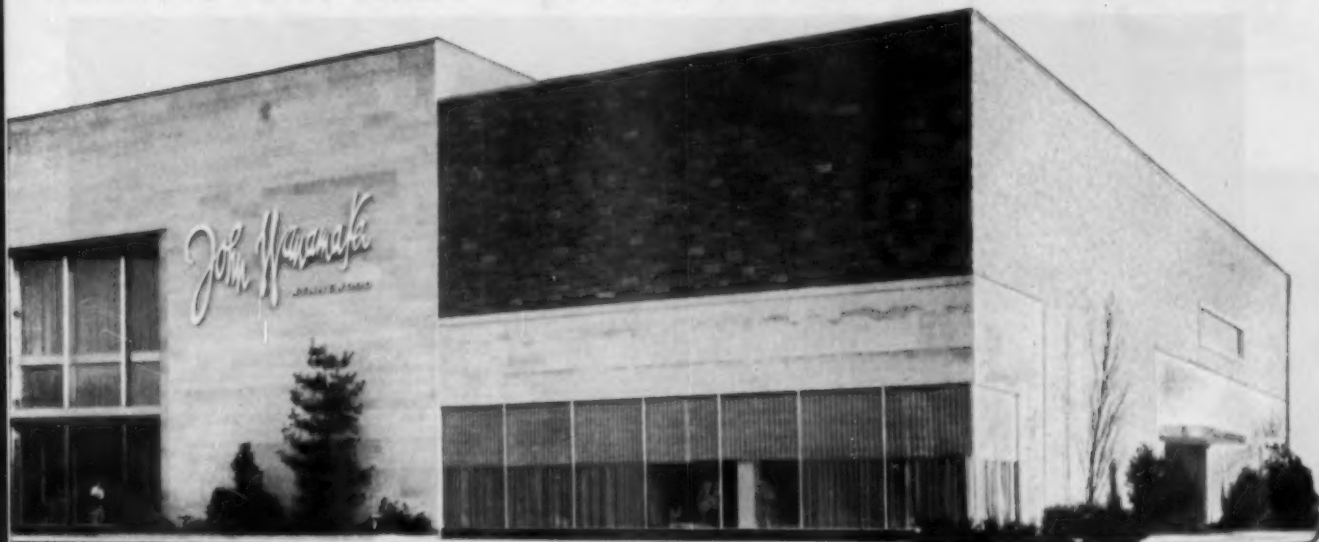

## Certified Craftsmanship IN ACTION...

• The Certified Craftsmanship Certificate is a written pledge of adherence to work schedules, job cooperation, work of craftsmanship caliber and nationally recognized standards of quality. A certificate is yours for the asking from lathing and plastering contractors adhering to the Code of Standard Practices for Lathing and Plastering.

We suggest a thorough reading of the Code of Standard Practices which appears on the back of every certificate. Ask your lathing and plastering contractor for a copy, or write National Bureau for Lathing and Plastering, 1401 K Street, N.W., Washington 5, D. C.



*This is the emblem of the National Bureau for Lathing and Plastering. It symbolizes high standards of job performance and responsibility.*

**Associated Manufacturers  
of Lathing and Plastering Materials**  
520 N. Michigan Avenue, Chicago 11, Illinois

FINISHING LIME ASSOCIATION OF OHIO • GYPSUM ASSOCIATION  
METAL LATH MANUFACTURERS ASSOCIATION  
PERLITE INSTITUTE • VERMICULITE INSTITUTE

Edmond F. Venzie, Plastering Contractor presents Certified Craftsmanship Certificate covering Wanamaker Store to Brigadier General Brenton G. Wallace, R. A., and R. R. Fields, A. I. A., Wallace and Warner, Architects.





Euclid Ave. Home, Stockton, California. Contractor: Harold Collins, Stockton. Windows: Lupton Casements.

## "... They're Lupton Windows"

... it's a builder pointing out a quality feature of a new house — or an owner showing-off his new home. Whichever it is, when they say, "... they're Lupton Windows," they say it with pride.

Like "virgin" wool, or "sterling" silver, or "solid" mahogany, "Lupton" coupled with "windows" has come to be accepted as a standard of quality. So, build with Lupton Windows and gain these benefits..

First, it's easy to find the window you need in the wide selection of Lupton styles and sizes... in steel or aluminum... even picture windows.

Second, you offer lasting beauty with Lupton Windows. There's no warping, no shrinking, no swelling — just permanently trim lines in sturdy metal. And, with Lupton Aluminum Windows you offer an added plus — there's *no painting ever*.

Third, there's the satisfaction that comes from selling and installing an accepted

product that has stood the test of time. Back of the Lupton name is 50 years' experience in designing and manufacturing metal windows. Careful workmanship and rigid inspection assure day-after-day efficient window operation with little or no maintenance.

That's part of the profitable Lupton story. Find out how you get more... and offer more... when you say — "they're Lupton Windows". Check with your local Lupton representative — listed in the Yellow Pages — or write direct to..

**MICHAEL FLYNN MANUFACTURING COMPANY**  
 Main Office & Plant: 700 E. Godfrey Ave., Phila. 24, Pa.  
 New York: 51 E. 42nd St., New York 17, N. Y.  
 Los Angeles: 672 S. Lafayette Pk. Pl., Los Angeles 57, Cal.  
 Stockton Warehouse & Office:  
 1441 Tremon? St., Stockton, Cal.

Sales Offices & Representatives in other principal cities

**LUPTON**  
 REG. U. S. PAT. OFF.  
**METAL WINDOWS**



Lupton Casement  
Steel or Aluminum



Lupton Aluminum  
Double Hung Window

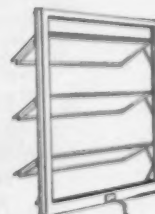

Lupton Aluminum  
Awning Window

**AMERICAN BUILDER**

# Weldwood "best sellers" — powerful salesmen for your model homes

Invest only \$22 to \$64\* in beautiful wood paneling in a model home—get back 4 or 5 times the value in a higher price or faster sales!

THESE ARE THE PANELS most in demand by homeowners, architects and builders . . . feature one paneled wall in your next model home—offer it as standard or optional in all models—see what a big difference it makes in your sales!

SEND THE COUPON for more details, then see your lumber dealer for actual Weldwood panels and samples or visit any of the 87 United States Plywood showrooms in principal cities.



(A) **KORINA**® the exotic blond wood imported exclusively by us from the Belgian Congo. In a living room it complements any type of furnishings, traditional or modern. About \$53.

(B) **KNOTTY PINE** — cheerful in the kitchen, handsome in playroom or family room. About \$35.

(C) **RIFT OAK**. Its rich mellow texture enhances a fireplace wall, a den or library. About \$64.

(D) **WELDTEX**® the popular striated wood patented by

Weldwood. Looks fine finished natural, painted or stained. About \$24.

(E) **SEA-SWIRL**® and **SURFWOOD**® create rustic, weather-beaten effect that is most unusual. Fine for den or playroom. Clear faced Sea-Swirl about \$30; knotty Surfwood about \$22.

(F) **NOVOPLY**® the dramatic new panel that gives a wood-mosaic look to a wall. In pine about \$25.

**PLANKWELD**® panels are edge grooved, 16¼" wide by 8' high. Easily installed with metal clips supplied;

installation method hides nail heads. Package contains about 108 sq. ft. Can be installed directly on studs. Plankweld needs no finishing whatsoever! Appropriate for any room in the house. Available in birch, walnut, oak, knotty pine, Korina, Philippine mahogany and Honduras mahogany.

(G) Philippine Mahogany Plankweld about \$54.

(H) Birch Plankweld about \$54.

\*All prices are approximate and are based on a wall 8 feet high, 12 feet long.

## Weldwood® PANELING

United States Plywood Corporation  
World's Largest Plywood Organization

United States Plywood Corp.  
55 W. 44th Street, New York 36, N. Y.



Rush details on the full Weldwood line of hardwood paneling. AB 7-5

Name .....

Address .....

City ..... State .....

## OWENS-ILLINOIS GLASS BLOCK\*

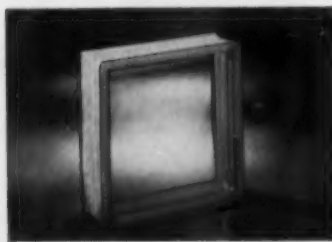

### EASY TO HANDLE

Owens-Illinois Glass Block are handled in the same way as cement blocks—same mortar, same laying technique. They go in at the same time, or they can be used for remodeling jobs.



### EASY TO STORE

Glass Block arrive on the job site packed in sturdy cartons of convenient size. Cartons can be opened as block are needed. No loose block for you to handle.

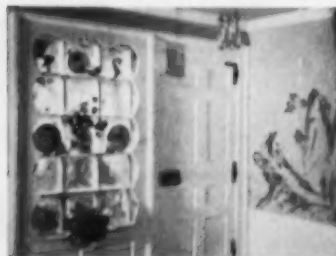

### EASY TO SELL

Let Owens-Illinois Glass Block help you sell your homes faster by adding visible evidence of extra value. Tell your customers that a panel of glass block has the insulating efficiency of an 8-inch thick brick wall. The panel won't frost or sweat in winter... provides better insulation than a window with storm sash. Point out block are hard to break... easy to clean.

For information or help with a specific problem, write Kimble Glass Company, subsidiary of Owens-Illinois, Dept. AB-7, Toledo 1, Ohio.

\*Formerly known as INSULUX.

## OWENS-ILLINOIS

GENERAL OFFICES  TOLEDO 1, OHIO

## ON THE RECORD

### and OFF THE RECORD

**PROBLEMS** in building are recurrent. Now, once again, it is scarcity of land. The same problem commanded the earnest consideration of builders in the lush mid-twenties.

**IMPROVED ROADS** and the growth of individualized transportation solved the problem by extending the radii of suburbia. New transportation forms made it possible to build individual houses and housing developments much farther away from centers of employment than had been considered possible theretofore.

**THE CURRENT PROBLEM** will be solved in exactly the same way. New suburban, intra-city and interstate freeways are rapidly extending the habitable radii by 10 to 30 miles.

**WHAT THE NEW AIR** age will do is conjecturable. But only in the sense of how far it will extend habitable radii, not whether it will do it.

**THAT MAY BE** the answer to the next land shortage problem. Anyway, there never will be a land shortage problem that a new form of transportation will not solve.

**AND THE SMART** builders and realtors are already picking up the new unbuildable land that in two to five years will command premium prices for home developments.

**THE THOUGHT FOR** the month is that we are having serious growing pains emerging to another and higher economic plane and that, as always, the courageous and the confident will reap the new harvest.

**"CONTINUED EXPANSION** of federal government activities in the fields of housing and the financing of housing may well have reached the point of socialization if Congress approves the proposed bills which would create a new mortgage insurance fund for loans to construct medical facilities," said Wallace Moir, president of the Mortgage Bankers Association of America.

"Such legislation is entirely unnecessary," he declared, "because private lending sources can provide all legitimate financing needed in these fields."

**CARNOY HOMES CORP.** of White Plains, New York says their experience proves that private homes—5½ rooms, 800 square feet on a 50x100 lot—cost \$9,000. By comparison, they say, figures presented by Greenburgh Housing Authority show that public housing—750 square feet, five-room apartment—costs \$14,250.

**IT'S ANOTHER DOCUMENTED** example of how public housing is one of the best known devices yet conceived for wasting the hard-earned money of taxpayers.

**NAREB** and its president, Henry G. Waltemade, believe that the newly established program for insured, long-term, low-down-payment mortgages to finance rehabilitation of homes will succeed in eliminating slums.

**WE CANNOT AGREE** that these new mortgage terms will alone eliminate slums. We believe the terms to be an essential in arresting the development of slums. But elimination will come from the better maintenance made possible by these terms, plus, most importantly, the construction by private enterprise of ever-better houses, and the rapid stepping-up of trade-in selling by builders.

**URBAN RENEWAL** is principally a matter of local, individual civic pride. Once we recreate that pride the whole problem will evaporate. Without it nothing will avail.

**THE NEW LOOK** in lumber and building materials stores was never better exemplified than in the recently opened store and yard of the Wilbur Lumber Company branch in Waukesha, Wisconsin. It looks like what it is—buying headquarters for builders, contractors and consumers—specializing in lumber, lumber products and building materials, uncluttered with gadgets.

(D) WELDTEX® the popular striated wood patented by

by 8" high. Easily installed with metal clips supplied;

(M) Birch Plankweld about \$54.

Address.....  
City.....State.....

# Add Glamour to your heating plants with New Electronic Moduflow!

*Thermostat outside your houses  
gives your home buyers luxurious electronic comfort*

**N**OW YOU CAN ADD a glamorous new sales appeal to one of your major home products—install Honeywell Electronic Moduflow Temperature Control to highlight your heating plants!

Moduflow has been wonderfully redesigned to give it even stronger impact as a sales feature for your houses. Its new styling will add greatly to the decor of your customers' homes.

Electronic Moduflow is *completely automatic*, and reacts with electronic swiftness. It makes all other control systems obsolete because it features an electronic thermostat *outside* the house that varies indoor temperatures as the weather changes, providing the ultimate in home comfort!

Hundreds of builders all over the country have already discovered the tremendous sales appeal of Electronic Moduflow—and the *electronic comfort home*.

Moduflow controls both heating *and* cooling—so turn your houses into luxurious *electronic comfort homes* today!

Be sure to see your Honeywell salesman or heating dealer right away for costs and availability...or write to Honeywell, Dept. AB-7-93, Minneapolis 8, Minnesota.



**New Outside "Weathercaster" Thermostat**

With electronic swiftness, the Honeywell Weathercaster continually senses outside temperature changes and tells the indoor thermostat what adjustment is necessary to maintain perfect comfort.



**New Inside "Golden Circle" Thermostat**

Your customer simply dials the daytime and nighttime temperatures he wants with this beautiful thermostat. He just sets it once. Thereafter, the outside thermostat raises or lowers settings *automatically* as outdoor temperatures change.



**New Electronic Control Center**

This handsome new appliance—white clock is styled for the utility room or kitchen. It receives electronic signals from the indoor thermostat and adjusts the heating or cooling plant accordingly. In winter, it *automatically* lowers the temperature at night to save fuel, and raises it in the morning.



*For heating or cooling*

MINNEAPOLIS

**Honeywell**

**Electronic Moduflow**

112 OFFICES ACROSS THE NATION





Edward G. Gavin  
Editor-in-Chief

Arthur J. McGinnis  
Publisher

Joseph B. Mason  
Executive Editor

## American Builder Enlarges Staff

Functional organization centralized and strengthened under new publisher, McGinnis—Editor Gavin's staff augmented

A program to better integrate the entire *American Builder* operation is under way. Arthur J. McGinnis has been appointed publisher, and about August 1 the editorial production staff and technical and news editors will be transferred to New York, where they will be in charge of Joseph B. Mason, who becomes executive editor.

Edward G. Gavin, editor-in-chief, will continue to direct editorial policy from his headquarters in Chicago, with an augmented field and reporting staff. Fred A. Clark, business manager, and Lyman M. Forbes, of the sales promotion department, will transfer to New York, as will the editor of the *Light Construction Merchandiser*—a new 16-page publication distributed monthly to more than 30,000 dealers, wholesalers and jobbers in the building industry for the purpose of merchandising the products of *American Builder's* advertisers. Conrad J. Wageman, former publisher of *American Builder*, continues as a vice president of Sim-

mons-Boardman on special assignments. No other changes or transfers are contemplated.

*American Builder's* parent company, the Simmons-Boardman Publishing Corporation, maintains centralized circulation, production and advertising sales direction for its eight magazines in the New York office; all are printed in the east.

In announcing these plans, James G. Lyne, president of Simmons-Boardman, said this expansion and the closer staff coordination which will result will make *American Builder* more useful than ever before to the active, fast-changing light construction industry which it has served for 77 years.

A graduate of Fordham University in 1932 and the Harvard Graduate School of Business Administration in 1934, Publisher McGinnis joined the Simmons-Boardman organization in October, 1940, as an editor. He was elected treasurer of the company in November, 1950, and executive vice-president in February, 1954, which positions he

will retain. Before joining Simmons-Boardman and since then he has been active in real estate, principally in the financing and management of commercial and residential properties.

"The building industry faces fast-moving, far-reaching changes in this expanding, postwar market by reason of the swift march of technological progress," he said in commenting on the editorial changes. "We are adding greater effort to an editorial program geared to today's and tomorrow's building needs and designed to maintain our position of constructive leadership.

"Through the pages of *American Builder* we will provide a steady flow of information about new developments in materials and equipment and report and interpret the new ideas, techniques and methods in building practices. This information will be written and placed on our pages according to the most modern concepts of editorial presentation to attract and hold reader interest and to inspire action."





U. S. Gypsum Research Village; Designing Architect: Harris Armstrong, AIA; Builder: D. H. Drummond; Photograph: Hedrich-Blessing

*Selected for the U.S. Gypsum Research Village...*

## **GOLD SEAL Cork Tile**

Featured in the famous U. S. Gypsum Research Village, Gold Seal Cork Tile is being used in more and more homes and businesses throughout the country. It's the tile that takes all the warmth, beauty, quiet and resilience of top quality natural cork, and binds it together into a highly superior product.

**Unsurpassed in resistance to soiling by any other cork tile on the market**—proved by laboratory tests. You can actually feel the super-smooth factory finish of Gold Seal Cork Tile by running your hand over the surface.

**Carefully blended cork granules** make each tile look handsomer—and as natural as if it were planed from the original tree.

**Tremendous durability** of Gold Seal Cork Tile is due to the use of superior synthetic resins and top quality cork.

**Ideal for floors and walls** in residential areas; offices, reception rooms, libraries, churches—any place where quiet luxury is the prime requisite. Can go on-grade, even over radiant heat, as an excellent basic floor.

**Satisfaction guaranteed**—or your money back; that's the way the Gold Seal protects you and your clients.

Specifications: 6" x 6", 6" x 12", 9" x 9", or 12" x 12" tiles in either  $\frac{1}{8}$ " or  $\frac{3}{16}$ " gauges. Beveled edges for easier installation. Packed two ways: light only . . . or a random combination of light, medium, dark. Installation over concrete or wood, on or above grade, with or without radiant heat (on-grade, specify Gold Seal "Three-Twenty" adhesive).



**For home or business...**  
**you get the finest choice of all in...**

INLAID LINOLEUM • RANCTILE® LINOLEUM • VINYLFLOR • VINYLTOP •  
LINOLEUM, VINYL, VINYLBEST, RUBBER, CORK AND ASPHALT TILES •  
CONGOLEUM® AND CONGOWALL® ENAMEL-SURFACE FLOOR AND WALL COVERINGS



**GOLD SEAL**  
**FLOORS AND WALLS**

CONGOLEUM-NAIEN INC. KEARNY, N. J.



**GARDEN SIDE** has clerestory windows which form an interesting pattern under the wide gable roof sweep. Walls are faced with vertical cypress and brick

## Arresting to look at, easy

**AMERICAN  
BUILDER**

### BLUEPRINT HOUSE

**BUILDER:**

Alvin Lukashok, Inc.  
Mamareneck, N. Y.

**ARCHITECT:**

Allen and Edward Kramer,  
New York, N. Y.

**SQUARE FOOT AREAS:**

House, full area .....	1,835
Porch, 2/3 area .....	92
Carport, 1/3 area .....	192
<b>Total square foot area .....</b>	<b>2,119</b>
<b>Cost per square foot .....</b>	<b>\$9.60</b>

For computation purposes, porch and carport are fractional so that their cost per square foot will be in ratio with that of the house.

When a well-designed house can be brought down to a simple, basic form, such as a rectangular shape, and a framing unit for doors, windows and walls which is repetitive, then it is possible to obtain size and quality, both inside and out, and economy in construction.

These attributes can be quickly applied to this house, particularly in regard to the framing unit. This unit is milled from 2x6-inch stock and is shaped the same in all cases. It is used as a door jamb and head, and doubled up for a mullion. The windows are the same, both for fixed glass and hinged sash, with the addition of a sill member.

The same unit is used for the plywood wall panels that occur under and between window groupings. It acts as a closer frame for the masonry and stud walls, and also for the finished frame adjoining the roof soffit. It also encloses the wall posts that support the roof beams above. As a matter of fact, the extensive use of fixed glass units above the normal door height on the two side walls, cause this unit, in many cases, to be continuous from sill at the floor line to the roof soffit. The unit acts as a supplementary finished framing member. The



**STREET SIDE**, partial view at carport. Entrance porch is large enough to be used for auxiliary dining. Note that the roof line is flush with the wall on this side

The Spacemaker combines style, thrifty use of space, and an economical framing unit

to build



*Continued next page*

**A STEP INSIDE FROM GARDEN**, living-dining area balances openness with privacy of yard



**GUEST CLOSET is suspended from exposed horizontal and vertical supports**

application of a simple stop for the glass and a 1/2-inch-thick casing, inside and out, completes the ensemble, ready for decorating.

Of great interest is the design technique that is used on the exterior. Here the roof gable is made to span the long dimension of the house. This arrangement makes possible a continuous battery of clerestory windows on the two side walls with the ceiling of all the rooms following the slope of the roof. Of further in-

terest is the roof projection which extends 4 feet out from the wall on the garden side, 3 feet 6 inches on the two end walls, but is kept flush with the wall on the front, which is the north side of the house. This has been done for economy's sake without sacrifice of appearance.

The floor plan provides access to all the important rooms without passing through others. The rooms are arranged around the entry like the spokes of a wheel, making it easy to move from one to another. In this way a feeling of spaciousness is obtained.

All rooms have an abundance of light, through clerestory windows which supplement the regular ones below. Open panels in the roof over the passage between carport and house permit full light to penetrate into the windows of the multi-purpose room.

The house is placed on poured concrete walls that extend below the frost line. The concrete slab which covers the entire floor area is placed on a sand bed at grade.



**BRICK AND PINE KITCHEN. Clerestory windows let the light pour in on work area. Over sink is a 10-foot window**

**BRAND NAME PRODUCTS USED**

American Standard plumbing fixtures	F. O. Pierce interior paints
Barrett built-up roof	G-E gas fired warm air furnace
Carey insulation	Kentile asphalt tile
Duralite aluminum windows	Minneapolis-Honeywell controls
Dutch boy exterior paint	Mosaic Tile
Formica counters	U. S. plywood
	U. S. Rocklath

Quarter scale working drawings are available from the architects, Allon & Edwin Kramer, 33 West 42nd Street, New York City.

**SEE BLUEPRINT FOR WORKING DRAWINGS ►**

**AMERICAN BUILDER**

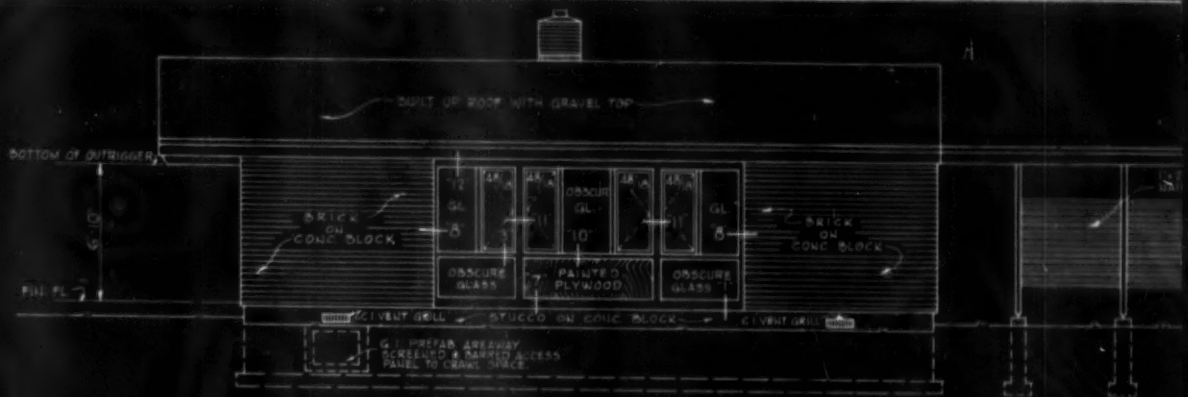

EAST ELEVATION

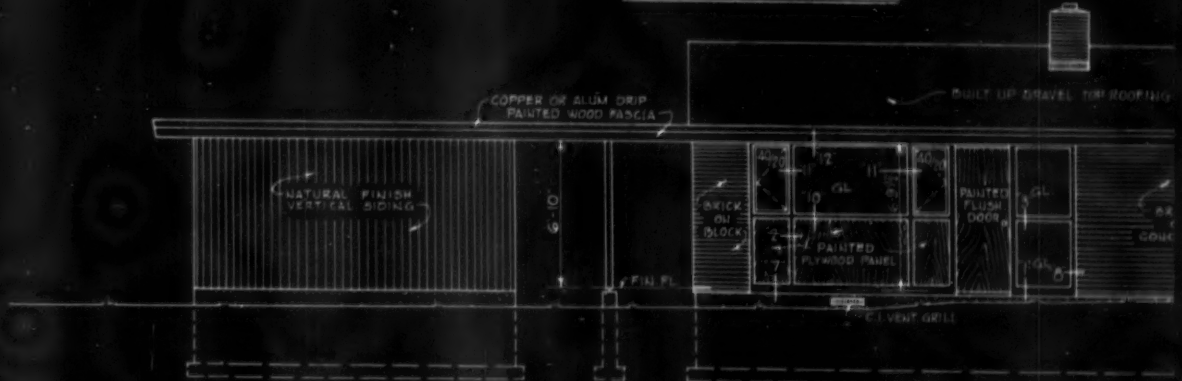

WEST ELEVATION

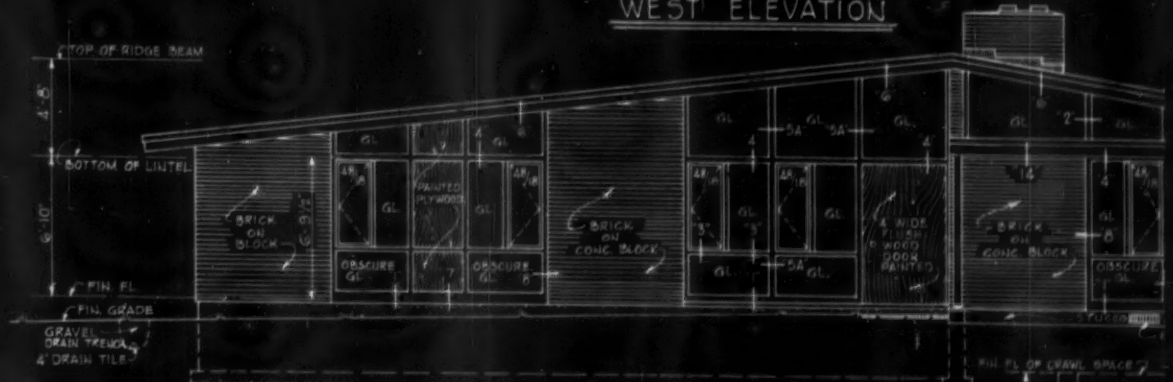

NORTH ELEVATION

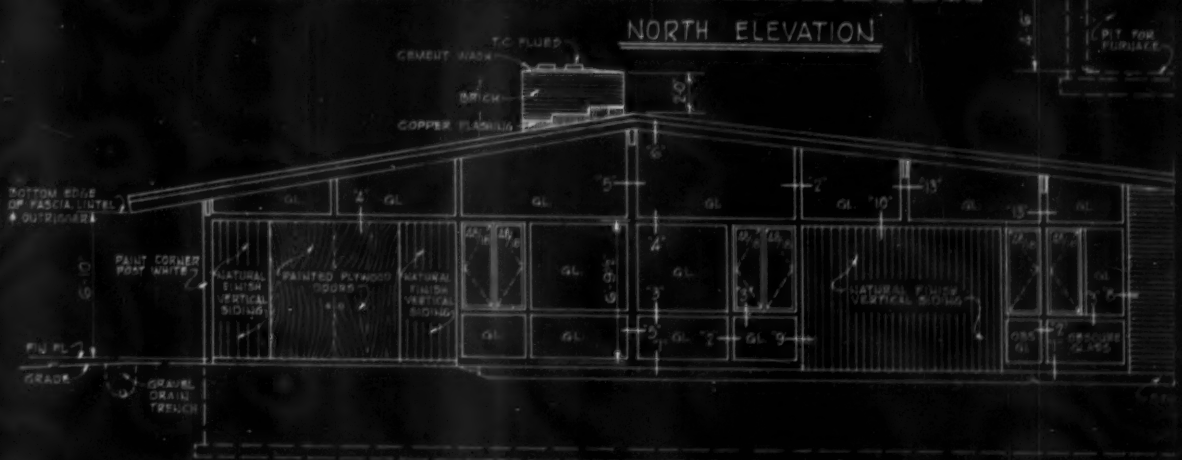

SOUTH ELEVATION

PULL OUT FOR FLOOR PLAN





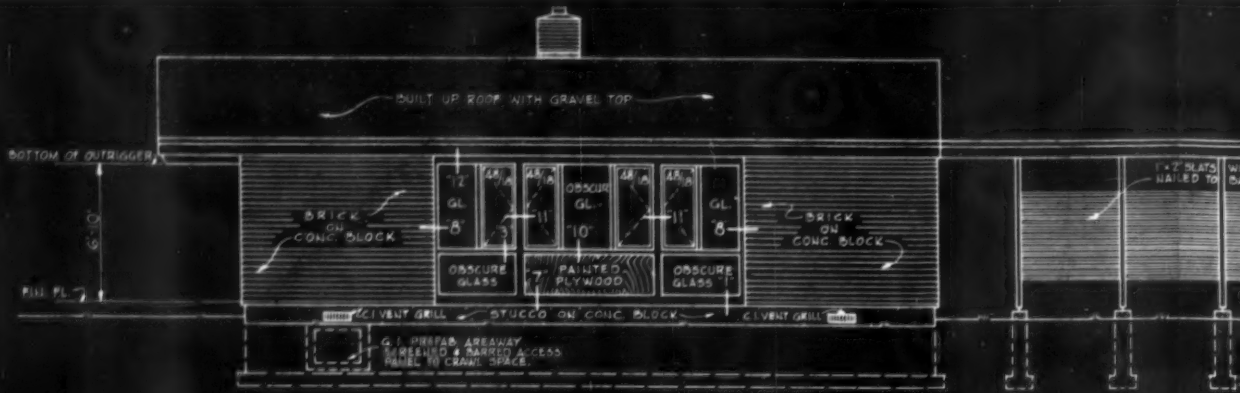

EAST ELEVATION

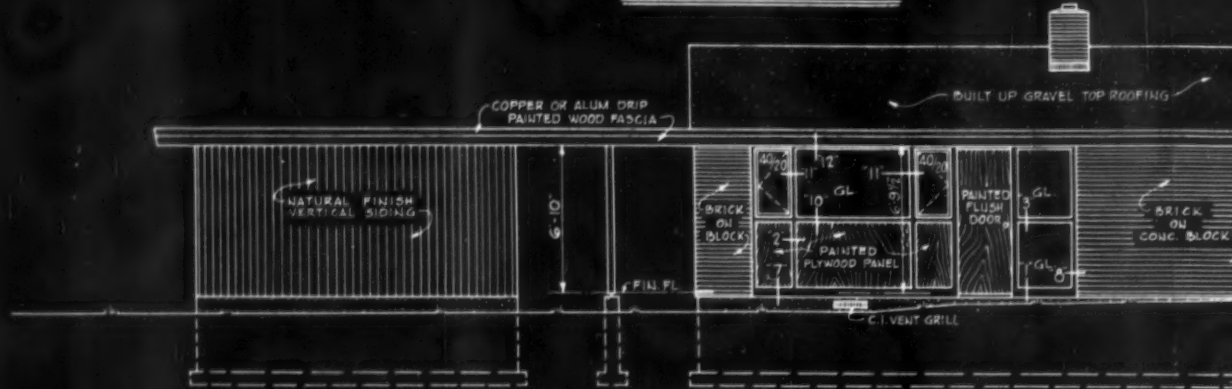

WEST ELEVATION



NORTH ELEVATION

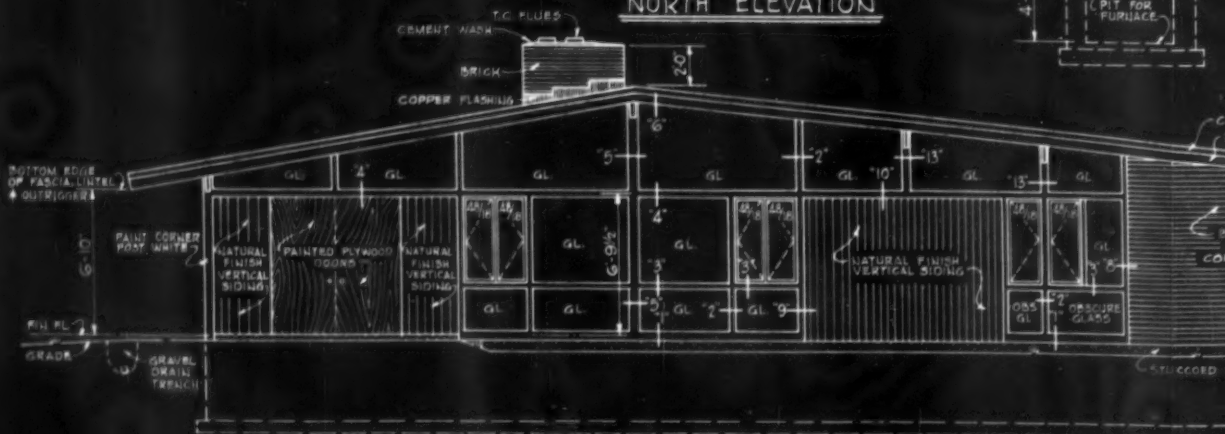

SOUTH ELEVATION

← PULL OUT FOR FLOOR PLAN ←



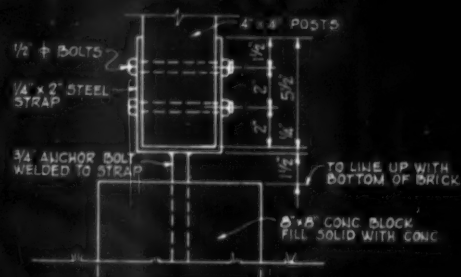
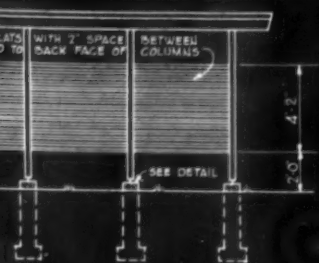

POST BASE DETAIL

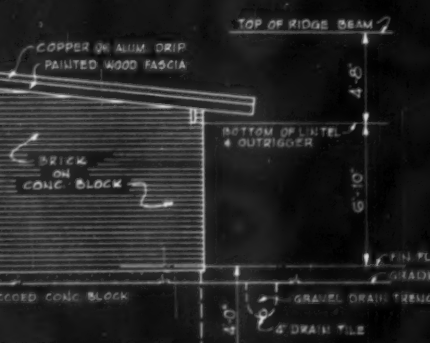
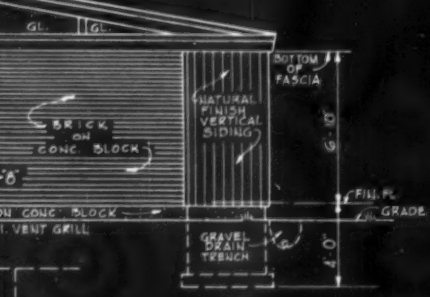
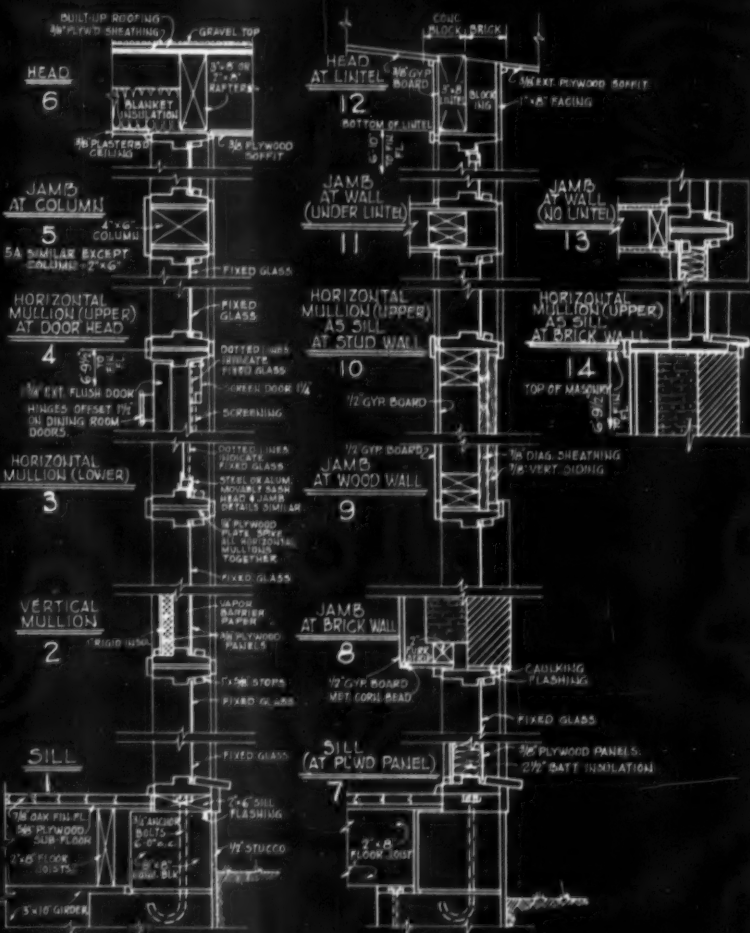
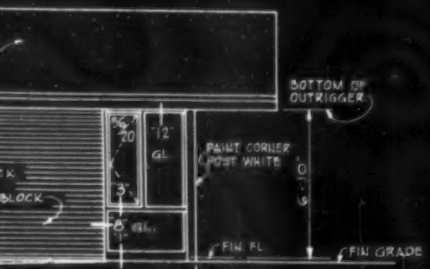

DESIGN NO. A.B. 221  
 AMERICAN BUILDER BLUEPRINT SERIES  
 DESIGNED BY  
 ALLEN AND EDWIN KRAMER - ARCHITECTS  
 33 W. 42<sup>ND</sup> ST. NEW YORK CITY, N. Y.  
 Simmons-Boardman Publ. Corp., 79 W. Monroe St., Chicago 3, Ill.



# Quantity List of Materials

## For American Builder Blueprint House No. 221

Alvin Lukashok, Inc., Designer

### General Information

House — Type .....	masonry and frame
Area .....	1,972 sq. ft.
Cube .....	21,692 cu. ft.
Height taken for cube was 11 feet	
Carport — Area .....	550 sq. ft.
Cube .....	4,400 cu. ft.
Height taken for cube was 8 feet	

### Excavating

Trench for foundation .....	270 lin. ft.
Column footings .....	17
Excavation for crawl space .....	183 yds.

### Cement Work

Foundations .....	360 cu. ft. footings
6 — 8"x 8" block piers @ 2'8"	
11 — 12"x12" block piers @ 2'8"	
220 sq. ft. of 8" block wall	
820 sq. ft. of 12" block wall	
Concrete work .....	274 sq. ft.
Thickness .....	4 in.
Sidewalks .....	86 lin. ft. flagstone 3' wide
Porch and terrace .....	232 sq. ft. flagstone
Anchor bolts .....	21 — 3/4" dia.
Foundation vents .....	4
Miscellaneous .....	400 sq. ft. blacktopping
1/2" thick stucco 800 sq. ft. applied to face of foundation walls	

### Masonry

Type .....	brick
Walls .....	1,200 sq. ft. of 8" masonry wall
Window sills .....	in frame walls only
Chimney .....	150 cu. ft.
Flue lining .....	16' of 8" dia.
12' of 12"x12"	
Cap .....	cement
Fireplace .....	one
Throat and damper .....	1
Lintels .....	1
Miscellaneous .....	Stone trim at fireplace — no detail

### Iron Work

Door lintels .....	6 — 3"x4" angles 3'4" long
Miscellaneous .....	1 G.I. areaway and grille with access door
	6 special "U" brackets, welded assemblies; see detail for post base

### Millwork

Windows — type .....	casement and fixed material
material .....	steel or aluminum and wood
Windows glazed including trim:	
steel or aluminum — vent sash —	15 — 18"x48"
	2 — 20"x40"
	1 — 20"x56"
wood fixed sash —	7 — 22"x52"
	1 — 68"x44"
	1 — 24"x60"
	6 — 48"x24"
	1 — 32"x44"
	1 — 32"x38"
	3 — 52"x24"
	2 — 50"x24"
	2 — 24"x52"
	2 — 52"x52"
	2 — 44"x24"
	1 — 24"x24"
Exterior doors .....	See plan for trapezoid windows
1 slab type .....	4'0"x6'8"
2 flush doors .....	3'0"x6'8"
1 flush door .....	2'8"x6'8"

Garage door .....	2 flush doors in carport, no size given
Exterior millwork	
Lattice on carport .....	500 lin. ft. 1"x2" lattice
Interior doors including jambs and trim .....	7 — 2'8"x6'8"
	1 — 2'4"x6'8"
	2 — 2'0"x6'0"
	5 — 1'6"x6'8"
	4 — 2'8"x6'8"
Sliding doors .....	1 pr. special folding doors for 10'x6' opening
Special interior doors .....	1 special floor access door
	1 set kitchen cases
	1 oak plywood wardrobe cabinet
	2 lavatory cabinets
Special interior millwork .....	
	1 set kitchen cases
	1 oak plywood wardrobe cabinet
	2 lavatory cabinets

### Carpentry

Beams and girders .....	1 — 3"x10" — 22'0"
	1 — 3"x10" — 20'0"
	2 — 3"x10" — 14'0"
	2 — 3"x10" — 12'0"
	1 — 4"x6" col. — 12'0"
	8 — 4"x6" col. — 8'0"
	5 beams — 4"x14" — 16'0"
	5 outriggers — 3"x8" — 10'0"
Foundation plates .....	140 lin. ft. 2"x6"
Floor joists .....	23 — 2"x8" — 24'0"
	25 — 2"x8" — 20'0"
	17 — 2"x8" — 14'0"
Bridging .....	450 lin. ft.
Studding and plates .....	116 pcs. 2"x4" — 10'0"
	50 pcs. 2"x4" — 8'0"
	500 lin. ft. 2"x4" plate
Ceiling and roof joist .....	22 — 3"x 8" — 26'0"
	11 — 2"x 8" — 26'0"
	11 — 2"x 8" — 14'0"
	12 — 3"x 8" — 20'0"
	13 — 2"x 8" — 20'0"
	11 — 2"x 8" — 12'0"
Framing lintels .....	2 — 2"x12" — 18'0"
	2 — 2"x12" — 16'0"
	1 — 2"x 6" — 10'0"
Subfloor .....	1,950 sq. ft. 5/8" plywood
Roof sheathing .....	2,500 sq. ft. 3/8" plywood
	1,700 b.f.m. of 2" sheathing
Side wall sheathing .....	500 bd. ft. 1" sheathing
Side wall materials .....	500 bd. ft. vertical siding
Flooring — hardwood .....	1,200 sq. ft. area to cover
softwood .....	400 sq. ft. area to cover
Exterior material	
soffits .....	3/8" exterior plywood, 590 sq. ft. required
fascia .....	285 lin. ft. 1"x10" fascia
porches .....	flagstone (see cement work)
Insulation .....	80 sq. ft. of 2 1/2" batts
	2,000 sq. ft. of blanket insulation for ceiling

### Sheet Metal

Copper or aluminum drip .....	285 lin. ft.
Flashing .....	at chimney, and 25 lin. ft. at junction carport roof with house wall

### Roofing

Type .....	tar and gravel
	31 squares

### Interior Walls

Area to be covered .....	4,600 sq. ft. not including masonry walls shown unfinished
--------------------------	--

● This quantity list will be subject to variation depending on the common practices in various sections and municipalities of the country. It was prepared by experts at The Edward Hines Lumber Co., Chicago.

# Try this clever approach to a COOL,



**DRIVING UP FROM SOUTH**, you park under stilted master bedroom, air-cooled "through and under" by southeast breeze. Awning windows and cantilevered balcony give fine view to Mount Bonnell. Clean use of stone, as embankment and bearing wall at bedroom-bathroom line, is repeated at entrance.

## breeze, stone,

**Low cost techniques applied in building architect's home make most of Austin foothill site**



**ENTRANCE EXTERIOR** is dramatized by open rafters from studio, which shares main axis roof and 63' ridge. Stone forms steps, planter, and entrance wall. Stationary glass is used over studio's awning windows.

**INTERIOR** of entrance continues stone wall as anchor of bedroom wing (through door at right). Louvred door catches breeze past and through studio. Grate at upper left is sole outlet of 150,000 BTU gas heater on slab. ▶

**W**hat is the cheapest way of building to beat the hot weather? Use what's there and plan your layout to make the most of it.

Builder Douglas Hicks of Austin took the plans of R. Gommel Roessner, associate professor of architec-



# COOL house ...



## shade do it

ture at the U. of Texas, and helped translate a textbook in climate control into stone, concrete and wood.

What was there already? A fairly complex slope contour, plenty of cheap local stone, stands of bushes and trees and, the decisive factor in layout, a prevailing southeast breeze.

What was done? First, master bedroom, kitchen, and studio (detached from the main house) were oriented for fullest air movement.

Second, the bedroom wing, wood-framed and cork-floored, rested not on a slab but on concrete piers and stone, which was also used for retaining walls and as a temperature stabilizing factor with the main slab, waxed to a marble-like finish.

Third, overhangs were figured to be effective until 5 p.m. at 30° lat., when foliage took over. In winter, cold north winds are cut by cedars.

Cost? "So far under \$20,000 you wouldn't believe it," Roessner says.

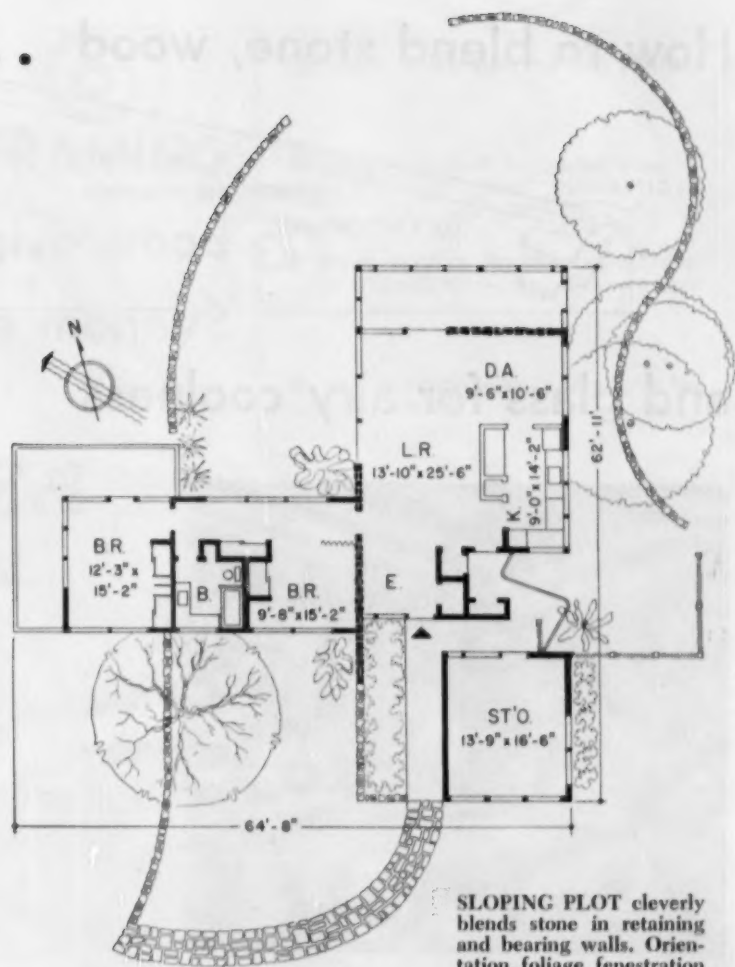

**SLOPING PLOT** cleverly blends stone in retaining and bearing walls. Orientation, foliage, fenestration help master the climate.

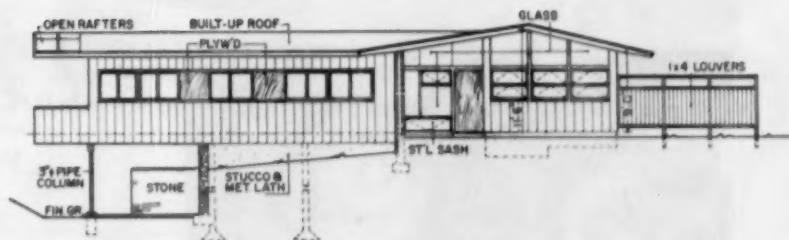

**SOUTH ELEVATION** is marked by rough-sawn redwood, artificially aged by owner's formula. Breeze-catching louvers (right) fence drying yard.

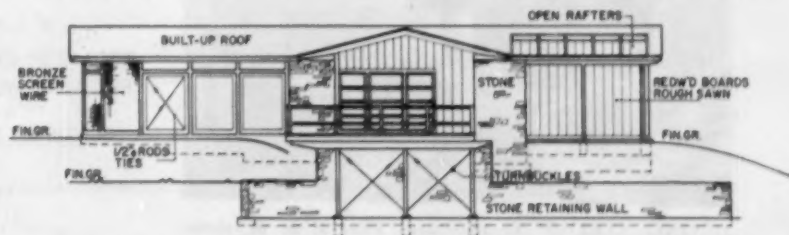

**WEST ELEVATION** shows 3" pipe columns stiling bedroom. Living room, screened porch at left. Retaining walls follow contour economically.



## Will steel for FRAMING give wood a run for the money?

For steel, these are the big points:

- low unit cost of fabricated steel
- rapid erection time for steel—total of 13 hours for the house shown here
- steel is simple way to free-span interior space



Bid price for the steel frame of this house in Salt Lake City was \$1,400, fabricated, erected and including all welding and grinding

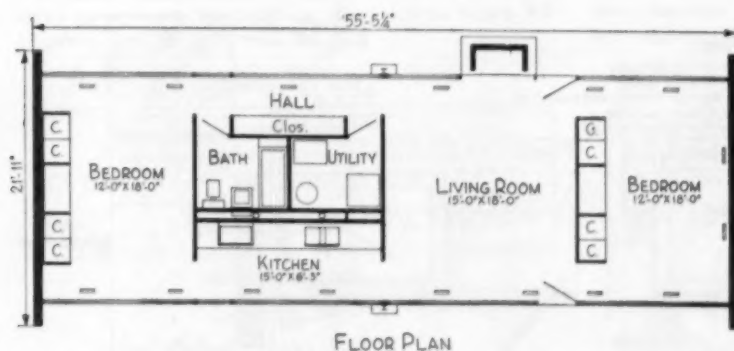

Colored concrete floor is scored into squares and ground very smooth. Perimeter heating ducts in slab

This steel-framed building designed by architect Dean L. Gustavson has 1,000 square feet of living area. Cost was \$12,700 including built-in furniture and kitchen equipment but not including the architect's fee and the lot.

The steel framing was erected in five hours, welding and grinding took another eight hours. The building was produced at a cost comparable with wood in the intermountain area.

The building is divided into four bays one of which has an interior  
(Continued on page 84)



Construction photograph shows the steel in place and the plumbing core for interior bathroom-utility area

plumbing core so that the bath, utilities, and kitchen can be backed up.

The steel framing of the building has an 8-inch WF 48-pound member

running through the center supported on a 5x5 16-pound column. The front and rear members are 12-inch channels of 10.6-pound steel. These are supported on the same 5x5

16-pound column and the masonry end walls.

Intermediate supporting members are 6-inch channel and 8-inch WF units. These members support the

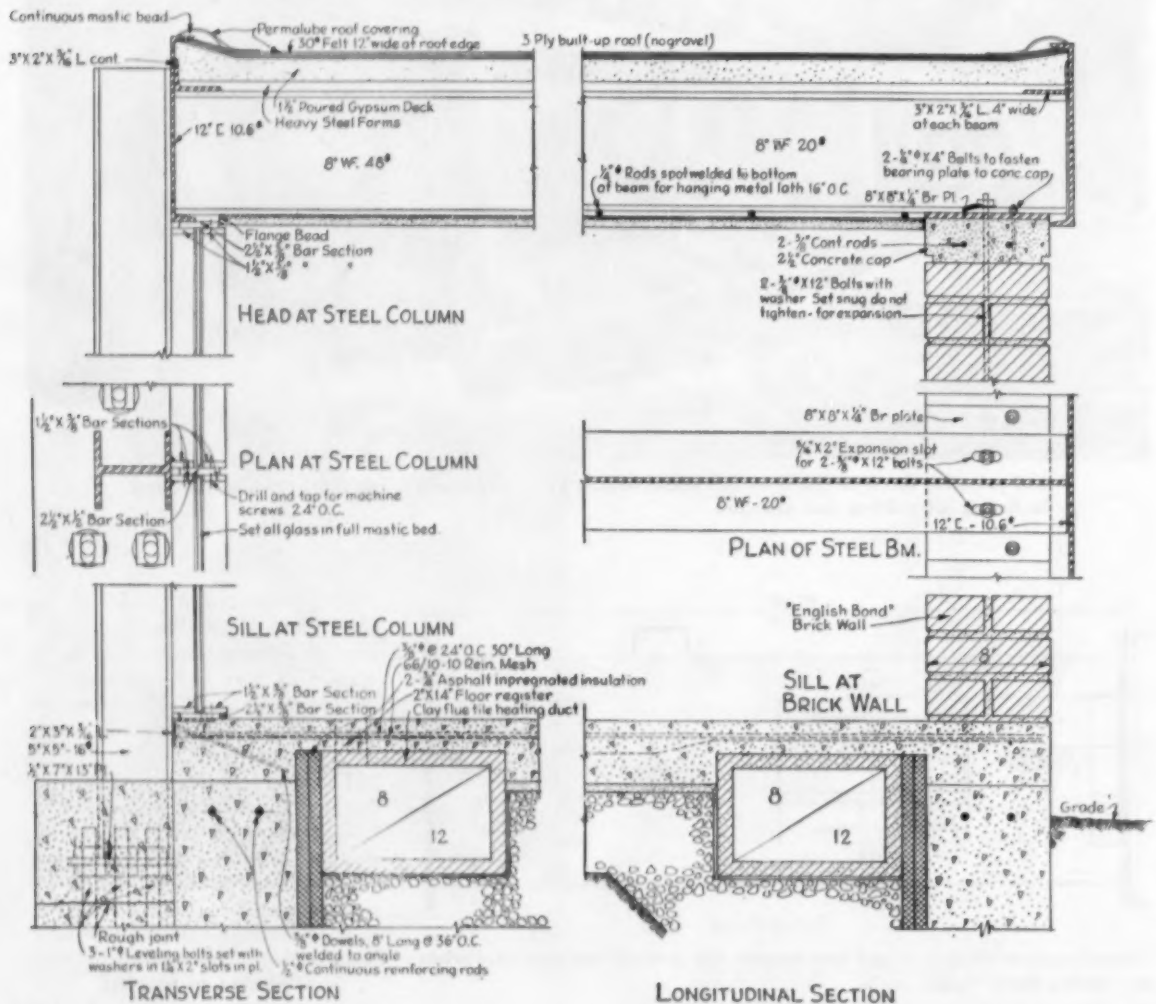



## STEEL FRAMING PLAN AND DETAILS

roof decking material. The roof deck is 1½-inch poured gypsum over a heavy duty "Corruform" base. Roof is finished with a 3-ply built-up construction.

The ceiling of the house has ¼-inch steel rods welded to the underside of the steel beams every 16 inches. Metal lath is tied to the rods and plastered. Side walls are masonry, front and rear walls are glass, and the interior partition walls are non-bearing plywood or plaster-board.

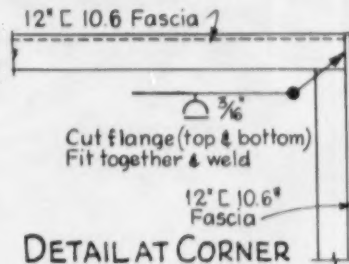
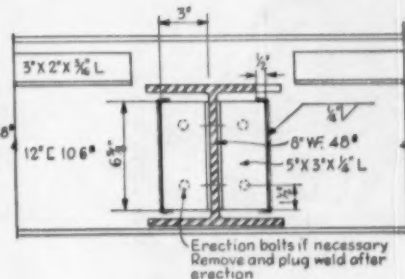
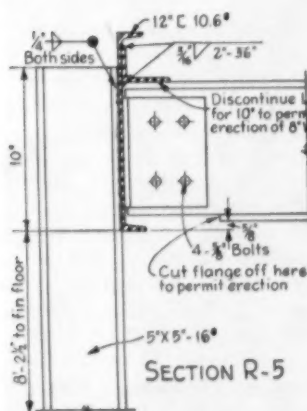
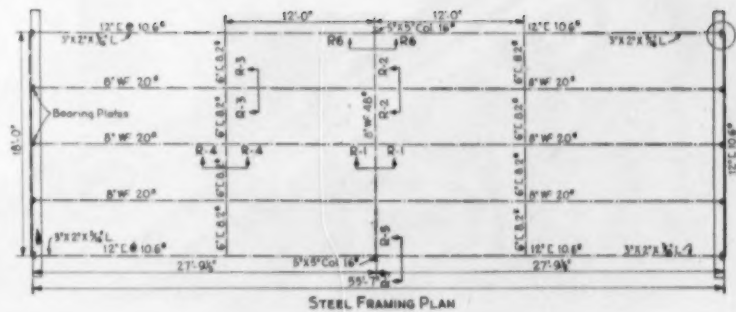

Detail shows the 12-inch channel used as a fascia around the building

This detail shows how the 8-inch WF 48-inch beam is fastened to 5x5 column

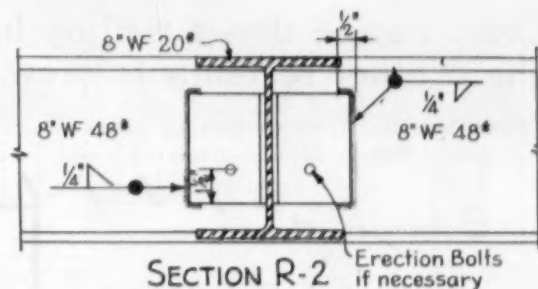
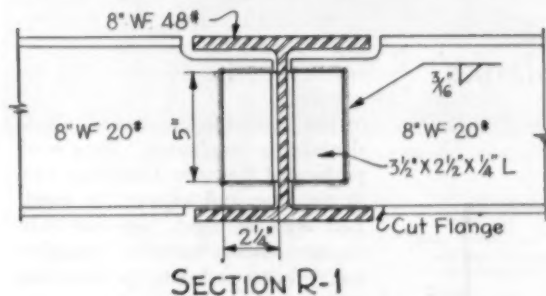

This detail shows the steel girder construction which spans the center of the building. Member is an 8-inch WF 48-pound steel beam

Smaller 8-inch WF 20-pound steel beam spans the distance between the masonry wall and the large beam center support

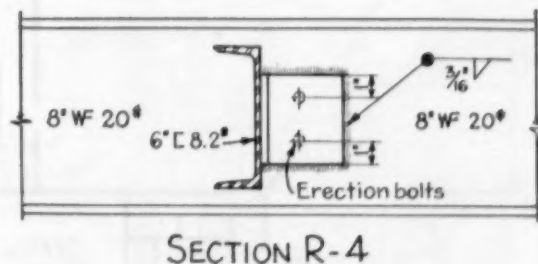
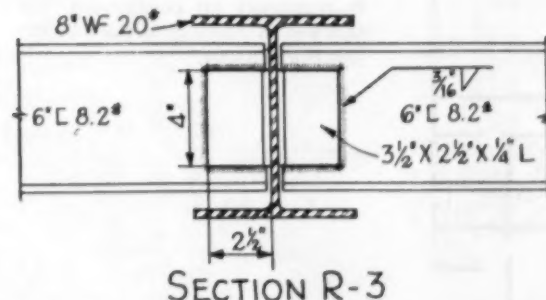

This details the connection of the 6-inch channel and the 8-inch WF 20-pound member

Six-inch channel and its connection with the 8-inch WF 20-pound member



People look twice at zig-zag glass walls, solid overhang, stone planter

## Novel design draws waiting lines where other restaurants drew 'blanks'

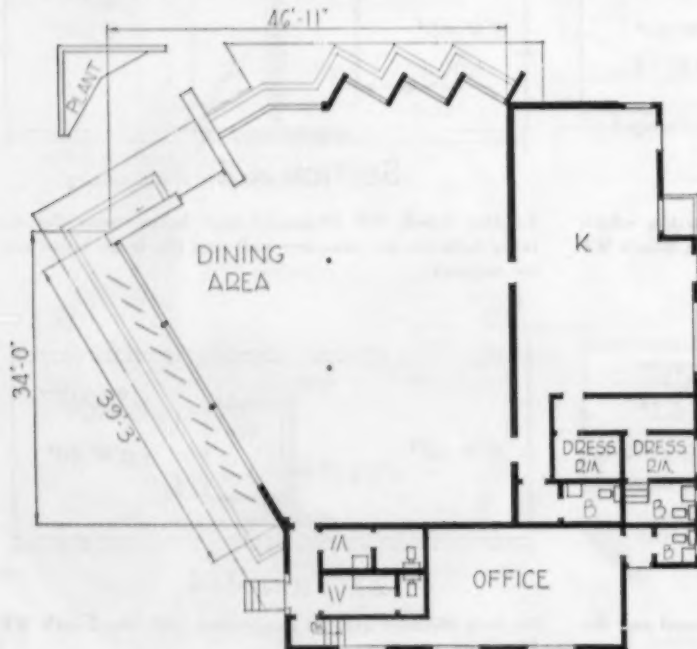

## Fresh ideas

The busy Pasadena intersection now occupied by the "Headliner" coffee shop was formerly known in the trade as a "bad restaurant corner." Several owners had gone through their resources trying to make it pay.

But the Headliner people, who already had two successful places in town, felt there was nothing wrong with the location that an eye-catching building wouldn't correct.

They believed this firmly enough to stake their record on it, plus a \$33,000 construction bill. A good flow of business vindicated their judgment from the start, and now waiting lines are a common sight.

None of the Headliner's striking design features is for effect alone; the designers and builders, William J. Moran and Company of Alhambra, California, don't go in for gingerbread unless a purpose is served. The louvers, for instance, protect against the afternoon sun; the "zig-zag" shape provides more table space; the pylon shields part of the entrance.

The term for the louvers, incidentally, is "surfboard." They're of perforated Masonite, linked together at the base, and adjusted by hand. Left open at night, they not only capture passing motorists' attention but permit a peek into the attractive interior.

The Headliner is virtually all new; only the kitchen was salvaged from its predecessor. The building is completely air conditioned, but this was in addition to the \$33,000 construction cost.

that paid in the commercial market



Pylon and exterior walls are California redwood, stained brown. Unusual louvers are detailed below

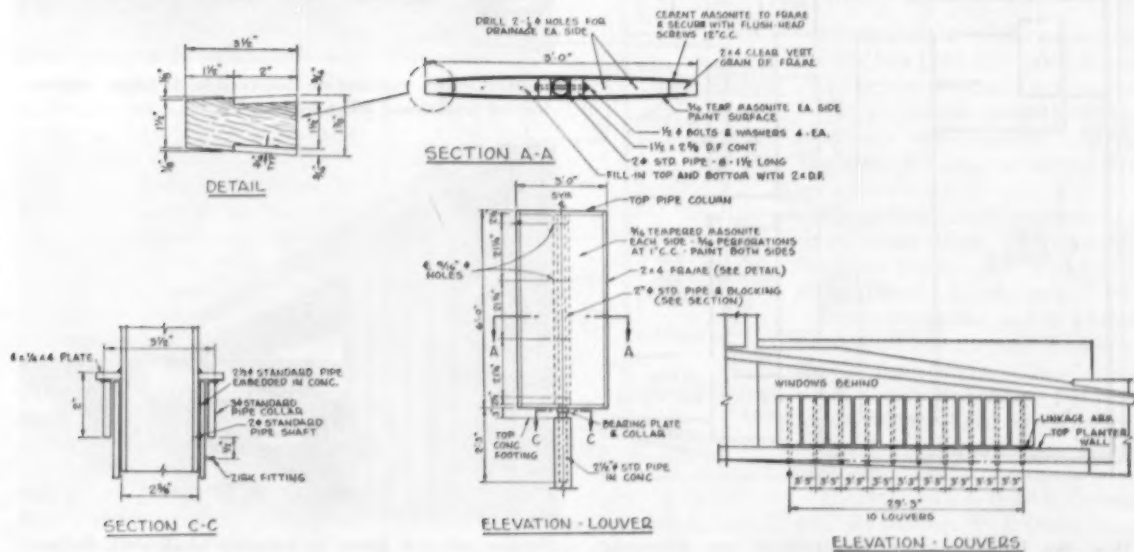

MORE ►

Fresh commercial ideas, continued

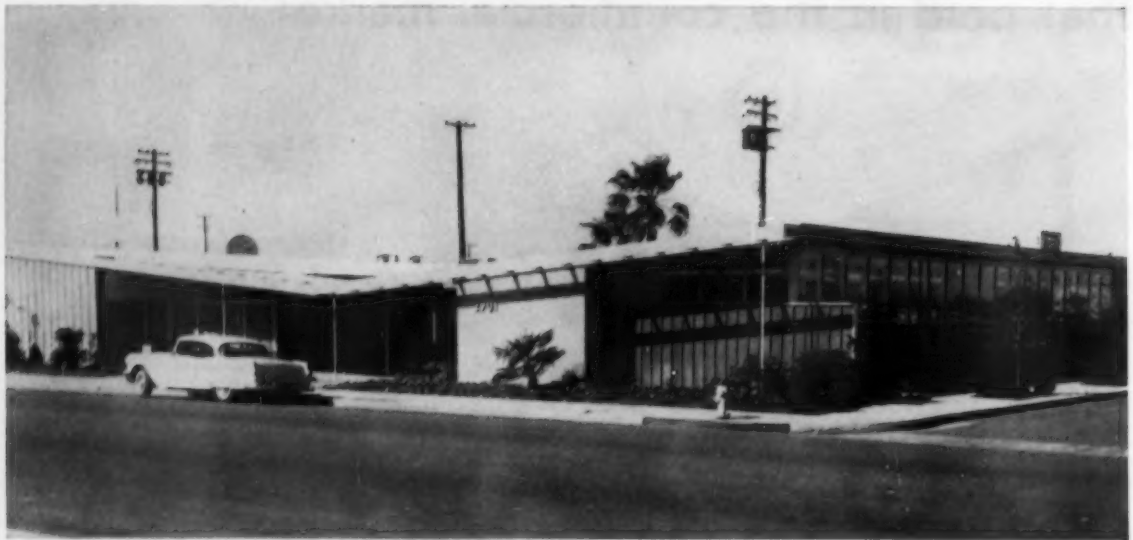

Special attraction of this office building: by not looking like an office it creates a relaxed, informal atmosphere

## California living for offices makes steady

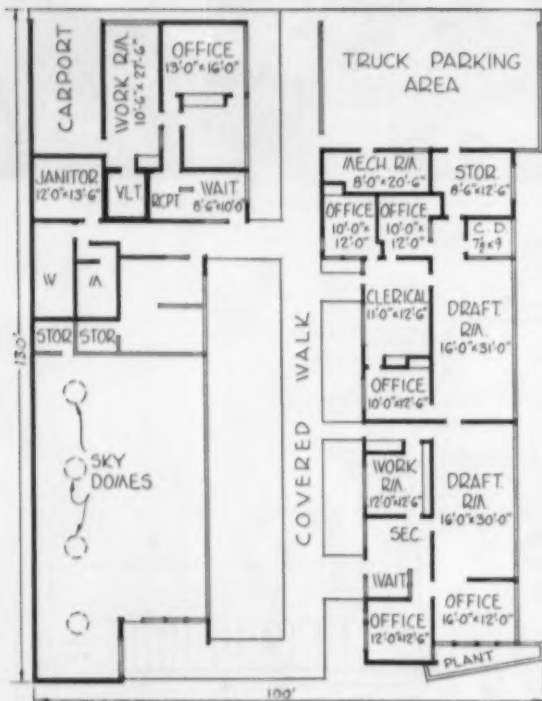

How the indoor-outdoor arrangement was achieved; all rental units open on courts and walks



Central court, covered on sunny side, is happy equivalent of traditional office lobby



Shadow effect is given by concrete block wall. Rafters slant downward for butterfly design

Because there was an earthquake in Bakersfield, California, an architect found himself in the market for a new office. And because the size of the lot he bought was in excess of his own needs, an interesting innovation was made in the design of rental office buildings.

The architect, R. N. Eddy, completely disregarded the conventional notion of The Office—a vertical affair where elevators, cubicles, narrow halls and the like conspire to produce the world of “business.”

In the first place, the lot was in an outlying area where there was freedom to plan horizontally. The design Eddy worked out resembles, more than anything else, a rambling ranch house where tension’s off and the place is leisurely.

The building is of butterfly design, with a central court. The two separate wings are joined at both

## tenants

ends of the court by 4x10 rafters. Along the north wing, these rafters run the length of the building; they’re attached to a row of steel posts down the center of the court. The rafters are roofed here, and there’s a concrete walk underneath. The south strip of the court is left open.

The building is concrete block, painted green. The rafter color is coral. Glass wall area is abundant.

Cost of the 7,400 square foot property (plus 1,200 square feet of covered walk) was \$115,000. Rent is 35 cents per square foot, which—including Eddy’s own space—adds up to \$2,284 a month.

Monthly operating expenses are \$1,400, payment on the loan \$600. Thus Eddy realizes a monthly profit of \$284, which is practically what his own rent would be. And when the 10-year mortgage is amortized, he’ll own the building free and clear.

Space is leased for five years, and with the advantages offered, Eddy doesn’t expect to have a vacancy problem. Among these advantages: all offices face the picturesque court; they’re all air conditioned; and there’s plenty of street parking for tenants and customers.



In simple, cost-reducing system, span of plywood girders eliminates interior load-bearing walls



## Plywood girders solve problem of music studio flexibility

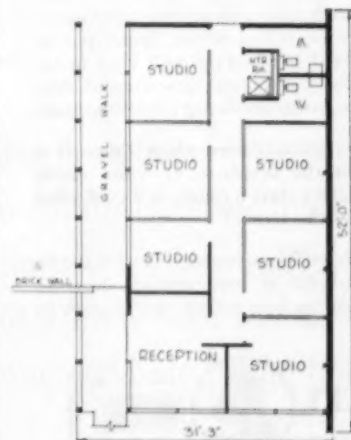

Rooms are set now, but movable wall panels permit easy change

Plywood girders make a free span for this Salt Lake City music studio—the architect’s answer to a request for an economical building with a completely rearrangeable interior. The cost: \$13,500, or around \$10 per square foot.

The girders are left exposed for a clean, simple effect. They span 30 feet at six feet o.c., with a roof deck of 2x6 Douglas Fir t&g plank.

Plywood was also used to achieve the desired interior wall flexibility. Here, light-weight, thin-stressed panels were bolted at base and head for easy removal and relocation.

Exterior walls are glass, set in plywood panels.

The architect was Dean L. Gustavson; the builder, W. J. Deans Sons, both of Salt Lake City.



SelecTemp room units, only 18 inches high, are recessed into wall between studding, and can be painted to match color scheme. Three sizes; 6,000, 12,000, and 18,000 Btu output. No electric wiring or power is used. Small flexible copper tubes carry steam to each room unit.

Why Iron Fireman® *SelecTemp* is the greatest advance in modern heating

## This Quick Quiz Tells Story

*Features never before available help make SelecTemp heated homes highly salable. Installation cost, operating expenses are low.*

**Q.** What features are new and better in Iron Fireman SelecTemp heating?

**A.** (1) Thermostat in every room; (2) modulated (not "on-off") heat; (3) filtered warm air continuously circulated; (4) easily installed in new or old construction; (5) boiler can be located anywhere; (6) moderate operating costs.

**Q.** How does SelecTemp provide individual room temperature control?

**A.** Each room heating unit has its own thermostat. Temperature in any room, including bathrooms, can be raised or lowered without affecting temperature in any other rooms.

**Q.** What is meant by "modulating" heat?

**A.** SelecTemp is not "on-and-off" heating. Each room unit automatically modulates its own heat output. Steam turbine operated fan in each unit runs faster or slower, according to amount of heat needed, gently circulating filtered warm air.

**Q.** What happens when there is a fire in the fireplace, or when warm sunlight enters a room, or a cold wind strikes the house?

**A.** SelecTemp heaters in the rooms affected act at once—cutting down or stepping up heat output—just enough to

maintain the desired temperature in each room. SelecTemp units, mounted in outside walls, quickly sense outdoor temperature changes and automatically increase the room temperature to keep the comfort level constant.

**Q.** Is SelecTemp reasonable in cost?

**A.** Yes. The system is engineered for very economical installation and operation, both in new construction and modernization. SelecTemp, a new, different and revolutionary kind of heating, is one of the most powerful *selling features* you can put into a house.

**Q.** Can SelecTemp heating be used in commercial buildings, too?

**A.** Yes. The same advantages which make it desirable for use in homes also make it ideal for heating motels, apartment houses, schools, office buildings, hospitals; ANY buildings of any size or type.

**SEND FOR FREE SELECTEMP BOOKLET . . .** Contains complete description, with specifications for builders and architects. Use coupon below.

Iron Fireman   
*SelecTemp*  
MODULATING ZONE HEATING



**Iron Fireman Manufacturing Company**  
3102 W. 106th St., Cleveland 11, Ohio.

In Canada: 80 Ward St., Toronto, Ontario.

Please send free descriptive booklet on SelecTemp heating.

Name

Address

City  State



Bedroom telephones are a convenience as well as a reassurance.



Terrace and porch are ideal locations for plug-in telephones.

BUILT-IN CONDUIT

BUILT-IN CONDUIT

Modern, step-saving telephone conveniences are marks of thoughtful construction especially when you install built-in conduit. Wire-free walls add to the salability of a home and the satisfaction of its owner. Include telephone conduits in the homes you build.

Your Bell telephone company will be glad to help you work out economical conduit installations. For details on home telephone wiring, see Sweet's Light Construction File, catalog 8i/Be, or just call your nearest business office.

**BELL TELEPHONE SYSTEM**



# Pittsburgh Glass puts



**WINDOW WALLS OF TWINDOW®**, Pittsburgh's window with built-in insulation, are practical in homes in every price bracket. For Twindow openings mean high-grade workmanship, out-of-the-ordinary value. Another proof of this is the installation of these units in the houses of Place Homes, Inc., South Bend, Indiana, shown here. Fact is, the cost of glass walls compares favorably with that of conventional masonry or other construction. Buyers of new homes, as well as homeowners interested in remodeling, know that Twindow means greater interior comfort, actual savings in heating costs, increased enjoyment of the outdoors from indoors.

**THIS CUTAWAY** shows the make-up of a Twindow unit. Two panes of Plate Glass enclose a dead-air space, giving Twindow its high insulating properties. A stainless steel channel frames the unit, protects the seal and glass edges, making handling easy, quick and safe.

*Every nickel you spend on glass shows.*

*And the results far outweigh the cost.*



# the stamp of *quality* on your homes and remodeling jobs!



**WALL MIRRORS** of Pittsburgh Plate Glass, in the bedroom, living room, bathroom, entrance hall, help you sell your homes faster. For they impress prospective buyers with the superior value of your homes. And in renovating work, they're always in big demand. There's nothing like a Pittsburgh wall mirror to add sparkle to a room. It can make a small room look larger—a narrow one appear wider. Ask your local Pittsburgh glass distributor for full details on structural wall mirrors.



**FULL-LENGTH DOOR MIRRORS** are much in demand, in new homes as well as in remodeling work. You'll be wise to include several—in bedrooms, bathrooms and entrances. They're very easily put up. And they come in five widths—16, 18, 20, 22, and 24 inches. All of them are a full 68" in height and are made to fit all standard interior millwork doors of 80" in height.

## Build it better with **Pittsburgh Glass**

See Sweet's Builders Catalog for detailed information on Pittsburgh Plate Glass products.



PAINTS • GLASS • CHEMICALS • BRUSHES • PLASTICS • FIBER GLASS

**PITTSBURGH PLATE GLASS COMPANY**

IN CANADA: CANADIAN PITTSBURGH INDUSTRIES LIMITED

*Amweld Announces*  
**A NEW PRODUCT** in the LINE  
*designed with the builder*  
*in mind*

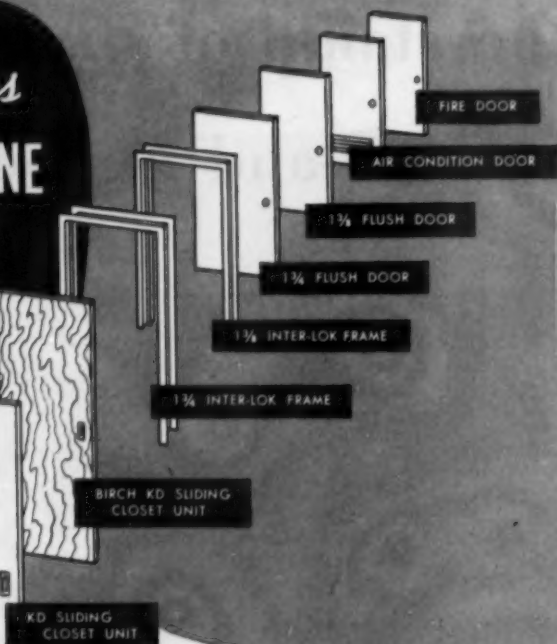
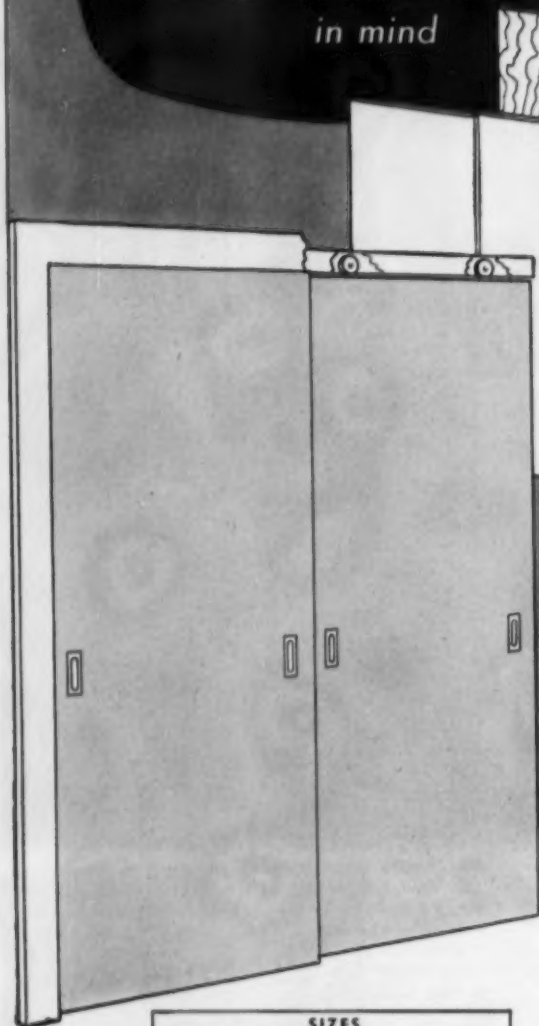

**THE**  
**NEW**  
**top hung "KD"**

SIZES		
Standard 6'10 <sup>7</sup> / <sub>16</sub> " Prime	Standard 6'10 <sup>7</sup> / <sub>16</sub> " Birch	King Size 8'0" Prime
3'0"	3'0"	4'0"
4'0"	4'0"	5'0"
5'0"	5'0"	6'0"
6'0"	6'0"	6'0"

The famous — easy to install — Amweld "KD" steel sliding closet unit, is now available with top hung doors.

Extruded aluminum track and derail-proof nylon rollers give smooth, easy operation.

Valance trim conceals adjustable hangers that insure proper fit.

Complete in one carton, as standard 6'10<sup>7</sup>/<sub>16</sub>" or King size 8'0", the Amweld "KD" unit is quickly and easily installed.

Give your house top sales appeal at low installation cost with Amweld products.



**THE AMERICAN WELDING & MANUFACTURING CO.**  
 310 DIETZ ROAD • WARREN, OHIO

AMERICAN BUILDER

# Doors for closet openings

There are two basic types . . . both have advantages

## 1 Hinged door

the back can be used for extra storage, the front for full-length mirror

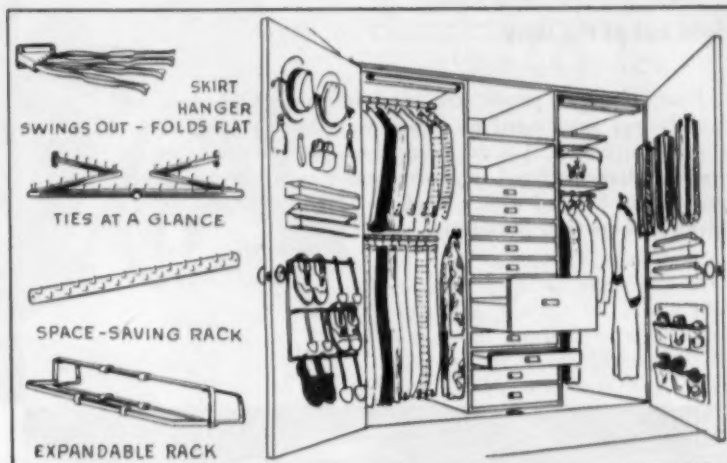

## 2 Sliding or folding door

average unit frees about 6 square feet of floor space

A heavy door works best when hung at top. A track fastened to the frame holds the rollers. Door hooks on with special plates bedded to its top. Small groove guide or roller stop keeps door snug at bottom. Doors on bottom tracks can be used when space at head is narrow. Ball bearings ease the motion.

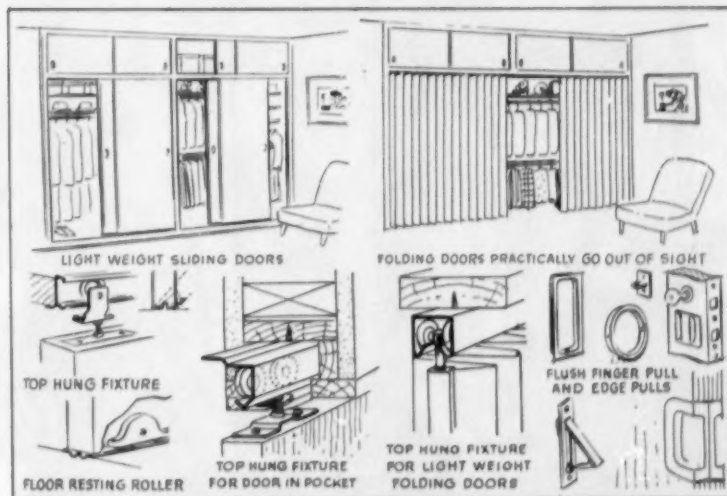

## Your Guide — 14 DOORS TO BETTER CLOSETS

Cooperators in this report on closet-door types:

Acme Appliance Manufacturing Company  
 American Bamboo Corporation  
 Douglas Fir Plywood Association  
 Engineering Sales Company  
 Georgia-Pacific Plywood Company  
 Grant Pulley & Hardware Corporation  
 Heinley Mastercraft Products

Holcomb & Hoke Mfg. Co., Inc.  
 The Hough Shade Corporation  
 Kennatrack Corporation  
 Knappe and Vogt Manufacturing Co.  
 New Castle Products, Inc.  
 Robin Wood Products Co.  
 Rolscreen Company

The Stanley Works  
 Steel Door Institute  
 Sterling Hardware Manufacturing Company  
 Stiles, Inc. (Decor)  
 Warren Shade Co., Inc.  
 Washington Steel Products, Inc.  
 Woodall Industries, Inc.

# 14 doors to better closets

## Hinged panel doors fold out of the way

Four plywood panels are used in this closet door assembly and are hinged in such a way that any part of the closet is accessible. The doors are stock panel units made of a special plastic-surfaced plywood that has a dense surface and can be finished with a single coat of paint. Piano hinges give the doors their flexibility.

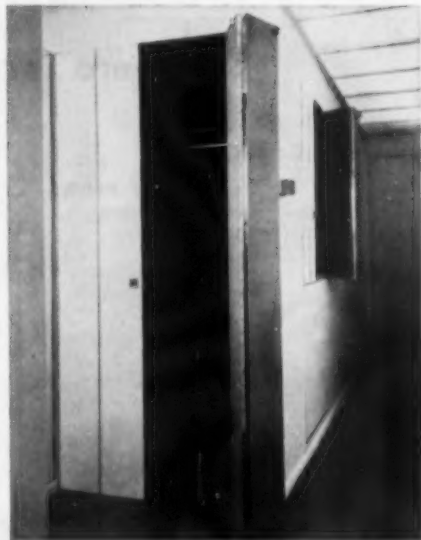

## Birch sliding doors have metal margins

These birch-veneered Novoply doors are easy to install (see drawings), have metal strips at edges. Such doors are also available in Novoply alone, and can be painted to match walls. Doors are 8 feet high, eliminating the need for extra set of doors for closet shelf near ceiling.

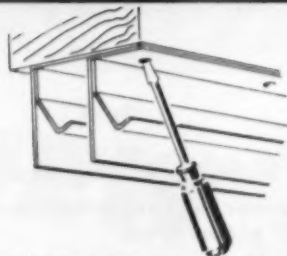

Two hangers are inserted, for front doors, into track and track is screwed to head jamb

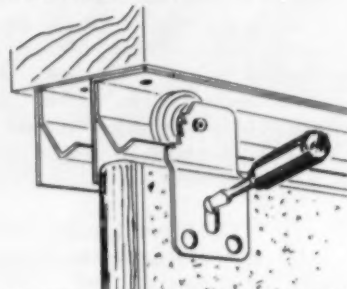

Hangers are attached to door with center screw only. Front door is plumbed and remaining screws are inserted

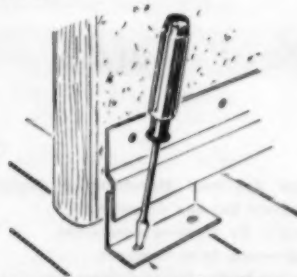

Guide angle is screwed to floor even with end of bottom guide strip

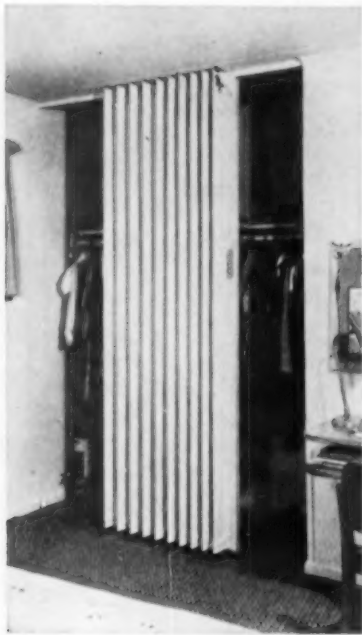
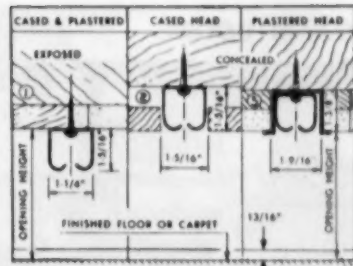

Photo: Hans Geiger Studios



TYPICAL TRACK

Fabric folding doors can be installed at center of closet opening or can be opened at either end and shoved toward center. Accordion-like, these doors can be folded almost out of sight. Some fabric doors can even be slipcovered to match the room. As shown in photograph, all that is needed is  $2\frac{1}{2}$  yards of fabric, 36, 48 or 56 inches wide, iron-on-the-rug tape and a rule and scissors. Instructions to slipcover are simple to follow.

Fabric folding doors come in various widths

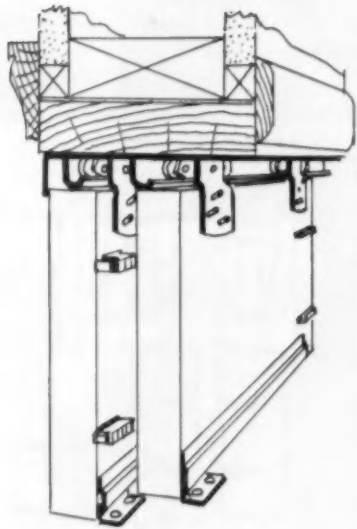

Sliding wood panel doors hung in pairs or multiples

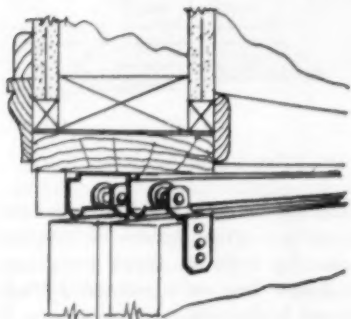

Wood panel doors that by-pass each other are hung in multiples to cover a wall of closets. Track apron in this installation is left exposed and painted to match walls. Hardware is shown as used in drywall construction, without casing. Track can be completely cased as shown in smaller diagram.

## CLOSET DOORS

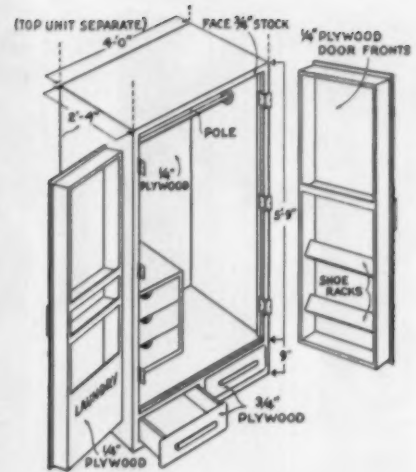

### Backs of hinged doors pay off in extra storage space

These shelf door wardrobe closets make use of the backs of the hinged plywood doors for shelves, shoe racks, mirrors.

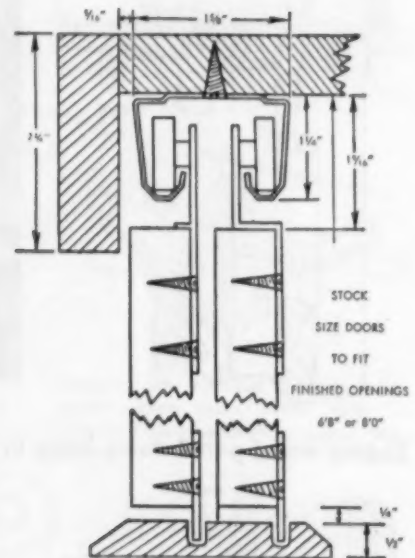
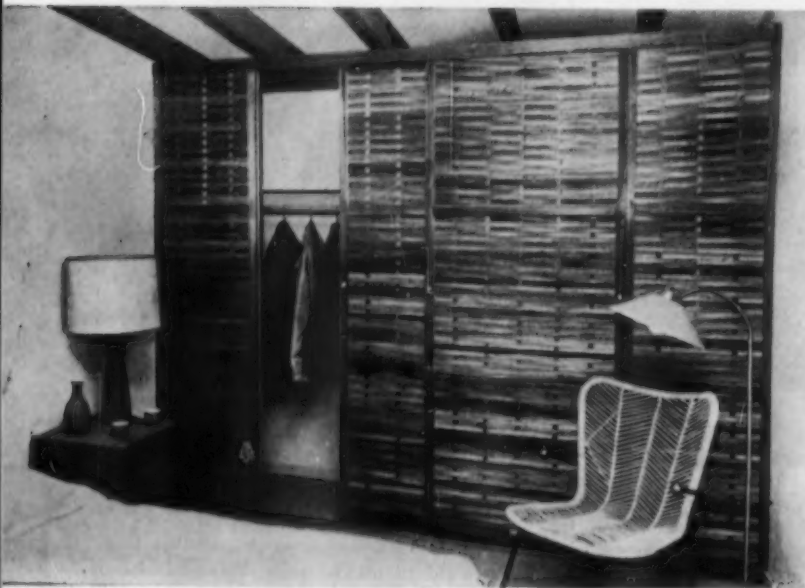

### Sliding doors of basketweave on wood frames

Interwoven sections of Canadian basswood or dark red Philippine mahogany have basketweave pattern, are set into wood frames of standard mortise and tenon construction. The covering material allows ventilation. Two-, three- and four-panel wardrobe doors slide on a concealed track. Standard installation of these doors is shown in drawing.

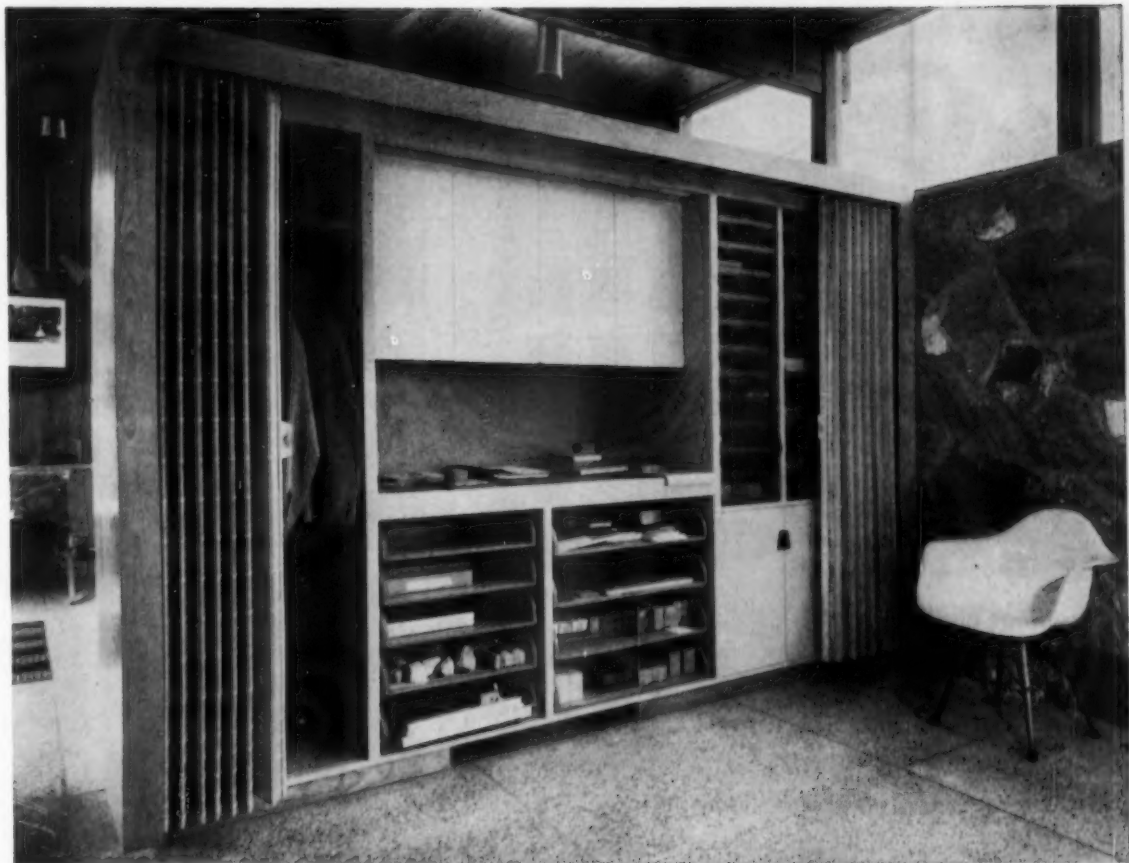

Photo: Kenneth S. Brown

**Basswood slat folding doors can be easily cut to size**



Wood slat doors adapt well to economy installations, can be put on circular tracks for projected closets or room corner closets. Wood slat doors usually come in stock sizes in height to fit a particular installation, but can be cut down to size. A saw is used to cut through the stile molding. Then the wood slat fabric is cut with a shears along a predetermined line.

Wood slat folding doors add to the warm beauty of wood as used in the combined room divider, wardrobe and closet unit shown above. Doors are installed as shown in drawing.

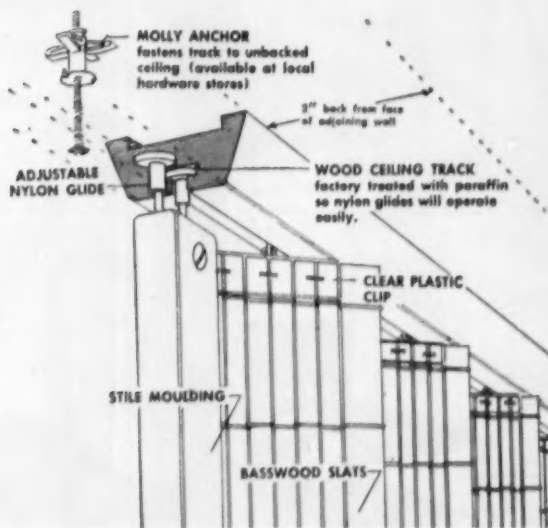

## CLOSET DOORS

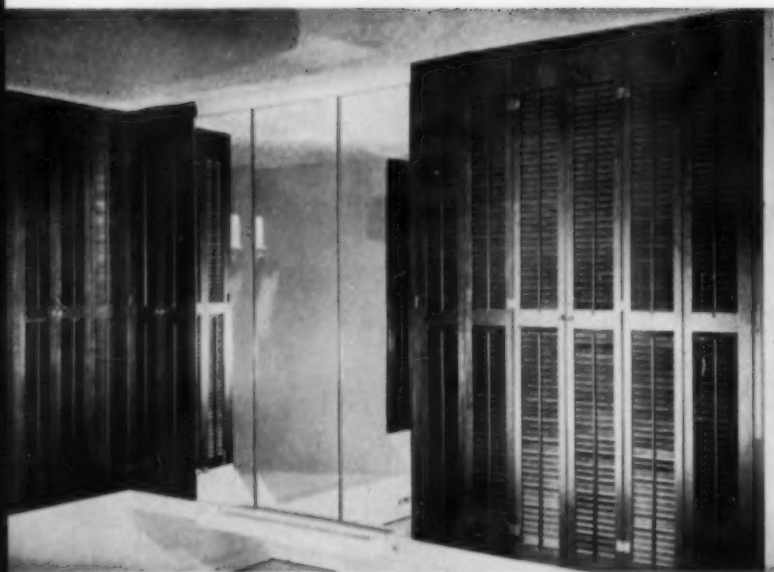

*Photo: Robert C. Cleveland*

### Shutters hinge and fold, allow closet to breathe

Shuttered doors for this closet wall are easily installed with loose pin hinges.

### Louvered doors can be hinged or sliding

Photo shows three installations of louvered doors. Single door is hinged. The tall doors in foreground slide on an exposed track. Double doors to rear background are used in third type of installation. Where closet openings are more than 5 feet wide, a track installation is recommended.

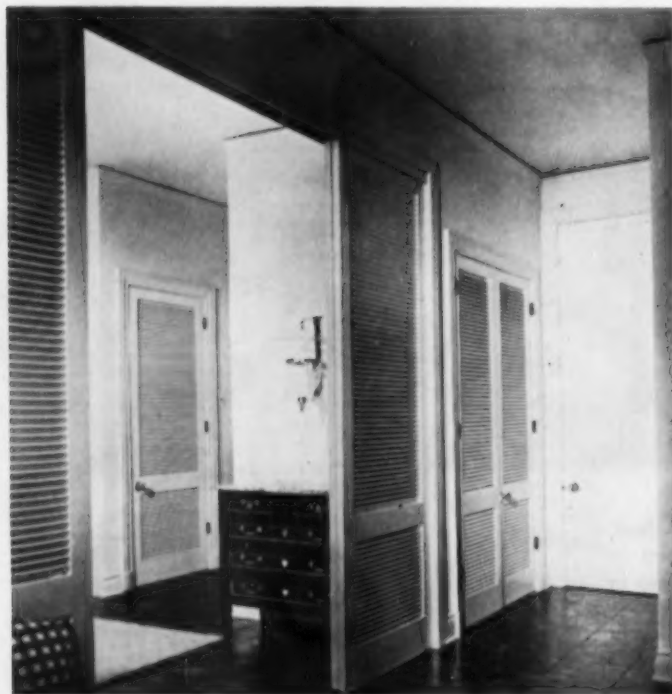

*Photo: Schube-Soucek*

### 8-foot high doors of Masonite

Four edges of these Masonite panels are reinforced with rolled steel tubing, have aluminum thresholds. Doors may be papered, painted or finished to complement room decoration.



### Steel doors can slide or hinge

Steel doors are available for closets in either hinged or sliding units. Hinged doors come complete with door frames. Sliding doors can be purchased two ways: with steel door frame, or with knocked-down header, jamb and track sections for installation in wood frame partitions. For installation details of steel closet doors see the Technical Guide on page 152 of this issue.



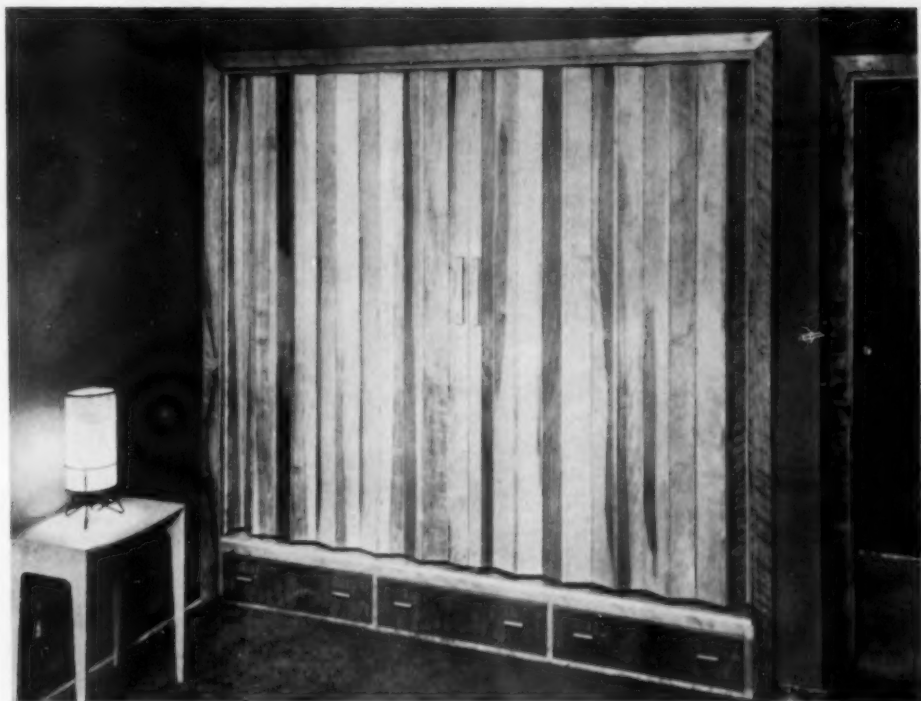

**Wood folding doors**

Natural finish of these wood folding doors gives warm tones to room. Doors can also be purchased painted or unfinished. When the doors are folded back, 95 per cent of the closet is open to view and easy reach.

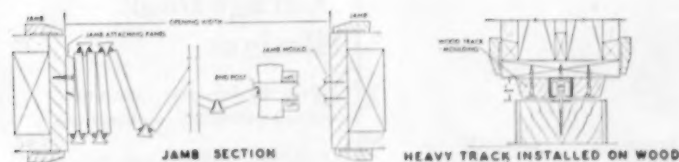

Photo: Marc Neuhof

**Bamboo fabric doors, accordion fold**

Bamboo fabric doors are constructed of strips of innercore bamboo and usually have special molded clips to assure true accordion action. Such doors are space savers, easy to clean and provide an inexpensive ventilated closure. These doors do not require a floor track.

**FRAMING DIMENSIONS FOR SLIDING CLOSET DOORS**

SIZE OF DOOR	12"	14"	16"	18"	20"	22"	24"	28"	30"	32"	36"	42"	48"
<b>2 DOORS</b>													
Rough Opening	2'-1 1/4"	2'-5 1/4"	2'-9 1/4"	3'-1 1/4"	3'-5 1/4"	3'-9 1/4"	4'-1 1/4"	4'-9 1/4"	5'-1 1/4"	5'-5 1/4"	6'-1 1/4"	7'-1 1/4"	8'-1 1/4"
Finished Opening	1'-11 1/4"	2'-3 1/4"	2'-7 1/4"	2'-11 1/4"	3'-3 1/4"	3'-7 1/4"	3'-11 1/4"	3'-7 1/4"	4'-11 1/4"	5'-3 1/4"	5'-11 1/4"	6'-11 1/4"	7'-11 1/4"
<b>3 DOORS</b>													
Rough Opening	3'-1 1/4"	3'-7 1/4"	4'-1 1/4"	4'-7 1/4"	5'-1 1/4"	5'-7 1/4"	6'-1 1/4"	7'-1 1/4"	7'-1 1/4"	8'-1 1/4"	9'-1 1/4"	10'-7 1/4"	12'-1 1/4"
Finished Opening	2'-11 1/4"	3'-5 1/4"	3'-11 1/4"	4'-5 1/4"	4'-11 1/4"	5'-5 1/4"	5'-11 1/4"	6'-11 1/4"	7'-5 1/4"	7'-11 1/4"	8'-11 1/4"	10'-3 1/4"	11'-11 1/4"
<b>4 DOORS</b>													
Rough Opening	4'-0 1/2"	4'-8 1/2"	5'-4 1/2"	6'-0 1/2"	6'-8 1/2"	7'-4 1/2"	8'-0 1/2"	9'-4 1/2"	10'-0 1/2"	10'-8 1/2"	12'-0 1/2"	14'-0 1/2"	16'-0 1/2"
Finished Opening	3'-10 1/2"	4'-6 1/2"	5'-2 1/2"	5'-10 1/2"	6'-6 1/2"	7'-2 1/2"	7'-10 1/2"	9'-2 1/2"	9'-10 1/2"	10'-6 1/2"	11'-10 1/2"	13'-10 1/2"	15'-10 1/2"



*Garage Door Beauty  
that helps sell the home*

**Rō-WAY**  
Individualized  
Garage Door  
Designs

Over 40 decorative designs  
afford unlimited combinations

Flush Doors • Raised Carved Panels  
Applied Rosettes • Accent Molding

*there's a Rō-WAY  
for every  
doorway!*

**Rō-Way**  
OVERHEAD TYPE  
DOORS

Nationwide sales and installation  
service. See your classified  
telephone directory for nearest  
Rō-Way Distributor.

SEE OUR  
CATALOG IN  
SWEET'S

ROWE MANUFACTURING COMPANY 759 HOLTON STREET • GALESBURG, ILLINOIS



**FLEXIBILITY** of arrangement: side by side, one over the other, on opposite walls. Each has its own compressor and condenser in one unit for easy, nearby installation.

**Betty Furness says:**

"These built-in appliances reflect the accent on modern living... their beauty, convenience and compactness insure the homeowner's satisfaction."



House prospects today are shopping more and more for unusual house features. You can steal the thunder from your competition by using this new and exciting built-in refrigerator and freezer. These handsome, new built-in appliances offer wide flexibility of arrangement; a high degree of space organization; and well-integrated storage of all foods, fresh and frozen. Available in Brushed Chrome, Sunshine Yellow, Cascade Aqua or Gleaming White, this built-in pair will keynote the trend to modern living.

## New Westinghouse Built-in Refrigerator and Freezer

An excitingly different idea to quicken prospect interest!

The 8.3 cu. ft. Westinghouse Built-in Refrigerator, Model BRH-80, has automatic defrosting, adjustable shelves, door shelves and a giant double-door crisper. The companion 6.3 cu. ft. Freezer, Model BFH-60, has a roll-out drawer for odd-shaped frozen packages and a 220-lb. frozen storage capacity.

For complete details, contact your distributor or write direct.

WESTINGHOUSE ELECTRIC CORPORATION  
Electric Appliance Division • Mansfield, Ohio

**YOU CAN BE SURE...IF IT'S Westinghouse**

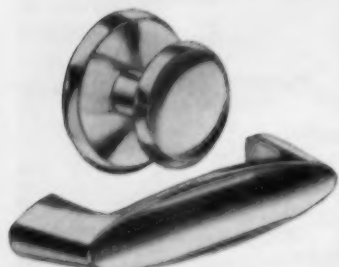

MATCHING CONCAVE CABINET HARDWARE

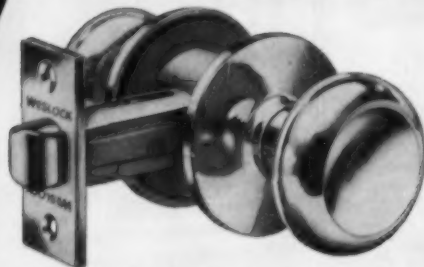

NO. 500 CONCAVE SERIES IN REGULAR  
AND BLACK ROSE® FINISHES

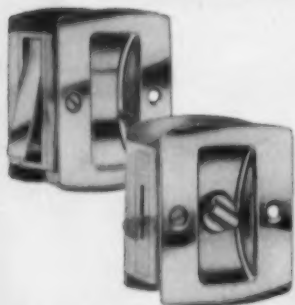

WESLOCKS FOR SLIDING POCKET DOORS



NO. 95 SCREEN DOOR LATCH

WATCH FOR AN  
IMPORTANT NEW  
WESLOCK ITEM  
TO BE ANNOUNCED SOON

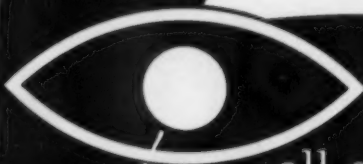

all eyes are on  
**WESLOCK**

The style leader in  
residential builders hardware

Weslock creations add distinctive  
styling to basic dependability,  
and ease of installation  
at budget prices.



WESTERN LOCK MFG. CO.

*Manufacturers of Weslock Residential Locksets and Builders Hardware*

GENERAL OFFICES:

211 NORTH MADISON AVE., LOS ANGELES 4, CALIF.

FACTORY:

HUNTINGTON PARK, CALIF.

# How Timken Silent Automatic heating equipment helps you sell homes faster!

**Home Buyers Are Especially Brand Conscious Today! That's Why It Pays Off—In Faster, Easier Sales—When You Build Timken Silent Automatic Units Into Your New Houses!**

Yes, years of building fine products, plus years of national advertising, backed by aggressive sales promotion have made the Timken Silent Automatic name a standard of top quality for home buyers. This means that heating units that carry this name help create faster acceptance for your houses.

**Timken Silent Automatic Heating Means Buyer Satisfaction over the Years!** Top-quality materials and finest engineering standards are part of the time-tested Timken Silent Automatic tradition. These units stand up year after trouble-free year. Make friends for you as a builder.

**Our Plans Engineering Department Helps You with Heating Layouts!** Here's a handy service that can mean extra money in your pocket. Timken Silent Automatic service engineers will help with your heating plans! They will be glad to suggest exact unit, size and shape, from our full range to fit your exact need. Help you avoid costly waste, over-buying.

**Ask About the "Development Builder Plan."** Whether you are building one house or 50, there is Timken Silent Automatic heating equipment to suit your needs, and at a profitable price for your project. If you are specifying for a group of housing units, be sure to ask for details of the Timken Silent Automatic "Development Builder Plan."



**Closet-Size GFK-100 Counter-Top Gas Furnace.** Ideal for small slab or crawl-space houses. Three sizes, from 75,000 to 125,000 BTU. 66 inches high, 29 inches deep, from 16 3/4 inches to 23 3/4 inches wide.

**Modern Home Special. The compact OFH-80 Oil Furnace!** Complete in fully-integrated, accurately balanced unit. 26 inches sq. by 66 inches high. Saves space, saves installation costs. No noise, no roar. Only one moving part in burner.

**Thrifty Heater that produces more hot water. Oil-fired QWK-50.** Provides 50 gallons hot water per hour. Amazing low-cost operation. Fully automatic. Uses less than four sq. feet of floor area. Comes with all copper heat exchanger.

And these are only three examples from a full line of quality oil and gas heating equipment manufactured by Timken Silent Automatic



Check this coupon for helpful information on heating . . .

Dept. AB-75, Timken Silent Automatic Division  
Scaife Company, Jackson, Michigan.

Please send me information about  
 Gas Heating Units    Oil Heating Units    Oil-Fired Water Heaters

I plan to build \_\_\_\_\_ houses.

Name \_\_\_\_\_

Address \_\_\_\_\_

City \_\_\_\_\_ State \_\_\_\_\_

## Look what's happening



This carport design provides protection on two sides, creating a sort of half-garage . . . But even here, in a house of similar design (right photo) the owner is enclosing the voids in the exposed walls with masonry. The front faces north, and when left open as a carport, the shelter is subject to drifting snows in the winter time



These two houses have the same plan but different elevations. In both, the carport has the same relation to the plan. In the left view, storage cabinets line the rear wall of the carport, but rubbish cans can only be left in full view of the street. Photo right shows how owner is filling in with framing studs for enclosing carport



These two houses are a part of a development in which each house has an attached breezeway and carport. To encourage a sale, owner of the house at right has enclosed carport, with a high fence adjoining to shield the breezeway from the street

## to the carports!

Carport or garage? Do buyers really want garages or will carports do just as well? This is a constant question that haunts builders of projects when in the planning stage. An argument which has had general influence is the one which says that the carport, being cheaper, creates a price advantage for the house and gives it a competitive edge in the market. But when the carport becomes as common in new developments as it now is, this argument loses most of its meaning. Maybe the time has come to face the truth that carports rarely add either to the looks of the house or of the development as a whole, and that Mr. and Mrs. Buyer all along would rather have had a garage, and could have paid for it. In any case, this roving-camera study taken recently by *American Builder* in several new projects shows what owners think of their new carports after living with them for a while.



The extension of the roof line over to the corner masonry piers forms an inexpensive carport, open on three sides except for a group of storage units which extend part way up on the rear wall. BUT . . . see below



The owner of an identical house, plan reversed, has now enclosed the carport with frame on two sides and an upward-acting door on the front



JOHNSON, FRONK AND OLSON (l. to r.) call themselves Builders and Developers, Inc. Their first venture is a 120-acre tract acquired for \$185,000. Here the builders will feature houses in the \$30,000 to \$50,000 range. Land for Forest Hills was bought on a purchase release contract, with a down-payment of \$15,000. The contract term is 10 years with a 4 per cent interest rate. The builders have a clause in the contract which enables them to pick up the land faster, if they so desire. For the present, they plan to develop the 20 acres shown here, opening the project with three houses to be shown during National Home Week in September. Forest Hills will have a central water system, septic systems, 2-in. black-topped roads, curbs and gutters. Lots run from \$2,500 to \$5,000.

## Cooperative land purchase and development

Is this the answer for small builders who are up against a scarcity of building sites and rising lot costs?

Minneapolis builders Emil Fronk, Roy Olson, and Harold Johnson have recently formed a corporation to purchase and develop land for their own use. Though this is not the first of such new groups springing up around the country, it is a good example of what may be a strong trend for the future.

Cooperative land development has many aspects. Many things must be taken into consideration at the outset; otherwise, many problems can come up, many serious enough to split the organization later on. Emil Fronk believes that the one most important factor is picking the right men to form the combination. He sets down these prerequisites:

- 1) The cooperating builders must build houses of similar nature in the same price range;
- 2) Must have the same credit rating;
- 3) Must be industry minded;
- 4) Must be equally energetic;
- 5) Must be willing to cooperate.

Fronk suggests that a cooperating group should not include more than five builders; otherwise the organization will be too unwieldy.

### *Finding the land*

After the corporation has been formed, the builders can begin the search for land. This should be a long-term affair, according to Fronk, who suggests that it is not out of line to tie up land that might not be used for 10 years. The group will either have to pay cash for the land or may be able to get it on a purchase release contract. The purchase release contract has a better tax advantage for the land owner and might be a selling point.

### *After acquiring the land—then what?*

This is where the "equally energetic" precaution is important. Fronk and his colleagues divided up the many questions that arise in land development, such as: preliminary

the necessary work and each proceeded to find his set of answers to land planning, preliminary FHA and VA approval, zoning, engineering, roads, water, electricity, gas, telephone, septic or sewer system, curb and gutter, financing, and finally the actual platting.

### *How are the lots divided?*

After the land has been staked out, the Minneapolis builders appraised the lots at the going market price for similar property. When they finished, they had, for instance, six lots at \$5,000, 12 lots at \$3,000, and 12 lots at \$2,500. They divided the lots equally among themselves; one builder would take a high lot and then a low one, and so on.

Other similar ventures have thrown the lot numbers in a hat, for a drawing. However, this procedure can lead to hard feelings, if one builder feels that his "lot" has not turned out as well as the others. Fronk believes that strict coopera-





Plot plan of the first 20 acres of Forest Hills

tion is the only way to divide lots.

Each Minneapolis builder plans to use his own subcontractors. By so doing they believe they will cut down on delays, achieve greater individuality and lessen the chance of dissension developing.

**Who will sell the houses?**

One of the builders, Harold Johnson, operates a real estate firm which is doing big things with trade-in selling. The corporation has decided to use the Johnson office as sales agent for all the houses.

The group has set up rules for the selling of the lots. For instance, if a customer of one builder wants a lot owned by another builder, the two builders will trade lots.

**How will the corporation make money?**

The land development corporation will make its money on the sale of the land to the cooperating builders. The funds will be used to build the capitalization so that the corporation will be able to purchase and develop land in the future. With small developments of from 20 to 30 acres, Fronk and his associates plan to handle all details themselves.



Typical of the houses that will be built in Forest Hills is this one by Harold Johnson



Emil Fronk plans houses of this size for Forest Hills, to be built on contract only



Roy Olson will duplicate houses of this character. Olson builds on speculation

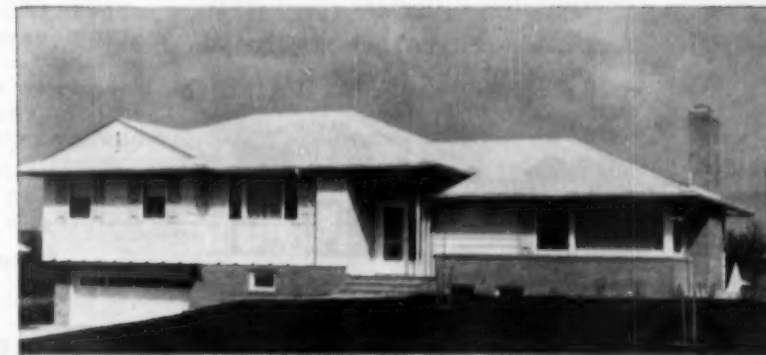

This split-level design will be used by Harold Johnson for some of the sites on rolling land in the tract

# HERE'S the "MAGIC" of the MAGIC CIRCLE!



perspective

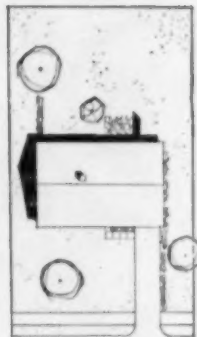

interior lot

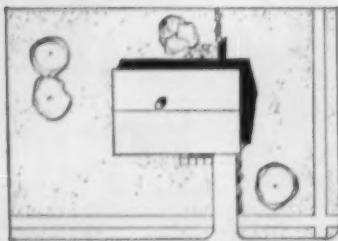

corner lot  
site plans



side

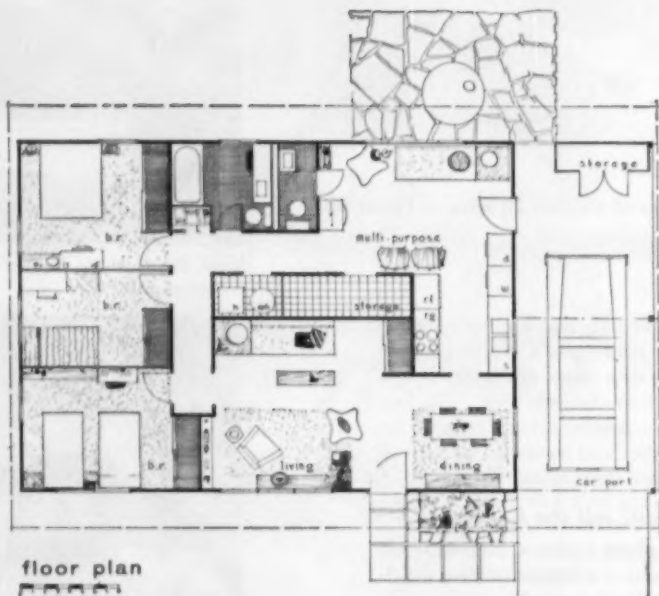

floor plan

## A PLAN WITH REAL SALES APPEAL!



front



front (alternate)  
elevations

a glance at the Magic Circle floor plan tells you that this is a home that will appeal to parents with small children. look at the ease and step-saving efficiency of moving from one part of the house to any other. how easy it is to route the youngsters with muddy feet away from areas mother has just cleaned.

intelligent planning and competitive prices sell homes. you'll find both these features in Richmond Homes.

for detailed information write



**RICHMOND HOMES, INCORPORATED**  
DEPARTMENT 1 • RICHMOND 1, INDIANA • PHONE 8-1636



*nothing's more violent than a tea party!*

## POMONA TILE

Scorching utensils, acids, rough abrasions, anything that mars ordinary hard surfaces has no effect on Pomona Tile's "Space-Rite" Perma-glaze deck tile. Fused by an exclusive Pomona process, Perma-glaze has flint-like hardness. That is why this steaming kettle and potent lemon juice acid prove harmless to its lifetime jewel-like surface. Note the smart, new 6" by 4 1/4" size tile in Pomona's textured Sun Yellow Perma-glaze. To guarantee complete client satisfaction, specify Pomona "Space-Rite" tile.

*Write for free catalog with actual tile samples of full line of colors.*

**POMONA TILE MANUFACTURING CO.**

629 N. La Brea, Los Angeles 36, Calif. • York 1177

Seattle • San Francisco • Pomona • Long Beach • Arkansas City, Kan. • Houston • St. Louis  
Phoenix • Salt Lake City • N. Hollywood • N. Kansas City, Mo. • Chicago • Denver • Dallas



BUILDER — EICHLER HOMES, INC. ARCHITECTS — A. QUINCY JONES AND FREDERICK EMMONS

## Stanley Track and Hangers slide these smart new garage doors!

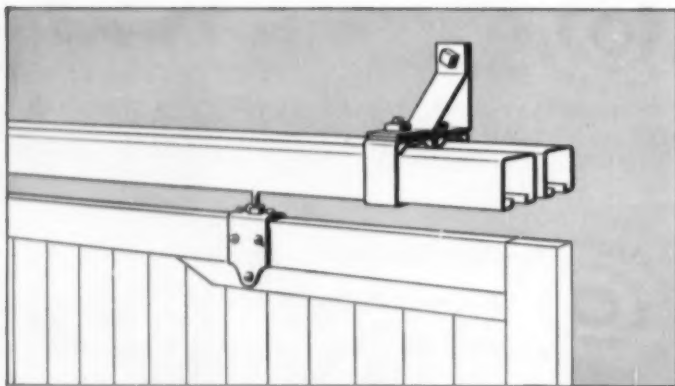

Sectional view showing Stanley Hardware used in garage shown above.

X2650 Hangers — Ball bearing swivel and roller bearing wheels. BBX2650 has ball bearing wheels.

X2641 Track — Wrought steel in japanned finish and straight as a die — galvanized available.

X2651-D Track Brackets — Vise-like action prevents rattling — assures flat, straight surface for hangers.

Other track and hanger hardware available for sliding doors of all types, weights and thicknesses.

These garage doors hang on Stanley X2650 Hangers and slide on Stanley X2641 Track. Notice how the builder and architect of this \$50,000 house in Palo Alto, California, achieve the unbroken wall effect on this side.

Track and hanger hardware for residential sliding doors is not new, but this striking use suggests interesting possibilities. Rugged, simple, easy to install and low in cost, track and hanger sliding doors may be just what you're looking for.

See your supplier, or write Stanley Hardware, 107 Lake St., New Britain, Conn., for complete information on Track and Hanger Hardware and Interior Sliding Door Hardware. Ask for Folder G43R.



**STANLEY** Hardware  
© A Division of The Stanley Works

# How **apco** America's Finest Aluminum Window... reduces building costs...speeds new home sales!

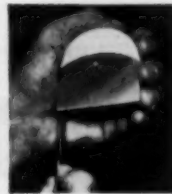
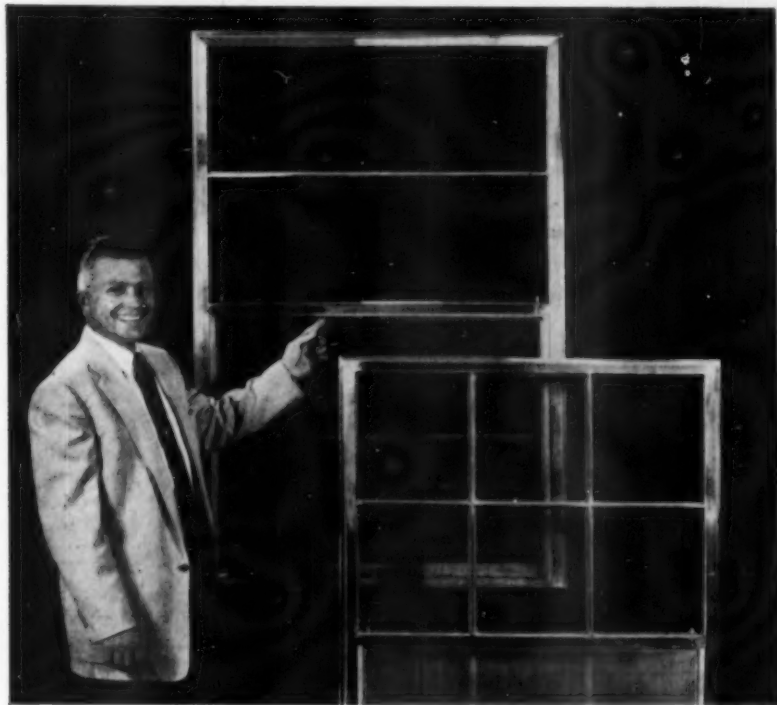

**PULLMAN SPRING TAPE BALANCES** of stainless steel are concealed within jambs. Offer silent, trouble-free service... assure **EASY**, finger tip operation.



**TWIN LOCKS** assure maximum protection. Made of sturdy aluminum alloy, they are placed at extreme sides of meeting rail. Do not obstruct vision.

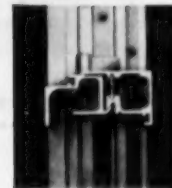

**BUILT-IN WEATHER-STRIPPING** of aluminum-backed woven wool pile makes APCO Windows weathertight... dust-free... draft-free. Eliminates binding and sticking.

**SUCCESSFUL BUILDERS HAVE USED OVER 1,000,000 **apco** WINDOWS TO SELL HOMES FASTER!**

Beautiful APCO design and smooth operating performance impress prospective home buyers... make homes easier to sell. APCO adds style and grace that makes windows a strong selling feature rather than a construction detail.

*Completely Assembled Unit... Ready to Nail Into Opening... Reduces Building Costs!*



APCO Window arrives completely glazed, screened, weather-stripped, with installation hardware attached.

APCO Window can be handled easily by one carpenter. Needs no adjusting, no fitting.



Easily installed in a matter of minutes, APCO Window gives lifetime, trouble-free operation.



The single-hung APCO Aluminum Window is engineered to reduce costs of new home construction, remodeling and light commercial building. Because APCO's fixed meeting rail is tenoned through the jamb, APCO Windows are stronger, more rigid, easier to operate.

You insure structural beauty and lifetime customer satisfaction when you use APCO. Single-hung and picture window units available in all popular sizes. See Sweet's Light Construction File 5a/ALM for complete details and specifications.

### Special offer to dealers and distributors!

All over America dealers and distributors are selling APCO Windows with the help of APCO's strong national advertising program. Over 1,000,000 selling messages in HOUSE & HOME, PRACTICAL BUILDER and AMERICAN BUILDER, plus direct mail, pre-sell your window customers, make greater profits for you. Inquire about the APCO franchise in your area. Mail coupon today.

### Get the **apco** story!

#### ALUMINUM PRODUCTS CO.

1901 Franklin Ave., Houston 2, Texas  
Rush me the complete APCO story.

I am a:  Builder  Distributor  Dealer  Architect

COMPANY \_\_\_\_\_

ADDRESS \_\_\_\_\_

CITY \_\_\_\_\_ STATE \_\_\_\_\_

BY \_\_\_\_\_

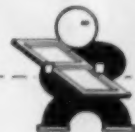

(AB-2)

## Test your building

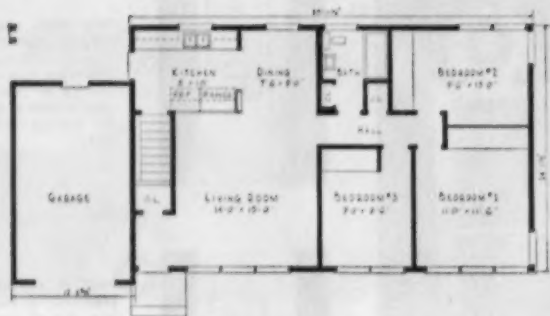

House has 960 square feet plus garage, and full basement. Assume that all lumber and millwork material is precut, banded and delivered to the site

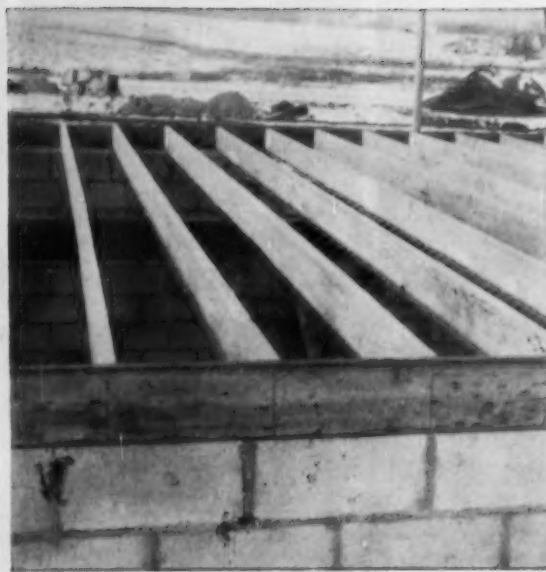

**1** CAPPING: for speed, use 24-foot joists, with 4x8 sheets of plywood for the deck

## Could you build it in 325 man hours



**3** TRUSSES AND ROOFING: use 1x8's for roof decking, then lay 210-pound asphalt shingles. How much time?



**4** EXTERIOR FINISH is done after roofing. Use shakes with shingle backer, plywood and battens for gables



**5** FLOORING: lay oak flooring over the entire 24x40 area at one time. Partitions can be tilted up later

know-how on this one:

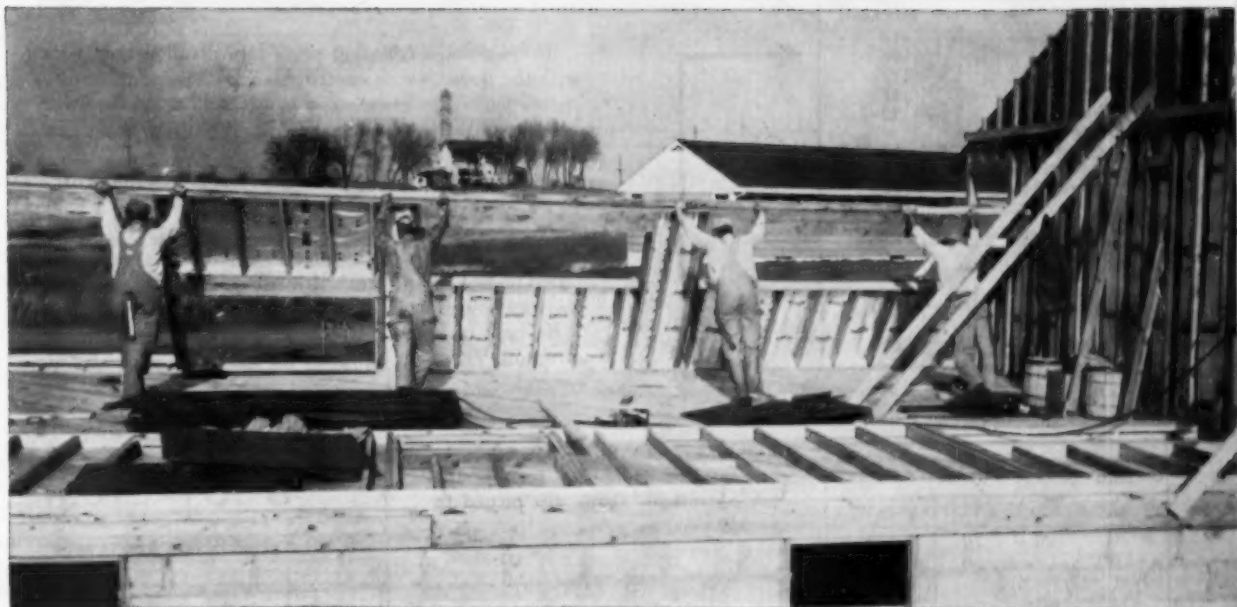

**2** FRAMING: build walls in sections, installing 4x8 sheets of 25/32 insulated sheathing and 48-inch blanket insulation. Tilt walls into place. How many hours should it take?

for carpentry and labor?

FOR TIME SCORE on each of these operations, turn the page →



**6** FRAMING INSIDE AND PARTITIONS: apply plasterboard to walls and ceilings before partitions are installed. Taping of plasterboard comes after partitioning



**7** INTERIOR FINISH: Trim-out is the last step. Use power tools, to keep the job to what total time?





PLAN NO. 301 STANDARD

HOUSE NO.	DATE COMPLETED	CEILING	WALLS	CONCRETE	ROOF	FLOORING	PAINT	GLASS	IRON	STEEL	MECHANICAL	ELECTRICAL	PLUMBING	LAND	REAL ESTATE	TOTAL COST	NET PROFIT
ESTIMATED COSTS																	
1																	
2																	
3	1924 EMERSON	4/8/55	1870	11200	6000	700	165000	1500	5700	13000	18000	17000	17000	17000	17000	17000	17000
4	8100 FLEMING	4/15/55	1870	11200	6000	700	165000	1500	5700	13000	18000	17000	17000	17000	17000	17000	17000

HOUSE NO.	DATE COMPLETED	CEILING	WALLS	CONCRETE	ROOF	FLOORING	PAINT	GLASS	IRON	STEEL	MECHANICAL	ELECTRICAL	PLUMBING	LAND	REAL ESTATE	TOTAL COST	NET PROFIT
1																	
2																	
3																	
4																	
5																	
6																	

SUMMARY RECORD: After the building is completed and all costs are known, they are entered on this form, which is a summary record of 28 accounts showing all costs, overhead, land, real estate commission, total cost and profit

CARPENTERS												LABOR				
ESTIMATED	CAPPING	FRAMING	ROOFING	ERT FINISH	SHEETROCK	FLOORING	INSIDE FINISH	UNCL.	CLEANUP	HAULING	GRADING	MISC.				
	415.60	1932.490	48.45	916.90	681.00	30.20	68.40	69.16	3.90	8.55	52.80	1.20	1.20	1.60		1
	416.38	1934.53	49.25	1960.24	74.20	15.00	85.88	28.70	79.80	8.20	9.10	1.07	1.07	1.02		2
	53.14	96.19		16.20	41.70	30.80	23.80	64.80	1.80	7.05	5.12	3.07	1.02			3
	2.00	7.00		1.40					4.15	1.02		1.02				4
	1.80	4.80		7.20					3.05	8.20		3.07				5
				20.40					5.32							6
	46.78	185.70	49.25	916.90	105.00	47.70	114.80		5.60	5.27						7
									22.84	16.36	4.09	6.13				8
																9
																10
																11
																12
																13
																14
																15
																16
																17
PRICE	160.00	816.00	649.00	75.50	4050.00	9.200	5760	13600	14600	6500	55000	110000				18
	122.25	816.00	649.00	75.50	4057.84	9.200	5760	13600	14600	6500	55000	110000				19
	57.50															20
LABOR	409															21
	185.84															22
																23
																24
																25
																26
PRICE	540.00	320.00	2600	5.00	20.00	60.00					16.00					27
	560.00	320.00	2576	1.76	15.62	869	14	14			16.00					28
				1.85	19.27	310	14	14								29
				1.00	7.81	1470	14	14								30
				4.61		500	14	14								31
						500	14	14								32
						6.00	14	14								33
						200	14	14								34
						400	14	14								35
						500	14	14								36

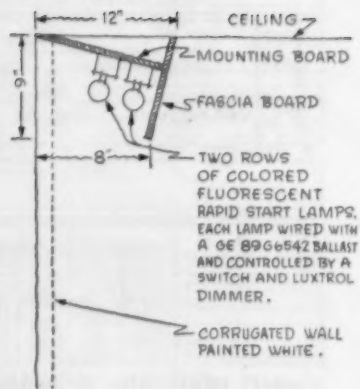

Dimmer-control for cornice lighting over corrugated curtain wall gives changing intensity of colored light. Note that the birch cornice board and mounting board for the fluorescent tubes are angled

## Bright-as-Day Basement . . .



Lighting for work bench in basement hobby room is by an 8-foot fixture with 4-40 watt rapid-start warm white fluorescent lamps. The light is thrown on the bench and not into the eyes of the person standing at the bench. Outlets below pegboard provide power for tools

Lighting and switch control layout for basement of Brynhaven house

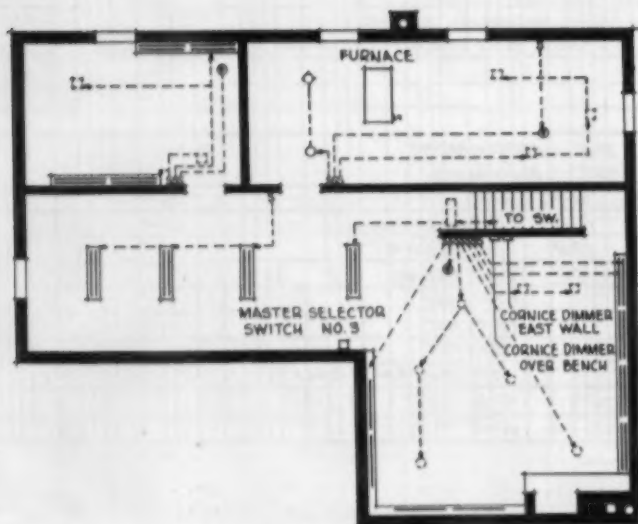

Fresh from a successful opening in Elmhurst, Illinois, is a furnished model for the 400-unit Brynhaven subdivision of Cooperative Home Builders, Inc. of Chicago. The Public Service Company, a division of Commonwealth Edison, cooperated with the builders in designing the latest in light-conditioning into the house.

This expert planning for lighting shows up with great effect in the basement area, the largest portion of which is used to create a sparkling recreation room. As the above photograph shows, lighting-wise the central feature is a curtain wall of corrugated cement-asbestos board, painted white, with cornice lighting above it, operated by dimmer control. This material is ordinary industrial siding, is inexpensive and in this case is applied with patented nails to furring strips. Non-metallic, it avoids condensation problems and makes a successful surface for the reflection of the colored light thrown on it in varying degrees of intensity by switch control.

Cornice lighting over built-in seating on the other side of the fireplace, four large recessed ceiling

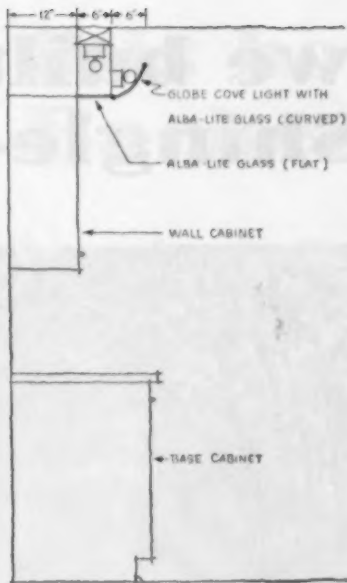

Kitchen lighting for sink area in the Brynhaven house is by a soffit scheme using 1-20 watt trigger start warm white fluorescent lamp for one unit and a 2-40 watt lamp for the other unit

## and two new ways to light kitchen and bathroom

lights, and a set of four fluorescent ceiling units round out the lighting scheme for the recreation room. Electrically, the recreation room also provides for TV, telephone and intercommunication system connections.

The finish work on this recreation room is interesting. Note in the photo how the Lally column and steel I-beam have been faced with  $\frac{1}{4}$ -inch birch Panawall. This was done by securing 2x4's to the column and to the steel webbing of the beam with a Ramset power fastener. The Panawall was then wrapped around the post, with edges mitered and glued, and glued and partially nailed to the beam. Panawall was also used to face the wall to the right of the fireplace. After furring strips were applied to the concrete wall,  $\frac{1}{2}$ -inch foil-backed plasterboard was applied, then Panawall was nailed to the plasterboard.

Ceiling of the room is 12x12 acoustical tile in stria pattern, applied with mastic to plasterboard furred down. The floor is asphalt tile.

Operating the entire lighting



Soffit lighting over lavatory in bathroom of Brynhaven house has a 2-40 watt rapid start warm white fluorescent lamps controlled by wall switch in bathroom as well as by three other wall switches, one in each bedroom

system in the Brynhaven house is a remote wiring system which provides low voltage switching. Three conveniently located master selector switches permit lighting to be activated in several locations.

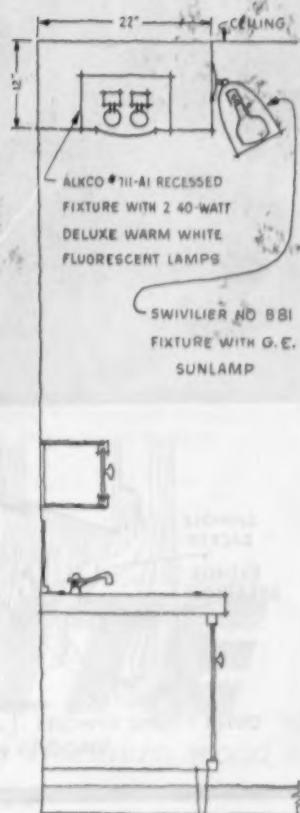

# “Saved \$130, yet we built Insulite’s Shingle-



**This is the system that saves you money** on homes like this. Cuts application time. Practically eliminates waste. Builds a tighter, stronger home. See how you can build better and save with the Insulite Shingle-Backer System. Free cost-comparison forms and picture literature show how. Write Insulite, Minneapolis 2, Minnesota.

# this home better with Backer System"

... Lawrence Wanhouse, Jr., president,  
L. Wanhouse and Son, Madison, N. J.

"We save anywhere from \$85 to \$130 per home with Insulite's Shingle-Backer System depending on the size of the house. We've discovered that it not only cuts our sheathing and under-coursing time, but it gives us a tighter, stronger sidewall with extra insulation value. On top of that, there's practically no waste." Here's how Insulite's Shingle-Backer System can help you build better for less.



**Bildrite Sheathing goes up faster, easier.** Cuts application time as much as 43%. Four-foot sheets have twice the bracing strength as horizontal wood sheathing, thus save corner-bracing. Waterproofed throughout with asphalt... eliminates need for building paper. Can be used or stored anywhere in any weather. Practically eliminates cutting and matching waste.



**Insulite Shingle-Backer speeds completions.** Adds extra insulation value to sidewall. Developed by Insulite, the handy panels apply far faster and easier than wood under-course shingles... cut application time in half. Produce deep, modern shadow lines. Eliminate waste. Waterproofed throughout with asphalt. Delivered in easy-to-handle packages.

Build better and save with

# INSULITE

Made of hardy Northern wood



INSULITE DIVISION Minnesota and Ontario Paper Company Minneapolis 2, Minnesota

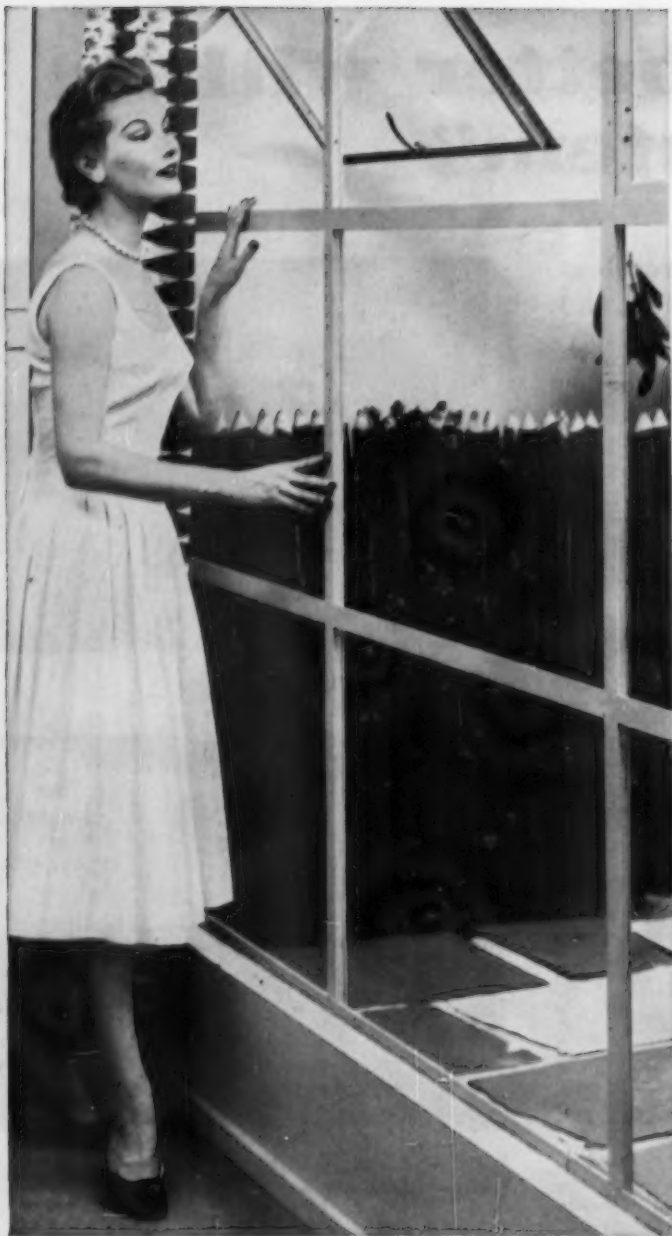

## Here's how that "better"

### Win her with windows and wide open space.

Give her a view through Truscon Steel Ranch Windows. They're ideal for every "picture window" use—and provide ventilation, too! All steel—no chance of warping, swelling, shrinking, rotting. Paint to match room decorations and exterior siding. Awning-type ventilators can be fitted with sliding wicket screens. When viewed from outside, this window tends to minimize the "wide open" effect characteristic of large undivided glass areas. Sizes for dining rooms, dens, sleeping rooms. All take standard double insulating glass. A Truscon value carried in warehouse stocks.

### Show her a take-it-easy kitchen.

Give her a Republic Steel Kitchen. Design your "custom tailored" kitchens using economical, easy-to-install, standard cabinets in Republic's big line. Load it with work-saving accessories and clever special cabinets to catch her eye, make her want *your* house. Splash it with colorful Formica counter tops or gleaming stainless steel. Provide special cabinets for built-in cooking units. Contact your Republic Steel Kitchens distributor; get his special builder prices and quick delivery-to-site service. Look him up, or write Republic for his name.



**REPUBLIC STEEL CORPORATION**  
3128 East 45th Street  
Cleveland 27, Ohio

Please send me more information on:

- Truscon® Metal Windows and Doors  
 Republic Steel Kitchens

Name \_\_\_\_\_ Title \_\_\_\_\_

Firm \_\_\_\_\_

Address \_\_\_\_\_

City \_\_\_\_\_ Zone \_\_\_\_\_ State \_\_\_\_\_

K-0581

# to sell her home she wants

Folks are actively in the market for bigger, better, more attractive homes.

Signs indicate that "desire" is beginning to replace "need" in buying homes.

You builders have done a tremendous job of providing shelter when the overwhelming need for shelter existed.

Now is the time to cash in on "desire."

And, several ways to help you cash in are demonstrated by these highest quality Republic Steel Building Products.

See Sweet's File; and send coupon below for your personal copies of facts, details, specifications.



## Capture sun and sky for her.

Vary your design with Truscon Aluminum Awning Windows for maximum light and ventilation. Here are heavy substantial aluminum sections. Weathertight, too, thanks to vinyl plastic weatherstripping which completely seals the perimeter of all ventilators . . . actually triple sealed to assure complete protection. Popular modular and regular sizes quickly available from Truscon warehouse stocks.



## Show her wide see-in, reach-in closets.

Convince her with closets that your house is *for* her. Use Truscon Steel Sliding Closet Doors in every closet opening. You'll save dollars on framing, fitting, hanging these doors, too. And quiet! They glide on nylon. Truscon Sliding Closet Doors and Flush-Type Swinging Doors are available from Truscon warehouses.

# REPUBLIC STEEL

*World's Widest Range of Standard Steels and Steel Products*



World's most  
glamorously lighted  
room holds many  
sales ideas!

**T**HE lighting concepts in this "Celestial Room", created by General Electric lighting specialists, are far advanced over anything in even today's costliest homes. In daring and imagination, it looks like a room in 2055 instead of 1955. But it's full of down-to-earth, practical ideas you can use (even in the most modest homes) to add the show-off selling points that alert builders use to close sales.

Here are some of the secrets of the "Celestial Room's" beauty and usefulness; It's lighted by ceiling-recessed G-E color reflector lamps—twelve in all, with four pink, four blue-white and four yellow lamps.

Three dimmers, each controlling ceiling lamps of a single color, can produce an almost unlimited number of changes in color and intensity, ranging from a gentle glow to a blaze of sunlight. The changes in brightness and color values seem to create a new kind of world indoors.

Valance and cornice lighting in the room uses General Electric 20-watt fluorescent lamps, also on dimmers.

Any or all of these General Electric Light Conditioning ideas can add sales appeal to your living, dining and recreation rooms. For more information on these and scores of other light conditioning ideas, write General Electric, Dept. 482-AB-7, Nela Park, Cleveland 12, Ohio.



No, the lamp in the background can't light the chair as well as shown here. Most of the light on the chair comes from a distance—from a G-E 75-watt reflector spotlight recessed in the ceiling, and from a valance on the wall behind the chair.



The desk is lighted by a ceiling-recessed spotlight. In addition, General Electric 40-watt fluorescent lamps are mounted in the wall valance over the desk, to add diffused light to the whole area.

**GENERAL**  **ELECTRIC**



**Your Guide to NEW PRODUCTS Information**



Markwa marble tile can be applied with adhesive or mortar. The adhesive is spread with notched trowel, covering only the wall space that can be tiled in an hour's time



No adhesive is placed on tile, but tile is pressed into adhesive firmly and twisted in place. Tiles are applied just as they are lifted from the package



A string is used to space the tiles correctly, row after row. It can be removed after all the tiles are set, or row by row



When setting marble tile with mortar, each tile is buttered and placed exactly where it belongs without twisting and then is tamped into place



Markwa marble tile is cut to fit with the usual tile setter's tools. A tile setter's saw is used to make initial cut, clippers are used to complete it

## Thin slices of quarried marble available as floor and wall tile

Markwa tiles are sliced to a thickness of one-half an inch, are available in 18 marble colors. The wall tile has a polished finish and is furnished with the usual cushion edges. The floor tile has square edges and a matte finish. Cushion edges for the floor tile can be specially ordered. Packed, ready for shipment, Markwa marble tile weighs only 7½ pounds per square foot. It is fabricated in three sizes: 8x8 inches, 8x12 inches and 12x12

inches. The marble can be applied over painted plaster walls, over plywood, cement or concrete walls or floors with adhesive. It can also be applied over any uniform concrete, masonry, cinder block or similar construction with mortar. Available through selected tile dealers. Retail price: about \$2.85 per square foot, varying somewhat with varying costs of the marbles. Vermont Marble Company, Dept. AB, Attn., F. E. Aronson, Proctor, Vt.



All joints are filled with white Portland non-staining cement mixed with water to consistency of thin cream, and spread on with the hand. Excess grouting cement is washed off later

**New builder trucks on the market**



**Ford half-ton pickup truck has payload up to 1,718 pounds**

Ford's new F-100 6½-foot pickup offers a choice of two short-stroke engines—the 118-h.p. "Cost Clipper Six" and the

132-h.p. "Power King V-8." The truck features a 45 cubic foot pickup box that is riveted and bolted to give extra

strength and rigidity. Smooth, heavy-gauge steel side panels give unobstructed loadspace full length (78 inches) of body. Seasoned wood floorboards are interlocked with durable steel skid strips extending the full length of the floor. Truck has four stake pockets in corner posts to mount uprights for special tops. Special equipment like Fordomatic drive, power brakes, radio and overdrive are extra. Wheelbase: 110 inches. Loading height: 24.2 inches floor to ground, loaded, with standard tires. Ford's F-100 line of trucks also includes 6½-foot platform stake trucks and 8-foot panel ½-ton trucks. Distributed through independent Ford dealers. The Ford Division of Ford Motor Company, Dept. AB, Attn. W. E. Blanchard, Coordinator Ford Truck Advertising, P. O. Box 608, Dearborn, Michigan.

Circle No. 702 on Readers' Reply Card, p. 146

**Dodge line features 12 power ratings**

Seven engines with 12 different horsepower ratings power the new C-3 series of Dodge job-rated trucks. Realizing that users of low-tonnage trucks have different hauling problems, Dodge makes available either 6-cylinder or V-8 Dodge truck engines for any type of hauling job in the ½-ton, ¾-ton and 1-ton fields. Four entirely new cabs are offered in the low-tonnage line and also in most all of the new C-3 models. Each cab has about 62 inches of hip room and 59 inches of shoulder-room

to provide comfortable space for three large men. The new 169-horsepower power-dome V-8 engine used in ½, ¾, and 1-ton models features a single rocker shaft, free-turning valves, vacuum spark advance, valve guides that are integral with the head, hydraulic valve tappets, and a 7.6 to 1 compression ratio. Distribution through Dodge dealers. Dodge Division, Chrysler Corporation, Dept. AB, Attn. W. L. Kessinger, Detroit 31, Mich.

Circle No. 703 on Readers' Reply Card, p. 146



Three men ride in comfort in cab

**Chevrolet puts new design features in truck models**

Style leader in Chevrolet's new line of 75 truck models is this "Cameo Carrier" truck with red-trimmed cab. In answer to the trucker's desire for more compact design, most Chevrolet wheelbases have been reduced—some as much as 8 inches. Panel bodies are wider with a gain in load space. Models also have wider front treads, straight frame side-members, improved suspensions, improved cab comfort, appreciable gain in window area, tubeless tires as standard equipment. New cowl-type ventilation admits air through a plenum chamber with controls on either side of the dash. Six choices of transmissions are available: 3- and 4-speed Synchromesh, the Hydramatic and Powerglide. Automatic shifts are confined to the light- and medium-duty models. An



overdrive, which reduces engine speeds at cruising range, is available for light-duty trucks. Sold through established Chevrolet dealers. Chevrolet, Central Office, Division of General Motors

Corporation, Dept. AB, Attn. Herman P. Sattler, A-209 G. M. Bldg., Detroit 2, Michigan.

Circle No. 704 on Readers' Reply Card, p. 146

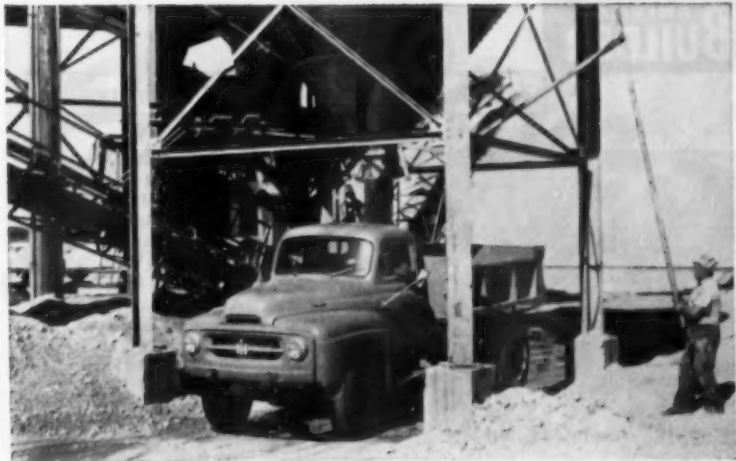

### International Harvester's R-line features dump and utility models

International model R-164 Loadstar, shown above, is a truck of 142-inch wheelbase, with 2½-yard dump body. It is one of 168 basic truck chassis models just introduced with International Harvester Company's new R-line. Gross vehicle weight rating of the illustrated model, one of a balanced group of Loadstar models the manufacturer builds in medium, heavy-duty chassis, is 17,000 pounds. Standard engine is the 108-horsepower International Silver Diamond 240. Gasoline or LPG fuel systems are available. Service-utility bodies, matched to chassis and designed

specifically for on-the-job service or utility work, are available on two International light-duty models, the R-110 and R-120, with gross vehicle weight ratings from 4,200 to 6,500 pounds. There are two body sizes, the 77-inch for 115-inch wheelbase models and 89-inch for 127-inch wheelbase models. Available through International Harvester motor truck dealers, International Harvester Company, Dept. AB, Attn. John W. Branta, 180 No. Michigan, Chicago 1, Illinois.

Circle No. 705 on Readers' Reply Card, p. 146



### Willys Jeep can do many things

Attachments that go on the Willys "Universal Jeep" make it a versatile machine for building operations. Shown in the photo is the Jeep-A-Trench attachment driven by the Jeep's rear power take-off. A gear reduction to the wheels gives it forward movement controlled by the operator. A controllable speed winch is available for propulsion in extremely muddy conditions. The trencher can be furnished with either winch or wheel propulsion, or with both at extra cost. Depth is controlled in this model by hydraulic pressure.

Other attachments available with the Universal Jeep: lift-type post hole digger, earth-moving equipment, fork lift hydraulic loader, and grader blade for smoothing, grading, ditching. Willys also is offering a 4-wheel-drive Jeep truck with back hoe digger which has a maximum digging depth of 12 feet, maximum reach of 13 feet, maximum swing of 160 degrees. Available through Willys commercial vehicle distributors and dealers, Willys, Motors, Inc., Dept. AB, Attn. S. A. Green, Toledo 1, Ohio.

Circle No. 706 on Readers' Reply Card, p. 146

## 10 DAY TRIAL WARREN-KNIGHT TRANSIT-LEVEL

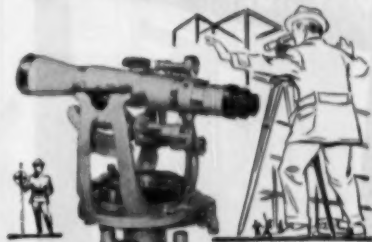

MODEL 38bf

Try 10 Days On Your Job With No Expense Or Obligation to Purchase

New Model Warren-Knight Transit-Level shown above operates like a transit—but costs only ONE-HALF THE AVERAGE TRANSIT PRICE. Yet, it has the exclusive advantage of being adjusted like a Wye Level. This new instrument has a 24 power internal focusing telescope, coated optics, sealed in objective, covered leveling screws, heavy reinforced horizontal limb, limb vernier reading to one minute, and has a beautiful finish.

Of special advantage are features of design and construction that assure you a greater value per dollar of investment.

Get the full facts. Write for Bulletin F-57



136 North 12th St., Philadelphia 7, Pa.

CONTRACTORS, BUILDERS...

cut cement  
finishing time  $\frac{1}{2}$

**AUTOMATIC ELECTRIC  
PONY TROWEL**  
(PAT. PENDING)

**PAYS FOR ITSELF  
IN ONE-DAY'S OPERATION!**



Floats and finishes complete to wall. One-man operation. Self-adjusting blades. Successfully tested two years nationwide. Use own ½" or ⅝" drills. Easily assembled. Sturdily built.

HANDLE AND TROWEL COMPLETE LESS DRILL **\$4950**

F.O.B. Muncie, Ind.

Extra Blades Only \$3.50

See Your Dealer or Order Direct  
**ELMO MANUFACTURING CO.**  
DEPT. 3, 324 W. HOWARD ST., PARKER, INDIANA

A PERFECT  
INSTALLATION  
EVERY TIME



ALL-STEEL  
**Kennaframe!**  
sliding door wall pocket

- Prefabricated
- Completely adjustable
- Easy to install
- Warp-proof
- Trouble-free

The simplest and surest way to install a 1 $\frac{3}{4}$ " door that slides into the wall is to use prefabricated, WARP-PROOF KENNAFRAME. Adjustable three ways to fit all 2x4 walls. Takes any kind of wall finish. Nails can not pierce steel jamb to damage door. Choice of two types of hangers. Eight nylon wheels per door.

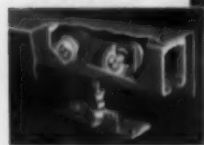

**FREE BUYER'S GUIDE** describes and illustrates the complete Kennaframe line. Write for your copy today.



**KENNAFRAME CORP.**  
ELKHART, INDIANA

**AMERICAN  
BUILDER**

Your Guide to **NEW PRODUCTS** Information



**Asphalt tile simulates wood plank floor**

A departure from the square-cut look of floor tile, "Modnar" is an asphalt tile in plank form 4 inches wide and 24 inches long. Made in  $\frac{3}{8}$  inch and  $\frac{3}{16}$  inch thicknesses, the woodtone colors are driftwood, oak, maple and walnut and may be laid in one color or any combination. Available through flooring contractors at approximately 25 cents per square foot installed. The Tile-Tex Div., Flintkote Co., Dept. AB, Attn. M. C. Howell, 1232 McKinley Ave., Chicago Heights, Ill.

Circle No. 707 on Readers' Reply Card, p. 146

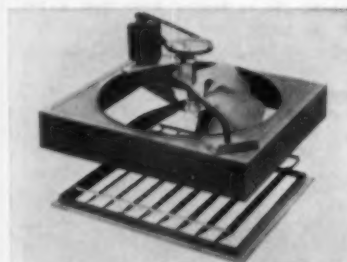

**Low-cost attic fan for project builders**

The "Suburban" attic fan, while it has quality features necessary for long-life and efficient operation, is specifically designed and priced for builders who purchase in large quantities. Easily installed—well opening of 32 $\frac{1}{2}$  inch by 36 $\frac{1}{2}$  inch—the fan comes complete with automatic ceiling shutter. In addition to bearing the certification label of the Power Fan Manufacturers Association it also carries a factory guarantee. Reed Unit Fans, Inc. Dept. AB, Attn. Harold B. Patterson, 1001 St. Charles Ave., New Orleans, La.

Circle No. 708 on Readers' Reply Card, p. 146

**New copper tube for interior sanitary drainage systems**

The new copper drainage tube, Type DWV, recommended for interior sanitary drainage systems, is lighter and has a thinner wall than Type M also pro-

duced by this manufacturer. Type DWV tube is supplied, hard temper, in 20-foot straight lengths. When drainage lines are laid underground, Type L or heavier copper tube should be used. Type DWV copper tube is designed for use with standard solder-type cast bronze drainage fittings. Available now through plumbing supply wholesalers. The American Brass Company, Dept. AB, attn. S. F. Cook, 25 Broadway, New York, N. Y.

Circle No. 709 on Readers' Reply Card, p. 146



**Access door for crawl spaces**

This new door has been developed to eliminate the problem of entry to crawl spaces. Pivoted at the bottom, the door may be easily removed from the frame, for easy access. Installation is similar to that of a metal basement sash as the frame is flanged to project into mortar joints of brick or slots in concrete block. Available through building supply dealers it is made in two sizes: 30 $\frac{1}{8}$  inch by 12 $\frac{1}{2}$  inch lists at \$7.75; 32 $\frac{1}{2}$  inch by 18 $\frac{3}{4}$  inch lists at \$8. The Donley Brothers Co., Dept. AB, 13910 Miles Ave., Cleveland 5, Ohio.

Circle No. 710 on Readers' Reply Card, p. 146

**Heating cable staples to ceiling lath eliminates central heating plant**

A home heating cable that is stapled to ceiling lath and then completely covered with plaster is now available. Called "Meier Radiant Cable," the cable can be installed in a whole house in a day. The only visible part of the system, once installation is completed, is a small thermostat in each room. The system has been approved by Underwriters' Laboratories for either plaster or dry-wall construction. Available now through electrical wholesale houses. Price: cost per 1,000 watts installed (including thermostat, will vary from \$50 to \$60 according to area. Meier Electric & Machine Co., Dept. AB, attn. Heating Division, 3525 East Washington St., Indianapolis, Ind.

Circle No. 711 on Readers' Reply Card, p. 146

*Everything  
the gals want!*



**built-ins\***  
**new colors**  
**work-saver**  
**features**  
**modern styling**  
**enduring**  
**beauty**

**make the kitchen  
your salesroom!**

You build a good house. So do hundreds of other quality builders. But your models can have greater sales appeal at no extra cost.

Better kitchen planning makes the big difference. Color and practical beauty are your best salesmen.

With Beauty Queen, finer quality

and extra refinements stand out... Beauty Queen kitchens look like more value; they are more value!

Let a Beauty Queen kitchen specialist help you plan better kitchens with all the glamour of custom built installations but at a much lower cost.

Write today for color folders and A.I.A.  
File on the complete Beauty Queen line.



\*Norge Built-In Unit 2400  
shown above

**Beauty Queen**

DIVISION TOLEDO DESK & FIXTURE CO. MAUMEE, OHIO

**for project homes!**



**for apartments!**



**for economy remodeling!**



**Pacemaker** **STAINLESS STEEL SINKS**  
by *ELKAY*

**a new name \* a new price  
costs no more than cast iron!**

So that you, the builder, can now offer "wanted" stainless steel in all your jobs, ELKAY has introduced Pacemaker stainless steel tops and bowls. This new, low priced line is ideal for project building, apartments and remodeling — for all budget kitchens. And, it costs no more than cast iron! The public wants stainless steel so they can forget sink replacement—forget chipped and worn porcelain. You can give them Pacemaker... the "eye-catcher" in your house-selling kitchens. Write, now, for complete information.

\* Backed By An Established Reputation

**ELKAY MANUFACTURING COMPANY**  
1874 S. 54th Ave., Chicago 30, Illinois  
The World's Oldest and Largest Manufacturer of Stainless Steel Sinks Since 1920

AMERICAN  
**BUILDER**

**NEW PRODUCTS**



**Stainless steel used throughout in lock set**

This new series of heavy duty cylindrical locks is recommended for marine, commercial, industrial and residential installations requiring hardware to withstand extreme corrosive abuse. Not only is stainless steel used for finish and trim but all parts of the mechanism are of this non-tarnishing and corrosive-resistant metal. Available through hardware distributors, firm prices will be quoted on specific request. Schlage Lock Co., Dept. AB, Attn. R. W. Ebey, San Francisco 9, Calif.

Circle No. 712 on Readers' Reply Card, p. 146

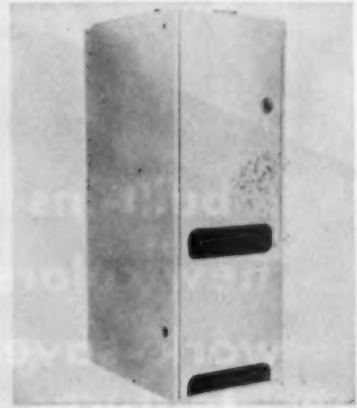

**Counterflow furnace features self-sealing base**

Outstanding feature of Holly's new counterflow furnace is an accessory base which provides an airtight seal at floor level and may be used on all types of floors. Rated at 105,000 Btu's the unit requires a floor area of 20-inch by 28-inch and is 58 inches high. Gas-fired, the supply line can be connected through the top or side of the casing. An easily accessible summer switch is located on top of the furnace. Available through Holly distributors and dealers. Holly Mfg. Co., Dept. AB, Attn. Kent Cochran, 875 South Arroyo Pkwy., Pasadena 2, Calif.

Circle No. 713 on Readers' Reply Card, p. 146



...and the  
right man is  
 an old friend  
 of yours!

\* You know him well. He's your lumber dealer. And today, millions of prospective home owners are getting to know him—and YOU—through the pages of their favorite magazines.

In big national publications such as The Saturday Evening Post—Better Homes & Gardens—American Home—House Beautiful—House & Garden—Living—they are learning why you and your lumber dealer are the ideal source for quality workmanship and quality building materials.

**Get this BALANCED INSULATION sales help!** Today your lumber dealer can help you capitalize on a brand-new trend that is sweeping the country—and is making a powerful appeal to prospective home owners everywhere. It is *balanced insulation*—the right combination of Balsam-Wool® Sealed Insulation and Nu-Wood® Insulating Sheathing, storm sash and weather-stripping to provide maximum fuel savings and greater summer comfort, too, in any home in any climate.

Waiting for you at your lumber dealer's is a complete balanced insulation kit. Here is everything you need to give your sales of quality homes an extra push. Ride the balanced insulation trend to more profit in 1955! Wood Conversion Company, 118-75, 1st National Bank Bldg., St. Paul 1, Minn.



“Thank goodness, we found  
the right man, Sonny!”

“See that guarantee, Sonny? It means this house has *balanced insulation*—the kind that keeps us comfortable all year around and saves your dad plenty of money on fuel bills. But we'd never have a guarantee like that if we hadn't found the *only man* who could offer it.”

Who is the man that can offer YOU such lasting assurance of home comfort and fuel savings? He lives right in your community: your lumber dealer. He alone gives you a *money-back guarantee* of satisfaction when you insulate your attic with Balsam-Wool® Sealed Insulation. He alone, working with your builder, can provide the right combination of Balsam-Wool Insulation and Nu-Wood® Insulating Sheathing for balanced insulation benefits—for these products are sold by lumber dealers only.

Whether you build or remodel, remember, your lumber dealer knows and sells quality building materials. *He knows quality builders, too*—and can help you select the right one for your job. Wood Conversion Company, Dept. 118-75, First National Bank Building, St. Paul 1, Minnesota.

Send for Copy, “Facts About Insulation For Your Home”



\*Reg. U.S. Pat. Off.

**BALSAM-WOOL**

*Sealed Blanket*

*Guaranteed*

**INSULATION**

**QUICK WORK**

*but good*

**DRYWALL TRIM  
EDGE GUARD**

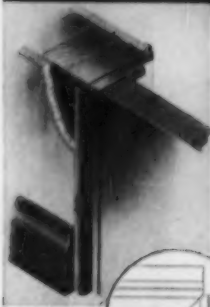

**No. 101  
Edge Guard**  
— for door and window casings. Easily installed before or after wallboard is in. No spackle required around this trim.  
Galvanized steel for  $\frac{3}{8}$ "- $\frac{1}{2}$ "- $\frac{5}{8}$ " board. 7'-12' lengths. U. S. Pat. No. 2,663,390, Canadian Pat. No. 506,022.

$\frac{3}{8}$ "- $\frac{1}{2}$ " Factory Mitered at no extra cost.  $\frac{1}{2}$ " square cut.

Patented design—grips board with firm spring action. No spackle required.



**No. 106 —  
No. 108 Edge Guard**  
Insure neat, protective finished edge. Is built at corner, nailed through board into stud. Knurled for good spackle adhesion. Paint adheres. Means beautifully

No. 106

finished job. For  $\frac{3}{8}$ "- $\frac{1}{2}$ "- $\frac{5}{8}$ " board, 7'-12' lengths. Packaged —

96 — 7' pieces 60¢  
50 — 12' pieces 60¢



No. 108



**No. 220  
For External  
Wallboard Corners**

Note rounded corner design to give extra protection against hard bumps. Means correctly finished corners — permanently. Knurled for good spackle adhesion. Easily cut and fitted. Nails easily, quickly

through board to stud. A better job — no extra cost.

Size 1"x1"-8'-8' lengths packed 1000' to crate.



for complete information write.

**SPECIAL LENGTHS on all PRODUCTS**

**DRYWALL TRIM, INC.**

2808 N. Fairwell Ave. • Milwaukee 11, Wisconsin

**AMERICAN  
BUILDER**

**NEW PRODUCTS**

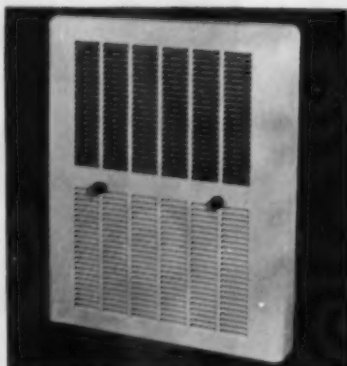

**Heating or cooling available from same unit**

A new, improved model of the "Penn Air-rad" heating-cooling unit offers hot water heat plus summer air conditioning from the same radiator. Designed for modernization as well as new construction, the units fit between studs and are adjustable for varying wall depths. Fittings are adaptable for  $\frac{3}{8}$  inch or  $\frac{1}{2}$  inch tubing and built-in electrical connections are made to the blower. Model 10-R with a heating capacity of 10,000 Btu is listed at \$49.95, while model 22-R with a capacity of 22,000 Btu's retails at \$83. Penn Boiler & Burner Mfg. Corp., Dept. AB, Attn. C. M. Lane, Lancaster, Pa.

Circle No. 714 on Readers' Reply Card, p. 146



**Lightweight laundry tub of Fiberglas**

For laundries and wherever a utility tub is needed, the "Utilatub" of lightweight plastic will be available from plumbing supply houses within sixty days. Mounted on tubular aluminum self-leveling legs this tub with 20-gallon capacity will retail for \$32.75 complete with faucet. E. L. Mustee & Sons, Dept. AB, Attn. Frank Mustee, 6811 Lorain Ave., Cleveland 2, Ohio.

Circle No. 715 on Readers' Reply Card, p. 146



Ozone Park housing project near New Britain, Conn.

**Set of Symons Forms Used 700 Times**

Kozikowski Bros. Builders, New Britain, Conn., used this set of Symons Forms every day and the plywood did not have to be reversed. They were used on one housing project . . . they were used by the same crew, and one of the Kozikowski brothers was job superintendent. No one used a wrecking bar for stripping. Every day usage avoided drying out and the use of Ready-Mix Concrete saved wear and tear.

Symons Forms are available on a 60-day Rental-Purchase plan.

**WANT MORE FACTS ON SYMONS FORMS?**

Attach this to your letterhead, sign your name and mail to us immediately.

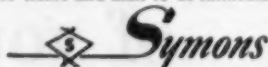

**SYMONS CLAMP & MFG. CO.**  
4261 Diversey Ave., Dept. G5, Chicago 39, Ill.

**Avoid Tool Damage And Loss With KARYALL COMPARTMENTS**



**KEEP YOUR TOOLS AND MATERIALS ORGANIZED — SAVE TIME AND INCREASE YOUR PROFITS**

- KARYALL COMPARTMENTS convert any  $\frac{1}{2}$ ,  $\frac{3}{4}$  or 1 ton pick-up truck into a handy mobile workshop.
- KARYALL COMPARTMENTS give you more strength for less money. They are built in 78", 88", 96" and 108" sizes to fit full length of truck bed. Shipped complete with mounting brackets for easy installation.
- Immediate delivery from our stock.

—Call Atlantic 1-0470—  
or write for prices today

Name .....

Company .....

Address .....

City ..... State .....

**KARYALL BODY, INC.**  
8221 Clinton Road Cleveland 9, Ohio  
Department A

AMERICAN BUILDER



**"We put a lifetime  
of good looks and  
fire-safety into our roof"**



say Sherman Huffman, Melvin Huffman and Z. G. Huffman, Jr., of Huffman Bros., Charleston, West Virginia, builders of this hillside ranch house.



**Gold Bond "Economy 250" forms  
an attractive, maintenance-free roof**

"We used Gold Bond Corrugated Asbestone to give this fast-selling Charleston house a roof that will stay bright and fresh looking permanently and stand up in all kinds of weather. 'Economy 250' has a heat reflective value that keeps homes considerably cooler. These features mean a great deal to prospective home buyers.

"We used a staggered joint method of roof construction, putting on 24" by 42" panels of Gold Bond Corrugated Asbestone with an 18"

exposure and 6" lap. Roof sheathing was eliminated and the factory pre-cut sheets went up fast and easily. As a result, we not only put up a beautiful roof, but saved on materials and labor at the same time. There's a very definite place in today's home construction for Gold Bond 'Economy 250'."

See how this economical roof can help you build *your* home sales. WRITE Dept. AB-75 for full roof construction details on the Charleston House.

NATIONAL GYPSUM COMPANY • BUFFALO 2, NEW YORK

**Build better with  
Gold Bond**



LATH, PLASTER  
AND LIME



GYPSUM BOARD  
PRODUCTS



INSULATION BOARDS  
PLANKS AND TILES



ROCK WOOL  
INSULATION



PAINTS AND  
TEXTURES



ACOUSTICAL  
TILES

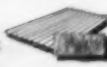

ASBESTOS ROOFING  
AND SIDING

... **CORRUGATED ASBESTONE**



*Smooth!*

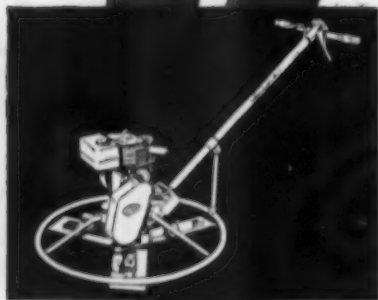

... We're talking about the finish our new Stow G-34 and E-34 Roto Trowels deliver on any floor finishing or paving job:

We've some interesting figures on performance for you, too!

**Write today for complete information on STOW Roto-Trowels.**

**STOW MANUFACTURING CO.,  
142 SHEAR ST., BINGHAMTON, NEW YORK**

**AMERICAN  
BUILDER**

**NEW PRODUCTS**

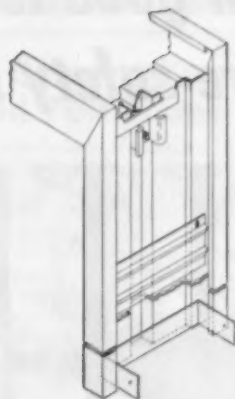

**Steel jamb for drywall construction**

The "Kwik-Fit" steel door frame is designed for installation over 2x4 stud partitions with 1/2 inch drywall. Installed after the walls are finished, it is held in place with four nails (concealed by baseboard) and adjustable compression lugs. For job finishing, the zinc-coated steel is bonderized for good paint adhesion. Available for all standard sizes of 1 3/4 inch doors, through building material dealers at approximately \$8.10. Kewanee Mfg. Co., Dept. AB, Kewanee, Ill.

Circle No. 716 on Readers' Reply Card, p. 146

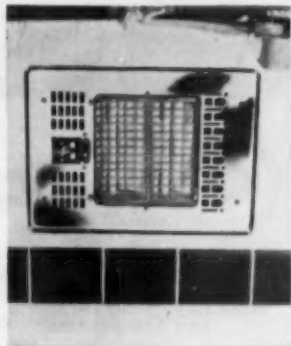

**Electric heater has built-in thermostat**

Glowing bars that produce infra-red rays comprise the heating element of the "Heetaire" 240 Series and the self-contained thermostat is adjustable for constant temperature control. Designed to fit into ordinary stud space the face plate of nichrome or ivory enamel measures 12 3/4 inch by 17 3/4 inch. Available at \$17.95. Markel Electric Products, Inc., LaSalle Products, Inc., Dept. AB, Attn. Sales Dept., 145 Seneca St., Buffalo, N. Y.

Circle No. 717 on Readers' Reply Card, p. 146



OIL STORAGE WAREHOUSE of Carter Oil Co., Tulsa, Oklahoma.

## To beat high maintenance costs . . .

You virtually eliminate costly building maintenance with Kaiser Aluminum Industrial Roofing because it's rust-proof—needs no painting or other expensive upkeep.

Even when exposed to most highly corrosive fumes and gases, Kaiser Aluminum Industrial Roofing requires no special protective measures.

Not only does Kaiser Aluminum Industrial Roofing provide greater protection and lower maintenance . . . it also assures *immediate savings*. Its light weight reduces

transportation and handling costs. And it often requires lighter, less expensive supporting structures.

Whatever you're building—figure first in Kaiser Aluminum Industrial Roofing—for better value at lower cost! For A.I.A. File and complete information, contact any Kaiser Aluminum sales office listed in your telephone directory. Or write Kaiser Aluminum & Chemical Sales, Inc. *General Sales Office*, Palmolive Bldg., Chicago 11, Illinois; *Executive Office*, Kaiser Bldg., Oakland 12, California.

# think of Kaiser Aluminum

## Industrial Roofing and Siding

**LOW COST**—Provides a combination of advantages not available in other materials at any price.

**LIGHT WEIGHT**—Reduces transportation costs. So easy to handle that construction is faster, lower in cost. Often permits the use of lighter, less expensive framing.

**STRONG**—The increased depth ( $\frac{7}{8}$ " ) of the corrugations of Kaiser Aluminum sheet provides greater load carrying capacities over the longer spans of modern industrial construction.

**CORROSION RESISTANCE**—High resistance to most industrial fumes. Can't streak with red rust. Maintains attractive appearance indefinitely.

**LOW MAINTENANCE**—Never needs painting. Resists heavy winds and hail.

**COOLER, BRIGHTER INTERIORS**—By reflecting hot sun rays, aluminum keeps interiors as much as 15° cooler. Aluminum's reflectivity insures extra interior light.

For Top Profit...

SAND  
FLOORS  
TWICE  
AS  
FAST!



### American Super 8

For the contractor who wants to do the job in half the time—and do the finest work—it's the Super 8! Sands floors nearly twice as fast as Standard Machines!



### American Spinner

This teammate of the Super 8 keeps up the fast pace when you do edges, stairs, halls, closets. New "B" Spinner with powerful new motor is *fastest cutting, most efficient 7" disc sander.*

Get best results, greater profits, with American from start to finish. For best-cutting abrasives—use the all-new American Super-Speed and American Combination papers. For the finest finish—American quality seals, finishes and waxes for wood, asphalt, rubber, linoleum, *all floors.*

Send for latest catalog on:

Floor Sanders

Floor Edgers



Maintenance Machines

Concrete Grinders

Abrasives

Seals, Finishes

Saws



511 So. St. Clair St., Toledo 3, Ohio

136

AMERICAN  
BUILDER

Your Guide to NEW PRODUCTS Information



### Pocket door pull features easy installation

Designed for all door thicknesses from 1 3/8 inch to 1 3/4 inch this new pocket door pull does the work of an edge pull and two flush pulls. Only one cut-out is needed instead of separate installations, thus effecting labor savings. Individually packaged in popular hardware finishes it is priced at \$1.50 per set. Sterling Hardware Mfg. Co., Dept. AB, 2345 W. Nelson St., Chicago 18, Ill.

Circle No. 718 on Readers' Reply Card, p. 146

a high proportion of aluminum flakes. The aluminum forms a dense, metallic skin which protects the job against the effects of age, weather and ultra-violet rays. Like regular Handi-calk (white or natural) the aluminum type is sold in metal cartridges with air-tight soldered seam and flexible plastic nozzle. Available now. The Gibson-Homans Co., Dept. AB, 2366 Woodhill Rd., Cleveland 6, Ohio.

Circle No. 720 on Readers' Reply Card, p. 146



### Aluminum sliding glass doors have many features

Ludman's new aluminum sliding glass doors have 15 exclusive features. Among these are vinyl bulb-type weatherseal at jambs and by-passing door stiles, positive latching and locking. Drip cap, screen stop, screen tracks, and sloping threshold may be attached to standard unit for exterior use. Top and bottom rails telescope into stiles, are secured with large die-cast aluminum corner lock and 4 screws per corner. Single sliding screen seals either door opening. All screen members are of extruded aluminum tubular sections. Doors are made for standard or double glazing. Available now through Ludman distributors. Ludman Corporation, Dept. AB, attn. Harry Weigle, 14100 Biscayne Blvd., North Miami, Fla.

Circle No. 721 on Readers' Reply Card, p. 146

### New Upson primed siding resists molds, termites, fungi

Upson Primed Siding comes in 16-foot standard lengths and is available in 20-foot lengths for special purposes. Its greater length reduces joints to a minimum and speeds application. The new siding is laminated of six plies and is now being produced in 12-inch widths. Pre-primed at the factory, it has a resinous emulsion coating that provides excellent adhesion for finish coat, permitting it to dry quicker and harder. Available now. The Upson Company, Dept. AB, Lockport, N. Y.

Circle No. 722 on Readers' Reply Card, p. 146



### Plaster-mortar mixer goes through ordinary door

This 3 1/2 cubic foot capacity mixer has been designed for portability on the job site. Equipped with a telescopic tow pole, its over-all width of 29 inches, pneumatic tires and a gross weight of 500 pounds allows for moving indoors when desirable. The drum tilts in either direction and optional rubber tips can be attached to the mixing blades. Power is transmitted by multiple V-belts from a 3 h.p. air cooled engine. Kwik-Mix Co., Dept. AB, Attn. Ray Sell, S.M., 235 W. Grand Ave., Port Washington, Wis.

Circle No. 719 on Readers' Reply Card, p. 146

### Calking compound contains aluminum flakes

Aluminum Handi-calk is a new kind of calking compound offered in a handy, time-saving cartridge. Aluminum Handi-calk contains in addition to the oils, pigments and Canadian asbestos fibre,

AMERICAN BUILDER

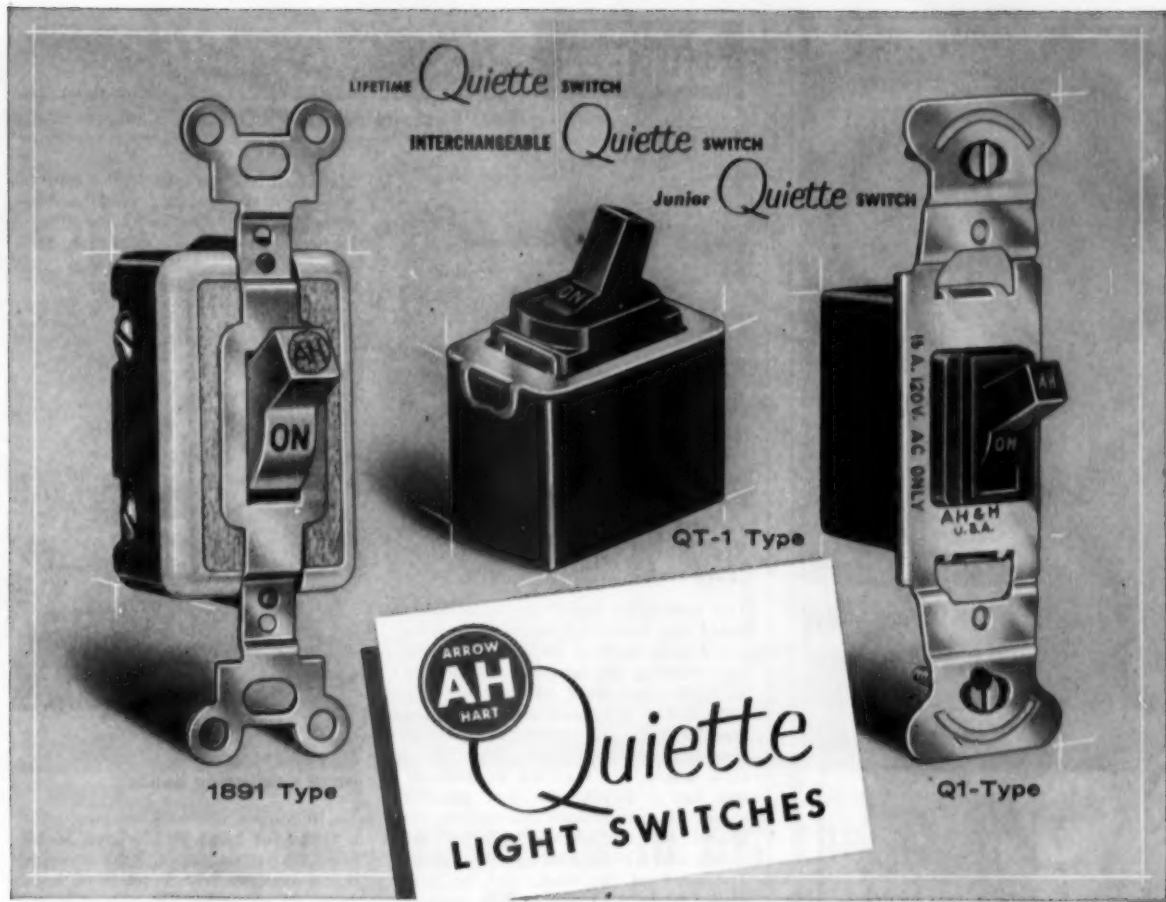

## QUIET, SAFE OPERATION FOR BOTH INCANDESCENT AND FLUORESCENT LIGHTS

Today, your prospects expect a house that's modern in every detail, and are quick to notice whether the light switches snap on and off noisily . . . or work with a whisper. That's when Arrow-Hart QUIETTE Light Switches start selling for you. And they keep selling because contacts are not mercury but are alloy silver that will carry substantial loads.

Use Arrow-Hart QUIETTE Light Switches in the homes you build. You'll be increasing their salability and your reputation by adding this big touch of luxury at small cost.

- LIFETIME 1891 Type ratings: 15 amp — 120-277 volt ac only; also 20 amp — 120-277 volt ac.
- INTERCHANGEABLE QT-1 Type ratings: 15 amp — 120-277 volt ac only.
- Junior Q-1 Type ratings: 15 amp — 120 volt ac only.

All are listed as standard by Underwriters' Laboratories available in single or double pole, 3-way or 4-way.

### ARROW-HART

WIRING DEVICE DIVISION

103 HAWTHORN STREET, HARTFORD 6, CONN.

OFFICES, SALES ENGINEERS AND WAREHOUSES IN:

ATLANTA	DALLAS	MINNEAPOLIS	SEATTLE
BOSTON	DETROIT	NEW YORK	
CHICAGO	INDIANAPOLIS	PHILADELPHIA	HAVANA, CUBA
CINCINNATI	LOS ANGELES	ST. LOUIS	TORONTO, CANADA
CLEVELAND	MILWAUKEE	SAN FRANCISCO	LONDON, ENGLAND

**Quality**

WIRING DEVICES • MOTOR CONTROLS  
ENCLOSED SWITCHES • APPLIANCE SWITCHES



WIRING DEVICE DIVISION

AS  
**THE ARROW-HART & HEGEMAN ELECTRIC CO.**

103 HAWTHORN STREET, HARTFORD 6, CONN.

Please send my copy of "New Quietie Switches" folder (Form WD-5T-75)

NAME \_\_\_\_\_

POSITION \_\_\_\_\_

COMPANY \_\_\_\_\_

CO. ADDRESS \_\_\_\_\_

CITY \_\_\_\_\_ ZONE \_\_\_\_\_ STATE \_\_\_\_\_



ARE RICHER LOOKING LONGER WEARING

**TOLEX**

Supported Vinyl  
Covered in

FOLDING DOORS and PARTITIONS

FOR HOMES



FOR BUSINESS



For Home, Office or Institution  
In Waves, Fabric or Leather Effect  
Full Range of Decors, Colors  
Clean With Just Soap and Water

**GENERAL PLASTICS**

For Saunas Write

**TEXTILEATHER**

1000 W. 12th St., Dept. C  
OAK BROOK, ILL. 60451



**Roto-trowel has stationary guard ring**

This new rotary trowel has a stationary guard ring instead of the usual rotating guard ring, making the machine safer and allowing the operator to work up to walls and other obstructions. No extra handle is needed when lifting the machine since it can be picked up at any point on the guard ring. Model G34, above, is 34 inches in diameter and has a 4-cycle 2½ h.p. gasoline engine. A control stops the machine the instant the operator lets go of the handle and without stopping the engine. The pitch of the blades can be controlled while the machine is in motion, by a convenient knob on the handle. Available now through construction equipment houses. List price: \$375.00. F.O.B. Binghamton. Stow Manufacturing Company, Dept. AB, attn. C. Hotchkiss, Jr., 443 State St., Binghamton, N. Y.

Circle No. 723 on Readers' Reply Card, p. 146



**Air vents help prevent paint failures**

Morell Air Vents are made in one piece of die-cast aluminum, have a dome-shaped vent cap that sheds rain and when inserted into the cavity space of frame walls, lock permanently in place. The air vents can be painted along with the house and are almost invisible at short distance. These vents are installed by using a 3/8-inch auger bit and by drilling straight through siding and sheathing into the innerwall. Tube is

placed in hole, tapped lightly and the Air Vent is secure. Available now through paint, hardware, and lumber jobbers. List price: 35 cents each. Morell Air Vents, Dept. AB, attn. J. J. Morell, 1041 Carlyon Rd., Cleveland 12, Ohio.

Circle No. 724 on Readers' Reply Card, p. 146



**Hood light accessory for range ventilating hoods**

To illuminate the cooking area under a ventilating hood, Trade-Wind Motorfans has introduced a light accessory that is available with Trade-Wind hoods or as an accessory. Designated as No. 311, it is supplied as a complete unit with two light sockets and switch. The fixture is supplied with a reflector to direct the light back and down. The hood light can be used with the company's expansion type hood, with the stationary type or it may be adapted for use with most other types of hoods. Available now through electrical dealers and contractors. List Price: \$7.50. Trade-Wind Motorfans, Inc., Dept. AB, attn. Miss Mary Phillips, 7755 Paramount Blvd., Rivera, Calif.

Circle No. 725 on Readers' Reply Card, p. 146

**New washable paint**

Ready-To-Use Luminall is a washable, latex-alkyd interior paint that does not require mixing and has a built-in primer, sealer, and undercoat. The paint can be applied to any interior surface, including cement, brick, plaster, wallboards, woods, wallpaper, cement-astbestos compositions, and surfaces previously painted with oil flats, enamels, and resin emulsion paints. Available in 12 colors, the new paint can be applied with roller, brush or spray. Available now through franchised dealers. Retail price: \$5.35 per gallon (slightly higher west of Mississippi River and in South). National Chemical & Manufacturing Company, Dept. AB, attn. Edward Gresk, 3617 So. May St., Chicago 9, Ill.

Circle No. 726 on Readers' Reply Card, p. 146



## Bring "hot" prospects in off the street with **Servel** All-Year® air conditioning

On summer dog days . . . no house sells like a Servel air-conditioned house. Cool, cool comfort helps put customers in a mind to buy.

And when they discover that this unit *heats*, too, you'll find it a real sales plus. Investigation will prove the Servel heating system to be the ultimate in controlled comfort. A single unit cools or heats . . . dehumidifies or adds moisture . . . cleans the air . . . ventilates and circulates.

What's more, Servel's *exclusive* absorption principle operates with *no moving parts*. That means year-around cooling and heating with low, low upkeep. And the Servel refrigeration unit is backed by a full five-year warranty.



**Perfect for medium-size homes.** Compact 2-ton model occupies only 2½' x 4' of floor space. 72,000 Btu/hr. heating capacity.

Put this proven salesman to work in your model homes. Servel air conditioning is available in 2-, 3-, and 5-ton capacities. Send today for details.

# Servel

*the name to watch for great advances in*

**AIR CONDITIONING ✓ REFRIGERATION**

Send the coupon or see your Servel distributor for facts.

**SERVEL, INC., Dept. AB-75, Evansville 20, Indiana**  
Please send me complete information on Servel All-Year Air Conditioning.

Name

Address

City  Zone

County  State



## Jaeger pays a bonus of 12 to 15 yards

With the automatic shaker hopper on the Jaeger 3½S Auto-Loader you can load and measure while you mix, then power-shake the new batch into the drum *quick as a flash*. It means 12 to 15 more yds. per day — the fastest mixer of its size. The huskiest, too, with machined steel drum tracks on ball bearing car-wheel rollers. Send for Catalog SM-2.



3½S Tilter  
Also — 6S, 11S and  
16S Power Loaders

**THE JAEGER MACHINE COMPANY** 521 Dublin Avenue  
Columbus 16, Ohio

Sales, Rentals, Service in over 150 Cities of United States and Canada

**PUMPS • COMPRESSORS • HOIST TOWERS • LOADERS**

# 50-50 PUSH-OVER ALLITH GARAGE DOOR HARDWARE

USE YOUR OWN OR  
ANY STANDARD DOOR

NO MAINTENANCE COSTS

SIMPLIFIED INSTALLATION

ADAPTABLE FOR ANY  
TYPE GARAGE

ALLITH hardware works with equal efficiency on either custom or mill-made doors. All working parts simple and sturdy—no springs to stretch or loosen. All hardware parts inside and protected from weather.

Unit shipped complete to the last screw. Quickly and easily installed. Standard set fits any opening up to 9' wide x 7'6" high when doors do not exceed 275 lbs. Other sets available for openings up to 10' wide x 10' high. Write for details.

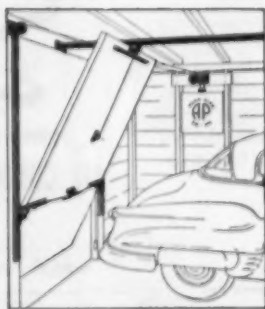

MANUFACTURED BY  
**ALLITH**  
PROUTY, INC.

DANVILLE,  
ILLINOIS



## Base cabinets are designed to take stack-on range, oven

Base cabinets that will accommodate nearly all of the stack-on gas and electric range and oven units on the market are now in the Youngstown Kitchens line. The cabinets, available in any of Youngstown's four Go-Together colors (star white, dawn yellow, meridian blue and sunset copper) are 28 inches high, 24 inches front to back, and have widths of 24, 27, 30, and 36 inches. Use of a 30-inch high wall cabinet above the oven brings an installation to the standard 84-inch height. Suggested Eastern retail prices: 24-inch wide base cabinet, \$47.50; 27-inch width, \$51.00; 30-inch width, \$52.50; 36-inch width, \$60.50. Mullins Manufacturing Corp., Dept. AB, attn. H. F. Howell, Warren, Ohio.

Circle No. 727 on Readers' Reply Card, p. 145



## Plastic fabric covering has 3-dimensional look

"Virtex Shado-Star" is the newest addition to the Carpenter line of 3-dimensional fabrics. Striated in alternate directions, Shado-Star is vinyl-electronically fused and can't be snagged, chipped, peeled, cracked or scratched. It is waterproof, weather-proof, flame and strain resistant, wipes clean with a damp cloth, is available in 18 colors. Available now through established dealers. List price: \$4.50 per yard. L. E. Carpenter and Company, Dept. AB, attn. C. V. Roff, 350 Fifth Ave., New York, N. Y.

Circle No. 728 on Readers' Reply Card, p. 146



# NEW

## Prefabricated FIREPLACE

installs in 4 to 6 man-hours

no masonry required



Frame is fastened directly to studs with lag screws.



Hearth and firebox are formed of interlocking ceramic sections.

Never before has it been possible to install a real fireplace and chimney so easily and economically. The Uni-bilt Fireplace provides a low cost, high prestige feature that increases the salability of every home you build. It is adaptable to any style of architecture and can be painted to harmonize with any room decoration. Approved by Underwriters' Laboratories for installation directly against any wall, floor, ceiling, or roof material with complete safety. Be the first to offer the Uni-bilt Fireplace in your homes. Mail coupon below for full-color brochure.



Stainless steel trim and built-in flexible screen are easily installed.

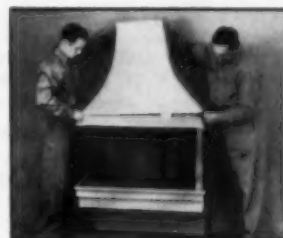

Fireplace hood sets on hood support channel — fits tight to wall.



Interior chimney sections are extended through ceiling and roof.



Attractive exterior chimney housing completes the installation.



Vega Industries Inc.  
Uni-bilt Division  
417 Glen Ave., Syracuse 5, N. Y.

Send complete descriptive information on the Uni-bilt Fireplace.

Name .....

Company .....

Street .....

City ..... Zone ..... State .....

I am a ..... Builder ..... Architect ..... Dealer

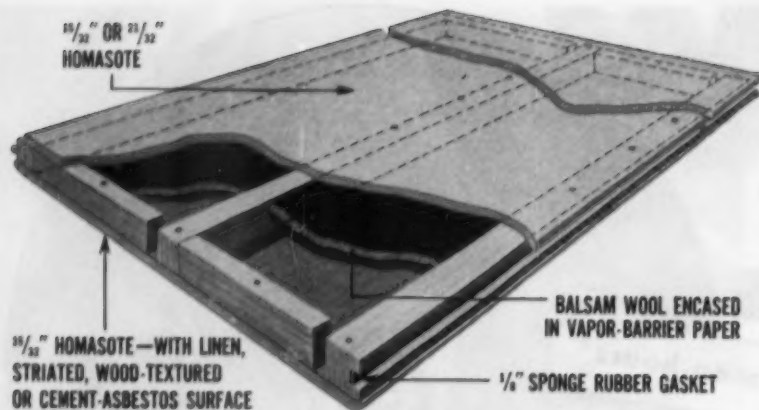

1/2" HOMASOTE—WITH LINEN, STRIATED, WOOD-TEXTURED OR CEMENT-ASBESTOS SURFACE

ANNOUNCING

## WILSON AIR-COR ROOF DECKING

- makes condensation problems a thing of the past
- custom-made to your specifications

No matter what the interior or exterior conditions—of climate, temperature or humidity—you need no longer have a condensation problem. The solution—as presented in Wilson Air-cor Roof Decking—is scientific, unique, yet amazingly simple.

*Two air channels, running the length of each 2' x 8' panel, insure continuous air circulation across the entire roof—automatically and in sufficient volume (1945 cubic inches per panel) to absorb all normal condensation. For extreme conditions, forced air could be used.*

Use this scientifically engineered roof decking on flat or pitched roofs—and on any type of structure. Then apply built-up roofing, shingles, slate or metal, as your design requires. The panel is designed for rafter spacing up to 48" o.c.; nail holes are pre-drilled to your order.

The strength is there; the insulation value is there. (With built-up roofing and 1/2" Homasote, the U factor is 0.15.) Here is new insurance on air-conditioning investments.

Each panel is made up of three 2" x 2" wood members, 12" o.c., horizontally. On one edge is a wood tongue; on the other a groove. Within the groove a sponge rubber gasket insures a tight seal. The top and bottom sheets are weatherproof Homasote. According to your specifications, the top sheet may be either 1/2" or 3/4" in thickness; the bottom sheet (which can serve as finished ceiling) may have a linen, a striated, a wood-textured or a cement-asbestos surface.



**HOMASOTE COMPANY**  
TRENTON 3, NEW JERSEY

The top piece overlaps 1/8" on the groove side, thus shutting out moisture (and also the asphalt of built-up roofing). The bottom piece has a 45° bevel on each side. This overlaps the wood members by 1/2" to insure a tight joint between sections. Between the wood members—under the top piece—a barrier of 3/8" Balsam Wool, completely encased in vapor-barrier paper, is glued. At each end of each panel two wood blocks—2" x 2" x 8"—provide for satisfactory nailing to rafters or joists. Panels are easily cut to any dimension (or supplied in special lengths, to order).

**Sound-deadening partitions and sub-flooring.** For interior, sound-deadening partitions, Wilson Air-cor Panels are supplied in 2', 3' and 4' widths and in heights up to 11' 2". The combination of Homasote and Balsam Wool creates an unusually efficient sound-deadening barrier. . . . For use in partition walls, the Homasote surfaces are applied as panels beveled on both sides—and without overlap. . . . For sound-deadening between floors, use the panels as sub-flooring; nail the finished flooring direct to the wood members of the panels.

**Wiring**—An additional advantage of the air cores is that electric wiring—whether conduit or cable type—may be passed across the roof, thus wiring the building from above. This is not only the most economical method, but permits the placing of light fixtures wherever desired.

Our Engineering Service is available to work with you on any specific problems of roof decking, partitions or sub-flooring. Let us give you complete details and specifications. Kindly address your inquiry to Department G-8.



## CATALOGS

**WATER HEATING AND COOLING SYSTEMS**—This new 24-page catalog presents a complete line of equipment for forced hot water heating systems and chilled water cooling systems. Bell & Gossett Co., Dept. AB, Morton Grove, Ill.

Circle No. 729 on Readers' Reply Card, p. 146

**CAULKING COMPOUNDS**—A new bound-in catalog on caulking compounds, including prices. Calbar Paint & Varnish Co., Dept. AB, 2612-26 N. Martha St., Philadelphia 25, Pa.

Circle No. 730 on Readers' Reply Card, p. 146

**MOLDED SILICA PIPE INSULATION**—An 8-page illustrated brochure entitled "Fibrocel" describes a new molded silica pipe insulation. Johns-Manville, Dept. AB, 22 East 40th St., New York 16, N. Y.

Circle No. 731 on Readers' Reply Card, p. 146

**KITCHEN, BATHROOM CABINETS**—Two booklets are now available in full color showing the Beauty Queen kitchen cabinet line and Beauty Queen Lavenettes. Toledo Desk & Fixture Co., Dept. AB, Maumee, Ohio.

Circle No. 732 on Readers' Reply Card, p. 146

**TILE BOOK OF BEAUTIFUL HOMES**—"The Mosaic Tile Book of Beautiful Homes," No. 12, is a 16-page booklet in full color showing kitchens, living rooms, bathrooms and terraces. Price, 25 cents. The Mosaic Tile Co., Dept. AB, Zanesville, Ohio.

Circle No. 733 on Readers' Reply Card, p. 146

**SHEAVES AND TRACKS**—A four-page folder on sheave and track line for sliding doors, partitions, walls, and store fixture applications. Grant Pulley & Hardware Corporation, Dept. AB, 31-85 Whitestone Pkwy., Flushing, 54, N. Y.

Circle No. 734 on Readers' Reply Card, p. 146

**KIMSUL SHEATHING BLANKET**—Kimsul "48" sheathing blanket is described, including application technique. Well illustrated. Kimberly-Clark Corporation, Dept. AB, Neenah, Wis.

Circle No. 735 on Readers' Reply Card, p. 146

**PORTABLE ELECTRIC AND PNEUMATIC POWER TOOLS**—This 1955 catalog of industrial line tools is a 60-page booklet showing more than 150 models of portable electric and pneumatic power tools including saws, drills, grinders, planes, sanders, blowers, drivers, runners and shears, with related accessories. Skil Corporation, Dept. AB, 5033 Elston Ave., Chicago, 30, Ill.

Circle No. 736 on Readers' Reply Card, p. 146

COMPLETELY NEW... AN INDUSTRY FIRST

# MOR-SUN

AUTOMATIC GAS-FIRED  
**VENTED  
RECESSED HEATER**



The new MOR-SUN Model C-70-GA automatic gas-fired Recessed Heater is engineered and quality constructed for long life and fuel thrifty operation. Extremely compact — low in initial cost — high in performance — the MOR-SUN C-70-GA is an excellent heating unit for all types of homes in the South and for smaller homes in northern climates.

Designed with the builder in mind, the Mor-Sun Recessed Heater saves valuable living space by fitting snugly into the wall so that only its smartly styled louvered grille is visible. It fits equally well into the most modest building budget without sacrificing any of the traditional Mor-Sun quality.



**OIL-FIRED  
RECESSED  
HEATER  
C-75-O**

Completely approved by UL for minimum clearances to combustible surfaces. Output—57,000 BTU/Hr., input—33 c.c.

Here are some of the  
**FEATURES**  
that make the Model C-70-GA  
**IMPORTANT  
NEWS TO EVERY  
BUILDER**

- Approved for minimum clearances to combustible surfaces when recessed in the wall.
- Conforms to all details of F.H.A. Minimum Property Requirement Pamphlets Nos. 51 and 52.
- Permits installation of Type B chimney vent.
- Capacity — 70,000 BTU/Hr. input, 52,500 BTU/Hr. output.
- Completely factory-assembled — draft hood installed — pre-wired — painted Autumn Haze Green.
- Compact — only 25" square by 52¾" high.
- Adaptable — grilles available for side wall or corner installation.
- Fully automatic — wall thermostat is standard equipment.

For complete details... fill in  
the coupon... **MAIL TODAY**

Mor-Sun Furnace Division  
Morrison Steel Products, Inc.  
605 Amherst St., Buffalo 7, N. Y.

Send me complete information on the  
Mor-Sun Recessed Heaters.

Name..... Title.....  
Firm.....  
Street Address.....  
City..... Zone..... State.....

**HEAT EXCHANGER GUARANTEED FOR 5 YEARS**



*You get so much more with MOR-SUN*

Also manufacturers of ROLY-DOOR STEEL GARAGE  
DOORS and MORRISON SERVICE BODIES.

**MY HOMES  
ARE BUILT TO  
SELL!**



says prominent builder, **MARTIN BARTLING**, chairman of the NAHB construction committee, chairman of the NAHB components conference.

"The most important 'built-in' to put in a home is customer appeal . . . features that catch the eye and turn prospects into buyers. That's the big reason I use Veni-Flex Folding Doors in many of the homes I build. The decorative appeal of woven wood gives an extra touch to contemporary interiors, as well as affording more space by eliminating troublesome 'door swing'."

**ADD SALES APPEAL TO YOUR HOMES  
with  
BEAUTIFUL . . . VERSATILE . . . ECONOMICAL  
VENI-FLEX  
WOVEN WOOD FOLDING DOORS**



Veni-Flex meets these important specifications:

- **DURABLE HARDWARE** . . . only folding door using brass roller hardware . . . smoother, more rugged for years of service.
- **HIGH QUALITY** . . . top-grade basswood slats and long-wearing seine twine.
- **EASY TO INSTALL** . . . cuts construction costs.
- **SPACE-SAVING** . . . eliminates "dead" corners, inaccessible closets.
- **DECORATIVE** . . . wide choice of exciting colors.
- **VERSATILE** . . . ideal for closures, room division, room separation, special effects.

**WRITE TODAY FOR COMPLETE INFORMATION!**  
**CONSOLIDATED GENERAL PRODUCTS, INC.**  
P. O. Box 7425A, Houston 9, Texas  
P. O. Box 559A, Waukesha, Wis.

**CONSOLIDATED  
GENERAL PRODUCTS, INC.**

## CATALOGS

**HARDWOOD PANELING BROCHURE**—Describing 18 southern hardwoods, this 16-page brochure in full color is titled "Southern Hardwoods for Paneling and Interior Woodwork." Copies are available through the Southern Hardwood Producers, Inc., Dept. AB, 805 Sterick Bldg., Memphis 3, Tenn.

Circle No. 737 on Readers' Reply Card, p. 146

**STEEL-FRAMED SLIDING GLASS DOORS**—This 12-page catalog describes the uses, sizes and types of steel-framed sliding glass doors. Technical specification data and quarter-size details are included. Unusual feature of the catalog is the "Data Chart" which lists dimensions of glass required for the most popular Arcadia door sizes, rough opening sizes and shipping weights of the product. Arcadia Metal Products, Dept. AB, P. O. Box 657, Arcadia, Calif.

Circle No. 738 on Readers' Reply Card, p. 146

**MIAMI-CAREY MASTER CATALOG**—This company's 1955 Master Catalog describes bathroom ensembles, sliding door units, individual cabinets, bathroom accessories, storage and decorative recessed shelf units. The 36-page catalog is listed as A.I.A. File No. 29i. Miami Cabinet Div., The Philip Carey Manufacturing Co., Dept. AB, Middleton, Ohio.

Circle No. 739 on Readers' Reply Card, p. 146

**NEW LOCK DESIGNS AND INSTALLATION TOOLS**—Two brochures are available illustrating and describing new lock and escutcheon designs and lock installation tools. Booklet No. 626 pictures Schlage's five new designs. Booklet No. 625 describes lock installation tools. Schlage Lock Company, Dept. AB, 2201 Bayshore Blvd., San Francisco, Calif.

Circle No. 740 on Readers' Reply Card, p. 146

**INSULATION AND MOISTURE CONDENSATION**—A 12-page booklet which discusses the facts of life about moisture condensation—the enemy of insulation. Ask for the "Enemy of Insulation" booklet. Forest-Wool Insulation Co., Inc., Dept. AB, 720 No. State St., Big Rapids, Mich.

Circle No. 741 on Readers' Reply Card, p. 146

**NEW LIGHTING FIXTURES**—A 16-page brochure, listed as A.I.A. File No. 31-F-23, discusses and illustrates modern lighting fixtures. The booklet gives sizes, material content and recommended wattages. Globe Lighting Products, Dept. AB, 1710 Flushing Ave., Brooklyn 37, N. Y.

Circle No. 742 on Readers' Reply Card, p. 146

**G-E CATALOG ON CONTROL DEVICES**—A 68-page catalog of general purpose control devices. Includes prices, wiring diagrams and dimensions on motor starters, contactors, relays, solenoids, switches, push buttons, and pilot devices. General Electric Co., Dept. AB, General Purpose Control Dept., Schenectady 5, N. Y.

Circle No. 743 on Readers' Reply Card, p. 146

**VENTILATING UNITS**—Bulletin No. UVS 103 is a 20-page booklet describing Util-A-Vent ventilating units for forward curve and backward blade equipment. General Blower Company, Dept. AB, Morton Grove, Ill.

Circle No. 744 on Readers' Reply Card, p. 146

**WOOD SCREWS**—Catalog WS-1 is a 4-color, 14-page catalog describing a complete line of wood screws. Phillips and slotted, flat, round and oval, in steel, brass, silicon bronze, stainless steel, aluminum and all popular plated finishes. Instruction on pilot hole boring and how to measure is broken down for quick comprehension and is generously illustrated. Southern Screw Company, Dept. AB, Box 1360, Statesville, N. C.

Circle No. 745 on Readers' Reply Card, p. 146

**FOAMGLAS INSULATION**—A 12-page brochure called "Foamglas in Thin Wall and Sandwich Panel Construction" covers the specific advantages of Foamglas cellular glass insulation and discusses porcelain enamel panels, aluminum and stainless steel facings, concrete panels, and spandrel construction. Under each heading are photos, panel cross sections and job data. Pittsburgh Corning Corp., Dept. AB, One Gateway Center, Pittsburgh 22, Pa.

Circle No. 746 on Readers' Reply Card, p. 146

**ARCHITECTURAL WINDOW DECOR**—How problem windows can be treated decoratively and practically is illustrated in a 4-page color catalog entitled "Architectural Window Decor" Write for Catalog A.I.A. File No. 35-P-3 (3), Vertical Blinds Corp., of America, Dept. AB, 1936 Pontius Ave., Los Angeles 25, Calif.

Circle No. 747 on Readers' Reply Card, p. 146

**GARAGE DOORS**—Four-page, colored and well-illustrated booklet shows the various garage door styles now available from the Ridge Door Co., including raised panel models with carved motifs, and recessed and flush models. Ridge Door Co., Dept. AB, Monmouth Junction, N. J.

Circle No. 748 on Readers' Reply Card, p. 146

**CONTEMPORARY KITCHENS**—"Contemporary Kitchens in Charming Homes" shows numerous kitchen plans and full-color illustrations of built-in refrigeration installations. Revco, Inc., Dept. AB, Deerfield, Mich.

Circle No. 749 on Readers' Reply Card, p. 146

*Your Guide to* **NEW PRODUCTS** *Information*

**HERE'S  
REAL HELP  
for  
YOU**

The post card below is designed to help readers of American Builder get complete data about new product items and catalogs shown on pages 125 through 144. All you need to do to get further information is to circle the desired items listed on the reverse side of this card and mail it to us.

No postage is necessary. We will forward your requests to the manufacturer who will send you complete data.



**BUSINESS REPLY CARD**  
First Class Permit No. 31775, Sec. 34.9, P. L. & R., Chicago, Illinois

4 cents Postage will be paid by

**Business Manager  
AMERICAN BUILDER  
79 West Monroe St.  
Chicago 3, Ill.**



# USE this handy

# Circle

# new products information service

**ITEMS BELOW  
and MAIL this  
POSTCARD  
TODAY**

## FREE INFORMATION - ON PRODUCTS and EQUIPMENT

- 701. Marble wall and floor tile
- 702. Ford half-ton pickup
- 703. Dodge has 12 power ratings
- 704. Chevrolet with new design features
- 705. International Harvester dump and utility models
- 706. Willys and attachments
- 707. Asphalt tile looks like wood planking
- 708. Low-cost attic fan
- 709. Copper tube for drainage
- 710. Access door for crawl spaces
- 711. Heating cable staples to ceiling lath
- 712. Stainless steel lock set
- 713. Counterflow furnace
- 714. Heating and cooling unit
- 715. Lightweight laundry tub
- 716. Steel jamb for drywall construction
- 717. Electric heater

- 718. Pocket door pull
- 719. Plaster-mortar mixer
- 720. Caulking compound has aluminum in it
- 721. Aluminum sliding glass doors
- 722. Upson primed siding
- 723. Roto-trowel for cement finishing
- 724. Aluminum air vents
- 725. Hood light accessory for ventilating hood
- 726. Washable paint
- 727. Base cabinets for stack-on ranges, ovens
- 728. Plastic fabric with 3-dimensional look

### CATALOGS

- 729. Water heating and cooling systems
- 730. Caulking compounds
- 731. Molded silica pipe insulation
- 732. Kitchen, bathroom cabinets
- 733. Tile book of homes
- 734. Sheaves and tracks
- 735. Kimsul sheathing blanket
- 736. Portable electric and pneumatic power tools
- 737. Hardwood paneling brochure
- 738. Steel-framed sliding glass doors

- 739. Miami-Carey master catalog
- 740. New lock designs and installation tools
- 741. Insulation and moisture condensation
- 742. New lighting fixtures
- 743. GE catalog on control devices
- 744. Ventilating units
- 745. Wood screws
- 746. Foamglas insulation
- 747. Architectural window decor
- 748. Garage doors
- 749. Contemporary kitchens

**MAIL THIS CARD TODAY — WE PAY THE POSTAGE**

NAME .....

FIRM ..... TITLE .....

STREET .....

CITY ..... ZONE ..... STATE .....

PLEASE PRINT NAME AND ADDRESS

JULY, 1955

**SERVICE ON THIS CARD EXPIRES IN 90 DAYS — ACT NOW!**

# Clipper

SAILS RIGHT THRU

**CLIPPER Abrasive Blades**  
**—All CLIPPER BLADES—**  
 are guaranteed to...  
**"Consistently Provide**  
**the Fastest Cut—at the**  
**Lowest Cost—with the**  
**Greatest Ease"**

Look for the bright Orange Centers that identify the genuine Clipper Superior Blades—by the makers of Clipper Masonry Saws—and Clipper Concrete Saws.



Mr. Clipper

...The Mark  
 of **QUALITY!**  
 Your Assurance  
 of Cutting  
 Perfection!



## MASONRY BLADES

● **WET or DRY ABRASIVE**  
 There's a Clipper Abrasive Blade to quickly, efficiently cut ANY Masonry Material—with PROVEN performance and at lowest cost to you.

● **"POLK-A-DOT" Break-Resistant** "Safest Blades Ever Made"—in specifications for EVERY material—HARD to SOFT! Triple-Reinforced for Triple-Protection.

● **DIAMOND** Outstanding Performance—a part of every Clipper Diamond Blade. Available for cutting ANY Masonry Material.



## CONCRETE BLADES

● **DIAMOND** A Blade for any job—any aggregate—every saw! Choose your Clipper Diamond Blades from a wide variety of specifications to cut green or old concrete with outstanding speed and economy.

● **"GREEN-CON"**  
 Savings as high as 80% with Clipper's new Reinforced Abrasive Blades for cutting "green concrete" with the widest possible range of Hard to Soft Limestone aggregates—Coral—Slag.



GENUINE  
**Clipper**  
 SAILS RIGHT THRU  
 SUPERIOR  
 BLADE

MADE IN U.S.A.

SPECIFICATION  
**C-2-16-4**  
 DO NOT EXCEED  
 3275 R.P.M.  
 FOR DRY  
 CUTTING ONLY

This specification is but one of many developed by the Clipper Manufacturing Co. for fast, economical cutting of any masonry material.

THE CLIPPER MANUFACTURING CO.  
 2801 WARWICK • KANSAS CITY 8, MO.

ATLANTA    BOSTON, MA.  
 CHARLOTTE    CHICAGO    CINCINNATI    CLEVELAND    DALLAS  
 DENVER    DETROIT    INDIANAPOLIS    KANSAS CITY, MO.  
 LOS ANGELES    MEMPHIS    NEW ORLEANS  
 NEW YORK    PHOENIX    PITTSBURGH  
 SAN FRANCISCO    SEATTLE    ST. LOUIS  
 ST. PAUL    WASHINGTON, D.C.

**MAIL  
 COUPON  
 NOW!**

See Why "4 Out of 5 Buy Clipper"

## Clipper PRODUCTS

● **SOLD ONLY DIRECT**  
 Same-Day Shipment from  
 Factory Branches in Principal  
 Cities, Coast to Coast.  
**Mail Coupon NOW!**

**CLIPPER MANUFACTURING CO.**  
 2801 E. WARWICK • KANSAS CITY 8, MO. 303X

- Please send me complete information on Genuine Clipper Wet-or-Dry Abrasive Blades.
- "Polk-A-Dot" Blades       Diamond Blades  
 Clipper Masonry Saws       Clipper Concrete Saws

NAME \_\_\_\_\_  
 ADDRESS \_\_\_\_\_  
 CITY \_\_\_\_\_ STATE \_\_\_\_\_

# New design ideas for corner fireplace construction,

AMERICAN BUILDER'S  
BETTER DETAIL PLATE

## NO. D-129 CIRCULAR FIREPLACE . . .

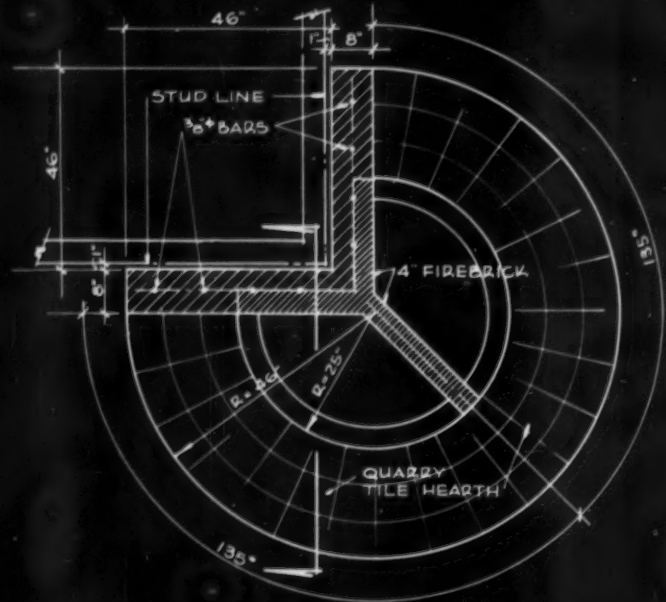

HEARTH PLAN . . .

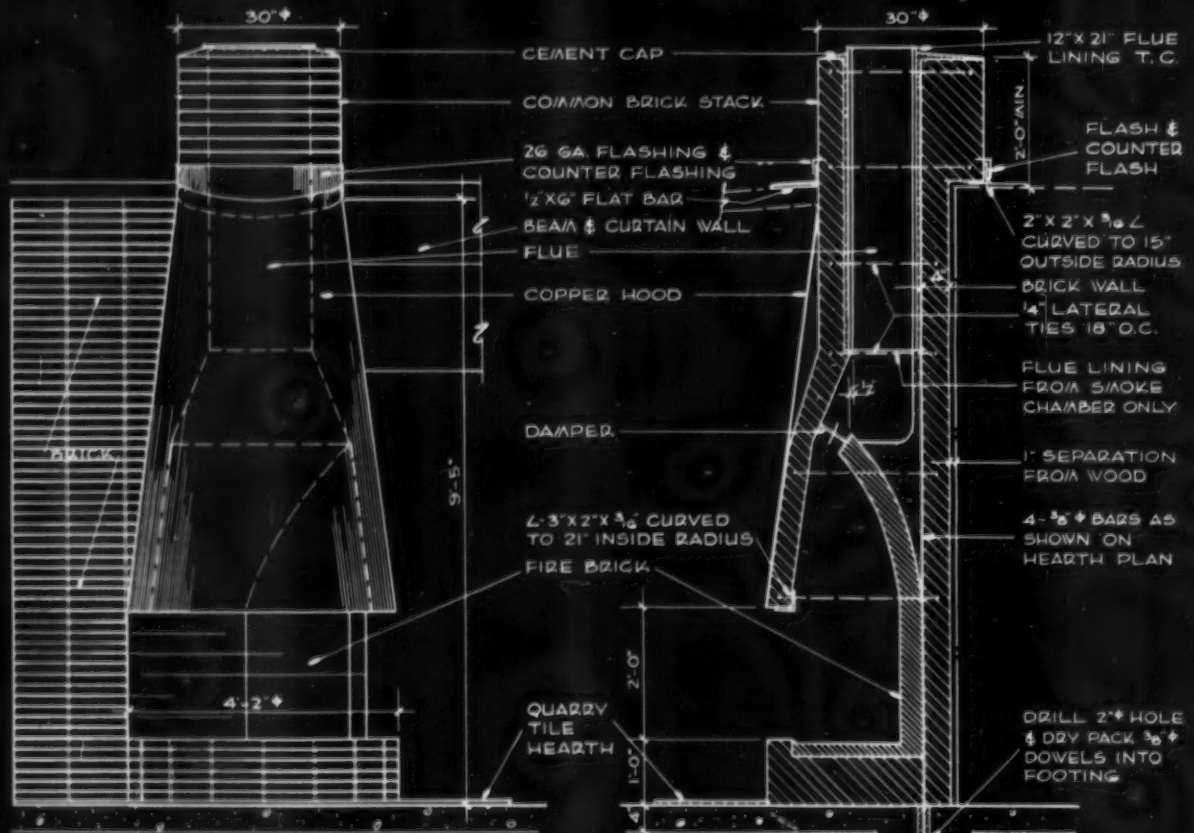

ELEVATION . . .

SECTION . . .



## circular style

This fireplace designed by Richard J. Twohy of San Pedro, California, effectively uses the corner position between living room and dining room. The fireplace area is equally divided, as indicated in the plan. This means that a fire can be burning in one side or the other, or in both at the same time.

This fireplace has a double hearth, one of quarry tile which is placed flush with the floor of the room with a radius of 46 inches at the intersection, and the other of firebrick placed one foot above the floor and having a radius of 25 inches.

The fireplace throat is one brick thick and formed on an outside radius of 25 inches, which in turn is supported on a curved steel angle imbedded into the adjoining masonry walls. The face of the masonry enclosing the throat and the smoke chamber is covered with a copper hood. This hood starts with a 25-inch radius at the top of the fireplace opening and reduces in size as it reaches the ceiling line.

A separate damper is provided for each fireplace opening. However, the smoke chamber above extends across the top of both openings, and then tapers up to a point of intersection with a 13-21-inch flue lining. The chimney extends two feet above the roof line.

One of the interesting characteristics of the modern fireplace is its lack of bulk. In this case an eight-inch thick masonry wall is placed at right angles in back of the fireplace openings. This extends a distance of 46 inches both ways, which is also the radius of the lower hearth. This wall constitutes the background for the fireplace.

Detailed by  
K. Roderick O'Neal, Architect  
Chicago, Illinois



**you can't miss with a WHITE**

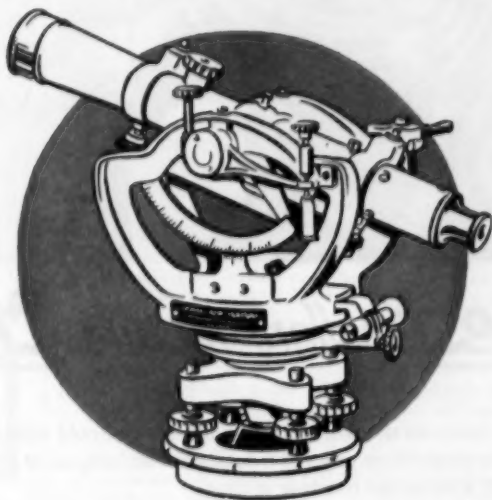

## Universal Level-Transit

everything you could ask for in a transit

Whatever you're looking for in a transit . . . look no further . . . WHITE'S got it . . . and in good measure! More than 40 years of know-how assure you of **ACCURACY** . . . to within 5 minutes on the vernier. **SIMPLICITY** . . . designed without unneeded frills or gadgets for fast adjustability and easy reading. **DURABILITY** . . . built for rough going, winter or summer and for years on end. **PRICE** . . . model 3000 complete with tripod for only \$195.00\* is a value you can't equal. Fill in coupon below for complete details and name of nearest dealer.

*\*Prices subject to change without notice*



**Do you want ALL the details?  
MAIL THIS COUPON TODAY**

DAVID WHITE COMPANY—Dept. 555  
301 West Court St., Milwaukee 2, Wisconsin  
Yes, I'd like full details and prices on DAVID WHITE  
instruments and name of nearest dealer.

NAME \_\_\_\_\_

ADDRESS \_\_\_\_\_

CITY \_\_\_\_\_ ZONE \_\_\_\_\_ STATE \_\_\_\_\_

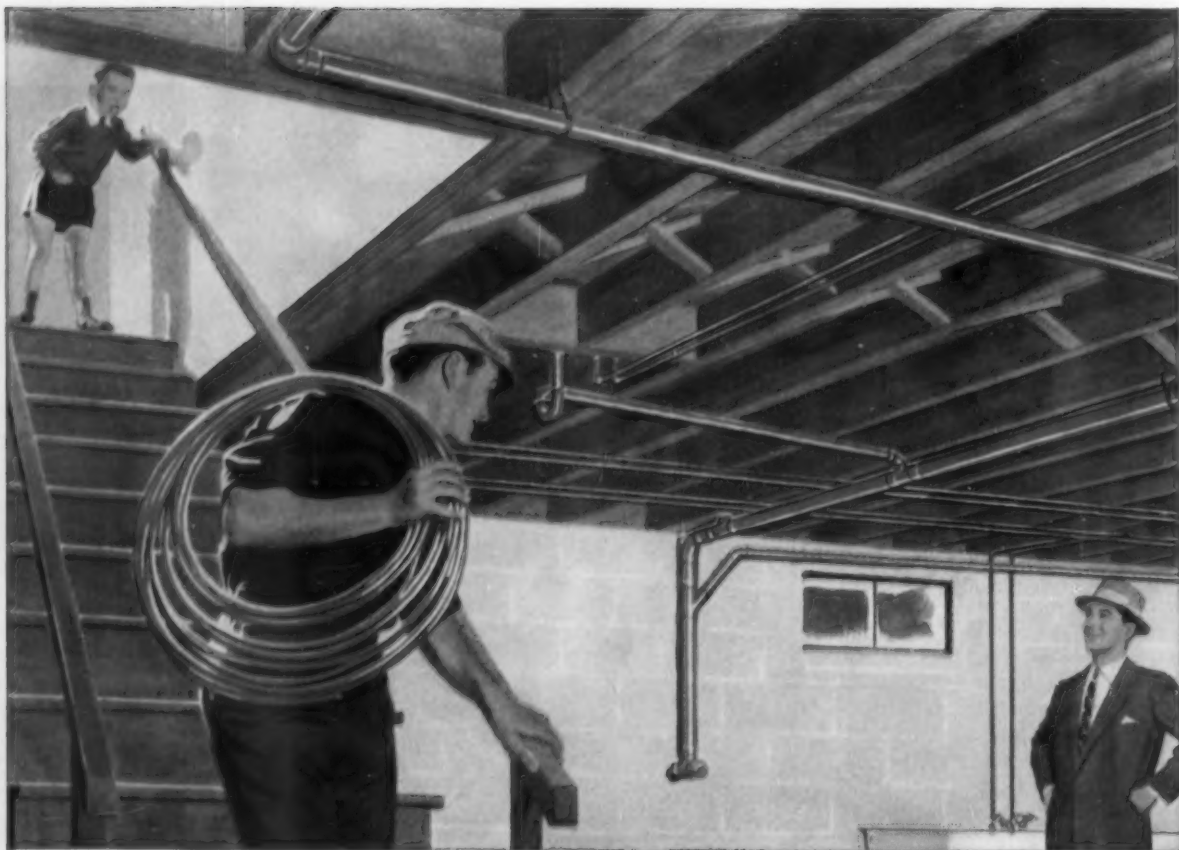

## The best cellars feature Chase Copper Tube

You add *extra-value* to the whole home with hot and cold water lines of Chase copper tube. *More years* of trouble-free service, *more efficient* water flow with little or no increase in cost!

That's because Chase copper tube *resists* corrosion—can't clog with rust! Diameter for diameter, this copper tube passes *higher water volume* than lines of rustable metal! Its smoother inside surface cuts friction to a minimum, assuring fast and efficient discharge of fixtures.

Chase copper tube is easier to handle. Can be *quickly* cut to the required length with ordinary tools. Rugged, leakproof solder joints are made *without* time-consuming threading. Long lengths are available; require *fewer* joints.

Specify Chase copper water tube for hot and cold water lines. Add extra quality at little or no extra cost!



*Chase copper drainage lines, too, give superior service over the years...add extra-value to any home!*

# Chase



**BRASS & COPPER CO.**

WATERBURY 20, CONNECTICUT • SUBSIDIARY OF KENNECOTT COPPER CORPORATION

*The Nation's Headquarters for Brass & Copper*

Albany†	Chicago	Detroit	Los Angeles	New York	St. Louis
Atlanta	Cincinnati	Grand Rapids†	Milwaukee	Philadelphia	San Francisco
Baltimore	Cleveland	Houston	Minneapolis	Pittsburgh	Seattle
Boston	Dallas	Indianapolis	Newark	Providence	Waterbury
Charlotte†	Denver	Kansas City, Mo.	New Orleans	Rochester†	(†trades often only)

**It's New!**

**Champion's**

NEW CONCRETE FINISHER WITH

# ONE MAN PORTABILITY



That's Right! Only *one man* can move this New Champion about the job, with speed and ease... and that means this Champion Concrete Finisher...

**SAVES YOU TIME!  
SAVES YOU MONEY!  
on the job**

- Positive Action Clutch (a Champion Exclusive)
- One-Man Portability (a Champion Exclusive)
- Oversize Reduction Gears and Sealed Lubrication.
- Snap-On trowels and Free-Floating Drive Base.
- Choice of Sizes, Gasoline or Electric Power, and many other Champion features!

### See this Newest *Champion*

Check the features yourself that make this finisher a natural for any job where concrete is laid. The controls are built for quick, effective use with no waste motion, and the entire unit is engineered for trouble-free use on yard after yard of concrete. See it this week!

by **Champion** - MAKER OF THESE FINE PRODUCTS:

Masonry Saws • Concrete Saws • Blades for Concrete and Masonry Cutting • Portable Masonry Saws

See Your Champion Distributor This Week!  
Or Write Direct To:



**Champion**  
**MFG. CO.**  
2028 WASHINGTON AVE.,  
ST. LOUIS 3, MO., U.S.A.

JULY 1955



**this stamp is your  
guarantee against  
door troubles!**

Cheap, low grade doors rob you of customers, reputation, money. The FDI hallmark on a door is your insurance policy. It protects you against complaints and replacements arising from use of shoddy doors that warp, twist or come apart.

FDI hallmarked fir doors are built like fine furniture—with top quality and top appearance that *lasts*. The FDI hallmark means the door has been precision-built of finest materials... has been critically inspected to meet rigid industry and U.S. Commercial Standards... is backed by the manufacturer's guarantee of highest quality and performance.

Don't risk your reputation and money with doors that cause trouble. Insist on FDI quality—proved with the FDI stamp on every door.

### the **FDI** hallmark also means

**Style that sells** Today's canny home buyers are quick to recognize real style trends. Fir "Picture Panel" and exciting new louvre doors lead in the style race.

**Wide selection** There are 68 interior, entrance and garage doors in the FDI catalog... a door for every home purpose. Each is built to deserve the FDI hallmark.

**Low initial cost** Tops in quality, tops in style, FDI hallmarked fir doors *still* cost less than most quality doors on the market.

Eliminate your door troubles **FDI** Use only doors bearing this

**guarantee of quality**

If you have questions, write Fir Door Institute, Tacoma 2, Washington

# KOHLER Electric Plants

Your own electricity on the job saves expense and bother of temporary power line hook-ups



MODEL 1.5M25, 1500 watts, 115 volt AC. Manual starting. Weight 130 lbs., also 115 volt DC, 101 lbs.

Portable Kohler model operates vibrators, saws, drills, planers, grinders, plumbers' pipe threaders and cutters. Develops 1500 watts AC. Engineered by Kohler throughout. Two-wheel, rubber-tired hand truck available. Other sizes, 500 watts to 35 KW. Write for folder C-8.



Kohler Co., Kohler, Wisconsin  
Established 1873

## KOHLER OF KOHLER

PLUMBING FIXTURES • HEATING EQUIPMENT • ELECTRIC PLANTS  
AIR-COOLED ENGINES • PRECISION CONTROLS

### Foundation & Cornice Ventilators

Die Cast From Properly Alloyed Aluminum

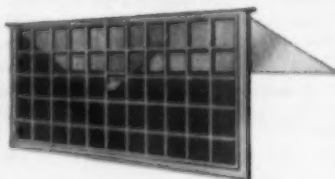

Model 404  
Size 4 x 16

Designed for installations where 3" maximum width is permissible—30 sq. in. free area after screening. Shipping weight per dozen—4 pounds.

Model 106  
Size 8 x 16

- Easy to install
- Uniform in size
- Hinged Aluminum cover permits opening in 14" area
- 8 mesh aluminum screen
- Shipping weight 17# per dozen

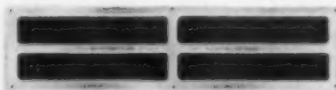

Model 408  
Size 8 x 16

90 Sq. inches of free area opening after screening. This enables builders to meet F.H.A. minimum requirements with fewer ventilators. Shipping weight per doz. 7 pounds.

Accepted by Architects, Public Housing and F.H.A.  
Maximum free area ventilation

All ventilators equipped with 8 mesh aluminum screen (Natl. F.H.A. Requirements).

## HAMLIN PRODUCTS, INC.

Manufacturers of Builders Supplies

P.O. BOX 2016 • 7523 ASHER AVENUE, LITTLE ROCK, ARK.

## AMERICAN BUILDER

### Steel Door Standards

The first page of this month's *Technical Guide* is devoted to the standards of the Steel Door Institute. The details shown for both swing doors and jamba as well as the bypassing closet door unit are established by the Institute's members to assure the building industry of the highest quality product and a standardization of sizes and design.

Complete specifications for the door units shown here may be obtained from The Steel Door Institute, 2130 Keith Building, Cleveland 15, Ohio, or from any of the six member companies listed below:

AMERICAN WELDING & MFG. CO.  
Warren, Ohio

DIEBOLD, INC., UNITED METAL PRODUCTS DIV.  
Canton, Ohio

THE STEELCRAFT MFG. CO.  
Rossmoynne, Ohio

TRUSCON STEEL DIV., REPUBLIC STEEL CORP.  
Youngstown, Ohio

UNITED STEEL FABRICATORS  
Wooster, Ohio

VIRGINIA METAL PRODUCTS, INC.  
Orange, Va.

### Estimating Structural Steel

The second page of the *Technical Guide* contains tables to aid the builder in the estimating and calculating of such structural steel as simple I-beams, pipe and I-beam columns which he may be called upon to furnish for his jobs. Where load and other structural requirements exceed the scope of these tables, professional engineering service should be consulted.

# Technical Guide

## STEEL DOORS & JAMBS

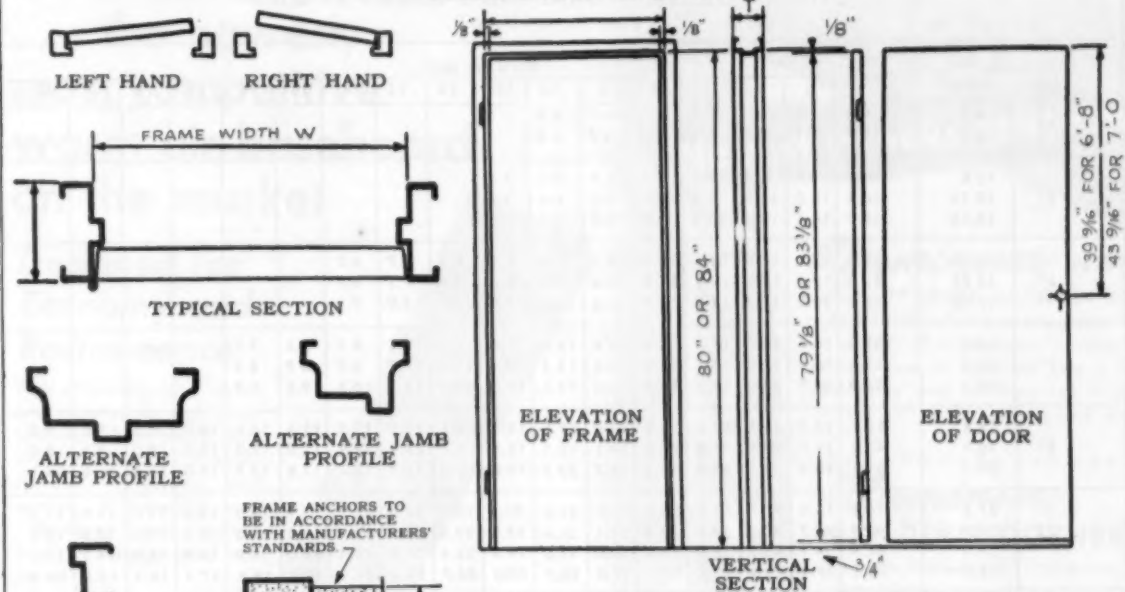

## SLIDING CLOSET DOOR UNITS

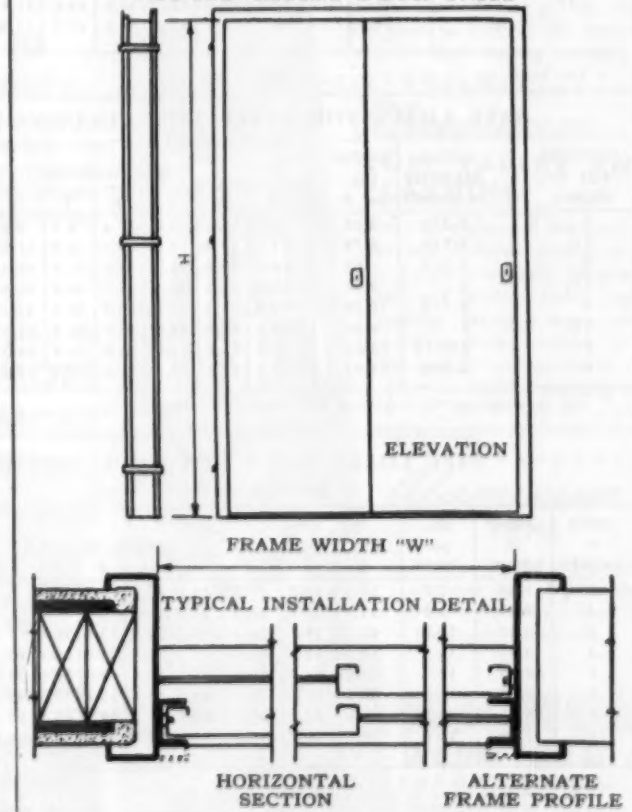

### STANDARD WIDTHS

1 3/8" Doors	1 1/4" Doors	
2'0" x 6'8"	2'6" x 6'8"	2'6" x 7'0"
2'4" x 6'8"	2'8" x 6'8"	2'8" x 7'0"
2'6" x 6'8"	3'0" x 6'8"	3'0" x 7'0"
2'8" x 6'8"		
3'0" x 6'8"		

**SAFE LOADS FOR STANDARD I BEAMS IN KIPS\***

Fiber Stress--18,000#

BEAM		SPAN IN FEET																	
SIZE	WEIGHT	4	5	6	7	8	9	10	11	12	13	14	15	16	17	18	19	20	
4"	8.5	9.5	7.6	6.3	5.4	4.7	4.2	3.8											
	10.5	10.7	8.5	7.1	6.1	5.3	4.7	4.3											
5"	10.0	14.5	11.6	9.7	8.3	7.3	6.5	5.8	5.3										
	12.25	16.2	13.0	10.8	9.3	8.1	7.2	6.5	5.9										
	14.75	18.0	14.4	12.0	10.3	9.0	8.0	7.2	6.5										
6"	12.5	21.8	17.4	14.5	12.5	10.9	9.7	8.7	7.9	7.3	6.7	6.2							
	14.75	23.8	19.0	15.9	13.6	11.9	10.6	9.5	8.7	7.9	7.3	6.8							
	17.25	26.0	20.8	17.3	14.9	13.0	11.6	10.4	9.5	8.7	8.0	7.4							
7"	15.3	31.0	24.8	20.7	17.7	15.5	13.8	12.4	11.3	10.3	9.5	8.9	8.3	7.7					
	17.5	33.4	26.7	22.2	19.1	16.7	14.8	13.3	12.1	11.1	10.3	9.5	8.9	8.3					
	20.0	36.0	28.7	24.0	20.5	18.0	16.0	14.4	13.1	12.0	11.1	10.3	9.6	9.0					
8"	18.4	42.7	34.1	28.5	24.4	21.3	19.0	17.1	15.5	14.2	13.1	12.2	11.4	10.7	10.0	9.5	9.0	8.5	
	20.5	45.2	36.1	30.1	25.8	22.6	20.1	18.1	16.4	15.1	13.9	12.9	12.0	11.3	10.6	10.0	9.5	9.0	
	25.5	51.1	40.9	34.1	29.2	25.5	22.7	20.4	18.6	17.0	15.7	14.6	13.6	12.8	12.0	11.4	10.8	10.2	
9"	21.8	56.6	45.3	37.7	32.3	28.3	25.2	22.6	20.6	18.9	17.4	16.2	15.1	14.2	13.3	12.6	11.9	11.3	
	25.0	60.9	48.7	40.6	34.8	30.5	27.1	24.4	22.2	20.3	18.7	17.4	16.2	15.2	14.3	13.3	12.8	12.2	
	30.0	67.6	54.1	45.1	38.6	33.8	30.0	27.0	24.6	22.5	20.8	19.3	18.0	16.9	15.9	15.0	14.2	13.5	
	35.0	74.2	59.4	49.5	42.4	37.1	33.0	29.7	27.0	24.7	22.8	21.2	19.8	18.6	17.3	16.5	15.6	14.8	
10"	30.0	80.1	64.1	53.4	45.8	40.1	35.6	32.0	29.1	26.7	24.6	22.9	21.4	20.0	18.8	17.8	16.9	16.0	
	35.0	87.5	70.0	58.3	50.0	43.7	38.9	35.0	31.8	29.2	26.9	25.0	23.3	21.9	20.6	19.4	18.4	17.5	
	40.0	94.8	75.8	63.2	59.2	47.4	42.1	37.9	34.5	31.6	29.2	27.1	25.3	23.7	22.3	21.1	20.0	19.0	

\* The loads are given in kips, a kip being 1,000 lbs.

**SAFE LOADS FOR STEEL PIPE COLUMNS IN KIPS\***

NOMINAL SIZE in INCHES	ACTUAL DIAMETER in INCHES	WEIGHT lbs. per Ft.	LENGTH IN FEET															
			5	6	7	8	9	10	11	12	13	14						
2	2-3/8	3.65	12.2	10.6	9.0	7.4	6.6	5.8	5.0	4.1	3.3							
2 1/2	2-7/8	5.79	21.6	19.4	17.3	15.1	12.9	11.4	10.3	9.2	8.1	7.0						
3	3-1/2	7.58	29.0	26.6	24.3	24.0	21.7	19.4	17.1	15.2	14.0	12.9						
3 1/2	4	9.11	34.8	34.8	34.1	31.7	29.3	26.9	24.5	22.1	19.7	18.0						
4	4-1/2	10.79	41.2	41.2	41.2	40.1	37.6	35.1	32.6	30.0	27.5	25.0						
4 1/2	5	12.54	48.0	48.0	48.0	48.0	46.4	43.8	41.2	38.5	35.9	33.3						
5	5-9/16	14.62	55.9	55.9	55.9	55.9	55.9	54.2	51.5	48.7	46.0	43.2						
6	6-5/8	18.97	72.5	72.5	72.5	72.5	72.5	72.5	72.5	70.2	67.3	64.3						

\* The loads are given in kips, a kip being 1,000 lbs.

**EXAMPLES**

To find correct I beam size:

1. Determine uniformly distributed load.
2. Locate this load figure in column under span in feet.
3. Read size and weight of required beam in column at extreme left.

To find pipe column size:

1. Determine load in kips. If column is to support center of beam supported at ends divide load in half.
2. Locate nearest load figure in column under required length.

3. Read size of pipe required in column at extreme left.

To find I beam column size:

- Follow same procedure as outlined for pipe columns.

**SAFE LOADS FOR I BEAM COLUMNS IN KIPS\***

American Standard Sections

DEPTH in INCHES	AREA in SQ. IN.	LBS. per SQ. FT.	LENGTH IN FEET															
			3	4	5	6	7	8	9	10	11	12	13	14				
3	1.64	5.7	23.5	20.3	17.2	14.6	12.3	10.5										
4	2.21	7.7	33.0	29.1	25.3	21.8	18.7	16.1	13.9									
5	2.87	10.0	43.1	39.7	35.1	30.7	26.8	23.4	20.4	17.9								
6	3.61	12.5	54.2	52.1	46.9	41.8	37.0	32.7	28.9	25.5	22.6	20.2						
7	4.43	15.3	66.5	65.9	60.0	54.1	48.5	43.3	38.6	34.5	30.8	27.6	24.7					
8	5.34	18.4	80.1	80.1	74.9	68.3	61.8	55.7	50.1	45.0	40.5	36.5	33.0	29.8				
9	6.32	21.8	94.8	94.8	91.2	83.9	76.7	69.7	63.2	57.2	51.8	47.0	42.6	38.7				
10	7.38	25.4	110.7	110.7	109.5	101.7	93.8	86.0	78.7	71.8	65.6	59.7	54.5	49.8				

\* The loads are given in kips, a kip being 1,000 lbs.

# VULCAN AIR-TRIM

warm air baseboard

... the newest,  
most competitive  
warm air baseboard  
on the market

## Designed for Economy and Performance

Top efficiency plus economy assured through easy-to-install baseboard that distributes warm air evenly over extended wall areas. Eliminates wall "streaking" and "scorching" of drapes and curtains.



## Styled for Beauty

Yes—outstanding in style and beauty because its fashioned after Vulcan's famous TRIMLINE design, the choice of discriminating homeowners.

Designed and Styled to  
help you **SELL MORE**  
... **PROFIT MORE**

The distinctive design helps to make your selling job easier. Smarter looking, more attractive, AIR-TRIM pays you a bonus in increased sales. And its packaged for easy stocking 2, 4, 6, 8 and 10 ft. lengths.



Write now for your AIR-TRIM Bulletin. Data and installation instructions included.

ORIGINATORS  
OF FIN-TUBE  
AND  
BASEBOARD  
RADIATION  
IN AMERICA

The VULCAN Radiator Company  
775 Capitol Avenue • Hartford 6, Conn.

# NEVER RUST-PROOF Aluminum

BUILDING PRODUCTS

No rust streaks or stains

## Aluminum NAILS

Made of HI-TEMPER ALUMINUM ALLOY — easy to drive. Etched for greater holding power. FHA approved. Available in a wide range of types and sizes in handy "pull-string" unit packages and in 50 lb. cartons. Write for samples and counter display.

## Aluminum BUILDING CORNERS

The new modern-look "Straightline" design building corner. Available in all popular sizes. Packed to sell in sturdy counter-display boxes of 100 each—five boxes to a carton. No coating to chip off—no counting necessary.

## Aluminum ROLL VALLEY AND FLASHING

The most economical rust-proof valley and flashing. Strong — easy to handle — specially tempered — extremely pliable. Never requires painting. Packed in sturdy cartons, Aluminum Valley available in 14", 20" and 28" widths—50 ft. coils. Aluminum Flashing available in 3", 4", 5", 6", 7" and 8" widths—50 ft. coils.

## Aluminum TRIM

A complete line of high-quality aluminum trim. Modern design — never requires painting. Write for descriptive circular.



# NICHOLS

WIRE & ALUMINUM CO.  
BAYENPORT, IOWA

World's Largest Manufacturer of Aluminum Nails

# ask the EXPERTS about



- Planning
- Concrete Work
- Framing
- Roofing
- Heating and Plumbing
- Air Conditioning
- Wiring
- Insulation
- Interior Finish
- Power Equipment

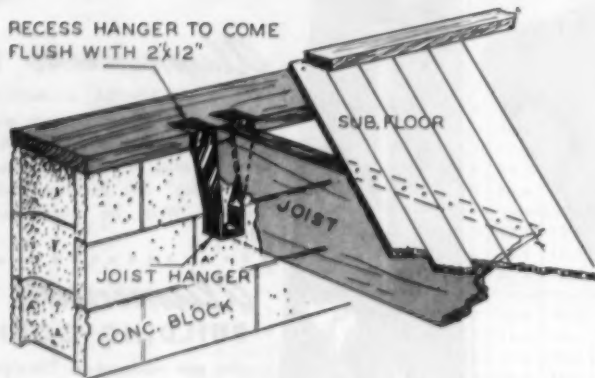

## How to get low silhouette for a house with basement

I want to lower the silhouette of my houses to one similar to those on slabs. I am building one-story houses over a full basement of concrete block construction. Enclosed is a detail of one method of accomplishing this. Can you suggest a better one? There is also the problem of spanning the window openings. Could the sill be reinforced with steel angles, and if so, what size? A concrete lintel is also a possibility, but what size of steel must be used for reinforcing?

J. A. C., Annandale, N. J.

The detail you indicate (see above) in your sketch is very good. An alternate method of construction would be to use a 12-inch thick concrete block for the wall, reducing the course of concrete blocks at the top to 8 inches in thickness and in this way provide a 4-inch shelf for the reception of the floor joists.

When windows occur it is assumed that the head will be placed at the bottom of the top course of concrete blocks. These blocks should then be reinforced with two 1/2-inch rods and voids filled with concrete.

## For a studio ceiling, try a scissors truss

I saw an article in your July, 1954 edition that interests me very much. Would it be possible to secure more detailed information on the scissors truss that creates a studio ceiling?

E. J., Walworth, Wis.

Scissor trusses and other types of raised lower chord, pitched-roof trusses are used for special conditions where clearance or appearance require the arched or sloped bottom

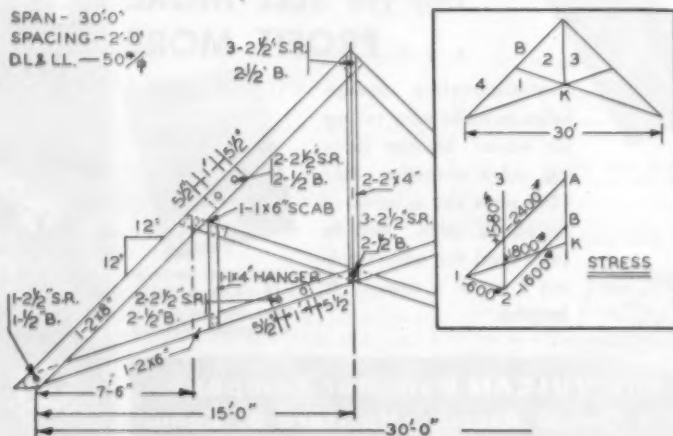

chord. The scissors type is commonly used for churches and other public assembly buildings where the arched ceiling is desired. See the accompanying drawings for technical information.

George A. Kennedy,  
Structural Engineer

## What is a fair profit for a builder to take?

What is the correct figure to allow for overhead in home building? What is properly classed as overhead? What is the proper pay for a builder to allow himself, when he works with his tools, as a carpenter, on his own work? What is a fair profit to take on home building?

A. E. N., Los Altos, Calif.

The overhead, which includes insurance, hauling, office expense and the expense of a foreman or superintendent, should be listed as 10 per cent of the total cost of the job. The insurance includes liability and workman's compensation. Hauling includes the rental of trucks, if you do not own your own equipment; otherwise, it would include the

(Continued on page 158)



# ONE LOUVER

*FITS any Roof Pitch*



The **ADJUSTABLE, ALUMINUM**

## VARI-PITCH LOUVER

The modern trend to low pitch roof design in homes, multiple dwellings and commercial construction requires new types and sizes of louvers . . . THE ADJUSTABLE, VARI-PITCH LOUVER ADAPTS ITSELF TO MODERN DESIGNS.

And with the increasing use of air conditioning in building, ventilation is of major importance . . . THE VARI-PITCH LOUVER PROVIDES THE KIND OF SCIENTIFIC AIR CIRCULATION THAT IS DEMANDED.

Here's the practical, economical solution to any ventilating problem.



**INSTALLATION IS SIMPLE**—labor and fitting time is reduced to a matter of minutes. VARI-PITCH conforms instantly to the opening . . . fits tightly, securely.

**ONE LOUVER FITS MANY SLOPES** therefore only 1/5 the storage area is required to stock VARI-PITCH in quantities than is ordinarily required for standard units.

**ALL ALUMINUM CONSTRUCTION INSURES LIFETIME SERVICE** . . . no rust, no maintenance, no replacement . . . ever! F. H. A. approved design.

**VARI-PITCH LOUVERS** are attractive louvers that actually cost less per square foot than the building materials they replace.

Complete with 8" mesh screen, VARI-PITCH is available assembled, ready for quick easy installation or knocked-down for on the job assembly.

Get all the facts on this adaptable, adjustable louver from your dealer or write to LOUVER MANUFACTURING AND SUPPLY CO. for complete information.

## LOUVER DIMENSIONS



Approximate opening dimensions VARI-PITCH louvers will fit when set at the maximum or minimum pitch each will accommodate.

Model Number	Inch Rise Per Foot	Dimension A	Dimension B	Dimension C
A50B	6	38"	21 1/2"	10"
A50B	12	29"	21 1/2"	14 1/2"
A56B	6	44 1/2"	25"	11 1/2"
A56B	12	34"	24 1/2"	17"
A88B	6	51 1/2"	29"	13"
A88B	12	40"	28 1/2"	19 1/2"
A44B	4	27"	30"	10"
A44B	5	54"	29 1/2"	11"
A33B	4	41"	22"	7 1/2"
A33B	5	40"	22"	8 1/2"

**LOUVER** MANUFACTURING & SUPPLY COMPANY

5813 West 36th Street • Minneapolis 16, Minn.

JULY 1955

## NEW FACES JOIN THE

## OPTIONAL KOLOR PLAN CAST

### SANDED-FACE PRYME-SHAKES

These are 18" long for a 14" exposure and may be applied by double wall or double course methods, although double wall is recommended. As with regular Pryme-Shakes, these are square butted and jointed and have parallel sides. The smooth sawn face is lightly sanded to remove saw marks. Packed in cartons bearing the Certi-groove label—1 sidewall square per carton,

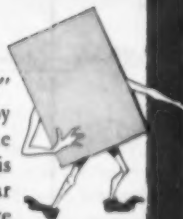

### HAND SPLIT PRYME-SHAKES



These are 18" long, have a butt thickness from 1/2" to 3/4", permit a 14" exposure. May be applied by double wall or double course methods, although double course is recommended. Backs are resawn so shakes lay flat and snug. To heighten the rustic effect, sides are not parallel and tips and butts are not squared. Kiln-dried and carton packed—1/2 sidewall square per carton.

With these two new factory-primed shakes joining the original Weatherbest scored Pryme-Shake in the Optional Kolor Plan, there is now a Pryme-Shake to suit every personal taste, satisfy any architectural requirement, work perfectly in combination with any other exterior material. Price of all three Pryme-Shakes, of course, includes choice of 20 Fynal-Kolors for a finish coat on the job.



See your nearest Weatherbest Distributor for full information, or write

WEATHERBEST CORPORATION, NORTH TONAWANDA, N. Y.

157

Are you  
as proud of the  
**HEATING SYSTEM**  
as you are  
of the kitchen?



J-C Poweraire  
Series Furnace  
for Oil or Gas

In all too many new houses the heating system is the "poor relation" to the smart, modern kitchen.

Sure, kitchens sell houses—but cheap heating systems can unsell them, fool! And the woman who is attracted by the beautifully appointed kitchen is also interested in a dependable, trouble-free furnace.

The J-C line offers a furnace to fit every need. Best of all, with J-C you can provide a quality furnace—at a common sense cost! Sell your houses with a furnace you can be proud of — a JACKSON & CHURCH!

*J-C . . . America's Largest and Most Complete Warm Air Heating Line!*



JACKSON & CHURCH  
FURNACE DIVISION  
Saginaw, Michigan

## ask the EXPERTS

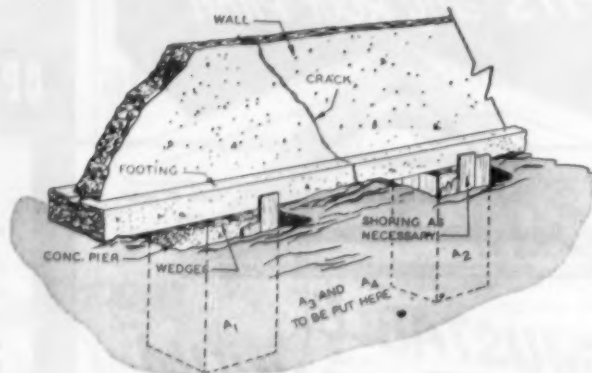

### Supporting a cracked foundation wall

*A house 24x34 is located on land which slopes down from the street level. The owner intended to place the necessary fill on all four sides of the house, but after the footings were cast, he decided to have a garage in the basement, and sloped the fill down to each side of the doorway. During the winter, below-zero weather made the footing and wall near the garage door heave and crack. The owner has asked for my advice. I feel that the foundation should be made deeper at this point, but this will require expensive shoring and in addition to this, I fear that the wall may sink during excavation because the footings rest on rather wet, soft clay. What do you think can be done?*

*J. G. E., Lee, Mass.*

The only remedy is to underpin the wall. Do the excavating in small sections, starting at the two ends of the wall to be underpinned. This allows the load to be resisted temporarily by the intervening undisturbed soil. Thus, pits represented by A-1 and A-2 are dug, using sheathing to make sure that the intervening soil does not slip. Then a solid concrete pier is made up to about 2 to 3 inches below the old footing. After the concrete has set properly, steel or hardwood wedges are driven between the new pier and the old structure, as shown in the drawing, in order to force the load into the pier. The rest of the space is then packed with stiff mortar. The next step is the excavation of

pits A-3 and A-4, following the previous procedure until a continuous foundation wall is constructed.

*George A. Kennedy,  
Structural Engineer.*

### Fair profit

*(Continued from page 156)*

maintenance of that equipment. If the foreman or superintendent has a number of jobs to handle, then his salary and entire cost of operation would be included in overhead.

In a case where the builder works with his tools on the job, he should then figure the cost of his labor at a foreman's rate, which varies (in Chicago it would be about \$3.45 per hour).

A fair profit for erecting a home and taking care of all the details would be 5 per cent of the total cost of the house.

### Timing the building processes

*I would like to know the length of time certain operations such as shingling, siding, or sheathing, joist laying and the like should require.*

*H. A. K., Fort Atkinson, Wis.*

Your question is rather difficult to answer specifically, so the items discussed here are only approximate and are set forth merely to give you a general idea. They are not quoted for the purpose of being used specifically or as a basis for estimating.

If three-in-one asphalt shingles  
*(Continued on page 160)*

Demonstration house—section shows all-copper plumbing installation.

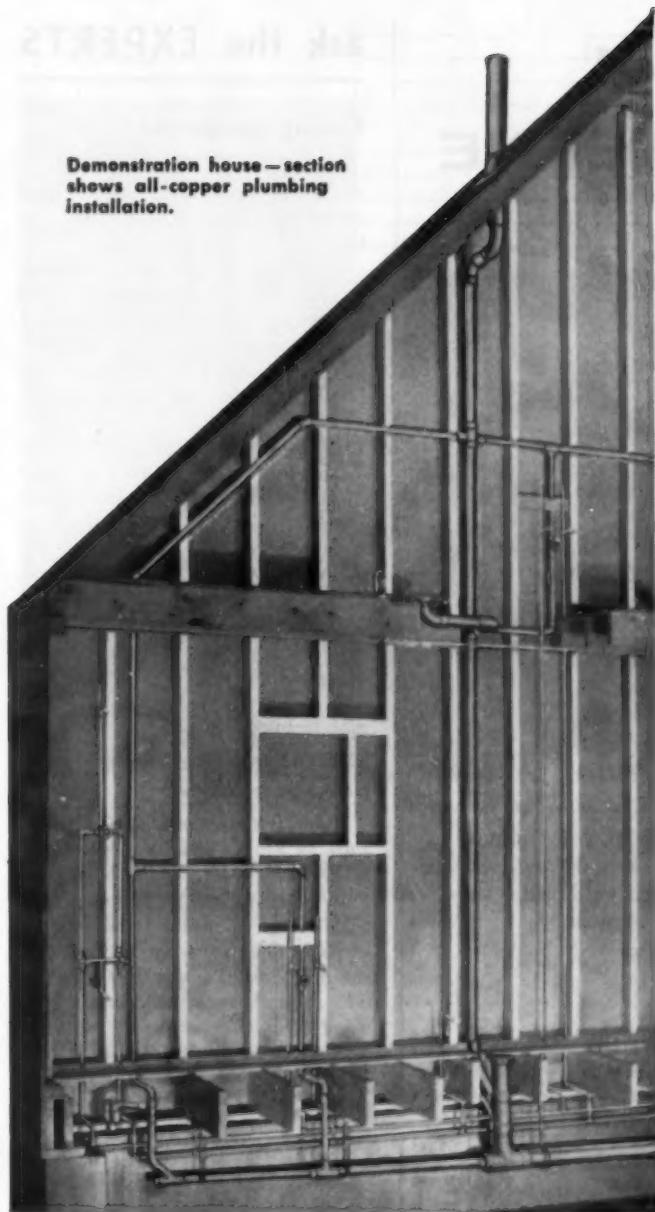

Anaconda Copper Tubes are available in all standard wall thicknesses—Types K, L, M and the new lighter weight Type DWV, which offers additional savings in job costs.

Within the past few years, many state and local sanitary plumbing codes have been modernized to include approval of the use of copper tube and solder-type fittings. Others are in process of revision. The recently issued American Standard National Plumbing Code (ASA A40.8-1955), published by The American Society of Mechanical Engineers, lists copper tube as approved material for sanitary drainage systems.

Types M and DWV are recommended for all lines of the sanitary drainage system above ground, and Types K and L for that part of the system buried underground.

5610A

## USE COPPER

for sanitary drainage systems and gain these advantages

1. **Fast, tight connections easily made** in even the hard-to-get-at spots!
2. **Carpentry and space savings.** No costly and space-consuming "build-outs" or extra-wide partitions. A 3" copper tube stack *with fittings* can be installed within a standard 4" partition.
3. **Long lengths eliminate many joints.** Anaconda copper tube is furnished in standard 20' lengths.
4. **Pre-assembly saves time, reduces costs.** Copper tube's light weight permits economical shop fabrication of standard sections for housing developments. Units can be easily transported to job site and installed in place without special lifting equipment.
5. **Roughing-in is faster.** Workmen handle 75% less weight when using copper tube. For example, a 20' length of 3" Type DWV copper tube weighs only 34 lb.
6. **Salability of homes increases.** Exposed lines are neat and trim. To prospective home buyers one sign of quality construction is all-copper plumbing.

**ANACONDA COPPER TUBES  
ASK YOUR PLUMBING CONTRACTOR**

**ANACONDA®  
COPPER TUBES**



**FREE BOOKLET**

**The American Brass Co., Waterbury 20, Conn.  
In Canada: Anaconda American Brass Ltd.,  
New Toronto, Ontario**

Here's the information you need on copper tubes and fittings for sanitary drainage systems. For your free copy mail coupon today.

NAME.....  
COMPANY.....  
STREET.....  
CITY.....ZONE...STATE.....

# The *Workability* of FOLLANSBEE TERNE

will cut  
installation costs  
here!



Your cost for weathersealing and roofing one of your homes depends for the most part on *how long* it takes to do the job.

Ask an experienced sheet metal man and he'll tell you Follansbee Terne will cost you less installed because:

1. Terne is ductile—easy to handle and bend.
2. Expansion joints are unnecessary.
3. Follansbee Terne comes in 50 ft. rolls without cross seams and in ten different widths.
4. It's easy to solder. The lead-tin alloy coating forms a perfect joint.
5. Follansbee Terne will live with other metals. The lead coating makes it chemically inert and safe to solder to any other metal.

You're sure of the best job at the lowest cost when you insist on Follansbee Terne for weathersealing or the complete roof. Ask your sheet metal contractor about Follansbee Terne.

*Write for information about our new pan former and seamer which make standing seam Terne roofs economical.*

Follansbee Terne is Carried in Stock by Leading Sheet Metal Distributors Everywhere.

## FOLLANSBEE STEEL CORPORATION

General Offices, Follansbee, West Virginia

Cold Rolled Strip  
Seamless Terne Roll Roofing  
Polished Blue Sheets and Coils



Sales Offices in Principal Cities

## ask the EXPERTS

### Timing processes

(Continued from page 158)

are to be used, then assume that about  $\frac{1}{2}$  square can be laid per hour.

If siding is the 8-inch beveled type, then approximately 100 square feet can be laid per hour.

If the sheathing is of the 4x8-inch insulation type, then approximately 100 square feet per hour can be applied.

If the joists are 2x8's, 16 inches o. c., and are laid over a crawl space, approximately 1,000 square feet can be laid per day by two men. This will include placing of the plates, bridging and all except the rough flooring, which would leave the operation complete for the laying of the floor and the erection of the studs.

### Framing a floor: Should we use bridging between joists?

*What is the correct size of floor joist to use to span a 12-foot distance? For example: the homes we build always have a 24-foot width with a steel "I" beam down the center. The floor joists we use at present are 2x6x12's spaced 16 inches o.c. with  $\frac{3}{4}$ -inch waterproof plywood for the subfloor, without bridging. What percentage of strength would this add to our floors?*

C. C., Fort Wayne, Ind.

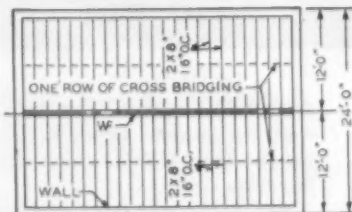

The size and spacing of floor joists depends greatly on the ceiling treatment put below the joists. If you do not have plaster ceiling attached to the floor, then you do not have to worry about excessive deflection on the floor joists. In this case you may use 2x8 joists at 24 inches o. c. on a span of 12 feet. With an attached ceiling, large de-

(Continued on page 163)

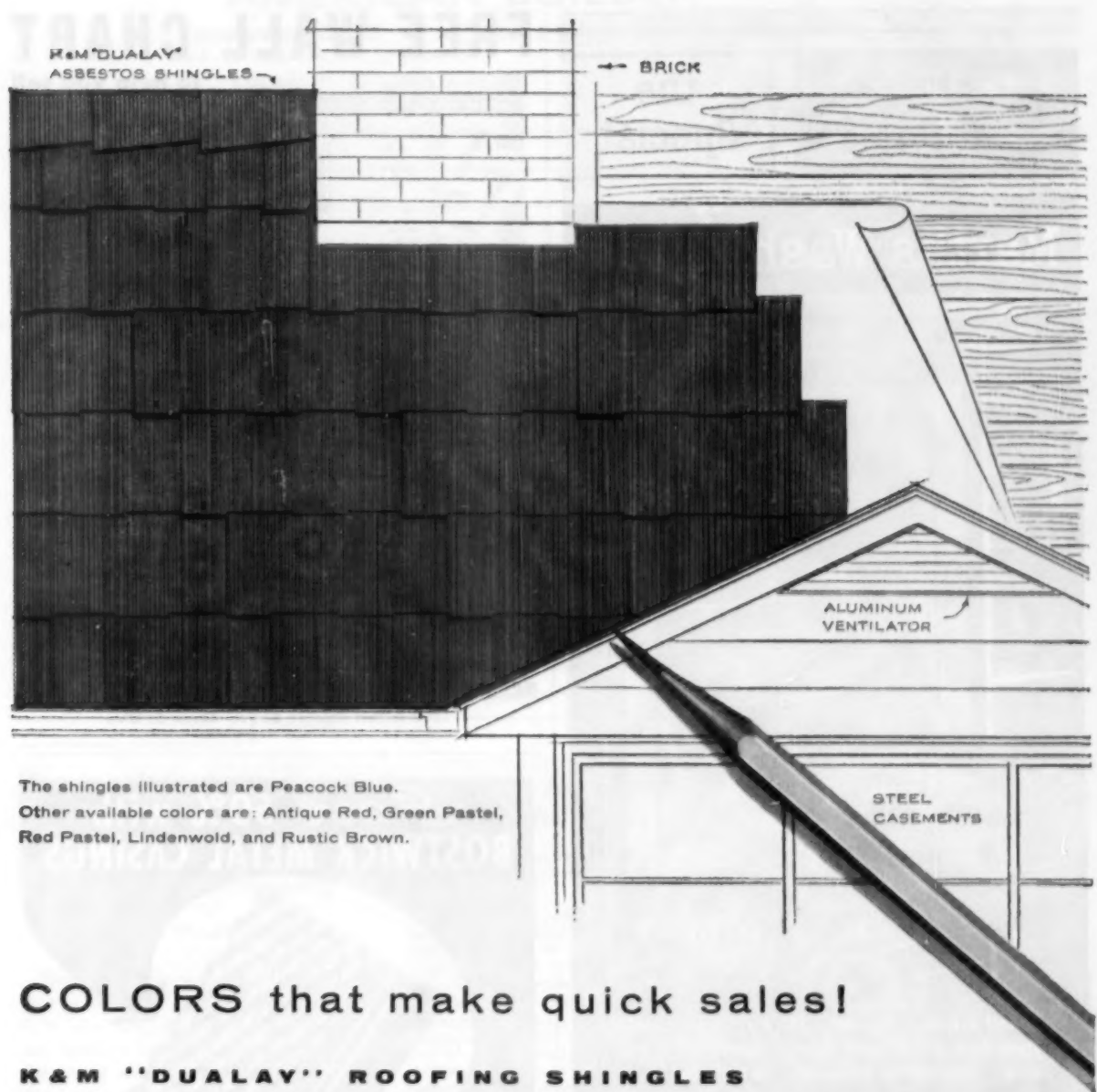

The shingles illustrated are Peacock Blue.  
 Other available colors are: Antique Red, Green Pastel,  
 Red Pastel, Lindenwood, and Rustic Brown.

## COLORS that make quick sales!

### K&M "DUALAY" ROOFING SHINGLES

Show a prospect a home roofed with colorful *Dualay* shingles, and he's on your side right from the start. The sales magic of the six *Dualay* colors does the job, wins customers fast! What's more, there are many other solid sales features in these tremendously appealing shingles. *Remarkable durability.* Made of asbestos fiber and portland cement, K&M *Dualay* shingles offer lifetime roofing protection. They won't burn or rot; in fact, they become harder with age. And because they're "anchored" in place, they're especially wind-resistant.

**Easy to apply.** *Dualay* shingles are self-aligning. They're made to lay up like Dutch-Lap shingles, but the effect is similar to that obtained by the American method. And *Dualay* shingles are made so they can be laid up to give either a straight or a thatched butt.

Write today for literature giving complete details on these highly salable roofing shingles. Ask also about the modern appeal in design and color of the siding shingles that K&M makes. Information on both in Sweet's Light Construction File.



Can be laid up two ways—  
 with either straight butt or thatched.  
 Straight butt effect of *Dualay* shingles  
 is pictured here; thatched effect is shown  
 in upper illustration

**KEASBEY & MATTISON**  
 COMPANY • AMBLER • PENNSYLVANIA



Great  
Utility

the  
Special

by  
Martha Washington



Lowest priced in the line... 16" x 19" x 14"... with glass door and interior light... automatic, if you wish... completely equipped... a real buy!

In Copper, Stainless or 4 Colors!

Write for Brochure & Name of Your Distributor

MARTHA  
WASHINGTON

151 Avenue A  
Bayonne, N. J.

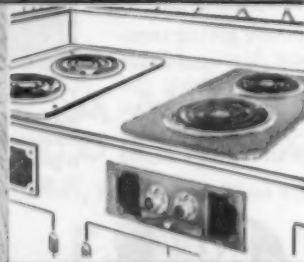

## FREE WALL CHART

to help you sell

**BESSLER  
DISAPPEARING  
STAIRWAYS**

quickly...  
profitably!  
easily...



### FREE CATALOG!



Gives you complete handy reference data on entire Bessler line, for quick selling or application to any stairway job. Write for it now! Ask for your FREE copy of the Bessler Wall Chart too.

Here's a real 24-hour-a-day salesman for the famous line of Bessler Disappearing Stairways. Hang it anywhere in plain sight, for ready reference by you and prospects. Seven Bessler models to meet any home building or remodeling need.

Millions of Bessler units now in use. Millions of homes, outbuildings, offices, commercial establishments need this efficient stairway. There's a big market for you in your community! Popular prices!

**BESSLER DISAPPEARING STAIRWAY CO.**

1900-A East Market Street, Akron 5, Ohio

Save 50% with  
**BOSTWICK METAL CASINGS**

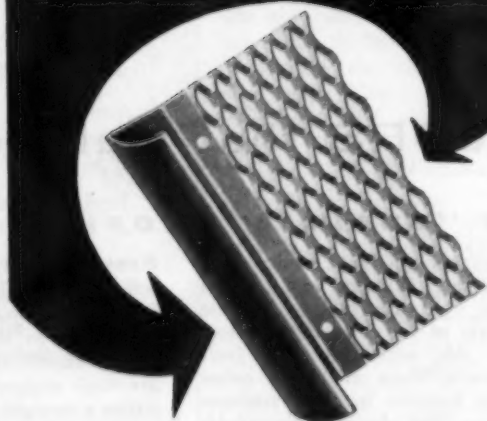

Bostwick end-to-end straightness cuts costs on splicing, eliminates cutting and trimming, knocks wasted material costs flat! Complete uniformity produces fast, accurate miters. Joints are snug, neat and secure. Scream and trim are in one piece for fast installation. You save on casing costs on every frame opening when you use Bostwick Metal Door and Window Casings. See them at your Bostwick dealer's today.

**Bostwick**

THE BOSTWICK STEEL LATH CO.

103 Heaton Ave., Niles, Ohio

AMERICAN BUILDER

## ask the EXPERTS

### Framing a Floor

(Continued from page 160)

flections should be avoided. To accomplish this, 2x8 joists at 16 inches o. c. should be used. Also, a row of bridging on every 7-foot clear span is always recommended.

George A. Kennedy,  
Structural Engineer.

### The minimum thickness for foundation walls

What would be the thinnest concrete wall advisable for a foundation 26 feet by 42 feet and 7 feet 6 inches in height? The house is to be placed on a level lot with the grade from 8 to 12 inches of the sill.

H. N., Oneonta, N. Y.

If the foundation wall is enclosing a basement, use at least a 12-inch concrete wall. If there is fill inside and outside the wall, use an 8-inch thick concrete wall.

### How to paint copper screening

What kind of paint can I apply to copper or bronze screening to keep it from running or discoloring the paint work?

R. L. M., Arlington, Va.

Because of the very small diameter of the wire used in screening, it is, of course, difficult in applying any finish to be absolutely sure that the entire area is covered. Perhaps the best way to apply a protective coating to screens is to use a small roller. These rollers are actually covered with small pieces of carpeting, and by carefully rolling back and forth across the screening area, you can get good coverage. We would suggest, however, that a minimum of two coats of material be put on, allowing at least 24 hours between coats. Use a top-grade alkyd varnish. Re-coat the screening at least every two years for an adequate film coating, to prevent oxidation of the copper or bronze screening.

The Valspar Corporation

Renew your subscription TODAY

JULY 1955

## ONAN Announces Two New Series of **POWER PACKED ELECTRIC PLANTS**



### **MORE POWER, LESS WEIGHT, SMALLER SIZE, LOWER COST!**

**2,500-watt unit weighs only 154 pounds! Gives you more power per dollar than any other 4-cycle electric plant.**

Higher output in a smaller, lighter package gives these new Onan units marked advantages for every type of service . . . portable, mobile, primary, or emergency standby.

Wherever you use portable electric plants, you can now put more cost-cutting electric light and power to work for you . . . at less cost. In mobile applications you can take along more power in less space . . . with less weight. In primary and emergency standby applications you get more power at less cost with all the Onan advantages of quick starting, long life and easy maintenance.

These new units are completely Onan-built, with Onan engines direct-connected to Onan generators in a single compact unit. The new, modern, short-stroke, single-cylinder, 4-cycle engines feature extra-large bearings and free-breathing intake and exhaust systems to give you thousands of hours of operation without major servicing. Generators are drip-proof and specially insulated for all-weather, all-season use.

Equipped with carrying frames or two-wheel rubber-tired dollies, Onan AJ and AK series electric plants can be taken anywhere . . . moved around easily on the job.

See your Onan distributor or write for new folder describing all 18 new models



### **POWERED BY MODERN SHORT-STROKE ENGINES**



**AK A.C. MODELS**  
500 and 750 watts, 115 or 230 volts.



**AK D.C. MODELS**  
(Battery chargers) 500 and 750 watts, 6, 12, 32 volts.



**AJ A.C. MODELS**  
1,000 and 2,500 watts, 115 or 230 volts.



**AJ D.C. MODEL**  
(Battery Charger) 1500 watts, 32 volts



**D. W. ONAN & SONS INC.**

3769 University Ave. S.E., Minneapolis 14, Minnesota

Give **STAIRS** this  
extra margin of  
**SAFETY**  
and durability

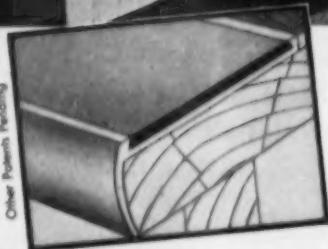

Patent No. 2,930,446  
Other Patents Pending

**NEW, IMPROVED**  
**TUFF-TRED**  
**SAFETY STAIR NOSING #3**

Wherever there are stairs . . . you can eliminate slipping hazards, protect and preserve architectural beauty with TUFF-TRED Safety Stair Nosings. Constructed of polished extruded aluminum with an anti-slip replaceable filler  $\frac{1}{8}$ " overall thickness, TUFF-TRED Safety Stair Nosing #3 can be used in conjunction with resilient floor covering of  $\frac{3}{32}$ ",  $\frac{1}{8}$ " and  $\frac{3}{16}$ " thickness. Standard length 12 feet; colors—tile red, brown, silver and black (for extra safety, choose a contrasting color). Nosing dimensions—3 in. wide x  $1\frac{3}{16}$ " high. Investigate TUFF-TRED and you'll understand why this stair nosing is used so extensively . . . for the extra margin of safety and durability so important today. Write, wire or 'phone for your free copy of descriptive literature. There's no obligation.

**GOODLOE E. MOORE**  
INCORPORATED  
DANVILLE 22, ILLINOIS  
In Canada: W. D. ELMSLIE, Ltd.  
4837 St. Lawrence Blvd., Montreal, Canada

## How to do it better

Ideas for the man on the job

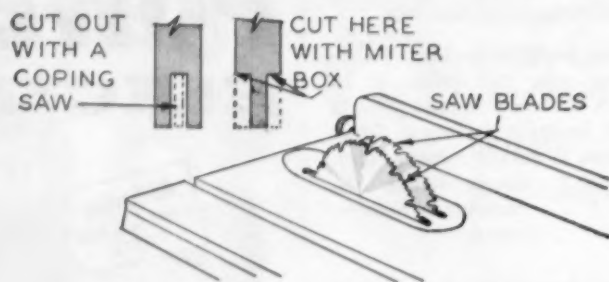

### Cuts mortise and tenon on table saw

Here is a good way to cut a mortise and tenon on a table saw. Use a widethroat table insert and two saw blades of the same diameter. The width of the mortise is obtained by using washers as spacers between the saw blades.

The guide is adjusted so that the mortise is centered in the board. After passing the wood through on end (adjusting height of blade to

depth of mortise) the mortise is easily cut out with a coping saw.

To cut the tenon, remove the outside saw blade and add washers equalling the total width of the saw kerfs, and replace the blade. Make the cut and the two outside waste pieces of the tenon are cut in a miter box.

C. O. Yankovich, Meadville, Pa.

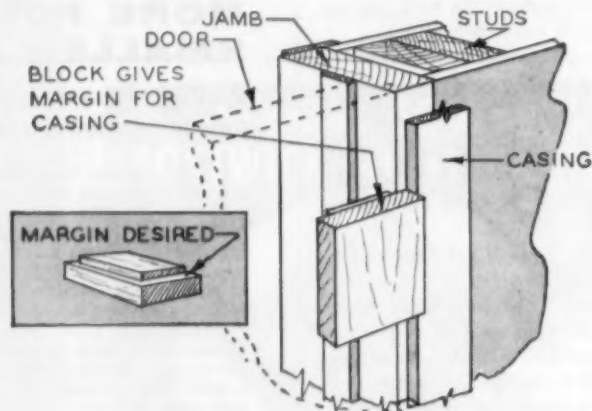

### Margin block eliminates measuring and marks

To save time, get a more accurate fit, eliminate pencil marks and keep trim clean, use a margin block made out of a scrap piece of oak flooring. The margin you want to maintain when nailing casings around win-

dow and door jambs will determine how much to cut out of the four sides of the block. In this case, a  $\frac{1}{4}$ -inch edge is left exposed on the face edge of the jambs.

F. Friedle, Logan, Utah.

### Eave detail for garages

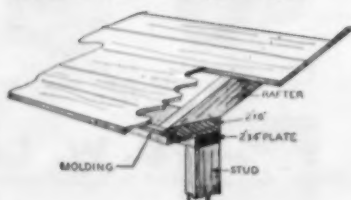

This simple eave detail is satisfactory for garages and other small utility buildings. It makes a solid and tight cornice by placing a 2x8 on the top 2x4 plate, the inside edges flush with the inside edge of the wall studs.

A. F. Taggart, Monrovia, Calif.



# Johns-Manville ASBESTOS FLEXBOARD®

provides  
contemporary  
exteriors  
for  
contemporary homes . . .



**Flexboard is a strong and tough building sheet...it looks and wears like stone...handles and works like wood**

Johns-Manville Asbestos Flexboard is specified and used as exterior side-wall material in thousands of new houses. Combined with wood battens and painted, it provides a serviceable and attractive contemporary exterior that today's home buyers want.

Made of asbestos and cement, Flexboard offers advantages never before combined in a single building material. The large 4' x 8' sheets in  $\frac{1}{8}$ ",  $\frac{3}{16}$ ", and  $\frac{1}{4}$ " thicknesses handle easily.

They can be nailed without drilling, worked with ordinary carpenter tools, and, if necessary, flexed to fit curves.

Flexboard won't rot, rust or burn. It needs no paint or special treatment to preserve it, yet it may readily be painted for decorative purposes. Once in place it provides years of maintenance-free service.

For complete information about Flexboard, write Johns-Manville, Dept. AB, Box 111, New York, N. Y.



## Johns-Manville

**GAR WOOD  
BUCKEYE  
403 DITCHER**

**ONLY 45 MINUTES  
TO COMPLETE FOUNDATIONS!**



**DESIGNED FOR PRODUCTION HOME BUILDERS . . .**  
Dig trench with a Buckeye 403 and pour concrete, all in 45 minutes! . . . Concrete can be poured immediately to prevent cave-ins . . . Full crawler mounting for work in any weather or on unstable ground. Digs to 5' depth. 8" to 16" widths.



**HOUSE FOUNDATIONS or SERVICE LINES . . .**  
Buckeye 403 squares foundation corners, leaves trench clean for pouring—eliminates hand finishing and ditch clean out . . . Digs service lines flush with foundations—cuts through tree roots. Accurate grade to  $\frac{1}{2}$ " with fast, easy operation.



**EASY TO OPERATE—EASY TO TRANSPORT . . .**  
The 403 is small and compact for fast job-to-job transport on small tilt-bed trailer. Low silhouette to clear overhead obstructions . . . Compact design gives maneuverability for fast digging around trees and other obstructions.

For complete information write Customer Service Dept.

**GAR WOOD INDUSTRIES, INC.**  
WAYNE, MICHIGAN

No. 5520



## How to do it better

Ideas for the man on the job

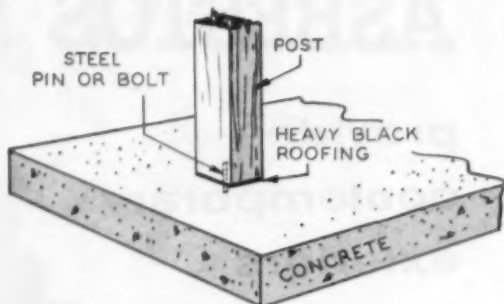

### Keep moisture out of post bottom

To keep moisture from going up the end grain of wood posts bearing on concrete slabs, indoors or outdoors, paint the bottom of the post and also place a piece of asphalt-impregnated felt roofing paper over the concrete cut to the size of the post. This practice will prolong the life of the post.

J. H. McDade, Phillipsburg, Kas.

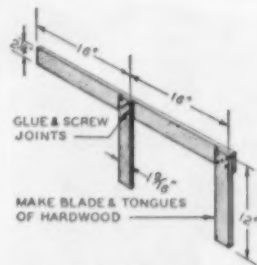

### Double square is time saver

Here is a layout square that will mark two spaces at a time instead of one. If you have spacings to mark on centers other than 16 inches, it probably would be wise to make a

second double square—depending, of course, on how often it is used.

A. E. Crozier, Portland, Ore.

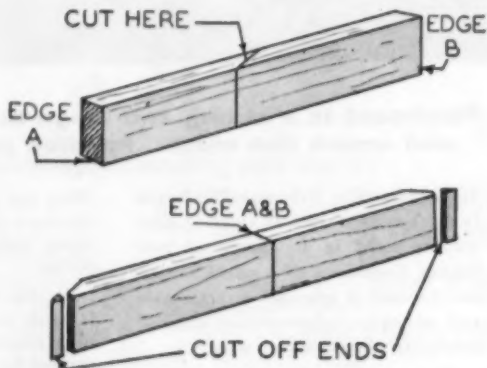

### How to make a short piece longer

Occasionally on a remodeling job the problem comes up of the trim being too short after squaring up an opening. This can be remedied by cutting the piece of trim or board in the center at an angle and splicing, as indicated in the drawing. In many instances a finished moulding covers the lumber.

H. H. Burkitt, Washington, D.C.

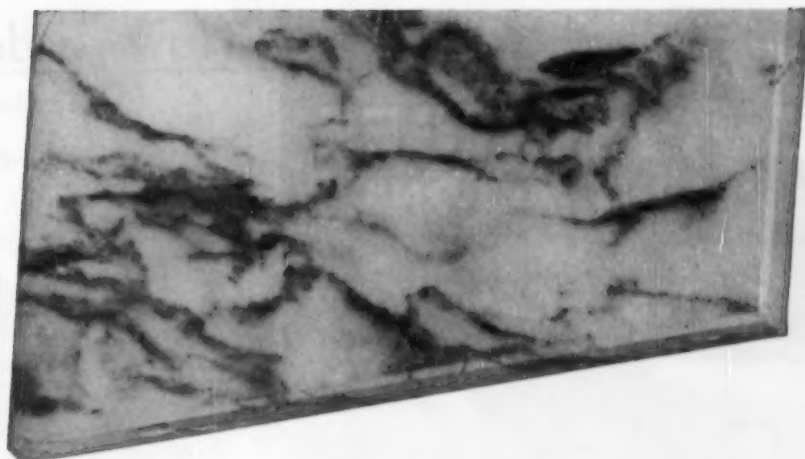

GENUINE



# marble WALL TILE

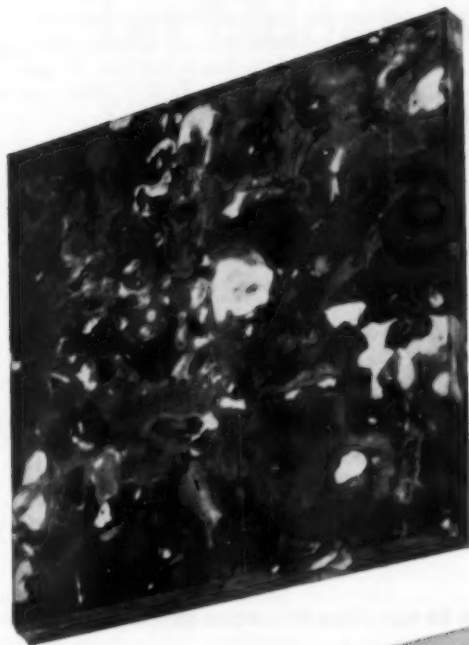

At last, for the first time, magnificent marble, with all its lustrous beauty and vibrant color, is now available in lightweight, half-inch *thinness* for wall or floor covering.

**Here are the facts:**

**MARKWA** marble wall tile is a true quarried marble, produced exclusively by America's foremost marble producer and fabricator, the Vermont Marble Company.

**MARKWA** marble wall tile is half the thickness and half the weight of conventional marble slabs - 1/2 inch thick, 7-1/2 lbs. per square foot. It is cut to three sizes: 8" x 8", 8" x 12", and 12" x 12". It is absolutely flat, uniform in size and thickness to a close tolerance.

**Modular sizes** (3/32" less each dimension) are also available at no extra cost. It is set by tile layers in exactly the same manner as clay tile, either with mortar or by adhesion.

**MARKWA** marble wall tile costs as little as \$2.85 per square foot set in the wall depending on variety of marble and type of installation. It is stocked in a wide variety and color range.

**MARKWA** marble wall tile is ideal for wall or floor, in bathroom, kitchen, living room or foyer, for countertops or fireplace facings, in residential or commercial buildings, for interior or exterior. It comes polished with cushion edges; matte finish available for floors.

**SEE MARKWA NOW!** Specify it for your next job.

More information and complete specification data are available by writing the Vermont Marble Company, Proctor, Vermont, or any of its branch offices.

The only quarried marble that is lightweight because it is thin.



MARBLE  WALL TILE

Produced exclusively by the Vermont Marble Company, Proctor, Vermont.  
BRANCH OFFICES: BOSTON CHICAGO CLEVELAND DALLAS  
HOUSTON PHILADELPHIA LOS ANGELES NEW YORK SAN  
FRANCISCO IN CANADA: ONTARIO MARBLE COMPANY,  
LIMITED, PETERBORO AND TORONTO, ONTARIO CONTINENTAL  
MARBLE COMPANY, LIMITED, VANCOUVER, B. C.

**FRANTZ**  
**BUTT HINGES**  
 PUT THE "ACTION"  
 In  
**SATISFACTION!**



NO. 440  
 FULL MORTISE  
 BUTTON TIP  
 LOOSE PIN

**Ball Tip or Button Tip**  
**ROUND or SQUARE CORNERED**

There are no "if's" or "and's" about FRANTZ Hinges. You can get many sizes and types from one convenient source—and be assured of real satisfaction every time. The dependability of FRANTZ Hinges has been built through a generation of skilled craftsmen who have made the Frantz name a true standard of quality in Builders Hardware. Thousands of doors are swinging on FRANTZ Hinges today...and thousands more will be in use tomorrow. *Get the facts on Frantz! Write today.*

**USE 3 HINGES for EVERY DOOR**

**FRANTZ**

GUARANTEED BUILDERS HARDWARE

FRANTZ MANUFACTURING CO., STERLING, ILLINOIS

**How to do it better**

Ideas for the man on the job

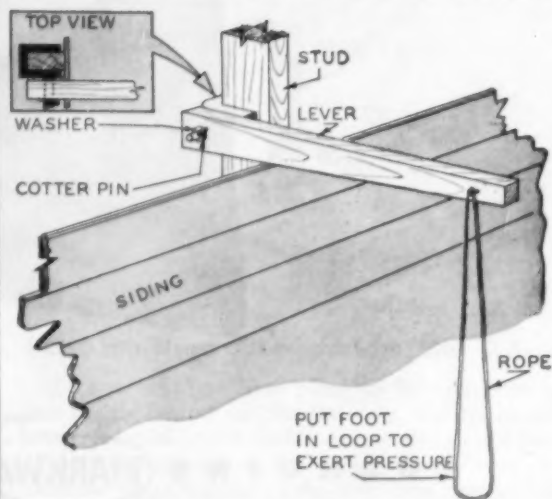

**Getting tight joints with groove siding**

Here's a device for forcing tongue-and-groove siding into place without hammering away at it. By using your foot in the rope loop, both hands are free to drive the nails. This device is easy to attach to the stud and release.

C. A. Silvis, Grand Rapids, Minn.

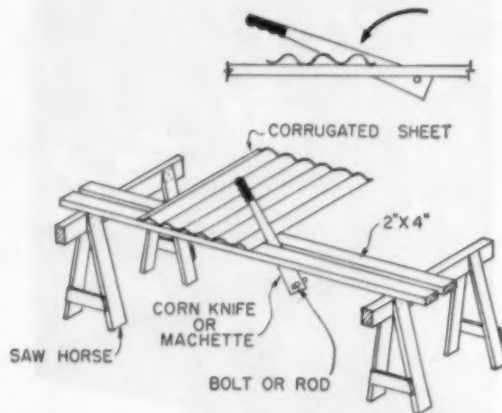

**How to cut sheets across corrugations**

To cut either aluminum or galvanized lightweight sheets across the corrugations, set up two saw horses with 2x4's or 2x6's to support the sheets. A corn knife or machette with a hole in the blade on the end opposite from the handle, for insertion of a pin or rod, is used for the actual cutting.

When pressure is put on the handle of the knife, the bolt or pin comes up against the 2x4's and holds the lower end of the knife solid while the pressure from the top slices through the sheet. After the handle is depressed as far as possible, the knife is slacked and moved ahead and pressed down again until the sheet is cut through.

W. W. Howe, Longview, Wash.

This couple knows they're getting lifetime protection against sewer failure. The tag tells them so.

**"Your plumbing drainage system is designed to last a lifetime—**



**it's Cast Iron Soil Pipe and Fittings"**



## Let hidden plumbing help sell today's "second home" buyer



Today's experienced home buyers know why Cast Iron Soil Pipe is their best buy. More than 20 million people have seen the cast iron story "Permanent Investment" on TV and in movie showings. Millions more have read it in their favorite magazines. They'll be quick to appreciate your cast iron story.

Today your average owner is buying his second home. He's experienced. He's more cautious about plumbing, wiring, and other functional features he can't see.

So where you've given him a soil and waste system designed to last a lifetime — by using **Cast Iron Soil Pipe** — *tell him so!* It's evidence to him that you've used quality materials throughout—even where they can't be seen.

### Don't Stop Quality at the Foundation

You wouldn't risk having to tear out walls or break up the cellar floor to get at a damaged pipe, so you use cast iron. Landscaping can be expensive, too. Don't take a chance under the lawn—any more than you would under a foundation or driveway.

*Only* cast iron is accepted by *all* municipalities for use from street to roof . . . it needs no elaborate trenching, . . . and it's *really* root-proof. Cast iron joints,

oakum-caulked, lead-sealed offer *lifetime protection* against leakage and root invasion. Cast iron is so permanent that Government depreciation tables give it the highest possible rating—equal to the life of the structure.

And cast iron costs little or no more than other types. For, when nonmetallic pipe is laid in *accordance with manufacturers' precautions* its total cost is on a par with cast iron's.

**TO HELP YOU SELL . . .** we'll give you tags and booklets that explain and dramatize the advantages of cast iron. Display the tag on cellar pipe to *show* your owners you've given them permanent protection. They'll also take home the colorful 16-page booklet which explains "What You Should Know About Plumbing Drainage." Samples of these valuable sales aids are yours for the asking . . . write for them today.

**CAST IRON SOIL PIPE INSTITUTE**  
Dept. AB-7, 1627 K St., N. W. Washington 6, D. C.



**THE MARK OF QUALITY AND PERMANENCE**

Want proof for yourself? Ask for "Best in the Long Run," which contains photographic evidence of what can happen to nonmetallic pipes. Also send samples of your sales aids. No obligation, of course.

Name \_\_\_\_\_  
Address \_\_\_\_\_  
City \_\_\_\_\_ Zone \_\_\_\_\_ State \_\_\_\_\_

NOW... AT NO EXTRA COST

## UNIVERSAL SCAFFOLDING

**GALVANIZED**  
FOR FASTER ERECTION

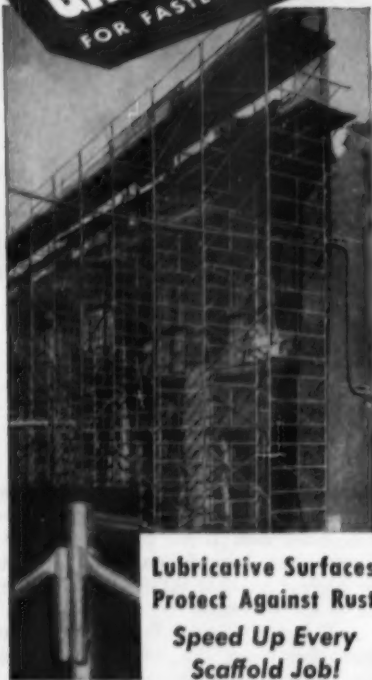

**Lubricative Surfaces  
Protect Against Rust  
Speed Up Every  
Scaffold Job!**

Universal's perfected galvanizing provides a smooth, rust-preventive and lubricative surface—makes your scaffold work faster, look better on the job, and last longer—eliminates rusted, rough surfaces that slow down scaffold operations. Get all the benefits of zinc-galvanized scaffolding—and, at no extra cost!

### **GALVANIZED PROTECTION CUTS OPERATING AND MAINTENANCE COSTS!**



Universal's clean, smooth surface assures more profitable scaffolding operations — substantially reduces costly recurring maintenance expenses.

You can count on Universal for more efficient scaffolding — and greater profits.

Write for complete information

**UNIVERSAL MFG. CORP.**  
ZELIENOPLE 13, PA.

## Milwaukee ordinance tackles problem of prices for condemned properties

By John F. McCarthy  
Attorney at Law



Public officials in charge of condemning properties long have complained about being required to pay higher prices because of improvements to the properties made after notice that they would be taken for some public purpose or use. On the other hand, property owners have protested because they felt that they received too little for the properties which they had improved under those circumstances. They often contended that in fact they had no notice of knowledge of the public purpose or use which had been planned. A Milwaukee ordinance, recently enacted, makes a novel approach to this problem.

The Milwaukee ordinance provides that at least once each year the city must prepare a map of all lands which it proposes to acquire. These properties must be divided into four categories, namely:

1. lands to be acquired during the following two years;
2. lands to be acquired in the ensuing third or fourth years;
3. lands not to be acquired for at least five years;
4. lands involved in the stage of final planning for a federally-aided slum clearance and redevelopment project.

Under the ordinance, when an owner makes application for a permit to build, or remodel existing improvements, on lands in categories 1 or 2 above—that is, to be acquired within the next four years—the building inspector may withhold the permit for a period not exceeding 45 days. During that period, the city

council must decide one of three things; (a) to authorize issuance of the permit; (b) to purchase the land, or (c) to institute proceedings for condemnation.

When an owner makes application for a permit to build or remodel in connection with lands in categories 3 or 4 above—that is, lands not to be acquired for at least five years or involved in the stage of final planning for a federally-aided slum clearance and redevelopment project—the building inspector must issue the permit but place a notice thereon that the property may be taken by condemnation, and that the owner will make any improvements at his own risk since he may not get full value for it.

Milwaukee's ordinance is heralded as a new and effective approach to a problem of long standing. It is said that now a way is found to prevent making cities pay more for improved properties at the time of acquisition by condemnation. The writer suggests that while such an ordinance may have certain practical effects, it is obviously unconstitutional. The states and cities may not prevent an owner from using or improving his property for any lawful purpose. Our constitutions guarantee that when properties are taken for public purposes or uses by condemnation, just compensation as of the time of the institution of the condemnation proceeding must be paid. This obligation to pay fair compensation requires the state or its municipalities to pay the fair cash market value of the properties, in the condition they are in, at the time of the condemnation proceedings.



Harry, Ted, and Tom Macksey, partners in Ranch Homes Inc.

**"Fifty-two sales the first**

**week end, and the majority of them chose  
Youngstown steel Kitchens in color  
over other makes shown in our exhibit homes"**

—say Harry, Ted, and Tom Macksey, partners, Ranch Homes Inc., Birmingham, Mich.



This steel Youngstown Kitchen is in the exhibit 9-room Capri model. It was shown in Dawn Yellow and Meridian Blue, a color combination that captivated the thousands who saw it.



Part of the 58,000 who toured four exhibit homes at Christian Hills the week end of April 16. Average down payment by the 52 who bought at once—\$8,100.

"The week end we opened our new Christian Hills subdivision, more than 58,000 people came out and 52 of them bought. Prices ranged from \$20,000 to \$40,000."

So say the three Macksey brothers, partners in Ranch Homes Inc., and builders of this beautiful, new suburban development north of Detroit.

"We showed different kitchens in four models, including knotty pine, birch, and Youngstown steel Kitchens in color. Buyers could pick the kitchen they wanted, and

so far the great majority of them have told us to put in Youngstown Kitchens in the new colors."

**Builders, look how Youngstown Kitchens  
can give you a sales edge,  
specially during National Home Week!**

Today's demand among home buyers is for color in the kitchen. They're also insisting on quality. Give them both in steel Youngstown Kitchens . . . particularly in your National Home Week models. Send coupon now!

 **STEEL**  
*Youngstown Kitchens*

Sold in the United States, Canada and most parts of the world  
**MULLINS MANUFACTURING CORPORATION • WARREN, OHIO**

In Washington, see the Youngstown Kitchens exhibit  
at the National Housing Center, opening August 15.

**JULY 1955**

Send facts on how  
Youngstown Kitchens can  
help my sales.

Director of Marketing  
Youngstown Kitchens, Dept. AB-758  
Mullins Manufacturing Corporation, Warren, Ohio

NAME (Please print) \_\_\_\_\_

FIRM \_\_\_\_\_

ADDRESS \_\_\_\_\_

CITY \_\_\_\_\_

ZONE \_\_\_\_\_

STATE \_\_\_\_\_

Please have your  
representative call on me  
—no obligation.

**PROFIT FROM THE NEW  
BERMICO PROMOTION  
IN BETTER HOMES AND GARDENS—  
SATURDAY EVENING POST**



*Today's pipe  
for  
tomorrow's homes!*

Match the marvels of your "kitchen of tomorrow" today! Be sure you use modern Bermico house-to-sewer connections.

**Bermico** is rust-proof, corrosion-proof, installs faster and easier and at lower cost.

**Best buy** all around is Bermico, made of tough wood fibre impregnated with pitch.

**Perfect** for modern house-to-sewer connections, toilet tanks,

downspout drains—new or replacement—perforated pipe for land drainage. It lasts and lasts! Complete line of Wytes, Tees, Elbows and Bends. Ask your plumbing and heating contractor or building materials dealer about Bermico—or write Dept. BH-7, Brown Company, 150 Causeway Street, Boston 14, Mass.

America's most modern communities today include Bermico bituminized fibre pipe in building codes. Yours should, too.

**BERMICO**

**10 MILLION FAMILIES** are reading BERMICO advertisements this year! That's going to make a lot of your customers ask about "Today's pipe for tomorrow's homes." Make the most of this new BERMICO promotion. Sell BERMICO for repeated sales and steady profits. Brown Company, Dept. BH-7, 150 Causeway Street, Boston 14, Mass.

**To Bermico Dealers**—Send your name and address and we will ship you brand new sales literature to give prospects and to increase your sales. We will refer direct inquiries in your territory to you.

## Something different

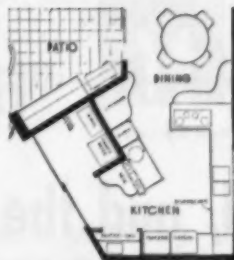

**1 LAUNDRY AND PLANNING DESK PENINSULA**  
Kitchen-planning specialists for the Los Angeles City Department of Water and Power offer this combined laundry-planning center as an efficient unit for incorporating into kitchen work space



**2 GRIDDLE CART WITH UNDER-OVEN STORAGE**  
Useful also as a broiler, this electric unit fits neatly under built-in oven, can be easily pulled out and pushed to patio



for a new kitchen



Planning desk has recipe and bill cabinet above, tilt-out clothes bin below. The desk abuts a ceramic tile wall with planter on top



Plenty of room for storage of utensils and supplies under broiler. This is view from rear of unit

This Year  
achieve greater sales appeal  
and more liveable space by making  
every interior door a  
**SLIDING DOOR**

with

**NORDAHL**

"in the wall"

**SLIDING DOOR FRAMES**

Meet and beat today's competition with this bonus sales feature. The low cost of Nordahl Sliding Door Frames is more than offset by savings in material and labor *plus* added appeal of increased living areas.

Check these **NORDAHL** features:

- ★ **BALL-BEARING ROLLERS**  
Kilian Nylon—Cadmium plated—greased with Baum's castorine
- ★ **SIMPLE FOOL-PROOF INSTALLATION**
- ★ **OVERHEAD SUSPENSION**  
on extruded aluminum track
- ★ **LIFETIME GUARANTEE**
- ★ **REINFORCED JAMBS**  
Aluminum—permanently rigid
- ★ **POCKET FINISHED**  
no steps required

For Wardrobes, Kitchen Cabinets, and Storage Closets, use

**NORDAHL**

*Tealies & Glue* **Wardrobe Hardware**

Packed in convenient tubes, Nordahl Wardrobe Hardware is easily installed on the job. Track comes in lengths up to 16 feet.

For information write

**NORDAHL MANUFACTURING CO.**

180 W Alameda Ave., Burbank, California

DESIGNED FOR TODAY'S HOMES

# PRECISION

America's No. 1 Stairway

## QUALITY PLUS SALES FEATURES

STOCKED BY 160 LEADING JOBBERS IN THE U. S. AND CANADA

7

**PRECISION FOLDING STAIRWAY LISTED IN SWEET'S**  
Approved by Leading ARCHITECTS, BUILDERS, and LENDING AGENCIES

**EXCLUSIVE FEATURES**

- 1—HYDRAULIC SAFETY CHECKS
- 2—ACTUATED BY COUNTERWEIGHTS
- 3—LIFE-TIME ROLLER BEARINGS
- 4—RUGGED AND STRONG
- 5—INSULATED DOOR PANEL
- 6—FULL WIDTH SAFETY TREADS
- 7—FITS ANY CEILING HEIGHT



Two Standard Sizes—8'9" and 9'9". For ceiling heights 7'0" to 8'9" use 8'9". For ceiling heights 8'9" to 9'9", use 9'9".  
Figure from Finished Floor to Finished Ceiling—not floor to floor. Frame fits 26" x 24" opening in ceiling, also 30" x 24" (special) at extra cost.

Requires No Valuable Attic Space—full height above attic floor is only 28 inches.

Shipped in One Package—assembled and ready for installation. Shipping weight, 115 pounds.

High Quality—constructed of select kiln dried lumber. Brackets, racker arms, and hinges cast in our own foundry of highest quality magnesium and steel alloys.

**NO OTHER STAIRWAY OFFERS SO MUCH**



**PRECISION PARTS CORPORATION**  
100-AR NORTH FIRST STREET • NASHVILLE 7, TENNESSEE

## A Point to Remember!

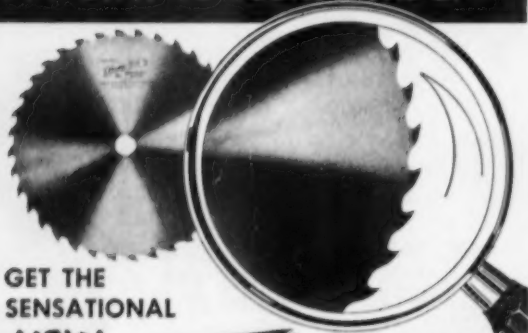

GET THE SENSATIONAL NEW

**HARD-TIP SAW BLADE**  
IT'S DISPOSABLE

Saves 50 - 60% of your saw costs because Hard-Tip Saws last from 4 to 6 times longer before dulling. Eliminates sharpening... and you're always assured of smooth, fast cutting—no vibration due to improper sharpening. Hard-Tip is the modern circular saw blade made to meet the most exacting requirements of the master craftsman, and the economical requirements of the week-end shopster. Only \$1.93 for Standard Type "C" 6 inch. Equally low prices on all sizes up to 16 inch.

Write today for Catalog & Folder and Prices  
Over 5,000 Dealers in U. S. A.

MANUFACTURED BY  
**THE F. HEINEMANN SAW & MANUFACTURING CO.**  
CANTON, OHIO

**CARLSON**  
**Super Chief**  
**16 FEET LONG—3/4" Wide White Blade**

Here's big news—in a compact, pocket-size package. The all-new Carlson SUPER-CHIEF Steel Tape Rule has 16 feet of wider, more rigid steel blade—designed into a pocket-fitting 2 1/2" case that weighs only 6 1/2 oz. Best of all... with the SUPER CHIEF, you alone can now make accurate extended vertical and horizontal measurements quicker... easier.

**for one-man measuring**  
**Handy Re-wind Crank** moves 16 ft. blade smoothly in and out of case, on snow-white blade won't surface crack or peel.  
**Quick Blade-Change—**  
**Do-It-Along—and do it better—** with a Carlson SUPER CHIEF See it at your Hardware Dealer!

**Easy-to-Read—**let black numerals blade smoothly in and out of case, on snow-white blade won't surface crack or peel.  
**Patented Swing-Tip**  
**Carlson & Sullivan, Inc.**  
MONROVIA, CALIFORNIA

Produced under Patents #2089209, #2510939, #2629180 & Pat. Pend.

**Goldblatt**  
**dry-wall applicators:**  
new corner taping tool

**\$4.95** Introductory Offer!  
(postage paid)

**FREE TOOL CATALOG —** 1,056 tools for trowel trades. 100-page illustrated book. 1955 edition. Send name on postcard.

**1056 Tools**

**Goldblatt exclusive.** Gives fast, clean inside corner taping with great ease. Highly flexible 4-in. sides of one-piece stainless steel. Lightweight aluminum mounting with comfortable wooden handle. Forms perfect corners. Eliminates chance of tape snagging. Materials, workmanship, unconditionally guaranteed. Check, money order, C.O.D. Order No. DWCT.

**GOLDBLATT TOOL COMPANY, Dept. C-7**  
1912 Walnut, Kansas City 8, Mo.

**HOUSE CONSTRUCTION DETAILS**  
by NELSON L. BURBANK

## YOUR EXACT WORKING GUIDE

and answers to **OVER 2,000 BUILDING QUESTIONS**

**Construction details from foundation to finish, with hundreds of photos and easy-to-follow scale drawings. One-eighth inch drawings of two modern houses included. Conforms to building regulations everywhere. A standard guide for altering stock plans or remodeling. Fourth revised edition.**

**SEND NO MONEY . . . Examine Free**

American Builder readers need not send money to get this book. After 10 days, remit \$4.95 plus postage; otherwise return book and owe nothing. (To save postage, remit with order. We refund your money in 10 days if dissatisfied.)

**AMERICAN BUILDER BOOKS, Dept. 755**  
30 Church St., New York 7, N. Y.

new weatherstripped

**WARE**

aluminum

**AWNING WINDOW**

Combines famous Ware quality with important new features—  
at modest cost!

**Smooth, Sturdy CENTER SILL operator**

Compound operator sealed in grease—completely enclosed—affords smooth, effortless operation.

Gear ratio prevents strain or stripping and increases power. Concealed in sill at factory. No on-the-job installation!

Entire operator and power bar nylon bushed—entirely self-lubricating—permanent.

Assures **balanced** power activating **both** window jambs simultaneously—prevents torque lag which causes ventilator distortion and puts unbalanced strain on linkage.

Torsion resistant tubular sill.  $\frac{3}{4}$ " solid extruded aluminum power bar.

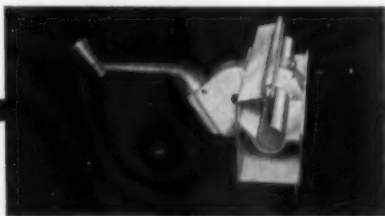

**FEATURES THAT ADD PLUS VALUE!**

Weatherstripped by premium vinyl locked in extruded channel unexposed to weather.

Wide overlap of weathering members. Minimum outside at jambs  $5/16$ ".

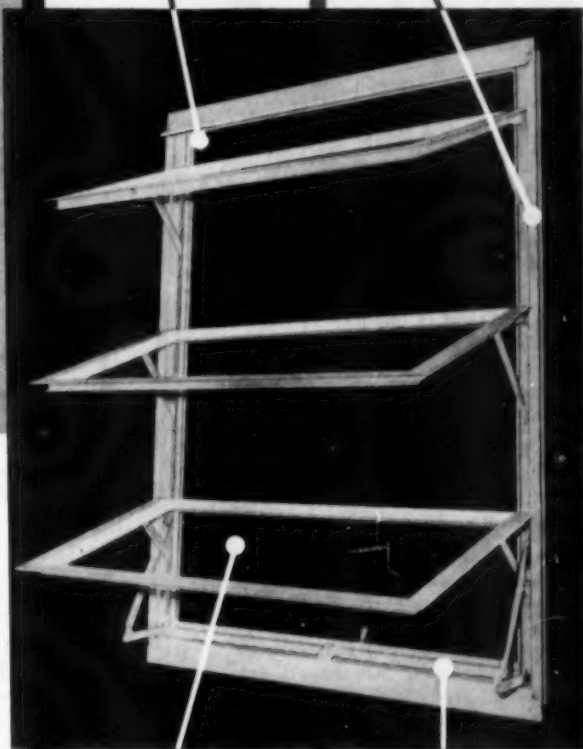

All ventilators have equal height and drop for easy cleaning.

Heavy reinforced sill.

Snap-on glazing bead available.

No special locking devices to cause distortion of ventilators and put undue strain on operator.

All windows chemically cleaned, etched and lacquered per FHA requirements.

Engineered for simple, speedy installation.

Designed for a great diversity of applications.

Write today for complete details  
Address Dept. AB-7

Aluminum **WARE** Windows



Jalousie

Econ-O-Wall

Econ-O-Ware  
Awning



Ware  
Awning Window

Projected

Casement

Ware Laboratories, Inc., 3700 N.W. 25th St., Miami, Florida



There is no other  
**WATER VAPOR BARRIER**  
 like  
*Richkraft* 65!

● Richkraft is impervious to the effects of Fungi. The Kraft sheets are treated with special fungicide in accordance with Housing Research Series No. 15 H.H.F.A.

● Richkraft is made up of two heavy Kraft sheets bonded together with Asphalt. This makes it a perfect water vapor barrier.

● Richkraft is the lowest cost membrane capable of meeting moisture, vapor and fungus conditions.

Richkraft is tough! It is easy to lay. Two men can do all the work needed—Richkraft 65 costs less laid down than two layers of 15 lb. felt mopped or 55 lb. roofing. It is clean—no sticky, tacky surface for the following trades and there is a size for every job—3, 4, 6, 7 and 8 ft. wide.

V. A. and F. H. A. accepted  
 in lieu of felt membrane  
 or 55 lb. roofing.

Ask also about other Richkraft Papers. There is a Richkraft sheet for every purpose—Reinforced Water-proof Papers, Richflex Reflective Insulation, Black Papers and Red Rosin—and there is Richbead, the metal corner for both interior and exterior corners.

THE RICHKRAFT CO.  
 510 N. Dearborn Street  
 Chicago 10, Illinois



Gentlemen:

Tell me more about Richkraft 65 and send samples.

NAME \_\_\_\_\_

ADDRESS \_\_\_\_\_

TOWN \_\_\_\_\_ ZONE \_\_\_\_\_ STATE \_\_\_\_\_

## Try these NEW PLANNING IDEAS

Last year an estimated 10 million owners made improvements and alterations in their homes. Another million made physical additions to present structures. Indications are that 1955 will be an even bigger year for modernization.

Armstrong Cork Company is helping this vast and profitable builders'

market along by demonstrating what can be done to bring modern planning principles to the average 30-year-old house. These before-and-after studies show what happened when Armstrong transformed a brick bungalow of 1923 into a house which has everything a newly built house would have—and more.

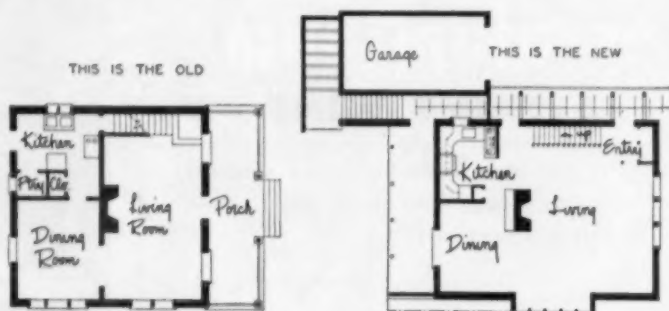

ON THE FIRST FLOOR, remove separating partitions to create the spaciousness of open planning; then unify the space by use of color and texture. Take old porch area into living space

FIRST FLOOR  
 BEFORE



FIRST FLOOR  
 AFTER



on your remodeling customers

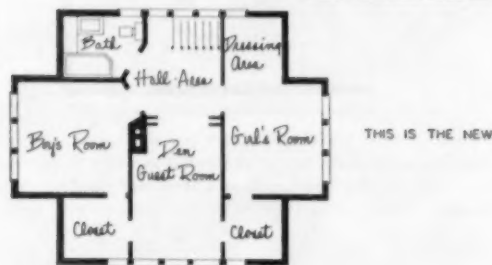
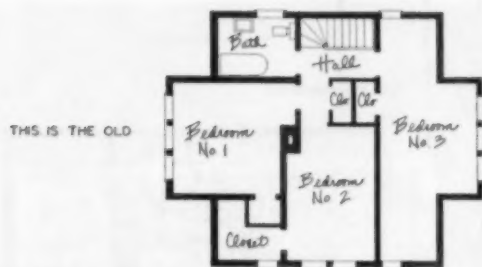

UPSTAIRS, the idea is to open up hall space by getting rid of the awkward closet arrangement and freeing space for the creation of an attractive den-guest room

UPSTAIRS HALL BEFORE ▼



UPSTAIRS HALL AFTER ▼



CONTINUED ON NEXT PAGE



In Air Conditioned Research Village...  
*lowest cost-to-operate*  
*air conditioned home*  
*is equipped with a*  
*Halstead & Mitchell*  
*Residential*  
*Cooling Tower*



According to cost figures comparing the twenty homes in the Air Conditioned Research Village in Austin, Texas, Halstead & Mitchell Residential Cooling Towers were installed in homes which ranked No. 1 and No. 6. (Ratings from *HOUSE + HOME*, March, 1955.)

*HOUSE + HOME*, reporting results from the project engineers, showed that water costs with cooling towers for the entire five-month Texas-summer season were as low as \$2.00 *per summer*. So small was the cost, indeed, that special meters had to be installed to read the daily consumption.

Certainly house design and air conditioning equipment design were the major factors in the low cost of air-conditioning operation in these homes. But it is a tribute that two of America's leading manufacturers selected Halstead & Mitchell's Residential Cooling Towers with such happy results.

AT LEADING WHOLESALERS EVERYWHERE  
Write for your Residential Cooling Tower Catalog today

**HM**  
*Halstead & Mitchell*

BESSEMER BUILDING, PITTSBURGH 22, PA.

# This FREE Book Tells You How to **END DUST**

on: Unpaved Streets • Parking Areas  
Driveways • Playgrounds • Tennis Courts  
... and any other Earth, Gravel, Unpaved Surfaces

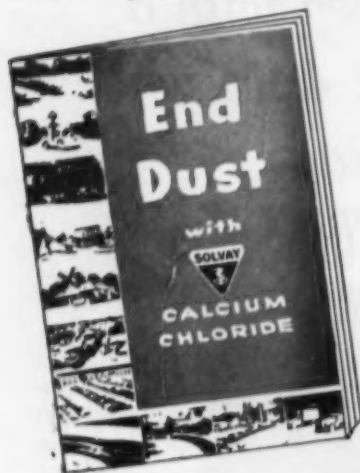

with Clean,  
Odorless,  
Colorless,  
LOW COST  
EASY-TO-APPLY



SOLVAY Calcium Chloride is the inexpensive, efficient way to eliminate dust. This clean, odorless, economical material keeps all unpaved surfaces and adjoining areas healthful and free of annoying, germ-bearing dust.

Solvay Calcium Chloride is easy to use—requires no special equipment or knowledge. It can be applied quickly and easily. No experience or expensive equipment is necessary.

**Send for FREE BOOK:** This highly informative book "END DUST" gives complete details on methods of application, quantities required, etc. It contains photos, illustrations, charts, and easy-to-follow, step-by-step instructions on how to end your dust problems.

#### DEALERS!

If you are not now handling Solvay Calcium Chloride, write for details, prices, advertising and promotion materials.

GET THE FACTS—MAIL COUPON NOW!

### SOLVAY PROCESS DIVISION



Allied Chemical & Dye Corporation  
61 Broadway, New York 6, N. Y.

Please send me at no obligation your FREE BOOK, "END DUST."

Name .....

Company .....

Position .....

Address .....

City ..... Zone ..... State ..... 34-7

## Remodeling Ideas, continued

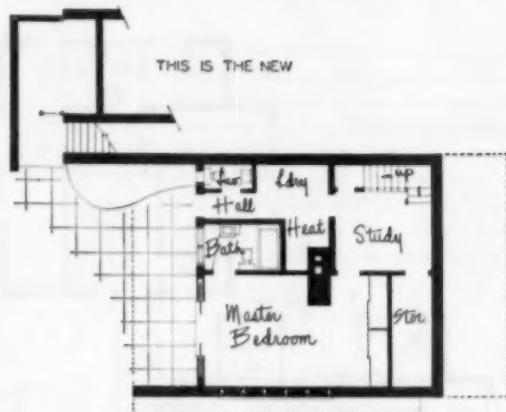

**BASEMENT INTO MASTER BEDROOM** is a daring idea which Armstrong worked out by removing grading to expose rear wall of the basement and then opening up wall for new windows and sliding glass doors to new patio



Sketch showing rear of modernized house, with basement level exposed. Attached to new garage (left) is a small greenhouse

#### BASEMENT BEFORE ▼



#### BASEMENT AFTER ▼





---

## Bank on a *Task-Force* Truck to Cut the Cost of Moving Goods!

---

You'll save money on the job and be way ahead at trade-in time with a work-styled Chevrolet Pickup.

You save with modern high-compression power—In Chevrolet's new pickup truck, a new Thriftmaster engine is supplying the power punch—a big *valve-in-head* wallop, which means you get the most out of a gallon of gas. Fast acceleration shaves stop-and-go time and helps keep you on top of crowded schedules. And even in cold weather, you start more quickly with Chevrolet's double-punch 12-volt electrical system. That's a big advantage in itself—a husky reserve of electrical power when you need it!

You save with the most modern truck features your field has ever seen—New Work-Styling—so distinctively different that your Task-Force Truck is a profitable advertisement-on-wheels. New Overdrive or Truck Hydra-Matic, each an extra-big time and money saver, available at extra cost. New front and rear suspension systems, High-Level ventilation, outstanding cab comfort—there's everything to make driving less a chore. And you're bound to save money when drivers maintain peak efficiency!

Why buy an old-fashioned truck and stand to take a licking at trade-in time? See your Chevrolet dealer for the most modern trucks money can buy. . . . Chevrolet Division of General Motors, Detroit 2, Michigan.

**NEW CHEVROLET**  
 ***Task-Force* TRUCKS**



## Why listen to the Grapevine?

*Rumors are often wrong, or reach you too late or not at all. To make money in today's market you need the facts*

You need *facts* to compete successfully in the highly specialized field of construction—*daily* information on who is going to build—what, when, and where.

Most leading firms and salesmen in construction today depend on Dodge Reports to keep informed. They know they cannot keep up with all that's going on in any other way.

Where is your stake in the business? Houses . . . general building (except houses) . . . engineering construction . . . or all three?

There is a specialized Dodge Reports service that covers the kind of work you do—in the specific area where you operate.

Find out now how these concise, day-by-day reports can give you the information you must have to do business. How you can *know* who to see, what his requirements are, where and when to see him.

Send the coupon today—check the kind of building activity you want to know about. No obligation.

We want you to see how much Dodge Reports can help you.

# Dodge Reports

*Timely, accurate, daily construction news service in the 37 eastern states.*



**F. W. DODGE CORPORATION**

*Construction News Division*

F. W. Dodge Corporation, Construction News Division  
Dept. AB755, 119 West 40th St., New York 18, N. Y.

Please let me see some typical Dodge Reports on current selling opportunities in my marketing area. Our stake in the business is in—

- House construction
- General Building (not houses)
- Engineering construction

Name \_\_\_\_\_

Company \_\_\_\_\_

Address \_\_\_\_\_



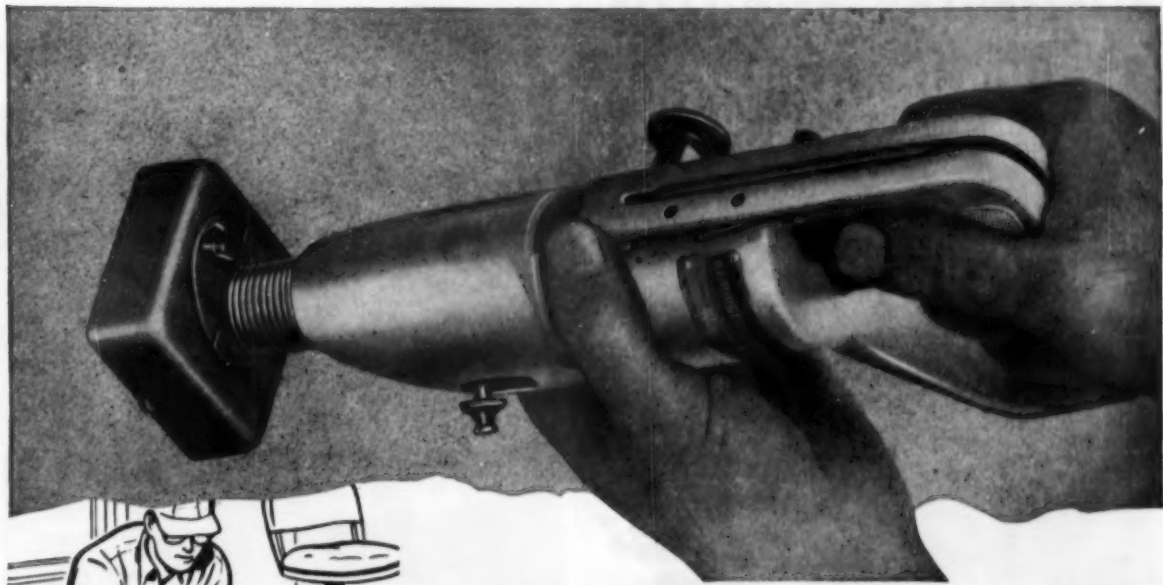

Anchoring seats, bar stools to concrete



2" x 4" plates to concrete floor



Carpet gripper anchored to concrete

## REMINGTON STUD DRIVER

### saves up to 80% fastening costs on "special" jobs

When it's an unusual fastening job that has to be done quickly, efficiently—let the Remington Stud Driver take over. There are special guards, interchangeable with the standard guard, that adapt it for practically any application. And the Stud Driver's cartridge-powered action enables one man to set up to 5 studs a minute—a saving in time and labor of approximately 80% over old-style methods.

Setup time is cut to a minimum with the Stud Driver. There are no holes to drill; no laborious hammering is necessary. A squeeze of the trigger and the tool's powerful cartridge drives the stud home—

solidly and permanently into steel or concrete. Compact and portable, the Stud Driver has a field of use limited only by where a man can go.

**DISCOVER FOR YOURSELF** how this lightweight (6 lbs.) fastening tool can cut costs for you. Let us send you our new booklet which shows how the Remington Stud Driver anchors furring strips, structural channels and many other fabricated materials to concrete or steel. Just clip and mail the coupon for your free copy.

**MAIL THIS COUPON TODAY**

Industrial Sales Div., Dept. AB-7  
Remington Arms Company, Inc.  
Bridgeport 2, Connecticut

Please send me a free copy of the new booklet showing how I can cut my fastening costs.

Name \_\_\_\_\_

Position \_\_\_\_\_

Firm \_\_\_\_\_

Address \_\_\_\_\_

City \_\_\_\_\_ State \_\_\_\_\_

"If It's Remington—It's Right!"

**Remington** **DUPONT**



Listed & Approved by  
Underwriters' Laboratories, Inc.



From picturesque Early American...



CAPE COD

to bold Contemporary...



BASKET WEAVE

## GRAHAM SECTIONAL GARAGE DOORS

... add that finishing touch of beauty to every home at no extra cost...

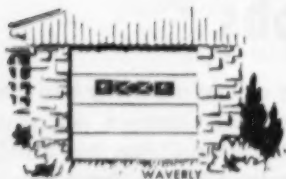

WAVERLY

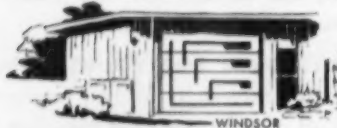

WINDSOR



CHALFONTE



MONTE CARLO



**Mr. Builder! YOU'LL HAVE TO DO BETTER IN '51**

Your homebuying prospects will expect more value! Graham "Architecturally-Correct" garage doors give "visible value"...the added, "finishing touch" of beauty... buyer appeal... individuality... and custom design...at no extra cost.

Some Distributorships Available.

Write for complete information.

Write for the "New Ideas" brochure which illustrates the importance of garage doors in today's architecture and home selling.

**GRAHAM industries, inc.**

6901 Carnegie Ave. • Tel. HE. 2-1200 • Cleveland 3, Ohio



Wrought Steel Butts  
Cat. # R240

more and more builders are saying:



Builder's Special  
Cat. # 540

"Let's use  
**GRIFFIN**  
In Our Houses"



Cat. # BB197  
Template Butts, Button Tips  
with permanently attached Bearings

Here's the "dependable line of hinges to use in all light construction work"... that's the trade's way of saying, "We like to buy and use Griffin products."

A full line of wrought steel butts and all shelf hardware. Send for new catalog sheet on our #540 Builder's Special.

**GRIFFIN**

"since 1899"

MANUFACTURING CO. ERIE, PA.

## MULLER MIXERS AND POWER TROWELS set quality standards in their fields

Muller's objective—the best contractors equipment for the lowest price—is achieved by: (1) specialization, (2) careful selection of materials, (3) experienced workmanship, (4) sound distribution methods.

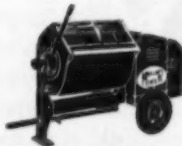

### PLASTER and MORTAR MIXERS

Five sizes, 2 to 9 cu. ft. Electric or gasoline. Muller Lifetime Paddle Shaft Seal. Power throwouts on smaller models, disc clutch on larger. Rubber scraper blades optional. \$160 to \$996 FOB Factory.



### CONCRETE MIXERS

3 models, 3 to 6 cu. ft., tilting type. Ample drums, fast mixing action. Timken Bearings, electrically welded construction. Electric or gasoline. \$230 to \$660 FOB Factory.



### POWER TROWELS

2 sizes 29" and 34" dia., 1 1/2 and 2 1/4 HP B&S Engines. Stationary guide ring. Clutch and speed controls on handle.

Send for information and name of local dealer.



**MULLER MACHINERY COMPANY, Inc.**

METUCHEN 4, N. J.

CABLE ADDRESS—MULMIX

take a good look at **WHITE FIR**

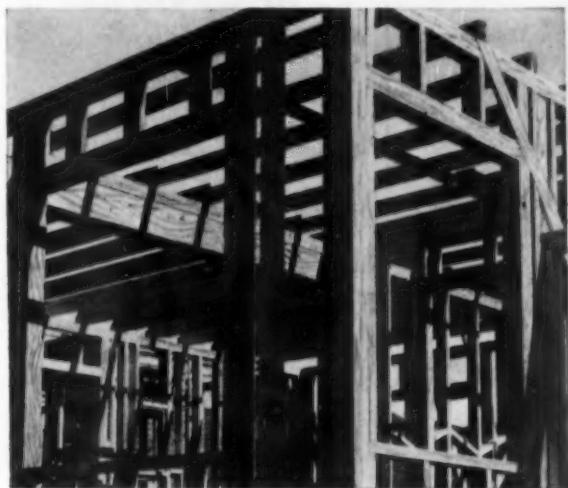

one of 10 woods from the **WESTERN PINE** region

Soft and even-textured, straight-grained, dimensionally stable, White Fir is widely used in residential and industrial construction, particularly for light framing. It's an excellent wood for crating and boxes, and much in demand for general industrial use. Light-colored, it's a favorite for modern paneling and woodwork.

White Fir comes in 3 select, 5 common, 4 factory, 4 dimension grades. You can order it in straight or mixed cars—together with other woods from the Western Pine region—from most Western Pine Association member mills.

the Western Pines

IDAHO WHITE PINE  
PONDEROSA PINE  
SUGAR PINE

the Associated Woods

WHITE FIR  
LARCH  
DOUGLAS FIR  
ENGELMANN SPRUCE  
INCENSE CEDAR  
RED CEDAR  
LOGPOLE PINE



"WHITE FIR" is a Registered Trademark of the Western Pine Association

get the facts to help you sell **WHITE FIR**

Write for the FREE illustrated booklet to WESTERN PINE ASSOCIATION  
Yeon Bldg., Portland 4, Oregon

JULY 1955

## SHAWNEE EQUIPMENT CUTS DIGGING COSTS



"I like the Shawnee Scout because it enables me to get in and dig where no other shovel can go. I'm able to dig under an 8 ft. ceiling. I was so well pleased with my first Shawnee (it was an older model traded in on his present Scout) that I bought a second one."

### Shawnee SCOUT DIGGER

- DIGS UNDER 8 FT. CEILING
- DIGS WHERE LARGER SHOVELS CANNOT GO



Operators like George Penniston of Independence, Mo., like the Scout for its speed and ability to work in close quarters. With a 20 inch bucket, Mr. Penniston recently dug ditches 4 ft. wide and 5 ft. deep which shows the versatility of a Scout. His fuel consumption is about a gallon per hour. He is presently digging 200 ft. of sewer line on the project, possible due to the 12 ft. depth digging ability.

### Shawnee HYDRO-CLAM

Another Typical Owner's Comment\*  
\*name on request.

- Digs through hard asphalt and frozen ground 8 1/2' deep
- Ideal for spot excavations
- Adaptable to most all tractors
- Loads trucks—1/2 yd. Clam Capacity

"The Hydro-Clam Digger has exceeded our expectations of versatility; has been very satisfactory; and has resulted in material savings of time and money in the planting operations of this Department. We have found that the Clam Shell and the Back Hoe attachment can be interchanged by our operator, with a helper, in approximately twenty minutes. The Back Hoe has been able to remove up to 12 inches of frost, which would have been impracticable to do by hand."



Purchase this machine for less than the cost of excavating jobs. All hydraulic operation. Digs straight down, forms square corners and level bottom of excavations.

CONVERTS TO BACK HOE IN MINUTES FOR TRENCHING TO 9 1/2' DEEP—ONE MACHINE FOR TWO OPERATIONS! AD #494

Write for additional information

**SHAWNEE MANUFACTURING CO., INC.**

1947-JJ Topeka Ave.

Topeka, Kansas

# Lux-Right

The Nation's Best  
**AREAWALLS**

**MOST COMPLETE LINE**  
ALL TYPES, SIZES, GRADES



ROUND ▲  
STREAMLINED  
STRAIGHT



ACCESSWAY ▲

**IMPERIAL LUX-RIGHT:** Standard for American Homes. Galvanized after fabrication. Streamlined-Straight, Round, Square.

**ECONOMY:** For medium-priced homes. Tight-coat galvanized.

**ACCESSWAY:** Right angle corners let doors to crawl space swing wide open. (F. H. A. Type.)

**CASEMENT:** For lower floor rooms with casement windows.

**FOUNDATION VENTS:** Corrugated.

We prepay freight on 12 or more units.

FREE Folder. See dealer or write. AB7

**SAINT PAUL CORRUGATING CO.**

Expert Fabricators of Sheet Metal Products for 70 Years  
SOUTH END WABASHA BRIDGE • SAINT PAUL 1, MINN.

## MAZE

Roofing  
Siding  
Lead Head  
Screw  
Drywall

## NAILS

Flooring  
Underlayment  
Pallet  
Ring Shank

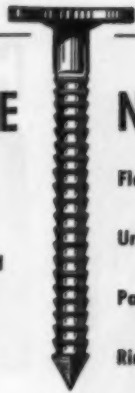

Write  
for Samples

**W. H. MAZE  
COMPANY**

PERU, ILLINOIS

Est. 1848

"Producers of better nails for the better application of siding and roofing"

## men over 45

More than six times as many men of your age will die of lung cancer this year as died in 1933. Our research scientists still don't know why.

They *do* know, however, that over half of those who will develop lung cancer can be saved... if they get proper treatment while the disease is still in the silent, symptomless stage. That's why we urge you to have a chest X-ray every six months no matter how well you may feel.

For more information call us or write to "Cancer", care of your local Post Office.

American Cancer Society



Send for our quotation on all your railing and column work. It pays! Send sketches or ask for our suggested designs.

Designers-Crafters of  
Ornamental Ironwork,  
Fencing and Gates.

2107 FLORENCE AVE.  
CINCINNATI 6, OHIO

**CINCINNATI IRON FENCE CO.**

INCORPORATED



## FLEX-CORNER

Reversible  
Metal Tape  
FOR BETTER  
DRYWALL  
FINISH

Covers inside or outside corners, any angle. Speedy application (no nailing); economical. Creates plastered look for baywindows, attic angles, arches, recessed windows and cathedral ceilings. Minimum waste—dispenser cartons of 100-foot rolls. Sample on request; dealers and distributors wanted. Made by manufacturers of Spackle-Band all-metal bead, available in any length.

**STEEL CORNER TAPE CORP.**

106-09 Rockaway Blvd.

Ozone Park, N.Y.

## ... "better than any transit!"

"When it comes to accuracy, the Levelall is better than any transit,"... writes Mr. Richard S. Otto. LEVELALL is a 75' transparent plastic tube with shut-off valves, mounting brackets and filled with a special anti-freeze liquid... a precision leveling instrument for only \$12.95. With it, one man can do the work of two men and a transit.

Send today for your **FREE** copy of "On the Level," a booklet that tells and shows how to use the Levelall.

LEVELALL, 83G Webster St., Rockland, Mass.

Please send free booklet, "On the Level."  Mail me 75' Deluxe LEVELALL @ \$12.95  Regular 50' model at \$9.95  Ship postpaid full price enclosed.  Ship C.O.D.

Name \_\_\_\_\_  
Street \_\_\_\_\_  
City \_\_\_\_\_ Zone \_\_\_\_\_ State \_\_\_\_\_

## ATTENTION: LUMBER DEALERS AND CONTRACTORS



### 50 DOORS FIT AND HUNG IN ONE DAY BY ONE MAN WITH MASTER DOOR JIG\*

One man can fit and hang 50 doors in one day—and the doors are hung with a precision never before possible. The high speed assembly of wood doors and frame openings is made possible with the Z & K Master Door Jig. The jig may be used in the shop or on the job. Send for descriptive bulletin today—

**Z & K TOOL COMPANY**  
407 Sand Hill Road, Lebanon, Pa.

\*Covered by Pat. & Pat. Pending



Fair Bldg., Albert Lea, Minn. 80' Span.  
Contractor, Engan Construction Co.



Anacosta Wire &  
Cable Co.,  
Sycamore, Ill.  
72' 10" Span  
Contractor,  
Johnson & Jacobson



IGA Foodliner, Weatherford, Okla. 46'  
Span. Johnny Klaassen, Contractor

## COSTS GO DOWN

### When RILCO Goes UP!

Lower cost, easier and faster erection plus outstanding appearance and better construction—that's what you get with Rilco glued laminated wood arches and trusses. Contractors tell us, "One job sells many more."

Rilco members can be erected manually with common labor, with a block and tackle or a portable hoist. But what really will please you is the precision craftsmanship evident in each unit which makes job-site assembly and erection so simple and satisfying.

Unskilled labor with Rilco precut and drilled members produces a professional result at a surprisingly low cost. Furnished hardware fits perfectly and the result is a pleasure to present to the owner.

*Rilco engineers will gladly  
work with you on the job.  
We would like to send you a  
free catalog or answer any of  
your questions—no obligation.*



RILCO LAMINATED PRODUCTS, INC.  
2511 FIRST NATIONAL BANK BLDG., ST. PAUL 1, MINN.

**CHICAGO'S BIGGEST PROMOTION!  
RECORD SALES SET UP FOR YOU!**

# 9th Annual Home and Home Furnishings Fall Festival

**September 11 - October 2**

HERE is a ready-made promotion—the biggest in the field—that can give you new volume—sales as big as you plan to make them! All you need to do is to gear your present operations to it.

Last year's Festival brought hundreds of thousands of Chicagoland homemakers into the market. In 22 days they bought 1,093 homes for over \$21,700,000. Buying action

set new sales records in furniture, home furnishings, appliance and other home goods.

Get set to cash in on the business to be generated by the 1955 Festival. There's nothing like it in the industry! Get in touch with a Tribune representative. Let him show you how to tie into this proved sales producer. Write, wire or phone now while the subject is fresh in your mind.

## Chicago Tribune

THE WORLD'S GREATEST NEWSPAPER



*For the smartest homes:*

—the one fine line of fixtures that emphasizes quality and fashion in product and in advertising. Your prospects see this emphasis in LIFE, Saturday Evening Post, major home-service magazines—and in better house construction everywhere.

ELJER, DIVISION OF THE MURRAY CORPORATION OF AMERICA,  
THREE GATEWAY CENTER, PITTSBURGH 22, PA.

# ELJER

DIVISION OF THE **MURRAY** CORPORATION OF AMERICA



\* *ELJER — the only name she needs to know in plumbing fixtures*

THE MARK  OF QUALITY

## *All this variety plus performance!*

Over three hundred separate hardware products are included in this extensive line. With an assortment as great as this, dealers can fill practically every requirement of their customers—a special size, weight or finish that is custom-built for the job at hand.

All products of this National hardware family are traditionally alike in their standard of high quality. Your trade will be quickly aware of the fact that every article in the line will perform with equal smooth precision.

If you are not already a National Dealer, may we suggest that you join this progressive group today.

Dealers everywhere are profitably catering to the trade that insists on the genuine National Hardware, stamped with the flag trade-mark symbol—a safe buying guide wherever good hardware is sold.



*National*

MANUFACTURING COMPANY

STERLING, ILLINOIS