

# AMERICAN BUILDER

THE WORLD'S GREATEST BUILDING PAPER

Build profitably  
all winter long

•  
**PLYWOOD'S**  
new uses

★ OCTOBER 1955

75 CENTS

NATIONAL HOUSING CENTER

INSIDE THIS BUILDING:

**ideas for your next house** see p. 92



**STOP the "SHOPPERS"  
with MATCHED  
Customized Design  
... they can see it  
from the street**

STOP THE "SHOPPERS"—you've GOT to stop them before you can sell them. And, one good way to stop them is to dress up your homes with a big, colorful, dramatic, up-front feature that they CAN SEE FROM THE STREET. That's the kind of feature you have in MATCHED CUSTOMIZED DESIGN—standard front doors and standard Crawford Garage Doors MATCHED in glamorous design and color, by your own men, using the new Crawford Customized Design Kits.

These Kits are easy to use and they contain everything needed (except paint) to enable your men to produce an endless variety of colorful, dramatic and different MATCHED designs on standard front doors and standard Crawford Garage Doors.

MATCHED Customized Design is one feature that every prospect CAN SEE FROM THE STREET. It's beautiful, it's different and it gives your homes that colorful, glamorous eye-appeal that really stops the "shoppers".

For Kit information and free sheets showing dozens of designs and color schemes, call your Crawford Door Sales Co., listed in your classified phone book under "DOORS". Or, write us direct, Crawford Door Company, 173-20263 Hoover Road, Detroit 5, Michigan. Plants in 10 cities; Warehouses in 95 cities; Sales and Service everywhere. In Canada, F. Fentiman & Sons Ltd., Ottawa, Ont.

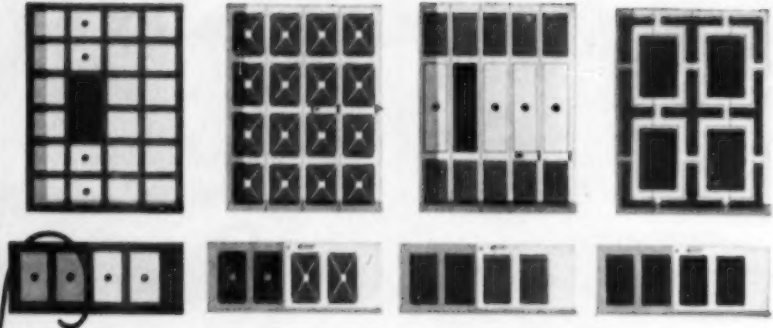

**Crawford**  
**MARVEL-LIFT Garage Doors**  
**in Customized Design**

# EASY *All Ways*

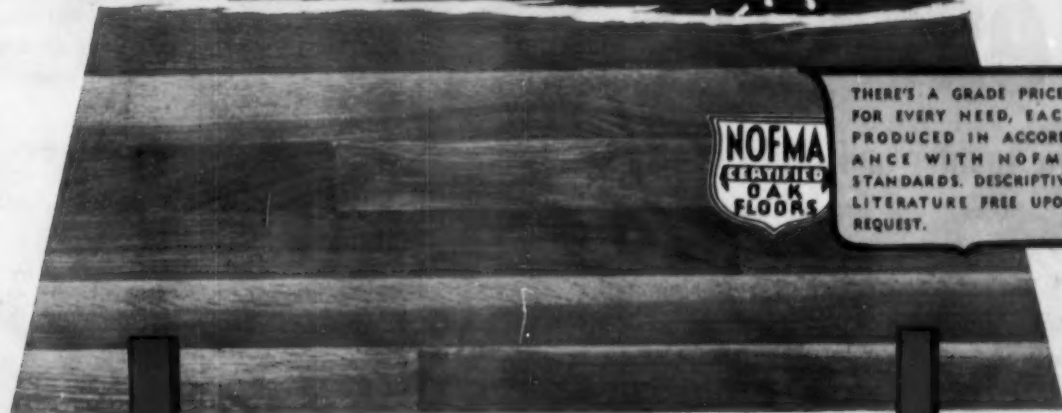
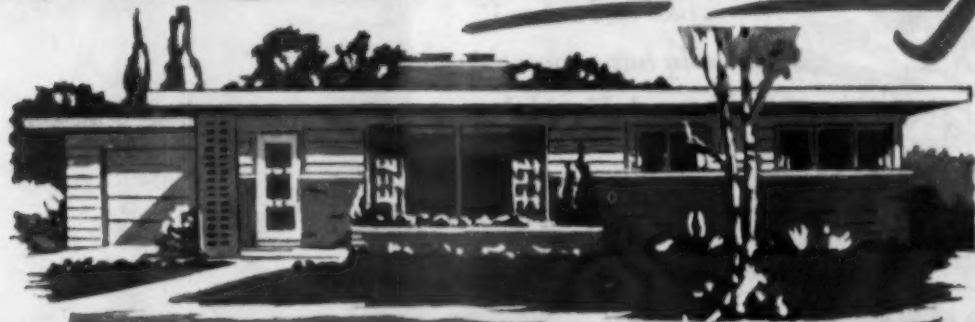

THERE'S A GRADE PRICED FOR EVERY NEED, EACH PRODUCED IN ACCORDANCE WITH NOFMA STANDARDS. DESCRIPTIVE LITERATURE FREE UPON REQUEST.

## *Cloud's* **Lockwood** *Tempered* OAK FLOORING



### **EASY to install**

Lockwood is the soft-textured Ozark-mountain oak that has the nail groove feature and double hollow-back design. Cloud's exclusive "Splinter Clipper" has eliminated the annoying chip or "spur" that so often slows installation. Precision-milling also contributes to the savings of up to 35% in laying-through-finishing costs!

### **EASY to sell to home-buyers**

Prospective home buyers see the extra quality and beauty at a glance!

### **EASY to walk on and live on**

Housewives love the resiliency of Cloud's Lockwood Oak Flooring! It saves them backaches...leaves them less tired at the end of the day!

### **EASY to maintain**

There's durability to the charm of Cloud's Lockwood Oak Flooring. It lays and stays straight with a snug fit. And a swish of the mop quickly renews its rich natural beauty.

SEE YOUR LOCAL DEALER

**CLOUD OAK FLOORING CO.**  
SPRINGFIELD, MISSOURI



Houses that sell  
like hot cakes...  
usually have something  
special inside!



# Textolite<sup>®</sup>

plastic counter and wall surfacing

Here's a sure-fire recipe to sell your houses faster! Just add G-E Textolite surfacing in kitchens and bathrooms... for beauty... for practicality... and for *real* sales appeal!

Now available in a tremendous selection of over 70 exciting patterns and colors, G-E Textolite wears for years—beautifully. Rugged Textolite resists *heat, stains, and scratches*... stays sparkling new through hard household usage with just a wipe of a damp cloth.

Textolite patterns include authentic wood grains, luscious marble effects, and distinctive G-E designs like Medley and Ming... all planned to charm Mrs. Prospect right into her first mortgage. And she'll love it!

To tie in with G.E.'s color-choice appliances, Textolite has a complete new selection of beautiful patterns that match exactly, or contrast smartly with each of the colors in the G-E kitchen line. See them soon!



THE CORINTHIAN BATH  
— as featured at the  
1955 NAHB Show and  
in leading national  
magazines.

Shown above on shower walls, tub, and vanity is the beautiful G-E Textolite pattern FANTASIA... designed to look like real marble!

- Over 70 exciting colors and patterns!
- Home buyers *know* Textolite through powerful ad campaigns!
- The G-E name helps insure customer acceptance!
- Complete G-E color-choice kitchens... appliances and counters match for color harmony.

*Progress Is Our Most Important Product*

GENERAL  ELECTRIC

Section AB 10-5  
General Electric Company  
P.O. Box 5911  
Cleveland 1, Ohio

Please send me the new 1955 full-color booklet showing a complete selection of G-E Textolite colors and patterns.

Name \_\_\_\_\_  
Firm \_\_\_\_\_  
Address \_\_\_\_\_  
City \_\_\_\_\_  
Zone \_\_\_\_\_ State \_\_\_\_\_

# The Opportunity Page

(Keynote page of the AMERICAN BUILDER, which is opportunity cover to cover, advertising and editorial)

## Check and double check

Want an opportunity to keep your housing costs competitive? Get your local association to follow an idea that worked in Vancouver, B.C. At a general meeting of the North West Building Contractor's Assn., a basic plan was selected as "average" for determining average cost. Each member got a blueprint and was asked to estimate. All the estimates were then averaged so that members got one figure against which to compare houses in the works.

## Better late than never

A law just passed by the Ohio Legislature (and there should be more like it) gives builders, if they're operating on one side of a street and have to put in sewer and water lines, an opportunity to reclaim part of the expense when owners on the other side eventually tap in.

## Lucky for you

Only two families out of three, according to the Federal Reserve Board, think their present housing is "satisfactory." In effect, then, every third family car that passes your new houses carries potential buyers.

## Money in the bank

We think it's smart business the way some builders are using slack periods to invest loose dollars in motel construction. We don't mean construction

for somebody else to buy and manage. We mean do-it-yourself all the way: buy the land, build the motel, get someone to run it for you, and hold on to it. A good motel makes a tidy source of income for a rainy or retirement day.

## Land of opportunity

America offers countless opportunities for bigger, better building. The purpose of this page—and this magazine—is to help you find them.



## Man: heater: house

Winter holds few fears for Billings, Mont., builder Vince Johnston. Like year-round builder Al Bartlett of Syracuse, N.Y., (see Winter Building story, pages 101-105) Johnston says, "I wouldn't pass up a winter of building for anything. In many cases, I make more profit in winter than in summer."

## 9 million opportunities

It's been estimated (by David O'D. Kennedy, president of Kentile, Inc.) that 9 million families, who make between \$3 thousand and \$5 thousand a year, are ready to spend \$34 billion for houses in the \$7 to \$10 thousand range. Trouble is, they can't find them.

American Builder is published by the SIMMONS-BOARDMAN PUBLISHING CORPORATION, Emmett St., Bristol, Conn., with editorial and executive offices at 79 W. Monroe St., Chicago 3,

Ill.; 30 Church St., New York 7, N.Y. James G. Lync, President; A. J. McGinnis, Executive Vice President and Treasurer; Samuel G. Dunn, Chairman Emeritus; J. S. Crane, Vice President

and Secretary; Fred A. Clark, Vice President and Business Manager; E. G. Gavin, Vice President and Editor; Bayne Sparks, Vice President; Robert G. Lewis, Vice President.

introducing  
the new  
**pryne**  
model "200"



only *Blo-Fan*  
has this blade!

A Pryne exclusive design! Scoops up smoke and odors and immediately redirects their discharge thru horizontal duct in continuous stream... eliminates back-wash "bottleneck" for greater efficiency.

now... a low cost,  
10-inch *Blo-Fan*

The answer to 10" fan requirements where price can be a factor! Ideal for large and small volume contractors and builders who want to combine economy with quality craftsmanship and superb performance!

New #200 Blo-Fan is midway between the famous Pryne #210 and the #208 in power and volume. It can be installed with or without standard 3-speed controls. Also features Pryne's popular simplified installation and "no call back" service!

**PLUS** these  
star performance  
features!

- ★ Exclusive combination blower-and-propeller fan blade!
- ★ Lifetime Neoprene mountings for "whisper quiet" operation.
- ★ Fits between floor joists or studding; needs only 3/4" behind plaster.
- ★ Ducts thru roof or joist area via wall, cabinet or soffitt.
- ★ Built-in shutters to prevent back drafts.
- ★ Polished chrome grills.
- ★ No tools needed to remove fan and motor assembly for cleaning.
- ★ Backed by 5 year guarantee.

A Blo-Fan for every need

# 200	950 CFM	3 speed*	89 watts
# 206	500 CFM	3 speed*	38 watts
# 208	750 CFM	3 speed*	58 watts
# 209	750 CFM	3 speed*	58 watts
# 210	1200 CFM	9 speed	136 watts

\*3-speed switch optional as extra equipment.  
9-speed control standard on # 210 only.

there's **MORE PROFIT** with...



... for Proof, **WRITE TODAY!**

PRYNE & CO., INC. ABB10  
BOX 698, POMONA, CALIF.

Please send more information about the new #200 Blo-Fan...and how I can make more profit with Pryne.

Name

Company

Street

City  Zone  State

AMERICAN BUILDER

# Reader's Guide

**October 1955**

**Editor** Edward G. Gavin  
**Executive Editor** Joseph B. Mason  
**Managing Editor** Walter R. Browder  
**Art Director** Russell F. Rypason  
**Assistant Art Director** Morris Neuwirth  
**Feature Editors** Welden Reynolds  
 William Dukse  
 Oscar Shaftel  
**News Editor** Carrott Winter  
**Assistant News Editor** June Vollman  
**Architectural Editor** Arthur V. Hansen  
**New Products Editor** William F. Koelling  
**Field Editors** J. L. Zar  
 Maxwell Huntton  
 John Novak  
**How-to-do-it Editor** Robert Rosner  
**Production Editor** William C. Rodd  
**Western Editor** Walter J. Taft  
**Washington Editor** Charles H. Goodall  
**Executive Editor, April Marketing Directory and Technical Guide Assistant** Arthur Felke  
**Research Director** J. W. Milliken  
**Assistant Research Director** Constance Nicolai  
**Director, Home Plans Service** Charles L. Combes  
**Legal and Tax Consultant** John F. McCarthy  
**Editorial Assistant** Gertrude M. Peinar

**Editorial Office:**  
 30 Church St., New York 7, N. Y.  
**April issue:** 79 W. Monroe St., Chicago 3, Ill.  
**Director of Production** M. J. Figa, Jr.  
**Sales Promotion** Lyman M. Forbes  
**Advertising Sales Representatives:**  
 New York 7, N.Y., 30 Church, WO-4-3060  
 Bayne Sparks  
 W. J. Kane  
 Banks Wanamaker  
 Chicago 3, Ill., 79 W. Monroe, RA-6-0794  
 George Hutchings  
 Harold Mann  
 Cleveland 13, O., Terminal Tower, MA-1-4455  
 D. T. Brickner  
 D. J. Casey  
 Coral Gables, Fla., 1809 Ponce de Leon Blvd., HI-8-1786  
 Joe Holzer  
 Dallas 4, Tex., 3908 Lemmon Ave., Lakeside 2322  
 Joe Sanders  
 Los Angeles 17, Cal., 1127 Wilshire, Ms. 6-0553  
 Fred Klaner, Jr.  
 Portland 5, Ore., 1220 S. W. Morrison, Br. 4993  
 L. B. Conaway  
 San Francisco 5, Cal., 244 Calif., Ga. 1-7004  
 Lewis Vogler

**Publisher** Arthur J. McGinnis  
**Business Manager** Fred A. Clark

American Builder (originally "Carpentry and Building") with which are incorporated Building Age, National Builder, Permanent Builder, and the Builder's Journal, was founded Jan. 1, 1879. Names registered in U.S. patent office and Canadian registrar of trade mark.

**Address all subscriptions and correspondence concerning them to:** Subscription Department, American Builder, Emmett St., Bristol, Conn. Changes of address should reach us three weeks in advance of next issue date. Send old address with the new enclosing if possible your address label. The Post Office will not forward copies unless you provide extra postage. Duplicate copies cannot be sent. Circulation Department: Robert G. Lewis, Director of Circulation; Lawrence L. Cope, Circulation Manager; Field Staff: Gerald Blackley, Chester Hanson, George Heinrich, Guy Hill, Ash Huse, Steve Jacobson, Don Paul, John Simpson, Earl Spohn.

**Published monthly by Simmons-Boardman Publishing Corporation, Emmett St., Bristol, Connecticut. Editorial and Executive Offices, 79 W. Monroe St., Chicago 3, Illinois, and 30 Church Street, New York 7, New York. Subscription price: United States, Possesors and Canada, 1 year, \$3.50; 3 years, \$7.00. Foreign countries: 1 year, \$12.00; 3 years, \$25.00. Single copies, 75 cents. April issue, \$2.00. Entered as second-class matter July 20, 1950, at the Post Office of Bristol, Connecticut, under the act of March 3, 1879. Copyright 1955 with all rights reserved. SIMMONS-BOARDMAN PUBLISHING CORP.**

- 3 The Opportunity Page**
- 5 Reader's Guide**
- 7 Reader's Guide to Advertising**
- 9 The Building Outlook**

- News**
- 21 National news**
  - 23 Dickerman's column**
  - 25 Northrup's column**
  - 26 News of your region**
  - 30 Selected homes from your region**
  - 32 Less work, more play**

- Features**
- 81 A plywood workbook**
  - 89 The land crisis**
  - 92 Home building takes a big step ahead**
  - 96 Framing beyond the call of duty**
  - 98 Estate planning for the builder**
  - 100 Did FHA turn you down?**
  - 101 Build profitably all winter long**
  - 167 Construction short cuts**
  - 176 Discovered . . . easy forms that control costs**
  - 272 Built-in parking**
  - 273 Block and knife drawer**
  - 274 Builder favors growing family**
  - 275 Swing-out cabinet**
  - 278 New grooved nail for gypsum wallboard**
  - 280 Concrete masonry proves a point**
  - 282 "Palletizing" keeps everyone happy—and busy**
  - 284 Garage gets its face lifted**

- Houses & Plans**
- 106 Getting real mileage out of a plan**
  - 114 Blueprint House: Getting maximum privacy with three levels . . . and convenience, too**
  - 121 Blueprint House: Quantity list of materials**
  - 168 Fewer partitions mean more light and space**
  - 160 Cooperative sales talk in Syracuse**

- Commercial Building** **172 Southern solutions for suburban business . . .**

Cover photo: Robert C. Lautman

- Departments**
- 213 New products and equipment**
  - 242 Catalogs: review of manufacturers' literature**
  - 248 Legal: Tenants under Section 608 financing denied rent reductions by N. Y. court**
  - 250 Technical guide: Metal casing beads are easy to use, fit every style**
  - 259 Ask the experts: Reader queries analyzed**
  - 266 How to do it better**
  - 290 The Month Ahead**

READER'S GUIDE TO ADVERTISING ON PAGE 7 →

# "STEEL WINDOWS are perfect for this job,"

says Lorin Warlow, President  
Warren Construction Co.  
Jamestown, N. Y.

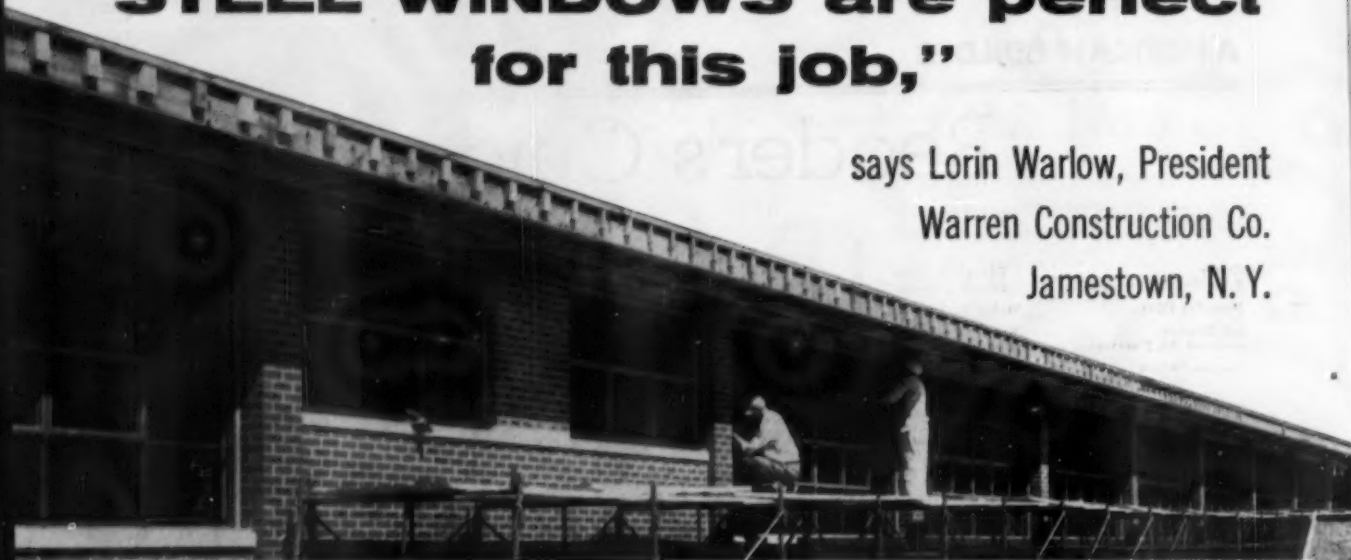

Two workmen are installing a big sidewall window. It measures 8'2" by 7'8" and must be easy to handle. Each window carries 12 panes of glass, 32" by 18", and weighs 6½ pounds. Another proof of the strength of steel windows.



Mr. Warlow, President, and job superintendent, Jerry Durham, discuss steel windows. Mr. Durham is illustrating the ease with which they adjust. "This is especially important in schools like Fluvanna," reminds Mr. Warlow.

The job Mr. Warlow is describing here is the new Bemus Point District No. 1 Elementary School, Fluvanna, N. Y. "The building is long and spread out," he continues, "with the long sides practically all window from floor to ceiling. This means large windows which need good, rigid support. Steel frames give us that.

"In all, we are installing 74 windows. They are the special types called for in the plans of our architects, Beck and Tinkham, a firm right here in Jamestown. The windows are made by Hope's Windows Co., also of Jamestown.

"We use steel windows in practically all our projects. We never have any trouble with damage or marring, and not once have we ever had to replace one. Because the men don't have to baby the frames, they can work faster. On a large job, every minute saved means reduced expenses.

"When we think of windows for our buildings we think immediately of steel frames. I am sure we'll continue to use steel frames in our future projects. They give us good results. I'd recommend them to any one."

★ ★ ★

For more than forty years United States Steel has been supplying window manufacturers with special rolled sections of high-grade open-hearth steel.



Look for this label—it is your assurance that the windows are made from quality steel.

SEE The United States Steel Hour. It's a full-hour TV program presented every other week by United States Steel. Consult your local newspaper for time and station.

UNITED STATES STEEL CORPORATION, PITTSBURGH • COLUMBIA-GENEVA STEEL DIVISION, SAN FRANCISCO  
TENNESSEE COAL & IRON DIVISION, FAIRFIELD, ALA. • UNITED STATES STEEL EXPORT COMPANY, NEW YORK

## USS STEEL FOR WINDOWS

UNITED STATES STEEL



# Advertising

"The better you buy—the better you build—the better you sell" ©

**A**

Allied Chemical & Dye Corporation, Solvay Process Division ..... 270

Aluminum Window Manufacturers Association ..... 134, 155

American Air Filter Company, Inc., Nelson Portable Products ..... 128, 129

American Bamboo Corporation ..... 186

American Brass Company, The ..... 62

American Builder ..... 245, 246, 283, 286, 287, 289

American Develer Mfg. Co. .... 281

American Floor Surfacing Machine Co., The ..... 70

American Houses Inc. .... 38

The American Machine & Foundry Company, De Walt, Inc. .... 141

American Photocopy Equipment Co. .... 71, 72

American Screen Products Co. .... 284

American Telephone & Telegraph Co. .... 241

American Welding & Manufacturing Co., The ..... 255

Andersen Corporation ..... 10, 11

A. B. B. Window Sales Company ..... 221

Arkansas Soft Pine Bureau ..... 244

Armstrong Cork Company ..... 60, 61, 191

Arrow-Hart & Hegeman Electric Co., The ..... 153

Atlas Electric Products Co. .... 18

**B**

Badger Machine Co. .... 265

Bakelite Company, a Division of Union Carbide and Carbon Corporation ..... 74

Balance-Seal Co. .... 261

Bar-Brook Mfg. Co., Inc. .... 286

Bell & Gossett Company ..... 231

\*Bellevue Metal Products ..... 321

Berger & Sons, Inc. C. L. .... 75

Besser Company ..... 183

Bessler Disappearing Stairway Co., The ..... 289

Binswanger & Co. of Texas ..... 289

Black & Decker Mfg. Co., The ..... 133

Bostitch ..... 189

Briggs Manufacturing Company ..... 256, 257

Brown Mfg. Co., Inc. .... 284

Brown & Co., Inc., Geo. C. .... 215

Brown Company ..... 208

Bruce Co., E. L. .... 187

Building Stone Institute ..... 194

**C**

Cabot Inc., Samuel ..... 281

Calbar Paint & Varnish Co. .... 289

Caldar Manufacturing Co. .... 220

Carlson & Sullivan, Inc. .... 286

Carrollton Manufacturing Co. .... 216

Cast Iron Soil Pipe Institute ..... 73

Ceco Steel Products Corporation ..... 143

Celotex Corporation, The ..... 242, 243

Central Metal Strip Co. .... 185

Chamberlin Company of America ..... 215

Chase Brass & Copper Co. .... 148

Classified Advertising ..... 285

Clipper Manufacturing Co. .... 47

Cloud Oak Flooring Co. .... 1

Columbia Geneva Steel Division, United States Steel Corporation ..... 6

Columbia Mills, Inc., The ..... 124

Connor Engineering Corporation ..... 285

Crawford Door Company ..... Cover 2

Crossett Lumber Company ..... 18

Curtis Companies Service Bureau ..... 126, 127

Curtition Corporation ..... 255

**D**

\*Dant & Russell, Inc., Fir-Tex ..... 32D

Deming Company, The ..... 49

Detroit Steel Products Co., Strand Garage Door Div. .... 35

Detroit Steel Products Company ..... 66

De Walt, Inc., American Machine & Foundry Company, The ..... 141

Dodge Corporation, F. W. .... 178

Dunley Brothers Company, The ..... 237

Douglas Fir Plywood Association ..... 276, 277

Drywall Trim, Inc. .... 265

Dur-O-Wal Division, Cedar Rapids Block Company ..... 14

**E**

Electromode Corporation ..... 261

Eljer Co. .... 20

Elkay Manufacturing Company ..... 264

Elmo Manufacturing Co. .... 282

Empire Stove Company, Inc. .... 140

Evans Rule Company ..... 14

Eveready Brikshaw Co. .... 29

**F**

\*Fabricon Products ..... 32J

Fastener Corporation ..... 282

Fiat Metal Mfg. Co. .... 228, 32D

\*Fir-Tex, Dant & Russell, Inc. .... 32D

Ford Motor Co. .... 146

Forest City Foundries Co., The, Niagara Furnace Division ..... 216

\*Forest Fiber Products Company ..... 32L

Frigidaire ..... 48

\*Fuller & Co., W. P. .... 32A

**G**

Garlinghouse Co., Inc., L. F., The ..... 15

Gates & Sons, Inc. .... 206

General Bronze Corporation ..... 58

General Electric Company ..... 2, 36, 37, 76, 77, 130, 138, 139, 192, 193, 210

General Electric, Textolite Division ..... 2

General Portland Cement Co., Trinity Division ..... 202

General Products Company, Incorporated ..... 262

Given Mfg. Co. .... 240

Goldblatt Tool Company ..... 261, 286

Gold Seal Division, Congoleum-Nairn, Inc. .... 113

Goodyear, Flooring Dept. .... 12

Grand Haven Stamped Products Co. .... 289

**H**

Hager & Sons Hinge Mfg. Co., C. .... 182

Hansen Mfg. Co., A. L. .... 281

Hardwood Plywood Institute ..... 249

Harnischfeger Homes, Inc. .... 179

Heatilator Inc. .... 52, 238

Holcomb & Hoke Mfg. Co., Inc. .... 147

\*Holly Manufacturing Company ..... 32B

Homasote Company ..... 230

Hope's Windows, Inc. .... 234

**I**

Infra Insulation, Inc. .... 8

Insulite Division, Minnesota and Ontario Paper Company ..... 122, 123

International Homes, Inc. .... 266

Iron Fireman Manufacturing Company, Select-Temp ..... 125

**J**

Jaeger Machine Company, The ..... 280

Johnson Co., S. T. .... 253

Junior-Pro Products Co. .... 206

**K**

Kaiser Aluminum & Chemical Sales, Inc. .... 56

Karyall Body, Inc. .... 280

Kaustine Furnace & Tank Corp. .... 55

Kawneer ..... 39

Kesbey & Mattison Company ..... 79

Kennatrack Corporation ..... 208

Keystone Steel & Wire Company ..... 42, 43

Kohler Co. .... 199, 263

**L**

Lennox Furnace Company ..... 150, 151

Lewyt Air Conditioner Corporation ..... 57

Libbey Owens Ford Glass Company, Thermopane ..... 205

Long-Bell Lumber Company, The ..... 196

Louisville Cement Company ..... 50

Lufkin Rule Co., The ..... 275

**M**

McCabe-Powers Auto Body Co. .... 222

McKinney Manufacturing Company ..... 223

Macklanburg-Duncan Co. .... 40, 41

Majestic Company, Inc., The ..... 18

Malta Mfg. Co. .... 206, 270

Marsh Wall Products, Inc. .... 204

Masonite Corporation ..... 152

Master Vibrator Company ..... 236

Mastic Tile Corporation of America ..... Cover

Maze Company, W. H. .... 230

Milwaukee Electric Tool Corp. .... 239

Minneapolis-Honeywell Regulator Co. .... 75

Minnesota and Ontario Paper Company, Insulite Division ..... 122, 123

Moe Light Division, Thomas Industries Inc. .... 65

Moore Incorporated, Goodloe E. .... 285

Morgan-Wightman Supply Co. .... 202

Morrison Steel Products, Inc. .... 159

Mossie Tile Company, The ..... 54

Mosley Electronics, Inc. .... 262

Moultilite Inc. .... 261

Mulkey Company, Sam ..... 270

Muller Machinery Company, Inc. .... 253

Myers & Bro. Co., F. E., The ..... 234

**N**

National Gypsum Company ..... 54, 219

National Manufacturing Company ..... Cover 4

Nelson Portable Products, Herman, American Air Filter Company, Inc. .... 128, 129

New Monarch Machine & Stamping Company ..... 260

Niagara Furnace Division, The Forest City Foundries Co. .... 216

Nichols Wire & Aluminum Co. .... 238

Norris-Thermador Corporation, Thermador Electrical Manufacturing Co. .... 268, 269, 271

NuTone, Inc. .... 28

**O**

\*O'Keefe & Merritt ..... 32E

Oliver Corporation, The ..... 45

Owens Illinois Glass Block, Kimble Glass Company subsidiary ..... 188

**P**

\*Pacific Coast Company ..... 32C

Pacific Lumber Company, The ..... 201

Pomona Tile Manufacturing Company ..... 157

Ponderosa Pine Woodwork ..... 34

Posttack Corp. .... 286

Precision Parts Corp. .... 242, 243

Pryne & Co., Inc. .... 4

**R**

Raynor Manufacturing Co. .... 254

Ready Hung Door Corp. .... 52

Red Cedar Shingle Bureau ..... 131

Red Devil Tools ..... 280

Reflector Corporation ..... 273

Remington Arms Company, Inc. .... 136, 137

Remington Rand Division of Sperry Rand Corporation ..... 190

Republic Steel Corporation, Truscon Steel Division ..... 144, 145

Revere Copper and Brass Incorporated ..... 156

Reynolds Metals Company ..... 181

Richmond Radiator Company ..... 211, 212

Rilco Laminated Products, Inc. .... 180

Rolscreen Company ..... 184, 185

Rowe Manufacturing Company ..... 158

R. O. W. Sales Co. .... 16, 37

Rubens Co., The ..... 238

Russell Company, F. C., The ..... 200

**S**

Sargent & Co. .... 198

Scharf Mfg. Co., J. H. .... 286

Scholz Homes, Incorporated ..... 33

Scott & Sons Co., O. M. .... 288

SelectTemp, Iron Fireman Manufacturing Company ..... 125

Shawnee Manufacturing Company, Inc. .... 267

Sherman Products, Inc. .... 278, 279

Skill Corporation ..... 226, 227

Solvay Process Division, Allied Chemical & Dye Corporation ..... 270

Sonoco Products Company ..... 267

Spotnails, Inc. .... 248

Stanley Hardware, A Division of The Stanley Works ..... 195, 225, 281

Sta-Tite, Inc. .... 286

Steel Corner Tape Corp. .... 32

Steel Scaffolding Company, The ..... 275

Sterling Hardware Manufacturing Company ..... 237

Strand Garage Door Division, Detroit Steel Products Co. .... 35

Sutton Corporation, O. A., The ..... 233

Symons Clamp & Mfg. Co. .... 282

Syntro Corporation ..... 232

**T**

Tappan Stove Company, The ..... 134, 135

Tennessee Coal & Iron Division, United States Steel Corporation ..... 6

Textolite Division of General Electric Company ..... 2

Thermador Electrical Manufacturing Co., Division of Norris-Thermador Corporation ..... 268, 269, 271

Thermo-Rite Mfg. Co. .... 32

\*Thompson Co., Inc., E. A. .... 32H

Trush & Company, H. A. .... 68

Thyer Manufacturing Corporation, The ..... 13

Timber Engineering Company ..... 283

Trade-Wind Motorfans, Inc. .... 59

Trinity Div., General Portland Cement Co. .... 202

Truscon Steel Division, Republic Steel Corporation ..... 144, 145

**U**

United States Gypsum ..... 203

United States Plywood Corporation ..... 51, 80

United States Steel Corporation, United States Steel Export Company ..... 6

Universal Atlas Cement Company ..... 44

**V**

Visking Corporation, The ..... 67

Vulcan Radiator Company, The ..... 149

**W**

Washington Steel Products, Inc. .... 19

West Coast Lumbermen's Association ..... 53

Western Lock Mfg. Co. .... 207

Western Fine Association ..... 271

Weyerhaeuser Sales Company ..... 209

White Company, David ..... 288

Williamson Heater Company, The ..... 63

Windsor Door Co., Inc. .... 262

Wirmold Company, The ..... 274

Woodall Industries Inc. .... 69

Woodco Corporation ..... 247

Wood Conversion Co. .... 132

Woodward Iron Company ..... 197

**Z**

Z & K Tool Company, The ..... 253

Zegers Incorporated ..... 46

\* Appears in West Coast edition only.

# The Invisible Enemy No.2

**moves with  
incredible speed**

In time of war it instantaneously devastates and obliterates with its searing heat, every human being within a tremendous radius, when released by a nuclear bomb. Though it has no temperature, its enormous energy changes into heat when it strikes and is absorbed by a surface.

Upon escaping from a building in winter, it leaves a chill behind. When it invades in summer, it takes its toll in excessive heat and human distress.

Its aliases are many—Infra-Red Rays, Heat Rays, Radiant Energy, Radiation.

It is responsible for 93% of the heat flow downward in summer through roof spaces; in wall spaces, for 65% to 80% of heat losses in winter, and heat flow inward in summer; for about 55% to 75% of heat loss upward in winter through ceiling and roof spaces.

Buildings are generally constructed with wall and ceiling air spaces, because the greatest flow of heat possible between two solids is by direct conduction—actual physical contact; and since air has low density, it allows little heat flow through it by conduction.

The enemy then becomes radiation in downward heat flow; and radiation and convection in upward and side heat flow.

## A STALWART SHIELD

A shield against these enemies is multiple accordion aluminum. Its surfaces have an absorptivity to heat rays of a mere 3%; reflect them at the rate of 97%, and emit them at a rate of only 3%. Thus they retard the flow of heat rays outward or inward. Accordion aluminum is likewise a stalwart shield against the flow of heat by convection, its multiple layers of metal and fiber offering extremely effective resistance. Heat flow by conduction is minimized by its multiple layers of large air spaces, because they have slight density.

Scientifically separated sheets of aluminum, giving UNIFORM, full-depth protection to every inch of space between joists, will imprison the invisible enemy indoors in winter, prevent its invasion in summer, and transform it into a friendly and useful servant.

Its continuous metal sheets, up to 750 feet long, have almost zero permeability to water vapor. Infiltration under its flat, stapled flanges is slight. Its scientific construction minimizes condensation on or within this type of insulation.

More than 250 million square feet are in use today. For 10 years it has been repeatedly specified and used by many of the leading architects, engineers and builders of America.

Yours for the asking is a discussion of how and why aluminum insulates even under extreme conditions. It will be found in the booklet, "Thermal Test Coefficients of Aluminum Insulation for Buildings," published by the AMERICAN SOCIETY OF HEATING & AIR CONDITIONING ENGINEERS. Use the coupon for the literature and free samples of this scientific insulation.

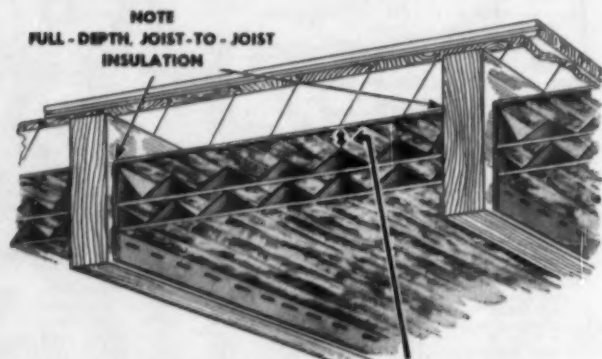

**NOTE FULL ONE-INCH EXTRA AIR SPACE**  
above accordion pleats for even more resistance to heat flow. Each sheet extends from joist-to-joist.

**COST OF EDGE-TO-EDGE INFRA**  
Multiple Aluminum Insulation  
installed in new construction between  
wood joists, material and labor

Type 6-PS about 10¢ sq. ft.

Type 4-PS about 8¢ sq. ft.

Infra Insulation, Inc., 525 B'way, N. Y., Dept. B-10  
Please send ASHAE Booklet: "Thermal Test, etc."

Name \_\_\_\_\_

Firm \_\_\_\_\_

Address \_\_\_\_\_

# The Building Outlook

## NORTHERN EDITION

### SMALL TALK

#### SWITCHEROO?

Says NAHB regional v.p. John R. Worthman of Fort Wayne, Ind., about the tighter VA and FHA credit regulations: "Formerly, the government has been 'too little and too late'. In a few months we shall see if it has been 'too soon.'"

#### SUCH LANGUAGE!

The FHA was given a going-over in a big article in Barron's, the influential business and financial weekly. They called it a "financial and architectural monstrosity" with "frightening power."

#### QUITE A FIGURE

Encouragement for builders who want to get into remodeling: government housing experts have made a survey of plans to buy used houses and say that in 1955 these will go up 50 per cent over last year.

#### SMASH

Early report on National Home Week, from real estate editors: a huge national success.

**THE MAN WHO ACCURATELY PREDICTED** the trend to ranch houses in the north and east, long before that trend was apparent to anyone else, has a new advice: Long Island architect Rudolph A. Matern says a garden court, partly or entirely surrounded by the house, will soon become quite common in areas where they never existed before. Another prediction: indoor gardens that "flow into" the outdoor planting, perhaps from kitchen or bathrooms, may also be standard.

**MILWAUKEE IS WAY UP FRONT**, among northern cities, when it comes to prefab houses. Last year, according to The Milwaukee Journal, prefabs accounted for the sales of about 1400 homes in that city, a little better than 10% of all residential construction. Local prefab distributors expect 1956 sales to be even better: one says 30 per cent better. Another says that in five years Milwaukee will be prefabbing 80 to 90 per cent of its homes. (National prefab figures: 1955 output is expected to reach about 125,000, or about 10 per cent of all new home construction.)

**YOU'LL BE HIT WHERE IT HURTS**, if NAHB economist Nathaniel Rogg is right: he says those recent government measures stiffening mortgage terms will force thousands of lower income families out of the market. If you've read The Opportunity Page (p. 3), you know just how big that market is.

**IT'S NOT A MINUTE TOO SOON** to start thinking about July 25, 1957. That's the day the Serviceman's Readjustment Act runs out. Between now and then, you'll be smart to do everything possible to get GI's to buy while they can still get VA insured mortgages, while you can still sell them so easily.

HERE'S HOW TO BUILD BEAUTY

# Andersen



AND SUNSHINE INTO THE FAMILY ROOM

# Windowalls

TRADEMARK OF ANDERSEN CORPORATION



*Andersen Casement Picture Window Unit  
specified by Architect Norman Johnson*

**Pleasant living** in this contemporary room is doubly assured through the beauty of Andersen WINDOWALLS. While blending attractively with interior decor, WINDOWALLS frame the outdoor view. At the same time they let in sunshine and fresh air, yet will always close tight to form a weatherproof barrier on windy, wet or wintry days.

It's easy to get complete information on Andersen WINDOWALLS for homes you build. Just see your lumber and millwork dealer, Sweet's Light Construction File or write Andersen. WINDOWALLS are sold by established lumber and millwork dealers throughout the country, including the Pacific Coast.

ANDERSEN CORPORATION • BAYPORT, MINN.

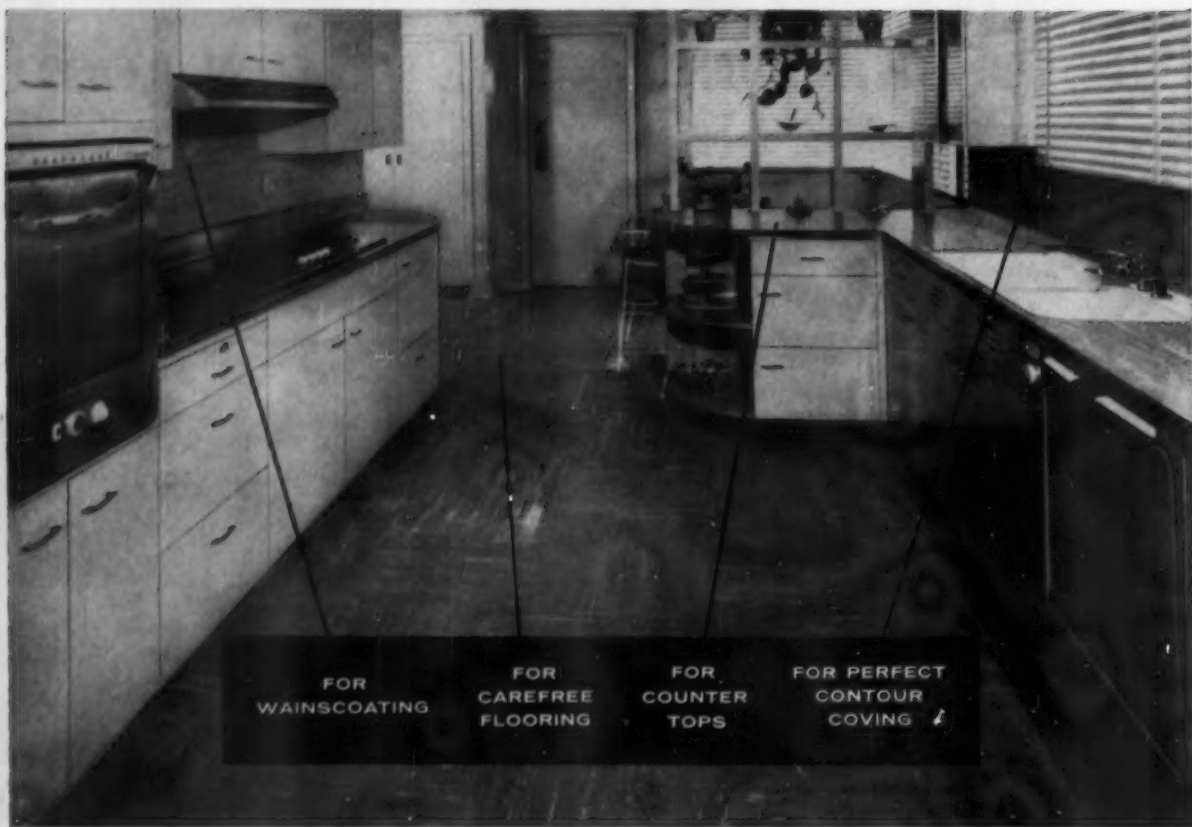

*Mortgage people and home buyers agree:*

**THERE IS NOTHING FINER ON THE MARKET!**

**T**HE quality and charm of Goodyear *All-Vinyl* are apparent to a prospective buyer the moment he or she walks into a new home.

It can be seen in the brilliant sheen of lovely floors that never require troublesome waxing.

It can be seen in the sparkling counter tops that stay beautiful under the normal abuse of grease, detergents, water and spilled foodstuffs. Even dents have a way of fading away if the counter top is famed Goodyear *All-Vinyl*!

It can be seen in the smooth way Goodyear *All-Vinyl* coves away sharp corners, swings up a wall from a horizontal surface with a clean, effortless sweep—with no tendency to crack or split.

All this, mortgage people know well—for they too, are well acquainted with the fact that “there is nothing finer on the market”!

**IMPORTANT!** Goodyear *All-Vinyl* is now available in *.080 DeLuxe gauge*—of solid, homogeneous construction where colors and quality run top-to-bottom deep!

Goodyear Vinyl has been used successfully in more than a million homes.

Choose from 3 great Vinyl floorings by Goodyear

- 1 – Goodyear Standard (.080 gauge)
- 2 – Goodyear DeLuxe (.080 gauge)
- 3 – Goodyear Super DeLuxe ( $\frac{3}{32}$ " and  $\frac{1}{8}$ " gauge) Rolls and Tile

When planning your next project, be sure you get fully acquainted with Goodyear *All-Vinyl*—the top-quality material that pays for itself in good looks, good service and good will. Write:

Goodyear, Flooring Department J-8321,  
Akron 16, Ohio

**GOOD YEAR** *All-Vinyl*

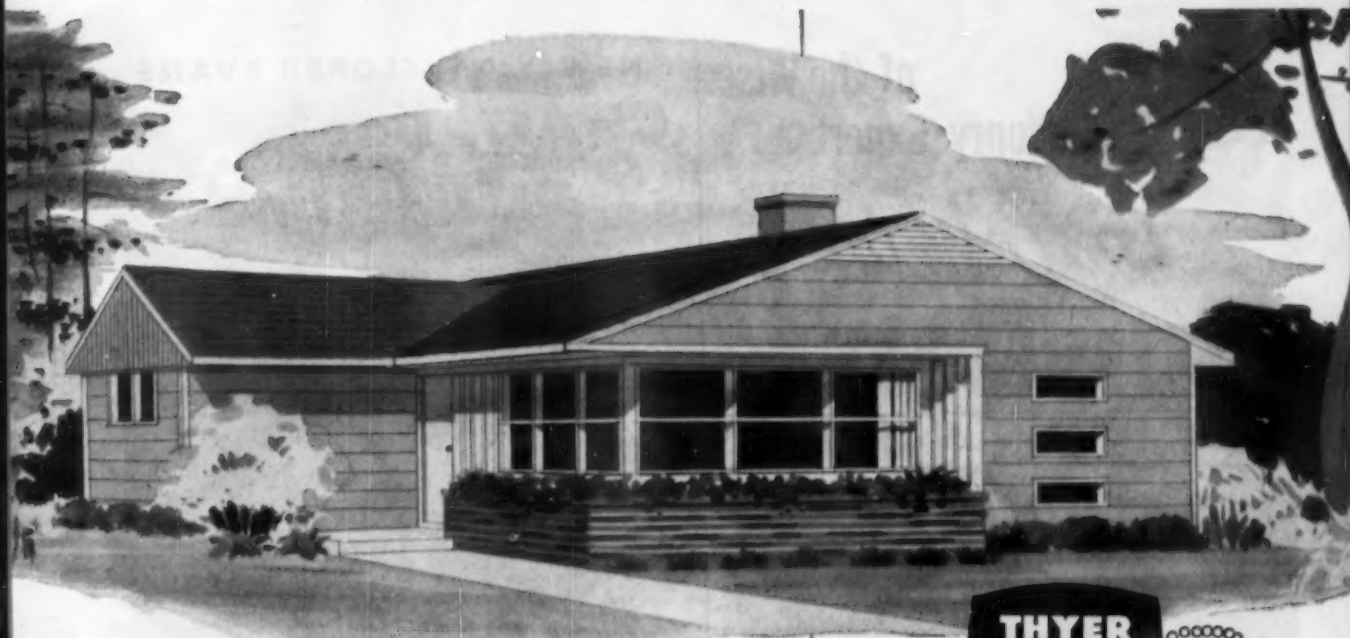

MODEL 30-L—  
3 bedrooms—Single Bath  
Available for both  
northern and southern areas

open the door to

*Better living!*

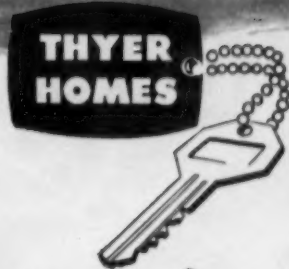

Attention to all builders! Open the door to better living in your community—and spark up your sales as well. Thyer homes are designed for the maximum in convenient living and custom-styled to appeal to the most discerning buyer. Backed by localized sales promotion and national advertising, they practically sell themselves.

The convenient floor plan of the L-shape model pictured above eliminates family traffic problems. Bedrooms and bath can be reached by hall without going through the living room, and there's also a handy short cut to the bathroom from the rear door via the kitchen. Added to this careful planning are such extra Thyer touches as wardrobe-type closets, birch kitchen cabinets and a separate dining area.

For further information on how Thyer Homes can help you triple the number of houses you build and sell, contact your local Thyer factory representative or write us today.

"Thyer fabricated structural units commended by Parents' magazine."



**THYER'S "SILVER PLATTER" PROFIT SYSTEM**



**Financing Service.** Your local Thyer Factory Representative will be glad to help you arrange construction and permanent financing for FHA, VA or conventional loans.

**Local Field Service.** Thyer factory representatives located in 28 states are ready to assist you in land development, arranging financing, erecting, and planning local advertising and model home showings.

**Turn-Key Contracting Service.** For developers who wish to build 100 or more houses at a time, Thyer can provide a turn-key building service that delivers houses at a bonded contract price. (At present this service is available in all Southern and in most Northern states.)

**National Advertising Support.** A hard hitting program in national consumer magazines pre-sells your prospects—helps create buyer interest in Thyer Homes.

**THE THYER MANUFACTURING CORPORATION**

2854 Wayne Street, Toledo 9, Ohio

515 E. Yazoo Street, Dept. 5, Jackson, Miss.



"BUY-WORD" of the Wise  
Masonry Expert . . .

*Butt Weld*  
**DUR-O-WAL**  
WITH **TRUSSED**



Patented Dur-O-wal Sets  
the Pace for Reinforcing  
Quality and Performance

Masonry industry leaders throughout the nation hail butt-weld Dur-O-wal for performance, quality and economy. Masons prefer Dur-O-wal because it lays flat . . . works fast . . . handles easily.

The masonry industry prefers Dur-O-wal because it safeguards the beauty of masonry by providing both vertical and horizontal reinforcing in all types of masonry walls.

**6 Reasons**  
why Dur-O-wal is  
**STRONGER, FASTER**  
**AT LESS COST**

- Mechanical Bond every 8 inches of wall
- High Tensile Steel (100,000 p. s. l.), shipped in convenient 10 foot lengths
- Double Mortar Lock at each weld
- Electric Butt Welds place all rods on a single plane
- Deformed Side Rods lay straight and flat due to hardness of steel
- Trussed Design causes side rods to work together.

GET ALL THE FACTS TODAY from the Dur-O-wal plant nearest you. Literature now available with new research data from independent tests. Request information today.

- SYRACUSE 1, N.Y. Dur-O-wal Products, Incorporated, Box 628
- TOLEDO 2, OHIO Dur-O-wal, Incorporated, 185 Utah Street
- BIRMINGHAM 7, ALA. Dur-O-wal Products of Ala., Inc., Box 5446
- PHOENIX, ARIZ. Dur-O-wal Div., Frontier Mfg. Co., Box 49
- CEDAR RAPIDS, IA. Dur-O-wal Div., Dept. 658, Cedar Rapids Block Co.

NEWLY DEVELOPED EVANS  
**CHALK line**  
**PLUMB line**



—precision engineered  
—real professional's tool  
—a popular price

RETAIL  
ONLY  
**\$1.49**  
50 ft.

*More features than any  
other Chalk Line made!*

- Slide action brake separate from rewind handle. Automatically unlocks on rewind.
- Absolutely accurate plumb bob for true plumb lining.
- Sturdy die-cast aluminum case practically indestructible.
- Easy to fill. ¼ turn screw opening—won't come loose accidentally.
- Hook ring for one-man chalking and plumbing.
- Rewind handle folds flush.
- Unconditionally guaranteed.
- Available with 50-ft. and 100-ft. lines.

**STOCK EVANS CHALK CARTRIDGES**  
*Spill-proof refills*

Perfect for use in any Chalk Line. Retail 10¢ each—one full ounce and Evans Replacement Lines—wound on re-usable plastic reel. 50 ft. 25¢ retail.



RETAIL **\$1.49**  
FROM 6 ft.

EVANS KING-SIZE  
6, 8, 10, 12-ft. TAPES

Stand Up Straight for  
One-Man Measurements

Now, long upright measurements are easy and accurate with these new Evans King-Size Tapes. 33% wider blade (full ¼") stays straight up—does not bend or buckle! Free belt clip for handy carrying, and Free Tenite Utility Case with every tape. Self-adjusting sliding end hook always starts at zero for accurate inside-outside measuring. Stock all four sizes for multiple sales!

**FAMOUS EVANS DOUBLE MARKINGS**

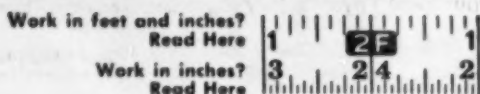

**Evans** RULE COMPANY  
400 Trumbull St. • Elizabeth, N. J.



# Garlinghouse HOME PLAN BOOKS....



*turn prospects into jobs!*

**Over 1,250 Home Plans To Show Your Prospects**

**In These 18 Beautiful Plan Books**

*Let them help you earn thousands of dollars — from an \$8.00 investment*

**A COMPLETE PLAN SERVICE for BUILDERS**

Garlinghouse Plan Books show all styles and sizes of homes—1 to 4 bedrooms. Pictures, floor plans with square feet and cubic feet dimensions describe each design to make it easy for your prospect to decide.

Complete working plans, specifications, lumber and mill lists available for each design. The moderate price of these plan sets is a fine investment since both you and your customer know in advance what is being offered, thus avoiding misunderstandings.

**Fast Service**

Complete plan sets will be sent by return mail (24-hour service) and POSTPAID to avoid delays.

**Plan Guaranteed**

All transactions with The L. F. Garlinghouse Co., Inc. are on a money-back guarantee basis. Unused plans may be returned within five days for full credit on other plans or for cash refund.

*For over 40 years—the Contractors' best job selling service.*

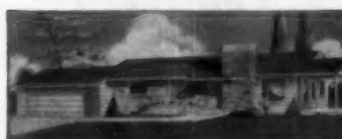

Here is No. 6375, one of our most popular 3-bedroom Ranch Design. Shows in full color in our New Ranch and Suburban book and several others. First plan set ..... \$20.00 Additional sets, ea. .... 5.00

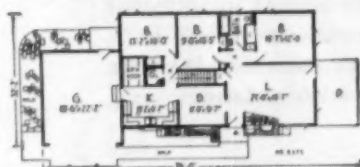

**ALL BOOKS POSTPAID IN U.S. & CANADA**

DESCRIPTION AND ORDER FORM

**SAVE \$2.75 BY ORDERING COMPLETE SET OF 18 BOOKS OR ORDER BOOKS INDIVIDUALLY AT PRICES SHOWN**

**CHECK BOOKS WANTED AND MAIL TODAY**

- 1.  **RANCH AND SUBURBAN**—125 very popular ranch-type designs—both conventional and contemporary. Suitable for town and country. Many in color ..... 50c
- 2.  **PLANS FOR NEW HOMES**—109 beautiful modern designs in wide variety of styles and sizes. 32 in full color ..... 50c
- 3.  **HOMES IN BRICK**—114 designs of medium and large homes. Includes color section of ranch styles in brick, stone and frame ..... \$1.00
- 4.  **SUCCESSFUL FIREPLACES**—200 pictures, outdoor (patio) and indoor types including correct construction details. Reliable, authentic information ..... \$ .75
- 5.  **ALL-AMERICAN HOMES** 3rd edition—featuring 120 different designs in varied types of construction. 64 in full color ..... 50c
- 6.  **SUNSHINE HOMES**—62 appealing designs, pleasantly styled. 2 and 3 bedroom sizes. Many without basements ..... 50c
- 7.  **AMERICA'S BEST**—2nd edition. Over 120 outstanding designs. All styles 2 and 3 bedroom. 64 in full color ..... 50c
- 8.  **COLONIAL HOMES**—A very fine selection—perhaps our finest. All types, Cape Cod, Southern, New England. 1½ and 2 stories—2 to 4 bedrooms ..... 50c
- 9.  **DELUXE SMALL HOMES**—Our 5th edition and largest selection of finest, modern designs. All time-tested for popularity. 1 to 3 bedrooms. 64 in full color ..... \$1.00
- 10.  **NEW SMALL HOMES**—Over 80 new plans. 32 in full color. Many sizes, 650 to 1175 sq. ft. floor space 1, 2 and 3 bedrooms ..... 50c
- 11.  **100 NEW HOMES**—A wide variety of styles—ranch, colonial and modern—makes selecting easy. 2 to 4 bedrooms. Many in color .... 50c
- 12.  **NEW BRICK HOMES**—64 designs in brick exteriors, every one a genuine beauty. Wide range of styles and sizes ..... 50c
- 13.  **SMALL SOUTHERN HOMES**—very pleasing designs for small families. All one story. Mostly 2 bedroom—3 few 3 bedroom. Suitable for all areas. Most without basements ..... 50c
- 14.  **DUPLEX DESIGNS**—41 varied designs of 1 and 2 story duplexes and small apartments in brick, stone and wood ..... 50c
- 15.  **KAMP KABINS AND WEE HOMES**—Over 60 designs suitable for year around and summer use—in town or country ..... 50c
- 16.  **NEW AMERICAN HOMES**—96 of our most popular larger homes. A beautiful selection—tested for popularity ..... \$1.00
- 17.  **BLUE RIBBON HOMES**—One of our most popular books—2nd edition. 107 designs. 32 in full color ..... 50c
- 18.  **YOUR NEW HOME PLANS**—A 2nd edition of 119 designs (many in color) widely varied in style and materials—2 and 3 bedroom ..... 50c
- 19.  **COMPLETE SET** of above books in one order for only \$8.00—a \$2.75 SAVINGS.
- 20.  **Plan set No.**..... shown on left.

**THE L. F. GARLINGHOUSE CO., INC.**

Dept. AM-8, GARLINGHOUSE BLDG., TOPEKA, KANSAS

Enclosed is \$..... cash, check or money order for books checked above.

Name .....  Contractor  Dealer

Address .....

City ..... State .....

# YOU CAN PAY MORE—

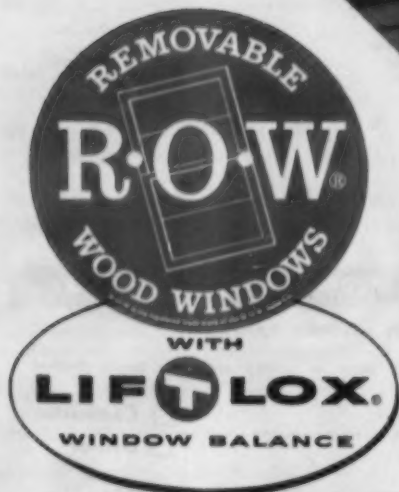
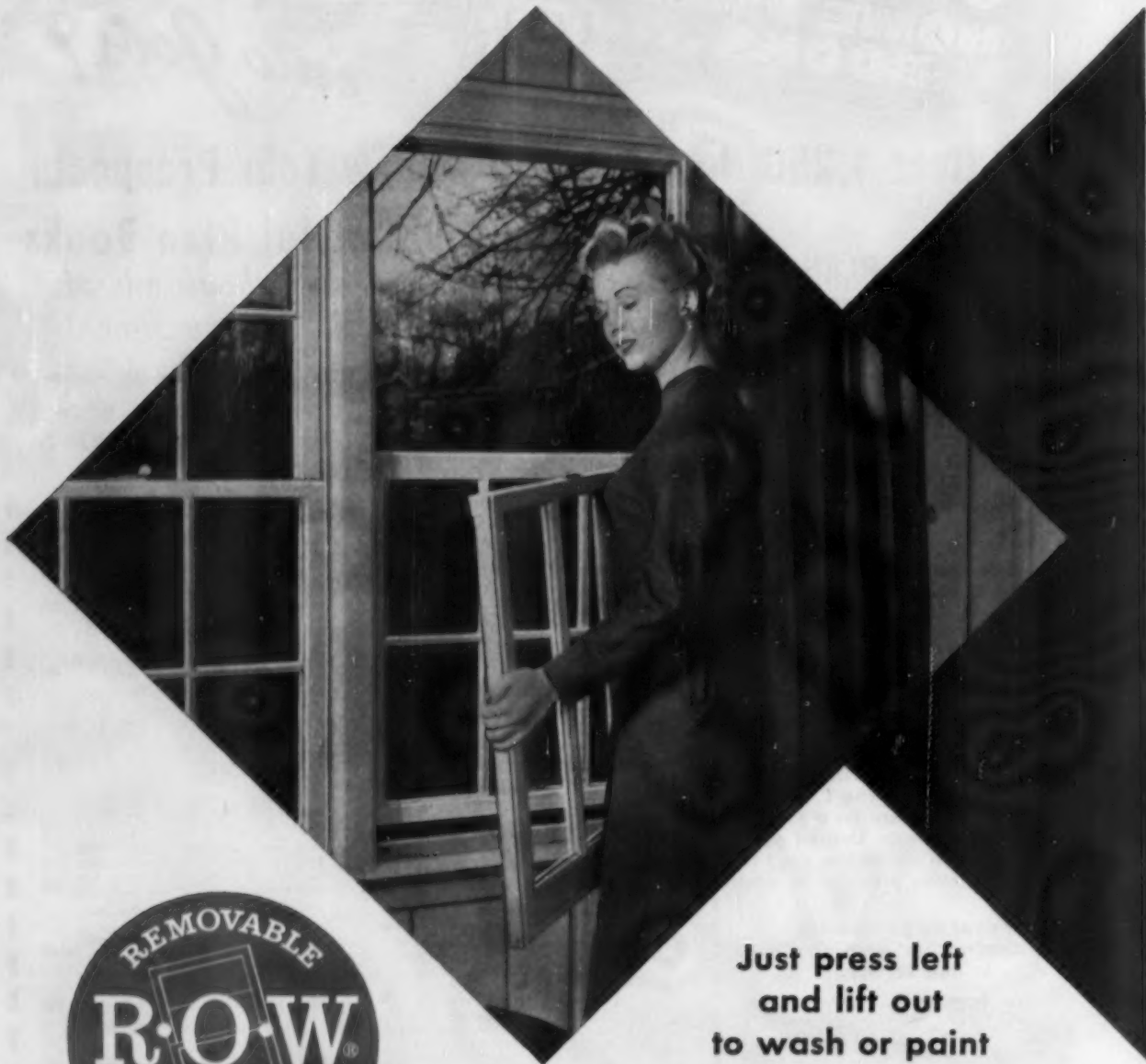

Just press left  
and lift out  
to wash or paint

Removable R·O·W windows cost no more (usually much less) than other good-quality wood windows. Because we manufacture far more double-hung windows than any competitor, you can buy the highest quality *plus* the removable feature—*plus* the exclusive LIF-T-LOX balance at no extra cost. If you pay more than the price of an R·O·W window, you're bound to get less.

R·O·W is the registered trademark of the R.O.W. Sales Co.

See your lumber dealer or write:

**R. O. W. SALES COMPANY, 1315 ACADEMY AVE. • FERNDALE 20, MICHIGAN**

# YOU CAN'T BUY BETTER

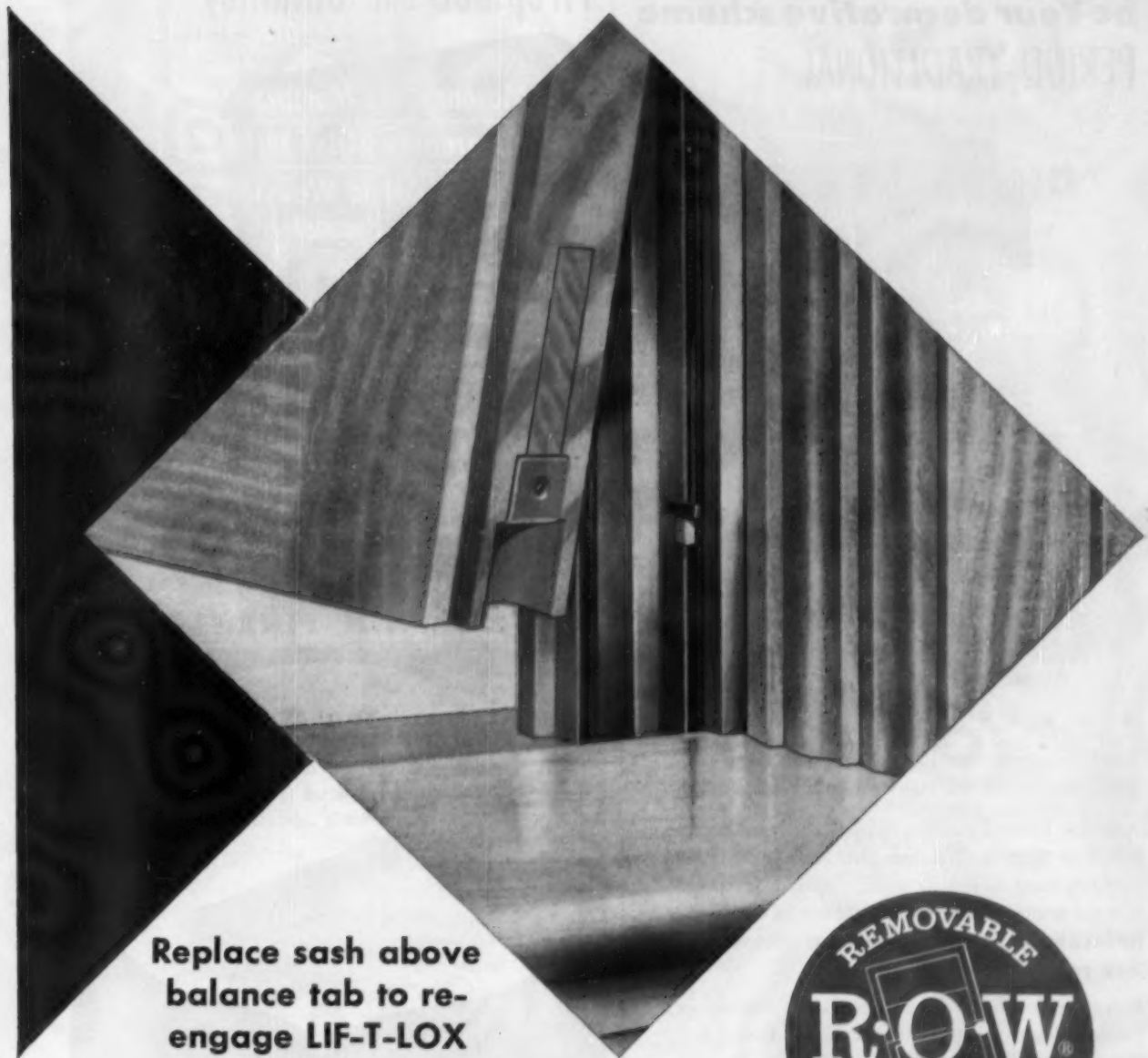

**Replace sash above  
balance tab to re-  
engage LIF-T-LOX**

Everyone *talks* about things that make homes sell faster. We have *done* something about it. Lift-out windows can be demonstrated as a bonus feature. Now, the exclusive LIF-T-LOX balance has been added for easier operation. It does not interfere with sash removal—there's nothing to unfasten. Just lift out the sash—the lock tab grips channel automatically, stays until sash is replaced.

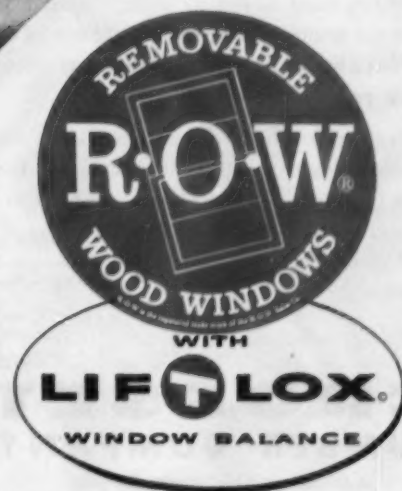

R·O·W is the registered trade-mark of the R.O.W. Sales Co.

See your lumber dealer or write:

**R.O.W. SALES COMPANY, 1315 ACADEMY AVE. • FERNDAL 20, MICHIGAN**

OCTOBER 1955

17

**Crossett Pine Paneling  
Sparks Quicker Sales...  
be Your decorative scheme  
PERIOD TRADITIONAL**



... or **TODAY'S MODERN**

There's magnetic appeal to your prospect's eye, especially hers, in the spiritual warmth of pine paneling.

And with Crossett paneling in particular, produced as it is from Satin-like Arkansas Soft Pine, you'll install Nature's finest in mellow color, beautiful figure and lustrous texture attractively brought out by the wood's perfect affinity for transparent finishes of whatever tone. Your prospect will love it!

Easy to get, too, right from your local supplier in various patterns, together with complementary Arkansas Soft Pine trim, finish and mouldings. Certified to Crossett standards by registered trade and grade marks for ready identification.

*Constant Betterment  
Through Research*

For data and information address:

**CROSSETT  
LUMBER COMPANY**

A Division of The Crossett Company

CROSSETT ARKANSAS



**SLASH COSTS**

with this  
**Fireplace and Chimney**

Aluminum top has wire-cut-brick texture and color

**No Masonry, No Mortar!  
All Clearances BUILT IN!  
Installs FLUSH to Walls,  
Floors, Joists, Beams!**



**One Man can  
install it!**

Majestic's new, approved Thulman Fireplace and Chimney cuts both material and labor costs to rock bottom. Saves space, —all clearance and safety features are BUILT IN! For 1, 1½ and 2-story units.

Fits Any Type Mantel



SEND FOR FREE ILLUSTRATED BULLETIN TODAY!  
The **Majestic Co., Inc.**, 433 Erie St., Huntington, Ind.

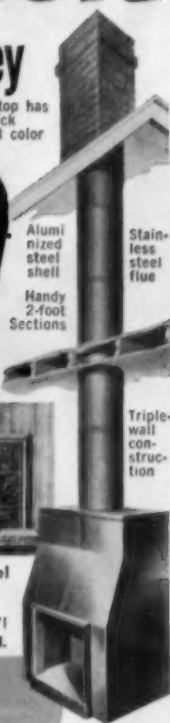

**Majestic  
THULMAN FIREPLACE**

**Model 22  
FLUSHED RECESSED FLUORESCENT**

with dropped Plexiglas. Fast, easy maintenance.  
All wiring is connected to removable pan,  
which is independent of housing.



another **ATLITE** designed for better lighting

**PRE-WIRED ASSEMBLY**

Fast, Easy Installation. Reduces inventory. Drive four nails — turn the screws. It's up — without carpentry! Available in six sizes. Carry only what you need.

Order from your jobber — or write for literature and competitive price list.



**ATLAS**

ELECTRIC PRODUCTS CO.

\*319 Ten Eyck St., Brooklyn 6, N.Y.



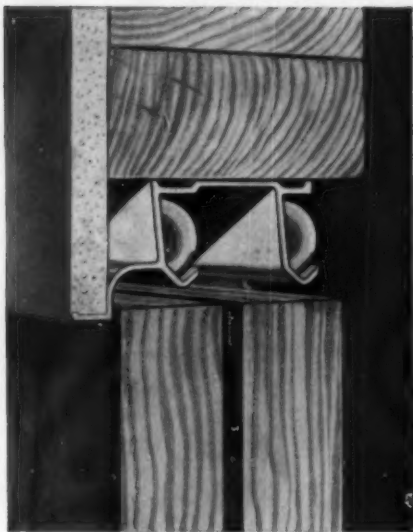

**a brand new concept of  
rolling door hardware!**

# Aluminum Track

**WITH "PLASTER GROUND"  
OR "BUILT-IN VALANCE"  
by "Washington"**

## **PLASTER GROUND TRACK\*** for By-Passing Doors

Cut labor costs with a new track that can be installed and made an integral part of the door frame by simply plastering right up to the bead on the track. Sheetrock may be used in place of the plaster, if desired. This track comes in two sizes and will handle doors from  $\frac{3}{8}$ " to  $1\frac{3}{8}$ " thick.

The new "Washington" double-wheeled hangers have pivoted cross arms to distribute the weight load evenly, and have a "whispering wheel" with sealed-in ball bearings.

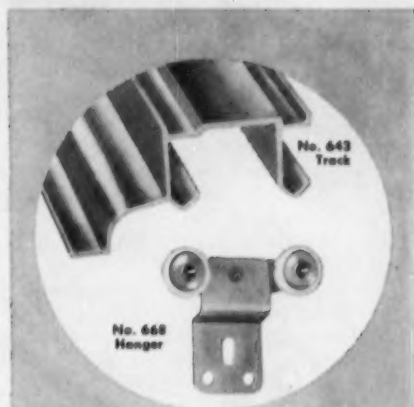

## **BUILT-IN VALANCE TRACK**

Like the plaster ground track, this "valance" track also becomes a part of the door frame and saves a great percentage of time and labor costs. The valance eliminates need for wood trim, and can be painted or left plain—as the track is etched for beauty and durability.

All "Washington" side-mount hangers are interchangeable on aluminum track.

Track and hangers available in bulk or complete packaged sets.

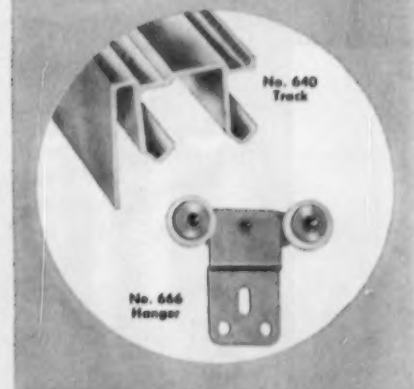

\*Pat. applied for



**WASHINGTON, LINE**  
WASHINGTON STEEL PRODUCTS, INC., TACOMA 2, WASH.

**For more information, see  
your dealer, or fill out coupon  
and mail to manufacturer  
for a free catalog.**



To: **Washington Steel Products, Inc.**  
Dept. AB-10, 1940 East 11th Street, Tacoma 2, Washington  
Gentlemen:  
Please send complete Rolling Door Hardware catalog on aluminum and steel track.

NAME.....  
ADDRESS.....  
CITY.....ZONE.....STATE.....

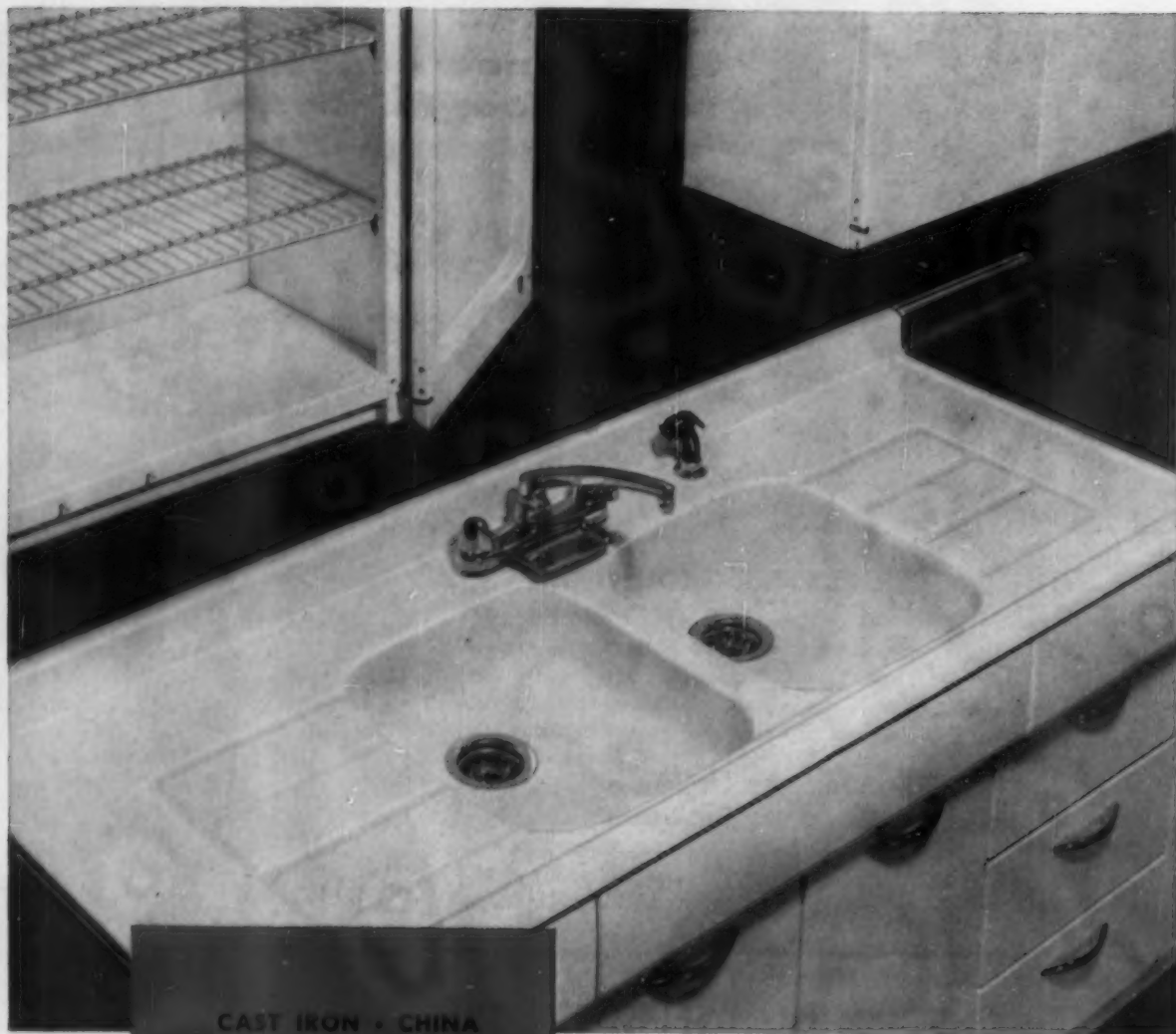

CAST IRON • CHINA  
FORMED STEEL • BRASS

# ELJER

Division of The MURRAY Corporation of America

Three Gateway Center, Pittsburgh 22, Pa.

*The only name  
you need to know in  
plumbing fixtures!*

## For sales appeal: a kitchen line built by quality plumbing craftsmen

Eljer formed-steel cabinet sinks and wall and base cabinets offer the quality builder extra profit advantages—including the prestige appeal of a plumbing manufacturer of known quality. And here are other benefits for you:

A complete, but uncluttered line for easiest planning . . . sinks with integral base, and top premounted, to save installation time and costs . . . and one-source benefits for all kitchen and plumbing units. See your plumbing contractor or write *Eljer, P.O. Box 836, Pittsburgh 30, Pennsylvania.*

## National Home Week stresses added livability

The seventh annual National Home Week, in progress as this issue went to press, promised to be another successful milestone among building industry drives to sell home ownership to the American people, according to early reports from several key centers.

Over 200 metropolitan areas were participating in intensely planned programs stressing higher standards of livability by combining improved design with increased space. Elaborate newspaper, television and radio promotion fanned the latent desires of average families for "a better home of their own."

Their response, now and later this fall, was expected to end any doubts which might still exist that the new-home industry was over-producing.

### Early attendance up 25%

Officials of the Long Island Home Builders Institute described the observance as "the biggest ever" and Emil M. Keen, president, estimated that 50,000 persons toured 300 models during the opening weekend. Attendance was adjudged 25 per cent over that of last year. "The event is merely the beginning of what we believe will be an extremely active fall season," said Otto J. Hartwig, executive vice



### BUILDERS' CHOICE

Hollywood actress Kim Novak: "Miss National Home Week, 1955".

president of the Institute.

Opening day brought over 2,000 home shoppers to visit a "Home-a-Rama" display of 15 scale models of current work by Westchester County, N. Y., builders. Mannie Shapiro introduced four Rye, N. Y., models in the \$30,900 to \$41,900 range; reported 30 deposits the first weekend.

Houston Home Builders Assn. patterned its show after the auto industry's annual introduction of new mo-

del with a "Homes of '56" display of over 60 houses which S. N. Adams, president, said "put house shopping on a supermarket basis." One van company there offered free moving to the first five buyers. Chicago builder Harry J. Quinn offered the same service to all buyers of his Pacesetter Homes during the "Week," regardless of distance.

### Smith leads St. Paul parade

Earl W. Smith, president, National Assn. of Home Builders, addressed a National Home Week banquet at St. Paul, Minn., after leading a downtown parade with Governor Orville Freeman and Mayor Joseph Dillon.

"This year's homes are definitely an improvement over last year's models," said Charles Marlow, president of the Birmingham (Ala.) Assn. of Home Builders. "Fine homes built today offer more encouragement than ever before for proud home ownership."

Irving C. Jordan, NAHB regional vice president of California summed up: "National Home Week not only marks the end of 10 years of great achievement but signals the readiness of the local home building industry to meet all future housing demands."

### 'I DO HEREBY PROCLAIM . . . NATIONAL HOME WEEK'



Florida Governor LeRoy Collins signing now-famous proclamation issued annually by many state and city executives. State home builder officials looking on are (from left) Bruce McCullough, vice president, Tallahassee; Ray N. Erskine, executive director, Orlando, and Perry E. Willits, president, Miami. A record Week is expected.



Walton Onslow, who has the year-long responsibility for "proclaiming" National Home Week as director of the program for the National Association of Home Builders, in his new quarters at the National Housing Center. Much of the program for NAHB's 12th annual convention and exposition will be arranged here.

## 10 Russian builders arriving for Housing Center debut; 4-week tour

On the heels of National Home Week and a day before formal opening of the National Association of Home Builders' headquarters in Washington, D. C., arrival of a ten-man team of Russian housing officials coincided with a time when the home building industry was to have its best foot forward. The delegation will spend four weeks touring the United States, after attending the National Housing Center's opening ceremonies on October 3.

The invitation was extended by NAHB president Earl W. Smith, through Soviet Ambassador Georgi N. Zaroubin after it had been approved

by the U. S. State Department. At the time, Smith said: "It is the earnest hope of the home builders of the United States that the Russians will accept this invitation in the spirit in which it is extended. We have received many similar delegations from Western countries in the past and have profited from a mutual exchange of information with them. I am confident that a visit by Russian building officials could be equally profitable to both the American and Soviet peoples."

The visitors are slated to inspect operations in New York and Long Island suburbs, Boston, New Orleans,

Austin and Tyler, Texas; Los Angeles, San Francisco, Tucson, Seattle, Chicago, Fort Wayne and Washington, D. C.

Local NAHB chapters were quick to echo the invitation. David H. Augustus, Indianapolis (Marion County) president, wired Ambassador Zaroubin: "Home builders of Indianapolis extend a cordial invitation for your delegation to include the Crossroads of America in your proposed tour . . ." Pat Harness, Houston executive officer, said builders there should welcome an opportunity to discuss housing "know-how" with the Russians. Sharon R. Shepard, Austin president, said he will invite Houston, Corpus Christi, Texas City and San Antonio builders to meet the Russians during their proposed visit to his city.

### DICKERMAN'S COLUMN

By John M. Dickerman, Executive Director, National Assn. of Home Builders

## Builders have chance to promote international good will

American home builders have long been proud of the remarkable accomplishments achieved by their industry since World War II. They built 10 million new homes in those booming post-war years, and built them better and more economically, in terms of real dollar values than anyone had ever built homes anywhere on earth.



Dickerman

For years they have been telling the story of their growth and progress to the American people through industry and individual public relations. Now they're telling the world about the housing revolution that has taken place and is still going on here in America.

That "let's tell the world" spirit has been emphasized in recent months by an influx of foreign architects, builders and city planners who have been coming to the United States to find out what's going on in American home building.

#### Host to Belgians, Germans

The National Housing Center in Washington, D. C. played host to teams of Belgian and West German builders even before the doors of NAHB's new housing showcase were opened to the public. Both groups were keenly interested in our industry's latest design and construction techniques as well as in the financing patterns that have made possible the astounding spread of home ownership in this country during the past decade.



Group of German builders gather in conference room of National Housing Center, Washington, D. C., after pre-opening tour of the building, to hear Joseph B. McGrath, NAHB legislative director, explain growth of the home building industry in the United States. The visitors have been studying housing methods in various sections of the country under the auspices of the International Cooperation Administration.

Of equal importance was their eagerness to pass along their own know-how and to persuade American builders to pay a return visit to Europe for a look at continental building methods.

Perhaps the most dramatic illustration of the new international look in housing, however, is the U. S. housing tour offered by NAHB to a group of Russian building officials. The significance of that offer goes far beyond an exchange of housing information, important as that is. It is a demonstration by the home building industry of its willingness to accept national responsibility and to help the U. S. Government in its efforts to promote world peace and stability. The free exchange of knowledge between peoples is an

essential to mutual understanding and friendship, and surely there can be no more effective way to telling the American story than by showing how Americans live and the homes they live in.

#### Can explain 'know-how'

We in the home building industry have a responsibility to broaden and extend this type of international exchange, through the facilities of the National Housing Center and through the efforts of individual American builders. In doing so, we shall also be taking advantage of an opportunity to show the world the real basis of America's strength—the "know-how" and ingenuity that have made this the best housed nation on earth.



## 8-month starts 130,000 ahead of 1954 pace

After a dip in July, the upward trend of housing starts was resumed in August, with the Bureau of Labor Statistics reporting 123,000 new units under way, compared to 114,300 in August a year ago. In each month, public housing accounted for but 1,300 homes.

During the first eight months, 927,800 starts were reported, or 128,100 more than the total for the first two-thirds of 1954. Though many early-season predictions have been revised downward to about 1,300,000 starts for the year, the figures for the remaining four months need only match those of last year to bring about a total of approximately 1,350,000.

BLS revised its estimate for May starts from 132,000 to 137,600. Dollar volume of new private residential construction amounted to \$1,492 million in August, a 14 per cent gain over the same month in 1954. Eight-month total was 27 per cent higher this year.

For the 12th straight month, the Veterans Administration received GI home loan guaranty applications topping the 50,000 mark, with a total of 54,310 reported in July. During the same month, VA received 85,339 appraisal requests of which 51,412 were for new houses and the balance, existing houses.

## VA eases loan curbs

Meanwhile, potential starts were raised when VA ruled it would exempt from credit requirements any home that FHA considers exempt from its July 30 regulations, provided that an appraisal request for such home was submitted by September 30. Thus, a large number of homes, reportedly ranging anywhere from 100,000 to 300,000 are eligible for the 30-year, no-down payment loans, provided the financing can be obtained.

Proposed extension of the GI housing program, due to expire July 25, 1957 for veterans of World War II, has aroused the opposition of Congressman Olin E. Teague of Texas, chairman of the House Veteran Affairs Committee. A much-decorated combat leader in that war himself, Teague has said that any veteran who did not use his housing rights within the ten years, ought to be able to join in the non-emergency housing program open to other citizens.

Teague has also charged that what was originally a veterans' emergency



## CHOICE OF 'EXECS'

Earl W. DeLaitre, executive director, HBA of Greater Cincinnati, who has been elected 1956 president of NAHB's Executive Officers Council. He will succeed John I. Hennessy of Oakland, Calif.

program has been converted to a program for mortgage bankers. "If it's a veterans program," he queried, "why did the administration recently heed the wishes of the bankers and raise the interest rates on GI housing loans from 4 per cent to 4½ per cent?"

VA's recent announcement about the average veteran who bought a home last year affords some interesting comparisons with a similar FHA study revealed three months previous.

The average VA buyer had an income of \$5,780, or \$641 more than the average FHA buyer. His home (60 per cent of the sampling referred to new houses, the balance to used dwellings) cost \$11,640 compared with the FHA average of \$10,679 for a new house or \$11,549 for an old one.

His down payment averaged \$1,100, while the FHA new home buyer's was \$1,816; used, \$2,519.

Two of every five VA new home loans were made without down payment and more than a third had maturities from 26 to 30 years.

## Two baths, please

Survey of plumbing supply houses in five states indicates that 22 per cent of new homes have more than one bathroom, while 12 per cent have two full-size bathrooms. Commercial Discount Corp., Chicago, made the study among plumbing suppliers in Illinois, Ohio, New York, Maryland and Massachusetts.

## Follow example of auto makers, Cortright urges

Builders who want to insure a continuing high rate of sales should take a leaf from the book of the automobile manufacturers and upgrade their product, declared Frank W. Cortright, former executive vice president of the National Association of Home Builders, at the first fall meeting of the Long Island Home Builders Institute in Garden City, N. Y.

"People are buying cars now," said the California builder and consultant to Youngstown Kitchens, "not because they need them, but because they get new colors, gadgets and power.

"If we're going to hit 1.3, 1.4 or 1.5 million new houses next year, we're going to have to upgrade, because people have adequate shelter now. We're going to get sales by giving them something better; put charm, appeal, etc., into our houses; pick a location people want and get the best possible design for this particular market."

Cortright pointed out that 30 million persons are moving every year, nearly one-fifth of the nation's population. To induce many of them to acquire new houses, he said "we must stand off and look at what we're doing, how we're doing it and decide how we can do it better."

Following the talk, Emil M. Keen, president, presented Cortright with a framed certificate designating him as a life member of the Long Island institute.

David C. Slipper, field service director of ACTION (American Council to Improve Our Neighborhoods), pointed out that "we're very close to losing one million homes a year to slums, so that we're not progressing as rapidly as new housing figures would lead us to believe."

Slipper, a builder associated with the Fritz B. Burns organization of Los Angeles, reported that the Advertising Council is now sending out kits to consumer and trade media to spread the story of ACTION and its drive for slum improvement.

To offset in part the high number of dwellings lost to slums each year, a new report from the Bureau of Labor Statistics reveals that as many as 300,000 older homes have been completely removed from the nation's housing supply in each of several recent years. This total is several times higher than those reported in previous BLS studies of housing demolitions.

## Offer special disaster loans to help rebuild flooded areas

Replacement housing in flood-stricken areas of New England and other Eastern states is being built with benefit of relief from the higher-down-payment and shorter-mortgage-term requirements recently imposed by the Federal Housing Administration.

FHA-insured mortgages on replacement housing may run 30 years and they may be of the maximum amounts authorized by law, which means 95 per cent of the first \$9,000 of value. Special disaster terms on low-cost housing, also made available by FHA, permit loans up to 100 per cent of value (no down payment) for housing valued up to \$7,000 per unit. Under Title I, FHA is insuring loans up to \$2,500 over a three-year term for repair and restoration of damaged homes.

Other constituents of the Housing and Home Finance Agency took corollary actions.

- Federal National Mortgage Assn. is making advance commitments to purchase from private lenders FHA and VA mortgages made to disaster victims.

- Voluntary Home Mortgage Credit Program is helping to find mortgage money for qualified applicants unable to get financing locally.

- Community Facilities Administration is able to make loans to public agencies for restoration of essential public works.

- FHA authorized all lenders to work out arrangements to suspend payments temporarily on home mortgages and Title I loans with FHA borrowers whose homes were destroyed or damaged.

### Flood insurance studied

Meanwhile, Administrator Albert M. Cole of HHFA has set up a flood disaster advisory committee, composed of representatives of the insurance industry, to study feasibility of flood insurance for home owners. A team of FHA technical experts is also working on the problem.

"What we want," said Cole, "is a system of flood insurance that the insurance companies will be able to offer persons living in potential flood areas at rates that are within the means of the people living in those areas. This should be a private industry program with the backing of the government."

Cole also directed the Public Housing Administration and Local Housing Authority to recondition immediately 200 housing units built during World

War II under the Lanham Act. They are to be made available to homeless flood victims in Waterbury, Conn., who will be certified by the Red Cross.

In other flood relief activity, Defense Mobilizer Arthur Flemming said home owners and businessmen in the affected areas can apply for Federal aid to temporary Small Business Administration offices which would handle applications from the \$900 million fund available under the Defense Production Act. SBA can make 20-year home loans and 10-year business loans under its disaster lending authority.

### Private groups act

In the wake of the report that some "15,000 homes had been destroyed or damaged by floods," John M. Dickerman, executive director of the National Association of Home Builders, reported that a two-man emergency team of housing experts had been sent to the New England area to help coordinate the relief and rehabilitation efforts of home builders.

Dickerman said NAHB's assistant director of construction, Gordon G. Hazell and Joseph F. Degnan of the field service department were sent to Providence to assist the Rhode Island Home Builders Assn. in immediate relief work and in planning for rebuilding and repair of housing.

He also noted that one of the home building industry's major concerns is to protect flood victims from the operations of "suede shoe boys" and other contracting racketeers who may attempt to sell "phony" rebuilding contracts. He was joined in this warning by Hugh R. Jackson, president of the New York City Better Business Bureau.

## Test for teachers

The National Association of Home Builders currently is conducting a contest in which an elementary school teacher can win \$500, \$250 or \$100 for reporting on "How I Teach Housing in My Grade."

Launched September 1, the contest will run until May 1. Under the direction of Ernest B. Norman Jr., chairman of NAHB's educational committee, its purpose is "to encourage teachers who already have the subject of man's shelter as part of their required curriculum to discover the many excellent ways there are to enrich their instruction in this particular subject area."

## FHA reserves up

Reserve funds backing up the Federal Housing Administration's loan insurance programs were increased about \$64 million during the fiscal year ended June 30. According to Commissioner Norman P. Mason, the total has now reached \$417.9 million. Of \$71 million net earnings during the year, he said \$7.2 million was distributed as participating payments from FHA's mutual insurance fund to eligible mortgagors.

FHA has turned over seven technical problems for study to the Building Research Advisory Board. By next June 30, it expects to have reports on protection against decay and termites in wood frame construction; performance standards for domestic hot water heaters; anchorage of exterior walls to various types of foundations; effect of automatic washers on individual disposal systems; data for establishment of standards for installation of wood block flooring, use of vapor materials under concrete slab floors as ground cover in crawl spaces, standards for manufacture and installation of concrete face brick.

Frank J. Meistrell, FHA general counsel for the past 13 months, has stepped up to the post of deputy administrator of the Housing and Home Finance Agency. Administrator Albert M. Cole said the appointment was in recognition of Meistrell's "excellent record in the FHA post," particularly on Section 608 "windfall" cases and in reorganizing FHA's legal division.



Meistrell

Cole also named Sidney W. Jagger as a special assistant to succeed Ralph A. Homan, who resigned. Jagger was formerly located in Fort Worth, Texas, as a field representative for the Urban Renewal Administration.

## Owners want space

Fifteen per cent of home-owning families and twice as large a proportion of renters are dissatisfied with their current housing arrangements, according to the Federal Reserve System's study of consumer finances.

Many reasons were given, but "insufficient space was apparently the most common source of dissatisfaction," the survey stated. Also noted was the fact that "availability of mortgage financing on favorable terms during most of the post-war period has encouraged owner-occupancy."

## Network telecast to open Cleveland NRLDA show

Second annual building products exposition of the National Retail Lumber Dealers Association, will open in the Cleveland Public Auditorium at 1 P. M. Tuesday, October 11, following a nationwide telecast on the NBC "Home" program describing the show and the city's neighborhood improvement program.

Highlighting the program are several actual demonstrations of ma-



Nowels



Nuttle

materials handling procedures and of store and office equipment, to be held during clinic discussions on each of the four days. Clinic leaders are: Thomas Dougherty, Cleveland, cost-cutting methods of handling materials; Russell W. Nowels, Rochester, Mich., modern store layout and dis-

play; Elias W. Nuttle, Denton, Md., mortgage money and consumer credit; Paul V. DeVille, Canton, Ohio, construction component techniques; Warren E. Carter, Akron, Ohio, correlating advertising to sales, and W. B. Kennedy Jr., Oklahoma City, developing the farm market.

## Start housing probe

Another Congressional housing investigation by the House Banking and Currency Committee's housing subcommittee, headed by Representative Albert Rains of Alabama, will begin hearings in New York October 5 and in Philadelphia October 12.

Rains said the subcommittee wanted to learn why slum clearance and urban renewal programs "haven't got off the ground." It is also interested in FHA's multi-family housing program, availability of mortgage credit, effects of the more restrictive down-payment and loan-term requirements, and operations of the Federal National Mortgage Assn. and Voluntary Home Mortgage Credit Program.

## 'Prefab' school unit

An eight-room school building was finished last month at the Edgelea School, Lafayette, Ind., 21 days after completion of foundation, floor slab and utilities, at a basic cost of \$18,444 per class room.

A permanent, functional structure, it comprised four basic units of two classrooms and project areas each, manufactured by National Homes Corporation, which held that it served as a practical solution to the urgent need for schools which can be built quickly and economically.

James R. Price, National Homes president, declared that the basic units were designed by Walter Scholer & Associates "working closely with Indiana school authorities . . . to satisfy fully every basic school need." He said that the Edgelea school will eventually have nine of the units and more, perhaps, if the need arises.

Each unit has 2,700 square feet of space, a utility core with twin washrooms, counter-flow warm air furnaces, storage space and classroom wash counters with sinks and drinking fountains. Price said the units would be made available through his regular builder-dealers and special-franchise contractors.

## DEALER'S VIEWPOINT

By H. R. Northup, Executive Vice Pres., National Retail Lumber Dealers Assn.

## Panel display boards gain nationwide acceptance

Even the best of new ideas often take hold rather slowly. That is true even in a highly competitive business like the construction industry where manufacturers, wholesalers, builders and retail lumber dealers eagerly watch for new ways to gain an advantage.

A case in point is the NRLDA panel display which made a big hit in October, 1954, when first introduced to dealers and producers at a merchandising clinic held during our first building products exposition.

Only now is the idea being put into effect on a national scale by manufacturers and dealers, although the principles have been open to anyone wishing to adopt them ever since they first were introduced.

The panel displays catch on because of these distinct advantages:

- They are simple and inexpensive to put up.

- They are designed to make sales as well as attract attention and create interest.
- They can be used to sell large ticket end-use packages as well as individual products.
- They can be used by any dealer no matter how large or how cramped his display space may be.

### Small display area used

That latter point is especially important. Many dealers who have relatively little display space in their sales room find it difficult to get any large number of products out on display. The display panels, which usually measure 30 by 80 inches, take up a minimum of space and can be placed along a wall or in any convenient spot in the room.

By using a swinging or sliding rack, a dealer can provide space for a dozen or more panels, and any one of them can be readily shown to a customer or moved out to good display space whenever desired.

Dealers with ample space also use the panel displays freely because they can be employed to give special emphasis to end-use packages when their seasonal appeal is at its peak.

### Easy assembly possible

The elements making up a panel display are simple: an attention-getting headline describing the central idea; a list of selling points; an end-use photo which can be cut out of a current magazine; samples of the principal products involved; literature describing the products; a list of related items needed; and price information in terms of the cost per month of carrying out the end-use theme.

All these parts are mounted on a piece of perforated hardboard giving the dealer a selling display that can be used over and over whenever it has a seasonal appeal and whenever a customer wants information about the package or products it describes.



Northup

## International home building exposition planned for May by New York builders

Plans for a 1956 International Home Building Exposition, said to be the largest show of its type ever undertaken, have been announced by a group of New York builders, including several officers of the New York State Home Builders Association. Open to the public, it is scheduled for May 12-20 as the first exhibit to utilize all 301,000 square feet of floor area in the New York City Coliseum, now under construction.

The sponsor is Home Building Industry Presentations, Inc., headed by Charles M. Jaeger of Rockville Centre, Long Island, who is president of the state association. More than 500 exhibitors are anticipated, displaying their newest products and services in an atmosphere described as a "showcase for better living." Special features are to include at least three houses, a "Hometown, U.S.A." section of 100 scale models representing current housing in the metropolitan area, a department for home furnishings and decoration, and a theater for presentation of industry films.

Robert A. Durk, former executive vice president of the state builders' group, has been named exposition director, while Hayward A. Cleveland resigned as field secretary of the Long Island Home Builders Institute to become public relations director. John Owen, formerly with National Home Shows, Dallas, Texas, is director exhibit sales.

Chairman of the exposition's board



### TOKEN OF APPRECIATION

A. J. Alexander (left), for more than 10 years serving without remuneration as secretary-treasurer of the HBA of Greater Akron, Ohio, received this new car as gift from members. Victor Gross made the presentation. E. E. Kauffman, president, is at right.



### HOUSING EXPOSITION SITE

Model of New York Coliseum, site of 1956 International Home Building Exposition, shown by Royal W. Ryan (center) of Convention and Visitors Bureau to Charles M. Jaeger, president, and Robert A. Durk, director of the big show.

is Walter G. Stackler of Roslyn, former president of the Long Island Home Builders Institute. Other officials, all builders, include Qscar R. Giesecke, Tonawanda; Henry J. Pileggi, Nyaek; Attilio Giarrusso, Syracuse; Martin I. Moss, Great Neck; Bernard Krinsky, Jamaica, Norbert H. Schickel, Ithaca, and Victor Heaps, Buffalo.

### Starts high, but builders move

If the rate of building permits issued during the first eight months continues unchanged (about 3 per cent above 1954), Long Island's total permits for the year will be about 50,820, predicts Emil M. Keen, president of the L. I. Home Building Institute. In the face of all this activity, the scarcity and high cost of available land for developments has influenced several Island builders to other areas . . .

Among them are Thomas Romano, who last September 18 opened a 2,000-home community near Washington, D.C.; Angelo Aragona, at work on a 175-unit tract in Albany; Alexander J. Fuller, building 92 units in Baldwinville, N. Y. and Crown Builders, starting 86 houses in the New Rochelle, N. Y., area . . .

Louis W. Licht, whose Lane Realty organization is sales agent for numerous Long Island building firms, reports he has organized a syndicate of these builders and several architects to buy 35 parcels of land near

Lakehurst, N. J., and eight more tracts near Toms River, N. J., totaling 15,206 acres. The builders were not identified, but Licht said that long-range plans were under way to develop the property with housing for 200,000 persons, after setting aside large sections for industry, shopping centers, schools and parks . . .

### Suites top Montreal housing

Greater Montreal area in Canada reported 11,739 new housing units completed in the first seven months, 24 per cent ahead of 1954 and heading for an almost certain record. Surprisingly, the bulk of the new units represents apartments. There were 5,516 suites, 4,427 private dwellings and 1,784 duplex units . . . One of Canada's largest new projects, the 500-home Bendale Park in Scarborough Township, Ontario, opened recently with four split-level, open plan designs as models. They were named for California—Pasadena, Santa Anita, Santa Barbara and Catalina—where that type of architecture has not yet become too popular. Price-Bilt Homes Ltd. (Harold Price) plans to erect 200 of the houses, while remaining units will be distributed among several other builders . . . H. S. Muroff has succeeded Charles Tabachnick as president of the Windsor, Ontario, HBA.

Members of HBA of Northern New Jersey, concentrated in Bergen County, have built more than 90,000 new homes valued at over \$1,260,000,000 since group was founded 11 years ago, reports Fred R. Brunetti, president, in a National Home Week statement . . . Max Odlen, vice president of the Home Builders League of South Jersey, at Camden, notes that the local planning commission estimates Camden County will increase its 1950 population by 26 per cent to 380,200 in the next decade . . .

NAHB president Earl W. Smith will address the forthcoming New England Council of HBA convention, to be held October 27-29 in the Sheraton-Biltmore at Providence . . . Smith will also do the honors at Ohio HBA's 12th annual convention and exposition November 13-15 at Dayton - Biltmore, Dayton. Past NAHB presidents Thomas P. Coogan and Rodney M. Lockwood are listed for talks . . . residential building contracts in Iowa were up 66 per cent the first half of 1955, according to a report from State U.

## Several St. Louis projects delayed by sewer problem

Several home projects in unincorporated areas of St. Louis are faced with extensive delays, following an order issued September 8 by County Supervisor Luman F. Matthews which required the withholding of construction and occupancy permits from builders operating in any section where the sewer problem is considered dangerous to public welfare. Shortly after the report, M. Eugene Baughman, county planning director, withheld approval of plans for a 97-home project and was considering halting seven other subdivisions. Metropolitan Sewer District was urged by Matthews to review plans previously submitted for a new trunk line before expending more funds for surveys . . .

Three years to the day after they started the 629-acre Ruskin Heights community at Hickman Mills, near Kansas City, Praver & Sons delivered the 1,850th and last home in the project and immediately announced acquisition of an adjoining 220 acres. New site, called Ruskin Hills, will be improved with 840 three and four-bedroom houses in \$10,700 to \$15,500. Pravers have built about 10,500 houses in past ten years, mostly in Kansas City and New York regions . . .

### Operation 'Green Thumb'

Chicago Metropolitan HBA is planning to finance "Green Thumb" clubs in the schools to encourage planting of trees, shrubs and flowers on school sites. According to Roy Davis, a director, builders and educators are joining forces in the hope that "Operation Green Thumb" will curb vandalism and spur beautification of blighted areas . . . HBA of Illinois will hold its second annual convention October 7-8 in the Leland and Abraham Lincoln Hotels, Springfield . . .

Although the Builders' Assn. of Metropolitan Detroit will not hold its annual home show until next April, the featured 1956 Ideal Home is already well under way by Edward Rose & Sons. It will have glass-covered porches between house and garage, two patios including a play court adjoining sliding glass doors of the family room. The Rose



### ST. PAUL STAFF GROWS

John E. Bohman, executive director of St. Paul HBA, welcomes Angelo Bartoletti "into the fold" as assistant director specializing in FHA-VA matters. Bartoletti had served eight years with VA office at St. Paul.

organization's new sound-color film, "Homes for America," has been selected for showing on seven Armed Forces television stations . . . Sam Hechtman, Nathan I. Golden and Jack Sylvan (Practical Home Builders, Inc.), who built over 600 houses in the first eight months of the year, opened a 175-unit project at Ecorse during National Home Week, plan to start over 200 more houses next month in Inkster, raising their year's output above the 1,000 mark . . .

### Cleveland seeks 'Ohio Home'

Second annual "Ohio Home" contest sponsored by HBA of Greater Cleveland and the Cleveland Home & Flower Show will close November 12, with large cash prizes to be awarded for winning designs of a basementless one-story house suited for a 70x120 lot and practical for a man and wife with son and daughter. Size is limited to 1,150 sq. ft., exclusive of breezeway and garage or carport. Melvin Freeland and Leonard Merrick of the HBA will serve as judges, along with Morgan Yost, Chicago architect, and several local architects. The winning design will be built by the HBA under sponsorship of the Chamber of Commerce as one of the featured homes in the 1956 home and flower show . . .

Other upcoming home shows include Saskatoon, Saskatchewan, Canada, November 8-12; Canton, Ohio, February 28-March 4 and Decatur, Illinois, March 7-11 . . . Indiana Limestone Institute will hold a stone industry convention October 9-11 at French Lick, Indiana . . . An NAHB-sponsored

advanced course for home builders will be held November 7-16 at the Small Homes Council, University of Illinois, Champaign-Urbana, Illinois . . . Milwaukee's 10th annual Parade of Homes, scheduled for National Home Week, has been postponed to October 15-23, according to Joseph J. Mollica, general chairman, because of delays attributed to the magnitude of the project—75 homes side by side . . .

### Personals in brief

Harry S. Lawrence of Hubeny Brothers Inc., Capitol Kitchens, Roselle, N. J., has been elected president of the Steel Kitchen Cabinet Manufacturers Assn., and R. A. MacNeille, president of St. Charles



Lawrence



Vescovo

Manufacturing Co., St. Charles, Ill., vice president . . . Gene L. Vescovo will succeed Richard C. Higginbotham as president of the HBA of Greater St. Louis at an installation banquet October 15 . . . Rapidly expanding Wichita Assn. of Home Builders has engaged an assistant executive officer, Milton Armstrong, to work with R. G. Lagenvalter . . . One of first tasks of Robert J. Golden, new field secretary of the Long Island Home



Armstrong



Golden

Builder's Institute, will edit the first edition of the organization's monthly magazine . . . Wisconsin's Senator Alexander Wiley will be the principal speaker October 31 at a building trades' apprenticeship competition and testimonial banquet at Madison, Wis., sponsored by the Madison Builders Assn. and several other trade groups and unions . . .

# ONLY NUTONE GIVES YOU A 10 Year Guarantee on Ventilating Fan Grilles

NUTONE ALUMINUM  
GRILLES CAN'T RUST  
*...they're Anodized*

TROUBLE-FREE PERFORMANCE  
GUARANTEED BY  
*\$500,000.00*  
Bond

Why take chances  
with Ventilating Fans  
still using old-fashioned  
chrome grilles that rust?

Now you can have NuTone's  
ANODIZED ALUMINUM Grille  
... GUARANTEED ABSOLUTELY  
RUST-PROOF.

NuTone's mirror-bright grille is  
easier to clean ... will not stain  
or streak ... and it is guaranteed  
for 10 years!

You can sell the idea  
of QUALITY in your  
homes — by displaying  
this 10-year Guarantee tag.

**NUTONE**  
Ventilating Fan Grilles  
Guaranteed  
10 YEARS!



NuTone backs up its  
Ventilating Fans and  
other products with a  
\$500,000.00 SERVICE  
POLICY — to protect  
you against service  
call-backs, due to any  
defective part.

This is not just an  
ordinary parts warranty  
— but a genuine bond  
that pays for LABOR  
TIME — in the event  
of a service call-back.

Write for FREE Catalogs and Installation Data on  
NuTone Ventilating Fans, Range Hoods, Door  
Chimes, Electric Ceiling Heaters.  
NuTone, Inc. Dept. AB-10 Cincinnati 27, Ohio

# NUTONE

## Prevents Service Troubles!



10 BASIC CEILING AND WALL MODELS, \$24.25 to \$39.70 List

# We Sawed This **TUFFIE** BLADE in Half! See For Yourself Why **EVEREADY'S NEW**

By the Makers of  
**EVEREADY BRIKSAW**  
and **EVEREADY**  
**CONCRETE**  
**SAWS**

**BREAKAGE-RESISTANT**  
**TUFFIE IS**  
**TUFFER!**  
**FASTER - and**  
**SAFER** than ever!



**3**  
**PLY**  
REINFORCED

- ① **FRICTION-FREE SIDES ADD MORE THAN 2,000 CUTTING EDGES TO EACH BLADE**
- ② **REINFORCED WITH TUFF FIBER GLASS (Breakage-Resistant)**
- ③ **AND ④ EXTRA REINFORCING AROUND THE HUB ON BOTH SIDES—YOU'RE PROTECTED 3 WAYS WHEN CUTTING WITH NEW TUFFIES**

## CUT HARD OR SOFT MATERIALS

There's a new TUFFIE Abrasive Blade to cut ANY Masonry Material—HARD to SOFT—with 3-Ply Protection built right in! Bend it! Drop it! Twist it! New Breakage-Resistant TUFFIES are SAFER THAN EVER!

Specifications  
to Cut ANY  
Masonry  
Material

New side-wall design, with more than 2,000 Xtra Cutting Edges, cuts FASTER and CLEANER—eliminates drag—puts all the power in the cut. ALL EVEREADY Blades—Xtra-Cut Abrasive, Ready-Cut Diamond and Reinforced TUFFIE—are made to fit every make or model Masonry Saw.



**WRITE FOR FREE BOOK** →

**NOW—CUT ALL  
MASONRY  
MATERIALS  
WITH NEW 3-PLY  
BREAKAGE-RESISTANT  
TUFFIE**

**OPPORTUNITIES**—For new EVEREADY Distributors in a few selected areas. Write Dept. CP., 1509 S. Michigan Blvd., Chicago 5, Illinois.

Your Local **EVEREADY Dealer**  
Has The New 3-PLY  
**TUFFIE**  
Ask for Them Today!

**EVEREADY BRIKSAW CO.**  
1509 South Michigan Blvd.  
**CHICAGO 5, ILLINOIS**

No. B-311



## They liked this salt box in Ohio

**L**ong a popular design on the eastern seaboard, the colonial salt box pictured here seems to be moving further inland, where its prestige is on the increase. Right now, it is going up in large numbers just outside of Columbus, Ohio, in a mushrooming suburb known as Lincoln Village.

It has appeal for those who deplore the passing of the dining room. It also appeals to those who like a separate family room complete with fireplace and picture window, and with utility room and entry closet. The house has an uncrowded kitchen and plenty of room on the second floor for storage. And it has a clothes chute, a step-saving feature if there ever was one. All in all, it offers the buyer more for his money than many of today's split levels.

Among its construction features are these: slab floor; gas-fired, forced air perimeter heating, with

furnace located in the storage room just off the family room; all heating ducts vented under windows; standard 2x4 stud walls and 2x8 floor and ceiling joists; 2-inch ceiling and roof insulation; pre-fab chimney. Garage is optional, and can be attached later if the buyer so desires.

Other features making this a very saleable salt box are: automatic washer, dryer and garbage disposal units; combination storm and screen doors; colored bathroom fixtures and ceramic-tiled bath and shower.

**WITH MORE STORAGE** area on its ground floor than many one-story houses have, salt box offers even greater storage space above. Bearing walls have extra footing support, while slab itself rests on 8-inch foundation. ▶



# the MONTH for October

## SALT BOX PLAN: TWO-FLOOR STORAGE

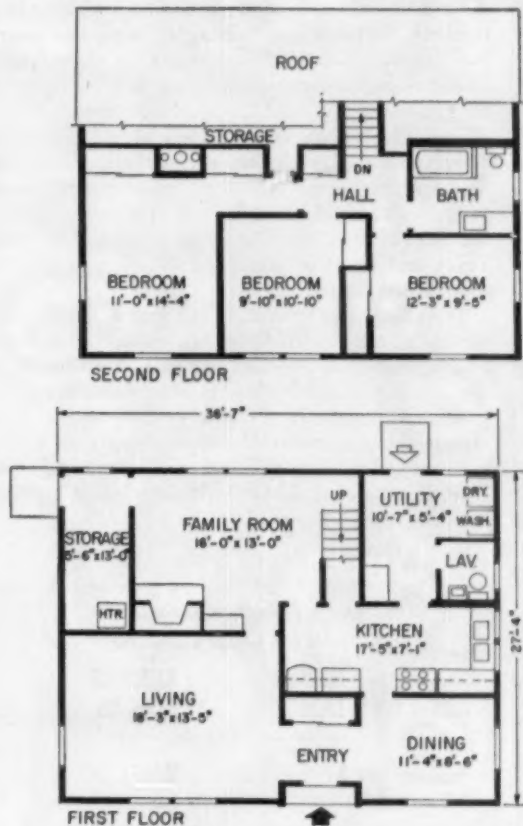

**SIMPLE RECTANGULAR** layout, unbroken except for inset at entry, is very economical to build. Total floor space is 1,627 square feet. House has bath on top floor, half a bath below. Circulation between rooms is generally good, though stairway to second floor could be more accessible.

## SALT BOX SECTION: TWO-STORY ON SLAB

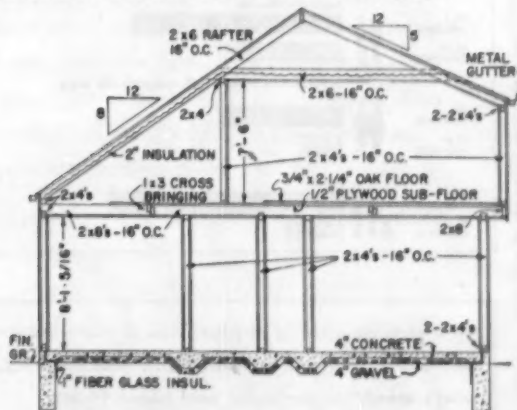

## SALT BOX CENTER: LINCOLN VILLAGE

1. One of the largest planned communities in the midwest, Lincoln Village is the brainchild of Murray Lincoln, head of the Peoples Development Co., Columbus, Ohio.
2. Originally a 1,170-acre tract of farm land two miles from Columbus, the Village was officially opened in April, 1953, is scheduled for completion in the latter part of 1960.
3. It is located in an area where incomes average over \$5,000. Two giant industrial plants built by Westinghouse and General Electric are close by—are in fact within walking distance.
4. It offers buyers a choice of several different house styles ranging in price from \$12,250 to \$34,000.
5. Its most popular house is the salt box, though contemporary designs, both brick veneer, clapboard and shingle are selling well.
6. It attributes popularity of the salt box largely to the moderate price, first floor family room and big storage room on second floor.
7. Its houses average about 1,000 square feet of floor space. Most are one-story with basements on 65' x 125' lots.
8. It includes practically all the necessities of community living—schools, parks, apartments, and a super deluxe mall-type shopping center.
9. Its curvilinear streets vary in width from 26 feet to 62-foot boulevard (U.S. highway 40) along shopping center.
10. Its king-size blocks reduce number of intersections to a minimum. Menace of most communities, the "blind" intersection, is eliminated.



**COMMUNITY** plan of Lincoln Village shows the transition from farm land to suburb. Note the curving streets.



## FLEX-CORNER

Reversible Metal Tape FOR BETTER DRYWALL FINISH

Covers inside or outside corners, any angle. Speedy application (no nailing); economical. Creates plastered look for baywindows, attic angles, arches, recessed windows and cathedral ceilings. Minimum waste—dispenser cartons of 100-foot rolls. Sample on request; dealers and distributors wanted. Made by manufacturers of Spackle-Bond all-metal bead, available in any length.

STEEL CORNER TAPE CORP.

106-09 Rockaway Blvd.

Ozone Park, N.Y.

COAST TO COAST DISTRIBUTION  
For prompt service contact the following:

**WEST COAST**

Kaifer Building Specialties  
5420 Fair Ave.  
North Hollywood, Calif.

**MIDDLE ATLANTIC STATES**

Woolson and Smith  
Daytown, Penna.

**CANADA**

Dewas of Canada  
191 James Ave., East  
Winnipeg, Manitoba

**SOUTHERN AND NEW ENGLAND**

**STATES**

Steel Corner Tape  
Branch Office  
35 Briarcliffe Rd.  
Glendora, Penna.

**MIDWEST**

Steel Corner Tape Corp.  
106-09 Rockaway Blvd.  
Ozone Park, N. Y.

## Less work ... more play

Families living in air conditioned houses get more and better sleep, spend more of their waking hours together, do more entertaining at home and require less time to maintain their homes than other families who occupy non-air conditioned residences in the same area.

These facts (see chart below) were revealed by The National Association of Home Builders from data taken by a research team which secretly tested psychological and physiological reactions of the 22 families living in "Air Conditioned Village" at Austin, Texas and those of families in similar, but not air conditioned homes.

The village was built early last year under the sponsorship of the NAHB Research Institute, Air Conditioning and Refrigeration Institute, National Warm Air Heating and Air Conditioning Association, and interested manufacturers. The prime purpose of the experiment was to develop engineering data leading to better and more economical air conditioning equipment. Results of these tests will be released later this year, the Association said.

*Saves Fuel!*

*Irresistable appeal for the home buyer who wants a Beautiful Fireplace*

**Solid Brass Adds Charm and Beauty!**

**THERMO-RITE**

# FIREPLACE

*Enclosure*

RADIATES FIRE HEAT THROUGH SWINGING

**HEAT TEMPERED GLASS DOORS**

SIZES TO FIT ALL FIREPLACES

*Completely Eliminates -*

- SMOKE
- LOSS OF HEAT
- DIRT
- COLD FLOOR DRAFTS
- SPARKS
- FUEL WASTE

**Control Fire with a Flick of the Finger.**

BURN WOOD • COAL • GAS

GOOD TERRITORIES STILL OPEN

Be the first in your area to Capitalize on the THERMO-RITE

FREE INFORMATIVE LITERATURE

Clip this advertisement to Your Letterhead and Send for Full Particulars!

**THERMO-RITE MFG. CO.**  
Box **AT-J**, Akron 5, Ohio

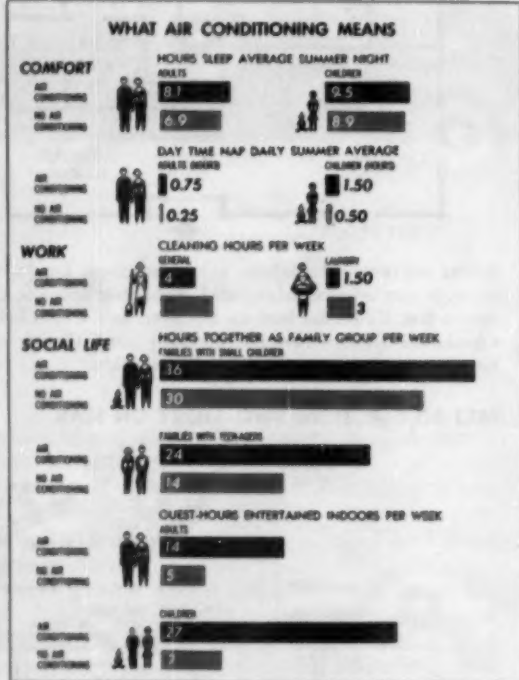

For a complete round-up of what's new in year-round air conditioning, refer back to "Cooling . . . what's new . . . what's ahead," in our August issue (pages 94-98).



# California contemporary

...complement to individuality

In all its relaxed dignity, the true answer to modern living. Gracious in every appearance, this is the type home that affords recognition to its individuality. Its pre-assembled construction is advantageous in many ways, and a far cry from the industry's original efforts. This masterpiece of coordinated design will surely complement the lives of its owners.

Illustrated is one of the many Scholz Hillside models especially tailored to rugged terrain.

Views of the Rear Terrace and the Front Elevation point up the many claims to outstanding design.

Bonafide Builders: Wire or call collect for complete information.



**SCHOLZ HOMES, INC.**  
2001 N. WESTWOOD • TOLEDO 7, OHIO

COPYRIGHT 1989

LITHO IN U.S.A.



## Which of these wood windows has its quality IDENTIFIED?

Here are two double-hung wood window units. Both may be of the same quality. The one bearing the A.W.W.I. Seal of Approval has such quality identified at a glance.

This seal is the fabricator's certification that the window unit meets the quality specifications of U. S. Commercial Standard 190-53. It is the fabricator's assurance that the unit is made of carefully selected wood—properly dried—preservative treated for long life. It is assurance, too, of effective weatherstripping and of easy, correctly balanced sash operation.

Today—when quality is the watchword in construction, the A.W.W.I. Seal of Approval is positive certification—to you and the home owner—of quality in windows. Get full information from your supplier or write Ponderosa Pine Woodwork, 105 West Monroe Street, Chicago 3, Illinois.



The use of this seal is not limited to members of Ponderosa Pine Woodwork. Any manufacturer or fabricator whose unit meets specifications can offer the quality seal under a licensing agreement.



*Ponderosa Pine* **WOODWORK**



Lights in Strand door optional

## HERE'S THE DOOR THAT GIVES YOU MORE! Strand Design Saves You Installation Time and Money

This all-steel "beauty" is the quickest garage door of them all to install! Your *installed* cost is reduced by Strand's quicker, easier installation. The one-piece door leaf saves assembly time at the job. Factory-assembled hardware (including new adjustable track hangers) cuts installation time. No prime coat of paint is needed — another saving.

Strand's horizontal lines blend with today's design. And — its beauty *lasts*, because Strand Door is all-steel, galvanized with a heavier, hot-dip zinc coat for rust

protection (steel can't *ever* rot, shrink, sag, warp!). You give your owners modern beauty and lifetime durability — you do away with the "grief" and cost of complaints and call-backs.

Huge volume, concentrated in only 3 sizes, makes Strand America's biggest garage door value. Strand all-steel Garage Doors come in 9' x 7', 8' x 7', and 16' x 7' sizes. Easy to get in a hurry — through 150 distributors and thousands of dealers all over the country.

### 5 NEW Features...

- New captive track provides added protection — keeps roller enclosed
- New stainless steel, automotive-type "T" handle has larger grip, more strength, better looks

- New Nylon rollers, for all single receding doors, ensure silent operation
- New round-corner vision lites have continuous auto-type rubber moulding (they're optional at added cost)
- New adjustable track hanger cuts installation time

*Strand Garage Doors are the product of a 50-year-old company, which also makes: Fenestra Steel Residence Casements, Projected Windows, Window Walls, Basement and Utility Windows, Metal Trim, Lintels, Metal Residential Swing and Sliding Closet Doors, Stock Steel Industrial and Intermediate Windows.*

**A 32-page book that will give you a lot of quick and easy garage "know-how."** Contains 12 smart designs and sensible floor plans, how-to-build instructions, material lists, driveway sketches, etc.



Strand Garage Door Division  
Detroit Steel Products Company  
Dept. AB10, 2242 E. Grand Blvd.,  
Detroit 11, Michigan

Please send 32-page booklet of Garage Plans and Ideas. I'm enclosing 10¢ for postage and handling

Please send free 12-page booklet showing how to modernize my garage

Name

Address

City  State



## NEW, DRAMATIC G-E "Kitchen

*Exclusive 4-in-1 unit comes internally plumbed and wired . . . in 5*

**IMAGINE THIS VERSATILE** "built-in" in your homes. What a powerful selling asset for you over other houses in your price range.

An internally plumbed and wired G-E "Kitchen Center" combining an automatic dishwasher, range, Disposall\*-equipped sink, and a washer-dryer. All mounted under one stainless steel counter. **ALL WITH A SINGLE INSTALLATION IN ANY TYPE KITCHEN!**

Not only is the G-E "Kitchen Center" beautiful, compact and appealing . . . but its simplicity and versatility permit just about any kitchen design you want. **AND WITH ONE INSTALLATION IN ANY TYPE KITCHEN.**

Why not see your nearest G-E distributor about this great new "Kitchen Center," or write direct to: General Electric Company, Kitchen Unit Section, Appliance Park, Louisville 1, Kentucky.



All "Kitchen Centers" are available in 5 G-E Mix-or-Match colors: Canary Yellow, Turquoise Green, Petal Pink, Cadet Blue, Woodtone Brown. Only G-E has the "Kitchen Center."



# Center" for your homes!

*Mix-or-Match colors for every kitchen . . . even homes as low as \$12,000.*

- **ONLY G-E CAN OFFER YOU** a complete selling program like this:

Here is a complete plan to help you sell your G-E-equipped houses faster and easier.

General Electric will help you design and plan your kitchens . . . help you determine just where your General Electric "Kitchen Center" and appliances should be installed and displayed for greatest appeal.

Furthermore, G.E. will provide you with a complete and *tested* merchandising program to help you promote and display this exclusive appliance in your model homes.

All this, plus a certificate that indicates to your customers that the kitchen design has been certified by the General Electric Company.

When you consider that 55 out of every 100 women think G.E. makes the best home appliances, you know what a powerful sales weapon this certificate can be.

*Progress Is Our Most Important Product*

**GENERAL  ELECTRIC**

*American Houses, Inc.*  
*presents a proved and profitable*  
*"Builder-Dealer Program"*

American Houses, Inc., one of the oldest prefabricating firms in the business, offers to selected residential builders a tested and proved "Builder-Dealer Program", carefully developed to give valuable advantages to those who qualify.

Authorized American Houses Builder-Dealers, under the terms of this new plan, get an assigned territory. All inquiries received by American Houses pertaining to that territory will be forwarded to the Builder-Dealer.

American Houses, at its own expense, will carry on a continuing general advertising program in the Dealer's territory.

American Houses will develop a model house promotion campaign designed to create interest in and sales of the model and will enter into a cooperative advertising program with the Builder in this promotion. In addition, American Houses will supply the Builder-Dealer with help in connection with his local advertising campaign, and will supply him with a quantity of sales and promotional advertising material.

## *Bonus Plan*

Each year, American Houses will pay to its Builder-Dealers a Bonus, based on the Builder's net sales during the fiscal year, according to an established schedule.

This new program is only one indication of the close interest and constant help which American

Houses offers its Builder-Dealers. Such interest and help can build your sales and give you increased returns from every working dollar. And there are American Houses designs which suit your markets—from \$7500 to over \$35,000, in traditional and modern styles.

### **AMERICAN HOUSES IS FRANCHISING BUILDER-DEALERS IN THE FOLLOWING STATES:**

Massachusetts	New York	Delaware	Virginia	Tennessee
Connecticut	Pennsylvania	District of Columbia	North Carolina	Georgia
	New Jersey	Maryland	South Carolina	

*For further information,  
write or call:*



**American Houses Inc.**

DEPT. AB-9, 165 WEST 46TH STREET  
NEW YORK 36, N.Y. PLaza 7-6100





The first  
new...all-new  
"Custom" door  
at standard prices

An outstanding example of the "Kawneer Touch" . . . the new all-welded aluminum door can be "customized" to your needs. Now you can specify a door that is 10% stronger than similar doors, provides a clean, seamless, eye-appealing appearance, and features interchangeable hardware . . . yet the cost compares with other standard doors. Here is the only stock door that can be styled to any type of store. Learn all about it now. See your Kawneer dealer or write Kawneer, Niles, Michigan.

Now! —identification hardware  
"individually designed"



Style "M": Cosmopolitan hardware for double-acting doors.

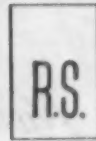

Style "B": Coronet "Pull Handle" ideal for symbol.

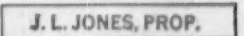

Style "B": Coronet "Push Bar" provides length for full name.

Kawneer offers a choice of four different styles of hardware. The two styles shown have interchangeable face plates. If you wish a face plate to identify any type of business or name, all you do is have artwork prepared. Kawneer will laminate it in plastic, etch it on aluminum, or produce it on any material you desire and in any color. The cross-hatch plate is then merely replaced right on the job with the new design.

Completely welded construction  
for greater strength—lower cost

- 10% stronger than most doors
- New "deep-weld" penetrates metal 100%
- Hairline joints and unblemished finish for attractive appearance
- No exposed, unsightly screws
- Seamless tubular frame construction
- Long lasting beautiful aluminite finish





# America's Most Complete Line for WEATHER-SNUG HOMES



*Quality Building Specialties*



**M-D**  
MACKLANBURG-DUNCAN CO.  
**FOR DOORS**

## *Numetal* WEATHER STRIP

This complete package unit means easier handling for you . . . easier installation for your customers. M-D Numetal door sets are available with regular door bottoms or with threshold and exposed hook.



**M-D**  
MACKLANBURG-DUNCAN CO.

## *Numetal* WEATHER STRIP

### Sets for windows

Handy to buy, handy to use. Here in one attractive package is a complete M-D Numetal Weather Strip set for a single window. Available for all standard 28", 30", 32" and 36" double hung windows. M-D packaged sets save selling time . . . cut handling costs . . . make inventory easy.

**HANDY PACKAGED SETS! Ready to hand customers! Ready to use!**



**M-D**  
MACKLANBURG-DUNCAN CO.

## *Numetal* DOOR BOTTOMS

Made of extra thick wool felt and heavy gauge stainless steel, brass or aluminum. Standard lengths—28", 30", 32", 36", 42" and 48"—packaged 1/2 doz. same length to carton. Special lengths available.

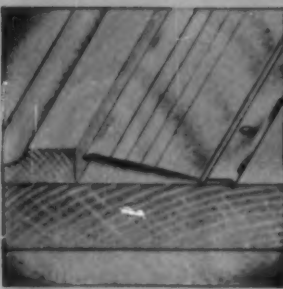

**M-D** On-GARD COIL  
MACKLANBURG-DUNCAN CO.

## WEATHER STRIP

This stainless steel or bronze coil weather strip is packed two ways—six 18 ft. rolls in free display carton, or in 100 ft. individual cartons.

**BUILDERS**  
For highest quality and dependability always specify M-D products. Sold by hardware, lumber and building supply dealers throughout the country!

**DEALERS**  
Order Today! Your order shipped same day it is received! All M-D products are fast sellers, nationally advertised.





*Nu-WAY*

# WEATHER STRIP

Easiest in the world to put on

This easy-to-put-on weather strip makes friends as it makes you profits. Works perfectly on windows, storm sash or doors. Made of wool felt and white metal. Each individual carton contains one 18 ft. roll with nails and instructions. Packed 12 cartons in display case.



This free, colorful display case takes very little counter space . . . but does a big job of selling.



*Nu GARD*

# Automatic DOOR BOTTOM

Here's the perfect automatic door bottom and draft eliminator for ALL doors. Completely solves old problem of clearing rug or floor every time door opens. Easily installed on right or left hand door. Smartly designed with silvery-satin finish—will not rust or tarnish. Furnished in standard lengths—28", 32", 36", 42" and 48". Packed in individual cartons.



**UP** automatically to clear carpet easily when door opens.



**DOWN** snugly against floor to seal out drafts when door closes.



*Nu-CALK*

## CALKING COMPOUND

World's best calking compound available in loads, with or without nozzle . . . hand squeeze tubes . . . or ½ pt., pt., qt. and gal. cans. Also 5-gal. and 55-gal. drums—gun or knife grade.



*Nu-Glaze*

## GLAZING COMPOUND

You can recommend this glazing compound with complete confidence that it always "stays put." Packed in ½ pt., pt. and qt. cans, 25 lb., 50 lb., 100 lb., and 300 lb. drums.



*Nu-Phalt*

## PLASTIC ASPHALT CEMENT

Ideal for sticking down asphalt shingles and general repair work on roofs and flashings. Comes in handy loads, with or without nozzle; 2½ lb. and 10 lb. cans; 50 lb. pallets and 550 lb. drums.



# MACKLANBURG-DUNCAN CO.

OKLAHOMA CITY 1, OKLAHOMA

Leaders in the Building Specialty Field for 35 years!





*why invite **FIRE?***

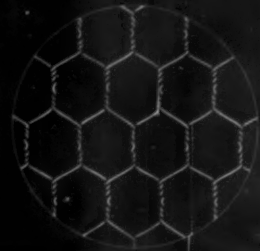

**KEYMESH** lath for over-  
all reinforcement.  
Made of galvanized  
woven wire. Especially  
recommended for  
ceiling construction.

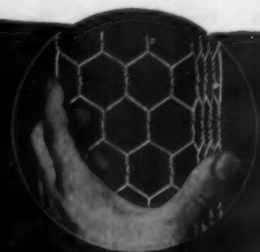

**KEYCORNER** strip lath,  
preformed to fit snugly in  
corners. Lies flat when  
applied to joints.  
Galvanized to prevent  
rust streaks.

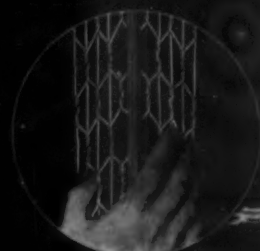

**KEYBEAD** corner lath  
with precision formed  
bead for outside corners.  
Open mesh assures  
strong, solid plaster  
corners.

*you multiply fire resistance  
for pennies per square foot with*



# KEYMESH

Some types of walls and ceilings invite fire.

When you use lath and plaster, plus KEYMESH, you cut fire hazard immeasurably. Just compare the difference.

With frame construction, a ceiling with exposed joists is gone in 15 minutes. Finished with gypsum lath, lightweight aggregate plaster and Keymesh, it stands up an hour and 38½ minutes.

With open web steel joists, the ceiling fails in 7 minutes when joists are exposed. Add gypsum lath and 1" of lightweight aggregate plaster over KEYMESH and the ultimate fire resistance is 4 hrs. and 26 min.

With most types of light construction you'll find that lath and plaster with KEYMESH reinforcement can make the difference between "heavy loss" and "light damage" to buildings. You can do this at negligible cost . . . for pennies per square foot of finished surfaces.

Firesafety is not the only advantage of using KEYMESH reinforcing lath. Beauty, durability, and economy must be part of everything you design. With Keymesh you get all these plus other important advantages for your clients such as lower insurance rates and complete adaptability for any type of decoration.

Before you specify or build again, weigh these facts.

*Fire Test Results on various types of  
construction by authoritative Testing Laboratories*

CEILING CONSTRUCTION WOOD JOIST FLOORS	ULTIMATE FIRE RESISTANCE	PROTECTION OF JOISTS
Exposed joists.	15 min.	None
Gypsum wallboard ½" thick finished with casein paint.	25 min.	15 min.
Metal lath, ¾-in. sanded gypsum plaster 1:2 for scratch and 1:3 for brown coat.	45 min.	12 min.
Gypsum lath, ½-in. of gypsum lightweight aggregate plaster reinforced with KEYMESH-type reinforcing lath.	1 hr. 38½ min.	36 min.

WALL CONSTRUCTION ON WOOD FRAMING	ULTIMATE FIRE RESISTANCE
½" fiberboard.	5 min.
Metal lath with ¾-in. sanded gypsum plaster.	15 min.
Tongue-and-grooved wood.	20 min.
¾-in. perforated gypsum lath with ½-in. sanded gypsum plaster.	30 min.
CEILING CONSTRUCTION STEEL JOIST FLOORS	ULTIMATE FIRE RESISTANCE
Ceiling unprotected.	7 min.
Ceiling of gypsum lath and ½" lightweight aggregate gypsum plaster.	55 min.
¾" gypsum lath covered with 1¼" of gypsum plaster with lightweight aggregate.	1 hr. 43 min.
Gypsum lath and ½-in. gypsum plaster with lightweight aggregate reinforced with KEYMESH-type galvanized reinforcing lath.	3 hrs. 26 min.
¾" gypsum lath, reinforced with 20-gauge, 1" KEYMESH-type lath; then covered with only 1" of lightweight aggregate gypsum plaster.	4 hrs. 26 min.
STEEL COLUMNS	ULTIMATE FIRE RESISTANCE
Structural Steel, unprotected 10 sq. in. min. area of steel.	15 min.
Gypsum lath, one layer, ¾" perforated, ½-in. gypsum plaster mixed with lightweight aggregate.	1 hr.
One layer ¾-in. perforated gypsum lath, 1-in. thickness of gypsum plaster, 100 scratch, 100 brown, mixed with lightweight aggregate.	2 hrs.
Two layers ½-in. long-length gypsum lath, 1¼-in. gypsum plaster mixed with lightweight aggregate. Lath wrapped with one layer 20 gauge galvanized 1-in. KEYMESH-type reinforcing lath.	4 hrs.

## KEYSTONE STEEL & WIRE COMPANY

Peoria 7, Illinois

KEYMESH • KEYCORNER • KEYBEAD • KEYWELD  
KEYSTONE NAILS • KEYSTONE TIE WIRE  
KEYSTONE NON-CLIMBABLE AND ORNAMENTAL FENCE





*Home of Mr. and Mrs. Robert Dando, Fellwick, Pa.  
Mason contractor: Joseph P. Serratore, Glenside, Pa.*

# B onded for lasting strength and beauty

Durable, weather-tight joints for all types of masonry begin with quality mortar. This handsome stone masonry, bonded with Atlas Mortar Cement, will stay attractive for generations.

Atlas Mortar's uniform color helps make *any* masonry job more attractive. Its smooth workability helps speed construction . . . makes it popular with the men who use it.

Careful control during the manufacture of Atlas Mortar Cement maintains consistent high quality and uniform performance in use. Specify Atlas Mortar Cement for *your* next project.

*Complies with all ASTM and Federal Specifications for masonry cement, including recent requirements for soundness (low expansion) in autoclave.*

**UNIVERSAL ATLAS CEMENT COMPANY**  
 UNITED STATES STEEL  CORPORATION SUBSIDIARY  
 100 PARK AVENUE, NEW YORK 17, N. Y.

*Offices: Albany · Birmingham · Boston · Chicago · Dayton · Kansas City  
 Minneapolis · New York · Philadelphia · Pittsburgh · St. Louis · Waco*

AB-M-54

## Atlas<sup>®</sup> Mortar Cement

**FOR BETTER MORTAR · FOR BETTER MASONRY**

UNITED STATES STEEL HOUR—Televized alternate weeks—See your newspaper for time and station.



## Cuts digging day to 3 hours with powerful ½-yard Hydro-Trencher



Here the Hydro-Trencher digs a ditch for a new sewer line. Hydraulic stabilizer blade also acts as a backfiller blade. By simply turning the bucket around you can convert the trencher to a swing loader. Hydraulic trip loading bucket is also available.

This Oliver 88WT Hydro-Trencher is working on a city sewer project—locating a manhole 8-feet deep through a 2½ by 5-foot street opening.

By hand this is a full day's work for three men. The Hydro-Trencher cut the time to three hours! Working in cramped quarters is duck soup for the 88WT. Powerful hydraulic down pressure, 170° bucket rotation and maneuverable, dual-circuit control let you dig in the most inaccessible places... work delicately around pipes, foundations without fear of damage.

With the 88WT you can slice through rocky soil, roots, hard Clay—dig all the way to 12 feet. The two complete hydraulic systems on the Hydro-Trencher give you unbelievable control—let you perform any two operations at once without loss of pressure.

Owners of Hydro-Trenchers enthusiastically report savings in time and money on many jobs formerly requiring hand labor or larger equipment. Get the low-down on the most profitable, maneuverable trencher in the field—the Oliver 88WT. See your Oliver Industrial Distributor for a demonstration.

**THE OLIVER CORPORATION**

400 West Madison Street, Chicago 6, Illinois



a complete line of industrial wheel and crawler tractors

# Here's how our good name can serve yours

If you use Zegers Dura-seal . . . the Combination Metal Weatherstrip & Sash Balance . . . you get complete advertising and sales promotion support. You get advertising in trade publications and consumer publications . . . display cards and window stickers. You benefit by using an identified product that home buyers are looking for!



**How do you know it's a good house?**

Be wise! Check, poke and peer into the window construction. Open and shut the windows. Do they move easily and quietly? Wiggle them. Do they fit snugly? Are they properly weatherstripped? Look for all these things because the quality of windows usually reveals the quality of the entire house.

Be sure of quality! Look for windows equipped with Zegers Dura-seal . . . the combination metal weatherstrip and sash balance that operates silently and at the touch of a finger. Dura-seal keeps out cold and drafts . . . keeps your home warmer and cleaner in the winter . . . saves 30% to 40% in fuel. Keeps out dirt and dust in the summer . . . seals the house perfectly for air conditioning.

Look for the Dura-seal sticker on the glass and for the name embossed on the metal! It's your assurance of quality. Your builder or architect knows about Zegers Dura-seal . . . ask him!

**ZEGERS, INCORPORATED**  
8096 South Chicago Avenue, Chicago 17, Illinois

**ZEGERS Dura-seal** COMBINATION METAL WEATHERSTRIP AND SASH BALANCE

Look for the Name on the Window

NATIONALLY ADVERTISED IN  
BETTER HOMES AND GARDENS

Millions of prospective home buyers are reading Zegers Dura-seal ads telling them to look for this quality product as it reflects the quality of the entire house!

Write today for complete information on:

**ZEGERS**  
*Dura-seal*  
Combination Metal Weatherstrip Sash Balance

**ZEGERS, INCORPORATED**  
8096 South Chicago Avenue, Chicago 17, Illinois

## DISPLAY CARD

Wherever window units . . . equipped with Zegers Dura-seal are displayed and sold . . . attention getting display cards call attention to the name of the window unit manufacturer and to Dura-seal . . . the nationally advertised equipment!

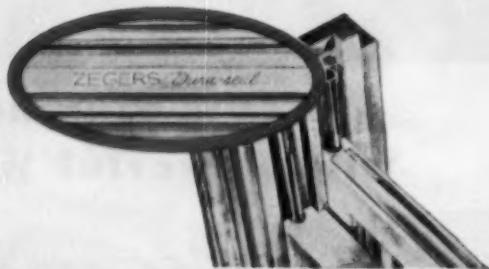

## PERMANENT IDENTIFICATION

"Zegers Dura-seal" is embossed on the parting stop! This assures everyone, including the ultimate home buyer that they are getting the genuine, quality product!



## WINDOW STICKER

Window stickers are available for use by the window unit manufacturer — imprinted with his name and identified as equipped with "Zegers Dura-seal" . . . the nationally advertised equipment.



# Clipper

"SAILS RIGHT THRU"

**CLIPPER Diamond Blades**  
**—All CLIPPER BLADES—**  
 are guaranteed to...  
**"Consistently Provide**  
**the Fastest Cut—at the**  
**Lowest Cost—with the**  
**Greatest Ease"**

Look for the bright Orange Centers that identify the genuine Clipper Superior Blades—by the makers of Clipper Masonry Saws—and Clipper Concrete Saws.



Mr. Clipper

...The Mark  
 of **QUALITY!**  
 Your Assurance  
 of Cutting  
 Perfection!



## MASONRY BLADES

● **DIAMOND**—Outstanding Performance with smooth efficiency is a part of every Clipper Diamond Blade—available in specifications for cutting every Masonry Material.

● **"POLK-A-DOT" Break-Resistant** "Safest Blades Ever Made"—in specifications for EVERY material—HARD to SOFT! Triple-Reinforced for Triple-Protection.

● **WET or DRY ABRASIVE**  
 There's an Abrasive Blade to quickly, efficiently cut ANY Masonry Material—with proven performance—lowest cost.



## CONCRETE BLADES

● **DIAMOND** A Blade for any job—any aggregate—every saw! Choose your Clipper Diamond Blades from a wide variety of specifications to cut green or old concrete with outstanding speed and economy.

● **"GREEN-CON"**  
 Savings as high as 80% with Clipper's new Reinforced Abrasive Blades for cutting "green concrete" with the widest possible range of Hard to Soft Limestone aggregates—Coral—Slag.

**Clipper**  
 PRODUCTS

● **SOLD ONLY DIRECT**  
 Same-Day Shipment from  
 Factory Branches in Principal  
 Cities, Coast to Coast.  
 Mail Coupon NOW!



**MAIL  
 COUPON  
 NOW!**

See Why "4 Out of 5 Buy Clipper"

**CLIPPER MANUFACTURING CO.**  
 2813 WARWICK • KANSAS CITY 8, MO. 304X

- Please send me complete information on Genuine Clipper Diamond Blades.  Wet-or-Dry Abrasive Blades.
- "Polk-A-Dot" Blades  Clipper Masonry Saws  Clipper Concrete Saws

NAME \_\_\_\_\_

ADDRESS \_\_\_\_\_

CITY \_\_\_\_\_ STATE \_\_\_\_\_

For homes in every price class -

## Air Conditioning is Practical the Frigidaire Way!

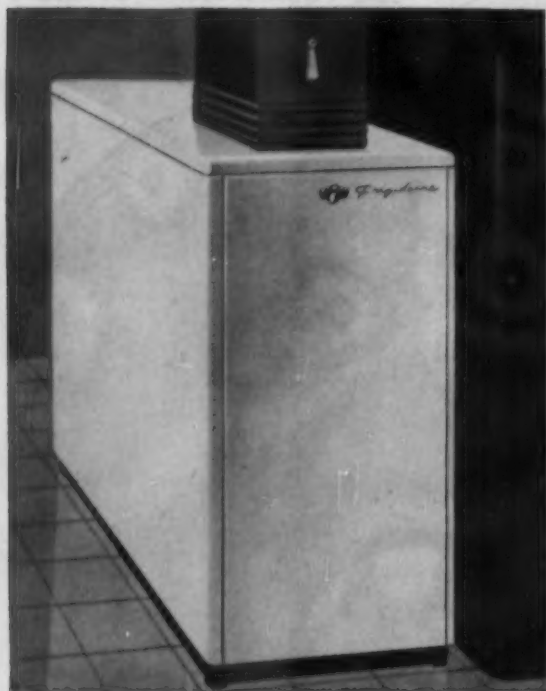

**Multi-matic Frigidaire Conditioner**

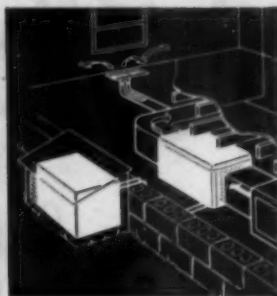
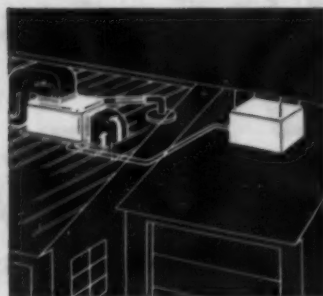

### Here's the ideal air conditioner to supplement heating systems in your homes

There's extra sales appeal in Frigidaire air conditioning - and now you can offer this wonderful new way of living as an easily installed optional feature.

The new Multi-matic Frigidaire Conditioner teams up with almost any forced air heating system and uses the same ductwork. Or, as shown above, the Multi-matic divides into two sections for convenient crawl space, attic or remote installations. Available in compact 2, 3 and 5-ton models. Operates as a complete, separate air conditioner - and uses air-cooled, evaporative or water-cooled condenser.

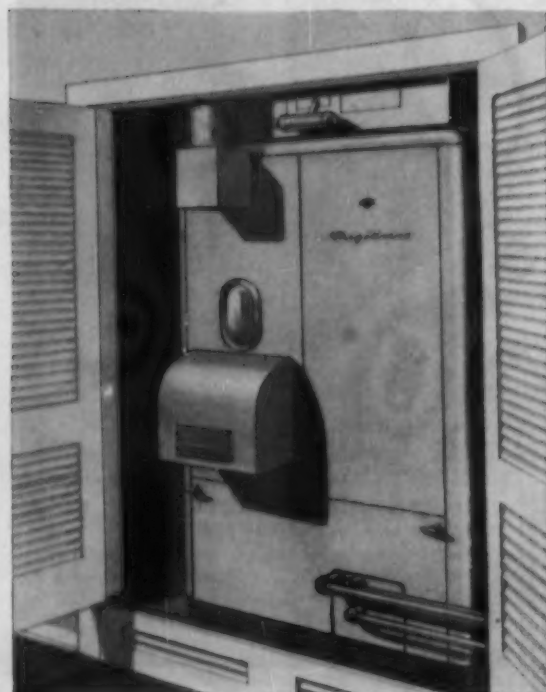

**Year-Round Frigidaire Conditioner**

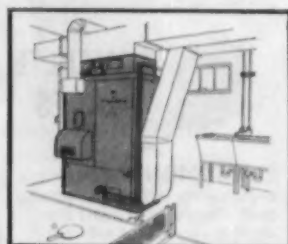
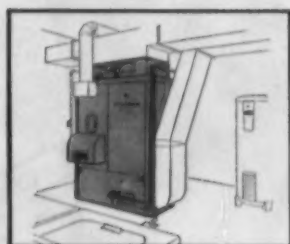

### Here's summer cooling and automatic heating in one compact package

If your plans call for heating and cooling, included from the start, use the Year-Round Frigidaire Conditioner. No larger than many furnaces alone, it fits easily into closets, basements or utility rooms. Available with your choice of automatic gas or oil heat, and 2 or 3-ton cooling power. For details call your Frigidaire Air Conditioning Dealer, Distributor, or Factory Branch. Or write Frigidaire, Dayton 1, Ohio. In Canada, Toronto 13, Ontario.

## Frigidaire Conditioners



Built and backed by General Motors

**PREMIUM VALUE**  
*at LOW PRICE!*



## Deming "MINIJET" Water System

**A Complete Packaged Unit—No Extras to Buy!**

Attention, Mr. Builder of small homes beyond city water mains! An adequate supply of running water for every house is a vital sales feature. It's a cost factor, too. Here's how to solve the problem quickly . . . economically. Install a Deming "MINIJET" Water System in each house!

The "MINIJET" (as illustrated) is a COMPLETE, packaged water system . . . all assembled . . . ready to install for shallow or deep well service.

Although low in price, the "MINIJET" is built with features found in much higher priced systems. Corrosion-and-wear-resistant materials are used where needed to insure smooth, efficient performance, dependable operation and long life. Write us for BULLETIN NO. 400-A. When you read the FACTS, you'll agree that the Deming "MINIJET" is the best answer to your problem of adequate, low cost water supply for small homes.

**THE DEMING COMPANY**

563 BROADWAY • SALEM, OHIO

MANUFACTURERS OF THE WORLD'S MOST COMPLETE LINE OF WATER SYSTEMS



## GET THESE IMPORTANT BOOKS!

THE three books at the left are a "must" for anyone who is interested in good masonry construction. One describes the type of *workmanship* recommended to secure dry brick walls. The second describes the *specifications* recommended to secure dry brick walls. The third describes the type of workmanship recommended for *good concrete-block walls*.

Each of these books has been endorsed by foremost authorities. Each has received a citation of merit from the Producers' Council and the American Institute of Architects. Each is fully illustrated, clearly written. Each contains a wealth of really valuable information.

These books are *not* advertisements for our product, Brixment. They are published and made available to members of the building trades solely as an industry service. Mail the coupon, *today*, for your free copies.

LOUISVILLE CEMENT COMPANY, LOUISVILLE, KY.  
Manufacturers of  
BRIXMENT FOR MORTAR

Louisville Cement Company—Dept. 1  
Second and Walnut Streets, Louisville 2, Kentucky

Gentlemen:

Without cost or obligation, please send me a copy of each of your three books on masonry construction.

Name \_\_\_\_\_

Firm \_\_\_\_\_

Street \_\_\_\_\_

City \_\_\_\_\_ State \_\_\_\_\_

**NOW!**  
 Add the "Sell" of  
 Paneled Walls  
 even to low-cost  
 housing!



## New Weldwood® Adhesive Puts Up Plywood Panels without nails!

**Slashes Costs! Speeds Sales!**



**BONDS INSTANTLY . . . PERMANENTLY ON CONTACT!**

- \* Ends nail-setting, puttying and finishing nail holes!
- \* No change in plans . . . no special construction needed!
- \* Install plywood panels directly to studs or furring strips!
- \* Makes pre-finished plywood panels more practical than ever!

### NEW WAY TO APPLY MICARTA, Etc.

Weldwood Contact Cement is also the new improved way to apply plastic surfacing materials like Micarta to kitchen counters, bathroom and powder room surfaces, etc. No clamps or presses needed! Bonds equally sure on any base.

New economies in installing . . . made possible by a revolutionary new concept in gluing . . . let you cash in on increasing trend to paneled walls! Amazing new Weldwood Contact Cement enables you to put up plywood paneling entirely without nails. Ready-to-use! In cans and drums at lumber yards, hardware and paint stores. If your dealer isn't yet stocked, write us for nearest source of supply.

## MAIL COUPON TODAY

for information on this new nail-less way to apply plywood paneling!



. . . and for finishing paneled walls, use these Wizards with Wood.

**WHITE FIRZITE®**— for a modern "woody" pickled or blond finish. A "must" undercoater for fir plywood paint jobs.

**CLEAR FIRZITE**— for a smooth even finish on fir plywood stain jobs. Tames wild grain.

**SATINLAC®**— for a rich satiny, natural wood finish.

(See Sweet's Catalog for specifications.)

**UNITED STATES PLYWOOD CORPORATION**  
 Dept. 66, 55 W. 44th St., N. Y. 36, N. Y.  
 Send me information about Weldwood CONTACT Cement.  
 Send information on FIRZITE and SATINLAC.  
 Company \_\_\_\_\_  
 Your Name \_\_\_\_\_  
 Address \_\_\_\_\_  
 City \_\_\_\_\_ State \_\_\_\_\_



".....The time spent walking around after all the material and tools it takes to case and hang a door costs just as much as the actual work in the opening. Ready Hung Doors sure put a stop to all that walking and a lot of extra money in my bank account at the end of the year."

Sincerely  
*Leonard Stulman*  
Leonard Stulman, President

**ASK YOUR LUMBER DEALER  
READY HUNG DOORS MADE BY:**

- ALBANY, N. Y.**  
Immens Millwork Corp.
- BALTIMORE, MD.**  
Central Building Supply, Inc.  
210 E. Monument St.
- BIRMINGHAM, ALA.**  
Distomat Woodworks, Inc.  
P. O. Box 5214
- BOSTON, MASS.**  
A. W. Hastings & Co., Inc.  
Somerville St., Mass.
- DUFFALO, N. Y.**  
The Whitmer-Jackson Co., Inc.  
267 Hamburg St.
- CLEVELAND, OHIO**  
The Whitmer-Jackson Co., Inc.  
Box 164, Massillon, Ohio
- DAYTON, OHIO**  
Dayton Lath & Door Co.  
8 Riverside Ave.
- DENVER, COLO.**  
Lumber Dealers, Inc.  
Box 6886 54th St.
- GRAND RAPIDS, MICH.**  
Haskins Mfg. Corp.  
211 Ave. G, 49501
- HOUSTON, TEXAS**  
Southwest Lath & Door Co.  
P. O. Box 124
- LOS ANGELES, CALIF.**  
Ready Hung Door Mfg. Co.  
200 E. Victory Blvd., Burbank
- MADISON, WIS.**  
General Millwork Corp.  
225 E. 2nd St.
- NEW YORK, N. Y.**  
Saylor Whelan Co.  
17 Park Ave., W. Orange, N. J.
- PITTSBURGH, PENN.**  
Iron City Lath & Door Co.  
36th St. and 860 E. 8th
- ROCHESTER, N. Y.**  
The Whitmer-Jackson Co., Inc.  
P. O. Box 696
- SAN ANTONIO, TEXAS**  
Ready Hung Door Mfg. Co.  
Box 298, Grayson St. Sta.
- SAN FRANCISCO, CALIF.**  
Ready Hung Door Mfg. Co.  
Oakland, Calif.
- SEATTLE, WASH.**  
Arms Millwork, Inc.  
Box 668, Kirkland, Wash.
- SHOUX FALLS, S. DAK.**  
Jordan Millwork Co.
- ST. PAUL, MINNESOTA**  
Blumensaat Wood Specialties, Inc.  
Box 216, St. Paul Park, Minn.
- SYRACUSE, N. Y.**  
Immens Door Co.
- TORONTO, CANADA**  
C. Lloyd & Son Limited  
N. Park P. O., Ontario
- WACO, TEXAS**  
Frank Havers Lath & Door Co.  
P. O. Box 1490



A door and frame packaged unit complete with the door hung and locked and the frame trimmed both sides, ready to install in any rough opening in 20 MINUTES.



READY HUNG DOOR CORP., FORT WORTH, TEXAS

3 out of 4  
buy...



**America's Leading  
Fireplace...**

**Here are the reasons why:**

- The Heatilator unit is the only fireplace unit specifically designed for today's homes.
- Exclusive Pressure-Seal Damper seals throat air tight—prevents loss of winter heating and summer air-conditioning.
- It is easier to install—takes any size or shape flue.
- The Heatilator unit is a complete unit—heavily constructed and fully welded for maximum durability.
- Scientific design assures a perfectly operating fireplace that circulates heat . . . will not smoke.



**Specify Heatilator . . .**  
the only fireplace especially designed for the modern home . . . preferred by builders and home owners 3 to 1 over all other fireplace units combined!

Sold by Leading Building Supply Dealers  
HEATILATOR INC. 3210 E. Brighton Ave., Syracuse 5, N.Y.

**HEATILATOR®**

AMERICA'S LEADING FIREPLACE UNIT

Tucker-Maxon Oral School designed by the office of Belluschi and Skidmore, Owings & Merrill. Another outstanding example of the use of wood in modern architectural designs produced by this firm.



## THERE ARE ALWAYS NEW USES FOR WEST COAST LUMBER

Contrasts of vertical and horizontal patterns make this modern application of wood especially dramatic. The attractive and practical suspended porch takes advantage of cantilevered beams and joists. Louvres shield the building's interior from direct sun, and add to the open feeling of a covered access area.

For freedom of expression, build with lumber... the economical, ever-modern building material. You can depend on the West Coast lumber species... Douglas Fir, West Coast Hemlock, Western Red Cedar and Sitka Spruce.

**WEST COAST LUMBER**

Douglas Fir • West Coast Hemlock

Western Red Cedar • Sitka Spruce

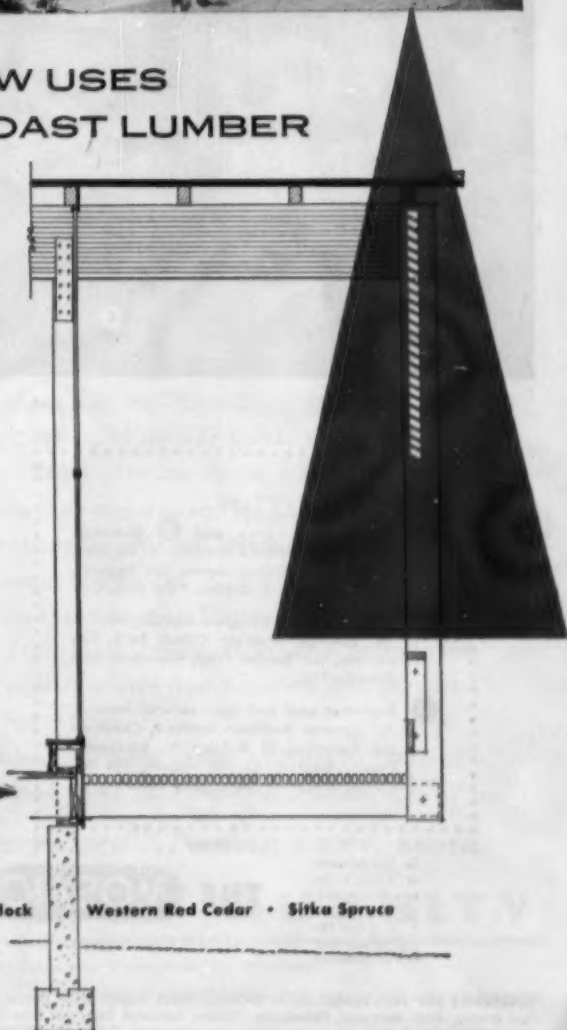

Send for folder describing free literature available for your reference files.  
West Coast Lumbermen's Assn., 1410 S. W. Morrison St., Portland 5, Ore.

## Mosaic Ceramic Wall and Floor Tile in U. S. Gypsum Research Village

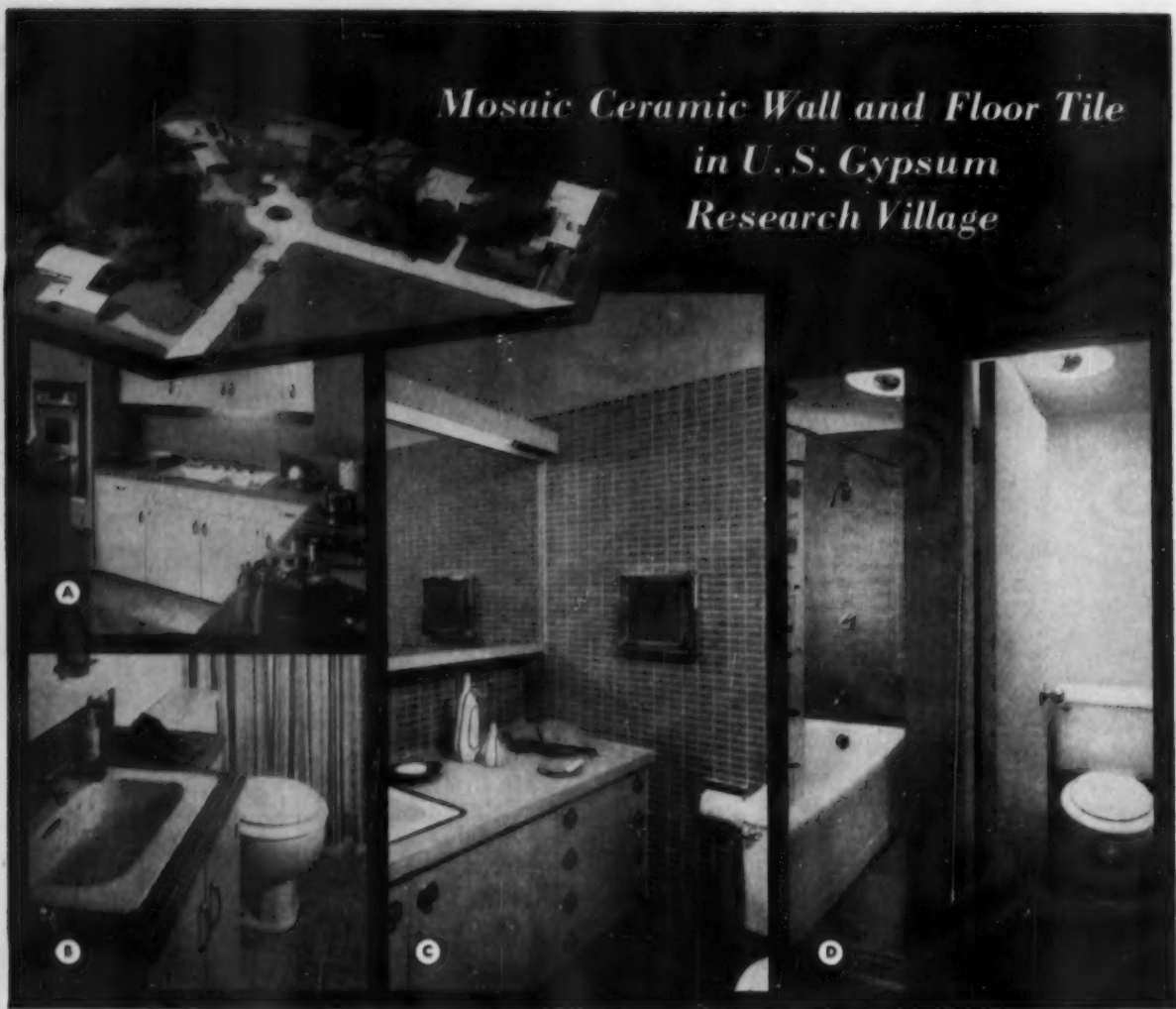

### Illustration notes . . .

- A** Kitchen work area and **B** Bathroom Vanity top, Velvetex mosaics,  $\frac{3}{4}$ " squares. Architect: A. Quincy Jones, Los Angeles, Cal. Builder: J. L. Eichler, Palo Alto, Cal.
- C** Bathroom wall, Granitex mosaics,  $1\frac{1}{8}$ " x  $\frac{3}{4}$ " oblongs. Architect: O'Neil Ford, San Antonio, Tex. Builder: Frank Robertson, San Antonio, Tex.
- D** Bathroom wall and floor, ceramic mosaics,  $\frac{3}{4}$ " squares. Architect: Brooks & Coddington, Columbus, O. Builder: W. Alexander Simms, Dayton, O. All Mosaic Tile installed by Allen Tiling Co., Chicago, Ill.

The United States Gypsum Company's research project at Barrington, Illinois, demonstrates how well-selected materials and new building methods can save cost and improve construction in low and medium priced homes. Mosaic ceramic wall and floor tile, whose *first* cost is its *last*, was used in kitchens and bathrooms of several of these homes to assure lasting beauty and homemaker satisfaction!

Whether you build single units or develop large tracts, your customers will be best satisfied with Mosaic ceramic tile and Mosaic All-Tile Accessories.

A selection of popular Mosaic tile types and colors is readily available from Mosaic's 26 warehouses through the Mosaic Service Plan. Ask for Bulletin No. 186.

See Mosaic, the only complete ceramic tile line, at your Tile Contractor's Showroom, or at the Mosaic Showroom near you. For helpful Mosaic tile literature, write Dept. 35-25, The Mosaic Tile Company, Zanesville, Ohio.



## THE MOSAIC TILE COMPANY

America's largest manufacturer of ceramic floor and wall tile.

Member: Tile Council of America and The Producers' Council, Inc.  
Over 5000 Tile Contractors to serve you.

**WAREHOUSES AND SHOWROOMS:** Atlanta, Baltimore, Boston, Chicago, Dallas, Denver, Detroit, Fresno, Greensboro, Hartford, Hempstead, L. I., N. Y., Hollywood, Little Rock, Miami, Minneapolis, New Orleans, North Hollywood, Philadelphia, Portland, Rosemead, Calif., Salt Lake City, San Diego, San Francisco, Seattle, Tampa, Washington, D. C., Zanesville. **SHOWROOM:** New York. **REPRESENTATIVES:** Buffalo, Cincinnati, Kansas City, Milwaukee, Pittsburgh. **FACTORIES:** Zanesville and Ironton, Ohio, Matawan, N. J., Little Rock, Ark., Corona and El Segundo, Calif.



# Kaustine



**NOW BACKED BY A  
10 YEAR WARRANTY**

**a "BIG PLUS"  
that Sells Homes!**



## **GAS-FIRED MODELS**

Forced warm air units for every type of residential installation delivering from 64,000 to 90,000 B.T.U.'s at the bonnet. High Boy, Low Boy and Counterflo models all fully tested and approved by A. G. A.

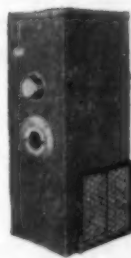

## **OIL-FIRED MODELS**

A complete line of warm air units for every type of installation delivering from 75,000 to 250,000 B. T. U.'s at the bonnet. All models equipped with high pressure burners to burn No. 2 fuel oil.

There is no substitute for **QUALITY** in home heating equipment...and that is why so many top builders install Kaustine Gas and Oil-fired Furnaces.

They *know* they can rely on Kaustine's most unique development, the "Tear-Drop" Designed Heat Exchanger System, to deliver quick, even heat with a minimum of fuel consumption.

They *know* they can depend on Kaustine warranty backed furnaces for efficient trouble-free operation and long years of service.

They *know* that Kaustine Engineering and Factory Assembly cuts their construction and installation costs to a minimum and that Kaustine Design saves valuable floor space.

So, whether you build modest homes or mansions...let Kaustine solve your heating problems.

**GET THE FACTS . . . WRITE DEPT. AB-10**

## **TOPS IN QUALITY**

There is a Kaustine Furnace or Winter

Air Conditioner for every type of home



# Kaustine



OIL STORAGE WAREHOUSE of Carter Oil Co., Tulsa, Oklahoma.

## To beat high maintenance costs . . .

You virtually eliminate costly building maintenance with Kaiser Aluminum Industrial Roofing because it's rust-proof—needs no painting or other expensive upkeep.

Even when exposed to most highly corrosive fumes and gases, Kaiser Aluminum Industrial Roofing requires no special protective measures.

Not only does Kaiser Aluminum Industrial Roofing provide greater protection and lower maintenance . . . it also assures *immediate savings*. Its light weight reduces

transportation and handling costs. And it often requires lighter, less expensive supporting structures.

Whatever you're building—figure first in Kaiser Aluminum Industrial Roofing—for better value at lower cost! For A.I.A. File and complete information, contact any Kaiser Aluminum sales office listed in your telephone directory. Or write Kaiser Aluminum & Chemical Sales, Inc. *General Sales Office*, Palmolive Bldg., Chicago 11, Illinois; *Executive Office*, Kaiser Bldg., Oakland 12, California.

# think of Kaiser Aluminum

## Industrial Roofing and Siding

**LOW COST**—Provides a combination of advantages not available in other materials at any price.

**LIGHT WEIGHT**—Reduces transportation costs. So easy to handle that construction is faster, lower in cost. Often permits the use of lighter, less expensive framing.

**STRONG**—The increased depth ( $\frac{7}{8}$ " ) of the corrugations of Kaiser Aluminum sheet provides greater load carrying capacities over the longer spans of modern industrial construction.

**CORROSION RESISTANCE**—High resistance to most industrial fumes. Can't streak with red rust. Maintains attractive appearance indefinitely.

**LOW MAINTENANCE**—Never needs painting. Resists heavy winds and hail.

**COOLER, BRIGHTER INTERIORS**—By reflecting hot sun rays, aluminum keeps interiors as much as 15° cooler. Aluminum's reflectivity insures extra interior light.



**FITS INTO ANY OUTSIDE WALL!** Nothing to mar beauty! No unsightly "overhang" inside or...outside!

# REVOLUTIONARY NEW LEWYT BUILT-IN wall air conditioner (BUILDER'S MODEL)

**NO UNSIGHTLY OVERHANG  
INSIDE OR OUT!**

## NOW, CASH-IN ON THE SALES MAGIC OF BUILT-IN AIR CONDITIONING FOR...

- LESS THAN THE COST OF A WINDOW UNIT!
- LESS THAN HALF THE COST OF A CENTRAL SYSTEM!

**NOW, LEWYT** brings you a totally new concept of BUILT-IN air conditioning! Each unit is complete in itself, fits into any outside wall. Best of all, the cost is amazingly low!

No matter what you build you can increase profits with the Lewyt BUILT-IN Wall Air Conditioner! You can install it in *any* or *all* rooms of every home, apartment, hotel, motel, factory or office building you construct!

Only 15 inches deep there's no *unsightly "overhang"* inside or outside to mar the beauty of your buildings! No "makeshift look" of window units—the Lewyt blends in with room decor. There are no ducts to install, no "window problems!"

The sensational Lewyt has individual controls and thermostat built right in! And it's sold direct from factory to you...ready to be installed quickly and easily.

### ONLY LEWYT INCLUDES ALL THESE BIG "EXTRAS!"

- Only 15" deep, 14 5/8" high, 32 7/16" wide!
- Individual 2-speed motor for extra power!
- Built-in controls and thermostat!
- Quiet! Easily serviced from inside!
- Choice of cooling capacities!
- 3-year warranty! UL Approval!
- Reverse-cycle pump for heating—optional!

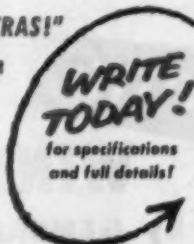

LEWYT AIR CONDITIONER CORPORATION  
DEPT. AB-10  
57th Street and 1st Avenue, Brooklyn 19, N. Y.

Please send me complete information on your revolutionary new LEWYT BUILT-IN WALL AIR CONDITIONER!

NAME \_\_\_\_\_  
COMPANY \_\_\_\_\_  
ADDRESS \_\_\_\_\_  
CITY \_\_\_\_\_ ZONE \_\_\_\_\_ STATE \_\_\_\_\_

LEWYT AIR CONDITIONER CORPORATION—57th St. and 1st Ave., Brooklyn 19, N. Y.

*Alwintite*  
**PAN-O-RAMA**  
*aluminum*  
**SLIDING WALLS**  
 in 32 standard stock sizes

*Irresistible appeal*  
**for today's home buyers**

Here's the "hottest" number in residential building today. It's the new Alwintite PAN-O-RAMA sliding wall and it comes in 32 sizes, from 6 ft. wide up to 24 ft. wide and in 7 ft. and 8 ft. heights.

No other single feature will add so much glamour and excitement to your new houses as these modern aluminum-glass sliding walls. Home buyers really go for them — and so will you when you hear about their low, low cost and see their superior quality appearance.

Made from strong, sturdy aluminum extrusions, they are quality designed and quality constructed. Sliding glass panels and screen unit glide effortlessly with ball bearing rollers on separate tracks. Completely weatherstripped. Strong outside lock — inside latch.

See the Alwintite PAN-O-RAMA sliding wall as well as the complete line of other Alwintite windows and door products today at your local Alwintite distributor, or write for full details to Dept. AB-5510.



**ALWINTITE**



*aluminum*  
**WINDOWS and DOORS**  
 by **GENERAL BRONZE CORPORATION**

ALWINTITE DIVISION • GARDEN CITY, N. Y.

AMERICAN BUILDER

# UNBEATABLE!

## TRADE-WIND HOOD/VENTILATOR COMBINATION

300 CFM  
VENTILATOR

SOLID CLAD  
COPPER HOOD



BOTH  
FOR ONLY  
**\$82.65**  
LIST

WITH GENUINE STAINLESS STEEL HOOD \$71.85 LIST

FOR LARGER KITCHENS  
USE THIS 425 CFM MODEL  
2501  
VENTILATOR.

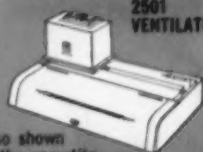

Also shown  
is the versatile  
Trade-Wind Expansion Hood—fits  
any cabinet from 30" to 54".  
Available in copper or stainless  
steel.

TRADE-WIND'S SUPER CLIPPER  
WITH TWIN INLETS, BUILT-IN  
FILTERS AND  
550 CFM IS  
STILL TOPS.



Here it is shown  
with the func-  
tional Fold-Under  
Hood in stainless  
steel only. 39"  
or 42" lengths.

With the efficient 300 CFM Trade-Wind Model 1501 Ventilator and the stunning copper Stationary Hood you get top Trade-Wind performance and quality at a bargain price.

The hood is available in 30", 36", 39", 42" or 48" lengths — at the same price.

The Trade-Wind Filter Kit and Under-Hood Light can be added at slight extra cost.

Demand this unbeatable Trade-Wind value or any of the 15 other outstanding Trade-Wind combinations.

*Trade Wind Motorfans, Inc.*  
7755 Paramount Blvd., Dept. AB, Rivera, Calif.



**Exposed beam ceilings** add beauty and sales appeal to your houses—and Armstrong Temlok® Roof Deck provides the fast, economical way to install them. Temlok is prefinished with two coats of light ivory paint. Applied to ceiling beams, Temlok Roof Deck creates a beautiful ceiling at no extra cost to you.



# SELL FASTER



**Tell the "hidden value" story** when Temlok Sheathing is covered by the exterior finish. Display a piece of Temlok and tell your prospects how the hidden material increases the value of a home. Explain how Armstrong Temlok Sheathing builds stronger, tighter walls . . . and saves on fuel for the life of the house.

**You never stop saving with**

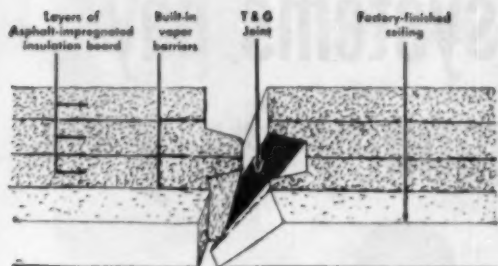

**In one application**, one material—Temlok Roof Deck—provides a roof deck, roof insulation, vapor barrier, and a finished ceiling. The tongue-and-groove joint assures a tight fit, built-in vapor barriers guard Armstrong Temlok Roof Deck against condensation.

**Contemporary homes are more saleable** when you explain how new materials like Temlok Roof Deck help build a better, more economical house. Temlok's extra insulation value impresses prospects. And Armstrong Temlok Roof Deck saves you up to \$250 per house.



# with TEMLOK



**Temlok adds strength.** Armstrong Temlok Sheathing exceeds all Federal Specification strength standards for insulating fiberboard. Laboratory measurements prove that a wall built with 2' x 8' x  $\frac{23}{32}$ " Temlok Sheathing is about 40% stronger than the same wall built with horizontal wood sheathing.



**Explain Temlok's insulating value** when you talk about the heating or air-conditioning system. Temlok Sheathing's extra insulating value cuts down heat loss through the walls, helps save fuel. Temlok keeps heat outside in summer . . . and often permits the use of a smaller, less costly air-conditioning unit.

**For full details** on how Armstrong Temlok products can help you sell houses faster, see your Armstrong lumber dealer or write Armstrong Cork Company, 3710 Rider Avenue, Lancaster, Pennsylvania.

**Armstrong TEMLOK . . . house . . . after house**

SHEATHING • ROOF DECK • INTERIOR FINISH

# How COPPER drainage systems pay their own way—make money for you!

Pre-assembly at the shop is quicker, more efficient — costs less. Because Anaconda Tubes and Fittings are about  $\frac{1}{4}$  the weight of their equivalents in ferrous materials, you can prefabricate whole assemblies like this.



**T**HE REAL COST OF USING COPPER for sanitary drainage systems—including savings in construction, faster completions, and easier sales—can be much lower than you think.

The savings are there because of the unique advantages of ANACONDA Copper Tubes:

**Pre-assembly at the shop.** Lightweight and ease-of-handling copper tubes and fittings permit more pre-assembly at the shop—more efficient, faster work. This also minimizes time plumbers must be in the house—helps you schedule other work more efficiently—can mean faster completions.

**Simplifies construction.** No need to juggle design or build space-consuming plumbing walls because a 3" copper tube stack with fittings can be installed within a standard 4" partition. You can put the plumbing where you want it for most efficient construction.

**Long lengths and light weight lower construction costs.** On long runs, the standard 20' lengths of ANACONDA Copper Tubes mean fewer joints, faster installation. A 20' length of 3" Type DWV copper tube weighs only 34 lb.

The bonus to you is that, with all these cost-saving advantages, you still offer a superior job, with *extra sales appeal*. To the prospective homeowner, an ANACONDA Copper Tube drainage system means quality, long life, high resale value.

For detailed information, write for a free copy of "Copper Tube Drainage Systems." Address: The American Brass Company, Waterbury 20, Conn. In Canada: Anaconda American Brass Ltd., New Toronto, Ontario.

ANACONDA Copper Tubes are available in all standard wall thicknesses—Types K, L, M and the new lighter weight Type DWV, which offers additional savings in job costs. Types M and DWV are recommended for all lines of the sanitary drainage system above ground, and Types K and L for that part of the system buried underground.

Within the past few years, many state and local sanitary plumbing codes have been modernized to include approval of the use of copper tube and solder-type fittings. Others are in process of revision. The recently issued American Standard National Plumbing Code (ASA A40.8-1955), published by The American Society of Mechanical Engineers, lists copper tube as approved material for sanitary drainage systems.

## ANACONDA<sup>®</sup>

### COPPER TUBES

Available through plumbing wholesalers

AMERICAN BUILDER





## COUNTER-FLOW TYPE

for basementless homes  
with counter-flow systems

2-3 TON SIZES

Use only 2 feet square of floor space for heating and cooling. Cooling coil enclosure serves as base for furnace. Install empty enclosure and conduit now . . . complete the system anytime. 3" conduit in floor carries all lines required to outside condensing unit.

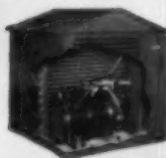

No extra floor space needed for cooling units. Attractive extra selling point for even the smallest homes.

## DUCT TYPE

for homes with  
basements

2-3-5 TON SIZES

Cooling evaporator boot connects to warm air plenum. Coil and compressor can be added now or in future. No floor space needed for cooling units.

Ducts may be installed on sides, top, bottom or end of boot. Lo-Boy or Hi-Boy heating units can be used. Simple connections to outdoor condensing unit.

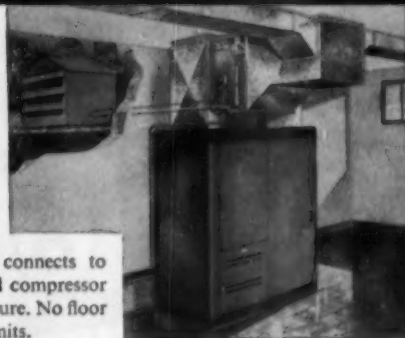

## PLENUM TYPE

for homes with basement or overhead duct work where system requires multi-sided plenum take off

2-3 TON SIZES



Cooling coil enclosure mounts conveniently over warm air plenum on Hi-Boy or Lo-Boy furnaces. Allows take off on any or all 4 sides on Hi-Boy furnaces. Adjustable damper permits air to bypass coil during winter furnace use. No floor space needed for cooling units.

**NEW** WHITE Assembled Gas Furnaces to match  
all other appliances in utility room!

Now choose  
from **3** types

of compact, low cost

# WILLIAMSON

YEAROUND

## AIR CONDITIONING

. . . and a complete line of  
CONSOLE AIRrefrigeration UNITS

### ASSEMBLED WARM AIR FURNACES

- Units occupying less than 2 feet square
- Hi-Boy, Lo-Boy, Counter-flow and Horizontal Units
- Pre-wired . . . pre-assembled . . . factory tested . . . 10-minute installation
- Gas or oil models
- Famous Williamson symbol on all units for extra merchandising value
- Color choice . . . Silver Brown or gleaming White baked enamel

### plus WATERLESS AIRrefrigeration

- No water, water tower, pump, plumbing or sewer connections needed
- No additional floor space required
- Easily installed . . . 90% factory pre-wired
- Condensing unit outdoors . . . saves space, eliminates indoor compressor sound
- Operating costs equal to other systems



Whatever size or type home you build, there's a WILLIAMSON Yearound Air Conditioning system that will boost its selling power, assure you *more profit* with less cost, less space and less labor. Rush us the coupon below TODAY for full details.

#### THE WILLIAMSON HEATER COMPANY

3515 Madison Rd., Cincinnati 9, Ohio

Please send me the profit-making facts on:

- Counter-flow Type    Duct Type    Console Type  
 Plenum Type Yearound Air Conditioning  
 White Assembled Gas Furnaces

Name \_\_\_\_\_

Firm \_\_\_\_\_

Address \_\_\_\_\_

City \_\_\_\_\_ Zone \_\_\_\_\_ State \_\_\_\_\_

D.C.M. Here are some good ideas for dressing up our homes with Gold Bond "Economy 250" + Permaboard N. I. S.



The drawing board above shows only a few of the thousands of application possibilities for rugged, long-lasting Gold Bond Corrugated Asbestone "Economy 250" and Permaboard or Pliaboard Asbestos-Cement Wall-board. Soffits, siding with battens, car port roofing, windscreen fences... the list could go on and on. Both of these durable building materials offer all kinds of advantages to busy builders.

Made from asbestos fibers and Portland Cement, Corrugated and Permaboard can't burn, rot or corrode. Weather, rodents and termites can't cause damage. And both these

versatile products are easy to handle and have sturdy strength that means on-the-job savings in time, labor and materials. Apply "Economy 250" or Permaboard with ordinary carpenter tools. Use them in their natural smooth gray finish or paint them any desired color. However you use these low-cost materials, there's no upkeep or maintenance problems... ever!

Call your Gold Bond dealer or representative for additional ideas on how to use economical Gold Bond Corrugated Asbestone "Economy 250" and Gold Bond Permaboard or Pliaboard... or write today for a new idea-filled booklet:

NATIONAL GYPSUM COMPANY • BUFFALO 2, NEW YORK

Build better with  
**Gold Bond**



LATH, PLASTER AND LIME



GYPSUM BOARD PRODUCTS



INSULATION BOARDS, PLANES AND TILES



ROCK WOOL INSULATION



PAINTS AND TEXTURES



ACOUSTICAL TILES

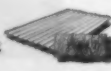

ASBESTOS ROOFING AND SIDING

... ASBESTOS PRODUCTS

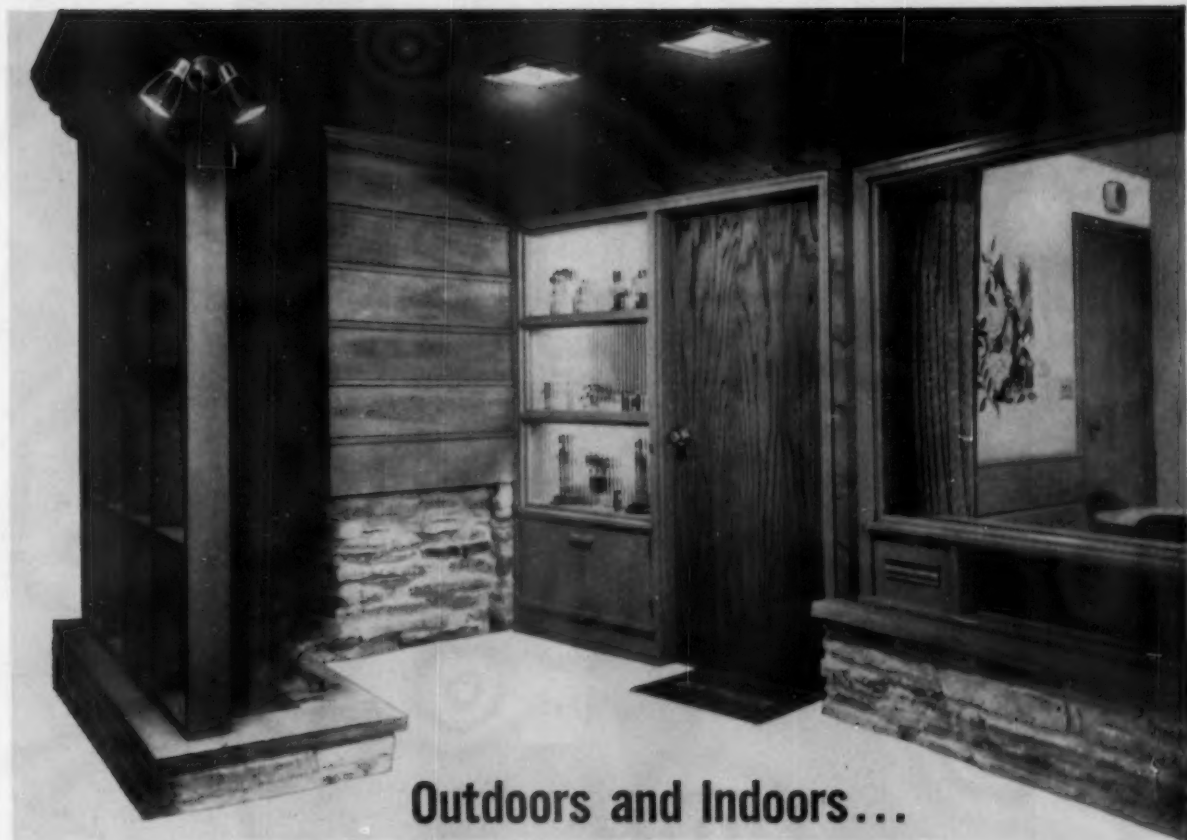

Outdoors and Indoors...  
**Inspiration-Lighting by MOE Light**  
**HELPS SELL HOMES!**



**M-852**  
 Transitional Post Lantern  
**\$15.95\***



**M-807**  
 Multiple-use  
 Outdoor Accent Light  
**\$9.95\***



**M-5608-B**  
 100-watt Pre-wired Recessed  
 Box. Solid Copper Trim.  
**\$11.95\***



**M-885**  
 Entrance Lantern  
**\$7.95\***

\*Prices slightly higher Denver and West

**BY DAY . . .** the very beauty of Moe Light fixtures delights every home owner, adds charm to every room, catches the eye as definite-quality extras that upgrade sales.

**BY NIGHT . . .** especially during evening selling hours, attractive outdoor Moe lighting dramatizes entrances while Moe Light *Inspiration-Lighting* creates a friendly glow throughout the entire home—a warm invitation to prospects.

**ANY TIME . . .** Moe Light *Inspiration-Lighting* adds the glamorous touches that convince customers of careful planning, quality construction—*helps close the sale!*

**For Your New Plans**

Moe Light suggestions based on nationwide home lighting experience can save you time and money. We will be glad to send you, free of charge, the new 48-page, full color Moe Light Catalog and Planning Guide showing groupings of the many types and styles of Moe Lights appropriate to living rooms, dining areas, kitchens, bedrooms, entrances, and patios. **Simply use the convenient coupon.**

**THOMAS INDUSTRIES INC.**



DIVISION

GENERAL OFFICES—410 S. Third St. Louisville, Ky.

In Canada: 1401 The Queensway, Toronto 14, Ontario, Canada

**MOE LIGHT, Dept. AB-1055**  
**Division of THOMAS INDUSTRIES INC.**  
**410 S. Third Street, Louisville 2, Ky.**

Please send your new planning aid,  
*"Inspiration-Lighting."*

NAME \_\_\_\_\_

COMPANY NAME \_\_\_\_\_

STREET \_\_\_\_\_

CITY \_\_\_\_\_ ZONE \_\_\_\_\_ STATE \_\_\_\_\_



Fenestra 1 3/4" Swing and Recess Doors in a 15-apartment building at 3350 Riverside Drive, Trenton, Michigan. Architects: Serota and Abrams.



**"We can install a Fenestra\* door  
in only a few minutes,"**

*says Isadore Mulias, Trenton, Michigan, builder*

Mr. Mulias, owner of Trenton Building Specialties, is enthusiastic about the speed with which a carpenter, working alone, can install these Fenestra "package unit" doors. He says, "The reason is that the Fenestra door, frame and hardware are machined for each other at the factory. There's no on-the-job preparation. Everything fits perfectly. That means a big savings in labor and building costs. Once in-

stalled, the job is complete—steel does not warp or shrink. The original installation is faultless."

If you would like to know how much time and money you can save on your next job, call in your Fenestra Representative. He's listed in the Yellow Pages of principal city phone books. Or write or call Detroit Steel Products Co., Dept. AB-10, 2260 E. Grand Blvd., Detroit 11, Michigan. \*B

*Fenestra*

**INTERIOR DOOR · FRAME ·  
HARDWARE UNITS**

Architectural, Residential and Industrial Windows · Metal Building Panels  
Electrifloor\* · Roof Deck · Hollow Metal Swing and Slide Doors

*VisQueen* *VisQueen* *VisQueen* *VisQueen*

# costs so little! saves so much!



No water can reach materials or tools that are protected by VISQUEEN film

You can turn pennies into dollars on the homes you build when you use VISQUEEN film in endless on-the-job applications. Here is the covering that protects your materials and tools from water damage, covers openings, guards half-finished structures from foul weather. Use it again and again to cover semi-finished work, keep water out of concrete, brick, millwork, prefinished flooring. No other material does so much for so little. A few dollars buys complete on-the-job protection. 20-foot widths for your convenience and economy.



VISQUEEN film locks moisture out of studwall, prevents damage to insulation, paint peeling, rot.



VISQUEEN film is the best permanent moisture barrier under concrete slabs or floors.



No weather damage to equipment or power tools when you protect with VISQUEEN film.

**important!** VISQUEEN film is all polyethylene, but not all polyethylene is VISQUEEN. Only VISQUEEN has the benefit of research and resources of The VISKING Corporation.

look for this name on the selvage!

*VisQueen*®

*VisQueen*® film... a product of  
**THE VISKING CORPORATION, Box AB10-1410**  
 Plastics Division, Terre Haute, Indiana  
 World's largest producers of polyethylene sheeting and tubing  
 In Canada: VISKING Limited • Lindsay, Ontario  
 In England: British VISQUEEN Limited • Stevenage

Name \_\_\_\_\_

Title \_\_\_\_\_

For complete details, clip this coupon and attach to your letterhead.

Another big development  
chooses **THRUSH**...



## **CHRISTIAN HILLS ADDITION**

# Heated with **THRUSH** HOT WATER

**BETTER HEAT . . . Thrush Hot Water Heat . . . sells homes.** All of the units in this big Christian Hills addition are heated with forced circulating Thrush Hot Water. Scores of these beautiful homes ranging from \$22,950 to \$39,950 are already built and occupied. Several hundred more are projected or in the course of construction.

### **BETTER HOME HEATING AT LOW COST**

The heating contractor, Ennis Plumbing and Heating Co., Rochester, Michigan, recommended and is installing Thrush Systems in all of these homes. The developers, Harry, Ted and Tom Macksey, owners of Ranch Homes, Inc., chose Thrush equipment because they have found that it definitely helps make the sale when they say, "Thrush Hot Water Heat."

Today's home buyers insist on quality. They know Thrush System will keep their home comfortable regardless of outdoor weather and cost less for fuel.

*See our catalog in Sweet's or write  
Dept. G-10 today for more information on  
Thrush Radiant Hot Water Heat.*

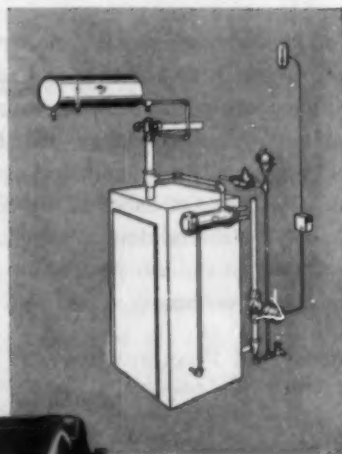

**The Complete  
Thrush System**



**Thrush Water Circulator**

# **H. A. THRUSH & COMPANY**

PERU, INDIANA

Today's Houses Need  
**GLIDE-ALL®** *Sliding Doors*

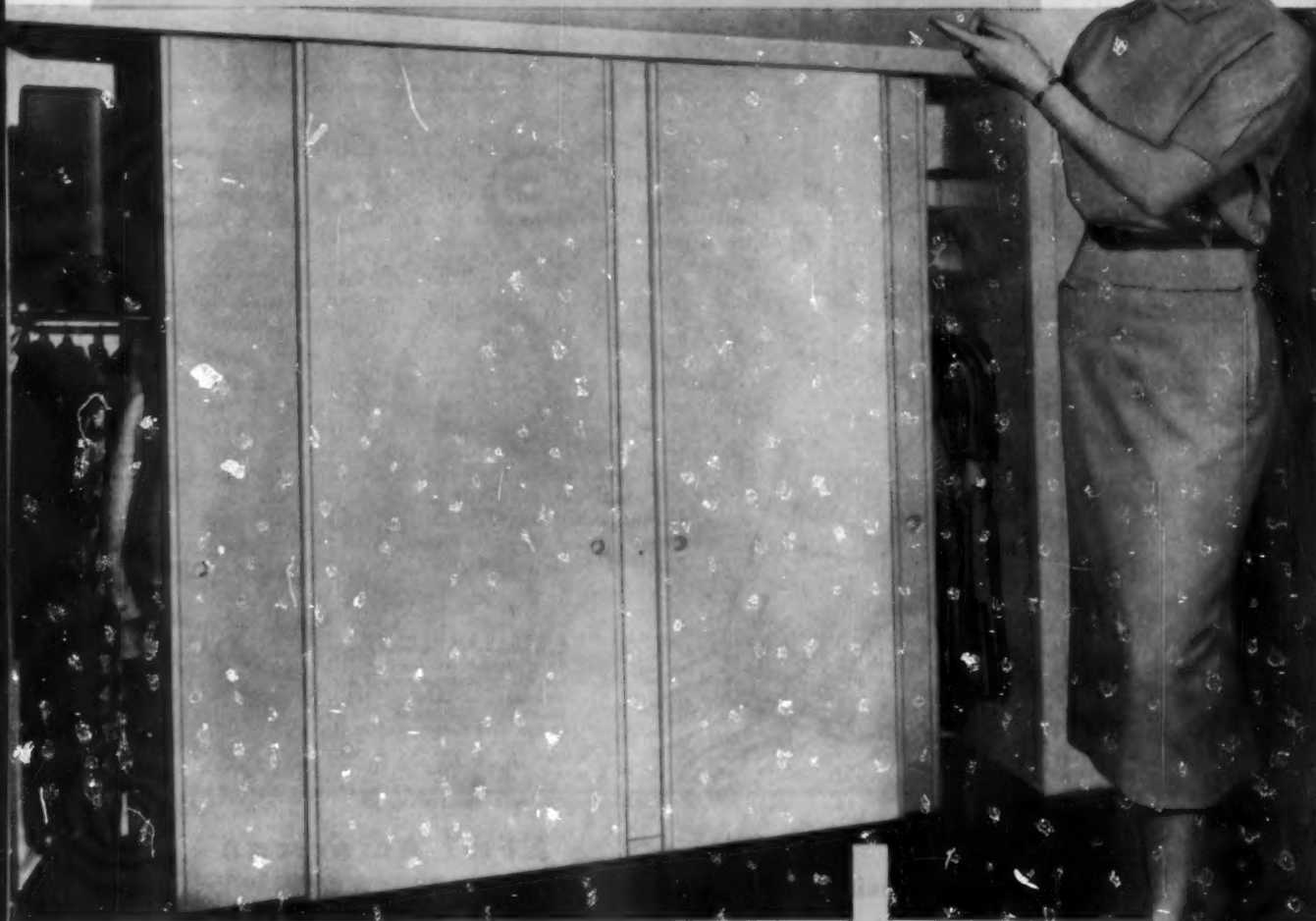

for More Storage Space the Low-Cost Way

Easy-to-use storage space, and plenty of it, is in great demand today. That's why Glide-All Doors are so popular with thousands of architects, builders and home owners. Glide-All Doors allow the simplest construction of wall-to-wall, floor-to-ceiling expansive wardrobes; full height, extra-space hallway closets; handy entranceway guest closets—in many "waste space" areas.

With all their advantages they save construction time and costs, too. Glide-All Doors come ready to install, with built-in adjustment features, in 8' and 6'8" heights, flush or recessed panel types. Send for specifications and other details.



*Glide-All Doors fit anywhere in the house . . . make closets wherever they're needed most.*

GLIDE-ALL DOORS ARE A PRODUCT OF  
**WOODALL INDUSTRIES INC.**

DETROIT 34, MICHIGAN

*Glide-All Doors are available from distributors throughout the United States and Canada. For information write Plant nearest you.*

**CHICAGO**, 3504 Oakton St., Skokie, Illinois  
**CLEVELAND**, Ohio, 1890 Carter Road  
**EL MONTE**, Calif., 801 West Valley Boulevard  
**LAUREL**, Miss., P. O. Box 673  
**NEW YORK**, Glen Cove Rd., Mineola, N. Y.  
**SAN FRANCISCO**, 1970 Carroll Ave.



*If you sand floors for a living  
and would like*

## **NO MORE DOWNTIME**

Here's exactly the sander you are looking for, Mr. Floorman . . . the American Super 8 designed to outperform all others with more plus features, more quality from drum to lever, more long-life dependability, more speed . . . a sander that consistently gives higher production, bigger profits on job after job!

American Machines are made of top-flight raw materials . . . supplied by leading reputable firms . . . fabricated, tooled and machined by our own expert craftsmen so as to produce a product that is *all sander . . . all-ways better!*

You as a user can feel secure in owning a Super 8 with the knowledge that you won't experience costly downtime. Features that spell Super 8 superiority include specially designed 2 H.P. American motor . . . drum driven by vari-speed pulley . . . speed range from 1600 to 2800 r.p.m. for greatest efficiency under varying conditions . . . motor starts under practically "no-load" . . . double capacity dust pick-up system . . . a great machine in every detail by "The Greatest Name in Floor Machines" for more than 50 years.

### **AMERICAN SPINNER**

This teammate of the Super 8 keeps up the fast pace when you do edges, stairs, halls, closets. First with 2 H.P. motor . . . exclusive disc pad construction!



**ADD TO YOUR INCOME!**  
Make repairs quickly, easily  
with all-new professional  
**CONCRETE GRINDER**

This completely portable Concrete Grinding Attachment fits all-purpose 16" American Floor-King . . . really works, anyone can operate! Complete with exclusive Thermoid Disc—you can run machine without shock or vibration, as easy as disc sanding! 6 fast-cutting carborundum stones quickly eat through rough uneven concrete, old or new, or brick surfaces . . . results in a smooth even job.



**THE AMERICAN**<sup>®</sup>  
FLOOR SURFACING MACHINE CO.  
ESTABLISHED 1903

811 SO. ST. CLAIR ST.

TOLEDO 3, OHIO

**NEW! American  
SUPER SPEED  
Abrasive Papers**

**...Astounding Results every time!**

Now it's here . . . the all-new American Super Speed . . . a paper that gives you everything you've ever wanted—and needed! Produced on the newest and most modern making machinery in the industry. One test will prove its superiority. Try some Super Speed today . . . made for floor sanding by floor sanding experts. It costs no more. Send for price list and free sample sheet . . . no charge, no obligation.

**Get Ahead—  
Write us today for  
Machine Demonstration  
... no obligation**

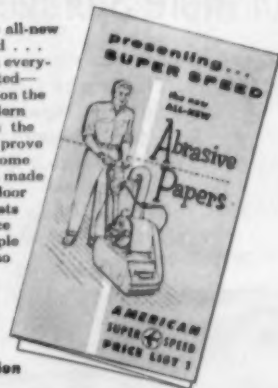



Revolutionary New Photocopy Machine

# Turn a Dial Get a Copy of Anything



Styled by  
Charles E. Jones & Assoc.



the brand new

**APÉCO** *Auto-Stat*  
DIAL-A-MATIC

**Now Get instant photocopies of anything written, printed, typed, drawn or photographed right in your own office.**

Turn the dial . . . get the clearest, fastest most convenient copy of anything. It's the new all electric Apeco Dial-A-Matic Auto-Stat with revolutionary finger tip dial control. It's light weight for easy portability . . . compact to fit on the corner of any desk and is styled in polished and satin finish

stainless steel. It copies any original up to 15" wide, any length or color on opaque or transparent paper—printed on one or both sides. The Apeco Dial-A-Matic Auto-Stat offers hundreds of money and time saving uses at a price well within the budget of even the smallest firm.

The secret to the world's easiest copying method is in the dial. Amazing newly designed automatic copy control assures perfect copies every time. Just set the dial to the type of copies you want—your copies are ready in seconds.

**Delivered with Lifetime Service Guarantee**

**Have You Read This  
NEW BOOK?**



**Mail This  
AIR MAIL  
Postage Paid Card  
for your FREE BOOK**  
*(See other side)*

AMERICAN PHOTOCOPY EQUIPMENT CO. (Dept. AB-105)  
1920 West Peterson Ave.  
Chicago 26, Ill.

Rush me, without obligation, your free book on new Apeco Dial-A-Matic Auto-Stat copying. I understand this factual report will show me how I can increase the efficiency of my business, speed work output.

NAME \_\_\_\_\_  
FIRM \_\_\_\_\_  
ADDRESS \_\_\_\_\_  
CITY \_\_\_\_\_ STATE \_\_\_\_\_

In Canada: Apeco of Canada, Ltd., 134 Park Lawn Rd., Toronto, Ont.



AMERICAN PHOTOCOPY EQUIPMENT CO.  
Chicago 26, Ill.

**This Card Tears Out  
Use it to get Your FREE Book!**



# *New* all-purpose copy maker

the brand new

**APÉCO** *Auto-Stat*  
DIAL-A-MATIC

**Easiest Way Ever  
To Speed Up Routine  
Office Copying!**

**Copy Anything**  
easiest way ever

**New FREE BOOK** tells you how!



Your free copy of this new book is jammed-packed with pictures and details about this revolutionary new copying method. Tells what Apeco Dial-A-Matic Auto-Stat copies are and how you can use these copies in your business. You as well as every executive member of your staff, should read this worthwhile informative,

factual report on this important new copying invention. You will find out how you can save time and money by speeding production, by cutting costly office paper work, by expediting shipping and receiving and hundreds of other ways to increase the efficiency of your business.



Use this Tear-out postage paid air mail card:

**FIRST CLASS**  
Permit No. 26670  
(Sec. 34.9 P.L.&R.)  
Chicago 26, Ill.

Via Air Mail

**BUSINESS REPLY CARD**  
No postage stamp necessary if mailed in the United States

3c—Postage will be paid by—

**AMERICAN PHOTOCOPY EQUIPMENT CO.**  
1920 W. Peterson Ave.  
Chicago 26, Ill.



**MAIL CARD TODAY!**  
**for free book**



## How many foundations can you start next month?

To get contracts, you've got to instill *confidence* in your owners. Here's one way to help build the confidence that sells houses: Use **Cast Iron Soil Pipe** throughout, and *tell owners what you've done*.

Why? Most home buyers today are after their *second* home. They want the *extras* now—extra bedrooms, extra room size, extra *quality*.

And they've had plenty of chances to become convinced that only **Cast Iron Soil Pipe** puts quality in their drainage systems. Through our consistent advertising and publicity work, millions of Americans have seen what happened to nonmetallic waste and sewer lines. Many of these folks have suffered personally through clogged-up sewer lines... even have paid through the nose to replace nonmetallic sewers, and repair other damage caused by their failure.

### So tell your owners you've used cast iron

Sure, one horse doesn't make a horse race, and cast iron alone won't build confidence. But when your agents bring out the cast iron story, along with the rest of the quality features you've built in—the selling job is a lot easier.

### We'll help your agents sell

Your agents *should* mention cast iron, but in case they forget, we'll say it for them. We'll give you free tags to tie on cellar pipes, for husbands to see while they're "checking the furnace." And there's also a free supply of booklets that explain fully and simply why **Cast Iron Soil Pipe** is the finest material known for the vital job of waste disposal. Samples of these sales aids are waiting for you right now. Just mail the coupon — or, for a complete supply, tell us how many.

### CAST IRON'S BEST FOR DEVELOPMENTS, TOO

Cast iron is ideal for mass installations. It needs no elaborate trenching... no special handling... no grading or sifting of backfill... it doesn't even need a separate trench. Lay it right in with your water supply line — in many cities, it's the only material you can do that with.



### CAST IRON SOIL PIPE INSTITUTE

Dept. AB-10, 1627 K St., N. W., Washington 6, D. C.

Send me samples of tag and booklets to show I've used cast iron throughout the plumbing drainage system. Also send "Best in the Long Run," which has photographic proof that Cast Iron Soil Pipe is the best there is.

Name

Address

City  Zone  State

# 10 Advantages

BAKELITE COMPANY, Dept. KF-5.  
A Division of Union Carbide and Carbon Corporation  
30 East 42nd Street, New York 17, N. Y.

Please send me information on variety of sizes of drawers molded of BAKELITE Brand Phenolic Plastics and names of manufacturers who can supply them.

Name \_\_\_\_\_ Title \_\_\_\_\_  
Company \_\_\_\_\_  
Address \_\_\_\_\_  
City \_\_\_\_\_ Zone \_\_\_\_\_ State \_\_\_\_\_

of drawers molded of BAKELITE Brand Phenolic Plastic  
for storage walls and built-in furniture

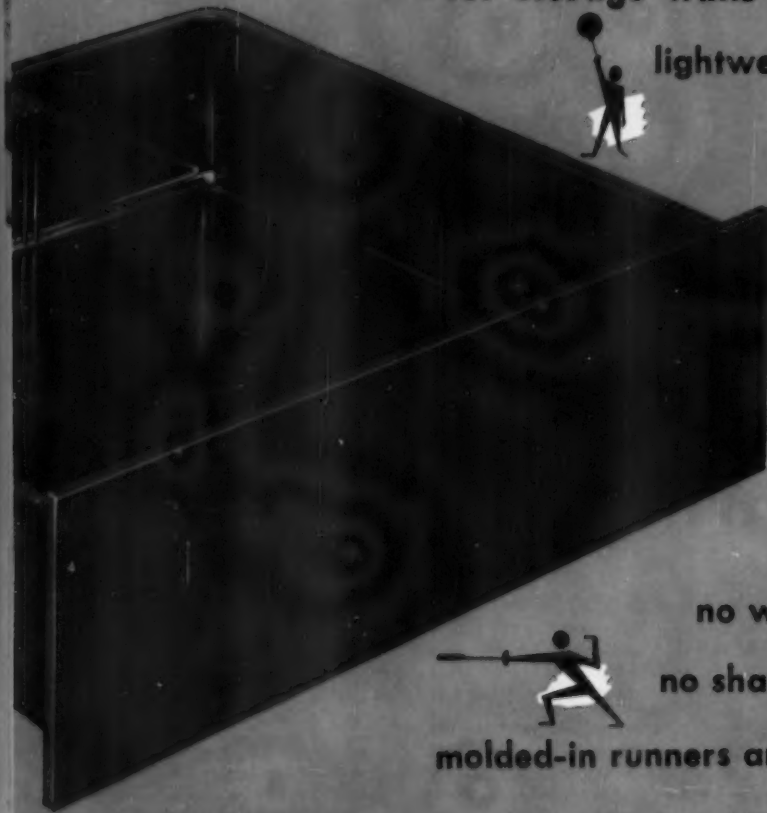

lightweight



sturdy



rounded inside corners

smooth lustrous finish



do not stain

divider channels molded in



resist moisture and heat

no warping with weather changes

no sharp edges



molded-in runners and center guide flange

The molded phenolic plastic drawer adds greater sales appeal to your homes, by offering your prospects more for their money. Greater convenience, too, at actual savings in cost over quality drawers of conventional construction.

A wide variety of sizes is available for module bookcases, chest and storage units, room dividers, and other home features that help close sales. Satin black is the standard finish, with other decorative effects available on special order.

Send the coupon today for names of manufacturers, or write Dept. KF-5.

BAKELITE COMPANY, A Division of Union Carbide and Carbon Corporation  30 East 42nd Street, New York 17, N. Y.

The term BAKELITE and the Trefoil Symbol are registered trade-marks of UCC



**"We keep our Berger Convertible  
busy on all kinds of construction  
...from the ground up!"**

... says A. Lowe Co.,  
Building Contractors, Newark, N. J.



"One day you'll see it at work laying out a new factory site, marking batter boards, checking elevations for excavating and grading. Or it's measuring elevation of concrete piers for the steel columns of an office building, setting lintels, aligning and plumbing structural steel. On another job, we'll have it picking up elevations for finished floors, measuring hung ceiling heights, setting door bucks, and checking all other stages of construction."

That's because the Berger is built for builders—designed to be consistently accurate, simple to set up for quick readings, easy to level up. The image you see through the 12", 24 power telescope with its coated optics is *right side up*. Rigid and sturdy—of brass and bronze construction—it takes the bumps in the field and stays on the job without time lost for repair.

**Before buying a Convertible... Compare!**

This table compares the Berger Convertible with the other two leading instruments—shows why so many more builders buy BERGER.

	Berger Convertible	Convertible No. 1*	Convertible No. 2**
TELESCOPE	24-26 power 34 mm. clear aperture bronze vial sensitivity 60 sec.	less 30 mm. clear aperture fabricated vial sensitivity 90 sec.	less 33 mm. clear aperture zinc die cast vial sensitivity 120 sec.
OPTICS	Coated	Coated	Coated
FOOT PLATE	Brass Trivet integral	Aluminum Trivet integral	Brass Trivet points separate
HORIZONTAL CIRCLE	Forged Brass	Aluminum	Brass
YOKE FRAME	Bronze	Aluminum	Zinc
TANGENT PIECE	Brass	Aluminum	Integral with clamp
TELESCOPE CLAMP	Brass	Aluminum	Zinc
PLATE LEVEL	Yes	No	No
CASE	Mahogany transit case	Level type box	Level type box
STRAP	Padded leather handle	Plain leather <i>*Retails higher than Berger</i>	Plain leather <i>**Retails lower than Berger</i>

**Quick delivery—thanks to enlarged capacity**

**Price \$219, complete with mahogany transit case,  
tripod, plumb bob, sun shade and instruction manual.**

Write for literature on this and 12" Dumpty Level, Service Transit-Level. And ask about our Engineers' Transits and Levels.

C. L. Berger & Sons, Inc., 47 Williams St., Boston 19, Mass.

THE BEST IN  IS  
**BERGER**  
ENGINEERING AND SURVEYING INSTRUMENTS... SINCE 1871

OCTOBER 1955

**T  
A  
P**

Now for as little as \$15.00 more per house...

New Honeywell decorator  
TAP-LITE switch  
adds sales **EXCITEMENT**  
to your houses



**TAP...**  
*light's on!*

**TAP...**  
*light's off!*

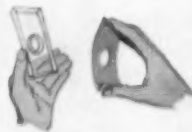

Approved by Underwriters' Laboratories, Inc.

**L  
I  
T  
E**

**Color styling—matches any decor**

An exciting new development in light switches for your homes—that's the new Honeywell Tap-Lite! It's a smart looking switch that will attract prospect's eyes in every room.

Pastel inserts—four colors come with each switch—or any wallpaper or fabric may be inserted behind the cover.

Installation is easy—simple snap-in wiring does the trick! It uses regular line voltage, and you don't have to fuss with unsightly wall plate screws.

For complete information and prices, call your local Honeywell office, or write Honeywell, Dept. AB-10-81, Minneapolis 8, Minn.

MINNEAPOLIS  
**Honeywell**

**TAP-LITE** Light  
Switches



112 offices across the nation



**Little or no remodeling necessary.** The new G-E Wall Refrigerator-Freezer can be installed with little or no remodeling in most homes. The cabinet is mounted securely to a sturdy, 5-foot "picture-hook" mounting bracket which is screwed to the wall. It can be moved and rehung in another location, if and when desired.

## Magnificent, new G-E Wall Refrigerator-Freezer

### HANGS ON THE WALL LIKE A PICTURE

**Now**, you can offer something unique in refrigerator design. This magnificent refrigerator-freezer that hangs from the wall provides a completely new and advanced concept of modern living. Truly, it is the most convenient and magnificent refrigerator-freezer ever produced!

The advantages of this utterly new G-E Wall Refrigerator-Freezer are obvious: there's no need to bend or stoop for foods because everything can be seen at a glance. The new G-E Wall Refrigerator is luxuriously convenient in other ways, too. It can be installed directly above a work counter to provide *extra* counter surface. And, there's room in the kitchen for *extra* base cabinets because this compact new appliance occupies no floor space.

All three doors are equipped with famous alnico magnets that grip the doors shut . . . no projecting handles.

The new G-E Wall Refrigerator-Freezer is available in a choice of six Mix-or-Match colors including white.

Only a limited number of G-E Wall Refrigerator-Freezers are now being produced. Call your G-E distributor, or send the coupon below. General Electric Co., Appliance Park, Louisville 1, Ky.



This de luxe refrigerator-freezer has 10.7 cubic feet of storage room—8.7 cubic feet for fresh foods and 2 cubic feet for frozen foods. It is 5 feet 4 inches long, 3 feet 3½ inches high and 17½ inches deep. **1.** Long-lasting baked enamel with a wide band of textured aluminum. **2.** All 3 doors are kept shut by famous alnico magnets. No handles, no catches. **3.** Separate vegetable and fruit compartments have transparent sliding doors. **4.** Top shelf provides space for tall bottles. Shelves are adjustable to various levels. **5.** Separate compartments inside door for butter, egg rack; and door shelves for small jars and cans. **6.** Zero-degree food freezer has room for up to 83 packages of frozen foods. **7.** Four new-style Mini-Cube® ice trays. **8.** Frozen fruit juice storage rack. **9.** Dependable whisper-quiet sealed-in G-E refrigeration unit is built into the refrigerator. No need to install it separately.



**A Mix-or-Match color choice**

This magnificent appliance is available in any one of six exciting decorator colors. You have a choice of: Canary Yellow, Turquoise Green, Petal Pink, Cadet Blue, Woodtone Brown and White. G-E Textolite® counter tops are available in Mix-or-Match colors.

*Progress Is Our Most Important Product*

**GENERAL  ELECTRIC**



**FREE, COLORFUL  
8-PAGE BOOKLET**

Send to P. O. Box 458,  
New York 46, N. Y.

Please send me your booklet containing detailed information and complete specifications about the magnificent new G-E Wall Refrigerator-Freezer.

Send for it now!

Name \_\_\_\_\_ Title \_\_\_\_\_

Company Name \_\_\_\_\_

Street \_\_\_\_\_

City \_\_\_\_\_ State \_\_\_\_\_

**"No 'call backs' on  
Ceco Steel Windows  
in 2 years..."**

**KIMBALL HILL—Builder**  
Rolling Meadows Development



Architect: A. J. Del Bianco, Chicago, Ill.  
Carpenter Contractor: Joseph T. Carp, Inc., Chicago, Ill.



One of three basic sizes of Ceco Fixed Windows with Hopper Ventilator used in Rolling Meadows homes. Two or three windows are joined with slender mullions to achieve a picture window effect with adequate ventilation.

■ Quite often the difference between profit and loss in a home building project can be "call backs." So builders everywhere give a critical eye to the materials going into the homes they build. Take the case of Rolling Meadows in suburban Arlington Heights, Ill. When Kimball Hill & Associates planned the project, an exhaustive study was made of all materials. After many comparisons, Ceco Windows were chosen. The window treatment was accomplished by using Ceco Fixed Windows with Hopper Ventilator. This achieved a picture window effect with adequate ventilation. Here's why there were no "call backs" on Ceco Windows: Simplicity of design and hardware combined with Ceco engineering to assure a fool-proof window. But let Kimball Hill, project builder, tell the story:

"In two years, with over 1,500 homes erected, there have been no complaints or call backs."

So when you build . . . protect yourself against costly "call backs." Use Ceco Steel Windows—field tested to assure dependable performance.

**CECO STEEL PRODUCTS CORPORATION**

Offices, warehouses and fabricating plants in principal cities  
General Offices: 5601 West 26th Street, Chicago 50, Illinois



In construction products **CECO ENGINEERING** makes the big difference

**AMERICAN BUILDER**



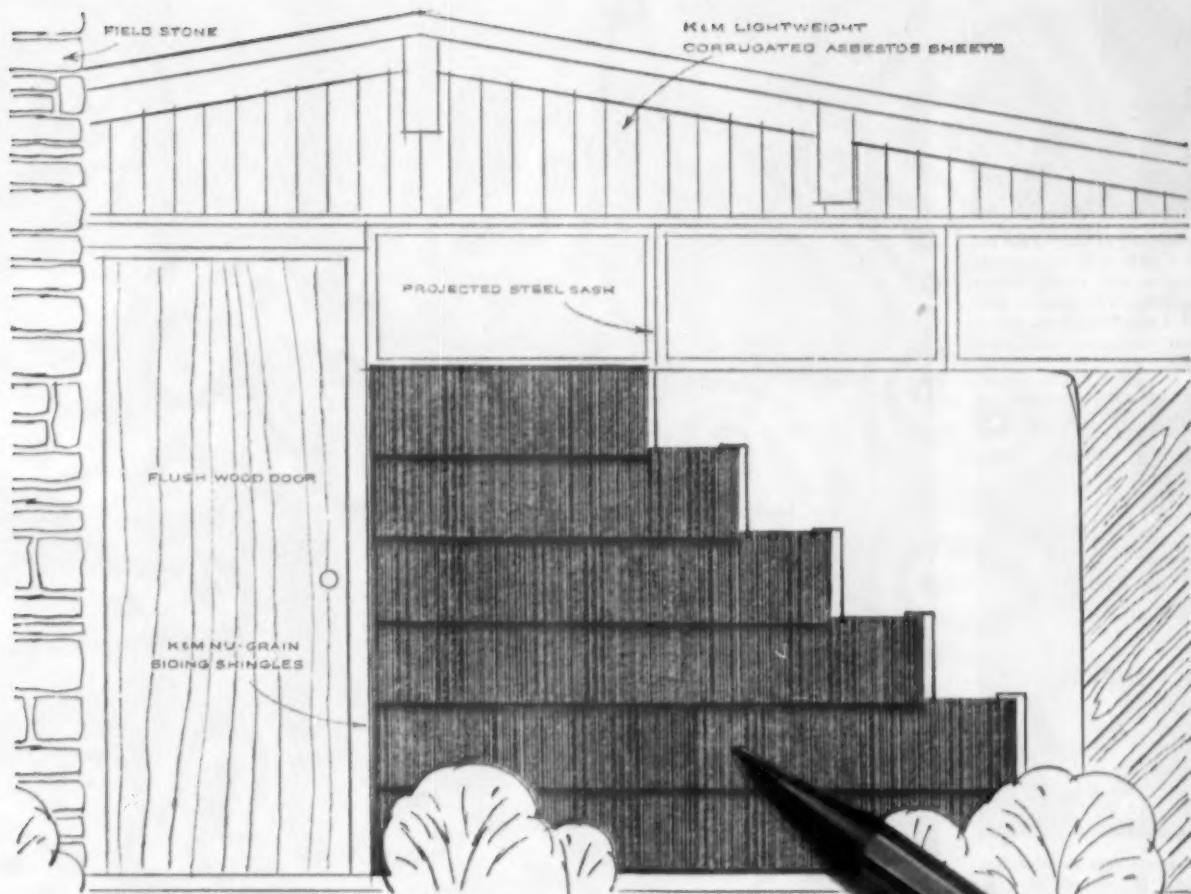

The shingles illustrated here are Nu-Grain Green. The other five available colors are: Brown, Red, Whitetone, Gray, and Canyon Coral.

## 6 exciting colors add "buy appeal" —in K&M Nu-Grain Siding Shingles

**Color's** the key to easier, faster sales. And a home with colorful Nu-Grain Siding Shingles puts prospects in a buying frame of mind in a hurry. For extra appeal, some builders are using the Nu-Grain colors in combination; for example, one for the patio wall, another for the carport, still another for the front.

**Attractive appearance.** The wood shake pattern in the Nu-Grain Shingles makes them especially desirable to a prospective homeowner. And the clear, pronounced shadow lines of the shingles, when laid, help make satisfied homeowners.

**Low upkeep.** Maintenance costs are cut to a minimum, as K&M Nu-Grain Shingles never require protective painting. Made of asbestos fiber and portland cement, they won't burn, rot, or corrode. In fact, they become harder with age.

You will find details on K&M Nu-Grain Shingles in Sweet's Light Construction Files and Sweet's Architectural Files. For more information, contact your K&M distributor. Or write directly to us for a FREE FOLDER on these colorful shingles. Literature also available on K&M roofing shingles.

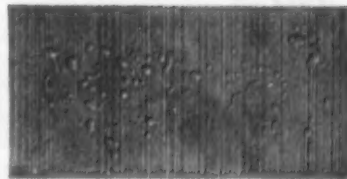

### SILICONE TREATED so water runs off!

Water-borne dirt, which ordinarily causes streaks under window sills and other trim doesn't readily gain a foothold on K&M Nu-Grain Siding Shingles. Water "balls up" instantly, and runs right off the shingles.

**KEASBEY & MATTISON**  
COMPANY • AMBLER • PENNSYLVANIA





Plankweld's so easy to put up! 16 1/4" wide by 8' high panels fasten to wall, studs, or furring strips with special concealed metal clips. No worry about joints—no nail holes to fill.



You choose from world's finest woods. (1) walnut at \$74, (2) Korina® at \$74, (3) birch at \$60, (4) Philippine mahogany at \$60, (5) oak at \$69, (6) Honduras mahogany at \$69, and (7) knotty pine at \$60. Prices are approximate (retail) for a wall surface 12' x 8'.

**FOR HOMES  
IN ANY  
PRICE RANGE**



Give a living room new life and new sparkle with Plankweld. Famous designer Russel Wright used panels horizontally to make fireplace more im-

pressive and to make room look wider. Beautiful Philippine Mahogany Plankweld shown in this living room covers a 12' x 8' wall for only

**\$60** (RETAIL PRICE)

## Plankweld is the easiest way to beautiful real wood paneling

New designer-styled rooms featured in Weldwood's advertising show how a handsome wall of wood sparks a model home with new beauty

**New way to wood-panel** a fireplace wall—horizontal panels of Plankweld! Famous designer Russel Wright designed this treatment for Weldwood. Use this idea in a model home and see how it helps you close sales.

**More than 60% of the buyers** in a large West Coast development said wood paneling had helped them decide to buy. It's easy to offer!

**Easy-to-put-up** Plankweld panels are 16 1/4" wide by 8' high. They fit perfectly on 16-inch centered studs, are held in place by special metal

clips that eliminate face nailing.

**Easy on the account book!** Plankweld comes to the site completely pre-finished by skilled factory craftsmen—it's even waxed. Just put the panels up! You can panel a straight 12' x 8' wall with Plankweld in 30 minutes... with unskilled labor.

**Your customers know Weldwood**—it's the best known name in plywood!

**For free contractor's catalog** send coupon. See our complete line at your lumber dealer's or our showroom—87 offices in principal cities.

UNITED STATES PLYWOOD CORPORATION  
55 West 44th Street, New York 36, New York



I'd like to know more about beautiful Plankweld and other Weldwood hardwoods. Please send Weldwood contractor's catalog . Also please have Weldwood representative call me .

AB-10-5

NAME.....

ADDRESS.....

CITY.....STATE.....

**Weldwood® Plankweld** THE BEST KNOWN NAME IN PLYWOOD Reg. and Patented



## A PLYWOOD WORKBOOK continued

### 1—space dividers

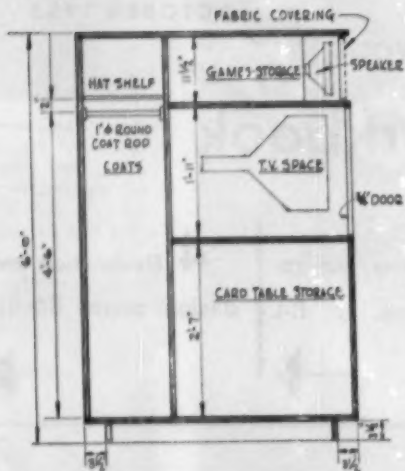

ARCHITECTS John Campbell and Worley Wong of San Francisco designed this unit.

Wall volume storage (below), conceived by Chris Choate, thickens partition space enclosure slightly, gaining volume within the wall for storage of various kinds. The idea is interpreted here as a space divider and incorporates small storage units with doors (or let-down leaves) and shelves. Texture One-Eleven grooved plywood is used to support shelves that can slide in and out to give spaces of varying heights. Choate applies this same idea to an outside wall, alternating areas of glass, flat wall surfaces faced with Texture One-Eleven, and small storage units between columns 4-ft. o.c.

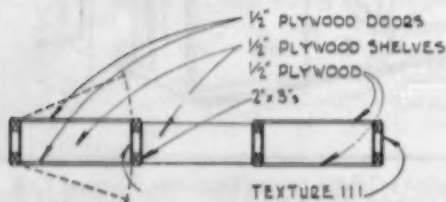
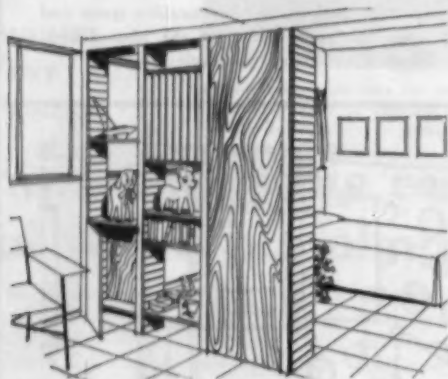

## Plywood's new

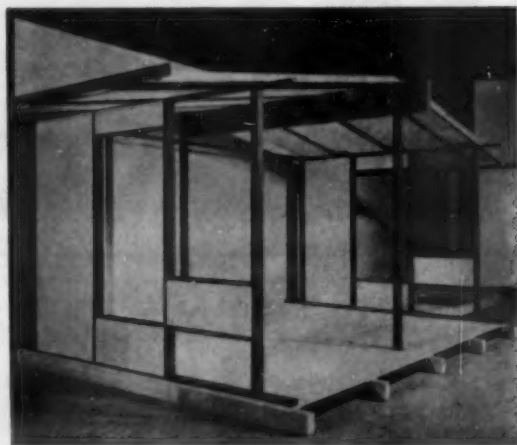

### STRUCTURAL WALL AND ROOF SYSTEM HAS 2-LEVEL LINEAR PATTERN

THIS SYSTEM departs from standard practice but suggests new possibilities in economy and design. It was devised by Chris Choate with vacation houses in mind. Wall structure consists of posts on 3-ft. centers with random rectangles of plywood rabbeted into the posts. These are alternated with glass rectangles in random size. Simple aluminum extrusions take the place of horizontal members. The 2-level roof system is shown opposite.

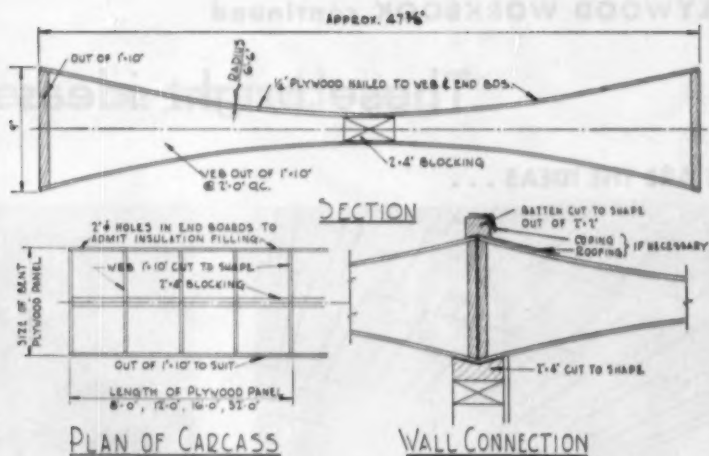

**BARREL VAULT ROOF PANELS WITH CONCAVE SURFACES COMBINE STRUCTURE AND ORNAMENTATION**

## construction ideas

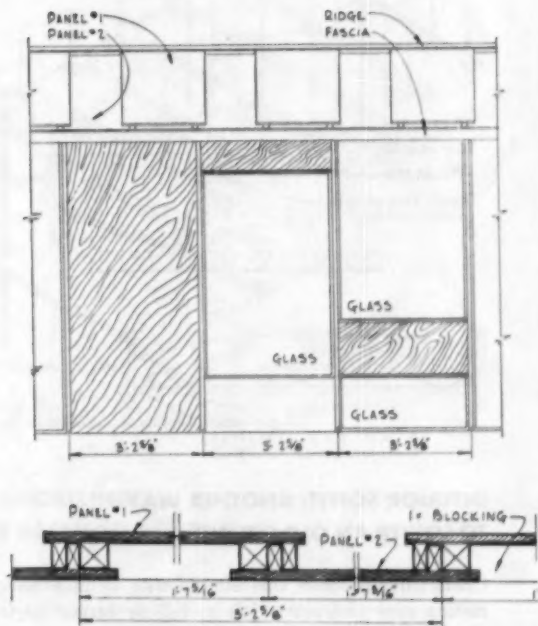

**ROOF PANELS** are sheets of  $\frac{1}{2}$ -in. plywood, two feet wide, spaced one up and one down in a parallel pattern spaced by stringers of 1x2's or 2x4's. With the former, the panels can span 8 feet; with 2x4's, 16 feet. Blocking closes off openings where panels overhang the walls.

The panels for the novel roof (above) consist of thin sheets of plywood nailed and glued to end and middle framing members curved inward at top and bottom to form a hollow stressed skin construction. When extended beyond the wall, the panels have a gently scalloped effect. The curve in the surface is said to offer greater rigidity. These panels can span at least 16 feet without interior supports.

Supporting fins shown here are 2 inches thick, have two  $\frac{1}{4}$ -in. sheets of plywood, 18 inches wide, nailed and/or glued to light framing members. This new development is the work of Anshen and Allen, San Francisco architects.

### SLIDING PLYWOOD CURTAINS CONTROL GLASS WALL AREAS

**THIS DESIGN** by architects Campbell and Wong integrates drapes, wall paneling and wall storage by repeating basic elements. The plywood panels for fixed wall areas, "curtains" and storage unit doors are all ceiling high, on a 16-in. module. Door and curtain panels are  $\frac{1}{4}$ -in. plywood nailed and glued to one-inch framing members.

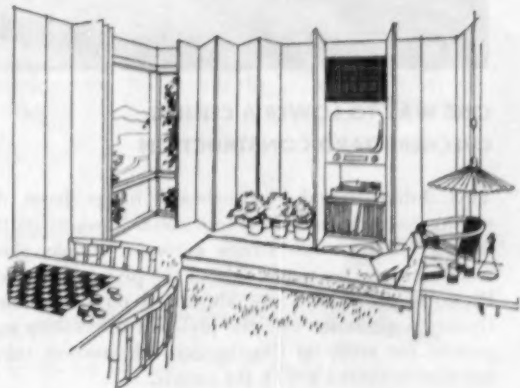

## These bright ideas will help solve

### HERE ARE THE IDEAS . . .

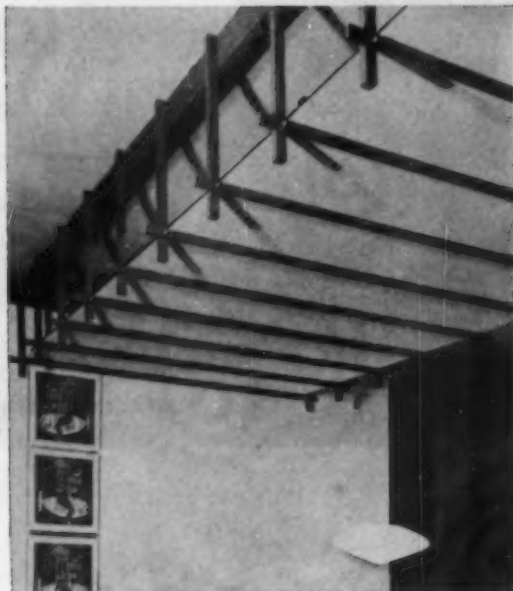
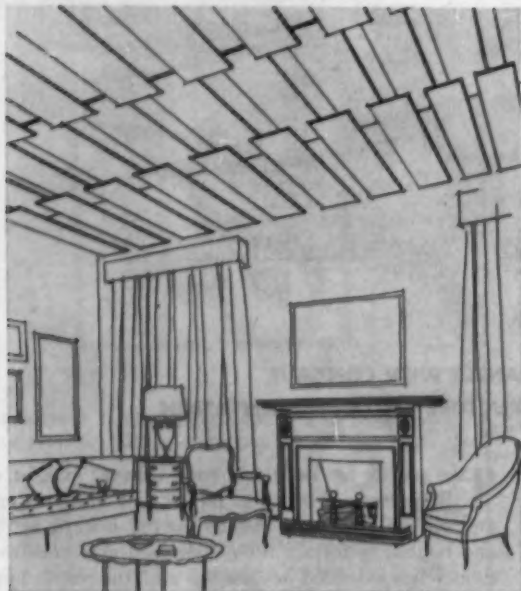

### HERE'S HOW THEY'RE DONE . . .

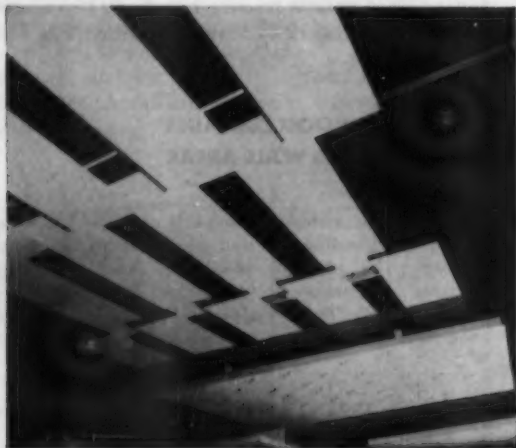

#### ONE WAY TO LOWER A CEILING: CHECKERBOARD CONSTRUCTION

This 3-dimensional checkerboard hangs from the ceiling on rods that screw into metal brackets on the ceiling surface, into straps across a simple glued wooden frame on upper side of the plywood surface. Plywood panels 2x8 are alternated on two planes. Openings alternate with the plywood to create a soft pattern for artificial illumination. Fluorescent tubes are then mounted above the panels.

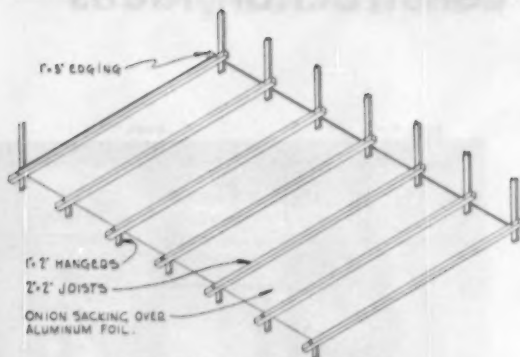

•ISOMETRIC OF SOFFIT•

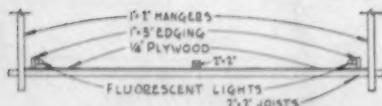

•SIDE ELEVATION•

#### INTERIOR SOFFIT: ANOTHER WAY TO LOWER AN OLD CEILING

Chris Choate offers this simple way to give an old ceiling new character. It's a 4x8 or larger surface of plywood simply hung from the original ceiling as an interior soffit. Supports are bare 1-in. square linear framing members joined at the edges of the plywood so that the ends overlap. This creates a simple ornamental effect and avoids fussy carpentry. Lights above surface give indirect illumination.

# common problems in remodeling

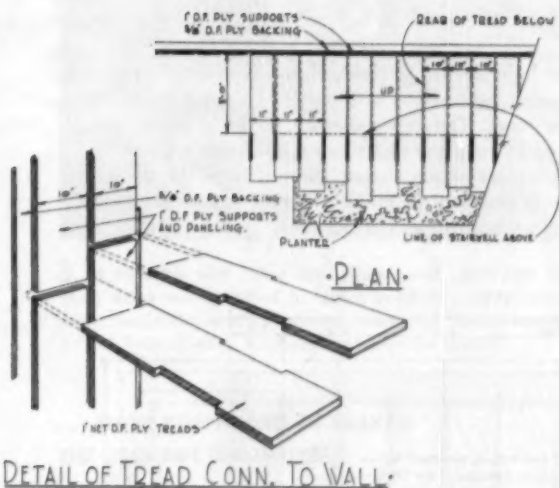
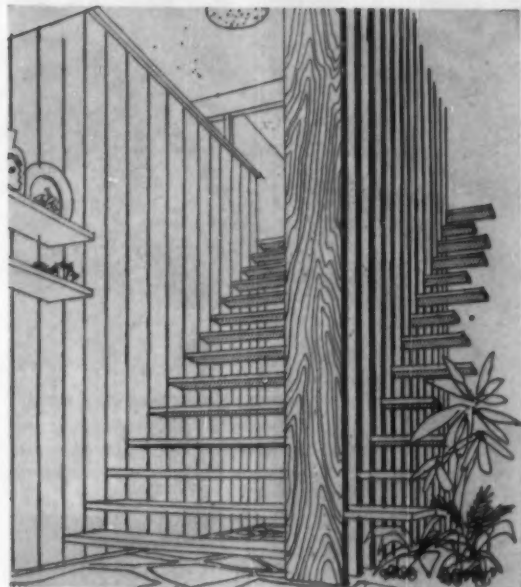

## FACE LIFTING FOR AN OLD FIREPLACE

After the old mantel is removed, a fireplace can be given a modern look by the simple device of enclosing it in a ceiling-high plywood screen bowed slightly outward. The old brick of the fireplace face would be plastered over. The design shown here, by architects Campbell and Wong, projects the plywood screen beyond the sides of the fireplace. This extension can be boxed in, simply faced with plywood or used as storage space with bookshelves or cupboards. Simplicity of the curved screen is its key to success.

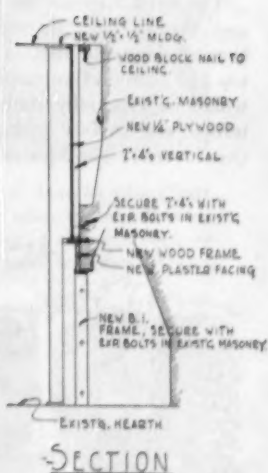

## GLAMORIZING THE BASEMENT STAIRS

Basement (and attic) stairs are always a problem. Architects Jones and Emmons of Los Angeles propose this answer: a completely open structure with treads of varying lengths supported on the outside ends by vertical fins or louvers that would carry out the feeling of a paneling scheme done in similar widths. The varying tread lengths, combined with the open supports make stairs an architectural feature.



# Adding simple custom touches

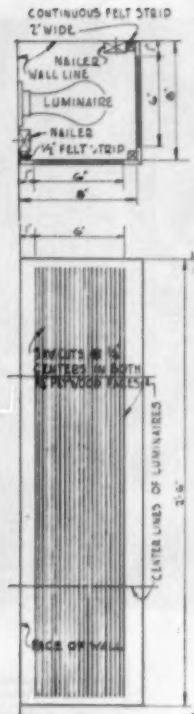
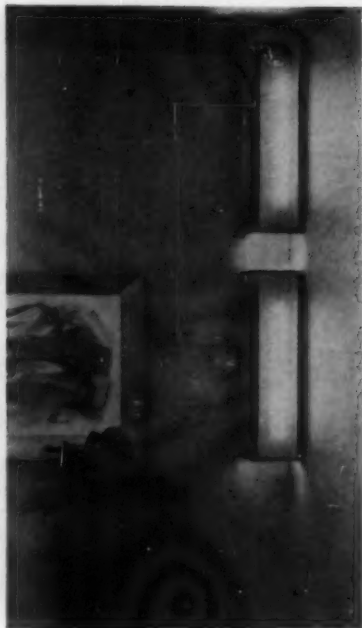
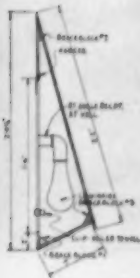

## EASY-TO-BUILD LIGHT FIXTURES

The fixture shown on the left is built of plywood and throws light through its irregular triangular-shaped sides and from a pattern of holes drilled in top and bottom. Contemporary in feeling, this fixture would be especially striking when used with a patterned wall surface with grooved plywood (Texture One-Eleven). The idea is by Campbell and Wong.

The light fixture at right, above, is created simply by boxing in the light with plywood against a corner of the room. The exposed sides of the plywood are marked by long parallel slits or saw kerfs backed by obscure glass or parchment. Simplicity of the fixture makes it practical in many different situations. This also is a Campbell and Wong idea.

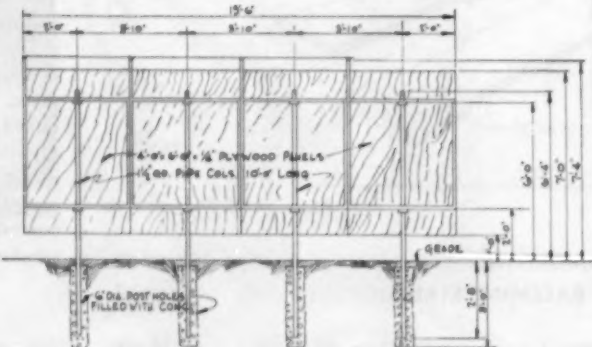
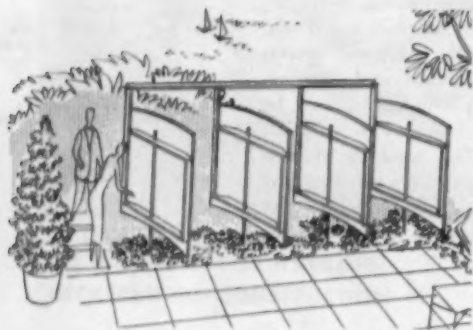

## LOUVERED WIND SCREEN

**THIS WINDBREAK** for a modern patio uses curved surfaces of 1/4-in. plywood in a screen series that can be adjusted to provide for larger or smaller openings, depending on the wind's strength and direction. The plywood panels are

pivoted on upright pipe supports and connected, so that by moving one panel the whole series can be opened or closed. The structure was designed by the firm of Jones and Emmons, Los Angeles.



# adds sales zest to your houses



**1 AFTER SKETCHING** Moke design on paper, trace all construction lines on fir plywood. Try to allow at least 10 inches for all cuts which will be woven. If shorter, cuts cause panel to distort, frame edges.



**2 START ACTUAL** construction with holes drilled to provide starting point for saw cut. Holes can be made  $\frac{1}{4}$ -in. to  $\frac{3}{8}$ -in. or larger, depending on the effect desired. Saw cut can be started in one hole and ended in another.



**3 IN CUTTING** with saber saw, place panel good side up when using saw installed in table; good side down when using hand-held saw. To prevent chattering, insert saw in drilled hole at start. Keyhole saws may be used.

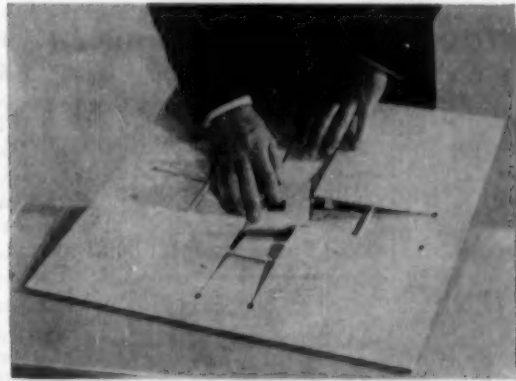

**4 AFTER CUTS** are made, weaving is done by lifting part of design and inserting dowel or other spacer. Weaving must be done carefully, one section at a time. Fabric or plastic background may be used. Finish according to taste.

## ... HAVE YOU HEARD OF MOKÉ? THE USES ARE UNLIMITED

The term Moké is based on *mok*, a seldom-used word meaning "to weave." Invented by architect Whitney R. Smith of Pasadena, California, Moké is the process of cutting patterns in the surface of fir plywood panels in such a way that dowels, pegs, circles, squares or other inserts form a third dimensional relief effect. Colorful finishes for panels, and lighting behind them, produce decorative features of great beauty. A whole ceiling, for example, could be finished with Moké panels repeating a motif, with lighting installed above the panels. In first experimenting with the new technique, stick to designs which do not call for intricate cutting. Practice on light cardboard.

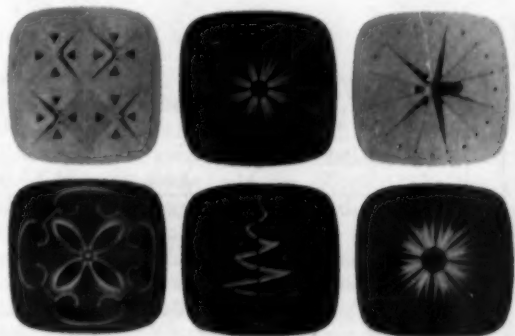

**5 HERE ARE** some of the patterns that can be created with Moke. "Noel," for example, center of lower row, shows a tree effect created by sawing a series of down sweeping curves, with slim dowel "trunk" used as spacer.

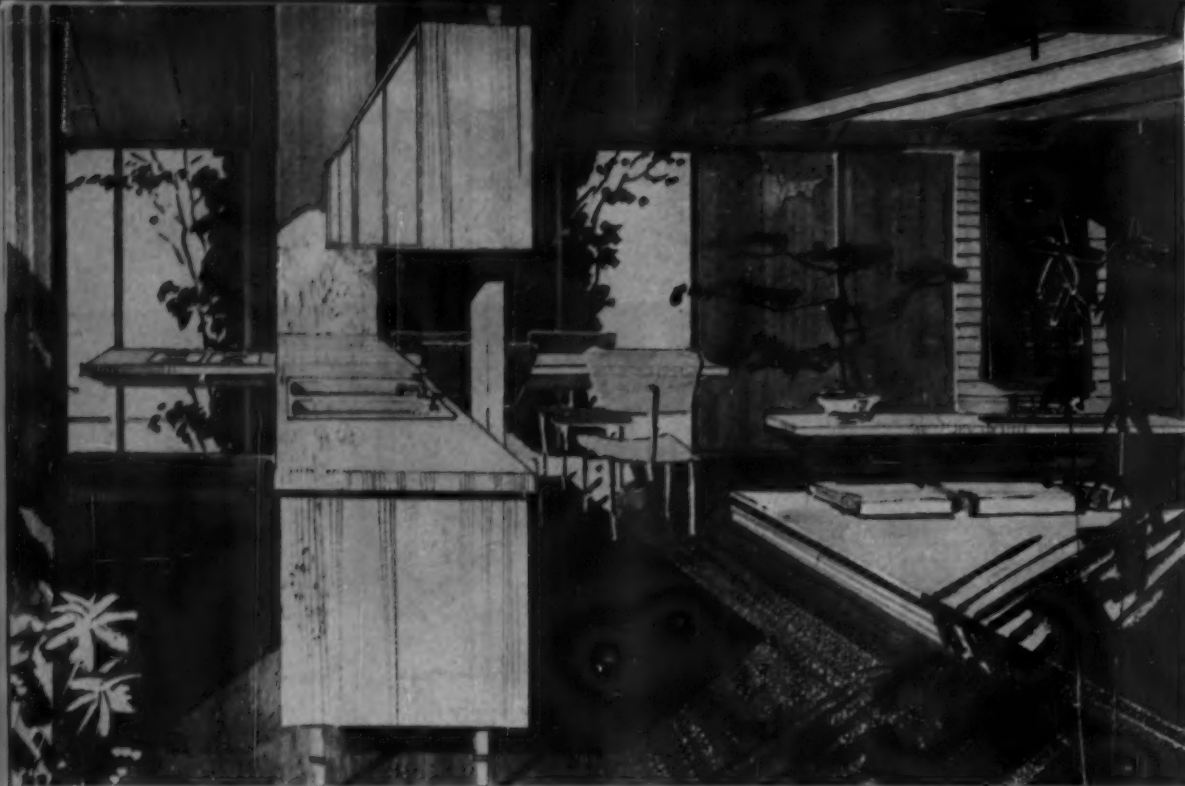

## A PLYWOOD WORKBOOK continued

## ISLAND KITCHEN-DINING CENTER SAVES SPACE IN SMALL HOMES

This free-standing structure combines food storage and preparation in one center. An idea of architect Chris Choate, the unit consists of a sink counter with an overhead cabinet hung above and with glass between. The counter is pierced at one end and at right angles by a floating slab which holds a built-in range on the counter side and which serves as a dining table on the other.

The counter top slab-table is formed by edge grain strips of fir plywood, 2-in. wide, making a slab of that thickness. It is given additional rigidity by two 6-in. deep runners projecting below the surface of the table. These are formed by 6-in. wide strips of plywood laminated into the 2-in. strips.

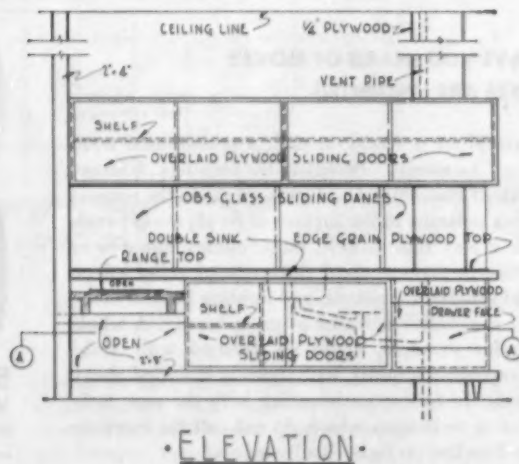
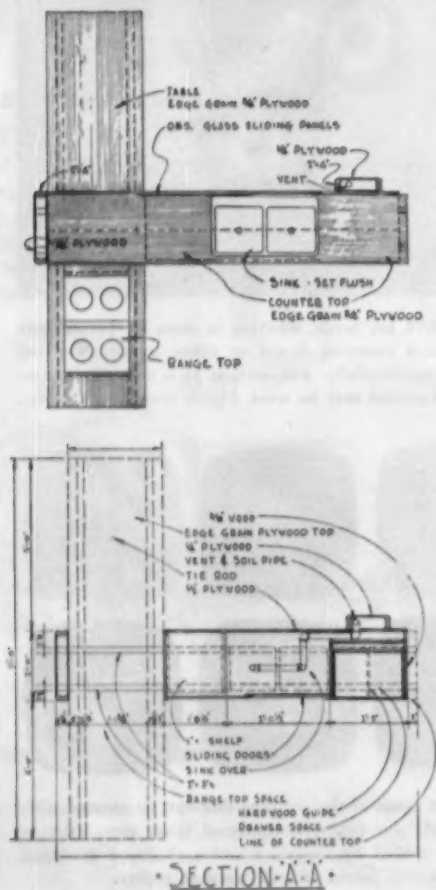

# Should builders take the rap for . . . The LAND CRISIS?

- ▶ for kids with spacious new houses and crowded old schools. Or maybe no schools at all?
- ▶ for towns of tomorrow that you reach with yesterday's roads?
- ▶ for "garden communities" whose lawns and gardens never have enough water?
- ▶ for shiny bathrooms and kitchens whose plumbing empties into old sewers, polluted streams and rivers, overflowing septic tanks?
- ▶ for two-car families that can't find space downtown to park a bicycle?
- ▶ for bigger small towns with not even small-town parks and recreation facilities?
- ▶ for American communities that won't share their diminishing land resources with all Americans, regardless of creed, color, or economic status?

## Here's the sorry picture . . .

The headaches that builders have been having in their own backyards have become a national brain-buster.

Headaches cover land costs, bad sites, tough-to-get permits, donations to school boards, touchy sessions with civic groups—name your headache!—have all turned out to be symptoms of one problem: land shortage.

And the worst of it is this: You have to stay where you are and cure the big problem in your community all at once. You can't run away from it; the symptoms are everywhere. And you can't cure the symptoms one by one.

But before you think about a cure, think about the definition of the big problem. We call it a "land

shortage." Actually, there's no shortage of land in America. What's short is land fit to live on, land with adequate facilities.

Earl W. Smith, president of the National Association of Home Builders, told our editors: "The big problem is to find some way to develop revenue to keep community facilities on an even keel with new housing. Most small residential communities, the kind everybody wants to move to, do not have the right balance between industry and private dwellings to develop that revenue. Still, the money has to come from somewhere!"

Right now, community officials seem to think that local builders are the guys to get it from.

**HERE'S THE LOCAL PICTURE ▶**

the question of community facilities is not only the big problem facing builders. It is a community problem that...

Smith builds modern... the economy produced by the same...

will have to study and plan... it is to be worth...

alone do towers...

Unless private enterprise...

Population Growth Citing the tremendous growth the NAHB president... the nation's pe...

# Builder Criticizes Cost Of Facilities Movement to Suburban Areas Reported Creating Big Problem

## Builders Face Serious Land, Cost Problems

NAHB Leader Warns Of Danger To Low Income Areas

Earl W. Smith, NAHB president, says that unless private enterprise... flat-top inexpensive modern designed home and the fourth largest home-builder in the United States...

### THE LAND CRISIS continued

#### ► Here's the local problem:

When you drive out of Chicago and through Evanston, you see bright new housing developments. Just before you reach Glenview, where some of the biggest are, you see a bold sign. It says: "Ask the builders where your kids will go to school!"

And when you drive out of Los Angeles and are 30 miles away on the freeway, a builder wonders: "I don't know what we're going to do for oranges, chicken and milk if this keeps up." He's pointing at more bright new communities. The communities themselves are wondering: "What are we going to do about the roads off the freeways, about the water pressure, about the problem of swift sewage disposal?"

You can drive, in fact, from Los Angeles to Glenview and straight east or south and run into some facet of the same problem almost everywhere. Communities that welcomed builders after the war are

now beginning to tell builders to get lost . . . or pay up for community facilities.

It's no wonder that a lot of builders, even some of the big ones, are worried about their future. Soaring population, the thing that once made building profitable, is now beginning to make building treacherous.

For even without the financial burden of being asked to share in the cost of new community facilities, which must keep up with soaring population and new houses, the land crisis is costing builders money; the cost of land has doubled since 1946 and has increased by nearly one-fifth in the last year. NAHB president Earl W. Smith gives himself as an example: his 1949 house cost \$8,100 while his 1955 house cost \$10,500. They're both of similar design and construction. But the 1949 lot was valued at \$900 and the 1955 lot is \$2,400.

#### ► Here's what may happen, unless . . . .

It's not hard to make builders the national scapegoat for America's lagging community facilities. All it takes is a little loud-mouthing on a national scale: "You built the houses. Now do something about the towns you built along with them."

That kind of talk breathes life into cold, national statistics. It's estimated that it will cost \$205 billion during the next ten years to keep community facilities abreast of population growth and housing. And if we spend each year at the 1954 rate, we'll spend only \$86 billion. In short, we are spending today less than half of what is necessary to keep our newly housed population in schools, roads, sewers, water, hospitals, parks. It's not hard to see that a national outrage may be just a stone's throw away.

Even now, local problems are zooming into the national spotlight. Take the case of Joseph E. Merrion of Chicago, a prominent builder. The Cook county

board has compelled him to promise to donate sites for public schools. Editorialized the powerful, widely read *Chicago Tribune*: "New towns face the problem of providing right now what the older suburbs have spent 50 years accumulating . . . It can't be done. The obvious solution is to add the cost of at least the minimum facilities—schools, streets, utilities—to the purchase price of the new homes. The law doesn't permit it now, but the law will have to be changed."

Predicts Earl W. Smith, president of NAHB: unless controversy is replaced with cooperation, the problem of community facilities will loom so large as to attract "political opportunists (who) will step in with grandiose schemes, the net effect of which will be that the community will have no voice in the type of housing built there, or the sites on which it is built." And you can be sure of this: builders won't have much voice either.

The Business Mirror

# Homes Costlier

ED MORSE,  
F. Financial Writer  
NEW YORK

## Building Field Facing Variety of Obstacles

From page 1, column 1

to build the housing

since entering the business in 1947.

Presently, he has some 650 homes under construction, with 50 or 60 unsold.

### The Problem

Put generally, the problem is this: The industry now is operating at almost peak capacity of about 1,300,000 dwelling units a year. Within the next decade, it will be required to use that to some 2,000,000 units if demand for housing

## Cooperation On Housing Is Advised

Unless builders and community leaders turn from controversy to cooperation on housing pro-

which threaten unless "all outlying areas with the expansion through the work"

## Public's Help Needed: Plea of Top Builder

Industry Is Facing Crisis Due to Expanding Population, Says Association Head

By William J. Manly  
Real Estate

## ► Here's what some builders are doing:

Builders are beginning to fight back against the land crisis.

To offset the shortage of suitable sites and avoid high land costs, they're building good houses on land they once thought unusable. In San Francisco, Standard Building Co. is building on Twin Peaks, a mountain side. In Lafayette, Calif., builder Garry Grover is using trusses to cantilever his \$16-\$18,000 houses out from a steep hill; in effect, he builds them on lots that aren't there. Those are merely two examples; there are many more and American Builder will publish them in detail, in future articles.

Many smaller builders, whose battle with land costs is particularly rough, are banding together to buy subdivision sites much the way large builders do. The San Fernando Valley chapter of the BCA recently sponsored a subdivision for its members: 10½ acres that were broken into 50 lots and divided among nine

builders. Result: the builders get their lots at costs comparable to those that big builders enjoy; they get financing which would have been difficult or impossible on individual lots; they can pool small ad budgets to make a big, collective splash; construction will probably cost less.

To offset the growing problems of community facilities, some builders have hit upon this idea: they invite community officials to a meeting and openly acknowledge their desire to learn, to appreciate, to help solve the problem. One notable session like that was sponsored by the Long Island (N.Y.) Association of Home Builders. Says NAHB president Earl W. Smith: "The problem is too big for builders alone, or even builders plus public officials. Other people in the community must be made to face it . . ."

Ultimate goal of such meetings: share-and-share-alike financial responsibility for community facilities.

## ► What AMERICAN BUILDER says:

Builders should not take the rap, but the critical nature of the land crisis calls for positive action by them on many fronts.

The place to begin is on the grass-roots, home-town level. Enlist the support of school, church and civic groups; help them set up committees to tackle each problem. Then the leaders can be brought together with builders and town and county officials to devise new ways to get or pay for the community needs.

This is not just a builder's problem. Babies, not builders, are to blame—it is a dynamic, expanding population that is creating the demand for better and more homes, schools, hospitals and all the rich equipment of life within the reach of all.

Everyone must help: the National Association of Home builders should step up its assistance to local builders, giving them more data, speeches, newspaper

stories, programs for home town meetings. We believe that NAHB should make this the Number One topic for next January's convention.

FHA should realize that this is their problem, too. We believe Norman Mason and his staff can do much to create a better understanding of the crisis.

Hard work should be done with civic bodies to find better uses of facilities already existing. Scattered lots can be utilized. Run-down areas can be improved to make existing sites more livable. And new highways, faster trains, fool-proof planes and helicopters are opening good sites where facilities do exist.

Certainly the American public will not long permit buildings to be choked by "Keep Out" signs against low-income families. American Builder invites readers to tell us of bad situations; publicity may help find a cure. Builders have faced tough problems before; let's not say this crisis cannot be handled, too.



## Home Building takes a big step ahead

**Here's your new National Housing Center at work. Eight-story, air conditioned building houses NAHB offices, exhibits library, press and conference rooms.**

**A** few years ago a builder got as much attention in Washington as an old nail in a pile of sawdust. Now it's different. He gets heard. He gets action. And he has his own new National Housing Center, just opened, which advertises that he's doing a big and vitally important job.

Builders from Azusa to Astoria now have a place to gather. It's a handsome headquarters that represents in granite, glass and aluminum what the industry is, where it stands, and where it's going.

AMERICAN BUILDER editors took their cameramen and toured the new Center just after it opened. On the following pages you see what they found.

*Handily Located*—it's midway between the Statler and the Mayflower; four blocks from the White House.

*Products displayed*—six floors feature a new and brilliant type of building exhibit. "Island" type displays are already being erected.

*Where builders meet*—there are conference rooms, an auditorium seating 200, reception rooms, and offices of the National Association of Home Builders. It's a logical place for Builders to meet, plus a site for conferences with FHA officials, manufacturers, architects, housing experts and the press.



### Going to Washington?



### Waiting for Washington's help?



**IDEAS** for your next home give spark to these new island type displays. Six floors cover products from disappearing stairs to "atomic" door openers. Center hopes to attract home buyers as well as architects and builders.



**LUMINOUS** ceiling extends over entire exhibit area, in bright, colorful display. Information desk on each floor handles product data, plus manufacturers' catalogs and literature. There's a complete reference library.



◀ **100,000 PIECES** of helpful literature are prepared each month in NAHB's new mimeographing and mailing department. Manager Florence Bittner, left, is currently preparing kits for NAHB's 21 Mortgage Finance Clinics.

**BUILDERS' PROBLEMS** are reviewed each week in staff conference of department heads. Recent conference, above, set up control center for all activities so that objectives of each project would be fully known to all.

# How NAHB solves your



**PRESIDENT** of NAHB is a busy builder, like Earl W. Smith (right), who works without pay, travels some 150,000 miles a year, sacrifices personal interests for NAHB.

**CURRENT PROBLEM**, being discussed here by Smith and Neal J. Hardy, NAHB Policy Consultant: the land crisis and how best to maintain America's community facilities.



**EXECUTIVE DIRECTOR** John M. Dickerman, administrative chief of staff, coordinates all NAHB matters for executive committee with help of Mrs. Margaret F. Raynor.

**CURRENT PROBLEM** of executive director's office: completion of all facilities in new \$2½ million housing center in time for formal opening on October 3.



**CONSTRUCTION DEPARTMENT-RESEARCH INSTITUTE**, headed by Ralph J. Johnson (not shown), helps keep government agencies abreast of everyday problems of NAHB builders.

**CURRENT PROBLEM**, reviewed here by assistant directors Richard J. Canavan and Gordon Hazell: bigger how-to-do-it section at the January-1956 convention in Chicago.



**LEGISLATIVE DEPARTMENT**, headed by Joseph B. McGrath, keeps tabs on national legislative developments that affect builders, advises federal agencies and committees.

**CURRENT PROBLEM**: the effect of new government regulations that tightened insured home loan credit. Shown with McGrath: his secretary, Martha Georgesson.



**ECONOMIC AND STATISTICAL DEPARTMENT** is headed by Nathaniel H. Rogg. It publishes "Economic News Notes," a monthly analysis of housing and the national economy.

**CURRENT PROBLEM** is preparation of material on community facilities for use by NAHB builders in local meetings; also, an analysis of latest family formation figures.



**PUBLIC RELATIONS DEPARTMENT**, headed by Robert F. Loftus (center), advises industry on PR matters, promotes home ownership, helps public understand builders better.

**CURRENT PROBLEM**, being discussed here with assistants Don A. Eaton (left) and Oliver DeWolf: public relations activities at the new center in months following opening.



# problems

NAHB's 2½ million dollar housing center is as modern as tomorrow. It is fully air conditioned, acoustically treated, lighted with brightly luminous ceilings. The heating and air conditioning equipment is on the roof, freeing the basement for pay space. The glass front is brilliantly lighted to reveal the product displays inside and the striking spiral staircase.

Services will include a large reference library, building catalogs and literature files, research and economic data on building. Special educational exhibits will show progress in home building, model homes, what to expect in the house of tomorrow. There is a fully equipped press room, complete with ticker tape, information files and a public relations staff.

The building was erected by Alvin L. Aubinoe, Inc. from plans by Aubinoe, Edwards and Beery. Interior decoration was by Knoll associates.

**HOME BUILDING HEADQUARTERS:** Eight-story granite, glass and aluminum building houses NAHB's offices, exhibits, press rooms, library and conference rooms. It's fully air conditioned, acoustically treated.



Photo: Robert C. Lautman

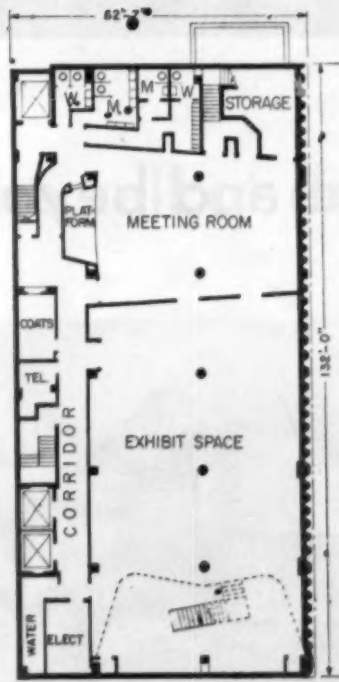

BASEMENT

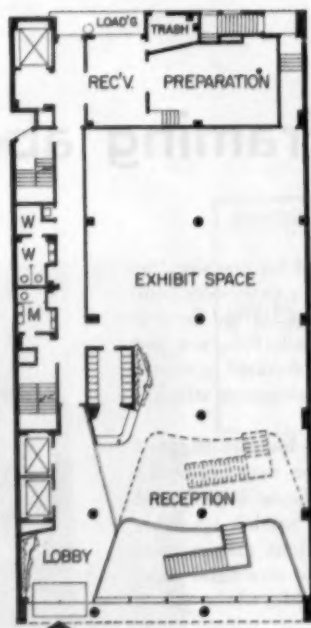

FIRST FLOOR

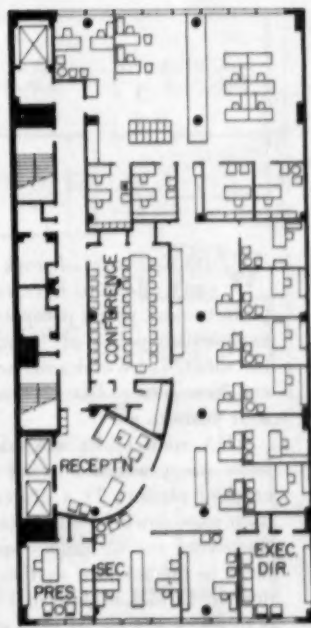

SEVENTH FLOOR

**SPACE TALKS** in this tightly engineered, expertly laid out building. The 62'-7" x 132' area is air conditioned and well lit, so all interior space is put to work. The seventh floor

reception room serves NAHB offices, including corner rooms for President Earl Smith and Executive Director John M. Dickerman.

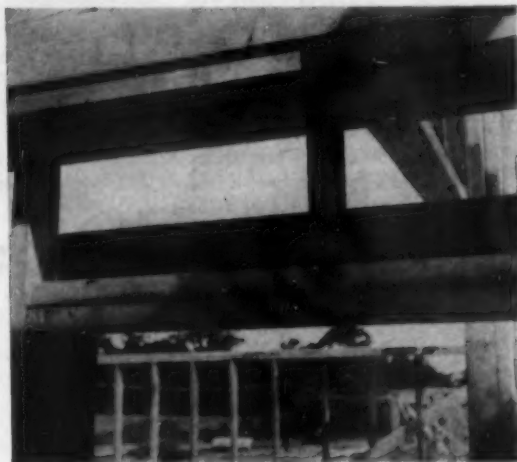
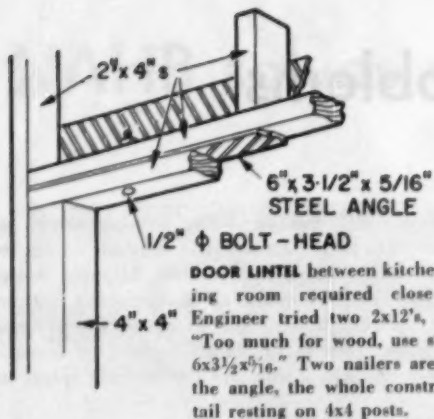
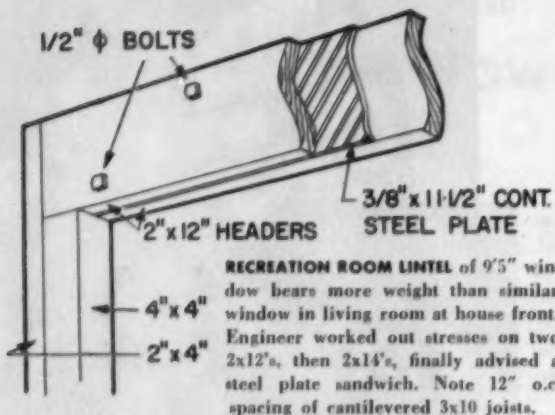

## Framing above and beyond

With five years of work planned for one site, "we can't afford to have last year's customers complain to next year's prospects." Thus Harold Sarshik explains his policy of "frame for deflection, not just for shear," at Woodcrest, near Haddonfield in southern New Jersey. His 1500-unit development still has four years to go.

FHA span tables are adequate, but the slightest belly on a weight-bearing member may mean 1) cracked plaster; 2) a disgruntled home owner; and 3) a slow-down in future sales. So Sarshik takes his architects' sound lumber specifications and submits them to the acid-test mathematics of structural engineer R. E. McLaughlin of Philadelphia, whose job it is to watch out for unusual stresses.

The "caution-plus" advice is illustrated here in some details of the Yale, at \$15,000 the most popular of the three split levels on sale. The Princeton is \$13,500; the Harvard is \$16,750.

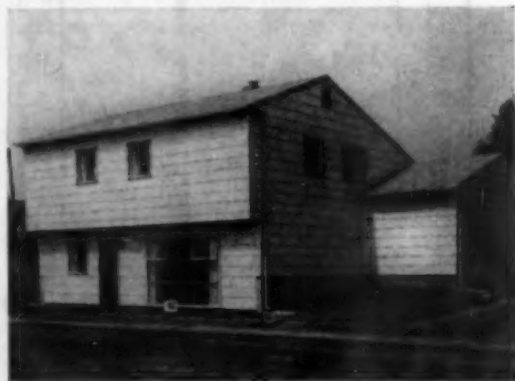

**REAR VIEW** of 20th Century's Yale Model, by architects York and D'Anastasio, demonstrates need for steel plate sandwich, to support cantilevered bedroom over big window of play room. (Reversed version at top left.)

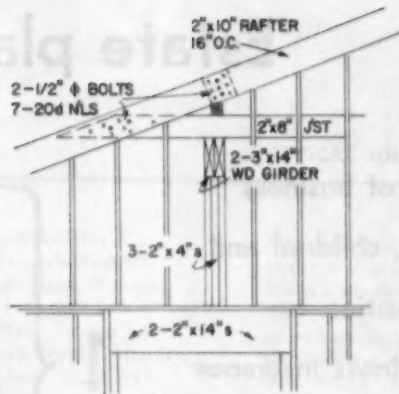

**KITCHEN WINDOW LINTEL** is focal point of stress from transverse girder (top); engineer OK'd two 2x14's on 4x4 posts. Girder itself, which supports ceiling ties, took 3x14's after "NG" on 2x14's. For upright above lintel, a 4x4 was OK, but three 2x4's fit.

**RAFTER DETAIL** shows use of bolts for splicing two lengths of rafter itself, and (beyond) fixing of rafter to ceiling tie. Starting with axial thrust on rafter and the values of 1/2" bolts and 16d. nails, engineer called for bolt and 7 nails at rafter-tie joint.

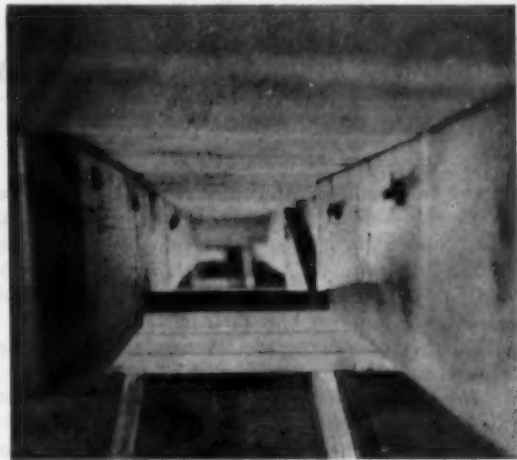

## the call of duty



**FRONT VIEW** of Yale, best seller at Woodcrest, shows popular features; real stone front, large windows of kitchen (see top of page), dining, living room. Latter has cathedral ceiling sloping to 12' at split line. Plan shows convenient traffic pattern.

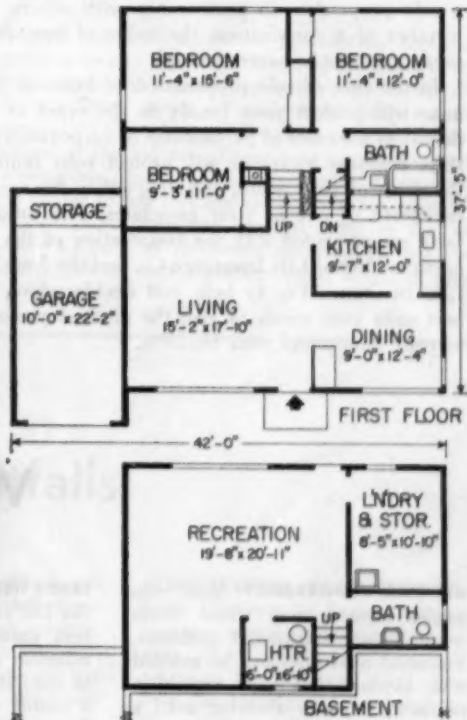

# Estate planning for the

How to build the kind of business that will put your wife, children and yourself in the best position—through the use of business insurance tailored to fit your needs.

You have your choice of three types:

Fire sweeps through a row of new houses, and the builder watches helplessly, but he is not beaten. His property is gone, but it can be replaced because he has fire insurance. A tornado strikes and property is destroyed. Houses rise again when tornado and windstorm insurance play their part.

There is one misfortune, though, whose striking power could be many times greater than fire, tornado or any other casualty recoverable through insurance: the death of the builder himself.

An ideal method has been devised to meet this crisis. It is business insurance, and whether you are a sole proprietor, in partnership with others, or a member of a corporation, the value of business insurance cannot be overestimated.

In the case of sole proprietorship, business insurance will protect your family in the event of your death; in the cases of partnership or corporate ownership, business insurance will protect your family in the event of your death, and yourself in the event of the death of one of your associates. The following facts are presented with the cooperation of the Connecticut Mutual Life Insurance Co. and the New York Life Insurance Co. to help you decide which plan best suits your needs to give the greatest protection to your family and your business.

## TYPICAL COMPANY

### Proprietorship



### Partnership



### Corporation

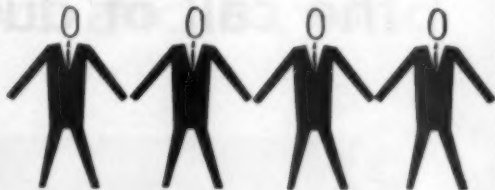

## Whichever plan you choose

**KEY-MAN VULNERABILITY:** Most companies have a man whose death would create substantial problems. Financial difficulties can be avoided with key-man insurance protection providing a shock absorber until a successor is found.

**CREDIT WEAKNESSES:** Policies covering the life of the owners or key members during periods of loans help maintain a firm's credit status, can be used as collateral for a loan, or as a source of cash in an emergency. The business is always protected.

**VERBAL AGREEMENTS:** Without a written buy-and-sell agreement, the deceased's heirs would still have the right to retain their share in the business, or sell to an outside interest, and surviving members might renege on their agreements.

# builder . . .

## TYPICAL PROBLEM

John Blank, who owned the Modern Building Co., died suddenly. His widow and children relied on the business for their income. Jones, who had been Blank's right-hand man, knew it would be a long time before his management would provide sufficient income for Mrs. Blank, her children and his own family. Mrs. Blank would have liquidated the business, but it was pointed out to her that liquidation often means heavy financial loss. Mrs. Blank was thus forced to hire a manager. This added expense and loss of income meant a long period of anxiety and forced economy for Mrs. Blank and her children.

## TYPICAL SOLUTION

An agreement is drawn between Blank and Jones under which Jones is to purchase the business upon Blank's death with funds from life insurance. Jones makes premium payments. (Notes are given to Blank in part payment of some of these premiums for which the business advances payment). When Blank dies, Mrs. Blank receives from the insurance company a predetermined amount of money arranged to give her an income for life. Jones becomes owner of the company, giving Mrs. Blank notes covering amounts advanced for premium payments. The Blanks are financially cared for.

Taft and Hansen were partners in a home building business. When Hansen died, his widow needed money as she had two young children to support. She demanded liquidation as soon as possible, which was against Taft's best wishes. It meant selling himself out of a job at a price not representing fair value, and would mean a loss to Mrs. Hansen. So he formed a new partnership with Mrs. Hansen, attempting to do his own work and Hansen's, too. Price advantages previously enjoyed because of teamwork are gone. The threat of liquidation is always present.

A buy-and-sell agreement, pledging the survivor to buy the other's interest in case of death, is drawn up between Taft and Hansen. Each partner is insured for an amount equal to his share in the partnership, with the partners paying premiums on each other's insurance. Thus, at Hansen's death, money is available for Taft to buy the deceased's share of the business from Mrs. Hansen, giving Taft sole ownership and giving Mrs. Hansen the cash she needs. The threat of liquidation is gone, and so is the need to take an inexperienced person into the business.

The ABC Home Corp. was equally owned by Stone, Taylor and Walsh. Taylor died and business fell off. Mrs. Taylor, who had inherited her husband's stock, consulted her banker and lawyer when income fell. The lawyer wanted to go to court; but at her banker's advice, she asked Stone and Walsh to buy her stock. With no money available, they would have refused were it not for the danger of her selling to someone else. An agreement was made to spread the purchase over five years with substantial income also to be paid. To do this, they had to mortgage their own stock.

A stock purchase agreement provides for surviving members to buy deceased's stock, money going to the heirs. Insurance is taken out on each other's life. At Taylor's death money is available to carry out the agreement. Surviving members are guaranteed full control of the business. Operations continue without interruption. Heirs receive a fair price. If members are unable to buy full amount of insurance, whatever is purchased represents first payment to the deceased's estate, an agreement providing for payment of any balance over a predetermined length of time.

## . . . watch out for these pitfalls

**OUTDATED COVERAGE:** As business grows and prospers, financial conditions change. What was once adequate coverage becomes outdated. Regular check-ups by experts insure that coverage will continue to be as complete as possible.

**INHERITANCE TAXES:** Be sure to consult with your lawyer and accountant when purchasing business insurance. Tax factors must be taken into consideration so that the plan will not unnecessarily involve additional taxes for your beneficiaries.

**MISUNDERSTOOD VALUES:** It may become necessary to borrow on your business insurance during an emergency. You should be completely aware of the cash and loan values over the coming years so that you can use them fully.

## DID FHA TURN YOU DOWN?

# Here are 94 probable reasons why

### CHARLOTTE MBA ISSUES LIST OF "FREQUENT ERRORS"

Group A: Some common errors in application submissions, causing delay in beginning processing.

#### ARCHITECTURAL PRELIMINARY EXAMINATION

1. Brick veneer plans with frame construction specified, or vice versa.
2. Items shown on plan are not specified, or vice versa.
3. Inadequate storage—linen, coat closets.
4. Stock plan with major changes to conform with local building practices.
5. Stock plan without proper changes. Failure of plans, specifications and details to conform with local practices.
6. Heating plan does not show size of all registers, ducts, radiators or convectors, or BTU heat loss for each room.
7. Floor furnace specified is inadequate to heat size of dwelling (Rev. 52).
8. Floor furnace, shown and specified, not in compliance with Rev. 51: a. violates 2' passage requirement; b. violates allowed distance from room to be heated.
9. Plans not properly dimensioned.
10. Inadequate plot plans fail to show walk, drive and required elevations.
11. Entrances from carport to dwelling without required stoops.
12. Kitchen cabinet details, wall sections not provided, or do not conform to plans.
13. Inadequate specifications. Form 2005 not filled out completely.

#### VALUATION PRELIMINARY EXAMINATIONS

14. Failure to show location of property for proper identification by appraiser.
15. Failure to send keys or help appraiser gain entry to vacant locked house.
16. Failure to indicate year built.
17. Discrepancies in lot dimensions shown in legal description, location sketch, and under Block C of the Property Description Form 2004a.
18. Failure to indicate type of water and sewer under utilities, Block E.

#### MORTGAGE CREDIT PRELIMINARY EXAMINATIONS

19. Failure to include amendatory language in sales contract.
20. Failure to insert in amendatory language the appraisal figure agreed upon between seller and purchaser.
21. Failure to show in the application

- whether the mortgagor proposes to rent, occupy or sell the property.
22. In connection with refinancing transaction, failure to state the use made of cash or cash proceeds from recently recorded second mortgages.
  23. Failure to supply Form 2560.
  24. Agreement to provide construction warranty for applications for proposed construction.
  25. Failure to supply current balance sheet statement for operative builder.
  26. Failure to furnish operating statement of the business of a self-employed applicant.
  27. Omission of signature of the mortgagee.
  28. Failure to return Form 2562 executed by the purchaser in substitution of borrower cases, or conversion of conditional commitments.
  29. Failure to show all assets of applicant.

Group B: Items of non-compliance most frequently encountered by FHA inspectors in the field.

#### FIRST INSPECTIONS

30. Sloped footings (on uneven lot, footings must be stepped).
31. Inadequate footings at piers in curtain wall; failure to provide full 4" projection at these points.

#### SECOND INSPECTIONS

32. Inadequate foundation vents and 16 mesh vent screening used.
33. Masonry not bonded every 7th course or every other block.
34. Piers not bonded to curtain wall.
35. Termite shields lighter than 26 gauge, do not extend 2" from face of wall and do not turn down 2" at approximately 45 degrees. Joints not soldered or lock joints not properly constructed.
36. Wrong stoop and porch flashing at sill.
37. Single sill on 4" curtain wall and pier construction.
38. Girders spliced between supports.
39. Subfloor not cut parallel with and over joist; wide subflooring not nailed sufficiently. No blocking under subfloor where cut for duct work, floor sills.
40. Ledger on sill and girder cut exces-

- sively into joist; 1/8 depth of joist maximum allowable cut.
41. Permanent shims not provided between sill and girders and bearing.
  42. Corner bracing not properly installed.
  43. Inadequate headers over large openings.
  44. Moisture content of lumber exceeds 19%.
  45. Warped studs not properly straightened and scabbed.
  46. Improper tub supports; end blocking required.
  47. 2" minimum clearance between framing and chimney not provided.
  48. Omission of 30# base flashing and weep holes on brick veneer construction.
  49. Omission of flashing at window sill and head on brick veneer construction; at window head on frame construction.
  50. Studs, ceiling joist and rafters inadequately nailed.
  51. Wood siding not back and end primed.
  52. 3/8" plaster grounds not provided.
  53. Window not wrapped around with 15# felt and corner and cut pieces of gylap sheathing not covered with felt.
  54. Work not progressed to second inspection stage because a. house not weathered in; b. utilities not roughed in; c. plaster grounds not in place.

#### THIRD INSPECTION

55. Work progressed past second inspection stage.
56. Work not ready for third inspection; some builders often use FHA inspection to provide them with a "punch" list.
57. Paint not adequate to cover grain of wood—interior and exterior.
58. Windows, plumbing fixtures not cleaned.
59. Insufficient kitchen cabinets to comply with Rev. 48.
60. Insufficient bath accessories.
61. Tops and bottoms of kitchen, bath and exterior doors not painted.
62. Tops and bottoms of window sash not painted.
63. Window hardware not provided.
64. Floor not waxed and cleaned.
65. Water supply cut-off not provided inside house.
66. Tile work not grouted adequately.
67. Dampers in heat ducts not provided.
68. Joints in heat ducts not wrapped.
69. Heat ducts inadequately supported from joists.

(Continued on page 288)

This collation of most frequent errors found in FHA and VA submissions was prepared for its members by the Home Builders Association of Charlotte, N. C., from information provided by Roy C. Millikan, Director, FHA, Greensboro, N. C., and Charles H. Ball, Loan Guaranty Officer, VA, Winston-Salem, N. C.



## When the big freeze comes . . .

**are you going to be ready for it?**

**I**f you're from below the Mason-Dixon line you'll probably be amused at this picture. But if you live up north in the big-freeze belt it isn't so funny. Rather your hat's off to these fellows—or should be. Why? Because they're ahead of the game. They're building at a 12-month's clip, with no time for seasonal layoffs. What's more, they've got the unusual distinction of having some *January and February starts*. You can do the same if you follow the rules of cold weather building that **AMERICAN BUILDER** gives you . . .



**THAWING AGGREGATE** with live steam jet is early morning chore when freeze hits. Just be certain that all ice and snow is removed before mixing. Raise temperature of the aggregate to 45° before adding warm water and cement.

## Winter building: what do you do outside?

# Preheat your materials and

**Stock piles can stand freezes**

**better than men—but even they**

**have to be given the steam**

**treatment once in a while**

With materials generally cheaper, shipping facilities less crowded, deliveries more prompt and dealers anxious to hold on to their men, winter building makes a lot of sense. The only real problem is to keep those materials in workable and efficient condition so you can keep operating.

**COVERING STOCK PILES** with tarpaulins, sisal-kraft or felt paper is one of the first rules you should follow. This applies especially to masonry units, which never should be left on wet ground but should be kept high and dry on heavy planks.

If ice and snow do collect on them, they should be thawed with jets of live steam, portable gas torches or

other defrosting devices.

**GOOD WINTER MORTAR** is a must for the mason. That means mortar which is really workable on the board. The mason can't afford to spend time retempering it. To get this kind of mortar in outside temperatures as low as 32° means the application of heat to sand and water, especially the latter. Piling sand over a smoke stack section (metal) and building a fire under it is one solution. Care should be taken, however, not to scorch it.

Batches of mortar should be heated at the mixer to a temperature not above 160°F. At the time of troweling its temperature should be between 70° and 120°F., which means that the mason has got to move right along to keep his mortar from overcooling.

**DRAPING TARPS** over a temporary framework is generally sufficient to keep masonry walls from freezing. Openings should be "canvassed in" with standard duck tarpaulins or with the newer aluminized (and flame-resistant) type. Also available from suppliers are lightweight reinforced plastic tarps that let in light and keep the cold out. They are especially effective in providing good working light. But even with this kind of protection you will probably need salamanders (see pages 104-105).





**HEATING CONCRETE** in tilting type mixer is easy with this portable burner and universal attachment. Heat is deflected into mouth of drum at desired angle. Burner operates from kerosene tank or fuel, comes in five sizes.



**MIXING MORTAR**, cement or plaster in steel box at proper temperatures is accomplished with same type of portable burner. Burner operating from 20-gallon tank at temperature of 1800°-2200°F. consumes 3 gallons per hour.

## forget about the weather

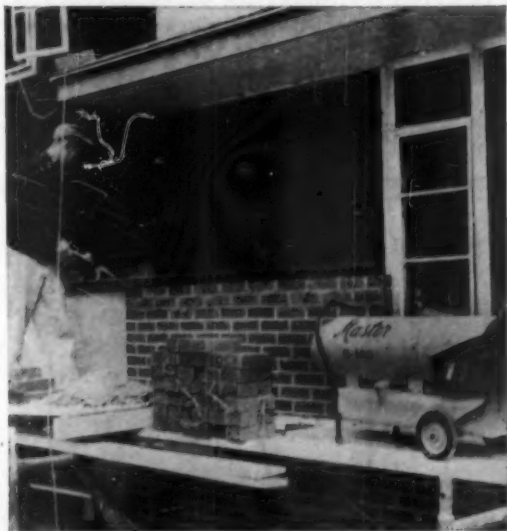

**HEATING MASON** as well as bricks is done with handy portable, lightweight unit. Heater operates off standard 110-115 volt AC current, has built-in fan. Another similar type uses infra-red rays to heat workers.



**TAKING COUNTRY** by storm, this portable infra-red heater burns LP-Gas. 100 lb. tank will supply spot-heater for 55 hours. Though not yet in full production, company should be by winter. Some dealers will rent unit.



**SNOWED UNDER**, Syracuse, N. Y. builder Al Bartlett, left, uncovers his footings. Bartlett built splits all last winter.

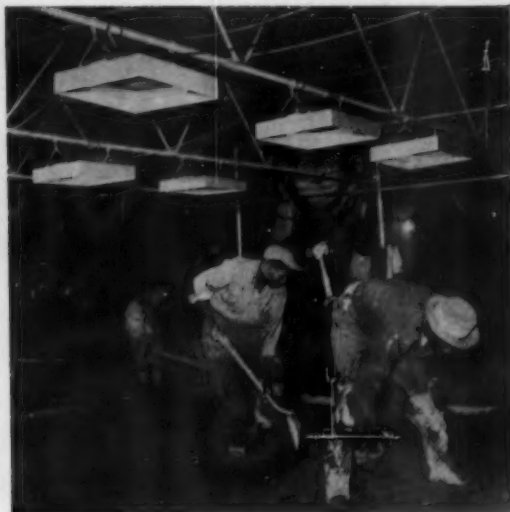

**OVERHEAD HEAT** supplied by new electric glass panels enables builders in Washington, D. C. area to pour slabs on coldest days. System also uses tarps over framework.

**Winter building: what do you do on the inside? And what do you do about pouring slabs?**

**With new warm-up techniques you can have**

## year-round concreting,

**T**o operate a building business on a 12-month basis you should be able to pour concrete in winter as well as summer. Afraid of frost? Then take these precautions:

**SPRINKLE STRAW** on a sub-grade to keep it from freezing. A foot or two of dry straw is usually

enough to insulate ground against freezing. If already frozen, a sub-grade may also be thawed with straw and sand. Spread straw over it to a depth of 4 feet, then cover with 100-150 lbs. of sand per square yard. Ignite the straw, and the sand will retain the heat.

**REMOVE ICE** from forms and

reinforcing rods with live steam or portable heater, Fig. 4 below.

**USE HIGH EARLY-STRENGTH** cement. That means low-water-cement ratio. Add calcium chloride—but sparingly and only to increase early strength.

**HEAT MIXING WATER** to temperature of 175°F., no hotter.



**HERMAN NELSON** unit burns gas or fuel oil, is well vented.

(Reader's Reply Card No. 1018)



**C. R. DANIELS** smokeless salamander is oil burning type.

(Reader's Reply Card No. 1019)



**JACKSON** salamander has heat deflector to warm floor area.

(Reader's Reply Card No. 1020)

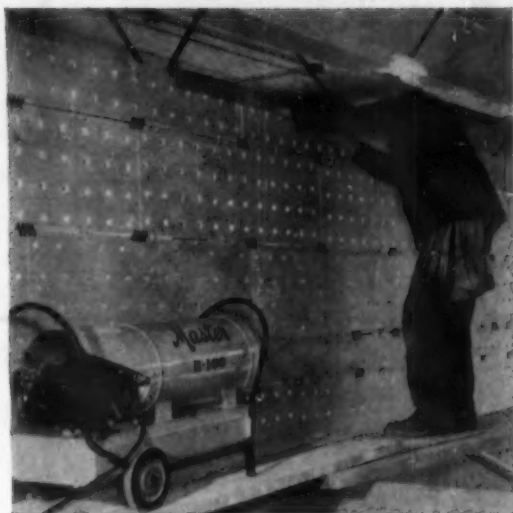

**LESS IRKSOME** is lather's job if he doesn't have to work in unheated space. Heater is light enough to be lifted on scaffold, permits lather to work without using gloves.



**PLASTERERS PREFER** to work in comfort too, but they also want plaster to dry out. Conventional heater for plasterers is salamander. Main requirement is steady heat.

## lathing and plastering

This should enable you to pour concrete at the proper temperature—between 50° and 80°F. Heat aggregates to about 45° if they are frozen.

**MAKE SURE** that the surface temperature of hardened concrete approximates that of your second course or finishing layer. This will

require heat. Big problem in curing winter concrete is to keep it moist (especially near heaters) and protected from too rapid drying and cooling. Some form of enclosure, of course, is essential, particularly during the early stages of curing.

**BEFORE REMOVING** heat and

protection from a slab, give it the strength test. If it can stand a compressive strength of 500 psi then frost can't touch it.

**LATHING AND PLASTERING** are two mighty irksome jobs in cold weather, and losses from winter conditions can be painful. Here again, heat plays an im-

*(Continued on page 276)*



**LITTLEFORD BROS.** torch type burner uses kerosene fuel.

(Reader's Reply Card No. 1021)



**SCHUE PRODUCTS CO.** markets this unit with return vent.

(Reader's Reply Card No. 1022)



**BICA'S SONIC RAY** heater has pilot light and control valve.

(Reader's Reply Card No. 1023)

## One plan . . .

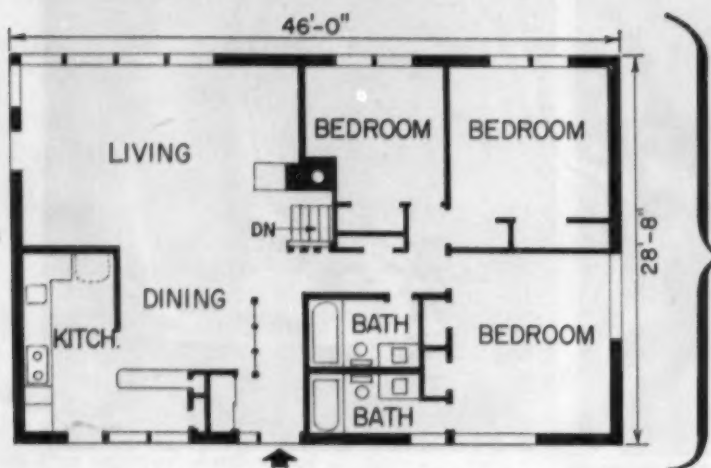

11 houses

1 style

2 materials

3 siting

4 carport or garage

5 roof pitch

6 ceilings

7 interiors

Getting real  
mileage  
out of a plan

with 7 variables

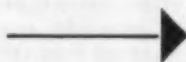

**F**ew builders get more mileage out of a plan than Nathan Manilow of Chicago. From sprawling successful communities like Park Forest and Des Plaines Villas, Manilow has turned to a higher price bracket. In his latest effort, Highland Park Highlands, he shows how important it is to start out with a good plan. He also shows how to manipulate seven variables common to all builders—and come up with something different each time. No small credit, of course, belongs to his architects, Fitch, Schiller and Smith.

They move from ranch to split level with equal ease, merely splitting the plan in half and raising the bedroom section 4 feet above grade. They take brick and stone and vary them with vertical or horizontal siding. They start with the standard 5:12 roof pitch and lower it to 2:12 for some contemporary models, 1:12 for others. They combine conventional 8-foot plasterboard ceilings with the plank and beam studio type. They exploit the gable window, using it in at least three different ways. They play carports against garages, breezeways against porches, wood fencing against brick, substituting one for the other with unusual skill. And, to gain further variety, they site their houses either of two ways on the lot.

**BROCHURE OF ELEVEN** plans, right, gives prospective buyer chance to compare one with the other. Highland Park Highlands incorporates latest thinking of Manilow Construction Co. From moderate priced houses, firm has now turned to luxury class.

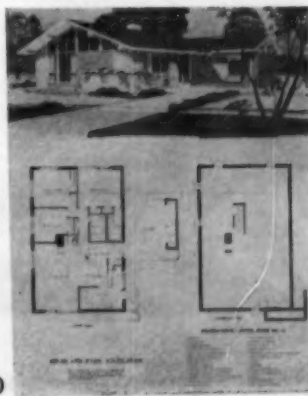
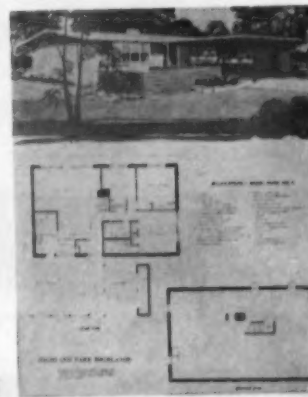
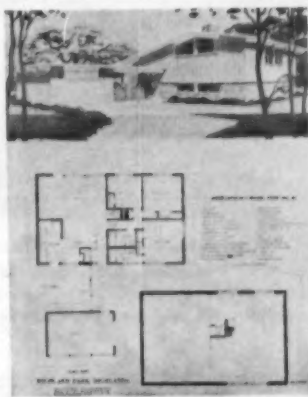
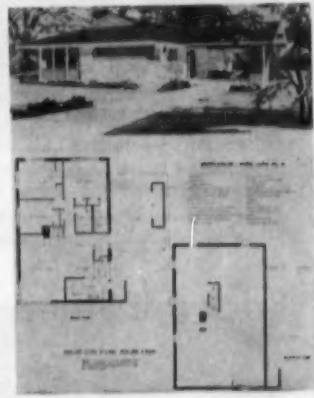
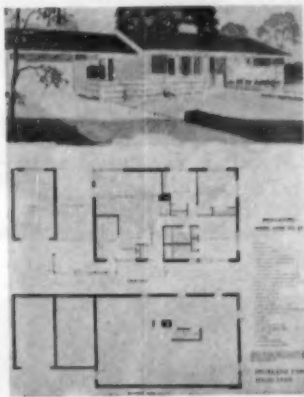
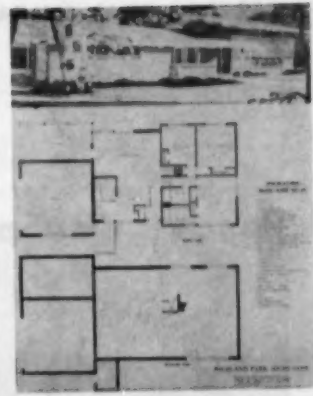
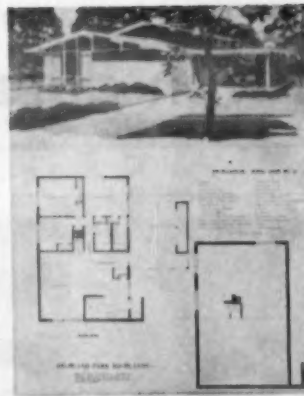
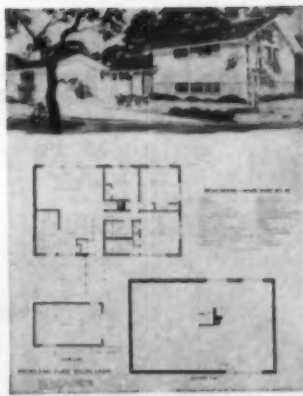

THE 7 VARIABLES—  
HOW THEY WORK



## Eleven different houses to

### Ranch . . . or Split level . . .

Turning a ranch house into a split level required no drastic changes in floor plans. The bedroom area was simply framed 4 ft. higher than the other half of the house, and the fireplace moved from the living room to the family room (lower level) of the split.

The family room, one of the big drawing cards of the split level design, corresponds to half a basement in the ranch house.

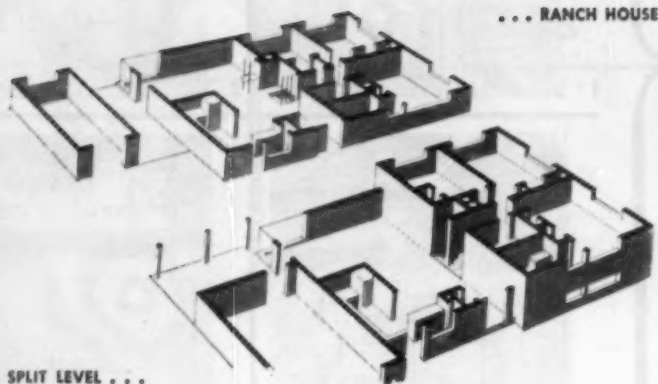

### Brick . . . Stone . . . Frame . . .

The use of several different materials to give variety is one of the stock tricks of the trade. Very often it's overdone, but not so here. Only one type of brick, common, is used, and only one type of stone. Different siding combinations are used, however: vertical, horizontal bevel, drop siding, tongue and groove and plywood with battens. Subtle color is found in the use of redwood.

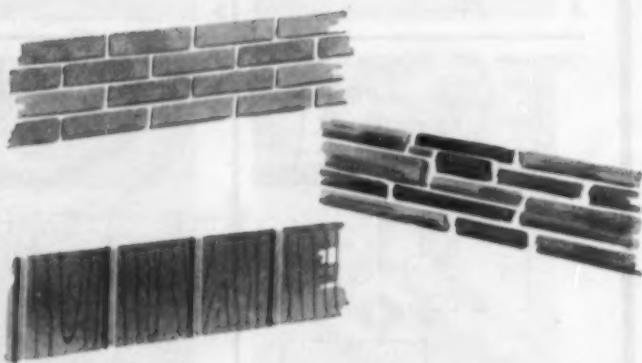

### Turned house on lot . . .

What you can do with three split levels with the same floor plan is illustrated here. In the first and third, the house straddles the lot, with garages or carports tacked on front or side respectively. In the center plan, the house parallels the lot; garage or carport is side-attached. Still other variations are possible, of course. With larger lots, use angular siting.

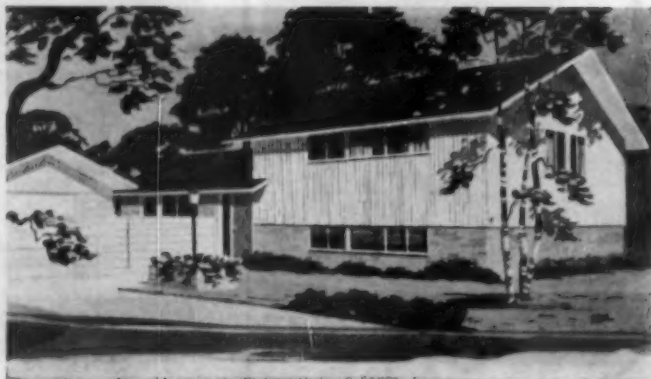

# please everyone . . .



**POPULAR RANCH** house looks small in comparison with split level at right, yet both have same floor area. Ranch has area wells for basement, while split level has windows above grade. Ranch plan also has attached garage.



**FAST-SELLING** split level looks large on lot, is same size as ranch. Breezeway joins garage and house. Lower level is family room, with bedrooms above. Exterior of house is redwood and common brick; garage door, trim are white.



**STILL ANOTHER** version of Manilow house: ranch with carport storage, louvered roof—and stone front. Where masonry is used it definitely predominates; wood siding is used only for contrast. Roof is asphalt shingle. This

conventional ranch has three bedrooms, two baths, basement and carport. Entrance to the kitchen is on the left just inside an alcove-extension of the stone wall. Overall dimensions of the house are 28'-8" x 46'-0".

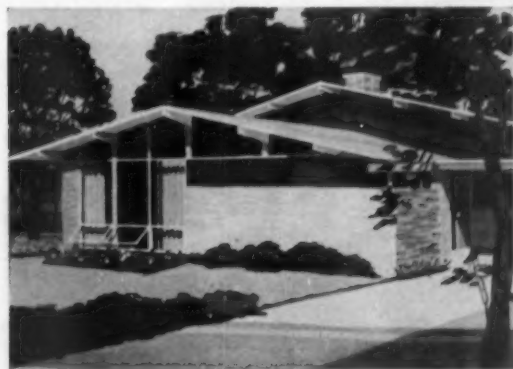

**PARALLELING LOT**, this split level has gable side facing street, with entrance through carport. This differs from other two versions, which are turned broadside to street. Top-swinging casements provide living room ventilation.



**SAME SPLIT** level with attached garage. Unlike version plan is only possible when all jogs and angles are fitted on far left, it has in-line plan. Extreme flexibility of into one simple rectangle of two-to-one proportion.

## Here are three more ways

### Carports . . . and garages . . .

Alternating garages with carports, both as to style and placement, gains unusual variety. Garages are attached by means of 15-foot breezeways, each of which encloses a "tot yard." Carports are attached directly and, unlike garages, are given 60 square feet of storage space. As already suggested, both garages and carports appear up front or at one side, and do not repeat each other.

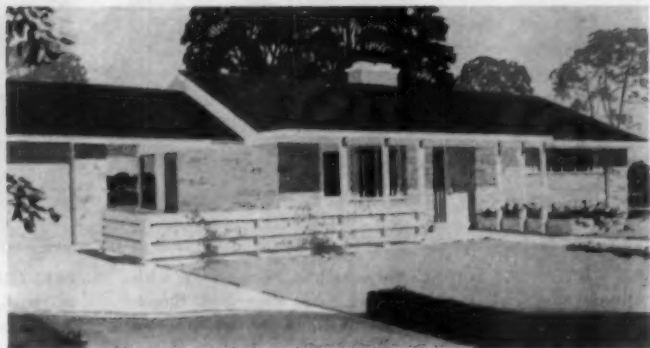

### Roof pitch: high and low

Pitches of 5:12, 2:12 and 1:12 are used by the architects, depending on the style of the house. Besides offering changing roof lines, this device also permits various treatments of gable windows in contemporaries.

To get further variety in their roofs, both built-up and asphalt shingle types were specified. Thus white gravel roofs are seen with dark asphalt shades.

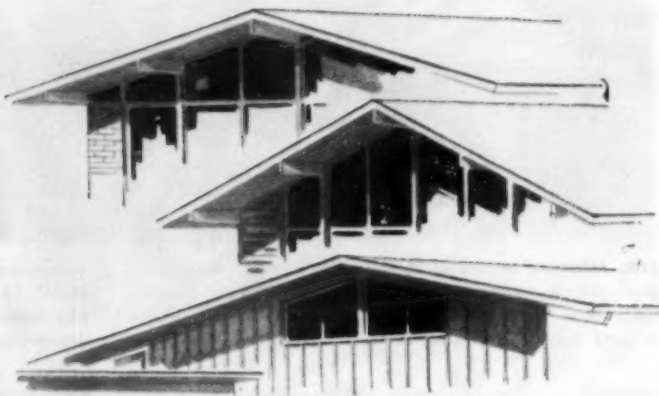

### Ceilings: open and closed

With plank and beam construction predominating in most houses, at least contemporaries, ceilings are either natural-finished or painted. Beams are laminated for extra strength and to prevent shrinkage, and are left unpainted. V-groove planking is treated in the same manner.

The use of open or studio type ceilings makes for greater spaciousness, increased height.

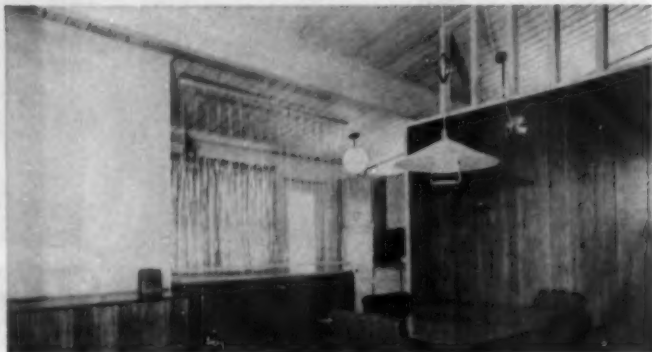



## to vary a basic floor plan



**OPEN CARPORT** has storage space at right for tools, gardening implements and athletic equipment. Area may also be used for terrace or play yard. In garage version

no such storage area is provided, though it might well be in basement. Only in the past few years has the carport, of California origin, found midwest favor.



**INTERESTING GABLE** treatment is given this model and one on right. Here sharp pitch of roof permits more glass area and allows combination of gable and picture window. Vertical siding is used below gable with common brick.



**CONTEMPORARY LOOK** is in this low-pitched roof with solid brick end-wall and fixed gable windows above. Front-facing carport has double posts, cantilevered beams, no pitch. Wood fence is repeat of L-shaped brick wall.

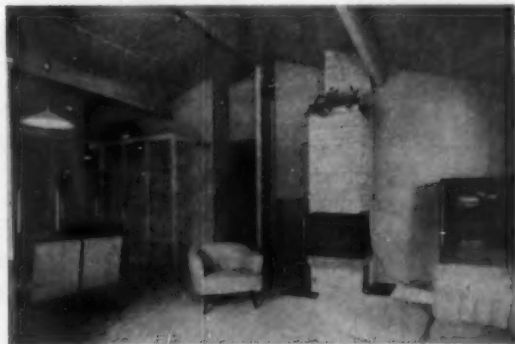

**THREE LAMINATED BEAMS** are enough to reveal structure of house without giving that over-timbered look. In bedroom area beyond, ceilings are standard height. Stairs to basement are located to right of the fireplace.



**LARGE GABLE** window of fixed glass reveals unique solution to curtaining problem. Drapes are fixed, do not draw, are cut short to let some light in. Beyond dining table is kitchen—well screened below, open at top.

GETTING REAL MILEAGE OUT OF A PLAN, continued

## Interiors: that luxury look

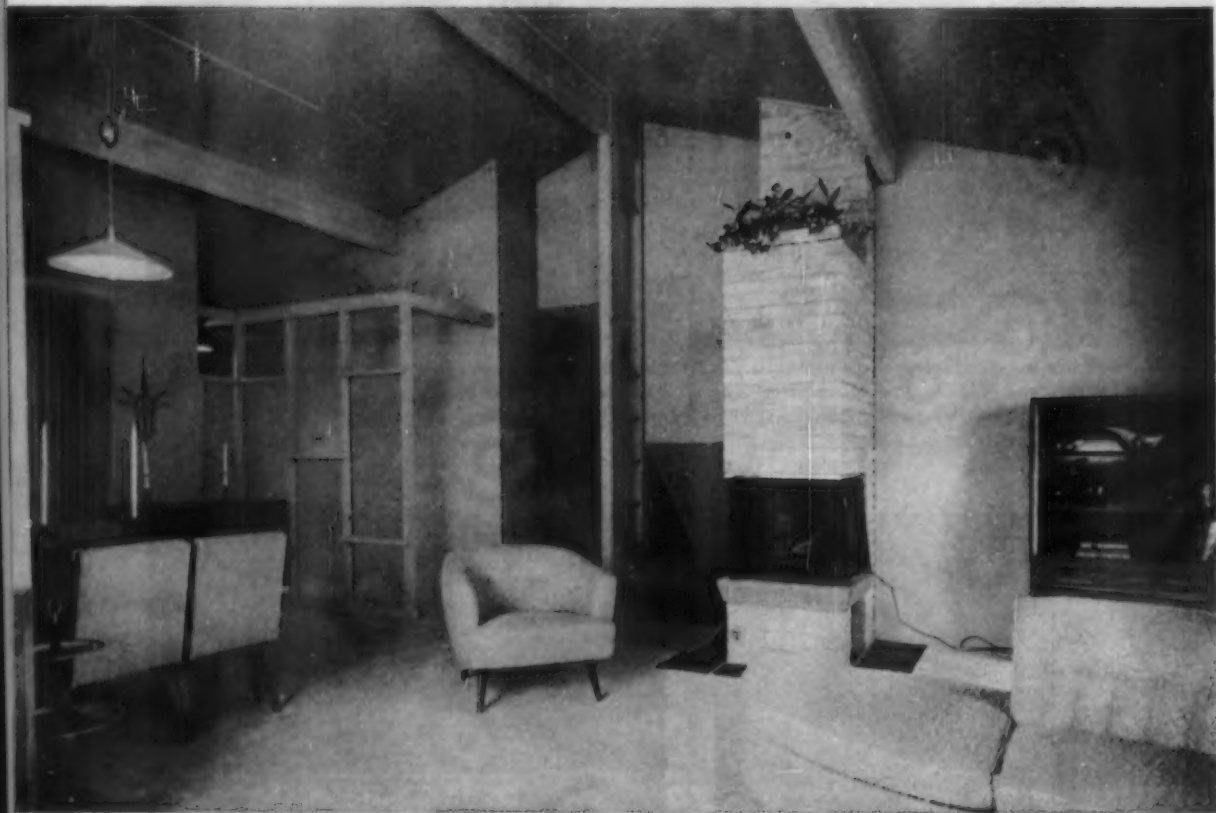

**GLASS PANELED SCREEN** divides entry from main living has log storage underneath and square hearth. Pull-down

room area. Slimmed-down fireplace takes little wall space, light fixtures are hung from ceiling tracks.

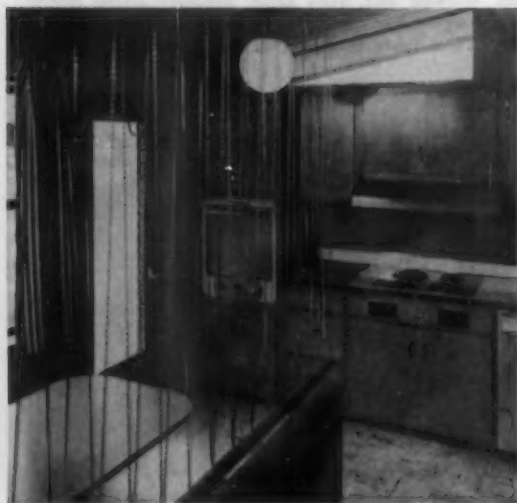

**ELECTRIC KITCHEN** has built-in range, stove and dish washer and natural birch cabinets. Stretched brass chain is used to separate food bar from dining area.



**INSIDE BATHROOMS** of contemporary models have daylight illumination from dome light above—plus diffused fluorescent light. All models have tiled double baths, showers.

K681—MINT GREEN

K662—CHARCOAL

K682—ROSEWOOD

K656—GREEN

K667—CALCUTTA GREY

K668—CORAL

K659—CHARCOAL & PINK

K655—GREY



Each of the 13 patterns in Jackstraw® (Floor: Spark Red—#K657) gives you many beautifully coordinated colors to pick up in accessories.

## Gold Seal "Jackstraw" INLAID LINOLEUM

GIVES YOUR HOMES THAT "EXTRA VALUE" LOOK

Gold Seal "Jackstraw" Inlaid Linoleum will help you sell your homes faster. Not only is it one of America's favorite designs (thanks to its gay patterns and mass promotions in LIFE, BETTER HOMES & GARDENS and other leading publications) but it also has a magic way of making small rooms look larger . . . all rooms look brighter.

The trend to basic, smooth-surface, virtually seamless flooring throughout the house is unmistakable. Here are just a few reasons why you are so correct in specifying Gold Seal "Jackstraw" Inlaid Linoleum:

**Ease of maintenance** . . . resists dirt, grime and dulling film. Cuts cleaning time and costs to a minimum.

**Resilient** . . . deadens floor noise. Resists permanent-indentation from furniture.

**Quiet and comfortable** . . . eliminates noisy

clatter common with hard floors.

**Beautiful** . . . suggests hundreds of smart, special designs . . . wide range of colors to harmonize with any decorative scheme.

**Stays beautiful** . . . colors are inlaid for long-lasting beauty.

**Economical** . . . initial costs can be amortized over a long period of time! Lasts longer than so-called lower-cost floors.

**Guaranteed** . . . Gold Seal Inlaid Linoleum gives you the famous Gold Seal guarantee . . . satisfaction or your money back. So for all the benefits of Gold Seal Inlaid Linoleum plus the versatile beauty of "Jackstraw," simply specify Gold Seal "Jackstraw" Inlaid Linoleum in houses you want to sell faster. You have 13 patterns to choose from, 6' wide, by-the-yard, standard gauge.



FOR HOME OR BUSINESS YOU GET THE FINEST CHOICE OF ALL IN . . .



**GOLD SEAL**  
**FLOORS AND WALLS**

CONGOLEUM-NAIRN INC., KEARNY, N. J.

INLAID LINOLEUM • RANCTILE® LINOLEUM • VINYLFLOR • VINYLTOP • LINOLEUM, VINYL, VINYLBEST, CORK, RUBBER AND ASPHALT TILES • CONGOLEUM® AND CONGOWALL® ENAMEL-SURFACE FLOOR AND WALL COVERINGS

**DEVELOPER:**

Dean Spratlin, Atlanta, Ga.

**BUILDER:**

Bert T. Millard, Atlanta, Ga.

**ARCHITECT:**

John W. Cherry, Atlanta, Ga.

**SQUARE FOOT AREAS:**

Main level of house, full area	1209
Upper level of house, full area	525
Carport, 1/3 area	84
Porch, 1/3 area	46
Total square foot area	1864
Cost per square foot	\$.11.80

For computation purposes, porch and carport are fractional so that their cost per square foot will be in direct ratio with that of the house.

**PRIVATE LIVES** are no problem at all in this Atlanta home, with sleeping zone and living zone neatly separated. Use of a retaining wall, continuous sweep of the living level into the carport, clever grading create a snug appearance. ▶



**THIS TRI-LEVEL HAS A SPECIAL SALES APPEAL**

**One level for family living ...**





## two levels for privacy

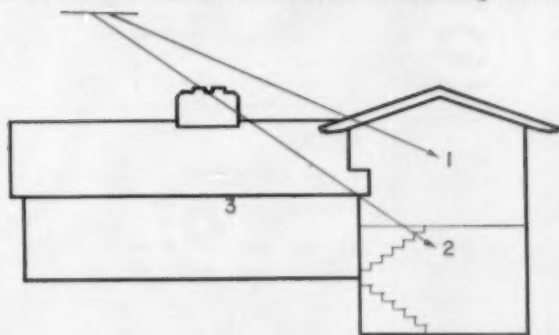

**T**his space-conscious split-level concentrates four bedrooms and two baths in a single two-level wing that is convenient to the rest of the house. This arrangement makes possible a family grouping of two bedrooms on one level and a similar guest grouping on the other, with complete privacy for both.

The overall plan features two connecting wings. One contains the service and living areas at the en-

trance grade level. The other wing contains the bedrooms, connected by a half flight to the entry. The rooms follow in an orderly sequence around the entry, with the kitchen facing on the street front, and the living-dining room overlooking the terrace in back of the house. Full length sliding glass doors lead out to the privacy of the porch.

The variation in grade levels on the exterior is handled effectively through the use of a retaining wall, placed at right angles to the front and rear. This allows the major part of the house to be graded level one step below the entrance floor line. The finished grade for the balance of the front and rear and one side of the house, three steps below the lower floor, is levelled and tapered off to conform to existing contours. This procedure offsets the usual sales resistance to bedrooms that seem to be located below the established grade level.

The inside living room wall, into which a fireplace has been set, is made wholly of used brick that was chosen for its texture and wide color range. The fireplace and the adjoining masonry wall, which is an integral part of this feature, extend for approximately twelve feet, and rise from the floor to the underside of the ceiling. The raised hearth reaches out from the face of the fireplace.

◀ **COLOR, TEXTURE AND FORM** are successfully blended in this living-room: the brick wall with its built-in fireplace runs for twelve feet, rises from the floor to the exposed plank and beam roof framing members.



**SPACED FOR WORK**, this kitchen provides wall space for all equipment, including washer, dryer and built-in desk, in 185 square feet. Breakfast bar separates the kitchen from dining area; carport doorway supplies entry to both.



**SPACED FOR LEISURE**, the living-dining area is wholly isolated from the sleeping quarters in this Atlanta, Ga. tri-level. Sliding glass panels, which offer easy access to the porch, are part of a 17-foot expanse of glass.

Contemporary and traditional styles are blended in the exterior of this house. A low-pitched roof, with wide overhanging eaves and gable ends and wide horizontal wall siding, accentuate the snug, close-cropped look, especially on the street side. Wood blinds painted a contrasting color and selected used brick for the porch rail also help to add a lively note to the front view of this home.

The house is of frame construction, with brick veneer extending from grade line to the underside of the upper level bedroom in the two-story wing. The plank and beam roof framing members are left exposed in the living, dining and kitchen areas.

The varying depth of the concrete foundation provides a depressed entrance at the intersection of the rear house wall and the rear retaining wall. This offers access to the basement below the living room for location of the furnace and heater. Thus it is possible to place the furnace flue in the fireplace unit, and a cleanout for the fireplace is provided.

The strategic location of the carport serves to accentuate the long, gracious sweep of the living-area

wing, and also affords sufficient weather protection to allow the use of a glass jalousie door, for direct entry to the kitchen area.

**BRAND NAME PRODUCTS USED**

- |                                      |                                |
|--------------------------------------|--------------------------------|
| Armstrong linoleum                   | Insulwool insulation           |
| American-Standard plumbing fixtures  | Lawson bathroom cabinets       |
| Bankhead kitchen cabinets            | Minneapolis-Honeywell controls |
| Central Woodwork Co., windows        | Mission hot water heater       |
| Certain-Teed wall sheathing          | Menclief furnace               |
| Certain-Teed asphalt shingles        | Prett & Lambert paints         |
| Flintkote building paper             | Shower Door Corp., shower door |
| Floraver rubber tile                 | Swiveller lighting fixtures    |
| Formica cabinet tops                 | Schlage hardware               |
| Gibraltar, Gen. Plywood Corp., doors | U.S. Mosaic clay tile          |
| Hotpoint kitchen equipment           | U.S. Gypsum wallboard          |
| Horizon sliding doors                | Victrol exhaust fan            |

For information about complete one-quarter inch working plans of this house write American Builder Home Plans Service, 30 Church St., New York 7, N. Y.

**SEE BLUEPRINT FOR PLANS AND ELEVATIONS** ▶

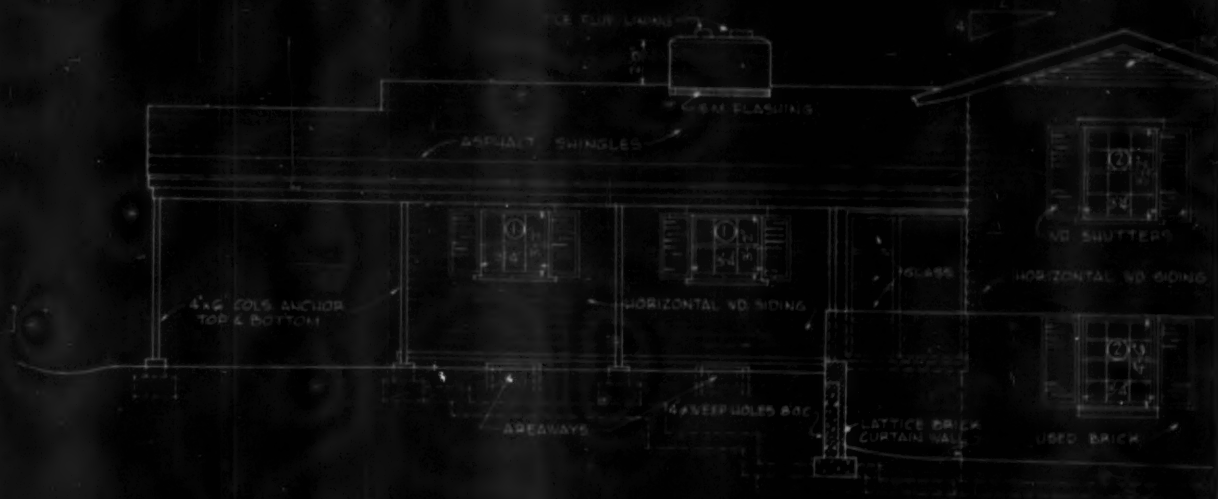

FRONT ELEVATION  
SCALE 1/8"=1'-0"



REAR ELEVATION  
SCALE 1/8"=1'-0"

PULL OUT FOR FLOOR PLAN

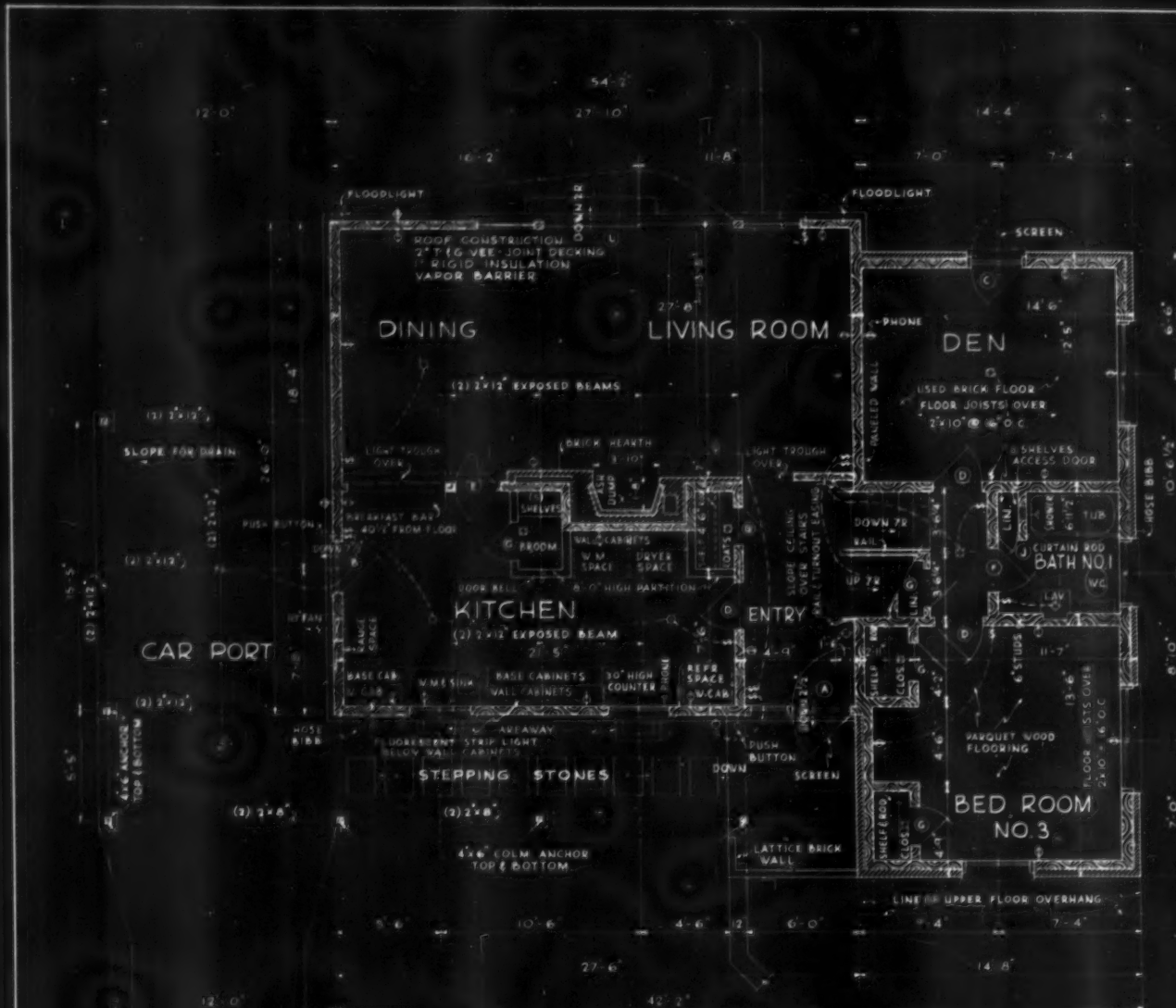

MAIN & LOWER LEVEL FLOOR PLAN  
SCALE 1/8" = 1'-0"



SECTION S-S  
SCALE 3/4" = 1'-0"



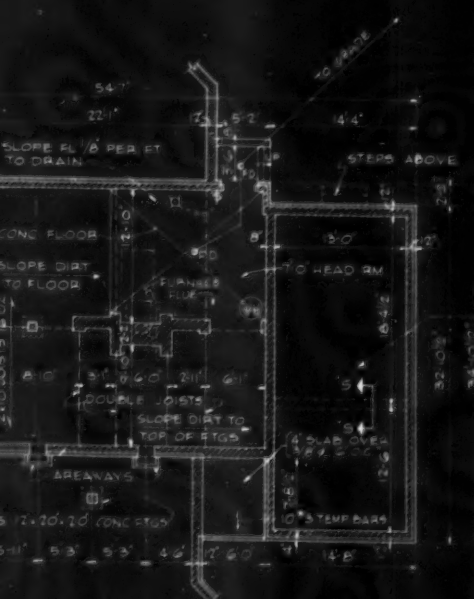
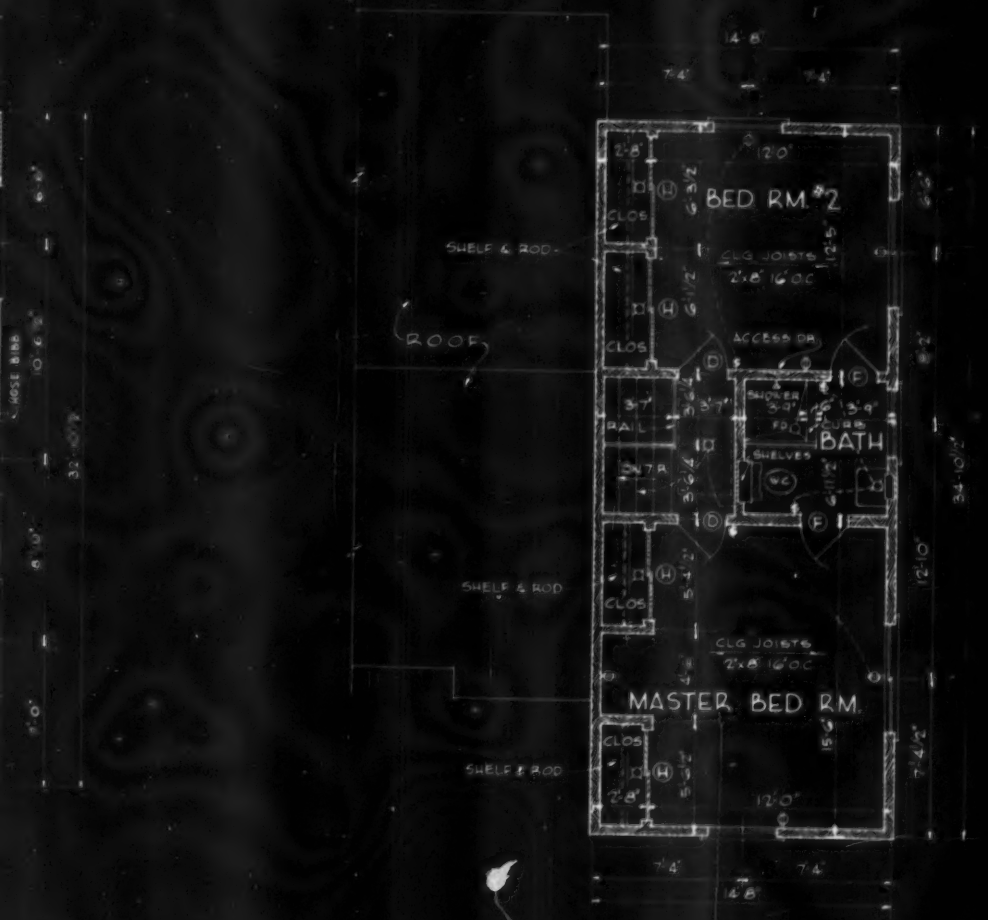

**DESIGN NO. A.B. 223**

AMERICAN BUILDER BLUEPRINT SERIES

JOHN W. CHERRY, ARCHITECT

1429 PEACHTREE ST. N.E. ATLANTA, GEORGIA

Simmons-Boardman Publ. Corp 79 W. Monroe St. Chicago 3, Ill.

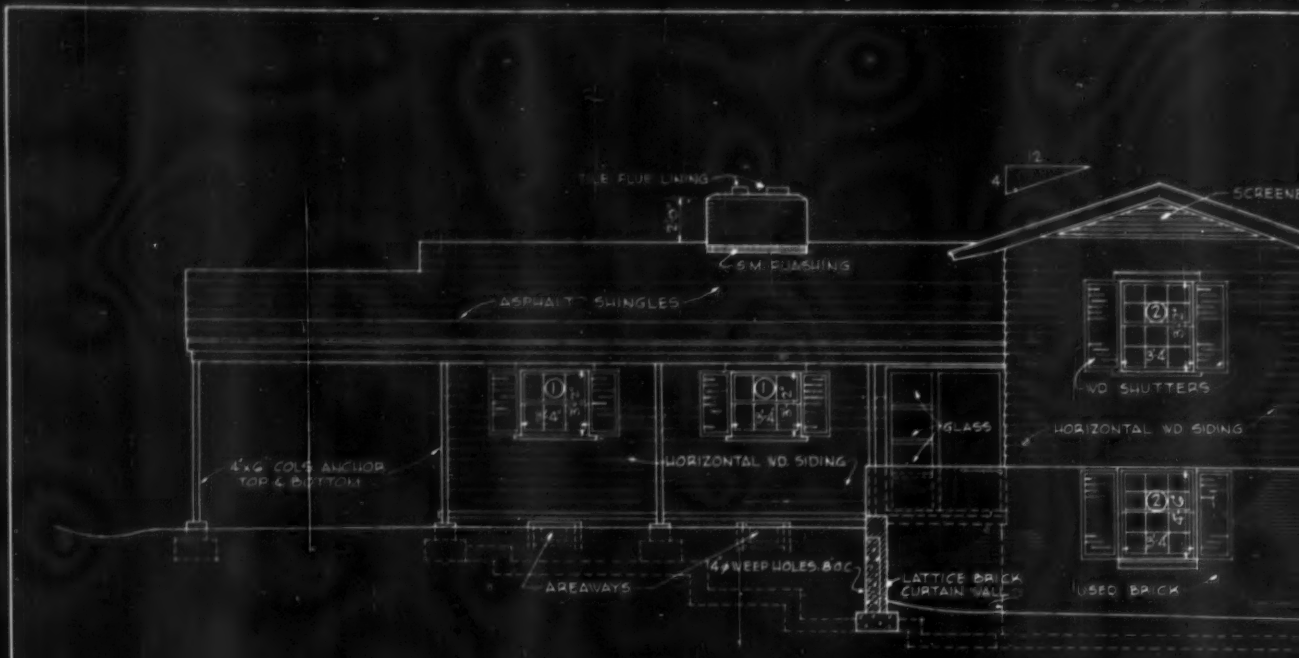

**FRONT ELEVATION**

SCALE 1/8"=1'-0"

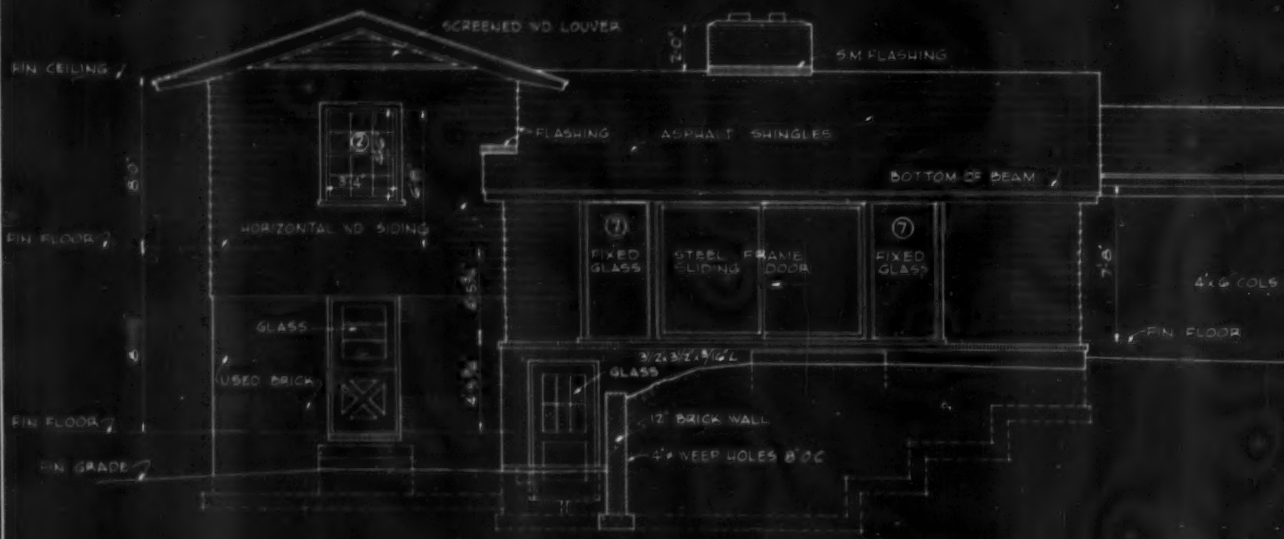

**REAR ELEVATION**

SCALE 1/8"=1'-0"

← PULL OUT FOR FLOOR PLAN

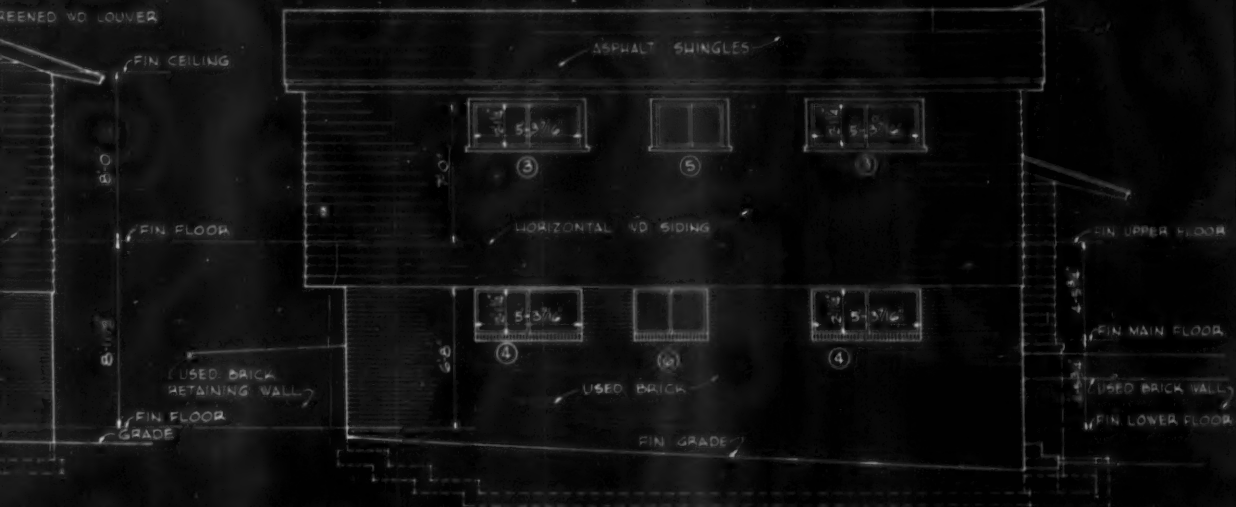

### RIGHT SIDE ELEVATION

SCALE 1/8"=1'-0"



### LEFT SIDE ELEVATION

SCALE 1/8"=1'-0"

#### DESIGN NO. A.B. 223

AMERICAN BUILDER BLUEPRINT SERIES

JOHN W. CHERRY, ARCHITECT

1429 PEACHTREE ST., N.E. ATLANTA, GEORGIA

Simmons-Boardman Publ. Corp. 79 W. Monroe St. Chicago 3, Ill.



RIGHT SIDE ELEVATION

SCALE 1/4" = 1'-0"



LEFT SIDE ELEVATION

SCALE 1/4" = 1'-0"

DESIGN NO. A.B. 223

AMERICAN BUILDER BLUEPRINT SERIES  
 JOHN W. CHERRY, ARCHITECT  
 1429 PEACHTREE ST. N.E. ATLANTA, GEORGIA

Simmons Boardman Publ. Corp. 79W Monroe St., Chicago 3, Ill.



**OUTDOOR** touch in the den is provided for by the use of brick flooring and Dutch door that may be opened as in the picture, leads to a terrace and play area behind the house. The room can also be used as an extra bedroom.



**SNACKS** can be served at this 5½-foot breakfast bar, which doubles as a pass-through between the kitchen and the dining area. It can be closed off by shutters, or co-ordinated with the louvered doors in the interior.

## Quantity List of Materials

For American Builder Blueprint House No. 223

John W. Cherry, Architect

### GENERAL INFORMATION

House—Type	combination
Area	1,209 sq. ft.
Cube	19,344 sq. ft.
Carport—Area	252 sq. ft.
Cube	2,520 sq. ft.
Porch—Area	138 sq. ft.

### EXCAVATING

Trench for foundation	200 lin. ft.
Excavation for basement	50 yds.

### CEMENT WORK

Foundations	300 cu. ft. footings plus 700 sq. ft. 8" concrete block
Concrete work	397 sq. ft. reinforced plus 256 sq. ft. regular floor slab
Thickness	4"
Anchor bolts	40—½" x 10"
Waterproofing	650 sq. ft. felt
Foundation vents	2

### IRON WORK

Metal railings	1 set with grill
Steel mesh reinforcing	400 sq. ft. #10—6" x 6"
Reinforcing rods	26 lin. ft.—¾" dia.
Tempered bars	10—#3—7'-0" long

### MASONRY

Type	brick
Walls	750 sq. ft.
Window sills	6
Chimney	240 cu. ft.
Flue lining	1—8" x 12" 1—12" dia.
Cap	1
Fireplace	1
Throat and damper	1
Lintel	1
Wall around fireplace	155 sq. ft.

### MILLWORK

Windows—Type	double hung; sliding metal sash in wood frames
Windows glazed including trim	Double hung 2—36" x 16" 3—36" x 24"
Gl. fixed in wood frame	2—3' x 6'-6"
Sliding metal sash	2—3'-2" x 2'-1 ¼" 4—5'-3 7/16" x 2'-1 ¼"
Exterior doors	wood and metal (wood) 1—3'-0" x 6'-8" x 1 ¾" fl. s.c. 1—2'-8" x 6'-8" x 1 ¾" Dutch 1—3'-0" x 6'-8" x 1 ¾" 1 Panel (steel) 1—2'-8" x 6'-8" x 1 ¾" 2 Panel (Glass jalousie 10'-0" x 6'-10")
Exterior millwork	Shutters 4 pair Louvers 2 peak head
Interior doors, including jams and trim	6—2'-6" x 6'-8" x 1 ¾" fl. h.c. 3—2'-4" x 6'-8" x 1 ¾" fl. h.c. 5—2'-0" x 6'-8" x 1 ¾" louver 8—2'-4" x 6'-8" x 1 ¾" louver 1—1'-0" x 6'-8" x 1 ¾" fl. s.c.
Special interior millwork	Stairs 2 sets, 7 risers each Kitchen cabinets 1 set Breakfast bar 1

### SHEET METAL

Gutters	G.I. drip—156 lin. ft.
Flashing	at chimney and at roof intersections with walls
G.I. termite shields	250 lin. ft.

### CARPENTRY

Beams and girders	1—6" x 12"—12'-0" 3—4" x 12"—10'-0" 4—2" x 12"—22'-0" 27—2" x 12"—20'-0" 6—2" x 12"—14'-0" 2—2" x 8"—24'-0" 2—2" x 8"—18'-0"
Columns	6—4" x 6"—8'-0"
Foundation plates	200 lin. ft. 2" x 8"
Joists	68—2" x 10"—14'-0"
Bridging	250 lin. ft. 1" x 4"
Headers	170 lin. ft. 2" x 10"
Studding and plates	700 lin. ft. 2" x 4" plus 540 pcs. 2" x 4"—8'-0"
Ceiling joists	26—2" x 8"—14'-0"
Roof rafters	58—2" x 6"—12'-0" 5—2" x 12"—12'-0" 5—2" x 12"—16'-0"
Sub-floor	1,500 bd. ft. sheathing
Roof sheathing	3,020 bd. ft. 2" D. & M. V-joint decking 975 bd. ft. 1"
Side wall sheathing	2,100 bd. ft. 1"
Side wall materials	1,600 bd. ft. bev. siding
Beam cover strips	4—1" x 3"—14'-0" 4—1" x 3"—12'-0"
Flooring—Hardwood	135 sq. ft. parquet
Softwood	220 sq. ft.
Fascia	156 lin. ft. 1" x 6"
Insulation	1,370 sq. ft. 1" rigid

### ROOFING

Type	asphalt shingles
Area	24 squares

### INTERIOR WALLS AND CEILINGS

Area to be covered	5,771 sq. ft.
--------------------	---------------

# Insulite Roof Deck cuts on this 2500

**They cut exposed beam ceiling costs 19¢ per sq. ft.** Arthur Pomponio, president (right) and Victor Marianni, supt., of M. Pomponio and Sons, Arlington, Va., were quick to recognize the growing appeal of exposed beam ceilings. Here's how Insulite's new 3-in-1 product—roof deck, roof insulation and finished ceiling—helped them capitalize on this trend by offering exposed beam ceilings at less cost.

**1. It's roof deck . . .** Two by eight foot units cut application time as much as 45%. On Pomponio's first job, six workmen started laying 2500 sq. ft. of Roof Deck at 7 a.m. At 3:30 p.m. they had a watertight roof—a complete built-up roof with the exception of final mopping and spreading of granules—and the ceiling was done, too! Roof Deck also reduces waste—only 1½% remained after this first job.



INSULITE DIVISION, Minnesota and Ontario Paper Company, Minneapolis 2, Minnesota

**Send for complete information now!** Actual on-the-job pictures and construction details show how to use new Insulite Roof Deck to build better for less. Write Insulite, Minneapolis 2, Minnesota.

**Build better and**

**costs \$475  
sq. ft. job**



The Trendsetter Home, Lake Barcroft Estates, Fairfax County, Va.  
Builder: M. Pomponio and Sons, Inc., Arlington, Va.  
Architect: Edward Pitt, A.I.A., Arlington, Va.

**2. It's insulation with vapor barrier...**

No need for other insulation. Roof Deck meets heat loss requirements for roof and ceiling construction. Exclusive vapor barrier protects against condensation within the unit. Absorbs sound better than wood or plaster. And it's tough. Pomponio's Victor Marianni reports no noticeable deflection or surface impressions even after heavy wheelbarrow traffic.

**3. And finished ceiling...**

The underside of Insulite Roof Deck is finished with a white flame-resistant surface at the factory. Lay Roof Deck over pre-finished beams and ceiling is done. No need to plaster, paint, stain or wax. First Pomponio job required no clean-up or touch-up after deck was down. New Insulite Roof Deck is available in 2'x8' units, 1½", 2" and 3" thick, with or without exclusive vapor barrier.

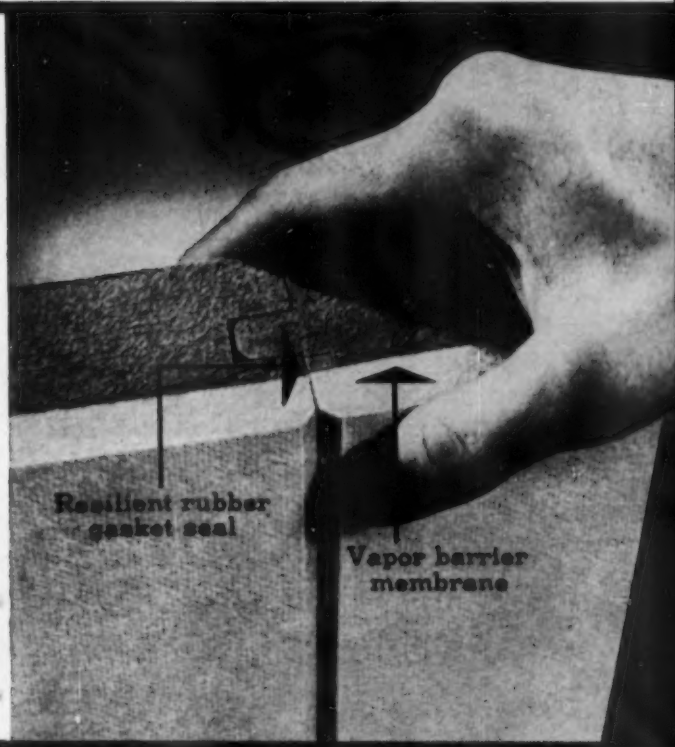

Resilient rubber  
gasket seal

Vapor barrier  
membrane



save with

**INSULITE**

Made of hardy Northern wood



3 reasons why it's good business to . . .



# INSTALL Columbia-matic TENSION SCREENS ON YOUR HOMES

## 2. Give your homes an extra selling feature . . . visible evidence of quality you can point to.

Look at these features: *Patented automatic tension*—spring-loaded bottom rail holds full-length mesh tight against blind stops at all times. *Save time*—easy to put up and take down from inside. Anyone can do it in seconds. *Save work*—no more struggling with clumsy rigid frames, ladders. Columbia-matics roll up for compact storage. *Save money*—no painting, maintenance. No drips on house.

Start giving your homes the economy and sales-plus of Columbia-matic Tension Screens. Send coupon for complete details today!

The Columbia Mills, Inc., Dept. A-10, Syracuse 1, N.Y.

Please send me complete information on Columbia-matic Tension Screens.

Name \_\_\_\_\_

Company Name \_\_\_\_\_

Street \_\_\_\_\_

City \_\_\_\_\_ Zone \_\_\_\_\_ State \_\_\_\_\_

## 1. Cost less—and cost less to install.

Columbia-matic all aluminum Tension Screens *cost less* than old-fashioned, carpenter-fitted, wooden screens. *Easily installed* by unskilled labor in minutes from inside. *No fitting*—Columbia-matics are delivered precut to your specifications. They arrive on the job site packed in cartons of convenient size . . . easy to store until needed. *No call-backs*—Columbia-matics can't swell, stick, warp . . . can't be removed from outside.

## 3. Nationally advertised to make them easily recognized.

Columbia builds consumer demand with homeowners and prospective homeowners by consistent advertising in national magazines.







Build **SALABILITY** and  
**LIVABILITY** into every home  
with

**IRON FIREMAN®**  
**SelectTemp**  
**ZONE HEATING**

**A THERMOSTAT IN EVERY ROOM**

Thousands upon thousands of prospective home buyers are now learning about Iron Fireman SelectTemp heating when they see it installed in new, modern homes throughout the country. SelectTemp heating both surprises and delights them. Every room (even the bathroom) has its own individual thermostat. Every member of the family can enjoy just the degree of warmth he prefers. Room temperatures are automatically adjusted to compensate for fireplace heat, or warmth from the sun, without affecting other rooms. Heating is by gently circulated, filtered warm air. Heat is distributed throughout the house with steam, which comes to each room through a copper tube no larger than your little finger. This same steam runs a turbine-driven circulating fan. No electricity or wiring is needed for fans or thermostats. It's all so simple and practical; many say it's the greatest advance in heating since the introduction of the thermostat. It's no wonder that SelectTemp heated houses attract attention—and buyers.



**Economical for old or  
new construction**

With all its advantages, SelectTemp heating is available at a cost that makes it practical for all types of construction, from the smallest residence to the largest commercial building, old or new. Read "SelectTemp Highlights" at left. Then send coupon below for specifications and full information.

**SELECTEMP  
HIGHLIGHTS**

**THERMOSTAT IN EVERY ROOM.** Temperatures can be varied in every room to fit the "activity plan" and personal preference of the occupants.

**MODULATED HEAT.** Air circulation is continuous. Both temperature and volume of air are automatically modulated, as required to offset heat loss from room.

**FILTERED, CIRCULATED AIR.** Individual room air circulation prevents transmission of odors or bacteria from other rooms. Air is cleaned by a spun glass filter in each room unit. Filtered outside air can be introduced if desired.

**BOILER LOCATION.** Boiler can be placed in any desired location, with proper distribution of heat to every room. Year-around domestic hot water coils available. Fuels: Gas, oil or coal.

**LOW POWER COST.** No electricity required to operate circulating fans. Non-electric thermostats.

**LOW INITIAL COST.** Easily installed in either new or old construction. Small soft copper tubing (3/4 inch I.D.) carries steam to individual room heater units. Return lines are 1/2 inch. Substantial savings in installation costs.

**LOW FUEL COST.** Temperature easily reduced in unused rooms. Overheating is eliminated.

**AUTOMATICALLY BALANCED.** No special adjustments of dampers, valves or orifices required to balance heating system. Each unit continuously regulates heat needed for each room. Automatically compensates for external heat sources such as fireplace or solar heat, without affecting temperatures of other rooms.



**Iron Fireman**  
**SelectTemp**  
**MODULATING ZONE HEATING**

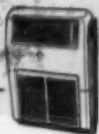

**IRON FIREMAN MANUFACTURING CO.**  
3104 West 106th Street, Cleveland 11, Ohio.  
In Canada, write to 80 Ward St., Toronto, Ontario.

Send literature on Iron Fireman SelectTemp heating.

Name \_\_\_\_\_

Address \_\_\_\_\_

City \_\_\_\_\_ State \_\_\_\_\_



Curtis Convertible windows are really something special! You can use them as awning windows—casements—ribbon windows—and more than a thousand combinations. Used as awning sash, as shown here, they provide draftless ventilation—let fresh air in, but keep rain out. Like all Curtis Silentite windows, Curtis Convertibles are guaranteed for materials and workmanship.



AMERICAN BUILDER



(1) Silentite double-hung windows are truly weather-tight. Special patented features, including the most effective weatherstripping known, bar out dust—protect furnishings—keep heating and air conditioning costs low. Curtis Silentite wood windows always open and close easily—and retain this ease of operation throughout a lifetime of service. See your Curtis dealer!



(2) Easy cleaning—from the inside—is only one feature of Curtis Silentite wood casements. A special adjuster holds these casements rigid in any open position—stops swinging or rattling. And Silentite casements are so weather-tight they can save up to 16% of fuel or air conditioning costs. They come in several sash styles and in all popular sizes. See your Curtis dealer!

# “Livability”...

a built-in feature  
of Curtis Silentite windows

If windows had only to provide an outlook and admit light, almost anybody could design and make them. But to design windows that make living happier, more comfortable, takes thorough research, unusual ingenuity, skilled craftsmanship and production. That explains the popularity of Curtis Silentite windows—and the substantial sales appeal they add to houses in which they are used.

Each type of Curtis Silentite wood window—and there are many—has *extra* features—exceptional advantages—which increase its “livability.” Curtis Silentite windows are sold by leading lumber dealers everywhere. See *your* Curtis woodwork dealer soon for full information on the Silentite window line and other Curtis products. For helpful literature, write to Curtis Companies Service Bureau, Clinton, Iowa.

Be sure to visit the permanent Curtis exhibit at the N.A.H.B. National Housing Center which opens in Washington, D.C., this fall. On display will be latest designs of Curtis panel and flush doors—the famous Curtis Silentite windows—Curtis birch kitchen cabinets—and other Curtis woodwork.



CURTIS WOODWORK  
Heart of the Home

# Announcing a complete Herman Nelson

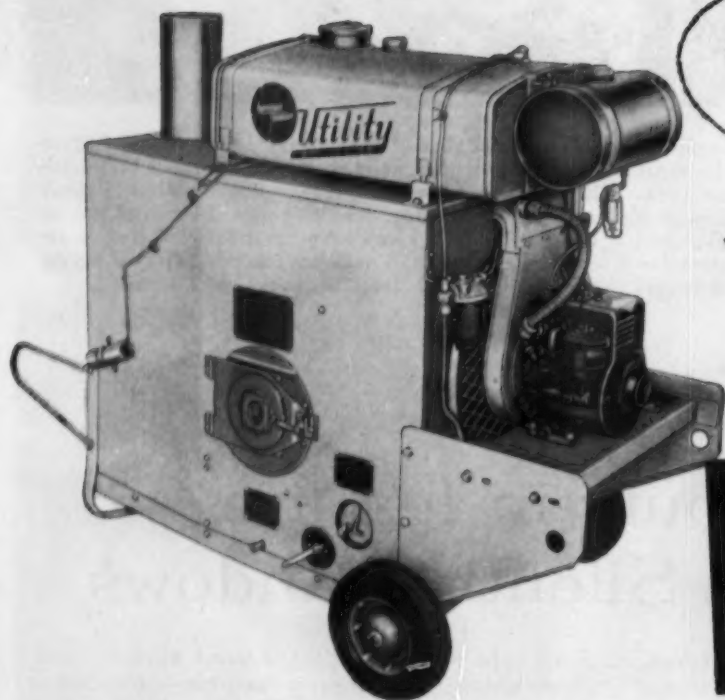

Never before such . . .  
**VERSATILITY!**

## Safe Heat for Big Jobs

Highway and Bridge Construction,  
Industrial Building, etc.

## THE "UTILITY"

Gasoline engine to electric motor  
. . . in 20 minutes!

The "Utility" gives you virtually two heaters for the price of one! Interchangeable power plants *double* the usefulness of this new Herman Nelson heater. Use motor drive where you have electric current, or gasoline engine for remote job sites. And use either gasoline or fuel oils without need of adjustments.

The "Utility" operates overnight without re-fueling. Use it with or without ducts, and with or without venting, depending on your job and location. Herman Nelson—engineered for top safety and simplicity. Has simple manual heat control and self-cleaning burner. 75,000 to 425,000 BTU capacity. *Send coupon for complete facts!*



Fully automatic in operation, with automatic ignition and temperature control. Use it for pre-heating, drying, thawing, spot heating or space heating. Gives you clean, safe heat, with combustion fumes vented outside. Oil fired, electric motor powered. 280,000 to 450,000 BTU capacity. *Send coupon for complete facts!*



ask your dealer about our FLEET USERS' REPLACEMENT PLAN

# new line of...

# Portable Heaters

Never before such ...  
**ECONOMY!**

## Safe Heat for Small Jobs

Home Building, Plastering,  
Industrial Plants

THE  
"THRIFTY"

New low price  
... new simplified design

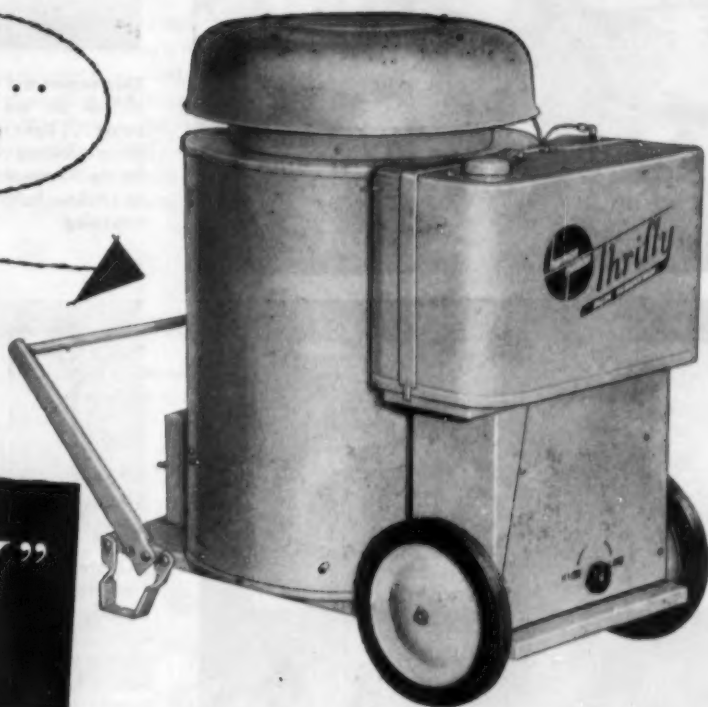

The "Thrifty" gives you traditional Herman Nelson quality at the lowest price ever! Its compact design, light weight and economy make it the highly practical heater for smaller construction jobs, and for emergency heating needs of small industrial plants.

The "Thrifty" operates continuously for 18 hours maximum without refueling. Oil fired, it requires only 0.7 to

1.25 gallons of fuel per hour. It may be used indoors or out, and canvas ducts may be used to spot heat where wanted. Heater has provision for venting when desired.

Electric motor powered, the "Thrifty" has safety controls that protect against overheating—flame failure—motor failure. Fewer moving parts assure longer, trouble-free service. Capacity 50,000 to 170,000 BTU per hour.



## HERMAN NELSON

Best Known Name in  
PORTABLE AIR HEATERS

AMERICAN AIR FILTER CO., INC.  
MOLINE, ILLINOIS

**FREE!**  
MONTHLY WEATHER  
FORECASTING  
SERVICE  
Better than 85%  
accurate over the  
past four years!

### HERMAN NELSON PORTABLE PRODUCTS

American Air Filter Company, Inc.  
Dept. 55, Moline, Ill.

Please rush complete literature on portable heaters. Also send me your monthly weather forecast chart, at no cost or obligation to myself.

NAME \_\_\_\_\_

COMPANY \_\_\_\_\_

ADDRESS \_\_\_\_\_

CITY \_\_\_\_\_ ZONE \_\_\_\_\_ STATE \_\_\_\_\_

# Here's why G-E Remote Control Wiring SELLS HOUSES

As determined from interviews with 555 owners  
of new homes equipped with G-E Remote Control

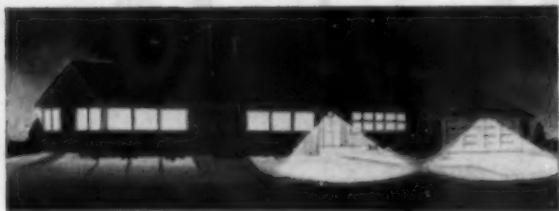

**This command of house lights sells the women.** From her bedside she can control important lights in and around the home . . . light up outdoors and indoors at the slightest sound. Gives a feeling of real security whenever the housewife is alone. Or the home-owner can light the way to a child's room, bath, or kitchen before getting out of bed, turns lights OFF after returning.

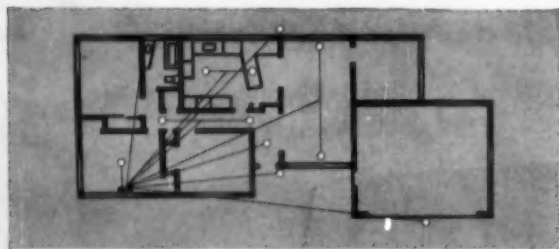

**This step-saving convenience sells the men.** No need to be concerned about lights that might be left ON. By using the bedside Selector Switch, the home-owner can make sure all the lights it controls are OFF. No steps and time spent in checking. There's also the convenience and security of being able to walk into a fully-lighted house. A *second* master selector switch located in the garage or entry hall turns ON selected lights, turns OFF these lights when the family goes out.

Like other reliable electrical control systems—for example, your dial telephone—G-E Remote Control Wiring uses low-voltage operated relays to do the control switching of line voltage circuits.

### Luxury — at Low Cost

With this modern wiring system, the home-owner can turn *one* light OFF, or ON, from many locations. He can also turn a number of lights ON and OFF (as many as 25 with the Deluxe Master Control from one point. G-E Remote Control Wiring is economically practical for homes of any size—or price. You can add this dra-

matic sales feature to your homes at a cost only slightly more than regular wiring.

### A Real Selling Feature

So install G-E Remote Control of lights in the homes you build. Let this convenient system of wiring prove to you that it speeds home sales. The "G-E Remote Control Wiring Manual" shows how to layout, estimate, and install this modern wiring system, with easy-to-follow, step-by-step instructions. Write Wiring Device Department, General Electric Company, Providence 7, Rhode Island.

*Progress Is Our Most Important Product*

**GENERAL  ELECTRIC**

THE ROOF has never been more obviously at eye-level than in today's long, low, rambling home designs. Anything so prominent – and so vital to the beauty and soundness of the home it shelters – has an important influence on prospective buyers . . . determines whether they will drive on . . . or step in. Invite them in . . . with the natural charm and friendly warmth of a *genuine* red cedar shingle roof.



## your best "outside salesman" is cedar...

WALLS, TOO, deserve the natural treatment that will stop traffic and speed sales. You'll not find a more attractive – or *less costly* – sidewall than double-coursed cedar shingles or shakes. Better join this trend to the *real article* in building materials . . . red cedar shingles and shakes . . . for roofs and walls . . . for new construction and remodeling.



### RED CEDAR SHINGLE BUREAU

5510 White Building, Seattle 1, Washington  
550 Burrard Street, Vancouver 1, B. C.



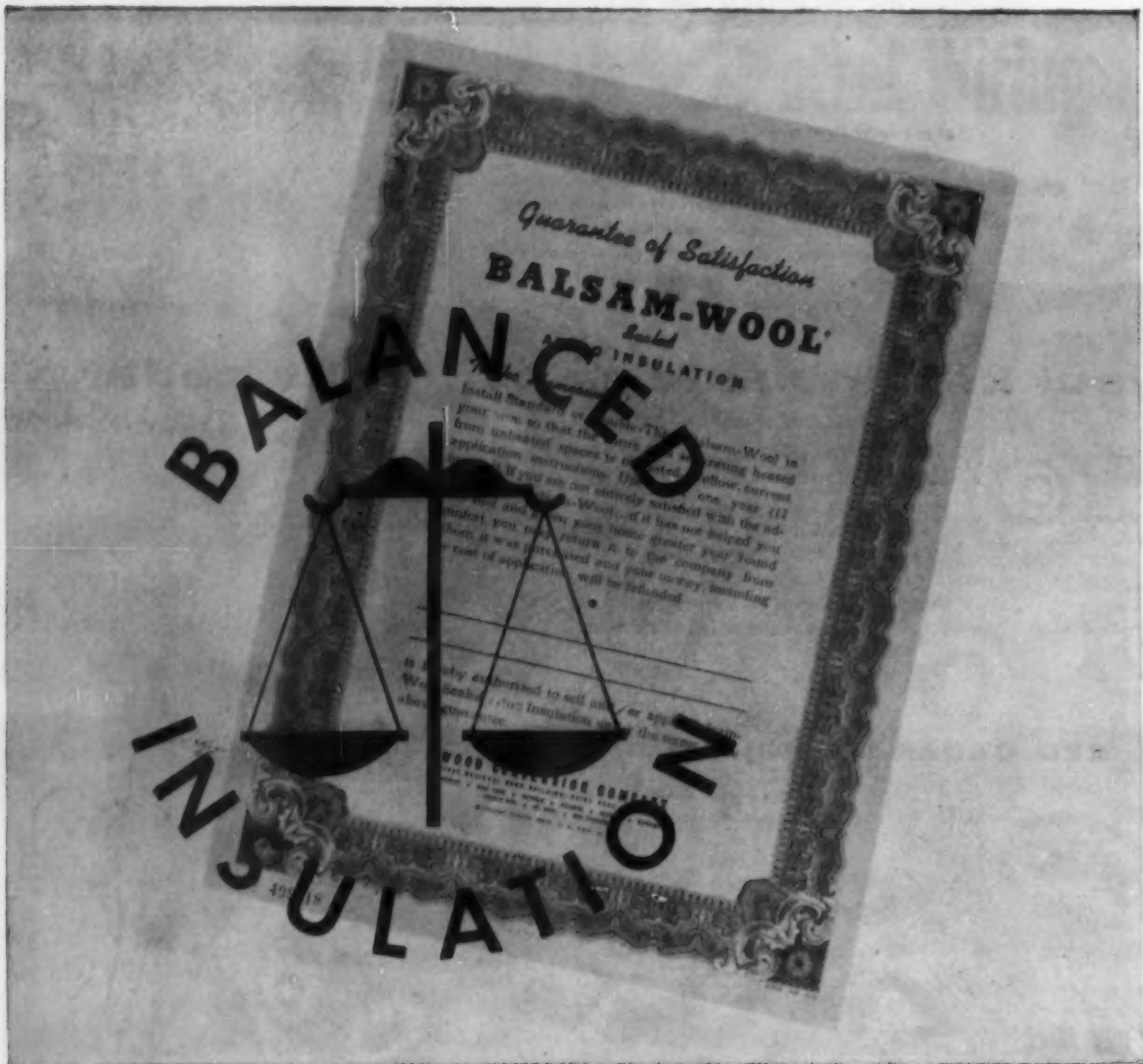

## Your symbols of success in selling more quality homes

The *first* is the famous Balsam-Wool insulation guarantee—a guarantee so complete that only Balsam-Wool can offer it. Here is extra assurance of quality for your prospects—assurance of lifelong comfort, low fuel bills, low air conditioning costs.

The *second* profit-builder for you is *balanced insulation*. That means the right combination of Balsam-Wool® Sealed Insulation—Nu-Wood® Insulating Sheathing—storm sash—weather-stripping—to assure maximum comfort in any home, any climate.

Today, the balanced insulation idea is sweeping the country—and you can cash in on it! Waiting for you at your lumber dealer's is a complete Balanced Insulation sales set. It contains everything you need to sell Balanced Insulation to the home owner as a big feature of your quality homes.

Only your lumber dealer sells Balsam-Wool—and only he has the Balanced Insulation Builders' sales kit. For fast home sales see him soon! Wood Conversion Co., Dept. 118-105, 1st National Bank Bldg., St. Paul 1, Minn.



**BALSAM-WOOL**

*Guaranteed Insulation*

*Insulating Sheathing*

**NU-WOOD**



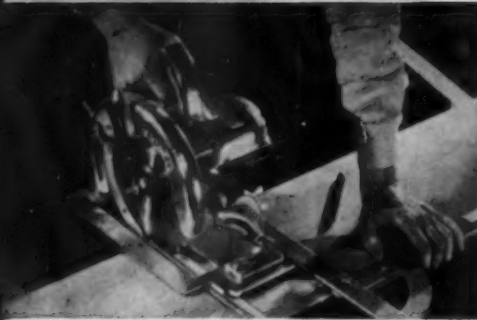

Depth adjustments in front and back plus rigid shoe give accurate cuts at any depth. Ideal for dado cuts.

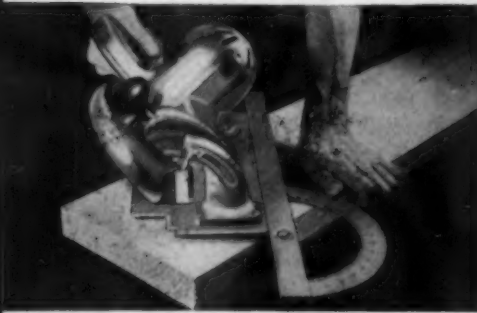

Angle cuts are made quickly and accurately with a B&D saw protractor, used above in cutting a rafter.



Bevel cuts are simple and accurate with quick wing nut adjustment, easily set and locked at exact angle.



Use with B&D abrasive discs for cutting and slotting slate, marble, tile and thin gage non-ferrous metals.



Large lift lever for lower guard keeps fingers away from blade; makes pocket cuts easy.

**Designed on the job... tested on the job...**  
**Black & Decker Saws are**  
**Proved on the Job!**

The men on the job said they wanted extra power and durability in a saw. They wanted features that would make sawing faster, safer, easier. So Black & Decker built the B&D Heavy-Duty Saws to those specifications! The result? B&D Saws have made thousands of new friends—men who proved to

themselves on the job that B&D Heavy-Duty Saws have what they want. Try them yourself and see what we mean. Your nearby Black & Decker outlet is waiting to give you a demonstration. See him soon and treat yourself to the most powerful, *easiest* sawing you've ever done!

LEADING OUTLETS EVERYWHERE SELL



**4 MODELS TO CHOOSE FROM!**

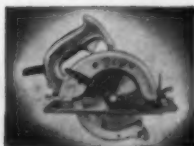

**6-inch Heavy-Duty Adjustable Saw.** Cuts from 0 to 2-inches at 0°, to 1 3/4-inches deep at 45°. **\$64.90**



**7-inch Heavy-Duty Saw.** Cuts to 2 1/4-inches deep at 0°, to 1 3/4-inches at 45°. Auxiliary knob handle. **\$64.90**



**8-inch Heavy-Duty Saw.** Cuts to 2 1/2-inches deep at 0°, to 2 1/4-inches at 45°. Auxiliary knob handle. **\$96.90**

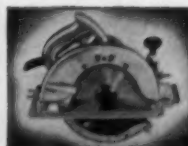

**9-inch Heavy-Duty Saw.** Cuts to 3 1/4-inches deep at 0°, to 2 3/4-inches at 45°. Auxiliary knob handle. **\$114.90**

**Mail Coupon for Free Catalog!**

THE BLACK & DECKER MFG. CO.  
 Dept. H110, Towson 4, Maryland.

Gentlemen: Please send me your free catalog (No. 10) showing B&D Heavy-Duty Saws and accessories.

Name \_\_\_\_\_

Address \_\_\_\_\_

City \_\_\_\_\_ Zone \_\_\_\_\_ State \_\_\_\_\_

**drop-in**

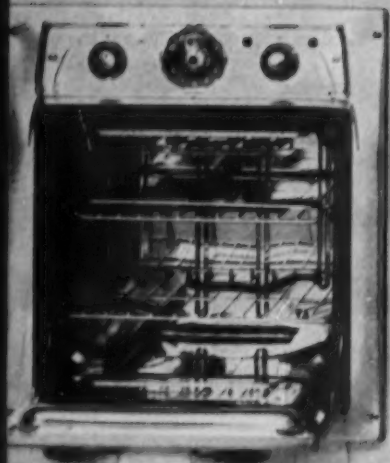

# **TAPPAN** built-ins fit standard cabinets... cut your costs

Now—as easily and fast as you can complete an ordinary kitchen—you can put modern, beautiful, sales-building Tappan Built-In Ranges in your homes. New Tappan electric Built-In ovens drop into standard 24-inch oven cabinets.

The Tappan stainless steel working top shown above drops into standard 36-inch cabinets and requires *only one rough opening*. No front cut-out for switches. You install it in minutes. Electric working tops are also available in 2-element, 24-inch drop-in units and 4-elements, 30-inch set-on units. There's even a matching griddle.

## Oven and surface units for every plan and price, all loaded with sell-on-sight features

You can choose the units to fit your plan and price. Ovens in smart Lusterloy or Copperloy finishes with solid or Visualite-Window doors. Surface units to fit any kitchen plan. And all of them have the quality cooking features that have made Tappan the finest name in cooking.

## No other built-in has so many wanted features

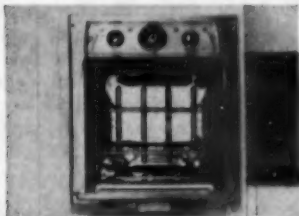

Best-baking chrome-lined oven



Convenient Visualite oven window



Lift-off oven door for easy cleaning

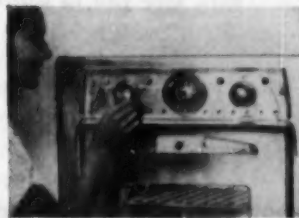

Eye-level automatic controls



Versatile, smokeless broiling

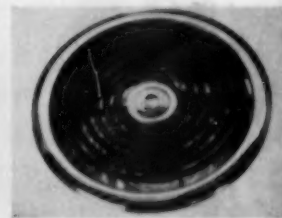

Super fast, 7-heat surface units

## Choose either electric or gas... please every buyer

Reduce labor costs, simplify specifications. Let the top name, Tappan, help you cash in big on the built-in trend. Get complete information and price lists right away.

**Special deal  
for builders!**

**Call, wire or  
mail this coupon  
today**

Dept. ABB-105, The Tappan Stove Co., Mansfield, Ohio  
Please send me complete information and prices on the new  
Tappan gas and electric built-in ranges.

NAME \_\_\_\_\_ TITLE \_\_\_\_\_

FIRM \_\_\_\_\_

ADDRESS \_\_\_\_\_

CITY \_\_\_\_\_ STATE \_\_\_\_\_

I build homes

I remodel homes



# NEW

## Interchangeable barrels for $\frac{1}{4}$ " and $\frac{3}{8}$ " studs



Operator can change from one barrel to the other in seconds, right on the job! No time lost in going from medium-to heavy-duty work—no need for second tool!



### A squeeze of the trigger and the job is done!



Anchoring wood furring to steel . . . steel angle to concrete

Compact tool can be used overhead, in tight places—anywhere a man can go. No outside power source required!

tool cuts costs on all stud fastening jobs!

with the

**Double-Duty**

**REMINGTON STUD DRIVER**

**You can anchor both  $\frac{1}{4}$ " and  $\frac{3}{8}$ " studs in steel or concrete... instantly!**

Here's the first cartridge-powered tool that can cut your costs on practically all construction fastening—light, medium and heavy duty. It's the new Model 455 Remington Stud Driver!

The secret of this amazing versatility lies in the tool's construction. *Two* sizes of studs can be used— $\frac{1}{4}$ " and  $\frac{3}{8}$ ". Changeover in barrels takes only 90 seconds *right on the job*. With either size, an operator can set up to 6 studs per minute... anchor conduit clips, wood sections, steel frames and many more fixtures with a squeeze of the trigger!

What powers the Stud Driver? Remington 22 and 32 caliber cartridges for the  $\frac{1}{4}$ " and  $\frac{3}{8}$ " studs respectively. For special medium-duty applications, the smaller cartridge may be used with the larger

stud, giving an extra-strong fastening at a saving. Every stud is driven arrow-straight, whatever the combination.

**GET ALL THE FACTS** about this new, useful fastening tool that goes anywhere, works anywhere—without wires or cables, hammering or predrilling. The Model 455 Remington Stud Driver makes the toughest fastening job a one-man, one-tool job and saves you time and money with every application! Just clip the coupon below for full details.

**MAIL THIS COUPON TODAY!**

Industrial Sales Division  
Remington Arms Co., Inc., Bridgeport 2, Conn.

Please send me your free booklet which shows where and how to use the cost-saving Remington Stud Driver fastening method.

Name \_\_\_\_\_ Position \_\_\_\_\_

Firm \_\_\_\_\_

Address \_\_\_\_\_

City \_\_\_\_\_ State \_\_\_\_\_



*"If It's Remington—It's Right!"*

**Remington** 

Designed with the builder in mind...

## NEW G-E DISHWASHER OFFERS UNMATCHED FOR QUICK,



We don't claim that kitchens like this will actually sell your houses for you—but it is a well-known fact that when kitchens are equipped with G-E Dishwashers and Disposalls,<sup>®</sup>

those houses are *easier* to sell! Why don't you contact your G-E distributor right away and ask about the new low, low prices available to accredited builders?



**G-E Dishwashers** are also available in this free-standing model with work surface of Textolite<sup>®</sup> or baked enamel. Front panels of free-standing and built-in models available in five Mix-or-Match colors or a choice of four natural woods.



## ACCESSIBILITY LOW-COST INSTALLATION!

Here's why G-E Dishwashers are easier to install:

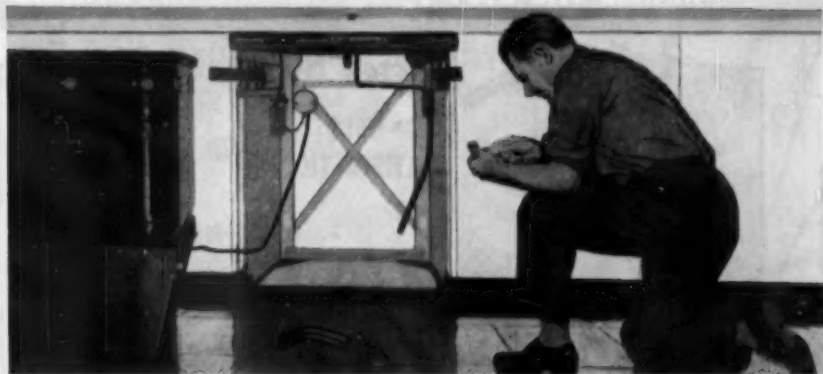

1.

**No reaching—no stretching** around unit to install! The entire tub can be easily removed from the cabinet, thus providing ample working room to

make plumbing and electrical connections. Pre-stamped knockouts on each side of the cabinet permit easy installation of right or left drain.



2.

**Simplified internal plumbing** makes possible quick installations in a number of different ways. A G-E Dishwasher may be connected to the drain directly, or through a waste air gap. It may also be connected to a disposer (as illustrated) or to the sink drain.



3.

**New, low-cost waste air gap** method of installation provides maximum sanitation, eliminates the need for prior roughing-in. One drain is used for both sink bowl and dishwasher, eliminating the cost of a second drain. An excellent installation for existing homes, too.

For a completely modern kitchen, install a G-E Disposall that flushes away food waste before it can become garbage! Illustrated are Models FA4 and FA45—exactly the same except that the FA45 is 2 inches shorter to accommodate installations with space problems.

*Progress Is Our Most Important Product*

**GENERAL  ELECTRIC**

# EMPIRE



MAKES THE BEST *Gas* HEATING APPLIANCES IN THE WORLD

*There's NO DOUBT about it!*

• USER  
SATISFACTION

• DEALERS  
ACCEPTANCE

• MOST EFFICIENT

*Gas*  
BURNER MADE

• MINIMUM FIELD  
SERVICE REQUIRED

• SILENT  
IN  
OPERATION



A complete quality line of standard Upflow and Counterflow gas central furnaces to protect your reputation. Empire heating appliances are recommended by outstanding architects, heating contractors and builders. You can't afford to use anything but the best. Empire furnishes the best, there is no doubt about it.

**EMPIRE**

*A Great Name in Gas Appliances*

WRITE FOR COMPLETE INFORMATION *Today!*

**STOVE COMPANY**

BELLEVILLE, ILLINOIS



**BIG  
CAPACITY!**

**LIGHTWEIGHT!**

**NOW \$ 382<sup>50</sup>  
ONLY**

Complete Delivered

(as shown, custom-built  
1½ H.P. motor, 10" saw  
blade, 4 detachable  
legs included). Easy Terms.

FLOOR TYPE  
STILL ONLY \$395.00  
Complete Delivered.  
(custom-built 1½ H.P.  
motor, 10" saw  
blade, 4 detachable  
legs included).  
Easy Terms.



**AMF De Walt's new lightweight GW-I offers you  
50% MORE POWER FREE!**

1½ H.P. motor instead of 1 H.P. . . . at the same old, low price!

Here's AMF De Walt's new model GW-I with a FULL 1½ H.P. direct-drive motor—just 1 of 12 new operating and safety features you get at no extra cost.

This lightweight GW-I is perfect for small builders to use on the job—for frame and finish cutting. Enjoy BIG SAW CAPACITY at small saw cost. 10" saw cuts 3" deep, rips 26" wide. Uses 12" blade to cross-cut 4" deep when needed. Weighs only 184 lbs. net. Welded-on carrying handles mean easy, quick job-to-job moving.

Buy yours NOW . . . start your next job using AMF De Walt® methods and increase your profits!



Safety Key switch

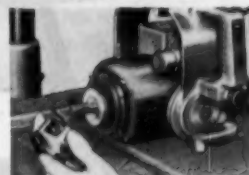

Powerful 1½ H.P. Motor



115/230 V change switch

**FREE!** New AMF De Walt Idea Book  
on Cutting Methods.

Another **AMF** Product

**DE WALT  
POWER TOOLS**



**AMF DE WALT**

Dept. AB-55-10, Lancaster, Pa.

- Please send me your new idea book for builders.
- Please send Pocket Size Common Rafter Meter (enclose 25c)

NAME \_\_\_\_\_

ADDRESS \_\_\_\_\_

CITY \_\_\_\_\_ STATE \_\_\_\_\_



Celotex

# TWINTEX

Reg. U.S. Pat. Off.



❖ for residence remodeling  
or new home construction... for those  
"special" rooms!

❖ for commercial remodeling  
or new store, restaurant, school, or  
plant construction!



**more business for you...**  
through Celotex national advertising

This year, Celotex is covering the residential construction market with an unusually powerful advertising campaign. Big, colorful, eye-catching ads, month-after-month, continue to work in your behalf pre-selling your prospects. *Let these prospects know that your homes are built with genuine Celotex Products.* You'll find sales easier to make... because over a third of a century of national advertising has created nationwide preference for the Celotex brand name!

# Insulating Tile Board

**smart, new design speeds installation!  
new colors...new textures! \***



... covers twice the ceiling area  
with each tile!

A time-saving, labor-saving ceiling finish for new construction of supermarkets, restaurants, stores, schools, recreation centers, libraries, auditoriums, churches... or for any remodeling therein! A best-selling feature in all your new-home building... or remodeling jobs... to finish off those "special" TV rooms, recreation rooms, all-family all-purpose rooms!

## **new "E-Z" joint design**

- New, scientifically designed "E-Z" Joint speeds application, conceals staples or nailheads. Units join quickly, interlock securely. Note tapered tongue for easier positioning without forcing, and improved stapling (or nailing) flange, designed for easier alignment and fastening of units.



That's Celotex Twintex† Insulating Tile Board... designed to cut costs as it gives twice the coverage of conventional square tile units.

Cross-scored to look like two square tile, each Celotex Twintex Tile goes up in much less time than two units. You reduce your costs through low material cost, rapid application (one-trade, one-step), and the fact that these are beautiful *pre-decorated* finishes.

Ideal for interiors of all kind... in a wide range of beautiful colors and textures to meet every job requirement. Combines superior insulation value with truly outstanding decorative appeal. Available in plain or perforated types.

## **Get the Facts Now!**

Contact your Celotex representative today, or write direct, for complete information on how Celotex Twintex Insulating Tile Board can help you sell more commercial jobs in both remodeling and new construction... make your homes more saleable... while holding costs down!

*Build Better... Build with Genuine*

# **CELOTEX**

Reg. U.S. Pat. Off.

## **BUILDING PRODUCTS**

THE CELOTEX CORPORATION, 120 SOUTH LA SALLE STREET, CHICAGO 3, ILLINOIS

Looking for Ideas to hold costs down?

# SAVE DOLLARS ON FRAMING, HANGING, FINISHING CLOSET

You save hours, save dollars and add closet convenience that sells homes—all with Truscon Steel Sliding Closet Doors.

Here's how. You simply build the wide opening to size and attach your Truscon Steel Door Frames. Shipped knocked down, they are easily assembled in minutes. Corner connections form neat hairline joints. These Truscon Frames are finish trim and molding, too. And, they're sized to fit practically every type of wall construction.

Now install the floor track, engage door leaves in header and track and you're done. No cutting, fitting, planing needed. You've erected a door that slides quietly on nylon rollers, that won't stick

because steel can't ever warp, swell or shrink. One-coat painting to match room decorations completes the job.

And what superb closet convenience you have to sell! Women love closets they can see in, see up, reach in, reach up. No fumbling. Everything in plain sight. Closets with sliding door convenience sell homes. Truscon is pre-selling them in extensive national advertising.

Truscon Steel Interior Swing Doors and Frames offer the same easy, time-saving, money-saving erection. They're sound-deadened, too. Both types quickly available in popular sizes from Truscon warehouses. See them at your dealer's, or write Truscon for details and specifications.



## REPUBLIC STEEL

*World's Widest Range of Standard Steels and Steel Products*



### TRUSCON STEEL RANCH WINDOWS HOLD COSTS DOWN

"Tollgate" is a 500 home development in Baltimore. Builder William F. Chew uses Truscon Ranch Windows throughout. He says, "We require a window that is reasonably priced, simple to install, architecturally attractive, with superior utility features. The Truscon Ranch Window suits our purpose. Our builders like the unit because it is free of troublesome adjustment and maintenance problems." This outstanding window value offers all these advantages to you. Write Truscon for details and specifications.



### SAFE, GROUNDED WIRING IS A SALES POINT

A modern pull-in, pull-out, grounded steel raceway system is safer . . . and saleable. Provide quality wiring protection with Republic ELECTRUNITE® E.M.T., the original lightweight rigid steel raceway. Exclusive "Inch-Marks" and new "Guide-Line" make ELECTRUNITE easiest of all to install . . . with minimum waste. Exclusive inside-knurling cuts friction, makes wire-pulling easier. No threads to cut. Compression-type connectors and couplings keep moisture out. It's galvanized to resist rust. Approved by the National Electrical Code for concealed, open and concrete construction. Tell your electrical contractor you want ELECTRUNITE E.M.T. for safety.

# FITTING, DOORS



## TRUSCON METAL LATH HELPS KEEP CEILINGS CRACK-FREE

Expanded metal lath is your best plaster base. It resists cracking and crumbling. Only metal lath grips plaster so tightly that the surface is virtually earthquake resistant! Fire resistant, too. Metal lath and plaster are ideal for ceiling radiant heating systems. Truscon Metal Lath is easy to erect, easy to work over. More than 40 different Truscon Metal Lath items and accessories are approved by all building codes. Tell your plastering contractor you want the crack-resistance of metal lath.



**REPUBLIC STEEL  
CORPORATION**  
3128 East 45th St.  
Cleveland 27, Ohio

Please send me details and specifications on:

- Truscon® Metal Doors and Windows
- Republic ELECTRUNITE® E.M.T.
- Truscon Metal Lath

Name \_\_\_\_\_

Company \_\_\_\_\_

Address \_\_\_\_\_

City \_\_\_\_\_ Zone \_\_\_\_\_ State \_\_\_\_\_

K-5400-A

# Announcing New Ford Trucks for '56



*New capacities carry more load; new power moves it faster.*

## Now! Most horsepower per dollar!

**NEW POWER!** More horsepower for your money than any other truck line—proved by comparisons of horsepower and suggested list prices of *all* trucks!

**NEW CARRYING CAPACITY!** New bigger payloads. New higher-capacity tubeless tires on every model.

**NEW COMFORT AND SAFETY!** New *Driverized* Cabs! New, exclusive *Lifeguard* Design safety features.

**NEW STYLING!** New "leadership look" from Pickups to 65,000-lb. GCW tandem-axle Big Jobs!

Ford's big advancements for '56 can make more money for you than ever. Choice of eight new engines with *Short Stroke* design (reduces piston travel, cuts friction) and up to 26% more power. New *Driverized* Cabs with full-wrap windshields to cut driving strain.

New exclusive *Lifeguard* steering wheel and *Lifeguard* door latches give added protection in case of accident. New styling builds prestige for your business. *Now on display at your Ford Dealer's.*

### New Features for Building Supply Distributors



**A new Money Maker**—the '56 Ford C-600! Choice of three Short Stroke Y-8 engines—up to 168 h.p. New Special Y-8 with 4-barrel carburetion, such durability features as sodium-cooled exhaust valves. Three transmissions, too! 18,000 lbs. GVW, 32,000 lbs. GCW.

# PROFITUNITY!



—new folding door for  
high-volume sales,  
year-around profits

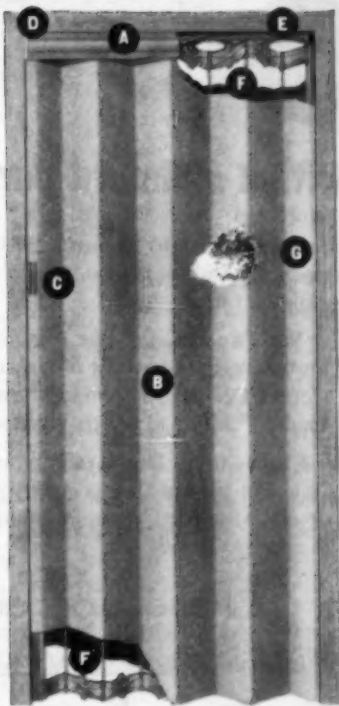

FOLDOOR "Beautyline" is the new and different fabric-covered folding door—in 11 stock sizes for all standard openings in homes, offices, etc.

● Any dealer who sells folding doors knows the high unit profit, steady pattern of daily sales and year-round demand offered by this popular product.

Here, now, is a *new* folding door—FOLDOOR "Beautyline"—with a host of exciting new features to outshine competition and make even faster sales and profits. Consider:

**A.** Attractive cornice at no extra cost. **B.** Deep-textured fabric for "drapery" look. Tough, pliable mist gray vinyl is entirely washable. **C.** Sturdy, unbreakable all-metal hardware for a lifetime of use. **D.** Nylon trolley wheels—and "Multi-V" construction with 61% less hinge friction for feathertouch action. **E.** Pantograph keeps folds evenly spaced at all times. **F.** "Truss-Embossed" hinges are stronger, insure greater rigidity. **G.** "Beautyline" stacks in less space—only 1½" per foot of opening.

With all this—and more—FOLDOOR "Beautyline" is built to list complete as low as **\$2245\***

\*Slightly higher in western states.

Ask your FOLDOOR Distributor—or send coupon.

In Canada: Foldoor of Canada, Montreal 26

HOLCOMB & HOKE MFG. CO., INC.  
1545 Van Buren Street  
Indianapolis, Indiana

Please rush me "Profitunity" Package on new FOLDOOR "Beautyline."

Company.....

Address.....

City..... State.....

Individual.....



# CUTS COSTS

## CHASE<sup>®</sup> copper drainage tube fits within standard partitions!

For a neater, more compact drainage installation, insist on *Chase Copper Tube* for soil, waste and vent lines.

Chase 3" Copper Drainage Tube fits *within* standard partitions, eliminates the need for costly and unsightly furring-out construction that's required with ordinary drainage materials.

The smooth inside surfaces of Chase Copper Drainage Tube and Solder-Joint Fittings permit fast, even drainage... there are no in-

ternal projections to form waste-trapping pockets. And, of course, *copper* can never clog with rust!

What's more, because *installation* costs are lower, the *total* cost of a quality Chase Copper Drainage System is little or no more than the cost of an ordinary system.

Chase Copper Drainage Tube and Solder-Joint Fittings can mean a *quality* job at little or *no* extra cost. When planning, be sure to specify *Chase!*

# Chase

BRASS & COPPER CO.

WATERBURY 20, CONNECTICUT • SUBSIDIARY OF KENNECOTT COPPER CORPORATION

Chase<sup>®</sup> Copper  
adds extra value  
to any home!

The Nation's Headquarters for Brass & Copper (12 sales offices only)

Albany†	Chicago	Detroit	Los Angeles	New Orleans	Rochester†
Atlanta	Cincinnati	Grand Rapids†	Louisville†	New York	St. Louis
Baltimore	Cleveland	Houston	Minneapolis	Philadelphia	San Francisco
Boston	Dallas	Indianapolis	Missoula	Pittsburgh	Seattle
Charlotte†	Denver	Kansas City, Mo.	Monk	Portland	Waterbury



# Vulcan **TRIMLINE** Baseboard Radiation

## Costs Less in the Long Run

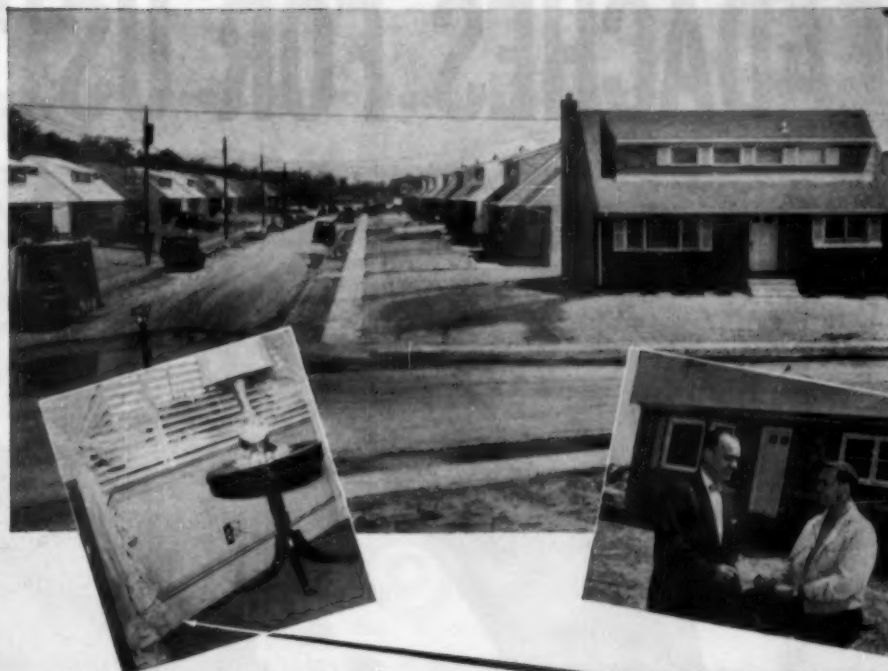

TRIMLINE installed in 200-home development at West Brightwaters, Long Island, by FERN HOMES.

Plumbing and Heating Contractor —  
NOR-FELD CO.  
Elmont, L. I.

Supplier —  
Hicksville Plumbing & Supply Co.  
Hicksville, L. I.

Architect —  
Herman York  
90-04 161st St.  
Jamaica, L. I.

Left, Nat Siegel, Builder and president of FERN HOMES, with Harry Sherman of YOKUM & GOODE, VULCAN Representatives, New York area.

### Successful Builder Chooses **TRIMLINE**

## 3 BIG Reasons!

#### 1. COSTS LESS TO INSTALL

New TRIMLINE features save time, materials, money. Fewer joints necessary, less fittings. All parts mount on one-piece back and top. Front cover snaps on. Great savings with reduced installation time.

#### 2. TRIMLINE HAS EYE-APPEAL

The beauty and design helps sell homes faster. Blends and harmonizes with any interior decor, modern or traditional. Preferred, too, by home owners.

#### 3. I-B-R RATED

Performance is important and TRIMLINE IS rated and listed for efficiency and output by I-B-R. Here is another vital selling feature, an important seal of approval!

#### LEARN HOW YOU CAN CUT YOUR COSTS WITH TRIMLINE

Write today for Vulcan's FREE Catalog 54 that tells you how you can cut your installation costs and increase heating efficiency.

Originators of Fin-Tube and Baseboard Radiation in America

**The VULCAN Radiator Company**  
775 CAPITOL AVENUE  
HARTFORD 6, CONN.

**THE VULCAN RADIATOR CO.**  
775 CAPITOL AVE.  
HARTFORD 6, CONN.

FREE DESIGN CATALOG — please send me at no obligation your TRIMLINE Catalog 54, giving Dimensional Data, I-B-R Ratings, Heating System Design and Piping Design Chart.

NAME .....

COMPANY .....

STREET .....

CITY ..... ZONE ..... STATE .....

"Doing business with *LENNOX* means

**NO HEADACHES FOR US..."**



## ■ says America's third largest builder

"With our projects going up in Phoenix, Albuquerque, Tucson, Salt Lake City, Denver and the Chicago area, we've plenty of problems," says Sam Hoffman, president, F & S Construction Company. "But none on heating—no headaches, no worries—when we do business with Lennox. Now we have an all-season air conditioning expert on our staff at no extra cost, giving us prompt, reliable and complete service from planning right down through promotion. We build homes in the \$8,500 to \$15,000 price range and find it pays to use nationally-advertised, top-quality equipment. That's why we chose Lennox—the top brand name in residential heating and cooling." (During 1955 Lennox heating equipment will be used in one out of every ten new homes throughout the United States.)

With as many as eight homes a day going up in the Denver F & S operation, Lennox equipment must be installed on tight production schedules. Here the Lennox dealer and the Lennox factory representative check installation of the compact, two-piece Lennox Stowaway that allows installation of blower section at either end of heat exchanger. No delays on equipment delivery to worry about either, with a Lennox warehouse right in Denver.

**FOR COMPLETE INFORMATION** and sample of builder personalized tract brochure get in touch with your Lennox dealer, or wire collect today to your nearby Lennox plant. The Lennox Furnace Company, Air Conditioning and Heating, founded 1895: Marshalltown and Des Moines, Iowa; Syracuse, N. Y.; Columbus, Ohio; Forth Worth, Tex.; Los Angeles, Calif.; Salt Lake City, Utah; Decatur, Georgia. In Canada, Toronto, Montreal, Calgary.

it's good business to buy

# LENNOX

through 5,516 all-season  
air conditioning experts



Sam Hoffman, president, F & S Construction Company discusses progress of his Denver building operation with Lennox dealer William Van Genderer of the same city.



William Van Genderer and factory representative talk over selection of equipment with F & S Denver project manager H. E. Buddemeyer. Lennox has the largest line of residential heating and air conditioning units for installation in basement, utility room, closet. Stowaway units for attic or crawl space.



Harold Michaels, F & S sales manager, discusses promotion ideas with William Van Genderer. Lennox offers builders more than a dozen selling aids in the Lennox model home promotion kit—personalized tract brochures, job signs, life-size Miss Lennox cardboard cutout display and the Lennox mystery voice that makes anything talk.

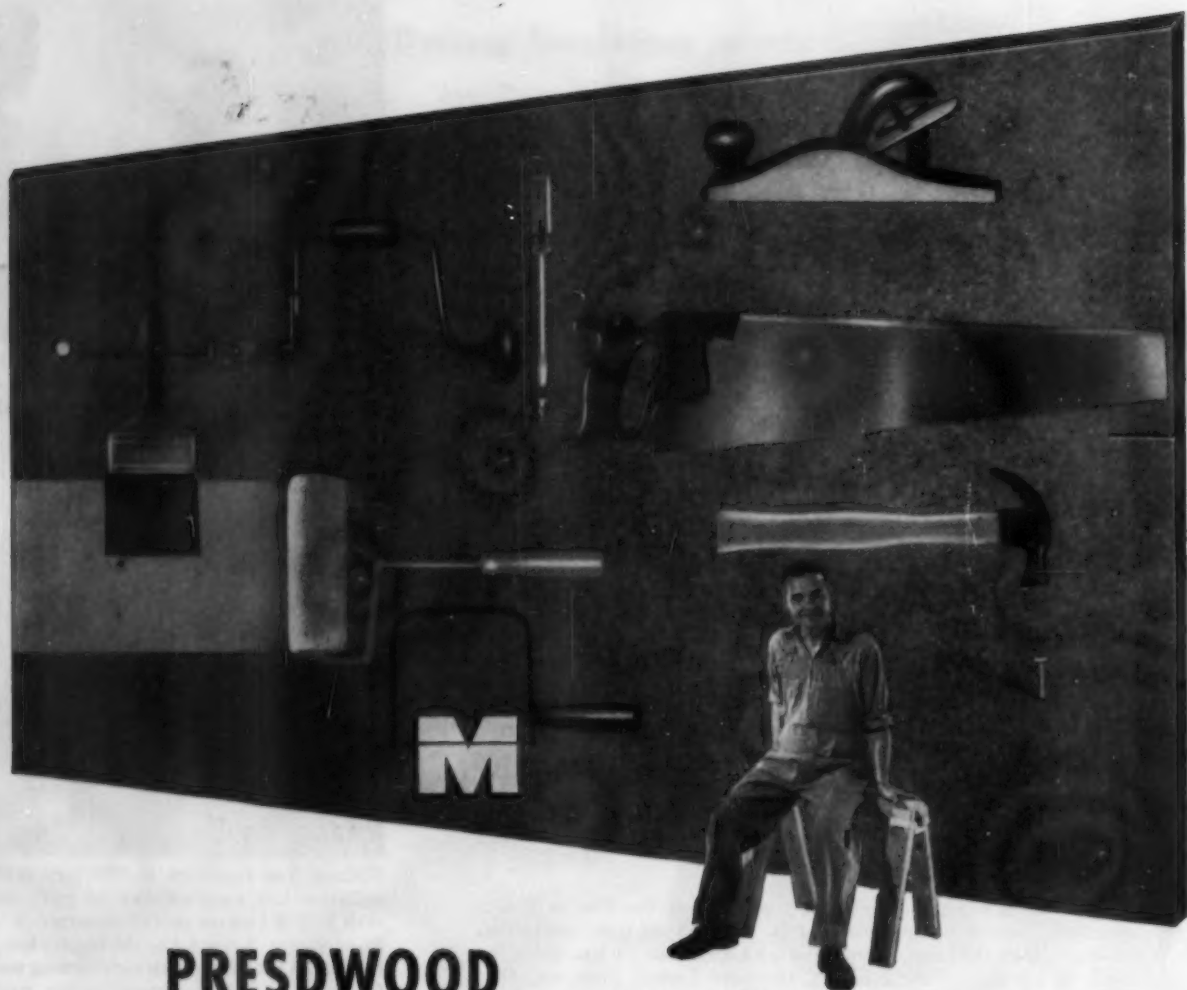

## PRESDWOOD works with you, all ways!

It's hard, tough and rigid, but you don't have to fight with it!

You'd say Masonite Presdwood® is made to order for the building trade. Not only does it come in a variety of types and thicknesses for every panel purpose, but it works readily with the tools you have.

You cut it with hand or power saw. You fasten it with nails, screws, rivets, bolts—or adhesives. You get cleanly beveled edges. You can drill it, rout it or punch it. You can even bend it to graceful, permanent curves.

Finishing? It won't rot or deteriorate even if you don't paint it. But the smooth, flat surface of

Presdwood forms a perfect bond for paint, enamel, lacquer, varnish and stain. Finishes stay new looking longer—there's no grain to rise and mirror through.

*Many types and thicknesses of Presdwood are available with Primecote—a smooth neutral gray finish equal to two coats of hand applied primer.*

Do you have any idea of the hundreds of ways builders are using these versatile hardboards? Your building materials dealer can tell you. He has helpful literature and application hints. Yours at no charge. Or write Masonite if you have a special problem. Masonite® Corporation, Dept. AB-10, Box 777, Chicago 90, Ill.

Look for this man



He makes the difference

# MASONITE PRESDWOOD

PANEL PRODUCT OF MASONITE CORPORATION

FOR BUILDING HOMES . . .  
and REPUTATIONS

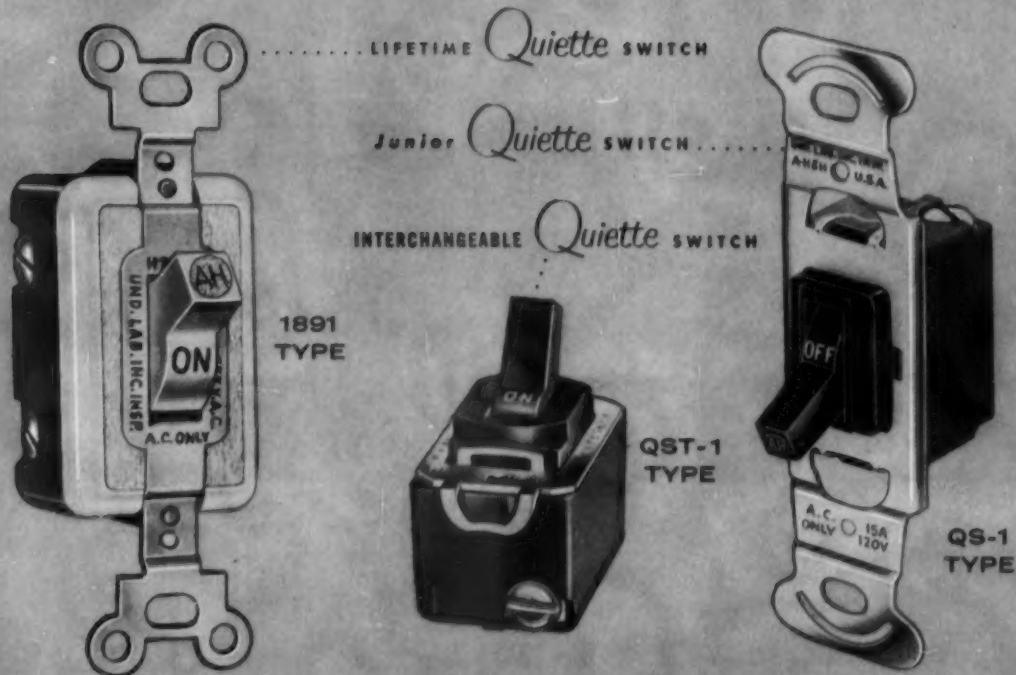

..... LIFETIME *Quiette* SWITCH

Junior *Quiette* SWITCH .....

INTERCHANGEABLE *Quiette* SWITCH

1891  
TYPE

QST-1  
TYPE

QS-1  
TYPE

ALL TYPES NOW AVAILABLE WITH SCREW OR SCREWLESS WIRE-LOCK TERMINALS

THE COMPLETE LINE of



*Quiette*

LIGHT SWITCHES

Quiet, Safe, Mechanical Operation For Both Incandescent And Fluorescent Lights

In light switches, quiet and quality are in demand. The *quiet* operation of Arrow-Hart QUIETTE Light Switches appeals to prospective home buyers and helps turn them into satisfied home owners. The *quality* construction of Arrow-Hart QUIETTE Light Switches helps keep them satisfied . . . and recommending the builder to other prospective home owners.

LIFETIME ratings: 15 amp - 120-277 volt ac only;  
20 amp - 120-277 volt ac only.

INTERCHANGEABLE ratings: 15 amp - 120-277 volt ac only;  
20 amp (with screws only) - 120-277 volt ac only. S.P. and 3-way screwless switches are available with line shunts.

Junior ratings: 15 amp - 120 volt ac only. Screwless switches are available with either line or ground shunts.

All types are listed as standard by Underwriters' Laboratories, have alloy silver contacts that will carry substantial loads, and are available in single or double pole, 3-way or 4-way, with Brown or Ivorylite handles.

**ARROW-HART**  
WIRING DEVICE DIVISION

103 HAWTHORN STREET, HARTFORD 6, CONN.

- OFFICES, SALES ENGINEERS AND WAREHOUSES IN:
- |            |             |               |                 |
|------------|-------------|---------------|-----------------|
| ATLANTA    | DALLAS      | NEW YORK      | HAVANA, CUBA    |
| BOSTON     | DETROIT     | PHILADELPHIA  |                 |
| CHICAGO    | LOS ANGELES | ST. LOUIS     | TORONTO, CANADA |
| CINCINNATI | MILWAUKEE   | SAN FRANCISCO |                 |
| CLEVELAND  | MINNEAPOLIS | SEATTLE       | LONDON, ENGLAND |

*Quality*

- WIRING DEVICES • MOTOR CONTROLS  
ENCLOSED SWITCHES • APPLIANCE SWITCHES



WIRING DEVICE DIVISION AB

**THE ARROW-HART & HEGEMAN ELECTRIC CO.**  
103 HAWTHORN STREET, HARTFORD 6, CONN.

Please send my copy of "New Quiette Switches" folder (Form WD-ST-75)



NAME \_\_\_\_\_  
POSITION \_\_\_\_\_  
COMPANY \_\_\_\_\_  
CO. ADDRESS \_\_\_\_\_  
CITY \_\_\_\_\_ ZONE \_\_\_\_\_ STATE \_\_\_\_\_

## "A definite SALES ASSET

in selling 260 houses within 1 month

at BIRCHWOOD PARK"

● says MORRIS SOSNOW  
successful Long Island  
development builder

# ALUMINUM

● Builder of more than 8,000 houses on Long Island during the past 10 years, (\$15,000 to \$30,000 price range) Morris Sosnow decided to feature ALUMINUM WINDOWS in his lovely new Birchwood Park development this summer... And here's what happened: 260 houses sold during the first month... More than \$10,000,000 in sales in 11 weeks time (including "slow" July and August).

When we asked Mr. Sosnow whether the aluminum windows played a part in this phenomenal success, here's what he said: "I am thoroughly convinced that aluminum windows are a definite sales asset. Prospective home buyers want good design, good construction and good materials. Both men and women recognize and appreciate the many money-saving features of these fine quality aluminum windows that never require painting or other costly upkeep."

If you, too, want to make your houses more readily saleable in today's market, give them the magic "touch of quality." Include "Quality-Approved" aluminum windows complete with screens and storm sash. They are nationally advertised in leading home magazines and are readily accepted by home buyers and mortgage bankers as a mark of quality construction.

"Quality-Approved" aluminum windows are available through many manufacturers (see list on next page) in all sizes and styles (awning, casement, double-hung, projected and sliding). All are tested against rigid performance standards. All are APPROVED for quality of materials, for strength of sections, for sound construction and for low air infiltration.

For additional information, consult any of the manufacturers listed on opposite page, or write to Dept. AB-510.

*Aluminum Window Manufacturers Association*

75 West Street, New York 6, N. Y.



This  
Seal  
Protects  
You



AMERICAN BUILDER



# WINDOWS

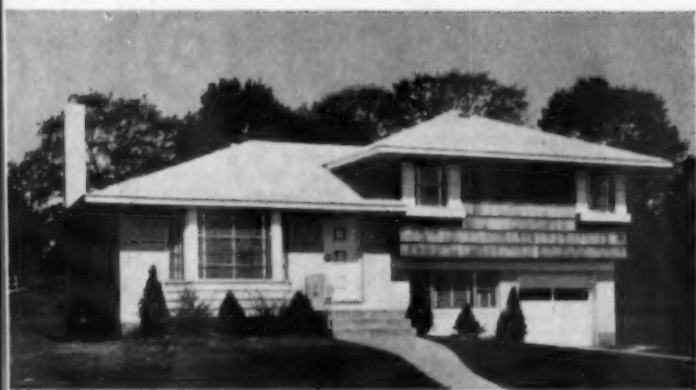

One of eight different model houses selling from \$19,950 to \$29,750 at Birchwood Park, Jericho, N. Y., featuring aluminum windows.

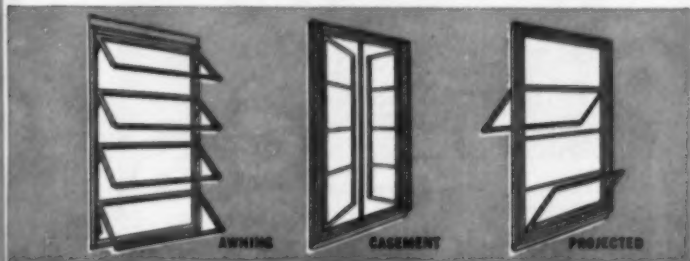

OCTOBER 1955

These Manufacturers are ready to supply you with Quality-Approved Aluminum Windows.

	DOUBLE HUNG	CASEMENT	AWNING	PROJECTED	ALUMINUM
<b>ALCASCO PRODUCTS, Inc.</b> 12640 Burt Road, Detroit 23, Michigan			*	*	*
<b>THE WM. BAYLEY COMPANY</b> 1300 Warder St., Springfield 99, Ohio			*	*	*
<b>BOURNE PRODUCTS, INC.</b> 900 Bourne Place, El Cajon, Cal.		*	*	*	*
<b>CICO STEEL PRODUCTS CO.</b> Sterling Aluminum Window Div. 5601 West 26th St., Chicago 50, Ill.	*	*	*	*	*
<b>CUPPLES PRODUCTS CORPORATION</b> 2630 So. Hanley Rd., St. Louis 17, Mo.	*	*	*	*	*
<b>DURALITE WINDOW CORP.</b> Carr St., Knoxville, Tenn.		*	*	*	*
<b>FENTRON INDUSTRIES, INC.</b> 2801 Market St., Seattle 7, Wash.		*	*	*	*
<b>MICHAEL FLYNN MFG. CO.</b> 700 E. Godfrey Ave., Philadelphia 34, Pa.	*	*	*	*	*
<b>GENERAL BRONZE CORP.</b> Stewart Ave., Garden City, N. Y.	*	*	*	*	*
<b>METAL ARTS MANUFACTURING CO., INC.</b> Harwell Rd., Atlanta, Ga.	*	*	*	*	*
<b>REYNOLDS METALS CO. (Window Div.)</b> 2000 S. 9th St., Louisville, Ky.	*	*	*	*	*
<b>THE F. C. RUSSELL CO. (Aluminum Division)</b> Box 27, Bristol, Pa.	*	*	*	*	*
<b>J. S. THORN CO.</b> 8501 Hegerman St., Philadelphia 36, Pa.	*	*	*	*	*
<b>UNIVERSAL WINDOW CO.</b> 950 Parker St., Berkeley 10, Cal.	*	*	*	*	*
<b>WARE LABORATORIES, INC.</b> 3700 N. W. 25th St., Miami, Fla.	*	*	*	*	*
<b>WINDALUME CORPORATION</b> Knoxville, N. C.	*	*	*	*	*

ANOTHER  
CASE OF  
**COPPER**  
WHERE IT  
COUNTS



350-HOUSE BRISTOL PARK TRACT, Santa Ana, California

**"Foot for foot, pound for pound,  
nothing installs as economically as  
COPPER WATER TUBE,"**

Says GARY STICE  
Earl O. Stice Co., Mechanical Contractors,  
Glendale, Calif.

Said Mr. Stice, "Whether or not codes call for copper when imbedding plumbing and heating lines or radiant panel heating coils in a concrete slab I play it safe and use copper anyhow. For with non-rusting copper, moisture and seepage are never a problem.

"And, as far as installation is concerned, fewer joints are necessary with copper water tube. Then, too, you can always be sure that the few solder joints that you do make are tight . . . a mighty important item when you're imbedding in concrete. So with all these advantages of copper water tube you can see why I have found it the most economical material to install."

You will find Revere Copper Water Tube installs economically when used for plumbing lines, radiant panel heating, air conditioning, underground service lines, waste, stack and vent lines, processing lines.

And if you want to know the short cuts, or have installation problems, involving Revere Copper Water Tube, let us know and we'll put you in touch with our Technical Advisory Service.

**REVERE**  
COPPER AND BRASS INCORPORATED

Founded by Paul Revere in 1801  
230 Park Avenue, New York 17, N. Y.

Mills: Baltimore, Md.; Brooklyn, N. Y.; Chicago, Clinton and  
Joliet, Ill.; Detroit, Mich.; Los Angeles and Riverside, Calif.;

New Bedford, Mass.; Newport, Ark.; Rome, N. Y.

Sales Offices in Principal Cities, Distributors Everywhere.



ONE OF THE HUNDRED completed homes shown in the large aerial view above. There will eventually be 350 homes in this tract. 34,000 feet of enduring Revere Copper Water Tube have already been installed in the first hundred homes in 1/2", 3/4" and 1" sizes. Bidr. and Gen. Cont.: M. J. BROCK & SONS, INC., Los Angeles, Calif. Revere Dist.: KEENAN PIPE & SUPPLY COMPANY, Los Angeles, Calif.

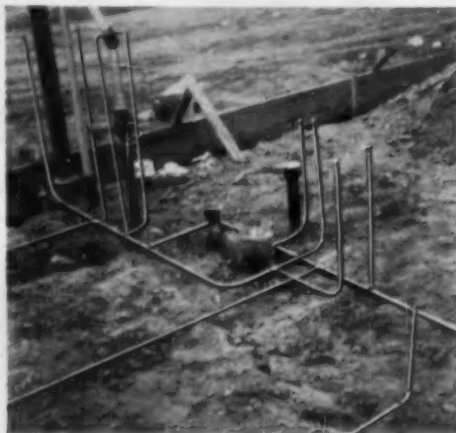

NON-RUSTING REVERE COPPER WATER TUBE before imbedding in the concrete slab.



*in the wake of a junior tornado!*

Havoc reigns when Junior takes a bath! But, as informed architects and builders know, Pomona's "Space-Rite" Perma-glaze deck tile is impervious not only to Junior's hard, scratchy toys and the dirt and grime of his day's foraging—but also to soapy water and even corrosive chemicals, harmful to ordinary surfaces!

That's because only Pomona's exclusive fusing process produces this beautiful pebbled finish of flint-rock hardness.

Uniform joints are assured through Pomona's "Space-Rite" feature. Shown here, exquisite new Mercedes Blue in Perma-glaze 6" x 6" deck tile.

*Write for free catalog with actual tile samples of full line of colors.*

## **POMONA TILE**

### **POMONA TILE MANUFACTURING CO.**

829 N. La Brea, Los Angeles 36, Calif. • WEbster 4-3861

Seattle • San Francisco • Pomona • Long Beach • Arkansas City, Kan. • Houston • St. Louis  
Phoenix • Salt Lake City • N. Hollywood • N. Kansas City, Mo. • Chicago • Denver • Dallas



# Ro-WAY BUILT



*is Built to Last!*

## OVERHEAD TYPE COMMERCIAL AND INDUSTRIAL DOORS

**F**ROM start to finish, long life is solidly built into every Ro-Way overhead type door.

It begins on the drawing board, where exceptional ruggedness is designed and engineered into every detail—the kind of ruggedness that can take years and years of ups and downs in stride.

It shows up in the fine quality of Ro-way materials—selected west coast lumber and specially designed hardware of heavy gauge steel.

It's assured by Ro-Way construction—with all joints mortised and tenoned, waterproof glued and steel pinned; with sections rabbeted for weather-tight fit; with millwork both drum

and hand sanded for finest finish; with all hardware Parkerized and painted *after* fabrication for maximum rust prevention.

And it's there in every Ro-Way operating feature—the Taper-Tite track and Seal-A-Matic hinges that work together for easy opening and sure, weather-tight closing; the ball bearing Double-Thick tread steel rollers that glide smoothly and quietly; and the Power-Metered springs that are matched and tension-balanced to the weight of the individual door.

Built? Yes—*built to last!* And that means satisfied clients. If that's what you want, specify Ro-Way overhead type doors for all commercial and industrial applications.



**FREE ARCHITECT'S MANUAL.** Complete details, specifications, drawings, etc. of entire line of Ro-Way doors. Especially helpful in selecting just the right door. Request Manual 55—on your letterhead, please. No cost or obligation, of course.

**ROWE MANUFACTURING CO., 753 Holton St., Galesburg, Illinois**

there's a **Ro-Way** for every Doorway!

**OVERHEAD TYPE DOORS**

Nationwide sales and installation service. See your classified telephone directory for nearest Ro-Way distributor.

**MOR-SUN FOR '55...**

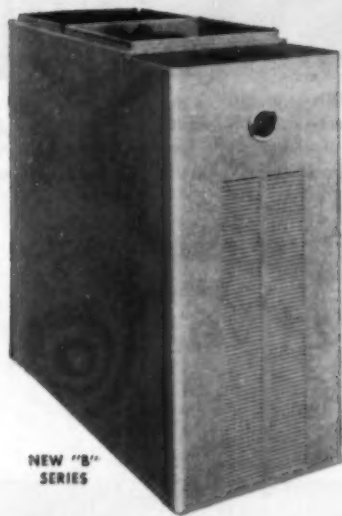

NEW "B" SERIES

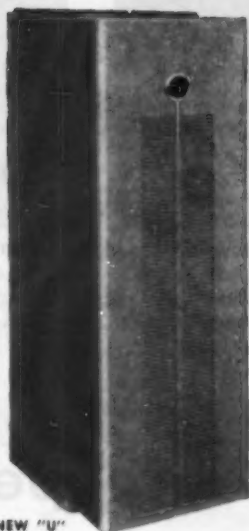

NEW "U" SERIES

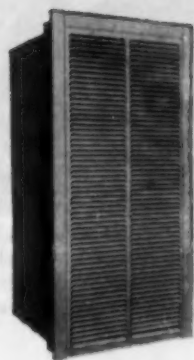

MODEL C-75 WALL FURNACE



DELUXE JMT SERIES



NEW "C" SERIES



GRAVITY SERIES



NEW "H" SERIES

*new models*

*... a complete line  
... designed with the  
builder in mind*

**THERE'S A MOR-SUN WARM AIR FURNACE** for every home heating requirement... the right size... the right price... for new construction or modernization

**DELUXE JMT SERIES** Gas and Oil. 4 Models. New, improved Heat Exchanger guaranteed for 10 years. Capacities from 105,000 to 190,000 BTUH Input for gas and 95,200 to 151,000 BTUH Output for oil. *The finest Automatic Forced Warm Air Furnace available anywhere.*

**NEW "U" SERIES** Gas and Oil Highboys. 4 Models. New, improved Heat Exchanger guaranteed for 10 years. Capacities from 75,000 to 125,000 BTUH Input for gas and from 72,800 to 112,000 BTUH Output for oil.

**NEW "B" SERIES** Gas and Oil Lowboys. 3 Models. New, improved Heat Exchanger guaranteed for 10 years. Capacities from 95,000 to 130,000 BTUH Input for gas and from 84,000 to 112,000 BTUH Output for oil.

**NEW "C" SERIES** Gas and Oil Counterflows. 4 Models. New, improved Heat Exchanger guaranteed for 10 years. Capacities from 75,000 to 125,000 BTUH Input for gas and from 72,800 to 112,000 BTUH Output for oil.

**NEW "H" SERIES** Gas and Oil Horizontals. 4 Models. Capacities from 80,000 to 140,000 BTUH Input for gas and 72,800 to 112,000 BTUH Output for oil.

**GRAVITY SERIES** Gas only: 2 Models. Capacities from 80,000 to 110,000 BTUH Input.

**MODEL C-75 WALL FURNACE** Gas and Oil. For flat wall or corner installations. Capacities — 75,000 BTUH Input for gas and 57,000 BTUH Output for oil.

**FOR ALL THE FACTS . . .**  
*fill in this coupon and mail today*

Mor-Sun Division, MORRISON STEEL PRODUCTS, Inc.  
605 Amherst Street, Buffalo 7, New York

Send us all the facts about Mor-Sun Warm Air Furnaces and Air Conditioners.

Name.....Title.....

Firm.....

Street.....

City.....Zone.....State.....

Also manufacturers of ROLY-DOOR STEEL GARAGE DOORS and MORRISON SERVICE BODIES.

*You get so much more with MOR-SUN*



Mor-Sun Warm Air Furnaces and Air Conditioners are distributed nationally and sold through leading heating equipment dealers everywhere.



**MODERN STYLE**, with light colors and low-pitched roofs, is apparent in aerial view of Syracuse Parade of Homes in suburban Orvilton Heights. Cooperative planning insured variety of styles, sizes, materials, equipment.



**90-FOOT CRANE** was catbird seat for Bob English, intrepid executive secretary (and official photographer), Syracuse HBA, who also flew plane for shot at left. Unusual date of show, June 18-July 10, entailed work in snow and mud.

## Building a cooperative sales talk

"Air cooled or not, our homes have climate control"—Poushter

White marble chip roofs and pastel siding are more than a stylistic fad. Syracuse builders stress built-in coolness for a changing climate; in addition, a half-dozen Parade entries featured year-round air conditioning. This split level by Harry Poushter typifies the trend: sound insulation and attics louvered at the peak or under eaves for air circulation were standard; overhangs were generous, and large glass areas were usually well shaded. Three ton cooling capacity in this house was favored for other year-round units.



**LIGHT COLORED ROOFS** are a clear indication that Syracuse builders recognize effectiveness of marble chip and light shades of asphalt shingle in reflecting sun radiation and lowering heat load.

"We tie our space together with solid stone"—Putvin

Stone, with its implication of luxury, is growing in favor, Parade builders reported, not only for fireplaces but for facades and front entrances and approach walks as well. Total of 15 tons of natural stone was used in James Putvin's spacious ranch, for both the fireplace-chimney and major exterior facing. Flagstone was used effectively for the jalousie porch of the Radcliffe house; builders Bartlett, Beattie, Cicci and Oot made good use of Roman rough brick for stone-work effects in playroom, fireplace and patio.



**MASSIVE FIREPLACE** of Lenroe stone from nearby Ithaca anchors the open-planned dining-living room section of Putvin's house. Hufcor doors at extreme left and at kitchen wall provide flexible command of space.

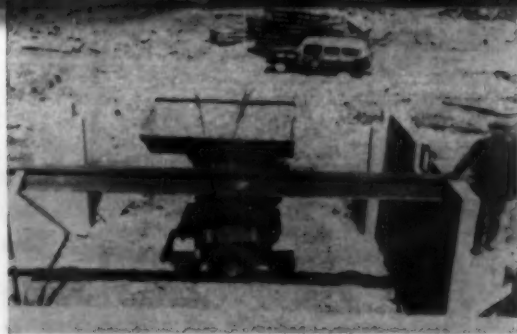

**BUILDERS** were their own job superintendents—and foundation diggers and carpenters. Harry Herrmann directs his sons Bob and Bill in bulldozer placing beam for their split level entry (extreme upper left in aerial view).



**CLOSE TO THE JOB** are three interested builders. Joe Cicel, last year's HBA president, who gets his best ideas on his bulldozer throne, discusses progress with Don Beattie and Ray Hoyt, president of the Orvilton Heights Corp.

## in Syracuse . . .

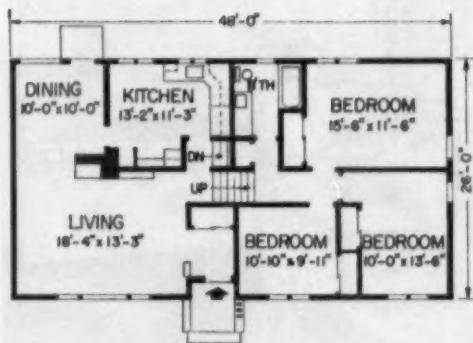

**PLAN** shows main levels. Under left side is a 26'x24' basement. Up six steps is a 12'x24' redwood paneled "den," which opens into the garage at right and fully equipped laundry room and half bath in rear.



**SIDING** of baby pink contrasts with Craigmar cut stone at lower levels. House, priced at \$28,000 equipped, has oak flooring, glass bath, mahogany doors and kitchen cabinets, tilt-up electrical range burner units and built-in double door oven.

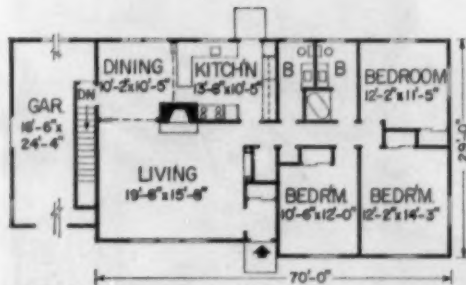

**PLAN** shows demarcation into two clear sections. The bedrooms and baths are approached by a single hall. Two-car garage contains freezer ("handy to the car") and stairway to basement full-length playroom.



**THREE-STEPPED ROOF** is master touch to break 66' line. Acoustical ceilings go naturally with open space. Valance lighting, stainless steel tiled kitchen, sun lamps in bath room, and year-round air conditioning are included in \$38,000 price.

## "A playroom can be worth more than a living room"—Herrmann

Playroom, family room, all-purpose room or, as it's called in this prominent Parade entry, activity room—whatever the name, it's a far cry from the "rumpus room" in yesterday's "finished" basement. Along-side the living room in placement and value, Harry Herrmann's activity room has appropriated the fireplace and the three-way view. Some of the Parade homes have both a "den," easily converted to an extra bedroom, and a below-stairs playroom, accessible to the outdoors, with an extra lavatory convenient for children at play.



**RAISED HEARTH** of Lenroe stone and butternut wood wall set rustic tone. Tilting valance, flexible housing for fluorescent tube, is demonstrated by Bob Herrmann. It can direct light to ceiling or drapes underneath at will.

## "Your kitchen is old-fashioned without built-ins"—Heck

In a Parade you put your best foot forward, and built-in kitchen appliances are practically a must in a show house. When each unit has its convenient niche, the process seems to have reached its peak, as in this spacious, handy kitchen by Emil Heck.



**WORK-LEVEL DISHWASHER** by Youngstown, one of first released and only one in the Parade, caught fancy of visitors to Heck's ranch house kitchen. Big maple chopping block and wealth of storage space also won favor.

Although 15 of the 16 Parade houses have gas heat, all of the kitchens are electrical. The same utility company provides both services. Dealers in town had several kitchen displays to thank for a rush business in tilt-up and fold-away burners, purchased for playrooms.

Built-ins also contributed to another trend-color. Bright steel, copper antique, chaircoaltone gun-metal, or bright pastel enamels on oven and refrigerator doors to fit in with carefully planned color schemes. John Bellinger, HBA president, contrasted dark "autumn finish" woodwork and dark red tile with the popular birch cabinets for his Hotpoint-designed house.

Also popular were maple chopping blocks, contoured plastic laminate surfaces, exhaust fans, sink disposal units and telephone jacks. Some kitchens found room for the laundry equipment.

Some builders went along with the built-in trend but expressed reservations. "Why, some visitors thought a spanking new store-bought refrigerator was old-hat because you could see above and around it!" one remarked. Another pointed out, "Built-ins are good for show, but around here people expect to supply their own appliances." In the next show the builders expect to install appliances for display, but will price their houses as stripped down, to give a fairer idea of relative value.



**SEPARATE BUILT-INS** for Revco refrigerator and freezer, separated by work surface, is another "exclusive" of Heck kitchen. Planter at right, an open balustrade to large basement playroom, helps achieve feeling of spaciousness.

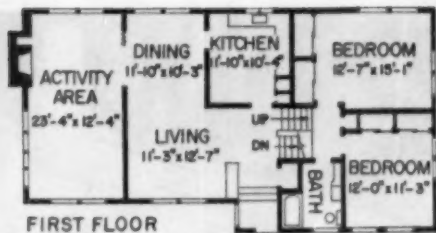

FIRST FLOOR

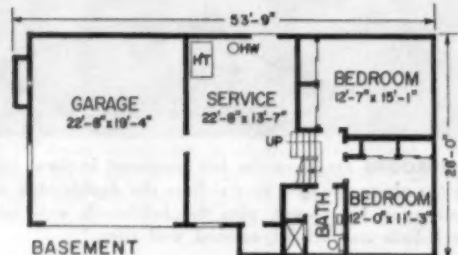

BASEMENT

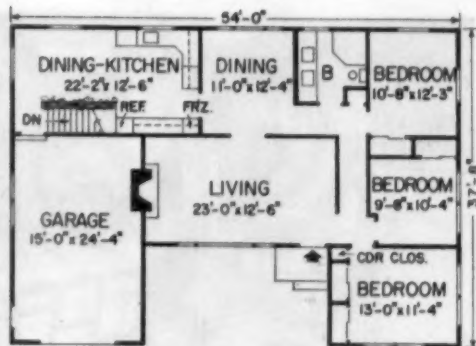

**PLAN** shows symmetrical U formed by garage and bedroom wings. Raised-hearth fireplace of French Lick stone uses garage space, saves living room. Corner angle tub and double vanity enliven glass bath.



**DARK RED VERTICAL PLANKING**, stone approach, and marble chip roof make a striking exterior of this \$35,000 four-level. An insul-metal flue serves the year-round conditioner. Plans show full bath room facilities on each of two bedroom levels.

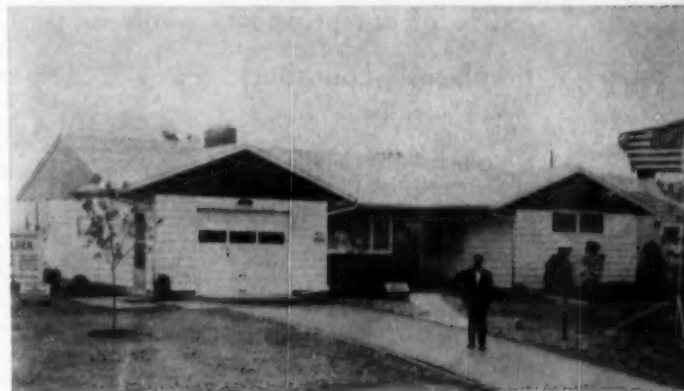

**REDWOOD GABLES** set off white clapboards and light roof of Heck's \$35,000 house. Moduflow control complements year-round conditioning. Note Thermopane picture windows in dining and living rooms, knotty pine in garage and playroom.



**WALL-HUNG** refrigerator-freezer combination in Cicci's all-General Electric kitchen has convenient location over work space, and eliminates bending. Doors, finished in yellow, have magnetic latches. Note vent above unit.



**TWO POPULAR NOVELTIES** appear side by side in Poushter kitchen: foldback burners and Frigidaire oven with slide-out heat guard to protect controls when twin-doors are opened. Custom built-in cabinets are mahogany.

## "No more family squabbles over the bathroom"—Cicci

Several developments make a second and even a third bathroom facility the new norm for a modern house: large families, downstairs family area, refusal to put up with the old-fashioned morning line-up and door-banging ceremony. Right on top of the trend is Joseph A. Cicci, a moving spirit in the Parade. Besides his own entry, he accepted responsibility for supervising construction of Safety House, a \$50,000 ranch, offered by the HBA and Station WSYR. Safety pledge signers were eligible; the wife of a totally disabled vet won it.

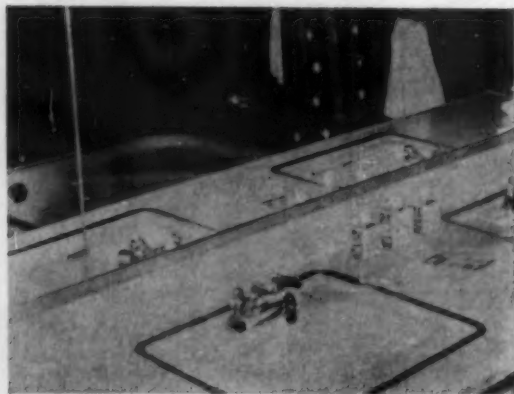

**BATHROOMS** are given the full treatment in these houses, as the above example shows. Note the double sink array, both sunk in counter, plus the full-length wall mirror, angle-bath and brightly-colored wall tiles.

## "90% of our prospects want fireplaces"—Lounsbury

Custom builders handle fireplaces as routine, and there is general agreement that most customers expect a fireplace in any house over \$20,000, however little they'll use it. With the growth of elegance in the basement, a natural step has been to add a flue in the main stack for a playroom fireplace. Jim Lounsbury made the broad stone stack dominant in his luxurious ranch model, even more so in the lower level than the living room. Roman rough brick, another popular material, was used effectively in Zube's two-sided fireplace.



**STONE FIREPLACE** takes almost entire wall of Lounsbury's basement den, merges with formica-topped semicircular stone bar. The floor is inlaid plastic tile. A fourth bedroom and a third bath with stall shower adjoin den.

## "Prefabs now belong—they give good value"—Cappuccilli

Nationally merchandised prefabricated houses were readily accepted as a growing trend in housing. The chairman of the Parade of Homes committee is regional director for National Homes, Peter L. Cappuccilli.



Prefabs are of interest to builders of both custom and development houses, as tests of public acceptance and demand. Patios, wood paneling, kitchen built-ins, fireplaces, lots of glass give the prefabs a custom-made look. Also of "outside" origin was Bellinger's Hotpointer, developed for a nationwide promotion.



**NATIONAL'S CANTERBURY** model competed with Kelly's small ranch for low-price title: both listed at slightly above \$20,000, equipped. California type in redwood with patio and nine Thermopane windows, it has two baths.



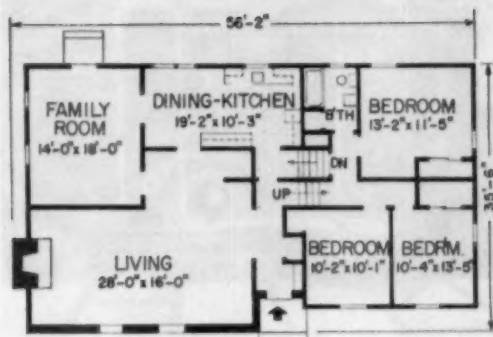

**PLAN** shows prominence of auxiliary living room. On lower level are full-size game room with fireplace, fourth bedroom (next to garage), and a second bath with shower, as well as a service room and laundry.

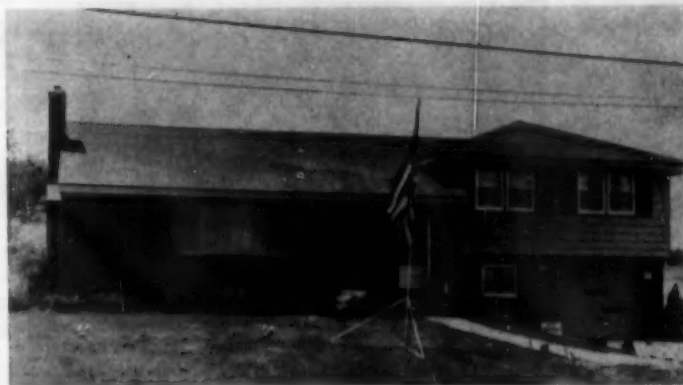

**SOLID COMFORT** is theme accented in Cieci's four-level brick entry, in \$40,000 range. Wallpaper creates rich effect in several rooms, paneling in others. Terrazzo, plastic panels, and hi-fi system enliven game room. Note garage door.



**PLAN** indicates isolated master bedroom, kitchen overlooking the entrance, french doors opening on the terrace, long breezeway, redwood paneled, alongside two-car garage, and numerous closets.

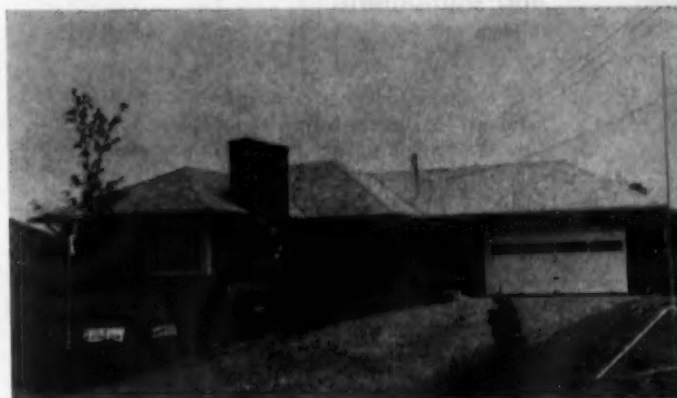

**DOMINANCE** of stone stack is enhanced by planters in shoulders. Width of basement fireplace is apparent. Charcoal shingle exterior contrasts with limed oak widely used inside. Zone heating helps carry air conditioning load. Price: \$45,000.

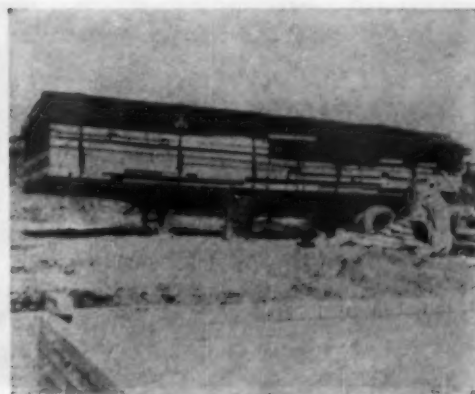

**PREFAB BEFORE:** this is the American Houses Northland model, entered by Emmett and Tormey Burns, as it arrived on its trailer, neatly packaged, with cork flooring for family room, redwood and pine panels.



**PREFAB AFTER:** gray and white double coursed cedar shake looks pleasant on Northland, at \$22,000 with year-round conditioning, 11-foot freezer and refrigerator, drop-down range units, dishwasher, divided bathroom with twin washstands, patio.

**SYRACUSE SALES TALK** continued



"We had one purpose:  
to stage a parade of new  
techniques in construction  
and equipment."

The eleven builders who attended a luncheon arranged by American Builder in August to discuss the Parade agreed that 1) it was a great success for suppliers of equipment on display; 2) its date was unfortunate, saleswise; 3) pricing to include equipment was a mistake; 4) they were glad they put on the show.

They knew they had accomplished the long-run merchandising function of showing the public honest craftsmanship and exciting new technical achievements. A fifty-cent admission charge kept out idle rubberneckerers, but not exhibitors' future customers. As Lloyd Zube said, "We gave them the idea of trading up out of their present quarters to a better style." Some contributions to that style are shown on this page.



**STEEL TRUSS JOISTS** gave Putvin some ideas. Here we see plenum from Lennox year-round conditioner with ducts to registers spaced between diagonals. Here joists are exposed, but covered in playroom (right).



**MOVEMENT OUTDOORS** is encouraged in some models. Lloyd Zube's patio is reached from living room through Arcadia sliding windows, with shadow boxing above. Charles Kelly's patio has a solid cover on iron posts.

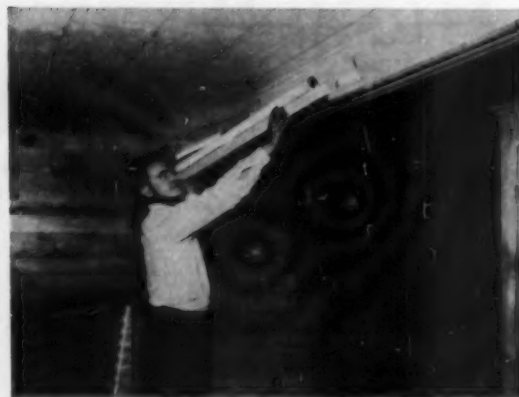

**NECESSITY INTO VIRTUE.** Emil Heck housed his columns and main beam in pine to match playroom, then set in fluorescent units behind snap-on pegboard deflectors. Bar at left lights up behind translucent corrugated fiberglass.



**CLEAR SPAN PLAYROOM** full length of house is result of steel trusses, (which required 14" higher foundation, cost \$300 extra, and were worth it, Putvin says.) Block wall at right contains fireplace and service room.

# Saving time and material by shortcut methods

**R.** K. Smith of Wichita, Kansas, is a builder with an architectural background, and is always devising new and simplified ways of reducing the time and material needed to do the many jobs that are part of house construction.

In the building of contemporary styled houses, he has reduced the construction of exterior walls, windows and door frames to their simplest forms. Here are a number of details that show how he does it.

A section through a frame wall is shown in this detail. Here, a 1 x 8-inch shiplap is used alternately between the 2'0" x 3'0" insulating sheathing. The lap of the wood sheathing corresponds with the lap of the insulating sheathing, and thus allows them to nest within each other. The vertical board facing can then be nailed securely, without inserting the usual 2 x 4-inch cripples between the studs.

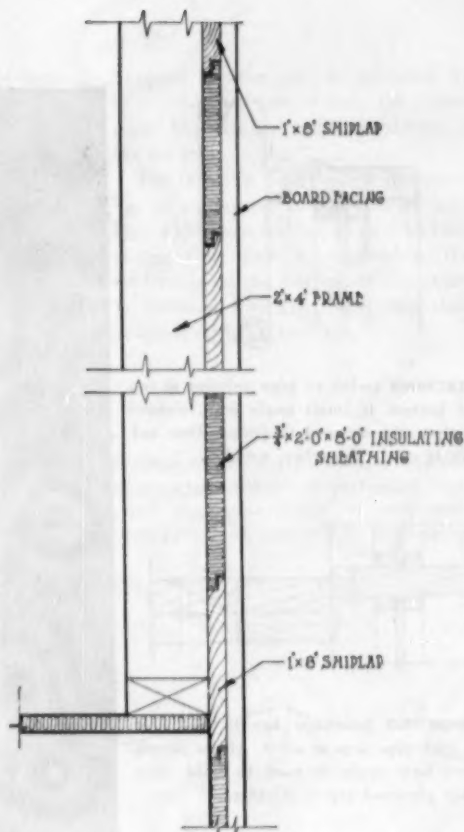

Detail of the typical interior door frame shows the 2 x 6-inch window frame member extended on both sides of the partition to form the finished casing. The head frame is split on center line and the jamb and head frame is plowed out 1/2-inch on the back. This permits a temporary Celotex ground to be applied to the framing stud face. The 2 x 6-inch finished frame can be removed to prevent defacement during construction. The dry wall is then set to the Celotex line, after which the ground is removed and the finished frame set in place.

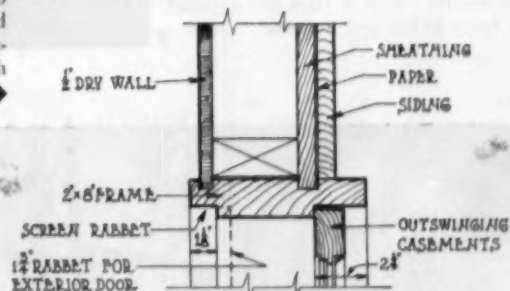
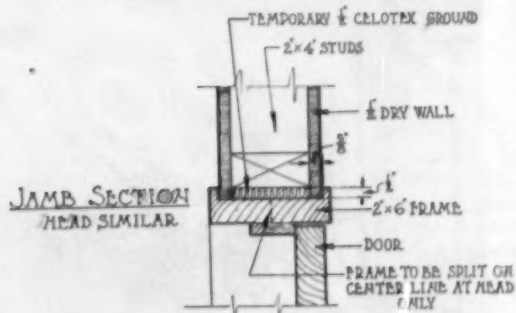

JAMB SECTION  
HEAD SIMILAR

The detail of the typical exterior door and window frame, as shown above, generally follows the character of the interior frame. The finished frame is made up of a 2 x 8-inch member plowed out on the back side for the sheathing and drywall. This frame can be used for fixed glass set in stops, or for outswinging casements. The ends of the frame, which project beyond the finished wall lines, is the finished trim.

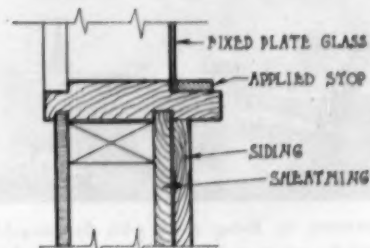

SILL DETAIL

## The fixed screen—

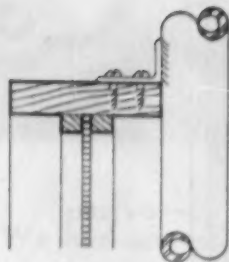

**ATTACHING** trellis to pipe column at top and bottom is small angle iron, welded to pipe and screwed to frame. One column is steel; the other, wood.

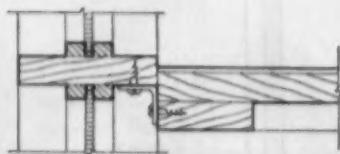

**SUPPORTING** breakfast bar is trellis at one end, pipe legs at other. Above sketch shows how angle is used to hold cleat under plywood top to divider.

**DIFFUSING** light above bar, trellis also serves as space divider and traffic diverter. Built-in closet at right was designed to house heater and furnace.



**OPENING** up living room with floor-to-gable window, using straight rafter construction instead of the truss—these are two ways of gaining spaciousness. Interior walls and ceiling of gypsum wallboard are same color, adding to effect.



**CONCEALING** kitchen from living area, free-standing wall stops 3 feet short of ridge beam. As seen from living room, vertical grooved plywood also emphasizes ceiling height. Rear entry does not interfere with furniture grouping.

## a translucent space divider



The kitchen of this house is separated from the living area, first by a free-standing wall and secondly by a fixed screen or trellis. The wall hiding range and refrigerator also supports part of the trellis.

Trellis framework consists of a vertical and horizontal section of red-wood 1x4's with a stain-wax finish. Inserts are either polyplastic or solid or of perforated sheets of hardboard.



**GIVING** effect of modern painting, trellis consists of lacquered panels of perforated hardboard and decorative sheets of polyplastic. Perforated panels are repeated in the kitchen.



**HANGING** trellis serves as light-baffle above breakfast bar, as shown in this detail. Vertical section of the screen helps support the bar top.

**REPEATING** perforated panels of trellis, cabinet doors also have ball knobs, metal stiffeners along their edge.

Support for the unit is provided by two columns, one wood, the other pipe. Mounting details are shown at the far left.

The sturdily constructed breakfast bar is supported at one end by pipe legs which are welded to two 14-inch plates. One plate is screwed to the underside of the bar cleat; the other is recessed into the floor, and then covered with asphalt tile.

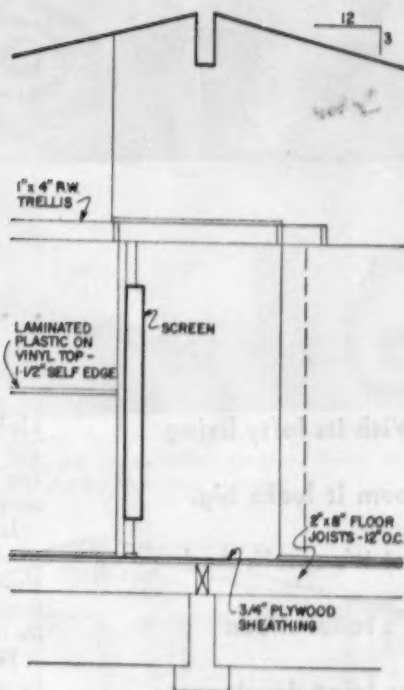

## Fewer partitions mean

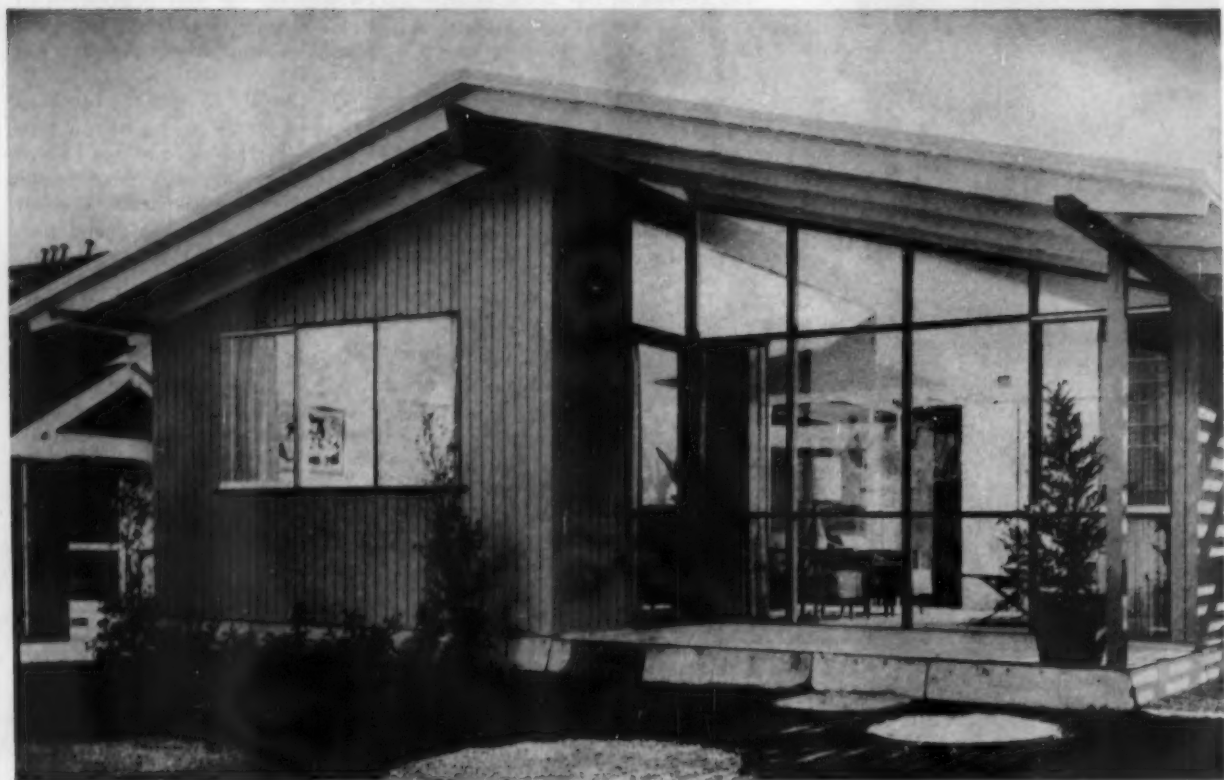

## ... key to opening up today's

**With its lofty living**

**room it looks big,**

**yet it's small. And**

**it's tailor-made**

**for tract developers.**

**B**uilt by the McDonald brothers as a prototype for a number of tracts in the Los Angeles area, this house features three bedrooms, two baths and a pullman-type

kitchen. Approved for both FHA and VA loans, it has 1,080 square feet of space and can be built for about \$9,000.

In the design by architect Edward H. Fickett, one of the main aims is for simplicity of construction. Another is to give loftiness to the living area.

That Fickett used considerable finesse in the layout of his floor plan is quite evident. To squeeze in heater and furnace, he put them in a wardrobe in the living room. To vent his windowless inside bathroom he used a suction fan to provide a complete change of air every 12 minutes. And to expand the

living-kitchen area of his house he utilized a free-standing wall as a separator, stopping it 3 feet short of the ceiling. The gable-high glass area also opens up this space.

Fickett could have put the house on a slab, but he chose to use ordinary floor joists over 2-foot-deep footings. As a facing for these footings he used light weight pre-cast concrete blocks 4 feet long, beveled and mortared in. Elsewhere on the exterior, he uses redwood or fir plywood. In addition, each window section makes use of at least one movable sash—a jalousie. A glass door forms part of the high living-room window.

more light and space . . .

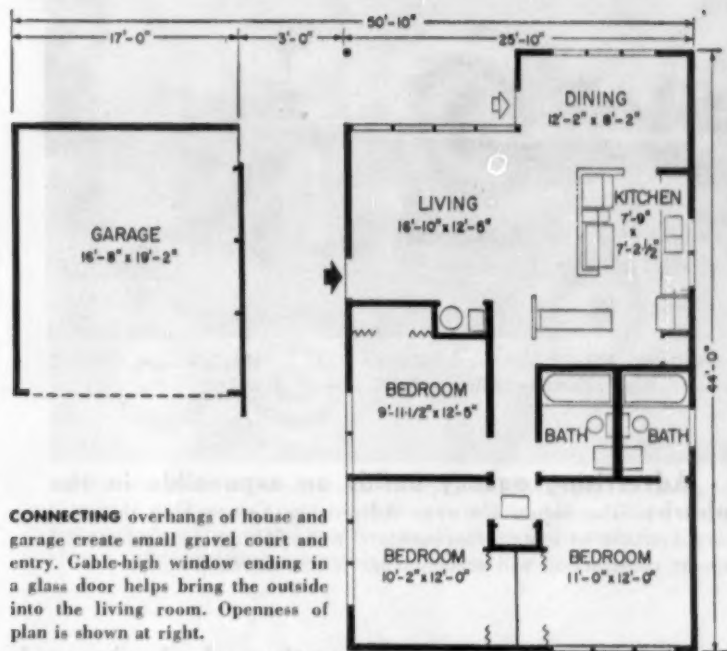

**CONNECTING** overhangs of house and garage create small gravel court and entry. Gable-high window ending in a glass door helps bring the outside into the living room. Openness of plan is shown at right.

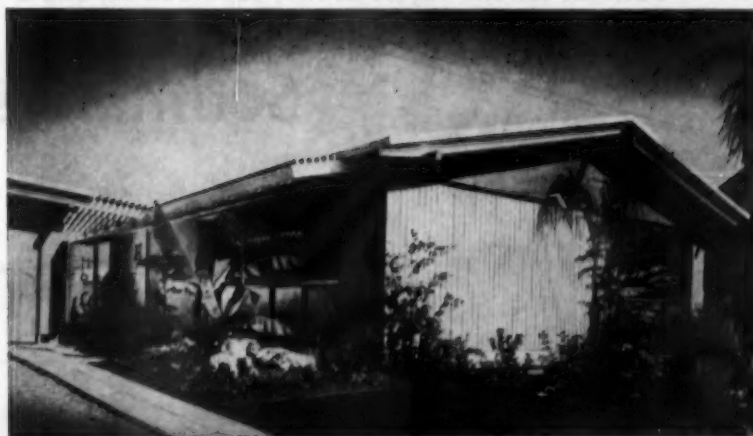

small house

**COMBINING** like materials, architect Fickett uses vertical-grooved plywood for exterior walls, redwood plywood for gable and panels below windows. House turns its bedrooms toward street, living-dining and kitchen areas to rear.

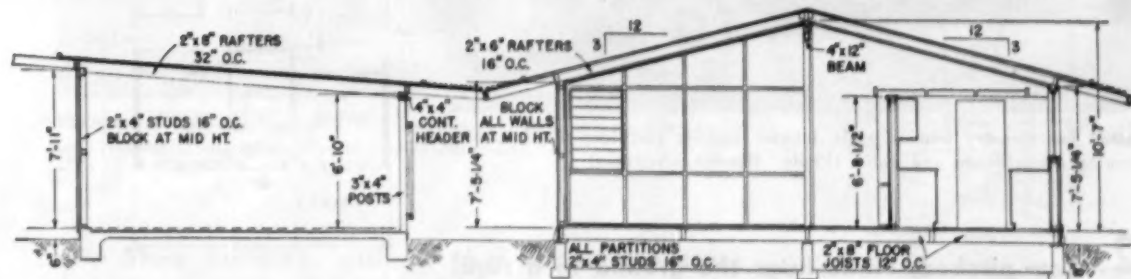

**CUTTING** through garage and kitchen side of house, section shows construction from ground up. Ventilation of living room is provided by screened jalousie. Though kitchen is virtually open to living room, cooking odors may be drawn off by fan.

## MEMPHIS COMMERCIAL

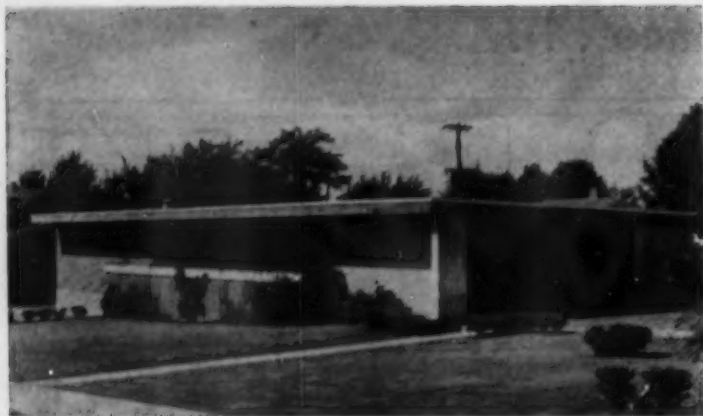

**ADVERTISING AGENCY** building by William Bond has simple design, flat roof, residential look. Exterior is Roman brick, stone, redwood.

**1. Advertising agency builds an expansible in the suburbs.** The Simon & Gwynn Advertising Agency built this one-story structure on a main thoroughfare in the Memphis suburbs. Steel support construction will accommodate a second rental story.

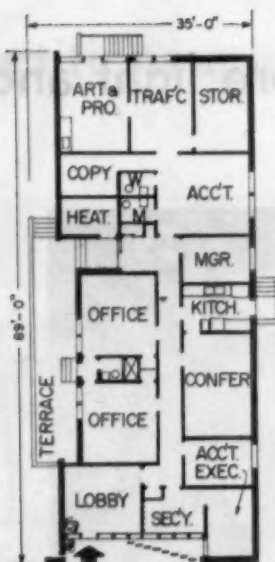

FIRST FLOOR

**FIRST FLOOR** has 3,000 sq. ft. of floor space, plus equipped recipe-testing kitchen. Building is on lot large enough for future parking.

**Business follows buyers as they suburbanize, and a residential appearance is part of the trend.**

## Southern solutions for



**CLINIC** has masonry bearing walls, interior bearing partitions. Roof is 4-in. decking above beams and walls. (Photo: Hutchings-Newman)

**2. Low pitched, clinic hugs the ground in a rural setting.** Placed on a busy street far from downtown Memphis, building looks decidedly unclinical. Architect was R. T. Martin; O. A. Emmons was contractor. Building cost \$60,000 without equipment.

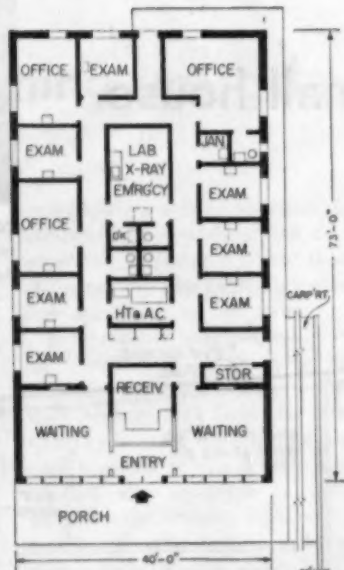

**CLINIC** has utility core at center, of-  
fices, examination rooms around it.

AMERICAN BUILDER



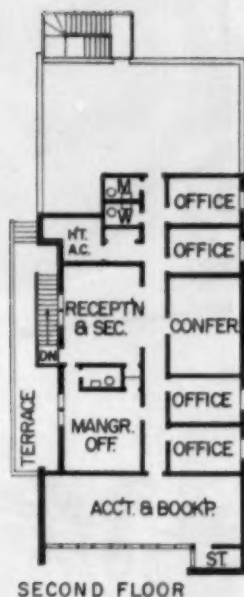

**PROPOSED SECOND STORY** for agency building would look like this, would add about 2,000 sq. ft. of office space for possible future rental.



**CONFERENCE ROOM** of the advertising agency, paneled in Philippine mahogany, is planned to fit agency's needs. Built-in work cabinets house radio, transcription playback equipment and tape recorder. Provision is also made for TV film viewing. (Photos: Jimmy Jamieson)

## suburban business space . . .



**PLANTING** is carefully integrated with building. Use of draperies aids illusion of a residential character. (Photo: Jimmy Jamieson)

**3. Store building, without that store-front stare.**  
A 3-unit store building designed by William Bond was designed as a beauty shop with additional rental units. Set back from the street, with ample parking, this is a small shopping center itself.

OCTOBER 1955

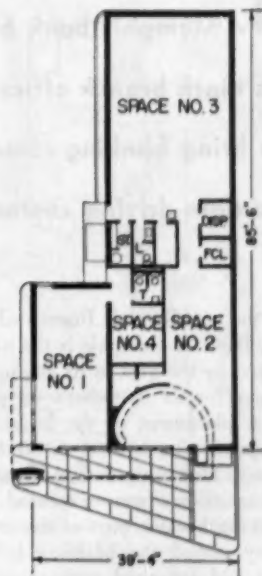

**PLAN** of store building shows three basic units to be rented separately or joined for larger operations. The building fits on 50-foot lot.

THERE'S MORE NEWS FROM MEMPHIS ▶

▶ **SOUTHERN SOLUTIONS** continued



**PITCHED** roof of Berclair Branch Bank, general appearance, distance from lot lines, give it a residential character.

**INTERIOR** of bank is inviting. Plaster and Roman brick walls, redwood paneling and plank and beam ceiling make it so. ▶



## Parking is part of their

**4. Memphis bank builds its ninth branch office, to bring banking closer to its auto-driving customers**

**T**he new Berclair Branch of the First National Bank of Memphis is the ninth location established by the firm in its attempt to make banking easier for its customers. In planning the structure, placement of the building on its lot was of prime importance to architects Eason, Anthony, McKinnie & Cox. Because many of suburban clients were expected to arrive by car, parking became part of the architects' planning. They placed the building in the center of the plot and arranged parking conveniently around it. For banking from the car, a drive-in window was planned. Contractors: United Construction Co. Cost: \$97,775.



**OFFICE** areas are open to view. This aids in creating a customer feeling that bank personnel are always available for service to customers. Floors in banking room are of terrazzo. Floors in offices and lounges are of cork.



Photos by Jimmy Jamieson

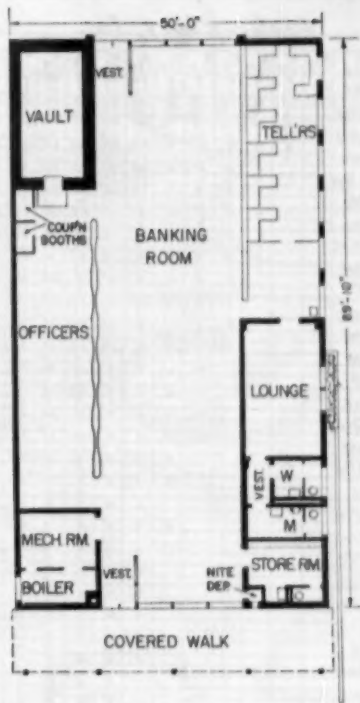

**BANKING ROOM** was planned as a corridor through building's center to aid in-and-out traffic. Entrances are at both ends.

## planning



OCTOBER 1955

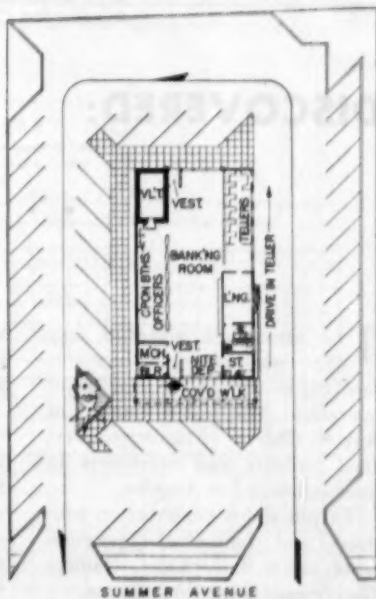

**PLOT** plan of Berclair Branch Bank shows how it was placed in center of plot and parking arranged around it for easy entrance and exit to bank, out to street.

◀ **VAULT** is located at end of open office area for personnel and customer convenience. Booths allow customers privacy.





# HEAR ABOUT THE BIG ONE THAT GOT AWAY?

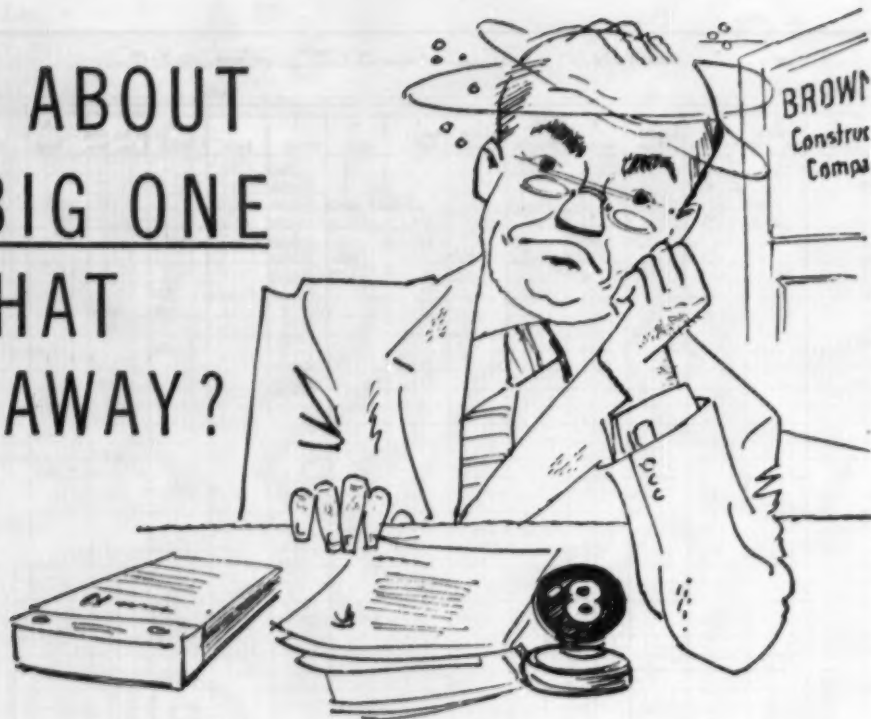

● There was a big one . . . a big construction job coming up right in his own back yard. Brown thought he had his territory covered like a tent . . . had sources of information he could depend on. Yet a competitor landed this nice piece of business . . . and Brown lost out because he didn't know about this choice opportunity . . . right under his nose.

How come? This competitor gets and *uses* Dodge Reports *every day*. He knew all about who was building what . . . and where. He knew who to see and when to take action. Dodge Reports told him about this job . . . and tells him every day about other choice jobs in his area too. He knew about this job when it was being planned and when the bids were due . . . he had ample time to do what was needed to get the job.

More than 1000 Dodge field men are constantly investigating new construction opportunities in every local market in the 37 eastern states. Their daily reports, issued locally or for any area you might suggest, are backed by the nation-wide facilities of the Dodge organization. This selling service insures a greater number of new, current business prospects for any firm with a stake in new construction.

Why not take a look at some typical Dodge Reports covering work right in your territory? We'll gladly let you see them and send along our informative book telling how others use Dodge Reports.



Write today  
for book.  
No obligation.

## DODGE REPORTS

TAKE THE FIRST STEP IN EVERY SALE

Dept. AB-1055, 119 W. 40th St., New York 18, N.Y.

Timely, accurate construction news service East of the Rockies

F.W. DODGE

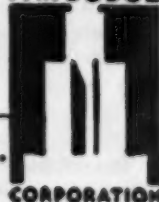

CORPORATION

# What sales appeal is made of

...it's designed and built into every P&H Home



**Top Materials**—Only seasoned kiln dried lumber, and the best materials go into Harnischfeger's P & H Homes.



**Craftsmanship**—Main sections of Harnischfeger Homes are built in forms under rigidly controlled conditions.



**Double Strength**—Fully insulated, glued and nailed, P & H wall panels are twice as strong as standard.



**Careful Erection**—Trained crews, erecting the P & H Homes quickly and efficiently, carry craftsmanship through to the last shingle.



**Planning, Design**—Handsome contemporary design, efficient space-making floor plans mean lasting livability and appeal. A wide range of models and sizes enables you to meet any market.

**BUILDERS**—Build Harnischfeger Homes, and you'll get expert counsel on land planning, financing, and promotion from Harnischfeger specialists—you'll build more profitably. Builders can get a preview of the 1956 Harnischfeger Homes at the P & H Builders Open House, Milwaukee, Sept. 15 to Nov. 15. Write for details: 110 Spring St., Port Washington, Wis.

## HARNISCHFEGER HOMES, Inc.

110 Spring St., Port Washington, Wis., Phone 611. District offices in: Chicago, Cincinnati, Cleveland, Detroit, Indianapolis, Kansas City, Minneapolis, Pittsburgh



the **P&H** Line



# Do You Consider

## THESE 4 IMPORTANT FACTORS

WHEN YOU SPECIFY GLUED LAMINATED WOOD MEMBERS?

**PRODUCT QUALITY** No matter how hard we try—we can't say it better than this contractor who wrote, "Our contract will be more profitable to us because accurately fabricated Rilco members were assembled and erected with surprising speed." Rilco quality also contributes to a "good job" and helps assure "owner satisfaction."

**SERVICE** Detailed drawings are provided to speed field work—save erection costs. Experienced Rilco service engineers are available to give bidding and on-the-job advice.

**DELIVERY** delays cost money and create ill will. Rilco plants are strategically located for shorter hauls and complete assurance of delivery when promised.

**PRICE** initially is seldom the true factor in determining the final cost. Considering all of the above advantages, completed cost is lower with Rilco.

Your reason for ordering Rilco arches, beams, rafters or trusses for your next school, church gymnasium, store, commercial or industrial building could be any of the above. Together they add up to an important ingredient . . . integrity.

For more information contact:

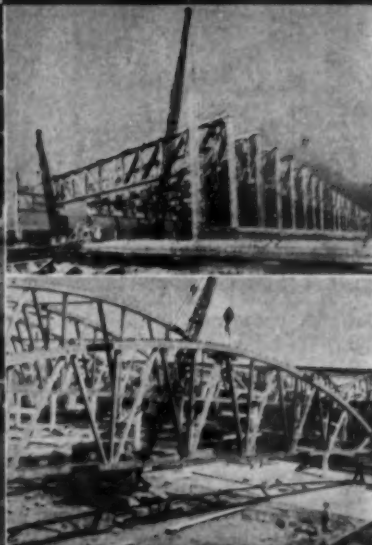
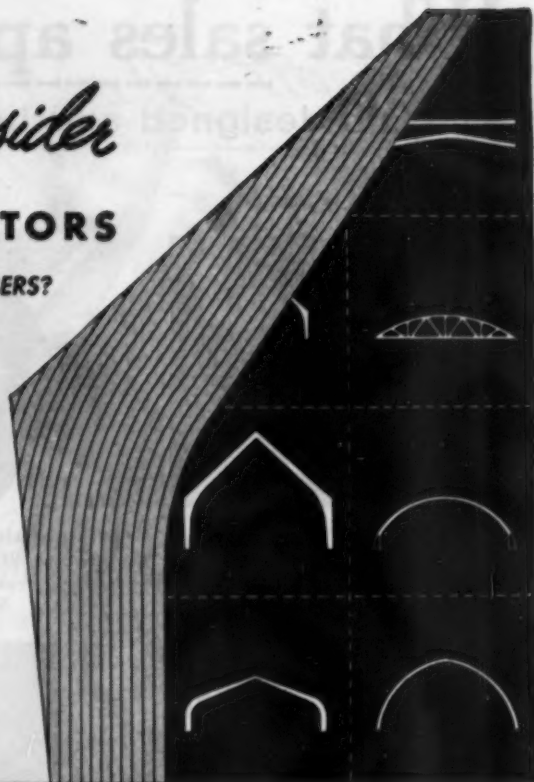

**RILCO**  
*works wonders with wood*

2511 First National Bank Bldg., St. Paul 1, Minnesota  
District offices: Wilkes-Barre, Pa.; Fort Wayne, Ind.;  
Manhattan, Kansas; Tacoma, Wash.



# First Order 1,400 ... Builder to continue with REYNOLDS ALUMINUM WINDOWS



**J. P. MEGILL**  
BUILDER  
101 THOMAS AVENUE  
BROOMALL, PA.  
Newtown Square 9118

October 23, 1954

Reynolds Metals Company  
2031 South Ninth Street  
Louisville, Kentucky

Gentlemen:

I want to express the satisfaction I have experienced by using your Aluminum Casement windows for the first time in my building experience.

When I put up my first two model houses for the Brookthorpe Hills Development, my intention was to use another type of window. One of your salesmen arrived at an opportune time because I had become interested in aluminum as a window material. His explanation of the advantages of the aluminum casement impressed me to the extent that I changed my plans and have included your window in all the houses in this development. The reaction of the home buyers has convinced me that this was a wise choice indeed.

The non-painting feature alone would be enough to sell this window to my conscientious builder. When you combine this with good looks and economy, you have a product that is hard to resist. When I start the next section of my development next Spring, you may be sure that I will continue to include the Reynolds Casement.

It may be of interest to you to know that I also insist on using your reflective insulation for all the attic of my development. The slight additional cost is more than justified by the comments of home buyers who remark on the tremendous difference it makes in reducing upper floor heat during the hot season.

Sincerely yours,

*J. P. Megill*  
J. P. Megill

See why J. P. Megill backs up his choice of Reynolds Aluminum Windows by using 1,400 throughout his latest development—with more to come. Read his letter.

These are Reynolds Aluminum casement windows and casement-picture combinations. They are distinguished by their "satinized" finish and by many superior design features including watertight lip and flash-welded corners.

In addition Reynolds Aluminum Windows are produced in these types: Traverse (horizontal sliding), Double-Hung, Awning, Basement and Utility. Quality controlled by Reynolds from prime metal to final assembly. Write for complete catalog. Reynolds Metals Company, Window Division, 2003 South Ninth Street, Louisville 1, Kentucky.

Note that all Megill Homes also feature ...

**REYNOLDS ALUMINUM  
REFLECTIVE INSULATION**



Superior efficiency at much less cost than most bulk insulations. Embossed foil on both sides (Type B) or one side (Type C), of tough kraft paper. In rolls of 250 sq. ft., 25", 33" and 36" wide. Reynolds Metals Company, Building Products Division, 2031 South 9th Street, Louisville 1, Kentucky.

# REYNOLDS ALUMINUM BUILDING PRODUCTS



**"EVERYTHING HINGES ON HAGER!"\***

C. Hager & Sons Hinge Mfg. Co. • 139 Victor Street • St. Louis 4, Mo.  
 Founded 1849—Every Hager Hinge Swings on 100 Years of Experience



AMERICAN BUILDER



Vibrapac Block in a Pleasing  
Ashlar Pattern



Alternate Rows of Full Height  
and Half Height Units

# Vibrapac Block is Versatile!

... Provides an Endless Variety of  
Textured Patterns... Sizes Available  
in Direct Proportion to Wall Areas

You get beauty at its permanent best when homes and other buildings are built of Vibrapac Block. This modern, low-cost building material provides almost unlimited opportunities for creative architecture and structural versatility. Numerous styles and sizes, interesting textures and distinctive color tones challenge both architect and builder in their efforts to achieve beauty and permanence. Ask your nearby Vibrapac Block plant for literature, or write direct:

**BESSER COMPANY, Box 183, Alpena, Mich.**  
Complete Equipment for Concrete Block Plants

*All pictures shown here are unretouched*



Basket Weave at Left and  
Vertical Stacking at Right



Half Block Stacked. Even the  
Clock is Made of Vibrapac Block



Vibrapac Block in Running  
Bond with Central Joint.



Coursed Ashlar at Left and  
Basket Weave at Right



Vertical Stacking at Left and  
Horizontal Stacking at Right.

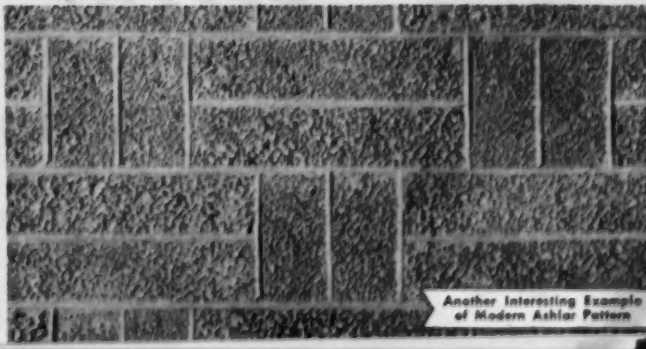

Another Interesting Example  
of Modern Ashlar Pattern



*Pella*<sup>®</sup>

**MULTI-PURPOSE WINDOWS**

## "big idea" windows at small cost

You can build the biggest window ideas into your homes without spending big money. With low-cost Pella Multi-Purpose Windows you can create unexpected window schemes that attract home buyers. The many modular sizes, fixed and ventilating, form hundreds of exciting arrangements. What's more, you can install inexpensive Pella Multi-Purpose units as awning windows, casements, hopper vents or picture windows.

While you're building a more appealing home, you'll also save on installation costs. Pella Multi-Purpose Windows come completely factory-assembled with all sash hardware attached. The frame is flat on all four sides for quick, easy installation. Sash and frame are made of select soft Western Pine, toxic treated. Joints are mortised and tenoned. Stainless steel weatherstripping all around. And made of wood, Pella Multi-Purpose Windows give your homes a warmth and beauty that prospects just can't experience with any other window.

See the Pella catalog in Sweet's Light Construction File. Or mail coupon. Distributors are located in major cities throughout the U. S. and Canada.

*Pella*

**MULTI-PURPOSE WINDOWS**



Lady prospects are intrigued with how easily windows open and close, without screen interference. Underscreen Operator furnished at no extra cost.



Women appreciate how easily screens remove for washing windows . . . and how screens and storms are self-storing, never take up extra storage space.



Show a prospect the way she can wash the exterior glass from inside the house. She'll be sold.

**MAIL COUPON TODAY**

ROLSCREEN COMPANY, Dept. G-23, Pella, Iowa

Please send free literature on Pella Multi-Purpose Windows, with name of nearest Pella distributor.

FIRM NAME \_\_\_\_\_

ADDRESS \_\_\_\_\_

CITY \_\_\_\_\_ ZONE \_\_\_\_\_ STATE \_\_\_\_\_

ATTENTION MR. \_\_\_\_\_

**Best builders  
in the Business  
are**

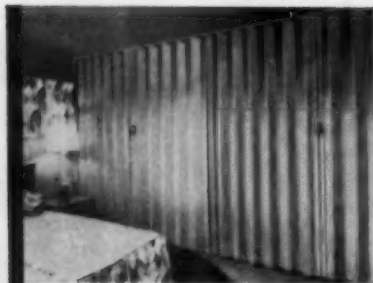

**Levitt & Sons, Inc., Pennsylvania.** World's Largest City Builders. Illustrated: Accordofold used in master bedroom. Two 4' pairs covering 16' area. Note ceiling to floor installation.

# Sold on ACCORDOFOLD

## FOLDING DOORS & ROOM DIVIDERS

### Here's why Accordofold is your best buy

21 stock sizes supply 95% of all needs. 6 decorator colors harmonize with 95% of all color schemes. 4" stack front to back assures flush fit. Exclusive nylon linkage assures uniformity of folds. When used in new construction, Accordofold eliminates the need for any furring, trim or additional hardware. The average closet closure, room divider or door is hung in 7 to 10 minutes. Accordofold gives *more* space because wasted *door* space becomes usable *floor* space. Makes any home more modern, more livable, more salable at a better price.

Top quality, wide use, low price! Durable washable Vinyl cover. Can be repainted with rubberized base paint. Solid core body. Precision-made hardware guarantees years of trouble-free service. *No wonder best builders in the business are Sold on Accordofold!*

### They're sold on Bamboofold too!

Ventilated closures or room dividers. Special imported polished bamboo gives furniture-like finish. Constructed with American hardware. True accordion action. Easy to install. Laboratory tested. Variety of colors and sizes. *New: Bamboofold birch doors in 10 low cost, widely adaptable stock sizes.*

*Write us today for complete Accordofold and Bamboofold Specifications. Please Address Dept. 56.*

**DESIRABLE TERRITORIES AVAILABLE  
TO FRANCHISED DEALERS & DISTRIBUTORS**

**AMERICAN BAMBOO CORPORATION**  
171-04 Jamaica Avenue, Jamaica 32, N.Y.



**Jones-Frederick Norwood Project, Florida.** Illustrated: Free hanging Accordofold, with left and right handles, affords accessibility to closet from either side.



**Cinderella Homes, New Jersey.** Illustrated: Accordofold's space-saving advantages in crowded corner of living room.



**Castle Construction Co., Ltd., Ontario, Can.** Illustrated: Accordofold used as room divider separating kitchen unit from dining or living area.



## It's Modern! It's Distinctive! It's Hardwood!



There's high style in this Bruce Block Floor to complement the most modern interior. The parquetry design is beautiful everywhere... giving full play to the delicate coloring and interesting grain of durable oak. Installation is simple... blind-nailed over wood sub-

floor or laid in mastic over concrete. Famous Bruce factory-applied "Scratch Test" Finish saves time and money. Bruce Blocks are also available for on-the-job finishing. Write for color booklet. See our catalog in Sweet's.

E. L. BRUCE CO., MEMPHIS 1, TENN.

**BRUCE BLOCK Hardwood Floors**  
Naturally Beautiful!

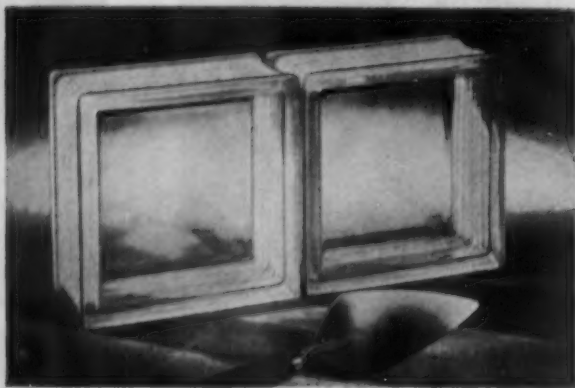

## OWENS-ILLINOIS GLASS BLOCK

— AND CONCRETE BLOCK

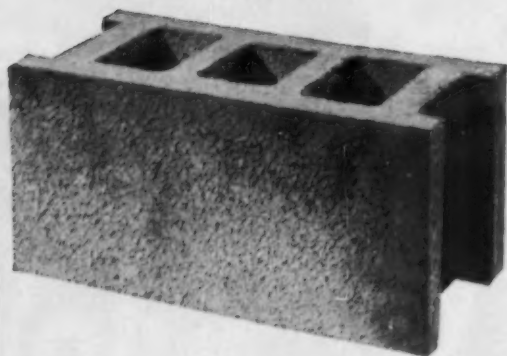

*...building materials  
that "belong" together*

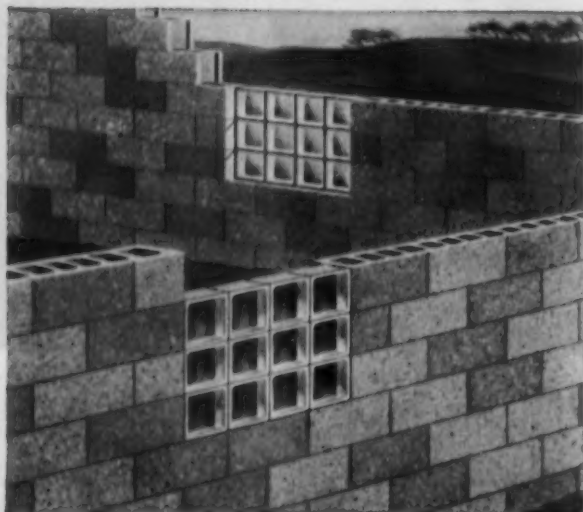

**Glass block and concrete block "fit."** Two 8" glass block equal a standard concrete block. When you use glass block in side walls you have no delays in construction. They go in at the same time as the concrete block.

Owens-Illinois Glass Block are handled in the same way as concrete blocks—same mortar materials and similar laying technique . . . go in at the same time.

Glass block arrive on the job site packed in sturdy cartons of convenient size. Cartons can be opened as block are needed. Panels can be made to fit any size opening . . . no frame is necessary.

*All Owens-Illinois Glass Block are face-coated for easy removal of excess mortar. Even the hardest, dried-on mortar rubs off quickly and easily, reducing finishing cleaning time to a minimum.*

Owens-Illinois Glass Block are available in a wide variety of designs from super-clear that you can see through to those that restrict sight completely. Literature for any glass block application is available free of charge. For information or help with a specific problem write: Kimble Glass Company, subsidiary of Owens-Illinois, Toledo 1, Ohio.

OWENS-ILLINOIS GLASS BLOCK

AN  PRODUCT

OWENS-ILLINOIS

GENERAL OFFICES • TOLEDO 1, OHIO





VISITING THE NATIONAL HOUSING CENTER IN WASHINGTON, D. C.? Be sure to see the Bostitch exhibit of cost-cutting builders' tools.



### 1. Lay shingles with Bostitch stapling hammer

Builders using the Bostitch H4 Stapling Hammer say they wouldn't be without it, claim they can halve the time required to lay asphalt shingles on new roofs. One quick blow with the H4 hammer drives a 3/4" galvanized staple all the way home, spreads the staple legs for extra grip.

## 3 Cost-cutting Ideas for Modern Builders!



### 2. Use tacker to put up ceiling tile

Ceiling tile with stapling flanges goes up a lot faster when you use a Bostitch T5 Tacker. Neater, too, since the danger of hammer-marred edges is eliminated.

Gummed staples with 9/16" legs hold fast, don't pull through like nails under stress. T5 tacker also drives staples with 1/4", 3/8" and 1/2" leg lengths for numerous other tacking jobs.



### 3. Save insulating time with H2B hammer

More than twice as fast as hammer and tacks and a good deal faster than a stapling tacker, the Bostitch H2B Stapling Hammer speeds the application of batt and reflective insulation.

H2B drives staples with 1/4" and 3/8" legs. H2B1/2 takes staples with 1/2" leg lengths. H2BR drives wide wire staples—ideal for felt and flashing papers.

*Fasten it better and faster with*

**BOSTITCH**  
STAPLERS AND STAPLES

**BOSTITCH, 830 Mechanic Street, Westerly, R. I.**

Please send me full information on the

H4 Stapling Hammer     T5 Tacker     H2B Stapling Hammer

Name \_\_\_\_\_

Firm \_\_\_\_\_

Address \_\_\_\_\_

City \_\_\_\_\_ Zone \_\_\_\_\_ State \_\_\_\_\_

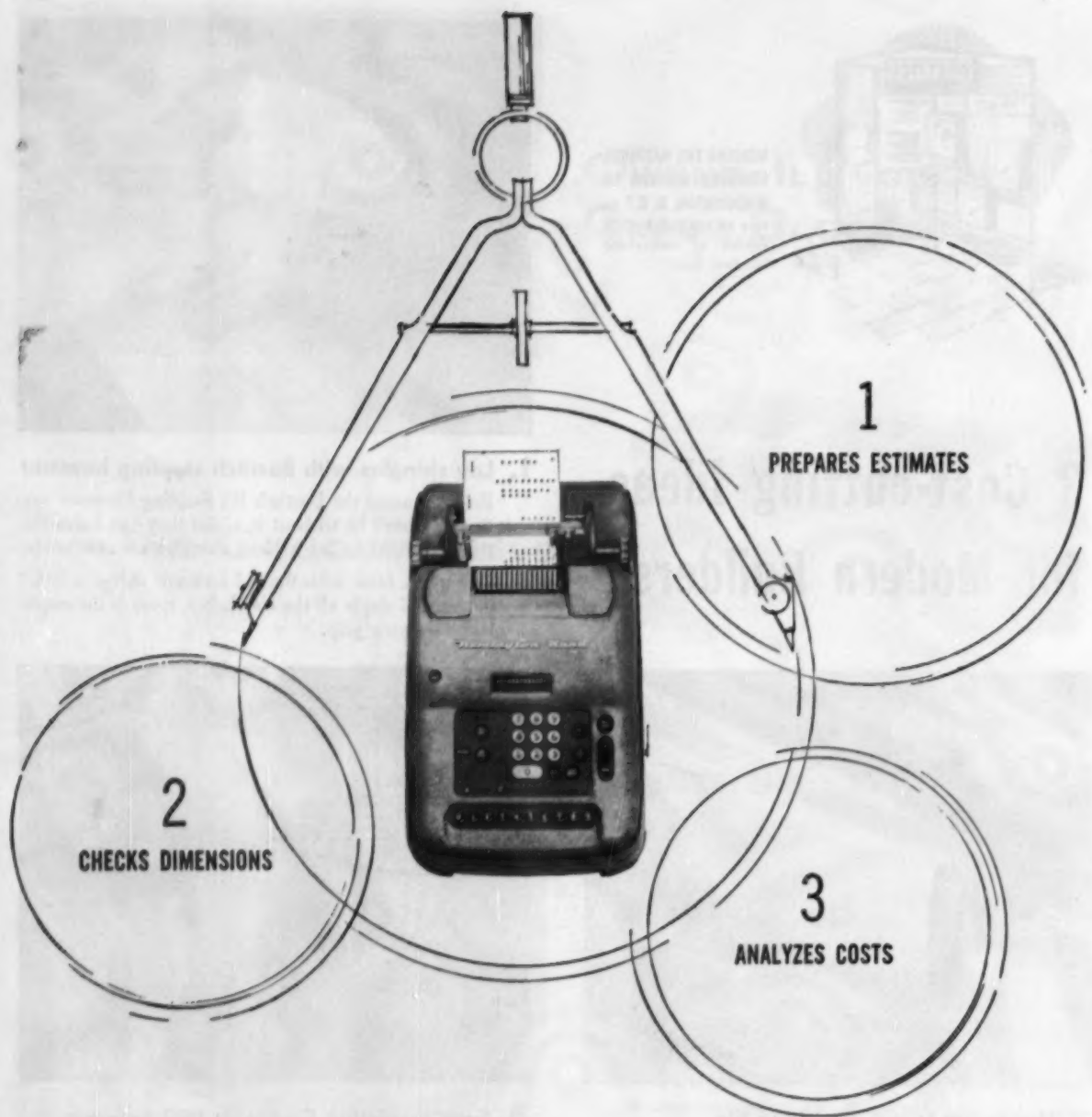

## make plans for - a Remington Rand Printing Calculator



The Remington Rand Printing Calculator can multiply, divide, add and subtract. Anyone can operate this fully automatic calculator; ten-key touch makes it so simple and speedy... and exclusive Simpla-tape gives the operator a printed record of all figurework.

For free applications in the building trade, write for Case History 974, Room 2030, 315 Fourth Avenue, New York 10, N. Y.

**Remington Rand**  
DIVISION OF SPERRY RAND CORPORATION





**Noise spreads rapidly** where walls between rooms have been eliminated. You can overcome this problem—and give your homes more sales appeal—by installing ceilings of Armstrong Cushiontone. This acoustical tile adds comfort by absorbing the sounds of children and appliances before they become disturbing noise.

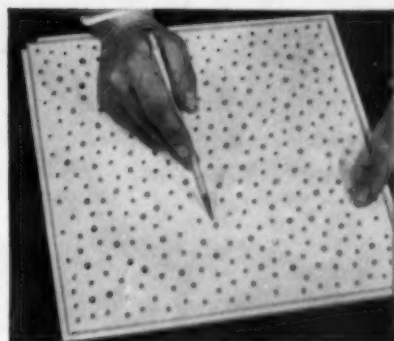

**For effective sound conditioning**, choose a genuine acoustical tile like Armstrong Cushiontone—it absorbs up to 75% of the sound that strikes its surface. Cushiontone perforations are in handsome Full Random design.

## Open-plan homes more saleable with sound conditioning

*You can add quiet and beauty  
to your houses by installing  
Cushiontone ceilings*



**Distinctive ceiling appearance** is another advantage of using Armstrong Cushiontone. The fresh styling and smooth white finish on Cushiontone Full Random will impress prospects.



**Quickly installed**, Armstrong Cushiontone provides a finished ceiling in one easy application. The new T & G joint speeds and simplifies installation. For full information on Cushiontone, see your Armstrong lumber dealer or write Armstrong Cork Company, 4210 Rider Avenue, Lancaster, Pennsylvania.



**Ads pre-sell prospects** on the new comfort of quiet with Cushiontone ceilings. Many home-minded families in your area are reading Cushiontone ads each month in home magazines. Cushiontone gives you another nationally known brand name to help you sell.

# Armstrong CEILING

Cushiontone® • Temlok® Tile

... to quiet and beautify homes



**G. E.'s new Custom Range**—the easily installed "built-in" appliance that housewives want in their modern kitchen. Completely automatic with all Calrod units—no open coils—especially vented to prevent staining of wall cabinets.



**G. E.'s Washer-Dryer Combination** with under-counter installation! Exclusively G-E . . . a versatile, fully automatic combination that frees over 5 square feet of kitchen floor space.

## Dramatize your homes with

THESE DRAMATIC G-E APPLIANCES are available in G.E.'s 5 Mix-or-Match colors: Canary Yellow, Turquoise Green, Petal Pink, Cadet Blue, Woodtone Brown. Only G.E. offers you this exciting color choice throughout the entire line!



G.E. sells the kitchens that sell your houses! Here are dramatic, "wanted" appliances that give your houses *extra value* . . . a solid selling edge over others in the same price range.

These G-E "built-ins" are versatile, and easily installed.

They permit you the kitchen design you want, and they answer the prospect's demands for styling, convenience, beauty and efficiency.

*Progress Is Our Most Important Product*



**G. E.'s new Wall Refrigerator-Freezer** hangs on the wall like a picture—freeing floor space for base cabinet storage and additional work surface—adds unmatched glamour and sales appeal to kitchen. Capacity: 11 cubic feet.



**G. E.'s Under-counter Dishwasher**—king-size capacity. Eliminates hand pre-rinsing. Front panels available in natural wood (knotty pine, birch, oak, or mahogany) as well as G.E.'s Mix-or-Match Colors.

## these wonderful G-E "Built-Ins"!

Best of all, these "built-ins" are financed through the Package Mortgage, making them available to home buyers at low monthly payments.

At the same time, you include the cost of these appealing appliances right in the cost of the house!

Furthermore, these dependable General Electric appliances are available in exciting G-E Mix-or-Match colors.

These are the dramatic appliances that open the way to more home sales for you. And why not . . . when 55 out of every 100 women think *G.E. makes the best home appliances.*

Contact your G-E distributor *right now*, and let him help you to the best sales season you ever had.

General Electric Company, Appliance Park, Louisville 1, Kentucky.

GENERAL  ELECTRIC



Photo: Reynolds, Photography Inc.

Architect: James Hunter

# stone

## A RUGGED SYMBOL OF DISTINCTIVE AMERICAN LIVING

Today's satisfied home-owner is silently thanking his architect for suggesting practical and distinguished STONE when his home was planned. Nature has furnished us with an abundant supply and a great variety of STONE, high in quality, attractive in appearance, economical in maintenance.

*For additional information about STONE,  
its variety, characteristics, availability or uses,  
write the Building STONE Institute,  
2115 Martindale Avenue, Indianapolis, Indiana.*



AMERICAN BUILDER

# Stanley Cabinet Hardware

*... for the quality your houses deserve*

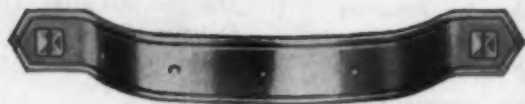

This is the Stanley 4308 5" Pull, a Ranch Craft style in a soft, satiny, old brass finish. Companion pieces in Ranch Craft are strap, semi-concealed and surface hinges, pulls, knobs and latches.

You expect the cabinet hardware in the houses you build and sell to do two things — to operate and to decorate. Every hinge, pull, knob and latch should work perfectly and add to the beauty of your house. This is the kind of hardware Stanley makes . . . the kind Stanley is known for. Here are a few typical examples:

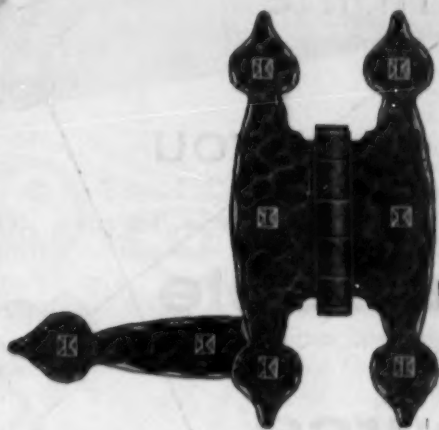

This is the Stanley W859 3" Hinge, an authentic rustic style in antique black finish. Companion pieces in Rustic are strap and semi-concealed hinges, latches, and pulls. Antique copper finish also available.



This is the Stanley 4482 ALD Knob with 4408 ALD Backplate, a modern style in solid aluminum. Companion pieces in Solid Aluminum are pulls, knobs, and hinges with aluminum barrel covers.

Solid Brass and Chrome styles complete the compact line of Stanley Cabinet Hardware. Take a look at it. Check with your hardware supplier. Write Stanley Cabinet Hardware, 100 Lake St., New Britain, Conn., and ask for your copy of fully illustrated cabinet hardware catalog F-100.

## STANLEY

The Stanley Works • New Britain, Conn.



now **27**



plants

combine

to give you

**1** reliable

source

of

supply!



We have added another top-efficiency plant to the 26 that have always meant prompt, dependable service for you—wherever you are. These Long-Bell plants and extensive timber stands are strategically located in eight states. That's why leading retailers, distributors and industrial users for 80 years have looked to Long-Bell as "one reliable source of supply" for available lumber and wood products.

**DOUGLAS FIR—WEST COAST HEMLOCK—RED CEDAR SIDING AND SHINGLES**

Longview, Wash.  
Vernonia, Oregon  
Vaughn, Oregon  
Austa, Oregon  
Gardiner, Oregon  
Reedsport, Oregon

**GLAZED DOORS AND WINDOWS**

Fort Smith, Arkansas

**HARDWOODS**

Sheridan, Arkansas  
Quitman, Mississippi  
DeRidder, Louisiana

**MILL WORK AND FACTORY PRODUCTS—KITCHEN CABINETS—SASH AND DOORS—FRAMES—WINDOW UNITS—BOX SHOOK**

Longview, Wash.  
Weed, California

**OAK FLOORING**

DeRidder, Louisiana  
Quitman, Mississippi

**PLYWOOD AND FLAKEWOOD—TEXTURE ONE-ELEVEN**

Longview, Wash.  
Gardiner, Oregon  
Weed, California

**CALIFORNIA PONDEROSA PINE—DOUGLAS AND WHITE FIR**

Weed, California  
Aetna, California

**SOUTHERN PINE**

Sheridan, Arkansas  
Quitman, Mississippi  
DeRidder, Louisiana

**TREATED PRODUCTS**

Joplin, Missouri  
DeRidder, Louisiana  
Longview, Wash.  
Weed, California  
Navasota, Texas

**FABRICATED TIMBERS AND TRUSSES**

Longview, Wash.

Give your local Long-Bell representative a call today. He will be glad to bring you reliable Long-Bell products and service to your door.



# The Long-Bell Lumber Company

Established 1875 — Kansas City 6, Mo.

DIVISIONAL OFFICES

EASTERN DIVISION—KANSAS CITY, MO. WESTERN DIVISION—LONGVIEW, WASH.





ONLY PERMANENT  
CAST IRON SOIL PIPE  
AND FITTINGS  
HAVE PASSED THE TEST OF TIME

CAST IRON is the *only* pipe material that has passed the acid test of time—*generation after generation*. Claims made for “equal performance” by substitute materials are based on the experience of a comparatively few years, since none can boast the long record of economy and efficiency of Cast Iron Pipe and Fittings.

As many of America's older homes are razed to make way for newer structures, the original Cast Iron Pipe has been found in such excellent condition that it can be re-used 100%.

### *Better Today Than Ever Before*

Thanks to research, better pig iron, close controls of iron analysis, new and improved processes, rugged and durable modern Cast Iron Soil Pipe is definitely *stronger, tougher, more uniform in quality and more economical* than ever before. That is why it is the first choice of architects and builders who recognize that the only sound foundation of a good reputation is specifying quality materials that will never cause come-backs or complaints.

Our Company does not manufacture pipe, but has long supplied the nation's leading Cast Iron Pipe Foundries with high grade quality iron from which permanent Cast Iron Pipe is made.

**WOODWARD IRON COMPANY**  
WOODWARD, ALABAMA



When the first thing prospects see in a new house is this guarantee . . .



and then when they notice this sign on a window sill or mantelpiece . . .



and later pick up and look through this colorful literature . . .

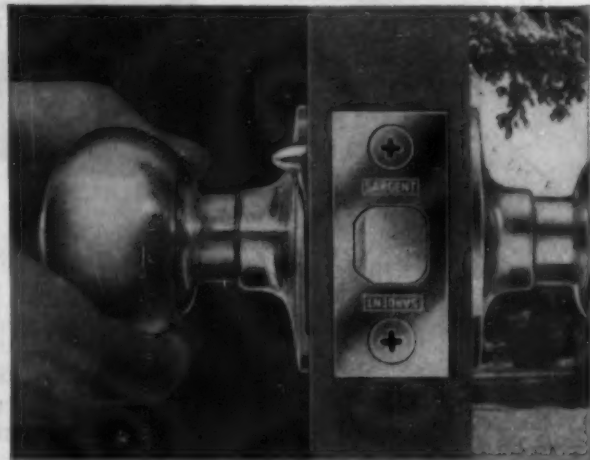

they are getting *very* sold on the house that has this lock —the handsome Sargent AlignaLock!

## **ALIGNALOCK Sales Aids Sell Houses!**

Above, you see a couple making up their minds to buy a house.

AlignaLocks and AlignaLock Sales Aids have convinced them that quality products have been used throughout their "new home."

Experiences like this are taking place today all over the country. Many hundreds of builders have told us that AlignaLock and AlignaLock Sales Aids help sell the house.

Put these sales aids to work for you. As shown above, hang the guarantee certificate on door knobs. It unconditionally guarantees AlignaLocks for the life of the house . . . and makes a tremendous impression on prospects.

Take full advantage of the house signs . . . the home

owner brochures . . . the colorful literature. Sargent gives them to you free. *Use them to put sell in every room!*

Get in touch with your supplier today and ask him all the facts about AlignaLock. Or write direct to Sargent & Co., New Haven 9, Conn. Dept. 9K.



## **SARGENT LOCKS**

**"A sign of a well built house"**

AMERICAN BUILDER



*Standish enameled iron  
recess bath K-305-F*

*Water-tight, 2-door, clear  
glass enclosure available.  
Doors open outward.*

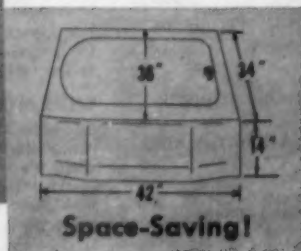

**You can locate  
bathrooms  
where they wouldn't  
fit before,  
with the  
**KOHLER**  
**STANDISH**  
**SHOWER BATH****

The compact Standish affords possibilities for locating complete, comfortable bathrooms in space of small or unusual dimensions. It is practical and economical for homes needing additional bathrooms; for apartments, motor courts, hotels, dormitories—wherever space must be conserved.

The Standish is roomy and deep for showering, suitable for tub bathing. The low front makes access easy, simplifies the bathing of children. Convenient 5-inch bench rim. The sparkling, easy-to-clean Kohler enamel is protected from strain because it is fused to a strong, rigid base of cast iron. Write for booklet.

**KOHLER CO., KOHLER, WISCONSIN**  
**ESTABLISHED 1873**

**KOHLER OF KOHLER**

PLUMBING FIXTURES • HEATING EQUIPMENT • ELECTRIC PLANTS • AIR-COOLED ENGINES • PRECISION CONTROLS

The **F. C. RUSSELL** Company announces a  
complete new line of **THERMOSEAL**<sup>®</sup>  
**ALUMINUM**  
**PRIME WINDOWS**  
 for NEW construction

**Here's big news for builders everywhere!**

Now you can build with Prime Windows made from finest quality, sturdy extruded aluminum—and backed by *The F. C. Russell Company*—world's largest manufacturer of metal windows and doors!

**The complete Thermoseal line of Prime Windows include:**

- ✓ Horizontal slide window
- ✓ Vertical slide window
- ✓ Fulvue ventilating window
- ✓ Multi-lite ventilating picture window
- ✓ Glass jalousie louvered window

**Take a look at these Thermoseal profit advantages!**

- No on-the-job glazing, painting, re-fitting or later adjusting.
- Big savings on installation time and cost.
- Built-in Fiberglass Screen that won't rot, corrode or stain—never needs painting.
- Fully weatherstripped with built-in felt weatherstripping.
- No sash cords, weights or balances. All hardware attached.
- Available with insulating sash (optional) which provides year 'round rainproof, draft-free ventilation.



**New Thermoseal HORIZONTAL SLIDE window**  
**AMERICA'S FINEST ALUMINUM PRIME**

Here's a brand new Prime Window made of finest quality satin-smooth extruded aluminum that really gives your homes "sales appeal" *plus!* This window has everything you *and your customers* ever looked for in a Prime Window! Available in both single slide and composite units.

For one story or split-level homes—it's an ideal space-saving window for bedrooms or bathrooms where high-window treatments are called for!

**THERMOSEAL HELPS YOU SELL!**

A trouble-free performance record—plus years of National advertising—have preconditioned your customers to expect a better home when it's equipped with Russell products! You can use this "consumer acceptance" as another big sales feature when you build with these precision-made Thermoseal Prime Windows!

Write for full information and free literature on Thermoseal Prime Windows and all the other nationally famous F. C. Russell products.

Thermoseal Prime Window Division  
**THE F. C. RUSSELL COMPANY**  
 Dept. AB-105, Cleveland 1, Ohio • in Canada: Toronto 13, Ontario



BY INVITATION  
 MEMBER  
 WARRANTY  
 OF QUALITY

AMERICAN BUILDER



Why every piece of **PALCO\***  
 Architectural Quality FLAT GRAIN Redwood  
 is run with the Pattern on the Bark Side



Beauty and functional advantages dictate the choice of flat grain in many applications. But only the side toward the bark offers the full advantage of the redwoods' permanent qualities. The heart side tends to splinter or "shell out" after long exposure.

That's why The Pacific Lumber Company has developed exclusive handling systems to control each piece through every step of manufacture, so that the pattern is *always* run on the bark side. Only Palco\* Architectural Quality assures this extra premium in value . . . at no extra premium in cost. For a handy free guide to aid in selecting the best in redwood, fill out and mail the coupon below, or write for Bulletin No. L-502.

When you specify Palco\* Architectural Quality Redwood for exterior or interior design . . . you can be sure that it is

- Certified Dry
- All Clear Heart or A Grade
- Highest uniformity of grade
- Vertical grain on all resawn patterns
- Where flat grain is specified, pattern is always cut from the bark side

L-502

Specify the best in Redwood **PALCO\***

**THE PACIFIC LUMBER COMPANY**

Since 1869 • Mills at Scotia, California

100 Bush St.  
San Francisco 4

35 E. Wacker Drive  
Chicago 1

2185 Huntington Drive  
San Marino 9, Calif.

\*Trade Mark ®

MEMBER OF CALIFORNIA REDWOOD ASSOCIATION

OCTOBER 1955

SEND FOR THIS FREE BULLETIN



**THE PACIFIC LUMBER COMPANY**

100 Bush St., San Francisco 4, Calif.

Please send me, without obligation, the new bulletin outlining basic redwood specification data, with charts showing standard Palco\* redwood patterns, sizes, grades and grains.

Name \_\_\_\_\_

Title \_\_\_\_\_

Company \_\_\_\_\_

Address \_\_\_\_\_

City \_\_\_\_\_ Zone \_\_\_\_\_ State \_\_\_\_\_



They will appreciate  
your suggestion of ...

# Trinity White

The mass of dazzling white or the truer colors and tints made with Trinity white cement gives distinction to any structure—large or small. Your recommendation to use Trinity white will be appreciated and remembered by all concerned with that building.

A Product of GENERAL PORTLAND CEMENT CO.  
Chicago • Dallas • Chattanooga • Tampa • Los Angeles



As white as snow



... plain or waterproofed

Another addition to **MORGAN-WIGHTMAN'S**  
**Windsor** line of Quality Building Materials!

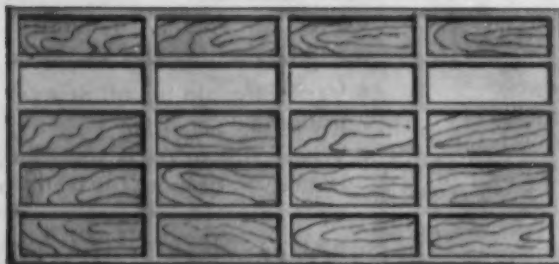

Electric operators available—also custom built doors made to specification with raised, ornamental or carved sections.

**BIG ST. LOUIS INVENTORIES!**  
Everything you need—including "hard-to-get" items and odd sizes. Orders Filled Same Day!

why look  
around?  
Always  
LOOK TO...

**MORGAN-WIGHTMAN**  
Supply Co. St. Louis 20, Mo.

**FREE**  
compare our  
prices



## Windsor GARAGE DOORS with Full Wedge-Tight Action!

Morgan-Wightman—the answer to all your garage door problems. Residential, commercial or industrial—all have high quality Douglas Fir stiles and rails. Thirty-four standard sizes with either Tension or Torsion springs carried in stock for immediate shipment. You'll find a complete line of Windsor overhead garage doors in both flush and paneled styles at Morgan-Wightman... the "one-stop warehouse" for all your building supplies.

For full information on our Windsor line of garage doors, send for our brand new catalog showing more than 2500 building supply items.

### SEND NOW FOR FREE NEW CATALOG

Shows More Than 2,500 Different Building Supply Items!

Morgan-Wightman Supply Company, Dept. 21

1541 Salzman Avenue, St. Louis 20, Missouri

Please rush me your big free Catalog No. 155

NAME \_\_\_\_\_

COMPANY \_\_\_\_\_

ADDRESS \_\_\_\_\_

CITY \_\_\_\_\_ ZONE \_\_\_\_\_ STATE \_\_\_\_\_

AMERICAN BUILDER



For  
smooth-selling  
walls!

No  
priming...  
No  
mixing

**New TEXOLITE\* Paints!**  
**JUST ONE COAT CONCEALS MOST  
DRY-WALL JOINTS...BEAUTIFULLY!**

Decorate faster with these new, washable latex paints—and there's "smooth selling" ahead for you. One coat beautifully conceals wallboard joints finished with PERF-A-TAPE\* system, dries fast, leaves a luxurious textured finish and no "painty" odor; permits earlier occupancy. Save time and money many ways with TEXOLITE Texture or TEXOLITE Ripple. Ready to use right from the container; have exceptional covering and hiding qualities. For complete information write Dept. AB-5, 300 W. Adams St., Chicago 6.

\*T. M. Reg. U. S. Pat. Off.



Sand Finish—  
17 colors



Smooth Stipple  
Finish—12 colors

**UNITED STATES GYPSUM**



the greatest name in building



**One man can install all this MARLITE  
PANELING in just one, eight-hour day\***

It's amazing what one man with a hammer and Marlite can do in an ordinary working day. Interior finishing is completed beautifully before you know it. That means you can handle *more* jobs and still keep promised completion dates. The exclusive tongue and groove joint of Marlite Plank and Block simplifies installation; conceals all fastening. And Marlite's soilproof baked finish resists smudges, grease,

and stains; wipes clean with a damp cloth. Prefinished in 10 "Companion Colors" styled by Raymond Loewy Associates, plus 4 distinctive wood patterns, Marlite adds beauty . . . eliminates costly finishing. Plan on Marlite for your next dry wall construction job. See your building materials dealer, refer to Sweet's File, or write Marsh Wall Products, Inc., Dept. 1003, Dover, O. Subsidiary of Masonite Corporation.

\*Although installation time varies with the requirements of each interior, on many jobs one man installed more than 400 square feet of Marlite Plank in 8 hours.



that's the beauty of **Marlite®**

PLASTIC-FINISHED WALL AND CEILING PANELING

Marlite is made with genuine **Masonite®** Tempered Duolux®



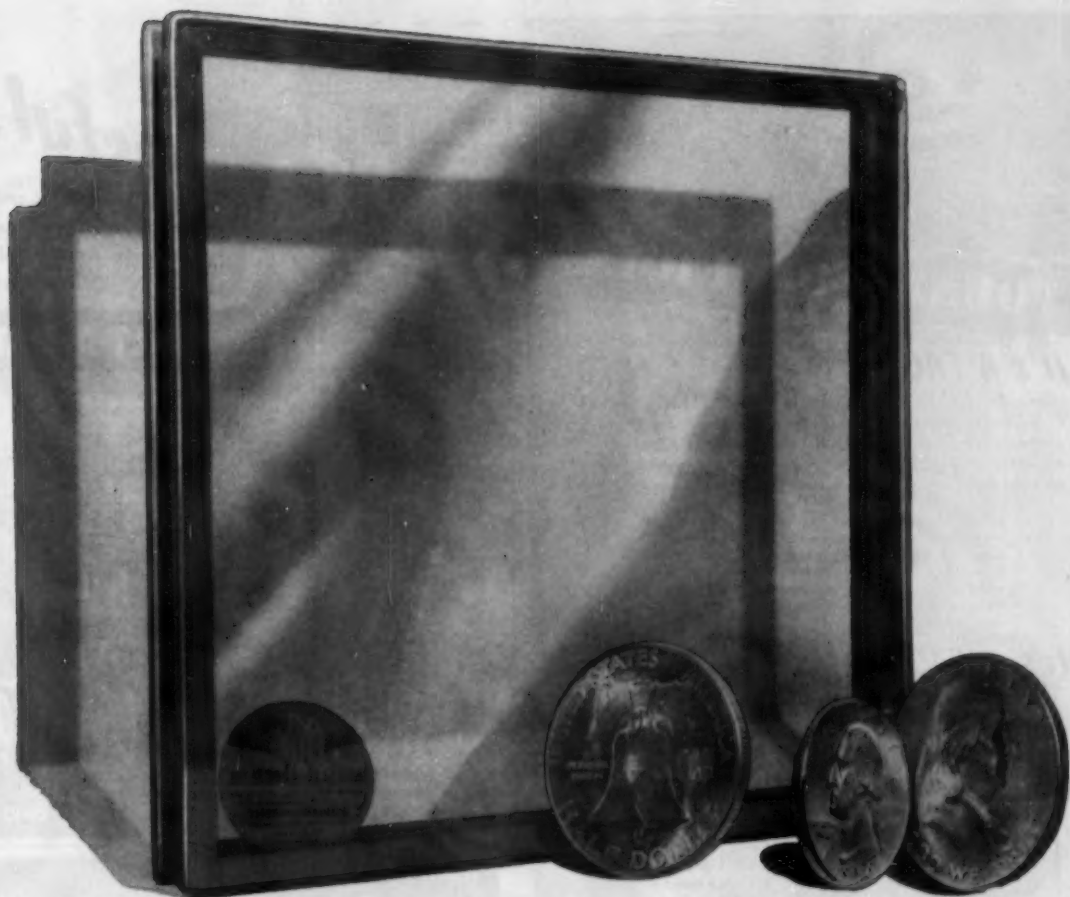

## Builder offers Thermopane® in every window for just \$1.25 per month!



A New Jersey builder sells his 20-window *Thermopane* house for \$18,250—just \$250 more than with single glazing. The cheapest storm sash available in the area is \$11 per window, or \$220 per house. His house buyers get *Thermopane's* permanent window insulation for about the same cost . . . and they pay only \$1.25 more per month on their mortgages than for single glazing.

And what a sales point *Thermopane* makes! No storm sash to fool with. Fuel savings for the life of the house. More year-round comfort. Less noise from outside.

Salesmen sure like to say, "This house has *Thermopane* in every window". And the home buyer is justifiably proud that his house has this outstanding symbol of quality.

Design your houses for standard sash that take standard sizes of *Thermopane*. It costs little and pays off big. For complete data, see your L·O·F Glass Distributor or Dealer. Or write to Libbey-Owens-Ford Glass Company, 608 Madison Avenue, Toledo 3, Ohio. \*®

**LIBBEY·OWENS·FORD**

*a Great Name in Glass*





## It's A FACT!

Using the GATES HORIZONTAL ROD SYSTEM, F. A. Illias, Spokane Foundation Contractor, can handle almost ANY forming job with ONE TRUCKLOAD of equipment! Mr. Illias braces the inside wall, letting the outside float—thus saving time, labor and money!

Illias' one truckload of equipment includes: enough regular panels to form 225 lineal feet, 8 feet high, with 16 pairs of corners, 10 fillers, a concrete trough, 10 window bucks, plus regular tools.



## It's A FACT!

GATES HORIZONTAL ROD PANEL FORMS are —  
• FAST • EFFICIENT • ECONOMICAL!

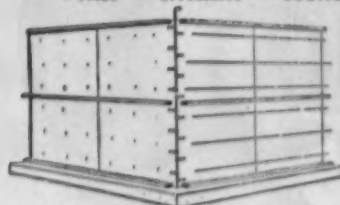

- Erection and stripping time reduced
- Minimum amount of watering required
- No hardware necessary
- Lightweight; easy to handle
- Re-usable time and time again

## It's A FACT!

GATES FORM TIES mean BETTER—FASTER CONSTRUCTION at lower costs!

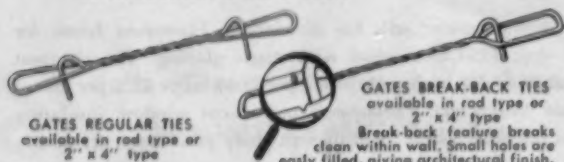

GATES REGULAR TIES available in rod type or 2" x 4" type

GATES BREAK-BACK TIES available in rod type or 2" x 4" type. Break-back feature breaks clean within wall. Small holes are easily filled, giving architectural finish.

**GATES** for every kind of forming—foundations, retaining walls, bridge abutments, and high wall construction!

Write for additional information on the Gates Forming System.

Please send me additional information on:

- Gates Form Ties  
 Gates Horizontal Panel Forms  
 Gates Dealership Availabilities

GATES & SONS, INC.  
80 S. Galapage Street  
Denver 23, Colorado

AB-10/55

Name.....  
Firm Name.....  
Address.....  
City.....Zone.....State.....

**GATES & SONS, INC.**  
DENVER • SPOKANE



**so successful...**  
... it has created another page in home building and selling!



The **MALT-A-MATIC**

wood window with easy-to-remove sash



THE **Malta** MFG. CO.

Sales Office:  
ATHENS, OHIO

See your dealer or write for literature. Turn to page 270 now!  
**Supreme Quality Since 1901**  
Makers of MALT-A-VENTS, MALT-A-GLIDES, MALT-A-MATICS, MALT-A-MASTERS

When it comes to the Built-ins—

Home Buyers Look for **DRAWERS** that **GLIDE OPEN** at a TOUCH!



There's a Fast, Easy, Inexpensive Way to Provide This—

Install **Roll-ez**

The World's Finest Roller Bearings for Wooden Drawers

**IN YOUR BUILT-INS**

**NOW!** Roll-ez are equipped with Lifetime **NYLON** Rollers

Simplicity of Installation Saves Time and Money

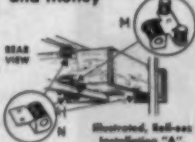

Two Roll-ez "N" nailed to rail at drawer opening. Third one nailed on drawer back under center guide. Guide Roll-ez "M" on bottom back edge of drawer straddles lower center guide.

Roll-ez "M" & "N" are equipped with **NYLON** rollers.

More often than not, it's the *conveniences* in a home that attract the women and help to swing the buying decision in your favor. You get just such a sales clincher when you equip built-ins with Roll-ez Roller Bearings for Wooden Drawers. For drawers equipped with these tough, durable **NYLON** rollers glide open to full extension at a touch... never stick or bind even in *hot, humid weather!* Made in nine styles, they eliminate friction of wood-against-wood and keep drawers rolling straight... may be used in many ways and combinations. Very low in price. Easy to install. Roll-ez also work magic in remodeling jobs.

Free Folder Shows 70 Applications You Can Make... at Little Cost!



**JUNIOR PRO PRODUCTS CO.**

118 E. MARCEAU ST. ST. LOUIS 11, MO.

*All eyes are on*

## WESLOCK'S

*New* #598 ENTRY HANDLE LOCKSET

Smartly modern in its simplicity of design, the New Weslock #598 Entry Handle Lockset adds distinctive beauty to any entry door.

- ★ Solid brass, bronze or aluminum trim
- ★ Completely reversible
- ★ Self-adjusting for doors from 1 3/4" to 2 1/8"
- ★ Simply installed — like all Weslocks
- ★ For the first time — an Entry Handle Lockset priced to meet the modest budget
- ★ Standard Weslock 5-pin tumbler. Available in keying combinations with any Weslock

✱ **SPECIAL INTRODUCTORY OFFER:**

Contact your jobber  
or write for details.

*Keep your eye on Weslock*



**WESTERN LOCK MFG. CO.**

*Manufacturers of Weslock Residential Locksets and Building Hardware*

GENERAL OFFICES: 211 NORTH MADISON AVENUE, LOS ANGELES 4, CALIFORNIA

• FACTORY: HUNTINGTON PARK, CALIFORNIA

OCTOBER 1955

207



# ANSWERS

to these questions take the guesswork out of SLIDING DOOR INSTALLATIONS



**Q** What are the advantages of center mounting and 8 wheels per door?

**A** Hangers that are center mounted support door weight in a true vertical position, relieving stress or pressure against door guides or frame. Hangers providing eight nylon wheels per door distribute weight more evenly over track, providing extremely quiet, effortless operation. Only custom Kennatrack offers these two highly desirable features.



**Q** When should adjustable hangers be used?

**A** Whenever headroom is sufficient. Vertical adjustment permits easy alignment of door to jamb. Readjustments are easy to make if settling and other changes occur. Kennatrack also offers non-adjustable hangers of exclusive design for use where extra strength and neatness are desired, or where headroom is limited to one inch. This type is highly desirable where plywood doors are used.



**Q** Why should a steel frame be used for all pocket door installations?

**A** To avoid costly as well as frequent troubles caused by warping of wood frames. An exclusive development of Kennatrack Corporation, "Kennaframe" is the steel frame that completely eliminates this danger. Easy to install, and with center mounted 8-wheel hangers for smoothest performance, "Kennaframe" is widely used for 2 x 4 wall installations. Any type of wall material or trim may be applied. Doors can't possibly bind if this prefabricated steel frame is used.

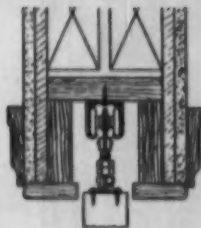

**Q** Can millwork be eliminated?

**A** Using Kennatrack hardware, the need for millwork has been eliminated for practically all installations. Complete packaged sets include versatile molded nylon guides that eliminate need of saw kerfs for doors of all thicknesses.

**Q** How can I be sure the right track is used?

**A** Selection of the right track for a specific installation is highly important. Reference to the Kennatrack Buyer's Guide takes all the guesswork out of selecting the right hardware. An easy-to-follow index leads to complete descriptive information, scaled detail drawings and architects specifications for each series. Write today for your free copy.



**KENNA TRACK CORPORATION, ELKHART, IND.**

**PROFIT FROM THE NEW  
BERMICO PROMOTION  
IN BETTER HOMES AND GARDENS-  
SATURDAY EVENING POST**



*Today's pipe  
for  
tomorrow's homes!*

Match the marvels of your "kitchen of tomorrow" today! Be sure you use modern Bermico house-to-cover connections.

Bermico is rust-proof, corrosion-proof, installs faster and easier and at lower cost.

Best buy all around is Bermico, made of tough wood fibre impregnated with pitch.

Perfect for modern house-to-cover connections, septic tanks,

downspout drains—new or replacement—perforated pipe for land drainage. It lasts and lasts!

Complete line of Wyes, Tees and Bends. Ask your plumbing and heating contractor or building materials dealer about Bermico—or write Dept. BL-7, Brown Company, 150 Causeway Street, Boston 14, Mass.

America's most modern communities today include Bermico bituminized fibre pipe in building codes. Yours should, too.

**BERMICO**

**10 MILLION FAMILIES** are reading BERMICO advertisements this year! That's going to make a lot of your customers ask about "Today's pipe for tomorrow's homes." Make the most of this new BERMICO promotion. Sell BERMICO for repeated sales and steady profits. Brown Company, Dept. BH-10, 150 Causeway Street, Boston 14, Mass.

**To Bermico Dealers**—Send your name and address and we will ship you brand new sales literature to give prospects and to increase your sales. We will refer direct inquiries in your territory to you.



THIS BRAND NAME ON LUMBER ALSO BRINGS YOU

A WIDE VARIETY OF *West Coast Hemlock Products*

★  
**West  
Coast  
Hemlock**  
is  
**versatile,  
too!**  
★

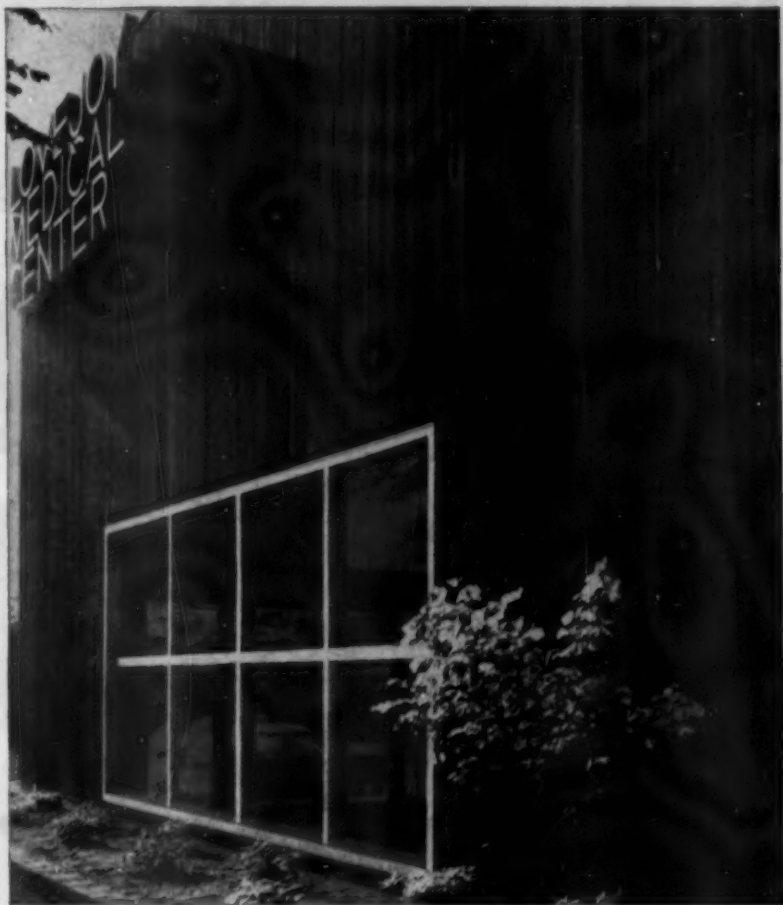

Above you see a unique application of Weyerhaeuser 4-Square West Coast Hemlock, the "Ability Wood." This modern building is finished with tongued and grooved Hemlock clear board siding—with the rough side exposed. It is creosote-stained to a dark brown.

West Coast 4-Square Hemlock is called the "Ability Wood" because it serves so dependably in a wide range of uses. This durable, kiln-dried lumber is light in weight, easy to work, and possesses desirable strength properties needed for framing and sheathing. Also, West Coast Hemlock lumber is widely known

for its excellent nail-holding properties.

The beautiful light color, straight grain, even texture, freedom from pitch pockets, and remarkable paint-holding qualities contribute much to the desirability of Hemlock for ceiling, flooring, siding, molding and other finish uses.

These features explain the popularity of Weyerhaeuser 4-Square West Coast Hemlock Lumber among builders.

Ask to see this fine "Ability Wood" at the yard of your Weyerhaeuser 4-Square Lumber Dealer, or write for literature.

**Weyerhaeuser Sales Company**

ST. PAUL 1, MINNESOTA



The woman you  
want to sell  
is already sold on  
this monogram



## it's the big plus that only G-E home heating and cooling gives you

When prospects look your homes over, you don't have to spend any time convincing them that G-E Home Heating and Cooling is tops in value. That would be like saying to a baseball fan, "Let me tell you about 'Stan The Man'...He's Good." Yes, sir; they're already sold on the value and performance of any product that displays the G-E monogram. So why fool around? Why not play the favorite?

Help move your houses faster by adding the greater comfort and convenience of draft-free G-E Air Wall\* System of home heating and cooling.

Space-saving advantages, complete design freedom, a terrific G-E warranty...these are just some of the facts you'll get from your G-E dealer. He's listed in the Yellow Pages. Call him today! He talks your language—and you'll like what he has to say to you. Let him deliver you a carload of "The Big Plus."

*Home Heating & Cooling Dept., Bloomfield, N. J.*

*Progress Is Our Most Important Product*

**GENERAL  ELECTRIC**

\*REG. TRADEMARK OF GENERAL ELECTRIC CO.

**AMERICAN BUILDER**

**Sell a New Approach!** A dual purpose bathroom-darkroom design color-keyed by Richmond fixtures in lustrous Fern Green. Present, the BRESLIN bathtub, the VOGUE lavatory, the EMPRESS toilet.

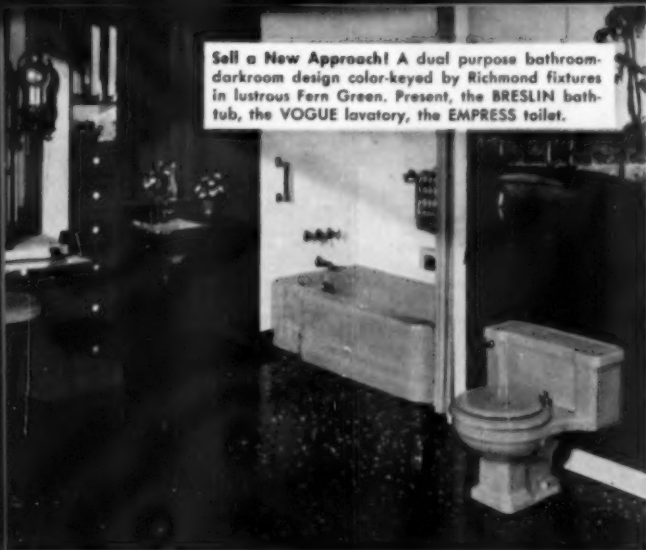

**Sell with Drama!** The BRESLIN recess bathtub is raised for elegance. The BROMLEY lavatory has a roomy ledge. The "Hush-Quiet" EMPRESS toilet is a marvel of advanced design.

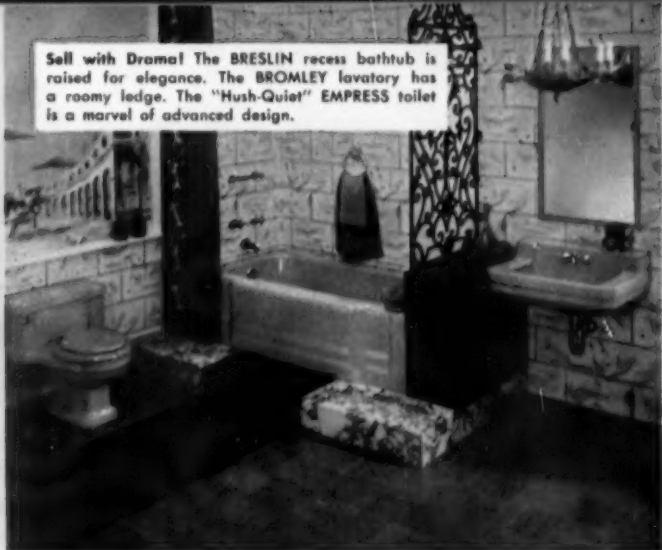

## Salesmaker Bathrooms by **RICHMOND**

**Sell with Charm!** The Bermuda Coral of the Richmond fixtures blends beautifully with warm wood tones. Featured: The COUNTESS lavatory, the EMPRESS toilet, the BRESLIN bathtub.



**Sell with Modern!** Warm brown and piquant tangerine set off by fixtures in Richmond's famous *Whiter-White*. The BLAKE corner tub, the BROMLEY lavatory, the CLAREMONT toilet are starred.



Decorator designed to create homebuyer interest... full of new ideas... these "bathrooms by Richmond" run the gamut from Empire to Colonial to Contemporary.

Each is a perfect setting for the graceful lines and functional perfection of Richmond fixtures... and Richmond fixtures will enhance any other design you may adopt... with the Richmond name winning instant customer approval.

Write for new illustrated catalog of salesmaking Richmond plumbing fixtures.



**RICHMOND RADIATOR COMPANY**

16 Pearl Street, Metuchen, New Jersey • AFFILIATE OF REYNOLDS METALS COMPANY



*and more*

More and more / quality conscious customers look for...

plumbing fixtures by

**RICHMOND**

Richmond National Advertising puts in the hands of your prospects a tested sales tool... the fascinating booklet "Five Little Bathrooms and How They Grew." Every page makes every reader want new home beauty... with bathroom fixtures by Richmond!



See the new "Bathrooms by Richmond" being featured throughout the Fall of 1955 in full-page, full-color ads reaching an audience of millions.







**OLD WALL**, with furring strips nailed through to the studing. Here, the adhesive (said to be equally good for rubber, plastic, leather, aluminum, carpet or stair treads) has been applied. Note glossy film. Cement takes 40 minutes to dry.



**AFTER** panels have been fitted to the wall area, apply adhesive to the contact areas at the back of the panel. Leave a 1/2-inch uncemented margin along the edge. It is important to give the adhesive plenty of time for complete drying.

## No nailing—no nail holes to fill

**T**he use of Roltite cement eliminates the need for nailing or clipping wall paneling to a wall surface, and there are no nail panels to fill when applying prefinished panels, such as plywood, Masonite, Novoply or other surfacing to studding or furring strips.

Roltite cement can also be used to bond plastic laminates, aluminum, rubber, leather, cove base, carpet, stair treads without sustained pressure

and without use of clamps.

Roltite cuts installation time by half or more on many bonding jobs, according to the manufacturer. An applicator is included with every can.

It is important to use enough adhesive and to let it dry completely. Under normal conditions, it is claimed, Roltite will dry in about 40 minutes. Material to be bonded should be positioned carefully. The bonding is immediate upon contact and although

sustained pressure is not required, pressure should be applied thoroughly over every inch of the surface. Price about \$7.00 per gallon. Available from plywood dealers. Midcontinent Adhesive Co., Department AB, Attn. J. W. Gaul, Asst. Mgr., Roltite Division, 70 Sunshine Drive, Grove City, Ohio.

Circle No. 1001 on Readers' Reply Card, p. 246



**SLIDE** the first panel into place along the spikes driven into the center line of the first joint.



**BOND** panel permanently in place by the application of pressure to the contact area with hammer and block.



**SWING** following panels into place, at the same time pressing butt joint firmly together, to allow perfect bonding.



## New packaged kitchens take little space

The new "Dwyer 400" includes electric burners, storage space, cutlery drawer, refrigerator, sink, and indirect lighting over the working surface in one compact packaged kitchen that takes up little space. The cabinet that contains these facilities is one that looks more like a TV console than a kitchen when the top of the unit is closed. A single plumbing connection suffices. The unit is available in sand or black mahogany colors. List price \$495. Dwyer Products Corp., Dept. AB, Attn. L. P. Dwyer, Jr., Michigan City, Ind.

The line of packaged kitchens made by General Air Conditioning Corp., include models called the "General Chef Twin" units with range, oven, broiler, freezer, twin sinks and refrigerator. These twin units are available with garbage disposer. Units are also available as either gas or electric cooking and baking units. List of Model E-600 (not shown): \$564.95 (F.O.B. Warehouse). General Air Conditioning Corp., Dept. AB, Attn. W. H. Laband, 4542 East Dunham St., Los Angeles, Calif.

Circle No. 1002 on Readers' Reply Card, p. 246



## Saw horse brackets clamp on and off quickly without use of tools

● Chesney brackets or "Speed Clamps" fit any 2x4 common or finished lumber in such a way that saw horses are easily set up. No miters are necessary. Assembly or disassembly takes only a matter of seconds. The brackets are self locking and require the use of no nails, bolts or screws. Two-by-four saw horse legs

are inserted into sockets, legs are pulled apart and pressure applied to lock legs in position. Five pieces of 2x4 lumber and a pair of clamps are all that is necessary to make a completed saw horse. List price: \$3.95 per pair. Chesney Inc., Dept. AB, Attn. Frank A. Drosch, 720 Towne Ave., Los Angeles 21, Calif.

Circle No. 1003 on Readers' Reply Card, p. 246



## New all-steel garage features easy assembly

● A steel garage that comes complete with all fastenings and fittings is now available. The garages are delivered with complete instructions for speedy assembly in 1-, 1½- and 2-car sizes. Each unit includes an overhead-type door with lock, key and all nec-

essary hardware. Walk-in doors and window kits, complete with the required framing and flashing, are available as extras. The structural members are of U-shaped 16-gauge steel, contoured, welded back-to-back, bonderized and painted. Siding and roofing are of galvanized steel formed to simulate weatherboard so that the garages blend with most types of homes. Prices: \$399., \$449., and \$625. f.o.b. factory. Steelcraft Manufacturing Co., Dept. AB, 9017 Blue Ash Rd., Rossmoynne, Ohio

Circle No. 1004 on Readers' Reply Card, p. 246



## New brush cutter makes quick work of clearing overgrown areas

● A new attachment on the Homelite Model 17 Chain Saw converts it into an all-purpose brush cutter. It is said to do clean-up jobs on brush, weeds and saplings 4 times faster than old fashioned hand clearing methods. It has a friction-free, flexible shaft that delivers full 3.5 brake horsepower to the 10-inch circular blade. Light weight and perfect balance makes it easy to use. Its 5-foot arm makes it easy to get under or reach high for overhead cutting. Homelite Corp., Dept. AB, Port Chester, N. Y.

Circle No. 1005 on Readers' Reply Card, p. 246

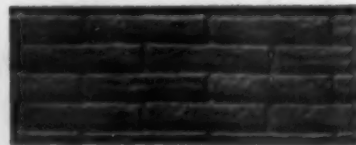

## Rigid vinyl sheets give depth effect of exposed brick

● Bakelite rigid vinyl sheets, molded to have the appearance and texture of real brick are now available in 3x5-foot panels. Retail price: \$12.75 per 3x5-foot panel, or 85 cents per square foot. Studio Brick, Inc., Dept. AB, 8428 Melrose Place, Hollywood 46, Calif.

Circle No. 1006 on Readers' Reply Card, p. 246

**Zip** 'em out! Then **Zip**  
They're in again!



**Chamberlin's  
New Weather Strip  
for Removable Sash**

Sash removal is a cinch—they literally ZIP OUT . . . ZIP IN! Flexible, floating full width metal runways hold sash weather tight—automatically adjusting to frame expansion or contraction. Sash slide easily but won't creep or drop. No home adjustments. Add this more modern, more efficient weather strip feature to your present line of windows.

**Has Unequaled Advantages**

**for the Mill**

- 1 Designed to save material and labor costs at the mill.
- 2 Designed to insure satisfied customers and minimum service.
- 3 Chamberlin stands behind it.

**for the Builder**

- 1 Sash can be primed, stored and kept clean during construction. Glass breakage reduced.
- 2 Roughing-in is as simple as A B C—no special blocking.
- 3 Balances and all weather strip installed at the mill.

**for the home owner**

- 1 Zip-in . . . Zip-out Chamberlin equipped windows are fully weather stripped.
- 2 Sash give and take with the weather like a cushion. Slide easily. Won't creep or drop.
- 3 Window washing becomes an 'inside' job. Press sash left and it rolls out. Zips back in place.
- 4 No need to remove stops and mar woodwork . . . ever.
- 5 Zip out the sash and it's a cinch to interchange and wash combination storm windows and screens.
- 6 Sash can be taken out and conveniently painted.

Another product of Chamberlin's 57 years of engineering and manufacturing experience

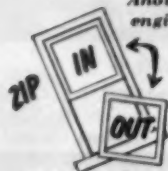

Write For Complete  
Information



**CHAMBERLIN COMPANY OF AMERICA**  
Direct Merchandise Div.  
1254 La Broeze St., Detroit 22, Mich.

Chamberlin products for the millwork and hardware field include: Automatic Door Bottoms—Thresholds—Door-Seals—(all types) Weather Stripping.

**FOR NEW HOMES!**

**FOR REMODELING!**

*include*  
.....  
*cedar*  
.....  
*closets*  
.....

USING ECONOMICAL

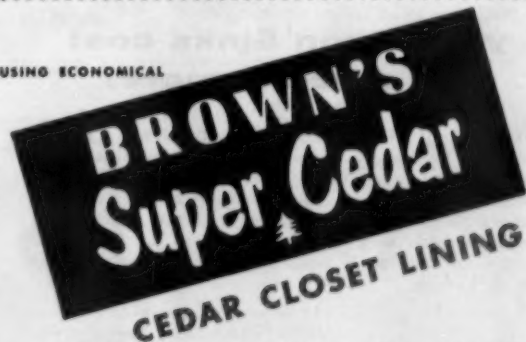

. . . because SUPERCEDAR enables you to include the saleable beauty and protection of genuine aromatic red cedar closets for little or NO MORE than ordinary plaster! SUPERCEDAR installs quickly over open studding or over old wood and plaster.

SUPERCEDAR is 90% red heart wood with 100% cedar oil content. Available in easy-to-handle, waste-saving 4 and 8 foot factory-sealed bundles . . . or in pre-built 10" to 18" wide panels, 8 feet long. Sold through building supply dealers everywhere!

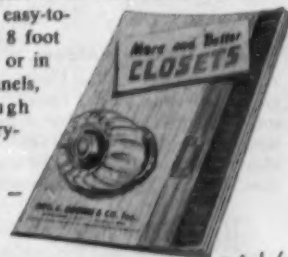

**GEO. C. BROWN & COMPANY, INC.**

Largest Manufacturers of  
Aromatic Red Cedar in the World  
GREENSBORO, NORTH CAROLINA

Please send me your FREE booklet on closet planning.

NAME \_\_\_\_\_  
ADDRESS \_\_\_\_\_  
CITY \_\_\_\_\_ STATE \_\_\_\_\_

**FREE**  
Closet Planning  
Booklet. Write  
today!

*Stainless Steel  
Beauty*

that lasts  
forever...



**yet Carlton Sinks cost  
not a penny more!**

When you put a Carlton Stainless Steel Sink into a new or remodeled kitchen, you add *permanent* extra eye-appeal. For stainless steel, when transformed by Carlton's exclusive sparkle finish, becomes an object of sheer beauty that lasts forever. No chipping or cracking of enamel... Luster that blends perfectly with every color scheme... When you want something *extra* in design and finish at no extra cost—specify Carlton!



*Don't overlook the special Carlton rubberized undercoating that cuts dish-washing clatter; changes garbage disposal noise from a growl to a purr! See for yourself how stainless steel's extra resilience reduces dish chipping and breakage. Carlton's narrower wall between twin bowls almost eliminates the splash from a swinging faucet, while the deeper (7¼") bowl allows up to a full gallon more water capacity.*

**Special Note to Builders, Wholesalers, Architects:**  
A Carlton Stainless Steel Double Sink Bowl (32"x21") weighs only 17 pounds, makes installation much easier. Stainless steel, lighter than cast iron or porcelain on steel, saves you money on shipping costs, too. Write for free Catalog 55, illustrating complete line, and send the name of your distributor. SINK DIVISION, Carrollton Mfg. Co., Carrollton, Ohio.

*The bright spot in your kitchen*

**CARLTON**  
STAINLESS STEEL  
**SINKS**

**NOW**

**NIAGARA**  
has a  
**100,000 BTU CAPACITY  
FORCED AIR FURNACE**

in its

**ALL NEW**

**Series 70  
LINE**



Model G-70-100FA

Model O-70-100FA

**Fully Automatic GAS or OIL MODELS**

**HIGH BOY—DOWN FLOW—BASEMENT MODELS**  
to fit ANY HOME HEATING REQUIREMENT

**15 DIFFERENT GAS-FIRED MODELS**  
FROM 50,000 BTU to 140,000 BTU

**9 DIFFERENT OIL-FIRED MODELS**  
FROM .75 g.p.h. to 1.5 g.p.h.

**NEW CONSTRUCTION FEATURES**

**NEW HEAT EXCHANGER**

Cylindrical in shape—made entirely of 14 gauge steel

**SELECTION OF CONTROLS**

Choice of A. G. A. approved Honeywell,  
Standard or Self-generating controls.

**DIRECT OR BELT DRIVEN BLOWERS**

Oil models equipped with famous NIAGARA  
OIL BURNER with the SUPRA-FLAME HEAD

*Solve your heating problems with a  
NIAGARA SERIES 70 FURNACE*

For Complete Information and Specifications Write or Phone



**NIAGARA FURNACE DIVISION**

The Forest City Foundries Co.

2500 West 27th St. • TOWER 1-5040 • Cleveland 13, Ohio

**NIAGARA—the word for maximum heat at minimum cost.**

**AMERICAN BUILDER**

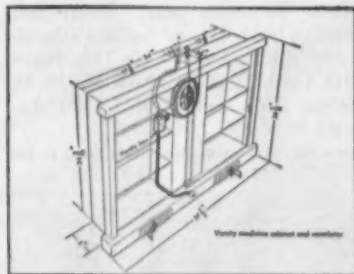

**Vanity medicine cabinet and ventilator  
are combined into one unit**

● The Cole "Ven-ett" is a 200 c.f.m. ventilator and a capacious vanity or medicine cabinet combined into one simple unit. The two large plate glass mirror doors are 18x21½ in. each and they slide at a finger touch. The doors are suspended on nylon rollers that operate in enclosed tracks at the top so no dirt can collect to jam the rollers. The blower in the "Ven-ett" is a rotary type powered with a standard brand lifetime-lubricated motor,

60-cycle, 110-volt. The finish of the "Ven-ett" is a high-gloss enamel baked at 325 degrees and is available in white and pastel shades. Trim is chrome and stainless steel. Rough-in of the unit is 25¼x35 inches. List price: \$84.95. Sold direct to builders, contractors, distributors. Cole Manufacturing Co., Dept. AB, Box 4103, Attn. James D. Cole, Austin, Texas.

Circle No. 1007 on Readers' Reply Card, p. 246



**New operator-hinge set is designed for awning type windows**

● The new H. S. Getty chain operator and hinge set features a chain which becomes rigid when extended to open an awning-type window. In addition to its easy, non-chattering, self-locking features (it eliminates the need for a separate window lock) the set permits easy cleaning of both sides of the window from inside the room. The operator-and-hinge set is packaged and sold as a unit for various height windows up to a maximum width of 48 inches. Retail price: approximately \$10.50 for Set #1 (windows 14 to 17¾ inches high). H. S. Getty Co., Inc., Dept. AB, 3348 No. 10th, Philadelphia 40, Pa.

Circle No. 1008 on Readers' Reply Card, p. 246



**Building insulation combines the qualities of Fiberglas, foil**

A new Fiberglas foil-enclosed residential building insulation combines the insulating efficiency of Fiberglas with the added summer reflective characteristics of aluminum foil. It is available in both roll and batt blankets in widths of 15, 19 and 23 inches and thicknesses of 2 and 3 inches. Depending upon the width and thickness, roll blankets are in lengths up to 60 feet while all batt blankets are 4 feet long. Retail price: 11 cents per square foot (3 inches thick); 9 cents per square foot (2 inches thick). Owens-Corning Fiberglas Corp., Dept. AB, Attn. W. A. Stutts, National Bank Bldg., Toledo 1, Ohio.

Circle No. 1009 on Readers' Reply Card, p. 246



**Acoustical tile attached to gypsum board with "ful-spline"**

● A fully mechanical, economical application of Fiberglas acoustical tile to gypsum board through an adaptation of the "ful-spline" system has been announced. Installation of acoustical ceilings of 24x24 inch Fiberglas tile can now be done at a cost approaching that of tile affixed with adhesives, the manufacturer says. The adaptation was made possible by development of a special Duo-Fast Air Tacker and flared, 7/8-inch staples. Aluminum splines are inserted in the slotted edges of the ceiling tile and the splines are affixed to the gypsum board with staples, which the specially designed air tacker halts a uniform ¼-inch short of full penetration. Owens-Corning Fiberglas Corp., Dept. AB, Toledo 1, Ohio.

Circle No. 1010 on Readers' Reply Card, p. 246



**Plastering machine does job quickly, pumps up to 3½ c. f. m.**

The Model C Plaster-Master pumps up to 3½ cubic feet per minute with half sand as the aggregate. The Model C is a self-contained unit, with built-in compressor and offers instantaneous control at gun head. Mounted on a well-balanced trailer-type chassis with pneumatic tire wheels, it is very maneuverable. The hopper has a 10 cubic foot capacity, the engine is a 2-cylinder, 15 H.P. with electric starter, generator and battery. The CG-124 gun is a full-flow-one-inch plaster gun designed so extension sections can be added. Santa Anita Manufacturing Corp., Dept. AB, 2828 Newell St., Los Angeles, Calif.

Circle No. 1011 on Readers' Reply Card, p. 246



**All-steel garage door rust-proof, has finger-tip operation**

● The "Seven WON-DOR" is a new seven-sectional residential garage door made of steel that is completely bonderized, fully rust-proof. It has 16 ball-bearing rollers for finger-tip operation. The manufacturer says that the door is placed on the market to sell for less than the average 1-piece door. The Windsor Seven WON-DOR is available in all sizes, including double and made-to-order sizes with or without glass inserts. Windsor Door Co., Inc., 2284 Jericho Turnpike, Garden City Park, L. I., N. Y.

Circle No. 1012 on Readers' Reply Card, p. 246



**Ring-type edge pull makes for easy installation**

● The new Ajax Edge Pull #315 is easy to install and is simple to operate. Said to be the only one with a ring-type pull and a beveled face plate on the underside, in installation, it automatically sizes the mortised hole to the face plate and leaves no ragged edges. It is die cast of pure virgin Zamak #5. Avail-

able in all standard finishes. List price: 56 cents each. Distributed through jobbers and builder's hardware distributors. Ajax Hardware Mfg. Corp., Dept. AB, Attn. Mrs. B. C. Fallon, 4351 Valley Blvd., Los Angeles 32, Calif.

Circle No. 1013 on Readers' Reply Card, p. 246

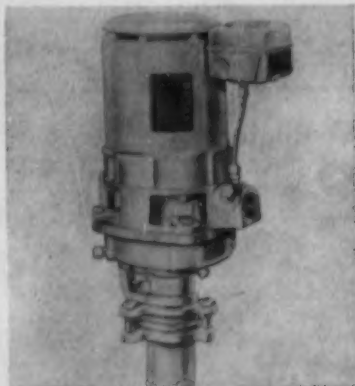

**New water pump has component adapting parts**

● A new, shallow-or-deep well water pump (1/4 h.p. Burks HV-15) for depths to 50 feet is now available. The Burks HV-15 is a basic centrifugal pump adapted at the time of installation for either shallow or deep wells by the use of the component part packages required by the job. If conversion is required after installation as a shallow well pump, inexpensive changes adapt it for deep well application. Capacities by practical tests, at 20 pounds pressure, range from 705 g.p.h. at 5 feet to 305 g.p.h. on 25-foot shallow wells, and from 540 g.p.h. deep well application at 25 feet to 380 g.p.h. at 50 ft. Decatur Pump Co., Dept. AB, Decatur, Ill.

Circle No. 1014 on Readers' Reply Card, p. 246



**Faucet attachment called "the most efficient dishwasher"**

● The new and improved Dishmaster is called by its manufacturers, "the smallest, fastest and most effi-

cient dishwasher in the world." Installation of a Dishmaster is simplified so that ordinarily old faucets can be removed and the new dishwashing unit installed in a few minutes. Improvement of the patented system of spraying hot aerated suds results in faster dishcleaning. Retail price: \$49.50. Dishmaster Corp., Dept. AB, Pontiac, Mich.

Circle No. 1015 on Readers' Reply Card, p. 246



**Wall resurfacer is said to eliminate need for painting**

● "Re-Nu-It" exterior wall resurfacer is a product developed for the rejuvenation of weatherbeaten exteriors. Thicker than ten coats of paint, this product can be applied by brush or spray. It contains two protective and insulating materials— asbestos and mica. Available in eleven colors, it carries a 10-year material replacement guarantee against peeling, cracking and chipping. Re-Nu-It Corp., Dept. AB, Attn. A. H. Hardy, 424 West 42nd St., New York 36.

Circle No. 1016 on Readers' Reply Card, p. 246

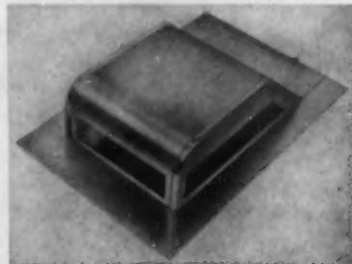

**New roof louver is sturdy, will fit any roof**

● A new series of advanced design roof louvers is now available. Called the "Lo Man Co Series 700" these louvers will fit any type of roof. They are made of heavy-gauge aluminum, designed with three sides open for maximum ventilation. Built-in aluminum 8-mesh screens keep insects, bird and leaves out, tend to break up rain and snow. Louver Mfg. & Supply Co., Dept. AB, 5807 West 36th St., Minneapolis 26, Minn.

Circle No. 1017 on Readers' Reply Card, p. 246

# Here's why Gypsum's short...

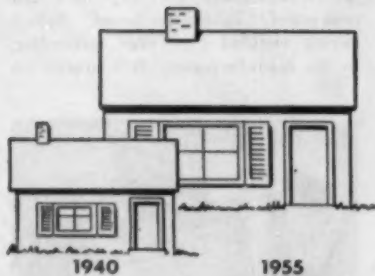

**HOUSES ARE GETTING BIGGER**—The average new house in '55 has 1 to 2 rooms more than the '40 model.

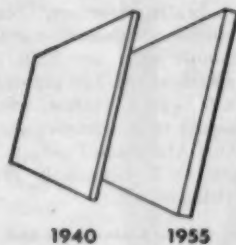

**WALLBOARD IS GETTING THICKER**—In '40,  $\frac{3}{8}$ " was standard; in '55 the trend is toward  $\frac{1}{2}$ "—takes more gypsum and more time to produce.

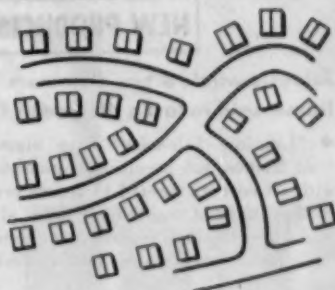

**AND BUILDING IS BOOMING**...602,000 houses were built in '40; in '55 over 1.3 million units will be started!

## and here's what's being done about it



**NATIONAL GYPSUM SAW THE SHORTAGE COMING**



**STARTED TWO-WAY PLANNING TO EXPAND PLANTS AND DEVELOP NEW DEPOSITS**

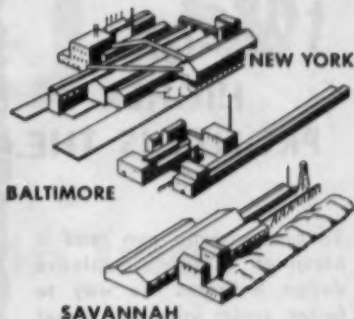

**RECENT EXPANSIONS AT THESE 3 PLANTS HAVE INCREASED THEIR OUTPUT 33%.**



**JUST COMPLETED: \$6 MILLION GYPSUM PLANT IN MIDWEST NOW IN OPERATION**

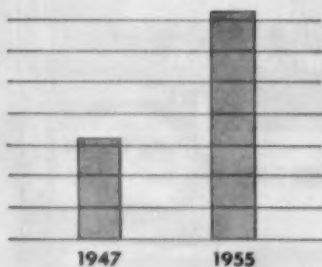

**WE HAVE MORE THAN DOUBLED OUR TOTAL GYPSUM PRODUCTION SINCE W.W.II AND THERE'S MORE COMING**



**THE NEXT STEP IN A NEW 5-YEAR \$75 MILLION EXPANSION PROGRAM ARE THESE PLANTS, SOON TO START PRODUCTION**

**THE NATIONAL GYPSUM COMPANY, BUFFALO 2, NEW YORK**

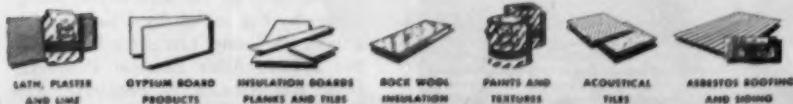

**NEW PRODUCTS**

**Jalousie window has aluminum frame, said to last a lifetime**

● "Lifetime Jalousies" have aluminum frames, are precision engineered with all corners welded to assure protection against rain and cold air. When the 4½-inch louvers are closed, each louver overlaps ½ inch to form

a solid sheet of glass. Lifetime clips have built-in springs to hold glass firmly. Balanced louvers assure ease of operation. Shoulder rivets provide greater bearing surface. Standard stock window and door sizes available. Custom-built units are built to detailed specifications. List price: \$42.10 for 37x50 ¾-inch window. (Substantial discount to distributors and dealers.) Atco Aluminum Products, Dept. AB, Attn. G. R. Grenawalt, 1910 So. Kuhl, Orlando, Fla.

Circle No. 1024 on Readers' Reply Card, p. 246

**Clay pipe is root-proof, infiltration-proof**

● "Wedge-Lock" clay pipe is a new root-proof, infiltration-proof, labor-saving vitrified clay pipe, according to its manufacturers. It features an



integral double-ball mechanical joint of corrosion-resistant plastisol, and can be installed easily in minutes. Both bell and spigot plastisol castings are simply coated with adhesive and pushed together by hand or with pinch bar. Available in both standard and extra-strength in 4-, 6-, and 8-inch diameters. The Robinson Clay Product Co., Dept. AB, Vitrified Div., Attn. A. E. Williams, Sales Mgr., 65 West State St., Akron, Ohio.

Circle No. 1025 on Readers' Reply Card, p. 246

**Semi-flush recessed fixture has satin black finish**

● Model 96 is a semi-flush recessed fixture with a satin black finish for incandescent installations. A molded



dropped glass inset diffuses the light evenly. Fixtures are also equipped with reflectors. Model 96 is available for 60, 100, and 150 watt bulbs, is 6¾ inches by 6¾ inches by 4 inches with a 9x9-inch frame. List price for Model 96: \$17.50. Atlas Electric Products, Dept. AB, Attn. S. B. Pearlman, 319 Ten Eyck St., Brooklyn, N. Y.

Circle No. 1026 on Readers' Reply Card, p. 246

**the TRACK follow...**

**-for  
HIGHER  
PROFITS IS THE...**

To anyone who can read a blueprint, Calder's exclusive design indicates the way to faster, easier sales and higher profits. That's because Calder overhead sectional garage doors feature the famous "Wedge Tight" action for built-in sales appeal to open and shut easier, fit tighter, last longer.

In addition...

**calder OFFERS A FULL LINE OF BOTH RESIDENTIAL**

...and commercial doors in varied styles to meet all door problems. And Calder's engineering department is always available to help you with special door applications.

**SOLD DIRECT TO DEALERS  
WAREHOUSES IN: Lancaster, Pa.;  
Chicago, Ill.; St. Paul, Minn.**



**KEYSTONE**

Address inquiries to Dept. 10

**calder MANUFACTURING CO.  
LANCASTER 2, PA.**

**calder TRACK**

Widely acclaimed as the easiest, fastest installing sectional door on the market. Backed by extensive national advertising in consumer magazines.

**STURDY**

**PARALINE FLUSH TRILINE**

**LEVELINE**

**Free!** Catalog gives complete specifications on Calder's full line. Catalog shows the Calder way to achieve custom effects without custom costs when home owners want decorated garage doors. Send for your copies today.

**ALL CALDER DOORS MAY BE ELECTRICALLY OPERATED BY REMOTE CONTROL**



Adjustable  
Removable

# A.R.B.

WOOD  
WINDOWS

**more than a million now in use!**

and in only 5 years. Furthermore, each of the five years has shown a substantial increase in volume . . . which proves growing public acceptance.

**a sales making feature in any home**

Any builder, any lumber dealer, who exposes his prospective customer to the desirable features of A.R.B. Wood Windows will find his sale made easier. The trend is to "lift out" windows. Wood is still first in popularity, and extending its lead. With A.R.B. construction, you'll get your share, easier.

*Lumber dealers, or*

**A.R.B. WINDOW SALES COMPANY**

19433 John R Street

Detroit 3, Michigan



**QUICK-LIFT-OUT**

Wash or paint both sides from inside the room—either double-hung or glider styles.

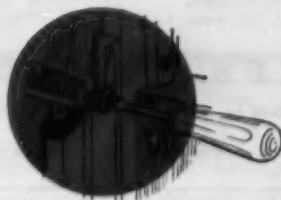

**"MICROMETER" ADJUSTMENT**

An A.R.B. exclusive. The coil springs behind each adjusting screw have patented variable tension.

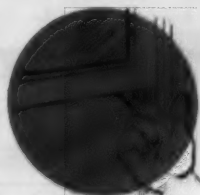

**"FINGER LIFT" BALANCE**

Push the plunger to disconnect; close the window to reconnect. Another A.R.B. exclusive.

**NEW PRODUCTS**

Laminated sandwich panels offer light weight, strength

● "Hasko-Struct" is an insulated sandwich panel construction using Haskelite's Fiberglas Cloth Polyester Laminate facing sheets bonded to various densities of styrofoam, ply-



wood and other types of core material. The product is a unified panel

construction with structural strength and light weight. It will not corrode or rot, is resistant to moisture, vermin, impact damage and deformation. "Hasko-Mold" shapes (strips, angles, channels, and jambs) match the panel face sheets in surface appearance and, like the panels, can be cut with hand or power tools. Available in various lengths, widths, and thicknesses, face sheet thicknesses, and densities of cores. Depending upon above factors, price for a 1-inch thickness panel may vary from \$0.60 to \$1.75 per square foot for a 48x96 panel. Haskelite Mfg. Corp., Dept. AB, Attn. Emory W. Stoner, 701 Ann St., N. W., Grand Rapids 2, Mich.

Circle No. 1027 on Readers' Reply Card, p. 246



# Service-Master

THE IDEAL BUILDING, PLUMBING, AND ELECTRICAL CONTRACTING SERVICE BODY

Here's the body that takes a completely equipped shop to the job, and saves up to 75 minutes per day. Using the latest average service base rate of 6 cents a minute and an average saving of 30 min-

utes a day . . . Service-Master saves \$478.00 worth of time a year. Available in sizes for 1/2, 3/4, 1, and 1 1/2 ton chassis — regardless of age or make. The coupon below will bring complete details.

**MAKE YOUR PICK-UP TRUCK A SERVICE TRUCK, TOO!**

with  
**SERVICE-TWINS**

These easy-to-install tool and material compartments are finished in baked-on, medium-dark green enamel. Parts bins are built-in. Doors have slam-action catches, with locks keyed alike. Available with overhead rack.

for 1/2 and 3/4 ton pick-up trucks



McCABE-POWERS AUTO BODY CO. 5900 NO. BROADWAY • ST. LOUIS 15, MO.

Please send me complete details on SERVICE-MASTER  SERVICE-TWINS

Name \_\_\_\_\_

Company \_\_\_\_\_

Address \_\_\_\_\_

City \_\_\_\_\_ Zone \_\_\_\_\_ State \_\_\_\_\_

Flush wall radio, 5 extensions is easy to install

● The Flush Wall Radio Model 5P-5X Master Unit and Extension Speaker System consists of a 5-tube master radio and 5 extension speakers. These units can be installed as easily as the installation of electric

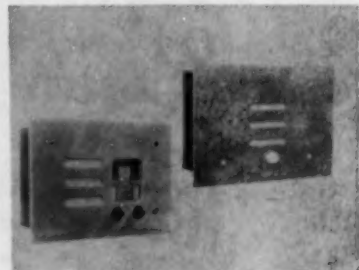

outlets. Like the radio itself, each speaker is mounted in its own 6 1/2 x 8 x 2 1/2-inch deep steel box so that it can be mounted flush in the usual 4-inch partition. To insure quality, each remote speaker has its own matched line transformer. The volume control on each speaker panel (masonite or white enameled steel) allows each listener to select his own sound level. Retail price of system with master unit and 5 extension speakers: \$99.95. Flush Wall Radio Co., Dept. AB, 1012 Cleveland St., Clearwater, Fla.

Circle No. 1028 on Readers' Reply Card, p. 246

Electric baseboard heater will serve in any climate

● Flameless home heating from electric baseboard units is now available in which units fit snugly to interior walls. The 2-foot long heater sections occupy only as much baseboard area as needed and have controls for room-by-room regulations. Units re-



quire the same 240-volt wiring used for electric ranges, eliminate central heating units, air ducts and radiators. Westinghouse baseboard heating sections list price at \$21. Control section containing switch and thermostat: \$19; corner section: \$5. Ends are not sold separately, are \$2 a pair. Control section will handle up to 12 heating sections but manufacturer recommends not more than 4 be used with one control. Westinghouse Electric Corp., Dept. AB, Attn. R. V. McGahey, P. O. Box 2278, Pittsburgh 30, Pa.

Circle No. 1029 on Readers' Reply Card, p. 246

**All-steel corner guard improves wallboard corner**

● No. 240 Corner Guard has a wide squared nose to space the spackle further away from the corner, giving

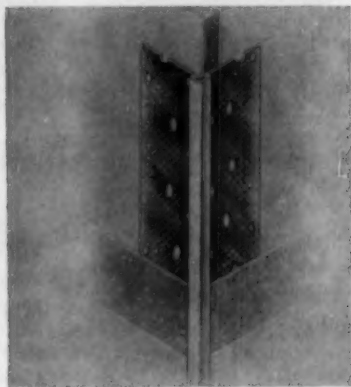

greater steel protection. The nose is also undercut to provide a better spackle grip, is tapered to the line of the feathered-out spackle. Spackle holes under the nose permit the spackle to rivet itself into the nose of the bead. Drywall Trim, Inc., Dept. AB, 2408 N. Farwell Ave., Milwaukee 11, Wis.

Circle No. 1030 on Readers' Reply Card, p. 246



**Forged Iron hardware  
by McKINNEY**

*a heritage from the past recreated in the  
finest craftsmanship of the present*

A complete line of matching hardware for the home in eight different period patterns — faithful reproductions of authentic historic designs in three finishes — Dull Black, Swedish (relieved) Iron and Olde Copper.



**McKINNEY**

*Quality Hinges Since 1865*

McKINNEY Manufacturing Company  
1725 Cambridge Street, Pittsburgh, Pa. 15



# Install **Plugmold** the modern electrical outlet system in your homes

**OUTLETS UNLIMITED**  
add **VALUE** and  
visible **SALES APPEAL!**



**PLUGMOLD is EASY, FAST & ECONOMICAL**  
to install . . . neat, permanent, safe.

In today's growing competitive market, builders everywhere are realizing more than ever before, that Plugmold not only upgrades the value of homes, but is also a convenience that helps **SELL HOMES!**

The house with plenty of outlets rates higher with buyers. Plugmold provides a continuous run of outlets every 60", 30" or closer, all around the house, or any part of it.

For more information, write to Dept. B 10

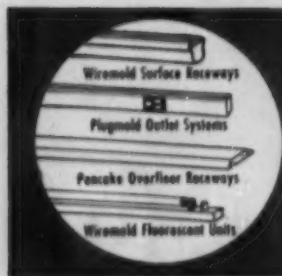

Stocked by electrical wholesalers . . . everywhere

**THE WIREMOLD COMPANY**

HARTFORD 10, CONNECTICUT

AMERICAN  
**BUILDER**

**NEW PRODUCTS**

## 2-stage cooling unit has oversize blower

● A two-stage cooling unit has been announced by the Lennox Furnace Co. in which two separate, fully hermetic water-cooled refrigeration assemblies along with an oversized sulky-type blower are enclosed in one attractive cabinet. Two-stage cooling, says Lennox, assures the

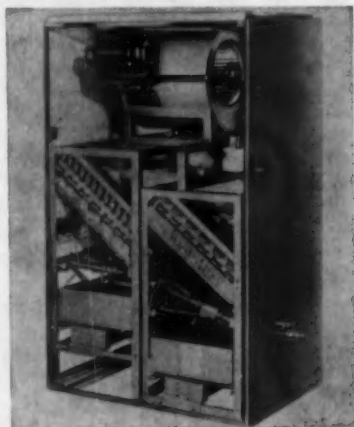

maximum in comfort and economy as well as quietness of operation. Units are available in 4-, 5-, and 6-ton capacities. Included are a completely wired automatic control panel containing 24-volt transformer and all necessary relays, also a combination heating-cooling thermostat with two cooling stages. The Lennox Furnace Co., Dept. AB, Attn. C. C. Floren, Marshalltown, Iowa.

Circle No. 1031 on Readers' Reply Card, p. 246

## Aluminum door edging designed to end wood door troubles

● An end to wood door troubles that often plague carpentry contractors is promised by a new product called "DoRoD." "DoRoD" is an extruded aluminum strip, 1/8-inch thick, that completely covers the edge of the door on all except the hinge side. With the door closed, a 1/2x1/8-inch strip of aluminum is visible, overlapping the door frame, on the side towards which the door swings. This lip of metal also overlaps a special threshold plate at the bottom of the door. With this arrangement, a small amount of shrinking of the door may take place without letting in wind

AMERICAN BUILDER



and weather. Quantity prices will be quoted upon inquiry. Available through lumber yards and wholesales building supply dealers. General Extrusions, Inc., Dept. AB, Attn. Myron L. Smith, 4040 Lake Park Rd., Youngstown, Ohio.

Circle No. 1032 on Readers' Reply Card, p. 246

#### Aluminum jalousie combination uses piano hinge construction

● The full-length piano hinge construction of the Air Master all-aluminum combination jalousie door prevents sagging, sticking and other un-



slightly wear characteristics of most combination doors according to the manufacturer. The full 1 1/8-inch thickness of the aluminum construction adds to the door's sturdiness. The adjustable louvers lock into position automatically and the inner aluminum screen never needs removal. List price: Between \$70 and \$90 depending upon area. Air Master Corp., Dept. AB, 20th and Allegheny Avenue, Philadelphia 32, Pa.

Circle No. 1033 on Readers' Reply Card, p. 246

OCTOBER 1955

## New Sliding Door Hardware

# STANLEY



Easy to Install

One Set Packaged For Both 3/4" and 1 1/8" By-Passing Doors

Stanley Quality at a Competitive Price

**HERE'S WHY:**

- Low headroom needed — only 1 3/8".
- Jump-proof track — doors lift on or off without removing hangers — cannot be derailed in vertical position.
- Steel track press formed for perfect straightness, bonderized and aluminum finished for corrosion resistance.
- V-shape track for smooth operation and dirt clearance.
- Nylon rollers permanently lubricated for silent operation.
- Heavy gauge steel hangers, electro zinc plated.
- 3/8" vertical adjustment\* with positive lock-in-place feature.
- Adjustable nylon floor guide. Only 3 screws required.

**\*VERTICAL ADJUSTMENT**  
Specially designed hangers permit 3/8" vertical adjustment without loosening the three installation screws. Serrations, machine screw and lockwasher insure positive locking and minute adjustment. Unique design permits the use of the SAME hanger for both the 3/4" and 1 1/8" doors by reversing both the bracket and roller on the REAR 3/4" door.



# STANLEY

## 2804 and 2808

2804 for 3/4" Doors  
2808 for 1 1/8" Doors

See these new 2800 Series Sets at your hardware or building supplies dealer. Check the ease of installation . . . low headroom — only 1 3/8" . . . doors lift on and off track without removing hangers . . . hangers adjust without loosening screws in doors. This is Sliding Door Hardware that's Stanley made to sell, to install and to operate easier.

For complete details write Stanley Hardware, 100 Lake Street, New Britain, Conn. Ask for 2800 Catalog No. G88.

## Two More New Sets With Built-In Header Trim

Same hangers, same features as 2800 sets, with built-in header trim as integral part of extruded aluminum track. Saves labor and expense of extra trim. Anodized aluminum finish ready for paint, or suitable as is. Everything in one package . . . for 2 or 3 by-passing doors . . . 4', 5', 6' or 8' openings.

# STANLEY

The Stanley Works • New Britain, Conn.

HARDWARE • TOOLS • ELECTRIC TOOLS • STEEL • STEEL STRAPPING

**"SKIL Saws are Best for**

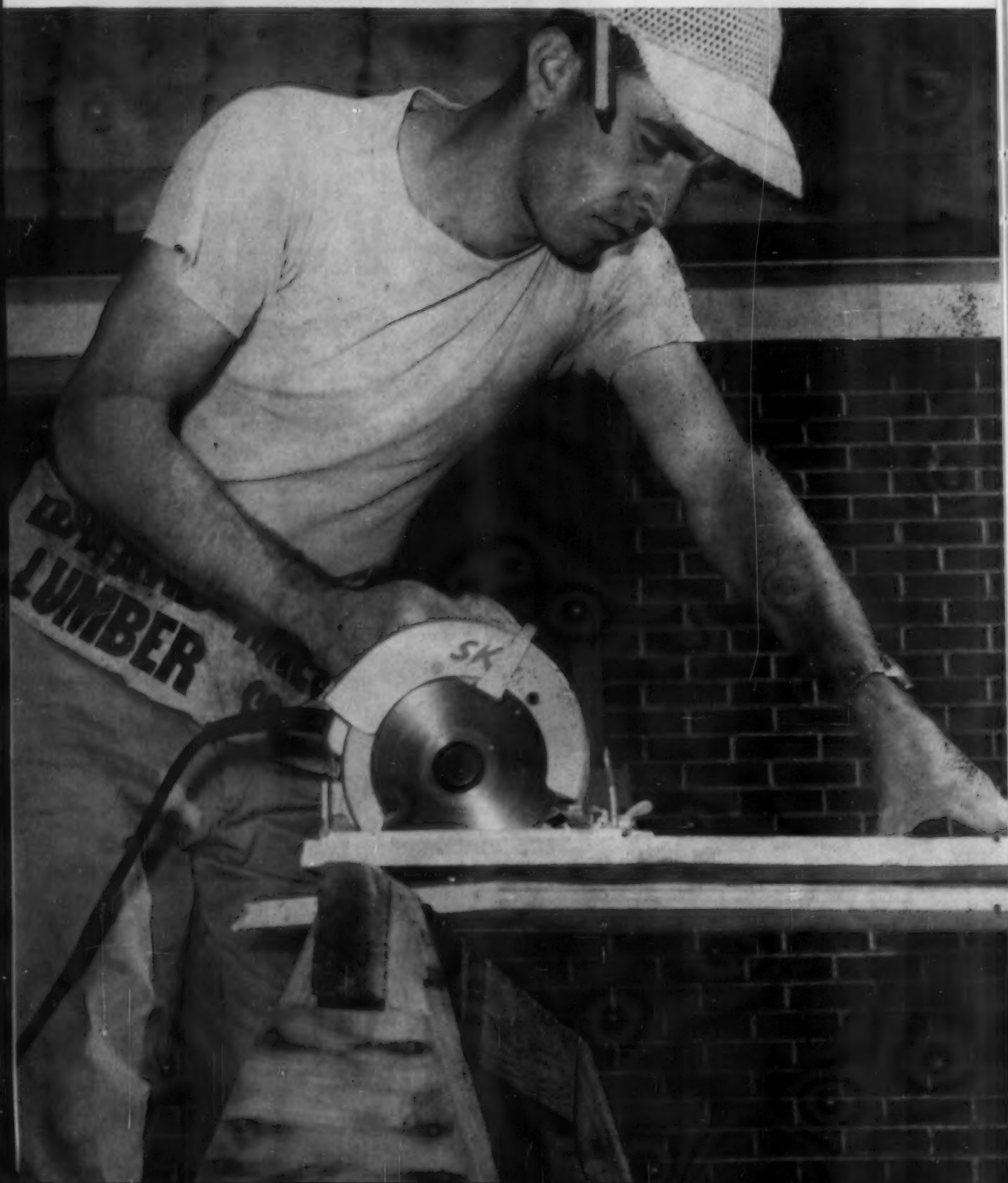

# Speed and Easy Handling"

Says **G. C. Hoppensteadt**,  
General Contractor  
Itasca, Illinois

"Our new 6½" SKIL Saw cuts all the material we use to build our homes. In less than three months it cut every board foot for three homes—each with an average floor space of 2000 feet! You can't beat SKIL for speed, ease of handling and workman-like results!"

That's how contractors, carpenters and builders everywhere talk about SKIL, as SKIL Saws set records for outstanding, dependable performance. Scientifically balanced handle gives lighter weight, easy one-hand operation. Motor gives ample power for every cutting job... and the high-speed blade reduces cutting time.

These and many more famous heavy-duty SKIL Saw features can be yours—at the lowest prices in SKIL history! Call your SKIL Distributor for complete information!

## Only SKIL Gives You These Most-Wanted Professional Saw Features!



• Safety Guard Retractor for pocket cuts, scoring, trimming, and abrasive disc use.

• Strong Steel Feet on both sides of blade gives full support on cuts from either side.

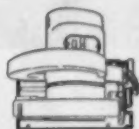

• Safest Telescopic Guard Model Automatically retracts—gives maximum protection!



• Perfectly Balanced Top Handle is scientifically placed to give easy one-hand operation.



### Models For Every Cutting Job!

New	New	New
6½" Model 864	7¼" Model 874	8¼" Model 884
Only \$64.50	Only \$74.50	Only \$84.50

# SKIL

PORTABLE TOOLS

Made only by SKIL Corporation, formerly SKILSAW, Inc.  
5033 Elston Avenue, Chicago 30, Illinois  
3601 Dundas Street West, Toronto 9, Ontario  
Factory Branches in All Leading Cities

-----FREE! MAIL THIS COUPON!-----

SKIL Corporation, Dept. AB-105  
5033 Elston Avenue, Chicago 30, Illinois

- I would like a demonstration and free trial.  
 Please send literature on SKIL Models 864, 874 and 884 Saws at once.

Name \_\_\_\_\_

Company \_\_\_\_\_

Street \_\_\_\_\_

City \_\_\_\_\_ Zone \_\_\_\_\_ State \_\_\_\_\_

TURN UPSIDE DOWN FOR THE ANSWER TO BETTER



3 The modern Precast floor provides perfect drainage permanently. Not fastened to framing or bonded to flange to complete an economical, attractive and absolutely leakproof shower.



2 The shower floor slides into place. It is a self-contained monolithic unit with both metal flanging-in-flange and drain cast integral. Plumber makes colked connection quickly and easily while installing floor. No call-backs—no other trades required—ideal with any wall material.

## money-saving way to build a shower



Flat makes a complete line of "Packaged Showers" ranging from models suitable for low-priced housing, to elegant models styled for the finest homes.

"I'm sold on Precast shower floors", says builder  
 "Our experience with the Flat shower floors installed in all of the 2600 homes of our Birchwood Park development has been satisfactory. This gigantic operation proved to us that the Precast floor provides a better and more attractive shower floor. Today's home buyers are quick to spot quality features such as Flat floors. I'm sold on your Precast shower floors."  
 —Morris Somrow  
 The Village of Birchwood Park, Jericho, Long Island, selects Precast Shower Floors by Flat.

FIAT METAL MFG. COMPANY, 9311 BELMONT AVENUE, FRANKLIN PARK, ILL.

multi-layer, built-up floors that are both inefficient and unsanitary. FIAT FLOORS are designed for use with any type shower wall material—come in a range of sizes—available in either Precast Terrazzo or Art-stone, both of which provide a smooth, joint free, easy to clean appearance with a warm foot-grip surface. And best of all, you can save up to 40% with FIAT FLOORS, according to leading builders who have installed them. Performance proved by thousands now in use! Get all the facts now. Write or wire today.

Make this easy test. It won't cost you a penny more and will save you important money from now on! Install a FIAT FLOOR in the next shower you build. You'll find it's the modern, money-saving solution to an age old building problem. You'll get conclusive proof that this is the right way to keep shower bath water where it belongs for the lifetime of the house. Now you can install guaranteed leakproof FIAT PRECAST SHOWER FLOORS so economically there is no reason to again risk your reputation on intricate,

Try the Modern Precast Method  
*and Forget Leaks!*



# SHOWER CONSTRUCTION



□ No special construction or added support needed. Sub-floor is laid in regular manner, cutting small hole for drain connection. No need for lead pan, sub-layers, mortar, etc. Savings of on-the-job labor makes installed cost substantially less than built-up floors.

## here's the modern,

First in Showers . . . since 1922



ne perplexed property owner, who recently came to on-the-job shower floors, said: "Since I can't stop the leaks for long, I've decided to hang mammoth flower pots from the ceiling under each shower floor . . . at least it will hide the water-soaked ceiling and prevent damage to floors and furnishings below."

Fortunately for him, Fiat could prescribe a much easier method than the ordinary, old-fashioned shower floor construction. And, fortunately for builders, this method will give life-long insurance against complaints resulting from leaking, cracked shower floors in every house built today. It's the modern way, the Fiat Pre-Cast Shower Floor way that has been enthusiastically used and approved by leading builders from New York to California. The most amazing thing about this new way to build showers is that it actually costs you less, and takes less time, than the old way.

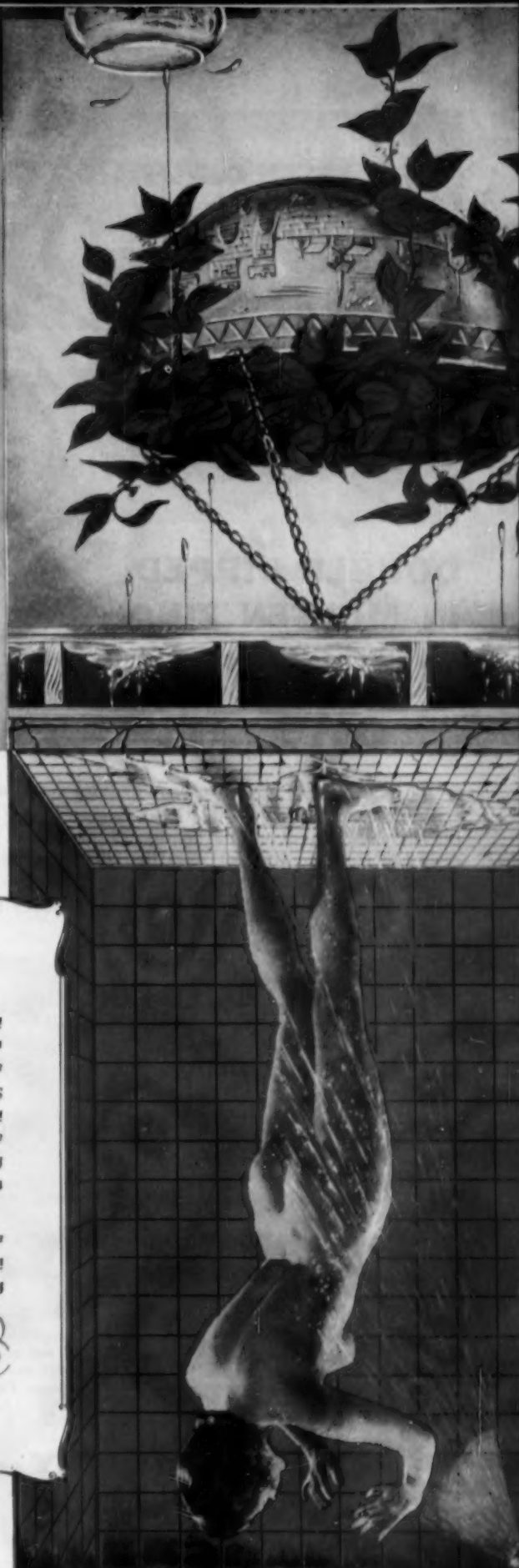

INTRODUCING

**STORMGUARD**

DOUBLE  
DIPPED

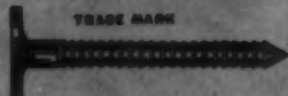

NAILS

*In Molten Zinc*

FOR EXTERIOR WORK

DOUBLE DIPPED  
IN MOLTEN ZINC

TO CHECK STAINS, STREAKS, RUST



At less cost per nail than non-ferrous nails, new STORMGUARD NAILS combine the stain, streak and rust resistance of zinc with the strength advantages of steel.

The result of 8 year's research and development by the Maze zinc coating department, STORMGUARD NAILS have a strong steel core for driving without undue bending, breaking or heads popping off. A heavy zinc over-coating applied by an exclusive Maze DOUBLE DIPPING process completely insulates this steel core, protecting it from rust, while being free itself of any tendency to form dark stains or streaks on surrounding surfaces.

**THE IDEAL NAILS FOR**

A stain-checking nail especially designed for exterior work, STORMGUARD NAILS are available in standard lengths and gauges, in all sizes needed for roofing, siding and trim. STORMGUARD NAILS check ugly stains, reduce repairs and painting, maintain a cleaner, neater appearance on every job.

**R**OOOFING

**S**IDING

**T**RIM

*Write for Samples and Prices!*

**A COMPLETE LINE OF NAILS**



For more than a century, W. H. Maze Company has produced better nails for the better application of roofing, siding and trim. A complete line of top quality nails conveniently packed for shipment, display and use: Drywall, Flooring, Underlayment, Roofing, Siding, Pallet, Lead Head, Screw, Ring Shank.

**W. H. MAZE COMPANY** ESTABLISHED 1948  
PERU 3, ILLINOIS

AMERICAN  
BUILDER

NEW PRODUCTS

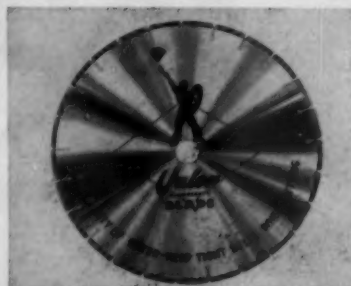

**Long life for diamond blade**

Tungsten carbide is the bond which gives these Tungsten carbide diamond blades so long a life. Diamonds are held so firmly by this material so that a great percentage of the diamond goes into cutting life. These blades will cut materials such as concrete block, firebrick, sandstone, granite, etc., as well as the regular materials. List price: \$189. Victor Engineering Corporation, Dept. AB, 17 Maple Ave., Paoli, Pa.

Circle No. 1034 on Readers' Reply Card, p. 246



**Redwood plywood can be used inside or out**

Malarkey Rusticwood has vertical grooves 3/8-inch wide and 1/4-inch deep on 4-inch centers. The face of the panel is softly brushed to give it additional texture. Panels are 4x8 feet in size with panel edges shiplapped to allow a channel and unbroken design where panels are joined together. Backs are left rough. Approximate retail price: 38 cents a square foot. Available through building supply dealers supplied by distributors of Malarkey products. M and M Wood Working Company, Dept. AB, Attn. Mel Carpenter, 2310 N. Columbia Blvd., Portland, Ore.

Circle No. 1035 on Readers' Reply Card, p. 246

AMERICAN BUILDER

Heats... Cools... Melts Snow  
... Provides Hot Water

# B & G Hydro-Flo System



Sunny, overall warmth from baseboards, radiant panels, convectors.



In a water cooled home, correct compensation can be made for summer heat gain.



A virtually limitless supply of hot water for kitchen, laundry and bath.



Snow melting for relief from shoveling—safe driveways and sidewalks.



### B & G BOOSTER

Noiselessly circulates water for heating and cooling the house and for snow melting panels. Known everywhere for quiet, dependable, long-lived operation.



\*Reg. U.S. Pat. Off.

The B & G Hydro-Flo System, using mechanically circulated water, offers an amazing variety of ways in which to create the ultimate in modern living comfort.

The sketch above illustrates the complete versatility of a water system. The heating in this home is with modern, inconspicuous baseboard panels. Cooling is achieved by circulating chilled water to a fan coil unit installed in a plenum formed by a dropped ceiling in the hall. Cool, de-humidified air is distributed through high grilles into the various rooms.

Snow melting coils under the sidewalk and driveway are circulated with an anti-freeze solution heated in an exchanger connected to the boiler. For domestic hot water, an indirect heater supplies the ample volumes demanded by modern labor-saving devices.

For the last word in year 'round comfort, convenience and health protection, backed by long-lived, trouble-free equipment, get the facts on the B & G Hydro-Flo System.

"Water is the most efficient and economical medium for conveying a BTU"

## BELL & GOSSETT

COMPANY  
Dept. EB-11, Morton Grove, Illinois

Canadian Licensee: S. A. Armstrong Ltd., 1400 O'Connor Drive, West Toronto

# The Fast, Easy Way To Drill Concrete



The New!

**SYNTRON**

## ELECTRIC HAMMER DRILL

- Exclusive, Automatic Rotation of Drill Bit
- No Laborious Hand Turning of Drill Chuck
- Continuous Operation—Practically No Maintenance
- Ten Times Faster Than Hand Methods for Drilling

The Only Electric Hammer Drill available with automatic, self-rotating drill bit. Operates at high speed for fast, clean production drilling. Electromagnetic drive—only one moving internal part. Requires little or no service even after constant usage on toughest drilling jobs. Electric Hammer models for chipping, cutting, pointing, scaling, etc., also available.

### Other SYNTRON POWER TOOLS That Reduce Job Time and Costs



#### Belt Driven ELECTRIC SAWS

Deliver full cutting power to blade—no bucking or jerking. For production cutting of wood, concrete block, plaster board, etc. 8" and 10" blades—2<sup>3</sup>/<sub>16</sub>" and 3<sup>1</sup>/<sub>4</sub>" cuts.

#### Gasoline Hammer PAVING BREAKERS and ROCK DRILLS

2000 blows per minute for digging, tamping, and busting in paving, clay and shale. Drills and cleans holes down to 13 ft. in rock. Automatic Bit Rotation.



#### CONCRETE VIBRATORS

Gasoline or electromagnetic models for uniform compacting and settling on large mass or form concrete projects.



Write today for Complete Tool Catalogue—Free

**SYNTRON COMPANY**

518 Lexington Avenue

Homer City

Penna.

AMERICAN BUILDER

NEW PRODUCTS

#### Thermostat with the round look

The Golden Circle is a thermostat about the size of a fine pocket watch. It carries forward into Electronic Moduflow systems the round design first introduced by Minneapolis-Honeywell in 1953. It is mounted in the

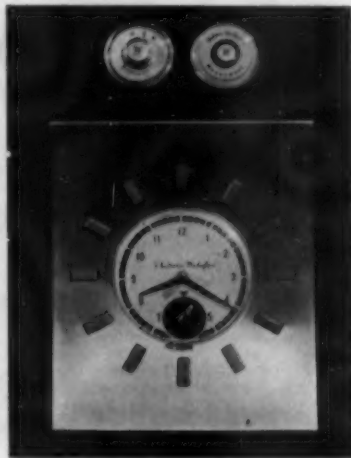

conventional thermostat location and works with an outdoor temperature sensing element and a brain control center to adjust indoor comfort scientifically according to outdoor weather changes. The control center operates on a 24-volt circuit and is supplied with a transformer and 15 feet of cable with a remote terminal block to make it possible to mount the brain unit wherever desired. Two models of the new thermostat and three different control centers are available. Two of the systems provide for automatic night temperature setback. Average installed price: \$199.40, unchanged from previous standard system for average installation. Minneapolis-Honeywell Regulator Co., Dept. AB, Attn. Warren Gammell, Home Products Div., 2747 S. Fourth Ave., Minneapolis, Minn.

Circle No. 1036 on Readers' Reply Card, p. 246

#### 10-Ampere switches are 50 per cent smaller

Two new sub-miniature TorBal toggle switches reduce by half the size and weight required before. Both are double-throw, and are in single-pole and double-pole types. They are contact rated for 10 amperes at 50 volts DC, and weigh .0095 pounds (.15 ounces) and .0135 pounds (.22 ounces), respectively. The Torsion Balance Co., Dept. AB, Attn. John Slane, I & R Electronic Division, Clifton, New Jersey.

Circle No. 1037 on Readers' Reply Card, p. 246

AMERICAN BUILDER

Complete technical specifications, installation details, and selling features...plus a new merchandising program to help you sell homes. IT'S ALL FREE AND WITHOUT OBLIGATION...

just mail the coupon

**THE O. A. SUTTON CORPORATION**

1811 West Second Street

Wichita, Kansas

I want complete information on your new low-cost central air conditioners. It is understood there is no obligation.

NAME \_\_\_\_\_

FIRM \_\_\_\_\_

POSITION \_\_\_\_\_

ADDRESS \_\_\_\_\_

CITY \_\_\_\_\_ COUNTY \_\_\_\_\_ STATE \_\_\_\_\_

# Vornado

GIVES ANY BUILDER  
CENTRAL AIR CONDITIONING  
FOR AS LITTLE AS

\$ 600<sup>00</sup>  
-  
INSTALLED

This revolutionary central unit is the answer to today's demand for low-cost, efficient central air conditioning for new construction.

New, simplified unit design, plus exclusive Fiberglas ductwork—pre-engineered and pre-fabricated—makes this amazing low cost possible.

And Vornado's reputation as specialists in the manufacture of comfort-cooling appliances is your assurance of the finest in quality and performance.

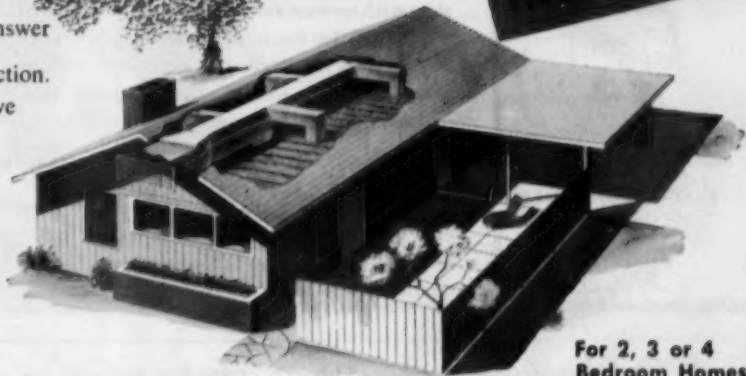

For 2, 3 or 4 Bedroom Homes

**HERE'S WHY Vornado's DRAMATIC NEW PACKAGED UNIT MEETS BUILDERS REQUIREMENTS**

Mail coupon above  
and we'll prove it

- LOWER UNIT COST
- LOWER OPERATING COST
- FASTER INSTALLATION
- HIGHER PERFORMANCE
- FULLY GUARANTEED
- and ... DESIGNED AND MANUFACTURED FOR USE IN FHA MORTGAGED-INSURED PROPERTIES

**Products of THE O. A. SUTTON CORPORATION**

WICHITA, KANSAS

*Specialists in the manufacture of comfort cooling appliances*



## MYERS PUMPS

profitable for builders...and here's why



*Full line . . .*



Includes jets, submersibles and plunger-type pumps in a full range of sizes and prices for shallow- or deep-well application in big home or small.

*Top quality . . .*



Myers design and engineering superiority is insured by the highest brand of workmanship with newest automatic, precision equipment and the finest of materials. Myers is able to back its products with a warranty unsurpassed in the industry . . . a valuable selling point with prospective home buyers.

*Excellent service . . .*



Myers dealers are factory trained to provide qualified service throughout the United States and Canada using only genuine, high-quality Myers parts.

*National reputation . . .*



Through consistent national advertising and promotion, Myers products are known for quality and dependability. Myers is a name you can merchandise profitably when it's time to sell your new homes beyond the city mains.

# Myers

**WATER SYSTEMS**  
POWER SPRAYERS AND WATER SOFTENERS

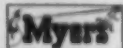

For free catalogs covering the complete Myers pump and water softener lines, write today to: The F. E. Myers & Bro. Co., Dept. AB-10, Ashland, Ohio.

Name \_\_\_\_\_

Company \_\_\_\_\_

City \_\_\_\_\_ State \_\_\_\_\_

AMERICAN  
**BUILDER**

**NEW PRODUCTS**



**Ceiling light is a heater, too**

Heat-A-Lite, NuTone's new combination heater and light for ceiling installation, has a housing diameter of 13 $\frac{3}{4}$ -in. and a depth of 7 $\frac{1}{2}$  inches. Its flange, mounted flush with the plaster, is  $\frac{1}{2}$ -inch. The grille has a 15 $\frac{1}{2}$ -inch diameter and is made of anodized aluminum. The unit is available in three models listing at \$49.95, \$59.95, and \$64.95. NuTone, Incorporated, Dept. AB, Attn. Paul Venezia, Madison and Red Bank Roads, Cincinnati 27, Ohio.

Circle No. 1038 on Readers' Reply Card, p. 246



**Kitchen stove hood removes fumes, heat about 300 cubic feet per min.**

The Rangaire Kitchen Stove Hood Model UC-2 is designed for installation in the cabinet above the stove and is said to remove greasy fumes and heat at approximately 300 cubic feet per minute. The UC-2 has a "squirrel-cage" type blower and a filter that is easily cleaned by removing two knurled screws, lifting off the stainless steel grille, and dipping the filter in hot water. Price: white baked enamel, \$64.95; coppertone or silvertone baked enamel, \$69.95; copper or stainless steel, \$114.95. Roberts Manufacturing Company, Dept. AB, Cleburne, Texas.

Circle No. 1039 on Readers' Reply Card, p. 246

## NEW LOW COST FOLDING DOOR



CURTITION

*Decorfold*

Made of Colorful Hi-Impact Plastic!

Add sales impact for budget homes. Here now is an innovation in folding doors that helps you answer today's demand for functional design and roomier convenience in any price home. It's another Curtition model with quality that surpasses anything else on the market for the money.

Plastic creates strong appeal. With Curtition Decorfold you offer a door that's acid resistant, scuff proof...virtually damage proof...and easy to keep sparkling clean.

For standard openings and wardrobes. Curtition Decorfold opens with the most compact stacking of any folding door. Saves space in close quarters...provides full access to wardrobes and closets. Saves you money over sliding doors...with faster, simpler installations.

Doors are completely assembled with Nylon clip-glides and pull handles for both sides. Packaged with track, screws and friction catch — ready for installation. Sizes to fit openings up to 10' in width.

2'0" x 6'8" door, only \$21<sup>50</sup> retail



### Fits new decorating trend

Curtition Decorfold's rich plastic surface provides a pleasing blend or contrast to soft fabrics, carpets, masonry and wood furnishings. Choice of soft colors; to fit any decorative scheme.



### Simplified trouble-free design

No wobble or chatter because of newly engineered one piece nylon clip-glides. No moving parts to jam up or come loose, no warping. Decorfold is center-line suspended in a steel track. Finger touch to open or close.



### A 24" door folds back to only 2"

Decorfold's compact stacking is unique in folding doors—1" for every 12" of door. The slim line stack provides maximum clear opening and a rich, subtle pillar effect.

Learn the 15 new points of superiority in the

### CURTITION ROYALFOLD

The King of Accordion Doors... also Manufactured by

**CURTITION CORPORATION**  
2227 Sawtelle Boulevard • Los Angeles 64, California

Send for our A.I.A. Brochure showing complete details and applications

See your nearest distributor or mail this coupon to:  
Dept. AB-105, Curtition Corporation  
2227 Sawtelle Blvd., Los Angeles 64, Calif.

NAME \_\_\_\_\_

COMPANY \_\_\_\_\_

ADDRESS \_\_\_\_\_

CITY \_\_\_\_\_ ZONE \_\_\_\_\_ STATE \_\_\_\_\_



Plasterers work on the coldest days, let the heater dry plaster overnight. It leaves no oil film on plaster.



Small and large operators like the savings of the B-100. 12c an hour keeps high-priced men on the job without a break through the coldest days.



One small Master warms this 5-room house. You can pour, finish and cure concrete all year long.

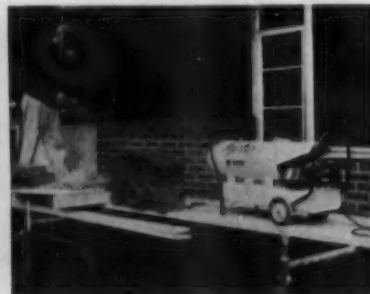

Brick and stone masons toss a Master on the scaffold to heat material as well as themselves. They haul the Master in a car trunk.

**NOW!**

## Portable Heat at New Low Price

The new Master B-100 Portable Heater puts 100,000 BTUs of heat per hour wherever you want it . . . costs only 12c per hour to run . . . burns kerosene or fuel oil so completely you don't need a vent.

It's powerful, but tiny. Weighs only 78 lbs. Fits in your car's trunk. Carry it, wheel it through doors, down stairs, up ramps, on scaffolds . . . almost anywhere you go. Just plug the cord in an electric outlet and flip the switch . . . warm air pours out immediately. Circulating air spot-heats outside, one heater warms a space the size of a five-room house inside.

The Master pays for itself by keeping your men on the job in the coldest weather. It takes the heat to them. Don't let the next cold snap cost you money. See your Master distributor or write today for all the facts on the B-100 and larger models. No obligation.

**MASTER VIBRATOR COMPANY**  
341 Stanley Ave., Dayton 1, Ohio

**MASTER**

### FILL OUT THIS COUPON FOR FREE FOLDERS

Master Vibrator Company • 341 Stanley Ave. • Dayton 1, Ohio

**FREE**



Please send me, without obligation, facts about low cost, portable heat and the

- Small Master B-100 Portable Heater
- Larger Master Portable Heaters

Name \_\_\_\_\_

Firm \_\_\_\_\_

Street \_\_\_\_\_

City \_\_\_\_\_ Phone \_\_\_\_\_

**AMERICAN BUILDER**

## NEW PRODUCTS

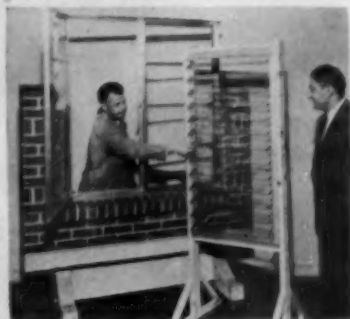

### Glass jalousie louvers that lock

This glass jalousie window has a glass retaining rectangular wedge of die-formed vinyl plastic that locks louvers securely. No bending of clips is required for installation. The manufacturer also offers a line of aluminum windows featuring the tubular section for all vented windows. Available in addition to the glass jalousie window: aluminum windows or awning type, casement, window wall, picture and special combinations. Dibbs Products, Inc., Dept. AB, 1410 W. Platt St., Tampa, Florida.

Circle No. 1040 on Readers' Reply Card, p. 246



### Crezon fused plywood has plastic overlay

A smooth bonded plastic surface is bonded to the sheets of plywood under intense heat and pressure to give a smooth, weather-resistant surface. The material resists checking, takes paint smoothly, saws and drills without splintering. Sharp smooth cuts are possible by jointing and edge planing. List price to builders: 3/8-inch Crezon 1 side (4x8), about \$254, M sq. ft.; 1/2-inch Crezon 2 sides (4x8), about \$370, M sq. ft. Distributed by wholesale and retail lumber yards under manufacturer's names. Crown Zellerbach Corp., Dept. AB, Attn. Bill Works, 343 Sansome St., San Francisco, Calif.

Circle No. 1041 on Readers' Reply Card, p. 246

**AMERICAN BUILDER**



FEATURE  
OF THE  
MONTH

## FOUNDATION PRODUCTS

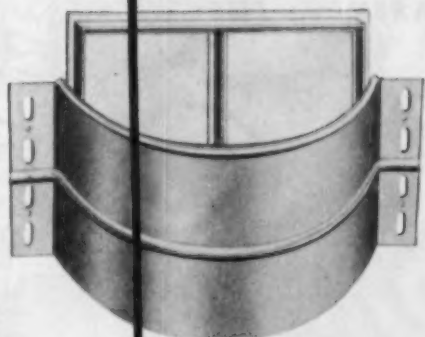

### WINDOWS

- Made from 1/8-inch steel stock
- Electrically welded for strength
- Fitted at factory to assure tight closure
- Two-position stops . . . open from top
- Standard sizes for putty or no-putty glazing

### AREA WALLS

- 16-gauge copper-bearing galvanized steel
- Ribbed for strength . . . minimum exposure to frost action
- Spans are 38" and project 16"
- Five standard heights available

For over sixty years Donley has manufactured metal building products to make fine homes better.

Some other Donley Foundation Products: • area gratings • cleanout doors • coal chutes • basement columns • thresholds • foundation waterproofing • wall plate anchors • foundation ventilators • joist anchors

Write for full information today.



THE **Donley** BROTHERS COMPANY

13910 Miles Avenue • Cleveland 5, Ohio  
6171-DB



## NEW and IMPROVED! WARP-PROOF, ALL STEEL NO. 1200 POCKET DOOR T-FRAME

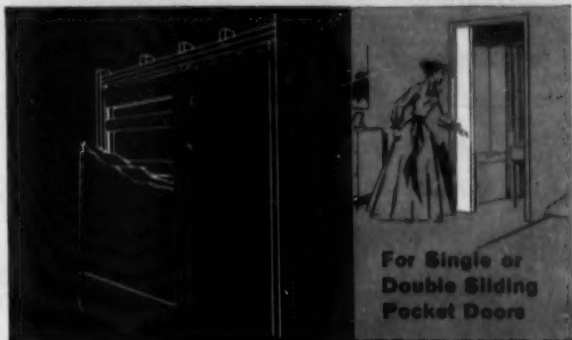

For Single or  
Double Sliding  
Pocket Doors

Here is the only universal, warp-proof Pocket Door T-Frame for all standard interior door requirements. It is designed for single or bi-parting doors 1-3/8" thick, 6'-6" or 6'-8" high. Any type of wall material may be used . . . lath and plaster, dry wall or plasterboard, wood paneling or tile. Available for 2'-0", 2'-4", 2'-6", 2'-8" and 3'-0" doors.

### PACKAGE INCLUDES:

Steel Header • Steel Jambs  
Aluminum Track  
Adjustable Hangers with Nylon Rollers  
Aluminum Door Guide  
Bumper • Screws • Instructions



## EASY TO INSTALL . . . FOR A PAIR OF DISAPPEARING DOORS

Double pocket doors give a center opening twice the width of by-passing doors and make a convenient opening for walk-in closets. They create extra living space if used between rooms. The doors disappear into wall pockets when opened and meet in the center of the doorway when closed. Easy to install. Ask for Series 1200B for Bi-Parting Pocket Doors which includes two T-Frames and coupling.

See our Catalog in Sweet's Architectural  
or Light Construction Files, or write

**STERLING HARDWARE MANUFACTURING COMPANY**  
2345 WEST NELSON STREET • CHICAGO 18, ILLINOIS

# NICHOLS

special threaded  
**STEEL NAILS**

**SCREW  
GRIP**



**HI-TEMP SCREW-GRIP  
TRUSS RAFTER**  
All Standard Sizes

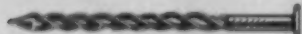

**HI-TEMP SCREW-GRIP  
PALLET**  
All Standard Sizes



**HI-TEMP SCREW-GRIP  
FLOORING**  
Lengths: 1 1/2", 1 3/4", 2", 2 1/4",  
2 1/2"



**SCREW-GRIP COMMON**  
All Standard Sizes



**SCREW-GRIP SINKER**  
All Standard Sizes

**RING  
GRIP**



**RING-GRIP SINKER**  
All Standard Sizes

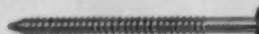

**RING-GRIP COMMON**  
All Standard Sizes

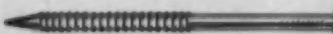

**HI-TEMP  
RING-GRIP POLE BARN**  
All Standard Sizes



**RING-GRIP  
UNDERLAYMENT**  
Lengths: 1", 1 1/4", 1 1/2", 1 3/4",  
2 1/8", 2 3/8"



**RING-GRIP GYPSUM  
WALLBOARD**  
Lengths: 1 1/8", 1 1/4", 1 3/8",  
1 1/2"

Special threaded steel nails are available in standard and non-standard sizes for use in all types of construction.

• Available in standard sizes for use in all types of construction.

• Available for the special threaded steel nails for use in all types of construction.

Special threaded steel nails are available in standard and non-standard sizes for use in all types of construction.

• Available in standard sizes for use in all types of construction.

• Available for the special threaded steel nails for use in all types of construction.



**NICHOLS**

WIRE & ALUMINUM CO.  
Baltimore, Md.

Special and World's Largest Manufacturer of Standard Nails



They go for the house with a

**SERVICE-WAY**

**BASEMENT ENTRY . . .**

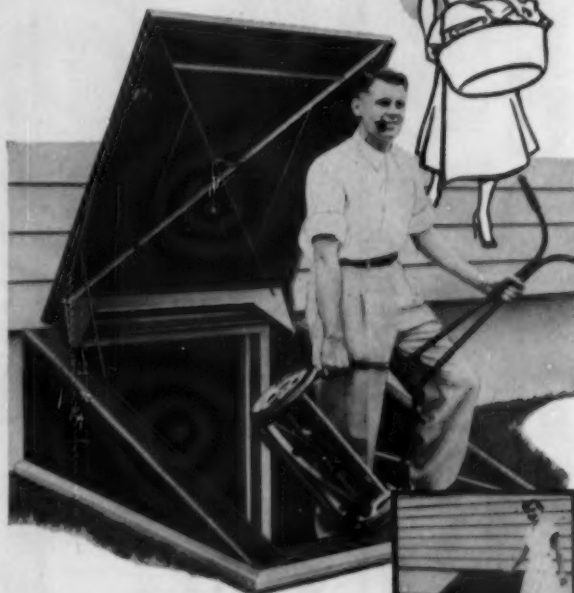

**H**OME BUYERS like the extra convenience of Service-way. It provides direct access to the basement from outdoors for storage of garden tools, workshop and recreational equipment . . . shortens the trip from laundry to clothesline . . . saves tracking dirt through the house.

The wide single door swings up out of the way . . . provides an unobstructed opening for bulky objects. The Service-way is built of heavy gauge steel—electrically welded and reinforced for maximum strength.

Overlapping flanges on the frame and door assure a snug fit—keep out rain, snow and wind. Slide bolts lock door securely from the inside. The Service-way comes fully assembled, ready to install.

Write for folder and specifications to:  
Heatilator Inc., 2610 E. Brighton Avenue,  
Syracuse 5, N. Y.

**Simple, Modern Lines**  
Blends with any style of architecture, becomes an integral part of the house.



**Finger-tip Operation**  
Double-acting springs counter-balance the door in any position.

HEATILATOR®  
**SERVICE-WAY**

AMERICAN BUILDER

**AN UNBEATABLE COMBINATION FOR**

*Profit!*

**Milwaukee**

MODEL 650  
6800 RPM  
BLADE SPEED

**6 1/2"**

\* *High Speed*  
**HEAVY-DUTY**

**SAW**

**The Only POWER SAW Needed To Build A Home**

For a real thrill in performance and handling ease, check the 6 1/2" MILWAUKEE Model 650 before you buy your next saw. It's the ONE saw that makes every cut necessary to build a house . . . even to the compound miter cuts. It's the kind of *light-weight . . . big capacity* saw you have long wanted . . . a saw that makes more cuts, faster, more accurately and with less effort . . . A saw that's fully versatile . . . that will handle all special purpose blades and abrasive cutting wheels and that can stand the gaff of all-day heavy duty use.



FULL  
1 1/2 HP  
MOTOR

Still Only  
**\$66<sup>50</sup>**

(with handy Steel Carrying Case — \$74.50)

. . . with So Many Outstanding Features

. . . including EXCLUSIVE Free-Wheeling Clutch Drive

- Grease sealed ball and roller bearings throughout
- Helical cut heat-treated gears and drives for greater power efficiency, quieter running
- Built-in quick setting depth and miter and rip adjustment, fully lockable
- Telescopic and automatic retractable blade guard
- Instant release safety trigger switch
- Light weight, only 12 1/4 pounds
- Perfectly balanced.

\* For bigger capacity High Speed saw ask to see the Model 700 with 7" blade or the Model 825 with 8 1/2" blade.

MODEL  
**. . . and the Famous 414 SAWZALL**  
**Compact Electric Powered HACKSAW**

A rugged dependable heavy-duty saw that fills perfectly every special sawing need. Zips easily through any sawable material, such as wood, metal, plaster, transite, embedded nails, wire, etc.

NEEDS NO STARTING HOLE . . .  
. . . In Wood or Comparable Materials

- NOT AN ATTACHMENT . . . but a complete HEAVY-DUTY sawing tool . . . Easily maneuverable with one hand.
- RUGGEDLY BUILT . . . powered by famous MILWAUKEE-Built 115 volt ac-dc motor . . . can also be operated from portable electric generating equipment.
- POWERFUL . . . 3/4" cutting stroke . . . 2250 strokes per minute.
- BALL and ROLLER BEARINGS . . . lifetime lubricated.
- WEIGHS only 6 3/4 lbs. . . . Just 14 1/2" long.
- SAWZALL Blades . . . available in types and lengths to suit every sawing need.

\* Furnished complete with handy steel carrying case and full complement set of Sawzall blades.



Only **\$89<sup>50</sup>\***



• The perfect tool in remodeling work — Breezes right through plaster, wood and nails.

*For Demonstration ... SEE YOUR DEALER ... Or Write Today To ...*

**MILWAUKEE ELECTRIC TOOL CORP.**  
5356 W. State St. Milwaukee 8, Wis.

Get Faster Sales with the "Magic Ring!"



Look for the  
New Blue  
Super "Hush-Cushions"

**HERE'S WHY—**

- 1 Waste King attracts more home sales and rentals than any other visible feature costing up to five times more. It's your lowest cost, highest quality feature!
- 2 Waste King is now a household word that means greater convenience. Saves time, steps, and work by eliminating garbage automatically. It's your best new saleable feature!
- 3 Waste King features exclusive Lifetime Grind Control for clogproof, longer service and exclusive Super "Hush-Cushions" for smoother, quieter, operation!
- 4 Waste King's service record is best in the industry... Less than 1% callbacks. Relieves the builder of post-sale complaints.



"The Eyes Buy the Visible Feature!"

A PRODUCT BY GIVEN MANUFACTURING CO., LOS ANGELES



America's Finest Garbage Disposer

Dept. AB-10



AMERICAN  
**BUILDER**

**NEW PRODUCTS**

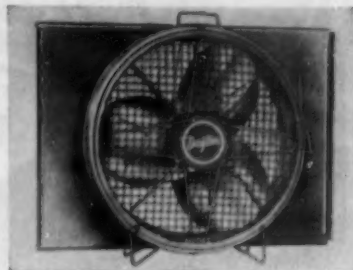

**3-way window fan has 3 speeds**

This fan serves as (1) a window exhaust fan, (2) a window blow-in fan, (3) a portable air circulator. The 3-speed motor has a 4-position switch. The 20-inch unit is retained in the window panel with two simple spring lock hooks. The fan unit can be easily reversed in panel or removed for portable use. Fan unit is 20½ inches in diameter by 8 inches deep. List price \$60.50 Dayton Electric Mfg. Co., Dept. AB, 118 So. Oakley Blvd., Chicago, Ill.

Circle No. 1042 on Readers' Reply Card, p. 246

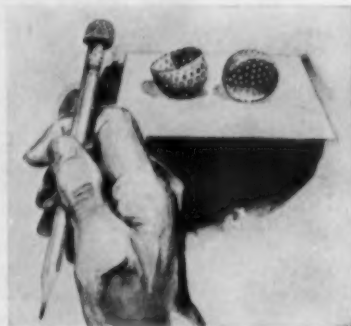

**Thimble louvers release trapped moisture**

Midget Thimble louvers are designed to solve the problem of ventilation for air space behind house siding. They are simply pushed into a ¾-inch hole drilled into butts of outside siding with an electric ¼-inch drill. Drilling only as far as air space back of siding, insulation efficiency is not affected, yet trapped moisture is released. Midget Thimble louvers are perforated to prevent clogging by paint, and to keep out insects. Midget Louver Co., Dept. AB, 6-8 Wall St., Norwalk, Conn.

Circle No. 1043 on Readers' Reply Card, p. 246

**Baseboard diffuser designed to eliminate wall streaking**

Air-Trim is a new warm air baseboard diffuser for warm air heating that has



been engineered and designed to simulate Vulcan's regular "Trimline" baseboard now used extensively for hot-water heating. The diffuser will distribute warm air from a single duct outlet over extended wall areas in the same manner as conventional baseboard radiation. Available in 2, 4, 6, 8, and 10-foot lengths, in either Standard Air-Trim (without dampers) or Deluxe Air-Trim (with dampers). Trade prices for Standard Air-Trim: 2-foot length \$3.05; 10-foot length, \$9.00. Deluxe Air-Trim: 2-foot length, \$4.05; 10-foot length, \$12.10. Vulcan Radiator Company, Dept. AB, Attn. M. L. Lundgren, 775 Capitol Ave., Hartford, Conn.

Circle No. 1044 on Readers' Reply Card, p. 246



#### An easily installed safety door lock

The Door-Gard safety door lock can be installed permanently or temporarily on any inward opening door. No screws, no cutting or drilling, no tools of any kind are needed. Complete installation is accomplished simply by placing the lock on the jamb and closing door. Grippers hold the lock securely. It can be used on any other door simply by removing it and placing it on other door. The lock uses leverage for its strength—the greater the force on the outside of the door the tighter it grips. It is precision made of tool steel with nickel plate finish. Price: \$1.00 each PPD. Dalbert Gard & Assoc., Dept. AB, 2760 W. 8th St., Los Angeles 5, Calif.

Circle No. 1045 on Readers' Reply Card, p. 246

#### Factory window panes get colorful fiberglas

Alsynite Flat Panes have built-in color and are recommended for use in the glazing of factory or industrial windows in a new approach to industrial daylighting. The shatterproof, glare-free panes come in three hues—rose, green and blue. Alsynite Flat Panes are available in 5 standard sizes: 12x18, 14x20, 16x20, 16x24 and 20x48 inches. Alsynite Company of America, Dept. AB, Attn. E. M. Dowling, 4654 DeSoto St., San Diego 9, Calif.

Circle No. 1046 on Readers' Reply Card, p. 246

OCTOBER 1955



*Only One*

## applicant can fill this job for you!

Who is this super-salesman? The 'Yellow Pages' of your telephone directory.

Your advertising in the 'Yellow Pages' tells folks all over town *where* you are located, *what* services you offer, *what* your telephone number is.

You make it easy for prospects to pick up the telephone and call...or to come in. Newcomers in town...or old residents...9 out of 10 use the 'Yellow Pages' when they're ready to buy.



Your Classified Telephone Directory representative will gladly help you choose the 'Yellow Pages' headings that will mean more business. Call him at your local telephone business office.



# PRECISION folding STAIRWAY

**QUALITY**  
plus  
**Sales Features**



LISTED IN SWEET'S  
Approved by leading  
ARCHITECTS,  
BUILDERS, and  
LENDING AGENCIES

5 YEAR  
written  
GUARANTEE  
furnished with  
each unit

STOCKED BY 130 LEADING JOBBERS  
IN THE U. S. A. AND CANADA

**PRECISION PARTS CORP.**

400-AB NORTH FIRST STREET

NASHVILLE 7, TENNESSEE

NO OTHER STAIRWAY  
OFFERS SO MUCH!

★ DESIGNED FOR TODAY'S HOMES—engineered for safety and ease of operation. Thousands of home builders across the nation have installed this quality salesman in their homes for quicker sales and more profits. Seven exclusive features plus Precision's big five-year guarantee have made Precision America's No. 1 Stairway.

### SEVEN SALES FEATURES

- 1—HYDRAULIC SAFETY CHECKS—prevent slamming of stairway on opening and closing; shut stairway door tightly and ease stairway into open or shut position quietly and safely.
- 2—ACTUATED BY COUNTERWEIGHTS—cleverly engineered, they close the stairway tightly every time. No springs to weaken; no adjustments necessary.
- 3—LIFE-TIME ROLLER BEARINGS—make operation noiseless and practically effortless.
- 4—RUGGED AND STRONG—all parts are secured by bolts and screws. Superior design assures long life and dependable service under constant use.
- 5—INSULATED DOOR PANEL—saves fuel in winter by preventing loss of heat to the attic and keeps out summer heat from the room below.
- 6—FULL WIDTH SAFETY TREADS—protect each step, add to appearance, and assure a safe footing.
- 7—FITS ANY CEILING HEIGHT—graduations on runners facilitate cutting off for different ceiling heights and insure a saving on both installation time and cost.

TWO STANDARD SIZES: 8'9" and 9'9". For ceiling heights 7'0" to 8'9", use 8'9". For ceiling heights 8'9" to 9'9", use 9'9". Figure from finished floor to finished ceiling—not floor to floor.

Frame fits 26" x 54" opening in ceiling; also 30" x 54" (special) at extra cost.

## CATALOGS

**QUARRY TILE FOR INDOOR-OUTDOOR USE**—An 8-page full-color catalog. Form No. 159 is now available describing Carlyle Quarry tile a product of Mosaic Tile Company. The booklet describes the many types of Carlyle Quarry Tile, suggests areas of use for each type and gives complete size, shape and trim unit information. All colors of the tile are accurately shown. The Mosaic Tile Company, Dept. AB, Zanesville, Ohio.

Circle No. 1047 on Readers' Reply Card, p. 246

**USES OF PRESSURE-TREATED LUMBER**—Uses in light and heavy construction of lumber pressure-treated with Wolman salts are detailed in non-technical language in a new 16-page illustrated booklet put out by Koppers Company, Inc. Copies of this booklet may be obtained by writing to Wolman Preservative Department, Koppers Company, Inc., Dept. AB, 1301 Koppers Bldg., Pittsburgh 19, Pa.

Circle No. 1048 on Readers' Reply Card, p. 246

**GLASS BLOCK TO REDUCE GLARE AND HEAT**—A new 8-page booklet, "Suntrol Glass Block for Reduction of Glare and Heat" describes the Suntrol Glass Block (with a pale green diffusing screen) and shows in detail the physical performance of the new glass block in reducing intensity of glare and heat. Pittsburgh Corning Corp., Dept. AB, One Gateway Center, Pittsburgh 22, Pa.

Circle No. 1049 on Readers' Reply Card, p. 246

**ONE-MAN VIBRATOR**—A new "1-man" vibrator that operates from regular 115 volt AC or DC outlet or portable generator is the subject of a new illustrated folder. The folder explains how the tool has the motor in the vibrating head instead of using a heavy motor or engine and flexible shaft to drag along behind the workman—eliminating a second man. Ask for MV 1162 and write to the Master Vibrator Company, Dept. AB, 164 Stanley Avenue, Dayton 1, Ohio.

Circle No. 1050 on Readers' Reply Card, p. 246

**LITERATURE FROM CHRYSLER AIRTEMP**—Chrysler Airtemp has three new pieces of literature which are now available. The brought-up-to-date "Facts" booklet is a handy reference to company history and management. The new Gas-Fired and Oil-Fired Furnace literature pieces list complete model specifications and, in addition, describe the application of Airtemp's recently introduced "V" type furnace cooling coils. Airtemp Division, Chrysler Corp., Dept. AB, 1600 Webster St., Dayton, Ohio.

Circle No. 1051 on Readers' Reply Card, p. 246

**PLYWOOD CATALOG**—A new 1955, 4-page basic catalog covering fir plywood grades and application data in condensed tabular form has been released by Douglas Fir Plywood Assn. Information in the catalog covers essential data needed in the construction field: standard stock sizes, recommendations on plywood siding and paneling, engineering data for best results with plywood sheathing and with plywood for concrete forms. Minimum FHA requirements, fundamentals of finishing, and applications for specialty products. Douglas Fir Plywood Assn., Dept. AB, Tacoma 2, Wash.

Circle No. 1052 on Readers' Reply Card, p. 246

**GLASS DOORWALL PANELS**—A new system of dual diagramming and coding of basic models for accurate specification of direction in which glass doorwall panels are to slide when opened, is introduced in a full color brochure released by Steelbilt, Inc. the 4-page brochure highlights Steelbilt engineering and weatherstripping features which permit application of sliding glass doorwalls as a functional design element regardless of climate. Steelbilt, Inc., Dept. AB 18001 S. Figueroa, Gardena, Calif.

Circle No. 1053 on Readers' Reply Card, p. 246

**VINYL ASBESTOS TILE COLOR CHART**—A folder titled, "1955 Vinyl Asbestos Tile Color Classification Chart" shows color comparisons and indicates the commercial equivalents of the various manufacturers' color lines which give the same general color tone or effect. Some 22 color combinations are listed. Asphalt Tile Institute, Dept. AB, 101 Park Avenue, New York 17.

Circle No. 1054 on Readers' Reply Card, p. 246

**ASPHALT TILE COLOR CHART**—Chart similar to one described above is available for asphalt tile. It lists some 27 colors of tile currently available. Asphalt Tile Institute, Dept. AB, 101 Park Ave., New York 17, N. Y.

Circle No. 1055 on Readers' Reply Card, p. 246

**STEEL FRAMING DESIGN DETAILS**—The "Architects & Engineers Reference Manual of V-Lok Steel Framing Design Details" is a 40-page booklet with a full discussion of V-Lok steel framing. Detailed drawings and photographs are included. Ask for Catalog No. 55-V. Macomber Incorporated, Dept. AB, Canton 1, Ohio.

Circle No. 1056 on Readers' Reply Card, p. 246

**NEW WAY TO FASTEN TO MASONRY**—Diamond Expansion Bolt Company has just released a new 8-page booklet containing complete instructions and diagrams on one-piece DHD Anchors. The anchor is made of aluminum alloy and the patented nail is hot-dipped galvanized. Diamond Expansion Bolt Company, Dept. AB, Garwood, N. J.

Circle No. 1057 on Readers' Reply Card, p. 246

## SIMPLEX folding STAIRWAY

**QUALITY**  
plus  
**LOW COST**

Your No. 1  
**PROFIT-MAKER**

**SELL MORE HOMES!**

Assure your prospects of adequate storage space at a cost low enough to satisfy today's budget-conscious home buyers. The Simplex "Balanced Action" Folding Stairway can help your homes move fast for more profits! Its economy . . . ease of operation . . . and durability make Simplex a **NO. 1 PROFIT-MAKER** for home builders.

**NEW**

**BALANCED SPRING ACTION**  
for EFFORTLESS OPERATION

- **SIMPLE AND EASY TO OPERATE.** No adjustments necessary.
- **RUGGED AND STRONG.** Manufactured of highest quality materials—No. 1 kiln dried lumber throughout. All hardware fabricated of heavy galvanized steel. All parts secured by bolts and screws—no nails.
- **TWO STANDARD SIZES**—8'3" and 9'9". For ceiling heights 7'0" to 8'3", use 8'3". For ceiling heights 8'3" to 9'9", use 9'9". Frame made to fit 26" x 54" opening in ceiling.
- **SHIPPED IN ONE PACKAGE.** Shipping weight 8'3", 52 pounds; 9'9", 56 pounds.
- **MANUFACTURED IN PRECISION'S MODERN PLANT.**

Approved  
by leading  
**ARCHITECTS,**  
**BUILDERS, and**  
**LENDING AGENCIES**

1 Year  
Guarantee

**WRITE FOR ILLUSTRATED FOLDER TODAY!**  
**DEALER INQUIRIES INVITED**

**PRECISION PARTS CORP.**

400-AB NORTH FIRST STREET • NASHVILLE 7, TENNESSEE

Your Owner Deserves the Strongest SHEATHING!

Give him Maximum  
Strength, plus  
high insulation  
factors with...



# ARKANSAS SOFT PINE *Certified* SHEATHING

Arkansas Soft Pine sheathing supplies superior material for three vitally important structural locations: (1) subfloors, (2) wall sheathing, (3) roof decking.

In all three, Arkansas Soft Pine sheathing, dry and correctly seasoned, with its great nail-holding power, provides maximum tensile strength and stiffness to the structure. It is tongue-and-groove material nailed on diagonally for extra bracing, and encloses the entire frame with a completely integrated "skin". It is vastly stronger than synthetic, blotter-like composition board sheathing. It insulates effectively, being immune to heat, cold and dampness. Seasoned to specified moisture content in automatically controlled dry kilns, Arkansas Soft Pine sheathing of standard thickness keeps out as much heat or cold as 5" of common brick, 9" of face brick, 12" of stone, and 13½" of concrete.

As subflooring, it is free from shrinking or swelling, provides a stabilized base over which the finish floor stays uniformly smooth. By the same token, it stays put as roof decking under all types of outside covering.

Certified by official SPIB grade-mark, as required for FHA and VA financing, and identified by registered trade-mark, Arkansas Soft Pine sheathing supplies every home builder the ultimate in enduring value.

Arkansas Soft Pine Certified sheathing comes in 4", 6" and 8" widths, center-and-end matched, or plain end. It is sold by local lumber dealers east of the Rockies. For data, illustrated grades and specifications, send for FREE Handbook.

FREE



## ARKANSAS SOFT PINE BUREAU

955 BOYLE BUILDING, LITTLE ROCK, ARKANSAS

## CATALOGS

**NEW IDEAS IN TILE**—"New Ideas in Tile" is a new booklet designed to provide ideas and show the most up-to-date types of ceramic tile treatments that can be incorporated into homes of all sizes. American-Olean Tile Co., Dept. AB, 1000 Cannon Ave., Lansdale, Penna.

Circle No. 1058 on Readers' Reply Card, p. 246

**FLOOR AND WALL TILE**—A 16-page booklet describing Matico floor and wall tile has been issued. The booklet shows, in color, a representative selection of Matico tiles as well as individualized floor installations. Mastic Tile Corp. of America, Dept. AB, Newburgh, N. Y.

Circle No. 1059 on Readers' Reply Card, p. 246

**DESTRUCTIVE MOISTURE PROTECTION**—A descriptive folder on "Sealtight Premolded Membrane" tells how to protect new home construction from destructive moisture with the help of photos and illustrations. W. R. Meadows, Inc., Dept. AB, 2 Kimball St., Elgin, Ill.

Circle No. 1060 on Readers' Reply Card, p. 246

**A WINDOW TO THE SKY**—The Wascolite Airdome is called by its manufacturers "a window to the sky" because it provides daylighting plus ventilation from above. A new illustrated folder on the Wascolite Airdome and Wascolite Hatchway is available by writing to Wasco Products, Inc., Dept. AB, 93P Fawcett St., Cambridge 38, Mass.

Circle No. 1061 on Readers' Reply Card, p. 246

**REFLECTIVE INSULATION AND MOISTURE BARRIERS**—A new pamphlet on reflective insulation and moisture barrier applications is now available, including photographs and diagrammatic sketches illustrating installation of Lumaskin in walls, in ceilings and under floors for cutting heat loss and minimizing between-wall moisture penetration. Angier Corp., Dept. AB, Framingham, Mass.

Circle No. 1062 on Readers' Reply Card, p. 246

**ELECTRIC HEAT**—A new 12-page catalog is now available describing Cavalier Electric Heat. The catalog describes the manufacturer's line of baseboard and wall heaters as well as other electric heating units. Cavalier Corp., Dept. AB, Electric Heating Division, Chattanooga 2, Tenn.

Circle No. 1063 on Readers' Reply Card, p. 246

**LOW-COST EARTHMOVER**—What makes an earthmoving unit give consistently high production at low operating cost? This and other questions about a low-cost unit are answered in a new booklet titled "DW21 Low Cost Earthmover" published by Caterpillar Tractor Co., Dept. AB, Peoria, Ill.

Circle No. 1064 on Readers' Reply Card, p. 246



# Your Guide to **NEW PRODUCTS** Information

**HERE'S  
REAL HELP  
for  
YOU**

The post card below is designed to help readers of *American Builder* get complete data about new product items and catalogs shown in this issue. All you need to do to get further information is to circle the desired items listed on the reverse side of this card and mail it to us.

No postage is necessary. We will forward your requests to the manufacturer who will send you complete data.

Postage  
Will Be Paid  
by  
Addressee

No  
Postage Stamp  
Necessary  
If Mailed in the  
United States

## **BUSINESS REPLY CARD**

First Class Permit No. 153, Sec. 34.9, P. L. & R., New York, N. Y.

**4 cents Postage will be paid by**

**Business Manager  
AMERICAN BUILDER  
30 Church St.  
New York 7, N. Y.**

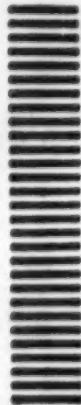

# USE *this handy*

# *Circle*

**ITEMS BELOW  
and MAIL *this*  
POSTCARD  
TODAY**

# *new products information service*

## FREE INFORMATION - ON PRODUCTS and EQUIPMENT

- 1001. Wall paneling cement
- 1002. Packaged kitchens
- 1003. Saw horse brackets
- 1004. All-steel garage
- 1005. Brush cutter
- 1006. Brick-effect sheathing
- 1007. Vanity cabinet-ventilator
- 1008. Operator-hinge set
- 1009. Building insulation
- 1010. Acoustical tile
- 1011. Plastering machine
- 1012. Steel garage door
- 1013. Ring-type edge pull
- 1014. Water pump
- 1015. Faucet dish washer attachment
- 1016. Wall resurfer
- 1017. Roof louver
- 1018. Herman Nelson unit
- 1019. C. R. Daniels salamander
- 1020. Jackson salamander

- 1021. Littleford Bros. burner
- 1022. Schou unit
- 1023. Bico heater
- 1024. Jalousie window
- 1025. Clay pipe
- 1026. Semi-Rush fixture
- 1027. Laminated sandwich panels
- 1028. Flush wall radio
- 1029. Electric baseboard heater
- 1030. All-steel corner guard
- 1031. 2-stage cooling unit
- 1032. Aluminum door edging

- 1033. Jalousie combination
- 1034. Diamond blade
- 1035. Redwood plywood
- 1036. Thermostat
- 1037. 10-amp switches
- 1038. Ceiling light-heater
- 1039. Stove hood
- 1040. Locking jalousie louvers
- 1041. Fused plywood
- 1042. 3-way window fan
- 1043. Thimble louvers
- 1044. Baseboard diffuser
- 1045. Safety door lock

- 1046. Window panes

### CATALOGS

- 1047. Quarry tile for indoor-outdoor use
- 1048. Pressure treated lumber
- 1049. Glass block
- 1050. One-man vibrator
- 1051. Chrysler literature
- 1052. Plywood
- 1053. Glass doorwall panels
- 1054. Asbestos tile colors
- 1055. Asphalt tile colors
- 1056. Steel framing details
- 1057. Fastening to masonry

**MAIL THIS CARD TODAY — WE PAY THE POSTAGE**

FIRM ..... TITLE .....  
NAME ..... KIND OF BUSINESS .....  
STREET .....  
CITY ..... ZONE ..... STATE .....

PLEASE PRINT NAME AND ADDRESS

OCTOBER, 1955

**SERVICE ON THIS CARD EXPIRES IN 90 DAYS — ACT NOW!**

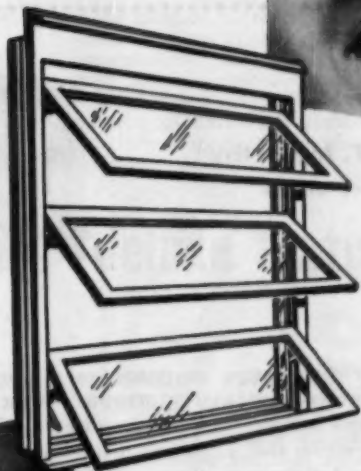

More and more, the home-buyer today is looking at windows. He seeks performance, quality and style all through the house. WOODCO E-ZEE Loc Wood Awning Windows suit *his* point-of-view.

*from any point of view...*

Then there's *your* point-of-view which is best represented by easier, faster sales. Economy of labor is provided for by ease-of-installation and prompt delivery to building site of completely assembled units. WOODCO E-ZEE Loc Awning Windows suit *your* point-of-view.

**WOODCO**  
**E-ZEE** Loc  
REGISTERED  
**WOOD AWNING WINDOWS**

**CHECK THE WOODCO E-ZEE Loc PATENTED FEATURES:**

- EASY TO LOCK
- SEQUENCE AIR CONTROL
- TOXIC-TREATED TO PREVENT DECAY
- EXTRA HEAVY SASH and FRAME
- DOUBLE VINYL WEATHERSTRIPPING (Pat. Pend.)
- WATER-REPELLENT TREATED
- COMPLETELY ASSEMBLED

STANLEY L. REBER, residence  
 Avon-by-the-Sea, New Jersey  
 ROMOLO BOTTELLI, Jr., architect



**Woodco** Windows for the Beautiful point-of-view...

For further information see your dealer or write to

**WOODCO CORPORATION**

Formerly General Woodcraft Co., Inc.

North Bergen, N. J.

Branches: Schenectady 3, N. Y.; Lowell, Mass. • Factories: Miami 47, Fla.; Randolph, Wisc.

HIGH VELOCITY  
NON-RECOIL

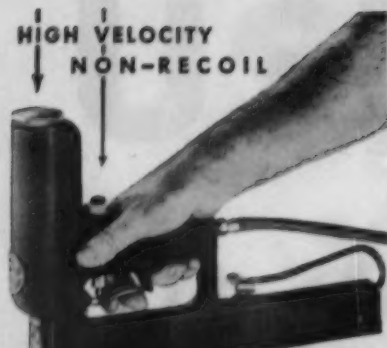

## AIR DRIVE SPOTNAILERS

FIRE LONG FASTENERS  
INTO HARDEST WOODS  
with 100 P.S.I. or less

All the heavy duty fastening jobs so ably performed for years by manually operated Spotnailers now can also be done with the super speed and convenience of air.

The new Models PEL and PHL Spotnailers are beautifully balanced tools which may be operated at arm's length because no effort is required except to position the gun and operate the trigger—astonishing to those accustomed to using air guns that must be held tightly to the work. It opens up great new opportunities for cost saving fastening.

See your local Spotnail Man.  
His experience can help you.

- ★ HIGH VELOCITY  
NO-BOUNCE ACTION
- ★ LOW HANDLE—  
EXCELLENT BALANCE
- ★ LIGHT WEIGHT—  
REDUCES FATIGUE
- ★ DRIVES 16 or 18 GAUGE  
1-3/16" LONG FASTENERS
- ★ LARGER, INSTANT-LOAD  
MAGAZINE HOLDS 200 FASTENERS
- ★ COUNTER SINKING TO  
SUIT—GLIDE PLATES

Most nailing jobs can be done more  
PROFITABLY with Spotnailers.



Write for complete  
information  
Spotnails, Inc.  
Evanston 6, Ill.

# SPOTNAILS, INC.

## Tenants under Section 608 financing denied rent reductions by N.Y. court

By John F. McCarthy

Attorney-at-law



Tenants of an apartment project, constructed with the proceeds of loans secured by mortgages insured by FHA under former Section 608 of the National Housing Act, have no right to have the courts require a review and reduction of the rents set for that project by FHA. This was decided in a recent opinion by the United States District Court in New York in a case entitled *Choy v. Farragut Gardens* (131 F 2d 609), wherein the tenants contended that excessive financing had resulted in so-called "windfall profits" to the owners and high rentals to the tenants. In reaching its decision the Court made some significant observations about mortgages insured by FHA under Section 608.

This litigation was one of the by-products of last year's Congressional investigation into apartment building projects financed by the proceeds of mortgage loans insured by FHA under Section 608. This particular case was brought against the Federal Housing Administration as well as against the owners of the apartment buildings involved.

The tenants contended that the owners had submitted to FHA misleading data about the cost of the project in question. They also took the position that FHA knew that this information was wrong but made no adequate independent investigation to determine proper costs. This, they concluded, had two results: first, mortgage loans substantially in excess of the cost of the project; and second, rents, fixed by FHA pursuant to the powers in Section 608, substantially higher than those necessary to support buildings and

mortgages on a proper cost basis. The tenants sought to have the Court require the FHA to fix a proper rent schedule, and to compel the owners to apply their so-called "windfall profits" on the mortgages and to refund any excess rents collected to the tenants.

The Court entered into a thorough consideration of Section 608 and its legislative history. It concluded that the tenants had no right to the relief which they sought. More important for the building industry as a whole, the Court made certain observations which Congressional investigators have chosen to overlook in accusing certain builders in committee hearings and in the press.

The Court observed that Section 608 was intended to provide rental housing promptly and in volume to meet an emergency, and that it had had that result. The Court pointed out that everybody knew that this was quite liberal financing designed to meet an over all housing need. The Court attached a footnote to its opinion, which stated:

*"It is not without significance that Congress was fully aware that mortgage insurance commitments by the FHA on the basis of 'necessary current cost(s)' resulted in liberal financing which in turn yielded what subsequently was referred to as 'windfall profits.' Past experience has shown that 90 percent insured-financing on a cost basis, while successful in obtaining production of housing, was also more liberal financing than was justified except under the most extreme emergency conditions."*

**Idea:**

**HARDWOOD PLYWOOD  
DREAM CABINETS**

In the kitchen, no material is more exquisite—none is more appreciated by women—than incomparable, natural hardwood plywood. Here, kitchen cabinets can match the door—repeat the warm color and lovely grain patterns of hardwood plywood paneling in the dining area—or provide a new note of contrast.



**Here are "deluxe feature" ideas that Close the Sale!**

**Idea:**

**HARDWOOD PLYWOOD  
"ACCENT" WALL**

In the living area, a luxurious accent wall and matching built-in sideboard of eye-catching hardwood plywood with its soft tones and lovely grain, matches your selling-feature hardwood door and adds a glamorous custom-built look to the room. Or, for an even more dramatic effect, plan the entire room with attractive, lifetime hardwood plywood.



**Idea:**

**HARDWOOD PLYWOOD  
IN A MAN'S DEN**

In that den or study for the man-of-the-house, panel the walls in natural hardwood plywood. Divider desk and built-in matching hardwood plywood bookshelves add a sales-stimulating extra touch, too.



Watch prospect's eyes light up as they enter hardwood plywood paneled rooms. Watch them warm up to your selling story as you point out the maintenance-free advantages of hardwood plywood. What's more, with the many species available, you can achieve "deluxe-feature" effects which can be varied from one house to the next for sales-building individuality. Whether you choose birch, mahogany, walnut, oak, maple or gum... wherever you use it in your plan...hardwood plywood is convincing proof of quality construction to every prospect—definitely helps close the sale.



The HPI seal, advertised nationally to your prospects in top-circulation consumer magazines, identifies American mills operating under a rigid quality control program. It is your assurance of consistent quality, uniform grading, sales-appealing beauty.

**HARDWOOD PLYWOOD INSTITUTE**  
600 SOUTH MICHIGAN AVENUE, CHICAGO 5, ILLINOIS

Hardwood Plywood Institute, Dept. 14-J  
600 S. Michigan Avenue, Chicago 5, Ill.

Gentlemen: Please send, free of charge, your builder's guide to selection and use of Hardwood Plywood, "A Treasury of Hardwood Plywood."

NAME \_\_\_\_\_

ADDRESS \_\_\_\_\_

CITY \_\_\_\_\_ ZONE \_\_\_\_\_ STATE \_\_\_\_\_



# Your last quarter's sales can top them all!

**In 1954, these popular, fast-selling Christmas figures helped hundreds of builders and dealers to boost their slow season into an all-time high for that period.**

We know a word to the wise is sufficient—in your case. The popularity of these indoor and outdoor figures keeps on growing.

You sell finished figures—or unpainted figures (together with painting pattern and the paints). You can make these for yourself—or buy them from us. To the real do-it-yourselfer—you sell an Easi-Bild® Pattern and the materials and paints.

From a full-size pattern, the outline is simply traced onto 2 1/2" Homasote Type RD and cut out with a saw. The pattern is simple and foolproof—specifies all the materials, including the painting scheme.

You have here a three-way opportunity to make the last quarter of the year the biggest it's ever been.

*Extensive advertising* will support your sales effort. Beginning in September issues, you will see advertisements on these Christmas Figures in Better Homes & Gardens, Sunset, Living For Young Homemakers, Popular Mechanics, Popular Science, Mechanix Illustrated, Science & Mechanics, The Home Craftsman, Family Handyman and Homecraft-Home Owner.

Every advertisement is couponed; every inquiry in your territory comes to you. Every inquirer from your territory gets your name.

Get ready to cash in on this dependable profit-making opportunity by writing us today. Kindly address your inquiry to Department K-10.

\*T.M. Reg. Easi-Bild Pattern Company



## HOMASOTE COMPANY

TRENTON 3, NEW JERSEY



AMERICAN  
**BUILDER**

**Metal casing beads**

**are easy to use,**

**fit every style**

Metal casing beads offer definite advantages to the builder on every type of residential and commercial building. From the aesthetic standpoint they fit well into almost any type of architecture and add a neat and uncluttered appearance to door and window openings.

On the practical side, metal casings offer an economical method for "trimming-out" the standard opening since their application normally requires less labor than the various other casing methods available. The painting labor, too, is reduced for the metal edge is usually finished the same as the wall, thereby doing away with the cutting-in process.

The facing page shows the use of metal casing beads for plaster construction. Since these are applied prior to the plaster finish, they also act as screeds, and eliminate that portion of the work.

The profiles at the top of this plate show the various casing beads available, according to the Metal Lath Manufacturers Association. Some slight design variation may occur among different manufacturers, but essentially all casing beads do the same job, are applied the same way.

Being of 24-gage metal, they are easily cut with snips or hack-saw, and are anchored to the buck with common nails. Intersecting corners may be mitered for top appearance.

The second detail page shows the metal casing beads available for dry-wall construction. Like the trim described above, various profiles are available to fit job conditions. Application is like that of plaster casings; ordinary tools are used.

*Renew your subscription TODAY!*

AMERICAN BUILDER

# Technical Guide

## METAL CASING FOR DRYWALL CONSTRUCTION

Metal casings are made in sizes for  $\frac{3}{8}$ ",  $\frac{1}{2}$ " and  $\frac{5}{8}$ " boards

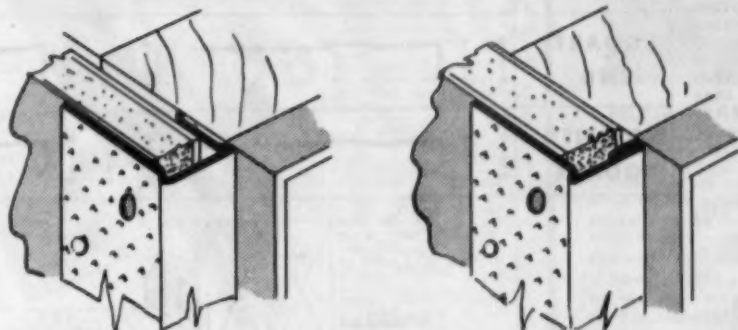

Two types of square edge metal casings which are used to finish edge of wallboard at door jamb or window. Corners are butted and casing is nailed through board into stud. Knurled side affords good spackle adhesion.

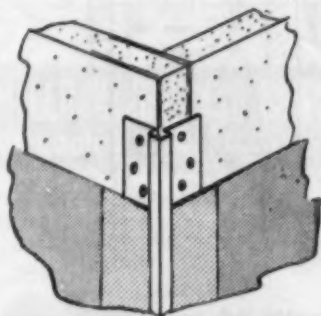

Corner guard for protection to exterior corners applied directly over wallboard and nailed through flange. Nose is undercut to provide grip for spackle finish.

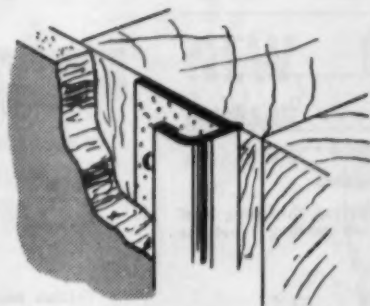

Round or square edge casings are nailed in place before board is applied. Corners are mitered. Inclined plane creates tension that draws board snugly into position.



SQUARE EDGE

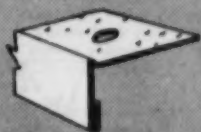

SQUARE EDGE

Lengths -- 7', 10', 12'



CORNER GUARD

Lengths -- 6'-8" and 8'-0"



ROUND EDGE



SQUARE EDGE

Lengths -- 7', 10', 12'

### DETAILS

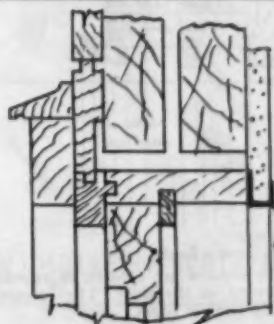

Wood Windows

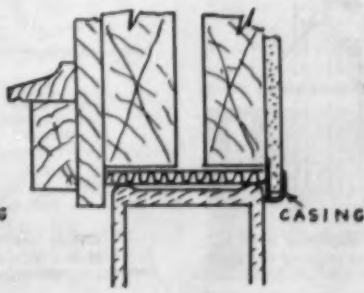

Glass Blocks

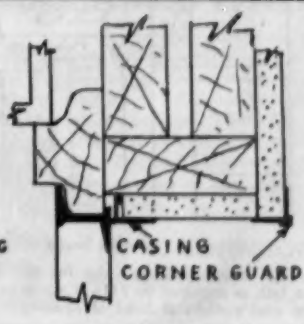

Metal Casements

**CASING BEADS**

Casing beads of different manufacturers may vary slightly, but the illustrations and dimensions shown here are typical and represent Simplified Practice Recommendation 3-52 promulgated by the U.S. Department of Commerce. They are fabricated from not less than 24 gage galvanized steel and are generally available in lengths of 7 and 10 feet.

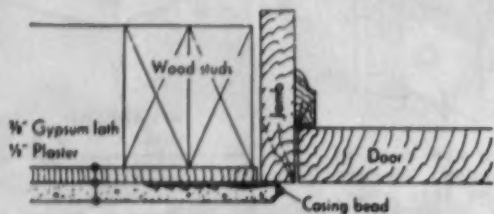
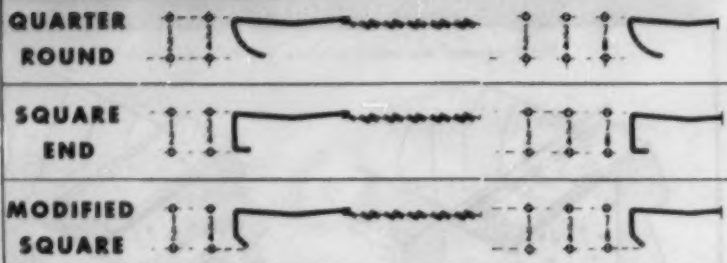

Here, 1/2" casing bead is used over the face of gypsum lath. If gypsum lath laps the bead, a 3/4" depth (with short flange) is used. With metal lath the depth is 1/4".

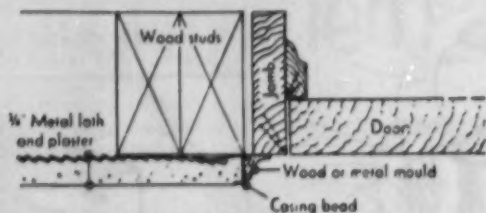

If the door frame is erected after plastering, the casing bead is installed flush with the buck. A small molding closes the joint between buck and frame.

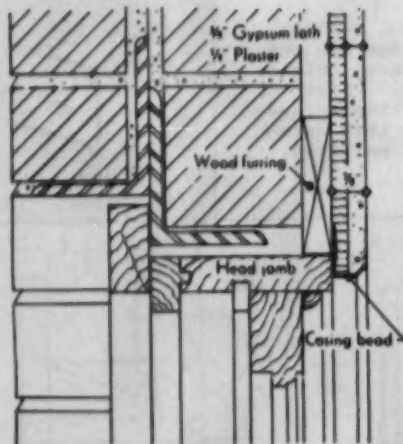

Jamb is Similar

This 1/2" casing bead provides for 1/2" of plaster over 3/4" gypsum lath as required by FHA. Casings are mitered or coped to form neat corners at head of opening.

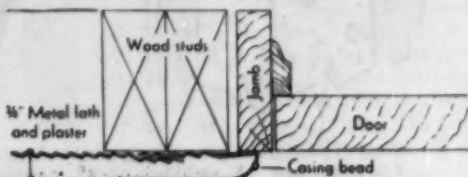

In this detail, the casing bead laps the door frame. Nailing flanges of casing beads have a slight bend to give a spring-tight fit against the frame when nailed in place.

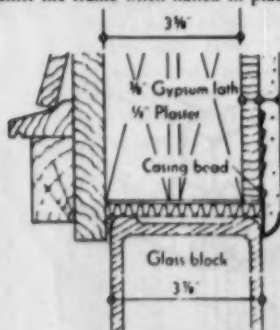

Jamb is Similar

Glass blocks are wider than wood studs, requiring a 1/2" casing bead to be placed over the gypsum lath. Expanded flange on bead reinforces the plaster.

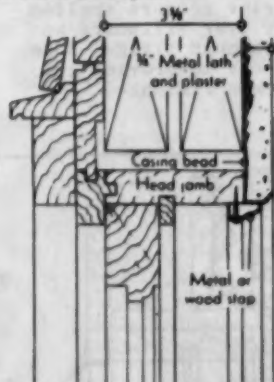

Jamb is Similar

Casing beads around a window are modern in appearance, and not subject to warping or shrinkage. They assure full plaster thickness and sharp straight edges.



## The ONLY Complete Disappearing Stairway Line

Build More Saleable Area into Homes with BESSLER

### Disappearing Stairways



**FREE New Catalog and Wall Chart**  
Illustrates and describes complete line of seven Bessler Disappearing Stairway Models to meet all your needs. This new catalog material should be in your hands for ready reference—write now!

1. The ORIGINAL disappearing stairway—made for over 40 years.
2. A real stairway—not a ladder.
3. Seven well-engineered models—for every need.
4. Safety-designed in every detail for your protection.
5. Suitable for the finest homes—old and new.
6. Operates from above and below.
7. Full width treads—SAFE for everyone.
8. ALL steps are of equal height.
9. Treads and stringers are made of Sitka Spruce.
10. Full door width provides ample access for large objects.
11. Full length SAFE hand rail.
12. Accurate architectural design assures easy and SAFE ascending and descending.
13. All metal parts are made of strong, SAFE pressed steel.
14. Repairs always available on quick notice for all models—no "orphans."
15. Doors made of White Pine and Fir in two-panel and flush types; hardwood doors in flush type only.
16. Tailor-made for all heights—no short or long steps.
17. Hundreds of thousands in daily use.
18. IMMEDIATE DELIVERY!
19. Meets all building codes.

**THE BESSLER DISAPPEARING STAIRWAY CO.**

1900-A East Market Street, Akron 5, Ohio

## MULLER MIXERS AND POWER TROWELS set quality standards in their fields

Muller's objective—the best contractors equipment for the lowest price—is achieved by: (1) specialization, (2) careful selection of materials, (3) experienced workmanship, (4) sound distribution methods.



**PLASTER and MORTAR MIXERS**  
Five sizes, 2 to 10 cu. ft. Electric or gasoline. Muller Lifetime Paddle Shaft Seal. Power throwouts on smaller models, disc clutch on larger. Rubber scraper blades optional. \$180 to \$99½ FOB Factory.



**CONCRETE MIXERS**  
3 models, 3 to 6 cu. ft., tilting type. Ample drums, fast mixing action Timken Bearings, electrically welded construction. Electric or gasoline. \$230 to \$660 FOB Factory.



**POWER TROWELS**  
Sizes 24", 29", 34" and 44" dia., B&S Engines. Stationary guide ring. Clutch and speed controls on handle.

Send for information and name of local dealer.



**MULLER MACHINERY COMPANY, Inc.**  
WETUCHEN 4, N. J. CABLE ADDRESS—MULMIX

## — ATTENTION — LUMBER DEALERS and CONTRACTORS



### NOW MAKE YOUR OWN PREFITTED DOOR UNITS INEXPENSIVELY!

Now you can make prefitting door units in your own mill or on the job by using this Z & K Master Door Jig.\* It comes pre-set and the first unit will be perfect even with unskilled help. One man can fit and hang 50 and more units in one day using floor space of only 3' x 7'.

Many leading contractors and lumber dealers in the country are using the Z & K Master Door Jig which is bringing them unbelievable profits. Increase your profits today—send for descriptive bulletin and list of users.

SEE US AT THE RETAIL LUMBER DEALERS CONVENTION,  
CLEVELAND, OHIO, OCT. 11TH TO 14TH.

### Z & K TOOL COMPANY

Prefitted Door Mfg. Equipment  
407 Sand Hill Road, Lebanon, Pa.

\*Covered by Pat. & Pat. Pending.

## NEW JOHNSON Model 53

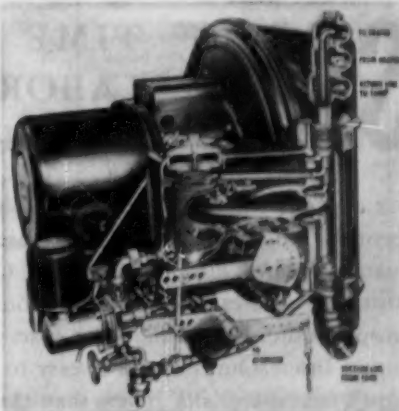

For

### SURER, SMOOTHER "COLD STARTS" BETTER ALL-AROUND EFFICIENCY

This amazing new Johnson 53 virtually eliminates the problem of "Cold Starts" and varying Oil Viscosities. It's a masterpiece of advanced oil heat engineering. Metering Pump Control Quadrant provides calibrated reading of oil being burned. Make it a point to find out what it can do for you. There are 8 sizes from 25HP to 500HP with either Direct or Belt Drive. Combination Oil and Gas Models may be had. May we send you full details?



**S. T. JOHNSON CO.**  
940 ARLINGTON AVE., OAKLAND 8, CAL.  
CHURCH ROAD, BRIDGEPORT, PA.



**2000**  
**Square Feet**  
 of WOOD SECTIONAL OVERHEAD  
 Door Satisfaction

SEE OUR  
 CATALOG IN  
 SWEETS

**RAYNOR**  
 MFG. CO.  
 DIXON, ILLINOIS

It's not due to the size of these particular doors that we bring them to your attention — it is due to the fact that here you see a typical example of the beauty and outstanding performance that has established Raynor as a dependable source of genuine and lasting Wood Sectional Overhead Door quality. No matter how large the opening, when you install a Raynor door you enjoy the advantage and satisfaction of knowing that the door is designed and built to fit the opening.

Check your telephone directory or write direct for the name of your nearest Raynor representative.

BUILDERS OF A COMPLETE LINE OF WOOD SECTIONAL OVERHEAD DOORS

# SAVE TIME LABOR MATERIALS

Our customers tell us they save up to four dollars per window opening using Hope's Residence Casements in Hope's Combination Inside-Outside metal trim. Our Inside-Outside trim entirely eliminates costly window stools, aprons, corner beads, outside mouldings and the labor costs of fitting all these items. Hope's Inside-Outside trim is easy to assemble and attach to Hope's steel casements. In less than 15 minutes the entire assembly can be completely installed in a rough opening in any type of construction...wood frame, brick veneer, masonry block... all that's left to do is run wallboard or plaster up to the trim on the inside and clapboards, shingles or brick to the trim on the outside. See Sweet's Files for additional details or write for our folder No. 132AB.



**HOPE'S**  
 JAMESTOWN, N. Y.

Since  
 1818

**INSIDE-OUTSIDE  
 METAL TRIM**

STEEL WINDOWS HAVE THE STRENGTH AND RIGIDITY THAT NO OTHER WINDOW CAN MATCH



## Every Room More Attractive, Every House More Salable... when you build with AMWELD®

Designed to decorator standards AMWELD steel doors and frames compliment contemporary and traditional decor. Whether the home you are building is large or small, expensive or modest, AMWELD doors and frames will enhance its appearance — and sales appeal. Installation is quick, easy and inexpensive — and AMWELD doors retain their handsome appearance year in, year out without maintenance.

Where low cost, attractive appearance and durability are important be sure to specify AMWELD Steel Doors and Frames, and Sliding Closet Units.

**THE AMERICAN WELDING & MANUFACTURING CO.**  
310 DIETZ ROAD • WARREN, OHIO



### "Amweld is a Plus Feature"

"Equipped with steel doors and frames, is one of our strongest sales arguments", says a Southern contractor and developer. "Amweld is something we are proud to talk about".



Send for "Cut Construction Costs" Folder—Complete information about Amweld Building Products—fully illustrated.



### NO DRILLING—MORTISING OR FITTING



With Amweld Inter-Lok Frames and Flush Steel Doors one man can finish a door opening in 10 minutes. Hammer and screwdriver are only tools needed.

### NO STICKING, WARPING OR SPLITTING



Sturdy steel construction guarantees doors that will last for years—never any maintenance required.

### SOUND-DEADENED FOR QUIET CLOSING



Interior of Amweld Flush Doors are coated with a special fire, heat, mildew, and vermin resistant, sound-deadening material which gives them the feel and sound of a solid door.

### EASY TO HANDLE ON JOB



Amweld "KD" Sliding Closets come knocked down. All hardware furnished—shipped complete in single carton.

### NEW 1 3/4" INTERIOR FRAME

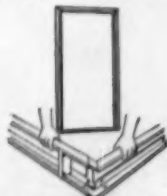

Easy to install Inter-Lok frames now available for both 1 3/4" and 1 3/8" flush doors. All standard sizes.



Her Bathroom in Beautyware Sea Green....His in Beautyware Sandstone

## Two Bathrooms of BRIGGS BEAUTYWARE - New Pattern for Today's Living



There is a new pattern for family living in America — more children, better health and hygiene, more personal grooming, greater luxury and convenience. All these add up to the need for *two bathrooms*.

Home designs can be made more desirable and livable with two bathrooms. Home sales can be made much more readily. And installation is so fast, easy and economical with modern, *engineered* fixtures.

Exceptionally pleasing pastel colors, surfaces hard as glass, exclusive safety and utility features, trouble-free fittings, time-saving installation, realistic prices — these are only a few of the many reasons why Briggs Beautyware is first choice for an ever increasing number of two-bathroom homes.

## TWO BATHROOMS—COLONIAL STYLE



Tropical Coral

Today's living has created the need for two bathrooms, and Beautyware fixtures have made this plan practical in every home. In a colonial residence, you may prefer a bathroom on both floors. You can have them in your choice of five rich, glistening Beautyware colors, or white—in a wide variety of modern contour-styled models—and for much less cost than you may think.

## TWO BATHROOMS—RANCH STYLE

For your ranch home, you can have two widely separated bathrooms—each a blend of luxury and utility. For example, Beautyware surfaces are *hard as glass*, stain resistant, and so easy to keep clean. Beautyware tubs have an exclusive safety bottom. Closets are whisper-quiet. Lavatories are deep-contoured, handsome. In every detail, Beautyware fixtures are smart, durable and practical.

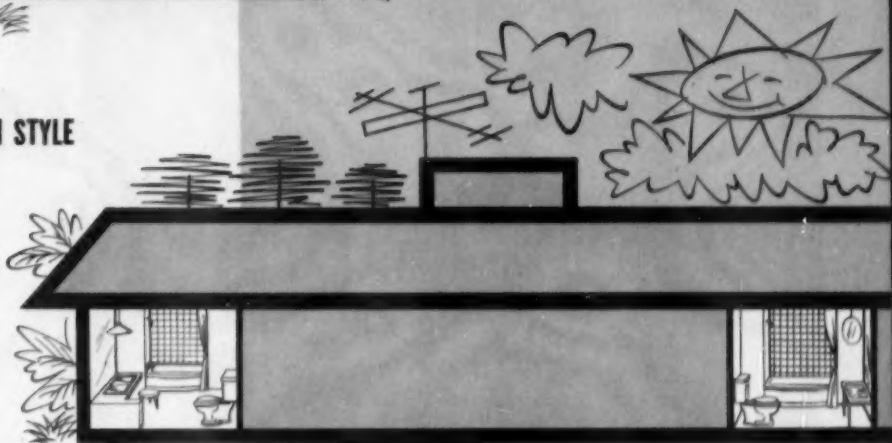

Sky Blue

## TWO BATHROOMS—CONTEMPORARY STYLE



Pearl Gray

In a contemporary dwelling, you may prefer a split level floor plan with two adjacent Briggs Beautyware bathrooms. Like all Beautyware two-bathroom plans, this is extremely practical, for Beautyware's matchless quality actually costs less. Better homes everywhere are featuring the practical luxury and convenience of two Beautyware bathrooms for today's modern living.

**SPECIFY BEAUTYWARE—TWICE;** a product of BRIGGS Manufacturing Company, Detroit 26, Michigan

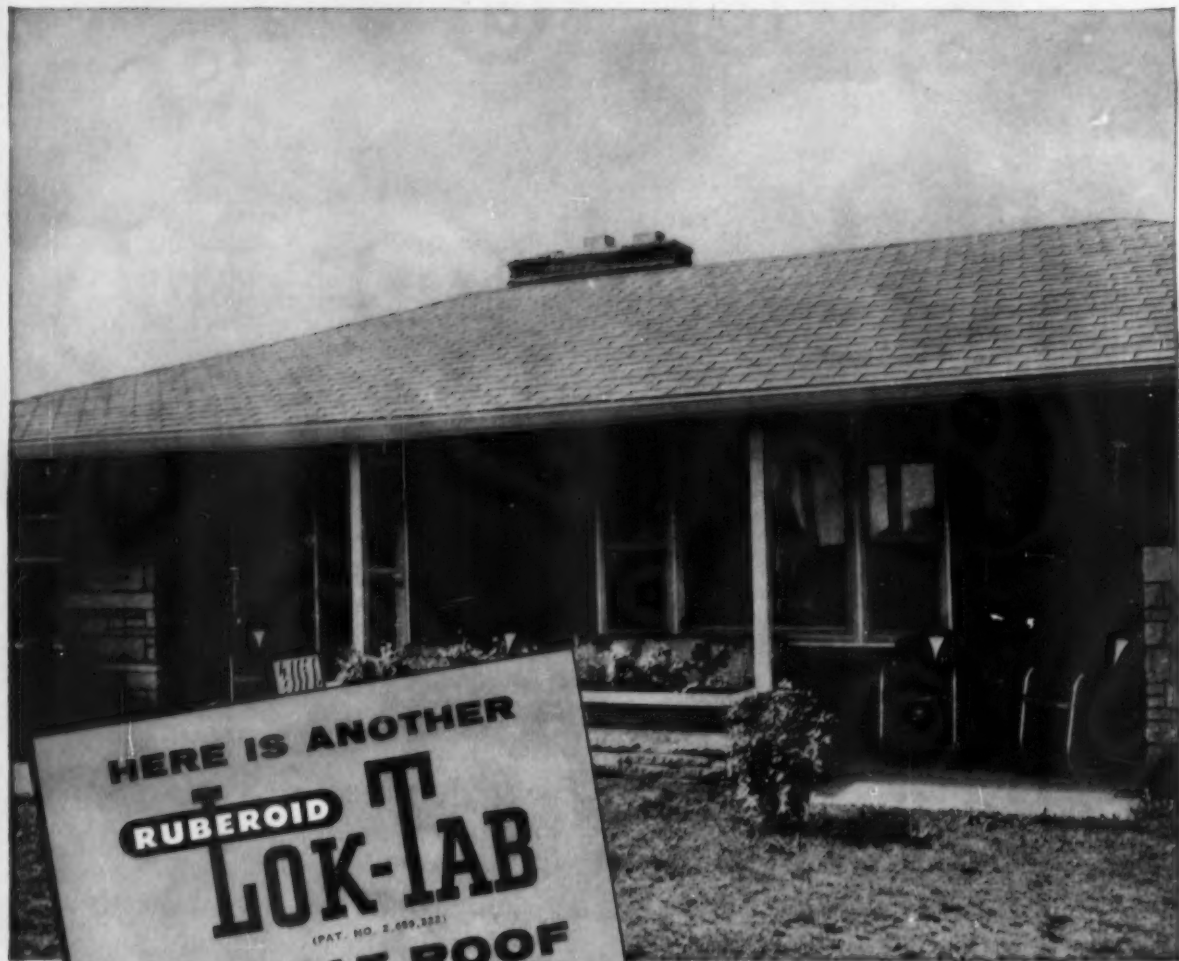

## SMART SIGN LANGUAGE FOR BUILDERS

More often than not, the difference between this sign **MODEL HOME** and this **SOLD** is the sales appeal of the building materials used in the house. Builders with sales on their minds specify Ruberoid's revolutionary new Lok-Tab asphalt shingles for the roofs of better new homes everywhere.

Lok-Tabs' features add important extra sales value to new homes. First, they offer a whole

new conception in roof beauty: New decorator colors, modern, random-spaced, straight-line texture and built-in shadowlines. Second, there's the locking tab at the center of each butt to make them wind-safe. Lok-Tabs' exciting new beauty *plus* their exclusive wind safety is a combination that can't be beat for sales value.

See your Ruberoid dealer today and prove to yourself why a Lok-Tab roof is an important sign of a *better* new home.

The **RUBEROID** Co.

**ASPHALT AND ASBESTOS  
BUILDING MATERIALS**

## ask the EXPERTS about

- Planning
- Concrete Work
- Framing
- Roofing
- Heating and Plumbing
- Air Conditioning
- Wiring
- Insulation
- Interior Finish
- Power Equipment

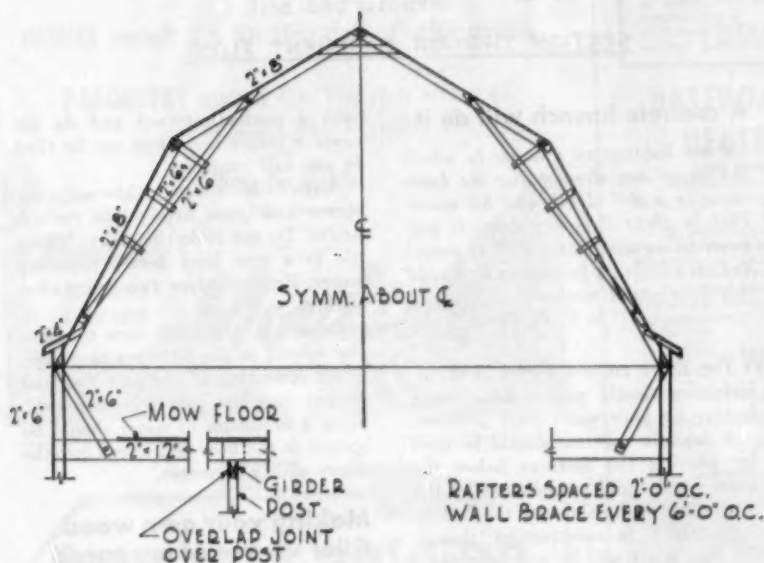

### Making the barn roof safe

We have a haymow job which requires a gothic type arch for a 50'0" span. This will be built on top of an 8'0" high concrete wall. Would 2x6 studs 24 inches o.c. be satisfactory? We intend to use car siding applied vertically. Could you suggest an end framing detail?

The drawing shown above is self explanatory.

This design has been investigated for conditions of loading:

1. Wind blowing at an angle of 90 degrees to the side wall with a velocity of 70 mph.
2. Wind of same velocity blowing against the end of the barn.
3. Hay track load of 1000# at the peak of the roof.

### Facts about the strength of mortars

Am I correct in assuming that a mortar made of 1 part lime, 2 parts cement, 9 parts sand is stronger and

harder than a mortar made of 3 parts lime, 2 parts cement, and 15 parts sand? If a mortar is made 3 parts sand, 1 part cement, and the lime content is varied from 10 per cent to 60 per cent, does the strength become less in the same proportion?

L. A. R., Woodburn, Ore.

You are correct in thinking that a mortar mixed in the proportions of 2 cement, 1 lime and 9 sand (by volume) will have a greater compressive strength than a mortar composed of 2 cement, 3 lime and 15 sand. Also, all other things being equal, increasing the lime content will result in decreasing compressive strengths, although not necessarily in the same proportions.

The compressive strength of a mortar, per se, is not too important except as it is a measure of durability and tensile bond strength. Even the lowest strength mortars used today provide more than ample

masonry compressive strength to handle the compressive loads customarily placed on such construction.

However, for resistance to weathering and for the development of higher tensile bond strengths, the higher strength mortars are required. The 2:1:9 mortar you mention is the same as the Type A-2 mortar found in American Society for Testing Materials Specifications for Mortar for Unit Masonry (C270-54T). In these specifications, the proportions are 1 part portland cement, 1/2 part hydrated lime and 4 1/2 parts sand. This is the mortar that is used widely in the earthquake areas of California because it does develop higher tensile bond strengths and, consequently, masonry walls with greater resistance to lateral forces.

In C270-54T, Type A-8 mortar is required to have a 28-day compressive strength (cubes) of 1,800 psi. Your second type of mortar (2:3:15) would fall in Type C of these specifications and the compressive strength requirement for that type of mortar is only 350 psi.

Structural Clay Products  
Research Foundation

### Good source of building information

Are there books to be obtained that give basic rules on accepted building practices?

P. P., Riverhead, N. Y.

This kind of information can be found in Don Graf's Data Sheets, published by the Reinhold Publishing Corp., 330 West 42nd St., N. Y., or Time Saver Standards, by the F. W. Dodge Corp., New York.

# IN-A-SLIDE

Superior  
frame  
structure

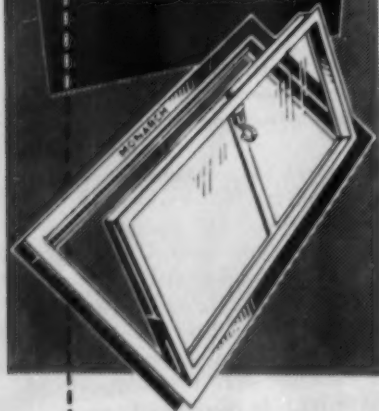

makes for easy  
basement window  
**SALES**

**New Monarch In-A-Slides Sell Themselves with These Quality Features:**

1. Made of heavy gauge steel, press formed, with reinforced corners.
2. Bonderized after fabrication and dip painted in baking enamel.
3. Sash easily removed and interchangeable, for off-site glazing.
4. Double weather protected against rain, snow, dust, etc.
5. Uniform bottom channel permitting window to stand by itself during installation.
6. Opens to 60 degree angle, assuring full ventilation.
7. May be built into units of from 2 to 6 windows, using Monarch Mullions.
8. Screens and storm sash to match.



**SOLD THROUGH DEALERS ONLY**

When you think of Basement Windows, think of  
**NEW MONARCH MACHINE & STAMPING COMPANY**  
816 S. W. NINTH STREET DES MOINES 9, IOWA

## ask the EXPERTS

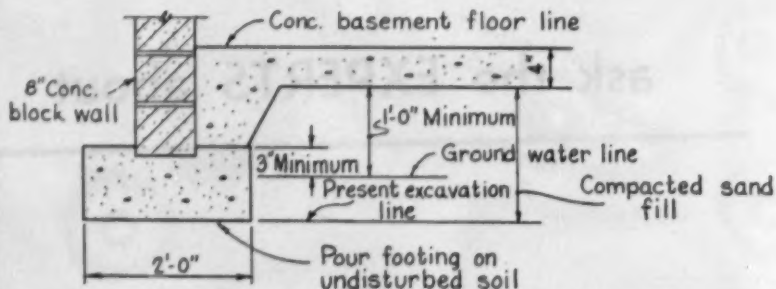

SECTION THROUGH BASEMENT FLOOR

### A concrete haunch will do it

*I am bidding on a house in which the owner has already dug the basement to a 6'0" depth and hit water. This is about 8 inches deep. It will mean filling with about 2'0" of gravel and then laying a footing on it. Would this be a sound method?*

D. V. F., Butte, Nebr.

The above method shown in the illustration should give a satisfactory footing for your water level problem.

A dry mix concrete should be used for pouring the footings below the water level. Build up a haunch at the connection of the slab and the footing for water tight construction, though the floor itself will be soil bearing.

### Setting ceramic tile in mastic

*I am planning on laying a ceramic tile floor over 1x6 inch rough flooring on 2x10 inch joists 16 inches o.c. Maximum span is 9'0".*

*My idea is to lay 5/8 inch water resistant plywood over the rough floor, and then set the tile in mastic. Is this considered sound practice?*

F. L. M., Chillum, Maryland

Authorities recognize the use of adhesives as good practice for installing tile floors.

The surfaces must be checked for firmness, and should be level and true. The base surface for tile should be not less than 5/8 inch exterior grade plywood nailed every 6 inches to joists. Allow 1/16 inch for expansion. The surface must be dry before the adhesives are applied. Always be governed by the instructions of the tile manufacturer in the selection of the adhesives.

In setting the tile floor use the floating method. Spread the adhesive

with a sawtooth trowel and do not cover a larger area than can be tiled in one half hour.

Align tile sheets with adjacent sheets and press firmly into the adhesive. Do not slide the sheets. Bring tile to a true level before removing paper. Remove paper two hours after setting.

Overnight is enough time to allow the solvent in the adhesive to escape. Grout consisting of one part Portland cement and one part screened sand, using a minimum of water should be spread on the floor and forced into the joints with a squeegee.

### Making your own wood filler vs. use of prepared types

*I recently finished some floors for a local contractor and I was told to save the dust from the last sanding and to mix varnish with it to use as a filler. Do you think that this would be as satisfactory as commercial filler?*

F. R. S., Center, Mo.

The procedure of mixing the dust from your final sanding with varnish for use as a filler has been used for some time by some of the "old timers." The modern products available today in the form of paste, wood fillers and similar filler-sealers are far less troublesome to prepare and at the same time easier to use. In fact, with the development of newer and better varnishes involving the use of many types of synthetic resins, there is the possibility that you might not achieve the desired results. This of course would have to be tested.

Devco & Reynolds Co., Inc.



Fine flooring for every installation

# MOULTILE

**MOULTILE** asphalt tile.  
Reinforced with plastic.

**MOULFLEX** vinyl plastic tile. In low cost  
standard gauge.

**JUBILEE** asphalt tile. Striking dots of color styling.

**PARQUETRY** asphalt tile. The rich effect of  
wood block at low cost.

Write for details

Dept. M5-10

**Moultile**  
FLOORING  
SINCE 1929

**Moultile** INC.

Chicago, Ill. • Long Beach, Calif. • Newburgh, N. Y.

R 20

## free tool catalog

for the trowel trades

Lists 1,056 different tools used by bricklayers, stone masons, plasterers, tilesetters, lathers, dry wall applicators, cement finishers, and contractors. Fully illustrated. 1955 edition. Detailed descriptions of many tools not available anywhere else. Almost everyone in the building industry needs this book. Write for your Free Copy today.

**Goldblatt Tool Co., Dept. X-10**  
1912 Walnut, Kansas City 8, Mo.



## BALANCE-SEAL

(Patented and pat. pending)  
UNIT FOR DOUBLE HUNG WINDOWS

**DOES FOUR JOBS**

- 1 SASH BALANCE
- 2 WEATHER SEAL
- 3 PARTING STRIP
- 4 INSIDE STOP (Optional)

**NO GROOVING REQUIRED  
SAVES LABOR**

NEAT APPEARANCE—No tubes in runways  
SASH BALANCE is concealed  
DOUBLE WEATHER SEAL on each stile  
FLEXIBLE FLANGES prevent binding  
FOR STANDARD OR SIMPLIFIED FRAMES  
Send for details

**BALANCE-SEAL CO.**  
312 W. LAKESIDE ST. MADISON 5, WIS.  
Send details and prices of Balance-Seal units.  
NAME \_\_\_\_\_  
STREET \_\_\_\_\_  
CITY \_\_\_\_\_ STATE \_\_\_\_\_

OCTOBER 1955

## ELECTROMODE

WORLD'S MOST COMPLETE LINE

ALL-ELECTRIC HEATERS

ELECTRIC  
HEATING SYSTEMS



100%  
SAFE

Only ELECTROMODE has the sealed-in CAST-ALUMINUM HEATING ELEMENT. No danger of fire, shock or burn. Guaranteed for 3 years. Built-in safety switch prevents overheating. Approved by Underwriters' Laboratories.

For More Than a Quarter Century Electromode Has Specialized in One Specific Industry

HEATING BY  
ELECTRICITY

### BASEBOARD HEATER

LOW LEVEL  
PERIMETER HEAT

Basic Unit: 32" long, 8 1/2" high, 3" wide. 600 watts, 120 or 240 volts. Blank sections, endpieces and corners available so that a completely harmonious, unbroken baseboard effect may be carried out in any size room. Separate thermostat for each room.



### WALL-TYPE HEATERS

- Capacities for All Size Rooms
- Fan-Circulated Heat
- Modern Designs
- Fast, Easy To Install
- Automatic Control
- Satisfied Users

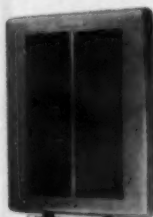

**For BIG ROOMS**  
MODEL WA

Distributes Heat by Down-Flo Principle. Silver Grey Hammerstone Finish



**For BATHROOMS**  
MODEL WJA

Choice of Chrome or White Enamel Finish

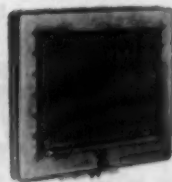

**RADIANT PANEL  
HEATER**  
MODEL RC-11A

Combines principles of radiant and convection heating. No glass or ceramics to break. Silver grey hammerstone finish.

### CEILING RADIANT CABLE HEAT

Electromode Heating Cable installed in ceiling radiates clean, sunlike heat downwards. Has Magic Seal coating which prevents streaks on ceiling when cable is embedded in plaster. Automatic temperature control by separate thermostat for each room.



Diagram showing sectional view of cable before plastering illustrates how Electromode Ceiling Radiant Heat warms floors and everything in room.

**ELECTROMODE CORPORATION, Dept. AB-105**  
45 CROUCH STREET, ROCHESTER 3, N. Y.

Please send free literature with specifications, illustrations, and how to figure and install Electromode Heaters and Heating Systems.

Name \_\_\_\_\_

Address \_\_\_\_\_

City \_\_\_\_\_ Zone \_\_\_\_\_ State \_\_\_\_\_

261

**NEW**

**EXCLUSIVE**

**DIFFERENT**

**7  
Sectional  
All Steel**

**SEVEN  
WON-DOR®**



**Overhead GARAGE DOOR  
for LESS THAN THE AVERAGE 1pc. DOOR!**

Seven WON-DOR, the most amazingly low price residential garage door on the market today.

Completely NEW in design, Seven WON-DOR requires less headroom, is completely bonderized, and its 16 rollers assures trouble-free, finger-tip operation. The unique 7 section features an interlocking arrangement, parallel-seal adjustable track and sturdy weather-proof construction - giving a perfect AIR-TIGHT, DRAFT-FREE installation.

The all steel Seven WON-DOR is by far the greatest advance in the garage door field.



**Windsor DOOR CO., INC.**

2284 JERICHO TURNPIKE • GARDEN CITY PK. N.Y.  
Pioneer 6-2565 • Pioneer 6-7090

**FREE!**

Write for additional information & literature on how you can cash-in on America's lowest price, all steel, seven sectional door.

**NEWSPAPER MATS — DEALER AIDS**

**Now!**

**NEW AIR-JET**

**"BRICK BEAUTY"**

Why bother to build a chimney? Now you can enjoy all the time and money-saving advantages of an Air-Jet packaged unit . . . and, at the same time, increase the value of your homes with a chimney that looks just like brick!

The new "Brick Beauty" is made of embossed aluminum, finished in brick red color with depressed off-white mortar lines. Weighs less than 100 lbs.! Can be installed in one man-hour! And look at these quality features.

Shockproof, high temperature porcelain steel smoke pipe. Special draft top guards against downdrafts. Exclusive rain groove eliminates all leakage. UL approved for use with all fuels. You can take your choice of 2 models in 3 different smoke pipe sizes.



**WRITE TODAY**  
for complete information!  
A few distributorships available.  
**GENERAL PRODUCTS  
COMPANY, INCORPORATED**  
DEPT. A-10  
FREDERICKSBURG, VIRGINIA

• A PACKAGED  
CHIMNEY  
WITH  
AUTHENTIC  
BRICK  
LOOK

**Homes Wired for Tomorrow . . .  
. . . are 'Wired for TV' with**

**mosley television lead-in  
wall plate sockets**

COLOR Television demands a good outside antenna installation!

Modern homes are ready for this modern home need when they are equipped with MOSLEY AC/TV Wall Plate Sockets that permit plug-in connection of TV set to antenna at any one of several different locations.

MOSLEY Wall Plate Sockets are low in cost - easy to install to meet requirements of electrical code. They are TV Engineered for efficient performance and styled to harmonize with existing electrical wall plates.

Your clients will want their homes **Wired For Tomorrow . . . Wired For TV** with MOSLEY TV Wall Plate Sockets!

MOSLEY TV Wiring Devices are available coast-to-coast. Write for name of nearest supplier.

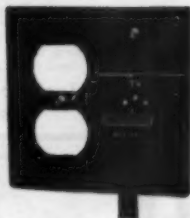

**Type AC-1PK. List Price \$1.87**

Single TV socket for one antenna lead-in plus matching wall plate for double convenience outlet. Complete with TV Plug, plated machine screws, metal barrier for separating AC and TV services and full instructions. Less box and AC socket. In brown or ivory.

Other types available for multiple lead-in lines and combination lead-in and rotor cable.



**Mosley Electronics Inc.**

6225 ST. CHARLES ROCK ROAD, ST. LOUIS 14, MISSOURI

## ask the EXPERTS

### Making the door shockproof

*An office in which the floor is carpeted has a metal partition. An electric shock is received whenever the door is opened. What can be done?*

*C. H., Newark, N. J.*

Would suggest that the metal door knobs be replaced with plastic or glass knobs. These are shockproof and would eliminate much of the difficulty if reasonable care is used.

### He does not want canvas

*What is the most satisfactory covering to put on an uncovered deck with a wood subfloor, other than canvas?*

*G. V. McC., Corning, N. Y.*

A metal deck with lock-seamed joints is a good substitute for canvas. The use of good edge grained D. & M. flooring is an acceptable alternate for either of the above materials. This should be treated with a good water repellent twice a year.

### Roof surface must be durable

*I am building a sun deck on top of a new porch and I would like to install a roof surface that can be walked on. What is your recommendation?*

*I. D. W., Shenandoah, Iowa*

An all weather anti-slip deck floor manufactured by the Armstrong Cork Co., Lancaster, Pa., that can be used in connection with wood, concrete, aluminum or steel. This material is referred to as D.C. 115-B. A heavy deck canvas well painted is also a good surface to use.

### Cleaning stone surfaces

*How do you clean Indiana Limestone on a fireplace wall so it can recover its original light grey color? This discoloration is due to smoke.*

*M. L. E., Columbia, Mo.*

The most effective way to clean small interior areas of Indiana Limestone is by using a good non-resinous soap powder and a stiff fibre brush. Rub vigorously and then rinse with clear water.

### Very annoying squeak

*Every time I go to my church I am greatly annoyed by the squeak of the*

OCTOBER 1955

## KOHLER Electric Plants for on-the-job power that saves time and expense



MODEL 1.5M23, 1500 watts,  
115 volt A.C. Manual starting.  
Weight 130 pounds.  
Also 115 volt D.C. weighing 101 pounds.

Kohler Co., Kohler, Wisconsin  
Established 1873



A portable Kohler Electric Plant provides low-cost electricity anywhere, any time—eliminates cost, bother and delays of temporary power line hook-ups. Operates saws, drills, planers, grinders, plumbers' pipe threaders and cutters, other power tools. Engineered throughout by Kohler. Two-wheel, rubber-tired hand truck available. Kohler sole supply models range in size from 500 watts to 35 KW. Write for folder C-10.

## KOHLER OF KOHLER

PLUMBING FIXTURES • HEATING EQUIPMENT • ELECTRIC PLANTS  
AIR-COOLED ENGINES • PRECISION CONTROLS

## Whatever the job — there is a strong, economical and durable WOOD ROOF TRUSS for it.



**CLEAR SPAN WOOD ROOF TRUSSES**, built with TECO Wedge-Fit connectors, provide the ready answer — whether the job calls for small span trussed rafters or free span 250-foot trusses.

**Free** booklet, describing the major types of wood roof trusses and their uses, will help you select the right truss for the job.

Whether you are building in "Hurricane Alley" or not, TECO Trip-L-Grip framing anchors will tie those roofs down more securely.

**TIMBER ENGINEERING COMPANY**  
1319 - 18th Street, N.W., Washington 6, D. C.

AB-556

Please send FREE booklet, "Clear Span Wood Roof Trusses," and information on tying down roofs with TECO Trip-L-Grip framing anchors.

NAME.....  
FIRM.....  
ADDRESS.....  
CITY, ZONE, STATE.....

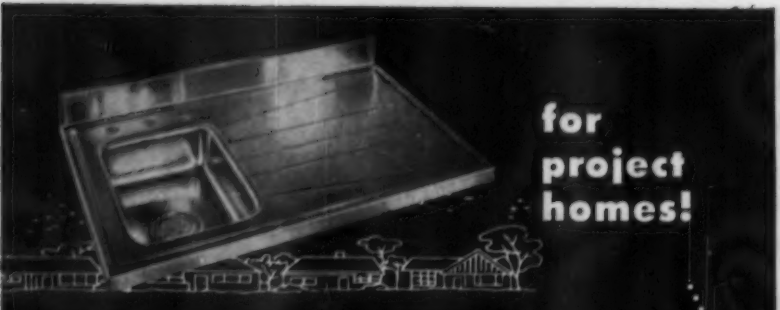

for  
project  
homes!



for  
apart-  
ments!



for  
economy  
remodeling!

**Pacemaker**  
by **ELKAY**

**STAINLESS  
STEEL  
SINKS**

**a new name \* a new price  
costs no more than cast iron!**

So that you, the builder, can now offer "wanted" stainless steel in all your jobs, ELKAY has introduced Pacemaker stainless steel tops and bowls. This new, low priced line is ideal for project building, apartments and remodeling—for all budget kitchens. And, it costs no more than cast iron! The public wants stainless steel so they can forget sink replacement—forget chipped and worn porcelain. You can give them Pacemaker—the "eye-catcher" in your house-selling kitchens. Write, now, for complete information.

\* Backed By An Established Reputation

**ELKAY MANUFACTURING COMPANY**

1874 S. 54th Ave., Chicago 50, Illinois

The World's Oldest and Largest Manufacturer of Stainless Steel Sinks Since 1920

## ask the EXPERTS

(Continued from page 263)

*benches. What is the remedy for squeaky benches?*

*E. J. S., Ottawa, Ont.*

It is safe to assume that the span between the vertical supports of the benches are too great. I would suggest that intermediate supports be placed between the present pew supports.

**Does a concrete slab and wood floors invite trouble?**

*Is it possible to prevent waves and bulges in hardwood floors, laid on a sub-floor and felt paper over a concrete slab?*

*A. M., Baton Rouge, La.*

It would appear from your description that the slab does not contain a moisture barrier, and that moisture is reaching the underside of the flooring. Place a 55# roll roofing on the concrete for a time, as a test, and then remove it. If moisture is present it will be very obvious.

**Which is the best way?**

*I have noticed on some houses that where wood gutters are used, some are placed flush against the fascia, while on others 1/4 inch thick spacers, 16 inches on centers are placed between the back face of gutter and the fascia. What is the advantage in having a spacer?*

*J. D., Rahway, N. J.*

The use of a spacer complicates the condition. It becomes impossible to repaint the backside of the gutter or fascia. Sealing the top joint between these two members with mastic would be more effective.

Got a problem you can't solve? "ASK THE EXPERTS" a group of industry authorities—experts in their fields. They'll give you the answer.

Write to "Ask the Experts," American Builder, 30 Church Street, New York 7, N. Y. We'll publish as many questions and answers as we can.

# HOPTO

DIGGER · TRENCHER · SHOVEL · CRANE

Does 101 jobs  
in half the time...  
at half the cost...  
with lower equipment  
investment!



MODEL  
120 TM-54

MOUNTS  
ON ANY 1½ TON  
OR LARGER TRUCK

Here's profit-making utility in a versatile, low cost unit! HOPTO mounts on any 1½ ton or larger truck... one already charged off to depreciation! HOPTO a mobile unit for handling bulk materials, pulling spotting trusses and steel, excavating for footings foundations! HOPTO does hundreds of jobs! Cuts labor costs in half or less!

### COMPLETELY HYDRAULIC... EASY TO OPERATE

An average unskilled laborer can easily master the simple handling of a HOPTO in a few hours. Four valve control levers give HOPTO a 200° swing, 11-foot digging depth, 14-foot lift (24-ft. with crane boom), and control the dipper stick extension to permit vertical, straight-sided digging.



### UNEXCELLED UTILITY

Unloading construction materials is but one of the hundreds of jobs that a crane-boom equipped HOPTO does more safely, in a fraction of the time! Crane boom, grapple hook, shovel buckets and back hoes in a variety of sizes and types equip the HOPTO for your kind of work. Units are easily interchangeable. Choice of power units, or HOPTO may be equipped to operate from the power take-off of the truck on which it is mounted.

**Check THESE PROFIT-MAKING FEATURES**

- ✓ No cables or chains to get out of order or be a hazard to safety.
- ✓ Easily interchanged units quickly adapt it for hundreds of uses.
- ✓ Digs 60' of 6' deep trench per hour in average soils.
- ✓ Highly transportable. Boom carried close-in as shown above.
- ✓ Long, high, deep reach and 200° swing give large working area.
- ✓ Equips you to handle more jobs PROFITABLY at lower equipment investment.

In addition to the track-mounted unit illustrated, HOPTO is available as a trailer unit, self-powered or power take-off operated, as unit for crawler tractor mounting, or as a complete self-powered, self-propelled track unit. Badger also manufacture a full line of Badger Trenchers.

WRITE TODAY for complete information on the unit that best fits your requirements.

**BADGER MACHINE CO.**

WINONA, MINNESOTA

DEPT. 23

No. 240  
(PATENTS PENDING)



a Finer  
**ALL STEEL  
Corner  
Guard**

under nose  
spackle holes  
permit spackle to rivet  
itself into nose of bead  
with positive key—even  
when board fits tightly  
in nose.

nose is wider  
to space spackle further  
away from corner,  
thus giving steel protection  
where most  
needed. Undercut to  
provide a better grip  
and tapered to con-  
tour of feathered-out  
spackle.

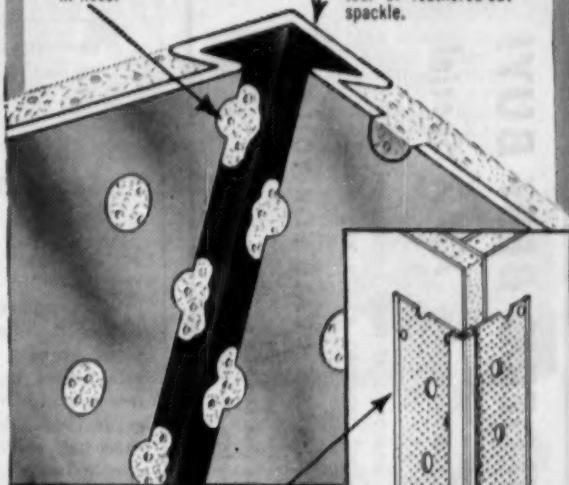

(Board's-Eye View)

Edge is tapered  
to provide a more uniform  
thickness of spackle from  
nose to feathered edge.

Knurled—and knurled again—  
for excellent spackle adhesion.

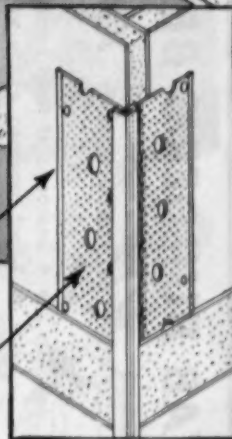

(FRONT VIEW)

For Door & Window Casings · No Spackle Required

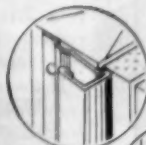

No. 102  
Square  
Profile

**Triple-Grip Spring  
Action Assures a  
Tight, Clamping Fit**

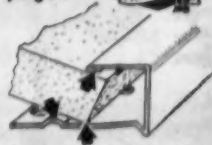

Pat. No. 2,663,390.  
Canadian Pat. No.  
506,022.

No. 101—Bullnose Profile. ¾" &  
½". Factory Mitered at no extra  
cost. (¼" square cut.)

For complete information write

**DRYWALL TRIM, Inc.**

2408 NORTH FARWELL AVENUE, MILWAUKEE II, WIS.

These warehouses in addition to our factory inventory:  
No. Hollywood, Calif. · San Francisco, Calif. · Denver, Colo. · Orlando, Fla.  
St. Paul, Minn. · Kansas City, Mo. · Helena, Mont. · Brooklyn, N. Y.

**HERE IS THE PRE-FAB BUILDER'S BEST BUY!**

*International's* **X-42 Special**

- 42' x 24' on foundation!
- 4 bedrooms at small home cost!
- 2-foot overhang all the way round!

**3 PACKAGE DEALS FOR YOU**

1. Basic shell only
2. Basic shell plus trim package
3. Shell, trim package, plus complete Youngstown Kitchen.



WRITE TODAY  
FOR COMPLETE  
INFORMATION!



3896 MARIONING AVE. • YOUNGSTOWN, OHIO

## How to do it better

Ideas for the man on the job

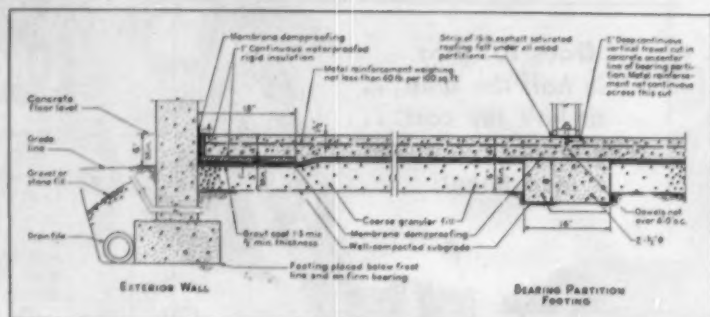

**PROVISIONS** can be made for embedding ducts for heating systems, water supply and waste plumbing lines under the fill.

### Damp proofing foundations and slabs for basementless houses

When preparing the subgrade for basementless floor slab houses, all sod, roots, growing plants and building refuse must be removed. Any holes, trenches and irregularities in the subgrade should be filled in layers not exceeding six inches deep and thoroughly tamped.

The best fill for utility trenches is coarse slag, washed gravel or crushed stone, ranging from 1/2 to 1-inch in size. All material for fill, including soil, should be of a uniform character without large lumps, large stones, frozen chunks or material that will decay.

For best compaction results there is a certain amount of moisture content required for each type of soil. When squeezing the existing soil in your hand, if the proper moisture content is present, the soil will cling together but will not be plastic.

If the soil is too dry, it should be sprinkled with water and mixed to the desired condition before compacting. If the soil is too wet (plastic or muddy), allow it to dry out some before compacting. Sandy soil will compact better with an excessive water content than ordinary soils.

Place a coarse granular fill of either coarse slag, washed gravel or crushed stone ranging from 1/2 to 1-inch in size. If gravel is used, the fines should be removed by screening. The maximum volume of air space in the voids in the fill adds to the insulating qualities of the fill because fines would attract moisture and reduce the insula-

tion value.

After the granular fill has been compacted and brought to grade, a stiff grout coat of one part portland cement and three parts sand is placed over it to provide a smooth surface for receiving the membrane damp-proofing. The grout coat should be at least 1/2-inch thick and broomed or floated in place.

After the grouted surface has hardened and dried, it should be mopped with hot asphalt as well as the tops of any bearing partition footings. As the mopping proceeds and before the asphalt cools and hardens, place a layer of 15-lb. asphalt impregnated roofing felt on the mastic with edges of the felt well lapped.

This membrane damp-proofing must be continuous over the entire floor area and carried up on the inside of the foundation walls to a point one inch or more above the finish floor level. Caution must be taken against puncturing the membrane when placing the concrete floor slab.

The mix for the poured concrete floor slab should consist of one part portland cement to approximately 2 1/4 parts fine aggregates well graded from 1/4-inch down, and three parts coarse aggregate well graded from 1/4-inch up to one inch.

For each sack of cement do not add more than six gallons of water, including the moisture contained in the aggregate. With average moist sand, do not add more than five gallons water per sack of cement.

# Only

## SONOAIRDUCT.

### FIBRE DUCT

for slab-floor, warm air perimeter systems  
gives you these  
exclusive money-saving features!



**Easy-to-Handle Long Lengths!**

Economical SONOAIRDUCT Fibre Duct's sturdy construction easily withstands the weight and pressure of concrete pouring, yet is lightweight and easy-to-handle. No breaking—no chipping!

**Can Be Sawn on the Job!**

SONOAIRDUCT is available in 23 sizes—2" to 36" I.D., in any length up to 50 feet. It can be cut to exact lengths on the job with ordinary hand or power saw!



**Installs and Levels Quickly!**



Because SONOAIRDUCT comes in long lengths, it can be easily installed and leveled in short time. Fits all standard metal T's, elbows, registers, etc. Entire perimeter systems, using SONOAIRDUCT, have been laid in as little as one hour!

SONOAIRDUCT Fibre Duct is made especially for gas and oil fired, slab-floor warm air perimeter systems where the duct is completely encased in dense aggregate concrete. It is designed to comply with FHA Minimum Property Requirements. SONOAIRDUCT is aluminum foil lined and wrapped with black asphalt duplex kraft. Widely used and approved by architects, builders and contractors.

See our catalog in Sweet's

For installation Manual and complete details, write—



# SHAWNEE®

## earth moving tools

PATENT NOS.  
2,689,367  
2,682,346



### SHAWNEE SCOUT 70

This Shawnee Ditcher available for mounting on 20 different tractors. Digs to a depth of 12 feet, loads to a height of 8 feet, 6 inches.

### SHAWNEE REAR BLADE

- 9 angle adjustments • Reversible • Tilts and Offsets
- Heavy Moldboard, 6-ft. wide sliding moldboard, 15 inches high. Fits all 3-point linkage. Replaceable cutting edge.

MODEL 150

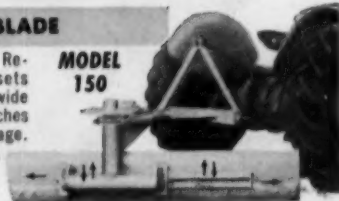

### SHAWNEE "SPECIAL" LOADER

Adaptable to almost all tractors. Depending on tractor installation, it has one or two bucket cylinders, 2,000 lb. lift to a 9 ft. dumping height. 2,500 lb. break away. All welded construction. Removes in 10 minutes.

PATENT PENDING



SEND COUPON FOR FREE LITERATURE

AD 517

## SHAWNEE®

### MANUFACTURING COMPANY, INC.

1947 J. N. Topeka Ave., Topeka, Kansas

Please send me FREE LITERATURE on:

Shawnee Scout 70  Shawnee Rear Blade  Shawnee "Special" Loader

NAME \_\_\_\_\_  
ADDRESS \_\_\_\_\_  
CITY \_\_\_\_\_ STATE \_\_\_\_\_

**Clear the Air  
for Faster Sales**



You clear the air for fast sales action when you install Thermador Ventilating Fans. They offer the newest and most efficient solution to the problem of dispelling smoke, steam, stale air and odors, and keeping air clean, fresh, healthful.

**New  
THERMADOR  
Ventilating Fans**

... in big 9" and 11" sizes... easily and economically installed in ceilings or walls... operating cost less than for the average light bulb... made and guaranteed by Thermador Electrical Manufacturing Company, Los Angeles, California. For descriptive literature and prices, write or phone today.

(Standard accessories available for 9" model: reducer; elbow; flush wall cap; automatic wall hood.)

Write for descriptive literature to: Dept. AB-1055

**THERMADOR**  
ELECTRICAL MANUFACTURING CO.  
Division of Norris-Thermador Corporation  
5119 DISTRICT BOULEVARD  
LOS ANGELES 22, CALIFORNIA



2-10418

**How to do it better—**

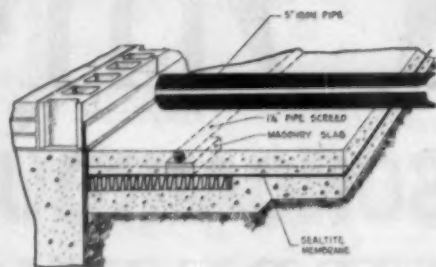

THE 54 FOOT concrete floor span was poured in 3 sections of 18 feet each.

**Compacts concrete with pipe roller**

To get a better-than-average finish on a 30x54-foot concrete floor slab on a school building job, we poured the concrete in three sections, setting 1 1/4-inch steel pipe for screeds to finish floor line.

On this we passed a 5-inch steel pipe roller 21-feet long back and forth to compact and smooth the concrete ready for trowelling. This was a great aid in producing level, smooth floors and experienced cement finishers produced superior results in preference to the drag-screed method.

As soon as a section of floor is leveled, pipe screeds are pulled up and concrete is placed in the small trench thereby created, and floated down to the level of the adjoining green concrete.

We find it very practical to make our own screed chairs out of masonry slabs. This masonry slab is secured to the membrane with hot pitch and then masonry mortar built under and up to the middle of the sides of the screed pipes. To get hot pitch we heated the masonry units and pressed them into some granulated asphalt which melts readily and cements the screed bases securely to membrane without puncturing it.

Howard M. Lemaster, Carlinville, Ill.

**Makes gains without variations**

I am illustrating the way it is possible to get any number of gained ends for cabinets, store fixtures or louvers without variations. A 1x2-inch strip with the desired number of gains is tacked down on the piece of wood to be gained and a bracket screwed on the cross cut arms indicated.

J. L. Carroll, Paris, Texas

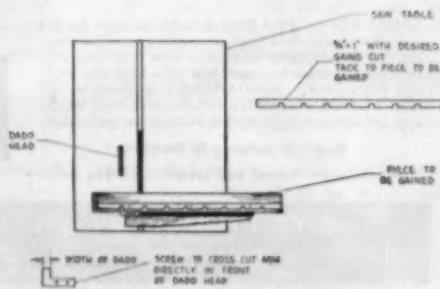

AMERICAN BUILDER



## Ideas for the man on the job

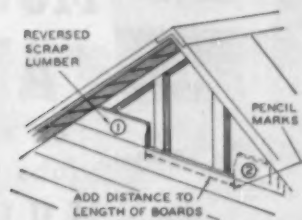

### Better fit in gable end

If the roof is already on and you want to get a perfect siding fit in one piece, try this sure method. Take a short but straight scrap piece of the same material and make the proper angle cut. Place this piece on top of the last siding nailed in place and make a pencil mark.

Then, reversing the short board and holding it in the same position on the opposite side, make a second pencil mark.

Add the distance between the pencil marks to the length (doubled) of the scrap piece to obtain the length of the piece to be fitted.

H. E. Fey, New Braunfels, Texas



### Picture window headers

Picture window openings spanned with 2x10's and 2x12's for headers can be made more rigid by bolting the doubled members with carriage bolts. Bolts should be spaced on 24-inch centers or closer and staggered.

This rigidity will help to reduce corner cracks when walls are finished because any moisture taken in by the headers will tend to rack or twist them upon drying out.

Do you know how to do it better? We'll pay ten dollars for each idea sent in that is used in the magazine. Address contributions to How To Do It Better, AMERICAN BUILDER, 30 Church Street, New York 7, N. Y.

# For HEAT

where it's needed

## ... INSTANTLY!

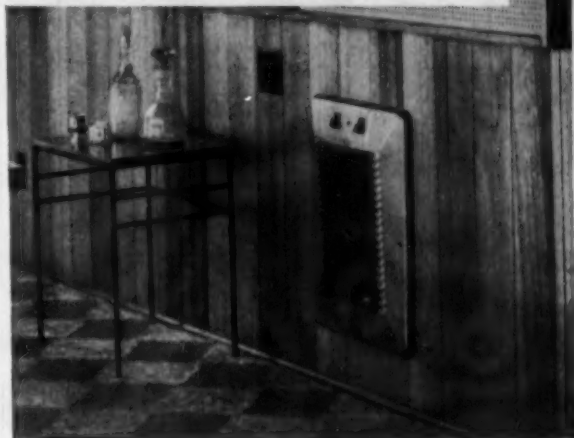

## Install THERMADOR

### Built-in Electric Wall Heaters



"Master Duty" Wall Heat-Fan



"Medium Duty" Wall Heat-Fan

Thermador Electric Wall Heaters satisfy all the heating demands of your buyers. A flick of a switch instantly delivers a surge of clean, healthful warmth. Scientifically designed heating element, fan and louvers direct the heat toward the cold floor. From there the heat rises, warming the "Living Zone" . . . quickly, safely, economically. Room-by-room heat control allows heating of just those areas where heat is desired. Heat your homes with Thermador . . . so efficient . . . so clean . . . so easy to install . . . and the fastest heaters made! There's a type and size for every room.

Fan or Radiant Models • Convenient Top Switches • Optional Thermostat Control • Sun Bronze, White or Stainless Steel Finishes • On-Off Indicator Lights • Approved by Underwriters' Labs., Inc.

## THERMADOR Electrical Manufacturing Co.

A Division of Horrio-Thermador Corporation

5119 District Blvd., Los Angeles 22, Calif. • Dept. AB-1055

Manufacturers of Built-in and Console Electric Ranges, Electric Water Heaters, Evaporative Coolers, Ventilating Fans.



Bathroom "Head-to-Heels" Radiant Heater



Bathroom "Space Saver" Radiant Heater

THERMADOR ELECTRICAL MANUFACTURING COMPANY  
A Division of Horrio-Thermador Corporation

5119 District Blvd., Los Angeles 22, Calif. • Dept. AB-1055

Please send me information and literature on

Built-in Electric Wall Heaters (Other Products)

Name \_\_\_\_\_

Address \_\_\_\_\_

City \_\_\_\_\_ Zone \_\_\_\_\_ State \_\_\_\_\_

3-10-54



# CALCIUM CHLORIDE

## KEEPS CONCRETE STRENGTH from DROPPING with the TEMPERATURE

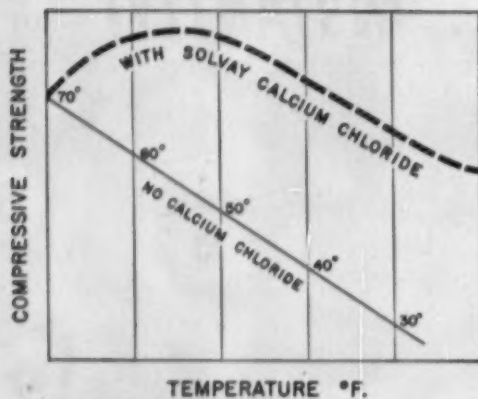

The Addition of SOLVAY CALCIUM CHLORIDE to Concrete During Cold Weather

- Speeds finishing
- Cuts delays between operations
- Permits faster removal of forms
- Provides greater safety
- Assures full strength

**NEW 25 LB. BAGS FOR READY-MIX CONCRETE**



Easy-to-Handle  
Assures Accurate Measurement



Saves Time

FOR FULL INFORMATION MAIL COUPON



SOLVAY PROCESS DIVISION  
Allied Chemical & Dye Corporation  
61 Broadway, New York 6, N. Y.

Gentlemen:

Please send me — WITHOUT COST OR OBLIGATION:

- "When the temperature drops BELOW 50°F., do you know what happens to CONCRETE?"
- "The Effects of Calcium Chloride on Portland Cement"

Name .....

Company .....

Address ..... Position .....

City ..... Zone ..... State ..... 34-10



# Move Ahead

on roofing jobs with a **MULKEY**

and cut costs up to 40%!

SAVE MONEY with MULKEY

- BALANCED and PORTABLE
- ONE MAN can operate with ease
- MOVES 30 to 40 tons of gravel per hour, plus roll roofing, insulation, cartons, packages and other building materials.
- Accommodates 8 ft. extensions.

write phone

**SAM Mulkey CO.**

P. O. Box 270, Dept. AB-10  
Lee's Summit, Missouri



# so successful...

... it has created another page in home building and selling!

The **MALT-A-GLIDE**

horizontally sliding wood window with easy-to-remove sash



See your dealer or write for literature. Turn to page 206 now!  
*Supreme Quality Since 1901*  
Makers of MALT-A-VENTS, MALT-A-GLIDES, MALT-A-MATICS, MALT-A-MASTERS

THE *Malta* MFG. CO.  
Sales Office: ATHENS, OHIO

take a good look at **ENGELMANN SPRUCE**



one of 10 woods from the

## WESTERN PINE region

Extremely light and strong for its weight, smooth and soft-textured, straight-grained—Engelmann Spruce has a wide range of uses from rough construction to fine interior finish. Its nearly-white color, small knots, ease of working suit it for paneling, moulding, window frames and built-in furniture.

Engelmann Spruce comes in 3 select, 5 common, 4 dimension grades. You can order it in straight or mixed cars— together with other woods from the Western Pine region —from most Western Pine Association member mills.

### the Western Pines

IDAHO WHITE PINE  
PONDEROSA PINE  
SUGAR PINE

### the Associated Woods

ENGELMANN SPRUCE  
LARCH  
DOUGLAS FIR  
WHITE FIR  
INCENSE CEDAR  
RED CEDAR  
LODGEPOLE PINE



get the facts to help you sell **ENGELMANN SPRUCE** write for the FREE illustrated booklet to WESTERN PINE ASSOCIATION Yeon Bldg., Portland 4, Oregon

OCTOBER 1955

# Be FIRST with the FINEST!



the **MASTERPIECE**

## Specify the new, large **THERMADOR** Bilt-in Electric Oven

Superbly styled in lifetime stainless steel, the brilliant new "Masterpiece" oven is proudly added to the celebrated selection of Thermador Bilt-in Electric Ranges... the Original and the Finest. Only with the "Masterpiece" can you offer: More usable space in oven 18" wide, 18" high, 19 1/2" deep (even a 37-lb. turkey leaves space to spare!) • Ventilated\* oven door, never too hot to touch • Cool, plastic handle\* and inclined controls



controls finished in deep Midnight Blue. Amazing new baking element\* distributes heat quickly, evenly, for the most perfect results! • Recessed\* Infra-Red broiler, with specially designed pan and tray\* for smokeless broiling • Electric Tele-minute Timer, with chime reminder • Clear-Brite oven interior in stippled, acid-resistant white porcelain • New, exclusive indicator lights\* • Automatic thermostatic controls • Automatic interior light • Heat-deflecting hood\* • Plus many other sales-building features in a super-size "Masterpiece" oven that fits any standard 24" cabinet.

Thermador, the genuine Bilt-in Electric Range made only by Thermador Electrical Manufacturing Co., offers a choice of 12 stainless steel cooking tops... 2, 4, or 6 easy-to-clean surface elements... large, versatile oven... 170 square inch griddle with Vari-Speed switch... Duo-Cook that converts from deep-well cooker to extra surface element. Also, special models in choice of eight porcelain enamel decorator colors.

\*A Thermador Exclusive!

Write or wire today for details.



## THERMADOR

ELECTRICAL MANUFACTURING CO.

Division of Norris-Thermador Corporation

5119 District Blvd., Los Angeles 22, Calif., Dept. AB-1055

Oakland Office—520 Pacific Building

2-10180

271



ANGLED wall gives big overhang with built-in lighting, which adds to striking effect of planter-wall.

## Built-in parking . . . California

Located on a busy street in Van Nuys, California, at a spot distant from parking lots, the Continental Escrow Building solves the parking problem by this novel interpretation of the 2-story structure. The general office floor is raised on steel columns to 2nd story position, allowing space for 14 cars to be parked beneath. A one-story wing at one end of this parking "floor" accommodates the offices of the escrow company, the second floor space being leased. This arrangement was found to be more economical than either roof or basement parking.

Yellow louvers screen the building from the sun on the west, and are activated by a sun dial. When the sun reaches a certain position, the louvers close automatically. These louvers are set in a frame of white stucco.

Designer of the building was John Hutchinson of Hutchinson, Kinsey & Larson. The builder was Kersey Kinsey Co. Both are from Studio City, California.

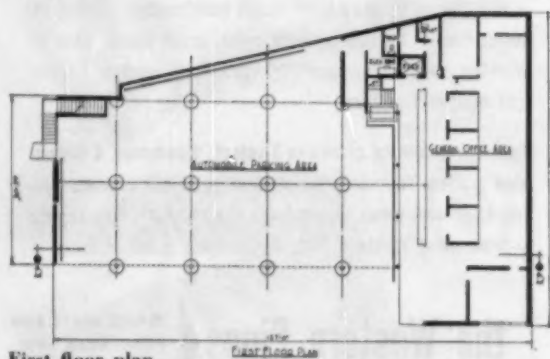

First floor plan

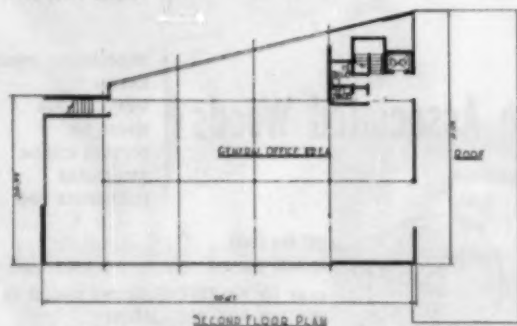

Second floor plan

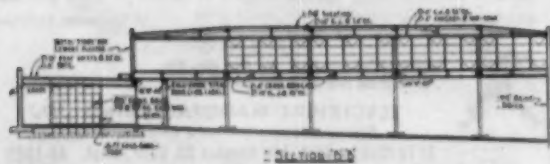

Section through building at B-B

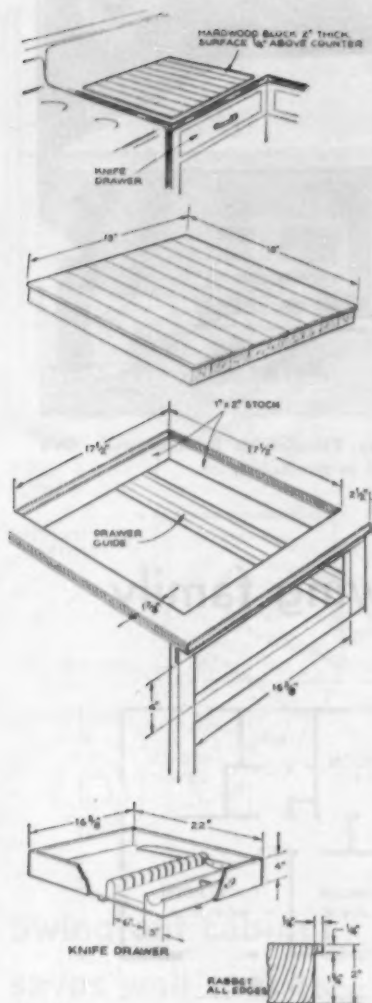

## Build in a block and knife drawer

This chopping block and knife drawer can fit into any base cabinet. It is one of the built-ins described in the Simmons-Boardman book, "How to Build Cabinets for the Modern Kitchen," recently published.

To build, round off one edge of the  $1\frac{1}{2}$ " x 3" x  $15\frac{1}{8}$ " hardwood strip with a plane or sander. Saw lots 2" deep into the 3" dimension to take the knives. With the drawer in place in the cabinet, screw a cleat under it to keep it from opening far enough to expose sharp knife blades. Glue hardwood blocks together and trip ends, smoothing surface as required. Cut a rabbet around all edges and set block into a hole cut in the counter, adjusting it to a snug and solid fit. Leave block without permanent fastenings so it can be removed for cleaning.



Another group of Fadco-built homes, Cincinnati, featuring Alfol in ceiling and sidewalls. Inset: E. B. Fadden, Pres.

## "... 'Fully-insulated with Alfol' is one of our top selling features!"

Just closing out a new 43-home project in suburban Cincinnati, Mr. E. B. Fadden, President of Fadco Lumber Fabricators, is a man who proves that it pays to build 'em better.

Every Fadco home ever built has been fully insulated—ceiling and sidewalls—with Alfol Reflective Insulation!

"... finest insulating comfort"

"This is one of our top selling features," writes Mr. Fadden, "since we can show prospective home buyers that they will have the finest insulating comfort, with economy, both winter and summer."

Fully insulating as he does, it is only natural that Mr. Fadden welcomes the savings provided by Alfol—and its remarkable speed of application. But his choice is primarily based on the selling advantage of delivering a better job of insulation!

### Foil layers self-spacing

The Alfol blanket, "First in Reflective Insulation," consists of multiple aluminum foil sheets that space themselves automatically, reflect 95% of all radiant heat. A tough duplex-and-121-55

kraft backing is built in to offer full application support, provide America's finest vapor barrier.

Clean, non-irritating Alfol takes the "itch" out of insulation. And its amazing compactness (500 sq. ft. to the roll) minimizes handling and storage expense. That's why Alfol usually costs less. Your dollar buys less labor, less "overhead" . . . more and better insulation.



### Write for details.

Whether you build one home or a thousand, whether you install your own insulation or buy it contractor-applied . . . it will pay you to investigate Alfol. Write today. A detailed and illustrated pamphlet will be forwarded without cost or obligation.



# ALFOL

ALUMINUM FOIL INSULATION

## REFLECTAL CORPORATION

A subsidiary of Borg-Warner Corp.  
310 South Michigan Ave., Suite 2845  
Chicago 4, Ill.





FROM THE STREET the large overhang and awning window are clearly visible. A completely sodded and landscaped 60x120

lot, blue stone driveway, Philadelphia flagstone walk, curb and gutter, are included in purchase price.

## Sales plus: builder favors growing family

Moderate price and convertibility are the high spots of the expandable rambler homes being built by Wesmond Building and Investment Company in their Arrow Rock and Deer Park developments in the Rockville and Gaithersburg areas of Maryland. Carport can easily be made into two additional bedrooms when need arises. Selling price for the 2-bedroom unit built on a crawl space is \$10,700, and with a basement below the 30-ft. portion of the house, \$11,700. At a slightly higher cost the homes are available with carport already converted. Book case divider cabinets, double shelves in all coat closets and formica top powderettes in the baths are extra features. Panafold doors between living rooms and front bedrooms is a construction alternate in 4-bedroom models.

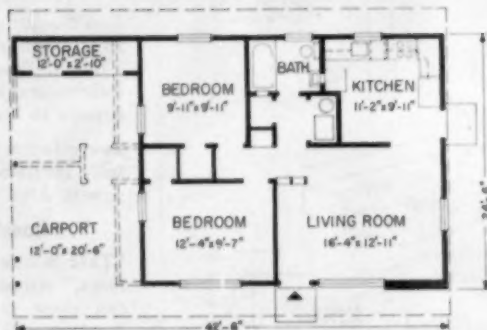

SPACIOUS CARPORT has ample storage space in rear. Center closet area can be converted into hall for easy access to carport when expansion to four bedrooms is desired.



STEP-SAVING KITCHEN has stand pipe and sill cocks supplied in washer space, deluxe refrigerator, sliding double drainboard. Purchaser has choice of formica counter top colors.



TWO LARGE WINDOWS, providing cross ventilation, give the living room an air of spaciousness, provide for maximum amount of sunlight. Dining area is in foreground.

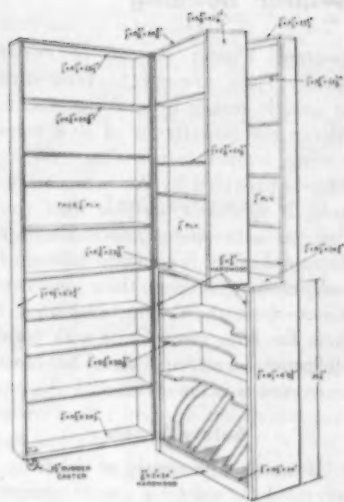

SWING STORAGE CABINET

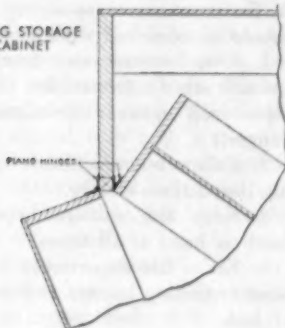

HINGING DETAIL

## Swing out cabinet saves wall space

To make this cabinet, one of the many built-ins featured in "How to Build Cabinets for the Modern Kitchen," published by Simmons-Boardman, cut the sides, top and two fixed shelves of rear unit and screw and glue four hardwood edge strips in place. Cut indentations for cutaway shelves  $3\frac{3}{4}$ " deep, centering cutouts 5" from each end and rounding inner and outer corners to a  $1\frac{1}{2}$ " radius. Middle swing unit is partitioned by a  $24\frac{1}{2}$ " x  $45\frac{7}{8}$ " panel of  $\frac{1}{4}$ " plywood. Glue edges of this panel into grooves cut in top, bottom and sides. Shelves  $3\frac{3}{8}$ " wide are used on side not visible in drawing. In the rear unit, two shelves are cut back to a 2" width. Material  $\frac{1}{4}$ " may be substituted for the  $\frac{1}{2}$ " material indicated. Install metal shelf strips in all units to support shelves and make them adjustable. Vertical grooves may be cut in sides for flush mounting of strips, or they may be screwed directly to the sides of the space-thrifty unit.

## NEW TRESTLES WITH 9 HEIGHT ADJUSTMENTS



FOR FAST MASONRY CONSTRUCTION, mason contractor L. Hubbard of Euclid, Ohio, uses new "Trouble Saver" Putlog Trestles on a project for Joe Miller Homes Co. The new Putlog Trestles are 6'-long and provide nine height adjustments, ranging from 4' to 6'. Masons set each Putlog on the top course, then brick is laid over them. Putlogs are pulled out of the wall and adjusted to new height as the job progresses. When a pin is removed, the new Putlog Trestle swings down flat for easy storage or shipping.

## THE STEEL SCAFFOLDING COMPANY

Telephone EV ergreen 3-5510 Dept. AB 856 Humboldt Street, Brooklyn 22, New York

## The First Choice of Craftsmen... The World Over!

### LUFKIN CHROME CLAD

### Steel Tapes and Tape Rules



#### REGULAR MEZURALL

$\frac{1}{8}$ " wide Chrome Clad blade in balanced mechanism—will not creep when extended. Self-adjusting end hook for hook-over or butt-end measurements. Markings in consecutive inches to 16ths both edges. 6, 8, 10 and 12 foot lengths.



#### SUPER MEZURALL

Rugged  $\frac{3}{16}$ " line extends farther unsupported. Diamond-shaped mark every 16" for easy rafter and stud spacing. Upper edge of line graduated feet and inches to 16ths, lower edge graduated consecutive inches to 16ths. Extra-long self-adjusting end hook. Case made of strong, featherweight magnesium alloy. 10 and 12 foot lengths.



#### LEADER CHROME CLAD

$\frac{3}{16}$ " wide tempered steel line stays easy to read. Attractive case covered in durable maroon vinyl. Welded steel liner protected by a rust-resistant coating. Graduated feet, inches and 8ths. Available with regular or hook type end ring. 25, 50, 75 and 100 foot lengths.

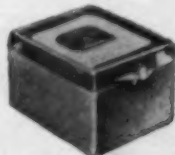

360

FREE "SEE THRU" BOX  
All Chrome Clad Tape Rules are packed in a handy, reusable plastic box.

CHROME CLAD TAPE LINES are durable, do not surface crack, chip or peel and are rust and corrosion resistant. Jet black markings banded to the line are protected by multiple electroplatings—they won't wear off and are always sharp and clear against the chrome white finish.

BUY LUFKIN TAPES • RULES • PRECISION TOOLS  
AT YOUR HARDWARE OR TOOL STORE

THE LUFKIN RULE CO., Saginaw, Mich.  
Burrie, Ont.

CUT  
APPLICATION  
COSTS  
with

FOR  
SUBFLOORS,  
WALL OR ROOF  
SHEATHING

GENUINE  
DOUGLAS FIR PLYWOOD  
**PLYSCORD**  
INTERIOR TYPE GRADE C-D  
SHEATHING

DFPA  
TESTED  
QUALITY

● SAVE up to 50% on application costs using time-tested PLYSCORD sheathing. Walls sheathed with PLYSCORD are up to twice as strong. On roof decking, PLYSCORD won't shrink or swell; the finish roofing won't be damaged by buckling. PLYSCORD subfloors provide a smooth, level working platform—firm, cup-free, squeak-free. Remember: PLYSCORD!

EXT-DFPA

PLYSHIELD

PLYANEL

PLYSCORD

PLYBASE

PLYFORM

INSIST on DFPA grademarked fir plywood! EXT-DFPA and PLYSHIELD for outdoor use. PLYANEL for paneling, 5/8-in. PLYSCORD for sheathing. PLYBASE for underlayment. PLYFORM for concrete form work. Other grades for other uses.

## Winter building

(continued from page 105)

portant. Plaster has to be cured slowly; any attempt to force-cure it usually results in hair-line cracks. Hence the importance of slow even curing temperatures—about 65°—ideally provided by the furnace system. If this isn't possible then you can use salamanders, forced air or infra-red units. A common failing of salamanders has been their tendency to overheat the ceiling and under-heat the floor area. Units with floor deflectors, however, seem to have corrected this condition.

### Safety factors

If handled carelessly or if left unattended for too long a time, almost any heater is a potential fire hazard. A few common-sense safety rules should be observed with heaters:

1. Keep heaters away from canvas and other combustibles. (Use of aluminized canvas minimizes this danger.)
2. Follow manufacturer's operating instructions closely.
3. Keep fire extinguishers and sand on hand at all times.
4. Know fire department regulations regarding heaters and storage of fuel.
5. Make sure that combustion chambers are adequately screened; no open flame should be permitted.

### Estimating heat needs

Although conditions differ with every job, you can estimate the heat requirements of a given enclosure if you know two things: the *heat output* of an individual heater and the *heat loss* of the enclosure to be heated.

According to Richard Lion, sales manager of the Stillwell Supply Corp., Elmsford, N. Y., heater requirements may be calculated from the following formula:

$$H = \left( \frac{G}{2} + \frac{W}{20} + \frac{Wc}{2} + \frac{Wg}{1.5} + \frac{V}{200} \right) \times 3.57 \times Ti - To$$

where:

- H = heat needed in BTU's per hr.
- G = glass area in sq. ft.
- W = wall area in sq. ft.
- Wc = canvas wall area in sq. ft.
- Wg = galvanized iron wall area
- V = volume of enclosure, cu. ft.
- 3.57 = constant for each degree of temperature rise F.
- Ti = inside temp. desired (F.)
- To = outside temp. (F.)

Note: Floor and ceilings should be included as wall areas—unless



exposed to heated area below.  
*Factors in formula which do not apply should be dropped.*  
 To determine the number of heaters required, divide heat loss by maximum output of heater.

#### Fuel sources

Heaters operate on a variety of fuels, namely fuel oil, kerosene, natural gas, and liquid petroleum gas. The simplest and least costly of all fuels, of course, is scrap wood, but its use is limited to the outdoors. It shouldn't be used on the inside as a space heater because the flames are not easily controlled.

LP gas is becoming increasingly important as a fuel source. It is clean, odorless and free of moisture and other impurities. Supplied in 100 lb. cylinders, LP gas can be used to operate various heaters, including salamander. They should, however, be of the low pressure type and equipped with both a thermostat and a 100% automatic shut-off valve. Tanks should be placed out of doors if possible, but if brought inside they must conform to local regulations and ordinances as to fittings and safety devices. The temptation to connect more than one cylinder to a salamander for prolonged drying periods is great, but in no cases should there be more than 250 lbs. of gas per cylinder. Likewise on big jobs, cylinders should be located no less than 50 feet apart. This rule applies to the new infra-red radiant heaters as well as salamanders.

#### Acknowledgements

- Pyrofax Gas Corp., 40 E. 41st St., New York 17, N. Y.  
 Littleford Bros. Inc., 457 E. Pearl St., Cincinnati 2, Ohio  
 Perfection Industries Inc., 7609 Platt Ave., Cleveland, Ohio  
 Master Builders Co., Cleveland 3, Ohio  
 Portland Cement Association, 33 W. Grand Ave., Chicago 10, Ill.  
 National Ready Mixed Concrete Association, 1325 E. St., N. W., Washington 4, D. C.  
 Metal Lath Manufacturers Association, Engineers Bldg., Cleveland 14, Ohio  
 Structural Clay Products Institute, 1520 18th St., N. W., Washington 6, D. C.  
 Home Builders Associations of Washington, D. C. and Syracuse, N. Y.

**IT'S NOT THE SAME WITHOUT THE NAME**

**INSIST ON THIS GRADE TRADEMARK**

**DFPA TESTED QUALITY**

**GENUINE DOUGLAS FIR PLYWOOD**

**PLYSCORD**

INTERIOR TYPE GRADE C-D

**SHEATHING**

● THIS distinctive PLYSCORD stamp on the panel identifies genuine DFPA fir plywood sheathing — quality-tested by DFPA to protect the buyer and assure performance. Write for new PLYSCORD calculator—handy slide rule giving recommended nailing procedures, thicknesses, etc. FREE from Douglas Fir Plywood Association, Tacoma 2, Wash.

INSIST on DFPA grademarked fir plywood! EXT-DFPA and PLYSHIELD for outdoor use . . . PLYPANEL for paneling, built-ins . . . PLYSCORD for sheathing . . . PLYBASE for underlayment . . . PLYFORM for concrete form work. Other grades for other uses.



## Picking Up the Pieces After "Hurricane Hazel"

MYRTLE BEACH, SOUTH CAROLINA—Necessary repair work after a recent hurricane included: (1) Build a sand bank to save the shoreline. (2) Gather and load sand to re-build roads. (3) Bulldoze new roadbeds. (4) General cleanup. All of this heavy work was in soft, shifting sand.

A husky Sherman Front End Loader, mounted on the economical Fordson Major Diesel Tractor, finished these jobs in record time. "Tailor-made" for Fordson Major wheelbase and tread, this loader features proper distribution of weight and loading stresses and gives the best traction in "rough going." A full-length mounting sub-frame reinforces the entire tractor and minimizes the effect of strain and shock. Rear axle supports reduce side sway when loading or carrying, making the entire unit more rigid. This eliminates side slippage when dozing or filling the bucket, also lets the bucket be filled with less power and less strain on clutch, steering gear and operator.

Various attachments adapt the Sherman Front End Loader to many earth-moving, excavating and loading jobs. Two models available . . . up to 2500 pounds bucket and 4500 pounds breakaway capacities. Ask your Ford Tractor Dealer for a demonstration, or write us for Bulletin 724.



Manufactured Exclusively for  
Sherman Products, Inc. by  
Johnson Hydraulic Equipment Co.,  
Minneapolis, Minn.

© 1955, Sherman Products, Inc.

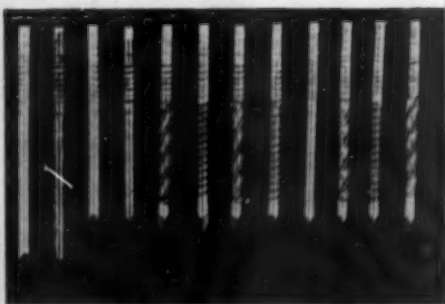

VARIATION in length, coating types of grooving along nail shank, and other

## New grooved nail for

Four years of laboratory research and two years of on-the-job testing have resulted in the development of a new nail for attaching gypsum wallboard to wood framing.

According to Lloyd H. Yeager, general manager of the Gypsum Association, the new nail has up to 40 per cent less creep than the 1 $\frac{5}{8}$ -inch plain shank nail previously used for this purpose. The new nail is also said to have equal or better holding power, and its resistance to racking and "pull-through" are considered at least equal to that of the standard cement-coated nail.

Use of the new grooved nail, Mr. Yeager emphasized, does not change the need for accurate framing, use of kiln-dried framing members, and for nailing in accordance with "good practice" recommendations, as follows:

1. Nails for gypsum wallboard driven into ceiling joists should be spaced 5 to 7 in. o.c. and 6 to 8 in. o.c. on wall studs.
2. When the nails are being driven, wallboard must be in firm contact with framing members.
3. When nailing start in the center of the wallboard panel and work towards the ends and edges.
4. The hammer used for driving nails should have a crowned face.
5. Nails should be driven home with the heads drawn slightly below the surface of the wallboard (except where joint treatment is to be applied) in a dimple made by the crowned face of the tool.
6. Nails should be spaced not less than  $\frac{3}{8}$ -in. from edges and ends of the wallboard.
7. Nails should not be staggered on adjoining edges or ends.
8. A nail set should not be used

AMERICAN BUILDER



characteristics are shown in 24 different gypsum wallboard nails.

## gypsum wallboard

(except for countersinking in 2-ply dry walls) and care should be taken not to break paper face.

To insure the best possible job, it is essential that joint treatment and final decorating be done in accordance with the Standard Specifications for Gypsum Wallboard Finishes of the American Standards Association and with the applicable recommendations of the Gypsum Association.

The new gypsum wallboard nail is currently being produced by the following manufacturers:

Independent Nail and Packing Co., Bridgewater, Mass.; American Steel and Wire Co., Chicago 4, Ill.; Sheffield Steel Div., Armco Steel Corp., Kansas City 25, Mo.; W. H. Maze Co., Peru, Ill.; Angell Nail and Chapellet Co., Cleveland 5, Ohio; Colorado Fuel and Iron Corp., Denver, Colo. and Frank L. Robinson Co., Oakland, Calif.

*Recommended*  
**ANNULAR RINGED  
 BRIGHT FINISH NAIL**  
 FOR APPLICATION OF  
 GYPSUM WALLBOARD

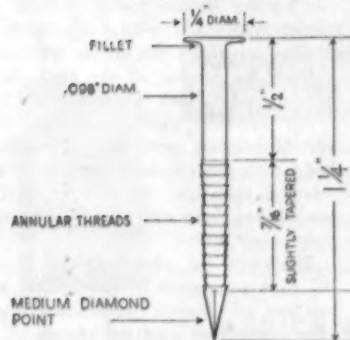

**SPECIFICATIONS** for the new nail type are indicated in diagram above. Finish is either bright or non-coated.



## Use This Actual Job Story for an Excavating Equipment Check List!

This one water line job demonstrates a combination of features that *only* the Sherman Power Digger offers every operator of excavating and trenching equipment.

Check this performance: (1) The machine has under-dug the curb without damage to the curb or sidewalk. (2) It has trenched through rocks and roots. (3) It is digging a bellhole in the street. (4) The excavation is 9 feet deep. (5) The tractor-mounted digger has operated over the curb, sidewalk and street without damage to paving.

And the Sherman Power Digger offers even more advantages to the operator who wants the savings of mechanized excavating. It's practical even on the smallest jobs, since it releases heavier equipment for bigger jobs . . . yet it digs at a fraction of the time and cost of manual labor.

The machine digs as deep as 10 feet below ground . . . in mud, hardpan, shale, oiled roads, blacktop and stony ground. Initial cost is surprisingly low, maintenance simple and inexpensive. Ask your Ford Tractor Dealer for an on-the-job demonstration, or write us now for Bulletin No. 721.

\*Designed, Engineered and  
 Manufactured Jointly by  
 Sherman Products, Inc.,  
 Royal Oak, Michigan,  
 Wain-Ray Corporation,  
 Hubbardston, Mass.

Patent No. 2-303-852  
 Other Patents Pending

© 1955 Sherman Products, Inc.



## Jaeger mixers make you bigger profits



**Pugmill type mortar mixers**—Jaeger 4-blade Power Hoes give you fast pugmill criss-cross mixing action. Turn out smooth, uniform, even-tempered mortar that's easy and fast to spread. 3½ and 6½ ft. sizes to keep ahead of any size crew.



**Mix better, pour faster**—Jaeger 3 1/8 Tiltler drum has patented "dual mix" V-bottom that gives double the mixing action of ordinary tilters and also speeds discharge. Produces big daily yardage of high strength, high quality concrete or mortar. Tows fast, spots fast.

See your Jaeger distributor or send for catalog.

**THE JAEGER MACHINE COMPANY, 521 Dublin Ave., Columbus 16, Ohio**



**Cut placing costs**—Jaeger Self-raising "Hoister" Tower makes quick work of material placing, saves labor. Assembles easily in 10' sections to 67'. 1-ton capacity. Available with material cage or 14' bucket. Easy to move. Positive automatic safety device.

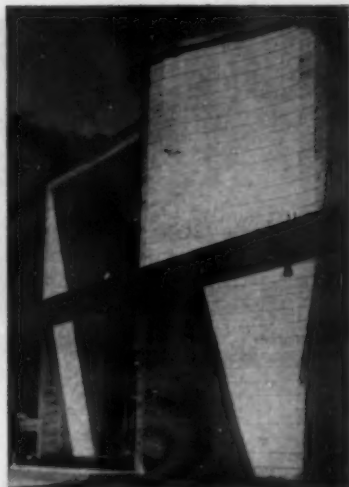

**FLEXIBILITY** of concrete masonry as a building material is shown above. The canopy runs the full length of the building, extends 20 ft. beyond it.

## Concrete masonry proves a point in Wauwatosa

A graphic example of the architectural versatility of concrete masonry is on permanent display in Wauwatosa, Wis., in the form of Economy Block Company's new office building.

According to William R. Menard, president, the company had three main ideas in mind: To prove the value of concrete masonry as a finishing material; to demonstrate that it does not have to be confined to 90 degree angles; and to show that it can be as architecturally flexible as any other building material.

The masonry units were fashioned by simple job-site tools, such as a power hand saw with carborundum blade. Curves for the facade were developed by sawing off the back ears of standard 12-inch block.

All exterior walls, including the curved sections, were laid in stacked bond with control joints employed at selected intervals. All interior partitioning was done with standard 6-inch lightweight units.

The electrical, plumbing and heating pipe runs were installed prior to erection of interior partitions, thus eliminating the need for chases.

The two-story-plus-full-basement building was designed by Robert W. Kemp, Wauwatosa, and engineered by O. Neil Olson, Wauwatosa.

### Avoid Tool Damage And Loss With KARYALL COMPARTMENTS



**KEEP YOUR TOOLS AND MATERIALS ORGANIZED — SAVE TIME AND INCREASE YOUR PROFITS**

- **KARYALL COMPARTMENTS** convert any ½, ¾ or 1 ton pick-up truck into a handy mobile workshop.
- **KARYALL COMPARTMENTS** give you more strength for less money. They are built in 78", 88", 96" and 108" sizes to fit full length of truck bed. Shipped complete with mounting brackets for easy installation.
- **Immediate delivery from our stock.**

—Call Atlantic 1-8479 or write for prices today

Name .....

Company .....

Address .....

City ..... State .....

**KARYALL BODY, INC.**  
8221 Clinton Road Cleveland 9, Ohio  
Department A

## Red Devil's Speed combination



**Automatic Driver Diamond Points**

Shoots 100 Zinc Coated Diamond Points into the hardest wood — as fast as a man can pull the trigger. Speeds up glazing of sash, frames and mirrors. Points can be driven at an angle, due to patented nose plate. For hand-driving — Perfect glazing with Red Devil Triangle Points. Zinc Coating prevents corrosion.

7978



A Product of  
**Red Devil Tools**  
Irvington 11, N. J., U.S.A.

**HANSEN** ONE-HAND **TACKER**  
CUT COSTS ON THIS JOB

*You, too!*  
Can Cut Your Costs—Do A Faster,  
Better Job—with HANSEN

...TACKING  
BUILDING PAPER



Hansen Tacker tacking insulating building paper—one of many uses in doing a faster, better job, and cutting costs.

HANSEN—the Modern Way to do all kinds of tacking and fastening jobs—is easy to grip and operate. Designed to do a better tacking job—faster!

ZIP! ZIP! FAST AS YOU GRIP—HANSEN drives Tackpoints for installing insulation, hydron, metal lath, cornerite, building paper—and does many other tacking and fastening jobs.

CUTS COSTS! Light weight, readily portable, one-hand operation; rapid, positive driving action; balanced design; steady, on-the-job performance—are features that insure economical operation and low-cost installation.

A BETTER JOB—FASTER! Accurate driving, with precision-made Hansen Staples, insures faster work without waste of time, steps or materials. Hansen holds 84 to 140 Tackpoints per strip. Staple sizes up to 1/2" length. Tackers in 36 models. Specify—buy—use HANSEN!

REQUEST  
FOLDER

**A. L. HANSEN MFG. CO.**

5029 RAVENSWOOD AVE., CHICAGO 40, ILL.

"American" Masterpieces in  
**MAIL BOXES**



"THE 400" LINE

3 models, each hand-crafted of aluminum, brass or bronze. Solid wrought brass magazine clips. Brass or bronze medallions.

**SEND for CATALOG**

Showing all Mail Boxes & Adjustable Mail Chutes



"Suburbia" Line

2 models, choice of wrought steel or wrought brass. Front drops down to permit easy removal of mail.

**AMERICAN DEVICE** Mfg. Co.  
Steeleville, Ill., U. S. A.  
TELEPHONE 3341

**BE PRECISE**

Say

**STANLEY**

IT'S A GOOD  
RULE



75¢ AND UP

96 inches of easy-to-read accuracy in an easy-to-pocket 2 inch case.

Model 1208W — only \$1.19 at your favorite hardware dealer. See his display of Stanley Rules — each in a useful plastic box with magnifying lens. Select the rule that you need from 6 ft. to 12 ft.



Write Stanley Tools, 1010 Elm St., New Britain, Conn., for free booklet on measuring tools and how to use them.

**STANLEY**

specify Cabot's

...for the "natural weathered" look...

**Cabot's**

#241 BLEACHING OIL



"We've used Cabot's Bleaching Oil with great success — in fact, all Cabot's stains and finishes rank high in our estimation."

William B. Crosby  
"Homes by Crosby", Builders,  
Milton, Mass.

With this unique finish, you can actually bleach new exterior woodwork! When first applied, Bleaching Oil gives raw shingles and siding a delicate gray tone which in 6-12 months gradually changes to a lasting, natural weathered gray effect.

Cabot's #241 Bleaching Oil — with its high creosote content — provides subtle beauty and sure protection with a minimum of upkeep. Use it on any kind of new wood.

A quality product from Cabot Laboratories  
...manufacturing chemists since 1877

*Samuel Cabot*

Write for further information and name of nearest distributor in U.S. or Canada.

**SAMUEL CABOT INC.**

1024 Oliver Building, Boston 9, Mass.

Please send me information on Cabot's Bleaching Oil

**TIME AND MONEY SAVERS**



These are some of the jobs on which Duo-Fast saves money by saving time.

Mail coupon for complete story on fully-guaranteed Duo-Fast Tackers.

MAIL COUPON

**FASTENER CORPORATION**  
860 Fletcher St., Chicago 14

Please send information on Duo-Fast Tackers for home building work.

Name \_\_\_\_\_

Business \_\_\_\_\_

Address \_\_\_\_\_

City \_\_\_\_\_ State \_\_\_\_\_



**MOUNTING** a Sherman fork lift on his Ford tractor meant easier handling of bricks for Jake Kutchai, as well as for masons who used bricks.



**SPOTTED** in convenient locations at the building site, the bricks cause fewer delays, have less breakage. It all means more business for Kutchai.

**"Palletizing"**  
keeps everyone  
happy—and busy

"Extra service" that promotes repeat business and brings in new customers is the policy of Jake Kutchai, owner of Eton Brick & Supply Co., Birmingham, Mich. He uses a Sherman fork lift mounted on a Ford tractor, to deliver "palletized" bricks to the site where the builder needs them. The result: faster delivery, less breakage, reduced handling costs, fewer delays all around.

His "palletizing" system works like this: He loads 630 to 720 bricks on pallets—directly from the freight car—places the pallets on a truck and heads for the building site. Here he unloads the truck, distributing the pallets close to where the masons will need the brick.

Next project: A way of using steel strapped packages of brick, thus eliminating the pallets.



**SYMONS New Wide Panel Forms**

Symons new wide panel forms are designed for low wall or grade beam construction and are available in 6 and 8 foot lengths and 30, 36, 42 and 48 inch widths.

Also new are the steel struts which allow the form ties to pass through the face of the panels thus enabling both inside and outside forms to be set up at the same time. Stripping the panels is easy because the ties can be broken back within the wall before removing the panels.

Symons Forms can be rented with purchase option—rental charges apply on the purchase price, during a 60 day period. Send for Catalog F-10 which describes and illustrates the Symons Forming System. Symons Clamp & Mfg. Co., 4261 Diversey Avenue, Dept. J-5, Chicago 39, Illinois

**CONTRACTORS, BUILDERS...**

cut cement  
finishing time  $\frac{1}{2}$

**AUTOMATIC ELECTRIC PONY TROWEL**

**PAYS FOR ITSELF IN ONE-DAYS OPERATION**

SAVE with this speedy cement tool. Job-tested two years and acclaimed nationwide. Floats and finishes complete to wall—gives smooth surface without topping. Use own  $\frac{1}{2}$ " or  $\frac{3}{8}$ " drill. Includes handle, blades and ring complete. F. O. B. Muncie, Ind.



Extra Blades only \$3.50  
Write, Phone or Wire your order today.

**ELMO MANUFACTURING, INC.**  
Dept. E-1 324 W. Howard St., Parker, Ind.

AMERICAN BUILDER

# Here's a preview of the Technical pages in the 1956 American Builder Directory

The NEW Marketing Directory and Technical Guide for 1956 (April issue) is another American Builder EXCLUSIVE in the Light Construction Field

**AMERICAN BUILDER**  
THE WORLD'S GREATEST BUILDING PAPER

**NEW** Marketing Directory and Technical Guide  
for the Light Construction Industry

1 Structural Materials  
2 Doors-Windows-Flooring & Wall Coverings  
3 Hardware & Building Specialties  
4 Plumbing-Heating-Ventilating-Electrical & Appliances  
5 Tools & Construction Equipment  
6 Management & Buying Reference

**APRIL • 1956**

THE BUILDING MANUAL OF THE INDUSTRY

The 1956 April Directory will provide builders and building material dealers with the one indispensable source of vital information on all types of building construction. It is by all odds the most useful reference work of its kind ever published. Here is a compact, quick-reference guide that contains explicit estimating facts and figures; concise planning and designing data; specific buying helps and sources that YOU can use every day—in the office and on the job.

American Builder  
1956 Directory

THE BUILDING MANUAL OF THE INDUSTRY



*Insist on*  
**HAR·VEY**  
ROLLING DOOR HARDWARE  
for all your rolling door needs

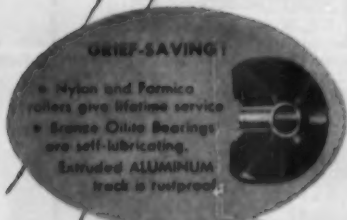

General Offices:  
807 N.W. 20th St., Miami, Florida

**AMERICAN SCREEN PRODUCTS CO.**

Southeastern Division: 3315 W. Dallas St., Houston, Texas  
Western Division: No. Temple City Blvd., El Monte, California  
Metal Screen Division: 278 N.W. 27th St., Miami, Florida  
Midwestern Division: 505 W. Harrison, Plymouth, Indiana



**BEFORE** face-lifting, this was the appearance of this suburban Chicago garage. Built about 17 years ago, the building looked out of date.



**AFTER** face-lifting, a contemporary appearance graces the garage. Use of Masonite siding, clever use of outlining, cutouts made the difference.

## Garage gets its face lifted

Walt Morrison built his garage in Berkeley, Ill., in 1938. At the time, it was as modern as any garage could expect to be. But the passing years brought a new look to garages, and Mr. Morrison decided it was time to give his garage a face-lifting.

Masonite siding, 12 inches wide, with lumber shadowstrip, was applied right over the old exterior, thus creating the illusion of a lower, sleeker building. The pecky cypress gable ends were left in place, but were painted maroon, as were the door and the cutouts mounted on the flowerbox. The cutouts and shutters were fashioned of scrap pieces of siding. The exterior was then primed and finished with two coats of white paint, and the garage panels outlined in white.

The result: A garage that looks as though it was finished yesterday.

**1 Broan Motordor 10' FAN**

**VENTILATES BOTH RANGE and OVEN**

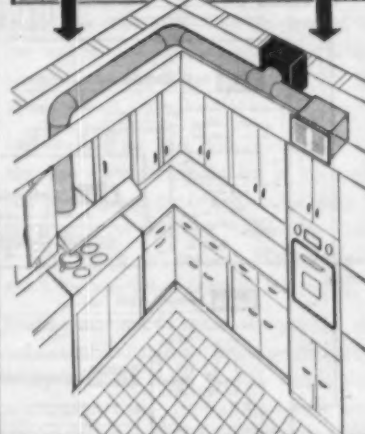

**No need to install Two Kitchen Exhaust Fans**

**SEPARATE** Range and Oven are an important improvement in the modern kitchen that already has received nationwide approval. For the complete ventilation of both cooking units, a satisfactory volume of air movement is assured by the No. 11 BROAN MOTORDOR Kitchen Exhaust Fan with Duct connection to both the BROAN No. 24 Adapter (over the oven) and Hood Exhaust (over the range).

This assurance is made possible by the high efficiency of the BROAN MOTORDOR Fan and the special No. 24 Adapter which can be installed in Soffit or Ceiling.

Installation is simplified, for only 7" round furnace-pipe is required to connect the MOTORDOR Fan, in the outer wall, to both Adapter and Grille in Soffit or Ceiling, over Oven and Range Hood.

The MOTORDOR Fan "pulls" the air through the duct, instead of "blowing" it, and thus eliminates pressures at turns. The insulated, weather-proof, motor-operated outside door of the fan—with sponge-rubber seal—provides perfect protection against weather, condensation, freeze-ups, back-drafts and insects. There is no damper to rattle on windy days. No annoying fan noise in the kitchen.

**FREE**... complete directions for suggested installations of a single BROAN MOTORDOR Fan to ventilate BOTH RANGE AND OVEN in any kitchen, forwarded promptly. Send today. Address:

**BROAN MFG. CO., INC.**  
1681 N. Water St. Milwaukee 2, Wisconsin



Give **STAIRS** this  
extra margin of  
**SAFETY**  
and durability



Patent No. 2792446  
 Other Patents Pending

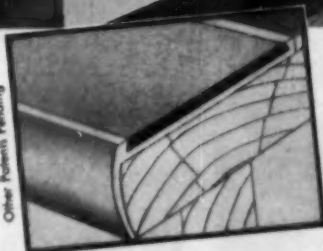

**NEW, IMPROVED**  
**TUFF-TRED**  
**SAFETY STAIR NOSING #3**

Wherever there are stairs . . . you can eliminate slipping hazards, protect and preserve architectural beauty with TUFF-TRED Safety Stair Nosings. Constructed of polished extruded aluminum with an anti-slip replaceable filler  $\frac{1}{8}$ " overall thickness, TUFF-TRED Safety Stair Nosing #3 can be used in conjunction with resilient floor covering of  $\frac{3}{32}$ ",  $\frac{1}{8}$ " and  $\frac{3}{16}$ " thickness. Standard length 12 feet; colors—tile red, brown, silver and black (for extra safety, choose a contrasting color). Nosing dimensions—3 in. wide x  $1\text{-}3/16$ " high. Investigate TUFF-TRED and you'll understand why this stair nosing is used so extensively . . . for the extra margin of safety and durability so important today. Write, wire or 'phone for your free copy of descriptive literature. There's no obligation.

**GOODLOE E. MOORE**  
 INCORPORATED  
 DANVILLE 22, ILLINOIS  
 In Canada: W. D. ELMSLIE, Ltd.  
 4837 St. Lawrence Blvd., Montreal, Canada

**IMMEDIATE SHIPMENT!**



COMBINATION  
 WEATHERSTRIP  
 AND  
 SASH  
 BALANCE

The sash balance with everything you need for fast, easy installation. 4 different types . . . special sizes to order. Simplified framing. Perfectly balanced with correct spring weight for each size. Gives you a low-cost, PROFIT-ABLE installation. Complete bulletin gives all details. Write today.

- Complete Line of Weatherstrips •
- Nosings • Architectural Bronze Thresholds
- Door Bottoms • Screen Guides •
- Bindings • Tools • Calking Compounds

SEND THIS COUPON for your free copies of complete weatherstrip and sash balance bulletins.

NAME .....  
 ADDRESS .....  
 CITY ..... STATE .....

CENTRAL METAL STRIP COMPANY  
 4343 North Western Ave. Chicago 18, Ill.

**CLASSIFIED  
 ADVERTISING**

The Market Place for buying and selling used merchandise, help wanted, positions wanted, and other classified listings.

Rates—\$7.50 minimum for 40 words or less. 15c for each additional word.

Display Classified—\$55.00 per inch. Reverse plates not accepted. No illustrations. No agency commission or cash discount. One column only—2 1/4 inches wide, 2 inches maximum. Signature cuts and trade names allowed.

**POSITION WANTED**

Young Air Force officer desires position with construction company in the home construction industry. Prefers central or northern California. 1953 graduate of the University of Wisconsin. B.S. degree in Light Building Curriculum (home construction). Married, reliable. Please write to 1 Lt Charles J. Rogers, 4624 W. Oklahoma Ave., Milwaukee 15, Wisconsin.

We need Air Dried Northern Hard Maple in truck lots. Wood must be absolutely straight grained, all white perfect stock, surfaced four sides, in six foot lengths, random widths and 1 1/2" full thick. We pay top premium prices.

**THE BLACK PALM SHOP**  
 Arthur, Illinois

**30 ELEVATIONS—30 FLOOR PLANS**  
 FROM HOUSTON'S FABULOUS  
 "PARADE OF HOMES"  
 Colonial, Modern, Contemporary,  
 Traditional, etc.  
**HOUSTON HOME BUILDERS ASSN.**  
 1719 Sunset Blvd. Houston 5, Texas

**BEST BUY  
 FOR HOME  
 BUILDERS**



**kno-draft.**  
 overhead air diffusers

**DISTRIBUTE WARM AIR  
 OR COOLED AIR  
 WITHOUT DRAFTS  
 WITHOUT SMUDGING**

**BULLETIN KH-76A** gives the full story: advantages of overhead air distribution, how to select diffusers, how to lay out systems, and the step-by-step details of quick, easy and profitable Kno-Draft installation. Write us today for your copy. No obligation, of course. Connor Engineering Corporation, Dept. 1-105 Danbury, Connecticut.



**CONNOR**  
 ENGINEERING CORPORATION  
**kno-draft.**  
 overhead air diffusers

# BAR-BROOK Package Unit FANS

FOR FAST,  
LOW COST  
INSTALLATION



### THREE SIZES:

Model No.	CFM Free Del.	Ceiling Opening
AVP-30	5000	31" x 31"
AVP-36	7500	36" x 36"
AVP-42	10000	42" x 42"

Fan, motor and ceiling shutter factory assembled and wired as single unit. Saves hours of installation time. Also other fans from 30" to 54".

Fan and Shutter  
ONE unit

**BAR-BROOK MFG. CO., INC.**

6135 Linwood Ave. Shreveport, La.



FAN  
MAKERS  
SINCE  
1932

# Scharf

MAGNELITE  
PROTRACTOR  
LEVEL



Measures  
Sets Angles  
Gives Drop Per Foot

**LIGHT • UNBREAKABLE**  
Stock Sizes 24, 28, 30 & 48"

Sales Representatives  
John H. Graham & Co., N. Y., N. Y.  
Gardner & Meredith, Chattanooga, Tenn.

If Your Dealer Can't Supply You, Write Dept. A10

**J. H. SCHARF MFG. CO. • OMAHA, NEBRASKA**

Nandy 10-second Blade Change •  
Double graduations—feet and inches •  
Easy action Swing-Tip •  
3/8" Wide White Blade •

make those "HIGH, HARD ONES"  
with the new... 12 FT.

### CARLSON BIG CHIEF

By the Originators of the Wide Blade Rule

If measuring is a part of your job or hobby, make it a pleasure with Carlson's new, longer BIG CHIEF. It gives you the extra length and rigidity you need to make these high, inside measurements without strain or fuss... makes measuring a one-man proposition. Why put off owning the one rule that gives you all the features you need in a steel tape rule?



Stud marks every 16"  
See the new  
**BIG CHIEF**  
at your  
dealer today!

PRODUCED UNDER PATENTS 2088209, 2010930, 2029100 AND PAT. PENDING

**CARLSON & SULLIVAN, INC.**

MONROVIA, CALIFORNIA

## STA-TITE STEEL BRIDGING FOR WOOD JOISTS

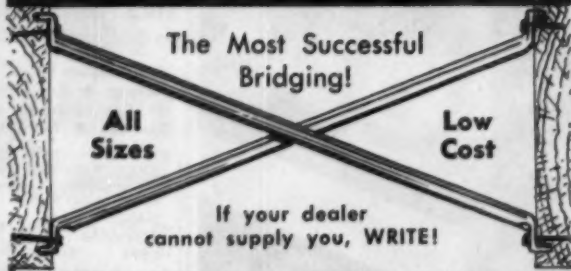

The Most Successful  
Bridging!

All  
Sizes

Low  
Cost

If your dealer  
cannot supply you, WRITE!

**STA-TITE, Inc.**

4022 N. Port Washington Ave.  
Milwaukee 12, Wisconsin

Jabber Inquiries Invited

**Goldblatt**

Introductory Offer!

## masons nylon line

**\$345** 250 ft. on winder  
postage paid

Abrasive resistant, tightly braided, over 100-lb. test. Won't sag after being stretched taut. Lasts 10 times as long as cotton—usable for years. Won't mildew, rot, or break down in normal use. Hardwood winder with handy cut-off blade. Order No. MNL-1/4 - 250 ft. Specify green or white. Check, money order or C.O.D.

**GOLDBLATT TOOL CO., Dept. E-10**  
1912 Walnut, Kansas City 8, Mo.

**1056  
tools**

**FREE TOOL  
CATALOG**—  
1,056 tools for  
trowel trades.  
100-page il-  
lustrated  
book. 1955  
edition. Send  
name on post-  
card.

## COST CUTTER

# LION UNIVERSAL TRIMMER

Accurate, razor-like cut any way of grain. Quick adjustments to 45 degrees or 90 degrees. Mitters, bevels, squares, chamfers—hundreds of uses! A time saver on every job.

**WRITE FOR FULL INFORMATION**

**POOTATUCK CORP.**  
50 Old Stratford Rd.  
Shelton, Conn.

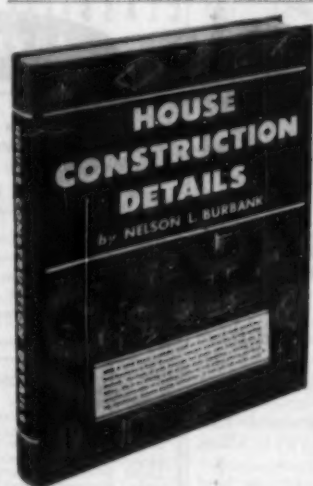

# YOUR EXACT WORKING GUIDE

and answers to  
**OVER 2,000  
BUILDING  
QUESTIONS**

Construction details from foundation to finish, with hundreds of photos and easy-to-follow scale drawings. One-eighth inch drawings of two modern houses included. Conforms to building regulations everywhere. A standard guide for altering stock plans or remodeling. Fourth revised edition.

**SEND NO MONEY . . . Examine Free**

American Builder readers need not send money to get this book. After 10 days, remit \$4.95 plus postage; otherwise return book and owe nothing. (To save postage, remit with order. We refund your money in 10 days if dissatisfied.)

**AMERICAN BUILDER BOOKS, Dept. 1055**

30 Church St., New York 7, N. Y.



*Like* STERLING *on Silver*

STERLING SILVER CHRISTENING BOWL BY REED AND BARTON



**This symbol means quality circulation.** Only publications with paid circulations are members of ABC. They are worth the advertiser's dollar because they have proved to be worth the reader's dollar,

AMERICAN BUILDER became a member of the Audit Bureau of Circulation at the time of its organization in 1914.

# FALL is the best season to start lawns

*It's Nature's Seeding Time*

**Scott's**  
YOUR BEST BUY  
For Lasting Beauty

Be wise! Complete lawns this fall and get a carpet of grass that helps make sales . . . keeps buyers out of the mud all winter.

Follow the experts who know that fall rains and summer-warmed soil insure maximum seed germination. New grass gets the jump on weeds and stools out into thick, deep-rooted turf.

Sow **Scott's** and get the lawn perfection which provides lasting buyer satisfaction. This famous all-perennial grass blend costs no more since you use less.



Write today for our helpful book on Lawn Building and details on Scott's builder service prices.

**Scott & Sons Co**  
15 Maple St., Marysville, Ohio

## 94 common errors

*(Continued from page 100)*

70. Horizontal furnaces not set on permanent foundations.
71. Oil storage tank not painted, vented and set permanently in concrete.
72. Damp crawl space and wet basements.
73. Pipe columns in basements not permanently attached with lag bolts to supporting girders.
74. Adjustable pipe columns used.
75. Door bumpers not installed.
76. Shoe mould not finished.
77. Shoe mould not provided around base kitchen cabinets in toe space.
78. Closets and kitchen cabinets not painted inside commensurate with rest of house.
79. Label not provided for attic insulation as required by MPR Rev. 49.
80. Inadequate attic ventilation.
81. No means provided for attic inspection where disappearing stair not installed.
82. Hand rails on stoops, porches and stairs not installed where required.
83. Porch slabs not cleaned.
84. Brick work not cleaned.
85. Inadequate lot drainage.
86. Chimney not counter-flashed.
87. 26 gauge G. I. gutters and downspouts provided in lieu of 26 gauge and gutter not painted on inside.
88. Openings not caulked on B.V. and asbestos siding construction.
89. Caulking not provided where B.V. and wood siding butt.
90. Walk not 3' wide; gravel drive not 4" thick and 8' wide is required.
91. Landscape work incomplete.
92. Flashing omitted where roof line joins wood siding.
93. Soil pipe (house drain) not supported at each joint.
94. Metal threshold strip omitted over joint where wood floor joins special floors—linoleum, etc.

### PROPER SUBMISSION OF PLANS

On the positive side, much time would be saved in FHA processing if builders followed these rules in submitting plans:

1. Submit two sets of plans (and only two) with an application.
2. Arrange plans in the following order from top to bottom: plot plan; foundation plan; floor plan(s) with kitchen cabinet details on same sheet; front, rear and end elevations; wall section, roof truss and other details; heating layout.
3. Arrange plan sheets so that top and left hand edges are even.
4. Use plan sheets not larger than 18x30".
5. Staple only at top near left hand edge.
6. Fold to fit legal size binder (9½x 14½") by first folding from bottom up and then from right to left.
7. Submit specifications, FHA form No. 2005, in duplicate (not triplicate), but not attached to plans.

Precision built for the man behind the gun

## Light construction levels ...by White



**NEVER BEFORE**  
...such accuracy  
and dependability  
at so low a cost

DEVELOPED originally for agricultural use, these levels have been recently improved and are now in big demand for a wide variety of light construction operations.

Small, compact and sturdy, these White levels are exceptionally simple in design and construction. And it's this rugged simplicity that makes them extra reliable and trouble-free.

**Model 8020** features 10-power telescope, 2½" long graduated spirit level and 4½" diameter circle graduated in degrees and numbered in quadrants (0-90-0), with an index pointer.

Price: \$38.00<sup>00</sup> complete

**Model 8022 convertible** — allows you to level and plumb from same setup. Features 10-power telescope, 2½" graduated spirit level, 2¼" graduated vertical arc and a 4½" diameter horizontal circle. Price: \$74.00<sup>00</sup> complete

For complete details, write for DAVID WHITE Bulletin 1053 and name of nearest dealer, 311 W. Court St., Milwaukee 12, Wis.



We offer expert REPAIR SERVICE on all makes, all types of instruments

*\*Prices subject to change without notice.*

AMERICAN BUILDER



WITH **Jiffy**  
SAWHORSE BRACKETS

- NO NAILS
- NO BOLTS
- NO SCREWS

All welded construction. Use any 2x4s for legs and crossbar.

Set up or knocked down instantly. Easy to move from job to job, and easy to store.

For sale in most hardware and lumber stores. If your dealer cannot supply you, write us direct.



GRAND HAVEN STAMPED PRODUCTS CO.  
GRAND HAVEN, MICH.

ANY Caulk Color...



has it!

When you call for COLOR . . . call on CALBAR! Calbar Caulking Compound is now available in any color your job may require, including Brilliant Aluminum . . . to match every building material on the market. COSTS LESS . . . because it's permanently elasticized, goes on easier, stays on longer! Calbar colors are non-fading. In bulk and cartridges.



FREE! CALBAR CAULK COLOR CHART  
Ask your jobber today

CALBAR PAINT & VARNISH CO.

Manufacturers of Technical Products  
2612-26 N. Martha St., Phila. 25, Pa.  
Our 35th Year as the Nation's leading Caulk Line

OCTOBER 1953

FOR A Glamour Bath THAT SELLS THE HOUSE...



SHOWER ENCLOSURES "PLUS" Quality

with eye-appealing home buyers demand —and safer, thicker (7/32") glass

Big sales point . . . QUALITY Gulf Spray tub enclosures skillfully engineered for beauty, PLUS durability, PLUS smooth operation.

- SLIDING ENCLOSURES: dependable overhead track
- SHOWER DOORS — full 66" high—piano-type hinges
- CHOICE OF: satin or bright aluminum or stainless steel

207 N. MAIN STREET

SERVING THE SOUTH AND SOUTHWEST WITH GLASS SINCE 1872



Contact us for details and literature . . .



HOUSTON, TEXAS

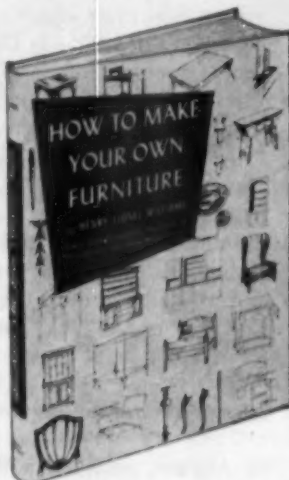

YOU CAN MAKE THESE PIECES

Seance, Pipe Box, Hanging Bookshelf, Standing Bookshelf, Cutlery Tray, Spice Box Lamp Base, Sawback Coffee Table, Lamp Table, Frontie, Dining Table, Drop Leaf Table, Hutch Table, Modern Tray Table, Loose-Seat Stool, Five-Board Bench, Joint Stool, Wing Chair, Chaise Longue, Modern Bedstead, Low-Post Bedstead, Tall-Post Bedstead, Welsh Dresser, Chest of Drawers, Framed Desk, Corner Cupboard, Side Chair and Arm Chair.

AND THESE BUILT-INS, TOO

Recessed Bookshelf Cupboard, Corner Cupboard, Door-Flanking Bookcase, Three-Unit Counter and Cupboard, Closet and Dressing Table Alcove, Corner Seat, Closet—Bunk—Desk, Divan with Drawers, Twin Beds with Bookshelf-Desk, Sofa with Bookcase and End Tables, Wall Angle Cabinet, Corner Counter with Drop Table, Bathroom Kitchen or Bar Counter, Double Bunk, Detached or Attached, Cabinet Table for Corner Bed.

10-Day FREE Trial

How To Make Your Own Furniture

WHY PAY HIGH PRICES FOR FURNITURE?

Make it yourself! Easy-to-follow, step-by-step directions in this big new book show you professional methods and tricks of the trade. Everything you need to know to make attractive, sturdy pieces for every room in the house. Have fun—and save up to 80% of the cost of store-bought articles! Gain a wonderfully relaxing hobby.

HUNDREDS OF PICTURES HELP YOU BUILD

Every job is explained in careful detail. Nearly 400 large, clear drawings show exact working procedure for each step. Professional methods given for setting up shop, choosing tools and equipment, selecting proper varieties of wood, cutting and joining operations, scraping, raising the grain, staining, varnishing, bleaching, taping, antiques, designing furniture—everything you'll want to know.

This interesting, heavily-illustrated book has nearly two hundred big 8 1/4 x 11 inch pages. It costs only \$3.95. You'll save 80 to ten times this amount on the first piece of furniture you make!

MAIL TODAY

Simmons-Bardeman Books, Dept. AB-10-95  
30 Church St., New York 7, N. Y.

Please send me for a FREE working trial a copy of HOW TO MAKE YOUR OWN FURNITURE. If after 10 days I am not completely delighted, I will return the book and owe nothing. Or, I will keep the book and remit \$3.95 plus a few cents for postage and handling in full payment.

Name .....  
Street .....  
City, State .....

SAVE MONEY! Send \$3.95 with your order and we pay postage and handling. Same return privilege guaranteed. Your money refunded if not satisfied.

# The Month Ahead

## **THOSE PHONE BILLS!**

We mean the ones that keep our new editorial offices at 30 Church St., New York 7, N. Y., in touch with our older editorial offices at 79 W. Monroe St., Chicago 3, Illinois. We've moved editorial production to New York—but the captain of the team, Ed Gavin, is calling the shots from Chicago.

## **ADDENDA ON CARPETING**

Robert D. Thompson, president of The Luxor Products Co., was first to tell us that since we put the August issue to bed—it included a big story on carpeting—the FHA Minimum Property Requirements have been altered to permit local offices to accept other than finished hardwood flooring if wall-to-wall carpeting is to be installed.

## **EYE-OPENER**

When NAHB opened its doors to let American Builder editors bring you the story on the new National Housing Center in this issue (pages 92-95), they didn't forget to open one that led to the snazziest press room in Washington, D. C. In fact, we were probably the first fourth estaters to use the room even before the typewriters were in.

## **Editorial invasion**

Busy Ed Gavin, who edits this magazine, travels 75,000 miles a year and manages to be "the daddy of National Home Week" all at the same time, was first in line when 10 American Builder editors parceled out assignments to cover upwards of 25 key cities during National Home Week. Their purpose: to bring you first-hand reports next month on what the big trends are this year, to bring you in December a major article on the best model homes of 1955.

## **Time's running out**

We're talking about our 1955 National Home Week contest to find the builders whose NHW houses and promotions most effectively express the week's purpose. Our deadline is October 12 for the entry. It should include complete working drawings; rough detail drawings of special features, if any; a selection of interior and exterior photographs; brief description of time and money saving techniques; a statement of NHW attendance and traceable sales from the model house; samples of advertising and promotion material and publicity; a list of major materials, equipment and appliances. You'll find more details in our August and September issues. *You* may be the lucky man to win the coveted First Award plaque.

## **What's ahead, money-wise?**

In August, economist William C. Bober wrote a three-page article for us (and for you) that kicked off our traditional economic forecast for 1956. He asked the question: "Are We Really Over-Building?" Then he answered it with a decisive "no." Next month, we go one step further: our lead-off feature will be an up-to-the-minute analysis of what lies ahead, the bright side and the dark side, next year. Don't miss it. American Builder's forecasts have hit the nail right on the head every year for five consecutive years.

A DISTINGUISHED NEW FLOORING  
*Designed for Luxury... Destined for Fame*

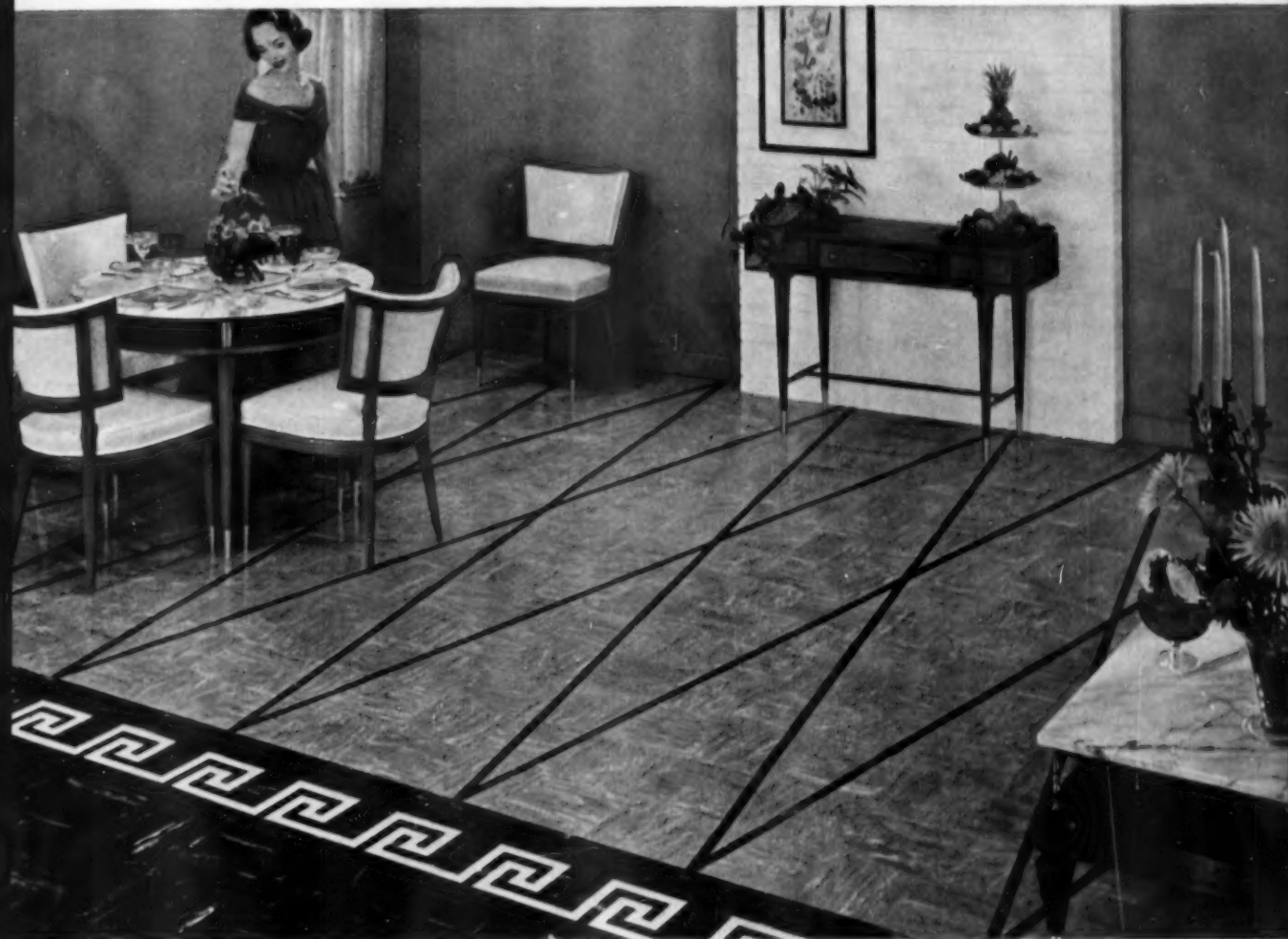

## new MATICO all-vinyl tile

Before you select flooring for your next project, be *sure* to acquaint yourself with MATICO's remarkable new all-Vinyl Tile. For here, indeed, is a new achievement in luxury, beauty and distinction in flooring—for virtually every type of installation.

Best of all, this beauty is life-long, because of the outstanding serviceability that MATICO Vinyl Tile offers. No floor cleans more easily or requires less maintenance. It resists grease, grime and most household chemicals.

MATICO all-Vinyl Tile is a safe and trouble-free flooring always. And because it is a truly *homogeneous* vinyl, its natural lustre gleams uniformly over the entire floor surface.

See for yourself what a major flooring accomplishment MATICO all-Vinyl Tile really is. Mail coupon today for full information and free samples of new MATICO Vinyl Tile.

MASTIC TILE CORPORATION OF AMERICA HOUSTON, TEX. • JOLIET, ILL. • LONG BEACH, CALIF. • NEWBURGH, N. Y.



*Confetti*  
*Aristoflex*  
*Parquetry*  
*Maticork*  
*Asphalt Tile*  
*Rubber Tile*  
*Vinyl Tile*  
*Cork Tile*  
 Plastic Wall Tile

MASTIC TILE CORPORATION OF AMERICA  
 Dept. 5-10, P. O. Box 986, Newburgh, New York  
 Please send me full information and free samples  
 of MATICO Vinyl Tile.

NAME.....  
 ADDRESS.....  
 CITY.....ZONE.....STATE.....

*National* .....



**"Big 4" Hanger**

*The hanger with "built-in" muscle  
provides a gliding ride for heavy doors*

Here is a hanger that has served the trade for generations. The "Big 4" was one of the earliest members to the National Line which now comprises over 300 individual hardware products on its 54th Anniversary.

The hanger has a large protecting hood, heavily embossed for extra strength. Hanger wheels operate on steel roller-bearings and carry the weight of even the heaviest of sliding doors without signs of strain or wear.

The special Braced Rail is designed to serve the "Big 4" with an even perfect tread to speed action.



**"Braced"  
Rail**

*National*

**MANUFACTURING COMPANY**

**STERLING, ILLINOIS**