

# American Builder

A SIMMONS BOARDMAN TIME-SAVER PUBLICATION • 75c



*Antiquated  
Codes*

They're holding back  
home building

SPECIAL REPORT

# Announcing the NuTone Intercom-Radio

NEVER BEFORE . . An Intercom System So Trouble-Free . .

DON'T "ROAR" LIKE A LION . . . . .

..the NuTone Intercom lets you speak softly . . and still be heard anywhere in house!

Fine-fidelity speakers also "pipe" radio programs or recorded music to any room and outside to the patio. Permits busy mother to "keep an ear" on her children's activities inside or outside the house. Can be set to answer door without opening . . or act as night watchman while asleep.



Patents Pending

**FREE ONE YEAR SERVICE POLICY**  
NuTone pays for labor & parts.

For years a really good intercom was a luxury beyond the reach of the average budget, Builders hesitated to install the "cheap" intercoms . . for fear of the service headaches . . or lack of demand. But suddenly . . public interest has skyrocketed. Intercoms are now one of the most wanted features in new homes.

If you have been waiting for a low-cost intercom that's trouble-free . . then here is the set for you. The world's first precision built intercom designed especially for builders . . and **GUARANTEED** with a **ONE YEAR SERVICE POLICY . .** to relieve you of costly "Service Calls."



## CHOICE OF FOUR LUXURIOUS MODELS

All sets include four remote stations 3 inside . . 1 outside . . plus fittings and installation wire. Extra Remotes \$12.95. Packaged in 2 cartons . . "A" contains all roughing-in material and wire. "B" contains master chassis and remote stations. . . Either package can be bought separately

↓ **STANDARD . Model 2011 Copper Enamel**  
.. Model 2012 Silver Aluminum Enamel  
28 watts, 117 volts. AC-DC \$129.50 list.

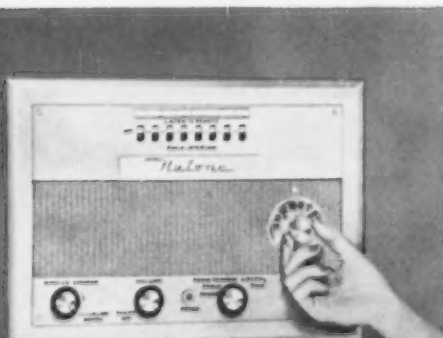

Send for **CATALOG**  
**NUTONE, Inc. Dept AB-3**  
Cincinnati 27, Ohio

↑ **DE LUXE FM-AM . . Model 2016 Copper Anodized. Model 2015 Brushed Chrome**  
42 watts, 117 volts. AC-DC \$179.50 list.



## *Beauty...*

*expressed in graceful form and*

*jewel-like finishes... another reason why*

*Kwikset's "400" line is America's largest selling residential lockset.*



KWIKSET SALES AND SERVICE COMPANY, ANAHEIM, CALIF.

# NOW



# with FASCIA TRACK

## NEW 400 SERIES SLIDING DOOR HARDWARE AMERICA'S FINEST LOW COST LINE!

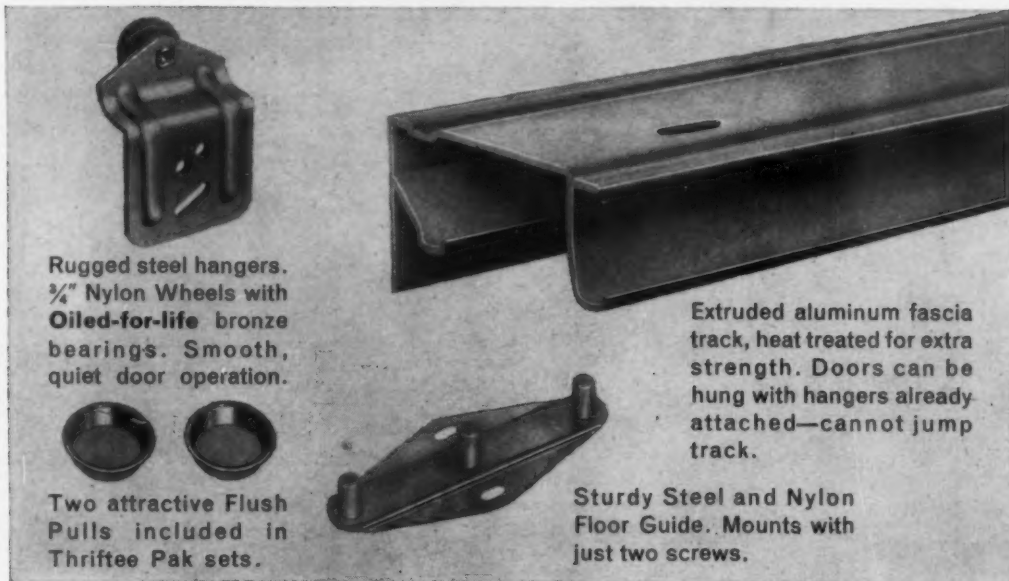

Rugged steel hangers.  
3/4" Nylon Wheels with  
Oiled-for-life bronze  
bearings. Smooth,  
quiet door operation.

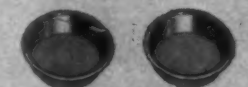

Two attractive Flush  
Pulls included in  
Thriftee Pak sets.



Sturdy Steel and Nylon  
Floor Guide. Mounts with  
just two screws.

Extruded aluminum fascia  
track, heat treated for extra  
strength. Doors can be  
hung with hangers already  
attached—cannot jump  
track.

**EASY AND QUICK TO INSTALL • LOW HEADROOM—ONLY 1 1/8"**  
**QUALITY OF HIGH-PRICED HARDWARE**

"Thriftee Pak" sets are available for by-passing doors of all popular sizes.



**NON FASCIA TRACK**  
for top performance at  
**LOWEST COST**

Track is extruded alu-  
minum, heat treated for  
long life and extra  
strength. Same hangers  
and guide as with fascia  
track illustrated above.



**ONE SET FITS EITHER**  
**3/4" OR 1 1/8" DOORS**

**OTHER SETS FOR**  
**1 1/4" and 1 3/4" DOORS**

For literature and prices write to:

**John Sterling Corporation**  
RICHMOND, ILLINOIS

# The Opportunity Page

(Keynote page of the AMERICAN BUILDER, which is opportunity cover to cover, advertising and editorial)

## Community planning—the new look

It's happening all over. Builders are learning it pays off in dollars and cents to map out an "entire" community. In February, AMERICAN BUILDER told you about the tremendous job done by Warner-Kanter, Inc., at Forest Point, Ohio. Now, David Bogdanoff, a Rye, N.Y., builder, has climbed aboard the "balanced community planning" bandwagon. Why? Because everyone benefits—now and for decades to come. By including industry, the builder can assure his buyers of a lower tax rate. He benefits from the sale of industrial sites (and possibly from construction of the plants). Homeowners and the town will both gain from a balanced tax load. Bogdanoff is building in what amounts to the last big tract (2,500 acres) in Westchester county at Yorktown Heights.

## Free legal advice

Here's a chance to avoid future legal problems. NAHB advises you to have your legal counsel review the wording of your warranties or sales contracts. Make certain buyers agree you aren't liable for claims arising after a stated period of time and not arising from any defect in workmanship or in any materials used. This warning results from a recent decision of a New York Court of Appeals. The court held that the doctrine of MacPherson v. Buick (which holds a manufacturer of an "inherently dangerous chattel" liable to the ultimate consumer) was equally applicable to architects and builders.

## The case for color

Comes the color coordination revolution, you'll want to be ahead of the game. Psychologists have long known that color affects consumer purchases. Blue and green, for example, are good colors to use during warm weather. They have a cooling effect. In winter months, warmer colors—such as red and orange—are favorites. All kinds of color planning and decorating helps are now available to you. For

a list of these, and for other new product highlights from the NAHB convention, check pages 109 to 112 of AMERICAN BUILDER's convention staff report. For convention profit ideas, see p. 19.

## Building codes—a national problem

Good building codes offer you and the whole building industry an opportunity to build more house for the money. If you want to know how to do something about modernizing the codes in your area, be sure to read AMERICAN BUILDER's big story: "Outrage," page 76. You'll learn why out-dated codes are hurting you and how modern codes will help not just the builder but everyone in the industry.

## Pepping up the off-season

Custom building and architectural services can help you take up the slack during the customary winter lull. Such a plan has been introduced by Melvin Senville at Lawrence Bay Park, a \$6,000,000 waterfront development on Long Island. Under the plan prospective buyers have the option of bringing their own plans and specifications to the development. Or, they can utilize the services of an architectural firm which has been retained to develop original home designs for interested purchasers.

## "Layaway" plan sells homes

Here's a new wrinkle to an old idea. Selling your houses on the "layaway" plan can help you plan your future construction program. Here's how the idea works in Memphis: Wallace E. Johnson, Inc., allows a buyer to make a \$100 payment to put his house in "layaway." Then the buyer makes monthly payments from \$50 to \$85. When the down-payment is accumulated, the deal is closed. Most of the Johnson houses are in the \$9,700 to \$10,700 price range. Requirements under FHA Title 203 are \$600 or \$700. The company reports an average of one house a week has been going on this plan.

American Builder (originally "Carpentry and Building") with which are incorporated Building Age, National Builder, Permanent Builder, and the Builder's Journal, was founded Jan. 1, 1879. Names registered in U.S. patent office and Canadian registrar of trade mark.

Address all subscriptions and correspondence concerning them to: Subscription Department, American Builder, Emmett St., Bristol, Conn. Changes of address should reach us three weeks in ad-

vance of next issue date. Send old address with the new enclosing if possible your address label. The Post Office will not forward copies unless you provide extra postage. Duplicate copies cannot be sent.

Circulation Department: R. C. Van Ness, Director of Circulation, 30 Church Street, New York 7, New York.

Published monthly by Simmons-Boardman Publishing Corporation, Emmett St., Bristol, Con-

necticut. Editorial and Executive Offices, 30 Church Street, New York 7, New York. Subscription prices: United States, Possessions and Canada, 1 year, \$3.50; 3 years, \$7.00. Foreign countries: 1 year, \$12.00; 3 years, \$25.00. Single copies, 75 cents; April issue, \$2.00. Entered as second-class matter July 20, 1950, at the Post Office of Bristol, Connecticut, under the act of March 3, 1879. Copyright 1958 with all rights reserved. SIMMONS-BOARDMAN PUBLISHING CORP.

# Textolite Ideas



Foyer in new Travara Marble pattern. Travara is available in standard or postforming grades.

## TEXTOLITE'S STUNNING NEW "BLOCK OF MARBLE" EFFECT costs no more than wood—gives you many more selling features

Available in 5 rich color schemes, General Electric Textolite marble-pattern surfacing curves to follow contours of any wall . . .  
looks more luxurious, cleans easier, and lasts years longer than wood

It's a luxury touch that helps close sales—at surprisingly low cost! Marble-pattern Textolite surfacing on walls looks like natural marble . . . costs no more than fine wood paneling—yet outlives it by years!

Unlike wood, General Electric Textolite surfacing does not need periodic refinishing. It resists scratches, scuffs, and stains—cleans to a sparkle with a damp cloth. And it's fast and inexpensive to install.

You can choose from 70 market-

tested colors and patterns in General Electric Textolite wall and counter surfacing. See them all in Sweet's Light Construction File, Catalog 7e/Ge.

For specific recommendations on where Textolite can be of most value in *your* homes, check with the Textolite dealer nearest you. He's listed in the Yellow Pages under "Plastics." Or send description of surfacing problem to Laminated Products Dept., Section AB-83, General Electric Co., Coshocton, Ohio. You'll get prompt help.

**Textolite**  
LAMINATED SURFACING  
**GENERAL  ELECTRIC**

# "NOBODY COVERS AMERICAN BUILDING LIKE THE AMERICAN BUILDER"

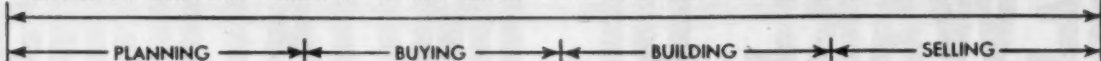

## Reader's Guide

### March 1958

The Opportunity Page .....	3
Reader's Guide .....	5
Reader's Guide to Advertising .....	7
Impact .....	9
The Building Outlook .....	11
Pulse of Building .....	13
Tomorrow's House .....	15
Coming Events .....	33

### NAHB Convention

Ideas to boost your business:	
These builders tell how they plan to meet the need for 2,000,000 homes .....	20-25
Answers to problems you'll face tomorrow .....	26
NAHB "Circus" for better building .....	28

### Merchandising

Double sales with scientific merchandising ..	98
Merchandising Ideas in Action .....	194

### Buying Guide

Product highlights for 1958 .....	109
Attic ventilators can save a/c dollars .....	164

### Features

<b>Outrage: Antiquated Codes—They're holding back home building</b>	
We need codes . . . but not like these .....	76
Imagine where the automobile industry would be if it had obsolete codes .....	78
How far would this house get in these municipalities? .....	80
What the building industry could do .....	82
Why outdated codes make them sore .....	84
Your house would cost \$1,000 less if your code were updated .....	86
What you could do with the \$1,000 .....	88

Where do we go from here? .....	90
Formula for a prize-winner: Blueprint House .....	92
He started a boom with low-cost housing .....	100
How you can build concrete tilt-up panels .....	102
A "4 bathroom" house for only \$500 more ..	104

### Houses and Plans

Tomorrow's House: building on an arc .....	15
Regional House of the Month .....	30
Blueprint House for March .....	92
Low-cost housing .....	100

### Commercial Building

How you can build concrete tilt-up panels ..	102
This warm-air radiant-heating system installed in a temple offers versatile operation	206

### Land Planning

This development is one of 3 winners .....	168
--	-----

### Cost Savings

This conveyor system saves 1/3 shingling time	182
---	-----

### Departments

The Payoff Departments .....	107
New Products .....	109
Supermarket for builders: new-products card	114
Catalogs .....	144
Buying Guide .....	164
Land Planning .....	168
Cost Saver .....	182
How To Do It Better .....	184
Ask The Experts .....	190
Merchandising Ideas in Action .....	194
Keeping Up With The Law .....	202
Technical Guide .....	204
Better Detail of the Month .....	206
Dickerman's Column .....	208
Northup's Column .....	208
Month Ahead .....	210

## READER'S GUIDE TO ADVERTISING ON PAGE 7

<b>Editorial Director</b>	<b>Joseph B. Mason</b>	<b>Editor</b>	<b>Walter Reese Browder</b>	<b>Managing Editor</b>	<b>William F. Koelling</b>
Art Director	Russell F. Rypsam	Western Editor	William C. Rodd	Production Editor	Kay Rice
Assistant Art Director	Morris Neuirth	Midwest Editor	Walter Veneigh	Legal and Tax Consultant	John F. McCarthy
Associate Editors		Washington Editor	Walter J. Taft	Editorial Assistants	Carol Snyder, Georgia Cookson
Construction	Maxwell Huntoon	Executive Editor, April		Director of Production	M. J. Figo, Jr.
Features	John Ingersoll	Marketing Directory		Publisher	Arthur J. McGinnis
Merchandising	Alvin M. Hattal	and Technical Guide			
News	June Vollman	Assistant	Charles H. Goodall		
New Products	Sally Anne Gassert	Director of Research	Ethyl Byrns		
Technical	Joseph Ferché		J. W. Milliken		

Editorial Office: 30 Church St., New York 7, N. Y. April issue: 79 W. Monroe St., Chicago 3, Ill.

American Builder is published by the SIMMONS-BOARDMAN PUBLISHING CORPORATION, Emmett St., Bristol, Conn., with editorial and executive offices at 30 Church St., New York 7, N.Y.

James G. Lyle, President; Arthur J. McGinnis, Executive Vice President and Treasurer; Duane Salisbury, Vice President and Director of Sales; Fred A. Clark, Vice President and Secretary;

Bayne A. Sports, Vice President; George Dusenbury, Vice President and Editorial and Promotional Director. The editors are not responsible for unsolicited manuscripts.

A SIMMONS-BOARDMAN TIME-SAVER PUBLICATION

# BEWARE OF IMITATIONS!



**Be Sure:** Look for the VISQUEEN mark on every foot of VISQUEEN film. This trademark is your assurance that you have the first and foremost polyethylene film.



**Be Safe:** VISQUEEN film meets Federal Housing Administration Minimum Property and Test Requirements and Federal Spec. UU-P-147B as it pertains to moisture vapor control.



**Be Ahead:** ONLY VISQUEEN film comes in seamless widths up to 32' for faster, lower cost coverage. No piecing together of narrow widths . . . greater durability and strength.



**Visqueen** film will not flash, sustain combustion. Tough: Won't break or pinhole when folded, flexed. Won't run or shatter if punctured. Unaffected by heat or cold, acids, alkalis, caustics. Write now and save.



**VISQUEEN** film—the first and foremost polyethylene film.

A product of the longer experience and outstanding research of **VISKING COMPANY** Division of **UNION CARBIDE** Corporation

P. O. Box 1410, Terre Haute, Indiana.

In Canada: **VISKING COMPANY DIVISION OF UNION CARBIDE CANADA LIMITED**, Lindsay, Ontario.

**VISQUEEN** and **VISKING** are registered trademarks of Union Carbide Corporation.



# Advertising

"The better you buy—the better you build—the better you sell" ©

<b>A</b>	Acme Appliance Manufacturing Co. .... 132	<b>I</b>	Infra Insulation, Inc. .... 10	<b>S</b>	Saint Paul Corrugating Co. .... 134
	Aluminum Company of America .... 37		Inland Homes Corporation .... 172, 173		Sasgen Derrick Company .... 134
	American Brass Company, The .... 123		Inland Steel Products Company .... 176		Schlage Lock Company .... 18
	American Gas Association .... 166		Insulite Division, Minnesota and Ontario Paper Company .... 58, 59		Shakertown Corporation .... 60, 61
	American Steel & Wire Division, United States Steel Corporation .... 70, 71		International Harvester Company .... 175		Simpson Logging Company .... 143, 145
	American Telephone & Telegraph Co. .... 106	<b>J</b>	John Deere Industrial Division .... 170, 171		Solvay Process Division, Allied Chemical & Dye Corporation .... 198
	American Window Glass Company .... 44		Junior-Pro Products Co. .... 200		Sonoco Products Company .... 178
	Amerock Corporation .... 138	<b>K</b>			Soss Manufacturing Company .... 154
	Atlas Electric Products Co. .... 207				Standard Steel Works .... 154
<b>B</b>	Badger Machine Company, Warner & Swasey Co. .... 174				Stanley Electric Tools, Division of the Stanley Works .... 136
	Bakelite Company, a Division of Union Carbide and Carbon Corporation .... 195				Steel Scaffolding Company, The .... 148
	Barrett Division, Allied Chemical & Dye Corporation .... 133				Sterling Awning Co. .... 189
	Bennett-Ireland Inc. .... 66				Sterling Corporation, John .... 2
	Berger & Sons, Inc., C. L. .... 141				Symons Clamp & Mfg. Co. .... 142
	Bestwall Certain-Teed Sales Corporation .... 120, 121				Syntrom Company .... 148
	Bird & Son, Inc. .... 72, 73	<b>L</b>	Lennox Industries, Inc. .... 16, 17	<b>T</b>	Tappan Company, The .... 158, 159
	Black & Decker Mfg. Co., The .... 62, 178		Leviton Mfg. Co. .... 144		Tennessee Coal & Iron Division, United States Steel Corporation .... 70, 71
	*Bourne Products, Inc. .... 32-D		Louisville Cement Company .... 32		Tennessee Fabricating Co. .... 188
	Broan Manufacturing Co., Inc. .... 203		Louver Mfg. Co. .... 154		Textolite Division, General Electric Company .... 4
	Brown Company .... 52				Thermador Electrical Manufacturing Co., A Division of Norris-Thermador Corporation .... 192
	Bruce Co., E. L. .... 55	<b>M</b>			Thompson Co., Inc., E. A. .... 152
	BullDog Electric Products Co. .... 65				Timber Engineering Company .... 126
<b>C</b>	Cabot Inc., Samuel .... 124				Trade-Wind Motorfans, Inc. .... 161
	Capitol Products Corporation .... 50, 51			<b>U</b>	United States Steel Corporation, United States Steel Export Company .... 70, 71
	Cascade Pools .... 190				Universal Atlas Cement Company .... 63
	Celotex Corporation, The .... 48, 49				Universal Pulleys Company .... 189
	C & H Air Conditioning Fan Company, Inc. .... 142			<b>V</b>	Van-Packer Company .... 193
	Classified Advertising .... 208				Vega Industries, Inc., Heatlilator Div. .... 122
	Clipper Manufacturing Co. .... 115				Vento Products Co., Inc. .... 126
	Columbia-Geneva Steel Division, United States Steel Corporation .... 70, 71				Visking Company, Plastics Division .... 6
	Columbia Mills, Inc., The .... 197	<b>N</b>	National Clay Pipe Manufacturers, Inc. .... 185	<b>W</b>	Warner & Swasey Company, Badger Division .... 174
	Crossett Lumber Company .... 203		National Gypsum Company .... 149, 151, 153		Warren-Knight .... 207
	Crown Zellerbach .... 155		National Lock Company .... 125		West Coast Lumbermen's Association .... 163
	Cummins Portable Electric Tools .... 68		National Manufacturing Company .... Cover 4		Western Pine Association .... 199
	Curtis Companies Service Bureau .... 118, 119		National Oak Flooring Manufacturers' Association .... 42, 43		Weyerhaeuser Sales Company .... 181
<b>D</b>	Davis Products, Inc. .... 184		Norris-Thermador Corporation, Thermador Electrical Manufacturing Co., A Division of Muller Machinery Company, Inc. .... 192		Wheeling Corrugating Company .... 188
	Dexter Lock Division, Dexter Industries, Inc. .... 108		Nudor Mfg. Corp. .... 209		White Instrument Company, David Wincharger Corporation .... 174
	Dodge Reports .... 201		NuTone, Inc. .... Cover 2		Wiremold Company, The .... 140
	Douglass Manufacturing Co. .... 202	<b>O</b>	Olympic Foundry Co. .... 140		Wolman Preservative Dept., Koppers Company, Inc. .... 91
<b>E</b>	Efron Mfg. Co., Theodore .... 207		Onan & Sons Inc., D. W. .... 134	<b>©1958 American Builder</b>	
<b>F</b>	Fasco Industries, Inc. .... 146		Orangeburg Manufacturing Co., Inc. .... 116		Advertising Sales Representatives
	Penetra Incorporated .... 74, 75		Owens Illinois Glass Block, Kimble Glass Company, subsidiary of .... 156, 157		New York 7, N. Y., 30 Church, WO-4-3060
	Fiat Metal Manufacturing Co. .... 45	<b>P</b>			Chicago 3, Ill., 79 W. Monroe, RA-6-0794
	Filon Plastics Corp. .... 117				Cleveland 13, O., Terminal Tower, MA-1-4455
	Firestone Tire & Rubber Company .... 67				Toledo 6, Ohio, 3545 Lincolnshire Woods Rd., Greenwood 9-2801
	Follansbee Steel Corporation .... 127				Dallas 19, Tex., 3908 Lemmon Ave., Lakeside 2322
	Ford Motor Co. .... 128, 129				Los Angeles 17, Calif., 1151 West 6th St., Ma. 6-0553
	*Forest Fiber Products Company .... 32-F				Portland 5, Ore., 1220 S.W. Morrison, Capital 7-4993
	Frantz Manufacturing Co. .... 188				San Francisco 4, Calif., 244 Calif., Ga. 1-7004
<b>G</b>	General Electric, Textolite Division .... 4				Atlanta 9, Ga., 22 Eighth St., N.E., Room 7, Trinity 2-6720
	Georgia-Pacific Corporation .... 147				Advertising Sales Manager
	Gering Products Inc. .... 14	<b>R</b>	Red Cedar Shingle Bureau .... 64		Field Sales Manager
	Goldblatt Tool Company .... 189		Reynolds Metals Company .... 130, 131		Sales Promotion Director
	Goodrich, B. F., Flooring Company .... 12		Roberts Mfg. Co. .... 150		Jack Wyatt
	Grant Pulley and Hardware Corporation .... 162		Rodale Manufacturing Company, Inc. .... 200		Sal Scarola
<b>H</b>	Heatlilator Div., Vega Industries, Inc. .... 122		Rolscreen Company .... 136, 137, 139		George Hutchings
	Henry Manufacturing Company, Inc. .... 186		Rowe Manufacturing Company .... 191		David Rompel
	Homasote Company .... 196		R. O. W. Sales Company .... 8		A. Lee Craft
	Home Comfort Mfg. Co. .... 140				D. T. Brickner
	Hotpoint Co. .... 38-41				D. J. Casey

\*Appears in Western editions only.

This index is an editorial feature, maintained for the convenience of readers. It is not a part of the advertiser's contract and American Builder assumes no responsibility for its correctness.

# LOOK AT YOUR WINDOWS-



## Your prospects do...

First impressions are mighty important. Whether or not they discuss it, prospects do look *at* windows—not just *through* them.

They like the custom flair of fine millwork styled to make homes more distinctive and more livable. More and more of them know about the insulating properties of wood. They understand the *extra* benefits of removable windows properly balanced. R·O·W removable wood windows, with LIF-T-LOX balances, help sell homes faster and keep them sold longer.



When your prospects lift out an R·O·W window sash, they understand how easy and safe window cleaning can be. Today, it's the *extra* features that close the sale.



Demonstrating the spring-pressure action of R·O·W windows is easy and offers convincing proof that *these* windows will *stay* weather-tight.



R·O·W SALES COMPANY • 1315 ACADEMY • FERNDALE 20, MICHIGAN

**To The Editors:**

American Builder  
30 Church Street  
New York 7, N. Y.

**Post-convention**

Sirs: Thanks for a most interesting and informative breakfast meeting at the Sherman Hotel during the NAHB convention in Chicago. I thought you displayed a keen sense of intimacy with the real market problems facing the building industry and that you used excellent judgment in your selection of speakers.

—Richard P. Monley, assistant account supervisor  
 MacManus, John & Adams Inc.  
 Bloomfield Hills, Mich.

● And thanks for your letter, typical of many messages of congratulations we have received. A summary of all three breakfast meetings appears on pages 20-21.

Sirs: Congratulations on the fine *Convention Daily* published by AMERICAN BUILDER in connection with the NAHB convention. Your outstanding coverage gives delegates a full report on so many items of interest that they feel they haven't missed a single session. . . . Several members of this association who were unable to attend requested that I bring copies of the *Convention Daily* home for them to read.

—Lawrence W. Nelson, executive vice president  
 Minneapolis Home Builders Assn.  
 Minneapolis, Minn.

**Hartford building down**

Sirs: Enclosed front page of the *Hartford Times* for December 2 will interest you. The lead story . . . agrees with what you have been saying in regard to our housing

volume. . . . We are not even holding our own.

—Clyde C. Carter  
 The Carter Construction Co.  
 West Hartford, Conn.

**Orchids in December**

Sirs: Your December issue is your best yet. . . . We were intrigued with the plans and details of your Hidden-Values prize winners.

How can any builder live without this issue!

—Peter Turchon, president  
 Homes Inc.  
 Boston, Mass.

Sirs: I am constantly amazed at the ability of an editor to boil down a complete story to a concise paragraph without losing any of the important information, as you have done with the bottom-up window shade story in December.

—Jessie M. Weaver  
 Window Shade Mfrs. Assn.  
 New York, N.Y.

Sirs: We certainly got a bang out of seeing concrete masonry publi-

cized in the December AMERICAN BUILDER. The Blueprint House of the Month layout is a real boost for the industry.

—William J. Blaha  
 National Concrete Masonry Assn.  
 Chicago, Ill.

**Due credit**

Sirs: As the architects of your January Blueprint House, we are very pleased that this Kramer & Kramer design received the AMERICAN BUILDER Award.

In your article on this house, builder William Shroder attributes its fine sales record to good planning and economical design.

We are proud to have created this award-winning design.

—Edwin R. Kramer, AIA  
 Kramer & Kramer, Architects  
 New York, N.Y.

● Kramer & Kramer has been doing a top-level design job for William Shroder as well as other quality project builders. For plan information write the firm at 33 W. 42nd St., New York, N.Y.



(By Virgil Partch—Courtesy Pomona Tile Mfg. Co.)

AMERICAN BUILDER WELCOMES YOUR IDEAS. We'll print them on this page if you write them in a letter. Include photographs or drawings if you have them. We'll not use your name if you feel strongly about it.

# Make this Test

## for Heat Flow in Buildings!

Try this experiment. Take a piece of multiple layered aluminum. (We'll send you some free samples.) Hold it very close to your cheek without touching. You'll be surprised! Notice how, in seconds, your cheek feels a glow of warmth. Why? Because the heat rays which are leaving your face (although without temperature), are being thrown back again at a 97% rate by this amazing insulation. Reflected to your cheek, the rays are now re-absorbed at a 90% rate and turned into heat.

### THE BIG THIEF

The same thing happens in building spaces. This simple experiment illustrates an extremely important principle of heat flow. The greatest thief of fuel, of heat, and of comfort in buildings in winter, and of comfort and electricity for air-cooling in summer, is the flow of heat by Radiation.

Put multiple sheets of scientific prefabricated aluminum insulation inside wall and roof spaces to bar the path of this thief. For multiple aluminum throws back, with 97% reflectivity, the heat rays that strike its surfaces. It also retards, most effectively, the flow of heat by Convection, Conduction, and Vapor Flow.

The tough aluminum sheets in multiple aluminum are almost completely impervious to water vapor, and are long and continuous. Infiltration under flat, stapled flanges is slight.

Where multiple aluminum is used, fortuitous vapor and water (for instance rain) which intrude into wall and similar spaces, will gradually flow out as vapor through exterior walls and roofs as pressure develops within, because vapor flows from areas of greater to less density. The vapor cannot back up through the continuous, almost completely impervious aluminum, so it flows out because exterior walls and roofs have substantial permeability compared to aluminum, far greater than the required 5 to 1 ratio.

For maximum uniform depth protection against heat loss and condensation formation, use edge-to-edge multiple aluminum, each sheet of which stretches from joist to joist.



Some very interesting heat flow tests in roofs and walls with aluminum insulations, at Massachusetts Institute of Technology and Pennsylvania State College Engineering Experiment Station, including exposure of aluminum foil over a period of 10 years to fumes, dust, salt sea air and even spray, are described in a booklet, "Thermal Test Coefficients of Aluminum Insulation for Buildings." Use coupon for free copy.

### THERMAL VALUES\*, INFRA RECTANGULAR INSULATIONS Non-metallic Insulation Equivalents†

	UP-HEAT	DOWN-HEAT	Cost, Installed‡
TYPE 2	C.177=1½"	C.064=5½"	5¢ sq. ft.
TYPE 3	C.142=2½"	C.049=6¾"	6¢ sq. ft.
TYPE 4	C.105=3½"	C.042=8"	8¢ sq. ft.
TYPE 5	C.081=4"	C.034=9¾"	10¢ sq. ft.
TYPE 6	C.068=4½"	C.034=9¾"	11¢ sq. ft.
TYPE 9	C.043=7¾"	C.029=11¼"	16¢ sq. ft.

Types 1, 7, 8 also available

\*Determined by method of National Bureau of Standards in H.H.F.A. Research Paper 32.

†Calculated on basis of limiting thermal values cited in Fed. Specs. LLL-1-321b; HH-1-585; HH-1-521c; HH-1-551a.

‡Approximate cost, material and labor, new construction between wood joists.

CAN BE PURCHASED THROUGH YOUR PREFERRED LOCAL DEALER

-----

Infra Insulation, Inc., 525 B'way, N. Y., B-3

Send booklet, "Thermal Test"     Infra samples

NAME \_\_\_\_\_

FIRM \_\_\_\_\_

KIND OF BUSINESS \_\_\_\_\_

ADDRESS \_\_\_\_\_

# The Building Outlook

## SMALL TALK

### GLOSSARY FOR CYNICS

We don't know who originated this. We traced it as far as we could, but here's what happened. The *Milwaukee Journal* attributed it to the HBA of Lexington (Ky.) It got it from the Omaha HBA which in turn picked it up from the Marion County (Indianapolis) Residential Builders. Dick Jones, executive secretary of that association, listed it as "translations from the realtors." There the trail ends. In any event, here's a tongue-in-cheek "dictionary" for prospective home buyers. **Established Neighborhood**—All the other houses in the block have been converted to homes for the aged.

**Newer Neighborhood**—The streets aren't in yet.

**Homey House**—The builder designed it himself.

**House With Character**—Nobody designed it; it just happened.

**Family Kitchen**—It's a half mile from sink to refrigerator.

**Step-Saver Kitchen**—The sink is in the refrigerator.

**Master Bedroom**—Room for twin beds.

**Large Bedroom**—Room for twin beds if you don't open the door.

**Good Sized Bedroom**—Room for twin beds if you stack them.

**Small Bedroom**—A closet.

**Loads of Storage Space**—Two closets.

**Modern As Tomorrow**—It isn't finished yet.

**Nearly New**—It's 20 years old.

**Needs a Little Improvement**—You can live in it if you're handy with money.

**Redecorated**—The kitchen has been painted.

**Fully Redecorated**—The kitchen and bathroom have been painted.

**Partly Modernized**—It has electricity.

**Fully Modernized**—It has electricity and an inside toilet.

EVIDENCE IS PILING UP THAT THE SECOND 6 MONTHS of 1958 will definitely witness an upsurge in new home building. (See *AMERICAN BUILDER'S Forecast*, Nov., 1957.) The mortgage money picture is the brightest it has been in many months. Speaking off the record, many builders who attended NAHB's convention told of lenders *asking* for good mortgages—a complete reversal of the situation a few months ago when even some "prime" mortgages went begging. But there's more than "off the record" reports to go on. A prediction that there will be . . .

. . . **MORE MONEY THAN MORTGAGES THIS YEAR** has been made by Oliver M. Walker, chairman, committee on real estate economics, National Assn. of Real Estate Boards. He based this prediction on NAREB's fourth-quarter (1957) survey of the mortgage market in 255 cities. Said Walker: "Mortgages at current interest rates will look attractive and be eagerly sought six months from today." NAREB also anticipates . . .

. . . **A DOWNWARD TREND IN INTEREST RATES** advantageous for home buyers and builders. Indications that this is already a fact in some sections of the country come from several sources. For example, a survey of leading savings banks and savings and loan associations in the New York-New Jersey metropolitan area by Price Mortgage Associates, mortgage brokers, showed: the permanent mortgage interest rate on new one and two-family houses has dropped from 5¾% to 5½%; there seems to be a marked trend toward an even further reduction within the next 6 months; there has been a drop in fees charged for conventional and construction loans of at least ½%. All of these factors should stimulate the . . .

. . . **LOW-COST HOUSING MARKET** which offers a tremendous potential to all home builders. At his last press conference as president of NAHB, George Goodyear discussed a spot-check of only 34 of the association's 300 affiliated locals. In the few cities involved, he stated, some 60,000 additional low-cost homes—not presently planned—could be built and sold in 1958 if lenders would finance them. A projection of these figures shows there is a waiting market for between 150,000 and 200,000 new low-cost homes this year. The current mortgage picture indicates lenders soon may be eager to accept low-cost home loans.

# B.F. Goodrich

## Koroseal<sup>®</sup>

VINYL ASBESTOS FLOOR TILE

# HELPS YOU SELL HOUSES



## It's the best-known name in vinyl...it says to buyers you use the best!

Home buyers usually judge construction by what they see. They know B. F. Goodrich Koroseal, most famous name in vinyl. It tells them your homes are built with the best.

And B. F. Goodrich Koroseal adds dazzling beauty to your rooms. Choose from marbled, terrazzo or cork shades in gorgeous colors. Once over with a damp mop and it *gleams* (walking feet actually buff it)! Defies grease, stains, even destructive solutions. Stands up under heaviest traffic.

For further information, see Sweet's or write B. F. Goodrich Flooring Co., Dept. AB-3, Watertown 72, Mass.

**SPECIFICATIONS:** 31 decorator colors.  $\frac{1}{16}$ " thickness for residential use. Also  $\frac{1}{8}$ " and 80 gage for heavier traffic areas. Tile size 9" x 9". Use on, above or below grade on wood, concrete, or composition floors.



MARBLEIZED  
PATTERNS!

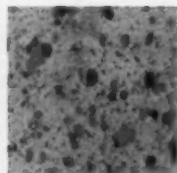

TERRAZZO  
SHADES!

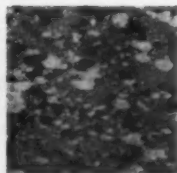

CORK  
SHADES!

## B.F. Goodrich flooring products

AMERICAN BUILDER

# Pulse of Building

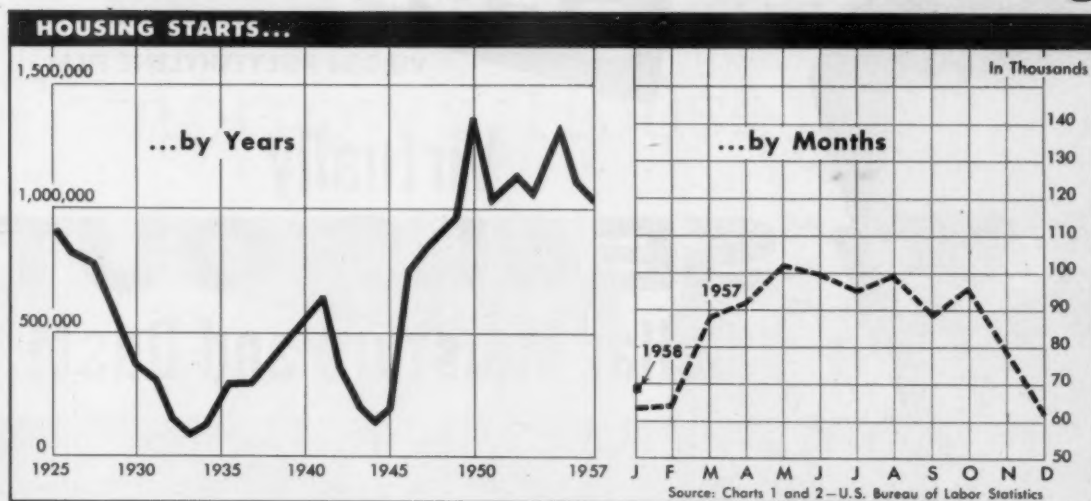

## Interpretations:

Unless weather interferes, there is evidence that housing starts will continue to show at least a seasonal rise throughout the first quarter. Units represented by applications for FHA-insured mortgages have been above year-ago levels since last summer and have been moving seasonally. The rise in building permit authorizations in January was strong in all but three geographical divisions—New England, the East, and West North Central.

- 1 RISING 11 PER CENT**, 69,000 starts in January resulted in the highest seasonally adjusted annual rate (1,080,000) since last August. The rise occurred largely in the South and West.

## 15 LEADING HOME BUILDING AREAS

Dwelling units built in Metropolitan areas during the first ten months of 1957. (BLS)\*

	Units	% Change Jan.-Oct. 1956-57
Los Angeles	70,582	- 9
New York	55,737	-18
Chicago	36,576	-19
Detroit	21,945	-24
Philadelphia	18,354	-15
San Francisco	15,885	-19
Miami	15,531	+ 6
San Diego	13,858	+29
Washington	12,274	-17
Baltimore	10,725	+ 6
Cleveland	10,259	- 8
Phoenix	9,925	+ 41
Milwaukee	7,451	+ 2
Denver	7,109	-12
Seattle	6,896	+11

\*Based on building permit reports and of estimate of units started in non-permit issuing parts of these areas.



- 2 A SMALL GAIN** in the building materials price index—the first since last summer—occurred mainly because of a rise in Douglas fir lumber and portland cement. Hourly earnings continued to rise.

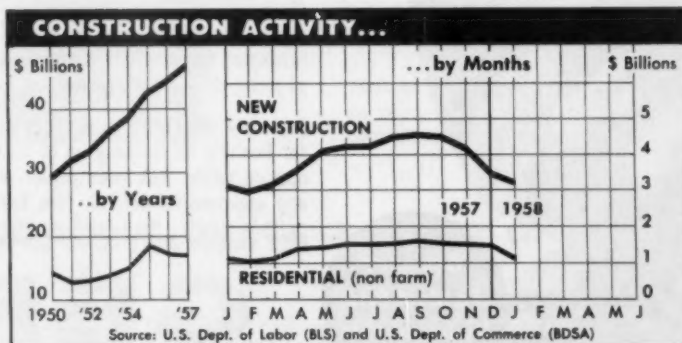

- 3 A JANUARY HIGH** of \$3.3 billion for new construction reflected record January expenditures chiefly for public utilities, highways, office buildings and various kinds of community facilities.

GER-PAK -- THE SHORT WAY TO SAY SUPERIOR POLYETHYLENE FILM

**GER-PAK**

VIRGIN POLYETHYLENE FILM

Virtually  
**SEALS OUT**  
Cellar Moisture and Dust!

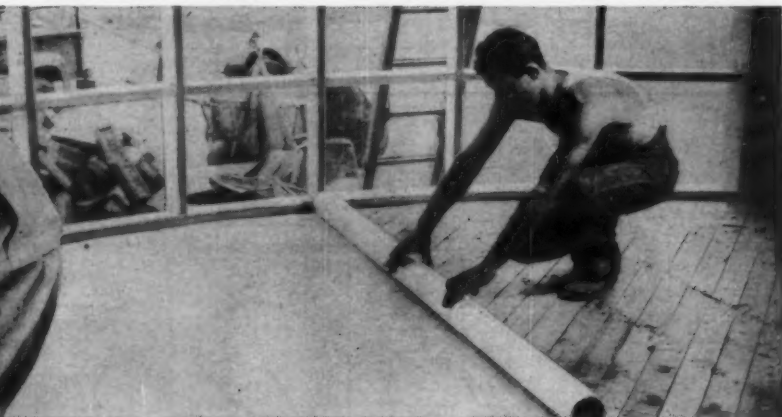

Satisfy yourself and the homeowner with a positive way of preventing moisture and dust from coming up through the basement. Use Ger-Pak film over sub-flooring to seal out unwanted cellar moisture and dust.

All over the country successful builders agree that Ger-Pak virgin polyethylene film is the most effective, versatile moisture-vapor and dust barrier material. In addition to its superior dust-sealing and moisture vapor protection in sub-flooring, Ger-Pak film excels under slab foundations to end wet basement problems, and to reduce sidewall moisture penetration to a minimum.

And that's not all. Ger-Pak film is the ideal material for concrete curing blankets, for protecting equipment and materials from bad weather, for painting drop cloths as well as many other on-the-job uses.

And only Ger-Pak film offers the widest range of widths — from 10-inch for flashing all the way up to 40 feet. Available in clear, black and special opaque white. Ask your dealer about tough, lightweight, easy to handle, and inexpensive Ger-Pak film today.

FREE samples and brochure are yours for the writing.

Designed  
To Meet FHA  
Requirements



**GERING**

Virgin Polyethylene Film

GERING PRODUCTS INC., Kenilworth, New Jersey



# Tomorrow's House



LANAI is formed between continuous curve of screening and house's facade, made of sliding glass doors.

◀ **NATURAL** finish of structural materials is left untouched. Scene is in hall between bedrooms, back wall.

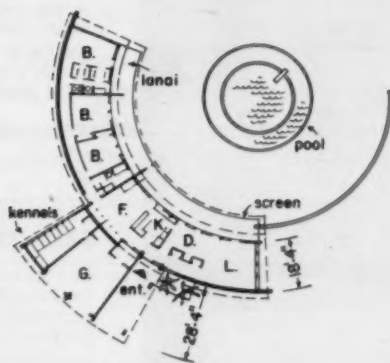

**PRIVACY** is neatly blended here with an open feeling by facing house into courtyard; away from street.

## Have you thought about building on an arc?

**Y**our next house may break out in curves. There's certainly mounting evidence of circular design in houses. The Shreveport, La., house shown here is a typical example—and it's easy to build.

A 10" brick cavity wall covers the back or streetside of the house, while 2'x12' beams support

the roof. Stock sliding glass doors serve as the exterior walls for each room (and also the exterior wall of the house). Roof is built-up over 2'x8' tongue-and-groove pine decking and covered with white marble chips. Designed by Frey, Huddleston & Assoc., it was built by C. K. Carter, Jr.



**NOW**—a dramatic new idea... to appeal to your prospects... to cut costs and solve heating and air conditioning problems...

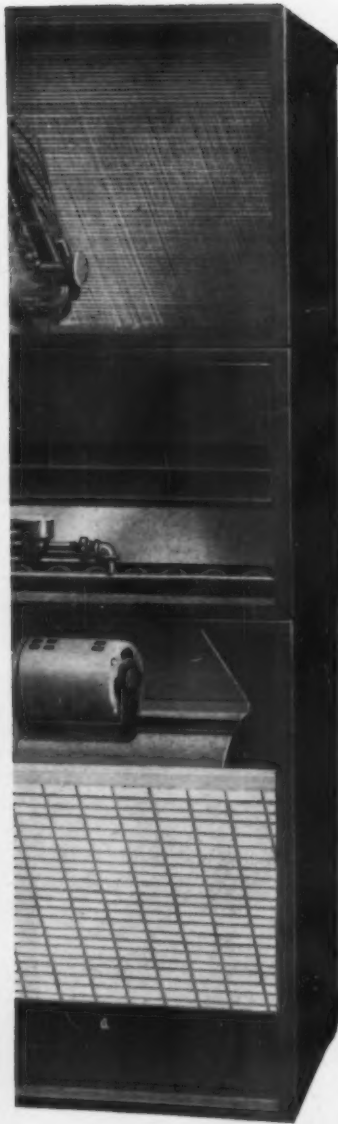

#### PERFECT AIR CONDITIONING

The cleanest, freshest indoor air ever known, cooled throughout each living area. Plenty of cooling, thanks to this super-efficient, specially-selected air conditioning unit. Unit capacities from two to ten tons.

#### PERFECT HEATING

Exclusive "accordion-type" heat exchanger of lifetime aluminized steel wrings maximum heat out of fuel for utmost comfort, economy. Use gas, oil, electricity; or the new Landmark Heat Pump, which heats (and cools) electrically. Adaptable to atomic fuel.

#### PERFECT CLEANING AND FRESHENING OF AIR

A big, two-speed blower, cushioned on live rubber in this roomy, sound-conditioned chamber, "floats" large volumes of air through the Landmark—in a straight line and unimpeded by obsolete dampers, so it's whisper-quiet. Oversize Lennox Hammock Filter cleans air up to four times cleaner.



*LANDMARK by LENNOX—sensation of the NAHB Show! Whether you saw it there or not, get more information about it now, from your Lennox Comfort Craftsman.*

# LANDMARK\*

by **LENNOX** the **LEADER**



Separate "blocks of comfort"... precisely fitted to your climate, your homes; low in installation cost; the most flexible heating-cooling system ever designed—the first true all-year comfort system!

Here is something entirely new in comfort! Not the usual pre-packaged furnace with cooling added, but *separate* comfort components—*blocks of comfort!*

Why separate? That's so your Lennox Comfort Craftsman can select the *one* right heating unit, cooling unit, air handling unit for each home you build. For the first time, you can offer prospects heating and air conditioning comfort that's precisely tailored—*made-to-measure*—to the climate, the home, the personal requirements of each family.

This new idea offers you new assurance of customer satisfaction, too. No more complaints about faulty operation, noise, or high operating cost. The Landmark functions so *effortlessly*, you scarcely know it's operating. No sudden "ticks," thumps or "popcorn" noise; no vibrations, no annoying air surges. Fuel bills are lower, for the air travels in "slow motion" to pick up *all* the heat it can hold—or all the cooling in summer—as it passes through the specially-designed units that combine to make up the Landmark. And these separate components *save you up to three hours of installation time!* (More details on the opposite page.)

NOW—WITH THE LANDMARK—YOU'RE OUT FROM UNDER THE AGE-OLD "COMFORT COMPROMISE"

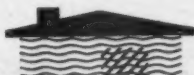

**HEATING ADEQUATE, COOLING UNBALANCED**  
—with an ordinary system that can't handle high daytime temperatures, heavy sun exposure. (Compromise on summer comfort.)



**COOLING ADEQUATE, HEATING UNBALANCED,**  
as the abundant air circulation required for cooling becomes excessive during heating months. (Compromise on winter comfort.)



**HEATING JUST RIGHT, COOLING JUST RIGHT—**  
with a Landmark, made-to-measure for your heating needs, your cooling needs, however special they may be. (No comfort compromise!)

See your Lennox Comfort Craftsman



He's the one man in your community who's equipped to handle *all* your needs—from plans to installation—because he's trained by Lennox engineers. He's ready to fill your requirements with over 140 Lennox products. Find his name in the Yellow Pages.

For further information, see Sweet's, or write Lennox Industries Inc., Dept. AB-83, Marshalltown, Iowa.



More families buy

## **LENNOX**

\*Trade Mark

© 1958 Lennox Industries Inc., Heating and Air Conditioning, founded 1895; Marshalltown and Des Moines, Ia.; Syracuse, N. Y.; Columbus, O.; Decatur, Ga.; Ft. Worth; Los Angeles; Salt Lake City. In Canada: Toronto, Montreal, Calgary, Vancouver, Winnipeg.

# We're Building New Public Appreciation of Schlage Quality



## Lovely Locks... The Jewels of Home

Your welcome said  
in sculptured metals by the  
famous locks of **SCHLAGE**

All who come to see you see your locks. And do you  
your family lives with locks, which are both safe and  
and if they be Schlage - doors a home. Yet even the  
locks are a very small cost item in building or remodeling.  
Should you make use of the Schlage name in your  
lock throughout your home, you will experience the  
extraordinary pleasure. For there are the heavy-duty  
each in its working is genuine as a fine watch.  
Your builder, architect and lock dealer know Schlage  
- the leading quality brand name for a quality product.  
Your preference will be theirs. Schlage Lock Company,  
San Francisco, New York, Vancouver, B. C.

One hand  
unlocking  
- see how Schlage  
lets it work



Security you can see  
with Schlage construction



The name  
that means  
years ahead protection



NO OTHER HOME ACCESSORY DESERVES SUCH THOUGHTFUL DELIVERIES

Each full-color, full-page ad like this in Better Homes & Gardens and other magazines puts the Schlage quality story before millions

Something is happening in the lock industry.

You in the building field know Schlage workmanship. Now the public is seeing the values of Schlage quality and beauty in full-color, full-page ads like this.

Now, more than ever, the Schlage products you use will be symbols of quality workmanship in the homes you build...so recognized by an increasing

number of prospects...a "sales aid" for you.

Your jobber or Schlage representative can show you how to capitalize on the visible and hidden values in the Schlage Locks you use. Or write P. O. Box 3324, San Francisco, Calif. Schlage Lock Company . . . San Francisco . . . New York . . . Vancouver, B. C.

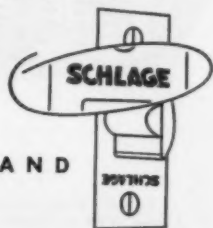

AMERICA'S MOST DISTINGUISHED LOCK BRAND

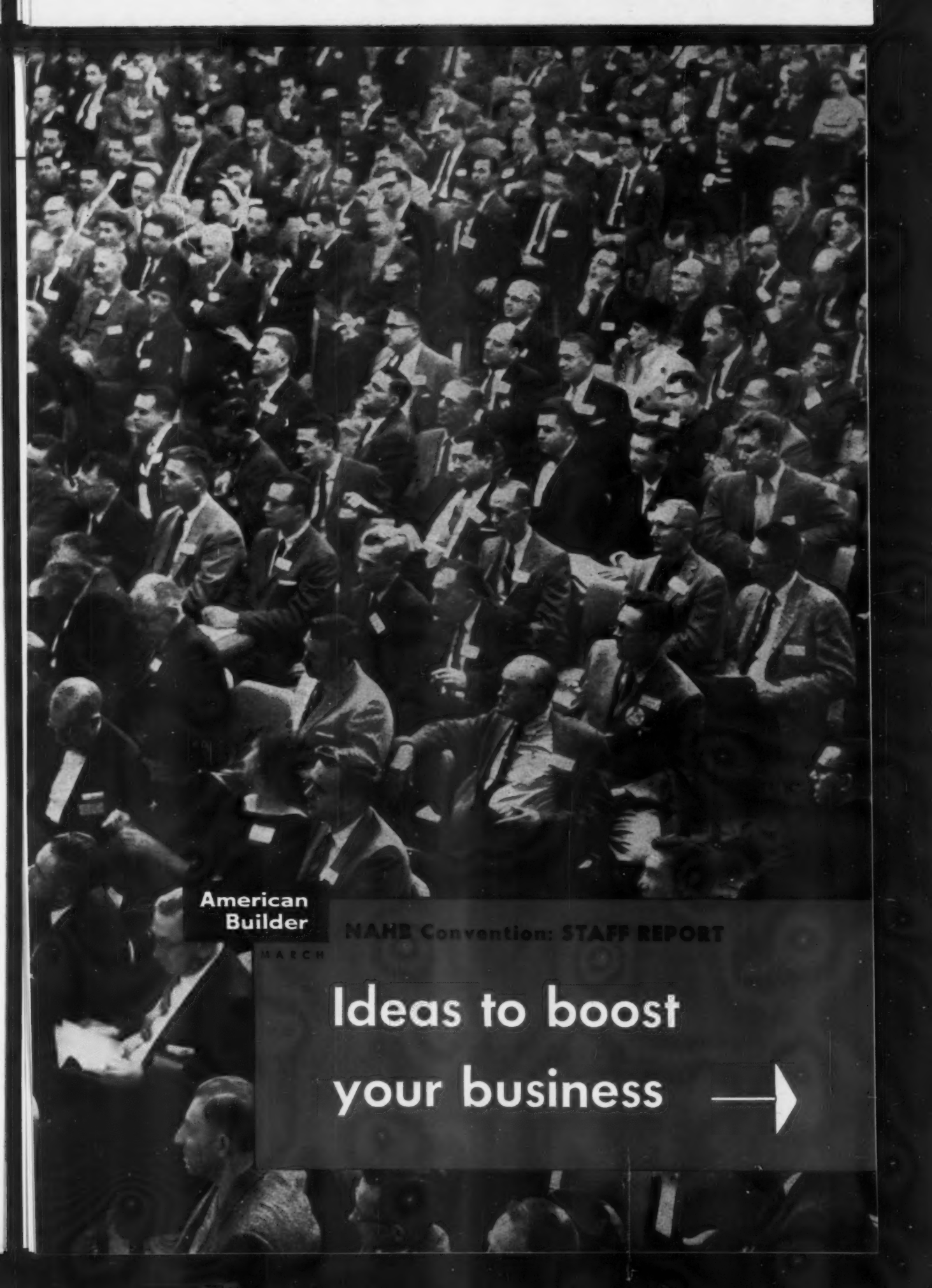

**American  
Builder**

**NAHB Convention: STAFF REPORT**

MARCH

**Ideas to boost  
your business**

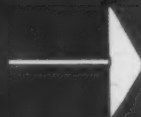

American Builder says: "There's a need for 2,000,000 houses right now."

These experts tell you:

"Here's how we plan to meet this need."



**LAND DEVELOPER BOB ROSS**  
WEST PALM BEACH, FLA.

"We're taking advantage of a tremendous growth area. Florida was the only state whose starts didn't drop in 1956. Most of it is due to new industry."



**PROMOTER KELLY SNOW**  
PORTLAND, ORE.

"We did a big promotion for Wedgwood Homes, found people wanted new ideas for their present houses. So we set up a remodeling business."



**BUILDER BOB SCHMERTZ**  
LAKEWOOD, N. J.

"We're shooting for the low-income buyer, with FHA 203i houses, and new model for \$12,000. We figure there are more poor people than rich ones."



**BUILDER JOHN LONG**  
PHOENIX, ARIZ.

"There's a good market if builders will use a little imagination. You must keep prices down. And the best house in the world will flop without promotion."



**BUILDER EARNEST NORMAN**  
NEW ORLEANS, LA.

"We're building for a big internal migration into New Orleans . . . office workers and engineers. They'd like to rent, but we show them it is better to buy . . ."



**COMMISSIONER EWAN CLAGUE**  
U.S. BUREAU OF LABOR STATISTICS

"The average per capita income will rise 20% in the next ten years. This means houses. And factory jobs will be steadier . . . there's a good market there too."



**BUILDER JIM BURKE**  
SAN ANTONIO, TEX.

"There's a big need for houses for people making \$300 a month. Our sales prove it. We're selling to newlyweds, older people who want less house."



**BUILDER DAVE BOHANNON**  
SAN FRANCISCO, CAL.

"There's a big market you can reach by making people dissatisfied with their present homes. And there are enough new features to let you do it . . ."



COMPONENTS of housing need are outlined by AMERICAN BUILDER's editor, Walter Browder.



**BUILDER AL BALCH**  
SEATTLE, WASH.

"If you're going to push into new markets, you can't do a little promotion now and then. You have to keep merchandising all the time."



**BUILDER BOB GERHOLZ**  
FLINT, MICH.

"One half of all owner-occupied dwellings are owned free and clear. Think of what an upgrading opportunity there is in a situation like this."



**BUILDER BOB SCHMITT**  
BEREA, OHIO

"The big need is in low-cost housing. We've priced our houses just one notch too high for the buyers' appetites, and we should get back into balance."



**BUILDER GEORGE MARTIN**  
LOUISVILLE, KY.

"The Louisville market was dropping, so we decided to give more than just a house . . . one big difference was adding a swim club for development residents."



**BANKER FRED JACKSON**  
BROOKLYN, N. Y.

"Even if there is a 2,000,000 house potential market, don't get complacent. You have to go out and sell. Merchandising is your biggest tool."



**BUILDER BILL UNDERWOOD**  
JACKSON, MISS.

"A 2,000,000 market is too damn low. A man in a 2-year old car is ashamed to be seen on the street. The same idea should apply to houses."

## MERCHANDISING

### Experts say:

◆ You've got to merchandise all the time—before you buy your land, while you're building, in your ads and after you've sold your houses.

◆ "Merchandising begins before you buy land. Tell them (the people) why you are there, what you will sell and how they can buy. . . . Keep the interior of the model house neat and clean. Landscape the exterior, use carpeting and draperies. Keep a maintenance crew on for months after sales. Play up your name. Build a reputation."—Ray Cherry, Los Angeles.

◆ "Not glamour, gadgets or carnival ballyhoo, but selling them basic value—construction value and low maintenance is what persuades people to buy. People are willing to pay for quality. One of the mistakes made by builders is that they don't spend enough to merchandise their own excellent products. If builders are not going to continue to be outsold by other industries, they must increase advertising and merchandising budgets."—J. W. (Bill) Underwood, Jackson, Miss.

◆ Prospective house buyers need confidence. Invite inspection, even from 'Uncle Joe' who is a carpenter. It's easier to sell an expert anything. . . . Snob appeal, even to running real-estate advertising in French—and pointing out to prospects that the home down the street was just bought by the man who was promoted—plays an important part in selling.—Stanley Edge, Pittsburgh, Pa.

◆ "Builders and realtors should not use cooperative ad money if it affects their advertising's appearance adversely."—Frank Robino, Jr., Wilmington, Del.

◆ Run ads on pages with editorial matter for better readership. . . . Ads should be tailored to the size of your budget. Continuing, long-term ads leaning to good layout rather than large space bring better results.—Angelo DiBernardo, Pittsburgh.

◆ The secret of selling success is participation—finding something to share with the prospect and gaining his interest. The first thing you must learn is that the real force behind a prospect's decision to buy is how you appealed to his feelings and emotions. The key to success is arousing these elements in your prospect.—Mildard Bennett, New York City.

◆ "If you've got the right heating contractor, you should have no worries. You can guarantee the buyer of your home the proper heating system. And, this is merchandising comfort. . . . The roof, the walls and other home fixtures—they are the basic components



of any household construction. But, don't forget that 'indoor comfort climate' is what your buyer really wants."—Herbert Gilkey, Cleveland.

◆ "The model house is the mirror of you and your reputation. Do everything to glamorize it. . . . A model house is every house you build. Use 'curb appeal.' Use it as a showcase. Furnish at least one room. Carpet the home; don't use runners. Don't rope off rooms. Use floodlights at night. Have a decorator furnish your interiors. Get merchandising help from manufacturers. Landscape the exterior. Use cut-away sections to merchandise construction. Furnish a den for prospects to relax in and look over blueprints as they sip coffee and cokes."—Dave Fox, Dallas.

◆ Don't think of selling your own products and services, but sell the broad concept of home ownership—the American concept that a plot of ground and a home of one's own is a traditional right. Use a motivation analyst to determine the market and its desires. Some key "selling" words are: freedom, roots, safety, quiet, credit, neighbors, comfort, price, value, fun, location and stability.—Carroll West, Los Angeles.

◆ If you're having trouble selling homes, let the utilities and manufacturers carry the ball for you. A utility or manufacturer will not only help you, but he'll pick up part of the tab. They are more than anxious to help builders in home sales. Utilities and manufacturers will aid in developing confident, enthusiastic salesmen for new homes. "You know, there's nothing that will kill sales faster than a salesman who doesn't know what he's selling. If I'm selling homes, I want salesmen full of enthusiasm, full of sales ammunition, knowing what they're talking about. That's the only way to do business today."—Chester Stackpole, New York City.

◆ Have everyone in town regard you as one of the finest and most ethical businessmen they have ever known. We place a lot of emphasis on "operation move-in day." We have a list of 100 items which must be checked off prior to that day. We make sure all utilities are turned on and that everything works properly. We prepare and serve a dinner to the new family.—James Nuckolls, Tulsa.

◆ "Prompt handling of any complaints from your buyers is important. Our average cost for this is between \$25 and \$30 per house. Satisfied buyers are our best salesmen."—Fred Falander, Indianapolis.



## COST-CONTROL

### Experts say:

◆ You'll never make money until you know where your money is. You can't cut costs until you know where the money is being wasted.

◆ Whatever cost-control system you choose, make it simple. You should have no more complexity than is necessary for your particular organization.—Earnest G. Fritsche, Columbus, Ohio.

◆ "Builders who don't keep records may do all right when the market is good, but when things get tough, watch out. I know a man who went bankrupt. He was selling lots of houses, but he was selling them \$500 under his cost and didn't know it. Remember, a cost-cutting system is no more accurate than information



fed into it."—T. F. McIntyre, Oklahoma City.

◆ For closest control, you should try to keep your units of costs small. These units represent groups of houses. And it helps to make up units out of houses that will be finished all about the same time.—Harvey (Bud) Meyerhoff, Baltimore.

◆ Know your most profitable level of activity. You could double your volume and cut your profits in half.—Harry L. Judd, Jr., Chicago.

## LAND-PLANNING AND CONSTRUCTION

### Experts say:

◆ The surest way to boost your business is to give more house for less money. You've got to keep costs low—from land buying to the final paint coat.

◆ "The best way to save money on land is to create high property values. You have to look ahead and figure out what land is going to be good land in the future. Then you should negotiate on large tracts; even if you only buy part of a big parcel, try to get options on the rest. Then when you start to build, adjoining property values won't skyrocket.

"If you can, build parks, clubs, and other community values. And it may be that over the next four or five years it will be cheaper, tax-wise, to put in and run your own utilities. The actual process of earth moving costs a lot of money, so unless it's absolutely necessary, try not to change the natural topography of the land."—Marvin Warner, Cincinnati.

◆ "We have a cooperative land development with six builders participating. . . . I find that I have less than one-third the capital tied up in land this way than if I were doing it alone, and I get the lots themselves for less money." (See AMERICAN BUILDER Land Planning, May, 1957.)—Clayton Powell, Savannah.



◆ Your labor can cost up to 50% more than the wages you pay. In other words, you're getting only two-thirds of the possible work out of your crews. If you're paying wages of \$3. an hour, your actual labor cost on the job is \$4.50 an hour.—Andy Place, South Bend, Ind.

◆ "Get in on the component parts system, or those of us who are already using it will put you out of business. Time is the big thing, not materials. You can use semi-skilled men on parts, but not on pieces. Parts, particularly for the scattered builder, won't 'walk off' the job. And get in on the modular system. Make your measurements from face to face, not center to center. Then you don't have any fractions. And work to existing material sizes.—Leland Lee, Dallas.

◆ "Contract your waste. Tell your suppliers, 'We want to contract for just enough to build the house.' Then anything extra is the suppliers' problem. He picks up the left-overs when he delivers the next load."—John J. Griffin, Oklahoma City, Okla.

## FINANCING

### Experts say:

**Use imagination and explore the numerous methods of obtaining financing. Shop as carefully for mortgages as you do for building materials.**

Visit all your sources of financing and become better acquainted with them. I've done it during the past nine years and I have about 40 sources on which to call. In this way you have a variety of propositions to offer prospects and can just about meet any situation.—Mal Sherman, Baltimore.

Builders and congress should rediscover FHA. We seem to have lost some awareness of the good work FHA has done and can do in activating private capital to finance housing production on liberal terms and on a sound basis. I venture you will quickly convince yourself the industry is overlooking a good opportunity when it uses FHA for only 17% of starts now as contrasted with the 36% used in 1950—especially since terms used then were far more stringent.—Rep. Henry O. Talle (R.-Iowa).

"I believe life insurance companies will have in total more funds for investment this year. However,

## BUSINESS

## MANAGEMENT

### Experts say:

**Versatility is the key to good management. It pays to hire experts on planning, budgets and other management problems if you're not an expert yourself.**

Forty-six per cent of builders who fail, do so because of insufficient or complete lack of management experience. Good management entails an understanding of planning, cost control, control of operations, sales promotion and analysis of results. For good planning you must know your market and systematize so that nothing is left to memory. To control costs you must schedule your operations to a tight time schedule. And don't forget such items as rent and other overhead expenses when preparing your budget. Continuous checking of estimates with actual time spent on jobs will insure proper operations control. Successful sales promotion lies in training yourself to get your story across, cooperation with local stores, building a good reputation through satisfied customers. When the job is done, be sure to study variations in estimates and



any easing in the supply of funds by insurance companies probably will not occur in significant amounts until the late spring or early summer. It is difficult to predict what form this easing will take. But, I am sure most of the following will be evident: discounts on FHA loans will not be as great and there will be a small decline in interest rates on conventional loans. . . . It is my opinion that lenders will be more willing to finance housing projects on the minimum terms permitted by FHA. And, companies that have increased down payment requirements on conventional loans will probably reduce these requirements."—R. B. Patrick, Des Moines.

Stick with one savings and loan association. There will be less chance of the institution saying it has "run out of money" if the institution is assured of repeat business. Savings and loan associations might use this line for those builders who call on them only in emergencies.—Norman Strunk, Chicago.



costs. Find out what threw the schedule out of whack so that it does not happen again.—William Bokum, New York City.

Only by paying hourly rates rather than sub-contracting can you hold the reins of your organization. Small volume builders can build better homes paying hourly. The boss is better informed, can get his ideas across to the men easier.—Ernest Zerble, Mason City, Iowa.

"Use a sub-contractor. His big problem is keeping overhead down. By sub-contracting, there's less equipment investment; less cost for repairs; estimating is simpler. Sub-contractors are committed to do the job efficiently and quickly."—Harold Smith, Dallas.

## HERE'S WHAT THE EXPERTS SAY ABOUT . . .



### ► COMMUNITY FACILITIES

"Get to know the members of local political bodies. It's easier to talk over your problems when you know them personally. In many cases they'll be able to help you build the most efficient plant at the lowest cost. In setting up a utility company, keep it a separate entity from the developing corporation. The latter should hold less than 50% of the utility company for tax purposes. . . . As a separate entity, a utility corporation is more flexible and you can sell it and take a long-term capital gain. . . . Most important, hire a competent sanitary engineer. . . . For a subdivision of 400 to 500 homes we use a rough figure of \$90,000 for plant and sewer pipe. While we're building the plant and the first 50 to 60 homes, we build a temporary facility—either a septic tank or an oxidation pond. . . . A water plant for a subdivision of this type runs about \$30,000 when we use asbestos-cement pipe."—George Wood, Jacksonville, Fla.

"I question the fear we first had when we faced this problem of community facilities. One of our early experiences was providing facilities for a subdivision of 200 units. Later we expanded the plant to handle 500 units, then 900. Our breakeven point is 500 customers. After that it's a nice business. People do pay their sewer bills and it becomes a nice annuity."—Carl Mitnick, Merchantville, N.J.

### ► RENTAL HOUSING

"There are many people who don't want to build or buy a home. In an area with a low tax base and suitable land valuation, a builder should get into some form of rental housing. . . . Before going into a rental project, we examine it for profitability. As a rule of thumb we expect to make 15 per cent on equity capital. This is based on the actual land value on the open market."—Franklin Burns, Denver.

"This market (rental housing) is created by population shifts; a growing junior executive (or white collar) class; a drop-off in home buying; and the growth of older age groups which prefer not to own and maintain a home. For business reasons, there are many income-tax advantages from the operation of rental housing that can't be duplicated elsewhere. There are also long-term possibilities for appreciation."—Harry K. Madway, Philadelphia.

### ► HOUSING FOR THE AGED

No special design is necessary except that these people prefer one-story houses with no stairs. Non-skid floors and other accident-prevention features are required. Everything should be done for easy maintenance.—Robert Hastings, Detroit.

Private pension plans plus social security make these people good risks. They are as good a risk—and in many cases better—than those in the 30-40 year age bracket.—Harry Held, New York City.

"There is a significant number of the elderly whose cash incomes are clearly adequate to buy moderately priced homes. . . . More than 1.6 million elderly families in 1955 had incomes of \$4,000 or more. Better than a half-million of these were in the \$7,000 or higher category."—E. Everett Ashley, Washington.

### ► LABOR RELATIONS

The construction worker is a rugged individualist. When production methods remove him from the results of his labor, he loses his sense of satisfaction and pride in his work. Develop a well-rounded program to properly motivate your workmen. Give them self-esteem, pride in their work and company. This is a realistic approach to getting the most out of your construction dollar.—Marvin Meyers, Rockford, Ill.



*Listen to these NAHB past presidents. They've learned from experience. That's why*



George Nixon



Edward Carr

## They've got answers to

**Q** The cost of a new home has not gone up as much as the cost of the lot it is built on. Land costs, utility requirements, etc., have caused this. Can't we, as an industry, use research to cut these costs?

**HAVERSTICK:** Zoning problems are exceedingly difficult to overcome. The uninformed landowner thinks in terms of driving the builder out in order to keep his area 'uncitified'. Zoning is upgraded; lot sizes are doubled or quadrupled. It is hard to deal with this situation on a national level. It is very local and must be met locally. The community must be taught that it must grow and that its economy will rise along with growth.

**LOCKWOOD:** You've got to make an organized effort in the local community where the trouble originates. First of all, don't knuckle in to everything. Offer persuasion, then resistance. Second, develop an educational program to get people to understand what zoning means and what zoning regulations your community should have. Third, remember that business people, manufacturers, etc., have a common interest in this problem with you. Approached properly, they will help you carry on this campaign of education.

**Q** How do you keep a superintendent cost-conscious?

**DURBIN:** As an example of what we run into, I often find 2x4s lying on the ground with my men walking over them and leaving them there. I've said, "If you found a 50¢ piece or a dollar bill lying on the ground, you'd pick it up and bring it to me. But, a sack of cement, a 2x4, a couple of pounds of roof nails, you walk right by. Any material lying around is cash. And cash like this comes from net profits.

**LOCKWOOD:** Incentive plans don't work. They're hard to apply and often are too complicated. I've found it more satisfactory to have a scheme of establishing standards on every house built—a unit-in-place formula for every part of the building. Our estimator

makes such a sheet for every house we put up. Control of this is put in the hand of the company controller. He administers the cost-control programs. The superintendent is then rated on the number of jobs which meet each norm, the number which go under the norm and the number which go over. His ratings are then checked and a bonus decided on. We allow a total of 13 weeks for each house from the time framing is started. Every week beyond that is charged against the efficiency rating.

**Q** Home building is losing its percentage of the take of consumer dollars. Is there anything we can do to counteract this trend?

**CARR:** Until we remember we're an industry—not just individual builders, manufacturers, bankers, real estate people—we're not going to get enough of the consumer dollar. We've got to sell the (building) industry approach. Home ownership should be stressed by all facets of our industry, both in national and local ads and in manufacturer's consumer ads. Once we adopt an industry-wide approach, we'll get a larger percentage of the consumer dollar. We builders cannot convince the consumer he should own a home without the cooperation of all members of the industry.

**Q** What new ideas are in the offing for builders?

**LOCKWOOD:** There are many new ideas in the research and development stages: One, for example, is polystyrene cores with impervious surfaces laminated to them. They make a single wall construction unit. I believe it retails for about \$1.45 a sq. ft. They can also take an anodized aluminum surface on the outside and a thin veneer of hardwood plywood on the inside. There's also a new method of treating joints which will be faster, easier and acceptable to the public.

**BROCKBANK:** There's a lot of new work in the adhesives field which looks very promising. If these adhesives are made better, we can do away with nails.



Joseph Haverstick



Rodney Lockwood



Alan Brockbank



Harry Durbin

## problems you'll face tomorrow

**Q** We've been told that in 1960 many new families will be needing homes. With the increased costs in building, do you think these young families will be able to afford houses we can offer them in 1960?

**BROCKBANK:** The housing industry must move into the automation column. Then it will be able to produce a house less expensively. Research efforts on our part must be directed toward this. Manufacturers, for instance, must make larger parts which can be put together in homes more easily. NAHB should spend more money in research. About \$1 million a year should be spent to seek cheaper building methods.

**LOCKWOOD:** Up until two years ago—in spite of rising home costs—it took less percentage of a man's wages to buy a home than it did 20 year ago. In the last two years this situation has not continued. Technology must be used to bring this situation back again—to help us build more houses more rapidly.

**Q** Is there a growing trend toward prefab? If so, what are the advantages of building prefab houses?

**NIXON:** The first advantage of component home building is the fact that you can do the job quicker and better. After you have prepared the site (and no matter how elaborate the house is even up to \$100,000) you can put it up the day it's delivered. The home, as you receive it from the manufacturer, is fifty per cent of the finished house. Secondly, vandalism is practically eliminated. Also, you know what the end product will cost before you start production. Another advantage is the fine design available and the great variety of homes you can build.

**LOCKWOOD:** Prefab is the logical result of the annual spiral of on-the-site wage costs. It is the only thing which can offset this factor.

**CARR:** There's no question that prefab houses have a place in this industry. They have been accepted. A builder can build up to 200 houses a year. However, with a small mill he can do amazing things with saws, jigs, etc. And, he can build at a minimum cost. Each year we must examine the job we can do against the prefab package cost and decide which is more advantageous. In smaller quantity building (10 to 15 houses) prefab is cheaper or as cheap to use. In larger quantity building, you may find that you can do the job more efficiently yourself.

**Q** Even though it may save builders money, isn't it possible that the economy in smaller communities may be hurt by pre-fab construction?

**NIXON:** The fact that the house is under roof the day it is delivered means the workmen and craftsmen can work continuously in these houses. Employment is not as spotty.



Dickerman



Northup

Dickerman discusses "How home building shapes up in overall economy."  
Northup discusses "Rx for lower costs: Use more component parts." See page 208.

## Onstage: NAHB's "Circus"

The nuts and bolts of building is the bread and butter of the builder. That's why NAHB's construction "Circus" was both a fitting and popular climax to the convention. The manufacturers' associations, shown here, along with the University of Illinois Small Homes Council, put on a dazzling display of the right way to put a house together. Andy Place was the chairman.

Hit of the show was the first public showing of the "SCR Masonry Process," developed by the Structural Clay Products Research Foundation. Consisting of a set of corner poles, a marked guide line, and a new adjustable scaffold (not shown on stage because of space limitations), the new method can actually double a bricklayer's output, and at the same time reduce his discomfort and fatigue.

Just to make sure everyone believed all this, the mason shown here (under far from ideal conditions) spent half-an-hour laying SCR 12" brick at a rate of more than 800 a day. And Bob Taylor, research director of the foundation, said that some builders were getting up to 1,100 bricks a day, including setting and removing the corner poles.

Most important, Taylor said, the system is much easier for the bricklayer. The marked line speeds positioning of the brick. The scaffold lets him work in a comfortable position and keeps the brick supply at the right height for him.

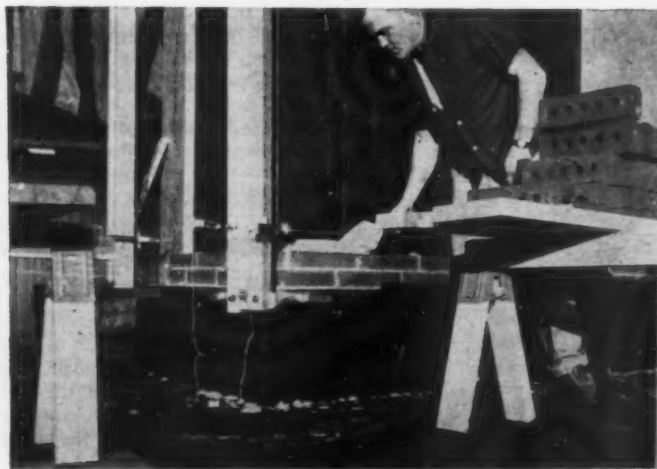

**CORNER POLE** of the SCR Masonry Process is set up and plumbed, at left. Above, the guide lines have been attached to the sliding fitting, which is indexed so that each notch raises it just one course in height.

## for better building



**CONCRETE** strength tests prove the value of putting the right amount of water into the mix. Extra water to make an easy pour, says the Portland Cement Assn., can cut the strength by as much as two-thirds.

◀ **GLUE-NAIL** construction of king post trusses is shown by the University of Illinois Small Homes Council. Casein is the recommended glue. Glued trusses, says the council, are much more rigid than nailed trusses.



**PROPER** preparation of gypsum wallboard for tiling is demonstrated by Lloyd Yeager of the Gypsum Assn. Also shown was the new adhesive-nail application of gypsum wallboard. (See February issue, American Builder).



**THE RIGHT PLYWOOD** for the right job is explained by Earl Remington of the Douglas Fir Plywood Assn. Also shown: a sheathing method that covers the whole wall, with holes for windows cut out afterwards.

**Why is American Builder OUTRAGED about obsolete building codes? Read the feature starting on page 76.**

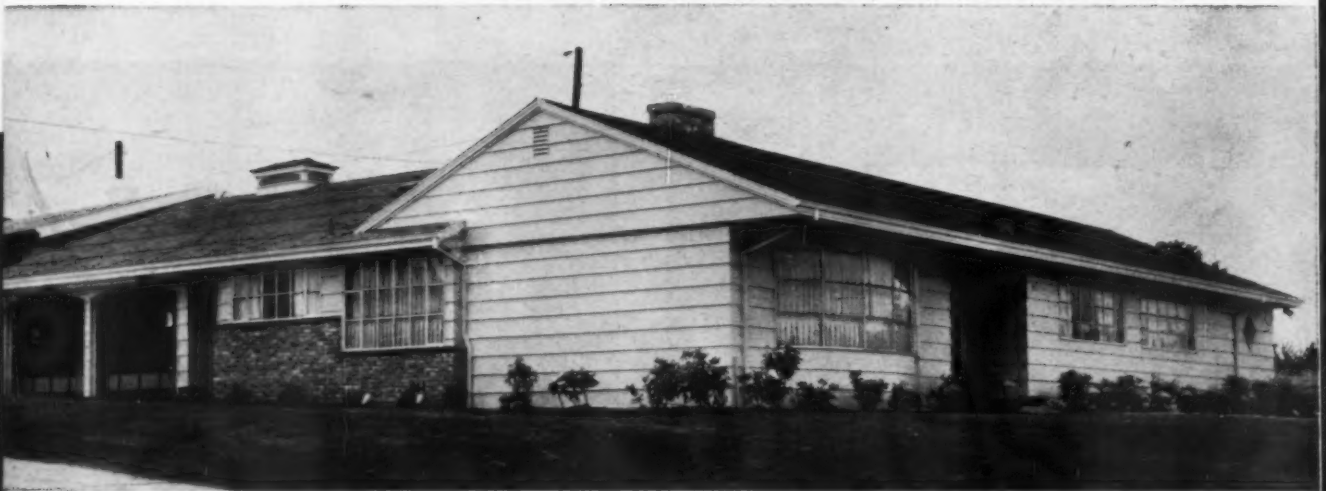

**UNDATED DESIGN** was one big selling feature. Horizontal siding, almost coral in tone, goes well with black cedar roof. Kitchen and garage are built of used brick.



**Award of Merit:**  
**Over \$16,000 category**

## Here's a house that lives

When the "good word" got around about this all-electric house, crowds came out in droves to see it. No one was disappointed. Neither were the judges of **AMERICAN BUILDER'S** best model home contest who gave it an award of merit.

Bob Hemstreet, Portland, Ore., who built the house with the Portland Electric Co., loaded it with

luxury equipment and custom touches. One week after it went on display—it sold. Here are the features the public liked the most.

- Every room is indirectly lighted by valances.
- Recessed in the ceiling of the family room is a "sun center" made up of infra red and sun lamps.
- Hemstreet included a Luxtrol light control, an

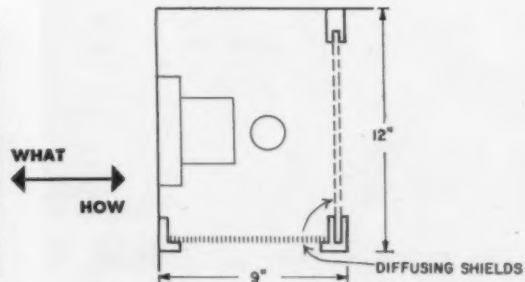

**THREE WALLS** of the family room are fitted with this luminous cornice. Forty-eight inch plastic diffusing shields at front and bottom are spaced to correspond with lamps. Note movable pull-down fixture.



# of the MONTH for March

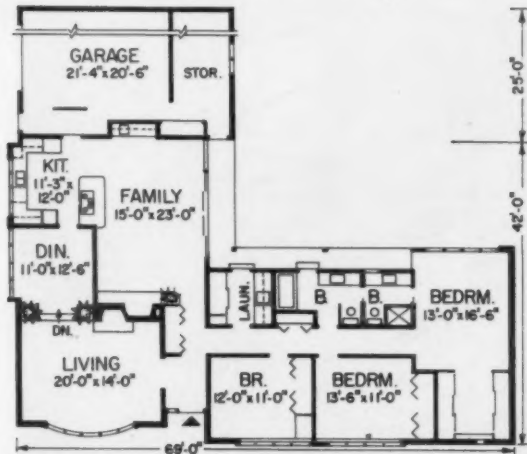

**DEAD END** traffic areas don't exist in this excellent L-shaped plan. The house, designed for outdoor living has five entrances to the patio, and a total of eight into the house. There's over 2,000 sq. ft. of space.



**CURVED PATIO** is smack up against the family room and accessible through sliding glass doors. The kitchen is conveniently close for outdoor serving. Note provisions for night lighting around the recreation area.

## up to its luxury billing

intercom and channel-type electro strips.

- Women loved the Hotpoint kitchen with its electronic oven.
- A centrally located control panel carried the electric load of the house. (This was one feature that helped Hemstreet walk off with a second prize—an AMERICAN BUILDER Hidden-Value award.)

Electrical equipment wasn't all that intrigued "lookers." Most wanted custom features included hardwood floors and paneling, and a two-way brick fireplace between the living room and family room.

The formal dining room, staging a comeback, and the large dressing room, off the master bedroom, were two musts in the original plans.

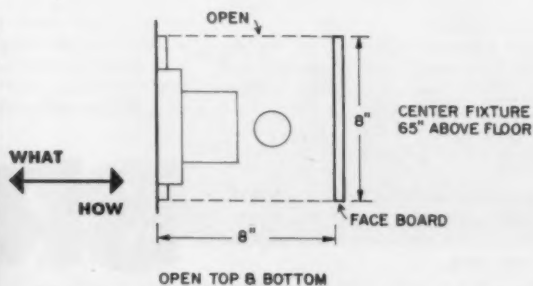

**STRETCHING** from wall to wall, the valance in the master bedroom contains four 48" fluorescents. The inside is painted white for good reflectance. Channel-mounted 65" above the floor, it provides good light for reading in bed.

WHEN YOU SEE THIS KIND OF WORKMANSHIP,  
**EXPECT TROUBLE...**



**G**OOD workmanship is one of the most important factors in preventing leaky brick walls.

Good workmanship includes wetting the brick, securing full head and bed joints, backplastering the face brick—and laying the brick carefully to keep the bond. The position of the brick should never be shifted after the mortar has stiffened.

Expect trouble when brick are shifted or tapped into place after the mortar has stiffened. Cracks will result and the wall may leak.

Brixment mortar has high water-retaining capacity. It resists the sucking action of the brick. It stays plastic and workable longer. Brixment mortar therefore makes it easy for the bricklayer to lay the brick accurately, before the mortar has stiffened.

Brixment mortar has great plasticity, high water-retaining capacity and bonding quality, great resistance to freezing and thawing, and freedom from efflorescence. Because of this combination of advantages, Brixment is the leading masonry cement on the market.

# **BRIXMENT**

LOUISVILLE CEMENT COMPANY, Incorporated, LOUISVILLE, KENTUCKY

**American  
Builder**  
SPECIAL  
WESTERN  
SECTION



**GABLE WALL** is of glass. Vertical slats diffuse light. Cross is made of glued laminated beams and copper ring.

## They planned this church ...

**E**veryone can't design a church like this, but any equipped builder can put it up.

St. Mary's Episcopal Church in Lakewood, Wash., is "all roof." Nineteen-thousand sq. ft. of PlyScord went into the decking and sheathing. It's the roof that sets the pattern for the building. For the full construction story, turn the page.

**WORKMEN** apply PlyScord over roof frame. Cedar was used for shingles; rough cedar went over plywood walls.



... around the roof design ▶

## SPECIAL WESTERN SECTION

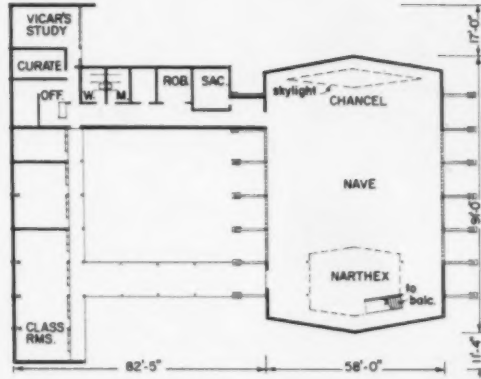

**IDEAL PLAN** separates the church from the teaching area. Classrooms used 3,200 sq. ft. of interior plywood for partitions. Building is 140' wide.

**SHEATHING** was applied to 1x4 nailers which were over 2x8 joists. These were laid over glued, laminated beams which form the arches or inverted "V".

**ROOF OVERHANG** is created by exposed beams which extend outside the building. It is here that the buttness holds them. Note concrete walk to classrooms.

WHAT

THIS WESTERN CHURCH, continued

# How the roof is built to create

HOW

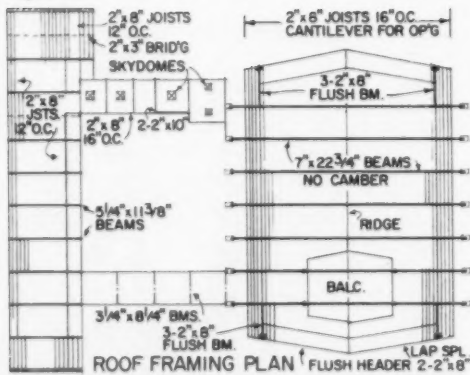

**MAIN** roof support comes from seven beams anchored into concrete buttness. They're separated by six 11' bays. Over the beams, cantilever 2x8 joists laid 16" o. c., lend added support.

The most dramatic element of St. Mary's is its roof. The rest of the building stems from it, particularly the exterior of the front wall. In front of a span of glass the architect, Robert Billsbrough Price, used three components to diffuse light—vertical wood slats, colored plastic panels and glass jalousies. The slats, set in frames, open out like doors. No problems are created when it's time to clean the glass. Besides creating an interesting design pattern, Price made the wall functional.

Under the roof is a plan for organized space. Two main areas, the classrooms and church, are separated by an indoor corridor and a walk.

Plywood, a flexible building material, is used for the roof, walls and other parts of the building. Korsmos Brothers, the builders, said that by using plywood as compared with an alternate material about 10 per cent was shaved off labor expenses. Considering the \$95,000 it took to build St. Mary's, this comes to quite a saving.

Products: Woodlam beams; Modernfold doors; Fiberglas insulation; American Standard plumbing; Armstrong acoustical tile; Norton door closer; McKinney hinges; American Window windows.



# the design

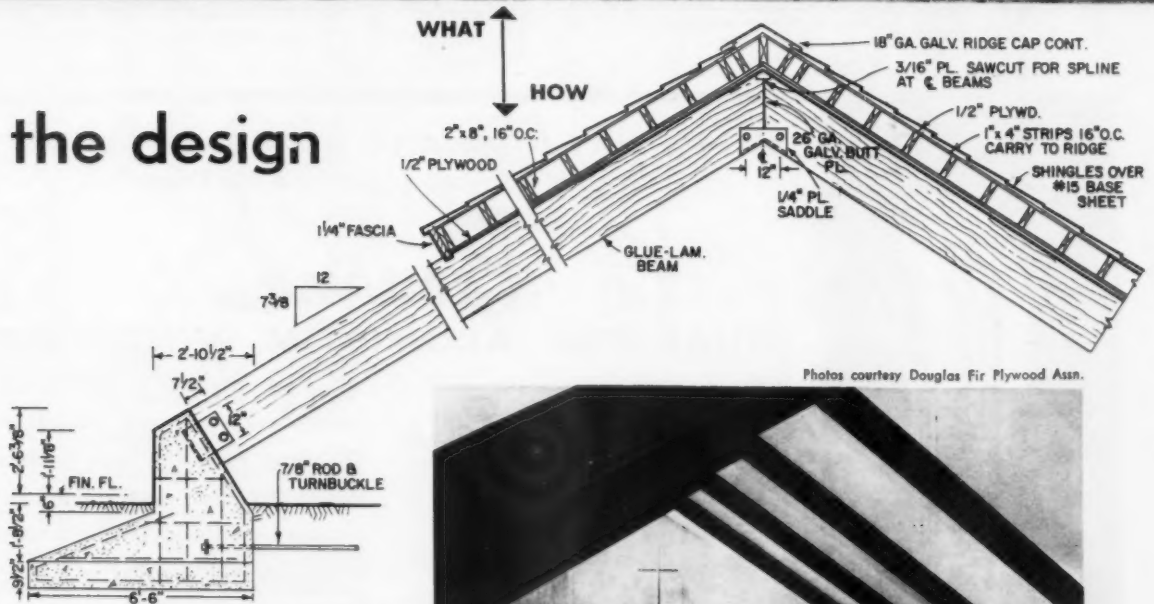

Photos courtesy Douglas Fir Plywood Assn.

**BEAMS** are anchored into this concrete buttress. It's 6½' wide and lies 2½' below the finished grade. Beam anchor, rod and turnbuckle are connecting units.

**ARCHED CEILING** soars to an impressive height of 24'. Interior features: a skylight over the chancel, and a cross suspended from the ceiling by a wire. St. Mary's seats 400.





**NOW!**  
 a ceramic glazed tile  
 with a New Look...  
**RAMONA**  
*Starline*

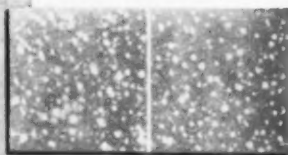

Give interiors a new look — enjoy new profits. The new look Starline is designed for use with RAMONA Wall, Trim and Krystal-glaze tile. Available in seven colors and sells on a competitive basis with plain color tile.

Tile Installation: William Van Zandt  
 Builder: George Taylor

**PACIFIC TILE  
 and PORCELAIN COMPANY**

*Manufacturers of Ramona and Ceratile*

Manufacturing Plant: 7716 East Olive St., Paramount, California, NEVADA 6-3233, MEtCalf 3-1195

Sales Office and Showrooms: 832 North Cole Ave., Los Angeles 38, California, HOLLYWOOD 3-2353  
 2213 15th Ave. West, Seattle 99, Washington, ALDER 8991

MEMBER OF THE TILE COUNCIL OF AMERICA.

**WESTERN EDITOR**

W. C. Rodd  
 8522 Lorain Rd.,  
 San Gabriel, Cal.

**ADVERTISING  
 REPRESENTATIVES**

Fred Klaner, Jr. Brad Erickson  
 1151 W. 6th St., Los Angeles 17  
 Lewis Vogler  
 244 California, San Francisco 4  
 L. B. Conaway  
 1220 S. W. Morrison, Portland  
 5, Ore.

**Western  
 Views**

By Bill Rodd

▼ **RECIPE FOR A LUXURY COMMUNITY** (from a TV commercial of the developer.) "Take 30 acres of choice level land, located on a plateau, with magnificent vistas. Plan to build only 69 superb residences on the full 30 acres, preserving the natural beauty of the terrain. Then, set the tone by building a few homes of unparalleled character with cul-de-sacs, ornamental street lighting and all utilities underground." This is the program of Encino Knolls in the San Fernando Valley, where lots start at \$14,500 and homes at \$53,000.

▼ **HBA OF GREATER SEATTLE** reports that its plan service is a benefit to all those connected with the industry. In its six months of operation more than 200 buildings were filed with the organization.

**HERE'S WHY MORE AND MORE BUILDERS SAY:  
 "It costs no more to provide the finest"**

**Bourne**

**DUAL-FIN® ALUMINUM WINDOWS**

Beautiful, weatherproof, permanent, economical — Bourne Aluminum Windows represent lifetime window satisfaction for the owner. This blue Bourne tag helps sell homes because it says "top quality"—and that's what buyers want.

**Send for FREE Catalog**

This new illustrated Bourne catalogue has complete installation details. Write for your free copy and name of nearest Bourne distributor.



**Bourne PRODUCTS, INC.**

904 Bourne Place El Cajon, California  
 Dept. AB



... One call for all ...

# NEW!



## HERE IS THE GREATEST DEVELOPMENT FOR THE INDUSTRIAL WOODWORKER IN 20 YEARS!

# Par- WOOD

OF DILLARD, OREGON



## A PRODUCT OF SCIENCE

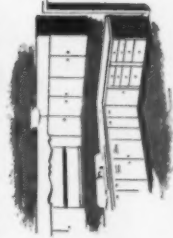
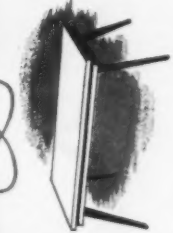
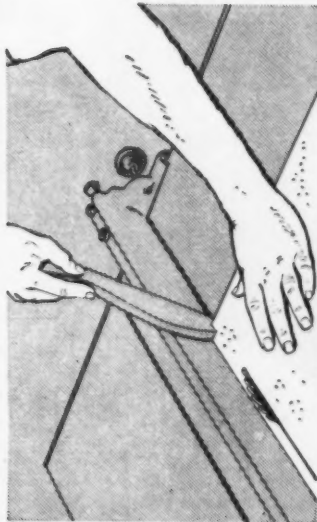

# NOW!

through scientific research and use of SPECIALLY DESIGNED MACHINERY ...  
Par-WOOD! — the greatest wood product on the market today!  
Sturdier ... more Durable ... Tougher ... Par-WOOD does not Warp, takes a fine natural Finish ... is Easy to WORK and Economical in USE.  
Par-WOOD is the Board with a FUTURE ... YOUR future ... your PROFITS!

- Economical to buy!
- Will not WARP or BUCKLE.
- SAWS to a fine edge ... takes screws and perfect edge-gluing.
- Takes a FINE NATURAL FINISH.
- Takes VENEERS and PLASTIC or other laminated finishes without telegraphing.
- MAR-RESISTANT ... MOISTURE-RESISTANT.
- Used for FURNITURE, CABINET WORK, SLIDING DOORS.
- Used for INTERIOR SIDINGS, PANELS, SOFFITS and CEILINGS.

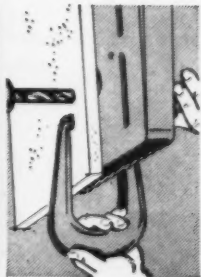
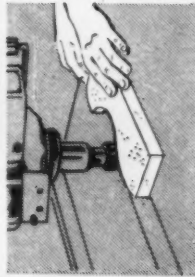

*Attention Boss! Sounds good - send!*



MFGD. BY: **PACIFIC PLYWOOD CO.**  
**PAQUA DIVISION**

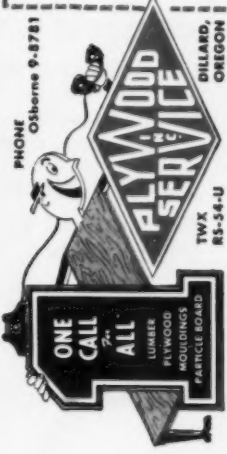

**PLYWOOD SERVICE, Inc.**  
**EXCLUSIVE SALES AGENTS**

Please send further detailed information on **Par-WOOD** to:

NAME \_\_\_\_\_ TITLE \_\_\_\_\_  
 FIRM \_\_\_\_\_  
 ADDRESS \_\_\_\_\_  
 CITY \_\_\_\_\_ ZONE \_\_\_\_\_ STATE \_\_\_\_\_

- PARTICLE BOARDS**
  - Par-WOOD
  - Par-Tile
  - Par-Tex
  - EMBOSSED PLYWOODS**
  - IMITATIONS
  - BETHLEHEMWOOD
  - HARDWOOD PLYWOODS**
  - BIRCH
  - LAMAR
  - HICKORY
  - PINE
  - PINE
  - PINE
  - SOFT PLYWOODS**
  - BREATHERS
  - INTERIOR PANELS
  - EXTERIOR SANDING PANELS
  - VENEERS**
  - MOULDINGS**
  - MANOYANT
  - PINE
  - PINE
  - LUMBER**
  - PR
  - PINE
  - SPRUCE
- Fast, Dependable Service
- Guaranteed Quality
- Missed Car Shipments

Dept. ARM

**HERE NOW! Because so many builders asked for it!**

*Look at the advantages*

**ADDED THICKNESS—STIFFNESS**

The rigidity makes it easier to handle, makes it warp resistant and gives it added resistance to stress deflection.

**CHOICE OF POPULAR PATTERNS**

Choose from plain, SANDALWOOD, or rustic (shallow texture) surfaces. Available in random grooves and grooves on 4" centers. Plain or shiplap edges.

**EXCELLENT WORKABILITY**

Like all FOREST Hardboards, new  $\frac{3}{8}$ " thick panels are scientifically engineered for workability with power and ordinary hand tools. It's kind to tools, too. Nails easily, securely.

**COVERS WITH LESS PAINT**

The smooth hard surface covers better and your paint goes farther... costs less.

**FOR INTERIOR OR EXTERIOR USE**

Check your local building codes and FHA requirements. In some localities  $\frac{3}{8}$ " hardboard may be nailed directly to studs with no sheathing.

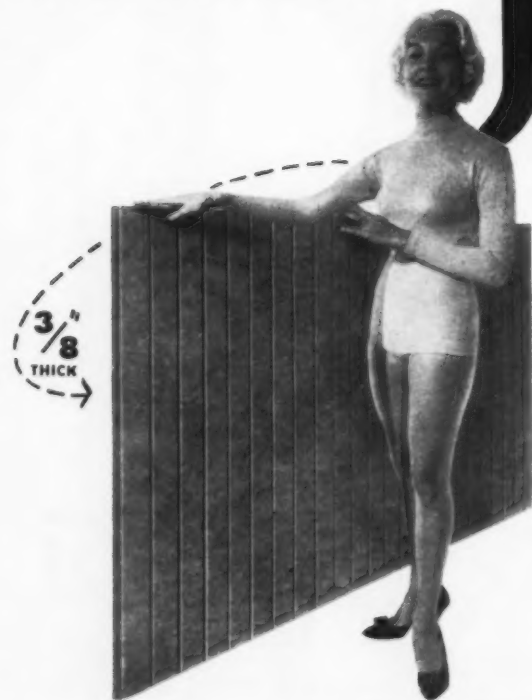

FOR MORE INFORMATION | Contact your nearest Forest Hardboard distributor or mail this coupon.

**3/8" THICK**

**FOREST  
HARD  
BOARD**

**IN SANDALWOOD • TEMPER-  
TREATED & STANDARD PANELS**

**PANEL SIZES** Panels are 4 feet wide in 4', 6', 8', 10', 12' and 16 feet lengths.

**FOREST HARD BOARD**

P. O. Box 68AB Forest Grove, Oregon

I'm interested in your New  $\frac{3}{8}$ " Hardboard panels.

- Send technical bulletin.
- Send Sample.
- Have your salesman call.

Name \_\_\_\_\_  
Company \_\_\_\_\_  
Address \_\_\_\_\_

Builder       Architect       Dealer  
Other \_\_\_\_\_



# DEMAND FOR KAISER FIR-TEX

## INSULATING BOARDS

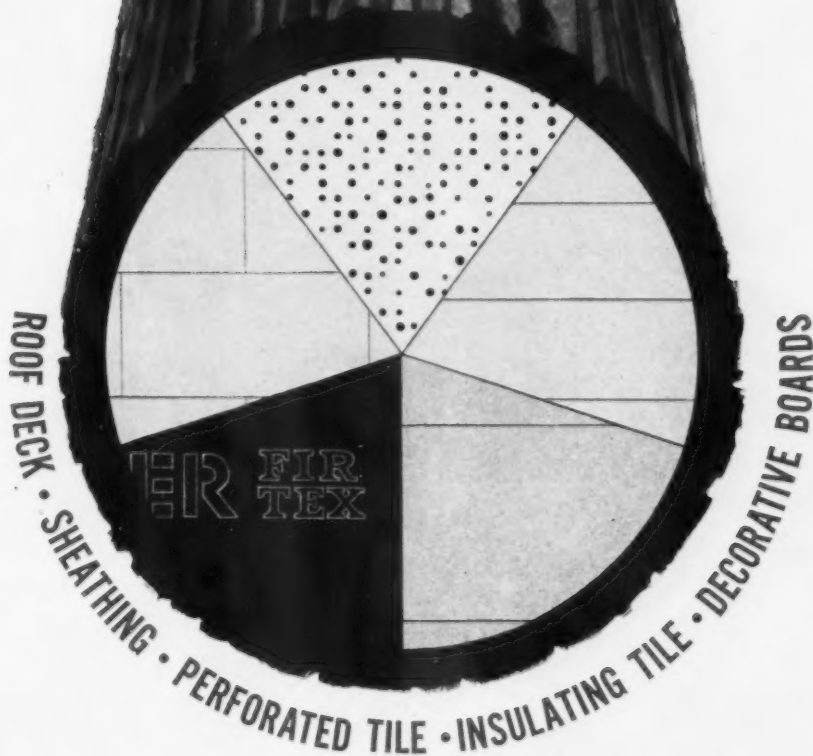

A complete new line of Kaiser Fir-Tex insulating products is now ready for immediate customer delivery. Since Kaiser Gypsum's purchase of Fir-Tex in 1956, modern, new production techniques and equipment have materially up-graded the quality of all insulating products. Personalized contractor service is always available from Kaiser Fir-Tex technical or product representatives. The new superior performing insulating boards, together with rock wool insulation and a complete hardboard line, are now more than ever the key to better installations, more jobs and greater profits for Western contractors.



**KAISER GYPSUM COMPANY, INC.** Kaiser Building—1924 Broadway, Oakland, California

MARCH 1958

32-G

# Round-up of Western Color!



take your  
pick of 47  
rootin', tootin'

**FLEXACHROME**  
colors for '58

—and you'll have  
no flooring problems,  
podner!



**TILE \* TEX**

PIONEER DIVISION  
**THE FLINTKOTE COMPANY**  
2116 E. 55th Street, Los Angeles 54, California

*See classified directory for representative*

## Convention Calendar

Here's a golden opportunity for you—a training course for home salesmen. The Sales and Merchandising Committee of the NAHB has arranged this selling course with Theatre for Industry. The itinerary covers the entire nation. Dates when it will come to your area are listed below.

Detailed information and advance registration may be secured from the local sponsoring home builder group in the scheduled city. All other associations, their members and members' salesmen are invited to participate in the most convenient meeting.

- Mar. 3: New Orleans, La.**
- Mar. 5: Fort Worth, Tex.**
- Mar. 7: San Antonio, Tex.**
- Mar. 11: Los Angeles, Cal.**
- Mar. 14: Berkeley, Cal.**
- Mar. 17: Portland, Ore.**
- Mar. 20: Denver, Colo.**
- Mar. 24: Kansas City, Mo.**
- Mar. 26: Memphis, Tenn.**
- Mar. 28: St. Louis, Mo.**
- Mar. 31: St. Paul, Minn.**
- Apr. 2: Chicago, Ill.**
- Apr. 7: Indianapolis, Ind.**
- Apr. 9: Dayton, Ohio**
- Apr. 11: Detroit, Mich.**
- Apr. 14: Cleveland, Ohio**
- Apr. 16: Pittsburgh, Pa.**
- Apr. 21: Boston, Mass.**
- Apr. 23: Washington, D. C.**
- Apr. 25: Richmond, Va.**
- Apr. 29: Wilmington, Del.**
- May 2: Garden City, L. I., N. Y.**

### Here are the regular association activities

- Mar. 1-9:** HBA of Greater Seattle, 170 Mercer St., Seattle 9, Wash. Home show; National Guard Armory. W. G. McDonald, director.
- Mar. 4-8:** HBA of Kalamazoo, 609 S. Burdick St., Kalamazoo, Mich. Home show; County Center Bldg. Don Wyman, manager.
- Mar. 10-15:** Grand Rapids HBA, 200 Ionia, N. W., Grand Rapids, Mich. Home show. Ward Blackall and G. W. Burbridge, chairmen.
- Mar. 13:** HBA of Hartford County, 14 Oakwood Ave., West Hartford, Conn. Combined meeting—builders and Real Estate Board. N. G. Severin, NAHB pres., guest speaker. Clayton W. Johnson, chairman.
- Mar. 15-19:** Southern Tier HBA, 257 Main St., Johnson City, N. Y. Home show. Mrs. C. Goodsite, chm.
- Mar. 16-23:** Tacoma Master Builders Assn., 1103½ Division Ave., Tacoma, Wash. Better homes exposition; College of Puget Sound Field House. Patrick J. O'Toole, chairman.

*(Continued on page 196)*

MARCH 1958

# HOME BUILDERS!

FORGET  
ANY IDEAS  
YOU MAY HAVE  
ABOUT  
CUSTOM KITCHENS



TAKE A LOOK AT THE FUTURE

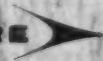

# ANNOUNCING PHILCO'S *Citation*

... A FULL FIVE YEARS



**FIRST TIME ANYWHERE... COOK 3 WAYS... SEE ALL WAYS!**

## *Citation* "SPLIT LEVEL"\* OVEN

**IT'S AN AUTOMATIC OVEN** with a new innovation: closed-door broiling. Nothing could be more ideal for roasting and broiling meats. It has full-window front, too . . . plus electric Roastmeter, automatic timer. It's the think-for-itself oven women want—cash in on it!

**IT'S A ROTISSERIE . . .** it's the new appliance women want most! And this one has the extra advantage of being *full width* for easy basting—easy viewing. No front-to-back inconvenience as in old-fashioned ovens.

**IT'S A BAKING DRAWER . . .** the cook looks *down* and *into* this glass-topped, waist-high drawer and watches how her pies, cakes and cookies are baking! All eyes will be on this never-before-seen feature!

**IT'S FIVE YEARS AHEAD.** Never has any builder been able to show anything as deluxe as this see-through Citation Split Level oven. It was the sensation of the Home Builders Convention. Make it your own sales clincher—now!

\*PAT. PENDING

# CUSTOM KITCHEN APPLIANCES

## AHEAD OF THEIR TIME!

*Citation*  
CUSTOM APPLIANCES

**PHILCO**

IDEAS SO REVOLUTIONARY  
THEY WERE SELECTED FOR THE  
FIRST NAHB RESEARCH HOME.

IDEAS SO EXCITING, BUILDERS AND  
PUBLIC ALIKE DEMANDED THESE RESEARCH  
APPLIANCES BE MADE AVAILABLE!



Never—except in a builder's dream—has there been anything quite like Philco's Citation Custom Kitchen Appliances. New ideas . . . new lines . . . ingenious flexibility . . . great economy . . . everything to sell your home faster, building *your* profits every step of the way.

Only Philco has the fabulous Citation Split Level oven . . . the automatic range top with remote controls. Only

Philco refrigerator-freezers have snap-in panel fronts to put every color, every wood grain right at your finger tips, for a perfect kitchen color match! And to top it all, Philco's Custom Appliances are easily installed in wood or metal cabinets made by national manufacturers or your local lumberman. Remember: Philco's Citation line was the sensation of the Home Builders Convention. It can be the high light of every home *you* build, too!

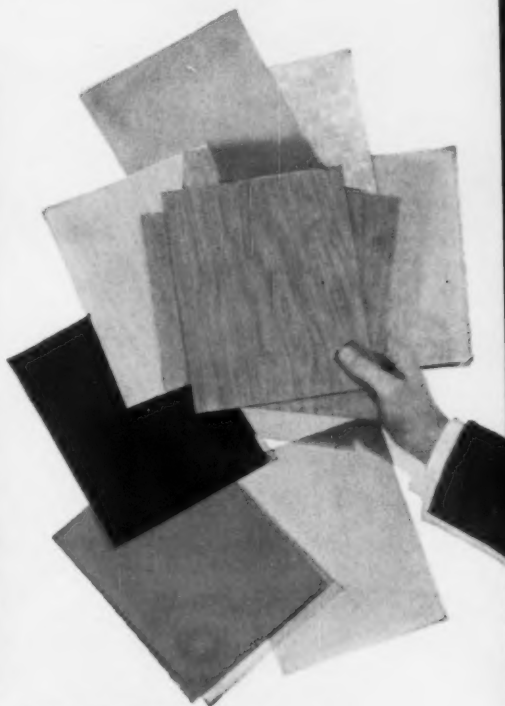

### NEW SNAP-IN FRONTS GIVE YOU AN UNLIMITED COLOR CHOICE ON REFRIGERATOR-FREEZER AND DISHWASHER!

**MATCH ANY COLOR, ANY WOODWORK BY SIMPLY SNAPPING IN FORMICA® PANELS.** For the first time you can sell a custom kitchen with the built-in appliances matching or complementing the cabinets. That's right . . . even wood effects can be carried right through to the refrigerator-freezer and dishwasher!

It's done simply, inexpensively with Philco's ingenious snap-in panel idea. The refrigerator-freezer and dishwasher are delivered with the front panel made of copper finish on the one side, stainless-steel finish

on the other. The customer may prefer the copper or stainless finish—or she can have her choice of any type of Formica paneling. Simply have your local cabinetmaker snap sheets of Formica into front panels to create a perfect custom-kitchen look.

Formica comes in more than 73 colors and finishes, so there's no limit to what color effects you can offer. Best of all, you do it without fuss or bother. The home buyer merely flips through a Formica color chart—and you can give her the kitchen of her dreams.

CONTINUED 

**PHILCO DESIGNERS HAD THE IMAGINATION  
AND DARING TO DO SOMETHING REALLY  
DIFFERENT WITH CUSTOM KITCHEN APPLIANCES**



**CITATION RANGE TOP WITH REMOTE CONTROLS...AND AUTOMATIC GRIDDLE**

This amazing range top adapts to *your* kitchen design. The Philco push-button panel operates by remote control and can be wired in any convenient spot you choose.

And there's more: Philco's Citation range top has cook-by-color push-button controls, fluorescent lighting, automatic griddle. In addition, automatic temperature-controlled and electrically timed 8 inch burner makes any cooking utensil automatic. Fits over standard 30 inch cabinet. Doesn't interfere with drawers. Choice of four styles: automatic remote control with griddle, automatic drop-in, standard drop-in, and standard built-in.

**Built-in wall oven** has new Philco closed-door broiling, complete window front, full-width rotisserie, Roastmeter... everything to make it wonderfully automatic!

*Citation*  
CUSTOM APPLIANCES  
**PHILCO**

Philco's Citation Custom Kitchen Appliances are built for easy installation in either wood or metal cabinets made by national manufacturers or your local lumberman.

For further information and specification write:

Philco Citation Custom Appliances, Philadelphia 34, Pa.

**PHILCO'S *Citation* CUSTOM KITCHEN APPLIANCES OPEN UP A NEW ERA OF DRAMATIC FEATURES AND DECORATING FLEXIBILITY**



**NEW *Citation* REFRIGERATOR-FREEZER**

Available in vertical or horizontal styles. Complete with famous Philco Supermarket features—even Tri-irrigation.

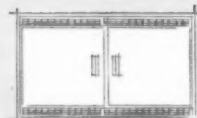

**NEW *Citation* DISHWASHER**

Snap-in front here, too. Individual roll-out basket and pump drain.

Food waste disposers also available.



**NEW *Citation* OVENS**

Each is completely automatic with closed-door broiling. Choice of 3 styles. Split Level oven, deluxe and standard wall ovens.

LOOK AHEAD.... *and you'll choose* **PHILCO**



**Easier, faster installation** comes naturally with siding of Alcoa Aluminum. No caulking, countersinking or puttying. Light, easily handled sections go up in a hurry for faster starts on interior work and earlier completion dates.



**Easier living, too**, because it takes no more than an occasional wash with the garden hose to keep the baked-on colors sparkling bright and clean. No other maintenance. It's as practical for new homes as it is for remodeling.

## Install aluminum siding... sell *Care-free* living

When you install clapboard siding of Alcoa® Aluminum, you get a big bonus on installation time and labor. Aluminum siding neither splits, warps nor buckles, and it ends the job of countersinking and puttying nails. But the big news breaks when your customers learn of the end of periodic painting . . . of siding kept radiantly beautiful, just by the jet from a garden hose . . . of the cool comfort aluminum brings by bouncing off the rays from a scorching sun. Because these advantages mean Care-free living, they can make buyers out of prospects and turn a larger, faster profit for you.

Like all 18 building products of Alcoa Aluminum, the best in clapboard siding bears this Alcoa Care-free tag—a mark of quality widely advertised and widely known to a whole nation of homeowners. Look for the Alcoa Care-free tag on the aluminum siding you install. Aluminum Company of America, 1965-C Alcoa Building, Pittsburgh 19, Pennsylvania.



Look for that Hotpoint Difference / Home Buyers do!



◀ Available from your **HOTPOINT Distributor**: New color-sound film and booklet that shows how to sell the home and its kitchen.

Available direct from **HOTPOINT**: "Kitchen Imagination"—▶  
New 28-page, full-color book on Hotpoint Built-In Kitchens.







Hotpoint Cooks— **Automatically!**

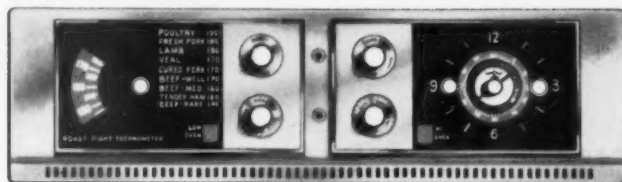

Hotpoint Sells—

# Automatically!

It's love at first sight—the instant that home-buyers see your Hotpoint Kitchens.

To women, the Hotpoint name means the ultimate in quality—in exclusive, years-ahead features that bring them completely automatic cooking.

Women love the Oven Control Center that automatically regulates baking and roasting—the Roast-Right Thermometer that automatically tells her when meat is done—the Rota-Grill Rotisserie that brings her barbecue treats all year 'round—the Handi-Raise Broiler Rack—the big Panorama Window.

Women know that Hotpoint surface sections are the very finest made—with the instant-heating Super "2600" Calrod® Unit—the Super-Matic unit that makes any pan an automatic utensil—the Mealtimer that automatically controls any unit—the 24-cup Coffee-Perk—lighted pushbuttons that show exact heat.

Women want all of these wonderful features. That's why Hotpoint sells automatically—that's why home-buyers know you're a *quality builder* when they see the Hotpoint Built-Ins in your kitchens.

# Hotpoint

Look for that **Difference / Home Buyers do!**

HOTPOINT CO. (A Division of General Electric Company), CHICAGO 44, ILLINOIS

ELECTRIC RANGES • REFRIGERATORS • AUTOMATIC WASHERS • CLOTHES DRYERS • COMBINATION WASHER-DRYERS  
CUSTOMLINE • DISHWASHERS • DISPOSALS • WATER HEATERS • FOOD FREEZERS • AIR CONDITIONERS • TELEVISION

◀ Pictured at left—Super Deluxe Bi-Level Oven, Super Deluxe Surface Unit. Built-In Refrigerator and Freezer. Available in Stainless Finish, Coppertone, and four Colortones—Pink, Yellow, Green and Brown.

This advertisement will "pre-sell" the great Hotpoint Dual-Cycle to your home-buying prospects.



## NOW! TWO-CYCLE DISHWASHING

SPOTLESS CYCLE FOR ALL YOUR DISHES—PLUS EXCLUSIVE  
EXTRA CYCLE FOR HARD-TO-WASH COOKING PANS

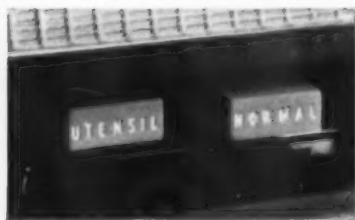

**Only Hotpoint** gives you an added *utensil* cycle that loosens and flushes away even stuck-on foods.

**Spotless Dishes, too!** Two power washes, with fresh detergent in each. Two scalding rinses, with super wetting agent added automatically in *spotless* second rinse. Water spreads so smoothly that drops cannot form, cannot dry as spots. *Spotless* drying in sanitary electrically heated air.

**Two-Level Water Action**—surging jets of water whirl

up from two rotors, one below each rack, scouring every individual piece. Whisper-quiet—yet so effective no rinsing by hand is necessary.

**New Extra Capacity**—easy, new straight-line loads. Racks roll out separately, hold complete service for take 13-inch plates, even range broiler racks.

**Hotpoint Dishwashers** are now available in three 24-inch undercounter models, and in four new plug-in mobile models on wheels. See them today.

**Easiest Installation of All!** Once plumbing has been roughed in, connections are easily made from the front—forward of the motor—with a screwdriver, pliers and a small wrench. 24" wide, 24" deep, 34½" high. For use on 115-volt, 60-cycle AC circuits.

**Interchangeable Front Panels**—In just minutes, you can have your choice of color—pale yellow, brown, green, white, Coppertone, Stainless Steel or provision for Natural Wood.

**Cross section showing exclusive  
Hotpoint Double-Deck Water Action**

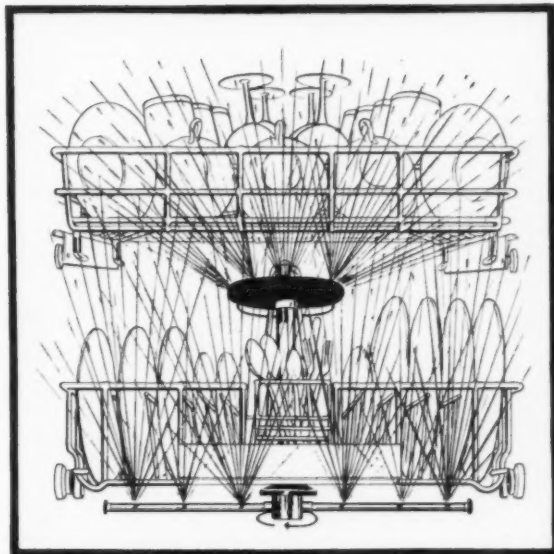

ADD THE SELLING POWER OF  
**AMERICA'S GREATEST  
DISHWASHERS**  
TO YOUR KITCHENS!

Millions of your home-buying prospects are reading this dramatic ad in TIME, BETTER HOMES & GARDENS, HOUSE BEAUTIFUL, SUNSET and other leading national magazines.

Women know that the Hotpoint Dual-Cycle is so brilliant in performance—in flawless beauty—in years-ahead features—that it's in a class by itself.

When they see famous Hotpoint Dual-Cycle Supreme Dishwashers in your kitchens, their estimates of your homes will soar.

The Hotpoint Dual-Cycle Supreme Dishwasher will be one of the most powerful selling features in your entire home—so contact your Hotpoint Distributor Builder Specialist today.

# Hotpoint

Look for that **Difference / Home Buyers do!**

HOTPOINT CO. (A Division of General Electric Company), CHICAGO 44, ILLINOIS

ELECTRIC RANGES • REFRIGERATORS • AUTOMATIC WASHERS • CLOTHES DRYERS • COMBINATION WASHER-DRYERS  
STOMLINE • DISHWASHERS • DISPOSALS • WATER HEATERS • FOOD FREEZERS • AIR CONDITIONERS • TELEVISION



## The ideal floor for modern living

Modern livability is the magnet that lures today's home buyers. They want smart, contemporary styling and freedom from maintenance. Oak Floors satisfy both those requirements far better than any other popularly-priced flooring. Oak's distinctive beauty complements any interior. Its durable surface makes upkeep easy in spite of constant hard wear. And Oak

Floors offer builders many other sales advantages. They're comfortable, healthful, mar-resistant. If you build on concrete slabs, Strip Oak Floors laid over screeds in mastic provide needed resilience and insulation against heat loss. No other floor offers so many merchandisable features for builders of modern homes. No other floor enjoys the public acceptance of Oak.

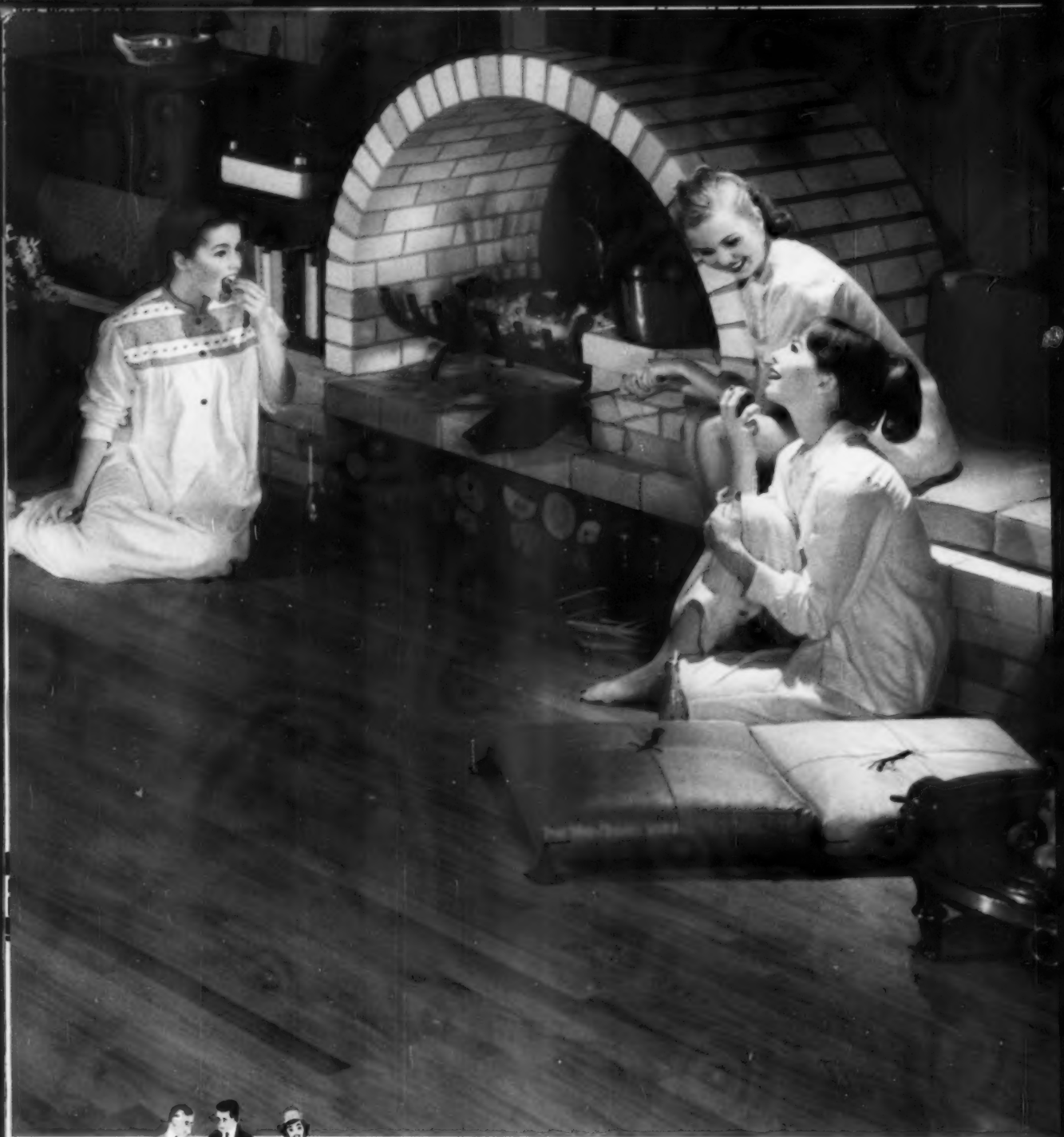

Room design by Ving Smith, Photo by Pagano



You know you're RIGHT  
when you specify Oak Floors

**OAK  
FLOORS**



NATIONAL OAK FLOORING  
MANUFACTURERS' ASSOCIATION

814 Sterick Building  
Memphis 3, Tenn.

Arch: Miloš van der Balje  
societe Architect:  
Friedman, Alschuler & Sincere

Thousands proved in residential  
building — low in cost, the FIAT



Residence of J. A. Haberkorn,  
Fort Lauderdale, Florida.  
Two photos at right show  
(first) glare through clear  
glass vs. (second) no glare  
through LUSTRAGRAY.  
Note how the neutral gray tint  
of LUSTRAGRAY  
actually sharpens the view.

# GLARE REDUCING SHEET GLASS



## American LUSTRAGRAY

**TRANSFORMS SUNLIGHT INTO SOFT LIGHT!**

After noting the Florida home pictured here, both before and after modernization with neutral tint glass, it seems logical to ask: "Why not glaze with AMERICAN LUSTRAGRAY at the very beginning?" Its unique effect will make your new homes more saleable.

Viewed from the exterior, LUSTRAGRAY is dark enough to afford interior privacy. Yet the occupant

is provided "clear glass" vision. LUSTRAGRAY sheet glass reduces glare approximately 50%. It allows maximum viewing pleasure from windows and glass doors. Another feature: it reduces heat transmission.

Use AMERICAN LUSTRAGRAY for economical reduction of glare. It's available through more than 500 glass jobbers. Look in your classified phone directory.

### American LUSTRAGRAY DATA

- Thicknesses:  $\frac{3}{16}$ ",  $\frac{7}{32}$ ",  $\frac{1}{4}$ "
- Maximum Size: 6' x 10'
- Slightly larger sizes on request when available



Architect: *Mies van der Roë*  
Associate Architect:  
*Friedman, Alschuler & Sincere*  
in. Cont.: *Herbert S. Greenwald*  
Contractor:  
*Economy Plumbing & Heating Co.*  
Plumbing Wholesaler: *Amston Supply*  
Division of *American Radiator and*  
*Standard Sanitary Corp.*

Thousands proved in residential  
building — low in cost, the FIAT  
PreCast Floor also saves labor.

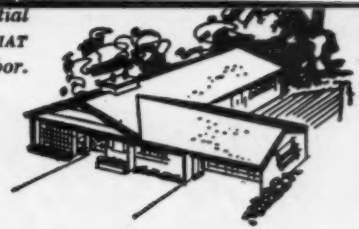

The new, six building luxury  
apartment project to be known as  
900 Esplanade and Commonwealth  
Promenade will have FIAT PreCast  
Shower Floors in every shower. Added  
proof that products by FIAT set the stand-  
ards of shower quality.

## THE Plus IN 1238 Plush APARTMENTS

### FIAT PreCast SHOWER FLOORS

Only the best is good enough on Chicago's  
fabulous "Gold Coast"

FIAT Shower Floors permanently answer the problem of shower floor leakage and high costs. Less product cost, less labor cost and less maintenance costs are the benefits of FIAT's one-piece unit cast in a solid, monolithic slab with genuine marble chips. The FIAT PreCast Shower Floor is simply placed into position and lead caulked to the drain outlet. Once this simple, fast, inexpensive job is completed, the shower wall may then be built of any type material desired; plastic or ceramic tile, marble, plaster or structural glass.

Send for specifications on the complete range of styles and sizes.

**FIAT. FIAT METAL MANUFACTURING CO.**

9319 W. Belmont Ave. • Franklin Park, Illinois

Since 1922... First in Showers / Packaged Showers • Doors • Floors  
Toilet Room Partitions

OTHER COMPLETE PLANTS: Long Island City 1, N. Y.; Los Angeles 83, Calif.; Orillia, Ontario, Canada



Look to



for the finest in

**M-D Numetal WEATHER STRIP FOR DOORS**



**M-D PACKAGED SETS FOR DOORS**

This complete package unit means easier handling for you . . . easier installation for your customers. M-D Numetal door sets are available with regular door bottoms or with threshold and exposed hook.

**M-D Nu GARD AUTOMATIC DOOR BOTTOM**



**UP** automatically to clear carpet easily when door opens.



**DOWN** snugly against floor to seal out drafts when door closes.

Here's the perfect automatic door bottom and draft eliminator for ALL doors. Easily installed on right or left hand door. Smartly designed with silvery-satin finish—will not rust or tarnish. Furnished in standard lengths—28", 32", 36", 42" and 48". Packed in individual cartons.

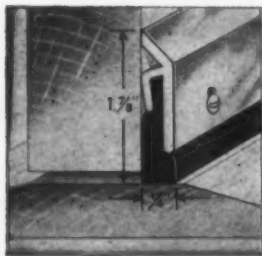

**M-D Extruded DOOR BOTTOM**

Extruded aluminum and felt door bottom — in natural finish or anodized satin, bright or brass colors.

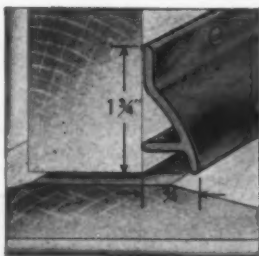

**M-D Extruded HEAVY DUTY DRIP CAP**

Extruded heavy duty drip cap—in natural finish or anodized satin, bright or brass colors.

**M-D EXTRUDED ALUMINUM THRESHOLDS WITH Vinyl Insert**

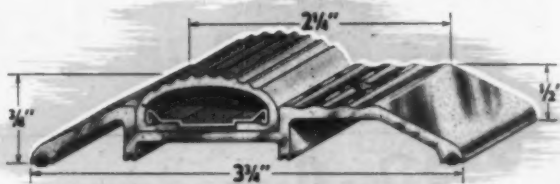

Now M-D Extruded Aluminum Thresholds Nos. AP-3 3/4 and AP-118 have vinyl calking strips along the outside foot on both sides, as well as the replaceable vinyl insert on top. Also available in Anodized Albrass (brass finish—never tarnishes—never needs polishing).



**M-D Numetal DOOR BOTTOMS**

Made of extra thick wool felt and heavy gauge stainless steel, brass or aluminum. Standard lengths—28", 30", 32", 36", 42" and 48"—packaged 1 doz. same length to carton. Special lengths available.



**M-D CALKING & GLAZING COMPOUND**



**Nu-CALK**  
World's best calking compound available in loads, with or without nozzle . . . hand squeeze tubes . . . or 1/2 pt., pt., qt. and gal. cans. Also 5-gal. and 55-gal. drums, gun or knife grade.



**Nu-Glaze**  
You can use and recommend this glazing compound with complete confidence that it always "stays put." Packed in 1/2 pt., pt., and qt. cans, 25 lb., 50 lb., 100 lb., 880 lb. drums.



**MACKLANBURG-DUNCAN CO.**

P.O. BOX 1197 • OKLAHOMA CITY 1, OKLAHOMA



# QUALITY BUILDING SPECIALTIES

## M-D Adjustable Screen Door Grilles available in 3 everlasting finishes

ALBRAS Anodized  
**BRASS**

ALBRIGHT Anodized  
**CHROME**

Silvery-Satin  
**ALACROME**

**NEW  
DESIGN!**

America's most beautiful screen door grilles are available in three permanent, exciting finishes. Never rust, never tarnish, never dull. Now you can offer your customers screen door grilles that match your front door hardware.

### M-D PUSH GRILLE NO. 23

Here's a beautiful new addition to the M-D line of grilles for every type of screen door—wood or metal. It's M-D Push Grille No. 23 . . . a smart, graceful new style designed to give extra protection where it is needed most. 23" high for 32" or 36" doors. 12 to a carton.



FITS-ALL No. 5



FITS-ALL No. 9



FITS-ALL No. 8

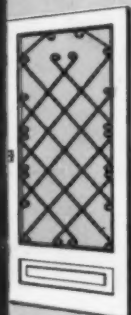

FITS-ALL No. FS



FITS-ALL No. S6

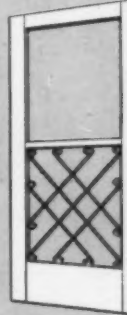

FITS-ALL Nos. 1, 3, 4, 7

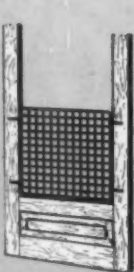

M-D MESH GRILLE

FITS-ALL grilles Nos. 1, 3, 4, 7 have an accordion like action that makes them instantly adjustable. Each comes packed 12 to carton.

No. 1 adjusts from 16" to 30 $\frac{1}{2}$ " in width between stiles, and 40 $\frac{1}{2}$ " to 30 $\frac{1}{2}$ " high.

No. 3 adjusts from 14" to 25" wide, and 25" to 32 $\frac{1}{2}$ " high.

No. 4 for upper section of doors. Adjusts from 19 $\frac{1}{2}$ " to 33 $\frac{1}{2}$ " wide, and 20 $\frac{1}{2}$ " to 34" high.

No. 7 adjusts from 14" to 26" wide, and 33 $\frac{1}{2}$ " to 26" high.



### M-D Push Grille No. 4

A graceful push grille 4" high for 32" or 36" doors. 12 to carton.



### M-D Push Grille No. 6

A handsome, low-priced push grille for aluminum or wood doors. 12 to carton.



M-D Push Grille No. 15  
A graceful addition to any door—wood or metal—16" high for 32" or 36" doors. 12 to carton.



M-D Push Grille No. 16  
Made especially for combination doors. 12 to carton.



## BUILDERS

For highest quality and prompt delivery always specify M-D product. Sold by hardware, lumber and building supply dealers throughout the country.

## DEALERS

Order today! Your order shipped promptly. All M-D products are factory-direct, nationally advertised.

Put this famous brand name

**CELOTEX**  
REG. U.S. PAT. OFF.

to work for you!

So familiar to millions, the good "known name" of CELOTEX on every sheathing board advertises YOUR high standards. It is visible proof of quality construction.

Noticed, recognized, respected by prospects everywhere, CELOTEX Insulating Sheathing does a double job: helps you build better for less . . . helps you sell more homes, easier. It costs no more to build with CELOTEX, the pre-sold brand with a reputation for Quality.

Double-waterproofed and impregnated types in a variety of sizes and thicknesses to meet every job requirement.

**BUILDS • BRACES • PROTECTS • INSULATES • SELLS!**  
**STOCKED BY YOUR CELOTEX DEALER**



A FAMOUS LINE OF NATIONALLY ADVERTISED QUALITY BUILDING



**A Celotex "Plus"**

With Celotex Insulating Sheathing, you get this "Life-of-Building" guarantee to give every buyer. Indicates quality building throughout . . . helps sell more homes, faster. Also, attractive folders with your name imprinted, free. Write for sample copies.

**CELOTEX**  
REG. U.S. PAT. OFF.



MITH BUILDER  
**CELOTEX**  
REG. U.S. PAT. OFF.  
 O MAIN ST. SPRING ON

PRODUCTS . . . pre-sold over a third of a century!

†T. M. \*REG. U. S. PAT. OFF.

INSULATING SHEATHING • ASPHALT ROOFING • MINERAL WOOL • FLEXCELL\*  
 PERIMETER INSULATION AND EXPANSION JOINT FILLER • INSULATING ROOF SLABS  
 HUSH-TONE† CEILING TILE • CELO-ROK\* GYPSUM PRODUCTS • HARDBOARDS •  
 INSULATING SIDING • CEMESTO\* STRUCTURAL INSULATING PANELS • AND OTHERS

**INSULATING  
 SHEATHING**

THE CELOTEX CORPORATION • 120 S. LASALLE ST. • CHICAGO 3, ILL.

*New!*  
 from  
**CELOTEX**  
REG. U. S. PAT. OFF.

Insulating  
**ROOF SLABS**  
 with exclusive  
**VAPOR SEAL**  
 at ALL joints!

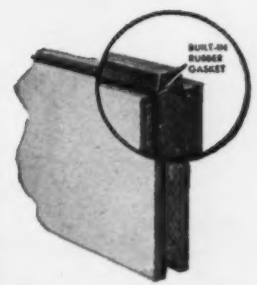

Now . . . perfected by Celotex for use in areas where a positive vapor-barrier is required . . . insulating roof slabs with integral vapor barrier plus vapor seal gasket on one long and one short edge of each slab!

- Now available nationwide!
- Also Standard Type for areas not requiring vapor barrier!

Attractive, White  
**FINISHED CEILING**



White ceiling surface of Celotex Insulating Roof Slabs is cleanable, paintable. Handsome appearance, ideal for modern exposed-beam construction. Adds "sell" to the job!

**Economical!**  
**SAVES LABOR,  
 TIME, MATERIALS!**

Roof Deck  
 •  
 Insulation  
 •  
 Finished Ceiling  
 •  
 Vapor Barrier  
**ALL IN ONE PRODUCT**  
 with  
**ONE APPLICATION**



**IT TAKES A WINDOW LIKE**

*this*

**TO SELL TODAY!**

**Capitol PRIME SLIDING WINDOWS**  
**have features no other can match**

Capitol is the first manufacturer to design a prime sliding window with a *positive* airtight, weather-tight seal. The new Capitol aluminum prime slider uses a special compressive vinyl seal and employs a new design of the meeting rails that is so efficient that wind-driven water at hurricane force cannot get through!

Sell Capitol and you'll further benefit from the product development and sales experience of Capitol, world's largest manufacturer of aluminum doors.

Keep in mind that you can get your aluminum combination storm doors and windows from Capitol, too.

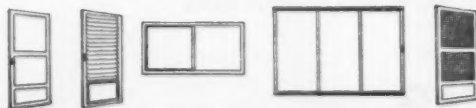

PRIME WINDOWS • ROLLING GLASS DOORS AND SCREENS • COMBINATION DOORS AND WINDOWS • JALOUSIES • EXTRUSIONS

**Capitol**



**RIGID FRAME . . . EASY OPERATION  
 . . . NOT A RATTLE**

Heavy aluminum extrusions are welded into a rigid frame, reinforced by the strength of a fixed center bar. This design plus perfectly mitered corners make sagging or warping impossible. Sliding sections have nylon guides. Units slide freely at the touch of a finger.

**PATENTED FINGER-TIP  
 AUTOMATIC LOCK**

This is the finest sliding window lock made today. Attractively designed, it opens at the touch of a finger . . . automatically locks when the window is closed. It's truly fool-proof.

**EASY, TROUBLE-FREE INSTALLATION**

With the simplicity of design and easy-to-follow instructions on every window, improper installation is virtually impossible.



**A wonderful sales opportunity . . .  
 ROLLING GLASS DOORS  
 by Capitol**

You can capitalize on the growing demand of homeowners for modern rolling glass doors with the complete line of magnificently engineered doors by Capitol.

Available in two and four-panel units, in widths from six to sixteen feet, in various heights to eight feet, Capitol rolling doors appeal to the builder because of their sound engineering, quality construction, ease of installation.

Perfect machining, careful assembly and factory checking assure trouble-free installations. You may have Capitol rolling doors with 1/4" plate or Thermopane.

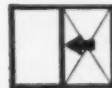

TYPE O-X

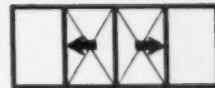

TYPE O-X-X-O



**A SINGLE SOURCE . . . SINGULAR SERVICE  
 for all your aluminum doors and windows**

AB-103

**CAPITOL PRODUCTS CORPORATION  
 Mechanicsburg, Pa.**

Please give me complete information as soon as possible on

- Capitol Prime Sliding Windows
- Capitol Rolling Glass Doors & Screens
- Capitol Combination Storm Doors & Windows

NAME \_\_\_\_\_

COMPANY \_\_\_\_\_

ADDRESS \_\_\_\_\_

TELEPHONE \_\_\_\_\_

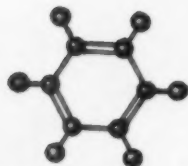

MILLION-YEAR-OLD WONDER CHEMICAL  
MAKES

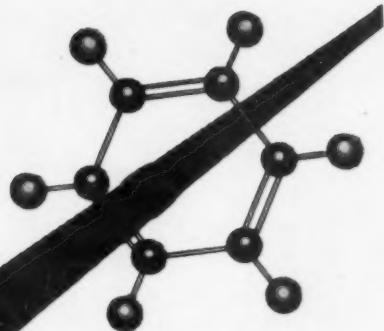

# BERMICO®

The Sewer Pipe That Serves  
Both Builder and Buyer Best!

From bituminous coal, formed by Nature millions of years ago, comes *coal tar pitch*—with its high molecular strength. On all types of outdoor structures, roads, roofs—wherever water and corrosion resistance is a *must*—*coal tar pitch* has proved its lasting effectiveness.

*Bermico*, the tough cellulose fibre pipe, is thoroughly impregnated with *coal tar pitch*. That's why it has such an impressive record of giving both home builders and buyers complete trouble-free service, year after year!

**Builders like Bermico** because it's economical—light in weight—fast and easy to install—does not rust, rot or corrode—comes in convenient 8-foot lengths—and has the only complete line of fittings including Wyes, Tees and Bends made of the same material.

**Home buyers prefer Bermico** because it's root-proof when properly installed—trouble-free—long-lasting, unaffected by household wastes.

Specify and install *Bermico* bituminized fibre pipe for house-to-sewer connections, storm drains, downspout run-offs—*Bermiseptic*® Perforated Pipe for septic tank disposal beds—and *Bermidrain*® for foundation drainage.

BROWN  COMPANY

Berlin, New Hampshire

General Sales Offices:

150 Causeway Street, Boston 14, Mass.

Guarantee of Quality



*A new stainless steel flue*

# PACKAGE CHIMNEY

BY

*McQuay*

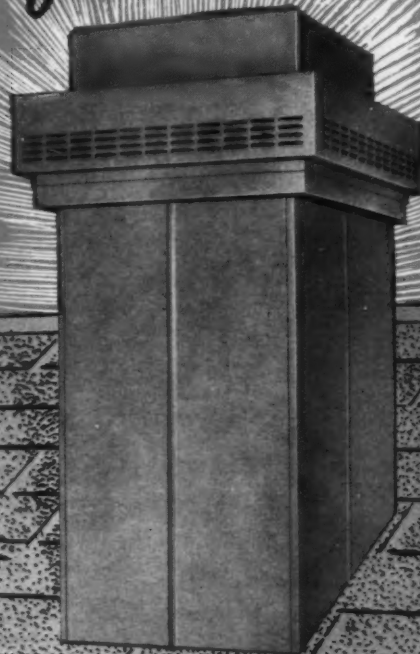

Here is the best engineered chimney ever built — by anyone. Designed and engineered by McQuay, and suitable for all fuels, (Type A) this new package chimney has a 7" stainless steel flue with aluminized steel interliner and outer casing. The interliner is supported by the exclusive McQuay stainless steel tension spring spacers for strength, rigidity and durability. There is nothing to deteriorate, nothing to collect soot. Roof housing is large, measuring 16"x20" with a 20"x24" cap.

Looking down through a McQuay package chimney section. Stainless steel tension springs separate and firmly position stainless steel flue. Steel tension springs also position aluminized steel interliner and outer casing for extreme durability and rigidity. McQuay thermo siphon design and tension springs permit fast and free air flow for quick draft and even temperature from top to bottom.

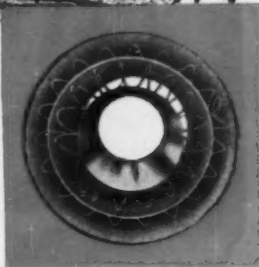

### Check These Features Against Those of Any Other Chimney!

**SAFETY**—Listed under the re-examination service of Underwriters' Laboratories, Inc., and on the approved list of F.H.A. and V.A.

**ECONOMY**—Costs from one-third to one-half as much as brick installed. All pre-assembly has been done to eliminate costly on-the-job time and labor.

**LONGEST SERVICE LIFE**—Flue is of stainless steel to permanently withstand effects of combustion gases. No cracking or chipping. Interliner and outer casing are of aluminized steel. Starter box and starter sections are in one unit for fast erection. Standard 24", 18" and 12" sections give any desired length. Average installation time is less than one hour after openings are prepared.

**LIGHT WEIGHT**—Load on support joists is only 9 pounds per foot of chimney length.

**SHIPPED COMPLETE**—With easy-to-follow instructions for installing. No special tools required. Units are individually packaged.

**McQuay**  
Means Quality

This McQuay design permits quick drafts and even temperature from top to bottom for peak efficiency under all conditions—steady winter firing or intermittent firing in mild weather. For the best results, and for greatest economy, recommend and use this McQuay package chimney on every job.

Territories are now being assigned. Write today to McQuay Chimneys, Inc., 1699 Broadway Street N.E., Minneapolis 13, Minnesota.

# McQuay CHIMNEYS INC.





Pleasant to be in, easy to work in, are these functional Fidelity Home kitchens — from the board of Seymour Weiner.



**PREWAY** Bilt-Ins give the best accounting to  
**Fidelity Builders**  
 one of the big five in Chicagoland

Because the kitchen is of vital concern to the housewife, Fidelity Builders lay special emphasis on it.

Seymour Weiner, designing and supervising architect, says, "Nothing sells and satisfies like quality. That's why PREWAY Bilt-Ins — electric or gas — are important to our thinking and are specified in our plans. In addition to speeding buyer interest in our kitchens by their look-of-tomorrow styling, PREWAYS outperform any built-ins we have known in the way of freedom from trouble. Our service calls are almost zero — an amazing 700% decrease over previous experiences . . . and we thought we were doing well before."

Seymour Weiner's comment may well serve as a reminder for you to re-evaluate your kitchen thinking to improve your competitive position and lower your costs — all costs. Hundreds of builders already have. Write today for colorful specification bulletins that give you full information on PREWAY Bilt-In appliances.



Inc. 8358 Second Street, North, Wisconsin Rapids, Wisconsin

SINCE 1917 — Pioneer manufacturer of built-in appliances — refrigerator-freezer combinations, gas and electric ovens and surface units, ventilating range hoods.





BEAUTIFULLY  
PREFINISHED  
and factory-waxed by  
Bruce... finish won't  
chip or peel

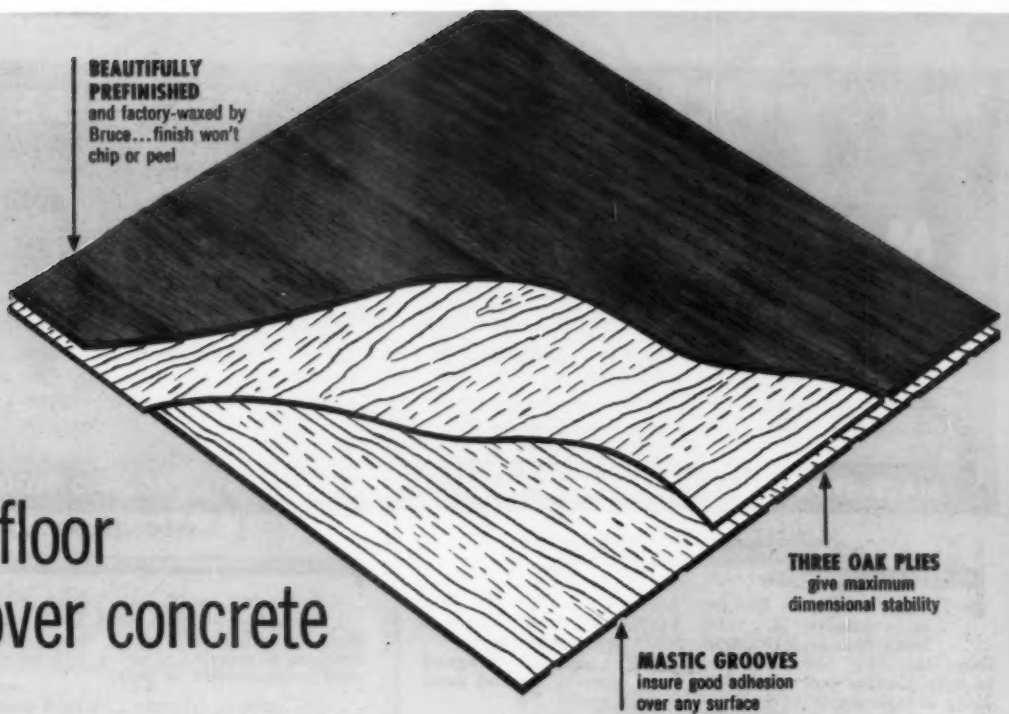

Ideal floor  
over concrete

THREE OAK PLYES  
give maximum  
dimensional stability

MASTIC GROOVES  
insure good adhesion  
over any surface

## New Bruce Laminated Oak Block



### Modern, inexpensive floor lays like tile over concrete subfloors

- Cross-laminated under heat and pressure with waterproof glue
- No surface dampproofing necessary when laid on slabs on grade constructed to FHA or VA specifications
- No expansion space necessary
- Lower in cost than most types of synthetic flooring materials
- Easily applied on wood or concrete subfloors in Bruce Everbond Cold-Stik mastic (no heating required)
- Ideal for private residential and commercial construction
- Smart, modern parquet pattern
- Manufactured in 9" x 9" squares, 1/8" thick
- Carton-packed for protection and easy handling and storage

## Bruce Laminated Oak Block

... designed for modern construction

E. L. BRUCE CO., Memphis, Tenn.



World's largest maker  
of hardwood floors

Find out about this low-cost oak floor today!

E. L. Bruce Co.  
1670 Thomas, Memphis 1, Tenn.

Please send literature on Bruce Laminated Oak Block.

Name \_\_\_\_\_

Address \_\_\_\_\_

# MR. CONTRACTOR...HERE IS YOUR 1958 REFERENCE GUIDE

## featuring... **MAZE STORMGUARD** NAILS

THE NAILS WHICH PROTECT YOU (AND YOUR CUSTOMERS) AGAINST STAINS, STREAKS AND RUST... **FOR LESS MONEY!**

- Strong steel nails Double-Dipped in Molten Zinc. (Steel for driving strength . . . Zinc for lasting protection.)
- Provide the same practical advantages of aluminum . . . cost about 1/3 less per nail . . . Plus, added driving strength.
- Available with threaded shanks for greater holding power.
- In colors to match all types of modern siding.

### MAZE STORMGUARD ROOFING NAILS

#### ASPHALT SHINGLE NAILS



In Lengths —  $\frac{7}{8}$ ", 1",  $1\frac{1}{4}$ ",  $1\frac{1}{2}$ ",  $1\frac{3}{4}$ ", 2"  
 Stock Nos. — R100, R101, R102, R103, R104, R105  
 Extra large  $\frac{1}{2}$ " head x 12 gauge. Nail is especially designed to help prevent asphalt shingles from blowing up and damaging in high winds on modern low pitch roofs.

#### ASPHALT SHINGLE ANCHOR-SHANK NAILS

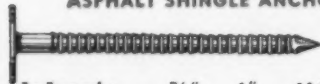

In Lengths —  $\frac{7}{8}$ ", 1",  $1\frac{1}{4}$ ",  $1\frac{1}{2}$ ",  $1\frac{3}{4}$ ", 2"  
 Stock Nos. — R100A, 101A, R102A, R103A, R104A, R105A  
 Same nail as above but with 20 self-anchoring rings per inch to give the nails great holding power, making them ideal for re-roofing over old roofs and for use over insulation sheathing.

#### ASPHALT SINGLE SPIRAL-SHANK NAILS

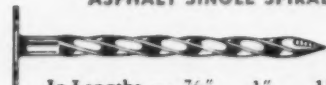

In Lengths —  $\frac{7}{8}$ ", 1",  $1\frac{1}{4}$ ",  $1\frac{1}{2}$ ",  $1\frac{3}{4}$ ", 2"  
 Stock Nos. — R100S, R101S, R102S, R103S, R104S, R105S  
 Same nail as above but with a screw shank which twists in when driven. Ideal for new roofs and especially popular for re-roofing.

#### CEDAR SHINGLE NAILS



In Lengths —  $1\frac{1}{4}$ ",  $1\frac{1}{2}$ ",  $1\frac{3}{4}$ ", 2"  
 Stock Nos. — R112, R113, R114, R115  
 Designed to specifications of the Red Cedar Shingle Bureau, these nails help to lengthen the life of a cedar roof. Zinc helps prevent shingle rot.

#### UMBRELLA HEAD SPIRAL-SHANK NAILS (Calk-Screws)

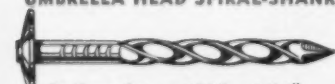

In Lengths —  $1\frac{1}{2}$ ",  $1\frac{3}{4}$ ", 2",  $2\frac{1}{2}$ "  
 Stock Nos. — R133S, R134S, R135S, R137S  
 One-piece construction — nothing to come apart or damage in driving. Concave head caps nail hole like umbrella. Threaded shank twists in like screw. Excellent for both corrugated and V-Crimp galvanized steel or aluminum roofing.

#### CAST LEAD HEAD ANCHOR-SHANK NAILS

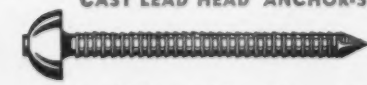

In Lengths —  $1\frac{1}{4}$ ",  $1\frac{1}{2}$ ",  $1\frac{3}{4}$ ", 2",  $2\frac{1}{2}$ "  
 Stock Nos. — R142A, R143A, R144A, R145A, R147A  
 Head is soft lead—nothing to dry out or disintegrate in sun. Lead head, formed by molten lead, stands hard driving and seals nail hole. Ring shanks lengthen roof life by helping to keep nails firmly in place. Excellent for all types of metal roofing.

### MAZE STORMGUARD SIDING NAILS

#### WOOD SIDING NAILS

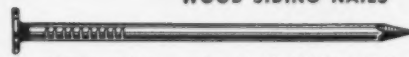

In Lengths — 2",  $2\frac{1}{4}$ ",  $2\frac{1}{2}$ ",  $2\frac{3}{4}$ ", 3"  
 Stock Nos. — S205, S206, S207, S208, S209  
 Made of stiff, slender stock, these nails drive without undue breaking or splitting of siding. Checkered heads hold paint. No need to countersink or putty.

#### WOOD SIDING ANCHOR-SHANK NAILS

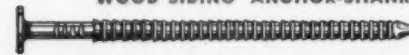

In Lengths — 2",  $2\frac{1}{4}$ ",  $2\frac{1}{2}$ ",  $2\frac{3}{4}$ ", 3"  
 Stock Nos. — S205A, S206A, S207A, S208A, S209A  
 Same nail as above, but with self-anchoring rings which draw down and hold siding tight and snug.

#### CEDAR SHAKE SIDING FACE NAILS



In Lengths —  $1\frac{1}{2}$ ",  $1\frac{3}{4}$ ", 2",  $2\frac{1}{4}$ ",  $2\frac{1}{2}$ "  
 Stock Nos. — S233, S234, S235, S236, S237  
 Made especially with easily concealed brad head. Short blunt point and slender shank minimize splitting. Type recommended by Red Cedar Shingle Bureau. In zinc finish and colors.

#### CEDAR SHAKE ANCHOR-SHANK FACE NAILS

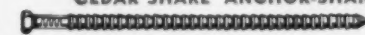

In Lengths —  $1\frac{1}{2}$ ",  $1\frac{3}{4}$ ", 2",  $2\frac{1}{4}$ ",  $2\frac{1}{2}$ "  
 Stock Nos. — S233A, S234A, S235A, S236A, S237A  
 Same nail as above, but with self-anchoring rings to give added holding power in insulation sheathing and old siding. Available in Stormguard zinc finish and in popular shake colors.

#### ASBESTOS SIDING ANCHOR-SHANK FACE NAILS

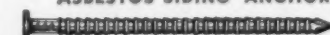

1",  $1\frac{1}{8}$ ",  $1\frac{1}{4}$ ",  $1\frac{1}{2}$ ",  $1\frac{3}{4}$ ", 2",  $2\frac{1}{2}$ "  
 S211A, S211- $\frac{1}{8}$ A, S212A, S213A, S214A, S215A, S217A  
 Designed to fit all makes of asbestos siding, these nails can be used interchangeably with nails supplied with siding for head nailing and face nailing. Made of stiff stock, they drive without undue bending or breaking. Self-anchoring rings give great holding power. In zinc finish and popular colors.

#### INSULATING SIDING NAILS

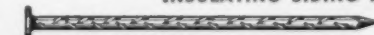

In Lengths —  $\frac{7}{8}$ ", 1",  $1\frac{1}{4}$ ",  $1\frac{1}{2}$ ",  $1\frac{3}{4}$ ", 2",  $2\frac{1}{4}$ ",  $2\frac{1}{2}$ "  
 Stock Nos. — S240, S241, S242, S243, S244, S245, S246, S247  
 Stocked in Stormguard zinc finish and in popular colors, these nails are especially designed for applying insulating siding. Stiff, barbed shank drives well. Checkered head holds paint. Also available in anchor-shank for greater holding power.

#### HARDBOARD SIDING SPIRAL-SHANK NAILS



In Lengths — 2",  $2\frac{1}{2}$ ", 3"  
 Stock Nos. — S255S, S257S, S259S (also plain shank)  
 Extra stiff steel . . . drives through two thicknesses of hardboard. Eliminates pre-drilling. Type nail recommended by hardboard producers.

# FOR MAZE NAILS

Your customers count on your experience and sound judgment—especially for small items like nails. Uphold their faith in you by using modern, chainproof STORMGUARD Nails for their roofing, siding and trim.

The farsighted decision to use Maze STORMGUARD Nails will win you the lasting appreciation of every new home buyer and remodeling customer you serve.

Your dealers stock Maze STORMGUARDS or can quickly get them from a local jobber. Ask for Maze STORMGUARDS by name. They are produced only by W. H. Maze Company, Peru, Illinois.

## MAZE STORMGUARD TRIM NAILS

### CASING NAILS FOR TRIM



In Lengths — 2", 2½", 3"  
Stock Nos. — T305, T307, T309

Without countersinking and puttying, these nails check the formation of stains, streaks and rust at such prominent locations as window and door frames, corner boards, bed mold, crown mold and cornices.

### FINISHING NAILS FOR TRIM



In Lengths — 2", 2½"  
Stock Nos. — T315, T317

Designed especially for porch ceilings, railings, basement steps, etc. These nails check the formation of stains, streaks and rust, making a permanently neat clean job without countersinking or puttying.

### BOX NAILS FOR TRIM



In Lengths — 1½", 2", 2½", 3"  
Stock Nos. — T323, T325, T327, T329

Slender and stiff with a neat flat head, these nails are made especially for construction of fences, trellises, gates, box posts, lawn furniture, bird houses, and ornamental exterior woodwork of all kinds.

### COMMON NAILS FOR TRIM



In Lengths — 2½", 3", 3½"  
Stock Nos. — T337, T339, T3391

Designed for use on roof dormers, louvers, vents, exterior steps, box sills, etc. to check unsightly stains, streaks and rust. Same sizes as regular common nails.

### ANCHOR-SHANK COMMON NAILS FOR TRIM



In Lengths — 2½", 3", 3½"  
Stock Nos. — T337A, T339A, T3391A

The annular ring shank of these nails greatly increases their holding power over that of standard common nails. Ideal not only for the same purposes as common nails, but also for corn cribs, heavy fences, tanks, etc.

### BUY THEM FROM YOUR LUMBER DEALER

All Nails shown are listed in your dealer's Maze Catalog 57.  
**FREE SAMPLES!** Specify Nail samples desired by stock number.

## OTHER TYPES OF MAZE NAILS

### NAILS FOR CORRUGATED METAL ROOFING

(Lead Head Nails below are available in 1½", 1¾", 2" and 2½"  
Bright or Galvanized.)

#### COMPRESSED LEAD HEAD BARBED-SHANK

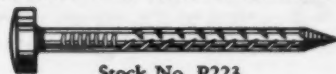

Stock No. P223

#### COMPRESSED LEAD HEAD ANCHOR-SHANK

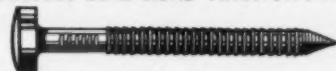

Stock No. P223R — Where greater holding power is needed.

#### HOT CAST LEAD HEAD BARBED-SHANK



Stock No. C223 — Superior type nail . . . heads have 25% more lead.

#### HOT CAST LEAD HEAD ANCHOR-SHANK



Stock No. C223R — Where greater holding power is needed.

#### UMBRELLA HEAD ANCHOR-SHANK NAIL

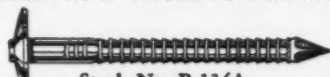

Stock No. R-134A  
Stormguard coated, one-piece construction.

## POPULAR "SPECIALTY" NAILS FOR INTERIOR WORK

#### "GRIPSTAYS" WALLBOARD NAILS

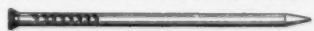

Stock No. W94 — 1"-2", Zinc plated . . . also in colors.

#### DRYWALL ANCHOR-SHANK NAILS



Stock No. D81 — 1¼"-1¾", Bright and hot-dipped.

#### UNDERLAYMENT ANCHOR-SHANK NAILS



Stock No. F142 — 1"-1¼", Cement coated.

#### SPIRAL-SHANK FLOORING NAILS



Stock No. F167, 1½"-2¾", Stiff stock and hardened.

#### HARDENED MASONRY NAILS



Stock No. H59S, ½"-4", Also plain shank.

#### POLE-TYPE ANCHOR-SHANK NAILS

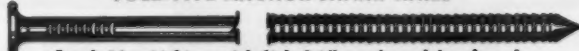

Stock No. 526A — 8d-60d, Stiff stock and hardened.



"IT PAYS TO BUY MAZE"  
**W. H. MAZE COMPANY**  
PERU 3, ILLINOIS

# **Bildrite has unexcelled 2-way moisture control**

*...because it's asphalt impregnated*

# **Bildrite has more insulating value**

*...because its sturdy fibers trap millions of air cells*

# **Bildrite has more bracing strength**

*...because it's made from cold ground hardy  
Northern wood fibers*



**"I tried 6 other sheathing materials...  
then settled on Bildrite exclusively"**

**Jack Dietrich, president of Homestead Construction Corp., Highland, Indiana, has recently completed a 680-home project using Bildrite Sheathing and Insulite Shingle-Backer exclusively. "When we started, I tried seven different brands of sheathing," says Dietrich, "but never found anything to match Bildrite for strength, easy cutting, or nail holding ability. Why should I gamble, when I can get Bildrite?"**

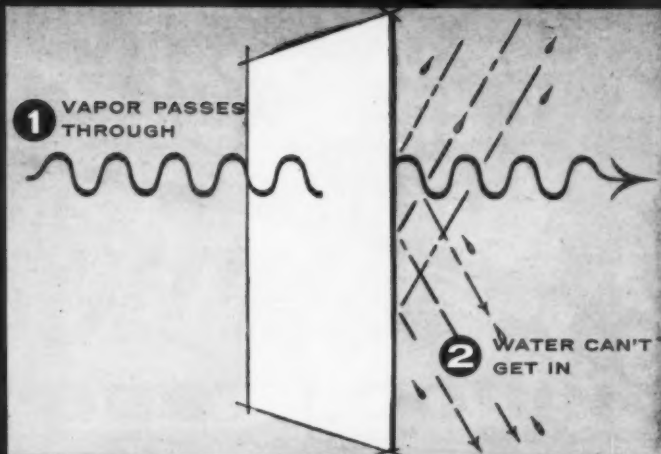

### Wherever moisture threatens homes

(and most damage occurs in outside walls), the only way to build safely is to provide a vapor barrier on the warm side of the wall, let any vapor that gets through the barrier escape rapidly to the outside. Bildrite Sheathing sets up NO VAPOR BARRIER ON THE COLD SIDE. Yet it sheds water like a duck. Used with proper interior vapor barrier, Bildrite vents excess vapor; controls condensation build-up that can rot framing members or ruin interior walls.



### Where temperatures reach 40 degrees below zero

—as at the Minnesota-Canada border—homeowners have proved through many, many years that Bildrite Sheathing gives priceless *extra* insulation to sidewalls compared to wood or gypsum. And the extra insulation costs builders nothing. Millions of air cells, trapped between asphalt-treated wood fibers, reduce heat loss most effectively. And being applied *over* studs, plates and sills, etc., Bildrite blankets the 15% or more of wall area *completely missed* by stud-space insulation.



### Where wind velocities hit 80 miles per hour

—as happened recently in New England—the value of Bildrite's very high bracing strength is seen dramatically. But even under normal stresses, too, this tremendous resistance to racking adds priceless extra quality to homes . . . and gives the builder real peace of mind. Want more information about how and why Bildrite's better fibers make a stronger board . . . and facts about Bildrite's contribution to moisture control? Write us—Insulite, Minneapolis 2, Minnesota.

*build better, save labor, with*  
**INSULITE**  
*Bildrite Sheathing*



Insulite made of hardy Northern wood. Insulite Division of Minnesota and Ontario Paper Company, Minneapolis, Minnesota  
 INSULITE AND BILDRITE ARE REG. T.M.'S, U.S. PAT. OFF.

**MY  
HOUSES SELL  
FASTER...**

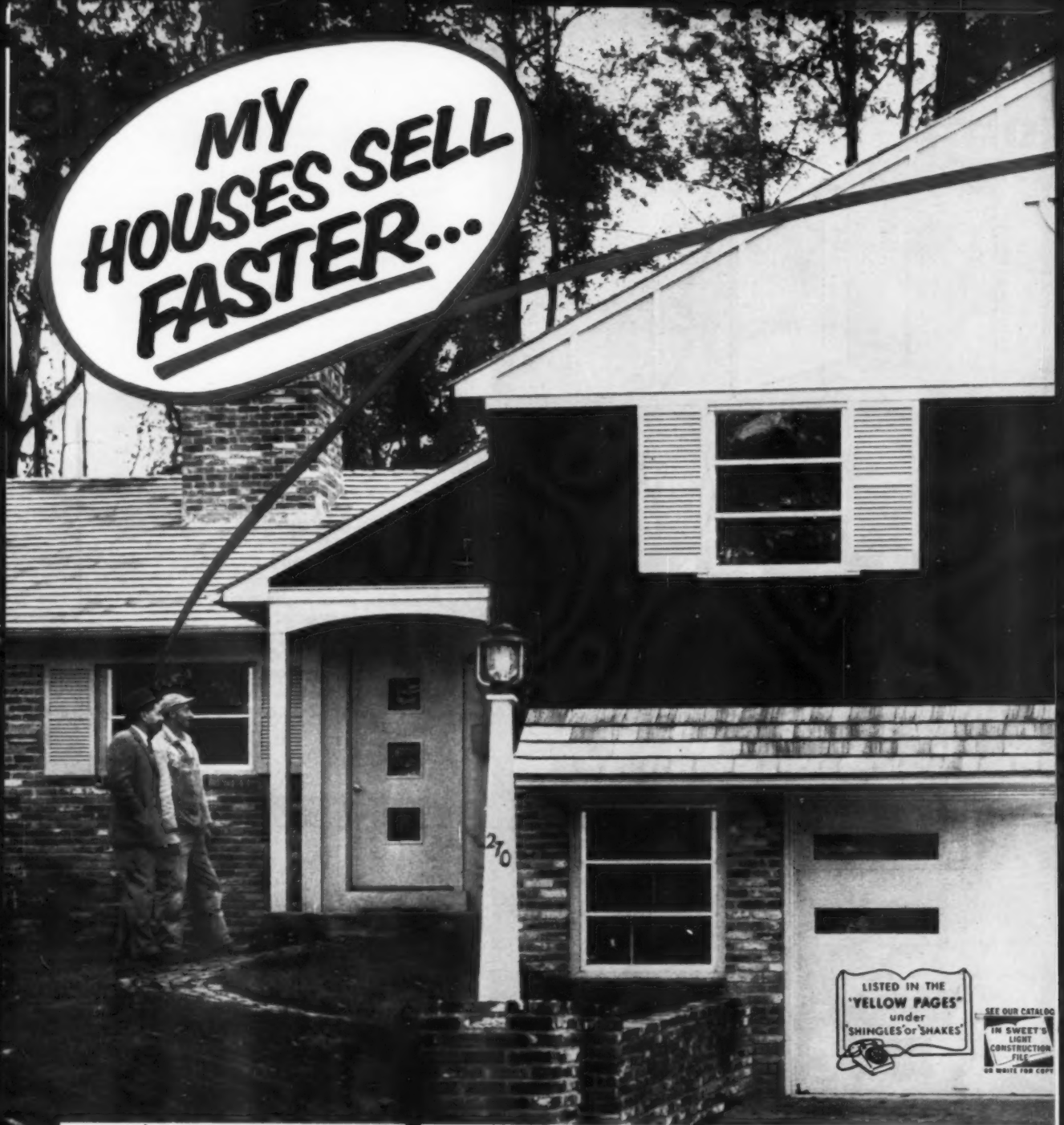

**UNIFORM  
COLOR AND TEXTURE**

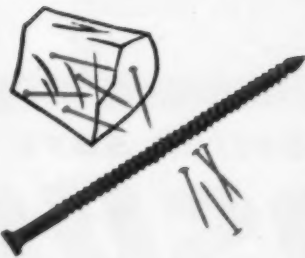

**MATCHING COLOR NAILS  
FURNISHED IN THE CARTON**

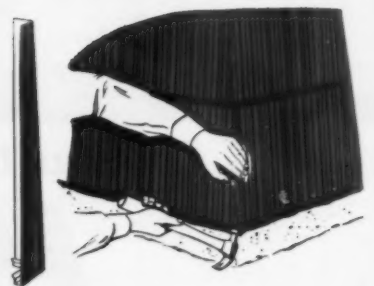

**MATCHING COLOR  
JIFFY CORNERS**

LISTED IN THE  
**'YELLOW PAGES'**  
under  
**'SHINGLES' or 'SHAKES'**

SEE OUR CATALOG  
IN SWEET'S  
LIGHT  
CONSTRUCTION  
FILE  
OR WRITE FOR COPY

... BECAUSE **Shakertown**  
**GLUMAC UNITS** ARE THE  
**BEST LOOKING SHAKES**  
**ON THE MARKET TODAY!**

U.S. Pat. 2,232,786  
 Other U.S. and Foreign  
 Patents Pending

*Joseph E. Palmer*

JOSEPH E. PALMER  
 BUILDER AND DEVELOPER  
 37 North Valley Road · Paoli, Pennsylvania

SAYS MR. PALMER: "My houses sell faster because Shakertown Glumac Units are the best looking stained shakes on the market today. Not only are the colors modern and beautiful, but they last longer. Glumacs blend naturally with other building materials, which give my homes a variation of exteriors with a minimum of architectural changes. To the builders who know application costs, the superiority of Glumac Units is quickly apparent."

Your customers are presold on Shakertown Glumac Units. The gorgeous colors and natural wood texture help put home buyers in a receptive mood. *Eye appeal* is only part of the story. Like Mr. Palmer, builders have found that Glumac Units *apply fast* with maximum economy in application costs. Like Mr. Palmer's, your houses will sell faster with Glumac Units.



Give us a chance to prove that the total applied cost of Shakertown Glumac Units is lower than almost any sidewall material you are now using. Send for full information today.

**Shakertown CORPORATION**  
 DEPT. AB3, 20310 KINSMAN ROAD · CLEVELAND 22, OHIO

Shakertown<sup>®</sup> GLUMAC UNITS · SIDEWALL SHAKES · STAIN · JIFFY CORNERS

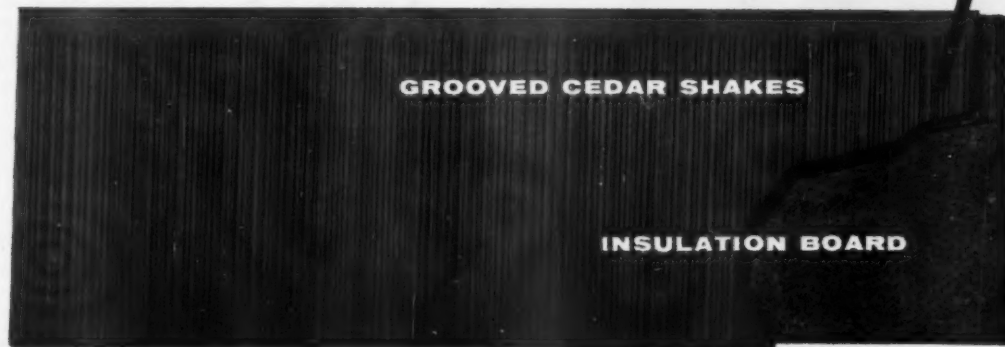

46" LONG . . . EASIER TO APPLY



**EASIER HANDLING** — Lightness and balance, easy adjustments, safety features give better control in the wood.



**MORE POWER** — Cool running B&D-built motor is custom engineered for abundant power on tough sawing jobs.



**BETTER VISIBILITY** — Exclusive picture-window view, double guide lines insure line-of-cut accuracy.

## HERE'S WHY BLACK & DECKER SAWS ARE TOO TOUGH TO BEAT!



### PROVED BUILDERS' BEST BUY IN 7-DAY TORTURE TEST!

The features of a product tell you what that product can do! And the features of Black & Decker Saws assure you the fastest, easiest sawing you've ever done! Those same features enabled a B&D Saw to stand up to the famous 7-Day Torture Test . . . to run continuously for one full week . . . to take more punishment than most saws ever get in a lifetime of use!

Try a B&D Saw at your supplier's now. Check its construction, heft it, pull the trigger and feel the surge of power. See for yourself why Black & Decker Saws are too tough to beat! THE BLACK & DECKER MFG. Co., Dept. H103, Towson 4, Maryland.

### NEW B&D CHAIN SAW ATTACHMENT

Cuts trees, timber, beams, heavy planking, stacked lumber. Cuts in any position, notching, etc. Heavy-weight performance, maximum versatility . . . safe, fast. Fits B&D #73 and #83 Saws.

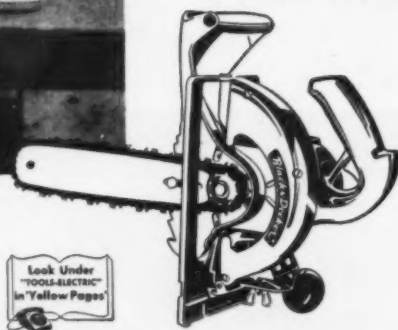

Look Under "TOOLS-ELECTRIC" in Yellow Pages

NEW LOW PRICES IN TIME FOR  
**SAWTIME '58**  
NOW, MORE THAN EVER, B&D  
IS THE BUILDER'S BEST BUY!

# Black & Decker®

Towson 4, Md. World's Largest Maker of Electric Tools



# ATLAS<sup>®</sup> MORTAR

IMPROVES MASONRY



"... has all the qualities desired for good workmanship."

Says W. L. Gossard, Masonry Contractor

- Builders report the excellent workability characteristics of ATLAS MORTAR cement help keep costs down in masonry construction.
- ATLAS MORTAR mixes are plastic, require less retempering, stay workable.
- Quality-controlled manufacture of ATLAS MORTAR masonry cement maintains high product standards, assuring uniform performance and appearance on every project. (Complies with ASTM and Federal Specifications.)

Write for your copy of "Build Better Masonry,"

Universal Atlas, 100 Park Avenue, New York 17, N. Y.



M-70



TRADE MARK

**UNIVERSAL ATLAS CEMENT COMPANY**—member of the industrial family that serves the nation—**UNITED STATES STEEL**

**OFFICES:** Albany • Birmingham • Boston • Chicago • Dayton • Kansas City • Milwaukee • Minneapolis • New York • Philadelphia • Pittsburgh • St. Louis • Waco





## stop the traffic...start the sale

In roof design, what *looks flat falls flat!* It takes *texture* and *scale* and *dimension* to make the roof important.

Today's trend to big roof areas, bold roof textures and expansive roof overhangs has made cedar shingles on the roof as valuable as another salesman on the ground.

For shingles of western red cedar have that vital *third dimension...* the thick butt-line that catches the sun and creates shadow accents of dramatic depth. Only cedar roofs offer the natural graining and rich texture of the genuine. Because only cedar *is* the genuine.

When you think of roofs this building season, think *big*, think *bold...* and you will think of cedar!

### RED CEDAR SHINGLE BUREAU

5510 White Building, Seattle 1, Washington  
550 Burrard Street, Vancouver 1, B. C.

Your Best "Outside Salesman" Is Cedar





## Pushmatic\* protection plus plenty of circuits

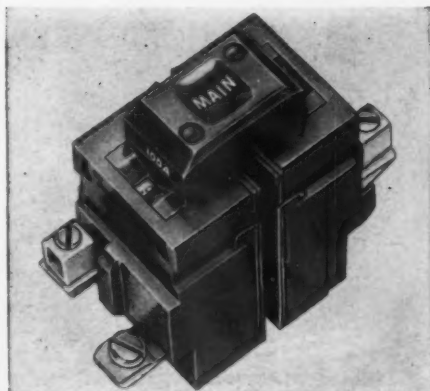

**BULLDOG DUO-GUARD PUSHMATICS** fit any Electri-Center panel. Main disconnects for each 100 amps of service prevent overloading of service entrance conductors. And Electri-Centers compare in price with ordinary panels.

\*Circuit breaker trademark registered by BullDog Electric Products Co.

Look at all these appliances! From small toasters to modern electrical heating, BullDog Electri-Center® panels provide homeowners with all the circuits they need now . . . plus space to add new lighting and appliance circuits later.

In addition, exclusive Duo-Guard® Pushmatic breakers provide two-way circuit protection—guarding thermally against overloads, magnetically against short circuits. No fuses to change, either. When power is interrupted by an overload or "short", the simple push of a button puts the circuit back in operation.

Give your homes full **HOUSEPOWER** . . . maximum protection and convenience. Contact your electrical contractor or BullDog field engineer for complete details on BullDog Electri-Center panels.

© BEPCO

# BULLDOG



BullDog Electric Products Co., Detroit 32, Mich. A Division of I-T-E Circuit Breaker Co.  
BullDog Export Division: 13 East 40th St., New York 16, N.Y.

In Canada: BullDog Electric Products Co. (Canada) Ltd., 80 Clayson Rd., Toronto 15, Ont.



# "THERE'S LESS TO DO, FROM HEARTH TO FLUE"

HERE'S WHY "BENEFIRE®" SAVES MY TIME— CUTS FIREPLACE CONSTRUCTION COSTS



"Thanks to Benefire, I show a bigger profit from fireplace jobs. It's the *complete fireplace form*. Just set it on the firebrick hearth on a 1/2" bed of fire clay. Bottom flange forms a neat, tight junction with hearth . . . speeds up construction, seals against heat and smoke leaks."

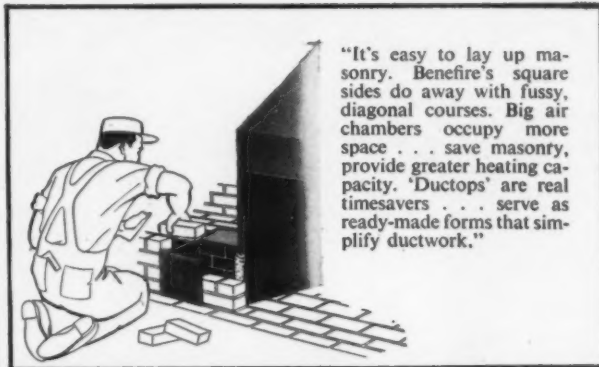

"It's easy to lay up masonry. Benefire's square sides do away with fussy, diagonal courses. Big air chambers occupy more space . . . save masonry, provide greater heating capacity. 'Ductops' are real timesavers . . . serve as ready-made forms that simplify ductwork."

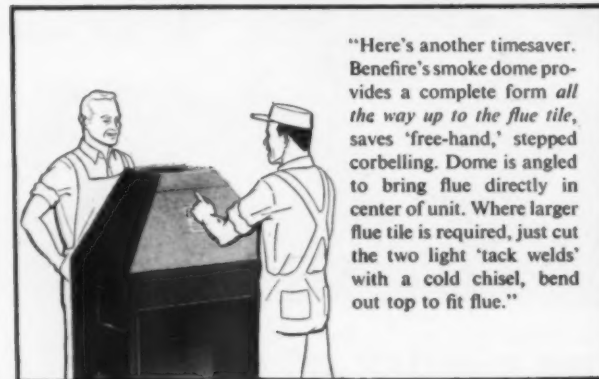

"Here's another timesaver. Benefire's smoke dome provides a complete form *all the way up to the flue tile*, saves 'free-hand,' stepped corbelling. Dome is angled to bring flue directly in center of unit. Where larger flue tile is required, just cut the two light 'tack welds' with a cold chisel, bend out top to fit flue."

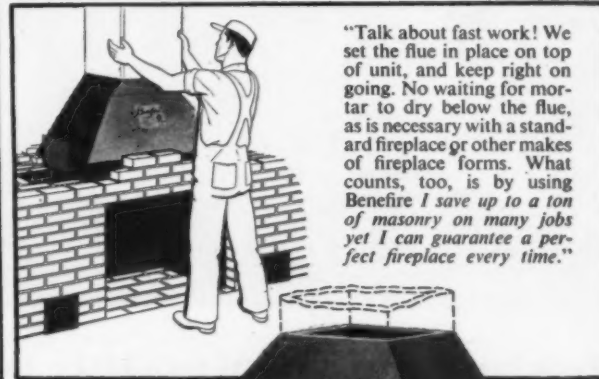

"Talk about fast work! We set the flue in place on top of unit, and keep right on going. No waiting for mortar to dry below the flue, as is necessary with a standard fireplace or other makes of fireplace forms. What counts, too, is by using Benefire I save up to a ton of masonry on many jobs yet I can guarantee a perfect fireplace every time."

... and these exclusive BENEFIRE® features make a hit with the homeowner

1. Tight seal flange prevents smoke leaks into room.
2. Dome design insures smoke-free draft.
3. Exclusive rotary damper controls provide just the right amount of draft to suit conditions. Nothing to get out of order.
4. New Tight-Seal Throat Damper seats tightly all around without packing . . . no annoying drafts when fireplace is not in use.
5. Depth and height of opening carefully proportioned to give broadest view of the fire and the most radiant heat.



**See your LOCAL BENNETT SUPPLIER**

... For full details and low prices on the new Mason-Designed Benefire Unit, and the complete line of dampers, ash dumps, grilles, grates, lintels, etc. For complete catalog, write to Bennett-Ireland, Inc., 358 Market St., Norwich, N.Y.

**AUTHORITIES ON FIREPLACES**

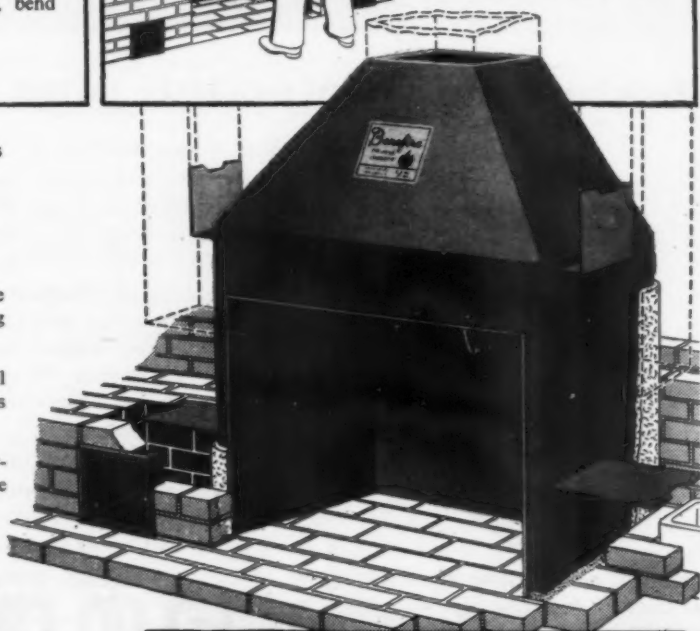

Find the firm going places...you'll find **FIRESTONES!**



Whether you operate one truck or twenty trucks, you can't buy a tire that costs less per mile than Firestones. Billions of miles of carefully kept fleet records prove Firestone truck tires outwear all others.

Firestones last longer because Firestones are built better. Take Firestone S/F—Safety-Fortified—cord. Firestone tempers cord, but doesn't stop there. Firestone gum-fortifies every fiber for a permanent lock between rubber and cord, measures every individual ply with electronic precision.

The result is extra miles, lower cost per mile for every user of Firestone truck tires with S/F—Safety-Fortified—cord. Every Firestone truck tire is an outstanding value in long-wearing, dependable performance. No wonder more going concerns go on Firestones! See your local Firestone Dealer or Store for truck tires or truck tire service.

**YOU CAN'T BUY A TIRE THAT COSTS LESS PER MILE THAN FIRESTONE**

Copyright 1958, The Firestone Tire & Rubber Company  
Enjoy the Voice of Firestone every Monday evening on ABC television



TRANSPORT SUPER ALL TRACTION

**Firestone**

**BETTER RUBBER FROM START TO FINISH**

even  
blindfolded .

you can't run  
a cut off course . . .

Now straight cuts come automatically — with MAXAW's exclusive True Course Guide! Follows the cut like a rudder to assure straight-line sawing . . . keeps cut open, prevents binding or stalling, speeds cutting, saves motor. MAXAW offers 8" blade performance with a 7/4" blade — deeper angle cuts with less weight and bulk, twice as many sharpenings per blade, easier handling. Heavy-duty dynamically-balanced Cummins-built motors assure top power, compactness and dependability. Let MAXAW speed your construction jobs — see your Cummins dealer now!

# Cummins® MAXAW®

## MAXAW 7800

100% ball and roller bearing construction! Only 7/4" saw with 8" cutting capacity . . . cuts 2 1/4" at 45° angle!

\$84.95

## MAXAW 757

100% ball and roller bearing construction! 6 3/8" blade cuts 1 7/8" at 45° angle!

\$69.95

Prices slightly higher in Canada

Exclusive  
True Course  
Guide



FINGER-TIP DEPTH ADJUSTMENT gives instant depth control



FINGER-TIP BEVEL ADJUSTMENT simple lever, calibrated quadrant for any bevel cut



BLADE SIGHTING SLOT view cutting edge at any angle . . . CALIBRATED RIP FENCE GUIDE assures accurate cuts



SAFETY GUARD retractable, telescoping, with safety grip

**Cummins Portable Electric Tools**  
5055 N. Lydell Ave., Milwaukee 17, Wis.

Please send me more information on Cummins MAXAWS!

Name \_\_\_\_\_

Address \_\_\_\_\_

City \_\_\_\_\_ Zone \_\_\_\_\_ State \_\_\_\_\_

© 1956 J.O.M.C. Made by *John Oster* Manufacturing Co.

**Only from  
Kennatrack...  
eleven series of  
by-passing door  
hardware**

Only Kennatrack offers you quality to meet *every* need for home, office and light industrial building.

Only Kennatrack concentrates all of its engineering and manufacturing skills to produce hardware for gliding and folding doors. This is the reason for such exclusive and important installation features as hangers with "floating" wheels, expansion sleeve and top center mounting.

Look for the name Kennatrack. It is your assurance of track that "lasts a housetime."



**KENNA TRACK** is sound-conditioned; it glides. Only Kennatrack offers hangers with eight *floating* nylon wheels.

**KENNAFRAME.** Original all-steel frame, with aluminum track and hangers for fast, easy pocket door installations.

*For quiet and for quality*

**KENNA TRACK®**

SOUND-CONDITIONED GLIDING DOOR HARDWARE

Kennatrack Corporation, Elkhart, Indiana  
A subsidiary of Ekco Products Company

©1958

# Why all your concrete American Welded





# needs

# Wire Fabric Reinforcement

**30% STRONGER.** In concrete slabs—sidewalks, patios, streets, floors—proper reinforcement with USS American Welded Wire Fabric adds 30% to the strength of the concrete.

**LONGER LIFE.** The added 30% strength of reinforced concrete prevents destructive cracking . . . keeps the concrete attractive and serviceable for many years without maintenance.

**HIGHER VALUE.** For less than 10% of the cost of the concrete itself, you can add 30% to its durability by reinforcing it with American Welded Wire Fabric. The greater beauty and quality this adds to a home helps to raise property value and to *keep* it high.

**REMEMBER:** Only the builder can add the extra strength, life, and property value made possible by American Welded Wire Fabric Reinforcement. It can't be added later!

**BUYERS WILL ASK**

*"is it Reinforced"*

## American Welded Wire Fabric

American Steel & Wire Division

United States Steel, General Offices: Cleveland, Ohio

Columbia-Geneva Steel Division, San Francisco,

Pacific Coast Distributors

Tennessee Coal & Iron Division, Fairfield, Ala., Southern Distributors

United States Steel Export Company, New York

**UNITED STATES STEEL**



— FREE MERCHANDISING KIT —

American Steel & Wire  
Room 842, Rockefeller Building  
Cleveland 13, Ohio

Please rush me a free kit of merchandising materials that will help me cash in on the benefits of American Welded Wire Fabric in my homes.

Name \_\_\_\_\_

Firm \_\_\_\_\_

Address \_\_\_\_\_

City \_\_\_\_\_ State \_\_\_\_\_



THIS HAS

# CAUSED THE REVOLUTION IN ROOFING

251 million of these automatic shingle seals are now at work proving that **Bird Wind Seal Shingles** are the "hottest" roofing product in the industry.

*Bird Wind Seal Shingles sell faster because:*

1. They're tested to stay sealed down in hurricane winds of 80 M.P.H.
2. They have FHA acceptance for 2" in 12" roof pitch without special cementing.
3. Spaced seals allow for drainage — prevent trouble.
4. They're packaged ready to use; no pulling apart, no tearing; each shingle face up in pack; no extra labor costs.
5. There's no hand sealing; cement is factory applied; no smearing or dripping; adhesive does not shatter to soil roof.
6. The sun "Spot welds" the roof down at over 19,000 points on the average home.
7. They're made for long life with double surface, *thick butt* Masterbilt construction.

8. They're available in a beautiful range of wanted colors.
9. Reroofing prospects ask for them because Bird Wind Seals are advertised month after month in full color in the Saturday Evening Post and demonstrated by Dave Garroway and Jack Paar on NBC-Television.

\* \* \*

*Ask your Bird salesman or distributor about Wind Seal Shingles — and ask for sales aids to help you demonstrate these shingles in your yard.*

BIRD & SON, Inc., Dept. AB-3, East Walpole, Mass.  
Chicago, Ill. . . . Shreveport, La. . . . Charleston, S. C.



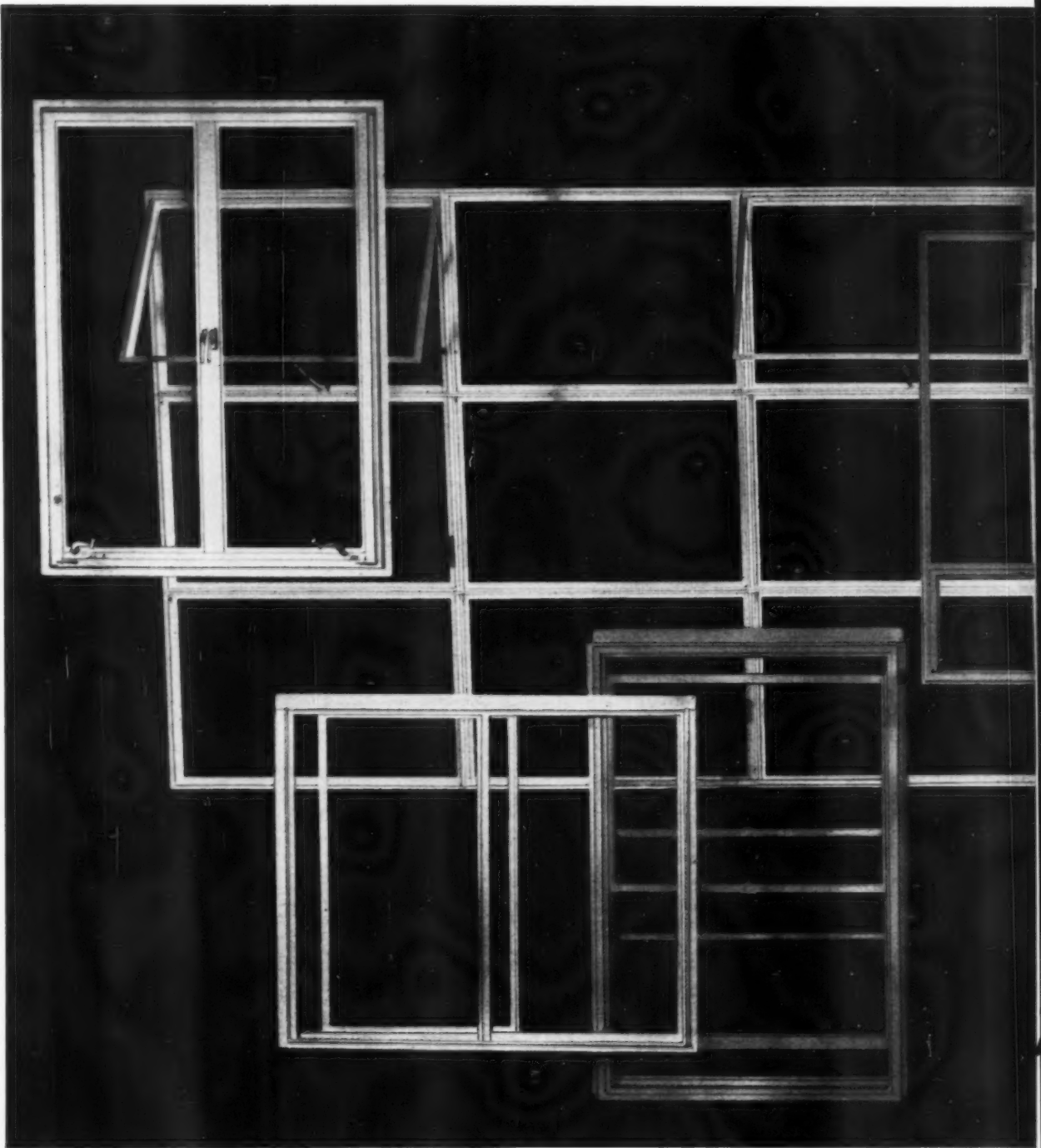

# NOW!

*The Man From Fenestra Introduces...*  
**A GREAT NEW SELECTION OF  
ALUMINUM AND STEEL WINDOWS**

Now you can choose any style, any size window you want—aluminum or steel—from a single source . . . *The Man From Fenestra!*

Take your pick . . . from a complete selection of casements, projected, double hung, single hung and sliders. Whatever style

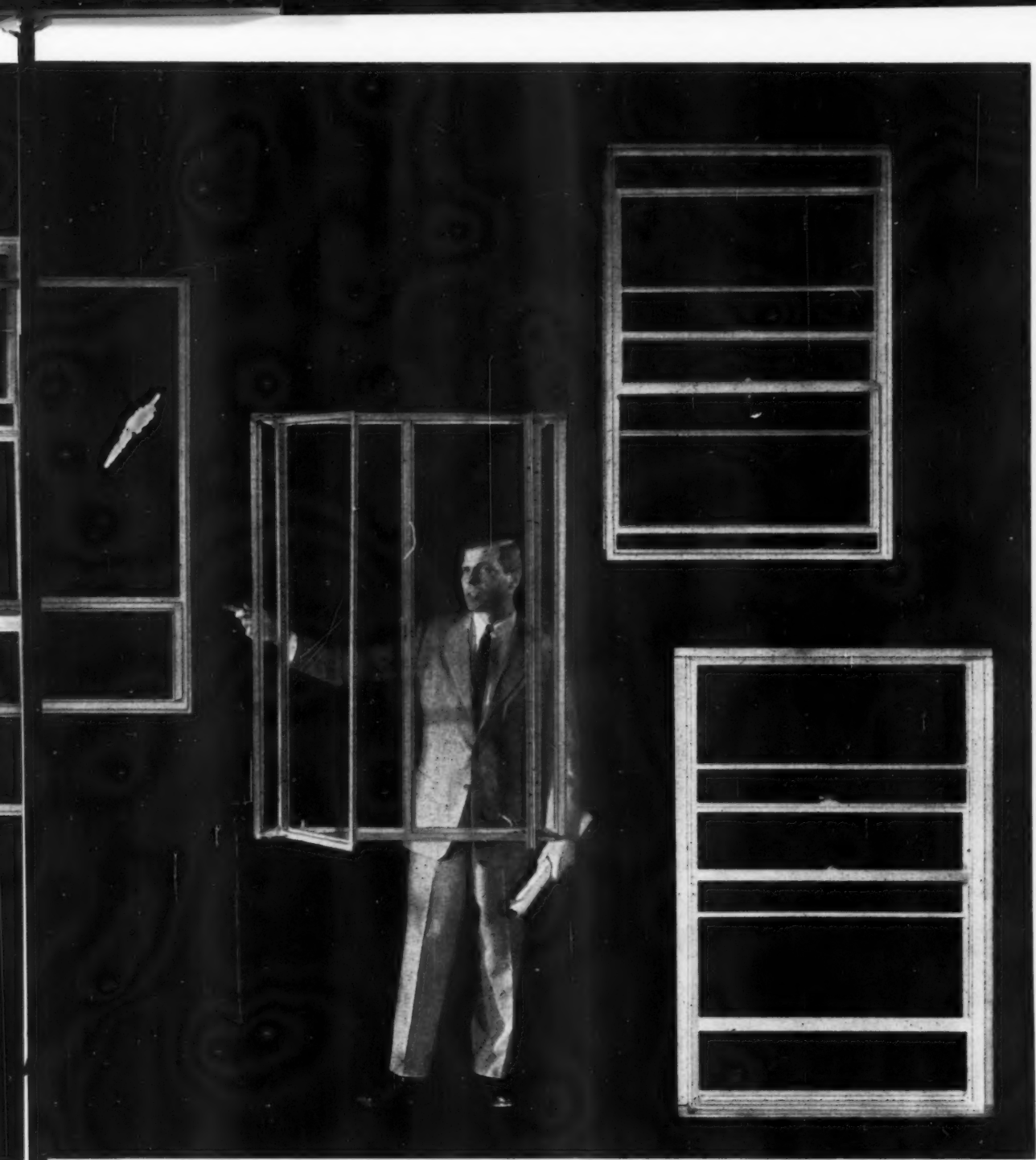

you select, *The Man From Fenestra* can supply you . . . in aluminum or steel. All have Fenestra® quality, Fenestra engineering.

And, your Fenestra representative can serve you three important ways: (1) window styling for your homes, (2) lower window costs and (3) savings on installation.

Call today and ask him to show you the new complete line of Fenestra aluminum and steel windows. Fenestra distributors are listed in the Yellow Pages. Or write to Fenestra Incorporated, Dept. AB-3, 2260 East Grand Boulevard, Detroit 11, Michigan.

# *Fenestra*

INCORPORATED

YOUR SINGLE SOURCE OF SUPPLY FOR  
DOORS • WINDOWS • SCREENS • STORM SASH



## Outrage Sure we need codes . . . . but

**A**ntique building codes are costing you and your home buyers close to a billion dollars a year.

You need codes. The assurance they give of safe and sound construction is one of the cornerstones of the building industry.

But you don't need codes that were out-of-date forty years ago. You don't need codes that bar the use of the latest materials and methods. And you don't need codes that force you to overbuild and overprice your houses.

This is not a technical article. We want to show you how the building business is being crippled by obsolete regulations. We want you and everyone else to know how much of the homebuyer's money is being wasted. And we want to see something done about it.

The purpose of a building code is to make sure that a house is a safe house. A roof must be strong

enough to carry a snow load in New Hampshire, or to stay put through a hurricane in Florida, as the one shown above did not.

But an old code can defeat its own purpose. Instead of promoting good construction, it can prevent a builder from utilizing the enormous technical progress we've made over the past few years. It can go so far as to produce the absurd situation shown in the picture on the opposite page, where eight vents are used for a simple plumbing system.

Most old codes have two bad characteristics in common. First, they are *specification* codes, calling for specific materials and methods. Anything not specified cannot be used, even though it may be better and less expensive.

Second, most old codes are *independent local* codes, which vary greatly from area to area. This can mean headaches for the builder, who may

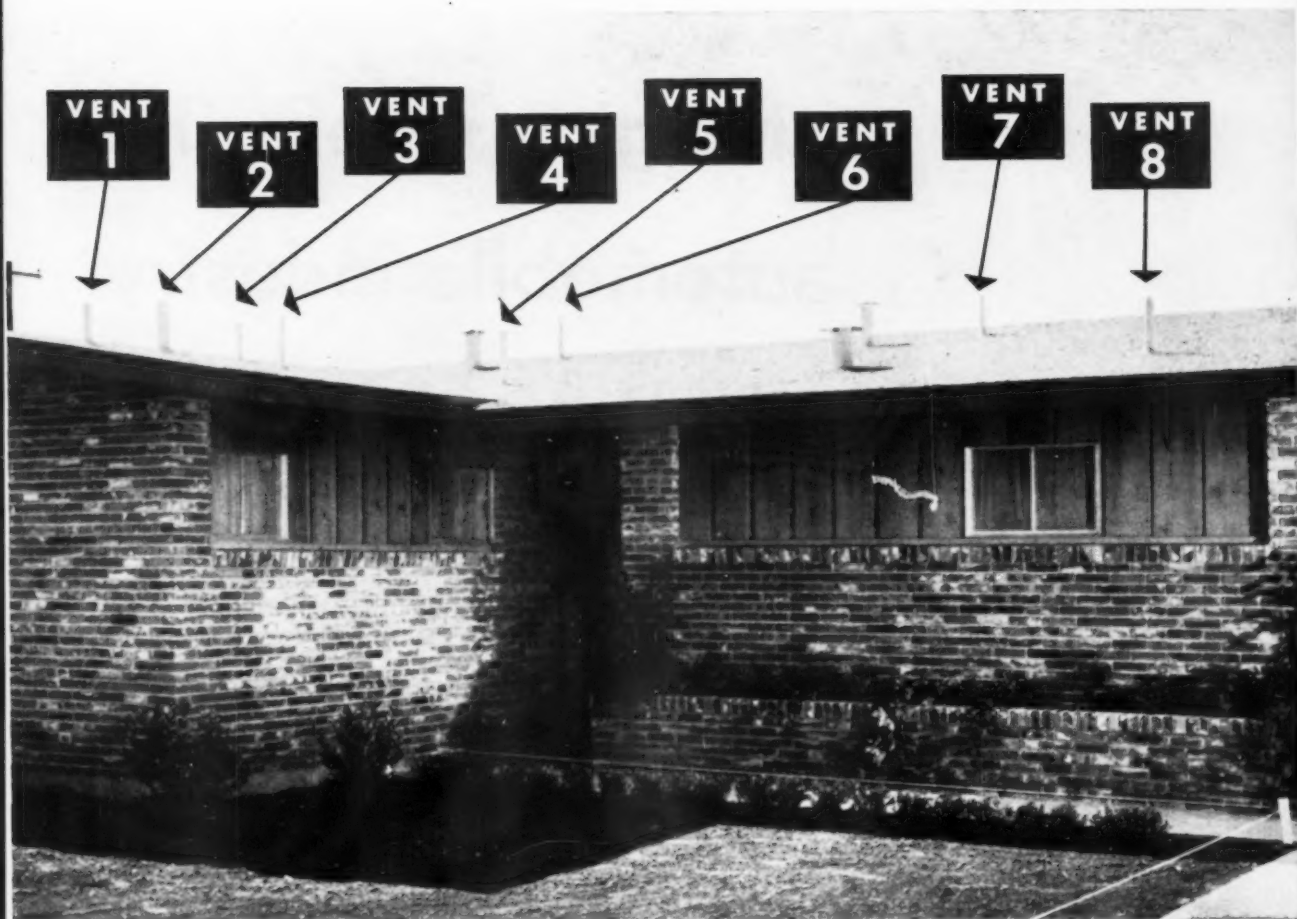

## we don't need codes like this

have to change his construction and his prices when he crosses a town line. They can force manufacturers into costly modifications of their products to meet the most restrictive of the local codes. And worst of all, they can keep the really revolutionary building ideas sitting on the shelf, simply because they would be rejected by too many local codes.

Let's make one thing clear: the building official is not to blame for old codes. He finds himself sandwiched between his sworn duty to uphold them and a massive public apathy. Even when his code permits him to make exceptions, he seldom has either the time or the facilities to make the necessary tests. He'd probably give his right arm for a good, workable code; but until something is done, he has to do the best he can with what he's got.

The codes themselves are at fault; not because they're necessarily bad, but because they're out of

date. We need codes that will allow builders to take advantage of new products and ideas. We need codes whose requirements, except for special local conditions, will be the same all over the country.

In short, if we're going to have a modern building industry, we need modern building codes.

Fortunately, we don't have to start from scratch. There are four major codes already in existence that will do the job very well. They are very similar in their technical requirements. And they are *performance* codes, based not on specific materials and methods, but on the needs of the job. These code organizations are listed on page 90.

You're in a rough fight for the consumer's dollar, and your best weapon is more house for less money. The sooner obsolete codes are junked in favor of modern ones, the sooner you'll be free to give your buyers more house for the money.

*Outrage*

Imagine where the  
automobile industry  
obsolete codes like

YOU'D HAVE RULES  
LIKE THIS . . .

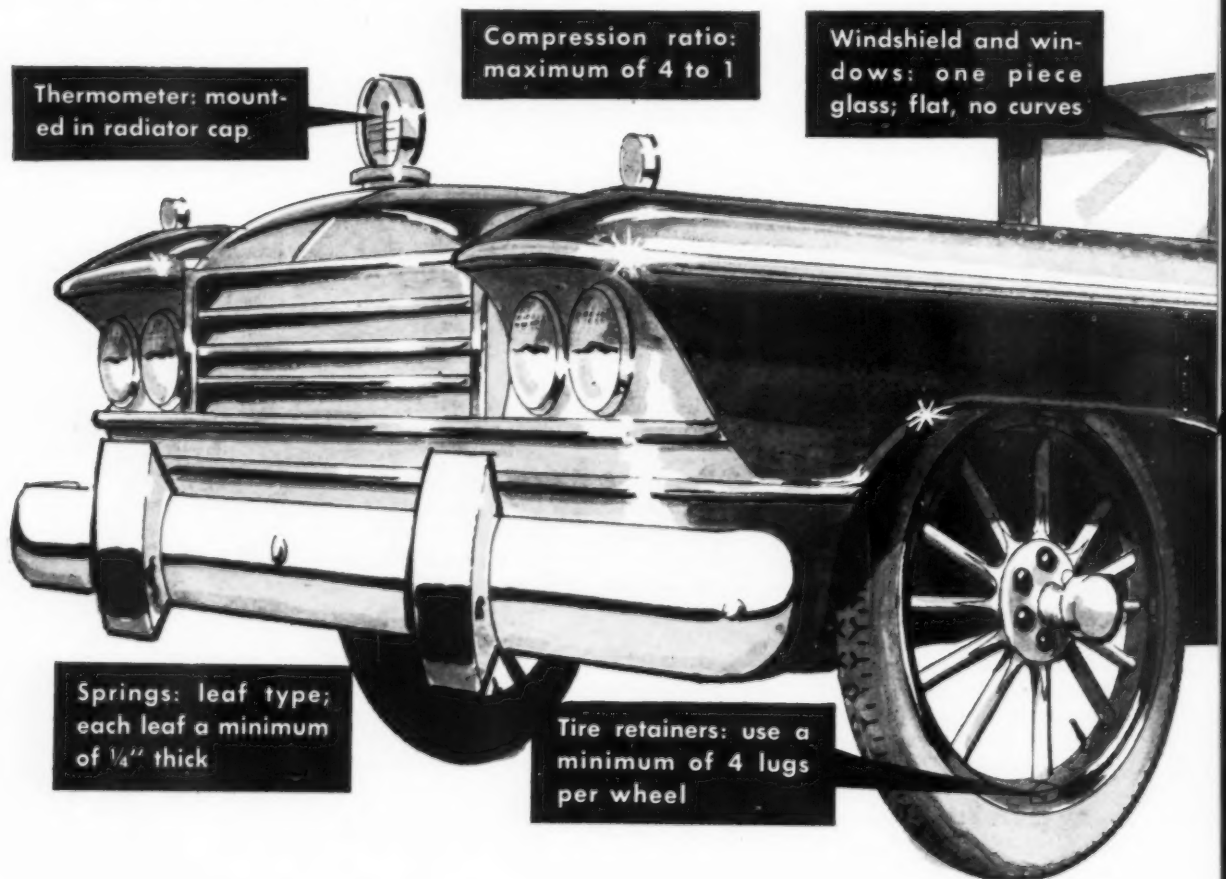



# 6,000,000 car-a-year would be if it had the housing industry

**T**he monstrosity shown below is absurd, of course. Car manufacturers have always worked under a minimum of restrictions. They have been free to build an efficient product.

But if you think a parallel situation is absurd in the building industry, ask a builder who works under an ancient specification code. Is it silly to

require wooden wheels on a car? No sillier than to require wooden wheels on a car? No sillier than to require corner braces on a house sheathed in plywood, or an expensive masonry chimney when a light, economical prefab chimney would do as well.

This is what obsolete codes can do to an industry. This is why really modern housing won't be available all over the country until codes are modernized.

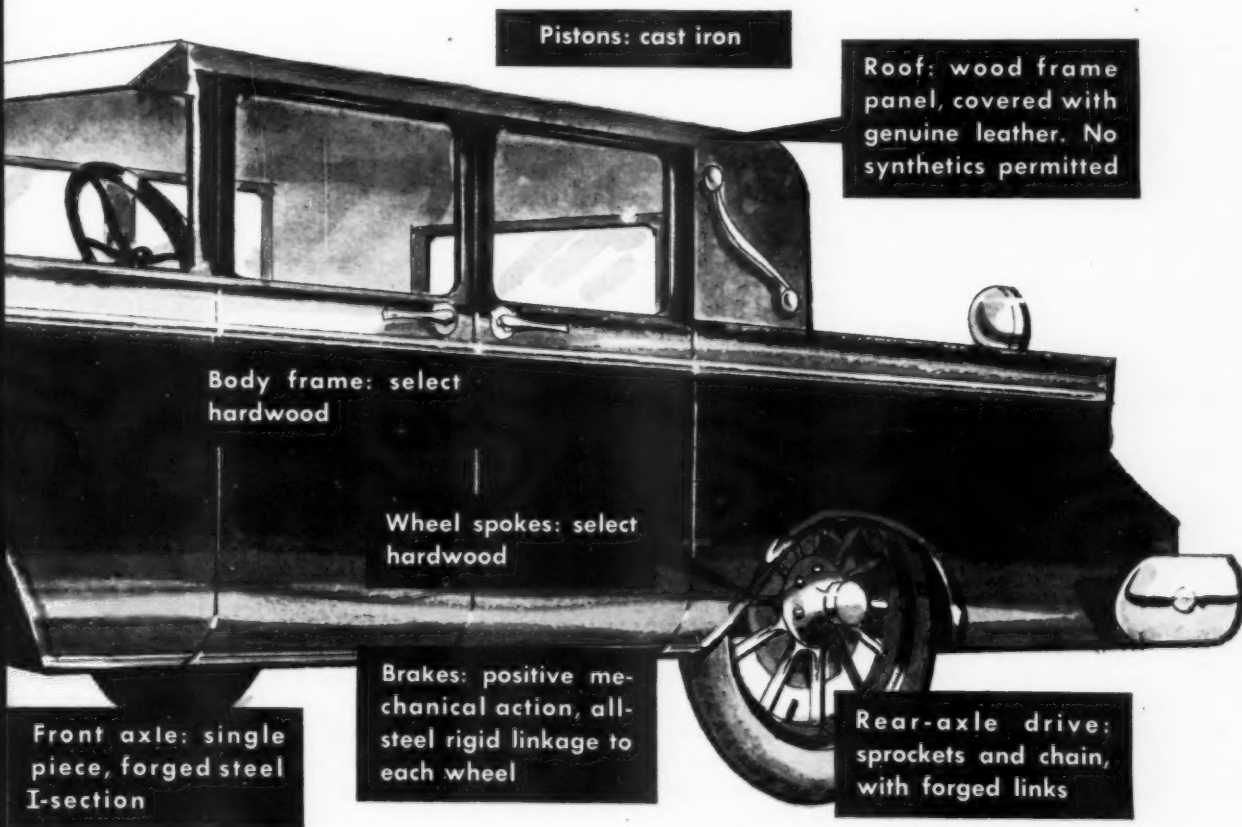

Look what old codes do to a really modern house ▶



# How far would this house get

	Scranton, Pa.	Mt. Prospect, Ill.	Prince Georges Co., Md.	Rose Twnshp., Pa.	Amherst Twnshp.
➡ 4" sand fill as base course under slab in place of gravel or rock	YES	YES	YES	?	YES
➡ Bituminized fiber ducts cast in slab for heating system	?	YES	YES	?	?
➡ Single fiber glass duct used as return for heating system	YES	YES	YES	?	NO
➡ 2x4's spaced 24" on center in the exterior walls	NO	NO	NO	NO	NO
➡ 3/8" panel in 4x8' sheets used as sheathing and exterior finish	NO	NO	NO	NO	YES
➡ All corner bracing eliminated due to use of 3/8" panel	NO	NO	NO	NO	YES
➡ Double 2x6 beam around top of exterior wall to replace plate, headers	YES	NO	NO	NO	YES
➡ King post glue-nailed trusses, 24" o.c.; 32'8" span; 2 and 12 pitch	YES	NO	YES	NO	NO
➡ Non-load bearing 2" thick prefab interior partitions	NO	NO	NO	NO	?
➡ Neoprene flashing materials around all roof openings	YES	NO	YES	?	NO
➡ UF cable (non-metallic sheathed cable) in all branch circuits	YES	NO	YES	YES	YES
➡ Prefabricated package chimney installed (non-masonry)	NO	NO	YES	NO	YES
➡ All plumbing lines above the slab, including the building drain	NO	NO	NO	NO	NO

? = Builders just aren't sure.

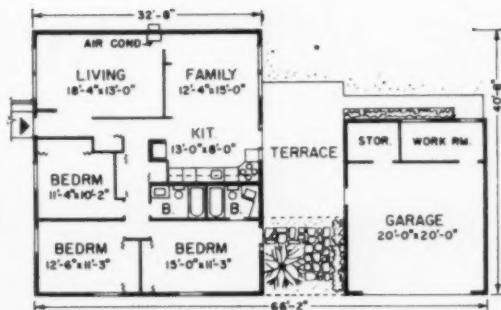

**NAHB'S RESEARCH HOUSE** is a product of much advanced thinking in the industry. Some of it was apparently so revolutionary that it didn't get through the local Montgomery County, Md. code. For instance, plastic piping, thoroughly performance-tested, was refused a waiver. And, a conventional foundation was called for in place of the proposed grade beam slab. All this poses a location problem for NAHB's next research house, anticipated for late 1959.

## in these municipalities?

	Mobile, Ala.	Albany, N. Y.	Harrisburg, Pa.	Louisville, Ky.	Minneapolis, Minn.	Oyster Bay, N. Y.	Dearborn, Mich.	Albany, Ga.	Shaler Twpshp., Pa.	Columbus, O.	St. Paul, Minn.
YES	NO	YES	YES	YES	?	YES	NO	?	NO	YES	
NO	YES	YES	YES	NO	?	YES	YES	?	YES	YES	
NO	YES	YES	YES	YES	NO	YES	YES	?	YES	YES	
YES	NO	NO	NO	NO	NO	NO	NO	NO	NO	NO	
NO	NO	NO	NO	NO	NO	NO	NO	NO	NO	NO	
NO	NO	NO	YES	NO	NO	NO	NO	NO	NO	NO	
NO	NO	NO	YES	NO	NO	YES	YES	NO	NO	YES	
?	YES	?	YES	NO	NO	NO	NO	NO	YES	NO	
NO	NO	NO	?	YES	NO	NO	YES	NO	NO	?	
NO	NO	YES	NO	YES	YES	YES	NO	?	NO	?	
NO	YES	YES	NO	NO	YES	YES	YES	YES	YES	NO	
?	NO	NO	YES	NO	YES	NO	YES	NO	YES	NO	
YES	YES	NO	YES	NO	?	NO	NO	NO	YES	?	

*This is only a random sample. Why not try checking these 13 modern building methods against your own code to see how much of this house you could build. Then tell us how you do*

Here's what you could do—if . . . ▶

# What the building

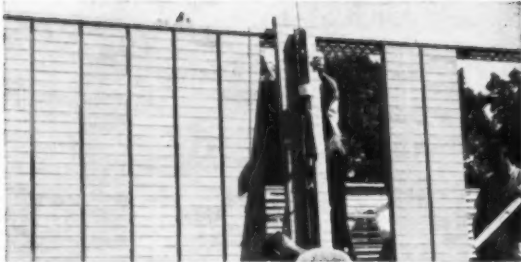

**FIVE MEN** can brick an average house in 8½ hours using SCR panels. Will your code let you do it?



**HERE'S** a new entry in the home building field—glue-laminated beams. Few codes even consider them.



**ROOF TRUSSES** are outlawed completely in some areas. Here, they're on 24" centers—also blocked by old codes.



**WHAT'S** the point of 4" stud walls when they aren't load-bearing? Here's a 2" prefab hollow-core section.

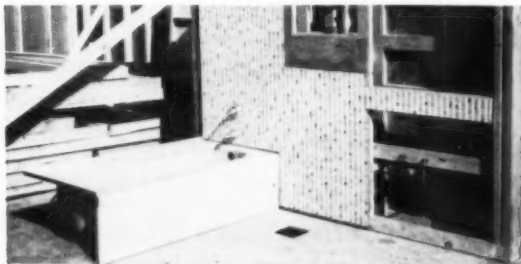

**PLUMBING** codes bar this pre-assembled wall in many areas. Check system in Feb. *AMERICAN BUILDER* (p. 80).



**REINFORCED** grade-beam slabs could go down fast; eliminate cost of digging and setting spread footings.

## ... and what it is permitted

**E**ach of the construction ideas on these pages can contribute toward more house for less money. Each has been tested and proven safe and sound. But each is outlawed by a substantial number of obsolete codes all over the country.

The building industry is on the verge of its first real industrial revolution. For each of these ideas, there are a dozen more ready to slide off the drawing board. But they'll be worthless to you until we have modern codes.

# industry can do . . .



**NEW BATHROOM** fixtures now permit above-the-slab plumbing, but many outdated codes say: "Absolutely no."

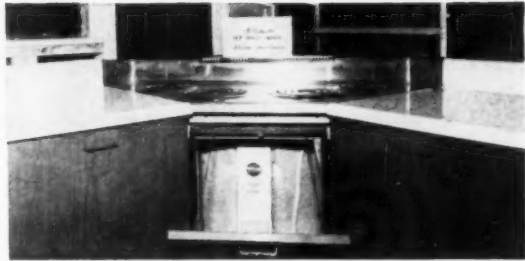

**UTILITY ROOM** was discarded in NAHB Research House when this water heater went into unused kitchen space.

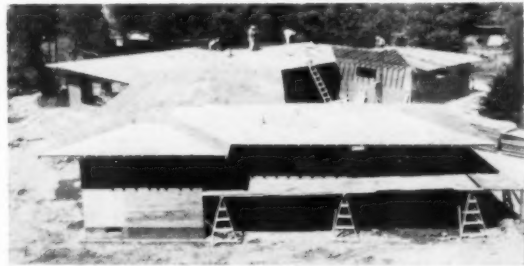

**AMAZING** as it may sound, plywood sheathing like this is still forbidden in many areas (like Pittsburgh).

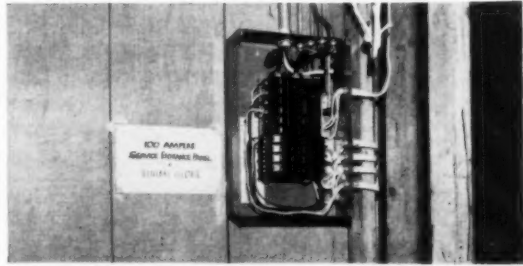

**NON-METALLIC** sheathing for cable used in Research House branch circuits would be axed by many codes.

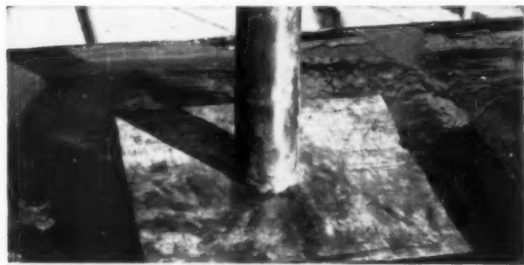

**NEOPRENE** flashing goes down quickly, and has been both lab and field proven—not approved in many areas.



**FIBER GLASS** reinforced plastic panels are finding many new uses in the home—where good codes permit it.

to do in some areas  
are two different things



# Here's why outdated codes

## For some, it's the codes themselves that set up roadblocks to progress...

- ▶ "Home buyers could pay between \$500 and \$600 less for their houses in the Pittsburgh area if the plumbing code was up-to-date. This code is our worst problem. A lot of things contribute toward making the situation bad: oversized piping, too many vents, restrictions on the type of piping, and so on. We builders would like to see the National Assn. of Plumbing Contractors' model code adopted here. I think this would solve 90 per cent of our worries. The building codes in this area need modernizing, too. For instance, most codes here don't permit any plywood on the roof. It's not in the code because plywood was unknown when the code was written. Obviously, there have got to be changes."—Harold Sampson, Sampson Bros., Inc., Monroeville, Pa.
- ▶ "Our building code was written in 1928. It was composed at a time when modern engineering methods were just a germ of an idea. That's why we can't keep pace with today's building methods—and why it costs us far more than it should to build our houses. Don't get me wrong. I believe in a strict code. As a matter of fact, I'm fighting for one right now—but one that's up-to-date."—a leading New Jersey builder.
- ▶ "Although it had been as thoroughly performance-tested as all the other advanced products in the NAHB Research House, plastic pipe was refused a waiver. I feel certain its installation would have saved us money. The local Montgomery County code also prevented us from putting in an 8"x20" grade beam with two ½" rods top and bottom. This would have saved us about \$175 over the conventional foundation we did put in. Actually, we needed waivers on several of the products and methods that went into the house because of code restrictions."—Clarke Daniel, Standard Properties Construction Corp., Kensington, Md., builder, NAHB Research House.
- ▶ "Our code is based on weather conditions in the most northern part of Georgia. This is all wrong. Albany is so close to the Florida line that its weather is identical with north Florida's. We've been fighting for years to eliminate perimeter insulation and furring on exterior masonry walls. Our temperature changes are just not big enough to warrant these expensive extras."—H. Jack Holland, Jr., H. J. Holland Constr. Co., Albany, Ga.
- ▶ "Our biggest headache right now is the out-dated plumbing codes throughout most of western New York State. This is an area of construction where we could effect real savings. For instance, with a modern code, we could size our piping smaller (and still give perfect service); cut out sweating lead joints; prefabricate our trees, and substitute some new (and proven) piping material for cast iron. It's been suggested that we make a drive to get the national code (as written by the National Assn. of Plumbing Contractors) accepted up here. The way I understand it, even this code could stand some modernizing. We have other code problems, but this one's the worst."—Don Drake, John Feist Construction Corp., Buffalo, N.Y.

# make these builders sore

## For others, local interpretations of the codes are the worst bottlenecks . . .

▶ "Lack of code uniformity in the many municipalities around Detroit is plenty troublesome. For instance, our plumbing code calls for oversized piping. That's bad enough, but it's worse when each area interprets the code in its own way. If it's tough for builders, it's also tough on taxpayers, though they may not always know it. It's true because 65 building departments, each concerned with judging and testing new materials and methods, makes for costly government. I think the solution is in one basic code, adopted by the state, and rigorously adhered to by each municipality. If this can't be achieved, then we must persuade the building departments to rely more often on results from recognized laboratory tests. As it is, I feel they depend too much on past practice. Such policies can only stagnate construction improvements."—Joe Curran, Curran Building Co., Dearborn, Mich.

▶ "Sure we have an antiquated code, and I think that's the source of our problems with the building inspectors. There just doesn't seem to be any uniform thinking in our building department. One month, we'll get a negative decision on something like the installation of prefab chimneys. Two months later, there's word passed around that these chimneys are accepted. When you're about ready to order one, you learn the department's reversed itself again. I don't blame the inspectors completely. They're really trying to protect the people. Here's the problem, though. First, they aren't able to keep up with all the technical advances in our industry, and, second, there's nothing in the code to tell them what to do when something new comes along. We're trying hard to change that now. When it's changed, we'll not only breathe easier, but in many cases we'll be saving as much as \$1,500 per house."—a leading Long Island builder.

## And, here's how NAHB'S code committee chairman sees codes at the national level . . .

▶ "It's high time the National Assn. of Home Builders did something about the annual billion-dollar loss on home construction brought on by antiquated codes. And, we are. We're organized (with funds), and we plan to proceed toward two major goals. First, we want to work for unification of codes, so the new cost-saving products introduced by manufacturers can be accepted (or rejected) on a national scale, rather than having to fight through 10,000 local ordinances. Second, we definitely want to have an appeal section written into every local code. We'd like to accomplish all this in three years. Looking at the hurdles realistically, though, it will probably take longer. However, the important point is that we've started the ball rolling."—Ernest Zerble, Mason City, Ia., chm., Building Code Committee, NAHB.

**This house should cost \$1000 less ▶**

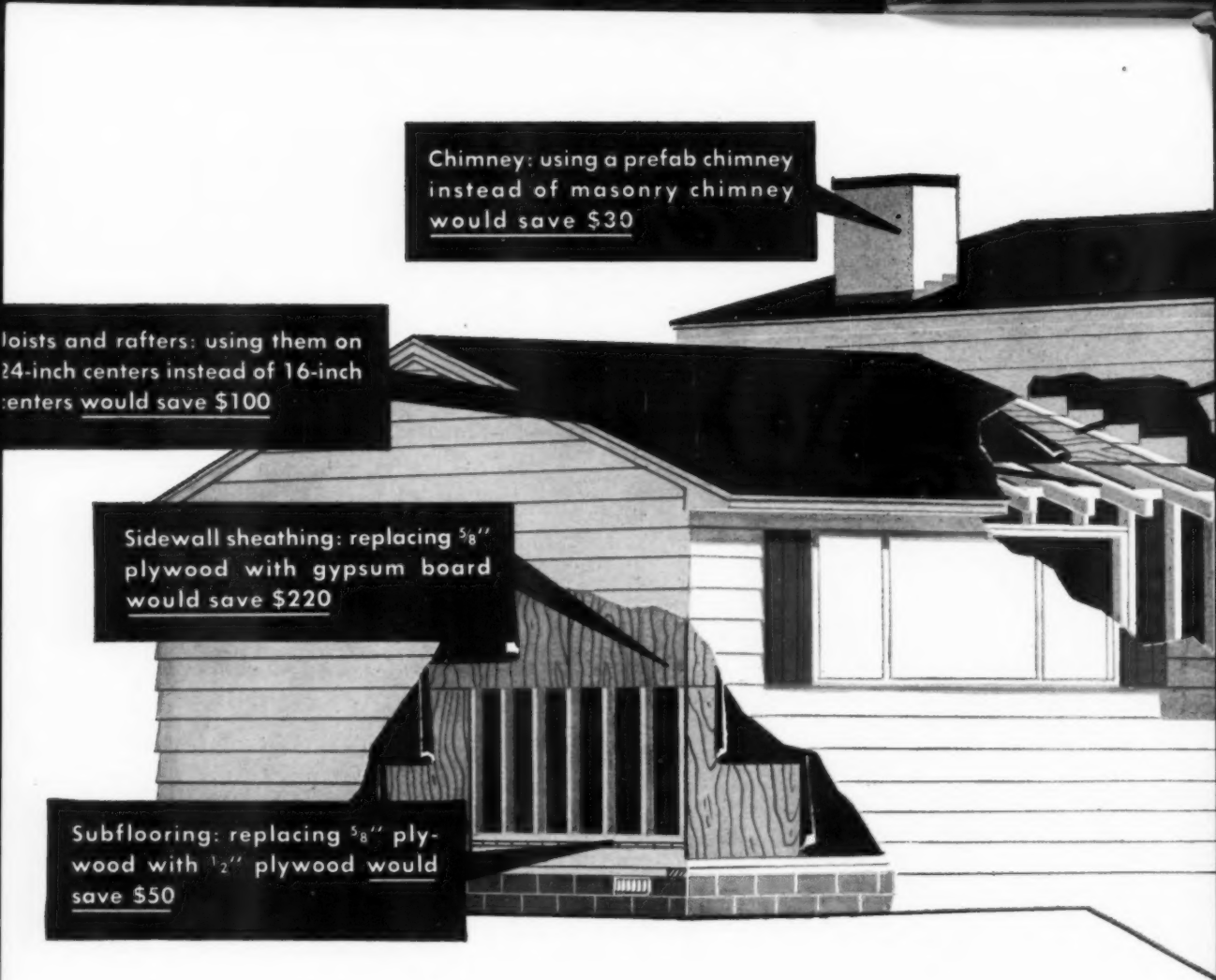

Chimney: using a prefab chimney instead of masonry chimney would save \$30

Joists and rafters: using them on 24-inch centers instead of 16-inch centers would save \$100

Sidewall sheathing: replacing  $\frac{5}{8}$ " plywood with gypsum board would save \$220

Subflooring: replacing  $\frac{5}{8}$ " plywood with  $\frac{1}{2}$ " plywood would save \$50

## *Outrage!* This house would cost under a

**If you're building low-cost homes, you can't afford to waste a single penny. Look what happened to this \$12,000 house when a ridiculous code got through with it**

**T**he greatest area of housing need today is low-cost homes. And no other price range takes such a licking from antique codes.

For example, let's take New Jersey builder Bob Schmertz. Schmertz is a low-cost specialist—last year he was the country's biggest builder of FHA 203 i houses—and every step in his operation is aimed at squeezing out the last drop of efficiency (see the June 1957 issue of *AMERICAN BUILDER*). But a bad code has put such a bite on him that he's calling it quits in his present location.





Roof sheathing: replacing  $\frac{5}{8}$ " plywood with  $\frac{3}{8}$ " plywood would save \$200

Non-bearing walls: replacing 2x4 studs with 2x3 studs would save \$50

Basement slab: radiant heat is required. Replacing it with a hot air system would save \$350

## \$1,000 less modernized code

"I've had it," he says. "Imagine—I have to use  $\frac{5}{8}$ " plywood for sheathing. Why, you could run a bulldozer into the house and nothing would happen. But I'm trying to build homes, not forts."

Schmertz's newest model, shown in the drawing above, was the last straw. He's going to sell it for \$11,950—in Delaware. He's moving there because in his present area, he would have to price it \$1,000 higher.

The boxes show where the price differences occur. There's obviously nothing even remotely

radical about the way Schmertz plans to build. Everything ruled out by his present code has been tested and proven in hundreds of thousands of houses all over the country. The code just doesn't make sense.

The family that buys a \$12,000 house is usually working right at the limits of eligibility. You don't have to be a mortgage expert to know how many such families an extra \$1,000 will eliminate.

We need low-cost housing and to get it, we need modern codes.

# Look what you could do with

You could add any one

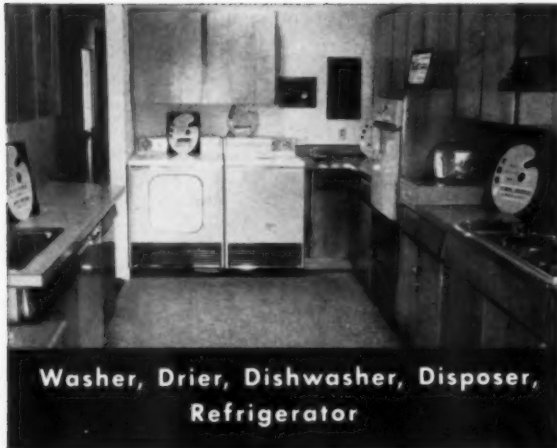

Washer, Drier, Dishwasher, Disposer,  
Refrigerator

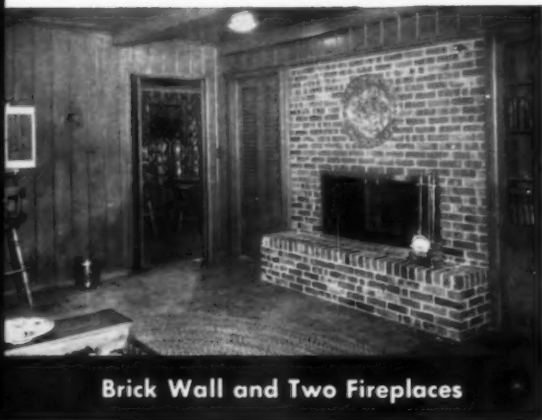
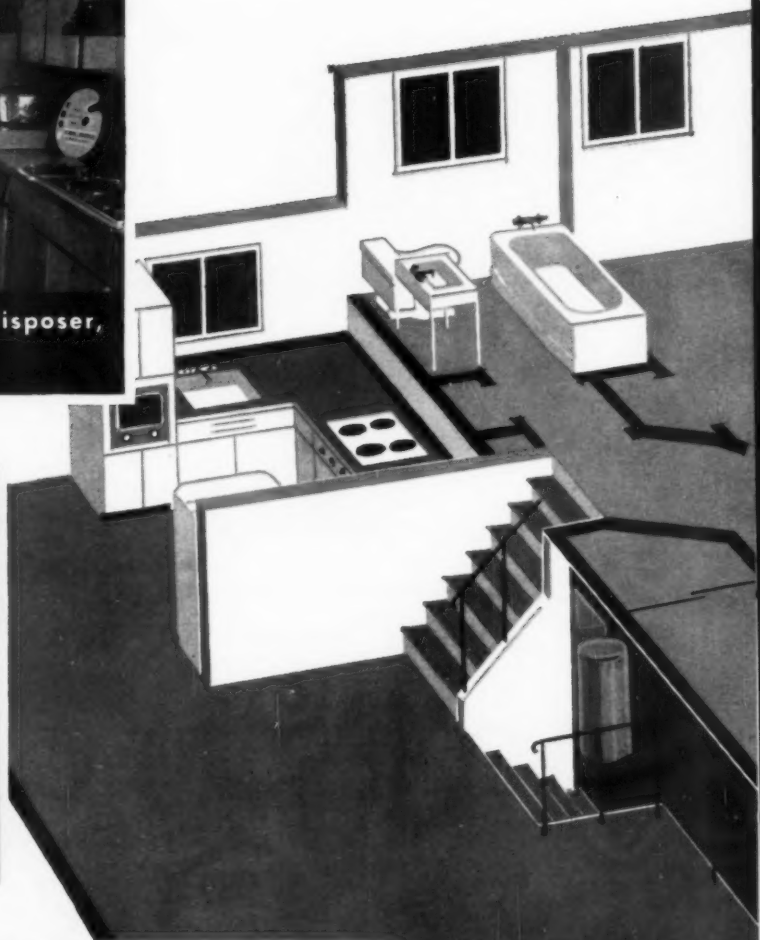

Brick Wall and Two Fireplaces

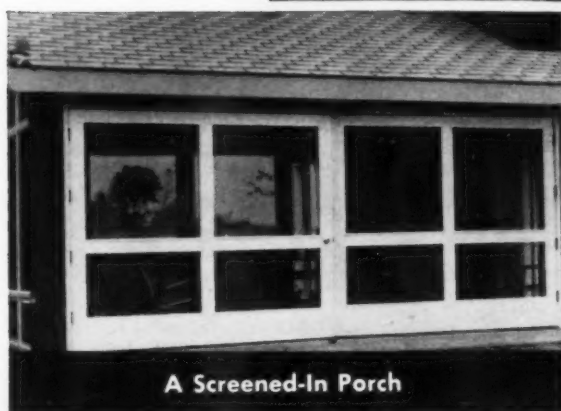

A Screened-In Porch

# \$1,000 from code savings

of these extra features



A Second Full Bathroom



Complete Central Air Conditioning



An 11x12 Room, or the equivalent space



Oversized Two-Car Garage

# Where do we go from here?

## The builder is the one who should carry the ball . . .

You, the builder, have the biggest stake of all in working for modern codes. You are the one whose business is most directly affected. You are the one who knows better than anyone else how much money goes down the drain to meet obsolete codes.

In other words, you're in a more authoritative position than anyone else to make a noise about antique building regulations. It's up to you to start the wheels turning.

**1.** Get help. This is much too big a job for any one person, or even any one group, to do alone. Builders are usually the most interested in the code problem, so get as many as possible working with you. Your local home builders' association would be the best place to start; and if you aren't a member, here's a good reason why you should be. Then bring in any other interested people, such as building offi-

cial and architects, who are willing to help.

**2.** Pick the best code for your area. At the bottom of the page we have listed the four major code organizations and their addresses. Write them and ask for all pertinent material.

**3.** Think in terms of the whole community, not just of people directly concerned with building. You'll want publicity to sell the idea of good codes, so work with your local newspapers, radio and TV stations. Emphasize the idea that obsolete codes hurt everybody, and get as many civic and business organizations as you can to help you. The code organizations will give you suggestions on how to arrange community programs, and if the distance is not too great, will often send experienced personnel to your area to help on legal and promotional pitfalls of getting a new code. NAHB has a program they will send for the asking.

## . . . but no matter who you are, pitch in and help.

### Good codes are good business for everybody

**IF YOU'RE AN ARCHITECT**, you'll gain by not having to change specifications to meet local codes. And you'll be able to use new materials and methods as they prove themselves. **IF YOU'RE A BUILDING OFFICIAL**, you'll have a modern code with workable provisions. You'll have the results of exhaustive tests to help you render decisions, and you'll have the backing of your code group to go with these tests. You may even find that some of the builders who have always blamed you for all their troubles will start speaking to you again.

**IF YOU'RE A MANUFACTURER**, you'll be able to distribute your products nationally without worrying about modifications to meet local codes. And you'll know that your new products, as soon as they are approved, will have a market all over the country.

**IF YOU'RE A MORTGAGE LENDER**, the economies possible under modern codes will assure you of investing in homes of high value. **AND IF YOU'RE A HOMEBUYER**, as most of us are, you'll benefit most of all. You're the one who will get a better home for less money.

## Here's where to write for more information

Building Officials Conference of America, 1525 E. 53rd St., Room 930, Chicago 15, Ill.

International Building Officials Conference, 610 South Broadway, Los Angeles 14, Cal.

Southern Building Code Congress, Brown-Marx Building, Birmingham, Ala.

National Board of Fire Underwriters, 85 John St., New York 38, N. Y.; 222 West Adams St., Chicago 6, Ill.; 465 California St., San Francisco, Cal.

National Association of Home Builders, 1625 L St., N. W., Washington 6, D. C.

#### How to get reprints of this article:

**Write: American Builder, 30 Church St., New York 7, N. Y.**

**Price: up to 100 copies, 50¢ each.**

**Over 100, write for special prices.**



**PRESSURE-TREATED LUMBER**

**HELPS CREATE  
A VISUALLY  
EXCITING**

**HILLSIDE HOUSE**



**A.I.A. Award of Merit, Merchant Builder**  
Architects: A. Quincy and Frederick E. Emmons  
Builder: Pardee-Phillips Construction Co.

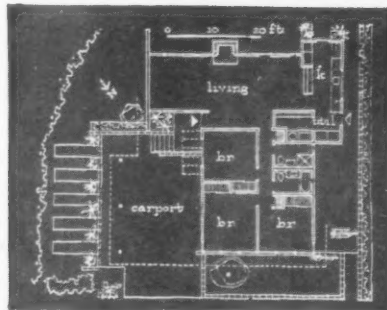
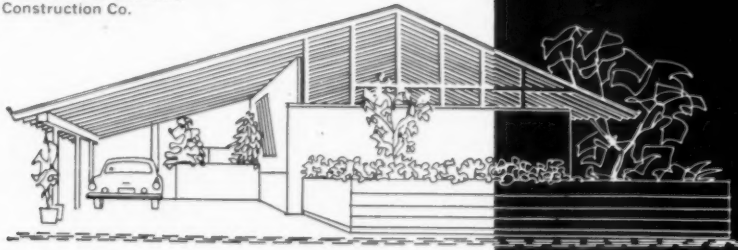

A hillside is always a challenge . . . one which offers real opportunity for creative design, construction and integration.

Now—with Wolmanized® pressure-treated lumber the limitations of using wood in hillside designing have been eliminated!

Moisture, masonry contact, nearness to the ground—are no longer restrictive factors. Wolmanized pressure-treated lumber offers complete protection against termite and decay damage . . . not only in residential construction, but in light and heavy commercial construction, too.

Wolmanized lumber, whether in dimension or as glulam timber, retains all of the *versatility* and *flexibility* of wood. And most important, it has built-in protection against decay and termites!

Wolman Preservative Department, Koppers Company, Inc. w-34  
769 Koppers Building, Pittsburgh 19, Pennsylvania

Please send me the 16-page Booklet on the use of Wolmanized pressure-treated lumber in light and heavy construction.

Name \_\_\_\_\_

Firm \_\_\_\_\_

Address \_\_\_\_\_

City, Zone, State \_\_\_\_\_



**Wolmanized® Lumber**



AMERICAN  
BUILDER  
AWARD

**Prize-winner builder**  
**Dwight Haugen has a**  
**3-part formula for doubling**  
**sales in a falling market**

## Formula for a prize winner:



**THIS HOUSE** is selling for \$13,900; was deliberately aimed at "bread and butter" market.

### 1. Start with a good house, priced right...

**T**his house has been a two-way prize winner for builder Dwight Haugen. It won him a first grand prize in AMERICAN BUILDER'S Best Model Home Contest last year. And it's been the big reason why, in a period when most builders have been tearing their hair, Haugen has more than doubled his sales.

When the building market started to sag, early in 1956, Haugen's Wedgwood Homes was producing at the rate of 40 houses a year. Today he's a 90-house-a-year builder, and is bidding to become Oregon's biggest. And this

house, representing half his output, is his bread and butter model.

One reason is the price. At \$12,300 without land, but including range, oven and brick fireplace, it's a solid buy.

Second, it's a good looking house. The lines are simple and clean, and the board-and-batten siding and cedar shingle roof give it a rustic ranch look.

Under the traditional appearance, Haugen has used modern construction methods. His moderate spans (22') allow him to use 2x4 trusses with 1x4 braces. And a double 2x8 continuous plate eliminates door, window headers.

↑  
**WHAT**

**HOW** →

**AMERICAN  
BUILDER  
BLUEPRINT  
No. 251**



FRONT ELEVATION  
SCALE: 1/8" = 1'-0"



REAR ELEVATION

CROSS-LOADING VALUES  
 SNOW 30 P.S.F. HORIZONTAL PROJ.  
 AND 25 P.S.F. UPWARD NORMAL  
 DEAD 10.5 P.S.F. HORIZ. PROJ.



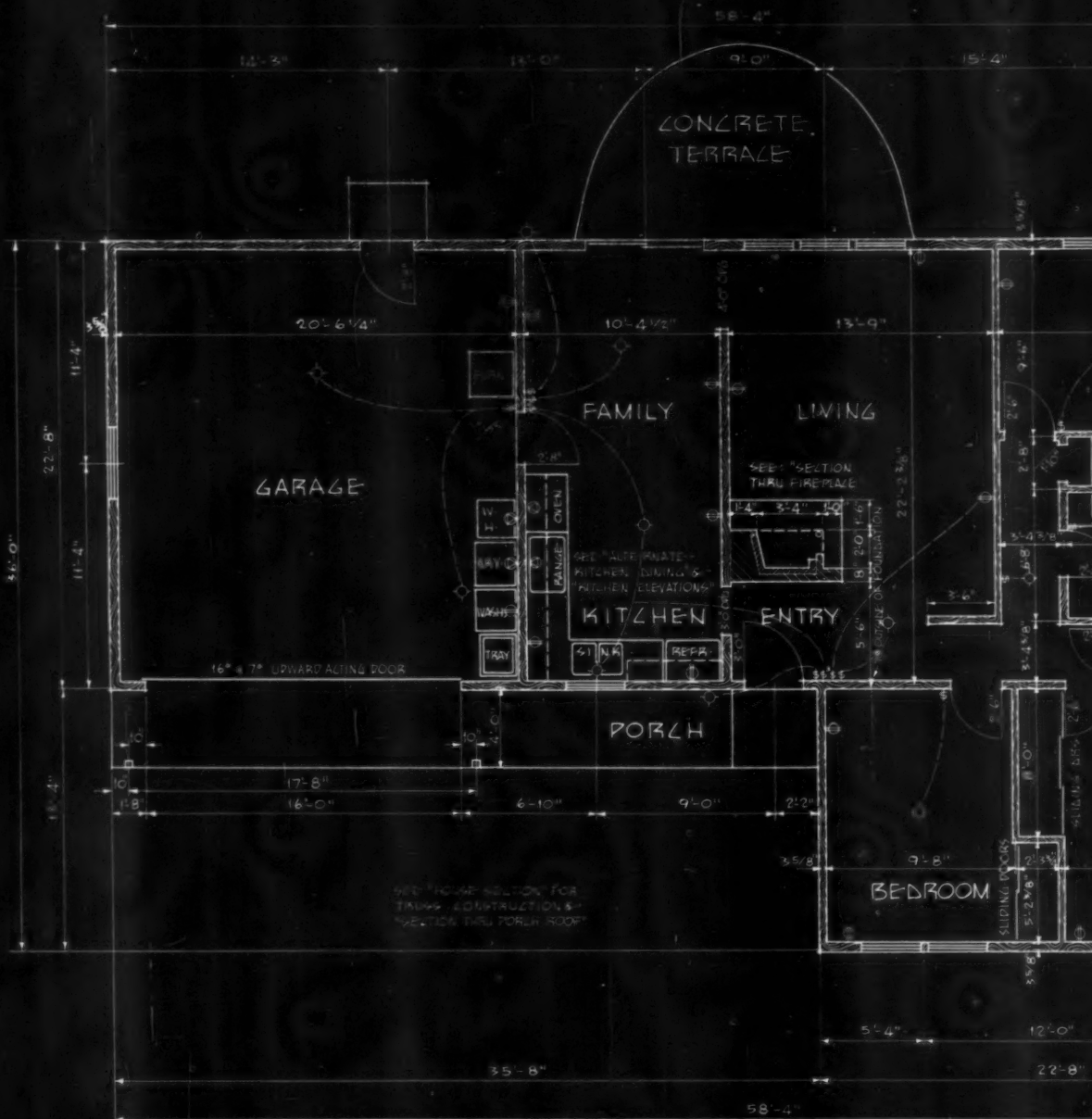

**FLOOR PLAN**  
SCALE: 1/8" = 1'-0"

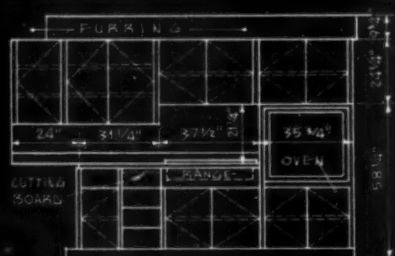
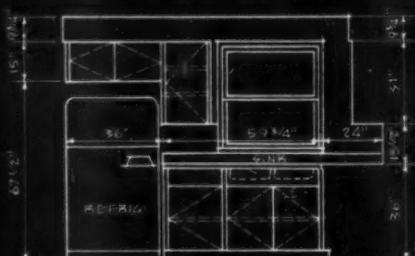

**KITCHEN ELEVATIONS**  
SCALE: 3/16" = 1'-0"

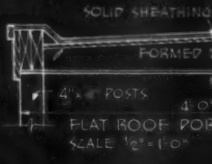





TRUSS DIAGRAM

NAILING SCHEDULE FOR 24-SPAN TRUSS

- TOP CHORD SPLICE 16-10d
- SHORT DIAG. 3 BOTTOM CHORD 4-8d
- LONG DIAG. 4 BOTTOM CHORD 5-8d
- BOTTOM CHORD SPLICE 11-10d

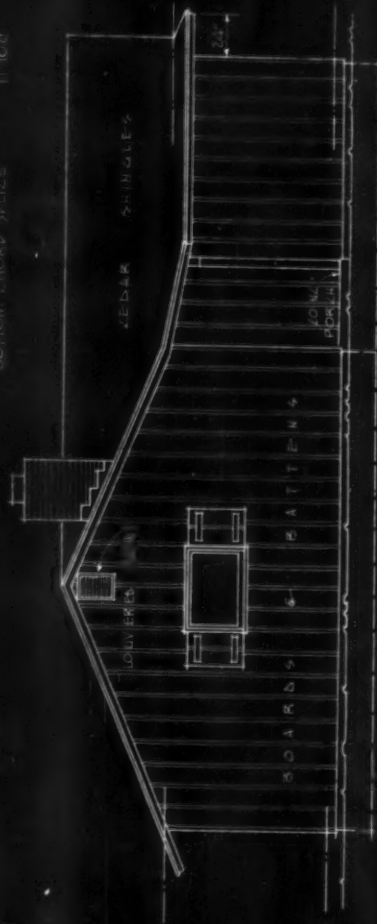

LEFT ELEVATION

SCALE: 1/8" = 1'-0"

FIREPLACE SECTION

SCALE: 1/8" = 1'-0"

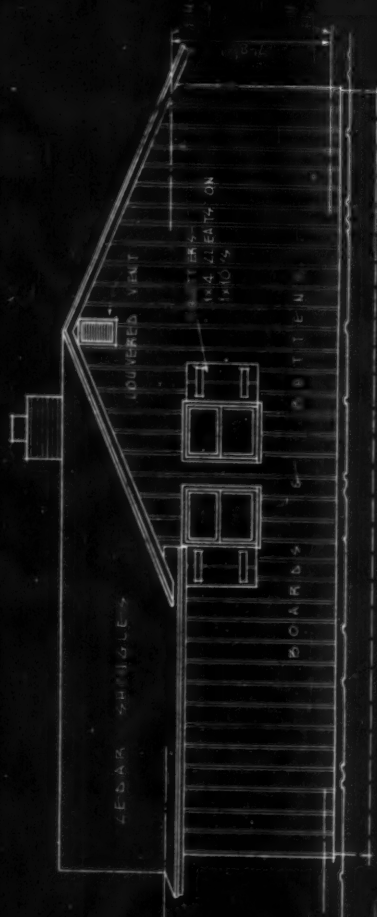
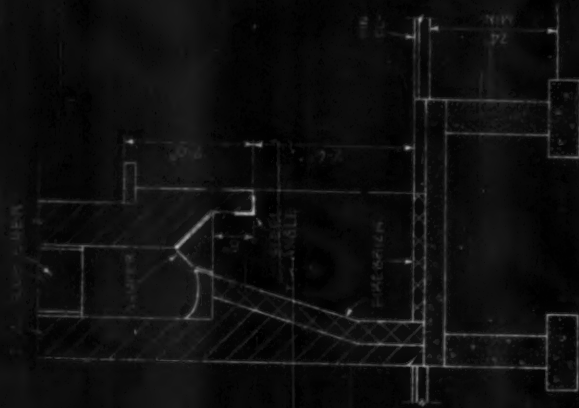

RIGHT ELEVATION

SCALE: 1/8" = 1'-0"

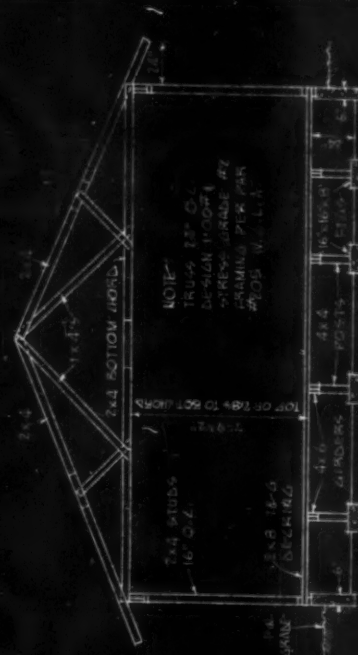

HOUSE SECTION

SCALE: 1/8" = 1'-0"



**CONSUMER-APPEALING** bath is one of the most important parts of Wedgwood's plan. What makes it appealing? Bath does triple duty.

**TRIPLE-DUTY** bath is centrally located. Compartments are so placed that one can be entered from bedroom, other from hall.

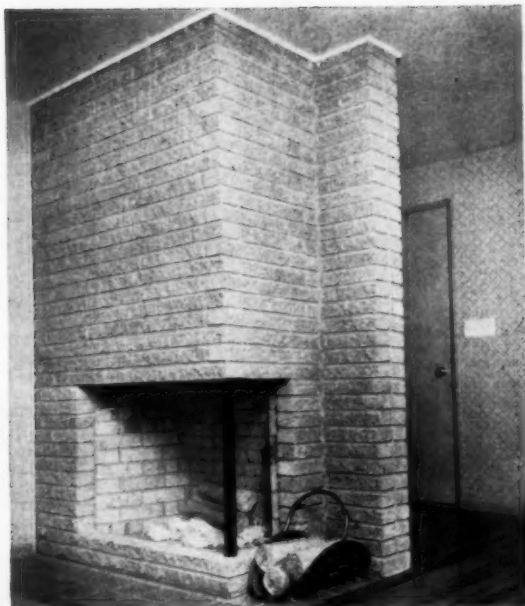
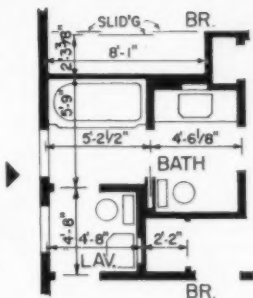

**MASONRY** fireplace is another sales asset. Simply designed, with raised hearth and two-view opening, it serves as a divider too.

**FIREPLACE** wall separates entry from living room and shields entry from view of living room, also helps circulation pattern.

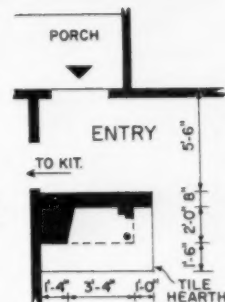

## ... 2. Give it a saleable plan ...

One reason that Dwight Haugen was a winner in AMERICAN BUILDER'S Best Model Homes Contest was that his model house has a saleable floor plan. His designer, Ormond Dean, Jr., planned Haugen's winner with a three-bedroom quiet area serviced by a compartmented bath—one of the most saleable features of this house. And the plumbing is back-to-back. Only one soil pipe is required. Other features: 1. A fireplace that does double duty. 2. Circulation that is nicely worked out. (See plan on gatefold at left.) Front and back doors can easily be reached from the work area in the kitchen. The entry hall is centrally located. All rooms radiate from it, can be entered without going through other rooms. 3. It has the important family room nicely located. 4. The garage anticipates

the two-car family—rapidly becoming the norm today. Result: a lot of house for the money.

Products used in the March Blueprint House: Insulite sheathing; Kwikset hardware; Armstrong Cork linoleum; Westinghouse kitchen; Columbia-Geneva garage doors; Textolite—GE—kitchen counters; Delco Appliances Div. heating; Nu-Tone fan; American Window Glass "Lustraglass"; Nicolai Door Mfg. Co. doors; Simpson Logging Co. doors; Alliance Ware, Inc., bathtub; American Rock Wool "Feltrock" roof insulation; Hastings Aluminum Products weatherstripping.

For a complete blueprint list of materials, see page 198.

**How merchandising sells this house** ▶

HOW HE SELLS THE BLUEPRINT HOUSE:

IT'S FREE!  
NEW ENERGY ERNIE COLORING BOOK  
KIDS! Tell your folks...

WIN THIS \$16,500 Wedgwood Home!  
ENTER KGW-TV CHANNEL 8 WHITE SATIN SUGAR WIN-A-HOME CONTEST!  
GRAND PRIZE: \$16,500  
Other Prizes: 164 prizes  
PLUS CASH PRIZES FOR YOUR FAVORITE ORDER  
CONTEST BEGINS June 10, 1957  
CONTEST CLOSES September 14, 1957



Dwight Haugen

Win this \$16,500 White Satin Sugar Wedgwood Home!  
Enter the KGW-TV House Contest!

### ... 3. Double your sales with

Dwight Haugen, president of Wedgwood Homes Inc., Portland, Ore., typifies the new type of "businessman builder." He's a graduate of the Harvard Graduate School of Business. To the business of merchandising homes he brings a scientific approach that has helped to double sales in a 2-year period while most of his competitors have seen business fall off.

How does he do it? What is this scientific approach?

To begin with, Haugen is one of the few Portland builders to retain an independent merchandising firm on a regular basis. Haugen puts his trust—and, to a large extent, his business future—in the savvy of a young dynamo named Kelly Snow. Snow is head of a Portland merchandising service bearing his name.

Together, Haugen and Snow have worked out a bristling merchandising formula stripped of all horse-and-buggy, leave-it-to-chance methods. Their concept of modern selling takes in the full range of present-day merchandising and marketing techniques—from basic market research right on

through to advertising, sales promotion, publicity, and post-sale relations.

Many of these techniques are tested techniques that have proved successful in other fields. Some are purely original. Following is a summary of how Haugen and Snow blend them:

**Sales-Control System:** shows changes in number of leads, sales, closing averages, etc.; cost per lead, sales, closing averages, etc. Costs per lead and per sale, show what media produce how many leads, date and cost. **Brand Identification:** the trademark was first developed for a folder series, and then used for newspapers, television spots, printed literature, point-of-sale, stationery. **Sales Aids:** sales force is equipped with many sales aids . . . ranging from watercolor renderings to sales kits. **"Detroit Selling":** Wedgwood adapted several sales techniques used in car selling to home selling. Productive techniques include the 60-second qualifying close, off-site selling, turnover or team selling and captive audience selling. **Saturation TV:** Wedgwood is the only homebuilder in the area to try saturation television spots—as many as 22 spots a day. The



**We NEED Sidewalk Superintendents!**

**Will you please help us**

... feel the effectiveness of our advertising? Your opinion is important to us! Just give your frank answers to the questions below.

Thank you!

**O.K.— You Asked For It... Here's What We Think!**

**1** How did you hear about Wedgwood Homes?

Newspaper  TV  Sign   
 Radio  Friends  Other

**2** What is your interest in housing?

Enjoy just looking around at new homes?   
 Looking for new ideas in my present home?   
 Considering buying a new home in the next year or two?   
 Need more rooms for our family?   
 We are definitely interested in a new home right now, if we can find the right house at the right price.

**3** Why are you looking in Berkshire Green?

Questions for looking around—

Increasing advertising—   
 Interesting advertising—   
 "I like trees and the peace, quiet and relaxation of quiet 18-minute drives to downtown."   
 "I like a location convenient to the freeway and an easy 10-minute drive to downtown."   
 "I like plenty of room for my children to play safely."   
 "I hear you have a lot of houses for the money."   
 "I want to live in a community where I can make friends easily with neighbors of similar interests."

Other reasons: \_\_\_\_\_

Name \_\_\_\_\_  
 Address \_\_\_\_\_

**4** You've helped us! Now, may we help you?

Thank you very much! We certainly appreciate your advice and time to help us. Maybe we can return the favor. We realize there are lots of questions in home buying. Our professional home consultants are available to help answer your questions. Please feel free to call on them at any time. Thank again!

## scientific merchandising

television program has become the largest, most spectacular and most controversial promotional campaign in the history of Oregon homebuilding.

Results of the new merchandising techniques: 1. Wedgwood is one of the most recognized brand names in Oregon homebuilding. 2. Every weekend,

several people drive over a hundred miles to visit Wedgwood's model home. 3. An occasional inquiry comes from as far away as Texas. 4. Biggest item is that sales have doubled in a falling market. Haugen has passed most of the "top 10", and ended '57 as one of Oregon's largest builders.

### Highlights of \$125,000 "Win-a-Home" promotion

**Television:** 1,300 spots on KGW-TV, ranging from 20 seconds to 3-minute interviews. Slides and films are used in spots, with live interviews. This is the heaviest single TV promotion for any product in Oregon in '57.

**Radio:** 550 commercials on KGW—5 commercials every day throughout the contest.

**Newspaper:** Wedgwood Homes uses classified section advertising. White Satin Sugar newspaper advertising in the Oregonian and the Oregon Journal all tie into the contest. Grocers use tie-in mats in their weekly food ads.

**Billboards:** 50 billboards each June, July and August

in selected Oregon markets.

**Direct Mail:** printed invitations and sales letters to special key groups.

**Signs:** window banners and shelf signs in hundreds of grocery stores. Scale models of the Wedgwood Prize Home used in six rotating displays for special promotions at grocery stores throughout the contest. Tract signs at the three Wedgwood community developments.

**Bus Cards:** on Rose City Traction Co. buses in Portland throughout the contest.

**Window Display:** 11-week window displays at Portland Gas and Coke Co. in high-traffic downtown location.

**YOU WANTED IT! YOU ASKED FOR IT! HERE IT IS!**  
**A NEW, LOW-PRICED BURKE FAMILY-PLANNED**  
**3-BEDROOM HOME**  
 In Fairlawn, the newest section of Highland Hills.

PRICES START AT **\$8250** AS LITTLE AS **\$350** DOWN INCLUDING CLOSING COSTS **\$63** A MONTH INTEREST AND INSURANCE INCLUDED

**Make your own choice from 21 WIDELY-DIFFERENT STYLES**  
 21 Burke, Jr., the man who has built more homes than has any other Southwestern builder, does it again!

Burke now offers an attractive, comfortable, airy, modern, 3-bedroom home in 11 different styles and eight different floor plans for an unheard-of low, low price that even families with very modest incomes can afford.

Think of it—a complete, airy 3-bedroom home in *Shadblow*, the newest section of Highland Hills—San Antonio's best residential district—for as little as \$800 down including closing costs and \$63 a month. And the total price—from \$8250 for your own personal choice of 11 different styles and 8 different floor plans—is absolutely unheard-of!

These are all true Burke family-planned homes designed for good living, fine landscaping, maximum ventilation in hot weather, low-cost heating in winter. The foundations carry the tons of strong, long-lived steel typical of Burke's rugged, top-quality construction. Roofing—weather grade or shingle—floors, doors and door frames, windows and window frames, trim, hardware—every single detail of construction meets Burke's high standards.

**Fairlawn—the Newest Section of Highland Hills**  
 You'll be proud of your spacious, handsome, new home in *Shadblow*. You'll live in a neighborhood of fine homes—all family-owned—and enjoy a big yard with naturally good soil. And Burke homes are adapted to the contour of the land. They naturally "fit in" with the neighborhood of smartly designed and built family-owned homes.

And having a choice of 11 styles and 8 floor plans gives you more than the *Shadblow* homes you've been seeing the extra—more space, larger, handsome bathrooms, ample wiring, plenty of convenient wall-plugs, larger utility and storage space, and bigger play areas for the children. And the location is an exceptionally 1 block off Loop 15.

**The Land Deal—A GILT-EDGED INVESTMENT**  
 The *Shadblow* section of Highland Hills in which these Burke homes are built is one of the most up-and-coming neighborhoods in San Antonio. The new Brooks Medical Center nearby is bound to attract quality homes and the variety of services and features that increase property values.

**21 STYLES 8 FLOOR PLANS! 16 HOMES ALREADY ON DISPLAY!**  
 Come out to *Shadblow*! Inspect the 16 fine homes on display. Consider carefully the full range of selection that the 11 exciting different home styles offer you. Take only a few minutes. Come out today!

**QUALITY — QUALITY — QUALITY!**  
 14 — Custom Quality Features — 14

1. Big High Ceilings
2. City Water and Sewers
3. Paved and Curbed Streets
4. 3 Bedrooms, CB
5. 2 Bedrooms and a Family Room
6. Refined Framing Trim
7. "Armstrong" Asphalt Tile Floors
8. "America Standard" Plumbing Fixtures
9. Combination Shower and Tub
10. "Flouresce" Wall Paper
11. Color Schemes Original
12. Big Kitchens
13. Large Wood Windows
14. Convexed Louvers

**Burke family-planned Homes**  
 SOUTHPORT AT FAIRLAWN LE 2-6341

**THIS IS THE AD** that lit the fuse that started Jim Burke's boom in San Antonio. The houses and plans are interesting, but according to Burke, it's the price at the top of the

page that really made the difference. People who hadn't thought "house" for months came out to see it. Down payment is now down to \$280.



**Jim Burke, builder and newly elected secretary of NAHB**

## He started a boom with

**J**im Burke is a Texas builder who isn't afraid to take a calculated risk.

During the latter part of 1957, Burke decided that sales in the San Antonio area had sagged to the point where a gamble was justified. Low-cost housing seemed the smartest way to take the plunge, and Burke went as low as he could with the homes shown here, and some other models.

The gamble paid off with unexpected extras.

First, Burke sold his low-cost houses at a brisk rate, proving that there was a solid market for houses in the \$8,000 class.

Second, he found that the success of the low-cost houses was pushing sales of his higher-cost homes in the same subdivision.

And third, the homebuilding business all over San Antonio took a perceptible jump upward.

Burke's pattern of building prior to his low-cost venture will be familiar to many builders. In 1955, he built 400 houses in the \$9,-\$10,000 range; in 1956, 268 houses averaging a thousand dollars higher; and in 1957, 180 houses between \$11,000 and \$15,000.

"I was selling bigger houses," Burke says, "but my dollar volume was dropping. I was doing a lot of glamorizing, but there are a lot of people who can't afford glamor. I decided to build for them."

FHA's Section 203 i, with its lower minimum requirements, looked like a good idea to Burke, and he planned models to sell for around \$8,250.

"We took out everything that a buyer could add at a reasonable cost later on," Burke said, "and worked out the simplest model we could."

Then he started to build; not one, but 86 units.

"We gambled on this many houses for two reasons," Burke explained. "First, we had to build in volume to keep costs down. Second, we wanted to build enough houses to really test the market."

Then Burke lit the fuse with the ad shown above, and sat back to see what would happen.



**SIMPLICITY** of elevation is one of the prime factors in keeping building costs down. Porch breaks up the facade, but allows the roof to stay in one straight line.

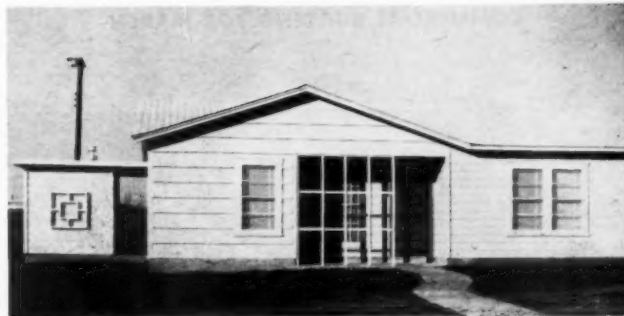

**TYPICAL** design variation with gable in the front. It gives the effect of a wing, still allows the house to be constructed as a simple, inexpensive rectangle.

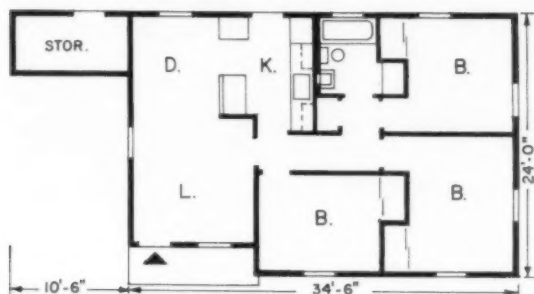

**CONVENTIONAL** plan has three bedrooms and one bath on one side of the house, living area on the other. An important feature of Burke's houses is lots of storage.

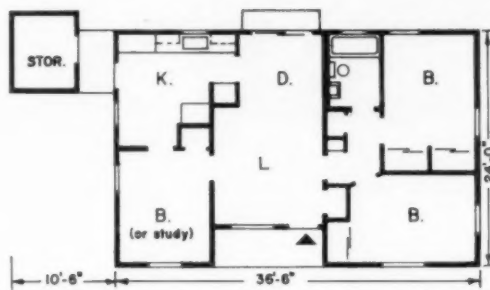

**UNUSUAL** floor plan splits one bedroom off sleeping wing, moves it to the other side as all purpose room. This house would be excellent for a retired couple.

## these low-cost houses

"It usually takes two or three weeks to get buyers actually buying after the first promotion. Most of them are young, but they aren't novices. They come, they look, and then they go shopping in other developments. If you still look good to them after all that, they come back. We opened over Christmas, and by January 20 we'd sold 46 houses.

"And here's something else. Eighteen of those 46 houses were higher-priced models in other parts of the subdivision. Apparently we started people thinking in terms of 'house.' Business got better all over town. It's a sort of mass psychology. First there's no business anywhere, then someone advertises an \$8,250 house, and everyone says, 'Let's go look.' First thing you know, business is better all over."

Burke is now considering shifting his emphasis to a slightly higher bracket—around \$10,000.

"We'll put back a lot of the stuff we took out of the \$8,250 model—maybe make it a little bigger. The down payment will be \$300—only \$20 higher—and it will require about \$35 a month more income. But we'll stay with the 203 i houses too. We think there are two distinct markets."

Burke broke one of the old rules with his new houses, and found it made sense. He built them only three blocks away from some \$14,500 models. This assures the buyer of the little house of constant values, and of a neighborhood that will stay good. So far, Burke reports no detrimental effects on the sale of the higher-priced houses.

If there's a moral to be drawn from Burke's success, it's this: too many builders are ignoring the low-price market. This doesn't mean they should stop building higher-priced, "traded-up" houses; it means that there's an additional market just waiting for someone like Jim Burke to make it boom.

According to FHA officials, building under Section 203 i is on its way up. In 1956, there were 4,800 applications; in 1957, with total FHA applications holding even, 203 i jumped to 5,700.

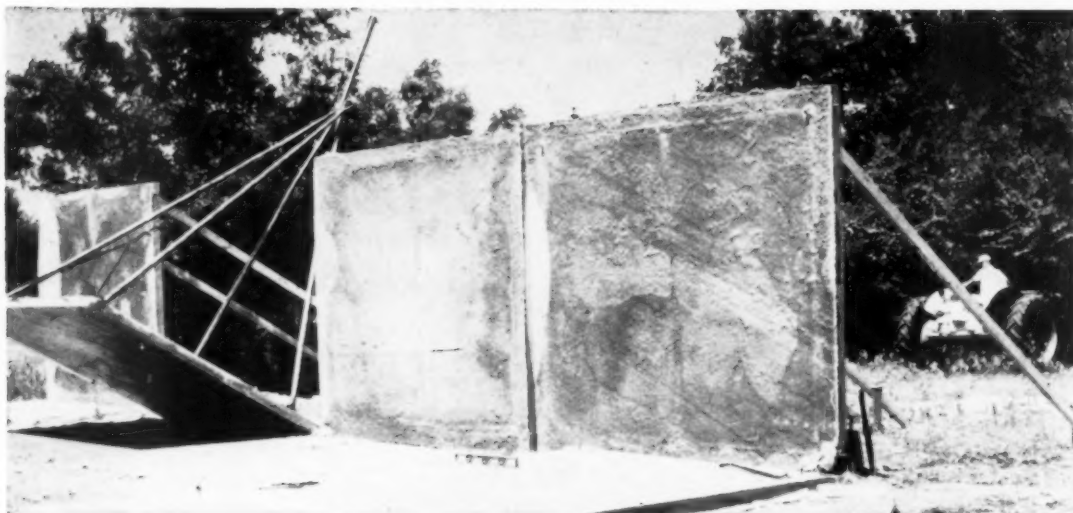

← WHAT

## How you can build low-cost

*Texas A & M research comes up with new ideas for concrete farm buildings...they're adaptable to other commercial building*

**I**n commercial construction it has been an accepted fact for some time now that tilt-up concrete panels allow the most economical type of construction for the one-story structure.

Limiting factor of this method of building for the small builder and rural builder is the heavy equipment needed to handle the concrete panels.

The new technique, shown here, was recently developed by a research laboratory for the farming industry. With it, light equipment can be used. As a result, rural, as well as small builders, will be able to take advantage of tilt-up construction.

There is, however, another consideration to make. Farm buildings seldom are restricted by existing codes. To apply this technique to other building operations, changes in the design of the building must be considered.

Here's how the new technique works: a two-man crew, utilizing a tractor pulling on a pyramid-shaped 2" pipe frame, can successfully erect a concrete panel house constructed of 10x10' panels. These panels are cast flat on ground or floor in perfect alignment, then merely tilted up into position.

Two 8" holes with 10" caps under panel junctions and three capped holes at corners form the foundation. For more data write the Portland Cement (Farm Bureau), 33 W. Grand Ave., Chicago 10.



**FARM TRACTORS** of the 2- to 4-row size were used as power source for tilt-up operations, leveling sand. Polyethylene is laid over sand bed before pouring concrete.



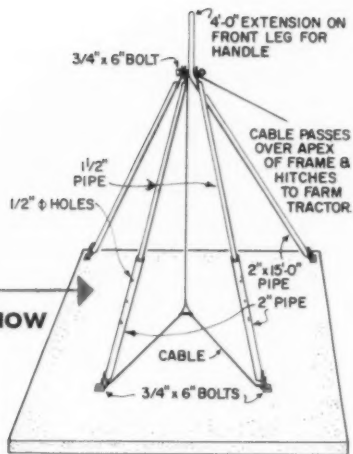

HOW

**SECRET** of successful tilt-up operation is use of tractor power, to tilt-up pyramid pipe frame. Have driver exert a constant forward pressure until panel is in vertical position.

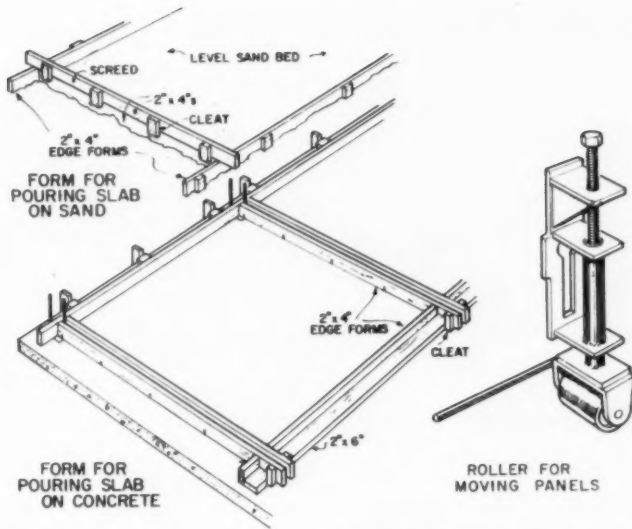

**SYSTEM** is flexible. Panels can be cast on sand bed or on the concrete floor slab, after slab is poured.

**2 ROLLERS** attached to panel enable them to be moved over concrete floor. Not needed when casting on sand bed.

## tilt-up buildings for \$1/sq. ft.

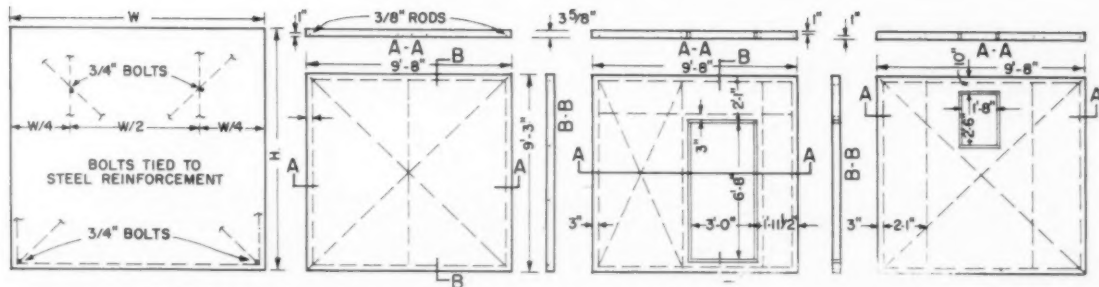

**MINIMUM** steel reinforcing necessary in various panel shapes allowing panels to be tilted.

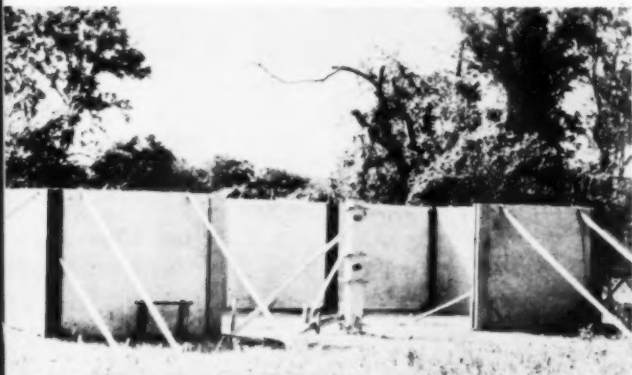

**AFTER PANELS** are tilted into position, they are anchored together with cast-in-place columns. To prevent cracking columns, panel ends are wrapped with plastic.



**HERE** is the end product of the practical engineering development. It's a low-cost, easily erected, 20x40' farm building. Walls and foundation costs: \$.63.8/sq. ft.

## EVOLUTION IN BATHROOMS

*One builder called this  
bath-bed-dressing room plan  
"the first big news*

*since plumbing came indoors."*

*He's proved that ...*

# You can offer a "4 bathroom" house for only \$500 more

**E**mphatically yes!" That's what one of the women attending last year's Women's Congress in Washington said when she was asked: "Would you pay from \$5 to \$7 more a month to get this new bathroom plan?" The question referred to the new arrangement which is outlined on these pages. There was a whole chorus of "Yes's" from the ladies; not a "No" in the crowd. The question was pointedly asked by the Plumbing Fixture Manufacturers Assn., creators of this compartmentalized plan, and co-sponsors of the Congress.

These plans are no longer dreams. Miami builder Sheldon Kay of Century Homes is erecting the house that will include the revised bath plan at right. He will be the first of 35 builders to use the plan. The other 34 are spread throughout the country: East, North, West and South. All these builders will get promotional help from PFMA (and probably additional aid from fixture suppliers). But, don't write or wire. The builders have already been chosen.

In devising this plan, PFMA members began by tossing out all previous notions of bathroom design. Next, they listed all the physical and psycho-



**TWO BATHROOM** plan is now a standard. Actually this was one of builder Sheldon Kay's best sellers, and why not? But, see how bath area is improved at right.

logical needs of the average family. The plan at the right is what evolved. Of course, what originally prompted them was lagging fixtures sales (traditionally tied to new house sales). This is their answer for increasing consumer demand for fixtures.

It's a good answer, as the Women's Congress delegates attested to. Let's not be rhapsodic though, because it's not the *final* answer. In its own survey, AMERICAN BUILDER turned up some women who had doubts about it. Several who responded to our queries said they didn't want their toilet-cleaning duties doubled. PFMA has countered this complaint already by claiming that the children can be taught to do their own cleaning.

Builder Kay's house sold for \$19,750 before the new bath-bedroom plan was put in. House with revised arrangement will sell for \$20,250.

**PRIVACY** when you want privacy is a sales theme Sheldon Kay is going to hit hard when his house opens late this month. Another talking point: during parties, lavatories in this room can be labeled "he" and "she."

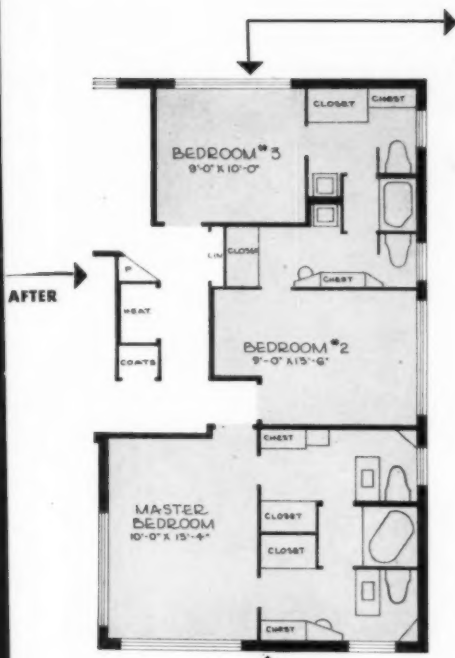

**DOORS** are installed at the entrance to each dressing area and divide the shower rooms from lavatories. Medicine chests are over each sink.

**SECOND** and third bedroom-bath areas at right would serve perfectly for two children, or one child and mother-in-law; accommodates more.

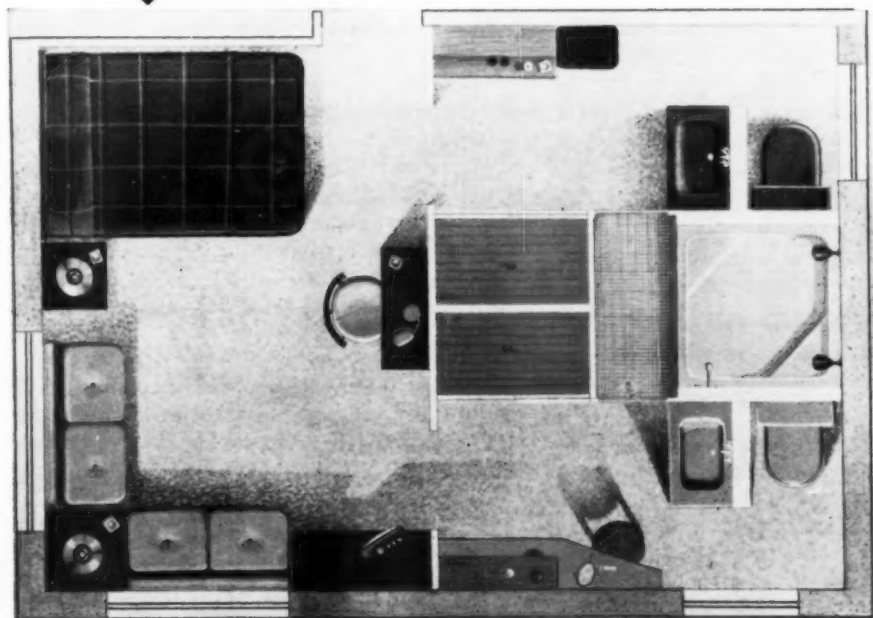
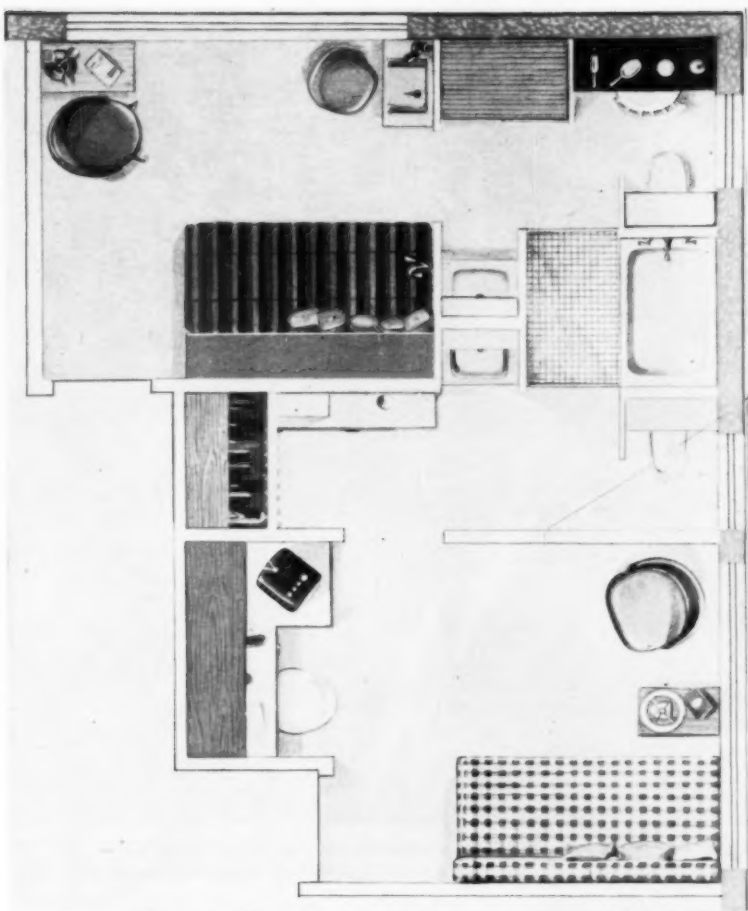



*Builder Dale J. Bellamah (right) discusses the location of a telephone outlet with J. P. McBurney of Mountain States Telephone and Telegraph Company.*

## "Concealed telephone wiring helps me merchandise my homes"

—says Mr. Dale J. Bellamah, Builder, of Albuquerque, New Mexico

"Right now I'm building a community of some 2000 homes," says Mr. Bellamah. "And in every home we're putting concealed telephone wiring.

"It's a real sales aid. It helps me merchandise my homes. We list it in our advertisements, and we point to it as an example of what we mean by our slogan, 'First in size—first in new ideas.'

"If you're in the business of building modern homes for people with modern ideas, you can't expose the telephone wiring any more than you can expose the plumbing!"

Mr. Bellamah is the biggest builder in New Mexico. During the past ten years he has built upwards of 5000 homes. He has been on the

Executive Committee of NAHB among many other positions he has held in that Association, and in 1956 he was National Chairman of the Military Housing Committee. Mr. Bellamah is one of many trend-minded builders throughout the country who are convinced that concealed telephone wiring is a modern feature that helps them sell their homes in today's highly competitive market.

\* \* \*

Your local Bell Telephone Business Office will be glad to help you with concealed wiring plans. For details on home telephone wiring, see Sweet's Light Construction File, 8i/Be. For commercial installations, Sweet's Architectural File, 32a/Be.

BELL TELEPHONE SYSTEM



# The Payoff Departments

- New Products and Catalogs** ..... 109 →  
Products highlights from the 1958 NAHB Convention.  
Other new product information, p. 116. Catalogs, p. 144.  
Reply card, p. 114.
- Buying Guide** ..... 164 →  
Attic ventilators can save air conditioning dollars.
- Land Planning** ..... 168 →  
Turner and Hay planned this land as well as the houses  
on it. Result: this project is their third award-winner.
- Cost Saver** ..... 182 →  
This motorized conveyor system saves 1/3 of their shin-  
gling time.
- How To Do It Better** ..... 184 →  
Builder devises new method for stripping forms.
- Ask The Experts** ..... 190 →  
New mortar costs less, reduces installation time.
- Merchandising Ideas in Action** ..... 194 →  
Case histories of successful sales-promotion techniques.
- Keeping Up With The Law** ..... 202 →  
New legislation would hold parents responsible for prop-  
erty damage by minors.
- Technical Guide** ..... 204 →  
"Hidden-Value" heating system uses plywood beams over  
a crawl space.
- Better Detail of the Month** ..... 206 →  
This warm-air radiant system offers versatile operation.
- The Month Ahead** ..... 210 →  
Things for builders to think about during April.

**NOW DEXLOCK IN TU-TONE COMBINATIONS**

**AND NEW INSERT-TOP, TULIP KNOBS**

Now Dexlock key-in-knob sets offer a new peak of entrance elegance in an economy lock. They're now available with such tu-tone finishes as Brass and Black or Bronze and Chrome in standard 2 3/8" or 5" backset. Available with Dexter designed escutcheons for entrance doors as well as all functions for interior doors. Plus, such Dexlock features as economy price, factory assembled tie screws, easy cylinder removal, self-aligning latch and solid brass pin tumbler cylinder—no die cast or powdered metal parts. No lock installs faster than a DEXTER.

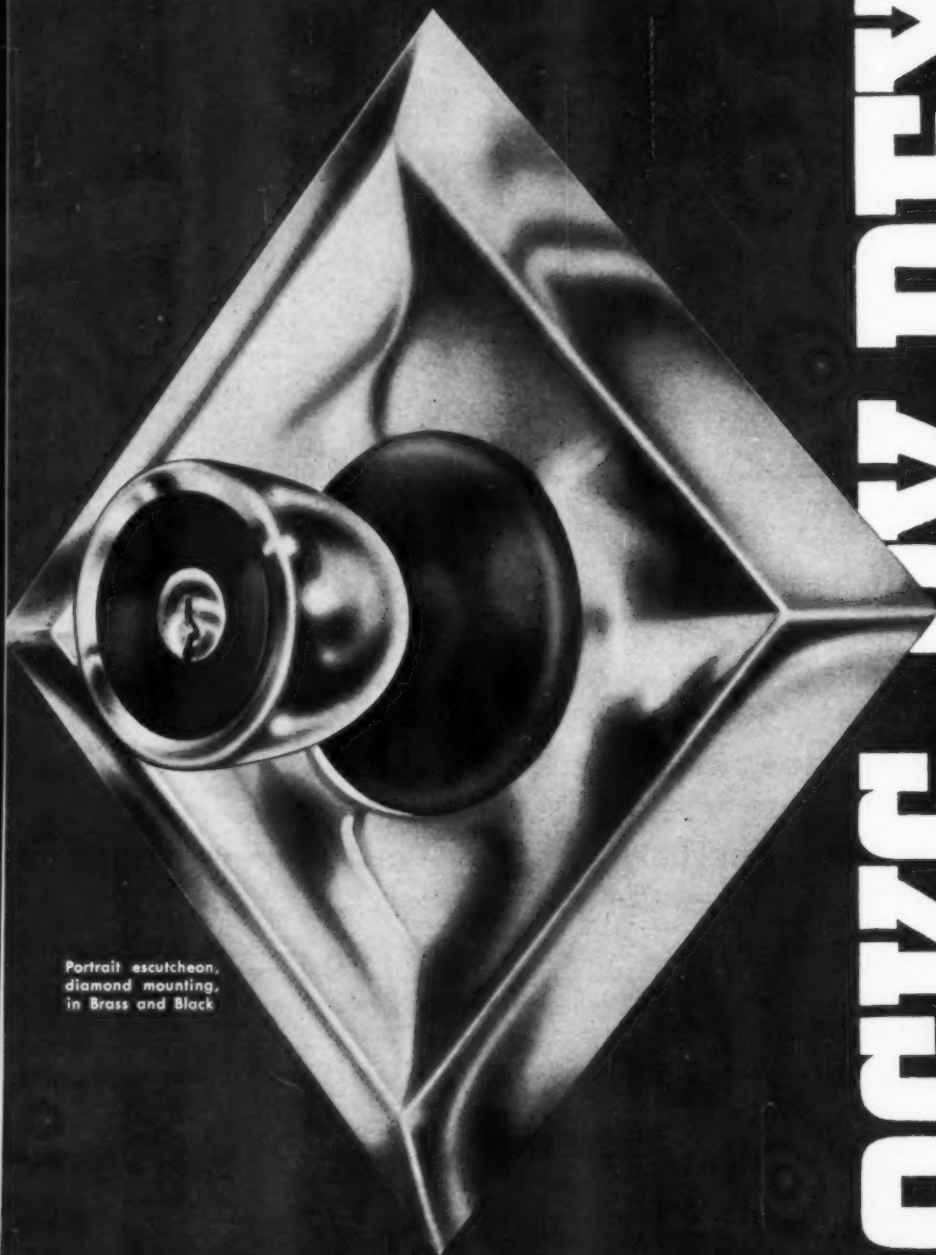

Portrait escutcheon,  
diamond mounting,  
in Brass and Black



Privacy set in  
Black and Brass

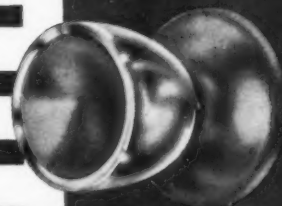

Passage set in  
Bronze and Chrome

**DEXTER LOCK DIVISION**

Dexter Industries, Inc., Grand Rapids, Michigan

**LOCKS BY DEXTER**

In Canada:  
Dexter Lock Canada Ltd.,  
Galt, Ontario.

In Mexico:  
Dexter Locks, Plata Elegante,  
S. A. de C. V. Monterrey.

Dexter Locks are  
also manufactured in  
Sydney, Australia; Milan, Italy  
and Porto, Portugal.

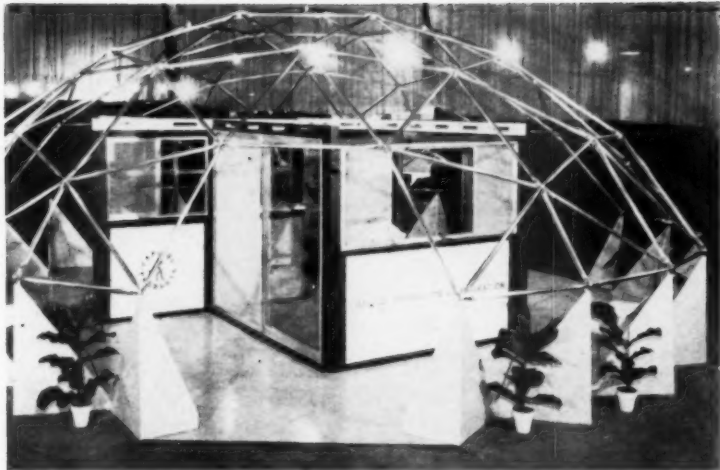

**ADVANCE DESIGN PRODUCTS** like these three drew big crowds. Exhibitors will use builders' reactions to help 1958 marketing plans. Above, Capitol Product's shelter type A of extruded aluminum. Lightweight and portable, it can be assembled rapidly. For commercial, vacation, farm use. (No. M1, p. 114).



**COOKING CENTER** of the future from Hotpoint will have two ovens (one electronic). Surface cooking units retract like drawers. Doors are elevator-type. (No. M2, p. 114).

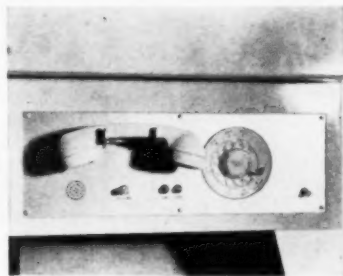

**HANDS-FREE** telephone is one of American Telephone & Telegraph's new designs for the future. Voice comes over speaker, can be raised or lowered. (No. M3, p. 114).

*Staff Report: from the 1958 NAHB  
Convention. Here's what builders saw  
at the big product exhibition . . .*

## Product highlights for 1958



**NEW** "off the floor" closet by Crane (left) has a tank  $8\frac{1}{2}$ " wide by  $5\frac{5}{8}$ " deep. Tank (right) fits between 16" studs. Front access wall panel snaps on, can be decorated. (No. M4, p. 114).

**WHAT**



**HOW**

**OTHER** wall-hanging water closets were American-Standard's floor-free Norwall (No. M5, p. 114); Borg-Warner's wall-hung closet (No. M6, p. 114); Universal Rundle's Wallborne unit (No. M7, p. 114).

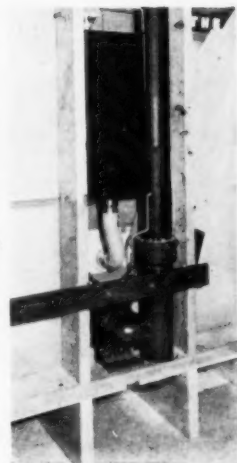

**STAFF REPORT: PRODUCT HIGHLIGHTS**

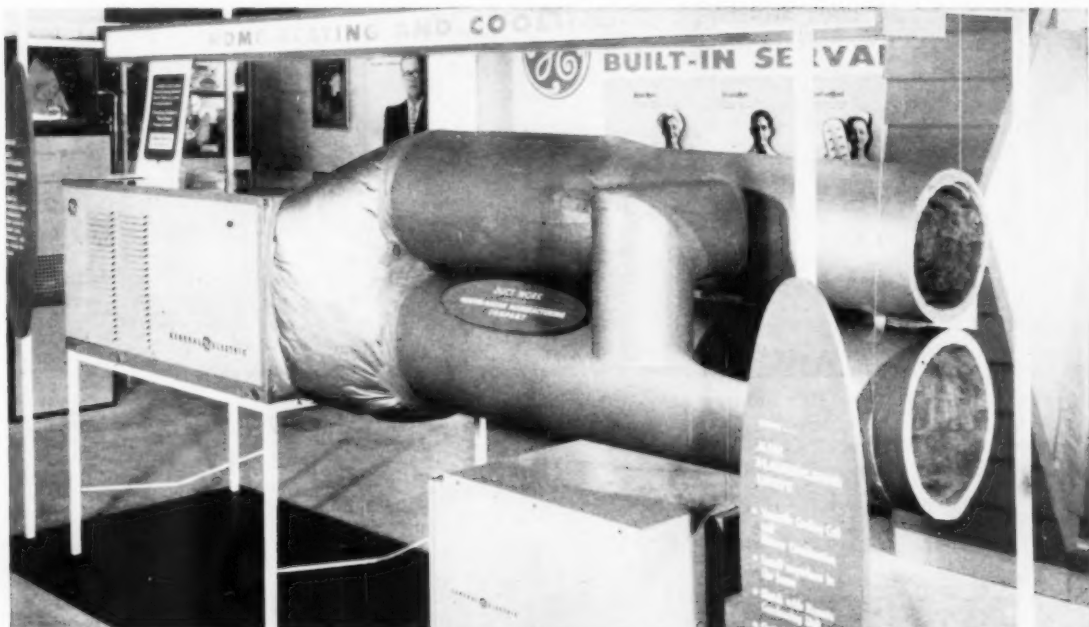

**PROMOTION AIDS** for builders were dramatized at the NAHB convention. Here, General Electric shows off its new nationally-advertised self-contained cooling unit. (No. M8, p. 114). Made for installation with independent duct

work, it will go into crawl space, basement, attic or outside the home. Gustin-Bacon Manufacturing Co. supplied the duct work of lightweight, extremely flexible insulated fiber glass. (No. M9, p. 114).

**WHAT** ↓



**EATING SPACE** for four folds out from above a base cabinet by Coppes Napanee. (No. M10, p. 114). Extension table unfolds to 33x45", has two matching benches. Out but unfolded, it makes an extra work surface.

↓ **HOW**



**HOW IT OPERATES:** table (on rollers) folds once and slides back above cabinet. Benches (also on rollers) telescope into half-size, fit into cabinet. Cabinet is topped with Formica. (No. M11, p. 114).





**COLORFUL KITCHEN UNITS** like this RCA Whirlpool Center were another NAHB Exhibition attraction. The checkerboard wall of cabinets was yellow steel alternated with wood-finished units. Door and drawer fronts here snap-on to steel shells without help of tools. (No. M12, p. 114). Built-in food mixing center is from Nutone. (No. M13, p. 114).

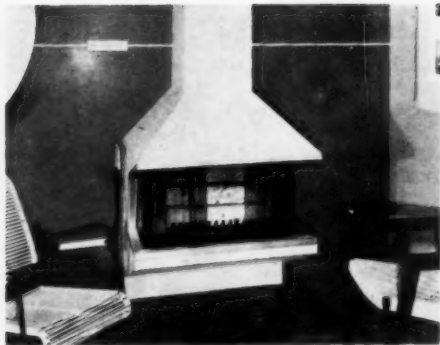

**BUYER'S DESIRE** for a fireplace in his new house is easily satisfied. Vega Industries offers its prefab Uni-bilt fireplace in new straight-cut modern lines. (No. M14, p. 114).



**TIME-SAVER** packaged hardware is used to save space, too. Kennatrack's new corner installation takes advantage of odd space, gives better closet access. (No. M15, p. 114).

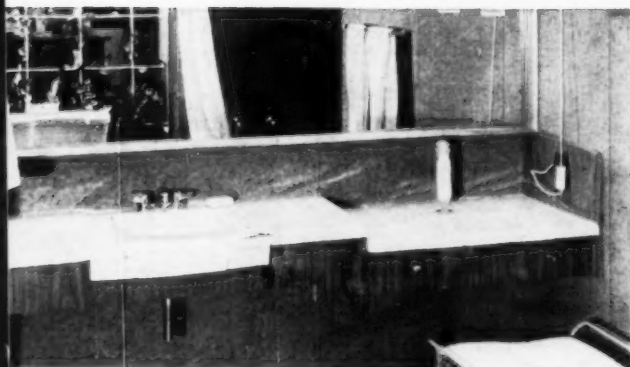

**TILE INNOVATION** for the bathroom. Universal-Rundle's Versa-Tile of vitreous china comes in long rectangular pieces. Easy to install, it is matched by the new Versa-Tile Lavatory. (No. M16, p. 114).

**WHAT                      HOW**

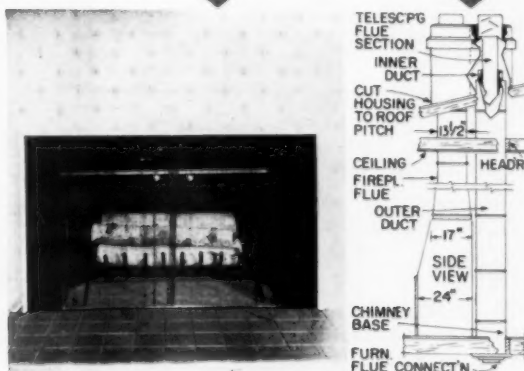

**TRADITIONAL FIREPLACE** but factory fabricated . . . Majestic's Thulman. Black marble surround, built-in sliding screen complete "traditional look." (No. M17, p. 114). Right, installation view with chimney top housings.

**Prediction: color will influence your sales**

Here's a catalog sampling from the NAHB exhibitors offering you help in color-planning . . .

- **HOW TO CHOOSE** colors and use them to complement architecture. A 32-page booklet from Pratt & Lambert. (No. M24, p. 114).
- **OPERATION COLOR** from Robbins Floor Products. Catalog gives color harmony scheme for floor tiling. (No. M25, p. 114).
- **CUSTOM DECORATING** service for kitchens. Free from Youngstown Kitchens. (No. M26, p. 114).
- **COLOR COORDINATION** of all paint and material used in a house. Service from L. C. Major. (No. M27, p. 114).
- **HARMONY CHART** for entire bathroom in "Eljer's Colors" leaflet. (No. M28, p. 114).
- **PACKAGED COLOR** schemes for builders. Information from Color Scheme Originals. (No. M29, p. 114).
- **GIVE THE LADY** what she wants . . . Curtis Kitchen's 4-page folder on colors and decorator service. (No. M30, p. 114).
- **PROFESSIONAL COLOR** styling for bathrooms. In 4-page pamphlet from Briggs. (No. M31, p. 114).
- **CUSTOM KITCHENS** from Philco. Unlimited color choice offered with snap-in panel fronts. (No. M32, p. 114).
- **PLANNING BATHROOMS** in color. American-Standard illustrates 16 complete bath color schemes. (No. M33, p. 114).
- **TILE COLORS** and how to choose them. A 16-page Mosaic Tile book of beautiful homes. (No. M34, p. 114).
- **COLOR GAME** in a 12-page catalog from Crane Co. Charts and drawings on bathroom planning. (No. M35, p. 114).

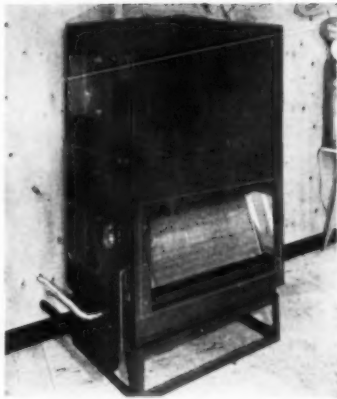

**TWO-SECTION**, year 'round air conditioner from Westinghouse offers design flexibility. Modular indoor section of remote heat pump shown above. (No. M18, p. 114).



**SPACE-DIVIDING** interior glass panels are now easier to construct. Owens-Illinois' glass blocks can be bolted together without use of mortar. (No. M19, p. 114).

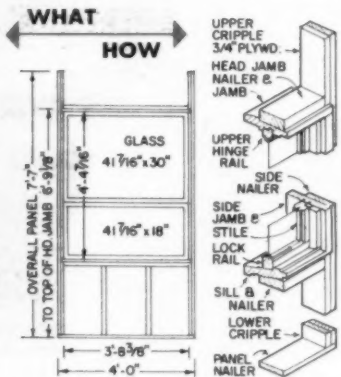
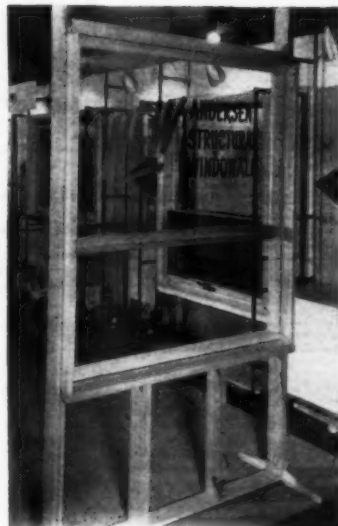

**WINDOW COMPONENT** for faster framing . . . this one from Andersen. New Structural Windowwall (No. M20, p. 114), is set at 7'7\"/>



**DIAMOND-PANELED** windows are for the traditional and Cinderella-type house. Style was shown in a wood casement model by Silcrest, above. (No. M21, p. 114). Carr Adams & Collier (No. M22, p. 114), and Rolscreens Pella (No. M23, p. 114), also featured windows with diamond mullions.

You are entering the **American Builder**

# Supermarket

Help yourself to everything you want in new information and literature about new products shown on the pages ahead. This is one-stop shopping for ideas. Instead of writing a dozen different manufacturers, just circle the numbers on the other side of the card below . . . then drop it in the mail (no stamp needed). AMERICAN BUILDER will forward your request to each manufacturer, who will send you complete data free of charge. Get your pencil out and help yourself . . .



**BUSINESS REPLY CARD**  
First Class Permit No. 153, Sec. 34.9, P. L. & R., New York, N. Y.

4 cents Postage will be paid by

**Business Manager**  
**AMERICAN BUILDER**  
**30 Church St.**  
**New York 7, N. Y.**



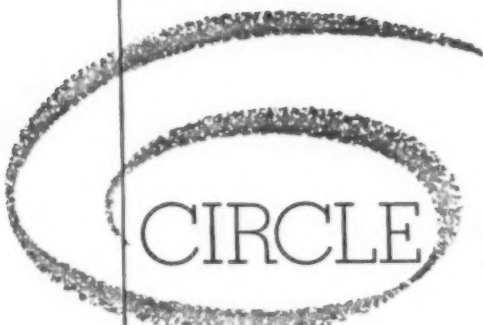

CIRCLE items below

...and mail this  
postcard today

FREE INFORMATION . . .  
on PRODUCTS & EQUIPMENT

**FREE INFORMATION - ON PRODUCTS and EQUIPMENT**

**NAHB SHOW PRODUCTS**

- M1 Capital Products shelter
- M2 Hotpoint cooking center
- M3 American Telephone & Telegraph telephone
- M4 Crane water closet
- M5 American Standard w.c.
- M6 Borg-Warner water closet
- M7 Universal-Rundle w.c.
- M8 General Electric cooling unit
- M9 Gustin-Bacon duct work
- M10 Coppes base cabinet
- M11 Formica counter tops
- M12 RCA kitchen units
- M13 Nutone mixing center
- M14 Vega Industries fireplace
- M15 Kennatrack hardware
- M16 Universal-Rundle Versa-Tile
- M17 Majestic fireplace
- M18 Westinghouse a/c unit
- M19 Owens-Illinois glass block
- M20 Andersen Windowall
- M21 Silcrest window
- M22 Carr, Adams & Callier
- M23 Rolcreen window

**COLOR-STYLING CATALOGS**

- M24 Pratt & Lambert
- M25 Robbins Floor Products
- M26 Youngtown Kitchens Div.
- M27 L. C. Major & Associates
- M28 Eljer Div. of Murray Corp.
- M29 Color Scheme Originals
- M30 Curtis Companies
- M31 Briggs Mfg. Co.
- M32 Philip Corp.
- M33 American-Standard
- M34 Mosaic Tile Co.
- M35 Crane Co.

**VENTILATION BUYING GUIDE**

- M36 Viking Air Products
- M37 Louver Mfg. Co.
- M38 Lou Blower Co.
- M39 Berns Air King
- M40 Bar-Brook Mfg. Co.
- M41 Leigh Bldg. Products

**NEW PRODUCTS**

- M42 Gilson Bros. Co. mixer
- M43 Charles Machine Works, Inc.
- M44 M. J. Fitzgerald garage door operator
- M45 General Engines Co. roller
- M46 Nuclear-Chicago d.M. Gauge
- M47 Humelite saws
- M48 Clipper Mfg. Co. saw
- M49 Massey-Harris-Ferguson Div.
- M50 Alisco, Inc. siding
- M51 Muller Machinery Co. mixer
- M52 Eckhardt Co. ducts
- M53 Robinson Clay Products
- M54 Satway steel scaffold
- M55 Wen Products soldering gun
- M56 Mutschler Bros. cabinets
- M57 Kennatrack folding door
- M58 Rice Pump & Machine Co.
- M59 Pacific Pre-Cast Products
- M60 Paine Lumber Co. doors
- M61 Jackson Mfg. mortar cart
- M62 Truscon Steel Div. doors and windows
- M63 American-Standard tub
- M64 Dixie Products gas range
- M65 Crane Co. lavatory
- M66 Henry Diston Div. saw

- M67 Norris Dispensers Cold-Bar
- M68 Straitville Ceramduct
- M69 Speed Queen Div. laundry units
- M70 United Cork insulation
- M71 Embassy Steel Products baseboard

**CATALOGS**

- M72 Holiday House prefabs
- M73 Minnesota Mining & Mfg. Corp.
- M74 Yankin-Majestic Paint Corp.

- M75 In-Sink-Erator disposer
- M76 P & F Corbin locksets
- M77 Empress Brick & Bricktile
- M78 Curtis-Wright "Curon"
- M79 L. A. Darling Co.
- M80 Colocrete Industries
- M81 United Steel Products Co.
- M82 Weatherbest Kolar plan
- M83 Redibrick Industries, Inc.
- M84 Phillips Drill fasteners
- M85 Western Pine Assn.
- M86 Wiremold Co. multi-outlet system
- M87 American Iron & Steel Institute stainless steel

- M88 U. S. Plywood paneling
- M89 Prime Windows, Inc.
- M90 Lou Blower ventilation
- M91 Simplex Forms System
- M92 Elkay Mfg. Co. sinks
- M93 G. E. Textolite
- M94 Cloud Oak Flooring Co.
- M95 Ador sliding glass doors
- M96 Malco door operator
- M97 Sky-Lite Pool Div.
- M98 G. E. "Light for Living"
- M99 L & M Tile Products Co.
- M100 Bakelite Co. plastics
- M101 D. W. Onan & Sons, Inc.

**Mail This Postcard Today—We Pay the Postage Act Now!—Service on This Card Expires in 90 Days**

MARCH, 1958

NAME (Please print) \_\_\_\_\_

STREET \_\_\_\_\_

CITY \_\_\_\_\_ ZONE \_\_\_\_\_ STATE \_\_\_\_\_

**PLEASE CHECK YOUR FIELD OR OCCUPATION**

- Builder or Contractor
- Sub-Contractor or Building Trades
- Building or Planning Own Home
- Architectural
- Engineering
- Manufacturer or Producer
- Other
- Distributor
- Finance
- Realty
- Organization
- Government
- Student or Teacher

I wish to enter a subscription to American Builder for one year (\$3.50)

3 years (\$7)  New  Renewal

Signature \_\_\_\_\_

**THE BEST SAW OPERATORS  
REACH FOR THE BEST BLADES**

That's Why  
**4 OUT OF 5 BUY...**



**TAKE THIS CD-7245-3...**

It's a New Clipper Bond with a full 3/16" Diamond Depth—that will positively out-cut, out-last and out-perform ANY BLADE ever developed, to cut all HEAVY and LIGHTWEIGHT BLOCK, STONE and BASIC REFRACTORIES. Here's a Long-Life Blade that will give you real performance! Call your Clipper Factory Trained Representative for a performance test on your job or for Same Day Shipment from your nearby Clipper Branch Warehouse.

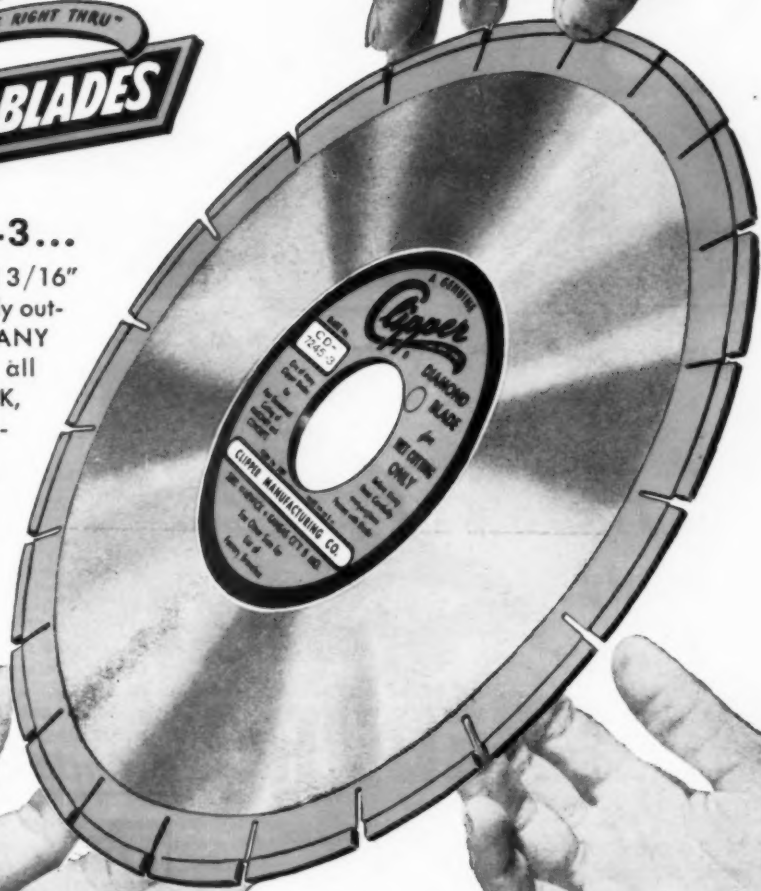

By The Makers of  
**CLIPPER**  
**SUPERMATIC MASONRY SAWS—**  
No Head Angle Adjustments to Make.  
HI-LO Control Wheel Does Everything!

Ask your Clipper Factory Trained Representative for **FREE TRIAL!**

**CLIPPER MANUFACTURING COMPANY**  
2808 WARWICK • KANSAS CITY 8, MO.

Sold Direct From Factory Branches in Principal Cities Coast to Coast  
FACTORIES IN ENGLAND—FRANCE—GERMANY—ITALY 323X



**They may look alike, but...**



**There's  
only  
one**

**ORANGEBURG® Brand!**

Like black cats, all bituminous pipe may look alike... but there's only *one* genuine Orangeburg.

It's the quality not the color that has made Orangeburg *THE* brand name in bituminous pipe.

Be sure you deliver Orangeburg *quality* on every job you install. It's your assurance of satisfied customers.

Experience shows that famous brands are the best, year after year, because they give you highest quality. Whenever you buy Orangeburg make sure you get the *genuine*. Look for the name "Orangeburg" on pipe and fittings.

ORANGEBURG MANUFACTURING CO., INC., Orangeburg, N. Y., Newark, Calif.



ADVERTISED IN  
**LIFE**

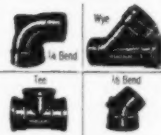

**Exclusive Orangeburg Fittings**, featuring Taperweld Joints, simplify installation.

**NEW PRODUCTS...**

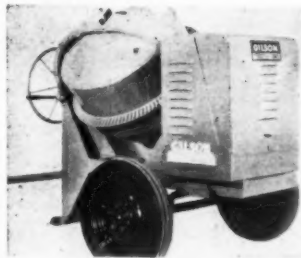

**Mixer has all-steel drum**

Lightweight model concrete mixer has an all-steel mixing drum. Weighs approximately 700 lbs. less than same capacity model with cast iron drum. Has 6 cu. ft. capacity and yet can be moved about by one man. Gilson Bros. Co., Dept. AB, Fredonia, Wisc.

Circle No. M42 on reply card, p. 114

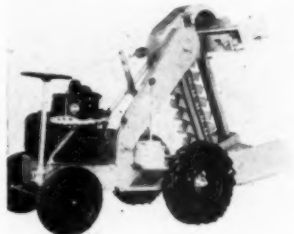

**Trencher is completely mobile**

Ditch-Witch trencher provides the contractor with a low-cost, high-performance model. Model LD, completely mobile, has trenching speeds up to 8 fpm and road speed up to 5 mph. Charles Machine Works, Inc., Dept. AB, 625-30 Birch St., Perry, Okla.

Circle No. M43 on reply card, p. 114



**Doors open like magic**

Comfort and protection are just two advantages of Merlin garage door operator. Simple in design yet rugged in construction, electronic operator has a 10-year guarantee. M. J. Fitzgerald Co., Dept. AB, 2815 Vliet St., Milwaukee, Wisc.

Circle No. M44 on reply card, p. 114

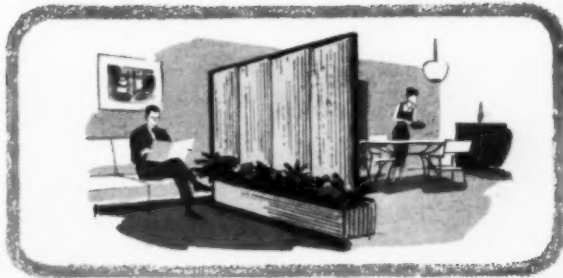

## The look that sells

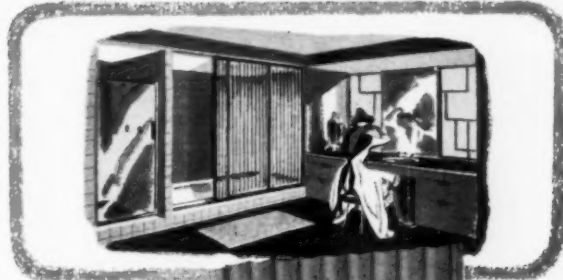
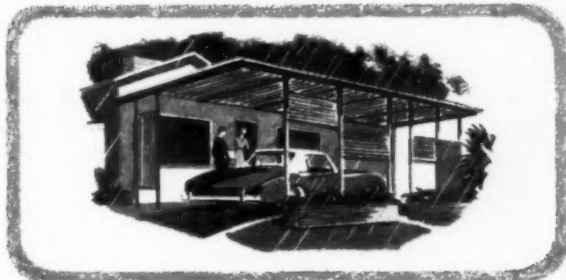

# costs less with **FILON**.

... GUARANTEED FIBERGLASS PANELS

The "look" that's selling today's home buyers is the look of beauty created with color and light, expressed in colorful interiors and outdoor living space. With FILON translucent fiberglass panels, you can put this "look" into the homes you build and give the buyers features they want, at low cost to you.

**FILON ADDS THE "LOOK THAT SELLS!"** Use it inside and outside in an unlimited number of ways in any style home—for patios, carports, breezeways, skylights, shower doors. Its strong, smooth, easy-to-clean surface also makes it a natural for shoji screens and doors, room dividers, sliding wall panels, etc. Guaranteed shatterproof, weatherproof—another "selling plus."

**FILON COSTS LESS—IS EASY TO INSTALL.** It goes up quickly with minimum framing, requires only ordinary tools, and can be pre-cut in sizes to your specifications. You are assured of maximum durability and superior strength, because FILON is reinforced with Fiberglass and Nylon by an electronically controlled Patented Process.

**FILON OFFERS 20 DECORATOR COLORS,** brilliant tones to soft pastels and white, to give your homes the "look that sells." No painting is needed; color and strength endure. FILON is easy to buy at all leading lumber, building materials and glass dealers. Select from a variety of corrugations, also flat or shiplap.

**5-WAY FILON  
GUARANTEE**

- Superior Fiberglass and Nylon reinforced strength.
- Uniform thickness for easier installation, better diffusion of light and color.
- Shatterproof for absolute safety.
- Weatherproof for maximum durability.
- Exceeds standards published by U.S. Bureau of Standards.

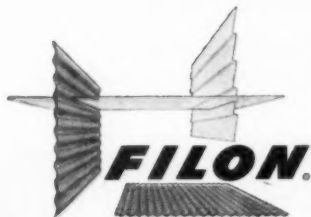

Los Angeles • New York  
Chicago • Atlanta • Palo Alto

**FREE Technical Service For You!**

**FREE Exclusive!** Let our trained technical staff work with you to show you how to adapt FILON fiberglass panels to your present home plans, help you to create a dramatic "look that sells" in your future model homes. Just tell us your problem or requirements.

**FREE A.I.A. Booklet,** containing detailed drawings and technical data or consult Sweet's File.

**Write to:** Filon Plastics Corp., 125 Lomita St., El Segundo 77, Calif.





Curtis folding louvre doors such as these will be featured in Curtis advertising during April in BETTER HOMES AND GARDENS, AMERICAN HOME, HOUSE BEAUTIFUL and HOUSE & GARDEN. Curtis windows and other woodwork will also be extensively advertised during 1958.

**CURTIS**  
WOODWORK *heart of the home*





# Bright new feature...to help you sell homes ...Curtis Style-Trend Folding Louvre doors

The widespread popularity of louvre doors gets an extra push in April when Curtis Style-Trend folding louvre doors are advertised to 8,706,474 readers of leading home magazines.

Used in your homes, these Curtis louvre doors give you major help in selling. With all the warmth and charm of wood, they offer the advantages of folding units which provide full width access to closets, wardrobes, linen closets and other storage spaces.

These louvre doors are made of durable ponderosa pine and use chevron-type fixed slats which permit free circulation of air. They roll silently on nylon bearings.

Doors are also made in flush door design—the famous Curtis New Londoner style. Both louvre and flush doors are made in four sizes—and all hardware is furnished. Easy, quick installation in old or new houses.

## 94 door styles in the complete Curtis Woodwork line

Whatever your choice of the widely varied Curtis line of entrances and doors, you can be sure of good taste in design and beauty that keeps fresh through the years. And, too, you can depend on the built-in quality that comes from fine materials and guaranteed craftsmanship. Curtis Woodwork has been the choice of successful architects and builders for 92 years.

Your Curtis Woodwork dealer will show you his big door and window selector charts, as illustrated on the right. These make door and window selection fast and easy.

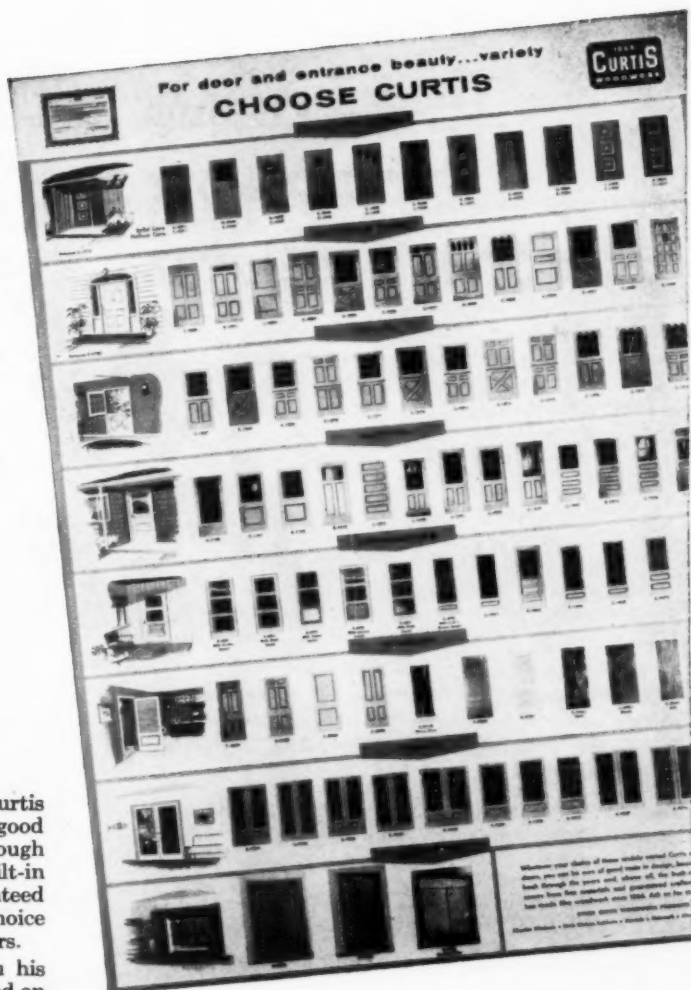

# CURTIS

WOODWORK *heart of the home*

AB-3-58

Curtis Companies Service Bureau  
200 Curtis Building, Clinton, Iowa

Please send literature on Curtis doors and  
other Curtis Woodwork.

Name .....

Address .....

City ..... State .....

are  
you  
being  
"COLOR  
SMOTHERED" ?



From sky-blue pink to rain-barrel red, an avalanche of roofing colors is smothering the building industry . . . DISTRIBUTOR, DEALER, CONTRACTOR, AND BUILDER ALIKE!

The resulting big inventories, slow turn-over, and costly left-overs have cut seriously into profits, and tied up working capital.

What's the solution? . . . Certain-teed's all-new C-T "Color-Tuned" roofing line of just 10 colors!

Certain-teed has retained the services of Beatrice West, one of America's foremost color authorities in the building

industry and an expert in building products color styling, to create an entirely new line of roofing colors based upon customer preference and style trends. Her findings prove that the 10 new "Color-Tuned" colors by Certain-teed will completely satisfy the needs of all your customers.

Beat the big inventory problem, step up turn over, eliminate costly left-overs! Stock the Certain-teed "Color-Tuned" line, and you'll cut costs and show bigger profits.

For all the news on this BIG news in roofing, call, wire or mail this coupon immediately.

*Color* **T**uned  
ROOFING SHINGLES

**Certain-teed**

REG. U.S. PAT. OFF.

Products of Certain-teed Products Corporation

SOLD THROUGH

**BESTWALL CERTAIN-TEED SALES CORPORATION**

120 East Lancaster Avenue, Ardmore, Pa.

EXPORT DEPARTMENT: 100 East 42nd St., New York 17, N.Y.

ASPHALT ROOFING • SHINGLES • SIDING • ASBESTOS CEMENT • SHINGLES AND SIDING  
FIBERGLAS BUILDING INSULATION • ROOF INSULATION • SIDING CUSHION

Color Service Division, Dept. AB  
Bestwall Certain-teed Sales Corp.  
120 E. Lancaster Ave.  
Ardmore, Penna.

I want more information on the NEW "Color-Tuned" roofing line and Certain-teed's new "Color-Tuned" Home Harmonizer.

Name.....Title.....

Company.....

Street.....

City.....Zone.....State.....

**NEW PRODUCTS...**

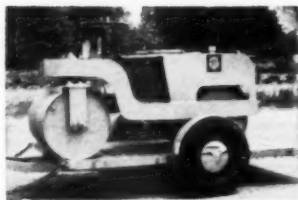

**Roller weighs a ton**

All-purpose one-ton roller features reversible, fully automatic transmission. Single-lever control simplifies operation. Moistening system is gravity-fed to cocoa mat on each roller. Weighs only 1,200 lbs. empty. Small tilt trailer available for hauling it. General Engines Co. Inc., Dept. AB, Rt. 130, Thorofare, N.J.

Circle No. M45 on reply card, p. 114



**Instrument is non-destructive**

First non-destructive instrument, the d/M-Gauge for field moisture and density determination, has many uses in building industry. Portable unit features simple application and speed of measurement. Large volume of soil can be quickly analyzed. Nuclear-Chicago Corp., Dept. AB, 223 W. Erie St., Chicago 10, Ill.

Circle No. M46 on reply card, p. 114

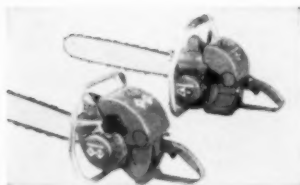

**Solve saw problems**

Two new models 6-22 and EZ-6, the "Power Twins", possess qualities for long chain saw life and low-cost dependable operation. Both permit cutting in any position, are lightweight, easy to control. EZ-6 is direct-drive, 19 lb. unit; the 6-22 is a gear-drive, 22 lb. unit. Homelite, Dept. AB, Port Chester, N.Y.

Circle No. M47 on reply card, p. 114

# Building Industry Acclaims New Strip Lamination By Bestwall

## Bestwall's Exclusive Hummer System Adds Another Dramatic Development

**Ardmore, March 1958:** Bestwall's announcement of the development of the Hummer System of Strip Lamination comes as a field-tested advance in the building industry.

By using strips rather than a complete back layer of wallboard, the Hummer System gives the advantages of high quality laminated construction without the extra costs.

Additional technical improvements of the system solve three basic problems of wallboard construction—nail popping, joint beading and delayed shrinkage.



Hummer System reduces cost of laminated construction by using strips in place of full sheets for back layer.

First, the reduction of the number of nails that go into framing, and the covering of all fasteners with paper tape and cement practically eliminate nail popping, and help to reduce both shrinkage and joint beading. Next, the use of a glue clamp with Phillips flat-head screws is an additional safeguard against the expense and trouble caused by joint beading. Finally, by eliminating high edges, by waiting until the joint system is completely dry, and by applying a final skin coat of joint cement, unsightly and costly shrinkage is prevented.

The improved methods of the Bestwall Hummer System of Strip Lamination mean quality work with actual savings to every builder—in cost, material and time. For more information about laminated construction at reduced cost, write or call our nearest sales office or mail the coupon below.



Send for this FREE 8-page book TODAY!



Bestwall Certain-teed Sales Corp. Dept. AB  
120 E. Lancaster Ave., Ardmore, Pa.

Please send me the free 8 page booklet explaining the Hummer System of Strip Lamination.

Name.....Title.....

Company.....

Street.....

City.....Zone.....State.....

Manufactured by Bestwall Gypsum Company—sold through

**BESTWALL CERTAIN-TEED SALES CORPORATION**

120 East Lancaster Avenue, Ardmore, Pa.

EXPORT DEPARTMENT: 100 East 42nd St., New York 17, N.Y.

**SALES OFFICES:**

ATLANTA, GA.  
BUFFALO, N. Y.  
CHICAGO, ILL.  
CHICAGO HTS., ILL.

CLEVELAND, OHIO  
DALLAS, TEXAS  
DES MOINES, IOWA  
DETROIT, MICH.

EAST ST. LOUIS, ILL.  
JACKSON, MISS.  
KANSAS CITY, MO.  
MINNEAPOLIS, MINN.

WILMINGTON, DEL.  
RICHMOND, CALIF.  
SALT LAKE CITY, UTAH  
TACOMA, WASH.

# Build Added Convenience . . . Extra Sales Appeal into Your Basements . . .

Prospective buyers quickly recognize the extra convenience of the modern Service-way. By providing direct access from the basement to outdoors, it saves countless steps, simplifies dozens of household tasks. Makes basement space easily available for storage or recreational purposes. Your homes will be easier to sell.

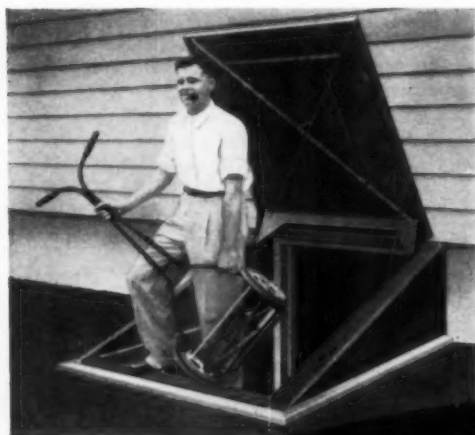

**Model "S"—Single Door** provides a wide, unobstructed opening, with plenty of clearance for bulky, hard-to-handle items. Double-action coil springs counterbalance door for finger-tip operation. The heavy gauge steel door is reinforced for maximum strength. Overlapping flanges on door and frame make it weathertight. A quick release safety rod prevents accidental closing. Shipped assembled for faster and easier installation on the job.

**NOW! AVAILABLE IN TWO MODELS!**

**Model "D"—Dual Doors** has concealed torsion bar counterbalancing for smooth, effortless operation. Flanges on doors and frame interlock to form a weathertight seal. Doors have anti-closing safety catches, easily released by a touch of the toe. Built of reinforced heavy gauge steel. Shipped knocked down for quick assembly and installation with a minimum of time and labor. Sold in two sizes.

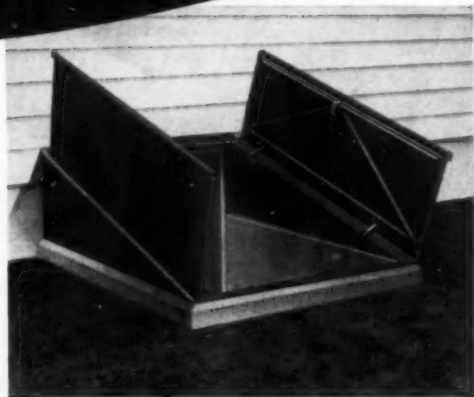

Include this practical sales feature in your homes.  
Sold by leading building material dealers.

**FOR FURTHER INFORMATION WRITE:**

HEATILATOR®  
**SERVICE-WAY**

Heatilator Div.  
Vega Industries, Inc.  
933 E. Brighton Ave.  
Syracuse 5, N. Y.

## NEW PRODUCTS . . .

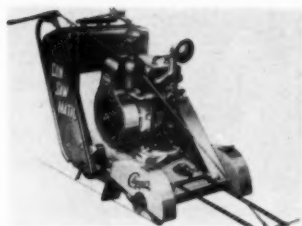

### Saw has increased power

New model 180 concrete saw has increased power. Engine with more powerful transmission delivers greater torque to the drive wheels. Maintains ease of operation and maneuverability. Clipper Mfg. Co., Dept. AB, 2800 Warwick, Kansas City 8, Mo.

Circle No. M48 on reply card, p. 114

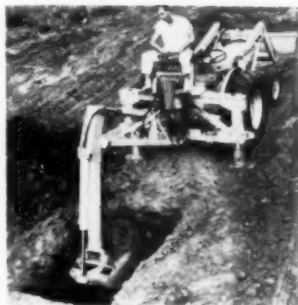

### Backhoe is easy to operate

Increased visibility for the operator is provided with the Davis backhoe. Seat is located high on the frame and travels with the boom. Comes in two models: the 210 with rotary boom swing cylinder and the 185 with conventional swing cylinder. Massey-Harris-Ferguson Div., Dept. AB, 1009 S. West St., Wichita, Kans.

Circle No. M49 on reply card, p. 114

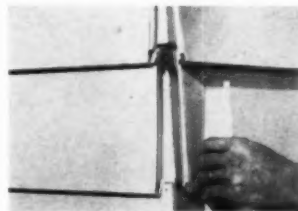

### Aluminum siding is insulated

Insulated siding has superior insulating and moisture dissipating properties. Aluminum lap siding, called "Bak-R-Foam," has bonded backing of expanded plastic foam. Backing of Dylite from Koppers won't rot, shrink, or warp. AlSCO, Inc., Dept. AB, Akron, Ohio.

Circle No. M50 on reply card, p. 114



PARTIAL VIEW of Rockledge Homes, Abington Township, Penna. All 106 homes have Anaconda copper tube sanitary drainage lines.

## "I do a better job at lower cost—with Copper"



J. L. FITZPATRICK of J. L. Fitzpatrick & Sons, Jenkintown, Penna., plumbing contractor for Rockledge Homes development, watches journeyman Sam Duper, Jr., connect a 3-inch copper tube soil line from bathroom to the stack. Anaconda Tube for the development was supplied by Fleck Company, Elkins Park, Penna., plumbing supply wholesaler.

J. L. Fitzpatrick switched to Anaconda copper tube for sanitary drainage lines—finds installation easier—gives builders and homeowners superior plumbing systems.

"We all know that copper plumbing is best and there's no mystery about the cost angle," said J. L. Fitzpatrick.

"It is simply a matter of copper tube and solder-joint fittings being so much easier and faster to install. Copper handles right. . . . It's light and easy to cut. And where you have long runs, the 20-foot lengths of copper tube eliminate many joints. We also save the time and trouble of making threaded or caulked connections.

"And our men like to work with copper, not only because it's easier—but because they can turn out a neat, trim job they're proud of."

More and more plumbing contractors are standardizing on copper tube for drainage lines for the reasons given by Mr. Fitzpatrick. And in areas where plumbing codes were written years ago, contractors are asking for revisions to include copper tube as an approved material for sanitary drainage systems.

Builders and owners also benefit from all-copper plumbing in many ways. A 3" copper tube stack with fittings can be installed in standard 4"-wide partitions. Carpentry, lumber, and space are saved. Plumbing can be laid out to meet owners' wishes regarding location of fixtures and appliances. All-copper plumbing is a mark of quality—a sign of low maintenance and high resale values.

Write for descriptive literature on ANACONDA ALL-COPPER plumbing. Address: The American Brass Company, Waterbury 20, Conn. In Canada: Anaconda American Brass Ltd., New Toronto, Ontario.

5801

# ANACONDA®

## COPPER TUBE and FITTINGS

Available through plumbing wholesalers

Made by

THE AMERICAN BRASS COMPANY

SPECIFY  Cabot's

for best results  
use a stain . . .



stains won't peel,  
crack or blister!

## Cabot's STAINS

Leading builders choose Cabot's Stains for shingles, rustic siding, smooth siding (clapboard, novelty), Texture 111, board and batten, because they

- permit moisture to escape — ideal for use on window frames, sash, trim
- need no scraping, thinning or priming
- cost only 1/2 as much as good paint
- can be restained in another color, or painted over
- preserve wood from decay, insects, weather
- are suitable for all kinds of lumber — cedar, redwood, etc.

35 distinctly different shades — from dramatic deep tones to weathering grays and modern pastels.

*Samuel Cabot*

**SAMUEL CABOT INC.**  
325 Oliver Building, Boston 9, Mass.

Please send color card on Cabot's Stains

---



---



---



---



---

### NEW PRODUCTS . . .



#### New mixer is non-tilting

New non-tilting concrete mixer has been added to the Muller line. Capacity is 6 cu. ft. of mixed concrete. Advantageous construction details include channel type drum track, 17" discharge opening, and 27" high discharge chute which makes wheelbarrow loading easier. Muller Machinery Co., Inc., Dept. AB, Metuchen, N.J.

Circle No. M51 on reply card, p. 114



#### Ducts are strong, lightweight

Aluminum foil lined fiber ducts are strong, yet lightweight. Easy to install and level. Suited for loop, radial or lateral systems for warm air heating in slab on ground construction. Richkraft Co., Dept. AB, 510 N. Dearborn St., Chicago 10, Ill.

Circle No. M52 on reply card, p. 114



#### Joint is root-proof

Wedge-Lock is a root-proof, water-proof joint. Speeds installation of vitrified clay pipe lines in plastered walls, under basement floors. Comes in standard and extra-strength. Provided with matched fittings and special union for jointing cut ends. Robinson Clay Product Co., Dept. AB, 65 W. State St., Akron 9, Ohio.

Circle No. M53 on reply card, p. 114

### SOCKET HUNTING

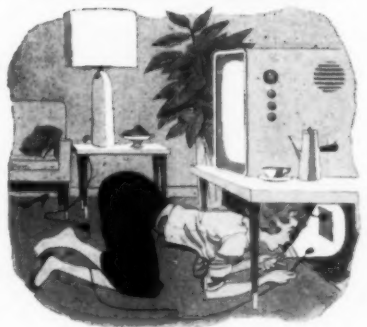

### CORD STRETCHING



Millions of people are being told\* that these "evils" never occur in homes that are Plugmold-ed. Give your homes the hallmark of extraordinary convenience—put in Plugmold and watch your closings soar.

#### \*Saturday Evening Post Time

House Beautiful's Building Manual  
House & Garden's Book of Building  
Home Modernizing  
New Homes Guide



SHOWN: PLUGMOLD  
2200 BASEBOARD

**PLUGMOLD®**  
by **WIREMOLD®**

THE WIREMOLD COMPANY  
Hartford 10, Connecticut



**What makes this lockset  
the standard of comparison for value?**

*Styling* that brings exceptional "buy appeal" to the new home you build . . . *precision engineering* that saves you installation time and assures positive security for the homeowner . . . *quality materials* that result in long life and troublefree performance with no "call-backs" . . . *competitive price* that keeps your cost down . . . these are the factors that determine value in a lockset. These are the features that make NATIONAL LOCKset the standard of comparison throughout the trade. Ask your building material supplier.



*Specify it with confidence . . . Install it with pride*

**NATIONAL LOCK COMPANY**

ROCKFORD, ILLINOIS



MERCHANT SALES DIVISION

WHEN YOU CHOOSE

# VENTO

## BASEMENT WINDOWS

YOU HAVE  
ADDED  
SOMETHING  
TO TALK  
ABOUT!

Basement Windows can be a definite selling feature. That's why so many builders now specify Vento Windows... either aluminum or steel.



**VENTO Champion Aluminum Basement Windows** are an improved type. Rigid 6063-T5 extrusions, a 2-point contact of vent in frame. An exceptional 1/4" clearance permits free operation of vent. Unique cam action latch provides positive locking. Putty or puttyless glazing, combination screen and storm sash available.



**VENTO Champion Steel Basement Windows** are made of 14 gauge formed steel sections. Welded construction. Three position ventilation plus 2 point contact of ventilator in frame. Unique cam action lock with greater tolerance provides positive and easy locking action. Putty or puttyless glazing. Bonderized.



**VENTO Thrifty Steel Basement Windows** are especially designed for lower cost housing. Simplicity of design provides an attractive window of sturdy construction, smooth operation, two position ventilation and easy ventilator removal. Putty or puttyless glazing. Bonderized.

Also VENTO Aluminum Awning Windows, Residence Steel Casement Windows, Steel Utility Windows, Projected Aluminum, Projected Steel, Pivoted Steel, Architectural Projected Steel and Security Steel Commercial Windows, plus factory-trained field representatives to give you added service including engineering service on large jobs. Let us have your inquiries.

### VENTO STEEL PRODUCTS CO., INC.

259 Colorado Street, Buffalo 15, New York

NOW AVAILABLE

## New TECO TRUSSED RAFTER DESIGN BOOKLET

AWARD WINNING  
24-PAGE BOOKLET  
CONTAINS . . . .

— TWELVE typical TECO trussed rafter designs.

— COMPLETE DATA to build, assemble, ship and erect economical TECO trussed rafters.

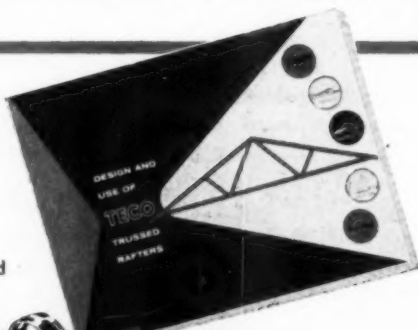

Using

**TECO WEDGE-FIT  
RING CONNECTORS**

**FREE**  
Please send copy  
of new  
DESIGN AND USE  
OF TECO  
TRUSSED RAFTERS

**TIMBER ENGINEERING COMPANY**  
1319 18th St., N.W., Washington 6, D. C.

Name.....  
Firm.....  
Street.....  
City..... State.....

AB-582

### NEW PRODUCTS . . .

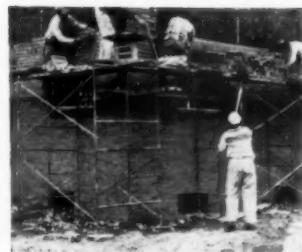

**Scaffold weighs only 22 lbs.**

Low-cost Safway steel scaffolding meets builders' requirements for a lightweight, compact, strong scaffolding. Supports masonry loads up to 40 ft. high. "4-x-4" frame weighs 22 lbs., has built-in ladder, multiple planking levels. Safway Steel Products, Inc., Dept. AB, 6228 W. State St., Milwaukee 13, Wisc.

Circle No. M54 on reply card, p. 114



**Featherlight, slimline gun**

Electronic soldering gun is said to be the most efficient transformer-type gun on the market. Develops full 100 watts of power in 2 1/2 seconds. Has replaceable, extra-long, steel-nosed, tip. Wen Products, Inc., Dept. AB, 5810 Northwest Highway, Chicago 31, Ill.

Circle No. M55 on reply card, p. 114



**Spotlight the family kitchen**

Modern trend family-type kitchen (above) is named the "Country Circle." Work areas have no sharp edges or angles. Cabinets are all of Mutschler hardwood. Designed by Mutschler and *Family Circle* magazine. Mutschler Bros. Co., Dept. AB, Nappanee, Ind.

Circle No. M56 on reply card, p. 114



# For Roofing Accessories . . . Weathersealing use complaint-free Follansbee Terne

## Here's Why Your Buyers Will Be Happier with Follansbee Terne

### TERNE FORMS A PERFECT BOND WITH PAINT

(Just think, your buyer will not have to look at peeling and scaling paint . . . and he needn't paint as often either!)

Terne's lead coating is perfect for painting. It can and should be painted as soon as it is installed. No special surface preparation or primer needed.

### TERNE FORMS A PERFECT SOLDERED JOINT

(He'll never have trouble with leaks around his chimney, windows or in drainage areas!)

The lead in Terne's coating is a natural partner for solder.

### WITH TERNE, EXPANSION JOINTS ARE USUALLY NOT NECESSARY

(What a blessing for the buyer. He'll never have loose or leaking gutters!)

Terne expands and contracts less than other roofing metals and therefore can be installed in greater lengths before expansion joints are necessary. This saves installation costs.

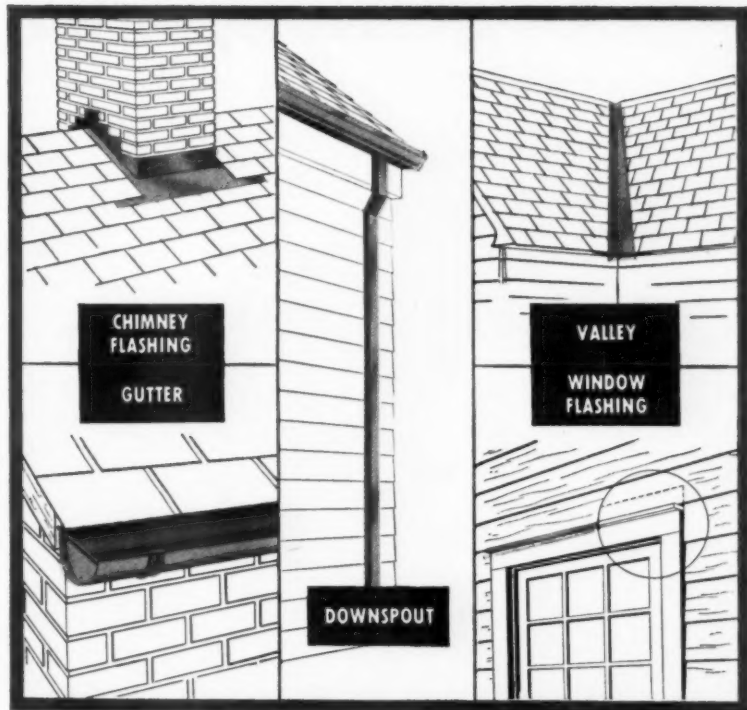

### TERNE LASTS A LIFETIME

(He'll not be faced with the costly job of replacing any of his roofing accessory or weathersealing metal!)

Terne has proof of its long life. Many installations are in service after 100 years.

Ask your roofing and sheet metal man. He can show you why Follansbee Terne is a better buy for you and—for that important man, your buyer.



# FOLLANSBEE

**STEEL CORPORATION**

FOLLANSBEE, WEST VIRGINIA

Terne Roofing • Cold Rolled Strip • Polished Blue Sheets and Coils

*Sales Offices in Principal Cities*

# '58 FORD

New, more efficient SIX...

**FORD'S NEW 223 SIX**

**Brake Horsepower**—139 @ 4200 rpm

**Bore**—3.63 in. **Stroke**—3.60 in.

**Displacement**—223 cu. in.

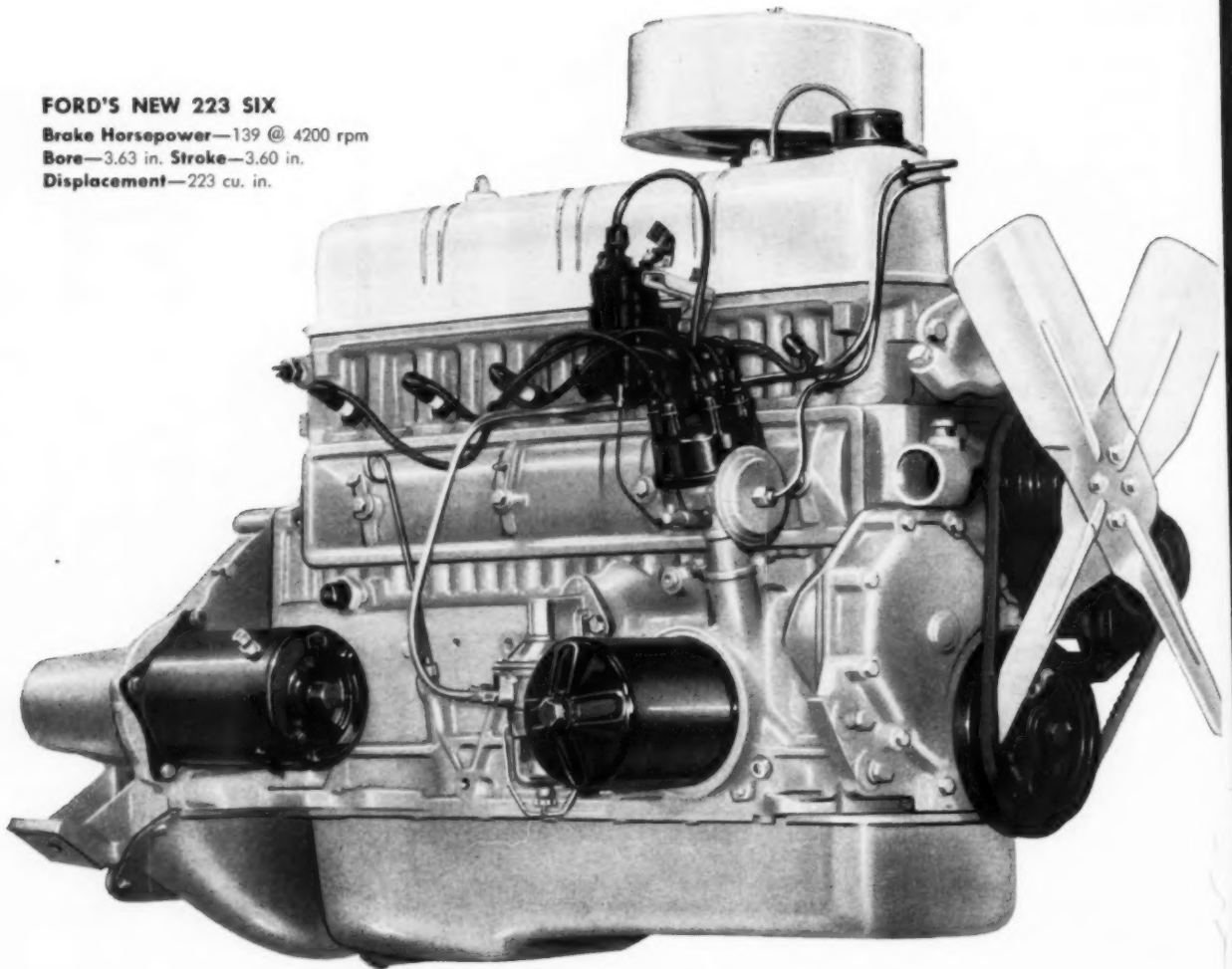

## FORD TRUCKS COST LESS

*less to own . . . less to run . . . last longer, too!*

# TRUCKS

## greater economy, longer engine life!

### The only modern Short Stroke SIX for Light and Medium Duty service

From pickups to two-tonners, the new '58 Ford truck line provides the most efficient SIX with more horsepower per cubic inch than any other in its class. This modern thrift leader features a new carburetor for up to 10% greater fuel economy. And engine features like Deep-Block construction, free-turn valves (both intake and exhaust) and aluminum alloy pistons with integral steel struts are all designed for extra durability.

Teamed with this more efficient SIX, the Ford Driverized Cab offers new riding comfort. The roomy cab has comfortable non-sag seat, suspended pedals, Hi-Dri ventilation and weather-protected inboard steps. Impact-O-Graph tests prove Ford pickups give smoothest ride of any half-tonner!

Ford trucks give dependable service. A study of ten million trucks by insurance experts proves Ford trucks last longer. When replacement parts are needed, Ford parts are priced *low* and can be obtained everywhere.



**New Ford F-500.** Rugged, versatile 1½-tonner with 15,000-lb. GVW. Two wheelbases for 7½- to 13-foot bodies.



**New Ford Styleside pickup.** Modern Styleside body is as wide as the cab and *standard at no extra cost.* Conventional Flareside box available.

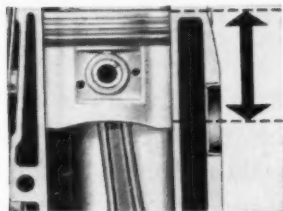

**Short Stroke design** means less piston travel, less internal friction—gives more usable power. Provides increased durability . . . prolongs engine life.

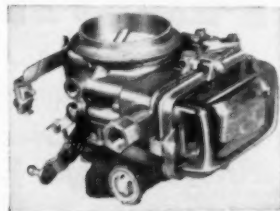

**New carburetor design** gives up to 10% more fuel economy. New vacuum control valve and accelerator pump system provide smoother operation.



**New Ford Parcel Delivery chassis.** Four P-Series chassis with GVW's from 8,000 to 17,000 lb., for up to 525-cu. ft. custom bodies.

**AMERICAN BUSINESS BUYS MORE FORD TRUCKS THAN ANY OTHER MAKE!**

The only line of Windows

# Quality Controlled from Bauxite to

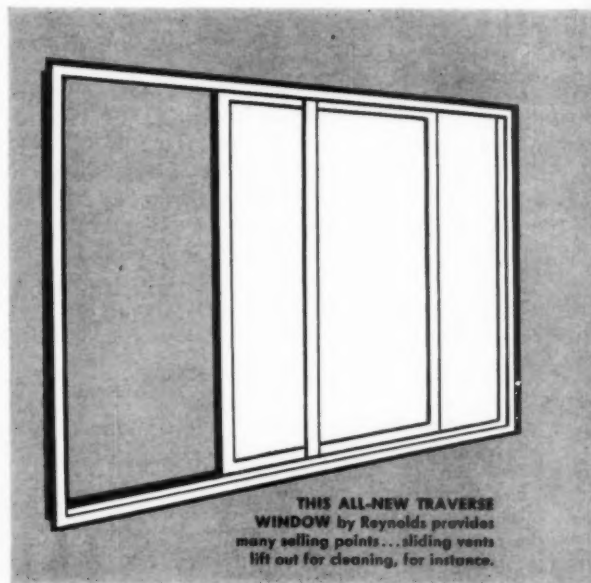
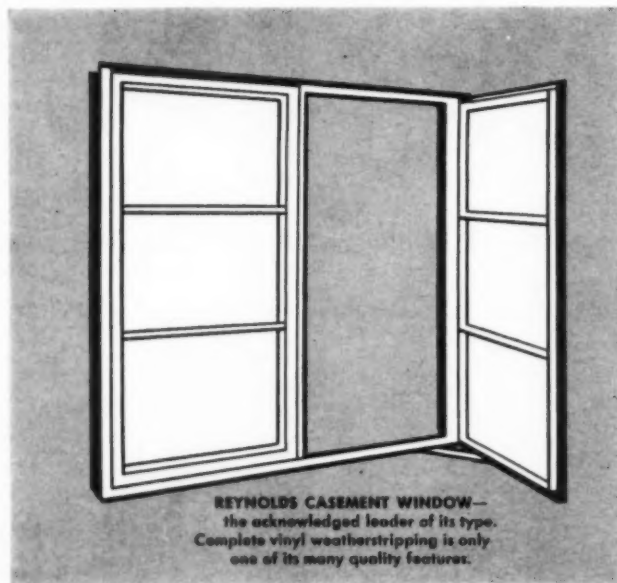

## REYNOLDS ALUMINUM

The manufacture of Reynolds Aluminum Windows is carried out with a unique and important advantage...single-source quality control. This quality control is truly continuous. It extends through mining, refining, alloying, extruding, assembly and through finishing processes which include the world's largest anodizing facilities. This Quality Control from Bauxite to Job Site

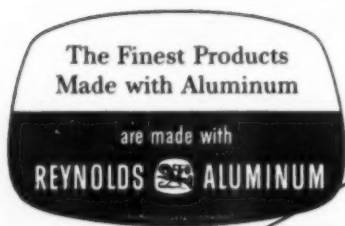

AS FEATURED IN  
"THE HOUSE OF EASE"



# Job Site

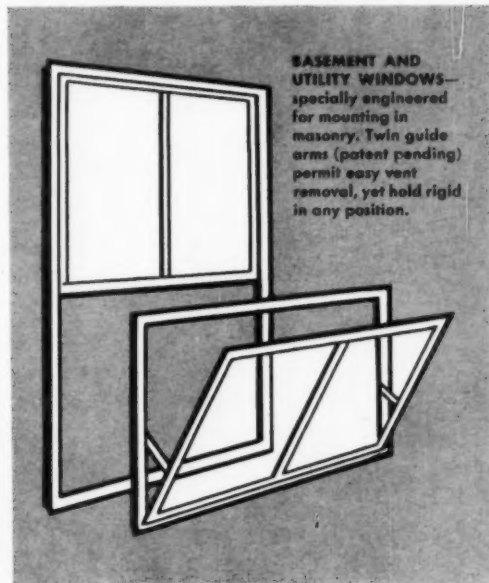
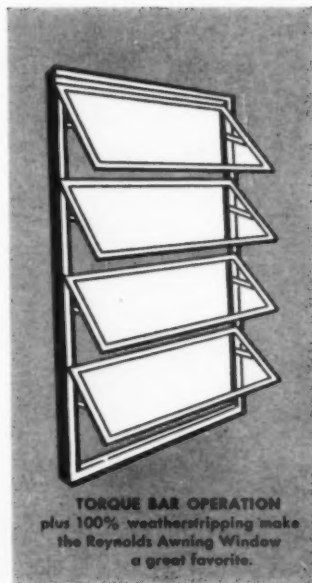
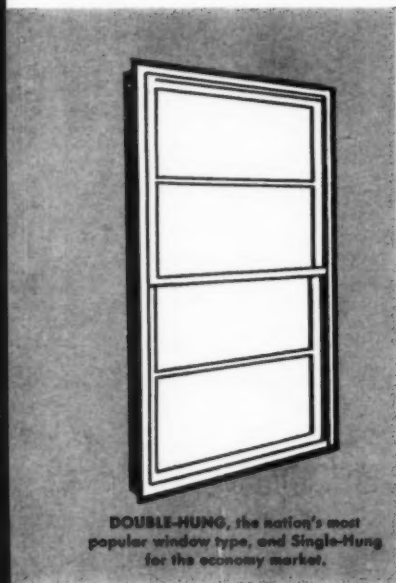
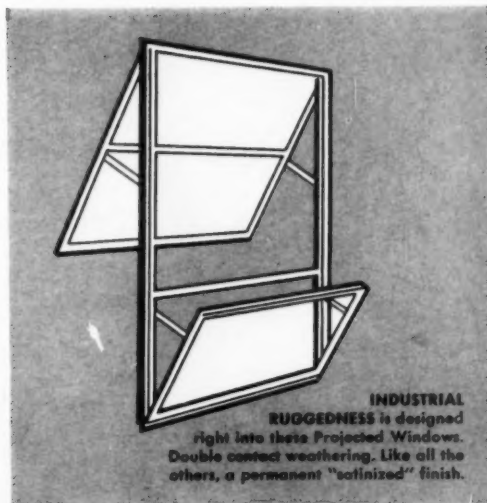

# WINDOWS

now applies to a *complete* line of Reynolds Aluminum Windows—competitively priced. For details as to availability in your area, call the nearest Reynolds sales office. For free literature, write to **Reynolds Metals Company**, General Sales Office, Louisville 1, Kentucky.



Watch Reynolds All-Family Television Program "DISNEYLAND", ABC-TV.

**DISCOVERED**

**EASIER FOLDING DOOR INSTALLATIONS**

WITH **ACME** CONCEALED FOLD-ASIDE HARDWARE

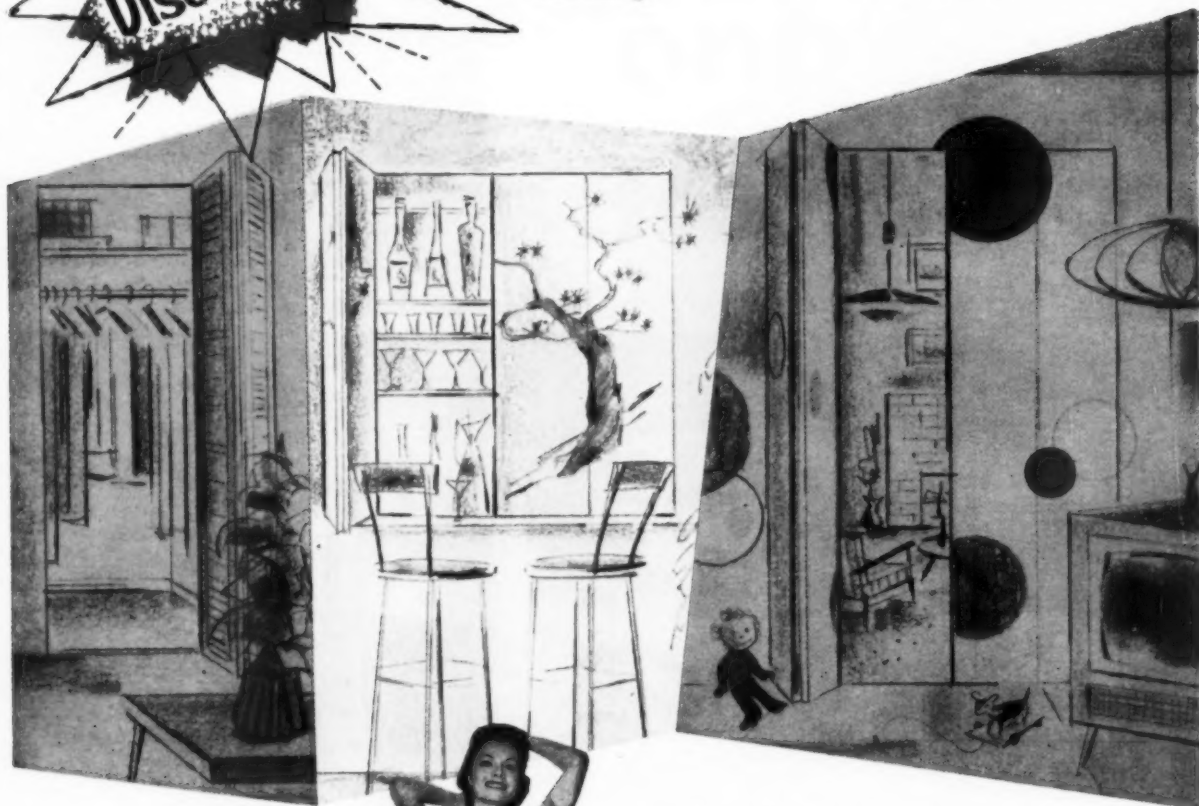

"Now with easier installation—there are so many places you can afford to add spaciousness and a warm atmosphere with stylish doors that Fold-Aside. Attractive folding doors increase the value of any home.

"You can use Acme Concealed Hardware for folding doors anywhere in the home.

"Style-conscious builders all agree doors look better, operate smoother and hang better when mounted with Acme Concealed Fold-Aside Door Hardware or Accordion Fold Hardware. They find installation faster...easier as vertical and horizontal adjustments can be made after doors are installed.

"Fold-Aside Door Hardware fits all standard openings 2'0" to 8'0" wide. Pivots and nylon guide wheels are completely concealed. No center guides are needed...adjustable aligner keeps doors snug. In wider passages where multiple doors are desired, Concealed Accordion Fold Hardware can be applied."

Write for the Acme Idea File on your company letterhead today! It's Free.

© Acme Appliance Mfg. Co. 1958

FOLD-ASIDE DOOR HARDWARE  
CABINET HARDWARE  
SLIDING DOOR HARDWARE



**ACME APPLIANCE MANUFACTURING CO.**

ACME BUILDERS HARDWARE DIVISION

200 E. RAILROAD AVE. • MONROVIA, CALIFORNIA



# RANCHLINE<sup>†</sup> SHINGLES

with *THE SLEEK LOOK*  
made expressly for the longer,  
lower houses of today

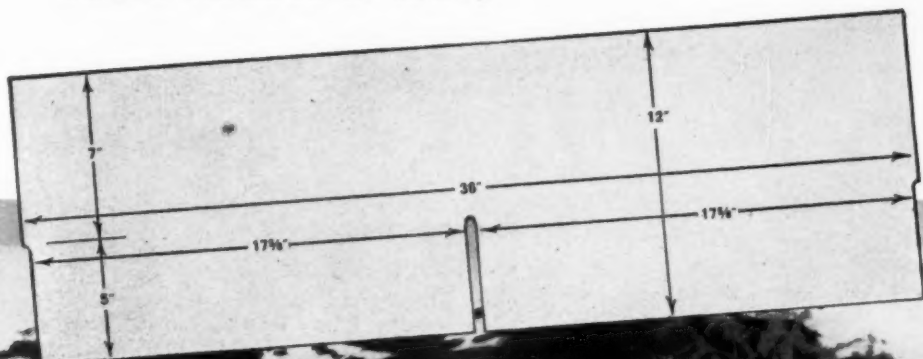

There's a daring modern sweep about a Barrett "Ranchline" Roof that will make a big difference in that all-important first impression. As designers know, more horizontal lines and fewer vertical lines give an illusion of greater length. That's why these longer shingles help give your home the long custom look that your prospects want.

With a Barrett "Ranchline" Roof, you have a unique selling feature . . . an important "extra" to talk about—at no extra cost. The sweeping "Ranchline" Shingle is available only from Barrett. Write for full information.

<sup>†</sup>Trade Mark of Allied Chemical

#### Other sales-winning points about Barrett "Ranchline" Shingles

- They're double-coated on the exposed butts to give double strength where the wear is greatest.
- Their larger tabs give them greater wind resistance.
- They're available in pastels and exciting color blends.

**BARRETT ROOFS**  
The greatest name in roofing



**BARRETT DIVISION**  
40 Rector St., New York 6, N. Y.

**You save  
hours  
on  
every  
job**  
with  
**ONAN portable ELECTRIC PLANTS**

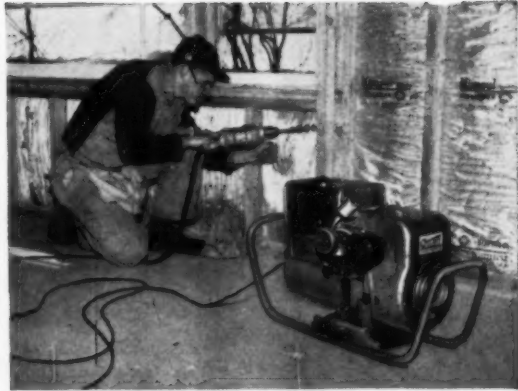

When you can't use motor-driven tools you lose profits *fast*. An Onan Electric Plant gives you plug-in electricity *anyplace, anytime* . . . no waiting for highline hookups . . . no long extension cords to get fouled up.

Onan 4-cycle electric plants feature split-second starting, long-life, and all-round dependability . . . with a big weight saving over usual 4-cycle units. The model 205AJ-1P pictured

above delivers 2,500 watts . . . enough for several saws, drills or other tools and all the lights you need . . . yet it weighs only 139 pounds. Model 105AK-1P delivers 1500 watts . . . weighs only 125 pounds.

Onan portable units are completely Onan-built with Onan engines direct-connected to Onan all-climate generators. They are compact, sturdy . . . and they run longer with minimum servicing.

WRITE FOR FOLDER SHOWING PORTABLE MODELS

**D. W. ONAN & SONS INC.**



2518A UNIVERSITY AVE. S.E. • MINNEAPOLIS 14, MINNESOTA

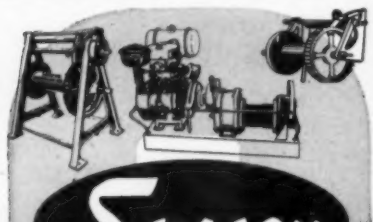

**Sargen**

**Derricks  
Hoists  
Winches**

Over 50 years serving contractors . . . easily rigged on the job . . . conservatively rated for safety . . . simple in design . . . low-cost maintenance.

See your dealer . . . or write for latest catalog.

**Sargen**  
DERRICK COMPANY  
3103 W. GRAND AVE., CHICAGO 22, ILLINOIS

COAST-TO-COAST,  
PROFIT-WISE HOME BUILDERS USE  
**IMPERIAL Lux-Right®**  
The Nation's FIRST AND BEST  
**STEEL AREAWALLS**

- Hot-Dip Galvanized AFTER Forming -- Can't Rust!
- Rolled Top-Edge for SAFETY



Three shapes, for all standard installations, accessways, casements. (Special sizes, too!) Three grades, for every use from luxury homes to housing developments.

Dealers everywhere . . . Or write for FREE Lux-Right folder today!

Freight PREPAID on 12 or more units. AB-3

**SAINT PAUL CORRUGATING CO.**  
ORIGINATOR & Largest Producer  
SOUTH END WABASHA BRIDGE • SAINT PAUL • MINN.

**NEW PRODUCTS . . .**



**Folding door is prefabbed**

Complete folding door assembly comes ready for installation. Available in four-door louvered units for standard sizes. Design features of track, wheels, and aligners permit neat, snug closing. Kennatrack Corp., Dept. AB, East Jackson Blvd., Elkhart, Ind.

Circle No. M57 on reply card, p. 114

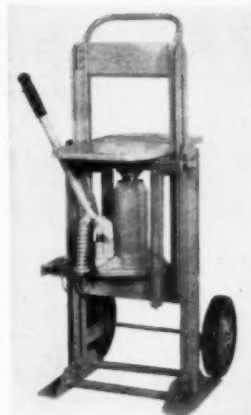

**Cutter is really speedy**

"Speedy" masonry cutter has two-wheel portability and full powered design. Eliminates need for other models. Said to step-up production 50%. Equipped with 12-ton hydraulic ram. Blades are of heat-treated steel alloy. Rice Pump & Machine, Dept. AB, Belgium, Wisc.

Circle No. M58 on reply card, p. 114

**Install shower floors easily**

Attractive Terrazzo shower floors are easily installed. These pre-cast shower floors require no special construction. Slide into place as a single unit. Available in decorator colors. Pacific Pre-Cast Products, Inc., Dept. AB, 1500 Calzona St., Los Angeles 23, Calif.

Circle No. M59 on reply card, p. 114



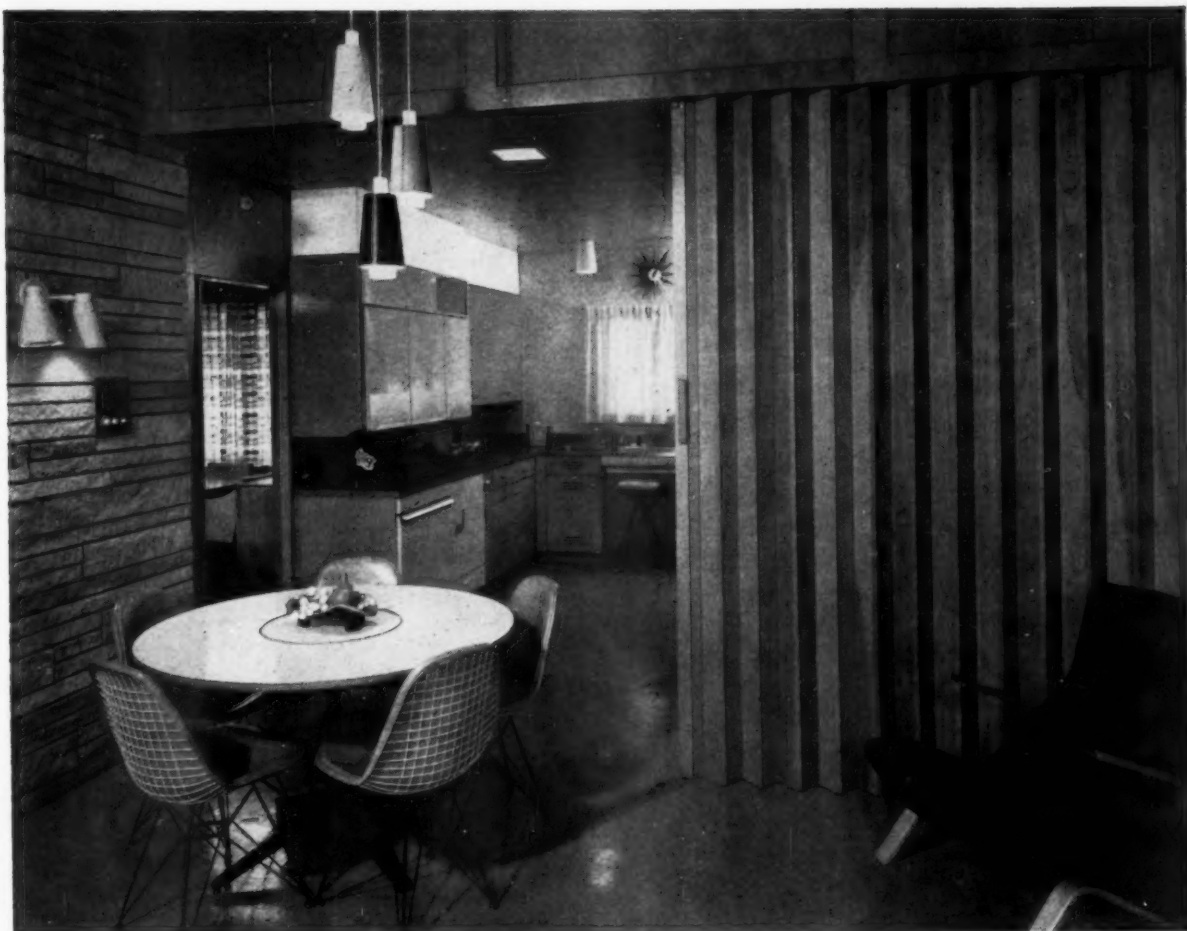

WILLIAM F. BERNBROCK, ARCHITECT; ERICSON CONSTRUCTION CO., BUILDER

**Bring out the  
beauty of modern  
materials with *Pella*<sup>®</sup>  
wood folding doors**

Convenience is just one big point you can talk up with PELLA WOOD FOLDING DOORS. See too, how handsomely they harmonize with the wood cabinets and furnishings, dramatically accent the masonry wall, create an eye-catching interplay of textures among appliances and floor materials.

PELLA WOOD FOLDING DOORS are the truly decorative answer to builder's problems in organizing modern open-plan living areas. Supplied ready for custom-finishing, or factory finished in pine, oak, birch and Philippine mahogany veneers. Packaged...ready for fast installation.

MAIL COUPON TODAY

.....  
**ROLSCREEN COMPANY**, Dept. J-48, Pella, Iowa

Please send me illustrated literature on PELLA WOOD FOLDING DOORS

FIRM \_\_\_\_\_

ADDRESS \_\_\_\_\_

CITY \_\_\_\_\_

ZONE \_\_\_\_\_

STATE \_\_\_\_\_

ATTENTION MR. \_\_\_\_\_



**WOOD FOLDING DOORS**

# STANLEY Electric Tools



Heavy-duty  
builders saws with...

**the performance you need at prices  
you can pay--\$59.95 to \$89.95**

You know you can pay more . . . but you won't find a saw anywhere that will give better performance and longer service than a new heavy-duty Stanley builders saw. For example, you get:

- **FREE-START GUARD.** Covers 90% of blade. Prevents hang-up when starting cuts.
- **MOTOR SAVER DRIVE.** Blade mounts on flange collar, not arbor. Protects motor against shock.
- **HEAVY-DUTY BALL BEARING CONSTRUCTION** throughout—for longer, more dependable service.
- **FAST, SIMPLE BEVEL ADJUSTMENT**
- **STURDY STEEL BASE**

#### 4 HEAVY-DUTY, LOW-PRICED MODELS—IN PROFESSIONAL CARRYING CASES, TOO!

6".....H65 cuts 2" at 90°, 1½" at 45°.....	\$59.95—complete Kit H665.....	\$75.95
6½".....H68 cuts 2¾" at 90°, 1¾" at 45°.....	\$64.95—complete Kit H668.....	\$80.95
7".....H70 cuts 2¾" at 90°, 1¾" at 45°.....	\$74.95—complete Kit H770.....	\$90.95
8".....H85 cuts 2¾" at 90°, 2¼" at 45°.....	\$89.95—complete Kit H885.....	\$107.50

*All of these saws have 5/8" round arbors.*

*Above kits include saw, extra blade, ripping gauge, lubricant, wrench and sturdy metal case.*

Ask your dealer or distributor about these new Stanley builders saws and Kits, soon. Or write for power tool Cat. No. 400E, Stanley Electric Tools, Div. of The Stanley Works, 103 Myrtle Ave., New Britain, Connecticut.

*Prices slightly higher in Canada.*

**AMERICA BUILDS BETTER AND LIVES BETTER WITH STANLEY**

# STANLEY

This famous trademark distinguishes over 20,000 quality products of The Stanley Works—hand and electric tools • drapery, industrial and builders hardware • door controls • aluminum windows • stampings • springs • coatings • strip steel • steel strapping—made in 24 plants in the United States, Canada, England and Germany.

## NEW PRODUCTS . . .



### Doors are problem solvers

Versatile Rezo-Fold doors solve any type of opening problem quickly and economically. Can be used for closets, room dividers and passageways. Doors and hardware are packaged for quick installation. No floor track or guide is required. Paine Lumber Co., Ltd., Dept. AB, 1621 Congress St., Oshkosh, Wisc.

Circle No. M60 on reply card, p. 114

### Mortar-Cart maneuvers easily

Mortar-Cart will carry 5 cu. ft. of mortar for brick masons or plaster for finishing. Despite its large capacity, is easily maneuvered by one man. Has heavy gauge steel body, overall width 27", length 56½", height 33". Finished with enamel. Jackson Mfg. Co., Dept. AB, Harrisburg, Pa.

Circle No. M61 on reply card, p. 114

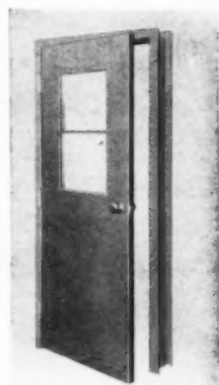

### Distinctive door styling

Distinctive styling, sound construction are features of the 1958 line of doors and windows from Truscon. Included are steel and aluminum windows, interior and exterior hollow metal doors. Truscon Steel Div., Republic Steel Corp., Dept. AB, Albert St., Youngstown 1, Ohio.

Circle No. M62 on reply card, p. 114



G. B. Cox, Architect. Harvey Construction Co., Builder.



### DRAMATIC WINDOW EFFECTS

like this are possible with PELLA MULTI-PURPOSE WINDOWS. 15 fixed and vented sizes can be combined to form numerous arrangements. And these are the *harmonious* windows—of warm, friendly wood. Not expensive either. PELLA's exclusive GLIDE-lock underscreen operator is supplied *at no extra cost*. Self-storing inside screens and storms can be specified. Mail coupon today for literature.

### WOOD MULTI-PURPOSE WINDOWS

**ROLSCREEN COMPANY**  
Dept. J-47, Pella, Iowa

Please send literature on PELLA WINDOWS.



FIRM NAME \_\_\_\_\_

ADDRESS \_\_\_\_\_

CITY \_\_\_\_\_

ZONE \_\_\_\_\_

STATE \_\_\_\_\_

ATTENTION MR. \_\_\_\_\_

TEL. NO. \_\_\_\_\_



*the lady goes for eye appeal  
..... at eye level!*

Maybe she knows a fuse from a circuit breaker, and maybe not. But just watch her come to attention for handsome Amerock hardware! Here's *her* kind of beauty and quality, at eye level—where she *won't miss* falling in love on first sight! No other product in your house has more sure-fire sales punch for the same money. And nobody nowadays underestimates the power of the little lady it hits right in the eye! Be sure you specify Amerock, the quality name in cabinet hardware she knows *best*. There is a beautiful "Contemporary," (shown at right) "Modern," or "Colonial" pattern for every interior, every budget.

SEE YOUR AMEROCK HARDWARE SUPPLIER  
FOR FREE BUILDER PROMOTION KIT  
OR WRITE DEPT. AB-83

**Amerock CORPORATION**  
ROCKFORD, ILL. • MEAFORD, ONT.

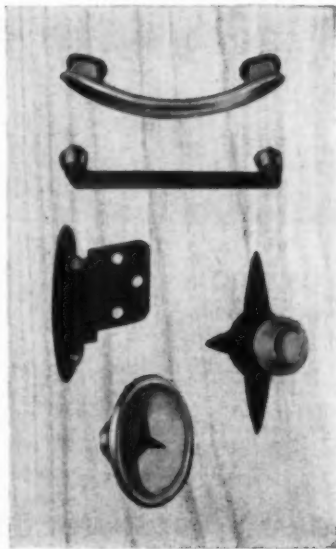

## NEW PRODUCTS...

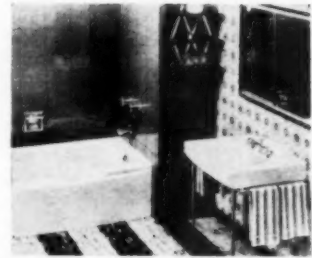

### Tomorrow's styling for baths

Bathroom ensemble styled with simple, sweeping lines provides contemporary design for bathroom. Recessed 5' tub has a curved rim lowered 2" at the center. Harmonizing vitreous china lavatory may be used as free-standing or countertop fixture. American-Standard, Dept. AB, 40 W. 40th St., N.Y.C.

Circle No. M63 on reply card, p. 114

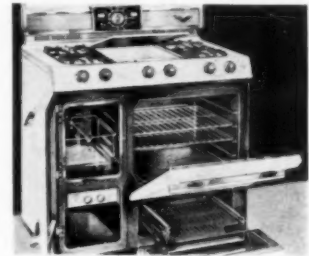

### Allows 5-way cooking

Deluxe gas range provides five ways for cooking. Contains automatic top burner with heat control, center cast aluminum griddle, full size oven, second oven with built-in rotisserie and drop-front broiler. Complete line of sizes available. Dixie Products, Inc., Dept. AB, P. O. Box 475, Cleveland, Tenn.

Circle No. M64 on reply card, p. 114

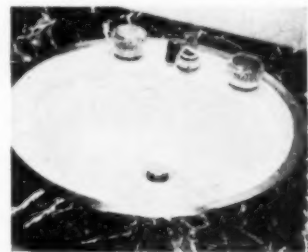

### Lavatory in a circle

For the bath beautiful in the modern home Crane has introduced the new Crown lavatory. Vitreous china lavatory is 20 $\frac{5}{8}$ " in outside diameter and has inside depth of 6 $\frac{1}{8}$ ". Crane Co., Dept. AB, 836 S. Michigan Ave., Chicago 5, Ill.

Circle No. M65 on reply card, p. 114



## WHAT...MUNTINS THAT SNAP IN AND OUT?

To speed window cleaning or painting, PELLA CASEMENTS now have muntins that can be easily snapped in and out! They are held securely to the sash by hidden ball-and-socket connectors, and their position between the exterior glass and interior dual glazing panel protects them from the elements. This optional removable feature is available in both regular and horizontal muntins, lending a traditional appearance to the window while offering the convenience of

an unobstructed pane of glass whenever it is desired. Other new features of these *wood casements* include a narrow, 4 $\frac{3}{8}$ " over-all frame, continuous cove at head and sill for composite groupings, and a new *wood* operator sill. The ROLSCREEN, with its convenient window shade action, has a new, simplified catch.

The steel frame, which makes the PELLA CASEMENT an exceptionally rugged unit, is, of course, retained.



For news of design improvements on all PELLA WINDOWS, see our catalog in Sweet's or fill out and mail coupon today.



### WOOD CASEMENT WINDOWS

**ROLSCREEN COMPANY**, Pella, Iowa  
Dept. J-46  
Please send your 1958 catalog of PELLA CASEMENT, MULTI-PURPOSE and TWINLITE WINDOWS.

\_\_\_\_\_ FIRM NAME

\_\_\_\_\_ ADDRESS

\_\_\_\_\_ CITY \_\_\_\_\_ ZONE \_\_\_\_\_ STATE

\_\_\_\_\_ ATTENTION MR.

## Building Tips from helpful Charley



NOW YOU CAN BUY  
PREFABRICATED  
CLOTHES CLOSET  
SHELVES, POLE  
AND HOOK STRIPS

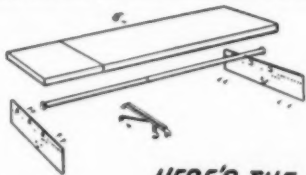

HERE'S THE  
X-PANDA CLOTHES CLOSET SET  
PACKAGE. ADJUSTABLE FOR  
ANY SIZE CLOSET



INSTALL X-PANDA HOOK STRIP,  
SHELF AND POLE IN LESS  
THAN 10 MINUTES...  
YOU CAN PAINT CLOSET  
BEFORE INSTALLING

STRONGER  
THAN WOOD...

THREE  
ATTRACTIVE  
FINISHES...

FOR CLOTHES,  
LINEN CLOSETS  
AND  
WALL SHELVES



\*X-PANDA SHELF is the Trade Mark of Home Comfort Mfg. Co.

WRITE  
FOR DETAILS  
TODAY

**Home Comfort  
Mfg. Co.**

3300 N.E. Adams

Peoria, Illinois

**WINCO**

**PORTABLE ELECTRIC POWER**

WITH  
*Automatic* **CONSERV-er**



✓ IDLING CONTROL  
✓ EXTENDS ENGINE LIFE  
✓ REDUCES FUEL  
CONSUMPTION  
✓ LOWERS MAINTENANCE  
COST

WINCO  
MODEL  
205B1452D-1M  
2500 watts, di-  
rect drive, 115  
volts, 60 cycle  
A. C. Light-  
weight. Carry-  
ing Cradle op-  
tional.

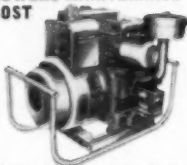

After starting, plant automatically idles,  
until load of 75 watts or more is ap-  
plied. Automatic CONSERV-er brings  
engine to full power when tool is turned  
on, reduces engine to idling speed when  
tool is turned off—all automatically.  
Get all the facts on this Profit-Building  
Winco feature.

FULL LINE OF PORTABLE AND STAND-BY  
AC & DC PLANTS. 300 WATTS TO 10 KW  
WRITE DEPT. AB-38

**WINCHARGER CORPORATION**  
SIOUX CITY, IOWA  
Subsidiary of Zenith Radio Corporation



Versatile

**"HI-JACK"**

A REAL HIGH LIFTER

Can Be Useful in Many Times  
and Money Saving Ways!

**OPERATION OF THE HI-JACK:**

Thread a 2 x 4 through the gripping dogs and  
place the jack in desired position.

**To raise:**

Insert the handle into the opening lever socket  
then raise and lower handle successively until  
object raised is in desired position.

**To lower:**

Reverse Operation  
Works Like Car Jack

**HI-JACK OPERATES ON A 2 x 4**

Any length for fast, high lifting jobs, such as  
raising a wall in house building.

✓ Approved by the Department of Labor and  
Industry Safety division of the State of  
Washington.

✓ Used in placement of sub-assemblies in the  
light construction field, the jack climbs a  
2 x 4. Designed to reduce man hours in fram-  
ing. A few accomplish the work of many.

✓ "HI-JACK" adapts itself to wall raising,  
tying-in, and the raising of timbers for high  
placement. Effects savings to the extent of  
cost of one jack per house.

**MANUFACTURED AND DISTRIBUTED BY:  
OLYMPIC FOUNDRY CO.**

IRON FOUNDERS

5200 AIRPORT WAY SEATTLE, WASHINGTON  
RAINIER 7123

## NEW PRODUCTS...

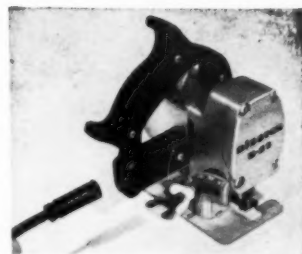

Cuts metal, plastic or wood

Versatile electric hand saw, model  
D-23, weighs only 5¼ lbs. Is of  
advanced sabre saw design. Newly-  
developed Orbit Action increases  
cutting speed, assures clean edge.  
Cuts bevells, scrolls, mitres, lines or  
circles. Henry Disston Div., H. K.  
Porter Co., Dept. AB, 300 Park  
Ave., N.Y. 22, N.Y.

Circle No. M66 on reply card, p. 114



A milk bar for the home

Convenient Cold-Bar will accom-  
modate several days supply of milk  
and dairy products, freeing the re-  
frigerator for other storage. Ex-  
pertly designed to fit on kitchen  
countertops under cabinets. Norris  
Dispensers, Dept. AB, 2720  
Lyndale Ave., Minneapolis, Minn.

Circle No. M67 on reply card, p. 114



Duct lengths angle-cut

Angle-cut lengths of Ceramiduct  
for heating and air conditioning  
systems increase savings in time  
and materials. For either perimeter-  
loop or radial heating and a/c duct  
installations under concrete floor  
slabs. Of vitrified fire-clay. Straits-  
ville Brick Co., Dept. AB, New  
Straitsville, Ohio.

Circle No. M68 on reply card, p. 114

— there's a BERGER instrument for every builder...every budget



**CONVERTIBLE TRANSIT-LEVEL.** Now with 3-ft. short focus, newly designed optical system. For laying out horizontal and vertical angles, leveling, setting building lines, etc. 22-power internal focusing telescope, coated optics. With field case, white ash tripod, instruction manual \$219.00



**12" HEAVY DUTY DUMPY LEVEL.** For setting grades and lines, measuring or laying off horizontal angles, setting batter boards, establishing foundation elevations. 12" internal focusing telescope, 24-power coated optics. With carrying case, white ash tripod, instruction manual \$174.50



**SERVICE TRANSIT-LEVEL.** Low in cost... high in versatility. Internal focusing, 10-power erecting telescope with rack and pinion adjustment. Simple lock converts instrument from a transit to a level. For setting construction grades and building lines, aligning foundations, brickwork, leveling floors and sidewalks. With carrying case, white ash tripod, instruction manual \$89.75

Other Berger low cost, easy-to-use instruments:  
Duplex Tilting Level \$59.50; Service Dumpy Level \$49.95  
Prices F.O.B. Factory

C. L. BERGER & SONS, INC., 47 Williams St., Boston 19, Mass.  
Send me literature on  
Convertible  12" Dumpy Level  Service Transit-Level   
Duplex Tilting Level  Service Dumpy Level   
Name \_\_\_\_\_  
(Please print)  
Address \_\_\_\_\_  
City \_\_\_\_\_ Zone \_\_\_\_\_ State \_\_\_\_\_

THE BEST IN  IS **BERGER**  
Engineering and Surveying Instruments Since 1871

# Koven

automatic **GAS or ELECTRIC**  
**WATER HEATERS**



*Super-Glass*

**POSITIVELY CANNOT CHIP, CRUMBLE, OR CRACK**  
**HIGH PRESSURE RESISTANCE RUST-PROOF**  
**SAFER — LONG-LASTING NO EXPOSED STEEL**

available in a variety of sizes and models

- lower fuel costs • 100% automatic safety
- smart looks • sturdy construction
- long-life 355 lb. test tank • trouble-free operation • precision engineering

**Nationally Advertised**

**L. O. KOVEN & BRO., INC.**  
154 OGDEN AVE., JERSEY CITY 7, N. J.  
PLANTS: JERSEY CITY, N. J. • DOVER, N. J. • TRENTON, N. J.

## NEW Improved PRECISION

America's Quality Stairway



LISTED IN SWEET'S  
Approved by leading  
ARCHITECTS, BUILDERS,  
and LENDING AGENCIES

### SEVEN EXCLUSIVE FEATURES

- 1—Hydraulic Safety Checks
- 2—Actuated by Counterweights
- 3—Lifetime Roller Bearings
- 4—Double Hinges on Joints  
New Swinging-Type Door Hinge
- 5—Insulated Door Panel
- 6—Full-Width Safety Treads
- 7—Fits any Ceiling Height  
Two Standard Sizes—8'9" and 9'9". No  
Other Stairway Offers So Much. Stocked by  
over 200 leading jobbers in the U.S. and  
Canada.

## SIMPLEX FOLDING STAIRWAY



Approved by  
leading ARCHITECTS,  
BUILDERS and  
LENDING AGENCIES

Balanced Spring Action for  
Effortless Operation  
Double Hinges on Joints—  
New Swinging-Type Door Hinge  
Rugged and Strong  
Two Standard Sizes—8'9" and 9'9"  
Shipped in one Package  
Manufactured in Precision's  
Modern Plant

write now for free illustrated folder!

**PRECISION PARTS CORPORATION**

100-AB NORTH FIRST STREET  
NASHVILLE 7, TENNESSEE

## NEW PRODUCTS . . .



### Washer-dryers for '58

Home laundry units for '58 from Speed Queen incorporate latest styling, engineering. Among new features is automatic rinse conditioner, "Wash-n-Wear" switch for drip-dry fabrics and the stainless steel drum in the dryer. Speed Queen Div., McGraw-Edison, Dept. AB, Ripon, Wisc.

Circle No. M69 on reply card, p. 114



### Polystyrene for insulation

Opening new horizons in perimeter insulation is Uni-Crest, a foamed polystyrene plastic. Can be molded into an infinite variety of shapes and sizes. Features light weight; ease of installation, and inexpensive cost. Technical data from United Cork Cos., Dept. AB, Central Ave. & Bay St., Kearny, N.J.

Circle No. M70 on reply card, p. 114

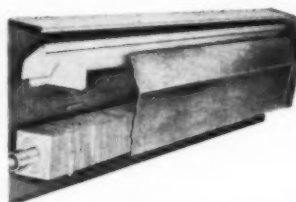

### Baseboard wastes no heat

Baseboard radiation gives heat at floor level for efficient, economical heating. Installation is fast, neat. Entire unit requires little space. Heating element comes in 3' lengths. Cover assembly, in varied lengths, consists of front, back panels, damper and hanger brackets. Embassy Steel Products, Dept. AB, 890 Stanley Ave., Brooklyn, N.Y.

Circle No. M71 on reply card, p. 114

## Shorelaine INDUSTRIAL QUALITY FANS AT BUILDER PRICES

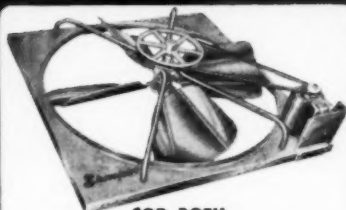

### FOR BOTH VERTICAL & HORIZONTAL INSTALLATION

WESTINGHOUSE—G.E. MOTORS  
S.K.F. BALL BEARING FAN SHAFT

Model	C.F.M.	Blade Size	Ht.	List Price	Your Cost
30-I.S.	7,505	30"	12"	\$ 99.95	\$49.90
36-I.S.	10,121	36"	12"	\$115.00	\$56.15
42-I.S.	12,523	42"	12"	\$135.00	\$57.40

F.O.B. FACTORY  
ORDER DIRECT FROM  
FACTORY OR DISTRIBUTOR  
Write for Catalog Showing Our  
Complete Line of Industrial Fans.

### DEALER SALESMAN WANTED

**C-H** Air Conditioning  
Fan Company, Inc.  
1591-1623 DeKalb Ave., N.E.  
Phone JACKSON 5-0443 ATLANTA 7, GA

## NEW Steel Stake

for . . .

Footing Forms

Bracing

Low Wall Forms

Available in 12, 18, 24, 30,  
36 and 42 inch lengths.



SYMONS CLAMP & MFG. CO.  
4261 Diversey Ave., Chicago 39, Ill., Dept. C-8

We will send contractors a sample 12", 18" or 24" stake if request is received on company letterhead. Please include 50¢ for 12", 75¢ for 18", \$1.00 for 24" to cover cost of postage and mailing.

Name \_\_\_\_\_  
Firm \_\_\_\_\_  
Address \_\_\_\_\_  
City \_\_\_\_\_ Zone \_\_\_\_\_ State \_\_\_\_\_





## HOW TO SAVE 30%+

*on siding installation and painting costs and still maintain the quality and strength of natural wood.*

**SAVE 30%+ ON LABOR.** Large, easy to handle 4' x 8' Simpson overlaid plywood sheets go up fast with fewer nails, less cutting, less waste, less bracing and blocking. **SAVE 30%+ ON PAINTING.** The overlaid surface has a unique velvety tooth that takes paint easier, saves paint and painting time, eliminates the need for sanding, sealing and patching. Two coats do the job of three and they last years longer between re-painting. Overlaid surface prevents checking and blistering. *Specify "Simpson Medium Density Plywood."* Write for free sample and additional information.

Simpson Medium Density Overlaid Plywood Siding is an exterior-grade fir plywood with a resin impregnated fiber (CREZON) bonded to one or both sides under heat and pressure. Color: yellow. Available through your dealer.

PD-81A

RELY ON



*Simpson Logging Company*  
 Sales Office, Plywood and Door Products  
 2301 N. Columbia Blvd., Portland 17, Oregon  
 Regional Offices in New York, Cleveland, Chicago, Denver,  
 Minneapolis, Memphis, Dallas, Los Angeles, Portland, Seattle.

# Meeting Your Rigid Specifications...

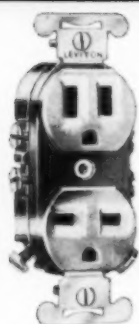

#5031

## U-GROUND

A complete line of 3-wire grounding devices — caps and receptacles.

## LEVITON SPECIFICATION 5000 GRADE

Look for a LEVITON 5000 number on the devices you specify. It proves that you are getting a LEVITON Specification Grade device—your assurance of top quality and dependability.



#5521

## QUIET SWITCHES

A full line of 15 A and Heavy Duty 20 A—AC Quiet Switches.



#5101

#5112

## LEV-O-LOCK

A full line of 2, 3, 4-wire devices in 10, 20, 30 amp. ratings... for dependable connections. (Push-turn-it's Lev-O-Locked!)

*your best jobs are done with...*  
**LEVITON MANUFACTURING COMPANY, INC.**  
 Brooklyn 22, N. Y.

**LEVITON**

Chicago • Los Angeles • Leviton (Canada) Limited, Montreal

For your wire needs, contact our subsidiary **AMERICAN INSULATED WIRE CORP.**

## CATALOGS...

**HOME SELECTIONS** for builders in contemporary, ranch and modern styles are presented in material from Holiday House. Shows a series of five homes with floor plans and exteriors. Holiday House Mfrs. Corp., Dept. AB, P.O. Box 8097, Fort Worth 12, Tex.

Circle No. M72 on reply card, p. 114

## PRODUCTS FOR CONSTRUCTION

... an eight-page booklet lists more than 50 products for all phases of building. Illustrated with product-in-use pictures, brochure is divided into type of specification and use areas. Covers adhesives, insulating materials, etc. Minnesota Mining & Manufacturing Co., Dept. AB, 900 Bush St., St. Paul 6, Minn.

Circle No. M73 on reply card, p. 114

**PLASTIC METAL** for weatherproofing and coloring is described in an illustrated brochure. Explains how plastic metal goes right on over existing roofs and walls to waterproof, insulate, decorate and preserve. Lists types, application details. Yenkin-Majestic Paint Corp., Dept. AB, Columbus, Ohio.

Circle No. M74 on reply card, p. 114

**HOW TO ADD CONVENIENCE** to the kitchen with a waste disposer is explained in a 12-page catalog. Lists construction assets such as motor and shredder with automatic reversing action, continuous feed. In-Sink-Erator Mfg. Co., Dept. AB, Racine, Wis.

Circle No. M75 on reply card, p. 114

**FACESETTING LOCKSET** lines are depicted in 10-page color catalog. Covers decorative doorknobs and rosettes in new shapes, colors, designs, and materials. Shows knobs of ceramics, exotic woods, and polished metals. P & F Corbin, Dept. AB, New Britain, Conn.

Circle No. M76 on reply card, p. 114

**CLAY PRODUCTS** for beauty and economy are discussed in color brochure. Bricktile weighs 80 per cent less than brick, allows great versatility. Regular brick is suited to traditional home with extra heavy foundation. Empress Brick & Bricktile of America, Dept. AB, P.O. Box 8005, San Antonio, Tex.

Circle No. M77 on reply card, p. 114

# TODAY

## QUIET HOMES SELL BETTER...

● Homes are noisier today than ever before. Sound-conditioning is a real need with most families.

Forestone\* sound-conditioned homes sell better. They're quieter, and the ceilings have a beautiful luxury look that's especially pleasing to women.

Your own men can install Forestone ceilings, easily and economically—at about the cost of your present ceiling materials.

Investigate the sales advantages of Forestone today. Get full details from your local Lumber Dealer, your Simpson Certified Acoustical Contractor, or write Simpson Logging Company, Shelton, Washington.

Make sure you have the New

**Slim Trim**  
**LOOK**

of

**FASCO**



Series 95 Power Range Hoods

**FASCO'S FIRST** with the smart new look in power range hoods to fit today's trim modern trend in kitchens . . . crisp, sharp styling featuring a sparkling gold instrument panel gives this hood the wanted look of tomorrow.

Featuring built-in light, easy to clean filter, and quiet, powerful ventilating fan, this new Fasco power range hood is the perfect finishing touch to any kitchen.

Lustrous copper, sparkling stainless steel or gleaming white finish fits any kitchen decorative scheme. Matching splash plates also available.

For full information on this and other Fasco power range hoods and Fasco ventilators use the handy coupon.

**FASCO INDUSTRIES, INCORPORATED**

126 Augusta Street • Rochester 2, New York

Fill in coupon below.  
Use page margin.

There's a fresh look at

**FASCO**

Please send me full information on the new power Range Hoods and Ventilators

NAME and ADDRESS

CITY and STATE

AB-358

**CATALOGS . . .**

**WALL, CEILING COVERING.** "Curon," provides both insulation and sound control plus decorative texture and color. Technical data on this new material is presented in a 20-page catalog. Plenty of charts and photos. Plastics Div., Curtiss-Wright Corp., Dept. AB, 50 Rockefeller Plaza, N.Y. 20, N.Y.

Circle No. M78 on reply card, p. 114

**HOW TO DIVIDE SPACE** with minimum loss of floor area is one idea presented in partition systems catalog. Shows how to install movable partitions and paneling with ease. Posts with patented channel design hold panels. L. A. Darling Co., Dept. AB, Bronson, Mich.

Circle No. M79 on reply card, p. 114

**COLORFUL MASONRY** for walls, patios and walks is the subject of a four-page color brochure. It illustrates 24 items of ornamental masonry which are made on the Gardencrete machine. Machine is compact and of moderate cost. From Colorcrete Industries, Inc., Dept. AB, 322 Ottawa Ave., Holland, Mich.

Circle No. M80 on reply card, p. 114

**WEATHER SEAL** with oak thresholds suggested in a descriptive brochure. Oak thresholds won't conduct cold or moisture. Seal locks tightly in place, wears indefinitely. Save time and labor due to pre-cut ends. United Steel Products Co., Dept. AB, 1820 W. Old Shokopee Rd., Minneapolis 20, Minn.

Circle No. M81 on reply card, p. 114

**OPTIONAL KOLOR PLAN** for Red Cedar shingles, shakes, and coatings is covered in complete catalog. Kolor plan provides flexibility in the selection of shingles, shakes and colors. Weatherbest Corp., Dept. AB, North Tonawanda, N.Y.

Circle No. M82 on reply card, p. 114

**MASONRY NEWS** for builders is available in catalog material. Describes paneled insulating building material. Masonry and insulating board is combined into panels for easy nailing direct to studs. Brings modern masonry to price-conscious owners. Redibrik Industries, Inc., Dept. AB, 351 Ottawa Ave., Holland, Mich.

Circle No. M83 on reply card, p. 114



"IN SNOW, OR RAIN, OR BURNING SUN..."

## New G-P Premium Sheathing speeds work in *any* weather!

Avoid delivery and weather delays for only pennies a panel more! G-P Premium Sheathing is guaranteed to store outdoors mold-free and without delamination up to one year!

Available in 5 thicknesses, all standard sizes. Edge-sealed panels are packaged in easy-to-handle steel-strapped 25" bundles.

*Made by the world's largest producer of plywood products*

### G-P PREMIUM SHEATHING special guarantee

Georgia-Pacific Corporation guarantees G-P Premium Sheathing against delamination and mold for 12 months when stored outdoors off the ground and under a tarpaulin, or for 6 months off the ground, uncovered.



## GEORGIA-PACIFIC CORPORATION

Dept. AB-358, Equitable Bldg., Portland, Ore.  
Please send specification literature on G-P Premium Sheathing.

Name

Address

City  Zone  State

**"TROUBLE  
SAVER"<sup>®</sup>  
SCAFFOLDING  
ACCESSORIES**

**For SAFE • EASY • FAST  
Roofing and Siding Work  
ADJUSTABLE • STRONG  
LONG-LASTING**



**RAIL-TYPE  
JACK**

Adjusts to any pitch. Provides extra safety by using ladder side rails for additional support. 24 lbs. a pair.

**LADDER  
JACKS . . .**

**Useful,  
Efficient  
Time Savers**

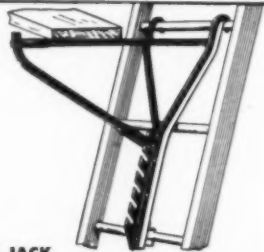

**ONE MAN JACK**

Strongest ladder-jack made. Distributes weight on three rungs. Adjusts easily to any pitch on either side of ladder. 20 lbs. a pair.



**LADDER HOOKS . . .**

makes difficult places easy to reach. Special pivot permits ladder to ride valley with complete safety. Plate protects roof. Only 6 lbs.



**ROOFING BRACKETS . . .**

Adjustable, safe for staging at any pitch. For all jobs on any roofing. Holds 2" x 10" plank. 5 1/4 lbs.



**SHINGLERS . . .**

Holds staging with just two hidden nails. "Regular" (17 1/2 lbs.) for 2 x 4 on edge. "Wide" (22 lbs.) for 2 x 4 on side. Removes without raising shingle.

Roofing Hoists, Studding Brackets, Trestles and other ladder jacks available. Get complete facts, write . . .

**THE STEEL SCAFFOLDING COMPANY, Inc.**

Uniontown, Pennsylvania, Dept. AB.  
Telephone: Geneva 7-7571

**SYNTRON**

**Gasoline Hammer**

**ROCK DRILLS**

**100% Self-contained  
Fast, Easy to Use  
Low Cost Operation**

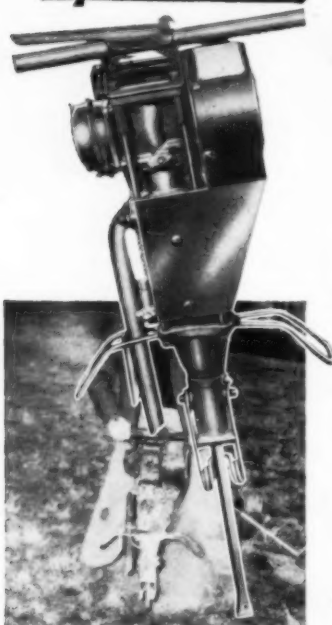

Drilling Rock to anchor fence posts  
**Write for catalog data—FREE**

Powerful, completely self-contained units — no air compressor, hose, batteries or cables required. Automatically rotate the drill steels to penetrate the hardest rock at speeds up to 2 feet per minute, to depths of 20 feet and blow the dust and cuttings out of the hole.

SYNTRON Gasoline Hammer Rock Drills are ruggedly constructed for rough service — easy to start — and portable. A complete drilling outfit at a low cost.

Also available — SYNTRON Gasoline Hammer Paving breakers — also 100% Self-contained — for busting concrete; digging clay, shale and frozen ground; driving ground rods and tamping backfill. C458

**Other SYNTRON Tools—Electric Hammers & Drills**

- Electric Saws
- Concrete Vibrators & Floats

**SYNTRON COMPANY**

618 Lexington Avenue

Homer City,

Penna.

**CATALOGS . . .**

**FASTENER REFERENCE CHART** pictures Red Head concrete fasteners in full size. Includes all types: flush end, snap-off end, stud anchor, rod hanger, tie wire and clinch nail. These self-drilling fasteners won't pull out or vibrate loose. Phillips Drill Co., Dept. AB, Michigan City, Ind.

Circle No. M84 on reply card, p. 114

**WESTERN PINE DIRECTORY** lists more than 350 lumber manufacturing plants and sales offices. Facilities and products of mills in a 12-state region are tabulated in 20-page catalog. Shows species each mill manufactures, products and specialties. Western Pine Assn., Dept. AB, Yeon Bldg., Portland 4, Ore.

Circle No. M85 on reply card, p. 114

**BUILDER BENEFITS** offered with multi-outlet systems are illustrated in Plugmold brochure. Tells how to plan and estimate. Depicts varied applications for residential and commercial buildings. Lists types to cover all requirements. Wiremold Co., Dept. AB, Hartford, Conn.

Circle No. M86 on reply card, p. 114

**STAINLESS STEEL** products reference manual tells builders where and when to buy stainless steel components. Lists stainless steel's assets. 44 pages with photos, detail drawings. Committee of Stainless Steel Producers, American Iron & Steel Institute, Dept. AB, 150 E. 42nd St., N.Y. 17, N.Y.

Circle No. M87 on reply card, p. 114

**PANELING IDEAS** are presented in 20-page colorful catalog. Gives Weldwood production methods from forest to finish, inexpensive ideas for custom touches, plus installation details. Also data on many types, sizes and approximate prices. U. S. Plywood Corp., Dept. AB, 55 W. 44th St., N.Y. 36, N.Y.

Circle No. M88 on reply card, p. 114

**PRIME WINDOWS** with easy operating sliders are described in a detailed brochure. Sketches show many types of simple installations. Among advantages are self-aligning jambs and casings, welded main frames. Prime Windows, Inc., Dept. AB, 1746 Bentley Ave., Youngstown, Ohio.

Circle No. M89 on reply card, p. 114

# "CONTRAST

that's what Gold Bond Siding gives our homes"

says **Richard and Robert Fox**, partners, *Fox Bilt Homes, Inc.*,  
*Plymouth Meeting, Pennsylvania*



## New concept in residential construction helps sell homes

New uses and combinations of building materials are allowing home builders to set design trends that attract buyers. Here's what two builder-partners in Pennsylvania say: "We chose Gold Bond Siding for our new 300-home development in Plymouth Meeting because of its beauty, versatility and durability. Gold Bond Siding, used in conjunction with brick and wood paneling, makes our homes most attractive to prospective buyers. We are delighted to be a part of this new concept in residential construction, and the way our

homes are selling is positive proof...that we have made the right choice in Gold Bond Siding."

Used with wood furring strips (as was done on the Fox Bilt home above), Gold Bond Permanized\* Siding creates a deep shadow line on sidewalls that gives a rich, custom look to the entire exterior...at low cost to builders. Ask your Gold Bond dealer about Gold Bond® Chroma-Tone, Chroma-Tex and Chroma-Shake Siding combinations—or write Dept. AB-38, National Gypsum Company, Buffalo 2, New York.

*\*\*"Permanizing"... Gold Bond's exclusive factory pre-curing process which reduces shrinkage to less than 1/2 of 1%!*



**GOLD BOND SIDING**

**NATIONAL GYPSUM COMPANY**

**Gold Bond**  
BUILDING PRODUCTS

Something New - New - New from Rangaire!  
the exciting "Slim Line-Trim Line"

**Rangaire**

MODEL UC **600** KITCHEN  
RANGE HOODS



Give Your Kitchens the Custom Quality Touch to bring out that "love at first sight" look in Mrs. Home-Buyer of '58



Completely new in design with smart push-button selector controls, new space-saving, extra powerful exhaust unit, and that very new "slim line—trim line" look so wanted by today's more discriminating home buyers. And — right now millions of people are being pre-sold on the Rang-

aire Brand with the largest advertising campaign in its history, putting them in that ready-to-buy mood when they discover that Rangaire in *your* home. Visit your Rangaire dealer today. See it—Install it—Sell it! The Rangaire 600 will be a tremendous Sales Clincher in any home.

FREE Color Booklet of complete Rangaire line. Write Roberts Manufacturing Company; Cleburne, Texas; DEPT. A20

Available in white or coppertone baked enamel and all major appliance colors.

ADVERTISED IN  
**LIFE**

**R** **Rangaire**

FOR BETTER LIVING AT HOME

## CATALOGS . . .

**VENTILATING FACTS** on complete line of air-moving products are available in Lau Blower's '58 portfolio. Introduces kitchen range ventilating hoods in several styles and types. Covers window fans, exhaust fans, portable air circulators. Lau Blower Co., Dept. AB, 2027 Home Ave., Dayton 7, Ohio.

Circle No. M90 on reply card, p. 114

**INCREASE PROFITS** by constructing swimming pools easily, economically. Suggestions in a 12-page illustrated catalog. Material offers several methods of forming, pouring pools with Simplex concrete forms. Simplex Forms System, Inc., Dept. AB, 5605 Industrial Ave., Rockford, Ill.

Circle No. M91 on reply card, p. 114

**SINK SELECTION**, all in stainless steel, is offered in six-page brochure from Elkay. Shows complete line with installation sketches. Highlights bar sinks designed for today's hospitality kitchens. Information on standard sink fittings. Elkay Mfg. Co., Dept. AB, 1874 S. 54th Ave., Chicago 50, Ill.

Circle No. M92 on reply card, p. 114

**NEW MOODS IN MARBLE** are presented in Textolite's Travara marble patterns. Plastic surfacing comes in three colors: beige, pink or gray. Was specifically designed for counter, vanity and wall applications. Sheet sizes come up to 4 x 10 ft. General Electric Co., Laminated Products Dept., Dept. AB, Coshocton, Ohio.

Circle No. M93 on reply card, p. 114

**HOW TO SELECT** the proper grade of oak flooring is shown in color brochure. Six grades are illustrated. Lockwood tempering makes flooring more resilient, easier to nail. Requires a minimum of sanding. Cloud Oak Flooring Co., Dept. AB, 1912 N. Weller, Springfield, Mo.

Circle No. M94 on reply card, p. 114

**SLIDING GLASS DOORS** for every installation from Ador. Colorful 14 pages of catalog point out practical and functional uses in residential, commercial and institutional building. Construction details plus sizes given. Ador Sales, Inc., Dept. AB, 2345 W. Commonwealth Ave., Fullerton, Calif.

Circle No. M95 on reply card, p. 114



# New Ceiling Tiles by Gold Bond mean more remodeling business for you!



You have something extra-special to offer your many remodeling prospects — with Gold Bond's four handsome new Decor Tiles. The smart, modern patterns are on bright, ivory-white background.

The lady holds gray-line Jackstraw. Other patterns are two-tone brown Jackstraw, travertine-gray Romanesque, and modern blue-line Crackle.

Other good selling tiles are the Plain Ivory-white, Full Random and Regular Acoustamatic, and brush-textured Quietex. Painted bevels soften joint lines. All styles have fast-stapling, interlocking edges—except Quietex, which goes up quickly with adhesive.

Send today for attractive sales samples to help you get your share of the growing remodeling market. Dept. AB-38, National Gypsum Company, Buffalo 2, New York.



NATIONAL GYPSUM COMPANY

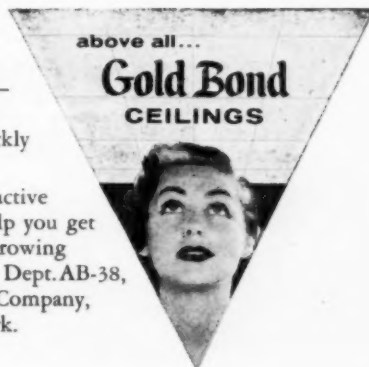

the one  
**SOLUTION**

for all these construction  
problems...

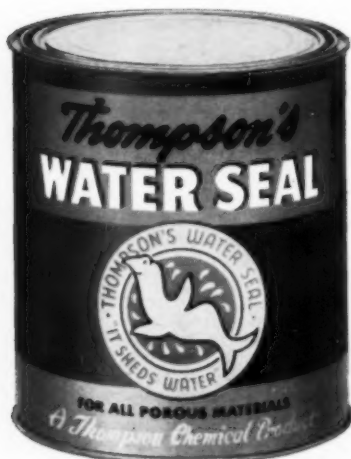

- ✓ **CRACKS IN CONCRETE SLABS AND PATIO** — Thompson's Water Seal helps prevent cracks, stains and dusting because it penetrates deep for hard water-repellent surfaces that are smooth and evenly cured.
- ✓ **SEEPAGE IN CONCRETE BLOCKS** — Thompson's Water Seal puts a deep-penetrating seal into concrete blocks to help maintain texture and color and to protect for 5 years or more against moisture seepage, leakage, stains, paint blistering and peeling.
- ✓ **JOB FOULED UP BY MOISTURE** — unlike surface-coaters, clear, colorless Thompson's Water Seal gives all porous materials a deep-penetrating seal for 5 years or more against moisture, alkalis, salt water, many organic acids — particularly valuable for door and window sections, masonry, plywood, basements, retaining walls, stucco.
- ✓ **EXTERIOR SIDING WARPS AND CRACKS** — Thompson's Water Seal penetrates deep into wood fibres — gives exposed structures protection for 5 years or more against weather and moisture that often cause warping, swelling, checking and grain-raising right on the job.

**NEW BOOKLET WITH COMPLETE SPECIFICATIONS —**

contains Thompson's Water Seal end-use specifications for porous materials in building and maintenance applications... and for TWS use with paints, floor hardeners and Thompson's Water-proofing Redwood Stain.

See your dealer for free copies or write to:



E. A. THOMPSON CO., INC. • WESTERN MERCHANDISE MART • SAN FRANCISCO 3, CALIFORNIA  
San Francisco • Los Angeles • San Diego • Portland • Seattle • Dallas • Houston • St. Louis  
St. Paul • Philadelphia • Denver • Detroit • Chicago • Cleveland • New York • Memphis

**CATALOGS . . .**

**AUTOMATIC OPERATOR** for garage doors has been designed for the mass market. Economical model sells for only \$59.95. Quality engineered, it has a five year guarantee. Brochure with diagram tells how to install, wire and adjust. Malco Industries, Inc., Dept. AB, P. O. Box 181, Bellaire, Tex.

Circle No. M96 on reply card, p. 114

**POOL IDEAS** are given in brochure from Sky-Lite. Residential swimming pool shown offers builders a luxury home item at economical cost. Sides are Ceramsteel with stainless steel rim, reinforced concrete bottom. Sky-Lite Pool Div., Dept. AB, Louisville 10, Ky.

Circle No. M97 on reply card, p. 114

**LIGHT FOR LIVING** is the subject of a 25-page home planning catalog. Floor plan shows how lighting divides the family room into four separate areas. Color photos illustrate changing moods created with various fixtures. General Electric, Lamp Dept., Dept. AB, Nela Park, Cleveland 12, Ohio.

Circle No. M98 on reply card, p. 114

**DRY TILE MORTAR** for all types of tile is introduced in this catalog. L&M system and products for installing tile work allows thin setting of mortar for real clay tile installation. Eliminates many costly procedures. Technical data from L&M Tile Products, Inc., Dept. AB, P.O. Box 35472, Dallas 35, Tex.

Circle No. M99 on reply card, p. 114

**PLASTICS REFERENCE FILE** in condensed version available from Bakelite. Booklet is illustrated and has thumb indices for quick reference. Gives data on polyethylenes, vinyls, styrenes, phenolics, and epoxies. Shows products and lists advantages. Bakelite Co., Dept. AB, 30 E. 42nd St., N.Y. 17, N.Y.

Circle No. M100 on reply card, p. 114

**SAVE HOURS** on every job with portable power plant. Onan brochure gives information on four series of portable electric plants. Describes engines, generators and standard equipment and gives suggestions for labor-saving applications. D. W. Onan & Sons, Inc., Dept. AB, Minneapolis 14, Minn.

Circle No. M101 on reply card, p. 114



*Illustration shows a Hines "Bonded" Garage built by the Diamond Construction Co., Chicago, Illinois.*

## **New Gold Bond Silver-Glo Sheathing glamorizes garages !**

Less than 2¢ more per sq. ft. gives you dollars more in selling value when you use new Gold Bond Silver-Glo Gypsum Sheathing. Decorative . . . light . . . fire-proof gypsum core . . . water repellent building paper surface . . . weather-tight tongue and groove edges. Easy-to-apply panels give added insulation value. Reflective aluminum coating "lights up" the garage when you drive in! Ask your Gold Bond® representative or write Dept. AB-38, National Gypsum Company, Buffalo 2, N. Y.



**NATIONAL GYPSUM COMPANY**

**"WOTAN'S FINGER"—**

**Secret of Man's Miracles**

If we didn't have thumbs, we might still be swinging from tree to tree to tree! Because the thumb is flexible and can close over the fingers, our hand becomes a grasping tool capable of performing miracles. In fact, the idea of forming objects to be held in the hand belongs exclusively to humans. Imagine all the things man could never have accomplished if he didn't have two little thumbs. So you see, there's no substitute for thumbs—or Soss Invisible Hinges, either!

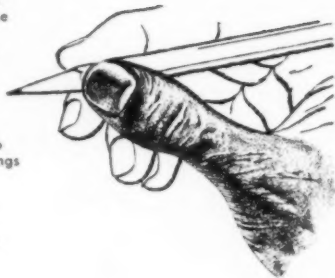

*there's no substitute for*

**SOSS**  
**INVISIBLE HINGES**  
*—either!*

**"The Hinge That Hides Itself."**

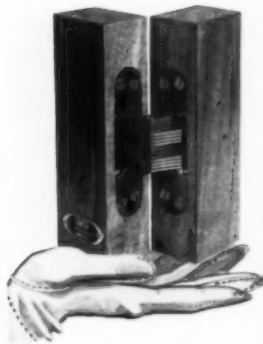

Here's the only hinge that creates flush, smooth surfaces. Around the globe, architects, builders, and home owners choose Soss Invisible Hinges whenever they want to create a masterpiece of modern architectural design. There's a place for Soss Hinges in every building. Use them whenever you want the best. There's no substitute for Soss Invisible Hinges, either.

*Other quality Soss Products that offer unusual architectural effects:*



This low cost Olive Butt Hinge will add style, design and interest to any door.



This attractive, new-style door opener eliminates knobs. Its modern design brings style and modernity to every interior.

*Write today for price list and free illustrated catalogue on these advanced Soss products.*

**SOSS MANUFACTURING COMPANY**

Department 215 • P. O. Box 38 • Harper Station  
DETROIT 13, MICHIGAN

**FOR BUILDING-  
AND RE-MODELING**

**INSTALL Pin-Point  
ADJUSTABLE  
SHELVING**

with  
**E-Z SHELVING**  
(BRACKETS & STANDARDS)

**Provides These Advantages:**

- (1) Helps Solve Uneven Floor Problem. Upper Shelves Adjust Level without shimming.
- (2) Helps Solve Odd Package Sizes. Permits vertical spacing to fraction of inch.
- (3) Rugged "back-bone" for many shelving requirements.
- (4) Individualized Displays. Wide variety of sizes permits tailored precision fabrication.

**FIXTURE FABRICATORS — GET THE "E-Z" STORY**

NO keyholes or slots. Brackets slide up and down in Standard groove and lock at any point on Standard. Fits most shelving and fixture needs.

**HANDLES ALL NORMAL DISPLAY LOADS**

WRITE FOR FREE FOLDER

**Standard Steel Works**

Dept. AB-3, NORTH KANSAS CITY, MISSOURI

**Meet new solution to an old problem!**



**WALL CABINET  
CLOTHES  
DRYER!**

Now there is a simple, easy, convenient way to dry wet towels and those problem "bathroom-washes" in the modern home! Just hang them in this new wall cabinet clothes dryer and let the Bath-O-Dry do the job right in the bathroom. Here's a low cost, economical-to-operate clothes dryer, which can be either flush mounted or recessed in the wall, where it will do away with messy bathroom clutter, and also double as a storage closet.

Features include electrically operated heater and fan, roomy drying compartment, 3 snag-proof swing-out hangers, and louvered door exhaust. Supplied with baked white enamel finish. Units equipped with 60 minute automatic timer; also available at slightly higher cost.

- DRIES TOWELS AND HAND LAUNDRY IN MINUTES
- LOW IN COST . . . ECONOMICAL TO OPERATE
- EASY TO INSTALL . . . FLUSH OR RECESSED

*See your dealer or jobber, or write today for complete information.*

**Louver MFG. CO.** 3609 WOODDALE AVENUE  
MINNEAPOLIS, MINNESOTA

AMERICAN BUILDER



*Mrs. Cleo Maletis*

## Cleo Maletis Specifies CreZon

● Who is Cleo Maletis? She's a popular young matron who spends her full time as housewife and mother to four active boys. However, when she and husband Chris were planning their custom home, they specified Diamond Super Siding\* with its CreZon overlay.

Why? Because the Maletises knew that CreZon gives a smooth flawless finish, heightened by vivid shadow lines of clean cut edges. In Portland's variable climate, durability proves a big plus for Super Siding's check-free CreZon surface.

And the builder found CreZon economical to use. The wide courses meant less handling and nails could be driven close to the edge without splitting or cracking. The painter liked CreZon too! No grain pattern to cover, so extensive priming and painting proved unnecessary.

Like a growing number of young moderns, Mrs. Maletis knows that she can count on CreZon surfaced plywood siding for trouble-free, attractive home exteriors that will last for years.

\*Super Siding is a registered trade mark of Diamond Lumber Company

the permanent protective overlay for plywood

**CreZon**<sup>®</sup>

CreZon overlaid plywood is available from leading plywood manufacturers under various brand names



**CROWN ZELLERBACH CORPORATION**  
343 SANSOME STREET SAN FRANCISCO CALIFORNIA

*it's new*  
**TOPLITE**  
**"TWO-BY-TWO"**

**First low-cost, sun-controlling**

**H**ERE IT IS... Toplite "Two-by-Two"... the new light-controlling roof panel! The only low-cost, home-sized roof panel which controls daylight and solar heat with scientifically designed prisms which pass cool Northern light, block out harsh sunlight!

Toplite "Two-by-Two" is easy to install, easy to handle. No curb or flashing needed. *Fits flat on roof.* You will find dozens of ways to cash in on Toplite "Two-by-Two's" sales appeal in your homes and smaller buildings.

Individually packaged for your convenience.

Call your dealer for details now, or write Kimble Glass Company, subsidiary of Owens-Illinois, Department AB-3, Toledo 1, Ohio.

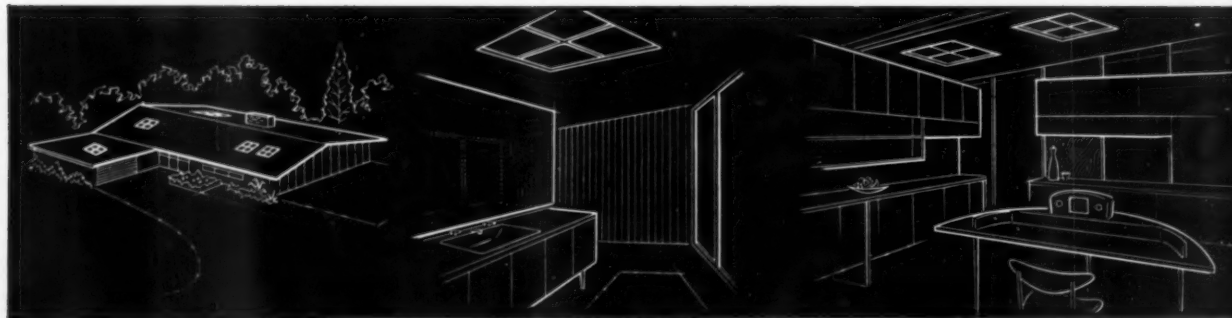

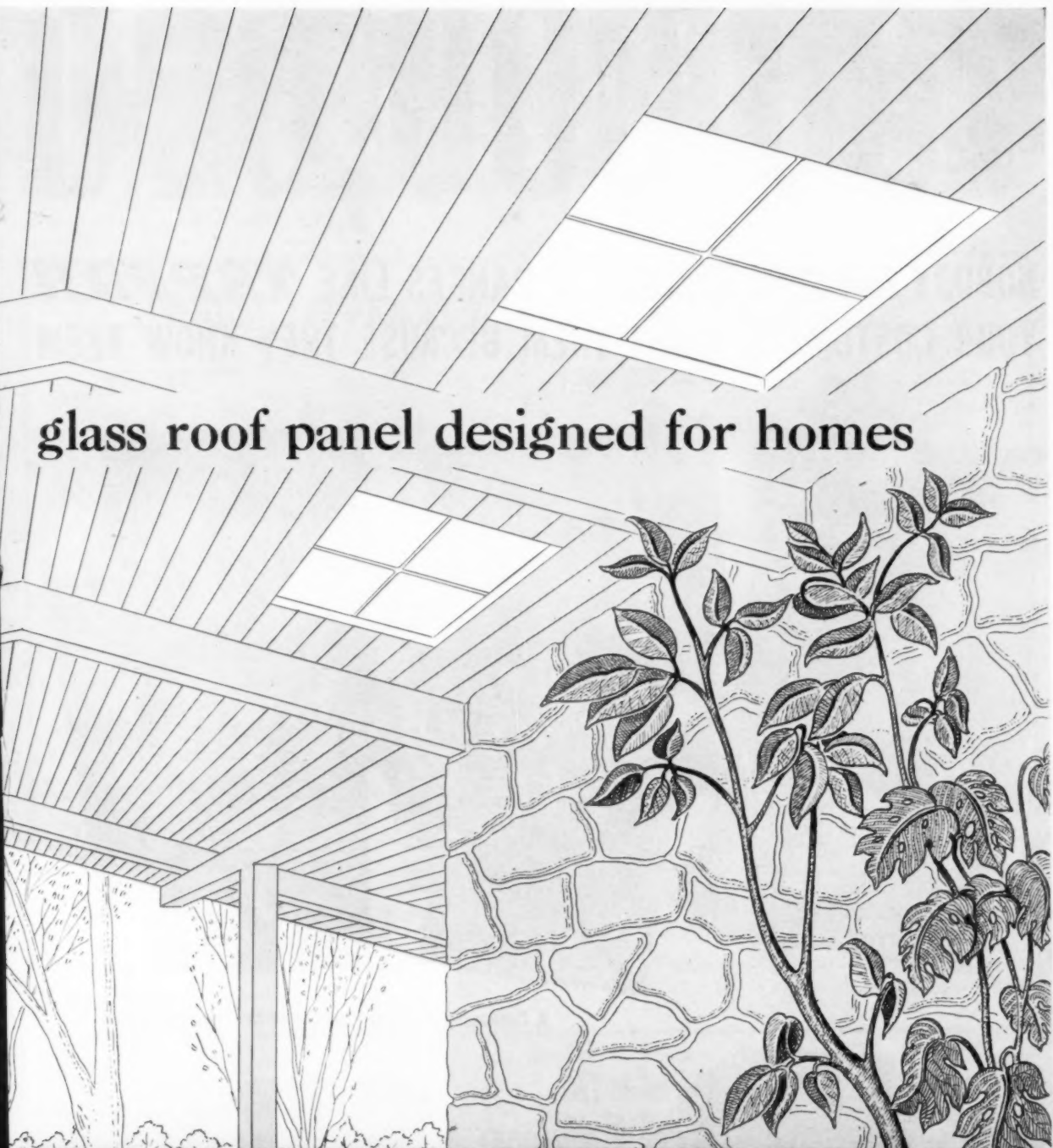

glass roof panel designed for homes



TOPLITE ROOF PANELS  
AN  PRODUCT

**OWENS-ILLINOIS**  
GENERAL OFFICES • TOLEDO 1, OHIO

# 400,000,000

NOBODY ADVERTISES BUILT-IN RANGES LIKE **TAPPAN**  
YOUR CUSTOMERS WANT THEM BECAUSE THEY KNOW THEM



A Continuing National Program in the Best Magazines



NBC and CBS Networks Daily TV participation

So profit from Tappan. The most preferred name in built-ins. The easiest and most economical to install. The most complete line. *And*, there

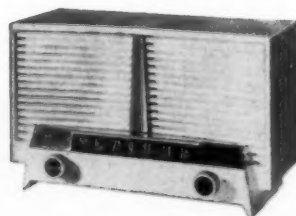

CBS, NBC and MBS Networks Daily radio participation

are Tappan distributors in all 48 states that back Tappan's Service Guarantee. You have NO service problems—NO post-sale call backs!



# IMPRESSIONS

## WHICH TAPPAN IS GAS, WHICH IS ELECTRIC?

"I LIKE GAS!"



"I LIKE ELECTRIC!"



## INTRODUCING THE 1958 TAPPAN TWINS INTERCHANGEABLE IN EVERY RESPECT

### GAS FEATURES

Lighted control panel  
Built-in rotisserie  
No visible vent  
Lifetime chrome oven lining  
Lift-off door  
Thermostatic controlled top burners  
Sizzle 'n Simmer burners on all models

### ELECTRIC FEATURES

Lighted control panel  
Built-in rotisserie  
No visible vent  
Lifetime chrome oven lining  
Lift-off door  
Thermostatic controlled top elements  
7-speed cooking elements

No costly fitting problems! The same size cut-out fits either a Tappan gas or electric oven. The same size cut-out fits either a Tappan gas or electric surface unit. Even at the last minute you can give a woman her choice—gas, electric, or electronic—never lose a sale.

**GET IN ON THE BIGGEST BUILT-IN PROMOTION  
IN TAPPAN HISTORY! MAIL THIS COUPON!**

The Tappan Company  
Dept. AB38. Mansfield, Ohio

I am interested in your new sales promotion brochure on the big year for BUILT-INS.

Name \_\_\_\_\_

Affiliation \_\_\_\_\_

Address \_\_\_\_\_

City \_\_\_\_\_ Zone \_\_\_\_\_ State \_\_\_\_\_

# TAPPAN



what goes  
**UNDERNEATH**  
makes the  
big difference  
in flooring, too!

## WAVE GOODBYE TO "WAVY FLOORS"

You don't know what trouble is, until you've had a costly call-back caused by "wavy floors".

Today, with the popular use of thinner vinyl tiling, underlayment must have *finished floor smoothness*. A base any less perfect will distort floor covering surfaces — wild grain patterns and defect outlines will telegraph right through.

To meet this new need, Pope & Talbot has engineered a particleboard underlayment *with finished floor smoothness*. This new board has no grain; no defects. And it often costs less than the problem materials now in common use. Specify new **POPE & TALBOT PARTICLEBOARD**. Available now for immediate delivery.

Call your supplier, or write for detailed information

Thicknesses:  $\frac{3}{8}$ ,  $\frac{1}{2}$ ,  $\frac{5}{8}$ ,  
 $\frac{11}{16}$ ,  $\frac{3}{4}$ , and 1-inch.  
Standard Sizes: 4x8, 4x4,  
and 4x2 ft.

Special sizes on order.

Available in five basic  
composition grades:

100% Shavings  
75% Shavings-25% Flakes  
50% Shavings-50% Flakes  
25% Shavings-75% Flakes  
100% Flakeboard

3021 Northwest Front Avenue, Portland 10, Oregon

PARTICLEBOARD  
AND FLAKEBOARD

# POPE & TALBOT INC.

forest products since 1849

YOU GET  
MORE  
WITH  
TRADE WIND

Two handsome Trade-Wind models for range and oven ventilation—the Early American Salem (left) in real antique copper—the modern Stationary (right) in real copper or stainless steel.

*Designed for HIGH STYLE  
built for performance*

Style is the keynote of modern kitchen design — and Trade-Wind gives you the most striking hood designs with which to accent the kitchen.

In addition, you get the *plus* of Trade-Wind performance — full capacity ventilation for *both* over-the-range and over-the-oven.

*Trade-Wind*  
**VENTILATING HOODS**



Model 3501—Supreme in performance with 2 inlets.

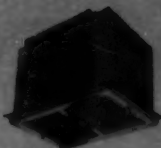

Models 2501/1501 with slide filters.

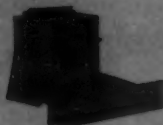

Model 1901 for ovens.

Three full capacity ventilators for over-the-range plus the special oven ventilator.

**WRITE FOR DETAILS AND PRICES**

*Trade-Wind Motorfans, Inc.*

7755 PARAMOUNT BOULEVARD, DEPT. AB, RIVERA, CALIF.

# GRANT

*throughout  
the house*

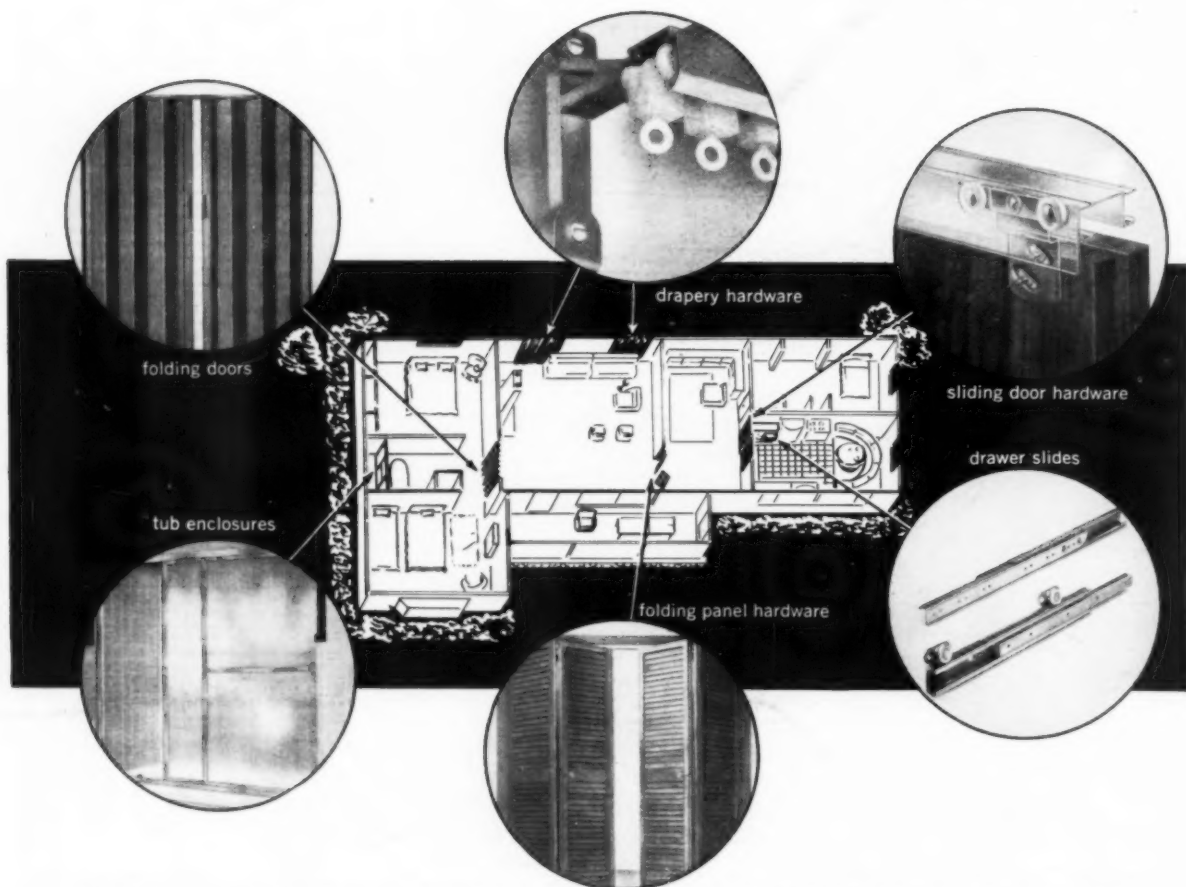

**FOR COMPETITIVELY PRICED, QUALITY SLIDING HARDWARE...YOUR ONE SOURCE IS GRANT**  
 ... in every room... wherever sliding hardware is required, your best move is to Grant. For Grant Sliding Hardware is designed and constructed to give the highest value, the longest service and the greatest possible cost economies. All Grant sliding hardware is guaranteed and all Grant products will perform efficiently and well, **keeping your home buyers happy.**



Write for your copy of the award-winning Grant Catalog.

## GRANT PULLEY and HARDWARE CORPORATION

1 High Street, West Nyack, New York 944 Long Beach Avenue, Los Angeles 21, California



SLIDING DOOR HARDWARE • FOLDING DOORS • DRAWER SLIDES • DRAPERY HARDWARE • TUB ENCLOSURES • PULLS • POCKET FRAMES • SPECIAL SLIDING HARDWARE

# WHAT YOU SHOULD KNOW about WHITE POCKET LUMBER

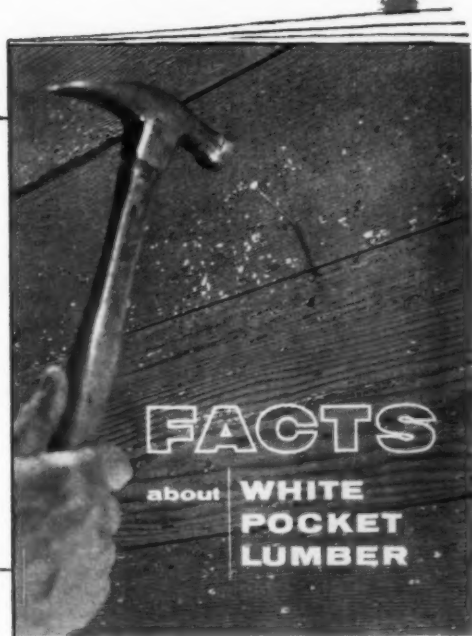

## WEST COAST LUMBERMEN'S ASSOCIATION

DOUGLAS FIR • WESTERN RED CEDAR  
WEST COAST HEMLOCK • SITKA SPRUCE

- 1** White pocket—or white speck, as it is sometimes called—is caused by a fungus which dies when the tree is sawn into lumber.
- 2** White pocket has never been known to grow or spread in lumber.
- 3** White pocket is no more harmful than any other characteristic permitted in a particular grade of lumber.
- 4** White pocket is found primarily in old-growth timber. Most pieces containing it are high-line pieces.

## NEW FULL-COLOR BOOKLET!

The latest information on white pocket lumber is now available in an 8-page booklet. Facts and reports by the United States Forest Products Laboratory furnish a background for full color photographs illustrating recommended uses for this lumber. Mail coupon below for your free copy.

WEST COAST LUMBERMEN'S ASSOCIATION  
1410 S. W. Morrison, Portland 5, Oregon

Please send your free booklet "Facts on White Pocket Lumber" to:

Name \_\_\_\_\_

Address \_\_\_\_\_

City \_\_\_\_\_ Zone \_\_\_\_\_ State \_\_\_\_\_



ATTIC VENTILATING FAN, below, lowered this house's air conditioning needs from 5 to 3 tons.

*According to a new  
American Builder survey,  
builders are now  
learning that ...*

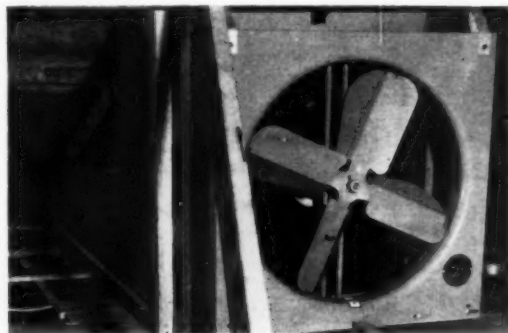

## ... Attic ventilators can save

**I**t may seem strange that an engineering principle known for decades to the construction industry is just now being applied to home building. Installation of venting equipment with air conditioning has long been standard with commercial and industrial work. It's beginning to crop up this year in houses with central a/c.

For example, the hip-roofed house above, by Louisville builder A. Rosenberg, has a 24" attic fan that "washes" the attic air. That is, it moves out the stale, heated air from the un-insulated portion of the attic. So dramatic was the change in the cooling load, that builder Rosenberg was able to install a three-ton air conditioner in place of the five-ton unit called for by cooling load calculations.

Our survey turned up several other builders who have begun to use attic ventilation as a simple way to lower a/c needs. Manufacturers are jumping on the bandwagon, too. At least one, Lau Blower Co.,

has developed a new 16" fan made specifically for "air washing" (see photo upper right).

Another supplier, Bar-Brook Manufacturing Co., has this to say: "The most important new trend in our field is the use of attic fans with air conditioning. It not only permits the builder to install a less costly air conditioner, but provides extra sales ammunition. Builders can point out to prospects that their a/c operating costs will be greatly reduced because of attic 'air washing'."

This ventilation technique applies even more forcefully in two-story and split-level houses. In these homes, cooling needs on the upper floors are greater because of temperatures up to 140 degrees in the attic. "Air washing" relieves the problem.

Incidentally, one producer follows up by saying that the attic fan can serve to cool the whole house at night, thus eliminating a/c operating costs all together during these hours.



**SMALLEST** member of the new Viking line is the "822" shown here. It's a complete unit; can be installed vertically or flat. (No. M36, p. 114).



**NEED** for proper venting when an attic fan is installed is a must. Here's a new unit from Louver Mfg. & Supply; 4-12' lengths. (No. M37, p. 114).

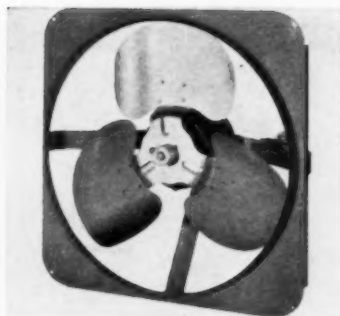

**DESIGNED** specifically to "air wash" attics and reduce a/c cooling loads, this is latest fan from Lau Blower. 1900 c.f.m. (No. M38, p. 114).



**HERE'S** another ventilator produced for installation vertically or horizontally. This fan is 13½" high; from Berns Air King. (No. M39, p. 114).



**COMPLETELY** packaged unit is now offered by Bar-Brook, which company reports a decided "air-washing" trend in the South. (No. M40, p. 114).



**RELATING** to venting, but this time for moisture instead of air, this new 4" aluminum miniature ventilator is offered by Leigh. (No. M41, p. 114).

## air conditioning dollars

### HOW TO SELECT THE RIGHT ATTIC VENTILATOR FOR YOUR NEXT HOUSE

First step toward selecting your fan is to compute the house's area in cubic feet. To do it, multiply floor area by ceiling-to-floor height. Don't include closets, the cellar, garage or closed-off porches.

Next, refer to the table at right to learn air moving needs in CFM for each region of the U.S. Figures are approximate. Each builder must determine variables like the strength of night-time breezes and natural obstacles to wind current flow.

Remember that a slower speed fan with a larger diameter can provide same CFM rate—more quietly. Table courtesy Diehl Mfg. Co.; Torrington Mfg. Co.

Approx. Vol. of House in Cu. Ft.	Minimum Fan Capacity Needed For Satisfactory Results (in CFM) Residential Locations		
	NORTH	CENTRAL	SOUTH
3,000	1,000	2,000	3,000
4,000	1,320	2,640	24" 4,000
5,000	1,650	3,300	5,000
6,000	2,000	4,000	6,000
7,000	2,310	24" 4,620	7,000
8,000	2,540	5,280	8,000
9,000	3,000	6,000	9,000
10,000	3,330	6,660	30" 10,000
11,000	3,630	7,260	35" 11,000
12,000	4,000	8,000	12,000
13,000	24" 4,290	8,580	3,000 42" 13,000
14,000	4,620	9,240	14,000
15,000	5,000	35" 10,000	15,000
16,000	5,280	10,560	16,000
17,000	5,610	11,220	17,000
18,000	6,000	12,000	48" 18,000
19,000	6,270	12,540	19,000
20,000	6,660	13,320	20,000
21,000	7,000	14,000	21,000
22,000	7,260	14,520	22,000

When they ask to see the Furnace... **SHOW THEM ONE  
THAT'S AN AIR-CONDITIONER, TOO...**

**SUN VALLEY\* by ARKLA-SERVEL**  
*(For All-Year® Gas Air-Conditioning)*

\*TRADEMARK PRODUCT OF ARKLA AIR CONDITIONING CORP., EVANSVILLE, IND. & SHREVEPORT, LA.



**Cools the entire home  
in Summer from a single  
compact Gas unit.**

*(Heats in Winter, too!)*

**SHOW THEM** the most effective way to beat any heat spell. No more drafty fans . . . no more spot cooling in a couple of rooms. The Sun Valley\* by Arkla-Servel cools the entire house (every room of it) from a single compact unit. And provides complete and correct moisture control both Winter and Summer. Your prospects will like the peace and quiet of the Sun Valley\*, too! There's no noise because there are no moving parts in the cooling system.

**SHOW THEM** how easily the air conditioner can be turned into a furnace when blustery winter comes booming in. A simple dial setting—and presto!—the Sun Valley\* by Arkla-Servel is the most wonderful furnace! It circulates gentle warm air to every room of the house. And with Gas your prospects will never have to worry about late fuel deliveries—dependable Gas is piped right into their homes, a modern convenience only Gas can give.

AMERICAN GAS ASSOCIATION

**ONLY GAS**  **does so much more...for so much less!**



what's it worth

to CUT CORNERS



this **DAVIS RIG** never gets cornered



DAVIS LOADER HAS MORE "FIRSTS" than any other make! It packs the stamina to stay on a job — has the close-in design requiring minimum clearance — allowing maximum visibility. Davis is truly America's finest loader buy!



NO REMOTE CONTROL NECESSARY — The Davis backhoe lets you see what's going on. The seat revolves with boom and bucket to always let you face your work.

You can't corner a Davis rig! Its unique ability to work in tight spots, superior maneuverability, and excellent visibility increase your profit potential by letting you perform tasks impossible for other rigs.

**Works In 3 Directions** — The Model 210 with exclusive 3-point mounting — at either side or center — lets you work at right angles to either side or to the rear. Eliminates hand digging flush against buildings, fences, or in finishing up footings in hard-to-reach positions.

**Excellent Visibility** — You sit where you can look right down on your work. Seat revolves with boom so you always face the bucket.

**Alert Controls Permit Precision Operation** — Superior valve, hydraulics, and finger-tip controls make your work faster, easier with lightning-fast response.

**Low, Competitive Prices** — Despite its quality and advanced engineering, the Davis sells for less than most other competitive models. You had better see your Davis Dealer soon!

Davis Loaders and Backhoes are available for all popular models of International, Ford, Fordson Major, Ferguson, Case, Massey-Harris, Allis-Chalmers, Oliver, John Deere, Minneapolis-Moline, and Work Bull Tractors.

SOLD AND SERVICED EVERYWHERE BY BETTER DEALERS

For the name of your nearest dealers call Western Union by number and ask for Operator 25... or write direct. Please specify make of tractor.



**MASSEY-FERGUSON INDUSTRIAL DIVISION**  
MASSEY-HARRIS-FERGUSON, INC.  
1009 S. WEST STREET • WICHITA 13N, KANSAS

LAND PLANNING  
SECTION



**HOUSES** were designed by architect Hay to fit the hilly terrain in this development. For instance, these split-levels were built when ground sloped gently. Ranches were constructed on flat, and "hillside" houses on steep grades.

**AERIAL** view clearly shows two of the reasons why this project won an NAHB neighborhood development award: (1) streets were residentially planned to thwart fast traffic, and (2) houses were sited to avoid deadening sameness.



**CHECKING** plat: George Hay (left), E. J. Turner.

*Builder E. J. Turner and  
George Hay planned this  
land as well as the houses  
on it. Result:*

**This project is**

**O**ne crisp fall morning last year, a resident here slipped noiselessly out his back door and shot a six-point buck. He was just 6 miles from the Philadelphia city limit in Rose Tree development—a part of a town called Media, Pa.

How much more natural can a development be? And it was this naturalness, a product of sound land planning, that accomplished two important things.

First, it went a very long way toward selling the

houses. Homes sold for slightly under \$30,000, and they moved at a brisk sell-and-build pace.

Second, it won an NAHB neighborhood development award in 1957 for builders Jesse Seal and E. J. Turner, Jr. This was the third such award they had received since 1953. Here's why:

Just prior to their winning the first NAHB plaque in '53, this building team hired George Hay for two jobs. He was to design the houses—not so unusual, and he was to plan all the land—rather

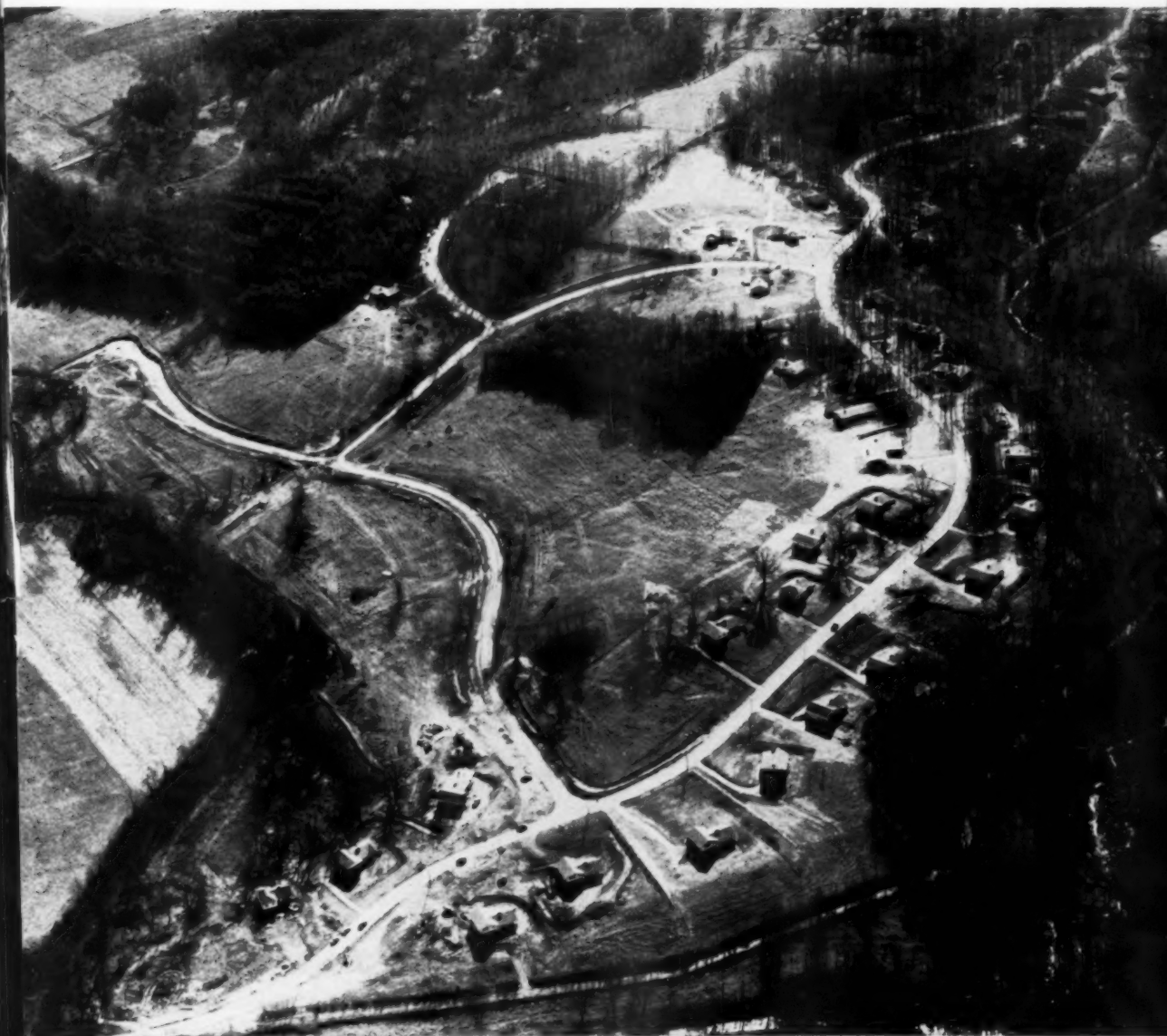

## their third award-winner

unique. These two jobs actually melted into one task in execution. That task was to plan the entire community, and it's important to take note of this. For, what could be more intelligent than having a competent man help plan both houses *and* land, each to complement the other?

Besides creating a prize-winning, easy-selling development, Hay also:

- Took over the worrying about meeting provisions of the county planning commission and the township

zoning conference—both exacting groups.

- Gave Seal & Turner the maximum number of lots under conditions set (that land was to stay as natural as possible, zoning rules, etc.). Out of 125 acres, and with one-acre minimum zoning, Hay worked in 91 lots. Five acres, incidentally, were donated to the Delaware County Park system.

Hiring an architect to plan your land as well as your houses isn't going to be a cure-all. But, it's something to think about.

# NEW



## WORTHY "STABLEMATE" of the POPULAR "420"

Every inch another "thoroughbred," the new John Deere "440" is a worthy "stablemate" of the ever popular John Deere "420," the busy, capable, and economical crawler that continues to merit the praises of efficiency-minded industrial users everywhere.

With a capacity for work that must be seen to be believed, combined with a nimbleness that cuts maneuvering time drastically, these tractors have the ability to squeeze more work out of every piece of equipment and to press more work into every hour.

### New Heavy-Duty Track Assembly—Simple Adjustment

New strength . . . new durability . . . in power train and in 5-roller track assembly assure outstanding traction and greater lugging capacity. Wide choice of track shoe sizes, including a new 12-inch all-purpose shoe, assures traction aplenty on any type or combination types of industrial jobs. Clutch-brake steering assures "turn-on-a-dime" maneuverability.

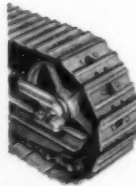

### New, Heavy Buffer-Type Front End

The strictly industrial design of the "440" is most evident in the husky front end—an immediate outward indication of the tractor's solid brawny strength throughout. No grille guard is provided for front crankshaft-driven pumps.



### Lounge-Chair Comfort for the Operator—Convenient Controls

New comfort and protection for the operator . . . new eye-centered controls and gauges . . . new easy view of work being done—all are here in full measure. Result—an easy-handling smooth-working unit that means more productive hours on the job, less operator fatigue.



### New, Clutch-Type Direction Reverser (Optional)

The new clutch-type direction reverser is simple, easy to use, and effective. A touch of the handy lever and the tractor travels forward or backward at the same speed. It is not necessary to shift gears.

You  
your  
tracto  
the lo  
ed an  
equip

. and Sure to Win Their Way to  
the Heart of Industry

# JOHN DEERE "440" Industrial TRACTORS

Here they are . . . trim and eager . . . and literally "born" to save you money, whatever business you're in—the New John Deere Industrial Tractors.

"Born" to save you money?

We could hardly put it better. For these are INDUSTRIAL tractors from top to bottom . . . ruggedly built from grille to drawbar . . . and designed, inside and out, to fill definite needs in industrial work of all types . . . to cut to rock bottom the costs of such jobs as earth moving, materials handling, sand and gravel work, maintenance, and many other—often specialized—jobs in contracting, construction, utilities, manufacturing, and public works.

Both, the John Deere Crawler and the John Deere Wheel-Type, are built around an amaz-

ingly efficient, precision-tooled John Deere engine, unmatched for delivering so much, for so long, for so little cost. Both have many construction features of hood, grille, frame, and either wheel or track assemblies that enable them to do more than their share of the day's work of pushing, pulling, lifting, digging, and hauling. Their clean, modern, functional design throughout makes them businesslike in operation, easy to service, and economical to maintain. A line of proved, matched working equipment gives them the versatility that industry demands.

Size up these modern tractors in the light of your requirements. It may be the start of making your power dollars go farther than you thought possible.

*Completely Engineered for Industry*

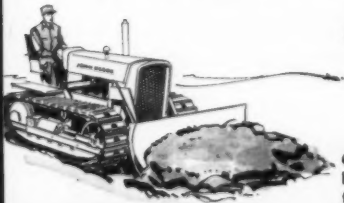

The John Deere Crawler is ideal for bulldozing and back-filling.

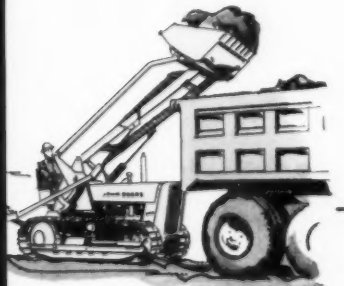

These tractors make loading and materials-handling fast, easy jobs.

You can team up your "440" Industrial Tractor with any of the long line of matched and tested working equipment.



It's the highly mobile new "440" for use by contractors of all kinds, public utilities, states, counties, municipalities, manufacturing concerns, and many others.

Many optional features, including built-in power steering, add to the versatility of the Wheel-Type.

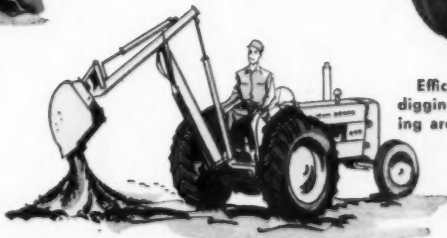

Efficient, low-cost digging and excavating are assured.

For Further Information Write:  
JOHN DEERE INDUSTRIAL DIVISION • Moline, Illinois



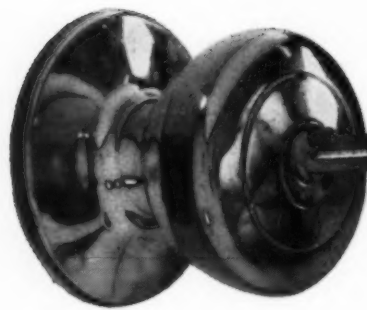

**LOCK**

**the front door**

**THE FIRST DAY**

Your Inland Home goes up . . . walled-in, roofed-over and safely locked . . . the day the truck delivers the package!

From the moment you check the Inland Component Package Price List and plan your package, you are in complete control of your building operation and of all costs. All Inland packages and components are clearly priced and covered by one invoice. You know your costs before you build and you can figure your profit right from the start. No changes, delays, wastage or pilferage will eat it up.

Inland offers a wide selection of models for basement, crawl-space or slab, 2, 3 or 4 bedrooms, 1 or 1½ baths, carports, 1 or 2 car garages. Factory-assembled room-size exterior wall sections, 2 x 4 studs, 16' o.c., with factory-applied primed siding, double-course cedar shakes or boards and battens. Double-hung windows, exterior doors, hardware installed. Complete gables, assembled trusses, plywood roof sheathing, asphalt shingles.

Exterior doors, trim, cornice, soffits prime painted. Factory-assembled interior partitions, 2 x 4 studs, 16' o.c. Fiberglas insulation. Youngstown Monterey kitchen cabinets and dishwashers, Tappan built-in ovens and countertop ranges, Westinghouse Space-Mates washer-dryer combinations. Modernfold doors, Over-head garage doors.

More than 200 Inland Home Packages, all clearly priced, give the variety you need to sell practically any home buyer. Our two plants give you quick delivery. Through Inland Mortgage Corporation, we offer financing plans to fit all builders' needs.



Let's get together. Get our new 1958 Component Package Price List. Visit, call or write either of our offices. Inland Homes Corporation, Box 915, Piqua, Ohio (Phone 3880) and Box 137, Hanover, Penna. (Phone Melrose 7-6681).

# INLAND HOMES

*Inland*®  
HOMES CORPORATION

**Cost Cutter!  
Schedule Booster!**

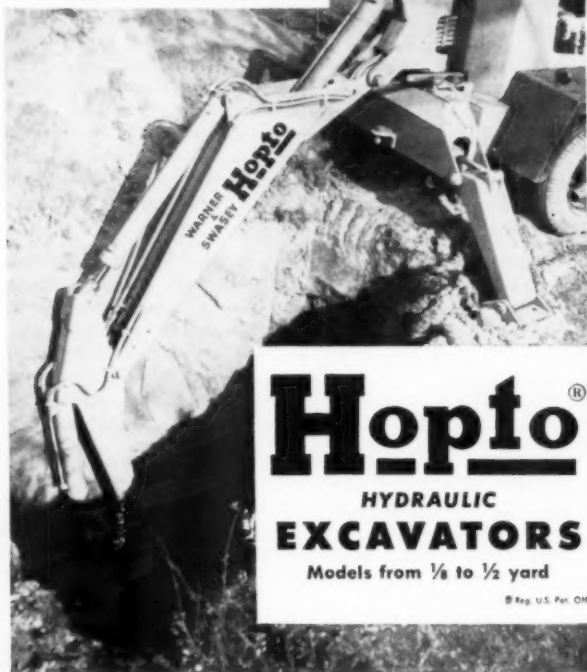

**HOPTO**<sup>®</sup>  
HYDRAULIC  
EXCAVATORS  
Models from 1/8 to 1/2 yard

© Reg. U.S. Pat. Off.

Trenching and excavating need not hold up schedules when you have a HOPTO. Model 200 HOPTO has a fast, smooth cycle, a 200° uninterrupted swing, and a digging capacity and ease of operation that knows no equal in its size and class range! Trenching or 'square-cornered digging' is simply handled by 180° wrist action of bucket.

HOPTO digs 13 1/2 feet deep . . . is easily converted to shovel bucket in ten minutes! It's the field-proven hydraulic excavator that equips you to do more work, *make more money, at lower equipment investment.*



*There's a HOPTO model to exactly fit YOUR requirements . . . exceed your expectations*

**HOPTO**<sup>®</sup> WARNER & SWASEY  
BADGER DIVISION • WINONA, MINN.

Please send me complete specifications on the models most frequently used in my field.

Name \_\_\_\_\_

Address \_\_\_\_\_

City \_\_\_\_\_ State \_\_\_\_\_

Builders and contractors know...  
**THE SIGHT IS RIGHT WITH A**



**FOR CONTRACTORS**

A brand new transit designed for your particular needs. Only one of its type on the market. Use for fast, accurate surveys for grading, road construction, other major jobs. Rugged, simplified construction with all the features you need: double centering, revolves 360 degrees for reverse readings, reads to one minute, vertically and horizontally. T8200 Contractors' Transit. Includes new American-style, wide-frame tripod. \*Retail for \$375.00

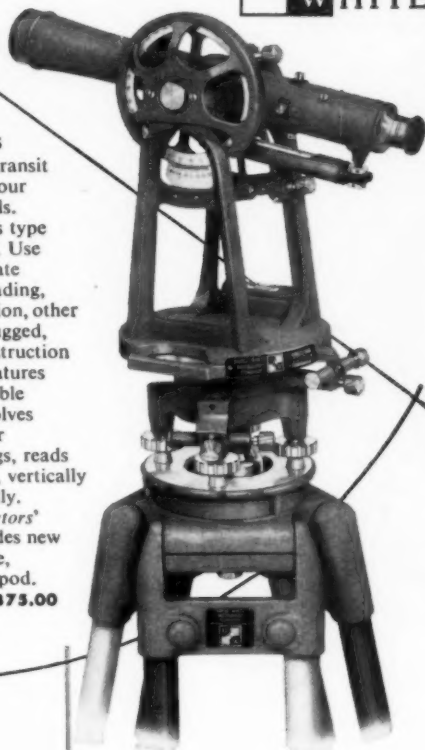

**For Concrete Contractors**—Determine differences in elevation, run lines for curbs, plumb walls, lay out angles. New streamlined styling. T8006 Light Construction Level-Transit. Tripod included. Retail for \$79.50



**For Excavators**—For determining grade, setting out building stakes, running lines, sloping drainage ditches. T8114 Builders' 12-Inch Dumpy Level. Includes new American-style, wide-frame tripod. \*Retail for \$169.50.



**For Builders**—Heavy-duty instrument for building construction. Use to align piers, plumb walls, level floors, lay out foundations and drain tiling. T8300 Universal Builders' Level Transit. Includes new American-style, wide-frame tripod. \*Retail for \$217.00

Write today for your free David White surveying instrument catalog. \*The T8200, T8300 and T8114 may be purchased at 10 per cent down at your lumber, building supply or hardware dealer.

Prices slightly higher west of the Rocky Mountains

**DAVID WHITE INSTRUMENT COMPANY**  
Dept. C, 2051 North Nineteenth Street, Milwaukee 5, Wisconsin



**NEW INTERNATIONAL®  
330 UTILITY TRACTOR**



**Now, International tractors with matched loaders and backhoes**—complete units backed by unexcelled IH facilities for parts, service and financing. Here, the new 330 Utility is equipped with International Wagner loader and backhoe.

**NOW! MORE  
'BEEF'**

**than ever before in a 35 hp rig!**

**Is terrific for trenching, loading, 'dozing!** Now you can get an International tractor in the economical 35 hp class, with strength and stamina for high capacity and low maintenance. The new International 330 Utility has up to 900 pounds greater built-in weight than other tractors of similar horsepower—really rugged construction! Handle 1,000 pounds with a front-end loader, lift 4,000 pounds with rear-mounted loader, dig faster with heavy-duty backhoe.

**Like the work-easing features** of larger IH tractors are available—10 speeds forward with Torque Amplifier drive . . . power steering . . . job-tailored Hydraulic equipment control . . . Fast-Hitch.

**How heavy-duty design can cut your costs!** Look in the classified directory . . . phone your IH Dealer. For the catalog, write International Harvester Co., Dept. 330, P. O. Box 7333, Chicago 80, Ill.

SEE YOUR

**INTERNATIONAL  
HARVESTER DEALER**

**International Harvester Products pay for themselves in use—** Farm Tractors and Equipment . . . Twine . . . Commercial Wheel Tractors . . . Motor Trucks . . . Construction Equipment—General Office, Chicago 1, Illinois



**Yardage-boosting traction!** Greater built-in weight puts the new International 330 Utility far in front for push-and-pull power that pays off in higher output.

**For extra-rugged service,** ask your IH dealer to show you the husky, 45-hp International 350 Utility . . . Over 5,500 lb drawbar pull; ¾-ton capacity with front-end loader.





**Under-Eaves Louver Ventilators.** Installed on the under-side of over-hanging eaves. Finned louvers deflect rain and snow, without obstructing air circulation. Three sizes: 4" x 16", 6" x 16", 8" x 16". Galvanized steel or aluminum.

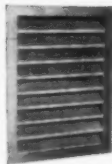

**Rectangular Louver Ventilators.** Most commonly installed on gables. Available in flush or self-casing designs for use with any type of construction. Insect screen. Available in sizes from 8" x 8" to 24" x 30". Galvanized steel or aluminum.



**Roof Louver Ventilators.** Installed on roofs of any pitch. Removable cantilever cap, an exclusive Milcor feature, simplifies aligning of roof opening and base collar. Insect screen. Free area, 50 square inches. Galvanized steel or aluminum.



## To help your homes Sell YOU!

### Milcor Louver Ventilators of steel and aluminum

You can build your reputation for quality construction by providing proper attic ventilation. Summer heat turns sealed attics into ovens that rob homes of comfort. Winter cold condenses moisture, causing damage that can become very expensive.

Milcor Louver Ventilators cost so little, you can't afford to leave them out of your plans. Leading dealers have them in stock, in a wide range of styles and sizes, both steel and aluminum.

*Making good products better  
through constant improvement*

# MILCOR<sup>®</sup>

member  
of the  
**INLAND**  
steel  
family

#### INLAND STEEL PRODUCTS COMPANY

DEPT. C, 4025 WEST BURNHAM STREET • MILWAUKEE 1, WISCONSIN • ATLANTA • BALTIMORE  
• BUFFALO • CHICAGO • CINCINNATI • CLEVELAND • DALLAS • DENVER • DETROIT • KANSAS CITY  
• LOS ANGELES • MILWAUKEE • MINNEAPOLIS • NEW ORLEANS • NEW YORK • ST. LOUIS. CP-168

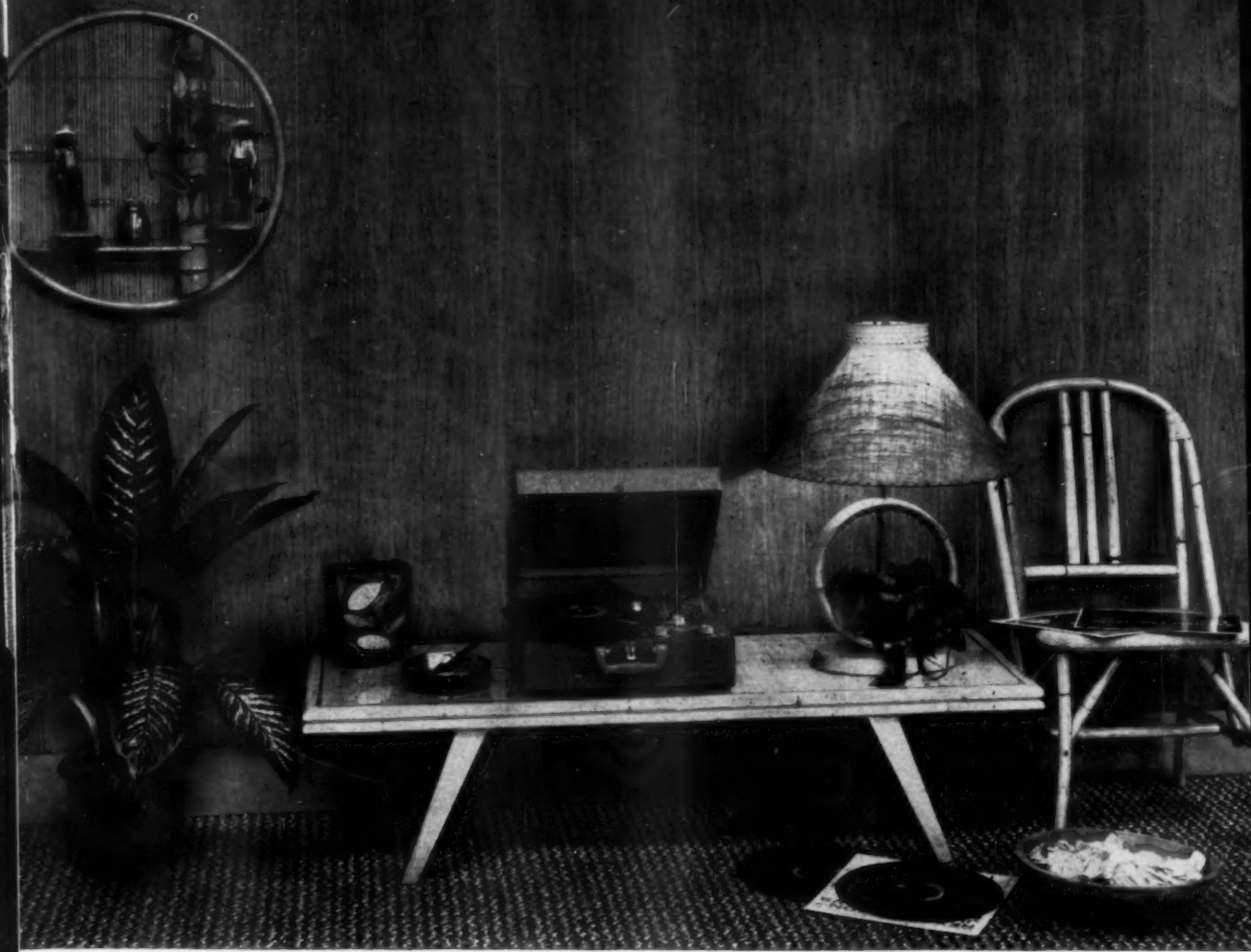

## Put wood paneling in your homes at half the cost!

**PLYWALL**... an exclusive new development gives your homes a luxurious look... costs you far less, saves labor time.

Now, with Plywall, you can give your homes the added sales appeal of fine wood paneling at a much lower cost (about half).

Plywall has a natural wood grain effect that is transferred to Plywood panels through a photographic process, without the use of paper or plastic laminations. Plywall comes to you prefinished in four-foot-wide panels. The grain finishes of the panels are uniform, eliminating matching problems. You cut the time needed to finish a room as well as drastically reduce labor costs.

Plywall won't warp and is back-sealed to resist moisture. It comes in ten different grain finishes, available in V-grooved or plain. Get full details now.

**PLYWALL PRODUCTS COMPANY, INC.**  
Fort Wayne, Indiana • Corona, California

*Plywall.*

**PLYWALL PRODUCTS COMPANY, INC.**  
P.O. Box 625, Fort Wayne, Indiana

Please send me your full color brochure describing Plywall. Also send the name of my Plywall supplier.

Name \_\_\_\_\_

Title \_\_\_\_\_

Address \_\_\_\_\_

City \_\_\_\_\_ State \_\_\_\_\_

to increase profits

on your next job . . .

# Ask your heating man

to figure an estimate using

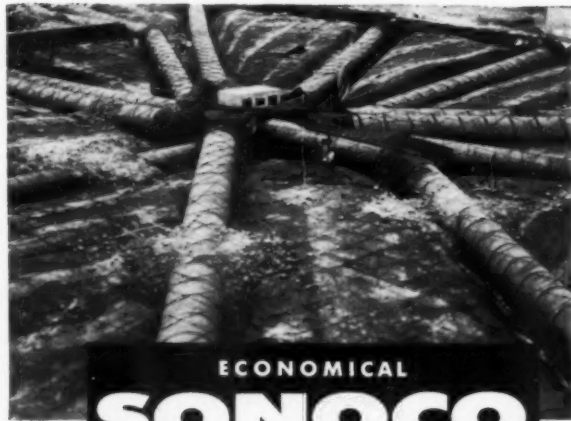

ECONOMICAL  
**SONOCO**  
SONOAIRDUCT®  
**FIBRE DUCT**

Your heating man can show you how SONOAIRDUCT reduces costs in gas and oil fired slab-floor perimeter heating systems . . . without lowering the quality of construction. SONOAIRDUCT is lightweight, easy to handle and levels quickly. It meets and exceeds F.H.A. criteria and test requirements for products in this category. 23 sizes - 2" to 36" I.D., up to 50' long. Can be sawed to exact lengths on the job. Free installation manual available. See our catalog in Sweet's.

Ask your heating man . . . or write for complete information and prices!

**SONOCO**  
Construction Products  
SONOCO PRODUCTS COMPANY

- HARTSVILLE, S. C.
- LA PUENTE, CALIF.
- MONTCLAIR, N. J.
- AKRON, INDIANA
- LONGVIEW, TEXAS
- ATLANTA, GA.
- BRANTFORD, ONT.
- MEXICO, D.F.

1428

## MULLER MACHINES

PLASTER AND MORTAR MIXERS  
5 sizes 2 to 12 Cu. Ft.  
Electric or gasoline.  
Power throw-out on smaller models, disc clutch on larger.

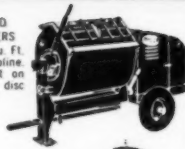

3 1/2 Cu. Ft. NON-TILTING CONCRETE MIXER  
Drum 36" dia. x 27" wide  
B & S Air-cooled engine 4.5 Hp. at 2700 RPM



4 BLADED POWER TROWELS  
24", 29", 34", 44" dia.  
B & S Air-cooled engines. Clutch and speed controls on handle.



CONCRETE MIXERS TILTING TYPE  
3, 3 1/2, and 6 Cu. Ft. (mixed concrete).  
Electric or gasoline  
Timken Bearings



Ask for prices and name of local dealer.

**MULLER MACHINERY COMPANY, INC.**  
Metuchen 4, N. J. Cable Address: MULMIX

for high output  
with low price  
and  
maintenance

Simple Design, Fewer Components; large scale production; a half-century of experience; explain the leadership of Muller Machines. Muller's low prices and low maintenance costs make Muller Machines the best investment for the contractor.

## Put the POWER PUNCH back in your Black & Decker tools



with  
**GENUINE  
FACTORY  
BRANCH  
SERVICE**

- ★ Free Tool Inspection
- ★ Standard B&D Guarantee

Look Under "TOOLS-ELECTRIC" in Yellow Pages

Look under "Tools-Electric" in Yellow Pages for address of your nearest FACTORY SERVICE BRANCH. Or write direct for address of nearest branch to:

THE BLACK & DECKER MFG. CO., Dept. 54203, Towson 4, Md.



**Black & Decker**  
QUALITY ELECTRIC TOOLS



## MATICO'S EASY CLEANING HELPS YOU SELL THE MISSUS!

Be kind to the guy who signs the check. Shake his hand when he leaves, answer his questions about the heating system and taxes. But remember, it's the gal he came with that you really have to sell. Show her Matico's bright, sparkling colors. Emphasize how easy it is to keep Matico Tile bright and sparkling. Yes, if you want to sell the missus, be sure to include modern Matico Tile Flooring in your plans . . . the tile she reads about in her favorite magazines. Available in smart colors and patterns to please any woman.



### MASTIC TILE CORPORATION OF AMERICA

Houston, Tex. • Joliet, Ill.  
Long Beach, Calif. • Newburgh, N.Y.

- Rubber Tile
- Vinyl Tile
- Asphalt Tile
- Vinyl-Asbestos Tile
- Plastic Wall Tile

For best results we recommend Milmark® wax . . . cleaner . . . adhesives

#### MAIL COUPON TODAY

Mastic Tile Corp. of America, Dept. 5-3 Box 128, Vails Gate, New York  
Please send me complete information on Matico Tile Flooring.

Name..... Address..... City..... Zone..... State.....

you'll get  
more jobs done—  
 and  
 done better—  
 with a



## PORTER-CABLE ROUTER

The Porter-Cable Router is one of the most useful woodworking tools you can own. With it you can do all these jobs: make decorative edges on table tops, bookcases and shelving; cut outlines for inlay jobs; grooves and rabbets for cabinet work; mortises for door hinges; circles and ovals—all with perfectly smooth edges and much more. Illustrated here is the famous Porter-Cable Router #100, now with full  $\frac{7}{8}$  h.p. It is quality built with a non-marking base, precision ball bearings and high-speed, interchangeable motor for Power Plane and Shaper. An outstanding value at only \$57.50. Model #162  $\frac{1}{2}$  h.p. Router, \$49.50.

See these new professional quality tools at your Porter-Cable dealer today or write for full information.

**ROUTER BIT KIT**—Contains everything you'll need for hundreds of basic Router applications and jobs. Three high-speed bits and sharpening wheel come in hinged transparent case. No. PR-138Y Bit kit . . . only \$9.95.



**PORTER-CABLE MACHINE COMPANY**  
 8013 Marcellus Street, Syracuse 4, New York  
**Saws, Drills, Sanders, Routers, Shapers, Planes.**

In Canada, write Porter-Cable Ltd., Box 5019, London, Ont. Canadian Prices Slightly Higher.



Give your customers their choice of...

# Beautiful Siding

● Many successful home builders have learned that modern home designs can be enhanced with the use of enduring wood sidings. These builders find they can take advantage of the wide choice of wood siding patterns to increase their sales opportunities.

Weyerhaeuser offers builders an outstanding selection of popular patterns. Each pattern is precision manufactured from one of the West Coast softwood species, and scientifically kiln-dried. Each bears the Weyerhaeuser 4-Square brand name, which gives your customers assurance of reliability and quality.

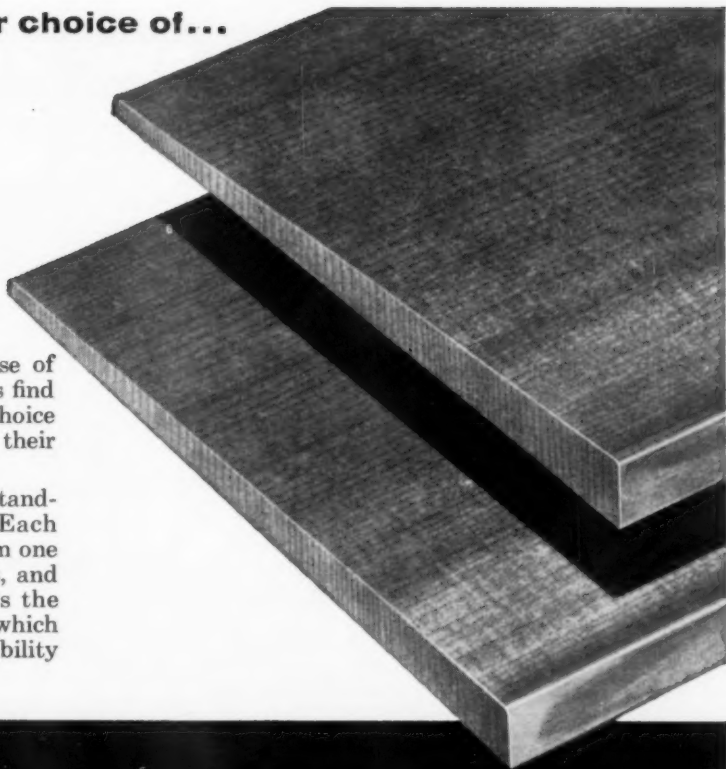

Weyerhaeuser

4-SQUARE®

LUMBER AND BUILDING PRODUCTS



*Basically better because...*

## **IT'S KILN-DRIED**

- Trademarked Weyerhaeuser 4-Square Lumber is properly seasoned by scientifically controlled methods of drying. The result is lumber which has maximum strength, finishes easily, and holds nails securely. Kiln-drying also promotes dimensional stability.
- Besides being kiln-dried, Weyerhaeuser 4-Square Lumber is precision manufactured, uniformly graded and identified, and carefully handled. All these features contribute to the consistently high quality of Weyerhaeuser 4-Square Lumber, creating customer satisfaction and profitable repeat business for builders who use it. The Weyerhaeuser 4-Square trademark is your assurance that you are buying lumber and building products which are basically better.



Natural finish Red Cedar siding gives this lovely contemporary home a pleasant informality.

Weyerhaeuser Sales Company  
ST. PAUL 1, MINNESOTA

COST SAVER FOR MARCH



**THREE MINUTES** is about all it takes to unload and set this conveyor up. Note how easily belt blades support bundles of shingles. It will also lift hammers, nail boxes, mastic, lunch pail—any compact parcel.

**This simple motorized conveyor system  
saves one-third of their shingling time**

**Y**ou can't keep 'em (good ideas) down on the farm. It's true. Builder Saul Cantor and Paul Goldman "stole" this cost-saving trick from local New Jersey farmers, who have been using conveyors for years to get hay bales into the barn.

Their Fleetwood Park development, site of these photos, is a true assembly-line operation. Prior to using a conveyor, they had a slow-down in shingling.

Roofers were formerly carrying the bundles up ladders, cracking them open, and going to work. This was more than just slow. It also tired the shingler, which meant that he did a more leisurely and less efficient job. Hand-operated hoists were an improvement, but still too slow. (The builders tried just about everything.) Mechanized conveyors turned out to be the answer.



**SHINGLERS** now do what they are trained to do—lay down shingles. Because they concentrate on it, the work not only goes faster, but they do a better job.



Masonite makes the news

*'Highly Desirable to Home Buyers'*

A Skylark Rancho home of Tietz Construction Co., Garden Grove, Calif.



**SOUTHERN CALIFORNIA BUILDER FINDS**

# MASONITE RIDGELINE

**SHORTENS SELLING TIME...CUTS DOWN CALL-BACKS**

"We're exceedingly happy with the performance and beauty of Masonite Ridgeline panels and Ridgeline siding," says John R. Nelson, vice president of Tietz Construction Co.

This prominent Southern California firm has built more than 750 homes in the past year on which it has used Masonite® Ridgeline® panels, set off with battens. As for the results, let Mr. Nelson tell you:

"This has proved a very practical application and

highly desirable to home buyers. We do not encounter the checking and splitting which we experienced with other exterior materials.

"We note also that it has great paint retention. It covers easily and economically. We are not bothered with the usual checking and peeling."

Need we say more? Except to add that you can get the full story plus a Ridgeline sample by sending in the coupon—or see your building materials dealer.



©Masonite Corporation—manufacturer of quality panel products.

MASONITE CORPORATION  
Dept. AB-3, Box 777, Chicago 90, Ill.

Please send me information about Masonite exterior products and a free sample of a Ridgeline panel.

Name .....

Firm .....

Address .....

City ..... State .....

Zone ..... County .....

## NEW CONSTRUCTION TECHNIQUE

PROVIDES  
FINEST POOL

AT

**20%**  
LOWER  
COST



NOW...  
**AWARD LINERS**  
puts a luxurious pool  
within the reach of all!

**GENERAL  
PRACTICE**

**Boltaflex**

**MORE SALES...  
GREATER PROFITS**

### FOR CONTRACTORS & DEALERS

#### LOWER ORIGINAL COST— LOWER UPKEEP

Because only a three foot retaining wall is required for a full 6½ foot deep pool, the saving is tremendous! AWARD liners made of 22 gauge laminated Boltaflex match the bottom contours of the most expensive pools. Maintenance cost is reduced to a minimum.

#### BACKED BY YEARS OF ENGINEERING EXPERIENCE

AWARD pools are produced by DAVIS PRODUCTS, INC., pioneers in low-cost vinyl-lined pools made of genuine Boltaflex by a division of the General Tire and Rubber Company. Every AWARD pool liner is sold direct to you from the manufacturer, thus eliminating another costly middleman operation.

#### UNCONDITIONALLY GUARANTEED

Every AWARD pool liner carries a written guarantee of complete satisfaction against any defect. You can be a part of the big future for AWARD pool contractors and dealers. Be ready for the big season ahead. Act now! Get the facts without delay...it will pay!

Write, Wire or Phone for complete details  
& dealer franchise availabilities!

## AWARD POOL DIVISION

DAVIS PRODUCTS, INC.  
1631 Tenth St., Santa Monica, California  
AB-3

American  
Builder

TRAINING YOUR MEN

## How to do it better

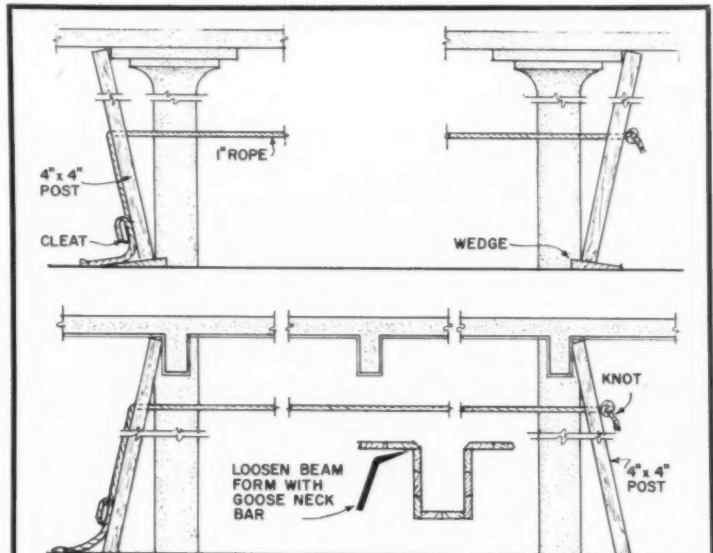

### Builder devises new method for stripping forms

The drawings above illustrate the method we have developed for stripping concrete forms that: 1. reduces injury to the builder's crew; 2. protects the new concrete; 3. reduces damage to forms during the stripping operation.

In concrete form work, after the concrete has hardened, the forms have to be removed. They should be constructed so that they can be removed easily and without injury to the men removing them. This is especially true if the forms are to be used more than once.

We have had great success with a rig that consists of four 4x4's used in pairs with a rope strung between a pair of posts placed under each end of the form being removed.

The rope is drawn up taut under the form. The form is then removed from the concrete and is carried by the ropes strung between the two pairs of posts. By releasing one end of rope at each pair of

posts the forms can be gradually let down from the ceiling.

To construct the rig: the uprights are cut a little longer than the height between the floor and ceiling slabs. Holes are then bored to take the rope at its upper ends, at a point just below the girder forms. See drawings. One end of the rope is strung through a post and knotted. The other end is strung through the opposite post and carried down the post to the point where it will be tied to a cleat after the posts are wedged into position.

If a girder form sticks, it can readily be loosened by using a goose neck bar as shown above. As mentioned, the forms drop on the ropes and are lowered to the floor by releasing the ropes from around the cleats. Same operation is used in stripping both beams and slab forms.

Harry Bryndza  
Scranton, Pa.

(Continued on page 186)

*nothing performs like Clay Pipe  
for Air Conditioning Systems*

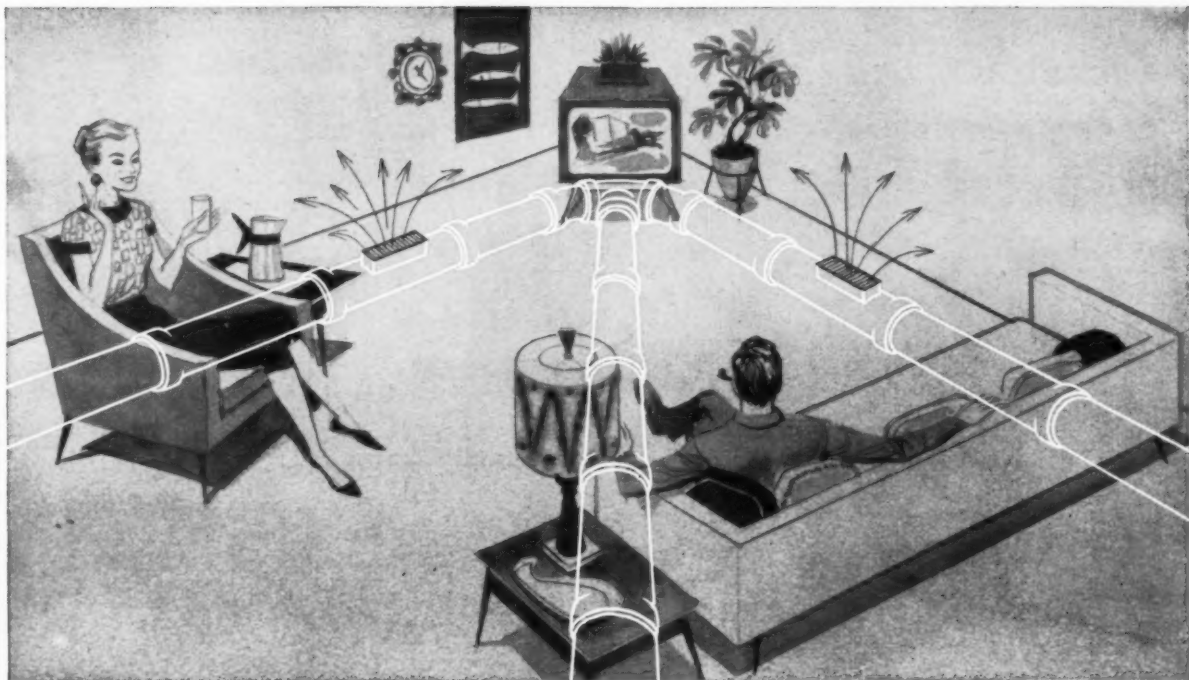

No other material is so easy and inexpensive to install . . . so efficient in its performance.

Ease of installation keeps material and labor costs at a minimum . . . requires no special skills. New longer lengths speed up the job. And Clay Pipe Ducts won't float or squash out during slab pouring.

The very qualities of clay itself make first costs the last. Clay Pipe—and only Clay Pipe—is completely rust, rot, and corrosion-proof. Its smooth vitrified surface won't flake off or collect dirt and odors, making it equally efficient for carrying heated or cooled air.

Protect your reputation . . . cut your costs. Install Clay Pipe Heating and Air-Conditioning ducts. Remember . . . *only Clay Pipe has ALL the features you can trust!*

C-558-4

*Vitrified*

**CLAY PIPE**

*Never Wears Out*

**NATIONAL CLAY PIPE MANUFACTURERS, INC.** 1820 N Street, N. W., Washington, D. C.  
311 High Long Bldg., 5 E. Long St., Columbus 15, Ohio • 703 Ninth & Hill Bldg., Los Angeles 15, Calif. • 100 N. La Salle St., Rm. 2100, Chicago 2, Ill. • 206 Mark Bldg., Atlanta 3, Ga.

# All New and Great

## HENRY

### MARK II BACKHOE



#### FEATURING...

STREAMLINED WITH GREATER EYE APPEAL • 200° CONTINUOUS SWINGING ARC LARGE CAPACITY BUCKET WITH 16 BUCKET SIZES AVAILABLE • QUICK DETACH MAXIMUM DIGGING POWER • MAXIMUM OPERATOR VISIBILITY AND COMFORT • INDIVIDUAL HYDRAULIC OUTRIGGER CONTROLS • EQUALIZED WEIGHT DISTRIBUTION • HEAVY-DUTY PERFORMANCE • GREATER OPERATING EFFICIENCY SECTIONAL CONTROL VALVE ESPECIALLY DESIGNED FOR SMOOTHER, FASTER BACKHOE OPERATION • NO SPECIAL BUCKET REQUIRED FOR BELLHOLES, GRAVES, OR OTHER VERTICAL DIGGING

#### AND ONLY HENRY HAS . .

Large diameter, chrome piston rods.  
Double-acting, heavy-duty cylinders, honed to micro finish.  
Large diameter pins, replaceable bushings at all pivot points.



## HENRY

MANUFACTURING  
COMPANY, INC.  
TOPEKA, KANSAS

... YOU CAN DO IT BETTER WITH A HENRY ...

#### How to do it better . . .

(Continued from page 184)

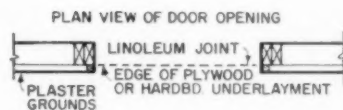

#### How to make floor surfacing join directly beneath door

A sure way to make joints at linoleum and hardwood floors come directly beneath the door when it is closed, is to line up the underlayment with the face of rough studs as shown in the above sketch.

Norman Hanson, Portland, Conn.

#### Precast curbing costs less, is easy to maintain

We used massive curbing to blend with the wide verandas and brick walls of the motel we were building. It was necessary to take precautions against frost heaving and damage caused by arriving motorists.

In order to keep down the cost of maintaining the curb, we used the type of curbing shown in the sketch. Five-foot sections of pre-

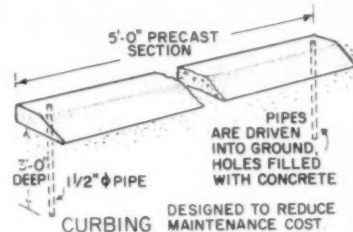

cast concrete were used, with a beveled face to stop car wheels. These sections lay on top of the ground, where they are less subject to frost heavings.

Two holes are cast into the curbing just in from each end. Two 1 1/2" dia. pipes are driven down into the hole, to be embedded 3' into the ground. The top of the hole is then plugged with concrete. When frost is working the ground under the concrete sections, the pipes are rarely affected because they are narrow enough to permit the ground to work around them.

If frost does heave a concrete curb out of line, it can be pried off the pipes, the pipes withdrawn from the ground, and the concrete plugs knocked out. Then the section can be reset.

Henry Josephs, Box 22  
Gardenville, Pa.

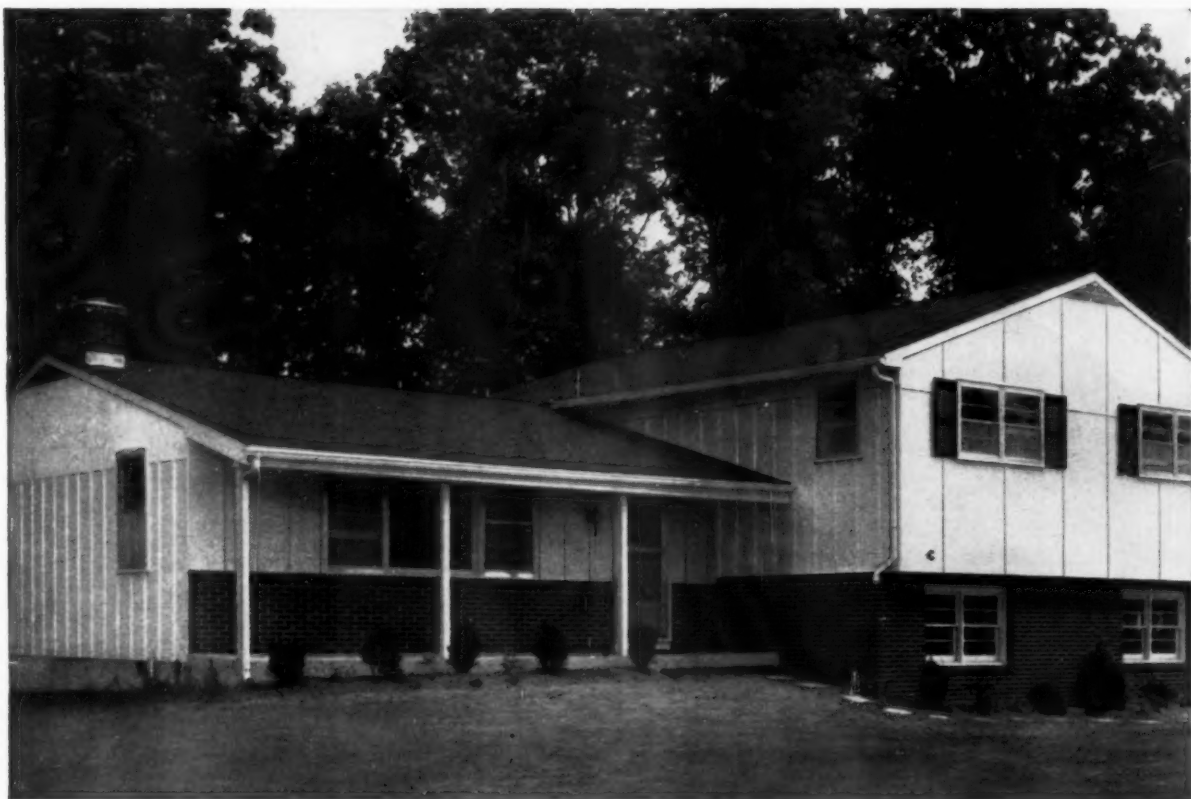

BYRNG E. CARLSON, DESIGNER AND BUILDER, LOWER GWYNEDD, PA.

## VERSATILE...ATTRACTIVE...LOW-COST

### K&M ASBESTOS-CEMENT DECORATIVE PANELS OFFER EXCITING NEW POSSIBILITIES IN DESIGN!

Here's how one builder utilized K&M Asbestos-Cement Decorative Panels to form striking combinations... at reduced costs.

On the left side of the house, he used K&M Ribbed Decorative Panels... with K&M Linabestos Flat Sheets forming the lower half. At the right, he installed K&M Fluted Decorative Panels. These combined with K&M Asphalt Roofing Shingles to give an attractive contemporary appearance to this medium-priced house.

In addition to good looks, K&M Asbestos-Cement Decorative Panels have many client-pleasing features.

Cost is low. Construction is inexpensive. Installation is fast. Maintenance is almost zero. K&M Asbestos-Cement Decorative Panels are vermin-proof and weather-resistant. Never need protective painting. Won't burn,

rot, or corrode. Consist of asbestos fibers and portland cement.

K&M Asbestos-Cement Decorative Panels offer you a good-looking, economical material that can enhance any residence... regardless of the price range of the house. Write to us today for complete information.



**KEASBEY & MATTISON**  
 COMPANY • AMBLER • PENNSYLVANIA

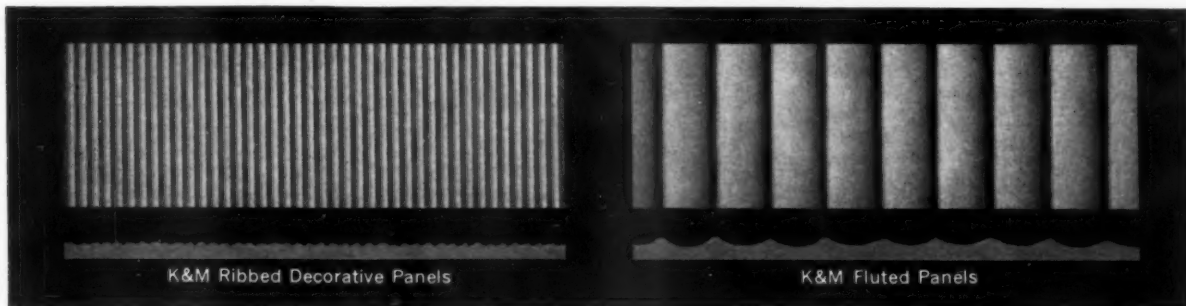

K&M Ribbed Decorative Panels

K&M Fluted Panels

# To OPEN YOUR GARAGE DOOR



... just  
press the button ... with

## FRANTZ

### electric operators

#### TWO MODELS TO CHOOSE FROM

**MODEL NO. 175**—With remote control as shown above. Easy to install, ready to plug in any 110 volt AC outlet. No interference with other frequencies. No tuning or adjustments required. No wiring.

**MODEL NO. 133**—A low cost electric operator (with remote control) with many features normally found only in higher priced operators. Operates all overhead doors up to 16' x 7' with complete safety and comfort.

Now—at moderate cost—you can enjoy the luxury of push button control for your Garage Door. Don't get out of the car—just press the dash button, anywhere from within 100 feet of your garage. The FRANTZ No. 175 Deluxe Model opens, closes the door, turns on, turns off the light.

Absolutely safe—if door strikes obstacle it *stops instantly*, then moves away from object. You get smoother, more powerful action, on either rigid or sectional doors, from size 8' x 7' to 16' x 8'. Ask about the No. 175, deluxe door operator with remote control, the operator that never forgets!

Nationwide Distribution—see your lumber dealer

**FRANTZ MANUFACTURING COMPANY**  
STERLING, ILLINOIS

## Why LaBelle Cut Nails hold tighter, longer

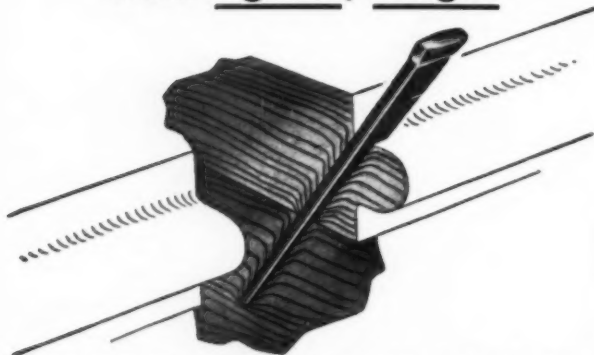

LaBelle Special Hardened Cut Nails cut and wedge their way into wood so that the wood fibers work like the barbs on fish hooks. This keeps floors tight, solid and silent for years.

Cut from solid steel, LaBelle Nails have four sharp corners and tapered shanks. They are available in many types—from 1½" to 8" long. For details, see our representative or write to Wheeling Corrugating Company, Wheeling, W. Va.



**WHEELING CORRUGATING COMPANY • IT'S WHEELING STEEL**

**LaBELLE CUT NAILS ARE STOCKED** in Boston, Buffalo, Chicago, Columbus, Detroit, Kansas City, Louisville, Minneapolis, New Orleans, New York, Philadelphia, Richmond, St. Louis. **SALES OFFICES** in Atlanta, Houston

## The NEW MODEL STAIR KING METAL-FOLD STAIR



Takes 2 men only  
**20 minutes**  
TO INSTALL

Low Prices  
to Builders

**3 WIDTHS  
5 LENGTHS**  
for every  
requirement

**STEEL  
STAIR**  
responds to the  
lightest touch

**FREE LITERATURE**  
on TFC's complete line of  
stairs is yours for the ask-  
ing—just attach this ad to  
your letterhead and send  
to...

**TENNESSEE FABRICATING CO.**

1229 Grimes St. • Memphis 6, Tenn.

Ask for info on these other TFC Products: ATTIC FANS • 3'-n-1  
STAIR-FAN COMBINATION-THERMAFLOW EXHAUST  
SYSTEMS • ORNAMENTAL IRON • MAIL BOX STANDS

AMERICAN BUILDER

# TRANSMIX UTILITY MIXER

FOR THE "ONE TIME"  
OR REGULAR  
USER!

1 OR 1½ BAG CAPACITY



- Mixes while transporting
- Dumps hydraulically
- Attaches in minutes
- No holes to bore
- No gears

The new TRANSMIX is truly the machine of a 1001 uses. Mix feed, silage, cement, haul dirt. Patented fins make cleaning easy. Save on your home or farm improvements. Barrel revolves on rubber wheels. Fits most tractors. For complete FREE folder, write: -

**UNCONDITIONAL  
GUARANTEE!**

**UNIVERSAL PULLEYS COMPANY**  
355 N. Mosley, Wichita, Kansas

## BUILDERS—this lady says

"My Inter-Call Saves Me a  
MILE OF STEPS EVERY WEEK!"

An INTER-CALL homemaker estimates she saves over 1700 steps a week, thanks to INTER-CALL! She monitors her nursery, front door and two bedrooms — all from her kitchen or any room in the house. And INTER-CALL gives her radio programs at the same time. Here's why INTER-CALL belongs in your Homes. You offer your prospects:

1. Two-way voice intercommunication.
2. Slide button selection of remote stations
3. Remote stations can call master
4. Remote stations can call other remotes
5. Turned off remotes can still call the master.
6. Monitor nursery and listen to radio at same time
7. Master and five speakers at budget prices
8. Answer the Front Door
9. AM radio programs and music
10. Phono jack for record player
11. Appliance outlet
12. Smart Copper or Gold styling



WRITE TODAY  
to Dept. A1 for folder.  
Some Dealer Territories  
Still Available

**MUSIC & SOUND, INC.**

118 Leslie Street  
Dallas, Texas

## NOW YOU CAN PAY-AS-YOU-BUILD

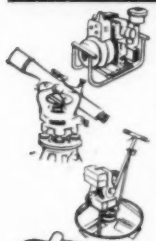

New, modern power equipment like Generators, Power Trowels, Transit Levels — can be yours to USE while you take . . .

**UP TO 12 MONTHS TO PAY!**

**FREE!** Full details on the new Pay-As-You-Build plan that lets you pay for new power equipment while it makes profits for you! Send for your free copy of this booklet! Write today!



**TOOL COMPANY**

1912 WALNUT STREET • KANSAS CITY 8, MO.

## BUILDING OFF CITY SEWER LINES ????

For Liquid Disposal Use Metal Seeping Wells

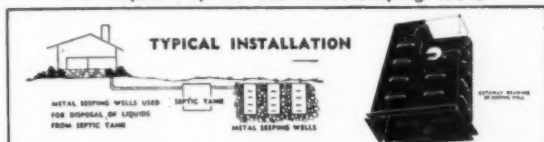

Unsurpassed for efficient disposal of Septic Tank Liquids, Drain Water, Roof Water — Makes possible use of automatic washers, dish-washers, etc. — Perfect for small lots — Easy and economical to install — Provides large open areas to handle large influxes of water — Will greatly increase efficiency of new or existing drain-fields when installed at end of drain lines — Ideal for steep slopes — 47 gallon capacity.

Write For Free Booklet

**STERLING AWNING CO.**  
Bldg. Material Division  
P. O. BOX 245 - BELPRE, OHIO

DEALER INQUIRIES INVITED

building  
a  
swimming pool  
without  
Modern equipment...  
is like  
building  
a house  
without



foundation!



Since 1935 — Modern has been the country's leading manufacturer and most reliable source for all pool building equipment and supplies. Just name it and Modern has it for concrete, tile, steel, fiberglass and plastic pools — over 100 top-quality products including filters, drains, underwater lights, ladders, diving boards, pool paint. Modern means more engineering know-how. Modern means less cost for greater value.

### FREE CATALOG!

52 page Catalog & Data Book, includes prices, descriptions, photos, facts on pool care. Call your nearest Modern distributor or write for his name and Catalog No. 21P

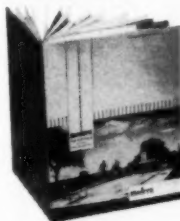

# modern

SWIMMING POOL CO., INC., 1 HOLLAND AVENUE, WHITE PLAINS, N. Y.

**BUSTER CRABBE**  
Swimming Pool  
**DEALERSHIPS**  
**NOW AVAILABLE!**

Cash in on the  
Prefab Pool that's  
revolutionizing  
the industry!



a whopping 16 x 32 ft.

**ONLY \$1095 RETAIL**

Imagine! You can now offer the public a lifetime, in-the-ground BIG pool at one-half the cost of a new family car! Yet you will actually be selling a superior swimming pool . . . one that outlasts and is far cheaper to buy, build and maintain than any type pool on the market. (As you know, comparable 16 x 32 ft. pools sell at \$3500 or more.)

Our secret? It's our prefab method of construction using "wolmanized" panels and vinyl liners. The Buster Crabbe Pools can be professionally installed or erected by the homemaker as a do-it-yourself project. Either way, your profit is great . . . your potential enormous.

A low four-figure investment is all that's required. Send for our story . . . NOW!

**Cascade  
Pools**

**ONE OF THE COUNTRY'S OLDEST  
BUILDERS OF SWIMMING POOLS**

.....  
**CASCADE POOLS**  
 811 ROUTE #33 • TRENTON 9, N. J.  
 JUniper 7-5555  
 Please send detailed information regarding Buster Crabbe Pools Dealer Franchise.  
 NAME.....  
 TITLE.....  
 FIRM.....  
 STREET.....  
 CITY..... ZONE..... STATE.....  
 .....

# Ask the experts . . .

**New  
mortar  
costs less,  
reduces  
installation  
time . . .**



NEWLY developed additive permits thin coat Portland cement mortar to do same job as thick coat.

**QUESTION:** Information on the following three-part question will be appreciated: (1.) I would like to know the materials and proportions for light-weight simulated brick work. (2.) Can white-coat plaster be applied directly to dry wall for a rough finish? If so, give the proportions and minimum thickness required. (3.) What is the source of supply and instructions for use of the new mortar mix for ceramic tile (see attached news clipping)? All information should be applicable to the Bellevue, Ohio, area.

C. E. Posegate  
Deerfield Beach, Fla.

**ANSWER:** The materials and proportions for lightweight simulated brick work are the same proportions as for regular stucco. The system is applied the same as stucco. It is applied in three stages: The first coat, called the scratch coat, is 3/8" thick, applied over screening or wire mesh. The second, or brown coat, consists of one thin coat followed by another. The brown coat is cured for two days by keeping it damp. Don't let it dry. There should be at least seven days between applying the brown coat and the third or finish coat. A pointing tool is used to mark off the finish coat into the sections of simulated brick.

White-coat plaster can be applied to dry wall for a rough finish. Here is the way to do it: Gypsum wood fibered plaster is used. This plaster is mixed with sand in equal proportions: one part of sand to one part plaster. The minimum thickness is 3/8".

You have asked for a source of supply of a new thin mix mortar used to install ceramic tile. This system was recently developed by the Tile Council. We suggest you write directly to them for this information. Their address is: Tile Council of America Inc., 800 Second Avenue, N.Y. 17.

Regarding the instructions for installing the tile with this new mix, The L & M Tile Products, Inc., Box 4655, Dallas 6, Tex., has compiled an installation manual that should answer all questions you might have. We have sent you a copy of this manual. There are many advantages to the new mortar: when setting tile over concrete block the new set can fill out and feather off-plumb walls, depressions and imperfections in the wall. Pre-soaking of the ceramic tile is eliminated. There is no need for costly metal lathing. The prime coat is also eliminated, with the mortar acting as its own primer and sealer.

(Continued on page 192)



*for the finishing  
touch to your  
higher priced homes*

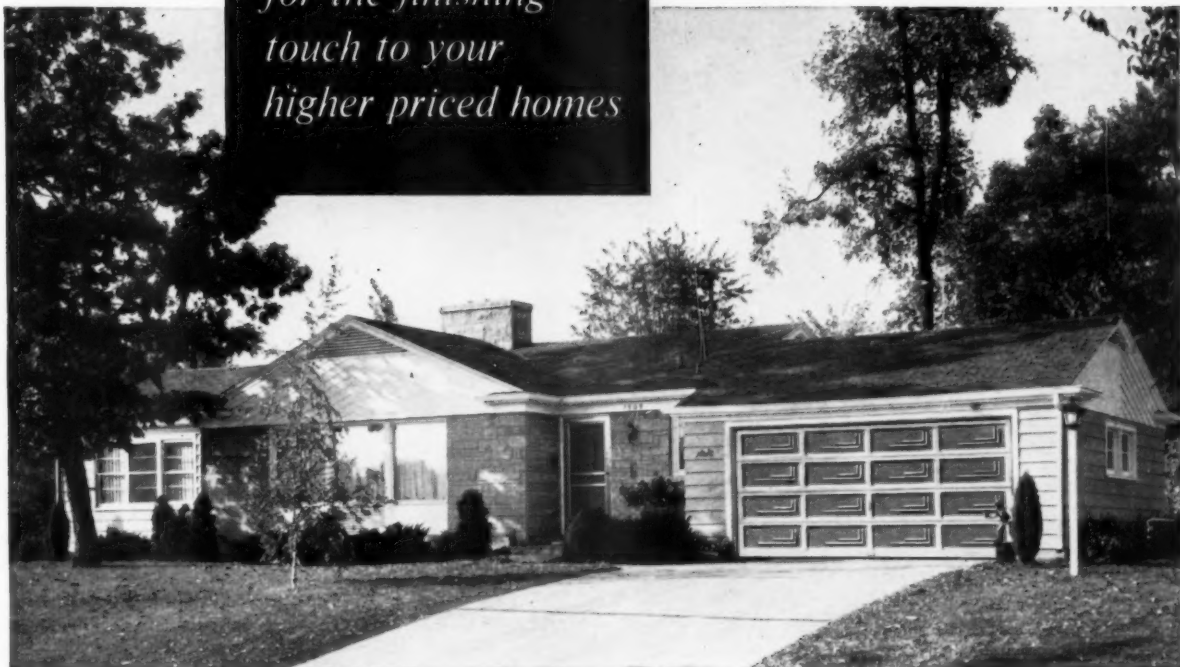

## RO-WAY GARAGE DOORS

If you're like most builders today, you're building bigger homes . . . better homes . . . with more of the deluxe features most buyers want.

For the finishing touch, the touch that adds a lot of value at little cost, install RO-WAY garage doors. In the complete RO-WAY line you'll find standard and special styles and sizes . . . models for virtually every headroom requirement . . . more than 40 decorative panel designs for individualized custom appearance.

And back of all this beauty is unmatched RO-WAY quality. Selected kiln-dried lumber. Precision-fit millwork. Mortise and tenon joints both glued and steel-pinned. Rabbeted sections. Taper-Tite track and Seal-A-Matic hinges for easy

opening, weather-tight closing. Quiet, smooth-gliding ball bearing track rollers. Power-Metered springs individually balanced to the weight of the door. And all hardware *doubly* protected against rust and corrosion—both Parkerized *and* painted after fabrication.

And for the last word in convenience, include a specially designed, completely dependable RO-WAY electric operator with either push-button or remote radio control.

That's RO-WAY—the quality designed, quality built garage door that adds the finishing touch to your homes for lasting owner satisfaction. Call in your experienced, helpful RO-WAY distributor, or write to Rowe for full details.

*there's a Ro-Way for every Doorway!*

RESIDENTIAL  
COMMERCIAL  
INDUSTRIAL

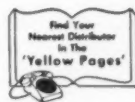

ROWE MANUFACTURING COMPANY • 790 HOLTON STREET • GALESBURG, ILLINOIS



Never too early to specify the  
**THERMADOR**  
 Masterpiece "Bilt-in"  
 Electric Range

More architects and builders each year are specifying Thermador "Bilt-ins" in the kitchens of their finer homes. They've learned that discriminating buyers who look to their new homes as lifetime investments want the finest electric ranges and refrigerator-freezers at so little extra cost.

The best time to talk Thermador to your client is right now, at the blueprint stage. Point out the advantages of Thermador "Bilt-in" cooking tops and ovens... the matchless quality, the Lifetime stainless steel (or decorator color) finish, the ease and low cost of installation during construction, and the Thermador "Bilt-in" reliability that pays for itself in minimum service and repair.

Do yourself a favor. Specify when you can, install when you make the choice... Thermador "Bilt-in" electric cooking tops and ovens and refrigerator-freezers... the "Bilt-ins" that make the builder look better.

Originator of the "Bilt-in" Electric Range



Air-cooled oven door has over-sized, easy-grip handle to avoid finger burns. Fully automatic. Three-spit rotisserie.

Most happy couple loves their handsome Thermador "Masterpiece" Electric Range and their builder for recommending it.



Please send illustrated literature on

"Bilt-in" Ranges  "Bilt-in" Refrigerator-Freezers

—ARCHITECT —BUILDER —ELECTRICAL CONTRACTOR —WHOLESALE —DEALER

NAME \_\_\_\_\_

ADDRESS \_\_\_\_\_

CITY \_\_\_\_\_ COUNTY \_\_\_\_\_ STATE \_\_\_\_\_



**THERMADOR ELECTRICAL MANUFACTURING CO.**

A Division of Norris-Thermador Corporation

5119 DISTRICT BOULEVARD, DEPT. 11 • LOS ANGELES 22, CALIFORNIA

Ask the experts . . .

(Continued from page 190)

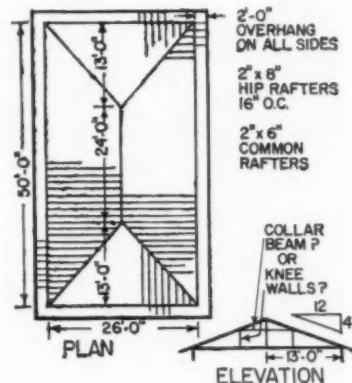

Do I need knee walls?

**QUESTION:** I am building a hip roof as shown above. Could you show how to frame the inside by using collar beams or do I need knee walls? I have a 4 and 12 pitch. If I have to use collar beams, could you tell me how to space them and how far down from the top they should be.

John F. Major, Jr., Md.

**ANSWER:** We would suggest you use collar beams on every other set of common rafters, and the collar beams should be 1x6's about 8' long. At the hip end, use wall ties on the ceiling joists 16" o.c. to prevent the walls under the hip section from being pushed out. The ceiling ties should take in at least 3 ceiling joists.

How to lay canvas roof decking

**QUESTION:** Can you give me any information on laying canvas roof decking, and on types of the cloth to use for the various jobs?

Malcolm Pickel, Orleans, Vt.

**ANSWER:** A mixture of linseed oil and white lead is placed on the surface to be covered and acts as a coater. The canvas lengths are laid on this primer coat with a minimum 1½" overlap and are fastened with ¾" flat head tacks. A good surface paint can be applied to the canvas upon completion.

For information as to the types of deck cloth write: C. R. Daniels, Inc., Daniels, Md.

Steinberg and Stemple  
 NYC Community College



## Packaged chimney is permanent masonry

The Van-Packer Chimney gives you masonry permanence and is safe even for incinerators. Asbestos-cement brick-design panel housing comes in red, buff, gray or white colors. It has natural mortar lines that give it the attractive appearance of real brick. Because the Van-Packer is factory produced, you save up to 40% on installation costs, one man can install it in 3 hours. See your jobber listed under "Chimneys—Pre-fabricated" in Yellow Pages, or write Van-Packer for Bulletin RS-1.—

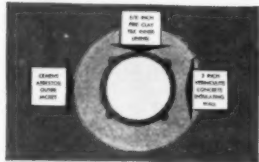

Permanent masonry construction makes Van-Packer safe even for incinerators. Withstands 2100° F.



One man can install a Van-Packer in 3 hours—saves on labor costs.



The Van-Packer comes completely packaged in sturdy, easy to handle cartons. All parts provided.

Snap-on housing cap

Brick-design panel housing

Aluminum flashing

Masonry flue sections

Snap-lock drawbands

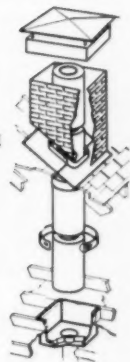

**Van-Packer** FACTORY-BUILT MASONRY **Chimney**

Van-Packer Company • Division of The Flintkote Company  
P. O. Box No. 306, Bettendorf, Iowa • Phone: East Moline, Ill. 3-5288

**IDEA OF THE MONTH**

## COUNT YOUR LUCKY STARS

**WIN \$100 BOND**



**CHAMPLAIN Park**

**LUCKY STAR CONTEST**  
PLATTSBURGH PRESS-REPUBLICAN

NAME \_\_\_\_\_ PHONE \_\_\_\_\_  
ADDRESS \_\_\_\_\_

THE NUMBER OF LUCKY STARS IS \_\_\_\_\_

DO YOU OWN YOUR OWN HOME? YES/NO \_\_\_\_\_

DO YOU USE OUR HOME JOURNAL? YES/NO \_\_\_\_\_

DO YOU KNOW HOW YOU CAN EASILY OWN YOUR OWN HOME AT CHAMPLAIN PARK? YES/NO \_\_\_\_\_

ENTRIES MUST BE POSTMARKED BEFORE THURSDAY OCT. 17th.

THIS CONTEST IS OPEN TO ALL RESIDENTS OF PLATTSBURGH AND VICINITY. THE WINNER WILL BE CHOSEN BY A JURY OF LOCAL BUSINESSMEN AND HOMEOWNERS. THE GRAND PRIZE IS A \$100 UNITED STATES BOND. ABSOLUTELY FREE!

SENDING TO BUY AND QUALIFICATIONS OF ANY KIND ARE NOT PART OF THIS CONTEST. THE PRIZES ARE NOT TO BE PAID TO ANYONE OTHER THAN THE WINNER. THE PRIZES ARE NOT TO BE PAID TO ANYONE OTHER THAN THE WINNER. THE PRIZES ARE NOT TO BE PAID TO ANYONE OTHER THAN THE WINNER.

**How to get 175 brand new prospects: run a contest**

Although standard, hard-sell newspaper ads had been used for several months, a series of ads featuring a contest turned up 175 brand-new prospects for Champlain Building Corp., Plattsburg, N.Y.

The company is building 500 National Homes ranging from \$10,800 to \$12,600 at Cumberland Head, near Plattsburg (pop.: 22,000). Through ads (see above) in the *Plattsburg Press-Republican*, readers were asked to count tiny white stars in the ad.

The only sales pitch in the ad was a "clue" such as: "Tiny details are important to us in Champlain Park Homes." But the key question in the entry coupon to be clipped from the ad and sent in by each contestant with his count was: "May we show you how you can easily own your own home at Champlain Park?"

Five third-page insertions were run over a two-week period. Total cost: \$200. Letters went out to all contestants after the closing date inviting them to the new furnished model, where the winner would be announced and an open house held. A phone call followed to each contestant. Another ad announced the winner.

Besides the new prospects, the campaign directly resulted in five sales.

Based on his experience, builder Jerome Lieberthal feels that a contest of this type is best suited for a small city like Plattsburg "where everybody reads the local paper and people have plenty of time to count the stars."

No. 8 of a series . . . . . File but don't forget

▶ **Open house turns out leads by the hundreds**

Another way to get to know your prospects—and vice versa—was dramatically demonstrated by two Pittsburgh builders with a flair for public relations. Harry E. Wilson Inc. and Gibson & Jamison Construction Co. held an "open house" for all Westinghouse employees in town.

The two building firms merged their merchandising efforts on this one. Westinghouse helped too, let the builders put notices (prepared by Stanley Edge Associates) on all of its 350 bulletin boards throughout the plant for 10 days. On "D" (for Demonstration) Day more than 200 cars showed up.

"We had a steady flow of people all day starting at 10 a.m. until we closed at 10 p.m.," says Harry E. Wilson.

Every visitor was invited to sign up for a door prize but, according to Wilson, "because of the crowd between 6 and 8 p.m., some were missed."

Gibson & Jamison and Wilson got an assist from The Danforth Co., local distributor for Westinghouse. Danforth provided trained personnel to show and explain its exhibits and publicized the invitation in the *Westinghouse News*, the manufacturer's house organ. Danforth also furnished refreshments.

Now everybody's happy. Says Wilson: "Our salesmen have contacted each visitor who signed his name. We can tie two definite sales the first week to this promotion."

"Danforth is very pleased. We have since placed over 30 orders with them for equipment and have about 20 more to place."

Where do they go from here?

"Since the Koppers Co., the Aluminum Co., and U.S. Steel are also our close neighbors," says Wilson, "we are planning to invite them for a special day too."

▶ **How to keep 'em sold on the community**

After you've made them members of the "family," how do you keep them loyal to the local scene? Builder-developer Al Branden of Hayward, Calif., includes a three-month subscription to the local newspaper with the key to each house he sells.

# The Molded phenolic drawer...

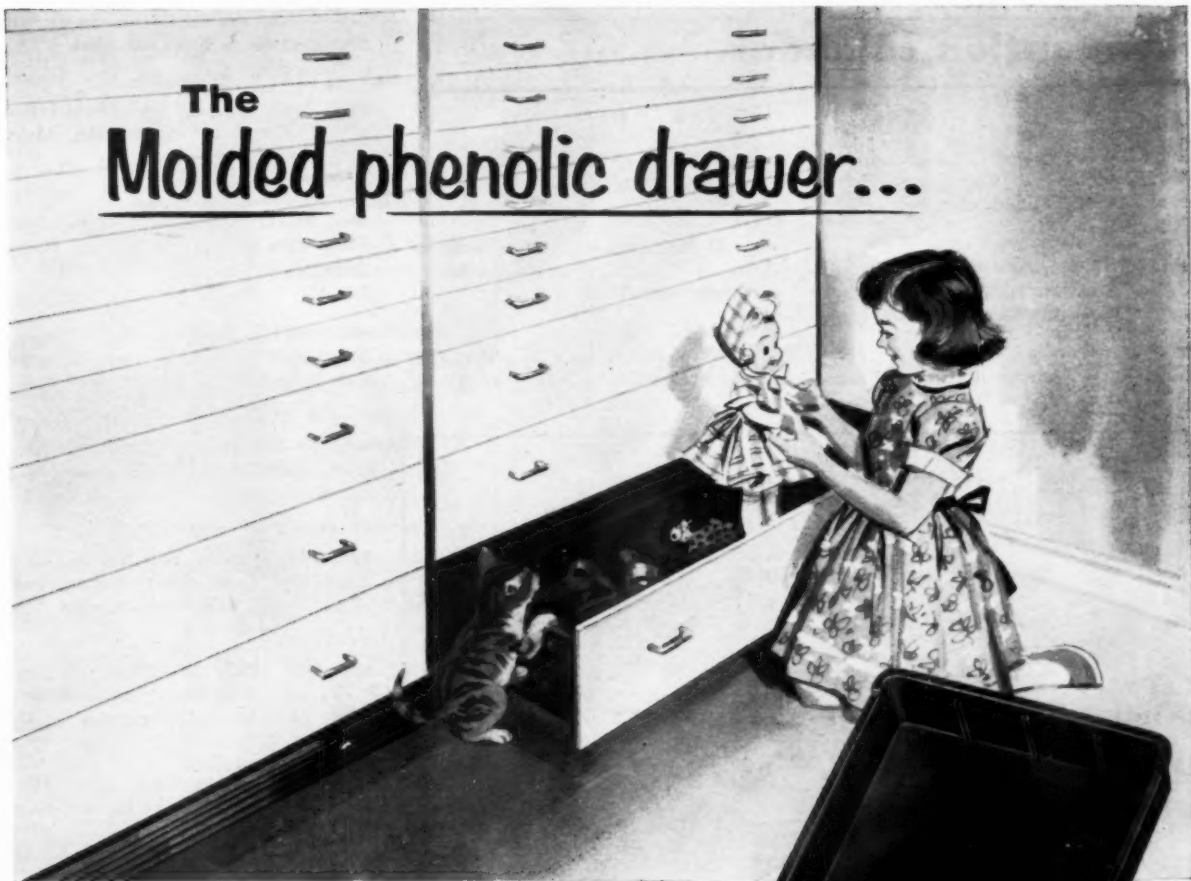

Beautiful to behold—

**EASIER TO INSTALL and—LIFETIME TROUBLE-FREE**

Molded drawers of BAKELITE Brand Phenolic add the look of "luxury living" everywhere they're used. Architects, builders, interior decorators and furniture designers looking for "something extra," specify these molded drawers for beauty, economy, and durability.

Adaptable to a wide range of uses and locations, these drawers are of permanently rigid, one-piece construction, with rounded interior corners. Quickly installed, with special runners and built-in

stops, they are easily wiped clean and are not subject to swelling and sticking.

Knoll-Drake Products, Inc. supplies these drawers in lustrous black finish, or with fronts spray-coated with tough BAKELITE Brand Epoxy Resins in grey or white finish.

For additional details and literature, write Dept. AB-58, Bakelite Company, Division of Union Carbide Corporation, 30 East 42nd Street, New York 17, N. Y.

**BAKELITE**  
BRAND  
PLASTICS

*Products of*



*Corporation*

# Convention calendar

(Continued from page 33)

**Mar. 22-30:** HBA of Chicagoland, 130 W. Randolph St., Chicago 1. Home show. G. McDonald, chm.

**Mar. 23-30:** Quad-City HBA, 1530 State St., Bettendorf, Iowa. Better homes exposition. D. Thoensen, chm.

**Mar. 23-30:** Associated Home Builders

of Louisville, 311 Madrid Bldg., Louisville 2, Ky. Home show.

**Mar. 23-29:** Niagara Frontier Builders Assn., 4 Erie St., Buffalo 2, N. Y. Home show. J. Wells, chm.

**Mar. 23-30:** Oklahoma City HBA, 328 Biltmore Hotel, Oklahoma City, Okla.

Home show. S. Davidoff, chm.

**Mar. 24-30:** Greater Springfield HBA, 134 Chestnut St., Springfield, Mass. Home show.

**Mar. 25-31:** HBA of Knoxville, 1004 Tulip Ave., Knoxville, Tenn. Home show. D. Dickey, chm.

**Mar. 26-30:** HBA of San Joaquin Valley, 3430 Normal Ave., Fresno, Cal. Home show. J. Rankin, chm.

**Mar. 26-29:** HBA of Greater Johnstown, 530 Cypress Ave., Johnstown, Pa. Home show. J. Custer, chm.

**Apr. 2-19:** HBA of Fort Wayne, 1306 Northlawn Drive, Fort Wayne, Ind. Home show. J. Worthman, chm.

**Apr. 3-6:** HBA of Miami County, P. O. Box 147, Troy, Ohio. Home show. Jack Meyers, chairman.

**Apr. 5-20:** Tucson HBA, Box 6186, Tucson, Ariz. Parade of Homes. Don Clark, chairman.

**Apr. 8-12:** HBA of Chattanooga, 2415 McCallie Ave., Chattanooga, Tenn. Home show. J. Gregory, director.

**Apr. 11-13:** Lawton HBA, 223 Koehler Bldg., Lawton, Okla. Home show. J. Johnston, chairman.

**Apr. 12-20:** HBA of Metropolitan Denver, 933 Sherman, Denver, Colo. Home show; Denver University Arena and Field House.

**Apr. 13-20:** HBA of Greater Kansas City, 4638 J. C. Nichols Parkway, Kansas City, Mo. Home show; Municipal Auditorium.

**Apr. 13-20:** HBA of Memphis, 2440 Central Ave., Memphis 4, Tenn. Home show. D. Savage, chairman.

**Apr. 15-20:** HBA of Mahoning Valley, 3119 Market St., Youngstown, Ohio. Home show. C. McGranahan, chm.

**Apr. 17-20:** Portland HBA, 3140 N. E. Broadway, Portland, Ore. Pacific N. W. home builders convention. Robert L. King, chairman.

ANOTHER HOMASOTE FIRST



This smart new material for

## EXTERIOR FINISH

**Grooved Vertical Siding**  
PANELS 4' x 8' TO 4' x 12'  
WITH GROOVE-LAP JOINTS

This new, weatherproof siding material is the most economical of its type and extremely easy to apply. Deeper, wider grooves—made possible by the high-density,  $\frac{3}{8}$ " thickness—run every 8" the length of the board. On both sides, the special 3-stage groove-lap joint assures rapid, true-line installation.

GVS is supplied in 4' x 8', 4' x 10', and 4' x 12' panels. On special order, GVS is also available in size 4' x 9'—at no extra cost. It is available primed front and back, or unprimed. Behind this board are more than 40 years' experience in the making of weatherproof materials. GVS offers superior insulation value, durability, and weather-protection—holds paint longer than wood. Use the coupon below to secure full details on this and other Homasote products, and for your copy of the 72-page Homasote Handbook.



### SOFFITSOTE

—the ideal soffit material—comes in 8' lengths and handy 12", 16", 24", 32" and 48" widths. Grooves—8" apart—run the length of the soffit—match the modern design of large overhangs. Groove-lap ends and sides assure true-line joining. Available primed or unprimed. The Wilson Air-Float construction method saves all the labor and time of boxing the rafters to support the soffit material.



## HOMASOTE COMPANY

In U. S., kindly address  
Trenton 3, New Jersey.  
In Canada: Toronto, Ont.—P.O.  
Box 35, Station R • Montreal,  
P. Q.—P. O. Box 20, Station W



Send the literature and/or specification data checked:

- Grooved Vertical Siding     Panel-Tile (on 4' x 8' panels)  
 Soffitsote     Beveled (clapboard) Siding  
 Wilson Air-Float Construction     Homasote (72-page) Handbook

NAME .....

ADDRESS .....

CITY ..... ZONE ..... STATE ..... C-5

But Rejoice He for...



HAROLD "Heavenly" HISWAY  
Angel and Builder

Here Lies  
Harold "Hidebound" Hisway  
Builder

A rugged individualist to the end,  
a believer in the past from the  
beginning, the 'exception' to every  
rule, the proverbial cart before the  
horse, he labored like the mountain,  
but brought forth a mouse.

Weep not for  
Harold Hisway...

In heaven, Harold now sees the light. And, as his heavenly reward for his earthly frustrations, Harold builds nothing but Dream Houses. The transition is complete. Harold is now feeler of the public pulse, purveyor of the public want, believer in the brand name, booster of the beautiful, user of the useful, seller of the saleable and builder of Heavenly Homes, all of which have

# Heavenly Columbia SCREENS

Fortunately . . .

You don't have to be an angel to appreciate the tangible builder benefits of Columbia Aluminum Window Screens.



There is a Columbia TENSION SCREEN or a Columbia TUBULAR ALUMINUM FRAME SCREEN for every type of window.



All Columbia Screens are delivered to your exact specifications, no fitting required, quick, easy installation—no template needed—cut labor costs.



All Columbia Screens are rigidly made and carefully inspected. Every screen you install in your homes has the unqualified backing of The Columbia Mills, Inc., and its entire distributive organization.



Columbia Screens are "brand name" merchandise, known, respected and accepted by your customers as a standard of window screen value.



Your Columbia Screen Dealer is stocked and equipped to give you perfect service, not only in standard sizes but also special sizes, and he is backed by Columbia manufacturing facilities strategically located from New York to California.



Rustproof, stainproof, lightweight but rugged Columbia Window Screens are built for years of "trouble-free," "no-service" operation.

Why not investigate all the advantages of Columbia Screens in your homes? Simply call your local Columbia Dealer, or write: Dept. 23.

**THE COLUMBIA MILLS, INC.**  
120 W. Onondaga Street, Syracuse 1, N. Y.



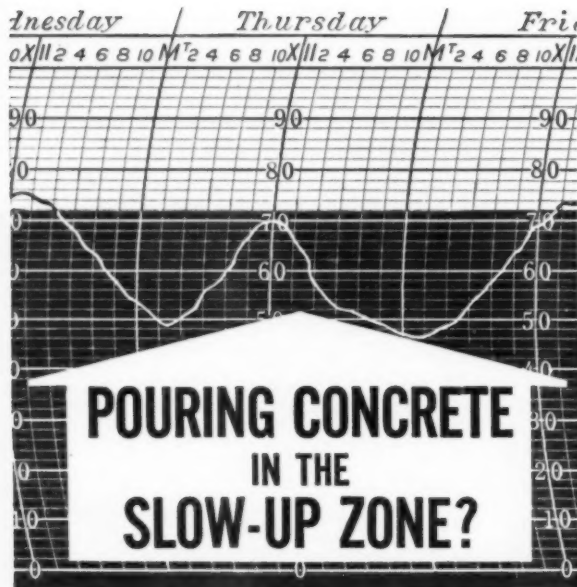

## Add SOLVAY CALCIUM CHLORIDE to Avoid Costly Delays!

When temperatures vary from 70° down to 50°—it spells "SLOW-UP" which means costly delays in your concreting operations. This drop below 70° sharply decreases strength development and lengthens the waiting period before finishing.

A drop from 70° to 50°, for example, cuts 3-day strength up to 40%. To prevent this, add a low-cost 2% of SOLVAY Calcium Chloride to your concrete.

With this acceleration, concrete poured at 50° has a 3-day strength up to 40% greater than ordinary concrete cured at the ideal temperature of 70°!

When you use SOLVAY Calcium Chloride, you do away with overtime finishing, delays in form removal, delays between operations. You save up to 50% on protection time. And you get better concrete—increased in both early and ultimate strength—with lower water-cement ratio for more moisture-and-wear-resistant concrete.



SOLVAY Calcium Chloride accelerates, but does not change the normal action of portland cement. Tests by the National Bureau of Standards proved its advantages in cold weather concrete construction. It is recommended by leading authorities, including American Concrete Institute and Portland Cement Association.

Write now for full data!

### SOLVAY PROCESS DIVISION



ALLIED CHEMICAL & DYE CORPORATION  
61 Broadway, New York 6, N. Y.

BRANCH SALES OFFICES:

Boston • Charlotte • Chicago • Cincinnati • Cleveland • Detroit • Houston  
New Orleans • New York • Philadelphia • Pittsburgh • St. Louis • Syracuse

### QUANTITY MATERIAL LIST

(Continued from page 97)

House Area	Frame	Ranch Type 1,155 sq. ft.
<b>CONCRETE WORK</b>		
Location	Actual	Actual +5%
Foundation Walls	195 cu. ft.	
Pier Footings	38 cu. ft.	
Concrete Terrace 6"	60 cu. ft.	
Fireplace Wall	20 cu. ft.	
Garage Slab & Apron 4"	172 cu. ft.	
Fireplace Footing	27 cu. ft.	
Fireplace Slab 6"	12 cu. ft.	
Porch Slabs	20 cu. ft.	
	544 cu. ft.	572 cu. ft. or 22 cu. yds.

<b>BRICKWORK</b>		
Location	Description	Amount
Chimney & Fireplace	Brick	125 cu. ft.
Flue Lining	8 x 8 T.C.	15 lin. ft.

<b>TILE WORK</b>		
Location	Description	Amount
Bath Floor	ceramic	45 sq. ft.
Bath Walls	ceramic	132 sq. ft.
Lav. Floor	ceramic	22 sq. ft.
Lav. Walls	ceramic	60 sq. ft.

<b>DRY WALL</b>		
Location	Amount	
House Walls	approx. 2,560 sq. ft.	
House Ceiling	approx. 1,155 sq. ft.	
Garage Walls	approx. 510 sq. ft.	
Garage Ceiling	approx. 420 sq. ft.	

<b>FRAMING LUMBER</b>					
Location	Size	Pieces	Lin. Ft.	B.F.M.	
Posts	4 x 4	—	50	67	
Girder	2 x 6	—	600	600	
Plates and cats	2 x 4	—	1,050	700	
Studs	2 x 4	425/8	3,400	2,267	
Sills	2 x 4	—	190	127	
Rafter Chords	2 x 4	72/16	1,152	768	
Bottom Chords	2 x 4	72/14	1,008	672	
Purlin	1 x 4	72/12	864	288	
Rafters for Valley Framing	2 x 4	15/14	210	140	
Top Bearing Plate	(2) 2 x 8	—	380	507	
Porch Rafters	2 x 4	18/14	252	168	
Porch Header	(2) 2 x 8	—	72	96	
Posts	4 x 4	2/8	16	22	
Ridge Board	2 x 4	—	80	54	
Rafter Blocking	2 x 4	—	160	107	
Porch Rafter Blocking	2 x 4	—	36	24	

### SHEATHING, SIDING, ROOFING, INSULATION, ETC.

Location	Description	Actual	Actual +10%
Side Wall Sheathing	1/2 plywood	1,400 sq. ft.	1,540 sq. ft.
Battens	1 x 2	1,400 lin. ft.	1,540 lin. ft.
Decking	2 x 8 plank	1,155 sq. ft.	1,271 sq. ft.
Roof Decking	1 x 6	2,180 sq. ft.	2,398 sq. ft.
Roof Decking	1 x 8 T & G	320 sq. ft.	352 sq. ft.
Roofing	cedar shingles	2,500 sq. ft.	2,750 sq. ft.
Finish Floor	3/4" stock	1,100 sq. ft.	1,210 sq. ft.
Ceiling Insulation	3" blown insulation	1,155 sq. ft.	1,271 sq. ft.
Gable Sheathing	lap siding 3/4 x 10	72 sq. ft.	79 sq. ft.
Gable Battens	1 x 2	144 lin. ft.	158 lin. ft.
Gable Sheathing	1/2" plywood	144 sq. ft.	158 sq. ft.

Note: The waste factor is determined by the type of material used and the method of installation.

### MILLWORK

Exterior Trim Location	Description	Amount
Fascia	1 x 6	250 lin. ft.
Frieze	1 x 8	110 lin. ft.
Louvered Vents	wood	3 pieces
Shutters	wood	10 pieces
Interior Trim Location	Description	Amount
Base	1 x 4	320 lin. ft.
Cl. Pole	1 1/2" diam.	24 lin. ft.
Pole Sockets	wood	4 pair
Cleats	1 x 3	30 lin. ft.

(Continued on page 200)



For knotty pine paneling...

consider **LOGEPOLE PINE**



small, non-bleeding knots characterize this light, easy-to-work wood

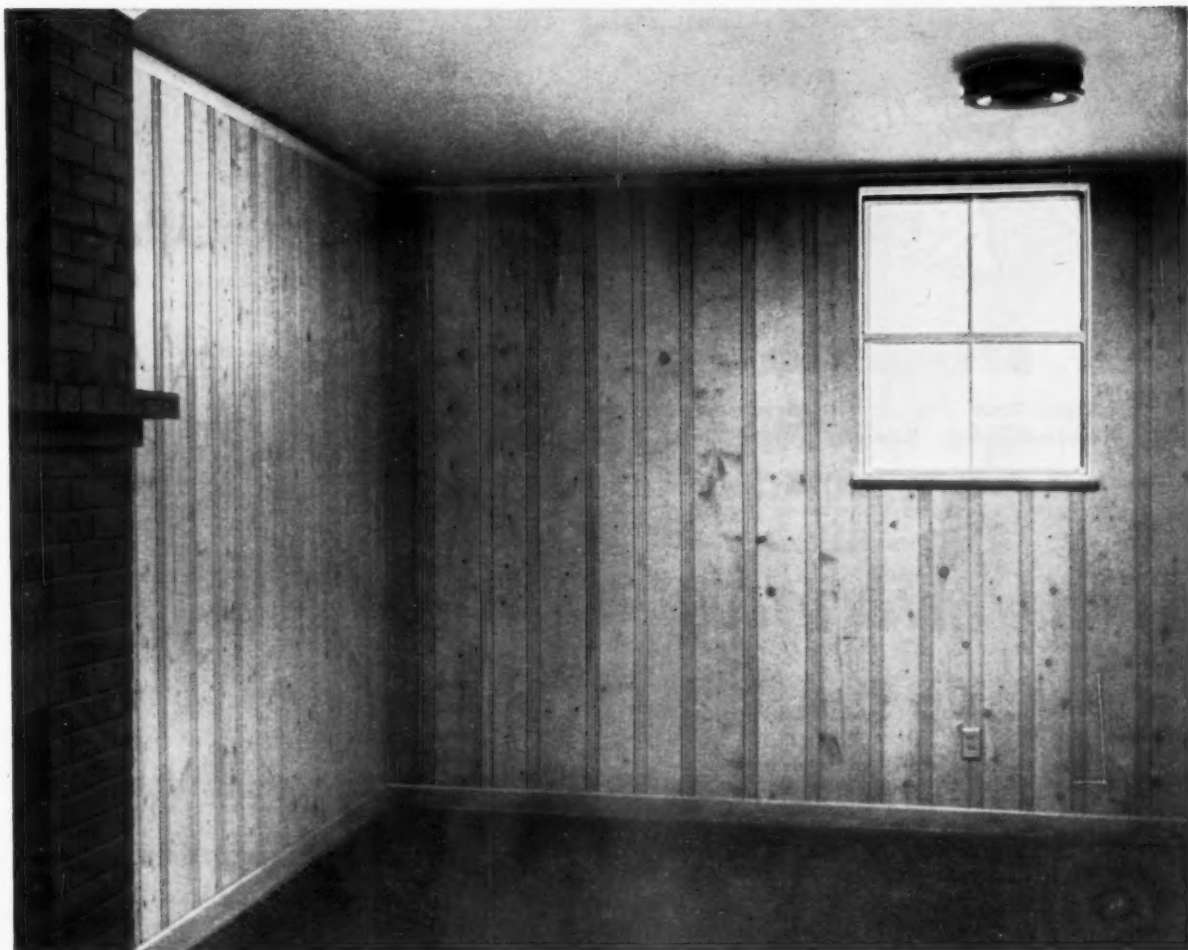

**LOGEPOLE PINE**—an ideal knotty pine. Home owners like it because its knots are small, and do not bleed. It machines to a smooth, satiny surface; and it has excellent paint and stain holding characteristics. In Lodgepole Pine, you have an attractive, practical knotty pine for any home setting.

Carpenters like it because it is light in weight, easy to handle and work. Lodgepole Pine is soft-textured, and it is easily nailed without splitting.

Sheathing, siding, subflooring are other excellent uses for Lodgepole Pine because of its smooth milling, accurate sizing and good insulation qualities. And it is *carefully dried*, assuring more accurate sizing and improved woodworking qualities, insuring lower maintenance costs.



Write for FREE illustrated Facts Folder about Lodgepole Pine to:  
**WESTERN PINE ASSOCIATION,**  
Dept. 703-B, Yeon Building,  
Portland 4, Oregon.



**Western Pine Association**

*member mills manufacture these woods to high standards of seasoning, grading and measurement*

**Idaho White Pine • Ponderosa Pine • Sugar Pine  
White Fir • Incense Cedar • Douglas Fir • Larch  
Red Cedar • Lodgepole Pine • Engelmann Spruce**

Today's Western Pine Tree Farming Guarantees Lumber Tomorrow

# E-A-S-Y DOES IT!



## Rodale

Sets The Pace In Modern,  
Push-Button Living With The

## E-A-S-Y ACTION

# "B" Touchette®

No knob to turn. No toggle to flip. Now, there's a switch designed for today's push-button living. It's "B" Touchette, the touch switch with feather-light operation.

Consider, too, Touchette's tremendous merchandising potential for your convenience-minded buying public. There's no time wasted freeing the hands . . . no spilling or breakage while juggling trays or groceries. And "B" Touchette is easy to install . . . needs no special wiring . . . fits standard outlet boxes and toggle wall plates. It operates on full line voltage, withstands motor loads up to 80% of rated capacity. Rated: 15A-120-277V (A.C. only).

All these features . . . and "B" Touchette is the least expensive touch switch on the market!



UL LISTED — CSA APPROVED

U.S. Pat. No. 2,820,113  
Other patents pending  
Foreign patents applied for

Available in single pole, double pole, 3-way and 4-way models. Brown or ivory button.

Sold only through electrical wholesalers.  
Or for further information and prices, write:



**Rodale** manufacturing co., inc.

Dept. AB3 Lemmas, pa.

## QUANTITY MATERIAL LIST

(Continued from page 198)

Hook Strip	1 x 4	40 lin. ft.
Shelving	1 x 12	68 lin. ft.

### DOOR SCHEDULE

Exterior Doors Size	Description	Amount
16'0" x 7'0" x 1 3/4"	O. H. 4 panel	1
3'0" x 6'8" x 1 3/4"	S. C. flush	1
2'8" x 6'8" x 1 3/4"	S. C. 1 lite flush	1
2'8" x 6'8" x 1 3/4"	F. P. S. C.	1
2'8" x 6'8"	glass sliding	2
Interior Doors		
2'6" x 6'8" x 1 3/4"	H. C. flush	4
2'4" x 6'8" x 1 3/4"	H. C. flush	3
1'10" x 6'8" x 1 3/4"	H. C. flush	1
Sliding Doors		
3'0" x 6'8"	—	8
		<b>Total 22</b>

Note: All doors are to be ordered from the door schedule complete with doors, door frames, trim, casing, stops, saddles, etc.

### WINDOW SCHEDULE

Size	Description	Amount
3'0" x 3'0"	D. H. wood	1
2 (3'0" x 3'0")	gang of 2 D. H. wood	3
3 (2'8" x 6'0")	gang of 3 fix & swing out	1
4'0" x 2'6"	wood fix	1
2'8" x 3'6"	D. H. wood	2
		<b>Total 8</b>

Aprons	1 x 6	70 lin. ft.
Stools	1 x 8	70 lin. ft.

Note: All windows are to be ordered from the window schedule complete with frames, sash, trim, casing, stops, etc. and in gangs as specified.

### KITCHEN CABINETS

Location	Size	Amount
Sink Counter	5'0" x 3'0" x 2'0"	1
Range Counter	5'6" x 3'0" x 2'0"	1
Ref. Hanger	3'0" x 1'3" x 2'0"	1
Hanger	1'8" x 2'6" x 1'0"	2
Hanger	3'0" x 2'6" x 1'0"	1
Range Hanger	3'0" x 2'0" x 1'0"	1
Oven Hanger	3'0" x 2'0" x 2'0"	1
Oven Counter	3'0" x 2'0" x 2'0"	1
		<b>Total 9</b>

Note: All counters are to be ordered complete with plastic laminate tops and backsplash.

Material breakdown prepared by Joseph Steinburg, professor, and Martin Stempel, associate professor, Construction Technology Dept., New York City Community College.

## moving?

**American Builder**  
should be the first  
to know . . .

**American Builder**  
Subscription Dept.

Emmett St.

Bristol, Conn.

## FINGERTIP DRAWER OPERATION

For Only **26<sup>4</sup>/<sub>10</sub><sup>c</sup>**

**PER DRAWER**

(Cost of One Roll-eez "A" Set in Bulk to Cabinet and Fixture Manufacturers)

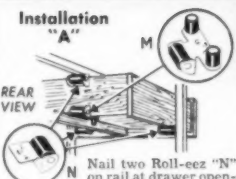

Nail two Roll-eez "N" on rail at drawer opening. If drawer has center guide, nail third Roll-eez "N" on top of back in middle, Roll-eez "M" on bottom of back, straddling guide. Roll-eez "M" and "N" are made with NYLON rollers.

Write for Free Sample Roll-eez "A" Set & Literature Showing Complete Line.

**Roll-eez**  
Trade Mark

**ROLLER BEARINGS FOR WOODEN DRAWERS**

Quick, easy to install, Roll-eez performance compares with high priced slides—yet you figure the cost in fractions! Made with perfectly molded NYLON rollers mounted on steel frames, they eliminate friction of wood-against-wood and keep drawers in alignment. Complaints, "call-backs" due to drawers sticking and binding are a thing of the past!

**JUNIOR-PRO PRODUCTS CO., 118 E. Marceau St., St. Louis 11, Mo.**

**CONTRACTORS!** Booming business and dud prospects don't go together . . . knowing where the "live ones" are—that's what you need!



## Write for a better way to make your profits go up

Advance information about new projects makes the difference between boom and bust when you do business with the construction industry. Dodge Reports not only give you early notice—they help you follow through by telling you whom to contact and when the job is out for bids (even who's bidding) on just the kind of work you want. If you'd like to know how to pin-point the "live" prospects that will help make your profits rise, just read and mail this coupon today.

TO: **DODGE REPORTS**, DEPT. 175, 119 WEST 40th STREET, NEW YORK 18, N. Y.

Yes! I'd like to pin-point my prospects by knowing in advance who's going to build, what, when, where.

I want to know whom to contact and when to submit bids.

I'd like to see some Dodge Reports, and I'd like a copy of your booklet that tells how to use this accurate, daily, up-to-the-minute construction news service.

I understand that I can pick just the area in the 37 Eastern States and the type of construction activity that interests me. Also, that I won't have to wade through mounds of data to find the information I need.

I'm interested in General Building  House Construction  Engineering (Heavy Construction)

in the Following Area: \_\_\_\_\_

NAME \_\_\_\_\_

ADDRESS \_\_\_\_\_

CITY \_\_\_\_\_ ZONE \_\_\_\_\_ STATE \_\_\_\_\_



New...

## Fireplace Heat Circulator Costs Two-Thirds Less!

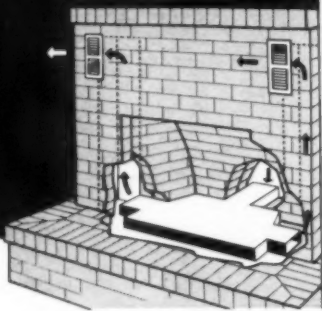

### DOUGLASS *hearth form*

Compare these advantages with any other fireplace heat circulator:

- Makes any masonry fireplace, including Swedish design, an effective forced air heating plant.
- Lightweight, compact for convenient handling and warehousing.
- Easily, quickly installed by one man.
- Serves as a form or template for the fireplace.
- As an air conditioner, draws fresh, smokeless air into the home.

Inexpensive to purchase, easy to install, DOUGLASS hearth form brings new utility to fireplace heating and increases the dollar value of any home.

**FREE:** Send for illustrated literature on the new low cost DOUGLASS hearth form fireplace heat circulator.

**DEALER INQUIRIES INVITED**

DOUGLASS MANUFACTURING CO.  
P.O. Box 905B, Los Gatos, California

Name \_\_\_\_\_

Address \_\_\_\_\_

City \_\_\_\_\_

American  
Builder

KEEPING UP WITH THE LAW

## New legislation would hold parents responsible for property damage by minors

By JOHN F. MCCARTHY • Attorney-at-law

Vandalism has plagued public officials and the owners of all types of properties. It has been growing and spreading in the field of construction. It has been a perplexing problem for the law to cope with.



McCarthy

Of course, it may include damage done by others, but it is the acts of the teen-agers that have caused the courts the most trouble. Minors are responsible for their own torts, both criminally and civilly by way of money damages. In view of the financial condition of most teenagers, this, at best, is an empty remedy. Generally, parents are not responsible for the torts of their children. Some exceptions to this rule exist, as, for example, if the child was acting as an agent or instrumentality of the parent. Acts of vandalism, however, do not fall within one of those exceptions, and with respect to them, usually the parent is without financial responsibility.

This situation has led many to seek corrective legislation. This movement finds support among public officials, particularly school authorities, property owners, builders, contractors, theater owners and the like. The proposed legislation seeks to impose liability on parents for damage to property done by their children. It has assumed various forms. Sometimes its operation is limited to damage done to public buildings. Often it imposes a limit on the amount of monetary liability of the parent.

Cecil Woods, president of the

Norman (Oklahoma) Home Builders Association and Chairman of that Association's committee on state legislation, writes about such legislation adopted in that State recently. That law imposed liability, not to exceed \$300, on parents for acts of vandalism by their children under eighteen years of age. The exact language of the law, found in Article 10 of Title 23 of the 1957 Supplement to the Oklahoma Statutes, is as follows:

*"The State or any county, city, town, municipal corporation or school district, or any person, corporation or organization, shall be entitled to recover damages in an amount not to exceed Three Hundred Dollars (\$300.00) in a court of competent jurisdiction from the parents of any minor under the age of eighteen (18) years, living with the parents, who shall maliciously or wilfully destroy property, real, personal or mixed, belonging to the State or such county, city, town, municipal corporation, school district, person, corporation or organization. Laws 1957, p. 19, Article 1."*

Woods reports that home builders, in their efforts to obtain passage of this law, received valuable assistance from theater owners. He attributes a sharp decrease in acts of vandalism by minors in Oklahoma due to this legislation. He enthusiastically recommends such laws to builders in other states.

The General Assembly of Illinois passed similar legislation at its recent session. The Governor, however, vetoed it. He reasoned that such acts were unconstitutional. Most authorities do not agree. They are of the opinion that such legislation is valid and may prove highly effective.

## Put *Broan* Range Hoods in your kitchen picture

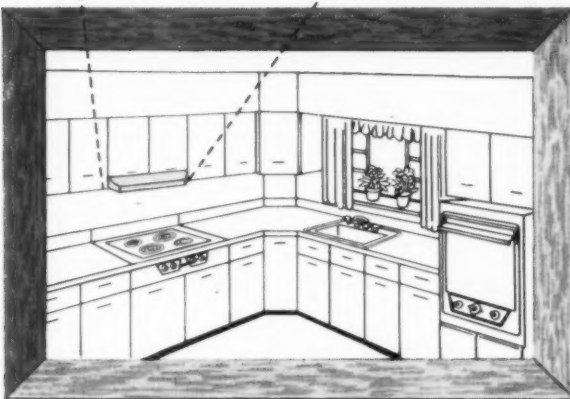
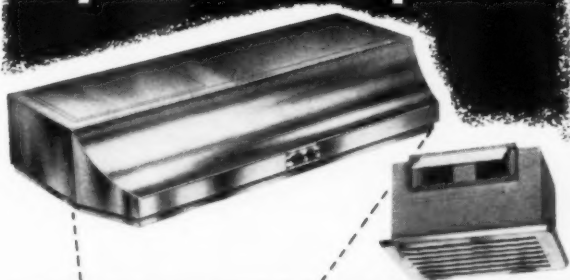

### Premium in Everything - but price

If you'd like solid ammunition to outsell your competition, if you're interested in easy, fast-running installations to hold down cost, if you're concerned about the right price in making a bid — take a look at the great advantages Broan hoods provide:

- a fresh new look in styling . . . with contour corners that allow adjacent cabinet doors to open fully
- removable, reversible top plate with rectangular and circular knockouts — a Broan origination — to save time and work in installation
- heliarc welded seams eliminate trim strips that collect grease
- push-button controls — out-in-front and eye-high — factory installed and wired
- concealed counter lighting; no shadows, no glare
- adaptable to 3 exhaust systems — a great performing twin blower, a 10" ceiling fan or an 8" ceiling fan

All of these plus values come your way without any premium in price. So check into Broan as hundreds of alert contractors already have. Write today for the name of the distributor in your area and for a fully illustrated specification bulletin.

**Broan** MANUFACTURING CO., INC.

946 W. State St.  
Hartford, Wis.  
Near Milwaukee

Specialists in Quality Ventilating Equipment for Over 25 Years.

## CROSSETT ROYAL OAK- FINEST FLOORING MADE



AT CROSSETT — logs harvested from deep shaded hardwood forests are the beginning of precision crafted Crossett Royal Oak Flooring. This raw material from managed woodlands makes possible high standards of quality manufacture. Then, skilled craftsmen who have devoted a lifetime to working in hardwoods bring out the beauty and build in the quality of Crossett Royal Oak Flooring. There's peace of mind and profit, too, in building repeat business with Crossett quality.

Now available in the new *Nested Bundles*.  
Information on request.

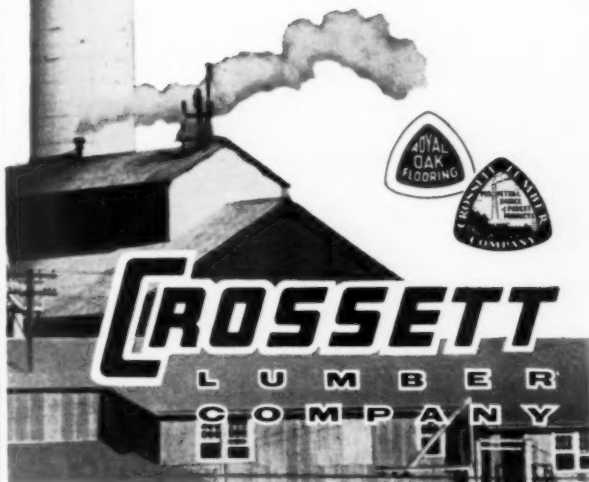

A Division of The Crossett Company

CROSSETT, ARKANSAS



**WHEN DAMP** winter breezes blow, ranch house built among tall trees will be warm as toast. Reason: heating system provides warm floors that reduces hot spots and drafts, costs builder less to build.

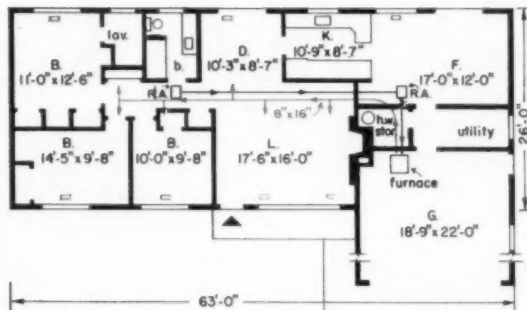

**SIMPLICITY** of heating system is illustrated by black and red lines. There are no lateral ducts. The openings in the main supply duct (red) are merely aimed at the floor registers (also red) along outside wall.

**STRIKING PHOTO** with wrap-around detail gives an excellent insight into the simple radiant warm-air system. Not indicated are six 24x6" screened vents with tight covers installed at top of concrete wall.

## "Hidden Value" heating system box beams over a crawl

**T**he most unusual feature of the six-room ranch house built by builder Don Johnson in Tacoma, Wash., is use of the crawl space as a heating plenum. The idea isn't new. A few of the more advanced builders have been using it for some time now. **AMERICAN BUILDER**, in its coverage of a NAHB technical conference, discussed the subject in the December '56 issue.

In his first installation of this type of heating, builder Johnson has gone further than the minimum requirements to insure a top quality job with this type of system. FHA accepts polyethylene or roll roofing as a vapor barrier in warm-air supply crawl spaces. Johnson placed a 2" skim coat of concrete on top of the vapor barrier to provide a vermin-proof crawl space.

Instead of usual floor girders, builder Johnson used box beams made in a jig in his shop (see photo). The beams were made by nailing and gluing 3/8" plywood to 2x3" wood flanges. Beams, made 8" deep and long enough to span 8', were set 4' O.C. 4x8' fir plywood, 1 1/8" thick, is used for the

sub-floor. This heavy plywood sheet provides a combination sub-floor and underlayment for the tile and carpeting.

The advantage of box beams used in conjunction with the 1 1/8" plywood is that there will be a minimum of warpage and shrinkage, reducing the danger of sagging and squeaking for the life of the home. Cost of box beams as opposed to solid 4x8" beams and steel I-beams is \$.49/ft., \$.26/ft. for the solid wood beam, and \$.76/ft. for the steel.

A 90,000 btu oil furnace at one end of the crawl space generates the heated air which flows through a single duct, about 35' long, running down the middle of the house. There are no lateral ducts, but there are openings in the main duct which are aimed at the floor registers. One comes below the bathtub and heats it. The estimated net savings in the duct work, which used only the main duct, came to \$46.00. This estimate takes into account the required insulation of the crawl space.

You can see another example of the radiant warm-air heating principle in a temple, p. 206.

# GUIDE FOR THE MONTH

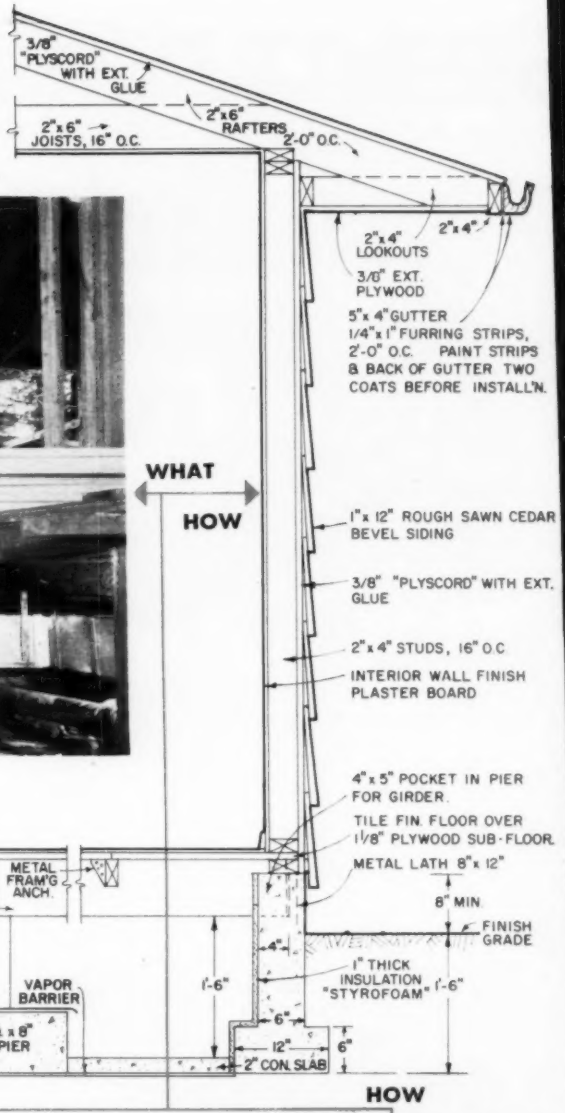
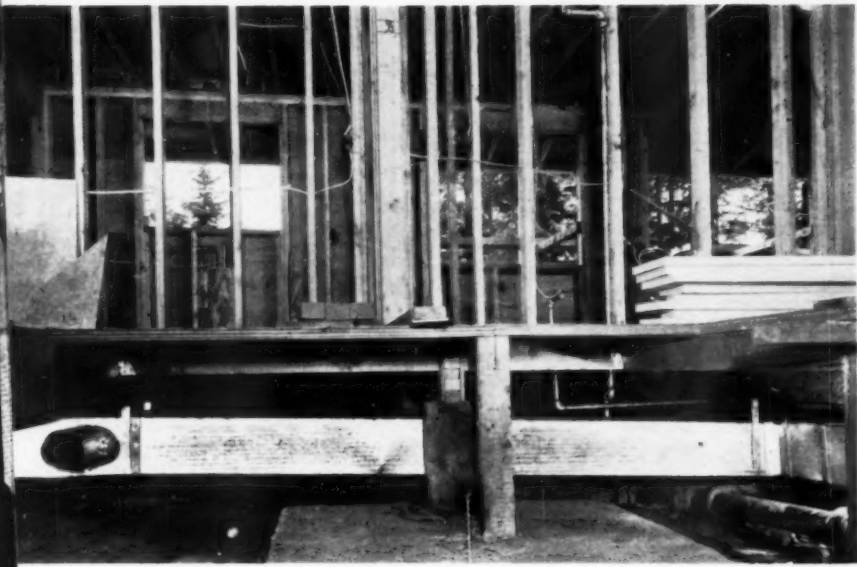

uses  
space plenum

HOW

HOW



**BUILDER** uses simple jig set-up to construct box beams. For a larger operation (100 homes) some sort of press set-up would be needed. Douglas Fir Plywood Assn. is coming out soon with booklet showing best method.



**WORKMAN** can be seen nailing down first sheet of 1 1/8" plywood sub-floor over box beams. Structural system consists of beams which run 4' O.C. with 2x4's attached by metal anchors which are also placed 4' O.C.

## Better detail of the month

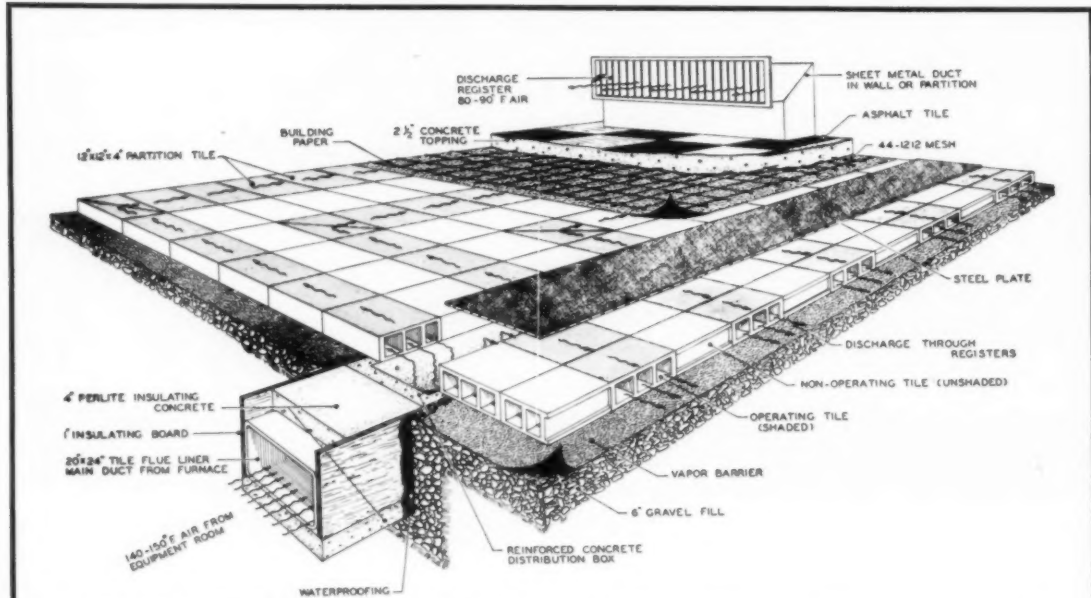

ULTIMATE in heating comfort is possible with this system. It has a more constant temperature with less

lag than conventional radiant systems because air volume as well as temperature can be controlled.

### This unusual warm-air radiant-heating system installed in a temple offers versatile operation

The problem of overcoming hot spots and drafts in commercial and residential heating is a consistent one in spite of advanced installation techniques and efficient heating units.

Percival Goodman's new Fairmount Temple, Beechwood Village, Ohio, is certainly a step in the right direction toward eliminating this problem. (Turn to page 204 to see how the problem is approached in the residential field.)

John Dillon, N.Y. engineer, designed the system illustrated above. It combines the best features of radiant heating and conventional warm-air systems. Cold spots and drafts are reduced by radiant slab and low velocity air that is discharged via wall, sill registers.

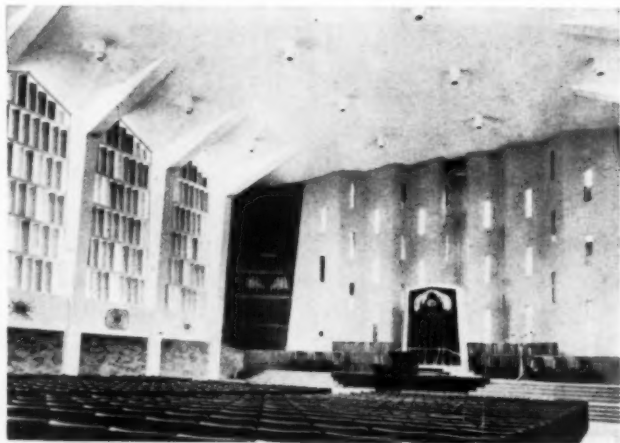

DAYLIGHT filtering through the series of tall, fixed, multi-colored wooden louvers (left)

gives a medieval stained glass effect to the temple's interior. The space serves 500 persons.





TRANSIT-LEVEL  
\$285.00

Model 38-BF

JUST  
ONCE  
IN A  
LIFETIME!

you acquire a

## WARREN-KNIGHT Instrument

Practically eliminated during an entire lifetime of service are repairs and maintenance to a Warren-Knight Transit-Level. The design and construction of these superb instruments is so superior and so different that it is prudent to investigate them, if you are in the market. After all, an instrument that promises probable total elimination of repairs and maintenance — and will probably never be replaced during your entire remaining professional career — certainly offers you a dramatic saving.

**FREE 10 DAY TRIAL** — So sure are we of your reception to this magnificent instrument that we offer it FREE for 10 days trial test on your own work sites. You will find that over 40 superior advantages will save you time and effort. Prove for yourself the full facts concerning this unique instrument.

Ask for Bulletin F-83 that lists Full Details.



136 N. 12th St., Phila. 7, Pa.

now! COMPETITIVELY PRICED  
for FAST ACTION  
NATIONALLY ADVERTISED

ShoweRite

GLASS BATHTUB  
ENCLOSURES AND  
SHOWER DOORS



new

## the PACER

Suggested \$54.95  
Retail Price

Highly styled! Promotionally priced! Two towel bars, nylon bearings and hammered frosted glass makes this an outstanding retail value. For 4½ or 5 foot recessed tubs.



NOW! AT NO INCREASE  
IN PRICE 7/32" GLASS

## SHOWERITE STANDARD

Suggested \$69.95  
Retail Price

Consistently the best selling bathtub enclosure in America! Choice of hammered frosted or fluted glass. Contains two towel bars, nylon bearings. For 4½ or 5 foot recessed tubs.

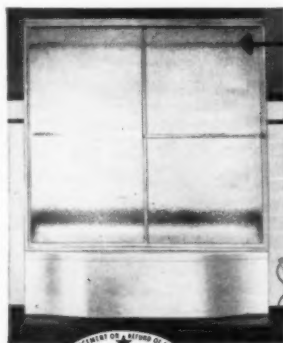

Guaranteed by  
Good Housekeeping

new

## TRIPLEX

Suggested \$94.95  
Retail Price

Ideal enclosure for bathing children. Three sliding panels afford more room . . . make cleaning easier. Features two towel bars. For 4½ or 5 foot recessed tubs.



write for fully illustrated brochure of complete line



THEODORE EFRON MFG. CO.  
7519 South Greenwood Ave.  
Chicago 19, Illinois

Dept. AB 1173

Gentlemen: Please rush me information about ShoweRite products.

Name \_\_\_\_\_  
Address \_\_\_\_\_  
City \_\_\_\_\_ Zone \_\_\_\_\_ State \_\_\_\_\_

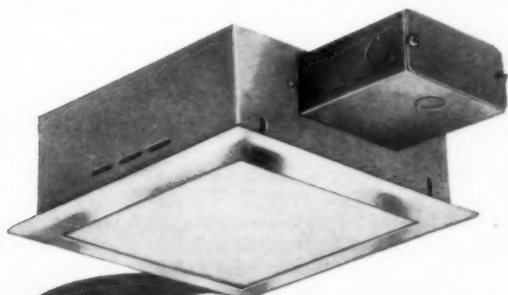

1. ONE PIECE  
FRAME WITH  
OUT WELDING  
MARKS.



2. Fibre glass  
gaskets pre-  
vent light  
leakage.



3. New torsion  
spring hinge  
frame.



advanced  
recessed  
lighting by  
**ATLITE**

Six Glass Designs

Seven Finishes

Send for  
NEW ILLUSTRATED CATALOG  
of the complete ATLITE line.



ATLAS ELECTRIC PRODUCTS CO.  
319 Ten Eyck Street, Brooklyn 6, New York

The Market Place for buying and selling used merchandise, help wanted, positions wanted, and other classified listings.  
Rates—\$7.50 minimum for 40 words or less. 15c for each additional word.  
Display Classified—\$35.00 per inch. Reverse plates not accepted. No illustrations. No agency commission or cash discount. One column only—2½ inches wide, 2 inches maximum. Signature cuts and trade names allowed.

**FACTORY REPS WANTED**  
MANUFACTURERS AGENTS AND SALES REPRESENTATIVES Calling On General Contractors, Sub-Contractors And Architects, To Represent National Manufacturer Of Building Specialties. Our Products Are A Non-Competitive, Heavy Volume Line Earning Some Of Our Representatives Over \$15,000.00 Annually. Write Stating Experience, Types of Lines Presently Handled And Exact Territory Served. Our Men Know Of This Ad. Box 272, American Builder, 30 Church St., New York 7, N.Y.

**BUSINESS SERVICES**  
DOUBLE YOUR INCOME from your newspaper advertising by using our Low Cost cartoons on Home Improvements and Building. We have series of 52 cartoons for Retail Dealers, Contractors, Roofers, Plumbers, Painters, Real Estate, Etc. Mats in One or Two column sizes to fit advertising from three inches up. We are Advertising Cartoon Specialists, with over 500 clients, and know what produces results. You get exclusive city franchise with Money Back Guarantee. For FREE proofs and details write DAVID LILLY CARTOONS, Box 167, Long Beach 1, Calif.

**SELL E-Z-ON**  
All Metal Interlocking WEATHERSTRIP  
Permanent, efficient, easy to install E-Z-ON all metal interlocking weatherstrip keeps out cold. Protects from drafts. Corrects loose fitting doors and windows with no interference in normal operation. Peak season profits NOW! Write for complete details and prices.  
ROBERT N. BALTZ & COMPANY, INC.  
1009 Harvard Terrace, Evanston 1, Illinois  
Also Caulking and Glazing Compounds

**FOR SALE: 50—Forced Warm Air Furnaces,** 75,000 BTU, gas or oil fired, popular make new in crates, \$130.00 ea. Several larger sizes also available. Write Box 273 American Builder, 30 Church St., New York 7, N.Y.

**SITUATION OPEN**  
CONSTRUCTION SUPERINTENDENT—Minimum 5 years experience in supervisory capacity. Permanent position with long-established concessionaire in Yellowstone National Park. Excellent working conditions and employee benefits. Give qualifications and expected salary. Apply by letter to: Yellowstone Park Company, Box 888, Gardiner, Montana.

**HELP WANTED—MALE**  
Manufacturer's Representatives for all areas to set up K.D. distributors for Ee-Ze-Do Aluminum Combination Windows. Ee-Ze-Do, P. O. Box 933, New London, Conn.

**SUMMER EMPLOYMENT WANTED**  
Third-year student in light construction at N.Y. State College of Forestry seeks summer employment with a firm engaged in home building, with a view toward possible employment after graduation. Write John Wixted, 801 Irving Ave., Syracuse 10, N.Y.

**American Builder reaches more builder-buyers than any other building publication!**

## How home building shapes up in

by John M. Dickerman, Executive Director, National Assn.

When business is good generally, few aside from the home building industry pay a great deal of attention to housing. But, the moment business tends to slow down, then all eyes turn to housing as the Moses that will lead the economy out of the wilderness. This is one of the oddities of our times.

On two previous occasions, in 1950 and again in 1954, housing was, of course, a major factor in pulling the economy out of slumps. Perhaps these two experiences are responsible for the increased attention again being focused on home building. For, as in 1949 and 1953, the economy generally has lost much of its forward momentum and recession has replaced inflation as the scareword of the day.

Barring new economic dislocations, such as a prolonged labor strike, I do not believe that the economic downturn will be unduly severe or long lasting. There is a prevailing view that a re-acceleration will set in about mid-year.

But will housing do as well?

The industry has been going through a prolonged period of busi-

ness troubles starting in 1955. It is not so likely to rebound with the zest and vigor it displayed on earlier occasions when its troubles were of a more temporary nature. Secondly, in a "soft" economy, housing markets are also likely to reflect general economic conditions. This is particularly true when the major housing shortages no longer exist.

On the other hand, one of the favorable factors is that we have already "taken our lumps." We have been "readjusted," while the rest of the economy is still facing up to its problems in this regard.

The pleasant probability of more mortgage money is an encouraging sign. Another is the renewed confidence with which home builders are moving into 1958. This change of attitude, in such marked contrast to that of a year ago, was apparent during NAHB's recent convention.

Further, there have been since late 1957 a number of substantial changes in FHA credit practices and the purchase prices of FNMA. The impact of these, which I expect to be enhanced by other beneficial administrative and

### LUMBER DEALERS . . .

## Rx for lower costs: use more

by H. R. Northrup, Exec. Vice Pres., National Retail

Once again we are beginning to hear the disturbing charge that new houses cost too much—that the cost of home building is too high. The recurrence of these statements may be due to the fact that higher interest rates have increased monthly payments, or merely to the fact that costs have continued to creep higher and higher.

Regardless of the reason, the charge is an unwelcome one. It adds emphasis to the fact that everyone concerned with home building should be taking full advantage of opportunities to hold costs down.

It is true, of course, that part of the higher selling prices of new homes is due to the array of appliances and other extras commonly installed in today's houses. Builders presumably add this equipment because they find—or at least believe—that homes sell faster with it. This is despite the fact that the equipment increases the selling price.

However, the basic reason why home building costs more today than it did 5 or 10 or 20 years ago is because wage rates have gone up—wages paid for production of materials, for transportation and distribution of building products, and for on-site construction.

It certainly is not feasible to lower home building costs by reducing wage rates, by using cheaper grades of materials, or by building smaller homes. Any important reduction is going to have to come by reducing the number of man-days of labor required to construct a well-built house.

Fortunately that goal is by no means an impossible one. Relatively few builders are making full use of the time-saving techniques that have been developed. And, a good many dealers have not yet begun to take full advantage of economies they can put into effect.

It has been demonstrated beyond

## overall economy

of Home Builders

legislative housing measures, should be reflected in increased building output and sales during the year.

To look to housing to pull the economy out of its troubles would be far-fetched. But I do think it realistic to believe that housing, if no further impediments are placed in its path, will be a major stabilizing influence.

There should be more houses produced and sold in 1958 than in 1957. But in saying this I do not for one moment suggest that the actual requirements of the American people will be met—or will ever be met—as long as those in authority feel that housing can be used as an economic safety valve; that it can be turned off and on to regulate or counter-balance economic trends.

This philosophy, to the extent it exists among both private and government leaders, must be replaced by the recognition that this industry's potentials and the housing needs of our people demand stable, long-term financing methods and money sources. This is one reason why NAHB has urged the creation of a true central mortgage bank.

## component parts

Lumber Dealers Assn.

doubt that almost any dealer can reduce material handling costs by using mechanized equipment for unloading, storing and assembling.

Likewise, it has been demonstrated that any builder can cut costs by using lumber cut to size in the shop and shop-built components. Numerous other time-saving techniques have been devised, tested and demonstrated. But, it takes a long while for new methods to come into general use in this business.

The building industry can't afford to dismiss charges of high costs by telling itself that the public also complains about high costs of cars, color TVs and taxes. It is the industry's duty to provide well-built homes at the lowest possible costs. That means taking full advantage of all legitimate opportunities to save on labor or materials. Whether or not home prices are "too high," it's just good business to get them down.

# NO OTHER DOOR...

## CAN MATCH NUDOR'S PRICE AND QUALITY



Feature for feature, the Nudor brings you and your customers America's outstanding door value, suitable for single or double glazing.

Once installed—and installation is simple and quick with Nudor—you forget it...you never have callbacks with Nudor...

Compare its outstanding features... compare its weather tightness... compare its price... compare its quality... you'll agree it's America's outstanding door value...

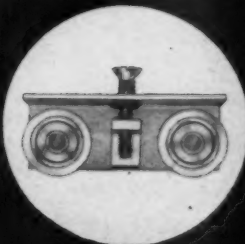

Fully adjustable ball bearing nylon rollers in line contact with flat threshold assure longest wear.

Elegance of sparkling lucite in full grip handle adds note of custom quality, rich appearance.

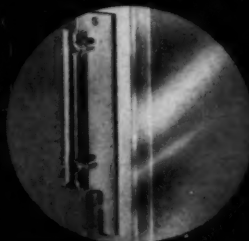

Streamlined, flat threshold has no track to trip on. No other door in Nudor's range offers this feature.

## and windows, too - by NUDOR

Nudor rolling glass windows have been tested to meet AWMA specifications, are weatherproof, waterproof, easy to install and operate and require no upkeep. Their positive action cam lock makes them virtually burglar-proof.

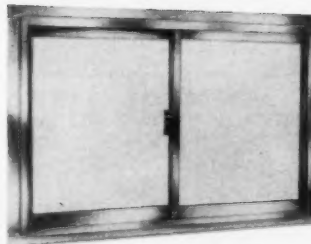

Member SLIDING GLASS DOOR AND WINDOW INSTITUTE.

# NUDOR

MANUFACTURERS OF HI-LO, NUDOR, D'COR ALUMINUM SLIDING GLASS DOORS AND NUDOR HORIZONTAL ROLLING GLASS WINDOWS  
7326 Fulton Avenue, North Hollywood, California

Look for our catalog in Sweets Architectural or Light Construction File... or write for your free copy. Address Dept. AB.

# The Month Ahead

## **DON'T OVERSHOP**

It's important to keep a close eye on the money market, and it's important to shop around and find the best possible source of mortgage money. But don't overshop.

In other words, when you find a lender that you like and have confidence in, try to stick with it. There will be times when another source may offer a slight advantage. But if you keep jumping around from lender to lender to take advantage of every penny, you aren't going to store up much good will with any of them.

If, on the other hand, you stick with one or two sources, and don't try to squeeze out the last drop of blood, you'll find that it will pay when money gets really tight. That's when a lender is going to make sure that regular customers get any good terms that may be available. So unless you have a clear cut, long term reason for switching, try not to change. In the long run you'll be better off.

## **IT'S HAPPY TIME AGAIN**

We've almost reached the time when Uncle Sam takes his annual nibble out of your financial hide. April 15 is the deadline for filing your personal income tax return, but if you are one of the lucky ones who has something coming back, the sooner you file the surer you'll be of getting your refund within a reasonable time. And anyway, the whole business is unpleasant enough without adding a last minute rush.

April 15 is also the deadline for partnerships and corporations who operate on the basis of the calendar year. Otherwise the return is due three and a half months from the end of the fiscal year.

## **Keep your eye on the money market**

You know the slogan about seeing your doctor at least once a year, and your dentist every six months. Well, we want to add another to the list.

See your banker every couple of months.

All indications are that the next few weeks will be active ones from a financial point of view. The present general business sag is making more money available from lenders; and this means more attractive terms for borrowers, particularly homebuyers.

That's why you should make a habit of just visiting your money sources—your bank, insurance company, saving and loan association, etc. The only way to make sure you're getting the best possible terms in a changing market is to keep in close contact with your sources.

## **The big difference—low-cost housing**

This business of mortgage terms is particularly important if you're building in the lower price brackets—say, \$12,500 and under. Whether you go FHA, VA, or conventional, a couple of points or a fraction of a percentage can be the straw that makes or breaks the sale.

If you read the story about Jim Burke and his low-cost housing program in this issue, you know that potential buyers of housing in this price range are shopping, literally, for the last two cents, both in down payments and monthly payments. A slight shift in the money market could be enough to push some of these buyers over the line. But you have to be ready to take advantage of the shift; and to do this, you have to keep your eyes and ears open.

## **In April, the working issue of American Builder**

The April issue of AMERICAN BUILDER will be the one that replaces that dirty, dog-eared one that's sitting on your desk now. We mean, of course, our annual Directory issue, which lists products, manufacturers, and practically everything you need as a working and buying guide.

Now if that last year's Directory issue is sitting nice and clean up on a shelf, something is very wrong. It's meant to be used, and it can be the most valuable reference source you have. When this year's copy comes, get busy! Mess it up! Use it!

## KENTILE® Vinyl on today's smartest FLOORS



KENTILE Solid Vinyl Woodgrain Planks come in 4" x 36" lengths. They are available in colors shown at right . . .  
*Limed Oak, Teak, Mahogany, Birch.*

### *New Woodgrain Planks in Solid Vinyl*

**EASIER TO INSTALL—NEEDS NO SANDING, NO VARNISHING!**

Home buyers will love the rich, polished beauty and subtle shadings of hardwood in this modern, easy-to-care-for vinyl floor. It's greaseproof. No dust-collecting open seams. So pleasant underfoot.

Capitalize on the overwhelming preference for famous KENTILE FLOORS. Kentile, Inc., supports this preference with outstanding full-page, full-color advertising all year in the country's top magazines.

#### **FREE! NEW KENTILE PERSONALIZED "MODEL HOUSE" SALES KIT!**

Write to Kentile, Inc., for complete details on the new sales kit which includes:

1. Lawn sign, personalized with your development name
2. Personalized interior signs, for floor & wall base
3. Helpful selling tips . . . for use by your salesman
4. 4-color giveaway leaflets

**KENTILE FLOORS**

AVAILABLE IN: SOLID VINYL • ASPHALT TILE •  
VINYL ASBESTOS • CUSHION-BACK VINYL • RUBBER  
AND CORK TILE . . . OVER 175 DECORATOR COLORS!

58 Second Avenue, Brooklyn 15, New York • 350 Fifth Ave., New York 1, New York • 3 Penn Center Plaza, Philadelphia 2, Pennsylvania • 1211 NBC Building, Cleveland 14, Ohio •  
900 Peachtree Street, N. E., Atlanta 9, Georgia • 1016 Central St., Kansas City 5, Missouri • 4532 So. Kolin Ave., Chicago 32, Illinois • 2834 Supply Ave., Los Angeles 22, California

# National



## SCREEN HARDWARE

*The sales leader  
of the month*

It's time for the annual changeover from storm sash to screens. Your trade is keenly aware of the urgency for prompt action to insure a full season of protection from the intrusion of flies and insects. Note the assortment of fine, precision built screen hardware now available — from the complete Screen and Storm Door Sets to the attractive Door Latches and Screen and Sash Hangers here illustrated. If it's genuine National, you can always depend upon smooth, trouble-free performance.



No. 79 Screen Hanger

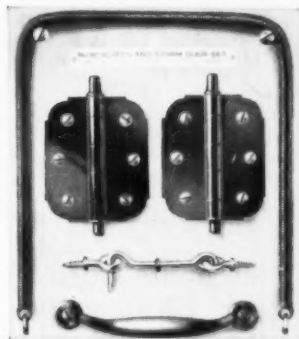

No. 90 Screen and Storm Door Set

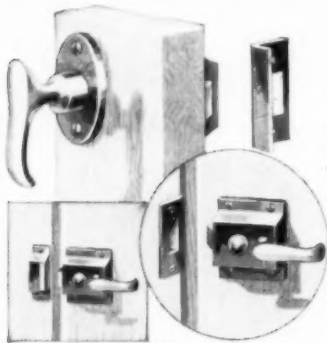

No. 95 Latch



No. 96  
Latch



No. 97 Screen and Storm Door Set

**NATIONAL MANUFACTURING CO.**  
STERLING, ILLINOIS