

American Builder

May
1961

New Ideas Spark Builder Growth

"We Changed Everything to Sell More Houses"

6802-AMB

NuTone

** Low-cost Luxury*

* L



NuTone Built-In
Clock and Chime
... flush with wall

NuTone Fold-Away
Range Hood-Fan
... in open position



Master Station for
NuTone Intercom
and Radio System



NuTone Food Center
Built-In to counter



** Low-cost*

Even your budget-priced homes
can feature these NuTone Built-Ins
with this low-cost 5-way Package!

Luxury

These are the features that give
your homes the "Custom-Touch" that
lifts them out of the competition!



for Your Kitchen

NUTONE'S 5-WAY PACKAGE ADDS GLAMOR TO YOUR HOMES

* NUTONE FOLD-AWAY HOOD FAN

Fresh, clean kitchen air! — with this sensational new Hood-Fan that folds flush with cabinets when not in use. Insert-Panels of wood, metal or plastic laminate afford unlimited color-matching!

* NUTONE INTERCOM-RADIO SYSTEM

Time and step saving Intercom with superb clarity at normal voice level—PLUS Radio with a new richness of tone. Completely built-in—and engineered to fit 4" or 2" standard walls!

* NUTONE BUILT-IN FOOD CENTER

The food-preparation center every woman wants! The concealed Power Unit is flush with counter — operates 6 light-weight appliances. Saves space and puts an end to the clutter of tangled cords.

* NUTONE BUILT-IN BARBECUE

Your choice of electric or charcoal models — for year 'round family-fun. The patented slanting Channel-Grids prevent flare-up. Fits any standard cabinet. All parts remove for easy cleaning.

* NUTONE BUILT-IN CLOCK & CHIME

This cheerful earful adds an elegant charm! Chord-Chime PLUS Built-In Clock with Telechron Movement. Two-tone chord at front door, one note at rear door. No separate clock outlet needed.



Built-in Barbecue with rotisserie attachment.



Entire Barbecue drops into standard cabinets.

WRITE FOR NEW ILLUSTRATED LITERATURE TO
NUTONE, INC., Dept. 5W, Cincinnati 27, Ohio

Hood folds away. Color blends with cabinets.

Hood folds open to become powerful exhaust.

Food Center in counter Intercom Radio in wall.



SEE
NEXT
PAGE

Here's how NuTone helps create
BUILDER PRESTIGE

..to help Merchandise Your Homes

←
 See
 previous
 page



NAHB GOLDEN PLAQUE



Nothing influences the home buyer more than your own reputation as a dependable builder! That's why NuTone has distributed the NAHB GOLDEN PLAQUE to thousands of Builders — to establish in the public mind the confidence, integrity and ethical standards that NAHB membership stands for.



1961 PARADE OF HOMES



NuTone also cooperates with local builder organizations . . . by offering without cost a thoroughly tested "Parade of Homes" Package — including large full-color posters, metal directional signs — and other promotional plans — all geared to build and sustain public interest in visiting your model homes.



To top it all . . . NuTone has a nationwide network of field representatives always available to help builders with promotional and merchandising ideas. This is our way of saying "Thank You" for helping NuTone grow.

For more information write NuTone, Inc., Dept. PL, Cincinnati 27, Ohio

All New, All Steel, Electrically-Operated

® PANEL-LIFT GARAGE DOORS

FOR RESIDENTIAL AND INDUSTRIAL INSTALLATIONS

The LOWEST-PRICED automatic door on the market

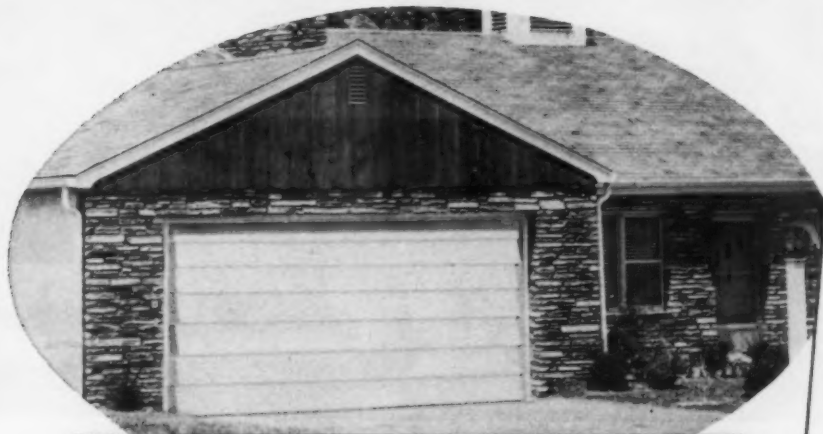

Lifts and Lowers Like a Venetian Blind!

● **PANEL-LIFT DOORS** bring a new concept in design to the garage door field that eliminates cumbersome, space-wasting overhead tracks, springs and/or counterweights. Instead **PANEL-LIFT DOORS** employ interlocking steel panels that glide up and down smoothly and quietly in heavy-gauge steel "tracks"—much like a venetian blind.

Installation is simple—only four bolts are needed to secure the door to the jamb. Headroom requirements are kept to a minimum.

Because of their simplified, well-engineered design **PANEL-LIFT DOORS** cost about 50% less than comparable electrically-operated doors, and installation costs are reduced almost two-thirds!

CONVENIENT, SAFE OPERATION. All doors are electrically operated. Residential doors have low voltage key-switch to foil intruders. Adaptable for radio control. Automatic locking and safety device locks panels in place at any point; provides for manual operation of door in event of power failure.

TROUBLE-FREE OPERATION. The simple, rugged design, heavy-gauge steel construction, prime-coated panels and amply-powered electrical operators of **PANEL-LIFT DOORS** assure a long life of trouble-free operation.

COMPLETE RANGE OF SIZES. Standard residential sizes are made of 20-gauge steel; industrial sizes of from 18- to 14-gauge. Sizes to 80 feet in length are available on special order.

Write today for brochure, specifications bulletin and complete information. Address Dept. A-561

PANEL-LIFT DOOR CORPORATION

Wholly-owned subsidiary of Standard Toth Industries, Inc.

1724 CHESTNUT STREET—PHILADELPHIA 3, PA.

(A few restricted wholesale distributorships are still available.)

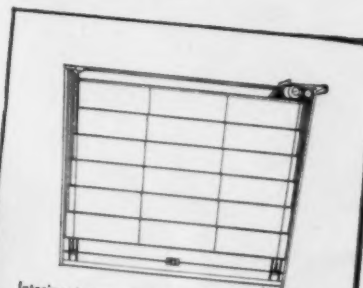

Interior view of Panel-Lift Door. Note absence of overhead tracks, springs and counterweights.

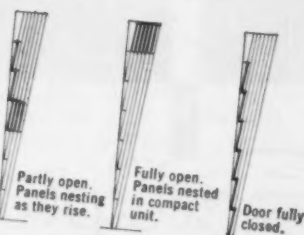

INTERLOCKING STEEL PANELS glide quietly and smoothly up and down in heavy-gauge steel "tracks"—much like a venetian blind—to "nest" compactly above the opening.

WEATHER-TIGHT. Interlocking steel panels plus multi-channel guide tracks form a weather tight, heat-saving seal when door is closed.

JUST 9 SIMPLE COMPONENTS.

Six panels and cap panel.



Left and Right side track.

EASILY INSTALLED. Having only nine components, secured to the jamb by four bolts, makes installation quick and easy—inside or outside the structure.





Architect Mario J. Ciampi of San Francisco blended square units with Shadowal block to form this handsome sculptured wall.

Sculptures in **SHADOWAL**[®]

from the wonderful new world of **BLOCK**

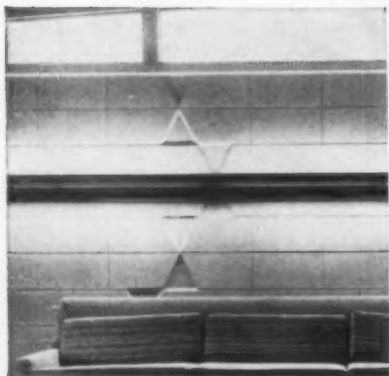

WALLS leap into life, become intriguing patterns of depth and dimension wherever Shadowal block is employed. Here you see five Shadowal block patterns. Each has a character and distinction of its own; each shows the unbelievable versatility of Shadowal concrete masonry. Small wonder it's called the block with 1000 faces. Your local NCMA member will be happy to assist you in working with new Shadowal block.



NATIONAL CONCRETE MASONRY ASSOCIATION • 1015 WISCONSIN AVE., N.W., WASHINGTON 7, D.C.

- Plain or fancy, inside or outside, beautiful, versatile Shadowal block gives walls a new and interesting look.
- Below right: Pattern was designed by Architect James R. Lamantia, Jr., of New Orleans.

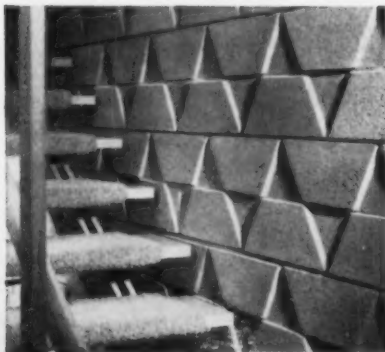

OPPORTUNITY

Builder enterprise and ingenuity—the best “aids” for lower cost housing

While Congress is grappling with the complexities of President Kennedy's housing proposals, we think it timely to point out that *there is nothing more important right now than to encourage builders to exercise ingenuity and enterprise.*

Low cost houses represent the greatest untapped market for new business. They represent a continuing and profitable livelihood. As one builder told AMERICAN BUILDER: “Why, those people are growing kids faster than all of us together in this town can build houses for them.” He was talking about low-income families that needed houses for less than \$50 a month.

Builders are willing and anxious to get into this field. A good example is Quincy Lee, the subject of our cover story in this issue, who sells many \$10,000 houses, but has now added a shell house line, with prices starting as low as \$2850.

Shell houses are one approach. The “sweat equity” house is another. We know many builders who have found a great new field in buyers who earn part or all of the down-payment by painting or finishing their homes themselves. Ernest G. Fritsche of Columbus, Ohio, proved this recently when he sold 175 houses in two weeks this way.

New ways to build duplexes, row houses or town houses are also helping builders cut costs. Roland Catarinella of Pittsburgh gets a saving of 25% over a detached house. Earl Smith of El Cerrito, California is building a clever “Mediterranean”-type requiring only a 40' lot. But, builders are often stymied when they try to do something different. The three biggest obstacles:

- Zoning that barricades the builder
- Codes that stop low cost methods
- FHA rules that are unreasonable

Something can be done about all of these, and we suggest to the Kennedy administration that more good can be achieved down this street than through public housing.

The San Antonio story: a remarkable example of builder enterprise and ingenuity in action. Thirty builders will shortly be spending their own money to build 30 demonstration houses in San Antonio to show what kind of low cost houses they could (and would) build if they were not restricted by zoning, codes or FHA. The wraps will be off. Each is free to try out any system, method or procedure he feels will enable him to produce a house to sell under \$7,000.

The builders drew lots for their sites: all are located on a piece of “marginal” land donated by the city and laid out in modern cul-de-sac or cluster plots. They are financed on an 80%, 20-year loan at 6%.

Thus in San Antonio the builders themselves will demonstrate what enterprise and inventiveness can do. The project was conceived and sponsored by the Home Builders' Association and its Low Cost Housing Committee headed by Tom McNeil, assisted by Jim Burke, president of NAHB.

The San Antonio builders actively fought public housing,—but in the fight, they learned that a real need and market do exist. They determined to do something positive. They have won the support of city officials, FHA, VA, and civic groups. Running the project is a Citizen's Committee appointed by the City Council consisting of three builders, two architects, an engineer, city health officer, FHA underwriter. This is a particularly good demonstration that builders can do something about low cost housing when they set out to.

Joseph B. Mason, Editor

American Builder (originally “Carpentry and Building”) with which are incorporated Building Age, National Builder, Permanent Builder, and the Builders Journal, was founded Jan. 1, 1879. Names registered in U.S. patent office and Canadian registrar of trade mark.

Address all subscriptions and correspondence concerning them to: Subscription Department, American Builder, Emmett St., Bristol, Conn. Changes of address should reach us three

weeks in advance of next issue date. Send old address with the new enclosing if possible your address label. The Post Office will not forward copies unless you provide extra postage. Duplicate copies cannot be sent.

Circulation Department: R. H. Lash, Director of Circulation, 30 Church St., New York 7, N.Y. Postmaster: send Form 3579 to Emmett St., Bristol, Conn.

Published monthly by Simmons-Boardman Publishing Corporation, Emmett St., Bristol,

Connecticut. Editorial and Executive Offices, 30 Church Street, New York 7, New York. Subscription price: United States, Possessions and Canada, 1 year, \$3.50; 3 years, \$7.00; single copies 75 cents. April issue \$2.00. Foreign countries: 1 year, \$12.00; 3 years, \$25.00; single copies \$1.00. April issue, \$2.00. Second class postage paid at the Post Office, Bristol, Conn. Copyright 1961 by SIMMONS-BOARDMAN PUBLISHING CORP. All rights reserved.



Before You Buy... Check **FASCO** Superiority



FEATURING EXCLUSIVE DOUBLE-WISHBONE FINNED HEATING UNIT

Double-wishbone finned heating elements give maximum heating surface exposure... results in faster convection heat.



"BLEND-IN" ACCESSORIES

Inside and outside corners, thermostat section, wall section, all designed to blend with lines and color of baseboard units.



FASCO BASEBOARD HEAT

Combines high-efficiency, progressive styling in a versatile, **"EASY-TO-INSTALL"** unit

Fasco electric baseboard heat is the advanced way to heat today's homes. It offers you and your customers a windfall of values that can't be exceeded anywhere in the building industry. Contractors and builders are naturally interested in heat units that can be installed quickly and which do not require costly callbacks... units that are styled to please, give dependable heat, and carry the solid, backed-up guarantee of the manufacturer—Fasco offers these things and more.

Fasco baseboard heat features unique double-wishbone heating element for high efficiency. Varying wattages and baseboard lengths provide versatile multiples for room by room heating. Users like the slim styling, the clean, uniform, draft-free heat. Front panel is easily removed for installation and cleaning.

So, before you buy, make the value check on available electric heat. You'll find Fasco has the value extras... for you and your customer.



Fasco manufactures a full line of quality fans, ventilators, range hoods, electric heat

Nobody covers American Building like **American Builder**



May 1961

Is Homebuilding Moving into the Factory?—A report on what some of the big companies are doing in the field of component manufacturing13

"We Changed Everything to Sell More Houses"—San Antonio's Quincy Lee shows how 20 steps put a new (and successful) face on his overall program77

Urban Rehabilitation: A New Market?—Points up the Government's all important role in what may well be the biggest building market of the future and two case histories of a community and a builder who've made the program work82

Blueprint House of the Month—A team of Washington State builders make a sloping lot pay off in this medium cost split-level88

All-Electric Living—Brainstorming session and field studies show "full housepower" from appliances to underground wiring as a factor in stepped-up home sales95

Managing an Efficient Operation—Wisconsin's David Showalter used his experience as a construction expeditor to create a simple scheduling form that will tighten up the operation of any builder102

Smart Ideas Make Small Builder Big—Louis McFarling of Omaha went from a two to 100-house-a-year builder by using cost-cutting construction methods and offering quality "extras" to potential buyers104

Vacation Houses—Builders' Big, New Market—Increase in leisure time and higher family incomes have created boom in second homes that will benefit the builder ..108

Go Build It on the Mountain—Two California builders carved out a mountain subdivision using their own rigs, found it cheaper than subbing job, and an important way to diversify into other profitable earthmoving operations152

Opportunity	5	Selected Regional House	44	Building With Brains	159
What's New	9	New Products	127	Tech Guide	162
Impact	17	Land Planning	152	Advertiser's Index	163
Regional News	43	Ask The Experts	156	Month Ahead	164

Cover: Young pro Cliff Morton discusses further expansion plans with veteran builder; Quincy Lee (with hat). Scene is Lee's Lyric South project, San Antonio, Texas. (Photo by Zintgraf)

EDITOR: JOSEPH B. MASON

Managing Editor: Richard Bullock

Senior Editors: . . . Andrew Boracci, Richard V. Nunn, William J. Hennessey . . . Associate Editors: Peter I. Cooper . . . Lawrence Laub, Arthur J. Maher, William C. Rodd, Walter J. Taft . . . Contributing Editor: Jackson Hand . . . Consulting Editor: Pat Harness . . . Art Director: Russell F. Rypsum . . . Assistant Art Director: Robert Gorlin . . . Production Editor: Larry I. Bernstein . . . Production Director: M. J. Figa, Jr. . . . Research Director: J. W. Milliken
Publisher: Bayne A. Sparks

Editorial office including April Buyers Guide issue: 30 Church St., New York 7, N.Y.

Regional editorial bureaus: **Midwest**—Robert Reschke, 79 West Monroe, Chicago 3, Ill. **West Coast**—William C. Rodd, 8522 Lorain Rd., San Gabriel, Calif. **Washington**—Walter J. Taft, 1081 National Press Building, Washington 4, D.C.

American Builder is published by the SIMMONS-BOARDMAN PUBLISHING CORPORATION, Emmett St., Bristol, Conn., with editorial and executive offices at 30 Church St., New York 7, N.Y. James G. Lyne, Chairman of the Board; Arthur J. McGinnis, President and Treasurer; Duane C. Salisbury, Executive Vice President and Advertising Sales Director; George A. Dusenbury, Vice President and Editorial and Promotion Director; Robert H. Lash,

Circulation Director; George Hutchings, Regional Vice President; Michael J. Figa, Jr., Vice President and Production Director; Bayne A. Sparks, Vice President and Publisher; Jack Wyatt, Vice President. The editors of American Builder are not responsible for unsolicited manuscripts sent to them. Manuscripts an author wishes to have returned must be accompanied by a stamped, self-addressed envelope.

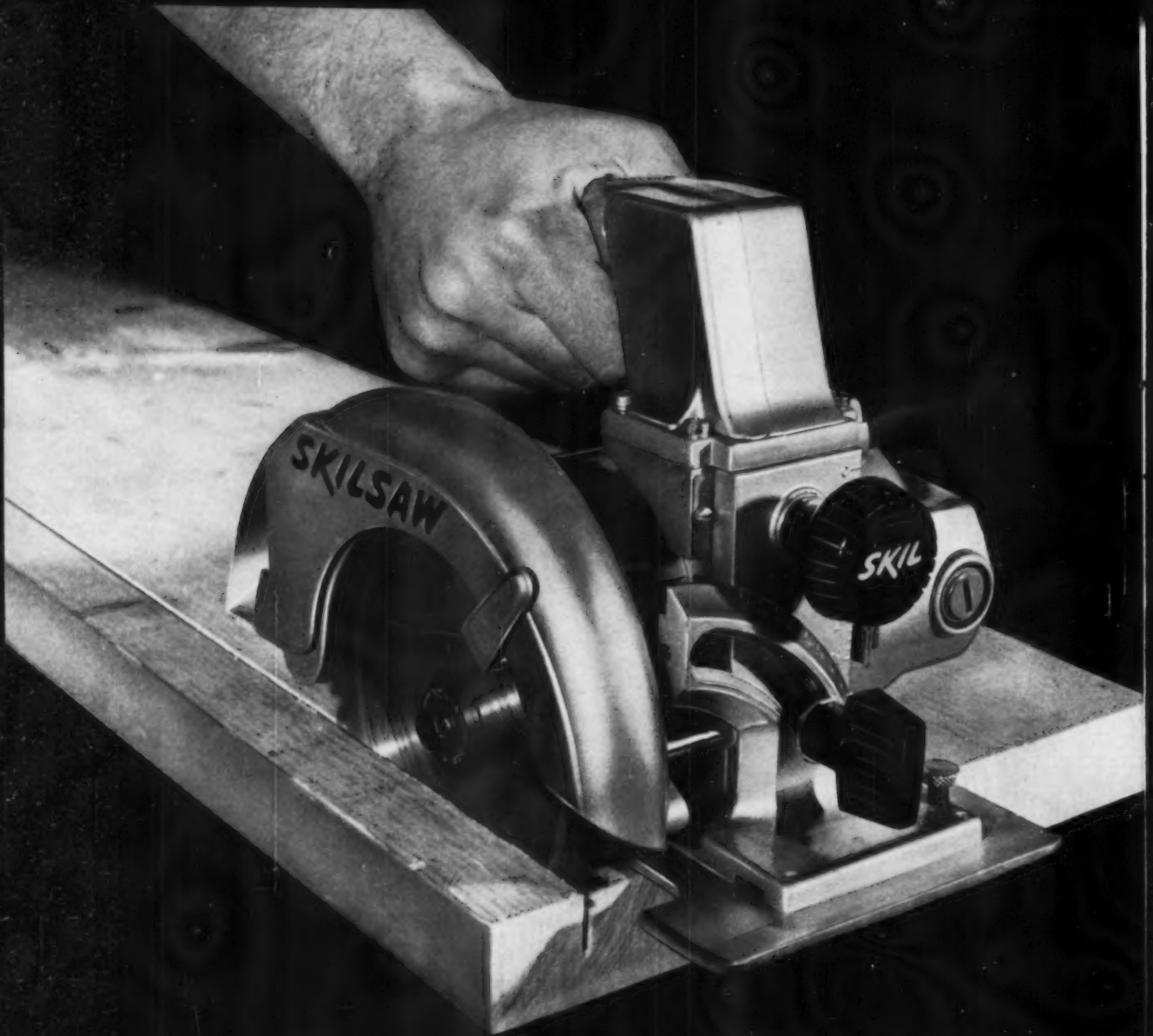

New Skilsaw 6½" model guaranteed against "burnouts"

... Motor is backed by full year FREE service* warranty

This new compact 6½" Skilsaw Model 856 has an exclusive Skil B-P Motor that gives "Burnout-Protection" even during frequent, excessive overloads. In fact, the motor is actually backed by a full year free service* warranty!

And this rugged new Skilsaw model has plenty of other features, too, like exclusive "Floating Guards" that cover the blade completely even on extremely shallow cuts... exclusive "Vari-Torque" Clutch that protects against kickback... easy-to-use depth

and bevel controls... all ball bearing construction. There's even an exclusive blade lock for quick, easy blade changes.

Compare the Model 856 with any top handle saw on the market. And, by all means, call or visit your Skil Distributor soon for a demonstration (he's listed under "Tools-Electric" in the Yellow Pages). Or write: Skil Corporation, 5033 Elston Avenue, Chicago 30, Illinois, Dept. 106E.

4 Top Handle Models

All have the features of Model 856 (see left) including new B-P Motor.

model no.	blade dia.	max. depth of cut	amp. rating at 115V
856	6½"	2⅛"	10
857	7¼"	2½"	11
858	8¼"	2⅞"	13
860	10"	3¾"	14



...and SKILSAW POWER TOOLS

*Service includes free repair or replacement of field and armature and is subject to return of saw to Skil Factory Service Center and to stipulations indicated on warranty certificate.

WHAT'S NEW *and what to do about it*

The condominium: an old system attracts new attention

Since cooperative apartments in which owner-occupants are actually shareholders in a corporation, has never caught on outside of the biggest cities—Chicago, New York, Los Angeles, etc.—lenders and builders are giving the centuries-old condominium plan a fresh appraisal. Under this system, the buyer takes separate title to his own apartment unit, enjoys rights of single-family ownership except for monthly fee for maintenance of grounds and building.

Many industry observers think condominiums will have strong appeal for older single people and couples who want convenience of apartments and security of owning property outright. Check your local market area for potential—and watch Kennedy proposal that FHA insure condominiums. If it passes, it could mean a boom.

Is the grass growing greener in the cities?

Apparently, Eichler Homes, long known for its ability to sell contemporary styled houses, predicted its new venture into urban renewal in San Francisco would mean \$2,100,000 in construction during 1961 and \$13,000,000 by the end of '63. And, from Baton Rouge, La., home manufacturer Crawford Corporation announced plans to enter urban renewal work. Crawford's new program under the direction of Philip Borden, former head of Ohio's Huber Homes, will provide assistance to residential builders in solving problems of financing, land planning, design, etc. W. Hamilton Crawford said he decided to get into urban renewal because of the growing insistence for single-family units—as “we are not interested in high-rise.”

If President Kennedy's proposal to authorize an additional \$2.5 billion for urban redevelopment gets through Congress, renewal work may become the biggest opportunity market for aggressive builders.

“Continue wallpaper onto the doors—make rooms look bigger”

This is only one of 119 ways suggested to increase new home sales at an “idea-session” sponsored by Batten, Barton, Durstine & Osborne, advertising agency. Participants included builders, realtors, writers and manufacturers.

Interested in the other 118 ideas? For a complete checklist send one dollar to Marketing, B.D.D.&O., 383 Madison Ave., NYC 17, N.Y.

Profile of today's buyer: Sharp with definite ideas, other interests

This was the majority opinion of almost 1,000 realtors surveyed nationally by Previews, Inc. The poll indicated that the average '61 buyer wants top-quality construction but wants to put down far less cash and is hoping hard for the 35 to 40 year mortgage—in all price ranges. The brokers said “the buyers want to keep as much cash as possible in their pockets, perhaps to make improvements or more likely to spend on outside interests such as boating, travel or golf.” Tops among the “most wanted” house features: push-button kitchens. Other “wants”—a full-scale dining room, basements, plenty of closets and at least one bedroom and bath on the main floor.

Manufactured houses win bigger share of the market

Following an announcement that 13%, or more than 1 out of 8 houses, built in 1960 were pre-fab, the Home Manufacturers Association predicted a total of 140,000 units would be put up in '61. The HMA also said that although Ohio (16,017 units), Pennsylvania and Illinois led the nation, the fastest rate of acceptance was in the West. Last year gains of 50% were reported in California, Oregon, Washington and Arizona.

cool an entire house

for about $\frac{1}{5}$ the cost of air conditioning

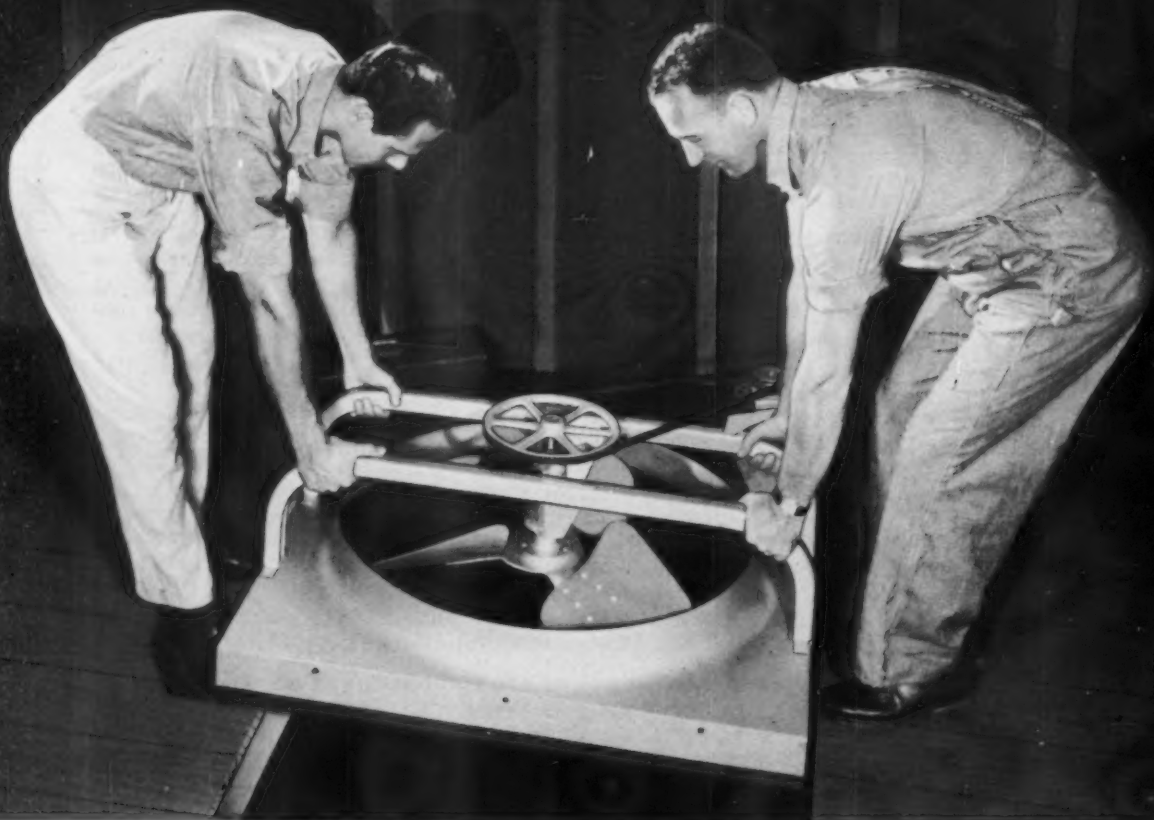

R&M-Hunter Package Attic Fan installs in a breeze

2-SPEED OPERATION FOR NIGHT/DAY USE—This low-cost home ventilating system gives cool comfort around the clock, in hot or warm weather. Refreshing breezes are pulled in and hot, sticky air forced out. Operating costs are low, and trouble-free performance is backed by R&M-Hunter's 80 years in manufacturing quality electrical equipment.



Automatic ceiling shutters install easily, too. Metal frame is screw-fastened and trim covers edges of ceiling opening. No finishing needed.

FEATURES

- Two-speed motors (single speed optional)
- Certified air deliveries from 5200 to 10550 cfm.
- Sound-tested ball bearings on fan and motor
- Heavy-duty motor, rubber mounted
- Built-in thermal overload protection
- Fan guaranteed 5 years; motor and shutter, 1 year



R & M-HUNTER ATTIC FANS



R&M-Hunter makes a complete line of Cooling Fans, Ventilating Fans, and Electric Heating Equipment.

MAIL TODAY

Hunter Division—Robbins & Myers, Inc.
2868 Frisco, Memphis 14, Tennessee

Please send data on the R&M-Hunter Package Attic Fan to:

Name _____

Company _____

Address _____

WHAT'S NEW and what to do about it

S & L's go after the conventional house, help builders sell

More and more of the conventional financing of houses is being handled by savings and loan associations. Many of them are now lending up to 90% whereas insurance companies are restricted to 66%, or 75% in some states. Also, some S & L's have come up with new methods to qualify buyers. In one system the builder opens a savings account in the S & L for his profit on the house—the money remains there drawing interest until the loan has been paid down that much, or 1½ times, according to the S & L's policy. In another case the S & L may ask the builder to pledge some stock to cover the difference on an increased mortgage valuation.

Model codes are worth the effort

Proof comes from St. Louis. Despite heavy opposition the mayor led a successful fight for a new performance code. First direct result: several new construction projects were proposed. The new code meant lower costs.

Builders stand to gain the most from performance codes. But to get them, they must be willing to spend more time and money in the fight. Jim Leibrock, E.O. of the Cleveland H.B.A. which is waging a code battle, says the biggest need is "men and money."

Keep an eye on the growing demand for more living space

It's no accident that one of the hottest model home titles used by builders this spring is the "Space House." That's because it places the emphasis on a better use of space—more living space for the money. Some home builders have even been experimenting with variations on thin movable partitions normally used in office buildings. Others are trying some of the new 2" gypsum board partitions with success—"not one noticed the difference."

Today's second and third-time buyers place a high premium on more space. Check your own house plans. See if you can't eliminate waste space entirely. Investigate new compact heating units. Consider more built-ins. Reappraise closet and storage ideas from the homeowners viewpoint. Or, if you're building on slab, re-evaluate the basement. One northwestern builder who switched recently says "this relatively inexpensive way of adding space has helped sales a lot—given me something my competitors don't have."

Mortgage market improves, but building still steps sideways

Building economists who know how this industry reacts to financial and other changes are cautioning against expecting any very sharp rise in starts this year. They expect a moderate improvement but not a boom. The Kennedy Program has already brought about a rather remarkable reduction in mortgage interest rates. In fact, the whole mortgage market has improved a great deal. But this isn't enough by itself to bring about a sharp change in an industry which moves so slowly.

Far more important is what builders are doing to redesign their houses, adapt new materials and techniques and in many cases tap a lower-price range. They're also reviewing their merchandising and selling methods. The beneficial effects are already being felt and both starts and sales are expected to rise the latter half of the year.

Biggest outrage in building—closing and financing costs

You hear it from every side: "no matter how we sweat to build a better house for less money we lose it all when we come to the closing and pay it all out there." Excessive discounts, closing charges, legal, title and insurance costs are adding more to the cost of the house than the builders entire overhead and profit, in many instances. While there has been some improvement in the discount situation in recent months, there is room for more.

Building a good house these days isn't enough. It will pay to spend more time with mortgage experts, saving & loan and FHA people.

finish the job
faster, better with
**G-P factory-sealed
redwood bevel siding**



1. Eliminates on-site priming: you save on both labor and material. 2. Faster finish application: paint or stain flows on quickly, smoothly. Special G-P "immersion-sealing" process coats wood evenly so finish penetrates evenly, holds better. 3. Can be finished immediately: no curing time needed. 4. Finish lasts longer. Special G-P resin-base seal coat allows internal moisture to escape so it won't accumulate beneath paint, causing blisters and cracks. 5. No delivery delays. G-P factory-sealed redwood bevel siding comes packaged in plastic-coated, heat-sealed packages. You can store at the site without special facilities, without fear of weather damage or discoloration.



GEORGIA-PACIFIC

plywood • lumber • redwood • hardboard • pulp • paper • chemicals

Dept. AB561R, Equitable Bldg., Portland 4, Oregon
Please send me full information and nearest
source for G-P factory-sealed redwood bevel siding

NAME _____

ADDRESS _____

CITY _____

ZONE _____

STATE _____

CHANGE

Is homebuilding moving into the factory?

Another big manufacturer—Johns-Manville—is marketing a component system. This one, called the Flex-Ponent System, uses stress-skin load-bearing insulated exterior panels, and load- and nonload-bearing interior panels, plus headers, corner posts etc. Initially, the panels will be sold only in a limited area around St. Louis, with production increasing as demand warrants. Distribution will be through normal Johns-Manville channels.

Unveiling of the system raises once again this important question: Is the day coming when all houses will be componentized? Obviously, no one can say for sure. But a check of the manufacturers does show that the switch to panels is picking up speed.

Koppers, for example, reports "very substantial growth" in demand for its Dylite foam-core panels. Besides its own manufacturing facilities, the company now has two other panel plants under license, and has "three or four others" in final stages of licensing negotiations. A similar number are also about to be licensed in foreign countries.

Homasote—a trail blazer in the field—reports a healthy demand. That company's Precision-Built system was reinstated last spring, and now has five plants turning out large (8x12' average size) conventionally built panels for custom houses. Three of these plants were added "just this past month," says a company spokesman, and current plans call for 16 plants.

Alcoa reports increasing demand for its Alply panels, primarily for commercial jobs. But they're pushing residential field testing, especially in the South, and hope to lower prices.

What's ahead? A lot of people aren't saying—yet. But look for more companies to climb on the bandwagon. Masonite, for one, reports substantial gains in field tests of a partition system it's working on with Lu-Re-Co. Hoffman Industries has just marketed honeycomb-core drywall partition panels. Kaiser is researching panel systems. Brick panels have been tried with success. And a major gypsum company is rumored to have up its sleeve an interior wall system that comes complete with electrical heating elements.

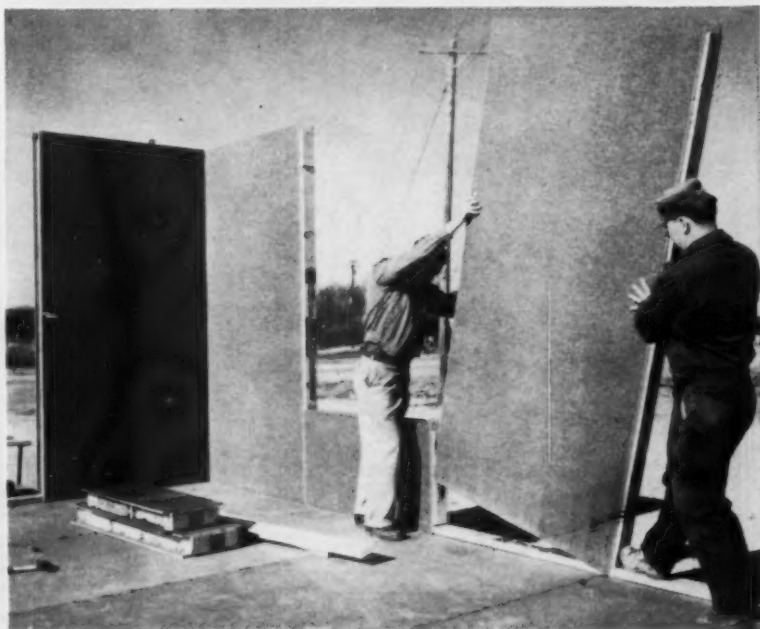

JOHNS-MANVILLE Flex-Ponent System uses panels of varied sizes (basic size: 4x8') faced with manufactured lumber. They cut with standard tools, take standard millwork. Joints are filled inside with epoxy adhesive, finished with drywall spackle.

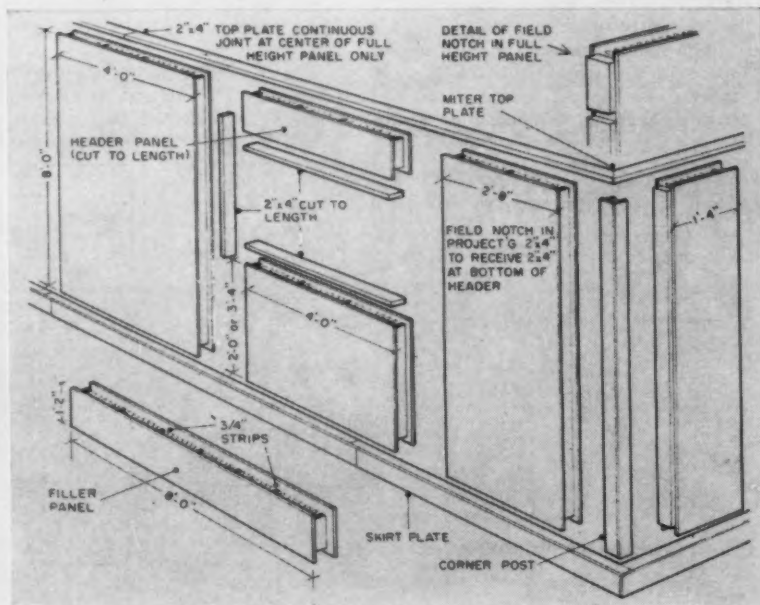

TOMORROW'S HOUSE



TEST HOUSE shows plywood panels formed as curved roof between roof beam and wall plates, giving design a Far Eastern look.

Flexible design from curved roof, big module

Here's a new design system that combines economy, eye appeal and wide variety of design.

The system is based on a 16' square space unit. Each unit has a post of three 2x4's at each corner, and two trusses. Each truss consists of a 4x8

bottom chord and two 4x4 diagonals (above). Connecting the trusses is a 1x10 ridgeboard with 1x6 nailers on each side.

The roof is formed by nailing 4x12' sheets of $\frac{5}{8}$ " plywood at ridgeboard and eaves. (Joints are battened on in-

side.) The plywood, being unsupported at the center, flexes into a curved, rigid, attractive, modern roof.

Outside finish will be mineral surfaced roll roofing over rigid insulation.

Designer of this new system is James Morrison Leefe, Architect, A.I.A.

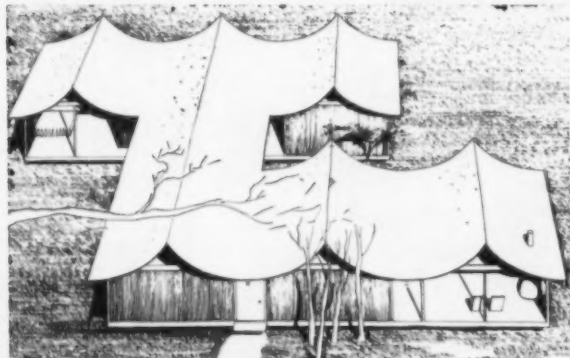

Roofs used in combination

Seven space units are joined to form spacious, modern looking house. Other layouts—rectangle, H- or L-shape—are also possible.

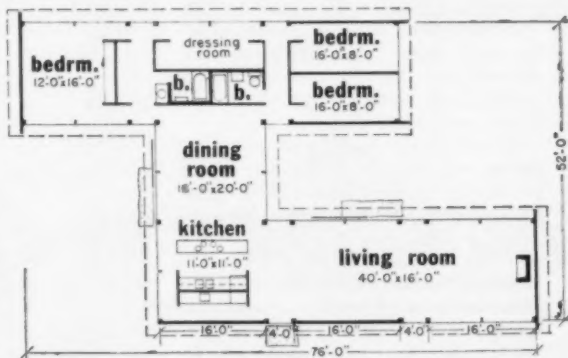

Flexible use of modular units

Plan uses 16' space units in 4' modular design. Multiple units form large rooms, while single units are used for smaller rooms.

YOU SAID:

"Give us a larger rose!"

KWIKSET made the new, larger 2 1/2" rose. It's stronger, more rigid, and provides a neater installation in 2" or 2 1/2" holes.

YOU SAID:

"Give me a spindle that can't break!"

KWIKSET now offers a new, unbreakable steel spindle and improved locking mechanism.

YOU SAID:

"Give us a longer lasting finish!"

KWIKSET developed a new, exclusive, protective plastic coating. Gives Kwikset finishes 5 times greater protection against weather, wear and scratches.

YOU SAID:

"Make a lock that's easier to install!"

KWIKSET offers the fabulous new Round Face Latch and Sok-It Strike that installs without mortising, chiseling or screws.

YOU SAID:

"Give me tools for faster installation!"

KWIKSET now offers the new bit jig with built-in, heavy-duty bits; the new Sok-It Strike Staking Pliers for on-the-job installation of Sok-It Strikes, and the new counter bore for use in Round Face Latch installations.

YOU SAID...and we listened. And we're still listening and improving on the best lockset value in the business.

If you have an idea, let us know. Your suggestions have helped Kwikset remain the largest selling residential lockset in America.



kwikset  **locksets**

Circle Postcard No. 2

KWIKSET SALES AND SERVICE COMPANY

A subsidiary of

The American Hardware Corporation, Anaheim, California

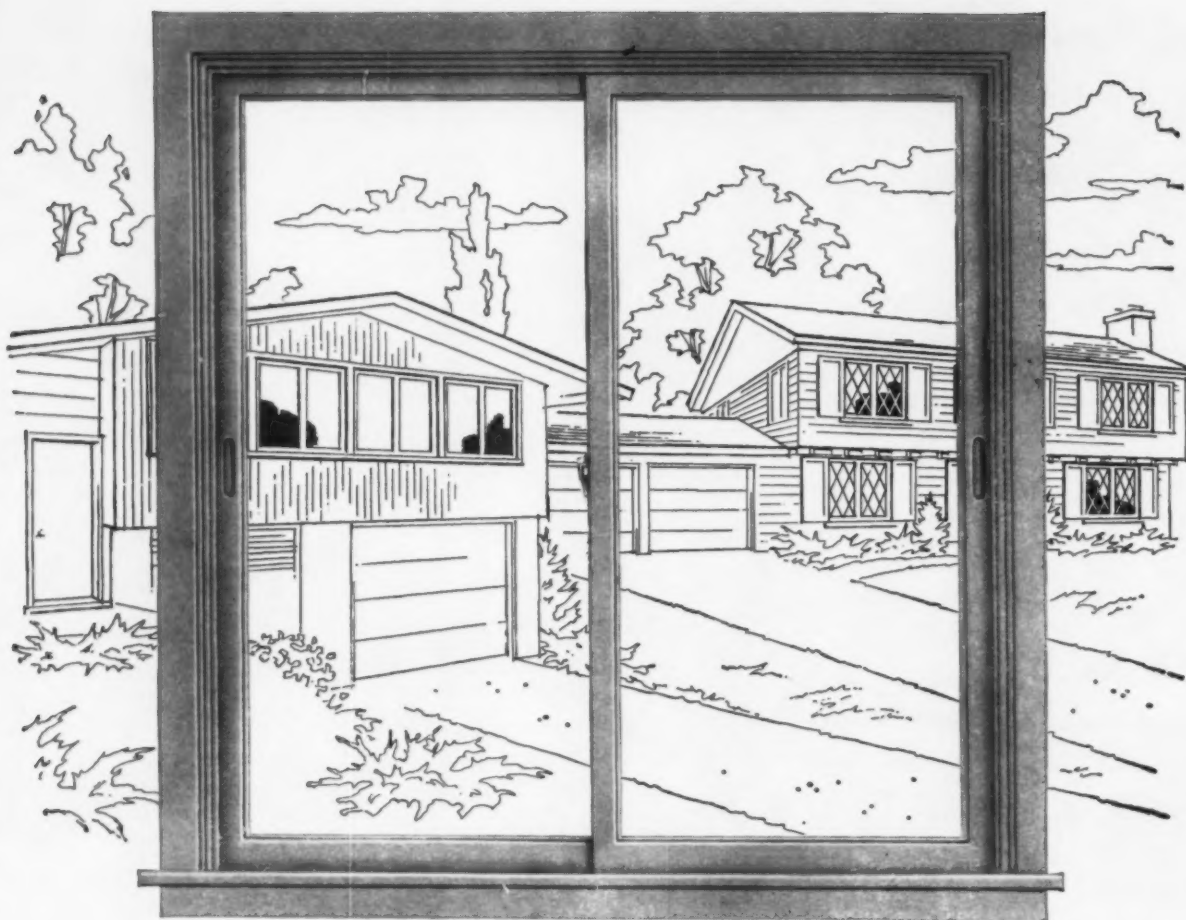

FOR CONTEMPORARY OR TRADITIONAL HOMES...

Here's the versatile Styletite slider—by **CURTIS**[®]

Consider this Styletite sliding window, designed to blend with both contemporary and traditional architectural styles. Beautiful, slim, trim lines...easy to install...trouble-free performance...extremely weather-tight...removable, of course.

Curtis engineered this new horizontal slider to meet builders' needs for a low-priced sliding window that is still tops in quality. Superior Curtis materials and construction make this sliding window practically call-back-proof.

The Styletite slider is part of a complete line of Curtis wood windows that includes *four* new double-hungs as well as casement, fixed sash, awning, hopper and basement styles—all designed to fit modular component panel construction.

Insulating glass installed in sash. Store in position on sash year round. Offers noise, heat and cold insulation. Aluminum framed. Fiberglas or aluminum screens.

Curtis and Styletite are trade-marks of Curtis Companies Incorporated



Ask your Curtis representative how you may qualify for this famous I-Q award, part of Curtis' I-Q merchandising program.

Look to Curtis for the finest in wood windows.

For complete details, contact your Curtis dealer or write to:



CURTIS COMPANIES INCORPORATED / CLINTON, IOWA

Individuality and Quality in windows, doors, cabinets and fixtures.

IMPACT

Letters to the Editor

Merchandising expert lauds our coverage

I was surprised at the large response to the article about me in AMERICAN BUILDER (Post-sale selling, January, 1961, p. 95).

I've been receiving letters from builders all over the country who do a top job of merchandising. They seem to be building more homes this year than they did last year—and yet they're not the publicized builders we hear so much about.

It was gratifying to know that AMERICAN BUILDER seems to hit this type of businessman, and that it has enough impact to make him take the time to write a letter . . . we need publications that get up the facts, hit hard and supply the information in a ready-to-use fashion.

Keep up the good work.

James H. Mills
President
Home Facts Research, Inc.

A pox on one of our houses

I just have to voice my opinion of your February blueprint house.

I am sure your judges had been smoking hashish when they picked it for its "excellent floor plan" . . .

The "gem" as you call it . . . from the outside looks like a WPA project that didn't quite get finished. If this is an excellent floor plan then I can reassure myself that I won't have to sit up nights to keep up with the contemporary thinkers . . .

I will close on the happy note that I enjoy your publication and would like to see more of the "Ask the Experts" feature.

C. Blaiser, Jr.
"Insulting Engineer"
Southfield, Michigan

Articles bring many inquiries

. . . This unquestionably tops all of the other pictures and articles we have had concerning (our) system (AMERICAN BUILDER, February, 1961, p. 109). We have already had

numerous letters and comments from . . . dealers throughout the country, and I expect we will get many more . . .

John M. Kemp, Jr.
President
The Kemp System

AMERICAN BUILDER last August published an interview (page 96) with Mr. Charles LeB. Homer, president of National Steel's Detroit headquartered Stran-Steel division . . . Since publication of the interview, Mr. Homer has arranged for responding to more than 1,000 queries—asking for further information on the general subject of pre-engineered steel buildings or specific information on how this modern mass-production concept of construction might be applied to a specific project.

For sure, this reaction dramatically reflects the great editorial interest your readers have in AMERICAN BUILDER. And, we like to think, it also reflects growing recognition for the time-saving, cost-saving quality results obtainable from the pre-engineered steel building concept.

Bernie F. Thomas
National Steel Corp.

. . . We do appreciate your help in publicizing our work. Your article on Lumber Rigid Frames a year ago (May, 1960, p. 116) resulted in hundreds of requests for information . . .

E. L. Hansen
Professor
U. of Illinois

Likes our emphasis on what's new in technology

. . . I am particularly interested in the technology of building from an engineering standpoint. I believe the most important job you do is to bring new concepts, and material uses, plus methods of fabrication to the builders.

B. M. Radcliffe
Assoc. Professor
Michigan State Univ.

Criticism . . .

. . . you spend too much time writing up people who have no basic

and fundamental knowledge of actual construction problems . . .

S. J. Cotter
San Francisco

Editor's note—we feel that, while construction know-how is a basic requirement for the builder, it is still only one aspect of this fascinating business. Therefore, we may often publicize an outstanding builder whose success is founded on, say, a strong merchandising program or a clever approach to land planning. In today's complex home market, such diversified coverage is vital to the growth of our industry.

And praise

. . . I have read many articles in your magazine that are devoted to modernizing. You . . . have a broader scope (on) home improvement than anyone I can think of.

Richard E. Burton
St. Louis Park, Minnesota

Editor's note—We intend to continue our coverage of the growing field of remodeling. See page 82, this issue, for the story on the builder's role in urban rehabilitation. Also, watch for our annual July remodeling feature.

. . . We were impressed and pleased with the articles (in your March issue) on the Portland Arena, the selected Western house, the Milwaukee bank and the Bellevue research house . . .

Robert E. Mahaffay
West Coast Lumbermen's
Association

. . . your magazine is the only trade journal which is directed to my residence. By receiving it there I feel (I can give it) the attention it deserves . . .

Walter L. Tally
Doraville, Georgia

. . . I read the John Long story and found it most interesting . . . I have always considered (AMERICAN BUILDER) one of the most outstanding magazines in the trade . . .

William J. Levitt, Jr.
Levitt and Sons, Inc.

The ladies buy the homes you build!



**Make your homes functional and practical
... instantly wanted! "Clothe" them in
genuine WOOD siding**

Today's "lady of influence" measures every major purchase by its functional and practical qualities as well as its beauty and design. Just as with fine fabrics, homes "clothed" in genuine wood instinctively appeal to her. Genuine wood siding combines qualities of strength, durability and superior insulation with its handsome appearance and design flexibility. Weyerhaeuser 4-SQUARE® sidings offer the product benefits smart buyers prefer . . . look for. See your 4-Square Lumber Dealer—and while you're there—ask him about the new Weyerhaeuser Prime-Coated and Dri-Shield sidings that reduce labor costs.



Weyerhaeuser Company
Lumber and Plywood Division

FREE COLORFUL "HOME FASHIONS" BOOK helps you sell your homes "clothed" in genuine Weyerhaeuser 4-SQUARE siding. Use in your model homes. Write for it now. Handy request form below speeds it on its way.

Weyerhaeuser Company, Trade Promotion Dept., Tacoma 1, Wn.

Firm

Address

City..... Zone..... State.....





NOW SPOTNAIL ROOF TRUSSES 4 TIMES FASTER!

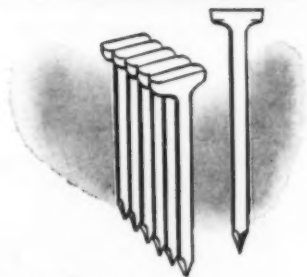

NEW 413J SPOTNAIL
For Metal Plates (Flat or Tooth Type)

The LC Spotnailer drives sturdy 1½" T-Nails through heavy metal plates with the touch of a button or trigger. No pre-drilling needed, no time wasted hitting the holes. Trendway, Inc., Crystal Lake, Illinois goes from pre-cut stock to a finished 26' truss in 1½ minutes with Spotnailers. Richard Arden, Trendway plant manager says, "These guns are 4 to 1 over hand nailing by actual test. The difference in cost of T-Nails means nothing compared with this big saving. Your 413J Spotnails penetrate the thickest plates we use for trusses up to 50' long. They equal hand nails in every way except they drive 4 times faster."

To See How Much Money You Can Save

PHONE OR WRITE FOR FACTS AND FIGURES

A demonstration will be made on your assembly line on request.

SPOTNAILS, INC. 1100 Hicks Road, Rolling Meadows 6, Ill., Clearbrook 9-1620

BRANCH PLANTS: CLARK, NEW JERSEY • LOS ANGELES, CALIFORNIA • AGENTS IN PRINCIPAL CITIES
Spotstaples also meet F.H.A. Standards for subfloors • wall sheathing • roof sheathing • lath • floor underlayment • asphalt shingles

15 ways to build better...and

ALBERT J. COREY & SONS
Toledo, Ohio



adds 25 sq. ft. per house with new 2" solid lath and plaster partition. Interlocking 1" gypsum lath panels give extra strength, fire protection, sound control.

CHARLES J. FOSS
Chatham, New York



saves \$150.00 per house. "Vinyl-surfaced Durasan® Wallboard gives me beautiful scuff-proof, washable walls fast, for less than other panels."

STANN CONSTRUCTION CO.
Whitney Point, New York



saves \$15.00 a house. "This clever wall-board cleat eliminates nailing strips and non-structural studs. Works on both walls and ceilings."

TROTTER AND ALLAN CONSTRUCTION CO.
Charlotte, North Carolina



saves \$143.00 per house with Gold Bond® Gypsum Sheathing. "Costs me \$201.00 applied vs. \$344.00 for wood." Gypsum is wind-tight and fireproof, too!

EDWIN G. WILLSON
Willson Hills, Montgomery County, Md.



cuts ceiling time in half. "We nail exclusive Gold Bond Clip-Strips direct to rafters, slide tiles permanently in place all in one operation."

A. W. NORTH
Minneapolis, Minnesota



saves \$52.00 per house with Classic-Shake. "90% of my customers prefer Classic-Shake vs. clapboards. They have all the beauty of wood shakes at a fraction of the cost."

RONALD D. HOMAN
Quincy, Illinois



simplifies crawl space insulation: "I staple Reverse Flange Insulation to floor joists, under sub floor, and cut application time by 30%."

STANFRED COMPANY, INC.
Penn Hills, Pennsylvania



saves \$70.00 on finishing costs. He has plasterers install metal casing beads, so plaster is terminated and trim applied in one easy operation.

GOLD LABEL BUILDERS, INC.
Romulus, Michigan



cuts application time 2 hours: "Extra Long Sussex "32"® Asbestos-Cement siding goes up 20% faster than 24" shakes, takes fewer nails, saves us \$12 a square."

save, with Gold Bond Products

WRIGHT HOMES, INC.
Raleigh, North Carolina



finishes trim in half the time. "Velvet Latex Enamel flows on, dries faster, saves me 4 hours per house. Tools and equipment clean up quickly with water."

PEARCE & PEARCE CO., INC.
Tonawanda, New York



cuts painting time 5 hours per house. "Exterior Velvet Latex House Paint flows on quickly, dries in one hour, and brushes and tools clean up quickly in water."

ROSENBLUM CONSTRUCTION CO.
St. Louis, Missouri



gets built-in ventilation and saves. Thousands of insect-proof holes ventilate without screening. They save money on every house with Asbestos-Cement soffits.

NASH PHILLIPS-COPUS
Austin, Texas



saves \$82.00 on sheathing. "I nail Asbestos-Cement siding *direct* to Brace Wall "N" Insulation Sheathing and save \$70 on furring strips, \$12 on corner bracing."

ELMER J. DREYER
Quincy, Illinois



saves hours with adjustable louvers. "I use sturdy Gold Bond aluminum louvers because they adjust easily to any roof pitch, don't need costly fitting."

DANCO BUILDERS' INC.
Dover, New Hampshire



saved \$1,500 per house with Tri-Dek. "It gave me a solid roof deck, insulation and an attractive ceiling finish all in one material with one application!"

a step ahead of tomorrow



NATIONAL GYPSUM CO.
BUFFALO 13, NEW YORK

Dept. AB-51 NATIONAL GYPSUM COMPANY, Buffalo 13, New York

Please send me more information about how to build better and save with these Gold Bond products.

- | | | | |
|--|---|---|--|
| <input type="checkbox"/> 1. 2" PLASTER PARTITION | <input type="checkbox"/> 7. REVERSE FLANGE INSULATION | <input type="checkbox"/> 13. BRACE-WALL "N" SHEATHING | <input type="checkbox"/> 15. TRI-DEK ROOF PLANKS |
| <input type="checkbox"/> 2. DURASAN WALL PANELS | <input type="checkbox"/> 8. CORNER & CASING BEADS | <input type="checkbox"/> 14. ADJUSTABLE LOUVERS | |
| <input type="checkbox"/> 3. WALLBOARD CLEATS | <input type="checkbox"/> 9. SUSSEX "32" SIDING | | |
| <input type="checkbox"/> 4. GYPSUM SHEATHING | <input type="checkbox"/> 10. VELVET LATEX ENAMEL | | |
| <input type="checkbox"/> 5. CLIP-STRIP CEILING | <input type="checkbox"/> 11. EXTERIOR VELVET | | |
| <input type="checkbox"/> 6. CLASSIC-SHAKE SIDING | <input type="checkbox"/> 12. ASBESTOS SOFFITS | | |

Name _____

Company _____

Title _____

Street _____

City _____ Zone _____ State _____



**GRANT'S
SPRING PIVOT
CAN REDUCE
FOLDING
PANEL
INSTALLATION
COSTS
MORE THAN
50%**

The exciting new design features in Grant's 2500 Folding Panel Hardware make it the most dependable and efficient line available.

Highlight of this remarkable product is the *spring loaded top pivot assembly* which assures constant, taut door-track engagement during installation. Other features include: hidden hardware for passageway installation, sturdy apron mounts for hollow core closet doors, aluminum track, nylon guides, adaptability for all panels, complete range of sizes.

2520: for passageway openings/2540: for closet openings

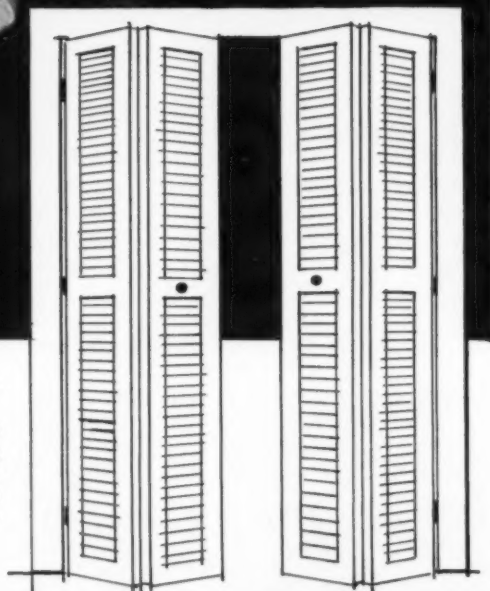

GRANT 2500 FOLDING PANEL HARDWARE



GRANT PULLEY & HARDWARE CORPORATION

Eastern Division/ 1 High Street, West Nyack, N. Y.

Western Division/944 Long Beach Ave., Los Angeles 21, Calif.

sliding door hardware • drawer slides • drapery hardware • pocket frames • pulls • special sliding hardware • closet rods

Rangaire



The Stereophonic Home... Rangaire's way to faster sales in '61!

Here's a completely new sales sparking promotional package to enhance the sales appeal of every home you build . . . and at an amazingly low cost to you.

Your selling job will be so much easier when you feature the Rangaire Stereophonic Radio Intercom System in every home you build. And Rangaire's Stereophonic Home promotional package helps you build a powerful sales promotion right in your own community.

Your prospects will be intrigued with the magnificent styling, the satin smooth hardwood cabinets and the unsurpassed tonal resonance of the Rangaire Stereo Radio Intercom System. A simple demonstration virtually turns any home into a concert hall . . . a touch of elegance that sets your home apart in your prospects' eyes. The price . . . Rangaire's low cost will surprise you . . . it's practical for even your lower budget homes. Better your sales in '61 . . . Rangaire has the product, the price and the promotion to help you profit. Return coupon for complete details today.

STEREO HOMES
Rangaire

Fill Out
and
Return

Roberts Manufacturing Company
Cleburne, Texas

Gentlemen:

Please rush details on Rangaire Stereophonic Home
Promotion immediately.

Name _____

Address _____

City _____ Zone _____ State _____

ALCOA SHOWS YOUR CUSTOMERS

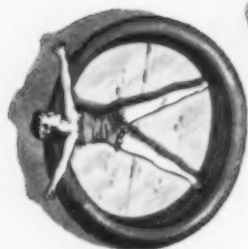

WHY ALUMINUM

For 1961 advertising, Alcoa spread out a typical house to show homeowners how much area does *not* need constant maintenance if it's all Alcoa® Aluminum. Alcoa tells your customers and prospects . . . "the more aluminum you use in, on and around your home, the more sunny Saturdays you call your own!"

That's why people buy products made with aluminum—that's why manufacturers make products with aluminum! Alcoa is reminding homeowners that there are many products made with Care-free Alcoa Aluminum that are available everywhere for building or remodeling—products that can *make a lot of house Care-free!*

Alcoa is also telling homeowners and home buyers why aluminum takes care of itself . . . aluminum grows its own protective skin—heals itself when scratched or damaged—aluminum *holds* paint! The remarkable physical properties of aluminum (like the one shown here)

are an important part of Alcoa's consumer advertising campaign. By learning more about the *natural* advantages of aluminum, homeowners will think twice about the materials that go into their new or remodeled homes. Homeowners will remember that *aluminum makes a lot of house Care-free!*

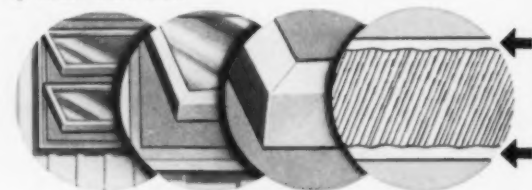

Less than a thousandth of an inch thick, this clear, protective skin keeps aluminum Care-free year after year.

Continuing Alcoa program shows you how to sell easier—sell more—
with building products made with Alcoa Aluminum

Alcoa's unique advertising, described above, is only part of a big and continuing program to help builders, remodelers and dealers sell products that homeowners want—products made with Alcoa Aluminum.

No matter what type of aluminum building product you're selling or including in homes, Alcoa's program can work for you because—*Selling the Aluminum Sells the Product!* Get all the details about Alcoa's exciting program from your supplier of products made with Alcoa Aluminum. He has a complete merchandising kit that shows you how to sell easier—sell more—with aluminum building products. And don't forget to see how Alcoa tells your customers why "Aluminum Makes a Lot of House Care-free!" Here's the schedule . . .



National Magazines: *American Home* (spring and fall), *Popular Mechanics* (spring and fall)
Network Television: "Alcoa Presents" (year-round)

ALCOA ALUMINUM
ALUMINUM COMPANY OF AMERICA

MAKES A LOT OF HOUSE CARE-FREE!

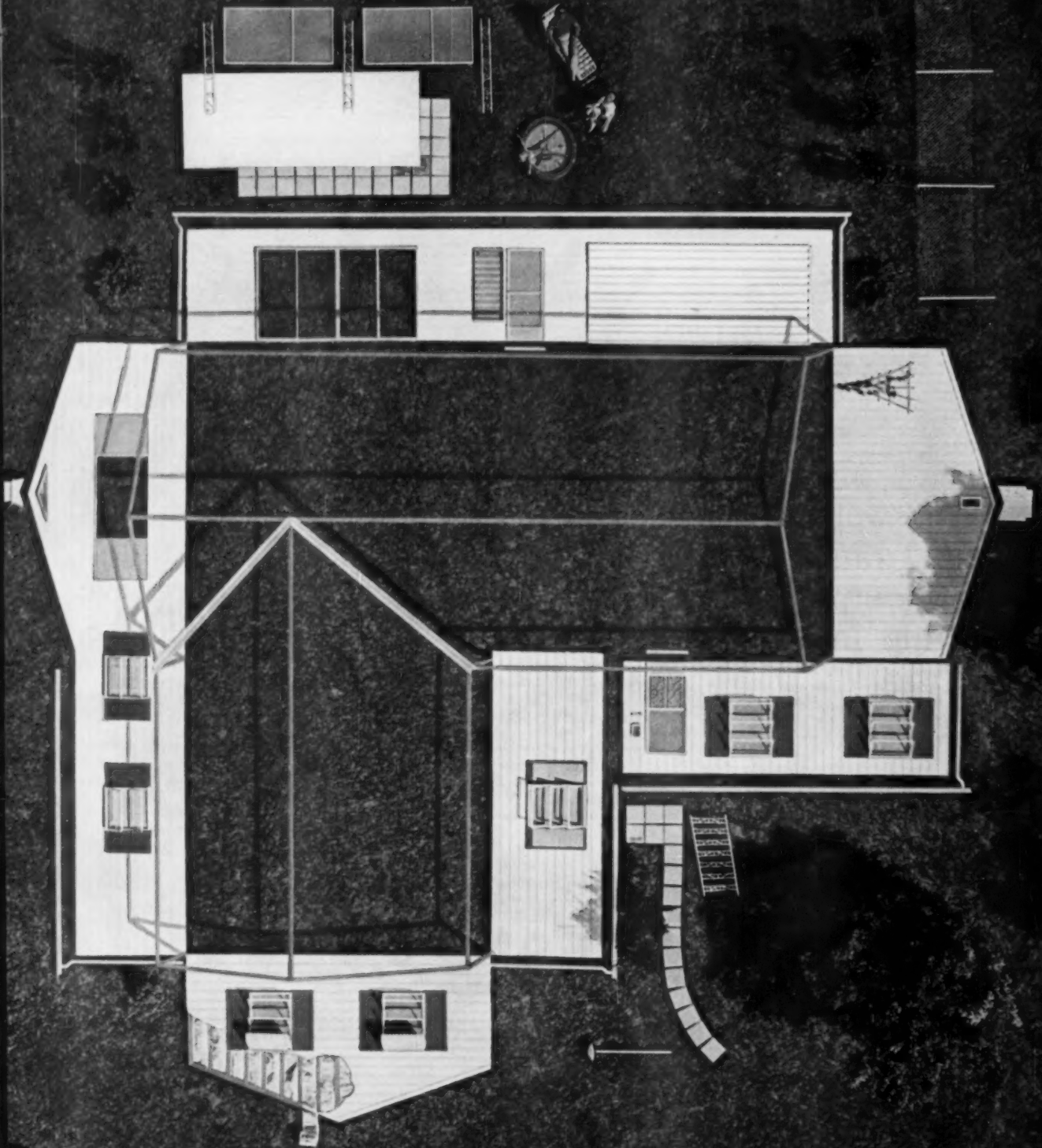

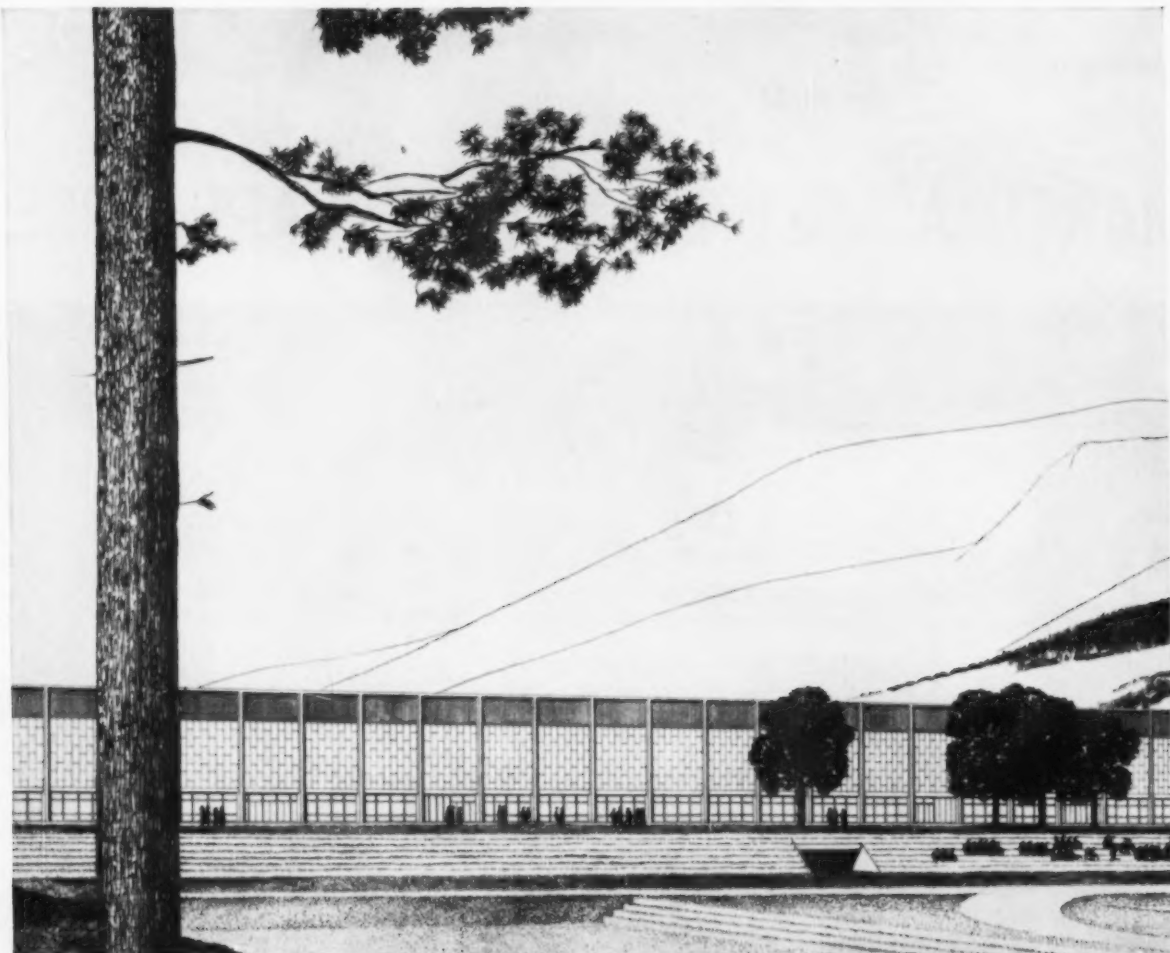

Windswept U.S.A.F. Academy, Colorado, installs 3 miles of trim Crane Sunnywall Finpipe Radiation. Gets maximum heat output with minimum space sacrifice. Unobtrusive styling integrates with the clean modern architecture.

Sunnywall type N was chosen because of its compact efficiency. Because of its flexibility. Because its attractive, modern lines are built to last. Even excessive heat won't buckle or bend its expertly die-formed, heavy gauge steel covers.

Just about the most complete line of finpipe radiation available, Sunnywall provides a wide choice of quick-fit enclosures and

easy-to-install accessories. This makes all the difference when time and labor costs are added up.

There's a choice of heating elements too. Economical steel — or superb non-ferrous elements with finest grade aluminum fins bonded to seamless copper tubing. All fins are permanently sealed to the pressure tubes for utmost durability.

For comfortable, clean convection heating with forced hot water or steam systems . . . for unmatched flexibility . . . for apartment or commercial building—specify Sunnywall by Crane.

See your regular contractor or your Crane representative for more details. Or write to Crane Co., Plumbing-Heating-Air Conditioning Group, Box 780, Johnstown, Pennsylvania.

AT THE
HEART
OF HOME AND
INDUSTRY

CRANE

VALVES AND PIPING
ELECTRONIC CONTROLS
PLUMBING
HEATING • AIR CONDITIONING



WORLD'S FIRST AND ONLY POWER BLOCK PLANE!

NEW FROM PORTER-CABLE...NO OTHER PLANE DOES SO MUCH, SO WELL



PLANES BROAD SURFACES



PLANES EDGES



PLANES RABBET CUTS



PLANES BEVELS

Model 167 Power Block Plane: Compact, lightweight, fits in palm of one hand. Powerful heavy-duty motor and construction. 21,000-RPM big-capacity steel cut-

ter. Positive belt drive. Bearings grease-sealed for life. Fingertip switch. Plus many more outstanding features. Write for folder and name of your nearest dealer.

PORTER-CABLE MACHINE COMPANY 1015 Marcellus Street
Syracuse, New York

SAWS • DRILLS • SANDERS • ROUTERS • SHAPERS • PLANES

IN CANADA: Porter-Cable Ltd., Box 817, Kingston, Ont. • EXPORT DEPT: 700 Marcellus St., Syracuse, N. Y.

Porter-Cable

Quality Power Products



VAN-PACKER[®]
Factory-Built
Tile-Lined Chimney

Chimney facts for home builders

Building higher priced homes that need a second chimney? Choose a Van-Packer for beauty and efficiency



Where your home designs call for a second chimney, you can cut your construction costs without sacrificing quality by putting up a Van-Packer factory-built tile-lined chimney. The masonry chimney often called for in the home design to serve a fireplace may not be located advantageously to serve the furnace, water heater or incinerator. The Van-Packer chimney easily handles such equipment and allows complete freedom for its location.

The Van-Packer chimney looks attractive on homes in any price range. The asbestos-cement panel housing has an embossed brick design with indented, natural-looking "mortar lines." Brick colors offered are red, buff, gray, and white. Colored housings have a Butyl finish to preserve their original beauty. Also available is a new metal housing described at right.

On single-chimney homes in any price range or as a second chimney on larger homes you'll find the advantages offered by the Van-Packer chimney add far greater value than its low cost made possible by factory mass production. See "Chimneys — Prefabricated" in the Yellow Pages, or write for Bulletin RS-1.

New embossed metal housing now available in three colors



In addition to the asbestos-cement housing, Van-Packer now offers a rugged new metal housing with embossed brick design, in red, buff, or white brick colors.

The new Van-Packer metal housing is ideal for homes in medium and lower price ranges. It is quickly, easily installed — paring your labor costs to the bone. Available in all standard sizes for Van-Packer tile-lined chimney or masonry gas vents.

Van-Packer chimney flue is lined with durable fire-clay tile

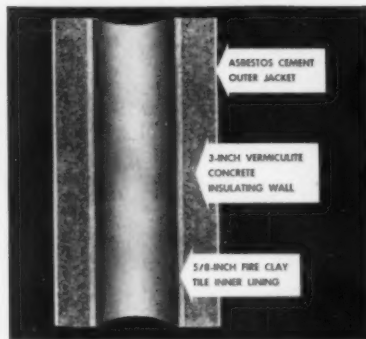

The fire-clay tile liner of the Van-Packer chimney won't corrode. It outlasts other factory-built chimney flues, and provides more efficient service because it retains heat longer for better draft. Fire clay is acid-proof, withstands temperatures up to 2100°F, and won't dent, flake or corrode even under severe conditions.

Van-Packer Model-G Gas Vent has rugged masonry flue

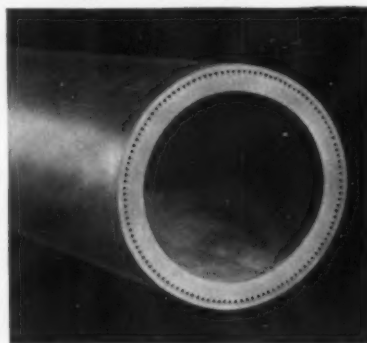

Made of 5/8" fire clay tile with a corrosion-resistant jacket, this gas vent is acidproof, fireproof, and won't dent, rattle, corrode or flake off. It is UL-listed for Class B service, for all gas-fired appliances (except incinerators) requiring a 3" to 7" ID flue. Model G gas vents are available with Van-Packer asbestos-cement or metal housing, or with kit containing flashing, storm collar, and rain cap.



Van-Packer chimneys are UL-listed for all fuels and all home heating plants, are safe for incinerators.



VAN-PACKER[®]

The Flintkote Company

Manufacturers of Diversified Products for Home and Industry
30 Rockefeller Plaza, New York 20, N. Y. Phone: PLaza 7-5500

In the West: Pioneer Division, The Flintkote Company, P. O. Box 2218, Terminal Annex, Los Angeles, Calif.
In Toronto, Ontario: The Flintkote Company of Canada, Ltd.



DESIGNER: LAMPERT WALLING



wood folding doors set the scene for versatile living

In this one picture we show PELLA WOOD FOLDING DOORS used three ways. In the foreground, one closes off a bedroom wing. Beyond that, one serves as a closure for well organized storage area. Another PELLA door in the background opens to kitchen and family room. Elsewhere in this exciting home, other PELLA WOOD FOLDING DOORS are used as a divider between kitchen and family room and as a closure for toy storage. You can order PELLA WOOD FOLDING DOORS factory-finished in any of 6 genuine wood veneers. Or, they can be painted or finished to match any color scheme. Solid wood "Lamicor" construction permanently prevents warping. Patented steel spring hinging provides easy operation. See the PELLA distributor listed in your classified telephone directory or mail coupon.

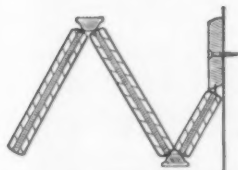

SPECIAL ALLOY STEEL
spring hinges run horizontally and are spaced 14-7/10" apart. Panels come together quietly, flat and compact.

6 Fine Wood Veneers... American Walnut • Philippine Mahogany • White Ash • Birch • Oak • Pine

.....THIS COUPON ANSWERED WITHIN 24 HOURS.....

PELLA ALSO MAKES WOOD FOLDING PARTITIONS, WOOD CASEMENT AND MULTI-PURPOSE WINDOWS, ROLSCREENS AND WOOD SLIDING GLASS DOORS

ROLSCREEN COMPANY, Dept. MB-34, Pella, Iowa

Please send me illustrated details on PELLA WOOD FOLDING DOORS by return mail.

NAME _____

FIRM NAME _____

ADDRESS _____

CITY & ZONE _____

STATE _____

"For higher quality at lower cost—"

HOMASOTE PRODUCTS

cut building time and cost

FOR EXAMPLE:

You save \$10.20 or more on every square of roof area with

HOMASOTE ROOF DECKING

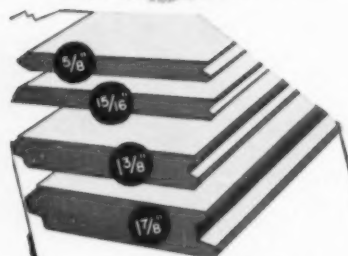

WEATHERPROOF HOMASOTE Roof Decking

Available in four thicknesses for four different joint spacings.

Thickness	Joint Spacing
5/8"	16" o.c.
15/16"	24" o.c.
1 3/8"	32" o.c.
1 7/8"	48" o.c.

All panels are 2' x 8'-V-grooved, or special tongue and groove as illustrated, but 5/8" is available in sizes up to 8' x 12"; 1 7/8" up to 4' x 8'.

HOMASOTE COMPANY,
TRENTON 3, N. J.

In one strong piece of weatherproof material, you have top structural strength, insulation, sound-deadening and an attractive finished ceiling. Application is simple and speedy. As evidence of Homasote's strength, note that the 1 7/8" thickness spans 48", where other materials require 3" thickness.

Homasote can help you cut your costs—either step by step or in terms of the whole structure. Both the size of the Big Sheets (up to 8' x 14') and their *weatherproofness* save you money at every point. Moreover, they permit uses not possible with other materials.

The major facts about each Homasote Product are presented in briefest terms—on a colorful Nutshell Card (as pictured below). Handy reference tables—such as fan locations—are included. Ask your Lumber Dealer—or write us—for a set of these cards. Each shows you where you can save money at some point of construction—and still give the home owner higher quality, finer appearance and more lasting satisfaction. And—be sure you always have available a copy of the latest edition of the 72-page Homasote Handbook. Kindly address your request to Department E-3.



VACATION HOUSE #703-1
(with Board-and-Batten exterior)

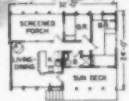

TO WIDEN YOUR MARKET... get the full facts about Vacation and Small Homes, Farm and Utility Buildings constructed by the new Versitruss-Panel System. Also—ask about the Homasote Financing Plan for Vacation and Small Homes.

Ask your Lumber Dealer
About Homasote P-B Components

HOMASOTE COMPANY
TRENTON 3, NEW JERSEY

Homasote of Canada, Ltd. • 224 Merton Street • Toronto 7, Ontario

PELLA PRODUCTS

THE FOCAL POINT OF QUALITY

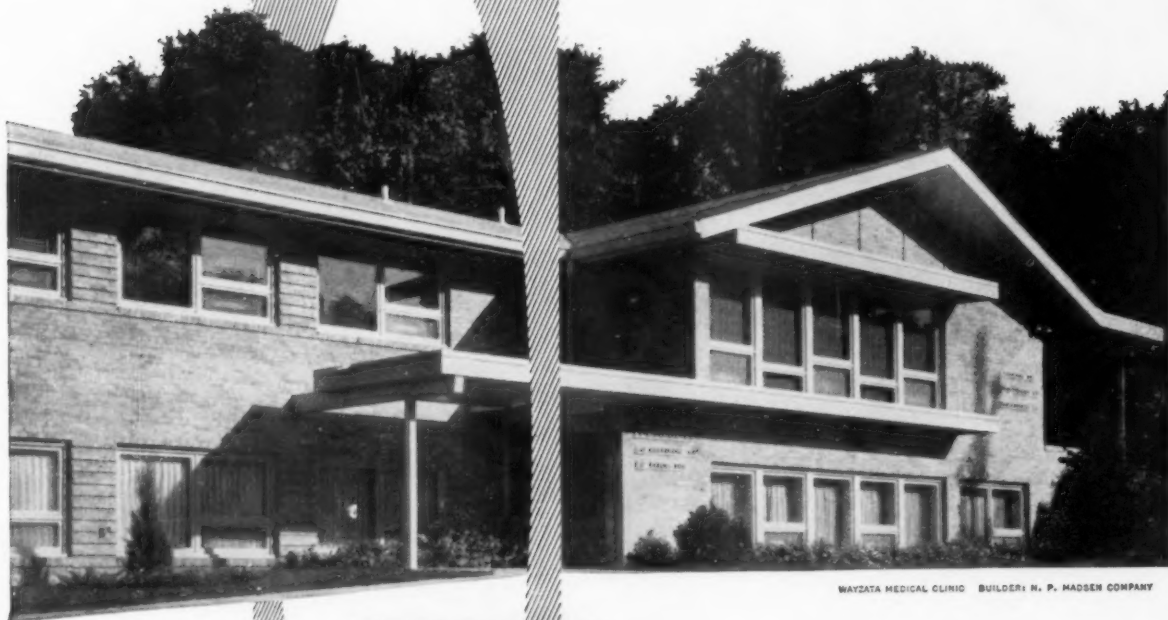

WAYZATA MEDICAL CLINIC BUILDER: R. P. MADSEN COMPANY

VISIT PELLA
 N.A.H.B. EXHIBIT
 SPACE 419-420
 McCORMICK PL., CHICAGO



wood multi-purpose windows

give commercial buildings "home" convenience

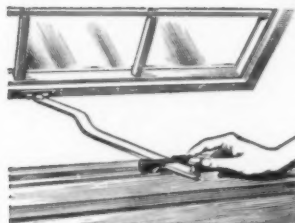

UNDERSCREEN OPERATOR
 is of extruded aluminum. Exclusive
 nylon GLIDE-LOCK® permits lock-
 ing M-P window in 10 positions.

Your commercial customers will long appreciate both the residential atmosphere and practical convenience of PELLA WOOD MULTI-PURPOSE WINDOWS. The handsome wood frames offer recognized insulating advantages and self-storing inside "storms." Stainless steel spring-type weatherstripping is on all 4 sides of the sash. A complete range of 20 standard-size M-P units combine into hundreds of combinations for any kind of architectural treatment. To save your construction time, PELLA WOOD MULTI-PURPOSE WINDOWS arrive factory assembled, and in many areas local warehouse stocks are available. PELLA also offers WOOD TWINLITE® WINDOWS, featuring awning convenience with the traditional "double-hung" look. Call the PELLA distributor listed in your classified telephone directory or mail coupon.

— THIS COUPON ANSWERED WITHIN 24 HOURS —

ROLSCREEN COMPANY, Dept. MB-35, Pella, Iowa
 Please send details on PELLA WOOD MULTI-PURPOSE and TWINLITE WINDOWS.

NAME _____

FIRM NAME _____

ADDRESS _____

CITY & ZONE _____ STATE _____

PELLA ALSO MAKES QUALITY WOOD CASEMENT
 WINDOWS, WOOD FOLDING DOORS AND PARTITIONS,
 ROLSREENS AND WOOD SLIDING GLASS DOORS



A dark finish gives Oak Floors a different, distinctive effect—at no extra cost.

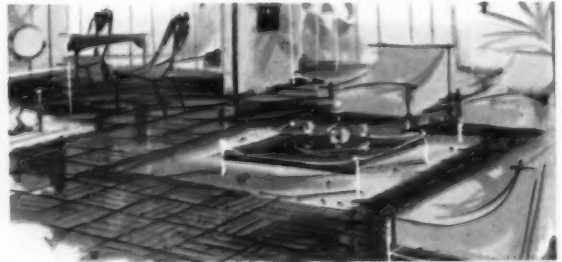

Vary your Oak Floors to attract home buyers

Here's an idea that will help you make faster sales: for a special "feature" room in your homes use one of the patterned Oak Floors. Random-width plank has ageless charm and beauty. Smart, sleek parquetry is appropriate for contemporary homes. Either floor design blends well with economical, popular Strip Oak.



*National Oak
Flooring Manufacturers'
Association
814 Sterick Building,
Memphis 3, Tennessee*



Dress up your
homes with
OAK FLOORS



Today's smartest homes have Oak Floors

In planning homes for the market, take a tip from the smartest contemporary houses and use Oak Floors. This preferred flooring for residential use dresses up any home to give you a definite selling advantage. With today's style trend favoring area

or accent rugs and exposed wood floors, Oak is the natural choice because of its beauty, durability and economy. Whether you build on wood joist or concrete slab foundation, always use Oak Floors and be certain of immediate buyer acceptance.

**OAK
FLOORS** 

Richer looking • Longer lasting • More comfortable

brand names and trademarks

Through years of happy experience,

the registered

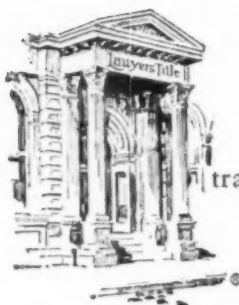

trademark

and the company signature of

Lawyers Title Insurance Corporation

have been synonymous with superior title service and protection to investors in real estate securities in the United States, Canada and Puerto Rico.

These symbols of established quality always identify Lawyers Title Insurance Corporation—the national company with financial stability, sound underwriting principles, and years of solid experience.

Lawyers Title Insurance Corporation

Home Office ~ Richmond, Virginia

CAPITAL, SURPLUS AND RESERVES OVER \$23,000,000

LAWYERS TITLE SERVICE AVAILABLE IN 44 STATES, INCLUDING HAWAII; AND IN THE DISTRICT OF COLUMBIA, PUERTO RICO AND CANADA. NATIONAL TITLE DIVISION OFFICES: CHICAGO • DALLAS • DETROIT • NEW YORK. REPRESENTED BY LOCAL TITLE COMPANIES IN MORE THAN 275 OTHER CITIES. THOUSANDS OF APPROVED ATTORNEYS LOCATED THROUGHOUT THE OPERATING TERRITORY.

LET US HELP YOU SELL YOUR HOMES

Use our point of sales material on title insurance.

1. 14" x 20" display cards for Model Homes.
2. A brochure and pamphlets for prospects.

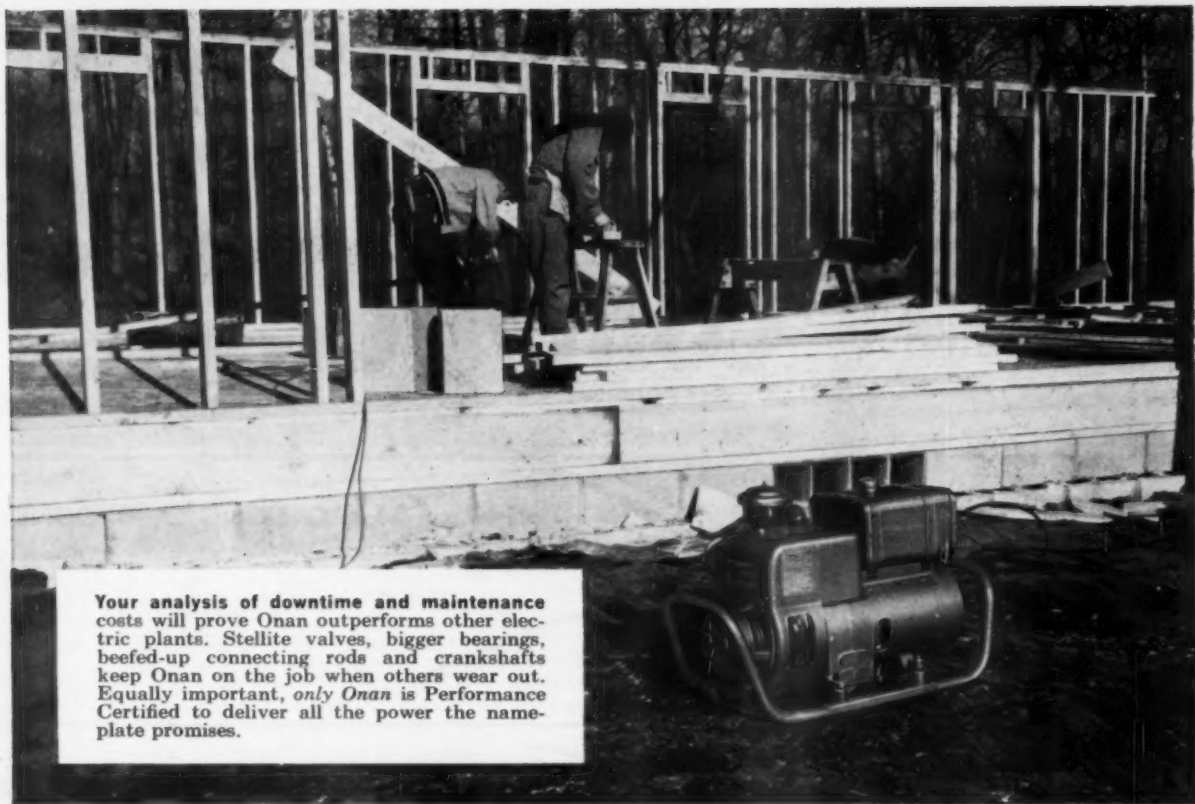

Your analysis of downtime and maintenance costs will prove Onan outperforms other electric plants. Stellite valves, bigger bearings, beefed-up connecting rods and crankshafts keep Onan on the job when others wear out. Equally important, *only Onan* is Performance Certified to deliver all the power the nameplate promises.

Only Onan is certified to give you all the power promised by its nameplate

It's a fact that many electric plants on the market today do not deliver the output promised by their nameplate rating.

Every Onan plant is given a rugged workout *under full load* before it is shipped—*your assurance* that the Onan you buy is ready for hard work the day you get it.

But this isn't enough. Independent laboratory inspectors pull surprise inspections to double-check our tests and testing methods. They pull a plant off the line, run it, stop it, load it, overload it, check and recheck. Their torture test gives positive proof of Onan's quality. End result: *Onan's exclusive Per-*

formance Certification . . . your assurance of getting every watt of power you pay for.

So when you're tempted by an electric plant "bargain," make sure its nameplate rating is not "inflated." Be sure you're getting full measure for your money. Remember, *the electric plant that short-changes you in power output is no bargain at any price!* Only Onan is Performance Certified to deliver everything the nameplate promises.

See Onan electric plants soon. Compare before you buy. You'll find your Onan distributor listed in the Yellow Pages. Call him or write direct.



World's Leading Builder of Electric Power Plants



ONAN Division, Studebaker-Packard Corporation, 2547 University Ave. S. E., Minneapolis 14, Minn.

Those who know Quality always want



CALKING & GLAZING COMPOUND



Nu-Calk CALKING COMPOUND in Bulk—Knife or Gun Grade

Off-White Color available in knife or gun grade. Pure White Color available in gun grade only. Off-White shipped unless White specified. Gun Grade meets Federal Specifications No. TT-C-598 (Grade 1). Available in ½ pt., pt., qt., gallon, 5 gal. and 55 gals.



HAND SQUEEZE TUBES for small jobs

No gun needed. Simply remove cap from built-in nozzle, fasten key over crimped end, turn key and start calking. Here's a fast-moving item for over-the-counter sales. Packed 12 tubes in a handsome "Silent Salesman" display carton that can be quickly set up on your counter.



Nu-Glaze GLAZING COMPOUND Always stays "PUT"

Here's the perfect material for glazing wood or metal sash, replacing putty, setting plumbing, filling cracks, boatwork of all kinds. Clean to handle, easy to use. Will not dry out, harden, crack or peel. Available in ½ pt., pt., qt. cans; 25, 50, 100, 880 lb. drums.



Nu-Phalt PLASTIC ASPHALT CEMENT for all jobs!

Ideal for sticking down asphalt shingles and floor tiles ... for use on roofs, chimneys, flashings. Packed 12 loads to a carton ... with or without plastic nozzle. Shipped without nozzle unless specified. Also available in 2½ and 10 lb. cans; 50 lb. pails; 550 lb. drums.

Advertised Nationally in 17
Leading Consumer Magazines

BUILDERS Sold by all
Hardware, Lumber and Build-
ing Supply Dealers.

DEALERS ORDER TODAY
—your order will receive
prompt shipment.



Perfect for Today's Quality-Built Homes!



AMERICA'S FAVORITE!

SPEED LOAD

WHEN ONLY THE BEST is good enough—builders and home owners choose M-D Speed Loads every time! With "controlled flow" action, M-D Speed Loads eliminate dripping or oozing of compound from nozzle. Get cleaner, neater jobs. It pays to tell customers about this feature. Point out the BUILT-IN Polyethylene pleated plunger (with accordion action) that STOPS flow of calking compound when desired!



- Available in white or off-white color.
- Available with or without plastic nozzle.

M-D Speed Loads are packed 12 loads to each carton. Please order in multiples of 12. Off-White loads without nozzle always shipped unless otherwise specified.

Meets Federal Specifications TT-C-598 (Grade 1)



NEW EXCLUSIVE FEATURES!

• NEW PLASTIC NOZZLE



New plastic nozzle provides on-the-job choice of 4 different size nozzle openings: 1/8", 3/16", 1/4" and 3/8". No longer do you have to change gun nozzle to get a small or large bead of calking.

• BUILT-IN CUT-OFF ON GUN HANDLE

As shown, the CG-4 gun now has a built-in cut-off knife blade on the trigger of the gun. Tip of plastic nozzle is cut off by squeezing trigger.



MACKLANBURG-DUNCAN CO.

MANUFACTURERS OF QUALITY BUILDING PRODUCTS
BOX 1197 • OKLAHOMA CITY 1, OKLAHOMA



Top outlet
upfeed

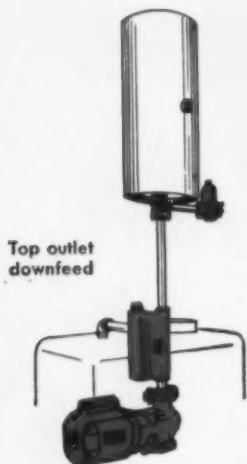

Top outlet
downfeed

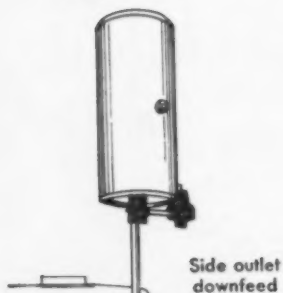

Side outlet
downfeed

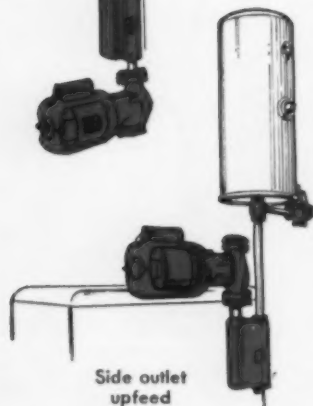

Side outlet
upfeed



PACKAGED FOR BUILDERS

B&G[®] *Hydro-Flo*[®] PAK

cuts the cost of forced hot water heating... saves space

For builders, the advantages of B&G *Hydro-Flo* Forced Hot Water Heating are now made easier to have because the pre-planned and pre-engineered *Hydro-Flo* Pak has *reduced the cost!* To homes built to sell competitively, B&G *Hydro-Flo* Heating adds distinction which gives them a strong selling edge.

Here, neatly packaged, is all the auxiliary equipment needed for most residential hot water heating systems. The Pak permits a correct installation in an incredibly short time—cuts boiler piping time from hours to minutes. Savings in labor mean a substantial reduction in the total cost of the installation...compact design saves valuable living space.

The B&G *Hydro-Flo* Pak features the B&G Airtrol System—the only *guaranteed* method of removing air from a hot water system and keeping it out.

Write today for complete information on this money-saving way of equipping your homes with hydronic heating.

WHAT YOU GET

The B&G *Hydro-Flo* Pak consists of a B&G Booster, famous for quiet operation... guaranteed B&G Airtrol System... choice of B&G Relief Valve or Flo-Control Valve or both... separately packed B&G Compression Tank. Pipe and fittings are also included, cut to exactly the proper lengths.



BELL & GOSSETT
C O M P A N Y
Dept. GQ-11 Morton Grove, Illinois

Canadian Licensee: S. A. Armstrong, Ltd., 1400 O'Connor Drive, Toronto 16, Ontario



**JUST SEE ALL
THE DOORS
BERRY IS
OPENING**





THE NEW BERRY AUTOMATIC INSTALLS IN 30 MINUTES !!! ONLY GARAGE DOOR OPENER GUARANTEED FOR 5 YEARS

■ Opens, closes garage door, lights up garage from inside your car. ■ Transistor-operated with portable pocket transmitter. ■ Completely pre-assembled, the Berry Automatic with pre-tuned electronic controls installs in just 30 minutes. *Other door openers require from two to four hours for installation.* ■ Servicing usually amounts to simple replacement of control box. ■ Mechanical components guaranteed for five years! *Most other makes guaranteed just one year.* ■ Installs on all types of garage doors—steel, wood, fiberglass, or aluminum. ■ For more information, write Berry Door Corporation, 2400 East Lincoln Ave., Birmingham, Michigan.



**BREEZE-LIGHT, STORM-STRONG—
BERRY STEEL DOORS PROTECT
YOUR QUALITY REPUTATION OVER
700 TIMES A YEAR !!!**

■ At least twice a day, over 700 times a year, Berry Steel Doors lift lightly, smoothly for owners. ■ Designed and constructed to trim your installation costs, yet they cost less than most others! ■ Sundrift primer saves on-site painting . . . won't chip, peel, or check. ■ Complete weather seal assures year-round protection against all weather in any climate. ■ Steel allows no warping, swelling or shrinking from heat or cold. ■ *Berry guarantees its quality-built steel doors for five years.* ■ Meets every need with a wide range of sectional and one-piece models.





**WOOD DOORS COME TO BERRY !!
STYLEMASTER HAS RUGGED
CONSTRUCTION WITH HARDWARE
THAT NEVER GROWS OLD !!**

■ A quality newcomer, Berry Stylemaster Door is of heavy, kiln-dried lumber that insulates against all weather. ■ Hardware is of finest heavy-gauge steel to last the life of the door. ■ Has operating safety of over 200%. ■ Easy-up operation maintained with torsion or extension springs. ■ Fittings are rustproofed for corrosion resistance. ■ Wear and noise reduced with rugged ball bearing rollers and roller carriers. ■ Stability and accurate alignment assured by sturdy tapered tracks and adjustable support brackets. ■ Five models for double and single openings. ■ For detailed literature and specifications on Berry Steel or Stylemaster Doors, write to Berry Door Corporation, 2400 East Lincoln Avenue, Birmingham, Michigan.

Berry
DOOR CORPORATION



Trowel points to Wide Flange Rapid Control Joint, a companion product used with Dur-o-wal

Two sure ways to better block construction

Dur-o-wal Reinforcement—Wide Flange Rapid Control Joint

More and more, architects and engineers are specifying this combination to assure permanent masonry wall construction.

Dur-o-wal Reinforcement, fabricated from high tensile steel with deformed rods, lays straight in the mortar joints with all of the steel in tension and working together as a truss. This is the basic engineering principle that makes for maximum flexural strength.

And the Rapid Control Joint, with its wide neoprene flanges, automatically assures the flexibility that lets a wall "breathe" under various natural stresses, provides a tight weather seal with minimum caulking.

For technical data, write to any of the Dur-o-wal locations below. Over 8000 dealers across the country are ready to serve you. See us in Sweet's.

DUR-O-WAL®

Masonry Wall Reinforcement and Rapid Control Joint

RIGID BACKBONE OF STEEL FOR EVERY MASONRY WALL

DUR-O-WAL MANUFACTURING PLANTS

- Dur-o-wal Div., Cedar Rapids Block Co., CEDAR RAPIDS, IA.
- Dur-o-wal Div. of Ill., 260 S. Highland Ave., AURORA, ILL.
- Dur-o-wal Prod., Inc., Box 628, SYRACUSE, N. Y.
- Dur-o-wal Prod. of Ala., Inc., Box 5446, BIRMINGHAM, ALA.
- Dur-o-wal Div., Frontier Mfg. Co., Box 49, PHOENIX, ARIZ.
- Dur-o-wal of Colorado, 29th and Court St., PUEBLO, COLO.
- Dur-o-wal Prod., Inc., 4500 E. Lombard St., BALTIMORE, MD.
- Dur-o-wal Inc., 1678 Norwood Ave., TOLEDO, OHIO
- Dur-o-wal Ltd., 789 Woodward Avenue, HAMILTON, ONTARIO, CANADA



IBI RATED
R2.06
INSULATION BOARD INSTITUTE

UNDER STUCCO, BRICK OR WOOD, QUALITY BUILDERS USE SHEATHING, AND ...
THIS IS THE SHEATHING THAT INSULATES

That's the difference between one sheathing material and another. Insulation board is the one that insulates. In fact, insulation board sheathing meets F.H.A. minimum requirements without supplementary wall insulation.

Now the Insulation Board Institute has established a precise rating system (see chart). Soon these ratings will be stamped on every sheet manufactured by our fourteen member firms. Watch for the "IBI Rated" seal.

Got time for three fast facts? (1) Insulation board sheathing is strong—up to five times as strong as horizontal lumber sheathing! (2) Insulation board requires 50% less labor than lumber sheathing—and involves at least 10% less waste. (3) Insulation board weighs less than half as much as gypsum sheathing.

HEAT RESISTANCE RATINGS (R)	
IBI RATED INSULATION BOARD SHEATHING (25/32 IN.)	R 2.06
IBI RATED INSULATION BOARD SHEATHING (1/2 IN.)	R 1.32
LUMBER (HOM. 1 IN.)	R 0.90
GYPSUM (1/2 IN.)	R 0.45
PLYWOOD (5/16 IN.)	R 0.39

Write for the new booklet, "How to Save with Sheathing."

IBI INSULATION BOARD INSTITUTE

111 West Washington St., Chicago 2, Illinois

Etched Bronze

BY DEXTER



New, exclusive combination of etched bronze and satin bronze creates rich, new beauty for traditional, colonial and modern homes. This new Dexlock finish available in all Dexlock functions. Mounted display available to Dexter dealers. When ordering specify U.S. 11-E/10.



No. 3331 with No. 43 diamond mounted modern escutcheon, 8" x 8" across points

No. 3301 passage set for interior doors. Also available in privacy sets and other Dexlock functions

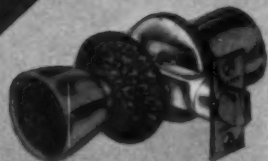

BUY DEXTER

DEXTER LOCK DIVISION

Dexter Industries, Inc., Grand Rapids, Michigan

IN CANADA: Dexter Lock Canada, Ltd., Galt, Ontario. IN MEXICO: Dexter Locks, Plato Elegante, S.A. de C.V. Monterrey. Dexter Locks are also manufactured in Sydney, Australia and Milan, Italy.

WESTERN NEWS

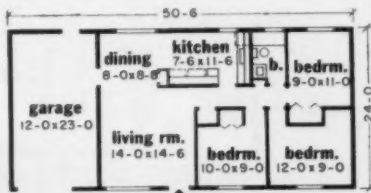

HALLBERG'S HOMES feature carpeting, sliding glass doors to patio, attic storage area, built-in bathroom vanity, gas heat, and 1-year warranty.

Low-Cost Home Fast Seller In Slow Portland Market

Builder Ray Hallberg of Portland has proven that if builders come up with a well-designed house with real value, it will sell.

During two spring weeks, Hallberg sold 28 homes—an outstanding record in a slow Portland market.

The houses, which sell for \$11,400, are promoted as suburban atmosphere with city conveniences. They're located about 18 minutes from the down-

town area; a short distance from a large shopping center.

Other Hallberg features include a large choice of models and color coordinated interiors, which stress individuality for every family.

The subdivision is complete—streets, curbs, and fire hydrants are in. Hallberg uses this as a sales point: "a bright, clean environment for your family's future."

5th Annual Hawaii HB Show Promises to be Big Affair

State-side homebuilders could take a lesson from their new sister state, Hawaii, which is sponsoring their 5th annual home show May 25 to 28.

Plans call for: (1) Contest with round trip passage for two to the U. S. (2) Auction of a home being built by students of American Factors and Honolulu Tech School. Profits will go to the school fund. (3) Door prize of two round trip tickets to Panama. (4) Giveaway of several electric ranges. (5) A grand prize, being considered now, will be a beach cottage.

Revenue from booth sales will total \$18,500.

March Construction Outlay Totals \$3.9 Billion; New Private Building Up 7%.

Value of total new construction for March, 1961, topped out at \$3.9 billion, reports the Bureau of Census, U.S. Department of Commerce.

This was 8% more than in February. Spending in March, 1961 was about the same as in March, 1960.

Total new private construction in March, 1961 totaled \$2.8 billion. This was an increase of 7% more than February, and about 4% less than in March, 1960.

Spending for private non-farm residential buildings in March totaled \$1.4 billion, 10% above February, but 11% under the level in March, 1960.

All figures are compared to a normal seasonal increase between months; according to the government.

Southern Cal. Builder Will Put Fall-Out Shelters in 850 Houses at \$1,300 Each

Richard Doremus, president of Exhibit Homes, Inc., developers of Sunset Conejo and the Dales, located north of Thousand Oaks, will install fall-out shelters in all of his new 850 homes.

The shelters will be constructed under the garage floor and will follow the design recommended by the government.

Cost runs \$1,300 each, of which \$1,100 is financed in the total cost of the home. Houses in the Conejo subdivision sell from \$29,500. Included in the fall-out chamber is an air exhaust and intake pipe—with hand pump—and an antenna for a radio.

U. of C. Offers Builders Correspondence Course

"Mechanics of Materials" is a new correspondence course now being offered by the University of California Extension Division.

The course, which covers the elastic and ultimate resistance of materials; stress analysis for bars, beams, columns, and shafts, deflections and combined stresses, and elements for wood and steel buildings, consist of 30 assignments.

Components Manufacturer Opens Office In Calif.

Seaboard Homes, Inc., Hawthorne, N. Y., major maker of homes and home components, has opened an office in Beverly Hills, Calif.

SELECTED WESTERN HOUSE

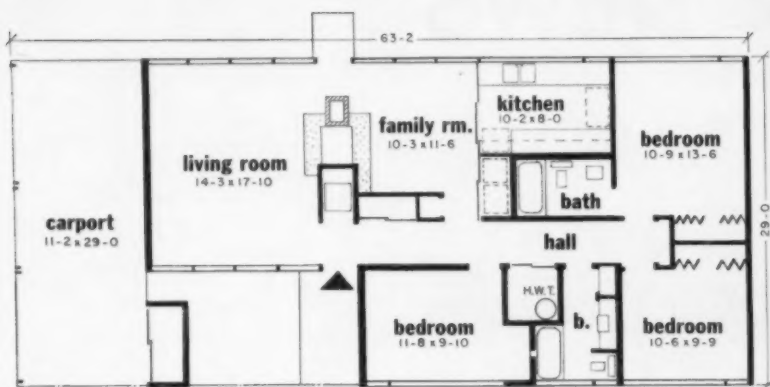

FLOOR PLAN of Arapaho Hills ranch model shows living and family rooms facing rear terrace. Rooms are divided by back-to-back fireplaces, one of the most popular interior sales features. Builders have provided abundant closet and storage space.

LOW-PITCHED ROOF gives home a long, ground-hugging appearance. Beams, which are exposed in interior ceilings, are carried out to support carport roof. Back of storage area at right center is a large planter area and main entrance to the home.



Terraces, fireplaces 'glamorize'

Moving past a reflecting pool in the spacious entryway of this attractive Littleton, Colo., ranch, visitors find themselves in a home that provides a truly Western flavor.

Open planning by the builder, Mannon Associates, Inc., is centered on a wide hallway that leads to all rooms, and is further featured by open beam ceilings and low partitions. There are

terraces in front and in back of this \$23,000 model, and a gas-burning firepit highlights the rear terrace.

With 3 bedrooms and 2 baths, this Arapaho Hills model offers 1,320 sq. ft. of finished living space. Mannon built the home on a slab, and a 75 x 152' lot is included in the purchase price. Planned landscaping, also included, is best exterior sales feature.

Quality Products Used in this House—Lennox heating; General Electric appliances, kitchen cabinets; Lightolier lighting fixtures; Simpson "Lifeclad" paneling, 7-11 interior doors; Crane plumbing; Robbins Pompeian marble floors; Forest Fibre Products "Rustic" siding; Ador sliding glass doors; Form-O-Glass fiber glass lavatory countertop; shower receptor; NuTone ventilating bath fan; Kwikset door hardware; Stanley door hinges, butts; Owens-Corning insulation; Visking "Visqueen" vapor barrier; Gold Bond drywall; Hall-mack towel bars; Trade Wind kitchen hood fan.



MODIFIED FRONT ENTRANCE has stone-chip bridge arching over artificial pool and leading to living room door. Pool area also adapts to plants and shrubs. Planters add to effect.

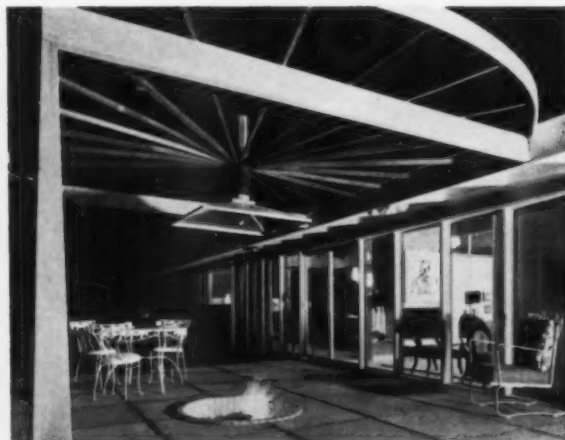

GAS-BURNING FIREPIT for outdoor cooking and winter warmth is a popular feature of rear terrace. "Wagon wheel" sun shade adds to Western flavor, supports firepit hood.

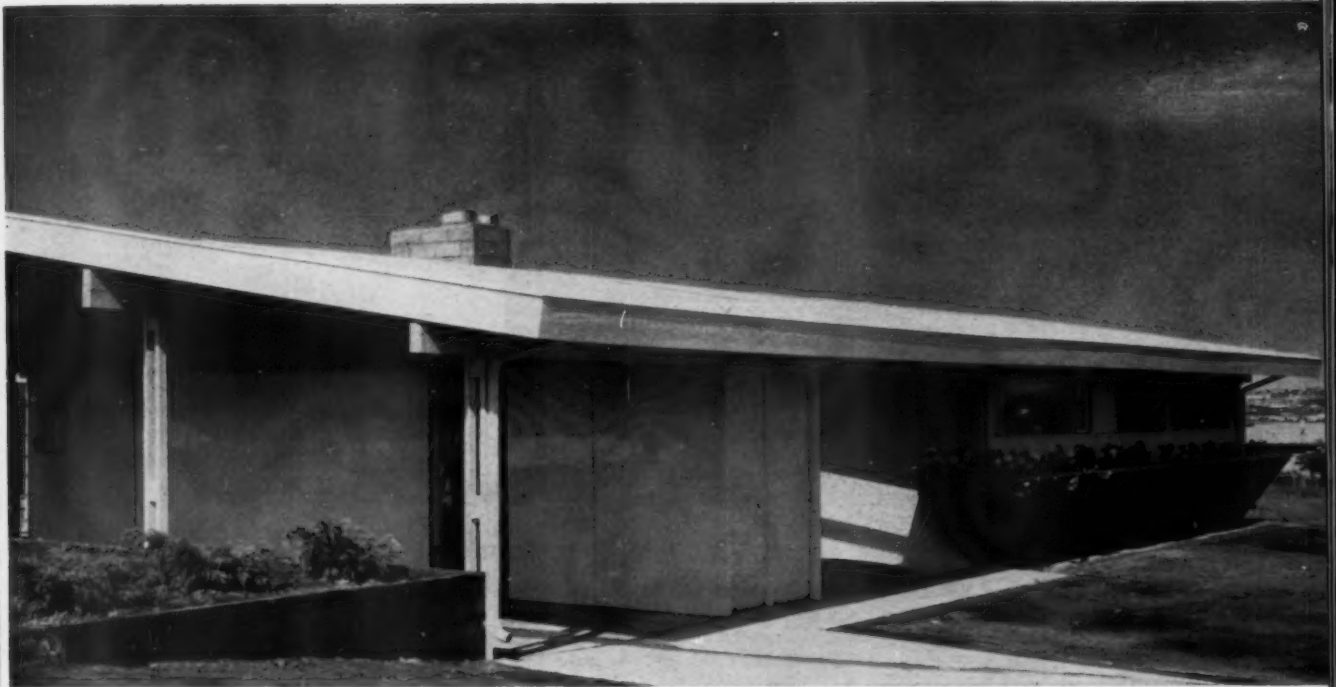

this Colorado ranch

HOUSE OF THE MONTH DETAIL PLATE

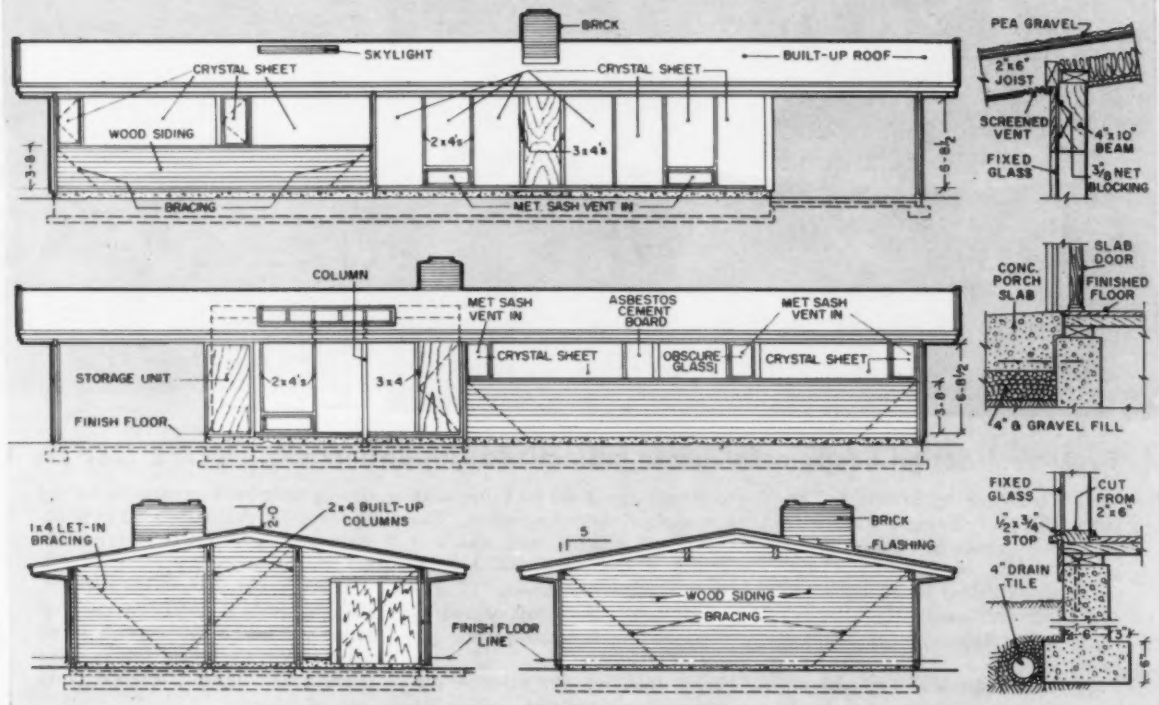

SELECTED NORTHERN HOUSE

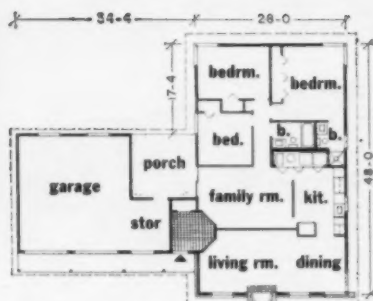

Family room, fully equipped kitchen highlight Kansas ranch

Reflecting the trend toward shared family life in its design, this ranch model has become a proven best-seller for Fischer & Frichtel in their Round Hill development, Johnson County, Kan.

The prime asset of the "Avalon" is a large family room just a step away from a fully equipped kitchen. A plywood screen with grilled pan-

els separates the two areas, but does it without sacrificing intimacy.

In its central location, the family room is bounded on one side by the living room and dining room. On the other side, there are three bedrooms and two full baths.

In their promotion, the builders stress the many brand names that are featured. The kitchen is particu-

larly well suited to this illustration of quality and value. It includes, among other appliances, a built-in electric range and oven, a lighted range hood and exhaust fan, a built-in dishwasher and a garbage disposal.

Priced at \$20,950, the "Avalon" offers 1,462 sq. ft. of living space. A full basement costs \$2,000 more.

SELECTED SOUTHERN HOUSE

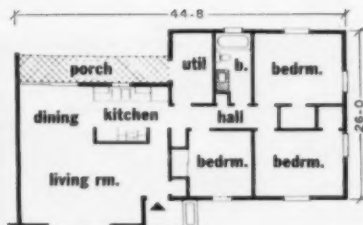
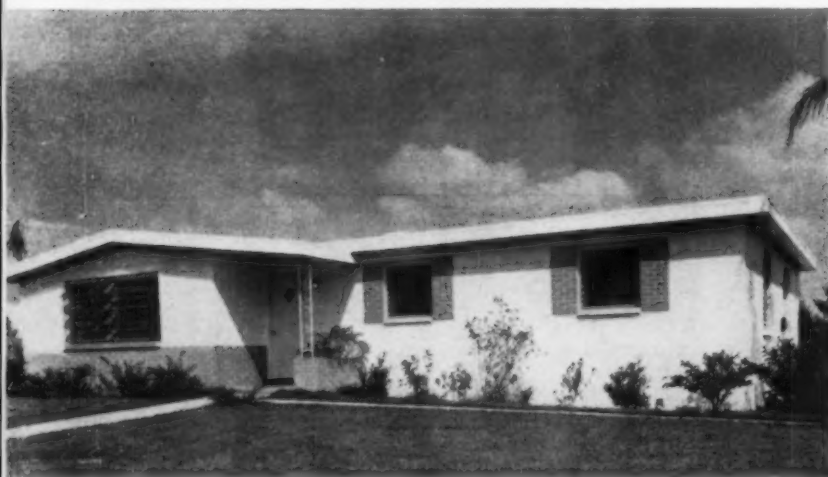

Functional design keeps costs low in customized Florida model

The "Flamingo" by Robert J. Terrence, Inc., of Tampa, Fla., is a new and attractive entry in the builder's line of economical custom homes. Priced at \$6,950 without land, the home still contains more than 1,000 sq. ft. of finished living area.

Terrence constructs the home on buyer's lots and, where necessary,

accepts the appraised lot value as an approximate down payment. The "Flamingo" is built on a slab and contains 3 bedrooms and 1 bath, plus kitchen, living-dining "L" and a utility room. Optionals offered by the builder include patios and garages or carports.

Brick trim on the exterior masonry walls, and a brick wall in the

dining area have proved to be top eye-catchers. A close second in popularity among buyers is an ornamental iron and brick planter.

When building in areas with existing municipal sewer systems, Terrence will make connections at no extra cost to the buyer. Where there is no system, he installs septic tanks free of charge.



**Let Built-In Cooling
Help Sell Your Home**

Lau Attic Fans add so much to the saleability of your homes. No other built-in appliance delivers as much comfort for so little cost. Versatile Lau attic fans are quickly installed, have a long trouble-free life and are available in sizes to fit both new or remodeled housing and low rise apartments. Lau attic fans, shutters and controls are distributed nationally through leading electrical, plumbing and heating outlets.

LAU ATTIC FANS ARE TODAY'S BEST VALUE IN HOME COMFORT

Home Comfort
Products Division



THE LAU BLOWER COMPANY
2027 Home Ave. • Dayton 7, Ohio

 . . . manufacturers of residential attic fans / commercial-industrial ventilating fans / range hoods / central ventilating systems / humidifiers / bathroom cabinets / air conditioning blowers



Anthony Chronis, (left) President, Lisle Electric, Inc., Lisle, Ill. talking to Al Jones, his Dodge Representative on a job site.

*“Dodge Reports saved our business in its early days
...today, they give us 1/3 of our volume”*

“Shortly after I took over this business, we lost an account that represented 50% of our volume,” says Mr. Chronis. “We had to round up a corresponding amount in a very short time in order to remain in business at all. We did it through Dodge Reports which we had never used before.”

“For the first three months of our subscription,” Mr. Chronis explains, “we conducted an intensive promotional campaign based on Dodge leads. It was so successful that after those first three months we had all the business we could handle.”

Mr. Chronis began with three men and three trucks, and restricted his contracts to residential construction. “Today,” he says, “we have 10 men, five trucks and a trailer. We handle stores, houses and apartment buildings and are beginning to establish our reputation in electrical heating work, engineering and quality custom installations. Last year we completed more than \$160,000 worth of contracts, \$50,000 of which we picked up solely through Dodge information.”

Mr. Chronis goes through each day’s Dodge Reports himself, and carries the ones he wants to bid on in

his car. When he passes a prospect’s site, he says, “I stop the car, walk through the mud and see the contractor on the spot. That’s where I can sell our services, because Dodge Reports have told me all I need to know about the job. And, whenever our name appears in Dodge Reports to show that we’ve been awarded a contract, we feel that it’s the best advertising our company can get anywhere.”

Dodge Reports can help you get the new business you want, too—for only a fraction of the profits they’ll help you earn. Send the coupon for further details. Or, consult your telephone directory for the Dodge office (in over 80 principal cities) nearest you.

F. W. DODGE CORPORATION
Construction News & Statistics Div., Dept. AB-51
119 West 40th Street, New York 18, N. Y.

I’d like to receive your free booklet, “How to Get More Business in the New Construction Field” and details on how Dodge Reports can help me increase volume and profits.

Name _____
Company _____ Title _____
Address _____
City _____ Zone _____ State _____

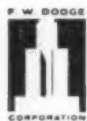

DODGE
reports

119 W. 40th St., New York 18, N. Y.



**V.I.P.
HOMES**

KAISER APPROVED
ALUMINUM SIDING

ALUMINUM SOFFITS
& FASCIA



BUILD VALUE INTO YOUR HOMES

UM
WS

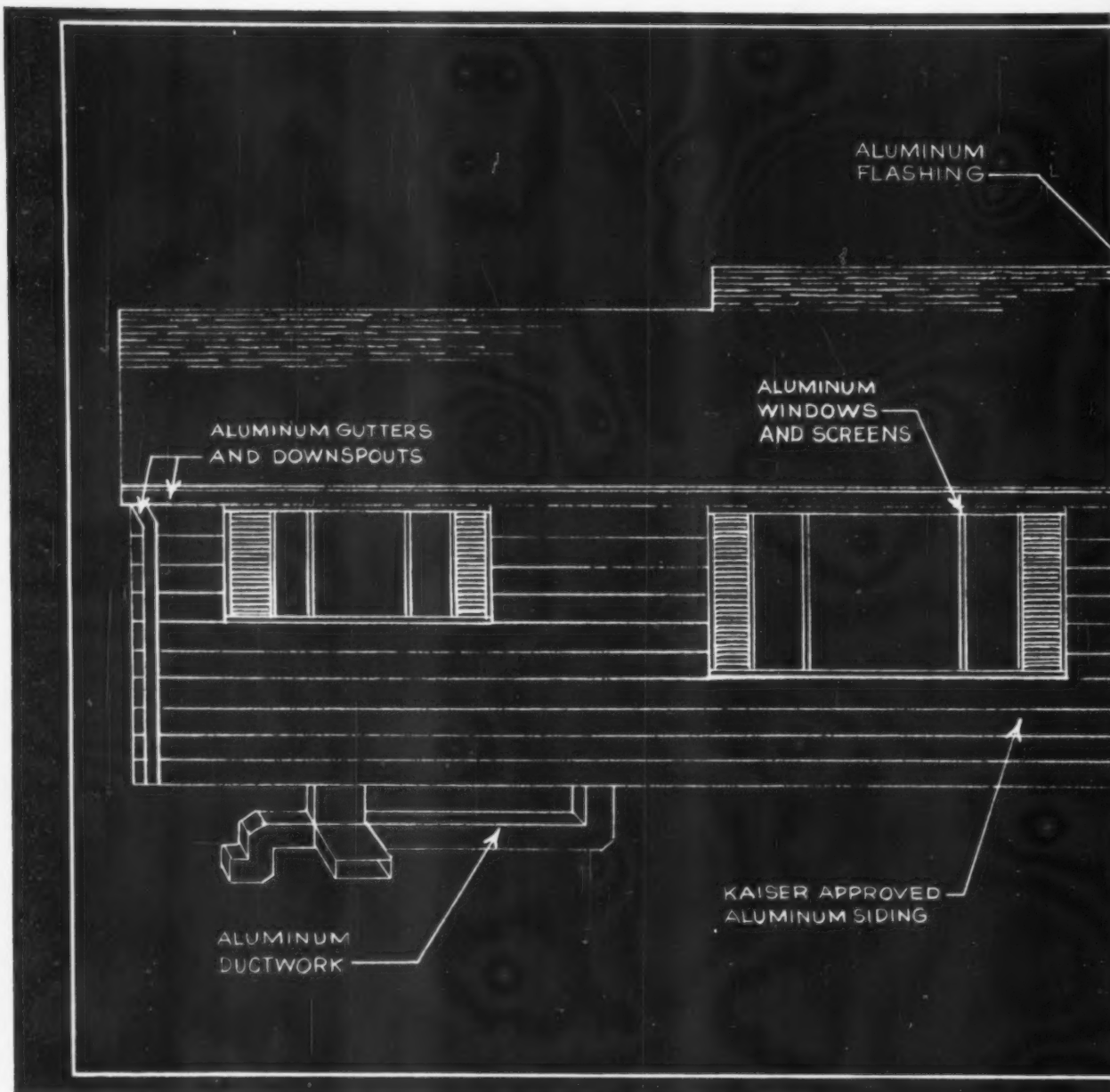

USE VALUE IMPROVING PRODUCTS MADE

Value is the most powerful sales force in home building today! And nothing promises more value for your prospect's dollar than "VIP" Value Improving Products made by customers of Kaiser Aluminum.

Here's how these "VIP" aluminum building products improve value—strengthen your sales message:

Of all building materials, only aluminum assures long lasting, maintenance-free beauty. Aluminum is weather-proof, termite-proof, seldom needs repainting or other costly care. Aluminum brings high appraisal valuations. And it goes up fast at low cost.

When you build with Value Improving Products—such as Kaiser Approved Aluminum Siding, aluminum sliding glass doors and primary windows, aluminum ductwork, aluminum soffits and fascia, aluminum gutters and downspouts—you're building a more saleable home. You're building a VIP Home.

POWERFUL SUPPORT FOR YOU—For additional selling impact, these Value Improving Products are heavily promoted week after week all year long over two of television's leading shows: *Hong Kong* and *Maverick*.

Locally, Kaiser Aluminum has developed a complete

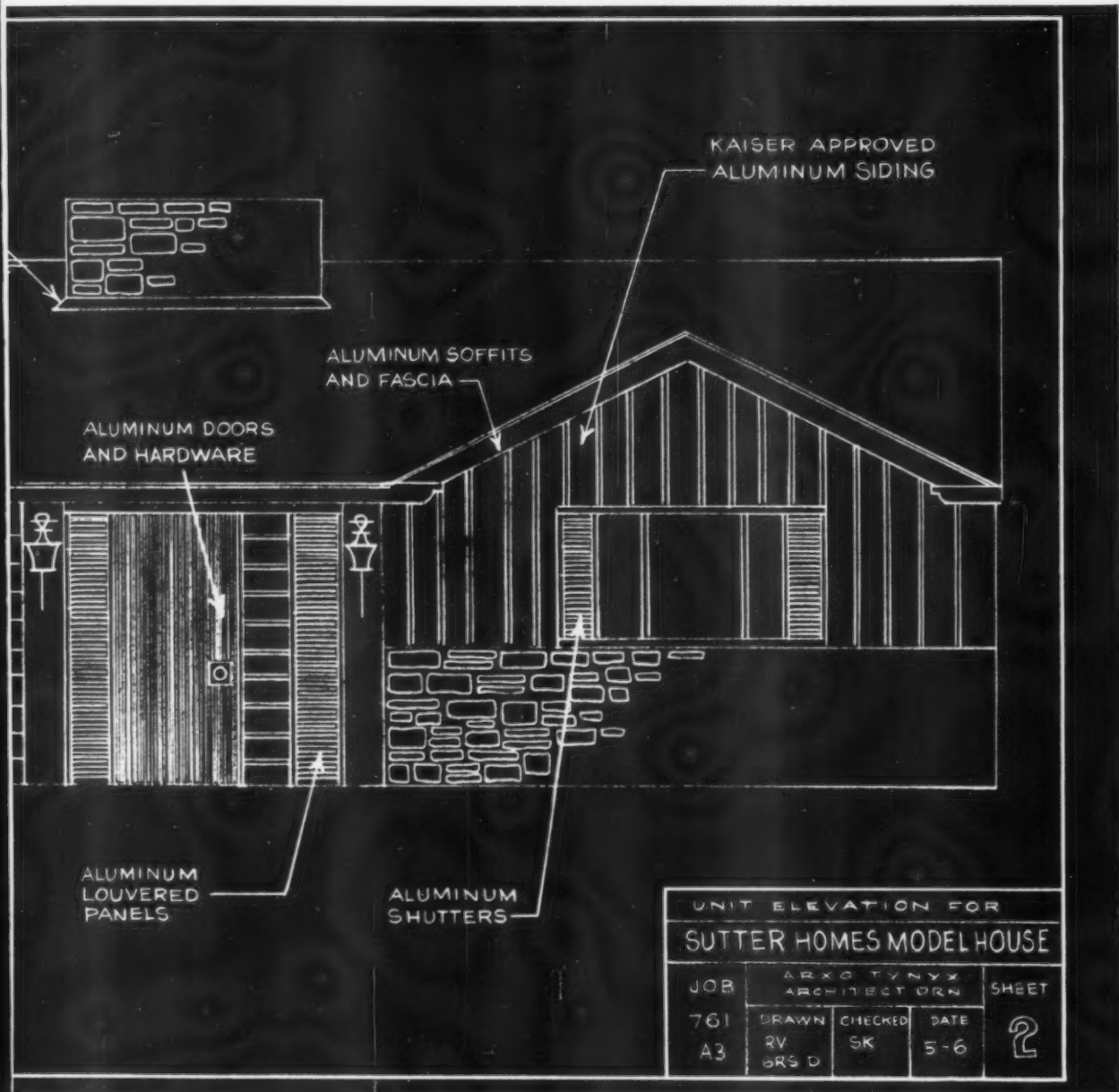

BY CUSTOMERS OF KAISER ALUMINUM

traffic-building program for qualified builders designed to put across the "value concept" right in your own front yard. From your own local television commercials to site signs, this program contains everything you need to make VIP Homes the most wanted homes in your area.

Right now, builders from coast to coast are discovering the special sales advantages only VIP products can bring. For full information write: Manager, Residential Business Development, Kaiser Aluminum & Chemical Sales, Inc., Kaiser Center, Oakland 12, Calif.



New Leadership in the World of Aluminum
See HONG KONG and MAVERICK on ABC-TV Network.



*A luxury home
with Gerber Plumbing Fixtures*

Beautiful Gerber fixtures were selected for this luxury home in Highland Park, Illinois, to provide a bathroom in keeping with the modern design and other fine interior features specified by architect Joel Hillman. Contractor: Ravinia Plumbing & Heating Co.

Gerber fills your luxury home needs for less yet gives "expensive line" features, quality

Builders are selecting Gerber Plumbing Fixtures for more and more of their luxury homes because Gerber's styling, quality, and beauty meets luxury requirements at sensible prices.

That's because Gerber fixtures are designed and produced for the Mighty Middle mass market only. This market specialization in a complete line of basic fixtures only, results in savings passed on in the form of added features — some exclusive, others found only on more expensive lines. Thus, Gerber fixtures are priced low enough for very moderately priced

homes, yet their quality, beauty and styling makes them highly desirable for expensive homes or motels, hotels, schools and similar applications as well.

It will be to your advantage to check on Gerber fixtures, available in white or six modern colors to match any decor. Write for our catalog showing the complete line of Gerber brass, steel, cast iron and vitreous china. Catalog shows special design features that make installation quick and easy, too, plus "packaged" bathrooms available for every building price range . . . saves time and money on every job.

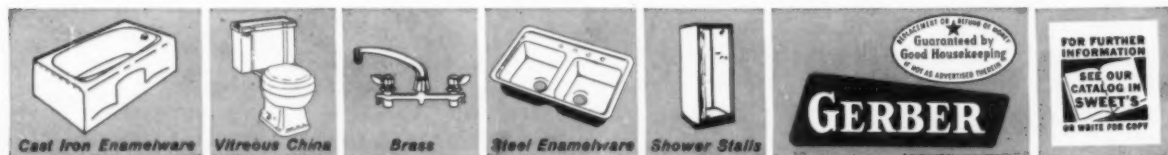

"Plumbing Fixtures for The Mighty Middle"

Gerber Plumbing Fixtures Corp., 232 N. Clark St., Chicago 1, Illinois

5 Factories: Kokomo, Ind., Woodbridge, N. J., Delphi, Ind., Gadsden, Ala., West Delphi, Ind. • Export Div.: Gerber Int'l. Corp., 500 Green St., Woodbridge, N. J.



Ceramic Tile...to catch a buyer's eye

This distinctive floor was created with American Olean's new SD-5 design in crystalline scored tile. The lustrous textured surface gives you a different looking floor that becomes a sales feature for the home. It's quick and easy to install, and not expensive. For more design ideas write for new booklet, "Crystalline Glazed Scored Tile."

In the bathroom shown: Wall: 21 Cornflower. Floor: 310 Cr. Blue and 365 Cr. White in SD-5 scored tile. American Standard fixtures in Regency Blue. Plate 123.

CERAMIC TILE
**American
Olean**

Strong
Tough
Economical
Efficient
Lasting



New dry wall
nail resists
popping

Cut installation and call-back costs with this unique Sheffield nail

When you use Sheffield's new dry wall nails, you not only build your reputation for quality construction, but you *also* cut your installation costs and call backs.

The nub in the conical head and the modified ring shank of these nails mean safer handling and faster, easier nailing. This can save up to one hour's labor per house.

More Nails For Your Money

And this new Sheffield nail will fasten 25% more dry wall per cwt. than its .098 predecessor. With its shank diameter reduced to .094, this nail gives you more nails per cwt.

Ask your Sheffield dealer today for these dry wall nails that resist popping because they *tighten* in the studs—

instead of loosening. Or write: Sheffield Division, Armco Steel Corporation, Sheffield Station, Kansas City 25, Missouri.

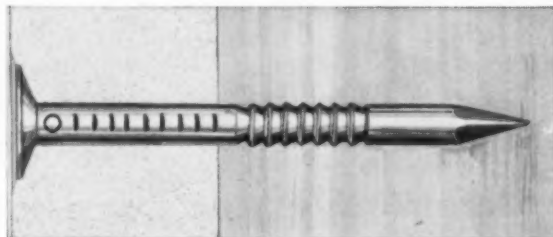

Annular rings concentrate holding power where it's needed. Conical head and modified ring shank allow faster nailing. Patent has been applied for on Sheffield pop-resisting nails.



Sheffield Division



Imperial Cherry "Heritage"

NEW *Imperial Cherry* BY ABITIBI

Rooms individualized with wood grain finish Imperial Cherry paneling are dramatically appealing. Warmth and charm replace the ordinary harsh monotony of solid colors. Whether buyers prefer modern or traditional decor, Imperial Cherry paneling is *smarter* — more beautiful and liveably *right* — always.

three delightful, distinctive **NEW TONES THAT ARE PRICED JUST RIGHT FOR YOU**

If you paid twice the modest price, you still couldn't buy better paneling. Imperial Cherry in three luxurious hues (Traditional, Futura and Heritage), is dura-surfaced for lifetime resistance to mars, scuffs and scratches. Easy to handle 4' x 7' or 4' x 8' panels go up fast — butt perfectly. Homes with Imperial Cherry have more original charm and will stay gracious forever.

manufactured exclusively by **Abitibi**® *Better building products through research in wood chemistry*

Producers of America's Finest Hardboard Paneling, Primed Exterior Hardboard Siding, Insulation Sheathing, Hardboard Underlayments and Ceiling Tile.

ABITIBI CORPORATION • PENOBSCOT BUILDING • DETROIT 26, MICHIGAN



NO RISK TRIAL

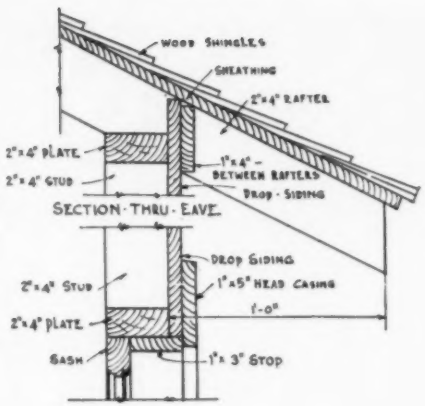
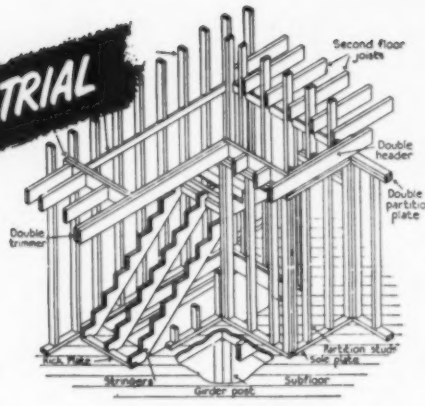

NEW !! 1961 Printing - Fifth Edition

HOUSE CONSTRUCTION DETAILS

Save Money and Time with these Latest Professional Methods

Here is an exact working guide on every detail of house construction from foundation to finish. Tells you dimensions, materials, processes, step-by-step working methods. Hundreds of scale drawings and photographs make every step easy to follow. Quick-reference index enables you to find instantly any construction detail on which you want modern, authoritative guidance. Can be used for alterations in a set of stock plans, for making additions or changes in a building,

or for complete construction of a dwelling. Conforms with modern practice and building regulations in all parts of the country. Gives you helpful ideas on how to build in accordance with latest developments in carpentry methods, materials, painting, heating and air conditioning, insulation and sound-reduction.

The guidance you get on even a single house construction detail can repay you a hundred times the small cost of this remarkable volume. Send for your copy today. Mail coupon below.

Every Step in House Construction Explained and Illustrated:

- Excavations • Footings and drainage • Foundation forms • Sills • Girders • Joists • Sub-flooring • Exterior wall framing • Interior wall framing • Ceiling joists • Gable roof • Hip roof • Gambrel roof • Dormers • Siding and shingling • Cornices • Porches • Exterior walls of wood • Exterior walls of brick • Interior walls finished in plaster, in plywood • Wall panels • Mouldings for interior trim • Stair construction • Windows • Sash details • Window framing details • Doors and door trim • Hardware used in dwellings • Closets, shelves, built-in equipment • Breakfast alcove • Sewing room • Flooring • Chimneys and fireplaces • Mantels and seats • Outdoor fireplaces • Scaffolds • Garages • Insulation • Arches and gates • Lattice porch, lattice trellis • Garden benches, tables • Fences • Barns • Feeders and nests • Septic tank • Painting and finishing • Heating systems • Air conditioning systems • Prefabricated houses • Useful information for home builders including architectural styles and data on modern building materials.

378 PAGES, SIZE 8 1/2 x 11. FULLY INDEXED. 2500 ILLUSTRATIONS.

Check this Comprehensive Coverage---

Table of Contents: House Design. Excavations—Foundation Forms—Foundations. Sills—Girders—Joists—Sub-Flooring. Outside Wall Construction. Inside Walls—Wall Sheathing—Ceiling Joists. Roof Construction—Bay Construction—Roofing. Cornices and Porches. Exterior Wall Covering. Interior Wall Covering—Interior Trim. Stair Construction. Windows. Doors. Hardware. Closets—Shelves—Built-In Equipment. Finished Flooring. Chimneys and Fireplaces. Scaffolds and Hoists. Garages and Carports. Insulation. Heating—Air Conditioning. Painting and Finishing. Modern Building Material. Prefabrication. Construction Detail Plates. Index.

More than 150,000 satisfied users!

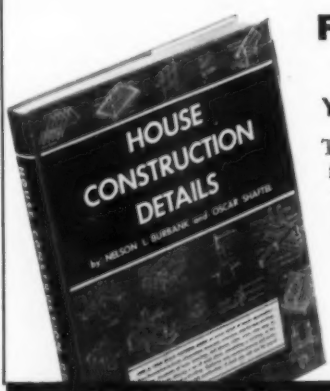

NEW Printing
FULL REFUND TRIAL OFFER—
You Take No Risk

This helpful book is yours for only \$5.95. If not convinced that it can give you clear, professional guidance on every building detail— simply return the book within 10 days for FULL REFUND. Mail the coupon below.

MAIL THIS COUPON

Simmons-Boardman Publishing Corp., AB-5-61
30 Church Street, New York 7, N.Y.

Send me "House Construction Details" with the understanding that if I am not completely satisfied I can return it in ten days for FULL REFUND.

Enclosed is \$5.95 check money order

Name

Address

City Zone State

ALSCO ALUMINUM SIDING

is PRACTICAL...



The London House,
S. Bronstein & Sons, Philadelphia

for New Homes in Every Price Class!

The superior quality of the aluminum siding manufactured by AlSCO is fast becoming the standard of excellence in the aluminum siding industry. *Important to you is the fact that it costs no more than ordinary aluminum siding.*

AlSCO Siding has been thoroughly researched and tested — not copied piecemeal from other makers. The aluminum alloy is blended especially for siding. It's rolled in narrow width to better control the uniformity of gauge.

It's protected both sides. On the front with thermosetting Acrylic which is rolled on (to prevent shallow spots or air bubbles in the finish) then baked in special high-heat ovens. The back of every panel is coated with exclusive Gold Bak polyamide—epoxy resin to block corrosive action.

The ten appealing colors and white were carefully selected for weatherability, color retention — and homeowner appeal. Independent color selector, Mrs. Vee Hesselbart, selected our colors from over 600 shades. AlSCO has been commended by HOUSE & GARDEN Magazine on its outstanding colors. Color Coordination Charts are yours for the asking!

ALSCO ALUMINUM

Akron 8, Ohio

Other fine products include:

Prime Windows, Sliding Glass Doors, Soffit and Fascia Trim, Louvers, Vents, Awnings, Shutters.

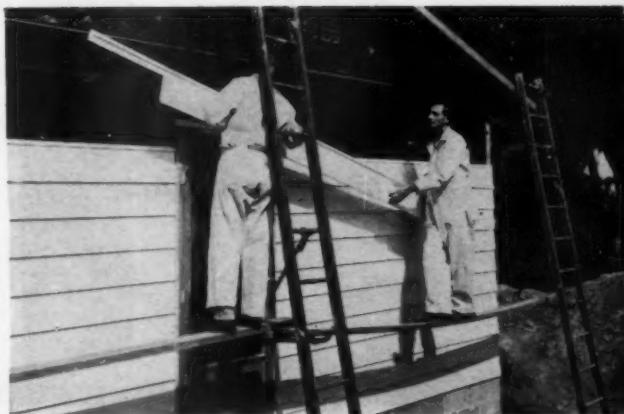

Take advantage of AlSCO's nationally advertised brand name, the award-winning sales promotion aids, simplified installation manuals. In short — let us tell you what you can expect from AlSCO — when you use our siding!

Home Building Products Division
ALSCO ALUMINUM, Dept. AB-561, Akron 8, Ohio

Send me complete information on AlSCO Aluminum Siding:
Our firm plans to build _____ homes during 1961.

Name _____

Firm Name _____

Street Address _____

City & Zone _____ State _____

(please clip to firm letterhead)



STARTED ROLLING OUT A BUSINESS ON THIS \$50 MACHINE

Forty-one years ago L. A. Macklanburg patented a metal weather strip known as Numetal to stop drafts around doors and windows. He called in his father, three brothers and a sister to help develop the product. They didn't draw much salary—just enough for beans and bacon.

This \$50 hand-cranked rolling machine was their only equipment. Today, the company has grown to where it is one of the largest building specialties manufacturers in America!

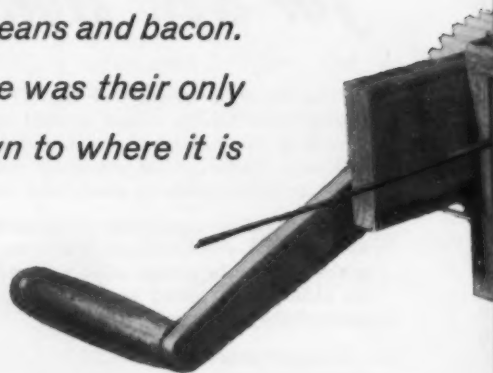

More Ideas Brought More Sales

M-D now dominates the immense building specialties field. They produce dozens of different kinds of weather strip for every possible building application. Their huge plant in Oklahoma City supplies thresholds, calking compounds and guns, mail boxes, house numbers, moulding, trim, grilles and sliding and folding door hardware... 6000 different products, sizes and finishes. Virtually every American home today is built better, thanks to one or more Macklanburg-Duncan products.

Bold Marketing Innovations

New approaches to selling have helped Macklanburg-Duncan grow. Dealers are especially loyal because Macklanburg-

Duncan gives personal attention to every order. The first company to package building specialties, Macklanburg-Duncan's familiar black and yellow packages encourage self-selection and show buyers just how each product should be used—to speed sales and reduce dealer selling time.

Consistent advertising in *American Builder* has been an important part of the Macklanburg-Duncan marketing program since 1943, and they have used two-page, two-color spreads every month since 1950. R. A. Macklanburg, Jr., President, says, "A large percentage of our total sales are originated and specified by professional builders. These men represent the hard core of our business—the men we must keep selling to keep growing".



The 300,000 sq. ft. plant in Oklahoma City where M-D products are manufactured, then shipped nationally to leading hardware, lumber and building supply dealers.

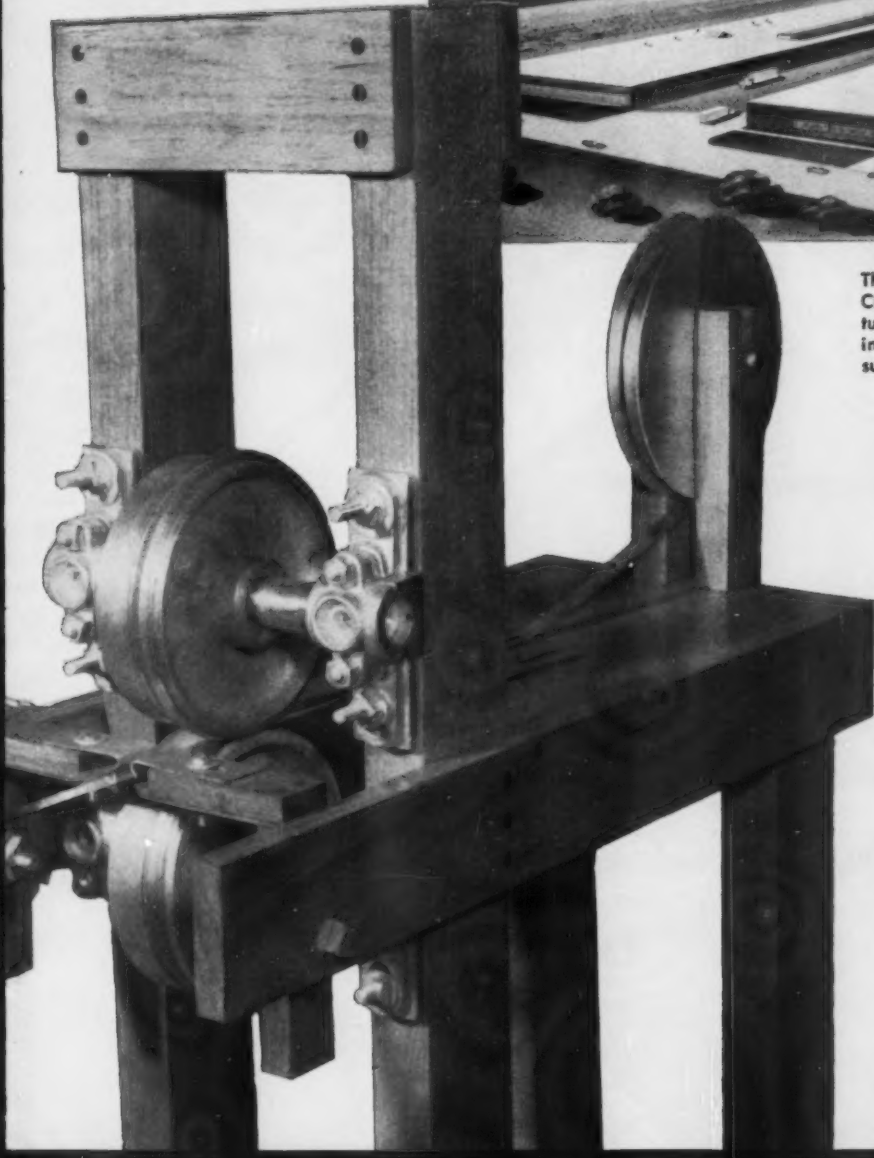

How American Builder Speeds M-D Growth

Harold Kranz, Advertising Director for Macklanburg-Duncan cites these four reasons for continuing his company's heavy program in American Builder:

1. "American Builder reaches the primary market for Macklanburg-Duncan—the active, buying builders who specify in volume."
2. "The builder is the largest consumer we have using M-D products."
3. "American Builder's bonus readership by lumber dealers gives us important help in dealer relations."
4. "American Builder forces distribution. We've seen builders come to dealers with an American Builder issue and point to the Macklanburg-Duncan ad, saying, 'I want that'."

Companies on the Move

Move More Building Products

Faster through

American Builder

**THE BUSINESS
MAGAZINE FOR
BUILDERS**

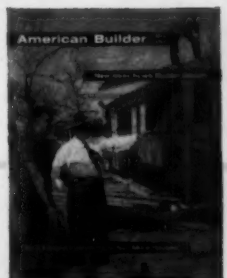

NOW, A PRACTICAL AND ECONOMICAL

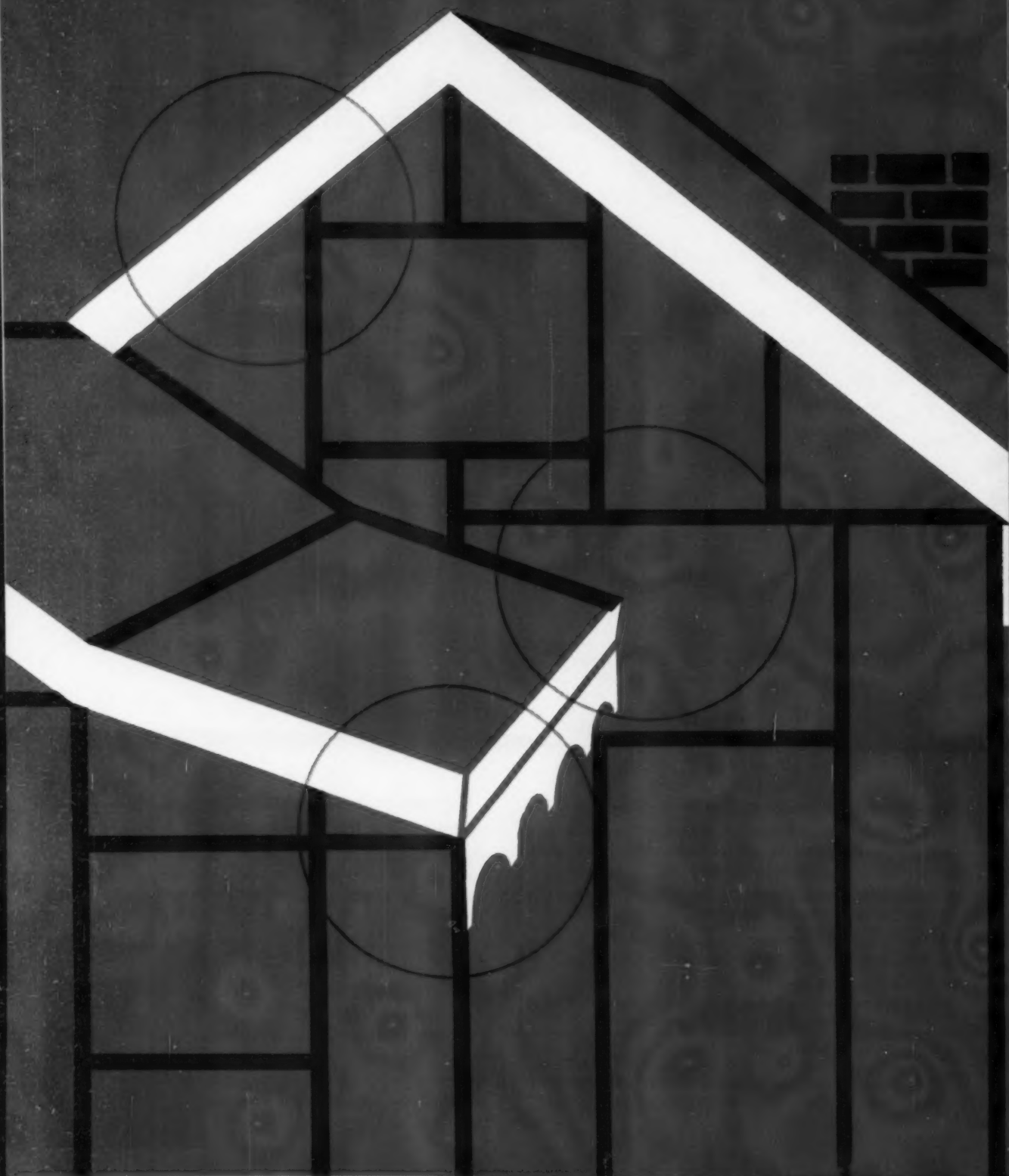

EXTERIOR TRIM BOARD, READY TO APPLY

TRIM-BILT

BY UPSON

for cornices, fascia and rakes!

At last! An attractive, economical and ready-to-apply trim board. It's Upson Trim-Bilt, the latest in our quality line of cost-cutting, ready-to-use specialty products. Factory priming front, back and along all edges deeply penetrates the board so that there is never any peeling. It's water-proofed, too. No raised grain! Will not warp, crack, split; is knot-free and easy to finish. It passes the ASTM accelerated aging test and has been used successfully in thousands of homes during the past two years by one of America's leading builders. Yes, the uniformity, quality appearance and long life of Upson Trim-Bilt are proven beyond a doubt. Trim-Bilt is available in 12' and 16' lengths • Nominal 6", 8", 10", 12" widths • $\frac{3}{4}$ " thick. Absolutely no random lengths or widths. For consultation, phone, wire or write, The Upson Company, Upson Point, Lockport, New York.

FREE



Please send me the FREE illustrated brochure about practical, economical, ready to apply Upson Trim-Bilt and related Upson products.

THE UPSON COMPANY

151 UPSON POINT • LOCKPORT, NEW YORK

NAME _____
COMPANY _____
ADDRESS _____
CITY _____ STATE _____

THE UPSON COMPANY • UPSON POINT • LOCKPORT, NEW YORK • PRIMED SIDING • DUBL-BILT • TRIM-BILT • SOFFITS • ALL-WEATHER • STRONG-BILT



Conventional

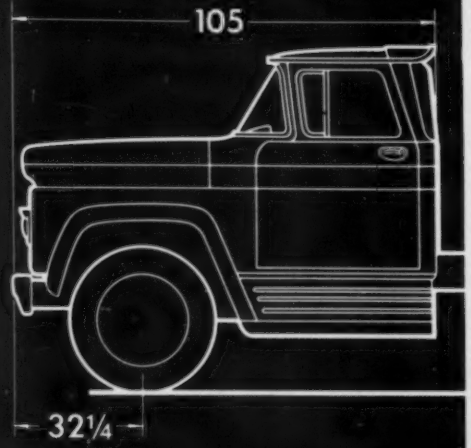

Low Cab Forward

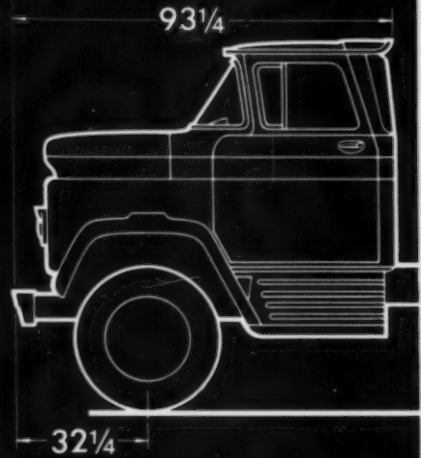

Tilt Cab

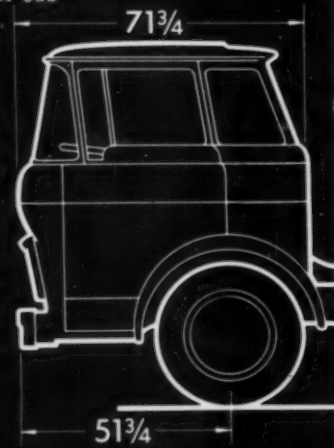

YOU GET THE WIDEST CHOICE OF CHOICE EQUIPMENT IN CHEVROLET MEDIUM- DUTY TRUCKS!

Cost-choppers for every chore—a *long* lineup of rough-and-ready Chevrolet middleweights, each one built to squeeze bonus earnings from your roughest runs. Just check this model choice for size: *Economical Conventional Cab* trucks with the strength and stamina to make short work of mean medium-duty hauls; *space-saving Low Cab Forward* Chevies for bigger bodies and payloads and easy short-wheelbase maneuverability; *short new Chevrolet Tilt Cab* trucks with a combination of ride, roadability and cargo capacity that's unsurpassed in the tilt cab field. *Only* Chevrolet gives you so *wide* a selection of middleweight might and muscle.

PICK YOUR JOB-TAILORED CAB TYPE—If your kind of hauling calls for a conventional cab truck, chances are you'll find one of Chevy's 58 models exactly suited to your needs. With GVW's ranging from 14,000 to 19,500 lbs. plus the toughest truck components, these Chevies know how to hold costs to a minimum.

Or, if your work requires maximum payloads and maneuverability, check Chevy's lineup of 18 Low Cab Forward models. Only 93¼ inches long from bumper to back of cab (90 inches on tractor models), these LCF's are plenty short to haul 40-foot trailers without exceeding 50-foot length limits. And LCF short-wheelbase design means easy handling.

And for the last word in big payload efficiency, look into Chevy's 8 medium-duty Tilt Cab trucks. They give you bonus payload capacity stemming from a 72-inch bumper-to-back-of-cab dimension . . . unsurpassed maneuverability . . . ideal weight distribution for handling king-sized payloads . . . and total engine accessibility for quick, easy maintenance.

Whatever cab type you choose, you'll get all the comfort you can use. Plenty of head, hip, leg and shoulder room . . . foam cushioned seat, non-glare instrument panel and big, full-view windshield.

CHOOSE TOUGH-TRUCK 6 OR V8 POWER—Durable power that never stops saving in four Chevrolet medium-duty

truck engines. For top-dollar economy, there's the famous 235.5-cu.-in. Thriftmaster 6, standard in Series 40 and 50 models; or you may prefer the lively Trademaster V8, optional at extra cost. Or, if you're looking for maximum torque and power you can choose either the 261 cu. in. Jobmaster 6, standard on Series 60 models, or the maximum-duty Taskmaster V8 (optional, extra cost in Series 60). You'll find these to be the workingest, savingest heavy-duty V8's and 6's that ever pulled a payload—true *truck* engines with premium features galore, including exhaust valve rotators, hard-faced exhaust valves, forged steel crankshaft, standard oil bath air cleaner and oil filter and many more.

SMOOTH INDEPENDENT FRONT SUSPENSION IN EVERY MODEL

—Sure protection for your truck, load, driver and profits! Tough, friction-free Torsion Springs cushion the ride; rugged control arms guide each front wheel precisely for stable, responsive handling; wear-resistant shock absorbers absorb road shock and provide better wheel control. You get a smoother, safer ride that lengthens truck life—and reduces maintenance, cargo damage and driver fatigue. It's more evidence that you'll find the *choicest* equipment (in the widest choice) when you see your dealer about a '61 Chevrolet medium-duty truck. . . . Chevrolet Division of General Motors, Detroit 2, Michigan.

1961 CHEVROLET STURDI-BILT TRUCKS



ANOTHER FIRST FROM INSULITE:

NOW 3 WIDTHS IN



*New 8" and 10" widths—in addition to the 12" width
give new design possibilities, match existing sidings*

In just four years this man-made siding has proved itself on more than 250,000 homes! Leading builders know from experience that homes built with Insulite Primed Siding are easier and faster to sell. And now Insulite Primed Siding is available in three lap siding widths for even greater versatility. Builders now can use Insulite Primed Siding to match existing 8", 10", or 12" sidings when adding a garage or an addition to an existing home.

NAILS EASILY — SEATS PERFECTLY. Has no structural grain—which means no knots or splits. It's easy to saw, easy to nail, easy to put up fast.

COMPLETELY PRIMED AT FACTORY. Deep priming on face, edges, ends and back saves time and cost of on-the-job priming coat. Finish coat goes on easily, bonds firmly, is extremely resistant to paint blistering.

PROVED DIMENSIONAL STABILITY. Four years of experience with exposure to all kinds of climates has demonstrated the superior stability of Insulite Primed Siding.



INSULITE PRIMED SIDING

*Horizontal siding
in all three widths—
8", 10", and 12"—
is available in
16' lengths. 8' lengths
available on order.*

3 TYPES OF INSULITE PRIMED SIDING GIVE EXTRA DESIGN FLEXIBILITY

- 8", 10" and 12" widths of horizontal (lap) siding. (10 pieces per bundle of 8" x 16' siding; 8 pieces of 10" siding; 6 pieces of 12" siding.)
- 4' x 8' grooved vertical panel with shiplapped edges. Grooves $\frac{1}{2}$ " wide and 8" apart.
- 4' x 8' plain vertical panel for board-and-batten construction.

Now available for fast delivery—plant capacity doubled for 1961. Contact your building supplies dealer, Insulite representative—or write Insulite, Minneapolis 2, Minnesota.

build better with
INSULITE®



Insulite Division, Minnesota and Ontario Paper
Company, Minneapolis 2, Minnesota

EXCLUSIVE WEATHER-DRIP EDGE. Both long edges of horizontal siding are angle cut causing water to run down and off the edge—rather than back and under the siding where it can cause staining, rot and paint damage.

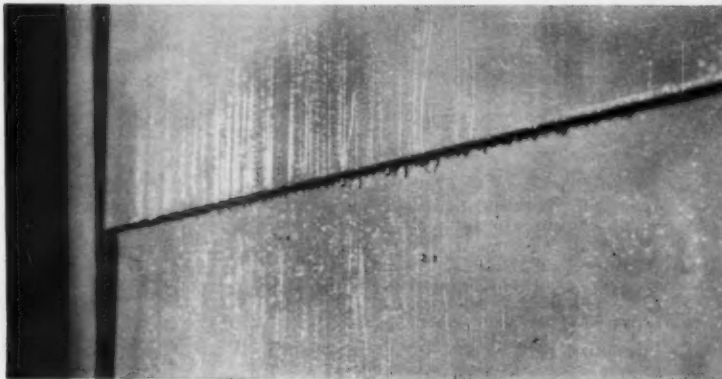

NEW
 "light
 ideas"
 from
 VIRDEN
 LIGHTING



A. Cheerful Greeting with this new garden or walk light. Fiberglass shade in tole green and white. Portable or permanent installation. **V-7600**

B. Capture Her Attention with this striking cluster of ceramic pendants in eggshell white with pierced diamonds. To duplicate, order 3 **V-1935** and **V-1683** spreader.

C. Dramatize Your Rooms with this modern design. "Square round" white opal globe is accented with strips of walnut and brass. **V-1961**. Note companion piece over stairway.

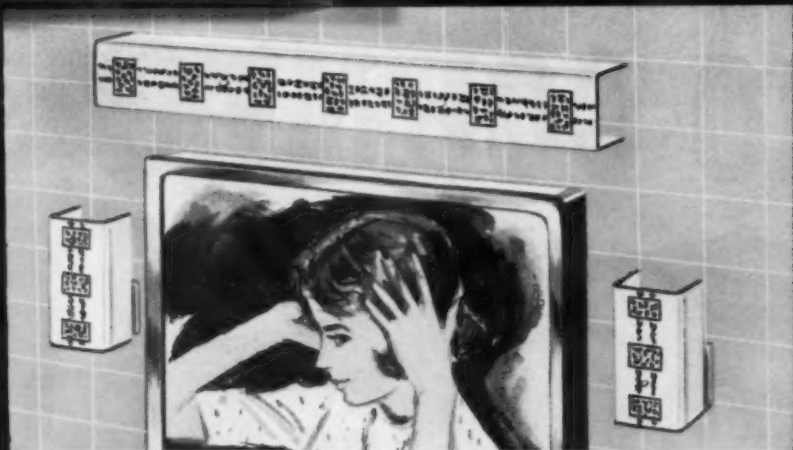

Brighten Your Bath with these new matching fixtures. Milk white glass inlaid with sparkling multi-colored mosaic. **V-6515** over mirror. **V-6510** at sides.

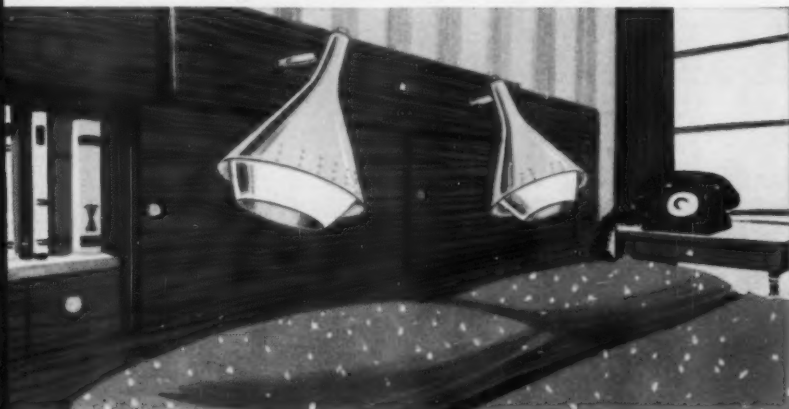

READ 'N RELAX with these adjustable twin brass designs. Panel is walnut, shade is polished brass with white metal directional inserts. **V-6095**

Gracious Hospitality with this striking pulldown. Shade has prismatic lens on bottom, iced glass flecked with silver on top. Accents are polished brass and walnut. **V-1161**. And don't forget valance lighting to bring out the beauty in draperies!



From Virden comes a brilliant *new* line of home lighting fixtures! New styles . . . new designs . . . new materials . . . in the finest collection of "light ideas" in our history.

Now you can add new glamour, new sales appeal to your homes in literally dozens of ways, and do it easily and inexpensively!

Your Virden distributor will have our new line on display soon. Be sure to see it. You'll find his name in the Yellow Pages of your phone book.

NEW CATALOG! Just off the press, it shows in full color our complete new line. New pulldowns, new ceramics, new clusters, a wonderful variety of ceiling and wall units, outdoor lighting . . . in fact, everything you need to make your homes more beautiful . . . day and night. Ask your Virden distributor for your free copy or write Virden Lighting, 6103 Longfellow Ave., Cleveland 3, Ohio. In Canada, John C. Virden Ltd., Toronto, Ontario.

VIRDEN

VIRDEN LIGHTING

Member American Home Lighting Institute

JOHN C. VIRDEN COMPANY DIVISIONS:
VIRDEN LIGHTING · LIGHTING DYNAMICS
Plants in Cleveland, Dallas, Los Angeles, Toronto

Virden Lighting, Dept. AB-5
6103 Longfellow Ave., Cleveland 3, Ohio

Rush me your new "light idea"
Catalog, V-62.

Name _____

Address _____

City _____ Zone _____ State _____

NOW...NO CORNER

Cuts Costs!*

NEW CELOTEX STURDY-BRACE[†]

Insulating Sheathing

*

\$20 per M square feet!

(Average cost of corner bracing—labor and materials—reported by contractors and builders in a nationwide survey. This saving may be considerably more in 2-story and multi-level construction).

New ½" STURDY-BRACE sheathing is so rugged it exceeds FHA racking strength requirements without corner bracing...whether you nail it or staple it!

A really great new sheathing, STURDY-BRACE gives your homes the extra insulation only fiberboard can give...and extra resistance to moisture is assured by through-and-through asphalt impregnation. No building paper required (except under stucco).

These "Big Board" panels go up fast, too. ½" thick, with high strength and rigidity...yet light in weight, easy to lift, non-tiring. Men like to handle STURDY-BRACE sheathing all day long. Sizes: 4' x 8' or 4' x 9' to cover sill and plate.

Your Celotex dealer inventories this and other famous Celotex insulating sheathings: STRONG-WALL® nail-base...Double-waterproofed and Impregnated ½" and ¾" sheathings. All carry a "Life-of-Building" guarantee (warranty available to every buyer).



**CUT APPLICATION TIME
50% OR MORE
WITH POWER STAPLING!**

Because STURDY-BRACE sheathing exceeds FHA requirements without corner bracing when nailed or stapled, you can make big extra cost-savings.

† Trade Mark

BRACING NEEDED!

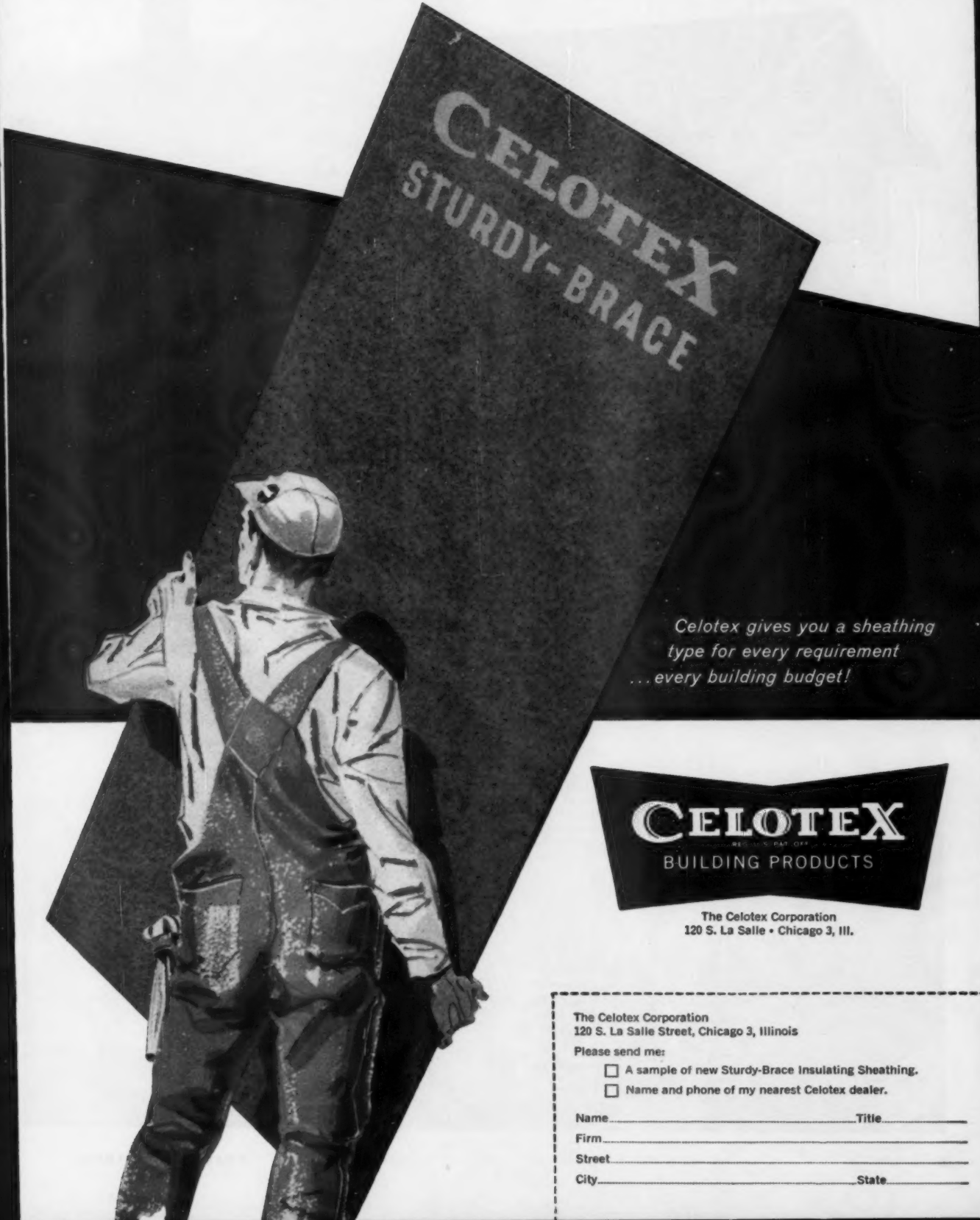

CELOTEX
STURDY-BRACE

*Celotex gives you a sheathing
type for every requirement
... every building budget!*

CELOTEX
REGISTERED TRADE MARK
BUILDING PRODUCTS

The Celotex Corporation
120 S. La Salle • Chicago 3, Ill.

The Celotex Corporation
120 S. La Salle Street, Chicago 3, Illinois

Please send me:

- A sample of new Sturdy-Brace Insulating Sheathing.
- Name and phone of my nearest Celotex dealer.

Name _____ Title _____

Firm _____

Street _____

City _____ State _____

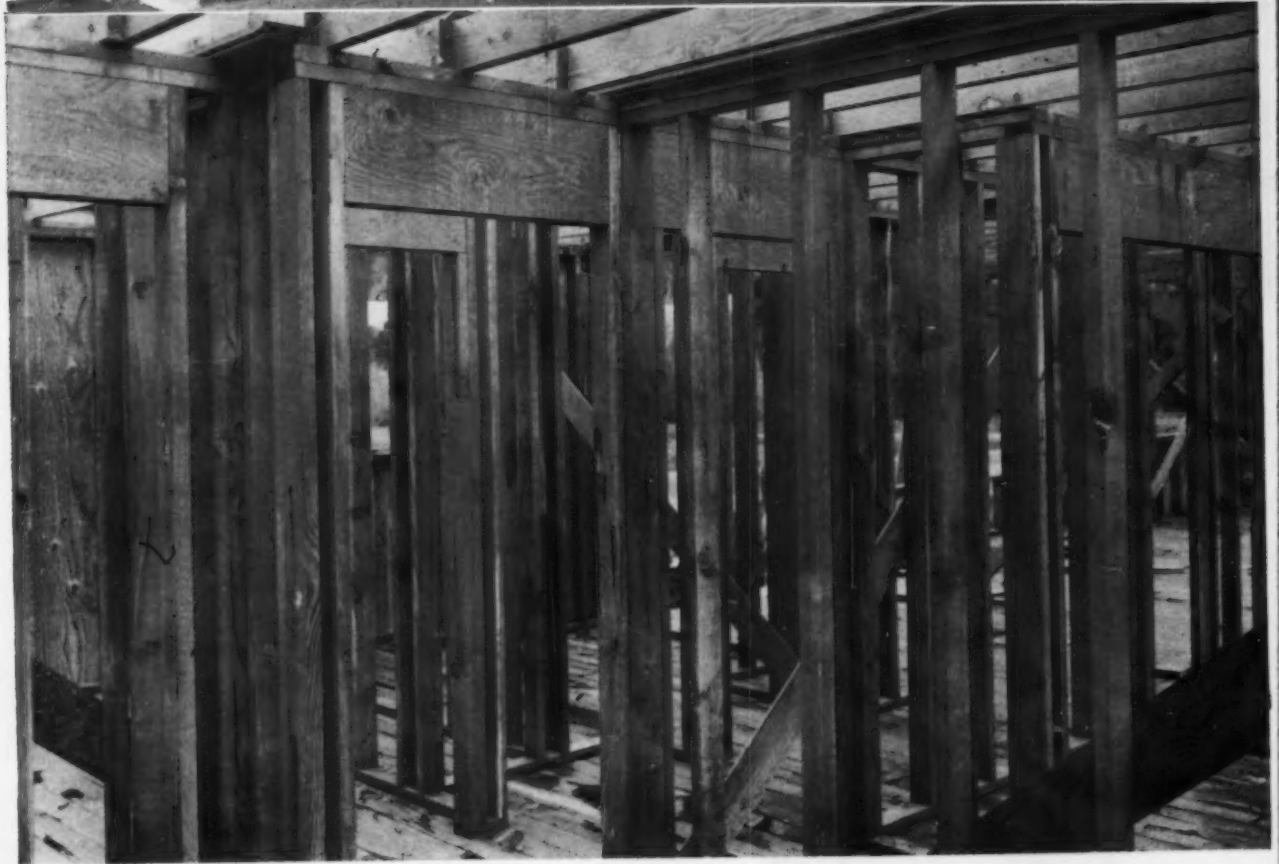

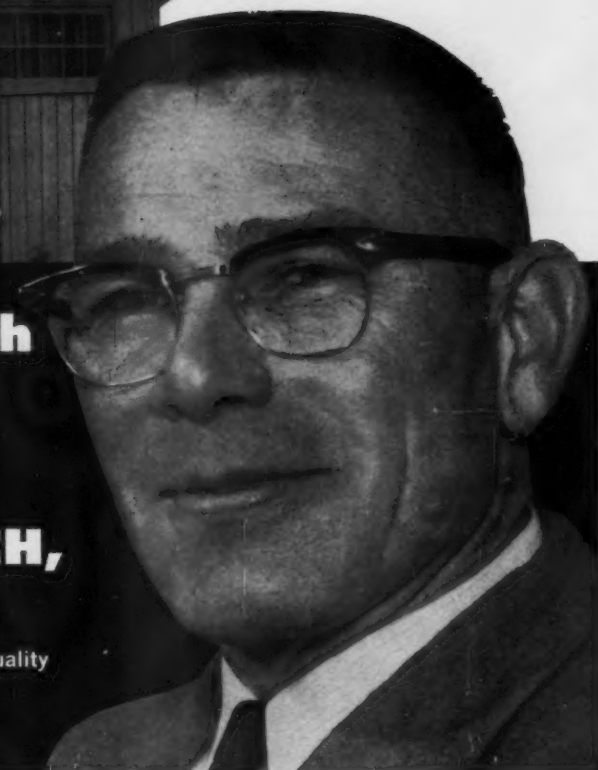

**"I have built with
UTILITY GRADE
West Coast Lumber
for 15 years,"
says GEORGE KOCH,
Oswego Builder.**

"I know from experience that Utility grade, properly used*, maintains my reputation for quality and saves 30% on framing lumber costs. Even when we called it No. 3, we found it the workhorse of the framing grades."



Just off the press! Full of application pointers and building facts*. Ask your lumber dealer for your copy or write us.

Utility grade can give your building profit a boost, too. For studs, plates, joists, rafters, headers and bracing*,

ask your lumber dealer... he'll point out the profit-points of Utility grade.

WEST COAST LUMBER

West Coast Douglas Fir • West Coast Hemlock • Western Red Cedar • Sitka Spruce • White Fir
West Coast Lumbermen's Association, 1410 S. W. Morrison Street,
Portland 5, Oregon

*When using in accordance with FHA Minimum Property Standards for 1 and 2 Living Units, FHA Bulletin No. 300.

A FINE BUILDER WRITES OF THE BIRD WIND SEAL SHINGLE:



*“Thank you for
a product that
is such a help
to the builder”*

Richard A. Osias of the Osias Organization of Williston Park, L. I., whose North-Point-in-Huntington is one of the outstanding Model Homes developments in the country.

The project comprises 2400 one-family homes, priced from \$16,990 to \$18,490. The Osias Organization has an additional development, The Village on the Hill, comprising 800 fine homes priced from \$23,990 to \$25,990.

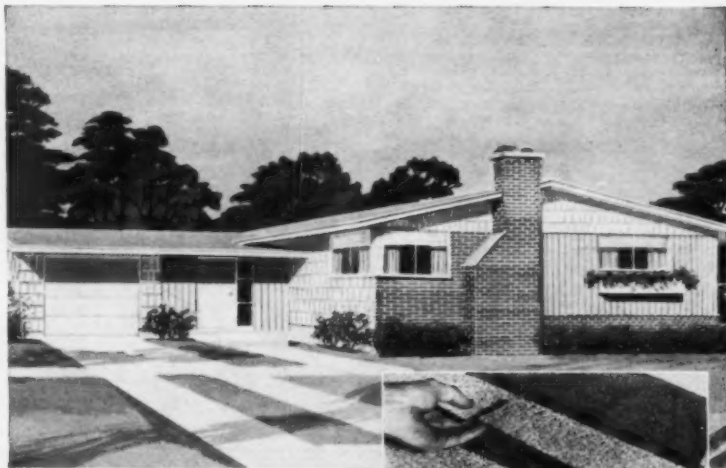

“The Bird Wind Seal Shingle is absolutely hurricane-proof” Mr. Osias makes this all-out statement. His letter says in part:

“Hurricane Donna devastated this section. The center of the hurricane passed directly over our development of about 100 houses. Our Bird Wind Seal Shingles did not alter their position regardless of the intensity or direction of the wind force.”

“In the adjacent area great interior losses resulted from water entering the houses through damaged roofs *not Bird Wind Seal roofs.*”

Here's why the Bird Wind Seal Shingle is absolutely hurricane-proof. These dots of adhesive are activated by the sun, cementing every shingle down in a mighty grip that does not let go.



BIRD & SON, INC., EAST WALPOLE, MASS.
CHARLESTON, S. C.; SHREVEPORT, LA.; CHICAGO, ILL.

CONTACT YOUR BIRD REPRESENTATIVE . . . FOR QUICK DELIVERY OF BIRD WIND SEAL SHINGLES AND SALES AIDS OF ALL KINDS



GET THE BIG BONUSES FROM BOSTITCH

- BETTER PROFITS
- MORE TIME



You get more profits because most jobs take less time when you use Bostitch stapling. You get more time for more jobs. And you get more jobs because you can bid lower and still make a good profit.

Here's proof:

Installing Fiberglas insulation with Bostitch H2B Stapling Hammer.

BOSTITCH BONUS—2 to 4 times as fast as hammer and nails.

Tacking to the face of studding is fast, neat, and secure with the Bostitch H5 Stapling Hammer.

BOSTITCH BONUS—lower cost, better profits.

Stapling shingles with Bostitch H4 Heavy Duty Stapling Hammer.

BOSTITCH BONUS—twice as fast as hammer and nails.

Stapling wire mesh to gypsum form bed with the T-5 Tacker.

BOSTITCH BONUS—50 per cent savings in time and labor.

These are just some of the jobs you can do more profitably with Bostitch fast-working stapling tools. For complete information on the uses and advantages of Bostitch tools, just fill out this business reply card and mail it today.



Fasten it better and faster with

BOSTITCH[®]
STAPLERS AND STAPLES

825 BRIGGS DRIVE, EAST GREENWICH, RHODE ISLAND



FIRST CLASS
PERMIT No. 34
Sec. 34.9 P. L. & R.
East Greenwich, R. I.

BUSINESS REPLY CARD

Postage will be paid by addressee
No postage stamp necessary if mailed in the United States

BOSTITCH
825 Briggs Drive
East Greenwich, Rhode Island

HERE'S THE BOSTITCH BONUS LINE OF STAPLING TOOLS



THE T-5 TACKER—the standard by which all spring tackers are compared—slashes installation time on ceiling tile, insulation, and low-voltage wiring. Three models, 14 staple sizes, cuts time on every job—makes work less tiring. Faster than hammer and nails.

H2B STAPLING HAMMER—for high-speed tacking and light nailing jobs. One easy swing drives staple into work. For applying roofing paper, insulation, cornerite, metal lath, undercourse shakes and other medium tacking jobs.

H4 STAPLING HAMMER—for heavy-duty stapling, the tough jobs where great holding power is needed as much as speed. Roofers say it cuts nailing time on asphalt shingles in half. Also used for tacking metal discs in built-up roofing and installing flashings.

H5 STAPLING HAMMER—for fast work on light fastening jobs. Used for applying builder's paper, foil-type insulation, vapor barriers. As in all Bostitch builders' tools, one hand is free to hold work in place.

Send this postpaid card for free literature on Bostitch tools and booklets on the Bostitch method of installing ceiling tile and asphalt shingles.

BOSTITCH, 825 Briggs Drive, East Greenwich, Rhode Island

Please send me the following bulletins:

- Bostitch T-5 Tacker
- Bostitch H2B Stapling Hammer
- Bostitch H4 Heavy Duty Stapling Hammer
- Bostitch H5 Stapling Hammer
- Ceiling Tile Installation Booklet
- Asphalt Shingle Installation Booklet

Name _____
 Firm _____
 Address _____
 City _____ Zone _____ State _____
 Name of Building Supply Dealer _____

Bostitch staples are available in packages of 1000 or 5000.

Try these profit-making tools on your jobs. It will pay you to see how Bostitch gets your building jobs done faster at less cost to you. See your building supply dealer for Bostitch staplers and staples.

Fasten it better and faster with

BOSTITCH[®]
 STAPLERS AND STAPLES

825 Briggs Drive, East Greenwich, Rhode Island

SPECIAL WESTERN SECTION

Spotlight on merchandising

by Bill Rodd

LET BUYERS SELL FOR YOU: "The period right after a buyer makes his deposit is the crucial one," says Wayne Brown of Palo Alto's Brown & Kauffman. "It is then that he begins to wonder if he has made a right decision; and sometimes he spends some sleepless nights."

To keep the buyer sold, and to help him sell others who might try to discourage him from going through with his deal, B&K sends each buyer a slide viewer, plus seven slides showing a typical B&K house and neighborhood.

Cost is less than \$10, and the builders think it a worthwhile investment—the buyer does more than look at the slides himself. He shows them to his friends, and thus does a selling job for the builder.

REC AREA BUILDS SALES: White & Bollard, Inc. (Seattle) have been outselling many of their competitors lately. Reason: they put in an outstanding recreation area—an Olympic-size pool, a base-ball diamond, tennis courts, shuffleboard and horseshoe facilities. All these were completed before the first homes were finished.

Total cost ran about \$160,000 but averages only \$145 per lot for the 1,100 lots in the subdivision. The builders consider that a small price to pay for the sales lift it gives.

The fun area is run by an association formed by the homeowners. They assess themselves \$6.00 a month for maintenance. New buyers in the community are not required to join, but may do so if they wish.

White & Bollard are land developers, rather than builders. They have twenty individual builders participating in their development, putting up homes in the \$17,500 to

\$30,000 range. W&B handle sales, insurance and financing operations for all the builders.

LOS ANGELES MARKET REPORT: A survey by Southern California Edison Company shows that three-fourths of the heads of households in the area surrounding Los Angeles are either over 55 (32%) or under 35 (41%). Edison's Frank Schultz points out that builders could profit by tailoring their facilities to buyers' needs. "Young couples with growing families need more rooms, more storage space, and recreational facilities," says Schultz. "Older folks want less space but a restful atmosphere, and a maximum of convenience."

CONFUSION, DELAYS, EXPENSE that builders incur in meeting widely varying state and municipal requirements are becoming unbearable. Attorney John Larson made this comment in a talk before the Home Builders Association of Los Angeles. Larson said that a builder with a subdivision lying in two or more different cities or counties may be forced to work under entirely different sets of rules.

Fortunately, state authorities are aware of this problem, and have appointed a commission to study the possible writing of a single, uniform code.

LEASEHOLDS CUT HOME PRICES: In Harbor View Hills (Newport Beach, Calif.) 92 houses were sold on leaseholds. In other words, the owner of the land leased it to the builder for 55 years. Home buyers, in turn, pay \$400 a year on the lease. Since the lots are worth about \$15,000 when fully improved, this \$400 is considerably less than

the interest on the land value.

The builder spent \$4,000 per lot for underground improvements, which is included in the \$15,000 value. This \$4,000 is the only part of the land cost included in the sales price of the house. Thus, the builder was able to sell his houses at \$30,000. If he'd had to include the entire land cost, prices would have been around \$40,000, with much larger down payments.

The builder profited because the lower price brought quicker sales; the buyer profits because he keeps \$11,000 in his pocket.

"\$75 BUYS THIS:" When Seattle's Bell & Valdez advertised that veterans could move in for only \$75—including all closing costs, wall-to-wall carpeting, built-in GE range-and-oven and washer-dryer—sales skyrocketed even to nonveterans, who needed larger down payments. Full price of the homes, with three bedrooms and family room, was \$16,275 each.

HOUSING GIANT: One of the largest, if not *the* largest, developers in California is an oil company—Sunset International Petroleum Co. The firm last year acquired the 4,000-acre San Carlos project in San Diego, a 12,000-acre parcel near Sacramento and the Sun Gold tracts near Whittier and Riverside.

WESTERN ADVERTISERS INDEX

Fibreboard Paper Products Corp.
Pabeo Building Material
Div. 72F, 72G, 72J, 72K
Forest Fiber Products Company .. 72I
Great Lakes Carbon Corporation,
Palos Verdes Stone Dept. 72H

Pabeo Building Material Div.,
Fibreboard Paper Products
Corp. 72F, 72G, 72J, 72K
Palos Verdes Stone Dept., Great
Lakes Carbon Corp. 72H
Pioneer Manufacturing Co. 72C
Roberts Co., The 72E

WESTERN EDITOR

8522 Lorain Rd., San Gabriel, Cal.
Atlantic 6-1842—W. C. Rodd

ADVERTISING SALES REPRESENTATIVES

Dallas 19, Tex., 3915 Lemmon Ave.
Lakeside 1-2322—Joseph Sanders

Los Angeles 17, Cal., 1151 W. 6th St.
HUNtley 2-4000—Fred Klaner, Jr.
David S. Clark

San Francisco 11, Cal., 916 Kearny St.
GARfield 1-7004—Lewis A. Vogler

Portland 5, Oregon, Terminal Sales Bldg.
CAPital 7-4993—Peter W. Klaner
Larry Conaway

SPECIAL WESTERN SECTION

Panelized cabin takes six hours to erect

A-frame is based on 4' module, is made of stress-skin panels that are bolted together at the site.

Sandpoint Builders Supply, of Mountlake Terrace (near Seattle) has developed a packaged A-frame cabin that's low in price, simple to transport and easy to erect.

The cabin (called Swiss Chalet) is a triangle with 16' base and 20' legs. Basic module is a 4'-deep section. Any number of sections can be joined in a series, but a typical Chalet uses seven—giving a 16x24' floor space and covered porch. Standard price is \$2,295.

Seattle contractor Byron V. Hartley recently erected a Swiss Chalet in about six working hours. He started by putting 4x10" beams onto precast concrete piers. He then placed the 4x16' floor panels over the beams and quickly put up the roof sections (below, right) and prefab end walls.

Floor panels are of 5/8" Plyon glued to a framework of 2x4's. Stringers (12" o.c.) protrude beyond panel ends to dovetail with stringers that protrude from the roof panels. Standard roof panels, also 2x4-framed, are sheathed with 3/8" plywood and covered with shop-applied clapboards. They are lined with 1/4" mahogany.



It took only six hours to erect complete shell of this house

Model shown here has aluminum roofing. However, shop-applied clapboard siding is used on standard models. Joints between roof panels are calked and battened. House has 384 sq ft of floor space, a covered porch, plus a 9x12' balcony inside.



House package fits on two trucks

Pickup carries end-wall sections; flatbed carries balance of package. Transportability is an important factor in selling vacation houses, as they often go to rugged, out-of-the-way sites.

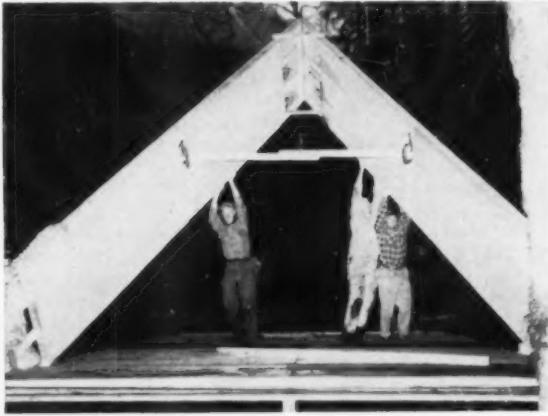

Lightweight roof panels go up easily

Workmen fasten panels temporarily at ridge, then walk them into position. Stringers extending outward from the panels are bolted to similar stringers that protrude from the floor panels.

*Harry Hood**... PLUMBING AND HEATING CONTRACTOR
FOR OVER 8,000 HOMES



BUILDS HIS BUSINESS WITH PIONEER



*of Kidder & Hood, Inc., Arlington, California

For Dependability... Greater Profit... Top Value

Harry Hood says: "Not only do you make a fair profit when you use PIONEER quality products, but you are backed by excellent factory service and a company who always stands behind its warranty." Pioneer Manufacturing Co. — always competitive with the market.

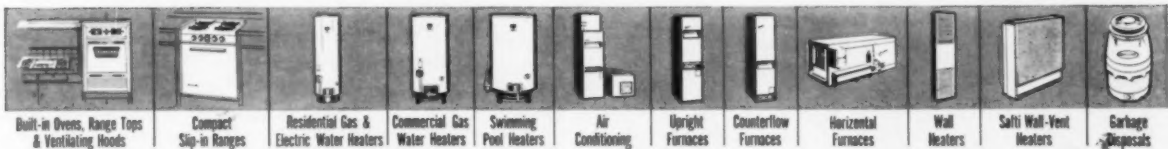

Built-in Ovens, Range Tops & Ventilating Hoods

Compact Slip-in Ranges

Residential Gas & Electric Water Heaters

Commercial Gas Water Heaters

Swimming Pool Heaters

Air Conditioning

Upright Furnaces

Counterflow Furnaces

Horizontal Furnaces

Wall Heaters

Safe Wall-Vent Heaters

Garbage Disposals



For further information, write:

PIONEER MANUFACTURING CO., QUALITY PRODUCTS FOR MODERN LIVING!

3131 San Fernando Road, Los Angeles 65, California

SPECIAL WESTERN SECTION

Finds apartment house construction a good answer to vital problems facing specialists in one-family homes



California builder still operates in small-home market . . .

George D. Buccola still builds single-family houses. This French Provincial is in his Sherwood Estates development, Anaheim. Prices in the tract start at \$25,000.

Home builder profits in hi-rise venture

Like many home builders today, George D. Buccola (G. D. Buccola Investment Co.) is concerned about two important problems—the need to diversify, and the growing scarcity of choice building land.

Also, like many home builders, he feels that hi-rise construction may answer both these problems. In the first place, it opens another market to the

home builder. In the second place, it packs a lot of dwelling units into relatively small sites.

Buccola recently plunged into the field of hi-rise with an 8-story co-op (below) in California's Newport Beach resort. The \$2,700,000 structure is really big stuff compared to the one-family homes he usually builds. But since Newport land runs \$2,000 to

\$3,000 per waterfront foot, Buccola needed maximum utilization of his site.

The building's 41 one-and-two bedroom co-op apartments offer 1,200 and 1,800 sq. ft., respectively, and have soundproofed walls. They sell for \$28,000 to \$105,000. Demand has been good, and over half the apartments sold inside of two months.



But he can also do hi-rise jobs like this 8-story co-op at Newport Beach

Building has 41 one- and two-bedroom apartments. Each apartment has a 10x29' balcony that's reached by sliding glass doors.

Two-bedroom apartments have an additional 5x20' balcony. Other attractions include all-electric kitchens, soundproof walls.



PATRICIAN

VOGUE

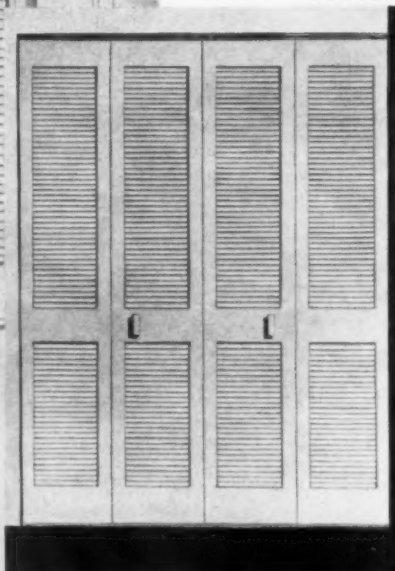

MODERNE

ROBERTS-FOLD® METAL FOLDING CLOSET DOORS

*The look of custom design preferred by
leading Builders, Architects and Designers*

- **3 DECORATOR STYLES** ... Patrician, Moderne, Vogue... designed to give a custom-finished look.
- **14 STANDARD SIZES** ranging from 2'0" to 8'0" width in 6'8" and 8'0" heights. Can be combined to close any size opening.
- **EASE OF INSTALLATION** Each unit is fully assembled and factory-balanced for fast and easy installation.
- **PRECISION-ENGINEERED ROBERTS-FOLD®** closet doors are made of top quality 24-gauge cold rolled steel panels with rigidly reinforced weldings. Even 8' doors never buckle, warp, stick or jam. Nylon-surfaced bearings glide whisper-quiet along exclusive ROBERTS® twin-tracks.
- **PRIME COAT FINISH** takes all types of paint without streaking or bubbling. Easy to wipe clean with damp cloth.

WRITE for A.I.A. File No. 101 RM



THE ROBERTS CO. DEPT. AB-5
600 NORTH BALDWIN PARK BOULEVARD • CITY OF INDUSTRY • CALIFORNIA

Quality Products for Home and Industry for over 20 years...including:

SMOOTHEDGE® Carpet Gripper • ROBERTS® Tools • ANCHOR-WELD® Adhesives
DRAFSTOP® Weatherproofing • NAP-LOK® Binder Bar • ZEPHYR Range Hoods

STOP N

QUIET ZONE PABCOWALL

with Quiet Zone Pabcowall, the new version of Pabcowall that soaks up sound. It reduces noise between rooms by as much as 51 decibels. And it still has all the wonderful features of Pabcowall: it's strong, economical, fire rated, easily erected without special clips, springs, accessories. Want more facts and figures? Just shout at: PABCO, Technical Services Dept., 475 Brannan Street, San Francisco, California.

Pabcowall

There are two versions of Quiet Zone Pabcowall: for the utmost privacy, Quiet Zone Pabcowall 51 has a noise reduction rating of 51 decibels plus a two-hour fire rating. And for other requirements, Quiet Zone Pabcowall 47 has a rating of over 47 decibels plus a one-hour fire rating.



Attention...

BUILDERS!!

DEVELOPERS!!

A New Program To Help You Sell More Homes

Authentic Palos Verdes Stone has a new program to help you sell more effectively (whether you build 10 or 1,000 homes). The Program includes, free of charge:

- ... merchandising material to give to prospects
- ... landscaping stone for model homes
- ... special display material for the GRAND OPENING
- ... personal assistance in economical use of stone

**IF YOU'RE INTERESTED IN USING
PALOS VERDES STONE WRITE US
TODAY FOR MORE INFORMATION ON
PRODUCT AND PROGRAM.**

Builder Program, Palos Verdes Stone Dept.
GREAT LAKES CARBON CORPORATION
P. O. Box 1307, Waleria, California
SPring 2-1301 • FRontier 5-1013

Authentic

Palos **V**erdes **STONE**

sold only through dealers.

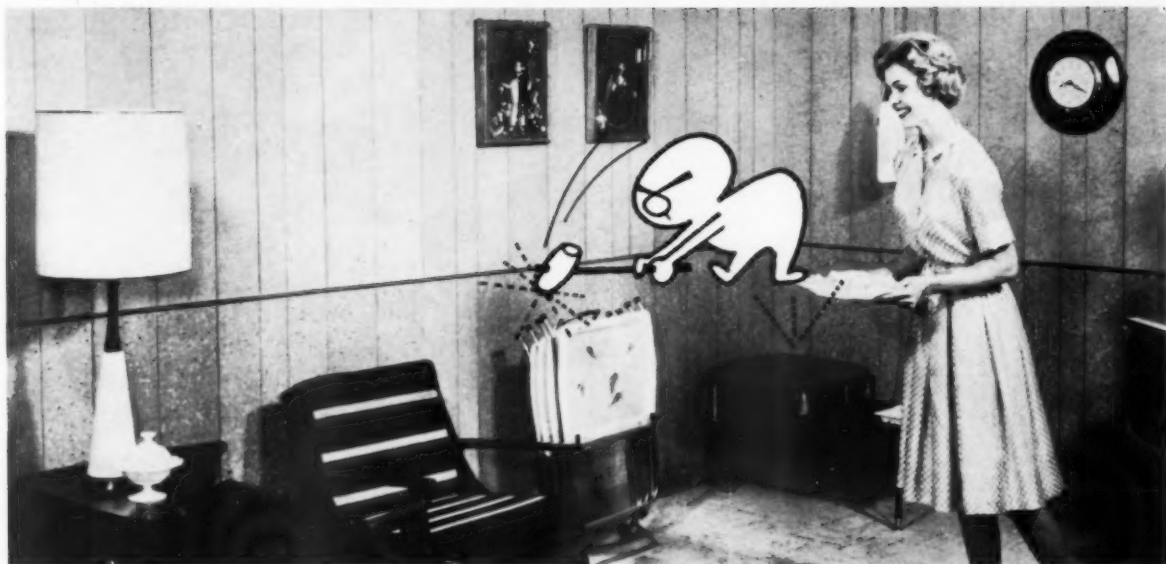

WALLS and WAINSCOTS
made of
FOREST SANDALWOOD  **HARDBOARD**

*are guaranteed
 to take abuse
 here's proof...*

Sandalwood Hardboard will stand up under hard use and still look beautiful. Applications like this grocery fixture point up these things: the pre-finished surface is permanent . . . it is baked in, not baked on . . . it won't wear off, is impervious to water, oil, food stains, dirt, grease, bumps and nicks.

Sandalwood Hardboard is beautifully modern, easy to apply, requires no painting when used inside and requires little or no maintenance.

Some typical applications of Sandalwood are for partitions in commercial buildings, wainscoting in schools and home family rooms and as feature walls. *Sandalwood stays beautiful and tough even when the use is rough.*

For samples, literature or further information, consult your favorite lumber or building material dealer or write Forest Fiber Products Co.



a quality product of . . .

FOREST **HARD BOARD**

Forest Fiber Products Co. P.O. Box 68-AB, Forest Grove, Ore.

NOW BUILDING TIME



CUT
5 TO 10 DAYS

WITH PABCO'S PRE-DECORATED SIDING: COLORED PAB-FLEX

It's the brand new exterior material that eliminates painting. Completely. (The color's built right in!) You can finish a home five to ten days faster. And save up to ten dollars a day in financing and supervisory help. What's more, Colored Pab-Flex is fire, termite, rot, and dent proof. All at less than a third the cost of brick or stone! In fact the applied price compares favorably with stucco. And there's no waiting for dry weather. No water on the job. No messy clean-up. (The colors? Nine of them in all — five textured, 3/16" thick; four smooth, 1/8" thick. In 4' x 8' panels and other lengths on special order.) Ask your Pabco dealer to show you samples. Soon! Colored Pab-Flex is brought to you by Pabco Roofing Division, Fibreboard Paper Products Corporation, 475 Brannan Street, San Francisco, California.

ROOFING AND SIDING, FLOOR COVERING, PAINT, GYPSUM... FROM PABCO DIVISIONS OF FIBREBOARD PAPER PRODUCTS CORPORATION. FIBREBOARD IS ALSO THE WEST'S LEADING PRODUCER OF PAPERBOARD AND PACKAGING.

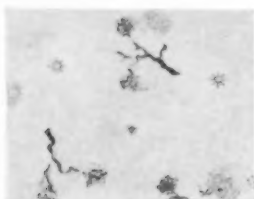

Laminate goes with any decor

Plastic laminate comes in the first of a series of new designs—the Compré pattern. Maker says its light color tones harmonize with any decor. Available in standard and postforming grades, in sheet sizes up to 60"x144".—*Ralph Wilson Plastics, Inc.*

Circle No. W72-W on reply card, p. 129



Tile takes any design

New application process allows acoustical or insulating wood-fiber tile to take any design desired by builder or architect. Called "Custom Ceilings," units meet all specs for cellulose fiber tile. Available in tongue-and-groove, butt joints; both with painted bevels.—*Kaiser Gypsum.*

Circle No. W76-W on reply card, p. 129



New low-cost light diffuser

Light diffuser of vinyl plastic comes in standard 2x2' panels that install quickly with T-bar grid system. Also removes easily for maintenance. Panels can be custom formed with company name, trademark or medallion molded into the honeycombed surface. Available with or without aluminum T-bar grids.—*Hexcel Products Inc.*

Circle No. W80-W on reply card, p. 129



Boilers are automatic, versatile

Line of fully automatic 3-pass packaged boilers have capacities of 50 to 500 H.P. Units are available to fire gas, all grades of fuel oil, or gas-oil combinations. Manufacturer says constant fuel delivery is assured, regardless of oil temperature or viscosity. Factory-assembled units have enclosed control cabinet with complete type flame safeguard controls.—*Ray Oil Burner.*

Circle No. W73-W on reply card, p. 129

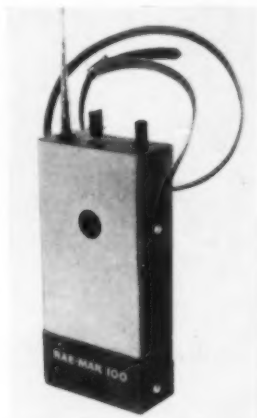

Radio saves time, labor

Low-cost, two-way fully transistorized radio requires no operator's license. Quick communication from job site to job site saves time, labor. Unit has seven transistors, 3" speaker-mike. Range is one mile, operates up to 50 hrs on 9-volt re-chargeable battery.—*Rae-Mar Electronics.*

Circle No. W77-W on reply card, p. 129



Modified T&G subfloor panels

Subfloor panels—called Solidply—are T&G all around to eliminate protruding edges, give an unbroken floor surface. First two plies are solid wood, cutting chances of punch-thru by heavy or pointed objects. Sanded top surface speeds cleanup, minimizes print-thru with pliant floor tiles. Panels are edge sealed, and are said to surpass DFPA requirements. They come in regular 4x8' size, with 4' lengths for staggered alignment. Thicknesses range up to 2½".—*Interstate Container Corp.*

Circle No. W81-W on reply card, p. 129



High-speed nailers and staplers

New air-powered nailers and staplers are portable, give high speed nailing of plywood subflooring, plywood and fiberboard sheathing, underlayment, gypsumboard, asphalt shingles, etc. The machines are light in weight, and can drive up to 160 heavy duty fasteners per minute.—*Power-Line.*

Circle No. W74-W on reply card, p. 129



Vanity hangs on wall

Combination medicine cabinet-vanity is wall hung, designed for bathroom where space is at minimum. Constructed with high-pressure laminates, models are 25" to 48" wide, 19½" deep. Require four screws for installation, come in six colors. Unit is ideal for remodeling jobs, hotels, motels.—*Kenneth M. Young Co.*

Circle No. W78-W on reply card, p. 129

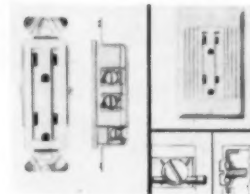

Stylish duplex receptacle

Three-wire electrical outlet called Biplux is said to be stylish yet inexpensive "U" ground duplex receptacle. It's UL approved and meets all applicable codes and standards for 15A-125V devices. Unit fits same wall plates as the manufacturer's Triplex receptacle, and is designed to eliminate loop wiring. Comes in ivory, grey, beige and brown. Matching wall plates come in two plastic designs, plus satin stainless steel and brush brass.—*Sierra Electric Corp.*

Circle No. W82-W on reply card, p. 129



Pool vacuum hose floats

Low-cost, light-weight pool vacuum hose is buoyant, does not require added floats. All-plastic hose comes in lengths up to 75', uses no metal supporting coil, will not rust out.—*Ductall Corp.*

Circle No. W75-W on reply card, p. 129

Color mixed in concrete

Color admixture goes right in concrete while material is being mixed on site. Creates color throughout entire mass. Can be used for patios, slabs, walls, pool decks. Comes in 10 colors.—*Admixtures, Inc.*

Circle No. W79-W on reply card, p. 129

Skylight gives strength, economy

New skylight is engineered for quick installation. Called Sky-Glo, it's molded of a polyester reinforced with glass fiber. Maker says an installed unit can support a man's weight with no danger of breaking; thus, it requires no protective screen or barrier. Also, unit is said to be shatter-proof and maintenance free. Comes in sizes from 20x20" to 4x8', for commercial and residential buildings.—*Fiberglass Supplies.*

Circle No. W83-W on reply card, p. 129

Ruberoid asphalt roofing helps **USS** U.S. Steel Homes sell more

"homes you'll want to come home to"



Illustrated—United States Steel Homes L-shaped "Albans" Model in 1961 Beacon Series. 1,260 sq. ft. of living space includes family room, living room, three bedrooms, two baths. Price: \$16,500—17,500 on average lot.

United States Steel Homes 1961 line of steel-framed, factory-manufactured homes sells customers with *beauty* to attract buyer interest . . . *value* to turn interest into sales action . . . and *long-life livability* to seal the deal.

And Ruberoid Square-Tab Asphalt Shingles used on the roofs help achieve every one of these aims, with:

More Beauty. Classic design and imaginative, decorator-styled colors harmonize beautifully with siding and trim . . . add a luxury look. Ceramic-surfaced mineral granules resist fading, are artfully blended for rich effect.

More Value. Economical Square-Tabs save even more because of their speedy, easy application. And Ruberoid's personalized service and deliveries geared to the builder's schedule insure economical production.

More Durability. Rugged asphalt construction withstands time and weather, resists fire. With this fine Ruberoid roof over his new home, the buyer gets more protection for his investment and his family . . . more certainty that during the years to come, his house will remain "*the home you'll want to come home to.*"

RUBEROID®

P. O. Box 129, New York 46, New York

This is the year
to cash-in on
the Vacation Home
market...

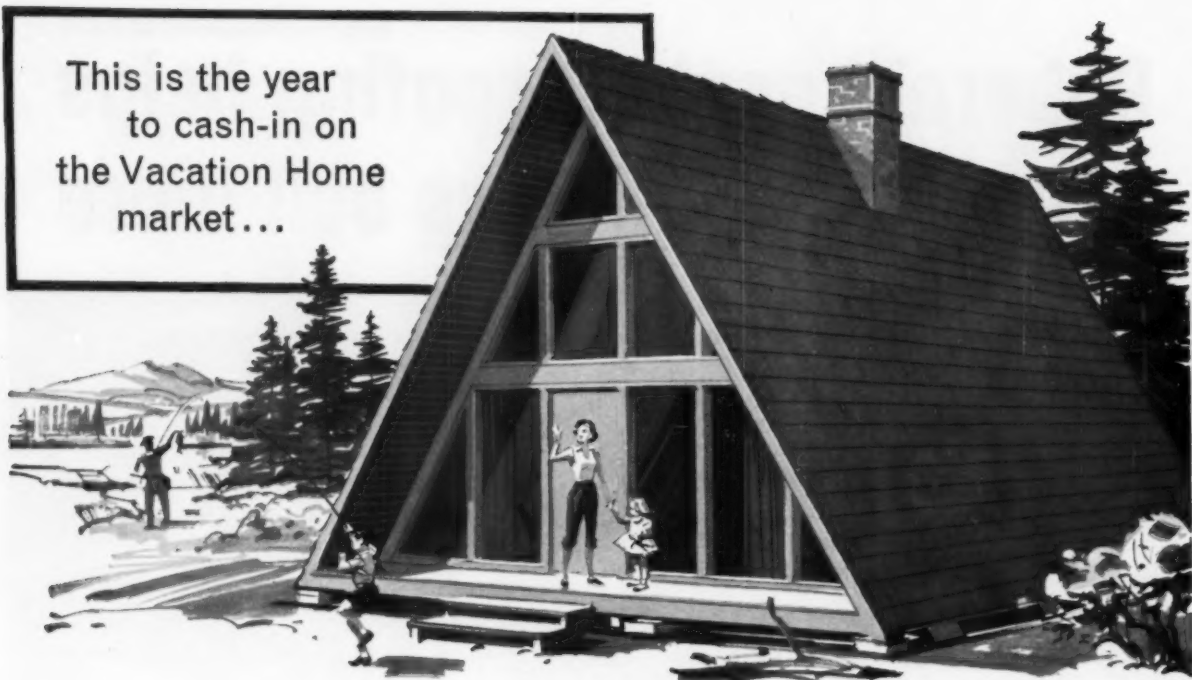

Potlatch LOCK-DECK "Free-Time" Homes offer you

the Plan · the Product · the Profit

This "A-Frame" second home will be built by hundreds of builders in vacation areas across the country. It is but one of 21 plans by America's leading Home Plan service ready to make additional profits for you. Each is attractively designed, practical, economical. With Potlatch LOCK-DECK—the laminated tongue-and-groove building material—you get more structural strength, better insulation and the beauty of natural wood interiors. LOCK-DECK is easy to use, goes up fast . . . providing a better building at a lower cost.

YOU, TOO, CAN MAKE BIGGER PROFITS WITH LITTLE ADDITIONAL EFFORT

Each Potlatch "Free-Time" Home is designed for easy-style living with just a touch of luxury. Construction ideas include "A-Frames," expandable homes, mountain retreats, and lake-side beauties. A "Free-Time" second home is leisure-time living at its best. Mail coupon today for FREE copy of Potlatch's Plan Idea Book in full color.

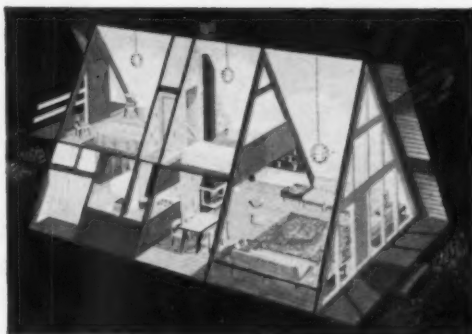

MAIL THIS COUPON FOR FREE PLANS BOOK

Check which you are:

Architect Builder Wholesaler Dealer

POTLATCH FORESTS, INC. • Lewiston, Idaho

AB-MY

Name _____

Company _____

Address _____

City _____ Zone _____ State _____

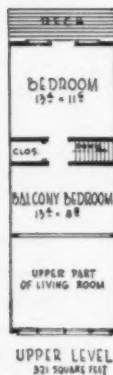

POTLATCH FORESTS INC.
GENERAL OFFICES • LEWISTON, IDAHO



Symbol of
Quality
Since 1906



Copper batten seam roofing on the new Senate Office Building, Washington, D. C.

New Senate Office Building has copper roofing for enduring protection

Approximately 75,000 pounds of Anaconda copper were used for the batten seam portion of the roof and the deep, boxed concealed gutter on the new Senate Office Building. In the nation's capital and in cities throughout the country, copper roofs are establishing records of long service and low maintenance costs.



The roof was fabricated and erected by the Overly Manufacturing Company, Greensburg, Pa. A modified "Overly" batten was formed from copper strip. Roofing sheets were formed from 20-ounce cold-rolled copper. Architect of the Capitol, J. G. Stewart. Architects: Eggers and Higgins, New York City. General Contractor: George Hyman Construction Co., Washington, D.C.

A realistic comparison of roofing costs requires the inclusion of two important factors—estimated maintenance costs over the years, and estimated serviceable life of the roofing material. Copper has proved its economy. Performance records covering many years of service show that expected long life and minimum upkeep are based on fact, not guesswork. Here is an example:

When the 47-year-old Grand Central Terminal Building was razed recently to make way for the huge new Pan-American Building, more than 150 tons of sheet copper were removed from the roof. The copper was still sound and beautifully colored by nature's patina. It is also worthy of note that the scrap value of the removed metal was considerably higher than the price for ingot copper prevailing when the roof was installed in 1913.

FOR MORE INFORMATION on Anaconda Sheet Copper for building construction, see your Sweet's File or write for Publication C3-SA. Also, if you do not have your copy, ask for our "Modern Sheet Copper Practices," 109 pages of drawings, specifications, and general information. Address: Anaconda American Brass Company, Waterbury 20, Conn. 611

ANACONDA[®]
SHEET COPPER
FOR BUILDING CONSTRUCTION
Anaconda American Brass Company



by
GENERAL
ELECTRIC



Success Story #6



“Sales of Medallion Homes have been tremendous”,

says Mr. Alfred Campanelli, a builder of *Weathersfield*, Schaumburg, Illinois. Weathersfield is a Medallion project of 3,000 Modern Colonial units, priced from \$16,000 to \$22,000.

“The single feature that has helped us most with sales is the General Electric kitchen included with the price. Buyers and prospects say it’s ‘terrific’. In fact, one housewife, who calls it a ‘woman’s dream’ is responsible for the sale of five other houses to friends.

“Another important selling feature is Full House-

power. Homebuyers like having all the electrical capacity they’ll ever need. We’re glad that we’re building Medallion Homes to the award standards of the Commonwealth Edison Company.”

Homebuilders: Medallion Homes equipped by General Electric are easier to build and *sell*. Here’s why:

1. *One source* saves you time. 2. You get expert assistance in all your electrical planning. 3. General Electric stands for quality. 4. A new local plan helps you sell your homes! Call your General Electric Major Appliance Distributor *today*.

Progress Is Our Most Important Product

GENERAL  ELECTRIC



QUINCY LEE (right) discusses plans to expand production and sales with Cliff Morton, his vice-president and general manager.

"We Changed Everything to Sell More Houses"

Quincy Lee of San Antonio had 71 unsold houses in a tough market. Here are the 20 giant steps he took to turn the decline into a profitable rise in business.

It took a drastic but well thought out series of steps to stop the decline. Quincy Lee is a veteran of 20 years successful work in San Antonio: it was the first time he had so big an inventory.

In the space of a few months he put an entirely new face on his marketing program. But what he did went far beyond the usual ideas of merchandising. He literally "changed everything"

—and the results in sales were remarkable. AMERICAN BUILDER believes this is a success story every builder may read with profit. Step by step, here is what Lee did:

1. "Find out where you stand." He employed Real Estate Research Corp. of Chicago to make a depth-study of the local market: to find out price ranges and types most needed, set a framework for his program.

2. "Hire a new sales manager." Since the first big problem was those 71 unsold houses, he tackled sales first. He hired young (28), personable Clifford E. Morton, backed him with an equally aggressive and youthful sales staff. Morton has since been made vice president and general manager.

3. "Get new ideas from other projects." Lee and his associates took a coast-to-coast trip to visit successful builders, get ideas they could apply. "This certainly paid off," he says.

4. "Found a smart advertising agency." Lee went to nearby Dallas to find an ad agency which could give complete marketing advice and service.

"We re-designed our line, added shell



"We expanded our price range—sell houses at \$2850 to \$21,000"

Royal Crest models above sell at \$2850 for shell alone; partially finished: \$6950.

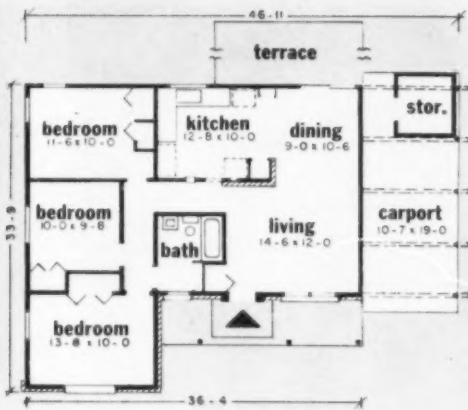

"Lyric model:—3 bedrooms and bath (985 sq. ft.)—sells for \$10,950"

Value and extra features at a low price are the objective of the Lyric House.

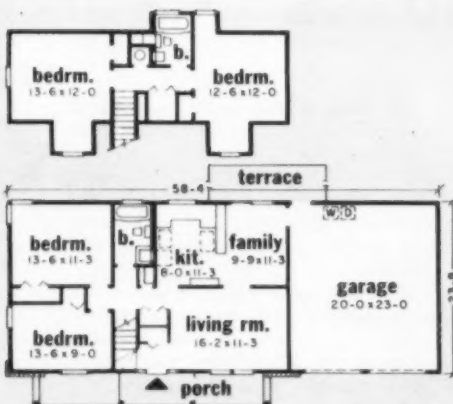

"Concept model: 4 bedrooms, 2 baths, family room sells for \$21,000"

Colonial model with double garage is popular. Rooms are large at this price.

houses, took orders on scattered lots"



Models in this group sell in various stages of completion. Top price: \$8250.

The Sanders Agency developed a coordinated program: its work includes advice on model home styling, project names and concepts, promotional ideas as well as unusually distinctive brochures and newspaper advertising.

5. "Redesigned our models." A change in consumer buying ideas has taken place, Lee found. He restudied and redesigned his houses, added new models, retained New York architect Hank York to create additional designs.

6. "Added a shell house line." The surveys showed an important market for very low cost houses. Lee built four models starting with a shell at \$2850. He sells a "livable" model at \$6950 and a "finished" model at \$8250. Thus he offers houses in various stages of completion as the buyer can afford. He merchandises the shell, low cost line under "Royal Crest" name.

7. "Builds on scattered lots." To reach more buyers of all types, Lee now sells to individual lot owners within a 150 mile radius. His shell house line taps a big new vacation or second home market.

8. "Broader price range." With the addition of the shell house line, Lee's range of prices is now from \$2850 to \$20,000. He is able to reach the bulk of the San Antonio home market with these prices.

9. "Save \$200 per house through package production system." Lee has perfected his component building system into an organized "package" home production system that saves money. Trusses, wall panels and interior components for all houses are built in one strategically located shop on San Antonio's belt highway. Among the advantages are tighter cost control, quality control, no storage on jobs, material savings, less inventory, less insurance, no pilferage.

10. "Diversify as to price and location." Projects are spaced around the belt highway so that they are only 15 minutes apart: easy to reach by the new highway system. Each has a special price range to appeal to the maximum market in the area.

11. "Names make sales." Lee's marketing men came up with striking and interesting names for each line of houses. The top are called "Concept": they are in the \$17,000 to \$21,000 range, include some 4-bedroom, 2-bath models. Middle range houses are labelled "Lyric": they feature "extra value and features at a low price." The range here is from \$10,000 to \$12,500. The lowest cost line, including the shell homes, are marketed under the glamorous title "Royal Crest."

12. "Coordinated marketing plan pays off—and how!" Most important to Lee's turnabout success has been the smartly paced marketing campaign which starts with selection and naming of the site and runs through naming streets, decorating model homes, color selection, making the sale, and post-sale servicing. Signs, brochures and newspaper ads have a single theme and character.

The advertising agency participates from the start in styling, naming and selling the product.

13. "Personalized campaign." Although a similar theme and quality runs through all Quincy Lee advertising, each project has a personalized campaign. It is planned to have its own distinctive name, price range, colors, symbols, slogans, jingles, signs and brochure styles.

14. "Construction and sales work as a team." On each project the construction superintendent and the sales manager work as a team. Their jobs are closely coordinated and they profit jointly as final closings are made. This results in sales and production being kept in harness.

15. "Make the most of model homes." New model homes are color-styled and smartly decorated by a firm of interior designers that specialize in this field. In last year's campaign, five models were fenced in as a model village. Two were furnished, one was used as a merchandising display house, one as a sales office. The fifth was partially finished and used as a show piece, with a five ton truck perched on the roof to demonstrate the strength of Lee's roof-truss system.

16. "Advertise your quality work." Lee goes to great lengths to build a quality house, and his controlled component system helps in this respect. He does a great deal to inform the public about the quality methods and materials he uses. An example is heavy truck mounted on house roof which shows durability. He also has a display on each project showing wall systems, cutaways, displays of quality products and a prominent enlargement of the guarantee he gives each buyer. One of the construction displays in his shell house contrasts "old fashioned methods" with "today's scientific research."

17. "Get the best professional advice." In developing his program, Quincy Lee has sought out "pros" in every field. He did this in retaining Real Estate Research Corporation of Chicago for his local surveys. He hired Phillips, Proctor, Bowers & Associates



Brick and frame on a concrete slab, quality products, good design are featured.



More space for less money achieved in this model by production economies.



"Package house production methods and components save us \$200 per unit"

House parts are built in a small, centrally located shop within easy trucking range of all projects. Cost saving is great. Quality

control is another plus achieved by component system. Quincy Lee builds own panels, trusses, cabinets, interior units.



"Quality work starts with this heavy slab"

Shifting soil in San Antonio calls for extra reinforcing in floor slab. Quality job is insured by careful engineering. There's no

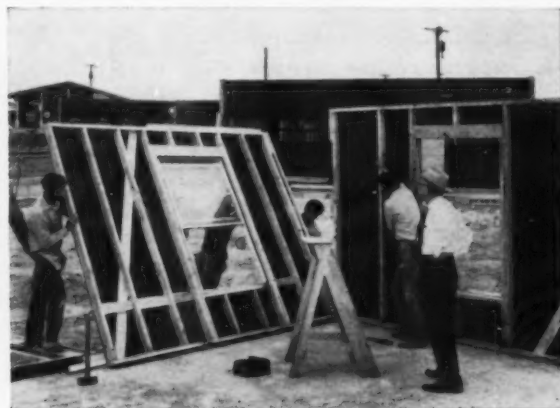

"Tighter job control with components"

waste of time or materials as wall panels are erected by the special erection crews. Job quality is also assured.

"We reduced prices by better techniques—

of Dallas for land planning, Sanders Agency for advertising, Architect York for design.

18. "More sales training." Even though the sales crew is competent and experienced, they need constant help and training, Lee believes. Sales training classes are held regularly. These are hard working sessions, with exams.

19. "Keep up on new techniques." The Quincy Lee construction methods are constantly being reviewed and improved to produce more value for less money. Standardized plumbing layouts are employed. All materials are packaged or bundled with tape. Loose pieces of molding are tacked to wall panels, ready for use. A great deal of the interior trim and cabinet work is built in the shop. The package system achieves lower unit

costs without sacrificing quality.

20. "Develop community spirit." On one of his projects, Lee donated a 40x100' community building. It is kept busy from dawn to dark with scout meetings, school affairs, clubs and community get-togethers. His organization works hard to make home owners proud of their community and participants in its affairs.

Results are what count. The campaign to stop the decline in business and build new sales started in December, 1959. It was at that time that Lee had 71 unsold houses, and faced a gloomy prospect marketwise in San Antonio. The process of change started at the 1960 NAHB convention in Chicago, and was pushed rapidly thereafter. The results have paid off very well. The 71 unsold houses were sold

in six weeks of intensive campaigning with bold color advertising in the newspapers and a quality radio jingle.

Then Lee introduced his three completely new and diversified home lines, based on the recommendations in the marketing survey.

His marketing methods were so successful that opening day crowds broke all records. And the crowds continued through the hot summer months.

In the first quarter of 1961, sales moved ahead again. Lee sold 50% of the total of 1960 during this period.

There's one bit of philosophy behind all this. "Give people the kind of house they want at a price they can afford," he says. "Use every possible idea, product or technique to give them more house for the money. Then merchandise to the limit."



"Distinctive names—distinctive signs"

Quincy Lee signs have a smart, unique look, are coordinated in design, color and symbols with other merchandising.



Low cost of line features "shield of quality"

Royal Crest line starting at \$2850 gets the benefit of this high-style, high-quality sign—a smart merchandising tactic.

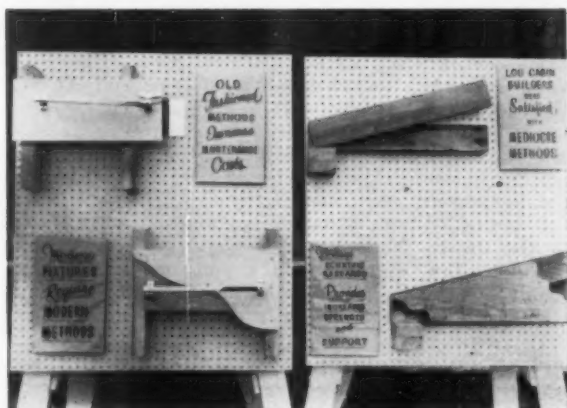

"Today's scientific research . . ."

Model house display contrasts "old fashioned methods" with "today's scientific research, increased strength and support."



"Increased strength and support"

Truck perched on roof of Royal Crest shell house demonstrates strength of roof trusses, calls attention to quality construction.

sold harder with smarter merchandising"



"Make it attractive to the children"

Unique playground equipment near model homes was designed by noted expert. It attracted attention: children loved it.



"Smart signs sell 24 hours a day"

These are the signs that go up when a house is sold. A few of them dotting a street have a heavy impact on visitors.



Urban rehabilitation:

Experts agree: Updating old houses—not bulldozing them to make way for “slum-clearing,” high-rise projects—is one of the best ways to attract builders into the nation’s urban renewal program. FHA is seeking financing.

Urban rehabilitation—if the Federal Housing Administration (FHA) and the Urban Renewal Authority (URA) have their way—will make it easier in the near future for you to buy older city dwellings and change them into multiple family homes.

To date, there has been very little urban rehabilitation—especially outside major metropolitan centers—primarily because of financing jibber-jabber, which has kept residential builders in cornfield developments. Too, urban rehabilitation has been confused with urban renewal—high-rise slum-clearance programs that most builders are not equipped to do. But the picture is changing: Government leaders are looking to the conservation approach . . . “fix ‘em up before the blight sets

in so we don’t have to bulldoze and start new.”

This approach—which directly affects your market—was brought into focus at the NAHB Eastern Regional Builders’ Urban Renewal Conference held the last part of March in Baltimore.

FHA lists proposals

Heading the speakers was C. Franklin Daniels, special assistant for urban renewal, FHA, who emphasized the Kennedy Administration’s thinking on urban renewal by calling it “deep concern for the consumer of housing as well as for the producer of housing.”

To encourage builders into this rehabilitation market, the FHA has proposed legislation that would:

1. Increase the grant for the URA

from \$2 billion to \$4½ billion.

2. Increase the government’s payment role in local urban planning from ½ the cost to ¾ the cost.

3. Support acquisition of open land within cities and create a “land bank” earmarked for parks or future development.

4. Fulfill “unmet” needs in middle income housing, under Section 221 of the National Housing Act, and extend insured mortgages to 40 years, with no down payment in the \$11,500 to \$14,500 class. This would embrace both cities and suburbs, and it’s proposed on an 18-month experimental stage. It is hoped that it would boost moderate income building, and/or rehabilitation.

5. Encourage home building and rehabilitation for lower income families

How a Washington D.C. builder found profit



FRANK CALCARA, a builder since 1939, puts up 35-40 custom homes per year; rehabilitates houses, commercial properties.

In July 1960, Washington (D. C.) builder Frank Calcara bought a 100 year old condemned “Federal”-roofed house for \$9,500. In nine weeks, after completely restoring the house, he sold it for \$35,000.

Since then he has bought and restored five rowhouses and one more Federal. The rowhouses alone represented a total original cost of \$32,500 and were upgraded to an overall worth of \$127,000. All but one of these have been sold.

Before he began his restoration work, Calcara had to face three major problems. First, he had to find the right neighborhood. It had to be run down, yet not sunk to the point of total blight. It had to be convenient to jobs and stores. Most important, it had to have character and local identity. After two years of investigation in such D.C. sections as Foggy Bottom, Cleveland Park, Kalorama Triangle, Calcara settled on Capitol Hill. “People,” he says, “who buy our restored jobs are buying a home in a neighborhood that’s increasing in value.”

Calcara’s next major hurdle was fi-

ancing. Going to various local building and loan associations, he found he could obtain a commitment only if the restoration work was 100 per cent complete. So he simply had to dip into his own pocket for the funds. Calcara feels that a payment plan similar to that for new construction would stimulate rehabilitation. “You would have your draws scheduled for the completion time (individually) of your gutting, framing, plastering and trimming.

Finally, he had the restoration work itself. After studying old plans and etchings of the building’s design, he completely gutted-out and reframed the house. On the two Federals, he put up clapboard siding and sprayed the exterior stucco side walls white. He replaced all old duct work, wiring, plumbing, chimneys, flues and fireplaces as well as windows and doors.

Pointing to the need for more building professionals in the restoration field, Calcara says, “You’ve got to know your neighborhood, financing and construction. There’s more to it than just buying, patching, repainting and putting two carriage lamps by the door.”

a new market opportunity?

by lowering interest on FNMA-financed mortgages to below the present rate.

Financing can "make" it

Said Richard L. Steiner, director of Baltimore's Urban Renewal and Housing Agency: "The pendulum has swung as far out to suburbia as it can go. Now it's swinging back. There's a definite return to the city.

Steiner, one of the nation's foremost authorities on urban renewal and rehabilitation, praised the new FHA proposals, and added that FHA financing can make or break a workable urban renewal program. As the various rehabilitation problems are worked out, the builder's role in rehab will become an important one.

James W. Rouse, chairman of the American Council to Improve Our Neighborhoods. (ACTION, INC.) predicted that the most important building developments in the next 10 years will be in the city—not the suburbs.

Getting down to cases, Rouse said mortgage and loan people might be too close to the day-to-day problems of

financing to gain a proper perspective on the reorganization of cities. Recognizing existing difficulties, he cited several builders who had attempted renovation of old buildings, changing them into multiple dwellings, and finding a vast lack of completion financing.

Rehabilitation spotty

In a spot check across the nation, AMERICAN BUILDER editors found little rehabilitation work going on, with the exception of large cities.

Answers to the question "why" followed a definite pattern:

- Financing. The rehabilitation job has to be nearly complete before lending agencies will supply cash. Too many loan firms have a "suburban fixation," and can't see city rehab.

- In smaller cities, builders felt that the housing market was still too strong in the suburbs. "Sub-developments are close enough to the city so transportation doesn't yet constitute a problem. Buyers don't want to live in the city when they can have suburban living 20 minutes from the office."

What you should know about rehab before you start

In a 9-city survey, the Urban Land Institute put together these conclusions about rehab:

1. Structural rehabilitation varies with the type of architecture and construction of buildings. Check for hidden defects.
2. Law enforcement can't fundamentally change the character of a slum neighborhood.
3. Costs that compete with new construction are beyond the means of most slum dwellers.
4. Cost of rehab is often equal to new construction.
5. Rehab requires close supervision, wide variety of skills.
6. Rehab of high density dwellings in slum areas usually isn't feasible.
7. Financing (now) of rehab is often difficult.
8. Large slum areas may have deteriorated to where clearance and redevelopment are the only answer to the problem.

in urban restoration



Before—restoring begins on old house

Work is started on 100 year old Federal-type house on Capitol Hill in Washington, D. C. Building is gutted and framed, doors and windows are all new. Note kitchen addition at rear.



After—old house becomes saleable as new

Restoration completed, house is sold as brand-new home. First floor has living room with two fireplaces, dining room, modern kitchen. Two large bedrooms, double bath make up second floor.

Builder Frank Calcara combines old designs



Rowhouses are reframed, resheathed

Entire face of five rowhouses is torn off. Interiors are completely gutted and reframed. Insulating sheathing is new, facing will be used brick. Wrought-iron fence, D. C.-style, is retained.



Parapet creates smooth front roof line

Used-brick facing extends up to form parapet. It stretches length of five units, gives smooth, straight line to different roof levels. Fascia, gutters, brackets, in old-style, are brand new.



Upstairs space fully utilized

Louver-door closet (right) encloses compact heating, air-conditioning unit. At extreme left is duplicate storage closet. Panel door leads to front bedroom. Scene is \$23,950 rowhouse.

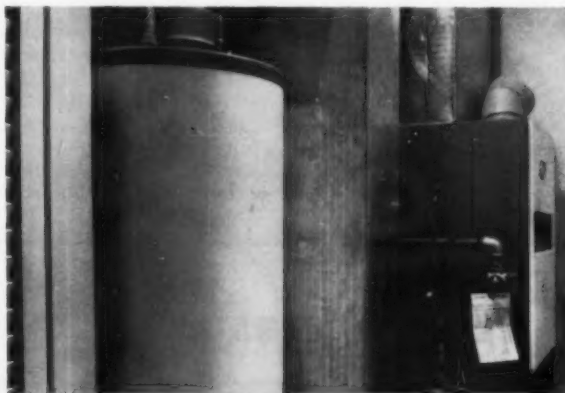

Closet holds heating-cooling package

Open, closet (photo, left) reveals complete heating, cooling and hot water heater package. Ductwork exhausts air-conditioner heat through roof vents. Unit leaves room for closet storage.



Twin fireplaces add elegance

Double fireplaces in living room of \$35,000 Federal home take design from early 18th century, yet have new hearths, flues and chimneys. Risk is too great to retain old masonry.



Porch opens off rear bedroom

New porch is built on rear of second Federal-type house, opens off rear bedroom. It shades sliding glass door entrance to modern kitchen. Rails and balusters are new, corner posts are antiques.

and modern methods for restoration



Different elevations leveled off

Rear of rowhouses show how parapet levels roof lines of different dwellings. Ventilators on roof tops act as air conditioning exhausts. Wood fence is new, constructed to resemble old.



Fences enclose town-type gardens

Workman puts up board fence which cuts rowhouses' rear lot into Georgetown-type lawns and gardens. Each garden will have a small fountain. Unpainted boards are random widths.



Dining room accessible to outdoors

Sliding aluminum glass doors open dining room onto side yard. Area (in Federal house) features period chandelier (not shown). Louver—doors lead directly into all-electric kitchen.



Kitchen added on to original shell

Kitchen in \$35,000 Federal, not part of original building, has 8" thick double-course brick walls with parging. Cabinets are made locally, built-in range, oven, hood are all-electric.



Completely restored rowhouses show builder a 7-8% net profit

Restored rowhouses on Fourth St., S. E., in Washington (D.C.) Capitol Hill area run in price from \$26,900, \$27,900 (with full basement) to \$25,900, \$24,000, \$23,950 respectively (without

basement). Separate dwellings (before restoration) cost about \$6,500 apiece. Buildings were in decay and ready to be condemned in neighborhood a few short blocks from the Capitol.

Seattle's first UR job had \$300,000 volume

For you as a builder, urban renewal means opportunity. It brings close-in land at a reasonable price. It creates a good rental market. It offers a big repair and remodeling market. It makes your community a better place in which to live by eliminating blight.

An excellent yardstick by which to measure this opportunity is Seattle, Washington's first urban renewal and rehabilitation project.

The first year, it brought a \$300,000 volume of new construction, remodeling, and maintenance work—all without the benefit of special FHA 220 financing. Now that it has been certified for FHA 220, local builders are moving in fast.

This project, Cherry Hill, located a few miles from downtown Seattle, comprises 51 acres with 456 structures.

A survey showed that about half the structures were sound, the other half were sub-standard. Because of the old dilapidated buildings, the area was considered a blighted neighborhood. Residents took no interest in keeping their homes in repair.

This trend was reversed through the action of a small group of public-spirited citizens who make up the Seattle Urban Renewal Enterprises (SURE).

After the city declared the area an urban renewal project, it was necessary to explain this action to residents. SURE, through contributions, hired a full-time executive director, Ray Baker, to do the job. He held neighborhood meetings and explained how ultimately the entire community would be renewed. He asked the residents to help with improvements.

Baker was able to line up lending agencies at the start to make Title I loans, matching owner's equities up to \$3,500. SURE found that when Cherry Hill was certified for FHA 220 last December, interest by builders jumped. Some had already purchased lots; others had bought older homes with the thought of remodeling them into apartments. Money was now available so building could start.

To interest residents and builders, SURE purchased a house and remodeled it into an office for Baker (see below). "Before and after" photographs of the house, along with a complete breakdown of remodeling costs, are posted on the walls of the office. This treatment goes a long way in explaining to residents and builders what can be done and a good estimate of costs.



Before: Blighted, but not beyond help

Urban renewal projects start in areas like this—run-down, but not far enough down for complete razing. Homes beyond rehabilitation were bulldozed; others fixed-up—from plaster to paint.



After: SURE headquarters sets the pace

Completely rehabilitated inside and out, SURE offices show what can be done to old, but sound, housing. Services of SURE include advice on remodeling, financing, where to obtain top contractors.



Before: Dilapidated dining room

Crumbling plaster, sagging, bare floor, dangerous wiring, and a chimney fire hazard was typical scene in SURE headquarters before rehabilitation. At first glance, project looked a little hopeless.



After: Dining room cost \$636 to re-do

Cost of improvements: Wallboard, \$90; painting, \$45; taping, \$65; light fixtures, \$40; adequate wiring for room, \$40; window repairs, \$15; linoleum tile, \$90; gas heater, \$176; and heating vent, \$75.

first year; test house helps builders

Here's an example of rehabilitation financing 220 as prepared by SURE organization

Hypothetical example on a home loan:	
Present value	\$6,000.
Repairs necessary	\$4,000.
FHA appraisals after remodeling	\$9,000.
Allowable closing costs	\$ 175.
Total	\$9,175.
As an owner occupant:	
97 percent of first	\$13,500
90 percent of next	\$ 4,500
70 percent of the balance	
Maximum loan (97% of \$9,175—rounded off)	\$8,850.
If sold to FNMA (Fannie Mae):	
Discount 1 percent (approximate)	\$ 88.50
Pre-commitment fee, one percent	\$ 88.50
Market fee: 1/2 of one percent	\$ 44.25
Processing fee, 2% (lenders) includes escrow ..	\$ 177.

Title insurance	\$ 60.
FHA appraisal	\$ 20.
Total closing costs (rounded off)	\$ 480.
Pay off—existing mortgage	\$4,000.
Necessary repairs	\$4,000.
Closing costs	\$ 480.
Total cash needed for job	\$8,480.
Amount of loan	\$8,450.
Cash needed to close loan	\$ 30.
Pre-paid reserves	\$ 156.
Three years' insurance	\$ 72.
Annual taxes	\$ 84.
Total cash needed	\$ 186.
Amount of loan	\$8,450.
Monthly payments run: 10 years, \$108.58; 15 years,	\$86.12; 20, \$75.36; 25, \$69.22; 30, \$65.35.



Before: Living room lacked luster

Falling plaster, inadequate and dangerous lighting circuits, rotted window frames, and a sagging floor were the biggest rehab problems in the living room of SURE's headquarters.



After: Cost of improvements totaled \$592

To put the room in order: Wallboard, \$90; painting, \$45; taping, \$65; new view window, \$75; remove doors, \$75; adequate wiring, \$40; tile, \$107; lights, \$40; windows, \$10; ceiling, \$90.



Before: Bathroom adequate, but antiquated

Like rest of house, bathroom had dangerous wiring, soil stack was broken and leaking into kitchen, plumbing was inoperative, and the plaster was crumbling and falling from the walls and ceilings.

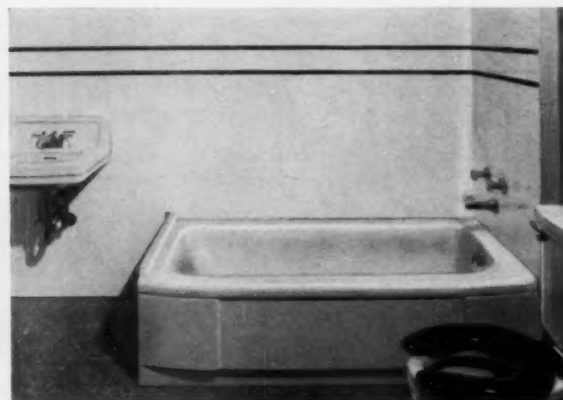

After: \$1,088.50 was spent in fix-up

Improvements included wallboard, \$55; taping, \$35; plastic tile, \$145; linoleum tile, \$80; plumbing, \$400; wiring, \$55; space heater, \$85; painting, \$75; new fixtures, \$145; window \$10; light \$3.50.

BLUEPRINT HOUSE



SEEN FROM THE STREET, this two-story house has the look of an attractive split-level, thanks to low eave lines, horizontal siding and the ingenious use of land as part of its overall design. Well-placed ground planting also helps its look of "belonging."

**American Builder Blueprint
No. 284 ▶**

Hill property pays off...

By using a sloping lot as part of their winning house design, Washington builders cut excavation, foundation costs, gained extra room, produced a good 'sell' at \$12,950

Many builders shy away from hilly land, considering it a liability, loaded with headaches and costly bulldozer problems. Not so, Bell & Valdez. Instead of bucking a sloping plot, this successful team of Washington builders, take the 'if you can't lick 'em, join 'em' approach. They put their land to work. One of their successes is shown on these pages; a house that was among the top winners in AMERICAN

BUILDER'S 1960 contest.

First of all, the grade was left in its natural state; the house nestled into the sloping contours so that foundation walls enclosed a full lower living floor. A combination garage-workshop and an unfinished family room occupy this area along with an entrance foyer which leads to the floor above. Piping was installed for a future bath and laundry.

Though the second floor, like its twin below, occupies but 1,007 sq. ft. there's a surprising sense of space in every room. The living-dining room, for instance, is 26' long and further benefits by an open kitchen set in an ell. Three bedrooms are more than adequate in size, each with plenty of storage space, and each opening directly into a centrally located hall. For outdoor living there's a patio, reached from the dining area.

For quality products and complete material list, turn to page 94. Architect—John M. Anderson.

... with "full expandability" on

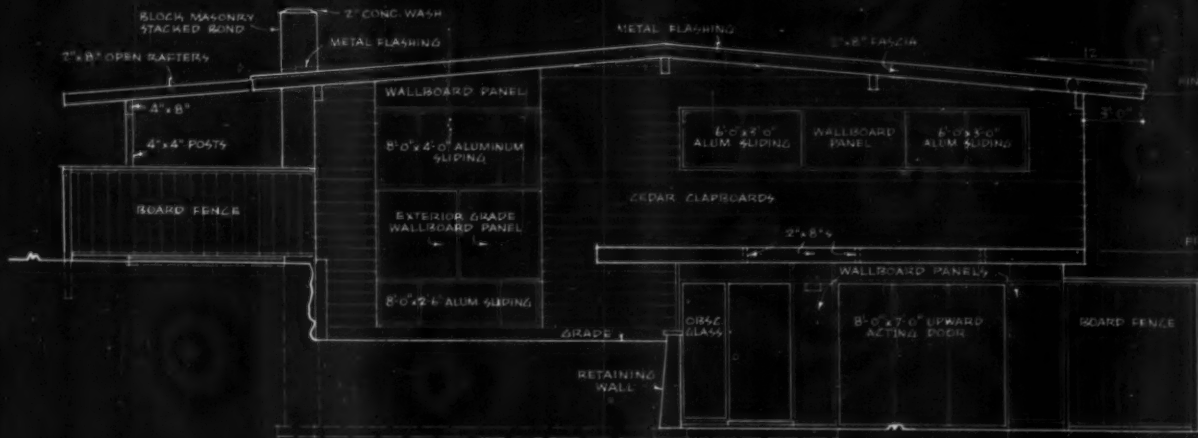

FRONT ELEVATION SCALE 1/8" = 1'-0"

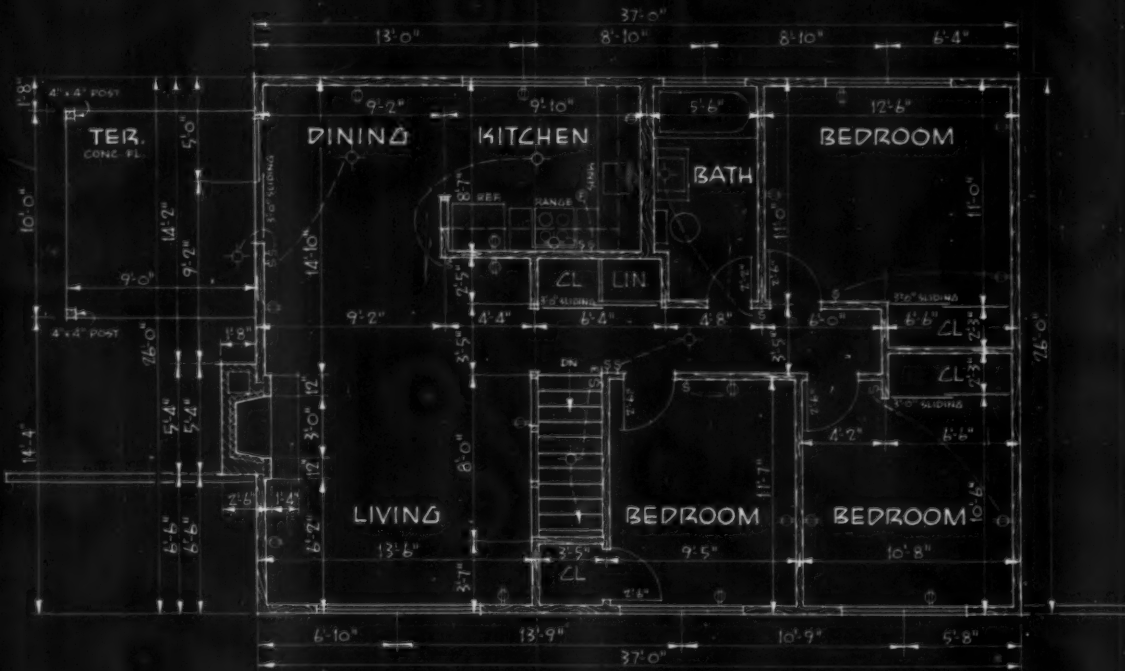

UPPER FLOOR SCALE 1/8" = 1'-0"

FIN. CEILING
FIN. FLOOR
FIN. FL.

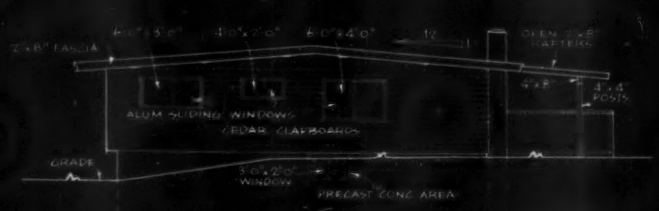

REAR SCALE 1/8" = 1'-0"

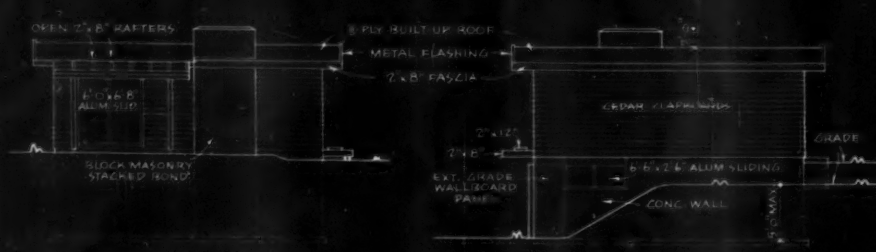

LEFT SIDE

SCALE 1/8" = 1'-0"

RIGHT SIDE

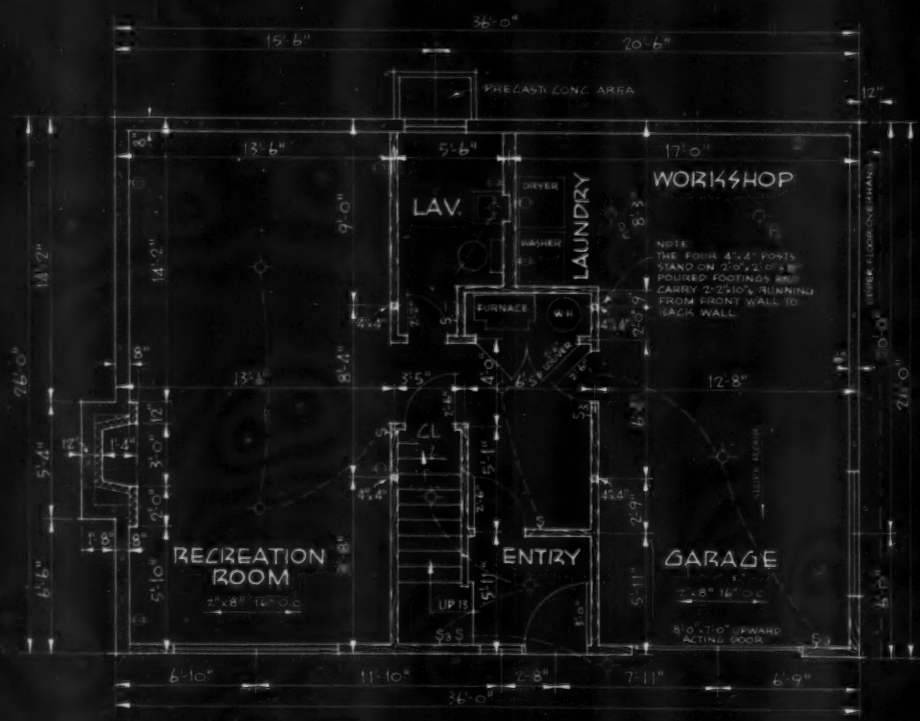

LOWER FLOOR

SCALE 1/8" = 1'-0"

NOTE: THE HOUSE AS PHOTOGRAPHED HAS AN UNFINISHED BASEMENT



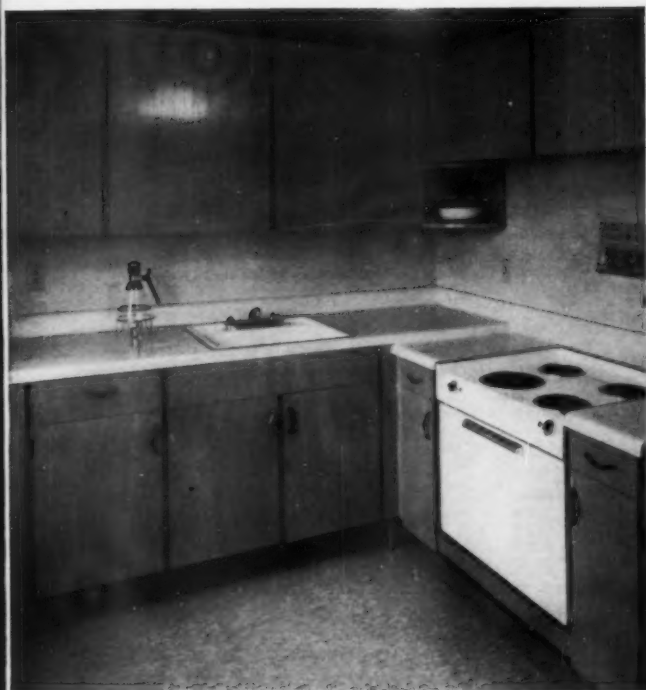

A WELL-ORGANIZED kitchen, easy to work in and easy to keep in ship-shape condition sells many a house. This one opens into dining area, has birch cabinets, plastic counters.



NATURAL WOOD of kitchen cabinets is reflected in decorative display built-in which faces dining room. Aluminum glass sliding doors open onto patio, make outdoor serving easy.



WALL-HUNG LAVATORY, in bathroom, is built into decorative cabinet with sliding plastic doors beneath. Centrally located bath is convenient to bedrooms, adjacent to linen closet.

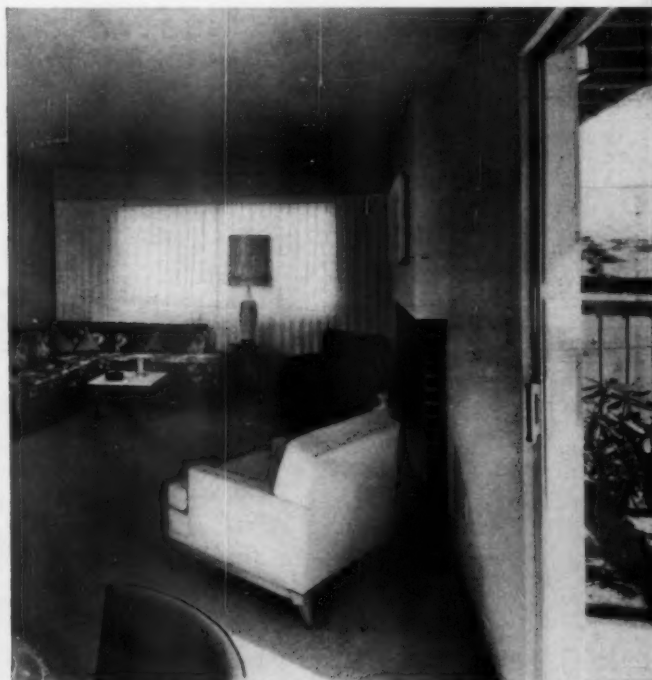

SPACIOUS APPEARANCE of living-dining room is shown above. Raised fireplace is of natural brick; walls and ceiling of painted wallboard. At right is view of red cedar fence that screens patio.

lower grade level

▲ SECOND HALF OF BLUEPRINT FOLDED UNDER.

Blueprint house products & material list

AMERICAN BUILDER HOUSE NO. 284

L = lin. ft. C = cu. ft.
S = sq. ft. U = unit(s)

FINISH BASEMENT FLOOR AREA 560 S
FIRST FLOOR AREA 965 S
GARAGE FLOOR AREA 335 S
TERRACE & PLATFORM AREA 90 S
BUILDING CUBAGE 16 M

—EARTH EXCAVATION & GRADING—

Topsoil 6" Grade Exc. & Pile 5,530 S
Earth Basement Excavation 6,490 C
Earth Hand Footing Exc. & B'fill 315 C
Earth Retain. Wall Exc. & B'fill 180 C
Exc. Mater. Surplus Removal 6,490 C
Gravel 6" Fl. & Terr. Sub-Fill 985 S
Water Encountered Drainage Sum

—CONCRETE CONSTRUCTION & FINISH—

2500# Conc. Wall & Col. Footings 105 C
2500# Conc. Wall & Col. Footings Forms 170 S
2500# Conc. Foundation Walls 440 C
2500# Conc. Foundation Walls Forms 1,430 S
2500# Conc. Retaining Walls 40 C
2500# Conc. Retaining Wall Forms 115 S
2500# Conc. Terrace Curb 20 C
2500# Conc. Terrace Curb Forms 20 S
2500# Conc. 4" Poor Slab O.G. 80 S
2500# Conc. 4" Terrace Slab O.G. 90 S
P.C. Conc. 4'x3'x2'4" Areway 1 U
Plastic Floor Isolation 895 S
Premoulded 1/2"x4" Floor & Terr. Expan. Joint 130 L
Monolithic Floor Sub-Finish 560 S
Monolithic Floor Finish 335 S
Monolithic Terrace Floor Finish 90 S
Kraft Paper Terrace & Floor Prot. & Cur'g 985 S
Carb. & Grot. Expos. Wall Rubbing 170 S
#10/6x6 Stl. Floor Mesh/Reinforcing 985 S
#5 Stl. 1.043# Rod Reinforcing 264 L
Trade Items Set-In Sum

—BRICK & BLOCK CONSTRUCTION & VENEER—

Face Brick 4" Fireplace Veneer 10 S
Face Brick 4 1/2" Fireplace Wall Lining 20 S
Face Brick 4 1/2" Fireplace Floor Paving 10 S
Pumice Block 4"x8"x12" F.P. S.B. Veneer 63 U
Conc. Block 4" Chimney S.B. Veneer 110 S
Conc. Block Chimney Construction 100 C
Terra Cotta 12"x12" Flue Lining 18 L
Terra Cotta 8"x12" Flue Lining 10 L
Quarry Tile 1/2" Fireplace Hearth 8 S
1:3 Cem. Mort. 2" Chimney Wash 12 S
1:3 Cem. Mort. 12"x2" Ret. Wl. Cap & Forms 6 L
Acid & Grot. Expos. Brick Clean & Point 40 S
Acid & Grot. Expos. Block Clean & Point 160 S
Trade Item Built-In Sum

—LUMBER FRAMING & CONSTRUCTION—

4x8" Dr. Fir Porch & Ceil. Beam 40 L
4x6" Dr. Fir Roof Ridge 30 L
4x6" Dr. Fir Overhang Let-In 20 L
4x6" Fir Bolted Wall Sill 85 L
4x4" Dr. Fir 7" Post Posts 2 U
4x4" Tr. Fir Fence Posts 15 U
4x4" Fir Beam Posts 30 L
2x12" Fir Balcony Plank 25 L
2-2x10" Fir Floor Beam 50 L
2x8" Fir Balcony Header 25 L
2x8" Fir Floor Joist Header 50 L
2x8" Fir 3" Balcony Outriggers 5 U
2x8" Fir Double Fl. Joist 30 L
2x8" Fir 16"-o.c. Floor Joist 680 L
2x8" Dr. Fir 16"-o.c. Floor Rafter 125 L
2-2x6" Fir Partition Plate 50 L
2-2x6" Fir Platform Joists 10 L
2x6" Fir Platform Joists 10 L
2x6" Fir 16"-o.c. Roof Rafter 540 L
2x6" Fir 12"-o.c. Roof Rafter 615 L
2x6" Fir 16"-o.c. Wall Studs 225 L
2x6" Fir Partition Sill 15 L
2x6" Fir Bolted Wall Sill 25 L
2-2x4" Fir Part. & Wall Plate 285 L
2x4" Fir Part. & Wall Sill 250 L
2x4" Fir 16"-o.c. Part. & Wall Studs 2,300 L
2x4" Fir Bolted Platf. Nailer 10 L
2x4" Dr. Fir Screen Mullions 15 L
2-2x3" Fir Partition Plate 25 L
2x3" Fir Partition Sill 10 L
2x3" Fir Fence Rail 40 L
2x3" Fir Cabinet Soff. Framing 75 L
2x3" Fir 16"-o.c. Part. Studs 145 L
1x3" Fir Joist Cross Bridging 160 L
1x3" Fir 16"-o.c. Wall Furring 415 L
1/2" Plyscore Wall Lining 930 S
1/2" Plyscore Roof Lining 1,335 S
1 1/2" Felt Floor Isolation 885 S
1 1/2" Felt Wall Isolation 930 S
Cedar 5" Expos. Wall Clapboards 830 S
1/4" Transite Ext. Wall Boarding 120 S
3-ply Comp. 15-Yr. Roof Covering 1,335 S
Fiberglas 4" Ceiling Insulation 990 S
Fiberglas 3" Wall Insulation 955 S
Wood Misc. Furring & Grounds Sum
Metal Structural Hardware Sum

—METAL SHEET WORK—

Aluminum 6" Roof Gravel Stop 135 L
16-oz. Copper 12" Chimney Flashing 15 L
16-oz. Copper Vent Pipe Flashing 1 U
16-oz. Copper 6"x1'6x8" Chim. Cricket 1 U
16-oz. Copper 2"-d. Rain Leader 50 L

—METAL ORNAMENT & MISC. WORK—

Cast Iron 12" sq. Cl. Out Door & Frame 1 U
Cast Iron 24"x12" Firepl. Damper & Frame 2 U
Cast Iron 5"x8" Ash Dump Door & Frame 2 U
3"x4"x3/8" Stl. Fireplace Lintel 10 L
1 1/2"x1 1/2"x3/8" Stl. L Floor Curb 8 L
1/2"-d. Steel 12" Anchor Bolts & Nuts 19 U

—GYPSUM BOARD 1/2" CEIL. & WALL BOARDING—

1/2" Gypsum T.J. Ceiling Boarding 1,710 S
1/2" Gypsum T.J. Wall Boarding 3,760 S
1/2" Gypsum T.J. Wall Lining 55 S
26-ga. Metal Corner Beads 90 L

—CERAMIC WALL & FLOOR TILING & TRIM—

Ceramic 3/8" Wall Tiling 40 S
Ceramic 1/4" Floor Tiling 40 S
Marble 1"x4" Door Saddle 3 L

—LINOLEUM FLOORING—

3/8" Linoleum Roll 80 S
1/2" Linoleum Roll 480 S

—WOOD EXT. & INT. MILLWORK—

1 3/8" Birch 5'6x7" Gl. Entr. Door, Sl. F&T 1 U
1-3/8" B. Ven. 6'x6'8" Flu. Int. Door, F&T 3 U
1-3/8" B. Ven. 5'x6'8" Louv. Int. Door, F&T 1 U
1-3/8" B. Ven. 2'6x6'8" Flu. Int. Door, F&T 6 U
1 1/2" B. Ven. 2'2x6'8" Flu. Int. Door 2 U
1 3/8" Fir & Pine 8'x7" O.H. Door, Trk. & Acc. 1 U
1 3/8" Mtl. Cov. 2'6x6'8" Flu. Int. Door, F&T 1 U
P. Fin. B. Ven. 8'x2'x3' Sink Cabin. & Hdw. 1 U
P. Fin. B. Ven. 4'6x2'x2'9" Range Cabin. & Hdw. 1 U
P. Fin. B. Ven. 8'x2'6x1' Wall Cabin. & Hdw. 1 U
P. Fin. B. Ven. 8'x1'6x1' Wall Cabin. & Hdw. 1 U
P. Fin. B. Ven. 1'x1'x1' Shelf Cabin. & Hdw. 1 U
P. Fin. B. Ven. 2'8x1'6x1'7" Sink Vanity & Hdw. 1 U
Lam. Plastic Counter Tops & S. Back 35 S
White Pine 2"x8" Roof Fascia 135 L
White Pine 1"x12" Closet Shelf 35 L
Red Cedar 1"x6" Fence Boarding 90 S
Red Cedar 1"x6" Part. Cap 10 L
Red Cedar 1"x4" Fence Cap 20 L
Red Cedar 1"x4" Wall Base 375 L
W. Pine 1"x3" Shelf Cleat 60 L
4" W. Pine 2'8x7" Panel Frame & Trim 2 U
4" W. Pine 2'x7" Panel Frame & Trim 1 U
4" W. Pine 2'8x7" Orna. Screen 1 U
3/4" W. Pine 2'x8" Closet Divider 1 U
Pine & Hardwood 13R x 3" Stairs 1 U
Pine & Hardwood 3'x3' Stair Railing 1 U
2"-d. Hardwood Stair Hand Railing & Bracket 11 L
1-1/4"-d. Fir Closet Pole & Bracket 20 L
3/8" W.F. Plywd. Soffit Boarding 25 S

—METAL & GLASS TOILET ROOM ACCESS—

Mtl. & Glass 2'8x2'8x4" Med. Cab. w/Mirr. 1 U
Mtl. & Glass 1'6x2'4" Med. Cab. w/Mirr. 1 U
Chrome Metal Toilet Paper Holders 2 U
Chrome Metal Soap Holders 2 U
Chrome Metal Tumbler & T.B. Holders 2 U
Chrome Metal Towel Bars 1 U
Chrome Metal Towel Bars 3 U
Mtl. & Fabric 5' Shower Rod & Curtain 1 U

—ALUM. & GLASS SLIDING DR. & WIND. & ACC.—

Alum. & Glass 6'x6'8" Sliding Door, Trk. & Acc. 1 U
Alum. & Glass 8'x4" Fix. & Sl. Wind., Trk. & Acc. 1 U
Alum. & Glass 8'x2'6" Fix. & Sl. Wind., Trk. & Acc. 1 U
Alum. & Glass 6'x4" Slid. Wind., Trk. & Acc. 1 U
Alum. & Glass 6'x3" Slid. Wind., Trk. & Acc. 3 U
Alum. & Glass 4'x2' Slid. Wind., Trk. & Acc. 1 U
Alum. & Glass 6'6x2'6" Slid. Wind., Trk. & Acc. 1 U
Alum. & Glass 3'x2' Slid. Wind., Trk. & Acc. 1 U

—METAL FINISH HARDWARE—

Metal Ext. Door Cylind. Locks 1 U
Metal Inter. Door Latch 7 U
Metal Inter. Door Lock Sets 3 U
Metal Slide Door Lock Sets 1 U
Metal 6" Slide Door Tracks 3 U
Metal Slide Door Thumb Sets 3 U
Metal Ext. Door Hinge Sets 1 U
Metal Inter. Door Hinge Sets 11 U

—PAINT EXT. & INT. FINISH—

Stain Ext. Millwork 3 coats 1,805 S
Latex & Enamel Int. Millwork 2 coats 825 S
Latex & Enamel Gypbd. Wall 2 coats 3,760 S
Latex & Enamel Gypbd. Ceiling 2 coats 1,710 S
Lead & Oil Doors 3 coats 200 S
Stain & Varn. Doors 4 coats 1,005 S

—PLUMBING SYSTEM & FIXTURES—

Water Service Connection & Piping 1 U
Sanitary Service Connection & Piping 1 U
Gas Service Connection & Piping 1 U
Gas Furnace Connection & Piping & Acc. 1 U
Hose Bibb, Connection & Piping & Acc. 2 U
Lavatory, Piping & Accessories 2 U
Bath Tub, Piping & Accessories 1 U
Water Closet, Piping & Accessories 2 U
Kitchen Sink, Piping & Accessories 1 U
Shower Head, Piping & Accessories 1 U
Elec. H.W. Mtr. Piping & Accessories 1 U

—HEATING SYSTEM & FIXTURES—

Gas Warm Air Furnace & Accessories 1 U
Gas Warm Air Ducts & Registers 12 U
Gas Warm Air Temp. Control Equipment 1 U
Gas Warm Air Furnace Filters 2 U
Gas Warm Air Vent Stack & Connection 1 U

—ELECTRIC SYSTEM & FIXTURES—

Electric Service Connection 1 U
Electric Service Panel & Switch 1 U
Telephone Service Connection 1 U
H.W. Heater Connection & Wiring 1 U
Gas Furnace Connection & Wiring 1 U
Oven, Connection & Wiring 1 U
Range, Connection & Wiring 1 U
Exhaust Fan, Connection & Wiring 1 U
Single Switch Outlets & Wiring 14 U
3-Way Switch Outlets & Wiring 4 U
Conven. Recept. Outlets & Wiring 27 U
Light Outlets & Wiring 17 U
Entry P. Butt. Connection Chime Wiring 1 U
Ceiling Fixtures & Bulbs 1 U
Wall Fixtures & Bulbs 3 U
Exterior Fixtures & Bulbs 2 U
Fluorescent 30" Fixtures & Tubes 1 U
Wall Mounted Cooking Contr. & Wiring 1 U

Builder's choice: Quality products

- Hood fan—Nu-tone, Inc.
- Floors—Armstrong Cork Co.
- Electrical Appliances—General Electric
- Lighting fixtures—Lightolier, Inc.
- Circuit breakers—General Electric
- Copper piping—Chase Brass & Copper, Inc.
- Plumbing & heating—American-Standard
- Kitchen countertops—Textolite, General Electric
- Vanity tops—Formica Corp.
- Roofing—Pabco Roofing Div., Fiberboard Paper Prod. Corp.
- Bathroom accessories—Franklin
- Doors—Seattle Door Co.
- Garage door—Overhead
- Silent switches—Slater
- Hardware, hinges—Stanley
- Door locks—Weiser
- Insulation—Owens-Corning Fiberglas
- Range—General Electric
- Kitchen cabinets, birch—Cascade Cabinet Co.
- Paint—Preservative Paint Co.
- Finish roof, built-up—Johns-Manville
- Sheathing, fiber board—Flint-kote
- Roof sheathing, plywood—Douglas Fir Plywood Co.
- Siding—Western Red Cedar
- Interior walls, plaster board—Kaiser
- Windows, aluminum—Durall-Centaur

Industry leaders seek ways to sell quality-minded buyers

American Builder's third "Brainstorming Session" called during the recent Electric Home Heating Conference in Washington, D. C., unveils methods by which builders can use electricity to sell the growing quality home market.

Things a prospect *can't* see, as well as those he *can* see, help sell a house. But everything connected with the building and selling of a house must add up to quality, or today's discerning prospect won't buy.

That is the unmistakable conclusion drawn from field studies which followed AMERICAN BUILDER's third "Brainstorming Session."

The session, moderated by Senior Editor Andrew Boracci, brought together leading figures in the electrical industry, top-flight builders, merchandising experts, and key editors and executives of this magazine.

Editor Joseph B. Mason, a leading spokesman for the housing industry, called on the group for ideas.

"Tell us the areas where the electrical industry feels it can help builders step-up house sales," said Mason, "and we'll field an editorial task force to find builder applications of the ideas throughout the country. Then we'll publish the results."

Ideas came fast and furious. Foremost was the suggestion that too few builders take advantage of the all-round help offered by their local utilities.

Help ranges from local market re-

search and technical consultation to local application of national promotions like the Medallion programs.

The group agreed that regardless of price, buyers today want quality. They know, and demand, smart design, good construction, quality materials.

But, the group insisted, they want more. The promotion directed to them must be smart and professional.

The feeling was strong that the more colorful appliances and built-ins that a builder includes with the price of the house the better his sales.

Other factors which the group felt could increase sales were electric heat or heat pumps which combine heating and cooling in a single unit.

Putting wiring underground, it was believed, gives a builder a good selling point, as does full housepower. Tying all-electric promotion with that offered by national magazines gives the builder dignified selling help.

AMERICAN BUILDER noted the ideas and the meeting came to a close. Our next step was to find builders who put these ideas to work and actually stepped-up sales through them. Here are the results of the studies that followed the Washington Brainstorming Session. ▶

Case histories exploded these builder misconceptions

- ▶ That utilities supply nothing more than current . . .
Truth is they supply market, technical and sell help of every sort.
- ▶ That you can't sell a depressed market . . .
Truth is there's no such thing as a depressed market, "hot" builders say.
- ▶ That smart merchandising alone will sell houses . . .
Truth is, quality is basic but smart merchandising makes the difference.
- ▶ That underground wiring is too costly to be practical . . .
Truth is, underground wiring makes the view and that's sellable, too.
- ▶ That prospects don't buy houses for full housepower . . .
Truth is, Schaumberg housewives sold housepower for the builders.



In Ft. Lauderdale

How Medallion promotion, heat pumps, and



The miracle of smart organization poses alongside the miracle of modern advances in technological know-how.

Component parts of a Haft-Gaines home represent a combination of some of the world's most ancient crafts and many of its most modern industrial processes. Putting this mammoth puzzle

together teams the services of skilled craftsmen working alongside organizational specialists and headed by the builders. It's the combination that lets Haft-Gaines boast 4,000 home sales.

- | | | | |
|--------------------------------|--------------------------|--|------------------------------------|
| 1. Swimming pool material | 16. Tile and accessories | 32. Dish washer | 46. Front door |
| 2. Structural steel | 17. Paint | 33. Waste disposer | 47. Interior doors |
| 3. Architect | 18. Burt Haft | 34. Pocket door | 48. Decor block |
| 4. Kitchen cabinets | 19. Jack Gaines | 35. Finished lumber | 49. Plumbing fixtures and material |
| 5. Decorator | 20. Framing lumber | 36. Cooking top | 50. Lawn sprinkler system |
| 6. Salesman | 21. Bath accessories | 37. Nails | 51. Structural steel beam |
| 7. Bath vanities | 22. Italian marble | 38. Concrete block | 52. Landscaping grass |
| 8. Roofing materials | 23. Exhaust hood and fan | 39. Rough siding | 53. Electrical equipment |
| 9. Plaster | 24. Oven | 40. Vents | 54. Circuit breaker |
| 10. Italian marble floor chips | 25. Television set | 41. Construction superintendents and foremen | 55. Awning windows |
| 11. Lighting fixtures | 26. Range | 42. Luminous ceiling material | 56. Fiberglass insulation |
| 12. Air conditioning ducts | 27. Washing machine | 43. Foundation steel | 57. Window screens |
| 13. Electric meter | 28. Hot water heater | 44. Ornamental iron work | 58. Roof trusses |
| 14. Light bulbs | 29. Refrigerator | 45. Hardware | 59. Patio glass doors |
| 15. Air conditioning units | 30. Dryer | | 60. Patio screen enclosures |
| | 31. Concrete | | |

smart design crack a depressed market

Florida builders Haft-Gaines combine a package of up-to-date components, smart design, the latest in appliances and a combination heating-cooling system in a smart community and sell proof that "a home is more than a house."

While 45,000 thirsty college students were making national headlines by their antics in this Venice-like town, Florida builders Haft-Gaines were quietly making important news on their own. They were successfully selling houses despite a so-called Florida market depression.

Florida Power and Light Company along with Southern Bell Telephone Company, General Electric and others who figured in the development of the

Imperial Point subdivision helped call the shots. They and the builders studied the area. They decided the biggest need was a quality house that would sell in the \$15,000 to \$30,000 price range.

Full recognition was given the new breed of quality home buyer. The houses had to offer the utmost in smart contemporary design and quality construction. There would be no options. Everything a buyer saw in the model

house was included in the price. This meant a complete fitting out for total electric living—plenty of built-ins, appliances and "extras," without extra cost. A big feature was the heat pump—a combination heating and cooling unit—which was counted on to make a big hit.

Still playing to the quality buyer, Haft-Gaines placed the homes on a handsome tract in the distinguished Coral Ridge area. Purpose of this was to create an integrated house and site.

All that remained was to get this quality story across to the market—Fort Lauderdale home buyers. And that's where the combined promotions of utility, manufacturers, and builders delivered the big sales punch.



"A thing of beauty is a joy to behold . . ."

Cactus plant frames approach to one of the smart contemporaries at the Imperial Point subdivision. Massive foliage throughout subdivision plays key role in helping builders sell.

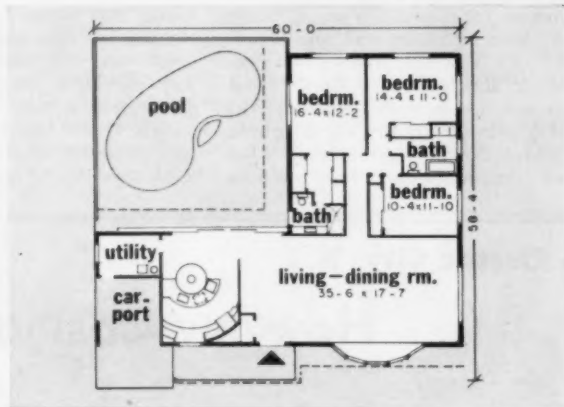

Self-contained plan boasts easy access to pool

Feature of the floor plan that delights prospects is the proximity of the pool to nearly every room in the house. Novel Kitchen-in-the-round doubles as entertaining area.



Kitchen-in-the-round sells modern electric living

Set in place as a component the round cooking center combines in one unit a range, oven, and dishwasher. Eating is done on a turntable which revolves and leaves dishes in front of dishwasher.



Builders' faces reveal no "depressed market blues"

Jack Gaines and brothers Burt and Richard Haft return to office after checking sales on a new cluster of houses just put up. Faces reflect success their approach has had in cracking market.

In Schaumburg, Ill.

How full housepower and underground

Unlikely sales aids—perhaps—but builder Al Campanelli found that a fully “powered” house and the uncluttered view made possible by sub-surface wiring turned buyers’ wives into his most potent sales force

Full housepower and underground wiring seem unlikely candidates for home-selling honors. But they played key roles in boosting house sales at the 3,000-home Weathersfield subdivision of Campanelli Brothers in Schaumburg, Ill.

Alfred Campanelli, one of the partners, tells the story this way:

“Our market research told us we could best sell modern colonials in the \$16,000 to \$22,000 price range. These would be 1,000 to 1,600 sq. ft. houses with three bedrooms and one or two baths. To add the quality story we qualified the houses for Gold Medallions and tied in with Commonwealth Edison, our local utility, for sales help.

“Throughout our promotion we featured the all-electric features—heat,

kitchens,—full housepower, underground wiring.

“Sales were impressive. Certainly a big factor in sales were the all-electric kitchens. Housewives fell in love with them. Why not? Included in the price were a wall-hung refrigerator, dishwasher and dryer, built-in wall oven, countertop range, and disposal unit.

“Another big factor was the electric heat. Our buyers are quality conscious and like the idea of the clean, neat house that comes from it.

“A third important factor in helping sales was the underground wiring. Let’s face it. It costs a little more than poles. But it adds tremendous sales punch. If you assume today’s buyer is quality conscious—and you’ve got to assume that if you want to sell houses—

underground wiring is a quality feature even though it’s hidden. What helps you to sell is what the house looks like in its setting. It gives your salesmen a strong talking point.

“Finally, the real freak was the full housepower pitch. You wouldn’t think the ordinary housewife would care about it. But that ordinary housewife isn’t ordinary any more. She asks questions about it and wants to be assured that she can plug in as many electrical appliances as she needs without blowing fuses or setting the house on fire.

“How can I be sure about these reasons for sales? Just this way. Almost every buyer in our community has been responsible for the sale of another home by either friends or relatives. Our best sales people are our housewives. One woman personally is responsible for the sale of five homes to friends of hers. What do these gals talk about? Certainly the kitchens. They’re big sales aids. But they also talk up the cleanliness of the heat. They talk up the underground wiring.

In Electric City, N. J.

How low-cost quality subdivision sells

Utility joins with builder and electric manufacturer to sell an all-electric city that boasts 12 different models of traditional design, quality construction, all electric living. Price tags start at \$12,500 and go to \$24,500

Today’s buyer demands a quality house even in the low-price range. Providing that quality with traditional design and all electric living is the key to brisk sales at New Jersey’s novel Electric City. In fact, 140 homes were sold on opening week.

A joint promotion of builder W. J. Happel & Company of East Orange, the Jersey Central Power and Light Company, and General Electric, the City is designed to bring the all electric quality house to buyers of moderate means.

The builder offers 12 models in prices ranging from \$12,500 to \$24,500. Designs are traditional cape cods, splits, ranches and duplexes. Every home in the city will be awarded a Gold Medallion. This shows that each unit is equipped with work-saving elec-

tric appliances, electric cooking facilities, electric baseboard heating, special lighting effects, and full housepower. The Medallion also signifies the uses of high quality components in the construction.

Other quality features include kiln-dried lumber and framing, Ponderosa Pine window units, Fiberglass insulation, ceramic bathroom tile, copper plumbing, wood siding and gutters, storm windows and doors, and double-hung weather-stripped windows.

How does Happel manage to maintain top quality and still sell at a low cost? “It’s by using modern materials and scientific construction methods, and large-scale buying and building,” said Happel.

Happel is making the homes available to families of moderate means at



Kitchen pleases quality buyers

Electric City kitchens feature modern appliances and built-ins that complement electric heat, special lighting.

approximately \$400 down and \$98 a month. Models will vary in price but the electric equipment that qualifies the house for a Medallion is the same in every home.

Electric City establishes a new marketing approach for General Electric’s

wiring help pace sales

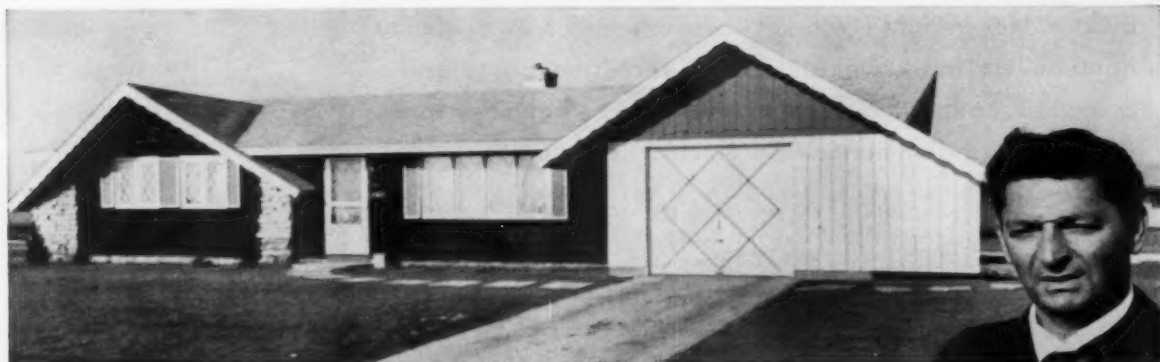

Alfred Campanelli poses by Gold Medallion model in his Weathersfield subdivision

Campanelli's 3,000-home Weathersfield subdivision boasts modern colonial architecture at prices ranging from \$16,000 to \$22,000. Builder's Gold Medallion community features hanging

wall refrigerators, dishwashers and dryers, built-in wall ovens, countertop ranges, and disposal units. Colorama kitchen appliances prove big sales stimulant to women, who clinch most sales.

And, so help me, they talk up the advantages of full housepower.

"There's little doubt that the Medallion promotion helps, too. Our customers are all too familiar with the Medallion concept through national

advertising, the shelter magazines, radio, television, and newspapers. They know that a Medallion certified home guarantees clearly defined quality concepts such as full housepower. It also suggests other quality features like full

insulation and quality materials. And buyers these days demand quality throughout."

Campanelli Brothers are noted for their ability to put up quality homes in quantity.

140 all-electric homes in first week



Crowds file through 12 different models on Electric City's opening day

Despite a bleak, overcast opening Sunday, thousands of prospects motor to the new all-electric subdivision just south of Perth Amboy, N. J. Tour starts with a G.E. display housed in

an A-frame auditorium then goes through series of models in traditional design. Despite low prices, buyers questioned sales-people closely on construction details, insulation,

efforts in residential construction. That is the complete selling of systems or electrical packages to builders.

G.E. manufactures nearly all of the electric products required for a complete city. That includes industrial plants, stores, schools, offices, apart-

ments as well as homes.

C. K. Rieger, vice president for marketing (G.E.), believes that the time now is ripe for the total electric living concept on the part of buyers. He says that since 1950 there has been a 16% decrease in electric rates.

"For years," he said, "the public has held a strong preference for electric lighting, refrigeration, cooking, cooling, washing and drying. Electric heating has been the one missing operating requirement. This is the key element of a Gold Medallion home.

In Huntington, W. Va.

How Medallions and Look promotions sell

Builder Mel Wright's market research tells him a quality homebuying market exists despite recession. To sell it he combines national magazine promotion, Medallion merchandising, maintenance-free electric heat pumps

One of the worst hit housing areas in the country during the recent recession has been West Virginia. And for good reason. Widespread unemployment was on a rampage. The population was decreasing. The low-to-medium-price house literally was unsellable.

That gave builder Mel Wright an idea. Check the market for high price houses. Wright got together with the Appalachian Power Company and made a market survey. They determined there was a market for executive priced houses. So Wright put together his Arlington Park subdivision of 180 homes that would sell for an average of \$31,000. These were mostly prefabs from Sholz, Pease, Showcase and Richmond. And, since he was tack-

ling a quality market he fitted each house for total electric living—right down to heat pumps for combined heating and cooling. This qualified his houses for Gold Medallion awards from the utility.

The problem then came up as to how to reach this quality market for whom he was building. Wright put together an aggressive sales promotion that combined the Medallion and other aids from his local utility, Look Magazine Home Marketing promotion, and advertising in newspapers, radio and television.

Gold Medallions were prominently displayed on all advertising along with participation by Look. The magazine provided Wright with a comprehensive marketing program designed to



Smart promotion starts sales . . .

Special awards dinner brings together builder, utility, magazines and manufacturer representatives for sales meeting.

boost consumer traffic.

Advertising and promotion developed and executed by the John J. McCormack Advertising Agency left nothing to chance. The agency made special showings of the development

In Laguna Beach, Calif.

Total electric homes in Far West combine

C. R. Bauman's 152-house "Top of the World" subdivision sprawls 1,000 ft atop a crest of hills overlooking Laguna and the Pacific. In line with project's theme, home buyers get unrestricted view of the off-shore islands

Another tough market hit by the recent recession is the \$35,000 to \$50,000 price range. But a combination of smart design, smart site-planning, quality features and Gold Medallion promotion are moving houses for C. R. Bauman Construction Co.'s "Top of the World" subdivision at Laguna Beach.

Bauman is building 152 houses on a crest of hills overlooking Laguna Beach and the Pacific Ocean. This gives the subdivision of Far Eastern-type contemporary, Colonial and ranch homes an unrestricted view of the off-shore islands of Catalina and San Clemente.

Bauman goes all out with electric features in his 1,600 to 2,200 sq. ft. houses. He includes with the price of each house, a range, oven, dishwasher, disposer unit, ventilating hood, water

heater and refrigerator.

Housepower is a big factor in sales. "Many clients," says Bauman, "ask whether they will have enough power for power tools, exterior lighting for swimming pools and the like. Its satisfying to tell them that the 400-amp service we provide will free them of any future worry about power service."

Bauman regards electric radiant heating in the ceilings as the one outstanding single electrical feature in his houses. "Our buyers," he said, "like the package of all-electric cooking and the heat."

Bauman decided to qualify his houses for Gold Medallions with the Southern California Edison Company in order to sell the quality customer.

"In this price range," he said, "the small extra cost of making it a Gold



Builder raises Medallion high

C. R. Bauman poses alongside Gold Medallion awarded him by utility company. This is the center of his program.

Medallion home is far overshadowed by the buyer demand for quality. Our buyers have the money and they want value. We sell them by explaining that the all-electric home is cleaner and will require less maintenance. These factors preserve the luxury standard he

electric heat in depressed areas



On this handsome all electric split level . . .

National magazine promotion lends status to merchandising effort when teamed with Medallion-created image of electric benefits. Adding smart design and quality construction helps.

with press and public officials invited. Suppliers and subcontractors also appeared in many public speaking engagements. McCormack also coordinated all tie-in advertising with subcontractors and suppliers around the



With this smartly designed kitchen

Counter-top dining area designed neatly into this smart kitchen fully fitted with wide range of time-saving appliances and built-ins combine to make this room double as eating-living area.

Look—Gold Medallion promotion.

How did the promotion work out? Builder Wright sold 48 of the high price homes within 60 days and boasts orders that will keep him busy for a year ahead.

To sustain interest in the subdivision promotion is continued in the form of follow-up "peaks." These include award competitions, special tours for local womens' groups, broadcasts over radio from the subdivision.

full housepower, terrific view



Builder accents 400-amp service

Big sales factor is power available for exotic lighting, power tools, operation of radiant ceiling heat and many appliances.

wanted when he bought the house."

Bauman says sales are the briskest in his area.

"There are homes going up in this area on speculation which have not been sold," he said. "Our homes are selling on their Medallion features.



But "east or west" housewives always like the kitchen "best"

Most popular room for buyers' wives in the 152-house hillcrest subdivision is the kitchen. Bauman kitchens include range, oven, dishwasher, disposal unit, ventilating hood, water heater and refrigerator—all electric. Ceiling radiant heat, and a host of outlets and circuit breakers make total electric living a big seller in California.

Simple scheduling form

Whether you are a small or a big builder—whether you concentrate on residential or commercial work—this simple scheduling form can save time—and that means profits in any business.

Job No. <u>404</u>		Owner <u>John Doe</u>		Loan <u>conventional</u>		
Job Address <u>66 Fuller Circle</u>		Model <u>Showplace</u>				
Excavation	Footings Foundation	Tarcoat	Basement Inspection	Backfill	Lumber	Frames
5/19 for 5/23	5/21 for 5/22	5/21 for 5/23	5/23 for 5/24	5/24 for 5/26	5/25 for 5/26	6/2 for 6/1
Rough Heating	Rough Plumbing	Rough Electrical	Fireplace Chimney	Prime	Flash Chimney	Inspection
6/7 for 6/10	6/7 for 6/10	6/13 for 6/14	6/13 for 6/14	Owner	6/7 for 6/18	Elect. OK Plumbing Heating Carpentry
Inside Sewer	Well	Electric Service	Gas Meter	Thermopane	Basement Floor	Garage Floor
6/17 for 6/20		6/20 Done 7/18	6/16 Done 6/21	None	6/22 for 6/23	6/22 for 6/1
Garage Door	Spray Drywall	Flooring	Furnace Registers	Millwork	Finish Hardware	Finish Carpentry
6/23 for 6/28	Done 6/27	7/7 for 7/9	7/13 for 7/19	7/9 for 7/10	7/9 for 7/10	
Order Eleet. Fixtures	Tile	Formica	Linoleum	Strip Doors	Caulk	Stain Woodwork
Same as model 7/13	7/19 for 7/21	7/19 for 7/21	7/22 for 7/28			
Mirror 51 x 36	Finish Plumbing	Finish Electric	Carpenter Windup	Cleanup	Carpets	Grading
7/29 for 8/2	8/1 for 8/3	7/28 for 8/4				
Excavator	<u>Brown</u>	Sheetmetal	<u>D + Z</u>	Drywall	<u>B + W</u>	
Mason	<u>Schmitt</u>	Roofing	<u>Roofing Service</u>	Millwork	<u>Kindt</u>	
Lumber	<u>Allied</u>	Plumbing	<u>West</u>	Painting	<u>Joe Le</u>	
Carpenter	<u>Our Crew</u>	Electrical	<u>Mayer</u>	Linoleum	<u>Smart</u>	
			<u>WO. 4-3060</u>			

Mimeographed form is simple—

Here's how it works. Each construction phase is listed in a separate box. Day of order and time of completion plus other

will help any builder

"I don't care what kind of an operation you have, you've got to know where you are and what you're doing if you want to make money in building. That's why I use this form." So says David Showalter, successful young builder from Milwaukee, Wis.

Showalter knows what he is talking about. Before launching his own business he was construction expeditor on more than 1200 houses built by two major Wisconsin firms, Tomsinger Construction and Don T. Allen Industries.

While he was with these two firms

he devised the scheduling form shown here along with a peg-board version for large-tract operations.

According to Showalter, the form offers these advantages: Tighter control of his subs; prevention of possible payouts until work is ok'd; and, more accurate answers to queries from buyers, suppliers and subs based on up-to-date information.

Subs reportedly also give Showalter lower bids because of the tight scheduling. It eliminates possibility of wasted time because work orders are based on fact not projection.

This form is only one of several that Showalter uses. Others include specific work orders, color schedules and a final-inspection report which indicates the condition of the building and is signed by the buyer before occupancy.

The forms work equally well on commercial jobs, Showalter says.

In his first year as an independent he reported 21 house sales, two 4-family apartments, one 16-family apartment, one gas station and a warehouse. He expects to double this volume during 1961—at least 50 houses and \$500,000 in commercial work.

Starting Date	5-23-60	
Est Com Date	8-23-60	
Act Com Date	8-15-60	
Rough Carpentry	Gutters	Roofing
6/2 for 6/6	6/7 for 6/10	6/10 for 6/11
Insulation	Rock House	Septic Sewer
6/20 for 6/21	6/13 Loaded 6/20 for Fri	6/13 for 6/20
Stoops	Well Pump City Water	Brick
Weather Stripping	Sinks	Oven Range
Inside Paint	Outside Paint	Sand Floors
Drive	Walks	Final Inspection
Formica	Smart	
Ceramic Tile	Brookfield	
Hardware	Joe	
Carpets	Ambassador PL 9-6391	



For the small builder, a clip-board version is sufficient

Here David Showalter checks status of one of the houses he builds on scattered sites. Use of the form helps him avoid confusion

and possible delays in construction. Clip-board form fits identically-numbered desk file which contains all data on the job.



For the large operator, a wall-mounted record is a must

almost self-explanatory

pertinent data are noted under it. An "X" through the head or dates means satisfactory completion by subs or builder.

On peg-board chart developed by Showalter, status of each house is shown by vari-colored golf tees. Listings across top

are steps in construction and listings along left side are job numbers. Projected completion dates are placed on the right side.



PLEASANT RIDGE ADDITION by McFarling has varied setbacks, lot widths.



Smart ideas made

A short six years ago, Louis McFarling of Omaha, Nebraska, was a two-house-a-year builder. This year he plans on putting up 100 houses—maybe more, if the market improves. The secrets behind his success are outlined here . . .

Can you match McFarling's business growth?

Since 1954 when McFarling started his own building business, his progress report shows a steady rise. This indicates a resounding acceptance by Omaha buyers of his product.

1954	2 houses
1955	10 houses
1956	12 houses
1957	18 houses
1958	25 houses
1959	35 houses
1960	62 houses
1961 (projected)	100 houses

Louis McFarling sells houses in Omaha in spite of the fact that his houses don't conform to the local market, i.e. storybook, colonial, low-cost.

Quality is the answer to his success—the custom touches that he has been able to add, even though he runs a project-type operation. To be able to build this type house, McFarling has had to come up with better building ideas to cut costs.

For instance, he does his own land development work to save money. For dirt moving and digging operations, he owns a front end loader, equipped with back hoe and grading equipment.

He also has a crawler tractor with

front end loader (80 hp.), a small crawler with dozer blade, a 5-ton dump truck, and a small wheel tractor for fine grading.

For materials handling and general construction use, the Nebraska builder owns a Hyster straddle truck; 6000# fork lift; a 4000# crawler fork lift, which is necessary in Omaha when the ground gets muddy; a 1-ton pickup truck, and several van-type trailers for tool and materials storage.

With few exceptions, McFarling purchased the equipment new—the fork lift, crawler fork lift, wheel tracker, crawler tractor, and small crawler with blade. He feels equipment soon pays



Minimum spacing of 24' between houses is builder's goal. One outstanding feature of homes is pleasant variety of exteriors.

this small builder big

for itself. Under present production schedules, down time is kept nil.

To shave slab and foundation costs, McFarling has devised a unique pouring system. He has invented a special scaffold bracket to speed all framing and finishing operations.

A gas-powered "brick buggy," also an idea of McFarling's, distributes palletized bricks on the job site—saving up to \$35 per house.

McFarling's houses, which sell in the \$18,000 price range, have, in the past, been sold through a realtor, instead of company salesmen. Too, surprisingly to some builders, he hasn't had a merchandising program.

The reason for this goes back to the custom quality—the good value—he puts into every house. The advertising word is spread by satisfied customers. This year, McFarling is planning a model home area, complete with community swimming pool.



TO SPEED BUILDING production, McFarling puts all materials possible on straddle buggy blocks so it can be quickly moved to building site. Stockpiled here is dimension lumber, casing (in large box), trusses. Van-type trailers are used for tools, materials.

These smart ideas let McFarling sell



BASEMENT FLOOR is placed before basement walls, saves steps in placing the slab and footing together. To date, there has been no leakage. Trick also gives surface for forms.



FOUNDATION WALL goes in next; and house is ready for floor system. Block wall is garage foundation (plan). Reason for switch is grades vary; it saves to go just to frost line.



POCKETS FOR BEAMS in foundation walls are handled conventionally. Junior beams are used: Builder has had shrinkage problem with wood joists, which caused base separation.



BASEMENT CEILING is fabricated with junior beams and 2-4-1. Big advantage of placing basement floor first is that it facilitates use of large screed and finishing machines.

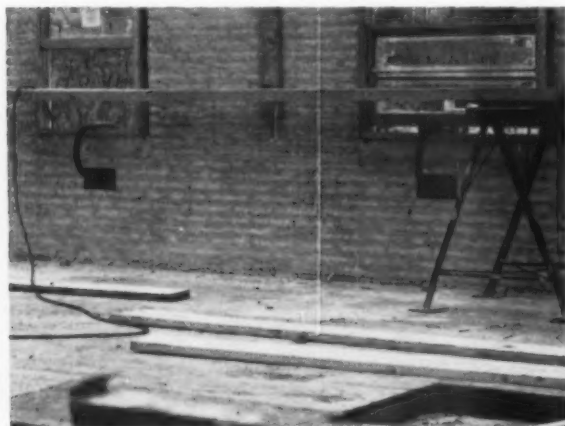

SCAFFOLD BRACKETS are idea of McFarling's; they speed framing, painting, other finish work. Builder uses pre-fabricated roof trusses with a continuous 3x12" top beam over windows.

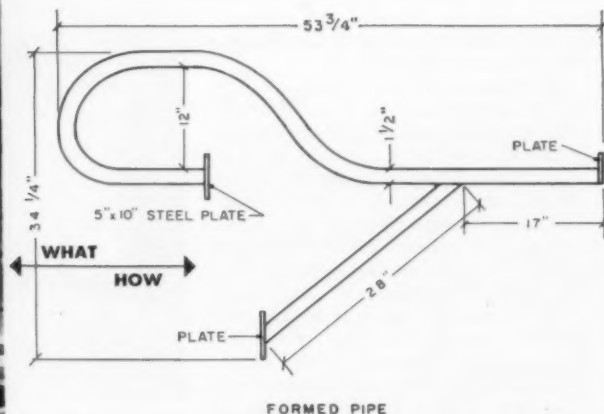

FORMED PIPE

BRACKETS—which McFarling has patented and will sell for \$25 a pair or \$140. a dozen, F.O.B., Omaha—are made from 1 1/2" formed pipe. They hook over walls or in window openings.

custom-type houses at project prices



FILL at right is for garage slab. Concrete wall at angle is actually reinforced concrete beam. To cut costs, driveway, sidewalk are poured at same time garage slab goes in.

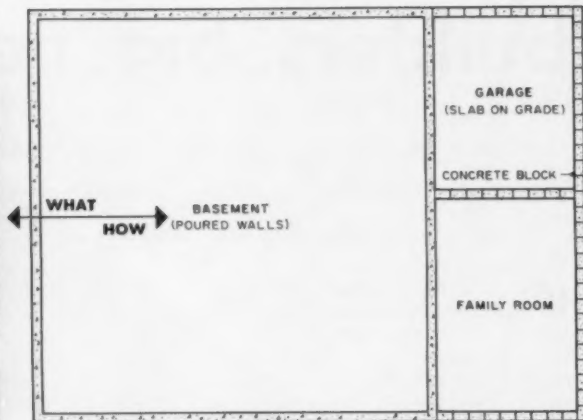

UNDER FAMILY ROOM is crawl space. Joists are supported by concrete beam on one side, block wall on the other. Junior beams are mortared in; 2x4s lay flat on beams for floor.



STORY POLES speed and assure perfect job. SCR masonry process is adapted to bricklaying inside. The SCR brick is all laid from inside; it's palletized, set on deck by lift.



BRICK BUGGY is another McFarling invention. Crews use it to distribute palletized SCR brick around deck. Machine cost about \$1,000 to make, saves roughly \$35 per house in labor time.



PRIMED TRIM BOARD is installed to receive prefab soffit, which is made up in 8' sections and primed against the weather. Note use of scaffold brackets, which speed jobs with safety.



TO INSTALL SOFFIT, top is nailed into the trim board. Gable ends are prefabricated and primed—ready for finish coats. McFarling uses fork lift equipment to position gables for nailing.

Vacation Houses— builders' big, new market

More leisure, higher family incomes, and retirement planning have started a boom in "second homes" that's bound to benefit builders, land developers, lending agencies and appliance manufacturers.

One bright ray of hope, during an otherwise recession-ridden 1960, was the tremendous interest shown in vacation houses. That year alone accounted for one-tenth of the million second homes built throughout the country and, according to leaders in the field, the pace will continue.

A "sleeping giant, just beginning to wake up" is what Donald Jaenicke, Douglas Fir Plywood's projects director, calls the second home field. Builders and realtors back up this view. Many believe that this off-shoot of home building will continue to attract a steadily increasing market and that, during the next decade, will have a significant impact on U.S. economy. An executive of Pope and Talbot, Washington (state) lumber dealers, predicts that "two homes in every family" may soon replace "two cars in every garage" as our country's status symbol.

More Time and Money

Why this sudden interest in a second home? Why is it more important today than ever before? For one thing, the average family has more leisure; super-highways cut down on travel time to beach, lake and mountain. To many, a vacation house looks like a good investment since it can be rented or winterized as a future retirement home. Family incomes, too, have gone up. Nathaniel H. Rogg, economist for the National Association of Home Builders, says that, today, one family in eight has an income of \$10,000 or more and that, by 1970, one family in four will reach this economic level.

One agency, specializing in the sale of vacation house plans, says that 70% of its prospects already own their homes. These are families who face the high price of summer rentals, often \$1,000 or more, and find a second home an economy. This prompts many of their clients to build on Cape Cod, Massachusetts, according to Everett P. Pope, president of Boston's Workingmen's Co-operative Bank. Their loans on the Cape currently number 610, representing the sizeable investment of \$5,067,000.

Interest in second homes show no regional preferences. Leisure Homes, Inc., of Alameda, California, leading builder of cabins and cottages, reports that over 25,000 people visited its two models in three months last year. "You can't categorize these visitors," a spokesman said. "They come from all walks of life—university professors, doctors, scientists, even longshoremen who own valuable resort area land. The majority want second homes purely for leisure; a small group for retirement. Leisure Homes, like many other vacation house builders, has tie-in arrangements with real estate brokers.

Experts Optimistic

Other experts agree about the potentials of the second home market. Wayne Daugherty, of the U.S. Census Bureau, says, "Within a year or two, we'll have to make special counts of families with two residences. Our worksheets show them increasing that fast."

President Thomas Korb, president of Harnischfeger Homes, reports that one automobile president listed vacation houses as the biggest competitors of the second car market.

Because of the fast-rising demand, vacation lots have already started to increase in price. Charles Fraser, president of the Sea Pines Plantation Co., South Carolina, reports 350 lots sold during the past three years at prices from \$3,000 to \$16,000 for 100 foot frontage. As recreational facilities are added, he expects prices to go up.

Builders in the field emphatically deny that the second home market is primarily a "do-it-yourself" one. They point out that only a fraction of buyers attempt major structural work, leaving that for the professionals. The majority purchase shells, usually in the \$1,500 to \$3,500 price range, and are content with minor jobs such as painting, insulating and interior finishing."

What, then, does the second home market hold for the builder? Advice comes from George Osborne of the Northwest Lumber and Millwork Co. (Chehalis, Wash.) who has had plenty of experience in the field. "Remember

this is a hard-sell market," he warns, "You have a great deal of competition for the discretionary dollar. Your cabin customer *could* buy a boat, car trailer, second car or swimming pool. However, a leisure home will almost always gain in value, while these other purchases depreciate heavily the first year."

Osborne found that the majority of visitors who inspected his yard-built model were just shoppers, coupon-clippers or curiosity-seekers. Those who inspected the model built on resort-type property were already 50% sold.

Shows Sales Success

The Douglas Fir Plywood Association, whose vacation house plan sales were over 600,000 during the past three years, offers this advice to builders with an eye on this growing branch of the home-building field: (1) Keep your designs as simple and as economical as possible. A cabin may have a unique appearance but it must be practical (2) Build your models on resort-type property. This may be your own land or belong to a co-operating developer (3) Precut or panelize the structural parts to speed up construction (4) Provide adequate financing. Many buyers will pay cash but you'll still find some who'll depend on monthly installments as a means to getting their second house (5). If possible, sell land and cabin as a complete package.

Overlooking a wooded pool, this Connecticut vacation house has a diagonal roof line, 250 sq. ft. of fixed and awning-type sash. Plan and interior on the following pages. Architect: Burton B. Bugbee; A.I.A. builder: Joe Tuz. (Courtesy—Woman's Day Magazine, Masonite Corp.)





See-through living room a feature of all-wood design

Low wing has four bedrooms, two baths, kitchen. Walls are stain-bleached redwood and weatherproof plywood. Pine boards cover inside partitions. Builder: Robert Graves; designer: Michael Wollman.

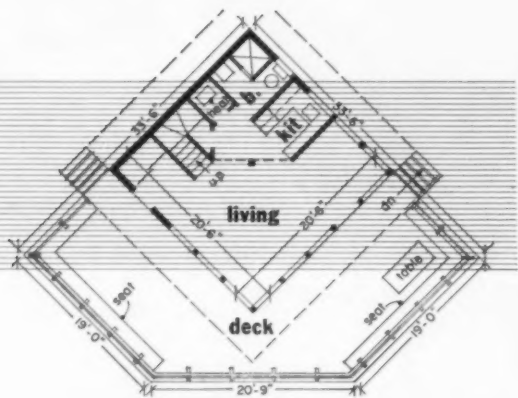

second home buyers

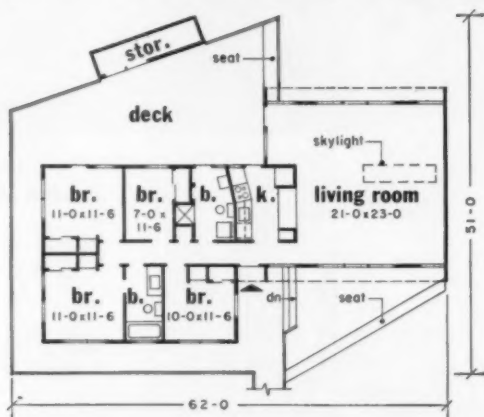

Robert E. Coates



Compact open kitchen forms one end of room

Built-in dining table doubles as work counter. Bathroom, at right, backs against kitchen wall, cuts down on plumbing lines. House sponsored by Woman's Day Magazine, Western Pine Association.



Single room serves for living, sleeping, eating

Interior has Idaho white pine walls, white fir ceiling and floor. Screens, between outside framing, protect windows on all four sides. Beds slide under closet, window alcoves.



Photo by Horst Trebor

Pre-fab shell built on site in three working days

Vacation houses are full-time job for Holiday Homes of Massachusetts; two models, shown here, are offered as shells or fully equipped. A-frame, with three floors on hill, two on flat lot, has twenty-two foot high window, four foot overhang in front.

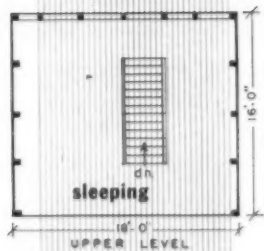

No limit to size or shape

Photo by Elsie Trask

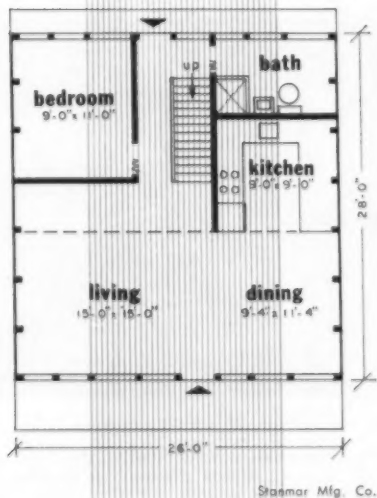

Starmar Mfg. Co.



Modular planning offers wide choice of sizes

Post-and-beam frame of above model fits 4' modules and standard plywood panel widths, can be enlarged to fit owner's needs. Shell costs approximately \$5 per sq. ft. erected, includes plywood walls, floors, aluminum sash, asphalt shingles.



Dirsa and Lampron, architects

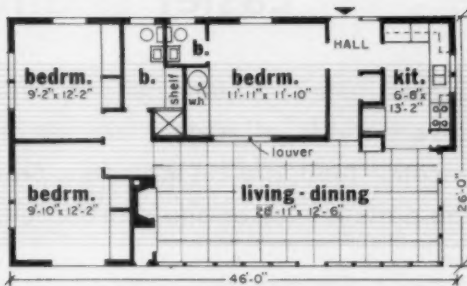

All-concrete Maine beach house

Glass walls of living room open onto ocean view, are ventilated by hinged lower sections. Walls, inside and out are concrete block; white asbestos roof deflects sun's rays.

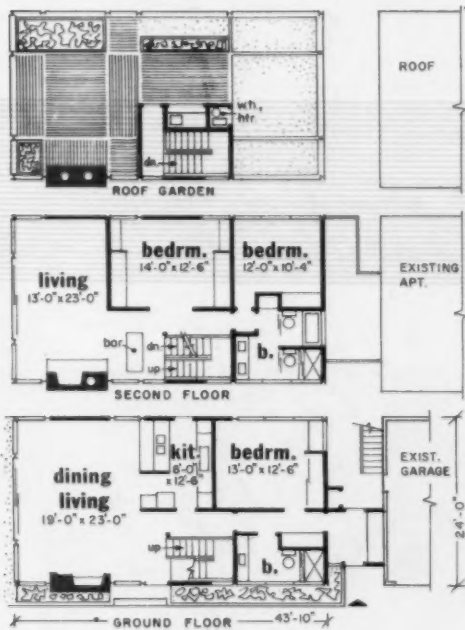
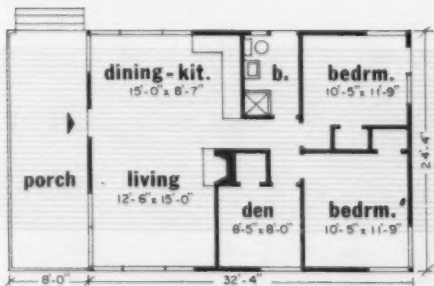

Photo by George de Gennaro



400 sq. ft. of year 'round comfort

Heat pump, insulation and all-electric kitchen make house ideal for leisure or retirement. Plan captures view on three sides. Ralph and Jane Bonnell, designers.



All-steel frame on narrow lot

Bay frontage (30') dictated vertical expansion, produced 2,000 sq. ft. at \$14 a ft. Walls—wood, glass, plaster. Designer—Richard J. Smith; builder—J. D. Hoskins.

Easier financing, retirement possibilities

Successful leisure home builders offer buyers choice of several models on vacation land; pre-cut materials, pre-fab parts reduce on-site construction.



Beach house has sliding plywood walls

Living area, 7' above grade, shelters car or boat. Screens transform rooms into open porch. Price, \$3,995. Clayton & Miller, architects; Albert Hallquist, builder.

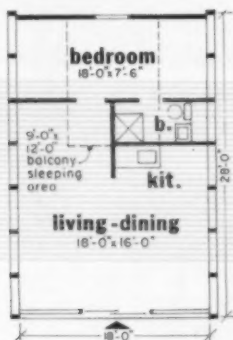

A-frame offers tent living deluxe

Built of pre-cut materials, glass-front house has full apartment on ground floor, bedroom on balcony. John F. Long Home Builders, Inc.



Prow-like front captures wooded view

Concrete foundation conceals circular stairs up to glass-enclosed living space. Plan has full kitchen, bath, plentiful closets. Spencer & Cone, architects.



National Lumber Mfrs. Assn.



Portland Cement Assn.



attract more buyers

About 75% of cabin owners pay cash; the rest are proving good financial risks, attracting more and more lending agencies to field.

Main drawback to prospects—high interest rates.

With more money in their pockets today, the majority of second home families pay cash. Builders find that they account for 75% of sales. Those who do borrow have proved excellent risks. Allied Building Credits, Inc., of California says they've had but one or two cases of payment problems in financing 500 vacation homes.

Though borrowing is easier now than in the past, many prospects still are faced with reluctant lending institutions or high interest rates. This is due to the fact that, to many loan agencies, a seasonal home is just a hastily put together shack with little resale value. A glance at the houses shown on these pages and thousands of others, scattered throughout the country, proves that this image is completely wrong. The majority of vacation houses today are as well designed, engineered and constructed as most primary homes. This is especially true of those built for future retirement.

New Financing a Possibility

Lending institutions, usually conservative in their thinking, often shy away from unusual house designs. Since architects and builders find, in the seasonal house, a chance to experiment with forms, materials and construction, it has not been too welcome in the lending chambers. However, this obstacle may soon be hurdled. President Kennedy has recently proposed a new F.H.A. program for insuring mortgages borrowed by buyers of homes built with "new and untried materials, design and construction

methods" with a transfer of \$1 million from an existing mortgage insurance fund to a new revolving fund. This is bound to result in an easing of summer home money where local building codes are satisfied.

Loans Dealer Originated

Commenting on mortgage loans in the field, Robert Murray, vice-president and manager of Salt Lake City's Prudential Federal Savings and Loan Association, says, "There are a lot of advantages in this kind of loan. First, of course, they are big deals. Generally speaking, they are going to be \$2,000 or more and very attractive from a profit standpoint. More important," he adds, "this type of loan is a dealer-originated loan with the dealer either supplying a pre-cut cabin, easily and quickly erected by the customer under the dealer's guidance, or with the dealer providing the material and labor for the completed shell. Eighty or ninety per cent of our loans are dealer-originated and we like them because we can handle them with a relatively small staff."

Since, at present, there are no provisions for financing cabins or cottages under Title 1 or any other F.H.A. program, Prudential Federal accepts this type of paper as a conventional property-improvement loan, made if the family already has a primary residence. Loans are made up to \$3,500 with nothing down and five years to pay. The borrower must qualify on the basis of his equity in his home, income and credit rating.

Allied Building Credit, Inc. of California, requires a bathroom and a kitchen sink but doesn't insist that they be hooked up right away. They lend 100% of a cabin's price up to \$5,000, although, because of the high carrying charges, their average loan is \$3,000 with monthly payments from \$50 to \$60. Interest rates range from 7% to 8%, discounted in advance.

Supplements Builders Income

Experience in the field, however, is somewhat limited. Building experts are in agreement that the future is bound to see easement in vacation house borrowing terms. The promise of a rapidly increasing and profitable offshoot of home building plus thousands of enthusiastic families with a second home in their future, is bound to attract more and more lenders. The retirement angle, too, is something that a wise banker should not overlook. The fact that, unlike cars and boats that now find ready borrowing money, a second home does not depreciate with use but is likely to add to its worth.

A builder, too, can spur this market to further activity. His best bet is to own vacation-type property or align himself with a developer who is willing and able to finance all or part of the house and lot or be able to arrange a financial agreement favorable to bank and owner. Since 50% of today's primary homes are free and clear or have mortgages retired to the extent that the home can be used for security on further borrowing, his job would be an easy one.

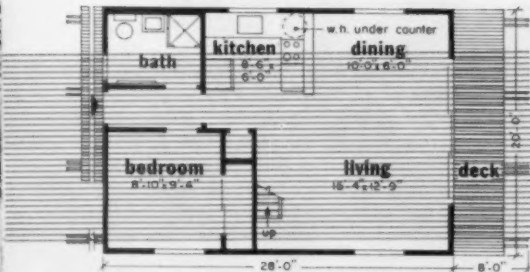

Complete building package costs \$3,800

Leisure Home, Inc., of California deliver material and equipment package or will erect cabin on owner's lot at extra cost. Plan includes 2nd. floor bedroom.

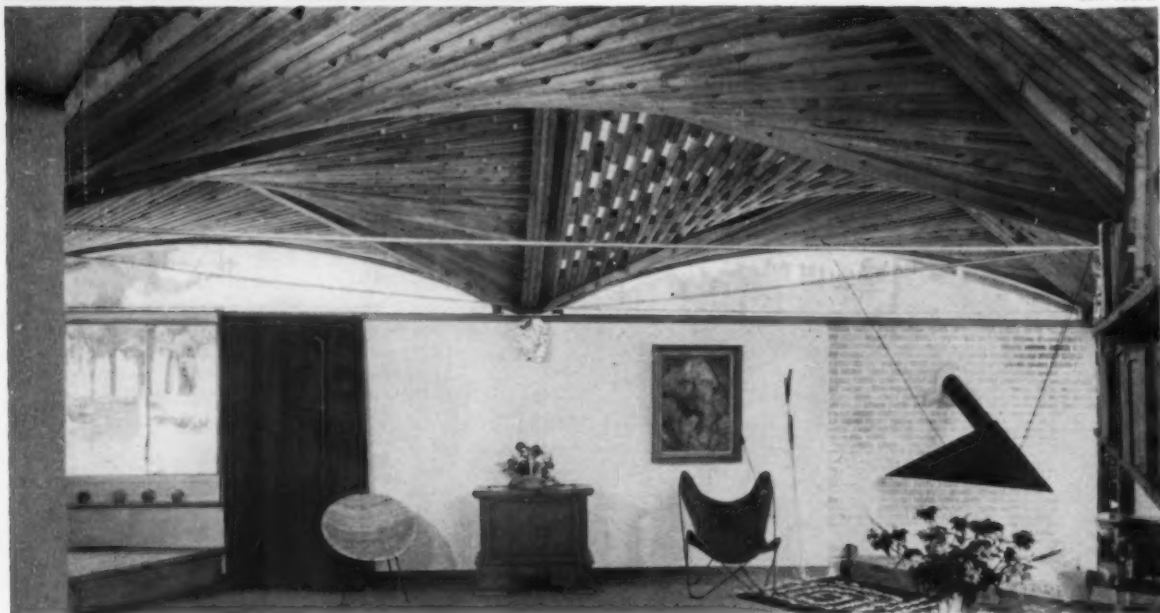

NINE PARABOLOIDS of natural red cedar give basketweave texture to ceiling; form curved windows above each wall.

WHAT

Paraboloids form unusual roof

HOW

Builder Sestock of Quebec experimented with model to figure costs and test construction of wood roof

The graceful lines of modern concrete paraboloids are captured here in a roof made entirely of red cedar 2x3's nailed and glued mill deck fashion. It spans a 30' triangular addition to an old Canadian house, eliminating interior wall-bearing partitions. Lightweight in appearance, with supports at the corners and mid-points of the side walls, roof can take 50-lb. snow loads.

Red cedar 2x8's at the intersections form the principal construction; spaces in between were filled with precut

2x3's, glued and nailed in place.

Over the strips 1" Styrofoam was used as insulation, topped by vermiculite concrete. The finished roof is of bitumen containing aluminum powder, reinforced with fiber glass cloth.

In the center three paraboloids, some strips were omitted to let in light. These spaces were sprayed with an epoxy finish over translucent insulation. The builder: Sestock Construction Ltd., Beaufort, Quebec; the architect: Victor Prus.

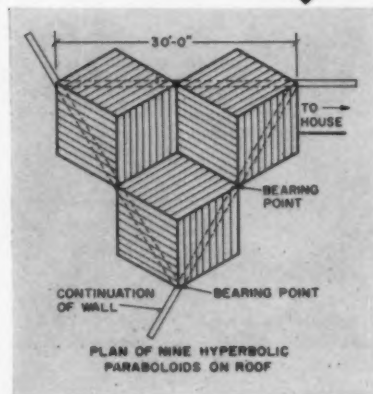

CURVED SECTIONS of red cedar ceiling extend far out over side walls to offer protection to clerestory windows.

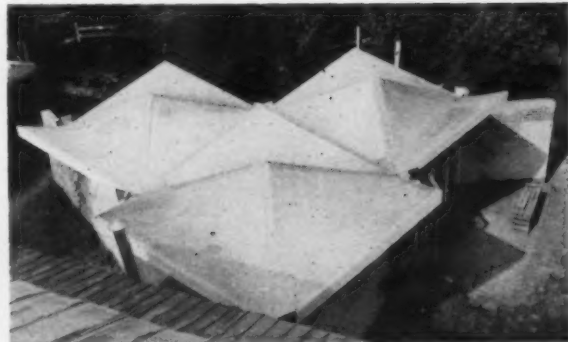

FROM ABOVE roof looks like series of small tents. The white finish of aluminum powder deflects hot sun's rays.

LOOK WHAT GAS IS DOING FOR BUILDERS!

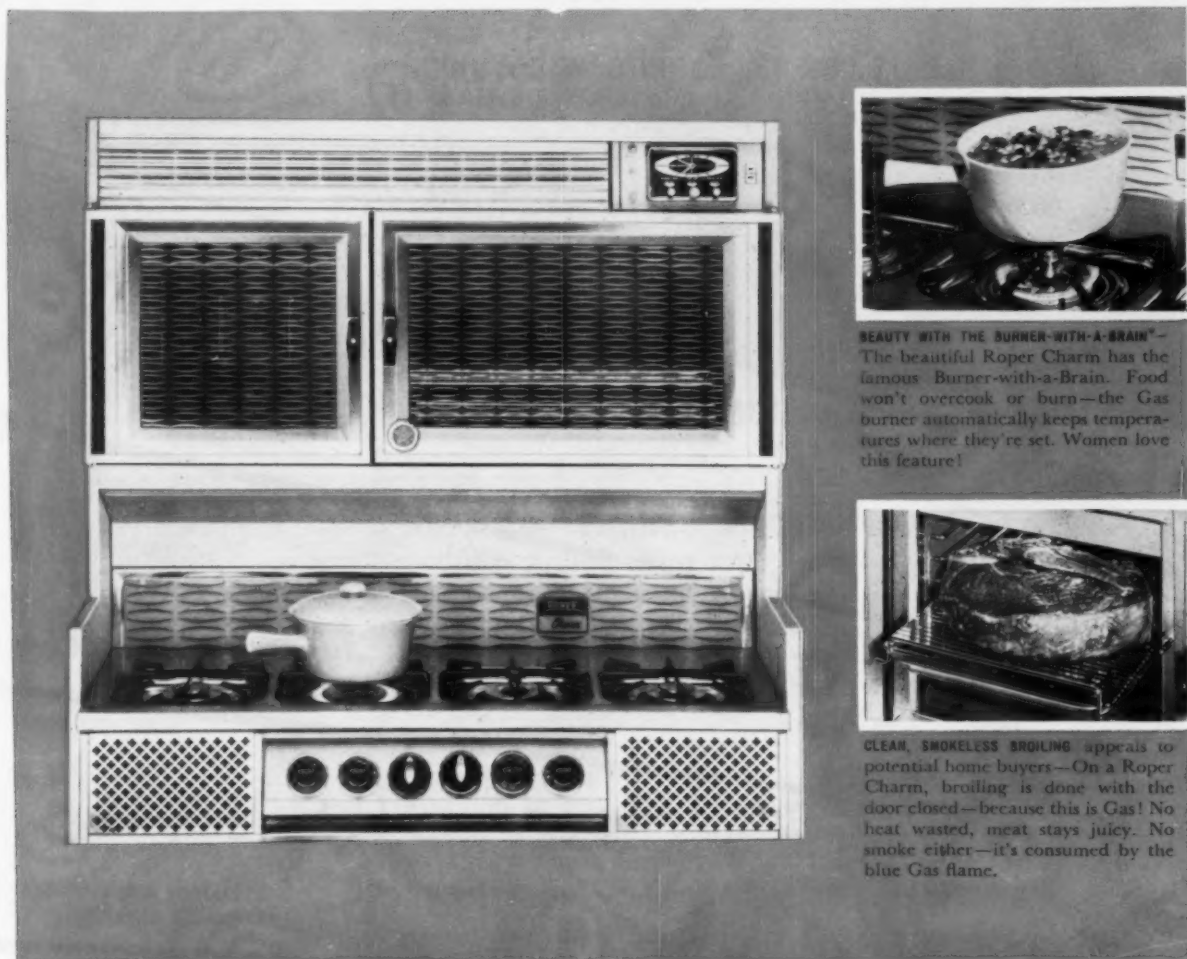

BEAUTY WITH THE BURNER-WITH-A-BRAIN*—The beautiful Roper Charm has the famous Burner-with-a-Brain. Food won't overcook or burn—the Gas burner automatically keeps temperatures where they're set. Women love this feature!

CLEAN, SMOKELESS BROILING appeals to potential home buyers—On a Roper Charm, broiling is done with the door closed—because this is Gas! No heat wasted, meat stays juicy. No smoke either—it's consumed by the blue Gas flame.

Roper Charm... with Gold Star features... modern as built-in ranges without expensive cabinets to build!

When they see, they're sold! New Roper Charm, the wall-hung, removable range, offers eye-catching, customer-catching beauty. Plus brains. Plus Gold Star appeal. Plus the proved economy, convenience and dependability of Gas. Successful builders are making this Beauty-Brains combination pay off. They're attracting buyers with modern Gas appliances like the stunningly styled Roper Charm Gas Range that offers "See-level" cooking. It's an eye-opener, sales-closer!

AMERICAN GAS ASSOCIATION



This Gold Star will catch her eye

A.G.A. awards the Gold Star to only the finest ranges. Each must be more automatic, more modern, better designed in every one of a long list of exacting specifications. They cook faster, cooler, cleaner than ever, automatically. This is important to any woman considering a new home.

Note to builders...

today more people than ever are cooking with  GAS!

*A.G.A. Mark ©Am. Gas Assoc., Inc.

WHY SUCH DEMAND FOR

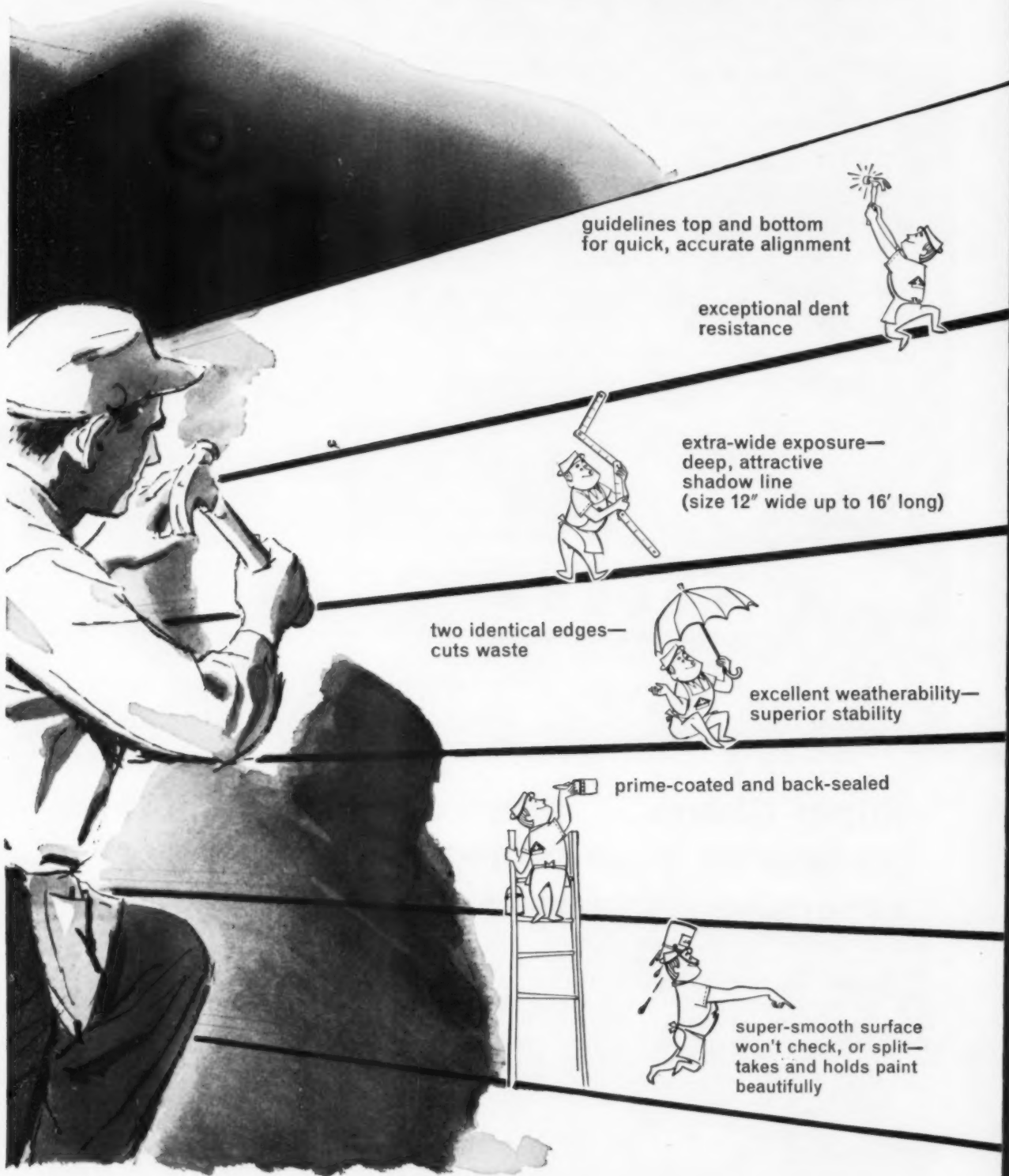

guidelines top and bottom
for quick, accurate alignment



exceptional dent
resistance

extra-wide exposure—
deep, attractive
shadow line
(size 12" wide up to 16' long)



two identical edges—
cuts waste



excellent weatherability—
superior stability

prime-coated and back-sealed



super-smooth surface
won't check, or split—
takes and holds paint
beautifully

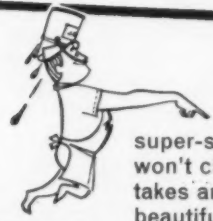

NEW MASONITE "X"-SIDING?

Improved weatherability and stability

—exclusive X-90 fibre formula developed through years of research and field experience—specially treated surface—greater thickness ($\frac{1}{16}$ " nom.).

Exceptional durability

—amazing dent resistance—toughness without brittleness—won't check or split—eased edges for longer paint retention.

Face primed

—for easier applied, better looking, longer lasting top coats. Back-sealed, too, for added protection.

Architecturally beautiful

—rich-looking, wide exposure—attractive shadowline—smooth, blemish-free surface—few joints.

plus a host of features which substantially reduce application costs:

Easy sawing and nailing.

Convenient 12' or 16' lengths.

Guidelines for fast, accurate alignment.

Identical edges mean less waste in gables.

12" width: fewer pieces than with narrower siding.

No special skills or tools required.

Low lap loss.

No essential extras or costly accessories.

You must actually see "X"-Siding to fully appreciate what it can do for you. The Masonite representative or your building materials dealer will be pleased to show it to you and give you more details; or write Masonite Corporation, Dept. AB-5, Box 777, Chicago 90, Illinois.

MASONITE

shows the way



Always look for this trade-mark on the panels you build with; it says this is genuine Masonite[®] hardboard. It's wood-made-better—made through the exclusive explosion process for unequalled strength, smoothness and uniformity.

©Masonite Corporation—manufacturer of quality panel products for building and industry

OFF TO HAWAII for two weeks are Mr. and Mrs. Tom Shannon. He is grand winner of Masonite's "Name the Siding" Contest and manager of Braun & Aldridge, Inc., leading Chicago area builder, which now uses "X"-Siding (with X-90 fibre formula) on many homes.





**SAVE ON PRICE
THE DAY YOU BUY!**

.....
**SAVE ON GAS AND
TIRES EVERY DAY!**

**FORD
PICKUPS**

Beginning with a price* that's below all comparable leading makes, Ford Styleside Pickups are especially designed to cut daily operating costs. Economical Ford Sixes, in certified tests with other makes over a three-year span, delivered outstanding gas mileage.

Tire replacement expense is less, too, with Ford's true truck suspension. Certified tests prove that the front tires on Ford ½-tonners last up to twice as long as those on other makes with car-type suspensions. And Ford's new longer wheelbase, new springs, and new cab construction provide a major advance in easy-riding comfort.

In addition to price, gas and tire savings, Ford's heavy-duty construction gives new freedom from nuisance problems. Ford pickups are built to stay on the job . . . out of the shop. So for a rugged truck that's made to tackle any pickup job, see your Ford Dealer. And when you do, ask him about the many heavy-duty options that can mean extra job-fitting economy in your construction work.



F-100 STYLESIDE PICKUP gives greater durability. New, one-piece cab-body design, and new huskier frame. New, wider tailgate for easier loading has snap-lock latches to save time. Max. GVW: 5,000 lb.

Heavy-duty options include 11-inch clutch, oversize tires, and extra-capacity springs.

Choice of 5 transmissions includes four-speed, overdrive and Fordomatic.

Six or V-8 power to fit your need. Ford's famous gas-saving Six, or the world's most popular truck V-8.

**Based on a comparison of latest available manufacturers' suggested retail prices*



F-250 FLARESIDE PICKUP has rolled-edge flareboards and running boards between the cab and rear fender for special side unloading work. Styleside Pickup, 7½-ft. Stake, Chassis-Cab, Chassis-Cowl, or Chassis-Windshield models also available. Max. GVW: 7,400 lb.



F-350 CHASSIS-CAB WITH DUAL REARS (9-ft. Stake body shown) has a man-size maximum GVW of 9,800 lb. This hard-working, versatile 132-in. wheelbase model features low loading height and the flotation of dual tires at a price much below 1½-ton trucks. Also available with single tires and big 9-ft. Styleside or Flareside Pickup bodies.

FORD TRUCKS COST LESS

SEE YOUR FORD DEALER'S "CERTIFIED ECONOMY BOOK" FOR PROOF!



FORD DIVISION, *Ford Motor Company*.



Sell 'em with
convenience
they can't resist!

SELL 'EM WITH BRAND-NEW ULTRONIC

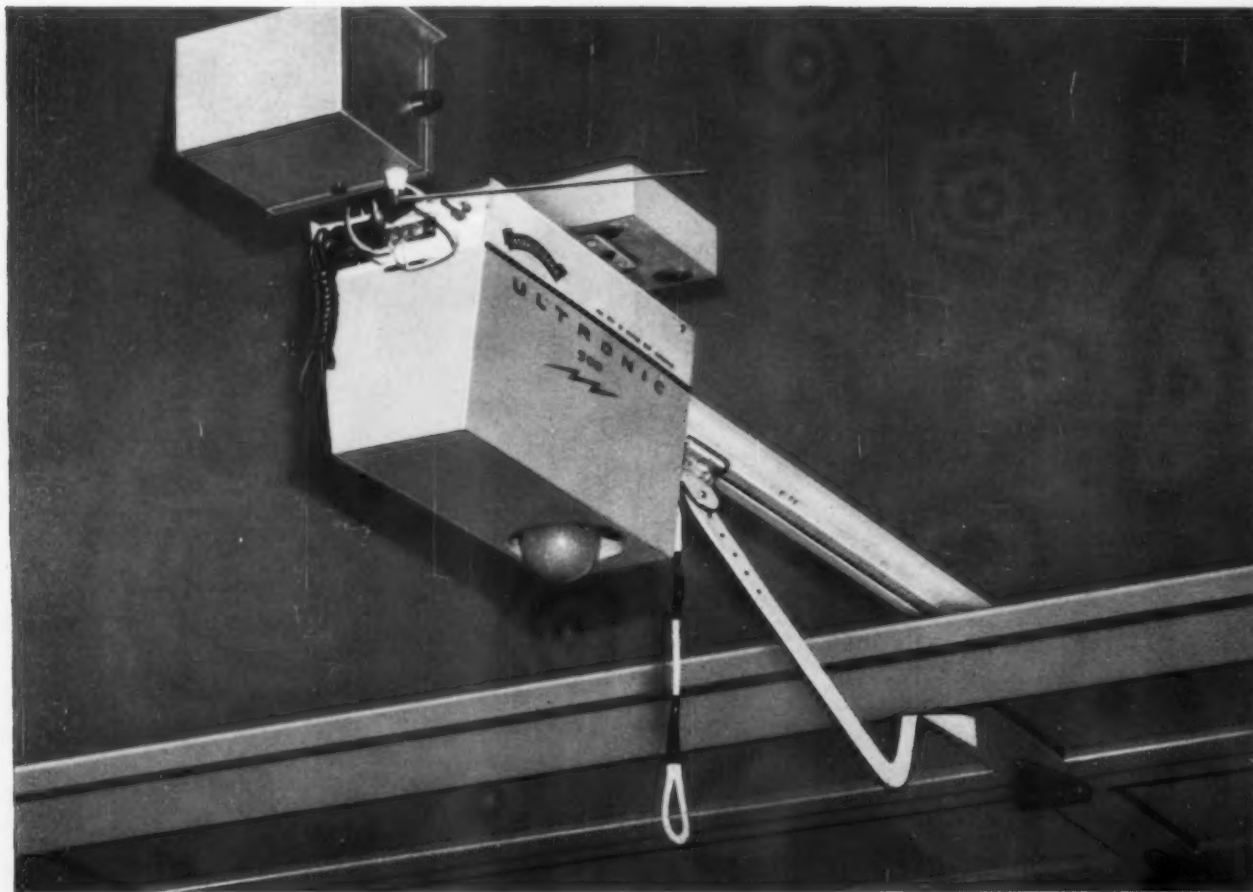

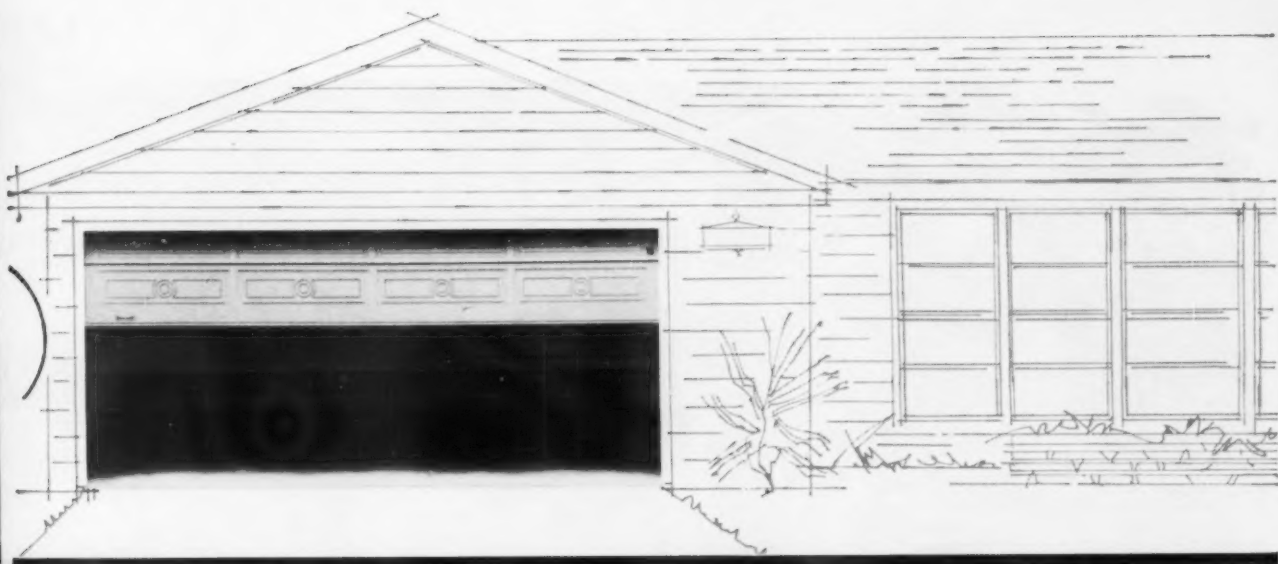

AUTOMATIC GARAGE DOOR OPERATOR

by **OVERHEAD DOOR CORPORATION**

Now, from Overhead Door Corporation research, comes the feature you've been looking for, sales-tested in model homes and sure to fire the imagination of your prospects! It's the ULTRONIC Garage Door Operator . . . with radio controls that open and close the garage door at the touch of a button . . . to make your homes truly modern. This new development makes normal door operation old-fashioned . . . turns a former luxury into a selling feature you'll want for every model home.

Look at the appeal from your prospects' point of view! The ULTRONIC Operator gives them effortless CONVENIENCE every time they drive into the garage. Just a touch of the button (on the compact little radio transmitter in the car) and they drive right in . . . SAFE from theft or assault, WARM and DRY in the meanest weather. They like the FUN of it, and the symbol of STATUS it provides.

Look at the appeal from *your* point of view. This site-tested selling feature has proved itself

to be one of the most effective "salesmen" that builders have ever employed. To set your homes apart from the crowd, put this operator to work now . . . to sell for you!

SPECIAL OFFER FOR YOUR MODEL HOME!

To prove how much sales persuasion this irresistible feature can add to your homes, "Overhead Door" is prepared to make you an irresistible offer—an ULTRONIC Operator (one to a builder) installed in one of your model homes . . . on a basis so attractive that you simply cannot afford *not* to accept the offer!

Your nearby "OVERHEAD DOOR" distributor will give you full details, also show you the free promotional aids that are included with the demonstration ULTRONIC Operator. Call him today. His name is in the white pages under "OVERHEAD DOOR." Or write for more information to Overhead Door Corporation, Dept. AB-15, Hartford City, Indiana.



*the original upward-acting sectional door . . .
made only by*

OVERHEAD DOOR CORPORATION

General Office: Hartford City, Indiana. Manufacturing Distributors: Dallas, Texas; Portland, Oregon; Cortland, New York; Hillside, New Jersey; Lewistown, Pennsylvania; Nashua, New Hampshire; in Canada: Oakville, Ontario

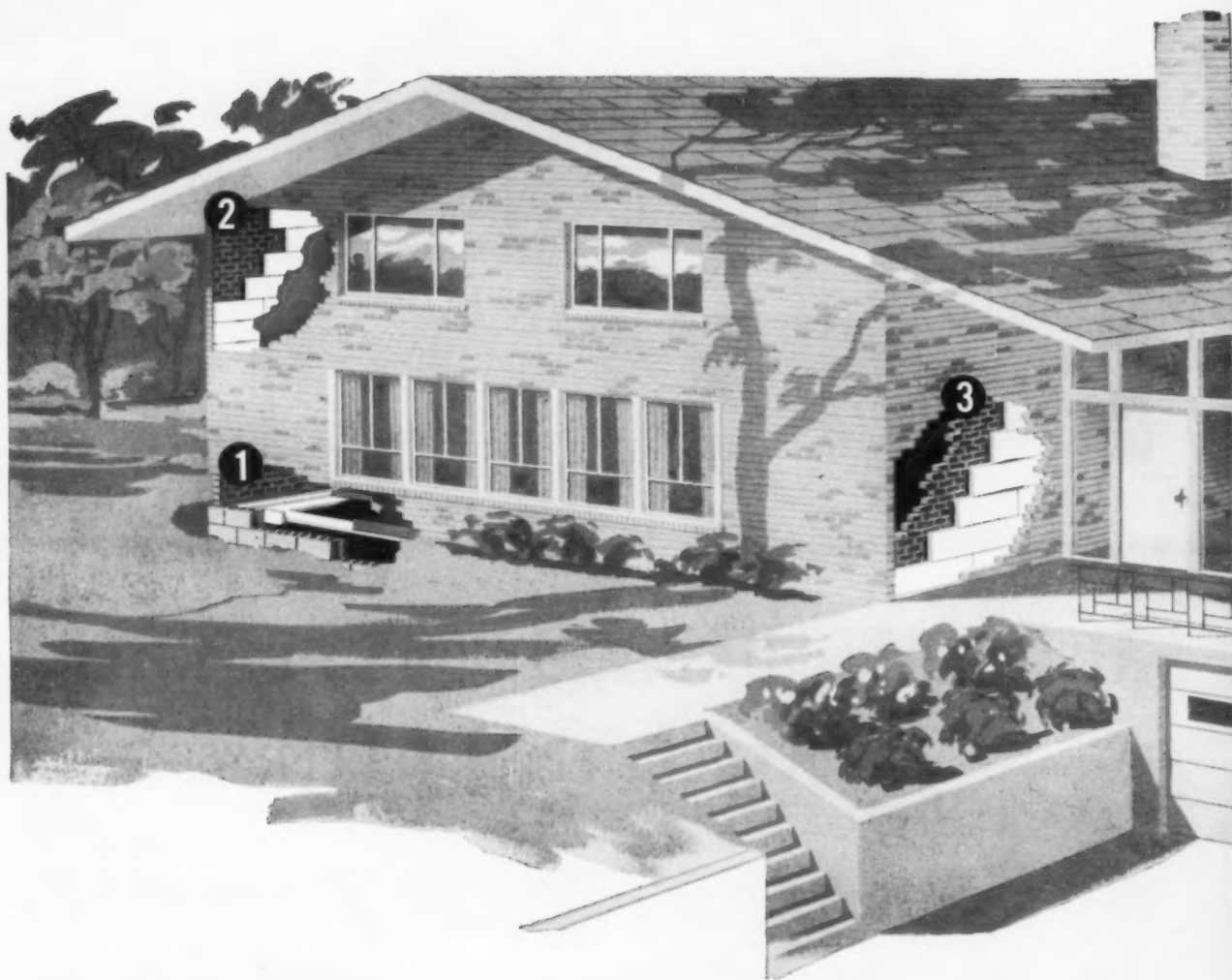

The most effective home insulation

Here's how it is used:

1. perimeter insulation
2. plaster base
3. cavity wall insulation
4. insulation backing for aluminum siding
5. built-up roof insulation
6. around ducts or water pipes

Insulation board made of DYLITE expandable polystyrene offers unsurpassed low-cost, lifetime insulation. It has the lowest "K Factor" of most commonly-used insulating materials. Because this board has a closed cell structure, it is less porous. It has excellent moisture- and vapor-resistance . . . it completely stops "cold wall" sweating in masonry construction above and below the ground. DYLITE board can provide homeowners with substantial savings in winter heat bills, can cut air conditioning costs, and will help muffle jangling street noises.

Board made of DYLITE is strong, not brittle. DYLITE board is rot-proof, fungus-proof, vermin-proof . . . it's ten times lighter than cork. It comes in any length, up to 4' wide, and you can cut, nail, staple, or glue it.

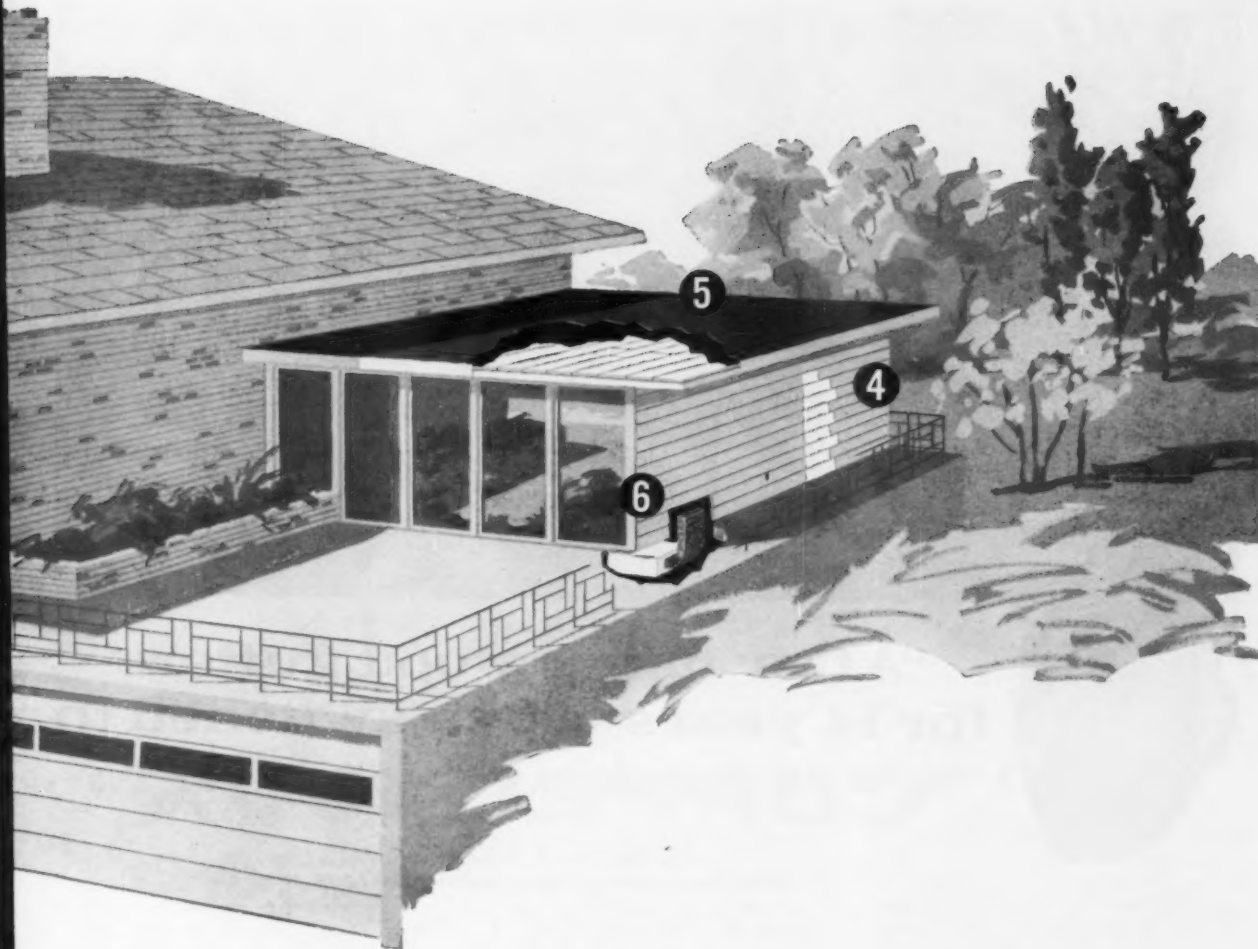

... insulation board made of **DYLITE**[®]

It is easily handled, quickly installed . . . saves time for the builder, money for the owner.

Board manufacturers buy DYLITE in the form of tiny sugar-like beads. When heated, these beads expand as much as 45 times their original size, fuse together and form millions of small cells that trap air and unite in a light, sturdy foam plastic board . . . the best insulating material available.

For more information on insulation board made of DYLITE expandable polystyrene and a list of quality board manufacturers, write Koppers Company, Inc., Plastics Division, Dept. 1517, Pittsburgh 19, Pennsylvania. Koppers also makes these other fine plastics: DYLAN[®] polyethylene, SUPER DYLAN[®] high-density polyethylene and DYLENE[®] polystyrene.

KOPPERS PLASTICS



MAY 1961

Here's how DYLITE compares with other commonly used insulating materials

"K" Factor of DYLITE vs. Other Thermal Insulations

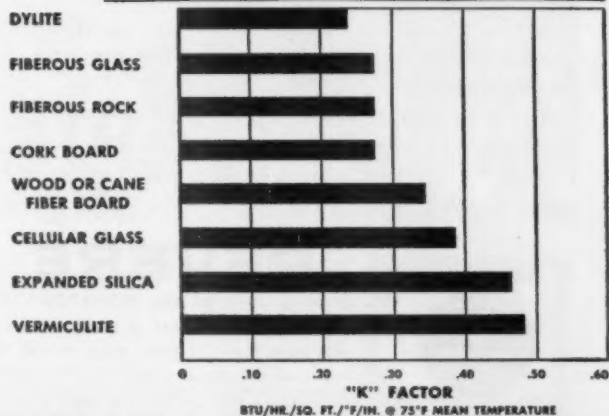

*The values illustrated are based on tests conducted with dry specimens. The K factor value will increase in relation to moisture absorption.

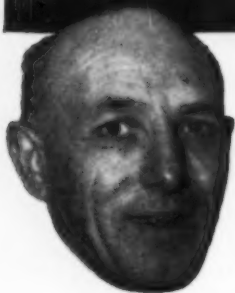

**"After using wood gutters
for 14 years we've switched to
COPPER 100%"**

Says NICHOLAS E. FIGLIOLA, *President*
MACY PARK CONSTRUCTION COMPANY, HARRISON, N. Y.

"The reasons," continued Mr. Figliola, "are: the price of copper is down . . . the cost of installing wood gutters is up. So, with such a small differential in price, we've switched to copper. It has other advantages, too. The end result is better, it lasts longer and requires little or no maintenance.

"Home owners like the idea of copper gutters, leaders, and flashing too, because copper in these spots is the mark of a quality home. And when they find out it's not going to add to the cost they're all for copper. It's a good selling point, believe me. That's the reason we've switched, 100%."

The RYE ROOFING & SHEET METAL CO., Rye, N. Y. was the sheet metal contractor for the home shown. Gutters, 18" in girth, were fabricated from 280' of cold rolled Revere Copper, while 130' of Revere Copper was

made into 2" x 3" leaders. Ten sheets of 36" x 96" soft Revere Copper were used for flashing.

Sheet copper was supplied by G. A. FELD CO., copper leaders by L. BIELER COMPANY.

Take advantage of the many qualities of copper, plus its low price and you'll add extra value to your homes without adding extra cost.



Always a preferred material for gutters on fine houses, Revere Sheet Copper is again competitive in price with wood.



REVERE

COPPER AND BRASS INCORPORATED

Founded by Paul Revere in 1801

230 Park Avenue, New York 17, N. Y.

Mills: Rome, N. Y.; Baltimore, Md.; Chicago and Clinton, Ill.; Detroit, Mich.; Los Angeles, Riverside and Santa Ana, Calif.; New Bedford and Plymouth, Mass.; Brooklyn, N. Y.; Newport, Ark.; Ft. Calhoun, Neb. Sales Offices in Principal Cities.

Distributors Everywhere

AMERICAN BUILDER



PLATES are nailed to floor and ceiling, after which panels are nailed to plates.

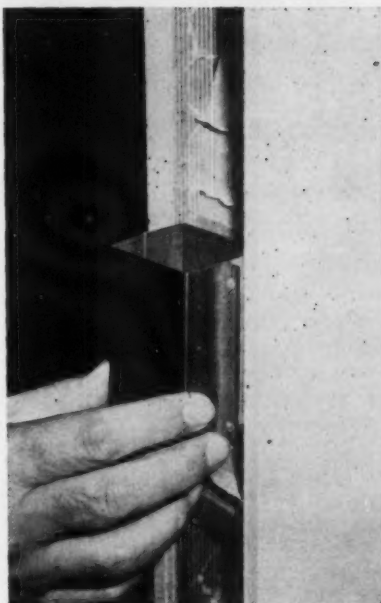

METAL SPLINES at joints are hollow, let joints serve as raceways for wiring.



CUTTING PANELS for beams and doorways is easy with hand or power saws.

Honeycomb panels cut partition costs

Hoffman Industries, Inc., has introduced a system of interior wall panels said to be 20% cheaper than conventionally framed partitions.

The system employs 2½" thick panels called Hof-Kor. They come in 2x8' and 4x8' sizes, and are made by

bonding two sheets of ¾" gypsum-board to a honeycombed core. Units are said to be thermal insulating, fire resistant and sound deadening.

To install the panels, bottom and top plates are nailed to floor and ceiling. The panels are then slid into po-

sition and nailed to the plates. Metal splines go into the joints (above, center) which are then taped and sanded like ordinary drywall. Door openings are cut after erection of the panels. For more information, circle No. W1 on reply card, page 129.



SLEEVE for a/c unit simplifies masonry lay-up. It displaces exactly four concrete block or equivalent even number of brick.



INTERIOR FRAMING is also simplified. Only one stud needs cutting, and addition of two single headers forms a perfect frame.

Air conditioner design speeds installation

York Corporation's new model B10 air conditioning unit is specially designed for thru-the-wall installation. Main advantage: the 10,000-BTU unit rests in a corrosion-resistant 19-ga. steel sleeve that displaces exactly four con-

crete block. To install, a mason lays a mortar bed for the sleeve, sets and levels the sleeve, then continues laying-up. Two more courses bring the wall level with the top of the sleeve (see photo, left), making a continuous bed

for succeeding courses. Later, the a/c unit goes into the sleeve. Another advantage: in frame construction, the sleeve interrupts only one stud (photo, right). For more information, circle No. W2, reply card, page 129.

FREE SAMPLES!

"Hi-RED" Plastic SCREW ANCHORS



**FASTEN ANYTHING . . . ANYWHERE!
CUT ANCHORING COSTS UP TO 70%
TREMENDOUS HOLDING POWER—"Hi-RED"
is the modern (and best) anchor for screws.
Use indoors or outdoors in concrete, brick,
cinder block, tile, wallboard, glass, wood, etc.
Superior holding power proved by Pittsburgh
Testing Laboratory. Sold in kits or cartons.**

MILLIONS IN USE!

SEND "Hi-RED" SAMPLES

NAME _____
FIRM _____
STREET _____
CITY _____ STATE _____

LIFETIME ANCHOR
Sizes for No. 4 screw
up to 1/2" lag . . .
size marked on every
anchor.



HOLUB INDUSTRIES, Inc.

467 ELM STREET • SYCAMORE, ILL.

The Cost of Quality more than repaid

in direct labor savings!

Columbia-matic® FABRIC DOORS



... and only real
quality will sell in
the 60's!

Spend just five minutes at your building materials dealers examining his Columbia-matic display model, and the total marketability of the folding door will be crystal clear. Installs in seconds, narrow, neat, with exclusive pantograph* mechanism, it is built to stand up to abuse. No complaints, no call-backs. Washable, fire retardant, highly styled, it comes in widths to 4 ft.—heights to 8 ft. Can be hung in pairs.

*Patent Pending

For complete details see your distributor, or write Dept. 115
THE COLUMBIA MILLS, INC.
368 S. Warren Street, Syracuse 1, New York



Richard Meyer of Toledo, Ohio,

is a happy example of what RMS can do for you. Just a few months ago, Dick was one of 16 men in the first training class of Richheimer Modernizing Systems. He had been in the home improvement business as a contractor for six years, never had sales over \$5,000 a month. RMS gave him two weeks of intensive training in every phase of the business—budgeting, pricing, cost control, design, selling, production techniques and many other subjects.

At the conclusion of his training, Dick wrote, "The RMS training school has been much better than I had hoped for. You have shown us proven methods which are not only successful for you, but can be applied immediately in our area. I know that by using these methods, we will become the largest home modernizer in our area. This has been the best investment of my life!"

And Dick wasted no time in making his own predictions come true. Just three months later—now as president of Richheimer-Guardian, Inc.—he opened Ohio's most beautiful home modernizing showroom. Despite the dreariness of February weather, 6,200 interested Toledo residents came to see it in the first two days. Dick and his general manager, (Willson Brumback, also RMS-trained) took 126 leads—from homeowners who asked to see a Richheimer-Guardian salesman. And in the next week, Dick wrote eight times as many contracts as in any month before!

You can do the same, or better. Your market is just as ready for a reliable, skilled home modernizer as Toledo. And that's what RMS training will make you in just two weeks.

Ask Dick. Or better yet, send in the coupon at left; RMS will send you complete details—including the (entire) list of 57 men who, like Dick, can give you a first-hand report on the effectiveness of RMS training.

Richheimer Modernizing Systems, Inc.

Date

1650 Hempstead Turnpike

East Meadow, Long Island, N.Y.

Gentlemen:

Please send full details on your training program and other services.

Name

Company

Address

City State

You can shop by postcard in

American Builder's Supermarket

Help yourself . . . to the wide variety of manufacturer's literature shown on the pages ahead. You don't have to write, just circle the numbers on one of the cards below. Then drop the card in the mail (no stamp needed). AMERICAN BUILDER will forward your request to each manufacturer and he'll send you complete data, free of charge. So . . . get out your pencil and help yourself.

Just circle the numbers at right and you'll receive the information you want FREE from the manufacturers

**American Builder
Reader Service**
★★ MAY 1961

NEW PRODUCTS	W17	W35
W1	W18	W36
W2	W19	W37
W3	W20	W38
W4	W21	W39
W5	W22	CATALOGS
W6	W23	W40
W7	W24	W41
W8	W25	W42
W9	W26	W43
W10	W27	W44
W11	W28	W45
W12	W29	W46
W13	W30	W47
W14	W31	W48
W15	W32	W49
W16	W33	W50
	W34	W51

NAME (Please print) _____

FIRM NAME _____ TITLE _____

STREET _____

CITY _____ ZONE _____ STATE _____

PLEASE CHECK YOUR FIELD OR OCCUPATION

- | | | |
|--|---|---|
| <input type="checkbox"/> Builder or Contractor | <input type="checkbox"/> Architectural | <input type="checkbox"/> Finance |
| <input type="checkbox"/> Sub-Contractor or Building Trades | <input type="checkbox"/> Engineering | <input type="checkbox"/> Realty |
| <input type="checkbox"/> Building or Planning Own Home | <input type="checkbox"/> Manufacturer or Producer | <input type="checkbox"/> Organization |
| | <input type="checkbox"/> Distributor | <input type="checkbox"/> Government |
| | | <input type="checkbox"/> Student or Teacher |

Signature _____

W52	W58	W64	W70	W74-W	W80-W
W53	W59	W65	W71	W75-W	W81-W
W54	W60	W66	WESTERN PRODUCTS	W76-W	W82-W
W55	W61	W67		W77-W	W83-W
W56	W62	W68	W72-W	W78-W	
W57	W63	W69	W73-W	W79-W	

**American Builder
Reader Service**
★ MAY 1961

NEW PRODUCTS	W17	W35
W1	W18	W36
W2	W19	W37
W3	W20	W38
W4	W21	W39
W5	W22	CATALOGS
W6	W23	W40
W7	W24	W41
W8	W25	W42
W9	W26	W43
W10	W27	W44
W11	W28	W45
W12	W29	W46
W13	W30	W47
W14	W31	W48
W15	W32	W49
W16	W33	W50
	W34	W51

NAME (Please print) _____

FIRM NAME _____ TITLE _____

STREET _____

CITY _____ ZONE _____ STATE _____

PLEASE CHECK YOUR FIELD OR OCCUPATION

- | | | |
|--|---|---|
| <input type="checkbox"/> Builder or Contractor | <input type="checkbox"/> Architectural | <input type="checkbox"/> Finance |
| <input type="checkbox"/> Sub-Contractor or Building Trades | <input type="checkbox"/> Engineering | <input type="checkbox"/> Realty |
| <input type="checkbox"/> Building or Planning Own Home | <input type="checkbox"/> Manufacturer or Producer | <input type="checkbox"/> Organization |
| | <input type="checkbox"/> Distributor | <input type="checkbox"/> Government |
| | | <input type="checkbox"/> Student or Teacher |

Signature _____

W52	W58	W64	W70	W74-W	W80-W
W53	W59	W65	W71	W75-W	W81-W
W54	W60	W66	WESTERN PRODUCTS	W76-W	W82-W
W55	W61	W67		W77-W	W83-W
W56	W62	W68	72-W	W78-W	
W57	W63	W69	73-W	W79-W	

**Mail one of these postcards today
to get free product information.
Service on May reply cards
expires August 1, 1961.**



BUSINESS REPLY MAIL
First Class Permit No. 153, New York, N.Y.

**Business Manager
AMERICAN BUILDER
30 Church Street
New York 7, N. Y.**

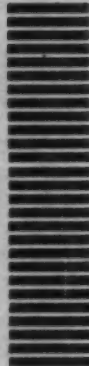

BUSINESS REPLY MAIL
First Class Permit No. 153, New York, N.Y.

**Business Manager
AMERICAN BUILDER
30 Church Street
New York 7, N. Y.**

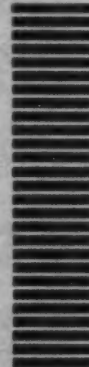

NOW... CUT PLYWOOD FORM COSTS

WITH
THOMPSON'S
WATER SEAL



Note these cost-saving features:

- Prevents absorption of water in concrete forms. Forms last longer.
- Saves labor. Eliminates cost of cleaning, sanding and recoating after each pour.
- Thompson's Water Seal permits eight or more pours per plywood form (min. 4 pours per side).
- Eliminates form damage during stripping. Forms can't stick. Won't soften wood, prevents deflection.
- Easy to apply by brushing, dipping or spraying.

Thompson's Water Seal is deep penetrating, colorless, leaves no residue, won't stain concrete; surface is dust-free, ready for painting.

Available in 5 and 55 gallon drums from suppliers to the construction industry.

See catalog in *Sweets Architectural file* and *Light Construction file*.



San Francisco, Los Angeles, San Diego, Portland, Chicago, Seattle, Denver, Dallas, Houston, St. Louis, St. Paul, Detroit, Philadelphia, New York City, Memphis, Tampa, Cleveland, Atlanta, Honolulu. Factory: King City, Calif. 56678

NEW PRODUCTS

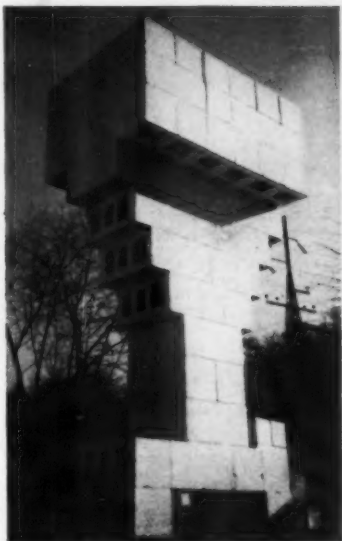

UNREINFORCED 5-block lintel supports 1,500 lbs. Lintel is bonded with Threadline, a greatly improved mortar by Raybestos-Manhattan, Inc.

New mortar combines great strength, economy

Raybestos-Manhattan, Inc., has introduced a new mortar—called Threadline—said to cut building costs by about 1/3. This is accomplished by cutting lay-up time for block and brick by about 50%.

The new mortar is mixed at the site, and is applied by calking gun or continuous trowel. It gives a waterproof joint several times stronger than regular mortar (photo, above). This strength has been amply demonstrated, says the manufacturer, by a series of tests in which the masonry units failed before the Threadline mortar which bonded them. The new mortar's other features include:

- Fast curing. At 70° it reaches initial cure in 24 hrs. It achieves full strength in 72 hrs.
- It can be used at lower temperatures than ordinary mortar.
- One gal. will lay up one-hundred 8x8x16" blocks.
- Thin joints—only 1/16" or less, vs. 3/16" to 3/8" for regular mortar.
- Excellent weather resistance.
- Fast cleanup after job.

Cost of the new mortar is about twice that of regular mortar, and it must be used with ground blocks. But, the maker claims, these factors are offset by savings in lay-up and cleanup time. (For more data, circle No. W3, reply card, p. 129.)

Seal-Draft Installs Fast!

Cut installation costs and increase profits by applying SEAL-DRAFT Weatherstripped Door Stop and Thresholds.



Seal-Draft Weatherstripped DOOR STOP

Use as a door weatherstrip or as applied door stop on un rabbeted jambs.

- Heavy, husky anodized aluminum body defies destruction.
- Green vinyl "feather-edge" sealing strip automatically molds to door warpage or misalignment.
- Absolutely stops drafts, dust and dirt infiltration.
- Quickly applied with 24 stainless steel screws to wood or metal doors.

Seal-Draft Wood Core THRESHOLD

Now... the first vinyl and aluminum threshold with wood core. Stops the possibility of "frost creep through" and condensation on floors and rugs.

New design is crush-proof and beautiful. Just right for easy application. Low-priced to fit into any plan.

Available at hundreds of building material suppliers throughout the U. S. or mail coupon for **FREE SAMPLE SECTION** and descriptive literature.

Mail to:
SEAL-DRAFT DIVISION
Sun Screen Products, Inc.
N. 1220 Division St.
Spokane 21, Washington

Name _____
Firm _____
Street _____
City _____ Zone _____
State _____

Type or print clearly.

STOW G-29 ROTO-TROWEL

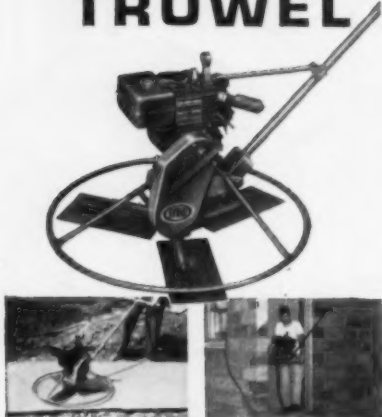

JUST THE TICKET FOR SMALL AREAS

Stow's 70 lb. G-29 Roto-Trowel is ideal for floating and finishing doorways, small rooms, basements, garages, patios, sidewalks! Speeds up small jobs, gives smooth concrete finishes fast—wherever needed! This 2.25 HP model features three 29" reversible combination float and finish blades, stationary 30" ring guard, adjustable-length handle, and handy pitch changer regulator. Dead-man control on handle operates exclusive manual clutch that stops blades instantly when released, leaves engine running, allows smooth starting at any throttle setting. Other 3 and 4-blade models available in 34", 42" and 46" sizes, with 3 HP, 4.5 HP, 5.75 HP or 7 HP gas engines, or 1½ HP electric motor.

For details, call your Stow distributor or mail this coupon for Bulletin 610-8.

STOW MANUFACTURING CO.
Dept. D-1 142 Shear St.
Binghamton, New York

Please send me Bulletin #610-8 on Stow Roto-Trowels.

NAME TITLE
COMPANY
ADDRESS
CITY STATE

STOW MANUFACTURING CO.
BINGHAMTON, NEW YORK

NEW PRODUCTS



Story poles cut labor up to 50%

Metal story poles, engineered for any type of masonry construction, can cut labor up to 50%. A key feature is the Cors-Rite scale that can be permanently attached to each pole. This scale prefigures the adjustments in courses to bring masonry to any level. The poles are easily transported, easy to set up, and work for any wall height—including multi-story buildings. Manufacturer gives money-back guarantee.—*Modern Masonry Mfg. Co.*

Circle No. W4 on reply card, p. 129



Attic fan has no drive belt

The newly developed drive system of this attic fan does away with drive belt and pulleys. This cuts installation costs, eliminates need for periodic retensioning or replacement of belts. Fan also has special blades said to give up to 18% more airflow. Sizes range from 24 to 48 inches.—*Consolidated General Products, Inc.*

Circle No. WB on reply card, p. 129



Simplifies hydronic heating

Preplanned, pre-engineered hydronic heating package complements gas or oil fired boilers up to 90,000 BTU/hr. Precut parts for shop installation reduce site costs. Package is sold under a new plan that simplifies price quotation for the contractor.—*Bell & Gossett Co.*

Circle No. W5 on reply card, p. 129

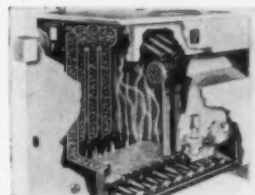

Boiler cuts installation costs

This gas boiler, for larger homes and apartment or commercial buildings, cuts installation costs of both steam and hot water systems. Greater BTU/hr. input per burner means fewer sections needed. Also, up to six sections may be ordered pre-assembled. Three-inch supply tappings at top and rear of each section simplify hook-up. Working pressure is 50 PSI.—*American-Standard, Plumbing and Heating Div.*

Circle No. W9 on reply card, p. 129



Masonry saw is versatile, portable

Lightweight, portable masonry saw can operate from the back of a station wagon or pickup truck, or in tight places like a boiler or kiln. 1½ hp motor is built for continuous operation on 115 to 230 volts. Electric water pump is same as on company's larger models. Head adjustment is quick, easy.—*Eveready BrickSaw Co.*

Circle No. W6 on reply card, p. 129

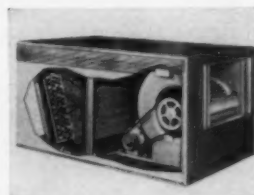

For remote air conditioning

The 939 line of blower-coil units, designed for use with remote a/c systems, comes in 2-, 3-, 4-, and 5-ton sizes. Can be used as upflow, counterflow or horizontal. Attractively finished in 2-tone green.—*Mueller Climatrol Div., Worthington Corp.*

Circle No. W10 on reply card, p. 129



C.I. lavatory has angle mounts

Lavatory of enameled cast iron is first of its kind with angled fixture mounts. Unit is 20x18", has a 16x11" basin with integral front overflow and built-in soap dishes. Machine-ground sides make for easy installation in countertops or cabinets.—*Kohler Co.*

Circle No. W7 on reply card, p. 129



Early American panel siding

Red cedar plywood siding gives board-and-batten effect. Available in 4'x8", 9' or 10' panels, ¾" thick, with rough-textured or abraded surface. Meets FHA standards for direct application to studs without corner bracing or building paper.—*U. S. Plywood Corp.*

Circle No. W11 on reply card p. 129



"Concealed telephone wiring is helping us grow"

**SAYS RON SORENSEN, SALES MANAGER,
ALLEN C. EDWARDS HOME-BUILDING SERVICE,
PORTLAND, OREGON**

"Our slogan," says Mr. Ron Sorensen, "is 'Oregon's only complete home-building service, from tree . . . to trim . . . to moving in.' Complete in every detail, and that includes concealed telephone wiring. We've used it for three years, and we're growing steadily. Concealed wiring and built-in telephone outlets are going to help us grow even more."

Allen C. Edwards is a complete home-building service owning many of its own sub-assembly and building supply operations. It is currently completing a 110-home operation in Sunset Heights, six miles west of Portland. Concealed wiring is going into these homes.

"I think it's a definite sales feature," says Mr. Sorensen. "I'm sold on it. It's worth promoting!"

BELL TELEPHONE SYSTEM



Your local Telephone Business Office will gladly help you telephone-plan your homes. For details on home telephone installations, see Sweet's Light Construction File, 11c/Be. For commercial installations, Sweet's Architectural File, 34a/Be.

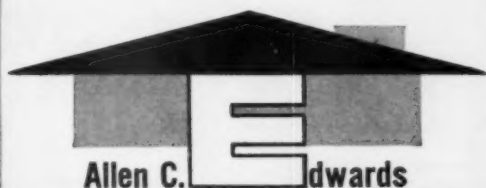

ABOVE: Homeowner finds dinette wall phone convenient.

"One of the chief complaints of home buyers," says Sales Manager Ron Sorensen, "is that builders show no consideration for an owner's needs. Telephone planning is consideration, and we plan for extensions in every important area of the house."

Ohio builder's blueprint for economy is a Volkswagen Truck

Pick-up goes 25,000 miles for 1.9¢ per mile

© 1961 Volkswagen of America, Inc.



TRAVELING TOOL CHEST! Tools and light equipment can be stored conveniently and safely in this 23-cubic-foot compartment under the truck bed. It's lockable and weatherproof.

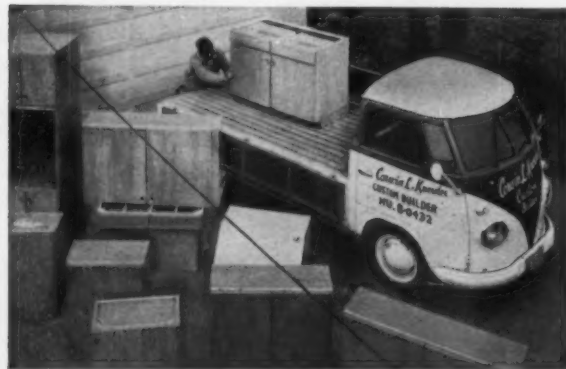

PUTTING THE LOAD TO BED! The VW Pick-up Truck's hinged sides drop down for easy loading and unloading, either from the back or from the sides. There's 45 square feet of cargo space . . . on a completely level, unobstructed, flat bed, which makes the VW both a pick-up and a platform truck in one.

Mr. Corwin Knowles, of Columbus, Ohio, a custom builder and local director of the N.A.H.B., talks about his hard-working "employee," the VW Pick-up Truck:

"Our VW is a terrific worker. Ideal for the building trade. It's easy to drive, to park and to load. Has amazing traction on snow, ice, mud. Saves us time traveling from job to job. It's economical to run, too. Gas, oil and maintenance cost us an average of 1.9¢ per mile over the past two years. And we haven't had a major repair bill in 25,000 road miles."

This report of satisfaction with the product is repeated over and over wherever you find VW Trucks at work. And that's in all 50 states. There are now over 110,000 Volkswagen Trucks in the U.S. Volkswagen is the advanced truck idea that's been proven on the road for the past 11 years.

Are you ready for a VW Truck? You are if you want a truck that costs less to buy, less to operate and less to service. The suggested retail price of the VW Pick-up Truck (East Coast Port of Entry) is \$1,885 (West Coast, \$1,995). To help you make the right decision, talk to your Authorized VW Dealer soon. Ask for a demonstration. And get your free copy of the 60-page illustrated booklet, "The Owner's Viewpoint." It documents with facts and figures VW Truck performance and owner experience in a wide variety of businesses. It shows what *you* can expect to get from a Volkswagen, too. There's no obligation.





EVERYTHING BUT THE KITCHEN SINK! Look at the carrying capacity of the VW Pick-up. When Mr. Knowles' VW isn't loaded with kitchen cabinets it's hauling 2 x 4's and masonite. Total payload: 1,764 pounds. Although the VW is almost 3

feet shorter than a standard half-ton pick-up (and easier to park), it carries 75% more cargo. Costs less to operate, too. Note how Mr. Knowles uses the ample outside display space on the VW Pick-up "traveling billboard" for his business.

NEW LOW PRICES

NEW STYLES

NEW PRE-PAID FREIGHT PLAN

... that helps you pinpoint your delivered material costs in advance on more than 7,000 items.



in your complete

MORGAN-WIGHTMAN CATALOG

Morgan-Wightman has become a great national institution because it helps builders, big and small—everywhere—to cut costs. Benefits include one stop shopping, one invoice, less paper work.

ST. LOUIS
CHICAGO
and now
MILWAUKEE

*If you don't have our
free catalog, send
for one today*



when you order
by mail,
**MORGAN-
WIGHTMAN**
is as near to
you as your
mailbox.

MORGAN-WIGHTMAN

Dept. 51, P. O. Box No. 1, St. Louis 66, Mo.

NAME _____

COMPANY _____

ADDRESS _____

CITY _____ STATE _____

NEW PRODUCTS



Range is compact, stylish

Compact 30" free-standing gas range has low-temperature oven control, built-in aluminum no-stick griddle, smokeless broiler, fluorescent lights, oven window, silicone door seals. Also available in 36" and 40" models.—Geo. D. Roper Sales Corp.

Circle No. W12 on reply card, p. 129



Plywood has invisible armor

A clear thermoplastic film bonded to new plywood doors and panels is virtually impervious to acids, abrasion, liquids, stains, etc. Yet, the decorative veneer remains natural in appearance. The panels and doors, now in production, will come in stock and custom sizes, and in "practically any hardwood veneer known to man," says the manufacturer.—U.S. Plywood Corp.

Circle No. W13 on reply card, p. 129

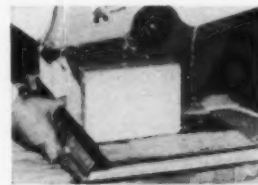

Durable blade for masonry saws

An addition has been made to the line of Blue Bond Break-Resistant masonry saw blades. The new MR 824 blade cuts lightweight block, dry press refractories, softer types of stone. It is reinforced with flexible glass cloth to give improved durability.—Clipper Mfg. Co.

Circle No. W14 on reply card, p. 129

Joint sealer pours like syrup

Cold-applied sealant is poured into concrete joints, cures to a rubber-like texture. The compound is suited to indoor and outdoor use, is unaffected by foot or vehicle traffic. Maintains a tenacious bond in temperatures of 0° to 150° F, and won't cold-flow after curing. Made from 2 components that are easily mixed at the site.—Servitised Prods. Corp.

Circle No. W15 on reply card, p. 129

THE STEEL HYDRONIC
HEATING BOILER GIVES YOU
THE ADDED SALES TALK

for faster home selling!

Koven HYDRONIC HEATMASTER



1. COMPETITIVELY PRICED
2. EXTRA HEAT
3. UNIFORM HEALTHY HOT WATER HEAT - FROM FLOOR TO CEILING, NO COLD SPOTS OR CHILLY CORNERS
4. EXTRA HOT WATER
5. NOISE FREE - NO BLOWER OR DUCT RACKET
6. PACKAGED BOILER READY TO INSTALL
7. ECONOMICAL TO OPERATE
8. EXTRA FIBERGLASS INSULATION
9. FACTORY SALES AIDS AND SELLING HELPS

THE STEEL BOILER THAT HELPS MAKE THE
DIFFERENCE BETWEEN LOOKERS AND BUYERS

L. O. KOVEN & BRO., INC. RICHMOND TON ROAD
DOVER NEW JERSEY

"Our Berger saves two men half
a day's work just setting grades!"



...says E. R. Schofield
E. R. Schofield Forms, Inc., Saxonville, Mass.

"Just 20 minutes is all the time it takes to set nails for concrete lines with our Berger Service Dumpy Level. The old way it would take two men better than half a day. Our Berger is rugged, too - it can take it even in this rough, messy business. We toss it around, bang it in the truck - yet when we set it up, it's still accurate. That's why we've bought Bergeries - six of them, so far. They're always accurate. And the time they save makes them indispensable. We just couldn't be competitive without them on a house like this."

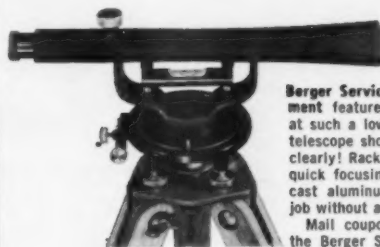

Berger Service Dumpy Level has big instrument features you'd never expect to find at such a low price. The 12-power erecting telescope shows your target **right side up** - clearly! Rack and pinion adjustment insures quick focusing and easy sighting. Sturdy - cast aluminum construction - stays on the job without a care about repairs.

Mail coupon for more information about the Berger Service Dumpy Level and other Builders' Transits and Levels.

Price: \$59.95 with tripod, plumb bob and field case. Special combination with 8 ft., 2-section rod \$67.45. FOB factory.

MAIL COUPON FOR DETAILS

C. L. BERGER & SONS, INC., 47 Williams St., Boston 19, Mass.

Send me literature on

- Convertible 12" Dumpy Level SPEED-A-LINER Transit-Level
 SPEED-A-LINER Dumpy Level Service Transit-Level
 Service Dumpy Level Duplex Tilting Level Pocket Level

Name _____ (Please print)

Address _____

City _____ Zone _____ State _____

THE BEST IN SIGHT IS

BERGER

Engineering and Surveying Instruments... Since 1871



ELASTOMERIC BUTYL CAULK



Available in Gun Cartridges and



Bulk Containers for Troweling

...an all-purpose single component sealant.

Sealtight Elastomeric Caulk is a new single-component sealer that offers most of the important qualities of the more costly two-component polysulfide sealants plus many additional advantages. It is an all-purpose sealant that can be used on any reasonably clean surface—porous or non-porous. It is a premixed single component material ready for use with no on-the-job preparation. Sealtight Elastomeric Caulk is ideal for sealing curtain wall joints, tuck pointing masonry, caulking concrete, channel glazing, and general caulking purposes.

OUTSTANDING FEATURES . . .

- Single-component, premixed ready for use.
- Offers indefinite storage life.
- Non-bleeding and non-staining . . . does not require a primer.
- Virtually unaffected by freeze-thaw cycles.
- Resistant to ozone and ultra violet exposure.
- Dries tack-free in 4 to 6 hours . . . cures in 30 to 60 days.
- Available in four colors: white, natural, grey, and aluminum.
- Fibre tube features no-flow device.

WRITE FOR COMPLETE INFORMATION

W. R. MEADOWS, INC.

8 KIMBALL ST. • ELGIN, ILLINOIS

NEW PRODUCTS



Small furnace gives lots of heat

Here's a compact furnace that needs a floor space of only 12x27 $\frac{1}{2}$ "², but delivers 40,800 BTU/hr. at the bonnet. It's shipped completely prewired and plumbed, has zero-clearance approval for sides and rear. The 37" high unit is approved for all gases, including propane, and is ideal for closet installation.—Lennox Industries, Inc.

Circle No. W16 on reply card, p. 129

Metal buildings restyled

Leading manufacturer of pre-engineered metal buildings has restyled and expanded its line to give smarter appearance, lower construction costs, greater adaptability. Important additions to the line are low-cost Wedge-Beam units in 24' and 48' modules that can form buildings up to 336' wide, in H-, L-, T-shaped or straight layouts.—Butler Mfg. Co.

Circle No. W17 on reply card, p. 129



Manufactured pools are free-form

Seven designs of packaged free-form swimming pools range in size from 12x26' to 25x44'. Available in choice of 3 types of construction (unitized panels, concrete, or steel), the pools will sell for \$3,000 to \$4,000. Packages will include filter systems and all accessories. An important feature is a vinyl liner that will reduce maintenance costs.—Cascade Pools Corp.

Circle No. W18 on reply card, p. 129



Saw cuts in any direction

All-purpose saw is claimed to be the only one of its kind that cuts flush up or down, left or right without special attachments. Two-speed operation permits cutting of wood, plaster board, composition board metals, plastics, other materials.—Stanley Power Tools.

Circle No. W19 on reply card, p. 129



Air duct needs no insulation

Round heating-cooling duct is made of fiber glass. Can be used without insulation in air conditioning systems, reduces air-borne duct noise 50%. Comes in 6' sections that install quickly, with standard sheet metal air boots, register boxes, other fittings. Gives same flow characteristics as round metal ducts.—Armstrong Cork Co.

Circle No. W20 on reply card, p. 129

Flashing has many uses

Galvanized steel flashing (24-ga.) serves equally well on ridges, in valleys, on corners or end walls, and at gables. Comes in 10' lengths, with 16" girth, 15 $\frac{1}{2}$ lb. weight. Vinyl closure strip also available for closing open ends of flashing.—Steel-tite Buildings, Inc.

Circle No. W21 on reply card, p. 129



Ranges offer new styling

Line of free-standing gas ranges has been restyled in 36" and 30" sizes. Standard features include 4 hr. timer, electric clock, low-temperature oven thermostat. Options include burner-with-a-brain, rotisserie, space heater.—Welbilt Corp.

Circle No. W22 on reply card, p. 129

Flexible flashing in 3 new sizes

Manufacturer has added 3 new widths of Saraloy 400 to its line, to minimize waste and increase maintenance applications. New sizes are: 12"x50", 18"x50" and 24"x50".—Dow Chemical Co.

Circle No. W23 on reply card, p. 129

Bonds gypsum board instantly

Instant-bonding contact adhesive laminates gypsum wallboard to gypsum backer board without temporary nailing. Joint treatment can begin as soon as face panel is applied. One gal. covers 140-180 sq. ft. Comes in 1-, 5-, 53-gal. containers.—U. S. Gypsum Co.

Circle No. W24 on reply card, p. 129



Provincial molding goes on fast

Special molding attaches quickly to give kitchen cabinets a provincial look. This eliminates need to store provincial-style cabinets, permits quick change in style of existing cabinets.—H. J. Scheirich Co.

Circle No. W25 on reply card, p. 129



Decorative walls of
CONCRETE
GRILLE BLOCK

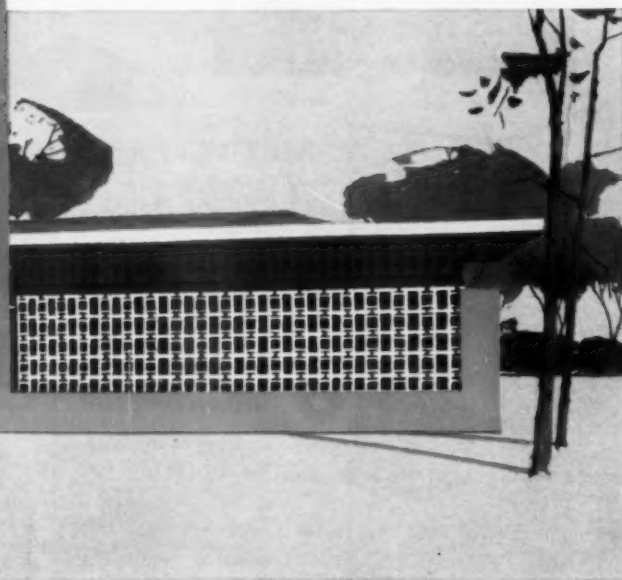

Newest way to give sales-winning beauty to your homes! For exterior and interior interest, more and more builders are turning to concrete grille block. Available now in hundreds of different patterns, this modern decorative masonry gives a fresh, custom look to accent walls, carport walls, sight and solar screens, and even space dividers. Here's a simple, low-cost way to excite buyer interest. And concrete's easy upkeep and long life are additional sales points. Grille block is one more example of how builders can use modern concrete to give homes that vital extra sales attraction.

For the newest in homes . . .
LIVING
CONCRETE

PORTLAND CEMENT ASSOCIATION

. . . a national organization to improve and extend the uses of concrete

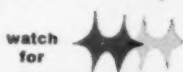

Concrete Industries **HORIZON HOMES Program**

THE
NEW
**Lindsay
Princess**

WILL SAVE
A HOUSE PAYMENT A YEAR
FOR YOUR
BUYER



5
Decorator colors

*this Lindsay water softener is
as important to your sales
as any appliance you might add*

Of all the fine "extras" builders can offer their potential home buyers, only the Lindsay "Princess" Water Softener can help make the house payments. Yes, it's a fact! Many well-known magazines and independent testing organizations have revealed that soft water plumbed in the home can save the average family up to \$117.00 a year! The homeowner saves on soaps and detergents, clothing, cooking, cleaning, etc.

Feature the Lindsay "Princess" in your homes; tell the savings story, and see how your prospects really appreciate it. Then, too, the "Princess" is beautiful, trim and modern, and comes in five colors to complement the interior decor of your homes.

Lindsay, America's leading water conditioning equipment manufacturer, has three profit-making plans for you to choose from . . . each designed to help you make extra money, and at the same time, help your customers save it.

For further, more detailed information, write The Lindsay Company today about this new, profitable program.



THE LINDSAY COMPANY

(Division—Union Tank Car Company)
1381 Marshall Ave., St. Paul 4, Minn. Dept. 14-B

Please send me additional information on the Lindsay Water Softener Plans for Profits.

Name

Address

City State

I build approximately homes per year.

NEW PRODUCTS



Disposers resist jamming

Two-model line of food waste disposers features automatic reverse system that helps clear jamming of the grinders. Adjustable sink flange makes for rapid installation by one man in standard sinks with 3½" to 4" openings. Both models connect easily to standard 1½" trap, can be hooked to a dishwasher.—*Whirlpool Corp.*

Circle No. W26 on reply card, p. 129

Decorative plastic resists fire

Only high-pressure decorative laminate to receive UL label for fire resistance is ideal for hard-use applications like public and commercial buildings. The .050" material comes in all standard patterns, colors, woodgrains and in all standard sheet sizes.—*Westinghouse Electric Corp., Micarta Div.*

Circle No. W27 on reply card, p. 129

Boiler features high efficiency

New line of 2" gas fired cast iron boilers respond to thermostat quicker, have shortened operating cycle, consume less fuel. Model 230 is prewired, preassembled, offers two optional features—a coil that eliminates separate domestic heater, and a control that blends hot and cold water.—*Bryant Mfg. Co.*

Circle No. W28 on reply card, p. 129

Submersible pumps are durable

New line of submersible pumps claims high resistance to abrasion, corrosion and fatigue. Available in 18 models, with ¼ to 5 hp, 7 to 31 stages. Maximum capacity: 1,900 GPH. Maximum service depth: 600'. Dismantling requires only screwdriver and adjustable wrench.—*Aermotor Div. of Nautec Corp.*

Circle No. W29 on reply card p. 129



Drills masonry 40% faster

Rotary-impact masonry drill is said to go through brick, tile, concrete more than 40% faster than others of comparable size. The drill, which uses standard carbide-tipped bits of ¼" to ½" dia., develops high power without relying on pressure from the operator. It also converts readily to a conventional rotary drill.—*Roto-Pak, Inc.*

Circle No. W30 on reply card, p. 129

Engineered by Edwards

INSTALL LOW COST, PACKAGED, ZONE CONTROL BASEBOARD HEAT

...build your reputation for value!

EDWARDS . . . the one dependable manufacturing source for all hydronic and electric heating and cooling equipment . . . for new homes, older homes, motels, apartment houses, schools, churches, etc. Factory guaranteed . . . virtually eliminates costly call-backs. Edwards zoned systems are competitively priced with non-zone hot air systems and are completely assembled at the factory.

OIL AND GAS HEATING UNIT

Space-saving design (3' long x 2' wide x 3' high). Completely wired. 100% automatic air elimination. Oil-fired units are completely smokeless; feature rumble suppressant design. 100,000 to 3,000,000 BTU/Hr capacities.

HYDRONIC BASEBOARD RADIATION

Lengths from 2 to 20 feet. Installation is simple and fast; quiet wire slide for 1/2" and 3/4" sizes. I.B.R. approved ratings. Available in chrome, copper-tone, wood-grain, white primer coat.

COMPACT MOTORIZED ZONE CONTROL VALVES

Sealed mercury switches. Completely silent, long life. Positive shut-off valve. Powerful electric motor gear drive. For hot water, steam or chilled water systems. 1/2", 3/4", 1", 1 1/4", 1 1/2", 2".

ELECTRIC BASEBOARD RADIATION

Ideal for new construction, remodeling or mobile homes. Low cost. Perfect for zoned heat — just plug it in. No need for pipes, ducts, furnaces or chimneys. Portable models also available. Lengths from 3' to 12' in chrome, copper-tone, wood-grain or white primer coat.

For complete data on any or all of the above EDWARDS products, write today to:



EDWARDS ENGINEERING CORP.

239-5 ALEXANDER AVENUE
POMPTON PLAINS, NEW JERSEY
TEmple 5-2808

MAY 1961



Handsome

NOVAFOLD

solid core plastic doors

*with advanced mechanical features
in the low-medium price field*

You can pay 30% to 100% more—without getting any finer folding doors. Here is a combination of strength, mechanical excellence and fine appearance that is hard to beat at any price.

The leaves are 4" wide—each having a solid core running the full height of the door. This means rigidity, even on wide spans, with good insulation and sound-deadening values.

The 12-gauge vinyl plastic covering has a luxurious leather texture. It is mildewproof, rotproof, washable and replaceable. Color-matched valances with the same solid core and vinyl plastic covering are available. Novafold Doors are made in 21 stock sizes and in six attractive colors: Off-White, Chartreuse, Dark Green, Beige, Gray and Red.

Self-lubricating nylon slides run silently on a steel overhead track. Each door folds into a 4 1/2" stack. Only a screwdriver is needed for installation; no furring, trim or roughing.

Also available . . . NOVAFOLD CUSTOM DOORS—with pantographic mechanism—for folding doors, flexible walls and room dividers . . . in sizes up to 16' high by 25' wide.

Mail the coupon today for full information on this and other fine quality Nova Products.

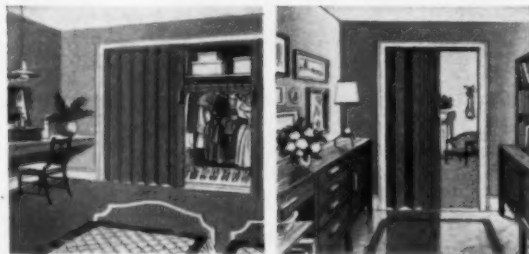

NOVA Co. SALES

A wholly owned subsidiary of Homasote Company

In Canada: Homasote of Canada, Ltd., 224 Merton St., Toronto 7, Ont.

Send the literature and/or specification data checked:

- Novafold Doors Nova Shakes and Shake-Panels
 Nova Vista-Lux (Fiberglas®-Reinforced) Panels
 Novaproofing (for waterproofing concrete and masonry)

NAME

ADDRESS

CITY ZONE STATE E-19



Give your homes
more **sell-power**
with radiant
hydronic heating



NEW and budget-priced!
BASMOR 100 SERIES
packaged gas-fired boiler

Your customers want "Automatic Sunshine"—the clean, healthful, sun-like warmth of radiant hydronic heating with a Basmor Boiler, uniformly comfortable with positive temperature control. No drafts or hot spots!

Luxury heat at small cost. With the new Basmor 100 Series small and medium size homes can now afford the finest. Deluxe extended jacket and flush jacket models, factory assembled. Both available "packaged" with circulator, full wiring and complete assembly, ready for instant installation. Three sizes, 70,000 to 120,000 BTU input/hr. for all hot water systems.

Modern, compact—fits in anywhere. Less than a yard high. Beautiful turquoise and desert sand baked enamel finish. New tubular design cast iron sections and finest controls insure top efficiency. AGA approved for installation on combustible floor.

Write for complete information!



BASTIAN-MORLEY CO., INC.
(Incorporating H. C. Little Burner Co., Inc.)
LA PORTE, INDIANA

Basmor-Little Boilers, Furnaces, Gas Heaters, Water Heaters, Incinerators.

NEW PRODUCTS



Bathroom as small as a closet

Full-size shower, full size vitreous china flush toilet, stainless steel washbasin, 3-shelf medicine cabinet, and separate towel and supply cabinet are packed into 34x42 x84" unit. Installs in a matter of hours, costs less than \$400. Comes with folding door; frosted glass, mirror or wood doors cost extra. Unit is ideal for vacation houses, or for adding a second bathroom.—*Morse Boulger, Inc.*

Circle No. W31 on reply card, p. 129



Hood meets all FHA requirements

Manufacturer's latest range hood meets all FHA requirements whether air is to be discharged horizontally or vertically; air can be directed through wall, eaves or roof. Comes prewired, in copper or satin chrome. Sizes are 24", 30", 36", 42". Has built-in light and bears 5-year guarantee.—*Fasco Industries, Inc.*

Circle No. W32 on reply card, p. 129

Machine cuts 1 1/2" dia. steel bar

New 12" cut-off machine has more power, capacity than previous model, plus hollow arbor mist coolant and retractable size gauge. Cuts 1 1/2" dia. solid round steel bar, 2x8" wood or plastic, 3/4" steel tubing or nonferrous round bar, 3x3" angles and 4" channels.—*Rockwell Mfg. Co., Delta Power Tool Div.*

Circle No. W33 on reply card, p. 129



Circuit breakers protect buyers

Line of circuit breakers and enclosures meet latest NEC code requirements for non-interchangeability. Make it extremely difficult for the homeowner to substitute breakers with excessively high ratings. Fit existing installations.—*Federal Pacific Electric Co.*

Circle No. W34 on reply card, p. 129



Efficient boiler is easily serviced

Squate jacketed boiler gives 11% more thermal efficiency, operates properly with undersized chimneys. Burner removes quickly for servicing, and boiler can be cleaned without disconnecting pipes or draining system. Extra large volume of water gives ample heat reserve.—*Koven.*

Circle No. W35 on reply card, p. 129



Foam gives double insulation

Rigid polyurethane foam has about the same density as other foams, but gives average K-factor of .14. Applies with asphalt, mastics, etc., and provides a good plaster base. Ideal where low-volume insulation is needed.—*Pittsburgh Corning.*

Circle No. W36 on reply card, p. 129

Aluminum Shutters vary sizes, styles

New line of aluminum shutters come in 16 different sizes, and in 6 baked enamel finishes—tile red, charcoal black, mint green, forest green, satin white, prime white. Dealers display available.—*Lower.*

Circle No. W37 on reply card, p. 129

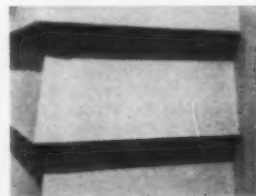

Siding gives bold shadow

Manufactured 2" siding gives deep, dramatic shadow line, but is lightweight. Consists of plastic-overlaid exterior plywood with three lumber backing strips. It's self aligning after first course, and won't cup or warp.—*Diamond Lumber Co.*

Circle No. W38 on reply card, p. 129

Metal screeds save man-hours

Job-tested system of thin metal screeds is said to cut by one-fourth to one-half the time used in setting screeds and filling screed cavities. Come in 4' lengths, good for depths of 3/4" to 6".—*Emmetsburg.*

Circle No. W39 on reply card, p. 129

DELTA

**THE
FAUCET
WITH
ONLY
ONE
MOVING PART**

DISPENSER MODELS

Delta Dispensers for soaps—hand creams—etc. fill and re-fill from the top . . . no need to get under the sink at all. Merely pull out stem—pour in contents—replace stem—and presto—you're ready to "Dispense" the easy way . . . (the Delta way).

for free literature . . . write to:

DELTA FAUCET CORPORATION
GREENSBURG • INDIANA

DELTA FAUCET OF CANADA LTD. • 2409 BLOOR STREET, TORONTO 9, CANADA



STATEMENT OF A SERVICE OF HONOR
Guaranteed by
Good Housekeeping
MADE AS ADVERTISED THEREIN

INTRODUCING...new, low cost BARCLITE XR1000 Fiberglass Panels
... give more light...last years longer! New scientific formula makes BARCLITE XR1000 absolutely weather-resistant! The reason: an improved Acrylic base resin—tougher, stronger, longer lasting than anything you've ever known. And panel after panel is absolutely uniform...identical in color, clarity, thickness, quality! Colors stay clearer, brighter, purer! Resists rust, mildew, fading. Shatterproof BARCLITE XR1000 takes on storms, stress, years of wear. (Write for results of 5-year outdoor torture tests!) Exclusive Infrablok® process insulates against heat and cold. Light in weight, easy to handle—means less installation time and costs for you. Maintenance-free! Perfect outdoors, indoors—for patios, carports, awnings, interior partitions, skylighting, glazing, roofing—wherever you want light plus strength! BARCLITE XR1000 at your lumber dealer, or write: Barclite Corp. of America (an affiliate of Barclay Mfg. Co., Inc.) Dept. AB5-XR, Barclay Building, New York 51.



"WHY I SUBSCRIBE TO AMERICAN BUILDER"

I rode American Builder 9,000 miles last month

I just figured how far I would have had to travel last month to see all the things I saw in American Builder...houses in California, New York, Michigan, Idaho, North Carolina...a neat way to pour footings in Ohio...a new twist on work planning in Louisiana...etc., etc., etc.

It figured out at a little over 9,000 miles!

Reading American Builder is one of the most important things I do. How else could I possibly keep up with the new ideas?

— A SMALL BUILDER

American Builder is the best insurance I know

Why do some builders hit the skids? From what I've seen, it's because they let themselves get out of touch.

That's a chance I don't take. Every month, I expect all my key people to stop, look and listen to what you publish in American Builder. How are the smartest builders handling their financing today? How are they cutting costs, picking design winners, merchandising their houses?

Studying American Builder is a basic part of our work.

— A LARGE BUILDER

AMERICAN BUILDER, Dept. 261, Emmett St., Bristol, Conn.
Yes, enter my subscription for one year of American Builder at \$3.50 with money-back guarantee if I am not delighted.

Amt. enclosed \$..... Bill me

Send to: _____

Address: _____

City, Zone, State: _____

CATALOGS

Lists drywall cement formulas

Technical bulletin shows formulas for drywall tape joint cements said to have superior troweling and bonding qualities.—Archer-Daniels-Midland, Prochem Div.

Circle No. W40 on reply card, p. 129

Service bodies boost truck utility

Colored brochure describes Service-Master truck bodies that save job time by keeping supplies and equipment well organized and easy to find. Also protect equipment from the weather. Bodies offered for 1/2-, 3/4-, 1-, and 1 1/2-ton chassis.—McCabe-Powers.

Circle No. W41 on reply card, p. 129

Describes liquid tile

Plastics manufacturer has just released a brochure on a compound that gives a durable tile-like finish, but is applied with spray, brush, or roller. Works on masonry, concrete, wood, metal, plaster, wallboard.—Plastic Kolor Inc.

Circle No. W42 on reply card, p. 129

For installing roof exhaust fans

Brochure describes aluminum curb said to assure trouble-free installation of roof exhaust fans. Cutaways, charts give full technical information.—Davidson Fan Co.

Circle No. W43 on reply card, p. 129

Outlines plywood specs

Full-color catalog presents full line of standard and specialty plywoods and doors for residential and industrial use. Gives technical data and specifications.—Simpson.

Circle No. W44 on reply card, p. 129

Explains submersible pump

Three-inch electric submersible watering pump is subject of colorful 8-page brochure. Cutaway drawing, application pictures included.—Gorman-Rupp.

Circle No. W45 on reply card, p. 129

Has list of heating components

Gas hydronic heating systems and components are featured in a looseleaf binder that serves as a specifying aid. Offers complete data on installation, accessories, parts, application. Prices included.—Hydrotherm.

Circle No. W46 on reply card, p. 129

Tells all about insulation

Insulations for commercial and industrial buildings are listed and described in 64-page catalog. Thumbtabbed booklet has photos, how-to information, detailed specifications.—Johns-Manville Corp.

Circle No. W47 on reply card, p. 129

Help specify tile patterns

Color comparison charts for asphalt and vinyl asbestos tile list all patterns available from nine manufacturers.—Asphalt and Vinyl Asbestos Tile Institute.

Circle No. W48 on reply card, p. 129

Abrasives for the Builder

Complete line of abrasives and related products for the masonry and concrete trades are cataloged in 2-color, 42-page book. Packed with technical data.—The Carborundum Co.

Circle No. W49 on reply card, p. 129

Explains R-factors in insulation

Manual clearly explains R-factors in insulation and the recently adopted "All Weather Comfort Standard." Shows how to get maximum benefit from insulation, vapor barrier, ventilation.—National Gypsum Co.

Circle No. W50 on reply card, p. 129

Invest In Yourself For Permanent Dividends

Books by Experts to Help You Increase Your Income—

Advance Your Business—Secure Your Future

ACCOUNTING

1. ACCOUNTING FOR MANAGEMENT CONTROL. W. H. Childs. For the man who is not an accountant but must have a good knowledge of the process. This new book (published May 1960) emphasizes the *understanding* rather than the *doing*, stresses the internal or managerial function of accounting rather than the external or public function. 727 pp. \$10.50.

ADMINISTRATION and MANAGEMENT

2. FUNDAMENTALS OF PROFESSIONAL MANAGEMENT. John G. Glover. For the man who's moving up, or wants to, this book presents the guiding principles of sound business management practice and techniques for developing managerial leadership. Includes sections on such recent developments as automation and linear programming. Clearly written in easy-to-understand language. 406 pp. \$6.50.

3. THE DEVELOPMENT OF AMERICAN INDUSTRIES. John G. Glover and Rudolph L. Lagai. A complete survey of the role of industry in the economic growth of the U. S. Thirty-six major industries (including railroading, automobile, shipbuilding, telephone, atomic energy, etc.) are discussed, history, pioneers, sales, location, earnings, future, etc. 768 pp. \$10.

ARCHITECTURE and DESIGN

4. OVER THE DRAWING BOARD. Robert Forman. A beginners introduction to architectural drawing. Many illustrations. Helpful instruction in special lettering problems, sketching, floor plans, office organization and layout, etc. 120 pp. \$2.50.

5. STAIRCASE MANUAL. J. A. Corns. Virtually the only book in print today on the design and construction of staircases and hand rails. Numerous double tip-ins provide actual design plans. 144 pp. \$7.50.

6. FORMWORK TO CONCRETE. W. F. Austin. Theory and practice of concrete formwork. Covers both timber and steel forms, tubular steel

scaffolding, plywood, composition boards and plastic linings. 288 pp. \$5

7. HOUSE CONSTRUCTION DETAILS. Nelson L. Burbank, as revised by Oscar Shaftel. Now more than 170,000 sold. The most complete and authoritative guide to home construction available. 384 pp. \$5.95.

8. HOUSE CARPENTRY SIMPLIFIED. Nelson L. Burbank, revised by Charles Phelps. The most comprehensive coverage of carpentry with hundreds and hundreds of easy-to-understand illustrations. More than 150,000 copies sold. 252 pp. \$5.95.

9. HOW TO BUILD CABINETS FOR THE MODERN KITCHEN. R. P. Stevenson. Sales now total more than 60,000 copies. Of interest to homeowner and builder. Shows how to modernize kitchen cabinets and gives complete plans and designs. 246 pp. \$4.95.

10. HOW TO REMODEL YOUR HOME. Compiled from AMERICAN BUILDER magazine. Tested remodeling methods. By the practical utilization of the information in this book, you can save cost on any remodeling job. Precise, illustrated detail. Many illustrations. 94 pp. \$2.95.

11. BOOK OF MODERN BATHROOMS. Compiled from AMERICAN BUILDER magazine. This is the most complete book on the modern bathroom available today. Its coverage includes planning, design, a portfolio of outstanding bathrooms, new product utilization and technical detail plates, with special details on floor plans, cabinets, built-ins, fixtures, floors and walls, plumbing, lighting, heating and ventilating. 112 pp. \$3.95.

ESTIMATING

12. SIMPLIFIED CARPENTRY ESTIMATING. J. Douglas Wilson and Clell M. Rogers. New sixth edition. How to "take-off" from a set of blueprints and specifications a bill of materials for the construction of a frame house is clearly explained in this book. Rules and short-cut methods for making accurate lists of building materials required for a house are described and completely illustrated. Simple arithmetical methods of accurately estimating all costs are given step-by-step. 304 pp. \$3.95.

13. SELLING HOUSES SUCCESSFULLY. Alfred Gross. One of the nation's top marketing experts shows you the tested house sales techniques to pep up your marketing program. Where to get the best value for your advertising dollar. How to point out the hidden values. How to use the model house most effectively. 160 pp. \$2.95.

STANDARD REFERENCE

14. INVESTMENTS. Douglas H. Bellemore. New second edition is practically an encyclopedia of the subject. Explains the mechanics of the market and provides sound, tested techniques of security analysis invaluable for every investor. 906 pp. \$10.

15. WORLD ATLAS. John Bartholomew. An up-to-date, sturdily bound world atlas for office use with political maps of the nations plus thirty pages of maps illustrating climate, population, distribution, shipping routes, etc. 112 pp. \$2.75.

SIMMONS-BOARDMAN BOOKS

AB 5-61

30 Church Street, New York 7, N. Y.

Gentlemen: Please send me the books whose numbers are circled below.

1 2 3 4 5 6 7 8 9 10 11 12 13 14 15

Name

Address

City Zone State

Check Enclosed

Money Order Enclosed

all the
assistance
you need for
reliable,
low cost
master tv
systems—from
**BLONDER
TONGUE**

free
system
layout

If you're planning a master TV system, Blonder-Tongue will provide a layout specifically tailored to your requirements. Send us this information: channels desired; description of picture available at location of installation (i.e. snowy, or clear); sketch of buildings; number of outlets required. Field engineering available on a fee basis commensurate with job.

free
installation
manual

Contains typical installation layouts; how to plan a master TV system; based on thousands of successful master TV installations in motels, community systems, apartment houses, schools, etc. Also available: architect's specifications.

finest master
tv system
equipment

Blonder-Tongue master TV system products (signal amplifiers, converters, etc.) provide topflight reception to more than 2 million TV receivers throughout the country. They're engineered by Blonder-Tongue to do the job best, with the least maintenance, at a sensible price. Write today to Dept. AB-5.

engineered and manufactured by

BLONDER TONGUE

9 Alting St., Newark, N. J.

Canadian Div.: Benco Television Assoc., Ltd., Tor., Ont.
Export: Morhan Export Corp. New York 13, N. Y.
Home TV Accessories • UHF Converters
Master TV Systems • FM-AM Radios

CATALOGS

On "Rayescent" lamps

Four-page brochure from Westinghouse is packed with information about new Rayescent Lamps . . . flat panels of glass with an electrical conductive film. "Electroluminescent" panels are shown in cutaway drawings, with suggested applications, size tables. Technical data on frequency and maintenance.—Westinghouse Lamp Div.

Circle No. W51 on reply card, p. 129

Outlines residential marketing plan

Well-illustrated 24-page booklet describes national promotion that's keyed to manufacturer's full line of builder products. Gives technical and cost data on electric heat.—Westinghouse Electric Corp.

Circle No. W52 on reply card, p. 129

Gives light-truck economics

Sixty-page booklet presents European manufacturer's line of economical light trucks, gives detailed cost breakdown on their performance based on actual case histories.—Volkswagen of America.

Circle No. W53 on reply card, p. 129

Introduces new freight plan

Wholesale mail-order catalog presents complete line of builder supplies. Also introduces new prepaid freight plan that helps pin-point delivered costs on more than 7,000 items.—Morgan-Wightman Supply Co.

Circle No. W54 on reply card, p. 129

Gives specs on roofers' equipment

Company's first complete catalog shows full line of roofing equipment—from one-man hoists to trailer-mounted kettles. 12-page booklet is well illustrated, has detailed specification charts.—Hauck Mfg. Co.

Circle No. W55 on reply card, p. 129

Contains varied products

Pocket-sized catalog lists and illustrates extensive line of mechanical and electrical products. Shows fasteners, screws, self-drilling anchors, core drills, expansion bolts, etc.—Holub Industries, Inc.

Circle No. W56 on reply card, p. 129

Extols decorative glass

Illustrated brochure shows many residential and commercial uses of translucent glass panels—from skylights to shower and tub enclosures. Gives detailed specs.—Mississippi Glass Co.

Circle No. W57 on reply card, p. 129

Kitchen appliances

Looseleaf folder contains 4-color illustrations of gas ranges, plus gas and electric built-ins, range hoods. Gives prices, detailed specs, unit dimensions.—Mt. Vernon Furnace & Mfg. Co.

Circle No. W58 on reply card, p. 129

Aluminum roofing and siding

Booklet describes aluminum batten roofing and siding, V-beam roofing and siding, ribbed siding sheet, perforated corrugated sheet. Gives complete specs and installation data, shows available finishes, contains color-chips.—Alcoa.

Circle No. W59 on reply card, p. 129

Features new kitchen cabinets

Wood-grain, piowite covered wood kitchen cabinet group is featured in new 16-page catalog. Booklet also includes shower and tub enclosures, vanities, bathroom accessories, etc. Specifications given.—Standard Steel Cabinet Co.

Circle No. W60 on reply card, p. 129

Panel product has many uses

Brochure describes and illustrates use of wood Versabond as floor and countertop underlayment, and as cabinet parts, shelving, closet doors, wall paneling. How-to-information given.—Weyerhaeuser Co., Sil- vatek.

Circle No. W61 on reply card, p. 129

Aids in designing schools

"Blueprint For Better Schools" presents three wood framed schools designed for varied sites.—National Lumber Manufacturers Assoc.

Circle No. W62 on reply card, p. 129

Reviews a/c control valves

Eight-page bulletin features dual-purpose year 'round air conditioning control valves. Explains how thermostatic valves cut installation costs; gives specifications, selection data.—American-Standard, Controls Div.

Circle No. W63 on reply card, p. 129

Reports on reinforcing tests

Comprehensive report goes into detail on tests of masonry wall reinforcing. Compares merits of brick header course vs. continuous wire reinforcement.—Dur-O-Wal Div., Cedar Rapids Block Co.

Circle No. W64 on reply card, p. 129

On dampproofing, waterproofing

Guide to latest methods of dampproofing and waterproofing contains specs and illustrations for use of bituminous-based coatings above and below grade. Gives application details.—Barrett Div., Allied Chemical.

Circle No. W65 on reply card, p. 129

Residential aluminum windows

Sectional drawings, installation details, specification charts are presented for complete line of residential aluminum windows.—Cupples Products Div., Alcoa.

Circle No. W66 on reply card, p. 129

For commercial remodeling

Describes new curtain wall for refacing commercial buildings with system of expanded aluminum panels.—Reynolds.

Circle No. W67 on reply card, p. 129

Keeps gas lines trouble-free

Catalog sheet has mechanical drawings, complete specs on low-cost consumer gas line filters that are easily removable for cleaning.—Air-Maze Corp.

Circle No. W68 on reply card, p. 129

Soil testing made easy

Bulletin describes procedure and equipment for simple accurate way to check moisture content of soils. No special skills required. Test takes 1-3 minutes.—Soiltest, Inc.

Circle No. W69 on reply card, p. 129

Concrete forms, accessories

Fifty-six-page catalog shows full line of concrete forms, form ties, accessories, construction specialties, highway products.—Universal Form Clamp Co.

Circle No. W70 on reply card, p. 129

For watertight concrete

Publication discusses watertight concrete, tells how Pozzolith reduces shrinkage, bleeding, segregation of concrete. Lots of technical data.—Master Builders Co.

Circle No. W71 on reply card, p. 129



BRUCE Laminated Block

*Ideal floor for
use over concrete*

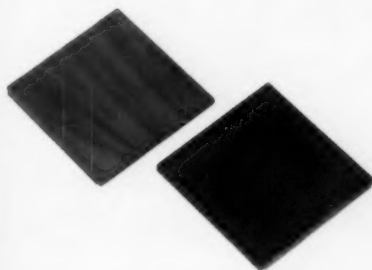

When you use Bruce Laminated Blocks you add a lot of warmth, beauty and comfort to your homes. The three plies of close-grained Southern Oak keep out concrete slab chill and dampness, yet provide foot-cushioning comfort. Heat and pressure bonding produce a highly stable unit and the famous Bruce factory finish saves labor, time and expense. Choose either light or dark finish . . . or mix them for really distinctive floors! Over wood subfloor or old floor use Bruce Blocks, strip-type for nailing. Write for color booklet. You'll find our catalog in Sweet's Files.



**E. L. BRUCE CO.,
MEMPHIS 1, TENN.**

World's largest manufacturer
of hardwood flooring

A feature floor for "special" rooms

THE DEPENDABLE FIBRE DUCT that's easier to install



SONOCO SONOAIRODUCT. FIBRE DUCT

In slab perimeter heating and cooling, do you want to hold down costs while maintaining high quality? Do you want dependability you can count on, in a system that's easily and quickly installed? Then you want SONOAIRODUCT Fibre Duct for your next slab perimeter job!

Year after year, SONOAIRODUCT has been America's best selling Fibre Duct—proving its dependability in thousands of installations. And, aluminum foil-lined SONOAIRODUCT meets or exceeds all F.H.A. criteria and test requirements for products in this category.

FREE INSTALLATION MANUAL



Contains latest, detailed, step-by-step installation data for SONOAIRODUCT Fibre Duct. For copy, send us name, address on company letterhead.

This low-cost, lightweight fibre duct saves you time, labor and money too! Easy-handling SONOAIRODUCT joins and levels quickly... can be cut to length or mitered with a hand saw. There are no sharp edges, and it won't chip, crack or break when dropped—every piece is usable!

To protect your reputation, your profit margin, and the interests of your customers, always install Sonoco SONOAIRODUCT—the Best in Fibre Duct. Available in 23 sizes, 2" to 36" I.D., standard 18' lengths. Special sizes to order.

For complete information and prices, write

SONOCO Construction Products

SONOCO PRODUCTS COMPANY, HARTSVILLE, S. C. • La Puente, Calif. • Fremont, Calif.
• Montclair, N. J. • Akron, Indiana • Longview, Texas • Atlanta, Ga. • Ravenna, Ohio
• MEXICO, Mexico City • CANADA, Brantford, Ont.

FREE SAMPLE FIBRE DUCT

Moisture-Proofed • Extra Strong • Crush-Proof • Termite-Proof the most rigid fibre duct made!

NOW SAVE 75% on MATERIAL
80% on LABOR COSTS

On Ducts for AIR CONDITIONING
and PERIMETER HEATING

INTERNATIONAL FIBRE DUCT DIVISION
3800 Park Ave., St. Louis 10, Mo.

Do away with costly metal or concrete ducts. Set up for fast installation—no delays—in heating and air conditioning. For free literature



NAME

ADDRESS

MAKE THIS AMAZING DRAWER TEST AT OUR EXPENSE!

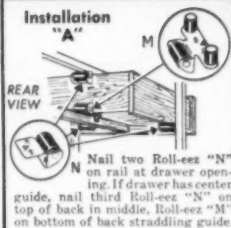

Nail two Roll-eez "N" on rail at drawer opening. If drawer has center guide, nail third Roll-eez "N" on top of back in middle, Roll-eez "M" on bottom of back straddling guide.

ROLL-EEZ "A" SET fits any size drawer... simplifies ordering & inventory problems. Send for FREE sample & literature now!

Send today for FREE sample ROLL-EEZ "A" SET. Install it on a cabinet drawer in your office or home... and COMPARE! Prove to yourself that ROLL-EEZ with Improved NYLON rollers are quicker, easier to apply... offer performance characteristics that will excite even the most discriminating prospect... can eliminate costly callbacks due to stuck, unopenable drawers... that in spite of their small size and extremely low cost, ROLL-EEZ will help you meet competition by adding immeasurably to the value and convenience of your built-ins.

JUNIOR-PRO PRODUCTS CO., 118 E. Marceau St., St. Louis 11, Mo.

NEW IT'S LIKE USING A 10 TON ROLLER

MULLER MASHER

hits with a force of 2,700 lbs., equal to a 10 ton roller, 2,500 times per minute. Travels up to 75 ft./min. Compacts 37 to 50 cu. yds. per hr., with 6" lifts. Can be used for all jobs. Low initial cost and low operating cost.

Write today for free brochure and prices.

MULLER MACHINERY CO., INC.

2 Whitman Ave.
Metuchen 4, N. J.

MULLER MACHINERY CO
2 Whitman Ave.
Metuchen 4, N. J.
National Sales and Services

Yes... please send me more information on the new Masher and your free brochure.

Your Name

Street

City

State



5508

INLAND HOMES ASKS THAT YOU

Compare

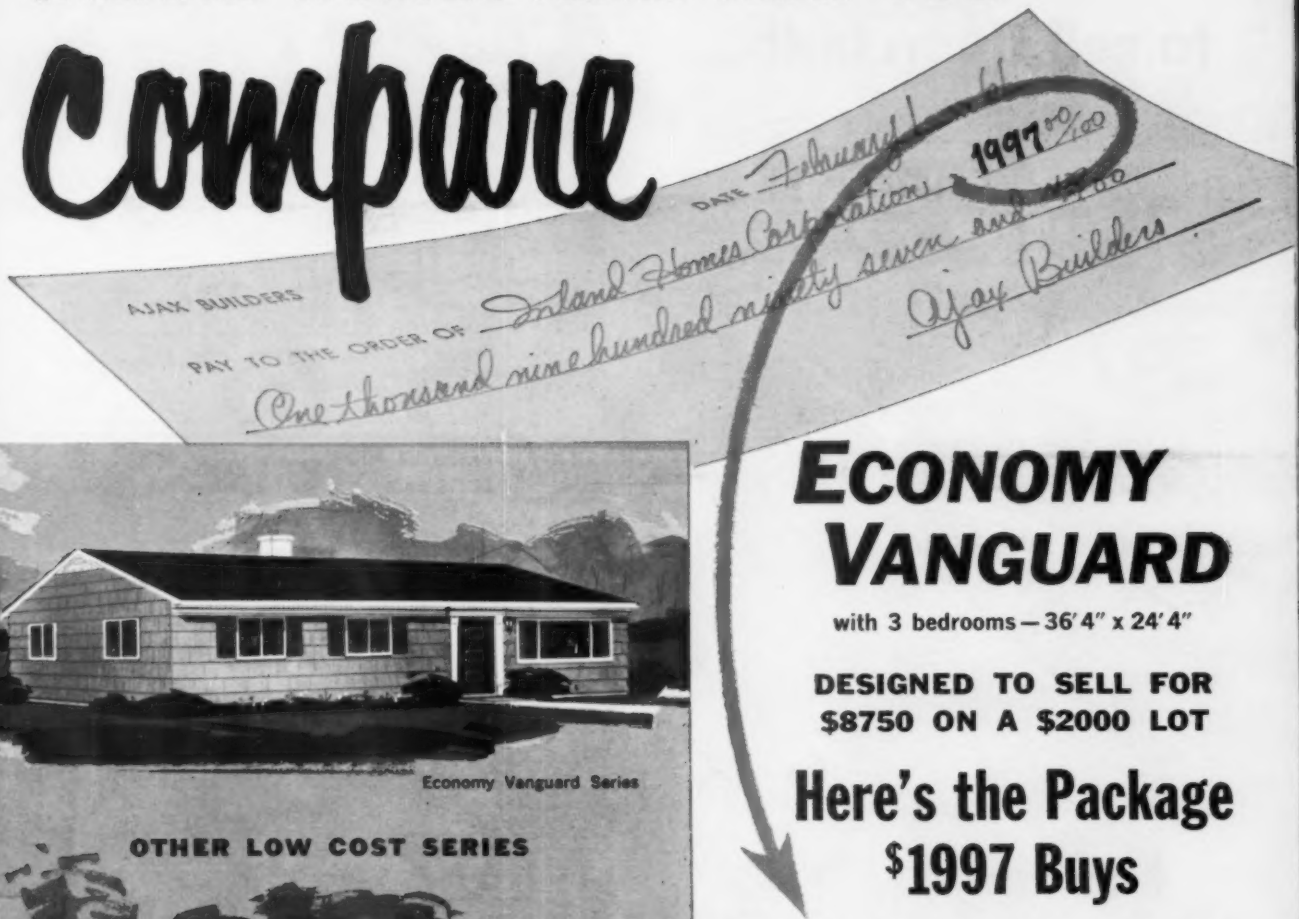

Economy Vanguard Series

OTHER LOW COST SERIES



Matador Series



Thunderbird Series



Mustang Series

©1961 - Inland Homes Corporation

ECONOMY VANGUARD

with 3 bedrooms — 36' 4" x 24' 4"

DESIGNED TO SELL FOR \$8750 ON A \$2000 LOT

Here's the Package \$1997 Buys

- Exterior wall sections with primed double coursed cedar shakes *factory applied* over impregnated sheathing
 - Prefinished exterior doors and glazed aluminum slider windows *factory installed* in the wall sections
 - Gables with cedar shakes *factory applied*, louvers installed
 - Roof trusses, roof sheathing, felt, and 210# asphalt shingle roofing
 - Primed exterior architectural trim
 - Interior partitions, complete interior trim, passage door assemblies, and closet closures
 - Ceiling insulation, rough and finish hardware, and *factory applied* weatherstripping
 - Birch wood kitchen cabinets, sink and fittings
 - 2" x 4" construction throughout
- Quantity discounts, cash discount and cooperative advertising allowances*

Prove to yourself that Inland Homes is the low cost leader. Write, wire, or phone (PR 3-7550) Neal B. Welch, Jr., Vice President-Sales, Department A-5, Piqua, Ohio

INLAND HOMES



INLAND HOMES CORPORATION
Executive Offices: Piqua, Ohio
Plants in Piqua, Ohio; Hanover, Pa.; and Clinton, Iowa

to sell them both...

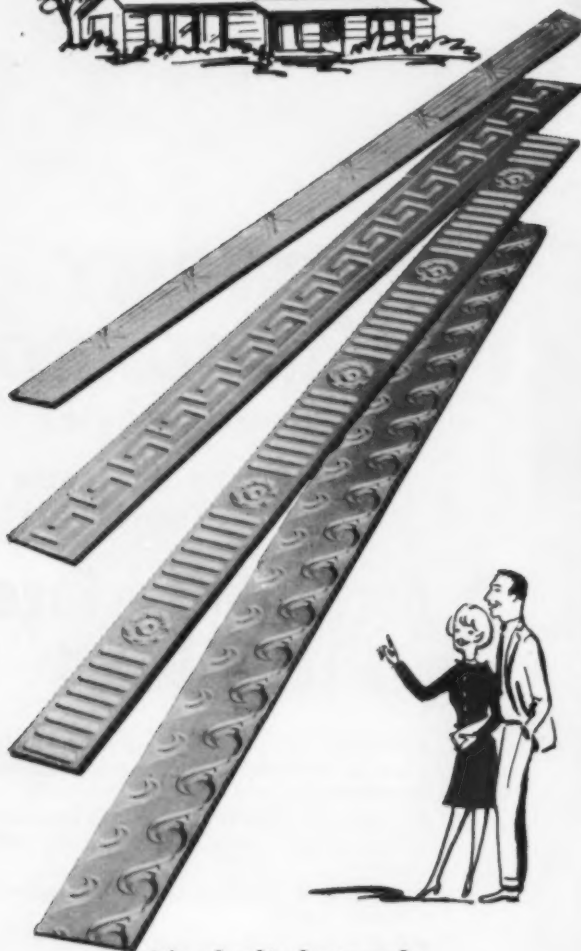

*it's the little touch
that makes the big difference*

Strategically placed decorative mouldings add eye appeal as well as dollars to the value of your houses.

Approved by Leading Architects and Builders
For free illustrated catalog, write to:



192 LEXINGTON AVE., NEW YORK 16, N. Y.
TEL: MU 6-3395

**BETTER
FAST
WHITEPRINTER
at
LOWEST
PRICE**

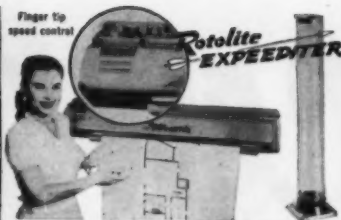

FOR INDIVIDUAL OFFICE USE

Finger tip speed control,
Dry Paper—Vapor Develop-
er. Fastest Diazo Lamp
on market. Priced below
all other makes. Rotolite
prices start at \$129.50.

ROTOLITE SALES CORP., Stirling, N. J.
Phone Willington 7-1040
Please send literature on Rotolite "Expediter"
Name _____
Company _____
Address _____ City _____ State _____
P-5

NOW

**PATENTED PUMP JACKS CUT SCAFFOLDING
COSTS 65% Over Old-Fashioned Way**

for Siding,
Painting, all
Repair work.

Moves up with your
work, on common fir
poles, by simple foot
lever motion. Auto-
matic locking action.
FAST. EASY. SAFE.
N. Y. Approved. In
use 35 years. Low
price. Cut job costs.



NEWARK LADDER & BRACKET CO., INC.
Manufacturers of Dependable Equipment Since 1902
Write today for information and FREE 4 page catalog
BOX 2, CLARK, N. J.

HELP! US HELP YOU ...
HELP! THE POST OFFICE ...
HELP! THE POST OFFICE
HELP YOU ...

This magazine is cooperating with the Post Office Department to achieve economical, efficient and fast delivery of your magazines. Please do your part by telling us what your postal zone is—if you have one. If you don't know, ask your letter carrier.

ALWAYS SHOW ZONE NUMBER
when RENEWING
ORDERING
WRITING ABOUT
SUBSCRIPTIONS

"GOOD IDEA" COUPON (clip and mail)
AMERICAN BUILDER

BOX 961 BRISTOL, CONN.

PLEASE ADD MY POSTAL ZONE

NAME

ADDRESS

CITY ZONE STATE



"These machines will really do the work!"

Jim and Andy Henderson, owners of Cheboygan Construction Company, Cheboygan, Michigan, employ two new John Deere "1010" Crawler outfits—a loader and 612 All-Hydraulic Bulldozer—and they like them:

"The machines will really do the work," reports Jim Henderson. "A contractor of our size has more use for small crawlers than larger ones. We have to keep down load limits in the spring, and would have problems moving big machines around. The size of

these machines lends them to close-quarters work, too. We use the loader and blade to backfill trench around buildings and for work inside. The full hydraulic blade is the answer to good work with small dozers."

Cheboygan Construction Company learned about the new John Deere "1010" through a dealer demonstration. To see for yourself, locate your nearest John Deere earthmoving equipment dealer through the yellow pages of your telephone directory now.



LOADERS
BULLDOZERS
BACKHOES
AND
EARTHMOVING
EQUIPMENT

Builders carve mountain

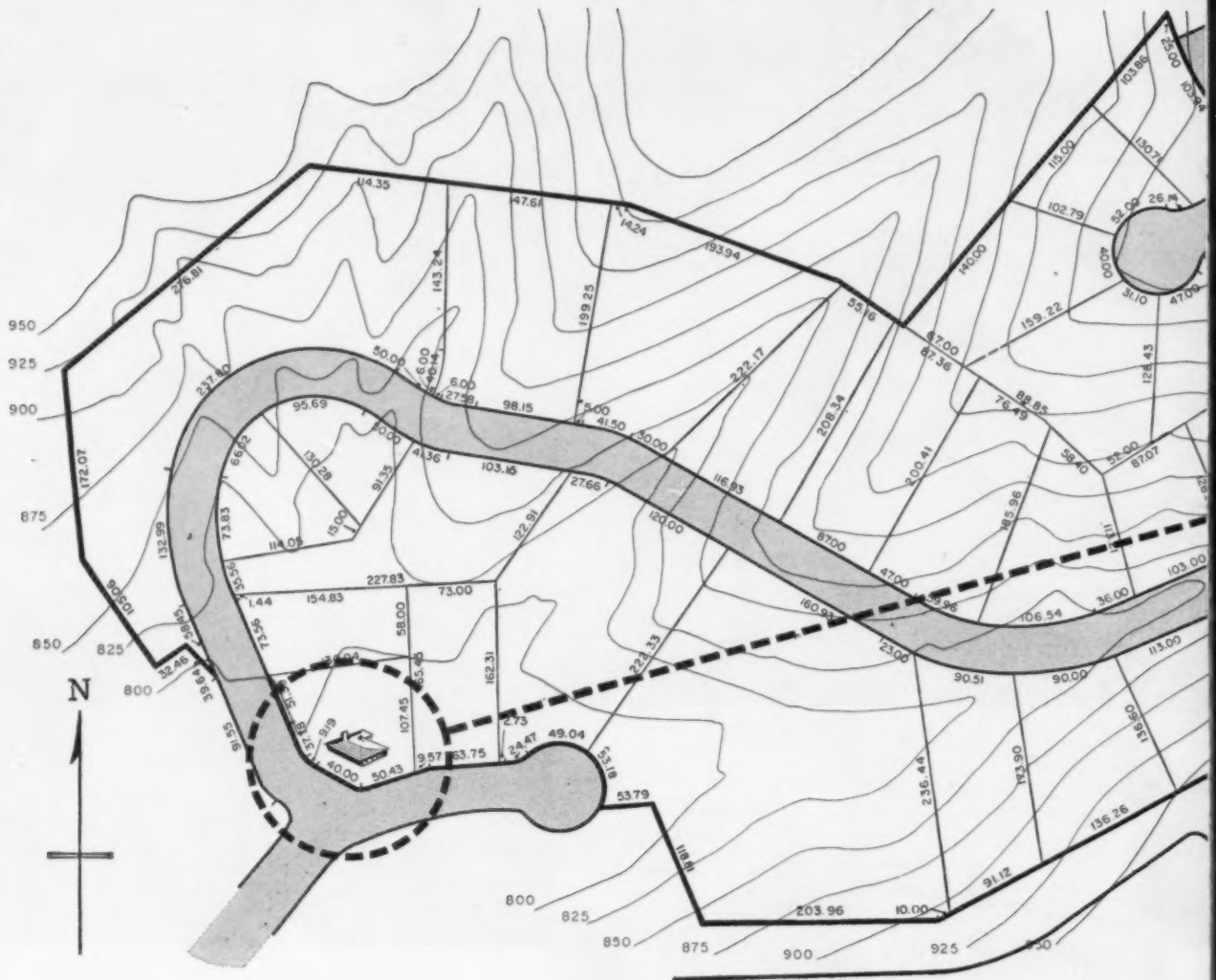

Two young pioneers tackle development of a 60-acre mountainside subdivision with their own and rented machines. Glendale, Calif. pair learn that its not only cheaper to do your own but it opens way to new opportunities

You're Carl Maginn and Charlie Gangi, a couple of young Glendale, Calif., builders who have to make the decision of your business life. That's whether to tackle the reshaping of 60-acres of rugged mountainside for a housing development.

Actually, there's no choice. You've already bought the land . . . the only kind you can get in California these days. And the lowest price quoted by an earthmoving contractor is too high

to let you go ahead with the project.

So you decide to do it yourself. The job, though, is a formidable one. Differences in elevations between high and low points sometimes reach 375 ft. involving cuts and fills of more than 100 ft. in places.

Where do you begin? You've done some grading with small machines. But this job will involve the moving of more than 1,200,000 cu. yds. of dirt. First people to see are engineers.

Barnett, Hopen, Smith and Salit of Pasadena are retained to do the engineering. They study the site and design as a starter a 15-acre section involving 34 lots requiring 100,000 yds. of cuts and 275,000 yds. of fill.

The engineers tip you off that you can get a lot of valuable information at no cost from one of the large tractor dealers, Shepherd Machinery Company of Los Angeles.

Shepherd places at your disposal the services of Civil Engineer, Horace K. Church, an earthmoving consultant. Church accompanies you to the site to analyze the soil that will have to be moved on the mountain. And the best way to move it.

Church makes a seismic analysis of

with own rigs at 29¢ cu. yd.

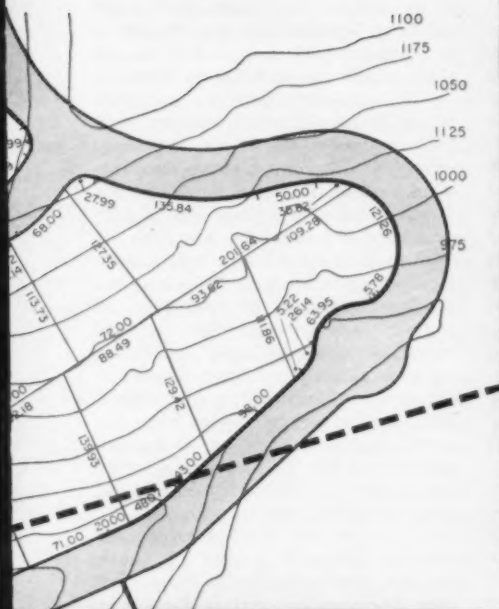

Heavy earthmovers make a cut high above first house location

Caterpillar D9 push-loads a Cat DW21 scraper full of decomposed granite that previously was ripped loose by the tractor's ripper attachment. Scrapers move fill over the side where fill

tumbles down to low areas. There a motor grader and a smaller D8 tractor spread fill in 6" lifts. Fill then is watered down by hose and tractor-drawn sheepfoot rollers compact it.

Science joins two builders to create a

the subsoil and determines that most of the material you'll have to move is decomposed granite. This turns out to be a break. You can rip decomposed granite with a heavy duty tractor ripper at reasonable cost. Had the rock been harder, expensive blasting would have been necessary. It would also require the approval of the city.

The seismic analysis also helps determine the number of cu. yds. of material per house which should be moved. This helps fix your costs.

Church supplies other cost data. This includes the direct hourly costs of operating your own machines, move-in, move-out and other overhead costs.

Then comes the obvious question: how many machines will you need to do the job? The dealer and engineer Church advise you to buy two big pieces of equipment—but to rent the rest. The idea behind this is to have the two rigs always available because they would be involved with crucial phases of the work where obstacles might be encountered.

You buy a big Caterpillar D9 tractor with bulldozer blade and ripper attachment and a Cat D8 tractor with dozer blade and tamping roller.

Together, the rigs cost a total of \$120,000. But the cost proves to be less formidable than it seems at first.

You figure it will take about two years to complete the development of the entire 60 acres. By that time the two machines will have been well depreciated.

Should there be inactive periods before completion of the work, you can figure on renting the equipment. And should house sales go well, you'll have the machines to develop other purchased hilly terrains.

Start Job

So you get to work. The first job is dozing off the top of the hill and letting the material cascade down to lower levels. Your D9 rips the decomposed granite and pushes it over the top. At the lower level the D8 spreads the material and compacts it with a sheep-foot roller. Design requirements tell you to water down and tamp the material in 6" lifts, for maximum compaction. This operation accounts for roughly half of the 310,000 yds. in the first phase of the job.

You analyze your initial costs. They prove impressive. The D9 complete with amortization costs you \$30 per hour to operate. The D8 costs you \$17.50 per hr. Two laborers hosing water on fill along with the water cost you \$10 an hr. Records show that

you move an average of 200 cu. yds. of material an hr. at an hourly total cost of \$57.50. That brings your early earthmoving costs to the remarkable unit price of 29¢ per cu. yd. So you go into the second phase of your earthmoving experiment.

The second phase involving 155,000 yds. of earthmoving will require more handling than the first phase. More equipment is needed, so you add to the fleet via the rental route. You rent two DW21 Caterpillar scrapers each at an estimated \$21.00 per hr. complete with operators. Also, a Cat motor grader with operator is rented at \$12.00 hr.

You put your D9 to work again ripping the granite. This rig does double duty push-loading the two scrapers. The D8 continues to spread fill and pulls the compacting roller.

Analyze Costs

You finish the second phase of the work and again analyze your costs. The two scrapers operate at a cost of \$42 per hr. The grader adds another \$12 an hr. to the costs. These rented units added to the \$57.50 hourly costs of the owned equipment, brings earthmoving costs for the second phase to a total of \$111.50 per hr. Moving the material at a rate of 275 yds. per hr. brings your unit costs to 40¢ a cu. yd.

Again, you're impressed. The first phase cost 29¢ a yd. to move earth. The second cost 40¢ a yd. to handle. That averages out to 34½¢ per yd. for the work that would have cost at least 45¢ a yd. if handled by a subcontractor.

Actually, you figure you're saving more than just 10¢ a yd. by doing it yourself, (though that comes to about \$31,000 on the first 310,000 yds. of earthmoving with 890,000 yds. still to go.) An earthmoving subcontractor would have had to add on a profit to his costs. And, because the job was such a tough one, he probably would have added on more money to protect himself against unforeseen contingencies. You figure that would all come to about 25% over the cost.

But these savings reflect other factors. You're not only saving money in direct costs, but you have close control over the equipment and the job. You can make on-the-spot decisions to keep costs down without submitting the changes to the subcontractor.

You're now near completion with the first phase of the work involving the first 34 lots designed by the engineers. Each averages almost ½ acre on a level pad of about 8,000 sq. ft. You figure on getting from \$13,500 to \$19,500 for the lots and between \$40,000

to \$75,000 for the houses you'll build on them. Some lots are quickly sold to get the cash rolling in, but later, you plan to sell lots and houses together.

Now you can command premium prices for the newly developed land because you've really got something to sell. The lots are high up overlooking Glendale. The view is an easy one to sell along with a "new way of life" merchandising program. The sites are close to built-up sections, within walking distance of a school. To add to the premium value of the land you will feature underground electrical and telephone wiring to avoid obstructing the view, ornamental street lights, and city sewers. Maximum grade exceeds 15%. And sewer and water lines will be stubbed into each lot so hookup costs will be low. Yet, putting in streets and utilities will run you unavoidably close to \$4,500 a lot.

So, you're still Carl Maginn and Charlie Gangi, a couple of young builders who've made the decision of your business life and it looks like you've come out winners. Not too long ago you were competitors building on scattered lots. Then there weren't many scattered lots left that could be bought at a reasonable rate. A chance meeting at your local Building Contractors Association gave you the idea to tackle the "gold in the Glendale hills."

So you bought part of a hill and suddenly found yourselves building with a brand new concept. You now were members of a brand new fraternity—the earthmovers. Before, the machines were complex mysteries; something to be avoided. Now they had become tame slaves who paved pathways to profit for you. And the strangers—equipment dealers, engineers, consultants—suddenly became familiar, helpful friends as well as business advisors.

Start Selling

But now you have to sell houses to get some money coming in. Earthmoving land will be cleared when sales reach a satisfactory level. But there's no doubt in your minds now about going on developing the raw, mountainous terrain yourselves.

You don't figure *per acre* cost on hilly land. You might buy 100 acres and be able to use only 50% of it. You *can* afford to pay up to \$2,000 a lot for raw land provided you can develop it at reasonable cost. Your problem is to see how many usable lots you can get out of it. But the total land area is sellable as a Bonus part

mountainside "new way of life"

of the community that will grow on it.

You've got time now to do a little book work on the art of earthmoving.

First, what is seismic analysis? It's simply the method by which you send a shock into the subsurface and measure the shock waves by instrument (see plate). The measurement provides quick and accurate information on subsurface materials and the depths of the various layers.

Having this information about depths and types of subsurface materials makes the most important difference in planning and making profits on almost any earth job.

The analysis—made with a seismograph—plumbs the depth to bedrock without drilling or use of explosives. It will determine the thickness of alluvium, glacial drift, soil, unconsolidated material, weathered material and the presence or absence of rock to 75-ft. depths or more.

It also helps in surveying sewer and pipe-line routes and locating and estimating the size of sand deposits.

It works rapidly, too. A builder can get complete pre-bid profiles of a terrain at the rate of $\frac{1}{2}$ to $\frac{3}{4}$ mi. a day. What impresses you most, though, is that making the analysis is simple and can be taught quickly to persons completely unfamiliar with the equipment.

An interim period allows a little time to look more deeply into costs.

Study the big D9 tractor. This is a diesel-driven machine boasting 335 flywheel horsepower. Together with the ripper attachments it costs in the neighborhood of \$70,000. You learn how inexpensively it can work for you despite (for two small builders) a seemingly overpowering price tag.

You learn that you can depreciate \$57,500 of its cost after 10,000 hrs. of operation. Depreciation along with interest, taxes, insurance, and storage gives you an hourly ownership cost unit of \$7.91. Your fuel, oils, grease, parts and maintenance, along with your operator's wage rated at \$4.63 per hr., creates an hourly operating cost unit of \$20.30. Thus, your estimated hourly expense to own and operate one of the biggest production machines made comes to \$28.21.

Look at your smaller D8 tractor. This, together with the roller, costs approximately \$50,000. Your ownership costs involving depreciation, interest, taxes, insurance and storage, come to \$5.47 an hr. Operating costs, which include fuel, oils and greases, maintenance and the operator, come to \$11.09 per hr. Thus, you find that owning and operating this heavy-duty rig comes to approximately \$16.56 hr.

You don't own the self-propelled motor scraper—yet. But analyze their costs as if you *did* own the machines. Each is priced in the \$60,000 bracket. Depreciation and overhead costs give an ownership hourly unit of \$5.65. Fuel, maintenance, and operator add an hourly operating cost of \$14.30. It would cost you approximately \$19.95 for the hourly operation of each of these big rigs. Two of them (with the tractors) balances your fleet.

The motor grader you feel is an optional machine. You could grade with the tractors; but they don't give you the motor grader control. This machine costs in the upper \$20,000 bracket. Depreciation and overhead gives you an hourly ownership cost of \$2.91. Field operating costs come to \$8.79. Hence, owning and operating the grader comes to \$11.70 per hr.

All told, your balanced fleet of two tractors, ripper and rollers, scrapers and grader would cost you nearly a quarter of a million dollars. Your fleet would cost to own and operate between \$95.00 and \$100 per hr.

But, this fleet offers you two important advantages: (1) the ability to tackle any type of earth job required for a building operation. (2) an important means of diversification. It can do earthmoving for others.

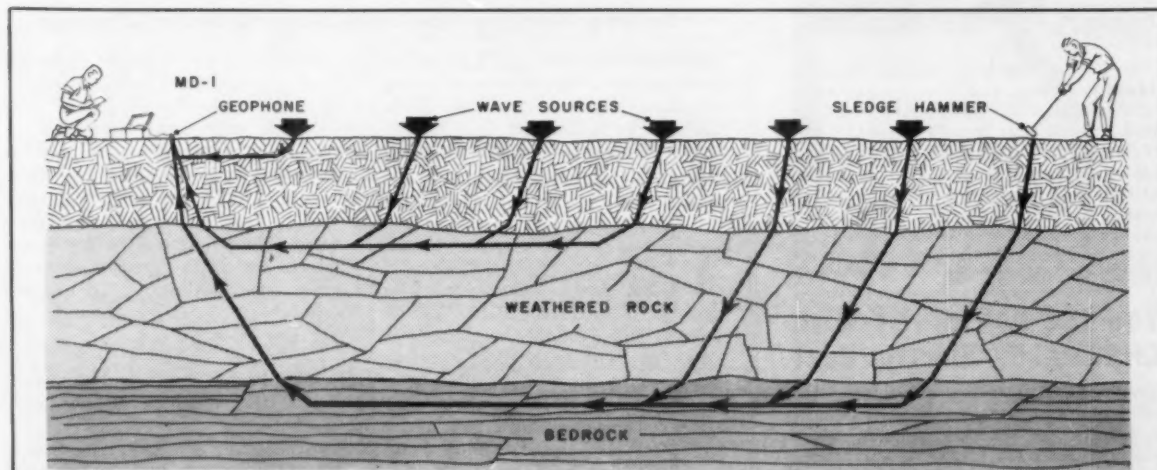

Two-man seismic probe measures and describes materials lying under surface

Key to the two-man seismic analysis is a 16-lb seismograph like Geophysical Specialties MD-1. The kit includes a sledge, insulated wire, and geophone. Operation is fast. One man with a sledge strikes a steel peg to send shock waves down into the subsurface as deep as 75 ft. Soundings made at different points

create different wave lengths that are recorded by the Geophone and registered in the MD-1. Readings provide a speedy profile of types and thicknesses of material lying below the surface. This information makes the important difference in determining quantity and cost data necessary for moving the earth.



**"CHROMALOX
electric heating
helped sell this home
5 times the first day
we showed it"**

*says E. N. Roberson
Builder, Longview, Texas*



"We have 108 lots in our Rolling Meadows tracts, and from the way we're selling all-electric homes now, we'll be building all year long!" That's E. N. (Eddie) Roberson's reaction to a selling idea suggested and urged by Chromalox Distributor Carl Hagen. 1,000 adults visited Roberson's all-electric 3 bedroom model home the first weekend it was on view. Five bought, many others went on the active prospect list.

You too can profit with CHROMALOX Electric Heat

Your customers will go for safe, clean, efficient electric heat and the neat, modern appearance of the new, only 6" high, Chromalox PRIM TRIM® electric baseboard heaters. And you'll go for the savings in installation costs—up to \$500, per house.

To learn more about Chromalox electric comfort heating, send for new Bulletin No. 975, or ask for name of nearest Chromalox Sales Engineering Representative.



WR-1



EDWIN L. WIEGAND COMPANY
7742 Thomas Boulevard, Pittsburgh 6, Pa.
Churchill 2-6400
CHROMALOX ELECTRIC HEAT

ASK THE EXPERTS

Oriental roof is easy to build

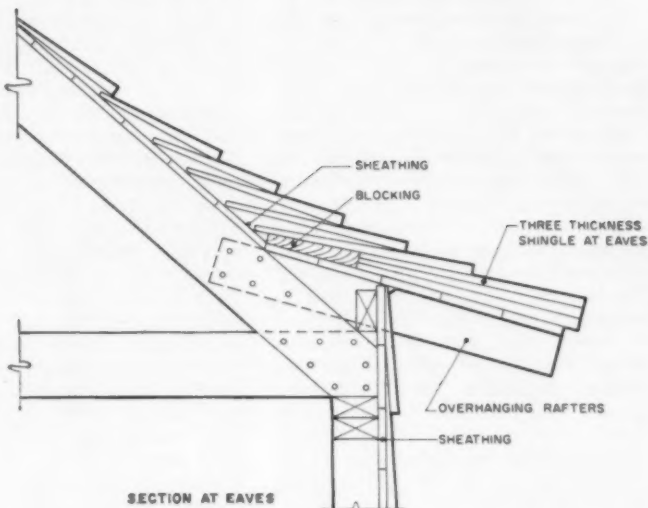

QUESTION: Can you show us an easy way to simulate oriental design, in either hip or gable roofs? Which type of roof would be the easiest?

Rush Bros. Builders
Modesto, Calif.

ANSWER: Just break the roof line at the eaves, as shown in the above sketch. This method works with either a hip or gable roof. However, a gable roof would be considerably easier.

The Editors

Twisting, checking reduced by proper selection of beams

QUESTION: How can I reduce or prevent twisting and/or checking of an exposed structural grade Douglas fir beam after installation? Also, does checking (or horizontal splitting) of these large beams weaken them seriously?

A. Hothan
Downers Grove, Ill.

ANSWER: Beams that contain the pith of the tree (called "boxed heart") have more tendency to check or twist than those that do not contain the pith ("side cut"). Checking and twisting are caused by shrinkage that results from drying after installation. It may be practical to require that beams up to 3 or 4 inches thick be dried to about 15% moisture content before use. Thus, beams that are most likely to check or twist can be detected and not used in exposed work. With thicker beams, the moisture content requirement is impractical; best way to minimize trouble is to use only those that are side cut.

Checking and splitting have little

direct effect on strength of beams used under normal loadings in residential construction—unless the beam is split more than half in two. However, splits that run at an angle to the length of the beam are an indication of cross grain, which has a pronounced weakening effect. The strength reduction is not serious unless the general slope of grain (disregarding local deviations around knots) exceeds about 1 inch per foot of length.

J. A. Liska
Forest Products Laboratory
U.S. Dept. of Agriculture

Do you have a
construction problem?

Write to:
Ask the Experts
c/o American Builder
30 Church Street
New York 7, N. Y.

ASK THE EXPERTS

Closet becomes powder room

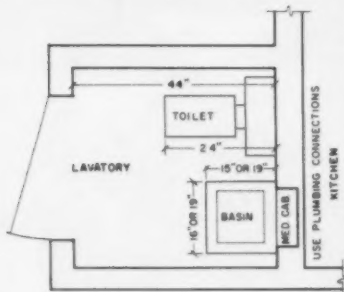

QUESTION: I have a summer house with only one bathroom, and would like to convert a 44"x44" closet that adjoins the kitchen into a powder room. Can you give me a plan for this conversion?

Dora Bailey
Brooklyn, N.Y.

ANSWER: Follow the above plan, and you should have little trouble. The proximity of the kitchen will simplify the plumbing job, and the wall-hung fixtures will simplify your cleaning problems in the small floor space.

The Editors

Why switch problems?

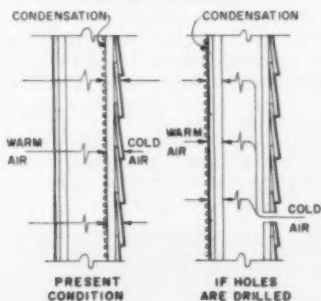

QUESTION: My frame house has a moisture problem that's blistering the paint on the outside walls. Would it help if I drilled 1/8" dia. holes in the exterior walls?

Richard Ederati
North Aurora, Ill.

ANSWER: While drilling the holes might solve your original problem, it could create an even worse one. By letting in cold air, you are likely to cause condensation on the inside walls, where the warm air meets the cold wall (detail above).

We suggest using one of the new latex-based, blister-resistant paints on the siding, following the manufacturer's instructions.

George A. Kennedy & Assoc.
Structural Engineers



The measure of Success

CALL COLLECT

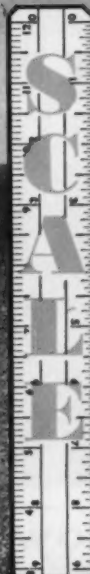

COMPARE

SIZE: DIGS FROM 4" TO 16" WIDE AND UP TO 6' DEEP

COSTS: AS LITTLE AS 2c PER FOOT!

RELIABILITY: JOB PROVEN!

LIFE: AS HIGH AS 1/2 MILLION FEET!

EASE OF OPERATION:

See a demonstration!

CALL COLLECT!

CHARLES MACHINE WORKS, INC.

CLASSIFIED ADVERTISING

The Market Place for buying and selling used merchandise, help wanted, positions wanted, and other classified listings.
Rates—\$7.50 minimum for 40 words or less. 15c for each additional word.
Display Classified—\$35.00 per inch. Reverse plates not accepted. No illustrations. No agency commission or cash discount. One column only—2 1/4 inches wide. 2 inches maximum. Signature cuts and trade names allowed.

POSITION WANTED

Dynamic, energetic young French Assistant Sales Manager of important firm, excellent sales record, wide French market experience, seeks post in U. S. as manager export to European Common Market. Chief experience building cranes, public works equipment. BOURASSIN, 6 Residence Dulac-Plaisance, Maison Alfort, Paris, France.

POST OFFICE WILL NOT FORWARD MAGAZINES!

You must write us, prior to moving if possible, giving both old and new address, also postal zone. Allow three weeks for change.

AMERICAN BUILDER
BOX 961 • BRISTOL, CONN.

GET INTO THE SWIMMING POOL SUPPLY BUSINESS!

WE take the Risk... YOU take the Profits...

modern
POOL EQUIPMENT AND CHEMICALS

Highly seasonal, but highly profitable . . . that's the danger and the lure of the Pool Supply Business. Now Modern eliminates the risk . . . gives you a one-step resource for your complete department . . . guarantees the sale of your stock to 90% of your initial order . . . supplies the know-how you need for a profitable operation. You're in the business at the start of the season . . . out clean when the season ends . . . and you've made money all the way. Write on your letter head for complete details without obligation.

FREE!

The industry's most complete "bible" . . . 48 pages of authoritative facts on pool care and operation PLUS descriptions, photos, prices on every item required for pool construction, operation and maintenance.



MODERN, One Holland Ave., White Plains, N. Y.

PRINT NAME _____

ADDRESS _____

CITY _____ STATE _____ 21E



DIGGING • LIFTING
HANDLE WITH CASE
Utility
 GRADING • CARRYING

How big a tractor do you need for basements, materials-handling, grading?

If you build 5 to 25 houses a year, you may not need as big an outfit as you think

Why use a big expensive tractor that costs you \$27 per day or more, when your general excavating, grading and materials-handling work can just as easily be done by a Case 310 Utility Loader... for only around \$9 per day? These per-day costs are an estimate of what it would cost you for depreciation, taxes, insurance and interest every day, for a 200-day work-season. Even if you use a different accounting method, you'll find the relationship still true... over 60% per-day saving in favor of the Case 310.

Consider these jobs:

BASEMENTS—Let's agree that a bigger rig may dig a basement faster than a 310. But if the larger rig finishes the job and then "sits idle", the high daily "ownership" cost quickly offsets extra operator-time for the Case 310. So in reality, your "310-dug" basement costs the same or less, and yet you have reduced your investment cost over 60%.

EXPEDITING, MATERIALS-HANDLING—You probably couldn't afford to have a \$135-a-week machine "sitting" on your job while you're framing and finishing a house. But a \$45-a-week Case 310 offers constant opportunities for extra cost-savings, if used just a couple hours a week—to move dirt-piles for easier access by employees and sub-contractors, for closer unloading of materials, and to carry lumber, siding, roofing, block, brick and mortar right to workmen... even through deep mud.

GRADING—You can readily see that a utility-size machine offers cost-savings in its speed, maneuverability, and precise control of finish grade around houses. But a Case 310 will also make extra money on larger-yardage dirtmoving, too... whenever "sit-idle" costs of a larger rig exceed added operator expense for the 310.

A low-cost Case 310 Utility Loader develops 5815 lbs draw-bar pull. Available with high-torque Case gasoline or diesel engine, it digs easily, gets heaped ¾-yd bucketloads. Machine reverses direction instantly... turns short smoothly with power on both tracks. Loader lifts 3500 lbs to full height, dumps clean with 8'10" clearance for fast dump-and-go. This unit may be equipped with scarifier or winch, and interchangeable front pallet fork, log fork or dozer blade for specialized or off-season work. And, in addition, it costs less to move the 310 from job to job, than a bigger rig.

See how Case 310 Loader can make extra profit on your general excavating, grading and materials-handling, at 60% saving in outlay. Ask for free demonstration right on your job. Or send coupon for machine details.



310 Power-Angling Dozer

Case 310 tractor with wide-mount hydraulically-operated 92" blade pushes dirt quickly where you want it. Blade angles to 25° right or left on-the-go, offers blade "float" for easy pushing of rough-grade dirt and for fine "back-blade" finishing.

J. I. CASE CO., Dept E-1401, Racine, Wis.

Send free information on Case 310 machines:

3500-lb loader Power-angling dozer Other

Name Address

Position City

Company State

CASE *Utility*

BUILDING WITH BRAINS

Johnny-on-the-spot materials save roof framing time and labor



To shave production costs, Builder-Developer Don Decker, Omaha, Nebraska, uses this framing system.

Rafters are pre-cut and notched at the firm's cutting yard. Then the components are trucked to the building site where crews sort them. Stock that's too short to be propped against the structure is tacked to the sheathing. Parts are carefully spotted where they will be used.

When roof framing crews arrive on the job, the material is ready to go; the carpenters simply reach down for the rafter they need as they raise the roof. No "ground" crew is necessary.

Smart countersinking trick tightens joints, speeds job

When installing tongue-and-groove paneling and flooring, it's often difficult to get a tight joint.

Next time, try punching galvanized 4-penny common nails into the surface with the side of your countersink, as shown. Schaefer Brothers, Westport, Conn., say this system not only forces the joints together, but eliminates nail drive-through and damage to the stock. Galvanized nails hold stock best.

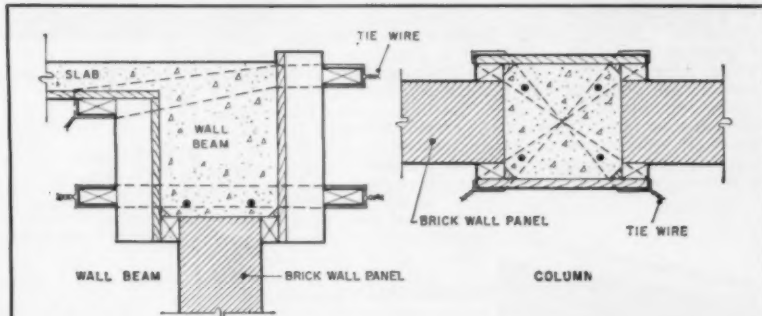

Short-cut for fabricating concrete columns and beams

To keep crews busy, Robert L. Reisinger Co., general contractors, Milwaukee, Wisc., put together this better way to build concrete columns and curtain walls:

Foundations were placed first; then brick curtain wall panels with column-sized gaps between.

Carpenter crews then built forms for columns and wall beams, using the brick panels as a base.

Forms are held together with tie-wires; very little bracing is needed. Forms for the wall beams were fabricated on top of the wall so no beam bottoms or shores were required.

Less dig, little more fill saves this builder more money per job

Bookkeeping totals show Builder Don Decker, Omaha, Nebraska, that he can put in footings cheaper by:

- (1) Having his excavation crews dig about 4 inches deeper for basements;
- (2) Having shovel workers trench out an additional 4 inches below this depth—along a prescribed course.

- (3) Forming up for the 8-inch footings—above the trench—with utility grade 2x4 forming members on edge.

After the concrete is placed and screeded for footings, the forms are removed and sand-and-gravel fill is spread to bring the surface to level.

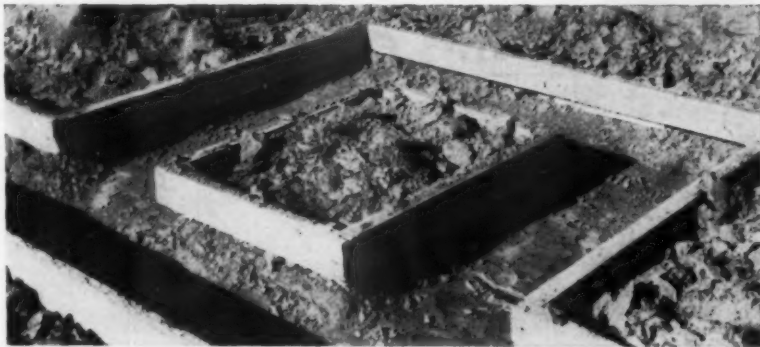

NOW! Earn Better Pay
This Easy Way

CARPENTRY ESTIMATING

... QUICK ... EASY ... ACCURATE
with this simplified guide!

You can earn higher pay when you know how to estimate. Here is everything you need to know to "take-off" a bill of materials from set of plans and specifications for a frame house. Saves you time figuring jobs, protects you against oversights or mistakes that waste materials and cost money. Nothing complicated—just use simple arithmetic to do house carpentry estimating with this easy-to-use ready reference handbook.

SIMPLIFIED CARPENTRY ESTIMATING

Shows you, step by step, how to figure materials needed for (1) foundation, (2) framing, (3) exterior finish, (4) interior finish, (5) hardware, and (6) stairs. Gives definite "take-off" rules, with many quick-reference tables and short-cut methods that simplify the work.

SPECIAL FEATURES: Lumber Checking List. Mill-work Checking List. Hardware Checking List. Materials Ordering Information. Quick-Figuring Tables for estimating concrete footings and walls, concrete piers, window frames, door and window areas, sash weights, nail quantities. How to figure labor hours per unit of work. Rules for linear, area and volume measurement. Mathematical reference tables, including decimal equivalents, lumber reckoner, conversion of weights and measures, etc. New chapter, "How to Plan a House," gives useful data for contractors and material dealers.

TURN TO CHAPTER 8

when you receive this book, and see the "Estimating Short Cuts" you can use for quick figuring of board footage. Here are simplified ways to estimate lumber needed for floors, walls, ceilings, roof, door and window frames, inside trim for these frames, inside trim for inside doors, and drawers and cabinets. This chapter alone can be worth the entire price of the book to you!

NO RISK TRIAL—ACT NOW!

Just fill in and mail coupon below to get your copy of "Simplified Carpentry Estimating." See for yourself how this valuable, easy-to-use reference handbook can tell you everything you need to know about all phases of carpentry estimating.

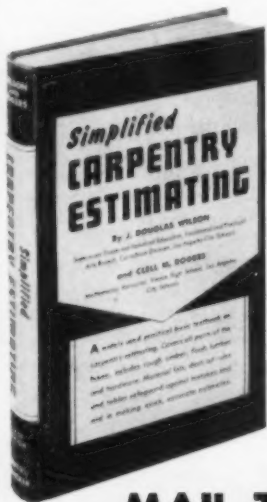

MAIL THIS COUPON

SIMMONS-BOARDMAN Dept. AB-5-61
30 Church Street, New York 7, N. Y.

Send me "Simplified Carpentry Estimating" with the understanding that if I am not completely satisfied I can return it in 10 days for FULL REFUND. enclosed is \$3.95 check money order

Name
Address
City Zone
State

INCREASE HOME SALES IN 1961 THIS PRACTICAL WAY—

give your home buyers a copy of THIS IS YOUR HOME—use it these four practical ways:

1. AS A DIRECT SALES AID. . . . Your looseleaf "builder's edition of This Is Your Home has extra space on the dedication page. This allows you to give personalized copies to each purchaser of your homes.
2. AS AN INDIRECT SALES AID. . . . Give each home buyer an appreciation of your own skill—with a book that points out the craftsmanship and hidden values in your homes.
3. AS A PRESTIGE BOOSTER. . . . Your special looseleaf edition allows you to insert a model home picture with instruction sheets about materials and appliances used in the home.
4. AS A GOODWILL BOOSTER. . . . Home buyers will appreciate the "do-it-yourself" emphasis and these essentials of good home maintenance eliminate expensive, unnecessary service calls for you.

Look at this book through the eyes of your home buyers, and you'll see a substantial increase in your own sales.

Order a copy today and see how readily this recently published book will fit into your home sales plans.

Sample price, looseleaf Buckram binding, \$4.75 per copy (plus 30¢ for your business name, gold stamped on cover.)
Case bound edition (not looseleaf) \$3.95 (quantities only stamped 30¢ extra.)

Simmons-Boardman Pub. Corp.
Dept. AB-5-61
30 Church Street, New York 7, N. Y.

Yes, rush me a sample copy of THIS IS YOUR HOME for which I enclose \$..... (\$4.75 per copy, \$5.05 per copy with name stamped) or bill me.

Name

Street

Address

Imprint as follows:

A Guide to Your
Financial Success

INVESTMENTS

Principles, Practices and Analysis

by DOUGLAS H. BELLEMORE

Professor of Finance,
New York University.

An exhaustive treatment, just published of basic investment principles and current practices designed to provide the investor with authoritative and time-tested guidance in formulating sound individual or institutional investment policy. Several chapters are devoted to the important problem of how to analyze the worth of an individual security. An entire chapter is devoted to the analysis of railroad securities. Clearly written, scores of charts and tables, 898 pp., 6 x 9, cloth bound. \$10.00.

Simmons-Boardman Books, Dept. AB 5-61
30 Church St., New York 7, N. Y.

Send a copy of Bellemore's INVESTMENTS, for which I enclose \$10.00 (we pay postage if remittance accompanies order).

Name

Street

City State



Assembly-line technique helps masons set concrete blocks faster

Detroit-born and builder-adopted automation methods have helped Minneapolis Builder Marvin Anderson speed concrete block foundation jobs in his developments.

After one wall is practically installed,

it is used as a "conveyer belt" to feed materials to blocklayers at the point where the wall goes at right angles.

The mason's helper simply stacks the blocks along the top course of the adjacent wall and shoves them along to

supply the block masons.

Staggered in a series of five or so, the blocks are easy to push into position, making continuous feed fast.

Blocks for the helper are stacked in the foundation square.

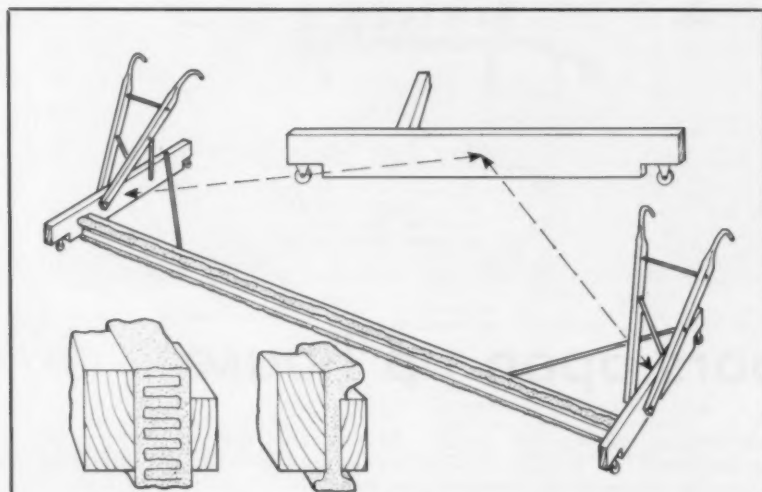

Here's better way to apply liquid hardeners to concrete

The Allen Construction Co., Quincy, Ill., thinks this tested, shop-made rig is a great time-saver in spreading liquid hardening compounds to concrete.

Main element of the rig is a long brush made by sandwiching 6" glass-fiber insulation between a 2x4 and

1x4. The brush runs between two 2x6s, fitted with casters. Pair of old plow handles is bolted to each 2x6. (Any handles will work.)

In operation, the rig is pushed forward and back by two men, while a third crewman throws curing compound in front of the rig,

Dormer roof sealing is easy with this tested-technique

On many houses with high-pitched roofs, leaks occur fast above the dormers—especially when they're flat.

You can solve this problem, says Builder Arthur N. Nelson, Kansas City, Missouri, by providing a good seal first—underneath the shingles. How?

Use two layers of 15-lb. building felt with one layer of plastic vapor barrier sandwiched between. After you drive in the nails, don't remove them.

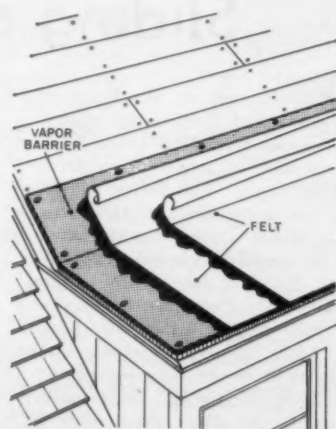

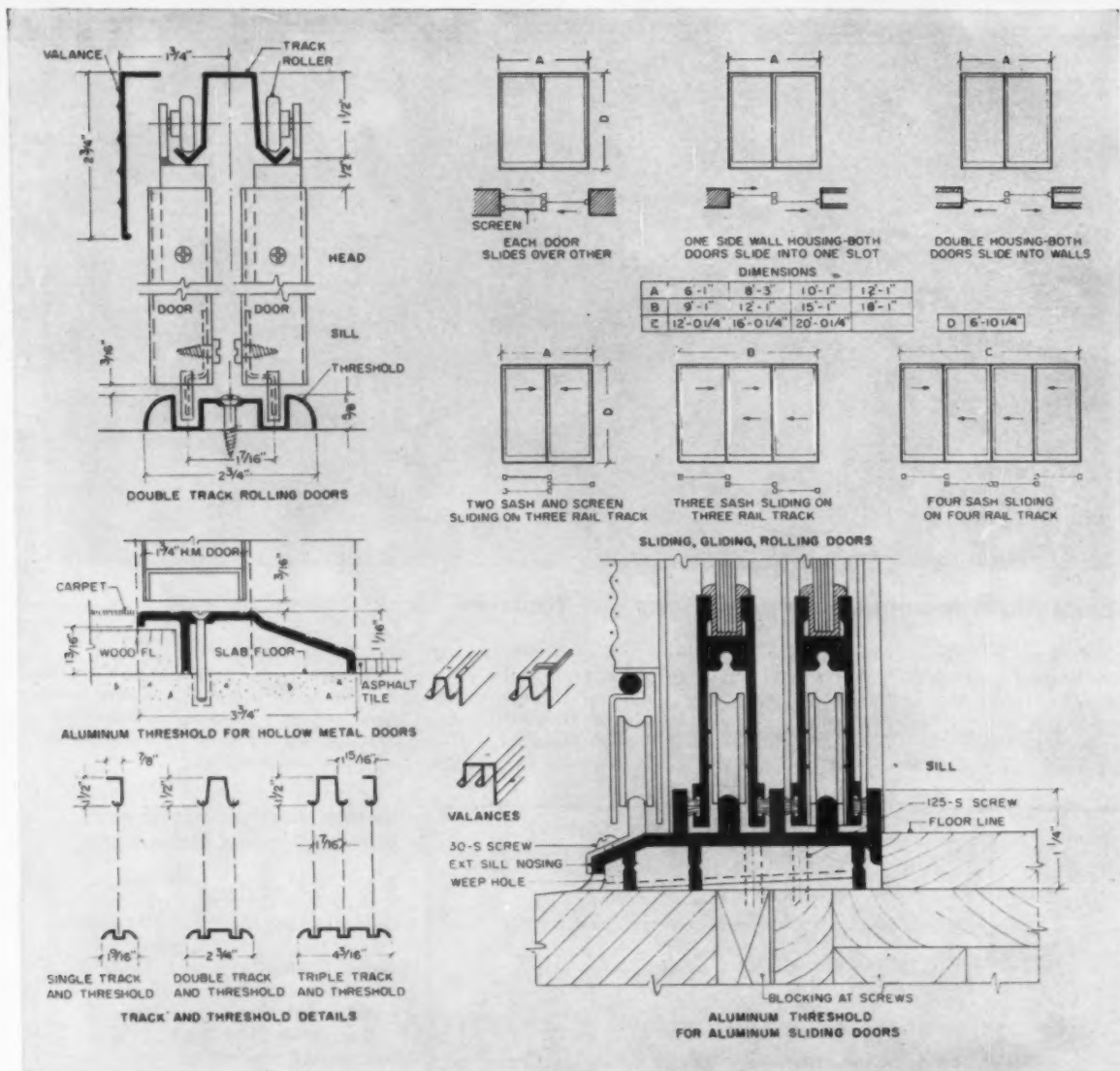

Sliding doors open up house

Any builder on his toes knows that a satisfied homeowner today is one who can spread his living beyond the four walls of a house onto terrace, patio or porch. The buyer wants to enjoy life under the sun and stars as well as under a roof. Luckily a wide selection of sliding glass doors helps to achieve this aim; doors made of metal and wood, in a number of sizes and with price tags to satisfy any pocket-book. Many come with easy-to-install screens, turns room into porch.

However, to gain maximum comfort and enjoyment from these wide ex-

panses of glass and screening, special attention should be paid to certain architectural details. Eaves should be wide enough to control the hot rays of a summer's sun; exposures should be away from strong regional winds. Otherwise the doors can be used on both traditional and modern design. Since most units come as package jobs, they are equipped with well engineered frames, hangers and weather-stripped saddles to keep out drafts and dirt.

The most popular sliding glass doors are of either wood or aluminum although steel has also proven suitable

for residential work. If quality products are used, units can be used as soon as installed.

On track rolling doors, the roller assembly at the head is completely concealed and can be easily adjusted to suit variations in the height of an opening or an out-of-plumb condition. Differences up to 3/4" can be quickly rectified by the loosening of a single screw and the moving of a special ratchet mount. Adjustable lower guides, concealed inside the tubes, meet variable conditions and assure smooth operation.

Advertiser's Index "The better you buy—the better you build—the better you sell"®

A

Abitibi Corporation	53
Alco, Inc.	55
Aluminum Company of America	20, 21
American Builder	54, 160
American Gas Association	117
American-Olean Tile Company, Inc.	51
American Telephone & Telegraph Co.	133
Anaconda American Brass Co.	75
Armco Steel Corporation, Sheffield Division	52

B

Barclay Manufacturing Company, Inc. ..	143
Bastian-Morley Co., Inc.	142
Bell & Gossett Company	34
Bendix Moulding	150
Berger & Sons, Inc., C. L.	137
Berry Door Corporation	35-38
Bird & Son, Inc.	70
Blonder-Tongue Laboratories, Inc.	146
Bostitch	71, 72
Bruce Co., E. L.	147

C

Case Co., J. I.	158
Cedar Rapids Block Co. Dur-O-wal Division	39
Celotex Corporation, The	66, 67
Charles Machine Works, Inc.	157
Chevrolet Division of General Motors ..	60, 61
Classified Advertisements	157
Columbia Mills, Inc., The	128
Crane Co.	22
Curtis Companies Incorporated	16

D

Delta Faucet	143
Dexter Lock Division, Dexter Industries, Inc.	42
Dodge Reports, F. W. Dodge Corporation	46B
Dur-O-wal Division, Cedar Rapids Block Company	39

E

Edwards Engineering Corp.	141
--------------------------------	-----

F

Fasco Industries, Inc.	6
*Fibreboard Paper Products Corporation, Pabco Building Material Division 72F, 72G 72J, 72K	
Flintkote Company, The Van Packer Division	24
Ford Division, Ford Motor Co.	120, 121
*Forest Fiber Products Company	72I

G

General Electric Co., Medallion Homes ..	76
Georgia-Pacific Corporation	12
Gerber Plumbing Fixtures Corp.	50
Grant Pulley and Hardware Corporation	18D
*Great Lakes Carbon Corporation, Palos Verdes Stone Dept.	72H

H

Holub Industries, Inc.	128
Homasote Company	26
Homasote Company, Nova Sales Company Subsidiary	141
Hunter Division-Robbins & Myers, Inc.	10

*Appears in Western Editions Only.

I

Inland Homes Corporation	149
Insulation Board Institute	40, 41
Insulite Division, Minnesota and Ontario Paper Company	62, 63
International Oil Burner Co.	148

J

John Deere Industrial Division	151
Junior-Pro Products Co.	148

K

Kaiser Aluminum & Chemical Sales, Inc.	47, 48, 49
Kentile, Inc.	Cover 3
Koppers Company, Inc., Plastic Divi- sion	124, 125
Koven & Bro., Inc., L. O.	137
Kwikset Sales and Service Company ...	15

L

Lau Blower Company, the Lau Builder Division	46A
Lau Builder Division, Lau Blower Com- pany, The	46A
Lawyers Title Insurance Corporation ..	30
Lindsay Company, The, Division—Union Tank Car Company	140

M

Macklanburg-Duncan Co.	32, 33
Masonite Corporation	118, 119
Meadows, Inc., W. R.	138
Minnesota and Ontario Paper Company, Insulite Division	62, 63
Modern Swimming Pool Co., Inc.	157
Morgan-Wightman Supply Co.	136
Muller Machinery Company, Inc.	148

N

National Concrete Masonry Association	4
National Gypsum Company	18B, 18C
National Manufacturing Company ..	Cover 4
National Oak Flooring Manufacturers' Association	28, 29
Newark Ladder & Bracket Co., Inc.	150
Nova Sales Co., Subsidiary of Homasote Company	141
NuTone, Inc.	Cover 2, 1, 2

O

Onan Division, Studebaker Packard Corporation	31
Overhead Door Corporation	122, 123

P

*Pabco Building Material Division, Fibre- board Paper Products Corporation 72F, 72G, 72J, 72K	
*Palos Verdes Stone Dept., Great Lakes Carbon Corporation	72H
Panel-Lift Door Corporation, Subsidiary of Standard-Toch Industries, Inc.	3
*Pioneer Manufacturing Co.	72C
Porter-Cable Machine Co.	23
Portland Cement Association	139
Potlatch Forests, Inc.	74

R

Revere Copper & Brass Incorporated ...	126
Richheimer Modernizing Systems, Inc. ...	128
Robbins & Myers, Inc., Hunter Division	10
*Roberts Co., The	72E
Roberts Mfg. Co., Rangaire	19
Rolscreen Company	25, 27
Rotolite Sales Co.	150
Ruberoid Co., The	73

S

Seal-Draft Division, Sun Screen Products, Inc.	131
Sheffield Division, Armco Steel Corpora- tion	52
Skill Corporation	8
Sonoco Products Company	148
Spotnails, Inc.	18A
Standard-Toch Industries, Inc., Panel- Lift Door Corporation, Subsidiary of	3
Stow Manufacturing Co.	132
Studebaker Packard Corporation, Onan Division	31
Sun Screen Products, Inc., Seal-Draft Division	131

T

Thompson Co., Inc., E. A.	131
--------------------------------	-----

U

Union Tank Car Company, The Lindsay Company Division	140
Upson Company, The	58, 59

V

Van-Packer Company, Division of The Flintkote Company	24
Virden Co., John C.	64, 65
Volkswagen	134, 135

W

West Coast Lumbermen's Association 68, 69	
Weyerhaeuser Company, Lumber and Plywood Division	18
Wiegand Company, Edwin L.	156

© 1961, American Builder

Advertising Sales Staff:

Advertising Sales Manager	A. W. Brownell, II
Manager of Sales Service	Alex McBride
Sales Promotion Manager	Bernard L. Perry
Production Manager	John V. Mitchell
Manager, Contract Dept.	Constance Nicolai
NEW YORK 7, N.Y.	
30 Church St.	Jack Wyatt District Manager
Phone: Worth 4-3060	Sal Scorsio District Manager
CHICAGO 3, ILL	
79 West Monroe St.	George W. Hutchings Western Adv. Sales Mgr.
Phone: Randolph 6-0794	Jim Dolan District Manager
CLEVELAND 15, OHIO	
1501 Euclid Ave.	D. J. Casey Regional General Manager
Phone: Main 1-4455	Arthur W. Steckdale District Manager
TOLEDO 6, OHIO	
3545 Lincolnshire Woods Rd.	Harold Mann District Manager
Phone: Greenwood 9-2801	
DALLAS 19, TEXAS	
3915 Lemmon Ave.	Joe Sanders Representative
Phone: Lakeside 1-2322	
LOS ANGELES 17, CALIF.	
1151 West 6th St.	Fred A. Kliner Representative
Phone HUntley 2-4000	
SAN FRANCISCO 11, CALIF.	
916 Kearny St.	Lew Vogler Representative
Phone: GARfield 1-7004	
PORTLAND 5, OREGON	
1220 S.W. Morrison St.	Pete Kliner Representative
Phone: CApital 7-4993	
ATLANTA 9, GA.	
22 Eighth St.	J. Sidney Crane Representative
Phone: Trinity 2-6720	

This index is an editorial feature maintained for the convenience of readers. It is not a part of the advertiser's contract and American Builder assumes no responsibility for its correctness.

MONTH AHEAD

Project planning—a future “must”

Today, there's a revolution occurring in subdivision planning and development that affects you.

The smart builder is realizing more than ever that he can no longer sell just a house; he has to sell a *community*, too.

There are many reasons for this—consumer education through newspapers, magazines, and television. Advertising plays a mighty role, too.

It all boils down to the fact that if you're going to sell houses in the next few years, you're going to have to plan your community carefully.

How you can gear your operation to this new way of building will be an important feature of the upcoming issue of AMERICAN BUILDER.

We'll show you why it's important to save all the trees possible in your project; the importance of leaving in natural drainage runs, instead of sinking metal culverts to do the same job. Sewage problems will be answered; facts on cluster building; streets—and even street identity.

To top it off, we'll investigate community facilities—swimming pools, tennis courts, junior playgrounds, and all the other big features buyers are demanding.

Retirement housing—a hot new market

A special report in next month's issue will tell you what the potential is in this new market—and how you can crack it. Even more interesting—so-called retirement houses are finding a great deal of appeal with young buyers as well.

A smart “Parade” will stimulate sales

Time is getting short. If you haven't firmed up your Parade of Homes plans by now you'll be risking the loss of one of your greatest salesmaking promotions. What are some smart builders doing? We're getting reports back that some local

homebuilding associations are setting their parade on a single tract and are planning to pull crowds in with a “House of Tomorrow,” that reflects the changes ahead for housing in the not-too-distant future.

How you gonna' profit down on the farm

The farm market is literally a billion-dollar market that most builders have bypassed in the post-war period.

New farm structures require the builder's skill and knowledge. We'll bring this profit picture into focus for you—the building that is needed—the latest techniques for putting up a farm structure.

Components play a big role here. So do pole-type buildings for machine sheds, brooder houses, hog houses, cattle shelters, corn cribs, chicken coops, and so on. There also will be ideas on building feed areas, hard-surfaced barnyards, milking parlors, and animal feeding systems.

Start selling a “new way of life”

As important as the houses you build now is the site on which you build them. Rapid changes are taking place in the field of project planning—cluster housing, terraced subdivisions, odd-shaped lots, community swimming pools. So, don't forget the special report next month on this subject. It will tell you what the growth builders are doing in the field of better project planning and how you might better plan your own subdivisions. Remember, you're operating in a buyers' market and they want more than “just a house.”

Keep your eye on the newspapers

President Kennedy seems determined to give housing an economic boost.

There's little doubt of his good intentions, in fact he's doing something new nearly every week. The President would welcome some word from you telling him how you feel about the industry.

IN JULY—American Builder studies the “hottest” market today:

- Remodeling: What this money-making market offers all-volume builders;
- Remodeling: How you can sell to this highly specialized market;
- Remodeling: Your best opportunities in the commercial end of it;
- Remodeling: Practical, on-field ideas you can get to work for you.



Floor and lighted steps in new KENTILE Mosaic Solid Vinyl Tile. Color is Santa Sofia. Feature Strips: Avocado and White. Long-wearing Beige Wall Base is Vinyl KenCove® . . . cleans easily, never needs painting.

IT'S NEW! KENTILE MOSAIC SOLID VINYL TILE. Hundreds of colorful vinyl chips in each tile, surrounded by translucent vinyl, give this floor true dimensional depth. Top-quality Kentile® Floors in your homes assure brand-wise prospects you've used the best materials throughout. You get trouble-free flooring that means no costly call-backs . . . and the opportunity to create distinctive floor designs in your model homes. See your flooring contractor.

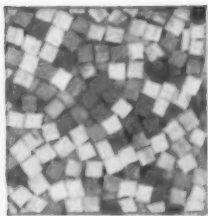

YOU CAN BENEFIT FROM BIGGEST ADVERTISING IN THE TILE BUSINESS!

Outstanding consumer acceptance for Kentile Floors comes from steady advertising in LOOK, THE SATURDAY EVENING POST, BETTER HOMES & GARDENS plus 12 other leading National publications, as well as the Magazine Sections of 324 Newspapers.

KENTILE FLOORS

There's a Kentile Floor for every home—in every price range. Over 200 decorator colors in 5 types of resilient tile.

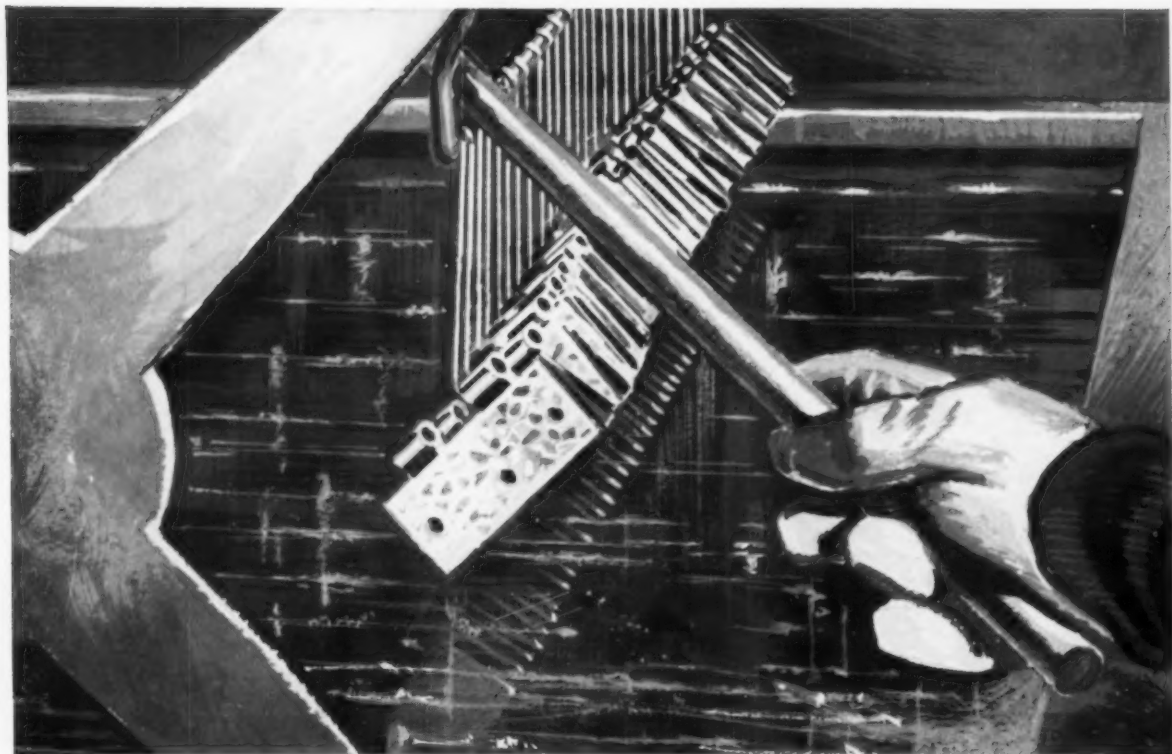

Here's why galvanized hardware by *National* is so smooth and free of "sags"

National hot-dips for maximum galvanize deposit. The "sags" produced by dipping are eliminated by tapping the racks of hinges as they leave the tank, even though this slows production. All of the plating material that will adhere evenly remains on the hinge; only the "sags" are removed. Pick up and examine any piece of *National* galvanized hardware . . . see how smooth it is, how heavy the protective coating is.

This manufacturing extra is another example of the "hidden-quality" built into *National* Hardware . . . another good reason to always ask for "*National*"—the quality hardware you can hang your reputation on.



NATIONAL MANUFACTURING CO.

18105 First Ave.

Sterling, Illinois

