

JULY 35¢

# American Home

## YOUR ENTERTAINING SUMMER

14 Pages of Happy Decorating for Outdoor Parties...  
Fun-in-the-Sun Menus & Recipes

HOW TO • Bring on the Berries • Buy a Tent  
Make Your Garden Glow • Dry Summer Flowers



Clearwood...The Vacation Colony Everyone Can Afford

New break for home buyers: TRUTH-IN-HOUSING



# Solarian<sup>®</sup> by Armstrong

The sunny floor that shines  
without waxing

Armstrong developed Solarian especially for people who like bright, shiny floors—but don't like the waxing it takes to keep them that way.

Solarian gives you the shine—without the waxing. Its special Mirabond™ wear surface has a gleaming shine of its own. And it keeps its high gloss—without waxing—far longer than an ordinary vinyl floor.

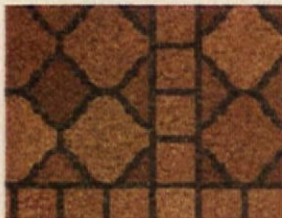

Of course, any floor shines brightest when it's clean; and that's another plus for the Mirabond surface. Most spills, dirt—even black heel marks—come up easily. Sponge-mopping with a mild detergent is all it takes to keep Solarian sparkling bright.

Eventually, heavy-traffic areas may begin to show a reduction in gloss. So in case you need it, your Armstrong retailer can supply a special Solarian Floor Finish that you can use occasionally to touch up the shine in these areas.

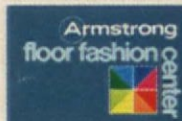

You'll find a list of Armstrong retailers in your local Yellow Pages. Many are authorized "Floor Fashion Center<sup>®</sup>" retailers, offering the complete selection of Armstrong floors, color-coordination assistance, and professional installation. Look for their sign.

For our free Solarian brochure showing all the designs and colors, write Armstrong, 7307 Pine St., Lancaster, Pa. 17604.

**Armstrong**

CREATORS OF



THE INDOOR WORLD<sup>®</sup>

Certain floor designs copyrighted by, and Floor Fashion Center logo is a trademark of, Armstrong Cork Company.

# American Home

FOR FAMILIES WHO KNOW HOW TO LIVE

## BUILDING AND ARCHITECTURE

- 6 Truth-in-Housing: Senator Hart's New Bill to Protect Home Buyers
- 14 The Vacation Colony Everyone Can Afford
- 20 New-Style Getaway Living
- 32 Vacation House of the Month: Precut to Suit in Cedar
- 38 It's Private, It's Cool
- 42 Make Your Garden Glow
- 59 The Ultimate Vacation Package
- 63 Very Personally Theirs

## INTERIOR DESIGN AND DECORATING

- 49 Decorating Q's & A's  
Entertaining Summer
- 67 July 4th Party
- 68 Cool Pool Act for Teens
- 70 Tennis Tie-In—an Inviting Idea

## FOOD

- Fun-in-the-Sun Food
- 73 Family 4th of July
- 74 Teen Crowd-Pleasers at Poolside
- 77 After-Tennis Welcome
- 78 Plus: The ABC's of Ham
- 81 Food Questions You Ask

## EQUIPMENT

- 40 Great Gear for Cookouts
- 51 From Home Base: Sharpen up on Knives
- 56 Editors' Choice: Keep It Hot . . . Keep It Cold

## KNOW HOW: 8-Page Special

- 37 Bring on the Berries
- 38 It's Private, It's Cool
- 40 Great Gear for Cookouts
- 41 Tent Coverage
- 42 Make Your Garden Glow
- 43 Pick, Dry & Preserve
- 44 The Good Life

## FEATURES

- 9 Lifestyle: The David Stileses of East Hampton, New York
- 12 The Don Gordons of Villa Park, California
- 46 The Woman Driver: Hot-Weather Car Care
- 52 Shopping Information
- 53 On-the-Go Guides to Travel Fun
- 92 Dear American Home

## HOME PROJECTS

- 25 "Church in the Wildwood" Stitchery Kit

## SHOP BY MAIL

- 86 American Home Market Place

**COVER: Crisp red, white and blue tableware leads off the sunny, summery party accessories you'll see more of in "Entertaining Summer," beginning on page 67. Earthenware is in a punchy polka dot; calico-print plate and checked napkin are easy-living disposables. Flatware teams plastic and stainless. Photographer: Rudy Muller.**

© 1973 Downe Publishing, Inc., a subsidiary of Downe Communications, Inc., 641 Lexington Ave., New York, N.Y. 10022. All rights reserved. Title reg. U.S. Patent Office. Published monthly. Second-class postage paid at New York, N.Y., and at additional mailing offices. Authorized as second class mail by the Post Office Department, Ottawa, Canada, and for payment of postage in cash. All mail concerning subscriptions should be addressed to American Home, P.O. Box 4568, Des Moines, Iowa 50306; Subscription Price: U.S. and Possessions and Canada: One year \$4.00, Pan American countries: One year, \$5.50. All other countries: One year, \$6.00. Downe Communications, Inc., also publishes Ladies' Home Journal and Family Weekly. Editorial and advertising offices, American Home, 641 Lexington Ave., New York, N.Y. 10022. California office, 426 California St., San Francisco, Calif. 94104.

**Advertising and Sales:** Donald M. Hufford, Associate Publisher/Advertising Director; Robert E. MacVicar, Eastern Sales Manager; John D. Culp, Western Sales Manager; Richard Daneshe, Los Angeles Sales Manager; Richard S. Wasley, San Francisco Sales Manager; Elizabeth Riggins, Manager Special Services; Stephen E. Silver, Marketing Director; Mary Powers, Director of Reader Reaction Bureau.

Manuscripts must be accompanied by self-addressed envelopes and return postage. Publisher assumes no responsibility for return of unsolicited manuscripts or art.

**CHANGE OF ADDRESS:** If you plan to move, notify American Home, P.O. Box 4568, Des Moines, Iowa, 50306, at least 8 weeks in advance. See coupon elsewhere in this issue. Send new and old address from a recent copy. Postmaster: Send form 3579 to same address. Other subscription correspondence to: P.O. Box 4571, Des Moines, Iowa 50306.



### Send for Thomasville "Homemaker's Guide"

Find out how to buy, decorate with, and care for fine furniture. Send \$2, and we'll send you over 100 pages of helpful information on room planning, color coordination, and illustrations of Thomasville furniture for every room. Write Thomasville Furniture, Dept. AH-373, Thomasville, NC 27360.

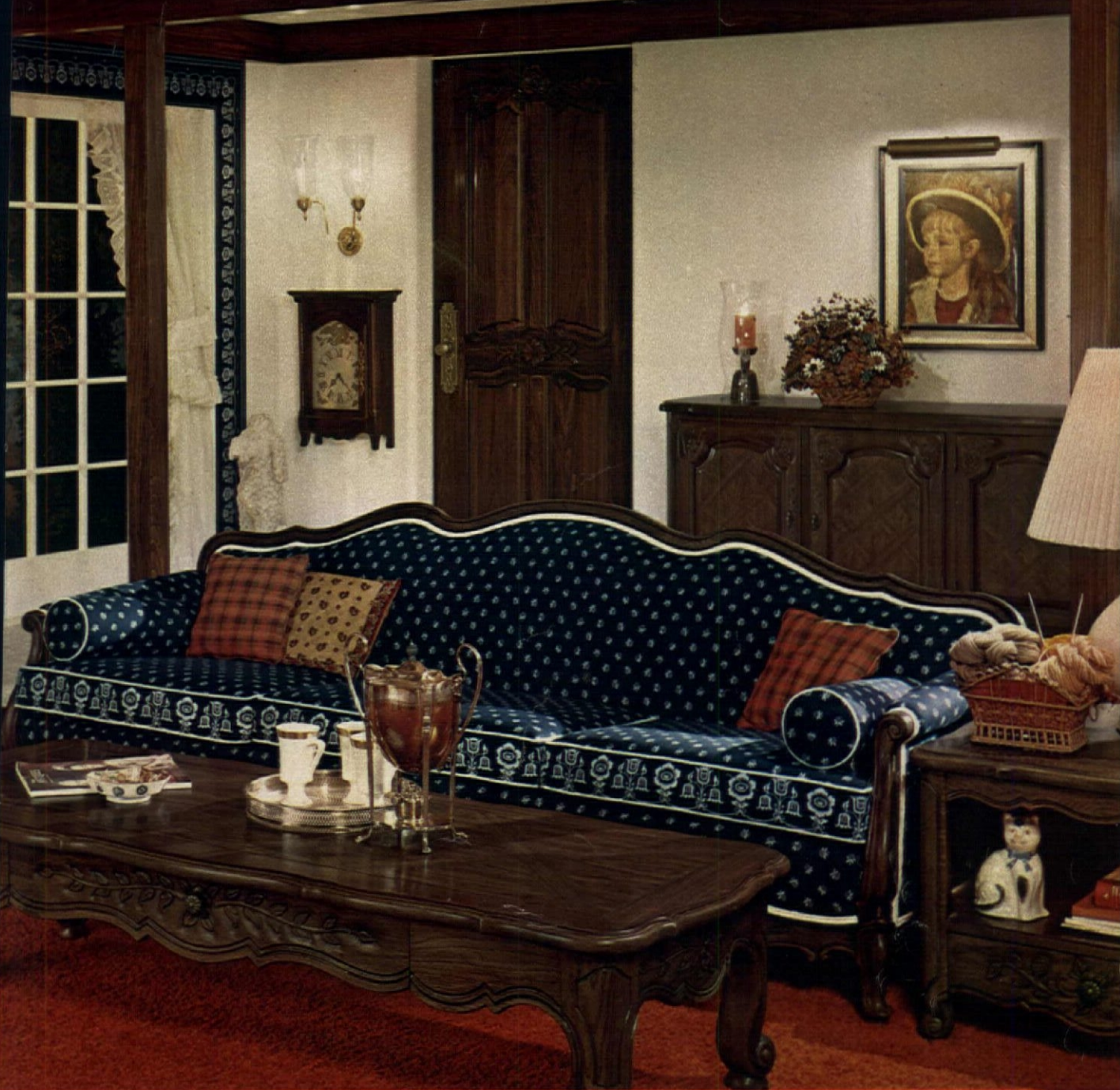

## Chateau Provence: Country furniture with an authentic French accent

In the French Chateaux regions, many of the great country houses have retained their original 18th century furnishings. This exciting furniture styling, handmade by meticulous old-world cabinetmakers, is the model for our Chateau Provence collection.

The Thomasville craftsmen have captured the bold styling, the deep relief carving, and the naturally distressed finish so typical of French country furniture. It is this kind of care and attention to historical detail that creates "that Thomasville look".

Spend a few minutes with a Thomasville dealer, enjoying the entire Chateau Provence collection. It includes 23 occasional pieces plus a wide assortment of bedroom and dining room suites. It's almost like a tour of the Chateaux Country.

For the names of dealers near you, call this toll-free number anytime: 800-243-6000. (In Conn., 800-882-6500.) Ask for Thomasville Chateau Provence dealers.

The sofa and chair are part of Thomasville's large selection of made-to-order upholstered furniture.

*Thomasville*  
FURNITURE

FROM  **Armstrong** CREATORS OF  **THE INDOOR WORLD**®



## Isn't It Time You Discovered This Unwritten Beauty Secret?

Somehow you thought it would never happen to you. You blithely went on believing you'd look young indefinitely. Then almost without warning, your mirror tells you. Your skin is obviously becoming dry and older-looking, and you can't help resenting your mirror for revealing the distressing truth.

How reassuring to know that you are not alone. Women in many countries around the world have shared your concern at looking older than a woman likes. Then these fortunate women discovered the beautiful secret of a world-renowned beauty blend, and soon found themselves with a new radiant, more-youthful complexion glow. Now share their secret, the precious secret of Oil of Olay moisturizing lotion.

Oil of Olay was created by beauty researchers to soften, smooth and silken your skin. To ease away the dryness that accents those little lines and wrinkles that can make you look older than you are. Day by day you will notice an appreciable difference in the suppleness and resiliency of your skin, as regular use of the remarkable beauty blend helps restore the balance of oil and moisture needed for a more youthful complexion.

Almost before you know it, Oil of Olay penetrates the important surface layer of the skin, where its wealth of natural moisture, tropical moisturizing oils and other emollients work with nature to help restore youth-giving moistness to your skin. The skin-loving liquid sets up a barrier that helps retain your own skin fluids, an

added beauty benefit that lets you look younger still.

For the most beneficial and quickly apparent results, join the younger-looking women who use Oil of Olay in a twice-a-day beauty ritual. In the morning, as a near-perfect makeup base. Oil of Olay spreads so evenly and penetrates so quickly it never leaves a sticky after-feel. Cosmetics don't streak or discolor; rather they stay fresh for hours. Apply Oil of Olay again at night, so that the complexion-cherishing liquid may pamper your skin for hours as you sleep.

You will find world-famous Oil of Olay as near as your drugstore. You, too, will discover the unwritten beauty secret of so many young-looking women.



### Beauty Hints

*Lines around your mouth and eyes betray age far too soon. Gently smooth extra amounts of Oil of Olay into these special, dry areas often. Your skin will respond beautifully to this additional attention.*

\* \* \*

*After exposure to wind, sun, air pollution or any of the many elements that seem to conspire to increase skin dryness, soothe on Oil of Olay®. In today's world your complexion needs all the help it can get from this treasured fluid.*

# American Home

FRED R. SMITH

Editor

BETTY KLARNET

Managing Editor

JOSEPH TAVERONI

Art Director

MERVYN KAUFMAN

Copy Editor

HELENE BROWN

Interior Design

GUY HENLE

Building and Architecture

FRANCES M. CRAWFORD

Food

JEANNE M. BAUER

Equipment

DOROTHY L. BRIGHTBILL

Home Projects

BINA BERNARD

Features

ROSEMARY L. KLEIN

American Treasury

LYNN HEADLEY

Market Place

FERDINAND D'ESPOSITO

Production Coordinator

DOROTHY B. HUMANITZKI

Production Editor

### ASSOCIATES

Art / Carol Ceraldi

Chef / Jacques Jaffry

Copy / Eileen Denver Mimoso

Decorating / Christine B. Roth

Food / Lucy Wing

Housing / Jane Levy

Reader Service / Lietta Dwork

### ASSISTANTS

Susan Abbott

Sara Baudry

Elizabeth C. Berens

Phyllis Cignarella

Phoebe Fox

Anne Gordon

Billie Heinrichs

Kathy M. Ripin

Nancy Rueth

Alexandra C. Wallner

Barbara Weinfuss

### CONTRIBUTORS

Special Projects / Helen Carlton

The Woman Driver / Denise McCluggage

Gardening / Lawrence V. Power

W. PAGE THOMPSON

Publisher

A. EDWARD MILLER

President, Downe Publishing, Inc.



## American Home

A Magazine of Downe Publishing, Inc.

A Subsidiary of

**DOWNE COMMUNICATIONS, INC.**

EDWARD R. DOWNE, JR.

Chairman of the Board

JOHN MACK CARTER

President

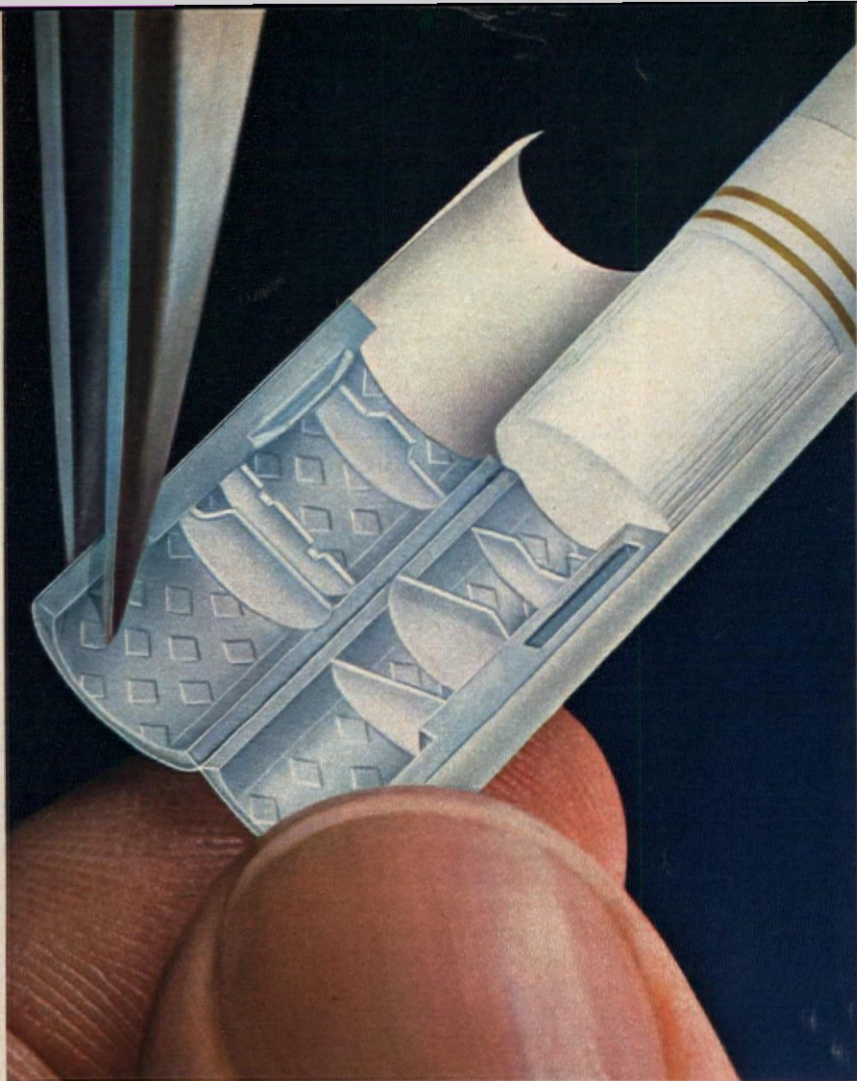

Doral's unique recessed filter system: Cellulose fiber to reduce "tar" and nicotine plus a strange-looking polyethylene chamber with baffles and air channels.

# Doral has fixed what you don't like about low "tar" & nicotine smoking.

You know what's wrong with most low "tar" and nicotine cigarettes. They taste flat—like sponge cake made with real sponges.

But Doral has changed all that.

With a unique recessed filter system. And a flavor so good, you may want to double-check the "tar" and nicotine numbers on the back of the pack.

Try Doral today. You can't go wrong.

"I swear you can really taste me."



Warning: The Surgeon General Has Determined That Cigarette Smoking Is Dangerous to Your Health.

© 1973 R. J. REYNOLDS TOBACCO CO.  
 FILTER: 15 mg. "tar", 1.0 mg. nicotine, MENTHOL: 15 mg. "tar" 1.1 mg. nicotine, av. per cigarette. FTC Report FEB. '73.

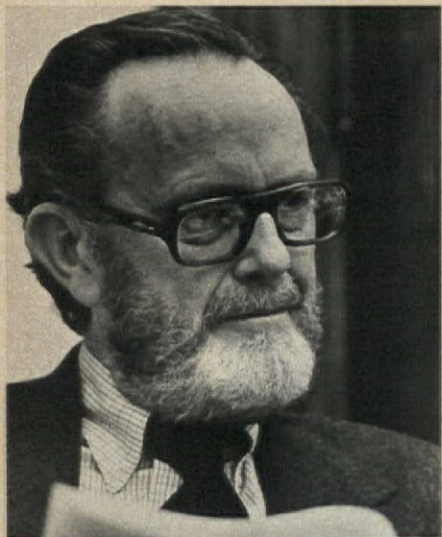

Senator Philip A. Hart, Democrat of Michigan, has been the author or cosponsor of almost every major piece of consumer legislation enacted by Congress in recent years. Specifically, he wrote the Truth-in-Packaging Act, passed in 1965, and cosponsored the Truth-in-Lending Act, passed in 1966. He and his wife, Jane, have four sons and four daughters, ages 15 to 25.

"Let the buyer beware!" Too many unhappy home buyers have been given that answer after discovering an unsuspected defect in a newly purchased house. With the rising costs of housing and home repairs, such an answer often leaves a family with a choice between a broken budget and a busted home. A better response would be a truth-in-housing law requiring that a prospective home buyer be told the structural condition of a unit before the sale is concluded.

Complaints about the "buyer-beware" rule are not new, but the need to discard that approach has been highlighted by recent investigations of federal housing programs. In a study of units sold under one subsidy program, the General Accounting Office found defects in 24 percent of new houses inspected and in 39 percent of existing houses.

Factual information on the defects of a house and estimates of possible repair costs would help a family, regardless of income, decide if it could afford to buy a particular house. Some private firms now offer an inspection and reporting service, but too few families, particularly first-time buyers, are aware of the existence of these firms or of the need for inspection. It is true that the Federal Housing Administration now inspects new units before insuring a mortgage, but FHA inspections have often been less than adequate and, of course, are not made at all when sales involve existing houses or new houses not FHA-insured.

Purchase of a house will be the largest financial commitment many families will ever make. Whether you are a family buying the once-in-a-lifetime house or a family that moves often, you still want

## SENATOR PHILIP A. HART PROPOSES **TRUTH IN HOUSING**

*American Home* presents the first announcement of Senator Hart's just-introduced bill to protect consumers from deception in the purchase of new or existing houses by insuring full disclosure of structural and other defects. We strongly support Senator Hart in this effort to formalize an inspection procedure that would practically eliminate your chance of being stuck with a "lemon" of a house. This is the third in our series of consumer-protection reports. The first two dealt with the "guaranteed house" concept, designed to protect buyers of new houses; Senator Hart's proposal adds to this with a program that will extend protection to buyers of all houses.—The Editors

value for your dollar. The truth-in-housing bill I have just introduced attempts to meet this problem as follows:

- The law will be administered by the Federal Trade Commission, in consultation with agencies traditionally concerned with housing and lending.

- Every seller, agent or lender involved in the sale of a one-to-four-family house will be responsible for preparing a standard inspection form that includes a report on any defects in the unit.

- The form must be presented to the buyer prior to closing. If it is not, the buyer may void the sales contract. Further, if the form is not available more than 48 hours before closing, the buyer has up to 48 hours after closing to void the contract. This provision is designed to urge responsible parties to prepare the report in advance of the closing date.

- The form must disclose any defect that seriously affects the usefulness and livability of the unit. However, the defect must be one that can be detected by reasonable inspection. An inspector, for example, would not be required to cut into walls to examine every foot of electrical wiring.

- All defects in the plumbing, heating and electrical systems must be reported, in addition to defects in the structure or to other major components of the house (termite damage, roof leaks, damp basement), as defined by the Federal Trade Commission.

- The report would include estimated repair or replacement costs resulting from any defect and might even indicate the useful lives of such components as roofing, plumbing and heating.

- The cost of any inspection would be paid by the buyer at closing.

- A buyer may sue for damages and costs if the written disclosure includes a false statement or fails to report a detectable defect. The suit may be brought against any or all of the parties responsible for having the disclosure made.

Those parties, in turn, may ask the court to determine who should pay and how much.

It is my hope that lending institutions might take the lead in developing sound inspection procedures, for the information should be as useful to them in approving mortgage applications as it would be to a prospective buyer.

Criminal penalties will be established for willful violations of requirements to file a form and to report serious defects. However, neither the criminal nor the civil liability provisions apply to any part of the report dealing with estimates. This information is for guidance only; it would be unreasonable, if not impossible, to hold an individual liable for such estimates.

At this point, let me insert the politician's usual disclaimer. This is the first generally published presentation of my truth-in-housing proposal, and I do not pretend that it exhausts the discussion of this topic or that the present bill is a final answer. On the contrary, several unaddressed questions quickly come to mind:

What controls, if any, should be instituted to guard against inflated charges for inspections?

Will such requirements unduly delay closing house sales?

How should the sale of individual condominium units be handled?

Would such legislation discourage lenders from making mortgage money available?

In view of these questions—and others that are certain to arise—this bill is offered more as a vehicle to launch a dialogue than as a solution. However, we *must* start such a dialogue. Housing is too important an investment, for the individual and for the nation, to be left to chance. Providing adequate information about the structural condition of a house is one way to reduce reliance on chance.



Artist: Charles Lyman Bates AIA  
Iron Head, N.C.

## **Olympic Stain: For people who love wood.**

Olympic Stain is one of the most beautiful things you can do for wood.

Olympic brings out the wood's grain and subtle beauty, it also penetrates for protection.

Because Olympic Stain allows wood to breathe, the finish will never crack, peel or blister.

The solid colors are trouble-free for re-do over old paint on rough wood.



For your dealer's name call 800-243-6000, toll-free.  
In Connecticut dial 1-800-882-6500. For a free color folder, write:  
1148 NW Leary Way, Seattle, Wa. 98107. Olympic Stain. A division of COMERCO, INC.



# ONLY A DENTIST CAN GIVE HER A BETTER FLUORIDE TREATMENT!

A kid in the cavity-prone years can wind up with a mouthful of cavities. 11 is average between the ages of 5 and 15. But a Colgate fluoride

treatment every day can help prevent some of those cavities. Colgate with MFP fluoride helps strengthen teeth against decay. Remember, only your

dentist can give teeth a better fluoride treatment. Ask him.



"Colgate with MFP fluoride has been shown to be an effective decay-preventive dentifrice that can be of significant value when used in a conscientiously applied program of oral hygiene and regular professional care." Council on Dental Therapeutics, American Dental Association

©1973, Colgate-Palmolive Company

# LIFESTYLE

David Stiles  
East Hampton, New York

Right: "This is the way the barn looked originally," says David Stiles. "The outside isn't much different today. We wanted to keep that old-barn quality, and we did!"

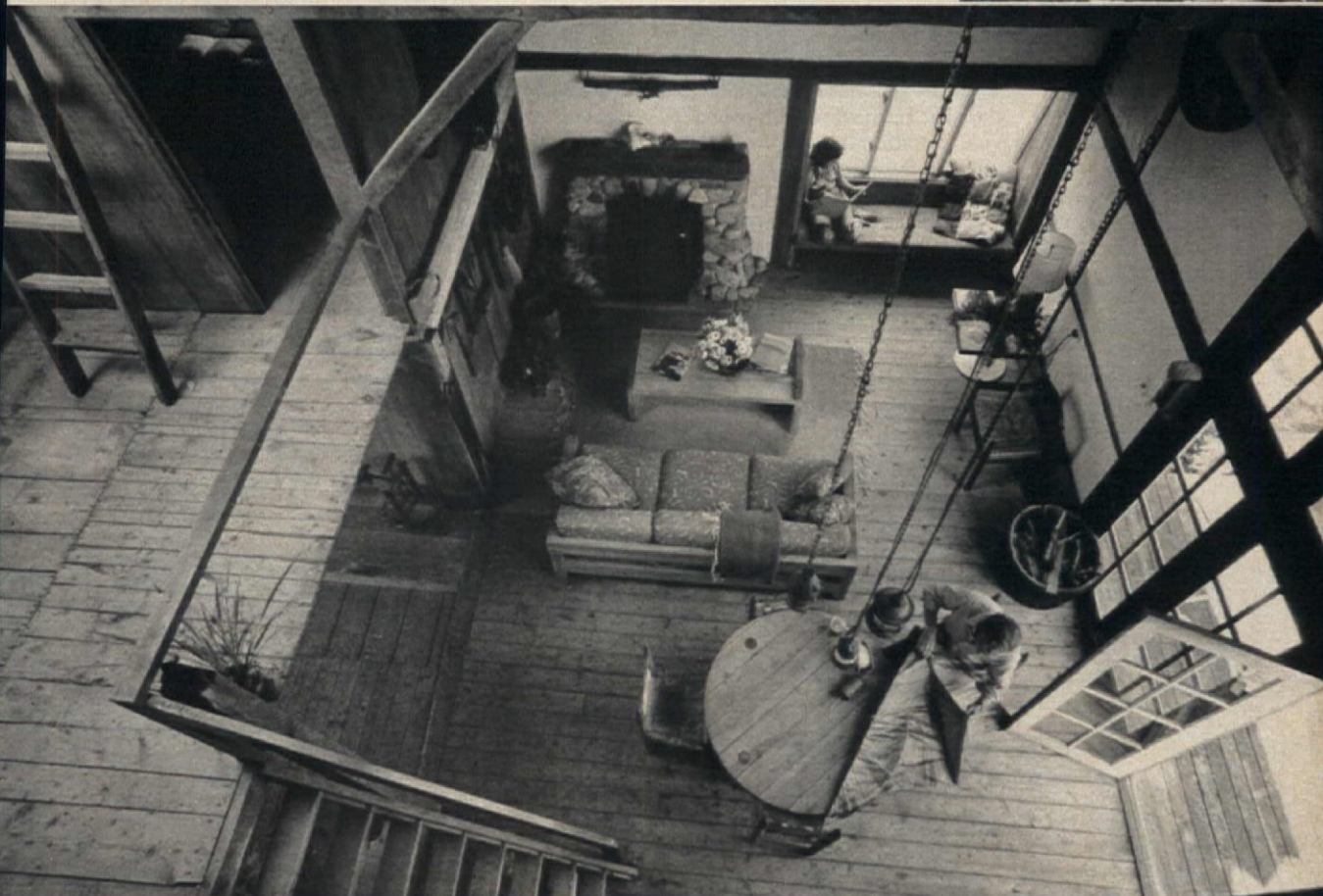

For David and Jeanie Stiles, turning a weathered 19th-century barn into a livable vacation home on Long Island has been an all-consuming hobby and an enjoyable change of pace from their weekday life in New York City. David, an architectural illustrator and designer, bought the barn in 1962 from a local farmer (for \$1,500), had it moved (for \$3,500) to a nearby wooded lot and went to work remodeling it. At first he tackled each project at a leisurely bachelor's

pace; then in 1968, when he married Jeanie, a model and TV actress, the renovating accelerated to double time.

"We started out with the firm conviction that the barn-like quality should never be lost," says David. "To make sure of that, we've done all the work ourselves." Reshingling the roof took an entire summer; another summer, David and Jeanie hauled stones back from a nearby beach in order to build their massive living-room fireplace. (continued)

Above: The Stiles living room has a three-story-high ceiling and a spacious, bright feeling. Overlooking it are bedrooms and the loft areas.

Right: David and Jeanie reenact a typical Stiles welcome for guests, many of whom have helped with the renovation.





David surveys the sofa and coffee table he crafted from butcher block (far left). He plans to enlarge the two stairways leading to barn's second and third levels.

Just off the living room, they added a wooden deck that juts out into the woods, then opened up a side wall to accommodate a large slanted window and window seat. Even with these additions, they have kept 80 percent of the barn the way it was originally. The old timbers remain intact; occasionally the Stilese find bits of straw wedged between the floor boards. "We left the front and rear exteriors essentially the same," says David, "though we did substitute multipaned glass doors for

the rear barn doors." To provide additional light without altering the exterior walls, they added a skylight.

The Stiles barn is not centrally heated, but portable heaters and a roaring fire enable Jeanie and David to work and entertain comfortably from April through December. Jeanie, who once studied cooking with Dione Lucas, likes to entertain informally in the country. She enjoys baking pies, using the blueberries that grow in abundance outside her front door.

Right now, back in the city, Jeanie is the producer of a Hallmark Gallery show on neon as an art form. But weekends, she and David head for the barn—and sailing, tennis, kite flying and tending their small garden.

"Owning this old barn has been a most satisfying experience," says Jeanie. "Our city place is contemporary, so we wanted our weekend house to be a real change of environment, one that reflects the simplicity of another era."

Another "Lifestyle" follows

As a wedding gift for Jeanie, David made the bedstead (left). He even carved their wedding date on the headboard—once an old oxen yoke. Jeanie's gift to David was the quilt she made to adorn the bed.

Jeanie selects glasses from the serving bar (below that she and David made from bricks and barn siding). Laying the Mexican-tiled floor in the kitchen took the two of them a week

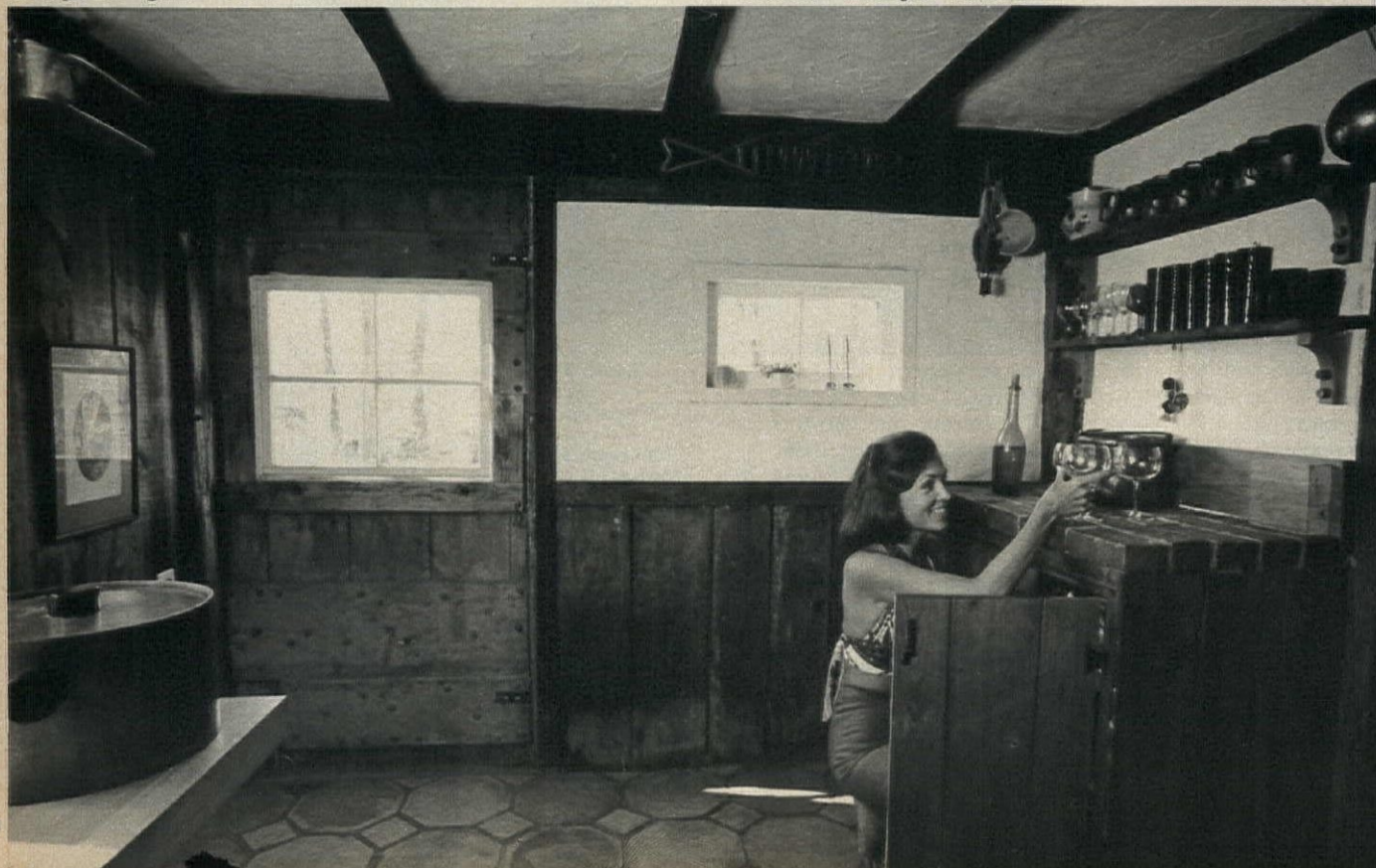

# The Sears Ah-h Bra.<sup>™</sup> It understands everything about your shape:

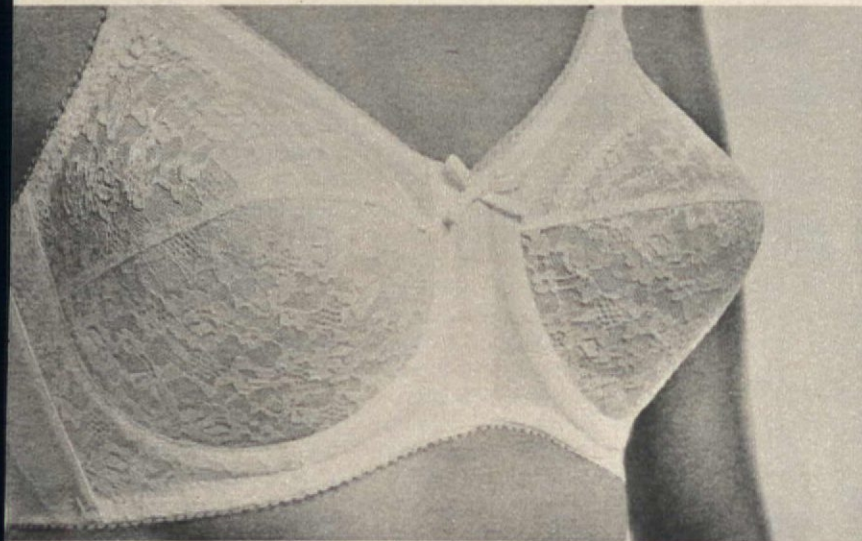

**Outside.**

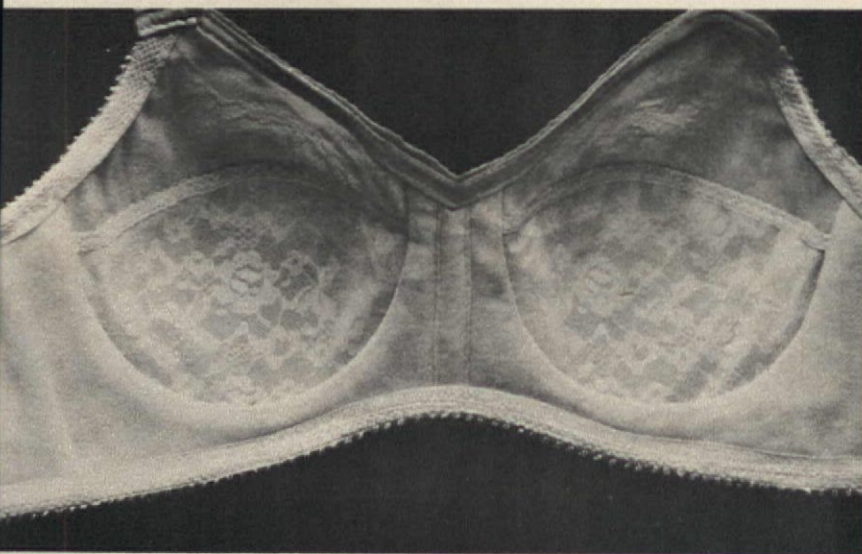

**And inside.**

Just by looking you can tell our wire bra is different. It gives support and separation in comfort. There's no bulky framework to embarrass or burden you.

Next to your skin you feel a blanket of softness, our own Wonder-Fil lining. The side boning is thin, flexible. The fit is smooth, not rigid.

Our wire is flat, not round. It lies flat to your body. We put it in a soft channel of double-layered fabric, so it's guaranteed\* not to poke through.

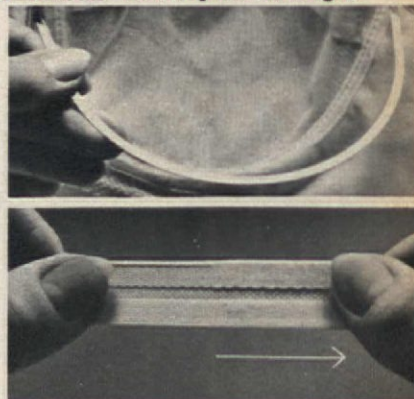

Our strap is unique. The stretch part is woven to the nonstretch in one smooth piece. You get the release you need for comfort without feeling or seeing a bump.

You'll notice the center section gives, for easy breathing. And the top of the cup is elasticized at the side, to adapt to your fullness.

The Ah-h Bra improves any shape from 32B to 42DD. A Perma-Prest<sup>®</sup> fabric, (including the Dacron<sup>®</sup> polyester lace), it keeps its shape through many washings.

When you try it on, your experience should indeed be: "Ah-h!" You'll find saleswomen in Sears Figure Shop trained to measure and fit you correctly.

Let your body get used to the new feeling. Then look at your Ah-h Bra shape in our dressing room mirror.

If you like what you see, the Ah-h Bra is right for you.

Also available in tricot. At most Sears, Roebuck and Co. larger stores, through the catalog or by telephone, if you call Catalog Shopping Service.

**Sears**

The Figure Shop.

\*We guarantee your Ah-h Bra underwire will stay in place for the life of the garment or return bra for free replacement.

## The Don Gordons of Villa Park, California



The Gordons' backyard (left) is strewn with the colorful exercise forms Don has created. Here, Audra and her parents relax on the "Merry Mountain," while Donna and Shawn play with "Jousters," Heather tumbles in the big, soft "Donut" and Piper perches on a foam-filled cylinder.

Piper's favorite chair (below, left) is a bright-purple kangaroo rocker, part of her dad's collection of five super-functional pieces of animal furniture. Each animal also comes in green, yellow, orange.



The spacious backyard of Don and Melody Gordon's home in Villa Park, Calif., is both a playground and a workshop. It's where the Gordon children—Donna, 15, Shawn, 10, Heather, 8, Audra, 5, and Piper, 3—"test" the brightly colored exercise forms and furniture their dad, a former physical-education teacher, designs. All five delight in playing with the designs, rolling and tumbling on the soft vinyl shapes. Actually, the whole family enjoys physical activity. Whenever possible, they swim in their backyard pool or work out on the balance beam, monkey bars and rings that Don has set up. And a favorite all-in-the-family game is volleyball—played, if you please, on backyard trampolines! The children are accomplished gymnasts, and the girls have learned dance from

their mother, who teaches dance-and-exercise classes in a fully equipped studio the Gordons set up over their garage.

"Physical exercise increases self-confidence and coordination," says Melody. "And, far from being a chore, it can be fun and rewarding!" The skill-development equipment Don has designed over the last two years does make exercise fun. The colorful forms run the gamut from a foam-filled cylinder to a huge, inflatable, multi-handled "mushroom" for tug-of-war.

Don created many of his exercisers with handicapped and mentally retarded children in mind. "These children find it easy to manipulate the large, soft forms," he says. "And they love the colors." Don now serves on the advisory board of the California Special Olympics for mentally retarded children, which was begun by Eunice Shriver and the Kennedy Foundation.

His latest project is creating a line of whimsical animal furniture made of impact-resistant molded plastic. They're durable, at home indoors or out and come in punchy colors that won't fade in the sun. Now they are going to market, with Melody serving as bookkeeper and publicity director for the enterprise, as she did with the exercise forms. And like them, the "animals" have passed the Gordons' backyard test with flying colors. Says Melody, proudly: "We hope other children will enjoy the funny furniture as much as ours have."

Don's animal designs (right) are named after the children. He and Melody share the fun as Piper pops out of "Piper the Pelican," Shawn sprawls on "Heather the Hippo," Heather straddles "Audra the Squirrel," and Audra investigates "Shawn the Frog." ("Donna the Kangaroo" is pictured above.) Each piece can be sat on or in, or used to store toys and other gear.

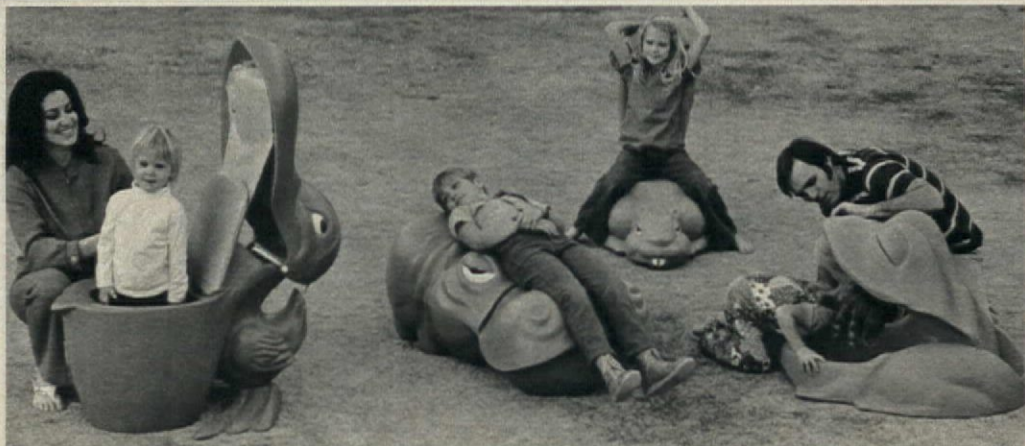



# Spend a milder moment with Raleigh.

A special treatment softens the tobaccos for a milder taste.

Take this beautiful plaid Troy blanket everywhere. 50" x 70", 100% acrylic, mothproof, and machine washable. Yours for free B&W Raleigh coupons, the valuable extra on every pack of Raleigh.

To see over 1000 gifts, write for your free Gift Catalog: Box 12, Louisville, Ky. 40201



© 1973 BROWN & WILLIAMSON TOBACCO CORP.  
 Filter Kings, 16 mg. "tar," 1.2 mg. nicotine; Longs, 18 mg. "tar,"  
 1.3 mg. nicotine, av. per cigarette, FTC Report February '73

**Warning: The Surgeon General Has Determined That Cigarette Smoking Is Dangerous to Your Health.**

# WISE BUYS

There are stubborn wrinkles you can do something about. The GE Power Spray Iron gets out wrinkles, fast. All you do is press the Power Spray button (that's press, no pumping with this iron), and out comes a stream of sprinkles when and where you need them. There are two settings, one a light mist for Permanent Press and the other a concentrated spray for stubborn wrinkles. Smooth.

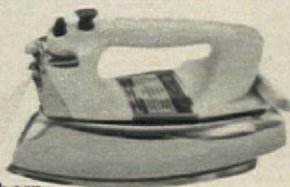

Get a GE Buffet Skillet and eat happily ever after. It's the only thing you need to braise, stew, fry, roast, pan broil, bake, simmer, steam, sauté, warm and hold!

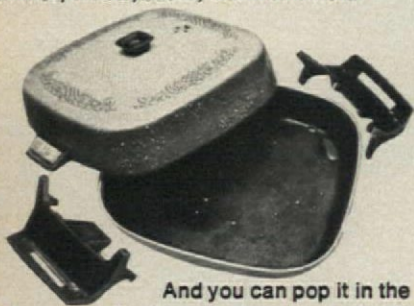

And you can pop it in the dishwasher. Cord and probe come out at the push of a button and legs and handle snap off. Just like that. Easy.

If you hate curlers and love curls, get yourself a GE Speedsetter. GE rollers are tangle-free. So smooth and easy to roll up. You get the fastest set you can imagine.

There are 6 Jumbos, 10 Mediums and 4 Smalls, and can be used dry, with conditioner or with mist. Nifty.



Mirror mirror on the wall, you're not as honest as a GE Lighted Make-Up Mirror.

Have you ever checked yourself out in daylight after you've made up in the bathroom? Different? Can't happen with a GE Lighted Make-Up Mirror. It has four separate light settings: Day, Office, Home and Evening. To let you see yourself as others see you, wherever you are. Honest.



others see you, wherever you are. Honest.

**GENERAL  ELECTRIC**

## THE VACATION COLONY EVERYONE CAN AFFORD



"This is what Clearwood's all about," explains the mother of two junior-high-age boys. We are lounging on the porch of the family's second home deep in the foothills of Washington State's Cascade Mountains. "Clearwood is a vacation community that lets you do it now, while your children are young enough to enjoy being in the outdoors with you. Children can't wait until you can afford it. They grow up.

"From the first, long before we started the house, we camped out here weekends and vacations. We're still camping, but in the house now, doing the inside a room at a time, starting with money we got from selling the trailer." She spreads her arms to encompass spring-fed, 175-acre Clear Lake, the surrounding forested hills, a view that looks Mt. Rainier right in the eye. "For five years now, the children have had all this. And we have had the children." (For a closer look at "all this," see pages 59-61.)

Parks and recreation areas, trails and open lands for everyone's enjoyment are the heart of Clearwood, developed by The Quadrant Corp., subsidiary of the Weyerhaeuser lumber colossus of the Pacific Northwest. A decade ago, Weyerhaeuser surveyed the nearly two million acres in its Washington State land bank, planted to second-growth Douglas fir stands with some virgin groves still uncut. Certain areas suggested themselves as potential recreation communities. One was the tree farmland surrounding clean, trout-rich Clear Lake in rolling Cascade hills. Thus in 1968 Clearwood was born.

The company's aim since then has been to put a second home within reach of anybody who wants it—without eliminating privacy or communion with nature. Such a goal is achieved easily in developments geared to relatively high-income living, but when attained for families of more modest means, it is a

triumph of taste over expediency. Among other problems Clearwood's developers faced—and solved—was the need to avoid duplicating a city-life setup, which would have destroyed the appeal of the magnificent location. Also they had to consider easy access to population centers—Olympia, Tacoma, Seattle, Portland—so that second homes could be enjoyed weekends the year round. Wilderness isolation had to be maintained along with the protection of property during homeowner absences. Roads were kept private, with gatekeepers at entrances.

Here's how a typical homeowner describes the concept of Clearwood: "It's Walden Pond with a congenial social life, a kind of live-in country club in the forest." Almost without exception, other property owners agree. One remarks: "We never cared for developments, but respect for the environment shown here changed our minds."

The Quadrant management employed subtle means to fit people into wilderness—not vice versa. As an officer sums up, "You don't change the lifestyle of a 250-foot fir tree or a clam bed, but you can persuade people." Disturbed by the threat of motorbikes and the increasing use of automobiles on the colony's few roads, the corporation gifted early homesite purchasers with 10-speed bicycles. At once cycling and hiking became the way of life. Residents now put up their cars when they arrive and take to the more than 10 miles of lake trails. An unexpected bonus of this attention to detail and consideration for setting is that there is no litter—none at all—and not a single incident of vandalism has occurred.

Clearwood lots range from 9,000 to 11,000 square feet (priced from \$4,900 to \$9,500), their boundaries varying with the contours and irregularities of the terrain. Generally, the lots fan out from cul-de-sac access lanes. (continued)



# ORTHO wishes you a happy harvest.



Who thinks about harvest in the spring? Just about any home gardener who can tell an apple from a croquet ball. It's just good common sense to anticipate problems before they are problems.

A good crop is pretty often the result of good planning.

Fortunately, you needn't go it alone. Today, ORTHO® backs you with the most complete line of garden and home products anywhere. There are dusts, sprays, plant foods, plus a variety of applicators to nourish and protect every inch of your outdoors. For example:

ORTHO Fruit and Vegetable Insect Control is for control of a broad spectrum of insects and mites on fruits and vegetables. Use it to get rid of such garden insect pests as codling moths, aphids, leafhoppers, and Colorado potato beetles to name just a few of them.

ORTHO Tomato Vegetable Dust protects tomatoes, melons, potatoes and certain other vegetables against many common insect pests. In particular: aphids, thrips, tomato fruitworms and Japanese beetles. In addition, it works against damaging plant diseases such as early and late blight, anthracnose, fruit rot



ORTHO Tomato Food is highly recommended for feeding tomatoes. It helps assure good growth and larger fruit. This product is available in

both pellet and liquid form, whichever you find more suitable to your needs.

Of course there are a great many more fine ORTHO products to insure healthier crops and better yields.

No, springtime isn't too early to start to think about protecting what you grow. In fact, it's the surest way to a happy harvest. There's a man who can be very helpful to you. He's your local ORTHO Dealer, an expert on growing things.



and Botrytis rot. You can use it as a dust or spray.

ORTHO Home Orchard Spray is an outstanding multi-purpose spray for apples, pears, stone fruits, strawberries and grapes. It's effective against a variety of insects and mites as well as such crop-damaging diseases as black rot, brown rot, scab and fly speck.

**Introductory offer - \$295 value for \$100.** Here's a book for everyone who grows vegetables. 112 pages, 48 pages of color pictures. Three regional editions: South, West, Midwest/Northeast. Mail \$1.00 plus 25¢ handling per copy to Book Offer, P. O. Box 660, Dept. AH-7, Long Beach, CA. 90801. The regular suggested cover price will be \$2.95 after October 1, 1973.



**ORTHO** Chevron Chemical Company

TM'S: ORTHO, CHEVRON AND DESIGN — REG. U.S. PAT. OFF. AVOID ACCIDENTS: READ THE LABEL AND USE ONLY AS DIRECTED.



## Invitation to a hot summer day: dress accordingly.

Hot weather brings out skinny little swimsuits and clingy little sunsuits—and that means discreet sanitary protection is more important than ever.

You want dependable, comfortable, yet invisible protection. You don't want the bulges and chafing of napkins, the embarrassment of pins and belts. You *do* want internally worn Tampax tampons.

You'll hardly know you have your period, because Tampax tampons can't be felt when properly in place. And of course no sign of them can be seen, so you're free to dress for the season. Without worrying about anyone else "knowing."

Short, cool, bare little clothes were made for summertime. And Tampax tampon protection was made for your short, cool, bare little clothes.

The internal protection more women trust

**TAMPAX**  
tampons

MADE ONLY BY TAMPAX INCORPORATED, PALMER, MASS.

## VACATION COLONY continued

And as a result of protective covenants, the shores of Clear Lake are lined with a community greenbelt extending 50 to 150 feet from the water's edge. Wherever cliffs border the lake, trails rise to open viewpoints. At each of the beaches, there are showers and heated dressing rooms and, nearby, a "ramada"—a sheltered picnic area and kitchen containing electric stoves and barbecue pits. Owners can use these facilities for large-scale entertaining simply by clearing whatever date they prefer with their immediate neighbors. Also in community ownership are tennis courts, a baseball diamond, basketball courts, a store and a heated swimming pool partly covered for winter use.

Early in the planning stage, a forester, Ken Jones, was called in as a professional voice in overall landscaping. Ken had cruised the first timber stand at Clear Lake many years ago. Now his special domain is planning roads and paths that least disturb the environment, and designing arched bridges, boat-launching ramps, fishing docks, playgrounds and lake swimming floats.

Clearwood's town-house-like "Lake Houses" were designed by Seattle architect Richard Bouillon, whose concern for the area's natural beauty made him an innovator. "I was so enamored of the site that I thought it insensitive to run in concrete-mixer trucks that might impact the roots of the trees," he says. To avoid this, Bouillon created a pole-foundation system that requires the use of concrete only for fireplace foundations and as an apron around the swimming pool. The Lake Houses (eventually, they will number 35), with rough-sawn fir stained earth colors both inside and out, are two-story, two-family units.

Though most property owners prefer building their own homes, Quadrant does offer, in addition to the Lake Houses, plans for a variety of company-constructed houses intended to appeal to young families. Their features include spiral stairways, loft bedrooms, breakfast bars, bathrooms with stall showers, and with childproof materials used throughout, they are practically carefree.

Clearwood generally appeals to young couples just realizing their first dreams. A Clearwood family's entire investment in land and in a home that meets building and landscaping requirements—external design and finish in harmony with the topography and with existing structures—could run as little as \$15,000. The annual assessment for full use of recreational facilities and common areas is \$50 per residential lot. Funds go to the Clearwood Community Association, in which each owner is a voting member, to improve and maintain common areas "and generally promote the recreation, health, safety, comfort, convenience and

welfare" of the owners in the community.

Clearwood makes an extraordinary concession: An owner has no short-term deadline to meet in building a house. The usual time lag between 10 percent property down payment and home construction is two to five years, but it can extend almost indefinitely. In the interim, lot owners can make full use of their land. As facilities for cooking, dining and bathing are located within short walking distance of every residential lot, and a company water system serves each lot, it becomes entirely practical to launch second home-living in a tent. To avoid the appearance of a mobile-home park, campers, trailers (limited to 20 feet) and tents must be removed—that is, depart with their owners when a weekend or vacation ends. There are Clearwood dwellers who will never build. "The land's a good investment and we've got a place to go, all ours," they say. A touching love of the land is apparent everywhere. Fruit trees, ornamental shrubs, flowers and even vegetable gardens flourish. Elaborate stone firepits, rock-bordered paths, bird houses and feeders, platforms for trailer extensions and tents sprout on the lots while owners study their views, the direction of the prevailing winds and other factors influencing design of the home-to-come. Land is hand-cleared, with written permission required of the Community Association for removal of any tree or natural feature.

Quadrant admits it is choosy about its buyers. Now and again "urban types," a euphemism for swingers looking for a place to lose their weekends, are firmly discouraged. "We recommend that they do not buy because of the basic family appeal of these properties," says a Quadrant executive. "We just haven't had that kind of difficulty, and as the community will never have convention centers, cocktail lounges, restaurants or even coffee bars open to outsiders, the public is not going to move into property owners' front yards. With the same objective—privacy—we have no arrangement for renting homes while owners are not using them."

Not everyone sings a paean of joy to the developing community. A few first-comers, the pioneers who once had it all to themselves, are predictably churlish toward a new "sold" sign if it's within the aura of "their" picnic-beach-barbecue site. But, as the community assets are well designed for both intimate and general use, they discover that somebody else's steak on the coals isn't so intolerable after all. Besides, newcomers' children are inclined to become pals of old-timers' offspring on sight. The sense of community that has developed at Clearwood melts away such minor problems as these. —Dolly Connelly

# There's something almost "sinful" about being an Interior Decorator.

You can get paid handsomely for doing what you love to do. Arrange beautiful pieces of furniture, rugs, draperies, etc. Go on buying trips (even to Mexico and Europe). Advise many wealthy, interesting people. Enjoy the discounts and tax deductions not open to everyone. Even at your own hours. If all this sounds "too good," read on.

Putting together rooms that are both beautiful and livable is the work of an Interior Decorator.

But it never seems like work. Because no day is exactly like any other. There are always new challenges, new people to meet, new ideas to evaluate.

It's a pity that more people don't take up Interior Decorating, professionally.

Designing interiors means that you could be buying and handling beautiful, beautiful objects; warm and timeless antiques; distinctive rugs and a wealth of beautiful colorful fabrics; paintings; lamps; accessories to add the finishing touches. And so much more.

When you combine them all, creating, as you will, a room that is beautiful, comfortable and even dramatic—it is as satisfying as creating any work of art.

The people you buy from are artists, cabinetmakers, collectors, designers, and importers. People whose creative zest for life is bound to affect yours.

Interior design is growing so fast (*Forbes* magazine calls home furnishings, perhaps the hottest growth field in the 1970's), that jobs abound for trained professionals.

You can often choose a job with very flexible hours. Or set up your own business, right in your own home. And expect to be paid very well for your time.

You may wonder why more people aren't crowding into this rewarding, fast-growing field.

Of course, it's not for everyone. You have to love it. And until recently, professional training in Interior Decoration has not been readily available.

But now you can get thoroughly professional training. At home. On your own time schedule.

## Train at home

Today, ICS, America's oldest home-study school offers a complete, practical and up-to-date program in Interior Decoration and Design.

The entire program is based on the experience of John Gerald, the founder of one of America's top-flight decorating firms.

And you can be sure there's no dull,



dry text. Marguerite Rittenhouse, Ph.D., a well known educator, worked closely with Mr. Gerald. She also checked out every lesson with untrained but interested women, as well as sales people in furniture departments and decorating shops to make sure each idea or way of working is not only interesting but logical and easy to follow.

Right from the start, you work with top-notch professional equipment. Templates, sketching materials, architect's scale, folding rules, T-square, triangle, fabric swatches and color charts are included in the material you get. (The basis for your business workshop later on.)

## Ways to make learning easier

You also receive: a three-dimensional viewer and 130 slides that put you "inside" rooms; and a cassette tape player with tapes—modern audio-visual learning aids that bring your lessons dramatically to life.

Each lesson takes you one step closer to your goal—the confidence and knowledge you need to be a professional.

Soon you'll be analyzing a room's architecture, exposure, and traffic patterns like a "pro."

You'll talk expertly about furniture periods, oriental rugs, color, balance, lighting, and more.

You'll master all the principles of Interior Design: form, proportion, scale, balance, and unity.

## Your home as a showplace

Your friends will first notice the

difference in your own home. You'll know it from their comments. Your advice will be sought. And you'll know you're ready to make a place for yourself in Interior Decorating.

At this point your lessons change from the principles of decorating to the practice of making money.

You'll learn how to get assignments. How to charge. How to set up your own business. Even what to say to clients who want to bring friends on shopping trips (*never*)—or to those who want you to talk budgets with their husbands (*always*).

You will be asked to complete assignments and return them to ICS. Skillful, interested instructors will review your work. Suggest new ideas or alternate solutions. Then return your corrected assignments to you with their comments.

## Extra help as near as the phone

Although you work at home, you're never alone. You can call ICS—Dial-a-Question—toll-free—any time of day or night—to ask any questions about your studies.

Interior Decorating is an ideal part-time career that can grow into a full-time job when you're ready. And ICS is the ideal way to study—at home.

## Mail card for free information

To find out whether becoming a professional interior decorator could give you a more interesting and rewarding life, simply mail the attached card today. We'll send you by return mail "Should I Become an Interior Decorator?" a helpful booklet containing the questions you probably have on your mind right now and detailed information that will help you answer those questions.

We'll also include a demonstration lesson so that you can see how you can develop professional skill in interior design at home on your own time schedule. There is no obligation whatsoever.

If card is missing please mail coupon for information.

## ICS School of Interior Design

International Correspondence Schools  
Scranton, Pa. 18515

Send me your free booklet, "Should I Become an Interior Decorator?" plus a demonstration lesson and other information about your training in Interior Design. I understand there is no obligation whatsoever.

LA616W

Name \_\_\_\_\_ Age \_\_\_\_\_  
Address \_\_\_\_\_  
City \_\_\_\_\_  
State \_\_\_\_\_ Zip \_\_\_\_\_



### CALIFORNIA

Brockway Springs at Lake Tahoe sells both condominium apartments (above) and town houses (inset, left). By an alternate time-sharing ownership plan, a buyer pays according to the time he plans to use his unit—a fraction of its total cost.

## NEW-STYLE GETAWAY LIVING

A second generation of vacation communities is now maturing. Some are modest, such as Clearwood in Washington State, pictured on pages 59-61; others are as luxurious as California's Brockway Springs, above. Nearly all have profited from mistakes of the past. The best of these leisure-life colonies now involve distinguished architects and land-planners from the start, and concern for the environment is clear. They range from small condominium clusters by lakes or mountains to multifacility developments on thousands of acres. Here and following is a sampling from around the country. For ways to find—and judge—similar ones in vacation areas near you, see page 24.

### NORTH CAROLINA

Sapphire Valley in the Blue Ridge Mountains, with sports for all seasons, has all-wood condominium units (below) and also offers individual homesites.



### NEW HAMPSHIRE

Eastman, near Grantham, was designed by planner Emil Hanslin, who pioneered the vacation-home community with New Seabury, on Cape Cod, in 1961. New England forms are favored (below).



### COLORADO

Woodmoor at Breckenridge is in Rocky Mountain ski country. Its town-house units (below) may be purchased or rented. Management maintains architectural control over home building.



continued



**Sears Sudbury Square Collection.**  
**Superbly quilted.**  
**Beautifully priced.**

Romance your bedroom with any one of these beautiful bedspreads. Choose from five exclusive designs. Like English country morning glories. Chinese tiger lilies. Or French roses wrapped in ribbons. Flowers to bloom all year in Sears Sudbury Square Collection.

Delicate looking. Yet made to last. The quilting is "lock-stitched" to prevent threads from raveling. And each design has its own unique quilting pattern that harmonizes with it.

The chintz is 100% cotton, backed with the same soft nylon tricot used in the finest lingerie. Lushly filled with Sears own Dura-Puff® polyester. Every bedspread is pattern matched at the seams. And each is easily dry cleaned, of course.

These are the elegant bedspreads you expect to find in a decorator's shop. But they're only at Sears. Look for them at most larger Sears, Roebuck and Co. stores. Or in the catalog. We think you'll be astonished at the price.

Five elegant designs. Only at

**Sears**



## VERMONT

Quechee Lakes (above) blends modern facilities and early Americana. Covered bridge links homesites and condominiums to town center: buildings restored as restaurant, theater, shops.

GETAWAY LIVING continued



## COLORADO

Crested Butte, with its rustic condominium lodges (left), made its name as a ski resort. Now it boasts summer activities as well and, like other vacation communities, can rent homes and apartments when not in use by owners.



## MICHIGAN

Sudendorf, a small condominium colony in the foothills of Schuss Mountain, was designed with an eye for privacy—and also to preserve the tall trees. Rough-sawn plywood faces interiors and exteriors of units (above), creating easy maintenance.

## NEW HAMPSHIRE

Waterville Estates in Campton takes advantage of the White Mountains' summer-winter appeal. Condominiums (left) offer a measure of seclusion—"a way to live alone within a group," says the designer.

## FLORIDA

Amelia Island Plantation, off the northeast coast, was begun only after a year-long study of the area ecology. Three of the earliest condominium "villas" (right) are shaded by giant live oaks.

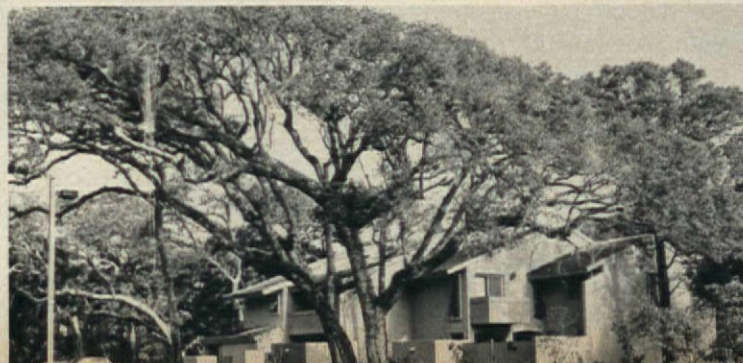



# Start fresh with Belair.

## Just the right touch of menthol.

Pour out hot coffee anytime with the help of an Insulated Picnic Set by Thermo-Serv. Get one just like theirs for free B&W coupons, the valuable extra on every pack of Belair.

To see over 1000 gifts, write for your free Gift Catalog:  
 Box 12, Louisville, Ky. 40201.



© BROWN & WILLIAMSON TOBACCO CORP.  
 Kings, 16 mg. "tar," 1.2 mg. nicotine; Longs, 18 mg. "tar," 1.3 mg. nicotine, av. per cigarette, FTC Report February '73

**Warning: The Surgeon General Has Determined That Cigarette Smoking Is Dangerous to Your Health.**

If the idea of a planned vacation community appeals to you, visit the ones near where you live and see what they're like. To locate communities in your area, check real-estate sections of local newspapers—and papers published in vacation areas—or write for lists from:

- American Land Development Assn., 1000 16th St., N.W., Washington, D.C. 20036. Specify state or states.
- Leisure Living Magazine, 130 Shepard St., Lawrence, Mass. 01843. Northeast and Mid-Atlantic directories are available now; others will be, in the future.
- Office of Interstate Land Sales, HUD, 451 7th St., S.W., Room 9260, Washington, D.C. 20410. Specify state or states (small cost, based on length of list).
- Department of Development, your own state (agencies of some states will be very helpful, others not at all).

Once you've pinpointed accessible

vacation communities, you'll need some guidelines for comparing them. If a community has been established for some years, with all recreational facilities built and operating, judging it will be fairly simple. You can actually see what you're getting, and veteran residents can testify not only to the costs involved but also to how well facilities are maintained.

It will be much harder to appraise the community that exists only on paper—whether it be a simple plot plan or an elaborate color brochure. Beware of developers whose primary interest is selling land; focus on those whose long-range involvement in the community is clear. To help you make this judgment—and others—consider these questions:

**What does the master plan show?** Is it imaginative and well thought out? Is there plenty of undeveloped common land for your use? Are there buffers of

undeveloped land between groups of houses, between houses and service facilities and along waterways and lake fronts? Does this land include natural areas? Do roads fit into the landscape?

**What will the area be like in the future?** Has enough interest and building activity been stimulated to complete the development? Will the area retain the character you now envision? Can facilities accommodate future growth? If town services are to be relied upon, will the town be able to provide them?

**Does the community comply with all applicable laws?** (New laws protecting the environment affect such things as sewage disposal, drainage patterns, density of building, etc.)

**Is your investment protected legally?** Will you receive a clear title and deed? What restrictions are there on the use of your property? Who will enforce them?

What benefits and obligations do they impose on you? What effect might they have on resale? What guarantees are there that undeveloped common land and open spaces will not be developed in the future? Are there effective controls on land surrounding the development?

**Will all necessary utilities and services be available, and when?** These include water supply, sewage and solid waste disposal, electricity, fuel supply, telephone, roads (and their maintenance), shopping facilities, security and fire protection. Who will furnish them? Who will pay for installation and maintenance?

**What improvements and amenities are promised?** What is the developer's timetable for completion of recreational facilities? How will they be financed? Who will own them and when will they be conveyed to the ultimate owner? If a homeowners' association is to assume responsibility for the common facilities, what will the cost of membership be and how has it been determined?

**What financing arrangements has the developer made?** What is his financial backing, and is it adequate to complete the community as planned? What financing terms and conditions does he offer you? Are they as favorable as you might obtain on the open market? Does he retain the right of immediate repossession in case of default?

These questions are condensed from a pamphlet published by Land Use Foundation, a nonprofit group promoting better land-use practices. For a copy, send \$1 to the foundation at 7 S. State St., Concord, N.H. 03301.—Guy Henle

**"Do you want a manicure or a pair of mittens?"**

**"It's dishwashing, Madge."**



**"Ever try Palmolive Dishwashing Liquid? It softens hands while you do dishes."**

Palmolive® Liquid is a lot more than just mild. Suds last from the first glass, clean through to the last greasy pan. And it softens hands while you do dishes.



FREE BOWLING!... Bowl a game, get a game free with each label from Palmolive® Liquid, Ajax® All-Purpose Cleaner or Cold Power® Powder. Offer good at all participating bowling centers until 5 P.M. during open play. © 1973, Colgate-Palmolive Company





# "CHURCH IN THE WILDWOOD" STITCHERY KIT

By Dorothy Lambert Brightbill

ANOTHER AMERICAN HOME EXCLUSIVE

"The Little Brown Church in the Vale," immortalized in song back in 1864, still stands on Route 346, near Nashua, Iowa. Don and Carol Henning have designed an authentic needlework portrait of the church in nostalgic fashion (above), taking artistic license only with the delicate birch trees and the flowery path. The design is stamped on sky-blue homespun, 16 by 20 inches, and wool yarn is included in the kit, along with easy-to-follow instructions, stitch chart and color guide. The handsome wood-brown and weathered-gray frame is also available, unassembled; special braces make it easy to put together. Add a nostalgic note to the nursery with a Child's Prayer (below), 14 by 17 inches, stamped on linen. Wood frame is available.

**Mother animals, birds and their young frame the familiar words of this cross-stitched version of a Child's Prayer.**



Fill out coupon and enclose check or money order. Sorry, we are unable to handle Canadian or foreign orders.

**American Home Dept. 3509, 4500 N.W. 135th St., Miami, Fla. 33054**

Check items desired:

- \_\_\_ Kit 61717 Church in the Wildwood @ \$8.98 ea. plus .75 post. & hdg. . . . \$
- \_\_\_ Kit 61718 Frame for above @ \$6.99 ea. plus .75 post. & hdg. . . . .
- \_\_\_ Kit 61015 Child's Prayer @ \$2.50 ea. plus .50 post. & hdg. . . . .
- \_\_\_ Kit 61135 Frame for above @ \$3 ea. plus .50 post. & hdg. . . . .
- \_\_\_ 61014 Colorful catalog of other kits @ .35 ea. . . . .

**For great make-it ideas—Ladies' Home Journal Needle and Craft**

- Issues @ \$1.25 ea. (please specify choice)
- 61655 Spring '73 \_\_\_\_\_ 61563 Winter '72 . . . . . \$

**New ideas in crafts, stenciling, needlework—**

- American Home Crafts Magazines @ \$1.25 ea. (please specify choice)
- 61681 Spring '73 \_\_\_\_\_ 61597 Winter '72 . . . . . \$

You may use your charge card for any purchase over \$4.98.

Sales tax, if applicable . . . . \$  
Total enclosed . . . . \$

<input type="checkbox"/> BankAmericard	_____
Acct. No. _____	print name _____
Good thru _____	_____
<input type="checkbox"/> Master Charge	_____
Acct. No. _____	address _____
Good thru _____	_____
Interbank No. (Find above your name) _____	city _____ state _____ zip code _____

**Bonus extra! A copy of the song comes with "Church in the Wildwood" Kit.**

Ben Swedowsky

# "AFTER SEVEN YEARS AS A HOUSEWIFE, I DIDN'T WANT A JOB THAT WOULD JUST 'KEEP ME BUSY.'"

## I WANTED A CHALLENGING CAREER-AND A LOT MORE THAN \$135 A WEEK."

Seven years of running the house, raising kids, painting the living room, wallpapering the kitchen, glorifying chickens and figuring out how to pay the orthodontist with what's left over after you get back from the supermarket.

Sound like you? Okay, so maybe now it's time to do something for yourself. Time to get out in the big, wide world, meet more people, discover a new arena—and earn a decent salary while you're at it.

If you've been the nerve-center for whole household, you've got maturity, judgment and a sense of responsibility. Employers need that—and they may offer you \$120, \$130, maybe \$135 a week for it.

But let's face it, being a housewife doesn't give you a whole heck of a lot of real job skills to offer. At least not the kind that can help you build a really challenging career that pays a lot more than \$135 a week!

If you've got your eye on the business world now, you want an important job that puts you at the center of things. A career where the opportunities for women who can handle big responsibilities are wide open.

**If you know what you want from your new career...**

...you know that most successful women got that way because they figured out what kinds of skills employers are willing to pay for... and then figured out how to get them.

Whether you're looking for a way out of a dead-end job... searching for a rewarding part-time career you can work around your family's schedule... or

thinking ahead to the kind of career you'll want when the kids are in school and your time is your own... you need to find a place in

business where women today can build an interesting and rewarding career.

**If you want to build a real career, you need to take a long hard look at...**

...what's happening in the business world today. Demand for qualified people in one important career category is soaring—to the tune of 33,000 new job openings every year during the 1970's!

Well-paid jobs for the kind of women employers can depend on. Satisfying jobs with lots of room at the top.

Prestigious jobs with big companies, small companies, law firms, advertising agencies, hospitals, investment firms,

vision stations, banks, universities, government agencies, insurance companies, hotel chains.

Jobs in metropolitan areas, medium-sized cities, small communities, suburbs, shopping centers... all over the country. Could one of these be the job you're looking for?

**To qualify for these exciting careers, you need...**

... the priceless ingredient that more than four million separate businesses in the United States *must* have to survive: financial know-how.

**The golden key to the kind of career you want...**

... could be easier to come by if you understand the financial language of business — and can interpret it to management.

An article in a leading business journal quotes an official of a national professional association describing today's accountant as a doctor who checks the pulse rate of a business to determine its financial health.

**If you'd like to take your place as a member of a management team...**

... find out how Bell & Howell Schools can help you build financial know-how and skills in accounting in your spare time. You can set your own pace — work your study time into your family's schedule. And you can do it all without neglecting your responsibilities at home or trying to find babysitters so you can attend classes.

**Mail the card for all the facts about...**

... Bell & Howell Schools programs in accounting that are designed to give you the knowledge and skills employers are looking for. Skills that could put you in the nerve-center of the rapidly evolving business world, or give you the know-how you may need to start an accounting or tax service you can operate from your own home.

**Our National Career Placement Center...**

... will help you step into a new career after you graduate. And this unique service is available at *any time* after you graduate.

**A glance at the "help wanted" ads in your newspapers can show you...**

... how career opportunities in accounting can help you move into a challenging career that offers you the salary you want, the responsibility you can handle, and the satisfaction and success you expect from a career you can really dig into. Compare the salaries to the kind of money you'd like to make! See where the real opportunities lie! *Then mail the postage-free card to get the complete details!*



A Home Study School Since 1903  
INTERNATIONAL ACCOUNTANTS SOCIETY

ONE OF THE  
**BELL & HOWELL SCHOOLS**  
4141 BELMONT, CHICAGO, ILLINOIS 60641

# Authentic BLUE DENIM TOTE BAGS for Everyone

- ★ Genuine Saddle Stitching ★ Leather-Like, Nailhead & Buckle Trim  
 ★ Designer Originals for Cross Country or Crosstown ★ 100% Washable Cotton Blue Denim



**Blue Jean Shopping Bag**  
 only \$2.98

The shape of things to come! Blue Jean shorts become fantastic tote bag, shopping bag, beach bag, even overnight bag. Quality-made of genuine western "blue jean" cotton denim with eye-

catching white saddle-stitching and red buttons, as bright as a prairie sunset. Holds everything for home or room! Snaps closed. 18" shoulder strap, 10"x10 1/2".

13146 - Blue Jeans Hobo Bag ..... \$2.98

## An Open and Shut Case for Big Values!



**PERSONALIZED PENCIL CASE** - for the young cow pokes! Looks like pair of blue jeans. Brings joy to girl or boy! Room galore for pencils, pens - avoids loss; child is always prepared! 10" long.  
 P13261 - Pencil Case ..... \$1.69



**2-IN-1 "FRENCH" PURSE & CLUTCH** - Dynamo in denim! Small enough to fit into your regular purse—large enough to function as separate tote for coins, make-up, whatever. 4 1/2"x6".  
 13584 - 2-in-1 Purse ..... \$1.49



**WALLET** - Styled like fine purse, but wallet-sized. Vast area inside for cash, coins, etc. 7" when closed. Self-handle.  
 13588 - Wallet ... \$3.98



**EYEGGLASS CASE** - Truly spectacular "spectacle" case! A denim darling, high in "eye-qi!" Prevents scratches. 6 1/2" d.  
 13583 - Spec. Case \$1.49



**"WAR PAINT"** - Cosmetics Case totes everything to keep you looking pretty! Vinyl interior, golden closure; mirror! 2 1/2"x2 1/2"x5".  
 13585 - Cosmetics Case ..... \$1.49



**"TEEPEE KEEP-Y"** - Snug mini purse holds coins, keys, so you'll always get into your teepee! 3 1/2"x3 1/2".  
 13586 - Coin/Key Case ..... \$1.49



**"SMOKE CASE"** - in denim totes cigarettes. Leather-trimmed outer pocket holds matches, lighter!  
 13582 - Cigarette Case \$1.49

**"PERSONALIZED" DURANGO TOTE BAG**  
 only \$3.98



Hit the trail with this designer original. Real "blue jean" cotton denim has untamed Western styling, huge 445 cubic-inch tote space. Full top zipper, pockets galore, adjustable carry-strap. Accented with belt tabs, saddle-stitching. 13x10x3 1/2".  
 P12623 - Denim Tote Bag ..... \$3.98



**PHOTO WALLET** - Wins in a photo finish. Wallet-like album fits neatly into purse or shows off 16 pictures at home! Belted closure. 4x4".  
 13596 - Photo Wallet \$1.49



**THAT'S YOUR BAG** - "Blue Jeans" Shopping Bag with "fringe" benefits on bottom. 22 sturdy inches deep, double handles, outer patch pockets.  
 13262 - Shopping Bag. \$2.98

**MAIL THIS 10-DAY NO-RISK COUPON TODAY**  
**GREENLAND STUDIOS**  
 3709 Greenland Bldg., Miami, Fla. 33054.

Enclosed is check or m.o. for \$\_\_\_\_\_ send items checked below:

- \_\_\_ Shopping Bag(s) # 13262 @ \$2.98; add 65¢ post.
  - \_\_\_ Cosmetic Bag(s) # 13585 @ \$1.49; add 45¢ post.
  - \_\_\_ 2-in-1 Purse(s) # 13584 @ \$1.49; add 45¢ post.
  - \_\_\_ Cigarette Case(s) # 13582 @ \$1.49; add 45¢ post.
  - \_\_\_ Wallet(s) # 13588 @ \$3.98; add 65¢ post.
  - \_\_\_ Spectacle Case(s) # 13583 @ \$1.49; add 45¢ post.
  - \_\_\_ Photo Wallet(s) # 13596 @ \$1.49; add 45¢ post.
  - \_\_\_ Pencil Case(s) # P13261 @ \$1.69; add 45¢ post.
  - \_\_\_ Personalized—Print 1 Name: \_\_\_\_\_
  - \_\_\_ "Durango" Tote(s) # P12623 @ \$3.98; add 65¢ post.
  - \_\_\_ Personalized—Print 1 Name: \_\_\_\_\_
  - \_\_\_ "Jeans" Shopping Bag(s) # 13146 @ \$2.98; add 69¢ post.
  - \_\_\_ Coin/Key Case(s) # 13586 @ \$1.49; add 45¢ post.
- (Florida residents, add 4% sales tax)

Name \_\_\_\_\_  
 Address \_\_\_\_\_  
 City \_\_\_\_\_ State \_\_\_\_\_ Zip \_\_\_\_\_

# FABULOUS DECORATOR SALE!

## GIANT Wrought Iron Parisian Cart Plant Stand

Only  
**\$9.98**

Three Tier Portable Cart  
Adds That  
"House Beautiful"  
Look . . .  
From Room to Room!

What an elegant "French"  
accent for plants, flower dis-  
plays anywhere in your  
house, patio or garden. Roll  
cart to a sunny window,  
sheltered nook. 25" high,  
26" long, 18" wide with 3  
scalloped-edge trays. Rust  
and weather-resistant en-  
amel finish in white. Doubles  
for party-serving indoors  
and out, too! Order now!

### NO-LIMIT CONSUMER GUARANTEE

We take such pride in the merchandise we offer, that we're completely confident in offering this NO-LIMIT guarantee: If you are not satisfied for any reason whatsoever with your order, please return for a full refund of purchase price. A satisfied customer is our greatest reward.

Parisian Flower Cart  
(Z87916X) **\$9.98**

### HANOVER HOUSE, Dept. Z-844

Hanover Bldg., Hanover, Penna. 17331

Kindly rush \_\_\_\_\_ Parisian Cart Stands (Z87916X) for the amazing low price of only \$9.98 plus \$2.00 to help cover postage and handling. I understand that if I am not completely delighted, I will return for a full refund.

**SAVE! Special Offer: Order TWO Parisian Carts for only \$18.98 plus \$3.50 postage and handling. Makes ideal gift!**

Charge it:  Diners Club  American Express  
 BankAmericard  Master Charge Inter Bank No. \_\_\_\_\_

Acct. No. \_\_\_\_\_ Expires \_\_\_\_\_  
Penna. & Md. Residents Add Sales Tax.  
Enclosed is \$ \_\_\_\_\_

NAME \_\_\_\_\_  
(please print)

ADDRESS \_\_\_\_\_

CITY \_\_\_\_\_ STATE \_\_\_\_\_ ZIP \_\_\_\_\_

Check here for FREE catalog of fine gifts. (Z-89938X)

**Hanover  
House** Hanover, Penna. 17331





**PRECUT  
TO SUIT IN  
CEDAR**

Nancy and Hath selected a wooded site that overlooks a winding stream and oriented their house toward the water (above). On far side the view is of golf course's 14th fairway, a plus for these avid golfers.

In floor plan (below), deck, an option except in deluxe packages, wraps around three sides of house. The Harveys omitted one upstairs bedroom to create two-story living area.

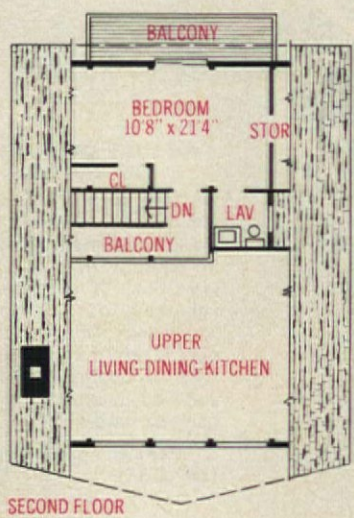
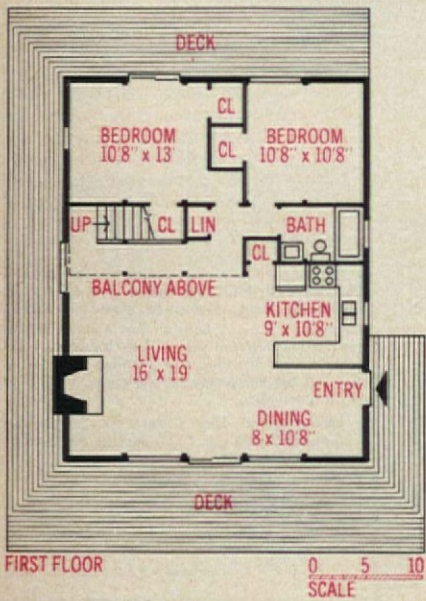

Nancy and Hathaway Harvey weren't house-hunting, just visiting friends at Bent Tree in the mountains of north Georgia. But when they saw this new vacation-home community—with its woods and streams, sports and recreation facilities—they bought not one, but three adjoining lots. (More about other pace-setting vacation colonies begins on page 20.)

Almost as quickly as they decided to buy land, the Harveys chose a house to put on it. They felt that, based on design and price, the "Banff" model from Lindal Cedar Homes best met their needs. It's a precut house, ready for assembly when shipped to a site—a flexible design the Harveys modified slightly at the time they ordered it.

"We wanted to open up the first-floor living area," says Hath, "so we eliminated the walls that enclosed the kitchen and created one large living-dining-kitchen area and added a deck." They also omitted one bedroom from the second floor to allow the ceiling of the open living area to rise to a towering 23 feet. The Harveys and their sons, John, 6, and Bradford, 4, use the downstairs bedrooms; the single upstairs bedroom, with its two trundle beds, sleeps four guests.

Cedar interiors minimize upkeep, allowing the Harveys plenty of time for golf, tennis, fishing and boating. Including the carpeting and appliances they bought, their 1,400-square-foot "Banff" cost \$30,000. (continued)



The sounds of the rushing stream make alfresco dining pleasurable, as all four Harveys and the family dog enjoy a barbecue on the deck (right). Privacy is complete with only woods as near neighbors.

# National's 8 day week. Because a week's vacation is longer than 7 days.



Our 8-day week puts Father Time on your side.

Most week vacations come with two weekends. And the beauty of National Car Rental's 8-day week\* is that you can take advantage of both of them.

Let's say you fly somewhere Saturday morning. The car you rent from us when you land is

ours until Sunday of the following weekend.

The 8-day net package rate is just \$118 for a Pontiac Le Mans, a Monte Carlo or similar-sized fine car.

We throw in 1,000 free miles (12¢ a mile after that). And we give you the first tank of gas free. All we ask is that you return the car to the city where you rented it.

If you're taking a shorter trip ask us about our 26-hour day and our 4-day weekend.

At National we've got the world's largest fleet of new GM cars. A sophisticated computerized reservation system<sup>†</sup> (you can even reserve a car in Europe by just picking up the phone). Plus S&H Green Stamps on every U.S. rental. And now we give one more thing to make the customer number one.

More time for your money.

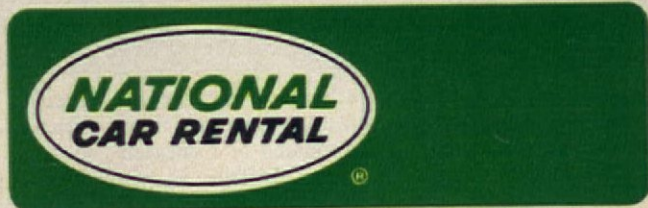

\*Available at participating locations in U.S. cities. †For reservations worldwide see your travel consultant or call 800-328-4567 toll free. In Minnesota call 612-830-2345 collect. ©1973 National Car Rental System, Inc. (in Canada it's Tilden-Rent-A-Car).



Nancy, Hath, John (beside his mother) and Brad enjoy a quiet respite from their active outdoor life (below). Wide expanse of glass floods living area with light and brings nature in.

Ruggedness of mountain-stone fireplace (left) is an ideal complement to warm exposed-wood interiors. Dining table (below) occupies a corner of living area a few steps from kitchen. Counter-divider, beside front door, is a drop-off spot for packages.



The Lindal system of manufactured housing uses a post-and-beam frame. For extra strength, all beams and floor and roof reinforcements are steel laminated and encased in cedar. The flooring itself is two inches thick.

The "Banff," which the Harveys had built, is one of 79 Lindal models. Each comes in several versions that can be ordered in one of four construction packages. The houses are sold through some 300 distributors in most parts of the United States and Canada. Prices vary slightly from

area to area, ranging from about \$3,000 for the 260-square-foot "Hideaway" in the lowest-priced construction package to \$33,000 for the 2,848-square-foot "Lincoln" in the deluxe package. Prices include walls, flooring, partitions, roof, insulation, all doors and windows—and exclude foundation, masonry, plumbing, heating and kitchen cabinets. For a Lindal Plan Book, with pictures and plans, send \$1 to Lindal Cedar Homes, Dept. AH, 10411 Empire Way South, Seattle, Wash. 98178. —Jane Levy



# The Shell No-Pest Strip.

Helps protect your family from germ-carrying flies and annoying mosquitoes. For up to four full months.



There are many products to kill flies and mosquitoes in your home.

But Shell No-Pest® Strip Insecticide helps protect your family from these insects when used as directed on label.

And unlike most other household insecticides, the No-Pest Strip can be hung or placed well out of reach of children even while it's working.

Use No-Pest Strips according to label instructions in bedrooms, living rooms, dens, hallways, family rooms, attics, basements and garages. Each Strip protects a 1000 cubic foot area.

Get No-Pest Strips for your home next time you shop.

You and your family will have fewer flies and mosquitoes to worry about for the next four months.

**America's No.1 flying insect killer.**



Use as directed on label.

THERE'VE BEEN 24 CHARCOAL FILTER CIGARETTES, BUT  
**THERE'S ONLY ONE  
NUMBER ONE.**



**THIS ONE.**

Tareyton was America's first charcoal filter cigarette.

It's been America's best-selling charcoal filter cigarette ever since.

No surprise. Tareyton is America's best-tasting charcoal filter cigarette. Twenty-three other charcoal

filters have come. And mostly gone.

But today, more people smoke Tareyton than all the other charcoal filter cigarettes combined.

The number one charcoal filter? There's only one. The first one. Tareyton.

Warning: The Surgeon General Has Determined That Cigarette Smoking Is Dangerous to Your Health.

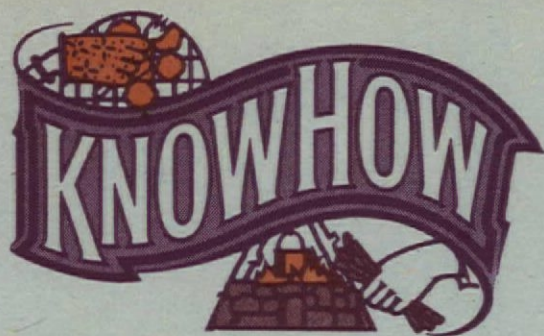

It's a bounty of berries, a way to enhance your property with redwood—then give it a nighttime glow. It's also handy musts for cookouts and tips on tents.

Summer is the berries for berries. From May to September the markets will grandstand those little square boxes mounded with glorious colors, and you'll be too tempted to resist. Good. Take advantage of these peak-season supplies, when prices are low and the berries are at their fresh best. You can use them fresh in a hundred delicious ways, from muffins in the morning to dessert after dinner, or stretch the season by turning them into your own special jams, jellies, preserves. You can even freeze this summer's crop for later use: Wash the berries carefully in cold water, freeze them separately on a cookie sheet, then pour into a container, leaving some headroom. Now, a bit about the berries.

**STRAWBERRIES** are a national favorite that grow in every state. The small, firm, bright-red ones have the most flavor. Look for berries that are plump and well shaped, uniform in color, with the caps still on. Sort them, but don't wash before storing in the refrigerator. Before serving, wash them gently in a colander and remove stems and hulls; don't let the berries soak. Try strawberries the French way—with wine or lemon juice and a little sugar. Or cut some up, sprinkle with sugar and put in the refrigerator, covered; they'll soften and create a rich syrup that's marvelous over a mound of lemon ice cream.

**BLUEBERRIES** are sometimes called bilberries, whortleberries, huckleberries and even, mistakenly, huckleberries (they're all very similar). Wild blueberries are fairly common across the country, and a handful of the small, low-bush types still provides one of the most sharply flavorful

mouthfuls known to man. Buy firm, plump berries that are rich in color. To store, sort, but don't wash; refrigerate them spread out in an uncovered pan. Wash gently, but don't soak, before serving. These light-blue-to-almost-black nuggets do wonders for most muffin and pancake recipes. They make good syrup, too, and pies and cobblers. Or try them for color contrast in a tasty macédoine of melon balls, strawberries, raspberries and bananas.

**RASPBERRIES** are a fruit of the bramble (a relative of the rose) with a fine, delicately tart taste. They are best when bright, firm and dry. They crush easily, so don't buy if boxes are stained—a fair warning with any berries. You can use raspberries in almost any recipe that calls for strawberries. They're a great pie berry and they combine well with applesauce.

**BLACKBERRIES** are a colorful fruit: When green, they are red; when ripe, they are almost purple, and some may be white. Loganberries, youngberries and boysenberries are well-known special varieties. Buy blackberries shining and plump, solid in color. They are highly perishable, so use them as soon as possible. To store, keep berries unwashed in the refrigerator, covered lightly with wax paper. Before serving, wash them gently but do not let soak.

Blackberries have a wonderful affinity for apples, when stewed separately and then mixed, or when baked up together in a pie. And they make good syrup for pancakes, particularly the Swedish variety. But as with all the berries, they're perhaps best of all served with sugar and cream—classic, simple, delicious. —Denise McCluggage



# IT'S PRIVATE

# IT'S COOL

Using redwood slats and a simple technique, you can tailor a fence or a shelter to suit your home.

With quick and easy spaced-slat construction, you can create a fence or a shelter of any size or shape to add privacy, shade and casual charm to your home. The ultimate use of this technique is seen in the redwood screening fence (right) and outdoor garden room (opposite) that landscape designer Lorenzo Foncerrada created for a tile-roofed California home.

The garden room wraps around two sides of the house and is reached by doors leading from the kitchen and living room. Openwork construction at the sides and overhead lets breezes penetrate.

## WORKING WITH REDWOOD

Drawings at right show fence and roof details and illustrate how curved openings are done. This simple trellis construction can be used to make a fence or shade roof any size or shape you wish. To build outdoors with redwood, according to the California Redwood Association, use any of the garden grades. To resist insects and decay, redwood that touches the ground or comes within 6 inches of it should be heartwood, rather than lightly streaked, less-resilient sapwood.

We recommend "Construction Heart" grade for posts and bottom rails shown in our drawings. "Construction Common" or "Merchantable" grades would suit the other pieces. Use aluminum, stainless-steel or high-grade galvanized nails to prevent staining. Redwood requires no finish—it weathers gradually to a driftwood gray—but can be bleached, stained or painted. —Guy Henle

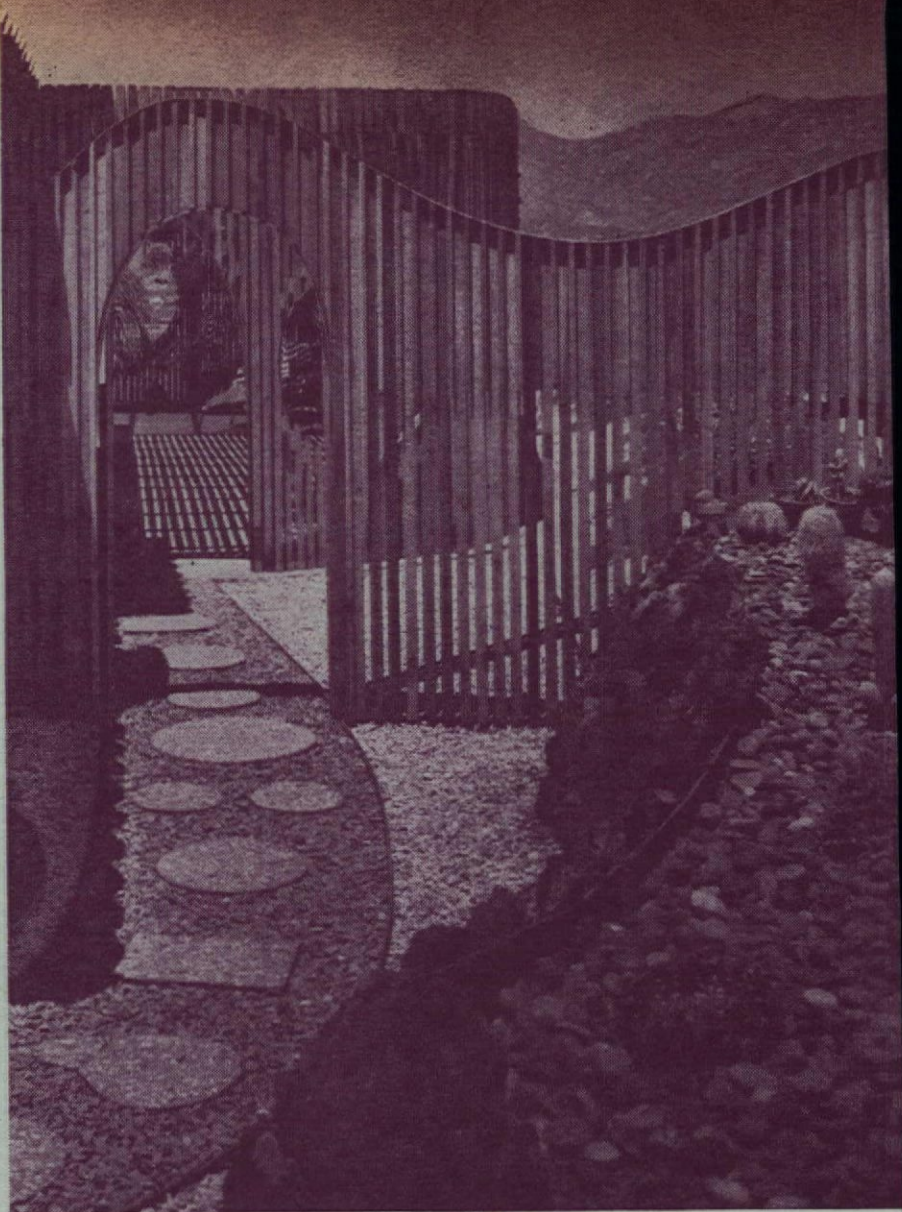

In Lorenzo Foncerrada's readily adaptable design, you enter the outdoor garden room of this suburban San Diego house through an arched gate in an undulating screened fence (above). The approach is enhanced by a bed of cactus that does well in direct sunlight. Garden room itself (opposite, above) has arched openings and porthole-like "windows" that frame mountain views. Plants hung from rafters and banked along sides add to cool, casual atmosphere.

Screening fence can be almost any size, but check local codes for any restrictions. Our adaptation (right) calls for 4x4 posts and 2x4 rails as a framework for 1x2 slats. Posts are spaced 8 feet apart and set in concrete. For drainage, slant concrete away from posts above ground. Posts set without concrete should go into the ground at least a quarter of the way. Nailing is from one side. To make yours a "good-neighbor" fence, set rails between posts and alternate slats on each side.

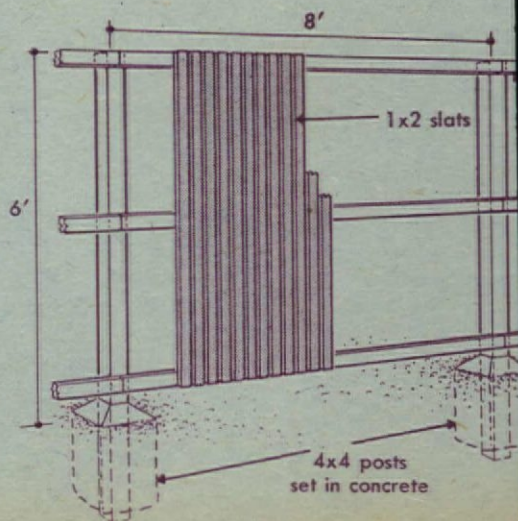



Trellis roofing rests on 4x4 posts anchored in concrete (below). Box frame of 2x6 beams set in cutouts on top of posts provides rigidity; intermediate rafters spaced at 2-foot intervals to support 1x2 slats are notched to fit over ledger strips at each side. Size and spacing of the post-and-beam framework must conform to your local codes.

To make arch (below), anchor first slat (1x2) firmly to post and top beam. Nail spacer block (1x1) to first slat, then nail second slat to top beam and spacer block. Continue alternating slats and spacer blocks across wall. Pencil in arched line; cut with keyhole or saber saw. Finish framework with 1/2x4 bender board nailed to each slat.

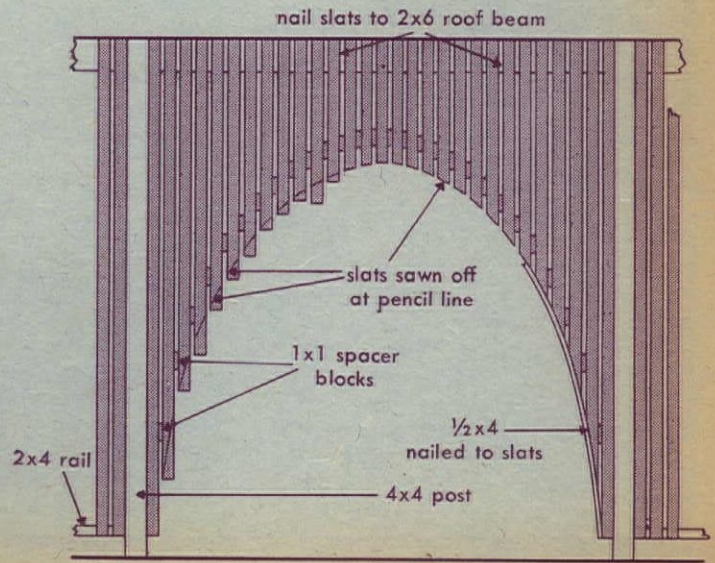
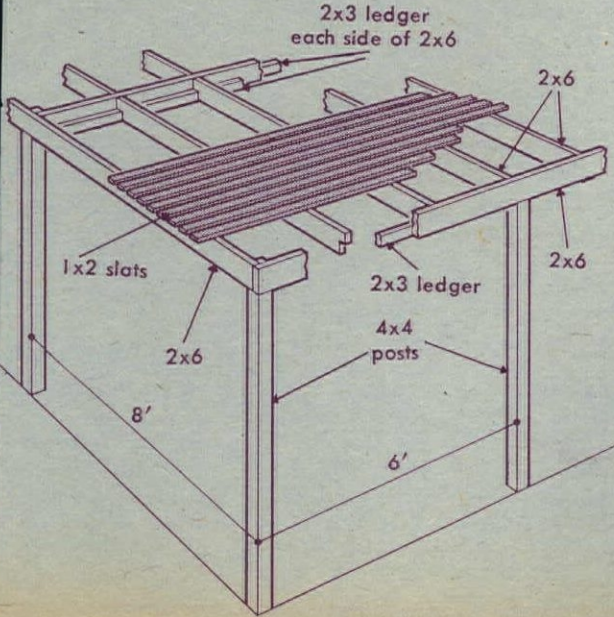

# GREAT GEAR FOR COOKOUT

Today's wide variety of equipment

makes for real backyard banqueting.

'Tis the season for the backyard barbecue—for sizzling burgers, tangy potato salad and spicy shish kebab. The cookout is one of America's great summertime traditions. Here's a rundown of the things that can make it a surefire success.

## CENTER STAGE

The grill is the star performer at any barbecue. You can find grills in all sizes and shapes, from small tabletop models (\$4 to \$25) to portables on wheels (\$12 to \$199) to permanent or semipermanent covered types (\$45 to \$309). Companies making them include Big Boy, Structo, Char-B-Que, Majestic, Strand, Weber, Char-Broil, Char-O, Hamlin Products, Inc., Sears, J.C. Penney and Montgomery Ward.

When buying a grill, look for sturdiness, stable construction and a rack that can be raised or lowered, with narrow spaces so food can't fall through.

Grills may be fueled by charcoal, electricity or gas (the latter two need an outlet, gas line or gas tank as a fuel source), and they may be portable or permanently installed. The advantage of gas and electricity is that you can regulate the cooking temperature more accurately; some designs have hoods or covers and can actually be used for baking. But charcoal grills are still the biggest sellers, probably because they come in the widest range of sizes and prices. Many gas



and electric grill manufacturers use charcoal substitutes such as pumice, ceramic or volcanic rocks, all of which are reusable, self-cleaning and noncombustible, producing no ash or residue. They need only 10 to 15 minutes preheating compared to charcoal, which takes 20 to 45 minutes.

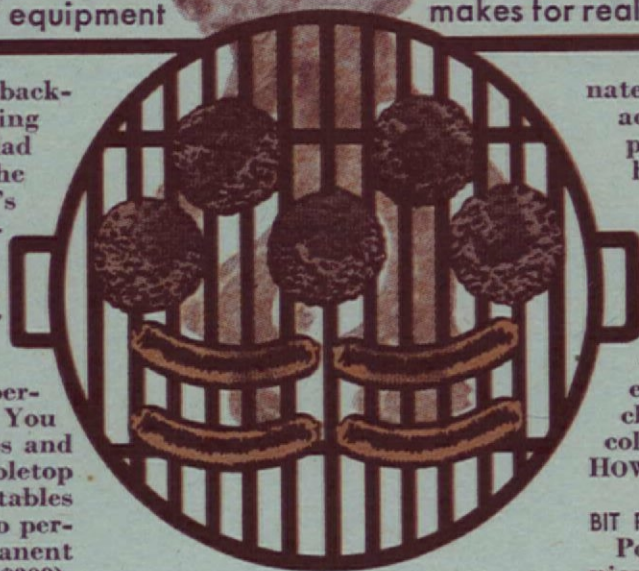

## SUPPORTING CAST

There are any number of special accessories (made by most grill manufacturers, and available in housewares departments and hardware stores) that can help your cookout go smoothly. Among the electric

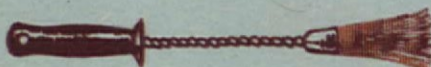

or battery-operated ones are a spit (\$12.50 to \$25), a shish-kebab rotisserie with four to eight skewers (\$35 to \$45) and a cylindrical wire basket for broiling ribs or chicken parts (\$8 to \$15). One of the newest gadgets is a food warmer that fits on top of an electric grill (\$14, from Char-B-Que). Among the nonelectrics are long-handled, shallow metal baskets for chicken, fish, ribs (\$4 to \$6); indispensable long-handled barbecue tools like basters, tongs, skewers and salt and pepper shakers (69¢ to \$4). There's a wire grill brush that makes scouring the grill much easier (\$1.29 to \$3.95) and there are heavy-duty, elasticized vinyl covers to protect the grills when not in use (\$5 to \$10).

For extra storage and work space, you can also get add-on shelves that fit on the grills. Produced by a number of grill manufacturers, these shelves come in various sizes and are made of metal, wood, or lami-

nated plastic (\$5 to \$6). Chef's accessories should include a pair of heavy-duty or asbestos-lined mitts and a good, big apron. Mitts and aprons are at housewares departments and hardware stores for under \$5. And of course you'll need some comfortable seating—picnic tables and benches or simple casual folding chairs (see the handsome collection in our June KNOW HOW section).

## BIT PARTS

Portable, rollable carts are nice to have for toting; you can find them in metal with an enamel or vinyl finish and with two or three shelves. They're made by Cosco and range in price from \$15 for a utilitarian model to \$55 for one with a removable electric serving tray.

If a cart isn't practical, use some of the ingenious baskets, trays and other carriers now on the market. There's even a special tote for bottles: Fein Imports makes one of lightweight, colorful plastic that can hold six bottles, cartons of milk or jars of condiments (\$2). Look for it in better house-

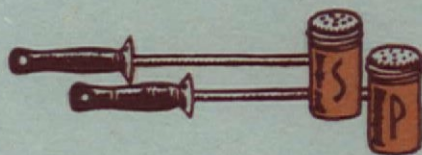

wares departments. Look, too, for dinnerware carriers by Dorothy C. Thorpe, Inc. They're wicker, with a brown-and-white checked wicker plaid border, in salad-plate and dinner-plate sizes (\$9 and \$11).

When your barbecue banquet is at night, you can add a nice touch with dime-store "Japanese" lanterns—or, even better, with a new candle-type light from Finland. Made by Scan-Plast, this five-inch-high cup-shaped plastic holder has a fat candle and comes with an 18-inch-high metal stand for sticking in the ground (\$6 a set of five). —Jeanne M. Bauer

# TENT COVERAGE

Here's how you and your family can relish the great outdoors—on a shoestring.

ing has caught on—but big—as a of vacation life. Come warm her, the roads are dotted with eational Vehicles, the hills with packers. But there's a happy me- between the backpackers, who a few scant provisions on their s, and the trailer people, who prac- y take their houses with them. It's world of family tent camping.

he proliferation of RVs hasn't pushed tent into obsolescence; on the rary, more and better tents are earing on the market each year. y families prefer them to trailers, e they're cheaper, easier to trans- and can be set up where RVs just t go. And of course, a tent brings closer to nature. But gone are the s of rough-and-tumble, pup-tent ing. Today's quality equipment is weight, efficient, sturdy and long- ing. Tents have floors and insect net- sleeping bags are down-filled and rious; efficient stoves make cooking eeze. Yet the new camping gear is expensive, when you consider the rs of happy vacation use you'll get of it. So if your family is interested, not try tenting together?

our first step, of course, is to buy nt. Find a good camping outlet and ilarize yourself with the different es. You'll find small pup tents and o-like pop-ups, octagonal tents, h-to's, tents that zip onto the opened k end of a station wagon and tents o look like the tops of covered gons. There are even tent kits you put together at home—and save 50 cent on cost. The array is dizzying you can narrow it down. Keep the e of your family in mind, and the kind camping you'll be doing (weekend s or month-long live-ins?). Find out special qualities of each tent: Some t too small or slope-sided for an ive family; some are just for back- ckers or mountaineering types; some t too confusing to put up.

For family camping, veterans say, arella or cabin tents are best. The arella has a square base, sloping lls and a pyramidal roof; the cabin oks a bit like a house, with fairly ight-up sides and a sloping roof milar to the illustration, right). Both me in family sizes, allow plenty of ad and living room and have out-of- rm's-way exterior poles and frames. ces range from \$80 to \$280, but it's st to choose at least a medium-priced

tent if you want to have a good one.

At the camping outlet check out a variety of styles set up for display; look them over, ask questions, try them out to see if you and the kids and your gear can all fit comfortably. (You may have to spend a rainy day in there sometime.) Perhaps you might consider buying two tents—one for yourself and the gear, and a pop-up affair for the kids. Most major dealers rent tents, and that's the best way to try out a candidate. Just reserve ahead of time in the busy season.

Here are some checkpoints to aid you in choosing a tent:

- It should have a big door and good-sized windows for ventilation; the openings should have insect netting, plus flaps against the rain.
- The best tent material for the camping family is cotton or a cotton blend, which is wind-resistant and highly water repellent. (Tents shouldn't be waterproof, since moisture from your body would then rise, condense on the inside roof and drop back in an annoying shower of drips.)
- Look for double seams and make sure all stress points are reinforced.
- Zippers should be heavy-duty; nylon is best. See that they don't catch on seams.
- Check for convenient pitching features, such as telescoping poles with locking devices. Poles should go together easily.
- Look for a sewn-in, tough, waterproof floor and, preferably, a good, high (perhaps six inches) waterproof "sill" all around to keep out heavy rain.

Besides the tent, you'll need other basics to make camp life enjoyably livable: sleeping bags, cots or mattresses, a lantern, a stove, a cooler chest and a water jug. It's also a good idea to take along a tent-mending kit.

When you get your new tent home, give it a trial run in your backyard to make sure all parts are present and that you and the kids can erect it on your own, quickly and efficiently. (And you might have a go at some of the books mentioned in "On-the-Go Guides to Travel Fun," page 53.) That done, you're all set for your first wonderful venture into the wilds. There you and your family can have the vacation of your life—exploring the woods, fishing, hiking, all day long, and coming home at night to a cozy, comfortable tent pitched in the great, dark outdoors.—Eileen Denver Mimoso



# MAKE YOUR GARDEN GLOW

Let outdoor lighting transform your garden into a nighttime fantasy.

Do dimming rays of sunlight send you indoors? With good outdoor lighting you can expand the perimeter of your living area and enjoy the beauty of your garden after hours. "One basic point to keep in mind," advises landscape architect Armand Benedek, "is not to try and reproduce daylight." To avoid flat, even lighting and to achieve a dimensional effect, he suggests using many fixtures of lower wattage rather than one or two high-watt floodlights.

Nighttime enjoyment of your garden needn't end when leaves and flowers are gone. The highlights and shadows created by well-placed fixtures will give you as much pleasure in winter months as in warm, green seasons. A wide variety of fixtures is available: floodlights and spots for up and down lighting; mushroom lights, louvered posts and decorative shapes for step, path and border lighting; lanterns to suspend from tree branches. Spike-bottom fixtures are portable, enabling you to follow the leaf and bloom sequence of your trees and flowers.

Like good stage lighting, outdoor illumination is most effective when it isn't obvious. And only when the fixture itself is particularly attractive does it deserve to be a focal point. Aluminum, brass, bronze, copper and steel are all good outdoor materials. Of the two types of available lighting systems, low-voltage (12-volt) lighting is less costly and easier for a do-it-yourselfer to install. High-powered (120-volt) lighting offers more illumination and a wide selection of fixtures. —Jane Levy



**Terrace.** Attach overhead floodlights to eave, roof or nearby tree for general lighting. Create a soft effect and bridge transition from lighted area to dark area beyond with border lights or low-level lights from surrounding flower beds.

**Paths, steps.** Use low-level down lighting or recessed step lights. Side lighting with low lights will make stone and other textures dramatic.

**Trees.** To make a tree your focal point, floodlight from two or three directions. For background effect, place floodlights on ground three to six feet from tree, aim toward upper or lower branches. For canopy effect to accent foliage, mount floodlights on tree trunk above eye level and aim into branches.

**Flower beds.** Give subtle illumination to flowers by means of a series of low-level lights. Fixtures should be portable—follow bloom sequence.

For more information, write: Director of Residential Lighting, Westinghouse Electric Corp., Lamp Div., Bloomfield, N.J. 07003; or Inquiry Bureau, General Electric Co., Lamp Business Div., Nela Park, Cleveland, Ohio 44112.



Enjoy the look of everlasting summer

with beautiful, bright dried flowers.

Flowers bloom, fade and die all too quickly—theirs a fleeting glory. But you can halt the floral cycle at its peak moment and perpetuate that glory, if you wish. The magic is in drying. Here's how to capture and preserve the seasonal beauty of the garden, the upland meadow, the wayside, the woods. Here are three methods:

Weeds, grasses, Queen Anne's lace, strawberries and other "everlastings" can be dried simply by hanging them in the air; many other flowers—from ageratum to zinnias—can best be preserved by burying them in a drying agent. Or you can press-dry your choices, particularly the flatter ones—pansies, violets, even ferns and leaves.

However you intend to dry your pickings, garner them when they are dry and rich in color—say, late in the morning on a sunny day. Select blossoms at the first edge of full development. Strip off all the leaves and, for the burying technique, cut off all but an inch or two of the stem.

**Air drying:** Make pencil-thick bunches of the grasses or flowers, using all-of-a-kind in each bundle since drying times differ. Tie the stems securely; rubber bands are best for this because the stems shrink as they dry and string-tied bunches might loosen and fall apart. Stretch a strand of picture wire or cord across a dark, dry, airy spot and hang the bunches upside down from this, allowing room for air to circulate. The dark keeps the colors from fading; the dry airiness hastens the drying process. Obviously, attics are more suitable than traditionally damp basements, but find a comparable spot in your house.

Drying times vary, but in a week, maybe two, of fair weather, the flowers should be ready. They will be crisp and dry to the touch—but beware, a humid spell can take the starch right out of them again. So until you're ready to arrange the blooms, store them in plastic bags or rigid plastic shoeboxes along with some moisture-absorbing chemical such as silica gel (see below). For arrangements, you might try a mix of strawflowers and short, colorful grasses in a small earthenware bowl or a combination of tall grasses and reeds in an old copper pot. Avoid putting your dried-flower arrangement in an overly humid, too-bright place.

**Burying:** Drying has been done for centuries by burying blooms in any substance that absorbs moisture. You can try this method, using clean, fine white beach sand mixed with a little borax, if you have access to the sand and care to wash it (soak it in fresh water, rinse, then dry it in the oven). Cat litter works too, but leaves a stubborn, dusty residue. Best, perhaps, is silica gel, a chemical capable of absorbing up to 40 percent of its own weight in moisture. It is widely used as a dehumidifier by the Navy (on ships afloat) and by industry. You may have seen little packets of this sandlike substance packed in with cameras, in the lids of cracker crispers or in salt shakers made for damp climates.

Special crystals are mixed with the silica gel to denote when it has absorbed its share of water. These indicators, blue when dry, turn pink as they drink up moisture. A special, fine "grind," about the texture of salt, is put out by the Plantabbs Corp. of Timonium, Md. Called "Flower-Dri," it is sold in nurseries and floral sections of many department stores. It can also be ordered by mail.

Silica gel is not cheap. When sold in four-pound quantities, it is about \$2 a pound, and that's enough for only five or six flower heads at a time.



## Pick

But the stuff can be used repeatedly. A half-hour in a slow oven will turn it from pink to blue, ready for another go-round.

Ideal receptacles for drying most flowers are cookie or fruitcake tins with lids. Carpet the bottom of the tin with about two inches of the gel; arrange the flower heads face up on this miniature beach, leaving space between them. Then cover the blossoms with a gentle sandstorm, drifting gel under and around and over the petals until they are buried completely under at least an inch of gel. Put on the lid and seal with masking tape.

After two days, open the tin and gently brush away the top layer of gel to check progress. If the petals are crisp and dry, the deed is done. If they are still limp, allow more time—up to a week, maybe, but keep checking to avoid the risk of "burning" the bloom and making it brittle. Don't worry if some of the flowers fade a bit; some retain their high colors better than others in the drying process. You can always touch them up with a bit of painted-on dye.

When the flowers are ready, carefully pour the gel away and lift them out. A camel's-hair brush, available from art-supply shops, is good for uncovering the flowers and dusting off their fragile petals. But don't fret if you dislodge one or two; a tiny touch of transparent glue will effect repairs. Place the flowers in screw-top jars or plastic boxes along with a few spoonfuls of silica gel; store in a dark, dry spot until you want to use them.

**Press-drying:** Put the prettiest pansy of the season in the encyclopedia or the daisy that told in a volume of poetry. Pressing flowers in books is still a common technique—only now the flowers go into a sandwich of white blotting paper first. However, using silica gel, pressing under books is even better than pressing in books, and the press-drying process can be completed in about a week.

One good pressing method is to take a piece of plywood or board large enough to accommodate your chosen pressings and cover it with white blotting paper, available at stationery stores. Sprinkle on a layer of silica gel, then cover with several layers of white facial tissue. Arrange the flowers on this surface. Small, flat flowers like pansies and daisies press well whole, but the more complicated blooms, or those with hard, thick centers, are best dismembered and pressed petal by petal. Press the stems of these blooms separately from the flower head, too. Now cover the collection with several more layers of tissue, another sprinkling of silica gel and another layer of blotting paper. Wrap it all snugly in plastic—a big bag from the dry cleaners, properly sealed, works fine. Now come the books, if the purist in you insists on them.

In a week, unweight your sandwich and dismantle it. To store, wrap your pressed blossoms loosely in tissue paper and place in plastic bags with some silica gel.

With dried flowers, you can create fanciful blossoms nature never dreamed of: You can put petals on a moiré or velvet background, or you can mount them between two panes of glass. A tiny splash of violet or a spray of fern carefully dot-glued onto stiff paper makes a distinctive place card or correspondence note. You can make floral bookmarks sealed in plastic. Use your imagination: There are so many ways to use your touches of "everlasting" summer. —Denise McCluggage



## Dry



## & Preserve

# The GOOD LIFE

Inspirational playing cards, a fish-loving reef made of old tires, new gourmet popcorn, plus a sumptuous meal afloat—they all add up.

## FLAMING FOURTH

July Fourth observances are everywhere, of course, but the one in Lititz, Pa., sounds like the most glowing event of all. Lititz's Fairyland of Candles celebration begins with the selection of a queen and court who light the "flame of independence"—a fiery ribbon of candles that lines both banks of Lititz Springs stream. The thousands of little lights glow in the night, a fitting tribute to Independence Day.



## GOSPEL TRUTH

Latest to be inspired by the current Jesus movement is a deck of 54 hand-somely illustrated cards depicting the life of Jesus. Devised by Rev. Ralph M. Moore, the deck consists of four suits dedicated to the Gospel writers, each card bearing a quotation from their writings. A team of distinguished Christian educators and theologians assisted Rev. Moore in creating the Jesus Deck as a visual aid in teaching Scripture and for playing games like Inspirational Solitaire, Gospel Bridge and Spiritual Concentration. It is available in church book shops and department stores for \$5.

## SOARING SATIRE

If you found that phenomenal best seller *Jonathan Livingston Seagull* a mite sugary, dip into a vinegary spoof of it—*Ludwig von Wolfgang Culture* by Dolph Sharp (Price/Stern/Sloan, \$1.50, paperback). This parody presents a presumptuous vulture who aspires to learn speed-reading and eat health foods (Jonathan was a fancy flier).



## GIANT FISH HAVEN

On Marco Island, a planned community near Naples, Fla., we had an interesting talk with Dr. Jay Harmic, director of the island's Environmental Laboratory. We were interested in the lab's special project, an artificial fishing reef built for research, ecology and sporting purposes. Dr. Harmic explained how the unusual reef was constructed: "We've taken 35,000 surplus tires that are a pollution problem, tied them in bundles, weighted them down with cement, then dropped them in the Gulf of Mexico, near the island. The tires were quickly encrusted with marine life, which attracted small fish first, then big fish. Now the reef is attracting waves of fishing fans—one of whom recently caught a news-making 24-pound bluefish." More artificial reefs are planned, both for better fishing and for scientific study of the fish species in the area.

## REALLY CORNY

According to the Popcorn Institute (did you know there was one?), more than 400 million pounds of the chewy kernels are sold yearly. Sales should pop even higher with the distribution of Orville Redenbacher's Gourmet Popping Corn, labeled the "World's Most Expensive." A 15-ounce jar costs 69¢, but is worth it, says Orville, who insists that his hybrid seed yields bigger, tastier kernels that won't stick to your teeth.

## DINING AFLOAT

You don't have to go to Paris to enjoy a gourmet meal on an elegant barge. *Le Bateau* is here—a mini-fleet of luxury boats that offers a short cruise plus continental cuisine plus candlelight and music. Sailing now from Fort Lauderdale, Fla., also Alexandria, Va./Washington, D.C. (and next year from San Francisco and New York), *Le Bateau* has both luncheon (two hours) and dinner (three hours) cruises.

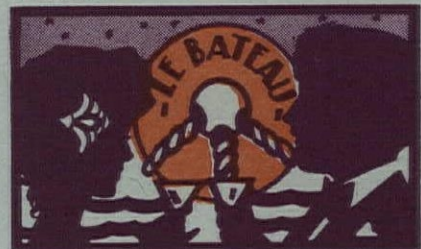

## VINTNERS' TALES

Nine out of 10 bottles of wine that Americans drink are made from U.S.-grown grapes. You will discover this heady statistic—and a good many others—in a stimulating, scholarly history called *The Wines of America* by Leon D. Adams (Houghton Mifflin Co., \$10.95), a book that traces the art of winemaking state by state from the 16th century to the present, and details the resurgence of domestic wines after the drought of Prohibition.

Another toast to wines is made by Winston Norman in his *More Fun with Wine* (Pocket Books, \$1.25, paperback). He tells how to enjoy wines, how to drink them and cook with them. (For example, try freezing red wine in ice trays; drop cubes in pitchers of chilled white wine, add soda—terrific!) The book is a basic primer of selecting wines, reading labels, ordering wine in restaurants, even giving wine-tasting parties. And Norman winds it all up with a quiz!

A visual aid to wine selection and enjoyment is now available to owners of Cartrivision TV: *Peter Sichel's Complete Guide to Wine*, available as a delightful lecture that runs 100 minutes (\$40), or as two shorter lectures of 60 minutes each (\$30 apiece). Sip along with Sichel, and wine is still more fun. —Louis Botto

Rekindle a romance,  
inveigle an invitation,  
feign an apology,  
or just leave a note  
for the milkman.

## Nostalgic Note Cards from the Virginia Slims Collection. Free.

(Free with four Virginia Slims  
pack bottoms, regular or menthol.)



**You've come a long way, baby.**

Mail today to: Virginia Slims Note Cards  
P.O. Box 7115  
Westbury, New York 11590

Please send me my set of 12 note cards (6 different  
designs, 2 of each) with matching envelopes. I enclose  
4 Virginia Slims pack bottoms, regular or menthol.

Offer void to persons under 21 years of age. Offer good in U.S.  
only, except where prohibited, licensed or taxed. All orders  
must be postmarked no later than October 15, 1973. Allow  
3 to 6 weeks for delivery. One order per envelope.

Name \_\_\_\_\_

Address \_\_\_\_\_

City \_\_\_\_\_ State \_\_\_\_\_ Zip \_\_\_\_\_

Warning: The Surgeon General Has Determined  
Cigarette Smoking Is Dangerous to Your Health.

17 mg. "tar," 1.2 mg. nicotine av. per cigarette, FTC Report Feb. '73

For a really clean wash,  
 Elena Foley uses Clorox®.

And her new Hotpoint  
 washer adds it automatically!

"I wouldn't dream of doing a family wash without adding Clorox Bleach. And the bleach dispenser in my new Hotpoint washer makes it *automatic*. Adds the Clorox at just the right time, to get out stains, dirt and grime my detergent alone can't. So all my bleachable whites, colors, synthetics and permanent press come out looking clean and bright. Not only that—I found a handy stain removal guide from Clorox in my new Hotpoint! They think of *everything*. My Hotpoint washer and Clorox!"

Elena Foley



## Clorox. It's automatic with Hotpoint.

Lady Executive™ Washer, Model WLW5900P. Automatic Soak and Wash control provides soak periods up to ten hours followed by whatever wash cycle you select—with fresh, clean water and additives. All automatically. Special "Rapid Wash" settings allow a complete wash-rinse-spin in just ten minutes. Five temperature, five speed settings including Handwash® control for delicate items. Infinite Water-Level control. 18 pound capacity.

Clorox has agreed with Hotpoint to supply Clorox literature packed by Hotpoint and to feature their appliances in Clorox advertising.

©1973, The Clorox Company. "Clorox" is a registered trademark of The Clorox Company.

THE WOMAN DRIVER

## HOT-WEATHER CAR CARE

By Denise McCluggage

It stands to pay off handsomely in safety and comfort for those sizzling days ahead.

In summertime the living may be easy, but where driving is concerned, it ain't necessarily so. True, the extremes of treacherously slippery roads and limited visibility are gone but summer has its own hazards. Heat is hard on engines on tires and on motorists. An escape to the breezy seashore may be beneficial to people, but salt air and wind-whipped sand are murderous to a car's finish and wearing on an engine. Here are some of summer's special problems for car owners and drivers, and some ideas on how to cope.

**Heat.** Your engine runs best in a certain range of temperature—warm enough so that the oil lubricates all moving parts sufficiently, but not so hot that a chemical change takes place and the oil all but becomes an acid bath, damaging your engine instead of protecting it. Certainly you put away your woolens and furs long ago, but did you prepare your car for hot weather? To avoid overheating, be sure your thermostat is functioning properly. Also be sure your cooling system is free of sludge and deposits. Modern antifreeze is a super-coolant as well, so it is a good idea to use this special fluid in your radiator year round. Be sure it is free to circulate, however. Have a mechanic check your car's "respiratory" system periodically.

Your summer oil should be a heavier weight than winter oil. And it might be a good idea to change it more frequently now. Extreme heat tends to break down oils faster and limit their efficiency. And summer dirt and blowing beach sand can sift into your car and create an internal sandpapering effect, drastically shortening the life of your engine. Whenever you change oil, change the oil filter, too.

If your car is dark-colored, absorbing heat rather than reflecting it, you are in for some particularly stifling moments when you first get in after it has been sitting in the sun. Air conditioning? You're lucky. But then you are paying well for it. All your power accessories—windows, seats and particularly air conditioning—are costing you more money in more gasoline. And gasoline is costing everybody more these days. Then there is the energy crisis and the threat of gas rationing. Think about it. Is it really necessary, or just more pleasant, to use your air conditioning as much as you do? Maybe just cooling off the car to tolerable levels when you first start out will be enough, letting open windows and natural breezes take over after that.

Heat plays hob with tires, too. Be absolutely sure you keep your tires inflated to the recommended pressures—and on the high side for high-speed highway driving. Test your tires with an accurate gauge in the cool of the morning before driving on them. Air expands with heat—you will not get an honest reading from a hot tire. And never let air out of a hot tire; that only encourages pressure buildup and aggravates the expansion problem. Leave the tire alone, and when it cools, the gauge will read correctly.

**Your car's finish.** Chances are, you do not expose your skin to the sun without some protection from lotions or oils. Your car's finish is sensitive, too. The paints and lacquers of recent years are an impressive improvement over early car finishes, but they, too, will oxidize and chalk and dull. A really good twice-yearly wax job—the paste kind mixed with generous amounts of elbow grease—should shield your car from an untimely old age. If you prefer the easier-to-put-on spray or liquid waxes, use them more often. And do the work—or have it done by that young driver in your

family eager to earn the use of the car—a cool surface in the shade.

What happens with a car finish is that pollutants in the air settle on it, dew provides a solvent, and there you have an furious soup eating away. With a coat of wax beneath all that, a hosing or quick wash will flush away the most damaging acids. Your chrome or brightwork may need special attention, particularly if there is a body of salt water nearby. Salt air is ruinous. So is the salt that northern states use to melt snow in the winter and keep down dust on back roads in the summer. Frequent washing—with a harsh hose spray directed under the car as well, will help. Commercial car washes with their dishwasher action reach places that are problems for the driveway car laundry. Wash off bird droppings and tree drippings promptly, too. These things will blight your car's finish, too.

New treatments for fabrics and amazing synthetics have made car interiors less vulnerable to a determined sun and the ravages of small feet tracking in sand and moisture, but some help from you is still warranted. Shake out and dry carpets frequently, and keep them well vacuumed if you spend much time near the beach. Sand is one of the most penetrating abrasives. To protect upholstery, specially made slipcovers of stretchable berry cloth are available for some model cars at various automotive shops or from mail-order firms. Or if you are clever, buy the fabric and make them yourself to fit the car. Comparatively cool berry is a far, far better thing to set a bare thigh on after a day at the shore than vinyl near its melting point. Also, easy-wash slipcovers keep the dripping Dairy Queens and melted chocolate off the seats, and keep the sun's rays off upholstery, too. While you are at it, when choosing a new car, you are better off with light tans, blues, greens, creams, rather than dark colors, if you live in a warm climate. As much as you may like a black leather-look interior, think of summer and choose a light upholstery.

**Your driving habits.** There are some conditions peculiar to summer that you should take into consideration—and modify your driving habits accordingly. Kids are out of school and outdoors playing at all hours. Maybe drummed-in safety programs during the winter months had a positive effect and kept them crossing streets at corners, but that discipline may be a dim memory now. Watch for youngsters.

Trees and bushes have leafed out and maybe even grown since the highway men painted those passing-zone lines on the road. What was a clear view of oncoming traffic in the budding stages of springtime might be blocked by clumps of mature foliage now. Stay alert for those seasonal blind spots and don't pass just because it is "allowed." Be

GREAT BUYS FOR COLLECTORS AND HOBBYISTS

# The 1972 Gold-Plated Eisenhower Dollar Jewelry

## Bracelet, Necklace and Key Chain



**THE EISENHOWER DOLLAR** commemorates America's great General and 34th President. Its depiction of the American eagle over the lunar surface is tribute to Eisenhower and our space achievements! A prime example of the engraver's art... now even more valuable with 24-Karat Gold electroplating!

Now wear thrilling history! A limited number of the dramatic Eisenhower dollar, the first dollar coin minted in years, have been electroplated\* with genuine 24-Karat Gold, and transformed into dazzling jewelry. Like the Kennedy half, the Eisenhower dollar, is already scarce.

Think of how sought after the Goldplated version, and the magnificent heirloom jewelry will be! Cherished as gifts! Choose necklace; antique mesh bracelet; or sturdy "rope" key chain. Each with authentic Eisenhower dollar coin, richly 24-Karat Gold electroplated. Extremely limited supply — order at once!

ALSO AVAILABLE — 24-Kt. Gold electroplated Eisenhower dollar coin, alone.

**MAIL 10 DAY NO-RISK COUPON TODAY!**  
**GREENLAND STUDIOS**  
3712 Greenland Building, Miami, Florida 33054

- Gold Plated Dollar Necklace(s) #13659 @ \$6.98
- Gold Plated Dollar Key Chain(s) #13657 @ \$4.98
- Gold Plated Dollar Bracelet(s) #13658 @ \$4.98
- Gold Plated Eisenhower Dollar(s) #12221 @ \$3 ea.

Add 45¢ postage each set or items

Name \_\_\_\_\_  
Address \_\_\_\_\_  
City \_\_\_\_\_ State \_\_\_\_\_ Zip \_\_\_\_\_

SAVE 90¢! Order any two or more of above and we pay postage. Their value can't be underestimated! (Florida residents please add 4% sales tax.)

## Doctors' Tests Show How You Can Actually Help Shrink Painful Swelling of Hemorrhoidal Tissues

... Due to Infection. Also Get Prompt, Temporary Relief in Many Cases from Pain, Itch in Such Tissues.

Doctors have found a most effective medication that actually helps shrink painful swelling of hemorrhoidal tissues caused by infection. In many cases, the first applications give prompt relief for hours from such pain and burning itching.

Tests by doctors on hundreds upon hundreds of patients showed this to be true in many cases. The medication the doctors used was Preparation H®—the same Preparation H you can get without a prescription. Ointment or suppositories.

sure to wait for a clear line-of-sight.

On winding roads where trees cast deep shadows across your path, dappling the way with high contrasts of shade and bright sunlight—look out! A car can be lurking in a dark spot. The demand on the eye's adjustment mechanism is great on such days, maybe too great to make out something dark in the shadows. There is little you can do about the other guy, except be aware that he might be there, but you can do something about you—turn on your lights. Feel silly with headlights burning on a bright day? You'll feel even sillier hoist on the hook of a tow truck.

Summer is also the time for floppy sandals—but please, not on the gas pedal. Those rubber beach thongs that

go slap, slap, slap as you walk are fine for keeping tender soles off hot pavements, but they are deadly for driving. They can catch on the accelerator, tangle with the brake pedal and keep you from stopping the car in time. Bare feet are also tricky, unless yours are as tough as two thicknesses of boot leather. For driving, choose footwear that is as cool as possible, but with no gap between its sole and yours. Wear sensible shoes when you drive.

Then there's that familiar summertime hazard—glare. Let's run through it one more time. Keep your windshield clean. Keep things off the ledge to avoid reflection. Wear proper-fitting polarized sunglasses to cut reflected glare. And take them off at night! **END**



## FAVORITE FLOWER NEEDLEPOINT PILLOW KIT

Fresh from the flower-vendor's wagon come three blooming, pretty pillows (above). The splash of irises and daffodils the little bouquet of violets and the delicate tracing of mountain laurel were all designed for us by Tina of California in the bright, beautiful colors so typical of that golden state. For those of you who love flowers *and* the crisp coolness of blue and white, we add her rose design (below). Pillows are about 14 inches square; designs are printed on monochrome canvas. The kits include all-wool tapestry yarn and simple instructions; no backings or pillow forms are included.

Fill out coupon and enclose check or money order. Sorry, we are unable to handle Canadian or foreign orders.

**Creative Stitchery Dept. 3510, 4500 N.W. 135th Street, Miami, Fla. 33054**

Check items desired:

<input type="checkbox"/> #61696—Iris Pillow @ \$9.98 ea. plus .75 post. & hdlg.	_____ \$ _____
<input type="checkbox"/> #61697—Laurel Pillow @ \$9.98 ea. plus .75 post. & hdlg.	_____ \$ _____
<input type="checkbox"/> #61698—Violets Pillow @ \$9.98 ea. plus .75 post. & hdlg.	_____ \$ _____
<input type="checkbox"/> #61699—Blue Roses Pillow @ \$9.98 ea. plus .75 post. & hdlg.	_____ \$ _____
<input type="checkbox"/> #61014 Colorful Catalog of other kits @ .35 ea.	_____ \$ _____

For great make-it ideas—Ladies' Home Journal Needle and Craft Issues @ \$1.25 each (please specify choice)

<input type="checkbox"/> 61655 Spring '73	<input type="checkbox"/> 61563 Winter '72
---	---

New ideas in crafts, stenciling, needlework—American Home Crafts Magazines @ \$1.25 each (please specify choice)

<input type="checkbox"/> 61681 Spring '73	<input type="checkbox"/> 61577 Winter '72
---	---

You may use your charge card for any purchase over \$4.98.

BankAmericard

Acct. No. \_\_\_\_\_

Good thru \_\_\_\_\_

Master Charge

Acct. No. \_\_\_\_\_

Good thru \_\_\_\_\_

Interbank No. \_\_\_\_\_

(Find above your name)

Sales tax, if applicable. . . . . \$ \_\_\_\_\_

Total enclosed . . . . . \$ \_\_\_\_\_

print name \_\_\_\_\_

address \_\_\_\_\_

city \_\_\_\_\_ state \_\_\_\_\_ zip code \_\_\_\_\_



## DECORATING Q's & A's

*Am trying to achieve an informal country look in my dining room. I have a new maple china cabinet, but will have to make a while with old scratched-up chairs, table and buffet. I've picked out a gold-and-blue striped wallpaper and plan to paint the chair rail blue. What else can I do to dress up this room without crowding my budget?*

*(Mrs.) C. Higgins  
Bristol, Vt.*

Use the wallpaper you've chosen, but put it only on the upper portions of your walls; paint lower portions and chair rail pale gold (not blue). Spruce up your old furniture by applying a high-gloss maple-nish paint. Stain the floor dark walnut, and when you feel like splurging, add a bold area rug. Finish off the room with blue linen draperies; repeat fabric on chair seats. Use baskets, brass items, dried flowers and wheat as decorative accessories.

*When my loose-back sofa was reupholstered recently, it lost its "personality." The workmanship was fine, but the soft, squashy look disappeared. In its place are perfectly squared cushions and zero comfort. I have moved since the work was done, so no action against the upholsterer is possible. What can I do?*

*(Mrs.) Bonnie J. Colliert  
Monterey, Calif.*

All is not lost. You can soften the look and feel of the sofa yourself, but you'll have to remove the cushion filling and start all over again. If cushions lack zippers, carefully open the seams with a small knife or razor blade. Replace filling with foam cores encased in fine polyester fiber fill. Your local fabric shop or department-store upholstery section should have these cores on hand and will be able to cut them to your specific cushion size.

*Help! I am a new housewife who bought a red-and-black Mediterranean sofa and matching chair on the spur of the moment. The minute they got here, I knew I'd made a mistake. They're sitting in my living room as big and bold as elephants. Is there any way I can make them less conspicuous?*

*Mrs. R. Fowler  
Baltimore, Md.*

Try softening the room around them. Use a large dose of one color—buttercup yellow is our choice. Paint walls this color; add sheer draperies to match. If you can find fabric that's subtly striped in yellow, red and white, use it for sofa pillows. Add a few solid white and yellow pillows, and your "elephants" will be completely tamed.

*Our circa-1800 house has its original wide floorboards throughout, even in the kitchen. Is there some kind of covering that would protect them? They're too fine-looking to cover up, but I really hate constant waxing and buffing.*

*Mrs. S. Fernald  
Troy, Maine*

A couple of coats of polyurethane varnish would work fine on your floors. Be sure the wood is stripped of wax or other finishes and is completely clean before you varnish. Later, if the finish begins to look patchy from wear and tear, just give it another coat.

*Our wood-paneled family room is in need of a lift. It has all the furniture and wall decoration it can accommodate, but still seems to lack color. How can we perk it up?*

*P. Madden  
Kearney, Neb.*

Consider adding wall-to-wall carpeting in a bold print—to give the room

texture as well as color. Printed carpeting in a great variety of patterns comes in nylon with foam-rubber backing. It's relatively inexpensive, long-wearing and easily cared for.

*What furnishings would look well with a glass-and-chrome étagère? I'd like to put one in my new bedroom.*

*(Mrs.) P. Goodrich  
Washington, Mo.*

A chest of drawers with a bright lacquer finish will look as slick and modern as the étagère does. A big fake-fur bedspread or a shaggy white flokati rug will soften that hard-edge style, and glass accessories will add sparkle.

*Direct your decorating questions to Decorating Q's & A's, American Home, 641 Lexington Ave., New York, N.Y. 10022. Letters submitted will be published on the basis of their general interest. Sorry, we are unable to send personal replies.*

# 95% Tuna 95% Tuna & Chicken 95% Tuna & Kidney 95% Tuna & Egg



No cereal fillers.

No gravy fillers.

There are no fillers in any of the 20 varieties of Purina Variety Menu. They're each 95% of whatever the label says plus 5% vitamins and other nutrients.

**Purina. More of what your cat loves.  
More of what you're paying for.**

1. TUNA 2. CHICKEN 3. MACKEREL 4. FISH & LIVER 5. TENDER MEAT BY-PRODUCTS 6. CHICKEN & KIDNEY 7. COUNTRY DINNER 8. SARDINES 9. TASTY TREAT 10. TUNA & CHICKEN 11. CHICKEN & LIVER 12. TURKEY & GIBLETS 13. CHICKEN & FISH 14. CHEF'S DELITE 15. LIVER 16. KIDNEY 17. TUNA & KIDNEY 18. SALMON & CHICKEN 19. FISH & SHRIMP 20. TUNA & EGG

**NEW!**

*Scientifically Designed, Hygienic*

# **messproof KITTY LITTER BOX**

**Keeps Litter In Box . . . Off Floor!**

- **SANITARY . . .**  
Hands never touch mess
- **EASY TO CLEAN . . .**  
Open hinged lid, lift out liner
- **WASHABLE . . .**  
Durable polypropylene construction

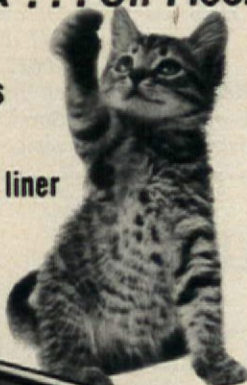

Here's a deluxe no-mess "john" for your cat that is clutterproof and messproof. Kitty simply can't scatter litter on floor no matter how energetic her "cover-up" efforts are! Hinged protective shield keeps litter IN the box where it belongs . . . locks disposable plastic liner firmly in place. Simply unlock hinged top, lift out liner and

dispose of it intact! Your hands never touch mess. When your house stays cleaner . . . with no litter tracked from room to room . . . puss becomes even more lovable! 15" x 20" long unit is of durable, washable polypropylene construction. And, if you add our spray deodorant to kill the unpleasant smell — Everything comes up roses! Extra liners come in pack of 12.

**Z70060X . . . Kitty Box . . . . . \$7.98**

**Z70078K . . . Extra Liners, Pk. of 12 98¢**

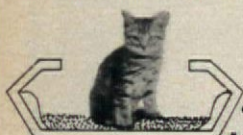

### ***Mail Handy Coupon***

**HANOVER HOUSE, Dept. Z-847**  
Hanover Bldg., Hanover, Penna. 17331

Kindly rush \_\_\_\_\_ KITTY BOX(es) (Z70060X) for just \$7.98 each, plus 75¢ to help cover postage and handling. I understand that if I am not completely satisfied, I may return for full refund of purchase price.

- Please send \_\_\_\_\_ Packages of 12 Extra Liners @ 98¢ each Package.. (Z70078K)
- SAVE!** Order TWO packages of Extra Liners (24 in all) for just \$1.79.

Enclosed is \$ \_\_\_\_\_  
Penna. & Md. residents add sales tax.

**PRINT NAME** \_\_\_\_\_

**ADDRESS** \_\_\_\_\_

**CITY** \_\_\_\_\_

**STATE** \_\_\_\_\_ **ZIP** \_\_\_\_\_

Send **FREE** catalog of fine gifts. (Z89938X)

© Hanover House, 1973

**COMES WITH 6  
PLASTIC LINERS  
FOR EASY DISPOSAL**

***Never Handle  
Litter Again!***



**TURN YOUR BARE WINDOW  
INTO A**

## ***Delightful Sunlit Garden***

**Double Decker Rack Makes Your Window An Exciting Garden Showplace**

Now your house plants get all the light and sunshine they need, and at the same time create a dazzling window display. Exquisitely scrolled white metal brackets hold a pair of 22" by 4" deep clear plastic shelves. Unit hooks quickly and easily right over your window . . . no installation needed. And it won't interfere with opening or closing the window.



**TREMENDOUS SAVINGS!**

They're great in pairs or as gifts! Give each window in your home that smart decorator look. And here's how to save more:  
**2 for only \$9.25 - 4 for only \$15.98 (you save \$4.00)**

**NO-LIMIT CONSUMER GUARANTEE**  
We take such pride in the merchandise we offer, that we're completely confident in offering this NO-LIMIT guarantee: If at any time you are not satisfied for any reason whatsoever with your order, please return for a full refund of your purchase price. A satisfied customer is our greatest reward. So order now with confidence.

**DAZZLING DISPLAY FOR PRIZED PLANTS, COLLECTOR'S PIECES**

Just think of all the marvelous uses . . . display fine china and glassware . . . those exquisite decorator pieces you've been collecting . . . even books and records. And at this low price, order several . . . they're great for double windows. But hurry, order now. Supplies are limited and they're sure to go fast. Money back if not completely delighted.

**Double Decker Window Rack. (Z54007) . . . . . only \$4.98**

### **MAIL HANDY COUPON**

**HANOVER HOUSE, Dept. Z-848 Hanover, Penna. 17331**

Please rush \_\_\_\_\_ Double Decker Window Rack(s) (Z54007) for the amazing low price of \$4.98 each plus 90¢ postage and handling.

**SAVE!** Special Offer: Order TWO Window Racks and for just \$9.25, plus \$1.50 postage and handling. Save over \$1.00. Great as gifts or in pairs.

**TREMENDOUS SAVINGS!** Order FOUR Window Racks for just \$15.98 plus \$2.00 postage and handling.

Enclosed is \$ \_\_\_\_\_  
Penna. & Md. residents add sales tax.

**NAME** \_\_\_\_\_  
(please print)

**ADDRESS** \_\_\_\_\_

**CITY** \_\_\_\_\_ **STATE** \_\_\_\_\_ **ZIP** \_\_\_\_\_

© Hanover House, 1972



# SHARPEN UP ON KNIVES

A homemaker uses a kitchen knife on the average of 32 times a day. Yet this indispensable tool is often taken for granted. If you want the best performance from your knives at all times, give them the same special care you give your lawyer or a carpenter gives his tools.

Start by buying good knives. The first important consideration is the type of metal used. Steel with a high carbon content will keep a nice, sharp edge, but it tends to rust if not well cared for. Most manufacturers add chromium, which resists rust, to the steel; the result is stainless steel. A high-carbon, stainless-steel blade retains its sharpness well and remains rust-free. Kitchen knives have a variety of cutting edges—straight, serrated, scalloped. The latter two are best for cutting bread, cake, fruits and vegetables, and for cutting and slicing meats. The straight-edge knife is for chopping, dicing, and also cutting meats.

Knife handles come in metal, hard rubber, synthetics and several types of wood. None has any great advantage over the other; it's your preference. However, the "tang," the part of the blade that fits into the handle, should be at least one-third the length of the handle and firmly riveted in place.

It's important to remember that kitchen knives are meant for slicing, dicing, chopping and mincing—not for opening packages and cans, or cutting string, paper and metal. Such uses will dull the blade.

Here are some tips for using cutters safely and keeping it in good condition.

When buying a knife, be sure the handle fits comfortably in your hand, so it will not slip when you're working with it.

Use the knife as it was intended. For example, the 2 1/4- or 3-inch paring knife is best for small jobs, such as peeling, paring and scraping fruits and vegetables. The French chef's knife is for dicing, chopping and mincing raw vegetables.

- When cutting, keep your fingers away from blade. Cut away from your hand.

- Wash knives after use and place them point down in a drainer or alongside the drainboard. Don't soak them.

- After washing, wipe dry immediately with the sharp edge away from you.
- Do not wash knives in the dishwasher unless the handles are heat- and moisture-resistant or unless clearly specified by the manufacturer. Keep knives you do put in the dishwasher separate from other utensils to prevent the blades from striking things and becoming dull.
- Do not leave knives near heat or flame.
- Always use a cutting board. If the knife slips during use, it can only gouge the board, rather than your counter top.
- Store knives separately so their cutting edges will not become dulled by jostling against other utensils. To protect their edges, never toss them in a drawer, but store them safely in a partitioned drawer or use individual drawer organizers. You can also keep them handy with magnetic holders or wall

racks with separate slots for each knife.

- Even with the best of care, knives need resharpening. You can have this done professionally, or do it yourself. There are several effective sharpening tools. One is the paddle-like sharpener of abrasive stone. To use, take the paddle in one hand and the knife in the other, with the blade facing you. Move the stone across the blade, working gradually down its length. Repeat on other side of blade. Wash and dry knife.

The oil stone is an old-favorite sharpener. Place the stone on a steady surface and moisten it with a few drops of oil. Hold edge of knife against it at a slight angle and draw the blade across several times. Repeat for other side. Wash and dry knife. An electric sharpener will do the job fastest of all, but be sure to follow instructions. —Phyllis Cignarella

## No dishwasher detergent can prevent water spots.

No detergent, even the best, can prevent water spots.

Jet-Dry is made to sheet off water in the rinse cycle.

(It's there that water spots form—after your detergent has gone down the drain.) Jet-Dry comes in liquid form for machines with dispensers. Or a solid little basket you hang in your dishwasher.

So the next time a dishwasher detergent promises you nothing but spotless, spotless, spotless, remember its claim goes down the drain when it goes down the drain.

Try Jet-Dry Water Spot Preventer.

You'll see what spotless really means.

Promise.

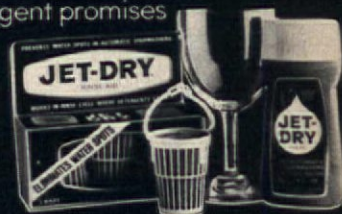

**Jet-Dry Water Spot Preventer.**

Get Yourself Organized! Early American



Right now your papers, stamps, envelopes, bills, postcards, what-have-you are in six different drawers around the house! Get yourself organized!... with this delightful Country Store Organizer copied from nineteenth century postmaster's pigeonhole classic. You'll find it perfect to keep all those losable items in one place—bills, messages, letters, even recipes! There's even a little drawer with ceramic pull for stamps, clips, personal items. Instantly create a neat nook next to phone! Measures 7½" x 10" x 4½" deep, mounts easily on wall, stands on table. So pretty, so practical, so useful! Never hunt around for scattered items again!

## COUNTRY STORE ORGANIZER

In Rich, Warm Colonial Finished Wood — Hang on Wall or Stand on Table or Bookcase

**\$4.98**  
ONLY  
2 FOR \$9.96

COPIED FROM  
TURN-OF-THE-CENTURY  
POST OFFICE ORGANIZERS

MAIL TO DAY NO RISK COUPON TODAY!

GREENLAND STUDIOS,  
3710 Greenland Bldg., Miami, Fla. 33054

Enclosed is check or m.o. for \$ \_\_\_\_\_

Organizer (#13228)  
@ \$4.98 ea. plus 85¢ post.

SEND C.O.D. I enclose \$1 deposit and will pay postman \$3.98 bal. plus all postal charges.

Name \_\_\_\_\_

Address \_\_\_\_\_

City \_\_\_\_\_ State \_\_\_\_\_ Zip \_\_\_\_\_

SAVE \$1.70. Order two Organizers for \$9.96 and we pay post. Extra makes a different gift.

## THE CLASSIC CARRY-ALL!

Lightweight **Safari Bag**

THE LOOK OF REAL LEATHER ONLY \$3.98



**Soft as a Glove, Rugged and Roomy!**

At last, world-famous design at a remarkably low price. The everything bag rapidly becoming the mark of travelers everywhere. All have found this to be their most versatile traveling companion. Roomy enough for overnighters or weekend stays. Two outside pouches, one with full zipper closure. Gigantic main pouch also fully zippered. Sturdily riveted and sewn throughout, double handled, in soft (looks like real leather) vinyl that wipes clean with a damp cloth. 14½ x 5 x 11". In Jet-Setter Brown or Classic Bone.

THE LOOK OF REAL LEATHER!

MAIL TO DAY NO-RISK COUPON TODAY!

GREENLAND STUDIOS  
3711 Greenland Bldg., Miami, Fla. 33054

Enclosed is check or m.o. for \$ \_\_\_\_\_  
Brown Safari Bag(s) #12704 @ \$3.98 ea.  
Bone Safari Bag(s) #12705 @ \$3.98 ea.  
(Please add 65¢ post. each.)

SEND C.O.D. I enclose \$1 goodwill deposit and will pay postman \$2.98 bal. plus all postal charges.

Name \_\_\_\_\_

Address \_\_\_\_\_

City \_\_\_\_\_ State \_\_\_\_\_ Zip \_\_\_\_\_

SAVE 90¢. Order two Safari Bags for \$7.90 and we pay all postage.

## SHOPPING INFORMATION

Merchandise listed here is available leading department and specialty stores you cannot find it, write to American Home Reader Service, 641 Lexington Ave., New York, N.Y. 10022. Items not listed may privately owned or custom made.

PRECUT TO SUIT IN CEDAR

(All sources Atlanta, Ga.) Page 32, bottom right: Requitti furniture, Har-vue barbed Royal Pool & Patio. Page 34. Top: Candy holder, Den Permanente wooden tick-toe, Lauffer vase, Daga Ramsey serigraph The Signature Shop; Suncraft end table Hurricane chairs, Royal Pool & Patio. Bottom, left: Daga Ramsey serigraph, The Signature Shop. Bottom, right: Napkins, bowls, dish, Findecor tablecloth, Holmgard vase, glasses, The Signature Shop.

ENTERTAINING SUMMER

Page 66: Triconfort furniture, Bloomingdale's, N.Y.C.; thermal mugs, Scan-P Industries, Inc., N.Y.C.; plastic glasses, Design Research International, Inc., San Francisco, Calif.; polka-dot earthenware, Pe Breck Corp., N.Y.C. Page 67. Left: bucket, Design Research International, Inc., San Francisco, Calif. Right: Triconfort table, Bloomingdale's N.Y.C.; vinyl tablecloth, Decor Home Fashions, N.Y.C.; paper tableware, Dixie Paper Products Div., American Can Co., Greenwich, Conn.; ware, Takahashi, San Francisco, Calif. paper napkins, Gibson Party Papers Div., Gibson Greeting Cards, Inc., Cincinnati, Ohio. Pages 68-69: Furniture, Samsom Corp., Denver, Colo.; cooler, Thermos Div. of King-Seeley Co., Norwich, Conn.; thermobowl, melamine tableware, Scan-Plast Industries, Inc., N.Y.C.; plastic glasses, Floyd and Floyd, Dallas, Tex.; Marimekko vinyl tablecloth, Design Research International, Inc., Los Angeles, Calif.; paper napkins, Contempo Paper Tableware, Beach Products Div. of Penn Corp., Kalamazoo, Mich.; plastic flatware, Azuma, N.Y.C.; melamine bowls, Rainbow Wood Products, Inc., Long Island City, N.Y.; Lucite bucket, Eagle Associates Div. of APL Corp., Brooklyn, N.Y. Pages 70-71: Furniture, LifeStyle by Syrod Syracuse, N.Y.; green plastic tray, glass Fitz and Floyd, Dallas, Tex.; plastic flatware, Azuma, N.Y.C.; paper plates, Contempo Paper Tableware, Beach Products Div., Penn Corp., Kalamazoo, Mich.; paper napkins, Party House, Inc., Pittsburgh, Pa.

FAMILY 4TH OF JULY

Pages 72-73: White bowl, Peter Breck Corp., N.Y.C.; oval plate with handle, Copco, Inc., N.Y.C.

TEEN CROWD-PLEASERS AT POOLSIDE

Pages 74-75: Oblong dish, ice-cream container, server and spoons, Hammacher Schlemmer, N.Y.C.

AFTER-TENNIS WELCOME

Pages 76-77: Paella dish, Copco, Inc., N.Y.C.; plastic serving ware in Roseberry Dansk Designs, Ltd., Mt. Kisco, N.Y.

## BUILDING MATERIALS AND SOURCES

VERY PERSONALLY THEIRS

Pages 62-63: Siding, Red Cedar Shingle and Handsplit Shake Bureau, Seattle, Wash.; roofing, asphalt shingles, Johns-Manville Co., Denver, Colo.; skylights, "Plexiglas," Rohm and Haas, Philadelphia, Pa.; windows, sliding glass doors, "Acadia," Northrop Architectural Systems, Los Angeles, Calif.; light fixtures, Prescolite Co., Warminster, Pa.; hardware, Schlage Lock Co., San Francisco, Calif.; ovens, range, Thermador Div., Norris-Thermador; disposer, Waste King Universal (all) Los Angeles, Calif.; dishwasher, KitchenAid Div., Hobart Mfg. Co., Troy, Ohio.

# ON-THE-GO GUIDES TO TRAVEL FUN

Each year, along about now, millions of American families are heading off for their long-awaited vacations. If your summer dreams or plans include a travel holiday, there are several new vacation guidebooks, all aimed at making your trip a success.

Some of the camping cognoscenti revel in fully equipped trailer-campers; others prefer roughing it, sleeping in pup tents, canoeing on lakes and rivers and hiking wilderness trails. If you'd like to join the outdoor action but don't know what equipment you need or where to find it, pick up Dan and Inez Morris's *The Weekend Camper* (Bobbs Merrill, \$5.95 cloth, \$3.95 paper). One of their many helpful suggestions: Rent before you buy; often your rental fee can be applied to the equipment's purchase price. For those who really want to rough it, Richard Langer's *The Joy of Camping* (Saturday Review Press, \$8.95) recommends appropriate sleeping bags, hiking boots and tents. His book even tells how to take the baby along and what to do if your kayak tips over. (For our tent tips—what to buy and how to use—see page 53 of this issue.)

Once you have your gear together, and McNally's *Campground & Trailer Park Guide* (\$4.95) will help you select a spot to park your camper or trailer. Among a myriad of other useful facts is a list of campgrounds where you may write ahead for reservations, those where space *must* be reserved and spots where you can just rent space when you arrive—first come, first served. If you're planning a camping trip to California or the New England states, three new books by Jim Crain and Terry Milne can pinpoint a site for your trailer or tent: *Camping Around California: the North*, *Camping Around California: the South* and *Camping Around New England* (Random House, each \$3.95). The books contain maps and detailed information on natural and historic sites, as well as campsites, and as a bonus, each includes a year-round calendar of events at area campgrounds. Strictly for kids is Aileen Paul's *Kids Camping* (Doubleday, \$4.95). Helpfully illustrated to guide young people in planning trips, it suggests easy meals to prepare in camp and prescribes safety measures to practice along the way.

Janet Groene's *Cooking on the Go* (Grosset & Dunlap, \$1.95) will guarantee you delicious vacation meals. Just published as an easily totable paperback, the book offers campers and boaters a myriad of recipes—running the full gamut of courses—plus tasty vacation-time snacks. It also includes tips on the foods and

utensils you'll need and some how-to's on food preservation/storage when space is at a premium.

Undecided about where to go? Here are two books to help you find your way. One, *American Wilderness* by Charles and Klaus Knab (Gousha Publishers, \$4.95), describes the trails and the available scenic canoe trips in national wilderness areas. The authors grade each trail on its difficulty and accessibility, and list the best months to go and whom to write for additional information. The second book, *A Hiker's Guide to the Smokies* by Dick Murlless and Constance Stallings (\$7.95), is put out by the Sierra Club, perhaps America's best-known environmental association. Every trail in the beautiful Smoky Mountains of North Carolina and Tennessee is included, as well as natural wonders that can be seen along the way.

Another way to fill vacation days with fun and adventure is to go spelunking—exploring underground caves and caverns. To advise on the where's and how-to's, there's *The Amateur's Guide to Caves and Caving* by David R. McClurg (Stackpole Books, \$5.95 cloth, \$2.95 paper). It also sets forth some very necessary safety precautions.

For the college crowd, Harvard students have put together *Let's Go: The Student Guide to the United States and Canada* (E.P. Dutton, \$3.95). With this book in hand, young people off to see America and the Far North can find decent accommodations and good food at moderate prices.

Families who fancy vacationing in the big city can rely on TWA's newly revised *Getaway Guides* to nine major American cities—New York, Boston, Washington, D.C., Denver, Phoenix, Tucson, Las Vegas, San Francisco, Los Angeles (Arthur Frommer Publications, \$1 each). The books, written under supervision of Frommer himself, that master of economy-minded travel, offer basic tips to hotels and restaurants, must-see sights and superlative shopping. If you prefer a seaside holiday, *The Visitor's Guide to Cape Cod National Seashore* by Margaret Koehler may be the book for you (Chatham Press, \$1.95). And while you're down on the cape, you might want to take a pleasant ferry ride and enjoy *Exploring Martha's Vineyard* with Polly Burroughs (Chatham Press, \$2.95). She creates the mood and tells the history of every minute portion of this scenic island. Take her book with you if you go, or enjoy it at home and stock up on dreams for a future trip.

Are you looking forward to the '76 Bicentennial? Then browse (continued)

Try the  
Wall Fixers  
from

# DAP®

America's First  
Name in  
Home Fix-up



DAP KWIK-SEAL®: the all-purpose caulk fixer. Stays flexible for lasting repairs of hairline cracks in plaster. Forms watertight seals for interior joints around door and window frames, tiled areas, tub, sink and shower. White. Takes paint.

DAP Spackling: the wall fixer. A smooth, creamy, ready-mixed vinyl-paste compound that patches cracks, holes, breaks in plaster, wood. White. Fast drying. Ends the bother of mixing dry powder patchers.

DAP Latex Caulk: the joint fixer. Flows smooth to fill cracks, joints and gaps in siding, around window and door frames. Takes paint after two hours. Stops air, water and heat leaks. Won't stain, blush or bleed through any paint.

DAP® DAP Inc., Dayton, Ohio 45401  
Subsidiary of Plough, Inc.



**Bac\*Os® proudly presents  
a salad you can present proudly.**

Avocado salad with Bac\*Os. Tasty, appetizing avocado and orange sections topped with Bac\*Os—crunchy, bacon-like flavor chips that snap foods to life. As easy to make as this:

- 1 avocado, peeled, pitted and cut into 1/4" slices
  - 1 orange, pared, sectioned
  - Curly endive
  - Watercress
  - 1/4 cup Bac\*Os®
- Arrange avocado slices and orange sections on endive; garnish with watercress. Shake on Bac\*Os chips. Serve with or without dressing. 4 to 6 servings.

Bac\*Os add a lively, appetizing touch to vegetables, potatoes, eggs — you name it! If it's good to begin with, it'll be even better with Bac\*Os!

**Bac\*Os makes what's good, better.**

Bac\*Os is a trademark of General Mills, Inc. for chips of soy protein.



**ON-THE-GO-GUIDES continue**

through *Discover Historic America* (Rand McNally, \$4.95), a guide to 2,800 landmarks that will delight family yearning for glimpses of America's rich past. Gousha Publications' *Best you see America by bike. The Bicentennial Bike Tours* (\$3.95) lists great cycling trips that take in historic places around the country. For example you can follow their Louisiana Purchase tour along the winding Cane River area in a weekend, see three huge restored homes, an 1808 church and the world's largest pecan plantation. If your vacation plans include Europe, travel writer Nancy and Temple Fielding, who have been offering comprehensive European travel guides since 1948. The Fieldings have just assembled *Super Economic Europe '73* (Fielding Publications, \$2.95) for the traveler on a limited budget. Have you ever had a yen to spend time bird-watching on the Danube Delta mining opals in Australia or, a little closer to home, houseboating on the Hudson River? Ferrell and William Cross's new *Guide to Unusual Vacations* (Hart Publishers, \$3.95) will intrigue you with these and other tantalizing jaunts. All are presented as vacation packages and some are more economical—as well as more exciting—than any trip you might be able to plan yourself. The Crosses describe 150 trips, their costs and how to prepare for them. Bent on a truly exotic vacation? *Pan Am's Total Travel Planner to The Republic of Hawaii to Hong Kong* (Bantam Books, \$1.95) may offer a leg up. It has on-the-spot advice for visitors to the distant shores of Tahiti, Tonga, Papua or any port of call between Hawaii and the Asia mainland. Whether you travel abroad or stay in the States, traveling with a guide-in-hand makes the getting there great.

—Nancy Rue

**To change or correct your address**

Attach label from your latest copy here and show new address below—include zip code. When changing address please give 8 weeks' notice.

All correspondence relating to your subscription should be accompanied by your address label. If you are receiving duplicate copies, please send both labels.

Send address changes to:  
American Home, P.O. Box 4568  
Des Moines, Iowa 50306.  
Subscription prices:  
U.S. and Possessions and  
Canada: One year \$4.00.  
Pan American: \$5.50. All other  
countries: One year \$6.00.

Name \_\_\_\_\_  
Address \_\_\_\_\_ please print  
City \_\_\_\_\_ State \_\_\_\_\_ Zip \_\_\_\_\_

Postmaster: Send form 3579 to American Home, P.O. Box 4568, Des Moines, Iowa 50306



# If you don't show your kids California, who will?

## Universal Studios Stunt Show. See it on an American Airlines Fly/Drive Vacation.

Imagine what fun your kids could have this summer seeing how their favorite TV show is made. Or taking a ride down the Matterhorn at Disneyland. Or watching the sea lions show off at Marineland. California is a perfect place for families on vacation. There are so many things to see and experiences to share. And now, we're giving you a chance to go there. We've put together some of the best Fly/Drive Vacations any airline has ever offered. Our \$187 vacation, for example, includes an Avis car for a week (unlimited mileage, you pay for gas). Plus 6

nights' accommodations for up to a family of four at selected Holiday Inns throughout California. Other vacations include a Hertz car and accommodations at Sheraton Hotels and Hyatt Houses. Air fare, of course, is extra (e.g. Dallas to L.A. it's \$150\* for adults and we have special fares for children). Why not talk to your Travel Agent. And get all the details about our Fly/Drive Vacations to California. There's nothing we'd like better than to make this summer's family vacation one you'll always remember. And one your children will never forget.

# American Airlines

To The Good Life.®

## EDITORS' CHOICE

Fashionable, functional thermalware servers make entertaining easy any time of year. And with their sleek designs, rich colors and sparkling finishes, they are especially inviting for summer, indoors or out. When used properly, they can maintain food and beverage temperatures for hours without cords, candles or complicated procedures. Pieces shown are a sampling of the newest servers on the market. Except where indicated, they are available nationally.

Some of these pieces, like the covered food keepers in the group below, come in three separate parts. You fill the bottom with ice or hot water and place food in the compartment above it. When topped with a lid, each unit keeps its contents either hot or cold. All three of these see-through servers are made of dishwasher-proof, break-resistant Lucite. Sizes range from one-compartment, one-pint servers to three-compartment, six-quart versions.

The two ice buckets below and the pitcher-

mug pairing are of double-wall construction. Each comprises two layers of plastic; the air space between layers acts as an insulator. Made of clear Lucite or polystyrene, an opaque acrylic plastic, they are durable and dishwasher-proof.

The chrome-and-plastic pitcher in the center, below, functions like a thermos bottle. But unlike its familiar predecessor, this container has a glass liner—with a vacuum between layers of glass—that can be replaced easily by simply screwing in if the unit is dropped and the liner is broken. This type of thermalware maintains temperatures longer than either of the other two.

No matter which form of thermalware you use, always make the most of it. If you have an extra thermal ice bucket on hand, for example, you can use it to tote hot fried chicken—or any hot dish, for that matter—on a picnic. And cold foods stay fresh and crisp for hours in thermalware, especially at party time when refrigerator space is at a premium.

—Jeanne M. Bauer

**These new two-way wonders save you time and space, and simplify serving at party time.**

**KEEP  
IT HOT...  
KEEP  
IT COLD**

Clockwise from top, left: double-wall ice bucket imported from France, Bonniers, N.Y.C., \$25; 1-quart vacuum pitcher, Georg Jensen, N.Y.C., \$18; 2-quart food server, \$15, and 3½-quart ice bucket with see-through lid, \$14, both from Milano Collection by Eagle; 1-quart pitcher with fitted lid, \$5, and 12-ounce mug, 4 for \$6, all Scandinavian imports from Seabon, N.Y.C.; Guzzini 1-quart double-compartment food server, \$13.50, and 3-quart double food server, \$19, from Eagle's Milano Collection, each with opaque inner compartments that stand alone for easy filling.





Test it yourself!



# Maybelline Ultra-Lash Mascara is really waterproof!



It's waterproof

Test Maybelline Ultra-Lash in the rain, in a swimming pool – even under running water – it simply won't run. Now that's waterproof! And see what nice things it does for your lashes. Ultra-Lash colors, curls and separates so softly and beautifully – you can really see your lashes look long, longer, longest. Test it yourself. Maybelline Ultra-Lash Mascara is beautifully waterproof!

*Maybelline*  
The finest in eye make-up, yet sensibly priced.

# We do wonders for your spirits.™

Just add liquor.



Of course, we at Holland House are the only ones who've been at it for nearly a century.

So we can promise you—and you can promise guests—the greatest drinks in town. Not just “the usual”. But the more adventurous drinks they may prefer, but are afraid to ask for.

Holland House Cocktail Mixes make your favorite brand of liquor taste even better. It's easy. And foolproof. Every drink, every time, will taste like you started from scratch. Because we did. With the finest natural juices and herbs and spices from around the world.

## Holland House™

Cocktail Mixes



**COLLINS**  
Incredibly refreshing—  
with gin,  
rum or vodka.

**DAIQUIRI**  
More “in”  
than ever.  
With rum.

**MAI TAI** Exotic tropical treat—  
with rum, gin or vodka.

**PINA COLADA** Lush Islands taste.  
With rum or vodka.





## THE ULTIMATE VACATION PACKAGE

With Mt. Rainier rising mightily behind them, Dane, Lissa and Alan Johnson fish the waters of Clear Lake, deep in the woods. Their parents own a house in Clearwood, a vacation community only 65 miles from Seattle.

If the '70s are to become the widely predicted Decade of Leisure, the new-wave "vacation community" will undoubtedly lead the way. Complete with environmental planning, recreation facilities, maintenance and security built into a single purchase—of either land, land-and-house or condominium—these new colonies are springing up all over the country. (A sampling of some of the best begins on page 20.) Clearwood in Washington State, shown above and following, is a young-family community with an enjoy-it-now-approach. —Guy Henle



VACATION PACKAGE continued

## At Clearwood you can buy or build— or just camp.

Clearwood's 850 acres center on Clear Lake, with its excellent boating, fishing and swimming facilities. Dotted around the community are sports fields, bicycle trails and picnic areas. Buyers have four choices of living arrangements in this Weyerhaeuser complex: They can buy a one- or two-bedroom "Lake House" (\$24,000 to \$30,000, including land), built as two-family units and sold fully equipped, except for furniture. They can choose a house from one of Clearwood's many available plans and have it built (\$15,000 and up, exclusive of land). They can design and build their own house, under certain restrictions. Or they can simply buy a lot (\$4,900 to \$9,500) and camp on it. With any of these purchases goes an owner's share in the common facilities. For more on Clearwood, turn to page 14.



Opposite: Gloria and Walter Johnson were among the first homeowners in Clearwood. Walter had fished Clear Lake for years and knew the area well. A Tacoma architect, he designed and built most of the house himself over a 10-year period. The family is here weekends and for a long stretch in the summer. The Johnsons' five children have cots for their sleeping bags in unfinished attic (opposite, below).

Below: Carol and Jack Lynch bought their "Lake House" last October. They had no desire to build, so Clearwood's ready-to-buy house had strong appeal. It meant they could have a place to use immediately, while the children—Skipper, 8, and Shaunda, 1—were still small. From deck outside their living room (bottom), the Lynches enjoy a compelling lake view.



Opposite, left to right: New landowners Carol and Kelly Kelstad camp out on their property—and will continue to rough it until they are ready to build; tidy, well-maintained campsite shows owners' high regard for the Clearwood environment; sailing on Clear Lake is one of the area's pleasures; a neighbor helps Louise and George Thompson raise a wall of their house.





om the side (opposite), the sharply angled  
of line of the Doolittle house is  
houetted against native oaks. Kitchen and  
stairs bedrooms are at left; carport  
d covered walk to front door are at right.

By Guy Henle

## VERY PERSONALLY THEIRS

"I think a house should serve people rather than force them to adapt to conventional stereotyped spaces," says Connie Doolittle. Out of this philosophy, and guided by sympathetic architects, she and her husband, Jeff, have shaped a house in California that scatters convention to the winds, but suits their special interests and those of daughters Caroline, 12, and Susan, 11. Tucked into a small site in an established neighborhood in Marin County, just north of San Francisco, the natural shingle house, crisply outlined in black, encloses nearly 3,000 square feet of living space and is so well arranged that there is an easy progression from intimacy to openness, from sunny warmth to cool enclosure. The architects, Marquis and Stoller, had remodeled a house for the Doolittles and were sensitive to their needs. Careful planning is evident—from the raised vegetable beds near the kitchen door, opposite (bottom), to the shelf-lined pass-through to kitchen, below. (continued)



Bank of skylights over windowed bay  
brings beautiful working light to  
kitchen (opposite). From deck it is only  
three steps down to vegetable beds.  
Enclosure hides trash receptacles.

Fully enclosed porch (see plan, next  
page) is an indoor room with  
outdoor virtues. When sliding glass  
doors are open, it's a cool spot  
on a warm day; at night, shielded  
from sharp breezes, it's more  
inviting than open deck just outside.

Conversation area of two-story family room (opposite) focuses on fireplace. L-shaped counter is built in. Sun pours in through skylight

**Much inspiration for the house came from experiences in vacation living.**

"Vacation houses are designed for enjoyment, and I think that's the way to plan any house," says Connie. The house the Doolittles planned and built is functional as well as enjoyable—and not very typical. It has no walls of glass, yet is light-filled all day—thanks to skylights. It has no standard living room, but only that's a cozy library. It has a family room that is not simply a large, amorphous space, but four small activity areas—for dining, relaxing and chatting, playing the piano, weaving at a loom. The Doolittle girls have their own floor with two bedrooms and playroom—up the spiral stairs from the family room, apart from their parents' first-floor bedroom

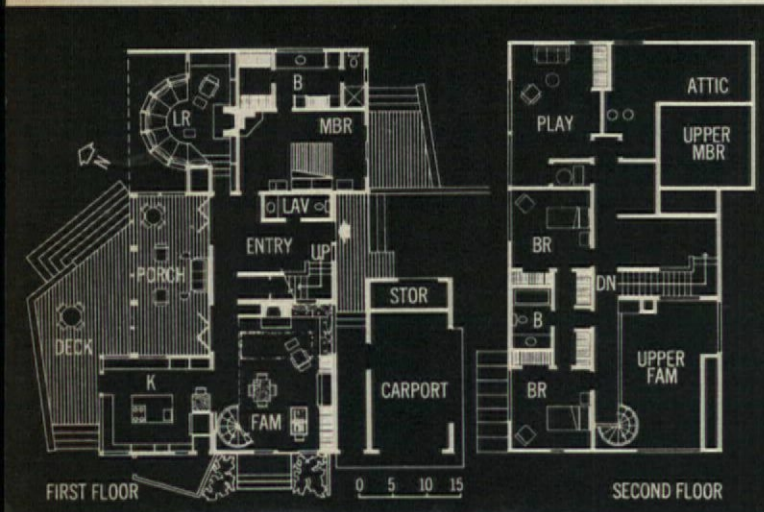

Stairway from family room (below) leads to girls' bedrooms and playroom. Cork-faced door behind it, shown open, closes off the kitchen.



Semicircular couch (top), which faces fireplace and parallels bay window, adds to ski-lodge intimacy of living room. The room is small, used mainly for reading.

Kitchen (above, center) has an island counter planned so all food preparation can be done from one side. Ceiling-high cupboards, 16 inches deep, replace usual cabinets.

Floor plan (above) shows ease of circulation. Every room on first floor except living room has an outside door. Indoor-outdoor porch is reached through folding glass doors.

PHOTOGRAPHS BY JOHN ZIMMERMAN







JULY 4TH  
PARTY TO SPARK  
YOUR

# ENTERTAINING SUMMMER

What better holiday gathering place than your own backyard—especially if it has super amenities like the southern California homes here and following. For Gloria and Jerry Lushing and their four youngsters (below), outdoor furniture and paper/plastic tableware all contribute to a relaxed 4th of July family reunion. By Helene Brown



**V**ersatile trolley bar and sun couch (opposite) are from new white plastic-finished wood furniture collection by Triconfort. Cushions and hood are waterproof canvas; wood is special-treated to withstand the elements. Nancy, 14, helps her dad get the refreshments going (above).



**t**he Lushings lounge by the pool while waiting for the clan to arrive. With balloons, ribbons and sparkling table settings, their landscaped exterior becomes party land.



**a** pileup of red, white and blue accessories creates a joyous variety of patterns, as Gloria readies one of her color-bright tables. Tablecloth is felt-backed vinyl; glasses and servers are durable plastic; calico-print tableware is plastic-coated paper; ribbons tie around red-checked paper napkins. For a "Family 4th of July" food spectacular, see pages 72-73.



## Cool Pool Act for Teens

**S**uper swim party (right) is hosted by Polly Daniels, 15. Samsonite Dacron/vinyl/tubular-steel furniture by the pool is light, but rugged enough for hard, young use. Table setting combines durable and disposable plastics. For teen crowd-pleasing food, see pages 74-75.





## Tennis Tie-in —an Inviting Idea

Phyllis and Allan Cone, both avid tennis players, spend as much of their free time as they can on the courts. Their entertaining ties into their tennis life—they like having friends at their home for an “After-Tennis Welcome” (see pages 76–77).



**S**leek white furniture in lightweight, long-lived ABS plastic is the setup for the Cone patio. Tables, seating and lounging pieces are from the LifeStyle group by Syroco.

Chaise is stackable, adjusts four ways and, when cushions are removed, flattens to become grid-patterned coffee table shown (right). Parsons tables are paired for a buffet (above and right).

Phyllis uses bright-pink Dansk servers to accent green-and-white setting.



PHOTOGRAPHS BY MARIS/SEMEL  
Shopping Information, page 52



By Frances M. Crawford  
and Food Staff

## FAMILY 4TH OF JULY

When the clan gathers at your home on Independence Day, plan a bountiful table like this one for the feast that's the heart of the celebration (see July 4th party, pages 66-67). And since it's a day for all to relax, our choice of menu—there's little last-minute cooking—will let you enjoy your own party. Prepare it yourself or encourage the spirit of independence and ask the guests to contribute appetizer, salad, cake and watermelon to the occasion. Recipes for dishes starred in the menu begin on page 82.



### 4TH OF JULY MENU

Stuffed  
Hard-Cooked Eggs\*  
Curried Chicken Salad\*  
Glazed Baked Ham\*  
Zucchini and Squash  
Casserole\*  
Potato Puffs  
Watermelon  
Coconut Layer Cake\*  
Lemonade Iced Tea  
Coffee

continued

Combine cool water, hot sun and great eats and you have a teen-ager's idea of heaven on a summer day (see "Cool Pool Act for Teens," pages 68-69).

To make the sunny scene perfect, make sure there's lots of food for seemingly insatiable young appetites. Our menu can't miss. To start, there are nibbles and soft drinks, then on to the main event: chicken wings, spicy and cold to eat out of hand; hot and tangy Italian hero sandwiches, meatballs and sausage generously laced with spaghetti sauce; plus a bean salad refresher that's guaranteed to rate raves from even the most adamant anti-vegetable member of the crowd. For the finish, there's everyone's favorite, ice cream, and a choice of three luscious toppings. Recipes for starred items in the menu begin on page 82.

### TEEN MENU

- Popcorn Pretzels
- Potato Chips
- Skewered Italian Heroes\*
- Seasoned Chicken Wings\*
- Assorted Bean Salad\*
- Celery Pickles Olives
- Make-Your-Own-Sundaes with
- Peanut Butter Sauce\*
- Mocha Sauce\*
- Peach Sauce\*
- Milk Soft Drinks
- Iced Tea





TEEN  
CROWD  
PLEASERS AT  
POOLSIDE



continued





## AFTER TENNIS WELCOME

Once the last set and game points have been scored on the court (see "Tennis, Tie-In," pages 70-71), good sportsmanship leads to convivial refreshment and a gratifying repast. Tall glasses of chilled sangría, crisp iced raw vegetables and a tantalizing dip will do the initial honors. Then on to paella, that superb Spanish concoction of seafood, chicken and rice. Complement it with your best green salad, perhaps some crusty rolls and, of course, more sangría. For the finale, bring out a light-as-a-cloud orange mousse. The recipes for starred items in menu begin on page 84.

### AFTER-TENNIS MENU

**Raw Vegetable Platter**  
**Creamy Horseradish Dip\***  
**Sangría**  
**Paella\***  
**Tossed Green Salad**  
**French Dressing**  
**Crusty Rolls**  
**Orange Mousse\***  
**Coffee**



Shopping Information, page 52

PHOTOGRAPHS  
BY GORDON SMITH

# THE ABC'S OF

# HAM

Baked, grilled, glazed, garnished, ham is a hearty all-seasons dish.

## HAM VARIETIES

Ham is the hind leg of pork and may be fresh—better called “leg of pork”—or processed. The latter is sold as either *fully cooked* or *cook-before-eating*, and often comes skinless. A fully cooked ham—cured, smoked and processed—is ready to eat; thus it's handy for sandwiches, salads and cold meat service. To warm, heat by baking at 325° until a meat thermometer inserted in the center of the ham's thickest portion registers 140°. Cook-before-eating hams are available both cured and smoked or just cured—and should be cooked to an internal temperature of 160°.

## SUPERMARKET STYLES

**Regular bone-in ham** comes fully cooked or cook-before-eating—in the following forms:

*Whole hams* weigh 10 to 18 pounds.

*Half hams* are either shank or butt halves. The shank half contains the shank bone and part of the leg and is lower in price than butt, which has a higher proportion of meat. When these cuts are labeled “portions” or “ends,” they cost less than halves. Reason: The retailer has removed the center slices to sell separately.

*Ham slice, or steak*, cut from the center of the ham, usually measures

1 inch thick, weighs 1 to 1¾ pounds and is the costliest cut.

**Partially boned ham** may be shankless (only the shank bone removed) or semi-boneless (shank and aitch-bones removed, leaving leg bone). Partially boned ham may be sold whole (8 to 12 pounds) or as halves.

**Boneless ham**—called “rolled,” “shaped” or “formed”—is fully cooked, ready to eat. Averaging 7 to 10 pounds when whole, it is also available as halves, quarters, pieces.

**Canned ham** is fully cooked, in weights varying from 1½ to 13 pounds. It may be smoked or unsmoked, or specially flavored. Sometimes it comes already glazed.

**Country-style ham**, a Southern specialty, was developed by early settlers so it would keep all summer without refrigeration. The ham is dry salt-cured and smoked a long time. Smithfield is probably the best known of this specialty, but to carry this name, the ham must be processed in Smithfield, Va., and aged at least six months. Country-style ham must be scrubbed, soaked and simmered before it is baked.

## BUYING TIPS

- Check the package label to see if the ham you've picked is fully cooked or cook-before-eating. If you are buying less than a whole ham, the butcher may have removed the

label. Check with him, but if you still have doubts, prepare the ham as for a cook-before-eating type.

- Allow ¼ to ⅓ pound per serving for boneless hams, ⅓ to ½ pound for bone-in ones.

- Buy ham only from a refrigerated meat case, except for small canned ham whose label indicates refrigeration is not needed.

- The term “Water Added” on the label means that the ham has retained water, essential to the cure, in excess of the weight of the fresh, uncured ham. (Moisture makes juicier meat.) This addition cannot be greater than 10 percent of the uncured weight and is usually less.

## STORING HAM

Refrigerate whole or half ham in its original wrapper (40° or lower) no longer than two weeks. Store ham steak no more than three days.

Canned hams whose labels indicate they need refrigeration may be so stored, unopened, up to six months. Small hams that can be kept at room temperature should be refrigerated after cans are opened.

Freezing is not recommended because of possible flavor and texture changes. However, when necessary, ham may be kept frozen one to two months, if wrapped closely and sealed tightly in moisture-vapor-proof wrap and kept at 0° or lower.

Whole



Shank portion



Butt portion

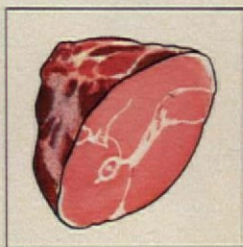

Slice or steak



Shankless

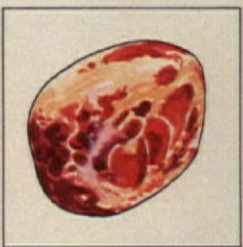

Semi-boneless

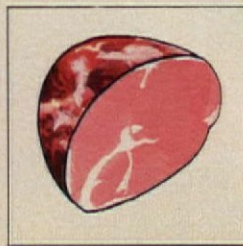

Boneless

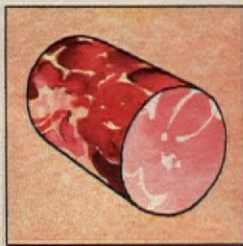

Boneless roll

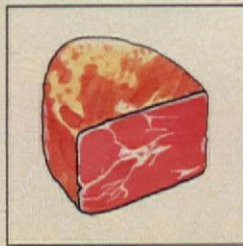

Canned



Country-style

it with these super summer ad ideas. All made from one basic Knox Gelatine recipe that fully lets you enjoy the natural and flavors. And they're all low too.

#### SUMMER SALADS

envelope Knox Unflavored Gelatine  
1 cup cold water  
to 4 tablespoons sugar or equivalent sugar substitute  
1/2 teaspoon salt  
to 4 tablespoons vinegar  
1/2 tablespoon lemon juice  
1/2 cup water, bouillon or juice  
Salad ingredients: Use 1 1/2 cups of any following combina-

tion . . . shrimp and celery; peas, cauliflower and pimento; carrots and mushrooms; tomato juice and cottage cheese. Or any of your own special favorites.

Sprinkle gelatine over 1/2 cup cold water in saucepan. Over a low heat, stir constantly until gelatine dissolves (3 min.). Remove from heat. Stir in sugar (substitute), salt, vinegar, lemon juice, and remaining water. Chill, stirring occasionally, until thick and syrupy. Add 1 1/2 cups salad ingredients and pour into 3 cup mold/bowl or individual molds. Chill until set.

Try them all. And get these

4 individual molds at a fabulous low price. 50¢ plus one Knox box top. Just send with your name, address, and zip code to: Knox Molds, P.O. Box 785C, Indianapolis, Ind. 46206. Offer expires Dec. 31, 1973.



# Mold your future figure.



# Tastiest little Irish dish as ever came out of Boise.



© 1972 by Ore-Ida Foods, Inc.



Potatoes O'Brien. Nope, we can't lay claim to inventing them. But here at Ore-Ida we've added a few wrinkles of our own.

First, we cut up fresh, firm Russet potatoes into neat little nuggets, so they'll cook up nice and brown. Then we add crisp chopped onions for flavor. Finally — and not just for looks either — some tasty red and green bell peppers.

Then we freeze the whole dish to keep it good and fresh and put it in stores all over.

So now you can enjoy Potatoes O'Brien without traipsing to some fancy eatery or doing a

lot of fussing and fuming around your own kitchen.

Just pop our Potatoes O'Brien into a skillet. One whiff of that tantalizing aroma will tell your family they'll soon be sitting down to some of the tastiest eatin' that ever came out of Boise. Idaho, that is.



Good eatin' from Boise.

# FOOD QUESTIONS YOU ASK

*What does al dente mean? I've heard the term used by Italian cooks, but have never had its meaning explained satisfactorily.*

G. M. Negron  
Bronx, N.Y.

*Al dente* is an Italian expression—meaning “to the tooth”—that is used in pasta cooking. It refers to a preferred degree of doneness: firm, but chewy to the bite. Depending on the pasta's thickness, five minutes or less of cooking may be sufficient to achieve *al dente*. Italian-food fanciers say this offers the best taste and eating quality.

*What is the best way to store canned foods and how long can I keep them on my kitchen shelves?*

T. Chester  
Toledo, Ohio

Canned foods may be kept indefinitely, as long as no damage causes cans to leak. The best storage is a cool, dry place. Prolonged storage at high temperatures—near steam pipes, radiators, kitchen ranges—may affect color, texture, appearance and nutritive value, but the food itself will remain wholesome.

*Why can't I find a calorie count for salt, pepper, spices, extracts, baking powder, etc.? I'm on a weight-loss diet and am trying to calculate the calories of every ingredient in my recipes.*

Mrs. L. Lacey  
Abingdon, Va.

These items do not appear on the average chart because they are normally used in small quantities and their calories are minute. They need not be included in your own calorie count.

*When can instant minced onion be substituted for fresh onion?*

(Mrs.) Laura Knott  
Baton Rouge, La.

Instant, or dehydrated, minced onion can be used in almost any recipe calling for chopped onion. You wouldn't want to put it in salads or other dishes where onion is served fresh, however. Reconstituted—that is, with liquid restored—1 tablespoon instant onion equals 1 medium-size fresh onion, chopped.

*Is it harmful to leave milk and milk products out in the sunlight?*

Mrs. N. Parker  
Fair Lawn, N.J.

Yes. Light destroys riboflavin in milk and also causes flavor variation. It is best to return milk products to the refrigerator as quickly as possible after use.

*Split peas have been a staple in my house for years. Can you tell me how the peas were split?*

Mrs. M. Irwin  
Stony Run, Pa.

When specially grown whole peas are dried and their skins removed, their natural break makes them split apart unaided.

*Direct any questions you have about food, food products and food preparation to: Food Questions You Ask, American Home, 641 Lexington Ave., New York, N.Y. 10022.*

# New for tuna!



## Betty Crocker<sup>®</sup> makes it easy, so you can make it good.

Presenting new Tuna Helper<sup>®</sup> from Betty Crocker. A variety of easy to fix main dish mixes that make tuna a deliciously different family treat!

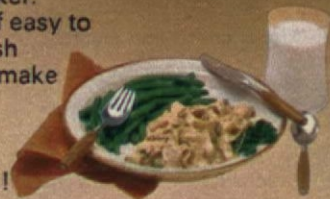

All you do is add one 6½-ounce can of tuna to Tuna Helper, heat in one pan on the stove, and serve.



Stuffed Hard-Cooked Eggs\*  
Curried Chicken Salad\*  
Glazed Baked Ham\*  
Zucchini-and-Squash Casserole\*  
Potato Puffs  
Watermelon  
Coconut Layer Cake\*  
Lemonade Iced Tea Coffee

**HERB-STUFFED EGGS**

6 hard-cooked eggs, shelled  
¼ cup mayonnaise or salad dressing  
½ teaspoon prepared mustard  
¼ teaspoon salt  
Dash of pepper  
2 tablespoons finely cut chives  
2 tablespoons chopped parsley  
Halve eggs lengthwise. Remove yolks gently. Sieve yolks into bowl. Blend in remaining ingredients. Fill whites with yolk mixture. For fancy touch, press yolk mixture through pastry bag. Makes 12.

**SHRIMP-STUFFED EGGS**

6 hard-cooked eggs, shelled  
1 can (4½ ounces) small shrimp, well drained  
½ cup mayonnaise or salad dressing  
2 teaspoons prepared mustard  
1 tablespoon lemon juice  
Halve eggs lengthwise. Remove yolks gently. Sieve yolks into bowl. Reserve 12 shrimp for garnish. Chop remaining shrimp finely. Combine yolks, chopped shrimp and remaining ingredients. Mix well. Fill whites with mixture. Top each with a reserved shrimp. Makes 12.

**CURRIED CHICKEN SALAD**

3 broiler-fryers (2½ to 3 pounds each)  
2 cups coarsely chopped onion (2 large)  
2 celery stalks, coarsely chopped  
1 bay leaf  
1 teaspoon peppercorns  
2 tablespoons salt  
½ cup heavy cream  
1 tablespoon curry powder  
½ teaspoon salt  
1 tablespoon lemon juice  
½ cup mayonnaise or salad dressing  
¼ cup finely minced onion (1 small)  
2 celery stalks, trimmed and sliced finely  
2 apples, quartered, cored and sliced  
Lettuce leaves

Place chickens in large kettle with chopped onion, celery, bay leaf, peppercorns and 2 tablespoons salt. Bring to boiling. Simmer 30 minutes or until chickens are tender. Remove chickens from broth; remove and discard skin and bones. Cut meat into large chunks. Refrigerate meat. Strain broth; keep for another use. Combine cream, curry powder, ½ teaspoon salt and lemon juice in small bowl. Mix well. Stir in mayonnaise or salad dressing. Mix well. Correct seasoning to taste. Combine chicken meat, minced onion, sliced celery, apples and mayonnaise mixture in large bowl. Toss lightly. Refrigerate until serving time. Spoon chicken salad into salad bowl lined with lettuce leaves. Makes about 12 servings.

**GLAZED BAKED HAM**

10- to 12-pound fully cooked ham  
½ cup light brown sugar, firmly packed  
½ cup undiluted frozen orange-juice concentrate  
1 teaspoon dry mustard  
¼ cup cider vinegar  
¼ cup light corn syrup  
½ cup light brown sugar, firmly packed

Heat oven to 325°. Place ham, fat side up, in open, shallow roasting pan. Insert meat thermometer in center of thickest part of ham. Do not let it touch the bone. Bake ham, allowing about 15 minutes per pound. Ham is done when meat thermometer registers 140°. Remove ham from oven 35 minutes before end of baking time. Remove rind. Score fat in diamond pattern with sharp knife. Combine ½ cup sugar, orange juice, mustard, vinegar and corn syrup in saucepan. Cook over medium heat, stirring constantly, until sugar is dissolved and mixture is bubbly. Spoon or brush half the glazing syrup over ham. Pat ½ cup sugar in thin layer onto ham. Bake 20 minutes. Spoon remaining syrup over ham. Bake 15 minutes longer. Place ham on serving platter. Garnish platter with halved orange slices, if desired. Makes 20 to 24 servings.

**ZUCCHINI-AND-SQUASH CASSEROLE**

½ cup olive or pure vegetable oil  
3 cups sliced onion (3 large)  
2 green peppers, seeded and cut in strips  
1 clove of garlic, minced  
2 pounds yellow squash, washed and cut in 2-by-½-by-½-inch sticks  
2 pounds zucchini, washed and cut in 2-by-½-by-½-inch sticks  
1 tablespoon salt  
¼ teaspoon pepper  
2 tablespoons chopped parsley

Heat oil in Dutch oven or large kettle over medium heat. Add onion and green peppers. Cook 2 minutes, stirring occasionally. Add garlic, squash, zucchini, salt and pepper. Cook 15 to 20 minutes, stirring occasionally. Transfer vegetables to serving dish with slotted spoon. Sprinkle with parsley. Makes about 12 servings.

**COCONUT LAYER CAKE**

1 package yellow cake mix (1 pound, 2½ ounces)  
1 package (3¾ ounces) lemon-flavor pudding and pie-filling mix  
1 package (7.2 ounces) fluffy white frosting mix  
1 can (4 ounces) shredded or flaked coconut

Prepare, bake and cool cakes in two 9-inch layer-cake pans according to package directions. Split each cake horizontally to make 4 layers. Prepare pudding and pie-filling mix according to package directions. Cool. Prepare frosting. Spread filling between cool cake layers. Frost sides and top of cake with frosting. Sprinkle sides and top with coconut.

Popcorn Pretzels Potato Chip  
Skewered Italian Heroes\*  
Seasoned Chicken Wings\*  
Assorted Bean Salad\*  
Celery Pickles Olive  
Make-Your-Own-Sundaes with  
Peanut Butter Sauce\* Mocha Sauce  
Peach Sauce\*  
Milk Soft Drinks Iced Tea

**SKEWERED ITALIAN HEROES**

1 pound ground chuck  
½ cup seasoned packaged bread crumbs  
1 large egg  
¼ cup milk  
1 tablespoon instant minced onion  
1 teaspoon salt  
1 pound sweet Italian sausages  
2 tablespoons water  
2 green peppers, seeded  
2 red peppers, seeded  
1 jar (about 2 pounds) spaghetti sauce  
6 hero rolls (each about 12 inches long)  
Heat oven to 400°. Mix meat, bread crumbs, egg, milk, onion and salt in bowl. Shape mixture into 18 meatballs. Place in greased, shallow baking pan. Bake 15 minutes or until browned. Place sausages and water in large skillet. Cover. Bring to boiling over medium heat. Cook 5 minutes. Uncover. Cook sausages until browned. Drain sausages on paper towels; cut into chunks. Cut green and red peppers into 1-inch strips. On each of 6 skewers, alternately thread meatballs, sausages and pepper strips. Place skewers on broiler rack over pan. Brush generously with spaghetti sauce. Broil 3 inches from heat, turning and brushing occasionally. Broil until peppers are tender and meat is heated. Split rolls. Insert skewered meat and peppers in rolls; slip off skewers. Heat any remaining spaghetti sauce to serve with heroes. Makes 6 servings.



**SEASONED CHICKEN WINGS**

1 package (0.6 ounces) Italian salad-dressing mix  
3 tablespoons water  
2 tablespoons lemon juice  
2 tablespoons pure vegetable oil  
1 dozen chicken wings (about 2 pounds)

Combine salad-dressing mix, water, lemon juice and oil in large bowl. Add chicken wings; toss to coat evenly. Cover. Marinate in refrigerator several hours or overnight. Heat oven to 400°. Place wings on wire rack over shallow baking pan. Bake 30 minutes or until golden brown, turning once. Arrange chicken wings on platter; garnish with parsley, if desired. Serve hot or cold. Makes 6 servings.



Micronite filter.  
Mild, smooth taste.  
For all the right reasons.  
Kent.



America's quality cigarette.  
King Size or Deluxe 100's.

King Size: 17 mg. "tar," 1.1 mg. nicotine; 100's: 19 mg. "tar,"  
1.1 mg. nicotine av. per cigarette, FTC Report Feb. '73.

Warning: The Surgeon General Has Determined  
That Cigarette Smoking Is Dangerous to Your Health.



Mildew-resistant Tub & Tile Caulk gives a tight, long lasting seal around tubs, sinks and showers.

# It's easy with the Devil



Renew tiled areas in seconds. Replace cracked or missing grout with Red Devil Instant Tile Grout. No mixing, no mess!

**Red Devil**

Red Devil Inc., Union, N.J. 07083

**TEEN CROWD continued**

**ASSORTED BEAN SALAD**

- 1 package (9 ounces) frozen cut green beans
- 1 package (10 ounces) frozen lima beans
- 1 can (1 pound) bean sprouts, drained
- 1 can (1 pound) cut wax beans, drained
- $\frac{2}{3}$  cup pure vegetable oil
- $\frac{1}{3}$  cup cider vinegar
- 1 teaspoon Worcestershire sauce
- $\frac{1}{2}$  teaspoon salt
- $\frac{1}{2}$  teaspoon dry mustard
- $\frac{1}{4}$  teaspoon celery seed
- Romaine leaves

Cook green and lima beans in separate saucepans according to package directions; drain. Place green and lima beans, bean sprouts and wax beans in separate bowls. Combine oil, vinegar, Worcestershire, salt, dry mustard and celery seed in screw-top jar. Shake well. Pour  $\frac{1}{4}$  cup dressing over each bowl of beans; toss gently. Marinate in refrigerator several hours or overnight. Just before serving, line salad dish with romaine leaves; arrange beans over leaves. Makes 6 to 8 servings.

**PEANUT BUTTER SAUCE**

- 1 cup chunk-style peanut butter
  - $\frac{2}{3}$  cup honey
  - $\frac{3}{4}$  cup milk
- Combine peanut butter, honey and milk in bowl. Makes about  $2\frac{1}{3}$  cups.

**MOCHA SAUCE**

- 1 package (6 ounces) semi-sweet chocolate pieces
  - 3 tablespoons instant coffee
  - 1 cup heavy cream
  - $\frac{1}{2}$  cup milk
  - $\frac{1}{4}$  cup sugar
- Combine chocolate, coffee, cream, milk and sugar in heavy saucepan. Cook over medium heat, stirring constantly, until chocolate melts. Reduce heat to low. Continue cooking and stirring until mixture is consistency of thin pudding. Remove from heat. Cover. Chill until cold and thickened. Makes 2 cups.

**PEACH SAUCE**

- 2 packages (10 ounces each) frozen sliced peaches, thawed
  - $\frac{1}{4}$  cup orange juice
  - 2 tablespoons sugar
  - 1 tablespoon cornstarch
  - 1 tablespoon lemon juice
- Place sliced peaches with their liquid in blender container. Cover. Blend until pureed. Pour puree into saucepan. Add remaining ingredients; stir to blend. Bring to boiling over medium heat, stirring constantly. Boil 1 minute. Remove from heat. Cover. Chill. Makes  $2\frac{1}{3}$  cups.

**AFTER TENNIS**

continued from page 77

- Raw Vegetable Platter
- Creamy Horseradish Dip\*
- Sangria
- Paella\*
- Tossed Green Salad
- French Dressing
- Crusty Rolls
- Orange Mousse\*
- Coffee

**CREAMY HORSERADISH DIP**

- 2 cups mayonnaise or salad dressing
  - $\frac{1}{4}$  cup prepared horseradish, well drained
  - $\frac{1}{4}$  cup dairy sour cream
  - $\frac{1}{4}$  cup finely minced onion (1 small)
- Mix all ingredients until well blended. Makes  $2\frac{1}{2}$  cups.

**PAELLA**

- 6 tablespoons olive or vegetable oil
- 2 broiler-fryers ( $2\frac{1}{2}$  pounds each), cut up
- 1 package (8 or 9 ounces) frozen lobster tails, thawed and cut in 3 pieces each
- 1 pound small shrimp
- 2 cups minced onion (2 large)
- 2 cloves of garlic, minced
- 1 package (1 pound) long-grain rice
- 2 cans ( $13\frac{3}{4}$  ounces) chicken broth
- 3 large tomatoes, peeled and cut in large dice
- $\frac{1}{2}$  teaspoon saffron
- 1 bay leaf
- $\frac{1}{2}$  teaspoon salt
- $\frac{1}{4}$  teaspoon pepper
- $\frac{1}{2}$  pound chorizo or hot Italian sausage, cut in 1-inch pieces
- 12 small clams, well scrubbed
- 1 package (10 ounces) frozen peas, cooked and drained
- $\frac{1}{4}$  cup pimientos, cut in strips

Heat  $\frac{1}{4}$  cup oil in large ovenproof pan. Brown chicken pieces on all sides, a few pieces at a time. Reserve. Add lobster pieces and shrimp to fat left in pan. Cook, stirring frequently, until shells are red. Remove with slotted spoon. Shell shrimp as soon as cool enough to handle. Reserve lobster and shrimp. Heat oven to 450°. Add 2 tablespoons oil to fat left in pan. Add onion and garlic. Cook 2 minutes, stirring frequently. Add rice, stirring well to allow rice to absorb all fat. Add chicken broth, tomatoes, saffron, bay leaf, salt and pepper. Bring to boiling. Return chicken pieces to pan. Cover. Bake 10 minutes. Add sausage, lobster pieces, shrimp, clams, peas and pimientos. Cover. Continue baking 20 to 25 minutes or until rice is tender. Discard bay leaf. Serve from pan or arrange paella in large serving dish. Makes 12 to 14 servings.

**ORANGE MOUSSE**

- 5 egg yolks
- $1\frac{1}{2}$  cups sugar
- 2 cups orange juice
- 1 cup sweet white wine
- 2 envelopes unflavored gelatin
- $\frac{1}{2}$  cup water
- 5 egg whites

Combine egg yolks and sugar in top of large double boiler. Beat until light and lemon colored. Add orange juice and wine. Place over hot, not boiling, water. Cook, stirring constantly, until mixture thickens. Be careful not to let it curdle. Soften gelatin in water; stir into custard. Pour custard into large bowl. Chill until consistency of syrup. Beat egg whites until stiff but not dry; fold into cooled custard. Pour mixture into serving dish. Chill several hours or until firm. Sprinkle top with julienne strips of orange peel, if desired. Makes 12 servings.

Amazing Iso-Tensor Bustline Increaser proves you increase your Total Bustline in our

# FREE "10-SECOND BUSTLINE TEST"

**OR YOUR MONEY BACK!**



PHOTOS  
CERTIFIED  
UNRETOUCHED

BEFORE

JANETTE COUPAR before her "10 Second Test."

**BUST 33 $\frac{1}{4}$ "**



RESULTS  
NOTARIZED

AFTER  
21  
DAYS

JANETTE COUPAR, after she followed the Instant Iso-Tensor course.

**BUST 36 $\frac{1}{2}$ "**

Take The Incredible  
**'10 Second-Bustline-Increaser-Test'**  
See — Feel Results in Seconds!

**IT'S FREE!**

Take this revolutionary new Instant Bustline Increaser — in your hands. Stand in front of your mirror. **USE IT!** In One Second, every muscle in your bustline comes alive with activity! Activity that instantly starts firming, and shaping your total bustline; making it fuller, shapelier — recontouring it to lovelier and more beautiful proportions.

In that **one second**, you must see bustline action—you must feel growth — your mirror must prove this to you—or return our "Instant Iso-Tensor Bustline Increaser and get back every penny you paid. That's proof—of the confidence we have in our plan! It's the fastest bustline shaper and Increaser ever—or your money back!

**What makes ISO-TENSOR  
BUSTLINE INCREASER work so fast?**

It's the only bustline Increaser and shaper plan—that works the total bustline over its fullest range! But more—its action is deeper and fuller — its contraction and extension is 100% complete. (Beware of imitations: If the bustline is not contracted, stretched and extended **over its fullest range from all angles**—the bustline will never reach its fullest and most beautiful potential.) In seconds—Instant Iso-Tensor Plan, accomplishes all this—miraculously!

Patent Pending. © Copyright by Iso-Tensor, Woodland Hills, Calif.

**Prove to yourself in seconds—  
your bustline firms and shapes  
or Every Penny Back!**

This plan is so thorough—so complete—so safe—you see bustline improvement in seconds; we can make you this Unconditional

**Guarantee.**

Take the "10-SECOND TEST."  
See and feel measurable gains or all your

**MONEY BACK!**

You make the "10-Second Test." Our proven results are already verified. The Guarantee is in writing. Now, can you think of any excuse for not ordering your **INSTANT ISO-TENSOR BUSTLINE INCREASING PLAN**—and starting to improve your bustline, instantly? **START TODAY!**

*Janette Coupar*

**Total Complete Bustline Increaser Plan only \$9<sup>95</sup>**

ISO-TENSOR PLAN, DEPT. AH-7  
21100 ERWIN STREET, WOODLAND HILLS, CALIF. 91364

I want to make the "10-SECOND TEST," at your expense. If I do not see improvement in seconds—as you claim—I will return the Exercise and Total Plan within 3 days and receive my money back. For The Total Bustline Improvement Plan I Enclose \$9.95.

Cash  Check  Money Order. (No C.O.D.'s Accepted)  
(Calif. residents add 5% sales tax. Total \$10.50). For rushed delivery, add 60¢ for Air Mail. Shipped in plain wrapper.

Name \_\_\_\_\_

Address \_\_\_\_\_

City \_\_\_\_\_

State \_\_\_\_\_ Zip \_\_\_\_\_

(In Canada: Iso-Tensor, 2875 Bates Rd., Montreal, Quebec.)

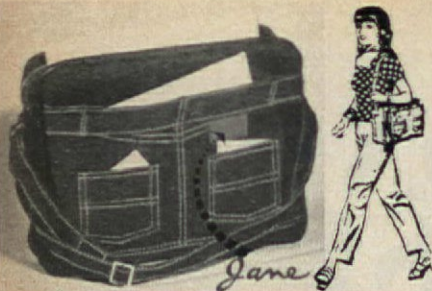

**BLUE JEAN SHOULDER BAG**

Swing into fun with this tough blue denim bag. You'll have plenty of room for all your stuff for the pool, hike, travel, shopping... It's roomy 13 x 10" with zippered center section plus side compartment and two outside pockets. Has authentic saddle stitching, belt loops and adjustable shoulder strap. We'll personalize with first name. Only \$3.95 + 35c postage.

**HOLLY HOUSE**

9924-A Edgecove, Dallas, Tex. 75238



**Suitcase Suspenders**  
**SET OF 3**  
**\$3.98**

Smartly personalized, terrific two ways! They make luggage easy to spot, save the day if a zip or a latch gives way!

Tough elastic webbing, striped red-white-and-blue (American-made, too!) Luggage tags of Gold-plated metal, custom engraved with your initials. Set of 3—no st. sizes to fit any bag.  
#1197—Set of 3 Straps. **PRINT INITIALS \$3.98**  
Add 35¢ post. & hdlg. N.Y. res. add taxes Dept. A71  
510 S. Fulton Ave.  
**LILIAN VERNON** Mt. Vernon, N.Y. 10550



**our famous ACTION-BACK STATION WAGON CLASSIC**

Easy snap-on front, graceful 7-gore skirt. In no-care, machine washable 100% Cotton Denim Chambray. **CADET BLUE** stitched in white. Sizes 10-20.

**\$16**

Add 80¢ post. Satis. Guar. Sorry no COD's

**VICKI WAYNE** 610-ATC-S. Country Club Tucson, Arizona 85718



**Tidy tool for golfers**

Golfer's divot fork and groove cleaner keeps that fairway fair 'n those iron shots sure! Fork lifts and levels divots. 5 nubs clean iron grooves and shoe cleats. Stainless. 2 1/2". Name engraved. \$5. Elgin Engraving, AH7, 946 Edwards Ave., Dundee, IL 60118.

LYNN HEADLEY-E

**AMERICAN HOME MARKET PLACE**



**Tasty needlework**

Herb Garden crewel kits: design-stamped Belgian linen, wool, needle, instructions. Thyme, Chives, Dill, Mint, Rosemary, Oregano, 8x8". \$1.50 each. Wood frame in maple, red, or green. \$1.25. Add 45¢ hdg. Victoria Gifts, 12 A Water St., Bryn Mawr, PA 19010.



**Forever favorites**

"If" by Rudyard Kipling, "Drummer" by Thoreau, and "Do I Love Thee" by Browning presented on three 8"x10" parchment and gold. Ready to frame. \$1 plus 35¢ hdg. Cad Dept. AH7, 2077 New York Huntington Sta., NY 11746.

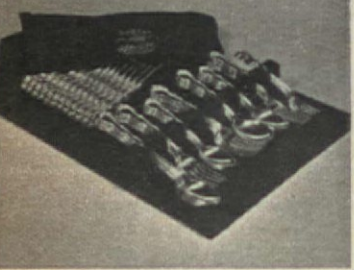

**Gorham Silverware Drawer Pads**

For women who prefer to keep silverware handy instead of hiding it on a closet shelf! Pad fits in buffet or sideboard drawer and keeps flatware nestled in dividers of soft Pacific Silvercloth. Silvercloth absorbs all the tarnish and folds over at the top, eliminating dust. Standard size, 14 x 12 x 2 1/2" holds 108 pcs. Jumbo size, 17 1/2 x 14 x 2 1/2" holds 120 pcs. (Standard)... **\$5.98** (Jumbo)... **\$6.98**  
Plus .95¢ Postage Each

**HOLIDAY GIFTS**  
Dept. 607-B, Wheat Ridge, Colorado 80033



**CURTAIN CHARM BALL FRINGE ON UNBLEACHED MUSLIN**

20", 25", 30", 36", 40" long **4.00 pr.**  
2 pairs to window as shown **8.00**  
45", 54", 63", 72" long **6.00 pr.**  
81", 90" long **7.50 pr.**  
(All pairs 80" wide) Matching Valance 9"x80" **1.75**

Our UNBLEACHED MUSLIN curtains have all the original New England simplicity, warmth and handmade look for every room in the house. Practical long-wearing, these off-white muslin curtains will retain their crisp appearance with a minimum of care. Satisfaction guaranteed. Check or money order. For orders under 5.00 add 75¢ hdg. Orders over 5.00 add 1.50 hdg. Sorry, no COD's. Mass. res. add 3% sales tax. Write for free brochure showing many styles and fabrics.

**COUNTRY CURTAINS**  
At The Red Lion Inn Stockbridge, Mass. 01262 Dept. 71



**Lined willow planters**

Three handwoven, lined willow baskets in-the-half-round make ideal wall planters, mail holders, even bath beauties to keep soap handy. 10x7x6 1/2"; 9x6 1/2x6"; 8x6x5 1/2". Set, \$7.95 plus \$1 hdg. Catalog, 25¢. Fran's Basket House, AH7, 89 W. Main St., Rockaway, NJ 07866.

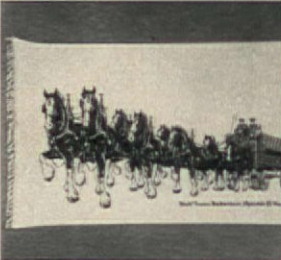

**Beach beauty**

World famous Budweiser Clydesdale horses are colorfully reduced racing across a giant 34" white terry beach towel. Fringed. Sensational wall "tapes" too! \$3.95 plus 75¢ hdg. Cat Dept. 25¢. House of Minnel, 173E 1st path Rd., Batavia, IL 60510.



**GLAMOROUS WEDGIES**  
"GINDY" — Great for indoor and outdoor wear; perfect for gift-giving. Made of soft glove leather with luxurious foam-cushioned insoles, 2 1/2 inch wedge heels, in Black, White or Beige, \$9.95 or combination of Gold and Silver, \$11.95. Sizes: 4 through 12; Narrow, Medium or Wide widths. No half sizes over 10. \$1.00 extra per pair for sizes over 10. Add 75¢ postage for each pair ordered. Money refunded if not delighted. Free catalog. Write: SOFWEAR SHOES, Dept. C. 1711 Main, Houston, Texas 77002.



**LIFE LONG ID TAG FOR PETS**

Don't worry about your dog or cat getting lost. This Identification Tag has all the necessary information for his safe return — pet's name, your name, address and phone number — all embossed FREE. Lifetime polished stainless steel, complete with collar hook. \$1.00 ppd. Satisfaction Guaranteed.

WEST-BERG ENTERPRISES, LTD.  
Dept. 307, 2842 E. Serendipity Cr. Colorado Springs, Colorado 80917

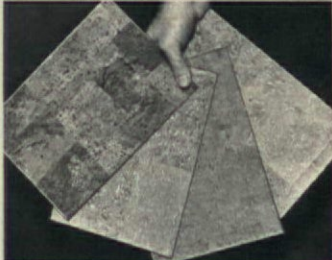

**Corker of an idea!**

Paint has its place, but cork wall-coverings in distinctive patterns and textures add a friendly, unusual atmosphere. At wholesale prices, too! Write for 70 samples that include grass cloths, burlaps, etc. Shibui Wallcoverings, AH7, Box 1268, Santa Rosa, CA 95403.



**Burglar's bell**

Fasten on door, as it's opened scroll shakes and brass clappers to announce arrivals. Encourages "the unwanted," but comes friends. 6 1/2 x 3 1/2". Flat back. \$2.50. Catalog with order; or, Sturbridge Yankee Workshop, Dept. AH1, Sturbridge, MA 01566.

**NOW HERE... THE AMAZING CHAIN REACTION ROACH KILLER**

# WIPES OUT ALL ROACH NESTS IN YOUR HOME FAST... OR YOU PAY NOTHING!

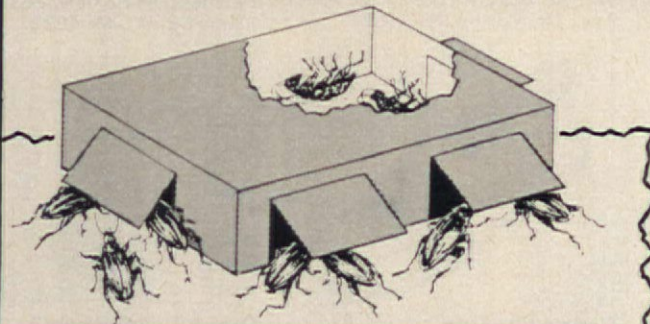

## FREE TO YOU: 3--ROACH TRAPS--3

*These baited traps  
can lure and destroy  
thousands of roaches.*

3 special 5 YEAR TRAPS sent free with each can you order. Bait with powder and place one to a room. You'll be astounded to learn how many roaches each trap can lure to their deaths within 5 years. Durably made to last. Mail coupon below for your 5 YEAR TRAPS—given free.

## JUST 1 CAN KEEPS YOUR HOME FREE FROM ROACHES UP TO 5 FULL YEARS!

**No DDT... No Odors... No Stains... No Fumes**

At last... you can get rid of roaches faster than you ever thought possible. Just ONE simple, easy application does it. It's called PHANTOM Roach Powder and Traps. This great CHAIN REACTION formula not only kills the roaches you can see. It also kills the invisible ones hiding in the walls, under furniture, sinks, books and crannies.

Each roach nest and egg is killed off. None escapes alive in the entire nest!

### 5 YEAR TREATMENT IN EVERY CAN

PHANTOM never evaporates or decays, because it's inorganic. Odorless. Stain-proof. No spraying. No DDT fumes. Powerful! One single treatment clears out an average 6 or 7 room house. And just one GIANT CAN contains enough treatments for 5 full years.

PHANTOM maintains its roach killing power for years. Thus it protects your home from new infestations by these pests. Not for just a few days or weeks, but INDEFINITELY. That's why we guarantee refund of purchase price for FULL YEARS! Phantom contains no DDT... no smelly chemicals or fumes. It has been registered with the EPA—an agency of the U.S. Government.

### DRIVES ROACHES CRAZY

Roaches of all kinds go wild over this terrific discovery. They gobble it up and stagger off to die. Then a strange CHAIN REACTION takes place. A fatal disease spreads like wildfire striking one roach after another—until each and every

**SPECIAL OFFER:** this giant can can be yours for the deep-slated price of 3.95, plus postage.

**FREE BONUS VALUE:** you get 3 roach traps free with each can. This is a Special Offer for a limited time only.

Even after it destroys the roach nests now in your house, PHANTOM doesn't lose its roach killing power. If new roaches sneak into your house from the outside, PHANTOM wipes them out fast—before they can get a foothold again. PHANTOM works round-the-clock, year after year. Merely set out the POWDER and TRAPS as instructed. From then on this CHAIN REACTION formula protects your loved ones, your dishes and food against contamination from these repugnant pests!

### SPECIAL ONE TIME OFFER TO READERS

This limited one-time offer with 3 free traps will not be repeated this season to readers of this publication. To avoid disappointment, please order your needs at once!

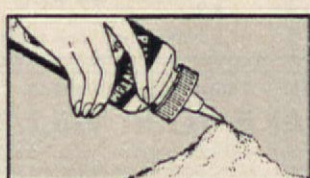

### Special Patented Applicator Pours Right Quantity Without Touching Powder

No fuss, No mess. No soiled hands. Simply squeeze the giant canister With the Patented Applicator. It instantly deposits the right amount of powder—automatically. Your hands never touch the insecticide. So simple! So neat! Easy instructions show you how to keep your home free from these repulsive bugs right around the clock, all year through.

## GIANT 5 YEAR TREATMENT warranted to keep your home free from roaches for years!

100% SATISFACTION GUARANTEED  
OR IT WON'T COST YOU 1 CENT!



### SPECIAL LIMITED OFFER!

REDUCED PRICE

**3.95**  
PLUS POST.

This size clears out all roaches in the average house.

### Try this 5 Year Treatment Without Risking 1 Penny!

No matter how many ordinary insecticides have failed before, you owe it to your family to investigate this great discovery! Try this 5 YEAR PHANTOM TREATMENT—without risk or obligation! Unconditionally guaranteed to get rid of all roach nests—quickly and thoroughly—thanks to its CHAIN REACTION killing power. But that isn't all. It's also guaranteed to kill off future roach infestations—year after year—INDEFINITELY! If you are not 100% satisfied, simply peel off and return the label—nothing else—anytime at all during 5 FULL YEARS for money back. You may keep the remaining powder and traps free. We'll shoot back every penny paid—including postage.

**GRAB THIS OFFER!** Rush the coupon today. Save plenty and also get the 3 traps free. You have everything to gain and nothing to lose... except those foul, uninvited guests. **NOTICE:** This is a short time offer. Rush coupon now. Orders received too late will be returned to senders.

**ASTOR-SCOTT INC. Dept. 5777**  
1231 E. Las Olas Blvd.  
Ft. Lauderdale, FL 33301

Copyright 1973—Astor-Scott Inc.

**5 YEAR ROACH-FREE  
GUARANTEE**

PHANTOM Roach Killer, with Chain Reaction, is guaranteed to wipe out every roach nest, and egg—no matter how many hundreds or thousands of roaches now infest your property. It is further guaranteed to keep your premises free and clear of new roach infestations, up to 5 FULL YEARS, when kept dry and in place. If not 100% satisfactory, simply return the package **LABEL only**—nothing else—for money back anytime before 5 years. You may keep unused powder and all traps, without cost or obligation. This guarantee is valid up to **December 31, 1978.**

**Astor-Scott inc.**  
Dept. 5777  
1231 East Las Olas Boulevard  
Fort Lauderdale, FL 33301

Rush Five Year Treatment Phantom Roach Killer and Traps as checked. If not satisfied with results—I may return the label only (nothing else) for money back—anytime within 5 years.

Florida Residents please add 4% Tax

Print Name \_\_\_\_\_

Address \_\_\_\_\_

City \_\_\_\_\_ State \_\_\_\_\_ Zip \_\_\_\_\_

- CHECK QUANTITY FOR YOUR NEEDS**
- Send 1 Giant Pack, plus 3 traps free. I enclose 3.95 plus 65¢ shipping cost. **Total 4.60.**
  - Send 2 Giant Packs, plus 6 traps free. I enclose 6.95 plus 75¢ shipping cost. **Total 7.70.**
  - Send 3 Giant Packs. I enclose 9.25 plus 75¢ mailing cost. Include 9 free traps. **Total only 10.00—POSTPAID.**
  - BIG SAVINGS OFFER.** 6 giant Phantom packs, plus a bonus of 18 traps (Regular single price \$23.70). Our special price—\$18 for all six. No extra charge for mailing.



### PRECIOUS PINK CRYSTAL

You'll fall in love with our captivating Baby Elephant. Hand crafted in Sweden of sparkling solid crystal in the most unusual shade of violet pink. It measures 5" tall to the top of his wrinkly trunk, and weighs in at 1½ lbs. If you're a collector of fine crystal (or elephants) or know somebody who is—coop him up.

**\$15.98 each plus 95¢ postage.**  
**FERRY HOUSE,** Dept. AH-773  
 Briarcliff Manor, N.Y. 10510

### KITTY A-GO-GO



Practical-Sanitary-Private. Fits over any litter tray to hide the ugly litter pan and the ever-present mess. Gives kitty the privacy she deserves at the same time. Heavy fibre-board of water-repellent construction. 22"x17" x 14½". Shaped like a barn with multi-colors.

**\$4.50 plus 75¢ P & H.** Ill. residents add 5% tax.  
 Gift Catalog 25¢  
**HOUSE OF MINNELL**  
 Deerpath Rd., Dept. 173, Batavia, Ill. 60510

### MAKE EXTRA MONEY

Sell GREETING CARDS & GIFTS  
 Jewelry • Stationery • Wrappings • Toys  
 Over 200 Name Imprinted Christmas Cards



OVER 100 FAST SELLERS  
 No experience needed. Organizations, individuals, shut-ins—all can succeed. Make big profits to 100%, plus Bonus Plan. Write today for samples on 30 day trial and Free color Catalog, Sales Guide, Party Plan and all details. Free Gift with first order.

FREE ALBUM of Imprinted Christmas Cards Available  
**HEDENKAMP, Dept. AH-58**  
 361 Broadway, New York, N.Y. 10013

4 BIG IMPRINT LINES  
 Name \_\_\_\_\_  
 Address \_\_\_\_\_  
 City, State, Zip Code \_\_\_\_\_

### FURNISHED IN EARLY AMERICAN?

Send 25¢ For Famous Sturbridge Catalogue "1,000 Items For Furnishing An Early American Home"  
 Everything in Early American. All by mail at modest prices. Money-Back Guarantee even includes shpg. chgs. both ways.

**STURBRIDGE YANKEE WORKSHOP**  
 the Nation's Center for Early American  
 473 Brimfield Turnpike, Sturbridge, Mass. 01566

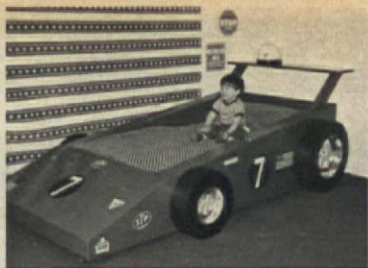

### LITTLE INDY 500

Youth car bed. Share the excitement and delight with your child by building this cute shiny unique Indy youth bed. Just like the big 500 racers. Easy to build using ¾ in. plywood for complete body and wheels. Frame is 88 in. long X 44 in. wide. Mounted on casters to move anywhere in the room. Send \$2.50 for the step by step plans and material list. **HAMMOND BARNES,** Dept. AH 17, Box 39027, Indianapolis, Indiana 46239.

### ADJUSTABLE T.V. POLES

Hold your portable T.V. right where you want it without awkward tables or stands. Takes any width, up to 14" deep. 17" high. Black decorator pole has spring tension rod to adjust to 7½ to 8½ ft. ceiling heights. Can be set up in Hi or Low position. Hi position is great for reclining watchers!

Made in U.S.A.  
**\$12.95** Ppd.  
 We ship in 24 hrs. Extension for higher ceilings, add \$3.00  
 Write for FREE catalog  
**Holiday Gifts**  
 Dept. 607-A  
 Wheatridge, Colo. 80033

### Isn't it time you planned to MAKE YOUR WILL?

Why delay? Be sure your wishes and possessions will be handled as you desire. Get full details with this Will Kit. Includes 4 WILL FORMS and up-to-date 64-pg. booklet, "What Everyone Should Know about Wills", written by a prominent attorney. Answers all questions. Tells what to do. Gives examples of wills. FREE: "Personal Assets Record", "Duties of Executor" and "Valuable Papers" Portfolio.

Complete Will Kit only \$20.00-2 for \$37.50 Michigan residents please add 4% for sales tax.

**HANLEY'S Dept. A-35, P.O. Box 554**  
 22502 Orchard Lake Rd. Farmington, Mich. 48024

### HEARING AIDS

Huge savings on tiny, all-in-the-ear, behind the ear, eyeglass and body models. New space age models are so tiny and well concealed your closest friends may never even notice. **FREE HOME TRIAL.** Low as \$10 monthly. Money back guarantee. Order direct and save. Write today for free catalog. **PRESTIGE, Dept. T-46, Box 10947, Houston, Tex. 77018**



### Shining Star of 1973

"Waiting for Santa," second in a collector series, is crafted of solid brass. Ideal gifts, too, each is engraved with name (specify). 4½". A treasured heirloom. \$1.98 each. 6 for \$9.98. Add 25¢ hdlg. Lillian Vernon, Dept. A71, 510 So. Fulton Ave., Mt. Vernon, NY 10550.



### Bouncy beauty

Walk happy in a featherlight wedge walker. Genuine leather uppers and bouncy rubber sole. Red, bone, black, white. Full and ½ sizes. 4-10 M, W; 5-10 N, M, W. \$12. Gold or silver, \$13. Add 80¢ hdlg. Old Pueblo Traders, 600-A7W-S. Country Club, Tucson, AZ 85716.

### How to Housebreak Your Pet



Train-O-Mat® makes it easy  
 No more stained carpets. When dog scents chemically-odorized mat, instinct says, "Here's the spot." No fuss or bother. Mats are disposable; both pole and 18" square holder are washable. Kennel-tested. Satisfaction or money back.

Holder & 2-mo. supply of mats 4.98 ppd  
 Holder & 6-mo. supply of mats 6.98 ppd  
 Attachable 12" pole for male add 50¢

**G & G RESEARCH**  
 Box 12274-96 Dallas, Texas 75225

### BLOW YOURSELF UP TO POSTER SIZE

A great gift or gag idea. Ideal room decoration. Perfect for parties. Send any b&w or color photo, polaroid print, cartoon or magazine photo. For slides and negatives add \$1.00 per poster ordered. Better original's produce better posters. Giant b&w poster mailed in tube.

**1½ FT x 2 FT \$2.50**  
**3 FT x 4 FT \$7.50**  
**RUSH SERVICE.** Posters only. Shipped 1st class in 1 day. Add \$2.00 per poster ordered. No slides.

**PHOTO JIGSAW PUZZLE** from any photo  
 1½ x 1½ ft. — \$1.49, 8x10" — \$2.49, 11x14" — \$3.49  
 Your original returned undamaged. Add 50¢ for postage and handling for EACH item ordered. N.Y. residents add sales tax. Send check, cash or M.O. (No C.O.D.) to:  
**PHOTO POSTER, INC.**  
 Dept. AH73, 210 E. 23 St., New York, N.Y. 10010



### Planning a home?

Plan book features how floor plans by Richard Po styles from Tudor to Co rary. For all budgets from to country estate. \$2. Fre ture on home categories Planners, AHE37MN, 1631 River, Detroit, MI 48227.

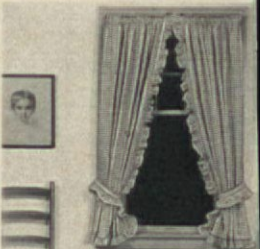

### Granny's gingham?

Just as pretty, but these ea gingham check glories of and cotton are permanen White with blue, yellow, or wide a pr. 45", 54", 63", 7 \$8.50 a pr. Add \$1.50 h order. Free brochure. Cour tains, AH7, Stockbridge, MA



### On the dash

Commuter Coffee Cup is g on-the-go folks. Mug fits outer cup which adheres dashboard. Of plastic, it ha proof cover with an opening ping. 3¾" high. \$3; 2 for Order from Bruce Bolind Boulder, CO 80302.



### Bedspread caddy

Enjoy sleep without your bedspread "crushing" you Toss spread across Caddy tha out from beneath mattress swing into position to hold s \$6.98; 2 (for king), \$12.9 90¢ hdlg. Garrett's, Dept. Box 12274, Dallas, TX 7522

THE WORLD'S FASTEST, MOST SUCCESSFUL WAIST SHAPER EVER

# "I lost 6 inches off my waistline in only 21 days



doing just one five minute exercise—and didn't even have to give up eating the foods I love."

"I never thought it would happen to me...but it did. I got fat. As a former fashion model, I'd always taken pretty good care of myself because if I didn't look good, I didn't work. But when I got married, and didn't need a job, it was a different story.

"For about 5 years I neglected my body, and ended up a mess. And worst of all, I looked about 10 years older than I really was. So I decided that it was time to do something drastic. I tried a few of those 'effortless exercisers' but, of course, they didn't do a thing.

"Then I heard about Joe Weider's 5 Minute Slimming Plan. After just 21 days on the plan, my weight dropped from 143 lbs. to 129. And my waist went from a sloppy 31" to a nice, trim 25", just about what it was when I was modeling. I can't thank the Weider 5 Minute Slimming Plan enough. It gave me back my youth." **Aleta Hopkins**

## What is this ingenious 5 minute body shaper plan?

The Weider "5-Minute Body Shaper" plan is based on doing ONE CONTINUOUS RHYTHMIC CO-ORDINATED EXERCISE. That's all you do! This one 5-minute exercise is designed to attack the Waistline and Hipline (where fat accumulates quickest, giving your body a flabby, weak and distorted look)—as well as burn off excess body fat fast by speeding up your metabolism, burning stored calories and releasing excess water — while reshaping your chest, shoulders, arms and hips, as well as firming up your legs and gut — YOUR TOTAL BODY!

It's safer than strenuous gym workouts, beats the time consumption and dangers of gym workouts . . . or any other vigorous sport.

The unit weighs about 16 ounces and fits any wallet-size case. You can carry it and use it wherever there's floor space — anytime. Even while watching television.

## How much can you expect to lose in 14 days?

Individual results vary, but during an average 14-day period, you can expect to lose up to 4 inches from your waistline and up to 10 pounds from your present weight. It strengthens your heart and lungs, increases stamina and endurance, improves your digestive function and general health. It also shapes you up — from head to toes. For a "5-Minute Exerciser" — it sure does a lot."

## Here's what the experts say:

"Doctors have always known, exercise done while lying on the back, virtually eliminates strain while slimming and reshaping the body. Yours is the finest Body Shaper Program on the market." **RICHARD TYLER**, Chiropractor

"Beats jogging and working out in gyms — and much safer. I lost 4½ inches off my waist in 14 days."

**JIM HANLEY**, famous athletic coach

"Based on sound physiological and medical knowledge, it burns fat and shapes the body without strain to the heart or other organs. I lost 32 lbs. of excess weight using it."

**PIERRE GRAVEL, D.C.**

## \*Exposing effortless exercisers

Reader's Digest (September, 1971), New York Times and Good Housekeeping, among others, exposed sauna wraps, inflated belts, weighted belts and effortless exercisers as frauds. Scientific researchers, medical and fitness experts all agree... there is only one way to firm, shape and trim up your body... you must work the inches off!

## Living Proof of Fantastic Results



BEFORE  
WAIST 44"

MICHAEL BENEDICT (AGE 55) LOST 22 LBS.



AFTER  
WAIST 38"



BEFORE  
WAIST 30"

SANDY DIXON LOST 7 LBS.



AFTER  
WAIST 25"



BEFORE  
WAIST 36"

KEN WALLER (AGE 26) LOST 6 LBS.



AFTER  
WAIST 33"

## '5' Minute BODY SHAPER

The Figure Shaper that Works

### NO GIMMICKS, NO CATCHES MONEY BACK GUARANTEE OFFER

Because this isn't a "gimmick" plan—and you have been fooled in the past by "effortless exercisers"—I make you this

**UNCONDITIONAL GUARANTEE.**

"GET IT OFF FAST"—and see measurable and firming results in 3 days or return the exerciser for a full 100% refund!

Proven results are already verified. The guarantee is in writing. Now, can you think of a reason for not ordering your "5-Minute Total Body Shaper"?

## FREE TRIAL OFFER!



Weight Just  
16 oz.

See your exciting new body begin to take shape in 3 days or return lightweight Body Shaper (small enough to fit into pouch shown) for a full 100% refund!

**Joe Weider, Dept. AH-7  
"5" Minute Body Shaper  
21100 Erwin Street,  
Woodland Hills, Calif. 91364**

Dear Joe: Rush me your 5 minute Body Shaper and Slimmers Course in plain wrapper, with your money back guarantee offer!

I ENCLOSE \$9.95 FOR THE ABOVE.

CASH  CHECK  MONEY ORDER

Send \$1.00 extra for Air-Mail. (No COD's Accepted)  
Calif. residents add 5% sales tax. (\$10.50)

Name \_\_\_\_\_

Address \_\_\_\_\_

City \_\_\_\_\_

State \_\_\_\_\_ Zip \_\_\_\_\_

IN CANADA: "5" Minute Waist Slimmer Plan,  
2875 Bates Road, Montreal, Quebec

Pat. Pend. © 1973 Body Persuasion System, Inc.

3 Documented, Notarized Medical and Fitness Tests Prove You Can...



Meet Mrs. Pamela Olson, Medical Test Subject.



BEFORE: October 14th  
Bustline: 35"



AFTER: October 28th  
Bustline: 38"

# GAIN UP TO 3 BUSTLINE INCHES IN 14 DAYS !

**A Happy Pam Olson Writes:** "Frankly, I was skeptical, when asked to participate in testing for the Beauti-Breast plan. I had tried other products, and they were totally worthless. But since the Beauti-Breast test cost me nothing, I decided to make one more try. The results were amazing! Three full inches to my bustline in only 14 days. (Fuller, higher, firmer!) I'd recommend it to every woman who wants to improve her bustline."  
— Mrs. Pamela Olson

**Medical Doctor, Physical Therapist, Athletic Coach in three independent, DOCUMENTED, NOTARIZED tests confirms Beauty-Breast of Paris is...**

## Why Did We Test Beauti-Breast So Intensively?

BEAUTI-BREAST is not the first to claim dramatic bustline improvement in a short time. But only BEAUTI-BREAST gives you documented proof of its results. We wanted you to see for yourself that where other products have failed you, where others have been exposed as frauds — BEAUTI-BREAST works on REAL women just like yourself. And that is why we asked three groups of women ages 19 to 58 to participate in three different tests, conducted by eminent medical and fitness authorities. Check their results for yourself. You'll be as impressed as our experts were! Our plan actually works in minutes.

## Our Plan Produces Startling Results Because...

Once the jealously guarded secret of exclusive European health and beauty spas, this three-point Beauti-Breast Plan is scientifically designed to compensate for Nature not supplying your breasts with strong muscle tissue, and also to make up for your daily lack of bustline stimulation, the major cause of premature sagging, aging or not reaching your fullest bustline potential. Our plan stimulates, invigorates, and massages the delicate breast tissue as well as the lax bustline muscles, helping to rejuvenate skin tone and make your total bustline "COME ALIVE."

### RESULTS:

**A higher, fuller, firmer bustline.**

## How the Beauti-Breast Plan Works

**Step No. 1**  
THE HYDROTHERAPY CONTOUR CUP  
Use this revolutionary device whenever you bathe. Instantly, mini-jets of pleasurable pulsating water help firm and tone your delicate breast tissue and complete chest area.

**Step No. 2**  
THE BUSTLINE INCREASER GUIDE  
A systematic bustline developing technique strengthens, shapes, firms and uplifts the entire bustline.

**Step No. 3** BEAUTI-BREAST CREAMS  
A trio of specially formulated cremes help the breast skin regain its youthful suppleness, as they help prevent ugly stretch marks!

**THE COMPLETE BEAUTY SESSION TAKES ONLY 15 DELIGHTFUL MINUTES — AND YOU CAN GAIN UP TO 1/2 INCH.**

## Test No. 1

14-Day BEAUTI-BREAST Results conducted by famous Los Angeles physician, associated with four Los Angeles hospital staffs, practicing in both General Medicine and Surgery.

Subject	MEASUREMENTS Initial	After first 15-minute treatment	After 14 15-minute treatments
K.S.	33 1/2	34	34 1/2
P.O.	35	36	38
M.B.	34 1/2	—	36
S.D.	35	—	38
L.L.	35	35 1/4	36 1/4
D.R.	34	35	37
D.T.	32	32 1/2	34
B.H.	32	32 1/2	34 1/2

PARTICIPANTS ALL AGREED: "I wish I had used BEAUTI-BREAST before."  
"Results made me feel like a new woman." "The BEAUTI-BREAST program is terrific!"

## Test No. 2

21-Day BEAUTI-BREAST Results conducted by JAMES HANLEY, prominent fitness expert and fitness coach.

Subject	MEASUREMENTS				
	Pre-test	After 1 treat-ment	After 7 treat-ments	After 14 treat-ments	Final
1	36 1/4	36 3/4	36 3/4	36 3/4	37 1/4
2	35 1/2	37 1/2	37	37 1/2	37 1/2
3	37 1/4	38 1/2	38 1/2	39	39 1/4
4	32	32 3/4	33	34	34
5	33 1/2	33 3/4	34	34 1/2	35 1/2
6	34 3/4	34 3/4	34 3/4	35	36 1/2
7	34	34	34 1/2	34 1/2	34 1/2
8	35	35 1/4	35 1/2	35 3/4	36 1/2
9	33 3/4	34	34 1/4	34 1/2	35 1/4

## Test No. 3

BEAUTI-BREAST Results—Four treatments conducted by RALPH P. JOHNSON, Philadelphia, Pennsylvania, physical therapist with 32 years experience, including ten as Chief Physical Therapist, U.S. Navy.

Lack of space prevents a complete description of complete results. However, Mr. Johnson's affidavit, sworn to and signed before a NOTARY, attests that after four sessions lasting 15 minutes each, gains from 1/4" to 1" were recorded. He states "each of the subjects were well pleased, and as a therapist I was more than pleased with the tests conducted."

## The Fastest, Safest, Most Successful Bustline Increaser!

### Who Needs Beauti-Breast?

Women of all ages who desire fuller, more feminine curves. Even if you have neglected your bustline for years, you can still be assured measurable gains. Results show up to three full inches in the first two weeks, depending on your body type. Send \$19.98 today for your Beauti-Breast, sent in plain wrapper.

### Test It — You'll Love It!

It's the easiest, safest, most pleasurable way to add inches to your bustline!



## Beauti-Breast

The only documented and proven bustline enhancement plan in the world.

Have the beautiful bustline you've always wanted—mail coupon today!

Betty Weider Dept. AH-7  
BEAUTI-BREAST OF PARIS, P.O. Box 3725, Beverly Hills, Ca. 90212

I am enclosing \$19.98 for the complete Beauti-Breast Plan, including hydrotherapy cup, bustline increase guide and Beauti-Breast cremes.

Enclosed is (check one):

Cash  Check  Money Order  (No COD's, please!)

California residents add 5% sales tax (\$20.98) Complete plan mailed postpaid!

Name .....

Address .....

City .....

State ..... Zip .....

(Please print clearly)

YOU MAY CHARGE YOUR ORDER:

BANKAMERICARD MASTERCHARGE

Acct. No. .... Acct. No. ....

Good thru. .... Good thru. ....

IN CANADA: Beauti-Breast of Paris, 2875 Bates Road, Montreal, Quebec





**ed for patterns!**

ion" pattern file holds 50 of your pet patterns neatly ready for reference. Reinforced board in bright yellow, 12" x 12". Alphabetized in 13 compartments. 8x7". \$2.95 plus 50¢ hdlg. Holiday Gifts, Dept. AH7, Wheatridge, CO 80033.

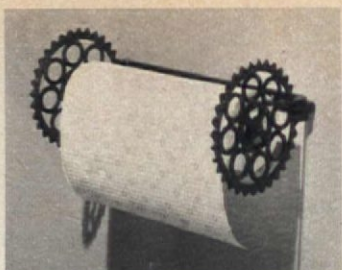

**Trivet towel holder**

Add charm and convenience to your kitchen with this handy holder inspired by Pennsylvania Dutch hex designs. 6-in. diameter cast iron trivets; rack holds regular or jumbo size rolls. \$3.50 plus 49¢ postage. Ferry House, Dept. AH7, Briarcliff Manor, NY 10510.

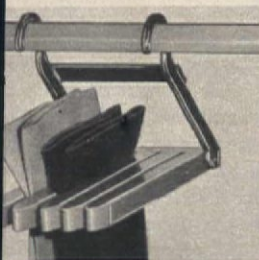

**cuff**

out, Pants Hanger holds 4 cuffed or cuffless trousers in slotted rack. Keeps 'em wrinkle free. Slide out while 5" hanger stays "put." \$2.95 plus 50¢ hdlg. West Dept. AH7, Box 4749, Colorado Springs, CO 80930.



**Silver coin sets**

Last silver set (1964) has full silver Kennedy half dollar. \$3.50; 10 sets, \$34. Other silver coin sets: 1963, \$4.25; '62, \$4.50; '61, \$5.50; '60, \$6. All 5 years, \$23. In plastic holders. Centre Coin, B/5490, Centre Coin Bldg., Suite A-7, Sherman Oaks, CA 91413.



**'s first shoes?**

them bronze-plated in solid as a forever memory! \$3.99 a pair. Also portrait stands (shown), books, bookends at big savings. No money. For details, money certificate, postpaid mailer: American Bronzing, Box 6504-G1, Columbus, OH 43209.



**Step on it**

Strap on a pair of spiked sandals and you have an instant foot lawn aerator! Step lively to loosen turf and soil, let air and water reach and revive roots. Ideal while mowing or watering lawn. \$8.98 plus 50¢ hdlg. Holiday Gifts. Dept. 607-C, Wheatridge, CO 80033.



**ie is a softy**

also the name of this marsh-soft, crinkle patent sandal. Elasticated sling strap as snug, comfy fit. White, or brown. 4-12 in N, M, W. \$5 plus 75¢ hdlg. Sizes over 1 extra. Sofwear Shoes, AH7, Main, Houston, TX 77002.

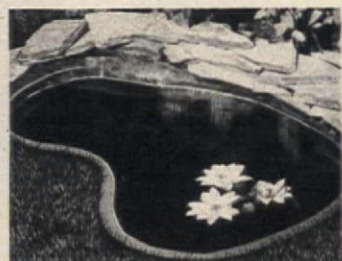

**Gay garden pool**

It's easy to install this sunken garden pool. Needs no plumbing. Recessed pot takes 1 to 3 water lily bulbs (1 comes with pool). Polypropylene. Aqua color. 3'5"x2'3"x8" deep. \$3.98; 2 for \$7.65. Add 50¢ hdlg. Michigan Bulb, Dept. BP-1402, Grand Rapids, MI 49550.

# NEED HELP GETTING UP?

**Cushion-Lift® Chairs** lift you slowly and safely to your feet and provide help and independence for people afflicted with Arthritis, Rheumatism, Stroke or Parkinsonism.



Write for information.  
**ORTHO-KINETICS, INC.**  
Box 436-41

Waukesha, Wis. 53186 • Phone (414) 542-8847



Tel. \_\_\_\_\_  
Zip \_\_\_\_\_  
Address \_\_\_\_\_  
City \_\_\_\_\_

**WICKER LAMP**  
Beautifully hand woven of natural rattan. Completely wired with on/off switch, 9 ft. rattan chain & bracket.

**\$12.95**  
plus \$1.00 postage  
SEND 25¢ FOR CATALOG

Shade is 12" dia. x 9". Painted in white, yellow, green, pink, orange, blue or black add \$2.00. Use up to 100 watt bulb.  
VISIT OUR WAREHOUSE SHOWROOM  
**FRAN'S BASKET HOUSE** Dept. AH7  
89 W. Main St., Rockaway, N.J. 07866

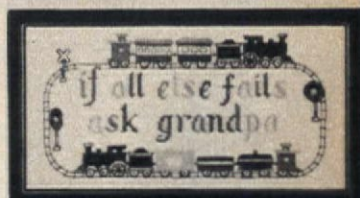

**DELIGHTFUL STITCHERY**

Two irresistible samplers. Each comes in kit form complete with oyster Belgian linen stamped for cross-stitch, floss in bright colors, 8 1/2" x 15" wood frame in maple or mahogany finish, and easy instructions. Also available, "Old Gardeners Never Die, They Just Spade Away." Allow three weeks delivery.

Grandmother Sampler Kit (shown) ..... \$3.75  
Grandfather Sampler Kit (shown) ..... \$3.75  
Gardener Sampler Kit ..... \$3.75  
PLUS 45¢ POSTAGE & HANDLING  
Pa. Res. Add 6% Sales Tax. Sorry No COD's

**VICTORIA GIFTS**

12-A Water St., Bryn Mawr, Pa. 19010

**ADDRESS LABELS with NICE DESIGNS**  
Any Initial, American Flag, Pine, Gull, Palm, Roadrunner, Saguaro, Rose (Also, Texas Flag, Maple Tree, Treble Clef, Palette). Up to 20 letters per line, 4 lines. Printed in black on white or gold gummed labels 1 1/2" x 3 1/2". In plastic box, 500 on white or 250 on gold, \$2 ppd. Or on Deluxe Size, 1 1/2" long, \$3 with design or \$2 without, ppd. Specify Initial or Design desired. Via air, add 33¢. Bruce Bolind, 167 Bolind Bldg., Boulder, Colo. 80302. Thank you kindly!

Mr. & Mrs. Alan 878 Beach Avenue Boston, C. 02114 94331	Robert R. Hayes 1282 Liberty Ave. Riverside, Pa. 15227
Mr. & Mrs. W. C. Cooper 2700 University Boulder, Mo. 64613	William D. Harris 22 Hillside Road Lee, Washington 98825
Mr. Dexter Cooper 681 Palto Dr. W. Haver, Florida 32229	Mr. & Mrs. George Miller 2384 Alamo Dr. Denver, Colo. 80205
Mr. John Austin 245 Eaglewood Street Austin, Texas	Christine David 238 Flower Terrace Madison, Wis. 53705

**NEW UPHOLSTERY FOR OLD!**

**LEARN UPHOLSTERY AT HOME . . . FOR FUN OR PROFIT!** Turn cast offs into chairs, sofas worth \$100's. No experience needed. We show you how . . . supply all tools and furniture kits to get started! Fascinating, creative . . . ideal for spare or full time business. Vet approved. Booklet Free!

**MODERN UPHOLSTERY INSTITUTE**  
Box 899-TAH, Orange, Calif. 92669

# FREE GIFT FOR YOU

Everything you need to make this charming

## ROCKING CHAIR PLANTER

when you join the famous National Handcraft Society.



**It really rocks!**

**T**HIS charming Rocking Chair Planter will win the hearts—and compliments—of everyone who sees it. Just 8" tall, it's a mini-replica of a real Colonial American Rocker, right down to the graceful turned spindles and glowing wood-grain finish. Comes with a breath-of-spring bouquet of tiny, life-like yellow jonquils and green fern. (Or fill the planter with your own arrangement of fresh flowers.) Take this Rocking Chair Planter as a FREE gift to introduce you to the benefits of membership in the National Handcraft Society.



Ritzzy Pig

**Imagine making beautiful things like these for only \$1.25**

(similar items sell in stores for up to \$4.98 each)



Lamp-Kin Holder

Coffee Mill Planter



### A Surprise for you every month

As a Society member, you receive a delightful surprise package every month.

And every package contains a new Handcraft Kit with everything you need to make a charming keepsake for yourself, your home... or to give as a gift.

One month you may fashion a charming planter. Or a rich-looking jewel box, or a lovely centerpiece to grace your table. It will always be something beautiful and different.

Similar items sell in stores for \$2.98, \$3.98 and even \$4.98. But these exclusive kits are available only to members for \$1.25 plus 25¢ postage and handling for each month's selection.

Assembling Handcraft Kits is easy—and such fun. Each Kit contains everything you will need, from materials to instructions. Mail the membership certificate today!

### NATIONAL HANDCRAFT SOCIETY

G-43 Handcraft Bldg., Des Moines, Iowa 50337

#### NATIONAL HANDCRAFT SOCIETY

G-43 Handcraft Bldg., Des Moines, Iowa 50337

Yes, please enroll me as a club member for 6 months and send my free Rocking Chair Planter Kit at once. Also send my first Handcraft Kit for which I enclose \$1.25 plus 25¢ postage, shipping and handling. I agree to send you this same amount each month. I understand that if my club payments do not reach you in time each month I will receive my Kit C.O.D.

I understand that you guarantee not to drop me from the list of members unless I notify you of my resignation and that you will immediately refund my \$1.25 for any Kit that does not satisfy me.

Name \_\_\_\_\_ (Please Print)

Street \_\_\_\_\_

City \_\_\_\_\_ State \_\_\_\_\_ Zip \_\_\_\_\_

NH-18

## DEAR American Home

### REMODELING RAVE

*I'm a two-year subscriber in the midst of remodeling an old farmhouse in New England. I had to tell you immediately that your May remodeling issue is worth the two years. It is practical and detailed as to new products. And you can't imagine the frustration of trying to find new products away from urban centers. Bravo, American Home!*

Mrs. Henry L. Parrish  
Lovell, Me.

### P.S. . . . IT'S GREAT

*I just had to take the time to compliment you on your Cooking Lessons by Jacques Jaffry. The utter simplicity of pictures and instructions on two pages has got to be the biggest boon to any would-be good cook. I must also add a P.S. on your new "KNOW HOW" feature in April. It's just great and opens up new worlds of ideas to many homemakers. American Home is the most varied magazine on the newsstand today. From always interesting articles to quality advertising, your magazine offers a lot for the money.*

Mrs. Richard Petta  
Arlington, Va.

### TREASURY LOVERS

*I cannot compliment American Home enough on the April issue, and Rosemary Klein on her excellent article, "Saltbox Simplicity." She has researched the subject well and managed to capture the essence of an architectural style and a way of life. How good it is to see the integrity and enduring worth of the center-chimney saltbox properly honored in your "now generation" magazine.*

Mrs. J. Dale Boyd  
Ann Arbor, Mich.

*I love your articles on America's restored homes. The one on Savannah (March AH) has inspired us to take our vacation there this year. No modern house or high-rise apartment will ever have one-half the charm and beauty of the older homes. Seeing Savannah made me insist on larger rooms in our new home and take more pride in our garden.*

Margaret Delfer  
Camdenton, Mo.

### MALE "SEAMSTRESS"

*I would like to respond favorably to the all-too-short paragraph in Louis Botto's "Good Life" entitled "Men and Sewing" (April AH). I am a 25-year-old American male who has recently taken up the creative and enjoyable hobby of sewing. I started last summer by making neckties, graduated to a simple smock for my wife and have since made myself suits, sport coats and a tuxedo jacket. I find it very relaxing and an outlet for creativity as well as an opportunity to beat the high cost of clothing.*

Gary McCann  
St. Paul, Minn.

### HUSBAND PLEASER

*I wish to express my appreciation and delight in "Best-Loved American Originals" in your March issue. Naturally, I still cook from scratch and my husband does justice to my efforts. Now he can have his Corn Oysters and Cocoa Cake that I've tried in vain to duplicate. American Home is tops!*

(Mrs.) Doris H. Currier  
Sacramento, Calif.

Address all letters to the editors to: Dear American Home, 641 Lexington Avenue, New York, N.Y. 10022.

# You'll do a Double Take

When you see how great the values are on two cartons of Coke.

Trade-mark ®



**Pick up two cartons of Coca-Cola today.**

**'s the real thing. Coke.**

Trade-mark ®

\*Coca-Cola® and "Coke" are registered trade-marks which identify the same product of The Coca-Cola Company

# Salem refreshes naturally!



## Natural Menthol Blend (means naturally fresh taste)



Salem's unique blend features natural menthol, not the kind made in laboratories. Like our superb tobaccos, our menthol is naturally grown. You'll get a taste that's not harsh or hot... a taste as naturally cool and fresh as Springtime.



**King or Super King**

© 1973 R. J. REYNOLDS TOBACCO CO.

Warning: The Surgeon General Has Determined That Cigarette Smoking Is Dangerous to Your Health.

KING: 19 mg. "tar", 1.3 mg. nicotine, av. per cigarette, FTC Report FEB 73  
SUPER KING: 21 mg. "tar", 1.5 mg. nicotine, av. per cigarette, FTC Report FEB 73