

ARCHITECTURE

THE AIA JOURNAL DECEMBER 1983





NOVA Lighting Controls

Rich. Rugged. Reliable.

Nova is the finest line of solid state energy-saving dimmers and controls . . . anywhere.

Handsome on the outside, but rugged on the inside.

Nova reflects a rich contemporary style complementing any decor. It's the unique lighting control that doesn't have unsightly metal strips on the front of the dimmer. In addition to a distinctly handsome appearance, Nova's rugged solid state circuitry and silver contact switch make it the sturdiest of all lighting controls.

Vertical Slide Control Dimming

Nova's patented calibrated vertical slide control glides to the precise lighting intensity you desire—the natural human-engineered way to control illumination. If you move the slider to the center of the control, for example, you know at a glance that the lighting is at 50 percent. With this feature, you can bring theatrical Square Law Dimming into your interior designs.

Unquestionably Reliable

Each component is carefully selected, and every finished unit is 100 percent tested to be sure it meets Lutron's strict standards of quality.

Styling Flexibility

Nova dimmers, on-off switches and system controls share the same faceplate design to give a clean uniform appearance no matter how you arrange them. They're available in many models and colors with your choice of tamper-proof faceplates and custom engraving.

Controls Incandescent & Fluorescent Lighting

A complete array of Nova wall-box dimmers and controls are available in incandescent and fluorescent models. Should you require a sophisticated control or high wattage application (including mercury vapor and cold cathode lighting), Lutron will custom build a lighting control system to fit your design. All models are available from lighting showrooms and your local electrical distributor.

Nova—the designer's choice for every lighting control need. *

UL Listed

* *Nova wall-box dimmers and custom-built systems have been installed in the Hyatt and Marriott Hotel chains, plus the Grand Hyatt, Coca-Cola, Disneyworld & Disneyland, AT&T, IBM, the World Trade Center in New York, Citibank, Arco, Revlon, Pennzoil, Texaco and the White House.*

LUTRON

COOPERSBURG PA 18036

EVENTS

Jan. 9-10: Seminar on Economic Design of Steel Structures, Department of Engineering and Applied Science, University of Wisconsin, Madison.

Jan. 20-21: AIA Energy in Design: Process Workshop, New Haven, Conn. Contact: Brenda Henderson at Institute headquarters, (202) 626-7353.

Jan. 24-27: Second Annual Interstate Solar Coordination Conference and Workshops, Arizona State University, Phoenix, Ariz. Contact: Carolyn Burby, Interstate Solar Coordination Council, 300 State Road, 401, Cape Canaveral, Fla. 32920.

Jan. 26-27: Workshop on Computers and You, Department of Engineering and Applied Science, University of Wisconsin, Madison.

Jan. 26-27: AIA Energy in Design: Energy Conscious Redesign Workshop, Washington, D.C. Contact: Brenda Henderson at Institute headquarters, (202) 626-7353.

Feb. 17-27: Solar Tour to Israel. Contact: Linda Bouwkamp, Jordon College, 360 W. Pine St., Cedar Springs, Mich. 49319.

May 5-9: AIA Annual Convention, Phoenix.

LETTERS

'A Large Mistake': The Paris opera house competition report by Dennis Sharp in the October issue (page 22) concentrated on how the jury dealt, mainly, with fitting the program on the site. In my opinion the jury did the profession a serious disservice by pandering to the impossible program instead of finding the most creative, expressive, and delightful esthetic solutions as their first responsibility. This would have been unfair if there had not been the directive in the program that they were going to redo the requirements before the opera winner started serious work, in any case.

The jurors must not have had the asset of a Saarinen, who helped pick Jørn Utzon's beautiful idea for the Sidney opera house. Instead, they picked one winner, who, according to one newspaper account, included "a neon-lit guillotine with distorted glass walls," among other things.

None of us has seen all of the winning ideas, but at the moment it looks like a large mistake has been made. No one will ever convince me that among the 766 entries there was not another beauty to grace the City of Light. Perhaps they should pick another jury and start over.

*Richard W. Snibbe, FAIA
New York City*

O'Neil Ford at Trinity University: I have read with interest the September article (page 58) concerning O'Neil Ford and Trinity University. The campus bears the imprint of O'Neil Ford and his desire to

make it a showplace campus different from any seen elsewhere. It also bears the imprint of Bill Wurster and his California concept of use of materials. It also bears the imprint of Arthur and Marie Berger, who knew most of all what plants look good in the San Antonio sunshine and occasional rain. And, acknowledged or not, it bears the imprint of Bartlett Cocke and his consistent attention to the mechanics of getting buildings built the way designers want them to be.

Lawrence Speck, the author, omitted the fact that the firm was Ford & Rogers up until past the middle of 1953. I should know—I was there. The office was doing large and important commercial work. That was what financed the big payroll that went to do the work at Trinity.

As for the nice story of O'Neil's about going under that first lift slab with President Everett of Trinity, it reads well and perhaps it gave everyone a good laugh when O'Neil told it. Who went under the slab? Neil and I did, to check to see how the slab had separated from the base slab and whether it left a surface that needed patching. I don't remember either of us being concerned about the slab falling, for we had already gone under the first experimental slab raised at Tom Slick's Southwest Research Institute a year earlier.

*Jerry Rogers, AIA
San Antonio, Tex.*

Lawrence Speck responds: My apologies to Mr. Rogers. I certainly did know that the firm was Ford & Rogers from 1949 to 1953, and I should have given that credit. Gerald R. Rogers worked with O'Neil Ford as early as 1939 on the Chapel in the Woods at Texas Women's University and was responsible for much of the diverse commercial work in San Antonio, Corpus Christi, McAllen, Mission, Pearsall, Fredericksburg, Bandera, Houston, and Dallas that the firm did in the early-'50s.

Trinity University, Another Account: It just so happens that I was on hand at the raising of the first lift-slabs at Northrup Hall on the Trinity campus. The upland site was already partly landscaped, and everything was neat as could be, not the usual construction mess for a building as large as Northrup. This, of course, was part of the lift-slab sales pitch—no scaffolding, no concrete forms, no big piles of materials or scraps. You could plant during construction, it since proved out.

The large concrete slabs, flat on the ground, were pierced by vertical steel columns at neat intervals and occasional rectangular apertures for plumbing and wiring. Surrounding the slabs were well made board frames, actually tailored boxes, into which the reinforcing had been carefully placed and onto which the concrete had been poured. There were three huge floor slabs, one on top of the other,

the top two to be lifted by electrically powered jacks at strategic locations so that the floor and roof slab would rise evenly to their allotted heights on the vertical members, where they were to be fixed by pins through predrilled holes in the columns. Each slab had been swabbed down with heavy mechanics soap after curing so that they could separate.

It looked clean and beautiful and impossible. It was Phil Youtz, I think, who with appropriately unprintable words switched the power on. Absolutely nothing happened except some unpleasant electrical noises. He turned it off and on. Not a budge.

Now, it just so happened that a carpenter's helper, ignoring all of us and the electrical buzzing, wandered on to the set with a sledge hammer. He began whacking off the wood frames. Whack! Whack! Phil had just turned the motors on again, and up rose the two giant slabs, softly and smoothly. The sound or vibration waves set off by the whacks had broken the vacuum seal that held the slabs together. Loud cheers! And we all went back to Ford's to celebrate.

*Carl Feiss, FAIA
Gainesville, Fla.*

Texas Rapid Transit: The news report in the September issue (page 11) regarding the rail votes in Houston and Dallas leaves erroneous impressions that should be corrected.

First, the Houston and Dallas votes should not be considered equivalent. Houston voters turned down a METRO proposal to sell \$2.35 billion in bonds to finance bus and rail improvements, including the 18.2-mile first phase of a regional rail system. Dallas voters voted to create a transit authority (DART) and to finance it through a 1 percent sales tax, both actions equivalent to the creation of Houston's METRO by Houston voters in August 1978. Dallas voters also approved a 160-mile light rail transit plan, but *did not* grant DART the right to issue bonds on their new sales tax. Thus, should

continued on page 83

Corrections: Through typographical and/or mental error on page 44 of the November issue we called James Marston Fitch a postmodernist. This is the approximate equivalent of calling Ronald Reagan a Socialist or the Pope an atheist. The word, of course, was intended to be preservationist, an appellation he has earned through decades of scholarship and activism. *Ed.*

The custom-made chairs shown in the Saarinen living room in the September article about the Cranbrook Academy of Art (page 55) were designed by Warren Platner.

Both Berlin housing projects shown in October (page 15) are by Rob Krier.



TACO BELL



CRYSTAL
CONFECTIONERY



THE CAFE



MOXIE'S



GRANDY'S



THE OYSTER BAR
& AMERICAN GRILL



G.D. RITZ'S

BEAUTIFUL RESTAURANTS

The Capital

Memorial Refinements Continue As New Controversy Arises

When veterans returned to Washington's Mall last month to mark the first anniversary of the Vietnam Memorial dedication, they found the memorial's sponsors under fire once again, this time over financial management, and the memorial site itself still undergoing modifications.

A series of reports by a Washington television station broadcast just prior to Veterans Day probed how the Vietnam Veterans Memorial Fund spent the \$9 million raised to build the memorial and charged that VVMF was withholding detailed accounting data. After three segments of the five-part series were aired, the fund invited the station to hire an independent auditor to examine the books. The station accepted the offer and did not air the final segment of the series.

Prominent in the broadcast reports were interviews with critics of the memorial design, including Texas industrialist H. Ross Perot, an early supporter of VVMF who turned against it after Maya Ying Lin's minimalist design was chosen in an open competition. No supporters of the memorial were interviewed in the segments aired. (In an article published in *The Retired Officer* magazine two weeks prior to airing of the series, Robert Doubek, secretary and legal counsel of VVMF until last June, gave an insider's account of VVMF's history and opposition to the memorial design. Five of the six people cited by Doubek as the primary opponents who tried to block the memorial, including Perot, were interviewed in the first three television reports.)

In response to the broadcasts, VVMF charged the reporter responsible for the series, Carleton Sherwood, with "unprofessionalism and malice." Jan Scruggs, president of the fund, told a press conference: "There is a little group of people who didn't like the memorial. We tried to make a deal with them, put a flag and statue there. But these guys are still mad." Doubek told ARCHITECTURE: "This is a continuation of the political controversy. When the memorial's opponents couldn't stop it, they tried to cram the statue and flagpole down the middle and make their mark on it. When they couldn't wreck it, they attacked the credibility and integrity of the principals involved in the memorial fund."

VVMF's financial data for the period

April 29, 1979, through March 31, 1983, indicate that of the \$9 million raised, \$3.9 million was used for memorial development, construction, and program costs, \$2.12 million was spent on fundraising, and slightly less than \$1 million was used for fund administration, including salaries. As of March 31, \$1.97 million was reserved for completion of the memorial.

Modifications to the memorial have been required by its great popularity—an estimated two million visitors in 12 months—and by the addition of a flagpole and statue as concessions to detractors of the original design. Scruggs says VVMF expected initial popularity of the memorial to dwindle, but that has not happened. Because of ongoing construction, visitors have not been able to view the polished granite walls in the setting intended by Lin. Much of the grass in front of the walls was destroyed during the heavily attended three-day dedication in November 1982, and the field remained muddy through much of last winter. New sod, reinforced with plastic meshing, was laid last spring, but access boardwalks remain in place at the ends of the two long walls. Over the summer, the paved walkway on the east approach was reconstructed, and the 50-foot-high flagpole was erected there.

Last month, 68 names of newly confirmed war dead and missing were being added to the walls and the site for Frederick Hart's sculpture of three infantrymen was being prepared. Ground around the statue is to be paved in a crescent shape using granite slabs like those that form the existing walkway in front of the walls. Meanwhile, that walkway is to be widened by approximately two feet on each side with small granite sets placed half an inch apart with grass as "mortar." Buried among the granite sets between the walkway and the walls, a series of more than 70 lights is to be installed. The lighting scheme, designed by Claude Engle, is to "exactly wash the wall," according to William Lecky of Cooper-Lecky Partnership, architect of record for the memorial. Cooper-Lecky has also designed access paths in granite sets to replace the boardwalks.

Scruggs says dedication of Hart's statue may take place next Memorial Day, May 28, depending on completion of its casting. In mid-November Hart said the clay model was "85 percent complete," and that he expected to have it ready for plaster casting within 60 to 90 days. Final casting in bronze, a "lost wax" process, could take from two to five months.

News continued on page 14



Above, the 50-foot flagpole in place with the memorial beyond. Below, Larry Century adds one of 68 names to the walls.

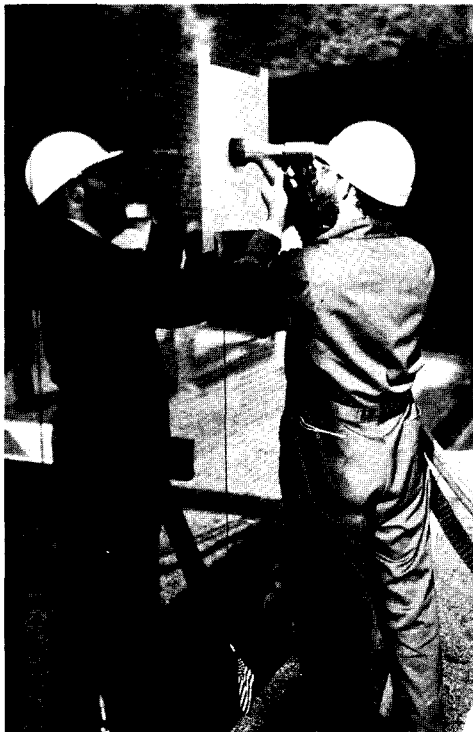

Photographs by Allen Freeman

J. Seward Johnson, Jr.

a sculptor of our time

By capturing human gesture in bronze, J. Seward Johnson, Jr. creates a sculptural experience that all can enjoy. The cast-metal muses that already populate the downtown activity centers and public spaces of many cities, have received an overwhelmingly positive reception. Through specific choice of placement, Johnson allows them to become silent participants in the daily lives of his public. Even people who do not usually look at sculpture are intrigued by the paradox of a gesturing bronze counterpart. In an age when so much of the art produced is indecipherable to the common man, Johnson introduces his statements in the most easily read form, the human figure, and depicting narratives of universal appeal and significance.

An untraditional aspect, one which enhances the sculptures' capacity to surprise, is the placement of pieces in outdoor settings appropriate to their narrative. What could be more natural than a boy, book in hand, having lunch perched on a fountain ledge, or a workman enjoying a break in his day stretched out on a curbside bench. These figures, except for their portrayal in bronze, seem to lose context as sculpture,

for they are never divided from the surrounding activity or their human counterparts by stand or pedestal.

By casting his works in metals, Johnson is able to eliminate the need for a protective indoor site, and situate pieces where they become a part of public life. Fascinated yet not intimidated, children and adults alike are often seen tactually exploring the textured surfaces of a figure, or joining a Johnson sculpture to share a bench. Johnson purposefully reaches for this public involvement, and in fact believes public response to be the sculpture's completing element. The human forms of these pieces convey spirit and emotion, drawing each viewer into self-association, and becoming a humanistic link to their surroundings.

Outdoor sculpture parks, National recreation areas, downtown centers of shopping and business activity, resort communities; placed in these settings Johnson feels that his sculptures act as a bridge between the populace and the man-made structures. By offering a familiar image, Johnson's figures imbue their environments with decidedly human gesture, humor, and spirit.

—Paula A. Stoeke

Current Exhibitions

Yale/New Haven Parklands
New Haven, Connecticut

Wave Hill Sculpture Park
New York, New York

Boca Raton Hotel and Club
Boca Raton, Florida

Exxon Park
Rockefeller Center
New York, New York

Richard J. Hughes
Justice Complex
Trenton, New Jersey

Bronze at
Washington Square
Washington, DC

We are overwhelmed in the twentieth century with what technology has brought us. We need to be reminded of the warmth of the human spirit, and so examples should be present in our environments. We have to understand that our age can be a humanitarian one, and not one which relegates the human being to an alienated condition."

J. Seward Johnson, Jr.

The sculpture works of J. Seward Johnson, Jr. are available for purchase. For brochure and information please contact:

SCULPTURE PLACEMENT
P.O. Box 9709
Dept. 4
Washington, D.C. 20016

Phone: 202-362-9310

Announcing a new work by



“Match Point”

Bronze

J. Seward Johnson, Jr.

For brochure and information contact:
SCULPTURE PLACEMENT
P.O. Box 9709 • Washington, D.C. 20016 • 202-362-9310
LIFESIZE FIGURES PRODUCED IN LIMITED EDITIONS OF SEVEN OR LESS

Circle 6 on information card



No Structural Damage Found After Bomb Blast in Capitol

An explosion in a corridor near the Senate chamber in the U.S. Capitol on Nov. 7 resulted in broken plaster and glass but no structural damage, according to Elliott Carroll, FAIA, executive assistant to the architect of the Capitol. The impact of the explosion, says Carroll, "was considerably less than many of the newspaper stories implied, because this is a massive building and it can take explosions better than some.

"It's really a matter of repointing some brick," says Carroll of the repairs, "re-plastering, repainting, re-hanging some doors, and replacing glass." Repairs were expected to be completed within six weeks at a cost of \$250,000.

Carroll says that no tests for structural damage were conducted because it was clear from inspecting the exposed masonry that none had occurred. There was no damage to the floors immediately above and below the blast site.

Tavern's Preservation Voted

District of Columbia voters last month gave an overwhelming endorsement to a campaign to save the remaining fragment of the 183-year-old Rhodes Tavern one block east of the White House. Washington's preservationist community is divided over the issue, with some arguing that too little of the original building remains to warrant saving.

Passage of the referendum designed to preserve the Rhodes does not guarantee that it will be saved from demolition, but it will require Mayor Marion Barry to appoint a committee to negotiate with developer Oliver Carr, the building's owner. A six-year dispute over the tavern has blocked Carr's completion of Metropolitan Square, a retail/office complex that already incorporates the facades of a theater and a bank (see Nov., page 68).

Government

GSA Buildings Head Resigns; Dibner's Post Still Unfilled

Richard O. Haase has resigned as GSA's commissioner of the public buildings service. Haase's resignation leaves two key vacancies in the public buildings service, the other being the post of assistant commissioner for design and construction vacated by David Dibner, FAIA, a year ago.

As commissioner, Haase was responsible for the construction, leasing, and maintenance of space in over 10,000 federal buildings nationwide. He came to the post two years ago with a background in real estate appraisal. He leaves to assume the vice presidency of a real estate investment trust.

A major part of Haase's program as commissioner was to develop new forms of partnership between government and the private sector to stimulate construction. Charles W. Sampson, acting deputy commissioner, says Haase instituted new business methods in the public sector, primarily in the form of an opportunity purchase program, where buildings in which GSA is a leasee can be purchased for much less than the cost of building new facilities.

"He was successful in establishing that account in our budgeting system and then getting Congress to approve it," says Sampson. GSA bought its first building through the program last summer. Sampson says that Haase also arranged for several government leased spaces to be sublet, "reducing the cost to the taxpayer."

Herb Koster, GSA director of public affairs, says Haase enthusiastically promoted implementation of the Cooperative Use Act of 1976, under which commercial space in federal buildings is leased to private developers. Washington's Old Post Office is a notable example of the act's use. A post office in St. Louis was redeveloped in a similar way, and a concourse in the Pentagon is being considered for refurbishing.

"Another project that he was enthusiastic about was the international cultural and trade center," says Koster, which will concentrate many of Washington's international activities in one place. The site is approximately 2 million square feet near the city's waterfront. GSA is only one of several agencies involved in the project ("at Dick's insistence," adds Koster), which was organized by the Federal City Council.

Projects under Haase's stewardship not yet realized, says Sampson, include the updating of computers that are used in the management, design, and construction of space in federal buildings. "We're

working on a computer-aided design pilot project," says Sampson, "research and development of 'data highways' in new buildings, and incorporating high technology into a couple of buildings currently underway."

Meanwhile, the post vacated by Dibner may soon be filled. GSA says it has received 30 applications for that position and is currently screening and interviewing candidates.

Baltimore Subway Debuts As Miami Postpones Opening

Late last month Baltimore opened nine stations on eight miles of track, thus joining the ranks of San Francisco, Washington, and Atlanta as major cities adding rail lines to their mass transit capacities in the last eight years. Miami, which had planned this month to open nine stations on 11 miles of track stretching south from downtown, postponed opening until next July, citing flaws in design and construction.

Under construction since 1976, Baltimore's system, known as Metro, is being built one line at a time. When completed in four years, the 17-mile first line will have cost an estimated \$1 billion, mainly in federal funds. Metro officials say that it could take 40 years for the system to rival Washington's in size. Each of the seven underground stations closest to downtown is of different design by different firms; the two above-ground stations farthest from downtown are similar in design.

continued on page 16

NEWS CONTENTS

The Capital	
Vietnam Memorial finances	11
Bomb explosion damage	left
Government	
Haase resigns at GSA	above
Baltimore subway opens	above
Public Buildings Act	16
Practice	
Design quality in era of change	18
The Institute	
Regional exhibits at the convention	22
The Arts	
Nurturing WPA heritage	26

Unless otherwise indicated, the news is gathered and written by Allen Freeman, Nora Richter Greer, Michael J. Crosbie, and Lynn Nesmith.



Speed was critical for the developers of this 120-unit retirement living project. With occupancy slated just 10 months after contracts were let, no delays in frame erection could be allowed.

By prefabricating the Inryco light gage steel framing sections, the contractor completed erection in just 13 weeks. In addition, the system's load-bearing strength and light weight permitted all five levels, without costly oversized footings, on the site's sandy soil.

Find out the details of how Inryco lightweight steel framing helped keep this project on schedule — and how it can benefit your next project. Write for Catalog 37-20, INRYCO, Inc., Suite 4127, P.O. Box 393, Milwaukee, WI 53201. TLX 26683 INRYCO A WMIL



Inryco

an Inland Steel company

Circle 8 on information card

FIVE LEVELS IN 13 WEEKS

Government from page 14

Most expensive and elaborate of the nine stations is the southern terminus, Charles Center. Designed by RTKL, the three-level station has an exposed, poured-in-place concrete roof structure of triangular coffers. That station also serves the Inner Harbor area, including Harborplace and the National Aquarium. West of Charles Center is the Lexington station, serving the recently enlarged market there, centerpiece of Baltimore's series of neighborhood markets. From Lexington, the line stops near state government offices, low income neighborhoods, and shopping malls. One station will serve the Baltimore Zoo, another Cold Spring, a city-instigated development of mostly middle-class housing designed by Moshe Safdie.

Streamlining Is Sought In Buildings Act Revisions

Stressing AIA's support of a "coherent, rational plan for managing our nation's public buildings," former Institute President R. Randall Vosbeck, FAIA, testified on behalf of AIA in favor of an amended Public Buildings Act. Vosbeck spoke before the House subcommittee on public buildings and grounds.

The act, on which AIA has worked with Congress for six years, would provide, said Vosbeck, "a responsible and efficient policy to govern the financing, design, and construction of high quality public buildings throughout the country."

One provision of the act would autho-

rise GSA's administrator to carry out preliminary engineering and design work for new construction or renovation before a project is authorized by Congress. "The effect of the amendment will be to significantly speed up the process with the attendant reduction in construction and operation costs," said Vosbeck.

The act also provides that GSA put greater emphasis on preserving buildings of historic, architectural, or cultural significance under the Public Buildings Cooperative Use Act of 1976. Vosbeck cited Washington's recently restored Old Post Office as an "excellent example of the Cooperative Use Act at work," along with several other public buildings that have been preserved and opened for public use. He urged that GSA make greater use of the act.

Vosbeck also spoke in support of an amendment that would serve to improve energy efficiency in public buildings. "Public structures should set an energy efficient example," said Vosbeck, "that can be followed by the rest of the nation."

Masking Emptiness



Courtesy of New York City Department of Housing Preservation and Development

Since 1980, New York City's department of housing preservation and development has applied decorative window decals (like those in the photo above) to 325 city-owned abandoned buildings throughout Brooklyn, Queens, Manhattan, and the Bronx. City housing official Bruce J. Gould says that the "Occupied Look" program was started at the request of community organizations to minimize the effects of derelict buildings in otherwise healthy neighborhoods.

Gould says that the intent was not to "fool anyone" into thinking that the buildings are occupied, nor as a remedy in lieu of redevelopment. It is rather a morale boost for the neighborhood, says Gould; some evidence that the city is cognizant of the problems. Approximately \$100,000 has been spent on the program. As a result, vandalism and break-ins at such buildings has dropped significantly, and the city plans to extend the program, he says.

News continued on page 18

KALCURVE™
A MAJOR DEVELOPMENT OF KALWALL®

Robert Wagensesell Jones & Associates, Architect

"For the purity of a true curvilinear surface!"

UNLIMITED DIAMETERS; MANUFACTURED TO YOUR DESIGN. DESIGN/DETAILING/ENGINEERING ASSISTANCE IS AVAILABLE. TO ARRANGE A PERSONAL PRODUCT PRESENTATION, CALL.

Kalwall®
 CORPORATION

P.O. Box 237, Manchester, New Hampshire 03105
PHONE 800-258-9777

© 1983 KALWALL CORPORATION PATENTS PENDING

Open new markets with this landmark reference

The Architect's Guide to Facility Programming

by Mickey A. Palmer

**Practical, cost-effective
methods to increase the
efficiency of buildings
and the people who use
them**

Consolidated Information on an Important Technique

An American Institute of Architects publication, this comprehensive volume gives detailed information on facility programming, the modern technique that decreases costs, increases efficiency of the physical plant and the productivity of its users, minimizes last-minute revisions in building or rebuilding commercial and private facilities.

From Concept through Contract Documents

Including over 150 charts and illustrations, the Guide explores the nature and benefits of facility programming, gives how-to-do-it specifics, includes a complete index and bibliography.

Starting with an amplification of the fundamentals, it follows up with the techniques of data collection, analysis and organization, covers communication and evaluation as well as computer aids to facility programming.

The heart of the Guide—the section of applications—details fourteen case studies from initial planning through completed program report and its use as a tool for design. Programs, feasibility studies, design criteria, master plans and other material are covered comprehensively for such projects as:

Neighborhood Service Centers
Schools
Health Clinics
Cultural Art Centers
Hospitals
Single Family Residences
Riverfront Developments
Research Facilities

**Essential for Architects, Developers,
Building Owners**

The in-depth coverage of *The Architect's Guide to Facility Programming* gives architects the skills required to analyze client needs, clarify problems and find effective solutions.

Non-technical in its approach, the Guide is equally valuable to developers and building owners who want to understand how to make the best use of their facilities.

Hardcover, 8 1/2 x 11", 292 pages.
\$32.00 (AIA members); **\$39.95** (nonmembers).
AIA/SC Catalog #2M726.
(ISBN 0-07-001490-6)

SPECIAL 15% DISCOUNT
Hardcover, 292 pages. AIA/SC
Catalog #2M726.

	AIA Members	Nonmembers
Sale Price	\$28.95	\$36.25
Regularly	\$34.00	\$42.50

To order your copy, send a check in the correct amount to:

Director, Publications Marketing/Sales
The American Institute of Architects
Service Corporation
Department SA
1735 New York Avenue, NW
Washington, DC 20006
(202) 626-7332

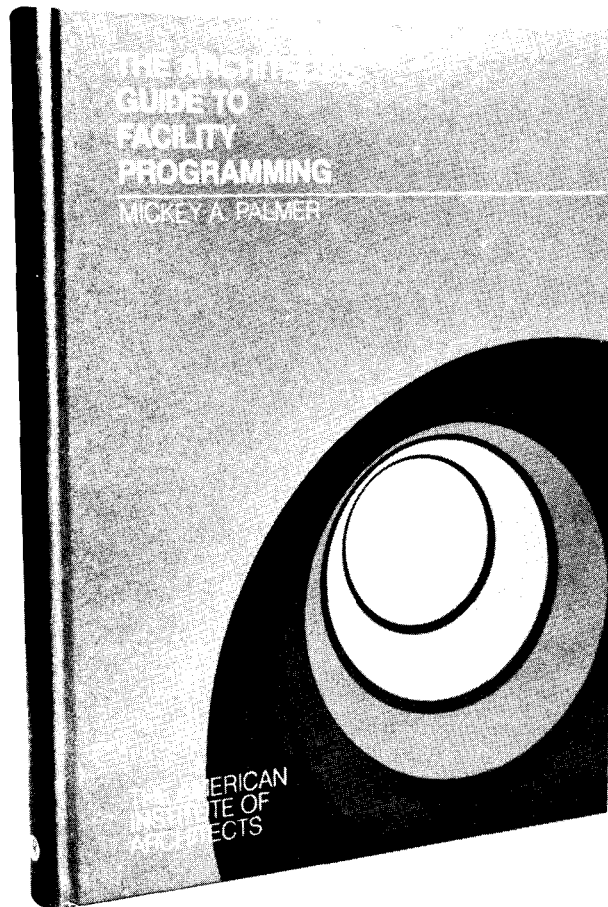

Designers Probe the Pursuit Of Quality in Era of Change

"Turning Points: Pursuing Design Excellence in a World of Change" was the subject of an October design conference held in Houston, sponsored by the Institute's design committee. John Louis Field, FAIA, who chaired the conference, introduced a panel of five architects who were invited to discuss their personal response to change and its effect on their practice.

Commenting on how the media have quickened the pace of life, Field observed that "in the time it used to take to build a cathedral, we've gone through several styles. The poor old International Style lived less than 50 years, and some people are saying that postmodernism is already dead."

John Burgee, FAIA, of John Burgee Architects with Philip Johnson castigated the modern movement's emphasis on the architect's moral and social responsibility. Because the movement failed on a social level, Burgee said, "the world became a more boring place."

Burgée believes, however, that architecture is at an important historical moment. "All of us architects are now at the biggest turning point of our careers," he said. "We're pulling out of the modern movement, which itself rejected 2,000 years of architecture and said that the whole past was wrong." A new appreciation for the past is now evident in architecture, and Burgee pointed to the preservation movement as its source, saying that it "broadened the profession to include a sensitivity for context and a renewed interest in history."

Charles Gwathmey, FAIA, of Gwathmey Siegel & Associates agreed with Burgee on the influence of preservation, saying that it has also led architects to a new "fervor for materials." Gwathmey saw his role as a teacher important in helping to clarify his own ideas about architecture, but expressed concern over today's crop of architecture students who seem overly concerned with stylistic clichés. "Becoming facile at doing pretty pictures," said Gwathmey, "does not constitute the practice of architecture. Architecture today is actually once again about materials, not abstractions."

On an up note, Paul A. Kennon, FAIA, of Caudill Rowlett Scott said that since change is the one absolute, architects should embrace it and transform it into a positive force, and not abdicate their role as designers. "People, not machines," said Kennon, "produce better designs."

Danny Samuels, AIA, of Taft Architects saw the act of design as an "abstract

process that can clarify," leading to a sense of order. Samuels sees such order as a frame of reference that gives space its special character.

Peter Samton, FAIA, of the Gruzen Partnership concluded the presentations by saying that the "cookie cutter" design days are over, and that firms such as Gruzen had become topheavy due to their emphasis on the studio system of practice. Samton said that firms will need to reorganize themselves in the future, as architecture becomes, in his opinion, even more competitive.

Plan for Wright's Willits House Denied by Illinois City Council

A proposal to turn a Frank Lloyd Wright house in Highland Park, Ill., into a "living museum" has been denied by the local city council. The Ward W. Willits house, designed in 1902, is one of Wright's first prairie style houses, referred to by historian William Storror as "a radical step forward in Wright's emerging design maturity."

The Willits Residential Foundation was initiated to save the six-bedroom, 6,500-square-foot house, now in an advance state of disrepair. Woodson Rainey, AIA, and William McDonough, AIA, of New York City and David Sellers, AIA, of Warren, Vt., started the group a year ago in an effort to transform the house into a retreat where visiting students and scholars, paying their own way, could stay.

"We want to offer an opportunity for architectural students and architects to experience a Frank Lloyd Wright house," says Rainey, "by actually living in it for a few days rather than simply observing a series of rooms as tourists from behind vel-

vet ropes." By institutionalizing the house, which was added to the National Register of Historic Places in 1980, the foundation also hoped to gain a loan from the National Trust for Historic Preservation for restoration, and would act to maintain the house with live-in curators, ensuring for it a "more certain future," says Rainey.

The foundation's request for a \$250,000 loan from the trust's endangered property fund depended upon its getting permission from the city of Highland Park to ease a zoning restriction that prohibits more than five unrelated persons from occupying the house at one time. Highland Park denied the request, squelching the foundation's hopes for funding.

Three years ago the current resident, architect Sakip Altay (who with his family has lived there since 1960), sold at least one of the house's leaded windows to raise money to halt further deterioration. Of the original 115 windows, 90 percent are still in place, each valued at between \$5,000 and \$10,000, but capable of bringing at least double that at auction. When Altay offered to sell two windows to the Frumkin & Struve art gallery in Chicago, the gallery declined but agreed to help Altay sell the house.

It was then estimated that the cost of restoration would match the \$510,000 price tag. The Ravinia Festival Association of Highland Park, a musical arts group, considered the house similarly as quarters for visiting conductors, but the neighborhood balked at the idea of such use. At one point the University of Texas school of architecture considered buying the house and moving it to Austin as part of its 196-acre, open-air architecture museum.

The efforts of the Willits Residential Foundation, however, have not ended. Rainey says that the group is planning to reproduce Wright-designed glassware and furniture from the Willits and other prairie style houses and market the items through a furniture company. This, says Rainey, would build an endowment that might be used if permission eventually is granted for institutional use.

Willits house: 'radical step' for Wright.

News continued on page 22



Carlisle introduces M.A.R.S. Design NP™

It's here. The ultimate single-ply roof system. With the lightweight advantage of adhered systems. The low-cost holding power of ballasted systems. And the economical advantage of quick, easy mechanically attached systems—all without having to penetrate the membrane!

Faster and easier than ever.

In fact, it's a snap! (see drawings) Sure-Seal™ membrane is rolled over specially designed base plate anchors. White retainer clips are rolled and snapped over top of membrane. Black caps screw on clips, tightening everything into place.

Time is money.

And M.A.R.S. Design NP saves both. Small crews of approved Carlisle applicators install the new system faster than ever thought possible. Even in marginal weather. No special equipment. No interruptions to the business below.

A proven performer for nearly a decade.

This fastening system has already mounted an impressive track record for performance all over Europe. And now it's coming on strong in America with numerous applications already successfully in place.

Versatility plus.

M.A.R.S. Design NP is truly a roof for all reasons. Rolls out right over top of failing built-up roofs—saving tearoff time and costs. For all types

of new buildings—especially those that can't support much weight. Also takes to unusual shapes, and fastens to most substrates. Accommodates building expansion and contraction, and can even be moved to another location!

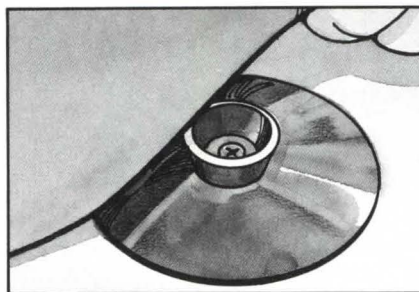

1. Roll membrane over knobbed base plate.

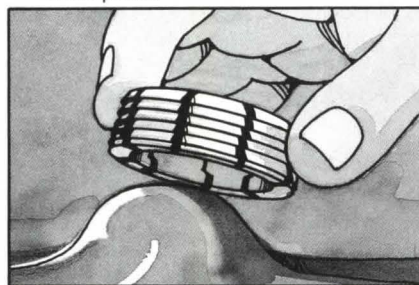

2. Roll and snap on white retainer clip.

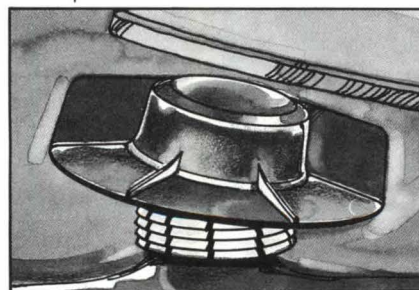

3. Snap and screw on threaded black cap.

Warranted for up to 15 years.

When we say the M.A.R.S. Design NP is the roof of the future, we prove it! By offering to cover its future with up to 15 years of warranted watertight protection!

Best of all, it's from Carlisle.

A name you've known and trusted for quality roofing products for over two decades. The company that helped pioneer the single-ply revolution and has made all the major breakthroughs since. The company that has built the most reputable and experienced single-ply systems organization in the world. All of which assures you of:

- Single-source responsibility for all components.
- Unequalled experience—over 20 years and 25,000 roofs.
- Carlisle approved applicators only.
- State-of-the-art technical back-up and inspection services.

So don't wait another day—make the snap decision, now.

Specify and apply the new M.A.R.S. Design NP System that:

- Doesn't penetrate the membrane
- Saves time, materials, weight—and money.
- Saves buildings—with up to 15 years of warranted protection.

Carlisle, M.A.R.S. Design NP and Sure-Seal are trademarks of Carlisle Corporation. M.A.R.S. Design NP Patent Pending. ©1983 Carlisle Corporation.

The roof that's requested by name

CARLISLE

Carlisle SynTec Systems

Division of Carlisle Corporation, P.O. Box 7000, Carlisle, PA 17013

Call toll free 800-233-0551
In PA, 800-932-4626

Circle 11 on information card

Artifacts of Southwest Cultures Will Be Exhibited at Convention

AIA's annual convention in Phoenix next year will feature exhibits on native Indian culture and the architecture of the area, and explore the interaction of architecture and the public.

Robert A. Harris, AIA, convention exhibit designer, is working with the Museum of Northern Arizona on the exhibits, one of which will cover the Southwest culture from prehistoric times up to the present. The exhibit will concentrate on

three prehistoric Indian civilizations: the Hohokum of the Sonora Desert, the Mogollon of the Rim area, and the Anastasi of the Mesa Mountain area.

"The center focus of the exhibit," says Harris, "will depict these civilizations through the use of original artifacts and graphic material." As many as 50 artifacts including pottery, basketry, tools, and textiles will be set within a landscape scene and will be keyed to different des-

ert areas through the use of native plants. Demonstrations of native crafts will also be included, such as rug weaving by the Navajo and pottery by the Hopi.

Three other exhibits are also planned. One, which Harris is working on with the National Park Service, will display the Anglo and Spanish influences on the architecture of the area from the 17th century through the 19th century. Two others will focus on more contemporary issues, namely the use of computers in architectural work and a recreation of a working architect's office.

The theme of the convention program is "American Architecture and its Public." Seminars, workshops, and speakers will consider the design of public space, the scale and density of cities, how well buildings serve the public, and public involvement in the design process.

AIA hopes to generate public involvement by sponsoring "Public Sunday," which will include tours of the city, a design competition, and other public events at the Phoenix Civic Plaza.

ABOVE & BEYOND

If your designs are above the norm, and your location is beyond natural gas service, we want to talk to you. 1-800-323-6556 EXT. R-99

We want to tell you all about a clean, efficient alternative to electricity. It's propane. The right choice for your special projects — the gas energy beyond natural gas service. Safe propane gas.

Less costly than electricity. Abundant, versatile, domestically produced. Simple to install with local service anywhere. The energy source your clients need, today and tomorrow. Economical propane gas.

We tell all. For free. Just ask, now, for Propane Guide for Architects & Builders. 1-800-323-6556 Illinois: 1-800-942-6345.

Beyond natural gas service, Propane gas: The right choice.

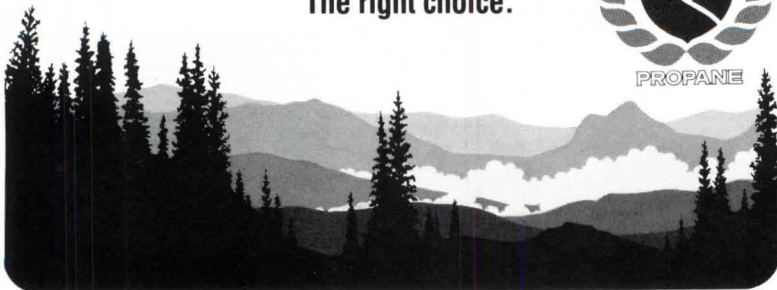

National LP-Gas Association, 1301 W. 22nd St., Oak Brook, IL 60521

DEATHS

Robert I. Abrash, Reston, Va.
George D. Akins Jr., Dallas
Alden Dow, FAIA, Midland, Mich.
Thor Gulbrand, Tarzana, Calif.
Peter Ficker, Pomona, Calif.
Ralph H. Harman, Springfield, Ohio
Leo J. Hosman, Union Lake, Mich.
Roger Byron Lewis, Philadelphia
Victor Gus Probst, Austin, Tex.
Terry L. Schneider, Toledo, Ohio
Robert A. Schwarz, Englishtown, N.J.
James R. Williamson, San Diego

BRIEFS

Call for Entries

The California Council/AIA has set Dec. 30 as the deadline for entry form requests and Jan. 20 as the deadline for completed entries in its 1984 honor awards program. Projects by CC/AIA member anywhere in the world are eligible as well as buildings in the state by nonmembers. Contact Ann Gowen, CC/AIA, 1414 K St., Suite 320, Sacramento, Calif. 95814.

Loeb Fellows Announced.

Harvard graduate school of design has named 12 design and planning professionals Loeb Fellows for the 1983-84 academic year. They are: Ellen Beasley, a Galveston-based preservation planning consultant; Rafat Chadirji, an Iraq architect; Constance Eiseman, project manager for Manhattan's Westway Park; Glenn L. Garrison, a New York City architect; Wensy Milner Herrett, a district ranger for the U.S. Forest Service; Michael Jacobs, a redevelopment director with the Boston Housing Authority; Charlotte B.

continued on page 84

VULCRAFT'S INTEGRATED ROOF SYSTEM ADDS A NEW DIMENSION TO CONVENTIONAL CONSTRUCTION.



Vulcraft's unique pre-punched, pre-notched end lap assures proper installation and weathertightness.

The Snow Moving & Storage Company facility in Fort Worth, Texas involved a design quite common in conventional construction: the parapet wall. While the design offers a number of advantages, both aesthetically and functionally, it presented a challenge to find a roof system that would meet the demands of time, budget, and endurance.

Vulcraft met the challenge by designing a totally integrated roof system using our innovative standing seam roof in conjunction with our steel joists and joist girders.

The product of two years of intensive research, the Vulcraft Standing Seam Roof offered the general contractor, RED-E Builders, Inc., a weathertight roof system which effectively resists the detrimental effects of the freeze/thaw cycle so harmful to built-up roofs. Our "floating" clips allow up to 1 $\frac{1}{16}$ " of roof expansion or contraction, independent of the internal structure. Our unique pre-punched, pre-notched end lap also helps assure proper, efficient installation and weathertightness.

Since the Vulcraft Standing Seam Roof was developed for conventional construction applications, we have roof-wall interface designs specifically for parapet walls.

Apart from the distinct advantages of the Vulcraft Standing Seam Roof, the real key to this job was the total integration of every element of the roof system. The joists, joist girders, and the standing seam roof were designed to work together for maximum efficiency. This also offered the contractor the added benefit of an enduring integrated roof system from a single source in a single shipment on a single purchase order. Couple these benefits with Vulcraft's lower costs and you have an exciting new dimension in conventional roof construction that can easily be summed up in one word: performance.

For more information concerning the Vulcraft Integrated Standing Seam Roof System or a copy of our catalog, contact the nearest Vulcraft plant listed below. Or, see Sweet's 7.2/Vu.



Roof-wall interface details for parapet wall.

P.O. Box 637, Brigham City, UT 84302 801/734-9433

P.O. Box F-2, Florence, SC 29502 803/662-0381

P.O. Box 169, Fort Payne, AL 35967 205/845-2460

*P.O. Box 186, Grapeland, TX 75844 409/687-4665

P.O. Box 59, Norfolk, NE 68701 402/371-0020

*P.O. Box 1000, St. Joe, IN 46785 219/337-5411

*Standing Seam Roof manufacturing locations

VULCRAFT

A Division of Nucor Corporation

Circle 15 on information card

Nurturing the Heritage of WPA Art

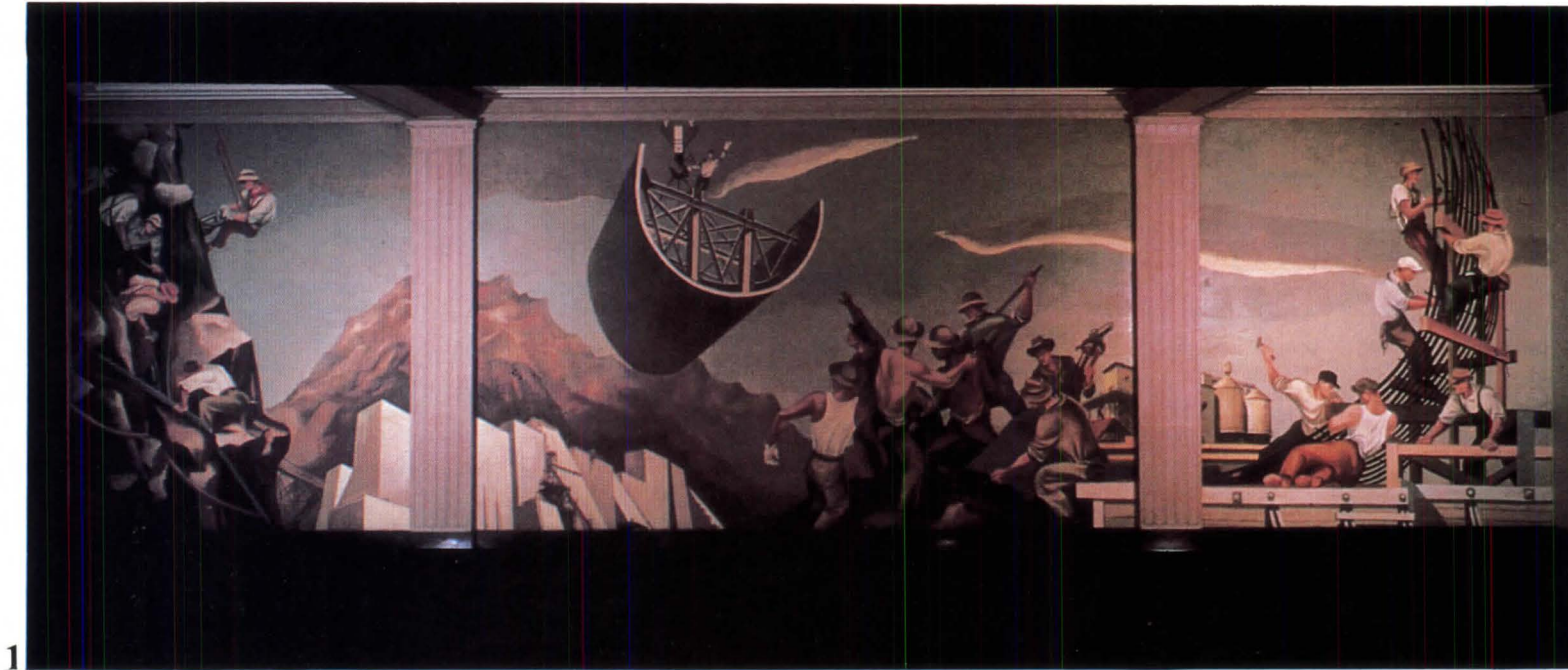

1



2

During the Great Depression more than 10,000 artists were commissioned by the federal government to design murals, sculpture, drawings, etchings, lithographs, and pottery for public buildings. Now, 50 years after that effort first began, GSA, under the direction of Karel Yasko, FAIA, is working to locate, catalog, and restore as many of the art works—numbering about 225,000—as possible.

Commonly known as the WPA art program, there were in fact seven federal programs supporting artists from 1933-43. Most of the artists were chosen through competitions, and the programs sustained many of the artists who became well known after the war, including Jackson Pollack, Mark Rothko, and David Smith.

On these pages is a small sampling of the murals that were designed for post offices, schools, hospitals, federal office buildings, state government buildings. In designing the murals, the only formal guidelines were that the subject matter be "American," and preferably of local historical significance. While scores of murals have been destroyed, many still exist, although some are painted over. They are a fabulously varied collection of images, from the strict representational (such as the farmers digging a canal, shown at lower right corner) to the surrealist and bizarre (such as "Contemporary Justice and the Child," lower left corner). Reflected in the murals are the political turbulence of the '30s and '40s, the economic hardships, the American ethic of hard work, and growing nationalism. Those influences of art deco design, streamlining, and cubism are also evident, along with that of more vernacular styles.

NORA RICHTER GREER

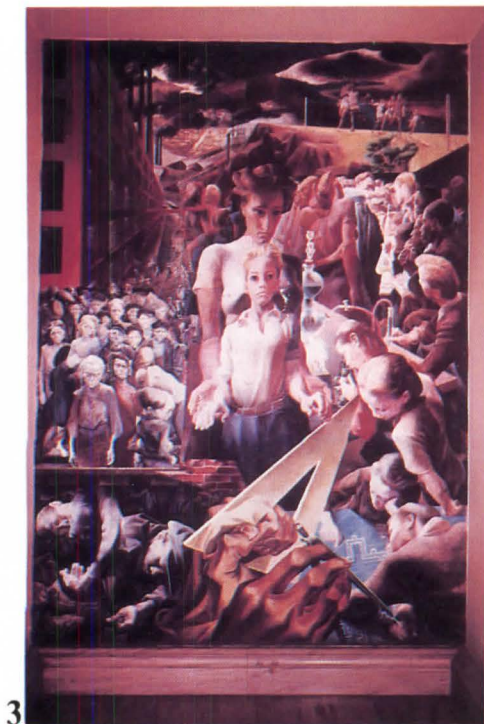

3

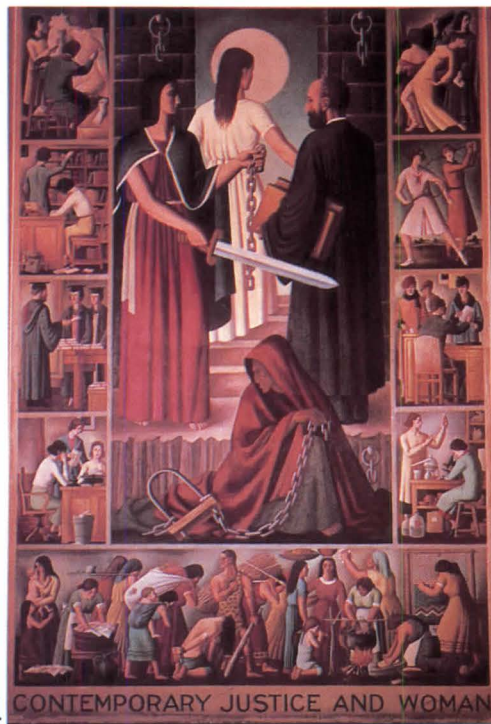

4



5



6



7

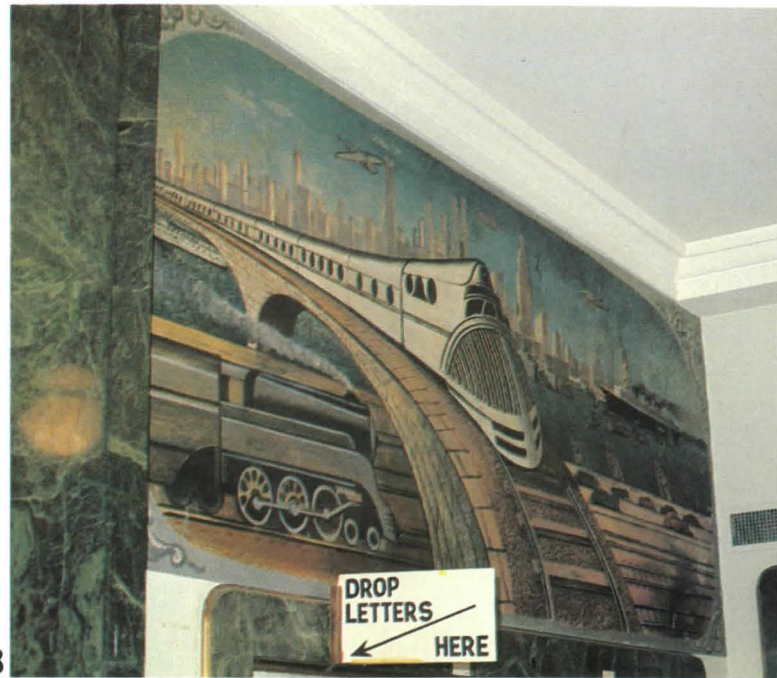

8



9

Murals from the federal arts program: (1) 'Construction of a Dam,' by William Gropper, Interior Department, Washington, D.C., (2) Social Security/Railroad Retirement building, Washington, D.C., untitled, Gertrude Goodrich; (3), (4), (5), respectively, 'Contemporary Justice and the Child' by Symeon Shimin, 'Contemporary Justice and Woman' by Emil Bisttram, 'Society Freed Through Justice' by George Biddle, all Justice Department in Washington; (6) untitled, Scottsdale, Pa., post office, Harry W. Scheuch; (7) Callanan Junior High School, Des Moines, Glen Chamberlain and George Grooms; (8) Towson, Md., post office, Nicolai Cikovsky; (9) 'Corn Parade,' Orr C. Fisher, Mt. Ayr, Iowa, post office; (10) Interior Department, Nicolai Cikovsky.

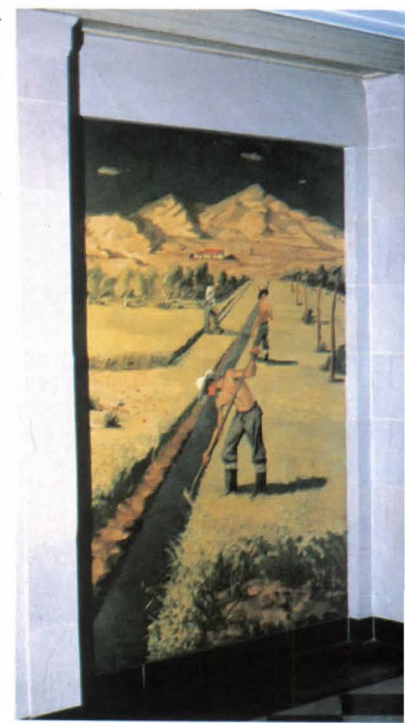

10

David

"Practicality"

His buildings seem now timeless. By attention to all detail he achieved the design mastery he sought. And time has proven the superb, enduring, practicality of what he created.

The lesson was well taught. Rixson door pivots in Frank Lloyd Wright buildings provide more than obvious aesthetic advantages. Their mechanical superiority has, unnoticed, better protected countless doors and frames from the ravages of the years. There is no better means of door hanging than the Rixson pivot.*

*Additional information, on request.

RIXSON-FIREMARK

9100 West Belmont Avenue, Franklin Park, Illinois 60131
and Rexdale, Ontario— 312/671-5670

A DIVISION OF
CONRAC
CORPORATION

ARCHITECTURE

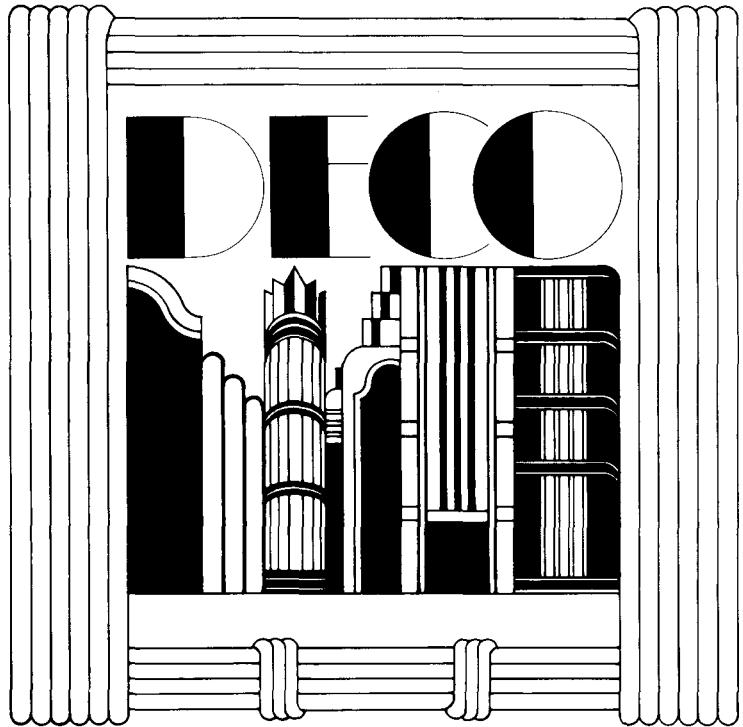

Last January tens of thousands of people flocked to Miami Beach's art deco district for a three-day celebration of the mood, design, architecture, music, film of the '20s and '30s. Last August in Chicago, thousands joined a similar nostalgic tour. This tremendous reawakened interest in art deco is more than just sweet reminiscence, however. It involves a dedication by a growing number to elevate what was essentially viewed as a popularized "low-art" style to its proper legitimacy and to preserve the remnants of that era for future generations.

It was in the late-'60s that the art deco revival began. English art historian Bevis Hillier in his book *Art Deco* popularized the appellation, which was derived from the 1925 Exposition Internationale des Art Décoratifs et Industriels Modernes. Hillier described deco as an "assertively modern style, developing in the late-'20s and reaching its high point in the '30s." Since then many more historians and critics have dissected the era including David Gebhard (see page 34), arguing over what is "properly" termed art deco. Gebhard also discusses what he calls its offshoots, streamline moderne and classical moderne.

Deco borrowed from the ancient past and distant future. It is an eclectic style that relied on exotic materials and juxtapositions of opulent colors, textures, and patterns. It is a style that reflected the hectic frivolity following World War I (bubbles, color, fizz); the great technological advances in communications, travel, industry (the zigzag, the aerodynamic teardrop, the electric flash); and, in the '30s, the devastation of the Depression (streamlining, the rising sun, and the bold eagle as symbols of hope).

Today the most organized and vocal promoters of the style are the several art deco societies that are springing up throughout the country. The biggest groups are located in California, Chicago, Miami Beach, New York City, and Washington, D.C. Membership in each hovers between 100 to 400 and includes a mix of business people and professionals ranging from architects, interior designers, and preservationists, to antique dealers, lawyers, and bankers. Each group's activities reflect the varying interests of its members.



It was the Miami Beach group, the Miami Design Preservation League, that under the direction of the indefatigable Barbara Baer Capitman fought for and won listing on the National Register of Historic Places in 1979 for the one-square-mile Miami Beach art deco district, the first 20th century historic district in the country. While the efforts of the other societies are not quite as dramatic, all groups are devoted to the preservation of art deco buildings. And in some cities, such as Tulsa, Okla., and Kansas City, Mo., where there are no deco organizations, individuals and local preservation groups are working to educate developers and the business community of the value of art deco architecture.

The task varies greatly from city to city. Perhaps it is easiest in New York City and hardest in Miami Beach. In New York City the deco skyscrapers (which were subject to 1916 zoning laws) have the same, if not greater, density than post-1961 buildings (when the zoning law was changed to permit slab towers). In Miami Beach, the two- and three-story structures are greedily eyed by developers who would love to see them replaced by massive, profit-making, modern-day condominiums and who lack an understanding of the economic benefits of a historic district.

In general, this seems to be the pattern: The larger, skyscraper deco buildings are seen as meeting contemporary density requirements and economic demands. Therefore, there seems to be no great rush to tear them down. It is the smaller structures—the movie houses, drive-ins, gas stations, warehouses, garden apartments—that are most threatened and that have already disappeared in great numbers.

Conversely, in Los Angeles the fantastic black and gold Atlantic Richfield building was demolished to make way for a super-block structure. In Chicago, the Michigan Square building and its evocative Diana Court met the wrecker's ball to be replaced by a rather bland Marriott hotel. In Tulsa, the Skaggs building (also known as the Halliburton-Abbot building) was torn down for what was to be a 47-story tower. Plans now call for a replacement building of smaller square footage than the Skaggs. Says Lanny MacIntosh, a Tulsa preservationist, "Our business community is pretty well aware of the significance of art deco buildings, but they are not going to get too upset if a developer wants to put up a 40-story office tower in place of a smaller building."

What Tulsa and other cities need is what New York City has: an extremely strong local preservation law and a landmarks commission that is willing to review art deco buildings. The first deco landmark in New York City came in 1973—the American Radiator building—and since then eight buildings have been designated (the Chrysler, Chanin, Empire State, Daily News, and McGraw-Hill buildings; Radio City Music Hall; the lobby of the Film Center building; and the Sophia Warehouse). Public hearings have been held on four others, including Rockefeller Center. Once a building is designated, it is completely protected from demolition or "nonapproved" changes to its exterior or interior public spaces.

Left, New York City's Chrysler building flanked by the RCA Victor building on the left and the Waldorf-Astoria. Above, luscious pastels of Miami Beach's Friedman's Bakery.



Steven Brooke Studio

Another alternative is having a building listed on the National Register of Historic Places, although that in itself doesn't guarantee survival. (Miami Beach's New Yorker Hotel was torn down after the historic district designation.) What it does bring, though, are attractive preservation tax incentives that might lure a potential developer. However, if a building is less than 50 years old, there must be "special justification" for listing on the national register. Again, in some areas of the country this is not a problem; in others there is little local support. In Kansas City, for example, where there is a vast collection of deco buildings, a member of a local preservation group says, "We're still having a

difficult time convincing people that we should save buildings that are 100 years old, let alone convincing them there are buildings that should be saved that are 50 years old."

What may be a tremendous help in promoting art deco in Kansas City is the work of a local architect and photographer, who are documenting the city's deco structures (Richard Farnan, AIA, and Bob Barrett, respectively). Their goal is a book on the subject, but in the meantime they are showing slides of the buildings to local officials and businessmen. "I think historic preservation people, landmarks people, and several politicians are beginning to realize that, my god, we do have quite a stock of buildings from that period, and that they are a significant resource," Farnan says. One such local study sponsored by the Junior League of Tulsa, Inc., has proved to be a "tremendous impetus" for preservation of art deco structures in that city, says MacIntosh. "It has made the city aware of the extensive collection of art deco buildings." A direct result is the \$7 million restoration of Tulsa's Union Depot.

Other studies—most of them to be published in book form—are being conducted in Washington, D.C., Baltimore, New York City, San Francisco, the Southwest. And the newly formed Art Deco Trust and Foundation in Washington, D.C., has applied to the National Endowment for the Humanities for a grant to "conduct a nationwide survey to find the best examples as well as the greatest concentrations of art deco structures," in the words of foundation founder Richard Striner. (Striner is also the president of the Art Deco Society of Washington, D.C.) Striner and others involved in the project hope that their work would in turn lead to a wider recognition of the country's art deco architectural heritage and better protection of deco structures.

All these efforts to increase public awareness of art deco architecture are occurring at a crucial time. A handful of important deco structures has already been restored: the Chrysler building, the Waldorf-Astoria's ballroom and Park Avenue entrance, Cincinnati's Union Terminal and Netherlands Plaza Hotel, the Forum Cafeteria in Minneapolis, the R. J. Reynolds Tobacco Co. building in Winston-Salem, N.C. But far more buildings have been lost or are threatened with demolition.

Even if some deco structures are to be lost, the style lives in new buildings plying deco themes in this historicist era. So following a look to the deco past we present seven buildings explicitly or implicitly influenced by its shadow. NORA RICHTER GREER (Ms. Greer was editor in charge of this issue—Ed.)

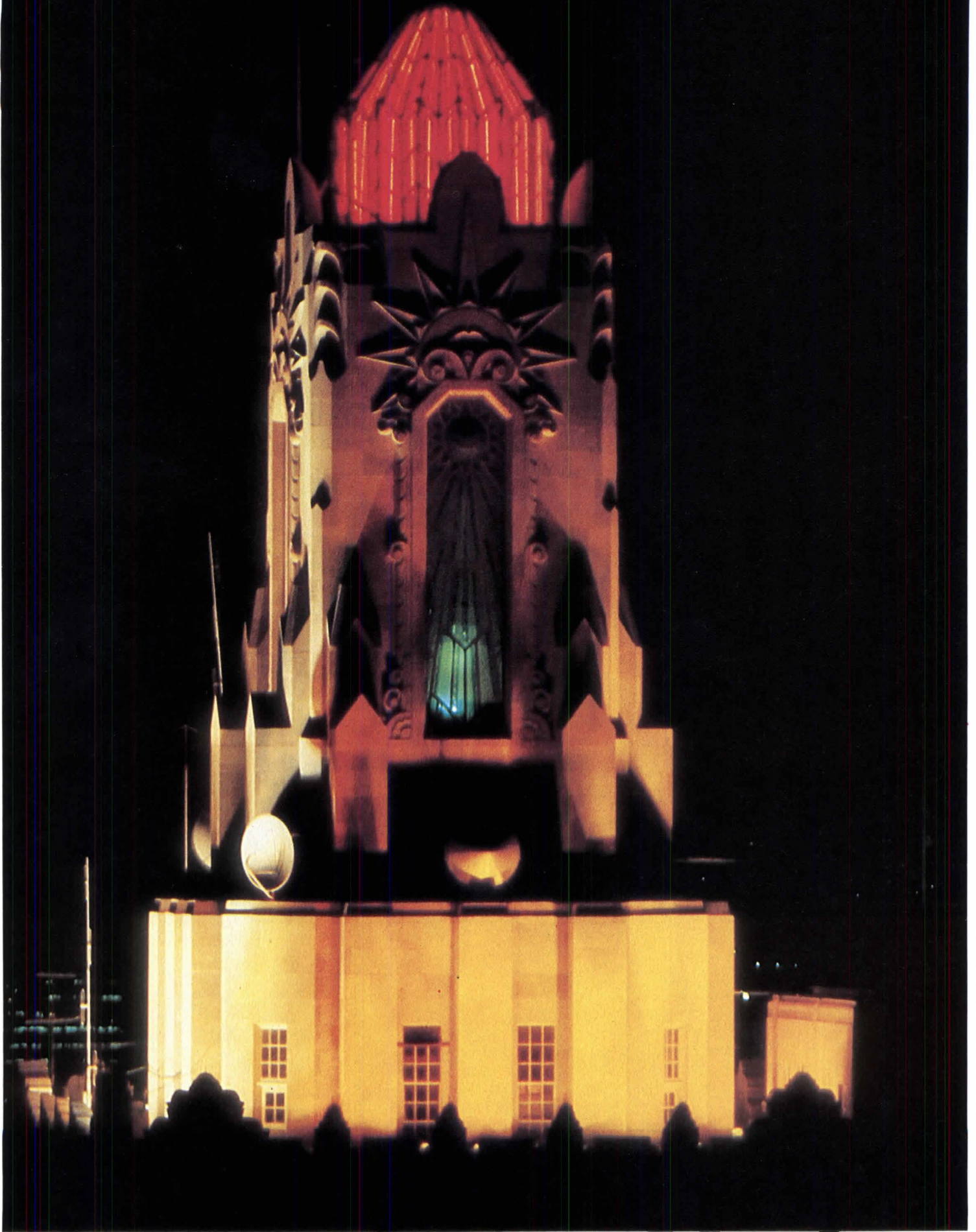

About Style, Not Ideology

The Art Deco period has close parallels to the present. By David Gebhard



"The Black Bottom and the Charleston typify the new rhythm of modern life. An architect of today to be successful must be able to translate that rhythm into something of beauty in brick and stone."—Adolf Loos, 1927

In 1930 Paul T. Frankl, then famed for his designs of "skyscraper furniture," published a small volume, *Form and Reform*. In a chapter, "Style vs. 'Styles,'" he wrote, "What elevated men, in the last analysis, above the bees is the mastery and the recognition of Style." And indeed the opening years of the '30s were, like the present episode of Postmodernism, those of clashing views of the whys and wherefores of architecture and design. In fact, there are so many points of similarity between the early-'30s and our own day that we should feel slightly uneasy about our current scene. Architects were not only expressing strong views about style (or nonstyle) via the design of their buildings, but they were turning to the written word to defend their varied allegiances. Then, as now, the conflicting views were not only within the realm of "serious" High Art architecture, but equally between the High Arters and the populists. Matching Charles Jencks' Postmodernism with its purposeful ignoring of the common was Philip Johnson's Post Functionalism of 1931, which pitted the elite Internationalists against those lowly creatures who expressed the popular American Perpendicular (the Art Deco) style.

Today if we try to reconstruct what took place in American architecture during the decades of the '20s and '30s, we would more likely than not limit our comments to the work of Frank Lloyd Wright, Richard J. Neutra, and R. M. Schindler, and later to William Lescaze, Gregory Ain, and a few others; we would reveal how well we have been programed to recite the canonical tale of High Art Modernism. But those who lived in the early-'30s were far more sophisticated in their knowledge of history and what was occurring than we. As in our current encounter between the Postmodernists and the traditional Modernists, conflict existed between those who passionately believed that design must rely on precedent and those who expounded the New (the International Stylists). In addition, an equally hot battle occurred between the Internationalists and the popular-

izers of the Moderne—in the '20s the Perpendicular (Art Deco) Moderne and in the '30s the Streamline Moderne.

The intensity of the struggle between the High Art Modernists and the Traditionalists came close to being a religious war with far more verbiage exchanged about ethics, morality, social and political stances than about design and imagery. Lewis Mumford in an article on "The American Dwelling House," published in *The American Mercury*, April 1930, said that the answer to the design of the American house must "be found in the modern hospital"; but for Aldous Huxley there was nothing delightful about lolling around in a dwelling that reminded him of a dentist's office. Henry Russell Hitchcock and Philip Johnson continually emphasized the theme that the necessity of the new age was to express structure, materials, and function in the design of modern buildings. Leicester B. Holland at AIA's 68th convention in 1936 responded to such "expressive necessity":

Skin deep and valued at a pin
Is Beauty such as Venus owns,
Her beauty is beneath the skin
And lies in layers on the bones.

Toward the conclusion of his remarks he commented: "A quiet chat with an anatomical convive, lolling, as it were, in his viscera, would be very difficult for me."

The Viennese pioneer Modernist Adolf Loos wrote in 1908 that ornament was crime. H. Roy Kelley, one of California's gifted Traditionalists, responded in 1929, with tongue in cheek, that the modern movement in art and architecture was characterized by "restlessness and uncertainty leading to mayhem . . . and after all modern art (and architecture) and modern crime, perhaps, bear a closer relationship than some of us suspect."

Fortunately, the popularizers of Modernism in the '20s and '30s avoided much of this spiteful and vicious battle. The exponents of what we today label as Art Deco in the '20s and as Streamline Moderne in the '30s assumed a lackadaisical middle course between High Art Modernists and the Traditionalists. Their course partook of both because their interest lay essentially in design, not ideology. While they certainly hoped their designs would convey a modern view of the past, present, and future, they were involved with the question of visual languages.

Dr. Gebhard, a professor of architectural history and director of the Art Museum at the University of California, Santa Barbara, has written several books on Art Deco in the U.S.

Left, brightly lit *Kansas City Power and Light Tower* by Hoit, Price & Barnes. Above, *Administration Building, Chicago's Century of Progress Fair*, by E. H. Bennett, H. Burnham, J. A. Holabird.

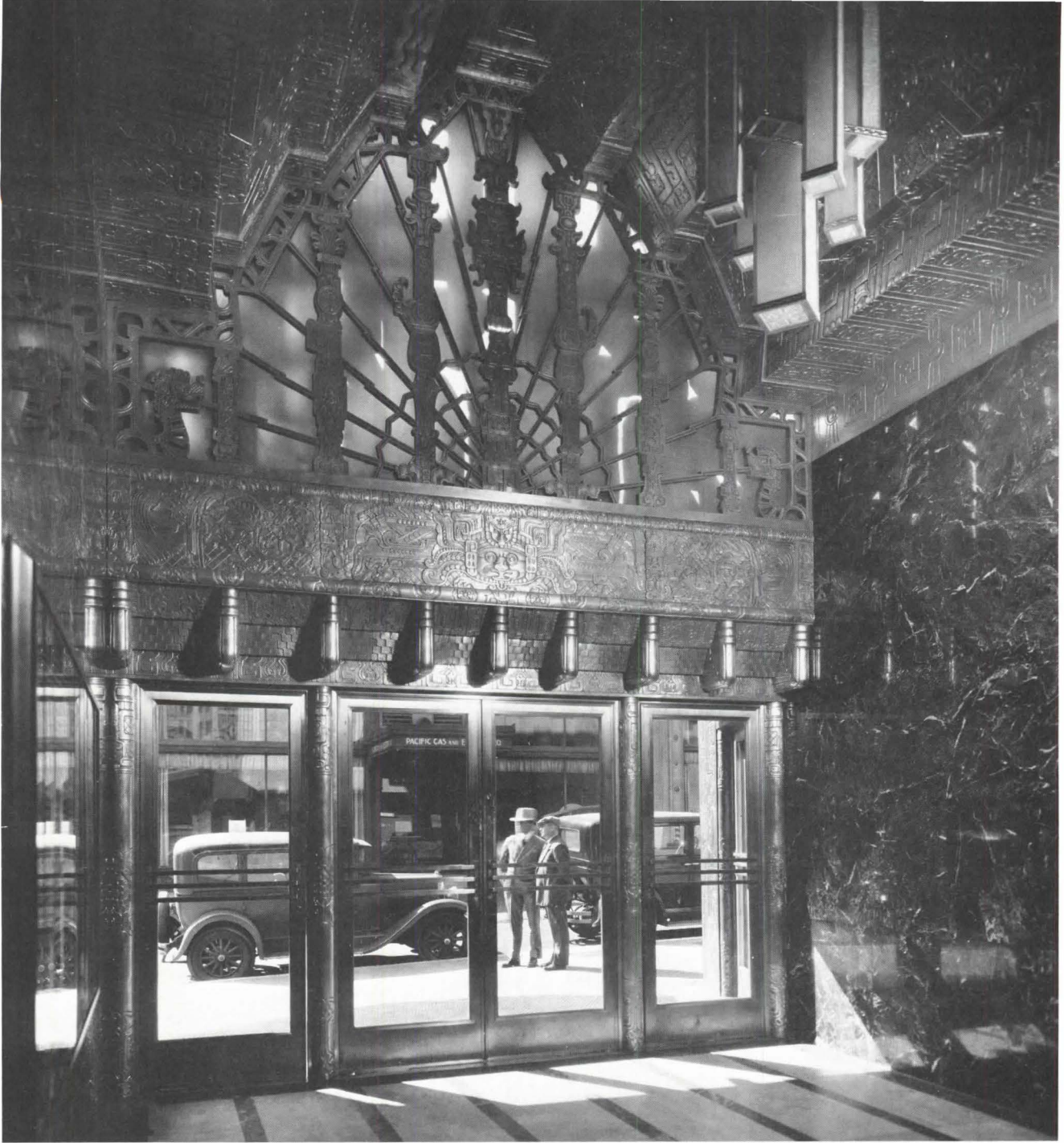

The building's program, its structure, materials, and mechanical core were a means of realizing style—not a basic conditioner of style. "It is in America," wrote Roger Gilman of the Fogg Museum at Harvard University (1936), "that this conservatively modern, which we might call the transitional style, maintains itself so strongly." Gilman went on to touch upon a question that is often ignored or dismissed in architecture, that of producing designs that employ a language readable by a large audience. The popular Art Deco of the '20s and the later Streamline Moderne produced images that "appealed to the public by their air of progress and charm, yet cannot venture too far beyond the public taste, for our man in the street is not so readily impressed by his architectural leaders as the European bourgeois," Gilman wrote.

The Art Deco Perpendicular or Zigzag Moderne and the Streamline Moderne did succeed most effectively in capturing the public's imagination. Their widespread acceptance was due not only to their persistent adherence to the "beauty" of traditional architectural languages, but equally to their optimistic symbolism of the present and future, and their feeling that romance, playfulness, and joy were integral ingredients of a well-designed building. The popular Moderne architects of the '20s and '30s had little or nothing to do with the perennial ideological hallmark of High Art Modern morality. Instead, as the gifted

Clockwise from above: San Francisco's 450 Sutter Medical Office Building, T. L. Pflueger Architects; bathroom, New York City's Chanin Building, Sloan & Robertson; Rockefeller Center's International Building entrance, screen by Lee Lawrie; bubblish ladies lounge, Chez Paree Restaurant, Chicago.

Colonial Revivalist architect Dwight James Baum wrote in 1933, the aims of an architect should be to produce buildings that evoke a respect for the past, for the new spirit of the day, and "satisfy man's love for beauty."

Those architects and designers who produced Art Deco and Streamline Moderne designs did not see themselves as advocates of a single image. Images had their suitable places; thus a typical practitioner such as the Los Angeles firm of Morgan, Walls & Clements or Holabird & Root of Chicago might find the design for an Art Deco skyscraper on one board, a concrete Spanish Churrigueresque or American Georgian stone building on another, and on still another a residence in the form of an Andalusian farm house. "Change is the life of style," wrote Frankl in 1930; he might have added that style (or the plurality of styles) is the result of fashion and taste. So when we look back on the popular Moderne of those decades, we must be aware that it was one among several styles, and as a style (a language) it underwent tremendous changes from the early-'20s through



Hedrich-Blessing

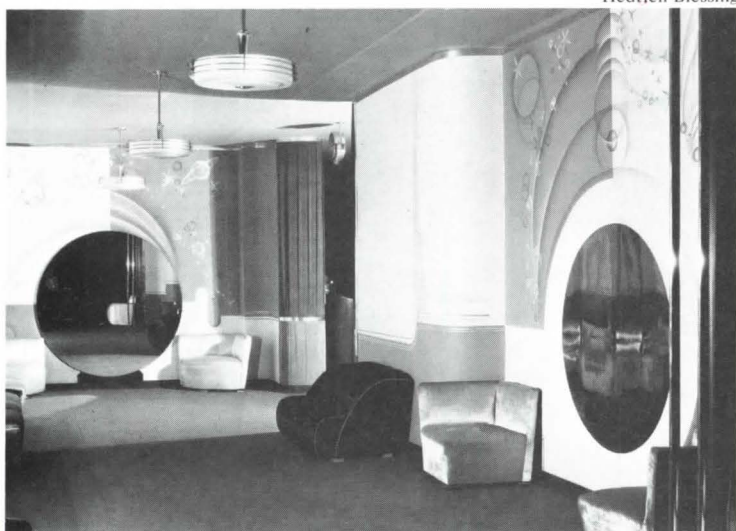

the beginnings of the '40s. The design of a baked enamel, metal-clad dry cleaning establishment of 1939 is as different from a mid-'20s Art Deco store or office building, with its verticularity and ornament, as is a traditional English Tudor house of 1925 from a Queen Anne dwelling of the 1880s. The only common ingredient of '20s Art Deco Moderne and '30s Streamline Moderne is their shared sense of conveying modernity.

The 1925 Parisian Exposition Internationale des Arts Décoratifs et Industriels Modernes was seen both then and now as the starting point for the American Art Deco. This exposition, which was well-visited by American architects and amply written about in the American press, was compared to the initiation of the Italian Renaissance. No question arises as to its impact upon American architecture, for one should recall that the teens and '20s were the heyday of classical Beaux-Arts education and design in the U.S. As one observer noted in 1925, whatever came from Paris had an immediate stamp of approval. And while we might think that Parisian Moderne and the Beaux-Arts would by their very nature represent quite different poles of design, such was not the case. The predominant designs at the Paris Exposition—whether an entire building and its landscaped siting or the approach to decorative use of sculpture and of new and old materials—beautifully expressed what the Beaux-Arts was all about. In a way, this not only explains the rapid assimilation

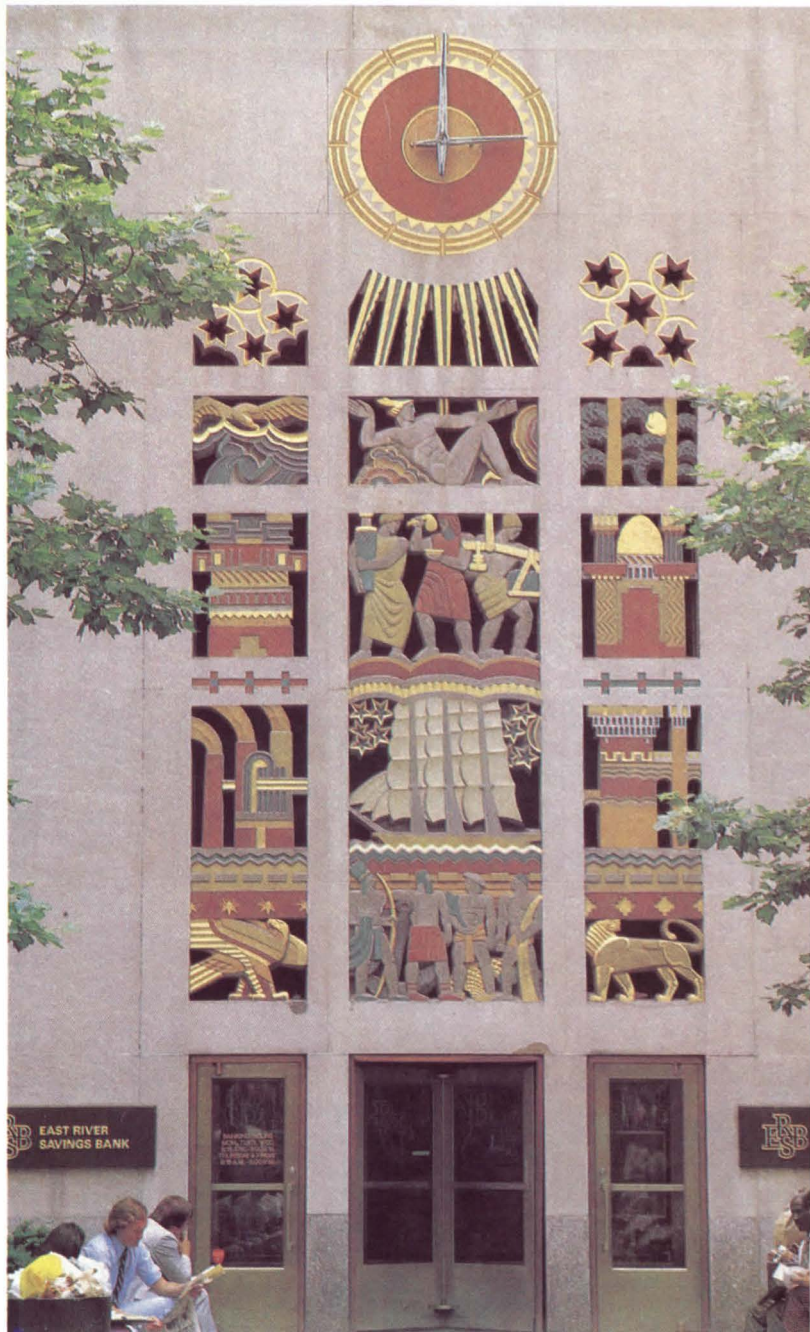

of the new style by Beaux-Arts trained American architects, but also the generally sophisticated, high quality of design that consistently marked the major American examples.

Although the Paris exposition was cited as the source for the "new and original" Art Deco, architects and critics of the time were well aware that the abstracted classicism underlying the exposition buildings had been around for some time. The architect Alfred C. Bossom, writing in the 1925 *The American Architect*, mentioned the pre-World War I work of Eliel Saarinen in Finland; others noted that there was really nothing in the Paris exposition that could not be found in the earlier designs of Josef Hoffmann, Peter Behrens, and other turn-of-the-century Viennese Secessionists.

The design process of abstracting and simplifying traditional forms and details itself had been going on for some time in American architecture, ranging from the work of Bertram G. Goodhue to John Russell Pope and the avant-garde Prairie School architects. By the early-'20s American architects were looking at other sources with an intensity not found in Europe. Although not greatly loved by the American middle class and their architects, European and American Modern art, particularly what was considered "Modernistic" art, did become incorporated into the American version of Art Deco—not as High Art but as amiable decoration.



© Bob Barrett

© Cervin Robinson



Another quality that helped distinguish the American version from the European was the American fascination with things ancient and primitive. While the architecture and artifacts of Egypt and Assyria readily entered into the Continental and English Art Deco, they became even more stylish and fashionable in the U.S., via the great Hollywood silent film sets of the teens and '20s. And while for many decades Europeans had been intrigued by art from Africa and the South Pacific, Americans tended to look to their own primitive past in the art and architecture of the Mayans of Mexico and Central America, and of the native American peoples of the American Southwest.

Finally, there was the allure of the machine to the American middle class, both as fact and symbol. Here again there was a decided difference between the Europeans and American experience. Both before and after World War I the symbol of the machine in Europe remained an elite, High Art object. In America it was commonplace, accepted without fanfare or highfalutin poetic or High Art intervention. Within the American Art Deco of the '20s, the fact of the machine, via new technology, new structural forms, and new materials, was fully endorsed by the middle class. With no urgent desire to directly

symbolize the machine in the design of buildings, the machine in America was seen as a means, not an end. The question in the popular mind (and in the minds of most practicing architects of the day) was what sort of attire (image) should be conveyed by a building that was to be considered modern. It was taken for granted that the latest technological advances would be incorporated into the building.

The striking difference between European High Art Modernism and the emerging American Art Deco can be seen by comparing Le Corbusier's projected city of "Three Million," with its principal emphasis on the imagery of the machine, and Hugo Gernsback's 1920 project for a city within a city, composed of 40- to 50-story towers set in a park. Gernsback, one of the originators of popular science fiction in the U.S., conveyed his modernity vis-à-vis the idea of a city within a single building; the designs of his buildings were routine and traditional, so they were seen as working machines clothed in an accepted readable imagery.

Alfred C. Bossom, who became an exponent of pre-Columbian Mayan forms in Modern American architecture, had written of the 1925 Paris exposition buildings: "The vertical is dominant everywhere. Here are straight lines and forms in endless

© Bruce Boehner

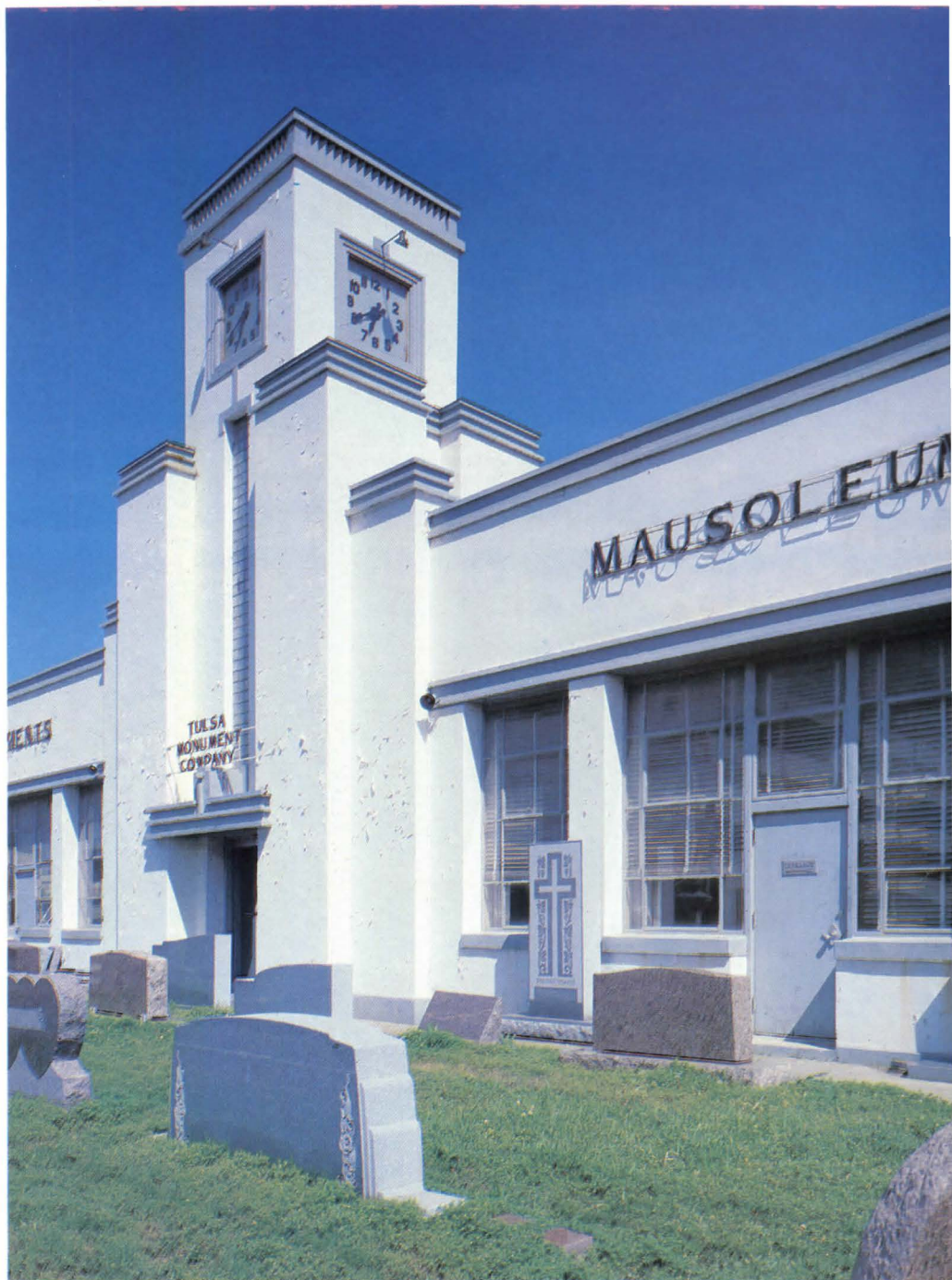

Across from left: Kansas City's Katz Store by Clarence Kivett, Kivett, Frower & Bloomgarten; rear view of Two Central Park West apartment buildings, New York City, office of Irwin Chanin; Los Angeles' Bullocks Wilshire store, Parkinson & Parkinson; and the Tulsa, Okla., Monument Co. building by Harry H. Mahler.

repetition. Long upright lines rush upward in that heaven-daring spirit which marks the architecture of the ancient Mayans—and that which we see in some of our modern architecture in this country, where skyscrapers stand like Titans with their heads in the sky.” And without question it was the skyscraper that most poetically expressed the '20s Art Deco Moderne in this country. The great (and one might add perceptive) popularizer of the time, Sheldon Cheney, observed in his widely read 1930 volume *The New World Architecture*, “The skyscraper, then, is the building that symbolizes the times, the peak of human trade-progress, that reflects the thinking of the ruling businessman.”

We need not be nostalgic to sense how successful the designs of the Art Deco skyscrapers of the '20s were, especially when compared to the barrenness of America's skyscrapers of the post-World War II years. Hugh Ferriss captured their enchantment in his drawings of those years, especially those contained in his

1929 volume *The Metropolis of Tomorrow*. But the enchantment of his drawings was equally matched in many of the real buildings, particularly when they were lighted at night (to exclude the surrounding sordid environment).

If it were possible to visit the dozens of Art Deco Moderne skyscrapers and other buildings constructed across America in the late-'20s, one could see why those designs were extolled and why the professional architectural journals and popular magazines and newspapers of the day characterized them as constituting the new American Perpendicular Style. Projecting pilasters or buttresses emphasized the verticality of their forms, and the ornamentation that flowed smoothly across their surfaces was a set, repeated vocabulary of spirals, disks, triangles, zigzags, and stylized plant forms. Color and richness of materials were evident both inside and out. Brilliantly glazed terra cotta was employed to sheath whole buildings, and the newest of materials, ranging from exposed concrete to aluminum, occurred throughout. For those living at the time, these Art Deco Moderne buildings were, as the historian Fiske Kimball wrote in his *American Architecture* in 1928, “magic mountains of steel and stone, shining and glorious, as one of the crowns of human endeavor.”



Courtesy Public Service Co. of Oklahoma

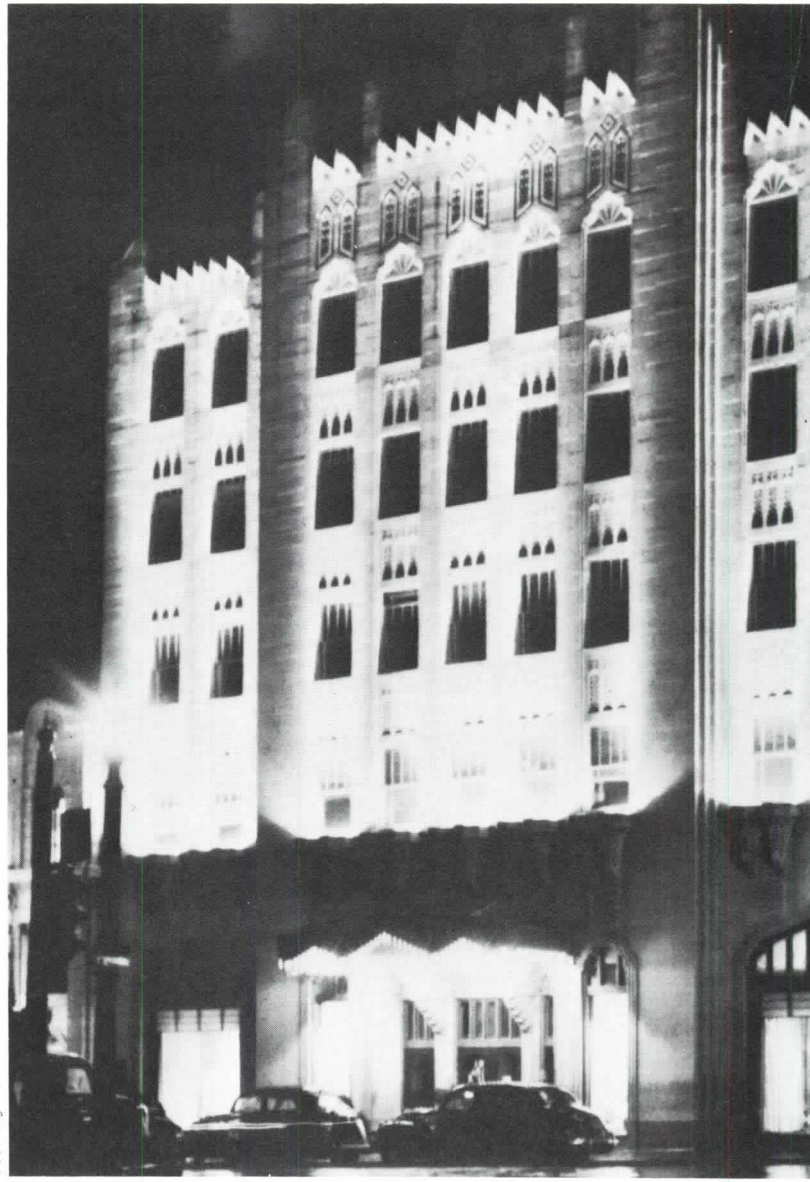

Though we associate the Art Deco Moderne with the vertical American Perpendicular Style, there was a second component of popular Modernism that was based directly upon the Classical tradition itself. As Kimball pointed out, the essence of the Classical tradition was its precept that design should be conceived “in terms of mass and space, instead of structure.” And like the perpendicular Art Deco, the Classical tradition played the same game of being traditional and authoritative, and at the same time wanted to be regarded not just as time-honored Classicism, but as modern up-to-date Classicism. Bertram G. Goodhue’s work of the teens and early-’20s immediately comes to mind—his Nebraska State Capitol at Lincoln (1920-1932) and his Los Angeles Public Library (1922-1926)—as an exemplar of the essence of modernized Classicism; and Goodhue was the figure most often referred to. But a look at the work of principal proponents of Classicism in the teens, ’20s, and ’30s—John Russell Pope, H. Van Buren Magonigle, Cass Gilbert, and Paul Cret—clearly indicates that they were following Frankl’s axiom that “change is the life of style.” As was the case with the Art Deco Moderne, this Classical Moderne of the later ’20s and ’30s looked to the past, present, and future via the archaic or “primitive” beginnings of the Classical tradition. Even a glance at the work of the proponents of the Classical mode indicates how their work often had as much to do with popular modernism as with their own time-honored tradition. And in many ways the American Classical tradition was more directly related to the architecture displayed at the Paris exposition (and the earlier Viennese Secessionists) than to the Perpendicular Art Deco Moderne.

Left, Hollywood, Calif., Citizen News Building’s terra-cotta decorated entrance; above, Tulsa’s Public Service Building at night by Arthur M. Atkinson; right above, typical black-glass Diamond Service Station, Tulsa, and right below, the vernacular deco KiMo Theater, Albuquerque, N.M., Carl & Rober Boller.

By 1930 modernized Classicism was applied to post offices and other public buildings, which exhibit smooth facades (with, of course, the “correct” proportions) and classical details such as pilasters and entablatures drawn onto the surfaces, in some instances almost like delicate pencil lines on paper. Often, as with the Art Deco Perpendicular buildings, an array of modern materials was openly used: concrete with the horizontal pattern of the form boards revealed, rubber tile flooring, and aluminum (or other modernistic mixed metals) for window frames, doors, grilles, and relief sculpture.

In recent years this abstracted Classicism (which was similar to Albert Speer’s contemporary work in Nazi Germany) has frequently been spoken of as the WPA Moderne, since it was unquestionably one of the preferred images during Franklin Delano Roosevelt’s presidency and the New Deal. Though it could well be argued that the great monuments of modernized Classicism occurred in the ’30s—such as Trowbridge & Livingston and Francis Keally’s Oregon State Capitol Building at Eugene (1936-1939)—its most widespread usage came about during the administration of Herbert Hoover and his Secretary of the Treasury Andrew Mellon. By the end of the ’30s the Classical tradition once again shifted its emphasis, and its modernity began to embrace elements of the Streamline Moderne.

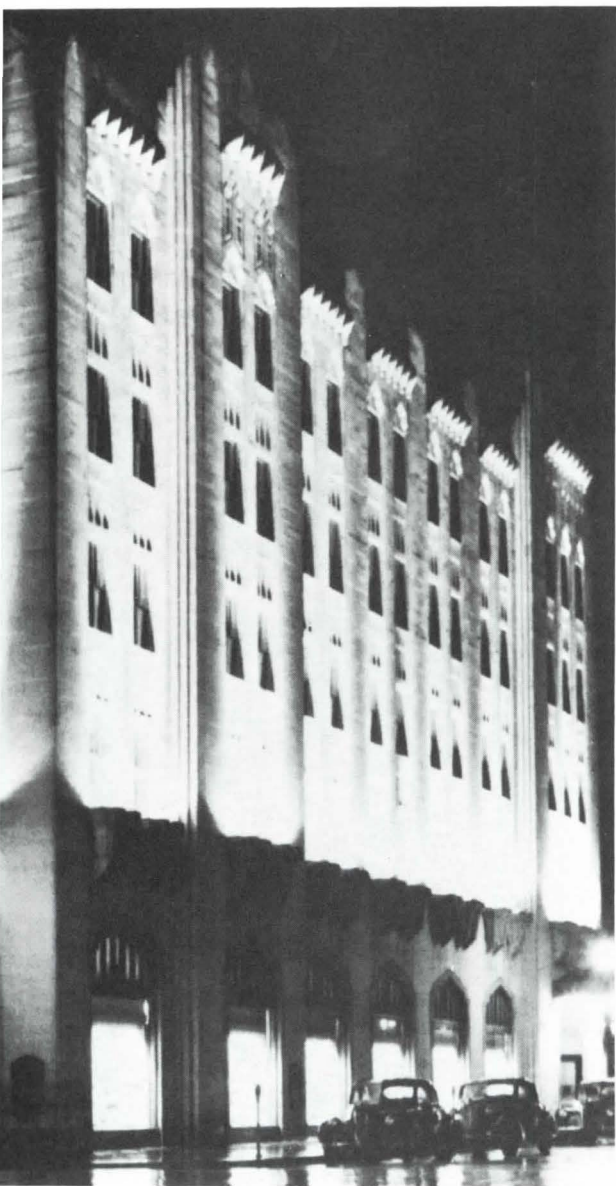

Courtesy Donald McCormick Architect



© Carla Breeze



As was the case with the Art Deco Moderne at the end of the '20s, it was Cheney who most eloquently caught the spirit of the Streamline Moderne—the new popular Modernism of the years 1930 through 1942. He, together with his wife Martha, produced another classic volume, *Art and the Machine* (1936). This work, like his earlier one, was tremendously popular with the middle class and equally despised by the High Art International Style Modernists. “We live in a world of streamline vehicles,” wrote the Cheneys. “The streamline as a scientific fact is embodied in the airplane. As an esthetic mark, and a symbol of 20th century machine-age speed, precision, and efficiency, it has been borrowed from the airplane and made to compel the eye anew, with the same flash-and-gleam beauty embodied in all travel and transportation machines intended for fast going.”

To the horror of the evangelical High Art Modernists, the designers of streamline buildings and objects not only continued to regard design as styling, but in an act of unmitigated treachery set about borrowing both the visual language and some of the ideology of the Modern Movement. The Modernists from Le Corbusier on had written and spoken of the hygienic nature of Modernism. Then in 1930, Cheney came along and wrote of a slightly streamline 1929 Chrysler Imperial: “Here is a clean athletic transportation machine for the modern clean athletic body—and we should have houses to match.”

The urge to employ Streamline design has, as one would expect, its own long history, reaching back into the late-19th century. But it was in the teens and early-'20s that the oval, curved, horizontal forms that connoted speed began to enter

the world of architecture and designed objects. For those whose view of history is a result of indoctrination in the Modern Movement, we immediately think of pre-World War I projects of Antonio Sant’ Elia or the sketches of Erich Mendelsohn and his realized Einstein Tower at Potsdam (1919-1920). While Mendelsohn’s works, including his sketches, were published in the U.S. at the beginning of the '20s, the principal source that explains its later vigorous acceptance occurred in the world of science fiction. Jules Verne, H. G. Wells, and E. M. Forster set the stage for what was taken up by Hugo Gernsback and others in such pulp magazines as *Amazing Stories* (1928). In 1929 Gernsback coined the term “science fiction,” and in that same year the first science fiction comic strip, “Buck Rogers, 25th Century” (John Dille and drawn by R. W. Colkin), appeared in newspapers across the country.

Both the High Art Modernists and the Streamline Modernists openly borrowed from the imagery of transportation machines. Le Corbusier illustrated his 1922 *Towards a New Architecture* with various automobiles, ocean liners, and airplanes. With the exception of one drawing of “The Airplane of Tomorrow,” none of his transportation machines was in any way streamlined; each was composed of individual parts that were intended to be read separately. The design of the characteristic automobile of the '20s consisted of autonomous parts: a grille and radiator, the hood, fenders, wheels, coach body, and often a separate luggage trunk. In a way, this was the manner in which an Art Deco, a historic-oriented design, or a High Art Modernist building of the '20s was to be experienced: an assemblage of individual parts forming the total image.

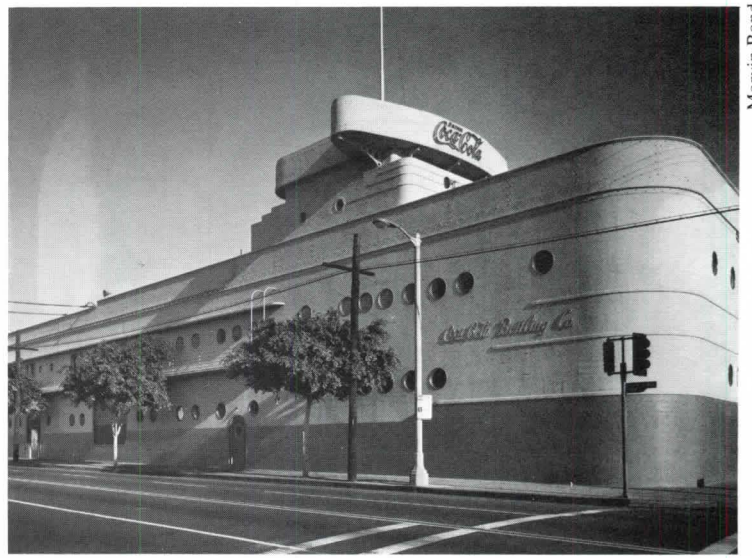

How different was the approach of those involved in promoting the universality of the streamline image. E. A. Whiting Jr., writing of the new streamline 1939 Hupmobile Skylark, summed up the difference between the '20s and '30s designs: "Many elements previously treated separately and applied here and there outside the basic shell are now either closed away or designed not to interfere with the sweep of the forms." In industrial design the most popular form was the aerodynamic teardrop, which came to be used for literally every object, ranging from a pencil sharpener to a house trailer. The rationale behind this was simple and to the point. "Simple lines are modern," Frankl observed in 1928. "They are restful to the eye and dignify and tend to cover up the complexity of the machine age. If they do not completely do this, they at least divert our attention and allow us to feel ourselves masters of the machine." The purpose of streamline in architecture and design was not to produce more efficient moving objects, but to symbolize the movement and, above all, conjure up visions of the future. The stage designer turned industrial designer Norman Bel Geddes captured this need for symbolism in his 1932 volume *Horizons*: "Today, speed is the cry of our era, and greater speed one of our goals of tomorrow."

Another irony in the relationship between the High Art Modernists and the popular Moderneists—in this case the Streamline Moderneists—was the emergence at the end of the '20s in America of the new profession of industrial designers—but hardly the architect/industrial designers the Bauhaus had in mind. By the early-'40s the star-studded galaxy of industrial designers enjoyed a prestige approximating that of Hollywood stars (see page 48).

Above, Chicago's Boulevard Bridge Restaurant with murals by Hans Teichert; streamline McGraw-Hill Building, New York City, by Raymond Hood; and Los Angeles' nautical Coca-Cola Bottling Plant, by Robert V. Derrah. Right, glass block Hecht Co. warehouse, Washington, D.C., Abbott, Merkt & Co.

These designers were not attracted to monolithic principles of Modernism; for them it was the image that romantically packaged the machine, whether a child's tricycle or a fast-food roadside inn. Frankl's 1932 comment (in *Machine Made Leisure*) that "successful styling implies progressive restyling" certainly must have produced shudders from Alfred Barr and others associated with New York's newly founded bastion of High Art Modernism, the Museum of Modern Art.

Among other traditionalists attacking the High Art Modern was James Dwight Baum, who commented: "Packing-box architecture with misplaced color may be evidence of a striving for a new architecture, but it is quite painful while being administered." This, however, did not overly concern the Streamliners, as their basic interest, like the traditionalist imitators, was in the styling of a product. And when William Williams complained in *Pencil Points* in 1932 that the Modern and Moderne buildings "resembled, somewhat, with their superimposed levels of terraces and the emphatic horizontals and their supporting struts, the superstructure of some sort of seagoing leisure craft," the Moderneists would have responded, "of course"; for one of the transportation machines that served as a source for the Streamline Moderne was the '30s ocean liner. But again, what a difference between the use of the ocean liner by Le Corbusier and



that of the Streamliners. Le Corbusier, with his eye on the elite High Art audience, abstracted the visual form (the superstructure only, of course) of the liner. In contrast, the Streamline Moderneist, aiming at a middle class audience, wished them to experience the building romantically as an ocean liner, frequently equipped with a semicircular glassed-in bridge and round portholes; not only as a contemporary ocean liner, but as an ocean liner of the future.

One of the great advantages of the Streamline Moderne was that its character could be established by a limited vocabulary of forms and details. Its basic form should be a volumetric container with surfaces symbolizing the machine: exposed concrete, stucco, vetrolite or Carra glass, or baked porcelain enamel panels. With the exception of concrete, all of these materials were to be read as a surface skin that did not reveal one way or another what lay beneath. Articulating this surface and parallel to it (with no suggestion of structural depth) were horizontal window openings, horizontal bands, and often near the top a grouping of three horizontal lines. The window and framing should ideally be machine-like (metal), and the doors should give one the impression of entering a Buck Rogers rocketship. Finally, the two most telltale marks of the style—curved walls and glass brick—should establish the indisputable modernity of it all.

Internally, the Streamline Moderne building was as shipshape as it was externally. Walls might be covered with plywood panels (to be read not as natural wood but as wood as a machine product) and sheets of plastic laminate used for cabinet tops and even for sections of walls, linoleum floors, and detailing of

chrome bands. Amid all of this were tubular chrome chairs and tables, clocks and other Bakelite objects, and in the more exuberant examples beds and couches of neon-lighted glass brick.

The Streamline Moderne was a fully established and accepted design and architectural style by the mid-'30s. It was taken up fragmentally or as a whole by the great majority of the American architectural profession. And as a group they carried it off well, for in essence it did not violate any of the cardinal principles of their Beaux-Arts training. The new popular style was not based upon a highfalutin ideology; it had nothing to do with the "silly" question of morality and architecture, and it, like other modern and historic styles, was intrinsically an image. Though extremely popular with the middle class, it was not seen as *the* universal design solution for all buildings. In fact, it came to be used and associated in the public mind with specific building types: restaurants, bars, neighborhood theaters, service stations, dry cleaning establishments, dog and cat hospitals, medical clinics, and soft drink manufacturing plants. The ideal of a home for the American middle class during the Great Depression years was the Colonial Revival, with its sense of puritanism and American nationalism. More often than not, one finds that when the Streamline Moderne was employed for single-family housing, the dwelling was built as a modern display house or used by a physician or veterinarian who wished to suggest to his community that here resided a man of science. The ideal middle class family rode in streamline autos, buses, trains, and airplanes, and they might have worked in a streamline building; but when they returned home, it was to the shelter of a white clapboard and green-shuttered Colonial Revival house.



© David Halpern, 1980

lements of the Streamline Moderne did, of course, penetrate far and wide. In the late-'30s, many of the PWA Moderne buildings created by or financed by the federal government exhibited curved walls, glass brick, and other ingredients of the style. And many middle-class apartment buildings and single-family houses erected in the mid- and late-'30s conveyed their modernity by using elements of the style. Though supposedly repugnant to them, many of the High Art Modernists either fully embraced the mode, as was the case with Edward Durell Stone and Lescaze; or as with Schindler and Neutra, they adroitly sampled here and there. And it can well be argued that the most impressive High Art version of the style was Frank Lloyd Wright's Administrative Offices for the Johnson Wax Co. in Racine, Wis. (1936-1939).

By the time of the 1939 New York World's Fair the Streamline Moderne had assumed the stance, as Reyner Banham has pointed out, of *the* new American style. Though the architectural firm of Harrison & Fouilhoux designed the theme of the fair—the Tylon and Perisphere—the real heroes of the fair were the industrial designers Norman Bel Geddes, Henry Dreyfuss, Walter Dorwin Teague, and Raymond Loewy. The fair was a triumph of the Streamline Moderne, wonderfully captured in the ideal cities of Henry Dreyfuss' "Democracity" and Norman Bel Geddes' "Futurama." Here in model form we immersed ourselves into "the city of the future," with a reality exceeding the science fiction film (Vincent Korda's 1936 set for "Things to Come") or

Above, in a '30s remodeling, Harry Mahler added reflective black glass to Tulsa's Security Federal Savings & Loan Building.

one of Frank R. Paul's cover designs for *Amazing Stories*.

The professed aim of the New York fair was "to portray the World of Tomorrow, and to commemorate the first inauguration of George Washington." And American architecture of the '30s and of the fair beautifully captured this dualism of past and present in the American middle class. The Colonial Revival and the national interest in the restoration of Colonial Williamsburg created the storybook linkage with early America, and the Streamline Moderne provided the vision of the future. At the fair itself this polarity was reflected in the dominant Streamline image of the future, countered by the placid lagoon of the Court of the State, governed at one end by a version of Independence Hall and at the other by a domed and porticoed Jeffersonian villa.

The Streamline Moderne as an image did not completely disappear during and after World War II, for scattered late examples were built here and there. But as a symbolic packaging it was out of fashion by 1945. After all, it, like all vigorous architectural styles, arrived on the wings of fashion and left the same way. As Frankl said, "Successful styling implies progressive restyling," and Frankl and the other designer/architects of the postwar period needed and found new symbols to express an era far different from that of the '30s. □

Massive Deco Monument

The enduring strength of Boulder (Hoover) Dam. By Richard Guy Wilson

Boulder Dam's impact has not lessened in 50 years. The approach remains the same, across a vast landscape of sand, rock, and greecewood with a sun broiling everything into the same gritty texture. Man is unwelcome, and occasional evidence of habitation appears tenuous at best. On top of a rise, a great blue lake stretches out—an apparition so alien to the surroundings that if not expected, would be thought a mirage. Soon the road begins to wind down into a canyon, and finally, around a bend, the dam: a gigantic smooth white cliff, a concave wedge pushed between shear rocky outcroppings holding back billions of gallons of water that stretches for 115 miles up the Colorado River. One becomes conscious of a low sound, more than a hum and less than a roar, that will increase with closeness. The contrast between the smooth and regular machine hand of man and the rough texture of nature overwhelms. The scale is not human but superhuman, as if giants or intelligent machines had created this monument in the middle of nowhere.

Dr. Wilson is chairman of the division of history at the University of Virginia school of architecture.

One can also approach Boulder Dam by night, and the effect is equally spectacular and moving. The dam's face and lower outbuildings are lighted by floodlights, and the towers with the setback tops that rise out of Lake Mead exude an eerie radiance, as if some dynamo hidden within the recesses of the dam is pulsating a supernatural energy.

Once the largest dam in the world, Boulder Dam, now named Hoover Dam, no longer holds that title. Yet nearly a half century after completion in Black Canyon on the Arizona-Nevada line, the dam still commands and attracts. For it is not simply another large dam but a powerful and ultimately a symbolic statement, a symbol of hope and confidence in man's power to control both his environment and the machine, relevant for both the 1930s when it was completed and for today. It is of course a functional structure, a result of precise calculations by engineers, but it is also a superbly designed and conscious work of architecture, which takes advantage of every possibility to make a statement. And as such it is one of the great designs of the 1920s and 1930s, a landmark example of both art deco and how one designs for power and the machine.

C. Segerblom

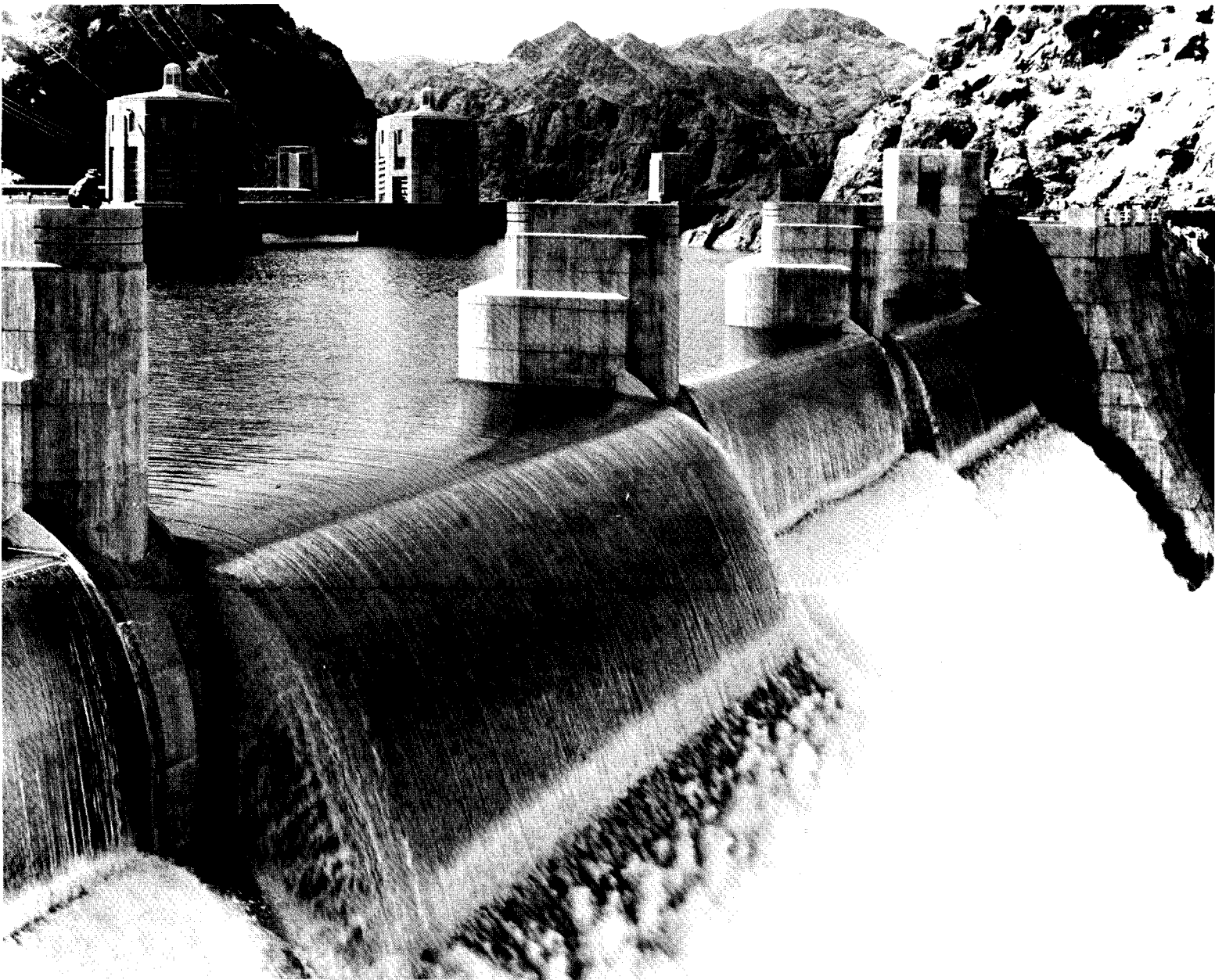

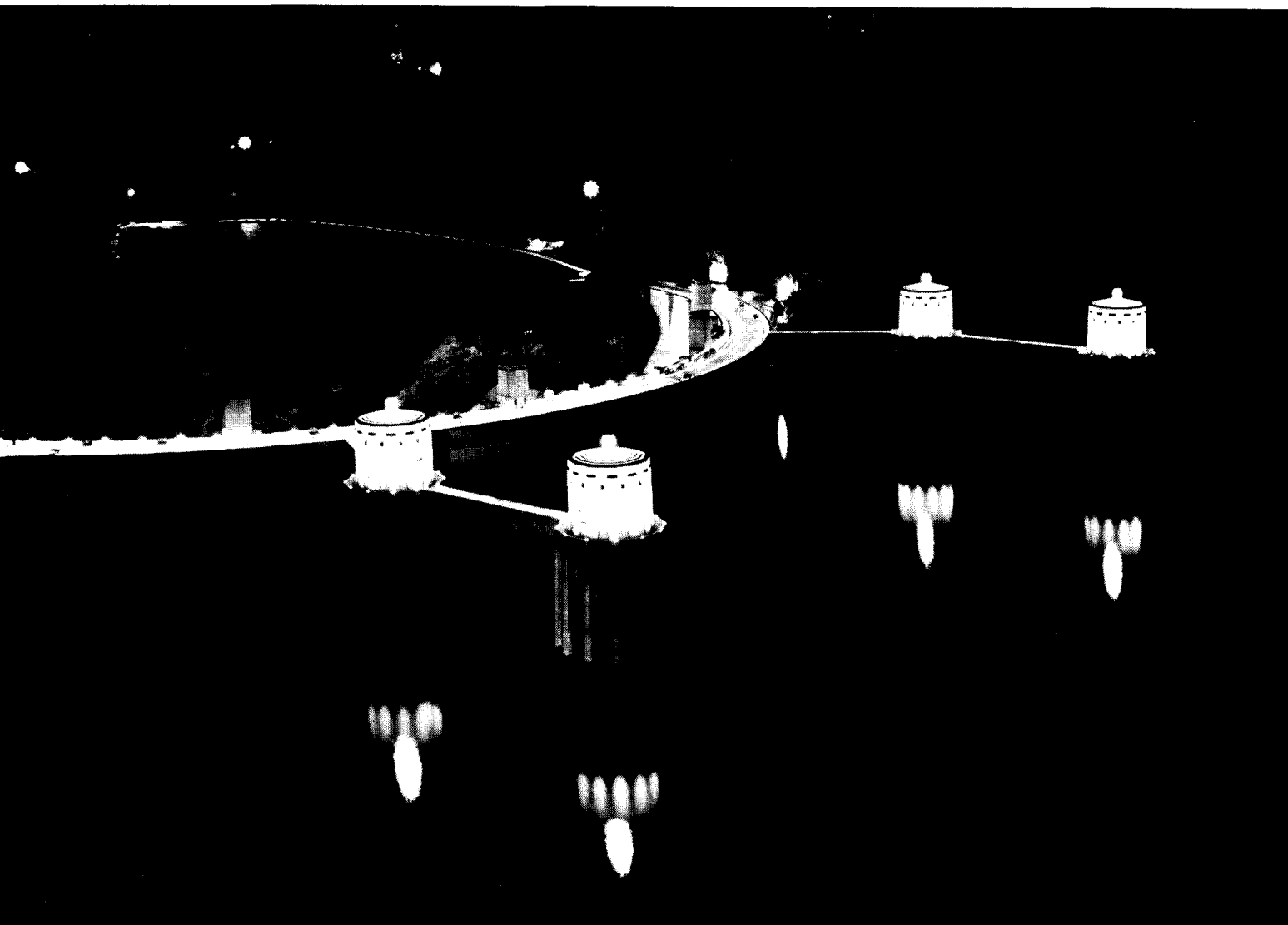

The design of the dam began in the 1920s with site investigations and a series of test models. Gradually the various engineers involved with the government's Bureau of Reclamation arrived at a consensus that of the various possibilities (earth fill, rock fill, straight gravity, and others) a massive concrete arched-gravity dam would be best. The basic principle that concrete works better in compression than in tension meant that a wedge, thicker at the bottom than the top and with a convex lake side profile, would carry the stresses by arch action to the abutting canyon walls and downward to the canyon floor. Load tests of models, carried out between 1928 and 1931, revealed facts such as increasing the thickness at the top would introduce more horizontal tension.

The design approved and built called for a massive concrete structure rising 726.4 feet from bedrock, with a base thickness of 660 feet, and a crest thickness of 45 feet, wide enough for four lanes of traffic and pedestrians. The crest length of 1,282 feet is nearly a quarter of a mile. The arch on axis has a radius of 500 feet. To build such a massive concrete structure an unprecedented system of pouring and cooling the concrete had to be devised. The concrete was poured in a series of columns or blocks about five feet thick and from 25 feet to 60 feet square. Left to itself, the concrete would have taken about a century to cool, and the shrinkage would have rendered the dam unusable. The solution: Artificially cooled water was circulated through tubing placed in the cement to cool each pour, and then grouting was injected in the resulting spaces. A monolithic mass resulted. The often told tale of workers buried in the concrete during

construction is apocryphal; the tolerances of the concrete work would never stand such a messy water-filled foreign object.

Responsibility for the dam's design was largely that of the Denver office of the Bureau of Reclamation. The "unsung hero" was a former director of the bureau, engineer Arthur Powell Davis. Other important engineering figures were Elwood Mead, the commissioner of reclamation for most of the construction period (and for whom Lake Mead is named); Raymond F. Walter, the chief engineer; and John L. Savage, the chief designing engineer. Chief architectural consultant was Gordon B. Kaufmann, who was born and trained as an architect in England and arrived in Southern California in 1914. He became known as an accomplished and prolific practitioner, designing houses, hotels, and schools in the various period styles. In the early-1930s his work became more art deco in style, and he designed a number of stripped classical schools and setback-buttressed commercial buildings. By the late-1930s, he had adopted the International Style. Kaufmann's work so suited the Bureau of Reclamation that he later worked on Parker, Grand Coulee, Keswick, and Shasta dams.

A brief article by Kaufmann and the official reports and other documents indicate how the dam reflects esthetic judgment. As he wrote: "The impressive beauty is not accidental," and "the architecture of Boulder Dam followed the structural design, and it was considered as a complementary treatment rather than a dominant phase of the whole design."

He recognized that since he was working with concrete and broad, plain surfaces, his role would be to emphasize them by shadows. He also discovered that the concrete could be subtly altered in coloration by the type of water and pipes used in curing the surfaces. The result is that the main face at the bottom and the powerhouses are shaded darker and the dam is lighter

Above, the four intake towers on Lake Mead glow like candles with the illuminated ribbon of roadway across the dam's crest; across page, the dam's sheer concrete face with outbuildings below.

at the top. The surfaces of the outlet works and gates located downstream were "cured to a dark warm color in order to have them merge as much as possible into the background of the canyon walls."

While Kaufmann noted the "engineering principles" determined the shape, size, and plan of the powerhouse, his role was to mold their facades into a more monolithic statement and arrange the fenestration into recessed vertical strips. Repair facilities and transformers, appended in smaller box-like units along the sides and with their contrasting horizontal fenestration fins, help to increase the apparent size of the powerhouse. The impact of the powerhouse is reminiscent of stripped classical governmental buildings of the 1930s, though here treated more severely and originally.

The crest of the dam bears a series of observation niches and towers that rise directly from the wall and continue upward unimpeded. The emphasis, according to Kaufmann, was "an orderly series of small vertical shadows punctuated by the larger shadows of the elevator and utility towers." These extrusions are treated as continuations of the dam face and not separated by moldings. The four large towers have cut-back corners and tops reminiscent of the vertical buttressing typical of high rise buildings of the period. The two outer towers are for utilities and public rest rooms, and the two inner towers were conceived as the public entrances to the dam since from them the elevator descends to the powerhouse and internal galleries. Consequently, these towers contain the only exterior ornament, two large cast concrete panels designed by Oskar Hansen and depicting on one the purposes of the dam such as flood control, irrigation, and power, and on the other, the history of the area. Their style is decidedly art deco. The doors are bronze, and the interiors have the typical high polish of the period: walls of dark green marble and the floors of green and black terrazzo with circular designs based upon Indian motifs embedded within. These Indian-based designs by Denver artist Allan True indicate the indebtedness of art deco to native American geometrical patterns. True's terrazzo patterns are continued throughout the floors in the lower galleries of the dam. He also advised on the color of the interiors of the powerhouses.

The four large intake towers, which provide water to the turbines, were purposely placed in a symmetrical position even though dictates of the site might have placed them asymmetrically. Actually the intake towers on the Arizona side of the dam are about 10 feet closer than those on the Nevada side. Anchored to bedrock about 250 feet above the original river bed, the towers are 395 feet tall, the equivalent of a 33-story building. The setback at the top and the vertical buttressing is pure art deco, as is the layered copper roof and the light globe.

To either side of the dam are the spillways used for controlling the reservoir level. Their design provides a telling contrast with the other appurtenant structures such as the towers, for the spillways are more streamlined—they have the smooth aerodynamic surfaces that were beginning in the early-1930s to appear on automobiles, planes, and buildings. Against the zigzags and setback buttresses of the crest and towers, the spillways—both the stainless steel drum gates and the piers—have continuous curved or streamline profiles, in the case of the gates for ease of the flow of the water, in the case of the piers as a purely visual effect. Two thin incised lines along the top of each spillway pier are distinctly reminiscent of other streamline decorations of the 1930s.

The dam also affords a great internal experience. The visitor drops 528 feet within the dam by elevator, exits into internal galleries decorated with True's terrazzo designs, and finally arrives at the great turbine chambers in the powerhouse. The setting overwhelms: Immaculate hygienic preciseness, large shiny green and black casings of generators, chrome flashing and pipe railings, and repetitious piers of the enclosing wall, all accompanied by a pervasive loud hum. It has an almost reverential quality, as if some alien gods are mysteriously spinning out a secret message and man is paying homage in this sacred space. □

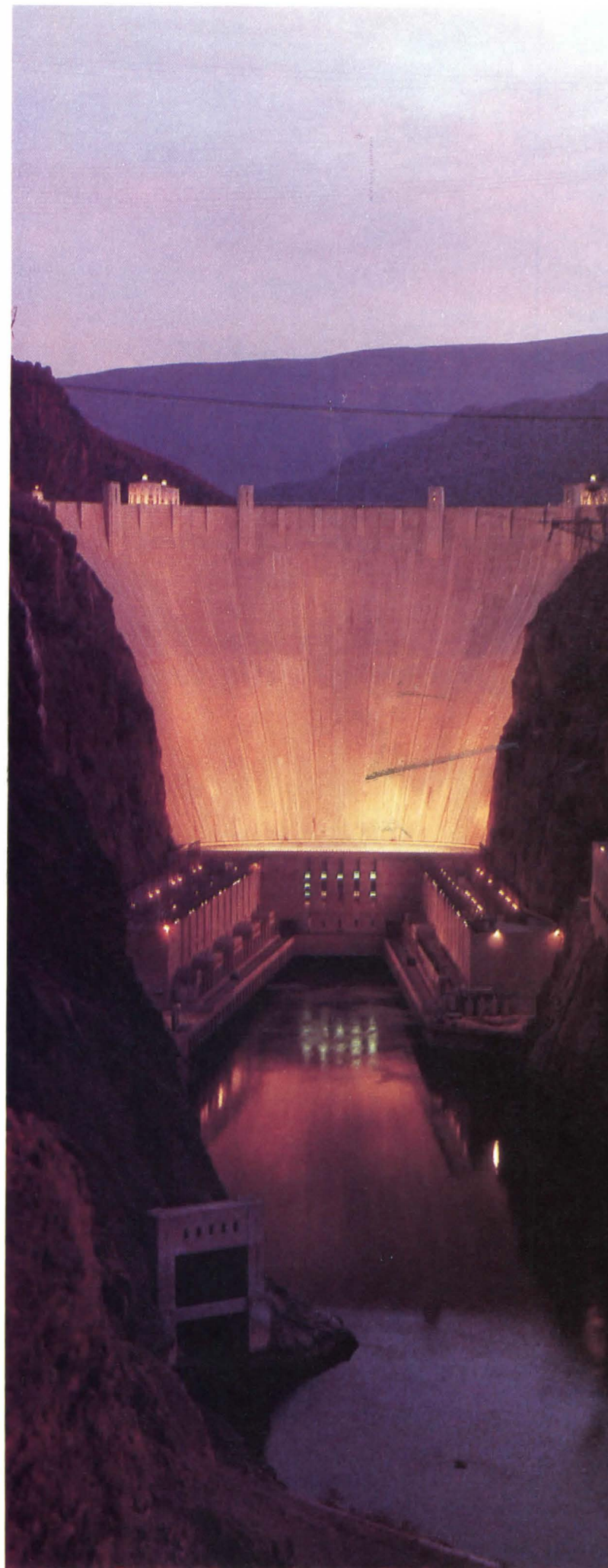



Celebrated Streamliners

Industrial designers who set the visual pace of the 1930s. By Jeffrey L. Meikle

With the year 1984 upon us, an unusual number of historians, museum curators, and, less predictably, architects and designers, have turned their thoughts to the past to consider the ways our culture once envisioned the future. This interest naturally focuses on the Depression decade of the 1930s, a time of extreme social and economic dislocation but also a time when sleek streamliners, teardrop autos, and gleaming store fronts and movie theaters promised a coherent machine-age environment just beyond the next frictionless curve of time.

During the 1930s, for one brief decade culminating at the 1939 New York World's Fair, industrial designers like Walter Dorwin Teague, Norman Bel Geddes, Raymond Loewy, and Henry Dreyfuss enjoyed a degree and type of cultural visibility that has usually remained the province of architects. Just as the Beaux-Arts-trained architects of the 1893 Columbian Exposition had set the forms of American public building for years to come, critics in 1939 predicted that the flowing, free-form, curving lines of build-

Dr. Meikle, assistant professor in American studies and art history at the University of Texas at Austin, is author of *Twentieth Century Limited: Industrial Design in America, 1925-39* (Temple University Press).

ings like Bel Geddes' pavilion for General Motors heralded a new, enduring American architectural style. Already forgotten were the jagged machine deco outlines of the 1933 Chicago Century of Progress Exposition, created by New York's modernistic skyscraper architects. And largely ignored were the handful of houses designed by European modernists like Neutra and Schindler in California or Gropius and Breuer in Massachusetts.

Streamlining, a uniquely American style created by industrial designers rather than by architects, seemed the wave of the future. In part, the generous publicity granted to industrial designers in the '30s indicated the filling of a vacuum. With the end of the prosperity of the 1920s, new construction also virtually came to a halt. If the skyscraper had provided the major architectural image of the '20s, that of the '30s was the temporary exhibition building. More importantly, if Americans could not afford a new house or office building, they could at least aspire to a new car, refrigerator, or radio. Thus the attention of journalists and critics (as well as of dozens of unemployed architects who sought work with industrial designers) turned from buildings to smaller-scale products and machines—the props of everyday life. By the end of the decade, buoyed by extravagant publicity the like of which their successors did not

enjoy, industrial designers had extended their vision to encompass the entire built environment.

Oddly enough, the origin of industrial design can be traced back to Henry Ford, a nuts-and-bolts “functionalist” who supposedly once declared that “they can have any color they want so long as it’s black.” As the automobile market reached saturation in 1927, Ford found his company losing ground to General Motors, whose aggressive President Alfred P. Sloan Jr. had introduced the concept of stylistic obsolescence. Forced to suspend production of the Model T and spend millions retooling for a more stylish Model A, Ford learned what one observer termed “the most expensive art lesson in history” and provided an object lesson for manufacturers of dozens of other types of consumer products who were beginning to suspect that the boom years of the '20s were coming to an end.

Executives soon realized that only visual appearance could distinguish competing products—whether automobiles or typewriters—that had reached a common plateau of technical performance. In many cases, however, conservative product engineers either balked at engaging in what they considered superficial redesign or professed an honest ignorance of rapidly changing public tastes. Often a company’s advertising agency solved the problem either by providing modest design services or more frequently by recommending a commercial artist to undertake a specific project. Most prominent in this regard was idealist Earnest Elmo Calkins, founder of the influential Calkins & Holden agency, whose many magazine articles expressed a progressive neo-arts-and-crafts philosophy. He hoped that direct patronage of artists by business would induce a cultural renaissance and uplift the taste of the average citizen while simultaneously improving the economy. Thus was born industrial design—with its often incompatible goals of stimulating sales and shaping a coherent machine-age environment.

The qualities required of a successful industrial designer emerged slowly by trial and error. Many of the most predictable occupations yielded few recruits to the profession. Although American architects had developed the machine deco style, few established practitioners deigned to work at a more circumscribed scale. Even craftsmen like Paul T. Frankl and Russel Wright who adopted the rhetoric of industrial design found it

difficult to switch to designing for true mass production. The so-called “Big Four”—Teague, Bel Geddes, Loewy, and Dreyfuss—who had emerged as leaders of the new profession by the mid-'30s, came from backgrounds in commercial illustration or stage design. Experience in creating illusions proved useful in endowing products with images that would attract consumers.

In addition, each of them possessed an essential flexibility, a willingness to learn details of manufacturing processes and materials, that was not shared by many blue-sky renderers who fell from sight as quickly as they had risen to premature success. As consultant designers, the four leaders also benefited from the generalist perspective gained through working on everything “from lipsticks to locomotives,” as Loewy phrased it. Design solutions commonly accepted in one industry often appeared highly original in others.

Within a few years of uncertainly embarking on their first commissions, the big four and some half dozen other successful designers had evolved a common product design method that has remained remarkably constant through the years. After receiving a commission to redesign a product, either by invitation or through solicitation, a designer toured the manufacturer’s plant, met with engineers and sales people, and collected samples or illustrations of competing products. The designer’s team then analyzed this material, sometimes conducted market research, and set the draftsmen to work preparing scores of preliminary sketches, three or four of which yielded finished renderings for formal presentation to the company. If this meeting went smoothly, and often it did not, the designer’s modelers prepared an exact full-size model that, when presented and approved, became the basis for blueprints for dies and molds. A designer’s services often included packaging, materials for arousing dealer enthusiasm, and suggestions for shaping an advertising campaign.

Across page, the New York Central’s Mercury passenger train, designed by Henry Dreyfuss and introduced in 1936. Below, Norman Bel Geddes’ Futurama exhibit, a vision of highways and cities of the future, installed in the General Motors Highways and Horizons building at the 1939 New York World’s Fair.





Courtesy of Chrysler Historical Collection

The typical designer's staff consisted of two or three associates with engineering or architectural training, several draftsmen, a couple of modelers, a business manager, a secretary or two, and a public relations man whose job it was to keep the designer's name continuously in print—whether through newspaper mentions, ghost-written articles for popular magazines on the shape of things to come, or anonymous articles planted in trade journals. Although success required teamwork, each designer appeared before the public as an individual. Especially during the Depression, the industrial designer led a dual existence as a rational businessman providing corporate clients with a professional service and as a prophet of the future, an inspired artist-engineer who frequently "signed" his radios or washing machines.

Despite the fact that all the major designers shared this common method of operation, their philosophies, professional aspirations, and life styles differed remarkably. Walter Dorwin Teague, the oldest of the group, projected the most business-like image. Born in 1883 in small-town Indiana, he gravitated to New York City to study at the Art Students League and aspired to join the ranks of Maxfield Parrish and Howard Pyle. Already in his late 40s when he entered the field of industrial design by creating several cameras for Kodak, Teague had enjoyed a long successful career as an advertising illustrator, first at the Calkins & Holden agency and later as a free-lancer. Drawing inspiration from his progressive mentor Calkins, from draftsman Jay Hambidge's mystical "dynamic symmetry" design theory, and from the evolutionary Platonism of Le Corbusier's

Towards a New Architecture, Teague developed a morally uplifting philosophy for industrial design and introduced it to his colleagues through a series of elegant self-written magazine articles.

In his opinion, the human race had only begun to repair the environmental ravages of the Industrial Revolution. The industrial designer could further this process of adjustment by imbuing the machine and its products with an appropriately modern esthetic dimension. Each type of machine slowly evolved toward its ideal form, a process easily observed in the development of the low, horizontally integrated automobile body from out of the ungainly elements of the horseless carriage. As each machine or product approached its perfect ideal form, the entire built environment approached a state of harmonious equilibrium.

In practice, of course, Teague often compromised his idealistic design philosophy by providing clients with superficial annual changes to the perfect designs he had previously given them. But he believed his approach would prevail in the long run, and that only big business possessed the resources and scope of operations essential to a total transformation of the environment under the direction of industrial designers. After all, Kodak continued to retain him not only to design its photographic equipment but also to design logotypes, packaging, showrooms, and temporary exhibitions.

Above, the 1934 Airflow Chrysler by Carl Breer. Below, Walter Dorwin Teague's Texaco station. Right, Albert Kahn and Bel Geddes' General Motors building with the '39 fair's Trylon and Perisphere by Harrison & Fouloux and Henry Dreyfuss.

Courtesy of Walter Dorwin Teague Associates, Inc.



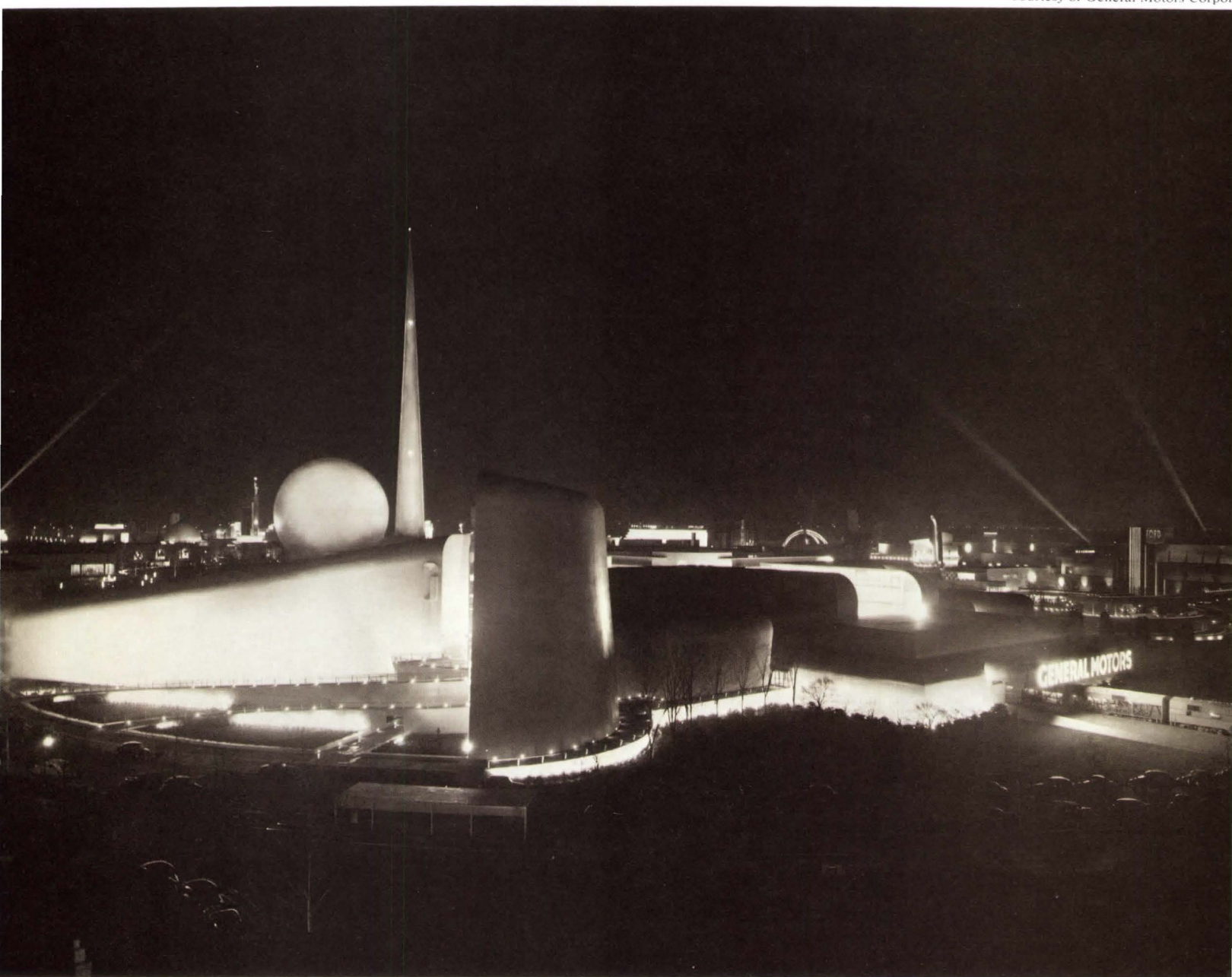

During the '30s, Teague enjoyed a similar relationship with the Ford Motor Co., providing showrooms, corporate office suites, and many exhibition buildings, though he never could convince company officials to entrust their cars to his talents. The most promising confirmation of the feasibility of his total vision came at mid-decade, when Texaco commissioned Teague to create prototypes for the restrained white service stations with green accent stripes that soon spread across the country. With the reforming potential of mass-production architecture in mind, he ended the decade by devoting his attention to a scheme for factory-built housing—a subject on which he corresponded with Le Corbusier. While never abandoning his vision, Teague satisfied blue-chip clients and shaped the future of his profession by establishing industrial design as a valuable adjunct of business.

More flamboyant though less successful than Teague was Norman Bel Geddes, another small-town Midwesterner with a mystical bent who studied briefly at the Art Institute of Chicago before becoming an advertising illustrator in Detroit. His Christian Science background gave Bel Geddes a profound faith in the power of the imagination to shape exterior reality—a faith later strengthened when he shifted from advertising to stage design around 1916. Experience with the German regisseur Max Reinhardt taught him that creation of true theatrical effect required total control by a single individual of script, direction, setting, costume, lighting, and even arrangement of theater and

audience. When boredom and eternal wrangling with Broadway producers motivated Bel Geddes to enter product design in 1928, aided by an informal association with the J. Walter Thompson advertising agency, he took with him the attitude that to envision something, and to do so boldly, was to bring it into existence.

Even with the Futurama, a series of vast dioramas of cities and highways of the future created for General Motors at the New York World's Fair of 1939, Bel Geddes intended an actual blueprint for immediate development.

Despite the fact that many of Bel Geddes' designs never reached actual production, he served the profession well by effectively projecting an image of the industrial designer as technocratic visionary. His ghost-written book *Horizons*, published in 1932, stimulated acceptance of streamlining as a design style through its renderings and photographs of models of teardrop cars and buses, a sleek tubular train, a totally enclosed torpedo-like ocean liner, and a vast flying wing with teardrop pontoons that would have carried some 400 passengers across the Atlantic in steamship comfort. Reproduced in newsreels and in the Sunday supplements, these futuristic designs brought streamlining to the masses. At the same time, the book itself, distributed to corporate executives as a publicity device, encouraged the Union Pacific and Burlington railroads to introduce the first streamliners in 1934 and gave Walter Chrysler the courage to go ahead with the Airflow automobile that same year.

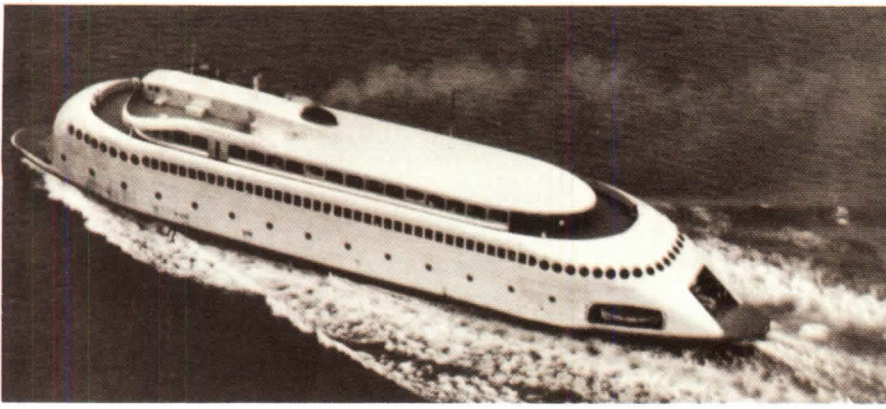

Chromium pencil sharpener. Raymond Loewy, 1934

Courtesy of Raymond Loewy International

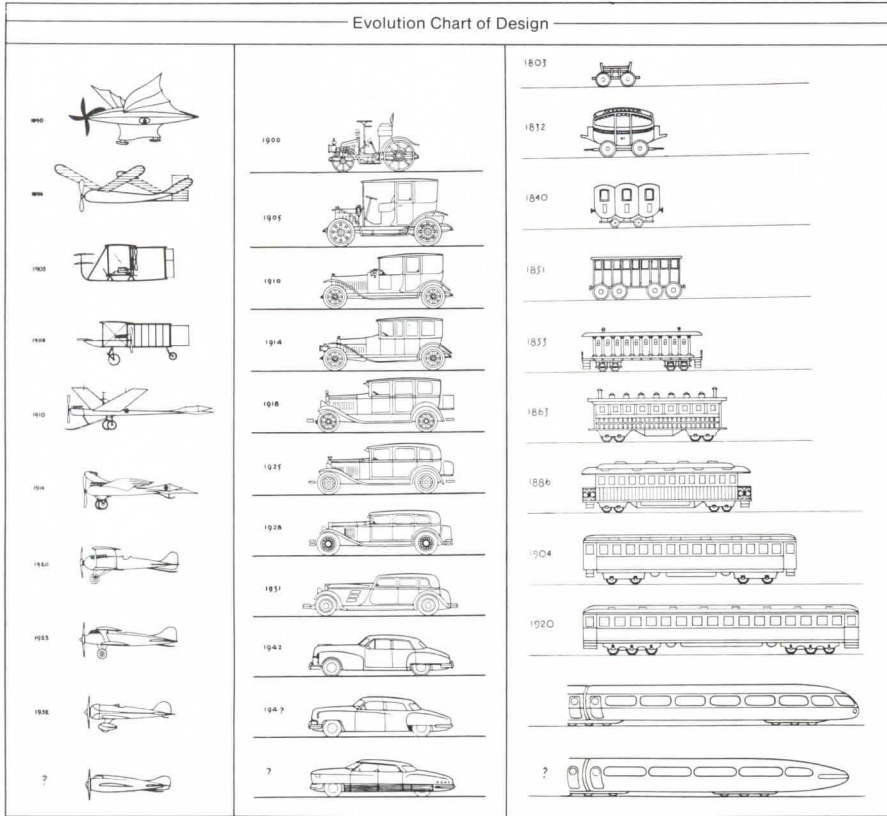

Gasoline pump designed by Joseph Sinel for Davis Hardoll, 1932. Courtesy of George Arenis Research Library, Syracuse University

Even Bel Geddes' failures brought favorable publicity both to him and to the profession. In addition to illustrating such actually manufactured designs as metal beds for Simmons, Philco radios, and a cleanlined Standard Gas stove, *Horizons* devoted considerable space to a grocery counter scale designed for the Toledo Scale Co.—along with a complete factory complex in which to produce it. Commissioned to replace a clunky cast-iron scale that salesmen found hard to carry, Bel Geddes and his staff designed a sculptural model intended to be manufactured of sheet metal. After a misunderstanding, however, Toledo Scale abandoned the project (and the factory), funded extensive research in plastics, and eventually engaged Harold Van Doren to design a plastic housing that did go into production. All the same, a luminous rendering of Bel Geddes' scale design nearly became a machine-age icon of the Depression years, appearing not only in *Horizons* but also in *Fortune* and other magazines as evidence of the power of industrial design. Recently a design historian fell victim, nearly 50 years later, to Bel Geddes' efficient publicity—and to his propensity for equating the imagined with the real—by citing the scale as a manufactured product. Such as the mystique of the man referred to by a contemporary as the P. T. Barnum of industrial design.

In a sense, Raymond Loewy combined the astute business practices of Teague with the dramatic flair of Bel Geddes. Born a Frenchman, Loewy effortlessly styled his own life to reflect an appropriate image. Often photographed at the wheel of an

auto of his own design, he appeared most at ease posed with elegant nonchalance in a streamlined designer's studio—not his own but one that he had created with Lee Simonson for a 1934 exhibit at the Metropolitan Museum of Art. Loewy had arrived in New York City in 1919 with the intention of using his engineering training to seek employment with General Electric, but he soon found himself engaged in fashion illustration and advertising art. Hired in 1929 to redesign the Gestetner mimeograph machine, Loewy slowly shifted from commercial art to industrial design and worked on Hupp automobiles and Westinghouse radio cabinets, the latter in a classic skyscraper deco style. His break came in the early-'30s with a commission from Sears Roebuck to redesign a boxy refrigerator with flimsy-looking legs—the horseless carriage of refrigeration. Loewy's 1935 Coldspot appeared as a single smooth, round-edged mass, its verticality emphasized by three parallel ribs running down the center of the door and repeated on interior fittings. Advertised by Sears as modern and streamlined, the 1935 model set a standard for the industry, earned Loewy commissions for three successive annual revisions (though his public relations man had pronounced it the perfect refrigerator), and brought him to the attention of executives in other major industries.

With his office expanding, Loewy abandoned to his associates the design of minor products, packaging, store fronts, and exhibitions in order to concentrate on his first love—vehicles. After his arrival in New York City, Loewy had marveled at the power of America's machine civilization but had been appalled

Upright Montgomery Ward vacuum cleaner, Walter Dorwin Teague, 1939



Sears Coldspot refrigerator, Raymond Loewy, 1935



1929 grocery scale, Courtesy of the Norman Bel Geddes Collection

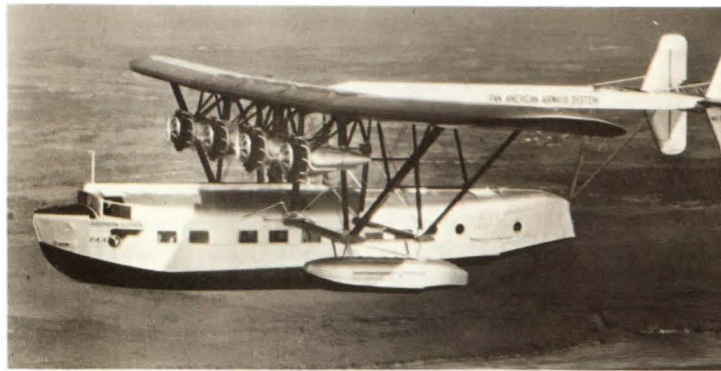

The Southern Clipper, Sikorsky s-40, 1931. Pan American World Airways Photo



RCA Victor television receiver, Model TRK-9, 1939. Courtesy of RCA

by the clumsy lack of grace of American machines. Whether designing the Studebaker Champion or the Princess Anne ferry, he sought to encompass its functionally essential projections within a series of envelopes flowing smoothly into one another and thus leaving the impression of a coherent whole. Loewy revealed his talent most clearly in his locomotive designs for the Pennsylvania Railroad. He transformed the GG-1 electric locomotive, for example, merely by specifying that its body be smoothly welded together rather than fastened by thousands of visually clumsy rivets. But his masterpiece was the S-1 steam locomotive of 1939, which improved on engineer Otto Kuhler's original design for a bullet-nosed engine by employing sweeping horizontal lines to integrate the front of the locomotive with what otherwise would have remained a static cylinder. More than any other designer, Loewy succeeded in capturing esthetically the essence of Depression America's fascination with speed. On the other hand, however, he was also the most frankly commercial of the leading industrial designers and once declared that his "conceptions of esthetics" consisted of "a beautiful sales curve, shooting upward."

Such was not the case with Henry Dreyfuss, the youngest of the men who led the profession during the '30s. Born in 1904, Dreyfuss brought to his work a reform impetus similar to but not as inclusive as that of Teague. As a child he was raised and educated according to the precepts of the Ethical Culture Society, an intellectualized semireligious group that emphasized the duty of each individual to strive to make a positive impact

on his environment. Although in later life Dreyfuss did not speak much of this background, his design philosophy indicated that he had internalized its principles. Since his family had long operated a theatrical supply store in New York City, it was natural for Dreyfuss to embark on a career as a stage designer. After several years as a student and apprentice of Bel Geddes, Dreyfuss began in the early-'20s to create sets for variety theaters, an occupation that gradually spread to the design of ballrooms for the Roseland Co. and movie houses for RKO, executed in a restrained version of French art deco. When a Macy's executive suggested that he prepare redesign sketches for presentation to the store's suppliers, Dreyfuss refused on the grounds that a product should be designed from the inside out, but the experience motivated him in 1928 to begin a slow process of transferring his interests from the theater to industrial design.

Like Teague and Loewy, Dreyfuss collected a select group of blue-chip clients—Westclox, Bell Telephone, Hoover, John Deere, the New York Central—on whom he could rely for a steady stream of commissions. With the exception of his Mercury and 20th Century Limited passenger trains, which effectively dramatized power rather than speed, few of his designs appeared visually innovative. But Dreyfuss paid particularly close attention to the ease of use of his products. Whether placing all controls on the top of a wringer washer so that housewives would not have to bend over, or making a thermos bottle rectangular in shape to prevent its rolling around, he indicated his adherence to design priorities that extended beyond the sales counter.

his focus appeared most clearly in his design of Bell Telephone's standard desk set, introduced in 1937 and not phased out until 1950. After rejecting sketches invited from 10 commercial artists around 1930, the company had hired Dreyfuss precisely because he had refused to contribute such a sketch. Working in close collaboration with Bell engineers, he and his staff produced an optimum design that was statistically based on head and hand measurements of scores of individuals. Thus was born the applied science of ergonomics, which Dreyfuss continued to develop until his death in 1969. By the end of the 1930s, however, he had formulated in writing a design philosophy that stressed the importance of eliminating all friction between a manufactured object and its user. Hardly an exponent of a machine-age world of total esthetic coherence, Dreyfuss injected into industrial design a more limited, realistic element of reform consciousness.

Dreyfuss's concern with eliminating friction underscored a theme that united the work of most industrial designers during the Depression. Even streamlining, the style of the decade, originally evolved from aerodynamic engineering as a technique for eliminating the friction of wind resistance to a moving vehicle. Automotive engineers, who tended to ignore styling as a superficial matter, considered the teardrop—the form naturally taken by a drop of water as it slides down a flat surface—to be the ideal shape for a motor car. When Bel Geddes portrayed such vehicles in *Horizons*, he thus popularized a design solution that serious engineers had already tested in wind tunnels and that they expected eventually to see embodied in actual production models.

But when the first streamlined trains attracted massive crowds as they toured the nation in 1934, it soon became apparent that streamlining encompassed more than technical considerations. Designers rapidly transferred the style from vehicles to such stationary products as radios, fans, and even pencil sharpeners, and then to commercial architecture, both exteriors and interiors. Inwardly flowing entrances no doubt functioned to attract the attention of pedestrians to the goods on display within, but no such logic applied to essentially rectangular rooms

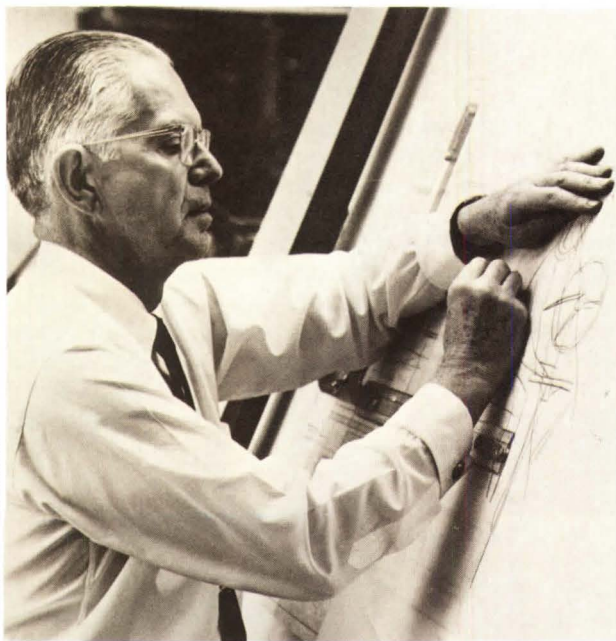
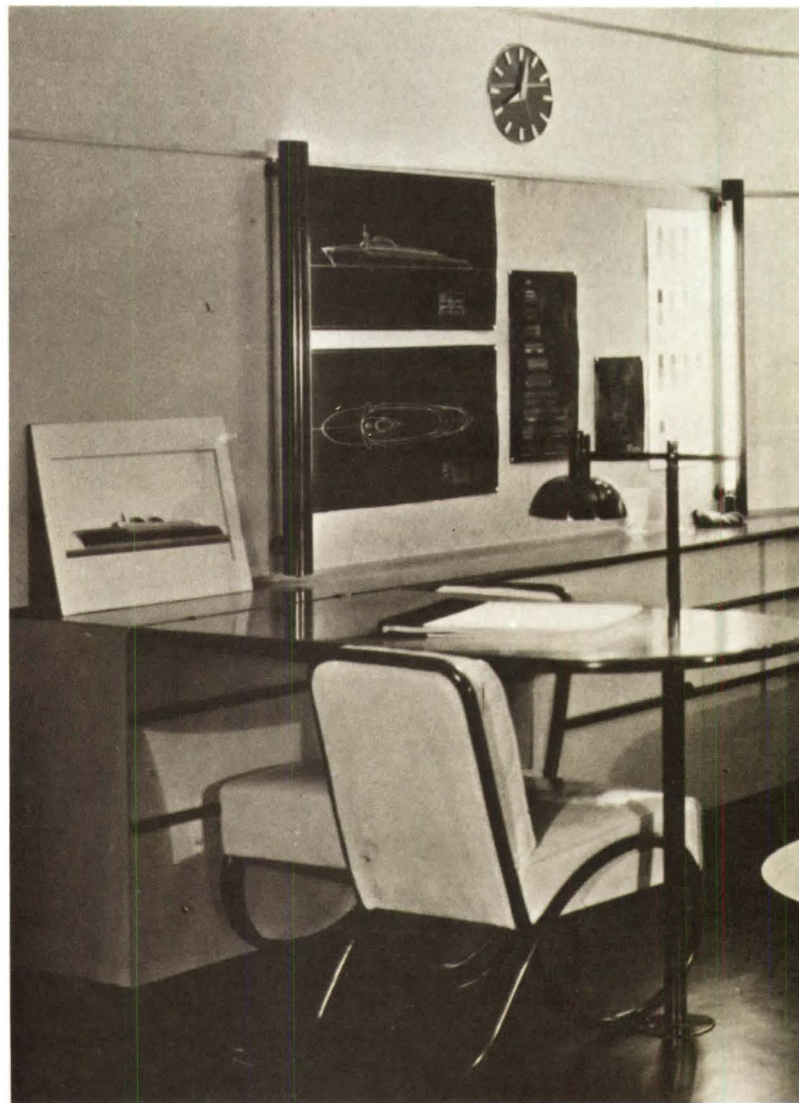

Courtesy of John Dreyfuss



Courtesy of Norman Bel Geddes Collection

Above, Henry Dreyfuss. Right, Norman Bel Geddes peering from an Airflow Chrysler. Above center, Raymond Loewy in a mock-up industrial design studio for the Metropolitan Museum of Art, 1934. Opposite page, Walter Dorwin Teague with Henry Ford (left).

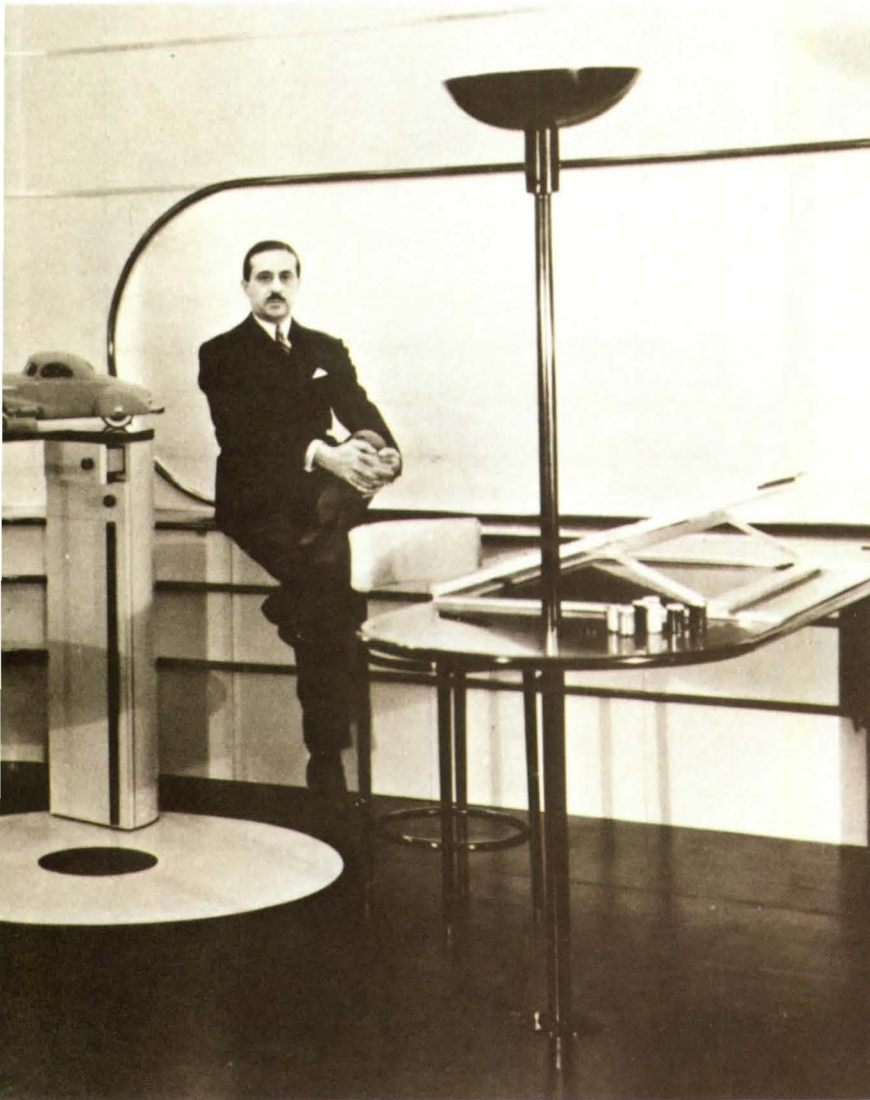

Courtesy of Walter Dorwin Teague Associates Inc.

whose corners had been rounded off with Flexwood paneling accented by narrow horizontal metallic flow lines. Streamlining as a popularly accepted style expressed the desire of the public to overcome the economic and social frictions of the Depression, to flow through time with as little resistance as a teardrop auto through air. And by shrouding complicated mechanisms in streamline housings, designers at least implied that a machine civilization need not be complex, that its functioning might be made smooth, effortless, and indeed nearly automatic.

Beyond that, streamlining also expressed the essence of industrial design itself as it had developed in the '30s. Faced with an economic crisis that they conceived of largely in terms of underconsumption, manufacturers had turned to product redesign as a possible solution. Applying the ever-present friction metaphor, they sought to overcome sales resistance, to return the flow of goods to its former speed and volume. Egmont Arens, an industrial designer with a background in the Calkins & Holden agency, declared that he and his colleagues were engaged in "consumer engineering." If the factory management movement of Frederick Winslow Taylor had made American manufacturing so efficient that production far outstripped consumption, then the distribution of products required a similar efficiency movement. These ideas received their clearest expression in the observation of a design publicist that "streamlining a product and its methods of merchandising is bound to propel it quicker and more profitably through the channels of sales resistance." For a single brief decade, popular aspirations and business needs thus coalesced in a successful, all-encompassing design style whose smooth lines and gleaming surfaces gave expression to

the hopes of all. As the shapers of this vision, the first industrial designers enjoyed a popular fame and sense of cultural significance that later dwindled with the postwar return of prosperity and the institutionalization of their profession.

A more dramatic fate awaited streamlining, the uniquely American expressionist style that industrial designers had imposed not only on vehicles and consumer products but on much of the nation's architecture as well. Banished by the rationalist tenets of European emigrés like Gropius and Mies van der Rohe, streamlining was relegated to the "borax and chrome" of Detroit tailfins. Only a single American architect, Eero Saarinen, continued to expand the possibilities of a style that had once seemed destined to reshape the built environment. Working as a draftsman in the office of Norman Bel Geddes, Saarinen had been largely responsible for the exterior of the 1939 General Motors building. As if he had taken the experience to heart, Saarinen in 1945 provided a preliminary design for the General Motors Technical Center with a long, shimmering research building that displayed in cross section a perfectly streamlined teardrop. Styles were changing, however, and he momentarily gave in by modifying his design to reflect the dominant modernist esthetic. Whether critics praised or attacked Saarinen's later TWA Terminal and Dulles Airport designs, they wrongly considered them unique aberrations rather than extensions of streamlining esthetic. Americans of the Depression, however, coached by their industrial designers, would have recognized Saarinen's sweeping parabolic arch of stainless steel in St. Louis as the expressive symbol of spiritual and technological progress that he intended it to be. □

Deco In a Revived Deli

*Brad Elias'
New York Delicatessen.
By Nora Richter Greer*

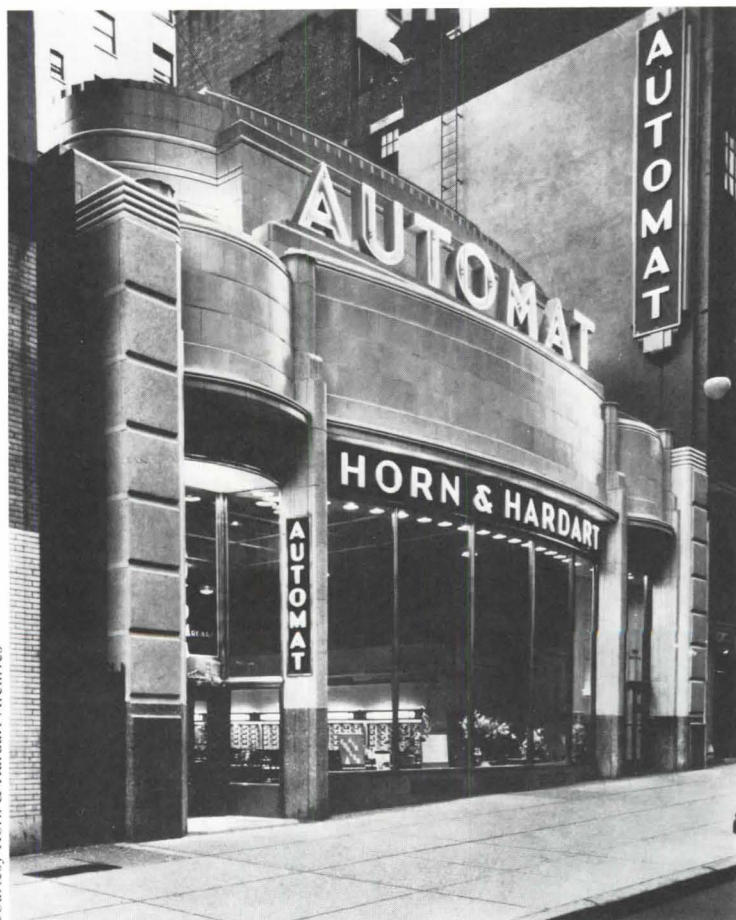
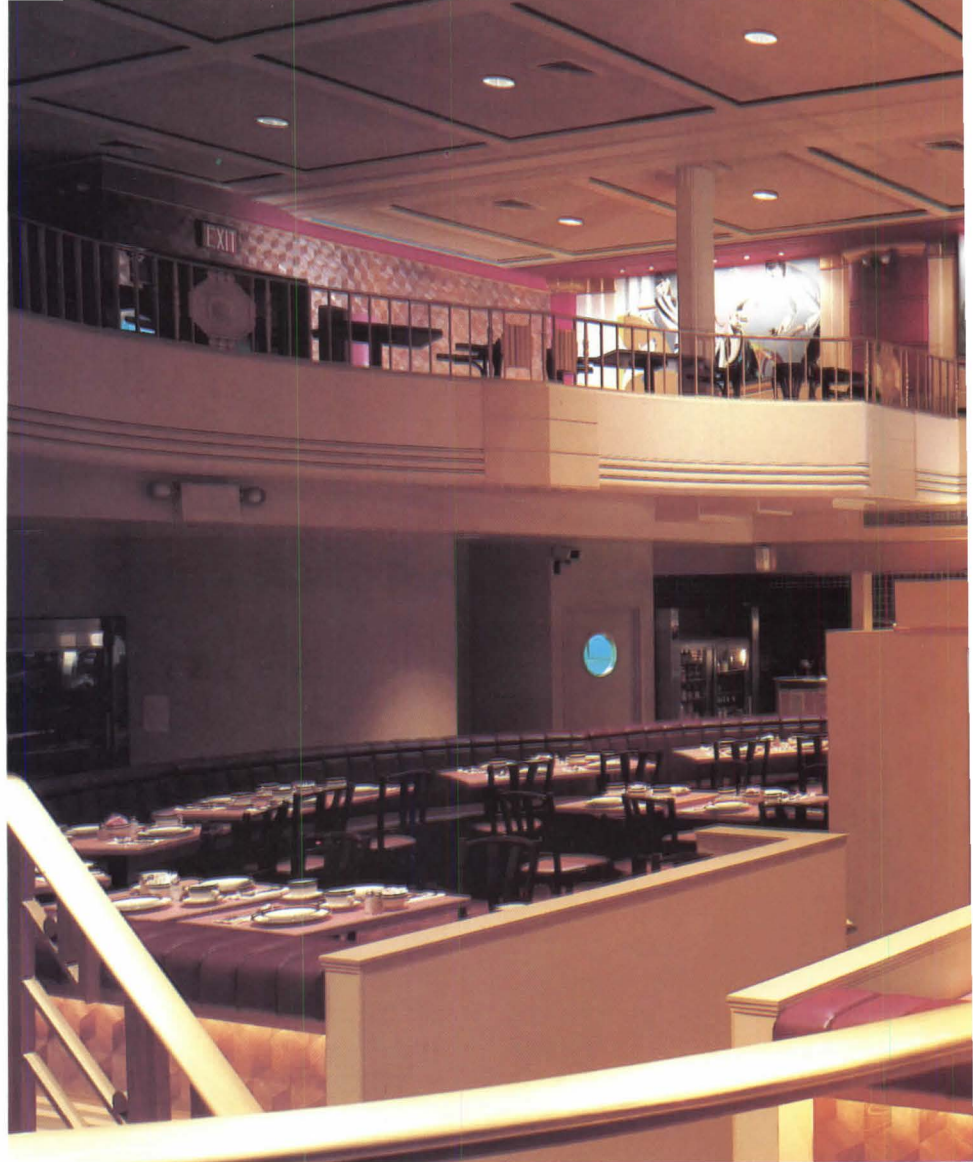

Courtesy Horn & Hardart Archives



Entering the New York Delicatessen is like walking into an art deco fantasia, replete with a gilded statue, angular murals, etched mirrors, and lavish tiles. It is, as interior designer Brad Elias says, "Hollywood deco, a bit of Busby Berkeley movie set, and a touch of Radio City Music Hall."

The deli is located in what was once a Horn & Hardart automat on West 57th Street near Sixth Avenue. The client—David Wolf, former owner of the famed Sixth Avenue Delicatessen across the street—wanted a restaurant that could seat 300-plus people. Elias, of the New York City firm Hochheiser • Elias Design Group Inc., chose to return the space to its original art deco look, retaining as much of the old as possible and adding pizzazz with the new.

For two months Elias and his design team researched the deco period and created new items in old images. Among the new is Clarite, the golden lady who stands 16 feet tall on top of an eight-foot-high bridge (underneath are waiters' service stations). A 1927 magazine illustration was the inspiration for the balcony wall murals. Other new objects are burgundy urns modeled after a Donald Desky Radio City Music Hall floor lamp, a gold leaf mural reminiscent of the works by French stage designer Erté, and curved mirrors shaped like deco-style skyscrapers. Elias retained the old plaster work, which in some cases has been brightened with rose trim; brass and gold metallic railings and Lalique-style cut glass have been patched and cleaned. Interior colors are creams and burgundies, with accents of teal and rose—warm colors chosen to soften the multilevel space. □

Focal point of the multilevel deli is 16-foot-tall Clarite, above. Stairs with original deco railings lead to balcony level, right. Formerly a Horn & Hardart automat, left, the exterior has been restored to its original appearance.





Deco Recalled in a Diner

Communication Arts' Oasis Diner, Boulder, Colo. By N.R.G.

Beginning in the '20s and '30s gleaming stainless steel streamline diners were a familiar sight along highways. With the advent of super interstates came the super chain restaurants—the Howard Johnson'ses and McDonald'ses—and the roadsiders nearly vanished. Now, at least in Boulder, Colo., the diner is back in all its flashy glory—this time on the city's busiest strip.

In Boulder, industrial designer Henry Beer of Communication Arts (with David Brown, AIA, of Everett/Ziegel/Tumpes & Hand) started with the clients' description of what kind of restaurant was desired and an existing 6,000-square-foot cinder-block building. Says Beer, "The more we listened, the more we recognized that what they were describing was a diner," but, as he says, the clients could not visualize a diner's traditional long, narrow interior in their squarish building. Beer solved the problem by designing a double diner. In a typical diner, booths line the front windows and are separated from the sweeping counter by a long aisle; in the Oasis Diner booths symmetrically surround an oval-shaped counter. It's as if there is a long mirror down the center of the restaurant, so balanced are the two sides.

The interior finishes were also chosen to reflect the traditional: quilted stainless steel, etched and painted glass, linoleum tile floors. In the Oasis Diner these materials are used in a "softer way than traditionally," Beer says. What he wanted to avoid was the feeling that all surfaces were porcelain panels and stainless steel and that the building "can be hosed out." Beer

does achieve a "softness" by using the materials more sparingly. For example, the counter has stainless steel bands that almost quietly step inward and downward. The quilted stainless steel is used as a trim along the upper edges of the walls. And the etched glass becomes a sound barrier between the central counter and the side booths.

For the exterior, Beer wanted a streamline appearance, along with a highly readable building. The streamlining is achieved with stainless steel horizontal bands that run along the diner's lower portion. The door's window and handle are deliberately curved, as are the left and right edges of the front windows. But, while the lower portion of the facade is streamlined, the upper is more zigzag deco. Here the horizontal lines step upward to culminate at the apex above the diner's entrance, where a clock marks the time and two spires reach up to the sky. The exterior materials are alucobond and fluted metal, which is manufactured by a truck siding company. (Beer calls it a material metaphor: "A truck stop made out of a truck.") Beer's inspiration for the design was the work of industrial designer Norman Bel Geddes and Chicago architect Fred Keck. □

Above, the diner's streamline and jagged-edged form by day and by night. Across page middle, the main door's round shapes are echoed in interior sandblasted glass dividers and one of the eight food paintings. Right, the glass dividers separate booths from the diner's centrally placed stainless steel counter.

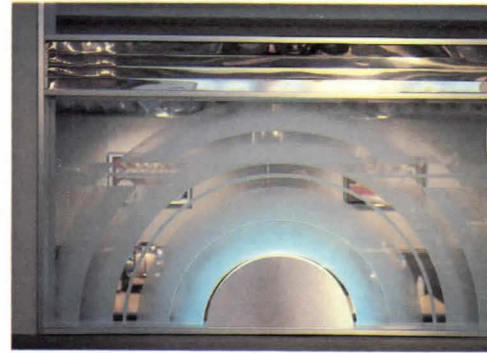
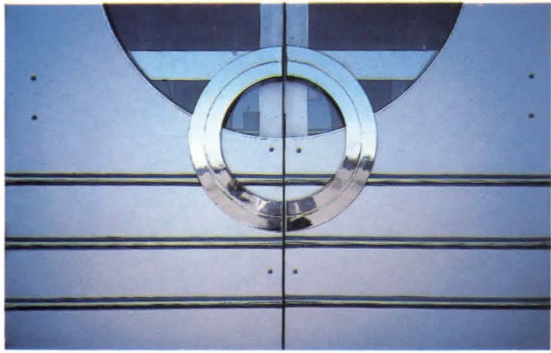

Deco Touches On a Seattle Tower

Bumgardner Architects' Watermark Tower, Seattle. By Andrea Oppenheimer Dean

Courtesy of The Bumgardner Architects

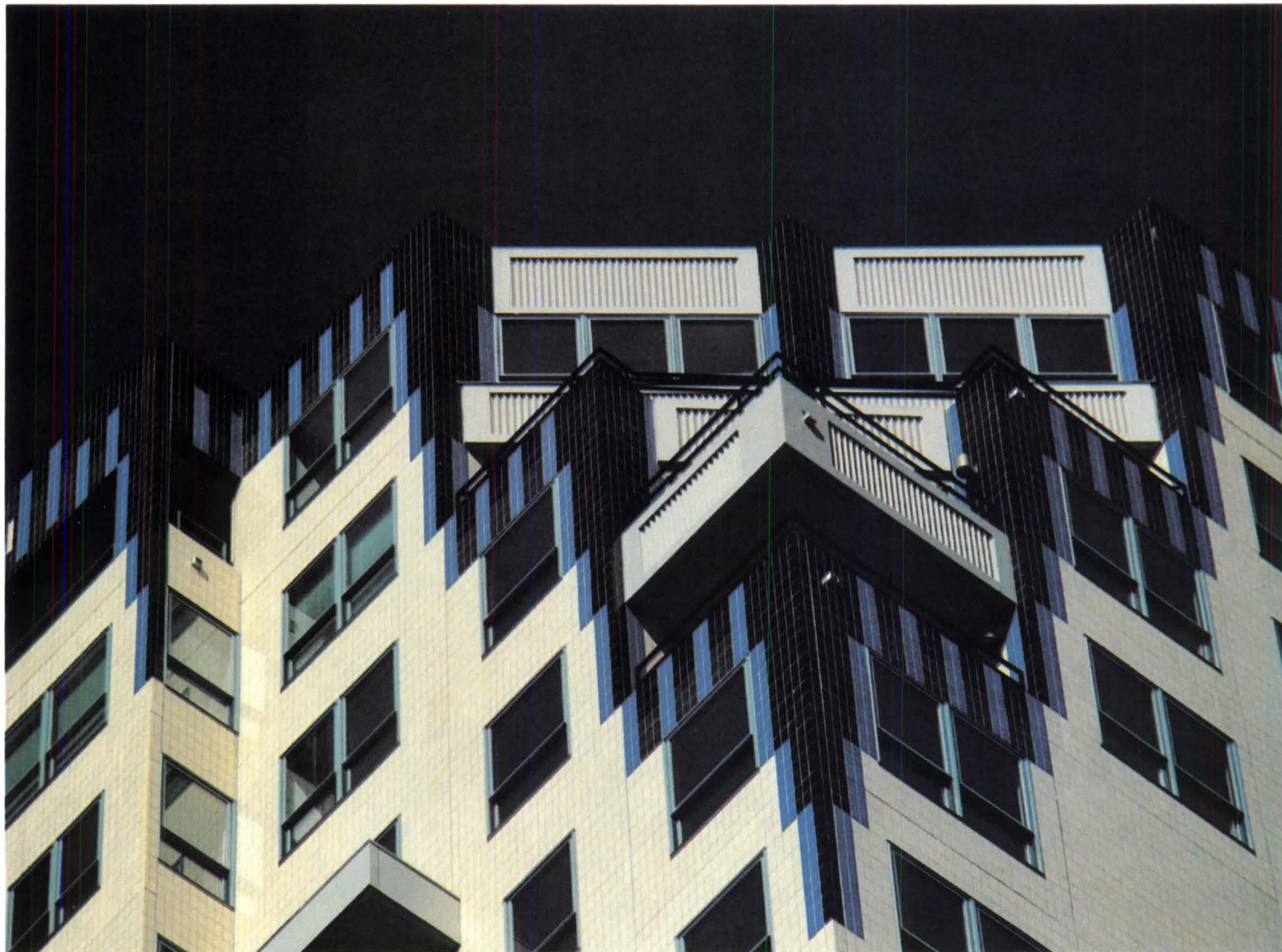

An odd thing about this deco tower: Its architects designed it without art deco in mind, they say. "The deco image is stronger to others than to us," insists Alan Grainger, design coordinator for Bumgardner Architects of Seattle.

What then is the source of Watermark Tower's typically art deco combination of elements—its series of setbacks and strong vertical articulation, its exterior tile paneling and strikingly decorated entry, its use of lush colors and geometric ornament?

Grainger explains it as forms following function—setbacks differentiate retail and office spaces on the first five levels from apartments on the remaining 15; in terms of style suiting context—the tower's downtown neighbors are mostly early-20th century buildings; and, he says, the shapes and colors create a familiar yet striking image.

Could it be that a deco-like design is a natural (even without conscious intention) for an architect working in a city and seeking an image that is contextual, colorful, functional, and friendly?

Watermark Tower's shape evolved slowly as a result of trial and error, according to Grainger. "We wanted the building to have a decorative top. Originally, it didn't have the colored tile, but only the modeling, which was an attempt to relate what is a fairly short tall building to the old skyscraper image where

the top is strongly articulated. It also allowed for more balconies on the topmost residential floors. The blue, black, and brown colored shapes that emerged were simply a celebration of the top with decoration."

The choice of cream-colored tile for cladding was made by the developer, says Grainger, "because it has a long-lasting look," comes in panels with inset windows, and helps the building blend with its neighbors. The \$16 million tower is part of a \$130 million, six-block redevelopment in downtown Seattle's recently seedy waterfront area. The Watermark is flanked by six historic structures, rehabilitated by Bumgardner, "and we didn't want a new building to look like a missing tooth," says Grainger. In fact, the tower incorporates at its southeast corner the preserved Italianate facade of a one-story 1915 building, and its setbacks follow the cornice lines of adjacent buildings.

At its first five floors, which house stores and offices, the Watermark rises broad and flat; then it pinches back where apartments begin. And it nips in again here and there to create balconies before culminating in a zig-zagging, colorful crown.

As these forms took shape, "what appealed to us most was that they were yielding a strong silhouette," says Grainger. "We're dealing with a mostly residential building sitting in the



Multicolored zigzagging crown creates balconies and visual interest, across page. In a waterfront district of historic buildings, Watermark's southeast elevation includes preserved facade and entrance of a 1915 structure, below. Main entry is left, below.

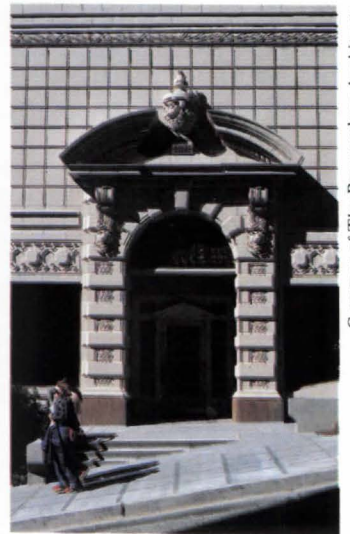

Courtesy of The Bumgardner Architects



middle of office towers. We wanted its shapes and decorations to make it more friendly and appealing to people from the street." A local columnist has written of the tower's "rumpled profile and polychrome icing," remarking that a building's mid portion and top are more important, because visible at street level, in a hilly city like Seattle, and that the Watermark's bright colors are a natural for this city of long, gray winters.

A green and blue entry canopy fans out with a typical deco (also postmodern) Egyptian headdress motif. Above it is a double-story decorative window with similar pattern. It's as though the building's asymmetric, slightly cockeyed shapes and compositions are funneled down into and visually pulled together by the V-shapes of the many-colored entrance.

The geometric pattern of tiles at the entry is carried into the building where it reappears on elevator frames on all floors. Unusual is that Bumgardner's design responsibility extended into offices and apartments. The last have muted colors, wood-framed windows, woody, elegant kitchens, coffered ceilings—very nice. And, interestingly, the two-bedroom units, with suites separated from each other and with separate baths, are intended for unrelated—even initially unacquainted—people living together just because it's more affordable. □

Deco Lines On a Houston High Rise

*Transco Energy Co. headquarters, Houston,
by John Burgee with Philip Johnson. By N.R.G.*



Photographs © Balthazar Korab



The Transco Energy Co. tower is a soaring structure of mirrored and nonreflective glass that has an upward thrust as dramatic as that of the finest deco skyscrapers. Also echoing the past are Transco's decorative top, broadened base, and symmetry.

Designed by John Burgee Architects with Philip Johnson, the tower is located in a sprawling, low- and medium-rise commercial area about 10 miles west of downtown Houston. Introducing a 64-story tower there was the response to the developer's interest in a "flagpole" building, a structure that would become the landmark of the area. So early on it became clear that Transco would be the "tallest building of anything around it by a couple of times, that it would stand alone, and would be visible from all angles," Burgee says. This in turn led to its elongated squareness and symmetry of all four sides. This same kind of solution to "total visibility" was often used by designers in high rises of '20s and '30s vintage.

The building is entirely sheathed in glass, but the intent is that it appear more like solid masonry. Says Burgee, "We are using the mirrored glass like a solid component because it is opaque. Even the module of the glass pieces are broken up more than necessary to express that stone-like quality." Against this "stone" wall are set vertical bays of transparent gray-tinted glass. In making the transition from reflective to clear glass, the message, according to Burgee, is that the bays are where the windows might have been on a stone building. The overall effect is to heighten the tower's verticality.

The use of a decorated top, rather than a flat one, harkens back to the '20s and '30s, although Transco's pinnacle tapers more quickly than most of the celebrated deco towers. And, too, Transco's base broadens like those on deco structures, but more abruptly. In Transco the contrasting horizontal base allows for the larger floors that the client wanted, but also prevents the building from "just coming down like a shear shaft into the ground with no ending," Burgee says.

What Transco has, though, that was only a fantasy for the designers of deco skyscrapers is the ability—through its mirrored glass—to take on different hues as the sun moves across the sky and fades over the horizon. □

Left, Transco's symmetrical appearance was a direct result of its visibility from all angles. Above, its verticality is heightened by the use of bay windows of a different material from the glass wall. Right, Transco with earlier streamlined Post Oak buildings designed by Johnson/Burgee in the foreground.



Streamline Shopping 'Ship'

Cope Linder Associates' Ocean One mall on a pier in Atlantic City. By Michael J. Crosbie

The Million Dollar Pier was a landmark of the "old" Atlantic City that featured, among other amusements, a famous horse that dove into a tank of water. Now occupying the same site is an amusement more in tune with today, yet evoking the past—a shopping mall that recalls an art deco ocean liner. On a shoreline teeming with casinos, each screaming for your undivided attention, Ocean One, designed by Cope Linder Associates of Philadelphia, is a quiet building that nonetheless commands your attention. It has a festive resort flavor that celebrates its place on the waterfront and almost makes you forget the rampant avarice and the decaying city just beyond its portholes.

Steven Henkelman, project manager, says that while Ocean One was under design considerable study was given not only to the ocean liners of the 1920s and '30s, but also to the art deco buildings of the same period. The deco ocean liner imagery, says Henkelman, is a device for relating the building architecturally to the old Atlantic City, the romance of a resort that used to be, rather than to the new Atlantic City, which defies relationship.

A good case for contextual design also could be made for Ocean One. On a very large scale, the state of New Jersey is filled with buildings that pose as something they're not: stainless steel diners as trains, discos as spaceships, and notably Lucy,

Christopher Ransom

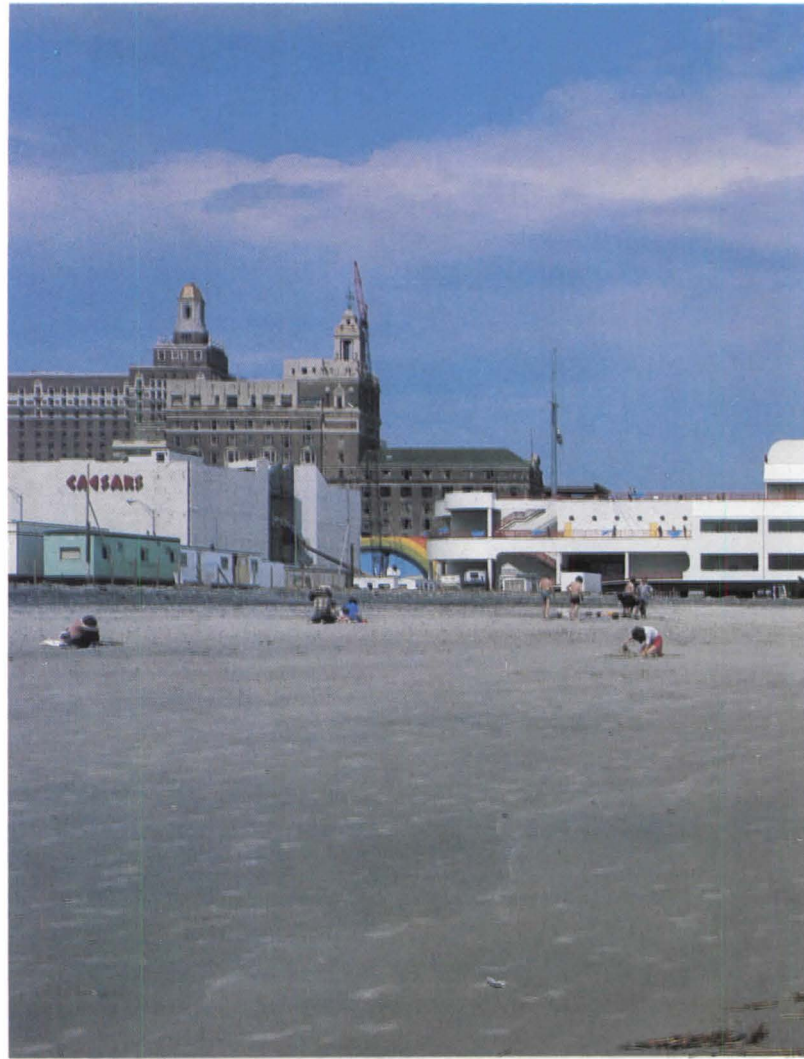

Michael J. Crosbie



Michael J. Crosbie

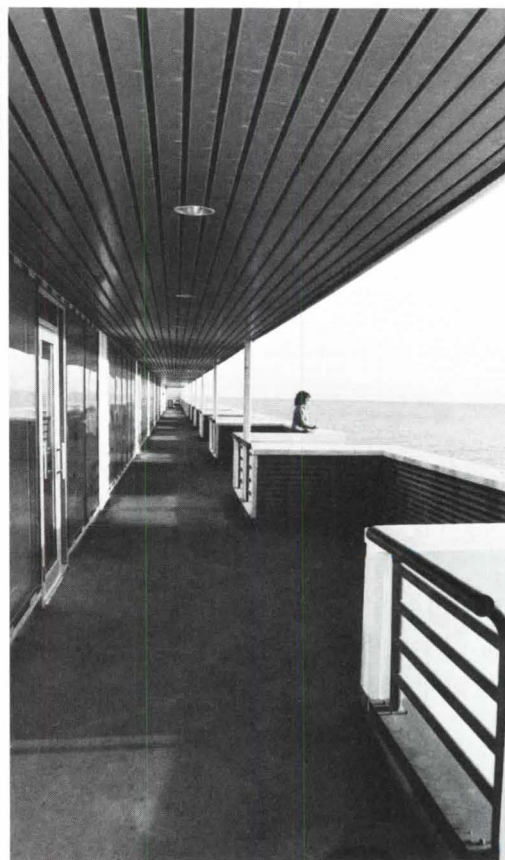



Above, Ocean One's ship shaped exterior from Atlantic City's beach; far left, a triple-decker stairway overlooking the ocean; left, one of four promenade decks offering views toward the city and the ocean, with alcove balconies that suggest lifeboats.

the former hotel that parades as an elephant, still standing in nearby Margate. Certainly the ship is an appropriate image for a building that extends half its 900-foot length into the ocean. And in Atlantic City, where to be subtle is to be invisible, the strong statement of Ocean One doesn't get lost in the shuffle.

Located across the boardwalk from Caesar's Boardwalk Regency, Ocean One was constructed from its concrete pilings up, replacing the deteriorated wooden structure of the Million Dollar Pier. Inside there are three levels or "decks." The first, up a ramp from the boardwalk, is pretty standard mall fare and a bit gloomy. But things get better as you ascend the free-standing staircases, which give you views up and down the lively, sunlit core. For three quarters of the core's length are the usual assortment of mall shops, but the last quarter on the first deck is a large exhibit area and on the second deck are a number of eateries, with generous dining space on the third deck.

Color abounds, notably red, white, and blue—uncharacteristic of Cope Linder's work, according to Henkelman, but especially successful here. The ocean liner imagery is reinforced in subtle ways: lots of pipe railings, exposed utility conduits, portholes, skylights, curved surfaces, accents on the horizontal, and a luxury liner flourish of special note—four art deco light fixtures that the architect salvaged from a Horn & Hardart automat in Philadelphia's Reading Terminal.

But Ocean One's most nautical attributes are its extensive

exterior decks, making it unique among its neighbors. As building types, both gambling casinos and shopping malls have similarities: Both are inherently inward-looking, both make little if any use of exterior space and relate little if at all to their surroundings, and both provide a controlled interior environment for the gambler/shopper to go about his or her business in a protective setting. It is to Ocean One's credit that it is not like a typical shopping mall or the casinos around it. It makes extensive use of its roof area in ocean liner fashion, offering sunshine, breezes, shuffle board, and room to lounge. There are spectacular vistas up and down the boardwalk and beach and of course a view out over the Atlantic. And these outside spaces have variety. Toward the ocean is a large space, down a level toward the boardwalk are smaller spaces for dining and sitting, and then around either side are narrow promenade decks on two levels, one with alcove balconies that from a distance suggest lifeboats.

Overlooking the boardwalk is another large deck dominated, unfortunately, by a huge billboard for Caesar's Boardwalk Regency—a bit of irony about building in an oceanside gambling resort. On the oceanside deck is a large wind generator that takes advantage of the prevailing off-shore breezes and provides additional power for the building; on the boardwalk side deck at the opposite end is a "buck generator," the billboard, which takes advantage of the prevailing on-shore commercialism and generates additional revenue for the building.

Ocean One revels in its locale on the water, amid the wheeling and dealing of Atlantic City. There is a great deal of merchandising here, but unlike most malls (and all of the casinos) the building itself is a good reason to go there and a good reason to stay.

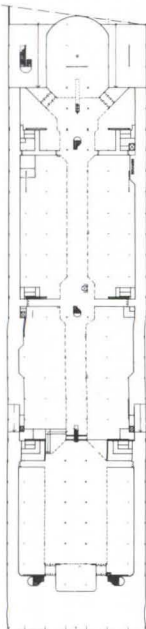
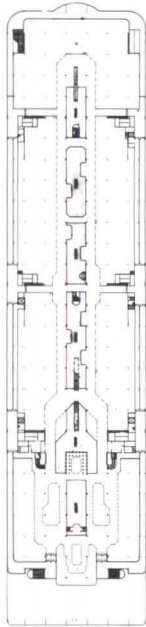
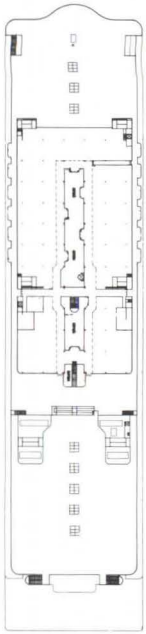

Christopher Ransom

Christopher Ransom



Michael J. Crosbie

Far left from top to bottom, third, second, and first level; above, the colorful interior core; left, installation in Ocean One's exhibit space on the first level; below, one of four art deco light fixtures salvaged from a Horn & Hardart automat, now in the interior core. □



New Toll Booths For a Moderne Bridge

Reflecting renewed regard for the Golden Gate. By Donald Canty

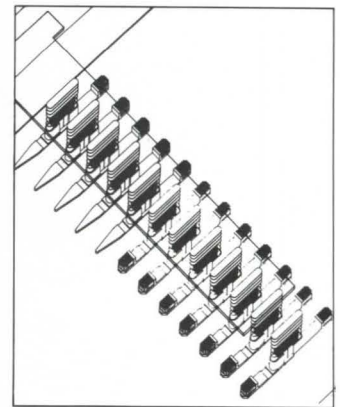

In the heyday of modernism, it was *de rigueur* in the San Francisco Bay Area architectural community to prefer the San Francisco-Oakland Bay Bridge to the more celebrated Golden Gate. The latter was a brilliant feat of engineering, it was acknowledged, but the towers and appurtenant buildings had been “architected” with deco detailing and even (horrors!) decoration (chief engineer was Joseph Strauss and consulting architect Irving Morrow). The Bay Bridge, in contrast, was unadorned purity of structure incarnate. Times have changed, and now many professionals share the affection that the public always has had for the great orange moderne presence suspended above the meeting of bay and ocean.

When it came time to replace the bridge’s worn toll booths, however, the engineering staff came up with plain little boxes. A delegation of prominent local architects, evidencing the change in views, objected, and the bridge directors engaged architect Donald MacDonald to design something more in keeping with Morrow’s original constructions. The results are shown above: The new booths are jauntily streamlined. Glass curved around the original booths, but that was deemed too costly for the new, so MacDonald artfully sent steel pipes curving out beyond the glass at the booths’ prows, achieving a similar effect. □

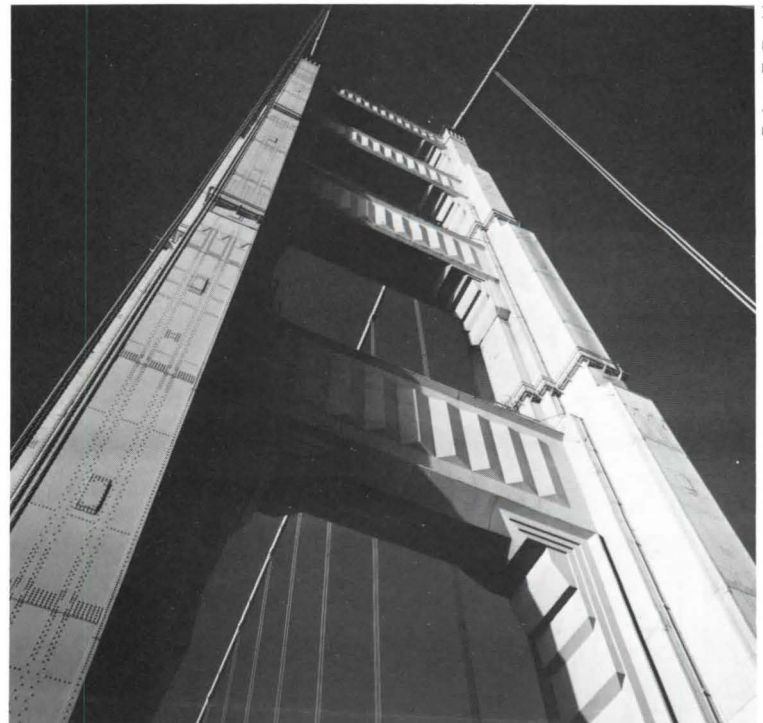

Robert E. David

An Amalgam of Styles In a Witty 'Spec' Building

*Hartman-Cox's 4250 Connecticut Avenue office building,
Washington, D.C. By A.O.D.*



Photographs by Robert Lautman



“In the '30s they used art deco because it was cheap and stripped down, therefore more modern—or moderne—but without being overly controversial. We used it for the opposite reason: It was a way of getting surface elaboration inexpensively,” says Warren Cox, FAIA, of Hartman-Cox Architects, designers of 4250 Connecticut Ave., a speculative commercial and office building in Washington, D.C. About the recent popularity of art deco Cox says, “Once you get beyond the appalling comic book nature of postmodernism and have the rightful concerns about scale, articulation, etc., that everyone professes to have, you need to find a better way than putting enormous keystones on buildings that look like table model radios. Deco is one way. Also, it has the virtue of retaining overtones of modernism, which allows people to be slightly naughty while still feeling virtuous, as though they haven’t completely sold out to the ancestors.” Cox exempts himself from such compunctions, having just designed a neo-Georgian addition at the University of Virginia, whose construction will start this spring.

Cox’s choice of an art deco-influenced style for 4250 arose in part from his firm’s long-standing good neighbor policy of design. Among nearby buildings several are art deco, some that are not are striped, as is 4250. And the neighborhood is filled with brick, which at 4250 is the same color as the concrete of its immediate neighbor to the south, the bulky, blandly modern University of the District of Columbia. When the district government insisted that the large new spec building (400x200 feet) defer to UDC and step down to meet it, and when Cox started thinking of “stripes as a system of stepping it,” all the pieces were in place for a nouveau deco design. Cox reread Robinson and Bletter’s *Skyscraper Style*, made numerous trips to the Hecht Co. warehouse (page 43), one of Washington’s best examples of art deco, and then proceeded to draw up “this stupid, 400-foot-long thing and have some fun in the process.”

A changeable creature, 4250 lies low near the University of the District of Columbia, at left in photographs, then steps up as it moves north. Connecticut Avenue facade bends (behind trees) to accommodate avenue buildings to UDC’s orientation.

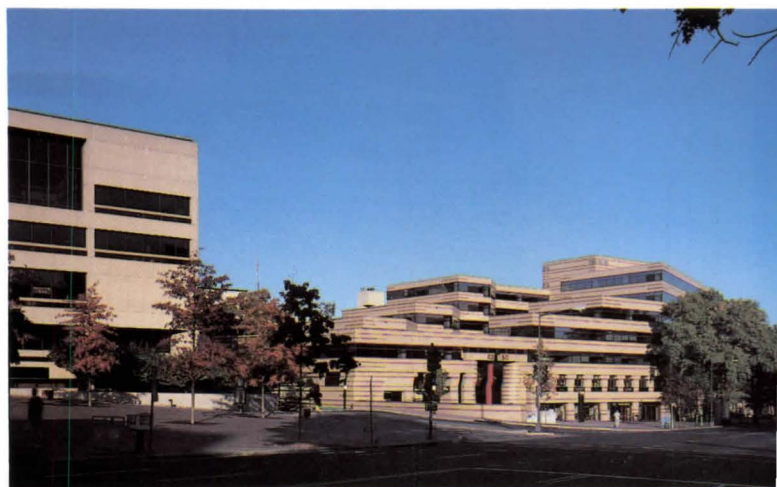

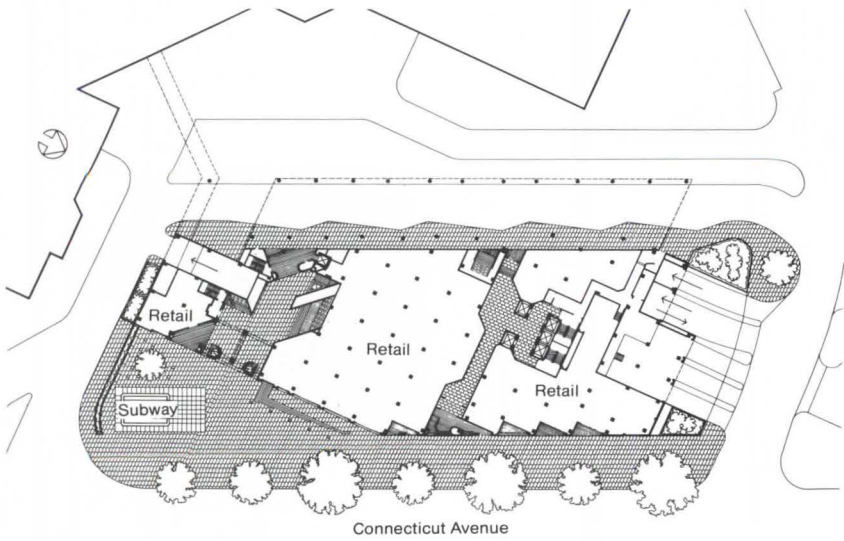

First though, he made two urban design decisions. One was to bend the principal facade on Connecticut Avenue so that the building would make a proper transition to the UDC campus, whose buildings, unlike others on Connecticut, face the side street rather than the avenue. "An act of urban vandalism," Cox calls UDC's orientation. 4250, he says, is a bridge between UDC and the street. "It's not supposed to be a monument; it's not even a corporate headquarters. It's a cheap building that every Tom, Dick, and Harry moves into. But the UDC buildings are so unassuming that to further defer to them would have practically put our building into a casket."

Second, because the site virtually covers a city block, Cox scooped out an oblong meandering courtyard to make two buildings—the one facing the avenue, the other directly behind it. "Who would have wanted to lease space 200 feet deep?" he asks rhetorically.

Finally, before going on to the fun part of the design, Cox had to address a series of requirements made by the Washington Metro authority, which sponsored a competition for the building won by Hartman-Cox with the Prudential Co. as developer. Metro's program called for a covered bus depot, which Cox placed at the back of the building, plus underground parking and an enclosed "kiss 'n' ride" drop-off. The result, Cox laments, "is that the first level of the building's north elevation is all doors."

The back of the building is all modern and quite pleasant, the remainder is a concatenation of art deco (the setbacks, striping, material), modern (the upper portion with ribbon windows), and pranky postmodern (columnless capitals suspended in midair, floating, broken lintels over entrances). The building reads as being divided into a base, middle, and top. The base is, of course, composed of street level shops, the middle is punctuated by capitals—some in a state of levitation others anchored down—and then comes a modern top, several times the size of the base and middle combined.

Very quirky business this, especially when you start thinking about these wallpaper-thin columns, and other elements associated with classicism being appended to this most anticlassical of structures.

The reason Cox gives for hanging such appurtenances on the building and bending the skin back at entrances to make make-believe columns is "to show that what you see is just a veneer, that you can curl it like a potato skin and slice it like salami. We intended the dropped pendentives and capitals to break up the rhythm, to be deliberately distracting. They're pranks. I think they annoy some people."

I am among the annoyed, feeling Cox's antics add little of real visual value and tend to break the building into too many busy bits and pieces, though one of 4250's more appealing characteristics is that it reads as a series of experiences rather than as an object, and has a variety of faces.



Courtyard twists upward and past stores, facing page and above. Views out of court, top, and of the elevator lobby, left, show consistent detailing, color accents, materials.



From the south it edges upward from UDC in a series of layered, sliding, and striped trays; from the north it looks like a warehouse; from the back it's a modern bus depot; and straight on from the avenue it's like two buildings, one low and filled with diverting details, the other bigger and quieter.

This diversity makes the building all the more human, which is to say it possesses a sense of seriousness, combined with playfulness, changes of mood and manner, plus a scale comfortable for humans, except in one place. The courtyard entrance, overhung with sundered pendentive, is overscaled, which may be one reason why some people report feeling somewhat oppressed entering the court; another may be the huge, red columns and steel beams that serve as greeting. Otherwise, the courtyard, which wends its way upward toward the north and an entry to the lobby, is a delightful surprise, though devoid of people because it lacks any commercial attraction. There was a plan at one point for a restaurant, but it never materialized.

Hartman-Cox's responsibilities for the interior of the building were restricted to lobby spaces at the elevator core, which look very much like the halls of a high school I once attended, though at 4250 Cox was able to bring inside exterior materials, colors, and detailing—the tan and red-striped brick, red stair rails, mullions, and flooring. Both inside the building and out, Cox struggled with a very limited budget, whose mischief is especially evident in the choice of precast outdoor pavers, which are already stained, bruised, and sad-looking.

"It's just a cheap building; not even a foreground building," Cox says as if in apology. Well, a foreground building it is, which is all to the good. For 4250 is a colorful, peppy, interestingly massed, and detailed building, which is a relief in this part of Connecticut Avenue dominated as it is by mostly bland and dumb buildings. In the end, 4250 is a good and classy neighbor, a likable fellow in whom it is easy to forgive occasional show-off lapses and pranks. □

Left, view from avenue looking north; bottom left, north facade; below, back of building. Right, court entry cladding folds back to form false columns; a split pendentive hovers.



Intriguing Look into Gaudí's Complexities

The Designs and Drawings of Antonio Gaudí. George R. Collins and Juan Bassegoda Nonell. (Princeton University Press, \$125.)

"Every book," says Juan Bassegoda Nonell in a preface to this handsome folio-sized volume, "has its own particular history, knowledge of which is very important to the reader who is thus able to understand the magnitude of effort made by the authors as they composed the work, and whatever difficulties they faced in bringing it to completion." Every book does have a history, to be sure, but not many have involved a labor of love over more than a decade, with endless searching for drawings by the Spanish master. Nonell himself describes the book as a "joint interatlantic effort," which is "quite rare and without doubt will represent a landmark in architectural investigation."

Nonell, who holds the chair of the Gaudí professorship at the Polytechnic University in Barcelona, explains how he and the scholar George R. Collins, professor of art history at Columbia University and a world authority on Antonio Gaudí, did not let a vast difference in miles separate them in their endeavor to bring the book into being. Collins worked in New York City on such matters as writing and coordinating the text and col-

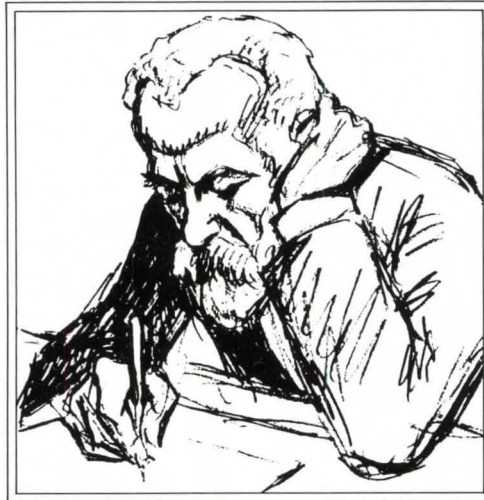

Above, sketch of Gaudí in 1900 by Ricardo Opisso; below, original drawing of the facade of the Casa Milá, Barcelona, 1906.

lecting plates for publication while Nonell, in Barcelona, outlined chapters, checked the text, and searched for unpublished Gaudí drawings. He tells how each discovery he made was duly reported to New York and was received "with the same enthusiasm as when the discovery was made in Barcelona."

Collins also explains other matters in this "magnitude of effort." He relates the tragic fate of all but a handful of Gaudí drawings when the architect's atelier in the Sagrada Familia church, where the drawings were kept, was gutted by fire in 1936 during the Spanish Civil War. For-

tunately, he continues, many of the drawings had been photographed or copied before their destruction and hence were available for publication here. Collins explains that the book is "hybrid" in that it contains not only Gaudí's sketches and renderings, but also modern measured drawings of his buildings. It would be virtually impossible to gain an understanding of Gaudí's architecture from his drawings alone, for "perhaps the most difficult thing to grasp about Gaudí's buildings is their complex spatial quality, and this can only be understood through a variety of measured plans and sections such as we include here."

In addition to the 186 drawings there are 30 plates of the measured drawings. Spatial relationships are seen in a rendering of the Palacio Güell, made by a student in the School of Architecture at Barcelona for the architect Luis Bonet Garí (1970). From Gaudí's own hand is the 1906 drawing (below) of the elevation of the Casa Milá. And delightfully whimsical is Gaudí's pastel drawing of the head of a goat done about 1900, possibly in preparation for the nativity facade of the Sagrada Familia church.

The book is further enhanced by Collins' account in precise and lucid prose of events in Gaudí's life and the development of his career, as well as his essay on the relationship of Gaudí's style to the Catalan architectural movement of his time, and another on how the drawings

continued on page 78

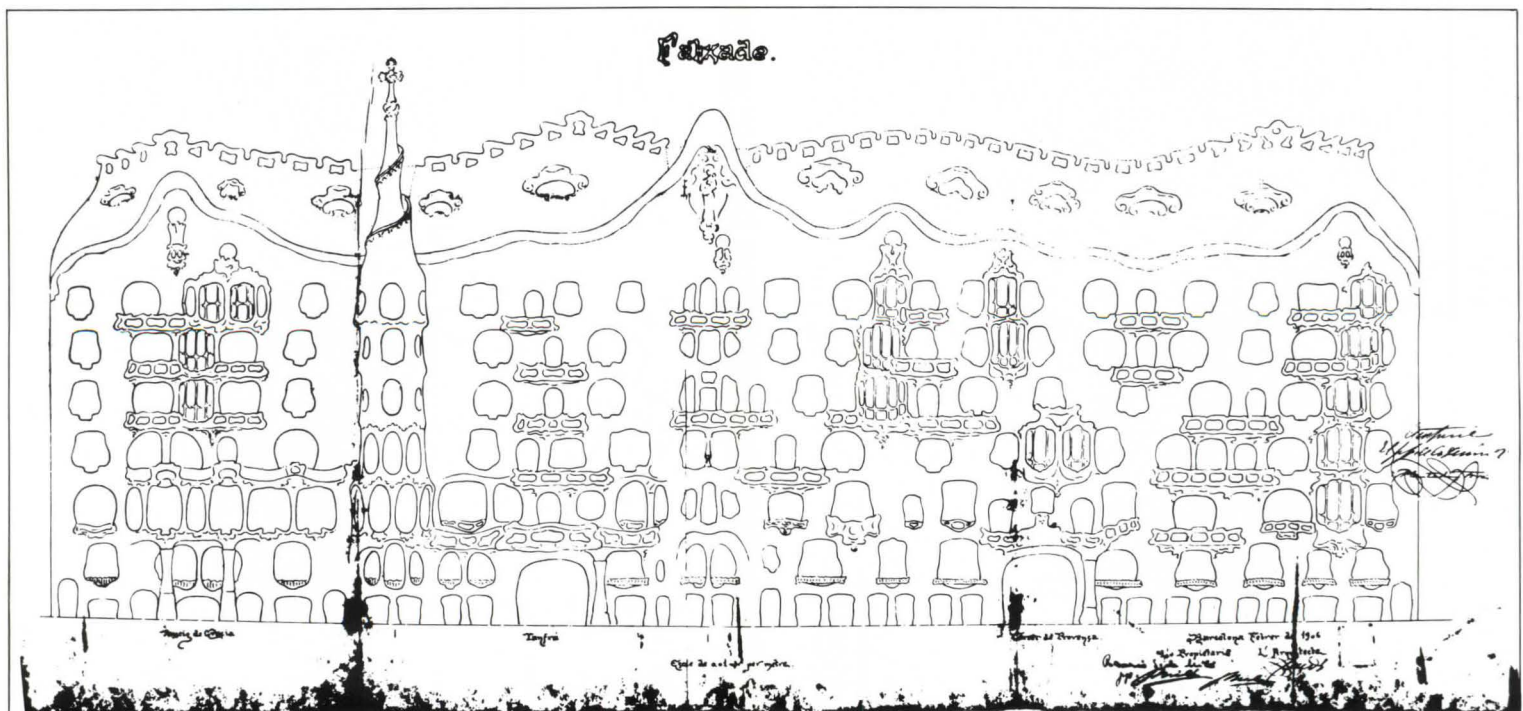

Books from page 77

show Gaudí's manner of working. There is also a chapter on the aphoristic sayings of Gaudí. One relates to the omnipresent problem of cracks. He said: "Cracks: all buildings have cracks as all men have sins; the question is that they be venial, not mortal."

Added to the insights into Gaudí's architecture afforded by the drawings and by Collins' brilliant text are a chronology of Gaudí's life and works and a *catalogue raisonné* of his drawings, meticulously compiled, as well as bibliographical and text notes.

One of Gaudí's maxims refers to books, but in no way can it be applied to this beautiful volume. Gaudí, perhaps in a cynical moment, said: "In books one seldom finds what one is looking for. And when one has found it, it is often wrong."

Traditional Japanese Houses. Edited and photographed by Yukio Futagawa; text by Teiji Itoh. (Rizzoli, \$75.)

Admirers of Yukio Futagawa's photographs, particularly in the "Global Architecture" series, will not be disappointed in this book in which he turns his camera on his native land, displaying in great detail vernacular architectural treasures of Japan now threatened by the onslaught of modernization and a different life style.

He is joined by Teiji Itoh, author of *The Classic Tradition in Japanese Architecture* and other books, whose vivid descriptions of the architecture and the manner in which it reveals Japanese culture supplement the handsome photographs (predominantly in black and white).

The book, a large and heavy one of 356 pages, concerns the *minka*, houses for farmers, tradesmen, fishermen, craftsmen, and laborers developed almost entirely between 1639 and 1853, a time of feudalism when there were strict laws as to what and how those outside the nobility or the military elite could build so that people's houses reflected their social status. It was a time when governmental policy isolated the nation from the rest of the world. Thus the *minka* reveal "pure Japanese elements," says Itoh, unlike other Japanese architecture that was influenced by China and the West. Even regions within Japan were isolated from each other, and the *minka* vary. People within a region built the same kind of dwelling generation after generation. Indeed, the introduction of any novelty was looked upon as a violation of the local social order.

Without benefit of architects, owners of these wooden houses erected them of whatever material was available—pine in the timber-rich Hida Mountains, chest-

nut in the northeast area of Honshu Island. Just as local materials reflected regional differences so did roof shapes. In some regions, there was the steeply pitched A-frame roof; in others the most frequent roof was gabled with plank covering, while in areas where silkworms were raised in attic spaces, a hipped roof was used. Of sturdy build, the *minka* was able to withstand Japan's climatic extremes—blizzards and deep snows in the north; heavy rains and typhoons in the south. "All these elements have contributed to regional differences in the *minka*," says Itoh. Built to the owners' requirements at a time when carpenters took great pride in their craftsmanship, the *minka* teaches us, says Itoh, "the importance of the enjoyment in building a house."

Different from Japan's other traditional residential architecture, the *sukiya*, or tea ceremony houses, which have a floor plan with structural posts and beams placed appropriately and roofs sometimes complicated in accordance with complex floor plans, the *minka* were of post-and-beam construction, providing a large space that could be divided later into smaller rooms as desired. In the *minka* the fundamental structure did not change, and the floor plan evolved after construction.

Itoh comments that today's modern *continued on page 81*

ACOUSTICAL ALUMINUM FLUSH PANELS FOR WALLS AND CEILINGS

- Removeable panel for easy accessibility.
- Flush wall surfaces do not pick up dirt easily.
- Lower wall surfaces resistant to abuse.
- Entire areas washable. To clean, sponge or hose down.

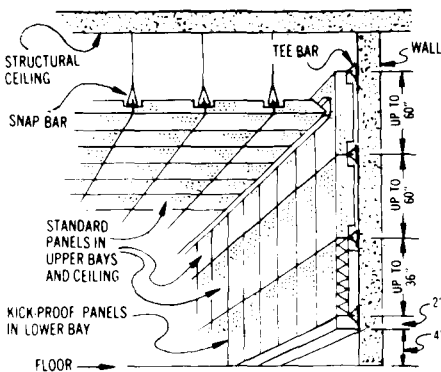

SOUND ABSORPTION COEFFICIENTS (ASTM C423-77)

PAD		THICKNESS				MOUNTING
Fiberglass Sealed in PVC		1 1/2" - 3/4 lb. density				7
125 Hz	250 Hz	500 Hz	1000 Hz	2000 Hz	4000 Hz	N.R.C.
.96	.90	.76	.91	.78	.59	.85

Supplied in several finishes and colors as well as baked white enamel. Refer to SWEET'S ARCHITECTURAL CATALOG Section 9.1/51

SIMPLEX CEILING CORP.

50 HARRISON ST., HOBOKEN, N.J. 07030 • PHONES (212) 349-1890, (201) 864-6630

• Sales "Reps" needed—Write to Simplex for information •



ARCHITECTURE AND THE CRISIS OF MODERN SCIENCE

Alberto Pérez-Gómez

"Geometry was demoted from its regal status as the generator of forms to being the servant of surveyors and engineers. It is a paradox that this happened as techniques of mensuration and construction, as well as geometrical speculation, intensified. Perez-Gomez has placed this paradox in its proper context, scientific and philosophical. But most important to me, he has shown how much that is done and written about architecture nowadays is a direct consequence of that demotion. This book is essential reading for anyone who believes that architecture must reaffirm its role as the theatre of memory and metaphor— that there is no such thing as a meaningless structure." —Joseph Rykwert

\$30.00 76 illus.

Write for our current architecture catalog.

The MIT Press

28 Carleton Street, Cambridge, MA 02142

Books from page 78

building is most beautiful just when it is completed and before maintenance problems set in. When the *minka* was erected, it was not really complete, and the beauty of the dwelling only emerged after years of use and the endless cleaning and polishing of natural materials. Now considered dark and lacking in privacy, the *minka* are disappearing. They either have become "lifeless" regional museums or they are occupied by those rich enough to make changes for contemporary living or those too poor to tear them down.

This book is a plea for their preservation as the quintessence of Japanese vernacular architecture, revealing the innate sense of proportion and the sensitivity to the colors and textures of natural materials of the Japanese. He finds it "natural" for people to want to renovate and repair the dwellings, but he bemoans the fact that "understanding the beautiful is lacking." There is no lack of beauty in this book about these ancient folk dwellings.

Planning the New Corporate Headquarters.

Bryant Putnam Gould. (Wiley, \$34.95.)

The author, a member of AIA who served as a member of the task force that assisted in the initiation of the Institute's publication *The Architect's Guide*

to *Facility Programming*, brings to this book his experience as senior vice president for predesign services for the Eggers Group. He calls a corporate headquarters building a "unique type of facility," but the principles he outlines for the successful planning and design of such a structure are applicable for any building type. He emphasizes predesign planning as essential in making sound decisions, considering in depth, for example, the scope of facilities, the size of site, and financial planning, all leading up to project initiation with the selection of design professionals and project scheduling. Gould shows how predesign planning can help "to avoid the penalties in cost, productivity, and morale arising from overcrowding, frequent space changes, and hasty expansion."

The Architecture of Ralph Erskine.

Peter Collymore. (Granada, distributed in this country by Renouf USA, Brookfield, Vt. 05036, \$39.95.)

At the age of 25, British born and educated Ralph Erskine left his homeland for Sweden where he has spent the vast portion of his architectural career. This move greatly influenced his architectural philosophy, both in his "adamant support" of user participation in the design process and his response to climate and

environment. In a strange country, it was essential to involve users in order for him to learn how everything operated, what the political and social history was, how buildings could be made appropriate for the climate. So he has come to use a process of investigation and discussion with building users in whatever project he has undertaken. And, he has studied in depth how to design for cold climates.

Against a backdrop of biographical data about Erskine, Peter Collymore has supplied a commendable introduction to Erskine's architectural philosophy. The major portion of the volume, however, is given over to Erskine's architectural works. The arrangement of this discussion of more than 60 of his buildings, projects, and designs is chronological, beginning with the 1942 design of his own home in Sweden and extending to a 1981 competition entry for an office building project in Cologne, West Germany.

Collymore categorizes Erskine's architecture as "romantic functionalist," meaning that the buildings are "useful and usable" and capable of "developing in different directions according to the demands of their use, the lie of the land, and the orientation. Erskine can allow his projects to develop with their own natural logic, with fewer constraints than formality would allow." □

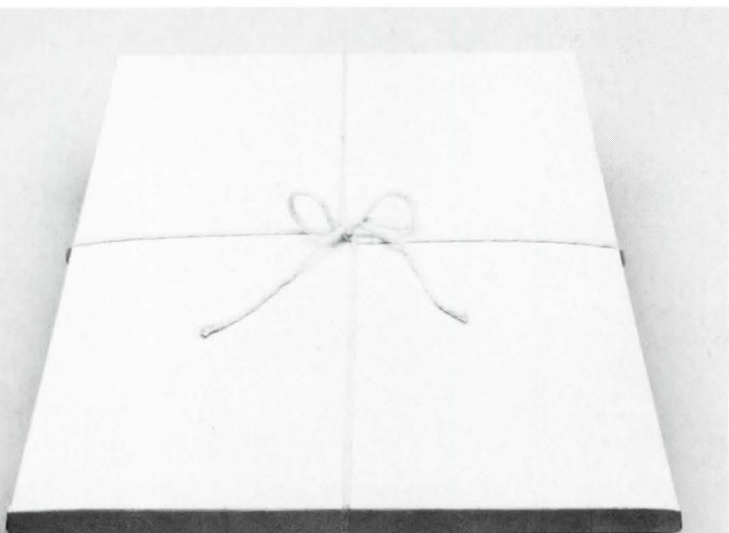

How to get your cedar design off the ground.

Send for this comprehensive Portfolio of eleven Outstanding Designs with Cedar Shakes and Shingles. Plus detailed sheets on Insulation. Roof ventilation. Roof junctures. Valleys and flashings. Product selection. Economy grades. How to specify. Care and treatment. Finishing. It's informative, imaginative and free. Suite 275, 515-116th Avenue N.E., Bellevue, WA 98004.

Or use the reader service number _____

Free.

Red Cedar Shingle & Handsplit Shake Bureau

Circle 25 on information card



SUN SYSTEM Prefabricated Solar Greenhouses are designed for fast, smooth installations in residential and commercial applications. The only 100% Thermally Broken passive solar greenhouse on the market.

For our new 24 page color catalog and price list write to:

SUN SYSTEM
PREFABRICATED
SOLAR GREENHOUSES

60U Vanderbilt Motor Parkway
Commack, New York 11725
or call toll free 1-800-645-4506
in NY 516-543-7766
Dealer Inquiries Invited

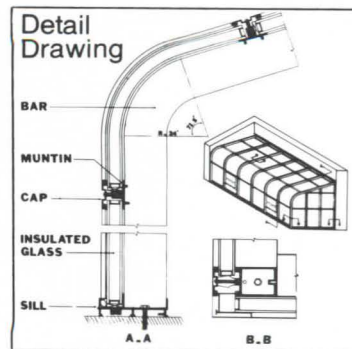

Sweets Catalog, Section 13.2c Sty

Circle 26 on information card

ARCHITECTURE/DECEMBER 1983 81

The Case for Steel Joists:

Deerwood Industrial Park Building

"When the client is a real estate development company you have to watch every penny. Because you know they'll be watching. We didn't want to compromise on strength, but we wanted the lightest, most economical construction possible. Steel joists were the obvious choice."

—Paul Hardaker, Engineer
Smith, Hardaker, Huddleston
& Collins, Inc.

Strength, lightness, economy are just a few of the many strengths open-web steel joist construction offers you.

Steel joists help speed erection, give you space between floors to run electrical conduit and HVAC lines, and provide a solid platform for simultaneous subcontracting.

We've put together all the facts you need to specify steel joists in our *Standard Specifications, Load Tables and Weight Tables for Steel Joists and Joist Girders*. And for retrofitting, renovation, reconstruction and restoration of existing joist-supported structures we've gathered 50 years of steel joist specification tables into our *50-Year Steel Joist Digest*. It includes all load capacities for steel joists published from 1928 to 1978.

Use the coupon below to bring your reference sources up to date.

The Deerwood Industrial Park Bldg./Owner: Rouse and Associates/Contractors, Norwood Industrial Construction, Inc. Architects, KBJ Architects, Inc./Engineers, Smith, Hardaker, Huddleston & Collins, Inc.



Clip and mail to:

Please send me _____ copies of the current edition of *Standard Specifications, Load Tables and Weight Tables*, at \$7.50 each including postage and handling. (\$8.50 outside U.S.)

Please send me _____ copies of the first edition *50-Year Steel Joist Digest*, at \$32.00 each including postage and handling. (\$42.00 outside U.S.)

Total amount enclosed \$ _____
(Payment must accompany order.)

83009

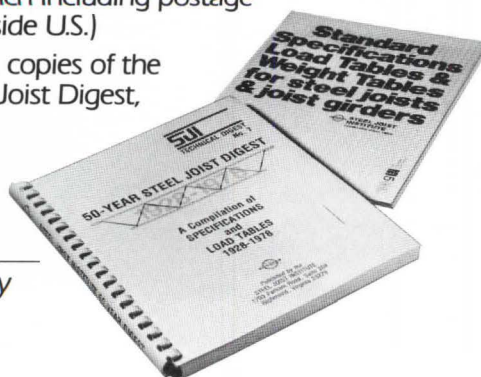

Steel Joist Institute

Station A
Myrtlewood Professional Building
48 Avenue North
Myrtle Beach, SC 29577



Name _____

Title _____

Firm _____

Address _____

City _____ State _____ Zip _____

Signature _____

Circle 27 on information card

Letters from page 7

DART wish to sell bonds to finance its rail plan, it must seek approval by another referendum. This future vote would be similar to the one Houston voters defeated.

Second, the picture given in your story of Houston's METRO bus service may have been correct a few years ago, but under the direction of new METRO General Manager Alan Kiepper, the bus operations have improved dramatically. Vehicle accidents have been cut to a third of 1981 levels, miles between mechanical road calls have increased by a factor of five, and on-time performance has increased from less than 50 percent to about 90 percent. In addition, virtually all METRO buses came through the hot 1983 summer with working airconditioning.

Third, with the passage of its referendum, DART must now put into place administrative machinery and procedures and must then begin to implement bus expansion plans before action on the rail system can begin in earnest. In the wake of the rail defeat, Houston's METRO has accelerated bus system expansion plans, including construction of additional maintenance facilities and construction of median bus lanes on three area freeways. At the same time, METRO is proceeding with the development of regional transit alternatives that it plans to take to the public in an intense community involvement program before settling on a single plan.

Finally, it is worth noting that transit referenda in cities such as Atlanta and Washington failed initially, but were eventually approved and led to construction of rail systems of which those cities are justly proud. *Jeffrey Karl Ochsner, AIA
Houston*

David Dillion responds: Jeffrey Ochsner's letter clarifies one aspect of the recent mass transit votes in Dallas, and muddies another. Ochsner is correct that Dallas voted to create a permanent transit authority, DART, and to finance it with a 1 percent sales tax, but did not give it authority to issue bonds. This action was equivalent to the creation of Houston's METRO in 1978. A permanent DART board has since been named. Dallas voters also approved a 160-mile regional rail plan, something that Houston still lacks. On the subject of Houston's bus service, the figures used in my article were from 1982-83, not "a few years ago." One consultant's report indicated that one day this spring 55 percent of the METRO buses were out of service, and approximately 10 percent broke down after leaving the garage. My article did not state or imply that Houston's transit system will not improve; only that it will take a lot to convince the much-abused Houston voters that the changes are real.

International Issue: Thanks for the international issue (August) and its diverting array of wide-ranging catholicity (and quality!) of design in the rest of the world. It's a refreshing change from our navel-gazing obsessions on whether Michael has shot his wad, or whence Philip cribbed his latest number, or how Arthur and Richard and Frank and Robert & Denise reacted to Peter's winning the latest competition. I hope the issue gets into all schools of architecture, to encourage students to think for themselves for a change in this world of incredibly varying possibilities.

*Jim Burns
San Francisco*

Kudos for 'Frankness': Finally the truth is spoken! Finally someone has come forth and made known the truth regarding the "mystery" of publishing architectural projects.

I would personally like to applaud your frankness shown in the editorial on page 33 of the July issue. From the point of view of a young, aggressive firm, it's time someone made a conscious effort to realize that architecture is and should be more than "skin" deep. I agree and encourage you to publish projects worthy of being called "architecture" and not just buildings with fashionable forms and pastel paint. In order for the relationship between architects and magazines to change, attitudes must change. Buildings should be accepted for publication based on more than just surface beauty. There should be a discussion of concept and purpose as well as photographs that "tell the story" in a realistic way.

I hope the time is over when the magazines feel they are doing you a favor by publishing your work. If it's good, it should be published, but it must be understood that if there are no architects, then there would be no architectural journals. I think it's time the process became a team effort. The lesson learned should be that good architecture can, in fact, speak for itself.

Team members should be able to talk to each other. I feel the architectural journals have an obligation to tell an architect why his project was or was not published. This kind of conversation will help both parties.

*Rand Elliott, AIA
Oklahoma City, Okla.*

Fuller's Vision: I've just finished reading "Buckminster Fuller: 'The Most Visionary Thinker of Our Times'" in the August issue (page 21). His vision for the future of humanity is awesome. A remarkable man.

How would someone explain to him the new NCARB requirements? "Sorry, Mr. Fuller, but you can't build your what-did-you-call-it (?)." Indeed, we are lucky that something like that didn't stop the magnificent dreamer. *Alvaro Andrade
Guatemala City, Guatemala*

Granite: silent eloquence



Texas Commerce Tower, Houston, TX
Architects: I.M. Pei & Partners -
3D/International, Inc.

Granites: Regal Gray, polished (on building).
Regal Gray & Regal Rose, thermal (in plaza).

Granite is unique among building stones in its combination of strength, stability and durability. With a choice of 10 richly varied colors and a range of finishes from polished to thermal, granite provides a surface that challenges your full creative powers. For information, our free brochure, samples and quotes, please call:



A NORTEK COMPANY

ROCK of AGES

Building Granite Corp.

McGuire Street

Concord, N.H. 03301

1-800-445-7050

In N.H. (603) 224-5325

Briefs from page 22

Kahn, executive director of Boston Urban Gardeners; Jane Lidz, architectural photographer; Phillip A. Morris, executive editor of *Southern Living* magazine; Shanker M. Pradhan, chief town planner of Katmandu, Nepal; Michael Pyatok, a Berkeley architect; and James R. Vaseff, an architect and urban designer for Georgia Power Co.

Decorative Arts Exhibit.

An exhibition focusing on the emergence of modern design in America, entitled "At Home in Manhattan: Modern Decorative Arts, 1925 to the Depression," is on view through Feb. 5 at the Yale University Art Gallery.

Parking Area Design Awards Program.

Federal APD and the Institutional and Municipal Parking Congress have selected three designs to receive awards for excellence. Winner as best design of a garage or lot with fewer than 500 spaces was the York City Parking Garage, submitted by Richard P. Goss, planning director in York, Pa. The best design over 500 spaces was awarded to Richard Choate and Greg Finstad for the St. Anthony Municipal Ramp in Minneapolis. For best design of parking program, winners were Harold Fredenburgh, AIA, and Anna Mutin, AIA, of I.M. Pei & Partners for the Texas Commerce Center, Houston.

BUILDING SPECS

New York Delicatessen, New York City (page 56). *Architect: Brad Elias, Hochheiser • Elias Design Group Inc., New York City.* Custom carpet: Durkan. Recessed lighting: Lightlab. Tables and chairs: Empire State Chair. Fabric wall-covering: Gilford. Kitchen wallcovering: Genon. Parabolic louvers: R&R Plastics. Carved glass and mirrors: Shefts Glass. Brass mouldings: Colonial Moulding & Frame. Wood wallcovering: I. D. International. Plastic Laminate: Nevamar. Brass laminate: Chemetal. Acoustical ceiling tile: U.S. Gypsum.

Oasis Diner, Boulder (page 58).

Architect: Communication Arts with Everett Ziegel Tumpes & Hand, Boulder. Stainless steel exterior siding: Fruehauf. Metal laminate: Alucobond. Galvanized steel metal: Paint Lok. Stamped metal: Mobile Metals. Sandblasted glass: Glass Inc. Specialties metal: Michael Davis.

Ocean One, Atlantic City, N.J. (page 64).

Architect: Cope Linder Associates, Philadelphia. Roof deck: Zonolite. Exterior metal cladding: E.G. Smith. Exterior finish: Sherwin Williams Superclad. Deck surface finish: Kelmar 350. Skylights: Fisher. Wood floor finish: Harris Bond. Tile floor: Summitville. Tile partitions: Dal Tile. Stair,

elevator, and mechanical shafts enclosure: Gypsum Shaftwall. Drop ceiling: Armstrong. Glass elevator: Eastern Elevator Co. Column lights: Lightoiler. Escalators: Schindler Haughton. Mechanical system: Trane and Webco.

4250 Connecticut Avenue, Washington, D.C. (page 68).

Architect: Hartman-Cox, Washington, D.C. Masonry: Belden Brick. Curtain wall: M.C.E., Alcoa. Glass: PPG, Guardian. Precast pavers: Hastings Pavement Co. Elevators: U.S. Elevator. Metal doors: Williamsburg Steel Products. Wood doors: Triangle Pacific Corporation. Hardware: Atlantic Hardware Supply Co. Building directories: Davson. Overhead doors: J. G. Wilson. Insulation: Johns-Manville, Grace, Owens-Corning, Dow. Roofing materials: Volken, Gates. Bathroom accessories: American Dispenser Co. Mechanical equipment: Singer, Titus, Ruskin, Environmental Elements. Toilet partitions: Global. Venetian blinds: C.D.S. V.A.T.: Armstrong. Drywall: Gold Bond. Sealants: Pecora Corporation. Ash receptacles: Watrous. Specialty signs: Belsinger Sign Works. Ceramic tile: American Olean. Parking entrance signs: Jack Stone. Fire extinguisher cabinets: Larsen. Louvers: Penn Ventilator. Lighting fixtures: Lithonia, Cal, Hi Tek, Devoe, Devine. Sprinklers: Fireguard Corporation. Expansion joint systems: Construction Specialties. □

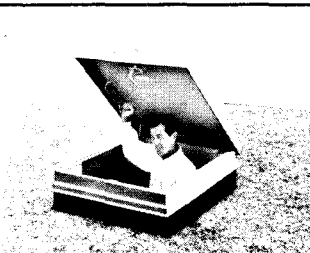

Bilco. The finest in horizontal doors.

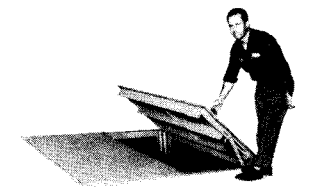

When your need is for roof scuttles, floor and pit doors, automatic fire vents — any type of horizontal door — look to the leader. Every Bilco product gives you the design, the quality, the workmanship, and the operation that assures long service and complete satisfaction.

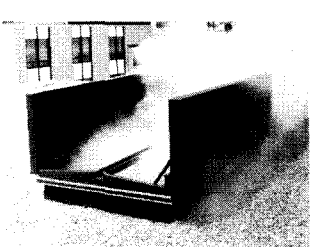

For full information, details and specifications, send for our catalog.



The Bilco Company, Dept. AJ-123 New Haven, Conn. 06505

Are you on the mailing list?

Quarterly newsletter features:

- question and answer column for those who specify insulating glass,
- brief description of buildings that make use of insulating glass units fabricated with Morton Thiokol insulating glass sealants,
- announcements of new products, new literature, helpful articles and other items of interest.

To receive your copy, write: Morton Thiokol, Inc., Specialty Chemicals Division Mkt. Comm-AIA, P.O. Box 8296, Trenton, NJ 08650

MORTON THIOKOL, INC.
Specialty Chemicals Division

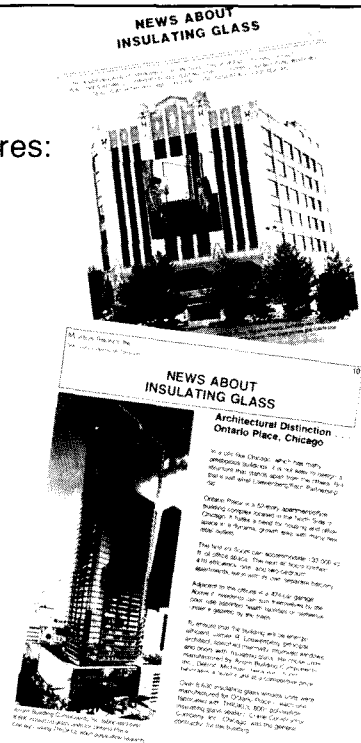

"18 years' service and still counting. That's the performance record of single-ply roofing of Hypalon.®"

—John Breitenstein, Du Pont

"Single-ply roofing membranes of DuPont HYPALON synthetic rubber have been weathering everything under the sun for the past 18 years," says John Breitenstein, Programs Manager. "That's because HYPALON is a high-performance rubber with durability benefits that meet the most demanding roof requirements."

A single-ply membrane of HYPALON is installed quickly and easily. Since it is thermoplastic when put down, seams are as strong and reliable as the membrane. The mem-

brane gradually cures in place to produce an integral, tough, strong elastomeric roofing surface.

Roofing membranes of HYPALON also offer:

- Reflective white color for energy efficiency.
- Resistance to flame propagation.
- Excellent resistance to oils, chemicals and pollutants.
- Excellent resistance to ozone and UV rays.

- Serviceability over a temperature range from -40°C (-40°F) to 93°C (200°F).
- Colorability for a range of aesthetic designs.

Specify HYPALON—made only by Du Pont*—for durable, low-maintenance roofing membranes. Call toll free, 800-441-7111, ext. 44, for further information. Or for free literature, write: Du Pont Company, Room X-40097, Wilmington, DE 19898.

*Du Pont manufactures HYPALON, not single-ply roofing membranes or systems.



Courtesy of Christie's



1

©Chun Y. Lai/ESTO



2

Furnishings

*Also drawn from the deco period.
By Nora Richter Greer*

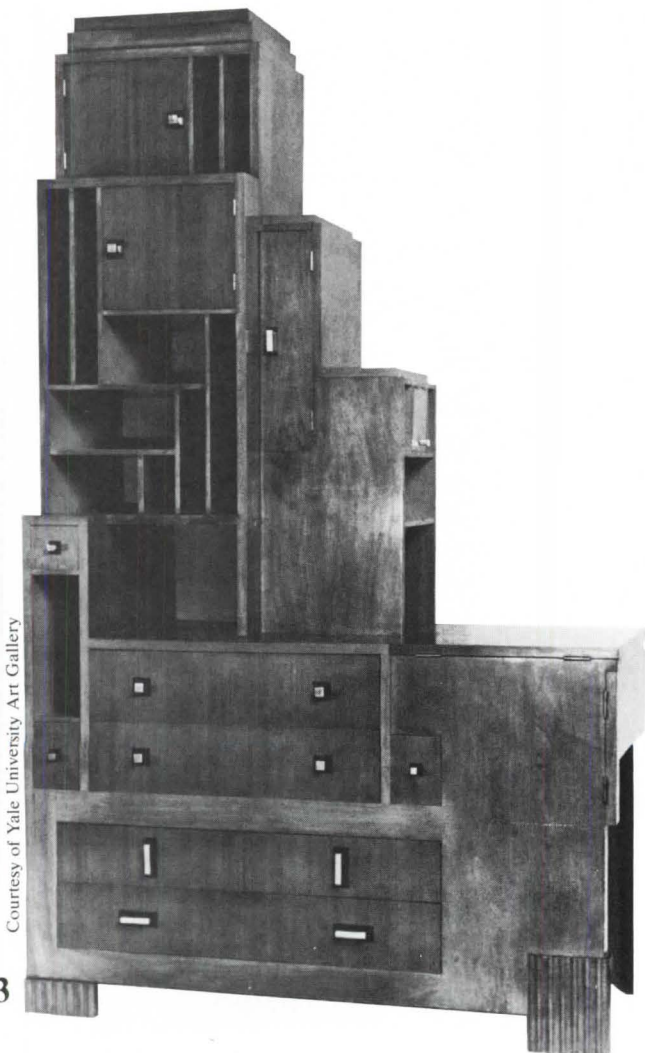

Courtesy of Yale University Art Gallery

3

By the time of the 1925 Exposition Internationale des Art Décoratifs et Industriels Modernes in Paris it was obvious that furniture design had been radically transformed from what was later called art nouveau to art deco. Gone were the flowery, flowing, curving lines. Instead the lines were straighter, the forms were simpler yet still very stylized, materials were more exotic, colors brighter. By the '30s, furniture design, particularly in America, became even more streamlined, with stainless steel and inexpensive woods replacing ivory, ebony, and rosewood. Currently, auction houses and galleries are commanding impressive prices for original art deco furniture, as it seems to be more popular, and correspondingly more expensive, than art nouveau.

One technique that was favored by the French for deco furniture was mother-of-pearl marquetry, as seen in Jean Dunand's fine black lacquer and "coquille d'oeuf" table (1), with jagged legs and patterned top. A red upholstered arm chair of the '30s (2) shows the use of bright colors and streamlining. And American designer Paul T. Frankl's highly stylized bookcase and desk (circa 1928) shows the influence of the deco skyscraper style (3).

Among art deco objects sought by today's collectors are the sometimes erotic statues. While many figures stood alone, others adorned lamps and clocks, such as Ferdinand Preiss' mantel clock (4). Its very geometric components are made of marble, onyx, ivory.

One of the premier American furniture designers of the '20s and '30s was Donald Desky, who designed the interiors of Radio City Music Hall. His mastery of streamlining is reflected in a table of brass-plated steel, Bakelite, and wood (5). An example of the more vernacular American deco furniture is the "six reed" chair (6), with almost gaudy, tropic-inspired material and streamlined reeded wood frame. These two American designed pieces contrast sharply with the French designed vanity (7) and cabinet (8). The vanity illustrates a common technique used by the French: exceedingly slender, tapering legs that end in tiny ivory feet, but in this case the feet sit on an ivory base. Emile-Jacques Ruhlmann's cabinet has ivory highlights and an octagonal metal decorative piece showing the "femininity" of art deco. □



6

5

Courtesy of Yale University Art Gallery

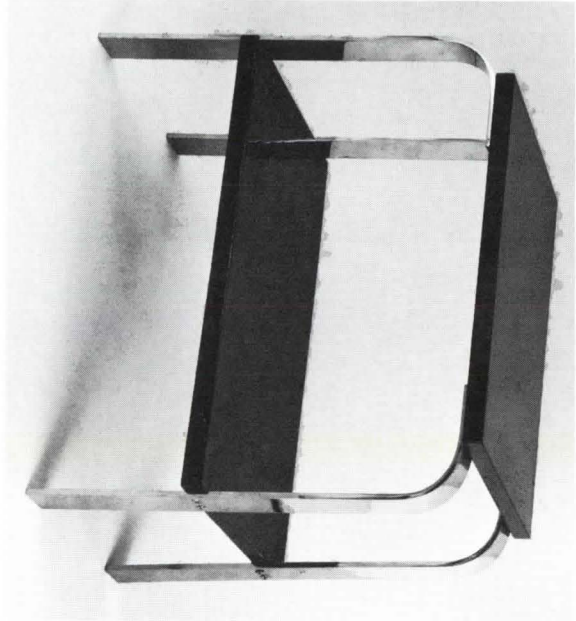

4

Courtesy of Cooper-Hewitt Museum

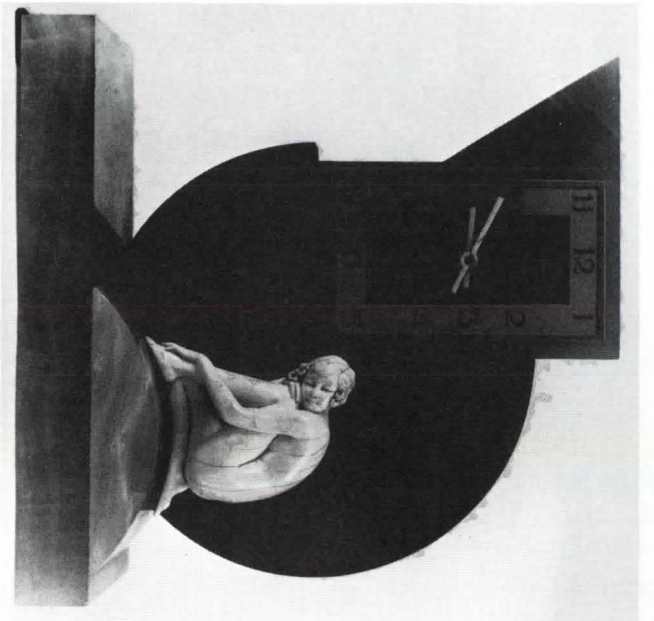

8

Courtesy of DeLorenzo Gallery



©Chun Y. Lai/ESTO

7





SYSTEM R RESPONSIVE

Addressing the Need for Flexible Storage.

Storage requirements are always changing — new technology, tools, work styles and functions, and the need for more printed data means that storage units once used for a single purpose will usually be required for another.

American Seating's System R responds to this requirement

with a universal cabinet, combining the minimal number of well-designed and engineered hardware elements for the maximum number of storage formats ... from open shelves to closed flipper door units, lateral hanging files to an almost limitless variety of horizontal and vertical space divisions. And, no storage unit need ever be permanently dedicated — functional change is always timely.

The result is totally flexible storage — responsive to the growing and changing business organization — American Seating's System R, for responsive facilities now ... and in the future.



901 Broadway, N.W.
Grand Rapids, Michigan 49504
800/253-8104 616/456-0600
Telex 22-6326

Circle 32 on information card

Products

A selection of notable offerings and applications. By Lynn Nesmith



1

Architectural metalwork (1) by Pittcon Industries is fabricated of polished stainless steel tubing rolled to any radius over six inches with two layers of epoxy adhesives. Metal sheets 18 feet long are bent and formed by computerized hydraulic equipment for large custom installations, including columns and telephone booths. (Circle 161 on information card.)

Westinghouse's Wes-Tech series (2) of interchangeable office furniture features independent terminal and keyboard height adjustments, a display screen that tilts, and nonglare work surfaces. The four drawer storage unit, available in solid colors, patterns, wood grains, or veneers, has movable diagonal and horizontal files. (Circle 162.)

The Solarium (3) in Denver by WZMH Architects incorporates the Moore Automated Daylighting System of sensors, louvers, and controls. The system is designed to interact with a building's energy management system, activated by interior and exterior sensors, or be operated manually with a rotary dial. The brushed aluminum blades may be installed in a pattern of either horizontal bands or vertical stripes. (Circle 163.)

continued on page 92



2

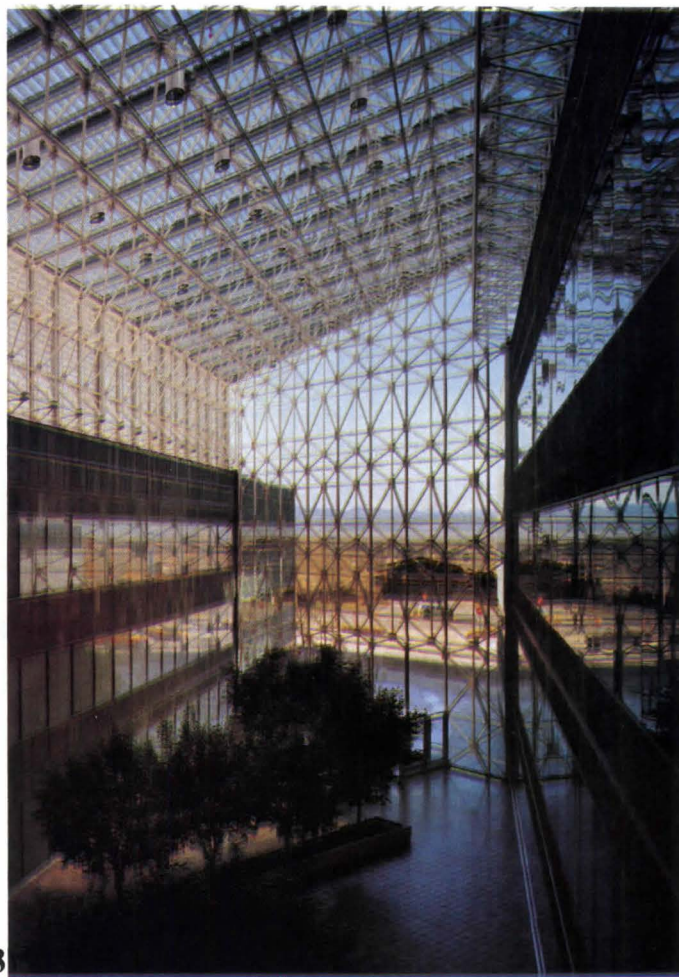

3

Ken Laman, Laman & Assoc

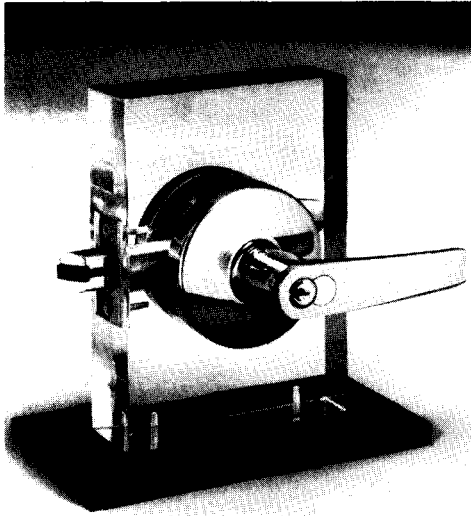

Cylindrical Lockset.

Corbin 700 series heavy-duty, lever handle cylindrical lockset (above) uses a single bolt mechanism in a 1/2-inch throw latch position and can be extended to a one-inch dead bolt position with a key or inside turnpiece. It is made of cast bronze or stainless steel with internal mechanisms constructed of hardened steel and is adaptable to standard cutouts for use in renovations and new construction. (Corbin Hardware Group, Berlin, Conn. Circle 188 on information card.)

Acoustical Wall Surfacing.

Acoustical Plus spray textured wall covering, applied over interior concrete or nonveneer plaster ceiling and noncontact walls, is designed to provide a decorative finish with acoustical absorption and fire resistance in multifamily housing, highrise apartments, institutional, and retrofit construction. It can be applied one inch thick and dries to a hard, nonflaking finish. (U.S. Gypsum, Chicago. Circle 187 on information card.)

Textured Wallcovering.

Vicrlite lightweight, vinyl coated fabric wallcovering, designed for light traffic commercial and residential installations, is available in three weight categories in 31 patterns and 500 colors. (L. E. Carpenter, Wharton, N.J. Circle 186 on information card.)

Energy Control Sensor.

Per-Sen low voltage ultrasonic personnel sensor is designed to detect human motion in a 450-square-foot area to monitor lights, fans, and airconditioning systems with a 1-to-12 minute delay. The unit measures 3 1/2 x 6 x 1 1/2 inches and is mounted on the ceiling. (Flec Systems, Inc. Wayne, Pa. Circle 181 on information card.)

Wooden Ceiling Panels.

Armstrong's Woodcuts ceiling panels feature solid wood veneers in walnut and light oak applied over a mineral fiber substance. Panels measure two feet square

and have a slightly angled tegular edge for installation in a standard metallic suspension grid or flush mounted in the Armstrong Trimlok grid system. (Armstrong World Industries, Lancaster, Pa. Circle 189 on information card.)

Vaulted Skylight.

O'Keefe's barrel vault skylight system, the Horizonvault, is made with an extruded aluminum sill, caps, and neoprene gaskets. It may be single-, double-, or triple-glazed with manually or electrically operable sections. (O'Keefe's Inc., San Francisco. Circle 179 on information card.)

Glazing Material.

Lexan profiled sheet, a double-walled polycarbonate resin structured glazing, is designed to resist ultraviolet rays, protect against impact and vandalism, and resist yellowing and hazing. It can be used as a flat glazing or cold-formed into a curved profile for barrel vault installations. (General Electric Plastics Operations, Pittsfield, Mass. Circle 178 on information card.)

Wallcovering.

Flexi-Wall Plaster in a Roll, a gypsum-impregnated, flexible, textured wallcovering, is designed to resist mildew and combat moisture problems in humid climates. It is fire-retardant, nontoxic, and can be applied directly over concrete block walls. Three weaves and 35 colors are available. (Flexi-Wall Systems, Liberty, S.C. Circle 177 on information card.)

Thatching Manual.

Warwick Cottage Enterprises, installer of water reed thatched roof coverings, has produced a 24-page thatching manual (below) that describes Warwickshire thatch and its application with full specifications, architectural detail, roof deck construction, and structural requirements. The thatch is designed to provide fire-retardation, insulation, and wind resistance. (Warwick Cottage Enterprises, Costa Mesa, Calif. Circle 176 on information card.)

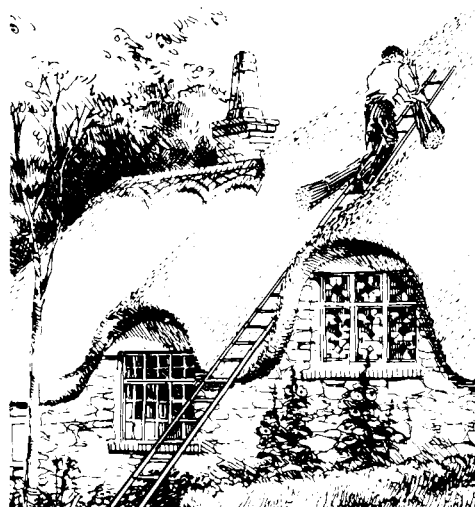

Vertical Blinds.

Newell residential blinds, available in two textures, four colors, and ivory, walnut, and woodgrain finishes, adjust to fit windows from 30 to 122 inches in width. (Newell Window Furnishings, Rockford, Ill. Circle 142 on information card.)

Panels of Glass Blocks.

Preassembled panels of Pittsburgh Corning GlassBlock are mortared into place to resist breakage and provide increased security. A variety of patterns provides varied degrees of light transmission and visibility. (Pittsburgh Corning Corporation, Pittsburgh. Circle 141 on information card.)

Greenhouse Window.

Garden Galleria Window, constructed of redwood framing with a thermally broken glazing system and operable screened vents, is available in seven standard sizes. (W. J. White Co., Minneapolis. Circle 140 on information card.)

Drafting Table.

Teledyne Post's Contempra drafting table has a white melamine drawing surface and four individual leg levelers. The table adjusts from horizontal to full vertical position, and from 32 to 42 inches in height. (Teledyne Post, Chicago. Circle 144 on information card.)

Entrance Mat.

Turfmat high traffic entrance mats are constructed of acrylic vinyl with perforated hinges covered with Antron nylon or vinyl treads either recessed or surface mounted. Four carpet colors and eight vinyl finishes are available for installations in apartment buildings, offices, factories, hotels, and retail stores. (Decogard Products, Muncy, Pa. Circle 184 on information card.)

Automatic Barrier Door.

Fire and smoke barrier door, controlled by LCN SED Setriconic series closer, is designed to automatically close when activated by smoke and fire. A hydraulic closer with adjustable single point hold-open and a built-in smoke detector can be worked alone or in conjunction with new or existing signaling or monitoring equipment. (LCN Closers, Princeton, Ill. 61356. Circle 183 on information card.)

Exterior Paneling.

Cameo lightweight exterior panels are constructed of a honeycomb core of aluminum between aluminum skin panels with a permanently bonded porcelain enamel coating with a semimatte or high gloss finish in a number of standard or custom colors. Panels can be fabricated flat or in curved modular shapes for corner or edge installations. (California Metal Enameling Co., Los Angeles. Circle 185 on information card.) □



It's too long
to wait for Abitare
by ship.

ABITARE

the magazine
specializing in
Architecture
Interiors and Design

is now available to you **BY AIR.**

Here is your chance to receive
up-to-the-minute issues of Abitare
directly from the Publisher **AT NO EXTRA CHARGE.**

A one year subscription — ten issues — now costs only US \$65.00 which includes air shipment from Milan to New York, instead of US \$140.00 (\$75.00 for ten issues plus \$65.00 for air shipment). We look forward to receiving your subscription soon. Please fill in and mail the enclosed order form to either one of our two offices in your country:

ABITARE/Virginia Gatti
6725 Allott Avenue
Van Nuys, CA 91401
ph. (213) 994-4462

ABITARE
127 East 59th Street
New York, NY 10022
ph. (212) 758-4372

Don't miss this opportunity to receive
ABITARE, the most
prestigious magazine
in the world.

ABITARE

Subscription to ABITARE for one year (ten issues, air shipment Milan — New York) at the special price of US \$65.00 instead of US \$140.00.

Mr Ms Last name _____

First name _____

Company _____

Address _____

City _____ State _____ Zip _____

Profession _____ Signature _____

Subscription starting from month of _____

Please enclose your \$65 check made out to ABITARE

Résumé des Articles Principaux

Renaissance de l'Art Deco.

Page 31: L'intérêt extraordinaire manifesté pour le design et l'architecture des années 20 et des années 30 se développe dans un contexte crucial. Quelques constructions importantes de style art déco ont été restaurées, mais un nombre important d'entre elles ont été détruites ou sont menacées de démolition.

Art Déco et lignes aérodynamiques modernes.

Page 34: L'Exposition de Paris de 1925 est considérée comme le point de départ du style art déco américain, qui se reconstruit d'abord dans les masses verticales et surchargées des gratte-ciel puis dans le style "classique" moderne et enfin dans le style moderne aérodynamique. Tandis que l'architecture et le design Art Déco ont été adoptés par les classes moyennes, les tenants du style International les ont dédaignés.

Boulder Dam.

Page 45: Construit au milieu des années 30, le Boulder Dam, qui s'appelle désormais le Hoover Dam, exprime la puissance des forces naturelles qu'il maîtrise dans un style art déco aérodynamique. La conception d'ensemble est due à l'architecte Gordon B. Kaufmann. Situé sur la rivière Colorado, le barrage s'élève à 726.4; sa base est large de 600 pieds et sa plate-forme compte 44 pieds. Les techniques de refroidissement du béton expliquent les différentes tonalités du barrage.

New York Delicatessen.

Page 56: En redessinant l'intérieur d'un self-service d'inspiration "art-déco" en un magasin d'épicerie fine, le décorateur Brad Elias a conservé le maximum des structures anciennes et a ajouté du piquant aux nouvelles. Aux dires d'Elias, le résultat offre un ensemble d'apparat hollywoodien", un zeste de décor des studios de Busby Berkeley, et une touche du Music Hall de Radio City.

Oasis Diner.

Page 58: La salle de restaurant, de ligne aérodynamique, décorée en métal inoxydable brillant, dans le style des années 20 et des années 30, a été réaménagée dans ce restaurant de Boulder, Colorado, et redessinée par Communication Arts. Afin de pouvoir adapter les formes longues et étroites d'une salle à manger aux exigences d'un bâtiment carré, l'architecte a décidé de créer une double salle à manger, les deux parties se regardant l'une l'autre.

La Tour Watermark.

Page 60: Les caractéristiques de cette tour

de Seattle, qui font penser à l'art déco, n'ont pourtant pas été conçues dans cet esprit, d'après les architectes du groupe Bumgardner. Les couleurs utilisées pour la couronne s'expliquent, d'après eux, par le souhait d'égayer cet immeuble. On a recouru aux revêtements de tuiles en raison de leur faible coût et de la présence d'emplacements prévus pour les fenêtres. Les structures décalées ont été utilisées parce qu'elles permettent de bien distinguer les commerces et les bureaux des habitations individuelles situées aux niveaux supérieurs, et de prévoir des balcons. De plus, les environs de la tour sont surtout occupés par des immeubles du début du 20ème siècle, et les architectes cherchaient à créer une image qui soit à la fois frappante et accueillante. D'après eux, l'art déco s'y prêtait tout naturellement.

Bâtiment de la Transco Energy Company.

Page 62: Conçu par le groupe d'architectes John Burgee avec l'aide de Philip Johnson, la Tour Transco Energy Company, à Houston, est une structure élancée, faite de miroirs et de verre non-réfléchissant, qui s'élève dans le ciel avec la même force que les gratte-ciel les mieux réussis des années 20 et des années 30.

Ocean One.

Page 64: Dessinée par Cope Linder Associates de Philadelphie, la galerie marchande Ocean One construite sur une

jetée d'Atlantic City se présente comme un paquebot qui réunit de façon très réussie les formes dépouillées du style art déco avec l'atmosphère qui est propre à la vie sur un navire. Le bâtiment comporte de nombreux ponts extérieurs sur le pourtour comme sur le toit, offrant de beaux points de vue sur le front de mer, la plage, et l'océan.

Postes de péage du Golden Gate Bridge.

Page 67: Quand il s'est agi de remplacer les postes de péage abritant les caissiers travaillant sur le Golden Gate Bridge à San Francisco, l'équipe d'architectes responsable de la maintenance du pont a conçu des petits réceptacles sans aucun rapport avec ce pont orange de conception moderne. Les architectes locaux ont protesté et Donald McDonald a dessiné ces abris solides aux lignes pures.

4250 Connecticut Avenue.

Page 68: Hartman-Cox à Washington, D.C. a eu recours à un style qui s'inspire de l'art déco pour concevoir ce bâtiment ramassé, très caractéristique, mais qui réserve des surprises car ce style permettait de gagner sur la surface à aménager. Il y a plusieurs constructions de style art déco dans le voisinage, et il fallait que l'énorme bâtisse (200 pieds sur 400 pieds) n'écrase pas la proche Université du District of Columbia, sa voisine située au sud. Une fois que les architectes ont fait le choix d'adopter des lignes qui mettent en évidence les structures décalées, l'art déco est apparu comme la solution toute trouvée.

Resúmenes de Artículos Principales

Renacimiento del arte decorativo.

Página 31: El enorme interés en el diseño y la arquitectura de los años veinte y treinta llega en un momento trascendental. Se ha restaurado ya un puñado de estructuras de arte decorativo importantes, pero un número mucho mayor se han perdido o están amenazadas con demolición.

Artes Decorativo y Moderno.

Página 34: La Exposición Parisina de 1925 se considera como el punto de partida para el Arte Decorativo estadounidense, que se expresó inicialmente como el estilo de rascacielos vertical y sumamente ornamental, luego como el estilo moderno clásico y finalmente como el estilo moderno aerodinámico. Aunque la arquitectura y diseño de arte decorativo fueron adoptados por la clase media, los defensores del Estilo Internacional lo despreciaron.

Presa de Boulder.

Página 45: La Presa de Boulder, llamada ahora Presa de Hoover, construida a

mediados de los años treinta, expresa el poder de las fuerzas de la naturaleza a las que subyuga con su aerodinámico estilo de arte decorativo, diseño del arquitecto Gordon B. Kaufmann. La presa, situada en el río Colorado, se eleva a una altura de 726.4 pies, con una base y cresta que miden, respectivamente, 660 pies y 45 pies de anchura. La variación en la tonalidad se debe a las técnicas para enfriamiento del hormigón.

Diseño aerodinámico.

Página 48: En la década de 1930, surgió en Estados Unidos una escuela de diseño comercial que se inspiró en el diseño concebido para reducir la fricción a medida que un objeto se movía a través del aire. Este concepto de diseño también se aplicó a objetos inmóviles, tales como los refrigeradores, los aparatos de radio y la arquitectura. Con este diseño se trataba de representar el movimiento y la velocidad y sugerir el paso sin esfuerzo de los productos a los consumidores. Water Dorwin Teague, Norman Bel

Geddes, Raymond Loewy y Henry Dreyfus fueron cuatro diseñadores americanos que dirigieron la escuela del diseño aerodinámico.

Fiambrería neoyorquina.

Página 56: Al volver a diseñar el interior de un antiguo restaurante de servicio automático de arte decorativo y convertirlo en una fiambrería, el diseñador interior Brad Elias mantuvo la mayor parte posible de la construcción antigua y añadió brío a la construcción nueva. La fiambrería acabada es, como dice Elias, "una obra con decoración de Hollywood, con cierto fondo de película de Busby Berkeley, y un toque de Sala de Música de Radio City".

Oasis Diner.

Página 58: El reluciente comedor de acero inoxidable, aerodinámico, de los años veinte y treinta fue reinterpretado en este restaurante de Boulder, Colorado, diseñado por Communications Arts. Para encajar la configuración larga y estrecha tradicional de un comedor en un edificio cuadrangular, el diseñador creó fundamentalmente un comedor doble, en el que un lado reproduce exactamente al otro.

Watermark Tower.

Página 60: Las características del arte decorativo de esta torre de Seattle no fueron intencionadas, declara Bumgardner

Architects. La corona policroma proviene, según afirman, de un deseo de decoración; el recubrimiento de azulejos se debe a su reducido costo y venía con ventanas insertadas; el retranqueo en los pisos se debe a que podía diferenciar los establecimientos de venta al detalle y las oficinas de las unidades residenciales de nivel superior y proporcionar balcones. Además, la vecindad de la torre contiene edificios pertenecientes predominantemente a los primeros años del Siglo 20 y los arquitectos deseaban conseguir una imagen espectacular aunque acogedora. Afirman que la decoración vino naturalmente.

Edificio de Transco Energy Co.

Página 62: La torre de la empresa Transco Energy Co., en Houston, diseñada por John Burgee Architects con Philip Johnson, es una estructura elevada de vidrio reflejado y no reflexivo con un empuje ascendente tan espectacular como el de los mejores rascacielos de los años veinte y treinta. Recuerda también el pasado de la parte superior decorativa, la base ampliada y la simetría de Transco.

Ocean One.

Página 64: La galería de tiendas de Ocean One en un muelle de Atlantic City—diseñada por Cope Linder Associates, Filadelfia—combina el aspecto de embarcación y detalles aerodinámicos festiva

de un barco de pasajeros construido al estilo del arte decorativo. El edificio hace un amplio uso de cubiertas exteriores, tanto en el tejado como alrededor de su periferia, y ofrece vistas del paseo de entablado, la playa y el océano.

Casetas del Puente Golden Gate.

Página 67: Cuando las casetas de los cobradores de peaje en el puente de Golden Gate en San Francisco requirieron reemplazo, los propios arquitectos del puente diseñaron pequeñas casetas que no tenían afinidad alguna con el propio monumento "orange moderne". Los arquitectos locales se opusieron y Donald McDonald diseñó estos albergues robustos y aerodinámicos.

4250 Connecticut Avenue.

Página 68: Hartman-Cox, Washington, D.C., empleó un estilo influenciado por el arte decorativo para este edificio interesantemente masivo pero algo jactancioso ya que una forma de obtener elaboración de la superficie. Además, había varias estructuras al estilo del arte decorativo en la vecindad, y el programa exigía que la enorme estructura (200x400 pies) bajara para encontrar a la Universidad del Distrito de Columbia, su vecina al sur. Una vez que los arquitectos optaron por el desmonte para articular el retranqueo, el arte decorativo fue el resultado evidente. □

Help America SAVE ENERGY

Specify Homasote Energy Saver Products

Send For Free Homasote
"Sweets" Catalog
Insert Describing...

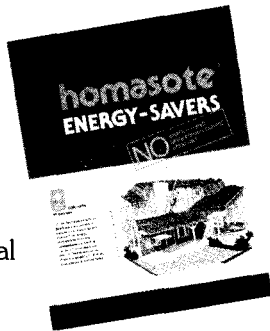

- New rigid urethane foam structural and non-structural insulation panels and substrates!
- UL rated fire-retardant structural panels and substrates!
- Homasote Roof Decking, Floor Decking and carpet underlayment!
- All without asbestos or ureaformaldehyde additives!
- Plus, tackable decorative paneling with authentic burlap and various cork surfaces!

Write:

homasote Company
P.O. Box 7240
West Trenton, NJ 08628-0240
Energy-Saving Building Materials Since 1909



GET TWICE THE INSULATION EFFECTIVENESS WITH ENERMMASTER™ ROLLING DOORS

Compare for yourself and get:

1. Twice the insulation
2. Insulation 1-1/2 inches deep
3. A 13/16" Thermal break
4. Insulation with the highest (R) resistance factor
5. No gaps or voids inside the slat
6. Two faces of galvanized steel to protect the insulation



Atlas Door Corp.
116 Truman Drive, Edison, New Jersey 08818
(201) 572-5700 Telex No. 710-480-6564

A

Aalto, Alvar. Je 58
 Abercrombie, Stanley: *Evaluation: Beaubourg Already Shows Its Years.* Sep 62; *The First Built Parts of a Cemetery Famous Before Building Began.* Aug 162; *Furnishings.* Jan 96; *Milan's Annual Design Extravaganza.* Apr 78; *Sturdy Set of Traditional Forms.* May 220; [bk rev.] Apr 78, Sep 82
About Style, Not Ideology. [Gebhard] Dec 34
 Accessibility. California buildings standards commission Mar 51
Activities of UIA and Other International Bodies. [Crosbie] Aug 59
 Adams, Jennifer A.: [bk rev] Jan 84, Apr 94
 Adler & Sullivan. Apr 44
 A/E procurement. Massachusetts Feb 15
AIA Directory 1983. [Nesmith, Crosbie] Feb 66
The AIA Honor Awards 1983. [Greer] May 248
 Airport facilities. Haj terminal at Jeddah International Airport, Saudi Arabia May 276
 Aldington Craig & Collinge. Aug 121
 Alikalfić, Dapa, and Morankić. Aug 158
An Amalgam of Styles in a Witty 'Spec' Bldg. [Dean] Dec 68
 American Telephone & Telegraph. Jy 60
 Ando, Tadao. Aug 154
 Arnold, Christopher: *Rolling with the Punch of Earthquakes.* Sep 74
 Art deco. Dec issue
 Art nouveau. house Mar 56
 Arthur Cotton Moore Associates. Nov 48
 The Arts. Jan 34, Feb 30, Mar 57, Apr 44, May 58, Je 31, Jy 30, Aug 53, Sep 29, Oct 45, Nov 39, Dec 26
 Asmusen, Erik. Aug 146
 Aspen, Colo. Sport Obermeyer office/warehouse Jan 44
 Aspen Design Conference. Jy 11
 Associated Space Design. Nov 48
 Association of Collegiate Schools of Architecture. Mar 28
 Association for the Development of Traditional African Urbanism and Architecture. Aug 110
 Atget, Eugene. Feb 30
 Atlantic City, N.J. Ocean One Shopping Center Dec 64
 Australia. Aug 172
 Austria. Aug 94
 Awards. Aga Khan Oct 22; AIA/ACSA Mar 28; Air Force Jan 26; components May 112; Easter Seal Jy 17; firm, AIA, Feb 43; gold medal, AIA Jan 13; honor May 248; honorary members, AIA Feb 21; IFRAA Jan 26; Indiana Society of Architects Mar 35; Institute honors Apr 43, 107; Kemper Jan 22, Mar 25; library May 31; Louis Sullivan Sep 21; Pritzker prize Je 11; Red Cedar Sep 25; Reynolds May 27; Reynolds student Je 11; Stone Institute Mar 28; 25-year May 31; Whitney Young Jan 22, Mar 20

B

Barrier-free architecture. Je 80
Barriers to Architectural Education. [Francis] Je 80
 Battle Creek, Mich. transportation terminal Jy 48
 Beijing, China. Fragrant Hill Hotel Sep 34, Nov 88
 Bel Geddes, Norman. Dec 48
 Belgium. Aug 112
 Belluschi, Pietro. May 238
 Bender, Richard. May 243
 Berkeley, Calif. St. Mary's College High School Feb. 60
'The Best Little Boathouse in Texas.' [Crosbie] May 208
 Beyer-Blinder-Belle. Sep 16, Nov 42
 Birkerts, Gunnar. Jan 50
 Blake, Peter: *Knoll.* Apr 72
 Blee, Michael. Aug 123
 Block Island, R.I. Coxe/Hayden house and studio May 260
 Bloomfield Hills, Mich. Cranbrook Academy of Art Sep 50

Board of directors, AIA. Dec. '82 meeting Jan 20; installation Jan 20; March meeting Apr 32; May meeting Je 14; officers Je 14; Sep meeting Nov 17
 Bohlin Powell Larkin Cywinski. May 202
 Böhm, Gottfried. Aug 134
 Book reviews (signed): *Adolf Loos.* May 365; *The Aesthetic Townscape.* Sep 83; *Alternative Natural Energy Sources in Building Design.* Jy 82; *Architecture as Nature: The Transcendentalist Idea of Louis Sullivan.* Jan 77; *The Architecture of Arata Isozaki.* Aug 194; *The Architecture of Richard Neutra: From International Style to California Modern.* Sep 81; *Architecture of the 20th Century in Drawings: Utopia and Reality.* May 371; *The Architecture of Wren.* Sep 81; *Architecture Today.* May 361; *Bruno Zevi on Modern Architecture.* Aug 194; *The Builder's Guide to Solar Construction.* Apr 94; *Building to Last: Architecture as Ongoing Art.* Jan 80; *Classicism Is Not a Style.* May 368; *Conservation of Historic Buildings.* Apr 94; *Design for Independent Living: The Environment and Physically Disabled People.* Apr 98; *The Designs and Drawings of Antonio Gaudi.* Dec 97; *The Forgotten Frontier: Urban Planning in the American West Before 1890.* Jan 82; *Great Drawings from the Collection of the Royal Institute of British Architects.* Aug 193; *Guide to Baroque Rome.* Sep 82; *Gustave Stickly. The Craftsman.* Oct 101; *Half a Truth Is Better Than None.* Apr 92; *H. H. Richardson: Complete Architectural Works.* Feb 77; *Horizontal-Span Building Structures.* May 84; *In Search of Modern Architecture: A Tribute to Henry-Russell Hitchcock.* Jy 80; *Inquiry by Design: Tools for Environment-Behavior Research.* Jan 78; *John Soane: The Making of an Architect.* Mar 110; *The LeCorbusier Archive.* Nov 91; *Letters to Apprentices.* Je 85; *Michael Graves: Buildings and Projects, 1966-1981.* Jy 78; *The New Jersey House.* Oct 102; *Ornamentation: The New Decorativeness in American Architecture and Design.* Jan 76; *Photography and Architecture: 1883-1939.* Jy 84; *The Politics of Park Design: A History of Urban Parks in America.* Jan 84; *Racing Alone.* Nov 92; *Richard Neutra and the Search for Modern Architecture: A Biography and History.* Sep 81; *Robert A. M. Stern, Buildings and Projects, 1965-1980: Toward a Modern Architecture After Modernism.* Mar 105; *Robert Stern.* Mar 105; *Uncommon Places.* Jan 78; *Washington Houses of the Capital.* Mar 110; *Weather and Energy.* Jan 84
 Boston. Marriott Long Wharf Hotel Jy 42
 The Boston Architectural Team. Oct 74
 Boulder, Colo. Oasis Diner Dec 58
 Boutelle, Sara Holmes: [bk rev] Feb 77, Mar 110, May 368, Jy 80
 Bridges. Brooklyn Bridge, New York City Jy 52
Bright Spot Along the Tracks. [Knight] Jy 48
 Broshar, Robert. Jan 21, Jy 17
 BRW Architects. Jan 44, 64
 Building Stone Institute. Mar 28
 Bull, Henrik. May 301
 Bumgardner Architects. Dec 60
Burly 'Machine for Performance.' [Dillon] May 217
 Burns, Jim: *Designing for (and with) the Christian Brothers.* Feb 60; *Piercing the Walls of an Urban 'Room.'* Nov 62
 Burns, John A.: *Structure and Mechanics Viewed as Sculpture.* Apr 44

C

Campbell, Robert: *Daylighting: Research and Design.* Je 54; *An Emotive Place Apart.* May 150; *A Strong Contextual Gesture Gone Awry.* Jy 42; [bk rev] Feb 77
 Canada. Aug 124
 Canty, Donald: *Glazed Gallery Behind an Elegant Tower.* May 174; *Islamic Jewel in a Modernist Box.* Jy 34; *New Meets Old in a Museum That Is a Neighborhood.* Nov. 42; *New Toll Booths for a Moderne Bridge.* Dec 67 *A Winery of Simple*

Elegance. May 211; [bk rev] Jan 76; Jan 39, Feb 35, Mar 67, Apr 53, May 149, Je 35, Jy 33, Aug 93, Sep 33, Oct 49, Nov 41
 Carter, Brian: *Broad Roofs Over a Series of Graceful, Light-Filled Spaces.* Aug 184; *Making an Idiosyncratic Face on a Street of Historic Facades.* Aug 112
 Castle Rock, Colo. Douglas County Administration Building May 270
 Caudill, William. Aug 34
Celebrated Streamlines. [Meikle] Dec 48
 Cemeteries. Modena, Italy Aug 162
 Charlotte, N.C. Mecklenburg County Courthouse May 257; Oct 64
 Chicago. Auditorium building Apr 44; Board of Trade May 152; '92 world's fair Feb 27; One South Wacker May 160
A Chinese View of Fragrant Hill. Nov 88
 Christian Brothers. Feb 61
 Clouten, Neville: *Brilliant Desert Complex by Architects from a Frigid Arctic Climate.* Aug 144
 Codes. state legislatures Feb 24; toxicity Feb 21
 Cold climates. designing for Feb 52
Color: Media and Messages. [Crosbie] Apr 54
 Columbia University. Je 24
 Comerio, Mary: *Inside Chinatown's Tiny Apartments.* Apr 68
 Communication Arts. Dec 58
 Community design centers. in Chinatown, San Francisco Apr 68
 Competitions. Harvard gate Apr 29; Parc de la Villette Mar 120; Paris Opera House Oct 22; San Diego waterfront development Sep 25; Santa Barbara, Calif., art museum Sep 25; Spectacle Island, Mass. Sep 25
 Components, AIA. May 112
 Computers. Sep 77
 Construction Specifications Institute. Mar 51
 Convention, AIA. '85 site Nov 17; resolutions Jy 17; speakers Feb 15; theme Jy 14; Dec 84
 Convention centers. Moscone convention center, San Francisco Jan 62
 Cope Linder Associates. May 184, Dec 64
 Copland, Hagman, Yaw, Ltd. Jan 44
 Cossutta & Associates. Jy 42
Cost Efficiency and Earth Sheltering. [Swenson] Jan 68
 Cox, Warren. May 243
 Craftsmanship, furnishings. Apr 84
Cranbrook's Glorious First Half Century. [Von Eckardt] Sep 50
 Crosbie, Michael J.: *Activities of UIA and Other International Bodies.* Aug 59; *'The Best Little Boathouse in Texas.'* May 208; *Color: Media and Messages.* Apr 54; *Happy Birthday to a Very Architectural Bridge.* Jy 52; *Industrialized Housing: The Residue of 'Breakthrough.'* Oct 78; *Is It a Catenary?* Je 78; *Old Made New, New Amid Old, Etc.* Nov 48; *Streamline Shopping 'Ship.'* Dec 64; *Suburbia Comes to the South Bronx.* Oct 65; *Vernacular Underground Villages of Iberia.* Jan 70; *The Year's Architectural Events.* May 67; [bk rev] Apr 92, Aug 193, Nov 92
 Cultural centers. Centre Pompidou, Paris Sep 62
 Czechoslovakia. Aug 156

D

Dallas. soundstage May 217; transit system Sep 11
 Dams. Boulder Dec 45
Darth Vader at the O.K. Corral. [Dillon] Nov 66
 Davey, Peter: *The Massing of a Village.* Aug 121; *Pop Arts and Crafts.* Aug 123; *Quietude in Canterbury.* Aug 123; *'Romantic Pragmatism' As a Contrasting Second Force to High-Tech.* Aug 120
 David, Theo.: *A New Community Composed of Indigenous Domed, Vaulted Forms.* Aug 110
Daylighting: Research and Design. [Campbell] Je 54
Daylighting: Six Aalto Libraries. [Moore] Je 58

- De Leon, Teodoro Gonzalez. Aug 183
 Dean, Andrea Oppenheimer: *An Amalgam of Styles in a Witty 'Spec' Building*. Dec 68; *Deco Touches on a Seattle Tower*. Dec 60; *Firm Extends its Reach into Underground Space*. Jan 58; *Going Underground to Escape Controversy*. Jan 62; *Jahn's Chicago. 1. Board of Trade*. May 152; *Jahn's Chicago. 2. One South Wacker*. May 160; *Jewelry Shop That Is 'A Sumptuous Confection of Rich Ingredients'*. Aug 108; *New Ways of Reviving an Old Neighborhood*. Nov. 72; *Old Downtown Reknit by New Construction*. Nov 75; *Refining a Familiar Vernacular*. Sept. 43; *Sculpting with the Earth*. Jan 61; *Small House Attests to Vienna's Continuing Tradition of Pluralism*. Aug 106; *Small Office Building Gains Depth and Visual Interest from Sun Shades*. Aug 170; *Sophisticated Fantasy in Three Parts*. May 194; *Speaking Softly in Soft Colors*. May 168; *'Splendor Beneath the Grass' in Michigan*. Jan 50; *Sports Facility Under an Exotic Tent of Two Fabric Membranes*. Aug 159; *State-of-the-Art Underground Design*. Jan 64; *Subway System That Is Part Sleekly New and Part Sensitive Renewal*. Aug 94; *Sumptuous, Variegated House for Collectors of Art Nouveau Objects*. Aug 102; *Tripartite Form. Country Accent*. Oct 82
Deco Lines on a Houston High Rise. [Greer] Dec 62
Deco Recalled in a Diner. [Greer] Dec 58
Deco Revived in a Deli. [Greer] Dec 56
Deco Touches on a Seattle Tower. [Dean] Dec 60
 Denmark. Aug 114
 Denver. transit mall Je 36
Designing for (and with) the Christian Brothers. [Burns] Feb 60
 Devine Architects. Oct 61
 Dibner, David. Jan 30
 Dillon, David: *Burly 'Machine for Performance.'* May 217; *Darth Vader at the O.K. Corral*. Nov 66
 Dirckinck-Holmfeld, Kim: *School Arranged Around a Cheerfully Canopied Central Court*. Aug 114
 Direction '80s, AIA. Jan 20
 Documents. CSI Mar 51
 Doshi, Balkrishna V. Aug 169
 Doumato, Lamia: [bk rev] Sep 81
 Drew, Philip: *An Arc Ascribed on a Narrow Hillside Site Above Sydney Harbor*. Aug. 172
 Dreyfuss, Henry. Dec 48
 Dunn, James Francis. Nov 51
- E**
 Earthquake resistant design. Coalinga, Calif. Je 21; conference May 55; Sep 74
 Economy. AIA regional reports Jan 26
 Education. American architecture study center, Columbia University. Je 24
 Educational facilities. Civil and Mineral Engineering Building, University of Minnesota, Minneapolis Jan 64; Consolidated Engineering Library, University of California at Berkeley Jan 56; Cranbrook Academy of Art, Bloomfield Hills, Mich. Sep 50; elementary school, Walla Walla, Wash. Jan 58; Hoje Taastrup secondary school, Denmark Aug 114; Legal Research Building, University of Michigan, Ann Arbor Jan 50; Luzerne County Community College Center, Nanticoke, Pa. May 202; Mellon Arts Center, Wallingford, Conn. Sep 43; National Pedagogical University, Mexico Aug 183; St. Mary's College High School, Berkeley, Calif. Feb 60; Stanford University, Palo Alto, Calif. Nov 78; Trondheim University, Norway Aug 174; University of Qatar Aug 168; Williamson Hall, University of Minnesota, Minneapolis Jan 44
 Eicholtz & Groth. Jan 44
 El Kafrawi, Kamal. Aug 168
- Elbansani, Logan & Severin Design Group. Nov 75
 Elias, Brad. Dec 56
An Emotive Place Apart. [Campbell] May 150
Energy and Earth Sheltering Revisited. [Sterling] Jan 48
 Energy conservation. AIA policy Jan 20; data bank Je 21; daylighting Je 54, 58; Department of Energy research programs Jan 42; Owens-Corning awards Jan 44; Jan issue
 Energy Department. research programs Jan 42
Energy Research Cut Where It Hurts. [Greer] Jan 42
 England. Aug 120
 Erskine, Ralph. Aug 122
Evaluation: Beaubourg Already Shows Its Years. [Abercrombie] Sep 62
Evaluation: Park Atop a Freeway. [Pastier] Je 42
 Exhibitions. Home Sweet Home Oct 45; Internationale Bauausstellung Oct 15
Exploring a New Vernacular. [Owen] Sep 34
- F**
Faceted Jewel Against a Blank Wall. [Freeman] May 214
 Falta, Ladia P.: [bk rev] Apr 98
Finely Furnished Shopping Spine. [Greer] Je 36
Firm Extends Its Reach into Underground Space. [Dean] Jan 58
'First Monument of a Loosely Defined Style.' [Pastier] May 232
 Flatow, Moore, Bryan & Associates. Jan 44
 Food resistant design. conference May 55
Food and Architecture in New Orleans. [Ivy] Mar 88
 Formaldehyde. Oct 36
 Fort Worth, Tex. Sundance Square Nov 66
 France. Aug 160
 Francis, Robert: *Barriers to Architectural Education*. Je 80
 Freeman, Allen: *Faceted Jewel Against a Blank Wall*. May 214; *New Orleans, New and Old*. Mar 68; *Old Facades Fronting for New Construction*. Nov 68; *Romantic Gardens on the Mall*. Je 48; *The Vieux Carré, 1983*. Mar 78; *The Vieux Carré, 1923*. Mar 83; [bk rev] Jan 78
 Fuller, R. Buckminster. Apr 18, Aug 21
Furnishings. Jan 96; Mar 125; Apr 78, 80, 84; May 388; Je 92; Jy 88; Aug 239; Sep 86; Oct 110; Nov 100; Dec 88
- G**
 Gebhard, David: *About Style Not Ideology*. Dec 34
 Germany. Aug 128
Glazed Gallery Behind an Elegant Tower. [Canty] May 174
 Goff, Bruce. Jy 12
Going Underground to Escape Controversy. [Dean] Jan 62
 Gold Medal, AIA. acceptance speech Jy 20; Jan 13
 Gordon, Jack. May 214
 Gottfried, Herbert: [bk rev] Oct 102
 Government facilities. California State Capitol, Sacramento May 266; Douglas County Administration Building, Castle Rock, Colo. May 270; Frank Carlson Federal Building, Topeka, Kan. Jan 44; Kuwait Chancery, Washington, D.C. Jy 34; Mecklenburg County Courthouse, Charlotte, N.C. May 257; Public Services Building, Portland, Ore. May 232; Sief Palace, Kuwait Aug 144; Town Hall, Rheinberg, Germany Aug 134; U.S. Capitol Apr 18, Jy 25, Dec 14
 Graham Gund Associates. Nov 54
 Graham/Meus. Nov 54
 Grave/Newman/Anderson. Nov 52
 Graves, Michael. May 232
 Greer, Nora Richter: *Deco* Dec 31; *Deco Lines on a Houston High Rise*. Dec 62; *Deco Recalled in a Diner*. Dec 58; *Deco Revived in a Deli*. Dec 56; *Energy Research Cut Where It Hurts*. Jan 42; *Finely Furnished Shopping Spine*. Je 36; *A Library Respects Its Elder Neighbors*. May 226; *Measuring Performance of Energy Design*. Jan 44; *The 1983 AIA Honor Awards*. May 248; *Furnishings*.
- Feb 84, Mar 125, Apr 80, 84, May 388, Je 92, Jy 88, Aug 239, Sep 86, Oct 110, Nov 100, Dec 88
 Gregory, Jules. Jan 22, Mar 25
 Groat, Linda: *Measuring the Fit of New to Old*. Nov 58
 Gropius, Ise. Jy 27
 Growald Architects. May 217
 GSA. Jan 30, Jy 25
 Gutbrod, Büro. Aug 159
 Gutheim, Frederick: [bk rev] Jan 84, Mar 110, Apr 94, Aug 194, Sep 83
- H**
 Haase, Richard O. Dec 14
 Hallen, Hans. Aug 170
 Halprin, Lawrence. Je 43
 Hammer Kiefer & Todd. Oct 73, 76
 Hanks, Nancy. Mar 17
Happy Birthday to a Very Architectural Bridge. [Crosbie] Jy 52
 Hara, Hiroshi. Aug 150
 Hardy, Hugh. May 241
 Hardy Holzman Pfeiffer. May 250
 Hartford, Conn. seminary May 264
 Hartman-Cox. May 265, Oct 82, Nov 56, Dec 68
 Hartray, John W. May 240
 Hasegawa, Itsuko. Aug 152
 Hayden, Michael. Je 31
 Health care facilities. Aono Ophthalmology Clinic, Matsuyama, Japan Aug 152; MacKensie Hospital, University of Alberta, Canada Aug 124
 Hellmuth, Obata & Kassabaum. Jan 62, Nov 62
 Higuera, Fernando. Aug 184
 Hillier Group. May 220
 Hirshen Gammill Trombo Architects. Oct 52, 60
 Historic American Buildings Survey. Nov 21
 Ho, Mui. Oct 60
 Hoban, Stewart Daniel. Nov 48
 Hoffmann, Josef. Apr 80
 Holabird & Root. Feb 43
Holabird & Root: Century of (Intermittent) Progress. [Wilson] Feb 43
 Hollein, Hans. Aug 108, 128
 Holmes, Hendrik S. Oct 76
 Holzbauer, Wilhelm. Aug 94, 102
 Honorary fellows, AIA. Mar 33, May 33
 Honorary members, AIA. Feb 21
 Hoover Berg Desmond. May 270
 Horký, Ivan: *Shining Subway Station Opens from a Stately, Refurbished Park*. Aug 156
 Horn, Gerald. May 241
 Hotels. Ixtapa Camino Real Hotel, Zihautanejo, Mexico Aug 180; Fragrant Hill Hotel, China Sep 34, Nov 88; Marriott Long Wharf Hotel, Boston Jy 42
 Housing. international conference May 44; Supreme Court decision Mar 46; Oct issue
Housing Designed for Special Needs. [Villecco] Oct 50
Housing the Poor: A Lost Priority? [Lawson] Oct 62
Housing Wrought from Other Building Types. [Knight] Oct 66
 Houston. Four Leaf condominium towers May 168; Transco Energy Co. building Dec 62; transit system Sep 11; YWCA Masterson Branch and Office May 254
 Hübschmannová, Anna. Aug 156
 HUD. housing policies Feb 13, Oct 62; Operation Breakthrough Oct 78
 Hurricanes. damage in Texas Oct 29
- I**
 Iberia. underground villages Jan 70
 Idaho Falls, Idaho. EG&G/Willow Creek Office Building Jan 44
 India. Aug 169
 Industrial design. Dec 48
Industrialized Housing: The Residue of 'Breakthrough.' [Crosbie] Oct 78
Inside Chinatown's Tiny Apartments. [Comerio] Apr 68

Interior Department. Vietnam memorial Feb 11, Mar 40
Interiors. April issue
Is It a Catenary? [Crosbie] Je 78
Islamic Jewel in a Modernist Box. [Canty] Jy 34
Italy. Aug 162
Ivy, Robert A.: *Food and Architecture in New Orleans.* Mar 88; *Planning a Fair Full of 'Wonder.'* Mar 96

J

Jacobs, Stephen B. & Associates. Oct 70, 72; Nov 53
Jahn, Helmut. May 152, 160, 239
Jahn's Chicago. 1. Board of Trade. [Dean] May 152
Jahn's Chicago. 2. One South Wacker. [Dean] May 160
Japan. Aug 150
Jeter, Cook & Jepson. Oct 55
Jewelry shop. Vienna Aug 108
Johansen, John M. May 286
Johnson, J. Seward Jr. sculpture Jy 30
Johnson/Burgee. Jy 60, Nov 62, Dec 62

K

Kansas City. Crystal Pavilion May 214
Kapfinger, Otto. Aug 106
Kappe, Raymond. May 290
Kessler, William & Associates. Jy 48
Kirschanitz, Adolf. Aug 106
Kivett & Myers. Jan 44
Kjaer & Richter. Aug 118
Knight, Carleton: *Bright Spot Along the Tracks.* Jy 48; *Housing Wrought From Other Building Types.* Oct 66; *Long Spine Punctuated by Lively 'Events.'* May 202; *Porch with a House Attached.* Oct 86; *Significant Clients: Ma Bell Builds Big.* Jy 60; *Significant Clients: Slayton at State.* Feb 36; *Significant Clients: Stanford Guards Its Original Character.* Nov 78; *Soaring Space Behind Sleek Facades.* May 184
Knoll. [Blake] Apr 72
Korean memorial. May 35
Kroll, Lucien. Aug 160
Kultermann, Udo: *The Offices of an Architect Who Holds to Traditional Values.* Aug 169; *A University Campus Whose Building Blocks Echo Indigenous Forms.* Aug 168
Kuwait. Aug 144

L

Lack, Antonio Attolini. Aug 182
Landscape architecture. Je 48
Larsen, Henning. Aug 114, 174
Lawson, Simpson: *Housing the Poor: A Lost Priority?* Oct 62
LeCuyer, Annette: *Contextual Combination of War-Torn Housing and New Construction.* Aug 142; *A Museum That is a Cluster of Eclectic Buildings on a Hilltop.* Aug 128; *Soaring, Ceremonial 'Interior Public Square' in a Layered Town Hall.* Aug 134
Legislation. Public Buildings Act Dec 16; subsidized housing programs Feb 13
Legorreta, Ricardo. Aug 180
Library architecture. Cushwa-Leighton Library, St. Mary's College, Notre Dame, Ind. May 226; Folger Shakespeare Library, Washington, D.C. Nov 56
A Library Respects Its Elder Neighbors. [Greer] May 226
Ligonier, Pa. Elliott house May 194
Lively Campus Center Atop a Buried Library. [Dean] Jan 56
Loewy, Raymond. Dec 48
Long Spine Punctuated by Lively 'Events.' [Knight] May 202
Long-Hidden Wonders of the Petra Valley. [Owen] Je 70
Longstreth, Richard: [bk rev] Jan 77, May 365

M

MacDonald, Donald. Dec 67
Mackey, Howard Hamilton Sr. Jan 22, Mar 20
Mackinlay, Ian: *The Neglected Hazards of Snow and Cold.* Feb 52
Maguire & Murray. Aug 123
Marketplaces. South Street Seaport Nov 42
Marquis Associates. Oct 54, Nov 51
Marshall, Clifton J.: [bk rev] Jan 88
Massive Deco Monument. [Wilson] Dec 45
Matsumoto, George. Jan 56
Mauritania. Aug 110
McIntyre, David: *New Health Hazards in Sealed Buildings.* Apr 64
McLean, Va. Foster house Oct 82; Immanuel Presbyterian Church May 265
Measuring the Fit of New to Old. [Groat] Nov 58
Measuring the Performance of Energy Design. [Greer] Jan 44
Meeker, David Olan Jr. Nov 13
Meier, Richard. May 247, 264
Memorials. Korean May 35; Navy Nov 32; Vietnam Feb 11, Mar 40, May 150, Dec 11
Metcalfe, Andrew. Aug 172
Mexico. Aug 180
Miekle, Jeffrey L.: *Celebrated Streamlines.* Dec 48
Milan's Annual Design Extravaganza. [Abercrombie] Apr 78
Milwaukee. Grand Avenue shopping mall Nov 75
Minneapolis. Civil and Mineral Engineering Building, University of Minnesota Jan 64; Williamson Hall, University of Minnesota Jan 44
Miriani & Associates. Nov 54
Missing Link. Aug 106
MLTW/Turnbull Associates. May 211, Oct 90
MMM Design Group. Nov 48
Modesto, Calif. Allewelt house Oct 90
Moore, Charles W. May 244
Moore, Fuller. *Daylighting: Six Aalto Libraries.* Je 58
Moore Grover Harper. May 194
Morgan, William. Jan 61
Morris, Phillip: *A Neighborhood Grows in Charlotte.* Oct 64
Mortar additive. Apr 29
Murphy/Jahn. May 152, 160
Museums. Städtisches Museum Abteiberg, Mönchengladbach, Germany Aug 128

N

Naticoke, Pa. Luzern County Community College Center May 202
National Architectural Accrediting Board. Jy 12
National Council of Architectural Registration Boards. annual meeting Sep 19
National Endowment for the Arts. Mar 17
National Institute of Building Sciences. Feb 21
Navy memorial. Nov 32
The Neglected Hazards of Snow and Cold. [Mackinlay] Feb 52
A Neighborhood Grows in Charlotte. [Morris] Oct 64
Nesmith, Lynn: *Products.* Jan 102, Feb 89, Mar 128, Apr 114, May 392, Je 96, Jy 94, Aug 243, Sep 89, Oct 115, Nov 103, Dec 91
New Health Hazards in Sealed Buildings. [Sterling, Sterling, and McIntyre] Apr 64
New Meets Old in a Museum That Is a Neighborhood [Canty] Nov 42
New Orleans. Mar issue
New Orleans, New and Old. [Freeman] Mar 68
New Toll Booths for a Moderne Bridge. [Canty] Dec 67
New Ways of Reviving an Old Neighborhood. [Dean] Nov 72
New York City. Brooklyn Bridge Jy 52; Ellis Island Sep 16; Lever House Jan 30; Apr 17; New York Delicatessen Dec 56; sliver building ban May 40; South Street Seaport Nov 42; Statue of Liberty Sep 16
Noelle, Louise: *Bold Courtyard Campus That Is Entered Through Huge Concrete Portals.* Aug 183; *A Monastery Made of Almost Windowless Geometric Shapes.* Aug 182; *Terraced Seaside*

Hotel Meant to be a Strong Presence in Its Setting. Aug 180

Norway. Aug 174

Notre Dame, Ind. Cushwa-Leighton Library, St. Mary's College May 220

Nuclear disarmament. June 16

O

Obituaries. Bush-Brown, Harold May 387; Caudill, William Aug 34; Childress, Ronald E. Feb 82; Davison, Robert L. Aug 44; Fuller, R. Buckminster Aug 21; Gropius, Ise Jy 27; Kastendieck, Raymond Jy 85; Pevsner, Sir Nikolaus Oct 108; Schieck, William H. May 387; Sert, Josep Lluís May 55; Toguchi, Fred S. Feb 82
Office Buildings. Beneficial Center, Peapack, N.J. May 220; Best Products Corporate Headquarters, Richmond, Va. May 250; Board of Trade, Chicago May 152; Central Pre-Mix headquarters building, Spokane, Wash. Jan 58; Crocker Center, San Francisco May 174; Doshi architectural office, India Aug 169; EG&G/Willow Creek Office Building, Idaho Falls, Idaho Jan 44; Lever House, New York City Jan 30; One South Wacker, Chicago May 160; Philadelphia Stock Exchange, Philadelphia May 174; SACCA headquarters, South Africa Aug 170; spec building, Washington, D.C. Dec 68; Sport Obermeyer office/warehouse, Aspen, Colo. Jan 44; Transco Energy Co. building, Houston Dec 62; Watermark Tower, Seattle Dec 60; YWCA Masterson Branch and Office, Houston May 254
Old Downtown Reknit by New Connections. [Dean] Nov 75
Old Facades Fronting for New Construction. [Freeman] Nov 68
Old Made New, New Amid Old, Etc. [Crosbie] Nov 48
O'Neil Ford's 'Caring Campus.' [Speck] Sep 58
Otto Frei. Aug 159
Ove Arup & Associates. Sep 62
Owen, Christopher: *Exploring a New Vernacular.* Sep 34; *Long Hidden Wonders of the Petra Valley.* Je 70
Owens-Corning Fiberglas Corporation. Jan 44
Owings, Nathaniel A. Jan 13, Jy 20

P

Palmer, Carole: *Whimsical Tower. Colorful House.* Oct 88
Paris, France. Centre Pompidou Sep 62
Pastier, John: *Evaluation: Park Atop a Freeway.* Je 43; *'First Monument of a Loosely Defined Style.'* May 232
Peapack, N.J. Beneficial Center May 220
Pei, I.M., & Partners. Je 36; Sep 34, 43; Nov 88
Pei, Ieoh Ming. Je 11
Pelli, Cesar. May 168
Performing arts facilities. Auditorium Building, Chicago Apr 44; Music Center, Aarhus, Denmark Aug 118
Peters, Paul Hans: *Arcaded Shopping Core Blends Inward-Facing Old and Outward-Facing New.* Aug 140
Peters, Williams & Kubota. Jan 44
Petra, Jordan. Je 70
Philadelphia. Stock Exchange May 184
Phoenix. urban design Mar 31
Piano, Renzo. Sep 62
Piercing the Walls of an Urban 'Room.' [Burns] Nov 62
Pietila Reima. Aug 144
Planning a Fair Full of 'Wonder.' [Ivy] Mar 96
Platt, Adams, Braht & Associates. Jan 44
Plestina, Lenko: *Winter Olympic Stadium Dominated by Huge, Angular Trusswork.* Aug 158
Pollution, indoor. Apr 64
Porch with a House Attached. [Knight] Oct 86
Portland, Ore. Public Services Building May 232
Postmodernism: Definition and Debate. May 238
Preservation. adaptive reuse for housing Oct. 66; Boston Citgo sign Nov 32; Calif. state capitol May 266; conference Nov 26; Ellis Island Sep 16;

federal advisory council Nov 24; Lever House, New York City Jan 30, Apr 17; New Orleans Mar issue; New York City Landmarks Preservation Commission chairman Sep 14; Statue of Liberty Sep 16; U.S. Capitol Apr 18; Willets House Dec 18; Nov issue

Presidential libraries. Carter Oct 36

Products. Jan 102, Feb 89, Mar 128, Apr 114, May 392, Je 96, Jy 94, Aug 243, Sep 89, Oct 115, Nov 103, Dec 91

Q

Qatar. Aug 168

R

Rainey, Reuben M.: [bk rev] Jan 82

Recreational facilities. Live Oaks Retreat, Rockport, Tex. May 208; sports facility, King Abdul Aziz University, Saudi Arabia Aug 159; Winter Olympic stadium. Yugoslavia Aug 158; YWCA Masterson Branch and Office, Houston May 254
Refining a Familiar Vernacular. [Dean] Sep 43

Religious architecture. Hartford, Conn., seminary May 264; Immanuel Presbyterian Church, McLean, Va. May 265; Monastery, San Luis Potosi, Mexico Aug 182

Residential architecture. Alençon, France, housing Aug 160; Allewelt house, Modesto, Calif. Oct 90; Bonita House, Berkeley, Calif. Oct 60; The Car Barn, Bedford, Mass. Oct 74; Castro Commons, San Francisco Oct 57; central Florida underground house Jan 61; Claflin School, Watertown, Mass. Oct 66; Cox/Hayden house and studio, Block Island, R.I. May 260; Elliot house, Ligonier, Pa. May 194; Folk house, Charlottesville, Va. Oct 58; Foster house, McLean, Va. Oct 82; Four Leaf condominium towers, Houston May 168; group homes for the developmentally disabled, Higginsville, Mo. Oct 61; Hakatsuka House, Kawana, Japan Aug 150; housing, Berlin, Germany Aug 142; La Macarrona, Spain, house Aug 184; Robert Mangrum house, Delaware coast Oct 86; New York City garage condominiums Oct 70; Noble Horizons, Salisbury, Conn. Oct 55; Parnow housing for the elderly, San Rafael, Calif. Oct 54; prototype housing, Rosso, Mauritania Aug 110; Rose Bay house, Australia Aug 172; Rudolf Steinerseminariet, Jarna, Sweden Aug 146; St. John's Church, Dover, N.H. Oct 73; St. Mark's Methodist Church, Brookline, Mass. Oct 76; Simon/Bellamy house, Conn. Oct 88; Suntech Townhomes, Santa Monica, Calif. May 272; 13th Street Presbyterian Church, New York City Oct 72; Vienna house Aug 102; Vienna house Aug 106; Winston Gardens, Oroville, Calif. Oct 52

Restaurants. Crystal Pavilion, Kansas City, Mo. May 214; New Orleans Mar 88; New York City Delicatessen, Dec 56; Oasis Diner, Boulder, Colo. Dec 58
Richmond, Va. Best Products Corporate Headquarters May 250

Riley, Jefferson B. May 194, 245

Rippteau, Darrel Downing. Nov 55

Robinson, Cervin. May 58

Rockport, Tex. Live Oaks Retreat May 208

Rogers, Richard. Sep 62

Rolling with the Punch of Earthquakes. [Arnold] Sep 74

Romantic Gardens on the Mall. [Freeman] Je 48

Rossi, Aldo. Aug 162

Rouse Co. Nov 75

S

Saarinen, Eero. Je 78, Sep 50

Saarinen, Eliel. Sep 50

Sacramento, Calif. California State Capitol May 266

San Francisco. Bay Bridge Toll Booths Dec 67;

Chinatown Apr 68; Crocker Center May 174;

Moscone convention center Jan 62; Union Square Nov 62

Santa Monica, Calif. Suntech Townhomes May 272

Sasaki Associates. Oct 66

Saudi Arabia. Aug 159; Haj terminal at Jeddah International Airport May 276

Schallenberg, William H.: [bk rev] Aug 194, Sep 81

Sculpting with the Earth. [Dean] Jan 61

Seattle. Freeway Park Je 43; Watermark Tower Dec 60

The Second Annual Review of Recent World Architecture. Aug issue

Sert, Josep Lluis. May 55

Sharp, Dennis: *The Arresting, Angular Forms of the Rudolph Steiner Aesthetic*. Aug 146; *A Kit of Parts for Taking the Curse off of Bland Housing Blocks*. Aug 161

Shaw & Associates. May 152

Shopping centers. Hanse Quarter Arcade, Hamburg, Germany Aug 140; Ocean One, Atlantic City, N.J. Dec 64; STEP, Takamatsu, Japan Aug 154

Shriver, Poul Erik: *Campus Organized Around a Series of Tall, Glazed Interior 'Streets'*. Aug 174; *Music Center in a Glazed Garden Pavilion Filled with Color and Artworks*. Aug 118

Significant Clients: Ma Bell Builds Big. [Knight] Jy 60

Significant Clients: Slayton at State. [Knight] Feb 36

Significant Clients: Stanford Guards Its Original Character. [Knight] Nov 78

Simon, Mark. Oct 88

The Sixth Annual Review of New American Architecture. May issue

Skidmore, Owings & Merrill. May 174, 276; Je 48; Jy 34; Nov 62

Slayton, William L. Feb 36, Sep 11

Soaring Space Behind Sleek Facades. [Knight] May 184

Solomon, Daniel. May 245

Solomon, Daniel, & Associates. Oct 56

Some Cautions on Computers. [Wendle] Sep 77

Sophisticated Fantasy in Three Parts. [Dean] May 194

Soundstage. Dallas May 217

South Africa. Aug 170

Spain. Aug 184

Speaking Softly in Strong Colors. [Dean] May 168
Speck, Lawrence: *O'Neil Ford's 'Caring Campus'*. Sep 58

'Splendor Beneath the Grass' in Michigan. [Dean] Jan 50

Spokane, Wash. Central Pre-Mix headquarters building Jan 58

Spring, Bernard P.: [bk rev] Jan 78

St. Louis. arch Je 78

St. Paul, Minn. Lowertown Nov 72

Stamberg, Susan. Nov 17

Stanford University. Nov 78

State Department. Office of Foreign Buildings Operations Feb 36, Sep 11

State-of-the-Art Underground Design. [Dean] Jan 64

Stein, Richard G.: [bk rev] Jy 84

Sterling, Elia and Theodore: *New Health Hazards in Sealed Buildings*. Apr 64

Sterling, Raymond L.: *Energy and Earth Sheltering Revisited*. Jan 48

Streamline Shopping 'Ship'. [Crosbie] Dec 64

A Strong Contextual Gesture Gone Awry. [Campbell] Jy 42

Sturdy Set of Traditional Forms. [Abercrombie] May 220

Suburbia Comes to the South Bronx. [Crosbie] Oct 65

Surveys. ATA '83 registered architects Sep 19

Swanke Hayden Connell. May 152

Sweden. Aug 146

Swenson, Mark: *Cost Efficiency and Earth Sheltering*. Jan 68

Symposiums. American Architecture, Columbia University Je 24

T

Tafel, Edgar: [bk rev] Je 85

Taft Architects. May 254

Tapley, Charles, Associates. May 208

Teague, Walter Dorwin. Dec 48

Thompson, Benjamin. Nov 42, 48

Topeka, Kan. Frank Carlson Federal Building Jan 44

Transit systems. Dallas. Houston Sep 11

Transportation facilities. Battle Creek, Mich. Jy 48; Baltimore transit Dec 14; King George of Podiebrady subway station, Prague, Czechoslovakia Aug 156; Vienna subway Aug 94

Tripartite Form, Country Accent. [Dean] Oct 82

Tuley, James. Oct 58

Turnbull, William Jr. May 211, 246; Oct 90

U

Underground architecture. Jan issue

Ungers, O. M. Aug 142

Upton, Dell: [bk rev] Jan 80

Urban design. AIA urban design and planning committee Mar 31

Urban Forms. May 272

V

Van der Ryn, Sym. May 246

Van Gerkan, Marg & Partners. Aug 140

Van Impe, Denis. Aug 112

Variations on a Regional Theme. [Villecco] Oct 90

Venturi, Rauch & Scott Brown. May 260

Venturi, Robert. Sep 21

Vernacular Underground Villages of Iberia. [Crosbie] Jan 70

Vietnam memorial. Feb 11, Mar 40, May 150, Dec 11

The Vieux Carré, 1983. [Freeman] Mar 78

The Vieux Carré, 1923. [Freeman] Mar 83

Villecco, Marguerite: *Housing Designed for Special Needs*. Oct 50; *Variations on a Regional Theme*. Oct 90

Von Eckardt, Wolf: *Cranbrook's Glorious First Half Century*. Sep 50

Vosbeck, R. Randall. Dec 16

W

Walker McGough Foltz Lyerla. Jan 58

Walla Walla, Wash. elementary school Jan 58

Wallingford, Conn. Mellon Arts Center Sep 43

Warehouses. Sport Obermeyer office/warehouse Jan 44

Washington, D.C. Constitution Gardens Je 48; Folger Shakespeare Library Nov 56; Kuwait Chancery Jy 34; Navy memorial Apr 20; Rhodes Tavern, Dec 14; spec office building, Connecticut Ave, Dec 68; U.S. Capitol Apr 18, Jy 25, Dec 14; Vietnam memorial Feb 11, Mar 40, May 150, Dec 11

Watanabe, Hiroshi: *Commercial Building Cut Through by a Cascading Stairway*. Aug 154; *Streetside Composition of Four Differently Finished Metal Panels*. Aug 152; *Undulating Wall Behind Exposed Rectilinear Frames*. Aug 150

Welton Beckett Assoc. May 256

Wendle, Ronald: *Some Cautions on Computers*. Sep 77

Whimsical Tower, Colorful House. [Palmer] Oct 88

Whiteson, Leon: *Soaring Atria Bring Sunlight and Space into a High-Tech Hospital*. Aug 124

Wilson, Richard Guy: *Holabird & Root: Century of (Intermittent) Progress*. Feb 43; *Massive Deco Monument*. Dec 45; [bk rev] Mar 105, May 361, Jy 78, Oct 101

Wineries. Fisher Vineyards, Santa Rosa, Calif. May 211

A Winery of Simple Elegance. [Canty] May 211

Wink, Joseph E., & Associates. Oct 86

Wolf Associates Architects Ltd. May 257

Wood & Starr. Jan 44

Woollen, Molzan & Partners. May 220

World's fairs. Chicago '92 Feb 27; Louisiana World Exposition of 1984 Mar 96

Wright, Frank Lloyd. Jan 34

Y

The Year's Architectural Events. [Crosbie] May 67

Yugoslavia. Aug 158

Z

Zabludovsky, Abraham. Aug 183

Zeidler, Eberhard. Aug 124

Zuk, William: [bk rev] Jy 84

ADVERTISERS

Michael J. Hanley
 Publisher
George T. Broskey
 National Sales Manager
James A. Anderson
 Western Manager
Jesse Sims
 Manager, Production and Business
 1735 New York Ave. N.W.
 Washington, D.C. 20006
 (202) 626-7484
Suzanne Maggi
 Assistant to the Publisher

ADVERTISING SALES OFFICES

Atlanta (201) 729-4937
 Thomas R. Crow
 46 Main Street
 Sparta, N.J. 07871
California (707) 762-6042
 James A. Anderson
 210 Vallejo, Suite B
 Petaluma, Calif. 94952
Chicago (312) 663-4116
 James A. Anderson, Western Manager
 Lisa Laidlaw
 53 West Jackson Boulevard, #1201
 Chicago, Ill. 60604
New England/New York State
 (617) 632-8185
 Robert L. Tegen
 87 State Road West
 Westminster, Mass. 01473
New York City (212) 697-3415
 Jeanne S. Cohen
 485 Fifth Avenue, Suite #1042
 New York, N.Y. 10017
Ohio (201) 729-4937
 Thomas R. Crow
 46 Main Street
 Sparta, N.J. 07871
Pacific Northwest (206) 621-1031
 (Washington, Oregon)
 James A. Anderson
 151 Yesler Way, Suite 317
 Seattle, Wash. 98104
Philadelphia (215) 639-3731
 George T. Broskey
 3 Neshaminy Interplex, #301
 Trevoise, Pa. 19047
Pittsburgh (215) 639-3731
 George T. Broskey
 3 Neshaminy Interplex, #301
 Trevoise, Pa. 19047
St. Louis (314) 569-3210
 Richard D. Grater
 1466 Summerhaven
 St. Louis, Mo. 63146
Washington, D.C. (202) 626-7471
 1735 New York Ave. N.W.
 Washington, D.C. 20006

Circle No.	Page No.	Circle No.	Page No.
	Abitare Magazine 93	19	Kawneer Architectural Products 74-75
4	American Gas Assoc. 8-9		<i>Garrison, Jasper, Rose & Co.</i>
	<i>J. Walter Thompson Co.</i>	78	Kroin Inc. 1
36	American Gas Assoc. Cov. 3		<i>Kroin Architectural Complements</i>
	<i>J. Walter Thompson Co.</i>	20	Krueger 76
32	American Seating 90	1	Lutron Cov. 2
35	Atlas Door Corp. 95		<i>Lutron Marketing</i>
	<i>American Adgroup</i>	22	MIT Press 78
3	Badische Corp. 4, 5		<i>Franklin Spier Inc.</i>
	<i>Compton Adv. Agency</i>	30	Morton Thiokol, Inc. 84
39	Badische Corp. 6	12	National LP-Gas Assoc. 22
	<i>Compton Adv. Agency</i>	15	Nucor Corp./Vulcraft Div. 25
5	Bausch & Lomb Interactive Graphics Div. 10		<i>Faller, Klenk & Quinlan, Inc.</i>
	<i>B.J.W. Marketing Communications, Inc.</i>	23	PSAE 79
29	Bilco Co. 84	25	Red Cedar Shingle & Handsplit Shake Bureau 81
	<i>Designline Studio</i>		<i>Cedarcrest Adv.</i>
11	Carlisle Tire & Rubber Co. . . 20-21	16	Rixson-Firemark Div. 28
	<i>Creamer Inc.</i>		<i>The Delos Co., Ltd.</i>
37	Clorox Cov. 4	28	Rock of Ages 83
	<i>Young & Rubicam Inc.</i>		<i>Rock of Ages Building Granite Corp.</i>
13	Columbia Lighting, Inc. 23	10	Schlage Lock Co. 19
	Dover Corp. 85		<i>B. J. Stewart Adv.</i>
	<i>John Malmo Adv.</i>	6	Sculpture Placement 12-13
31	DuPont Co.—Hypalon Roofing . 87	21	Simplex Ceiling Corp. 78
	<i>NW Ayer Inc.</i>		<i>Leschin Assoc.</i>
17	Edwin G. Smith Div., Cyclops Corp. 29	9	Southwestern Bell Telephone Co. 17 (M/W R)
	<i>W.S. Hill Co.</i>		<i>D'Arcy-MacManus & Masius, Inc.</i>
2	Forms & Surfaces 2	27	Steel Joist Institute 82
	<i>Sherrill Broudy Assoc.</i>		<i>Batz, Hodgson, Neuwoehner, Inc.</i>
18	Georgia Marble 30	26	Sun System 81
	<i>GMC Ad Graphics</i>		<i>Nephews Adv. Inc.</i>
38	Graphic Horizons, Inc. 86	24	Westinghouse Electric Co. 80
34	Homasote Co. 95		<i>Marsteller, Inc.</i>
	<i>Gillespie Adv., Inc.</i>		
14	Homasote Co. 24		
	<i>Gillespie Adv., Inc.</i>		
8	Inryco, Inc. 15		
	<i>Melrose Adv. Assoc.</i>		
7	Kalwall Corp. 16		
	<i>Synerjenn Adv., Inc.</i>		

BEAUTIFUL CERAMICS

**Metropolitan Ceramics
goes 100% natural gas to
produce its high-quality
IRONROCK® tile.**

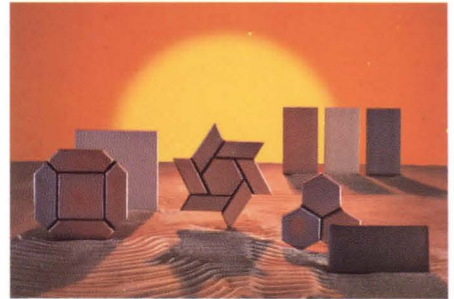

"We've taken out our dual-fuel capability, and we only use gas," says J. Steven Renkert, president of Metropolitan Ceramics, one of the country's leading tile manufacturers, located in Canton, Ohio. "Gas is more precise. It's cleaner and gives us better quality control for our critical color uniformity," he says.

Metropolitan's IRONROCK® tile is recognized as one of the best unglazed, high density tile lines made in the U.S. It is admired for the beauty of its natural earth-tone colors, and for its exceptional durability. 100 million shuffling feet a year haven't scuffed the IRONROCK that paves 10 acres of the new Atlanta airport.

For over 80 years, Metropolitan paving tiles and bricks have been used for flooring, walls, sidewalks and roads—including part of the original Lincoln Highway and several of the Manhattan tunnels. Using new technology, Metropolitan now produces IRONROCK split tile and the new Normandie® line for residential and fine commercial applications. Both lines are as durable as brick, but easier to ship, install and maintain.

The tile get their reduction-fired or clear-toned colors from the firing process in two large kilns. They were designed to burn either oil or gas, but after experimenting with both, Metropolitan decided to stick with gas exclusively.

Like Metropolitan Ceramics, more and more manufacturers are finding that clean, efficient natural gas works best to meet their energy needs.

Gas gives you more for your money.

© 1983 American Gas Association

Circle 36 on information card

***You've got the inside on designing it.
We've got the inside on protecting it.***

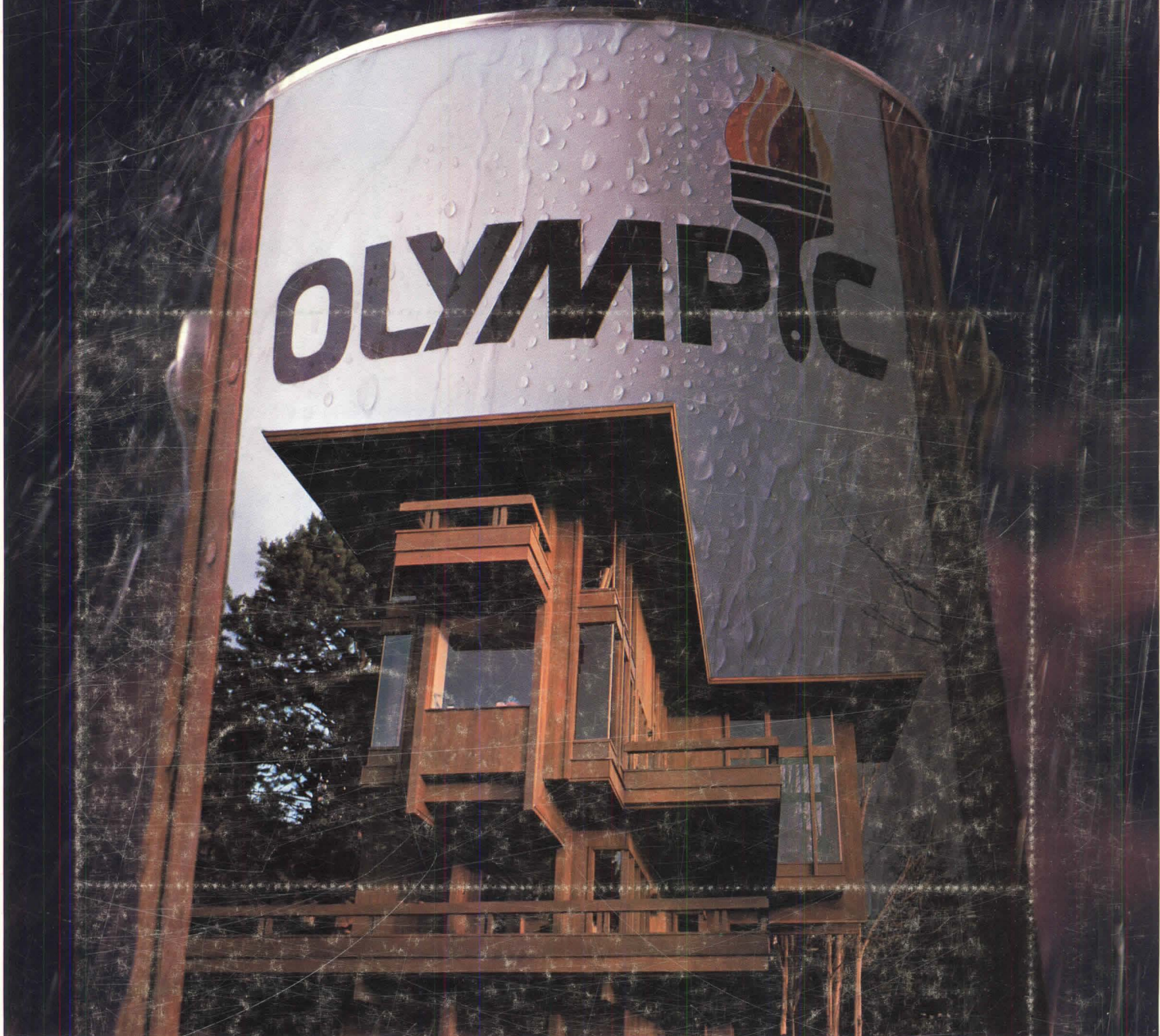

*Olympic has the inside on protecting the outside of the structures you design.
Inside every can of Olympic Stain with WEATHER SCREEN™ are specially treated oils and
additives that actually repel water and preserve wood.*

*Inside every can is the knowledge and experience of over half a century.
Which is one reason more architects prefer Olympic than any other stain.*

And when you use Olympic outside, you'll feel a lot better inside.

*For additional information, consult your
Sweet's Catalog. Or write Olympic: Department A,
2233-112th Ave., N.E., Bellevue, WA 98004.*

OLYMPIC



We've got the inside on outside protection.

Circle 37 on information card