

ARCHITECTURE

Incorporating Architectural Technology January 1989 Six Dollars





NEW VINYL FLOORS

Random chips of color contrast with a classic background.
Ten colorways. Rolls 6' wide. For our brochure,
call 1 800 233-3823 and ask for Suffield™.

Multiply the Possibilities



VELUX® prefabricated gang flashings let you group VELUX roof windows and skylights in almost any combination quickly and easily.

The precision engineering of VELUX gang flashings allows weather tight installation without the need for caulk or mastic. This means no weather delays, no mess, and less chance of callbacks. In addition, VELUX gang flashings are readily available nationwide in a wide range of standard sizes to meet your building requirements and your deadline.

Sales, Warehousing and Service Nationwide

VELUX® The world leader
in roof windows and skylights.

Circle 11 on information card

©1989 VELUX-AMERICA INC.
©VELUX is a registered trademark.



For more information on VELUX Gang Flashings for a free copy of "The Complete Guide to Roof Windows and Skylights", and a price list. Your inquiry will be answered within 24 hours.

Name _____

Firm _____

Address _____

City/State/Zip _____

VELUX-AMERICA INC.
P.O. Box 3268
Greenwood, S.C. 28648

VELUX-CANADA INC.
16817 Hymus Blvd.
Kirkland, PQ, Canada H9P

EVENTS

Feb. 4: "Architecture/Shaping the Future: Legoretta, Maki, Meier, Rogers," international symposium, La Jolla, Calif. Contact: Paul Lowenberg, University of California, San Diego, (619) 534-3123.

Feb. 6-9: Composites Institute of the Society of the Plastics Industry, Annual Conference, Dallas. Contact: Mark Wallinger, Brown Boxenbaum Inc., 655 Third Ave., New York, N.Y. 10017.

Feb. 6-10: Course on Airconditioning Controls, Milwaukee. Contact: Johnson Controls Inc., 507 East Michigan St., P.O. Box 423, C-19, Milwaukee, Wis. 53201.

Feb. 7-9: Course on Introduction to Federal Projects and Historic Preservation Law, Dallas. Contact: Peggy Sheelor, General Services Administration Training Center, P.O. Box 15608, Arlington, Va. 22215.

Feb. 8-10: Course on Engineering for Extreme Winds, Lubbock, Tex. Contact: Martha Hise, Department of Continuing Education, Texas Tech University, P.O. Box 4110, Lubbock, Tex. 79409.

Feb. 9-10: "Lighting Design: Economy, Efficiency, Aesthetics," seminar, Boulder, Colo. Contact: Karen George, Joint Center for Energy Management, Campus Box 428, University of Colorado, Boulder, Colo. 80309.

Feb. 9-10: Course on HVAC Testing, Adjusting, and Balancing, Boca Raton, Fla. Contact: Wendy Wheeler, Association of Energy Engineers, 4025 Pleasantdale Rd., Suite 420, Atlanta, Ga. 30340.

Feb. 13-14: Seminar on Mechanical Behavior of Plastics, Chicago. Contact: Michael Roop, L.J. Broutman & Associates, 3424 South State St., Chicago, Ill. 60616.

Feb. 13-17: Level I Qualitative Course on the Application of Infrared Scanners to Detect Building Energy Losses, Atlanta. Contact: Infraspection Institute, 33 Juniper Ridge, Shelburne, Vt. 05482.

Feb. 14-16: Course on Thermographic Applications Using Video Therm® Equipment, Phoenix. Contact: John Snell & Associates, 17 First Ave., Montpelier, Vt. 05602.

Feb. 17-18: "How We Build," conference, Charlottesville, Va. Contact: Dian Lofton, University of Virginia School of Architecture, Campbell Hall, Charlottesville, Va. 22903.

Feb. 19-23: International Exposition and Conference on Concrete Construction, Atlanta. Contact: Beth Gassen, World of Concrete, 426 South Westgate, Addison, Ill. 60101.

Feb. 23-25: American Architectural Manufacturers Association EXPO '89, seminars and exhibition, Washington, D.C. Contact: Tony Coorlim, Exposition Manager, American Architectural Manufacturers Association, 2700 River Rd., Des Plaines, Ill. 60018.

May 5-8: AIA Annual Convention, St. Louis. Contact: Ketchie Brassel at Institute headquarters, (202) 626-7396.

LETTERS

California Support Groups: Reading "Women in Architecture: Changes Over Time" [Nov. '88, page 106], I felt humbled by the immense, often absurd obstacles faced by my predecessors. Their perseverance in the face of the malicious ignorance, insulting comments, and humiliating situations in school and at work should inspire every woman architect to overcome the remaining inequities in our profession.

I can disagree with only one major point. Organizations of women architects may be on the wane in the East, as you state, but those in California are thriving. I am active in the San Diego group, Women in Architecture. Founded 10 years ago, WIA continues to grow. The original need, as elsewhere, was to provide a forum for mutual support and the exchange of ideas and resources. Today we also present educational and professional programs for members and the public. We have just awarded our fourth annual \$500 scholarship to a local woman architecture student. Our "old girls' network" has led to jobs and leadership opportunities for members, as well as friendship and moral support.

Actually, WIA is a relative newcomer in California. The Association of Women in Architecture in Los Angeles and the Organization of Women in Architecture in San Francisco have both been active longer, and have proportionally larger memberships and agendas. Just this year, these three groups have initiated the process of forming a statewide network of organizations, both for communication and for potential political involvement.

Clearly there is still a need for organizations of women architects. As the article states, discrimination continues. Equal pay remains elusive, from the intern level on up. Attitudes, whether of male employers, contractors, or other members of the building industry, may prove even more intransigent. We all fight for pay, for responsibility for respect, as individuals. But at least we are not as isolated as women were in earlier years. We benefit from the support and opportunities the organizations give us, and architecture as a whole benefits from their public presence.

Barbara Thornburgh Carlton
Associate Member, AIA
San Diego

Male Stereotypes: I found "Women in Architecture: Changes Over Time" interesting. It is not a subject I hear about often, and I would like to believe that the architectural profession is enlightened enough to realize women can play an equal role in producing our built environment.

For the most part, the article is well written and responsible. However, I take exception to remarks by Diane Legge of Skidmore, Owings & Merrill and two unnamed women architects. One quote claims that females "try to resolve a conflict before there is a confrontation."

Another suggests that women are "much more honest about solving problems for our clients." The third informs us that "men tend to think, 'I've designed this and, damn it, I'm not changing it.'" These remarks are broad and highly stereotypical of male architects. It would seem that not all of the architectural profession is as enlightened as I thought.

Christopher J. Sass, AIA
Chicago, Ill.

Female Stereotypes: I found "Women in Architecture: Changes Over Time" to be extremely disappointing. It implies that "nurturing, persuading, seeing holistically" are essentially female traits. These are human qualities that benefit any situation. Referring to these qualities in the context of the article stereotypes the "earth mother architect" designing nice things for unfortunate people. I am not especially interested in social housing. Does that make me less of a woman? There are women who are interested in every kind of architecture including nonsocial and non-nurturing, i.e., garden variety architects. Do we have a choice?

The basic problem is the article's attempt to define women architects. There is no such definition except that we are women and we are architects. We suffer from the many problems that go with being women in a male-dominated profession. We do not want to be expected to manifest distinct "female" qualities in the buildings we design. We want to be equal and, given that equality, choose to design anything.

Cindy Brenneis
Vancouver, British Columbia

A Gropius Legacy: I was delighted to see the Gropius house article, "Restoring a Modern Milestone," in the November 1988 issue [page 96]. Your presentation shows respect by a society for an unusual, white, New England house, built in 1938, on a grassy knoll. For a half-century, this world center has been an attraction to distinguished individuals.

It was this American manifesto by Gropius that moved me, in 1940, to design a house for myself in Texas. And, it is with this closely related example that I wish to point to a salient principle of Gropius's approach. His influence was one of spirit, not of style. His house was a faithful recognition of the essence of New England residential tradition: the compact mass, with central hall, for design against the cold. My concept drew from the vernacular of the central Texas region: a design against the heat; wood lattice screens to shade; limestone walls, blank to the west. My house was an extended, single-width space plan to effect maximum cooling. The distinctive bond between these two houses was the creative, light touch, not ponderous, and the openness of each on its secluded, private, garden side.

Chester Nagel, FAIA Emeritus
Denver

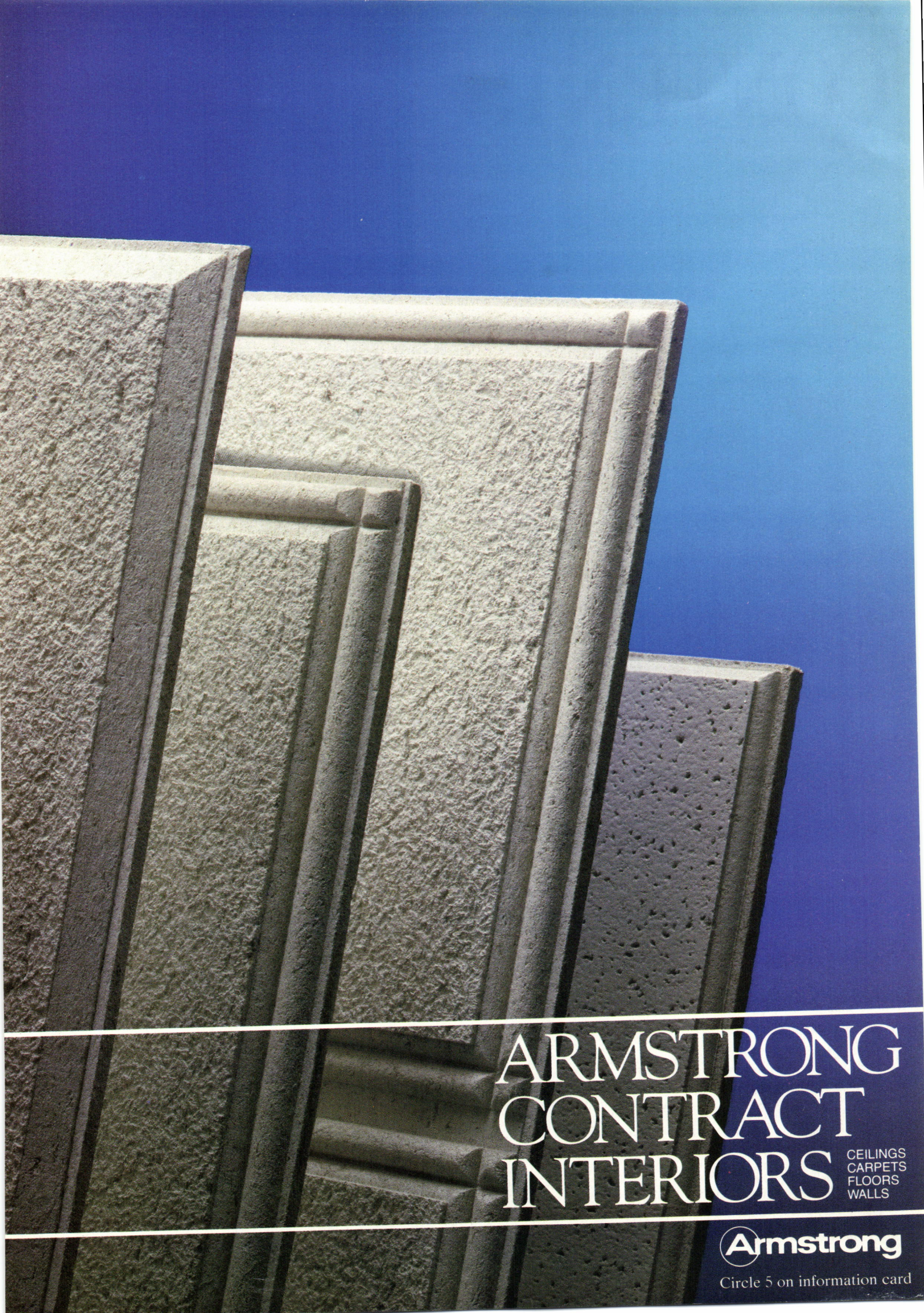

ARMSTRONG CONTRACT INTERIORS

CEILINGS
CARPETS
FLOORS
WALLS

Armstrong

Circle 5 on information card

CONTENTS



Page 42

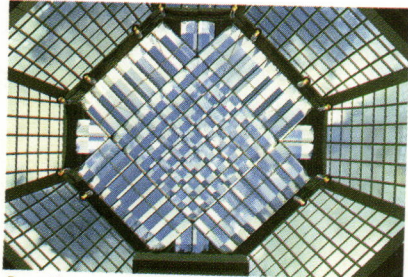

Page 48



Page 64

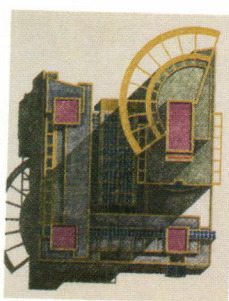

Above, overview of Canary Row. Right, roof plan of Frankfurt tower by Kohn Pedersen Fox.

Pei in Paris: The Pyramid in Place 42
But not yet in use.
By Charlotte Ellis

Roche in Versailles: Unbridled Neoclassicism 48
For a corporate headquarters.
By Donald Canty, Hon. AIA

Giurgola in Canberra: Quiet Colossus 52
'Avoiding anything overbearing.'
By Philip Drew

SOM in The Hague: Elegance Behind Blandness 60
A contemporary addition to a historic headquarters.
By Gerda ten Cate

Americans Abroad: Some Coming Attractions 64
Exports to Europe and Asia by U.S. architects.
By Nora Richter Greer

Mr. Wright in Japan: Beyond the Imperial 72
Little-known built and unbuilt work.
By Michael Kopp

Evaluation of a '50s Landmark 76
Edward Stone's New Delhi Embassy.
By Ranjit Sabikhi

The Current State of State Department Building 80
Does security dictate a fortress image?
By Bill N. Lacy, FAIA

Donald Canty, Hon. AIA, *Editor in Chief*

Carole J. Palmer, *Executive Art Director*; Andrea Oppenheimer Dean, *Executive Editor*; Allen Freeman, *Managing Editor*

Nora Richter Greer, Michael J. Crosbie, Lynn Nesmith, Forrest Wilson, *Senior Editors*; Douglas E. Gordon, M. Stephanie Stubbs, Elena Marcheso Moreno, *Technical Editors*; Amy Gray Light, *Associate Editor*; Karen Collins, *Assistant Editor*; Elizabeth Dahlslien, *Copy Editor*

Amy Leonardi, *Design Assistant*; Timothy B. McDonald, *Technical Illustrator*

Robert Campbell, AIA, David Dillon, Robert A. Ivy Jr., AIA, John Pastier, Bea Sennewald, AIA, Karen Haas Smith, Marguerite Villecco, Oliver R. Witte, *Contributing Editors*

Bernard F. Kroeger, *Circulation Manager*; Kelly L. Collins, *Assistant Circulation Manager*; Jesse Sims, *Production Manager*; Nancy Perri, *Assistant to the Publisher*; Bob Kliesch, *Publisher*

ARCHITECTURE, publication number ISSN0746-0554, official magazine of the American Institute of Architects, is published monthly by the American Institute of Architects at 1735 New York Ave. N.W., Washington, D.C. 20006. **Individual subscriptions:** U.S. and its possessions: \$39 for one year, \$57 for two years, \$74 for three years. Canada: \$45 for one year, \$65 for two years, \$84 for three years. Foreign: \$63 for one year, \$105 for two years, \$147 for three years. Single copies, \$6 each (except for May and September issues, which are \$12). Publisher reserves the right to refuse unqualified subscriptions. For subscriptions: write circulation department, ARCHITECTURE, 1735 New York Ave. N.W., Washington, D.C., 20006; allow eight weeks. Quotations on reprints of articles available. Microfilm copies available from University Microfilm, 300 N. Zeeb Road, Ann Arbor, Mich. 48106. Referenced in The Architectural Index, Architectural Periodicals Index, Art Index, Avery Index to Architectural Periodicals. Second class postage paid at Washington, D.C., and additional mailing offices. © 1989 by the American Institute of Architects. Opinions expressed by the editors and contributors are not necessarily those of AIA. The drawings, tables, data and other information in ARCHITECTURE have been obtained from many sources, including government organizations, trade associations, suppliers of building materials, and professional architects or architectural firms. The American Institute of Architects has made every reasonable effort to provide accurate and authoritative information, but does not warrant, and assumes no liability for, the accuracy or completeness of the text or its fitness for any particular purpose. VOL. 78, NO. 1.

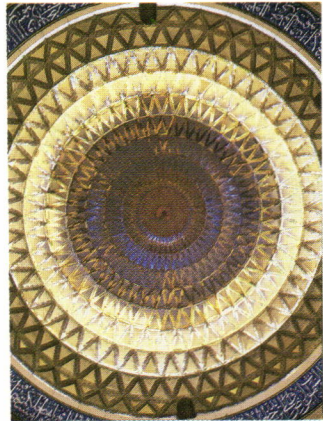

Page 87

Cover
I.M. Pei's pyramid at the Louvre amid fireworks and laser beams (see page 42).
 Photograph by Deidi Von Schaewen.

News			
<i>Esherick wins gold medal</i>		17	
<i>Cramer named new AIA CEO</i>		18	
<i>AIA, ASIA, and IBD sign accord</i>		18	
<i>U.S. Embassy in Moscow</i>		20	
<i>Women veterans' memorial approved</i>		22	
<i>Deaths: Luis Barragán</i>		23	
<i>Design conference in L.A.</i>		26	
<i>Boston's Vision competition</i>		30	
Events	12	Products	119
Letters	12	Credits	123
Briefs	30	Advertisers	125
Books	33		

The American Institute of Architects

Officers: Benjamin E. Brewer Jr., FAIA, *President*; Sylvester Damianos, FAIA, *First Vice President*; Gerald S. Hammond, AIA, C. James Lawler, AIA, Gregory S. Palermo, AIA, *Vice Presidents*; Christopher J. Smith, AIA, *Secretary*; Thomas J. Eyerman, FAIA, RIBA, *Treasurer*; James P. Cramer, Hon. AIA, *Executive Vice President/Chief Executive Officer*

Directors (year indicates expiration of term): Donald C. Axon, AIA ('89), *California*; Betsy Olenick Dougherty, AIA, ('91), *California*; Warren Thompson, AIA ('89), *California*; Vernon Reed, AIA, ('91), *Central States*; William B. Reiner, AIA ('90), *California*; W. Cecil Steward, FAIA ('90), *Central States*; Charles M. Sappenfield, FAIA, ('91), *East Central*; John M. Barley II, AIA, ('91), *Florida/Caribbean*; James A. Greene, FAIA ('90), *Florida/Caribbean*; Thomas Nathan, FAIA ('89), *Gulf States*; John K. Mott, FAIA ('90), *Gulf States*; Richard B. Cook, FAIA ('90), *Illinois*; Walter H. Lewis, AIA ('90), *Illinois*; Robert E. Greager, AIA ('89), *Michigan*; Michael E. Bolinger, AIA ('90), *Middle Atlantic*; William E. Pelham, AIA, ('91), *Middle Atlantic*; Kenneth DeMay, FAIA, ('91), *New England*; Douglas K. Engebretson, AIA ('89), *New England*; Eleanore K. Pettersen, AIA ('89), *New Jersey*; L. William Chapin II, AIA ('90), *New York*; Michael Maas, FAIA, ('91), *New York*; Robert G. Mutchler, AIA, ('91), *North Central*; Richard W. Hobbs, FAIA ('89), *Northwest*; Donald H. Phillip J. Markwood, AIA, ('91), *Ohio*; Susan Maxman,

Technology & Practice

Challenges of Building Abroad	87
Foreign billings by U.S. firms are again on the rise. By Bea Sennewald, AIA	
Foreign Investment in the U.S. Building Industry	91
It is being attracted by both economics and technology. By Elena Marcheso Moreno	
Where Does Modified Bitumen Roofing Belong?	95
It continues to be the center of controversy. By Karen Warseck	
The Behavior of Concrete in Harvard Buildings	99
It has been irregular. By Elena Marcheso Moreno	
Successfully Combining Masonry and Brick	103
By Stephen Szoke and Hugh C. MacDonald	
Adjusting to the Expanding Uses of Computers	109
By Mark Lauden Crosley, AIA	
Technical Tips	113
Specifying welding details. By Timothy B. McDonald	

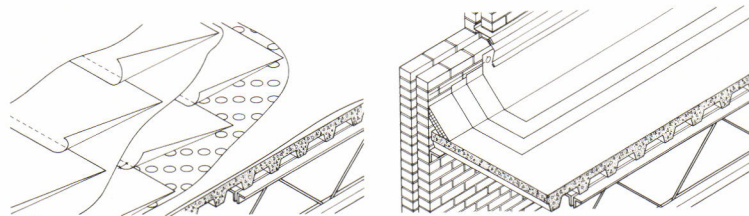

Page 95

AIA ('90), *Pennsylvania*; Robert S. Woodhurst III, AIA, ('91), *South Atlantic*; Thomas P. Turner, AIA ('89), *South Atlantic*; Thomas L. McKitterick, FAIA, ('91), *Texas*; Robert H. LeMond, AIA ('89), *Texas*; James R. Foster, AIA ('90), *Texas*; Paul H. Barkley, AIA ('89), *Virginias*; Gabor Lorant, AIA, ('91), *Western Mountain*; Jess Holmes, AIA ('90), *Western Mountain*; Matthew W. Gilbertson, *ex officio*, *President AIAS*; Kathleen L. Davis, Hon. AIA, *ex officio*, *Chair*, CACE; Lloyd Kaiser ('89), *Public Director*

Headquarters: James P. Cramer, Hon. AIA, Executive V.P./CEO and President, The American Architectural Foundation; James M. Bentley, AIA, Senior Executive/Client Services; Ann Polski Casso, Membership Services; Fred R. DeLuca, Chief Financial Officer/Assistant Treasurer; John A. DiNardo, General Counsel; James E. Ellison, FAIA, Education Services; Steven A. Etkin, Corporate Vice President; James R. Franklin, FAIA, Group Executive, Professional Services; John Gaillard, Convention; Timothy Hargrove, Controller; John R. Hoke Jr., AIA, AIA Press; Bob G. Kliesch, Publisher, Magazine Group; Kevin Fry, *Public Affairs*; Ronald J. Panciera, Hon. AIA, Accounting; Ann L. Oliveri, Marketing; Raymond P. Rhinehart, Public Outreach Vice President; James A. Scheeler, FAIA, Group Executive, Liaison and Special Programs; Jean L. Swarts, Personnel Director; Gregg Ward, Administrator, Government Affairs

“I don’t want to put something on the market that can be easily copied. I want people to scratch their heads and wonder how on earth it’s made. Edgewood’s miter detail—the chamfered edge—is as old as wood joinery itself. But here it is reinterpreted on new equipment, so technology is achieving a precision not possible when furniture had to

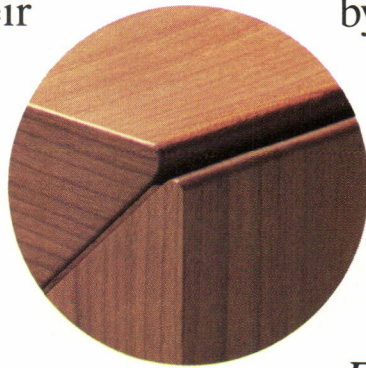

be hand-made. And you get absolutely no clue as to how it’s held together by looking at it.

“There’s no better way to do it than with heavy tooling, big machinery, and years of trying to get it right.”

—*Edgewood™ designer Robert Taylor Whalen.*

Edgewood—pedestal and table desks, credenzas, vertical cabinets,



Award winner.

Awards

Joseph Esherick Named Recipient Of AIA's 47th Gold Medal

Joseph P. Esherick, FAIA, the San Francisco architect and teacher whose masterful and unassuming buildings seem so perfectly fitted to their immediate surroundings as well as their larger social and cultural settings, has won AIA's highest honor, the gold medal. Never dependent on current fashion or styles, Esherick's buildings reflect a timelessness, yet his body of work is clearly of our time.

In announcing the award, AIA President Benjamin Brewer Jr., FAIA, said, "Joseph Esherick is the consummate architect, whose overriding concern is to create wonderful places for people, not extravagant statements."

Born in Philadelphia in 1914, Esherick studied architecture at the University of Pennsylvania. During this period he worked with several sculptors, including his uncle, Wharton Esherick. The younger Esherick graduated in 1937 and worked for a year in George Howe's office before moving to San Francisco, where he apprenticed with Walter Steilberg and Gardner Dailey.

"I was drawn to the openness of the West, not only in terms of the landscape but also a social openness and acceptance of different kinds of people with different philosophies," said Esherick.

After service in the Navy during World War II, Esherick returned to San Francisco and established his own office in 1946. Now known as Esherick, Homsey, Dodge & Davis, his firm received the AIA firm of the year award in 1986. (An extensive profile of the firm was published in this magazine's February issue that year.)

Esherick's early practice was largely residential—houses that represented an innovative, maturing response to the special attributes of the San Francisco Bay region. Throughout his career, Esherick has been intensely concerned with siting and with accommodating environmental factors, notably natural light. He also has shown an abiding concern for the needs of the user. "Beauty is a consequential thing, a by-product of solving problems correctly," Esherick once wrote. "No successful architecture can be formulated on a generalized system of esthetics; it must be based on a way of life."

His houses incorporate indigenous materials natural in finish and rough in texture

and make imaginative use of light. Charles Moore, FAIA, wrote, "Daylight doesn't just bathe [Esherick's buildings]; it comes alive in them—dances and dodges and surprises and glows. It is controlled and balanced, comfortable and adequate, but then it is suddenly . . . magic."

Esherick's collaboration on the overall planning of Sea Ranch and his cluster of seven demonstration houses designed in 1963 epitomize his design philosophy. "Of many other projects that have made innovative contributions to the architecture of 'indigenous things and universal dreams,' Sea Ranch will remain one of the most respected," said his nominators.

The Cannery of 1964 is one of first and still a successful example of adaptive use. However, the University of California at Berkeley's Wurster Hall of 1964, for which Esherick served on a collaborative team with Don Olsen and Vernon DeMars, compared with his other work now seems uncharacteristically harsh and monumental.

The highly acclaimed Monterey Bay Aquarium, of 1984 (for which Esherick emphasizes that his partner Chuck Davis was principal designer), incorporates a new structure while saving the best of existing

buildings to maintain the historic character of the old Cannery Row.

In addition to heading an active practice, Esherick has maintained a long-term association with the University of California, Berkeley, beginning in 1952 when he was asked to fill in as a temporary lecturer. He served as chairman of the department of architecture from 1977 to 1981 and retired in 1985. In 1982 he was awarded the AIA/Association of Schools of Architecture medal of excellence in education. Esherick's commitment to education makes it particularly appropriate that three of the firm's five national honor awards have been for educational facilities.

Esherick acknowledges that his association with Berkeley has greatly influenced his work. "I think I get pretty esoteric at times, kind of wandering off in distant fields, but my teaching has involved a very straightforward approach of trying to deal with very concrete problems that an architect faces," he wrote. "I really don't consider myself an educator, but an architect who likes to teach a little."

In a letter supporting the award, Frederick Schwartz, AIA, wrote, "I am an architect because of Professor Joseph Esherick. There are influential teachers and influential architects. Few have affected so many by the excellence of both their work and their teaching. For another generation there was Gropius or Kahn; for my generation there is Joseph Esherick—teacher of teachers, master builder, and friend."

Asking questions and sharing information are underlying principles that have remained constant throughout Esherick's practice and teaching. In determining what the client really wants, he takes the approach of separating real from imagined needs and requirements and starting the design process without preconceptions. According to Esherick, the constraints of preconceived approaches are unsatisfactory, simply because design dominated by style inhibits the flexibility necessary to satisfy what we see as the real problems. "Clients do not necessarily want to reshape their lives to accommodate a style; it should be the other way around," he said. His clients agree.

Esherick said he cherishes the relationships he has formed with his clients. "It's almost weird how many of my original clients still live in the houses," he said. "And a lot of them say to me that they are going to keep living in them and they are going to die in them. They really enjoy the houses—that's what I did it for."

—LYNN NESMITH

News continued on page 18

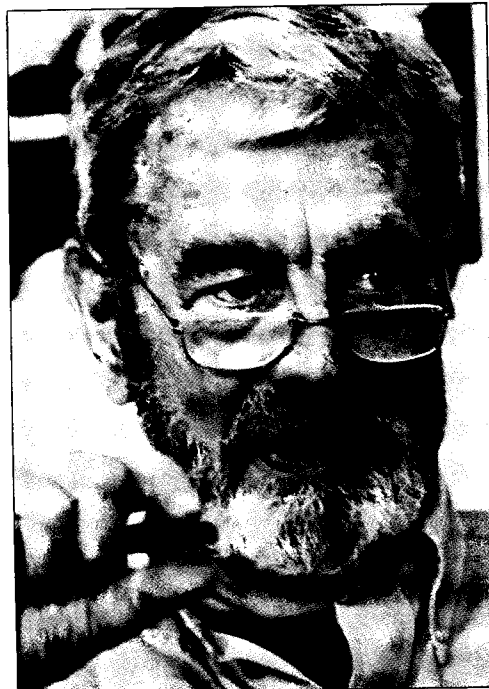

James P. Cramer Named AIA's New Executive Vice President/CEO

James P. Cramer, Hon. AIA, has been appointed executive vice president/CEO of the Institute. The announcement was made at the December AIA board of directors meeting in Washington, D.C., and became effective Jan. 1.

In accepting the position as the chief executive officer of AIA, Cramer reaffirmed his personal commitment and the continued commitment of the Institute to quality design. "We will live good design, breathe good design, and advocate good design at every opportunity," said Cramer. "I have learned that there can be no talk about the quality of life without talking about the quality of design."

Cramer joined the Institute staff in 1982 as president of the AIA Service Corp., the Institute's business division that merged with AIA in late 1986. He served briefly as senior vice president of AIA, and since 1987 he has served as deputy CEO of AIA and president of the American Architectural Foundation at the Octagon. Cramer also has served as the group publisher of ARCHITECTURE magazine.

Before joining the national AIA staff in Washington, D.C., Cramer was the executive vice president of the Minnesota Society of Architects and served as chairman of the Council of Architectural Component Executives. Cramer's experience at the state level has made him "a strong believer in chapter strengths. It is our components who are closest to our membership," he said. "We must empathize with the individual member whether she lives in Maine or he lives in Montana. The national organization will facilitate, not dominate, chapters; help, not hinder; and lead by example."

In addition to his background at the Institute, Cramer has served as an architectural adviser to several *Fortune* 500 companies. He has served on the faculty of the University of Minnesota and as an adjunct faculty member at Harvard University, the University of Maryland, and the University of Wisconsin.

A native of South Dakota, Cramer pursued undergraduate and graduate studies at Northern State, the University of Minnesota, the College of St. Thomas, and the Wharton school of business of the University of Pennsylvania.

Respectful of his Midwestern roots, Cramer said that AIA must try to avoid becoming too dominated by East Coast or Washington thinking. "This is not the Atlantic Institute of Architects," he said.

Cramer praised the accomplishments of Louis Marines, who has served as AIA's executive vice president for the past four



and one-half years and is moving to San Francisco to pursue other professional opportunities. "Marines's stewardship of this organization has made it possible for all of us to have the courage and resources to plan for the future of our own choosing," said Cramer.

New AIA officers were installed during the board meeting. Benjamin E. Brewer Jr., FAIA, of Houston, became AIA's 65th president. In his inaugural address, Brewer challenged AIA members to "celebrate

design excellence, honor the next generation of architects, and . . . make the profession of increasing service to society."

Brewer observed that architects' talents can help place the profession in positions of respect and leadership. "Good design can empower us to serve society by respecting its physical, intellectual, and spiritual values, and in return [we] will be afforded a fair profit for our services."

Other new national officers installed were first vice president/president elect Sylvester Damianos, FAIA, of Pittsburgh; vice presidents Gerald S. Hammond, AIA, of Hamilton, Ohio, C. James Lawler, AIA, of West Hartford, Conn., and Gregory S. Palermo, AIA, of St. Louis; and secretary Christopher J. Smith, AIA, of Honolulu. Thomas J. Eyerman, FAIA, of Chicago, continues his two-year term as treasurer.

Twelve national directors were installed as new members of AIA board of directors: John M. Barley II, AIA, of Jacksonville, Fla.; Betsey Olenick Dougherty, AIA, of Newport Beach, Calif.; Kenneth DeMay, FAIA, of Watertown, Mass.; Gabor Lorant, AIA, of Phoenix; Michael Maas, FAIA, of New York City; Phillip J. Markwood, AIA, of Columbus, Ohio; Thomas L. McKittrick, FAIA, of Houston; Robert C. Mutchler, AIA, of Fargo, N.D.; William E. Pelham, AIA, of Wilmington, Del.; Vernon Reed, AIA, of Kansas City, Mo.; Charles M. Sappenfield, FAIA, of Muncie, Ind.; and Robert S. Woodhurst III, AIA, of Augusta, Ga. Two ex officio board members were installed: Kathleen L. Davis, Hon. AIA, of Costa Mesa, Calif., president of the CACE; and Matthew Gilbertson, president of AIAS.—LYNN NESMITH

AIA, ASID & IBD Sign Accord On Designer Title Registration

The presidents of the American Institute of Architects, the American Society of Interior Designers, and the Institute of Business Designers have signed a joint statement to establish a "unified approach to title registration of interior designers." The accord spells out concepts that have resulted from year-long discussions by the leadership of the three design associations and calls for continuing negotiations among them.

The signing of the accord in early December came after the AIA board of directors granted preliminary approval of modifications to AIA's policy on licensing for building industry design professionals and a new policy on title registration of specialized design disciplines in the building industry. (Any new AIA policy or change in an existing policy requires reading and approval by the AIA board at two separate meetings before the policy becomes binding.)

As proposed, the two policies do not

advocate or endorse the licensing of interior designers. Rather, they "remove opposition to 'title registration' for interior designers and other specialized design disciplines within the building design industry. "Licensing: Practice Regulation," a modification of the existing policy on building industry design professionals, concerns practice regulation of design professionals for the protection of the public health, safety, and welfare. "Licensing: Title Registration" outlines the conditions under which title registration may be appropriate for specialized design disciplines in the building industry. ("Practice regulation" means that only those individuals who meet the legislated criteria may perform the services of the profession. With "title registration," only the use of the title is controlled; individuals who do not have the title may continue to perform the services.)

The ultimate goal of the agreement
continued on page 20

Innovative Answers to Your Flooring Needs



New worlds of lasting beauty.

VPI solid vinyl tile possesses a beauty that is undiminished by time. It's attractive the day it's installed, and just as attractive for years to come.

With a new array of eye-pleasing colors and variety of patterns, VPI solid vinyl tile coordinates with today's interior decors as well as VPI wall base.

Colors and patterns extend clear through the tile. Precision gauge control and our exclu-

sive Micro-squaring process result in a smooth continuous floor with tight-fitting seams and no high edges.

VPI tile resists abrasion and most common chemicals. It has good indentation recovery and conforms readily to minor subfloor irregularities without cracking, chipping, or breaking.

VPI solid vinyl tile. Innovative answers from VPI.



Floor Products Division

3123 South 9th Street, P.O. Box 451, Sheboygan, WI 53082 U.S.A.
Telephone 414-458-4664 • Telex 910-264-3891

The Institute from page 18

among the three design associations is "to reach a consensus on an approach to state regulation of interior designers that will benefit the design profession and the public they serve." The agreement spells out seven areas that will be addressed in future negotiations among the associations:

- Title registration.
- Requirements for registration, including a four-year minimum professional degree, accredited by the Foundation for Interior Design Education Research or the equivalent; National Council for Interior Design Qualification testing or the equivalent; and a monitored internship, to be developed.
- No grandfathering without strict and equivalent education, training, and testing criteria.
- Joint regulatory boards.
- The development of a clear definition of interior designer.
- Voluntary continuing education.
- Recognition of the right of licensed architects to continue to perform interior design services.

The accord also states that "final agreement will require resolution of these and additional issues" and that the three associations have "agreed to appoint representatives to work toward resolution of these difficult issues."

The AIA board of directors supported the joint statement at its December meeting and accepted the recommendations of AIA's licensing law task force in its report on interior designer practice regulations and title registration.

According to the task force's report, the proposed policies will "accommodate the agreement between AIA, ASID, and IBD" while allowing "flexibility for AIA components to deal with licensing issues and initiatives in the state legislatures." The report also recognizes that AIA wishes "to reach an acceptable compromise with the interior design associations but continues to have reservations regarding the long-term implications of title registration of specialized disciplines as opposed to private certification."

In hailing the joint statement, AIA President Ted P. Pappas, FAIA, praised the "spirit of cooperation that has brought us to this important moment. The willingness of all of our organizations to put aside our differences and work to find common ground will ultimately benefit not only our professions but the public we serve."

Expressing hope that the agreement is the beginning of an era of successful collaboration, Charles Gandy, president of ASID, said, "We are all members of the team responsible for the built environment, and each of us in our own professional role adds to the quality of life of the people we work for and with."

Michael Bourque, president of IBD, said that the accord "signifies only the first agreement of a blossoming relationship between our closely allied design disciplines." —LYNN NESMITH

Government

State Department Calls for Razing Of Bugged Embassy in Moscow

The chancery building of the U.S. Embassy in Moscow was uninhabitable before it was completed. The seven-building embassy complex, designed by Skidmore, Owings & Merrill/San Francisco with Gruzen & Partners, was to be the State Department's largest and most elaborate embassy, reflecting the United States' wealth, power, and architectural prowess. However, in August 1985 work on the chancery (the office building component of the embassy complex) was stopped when American intelligence agents discovered the building's structure was infested with permanent, sophisticated eavesdropping and transmitting systems that had been installed during construction.

Last November, following numerous private engineering and government studies, President Reagan recommended that the \$22 million chancery building be razed. The President's recommendation came after the State Department concluded that "dismantling and reconstructing the Moscow embassy office building offered the only solution which provides the degree of security required for use of the building as a chancery."

For more than three years, the eight-story chancery has stood empty, a stark reminder of the series of problems that have plagued the State Department and its Foreign Buildings Operations (see page 80) in the quest to build a monumental embassy complex in the Soviet Union's capital city. The tumultuous history of its construction began soon after the United

States established diplomatic relations with the Soviet Union in 1934. Within a year, William C. Bullitt, America's first ambassador to the U.S.S.R., reported that Stalin had promised him an embassy site high atop the Lenin Hills overlooking Moscow. While negotiations were being held, the embassy staff moved into temporary quarters downtown near Red Square.

Thirty years passed before an agreement was reached on the location of the embassy. Rather than the hilltop site, the State Department chose a 10-acre downtown parcel. In exchange, the Soviets were given a site atop Mount Alto, one of the highest spots in Washington, D.C. (At the time the agreement was signed in 1969, U.S. officials did not know that a hilltop site would become crucial as new espionage techniques became more dependent on microwave transmission.)

The agreement on the two sites was only the first of many State Department concessions and blunders. Next came negotiations for the construction of the two compounds. Responding to the spirit of detente during the Nixon Administration, the State Department agreed to allow site work, structure, and facade to be completed by Soviet workers. William P. Rogers, who was Secretary of State in 1972 when the agreement was signed, was quoted in a recent *New York Times* article saying, "I didn't favor it because it was a one-sided deal. But I was carrying out the orders of the [Nixon] White House."

While officials from the two governments were negotiating the construction details, the architects were put on hold.

continued on page 22

The taller building in the background is the chancery, scheduled to be razed.



David Drapkin/Time Magazine

AMERICA'S FIRST CHOICE IN MOBILE FILING AND STORAGE SYSTEMS.



S P A C E S A V E R

Double filing/storage capacity—or handle client needs in half the space.

Spacesaver systems can give you room for more offices, terraces, atriums—whatever.

And give your clients more efficiency, accuracy, security... with fewer steps and faster file retrieval.

From archives to active filing, the ideal choice.

You can customize systems to store virtually any type of material, and for the full range of business needs: massive records retention, central filing areas—or compact modules, handy for each department.

Exclusive Nationwide Local Area-Contractor Network.

And only Spacesaver brings you a coast-to-coast Area Contractor network.

Local installation.

Local service.

Two more reasons why we're America's first choice in Mobile storage systems. And why you can specify Spacesaver with confidence.

Spacesaver 

The Spacesaver Group, 1450 Janesville Ave., Ft. Atkinson, WI 53538
1-800-492-3434. In Wisconsin, call 414-563-5546

For more information, circle these Inquiry Card numbers:

Free Spacesaver Design Library Subscription

Spacesaver Systems for...

Business Offices 19 Libraries 29

Law Firms 21 Museums 31

Health Care Facilities 23

Government Facilities 25

Floor Loading Solutions 27

Get a grip on your filing problems.

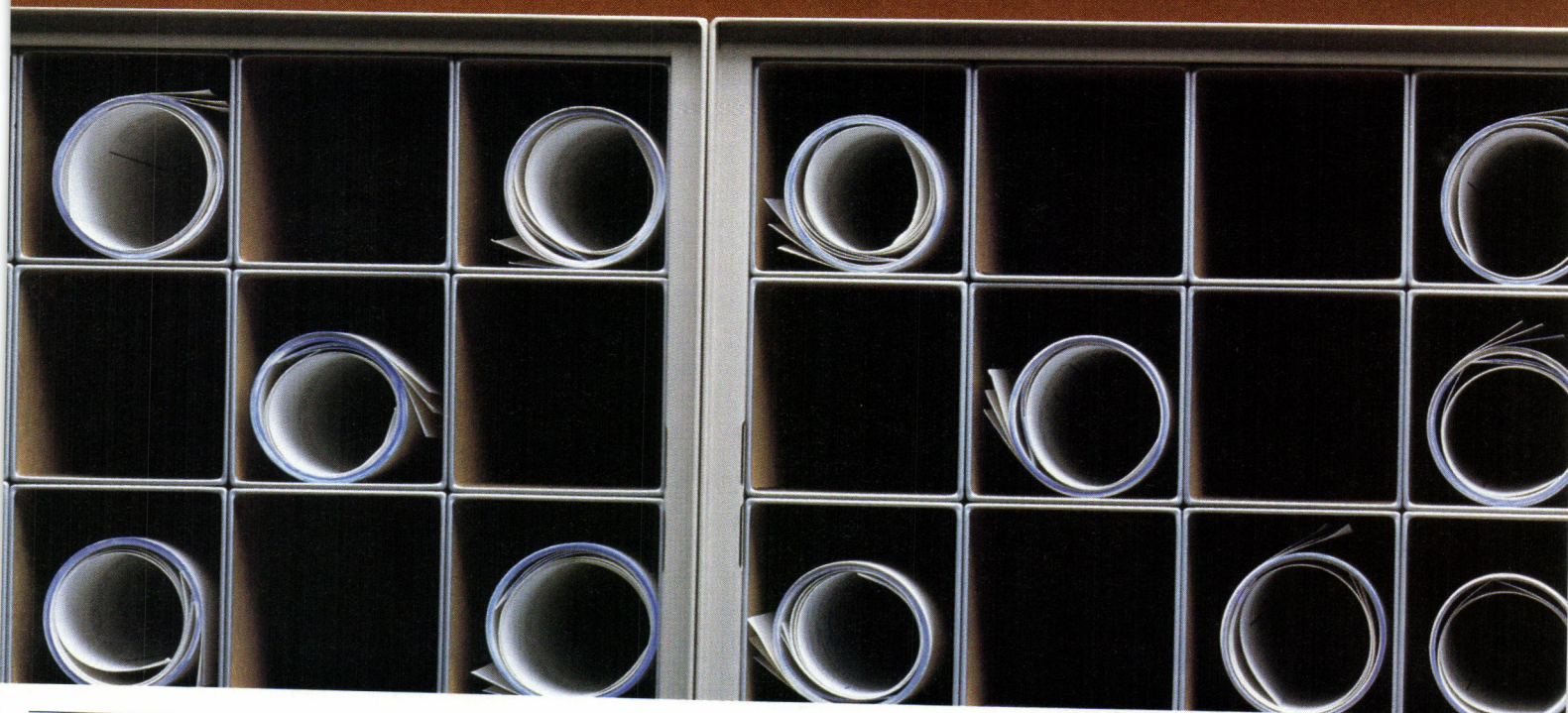

Government from page 20

SOM/Gruzen was awarded the embassy commission in 1968 but did not start active design until 1975. Ben Larson of SOM, who has worked on the project since the early '70s, recalled that the late John B. Rodgers, the SOM partner who signed the original agreement, reached mandatory retirement age before the design process was started. Larson said Rodgers later bemoaned the fact that "he had picked off one of the plums of the universe" and the firm never even started on the project during his tenure. (Edward C. Bassett, FAIA, was the senior design partner on the embassy project.)

Although working drawings were completed by 1976, construction did not begin until 1979 and was subject to numerous delays from the outset. State Department officials immediately were confronted with inferior Soviet construction standards and shoddy work habits and absenteeism of the Soviet workers. But the most serious problem resulted from the fact that precast structural components of the chancery were constructed at Soviet factories unsupervised by American inspectors.

Soon after construction commenced, security experts began to suspect that the Soviets were implanting spying devices. Rather than halt construction, the State Department moved ahead, confident that American security experts could neutralize the Soviet eavesdropping systems.

A U.S. Senate report in September 1985

charged that diplomatic objectives precluded full consideration of counterintelligence concerns during negotiations.

After construction was halted in August 1985, security specialists reported that it would be impossible to neutralize the sophisticated surveillance systems implanted within the steel and concrete structural elements and precast floor slabs, which the Senate report called "the most massive, sophisticated, and skillfully executed bugging operation in history."

Meanwhile, during the next three years, the other buildings of the embassy compound (four housing buildings, a school, Marine guard quarters, and a concourse with recreation and service facilities) were accepted and occupied, while the chancery building stood empty.

The Reagan Administration's recommendation that the chancery be demolished followed a study by the engineering firm BDM-MK Ferguson, under the auspices of the State Department, reporting that dismantling the building and constructing a new one would be more economical and less time-consuming than attempting to de-activate the surveillance systems in the existing structure.

The State Department hopes to develop a design scheme for a new chancery building as soon as possible. Joseph S. Hulings, head of a newly formed State Department office that oversees the embassy project in Moscow, said, "If the Congress decides to appropriate the money for the recon-

struction it will be a totally new effort."

According to Hulings, SOM most likely will continue as architect. "SOM must come up with a totally new design that will incorporate many of the elements recommended by the engineering study," said Hulings. In addition, one American contractor will be responsible for the entire chancery project, and all the construction will be done by American workers using American materials. Huling's estimated cost of the new chancery building is approximately \$300 million.

The fiasco of the Moscow embassy is not so much an architecture or construction failure but rather, in the words of the Senate report, "a textbook example of bureaucratic inertia, turf warfare, and inadequate interagency coordination."

—LYNN NESMITH

Women's Vietnam Memorial Approved but Site Unspecified

In November President Reagan signed into law a bill authorizing construction of a memorial to honor women Vietnam veterans. The memorial is to be built on a site as yet undetermined, somewhere on federal lands in or near the District of Columbia, but not necessarily on the site of the Vietnam Veterans Memorial.

Last June the Senate passed a bill (see Aug. '88, page 32, and May '88, page 48) that would have allowed a statue of a

We give you fingertip room to make your filing easier and faster. In a lot less space.
No binding, ever. For a FREE catalog, give us a call. 1-800-854-6868*.

PLAN  HOLD

The Originator of Square Tubes for Rolled Plan Filing

*In California: 1-800-432-7486 • 17421 Von Karman Avenue, Irvine, CA 92714 • Fax No: 714-474-8076

Circle 33 on information card

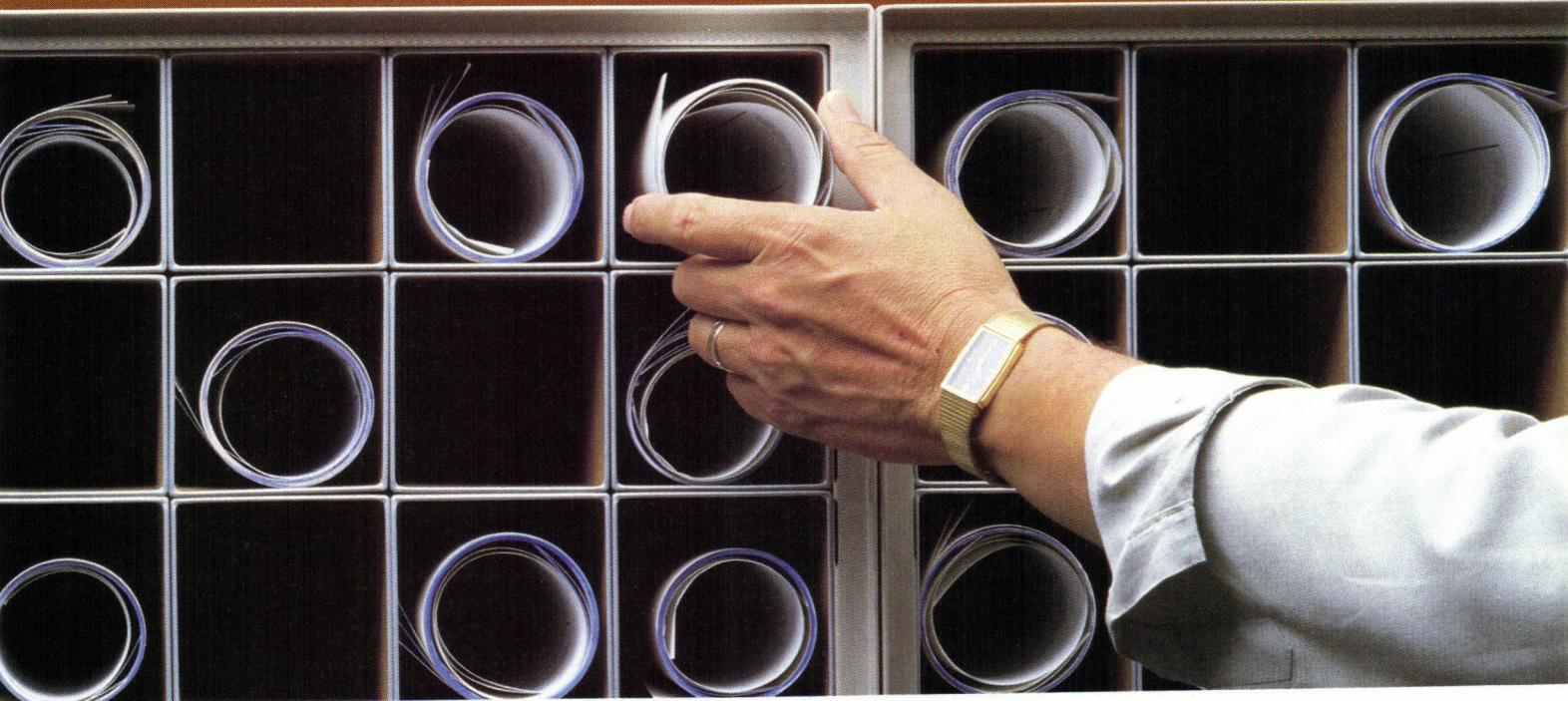

female nurse wearing army fatigues and holding a helmet to be placed on the site of the Vietnam Veterans Memorial, where also stands a statue of three infantrymen. The nurse statue had been proposed by the Vietnam Women's Memorial Fund, a nonprofit group concerned that women who served in Vietnam were not adequately represented by the existing memorial, although the names of the eight who were killed appear on the wall along with the names of their male counterparts. In addition, the Senate bill would have overriden the opinions of two federal advisory boards that opposed any further additions or alterations to the Vietnam Veterans Memorial.

The bill passed by the House, however, put those advisers—the Commission of Fine Arts and the National Capital Planning Commission—in key decision-making positions, in accordance with the 1986 Commemorative Works Act, which requires their approval of site and design. It was the House version that President Reagan signed.

Robert Doubek, former project director of the Vietnam Veterans Memorial Fund, opposes adding the nurse statue to the existing memorial, although he supports its placement elsewhere. He said he is happy with the new law and confident that with the assistance of the two advisory commissions an appropriate location will be selected.

—ELENA MARCHESO MORENO

Deaths

Luis Barragán: Mexican Architect of Poetic Imagination

Luis Barragán, Mexico's pre-eminent and most widely respected architect, died Nov. 22 in Mexico City at the age of 86.

Although he never designed a project outside Mexico, his distinctive work brought him international recognition. In 1980 he was awarded the Pritzker prize, which had been established the year before by the Hyatt Foundation to "encourage greater awareness . . . of the way people perceive and interact with their surroundings."

The prize seemed especially appropriate for the intensely private man who had no formal architectural training (his background was in engineering), who relied on intuition and emotional sensibility to create his works, consistently drawing on the traditions of Mexico he loved most—its ranches, villages, and convents.

Barragán's designs are well articulated spaces composed of natural materials and a sense of landscaping and incorporating water, land, and air, as well as a dramatic use of color and play of light. In an interview Barragán said, "I believe in emotional architecture. It is important for human-kind that architecture should move by its beauty. . . . Any work of architecture which

does not express serenity is a mistake."

In the preface to his 1976 book *The Architecture of Luis Barragán*, Emilio Ambasz wrote: "Barragán is one of landscape architecture's most refined and poetic practitioners. In the de Chirico-like settings he creates, the wall is both the supreme entity and the inhabitant of a larger metaphysical landscape, a screen for revealing the hidden colors of Mexico's almost white sun and a shield for suggesting never seen presences. His magnificent fountains and carefully constructed plazas seem to stand as great architectural stages for the promenade of mythological beings. While his design approach is classical and atemporal, the elements of his architecture are deeply rooted in his country's cultural and religious traditions. It is through the haunting beauty of his hieratic constructions that we have come to conceive of the passions of Mexico's architecture."

Some of Barragán's best-known works are the gardens of El Pedregal, his house in Mexico City, and the stables, pools, and house of San Cristobal.

—AMY GRAY LIGHT
News continued on page 26

**ONLY ONE
WINDOW COMPANY
DARED TO TAKE
ON THIS CITY HALL.**





When Baltimore decided to replace the windows in its 120 year-old City Hall, Baltimore talked to all of the major window companies.

Then Baltimore chose Marvin. Baltimore chose Marvin because no one had more experience at making windows to order. Because no one was better-equipped to actually make all of the different shapes and sizes. Because no one else could incorporate more maintenance and energy-efficiency features into such historically accurate replicas.

And because we make windows to order, we could apply more know-how and technical support to the job. We could deliver on a schedule and in an order that let the contractor do his job quickly and cost-efficiently.

No other window company could have handled this job as well as we did. The proof is right there at Baltimore City Hall.

And nobody can argue with City Hall.

For more information, call us toll-free at 1-800-328-0268 (in Minnesota, dial 1-612-854-1464). Or just write Marvin Windows, 8043 24th Avenue South, Minneapolis, MN 55425.

**MARVIN WINDOWS
ARE MADE TO ORDER.**



Circle 35 on information card

'Sprawling, Surprising' L.A. Hosts Conference on 20th-Century Design

The AIA committee on design met in Los Angeles last November to ponder the nature of "America's quintessential 20th-century city," thereby completing an ambitious set of westward-moving conferences that were meant to examine the evolution of American architecture over three centuries. The first event, exploring 18th-century design, had been held in Annapolis, Md., and the second, dealing with design in the 19th century, had taken place in St. Louis.

On this occasion, presented with a varied menu of talks and a widely scattered itinerary of buildings and events, the 1988 National Design Conference attendees found Los Angeles to be a sprawling and surprising city that does not yield its secrets easily. In keeping with the setting, items on the intellectual agenda included the issue of an appropriate developmental model for this nontraditional city, and whether architects should be content with a purely private-realm role or take the initiative in shaping the public environment as well.

The event began on Nov. 3 with a visit to Frank Gehry's nearly complete Santa

Monica Museum of Art. This talk was even more casual than planned, since the lack of a certificate of occupancy dictated a peripatetic conversation with the architect on the institution's grounds.

After a reception at the Los Angeles County Museum of Art, Vincent Scully addressed a packed house where local architects and Yale alumni outnumbered the committee members by a good margin. Before giving his talk on "Context, Not Style: The Revival of the Classical and Vernacular Traditions 1966-1988," he apologized for his unfamiliarity with the West Coast. The lecture dealt with East Coast and European buildings and emphasized the work of Robert Venturi, FAIA, and Ricardo Bofill, Hon. FAIA, and thus was not fully germane to the conference. While the issue of context was sometimes difficult to discern, the talk was nonetheless brilliant and was delivered with a theatricality that compensated for a recurring inaudibility brought about by the combination of a poorly placed microphone and a highly kinetic speaker. Alumni of Scully's course at Yale found the lecture familiar, and the same talk was given in San Fran-

cisco just a day before, but for a first-time listener the experience was revelatory.

One high point was recalled the next day by Robert Campbell, AIA, who cited the pairing of an image of Leonardo's drawing of a man in a circle with a graphically similar slide of Venturi's mother standing below a curved molding on a wall of the house that her son designed for her about 25 years ago. Scully used the second image as a symbol of both a new antiheroism in architecture and the rising influence of feminist perceptions in our society, saying, "not to be too circumlocutory about it, this design puts woman at the center."

The second day's events began with talks by historians William Westfall of the University of Virginia and Thomas Hines of UCLA. In "The Last Years of the American City," Westfall declared that "we do not regard our cities with the same affection that we do our way of life—our cities have ceased to exist." He illustrated the point with images of suburban development, urban renewal, and out-of-character insertions into small-town environments. But, in developing this provocative and promising thesis, he spelled out an academic, seven-part recipe for proper urban design that smacked more of Platonic philosophy than the act of building in late-20th-century America.

To make his points, Westfall used only his own Thomas Jefferson-designed campus and the nearby town of Charlottesville as examples, thus straying from the

continued on page 29

AnthroBench™



The workbench that is incredibly strong. Designed with a space saving arm. Cable management track. Height adjustment. Options to add.

Call us: 800-325-3841



Made in U.S.A.
Holds up to 600 lbs.
60" wide x 36" deep.



**Anthro® Corporation
Technology Furniture**

3221 N.W. Yeon St.
Portland, OR 97210
503-241-7113

Anthro is a registered trademark of Anthro Corporation.

Cities from page 26

geographic and temporal framework of the conference. In analyzing that sub-metropolitan Virginia setting, he ignored the inescapable forces of transportation and economics that shape contemporary development, and implied that the solution lay in the creation of the proper political order. This position might seem more realistic if political leaders (not to mention architects) of Jeffersonian quality appeared with greater frequency.

In contrast, Hines took a value-free approach. "The Issue of Tradition in a 20th-Century City" was a well-chosen introduction to the individual small-scale monuments of local design. He called Los Angeles "a city which in spite of its own self image has needed, called on, and exploited tradition." He identified five of those traditions: aboriginal, exotic, craftsman, modernist, and inclusive or post-modern, and later added a "tradition of distinguished visitors." Like Scully's and probably like Westfall's, it was essentially a stock lecture. Salted liberally with entertaining and informative quotes and images, it would seem to appeal mainly to outsiders unfamiliar with the region. Hines intentionally excluded "young hotshots, transportation, urbanism, and sprawl"—elements that inarguably make Los Angeles what it is, and emphasized the effectively invisible environment of sequestered canonic building examples over the real and public environment of everyday existence.

For the ensuing panel discussion, the three speakers were joined by Thomas J. Vreeland Jr., FAIA, Michael Rotondi, AIA, and moderator Campbell. Despite Campbell's best efforts at provoking discussion, this event did not flow freely. Vreeland lamented "the omission of the Municipal Arts tradition in Los Angeles," while Rotondi voiced such venerable and often-heard local sentiments as "Los Angeles is a microcosm of the United States" and, later, "Los Angeles is the city of the 20th century." Responding to the latter pronouncement, Campbell rejoined that "the 20th century is almost over, and Los Angeles is beginning to look like a city of the past."

Somewhat earlier, Scully observed that "everybody loves Los Angeles because they hate it," and later Hines stated that he "intentionally did not dwell on the horrors of L.A. . . . It is a horrible place in many ways." Vreeland said that, "if you have to live in this city, [its zany buildings] are not very interesting. Los Angeles does have its sane side." Rotondi countered that "architecture is now a guerrilla act, not something you do walking down Main Street. We're trying to produce architecture without feeling guilty about what we're doing."

He challenged Westfall's traditionalist prescription for communal order, saying "that's not the way the world moves forward." He also chided the profession for

looking to the past, suggesting that "architecture should look at astronomical discoveries" as a model, and then rather incongruously asserting that "architecture is now becoming the mother art once again." In summation, Campbell characterized Rotondi's views of Los Angeles by saying that "there's an old proverb: if you want to learn about water, don't ask a fish."

But on the next morning, a different school of fish gathered to summarize and conclude the weekend's proceedings. Richard Weinstein called Los Angeles a "Third World city" that is the nation's most productive industrial region thanks to a malleable worker pool and a dispersed "mulch" of small industries. He suggested that people who deem Los Angeles to lack public spaces should observe the beaches on weekends. Robert Harris said, "The city has a fundamental urban structure that

makes great sense to me. It is a montage of small communities . . . but there are some awful things too, including the wrong political structure. The city offers fantastic opportunities for its own evolution, but they are missed at every turn." Michael Dennis found Los Angeles to be the opposite of New York in the sense that "it's a nice place to live, not to visit."

And yet, through both design and inadvertence, the conference's architectural visits may have been the most informative part of the event. Barton Phelps, AIA, the meeting's local coordinator, devised the itinerary to show both the quality and diversity of Los Angeles's architectural monuments and the repetitive, horizontal nature of its urbanization. Attendees were bused to buildings and event sites that ran the gamut from Wright to Beaux-Arts,

continued on page 30

WHY ARE PC GLASSBLOCK® products the choice of America's leading architects?

Because there is a difference
in glass block quality . . .
and the service that comes with it.

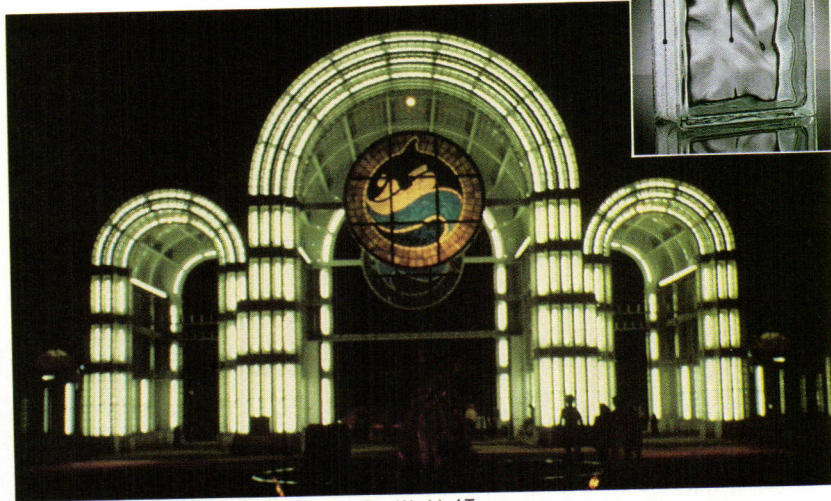

Sea World of Texas, San Antonio • Architect: Sea World of Texas
Production Architect: Jones & Kell Architects, Inc. • DECORA® Pattern

The clarity and brilliance of PC GlassBlock® products are unmatched, thanks to the exclusive use of low iron-content sand. No recycled glass is ever added because this affects color and clarity. And the unique edge coating on PC GlassBlock® products provides a superior bond with mortar, expediting installation. At Pittsburgh Corning we maintain strict quality control—for example, each block is visually inspected at least once before it's packed. The result: superior, consistent products.

Architects and designers have access to Pittsburgh Corning's drawing review and technical guidance . . . on-site assistance by trained, qualified Pittsburgh Corning representatives . . . full sample selection. And, even after

installation, we stand behind our product. The Difference—Pittsburgh Corning® quality and service. That's why American-made PC GlassBlock® products are your best choice. For more information, or details on our international distribution, call the PC GlassBlock® Products Hotline **800-992-5769** or write, Pittsburgh Corning Corporation, 800 Presque Isle Drive, Department AGB-9, Pittsburgh, PA 15239. In Canada call (416) 222-8084.

PITTSBURGH
pc
CORNING

Cities from page 29

from Eames to Gehry, and from high art to high kitsch, scattered over 11 communities and occupying an area 20 miles across.

Since the conference hotel was at one end of this wide swath, travel time was magnified and the often-frustrated bus riders had a chance to see much of the commonplace city while experiencing some of the traffic congestion and stress that Los Angeles drivers—which is to say virtually all functioning Angelenos—endure in ever-growing doses. This exposure to isolated satisfactions within a sprawling matrix of vehicles, highways, and semi-urban real estate probably told the conference participants more than the most eloquent speaker.—JOHN PASTIER

Design Competition Provides Visions of Boston's Future

Winners of the national "Boston Visions" competition were announced in November. There were seven first awards, of \$5,000; six second awards, of \$2,500; and nine special mentions.

Organized by the Boston Society of Architects/AIA—with backing from the city, the National Endowment for the Arts, the Beacon Companies and other sponsors—the competition sought new ideas, both pragmatic and visionary, for Boston. The assumption was that Boston's last major planning effort, undertaken by planner Edward J. Logue in the mid-1960s, is now fully implemented and that it is time for new thinking. The competition and its winners stirred considerable public interest.

Of the 22 awards and mentions, 21 proved to be from Massachusetts. (There

were 195 entries in all.) A fairly complex competition program may have tended to discourage entrants from outside the area. Competitors could submit visions in an "open" category—addressing whatever Boston issue they liked—or in any of three site-specific categories: The Charles River edge, the downtown, or the Washington Street corridor linking downtown with some of Boston's more troubled residential neighborhoods.

The seven first-award winners were:

- **Communitas of Boston**, with a proposal to relocate Logan Airport from its harbor site, replacing it with a new residential neighborhood reminiscent of the City Beautiful movement.
- **Communitas again**, with an idea to gird the harbor with a dike by linking existing islands with a causeway, thus protecting the city from future flooding caused by the greenhouse effect and, at the same time, creating a linear ocean park.
- **Graham Gund Architects of Cambridge**, for a scheme, presented in lovely autumnal renderings, to convert a dull stretch of Boylston Street through Boston's Fenway area into a Parisian boulevard.
- **Kuen-Shang Huang of Boston**, for a proposal to save chunks of the overhead Central Artery—due to be demolished—as triumphal ruins.
- **Paul R. Mortenson of Boston**, for a thoroughly worked-out infilling of two large areas of nearly vacant land, creating traditional, tightly clustered streets and squares.
- **Wellington Reiter of Newtonville, Mass.**, for a thoughtful proposal—presented in a single powerful image—to convert a little-used dry dock on the Boston harbor front into a new permanent facility for

Wellington Reiter's winning proposal.

the city's Institute of Contemporary Art.

• **Rothman, Rothman, Heineman Architects**, with a lyrically presented design for restoring a ravaged segment of Frederick Law Olmsted's Emerald Necklace.

Among other ideas were a regular water ferry along the Charles River and harbor front; a marathon route tracing the outlines of the original Boston peninsula; a proposal, bitterly ironic, to convert abandoned automobiles into shelters for the homeless; a new art-deco skin for the unloved Prudential Tower; and an idea to take the earth excavated for Boston's planned underground expressway and use it to enhance the harbor islands.

Bernard P. Spring, FAIA, president of the Boston Architectural Center, served as professional adviser to the competition. Jurors were John de Monchaux (chairman), Jonathan Barnett, FAIA, Robert Campbell, AIA, Linda Jewell, ASLA, David Lee, AIA, Homer Russell, and Adele Santos, AIA.—ROBERT CAMPBELL, AIA

BRIEFS

Brick Design Competition

The Brick Institute of America is sponsoring a competition for outstanding projects using brick as the dominant material. Eligible projects must have been completed after Jan. 1, 1983, and may be residential or commercial construction, extended-use, or restoration where at least 75 percent of the new construction material is brick. The entry deadline is March 31. For information and entry forms contact: Brick in Architecture Awards Program, c/o Earle Palmer Brown Companies, 6935 Arlington Rd., Bethesda, Md. 20814.

Pritzker Seeks Nominations

The Pritzker prize, established in 1979 by the Hyatt Foundation, seeks nominations for its 1989 Laureate. The \$100,000 prize is awarded annually to a living architect who has made a consistent and significant contribution to the built environment through the art of architecture. Send nominations by Feb. 1 to Bill Lacy, FAIA, The Pritzker Prize, 21 E 4th St., New York, N.Y. 10003.

Lighting Design Internships

Design students interested in architectural lighting design can explore career possibilities through a summer internship organized by the International Association of Lighting Designers. Students work for a lighting design or consulting engineering firm or a manufacturer of lighting equipment; the internships pay a stipend. Students must be in their junior or senior year of college and submit a portfolio demonstrating drafting, drawing, and design techniques. Portfolios for summer 1989 positions are due Feb. 24. Applications and information can be obtained from deans at design schools, student chapters of local professional societies, or the IALD, 18 E. 16th St., Suite 208, New York, N.Y. 10003. □

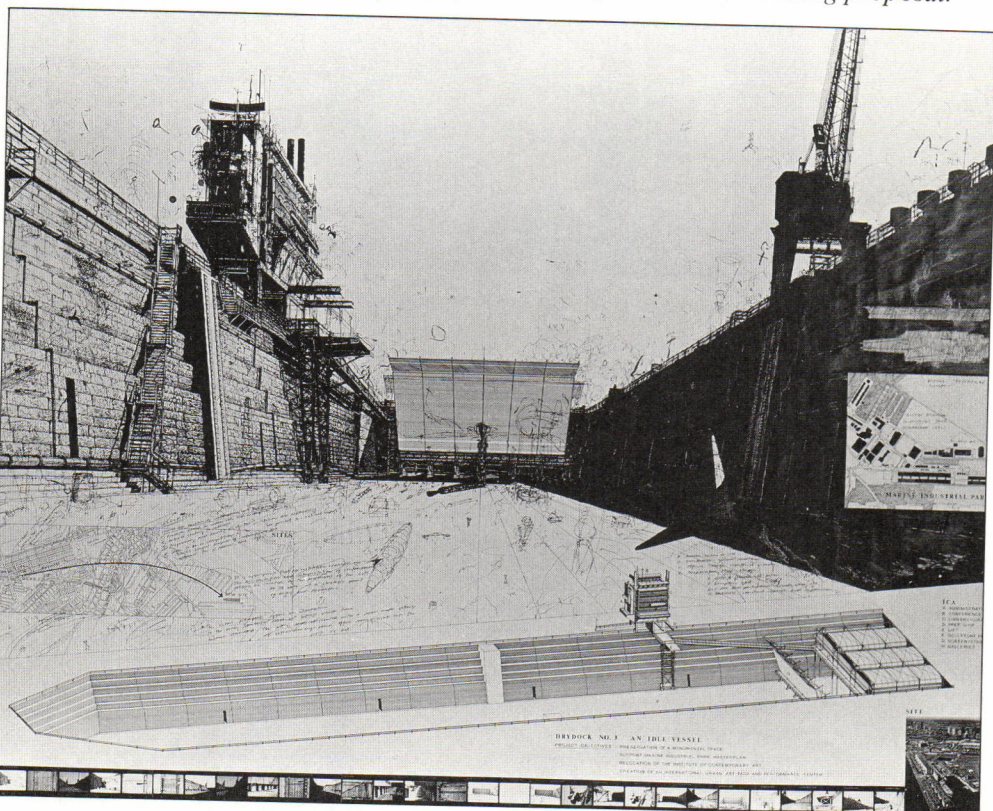

'Bound in Time to Be Reinstated'

Bruce Goff: Toward Absolute Architecture. David G. De Long. (Architectural History Foundation/MIT Press, \$50.)

Long and patient research has produced a book rich in facts about Bruce Goff's life; all his projects and executed works are covered and fully illustrated, and the back of the book contains a stuffed bibliography, a chronology, and footnotes that clarify Goff's life. It would be asking too much for the book to have Goff's audacity when it offers in such detail a life in middle America—from which, Frank Lloyd Wright predicted, our new architecture would arise. This book will do much to further the prediction. Certainly it will strengthen the already established offshoots of the Goff school, most particularly the Kebyar group and Jersey Devil. Frank Gehry acknowledges Goff's influence while noting that he rejected Goff as a young architect only to wind up in midcareer castigated by today's young "socially responsible" architects, as if "the artful manipulation of space, form and materials was in conflict with those social ideals." Certainly the deconstructivists took heart, if not substance, from Goff. But after Venturi led the flock away from the Bauhaus over a quarter of a century ago, and Moore injected the imagery of the Midwest into high art (the discontinuity of the rural farmyard, the latticed porch from the small town), Goff was bound in time to be reinstated.

I was put off in the beginning of the book by David De Long's comment that Goff is to be judged by the "unadorned values of the Midwest." Strange indeed, considering Goff's love of ornament, both surface and structural. Goff's approach to ornament came from the secessionists, the German expressionists, and other non-local sources. De Long carries the claim further when he compares Goff's achievements to "the everyday wisdom and humor" of the newspaper editor William Allen White, the "Sage of Emporia." White was a regionalist; Goff was not.

The reason for the disparity may well be that Goff was transported early from the everyday wisdom of the wheat country to the oil- and gas-gamblers' haven of Tulsa, some 50 miles from the southeastern corner of Kansas. Fortunes were accumulated in Kansas. In Oklahoma they were made overnight by an oil strike. (Getty's and Barnsdall's fortunes, which grew

from the oil and gas of the area, enriched Los Angeles architecturally, with Richard Meier's Getty Center and Wright's Barnsdall house. Easy money had always enriched Los Angeles, as old money enriched San Francisco. The latter looked to the Eastern seaboard and Europe; Los Angeles, with its plunger's psychology, made things up as it went along.)

Goff, born in the wheat country of Kansas, was offered at age 12 by his father as an apprentice to the Tulsa architecture firm of Rush, Endacott & Rush. The Goff family, which had moved from place to place, was hard-pressed. The boy could draw, so in 1916 his father stopped someone on a Tulsa street to ask the name of an architect. Thus, at 12 Goff was tracing Palladio's Basilica, and at 13 Wright's Unity Church.

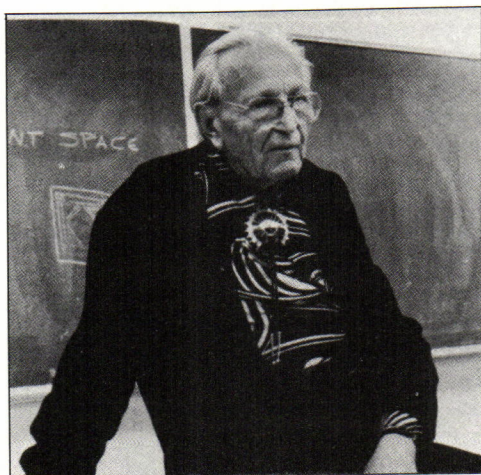

Right, Boston Avenue Methodist-Episcopal Church in Tulsa, completed in 1928 when Bruce Goff was only 24. Above, the 1970 Glen Harder house near Mountain Lake, Minn. Top, Goff teaching at the University of Oklahoma in March 1982, five months before his death.

By the time oil was struck in Oklahoma in 1901, its swelling population was mainly fortune seekers. The prospect of becoming rich overnight had a profound effect on the community. The diversity of the area touched off talent for miles around, including two Pulitzer prize winners—William Inge in the theater and Gail Kubik in music.

Oil freed Goff's talent to invent. His immense curiosity about Europe informed him about trends, and he picked up images eclectically. How much he was in touch with his own age is clear from his first major built design, the Boston Avenue Methodist Church, which drew from German expressionism. The church bespoke Tulsa's rapid growth: the church in three decades had gone from meeting place in open fields to wooden Gothic, to neoclassical temple, to Goff's expressionist cathedral.

Before he was 20, Goff was at home with the architectural movements in Europe. Kansas City, St. Louis, and Denver, three cities near Tulsa, had no such diversity in their borrowing, nor did they venture into the recent past or the contemporary as did Goff. His Page Warehouse of 1927 was indebted to Dutch brickwork he had come across in publications. Here he was as adept in dealing with a screen wall as with faceted planes. He moved with ease into the International Style for the 1928 Riverside Music Studio.

His projects and hypothetical buildings of the Tulsa years are astonishingly diverse and show his increasing grasp of what De Long calls his "angled geometrics." Before he had left his 20s his explorations were wide enough to provide themes for the

continued on page 34

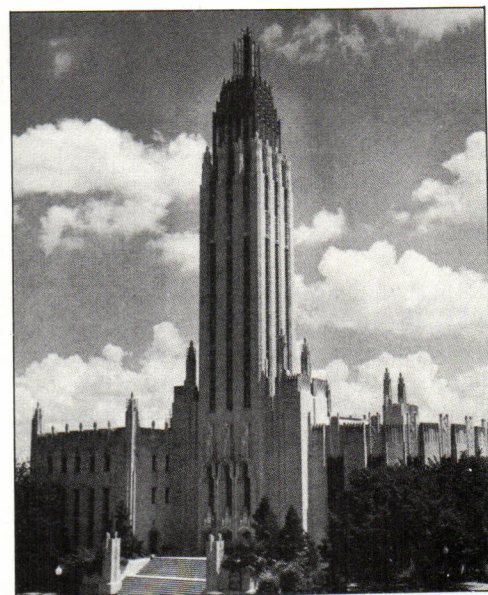

Books from page 33

rest of his career. One was the pleated walls of a 1930 project for a church, which he adapted freely for the Pavilion for Japanese Art at the 1988 Los Angeles County Museum of Art.

Goff's engineer during his last years told me how Goff had challenged the engineer of Rush, Endacott & Rush with hypothetical designs: "You can't build that!" Goff studied the solutions so carefully that he passed his engineering exam for his architectural license in his early 20s, and it may be noted that his theoretical designs were buildable.

By the time the Depression closed the office, Goff was a member of the firm and had some 35 executed buildings. His path had crossed Frank Lloyd Wright's, but Wright's scorn for any architect who copied his Prairie School had expunged Wright from Goff's design.

But there was one other brush with Wright—over Goff's design for a studio for Joe Price in Bartlesville, Okla. Goff described it as a composition of nonparallel planes in which he avoided regular geometric shapes to produce a livelier spatial relationship. Wright saw the plans in Bartlesville and wrote to Goff: "Why so elaborate and expensive a fiasco? It is practically on a plane of idiocy when its cost is counted." The plan was brilliant but unbuilt. Joe Price was a client for another studio and later for the Pavilion for Japanese Art. The plan for the pavilion at Bartlesville was developed after Goff's death by Bart Prince for the new site in Los Angeles.

Goff continued his explorations, though less intensely, in Chicago during the Depression, and while with the Naval Construction Battalion during the war he discovered the quonset hut, which he adapted for a handsome military chapel. By the time he became chairman of the school of architecture at the University of Oklahoma in 1947, he was carrying the lesson of the quonset hut further by embracing a long list of surplus war materials that he injected persuasively into his designs.

The finest of Goff's hanging structures, the 1950 Bavinger house in Norman, Okla. (winner of AIA's 25-year award in 1987; see Apr. '87, page 19), incorporated Army surplus and was built largely by unskilled labor. Goff described the spiral-plan, multilevel house as one "wherein neither walls nor floor and ceiling are parallel." De Long credits a Tatlin design as the source.

I had hoped from De Long's book to follow the thread of Goff's designs, to find the connections. But Goff's genius was sparked too instantly and genuinely by all he saw and read to make his biographer's task easy. The range of his sympathies is too immense. The last time I saw him was at breakfast at a drive-in restaurant on Sunset Boulevard with Lloyd Wright. The two men, then in their 70s, began talking about Josef Hoffmann's

Stoclet house in Brussels, and, as they lovingly scribbled to re-create the marvelous details, the plastic setting of the drive-in was slowly transformed. Their love of architecture kept them forever young.

—ESTHER MCCOY, HON. AIA

Ms. McCoy is an architectural historian and critic in Santa Barbara, Calif.

Parliament House Canberra: A Building for the Nation. Edited by Haig Beck. (Sydney: Collins Australia, \$39.95 Australian, hardbound.)

This book is reminiscent of Rembrandt's painting "The Night Watch": it is large and glossy and it struggles to do justice equally to all parts of the great building but never tells what the authors really think of it as a work of architecture. It can be recommended without reservation as an excellent reference that takes the reader on a painstakingly complete illustrated tour.

The illustrated section is introduced by four essays. Haig Beck describes the construction and architecture, concluding on the equivocal note that the "Parliament House is the triumphant result of the genius of determination and the cultural clarity of Mitchell/Giurgola & Thorp and their team." True, but what does it say? Beck's essay is followed by Carl Andrew's on the arts and crafts component and the furnishings; Ivor Indyk concludes with some semiotic insights in an analysis that recapitulates much that Beck has already said more simply.

The most serious criticism of the book is that many of the largest color illustrations show the Parliament House in an incomplete state. This resulted from the decision to publish in time for the opening of the building by Queen Elizabeth II on May 9, 1988. The latest photographs were taken by John Gollings in January of last year and inserted. Many of the best views are too small, while the larger shots show scaffolding and work in progress. The photographs are accompanied by extended captions that inform the reader exploring the building maze; its very complexity and obscure symbolism sometimes result in turgid and convoluted explanations.

Parliament House Canberra was clearly intended to be the book on the building but ends up a book about the construction of the Parliament House largely because of conditions imposed by the builder, Concrete-Holland Joint Venture. Beck as editor has struggled to make the book a document of the finished building instead of accepting the impossibility of that and seeking to tell the story of the people, the challenges, and the successes in the construction of Australia's greatest monument.—PHILIP DREW

*Mr. Drew, an Australian architect and author of *Leaves of Iron*, a monograph on Glenn Murcutt, is now writing *Veranda: Embracing Australia*.*

Paris 1979-1989. In French and English. Translation by Bert McClure. (Rizzoli, \$37.50 paperback.)

The scope of *Paris 1979-1989* is a great deal narrower than its title suggests. Coverage is restricted to the Parisian *Grands Projets*—the major cultural, communications, leisure, and government office complexes initiated, or amended and pursued, during President Mitterrand's first term and undertaken by the French state. Domestic architecture, private development, and all projects commissioned by the City of Paris are therefore excluded.

That said, the *Grands Projets* provide a more than adequate subject for a book. They represent massive national investment in architecture, there is a bewilderingly large number of them, and in some cases there is such a multitude of separate contributions by differing design teams that it is hard to decide which constitute *Grands Projets* in their own right and which are but parts of a larger whole.

By rights, then, *Paris 1979-1989* ought to be an extremely useful and enlightening book. It provides an illustrated account of each project (nine in all, three of them at La Villette), with details of costs and building schedules (an appendix) and biographical outlines of the principal architects (another appendix).

Unhappily, closer inspection suggests the book was hastily compiled on the cheap, simply by asking the civil servants in charge of the projects to supply texts and illustrations to fill a predetermined number of pages. Editorial work appears to have been minimal. Basic matters of fact are missing (notably, any acknowledgment of key consultants to certain projects), and some of the information in the appendixes is manifestly out of date.

The book therefore is not as informative as it might be; indeed, it resembles nothing so much as a series of public relations handouts designed to impress rather than to inform. In this hype for a best-of-all-possible-worlds where "architecture's renewed vitality is above all a confirmation of our society's confidence in the future," any suggestion that problems might have been encountered in the design and construction of the *Grands Projets* is firmly swept under the carpet. This is a great pity, for problems there have been—some of a major order—and, unless their sometimes surprising nature is understood, appreciation of the achievement represented by the *Grands Projets* is inevitably impaired—and dulled.

Such is the case with I.M. Pei's Grand Louvre project (see page 42). Hardly an eyebrow was raised when President Mitterrand first announced his intention to move the finance ministry out of the Louvre in order to make more space for the museum. The idea had been floated in the past, and the radical reorganization of the museum to exploit the potential of the space thus vacated seemed accept-

continued on page 37

Books from page 34

able to almost everyone. Violent controversy did erupt when Pei's project was first unveiled to reveal his proposal to erect a glazed pyramid in the middle of the Cour Napoleon, but that opposition dwindled after a full-size mock-up of the pyramid had been exhibited publicly on the site for a few days in 1985.

These events are outlined in the book, which also illustrates the archeological investigations carried out before the site work started, shows Pei's project, and includes an interview with the architect. But nowhere mentioned is the biggest obstacle to the smooth completion of the project, the point-blank refusal of one finance minister to leave the Louvre for new offices designed for his ministry.

By comparison, the Arab World Institute (see Sept. '88, page 92) has had a relatively easy ride, even allowing for the fact that the proposals drawn up during Valéry Giscard d'Estaing's presidency were ditched and the site changed before a competition, launched under President Mitterrand's auspices, resulted in Jean Nouvel and his team being appointed architects for the present building. Subsequent delays have arisen mainly because this *Grand Projet* is funded jointly by France and 19 Arab countries, and negotiations about who would pay for what have led to cost cuts.

Vicissitudes surrounded other projects initiated by former President Giscard. As inherited by President Mitterrand, the scheme for converting the former Orsay railway terminus into the Orsay museum had plunged into a downward spiral of self-perpetuating redesign. This process, the sequel, and the eventual completion of the museum is described in fascinating detail by Jean Jenger in his book *Orsay, de la gare au musée*. (Inexplicably, the English-language edition is not cited in the meager bibliography supplied in *Paris 1979-1989*.)

La Villette deserves at least two such volumes to explain its metamorphosis from Adrien Fainsilber's competition-winning design for a museum and park, as endorsed by Giscard, to the present total of three Villette *Grands Projets*: Fainsilber's museum (see Sept. '87, page 85); Christian de Portzamparc's Music City; and the park, which was the subject of an international competition won by Bernard Tschumi in 1983 and has since exploded into a galaxy of contributions and interventions by dozens of stars from the architectural firmament.

As if all this were not enough, *Grands Projets* now are springing up like daisies all over France. No doubt they, too, will become the subject of a book—with any luck compiled with more care and sparkle than this one.—CHARLOTTE ELLIS

Ms. Ellis, a frequent contributor to this magazine, is an architect and freelance writer living in Paris.

Three's a company.

 **Valli & Colombo**—the natural evolution of classic tradition, dedicated to the belief that no residence is truly beautiful until the last small detail is, itself, a work of art.



 **Fusital**—the designs of world-famous architects brought home in a collection of stunning simplicity and unequalled elegance—a true marriage of artistry and craftsmanship.

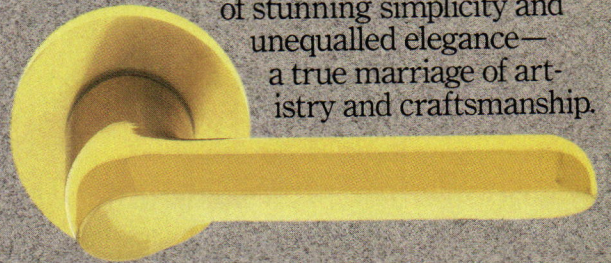

 **Forges**—the outstanding value in sparkling contemporary design, combines excellence in workmanship with imagination in concept—altogether a beautiful and practical solution for today.

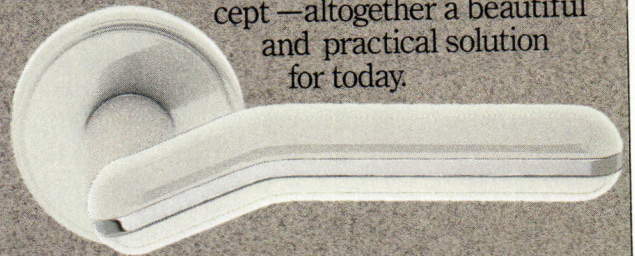

The Valli & Colombo tradition of quality and craftsmanship has found expression in these three superb collections of designer hardware. Each has its own personality. And its own unique interpretation of classical beauty and superlative workmanship. Isn't it nice to know that at least in this one area you can please all of the people, all of the time.

QUALITY IS A WAY OF LIFE

Le maniglie

Valli & Colombo

Valli & Colombo (U.S.A.) Inc., P.O. Box 245, Duarte, California 91010-0245
Phone: (818) 359-2569. Toll Free (800) 423-7161. TeleFax (818) 358-0743



The model shown above is Castlegate's *Symphony*™ 9-panel door in Ice Crystal/Clear Bevel/Brass Caming combination, with sidelites, door lites and elliptical transom.

Style. And Steel.



Circle 55 on information card

ARCHITECTURE

With our recent articles on Pennsylvania Avenue and Union Station we have been paying considerable attention to the city of Washington, D.C. This is not only because it is the home of this magazine and its staff. It is because Washington, in a real sense, belongs to all Americans. It is a company town, Peter Blake, FAIA, once pointed out, and we all own the company.

Having said that, we return to a matter concerning the architectural shape of the capital. The U.S. Commission of Fine Arts is its design review body, with jurisdiction over historic and federal precincts of the city. Its members are appointed by the President.

Amazingly, for the first time in its 78-year history, the commission has not a single architect sitting on it. To be sure, there are sophisticated laymen such as J. Carter Brown, Hon. AIA, director of the National Gallery of Art, but absolutely no bona fide professional.

It could be argued convincingly that the commission should be broadly representative of all those involved in the built environment, very much including the public. But it is equally clear that the commission needs an injection of the kind of expertise that only trained and eminent professionals can bring.

In his first year in office President Bush will have the opportunity to appoint all seven commission members. We respectfully but strongly urge President Bush to include architects in his appointments—not for the sake of the profession, but for the sake of the physical future of the capital.

To show that we are not entirely parochial we devote most of the rest of this issue to the overseas work of American architects, which is increasing in both scope and prominence.—*D.C.*

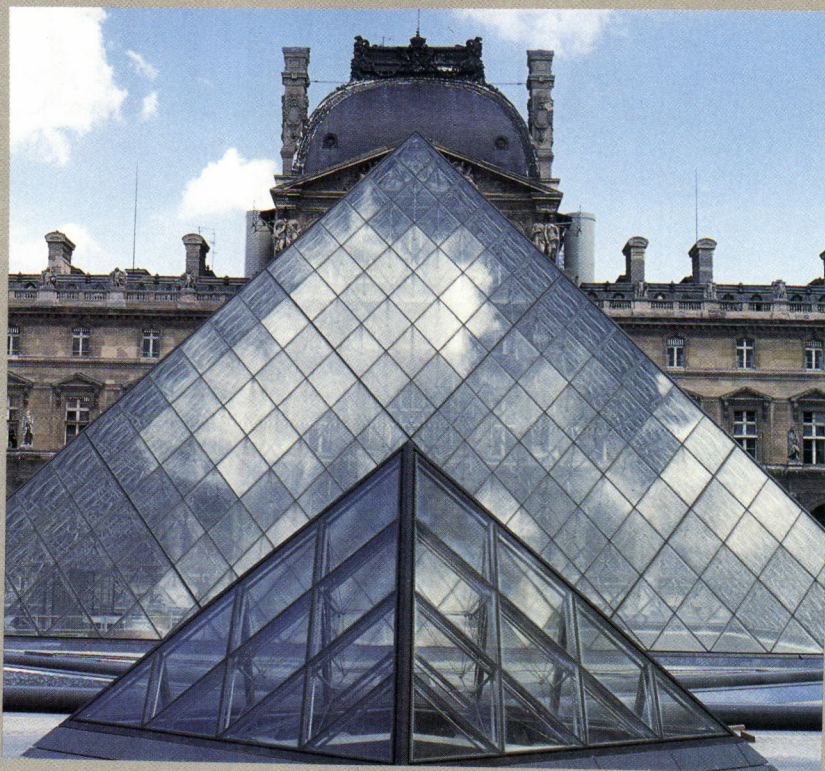

© A. Wolf

Pei in Paris: The Pyramid in Place

But not yet in use.
By Charlotte Ellis

As the French press never tires of pointing out, I.M. Pei's pyramid in Paris represents the tip of a large iceberg: the radical reorganization of the Louvre to increase the size and efficiency of the Louvre museum and restore its reputation as one of the most beautiful museums in the world.

The project is known officially as the "Grand Louvre"—and grand it most certainly is, in both French and English senses of the word. The Finance Ministry is to quit premises it has occupied at the Louvre since 1871, to make more space for the museum; a vast new reception area designed for 5 million or more visitors a year is being created beneath the Cour Napoleon; the museum's collections are to be rearranged around shorter, more efficient visitor routes; and back-of-house facilities for staff, conservation work, and the like are to be increased very substantially.

It was the tip of this metaphorical iceberg that was the focus of attention last October when President Mitterrand reopened the Cour Napoleon after four years' closure for archeological and construction work. The principal feature of this newly landscaped space, of course, is Pei's pyramid—replete with its three smaller "pyramidons," computer-controlled fountains and *bassins d'eau à la française*, set amid quantities of freshly laid hand-cut paving stones. Inaugurated at the same time was a new public right-of-way through the recently restored vaulted arcade known as the Passage Richelieu. Previously reserved for the exclusive use of Finance Ministry personnel, this passageway provides the public with a suitably imposing route to the Cour Napoleon from the Palais Royal and the Rue de Rivoli.

But if possibilities for promenading and picnicking in the vicinity of the Louvre are now much enhanced, the promised visitor

reception facilities beneath the Cour Napoleon will not be operational until next month at the earliest, and the pyramid remains closed to the general public in the meantime.

Such a schedule may seem to put the cart before the horse, but, in fact, nothing could more clearly demonstrate political determination to guarantee the future of the Grand Louvre project, by endowing it as rapidly as possible with physical and symbolic presence. Just as the completed but still impenetrable pyramid affords glimpses of the subterranean Aladdin's cave beneath and thereby provides a foretaste of the changes to come, so the opening to the public of the Passage Richelieu represents the imminent departure from the Louvre of the Finance Ministry.

Not that the Grand Louvre project has enjoyed completely trouble-free progress to date—far from it. Pei's proposals aroused a public furor when first unveiled. For many, the glazed pyramid seemed singularly inappropriate for the Cour Napoleon, where, it was thought, such modern gimmickry could only be at odds with the surviving testimony to French history (represented by the existing buildings on the site) and hence must constitute an affront to national pride. French architects, for their part, were highly indignant that so prestigious a commission should have been awarded to a foreigner in the absence of any architectural competition. (In France, public sector commissions almost invariably are subject to competition, following legislation to that effect passed in 1977.)

Controversy raged until May 1985, when a full-size simulation of the pyramid was erected on the Cour Napoleon site for a few days, at the insistence of the mayor of Paris. Public opinion then changed dramatically: polls suggest that, whereas 53 percent of the French population were opposed to the pyramid in 1985, 56

Ms. Ellis, an architect and freelance writer living in Paris, has contributed frequently to this magazine.

Above, small pyramid and 71-foot-tall main pyramid on east-west traverse axis. Right, lights, forms, and fountains.

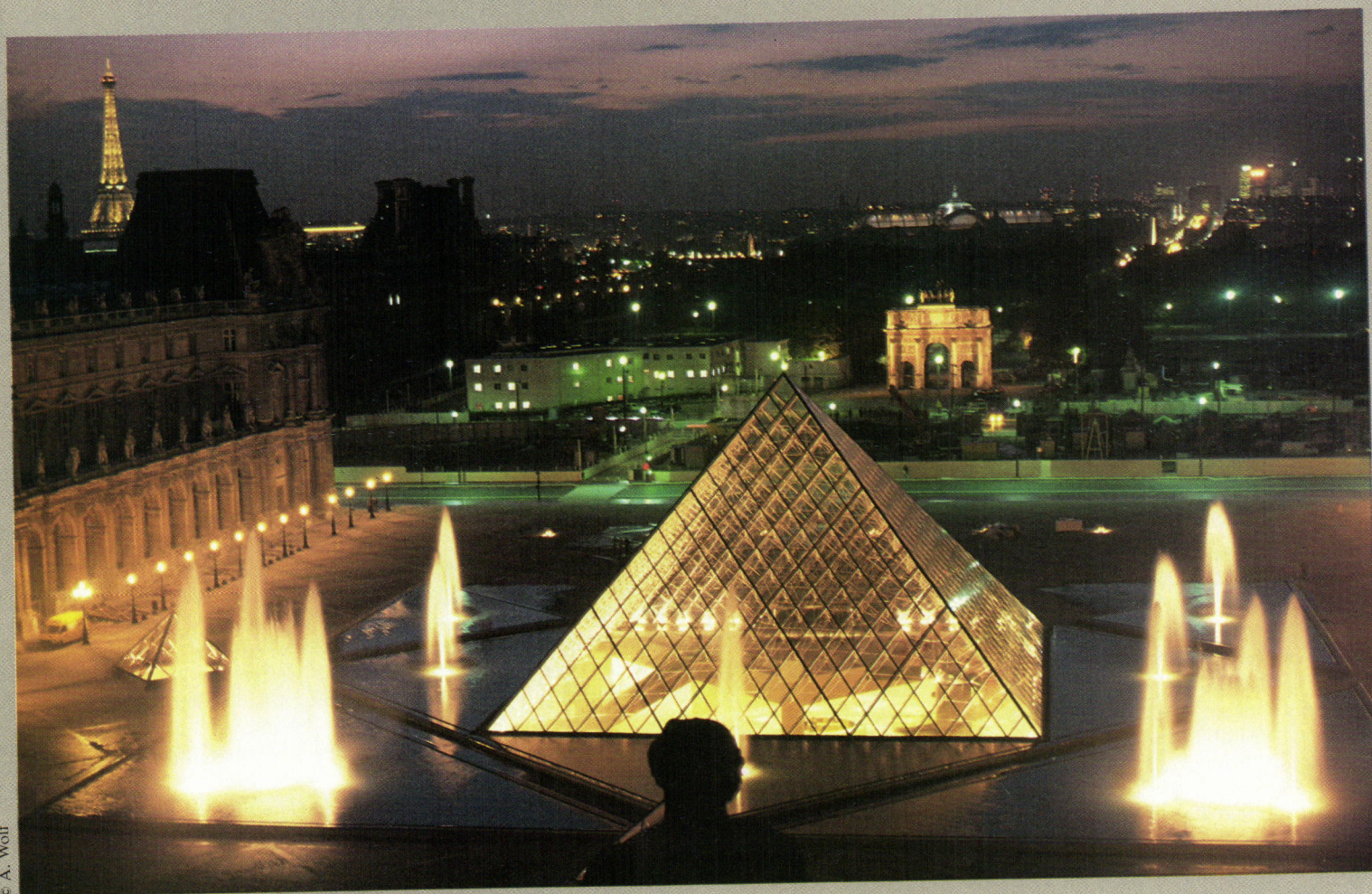



Above, a telescopic view into the northeast corner of Cour Napoleon showing one of Pei's small pyramids and the high fountains against the Louvre's Napoleon III facades. Each of the three small pyramids is 16 feet tall.

percent were in favor only a year later. The future of the Grand Louvre project seemed assured, even after the 1986 election resulted in political cohabitation. The incoming Prime Minister, Jacques Chirac, as Mayor of Paris not only had given Pei's project his blessing but had been involved, too, with the choice of a site for the new Finance Ministry offices at Bercy, near the Gare de Lyon in the 12th arrondissement.

But the new finance minister did everything in his power to prevent his ministry from leaving the Louvre. Arguing that a phased move was inconsistent with his department's efficiency, he recalled staff who had already moved to Bercy; their former accommodation at the Louvre had by then been stripped out and readied for conversion to museum use and so had to be reconstructed at a cost of several million francs. Next, he floated the idea of letting off or selling the new, specially designed Finance Ministry offices then nearing completion at Bercy. And, when he eventually agreed to move lower-ranking personnel to Bercy, it was on the condition that he and an "essential entourage" of some 1,200 staff remain at the Louvre until suitable alternative accommodation could be found for them in "central Paris." To avoid disturbing them in the meantime, certain work on the Grand Louvre could be continued only at night and on weekends, while conversion of the Rue de Rivoli wing had to be rescheduled or postponed.

These vicissitudes notwithstanding, I.M. Pei's project has not fared at all badly compared with many others. The present accumulation of buildings now described collectively as the Louvre obviously represents centuries of construction, demolition, reconstruction, and change. But the site is equally rich in dashed political and architectural aspirations. In 1863, for example, when Georges-Eugène Haussmann was at the height of his powers, the "New Louvre" was described in these words:

"It had often been in contemplation to purge the space between the Tuileries [palace] and the Old Louvre of the mean-looking

houses and unseemly sheds, many of which were still visible as late as 1850. The elder Napoleon was the first to grapple with the abomination, by making room for the northern gallery; and the architect Fontaine prepared designs for the union of the two palaces. Political events prevented the execution of this splendid project; nor was it revived again until the reign of Louis Philippe, when it was again thwarted by party squabbles and intrigues. In 1848, the last document signed by the Provisional Government was a decree for the completion of the Louvre and new plans were presented to the Legislative Assembly . . . but without success. Up to that time, upwards of fifty different plans had been presented by various eminent architects, whose chief aim was to conceal the defect in parallelism existing between the two palaces. At length, in 1852, the present Emperor . . . decreed 25,000,000 [francs] for the purpose. The first stone . . . was laid on the 25th of July of that year. . . . The rapid completion of this colossal undertaking, conjointly with other vast public works, is one of the most remarkable facts of modern times."

The present rectilinear Cour Napoleon, bounded to the north and south by ranges subtly adjusted in plan to correct the "defect in parallelism," was created as part of that "colossal undertaking." Particularly admired by the landscape correspondent to *The Times* were the gardens laid out soon afterward in the Cour Napoleon:

"I know of no spot more capable of teaching the most valuable lessons in city gardening than this. . . . On the one hand you have a space devoid of vegetation (the Place du Carrousel), on the other, by the creation of the simplest type of garden, you

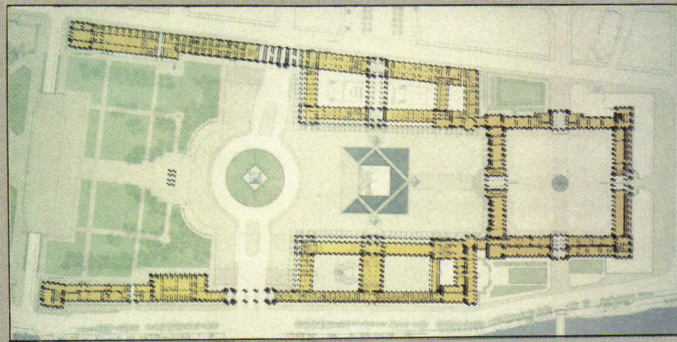

Ground floor

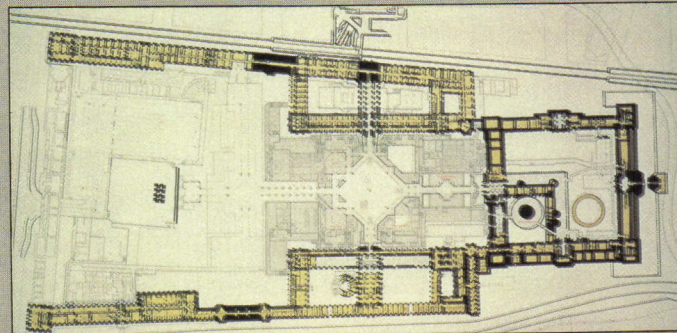

Mezzanine

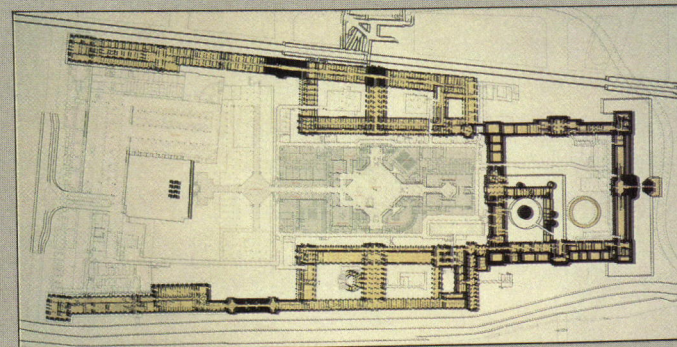

Lower level

Below right, freestanding helicoidal stair coils down under the big pyramid. Below left, mezzanine-level view from beneath one of the small pyramids.



© Detdi VonSchaewen

© Detdi VonSchaewen



© A. Wolf

relieve the sculptor's work in stone and the changeless lines of the great buildings by the living space of vegetation, so as to make the scene of the most refreshing kind, and all by merely encroaching a little on the space that would otherwise be monopolized by paving stones. . . . Visitors can go in and view the little gardens and the rich pavilions rising behind their small but sufficient foregrounds of verdure."

But for all these achievements Napoleon III finally was overthrown by the Paris Commune in 1871 when the Tuileries palace between the Louvre and the grand axis that runs in a dead straight line for more than two kilometers, from the Carrousel arch to the Arc de Triomphe and beyond, to "infinity." And, ever since the demolition of the Tuileries palace, the Louvre has appeared off axis when approached from the Tuileries gardens, even though this effect has been veiled to some extent by the planting of clumps of trees.

Pei has made no attempt to hide this "désaxement" in his present scheme but proposes instead to mark the termination of the grand axis in the Cour Napoleon with an equestrian statue (yet to be installed at the time of this writing), raised on a plinth immediately southwest of his pyramid.

The pyramid itself is set foursquare in the Cour Napoleon and appears resolutely off axis, to the left of the Carrousel arch, when approached from the Tuileries gardens. This is not at all troublesome, for, despite its severe geometric precision and resolutely 20th-century imagery, the pyramid makes surprisingly little urban impact, even at close quarters.

It has got the French talking about "immaterial monumentality," and certainly its sleek transparency and lightness of structure neither quarrel nor compete with the ornately carved stone facades of its Cour Napoleon neighbors. It sits sagely among them, politely responding to their somewhat pompous dialogue with reflections on the weather, like an extremely well trained

Above, the pyramid and, beyond, the misaligned grand axis through the Carrousel arch and Tuileries gardens to the Arc de Triomphe. In the Cour Napoleon, just to the left of the pyramid's point in this photo, Pei proposes an equestrian statue as termination of the grand axis.

ambassador from some far-flung planet, briefed to convey goodwill to the self-important elder statesmen of a once turbulent but powerful nation-state.

Yet, although remarkably discreet (and equally discrete), undeniably easy to find, and frankly of its own time, just as Pei promised it would be, the pyramid has an air or unreality about it; inevitably, perhaps, it seems about to take off for some other destination. It has no function as yet, save to symbolize an "iceberg" that has yet to materialize. Maybe it will seem more firmly anchored to the Cour Napoleon site when it becomes the main entrance to the museum and visitors flow in and out of its doors instead of merely milling around its perimeter.

Curiously enough, the computer-controlled fountains Pei has provided to endow the Cour Napoleon with life and movement are far more obtrusive than the pyramid. So finely honed are the massed water jets that they seem solid, static, and somewhat overscaled. No doubt this effect could be changed at the touch of a button. But for my taste the concept of these fountains is a mite too grandiose to provide the sought-after foil to the palatial architectural setting. This, of course, is precisely what was so successfully achieved by the modest gardens laid out in the 19th century. Latterly surrounded by a sea of parked cars and only scrubbily maintained, these gardens were cited in the early 1980s as being among the many factors thought to detract from the glories of the Louvre, and their removal seems to have been regretted by nobody—a salutary reminder of how each generation tends to throw out the baby with the bathwater in its anxiety to improve the past. □



© A. Wolf

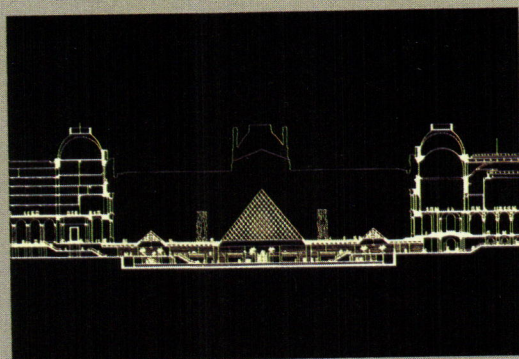
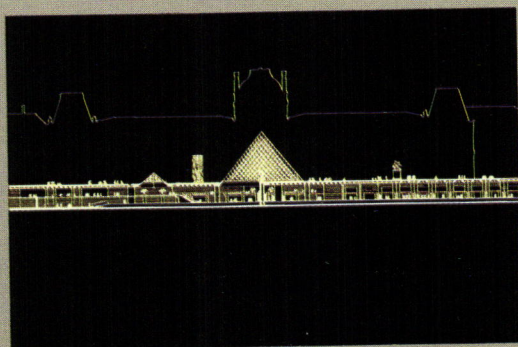
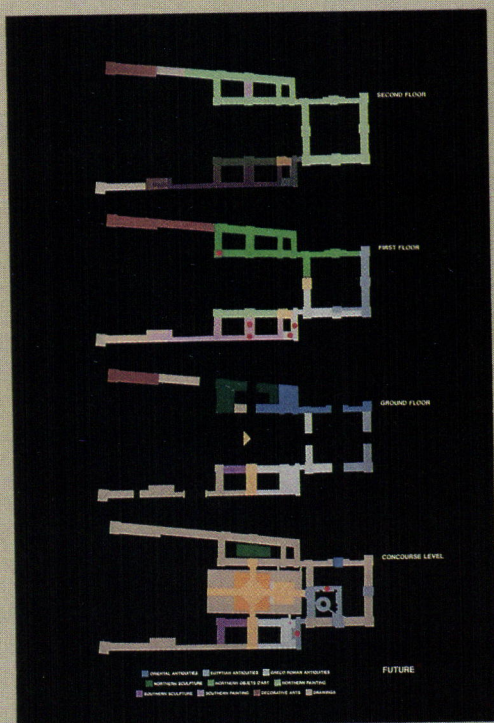

Colored diagram shows galleries as reconfigured by Pei. Top section is longitudinal on north-south axis with open end of the Louvre's U plan to the right.



Roche in Versailles: Unbridled Neoclassicism

For Bouygues world headquarters.

By Donald Canty, Hon. AIA

If you hate neoclassicism, you will hate this complex, a corporate headquarters adjacent to and on axis with the palace of Versailles. However, you don't have to love neoclassicism to admire the buildings' considerable virtues.

The palace may be the ancient antecedent for Bouygues's formal axiality, but in the context of Kevin Roche's work the new building is a direct and acknowledged descendant of his General Foods building in Rye, N.Y. The rear elevation of Bouygues, in fact, is almost a replication of the facade of General Foods.

They differ in two significant ways, however. At General Foods Roche was taking his first timid steps toward baroque symmetry. In Bouygues he has gone all out, and the result is more resolved.

General Foods is a behemoth in a mainly residential suburban landscape. Bouygues is in a parklike landscape of 74 acres partially bordered by a national park (which the corporation actually extended by planting 1,500 new trees). It can make its considerable statement without disturbing the neighbors.

Roche points to other differences. "Here [at Bouygues] there was the opportunity to elaborate the approach sequence and drive between buildings forming a gateway before arriving at the front door. Unlike General Foods, the arms of the building wrap around the entry courtyard. It is a development of the planning methods of Filippo Juvarra at Stupinigi or Sir John Wainbrough, whose great English country houses have their central entry element set inside a court formed by wings, and so one arrives in a space which is surrounded by the house before going in."

This idea, he continues, "has to do with the importance of seeing and the sense of identity of place—from the inside seeing the outside wrapping around and having that be part of the composition."

The gateway to the Bouygues complex is formed by two tri-

angular buildings housing subsidiary corporations. One then proceeds up a long, pool-flanked roadway to the courtyard enclosed by the enfolding arms of the main building. To underscore the classicist mood, two heroic equestrian statues stand in the courtyard atop stout columns. Parking for 1,890 cars (the working population is 2,100) is beneath the roadway and triangular buildings and in an elevated podium under the main building, which extends another pair of arching arms to the rear of the site.

The buildings are sheathed in a grid of reflecting glass and aluminum plate with painted aluminum muntins accented by polished stainless steel. In a particularly successful gesture, the window glass is canted back at the top level. This catches wonderful glimpses of skyscape and gives something of the effect of a mansard roof, thereby imparting a slight French accent.

The complex is punctuated by five domes roofed in mirror glass. They are hexagonal in form rather than round, and again recall the traditional architecture of France. Three of the domes are over open, becolumned porte cocheres at the entrances to the triangular building and the ceremonial entrance to the main building. A fourth roofs the expansive atrium that is the meeting point of the main building's arms, and the fifth, just behind it, soars over the central portion of the large dining hall. Stairs are placed in corner towers used to further punctuate the sweeping horizontality of the complex.

Interiors are light-filled and finished with the polish, even the elegance, one has come to expect of this architect. Inside and out, the entire complex is executed with great skill and confidence.

Still, it is hard not to imagine what would have happened if some soothsayer of the 1960s had showed slides of the project to an audience of architects and said, "This is what Kevin Roche will be building in the '80s."

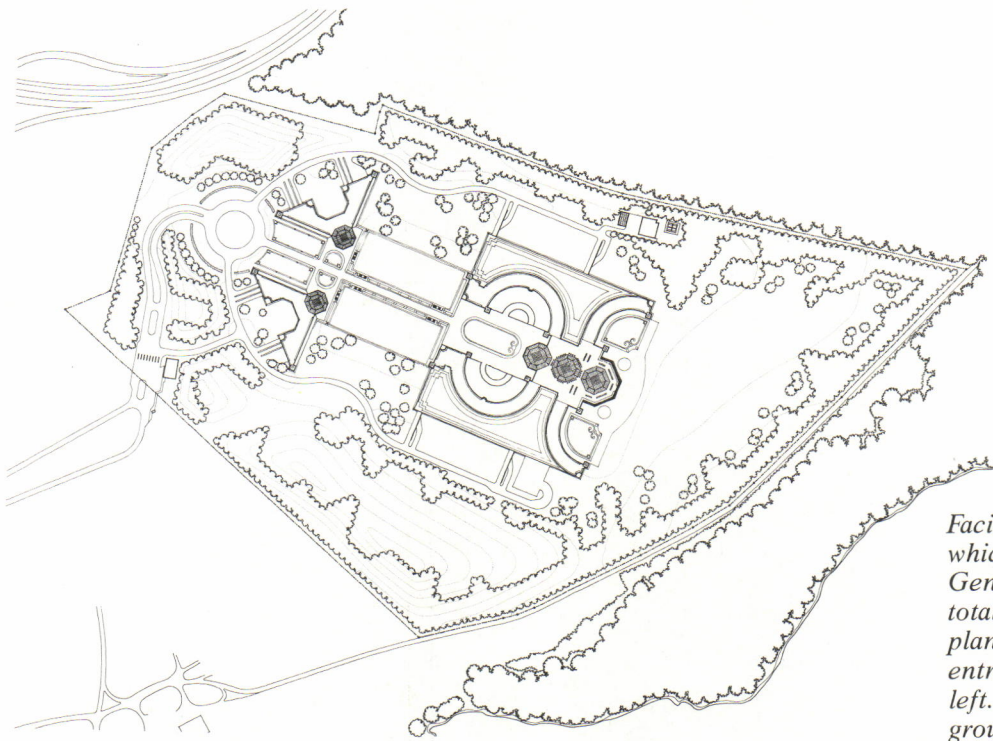

Facing page, the rear elevation, which strongly resembles General Foods. Above, the totally symmetrical, axial site plan. Below, overview with entrance from circle at lower left. Main building is in background beyond long roadway.

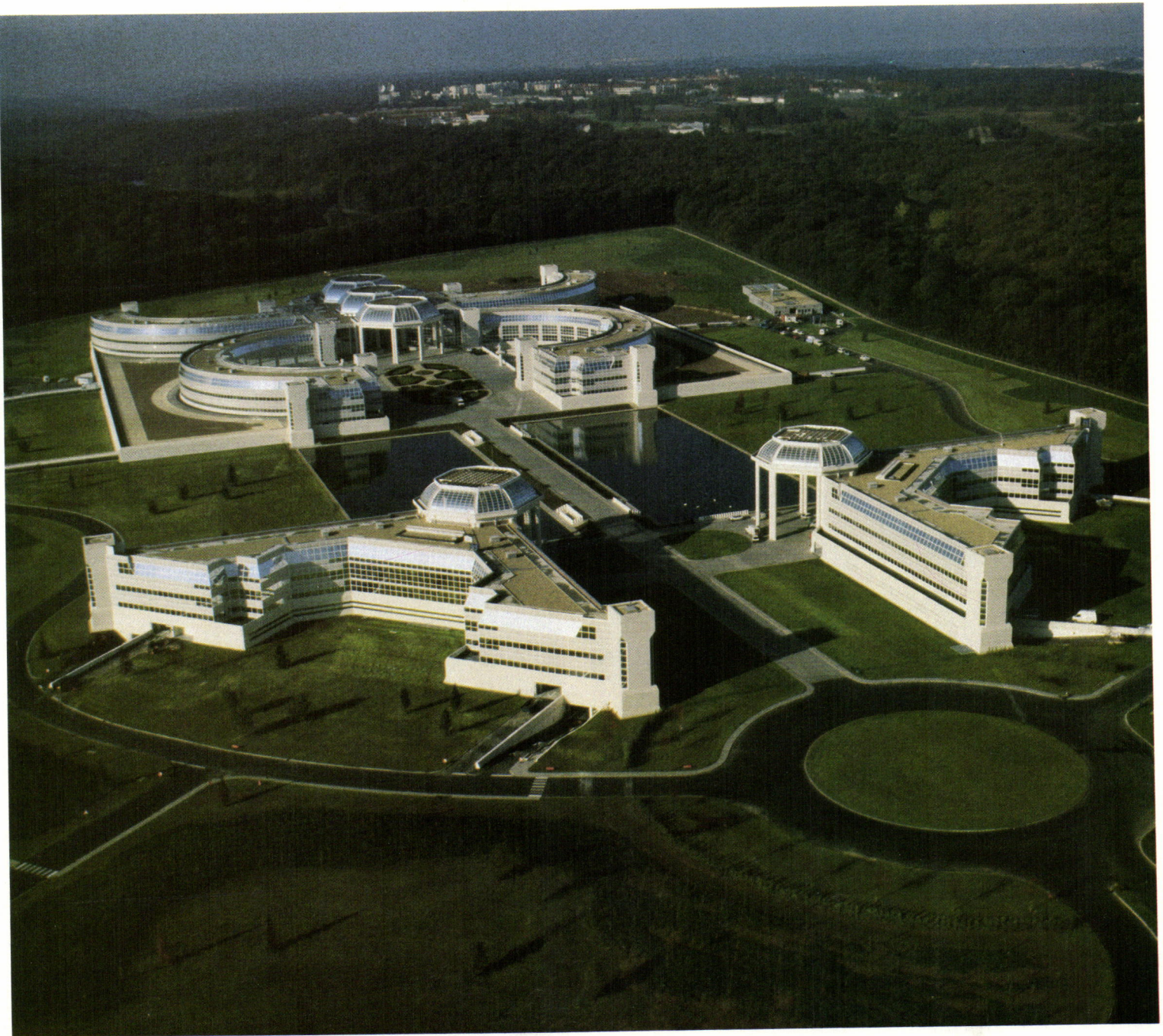

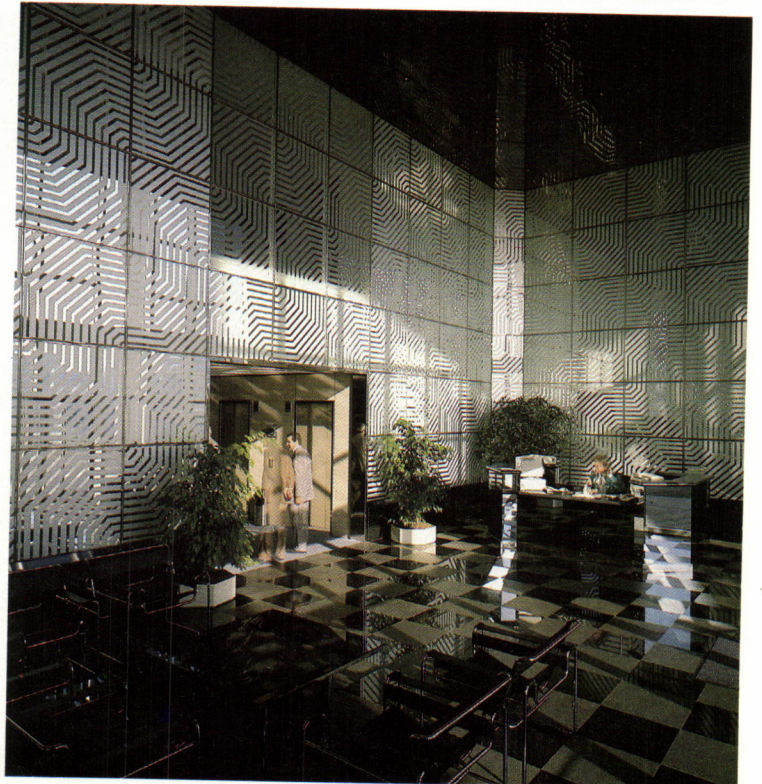
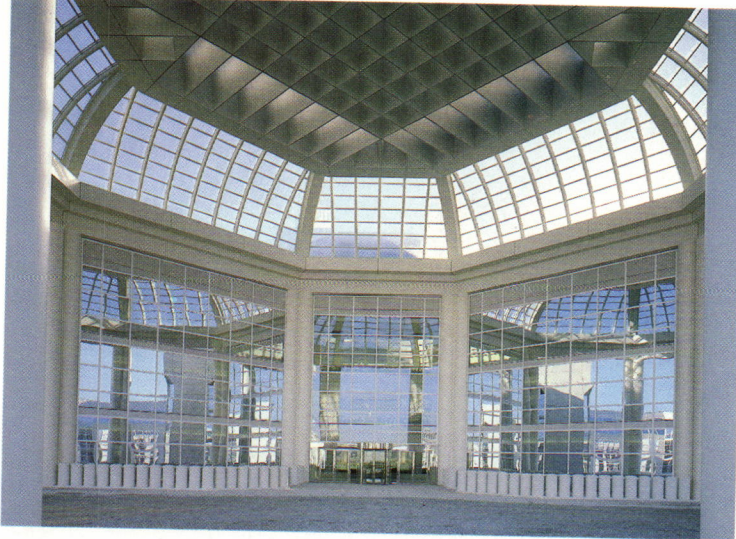
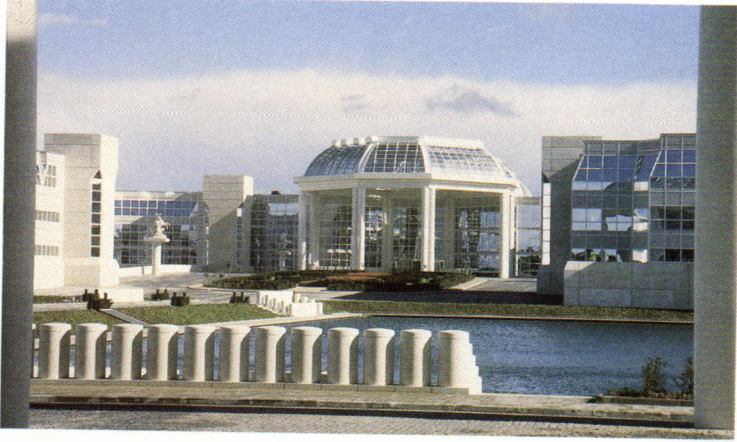



Above, view from entry. Facing page: top, view across bollard-studded pool to the rotunda of the porte cochere (note equestrian statue; stairs are in corner towers for vertical punctuation); center, looking upward in one rotunda and into another; bottom, employee dining hall; bottom right, lobby of triangular building with alternating mirror and black polished glass. Left, the central atrium. □

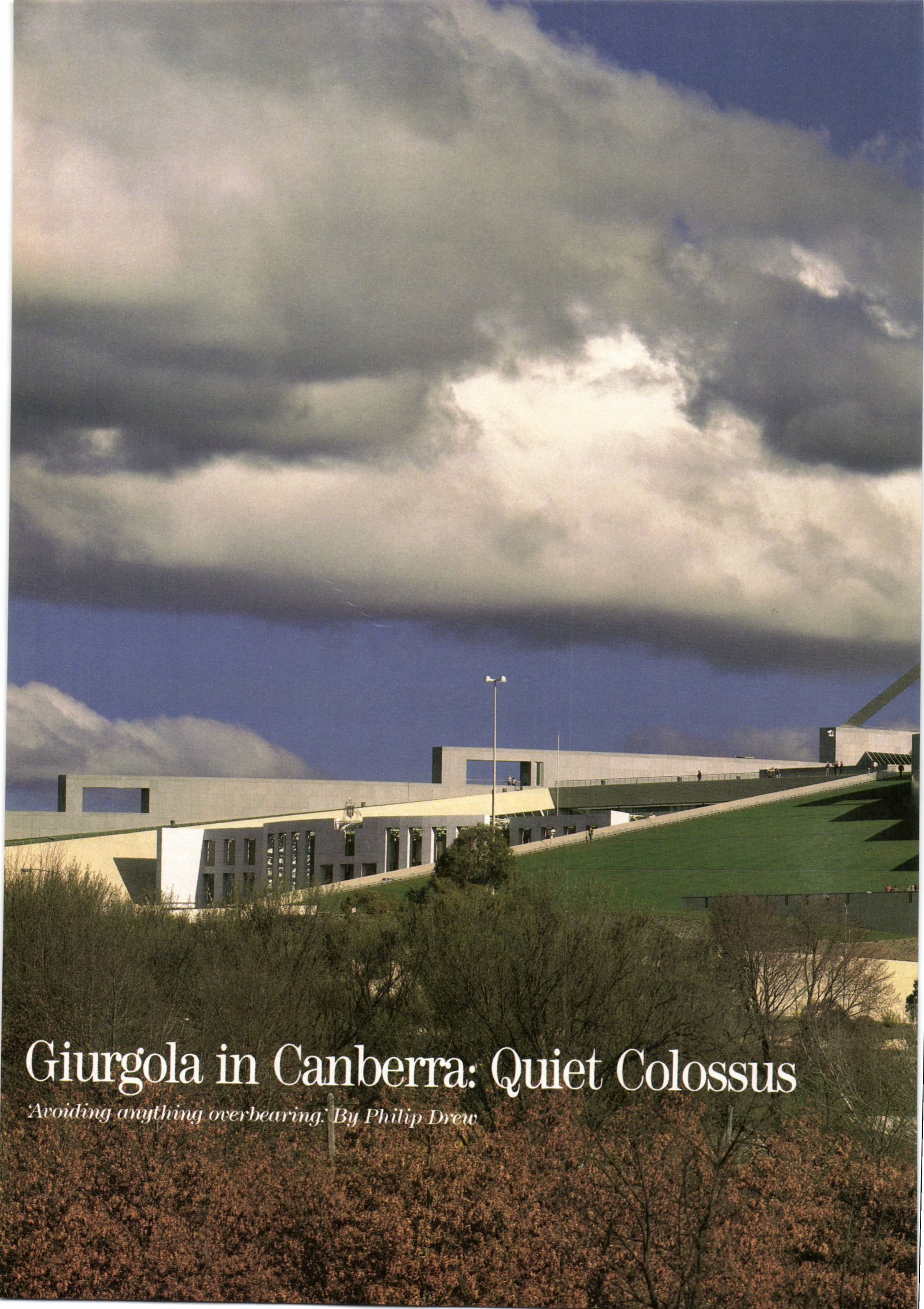

Giurgola in Canberra: Quiet Colossus

'Avoiding anything overbearing.' By Philip Drew





Photographs © Gollings Photographers

Being American is easier, somehow, than being Australian—at least, that is how many Australians see it. Americans seem to be intact, to have come out of the oven with a nice golden crust.

Australia, unlike America, remains something of a mystery. Any attempt to define it must seem like trying to spar around with a great shape. Eventually, you find yourself punching at clouds—it cannot be pinned down.

This, in part, was what faced Mitchell/Giurgola & Thorp when they decided to enter the international competition for the new Australian Parliament House at Canberra, 290 kilometers south of Sydney. Their design for a new complex to replace the temporary Parliament building that had been in use since May 1927 was unanimously and enthusiastically chosen from the second-stage submissions by the jury on June 26, 1980.

Seen from the lakeside, the newly completed Parliament House is much less imposing than might be expected. Beneath its green carapace of earth and lawn it is hidden from view except where the forecourt and silhouette of the great veranda push forward in front of Capital Hill. In front, between the new Parliament House and the lake, the old Parliament building, which has been retained, steals much of its thunder.

It is impossible to know what the Australian people expected of their new Parliament House, but one thing is apparent. It accords with the desire of many Australians to avoid anything overbearing or self-important. Australians are distrustful of bombast, ill at ease when confronted by formalism and pretention. In response, Romaldo Giurgola, FAIA, seems to have struck

the right note. If his building errs, it is in the direction of understatement.

Some buildings are outgoing, like some people. They come forward and inform you about themselves. The Parliament House is as elusive as its architect. Like the man, the building is quiet, inwardly reflective, and modest. At the same time, it infuriates because it is so self-contained and, in so many regards, inaccessible, if not evasive—a building far more complex than its appealing simplicity of plan suggests, whose meaning is not without contradictions.

From some angles, the new complex recalls the Cretan citadel of Mycenae. The landform is primary, as Australians perceive their identity to be closely bound up with their relationship to the land. Giurgola drew his inspiration from the landform and from the design of Canberra by Walter Burley Griffin, an American Prairie School architect who was once Frank Lloyd Wright's office manager. Giurgola derived his circular motif and the great swinging walls inscribed over his variation of the Renaissance cross-and-square centralized plan from an indication for Capital Hill in the 1911 rendered plan of the Australian Federal Capital made by Marion Mahony Griffin.

In effect, the Parliament House is a low-key St. Peter's in which the architect has disguised the formal classical character of the plan by cutting off the top of Capital Hill to make way for the building, then pulling part of the hill back over it to give the impression that it had been conserved, leaving four exposed terraces—three for buildings, and the fourth, on the north side facing Canberra, for the forecourt.

The great flag mast rising above the rounded profile of Capital Hill is visible from a considerable distance, an ungainly four-legged structure that gives much the same appearance as a

Mr. Drew is an architectural historian and author of Leaves of Iron, a study of the work of Glenn Murcutt.

Overleaf, a view from the north with bowed entry screen wall at left. Photograph © Gollings Photographers.



Aerial view at left shows Parliament House's fit into Walter Burley Griffin's plan for Canberra's Capital Hill. Ceremonial axis from Parliament House to Lake Burley Griffin is interrupted by the Provisional Parliament House of 1927, which is to be made into a museum and orientation center. In site/ground floor plan above (oriented to match aerial), the round element at lower right is the ceremonial pool, which, in photo at right, reflects the entry screen wall. Australian coat of arms is centered above the wall.



newborn giraffe struggling for the first time to stand upright. Its awkwardness has been commented upon many times; one especially troublesome factor is the connection of the legs to the two curved walls.

When you drive around the Parliament House on State Circle, which forms an encircling roadway, the building alternately springs forward or pulls back into the hill in an unnerving fashion. One moment it is large as life, and the next moment it is gone, withdrawn into the hill. There, yet not there. This phenomenon also makes the building appear smaller than it really is. So much of it is tucked away or hidden from view, either under the hill itself or behind the Parliament offices that stand in front of the other buildings in their retreat into the hill, where they are framed and held in check by the grand gesture of the two great curved walls.

If any single element dominates, it is these walls, not the buildings as such or the House chambers, which can be distinguished by their red tile roofs—reminiscent of the tiled roofs of the Australian suburban bungalow. The curved walls attract more interest even than the vestigial hill. These two deft surgical incisions into the belly of Capital Hill—precise, subtle trajectories of gray granite—connect the the Parliament House with the grander geometry of the city manifested by Commonwealth and Kings avenues, which converge at the Parliament House site.

The curved walls invite comparison with Bernini's magnificent colonnades encircling St. Peter's Square. They establish scale and grandeur, a generosity of gesture that is in keeping with the site, and they act as a palliative to the inevitable monotony that attends so massive and extensive an architectural composition. The walls constantly change direction as they cross the hill, and this produces subtle variations in the modulation of the sunlight

that penetrates the regularly spaced openings in the walls' face. They are to the Parliament House what Griffin's lakes are to Canberra.

Reduced to its simplest terms, Canberra is organized around two axes—a land axis intersected by the secondary water axis. This classical axial arrangement is overlaid by a triangle joining the three civic nodes: Parliament House at the apex, with City Centre and the Australian American Memorial establishing the baseline. Both the principal axes are aligned with mountains: the north-south land axis with Mount Ainslie and the east-west water axis, intersecting the lake system, with Black Mountain.

Griffin's baroque scheme is overstretched in Canberra. The distances are too great and the terrain too uneven, so the city that has emerged in the late 20th century is a city lost in a park, a 19th-century garden city trying to come to terms with the grandeur of Le Nôtre. Canberra lacks strong focal monuments and urban tissue to flesh out its skeleton and give organic substance to Griffin's overextended plan.

In underplaying its own monumentality, at least on its exterior, Giurgola's Parliament House does little to tighten the formal composition of the city. The pierced screen of the great veranda, for instance, has been scaled to relate to the old Parliament House, with the result that it is far too weak when read in relation to the building's forecourt and the city. It is a matter of proportion. Yet, in a curious way the building does manage to hold the city together, if not in balance, more by its gesture than by its presence.

The forecourt is the front terrace, a broad, sloping plate of red stone with radial patterning. It is the place of arrival, where the visitor can take stock of the building or, turning around, can look out over Canberra across the lake and appreciate the build-



ing as the hub of the city. Spilling downhill toward the lakeshore, the forecourt has an island at its center, a drop of Aboriginal identity surrounded by ocean on all sides. It is meant to represent the red center of Australia, the empty heartland, the land of Ayers Rock. On the island is a mosaic based on Michael Nelson Tjakamarra's "sand painting," representing ceremonial gatherings of the Aboriginal tribes of the dingo, wallaby, and iguana ancestors. The composition is a roundel of concentric circles on which converge white snakelike squiggles and arrows. But the image cannot readily be appreciated, spread out as it is over the pavement; it is even less intelligible from the water's edge.

Because the city axes converge on the new Parliament House, the view is better looking out from the building than toward it. From the top of Capital Hill, visitors easily recognize that they are standing at the center of the city—the political center of Australia. From the forecourt the space spills out over the edges: this is the Campidoglio in reverse, with diverging sloping walls but without the accompanying palazzo to contain the space. Perhaps that is an Australian flaw—too much openness.

Two rows of flagpoles on either side struggle valiantly to contain the forecourt. But the stepped profiles of the granite walls above the instep of the hill are too distant to lend a hand. In the middle of the forecourt, water surges and splashes as it rushes down the inclined paving, adding movement and contrast to an otherwise empty space. The forecourt needs people to bring it to life. Crowds. Demonstrators. Waving banners. Shouting.

You enter the Parliament House through the great veranda, really a classical portico in disguise. It is different from a real veranda, which in the 19th century was a cool place that visually connected the house with the garden. In lieu of the traditional veranda canopy of light corrugated iron, Giurgola has

inserted a series of V-shaped radial ridges of glazing that stretch outward from the foyer facade and grasp the freestanding screen wall. The curved line of this wall gathers the portico space in toward the center and sharpens the focus on the entry.

The rectangular openings in the portico screen are a little too routine, bland. The wall isolates rather than connects the building to the outside, an effect that is further accentuated by the entry into the foyer that seals off the interior.

The Parliament offices on the east and west sides of Capital Hill are severe concrete blocks punctuated in marching precision by regularly spaced vertical slashes serving as windows. The effect is deliberately simple. But Giurgola's serried groups of offices stand one behind the other and, instead of stepping up to catch the view, are arranged so that the outer row blocks the view of the offices behind them.

For all their dullness, these facades, the most exposed and public face of the Parliament House, do exhibit a certain primitive quality and precision that Giurgola has sought to enliven by adding sculptured porte cocheres attractively faced with red and gray stone. His aim was to draw attention to the entrances and contrast them with the flat office facades.

The Parliament House, like the city of Canberra, has two axes. The north-south ceremonial axis is aligned with Griffin's land axis and expresses the progressive experience of time from pre-history and Aboriginal habitation into the future. It is intersected by an east-west axis on which are situated the two legislative chambers, satellite centers on either side of the ceremonial axis, their accompanying support facilities, and the elected representatives' offices and suites. Imposed on these axes is a rectangular circulation route that circumnavigates the two legislative subcenters, rather in the manner of St. Peter's.

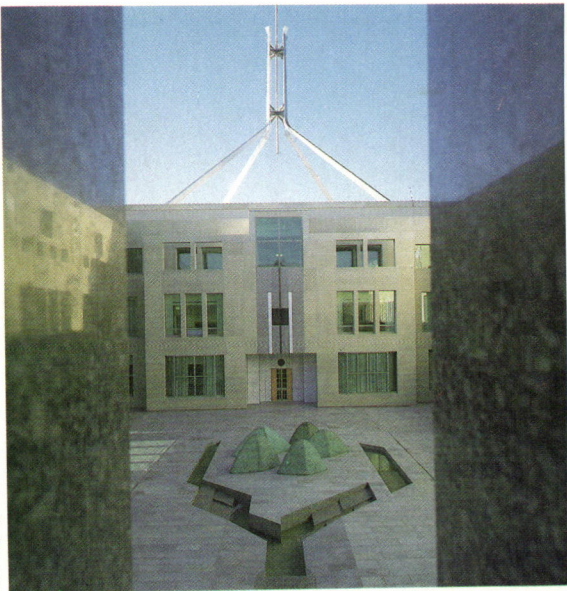

Facing page, courtyard with glassy link between the House of Representatives block (at left in photo) and the members' hall at dead center of plan behind curved wall. This page, clockwise from bottom left: the same courtyard from top of curved wall; sculpture of Australia's Olga Mountains in the executive courtyard; entrance to House of Representatives chamber on building's eastern periphery; pergolas in executive courtyard.

The great veranda leads to the foyer, which traces the path of the ceremonial axis and represents the 19th-century forest fastness that settlers encountered. The first impression is of regularly spaced, green, marble-clad columns, like tree trunks. Forty-eight in all, they rise in stately profusion from a glistening marble floor, patterned in elaborate square and circle designs, to about two-thirds the height of the gridded ceiling that comes down part of the way to meet them. Without question, the foyer is the most sumptuous space in the Parliament complex. It is a splendid gesture of welcome that makes people feel important. The space is cool and restful, especially after the red desert of the forecourt. But the green tree trunks seem unfinished, and there is something disconcerting about the cladding, which extends only two-thirds the way up. The intention, apparently, was to lower the apparent height of the space and make people feel more comfortable, but the white ceiling extending down increases rather than diminishes the height of the space.

It is in the foyer that one of the most significant dislocations in the building's conception occurs. The Parliament House was designed as a symmetrical composition of considerable richness and complexity about a central processional axis much like a cathedral with its nave. Yet, it remains a diagram, for the public is rarely, if ever, granted the privilege of experiencing this

space. Instead, visitors are redirected up the two grand staircases on either side of the foyer and led through the building on the second-floor level, from which they may look down on, but not enter, the members' hall. These two staircases with their exaggerated size and exquisite detailing are meant to tug attention away from the doors of the great hall, which are kept closed except on state occasions. The stairs are the dominant notes in this confused space; they pull the eye forward and sideways, never letting go for an instant. But it is a glorious confusion.

The great hall itself, for all its considerable refinement of detail and expensive timber paneling, is a great boxlike room for holding banquets and the like. It reminds one of nothing so much as an oversized multipurpose high school gymnasium. The set-out markings on the brown parquet flooring reinforce this impression. Giurgola attempts to make the size more digestible by introducing a human-scaled element in the form of door-sized panels—a module he carries around the walls. He opens up the ceiling to the sky by introducing a complicated central roof monitor, and, although this is an improvement, the great hall remains the most boring space in the Parliament House.

Following such mundane ordinariness, the members' hall is a dramatic climax to the ceremonial axis. A space intended for reflection, a place of silence, it is tall and square with a pyramid-shaped ceiling light towering high overhead astride the crossing of the two main axes at the precise center of the Parliament House. It replaces the domed crossing of the Renaissance plan, whose transepts have been shortened to accommodate the two Parliamentary chambers. The intricate layering of the high members' hall suggests, rather than reveals, the extent of the Parliament building spilling out across the leveled Capital Hill.

However, the members' hall is also a melancholy void. Except



for the elegant black reflecting pool cut out of the hall's paved floor, the space is empty. The circular latticed opening under Bernini's baldachin, which in St. Peter's in Rome allows a view into the crypt on the spot where St. Peter was martyred, has been replaced in the Parliament House by the reflecting pool. In it, weather permitting, you may glimpse the Australian flag on its giant mast above the skylight. The flag symbol seems a belated pop art image from the 1960s. The question arises whether it makes any sense at all to attempt to adapt the sacred symbolism of the Renaissance centralized church plan to convey something of the substance of the modern nation-state.

In many respects the Parliament House works extraordinarily well. It takes into full account the importance Giurgola's mentor Louis Kahn gave to daylight in architecture. Kahn is recorded as saying, "I realize that the daylight must come down from a high point where the light is at its zenith." That, in the more important working and ceremonial spaces of the Parliament House, is exactly what Giurgola has allowed to happen.

But there are also many unhappy moments in the House of Parliament. For one thing, the centralized plan is inflexible—it cannot be easily expanded. The centralized church was intended to be an image of perfection, something complete in itself that could neither be added to nor taken away from without destroying that perfection. It was never intended for change. But the Australian Parliament inevitably will grow in time. Even during construction the Parliament instructed the architects to provide additional offices for members of the House of Representatives.

Moreover, the principal architectural attraction in the two most important working spaces—the chambers of the House of Representatives and the Senate, located on either side of the members' hall—is, inappropriately, the ceilings. These are large,

oblong rooms, rather plain, which Giurgola has attempted to enliven by kicking out the corners and devising ceiling lights and lanterns of impressive complexity that focus all interest upward. In some ways the complexity of the lighting is self-defeating because it eludes comprehension. Also, in the House chamber the space spills out diagonally through a gap in paired columns. In the Senate chamber, on the west side of the Parliament House, a circular geometry has been introduced to distinguish this chamber from its larger brother. It has a similar diamond lantern at the center, but its skylight is simpler and much more effective. At night, when the House and Senate are in session, the lights will constitute a light sculpture marking the event.

The great size of the Parliament building sometimes defeats Giurgola. Thus, the mechanical repetition of so many identical elements results in monotony. It also has a human cost. Joan Child, the speaker for the House of Representatives, commented when interviewed that she could not maintain eye contact with members in the chamber. The House chamber is not scaled for intimate debate or attuned to the cut and thrust of exchanges on the floor. With provision for permanent seating of 170 members, the House chamber is also impersonal and dull. Like so much of the Parliament House, its design is tasteful and conservative, an interior that melts into the background. It lacks character.

The circular form and smaller size of the Senate chamber make it a more human and intimate room, which contributes to a greater sense of drama on the floor than is possible in the House chamber. The Senate's enclosing, inclusive geometry makes people a part of the interior.

The members' and senators' offices are uninspiring if roomy quarters that read all too clearly as standard barracks for politi-



Above, the Senate chamber lighted by clerestory slots in elliptical drum; eight speaker clusters are suspended from ceiling. Facing page, clockwise from top: the members' hall with screen wall supporting pyramidal skylight over square reflecting pool; the hypostyle foyer with columns partially clad in marble and strong floor patterns; and the square-plan House of Representatives chamber with lights on suspended track.

cians. Giurgola has insisted on a commendable Scandinavian restraint in the interiors and has avoided the more exuberant, funny, and at times outrageous color combinations of post-modernism. This limited palette of materials using a few natural finishes and graduated shades of green and red results in a building that is sober and lacking in personality. Furniture also is tasteful and dull, though it probably anticipates the members' own tastes. The same is true of the Prime Minister's office.

Another problem is the absence of views. With so much of the building overlooking internal courts, people look into other offices. It is the bane of the Parliament House. The Prime Minister's office is not exempt. It overlooks a bare, granite-paved desert peopled by a group of bronze tors by Marea Gazzard.

The art program for the Parliament House was enlightened and ambitious and deserved to be successful. Unfortunately there was no real precedent. There are some wonderful successes, but overall the artworks are a disappointment. The fault was not Giurgola's. The Arthur Boyd tapestry in the great hall is a typical example of what could and did happen. The idea for the tapestry was taken from a 19th-century painting by Tom Roberts of a forest scene at Sherbrook in Victoria. Boyd's painting lacked the necessary strength for translation to a larger scale. As a result, the 20x9-meter (66x30-foot) tapestry is a delight to

look at close up but a disaster in terms of its contribution to the architecture of the great hall. To make matters worse, a rectangle had to be cut from the tapestry for the doorway connecting the great hall with the adjoining members' hall.

There have been many attempts to explain the meaning of the Parliament House, some of which, responding to its part-subterranean nature, have inferred that it signifies death and have likened it to a mortuary tomb. In some ways the Parliament House resembles Daedalus's labyrinth, an underground complex with a single entrance. From this viewpoint, it is not something that has grown from nature, no matter how much its design might give that impression. It is a work of art. This means that it is a human copy of something.

Giurgola chose to fly with Daedalus, but, unlike Jorn Utzón, who flew with Icarus in designing his Sydney Opera House, and so suffered Icarus's fate, Giurgola stayed nearer to the ground so he could follow its established landmarks in finding his way across unknown territory. His wings, unlike Utzón's, held together.

In its own fashion the Parliament House says something equally important about Australia and Australians, and it is not about death. Quite the opposite. A mixture of cave and hill, the building is expressive of birth, of new life making its way into the world, forcing a passage for itself from under the earth. Like the Pitjantjatjara myth of the great creation spirits who emerged one by one from the depths of the earth, pushing the earth back as they came, so the Parliament House expresses the emergence of a new entity.

The form of the Parliament House suggests a country that is still emerging, a country as yet unfinished. It is the message of a country beginning to shape itself but, as yet, far from fully formed. □



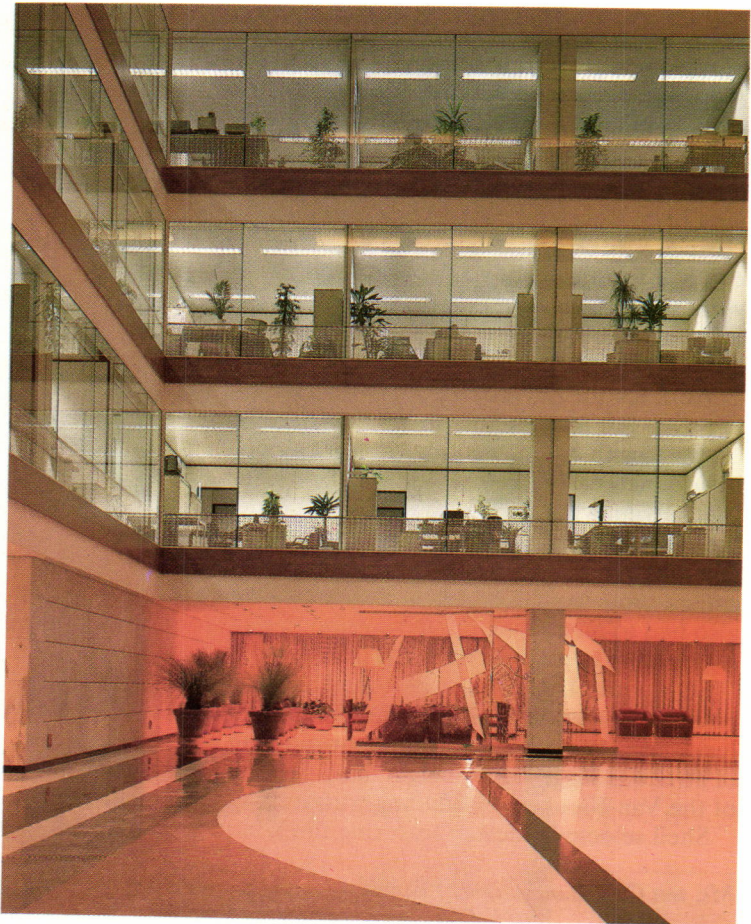
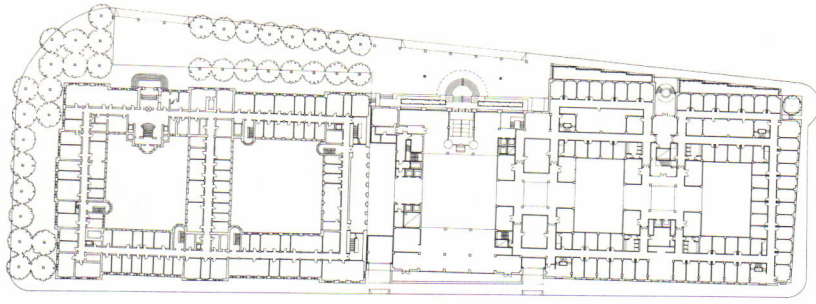

are highly secured and accessible only to board members. A sense of design cohesion is underscored by arcades surrounding the atrium, which adjoin reception rooms and suites for the board of directors.

The general offices also line the atrium and are separated from it by glass. They are largely windowless and artificially lit, a situation unappreciated by the Dutch, who set great store by views and the freedom to open windows for fresh air. The floors for management offices, designed by Charles Pfister, are sumptuous with expensive and beautifully detailed materials, but they are not overdone.

From the entry hall two large but shorter atria are visible. They connect with each other and the main atrium via a wide, attractive passageway whose marble floors are a reddish brown, black, and white. The atria are enlivened by huge, sculpturalike round balls and surrounded by offices, whose corridors have an occasional coffee corner overlooking the street.

In the new Shell building's interiors, as in its exterior design, SOM and Pfister have aimed at modernist stability. The outcome is not innovation but a beautifully crafted environment with high quality finishes. □

The old and new buildings are more alike in plan than in any other respect, both being organized around courtyards. Top right, the elegant boardroom; right, a typical office area in the new building; far right, a new office gets an intriguing glimpse of a stepped gable on the original building. Above, the central atrium of the new building with a swirling stairway encased in glass as a major design element.



Photographs © Peter Aaron/ESTO



Americans Abroad: Some Coming Attractions

Europe and Asia are fast becoming the leading importers of American architecture, as evidenced in the projects shown here. Some clearly transport the American urban esthetic overseas; others borrow from the host country's vernacular and traditions. All are intriguing.

By Nora Richter Greer

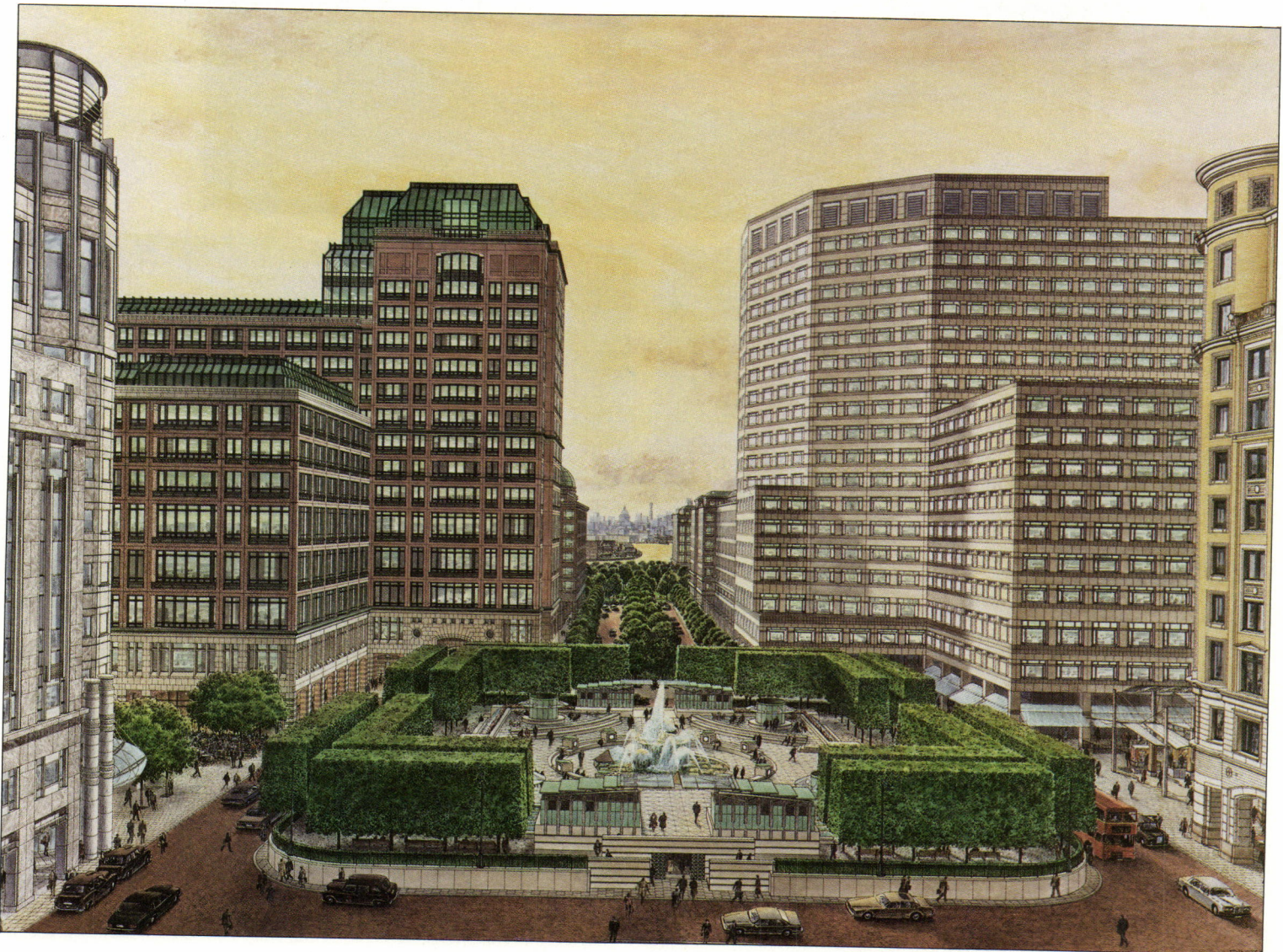

A 12 million-square-foot, mixed-use development ultimately will link two bends in the Thames River in London's Docklands district. For the 71-acre Canary Wharf site, offices, retail shops, two hotels, and parking are planned in symmetrical buildings flanking a formally landscaped boulevard and plaza. Left, the building in right foreground is by Skidmore, Owings & Merrill; the one in left foreground is by Kohn Pedersen Fox. Flanking the street on the right is a building by I.M. Pei & Partners, and on the left is one by SOM. At the complex's heart will be an 800-foot-tall, pyramid-topped skyscraper (right) designed by Cesar Pelli. Contrasting with London's mostly modernist towers, Pelli's is characterized by, in his words, "flair and dignity." Authors of the site's master plan are SOM, I.M. Pei & Partners, and YRM Associates. The landscape architect is Hanna Olin.



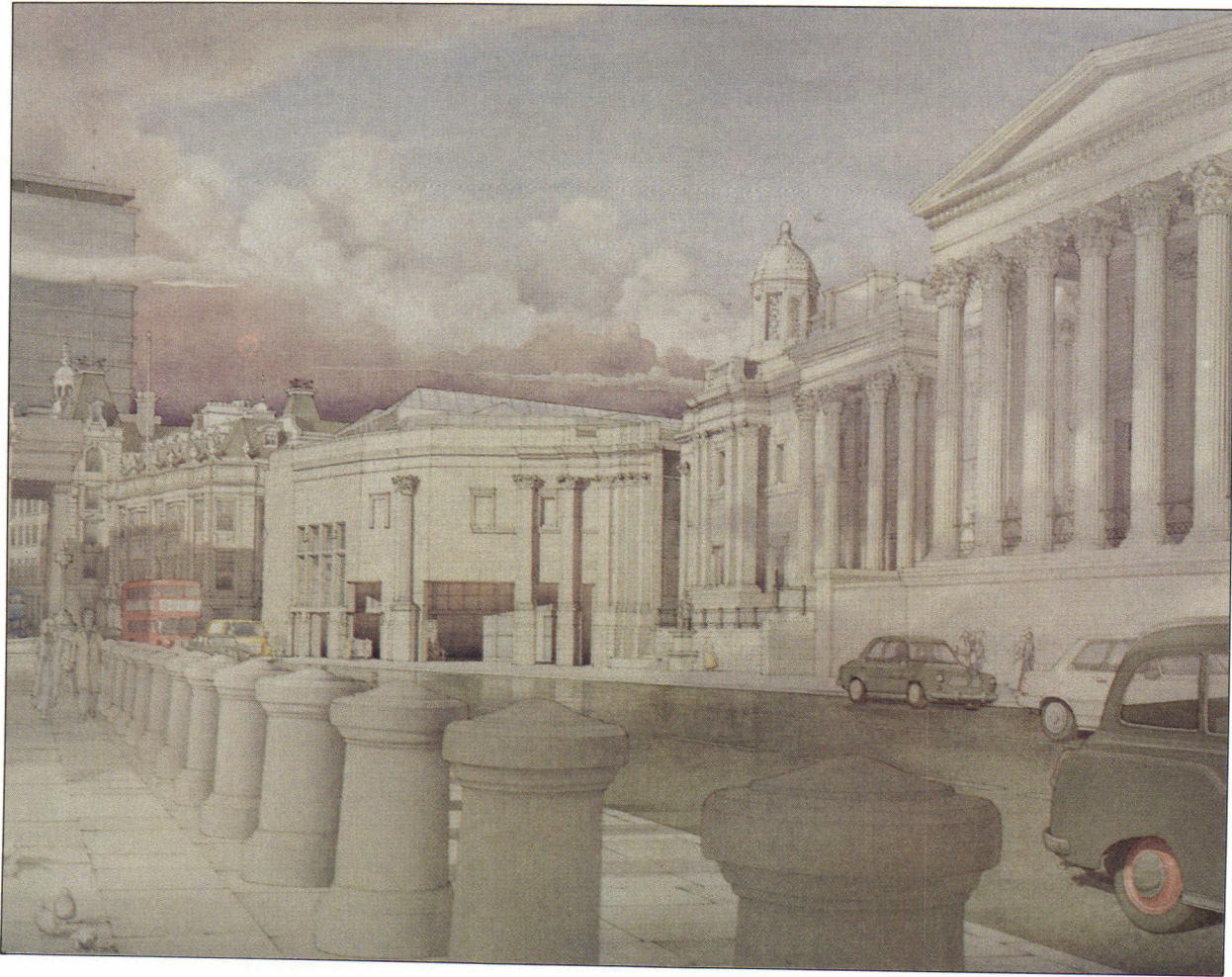

The Sainsbury Wing of London's National Gallery, designed by Venturi, Rauch & Scott Brown, relates to the 1838 original building by William Wilkins but also asserts its own identity. Cornice lines and materials are similar; new are large, square cutouts and small metal columns. Top photo, view from Trafalgar Square; above, elevation of entry lobby facing west; left, view of connecting galleries.

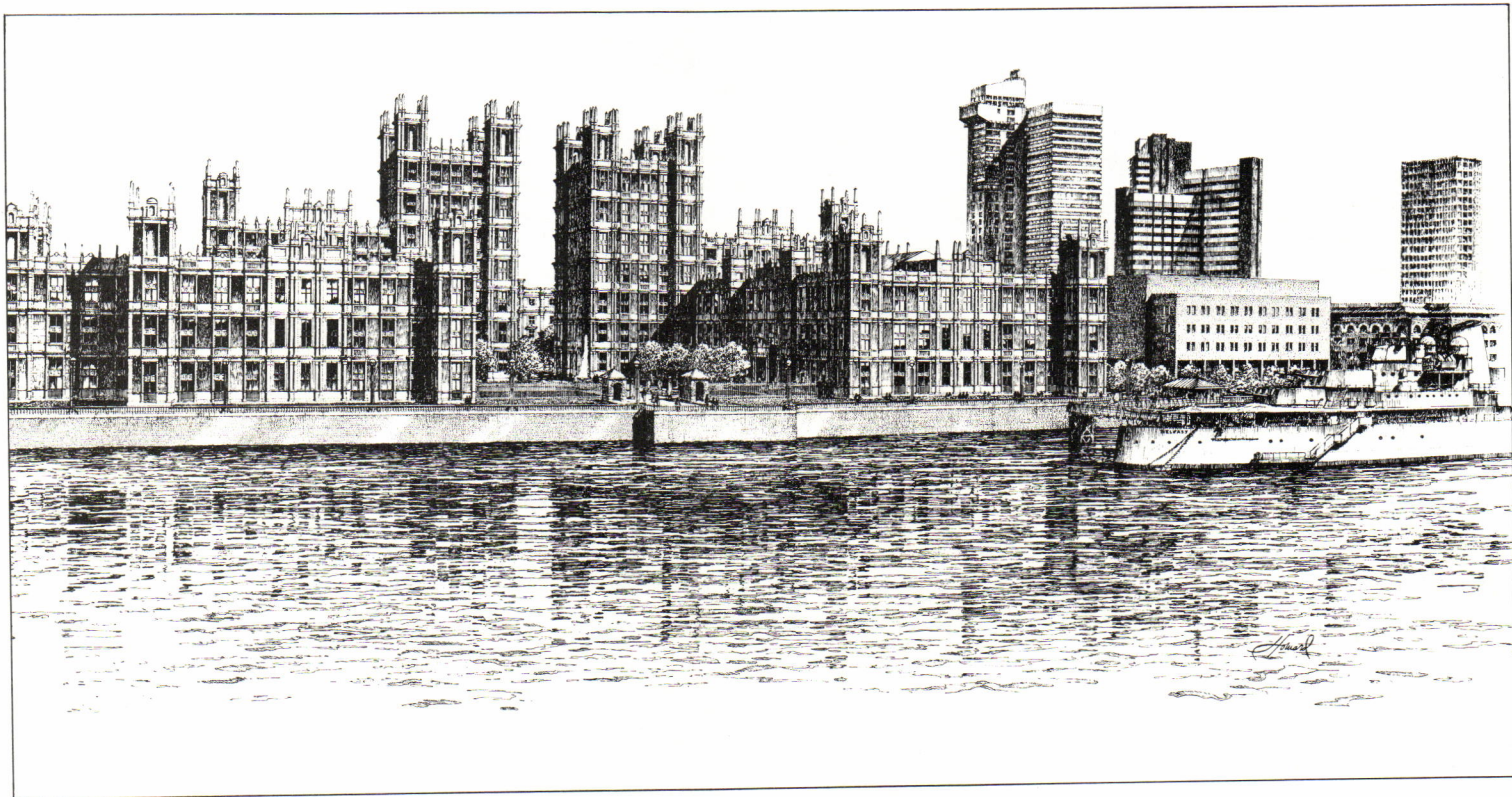

A new office retail complex that reflects traditional English architecture will grace the banks of the Thames. Designed by John Burgee Architects with D. Y. Davies Associates, the complex (London Bridge City Phase IIA, above) features two 14-story towers, which step down to nine- and

six-story wings. The focus of the complex is the river, with views of the London and Tower bridges. Materials and detailing are to be compatible with those of existing buildings—light-colored limestone stringcourses that alternate with dark gray granite panels and stretch out the building's lines horizontally.

Joint ventures are common between American and foreign architects. For the Palasport Milano arena in Milan, Italy, HOK teamed up with Italian architect Aldo Rossi to design this 18,000-seat velodrome and multipurpose arena.

In the center is HOK's contribution: the design of three levels of seating for sports and entertainment events. The perimeter spaces and towers were designed by Rossi for commercial and retail use. The building will be marble and granite.

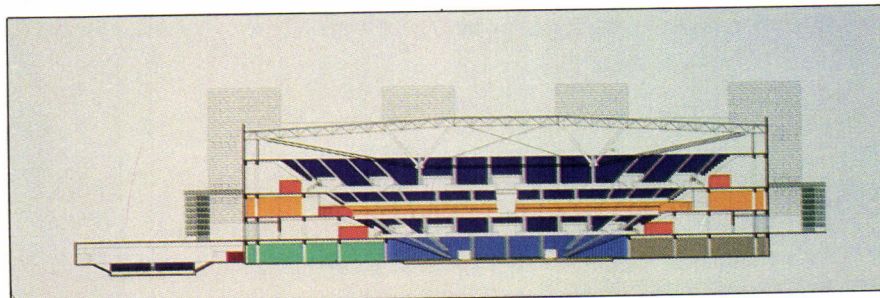
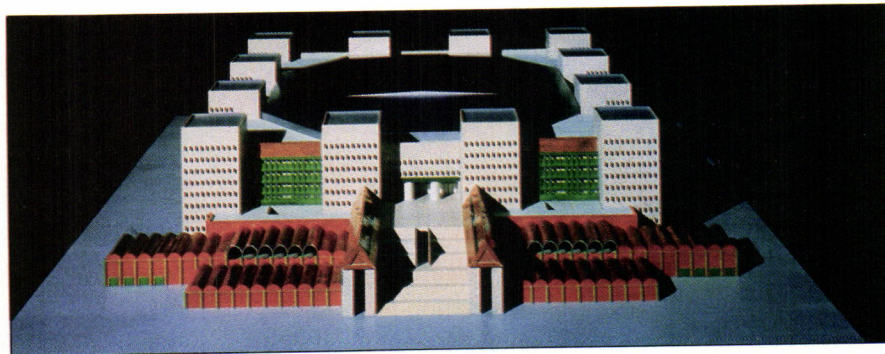

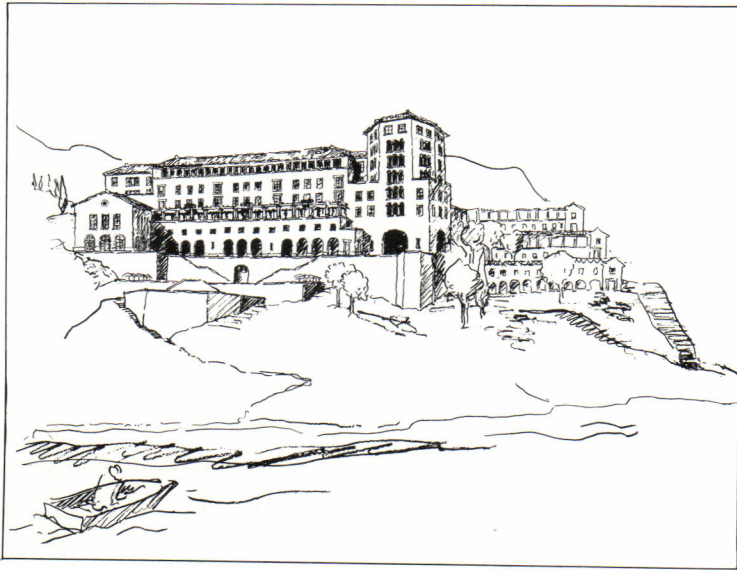

For an apartment house (below) in Japan's Akiya resort area, Stern took a "classical vocabulary" and "enriched it with materials and details traditional to Japan," he says. The design makes reference to Edwin Luytens and Frank Lloyd Wright.



With the Bancho House in Tokyo (right) under construction, Stern redesigned the facade and added a penthouse. The result respects the classicism of the British Embassy; the penthouse terrace reflects surrounding gardens.

Robert A.M. Stern Architects assisted the Boston firm SWA Group in master-planning the new resort community of Santa Agueda on the southern coast of Gran Canaria in the Canary Islands (left). The local vernacular and more formal, traditional Spanish design formed the basis for the architectural guidelines. The resort will be anchored by the new hill and harbor towns, for which traffic circulation, distribution of housing types, and location of specialty buildings were developed.

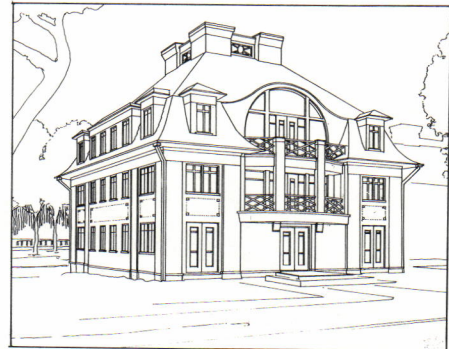

Stern is one of six who designed villas for Tegel, a suburb of Berlin ravaged by World War II. Turning away from "the stark impersonality of most contemporary German social housing," Stern says, his villa (right) instead recalls those of 19th-century Tegel and the "cool classicism of Bruno Paul."

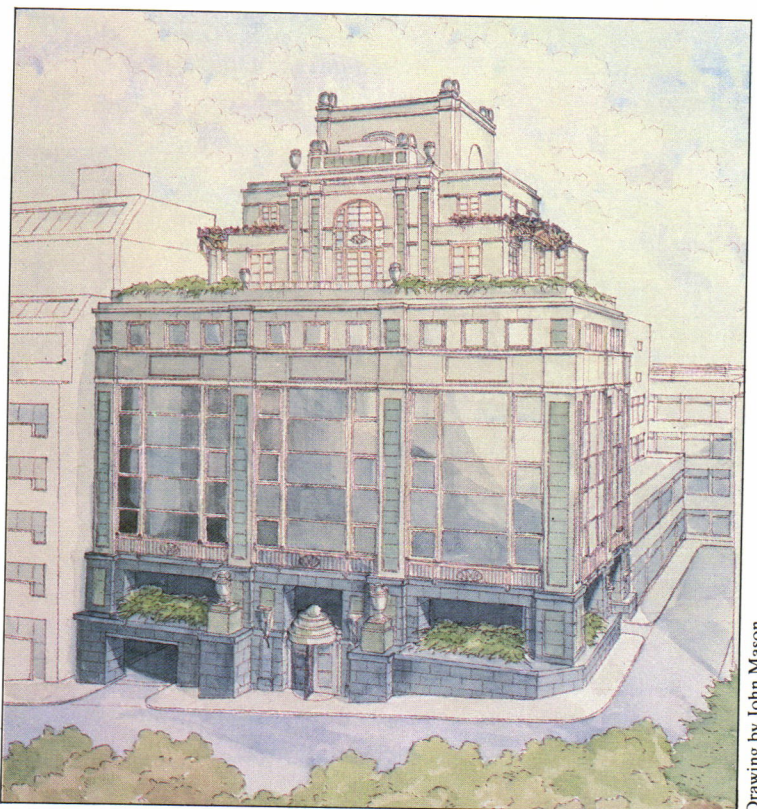
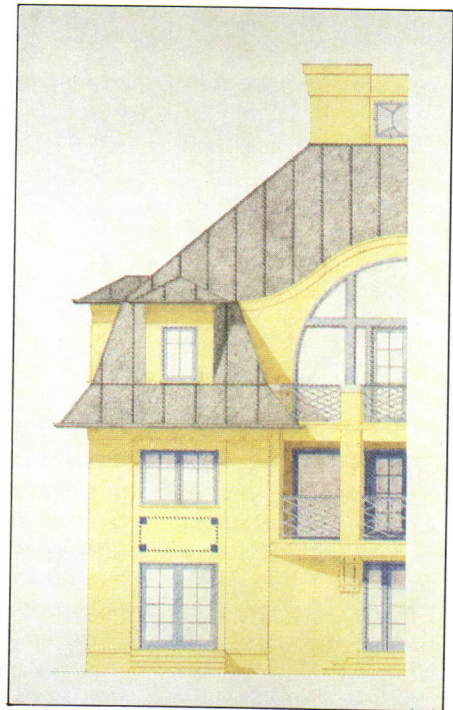

Drawing by John Mason

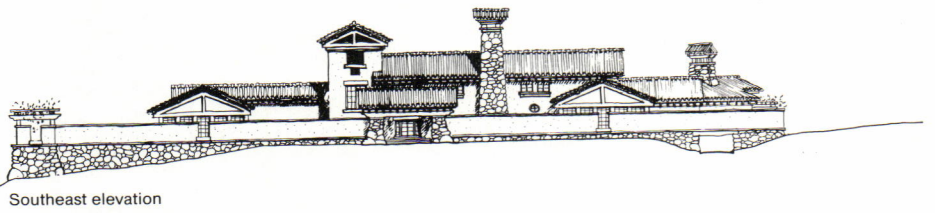
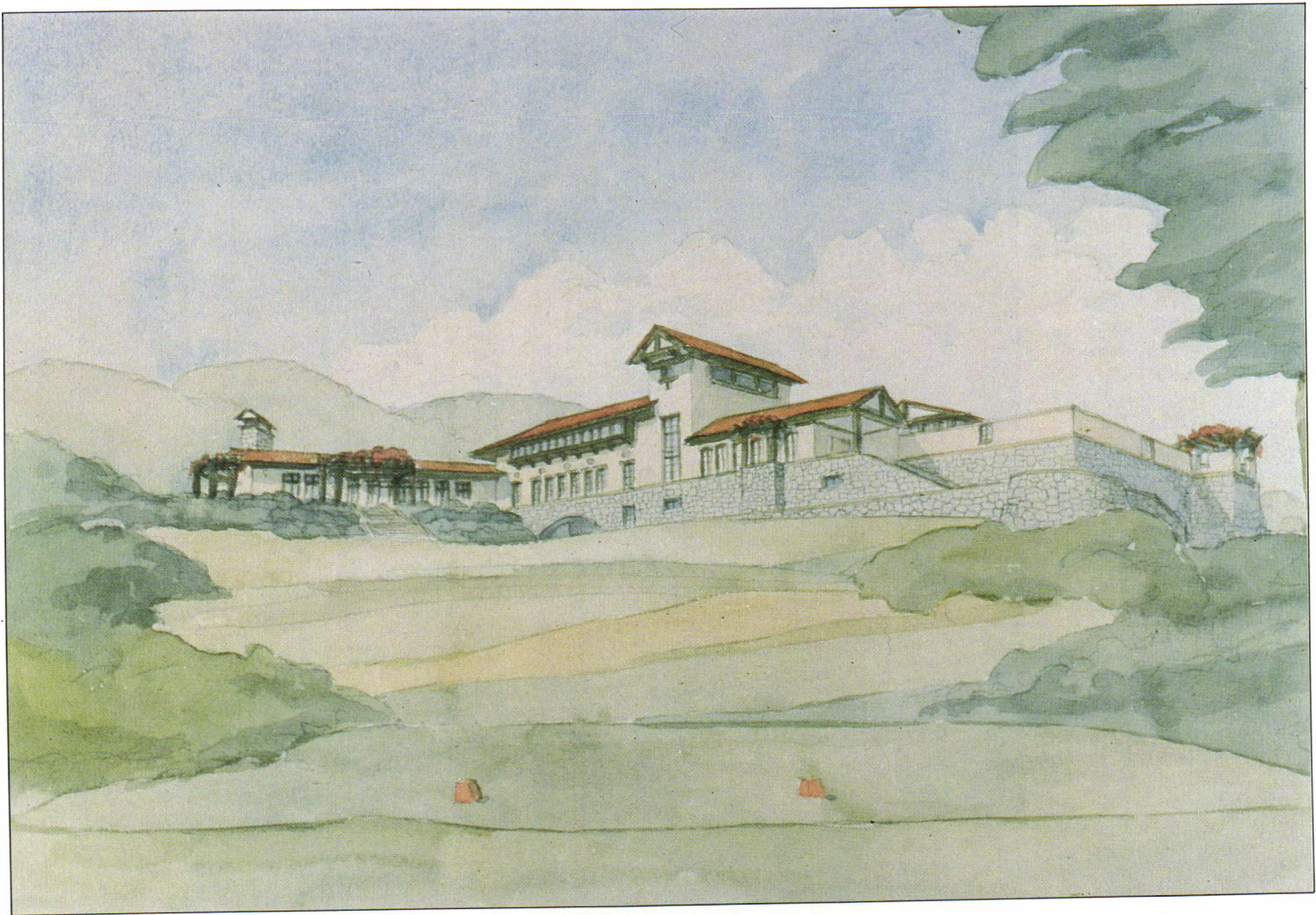

Southeast elevation

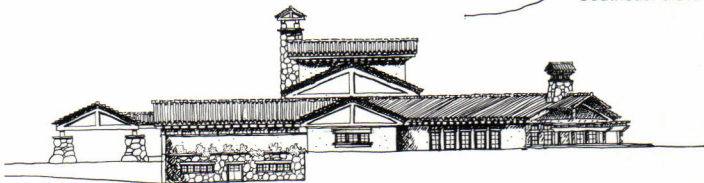

Northeast elevation

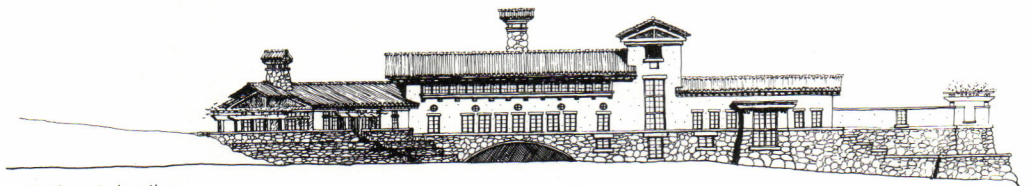

Northwest elevation

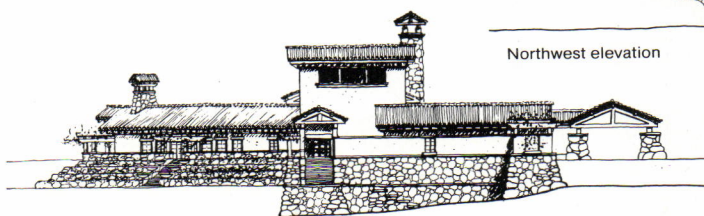

Southwest elevation

The Nittsu Fujimi Land Golf Club House will be situated on a steeply sloping site with views of Mount Fuji and Sagami Bay on Japan's Izu Peninsula, in close proximity to Tokyo. The image Stern chose is

of a grand villa complete with belvedere. The gathering rooms will be oriented outward to the magnificent views, the private rooms to intimate courtyards. The design is clearly influenced by the Japanese vernacular.

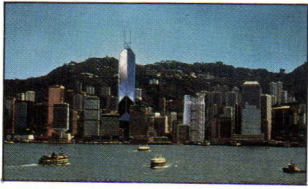

For its Hong Kong branch, the Bank of China asked for an "imposing bank hall." The design by I.M. Pei & Partners, with Leslie E. Robertson, structural engineer, is a 1,209-foot-tall "structural expressionist" design (right), according to Pei. The entire gravity load of the building is transmitted through diagonals to the four corner columns. In turn, the facade is a "tower of diamonds," says Pei, the geometry of which is an exterior expression of its internal structure. The interior focus is a 17-story atrium. Associate architect in Hong Kong is Kung & Lee.

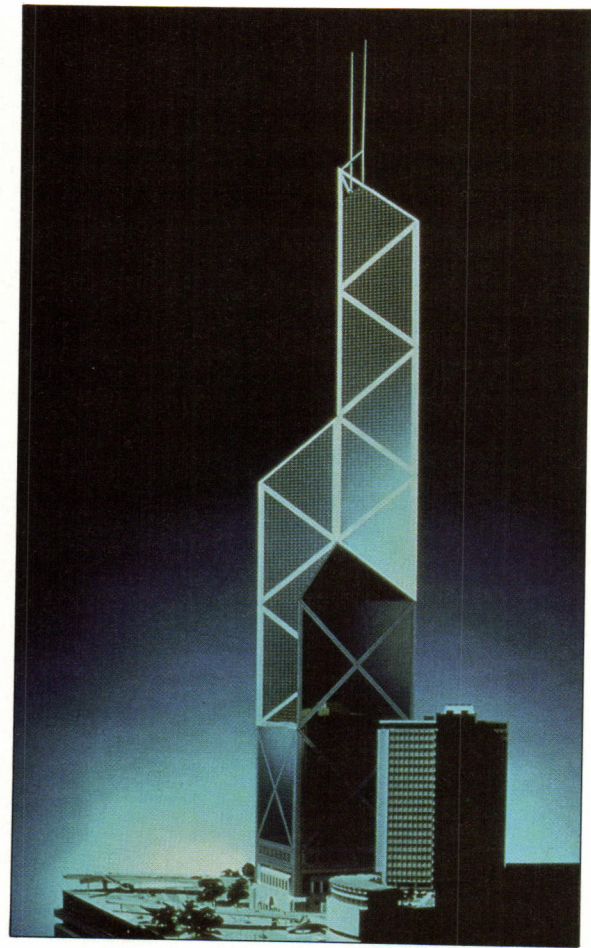
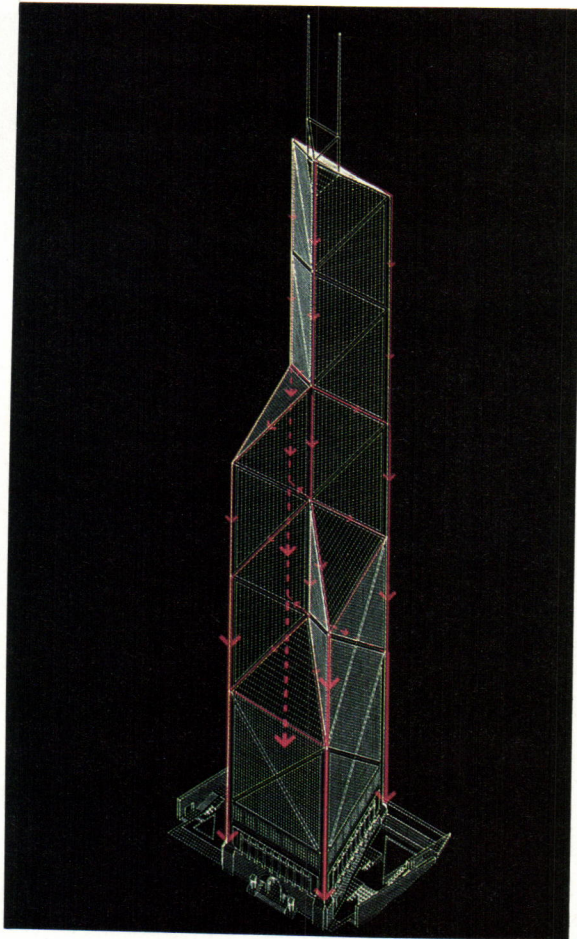

In Frankfurt, West Germany, a 700,000-square-foot, mixed-use complex (right) designed by Kohn Pedersen Fox will grace the new Mainzer Landstrasse commercial strip. The smaller components are to minimize the complex's impact on the residential community to the south. The office tower gestures to the city center. The lowest portions of the complex house apartments, the medium-height the hotel, and tallest the offices. At the center is a winter garden, like a "great European palm court," says the architect. At the tower's top is a two-story loggia and cantilevered crown. The design reinforces street walls and rooms and uses classical scale and rhythms to respond to surroundings.

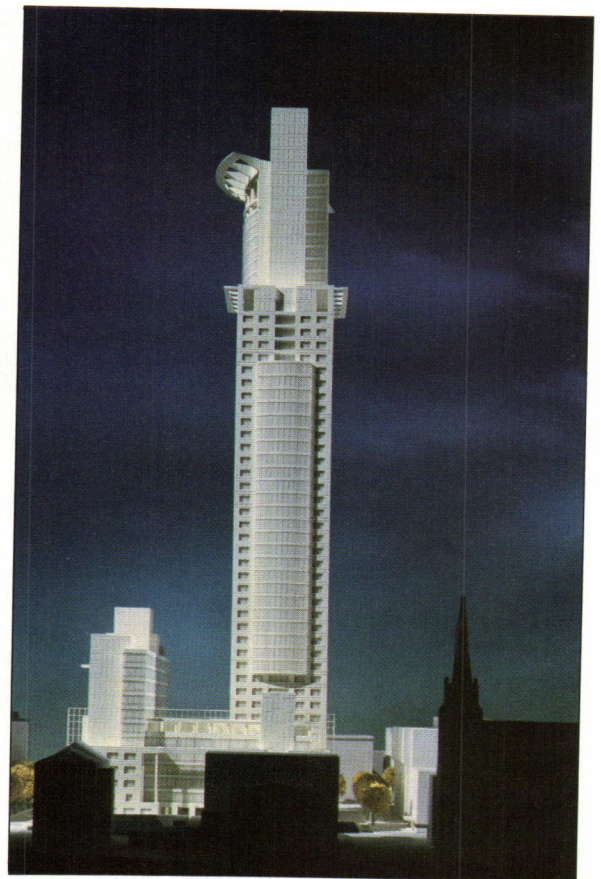
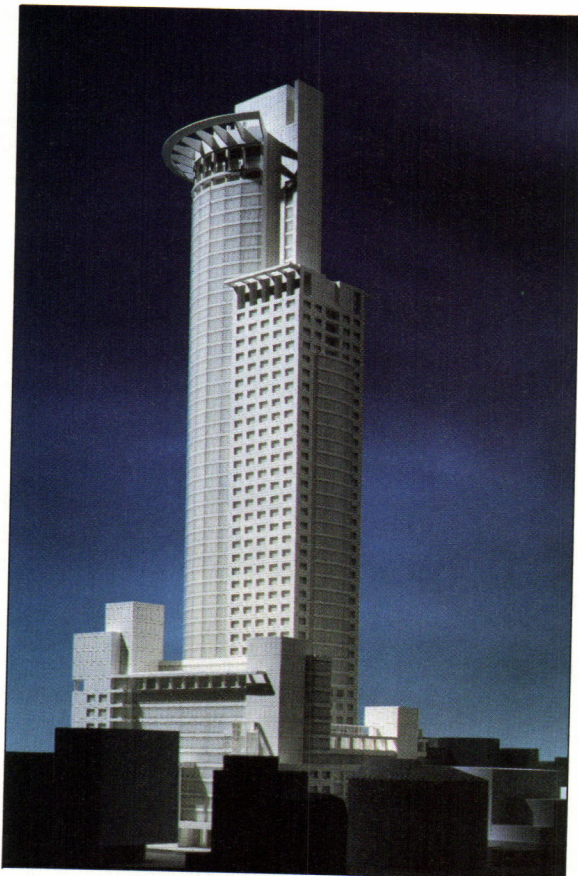



Drawing by P. Stevenson Oles

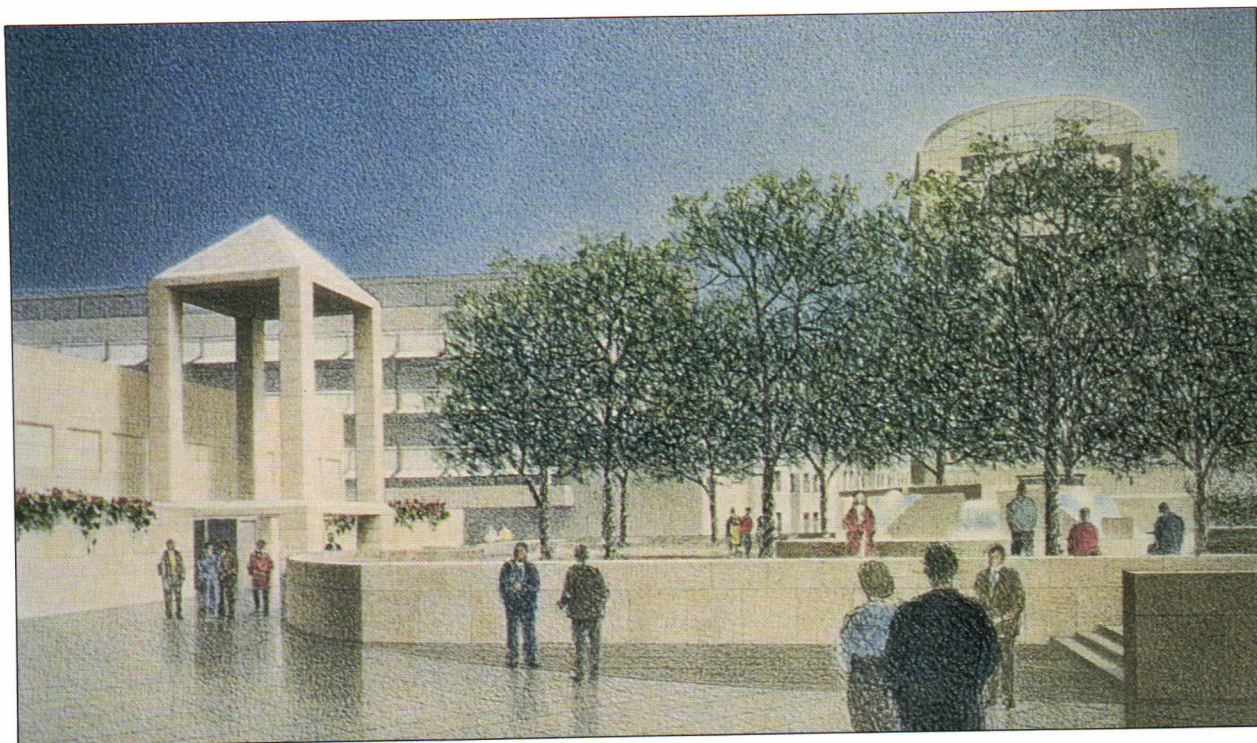

Drawing by P. Stevenson Oles

The task for I.M. Pei & Partners in designing the Galerie der Stadt Stuttgart was to insert a 80,000-square-foot art museum into a well established neighborhood in this West German town. A screen wall is wrapped around the building to minimize its bulk. The museum front entrance

tower will be approached on its more urban side across a paved plaza (top). Stepping up a hill, the rear entrance tower with its tree-filled plaza (above) will more closely relate to the nearby countryside. The overall goal is to smoothly link disparate urban spaces while giving the museum an identity of its own. □

Mr. Wright in Japan: Beyond the Imperial

By Michael Kopp

Though the story of Frank Lloyd Wright's work in Japan from 1911 to 1923 centers on the design and construction of the Imperial Hotel, there is more to be told and more built and unbuilt work of his there to be shown.

Wright is generally perceived as having been sought out by the Imperial Hotel. However, there is evidence that shows Wright got the job the old-fashioned way: he had competition from another architect and went after it for at least four years until he was formally selected. This is made plain in a Japanese book whose title translates as *Philosophy and Architecture*, by architect Kikutaro Shimoda (1866-?), which was published in 1928.

Shimoda wrote that he began working with the hotel on a design in 1909. The project then was suspended due to the Meiji emperor's death in July 1912. By this time, Wright had established contact with the hotel. In the book Shimoda claimed that at the hotel's insistence Wright used Shimoda's design. Unfortunately, there are no known drawings of Shimoda's work to help us come to our own conclusions. But Shimoda did sue the hotel for taking his design and received a financial settlement.

This was not the first time Wright and Shimoda crossed paths. Shimoda attended the architecture school of Tokyo Imperial University (Tokyo University's predecessor). He quit one year before graduation, reportedly because of a personal conflict with a professor. Interested in the then-emerging technology of structural steel, he came to the United States and worked here through most of the 1890s. During 1892-93 he was a field representative at the Columbian Exposition in Chicago for the New York architect A. Page Brown, who designed the California Pavilion there. At the same time, Wright also was involved with the exposition. In *An Autobiography*, Wright himself wrote that during this period he once literally kicked a man, who was derogatorily nicknamed

"Yerrow Socks" Shimoda, out of the office. Wright said he "was not a good Japanese."

Shimoda later worked for Daniel Burnham and for Shepley, Rutan & Coolidge and also opened his own office in Chicago. He became a licensed architect in Illinois and even claimed that he voted for William McKinley in the 1896 presidential election. Returning to Japan in 1898, Shimoda continued his practice with many non-Japanese clients. His experience therefore made him a plausible candidate to design a hotel intended for foreign, mainly Western, visitors in Japan.

Masami Tanigawa, author of many books on Wright, including *Wright and Japan*, has alluded to Wright's aggressiveness in seizing the opportunity to take over the hotel project after work was suspended, and then in promoting himself. Tanigawa also surmised that a 1914 Wright design for the United States Embassy in Tokyo never had a real client and was intended only to impress the Imperial Hotel's board of directors with his ability to design buildings other than houses. Drawings of the purported embassy project have been published from time to time, and similarities to the Imperial Hotel can be seen in the front courtyard, several wings, the low-rise construction, and the overall symmetry. While Wright already had at least two distinguished large buildings to his credit (Unity Temple in Oak Park, Ill., and the Larkin Building in Buffalo), the embassy's location in Tokyo and its conception before Wright was formally selected by the hotel board easily would have helped his cause.

Inquiries made to the U.S. Department of State's Office of Foreign Buildings Operations, as well as its Historian's Office, to help set the record straight, elicited no record or information indicating that Wright had ever been retained for the United States Embassy.

In addition to the Imperial Hotel, Wright completed four other projects in Japan, including the Arinobu Fukuhara house in the resort area of Hakone. He also made sketches for a number of unbuilt house designs.

The Fukuhara house was designed by Wright in 1918 and fin-

Mr. Kopp was employed by the U.S. Navy as an architect in Japan for five years and is now with Fluor Daniel in Greenville, S.C. He thanks Dr. and Mrs. Tanigawa, Raku Endo, Akira Watanabe, and Eiko Yachimoto for their research assistance.



Left, Wright's Fukuhara house as it appeared before the earthquake of 1923. Below, the house the day after the earthquake.



ished in 1920-21. Fukuhara (1847-1924) was president of Shiseido Co., a major cosmetics manufacturer. He and his family used the house as a vacation home. It is likely that Fukuhara became acquainted with Wright through his third-eldest son, Shinzo, who was graduated from medical school in Japan in 1906 and then studied at Columbia University for seven years. Shinzo reportedly used to visit the Imperial Hotel construction site with a Japanese architect, Kenjiro Maeda, a self-proclaimed (Louis) "Sullivanist." Shinzo eventually succeeded both his father and an older brother as president of Shiseido.

The Fukuhara house was badly damaged in the Great Kanto Earthquake of Sept. 1, 1923. Ironically, this was the same earthquake that the Imperial Hotel survived, winning praise and fame for Wright as a result. The house was much closer than the hotel to the quake's epicenter, offshore in Sagami Bay, southwest of Tokyo; its proximity undoubtedly contributed to its being more heavily damaged. It was never rebuilt, although other buildings occupy the site today. Recently, Tanigawa and a group of his Nihon University students began to re-create it in a scale model.

Among Wright's other commissions was the Tazaemon Yamamura house, still standing in Ashiya (between Osaka and Kobe). Only sketchy information about it is known outside Japan. Yamamura contacted Wright through a son-in-law, Jiro Hoshijima, who was a Tokyo lawyer and went to the same high school and college (Tokyo Imperial University) as Arata Endo, Wright's architect assistant. For a long time it was thought that the Yamamura house was completed by 1922, or even earlier, and that Wright was actively involved in its execution. However, a survey of the house several years ago discovered a *tosatsu*—(a piece of wood with the completion date of the project written on it—indicating a completion date of Feb. 11, 1924. Wright had left Japan for the last time in July 1922. The *tosatsu* also states that the house was designed at the Arata Endo Architectural Studio. A translation of an excerpt from a 1925 article written by one of Endo's coworkers, Shin Minami, appears to sum up the contributions of each architect to its design and construction:

"This building was first designed and sketched by Wright and was taken over by Mr. Endo and me in an unfortunate situation in which Wright left Japan unexpectedly. Now at the completion of this building I wonder how Mr. Wright would have liked this building. I bet he has many complaints. If Mr. Wright had been available for giving construction management to this project, the building might have taken quite a different shape."

In designing the Imperial Hotel, Wright established a close relationship with its general manager, Aisaku Hayashi. It is well documented that Hayashi played a role in selecting Wright for the job, having visited Taliesin with his wife in 1916. Hayashi was one of Wright's main supporters in dealing with the hotel's board of directors during design and construction. When in 1922 dissatisfaction among the hotel board members peaked over cost overruns and delays, Hayashi resigned to share in the responsibility for the situation. This was shortly before Wright himself was fired and left Japan, never to return. Wright also designed Hayashi's house in Tokyo in 1917, which still stands.

After World War II ended, Hayashi again established contact

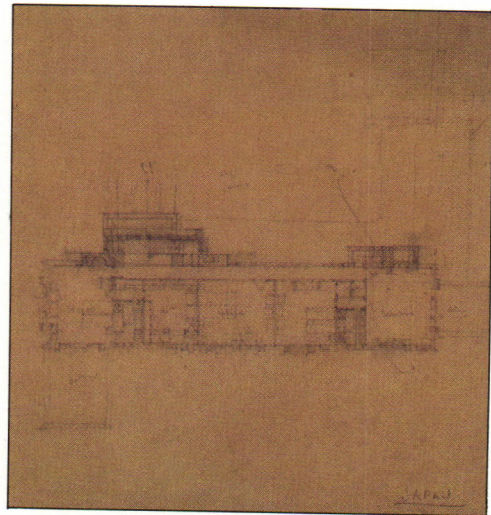
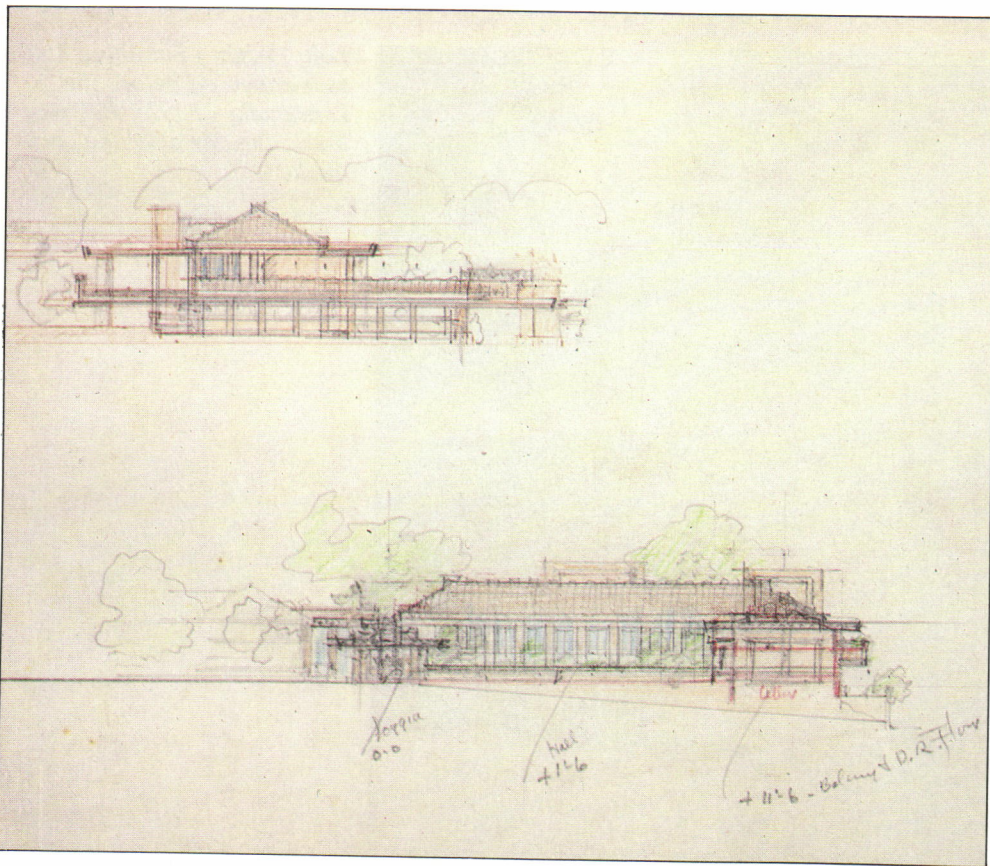

Above left, two elevations of the Goto house, color pencil and graphite pencil on tracing paper dated May 1921. Above, preliminary sketch of the Immu house, 1918.

with Wright. He informed Wright that the Imperial's banquet hall and south wing were damaged by the bombings but were being repaired by the U.S. Army, which had taken over the hotel for use as bachelor officer quarters. Hayashi then wrote: "The hotel industry is one of the few enterprises left for us to take up. It has a bright future. Why don't you come out? Ten million dollars will be sufficient to put up two or three best [sic] hotels in Japan. Let some enterprising hotel man get interest in [sic]. There is another possibility. Housing problem is vital, but no guiding spirit. Your occupation force, I understand, is planning to build twenty thousand cottages for its officers family [sic]. Still another is your idea of city planning. Many bombed cities are looking for suggestions." However, no work ever came from this for Wright, and Hayashi died in February 1951.

Like Hayashi, Endo became very close to Wright. Architectural historian Terunobu Fujimori says that Endo was always an outsider among the Japanese architectural establishment and so was described only as Wright's assistant and his imitator, notwithstanding the fact that other Japanese architects had learned from modernism in Europe and had done essentially the same thing with it in Japan in the late 1920s and 1930s, without being criticized for copying. Also, according to his son and daughter, Endo himself had no problem subjugating himself to his mentor.

But a closer look suggests that Endo had much to do with Wright's accomplishments in Japan by bringing clients to him, transforming his designs into working drawings, keeping watch on construction, and finishing Wright's projects after he left Japan.

Endo was born in 1889 in the Tohoku region (northern part of Honshu Island). Fujimori described him as a young adult (in a translation) as "a man of self-reflection with a natural inclination to things religious. On one hand there was Wright, who had the quality of a great leader preaching architectural problems as the problems of space and life. On the other hand there was young Endo, who was searching for what to do with life."

Endo learned of Wright when he was a student at Tokyo Imperial University. He then became acquainted with Hayashi, who

asked him to help work on the drawings for the Imperial Hotel. After graduating and being drafted for military service, Endo met Wright in January 1917. Later that year Endo went with Wright to Taliesin to continue working on the hotel design; he returned to Japan at the end of 1918.

After this, Endo was in Wright's Tokyo office supervising the Japanese draftsmen and acting as a liaison between the people Wright brought to Japan and the local people, including those on the construction site. Endo's son Raku also says that, besides his father's contacts with the Yamamura family and his role in finishing their house, he also introduced the clients for Jiyu Gakuen (Freedom School), the Hanis, to Wright in 1921. Like Endo, Mr. and Mrs. Hani practiced Christianity and were members of the same church.

After Wright left Japan, the elder Endo continued his own architectural practice. Many of his records were lost in World War II, but about 30 of his projects are known to exist, including an auditorium addition to Jiyu Gakuen across the street from Wright's building. Late in World War II, Endo was in Manchuria working on the design of a residence for one of Japan's representatives in the area. Shortly before the war ended he became critically ill. To complicate matters, like many Japanese overseas at the end of the war, he had to wait a long time under difficult conditions before being sent back to Japan. While Endo was still in Manchuria, Hayashi wrote the previously quoted letter to Wright in March 1946. Hayashi also told Wright in this letter that he was "expecting to return to Tokyo where I am building a small comfortable house. I wanted to have Endo design it, but he is lost in Manchuria where he and Minami had an office. Their whereabouts could not be found hard as we tried."

In February 1947 Wright received another letter from Sadaziro Kubo, who had attended Taliesin in the fall of 1938. Kubo told

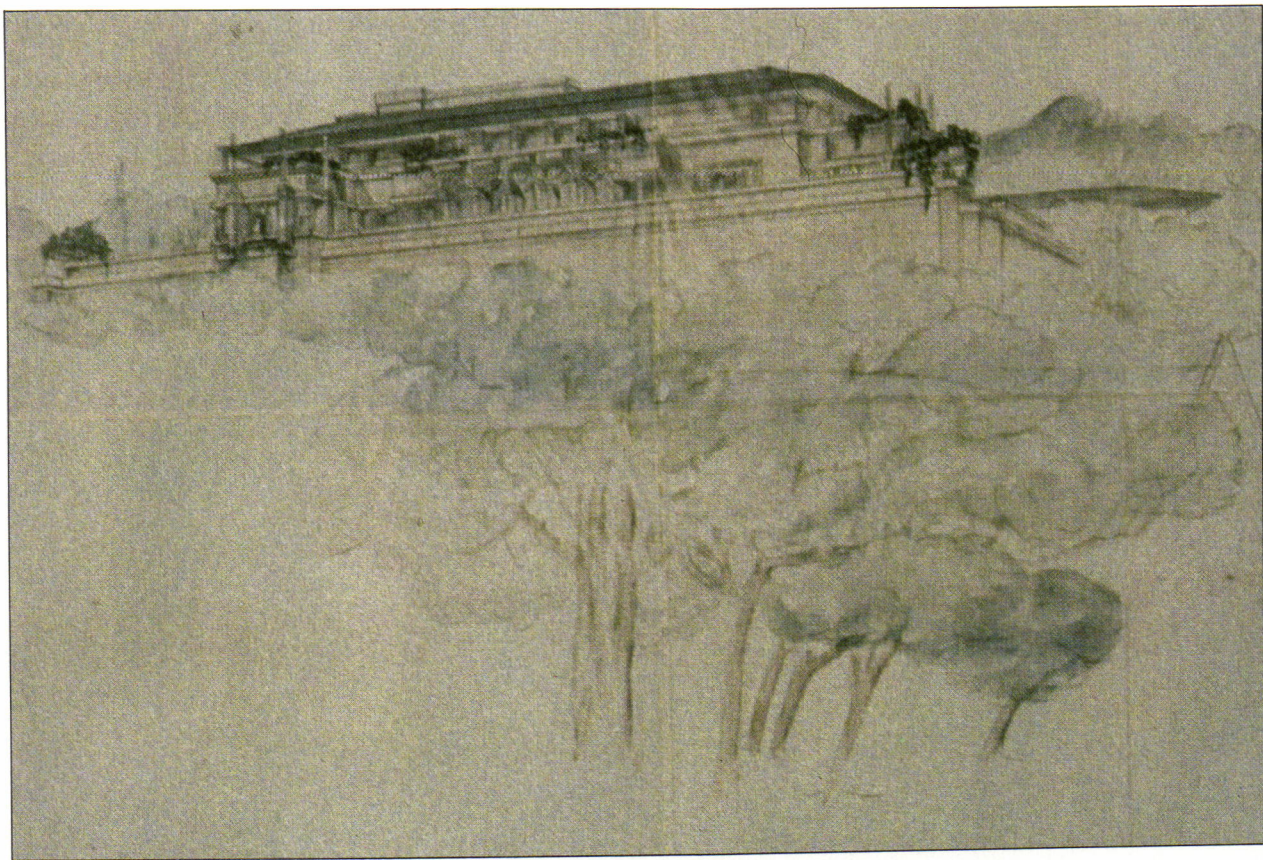

Drawing courtesy of Nihon University Engineering Library; photograph by Michael Kopp

Wright that “Mr. Arata Endo, your charming and characteristic disciple [sic], returned from Manchuria last September [1946] and was sent to a hospital in Tokyo at once . . . he was suffering from peritonitis and he would be very lucky if he could work at his desk for planning [i.e., architecture] in future [sic].”

Kubo then went on to inform Wright that Endo’s financial condition was even worse than most people’s because of his medical expenses. It was after this that Wright responded with a letter in April 1947 to Gen. Douglas MacArthur, the commander of the occupation force in Japan after the war. With the letter Wright sent a check, with equal amounts of money to be delivered to Hayashi and Endo, as well as an offer to sponsor both of them if they could, or would, come to the United States. Wright received word from one of MacArthur’s staff that the money had been delivered but that it would not be possible for either Hayashi or Endo to leave the country. Endo never recovered his health and died in June 1951.

Among the little-known, unexecuted projects for which Wright made sketches and about which we have some information are these:

- *House for Viscount Inoue, Tokyo, 1921*: The drawings of this house in the Meiji section of the city date from 1921. They were made by a draftsman who worked for Wright, Y. Tadokoro, and for many years were kept by the Inoue family. The house allegedly was not built because of its cost. But, like the Fukuhara house, Tanigawa’s students have made a scale model of it based on the drawings. Viscount Kyoshiro Inoue (1876-1959) was an engineer and politician who had lived in the United States from 1901 to 1907, and knew the manager of the Imperial Hotel, Aisaku Hayashi.

- *House for Baron Goto, Tokyo, 1921*: Two study elevations and a floor plan, dated May 1921, Los Angeles, are in the Frank Lloyd Wright Foundation archives. The client for this project very likely was Shimpei Gotoh, who had been a director of Japan National Railways and mayor of Tokyo around the time Wright was in and out of Japan.

Above, perspective of the Inoue house; drawings from 1921 of this project were by Y. Tadokoro, a draftsman in Wright’s office.

- *House for Viscount Immu, Tokyo, 1918*: Like the Gotoh house, this one exists only in preliminary sketches owned by the Frank Lloyd Wright Foundation. Nothing specific has been learned about the client. However, sources say that “Immu” is not a Japanese name. If such a person ever existed, the name could be a misspelling or possibly a Japanization of Korean or Chinese. At that time Japan was well on its way to building an empire, having annexed Korea in 1910 and obtained Formosa as a colony in 1895.

According to Tanigawa’s interpretation, Wright’s main objective in having clients with titles, whether real or imagined, was to enhance his reputation in the United States, which had been damaged by what were considered at the time to be scandals in his personal life. These included his divorce from his first wife, Catherine, his relationship with Mamah Borthwick Cheney (former wife of a previous client), and her subsequent murder at Taliesin. This “scandal theory” is further used by Tanigawa to show that the U.S. government would not have hired an architect with Wright’s reputation.

Translations by Akira Watanabe and Eiko Yachimoto, both of Yokosuka and former coworkers of mine at the U.S. Navy base there, were an important bridge in my interviews with the Tanigawas and Raku Endo and to what was written in books and articles. For too long the work of some Japanese architectural historians has been little known outside their country because of the language barrier. Through their work, some long-lost examples of Wright’s work have been rediscovered. However, just as the products of Wright’s work are interesting to us, so should be the methods by which he worked and the clients he had. These days, with the American construction industry trying to get more work in Japan, knowing that a different perspective exists there on Wright than what is normally seen in the United States could be a first step in applying the lessons of this story. □

Evaluation of a '50s Landmark

Edward Stone's New Delhi Embassy. By Ranjit Sabikhi



Photographs © Ram Rahman

At the dedication of Edward Durrell Stone's American Embassy at New Delhi on Jan. 3, 1959, Indian Prime Minister Jawaharlal Nehru declared himself "enchanted by the building and impressed by its combination of Indian motifs and modern techniques." The building charmed many, and public tours were organized every weekend in the early years.

The embassy was the first building of any architectural distinction on Shantipath, the broad avenue that forms the central axis of New Delhi's diplomatic quarter and remains an important landmark today. Occupying a prominent 28-acre site, the romantic chancery brought a bit of Hollywood to India and soon became a familiar and recognizable monument. But more important than its glamor, romance, and glitter was the appropriateness of the building to its time.

The time was unique. In the late '50s to early '60s, relations between India and the United States were at an all-time high. It was the era of Nehru and then Kennedy, both of whom had an idealistic vision of the future that assumed cooperation and mutual interchange. Stone's embassy complex sought to give effective expression to the friendly relationship existing between the two countries. Though it was somewhat pretentious and contrived architecturally, the embassy complex with its simple and attractive form generously invited visitors to enter and experience its dream world.

The chancery building sought inspiration in traditional Indian architecture. It was organized around a central courtyard and, like many major Mogul monuments, was designed as a pavilion on a raised podium using age-old devices to protect the building from the harsh summer climate. The building, though

airconditioned, was more than a sealed capsule. Deep overhanging canopies were separated from the second-floor ceiling by an 18-inch gap that served as a heat-dissipating breezeway to reduce airconditioning loads, and pierced screens were used to curb penetration of sunlight and reduce harsh glare.

The screens that wrapped the building not only protected the glass walls but effectively turned a two-story building into an elegant single-story pavilion, while the 14-foot-wide overhangs, in combination with the building's gilded steel columns, lent an air of grandeur in the form of a colonnade. The raised podium concealed a driveway and garage to shield cars from the sun's heat, and the central courtyard became a water garden that lowered the temperature by evaporative cooling. It had islands, tropical trees, fountains, ducks, and water fowl, all covered with an aluminium mesh sunshade that filtered and dispersed sunlight.

Seen from today's perspective, the form of the American Embassy complex and its attempt to absorb traditional Indian values seem simplistic. It served, however, to remind Indian architects of the wealth of their heritage at a time when their profession was dominated by the implications of Le Corbusier's contributions at Chandigarh and Ahmedabad. (Stone himself was less interested in the regional values of his interpretation than in abstracting the universal significance of basic vernacular devices and applying them to bank buildings in the United States, the American Pavilion at the World's Fair in Brussels, and the Kennedy Center for the Performing Arts in Washington, D.C.)

The embassy today still retains its air of quiet dignity—but it is a flawed dignity. The large circular pool in front of the chancery building still reflects the graceful pavilion and the fountains, and the majestic flight of marble steps still leads up to the podium and the central entrance with its double-headed eagle seal. But

Mr. Sabikhi is a New Delhi architect and critic.



Facing page, chancery from forecourt. Top, view of high gates leading to chancery forecourt; right, chancery as seen from rear with added building in service court; below, side of chancery shows grilles covering airconditioning units of new offices in former garage.

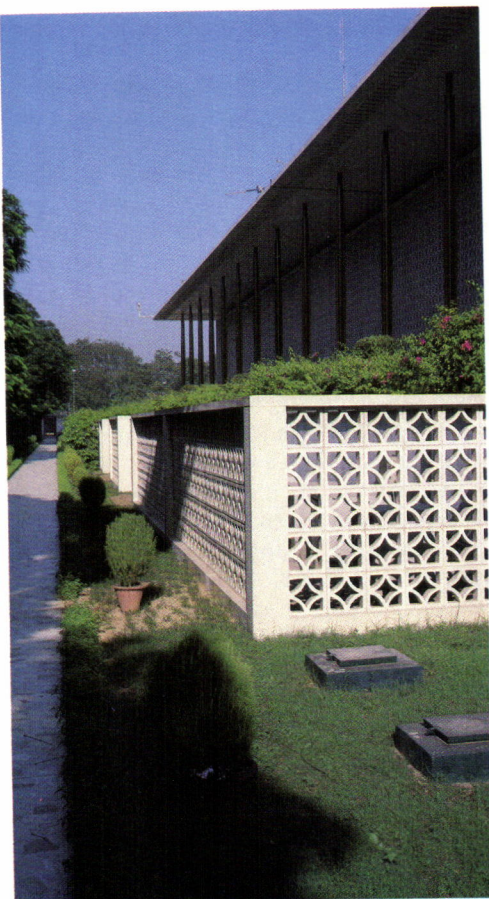

the days when the forecourt could be considered an adjunct of the spacious boulevard of Shantipath are gone.

Before you can experience the simple pleasure of the forecourt you are confronted by a high concrete wall punctured by badly designed bulletproof glass windows. You are led through a small chamber with security doors and metal detectors and are discharged at one side of the entrance court. Apart from being undignified, these changes destroy the pleasure of experiencing the simple grandeur and scale of the original concept.

Also because of security, employees no longer can go from office to office inside the building. They must walk outside, traverse an open arcade, and then proceed to their destination. In summer this can mean going from an airconditioned space into 130-degree heat, one employee reports. She also says that the pool heightens the impact by raising the humidity.

Security requirements have forced the need for enclosure, but buildings change and can be sensitively adapted to meet new contingencies. Unfortunately, in this case no attempt was made to integrate the additions with the existing complex. In the Mogul architecture from which Stone sought his inspiration, fortresslike high walls did provide security and subtly handled the spatial transition from exterior to enclosed courtyard and pavilion beyond. But the precedent wasn't examined.

This lack of sensitivity in reconciling security requirements with the original design has done more damage to the original buildings than anything else. The blank, fortresslike wall, surmounted by a steel grille that now surrounds the chancery, the residence, and the office building complex, together with internal security changes have been handled crudely.

The spaciousness of the entry lobby now is gone, and the once-inviting and generous anteroom drawing the visitor to the water



Above, a view of entrance and security wall of the ambassador's residence, Roosevelt House. Above right, rear view as seen from the swimming pool garden.



garden court is a constricted and forbidding obstacle course of security paraphernalia.

Functionally, much of the embassy works as before, though over time the need for office space has grown, as there are now 250 American officials and 700 Indian employees working in the complex. Most of the increased demand has been accommodated within the existing buildings without substantial structural changes. Some of the parking space within the podium has been converted into additional offices, and a series of airconditioning units now protrudes into the garden space along the sides of the chancery building.

The ambassador's residence, designated Roosevelt House, and the west office building complete the embassy complex. Though more modest in scale than the chancery, both of these buildings were designed in its idiom, and the facades of both are defined by the ubiquitous terrazzo screens. The ambassador's residence is not particularly effective as a home, and several American ambassadors have preferred to stay elsewhere in New Delhi, though the house overlooks a large, beautiful garden and swimming pool to the rear, and a wide, double-height veranda provides a gracious space for entertaining. Fortunately, the residence and its garden still retain their original flavor and have not been unduly affected by the new security wall built around the complex.

The west office building, which serves as the consulate where visas are obtained, attracts the biggest crowds and is barely able to handle them. This is where the major activity of the embassy complex is concentrated and where Stone chose to squeeze in the maximum number of offices in a small, modest, two-story building. While the chancery building originally provided for 90 offices, 144 office rooms were crowded into the west building, in addition to a cafeteria and a 344-seat auditorium. Secu-



rity changes have caused even greater crowding, and the problem has been handled by keeping large numbers of visitors outside regardless of weather. Queues form on the sidewalk, and only a few people are let in at a time.

The chancery and office building, though far apart, have been connected by an underground passage that allows for easy movement without exposure to the elements. Most functional problems have been resolved, but the need for more space has led not only to the partial conversion of parking spaces within the podium for office use but also to the addition of unsightly prefabricated structures in the service space at the rear of the chancery building.

The chancery remains in many ways a special building—dated, perhaps, but still a testimonial to the essentials of Indian architecture that it sought to abstract. Its attributes of simplicity as a courtyard pavilion set on a high podium visible from afar, and its attempt to deal with the problems of climate, are as valid today as they were in the '60s.

But the complex could certainly be better maintained. One gets the impression that those responsible for American missions abroad have lost interest in what was once considered an important architectural achievement and is still one of America's best designed embassies. The water garden pool needs cleaning and the ducks and water fowl have disappeared. The plants and shrubs no longer contribute to the vision of a dream world. The gilt on the once-golden columns has become dull and tarnished, and the edges of the roof show badly repaired bitumen patches. Though still clean and tidy, the whole complex has been allowed to get a bit tacky, and so the world of illusions has been shattered. Sensitively handled refurbishment could restore a measure of dignity to what was once a significant landmark. □

The Current State Of State Dept. Building

Does security dictate a fortress image?

By Bill N. Lacy, FAIA

Not since Jefferson was in the White House has architecture received great priority in the federal consciousness. Few Presidents since then, with the exception of John F. Kennedy, who caused the brief but cogent "guiding principles of federal architecture" to be drafted, have understood the importance of architecture. Andrew Jackson sited the Treasury building by arrogantly sticking his cane in the ground, ruining forever the axial view from the White House to the Capitol. And Harry Truman suggested making all our embassies miniature White Houses.

The Foreign Buildings Operations of the U.S. Department of State are often the butt of Senate criticism and are regularly castigated in the press for cost overruns and security lapses in embassies and office buildings abroad. But they also have received recent Presidential awards for excellence in architectural design and frequent commendation for their enlightened approach to the execution of overseas commissions.

Much of the credit for the favorable part of this assessment of the FBO is due to a procedure set up under former Secretary of State John Foster Dulles back in 1954. Acting on the advice of Pietro Belluschi, FAIA, Ralph T. Walker, and Henry Shepley, Dulles established a three-member outside panel to select architects and oversee preliminary designs. That system resulted in immediate critical acclaim for the New Delhi Embassy designed by Edward Durell Stone (see page 76) and has been successful, with minor setbacks, down to the present. The current three-member Architectural Advisory Board, which I chair, includes Charles Graves, FAIA, of Lexington, Ky., and Charles Moore, FAIA, of Austin, Tex.

Under the current procedure, we are summoned to Washington, D.C., periodically to review qualifications submitted by architecture firms throughout the country in response to notices of projects in *Commerce Business Daily*. Projects can range from an office building annex in Budapest to an embassy in Singapore. During the past few years the volume of building activity has increased dramatically because of the need to upgrade security at foreign outposts.

When our board meets, we are presented with a dozen or so

finalists whose technical qualifications have been reviewed and approved by a preselection board comprising FBO members and members from Sverdrup Corp., which has been retained to manage certain projects. Our board reserves the right to bring forth candidates from the prescreened pool of rejections if we feel that special design potential warrants such action.

When Belluschi set up the board he told Dulles emphatically, "You get the best architect, and you get the best architecture"—a simple maxim but one not always easy to implement. Basically, our recommendations are based on review of the somewhat tedious government forms called 254 and 255, which give a statistical portrait of a firm and its qualifications, supplemented by brochures containing photographic evidence of its skills. We review these materials and match up design talent and ability with projects that suit a particular firm's experience and potential. As architects increasingly are selected by the interview method, many architects welcome the FBO method because it doesn't require the persuasive theatrical skills called for in face-to-face client presentations.

Many of the more reputable firms, however, choose not to compete for any but the largest jobs, citing the problems of dealing with the federal bureaucracy as their reason. Another deterrent has been recent increased emphasis on security to the virtual exclusion of other criteria, mandated unfortunately by the Congress. Though well designed embassy projects such as Lisbon (Bassetti/Norton/Metler), Nicosia (Kohn Pedersen Fox), and Santiago (Leonard Parker Associates) have proved that security requirements need not dictate a fortress image abroad, nevertheless it is true the heavy emphasis on security has discouraged some architects with superior design talent from seeking consideration.

William Slayton, Hon. AIA, former executive vice president of AIA, served as deputy assistant secretary of FBO from 1978 to 1983. While he had his detractors within the State Department for the somewhat unorthodox management style he brought from the private sector, during his tenure some of the best architects in the country were engaged to design our embassies abroad. Harry Weese & Associates designed staff housing in Tokyo; Hartman-Cox designed the embassy in Kuala Lumpur; and even a small auxiliary facility in Brasilia, the Casa Thomas Jefferson, was designed by Mitchell/Giurgola for the USIA.

Mr. Lacy, former president of the Cooper Union in New York City and of the American Academy in Rome, now heads his own firm, Bill Lacy Design, in New York.

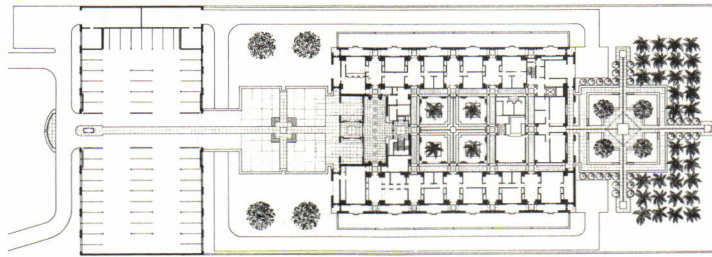

Below and left, U.S. Embassy in Muscat, Oman, by James Stewart Polshek & Partners. Organized around courtyards, the building is surrounded by a 10-foot-high fence. Bottom, U.S. Embassy complex in Lisbon, Portugal. Bassetti/Norton/Metler is architect.

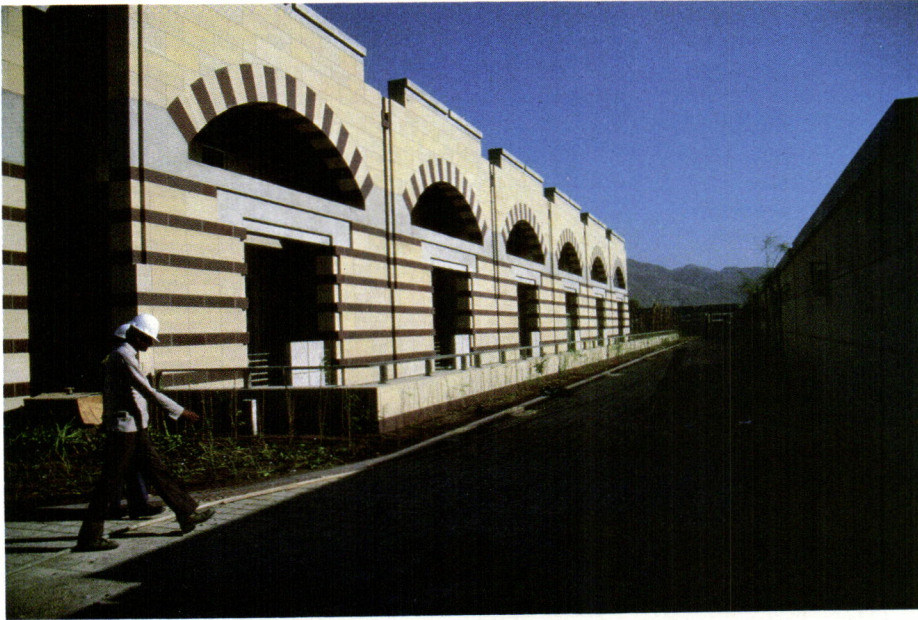

Coinciding with Slayton's departure in 1983, embassy design was thrust into the spotlight abruptly and tragically with the terrorist attacks in Beirut in October 1983 and in Kuwait two months later. Suddenly, a President who thus far had managed to escape any direct blame for his Administration's actions was held personally accountable for the deaths of 241 Marines. As a consequence, Congress acted with unusual speed to authorize \$2 billion for rebuilding our embassies to make them secure. Thick research documents were produced detailing how to ward off "pickup truck" bombers; high walls were erected at existing embassy sites; and new sites were procured with space separating them from the neighborhoods.

As the first high-security embassies were built, a furor erupted in Moscow over the \$190 million U.S. chancery, housing, and school. Security in the chancery was breached by Soviet contractors who infested the structure with bugging devices, and the incident focused even more attention on security and further contributed to its position of overriding concern at FBO.

It is a tribute to the present administration of FBO under Richard Dertadian that the Architectural Advisory Board continues to fulfill its original mission as outside consultants as effectively as it does. Our decisions still are upheld in the selection process at the departmental level, but top choices and recommendations sometimes give way to lesser selections. The exclusive emphasis on security has put too much stress on engineers' and technocrats' "delivery systems" without enough regard to what is being delivered; moreover, there is too much involvement by Congress in architect selection where constituent satisfaction supercedes concern for the U.S. image abroad.

Not even today's White House is immune to the damage that can be done by imposing security measures without design consideration. The view of the White House from the south lawn is still a beautiful and moving experience, but the north facade on Pennsylvania Avenue, once equally grand, has been reduced to a "tank trap" by the insensitive placement of a bollard barricade. The same situation has been played out around the world as a result of terrorist attacks and our security-prompted responses. The once beautiful and serenely graceful embassy in New Delhi has been visually obliterated by heavy-handed efforts to make it secure without taking into account any other considerations.

The United States is coming to the end of a decade in which our pre-eminence as a world power has been seriously challenged and altered in economics, if not in the arts. For the present we still dominate architecture. Our image abroad is too important not to put that talent to its most effective use. □

Below, the U.S. Embassy in Abu Dhabi, United Arab Emirates, by Harry C. Wolf, FAIA. This project (on indefinite hold pending funding) is conceived as four large, stone-clad cubes sitting on a plinth, one cube rotated slightly. A court (shown in the line-drawing perspective) is a cubic space carved into the center of the building. Right, colored drawing of the U.S. Embassy in a suburb of Santiago, Chile, by Leonard Parker Associates, a project in construction drawings phase. The building is to be entered through a two-story rotunda. Below right, Kohn Pedersen Fox's U.S. Embassy in Nicosia, Cyprus, now in construction. Offices occupy the larger block fronting a major street; the ambassador's residence in foreground at right.

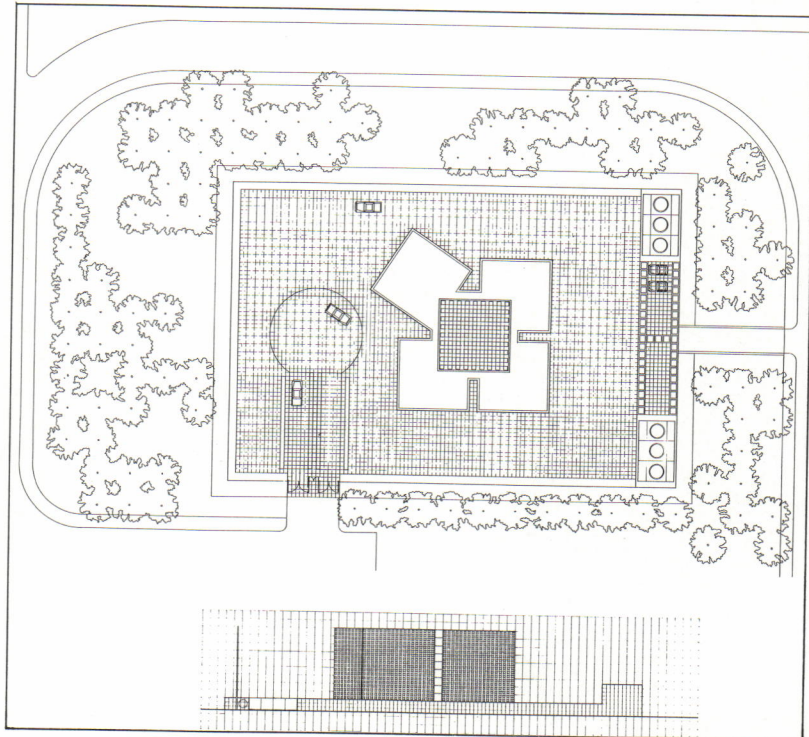
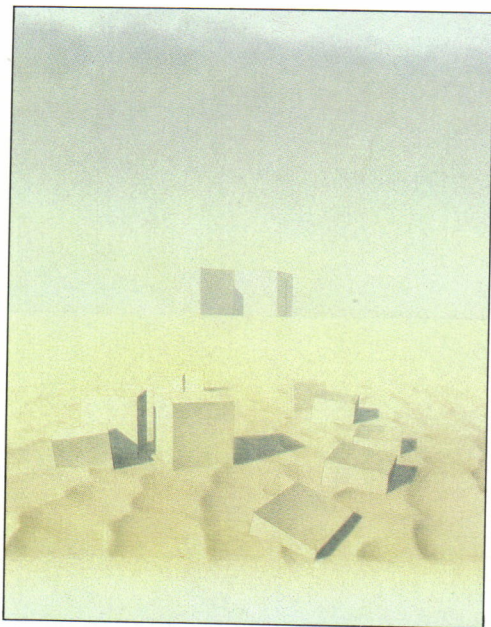
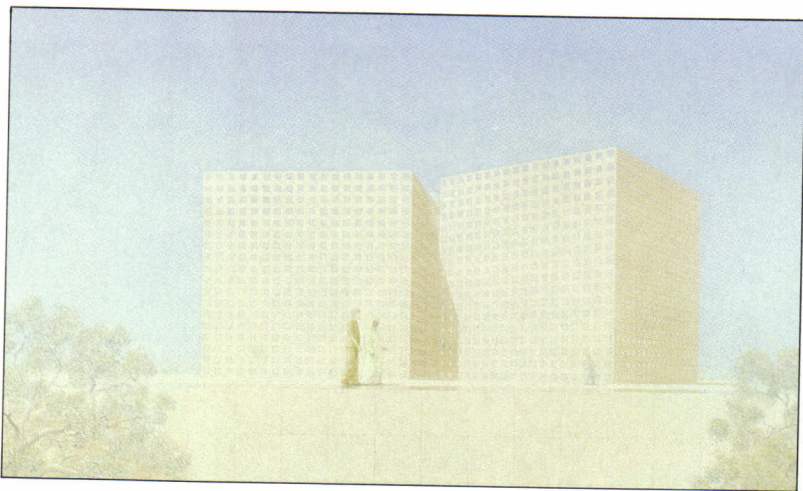
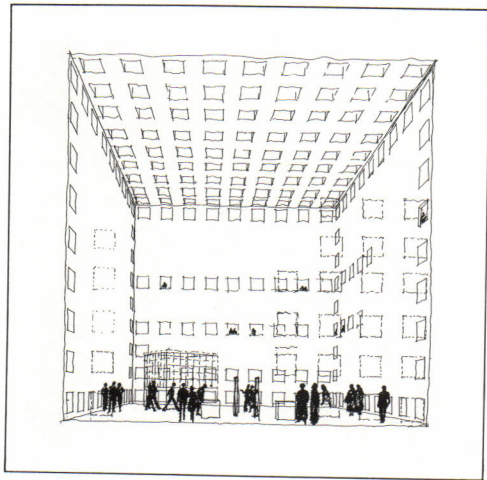

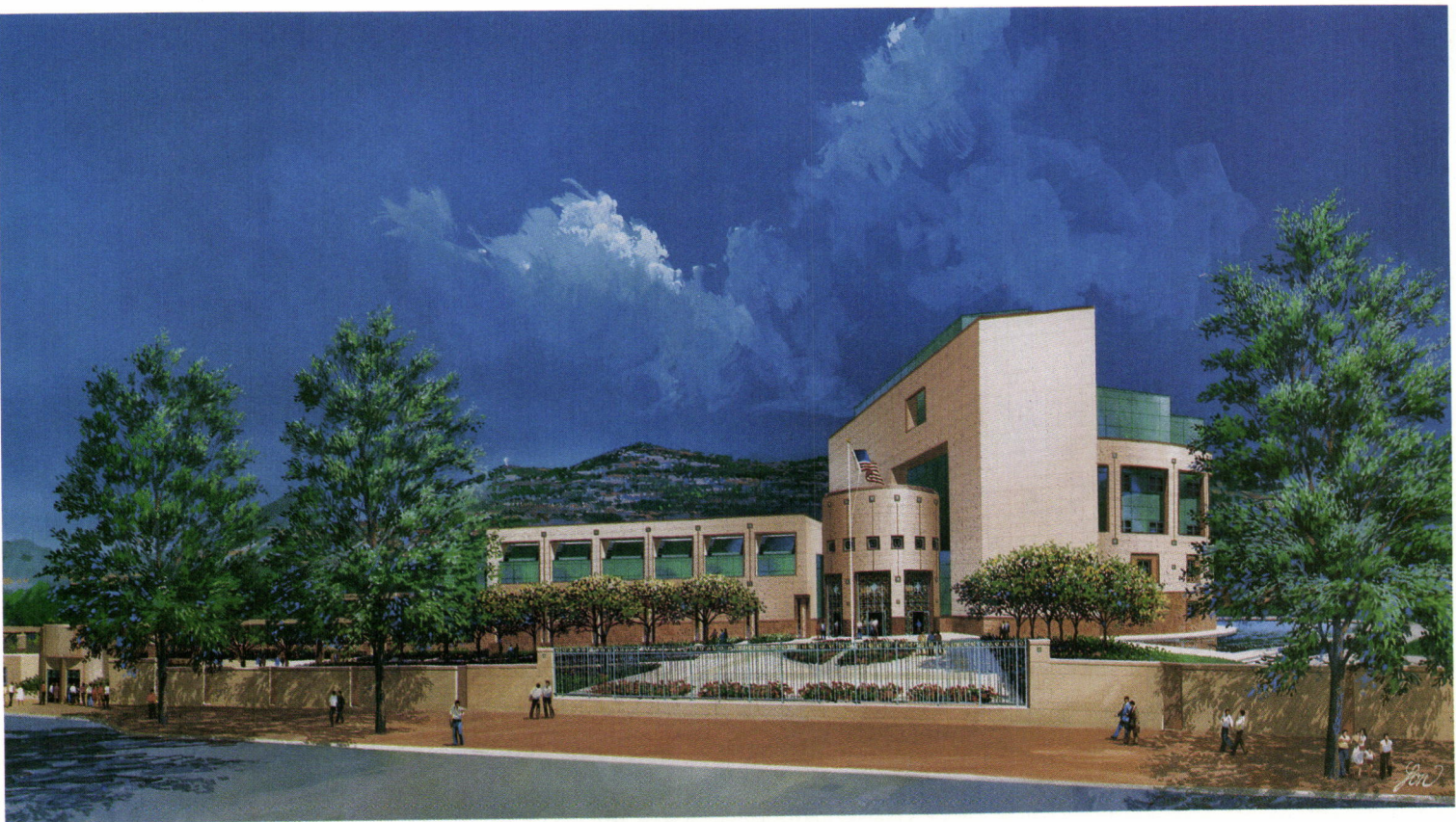

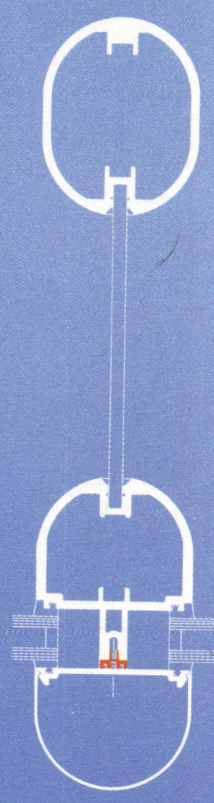

Challenges of Building Abroad

Foreign billings by U.S. firms are again on the rise. By Bea Sennewald, AIA

Most architects are not wanderers. Since classical times almost all buildings have been designed by architects who practiced at home. Styles are particular to a place as much as to an era: Georgian belongs to England as post-modernism belongs to America. When design does cross national borders it becomes the export of an idea. This is as true for L'Enfant's plan for Washington, D.C., as for Frank Lloyd Wright's Imperial Hotel in Tokyo.

American architecture in particular has remained focused inward over much of its history. It is not surprising that the job of building up a country roughly the size of Europe in just 200 years would absorb all the energy of our homegrown talent. For decades there was plenty of work for everyone at home, and many architects came to America from overseas. But even when circumstances were propitious for overseas work for Americans—such as during the expansion of U.S. economic dominance in the years after World War II—we did not take advantage of it. Perhaps it was impossible in the days when the Atlantic had to be crossed by steamer.

With the advent of commercial air travel and modern communications, the stage was set when, starting in the mid-'60s, a whole region of the Middle East was ready to replace medieval villages with modern cities. Saudi Arabia and its neighbors—intent on investing oil revenues in buildings and infrastructure—turned to American architects to design their hospitals, government offices, and sometimes whole cities. U.S. design was considered the paragon of technical sophistication and up-to-date style. So revered was the American architect that many Arab ministers and princes had their traditional desert palaces designed by firms in San Francisco or Tulsa.

Those two decades were a heady time for American architecture. Huge, futuristic buildings with sunshades began to appear on the annual awards pages of architecture magazines. Principals of firms of all sizes, even some small ones, became accustomed to the first-class lounges at the airports of Bahrain, Jiddah, and Tehran. Invoices went out in riyals as often as in dollars. In 1978, more than half of all New York City firms had at least one Middle East project on the boards, and the local AIA chapter had its own overseas practice committee.

Along with some well designed projects and good profits also came mistakes and frustrations. Many architects had no idea what materials or construction methods to specify for work in Middle East countries and resorted to producing U.S.-style specifications, complete with ASTM numbers and even U.S. manufacturers. One civil engineer who was supervising construction for the U.S. government in Saudi Arabia boasted, "We had such stringent ASTM standards that the contractor gave up and imported even the concrete block from the States."

The metric system also proved perplexing. Most designs originated in dimensions of feet and inches and were converted using calculators with the somewhat confusing result that a building might be 30.978 meters long and might have a 0.908-meter-wide entry door.

Burnout and high staff turnover were common, particularly in the larger firms that had the big projects. Because of distance and high travel costs, many architects working at the drawing

board never saw the sites of their projects, and direct communication with clients was limited. A team of architects would spend perhaps six years on the design development of a campus and then have to do it over again because design changes were required.

While frustration was running high in the drafting rooms, firm principals often had a difficult time collecting payment. Without the backing of U.S. laws and business practices, each firm had to rely on its own guile and perseverance, and only a few never had to post a loss.

Understandably, few people were unhappy when the oil money petered out and American firms backed away from the overseas market. By 1986, according to an AIA survey, only 4 percent of the total billing volume of U.S. architects came from foreign projects. Reluctant to go after much foreign work, American firms have had the strength of the American domestic economy on their side for the last few years.

It's not that overseas opportunities have evaporated. The foreign billings for the top 200 international design firms worldwide

HOK's King Saud University in Riyadh, Saudi Arabia, typifies American architects' work in the Mideast during the 1970s.





Left, the 245,000-square-foot St. Enoch Centre in Glasgow by HOK, an urban retail center due to be completed in spring 1989.

increased to more than \$4 billion in 1987, as reported in *Engineering News Record* (August 1988). The 60 U.S. firms in that group account for about a quarter of the total volume, while 91 European firms account for almost half. It's clear that firms in Europe have a much stronger stake in the international market at the moment.

Not everyone runs with the pack. A small but growing number of American firms pursues overseas work vigorously, with quite specific goals. "As architects we have to go where the work is," says Theodore J. Musho, AIA, senior designer with I.M. Pei & Partners in New York City, who is responsible for part of a large commercial project in London. "The U.S. construction market has swings of boom and bust just as foreign markets do. The more we can diversify our work the better."

As international markets have shifted from the Middle East to Europe and Asia—countries with strong architectural traditions of their own—American architects are asked to participate not because of superior design ability but as experts in particular building types or delivery methods. "We wouldn't be in London if it were not for our experience with fast-track design and construction," says Musho.

The London project Musho now is designing got its impetus from the deregulation of the British financial markets and the subsequent invasion by American banks and brokerage houses. In a move calculated to attract development, the Greater London Council created a tax-favored enterprise zone on the Isle of Dogs, an abandoned dock area of the Thames east of the city (see Sept. '88, page 17). A further enticement was a streamlined planning approval process. With its large scale and need for an infrastructure of roads and utilities, the project soon began to resemble Battery Park City in New York more than any project in the United Kingdom. American architects were brought in—the offices of Johnson/Burgee; Skidmore, Owings, & Merrill; and Cesar Pelli also are involved—to work with Canadian developer Olympia & York. In what was considered a revolutionary move away from the time-honored British practice of quantity surveys and unit pricing, the buildings were bid from construction documents—the American way. "This was a revelation for English developers. Construction in London won't be the same after this project," predicts Musho.

The New York City firm of Walker/CNI, which specializes in the design of retail and department stores, has found a different foothold in England, France, and Germany. "Our European clients think that the Americans invented the principles of merchandising. The best packaging, the best advertising, and the

best malls come from the United States," says vice president Anthony Logrande, AIA, who soon will head Walker's new London office. Logrande sees a big future for the firm when all trade restrictions disappear within the European Communities (EC) in 1992. "Many of the largest chains will open new stores and new malls in each other's countries," he says. "Personally, I think now is the time for American architects to get established over there."

One of the difficulties an American architect has to overcome on a project in Europe is deciding what building materials to use and how to detail them. "The Europeans are much more systems-oriented," says Logrande. "To them, a building is assembled from components and fixtures and not built from scratch by masons and carpenters." There also is much less access to product information. A centralized Sweet's catalogue does not exist in Europe, nor do manufacturers' representatives make rounds to stock the architects' sample libraries. "This kind of information network can take a very long time to develop," says Logrande.

While the differences in construction technology between Europe and the United States are rather subtle, in Asia there is a wide spectrum of contractor abilities, ranging from rudimentary to sophisticated. Japanese and Korean contractors can easily build to American standards, but in most of Southeast Asia and the Pacific a simpler approach is necessary. "We simplify our designs as much as possible, because skilled labor is so hard to come by," says Stuart D. Charles, AIA, of NBBJ in Seattle, who is active on projects in Guam and the Philippines. "The buildings also have to be easy to maintain, particularly the mechanical and electrical systems. I have seen buildings abandoned because the local owners could not maintain them."

Charles finds that the use of local materials and construction methods does much to improve workmanship, yet it is not always easy to convince the owner that local methods are appropriate for a modern building. One American firm that has made a mission out of the use of indigenous materials and craftsmanship is Wimberly, Allison, Tong, & Goo in Honolulu. A specialist in hotel design, the firm has exported the idea of the American resort to countries such as Korea, Singapore, Malaysia, and Australia. Firm representatives visit national museums and travel the region looking for ideas. Travel sometimes includes cutting a path through the bush or swimming ashore from fishing boats. George S. Berean, AIA, regional director of marketing, explains the firm's philosophy: "The concept of luxury and service in a resort is American, but the buildings we design may be grass shacks or teak pavilions. We use handmade clay tile and bamboo as readily as concrete." Sensitivity to local crafts and artwork earned the firm the Aga Khan award for a project in Tanjong Jara, Malaysia. "After all, most people travel because they want to experience a foreign culture, and they don't want to stay in the same hotel they have in Miami," says Berean.

Asia has a special surprise for the newly arrived U.S. architect. In countries such as China, Malaysia, and Indonesia, it is the custom to consult a local geomancer once the site plan has been finalized. He applies the rules of an ancient science called *fung-shue* to the design and decrees changes, often rearranging the orientation of buildings on the site. "Complying with the wishes of the *fung-shue* man is not optional," Musho says ruefully. He had to redesign the facade of the Bank of China in

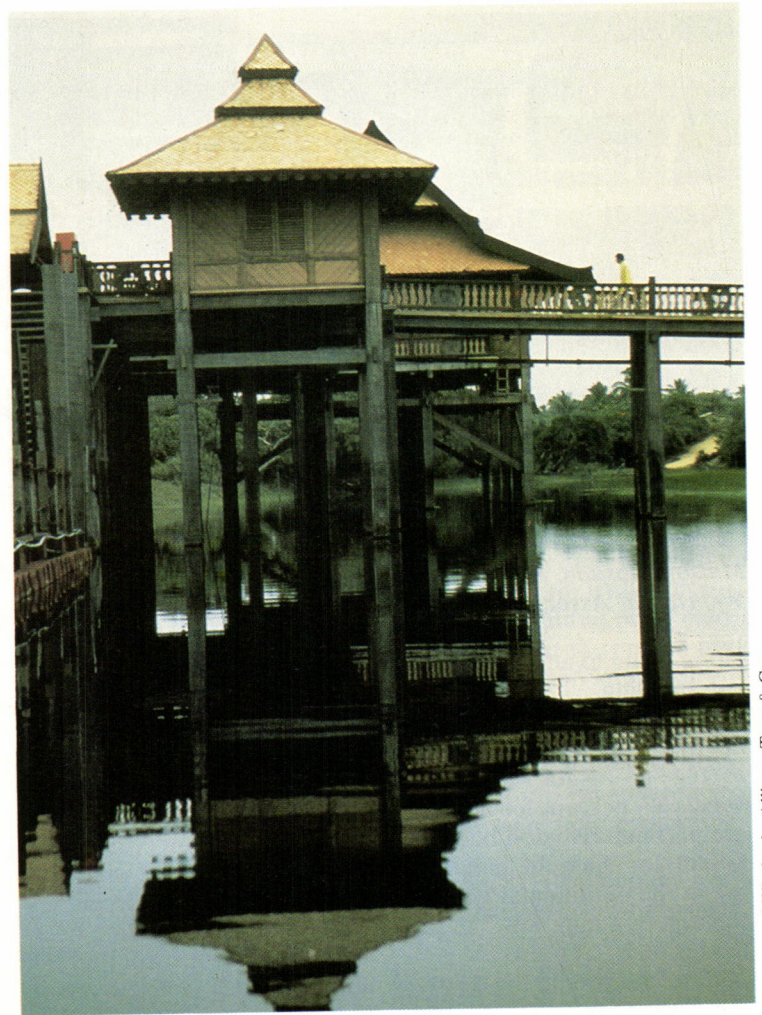
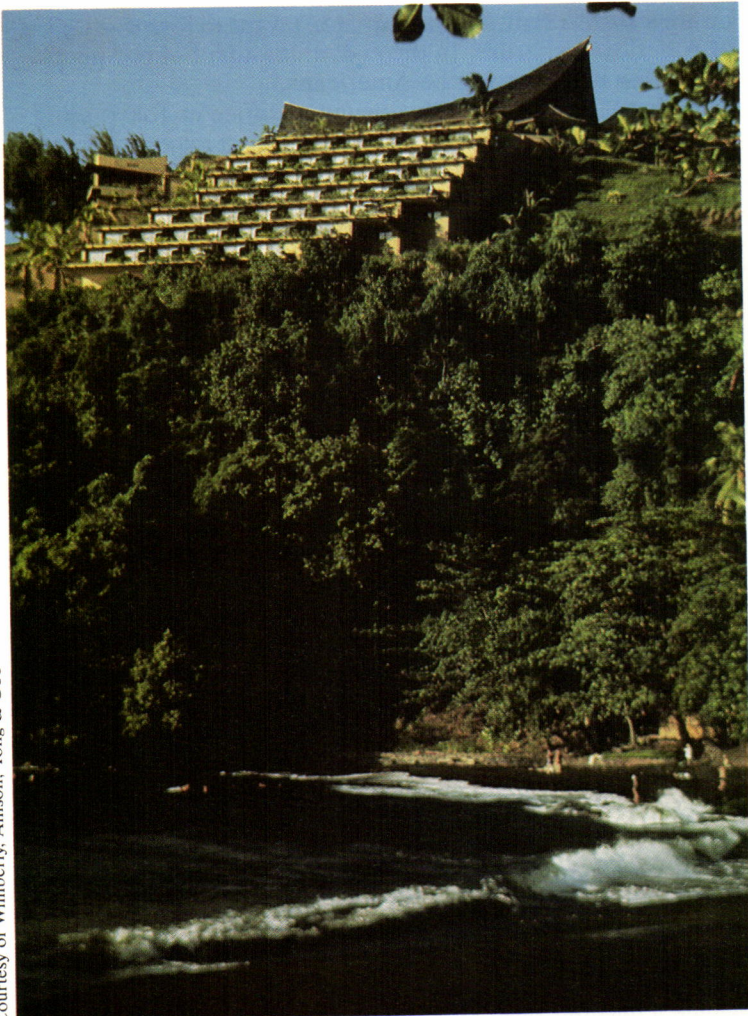

The projects above, by Wimberly, Allison, Tong & Goo of Honolulu, demonstrate the architect's concern with indigenous materials and forms. The left photo is the Tahara'a Hotel in Tahiti, and the right photo is the Rantau Abang Hotel in Malaysia. The photo and plan below show the Escuela Agricola Panamericana student dormitories in Honduras, by Oudens + Knoop of Washington, D.C.

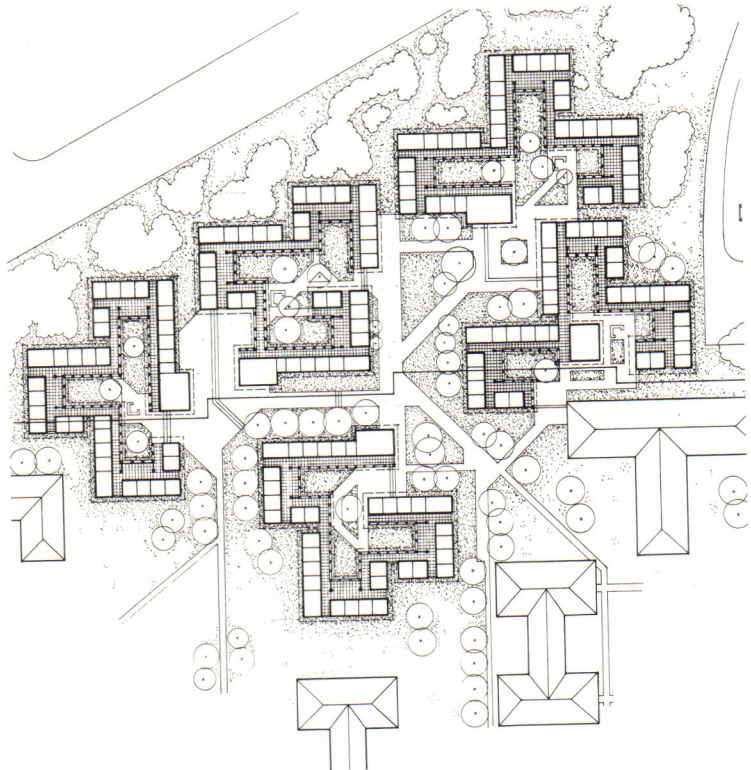

Rice believes it is precisely this specialized design knowledge that attracts foreign investors in the first place.

One recent foreign purchase of an interior design firm provides a look at the apparent mutual benefits of such an acquisition. After 20 months of negotiating, the London design consultancy Fitch & Co. took over RichardsonSmith of

rampant inflation, political strife, or low demand for real estate. Right now the United States is seen by international firms as their largest potential market for long-term growth.

Phil Schneider, program manager for a task force on foreign influences in the U.S. construction industry for the National Institute of Building Sciences, agrees that the trend is likely to con-

tinue, unless the country enters another recessionary period. "Foreign individuals or firms have no means of changing the economic conditions here," Schneider says. "If the bottom drops out of a real estate market, the investors will be more likely to pack up and leave." Likewise, Schneider believes that if markets in other nations expand, there will be less interest in acquiring an American design or construction company. For example, he says, the Japanese may be more interested in European markets after 1992, when the Economic Community controls are dissolved.

The issue of competition is probably the most sensitive in the foreign investment arena. The additional influx of capital can put an acquired firm in a stronger position than many of its peers. In addition, the firm is more likely to be involved in international projects than it was before, providing a certain amount of prestige. And foreign firms that come here often are vertically integrated. Some have the ability to plan, design, and construct projects, according to Francis T. Ventre, professor of architecture and urban studies at Virginia Polytechnic Institute and State University.

That trend is likely to continue, says Michael Joroff, of the MIT Laboratory of Architecture and Planning. He anticipates the elimination of medium-sized firms and a growth of large-scale conglomerates—which in the near term will probably be foreign-owned—that develop, design, construct, and finance their own projects. Because of liability problems this change is almost inevitable, Joroff says. "You do not sue yourself."

Often foreign-owned firms have a different approach to conducting business and take a broader view of their responsibility. Ventre recalls a recent magazine advertisement that said: "What does a Takenaka design team in Tokyo know about America's toughest zoning code?" They got a San Francisco building reviewed in two months when it could normally take up to 18 months. That, says Ventre, is sure to bring in clients.

Foreign involvement with U.S. design firms does not always take the form of acquisitions. One noticeable trend has been long-term, multiproject joint venturing. There are advantages to this type of liaison for both parties. Rice believes that such relationships help provide a fair exchange of technology. The United States may have a great deal of expertise in many areas, but other countries are ahead in different areas, such as the Scandinavians in housing. Recently, though, because of the low value of the dollar, international joint ventures have been less attractive than outright acquisitions.

Still, foreign acquisition is no guarantee of success, and Brian J. Lewis, a partner of the North Carolina-based Coxe Group, finds that it can just as easily spell disaster. In a study of the performance of 10 design firms under foreign ownership, Lewis found that most have not performed as well as they did under their American owners. Lewis says there are several factors that appear to work collectively against the likelihood of early success in these foreign acquisitions. "Cultural differences are probably the largest single factor," he says. The buyer comes from an environment vastly different from that in the United States, and if the buyer is a contractor buying a design firm there is even a further level of cultural difference, with different goals and methods of operation. The greatest differences occur, naturally, when the acquirer's native language is not English.

Some foreign firms have different accounting practices, both for the balance sheet and the record of operating results, and these can interfere with the American business operations. A red light should go on, says Lewis, when the foreign firm says something like, "We just want to make one or two minor adjust-

ments to your accounts to fit them into our system." There is no such thing as a minor adjustment, argues Lewis, and in fact those changes take up a lot of time and energy at a crucial time in the transition. According to Lewis, the rule should be, "Keep on doing what you are doing, just send money." Likewise, changes in a firm's management information system early on can be debilitating.

"Foreign corporate financiers are not immune to the same ailments that afflict their U.S. cousins—concern with short-term results instead of long-term performance," says Lewis. The regrettable fact is that most design firms cannot predict with 10 percent accuracy what their backlog will be in 90 days, he says. Overreaction to short-term dips can take away from management efforts to concentrate on long-term prosperity.

The lack of U.S. staff involvement in ownership is another factor that interferes with the success of foreign acquisitions, Lewis finds. Foreign owners tend to ignore the latent promise of ownership that may have existed before their acquisition, and which likely spurred nonowners to perform well in the hope of securing some equity. In his opinion, key staff need the potential of earning a bonus at least equivalent to 40 percent of base salary for them to turn in well-above-average performances; 10 percent potential bonuses have little impact. But this is an incentive usually overlooked by foreign owners.

To fuel his arguments, Lewis reviewed the performance data of the firms he has been analyzing between 1976 and 1987. The 10 firms had an average ranking by *Engineering News Record* of 109th with a median of 67th in 1976, when none was under foreign control. In 1981, when only two firms had foreign owners, the average was 110th, the median 81st. But by 1987, when all 10 were under foreign ownership, the average *ENR* ranking had slipped to 156th and the median to 128th. Fees by these firms increased by less than half the average increase for all of the *ENR* 500, while their performance prior to acquisition had been dramatically better.

The Omaha design firm HDR Inc. seems to prove some of Lewis's points. Acquired by the large French construction company Bouygues, HDR was changed into a design/build firm and began to suffer substantial losses. The French decided to return HDR to design only. *ENR* reported that the executives of HDR opposed that move, saying that it was never HDR's intent to have the French directly involved in running their business because of cultural and language differences.

Acquisition of U.S. building industry firms seems to be on the rise. The U.S. Department of Commerce reported that in 1986 foreign investments in U.S. design firms were greater than \$820 million. DOC has some concern about its more recent calculations, but it appears that the trend is continuing. In a study titled "International Competition in Services," completed in July 1987, the Congressional Office of Technology Assessment reported that the slowdown in the Third World countries was sending foreign design and construction firms here. According to the report, firms from Europe, Japan, and South Korea had announced plans to expand to the United States, presumably by acquiring American design and construction companies.

Although he does not see a dramatic escalation in foreign acquisition of U.S. design firms, Rice expects the trend to continue at a fairly steady rate. Rice sees foreign influence in design firms as an incentive for the whole industry to keep up with technology to remain competitive. As the marketplace becomes more international, that may be the true advantage of foreign acquisition. □

Using Modified Bitumen Roofing

It continues to be the center of controversy. By Karen Warseck

Single ply or built-up roof? The controversy rages on about the hybrid system known as modified bitumen roofing (MBR)—even the manufacturers don't agree. To attempt to classify it as one or the other ignores the very characteristics that make MBR special. Generally it is lumped in with single plies, but it is in truth a compressed, factory-assembled, built-up roof. So where does MBR belong?

Modified bitumens are a natural outgrowth of asphalt technology. The deficiencies of asphalt built-up roofing are well known—it cannot handle much movement in the substrate without splitting, the asphalt is not resistant to ultraviolet and as a result becomes brittle and cracks, and the roof is fabricated on site with all the attendant horrors that unskilled and semiskilled labor can force upon it. The growth of the single-ply industry with its factory-assembled rather than field-assembled membranes quickly took much of the commercial market from built-up.

MBR is a relatively new form of roofing system that combines the familiarity and trust of asphalt roofing with the high-tech formulations and factory assembly of single-ply roofing. As the technology progressed, manufacturers developed two very different methods of modifying asphalt: styrene-butadiene-styrene (SBS) and atactic polypropylene (APP). The chemical formulation, properties, and resulting influence on the asphalt of these two modifiers are radically different. It is difficult to say whether one is better, as each chemical modifier has its own purpose.

Advantages over other systems

Even though it is a relatively new building element, MBR has gained acceptance because under certain circumstances it fills a need better than the other two leading roofing systems. Most of the advantages of MBR over built-up systems lie in the factory assembly of the membrane. For instance, the roll is manufactured to a uniform thickness with quality-control tests at every step; this isn't often the case with the field assembly of BUR. In addition, the asphalt used in MBR is not oxidized to obtain the desired softening point, as is done with Types I, II, III, and IV asphalt, but rather the softening point is determined by the types of resins added. The presence of resins also means that there is a higher oils content than with BUR, so, in theory, the material will last longer.

The main advantage over EPDM is the product thickness—120 to 180 mils for MBR versus 45 to 60 mils for rubber—making the modifieds more resistant to traffic, punctures, and fastener backout. MBRs compare favorably to ballasted and mechanically fastened systems for the same reasons any adhered system does: ballast covering a membrane makes it difficult to find leaks and adds considerable weight to the roof, adhesives serve to some degree as dams that mitigate submembrane water migration, and adhesion provides better wind uplift resistance than either

ballast or mechanical fastening over a secure substrate.

A discussion of the specific attributes of MBR must differentiate between the two major types. APP is a thermoplastic material, which softens when exposed to heat. It is distributed throughout the asphalt to increase ultraviolet resistance and prevent the migration of oils, which would lead to brittleness. APP also provides cold weather flexibility and slightly improves elongation. The crystalline formation of APP means that when it reaches its melting point of 305 degrees Fahrenheit it rapidly changes phase from a solid to a liquid. SBS, on the other hand, modifies by forming molecular bonds between resins and the asphalt, and it gradually melts between 210 and 240 degrees Fahrenheit. SBS-modified asphalts have greatly enhanced elongation and recovery characteristics and much-improved low-temperature flexibility. This benefit, however, is provided at the expense of UV susceptibility and a low melting point.

Like built-up roofing, the modified bitumen membrane consists of layers of modified asphalt that waterproof a reinforcing material. Reinforcing in MBR may be of glass fiber mats, polyester scrim, or a combination of the two. Each type of reinforcing imparts different properties to the membrane. Polyester has excellent elongation and recovery characteristics, making it quite compatible with SBS-modified membranes. In room temperature tests performed according to ASTM D2523, elongation was close to 50 percent before fracture occurred. By comparison, glass mat fractured at 10 percent elongation and organic four-ply BUR at 3 percent. Polyester provides good puncture resistance and stands up to foot traffic but is not UV resistant or as dimensionally stable as glass fiber. Glass fiber resists foot traffic and UV radiation and adds tensile strength and greater dimensional stability than polyester. MBR reinforced with glass fiber mats at the top generally does not require surfacings for UV resistance or fire ratings. Glass fiber easily takes the heat of hot-mopped asphalt and torching without shrinkage or melting, but it is not as flexible as polyester, nor does it have the same amount of puncture resistance, elongation, and recovery.

The manufacturing process usually dictates the location of reinforcement within the membrane. Reinforcement sandwiched in the center of a membrane is the easiest to fabricate. However, properties of the reinforcement itself also affect its location. Because polyester is not UV resistant, it must be buried in the mat, but not too close to the bottom because heat will cause it to shrink and melt. Glass fiber reinforcement is generally placed close to the top of the mat to serve as a wearing surface to resist foot traffic and UV degradation and to provide a fire rating. One argument against this location is the potential for delamination during application. Manufacturers using both types of reinforcement put the glass fiber at the top and polyester in the middle. Applicators like reinforcement in the middle because the top will melt slightly when the next layer is applied, fusing it to the bottom of the layer above.

The asphalt in MBR membranes is generally thicker than a four-ply built-up roof, but its distribution in the membrane is affected by the location of the reinforcement. Again, manufacturers have different theories about where to put the waterproofing asphalt. One puts reinforcement near the top, contending

Ms. Warseck is president of Building Diagnostics Associates, a Hollywood, Fla., firm specializing in analysis and solving of building system problems and failures. Owens Corning and Nord Bitumi were principal sources in her research.

Mop-applied modified bitumen over structural concrete deck

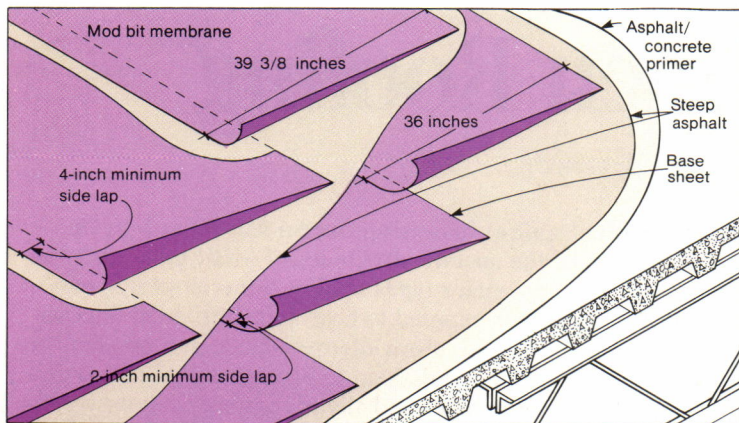

Torch-applied modified bitumen over insulated deck

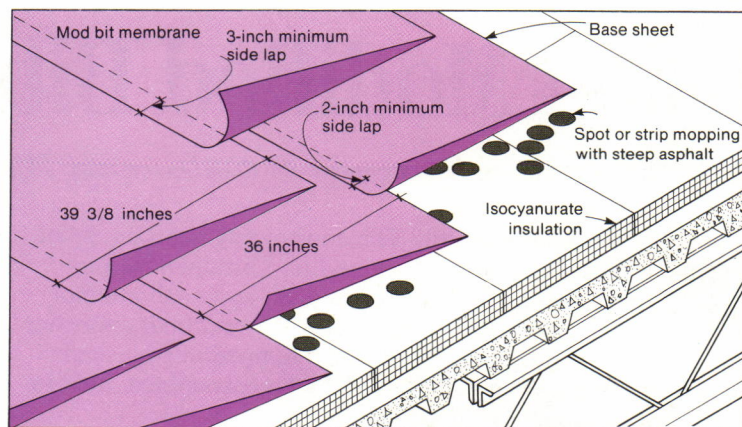

that asphalt above the reinforcement will alligator and no longer be waterproof. Then, because air is brought into asphalt mixtures during production and creates small bubbles in the MBR, the bubbles create craters in the thin layer of asphalt beneath the reinforcement. Alligating above and cratering below the reinforcement allow moisture to pass completely through the membrane, especially if the MBR is already thin. Another manufacturer places reinforcement in the center, insisting that substrate movement will crack the asphalt only up to the reinforcement, leaving the top truly waterproof. Mathematical models predict that the greatest strain loads occur at the lowest level, decreasing with each succeeding layer above. The answer may be to have three layers of asphalt—one to crack at the bottom, one to alligator at the top, and one in the middle to waterproof the system.

Surfacing and installation

SBS must be covered at all times because its UV and ozone resistances are low. Most surfacing consists of granules provided by the manufacturer. (Granule surfacing has the benefit of not adding much weight to a system.) Other coverings include manufacturer-installed metals or applied coatings of acrylics, asphalt emulsions, or fibrated aluminum. Of these, fibrated aluminum is most popular because of its reflective properties. Differential movement of metal applied over asphalt is solved by fabricating tiny expansion joints in the metal.

UV-resistant APP may be left uncoated but is usually coated to promote longer life. Coatings include fibrated aluminum, acrylics, and asphalt emulsions. Mineral surfacings are available, too, but generally are used only for their esthetic effect. Surfacing also are used to achieve fire ratings because most systems, with the notable exception of glass-fiber-reinforced membranes, cannot attain a fire rating alone.

APP modifieds are generally torch applied while SBS are mopped in with hot-steep asphalt. If hot asphalt were used with an APP membrane there would be no cohesion and limited adhesion since the asphalt cannot get hot enough to melt the APP. Some torch grade SBS membranes have been developed, but torching is not usually recommended, except sometimes for flashings, because of the material's low melting point. The heat of torching can interfere with an SBS mix's ability to adhere. The low melting point of SBS is a benefit in hot-asphalt installation where the membranes melt and fuse from the heat of the mopped asphalt.

The difference in melting point affects a number of decisions in specification. For instance, an APP membrane can be torched

to an SBS, but an SBS cannot be mopped to an APP because asphalt does not supply enough heat to remelt APP. Furthermore, APP should not be installed at ambient temperatures below 40 degrees and needs special care below 50 degrees. SBS is easily installed at low temperatures—because of its flexibility—as long as the asphalt is 400 degrees or greater at the point of application.

Flashings usually are torched-on APP, although they may be torched-on SBS. Mopped-on SBS generally are too cumbersome to be effective, and cold adhesives are still not fully developed or manufacturer-specific. Flashing materials should be determined by the material of the roof and the amount of movement expected in the substrate. An APP-modified flashing always should be used with an APP-modified roof membrane. A torch-applied SBS is more appropriate to an SBS membrane and especially useful where significant movement in the substrate is expected. Do not allow "torch and flop" or "mop and flop" flashings. And flashings never should be wider than the width of the roll (39 inches). "Heat and flop" and wide pieces both will allow the flashing to cool too much prior to installation, interfering with adhesion. Particularly in cold weather, substrates should be preheated because a membrane slapped on a cold surface will cool the mat rapidly and prevent adhesion.

Uses of modified bitumens

Modified bitumens work well for re-covering smooth built-up roofing—especially when no additional insulation is added—because of their compatibility with asphalt products. Modified bitumen roofing also is an easier system to install than built-up for roofs with many penetrations and lots of flashings. MBR is a reasonable alternative to EPDM on roofs where large rolls can't be moved or supported or on roofs that have a lot of traffic.

APP-modified membrane lends itself to steep slopes and barrel roofs because of its high melting point. Unlike SBS or BUR, slippage is not a problem. It also is recommended where long pipe runs mean that hot asphalt cannot easily be brought to the site, such as for high-rises or inner areas of extremely large warehouses. APP is not often used on new construction, because hot asphalt can be used and constraints of kettles and long hoses are not usually a factor. APP-modifieds are good for small commercial or residential projects (100 or 200 squares) since there is no need for kettles or to transport asphalt.

SBS is recommended where open flames are prohibited by fire regulations or insurance requirements or where flammable materials are located. It is also useful in cramped spaces where torches are too awkward, as a substitute for BUR on larger roofs and where movement of the substrate is expected,

Typical flashing detail

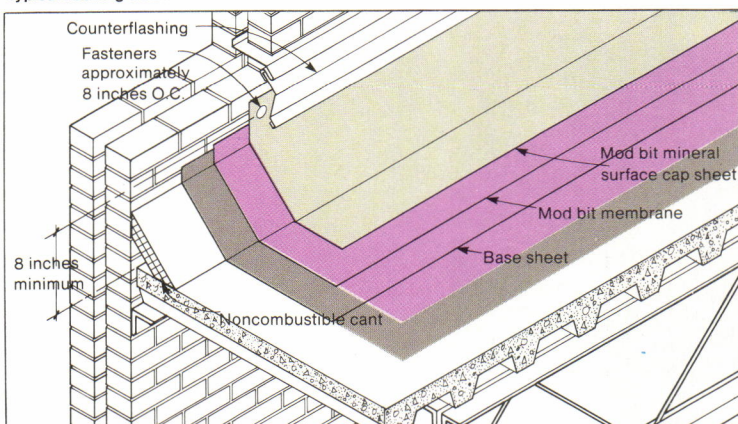

Modified bitumen system over existing built-up roof

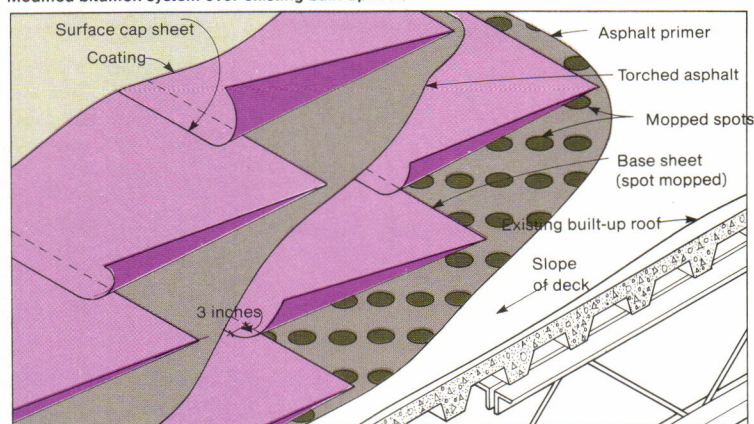

and where wind uplift requires an adhered roofing membrane.

Suggested substrate for MBR types include light steel, because there is no weight of gravel or ballast; primed concrete, which requires torch welding, particularly when not insulated; and mechanically fastened base sheets; uninsulated assemblies where the deck is wood, gypsum, lightweight insulating concrete, or cementitious wood fiber.

MBR is *not* recommended for roofs where there will be concentrations of acids, hydrocarbons, or oils. It also is not cost effective for wide-open spaces because large rolls of EPDM can be installed less expensively.

All manufacturers agree that they would like to see included in construction documents product-specific specifications and some provisions for prequalifying contractors. All agree that the real problems with the systems come from improper application by people who are not professional roofing contractors. It is suggested that a current certification as a qualified applicator be supplied with the bid.

Observing work on the roof

Oversight of roofing work by a knowledgeable agent of the owner is one of those "shoulds" that don't happen often enough. Inspection of the roof while it is being installed is much more important than looking at the finished product. Any architect who chooses to inspect construction is volunteering for all the liabilities that go with that, of course, but there are many points that one can examine to assure a better installation. For instance, a minimum flow of a ¼ inch of mix out of the side of a lap (not just at the roll) is critical. A roof inspector probes with a trowel any laps where flow is not visible. If there are any unbonded areas, the inspector requires the roofer to heat-weld or patch four inches on each side. If there is an unbonded section of membrane or seam through which moisture has penetrated, however, the water will vaporize and the seam will not hold. A thorough roofer will reheat these areas, put the membrane down again, and overlay seams by four inches on all sides. The knowledgeable inspector also will check bridging (gaps) where the plane changes from horizontal to vertical or vice versa, at the end lap, or where the end lap and side lap form a T. Bridging is the main cause of small leaks, and therefore the membrane should be walked on or troweled down so that mix comes out at those areas.

For a torch-applied system, specify that seams be heat-welded. Do not accept laps that are "sealed" with a hot trowel—these look good but do not provide any adhesion. If the pattern of the reinforcing membrane can be seen after installation of a torch-applied system, the material has been overheated. Be aware of

the melting point of the material you have specified, and be sure that the contractor knows it, too.

Other systems require specific kinds of care. On SBS systems, the asphalt should be tested with an asphalt thermometer to be sure it is at the correct temperature at the point of application. For a cold-adhered roof, excess adhesive may result in excess amounts of escaping solvents that may cause blisters.

Finally, for any type of system, do *not* accept roofing done on damp substrates—no matter what form the moisture takes.

Some other things to remember when specifying a modified bitumen roof:

- APP and SBS are *not* equal and should *never* be accepted as an "or equal" for each other. If possible, do not mix APP and SBS membranes on the roof.
- Require that the seam integrity be checked with a cold trowel and that unbonded areas be corrected with heat welding, not a hot trowel, at the end of every day.
- Know the history of the material you are specifying. Find out what problems others have had with the material or application.
- Get a financial statement from the roofing company to be sure the company can back up its warranty. However, don't rely on a warranty as a means of quality control.
- Do not allow the use of combustibles or cants. In general, cants are not required with modified bitumen systems.
- Back-nailing should be considered on slopes greater than half an inch per foot on SBS-modified bitumen.
- As with BUR, phased construction should not be allowed under any conditions. Phased construction is either laying the base sheet and coming back later to do the waterproofing membrane or laying a vapor retarder and coming back later to install the insulation and membrane. Either will cause problems.
- Base sheets are recommended. Require a base sheet over wood, and spot mopping or a vented base sheet over lightweight insulating concrete and polyisocyanurate insulation board.
- Keep in mind the reinforcement location when specifying a membrane for flashings.
- Specify priming of all metal and concrete surfaces before applying roofing membrane.
- Specify heating the substrate before applying the membrane when there are low ambient temperatures or when torching directly to masonry or concrete.
- Consider the ability and willingness of the owner to provide necessary regular maintenance to coatings.
- Require two layers of membrane where the plane changes.
- Require the product to be rolled out prior to application, to allow it to relax.
- Require on the roof a minimum of one fire extinguisher for every torch. □



Only one product sticks to more roofs than ours.

We make big roofs, small roofs. Round roofs, square roofs. Thick roofs, thin roofs. White roofs, grey roofs, tan roofs, blue roofs. Hundreds of millions of square feet of roofs. And we make every one out of Hypalon.*

Which can be mechanically-attached, ballasted with stone or pavers, or fully adhered. To metal, wood, concrete, and lightweight decks. Which, according to independent tests, works a whole lot better than peanut butter.

For proof, call 1-800-848-4400, ext. 163.

© 1988 JPS Elastomerics Corp., Roofing Systems Division,
395 Pleasant St., Northampton, MA 01060

*Hypalon is a registered trademark of DuPont.

JIF is a registered trademark of The Procter & Gamble Company.

STEVENS
Roofing Systems

Circle 67 on information card

The Behavior of Concrete In Harvard Buildings

It has been irregular. By Elena Marcheso Moreno

There are few demands made of concrete facades. They must have sufficient strength to carry design loads, be water-tight, be weather resistant, retain their appearance, and maintain their position. Fulfillment of these requirements is essential to the building's performance and determines the success or failure of the material's application.

Like many other building owners, Harvard University has been faced with deteriorating reinforced concrete on a number of its modern facilities, a result of design and construction practices of the 1960s and '70s, when misunderstandings about the material, its applications, and its properties were prevalent. Three of these buildings—Baker Hall, Gund Hall, and Holyoke Center—all were built within a few years of each other. Each was designed by well known architects using new technologies in good faith. Within a decade of their construction, all three were experiencing significant enclosure problems. Solutions for the concrete deterioration were quite different in each case, ranging from patching to complete replacement of the concrete facades.

A typical example of a late-1960s dormitory, Baker Hall was designed by Shepley Bulfinch Richardson & Abbott with deep concrete lintels beneath each row of windows, providing visual relief to the dark brick facade. When the Harvard business school hired the firm of Architectural Resources Cambridge to renovate Baker Hall, the school asked the architects only to upgrade its interiors, because the living accommodations were not up to the level expected by senior executives from around the world—the people the business school wanted to attract to its \$22,500, 13-week advanced management program. Harvard was feeling stiff competition from other universities for this program, pressing not on its curriculum but on its plebian housing facilities. At the time, neither the architects nor the school had any inkling there were extensive problems with the building fabric.

Off and on since its completion, Baker Hall had experienced some water leakage, but the problem was not serious enough to find fault with the brick-clad, concrete block on concrete frame construction. An earlier study of the building, during the energy crisis of the mid-'70s, looked superficially at the leakage problem as a part of a larger analysis of changing fixed sash glazing to operable aluminum windows. At that time, it was believed any leaks would be sealed when the new units were substituted, says Henry Reeder, vice president of ARC. In fact, altering the windows made the problem worse. During installation, workers cut through flashings to make the windows fit and then went back and sealed them with caulking. Unfortunately, the caulking never achieved a tight seal, and later when ARC started working on the interiors, water damage was observed in the walls around the windows. Still, the damage was not considered too extensive, and plans for the interior renovation continued.

It was when this work began that problems with the brick and concrete facade were uncovered. As workers were tearing out interiors, evidence of moisture surfaced in virtually every room, at the concrete lintels where the floors meet the exterior wall. There was additional moisture damage at the ceiling, traveling down from the floor above. The architects soon discovered that the only means of repairing the wall would be to replace whole portions above and below each floor because of severe damage to membrane flashing. The flashing had deteriorated everywhere, and in some places there was no evidence of flashing at all. Reeder says, though, that he believes the membrane had been properly placed during construction but had disintegrated in the presence of moisture. Midway through the renovation, construction was halted as the extent of the problem was determined.

Options were narrowed to two: either removing a few feet of wall at both the top and bottom of each floor height and replac-



© Steve Rosenthal

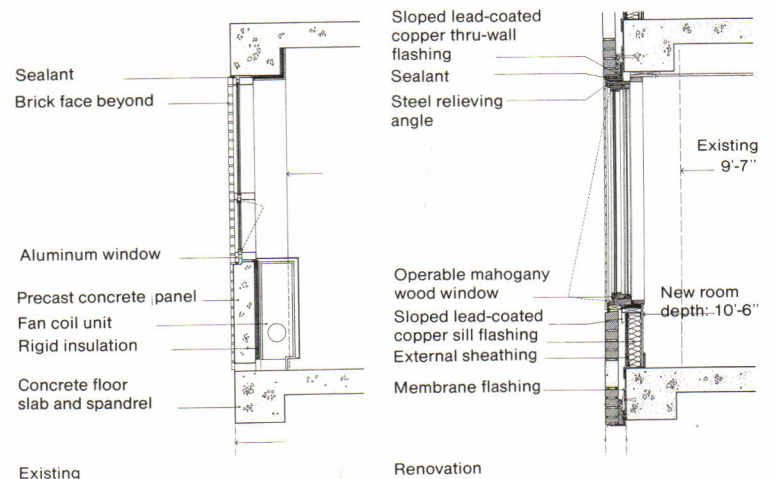

Right above, Baker Hall's new brick and limestone facade; below, window details before and after renovation.

ing all damaged components, or taking the wall down and building a new one. The trouble with the first option was that the bricks used in the wall were no longer being manufactured. It was also possible that all of the damaged materials would not be removed, degradation would continue, and in a short time the wall would leak again. As there seemed to be little difference in cost between labor-intensive option one and material-intensive option two, ARC was able to convince Harvard that there was a bright side to this cloud.

Building a new exterior wall using steel studs instead of concrete block as a backup for the brick facade would allow the architects to enlarge spaces, ultimately providing an additional foot of space in each bedroom. While one foot doesn't sound like much, it meant room for easy chairs, as well as a full wall of counter/desktop. Another benefit of the new exterior wall—besides its improved appearance—was that brought it Baker Hall back into scale with its neighbors. Because of the standing-seam metal roofing above the top row of windows, the building now appears to be lower and more in keeping with its surroundings.

Baker Hall's new brick veneer is regularly studded with limestone dots and pairs of parallel lines interrupted by the fenestration. Windows open out and up—a precaution against rain. Prominent relieving angles identify each floor, where concrete lintels previously had been displayed. Sloped lead-coated copper flashing was used instead of rubber, says Reeder, because ARC wanted to depend on proven, reliable materials. After the unanticipated expense in this renovation project, there could be no chance of future leaks.

Holyoke Center was designed by Sert, Jackson & Gourley and built in two phases between 1960 and 1964; it is a mixed-use facility with offices, an infirmary, and shops. It has a reinforced concrete frame with vertical, prefabricated concrete fins providing texture to the facade. The massiveness of the building, which spans from block to block, is softened by its H shape.

Phase one of the building was completed in 1962, and phase two, built with identical specifications but by different contractors, was completed in 1964. "There have never been any problems with phase one," says David Zewinsky, Harvard's vice president for property operations, "but by 1970 there was significant deterioration of the fins on the phase two portion of the building, and we were finding pieces of concrete on the ground."

The concrete fins are designed to stiffen the curtain wall, acting as mullions to fix the sides of the linked window frames. Wind loads to the window are transferred to the primary concrete structure via the precast fins. Within a year after the damage was noted, one-quarter of the fins were badly damaged, and more than 10 percent had to be removed as a safety precaution and shored up with timber on the inside, intended as a temporary solution but left in place until 1982 when the problem was solved.

Harvard eventually hired the Ehrenkrantz Group to evaluate the failure of the curtain wall as well as the building's mechanical systems to reduce energy consumption. Ehrenkrantz found that the failures were starting as hairline cracks at head and jamb connections. The cracks progressed until portions of the fins began to spall. The cause of the cracking was tied to water penetration, variations in concrete mix proportions and admixtures, and insufficient galvanic protection of reinforcing steel.

As it turned out, a number of factors contributed to the failure, and there was no way to determine who was at fault, says Zewinsky, so Harvard went ahead and repaired the building at its own expense. Despite the fact that the design of the two

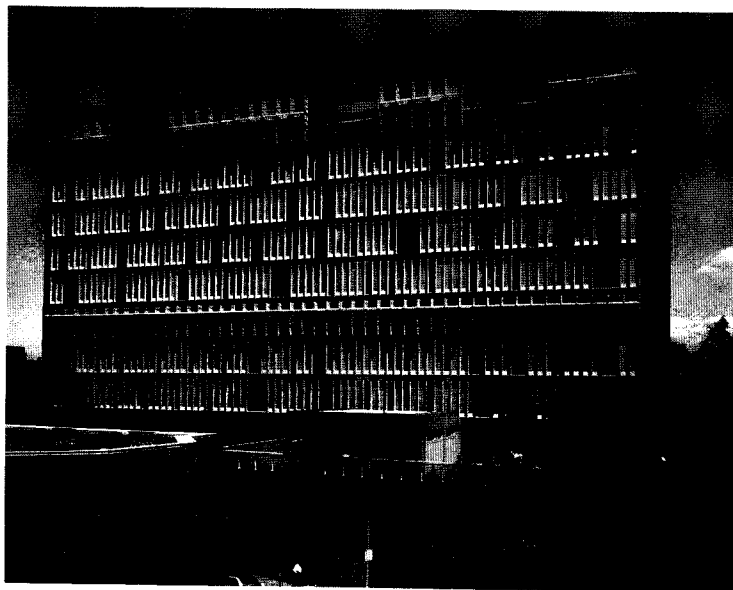

Replacement aluminum fins on Holyoke Center resemble the originals.

phases called for identical construction, some differences in detailing do exist, mostly by accident.

Solely on the initiative of the contractor, a butyl packing strip had been inserted at the head of all the fins of Holyoke Center's phase one construction, its only purpose to ease installation. The butyl material maintained its flexibility without cracking, with the result that water penetration was inhibited at the vulnerable juncture of fin and spandrel. Phase two contained no butyl packing strips; they had not been specified, nor were they necessary, according to 1960s building practices.

There was some evidence that concrete mix proportions varied between the two building sections. The chloride content in the concrete fins of phase two was quite high, despite prohibitions in the architects' specifications against using calcium chloride to accelerate curing. Thickness of galvanic protection on reinforcing steel was inadequate, particularly at welded connections, and has been linked to the concrete failures. Another weak point in the installation occurs where the aluminum framing system and the precast concrete sills meet. The joint was difficult to caulk and a likely site of water penetration.

In considering the appropriate curtain wall modification, Ehrenkrantz was limited by two important criteria. First, the weight of any new system had to be low enough not to require changes to the structural frame. This ruled out most masonry and precast panel systems. Second, the module of the precast fins of the existing system had to be replicated to interface correctly with interior partitions. And, whatever option was selected, it had to have a better thermal performance than the existing curtain wall system. There were three alternatives for the problem fins. They could be replaced with identical portland-cement or polymer precast fins, replaced with aluminum fins, or removed altogether.

The option of eliminating the fins was not pursued for both structural and esthetic reasons. The advantage of new precast components was that not all of the fins would need replacing; however, the casting procedures would need close monitoring to avoid the problems already encountered. Polymer concrete would solve the problems of spalling from water infiltration, but

it would introduce a new variable in terms of thermal expansion, which could be as much as 10 times that of concrete at a given temperature differential. Visual consistency would be difficult to achieve with either type of precast fin, and, although anchorage could be accomplished mostly from the outside, some interior access was necessary, requiring demolition of the junctions between partitions and exterior walls.

Eventually the aluminum fins were selected for their expected long life and weather resistance. The new fins were produced in two sections—a structural stiffener and a cover. The stiffener was fastened directly to the existing frame with a self-tapping fastener from the outside, and the cover clips over the structural element, hiding all hardware and duplicating the original profile. Because the color of the aluminum would not be the same as that of the concrete, all the fins on phase two were replaced.

“From the ground it is almost impossible to distinguish between the concrete fins of phase one and the aluminum fins of phase two,” says Zewinsky. Even the original designer, who consulted on the renovation, was pleased because the aluminum provided almost exactly the color and the effect he originally had in mind, according to Zewinsky.

The new system of fins is performing well, he says. A detailed investigation was made of the concrete fins on phase one, and they were sealed and caulked as a precaution. However, with the exception of some minor damage from vehicles, there has never been any evidence of concrete failure in that section of the building.

Gund Hall, which houses Harvard’s graduate school of design, was designed by John Andrews of Andrews/Baldwin Architects and completed in 1972. It received an AIA honor award for its unique shape, dominated by the cascading, stepped roofs of its rear elevation, covering a 134-foot, clear-span studio space descending four levels. The structure is reinforced concrete flat slabs over a 25-foot column grid. Almost since its completion the building has had trouble with leaks—associated with the glazing system, with the five-story roof, which is stepped into 15 tiers and divided horizontally by eight trusses into 120 mini-roofs, and particularly with the concrete facade.

The design was considered experimental at the time, says building manager Kevin Cahill, and it included many construction details that were not at all standard, increasing the potential for problems. Only one expansion joint was incorporated into the building, although it has numerous rustication joints—both horizontal and vertical—some of which have come to serve as control joints. In 1972 hairline cracks began appearing in the concrete walls, with a particularly high concentration of them in the vertical rustication joints. Between 1972 and 1983, when the building was partially renovated, the visible cracks were sealed three times, says Cahill. Many of the leaks were finally resolved during that renovation, but not all, he says.

The options for solving the enclosure problems were carefully analyzed, but those most likely to succeed could not be employed. It was suggested that the facade be altered, possibly with a new skin, and that the 120 flat mini-roofs be changed to sloped roofs. The result would have been a very noticeable change in the design and was unacceptable to Harvard.

Approved repairs consisted of spraying the concrete with a waterproofing compound, which is useful only if the cracks do not propagate or if they are not too large; injecting the cracks with epoxy; and inserting neoprene flashing at reglets and other junctions. These measures have been largely successful but have not completely solved the problem. Mysteriously, every year a

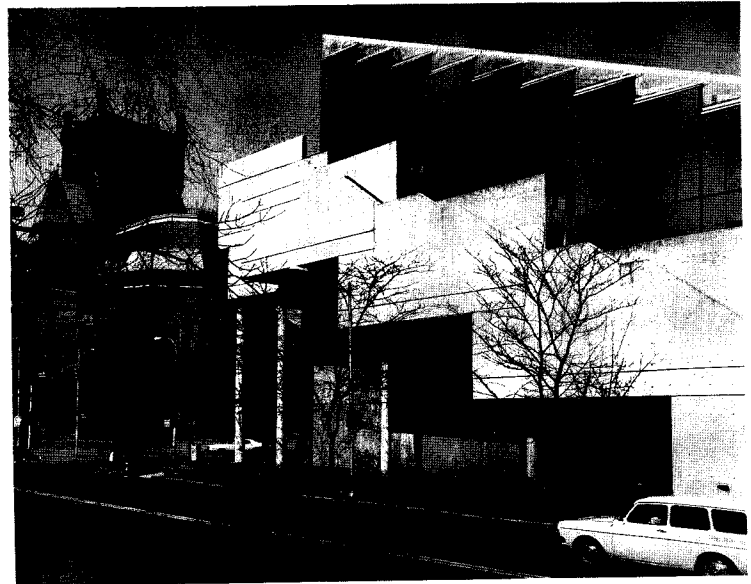

Clemens Kalischer

Many of the leaks in Gund Hall, above, were solved when window details were changed to include neoprene flashings, as shown on right

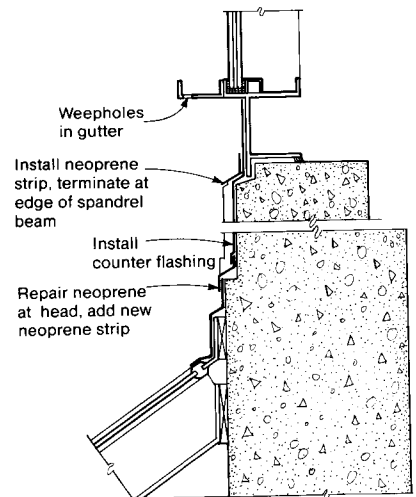

few more cracks appear, says Cahill, and a few more leaks.

Finding the cracks responsible for water penetration is not an exact science, says Cahill. “We have done water tests by hanging hoses over the roof or spraying water at points where we have seen leaks, and we find no leaks; then it rains for two hours and water is coming into the building.” Since the building was renovated, the largest degree of water penetration has been through the roof. Cahill says Harvard has analyzed the piers supporting roof trusses and found that they are buckled and warped, despite strict requirements in the specifications. He links the inadequate quality control to many of the roof leaks.

Unlike Baker Hall and Holyoke Center, no major changes will be approved for the envelope of Gund Hall. The way it stands now, says Cahill, is that cracks in the concrete will be repaired as they are discovered, and he is confident that the problem is under control.

Harvard has selected three diverse fixes for these concrete facade failures and may well be faced with similar problems on some of its other buildings. The university, like the construction industry, has learned a lesson. “We are not avoiding the use of reinforced concrete in our new buildings—indeed it would almost be impossible,” says Zewinsky. The university is just much more careful about specifying and detailing the material correctly. □

MODIFIED BITUMEN ROOFING SYSTEMS.

Component compatibility.
Protection against the
elements depends on it.

There's more to a roof than a membrane. Modified bitumen roofs start with insulation, base felts and membrane ply, and include flashing, cant strips, gravel stops, fascias, expansion joint covers, vents and drains.

All must fit together for long-lasting protection against the elements. And they're all available from a single source.

That source is Manville, and we stand behind the finished product like no one else can, with the most comprehensive systems guarantee program in the industry.

For the whole story on DynaKap, DynaKap FR, DynaPly, DynaFlex, DynaBase, the Manville family of fiber glass/polyester reinforced elastomeric roofing systems, call your Manville sales representative or contact the Manville Product Information Center, P.O. Box 5108, Denver, Colorado 80217-5108. (303) 978-4900.

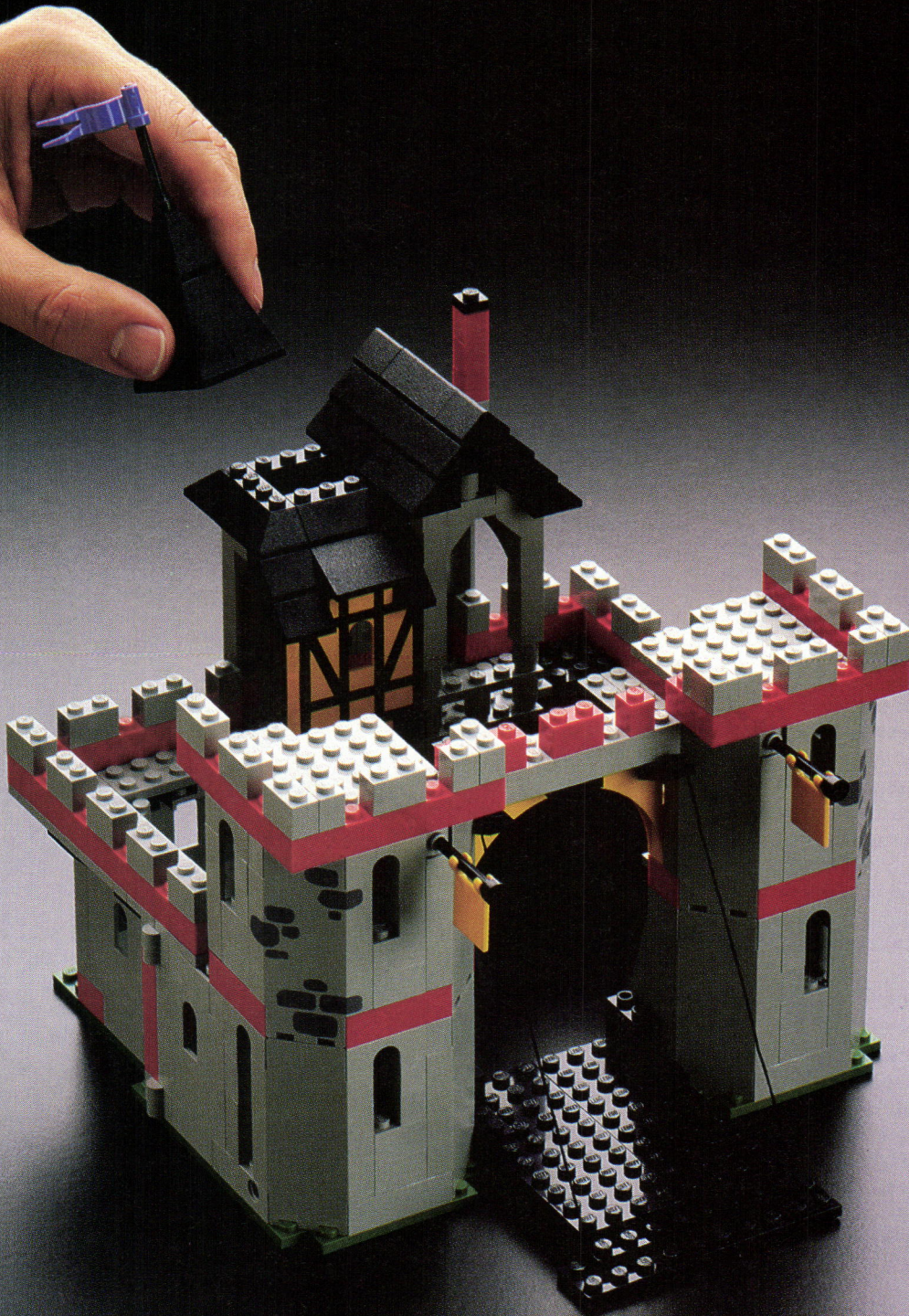

Combining Masonry and Brick

By Stephen Szoke and Hugh C. MacDonald

Some years ago, news in the construction press about failures of brick and concrete combinations scared off many designers. Stories such as one about a 33-story building with a concrete wall that shrank while its brick veneer expanded, buckling the facade and dumping 100 square feet of masonry 20 stories through the roof of an adjoining building, were the last thing a litigious industry needed to hear. A few reports like that, and suddenly conventional thinking changed: brick and block were not to be used together for wall construction. Period.

Such thinking is much too narrow. Although clay and concrete masonry respond differently to moisture and temperature changes, they are not incompatible building materials. Brick and block masonry units are frequently used together with a great deal of success despite their initial tendency to move in opposite directions under normal environmental conditions of outdoor temperature changes, solar loads, and varying humidity levels. Many of the design issues that must be addressed for brick and block construction under these conditions are the same as for any other masonry wall.

Moisture will cause some wall movement

Water absorption and evaporation will affect the dimensions of masonry building units. During the process of firing, all moisture is essentially removed from a clay brick. Once fired, the clay unit takes on moisture until it is at equilibrium with its environment, expanding as moisture is absorbed. Unlike clay, concrete masonry is molded and then cured in a saturated condition to hydrate the portland cement binder. As it cures, the concrete masonry gives off moisture to the environment, losing volume as it shrinks, until it reaches a point of equilibrium. Properly cured masonry units—brick or block—generally are at or close to equilibrium by the time they are used in construction. Most of the total expansion or contraction has occurred before the units are delivered to the site.

As outside humidity levels change, both products will expand and contract somewhat, but significant moisture changes within units are not expected once the materials stabilize at a moisture content similar to the average annual relative humidity for the area. Remember that masonry is always a local product—it is too expensive to ship long distances, and its composition and appearance do not depend on its source as with marble. So the relative humidity at the manufacturing plant should be close to that at the building site.

In laboratory tests governed by Standard C140 of the American Society of Testing and Materials, saturated concrete masonry is dried at 122 degrees Fahrenheit and 17 percent relative humid-

ity, and shrinkage ranges from 0.013 to 0.065 percent. But saturated units are never installed into construction, and the amount of shrinkage in the field is much less than in the laboratory, usually quite a small fraction.

ASTM specifications divide concrete block into two categories: Type I, moisture-controlled units, and Type II, non-moisture-controlled units. The majority of building construction projects use non-moisture-controlled block, which is typically much less expensive. The shrinkage of these, though, is not readily determined and mostly depends on their moisture content when they are placed in the wall. In typical building applications this shrinkage is not significant and does not need to be monitored or controlled.

The moisture content of Type I units cannot exceed a maximum limit when shipped to the job site. That limit is determined not only by the inherent properties of the block but also by the average humidity conditions at the intended final exposure. Although shrinkage is not eliminated, it is controlled to a predictable amount. If, for esthetics or some other reason, a wall design dictates that the maximum distance between control joints be 40 feet or more, then it is important to specify moisture-controlled concrete block to limit contraction, which has a greater potential for damage in larger, unbroken expanses of wall. Optimum volume shrinkage after installation is approximately 0.02 to 0.03 percent for concrete block masonry. If properly specified and detailed, both moisture-controlled and non-moisture-controlled block, as part of a wall construction, will be within that range.

Clay bricks start to expand immediately after firing, with most of the expansion occurring as the bricks are cooled to room temperature. By the time they are installed in a building wall, the bricks usually have expanded between 0.02 and 0.03 percent—almost the same amount that concrete block is likely to contract. However, most of the opposing movements of these two materials happen around the time of their fabrication and prior to building. Once wall construction has been completed, the actual moisture-induced expansion and contraction of the respective materials is generally insignificant.

Thermal movement is often a daily event

But thermal movement of masonry walls is quite different from moisture expansion. Virtually every building material will expand and contract when exposed to daily and seasonal temperature changes, but one material will respond differently from another, depending almost solely on its chemical and physical composition. While the moisture content of masonry will ultimately come to a balance with the average humidity of its final environment and then stabilize, thermal loads are something else.

Overall wall shifting must be accounted for as a result of discrete movement in individual masonry units caused by cyclical temperatures. This is true for all masonry; clay and concrete

Mr. Szoke is manager of technical services for the National Concrete Masonry Association. Mr. MacDonald is manager of engineering services for the Brick Institute of America. They are both professional engineers.

are treated the same. Just how much a brick or block wall will expand or contract because of temperature cycles depends on a number of factors such as outside temperatures during construction, prevailing winds, and orientation. But research has shown that the two most important predictions of thermal movement in masonry walls are their thermal conductance and their color.

Thermally induced movement within the material itself is usually measured by a coefficient of thermal expansion (a function related to thermal conductance), which is the relative increase in length, area, or volume of an object for each degree of temperature rise. Designs based on an understanding of the varying behavior of different masonry materials under thermal and moisture loads will be the most successful. Ignoring these properties will surely result in problems.

For each degree Fahrenheit, the coefficient of thermal expansion of clay masonry in a linear direction is 0.00045 percent. Concrete block, on the other hand, has a linear coefficient of thermal expansion that varies with the density of the unit, from 0.00021 to 0.00052 percent. Concrete block made up of lightweight aggregates falls in the lower end of the range and normal-weight units in the higher end. Block made with concrete having a density of 125 or more pounds per cubic foot is considered normal weight; lightweight units are made from concrete with densities of less than 105 pcf.

Normal-weight concrete masonry units may expand and contract as much as 15 percent more than clay units. The 15 percent difference in thermal expansion and contraction equates to about $\frac{3}{32}$ inch for a 100 degree Fahrenheit temperature difference in 100 feet of wall. As long as movement or crack control joints are incorporated appropriately into the design of the concrete masonry—at least every 40 feet—the different thermal expansions of the two wall materials will be of no consequence.

Thermal movement for each exterior wall should be calculated separately, for both summer and winter ambient design conditions, based on the average seasonal temperature of each masonry wythe. Average wythe temperatures are determined by calculating the temperature gradient through the entire wall for each design condition.

Both ambient air temperature and the effects of solar radiation must be considered when determining the maximum summertime temperature of a wall. Each of these factors is greatly dependent on hemispheric location. Ambient air temperatures generally are higher at lower latitudes (closer to the equator) than at higher latitudes. At lower latitudes the summer sun is much higher in the sky, with a greater angle of incidence than at higher latitudes. Therefore, much less solar radiation strikes vertical wall surfaces, particularly south and west wall surfaces, at lower latitudes. As a result, high ambient air temperatures and low solar radiation incidence will tend to offset each other.

Research has proved that, rather than air temperatures or solar loads, color is the primary factor determining the maximum wall surface temperature. Maximum summertime surface temperatures of light-colored walls—cream, buff, and white—facing south or west range from 100 to 120 degrees Fahrenheit. Dark walls—gray or brown—will have surface temperatures of 140 to 160 degrees; and medium-colored walls—red, light gray, light brown—will vary between 120 and 140 degrees.

Minimum winter temperature is the ambient air design temperature. For example, the 99 percent dry bulb temperature is 48 degrees Fahrenheit in Miami, Fla., and -31 degrees in Bemidji,

Minn. Greater total thermal movement of masonry walls is experienced in the colder locations at higher latitudes.

Temperature gradients are illustrated in Figures 1 and 2 for both multiwythe and insulated cavity walls where the maximum summertime surface temperature of the wall is 150 degrees Fahrenheit and the wintertime minimum is -10 degrees, with indoor temperatures held constant at 72 degrees.

Evaluation of total thermal movement is important because joint sealants must have adequate bond strength, tensile strength, compressibility, and extensibility to span movement joints under extreme conditions. Expansion design of masonry wythes needs only to consider expansion from the time of construction to the hottest summer day. Likewise, the contraction to be evaluated is that from the time temperatures fall below construction temperatures to the coldest winter day.

Typical construction of masonry walls

Control joints, which allow for the tension that results as individual elements contract, should be placed in concrete masonry wherever shrinkage control is required. In clay masonry, expansion joints absorb compressive movement and should be placed vertically to accommodate horizontal movement and horizontally for vertical movement. Contraction joints in block are detailed primarily for moisture shrinkage and thermal contraction, while the expansion joints in clay masonry accommodate combined thermal and moisture expansion. These joints do not need to coincide, but having them aligned will usually facilitate construction.

Two commonly used masonry wall systems are multiwythe and cavity walls. The multiwythe wall consists of two or more wythes of masonry bonded together with a filled collar joint. The wythes are connected by masonry headers or metal ties that cross the collar joint. Multiwythe walls that are constructed of different masonry products but designed so that the wall acts as a single element are called composite walls. The composite action may be desired for increased compression, flexural, or shear strength or any combination of these strengths. Not all multiwythe walls are designed as composite walls; in many designs, the clay brick wythe is essentially a veneer over concrete masonry backup.

The collar joint is a continuous vertical joint between two wythes of masonry that may be filled with mortar or grout. It is typically $\frac{3}{4}$ inch thick and can be difficult to fill. The joint may be filled by parging the backup and shoving the facing units into the thick parge coat while placing them in full head and bed joints.

Buttering the head and back of the unit prior to placing the facing unit in a full bed joint is another alternative. However, both these approaches are difficult because they limit the space for excess mortar to be extruded from the joints. Generally, the collar joint is formed by slushing mortar or pouring grout between the facing wythe and the backup wythe after each course of facing units is placed. Constructing two or three courses and then adding mortar or grout between wythes is not recommended because it is difficult to determine if the space has been completely filled. Completely filled collar joints are easiest to achieve by using grout. The American Concrete Institute and American Society of Civil Engineers combined Standard 530, "Building Code Requirements for Masonry Structures," sets minimum grout space widths as a variable of grout type and grout pour height. These widths vary between $\frac{3}{4}$ inch and three inches for both fine and coarse grouts.

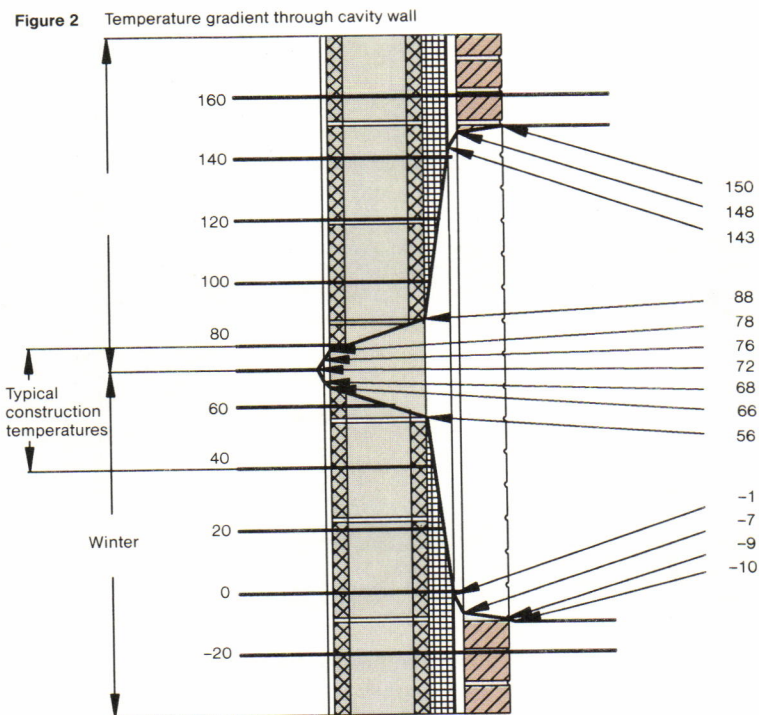
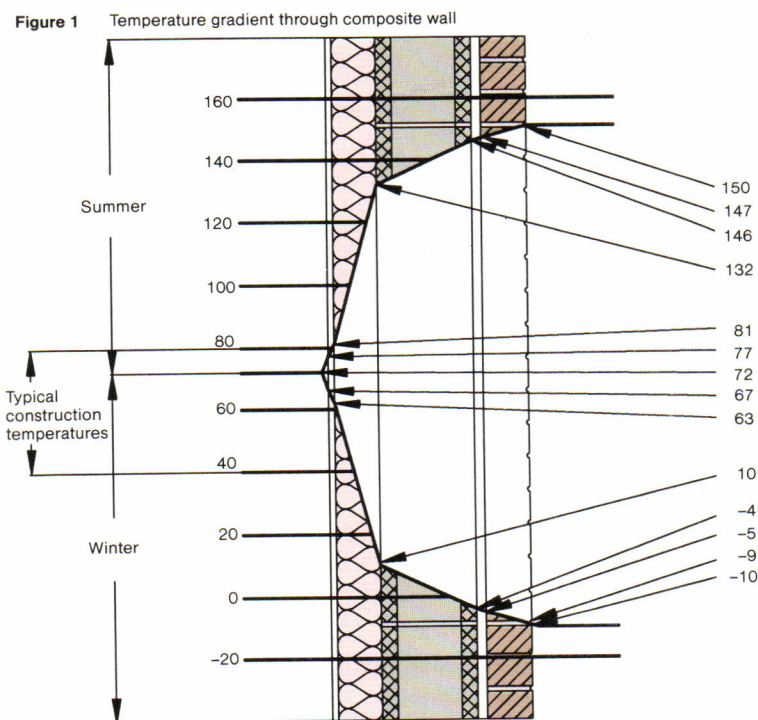

A cavity wall is composed of two wythes of masonry separated by a continuous vertical longitudinal space that is at least two inches wide. The two wythes are bonded together with metal ties; otherwise the dividing space remains empty, unless insulation is specified.

In a brick and block cavity wall, materials with different movement characteristics are successfully tied or bonded together. Expansion of the clay masonry will tend to restrain the shrinkage of the concrete masonry, and, conversely, shrinkage of the concrete masonry will tend to restrain the expansion of the clay masonry. Intermediate floors and other structural elements provide additional restraint to the masonry. However, if shrinkage or expansion stresses exceed those of restraint loads provided, cracks or bowing may occur.

Horizontal elongation of a wall will be restrained by its own shear strength and by friction between the wall and foundation. But the strain that builds up in walls that are too long, have too few expansion joints, and are bonded to the foundation can be greater than the wall's rupture strength and can crack the wall where it rests on the foundation, or crack the foundation itself. Closely spacing vertical expansion joints—20 to 40 feet apart—and providing bond breakers such as flashing or plastic film at the joint will prevent this problem.

The average temperature extremes of multiwythe walls vary only marginally between exterior and interior wythes, as illustrated. For both brick and block walls, the average maximum surface temperature fluctuates about three degrees Fahrenheit, from 145 to 148 in the summer and -4 to -7 in the winter. For the backup wythe, maximum temperatures are between 127 and 139, minimum between zero and 9. These are relatively small temperature differences between wythes. The thermal movement that does occur can be easily accommodated because the coefficients of thermal expansion of concrete and clay masonry are similar. Total differential movement due to temperature changes in this type of wall will be minimal, about $\frac{1}{32}$ inch per 100 degrees Fahrenheit for 100 feet of clay brick backed up with normal-weight concrete masonry units and $\frac{1}{16}$ inch if lightweight concrete masonry is substituted.

In multiwythe construction, the primary source of differential movement that must be addressed is moisture changes in the dissimilar materials as they approach equilibrium. Such movement can be expected to be between 0.05 and 0.07 percent. Moisture-induced movement between walls is usually not an issue as long as both brick and block wythes are equally restrained. Expansion and contraction of the vertical spans of masonry can cause height differences of about $\frac{1}{16}$ to $\frac{3}{32}$ inch over 10 feet, which is insignificant. But if the designer intends for the wythes to act as a composite wall supporting floor loads, then a bearing must be provided to load each wythe and restrain the brick wythe from moisture expansion. Except in low-rise construction (four stories or lower), the exterior wythe of clay masonry should not be permitted to continue past the edge of the floor slabs because the differential movement compounds itself with each story height. Movement up to $\frac{1}{2}$ inch in 50 feet of wall (as in a five-story building) is likely, and by the 10th floor differential movement caused by moisture could be as much as one inch. Steel bearing plates for the masonry are necessary in mid-rise and high-rise buildings designed with composite masonry walls having an exterior wythe that extends beyond the edge of the floor slabs.

Movements within the plane of a wall may become substantial if not properly provided for. The compound vertical shortening of elements must be addressed; $\frac{1}{16}$ inch of shortening in 10 feet will cause $1\frac{5}{8}$ inch of bowing. In 30 feet, that translates to three inches of bowing or more. The possible damage due to this much bowing deflection can have disappointing results. For example, in one building with an exterior brick facade, the window frame separated from a one-story wall and there were cracks through the masonry and penetrating into interior ceiling and wall joints. In this case, the structural concrete frame that supports the brickwork at each floor had shortened. While poured-in-place concrete is much more susceptible to shrinkage than concrete masonry, the concepts and results are basically the same. Here the solution would have been to make sure the shelf angle and the horizontal soffit joint underneath it were attached to the concrete frame. This isolates the

Figure 3

Truss type joint reinforcement in composite wall

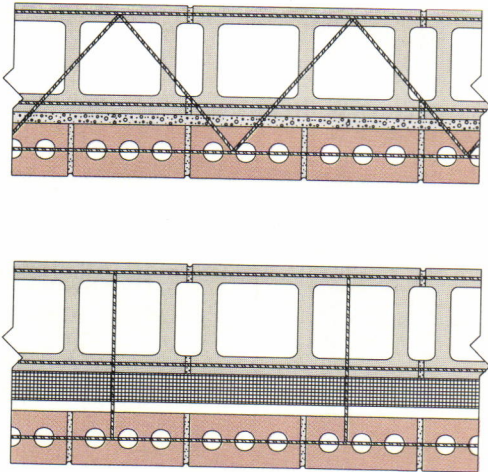

Figure 5

Joint reinforcement with eye and pintle ties

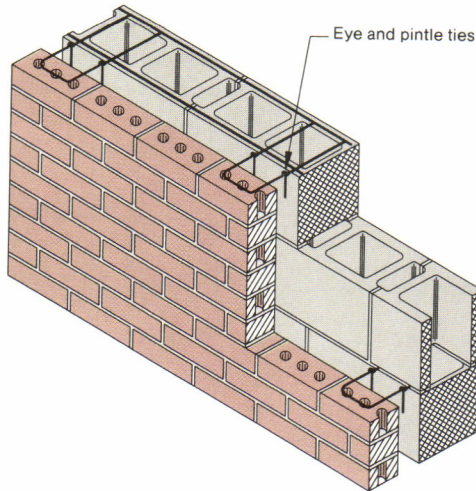
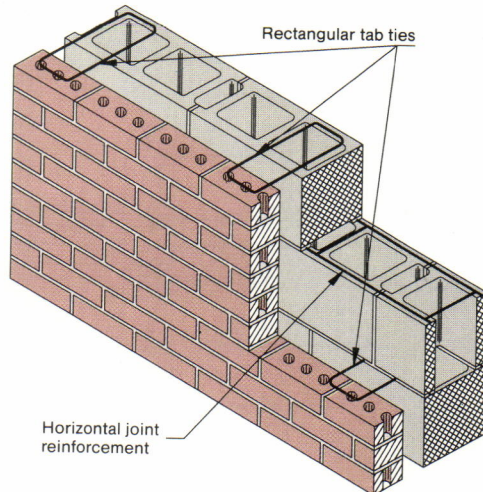

Figure 6

Joint reinforcement with rectangular tab ties



brickwork from the floor/ceiling assembly so that when shrinkage occurs each panel of masonry is protected.

Similar differential movement effects can be expected horizontally, within the plane of the wall, as well. Horizontal movement is almost completely controlled by the expansion of the brick, and shrinkage of the frame has little effect. This movement is easily controlled by placing expansion joints in the exterior wythe of brick and contraction joints in concrete backup.

To restrain shrinkage of concrete and expansion of brick in multiwythe walls, horizontal joint reinforcements are used. There should be one longitudinal wire in each face shell of hollow concrete units and a third in the exterior wythe of brick. Truss-type horizontal joint reinforcement serves to maintain an integral collar joint. Specifying three longitudinal wires will prevent faulty placement within the concrete and brick masonry wall; otherwise the reinforcement will be almost useless, providing neither shrinkage control nor resistance to lateral loads. Instead, bowing can be expected because the interior face shell of concrete with its joint reinforcement has different shrinkage from the exterior wythe. Longitudinal wires are a good idea even if both wythes are concrete masonry.

In cavity wall construction, thermally induced differential movement between the two wythes is a potential concern regardless of the materials used. When an exterior wythe is isolated from its interior partner by a layer of thermal insulation, the temperature differences between them will be much greater than with multiwythe construction. When outside wall surface temperatures are 150 degrees Fahrenheit and the indoor air temperature is 72, the interior wythe temperature will be 81 to 82 whether it is clay or concrete masonry, and the mean of the exterior wythe will range from 147 to 149. Under extreme winter conditions—down to -10 degrees Fahrenheit—the exterior wythe will fluctuate between -6 and -8 degrees, with the interior somewhere between 60 and 63 degrees. Even if both wythes are of the same material, with a construction temperature of 50, differential movement between them can be $\frac{5}{16}$ inch under summertime extremes and $\frac{3}{8}$ inch as temperatures drop to the minimum.

To provide for this movement between wythes, ladder-type joint reinforcement, with three longitudinal wires, should be placed horizontally within the plane of the wall. Adjustable ties (made of two pieces) and rectangular tab ties are also good

choices for joint reinforcement in cavity walls. When substantial vertical movement is anticipated, an eye and pintle connection is recommended. However, the inherent play in the two-piece construction must not be overlooked. Too much play in the tie system interferes with load transfer and can result in adverse deflection. Exacting horizontal alignment of bed joints is also necessary to prevent eccentricities in the two-piece tie. Large eccentricities inhibit transfer of lateral loads.

If a combination of joint reinforcement and individual tab ties is selected, the two should be placed in alternate courses of concrete masonry; otherwise construction will be impeded and integral contact with the mortar will not be achieved. A truss joint reinforcement is not appropriate for this application, as it may transfer stresses between wythes and initiate cracks.

For load-bearing construction, generally the same details can be used for composite walls as for cavity walls. There is one major exception, however. A design option available with a cavity wall has load-bearing concrete masonry as the backup with an exterior wythe of clay brick as a separate, single element for the full building height. Differential movement between wythes must be provided for at the parapet or roof details, and the tie system must allow for movement for the full building height of masonry. A similar detail may be used for roofs with gravel stops. But this design is not recommended for multistory composite walls, which are intended to act as a single element.

There are a few special considerations for wall designs where brick bears on concrete masonry. A bond break should be placed between the two materials. In addition, twice as many contraction joints are needed in the concrete masonry as would be required for a wall constructed solely of concrete masonry. Even in reverse circumstances, where the concrete masonry is supported by brick, the additional contraction joints are a good idea.

Although clay and concrete masonry respond differently to changes in moisture and temperature, they are compatible materials. The same principles apply to walls of a single masonry material as to those of two materials. Consideration of bearing on the wythes, the direction and magnitude of movement of each material, proper placement and construction of contraction joints, proper use of horizontal joint reinforcement, and the use of appropriate tie systems will produce walls with the desired quality, performance, and service. □

Adjusting to the Expanding Uses of Computers

By Mark Lauden Crosley, AIA

When new tools are adopted, change inevitably follows. Computers are no exception, and the magnitude of the resultant changes for the architectural profession is astonishing. Computer-aided design and drafting (CADD) is changing the architect's roles and requiring new skills and ultimately may change architecture itself.

Many architects are ambivalent about the changes. Certainly, increased efficiency and accuracy are improvements in a profession dogged by low profits and liability issues, but the cost of these improvements must be weighed carefully. Many firms hesitate even to begin the transition to CADD because it takes extensive personal and financial commitment, the end result of which is shrouded in an uncharted future.

Only now is the profession moving beyond the pioneer stage of CADD, and a look backward shows some pioneers with arrows in their backs. Many firms that purchased the first CADD systems were badly hurt financially. These first systems were extraordinarily expensive (often 10 times the cost of today's workstations) and far more difficult to use than the present PC-based CADD systems. The combination was devastating: often it was necessary to train specialized CADD operators and have them work in two or three shifts a day cranking out production drawings, just to make the system pay for itself.

Now that CADD hardware and software are less expensive, it no longer is necessary to work multiple shifts to justify the investment. Nevertheless, questions remain. Is extensive training in new skills necessary? If so, how will this affect the organizational structure of projects and firms? The answers revolve around two closely related issues: the CADD system's ease of use and its role in a project.

Computer-aided drawing often appears to be a direct threat to the hard-learned skills of many architectural employees, such as the drafter. This is a serious concern for many firms because manual drafting is traditionally a valued skill, and a master drafter has always been a prized employee. Designers have skills that can be affected by computers, too, because there are good reasons to do conceptual drawings with CADD. These drawings can become three-dimensional design studies, and both 2D and 3D drawings can be re-used easily for presentations and construction documents. The skills of the project manager and job captain also are in the domain of the computer, and managing a CADD project can be quite different from managing a project where current project drawings are sitting on the drafters' desks, available for inspection at any time.

CADD systems based on obscure codes require CADD operators who spend all their time at automated drafting. This is an electronic distortion of the drafting department because

it separates and isolates the drafter from the design process. It also deprofessionalizes and dehumanizes the role of drafter by making the drafter an extension of the machine.

There are two potential threats posed by computers. First, many drafters, designers, and managers worry that their manual skills will become unnecessary. This is particularly threatening because, not only are these skills often considered the basis for one's job, but they tend to be enjoyable as well. Second, many people fear learning new skills and are even more nervous about that than about giving up old skills. Professionals with 20 years of successful experience find little impetus to begin a long, exasperating process of learning a new way of working. And they should not have to. They should, however, learn to use tools that improve the quality and efficiency of their work. Moreover, if the learning process is exasperating, the tool is not well designed. Most of the CADD systems of the past decade have been guilty of this fault and so have required specialists to use them. Fortunately, the situation is changing.

If a practicing drafter or designer can't learn to use CADD without undue pain, it's worthless. Fortunately, accessible CADD systems are beginning to appear. There is still tremendous room for improvement, but architectural CADD systems finally are beginning to reflect the fact that architects create walls, doors, and windows—not lines and circles—and that they prefer drawing to typing at a keyboard. CADD programs are just beginning to recognize that architectural drawings are intricately linked parts of a larger, whole design project. As software interfaces become less obtuse, it's becoming reasonable to expect a CADD system to be intuitively usable.

True ease of use has extraordinary implications. Look at the impact of word processing on specification writing. At one time, specs were written longhand and then typed by a typist. The photocopy machine improved things by making it possible to cut and paste with handwritten revisions from a standard specification, but retyping still was necessary. Initially, word processing simplified this process, and then spec writers learned to type and so could print out a set of specs without assistance. This not only sped up the process but also left less room for misinterpretation by the typist. The thinker became the doer, too. The typist, meanwhile, became an executive assistant with more intellectual tasks, such as editing or organizing the spec writer's output.

There are signs of a similar transformation in design. It is becoming increasingly common to find firm associates or principals designing with CADD, sometimes taking the work to a point traditionally considered part of the construction document process. One architect-principal explained it this way: "As long as there are decisions being made, I want my hand in the game. If I know what needs to be done, I'd rather do it myself than describe it or sketch it for someone else to do." This architect

Mr. Crosley has an architectural practice in San Francisco and is a consultant in computer-aided architectural design.

works with other designers throughout the project but makes changes on drawings at his own workstation.

This trend is not likely to eliminate drafters from architectural practice, but it will change the meaning of both drafting and designing. Because drawing is so much faster with CADD, those who draw building designs will no longer be hired to put lines on paper according to someone else's instructions. They will instead be more responsible for thinking about where to put walls, doors, fixtures, and flashing and then recording this information. Knowledge of design, documentation, and construction becomes more important than drawing.

The very definition of a drawing has changed. Where CADD is used, a computer file might contain the information that usually appears in several drawings, such as a floor plan, a reflected ceiling plan, and an electrical plan. Furthermore, the file might include this information for several floors, and it might contain three-dimensional graphics, such as elevations, as well. A "drawing" is now a report that is plotted from this file, and many drawings may be extracted from a single source. Once this is understood, it becomes possible to plot new kinds of drawings, create new forms of client presentations, and coordinate consulting disciplines more effectively. Yet most firms with CADD simply use their systems to duplicate old-style individual drawings.

Using computers to imitate manual drafting is like using a printing press to imitate hand-lettered manuscripts. In her book *In the Age of the Smart Machine* (Basic Books, 1988), Shoshana Zuboff points to a number of cases in which computers have been used to automate manual work without taking into account the capabilities of the new tools. The results consistently show that, although production may be sped up, traditional skills are not replaced with new skills that are appropriate to the new tools. Dissatisfaction grows and creativity stagnates. Zuboff explains that, when technology is used to reduce reliance on people, opportunities to better utilize human talents are missed. Furthermore, the full potential of information-handling technology cannot be realized without concerted efforts to push it beyond the bounds of traditional practices.

We are beginning to see CADD systems that link different drawing types with each other, with data management programs, cost analysis software, code-analysis programs, and specification writing systems, and with external sources of information such as building materials manufacturers' catalogues. These applications can amplify the work of each architect beyond what was conceivable in the past. With the computer, it becomes possible for an individual to work simultaneously with drawings, materials schedules, and specifications on the same workstation. It's already possible to draw a building one day and come back the next morning to find perspective renderings and a cost estimate waiting for you. Soon you can expect to have the estimate and renderings available as you draw, updated constantly.

One of the unforeseen effects of this kind of transformation is that not only are old roles changed but new ones are created. In-house programmer/system customizers and network managers are useful to larger firms, and many firms can begin to hire people to do tasks that previously were impractical, such as in-house cost estimating, spec writing, or engineering. New services can be sold to clients as extras, such as renderings and animated tours of designs; drawing revision of as-built conditions; sale of electronic documents; and facilities management. As work becomes more efficient, some of the buildings that are usually built from off-the-shelf designs or by nonarchitects may also become cost-effective for architects to design.

Tools for the future

3D CADD has brought us to the point where it's practical to design and document a building using a single, three-dimensional model. The electronic building model used for design can also be used to produce shaded presentation renderings, and it can contain two-dimensional working drawings as well. Significant time savings can be achieved by eliminating redundant drawing—a window drawn in plan also appears in elevation. And dramatic improvements in consistency are possible—if you move the window in plan, it also is moved in elevation.

Computer networks are one of the keys to using CADD effectively in a large firm, especially with techniques such as integrated 3D modeling and drafting. A network makes drawings and other project data available to everyone on a project team while ensuring that there is a single, up-to-date version of each file. There is less risk of designers working simultaneously on different copies of the same drawing.

Expert systems are computer programs that use lists of rules to simulate human decision making. Sometimes referred to under the misnomer "artificial intelligence," these programs are used to simulate the decision-making process of an expert. In reality, expert systems are just tireless data searchers, except that they often can keep track of the patterns they encounter and note them for future reference, which is a crude form of learning. Expert systems are best used when large quantities of information must be sifted to match situations with alternative solutions. Building codes, manufacturers' data, and construction specifications all are based on unwieldy libraries of information that periodically must be waded through. Why not let the computer do the wading? Expert systems can do this far more quickly and sometimes more accurately than humans, even though they are only working according to human instructions. Several companies are developing such expert systems. McGraw-Hill soon will release SweetSpec, a MasterSpec-based specification writing system with some built-in expert system capabilities; and SweetCode, an expert system developed by Codeworks for checking the requirements of local building codes.

Although 3D CADD systems, computer networks, and expert systems as tools make sense, implementing them in architecture firms is another matter entirely. Designers are accustomed to working on individual drawings, whether paper or electronic, but not to all-inclusive building models. Few architects are adept at working in plan, elevation, and section simultaneously.

Moreover, drafters are used to having control over a sheet of paper or a file on a diskette rather than accessing a distant file that someone else may be working on. Managers are accustomed to supervising by looking over a drafter's shoulder—no longer an effective method. (Perhaps the manager will monitor surreptitiously all work being done on the network.) Regarding expert systems, there is no guarantee to the designer that the decision-making process modeled by a computer programmer is the right process for the job at hand. Choices might be incomplete.

CADD software marketing tends to fixate on miraculous productivity increases, and architects often are seduced into thinking that this is the only value of a computer-aided design system. Of equal or greater value is the potential to increase project quality if a CADD system is used wisely. CADD obviously can be used to increase drawing accuracy, but tools such as 3D, networks, and expert systems can also be used to study design alternatives far more thoroughly and to increase consistency levels by an order of magnitude. □

Specifying Welding Details

Welding details, with their multitudes of flags and systems of numbering and lettering, seem to be composed of an arcane symbology uniquely their own. Architects specifying welding details have two major sources to ease the task of choosing the most appropriate weld for the job. First, and more familiar, is the American Institute of Steel Construction's (AISC) *Manual of Steel Construction*. Its specifications are geared to the types of welded joints used in building construction and include member size, loading stresses, and weld location.

The second source is the American Welding Society (AWS), which sets the standards for structural welding. Although the AWS standards contain some applications not pertinent to building construction, architects should not overlook them. They often are referred to in the AISC manual, and they provide additional useful information.

Based on both shop and field experience, AWS and AISC "prequalify" structural welds. A prequalified welded joint has an established standard profile and geometry, as well as accepted welding process or processes, permitted welding positions, and joint tolerances. The AWS standards and the AISC manual both illustrate and detail a number of prequalified joints. However, selection of a prequalified weld is appropriate only after the magnitude, type of loading, and thickness and specifications of the base material are considered. Furthermore, the designer needs to consider welding access and position for cleaning, edge preparation, and making the weld. For structural welded joints that aren't shown in the AWS code or the AISC manual, the weld type must be tested and qualified before it is used in the field. In such a case, the fabricator must submit detailed specifications to the architect

or engineer, the inspector, and the welder.

While the fabricator decides the welding process, joint detail, and welding position, it usually is the designer who specifies the type and size of weld. The designer also determines the position of field welds and hence their strength and cost. The four positions for welds are: horizontal, flat ("down hand"), vertical, and overhead.

The most controlled and least expensive welds are done in the flat position. Because they are controlled easily, flat welds usually are the strongest type. On the other hand, the most expensive and least controllable welds are done overhead.

Welds are identified by their cross-sectional profiles. The two most common welds used in building construction are the fillet and the groove. Often groove welds are used in conjunction with back welds, with the groove weld serving to complete the penetration at the weld root. Architects should have at least a passing knowledge of the nomenclature of fillet and groove welds to communicate with engineers, inspectors, and welders (see Figures 1 and 5). Plug, slot, and flare welds also are types of structural welds but are not as common in building construction.

In welding, bigger is not necessarily stronger or more economical. Often it is wiser to specify a long, narrow weld than a short, wide one. For instance, a fillet weld of $\frac{5}{16}$ inch or smaller can be deposited in a single pass, but a $\frac{5}{8}$ -inch fillet weld, which contains four times the volume of metal but is only twice as strong as the $\frac{5}{16}$ -inch weld, takes several passes to complete.

Fillet welds

Fillet welds, like all other welds, are drawn using standard conventional symbols. Any standard welding symbol is made up of three basic parts: the arrow pointing to

the joint, a reference line on which dimensional data is placed, and a weld symbol that indicates the type of weld required. A fillet weld is symbolized by an isosceles right triangle drawn with one of its equal legs on the reference line. A single triangle drawn below the reference line indicates that the fillet weld should be made on the arrow side of the joint. If the triangle is drawn above the reference line, the weld is made on the non-arrow side of the joint. If triangles appear above and below the reference line, both sides of the joint are welded.

The weld size, in fractions of an inch, is placed to the left of the weld symbol; and the length of the weld, in inches, is placed to the right. When the weld is to be made along the entire length of the joint, the length dimension is omitted. When a large majority of the welds are the same size, the dimension notation is omitted and replaced with a general note stating that unless otherwise noted all welds will be of a particular size (see Figure 2). Intermittent welds require another dimension added to the reference line after the length dimension, indicating the weld's spacing, or "pitch," from center to center (see Figure 3).

A fourth, less-used symbol—the "tail"—denotes detail references or specifications. When there are several identical welds to identical components, the tail is added to the reference line along with the note "Typ." The tail relieves the drawings of extraneous information and saves time in their preparation (Figure 3).

The symbol for a weld made in the field—a triangular black flag placed at the junction of the reference line and the arrow line—often is used inappropriately, because more often than not the weld should be a shop weld. Usually shop welds are less expensive and their quality and strength are better. Architects should carefully review the erection process with the engineer to determine which steel members require field welds and which can be shop welded (see Figure 8).

The "weld-all-around" symbol is a cir-

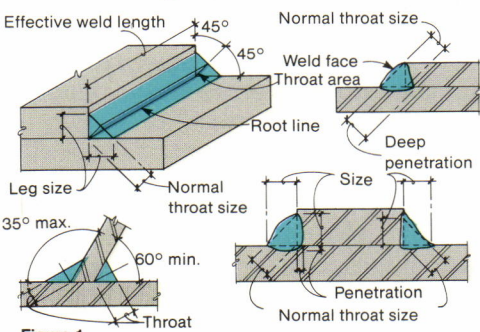

Figure 1

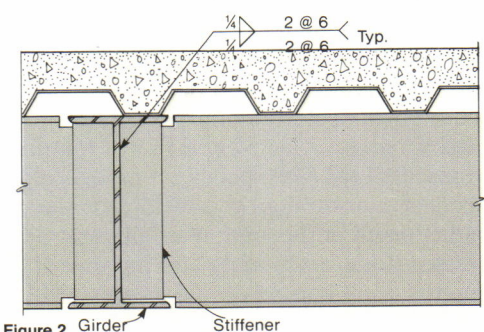

Figure 2

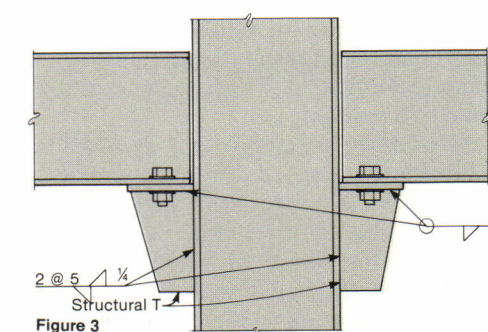

Figure 3

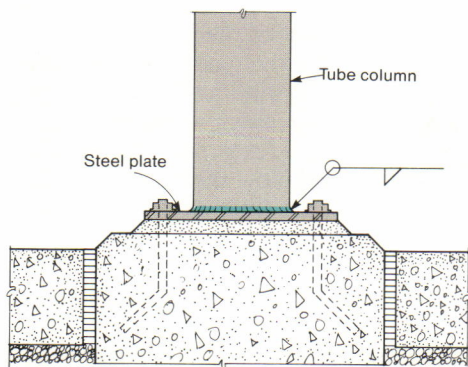

Figure 4

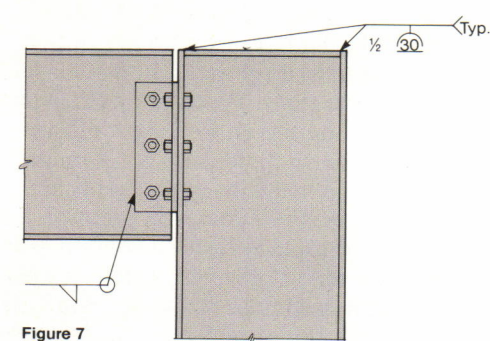

Figure 7

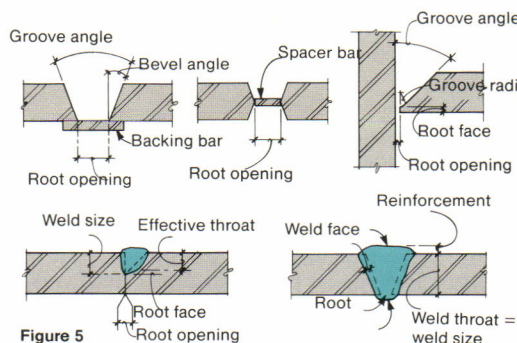

Figure 5

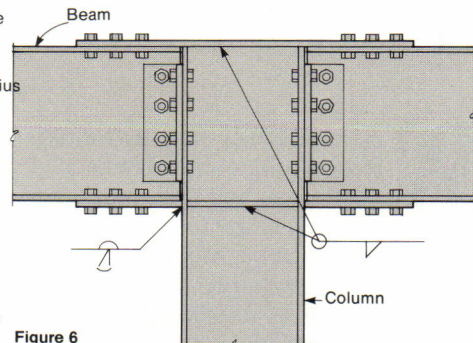

Figure 6

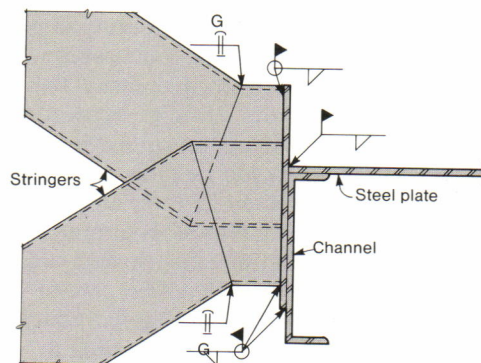

Figure 8

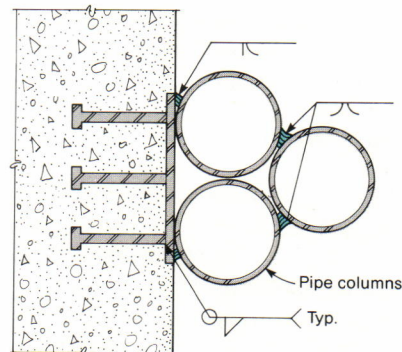

Figure 9

cle, always placed at the junction of the reference and the arrow lines. The weld-all-around symbol can be used for joints of any shape. When it is used however, the symbol for the type of weld—for example, a fillet weld symbol—is always placed to signify arrow-side welding. The architect should use all-around welding with discretion because it can cause joint distortion (see Figure 4).

Groove welds

Groove welds are placed into grooves that have been flame cut, arc-air gouged, or edge planed into the ends of adjacent pieces of metal. Groove welds are classified as either full-penetration or partial-penetration welds. A full-penetration weld must fuse the weld to the base metal for the entire depth of the joint. If the groove weld doesn't use a backing bar, separate welds from each side most likely will be required. Before the second weld is made, the first weld's "roots" must be chipped away (see Figure 5). When the stress to be transferred doesn't require a full-penetration weld, a partial-penetration weld will suffice.

Groove welds, unlike single-symbol fillet welds, have seven different symbols. They often are combined with other groove welds or other types of welds to create a wide variety of weld profiles and edge preparations. For example, the back weld symbol often is combined with the

U, J, vee, or single-bevel symbols to indicate that it is necessary to complete the second (root) side of these welds (see Figure 6).

Symbols for groove welds require the arrow to pull double duty. It must indicate the arrow side of the joint as well as the element to be grooved. The exceptions are where it would be impossible to groove the wrong side of the element or where the weld is symmetrical. Groove weld dimensions include the weld size; the root opening; the groove angle if it is a vee, bevel, J, or U weld; and the radii of J and U welds.

Noting the size of a groove weld usually is not necessary because it is understood that the weld should be the full thickness of the metal elements to be connected. The exception is when the groove weld is not symmetrical or when the preparation cannot provide for a full-penetration weld. In these two cases, the size dimension must be given, placed to the left of the weld symbol (see Figure 7). Also, the length of a groove weld usually is not shown because it is understood that normal preparation of a groove joint requires the weld boundary to run from edge to edge. (Any exception will require a special detail with special symbols.) And, because a normal groove weld runs the entire length of the joint, intermittent welds are not done, so spacing and incremental lengths don't appear on the groove weld symbol.

The root opening dimension is shown near the root of the symbol. The groove angle, in degrees, is written within the boundaries of the groove symbol. If the groove radii for U and J welds are not covered by the fabricator's standard weld proportions, or if a note is not made to an AWS prequalified joint, then the radii must be noted on the drawings.

If the weld's finished face is to be modified, the architect has to use supplementary symbols. A pair of contour symbols indicates whether the desired finished contour is flush or convex. Capital letters indicate the desired finish: for instance, G indicates "ground smooth" and M indicates "machined flush" (see Figure 8).

Some double-vee and double-bevel welds, made in a particularly thick material where a minimum permissible bevel or vee is desired, will require spacer bars. Both the backing bar symbol and the spacer bar symbol are the letter M within a box. The only difference is their placement on the reference line.

Finally, flare welds are a special type of groove weld often encountered in buildings. The groove is created by a rounded edge or face of one or both of the joined parts. Because complete penetration is difficult to achieve, the design values for flare welds have to be conservative. On any job, a number of flare welds should be randomly selected for examination and testing (see Figure 9).

—TIMOTHY B. McDONALD

PRODUCTS

Commercial Carpeting

The VersaTec line of commercial pattern carpet (right) from Lees Commercial Carpet Co., a division of Burlington Industries Inc., features a series of running line and custom patterns that draw on a bank of 176 yarn-dyed colors to create standard and custom effects. A graphics tufting technique assures clarity and absolute pattern definition.

Lees Commercial Carpets, division of Burlington Industries
 Circle 402 on information card

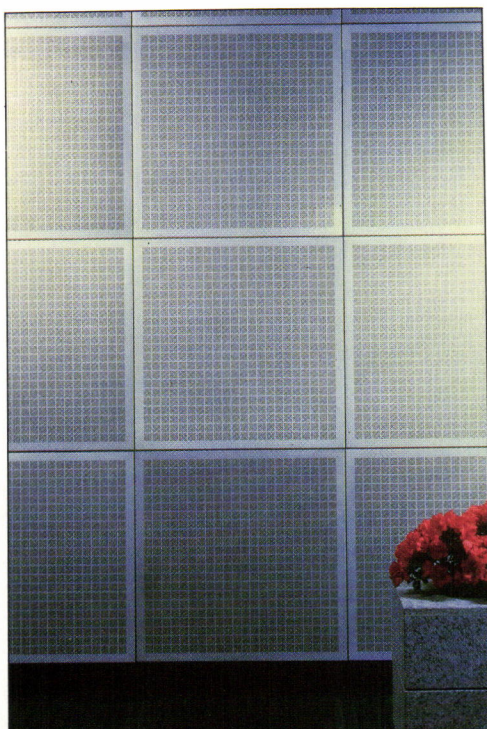
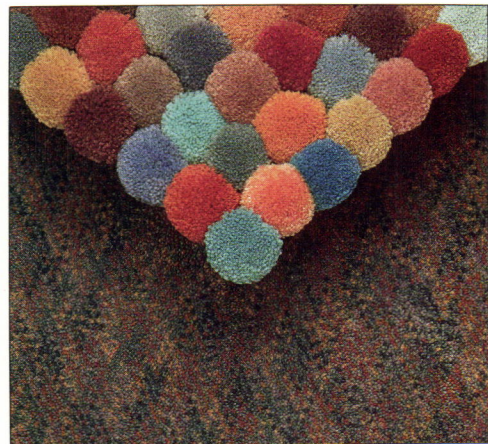

Acid Etched Metal Surfaces

Stainless steel and bronze sheet surfaces are permanently embossed or etched (above) using Forms + Surfaces' advanced technology and specialized production capabilities. Twenty-eight standard designs are available, as are custom patterns. The etched metal surfaces are suggested to dress up elevator doors, cab interiors, entry doors, lobbies, reception desks, wall and column corners, and for use as decorative accents, etched, or unetched borders.

Forms + Surfaces

Circle 403 on information card

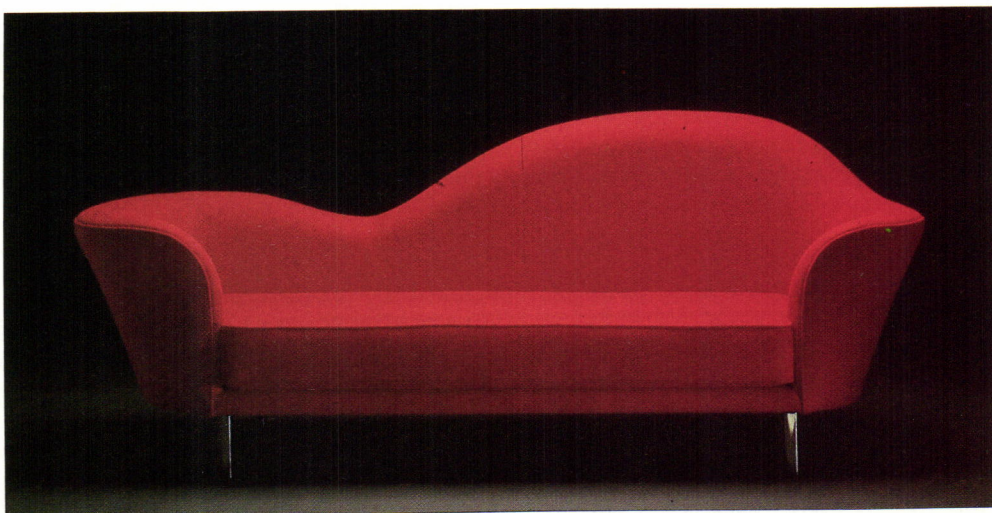

Chaise Lounge from Denmark

The Grand Piano chaise lounge (above) designed by Gubi and Lisbeth Olsen of Denmark, is built on a wooden frame with a foam seat cushion that is reversible and has a detachable cover. The 100-percent wool fabric is available in 24 colors.

Gubi Design

Circle 401 on information card



Integrated Palette of New Bath Colors

Four new colors—two shades of turquoise and two shades of a neutral called "mink"—now can be used together in tone-on-tone or in mix-and-match combinations (above) from American Standard. The palette choices are available for faucets as well as the full line of luxury bathroom fixtures, which will be available in new colors and palette in February.

American Standard

Circle 404 on information card

Products is written by Amy Gray Light

AEC Workstation Package

The Intergraph Corp. of Huntsville, Ala., recently announced a new product delivery system, called the Entry Level Sales Program, intended to provide large-system supplier support and peripherals to the workstation and PC-based market.

Emulating Intergraph's popular VAX-based AEC applications, the new CADD package is designed as a system to appeal to small- and medium-sized firms looking for their first system or an affordable "upgrade" from CADD packages developed exclusively for PCs. The ELS package includes powerful graphics hardware, application-specific software, and the capability to communicate between workstations and share with other disciplines. The basic system includes a workstation, five software programs, and a plotter for less than \$28,000.

The product delivery approach for the ELS program is unique for the Intergraph Corp., which has manufactured large, interactive systems for the past 15 years. To attract small and midsized firms, Intergraph has placed sales staff in 18 metropolitan areas to demonstrate the product's use directly in the customer's office. Products are delivered within seven business days, and come with a 30-day money-back performance guarantee and a 90-day warranty. Additionally, Intergraph is implementing the Intergraph Registered Consultant pro-

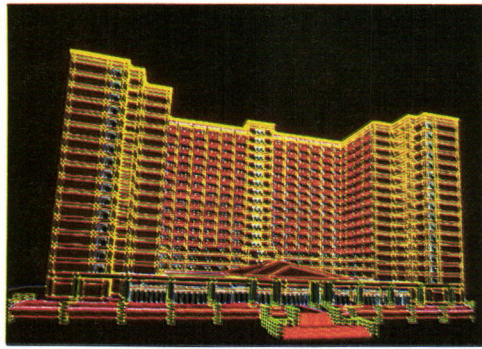

gram, through which independent consultants and service bureaus who are already familiar with Intergraph products provide entry-level customers with both training and productivity consultation. These consultants are trained, licensed, and monitored by Intergraph.

The workstation that comprises the system's main hardware device is an Interpro© 120 AEC Workstation. It features six megabytes of main memory, an internal 156 megabyte hard disk, a 1.2 megabyte floppy disk, a 19-inch high resolution (1184 x 884 pixels) color monitor that displays 32 colors from a palette of 4096, a 142-key keyboard and a mouse, and IEEE .802 (Ethernet®) networking capabilities (IEEE 802.3). The AEC Workstation comes bundled with Intergraph's Microstation 32™ core graphics (and its computer-aided instruction) and AEC project/file management software.

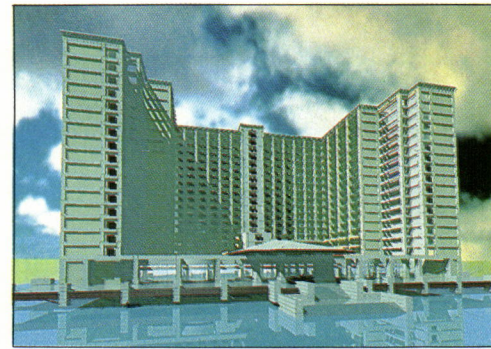

Five software packages form an integral part of Intergraph's new offering. They are: Project Architect, a drafting system used to produce detailed architectural drawings; Project Modeler, for 3D architectural modeling (example shown above, left); ModelView, which generates photo-like presentation-level graphics from 3D models (above, right); MicaPlus ModelDraft, a structural engineering modeling and extraction program; and EE Schematic, for functional or wiring circuit diagrams. All software is layered on the Microstation 32™ and includes full documentation, on-screen menus, and self-paced instruction. Beginning in the first quarter of 1989, six additional software packages, including one for facilities management and space planning, will be available.

*The Intergraph Corporation
Circle 430 on information card*

hp HEWLETT PACKARD Calculators

Now at a new low price!



HP-11C	\$44.95	HP-28S	\$167.95
HP-12C	\$57.95	HP-32S	\$55.95
HP-15C	\$57.95	HP-41CV	\$124.95
HP-17B	\$78.95	HP-41CX	\$177.95
HP-19B	\$124.95	HP-42S	\$86.95
HP-22S	\$49.95	Infrared Printer	\$96.95
HP-27S	\$78.00	Infra. Print. Module	\$56.95

PHONE ORDERS: MasterCard/VISA accepted. Call 1-800-334-0095.

MAIL ORDERS: Subtract 2% of your total when you pay by cash or check. Send a money order, certified check or business/personal check (bus./per. checks take 10 days to clear). Enclose your street address for UPS shipping and if different, your P.O. Box for paid invoice. N.C. residents add 5% tax. Mail to Surveyors Supply Co., P.O. Box 809, Apex, N.C. 27502.

SHIPPING: \$5.00 shipping charge per order. Sales are final. Defects are replaced free for 30 days.

Authorized Dealer For

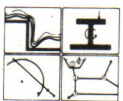

CIVILSOFT™



SURVA SOFT



AUTOCAD™

SURVEYORS SUPPLY CO.

Hwy. 64 at Salem St. • Apex, N.C. 27502 • 1-800-334-0095

SUSPENDED PLASTER CEILING TILES

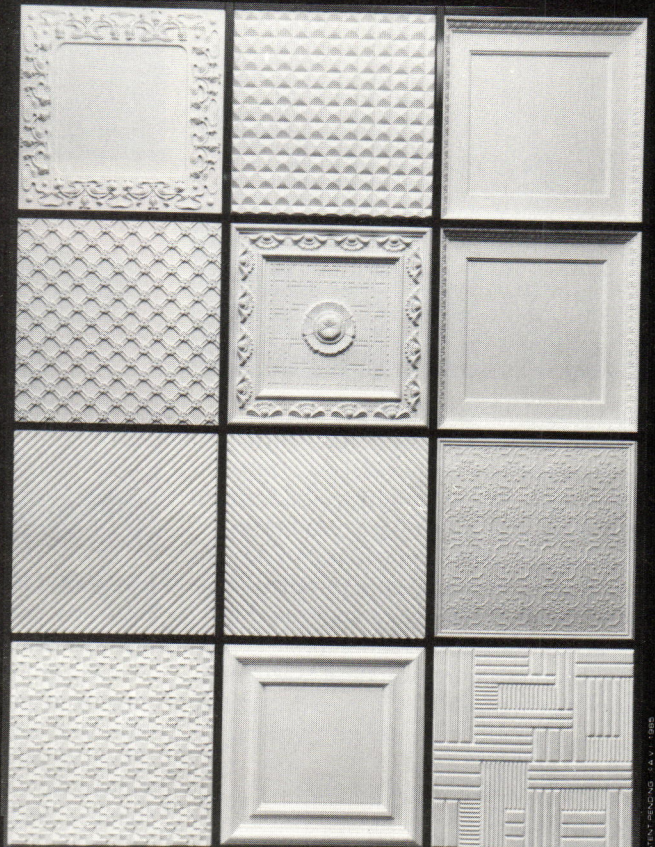

ABOVE VIEW, INC.

241 EAST ERIE STREET • MILWAUKEE, WI 53202 • 414-271-4477

Modernist Designed Chair

An ergonomic chair introduced in 1936 by the Domore Corp. is being offered again through a limited edition series. The Domore Air-Duct chair's industrialized look of perforated steel and adjustable parts appear as modern as when it made its debut. Red-leathered upholstery is built in channeled sections and fitted into a sheet-steel back-rest and seat. The upholstery is perforated with a series of small, round holes that permit air to circulate around the body. The Air-Duct chair may be upholstered in the user's own material as well. Domore plans to reissue other chairs from its archives in the future.

Domore Corporation

Circle 431 on information card

Acoustical Ceiling System

The new Geometrix ceiling system from USG Interiors Inc., visually integrates ceiling panels and the accompanying suspension grid for a contiguous look. The geometric patterns of the ceiling panels blend with the sharper lines of the narrow (1/8-inch reveal) suspension grid in five basic ceiling panel designs for a variety of design options for commercial, retail, and corporate office applications.

Geometrix acoustical panels are constructed of perforated mineral fiber and are highlighted with shadow-tone images in coordinated patterns. The Geometrix

system is available in 2- x 2-foot panels, with edges designed to fit flush in the suspension grid.

USG Interiors Inc.

Circle 432 on information card

Flat Glass Products

A manual published by Libbey-Owens-Ford provides information on the company's glass products for architectural, mirror, and furniture use, through photographs, tables, and charts that illustrate a concise, descriptive text. The company's pyrolytically-coated Eclipse reflective glass and Mirropane E.P. transparent mirror are highlighted in the manual, and topics such as product characteristics and performance data are covered in detail.

Libbey-Owens-Ford Company

Circle 433 on information card

Water Repellent

Chemstop SMS-250 from Tamms Industries Co., is a ready-to-use, colorless, deep penetrating, silane-modified siloxane water repellent designed for horizontal concrete surfaces subjected to high abrasion vehicular traffic, freeze-thaw exposure, and chlorohydrate-ion penetration. Chemstop SMS-250 is easily applied with standard low pressure spray equipment, and is available in 5 and 55 gallon containers.

Tamms Industries Company

Circle 434 on information card

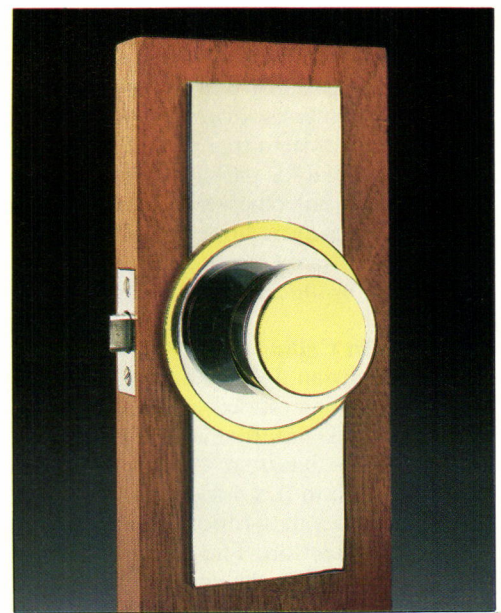

Decoplate Door Knob

Designed and manufactured exclusively by Kraft Hardware, the decorative lock (above) features a polished brass or chrome backplate and a chrome knob, and is available in a variety of finishes.

Kraft Hardware Inc.

Circle 435 on information card

Waterproof Floor Surface System

Polymer Plastics Corp. now offers a seamless, traffic-bearing membrane system that

continued on page 122

PORCH-LIFT®

VERTICAL WHEELCHAIR LIFT
provides a safe, simple solution
to architectural barriers

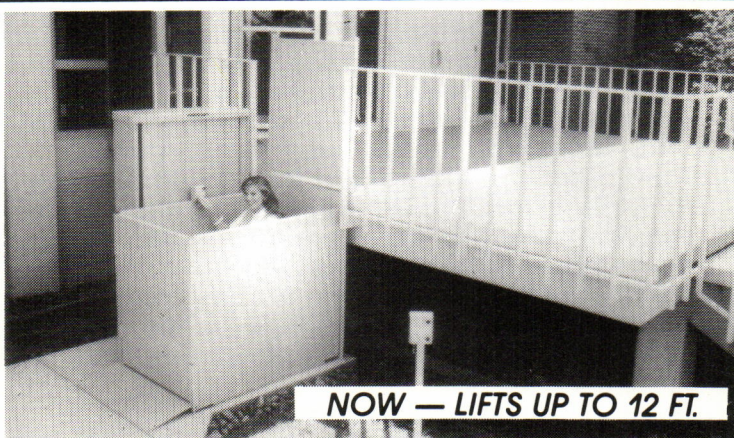

NOW — LIFTS UP TO 12 FT.

Whether you're modifying an existing building or designing a new one, accessibility to the handicapped is important. And PORCH-LIFT provides the simple, economical solution . . . indoors or outdoors. This safe vertical wheelchair lift platform anchors permanently beside the steps, using a minimum of space. Motor and mechanisms are enclosed. Runs on 110 volt current. Weatherproof finish. Choose from eleven models with varying lifting heights up to 144 inches. Shipped ready for installation.

WRITE FOR A FREE BROCHURE AND NAME OF THE DEALER NEAREST YOU.

AMERICAN STAIR-GLIDE CORPORATION

Dept. A1A-0189, 4001 East 138th Street, P.O. Box B
Grandview, Missouri 64030

Circle 93 on information card

How many ways to use cedar shingles? How many trees in a forest?



Architect: Bahri & Associates

The possibilities are as infinite as your own imagination. Because the enduring beauty of red cedar shakes and shingles adds striking warmth to any design you create.

To learn why red cedar shingles and shakes are such an excellent architectural solution, send for your free copy of our Architect's Cedar Library. It offers everything you need to know about cedar shake and shingles.



These labels on the bundles of Red Cedar shingles and shakes are your guarantee of Bureau-graded quality. Insist on them.

Red Cedar Shingle & Handsplit Shake Bureau

The recognized authority

Suite 275, 515-116th Ave. NE, Bellevue, WA 98004

Circle 95 on information card

ARCHITECTURE/JANUARY 1989 121

Products from page 121

is designed to be waterproof and to possess a high tensile strength. Polythane II is a slip-resistant, odorless, and non-carcinogenic system that the manufacturer suggests is ideal for parking garages, promenade decks, balconies, mechanical rooms, and other concrete floor areas.

*Polymer Plastics Corporation
Circle 436 on information card*

Pressed Tin Ceiling

Three Victorian designs for the pressed tin metal ceiling market are in stock from the Chelsea Decorative Metal Co. Two ceiling sheets feature a 6-inch or a 24-inch pattern, both in 2- x 4-foot sheets. A new cornice comes in a 4-foot section with a 7½-inch projection. The material is Tin Plate, which gives the sheets a shiny finish and is designed to be excellent for paint retention.

*Chelsea Decorative Metal Company
Circle 406 on information card*



Surface Water Detection System

The line of Water Alert subfloor, surface-water detection systems from Dorlen Products includes a new model, SS-3 (T), that does not require batteries, is capable of being remotely tested, and can interface with existing alarm security systems. The SS-3 (T) is designed to be used with Dorlen's PS-3 (T) Power supply tester. Sixteen SS-3 (T) detectors can be connected to a single PS-3 (T).

*Dorlen Products
Circle 437 on information card*

Facility Management System

The System 7000 Facility Management System uses Local Area Networks (LAN) and Distributed Control Units (DCU) to provide a control network of as few as 100 points or as many as 100,000 points, allowing for centralized command and control of many widely distributed processes.

The System 7000 is designed to operate in a foreground/background mode on a broad range of PC-based work stations. Supported PC's include the IBM XT, AT, and PS/2, as well as a number of similar computers operating under MS-DOS.

*Control Systems International
Circle 438 on information card*

HID Pendant Fixtures

SPI Lighting Inc. introduces the SMR series of pendant fixtures. The new series

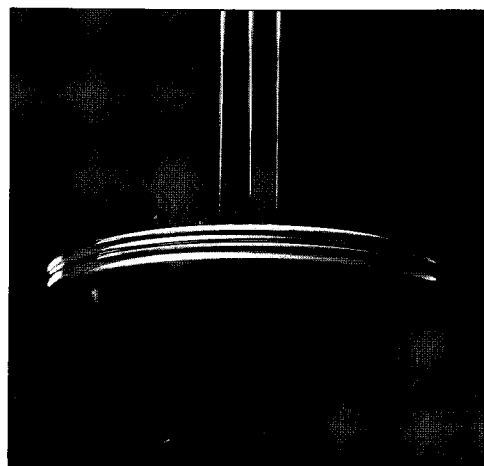

(above) features a diverse range of painted and plated domes, with both single and multiple stem designs available. Domes attach with a spring hook action for fast removal, and the reflector segments within the optical system are fabricated from prefinished 83-percent reflective specular aluminum sheet. The luminaires can be mounted to either accessible or non-accessible ceilings, and use either metal halide or high pressure sodium lamps ranging from 100 to 400 watts.

*SPI Lighting Inc.
Circle 408 on information card*

Clothes Hanger for Cubicles

The Anywhere hanger is designed for the cubicle, the small office, or the alcove

Redwood

Specifier's File

Free folio of literature for architects illustrates the beauty and performance of redwood.

Grades and Uses
Properties and Uses
Redwood Homes
Architectural Guide
Landscape Guide
Exterior Finishes
Interior Finishes
Rooftop Decks

Name _____

Firm _____

Address _____

City _____ State _____ Zip _____

Telephone _____

California Redwood Association
405 Enfrente Drive, Suite 200
Novato, CA 94948

Miller Redwood Company
The Pacific Lumber Company
Redwood Empire, Inc.

ASSOCIATE DIRECTOR OF FACILITIES

Under the general direction of the Director of Facilities the Associate Director of Facilities will be responsible for the overall administration of Capital Projects. Responsibilities will also include the conceptual development of preliminary program reports/plans for Construction Projects and preparation of background materials for the presentation of proposals for projects. The Associate Director will assist the Director in identifying, planning and scheduling routine and major Capital Projects. The Associate Director will perform other additional duties as may be assigned by the Director of Facilities. Position available as soon as possible. Salary range \$33,743-\$47,245. Requires a Bachelor's degree in an architectural discipline, plus a minimum of two (2) years' experience in Architectural Design involving a working knowledge of structural and mechanical systems. Professional architectural registration required. Supervisory level experience within the Facilities Management Division of a multi-building complex is desirable. Send resume and supportive materials by January 26, 1989 to:

Lawrence J. Reader, Vice President
Administration and Finance
Bole Administration Building
Glassboro State College
Glassboro, NJ 08028

Glassboro State College is an Affirmative Action/Equal Opportunity Employer. Applications from women, minorities and the handicapped are encouraged.

where there is no provision for hanging clothes. The hanger is made of enamelled steel and has a cushioned support angle that stays in place without marring or marking the surface. It hangs on any flat surface, from a desk edge to the top of a cubicle wall. The hanger is sold in packages of three. It won the bronze medal at an IBD-sponsored awards ceremony at Designer's Saturday in October in New York City last year.

Vogel Peterson Company
Circle 439 on information card

CREDITS

Grand Louvre, Paris (page 42). *Architect: I.M. Pei & Partners, New York City.* Design partner: I.M. Pei, FAIA. Management partner: Leonard Jacobson, FAIA. Architect in charge/design: Yann Weymouth. Director, Paris office: Norman Jackson. Design and administration: C.C. Pei, AIA. Director/construction: Arnaud Puvis de Chavannes. Contract documents/direction: Beatrice Lehman. Design detail documents: Chris Rand. Design and construction coordination: Masakazu Bokura. Pyramid, curtain wall design: Michael Flynn. Design architect, pyramid and courtyard: Andrzej Gorczynski. General design architect: Stephen Rustow. Design architect, pyramid, curtain wall: Yvonne Szeto. Design team: Vincent Wormser, Robert

Crepet, Claude Lauter, Ion Ghika, Svein Edvardsen, Francois Boillat, Elizabeth Cordoliani, Caroline Voss, Steven Elmets, Mihai Radu, Roland Nomikossoff, Elisabeth Mahon, Margaret Sobieski, Kristof Pujdak, Rijk Rietveld, Anna Mutin, Ian Bader, Marco Penanhoat. Associate architect: Michel Macary. Chief architect of the Louvre: Georges Duval. Pyramid structure design concept: Nicolet Chartrand Knoll Ltd. Pyramid structure construction phase site: Rice Francis Ritchie.

Bouygues, Versailles, France (page 48). *Architect: Kevin Roche, John Dinkeloo & Associates, Hamden, Conn.* Design team: Kevin Roche, Philip Kinsella, Stuart Gray. Consultants: R. Saubot, F. Jullien, W. Overcash.

Parliament House, Canberra, Australia (page 52). *Architects: Mitchell Giurgola, New York City, and Thorp Architects, Canberra.* Design architect: Romaldo Giurgola, FAIA. Project architect: Richard G. Thorp, ARAIA. Design coordinator: Harold S. Guida, ARAIA. Furniture and interiors coordination: Rollin La France. Art/craft coordinator: Pamille Berg. Site architect: Tim Halden Brown, FRAIA. Construction manager: Concrete-Holland Joint Venture. Structural engineer: Irwin Johnston & Partners. Associated con-

sulting engineers: Joseph R. Loring & Associates; Norman Disney & Young; W.E. Bassett & Partners Pty., Ltd.; Ledingham Hensby Oxley & Partners. Landscape architect: Peter G. Rolland & Associates. Interiors: Mitchell/Giurgola & Thorp Architects. Project planner: McLachlan Group Pty., Ltd. Cost planner: Rawlinson Roberts & Associates. Quantity surveyor: Donald Cant, Watts, Hawes & Lee Pty. Ltd. Civil engineer: Maunsell & Partners Pty., Ltd. Lighting: George Sexton Associates. Life safety: Rolf Jensen & Associates. Roofing: ARMM Consultants. Fountain consultant: Robert Woodward Pty. Ltd., Acoustical engineer: Louis A. Challis & Associates. Food services: Commercial Kitchen Consultants. Signs and graphics: Emergy Vincent Associates.

Shell Central Headquarters, The Hague, The Netherlands (page 60). *Architect: Skidmore, Owings & Merrill, San Francisco.* Associate architect: Luyt-De Iongh-Abels-Grasveld, The Hague. Project partner: John Merrill, FAIA. Design partner: Edward C. Bassett, FAIA. Project manager: Day Hilborn, AIA. Project designer: Steve O'Brien. Electrical and mechanical engineer: Verhoeven, Raadegevende Ingenieurs, B.V. Structural engineer: D3BN. Interior design: SOM and The Pfister Partnership, San Francisco. General Contractor: Wilma Bnew, B.V. □

DEAN, SCHOOL OF ARCHITECTURE UNIVERSITY OF CALIFORNIA, SAN DIEGO

The University of California invites applications and nominations for the position of Dean of Architecture on the San Diego campus. The position will become occupied on or about July 1, 1989.

The Dean will lead the development of a new School emphasizing the integrative nature of architecture and design in the broadest sense of the disciplines and maintaining the high architectural standards required of a top-ranked professional school. Research will be an important activity in the school. Interaction and collaboration between faculty in architecture and other disciplines will be encouraged. Current plans call for admission of the first students in the fall term of 1991. By the mid-1990's, the School is expected to enroll about 100 Master of Architecture students, 200 undergraduate liberal arts majors, and 10 doctoral students, and to have about 20 FTE faculty positions.

Candidates for the position of Dean should have a distinguished record of achievement and/or scholarship, teaching and administrative experience, as well as the vision, commitment, and leadership required to build a new school of the highest quality. Salary is commensurate with qualifications and experience.

UCSD is a major intellectual center with outstanding undergraduate and graduate programs. Despite its relative youth, the campus ranks fifth in the country in federal funding for research and first among public universities in the percentage of undergraduates who complete work for the Ph.D. It has a distinguished faculty, including numerous top scholars, prize winners, members of national academies, and holders of national awards in the arts.

San Diego is now the eighth largest city in the U.S., located in one of the fastest growing regions in the Sunbelt. UCSD has exercised a major influence on San Diego's growth over the past 25 years, guiding it into high-tech and biomedical corporate developments as well as remarkable rebirth of the arts. It is expected that UCSD's new School of Architecture will strengthen this leadership role in the future.

Applications (a resume and names of references) and nominations must be submitted by **February 15, 1989**, to:

Dr. William McGill
Chair, Search Committee
Office of Academic Affairs, Q-001
University of California, San Diego
La Jolla, CA 92093-0001

The University of California, San Diego
is an Affirmative Action/Equal Opportunity Employer

The heating system without cold spots.

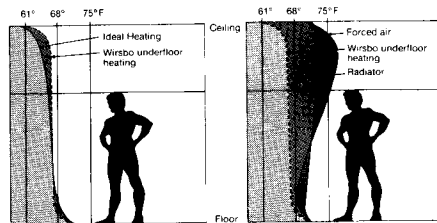

Traditional heating systems have two things in common — hot spots and cold spots. Either its too hot near the heat outlet or too cold at floor level, near an outside wall, or maybe in the center of a room. Here's a logical solution: put the heat where the cold is with an under floor radiant heating system from Wirsbo. It delivers uniform warmth from floor to ceiling and wall to wall.

For wood or concrete floors: The system radiates its warmth from the entire surface area of the floor. Installation is quick, easy, and generally less or equal to the cost of installing other heating systems.

For residential or commercial buildings: Under floor heating is almost always the most effective method of heating a building.

Your choice of heat source: Usually, the Wirsbo heating system only requires 90° to 110° water. Any heat source can be used, from oil and gas to solar and solid fuels.

Heat is easily controlled: Each loop of cross-linked polyethylene tubing can be actuated by an individual thermostat. Regulator valves balance a room's heat requirements with flow rates of water through the tubing.

Get the complete story: Your local Wirsbo dealer has details on the many benefits of this complete under floor heating system. Call or send for a brochure or better yet, ask for an installation proposal on your next heating job.

Wirsbo Company
1026 E. Riverside Blvd.
Rockford, IL 61111
(815) 282-1141
For more information, see:
Sweets byline #15840.



Advertisers Service Section



Phantom Sprinkler Heads Star Sprinkler Corp.'s Phantom decorative sprinkler heads feature a low profile design and close, clean fit. Colored cover plates blend in with ceiling treatment. Write for the 4 page, 4-color catalog. Circle No. 311

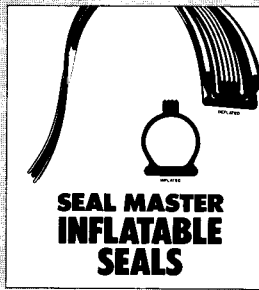

Seal Master Corporation of Kent, Ohio designed and manufactured inflatable rubber seals for the flood gates at Washington Harbour on the Potomac River. Circle No. 317

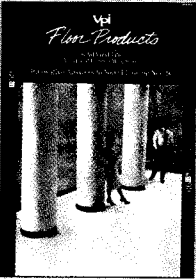

Tile and Wall Bases Solid vinyl tile and both vinyl and rubber wall bases are shown in a 16-page, four-color brochure with pattern samplings and technical data from VPI Floor Products Division.

VPI's Series 300 Vinyl and Series 700 Rubber Wall bases are featured with photographs and color swatches.

Circle No. 309



Fire-Rated Exit Devices With the introduction of their new Series 3000 fire-rated exit devices, Adams Rite Manufacturing Co. now provides a full range of UL A-label and general life safety exit hardware.

The Series 3000 devices feature brass, bronze or stainless steel full-polished and satin finishes. Circle No. 303



1989 Building Products Catalog Updated manufacturers catalog from Georgia-Pacific features information on eleven product categories such as decorative panels, siding, structural wood panels, insulation, and more.

Two new sections detail hardwood plywood and moulding/millwork. Circle No. 307

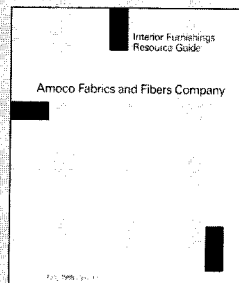

Amoco Fabrics and Fibers Co.'s Interior Furnishings Resource Guide features a complete listing of contract products made of polypropylene yarns. The guide lists manufacturers, styles, colors and specification information. Circle No. 315

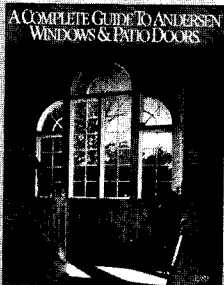

Commercial Product Catalog A new catalog from Andersen Windows pictures conservative and stylish offices; curtainwall and creative window combinations; standard and custom-sized units; new construction and renovation, technical data, specifications, and performance ratings. Andersen Windows, Dept. EH, Bayport, MN 55003

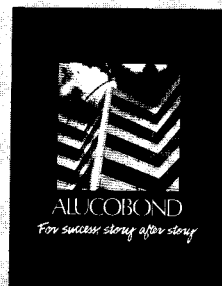

Updated Catalog A full color catalog from Alucobond Technologies Inc., provides information on Alucobond material and includes examples of projects along with technical data and specification information. Alucobond is used for new building projects and for retrofit applications. The catalog also includes examples of interior applications. Circle No. 301

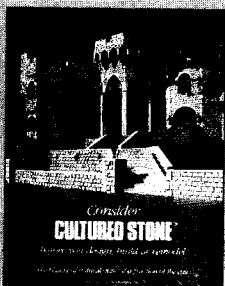

Cultured Stone Catalog A brochure from Stucco Stone Products Inc. illustrates the variety of uses for the manufacturer's line of stone products and shows the company's new Cultured Stone® brand line, including Buff Cobblestone and Wisconsin Weather-Edge. Brochure contains information on warranties, availability, packaging and accessories. Circle No. 305



H. H. Robertson's new 20-page brochure describing Formawall metal/glass curtain wall systems is now available. Photos, drawings, and an in-depth discussion of the system allow the specifier to evaluate the premier curtain wall system available today. Circle No. 313

MAIN OFFICE

1735 New York Avenue N.W.
Washington, D.C. 20006
(202) 626-7300

James P. Cramer

Group Publisher

Jesse Sims

Production Manager

Bernard F. Kroeger

Circulation Manager

Kelly L. Collins

Assistant Circulation Manager

Nancy Perri

Assistant to the Publisher

Bob Kliesch

Publisher

ADVERTISING SALES OFFICES

New York/Connecticut (215) 254-9800

Michael J. Davin
994 Old Eagle School Rd., Suite 1010
Wayne, Pa. 19087

New England (404) 980-6740

James A. Bauschka
6520 Powers Ferry Rd., Suite 200
Atlanta, Ga. 30339

Philadelphia/Pittsburgh (215) 254-9800

George T. Broskey, Eastern Sales Manager
994 Old Eagle School Rd., Suite 1010
Wayne, Pa. 19087

Southeast (404) 980-6740

James A. Bauschka
6520 Powers Ferry Rd., Suite 200
Atlanta, Ga. 30339

Midwest (312) 527-1055

Jack E. Bergren
Barbara Mitchel
1337 The Merchandise Mart
Chicago, Ill. 60654
Jack E. Bergren (414) 786-4286
2530 Coach House Dr.
Brookfield (Milwaukee) Wi. 53005

Southwest (314) 569-3210

Richard Grater
1466 Summerhaven
St. Louis, Mo. 63146

West/Northwest (619) 450-6462

James A. Anderson, Western Sales Manager
5830 Oberlin Dr., Suite 300
San Diego, Calif. 92121

Europe 0211-65-2031

Erich Hillerbrand
Media + Marketing Services
Eitelstrasse 32
4000 Dusseldorf 30
West Germany

Canada (416) 833-6200

Donald C. Fenn
148 King Road E.
King City, Ontario LOG 1KO CANADA

Circle No.	Page No.
47	AIA Convention 32
	AIA Foundation 112
	AIA Sales (C Reg.) 117
91	Above View 120
13	Adams Rite Manufacturing 13
93	Amer. Stair-Glide 121
15	Andersen Corp. 14-15
	Anthro 26
1	Armstrong Cov. 2-p.1
3	Armstrong 2-3
5	Armstrong 4-5
81	Avis (E & C Reg.) 116
99	California Redwood Assoc. 122
55	Castlegate Entry Systems ... 38-39
17	Chicago Faucet Co. 16
87	Emhart Russwin Corp. 118
41	Fry Reglet 28
39	General Electric 27
111	Georgia-Pacific Cov. 4
101	Glassboro State 122
71	Glen Raven 107
51	Grace, W.R. 36
63	Hewlett Packard 93
45	Intergraph 31
73	ISICAD 108
67	J.P. Stevens 98
75	JDL 111
9	John Wiley 10
109	Kawneer Cov. 3
59	Kawneer 84-85
97	Kroy 35
61	LCN Closers 86
65	LOF 94
49	Louisiana Pacific 32A-32F
69	Manville 102
35	Marvin Windows 24-25
43	Pittsburgh Corning Corp. 29
33	Plan Hold 22-23
79	Pozzi Windows 115
95	Red Cedar 121
57	Rixson Firemark 40
19	Spacesaver Corp. 21
21	Spacesaver Corp. 21
23	Spacesaver Corp. 21
25	Spacesaver Corp. 21
27	Spacesaver Corp. 21
29	Spacesaver Corp. 21
31	Spacesaver Corp. 21
7	Steelcase 8-9
85	Super Spec. (E Reg.) 117
89	Surveyors Supply Co. 120
107	Texas A&M Univ. 128
103	Univ. of Calif., San Diego 123
113	VPI 19
53	Valli & Colombo 37
11	Velux-America Inc. 11
83	Western Concrete Masonry Assoc. (W Reg.) 116-117
105	Wirsbo 123

Did you miss valuable information offered by advertisers in last month's issue of ARCHITECTURE?

The manufacturers listed below and on the following page were advertisers in last month's issue who are anxious to provide you with their latest product information and literature for your planning needs. To receive this helpful information, just circle the appropriate numbers on the adjacent self-addressed, postage-paid response card.

AT&T Technologies. Premises Distribution System: A single wiring system that meets all your client's communications needs. *Circle No. 112*

Adams Rite Manufacturing. Adams Rite Series 3000 exit devices meet stringent fire codes, and do it with imagination and flair. *Circle No. 16*

Alucobond Technologies. Retrofit with Alucobond materials and give any old building a miraculous new lift. *Circle No. 56*

American Gas Assoc. Send to receive full details on advanced gas cooling equipment. *Circle No. 116*

American Plywood Assoc. Check out our entire library. Send for eight free brochures today. *Circle No. 96*

American Stair Glide Corp. PORCH-LIFT vertical wheelchair lift is a safe, simple solution to architectural barriers. Send for a free brochure. *Circle No. 68*

Amoco Fabrics & Fibers. Perma Color™ warranted commercial carpets come in over 150 beautiful colors. Send for more information. *Circle No. 82*

Andersen Corp. Unlimited design potential with Andersen Perma-Shield® Flexi-frame® windows.

BASF. Creating a legacy of leadership in fiber design. Send today for a free brochure. *Circle No. 6*

Bethlehem Steel Corp. Send for more information on Galvalume™ Sheet and its many applications. *Circle No. 50*

Brite Vue Glass Systems Inc. When the toughs get going VigilPane® Plus out-toughs them all. Send for complete information. *Circle No. 166*

Burns & Russell Co. Spectra-Glaze® factory glazed concrete wall systems provide an extraordinary focus on design flexibility plus low initial life cycle costs. Send to receive more information. *Circle No. 118*

CNA. It pays to look high & low for your liability protection. CNA—For All the Commitments You Make.® *Circle No. 178*

California Redwood Assoc. Free folio of literature for architects illustrates the beauty and performance of redwood. *Circle No. 48*

Castlegate Entry Systems. With new Symphony™ Steel Entry Systems from Castlegate, you get the perfect harmony of steel and style. *Circle No. 32*

Chicago Faucet Company. Send for our brochure highlighting two collections of our decorative faucets and fittings for bath, kitchen, and bar installations in a 12-page color catalog. *Circle No. 2*

CPG/Clearprint. Try Clearprint vellum and see what you've been missing. Send today for further information. *Circle No. 74*

Columbus Coated Fabric. Guard® Wall-covering presents Deidre, a unique embossing that evokes the "tailored" look of a classic fabric weave. *Circle No. 100*

DPIC Companies. Professional Liability Insurance for design professionals. Send today to receive further details. *Circle No. 10*

EBCO Manufacturing Co. You'll find a full line of Oasis® Radii water coolers and fountains designed to fit your design. *Circle No. 72*

EFCO Corp. Send to receive performance specifications regarding the Shadowline™ and other EFCO windows. *Circle No. 60*

Emhart Russwin Corp. Design Freedom—Russwin Style. Russwin Designer Bolt™ Exit Devices give you more standard solutions to your custom design creation. *Circle No. 106*

Forrer Chemical. Water? No problem. Seal out water with Dry-Block® integral water-repellant system. *Circle No. 52*

Fry Reglet. Fry's Aluminum Architectural moldings add a third dimension to your designs. Send today for more information. *Circle No. 84*

General Electric. The new Monogram built-in refrigerator has something new built in—a dispenser. Send to receive more information. *Circle No. 102*

Georgia-Pacific. Send for more information on Dens-Shield™ Tile Backer from GP. It's not just light . . . it's water tight. *Circle No. 24*

Glen Raven Mills. Improve business with Sunbrella® Fabric—the #1 acrylic canvas in America. Send for more information. *Circle No. 54*

Grace, W. R. UL-classified Monokote Fireproofing meets or exceeds all recommended levels of performance. *Circle No. 12*

H. H. Robertson Co. When your roof just has to last—use our Total Performance Roof—protected by Versacor® PF. Send for a free copy of our Independent Test Results brochure. *Circle No. 14*

Haws Drinking Faucet Co. Haws drinking fountains and electric water coolers are the best you can buy. Send today to receive a free copy of our new catalog. *Circle No. 66*

Hewlett-Packard. The versatile line of HP Draft Pro plotters start at just \$3995. Send for complete information and a sample plot. *Circle No. 132*

For product information and literature from advertisers in this issue of ARCHITECTURE, circle the appropriate numbers appearing on the advertisements.

Houston Instruments. For nearly three decades, companies have drawn on Houston Instruments; now it's your turn. Send to receive more information.

Circle No. 140

ISICAD. The Cadvance/dBase connection. A new meaning for Cadd: "Computer-Aided Decisions."™ Send for a free brochure.

Circle No. 114

Intergraph. Send today for more information on Intergraph's advanced system for architectural design, presentation, and production.

Circle No. 30

Ioline. Introducing Ioline LP 3500 D-size pen plotter. The new standard in ease of use.

Circle No. 160

JDL. Use the JDL 8506L + plotter/printer and get precision 2-D or 3-D color plots on A- to C-size media.

Circle No. 130

Julius Blum Inc. JB Glass Railing . . . The clear choice. Send for our complete catalog #14.

Circle No. 76

Kansas State University. Opening for Dean at the College of Architecture and Design. Deadline for applications is January 16, 1989.

Circle No. 172

Kawneer Co. Inc. High-span entrance system with the structural strength and esthetic appeal of a rounded mullion—Trusswall, available in various colors and webbing.

Circle No. 26

Keuffel & Esser Co. For high-performance plotting insist on Comstoc® Plotter Media. Send for more information.

Circle No. 46

Kimball Artex. Brookside, Carrington, Lorado, Beaumont, and Avenue—Chairs that are designed to sit around a long, long time.

Circle No. 88

Kroy Inc. With a Kroy 360™ lettering system, you can look as good as you are. Send for more complete information.

Circle No. 58

Libbey-Owens-Ford. Eclipse® reflective glass offers incredible design freedom to create building facades. Send for product literature.

Circle No. 108

Lutron. Send today and receive a free Guide to Dimming Low Voltage Lighting.

Circle No. 180

Manville-Commercial Roofing. For 130 years, Manville has been manufacturing roofs that let building owners laugh at the weather. Send to receive more information on our roofing system.

Circle No. 64

McNichols Co. Gratings! All styles—all metals. 24 hour shipment. Send for a free catalog.

Circle No. 150

Monsanto Chemical Co. Laminated glass lets you put in the windows you want, and keep out the sound you don't. Send to receive a free copy of our Acoustical Glazing Design Guide.

Circle No. 62

Monsanto Chemical Co. Ultron® 3D nylon carpet fibers from Monsanto—truly everything you'd expect. And more!

Circle No. 110

Morton-Thiokol Inc. Joint Design Digest: LP® polysulfide-based joint sealants for metal curtain wall, concrete/masonry construction.

Circle No. 104

Musson Rubber. Disc-O-Tile™ Safety rubber flooring and Disc-O-Tred™ Safety stair treads. Meets ASTM-E84 flame spread rating of 25 or less.

Circle No. 152

National Concrete Masonry Assoc. Concrete masonry insulated walls deliver high thermal performance and won't rust, rot or burn.

Circle No. 94

Pella. Send today to receive the current literature on new Pella Clad Colors.

Circle No. 40

PEMKO. Pemko announces PemKote™; an incredible skid and corrosion-resistant stainless steel metallizing process. Send for a free sample today.

Circle No. 70

Pittsburgh Corning Corp. Don't be misled by incomplete information. Get the facts about glass block fire ratings. Send for the free brochure "Glass Block Fire Ratings Facts."

Circle No. 36

Pittsburgh Corning Corp. Second Annual Architectural Design Awards Competition. Send for full details, submission requirements, and official entry forms.

Circle No. 38

Point Line Cadd. Send to receive the product literature on Point Line Cadd.

Circle No. 120

Point Line Cadd. Send to receive name of the nearest dealer.

Circle No. 122

Point Line Cadd. Send to receive a coupon redeemable for a free Architectural Cadd Symbols Disk with the purchase of Cadd module.

Circle No. 124

Pozzi Windows. Imagine 4,000 window designs. send for detailed full-color product literature and dealer information.

Circle No. 164

Red Cedar Shingle. Send for your free copy of Architect's Cedar Library and learn why red cedar shingles and shakes are an excellent architectural solution.

Circle No. 34

Rhode Island School of Design. Full-time Faculty Positions—Senior Faculty Position/Potential Dept. Head and Junior Faculty Position/Design and Building Technologies. Applications postmarked no later than February 1, 1989.

Circle No. 176

Rixson-Firemark. Our surface closers combine a precise door control mechanism with clean, geometric lines and a durable metal cover for uncompromising plated finishes.

Circle No. 128

Schlumberger Graphics. Our new 18 Series pen plotters have been developed to work the way you work. Send to receive more information.

Circle No. 126

Seal Master Corp. Seal Master Corporation of Kent, Ohio designed and manufactured inflatable rubber seals for the flood gates at Washington Harbour on the Potomac River.

Circle No. 44

Sentry Electric. Send for details on the Light Classics and the name of the nearest Sentry Electric sales representative.

Circle No. 80

Shakertown. Shakertown Fancy Cuts®. Send for a free design kit.

Circle No. 98

Sloan Valve Company. Sloan flushometers offer proven, reliable service with built-in quality at an affordable price.

Circle No. 146

Sotheby's. English Neo-Classical Architecture by Damie Stillman—two volumes in a slip-case—\$295.00.

Circle No. 162

Southwall Technologies. Heat Mirror™—the only insulating glass that can offer "Total Performance."

Circle No. 18

Space Saver Corp. Your source for planning high-density storage systems in the library environment.

Circle No. 90

Spectrum Glass Products. Introducing the Duralec Structural Space Glazing System. A simple but innovative solution to the specific problems of glazing without outside stops.

Circle No. 86

Spectrum Glass Products. Offers a wide array of high-performance glass products that could be instrumental in resolving your fenestration problems.

Circle No. 92

Star Sprinkler. Sprinkler heads designed to blend quietly with their surroundings.

Circle No. 144

Steelcase. When you buy our desks, cabinets and bookcases, chances are good their paint job is almost indestructible.

Circle No. 8

Sternberg Lanterns. When you consider design options, authentic detailing, structural performance, illumination selections, Sternberg is the outstanding choice! Send for our catalog. *Circle No. 154*

Stucco Stone. With lightweight Cultured Stone® you can achieve the beauty of natural stone at a fraction of the cost. *Circle No. 170*

Thermo Materials Inc. Real Copper at a fraction of the cost! "Aging Copper" gives you beauty, design flexibility, and economy. Send today for more information. *Circle No. 28*

Thrislington Cubicles. Send for our new brochure describing the Combat Range of Thrislington Cubicles with FRP glass fiber panels, and the Lotus Range with Formica® laminates and Kinney® wall coverings for bathroom partitions, dressing room and shower units. *Circle No. 142*

U. C. Davis Medical Center. Opening for Associate Architect Sr. Facilities Requirements Analyst. Send for application. *Circle No. 174*

United States Aluminum. United States Aluminum's Series 3100 Silicone Curtain Wall creates beautiful undisturbed architectural reflections. Send for complete information. *Circle No. 156*

United States Gypsum Co., Ext. Durock. Enduring beauty in stucco-looks or textures in a spectrum of creative colors. Do it all, once and for all with DUROCK™ Exterior Finish Systems. *Circle No. 22*

Vinyl Plastics, Inc. Now, when you think sheet vinyl flooring think VPI. Custom Royale™ and Sure-Trac™ ... lasting beauty on a roll. *Circle No. 78*

Valli & Colombo Inc. The Valli & Colombo tradition of quality and craftsmanship has found expression in three superb collections of designer hardware. Send to receive more information. *Circle No. 168*

Versacad. With the combination of VersaCad and Dimensions 3D on today's powerful Macintosh computer, drafting and design are integrated as never before. Send for more information. *Circle No. 134*

Vistawall Architectural Products. Vistawall's revolutionary new system, More:Front, will color the way you think about storefronts. Send for more information. *Circle No. 158*

Wind-2 Research Inc. Fully integrated financial management and accounting software designed specifically for architects and engineers. Send for product or price information. *Circle No. 136*

Wirso Co. Send today and find out all the benefits of Radiant floor heating. *Circle No. 138*

TEXAS A&M UNIVERSITY Head, Department of Architecture

The College of Architecture seeks an acknowledged leader, with a record of significant professional accomplishments, to direct the teaching and research work of the Department of Architecture. The Department currently offers three degrees programs: A Bachelor of Environmental Design, a Master of Architecture, and a PhD in Architecture. There are 57 faculty in the Department, which is the major component of the College of Architecture (other departments include those devoted to Landscape Architecture, Urban and Regional Planning, and Construction).

Preference will be given to candidates with research and administrative experience who hold advanced degrees. A PhD or equivalent doctorate would be an advantage. The College has an overall emphasis on design strategy, and the realization of "Health by Design," with the support of a Visualization Laboratory and other initiatives in the creative use of computer-aided design. Candidates should be able to demonstrate that they are leaders within the architectural profession in their elected fields of specialization, and have a national or international reputation. Evidence of published scholarly work or professional endeavors must be submitted with applications.

Salary is competitive. The College is committed to the recruitment of women and minority candidates. Deadline is 28 February 1989. Review of applications will commence 1 March 1989. Position is available from 1 September 1989. Please send nominations and/or applications to:

Dr. Malcolm Quantrill
Distinguished Professor of Architecture
Chair, Architecture Department Search Committee
College of Architecture
Texas A&M University
College Station, Texas 77843-3137
Tel: (409) 845-1221.

DON'T KEEP IT TO YOURSELF!

ORDER REPRINTS

of articles that have appeared in

ARCHITECTURE.

Minimum Print Order:

100 copies

Call or write for a price quotation:

(202) 626-7451

Cynthia Kellar Duck
1735 New York Avenue, NW
Washington, DC 20006

JUST A FEW SIGNS OF OUR BUILDING SUCCESS WITH DENS-GLASS® GYPSUM SHEATHING.

A Lot Of Big Names Have Discovered The Big Benefits Of Dens-Glass.

The problems of wind, weather and dampness have become virtually obsolete with Dens-Glass® gypsum sheathing from Georgia-Pacific. This revolutionary gypsum sheathing stands up to job-site weather hassles and hazards like no other product on the market.

When exposed to weather, ordinary paper-faced gypsum sheathing can delaminate, sag and warp, resulting in expensive replacement costs. Dens-Glass, however, is manufactured with unique fiberglass mats on the front and back of a water-resistant core. This

design makes it the only gypsum sheathing panel durable enough to offer a six-month limited warranty** against the weather's damaging effects. And since Dens-Glass contains no paper, it provides unmatched fire resistance as well.

Because of its unique properties, Dens-Glass has become the sheathing of choice for a large number of

commercial architects and contractors. On building projects for big names such as Macy's, IBM, Lechmere, Holiday Inns, and Embassy Suites, the dimensional stability and resiliency of Dens-Glass has been perfect for a variety of exterior applications.

Discover what a lot of astute architects and builders already know: Dens-Glass is the absolute best at making the problems associated with exterior sheathing obsolete. It's a sure sign of your concern for superior, innovative building design—and that makes you look good, as a superior, innovative building designer.

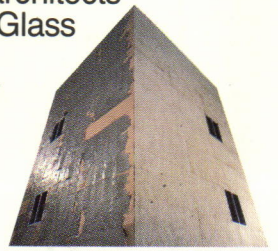

The long-term effects of weather on conventional gypsum sheathing, left; and on Dens-Glass, right.

For complete Dens-glass exposure test results, product information, warranty, samples and a brochure outlining Dens-Glass application details on a variety of recent projects, call 1-800-225-6119. In Georgia, call 1-404-521-5716. Or write: Georgia-Pacific, Dept. A-DGP, P.O. Box 2808, Norcross, Georgia 30091.

Georgia-Pacific
MORE POWER!
To you!

*ASTM E119 Fire Test of Building Construction and Materials; ASTM E48 Surface Burning Characteristics of Building Materials.
MORE POWER TO YOU! is a trademark, and Dens-Glass is a registered trademark, of Georgia-Pacific Corporation. ©1988 Georgia-Pacific Corporation. All rights reserved.
** See limited commercial warranty, available from Georgia-Pacific, for its terms, conditions and limitations.

Circle 111 on information card

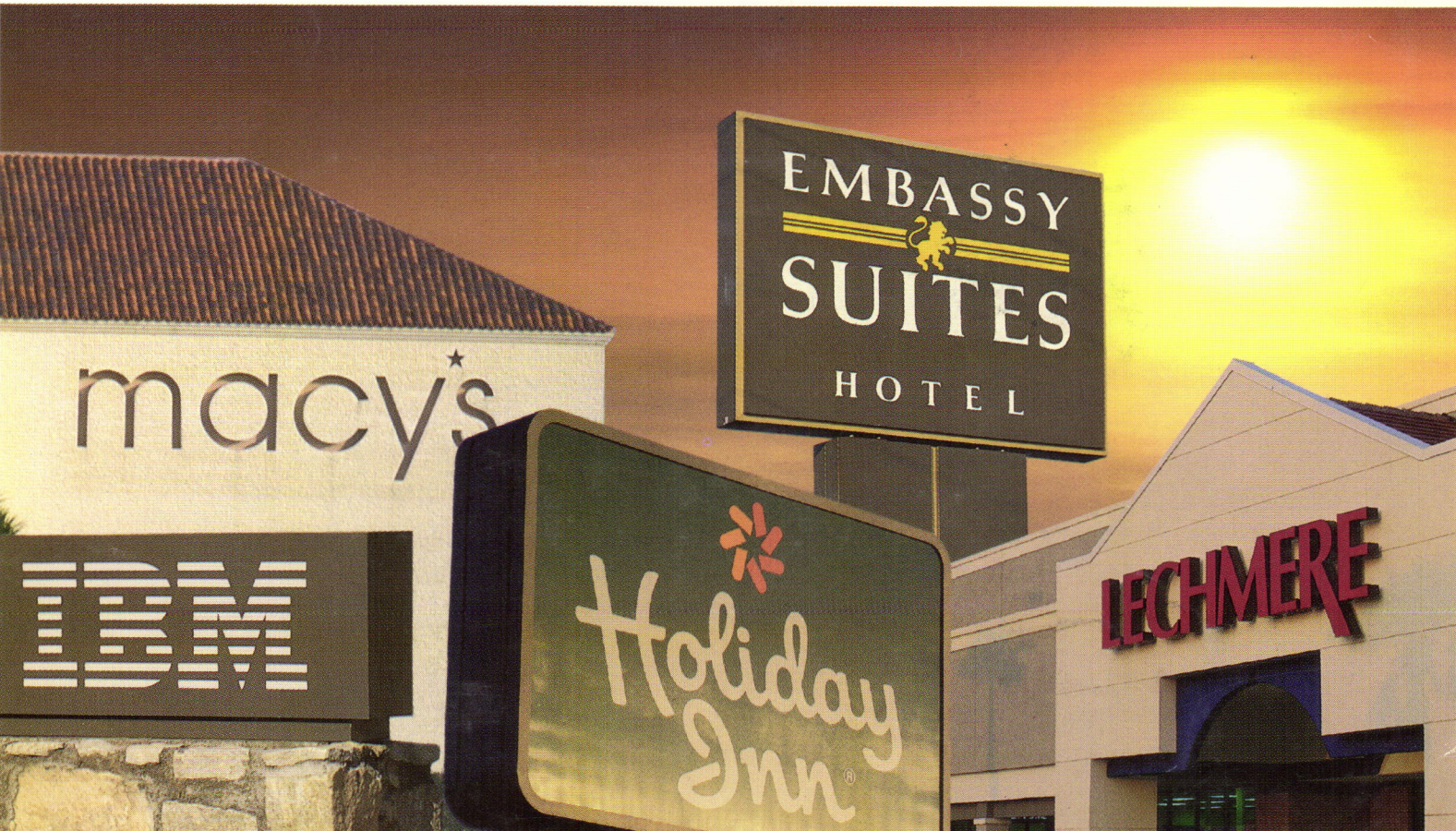

Dens-Glass Gypsum Sheathing

- DESCRIPTION:**
Water-resistant gypsum core, fiberglass mats front and back.
- SIZES:**
1/2" and 5/8" thick; 4' x 8', 4' x 9', 4' x 10'.
- APPLICATIONS:**
Sheathing; soffits; exterior ceilings. Ideal substrate for exterior insulation finish systems and other exterior finishes.
- INSTALLATION:**
Can be applied horizontally or vertically.
- FIRE RESISTANCE:**
Independent tests produced zero flame spread; zero smoke developed.*
- WARRANTY:**
6 month limited commercial warranty**

A FEW REASONS WHY A 350 TUFFLINE ENTRANCE LIVES UP TO ITS NAME.



AND A FEW REASONS WHY IT HAS TO.

350 Tuffline. Educational tool for the 80's. And beyond. For new and replacement doors at schools, college campuses, and in other high traffic and abuse-prone installations. Tuffline entrances are all their name says they are. Tested in the educational market,

Tuffline is offered as single-acting entrances in both singles and pairs to 8' heights. With durable butts, pivots, closers and panics to resist vulnerability and increase security when school's out. And design options such as Paneline® to customize without compromise.

Tuffline. At the head of the class.

Kawneer

For technical specifications contact: Kawneer Company, Inc. Department C, Technology Park-Atlanta, 555 Guthridge Court, Norcross, GA 30092

Circle 109 on information card