

# ARCHITECTURE

*Incorporating Architectural Technology December 1989 Six Dollars*

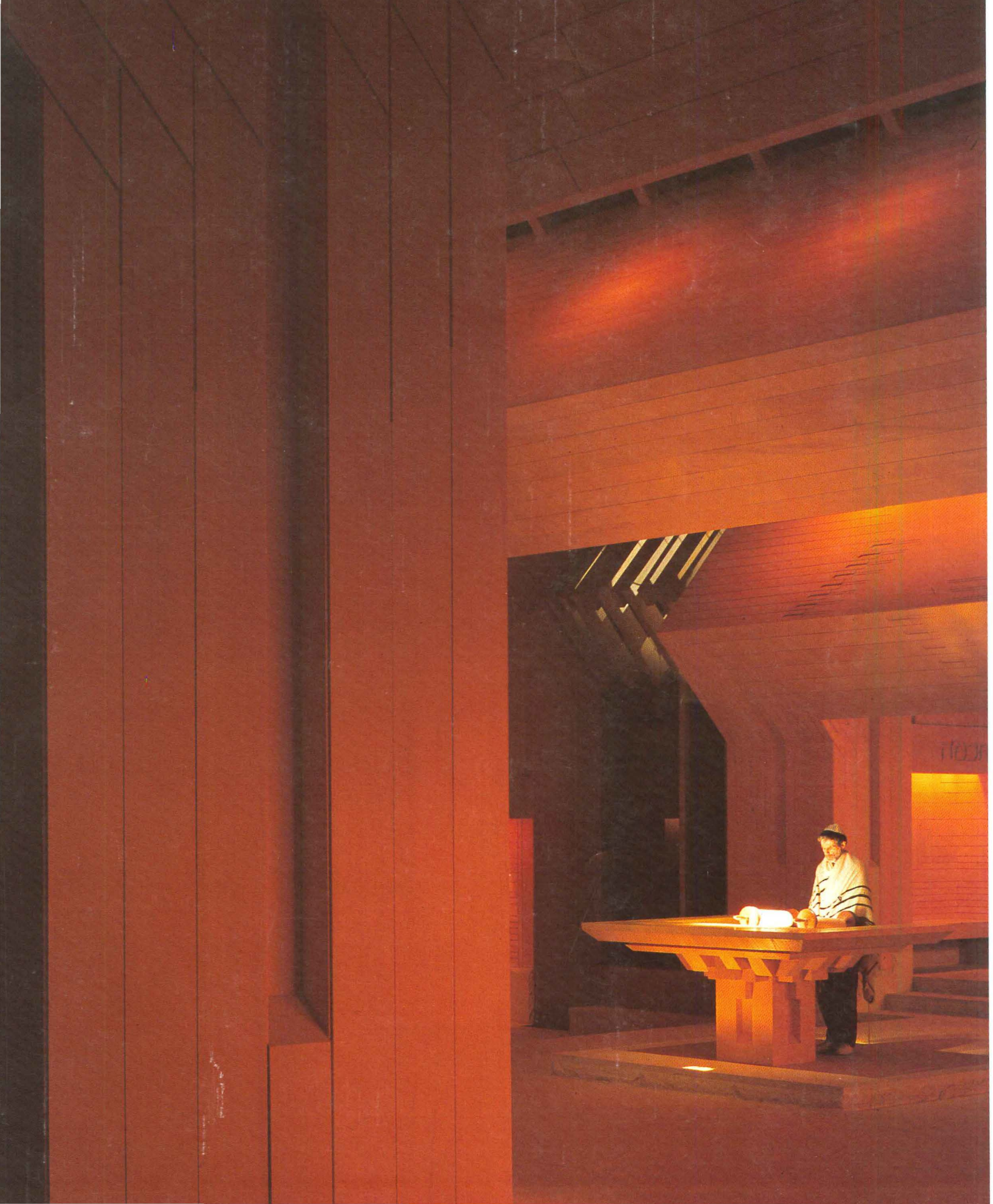



# GEOMETRIX

**TAKE A CLOSER LOOK.** You'll see a new

way to define and direct space with the Geometrix Ceiling

System. The shadow in this reveal, along with the shadow-tone

panel graphics, are all based on the same 1/8" dimension.

The result is an uninterrupted pattern, where suspension

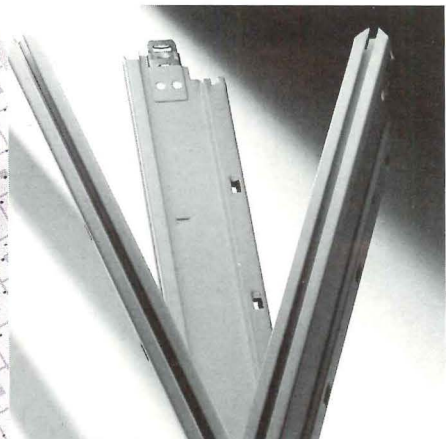
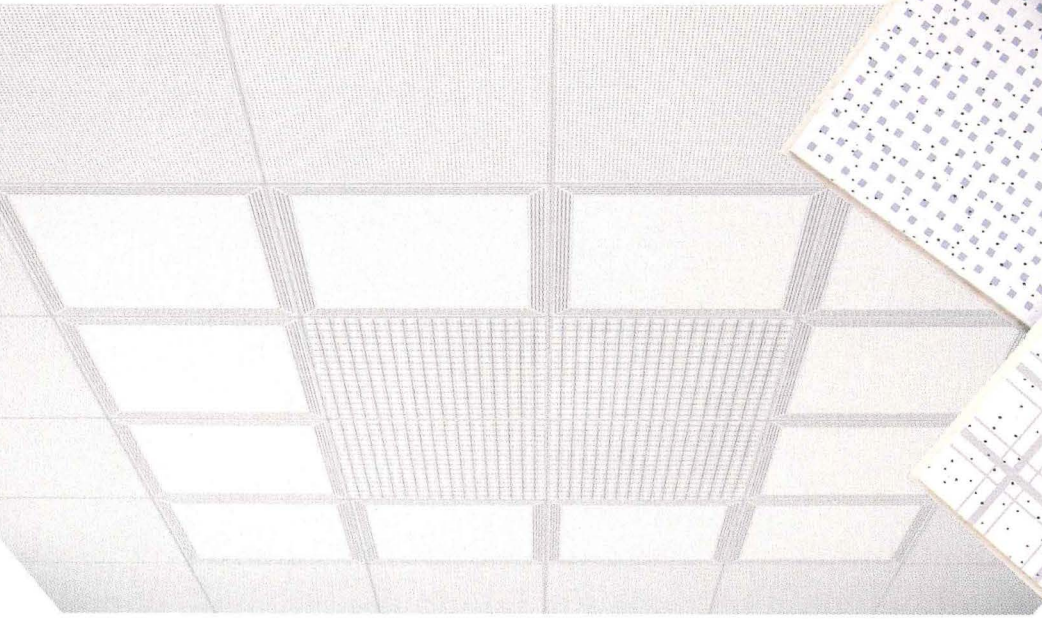

becomes one with any combination of points, lines and squares you create. This is geometry where every solution is possible. Write USG Interiors, Inc., 101 S. Wacker Drive, Chicago, IL 60606-4385. Dept. A1289  
Circle 2 on information card

Interiors from every angle.™

**USG Interiors, Inc.**

Showroom at IDCNY  
Copyright 1989, USG Interiors, Inc.



# CONTENTS

## Features: '80s Retrospect

### Three Essays:

#### A Feel-Good Decade

By Andrea Oppenheimer Dean

#### Intellectual Drift, Better Buildings

By Robert Campbell, AIA

#### An Imagery of Consumption

By John Pastier

### Six Evaluations:

#### Stuttgart, After the Hoopla

Neue Staatsgalerie, James Stirling Michael Wilford & Associates.

By Charlotte Ellis

#### Demanding Showcase

High Museum, Atlanta, Richard Meier & Associates.

By Allen Freeman

#### Attention to Its Users

Successful programming H.E. Butt headquarters in San Antonio.

By M. Stephanie Stubbs

40	<b>Exemplary Public Housing</b> Charleston's scattered site, contextual approach. By Michael J. Crosbie	58
44	<b>PPG's Unpopulated Places</b> Burgee/Johnson's office complex in Pittsburgh at street level. By Lawrence Houstoun Jr.	60
45	<b>'Near Magical,' Intimate Sequence of Spaces</b> Michael Graves's San Juan Capistrano Library. By John Pastier	64
46	<b>Three New Buildings:</b> <b>'The Beauty of Holiness'</b> Gates of Grove Synagogue, Norman Jaffe, architect. By Andrea Oppenheimer Dean	68
50	<b>'Architectural Chessboard'</b> House overlooking the Hudson, Charles A. Platt, architect. By Michael J. Crosbie	74
54	<b>Glittering and Controversial</b> 75 State Street, Boston, Graham Gund and SOM/Chicago. By Robert Campbell	76

Right, scattered-site public housing in Charleston, S.C. (page 58).



Left, Neue Staatsgalerie in Stuttgart by James Stirling Michael Wilford (page 46).

Deborah K. Dietsch, *Editor in Chief*

Carole J. Palmer, *Executive Art Director*    Andrea Oppenheimer Dean, *Executive Editor*    Allen Freeman, *Managing Editor*

Michael J. Crosbie, Lynn Nesmith, Forrest Wilson, *Senior Editors*; Douglas E. Gordon, M. Stephanie Stubbs, Elena Marcheso Moreno, *Technical Editors*; Amy Gray Light, *Associate Editor*, Karen Collins Harris, *Assistant Editor*

Amy Leonardi, *Design Assistant*; Timothy B. McDonald, *Technical Illustrator*

Robert Campbell, AIA, Lawrence W. Cheek, Hon. AIA, David Dillon, Robert A. Ivy Jr., AIA, John Pastier, Bea Sennewald, AIA, Karen Hass Smith, Marguerite Villecco, Oliver R. Witte, *Contributing Editors*  
Beverly Russell, *Editorial Director*

Maggie Cuomo, *Circulation Manager*, Rosemary A. Welding, *Production Manager*, Nancy A. Perri, *Assistant to the Publisher*  
Robert G. Kliesch, *Publisher*

ARCHITECTURE (VOL. 78, NO.12), incorporating Architectural Technology, publication number ISSN 0746-0554, the magazine of the American Institute of Architects, is published monthly by BPI Communications, Inc., a subsidiary of Affiliated Publications, Inc., at 1515 Broadway, New York, NY 10036. Postmaster, please send changes of address to ARCHITECTURE, P.O. Box 2063, Marion, OH 43305-2063. Individual subscriptions: U.S. and its possessions: \$39 for 1 year, \$57 for 2 years, \$74 for 3 years. Canada: \$45 for 1 year, \$65 for 2 years, \$84 for 3 years. Foreign: \$63 for 1 year, \$105 for 2 years, \$147 for 3 years. Single copies, \$6 each (except for May and September issues, which are \$12). Publisher reserves the right to refuse unqualified subscriptions. For subscriptions write: Circulation Department, ARCHITECTURE, P.O. Box 2063, Marion, OH 43305-2063; 1-800-347-6969, 8:30 AM - 8:30 PM EST, Mon.-Fri. Allow 8 weeks. Quotations on reprints of articles available. Editorial offices are located at 1130 Connecticut Ave., N.W., Suite 625, Washington, DC 20036. Microfilm copies available from University Microfilm, 300 North Zeeb Rd., Ann Arbor, MI 48106. Second Class Postage paid at New York, NY, and additional mailing offices. ©1989 by Billboard Publications, Inc. Opinions expressed by the editors and contributors are not necessarily those of AIA. The drawings, tables, data, and other information in ARCHITECTURE have been obtained from many sources, including government organizations, trade associations, suppliers of building materials, and professional architects or architectural firms. BPI has made every reasonable effort to provide accurate and authoritative information, but does not warrant, and assumes no liability for, the accuracy or completeness of the text or its fitness for any particular purpose. The contents of this publication may not be reproduced in whole or in part without consent of the



# ACRYLICS. FUTURE OF EXTERIORS.



SAND LAKE IV, Orlando, Florida  
Completed by Pizzuti Development, Inc.  
May 1987

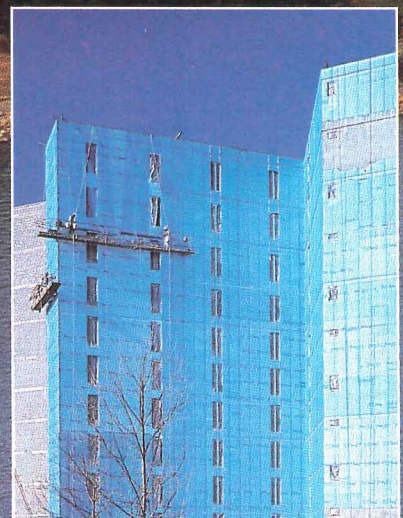
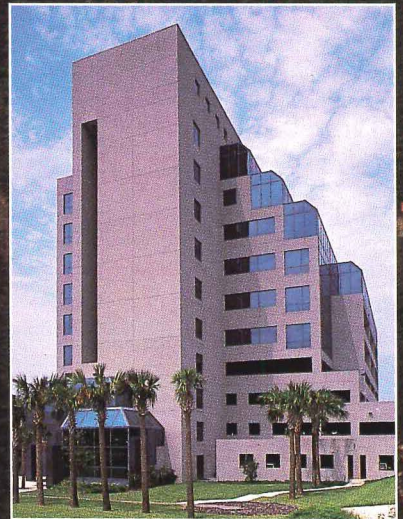

FULTON COUNTY JAIL, Fulton County, Georgia  
Now under construction  
Ova, Daniels, Busby — Architects

urable wall system that can keep the  
elements out and the colors in. And Rohm  
and Haas 100% acrylic polymers offer  
excellent lasting adhesion and mechanical  
strength properties for coatings, to help  
FS maintain its performance and  
esthetic appeal for years to come.

There's no time like the present to see  
what it can mean to your future building  
projects. For more information on the  
durability of Rohm and Haas 100% acrylic  
polymers, write to our Marketing Services  
Department, Independence **ROHM**  
Mall West, Phila., PA 19105. **HAAS**  
PHILADELPHIA, PA - 19105

IFES AND 100% ACRYLICS. FOR BEAUTY THAT ENDURES.

Circle 6 on information card





Architects of the '80s are not all cut from the same cloth (page 100).

## Technology & Practice

**Practice in the '80s** 81  
Evolution, not revolution: a look at five firms.  
By Douglas E. Gordon and M. Stephanie Stubbs

**Technology in the '80s** 89  
Sampling of changes and predictions for the '90s.  
By Forrest Wilson

**When Will CADD Come of Age?** 95  
What architects need most versus what's on the market.  
By Douglas E. Gordon

**Corporate Style** 100  
From polyester to tweed, and what they signify.  
By Frederick D. White and Mark Zweig

**Technical Tips** 102  
The '80s, from the Ground Up.  
By Timothy B. McDonald

## Departments

### News

<i>Exhibition explores the legacy of the Case Study Houses</i>	19
<i>Recent works by Jean Nouvel on view at AIA</i>	22
<i>Giulio Romano exhibition in Mantua: 'City on Display'</i>	24
<i>Aga Khan awards for architecture honors 11 projects</i>	26
<i>Major earthquake hits Northern California</i>	28
<i>Deaths: Percival Goodman, FAIA</i>	30

Events	12	Briefs	30	Products	105
Letters	12	Books	33	Advertisers	133

### Cover

*The Gates of the Grove Synagogue in Easthampton, N. Y., by Norman Jaffe, AIA (page 68). Photograph by Jeff Heatley.*

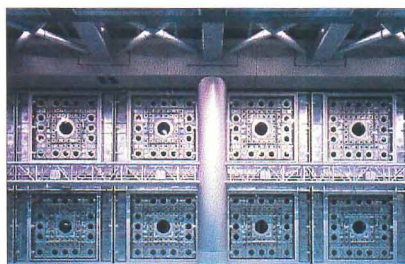

Left, the interior courtyard of Jean Nouvel's Institut du Monde Arabe, Paris (pages 22 and 26).

copyright owner, BILLBOARD PUBLICATIONS, INC., a subsidiary of Affiliated Publications, Inc. President and Chief Executive Officer: Gerald S. Hobbs; Executive Vice President: Samuel S. Holdsworth; Senior Vice Presidents: Paul Curran, Ann Haire; Vice Presidents: John Babcock, Jr., Robert J. Dowling, Martin R. Feely, Glenn Heffernan, Howard Lander, Rosalee Lovett. BILLBOARD PUBLICATIONS, NEW YORK: American Artist, American Film, Billboard, Back Stage, Hollywood Reporter, Interiors, Musician, Photo Business, Photo Design, Planis Sites & Parks, Watson-Guptill Publications, AMPHOTO, Whitney Library of Design, American Artist Book Club, Photography Book Club; LOS ANGELES: Billboard; NASHVILLE: Amusement Business; LONDON: World Radio TV Handbook, The Artists' Book Club.

### The American Institute of Architects

**Officers** Benjamin E. Brewer Jr., FAIA, *President*; Sylvester Damianos, FAIA, *First Vice President*; Gerald S. Hammond, AIA, C. James Lawler, AIA, Gregory S. Palermo, AIA, *Vice Presidents*; Christopher J. Smith, AIA, *Secretary*; Thomas J. Eyerman, FAIA, RIBA, *Treasurer*; James P. Cramer Hon. AIA, *Executive Vice President/Chief Executive Officer*.

**Directors** (year indicates expiration of term) Donald C. Axon, AIA ('89), *California*; Betsey Olenic Dougherty, AIA ('91), *California*; Warren Thompson, AIA ('89), *California*; Vernon Reed, AIA ('91), *Central States*; William B. Reiner, AIA ('90), *California*; W. Cecil Steward, FAIA ('90), *Central States*; Charles M. Sappenfield, FAIA ('91), *East Central*; John M. Barley II, AIA, ('91), *Florida/Caribbean*; James A. Greene, FAIA ('90), *Florida/Caribbean*; Thomas Nathan, FAIA ('89), *Gulf States*;

John K. Mott, FAIA ('90), *Gulf States*; Richard B. Cook, FAIA ('90), *Illinois*; Walter H. Lewis, AIA ('90), *Illinois*; Robert E. Greager, AIA ('89), *Michigan*; Michael E. Bolinger, AIA ('90), *Middle Atlantic*; William E. Pelham, AIA ('91), *Middle Atlantic*; Kenneth DeMay, FAIA ('91), *New England*; Douglas K. Engbretson, AIA ('89), *New England*; Eleanor K. Pettersen, AIA ('89), *New Jersey*; L. William Chapin II, AIA ('90), *New York*; Michael Maas, FAIA ('91), *New York*; Robert G. Mutchler, AIA, ('91), *North Central*; Richard W. Hobbs, FAIA ('89), *Northwest*; Donald H. Lutes, FAIA ('90), *Northwest and Pacific*; Phillip J. Markwood, AIA, ('91), *Ohio*; Susan Maxman, AIA ('90), *Pennsylvania*; Robert S. Woodhurst III, AIA, ('91), *South Atlantic*; Thomas P. Turner, AIA ('89), *South Atlantic*; Thomas L. McKetterick, FAIA, ('91), *Texas*; Robert H. LeMond, AIA ('89), *Texas*; James R. Foster, AIA ('90), *Texas*; Paul H. Barkley, AIA ('89), *Virginias*; Gabor Lorant, AIA, ('91), *Western Mountain*; Jess Holmes, AIA ('90), *Western Mountain*; Matthew W. Gilbertson, *ex officio, President AIAS*; Kathleen L. Davis, *Hon. AIA, ex officio, Chair, CACE*; Lloyd Kaiser ('89), *Public Director*.

**AIA Executive Management Committee** James P. Cramer, Hon. AIA, *Executive VP/CEO*; Fred R. DeLuca, *Chief Operating/Chief Financial Officer*; John A. DiNardo, *General Counsel*; James E. Ellison, FAIA, *Group Vice President, Education and Planning*; Steven A. Etkin, *Group Vice President, Business Centers*; Susan Hecht, *Group Vice President, Membership Services and Institute Affairs*; Norman L. Koonce, FAIA, *President, American Architectural Foundation at The Octagon*; James A. Scheeler, FAIA, *Group Vice President, Design Practice*; Jean L. Swartz, *Senior Director, Human Resources*; Gregg Ward, *Group Vice President, External Affairs*.



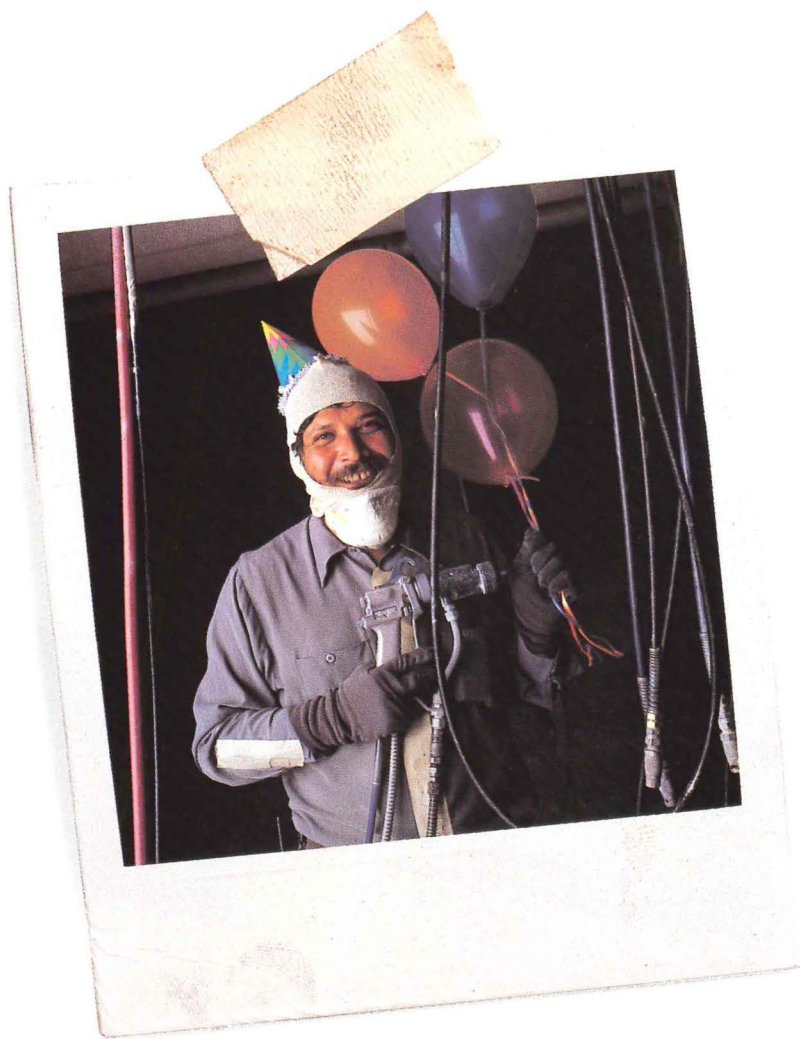





Sunbrella acrylic fabric and Sunbrella Firesist® fabric make a beautiful place like this even more beautiful. And there are so many uses for Sunbrella. From cabana covers to awnings to canopies to dividers and more. You can specify it for indoors or out too. And fire codes aren't a problem, because Sunbrella Firesist meets the requirements of the National Fire Protection Association and the California Fire Marshal's test.

Sunbrella Firesist is available in 22 beautiful styles. Regular Sunbrella fabric is available in 88. But beauty is only part of the story. Our fabrics are incredibly tough.

## SUNBRELLA FIRESIST

They retain their colorfastness and strength for years, even under the most extreme conditions. They have superior water repellency characteristics too. And they resist damaging mildew and mold attacks. So it's no wonder we offer the best five-year limited warranty in the business.

And it's no wonder Sunbrella is the number one selling canvas fabric in America.

So look in the Yellow Pages under "Awnings & Canopies" for the name of a dealer near you. And start specifying Sunbrella, around the pool, and everywhere else too.



Glen Raven Mills, Inc., Glen Raven, NC 27215  
©Registered trademark Glen Raven Mills, Inc.



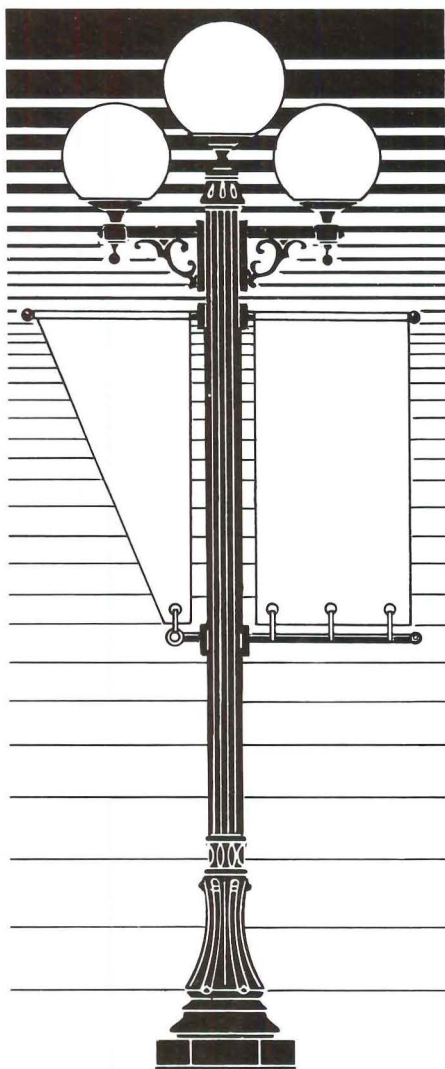

## STERNBERG

When you consider *design options...*  
*authentic detailing...* *structural perfor-*  
*mance...* *illumination selections...*  
 Sternberg is the outstanding choice!

And we've been proving it for over 60 years!  
 Post and coordinated wall bracket lighting.  
 Historic elegance! Quality crafted!

Call or write for our catalog today. Or see  
 Sweets File 16.6g/St.

Sternberg • 5801 North Tripp Avenue  
 Chicago, IL 60646 • 312-478-4777

*Masters of Lighting Artistry  
 for Over 60 Years*

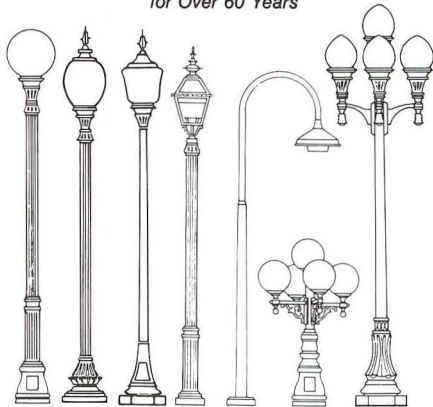

Circle 14 on information card

## EVENTS

**Through Jan. 28:** Exhibit of architectural photographer Cervin Robinson's photographs of Cleveland taken during the past two years, at the Cleveland Museum of Art. Contact: Adele Z. Silver, Public Information, Cleveland Museum of Art, 11150 East Blvd., Cleveland, Ohio 44106.

**Jan. 9-13:** Course on "Microcomputers for Builders," Madison, Wis. Contact: Don Schramm, Dept. of Engineering Professional Development, University of Wisconsin-Madison, 432 N. Lake St., Madison, Wis. 53706.

**Jan. 19-22:** National Association of Home Builders convention and exposition, Atlanta. Contact: Betty Christy, NAHB, 15th and M Streets N.W., Washington, D.C. 20005.

**Jan. 22-26:** Course on the use of infrared thermography for predictive maintenance of power systems and building facilities, San Diego. Contact: Paul Grover, Infra-spection Institute, 33 Juniper Ridge, Shelburn, Vt. 05482.

**Jan. 24-26:** Seminar on "Computer Assisted Estimating," Dallas. Contact: Sharene More, Associated General Contractors of America, Administrative Services Division, 1957 E St. N.W., Washington, D.C. 20006

## LETTERS

**Roger Williams College:** While I am gratified to read such high praise for the Roger Williams College architecture program in Senior Editor Michael J. Crosbie's article "Pulled Up by Its Own Bootstraps," [Aug., page 50], I want to correct an inaccuracy.

The general education program, which constitutes the college's liberal arts and science requirements, is currently comprised of over 50 courses, not 12 as reported by Mr. Crosbie. For architecture students general education amounts to about 25 percent of their total program, and they have considerable latitude in how to fulfill the requirements. As suggested by the director of the architecture program, general education continues to undergo strengthening each year.

If the concern expressed is due to lack of choice, I believe that issue has been resolved. If the question is one of quality, it is relevant that the New England Association evaluating team applauded these process-oriented, cross-disciplinary courses. In their words, "A talented faculty has produced an imaginative, well-balanced curriculum" that "provides undergraduates with a coherent and substantive program of liberal studies."

*Malcolm H. Forbes, Dean  
 Roger Williams College  
 Bristol, R.I.*

### Working with Landscape Architects:

Thank you for Timothy B. McDonald's excellent article explaining the advantages

of working with capable landscape architects [Sept., page 134]. Grant and Ilze Jones succinctly and eloquently state how the discipline can be put to use for real improvement in design of our built environments.

I work in a multidisciplinary office, and I have no doubt that the collaboration between building architects and landscape architects has worked to produce better, higher quality design. As Grant Jones indicates, not only are designs improved, but the designers grow and learn through working with each other. I hope persons in both professions will take this advice to heart and open up channels of dialogue early in the design process. The result should be well worth the effort.

*Timothy J. Moshier  
 Associate Member, ASLA  
 Baltimore*

**Wedding a Building to Its Site:** I applaud the fact that integration of landscape architecture into the design process at an early stage is being addressed [see Sept., page 134]. I am an architect who practiced architecture for seven years after graduation and for the past five years have been vice president of a regional landscape architecture firm.

Many architects mistakenly maintain that landscape architecture does not require a high degree of technical expertise. It is true that landscaping your basic backyard or low-budget industrial park is not a very technical experience. But projects with complex planting and hardscape relationships may require technical expertise that most architects do not possess. If this fact is not understood early in the design phase and a landscape architect is consulted too late to make a difference, the entire project may suffer.

Also, too frequently exterior paving, amenities, and site planning are designed by the architect to assure visual subservience to the building. A good landscape architect will provide an objective opinion for integration of the building into the site, which will ultimately enhance even the most sculptural building.

*William J. Kortsch, AIA  
 Palm Desert, Calif.*

**Criticism criticized:** The criticism of Dean Gordon Varey was unprofessional in your review of the University of Washington college of architecture and urban planning [Aug., page 56]. He should be commended for his support of innovation and the unequalled commitment of his school to partnership between educators and architects.

*Anne Taylor, Ph.D.  
 Director, Architecture and Children*

**Correction:** The architect of record for Bayshore on the Boulevard in Tampa (see Oct., page 54) was Compendium, a Houston firm that closed its practice in January 1987. As noted in the article, Josiah R. Baker, AIA, was the design architect.



## Exhibitions

# The History and Legacy Of the Case Study Houses

It is appropriate that the Museum of Contemporary Art in Los Angeles should devote its first original design show, "Blueprints for Modern Living," to the home-grown Case Study House Program and the architects who created it. However, the show, subtitled "History and Legacy of the Case Study Houses," is more visual titillation than a serious investigation of one of the most intriguing design experiments in 20th-century America.

The Case Study House Program was a series of experimental houses promoted in the 1950s by *Arts & Architecture* magazine and financed initially by then-editor John Entenza. The program commissioned architects to design and build houses for different types of families and encouraged the architects to "choose or reject, on a merit basis" old and new materials offered by national manufacturers, many of whom cooperated with the program. The houses, furnished under the supervision of the architects with the support of furniture manufacturers, were open to public view.

The results attracted a great deal of attention. The first six houses received 368,554 visitors, and the styles of architecture, particularly of the steel-framed houses, were influential worldwide.

Over the years many claims have been made about the program—among them, that it was intended to be social housing and that the houses were affordable. None of the claims is entirely accurate. While there is no doubt that the architects and the editor who set out to build the houses were fired with missionary zeal and hoped to change the world, the program's main impact was esthetic rather than social or economic. Many of the building techniques did not prove applicable to the real-world construction industry; and the houses themselves, while incorporating many planning innovations, contributed little to burgeoning suburbia or the changing needs of the American family. Therein lies the principal flaw of the MOCA show. Rather than investigating the program's legacy or the houses within their context, the show simply refers to the objects.

Architecture is best presented in full scale, as in the recent retrospectives on Richard Neutra, which reproduced architectural details; Frank Gehry, which featured a series of architectural spaces; and Frank Israel, who created a series of

*continued on page 22*



Top, Case Study House #22, Pierre Koenig's 1959 design, was cantilevered along a steep hillside overlooking Hollywood (one of the exhibition's two full-scale reconstructions). Above, Buff, Straub & Hensman's 1958 Case Study House #20 in Altadena.



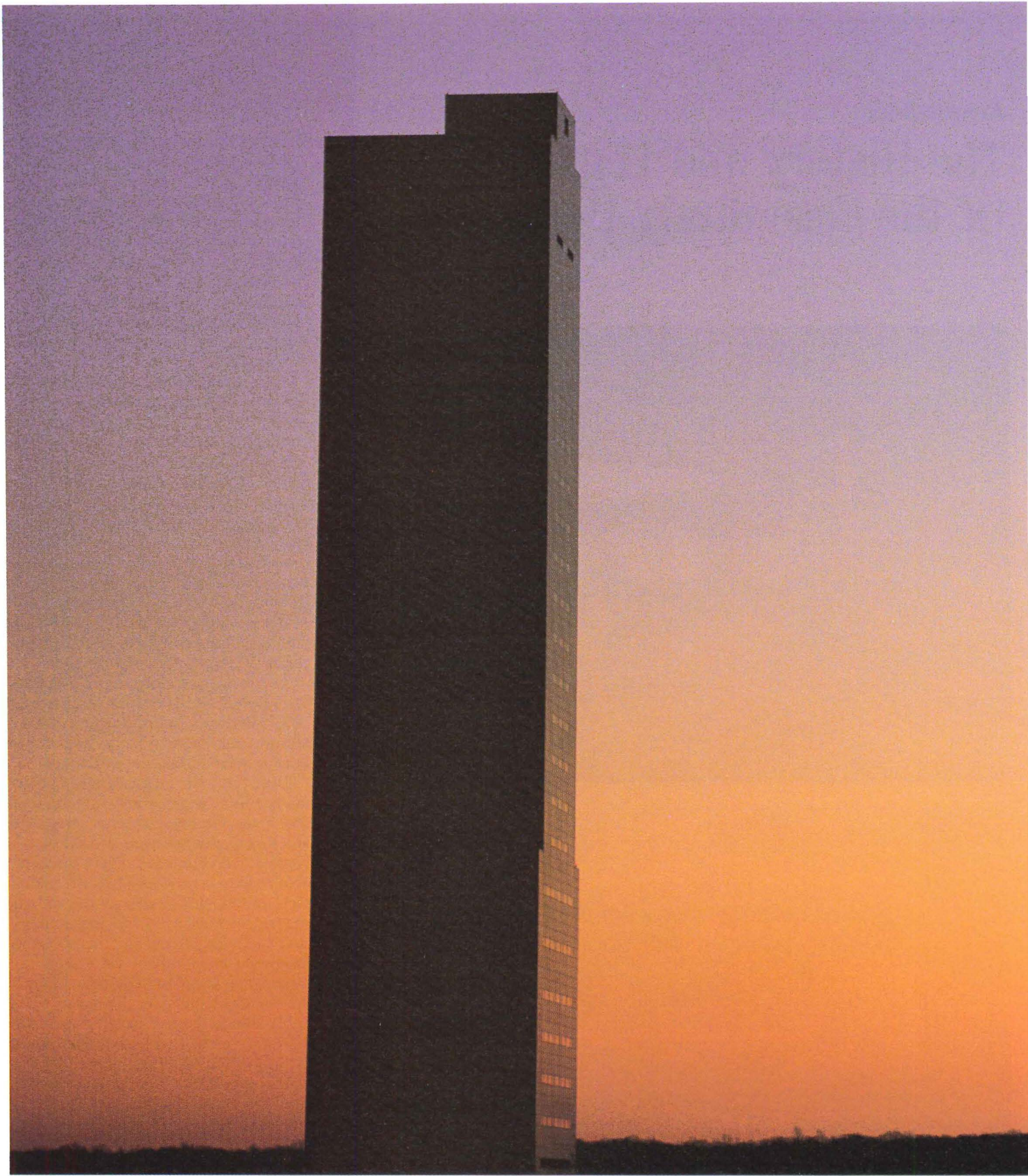



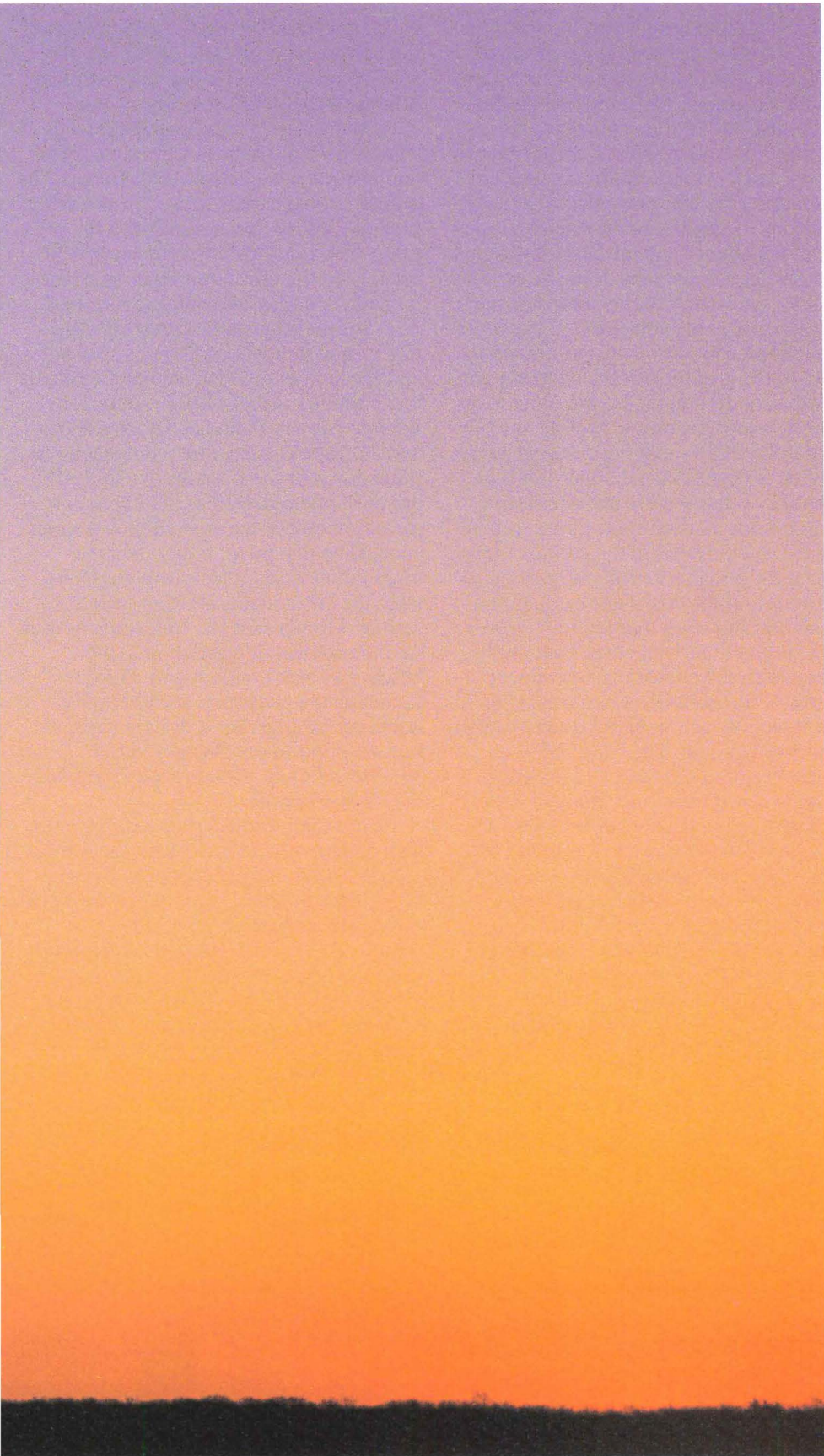

**Twenty-nine stories  
filled with nothing.**

No offices, no homes,  
no stores.

Nothing but elevators,  
up and down.

(And an escalator or two.)

This strange building is  
the new Otis test facility,  
by far the most advanced  
of its kind in the world.

No matter what wild scenario  
an engineer, architect or  
city planner might dream up,  
we can simulate it right here.

Twenty-nine stories filled  
with what-ifs.

Our Otis subsidiary is  
a leading company in the  
building systems industry.



Circle 24 on information card



## Exhibitions from page 19

architectonic pavilions to house his drawings and models. Continuing this idea in the Case Study House show, MOCA has reconstructed part of Charles Eames's house and two entire houses—Ralph Rapson's Greenbelt House and Pierre Koenig's Case Study House 21, poised on the museum mezzanine overlooking a landscape of suspended video monitors.

Seeing the houses reproduced, one is surprised at how small they were and at the simplicity of details proposed by the architects. The mock-ups were accomplished with skill.

It is a pity, however, that the Eames house is shown unfurnished. Although the interiors of the other two seem like "ideal home" exhibitions mounted by the architects, the magic of the Eames house was in the way the Eameses inhabited it and filled a complex but abstract shell with a living exhibition of objects, furniture, and art.

The exhibition has a substantial video component intended to illustrate aspects of the design context, but it fails for several reasons. The principal video display is located below the Koenig house and suspended from a series of small and smaller monitors. The programming consists of interviews with surviving Case Study House Program architects, clients, and devotees displayed with a second, silent video showing drawings and photographs of the houses. It is necessary to watch the graphic material simultaneously with the interviews to understand what is being said, but, because the monitors vary in size and height and the museum acoustics are poor, this is impossible. Still, the monitors look good, twinkling like stars beneath Koenig's Hollywood Hills house.

The only section of the show that attempts to place the houses in context is

underneath the Koenig house mock-up, hidden from view and missed by most visitors. The section contains, within a black anteroom, an enlarged photograph of Entenza's original proposal as published in the magazine (minus two important pages introducing the original group of architects with photographs and biographical information). Another room in this "subterranean" section contains a few photographs and models of earlier experimental work in modern housing design and fabrication. The only other nod toward context is a jazzy but uninformative time line mounted on a curved corrugated metal wall connecting sections of the show. This outlines the history of the era through a series of grainy blowups from publications and television programs and devotes more space to the invention of the ballpoint pen, Howdy Doody, and the Beatles than to social issues such as postwar housing, the McCarthy era, and a rapidly growing suburbia.

What is objectionable about this presentation is that the Case Study House Program, for all its graphic allure, can be understood only within the context of its time and through subsequent reaction to it. The exhibition omits any explanation of the housing crisis that led to the program, any comparison of the case study houses with the typical mass-produced houses of the period, any exposition of how the construction methods and design ideas were unique. The Case Study House Program did have an impact on thinking about houses. It influenced the hierarchy of the postwar house plan; it presented ideas for casual life styles, for merging indoor and outdoor space, and for innovations in kitchens and landscapes. None of these is discussed. The houses are merely presented, labeled like any other object in an art museum.

Neither are the program's failures exhibited. A number of the houses have been unsympathetically renovated. While

this is disappointing—like the renovation of Le Corbusier's house at Pessac, shown in Phillippe Boudon's *Lived-in Architecture*, an analysis could be instructive.

Finally, one wonders why, if the museum chose to extend the show by commissioning new work, it did not attempt to present any of it in detail, like the historical houses, through full-scale mock-ups.

In many ways the catalogue succeeds where the show fails, by offering a social and historic perspective. While most of its chapters could have benefited from editing, several provide new insights into the program. The catalogue includes historical articles on the houses and the magazine by Esther McCoy and curator Elizabeth A.T. Smith. It has three rambling chapters by Helen Searing, Thomas S. Hines, and Kevin Starr on architectural precedents and planning issues. Other chapters, by the late Reyner Banham, Thomas Hines, and Dolores Hayden, offer challenging re-evaluations of the Case Study House Program. Banham describes the impact of steel-framed houses on architects abroad, concluding that these, rather than the more purist work of Mies van der Rohe, were the antecedents for high-tech architecture. Hine places the case study houses into the context of popular, and often kitschy, postwar construction. Hayden evaluates the program's social implications, concluding that it did not successfully respond to the changes in the American family structure, particularly in the role of women.

Such thinking could have led to a more illuminating exhibition. Instead, since most museum visitors will never read the catalogue, the exhibition perpetuates the myth without investigating the reality.

—BARBARA GOLDSTEIN

*Ms. Goldstein is editor of the forthcoming anthology Arts & Architecture: The Entenza Years, to be published by MIT Press.*

## AIA Exhibit Features Nouvel

Five projects by French architect Jean Nouvel were recently on view at AIA headquarters in Washington, D.C. The exhibition featured photographs and working drawings of four buildings in France and Nouvel's competitions drawings for the Toyko Opera House (model shown left).

The exhibition also included the highly respected Institute du Monde Arabe (see Sept. 88, p. 92), Nemanus house in Nimes; a house in St. Ouen; and the Cultural Center in Combs-la-Ville.

Born in Fumel in the southwest of France in 1945, Nouvel graduated from the Ecole Nationale Supérieure des Beaux-Arts in Paris in 1971. He has won recent commissions for the tower at La Defense in Paris, and a hotel/health spa in Vichy. *News continued on page 24*





# Why Has Manville Made a Major Commitment to Bringing You Phenolic Foam Roof Insulation?

## **Because this new generation product is the most thermally efficient roof insulation available.**

Manville's new phenolic foam insulation, UltraGard® Premier, delivers the highest thermal value – 8.33 R units per inch – of any roof insulation. That means less energy consumption.

## **Because it offers an unmatched range of installation and performance benefits.**

UltraGard Premier provides designers, installers, and owners with a full range of benefits: can be used with all major roofing membrane systems; superior flame spread and smoke ratings; excellent dimensional stability; light weight; ease of handling; and lower installation costs.

Manville has made a major commitment of resources to assure that you can specify and install phenolic foam with complete confidence. For information on the roof insulation of the future that's available now, talk with a Manville representative or call the Product Information Center at 800-654-3103.



Leading our industry into the next century

Circle 26 on information card



# Giulio Romano in Mantua: The City on Display



This fall when Mantua, Italy, exhibited the career of Giulio Romano, its idiosyncratic late-Renaissance genius, the city afforded what few exhibitions can: architecture. Mantua is the site of Giulio's greatest architectural works, and practically his only surviving ones. The show was mounted in two buildings associated with Giulio, the Palazzo del Te, which he designed, and the Palazzo Ducale, for which he designed several wings, and an itinerary highlighted his other works in and around Mantua. Thus, while displaying Giulio as an architect, the exhibition celebrated the architecture of the city itself.

Giulio Romano came to Mantua from his native Rome in 1524, summoned by Duke Federico II Gonzaga, scion of the powerful family that had ruled the small but significant duchy for more than a century. In Rome Giulio had been the chief assistant and heir apparent to Raphael, whose studio was the largest and most important of its day. For the ambitious Federico, Giulio was an obvious choice of an artist whose prestige matched his own.

Probably the finest result of the ensuing 16-year collaboration between Federico and Giulio was the Palazzo del Te, a villa on the outskirts of town. Now restored, the palazzo is probably as close to its original form as at any time since the fall of the Gonzaga in the 18th century. It is the best surviving example of the high Renaissance villa, a 16th-century version of the seignorial country residence, inspired by and loosely based on the ancient villa. In the magnificence of its pretensions and the caprice of its architecture and decoration, the palazzo begs comparison with the villas of ancient Rome. On the interior, a progression of rooms decorated in fresco and stucco work assaults the faculties with the

*Far left, the main facade of a house in Mantua by Giulio Romano; above right, the glorious interior spaces Giulio's palazzo now restored. Center, the loggia of David in the Palazzo del Te.*

apparently inexhaustible variety of their invention. The result is an environment where the pleasures of the senses rule, and the artist's skill is foremost in manipulating the interior experience. The restored Palazzo del Te reveals the degree to which Giulio's architecture was inseparable from his decoration.

A collection of Giulio's paintings, drawings, designs for decorative objects, and documentation for architectural work was displayed in one of the palazzo's outbuildings. This last included 16th-century drawings of the Palazzo del Te and a model of the hypothetical reconstruction, which complemented the visit to the palace itself by clarifying the various layers of alterations brought about by earlier restorations.

Giulio's sense of humor and the apparent iconoclasm with which he manipulated the lexicon of classical architectural forms seem to anticipate the "architecture parlant" of enlightenment architects 250 years later, although one wonders now whether this view has not been fostered partly by the 18th-century restoration of the Palazzo del Te. The famous slipping triglyphs of the courtyard facade, the exterior plaster work that imitates outsized rusticated stone members, and the syncopated rhythms of his facades suggest that Giulio was an architectural rebel.

At the same time another view of Giulio, by no means exclusive of the first, emerged in this exhibition. This new Giulio is a highly classicizing architect. Unlike many of his Renaissance predecessors, he was

a native Roman and so grew up with the remains of ancient Rome as his study models. In the ease with which he worked within his classical vocabulary and the ingenuity with which he manipulated its forms, one sees an architect who understood the expressive ability of that idiom and could communicate with it much as the Romans had. In his hands, the versatility of classical architecture becomes apparent as he exploits it.

Shortly after his appointment as architect to Federico's court, Giulio became Mantua's superintendent of public buildings and streets. Sixteenth-century sources tell us he controlled all building in the city during his tenure, and we know that he supervised the raising and repaving of the streets in one quarter of town. Unfortunately, other than highlighting a few lesser-known works of the architect around town, the exhibition offered no further evidence of Giulio as urbanist.

If the exhibition did not transform our understanding of Mantua's urban form, it did provide an occasion to spruce it up. Although the city has always been a congenial place to visit for those interested in architecture, given the presence there of masterpieces by both Alberti and Giulio Romano, it has had a certain forlorn air of disrepair to it, and the Palazzo del Te above all. One of the long-lasting benefits of the exhibit should be that the Giulio Romano monuments will remain cleaned and accessible and that the information brought to light about their various histories will remain readily available.

—CLAIRE SCHIFFMAN

*Ms. Schiffman is an art historian and writer living in Florence.*

*News continued on page 26*



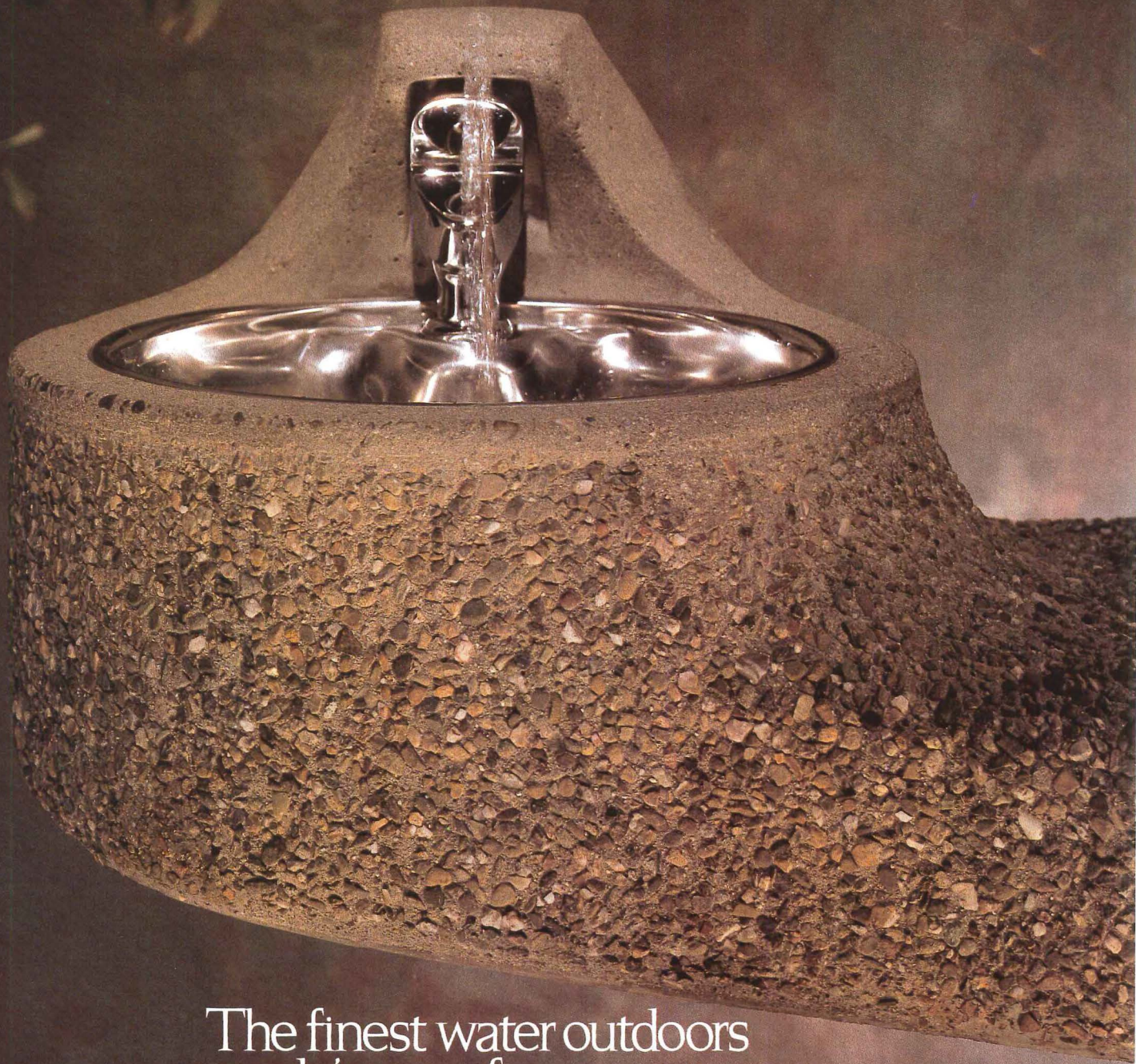

## The finest water outdoors needn't come from a spring.

Or from a bottle for that matter. In fact, Haws has a much better idea: How about trying your water on the rocks?

It'll open a whole new realm of choices for you. Including a full line of outdoor drinking fountains. In a *mélange* of textures, colors and styles—built to withstand even the most untame of guests.

So you see, it's really quite the beautiful thing to do. No matter your style. Or your surroundings.

Why, you'll probably never have water straight-up again.

**Haws**

H<sub>2</sub>O h h h h h h h h.



# The Aga Khan Honors Eleven Projects

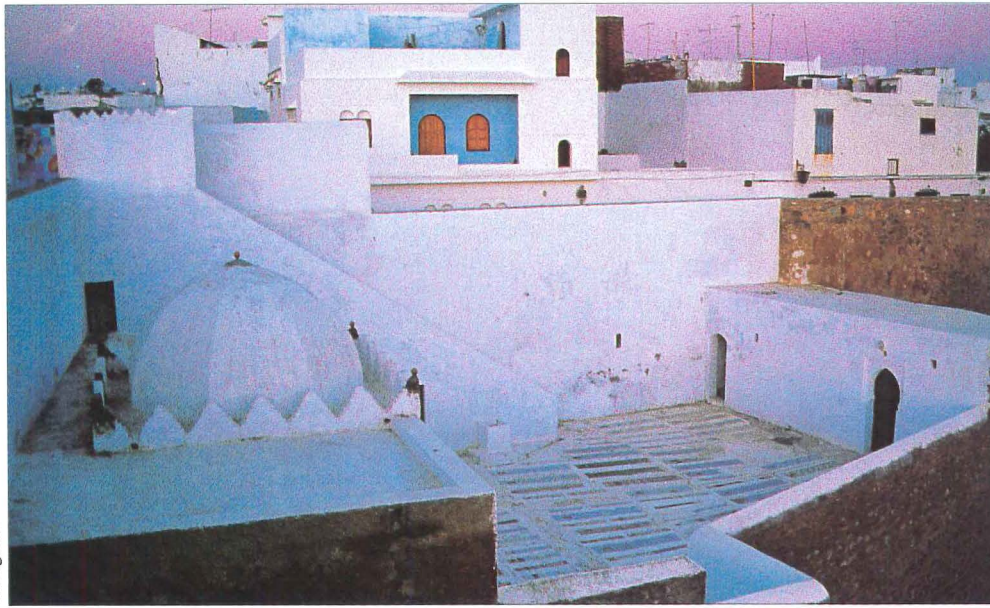

C. Lignon

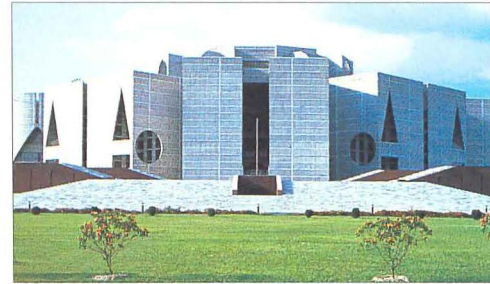

Dakshin

Left, the rehabilitation of Asilah, Morocco, a city on the Atlantic coast that dates to the times of the Phoenicians. Above, Louis Kahn's National Assembly Building in Dhaka, Bangladesh. Below left, Citra Niaga Urban Development a former slum into a viable commercial and residential area. Below, the Ministry of Foreign Affairs in Riyadh, Saudi Arabia, by Danish architect Henning Larsen.



Gary Otte



Dececal Merschaoui

Eleven projects have been selected for the 1989 Aga Khan award for architecture. The award program was established in 1976 by the Aga Khan to recognize Islamic culture within the profession and to encourage architectural excellence.

One of seven winners in the architecture category is the Institut du Monde Arabe in Paris by Jean Nouvel, Gilbert Lezenes, and Pierre Soria of Architecture Studio (see page 22).

The jury called Louis Kahn's National Assembly Building in Bangladesh "an imposing architectural work of extraordinary power, clarity of form, and beauty." Although the compatibility of the building with the needs and aspirations of a poor country has been questioned, said the jury, "over time it has come to enjoy overwhelming approval, stands as a symbol of democracy in Bangladesh, and has influenced that country in beneficial ways."

The Ministry of Foreign Affairs in

Riyadh, Saudi Arabia, by Danish architect Henning Larsen, is a fortress-like building with a triangular plan and a circulation system of barrel-vaulted "streets" lining the lobby and defining office areas arranged around covered octagonal plazas.

The Corniche Mosque in Jeddah, Saudi Arabia, by Abdel Wahed el-Wakil of London, is composed of a square prayer hall and an open-air narthex.

Sidi el-Aloui Primary School in Tunis, Tunisia, was premiated for "its courageous exploration of traditional architectural forms as an elegant and economical response to contemporary education needs." The design was developed by a citizens' group (with Denis Lesage as coordinator and Samir Hamaici as project architect).

Istanbul architect Sedat Gurel's summer house in Canakkale, Turkey, is a cluster of seven units along the Aegean coast. The arrangement of the buildings along the rocky, sloping site is intended to recall

on a smaller scale a traditional village.

The master plan of modern Riyadh covers a large governmental and diplomatic area as well as public urban spaces. Known as the Hayy Assafarat, the district includes a number of projects by various architects and planners. Two of these projects were honored: the landscaping of the whole quarter by the landscape architecture firm B.B.W. and the Al-Kindi Plaza by Beech Group Consultants with architects Ali Shuaibi and Abdul-Rahman Hussaini.

Two projects were honored in the restoration and renovation category: the Great Omari Mosque, the oldest standing mosque in Sidon, Lebanon, and the rehabilitation of the coastal town of Asilah, located in the northwestern corner of Morocco.

In the category of social development, the Grameen Housing Program and the Citra Niaga Urban Development of Samarinda, Indonesia, were honored.

News continued on page 28





*Medallion*

**An exciting new design  
concept for your glass entrances!**

Brite Vue's new Medallion Doors... a badge of distinction for your glass entrances. The innovative 2½" tubular framing presents an appearance of grandeur that is aesthetically pleasing and is a dramatic departure from the conventional designs so long in use. Framing is available in aluminum, brass or stainless steel with all popular finishes.

Doors can be full framed or without vertical frame members. Tempered glass can be clear or tinted. Laminated glass is offered with PVB interlayers in custom designs as shown here.

Be among the first to give your entrances the new Medallion look. Call or write for complete information.



**Glass Systems, Inc.**  
A Kawneer Company

1021 Walnut Ave., Pomona, California 91766 (714) 628-5557

So. Calif. (800) 344-4554, No. Calif. (800) 445-5525, Outside Calif. (800) 423-1885, Telex 757808, FAX (714) 628-5345

Circle 30 on information card



# Architects & Engineers

**Fact:** Your errors, omissions and liability insurance excludes coverage for asbestos related work.

**Fact:** With this Seal:

This is to certify that this building has been inspected and certified by



and is free of an asbestos hazard, in accordance with applicable regulations, as of this date.

**your asbestos problem is ended.**

Asbestos Abatement Services, Inc. is so confident of the quality of our turn-key engineering and consulting work—we certify each building we service as “asbestos hazard-free” with a seal bearing our name.

## Services Include:

- asbestos hazard assessment/total project management
- fully insured and AHERA accredited
- full indemnification
- complete environmental audits



**ASBESTOS ABATEMENT SERVICES, INC.**  
A Professional Environmental Engineering Firm

4801 Massachusetts Ave., NW  
Washington, DC 20016  
(202) 362-2525

Offices also in Atlanta, Boston, New York and Detroit.

Call AASI and let us do our job—so you can concentrate on yours.

1-800-247-8518

**Responsible Solutions.  
Building Confidence.**

## Technology

# Earthquake Hits West Coast: Still Not the ‘Big One’

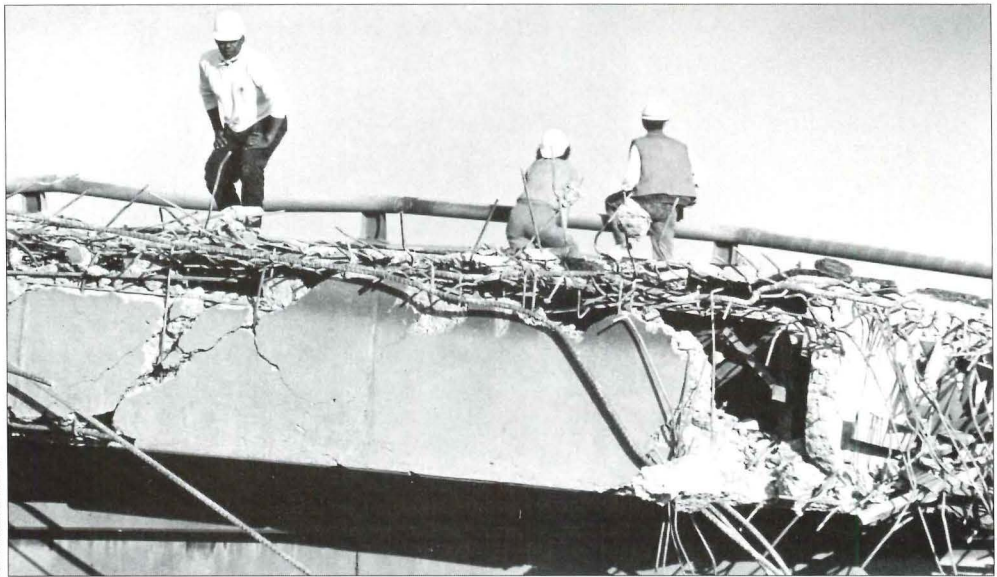

At 5:04 P.M. Oct. 17, an earthquake of Richter magnitude 7.1 struck on the San Andreas fault some 65 miles south of San Francisco, causing extensive damage and casualties.

In San Francisco, six people were killed in a street when an unreinforced brick masonry wall collapsed, and several others were killed by collapses and a major fire in some older wood frame apartments in the Marina District. In Oakland, more than 40 commuters were killed in the collapse of a double-deck section of freeway at the approach to the Bay Bridge. A section of the bridge itself collapsed, killing one driver and closing a critical transportation artery for at least a month.

Several other deaths were due to building collapses on the main street of Santa Cruz, a resort and university town on the coast about 70 miles south of San Francisco, near the earthquake epicenter. In all, the earthquake was responsible for about 70 deaths and several thousand injuries. Fortunately, no hospitals were seriously damaged or rendered nonoperational.

Relative to the size of the earthquake the casualties were light: the Armenian earthquake of December 1988, of approximately equal magnitude, caused 25,000 deaths. In general, newer California buildings performed well. The scores of new high rises in San Francisco and Oakland suffered no damage to structure or facade, though contents and equipment were tossed around considerably. Eyewitnesses at the top of one high rise reported that doors were torn off their hinges.

Extensive but unspectacular damage—often barely visible from the outside—

*In the aftermath of the recent earthquake, workers sort through the debris of the double-deck Nimitz Freeway in Oakland.*

occurred to older buildings throughout the region. Assessment was not complete by press time, but one week after the earthquake the San Francisco mayor's office estimated that 700 buildings containing 3,100 units of low- or moderate-income housing were damaged. Overall, in San Francisco alone it was estimated that at least 2,250 offices and residences were unsafe or potentially dangerous. Many historic structures were severely damaged, including San Francisco's City Hall and main library and Oakland's City Hall and Paramount Theater. In Santa Cruz, the entire six-block downtown shopping area was ravaged and many buildings were irreparable and required demolition. Most of these buildings had been attractively remodeled since the 1970s, but with little or no attention to seismic design.

The damage bill is estimated to exceed \$7 billion, and this does not include long-term economic losses caused by business closures or loss of investments. Though it was not the “big one” that California awaits, this earthquake will provide important information that may affect both design and disaster management practices for the future.—CHRISTOPHER ARNOLD, AIA

*Mr. Arnold, an architect and seismic researcher, is a principal of Building Systems Development Inc. in San Mateo, Calif. He is a frequent contributor to this magazine on seismic technology.*

*News continued on page 30*



**HIGHLY RESISTANT...  
HIGHLY EFFICIENT...  
HIGHLY BENEFICIAL...**

# HyChoice™

**...from CARLISLE.**

(single-ply, .045 in., reinforced membrane based on Hypalon®)

## Highly Resistant

**Environmentally resistant HyChoice™** is a lightweight reinforced membrane based on Hypalon, a synthetic rubber from Du Pont. This CSPE (*Chlorosulfonated Polyethylene*) membrane is resistant to oil, flame propagation, ultraviolet, ozone, corrosive chemicals, pollutants, acid rain, and abrasion.

## Highly Efficient

**HyChoice's heat-welded field seams** can be closed by hot-air welding at a rate of seven to ten feet per minute. When properly fused together, the two seam sheets make a completed seam as strong as the membrane itself.

**Carlisle's HyChoice (white)** reflects nearly 80% of the sun's radiant energy and the surface temperature of the Hypalon-based sheet is much less than other roofing materials . . . which can reduce cooling equipment costs and operational expenses.

## Highly Beneficial

**HyChoice's physical properties** allow for design versatility. A correctly applied HyChoice roof from Carlisle is UL classified and exceeds Factory Mutual's I-90 rating by 50%. And you receive Carlisle warranties with HyChoice Roofing Systems. Also, Carlisle has available all the quality accessories needed to properly install a HyChoice roof.

## Plus Carlisle...

**HyChoice delivers** all the above plus Carlisle's Design Assistance, Distribution Network, Service, Training, Authorized Applicators, Technical Expertise and More. For additional information write Carlisle SynTec Systems, PO Box 7000, Carlisle, PA 17013. Or call toll-free 1-800-233-0551. In PA 1-800-932-4626. In Canada 416-564-5557.



Carlisle's HyChoice is a lightweight, reinforced, single-ply membrane based on Hypalon.

**QUALITY ROOFS BY DESIGN**

# CARLISLE

Carlisle SynTec Systems

HyChoice  
Reinforced Membrane

Polyester-Reinforcement

HyChoice Membrane

Carlisle and HyChoice are trademarks of  
Carlisle Corporation  
Hypalon is a trademark of E.I. du Pont de  
Nemours & Co., Inc.

© Carlisle Corporation 1989

Circle 34 on information card



**Percival Goodman: Architect, Teacher, Planner, and Poet**

Architect, planner, teacher, author, and historian Percival Goodman, FAIA, succumbed to lung cancer in October at the age of 85. He was a lifelong resident of New York City.

Goodman began his architectural career at an early age, tracing drawings in an architect's office. At age 21 he won the Society of Beaux-Arts Architects Paris Prize and studied at the Ecole des Beaux-Arts. But, like other architects of his generation trained in the Beaux-Arts tradition, Goodman soon became intrigued by the modern movement and the relationship of architecture to society.

His landmark book, *Communitas*, written in 1947 with his brother Paul, surveyed city planning theories and presented a number of future scenarios based on their critique. The book, which Lewis Mumford called "a fresh and original theoretic contribution to the art of building cities," cast design as a social, political act 20 years before the idea became fashionable. Thirty years after *Communitas*, Goodman authored *The Double E*, which explored urban planning and environmental ecology. He also taught at Columbia's school of architecture between 1946 and 1971.

As a practicing architect, Goodman

designed more than 50 synagogues and religious buildings before closing his practice 10 years ago. His buildings were defiantly modern containers that reinterpreted traditional forms and religious symbols.

For the past four years Goodman was a prolific book reviewer for ARCHITECTURE. He pulled few punches and wrote with the spirit of a young man, yet his age no doubt contributed to an occasional dark view. "I see the world through the porthole of the Titanic," he confided in a letter, "nothing but icebergs out there."

In his last years Goodman was at work on a collection of drawings of utopian societies, accompanied by his own poetry. We publish one here, as Percy's last contribution to the magazine.

—MICHAEL J. CROSBIE

**In the Agora**

All the old gods were dead.  
Tumbled, heads off, on the dusty ground.  
With sledge in hand the vandals stared  
At the empty eyes and broken hands,  
Wondering how they dared.  
The sky turned gray,  
The sun hid behind curled clouds.  
The moon, when it came, a misty ball—  
Leaves wilted in the icy air.  
The immortal gods lay dead  
Unburied, on the frozen ground.

**Carpet Design Competition**

Amoco Fabrics and Fibers Co. is seeking entries for its 1989 Prestigious Installation awards competition, open to designers, specifiers, and architects. Judging will be based on design, composition, and the use of PermaColor carpet as a design element. Awards will be given in six categories: offices, retail, hospitality, health care, educational/public areas, and residential. Winners will receive \$3,000 and an engraved crystal trophy. Entries must be postmarked by March 1. For more information contact Suzanne Wright, Public Relations Coordinator, Amoco Fabrics and Fibers Co., 900 Circle 75 Parkway, Suite 550, Atlanta, Ga. 30339.

**Liturgical Arts Awards Program**

The Interfaith Forum on Religion, Art and Architecture, a national organization affiliated with AIA, announces its 1990 visual arts awards program. Entries will be judged for originality of design, quality of craftsmanship, appropriateness to sacred space, and quality of slides. Entries must be in the form of 35mm slides and will be on view at IFRAA's national conference in Boston next September. The submission entry deadline is May 1. For more information and entry forms contact Doris Justis, IFRAA, 1777 Church St. N.W., Washington, D.C. 20036.

**DESIGN SOLUTIONS FOR AGE OLD PROBLEMS**

**Custom Window Company**

is a leader in innovative window design. The name, Custom Window Company, has become synonymous with the rejuvenation of Historic buildings, designing window systems that emulate historic steel and wood fenestration from low maintenance thermally broken aluminum. The design and budgeting staff are always available to assist you. Call today.

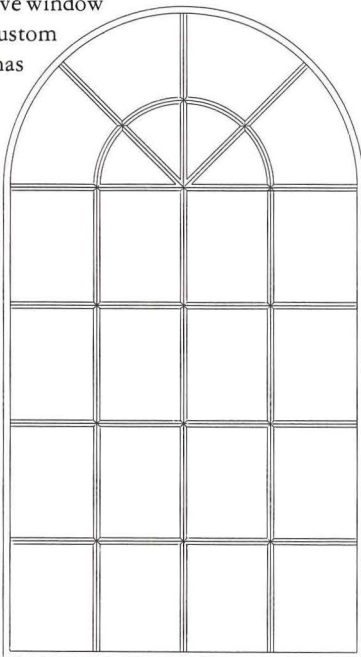

**custom window**

P.O. Box 118, ENGLEWOOD, COLO.

WATTS: 800-255-1820 FAX: 303-789-0111 PHONE: 303-761-2909

**CAD Details™**

ProSoft Solutions

*This library of standard graphic details on disk can save you countless hours and free your design team from tedious drafting.*

A series of comprehensive symbol libraries for design professionals. Stringently evaluated and tested in multiple professional offices.

- Drawn to C.S.I. Standards
- Allow Complete Customization
- Maintain Project Quality and Cost Control
- Deliver Projects Faster
- Placement program allows easy manipulation of details
- Work within the AutoCAD® environment, version 9.0 or later.

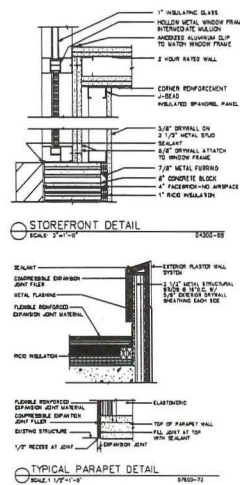

**Architectural Package** 275Details - \$395

**Mech, Elec, Plumbing** 175Details - \$395

**Structural Package** 300 Details - \$395

**FOR A FREE DEMO** or the name of your nearest ProSoft reseller call 415/492-1030 or FAX 415/492-8658.



Software Publishing and Distribution

4000 Civic Center Drive, Suite 202, San Rafael, California 94903  
All ProSoft products are backed by an unconditional guarantee.



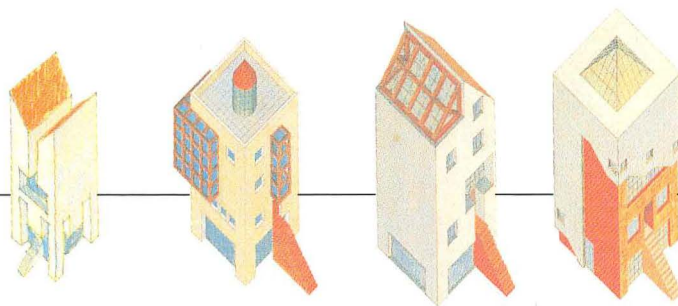

## A 'Flawed' Postmodern History

**The History of Postmodern Architecture.** Heinrich Klotz. (MIT Press, \$60.)

This entertaining and useful survey of recent architecture rests upon shaky premises. Heinrich Klotz, professor at the University of Marburg and director of the Deutsches Architekturmuseum, has been one of the most assiduous students and cataloguers of the phenomena of architectural postmodernism and is well suited to guide us in an exploration of its nooks and crannies. He almost convinces us that it has what his title suggests and what postmodernism has so desperately sought to construct for itself, namely, a "history." But history, as has frequently been pointed out, is different from mere chronicle. It is, in a way that would surely interest Klotz, a form of fiction. But at that characteristically postmodern level of narrative or plot this particular story is less than convincing.

In the first place, the story, if indeed there is a story as such, begins much earlier than Klotz seems to suggest. And, while an author is under no obligation always to begin at the beginning, different starting points entail very different approaches to the issues in question. Klotz, like so many others, would both account for and characterize postmodernism in terms of a reaction against certain aspects of the modern movement. Modernism, however, should by now be understood as a more complex and historically rooted set of events than has been suggested, in both its own polemics and the caricatures of its detractors, past and present. The various modern movements—and in particular those modernist orthodoxies and dogmas against which postmodernism has been presumed to react—could and perhaps should be understood in relation to successive attempts to re-establish an authoritative and non-

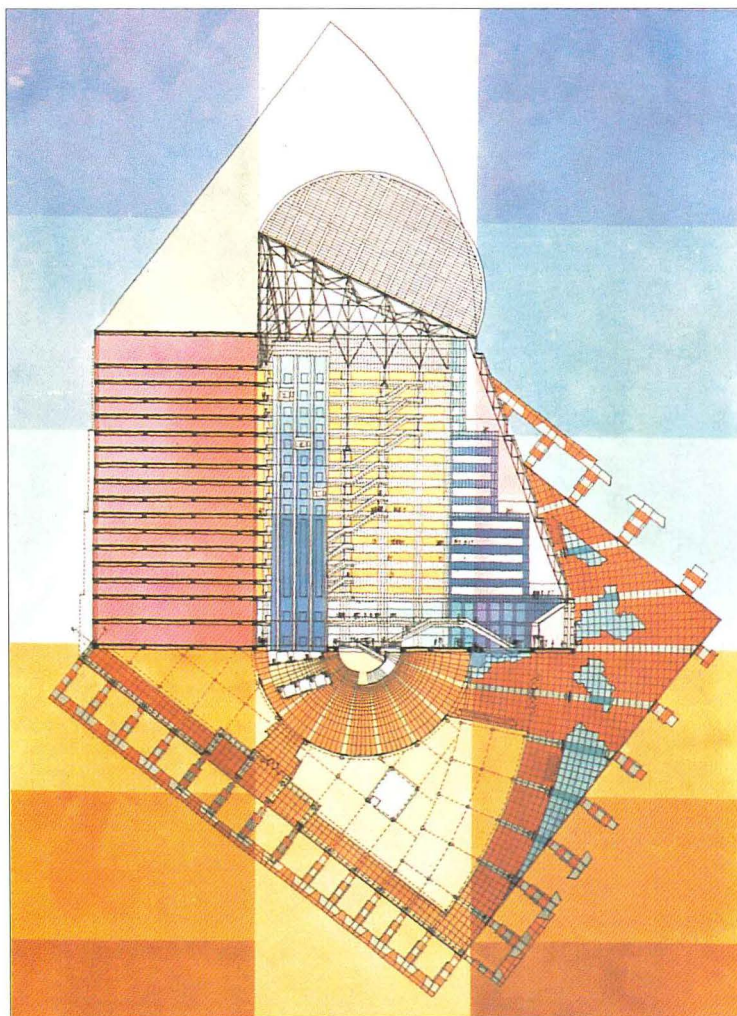

Top, town house designs for Marburg by O.M. Ungers.  
Above, State of Illinois building by Murphy Jahn.

arbitrary basis for architectural theory and practice in the wake of the erosion of traditional sources of cultural and political order and authority since the late 18th century.

This account of modernism points to its continuity with the history of art and architecture since the Renaissance. It is a continuity understood in terms of fundamental issues and underlying social and economic forces, rather than one that emphasizes stylistic or formal criteria. In the case of architectural postmodernism, however, one is speaking about a phenomenon the roots of which, different though they may be, are deep in Italian and American soil, fertilized by a fair sprinkling of French theory.

In this context postmodernism may be cast, in some of its manifestations, as a

new round of efforts to re-ground architectural theory and practice in the wake of the ultimate inability of the modern movement to do just that: to succeed where the 18th and 19th centuries, by their own accounts, seemed to have failed. In this enterprise postmodernism has not only recapitulated many of the theoretical strategies of the 18th and 19th centuries—from typology to eclecticism to outright revivalism—it has also had recourse to some of the same strategies invoked by modernism in its quest for a stable source of order and authority that would transcend the vagaries of style, taste, and the increasingly voracious art market. Neotraditionalism and neomodernism thus appear as more or less superficially different responses to the same problem. More recent efforts to escape the crisis of authority by accepting—and in some cases celebrating—its apparently radical consequences are heavily indebted, both formally and intellectually, to the experiments and polemics of one or another of the early

20th-century avant-gardes.

This latter approach would appear to endorse the attempt by the French philosopher Jean-Francois Lyotard to identify "the postmodern condition" with the end of the great "master narratives," which legitimized Western culture and politics and helped sustain its hegemony. The recognition that such grand narratives, indeed any narratives, are fundamentally "fictitious" would initially seem to confirm Klotz's formulaic description of postmodernism as promoting "fiction as well as function." It might even suggest, in a somewhat cynical way, an excuse for the absence of plot or hierarchy in any history of the recent past. The problem, however, is not simply that Klotz would appear to

*continued on page 117*



# Prepainted Galvalume™ sheet protects guests on a budget any president would



History tells us that during Andrew Jackson's presidency his homestead, The Hermitage, in Nashville, Tennessee, was destroyed by fire. So he insisted the home be re-built with a metal or "tin" roof as it was called at the time.

When the current owners of The Hermitage wanted to build a \$4 million Visitor's Center, they wanted more than just a roof over their heads. A sense of history was important. But they didn't want to imitate the historical structures on the property. They wanted the Center to be inspired by the old buildings, yet stand alone. Be timeless.

There were more practical concerns, as well. Like the need for long-lasting durability and low-

maintenance. They didn't want to be faced with roof repairs and repainting within a few years—activities which are costly, as well as annoying and distracting to visitors.

And finally, costs had to stay within the budget.

Both the architect and the administrators came to the conclusion that a prepainted Galvalume standing seam roof would provide the solution. The owners felt secure in knowing that the Galvalume sheet base material is backed by a 20 year warranty. And the architects were pleased that they could get the color they wanted from the wide range of colors available. It's this kind of flexibility that makes any job easier, more efficient.



# ARCHITECTURE

Just yesterday, it seems, we were recapping the 1970s and concluding, among other things, that the period had lacked strong passion. Modern architecture had spent its revolutionary fervor, and passionate postmodernism, if that is not an oxymoron, remained largely unbuilt.

The 1980s saw historicism adopted for buildings public and private, transcendent and tawdry. Our final issue of the decade, therefore, is in part an attempt to evaluate postmodernism's contributions. But the decade was too complex, contradictory, and diverse to be neatly filed into any stylistic slot. Like the '70s, the '80s lacked passion but, being more prosperous and politically stable, were more conservative and consumer-oriented. These and other defining characteristics of the decade's architecture are discussed in three essays, one by Robert Campbell, another by John Pastier, a third by myself.

We also went back for a fresh look at six influential works of the decade. Correspondent Charlotte Ellis traveled to Stuttgart, West Germany, to re-evaluate James Stirling's and Michael Wilford's Neue Staatsgalerie, which, Ellis contends, broke remaining international taboos against postmodernist buildings. Managing Editor Allen Freeman went to Atlanta to re-assess Richard Meier's High Museum, a premier example of the building type that arguably served as showcase for 1980s architecture. Senior Editor Michael Crosbie returned to Charleston for a second look at that city's rare, successful example of scattered-site public housing. Freelance writer Lawrence Houstoun re-examined and found largely vacant Johnson and Burgee's public spaces at PPG Place in Pittsburgh. Technical Editor Stephanie Stubbs chronicled the conscientious programming and reprogramming of the H.E. Butt headquarters in San Antonio and found the efforts largely successful. And, finally, Contributing Editor John Pastier examined anew Michael Graves's San Juan Capistrano library.

To cap the issue, we present three new buildings as diverse as the decade itself. The first in this holiday month happens to be a religious building, the Gates of the Grove Synagogue in Easthampton, N.Y., by Norman Jaffe. The second is a house in New York state by Charles A. Platt, the grandson, interestingly, of a prolific architect by the same name who worked at the turn of the century. To end with a bang, we close with one of Boston's most controversial buildings of the 1980s, 75 State Street, "the gold-hatted emblem of Boston's recent building boom," as Robert Campbell writes. It is the result of a new trend to match up seemingly mismatched collaborators, in this case Graham Gund of Boston and Adrian Smith of SOM/Chicago.

—ANDREA OPPENHEIMER DEAN



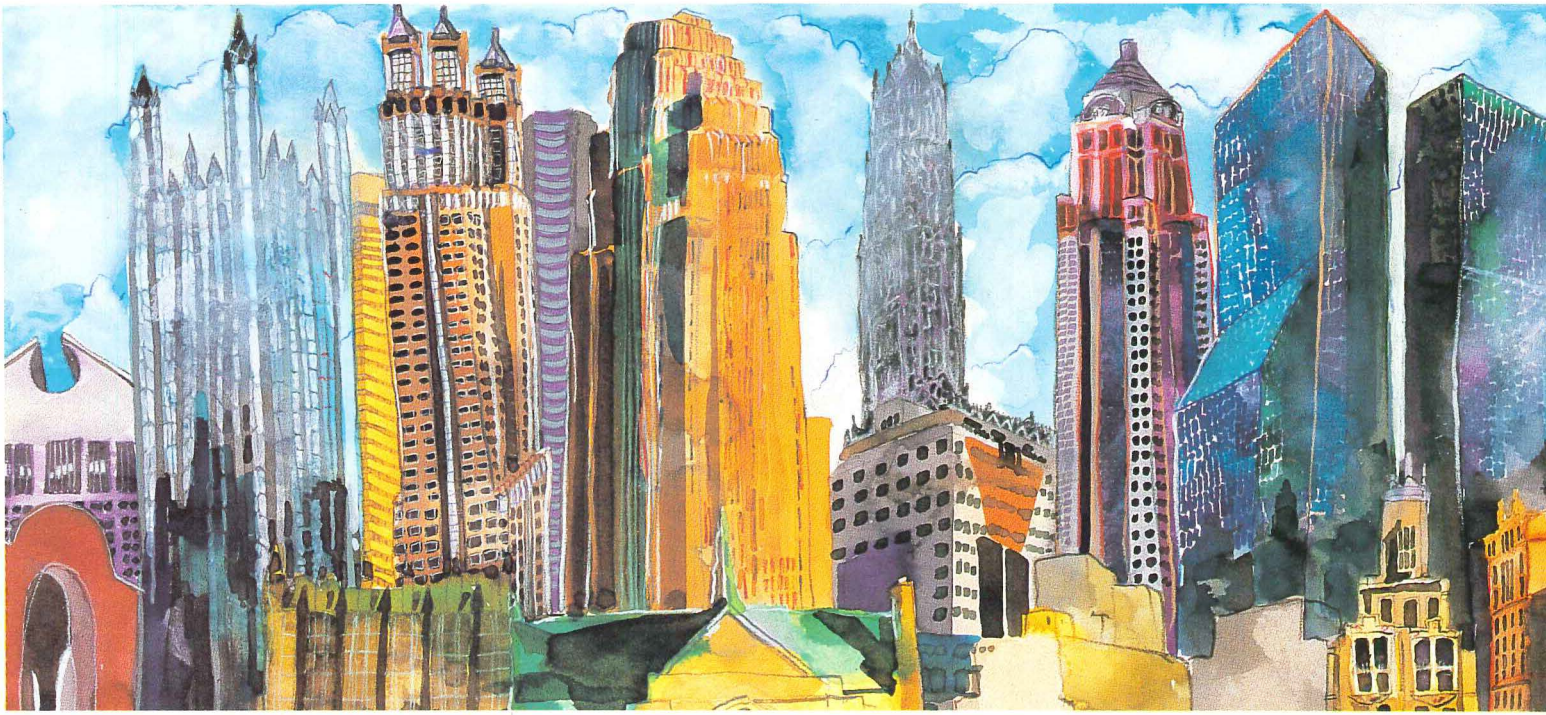

# A Feel-Good Decade

*Paradoxically, a period of social neglect  
the best design was more humane.*

*By Andrea Oppenheimer Dean*

The best American architecture of the 1980s was arguably superior to that of any decade since World War II. As ever, most new construction of the period was not architecture at all; it was simply building. But the decade's best was more humane, emotionally accessible, and sensitive to physical and cultural setting than comparable examples from other postwar decades.

If architecture is seen as reflecting the values of its time, the best of 1980s design was an achievement that transcended its setting. Like the 1920s, the '80s were years of unrivaled prosperity and economic growth, accompanied by conservatism and greed. The shadow of the stock market crash of 1929 hung over the roaring '80s, and a murderous drug trade recalled the massive lawlessness that accompanied Prohibition. There was a pervasive feeling of quiet before the storm, of being poised for a calamity that didn't occur. The stock market crashed, all right, in 1987, but the much-feared bust never came.

That seemed apt for a feel-good era, in which even the most disastrous events—potential or real—were, in the end, often reduced to mere spectacle, four-minute segments for the evening news, without palpable consequences or even existence beyond the nation's short attention span. Architecture, also as in the '20s, tended toward the theatrical, and often toward the insubstantial and nostalgic. As the government increasingly withdrew from its responsibility for mounting social problems, individuals also tended to retreat from unpleasant realities and fears for the future into a private, often make-believe, materialistic world.

Architecture, along with almost everything else, became a marketplace commodity with a short shelf life. In fact, architecture became a marketing tool as developers learned that, much

as Calvin Klein's name sells jeans, the names of prominent architects can help lease buildings. "Architecture has taken its hyped-up place on the world stage of celebrity journalism," wrote Ada Louise Huxtable in 1985. Form follows function seemed often to give way to form follows form, or, more insidiously, fashion.

The design of the '80s was neither new nor revolutionary. Intellectual conservatism enjoyed a respectability absent since the 1920s, as the decade's fragmented pluralism and eclecticism mirrored a society frayed by private hubris. Daunted by the future, most architects sought inspiration from the past. As historic preservation became a money-maker, designers redeemed styles from every 20th-century decade before the '60s. There was neorationalism, neoclassicism, neodeco, neomodernism. What made eclecticism so appealing was precisely its lack of dogma and ideology. There was a pervasive disillusionment with the causes that had informed and shaped the architecture of every decade after the '20s. Perhaps modernism as a style wasn't dead, but its animating idealism and belief in human progress now seemed naive. Architecture reverted to being first and foremost a fine art, and the overriding commitment of architects became composition of a visually appealing oeuvre by any possible means.

As governments and public institutions built less and architecture became more associated with private enterprise and personal wealth, the preeminent building type of the '80s, as of the '20s, was the commercial office building. Some corporations built new headquarters, some private and especially cultural institutions expanded, and the Gatsbys of the period built lavish, architect-designed houses. But architecture lost its place as a





for social betterment, in practical as well as moral terms. Its role was further diminished as commercial projects grew in size and complexity and architects were often supplanted by specialists in such disciplines as construction management and programming. Design architects increasingly were used more as decorators of facades and lobbies than as the master builders they had been in the modernist decades.

A major explanation for the superior quality of the best 1980s design lies in some of the very characteristics that made the decade seem culturally anemic and politically and socially regressive. For accompanying a loss of belief in single or simple answers was a disillusionment with the crusader mentality of modern architecture: modernism's defiant, brave-new-world emphasis on the universal, the new, and the heroic was replaced by increased concern with the particular, the familiar, and the humane. Years of macho brashness in design gave way to a new restraint, respect, and responsiveness. A softening of hard edges coincided with a shedding of inflexible and austere theoretic positions.

The architecture of the 1980s sought to retrieve and regroup by restoring interest in such bogeymen of modern architecture as the past and cultural continuity, the everyday, the vernacular, and the regional. And, because the first wave of postmodernism emphasized surface manipulation, it had the effect of refocusing attention on ornament, craftsmanship, materials, and the use of color and texture. The '80s produced some of the most exquisite detailing since the '20s. Taste replaced dogma; sophisticated finishes replaced raw-looking materials.

Overall, the greatest benefactors of 1980s architecture were America's downtowns. The cities, victims for years of modernism's emphasis on buildings as independent objects, breathed new life under postmodernism's view that a "great city is not a loose conglomeration of high-profile buildings but a densely woven fabric in which buildings are part of the whole," as architect Robert Geddes put it. Landscape architecture gained new importance as a way of making the connection between individual buildings and the rest of the world.

True to their decade, however, the new downtowns were built around consumption, frequently around so-called "festival marketplaces." These were the progeny of developer James Rouse and architect Benjamin Thompson, who, along with less talented followers, went on to seed downtowns from coast to coast with old-timey-looking shopping complexes. They rapidly became standardized, with slightly abstracted historicism, identical franchised retail shops, and a quality of theater. As Robert Campbell wrote in *ARCHITECTURE*, festival marketplaces catering to the affluent underscored the schism in American cities between

the monied and the poor, and thereby mirrored the priorities of their time. The revived, carefully groomed, and elegant downtowns were stranded in a bog of neglect, as ghettos grew more ragged and more violent.

Nineteen-eighties architecture, as we know it, didn't really begin until about 1983, when the economy began to rally after years of recession and high inflation. The first three years of the decade now look like leftovers from the '70s, when President Jimmy Carter proclaimed the energy crisis "the moral equivalent of war" and architects believed energy concerns and a new austerity would serve as form-givers for the design of the 1980s. Instead, as the price of oil fell the Sunbelt went bust, and measures to assure energy efficiency were absorbed into standard architectural practice but failed to appreciably affect form.

With hindsight, however, we can see benchmarks for the decade's prevailing trends as early as 1980. There was, for example, the American entry in the 1980 Venice Biennale, entitled "The Presence of the Past." It hoped to do for postmodernism what the International Style exhibition of 1932 at the Museum of Modern Art had done for modern architecture—confer legitimacy and move it into the mainstream. "La Strada Novissima," as the American contribution was called, consisted of a row of facades by Robert A.M. Stern, Robert Venturi, Stanley Tigerman, and others. It was just facades, as so much of '80s architecture was just facades. It looked thin, more like stage sets than real buildings, but La Strada Novissima did serve to refocus attention on decoration, composition, color, and diversity of expression.

The most talked-about building in 1980 was the Crystal Cathedral in Orange County, Calif., designed by Philip Johnson and John Burgee. Its patron was TV evangelist Robert Schuller, whose general message, appropriate for the '80s, was that the road to riches, as exemplified by Schuller himself, is paved with self-satisfaction. The dedication of Schuller's huge, \$18 million, glass-tent-cum-church headquarters building was pure Reagan razzmatazz. The President sent greetings, a Goodyear blimp hovered overhead, and Schuller delivered a sermon entitled "Why Did God Want the Crystal Cathedral to Be Built?"

A very different kind of religious building dominated the architectural stage in 1981. It was the highly personal, handcrafted Thorncrown Chapel by E. Fay Jones, a modest wood structure gently set into the edge of a forest near Eureka Springs, Ark. If the Crystal Cathedral is a television-studio church, Thorncrown is a timeless, modest, and quiet meditation center. Both buildings fall outside of postmodernism. The Crystal Cathedral is slick,





late modern, while Thorncrown has no identifiable style, though it is deeply indebted to Frank Lloyd Wright.

If the '80s were, in fact, the decade of postmodern corporate architecture—and to a large extent they were—two buildings were pivotal. The first was New York City's AT&T building, designed in the late '70s by Johnson and Burgee, the architects of Schuller's church, and finished in 1983. It was a first in restoring to skyscraper design the classical tripartite division into base, middle, and top—in this case a Chippendale top. The AT&T building became a media event, as *Time* magazine ran a picture of Philip Johnson as a caped impressario holding a model of the structure. The age of the celebrity-architect was upon us. But the completed building proved somewhat anticlimactic. As Paul Goldberger wrote in the *New York Times* in 1983, "Mr. Johnson and Mr. Burgee's commitment to classical architecture, which seemed so daring in 1978, now seems, oddly, not to go far enough."

The second benchmark building was Michael Graves's Portland, Ore., Public Service Corp. Building. Officially dedicated in 1982, it caused at least as much stir as AT&T, in part because Johnson, as professional adviser in the city of Portland's competition to choose an architect, intervened to give his favorite "kid" a chance to realize ideas until then restricted to paper. Though modern in its boxy shape, the vividly colored, classically ornamented Portland building was otherwise postmodern and the first large-scale commercial building by a member of the Venturi-Graves-Stern generation. It ushered in a new crop of urban towers. It also was roundly criticized. Pietro Beluschi, during hearings on the competition design, called it "an enlarged jukebox, an oversized beribboned Christmas package." Wolf Von Eckardt, in the *Washington Post*, proclaimed it "dangerous" to other architects. Graves's second skyscraper, the Humana tower in Louisville, Ky., was better received. Graves himself became the preeminent "starchitect." He was featured in the pages of *People*, mobbed by autograph seekers at the dedication of the Portland building, interviewed on network television news, and asked to design fabrics, furniture, and teapots. His drawings commanded prices in the thousands of dollars at a New York City gallery. Hundreds of architects at the 1982 AIA convention wore buttons proclaiming "We Don't Dig Graves," which only confirmed Graves's celebrity.

The most eloquent and perhaps most influential urban achievement of 1980s postmodernism was Cesar Pelli's World Financial Center at Battery Park City in Lower Manhattan. The largest

urban design project since Rockefeller Center, Battery Park City was a combined effort of state, city, and private investment and management. Its first accomplishment was as a masterpiece of planning by Cooper Eckstut. The planning firm produced guidelines specifying the relationship of the complex to Manhattan's financial district, the placement of the project's buildings, their heights, massing, setbacks, circulation patterns, and so on. Though Pelli devised a boldly contemporary, synthesis skyscraper style, featuring the towers' extraordinary, taut, and glistening skins, his complex evokes earlier New York skyscrapers in its setbacks, geometrical tops, and tripartite division. As a group, the towers became a new model of urbanism for showing that huge buildings could be related to a fine-grained, smaller-scaled, old part of a city, maintain the line of the street wall and the scale of the neighborhood, and create usable in-between spaces graced by public art and landscaping.

The skylines of cities from coast to coast were transformed by a spate of new skyscrapers. As large developers spread their purview to become national, a few architecture firms began dominating skyscraper design and changing the skylines of many American cities. In addition to Pelli they included Skidmore, Owings & Merrill, Johnson/Burgee, and Kohn Pedersen Fox. About the last, Walter McQuade wrote in *ARCHITECTURE* in May 1989, "The KPF approach to architecture is grounded in three tenets: first, a frank and literal connection with the past, sometimes in blunted reproduction; next, an emphasis on matching the building to its urban context, without relinquishing the impact of the new; finally, a certain confidence in intuition. They intend their towers to resonate, like Empire State, like Chrysler." That was equally true of Pelli, Burgee, SOM, and a few others.

One result, however, of the trend toward a small number of architects designing a large number of buildings in cities across the nation was to homogenize urban architecture and dissipate the benefits of regionalism. (As the Southwest regionalist Antoine Predock said, "A regionalist is an architect with no commissions out of state.")

By far the greatest concentration of U.S. urban development in the '80s was in the suburbs and exurbs rather than in the downtowns. At highway intersections everywhere, new pseudo-urban concentrations popped up with the vigor and logic of Topsy. They included vast, impersonal stretches of second- or third-generation slick office buildings organized around retail malls, which, in turn, served the '80s as combination cultural center and village square. These minicities, usually composed of strung-together,





sealed megastructures surrounded by cars, were sometimes called “urban villages.” But the majority had neither streets nor other vestiges of urbanity nor hints of village charm. Most were an advanced stage of what Lewis Mumford, more than 25 years ago, called Roadtown: “an incoherent and purposeless urbanoid nonentity, which dribbles over the devastated landscape and destroys the coherent smaller centers of urban or village life that stand in its path.”

The obverse of these soulless suburbs were the small-town new towns, which packaged nostalgic versions of bygone American village life, adapted for the rich and cleansed of Babbitry, tedium, and toil. The model was the new resort town of Seaside in Florida, designed by Miami architects Andres Duany and Elizabeth Plater-Zyberk. It had Victorian forms, detailing, and charm, porches to rock on and public squares to gossip in. At a time of mounting opposition to unlimited growth, Seaside was a deliberately limited community fashioned by a single organizing vision rather than a commercial or social imperative. It spawned offspring of varying quality from coast to coast.

Far more convincing as showcases for 1980s architecture were museums. Among the gems were Richard Meier’s High Museum in Atlanta and his Museum für Kunsthandwerk in Frankfurt, West Germany; Charles Moore’s Hood Museum at Dartmouth College; Harry Cobb’s art museum in Portland, Me.; I.M. Pei’s pyramid for the Louvre in Paris; and Renzo Piano’s De Menil Collection in Houston. Museums became the cathedrals of the ’80s.

As repositories of icons, symbols, and memories of days past and seemingly simpler, museums embodied that sense of permanence, continuity, and meaning so pervasively sought after in the ’80s. They also responded to our impulse to conserve and cherish anything predating 1960. In part, the museum boom of the ’80s was a reaction to the buildings of the last museum boom, that of the ’60s. Its progeny usually resembled warehouses for art—anonymous, all-purpose, boxy. Eighties museums, by contrast, had great variety, admitted light and sun, and, like everything else during the decade, became increasingly commercial. Museum shops became important as income-producers, and some museums added office and even condominium space. The best-known example was Cesar Pelli’s high-rise addition to the Museum of Modern Art.

As architecture gained celebrity status, publishing houses and magazines aimed at the general public devoted more pages to it, while television acknowledged it with air time. The results were

usually controversial, as in 1981 when Tom Wolfe, author and social critic, attacked modern architecture in *From Bauhaus to Our House*. Wolfe impaled modern architecture as a plot foisted on an unwilling world by a group of European intellectuals. His book, which similarly criticized postmodernism as the product of another out-of-touch compound, was received with hostility by architects of all stripes. But even bad publicity is good, and architecture hadn’t received this much attention in years. Only four years after publication of his book, Wolfe was asked to be keynote speaker at the 1985 AIA convention.

Robert A.M. Stern’s eight-part series “Pride of Place” aired on public television in the spring of 1986. Advertised as a personal vision of American architecture, it echoed Wolfe’s view of modern architecture as a lamentable break with the past but cast postmodernism as the redeemer. Largely a tour of opulent American premodern residences, “Pride of Place” was an abundantly 1980s view of American architectural history that traded on sentimentality and made history appear to be a matter of packaging, decoration, and facades. It ended with Stern and architect Leon Krier—the Aldous Huxley of the ’80s—riding the streets of Williamsburg in a horse-drawn carriage and agreeing that in many respects the meticulously reconstructed colonial town was—O, brave new world—the best hope for the future of American architecture.

Architectural historian Spiro Kostof’s television series, called “America by Design,” aired in 1987. More ambitious than “Pride of Place,” it was less about architectural history as such than about the sociological, technological, and political forces that shaped the American built environment. The series was about ideas more than images, and the American public—even the public television American public—tuned the program out.

By the close of the decade, the stylistic battles, tiresome arguments, and factional infighting of the early ’80s seemed as out of date as the Cold War. While much of the early built work had been ironical, two-dimensional, and cartoonish, by the decade’s end the best architects had become more genuinely comfortable with history; they tended to abstract and transform their sources and to agree that anything goes but only quality counts. By the late ’80s, even dyed-in-the-wool old modernists were designing retro buildings.

Not surprisingly, however, the pendulum had also begun to swing back again. Throughout the decade, modernism had remained an influential presence, a foil against which to react, test, and measure ideas. By mid-decade there was a revival of

*continued on page 130*



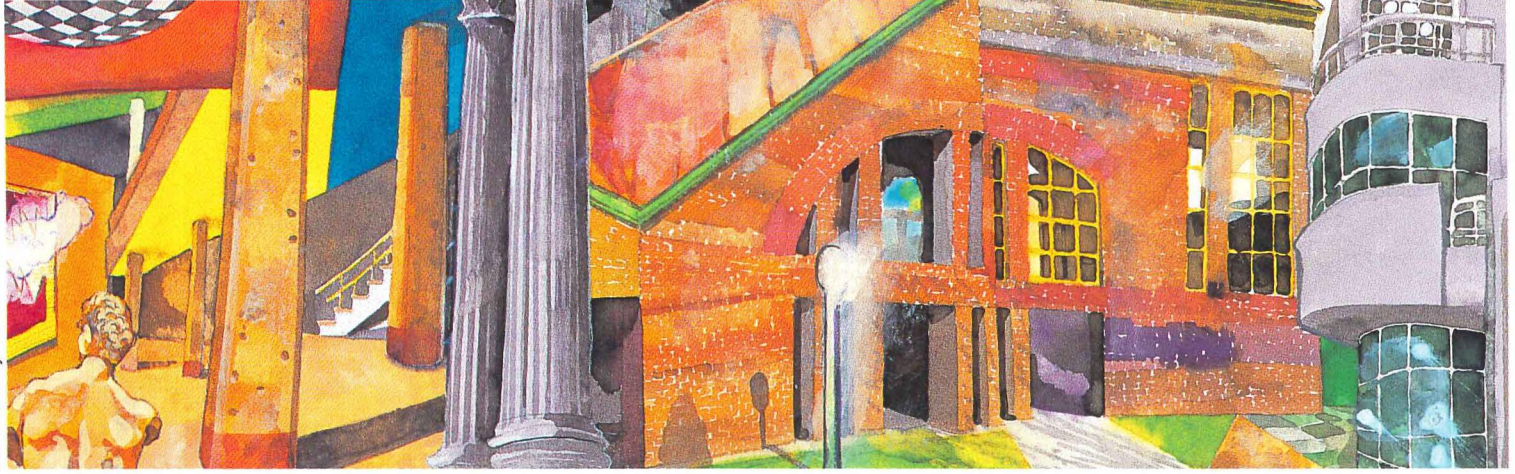

# Intellectual Drift, Better Buildings

Just three brief points about three traits of the 1980s that I'll call eclecticism, imagism, and academicism. The first is okay, but the second and third are problems.

*Eclecticism:* The 1980s was a time of confusion and drift in architectural thought. But it was also a time when the buildings kept getting better. I'm sure this paradox means there is no correlation between intellectual or stylistic consensus and architectural excellence.

An example, for me, was the experience recently of serving as juror for the AIA San Francisco Chapter awards program. The field of entries was strong and especially so in the category of the single-family, or sometimes two-to-five-family, house. But it was difficult to believe that these brilliant houses had emerged from the same culture, in the same town, at the same time.

One house was a wonderful exercise in the Bay Area style, sited on a steep hill among trees, with its walls made of wood and all its details crafted with the kind of hands-on love one associates with Greene & Greene. Another, just as good, was a light-flooded, high-tech renovation of a former garage, glittering crisply with its white walls and its glass and its articulated structure. A third was a dark interior symphony of blacks and metallic grays, taking its visual cues from the world of the sound stage and the mixing studio. A fourth, utterly different again, was a skilled attempt at a desert-style, Barragánish stucco hacienda. And a fifth nodded to the ornate bay windows of Victorian San Francisco.

We are thus at a moment of broad eclecticism that is also a moment of high quality. Instead of a tradition, we have half a dozen competing traditions. Perhaps the very fact that they are competing gives them extra strength. I find no problem in this. The Edwardian era was another time of much eclecticism that also produced an exceptional standard of excellence. We do have problems, but they aren't those of eclecticism.

*Imagism:* Speaking of problems, it should come as no surprise that I have been describing architecture largely in formal terms. The '80s have been, unfortunately—as were the '70s—a period in which architecture has been perceived as a matter of visual style. That perception is the result, undoubtedly, of the extent to which media representations of reality have replaced reality itself in all aspects of our lives. Just as we watch games on television rather than play them ourselves, we “watch” architecture—we architects do this, especially—as a series of framed visual images rather than experiencing it directly. I think we can trace our tendency to view the world in discrete images directly to the invention of photography. Photography is the removal of context—as well as, like painting, the removal of the nonvisual.

*Academicism:* The second regrettable aspect of the 1980s is the capture of many schools of architecture by academics—philosophers, critics, and historians—who have little interest in the notion of architecture as a service profession. The most important purpose of architecture is to create spaces—interior spaces and

urban spaces—in which the work and joy of personal and communal life can be carried out. Architecture is not *primarily* the embodiment of either an artistic or an intellectual concept—at least not in the contemporary usage of those words, which assumes that a work of art is an intervention or creation made by an individual commenting on other interventions or creations made by oneself or others, within the framework of some esthetic, political, or philosophical system. Indeed, a confusion between art and philosophy on the one hand and architecture on the other has been a persistent weakness of our century, manifested very clearly, for example, in the figure of Mies van der Rohe.

In pointing to these two problems—imagism and academicism—I don't want to sound priggish. The parade of images and visual fashions in architecture is and should be a source of wonder and delight. Making the world new—making us perceive it anew by revising its conventions—has always been a function of culture. And the fashion parade has its own kind of utility. It creates a visible time line in the built world, so that we can travel through that world and date what we see by its style.

The other parade, the parade of academic fashions, is stimulating too. Trends in ideas probably change even faster and more excitingly than visual trends. Philosophies are terribly interesting. But most of them are soon forgotten, at least by architects. We may be forgiven if we tire quickly of up-to-date persons who harangue us on Jacques Derrida but have never read, let us say, Jean-Paul Sartre or William James, or persons who talk of poetry but who we suspect are unable to cite 10 titles by Wallace Stevens. Ideas, like images, are fun. But they don't necessarily address the essential issue of architecture, which, again, is to create good public and private places for habitation. Architecture needn't be, as a matter of fact, an especially intellectual activity. Too often, when one visits schools of architecture today, one comes away with the feeling that these institutions are far too conscious of the fact that they are located in universities, and they are responding by becoming as academic as the philosophy department. The great danger in any insitution is that it will be taken over by its staff—in this case, the faculty—and run in that staff's interest, rather than in the interest of the clients—the students—or the interest of society as a whole. One must suffer in one's heart for the poor student who goes to school expecting to learn how to design and instead is subjected to a barrage of pompous, shallow, and self-righteous intellectual bigotry.

Looking ahead, I hope the 1990s will be remembered as a time when ethics returned to architecture. Architecture must do two things better than it's doing now. It must nurture and support our sense of ourselves as members of a community. And it must join with other disciplines to heal a sick planet. If these goals, rather than flashy images or bright ideas (valuable as both are), can be primary in the mind of every architect who sets out to design a building, we'll be doing well.—ROBERT CAMPBELL, AIA



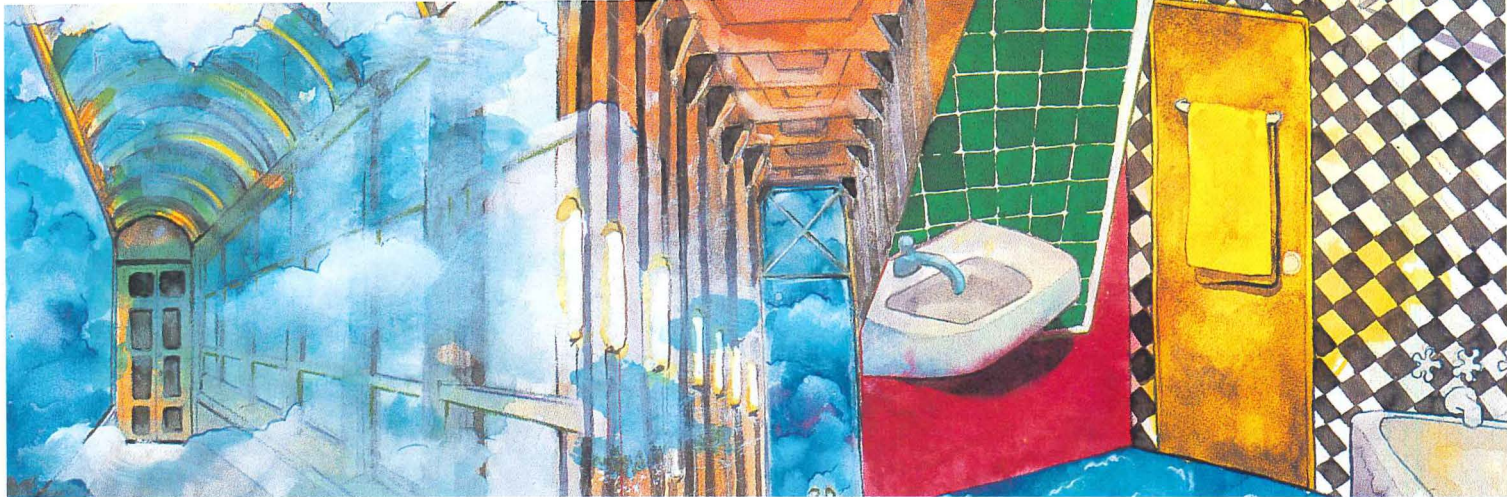

# An Imagery of Consumption

The 1980s have been a time of widespread privatization and consumption. Ordinary folk have vigorously patronized their mini-malls and megacenters, helped along by marketing experts who define market segments and consumer niches in amazing detail. But Joe and Jane Average have been Trumped by the superdevelopers and their ever-expanding property portfolios, by financial buccaneers who buy up large companies, and by cultural institutions whose appetite for product and output is immense. The public sphere has been subsumed into the private one. The shopping mall and the festival marketplace have taken over the role of Main Street and the town square. The corporate headquarters has overshadowed not just the church but the state as well. Much of the church's role also has been assumed by arts institutions.

Architecture has visibly served these tendencies. Where many designers once deemed themselves socially motivated, the profession now generally understands itself to be a provider of symbolism and imagery to the degree that budgets permit.

The '80s have been a time of great apparent freedom, but that freedom has been largely superficial. Mirroring this, architecture has burst forth in as wide and unrelated a range of visual styles as has been seen in the past six or seven decades. We have revived the past, not one period at a time, but seemingly all at once. Classicism, art deco, Gothic, Russian constructivism, Mussolini modern, and even elements of the International Style have become sources of today's various design expressions, along with an occasional nonrevivalistic essay in late modernism.

How can one possibly sort out all this visual pluralism? Hold a design competition. Better yet, hold a thousand. On this continent, at least, the '80s have been the decade of the competition. The process has often been abused, yet it usually has produced better designed results than more conventional forms of architect selection. Perhaps the most important aspect of competitions is that they commit clients to seeking design, not just pragmatic results.

The '80s gave birth to yuppiedom, and as a result architecture emerged as a category of consumer goods. Quite literally, certain architects have taken on the function of couturiers, designing tea services, tableware, jewelry, stationery, and lines of collectible furniture. Most of these products are intentionally quite expensive, disproving the adage that it costs no more to use an architect and rejecting the old modernist notion that industrial methods can make good design affordable to a broad segment of society.

Newspapers have discovered architecture as grist for their style sections. Star designers' drawings, models, and custom-designed prints also have become commodities, and commercial architectural galleries have appeared in the larger cities. The line between architecture, fashion, and art has become blurred, not only in the acceleration of stylistic change but also in a de-emphasis on actual building and a stress on exhibitible and salable artifacts.

The decade's glorification of consumption, combined with a drop in basic petroleum prices, has consigned energy considera-

tions to the back burner. Energy codes have assured a certain degree of efficiency, but there is no longer any great interest in resource conservation as form-generating principle. And with society's shift away from production there has been diminished emphasis on design that grows out of the way buildings are put together while correspondingly greater value has been placed on the characteristics of packaging. As has been the case since the beginning of the century, buildings have steadily become more sophisticated technically, but during the '80s the link between physical performance and visible form has been obscured.

Due to the continuing shift to white-collar employment and a quantitative explosion in the arts, skyscrapers and cultural facilities have become the prestigious commissions of the decade. Since these entities must compete with each other for identity and patronage, the profession has responded with an amazing variety of designs. Tall buildings have taken on incredible visual diversity that, coupled with a continuing escalation of size, has enabled the '80s to put a prominent stamp on most major skylines. Developers have come to use their architects' names and abilities as major selling points for their projects, as have arts institutions. More than ever, the designer has been given latitude to supply much of the identity for museums and performing arts complexes. The building is now tacitly acknowledged as a major item in the collection, or a significant piece on the program.

During the '80s, postmodern styles attained hegemony over modernism. However, since this new eclecticism has taken so many forms, there has been no dominant style or design outlook. Now, at the end of the decade, an aggressive modern mutant, deconstructivism, is emerging as the avant-garde style of choice. Because it is esoteric, difficult to work in, and more concerned with three-dimensional graphics than the creation of usable spaces, its widespread adoption or long-term architectural popularity seems unlikely. Its strongest influence probably will be in the decorative and graphic arts. Nevertheless, decon signals a weakening of postmodernism's hold on the profession.

While postmodernism has broadened the boundaries of visual expression, history may show those effects to be relatively ephemeral. In the long run, postmodernism's most important contributions may turn out to be urbanistic rather than architectural. The movement has revived interest in traditional urban verities such as building typology, figure-ground continuity, response to context, coherently shaped outdoor spaces, and the integrity of streets. These perceptions are valuable in a world where suburban values, real-estate economics, and demands of the automobile still seem to be the dominant generators of urban form.

The '80s were an unusually interesting decade for architecture, but not a totally satisfying one. As the decade draws to a close, I will do what I did 10 years ago and hope the new decade will be an improvement over its predecessor. Perhaps I'll be right once again.—JOHN PASTIER







Photographs © Richard Bryant



## '80s Retrospective

# Stuttgart, After the Hoopla

*James Stirling Michael Wilford and Associates' gallery is now a place for contemplation.*

*By Charlotte Ellis*

When Stirling and Wilford's Neue Staatsgalerie in Stuttgart first opened in March 1984, 4,000 people attended the inauguration and 8,000 queued to get in the next day. At the end of the year, admissions stood at 1,205,262 and the Staatsgalerie was declared the most visited museum in West Germany. Then the novelty wore off and visitor numbers fell, but by that time most architectural writers had filed their copy. Saturation coverage in architectural magazines showed the building full of contented people, mostly basking in nonstop sunshine.

The reality isn't quite like that on a cold, damp Saturday night. The advertised five-minute walk from the main-line railroad station takes in part of a shopping mall after hours, then a sparsely lighted park, and culminates with a less-than-alluring pedestrian subway under Konrad Adenauer Strasse—the eight-lane freeway that amputates the Staatsgalerie from the city center.

Full frontal to greet you when you regain ground level is a hoarding around a vacant lot. As you turn left with a headful of speculations about local street crime statistics, two bright red garbage containers catch the eye. Inexplicably, they are one story above the street and spotlighted. Closer inspection reveals them to be the revolving doors to the Chamber Theater foyer, at the western end of Stirling and Wilford's complex. Both doors are locked shut. The Staatsgalerie is closed too, but a major transformation is revealed on your ascent of the ramped right-of-way around the perimeter of the much-photographed roofless central rotunda: climbing plants cover most of the stonework to its full height. And the coved cornices beyond fairly drip with fronds.

Further exploration of the building's exterior discloses more locked doors and darkened windows. Halfway down the footpath skirting the music school, somebody has put out a saucepan of food, for stray cats. There are no takers.

In the midst of all this depopulated emptiness, the Neue

Staatsgalerie's Fresko cafe-restaurant is open for business and fast filling with a well-heeled clientele, for the most part balletomanes hotfooting it from a show elsewhere in town. This part of the building begins to look more like the magazine pictures.

Five years ago, the Neue Staatsgalerie provoked fierce controversy centered mainly on Stirling and Wilford's use of architectural imagery. At one extreme, overt classical references were held to condone Nazism; at the other, Stirling was accused of selling out to postmodernism.

Stirling's defenders went to considerable lengths to explain why the building represented a logical evolution of modernism rather than an example of postmodernism. They discussed its urban qualities, its dextrous planning and composition, they said it was witty (often several times), then pointed out and explained some of the more obvious architectural jokes. Few seemed able to resist entering into a laborious game of spot-the-reference that, no doubt, was provoked by Stirling himself. In the booklet published by the Baden-Württemberg finance ministry to coincide with the March 1984 inauguration of the building, a summary of its various design aims concluded with these words: "For the painstaking, there is much more innuendo to be discovered."

The frenetic double-guessing of sources stretched from Giulio Romano to Piano & Rogers's Pompidou Center, by way of Schinkel, Lutyens, Frank Lloyd Wright, and Le Corbusier. At its most obsessive, this naming of parts was accompanied by solemn cataloguing of classical details. Voussoir. Pediment. Architrave. Cornice. It somehow smacked of bravado, the kind used to dissemble embarrassment when saying *rude words* with intent to imply a worldliness belied by doubts about pronunciation. And, in a way, that was exactly what was going on. Architects who had doggedly refused to understand the niceties of their own inability to distinguish an abacus from an aedicule had broken the taboo. Not

*Ms. Ellis, a Paris-based architect and freelance writer, is a frequent contributor to this magazine.*

*Facing page, stone-faced ramps step up the hillside. Above, roofless, central rotunda, now covered with plants.*



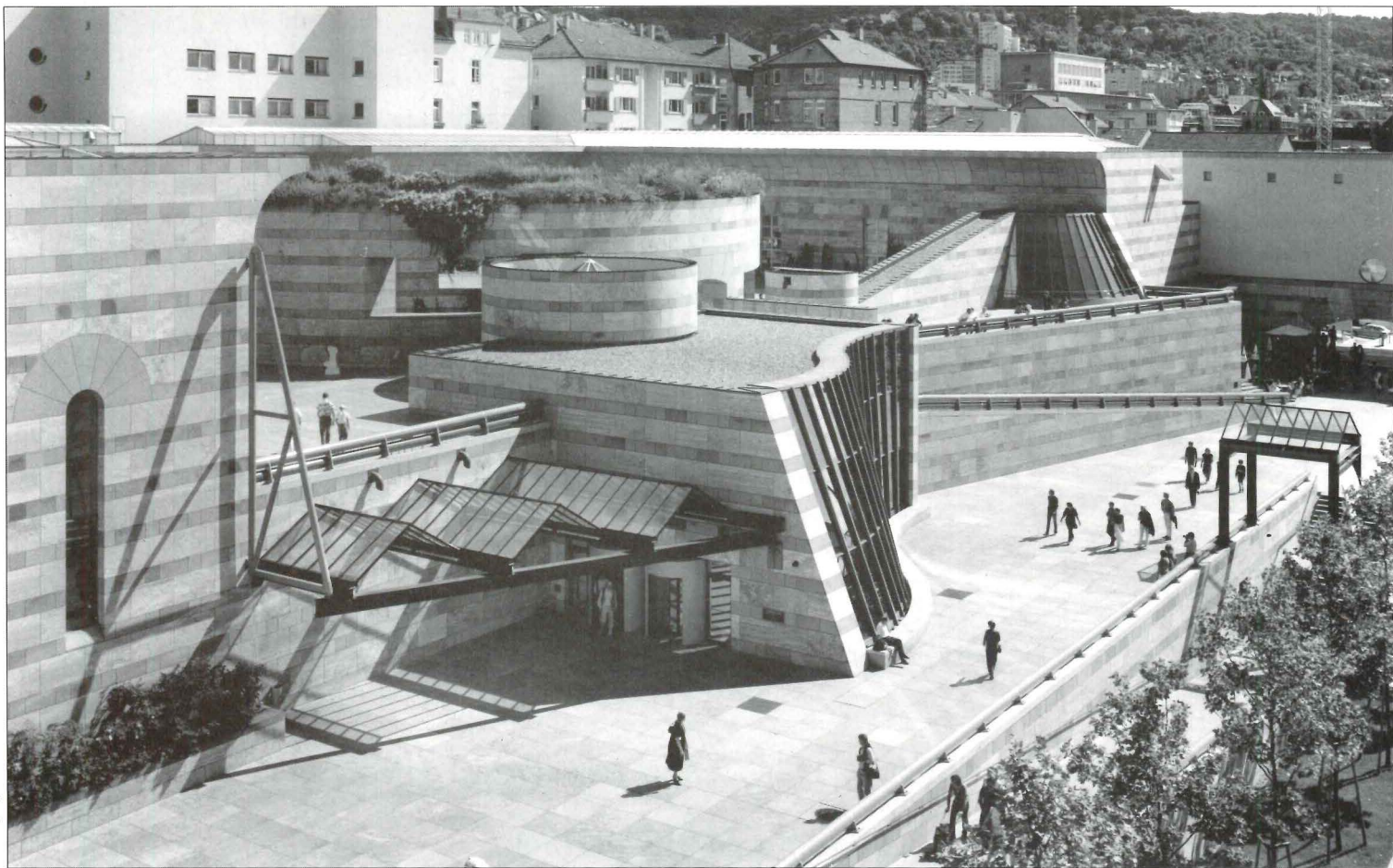

a few took their first faltering steps in what to them was the entirely foreign language of classicism, in the debate about the Neue Staatsgalerie. And, more often than not, they vented their spleen by dismissing the blue and pink handrails as unspeakably vulgar.

The profession was running scared. Modernist certainties had lost credibility, public confidence in modern architecture had collapsed, and speculators were floating a new paper currency called postmodernism, in a bullish attempt to prop up the market. Those who had invested heavily in the apparent security of modernism were fighting for survival.

James Stirling had long been recognized as one of modern architecture's world leaders, Britain's best (AIA honorary fellowship, 1976; Alvar Aalto award, 1977; RIBA gold medal, 1980; Pritzker prize, 1981). Yet he had built scarcely anything in the 1970s other than low-cost housing in Runcorn, England (some of it now threatened with demolition). Opponents of modernism were busily trying to discredit his earlier buildings, notably the U.K. Cambridge University history faculty building of 1964-67, which was stripped of its tile cladding for reasons of public safety.

In 1977, many had been delighted by the news that Stirling at last had won a commission in Germany. But Stirling's drawings are notoriously impenetrable, and the finished building came as a shock to men and women who never in their lives had doubted that form follows function, that ornament is crime. How were they to react to coving and truncated bits of cornice, to two-tone banded stone and oversized *oeil-de-boeuf* windows, to a sunken pair of Doric columns and an entire enfilade of pedimented doorways?

It was a dilemma quite as momentous as the one that faced Elvis Presley fans when the King had his hair cut, joined up, and started to sing sentimental ballads such as "Wooden Heart"—a song that, as you may recall, sounded nothing like rock and roll and even had some German lyrics. If purists were (and probably still are) disgusted, sales suggested the vast majority thought Elvis deserved their support while he was out there in Europe doing his bit to defend Western democracy.

So it was that, while hard-line modernists saw the Neue Staatsgalerie as a moral betrayal, their more flexible colleagues sensed Stirling might be on to something. The Neue Staatsgalerie clearly

had popular appeal. Moreover, the building was manifestly loaded with deep, albeit elusive, architectural meaning. If an architect with Stirling's impeccable modernist credentials could contrive such a cocktail, he deserved their support. Besides, if the public could be persuaded that modern architecture is both cerebral *and* fun, that would be in everybody's best interest. So they closed ranks and launched into flights of (frequently shaky) erudition, explaining how the classical bits of the Neue Staatsgalerie had been employed to truly modernist ends. The pity of it was that hardly anybody saw the forest for the trees.

The most memorable exception was Reyner Banham, who, as always, was way ahead of the field. He said, "If the visitor to the Staatsgalerie will look around him at the city beyond with only moderate attention, he will see that with barely a couple of exceptions—the pit-head gear redeployed as a lift shaft, the supposedly Piranesi plantings on top of the rotunda—the details seem to come from the museum's immediate urban surroundings." The remark remains as cogent as when Banham first made it.

There is, of course, nothing to stop anyone from expanding upon the list of details that may or may not come from non-Stuttgartian sources. But it seems to me there are worse ways to spend the day than taking a fresh look at the building as a whole and then pondering how on earth Stirling and Wilford contrived to make such skillful use of so unpromising a site.

Take the main Konrad Adenauer Strasse frontage, for instance. It overlooks eight lanes of traffic and the backside of a 1962 extension to the Staatstheater by the inappropriately named Hans Volkart. This building blocks all but the most oblique views to or from the city center and presents to the Neue Staatsgalerie site an elevation of such tedious length and unmitigated dreariness that, were it part of a prison, there probably would be pressure to demolish it on humanitarian grounds.

This type of urban no-man's-land is familiar enough: something very similar exists around every city with a beltway. But at Stuttgart the situation seems to have been reversed. Just where you might expect the beltway to be are hilltops crisscrossed with contour-hugging stone retaining walls that support perilously steep vineyards. Not everybody would have thought of reinter-



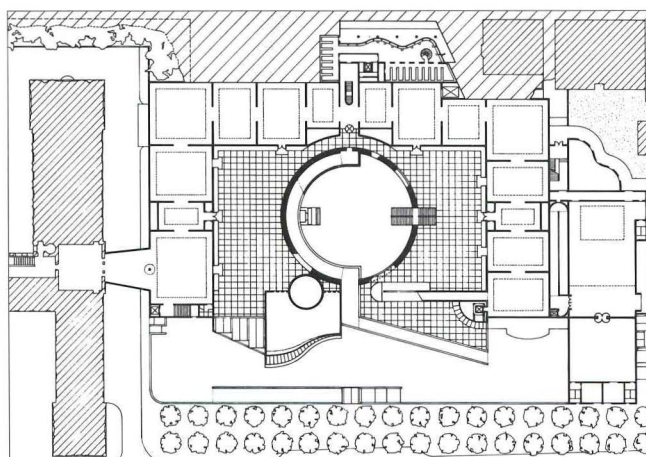
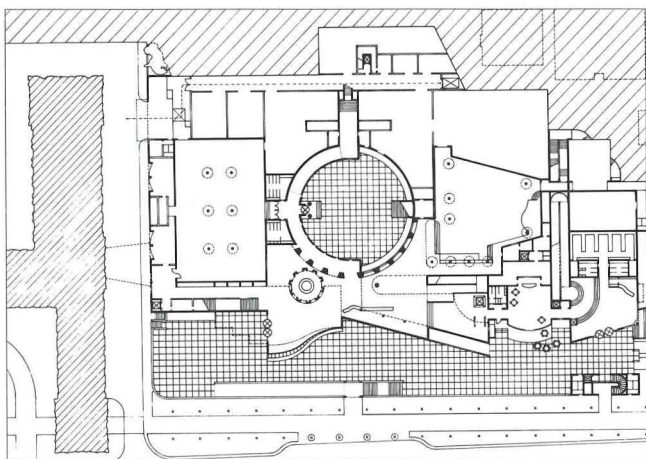

Gallery level

*Facing page, street elevation—with colorful entry, handrails, curved glazing, abundant people and plantings—softens adjacent through-way. Above, outdoor cafe with view of the old building.*



preting so rustic a device to civilize and soften Konrad Adenauer Strasse, let alone have found a way of doing it that was neither ham-handed nor hopelessly sentimental.

At the Neue Staatsgalerie, now that the planting has had time to grow and the stone-faced ramps stepping up the hillside, one behind the other, are interspersed with layers of vegetation, it is clear Stirling and Wilford have done just that. What is more, now that the saplings planted in a row along the “boulevard” have become a bit more treelike, the much maligned pink and blue tube handrails have come into their own. Seen from the freeway at, say, 25 miles per hour, they read something like a dotted line bisecting the foliage, and they signal that there might be something worth slowing down for. Even pedestrians on the other side of the strasse, poised miserably between braving the traffic and risking terminal injury or arrest and facing the unknown perils of the pedestrian subway, have a cheerful color to aim for. O.K., swallow hard, let’s make a dash for it.

Sunday morning, Sept. 24. All parts of the complex are shut except the Staatsgalerie, which is alive with people aged under 6 to well over 60, wandering hither and thither through the various foyer spaces and galleries, promenading up and down ramps, looking at the art, looking at the building, looking at each other. Some elect to make the most of the seasonally watery sunshine by exploring the rotunda, where the abundant creeper is a brilliant red. They climb the ceremonial staircase to the rooftop sculpture courts, then peer through windows from the outside. Others stay indoors. They make their way to the current Neue Staatsgalerie exhibition (which occupies all but two galleries in the first-floor enfilade) or to the excellent permanent collections in the Alte Staatsgalerie; or peruse the publications on sale, even buy some; or make a beeline for the cafe-restaurant (which again is doing a roaring trade); or simply watch the world go by. A small child is pushing an intriguing wheeled toy through puddles just

outside the main Neue Staatsgalerie entrance. Older children negotiate the ramped public route around the rotunda with skill and speed on roller skates.

All of this may sound just like Sunday at any public art gallery. Yet the Staatsgalerie offers the very antithesis of the claustrophobic conditions now prevailing in, say, Paris or London, where the prestige, success, and utility of public museums and galleries (and of their directors) is measured in terms of ever-increasing visitor numbers. Even the most cursory glimpse of any major public art collection in either city has become virtually impossible without first queuing for hours, or struggling through capacity crowds, or both.

Such is not the case at Stuttgart. For the record, combined visitor totals for the old and new buildings averaged just over half a million in 1987 and 1988. Attendance fluctuates with the popularity of particular exhibitions: for instance, an exhibition of German 20th-century art was six times more visited than a more recent exhibition of English 20th-century art—which would suggest that the Staatsgalerie now caters to a mainly local public.

The aim seems to be to increase the public’s enjoyment of the art on show, and the role of the Neue Staatsgalerie is to extend the Alte Staatsgalerie’s preexisting facilities—not just by adding more galleries, a new lecture hall, and so on, but qualitatively. Visitors may move at will between the two buildings without necessarily being aware of the juncture. Pictures are hung in a no-nonsense manner in what, in the main, is a fairly conventional sequence of galleries, supplemented by circulation spaces and areas for relaxation indoors and out. Generous allowance has been made for quiet contemplation, keen concentration, casual *clins d’oeil*, and creature comforts—for restful rumination, relaxation, recreation, and refreshment. There are no queues, nor admission charges, save for special exhibitions.

Stirling and Wilford’s contribution to the Stuttgart Staatsgalerie represented a crucial turning point for architects in the mid-1980s because it shook the profession out of a negative dither. Now that the architectural sightseers have left, Stuttgart has the benefit of what must be one of the world’s most civilized public art



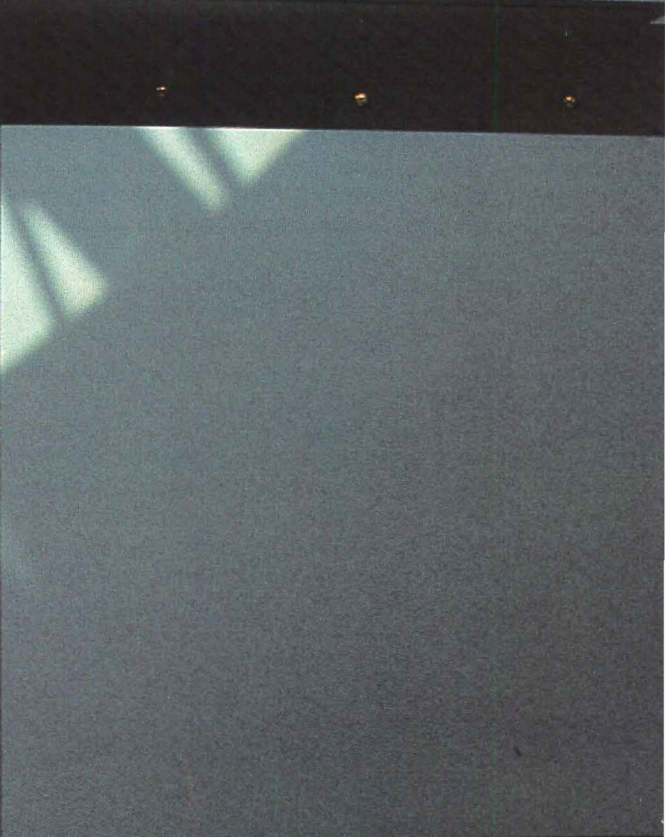
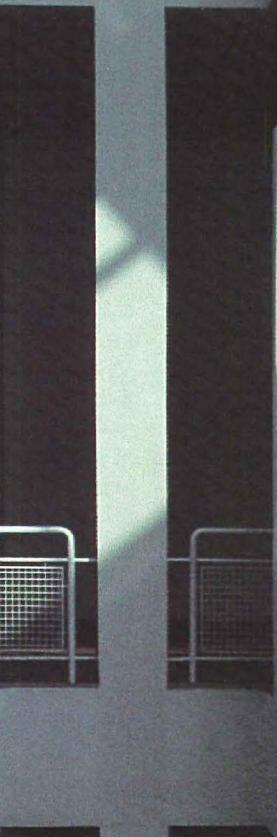
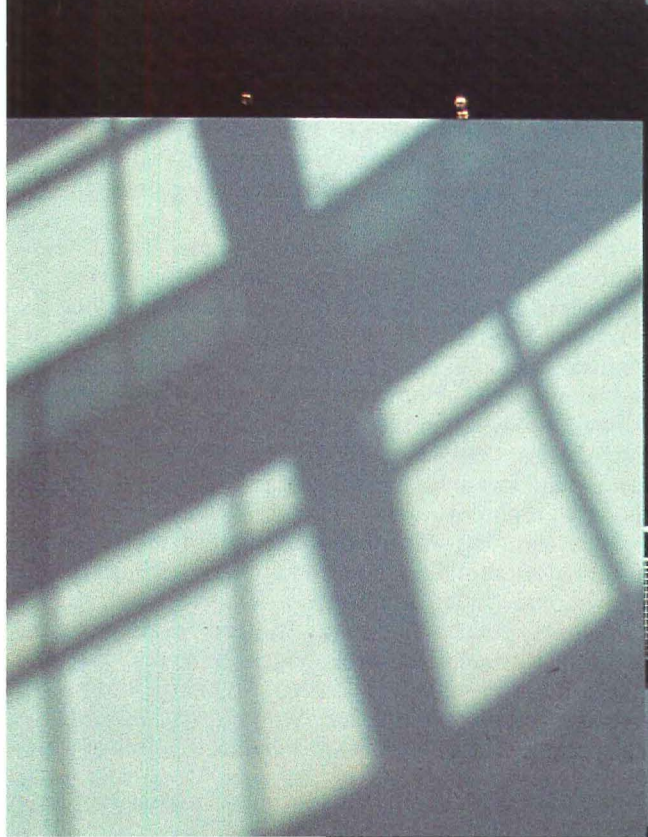
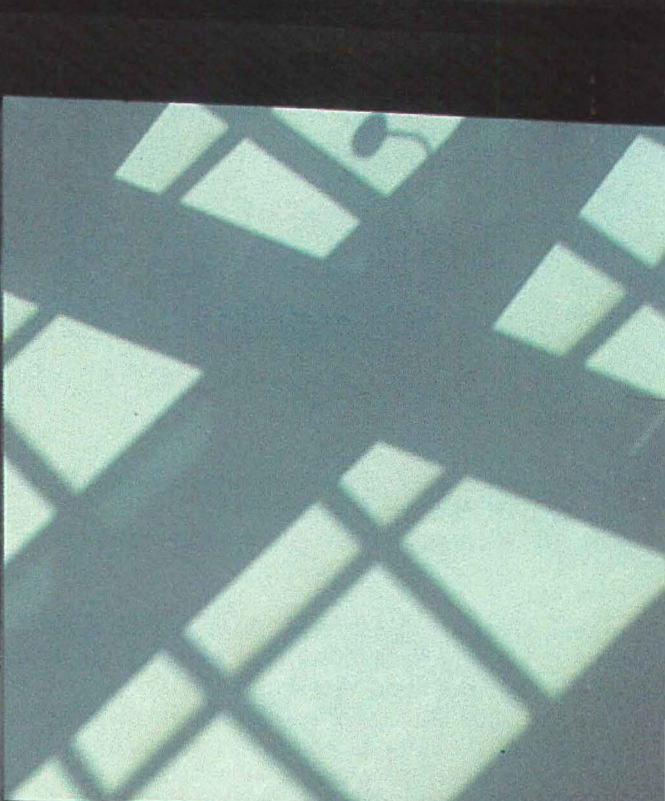
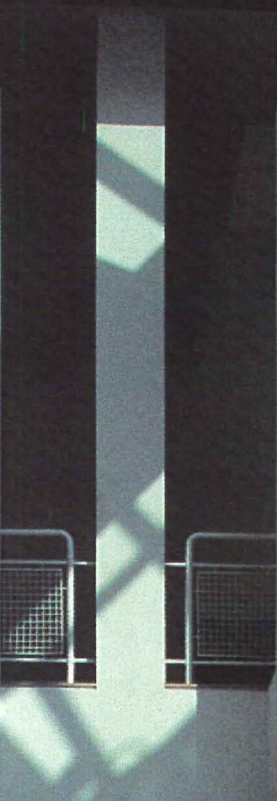
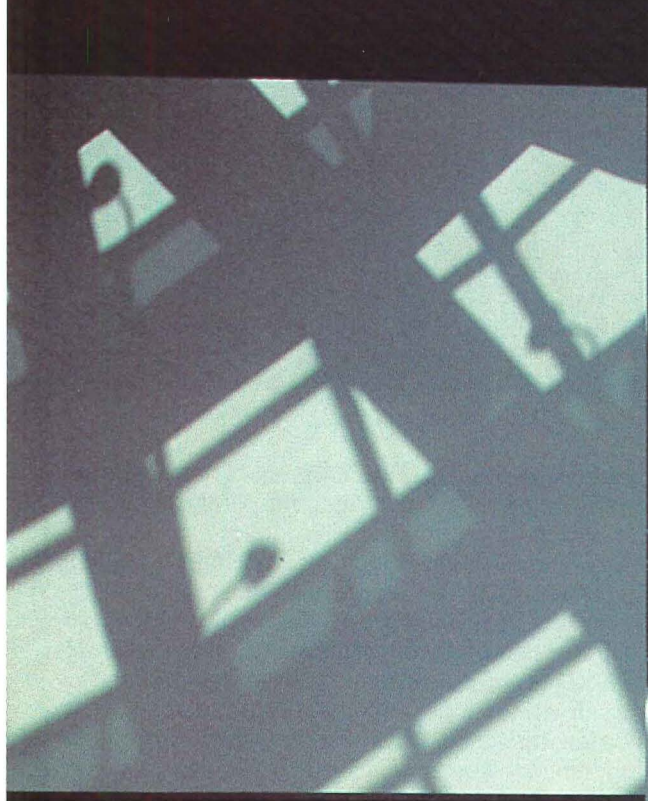
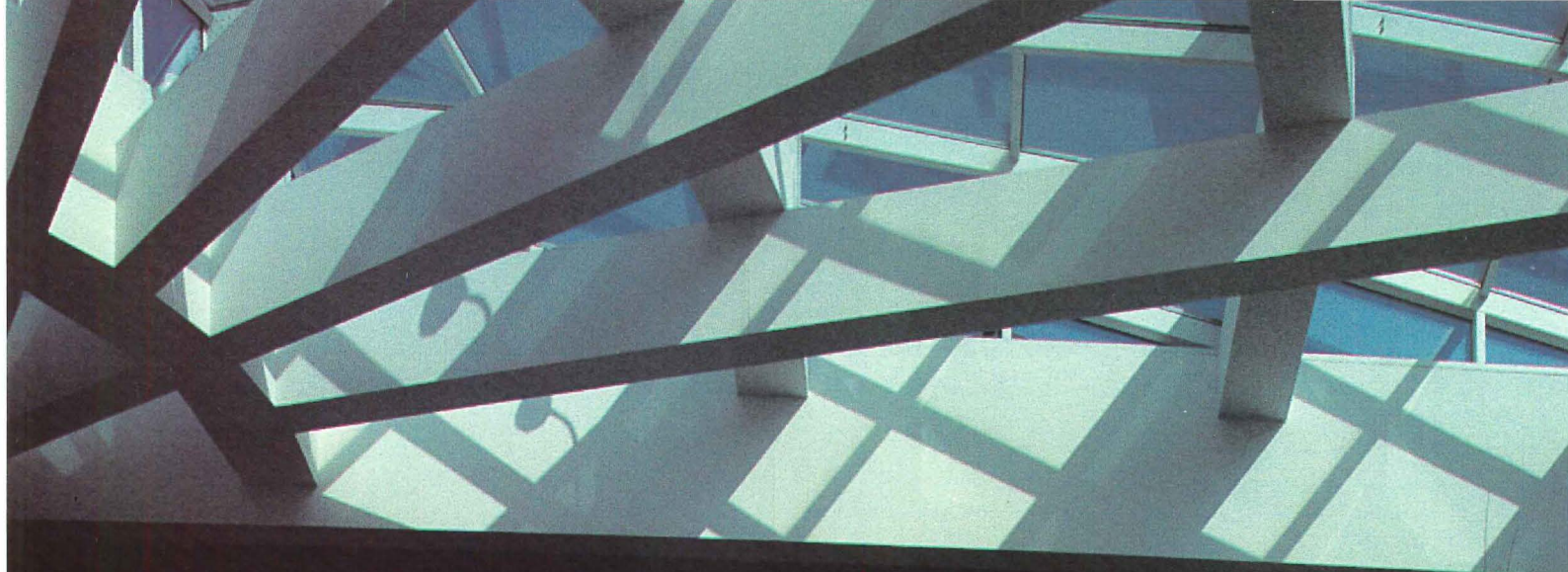



Photographs by Allen Freeman



*'80s Retrospective*

# Demanding Showcase

*Richard Meier's High Museum  
in Atlanta considers expansion.*

*By Allen Freeman*

The High Museum in Atlanta of 1983 solidified a trend, begun with I.M. Pei's East Building of the National Gallery of Art, that elevated museums to showcases for 1980s architecture. The High was the first of several new museums that created an identity for the institutions they housed and propelled them to national prominence. Among other examples are Henry Cobb's Portland, Me., Museum of Art, Piano & Fitzgerald's Menil Gallery in Houston, and Arata Isozaki's Museum of Contemporary Art in Los Angeles.

Six years ago the Atlanta museum moved out of a prosaic, late-'60s, multipurpose arts building and into Richard Meier's new white temple on an adjacent site. Today, you can't think of the museum without conjuring up Meier's building. It appears on picture postcards and television logos, signifying Atlanta.

Thanks largely to the building, the relatively young and small museum has prospered beyond all expectations. Membership has doubled to 25,000, putting it among the top 10 art museums nationally; annual attendance has more than doubled to almost 450,000; the yearly budget, derived entirely from endowments, membership fees, and operations, has quadrupled to \$8 million; and the staff has nearly tripled to 140. The collection of only about 8,000 objects, compared with 200,000 in the San Francisco Museum of Modern Art and 3 million in New York's Metropolitan, has grown more slowly. The High's directors are nevertheless considering physical expansion. Although no one is willing to speak on the record about the addition, the logical site is immediately behind Meier's building.

The architect designed the High just after the Hartford Seminary and in concurrent years with the Museum for the Decorative Arts in Frankfurt, West Germany, and the Des Moines Art Center addition, both of which opened in 1984, after the High.

The Atlanta museum is arguably Meier's grandest public statement and the most ambitious and complex building he has yet finished. The architectural press reviewed it with fanfare and favor, and AIA gave it an honor award in 1984, Meier's second. Not incidentally, just seven months after the High opened, Meier became, at 49, the youngest recipient of the Pritzker architecture prize.

As a place for viewing art the High has been controversial. Among its detractors are a museum professional from another Southern city and an Atlanta artist, both of whom contend that the building dictates what can be shown and where, and that the architecture overpowers the art. Its defenders include members of the current staff who feel challenged by the demanding building. Its strongest admirers say that some touring exhibits have never looked more vital and interesting as at the High.

The six-year-old building is the High's third home. The museum first opened in 1928 in the J.M. High house on Peachtree Street, two miles north of downtown in a section now called Midtown. In the mid-'50s the house was demolished and replaced with a modest modernist box, which 10 years later was encased within a much larger box, the Memorial Arts Center. As part of the arts center, trapped deep within an insipid building, the High suffered some loss of identity. Its galleries were ungainly, its circulation system was undecipherable, and it was without natural light.

In the late '70s, primed by a single gift of \$7.5 million for a new building, the museum obtained the present site and in 1980 chose Richard Meier & Partners from more than 75 applicants. During the final selection round, six firms were invited to make presentations. Meier, the only architectural candidate to appear alone, was the unanimous choice. This was based on his previous work, his understanding of art and art museums, enthusiastic



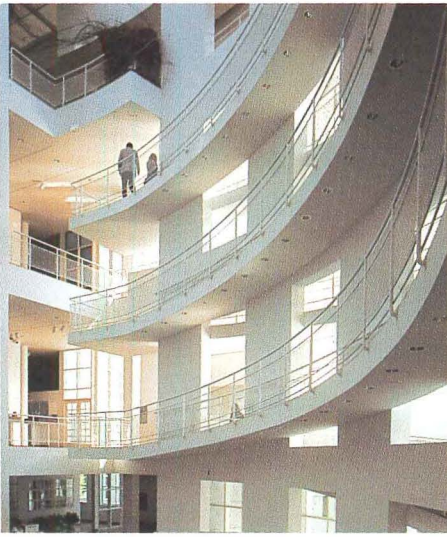

*Ramps wrap four-story partition.*

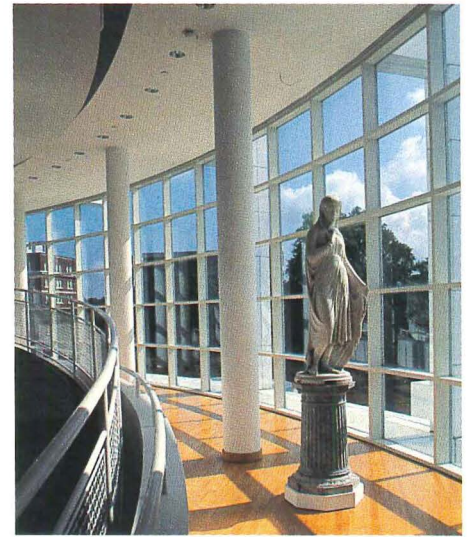
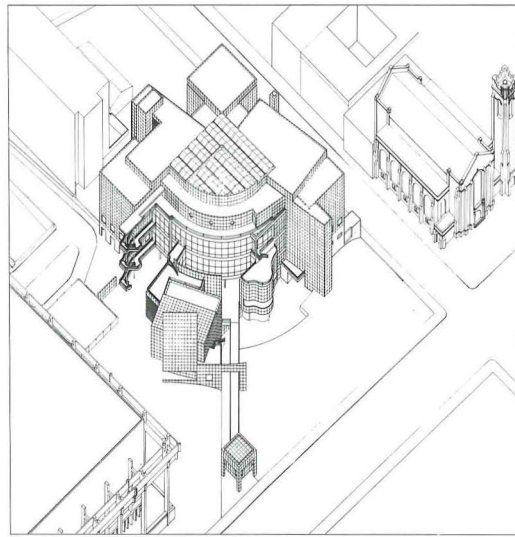

*Between ramps and atrium window.*

## *Vertical circulation*

*functions adequately,  
says the director, except  
when attendance  
skyrockets during  
touring exhibitions.*

references from previous clients, and his reputation as an architect, according to the building committee.

The building program was the work of Gudmund Vigtel, now in his 26th year as director of the High. His requirement for a major, independent space for social functions resulted in the atrium. It would become the building's prime locus. Because Meier designed the museum from the inside out, says Vigtel, he was unable to produce a model—ordinarily an important tool for fund-raising—until very late in the design process and well into the fund-raising campaign. (The balance of the \$20 million construction budget was raised nevertheless without government assistance before construction was completed.) The architect designed everything, including the exhibit partitions, platforms, and cases. Meier visited Atlanta at least once a month during both design and construction. The director says the architect's "personal involvement was 100 percent."

In plan, the building is four quadrants, the galleries occupying three and the atrium comprising the fourth. Of a total 135,000 square feet of space (triple that in the arts center) about a third, 46,000 square feet, is galleries. All are located on the three upper floors. The top floor is for 20th-century works and temporary exhibitions, the third floor for European and American art, and the second for decorative and African arts. The entrance level comprises the atrium, administrators' and curators' offices, conference and meeting rooms, a kitchen, a gift shop, and rest rooms. Two below-grade levels contain a children's exhibition, storage, security, and a loading dock enclosure big enough to hold and unload a truck's trailer sealed from the weather. Projecting in front of the atrium is a sinuously curved entry pavilion and an almost freestanding small auditorium. Cladding is three-foot-square white porcelain-enameled panels over a granite base.

Within the atrium, ramps switch back and forth as they wrap around a curved partition with windowlike cutouts just inside the window wall. Meier has written that the atrium was inspired by and is a commentary on the Guggenheim. But the High divorces the galleries from the ramps, making it rather a conventional museum with a dramatic vertical circulation system. Like the Guggenheim, the High is meant to be experienced from the top down. One takes an elevator located at the front of the building to the fourth floor, threads through the galleries on that level, returns to the area near the elevator, and descends to the third level on the ramp that switches back once per floor to position

the visitor directly under the entry point for the floor above and over that of the one below. The system functions adequately, says Vigtel, except when attendance skyrockets during some touring exhibitions.

Asked about circulation, Vigtel mentions three design shortcomings related to vertical movement. He regrets having had to eliminate a second passenger elevator in order to meet the construction budget. He would want the ramps six inches wider so that people could pass each other without feeling crowded.

And he would humanize the freight elevator door by having it sweep from the side on the cab's shorter dimension rather than open like jaws along its wider side.

The freight elevator became an issue during one attempt at crowd control that everyone seems to remember with displeasure. During a show of 6,000 years of Chinese civilization, people walked across the atrium and through a hallway to the freight elevator at the back of the building. A hundred at a time, they were taken to the fourth floor. Since then, either the passenger elevator or the ramps have been used to accommodate crowds at traveling exhibitions. At times last winter during a small but popular show of Monet paintings, lines formed down the ramps, out the door, and down to the street.

Awkward handling of large crowds is a fairly serious drawback in a building celebrated for its mastery of controlled movement. As Robert Campbell noted in these pages when the building was new, the High is "more than anything else the setting for a slow, processional dance through light and space. . . . The whole experience is a promenade through architectural sculpture that has rarely been surpassed." Less serious but sometimes annoying are the acoustics. The interior is very alive with sound, and it can be distracting, especially when schoolchildren tour in groups. Still another problem is that, although the High is not a difficult building to clean, its white surfaces inside and out show dirt readily, prompting one board member facetiously to seek an endowment for Formula 409 and Windex.

By far the most serious reservations when the High opened centered on light levels entering the atrium. Vigtel says light had been a primary concern of the museum from Meier's first interview, when the architect was asked to reconcile his reputation of "bringing the outside into building interiors with the requirements of works of art." Later, Vigtel says, fenestration was reduced by about 50 percent from Meier's early proposals.



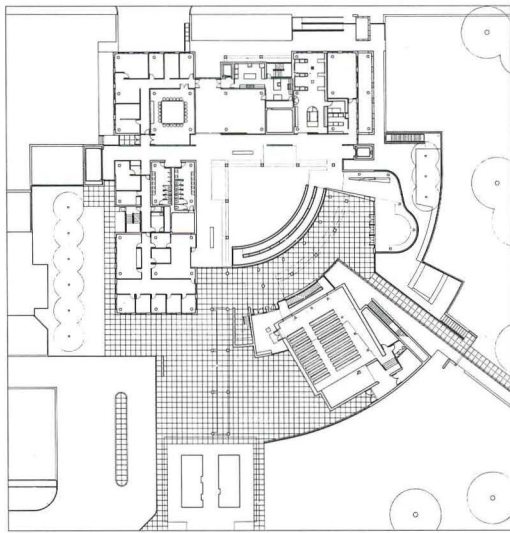

Entry level

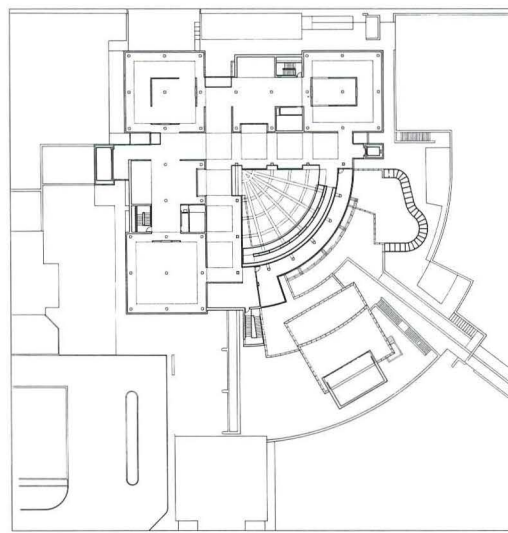

Fourth floor

*Exhibitions requiring  
rigid order are  
problematic at the High.  
As one curator says, 'You  
have to play around  
with the material.'*

Contrary to some published reports, ultraviolet light was not part of the problem. Atrium glazing and all windows into exhibition spaces were treated from the start for maximum UV blockage. But sunlight was reflected off the white atrium walls, raising levels in the galleries adjacent to the atrium several times over what is acceptable for works on paper and canvas. The light was harsh, in strong contrast to the galleries along the north and west walls, which receive relatively little or no daylight. Soon after the building opened, the museum replaced the atrium skylight glazing with glass that reduces light levels by two-thirds. Glass in the atrium's curved window wall was neither replaced nor screened, but other vertical windows have been covered with glass fiber screens. From the atrium floor, the retrofitted skylight glass is virtually undetectable, but from the fourth-floor galleries the glass has a noticeable gray tint.

Director Vigtel, the High's curators, and the in-house exhibition designer look at the building's natural light in terms of trade-offs. They weigh esthetic and psychological benefits against curatorial requirements and say they have learned to compensate and accommodate, tailoring exhibits to existing light situations. They either install art not susceptible to damage in the bright galleries—for instance, marble sculptures in a small, third-floor gallery with direct sunlight—or put up and take down interior screens as required. The screens, says Vigtel, "don't make Meier very happy, but we have to use them."

Vigtel says there are "completely safe levels that are accepted by all." He proposes that, when the museum takes advantage of the building's natural light, "the esthetic advantages make [the constraints and compensations] well worthwhile."

Meier's distinctive hand is evident in the galleries as well as the public spaces, and in some respects it limits curatorial choices. Meier designed platforms and cases for the museum's strong decorative arts collection, which is permanently installed on the second floor. The museum staff has added a few more of identical design to insert more objects. For the third and fourth floors, Meier designed a set of nonstructural partitions that are in plan either straight, U-shaped, or L-shaped. Windowlike openings in the partitions frame glimpses into adjacent spaces and beyond. The staff has found no reason to modify the partitions, although the dividers are augmented for some exhibitions. Additionally, all of the galleries are interrupted by the building's 21-foot grid of freestanding structural columns.

After the museum opened, Meier was asked to assist the staff in rehanging the permanent collection. "Richard broke some of our carefully developed chronological continuities—perhaps putting a late-19th-century American painting in a group from the mid-19th century," says Vigtel. "But he taught us how to take advantage of the vistas and the spaces."

All the staff I talked with seemed fully reconciled to the building. Marjorie Harvey, manager of exhibitions: "At first I saw a lot of columns and windows, more architectural elements than

gallery space. But space for the artwork became apparent when we started placing it." Judy Larson, curator of American art: "There are certain walls that have vistas, and you learn where they are. You place key pieces there, and they are terrific. But if a show requires one-two-three order, it just doesn't work here. You have to play around with the material." Susan Krane, curator of 20th-century art: "There are times when you wish you had another wall with a greater expanse for certain kinds of large-scale works. . . . [But] it's possible to manipulate the space differently than one would expect, and it is much more flexible than I had thought."

A guest curator, Clark Poling, an Emory University professor of art history, installed his show on Kandinsky's Bauhaus work, an exhibit that he originally created for the rigidly linear experience of the Guggenheim. He says that progressions and subcategories set up in the show in New York may have suffered in Atlanta, but many individual works looked better at the High, and the variety of kinds of places allowed him to single out particular work more effectively. Among initial skeptics who changed their perceptions of the High, artist Barry Le Va and photographer Richard Avedon are reported to have become its ardent proponents after installing their work there.

Shows like Le Va's and Avedon's, which disrupt installation of the permanent collection, and outgrown office quarters are the main reasons an addition is being considered.

Would the overall approval and popularity of the High make Meier the most likely architect for an addition? Vigtel says Meier would be a good choice, "if not the only choice," because of the "success" of the building and because of what he considers unsympathetic negative examples, such as the proposals for Whitney and Guggenheim additions. The High raises for the first time the question of who but Richard Meier could with felicity design an addition to a Richard Meier building. □





© Swain Edwards

*'80s Retrospective*  
**Attention to Its Users**

*Successful programming and  
reprogramming of H.E. Butt  
Headquarters in San Antonio.*

*By M. Stephanie Stubbs*





Readers of this magazine are no strangers to its high regard for the H.E. Butt Grocery Co. headquarters in San Antonio, Tex. The project was presented in these pages twice in 1986: first with emphasis on its role as contributor in the larger context of the city, which was AIA's convention city that year (March, cover and page 67), and later in its own right in the annual review of American architecture (May, page 118). It is, first of all, an architectural gem, this collection of two historic landmarks (a magazine arsenal and a stable), three other existing buildings adapted or renovated to new use, and one new building, all seamlessly joined with thoughtful site planning by landscape architect James Keeter into a *place*. But architectural buzzwords and beautiful photographs don't—perhaps can't—do justice to the skill of architects Hartman-Cox with associated architect Chumney & Associates (formerly Chumney/Urrutia). The complex must be experienced firsthand to be appreciated.

Secondly, H-E-B headquarters is a people project, due in large part to the careful programming accomplished by Building Diagnostics Inc. (BDI) of Boston. "In the H-E-B headquarters design and development process, the client, designer, and program can be likened to a well-balanced tripod," says sociologist John Zeisel, president of BDI. "The built-in checks and balances of the process resulted in an elegant building that contributes significantly to the effectiveness of the client's organization." The H-E-B complex has been likened to a successful campus, where generous support spaces (a friendly outdoor plaza, its circumferential covered walkway, a gym and a cafeteria and break rooms for employee use) complement efficient work areas and bring employees into face-to-face contact.

The third ingredient to the success of the arsenal complex is what associated architect Pat Chumney, AIA, of Chumney & Associates terms "the perfect client for this project." He explains, "For several years, different people had looked at the old arsenal property with the idea of restoring and redeveloping the individual buildings separately, and possibly without sensitivity to their relation of one to the other. Having one owner who would develop and be responsible for the whole complex really is an ideal situation."

Chumney also stresses the arsenal complex's substantial influence on the timing of development in the area, including the renowned riverwalk, which continues to this day. "For some time, the city and the San Antonio River Authority had plans to fix up the river, from the arsenal complex area up north to the downtown," he says. "For various reasons, a lot of them financial, the plans were put on the back burner. But because of the substantial investment that H-E-B was making in the arsenal, we were able to convince the city to dust off the plans and go ahead. They promised they would have the work completed by the time the arsenal was finished, and they did."

On top of that, Chumney says, H-E-B's president, Charles Butt, is highly committed and sympathetic to restoration and adaptive use—he restored and lives in an important house in the King William historic district just across the river from the arsenal complex. "And, finally," Chumney adds, "H-E-B is a very successful company. When they decide to do things, they do them right."

H-E-B considers and calls all of its employees "partners." Butt says of building and restoring the complex, "I think the most



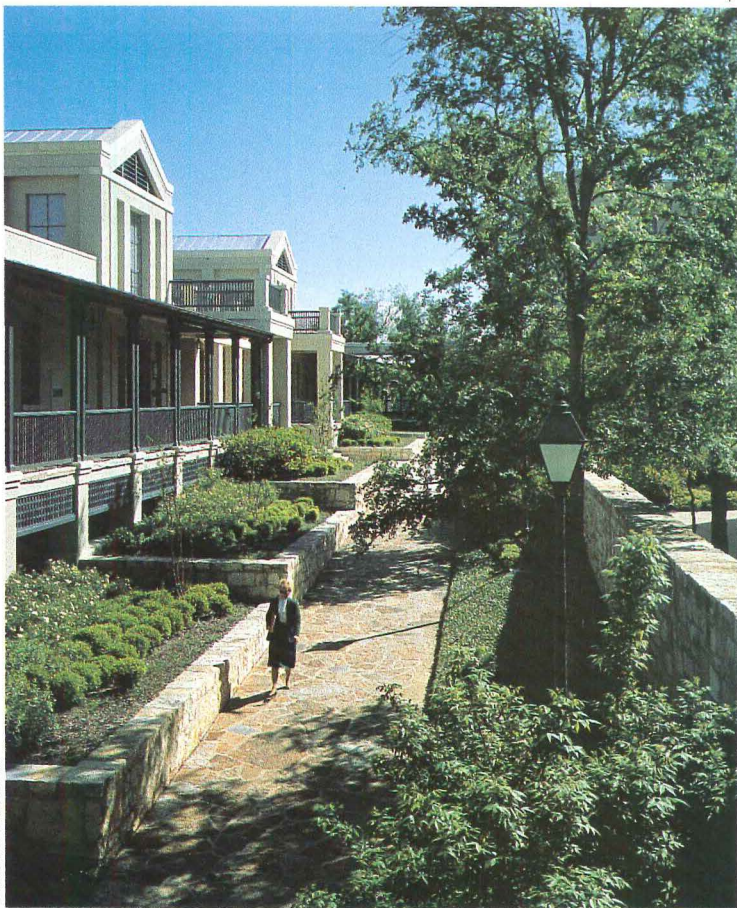

© Robert Lautman

A closer view of the restored North Building on the riverwalk side. Note vernacular rails, screens, and covered walkway.

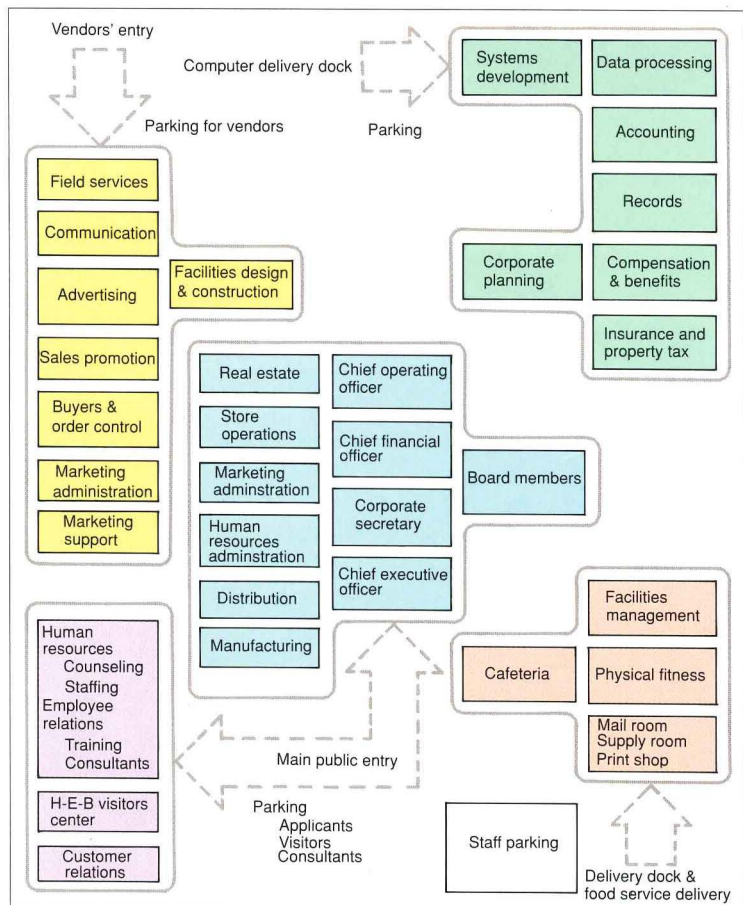

Building Diagnostic Inc.'s original programming established departmental adjacencies and links to points of building access.

important goal was to give our partners a sense of pride in their company. We also wanted to have an environment in which the different departments would come together, to enhance the sense of cooperation we had hoped to achieve."

BDI's programming process began with Butt's decision to consolidate H-E-B's disparate Corpus Christi offices into the complex in San Antonio, a more centralized location for the company's Texas-sized network of distribution. This physical consolidation, along with careful arrangement of work spaces, also has united the company's work force, as H-E-B's chief operating officer, Fully Clingman, explains: "In Corpus Christi, I had the 'fortune' of working in four buildings. Moving here is like the difference between night and day. There we were disjointed—you never had the *esprit de corps* we have here, working together, functioning together, solving problems over coffee. Here it's more of a family, a total group functioning together. In Corpus, the quality of the buildings varied so much that the pecking order seemed to result from where you were located, rather than your job. This conflict was resolved handily by the new headquarters."

Butt's insistence on fair play for all the partners has its mark on many aspects of the programming and the physical design—in size of offices, in nice but utilitarian finishes and furnishings. "The design forces you into an interface and dialogue with different levels of people," says Clingman. "It fits our informal, first-name, open-door policy. We're all partners. We don't have big, glamorous offices. It's functional and simple, and therefore, I think, has a touch of class of its own."

H-E-B Foods, the largest private employer in San Antonio, employs more than 16,000 people in 155 supermarkets, eight "Pantry" stores, and 20 "Super" video stores, plus the company's vast distribution and warehousing network. Butt considered it important that the 500 people who work in the arsenal headquarters not be viewed as an elite. The headquarters had to belong to *all* employees; hence, the new "gateway" entry building with its generous open space. It was the wants and needs of all the employees, as well as the input of the executives, that

shaped BDI's programming process.

For a job of this size and type, it made sense to everyone involved that the programming be done by a specialist firm such as BDI. Warren Cox, FAIA, of Hartman-Cox says, "Although our firm has done the programming for numerous smaller buildings, for this big commercial building we thought it better to have a separate firm do the programming. In the final analysis, most of the H-E-B complex is office space; the function is generic. The programming had a lot to do with how the offices and departments interrelate with each other, dealing mostly with the internal structuring and adjacencies. We worked very closely with BDI. Because most of the buildings were existing, there was a lot of give and take. The programmer in this case was an advocate for the client, and I think that helped."

"To set up the goals for the new facility," says Zeisel, "we asked, 'If you look back on the project in five years and judge it to be a success, what will you be looking at?' We then identified objectives by asking, 'What steps can be taken, today, in the design, to get there?' This process helped H-E-B define their corporate identity." The process included interviews, questionnaires, analysis of work records, visits to each employee's work space, allocation of work space square footages, and correlation of square footages to employee task descriptions. "We identified five primary organizational functions for the company: administering the company, dealing with the outside world, keeping the numbers flowing, linking the arsenal staff and services, and addressing individual needs," Zeisel explains.

Out of these functions grew eight general goals: public relations, corporate morale, employee unification, employee satisfaction, office efficiency, growth planning, neighbor relations, and economy. Each goal has its own subset of objectives. For instance, the goal of employee satisfaction leads to such ideas as: "give each employee a sense of his or her own work group territory with no one else walking through it to get to their own work space. Separate hallways from work spaces." The goal of office efficiency turns into objectives such as: "provide layouts ap-



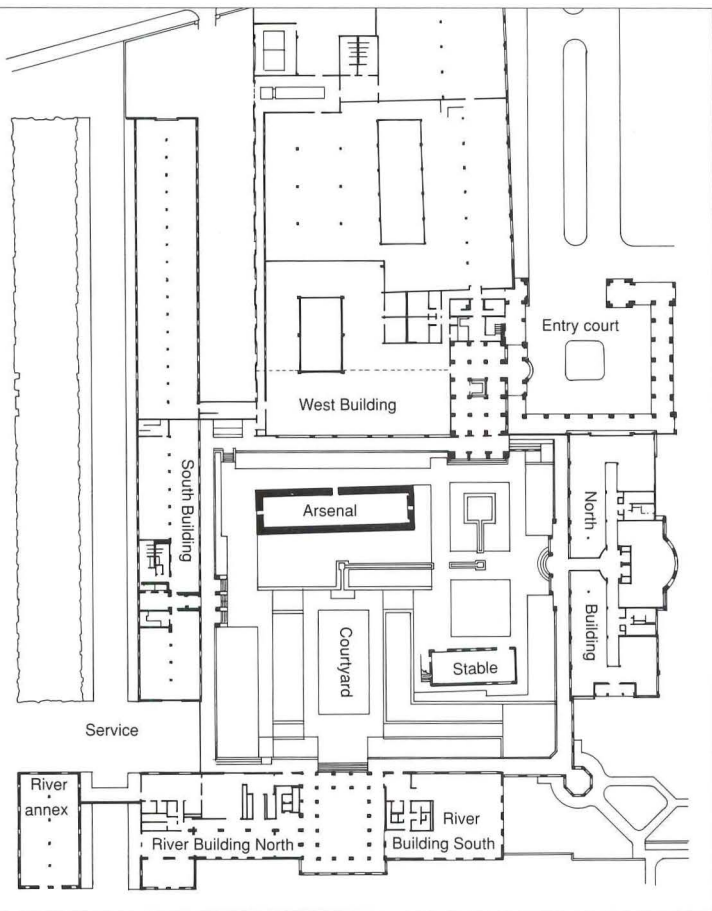

The campuslike plan developed by Hartman-Cox highlights the covered walkway that ties together buildings and site elements.

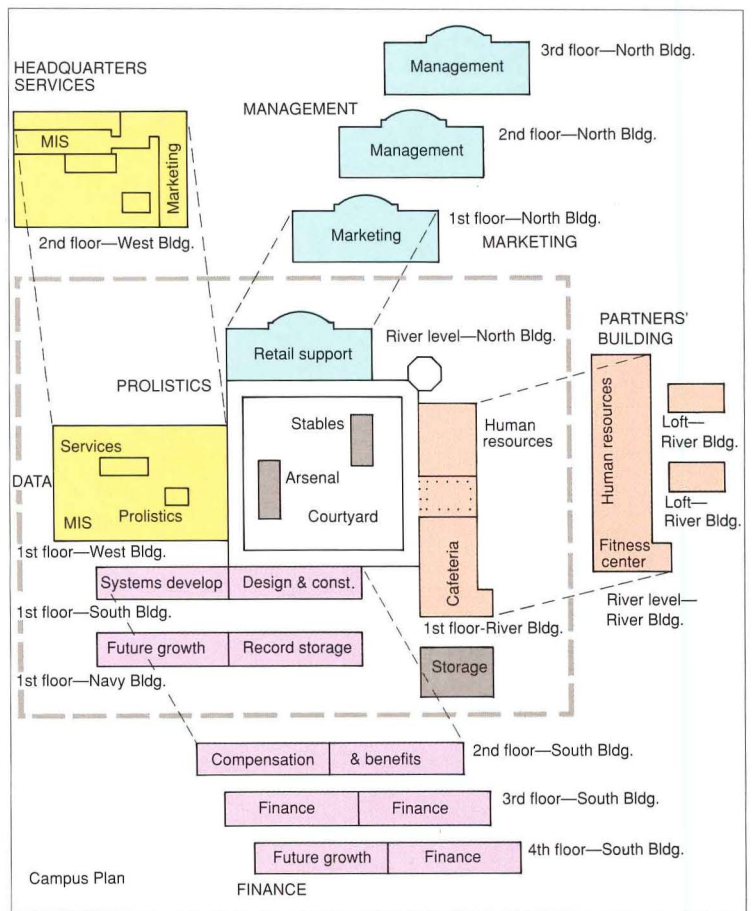

BDI's reprogramming effort includes this stacked plan that indicates relocation of departments in the existing buildings.

appropriate to the varied and unique requirements of each department," and "enable employees to manage their time better by providing facilities such as an exercise room where someone might go from 5 to 6 P.M. to beat the traffic."

For each work group, BDI developed the goals and objectives in a square footage space summary that included the needs for work space, support space, and net square footage. These turned into physical realities via the magic of Hartman-Cox and Chumney & Associates.

Five years later, Building Diagnostics Inc. is repeating the reprogramming process that worked so well. Zeisel is particularly proud of the fact that H-E-B company officials came to his firm when they began to anticipate a space problem. "To me, that defines the role of the programmer perfectly, as an intermediary—a translator—between the building owner and the architect. The programmer speaks for the users," he says.

Timing for a re-evaluation of space is right on target, as BDI's reprogramming was based on the outer edge for five-year goals. "The company has almost doubled in size," says Clingman. "The complexity of the business has made us segment the professionals more, and, as such, we have to have some delineation of functions and purposes. Growing pains and some segmentation of the business have caused us to begin to bulge a little. ...[Also,] we're headed into the '90s. We plan to add 15 more Pantry stores, additional large video stores, and three or four more supermarkets in the next year."

The major difference this time is that BDI's role extends into space planning, thanks to the staff architect/planner, Marc Maxwell, AIA, who functions as ground control for all the space data. BDI will translate the new work group support needs (space conditions, work/meeting space needs, special ambient conditions, and the like) plus staffing counts and projections for 1990, 1992, and 1994, into space plans.

For this go-round, the reprogramming and space plans will be turned over to Chumney & Associates, which will be responsible for translating them into construction documents. "We'll be

working on both the existing interior spaces and the restoration of the west half of the South Building, which has been used for storage until now," says Chumney. "We'll be consulting with Hartman-Cox. We've had a marvelous relationship with Warren [Cox] and his people. We divided the project up in the construction documents phase, and one of the buildings that my firm worked on primarily was the South Building, which is up for expansion now."

Even now that the honeymoon period for a new building has long passed, all who were involved are still enthusiastic about the project: client, workers, programmer, and, not least, architect. "It pleases me that we saved the arsenal. But that the project turned out as such a nice campus, and that they appreciate it so much and that it seems to be working so well pleases me most," says Cox. "I think people might be apprehensive about using [existing] buildings as corporate headquarters. They don't have to be. There's a lot of flexibility in that kind of project, and it was very easy to move H-E-B into the complex. The richness of it, as an experience and as a small-scale area, just makes it a heck of a nice place to be."

Butt agrees with his assessment. "The complex has served our needs well," he says. "In fact, just today we had a party and awards ceremony out in the courtyard to recognize the service of our people—the arsenal looked terrific and everybody had a good time. I think the complex gives people a sense of excellence and reaching out. It makes them feel special to be here."

The graceful combination of historic, old, and new buildings united by a people-friendly site plan makes the H-E-B headquarters an admirable architecture classic for any age. Given that it would have been both beautiful and successful as an isolated entity, its ties to the riverwalk and to the San Antonio community speak highly for the client, architect, and programmer. But eternal vigilance regarding the needs of the users has made H-E-B an exemplary workplace of the '80s. Five years later, BDI's postoccupancy evaluation should help keep the architecture alive for its users and the community at large. □









## '80s Retrospective

# Exemplary Public Housing

*Charleston's scattered-site,  
contextual approach gains acceptance.*

*By Michael J. Crosbie*

The 1980s were not kind to public housing. The first year of the decade ushered in a new Presidential administration that slashed funding for low-income housing and seemed bent on shutting down the program. As the decade closes, a scandal of mismanagement and political chicanery at the Department of Housing and Urban Development during the tenure of former HUD secretary Samuel Pierce is unfolding in Washington, D.C.

But the history of public housing in America had one of its finest moments this decade, in the form of low-density, scattered-site housing built in and around the historic district of Charleston, S.C. The recipient of numerous awards since completion in 1983 (including a Presidential award for design excellence), the 113 units on 14 sites around the city were designed to blend with surrounding neighborhood buildings, taking the form of the Charleston "single house," a long rectangle in plan with a short side to the street and a generous open porch on one long side to capture offshore, cooling breezes.

Donald J. Cameron, executive director of Charleston's housing authority, conceived the scattered-site, low-density approach as a way of diffusing neighborhood resistance to public housing and providing more humanely scaled buildings that were free of the stigma associated with super-block projects, à la Pruitt Igoe. Cameron also had the notion that public housing in this form might actually spur revitalization of neighborhood buildings and attract private investment into these areas.

Sixty-seven units were designed by Bradfield Associates of Atlanta, and the rest by Middleton McMillan Architects of Charleston. The number of units per site range from two to 22, with an average density of 13 units per acre—half the permissible density for public housing. The units are wood frame with front doors, wood clapboard siding, and shutters—pretty radical stuff for HUD, which had to bend its design guidelines into a pretzel to grant approval.

Nearly seven years after completion, Charleston's scattered-site, low-density units have proved a resounding success. Cameron says that resident interest in maintaining the units has remained unabated since their occupation. "People in these units have come

to expect more out of the maintenance people. They have a high expectation of service," says Cameron, who adds that the units have not experienced any extraordinary management or maintenance costs. (The units suffered little damage from hurricane Hugo, which battered Charleston in late September.) Local homeowners also have contin-

ued to upgrade their homes in the presence of the public housing, taking advantage of a home improvement loan program offered by the city.

And private development has taken place at one of the sites, surrounding the only project constructed in the city's historic district with 22 condominium town-house units, which sold out. Cameron says that the local developer who built the condos consulted with the low-income residents about the town houses' appropriateness as they faced the public housing, and used similar design elements. The developer also restored a house across the street from the public housing and now lives there.

Unfortunately, no new scattered-site public housing has been constructed in Charleston since the original 113 units. "We've applied to HUD every single year," says Cameron, "and have been turned down."

Cameron says that he continues to receive inquiries from other housing authorities who are curious about Charleston's achievement. Last May, he conducted a workshop in Orlando, Fla., for private developers interested in the scattered-site, low-density approach.

The two architecture firms that designed Charleston's infill housing have also built similar projects elsewhere. The North Carolina National Bank funded a revitalization investment program using the scattered-site approach in Raleigh, N.C. Bank officials toured the Charleston projects and hired Buck Gale, AIA, of Middleton McMillan Architects to design a number of low-density projects in downtown Raleigh. "The style was different," comments Cameron, "but the theme and the context were the same as far as setbacks, building size, roof pitches, and materials." Just a few years after the Charleston project, Richard Bradfield, AIA, of Bradfield Associates designed a scattered-site project for Mechanicsville, Tenn., that was constructed with HUD funding. □





*'80s Retrospective*

# PPG's Unpopulated Places

*Burgee/Johnson's office complex  
in Pittsburgh isn't alive  
at the street level.*

*By Lawrence Houstoun Jr.*





PPG Place offers some of the most interesting and least successful experiences for people on the street of any of Pittsburgh's many commercial complexes. Unhappily, it antedated and therefore lacked the benefit of Pittsburgh's guidelines for the design of outdoor public spaces. Based on an analysis by Pittsburgh's planning department of what worked best and worst in the city's growing number of small urban parks and open areas, the guidelines were issued some five years ago and have since been applied by design teams with relative ease and great success.

PPG Place is a dramatic collection of six office buildings arranged by John Burgee Architects with Philip Johnson to create a five-acre urban enclave for the world headquarters of PPG Industries. With a tower rising above 600 feet, the complex includes a million square feet of reflective glass and has four open spaces—Market Square, Market Street pedestrian way, the plaza and the winter garden. Interior public space also is provided in PPG's retail section, including its food court.

The issues were similar to those facing other cities, before and since. Two blocks of a major street of some historic importance would be sacrificed, and the controversial legal tool of public land assembly would be applied to assure that enough real estate in the desired place and desired shape would be available for construction. In return, the city would gain major improvements in and expansion of public open space, most particularly in the center of the six-building complex, with a plaza evoking the Piazza San Marco in Venice.

The first of the four public spaces, Market Square, physically abuts the redevelopment plan. A historic piece of open space bisected by two streets, it once was occupied by a public market.

*Mr. Houstoun is an urban issues writer and a principal of the Atlantic Group in Cranbury, N.J., urban development consultants.*

The challenge was to accommodate the highly reflective PPG facade to a mix of 19th- and 20th-century commercial buildings surrounding approximately an acre of open space. The solution is a physical relationship that appears to satisfy no one, save perhaps the loiterers, panhandlers, and eccentric orators who occupy the square day and night.

Market Square's principal retail offerings are in the six-story PPG II, a corner building. It is a startling 21st-century insertion into an enclosure that includes an early-19th-century restored brick building and food franchises behind contemporary facades. Streets intersect the park within the square and form boundaries for it, resulting in four smallish parcels, mostly grass-filled, with an old fountain in one corner and some seating. In a city whose vest pocket parks are among the nation's most attractive and lively, Market Square looks like a neglected relic of public and private indifference. Hardy Holzman Pfeiffer did produce an imaginative redesign reflecting the area's earlier marketplace role while adding eating facilities, seating, trees, and a better balance of pedestrian and auto-bus facilities. Alas, the plan so far has not been implemented because of scarce funds. The dormant plan addresses the fear of "undesirables" by creating outdoor spaces that attract more middle-class people, thus diluting the perceived impact of unwanted people. This is a strategy favored by urban critic William H. Whyte and seems to have worked in Boston's highly successful Washington Street pedestrian mall.

Four physical elements of outdoor urban spaces affect how people react to them and how and to what extent the spaces are used. A park, square, pedestrian mall, or even a simple street contains walls in the form of facades and signs that signal an at-

*Above, PPG Plaza: an obelisk, rich pavers, glass walls, but an absence of seating, shelter from the sun, and people.*



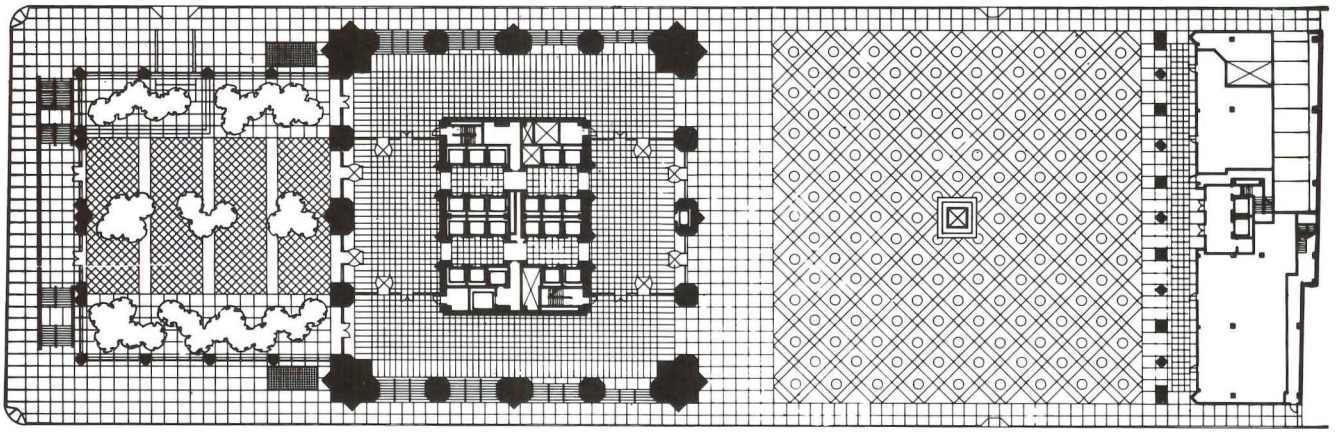

*Unlike the square and plaza, the new traffic-free pedestrian way is heavily used for lunches, reading, and people watching.*

people react to them and how and to what extent the spaces are used. A park, square, pedestrian mall, or even a simple street contains walls in the form of facades and signs that signal an attractive, secure environment or its reverse; a floor that must be suitable for intended uses; furniture in the form of seating, lights, fountains, eating facilities, newspaper or other vending machines or kiosks, trees and other landscaping

touches; and people and their activities. The people can range from police to prostitutes to picnickers. Activities can range from drug dealing to festivals, vending, and sunning.

As a public room, Market Square rates about a four on a scale of 10 overall and about the same on each of its discrete elements—walls, floors, furniture, and people and activities. As a destination, it attracts mainly a small population of loiterers. For most others, it is a route to buses, shopping, or Heinz Hall Plaza two blocks away, one of Pittsburgh's public spaces that rates a 10.

Unlike Market Square, PPG's second public space, the adjoining block of what was Market Street, has become a successful, traffic-free pedestrian way. Effective use of fairly ordinary materials and techniques make this an oasis and a magnet. Although its location curtails the sunshine so popular with downtown office workers, Market Street's tables and chairs are heavily used for brown bag lunches, reading, and people watching. Less than a block from Market Square and its drifters, the new mall is both a destination and a passageway to much of the rest of downtown Pittsburgh. In an interesting bit of contrast, it extends the gas-style lighting from Market Square into the heart of the PPG complex. One side of the mall is defined by retail stores with window displays.

The Market Street mall contradicts the new wave of urban open space criticism that proposes the restoration of city traffic to these quiet intervals to engender a renaissance in retail, which is thought to have been harmed by pedestrianization. As is frequently the

case in such spaces, there is no correlation here between problems in retail and elimination of traffic on what was Market Street. In contrast to Market Square, this comfortable urban space rates an eight or a nine. Its walls, floor, furniture, and activities send an inviting signal to Pittsburghers on foot.

In the May 1984 issue of this magazine Donald Canty praised PPG for the constantly changing scenery presented to pedestrians viewing the reflective bluish-gray glass and contrasted PPG's distinctive presence on the skyline to the "graceless and boring" towers nearby. While one may quarrel with Canty's observation that PPG's "historicist imagery is woven into the fabric of the city" or that the buildings make "good neighbors" to Market Square, there is little doubt that PPG's major strength is its impact from Mount Washington, across the Monongahela River, or from the highway approach from the airport. While it isn't Pittsburgh's answer to the Empire State Building, PPG is a major skyline presence.

Indeed, much of what is troubling about the public spaces is traceable to the see-the-whole-complex-from-a-distance school of design. Building Number One may be a remarkable skyscraper, but, like all buildings, it should also have a positive relationship to those walking about nearby. The uncompromising extension down from the skyline makes these six crystalline shafts awkward elements where they meet the ground in the public space.

This is particularly true in the plaza, the third open space. Its centerpiece is an obelisk that is reminiscent of, though shorter than, those used in the 19th century to adorn public spaces in London, New York, and Paris. The problem is not the obelisk concept itself but that this one, when juxtaposed with the futuristic glass curtain walls that are its backdrop, produces an irreconcilable contrast between walls and furniture. The floor and furniture speak of antiquity; the walls are sci-fi. But what of the people?

In a city that boasts two incline railroads worthy of Zurich, a train station restaurant evoking the Gare de Lyon in Paris, an intimate hotel created from a priory suggestive of a small Oslo hostelry, and a tram system reminiscent of Amsterdam, it was not unreasonable for Pittsburgh to anticipate a plaza as appealing as Venice's San Marco. Promised a San Marco, Pittsburgh received some nice pavers, a curious obelisk, and glass curtain walls that reflect each other, Narcissus-like—but the result is rarely a gathering place for people.

As with most great urban spaces, the secret of San Marco's success is less its floor and walls than its furniture and activities. It is a vast refreshment area, a place to eat and drink while watching the passing throngs and pigeons. PPG Plaza has no tables, no food, no pigeons, and virtually no people. It lacks the fundamentals prescribed by Whyte and later by Pittsburgh's own plan-





© Richard Payne

*Opposite, the footprint of the main tower flanked by the winter garden and PPG Plaza. Above, a view across a portion of Market Square, where PPG Place's glass towers edge a 19th-century urban space. It remains unrelandscaped and largely unused.*

ning board, including eateries, shelter from the sun, and comfortable seating. Except during occasional noontime concerts, the space is so vacant as to suggest that people are avoiding it. On an ordinary summer day, during lunch or commuting times, there are so few people that one wonders where the 6,000 men and women are who work at PPG.

Is there a design flaw? Local observers claim that the commercial space on the east side would not accommodate the restaurant promised at initial public project presentations. But why not provide less than full-service dining and beverages in the form of vending carts similar to those at Boston's pedestrianized Washington Street? Light food and beverage service from noon to 6 P.M. (when PPG retail establishments close) could be served at small tables and chairs in the plaza that could then be removed if there is concern about overnight visitors from Market Square.

The competition from nearby public spaces designed after the adoption of open space standards is instructive. The Heinz Hall Park is complete with food vendors, a waterfall, and delightful options of shade or sun. The small park at the Oliver Plaza has similar appeal, as does the network of parks at the Gateway complex. PPG Plaza meets the square footage

requirements of the city's rules, but it fails the test of public use.

The fourth public space, the winter garden, is a westward extension of the principal tower building and is used for exhibitions and other public activities. This tree- and flower-filled interior serves such purposes well and must provide, on cold winter days, a pleasant seasonal counterpoint for those employed in the building. It is, however, not easily accessible to the pub-

lic from either the office tower or the street. The latter entryway requires climbing more than one flight of concrete steps. The result is a winter garden that is less than a public place.

PPG does not have the makings for successful urban retailing. A peripheral zone extending 1,000 feet from the edge of PPG Place touches only a piece of Pittsburgh's Gateway office complex and misses most of the new and very large office projects at the eastern end of downtown. The more than 100,000 downtown employees cannot conveniently walk to PPG. Moreover, the project is small and there is little so special about the specialty retail or dining choices to warrant the trip. And downtown competition is awesome, with good and even exceptional shopping and dining destinations neither at nor near PPG.

In Canty's 1984 article, he also suggested that PPG Place "may be the most significant single large-scale addition to an American city since Rockefeller Center." But PPG lacks the appeal and amenities of Rockefeller Center. It is not an entertainment focus, its shops are not linked to streets and avenues to attract crowds, and it is not well integrated with public transportation. It is just an office complex, a block from the transit line, with a modest number of retail and dining options. Although it is promoted as a complex of 50 businesses, only about 30 are active and these include some money machines and a bootblack.

In addition, PPG's food court is below grade, and, though the portion located in the atrium courtyard is attractive and popular, the other half has some of the feeling of a subway entrance. The low ceiling and bad lighting are thought by locals to be responsible for high turnover among food vendors. Probably more important, however, is that both escalators bring customers directly to the atrium area. Only a single, hard-to-find elevator for handicapped access is near the non-atrium food area.

Only a few shops are accessible both from the food court and the street; these range from two or three very specialized stores to an optician's office occupying the most prominent corner on Market Square. A film store is all but invisible within an arcade. All shops that were designed with the principal door on the street or the pedestrian mall keep those doors locked during business hours for security reasons.

The locked doors smother impulse buying and force the customer to a circuitous route of entry, adding delay to a short lunch period. A locked door contravenes the most fundamental tenets of retailing, and unless the situation changes it will consign PPG's future to just more service businesses in retail spaces, attracting few people and thereby worsening the emptiness that engenders much urban fear. Moreover, PPG Place is dark, as they say of closed theaters, after 6 P.M.

The problem with PPG is that it appears to have been

*Retail doors facing the street are locked during business hours, and PPG Place is dark after 6 in the evening.*





# An Intimate Sequence of Spaces

*Michael Graves's*

*San Juan Capistrano Library.*

*By John Pastier*

The buildings that most interest architectural professionals exist in several forms that are often contradictory: as first designed; as built, frequently after some redesign; as published and inevitably altered in their translation to a printed medium; and as personally experienced by members of the design subculture.

Less often, a building's use by ordinary people also may elicit professional interest, particularly if the designer has explicit social concerns. Michael Graves is not usually thought of as such an architect, yet the six-year history of his San Juan Capistrano Regional Library is a remarkable story of public acceptance and use. People have come there to be married; to pass the time of day in comfortable armchairs; to attend stockholders' meetings, concerts, and public hearings; to sketch the building; to write fiction on their laptop computers; to buy books as well as borrow them; to vote; or to perform as unpleasant a task as preparing tax returns in as pleasant a setting as possible. And, of course, many have come to this mission town library as architectural pilgrims.

The Capistrano Library is an institution meant to feel noninstitutional, yet it is also rigorously and hierarchically planned. Much of its everyday success derives from the fact that its planning is tempered by architectural intimacy and subverted through actual use, and that its design is strong enough to accommodate those contradictions. Unlike Graves's other well known buildings of this decade, the Portland (Ore.) Public Services Building and the Humana corporate headquarters in Louisville, Ky., it is a place and a sequence of spaces rather than an object. This distinction is remarkable when one realizes that it contains perhaps a twentieth of the floor space of either of those structures.





© Peter Aaron/Esto

*Above, the main entry. The cap over the entry is one of about 30 architectural elements rising above the basic roofline.*

In Portland and Louisville, the program implied monumentality, and the architect provided it in abundance. In Capistrano, human scale and historic sensitivity were called for, and Graves was able to deliver those qualities just as generously. In the larger buildings, space was needed for public and private bureaucracies—not the most inspiring or stimulating of assignments. In the smaller one, autonomous individuals were clearly central to the agenda, as were books and the act of reading, and the resulting stimulus and inspiration is unmistakably reflected in the library's design.

Like its larger siblings, this is a quirky building, but its quirkiness operates on a plausible human scale and is therefore considerably more convincing than at Portland or Louisville. Paradoxically, it could also be argued that this intimate building is more effective than the others on a civic and urban scale. Indeed, it is a metaphorical city in itself, just as the California missions were in their time. With its multiple axes, courtyard, and strongly articulated plan forms and its complex and varied roofscape, it recapitulates the street grid, public open space, individual buildings, and skyline of a small town. And, unlike Portland or Humana, the library's architectural style does not stand apart from that of its context but rather reinforces and recapitulates local tradition.

In this respect, Michael Graves probably was aided by Charles Moore. Before the library was planned, Moore's Los Angeles office (Moore Ruble Yudell) prepared architectural guidelines for the city of San Juan Capistrano, applicable to nonresidential

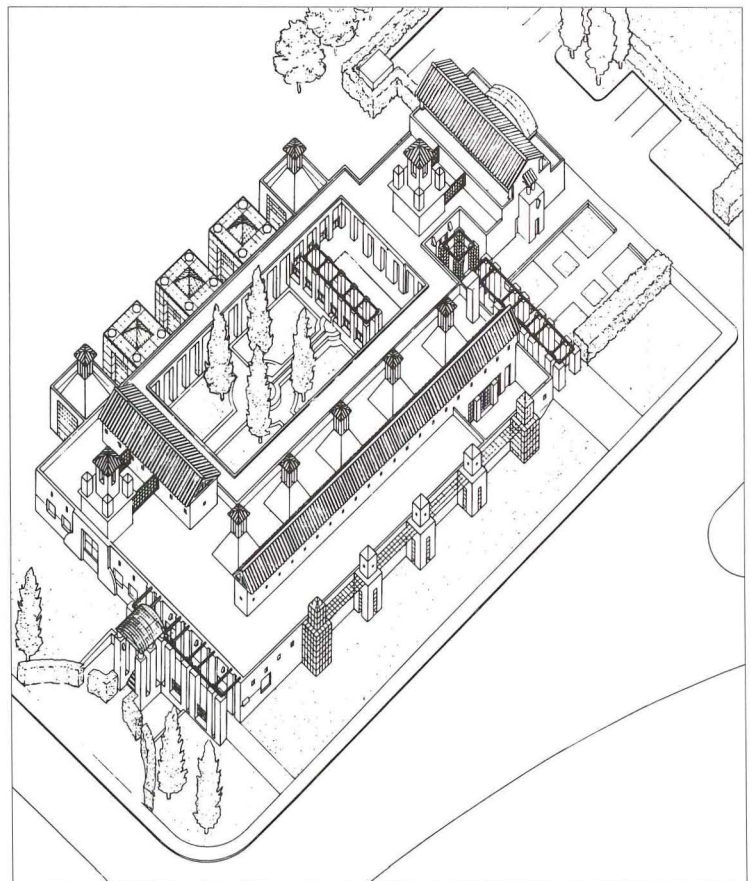



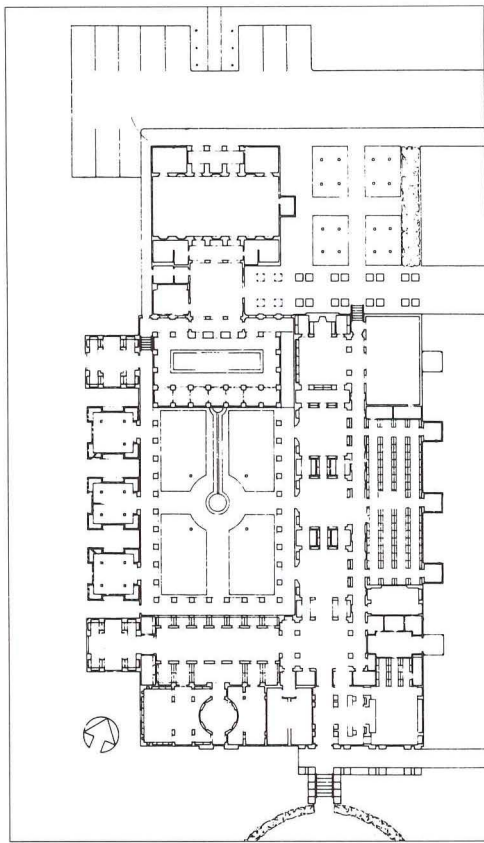

buildings in sensitive zones of that small but rapidly growing municipality. It identified the town's main historic styles (California coastal and mission) and put emphasis on richness of building surface, the play of light and shadow, layering of views and spaces, use of arcades and courtyards, and architectural intimacy in general.

These guidelines became official city policy in 1980 and were put to use when the city held an architectural competition for the library soon after. A field of 42 applicants was winnowed down to three firms that were asked to prepare designs: Graves, Moore Ruble Yudell, and Robert A.M. Stern. Graves observed the guidelines less literally than the other designers, but he captured their spirit more convincingly. Without so much as a single arch, he managed to give the building a strong and complex character embracing both old California and a somewhat abstracted postmodernism.

Before the library was built, its lack of arches provoked some local controversy among people who protested that the architecture was not in the "Spanish" style mandated by city policy. Emily Jackson, then the head librarian, recalls that the exterior appeared austere to many people, who may have been envisioning "Jack-in-the-Box or Marie Callender Spanish." Ironically, with little genuinely historic architecture in town other than the largely ruined mission, such franchise restaurants had become a major manifestation of the genius loci to some members of the community.

Construction of the building mollified the doubters. Jackson says that "they were seduced by the interior" and is pleased to call attention to a wood bas-relief sculpture of the facade that now is displayed inside the library. It was made by a man who once swore he would never set foot inside Graves's building but was won over by the finished product.

It is difficult to resist the library, for it is an extremely ingratiating design. Its scale is intimate and welcoming, its colors are soft yet rich, its natural and artificial lighting is generous and varied, and its intricate sequence of indoor and outdoor spaces invites exploration as persuasively as the streets of a New England seaport village or an Italian hill town.

Although just one long block from the center of town, the library's generous site was decidedly more suburban than urban. This provided the advantage of unfettered planning and the dis-

*Above, the lounge in the children's wing, paradoxically one of the library's highest spaces for the smallest users. Facing page, left, the narrow and high circulation spine in the adults' wing. Far right, the arcade that borders the large, rectilinear courtyard.*

advantages of a thin physical context and an absence of those limitations that often lead to strong architectural solutions.

Graves therefore created his own context, disposing his program elements to colonize as much ground as possible and arranging them in a complex but logical matrix that bound together circulation and destination, primary and support functions, and interior and exterior spaces into a single, well modulated entity. In a building of only 14,000 square feet, there are about 70 separate indoor and outdoor spaces (as well as others for utilities and storage), organized along nearly two dozen major and minor axes. Roughly 30 individual architectonic elements pop up above the basic roofline to both mark those spaces and axes on the exterior and to produce a roofscape more picturesque and varied than any other in town.

It is in this grand parti—even more than in specific forms, details, and materials—that the library most closely captures the spirit of a mission town. Like a mission or a monastery, the library appears to be a well differentiated but architecturally consistent universe in itself. Obviously, this symbolism is a bit fanciful since its functions are not as wide-ranging as those of a self-sufficient religious outpost. Nevertheless, they are more comprehensive than those of an ordinary library; parts of the building function as a civic building and are owned by the municipality rather than the county library system. These include the flat-floored, multi-purpose auditorium used for concerts, films, and lectures, the small Friends of the Library bookstore that sells surplus volumes and publications produced by the library, the central courtyard that is often rented for private events (the space is quite popular for weddings and receptions), and a future exhibit gallery for which Michael Graves's office is now preparing plans.

Even the pure library functions go beyond the ordinary. Reading is encouraged in the courtyard, in a smaller walled patio, and in the lath-house gazebos just off the courtyard. Surprisingly, in light of the benign climate and the pleasantness of these spaces, hardly any reading is done in them. This is quite likely a tribute



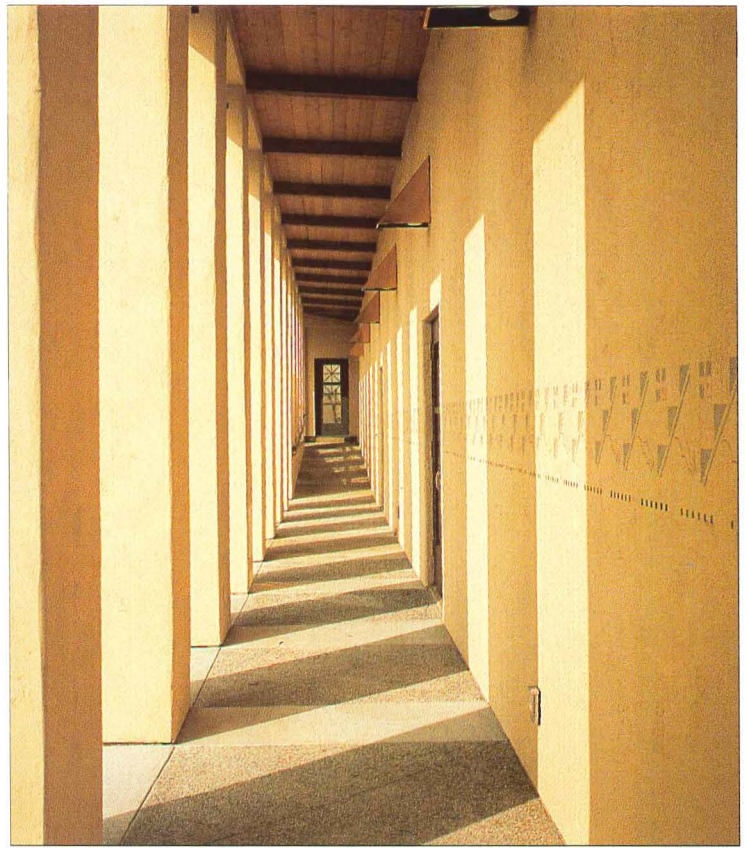
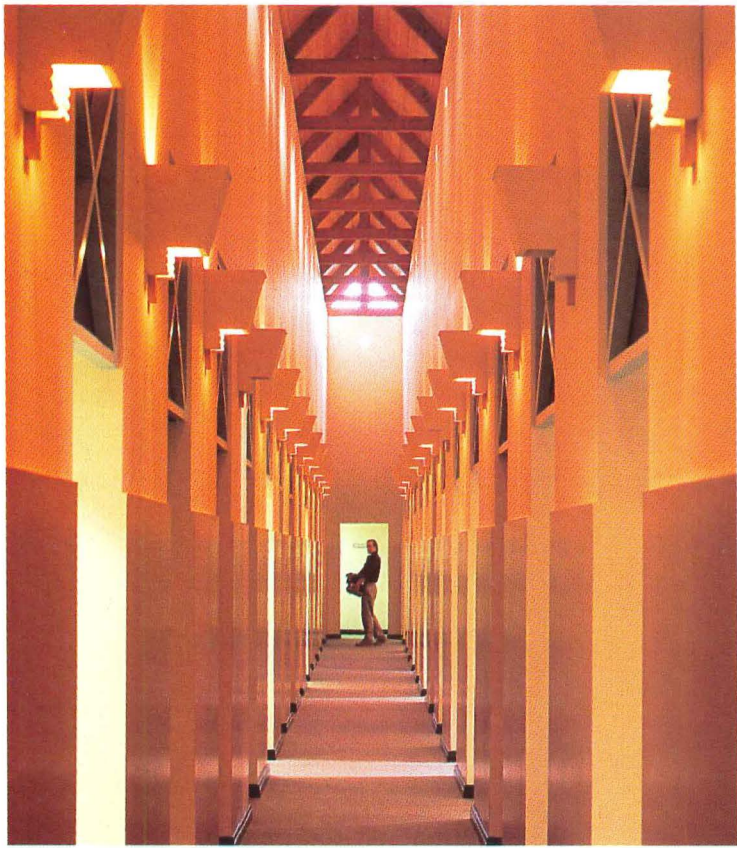

Photographs © Peter Aaron/Esto

to the interior arrangements; why go outside to read when it's so comfortable within? The atmosphere could be called homelike or clublike: there is almost no sense of institutionality. The lighting is ample and pleasant throughout. Comfortable, well-upholstered blue sofas and armchairs abound in the adults' wing, interspersed with coffee tables piled with books and magazines and end tables housing Graves-designed brass reading lamps. The lounge at the far end of this wing even has a working fireplace decorated by a plaster replica of an open book upon which Graves has painted a miniature pastoral landscape.

It is not unusual to see people remove their shoes and put their feet on the sofa cushions just as though they were home. Likewise, the padded benches in tiny reading alcoves off the stack area are conducive to reading in a reclined position and are used exactly that way. (They also accommodate the occasional naps of some of affluent Orange County's homeless population.) In the children's wing, carpeted floors, semicircular benches, and large plush animals are used to augment the normal furniture for sitting.

But there are paradoxes amid these scenes of bourgeois tranquility. In both his modernist and postmodern periods, Graves has been a mannerist architect, and, although Capistrano is probably his most popularly accessible recent work, it still harbors an irrationality or two. The highest ceilings and most ample spaces are devoted to the smallest users: the children's wing is lofty and broad-halled, while the adults' wing is lower-ceilinged and sports a narrow circulation spine that is far taller than the occupied spaces it serves and ceremoniously leads to only a fire exit door. Likewise, the boldest elevational element is on the children's side of the building; it contains a window that is far larger on the outside than on the inside.

These tricks are not really bothersome, but the library's near-miniature scale and superabundance of incident are more serious. One well-versed professor of architecture, speaking on condition of anonymity, says that "in Capistrano I feel that I'm in not a building but in a big model of one. It's over-complex for its scale, and when I'm there I'm always bumping into things."

This last phenomenon is not just a matter of taste. Graves was asked to alter his design so that the entrance axis moved from the narrow corridor mentioned above to the centerline of the row of adult reading rooms. Consequently, circulation is through

spaces that were never meant for it, and one does indeed bump into sofas and reference tables in negotiating the tight and crooked path from the front door through the reading areas. This situation has been worsened by the proliferation of electronic hardware—computer terminals, CD-ROM readers, and microfilm machines—since the building opened. (Graves was not allowed to reconcile his overall plan with this change because local officials feared it would somehow violate proper competition behavior.) In a way, this change has served to enrich the building by focusing its energies into a narrow channel. What the reading rooms lose in placidity they gain as social spaces.

Another imposed change was not as successful. The original courtyard was poetic and asymmetrical, evoking a miniaturized landscape, but it displeased the competition jury. What exists is largely the work of a local landscape architect, with a stock concrete fountain centered in a banal, foursquare, symmetrical plan. Graves's own garden was arguably the capstone of his design.

Aside from these relatively minor reservations, the Capistrano library is a remarkably successful work, particularly when judged in human terms. Emily Jackson, recently promoted from head librarian to a systemwide administrator, recalls her six years there as "wonderful professionally. The building stretched me a lot. It was a happy surprise. Staff morale was incredible, everyone was enthusiastic, and people asked to be transferred there from other branches. There is an extraordinary *esprit de corps* and pride in the building." She observes that the library has had a similar effect on patrons. At one point, new library cards were being issued at the rate of 1,000 a month, and, until another new branch was built nearby, circulation was fourth-highest out of 26 branches in the system.

Concluding, she finds Capistrano a near-magical place to work: "It almost doesn't matter what happens to you [in the course of the work day] if you're in such a beautiful place. I'm grateful to the building—it does me good."

In a time when traditional literacy has been declining, perhaps partly because of the ubiquity of electronic media, it is heartening to know that architecture can play some part in reversing that decline. Alas, under California's tax-cutting Proposition 13, it is not likely that the Capistrano story will be repeated in other parts of the state, for Orange County is one of the richest and best-educated enclaves in the nation. □







# The Beauty of Holiness

*Gates of the Grove Synagogue,*

*Norman Jaffe, architect.*

*By Andrea Oppenheimer Dean*

It is crafted, with great affection, of an amalgam of influences and symbols, often exotic and contradictory. Yet the Gates of the Grove Synagogue by Norman Jaffe, AIA, is highly individualized, resolved, and sure in its vision. In these ways it is a metaphor for Jewry itself, scattered helter-skelter for centuries across the earth, absorbing local practices, yet all the while retaining a core identity, based largely in the spirit and the word.

The Gates of the Grove has in common with Fay Jones's chapels a quality that even nonbelieving skeptics like myself—habitually and on principle hostile to high-flown and puffy pronouncements—can recognize as deeply spiritual and inspired.

The least important part, as Jaffe says, is the exterior. Like much of the neighboring architecture in Easthampton, New York, it is built of shingle and wood. Like the architecture of the eastern European *shtetls* and the synagogues of Poland—both only memories now—the Gates of the Grove has an unassuming esthetic of gently sloping roofs. Like the mosques that also served as inspiration, the synagogue is understated outside and glorious within.

The building sits back from the street in a grove of ancient trees. Its east end is attached to and on an axis with the house where services were held until the congregation outgrew it. The house will soon be demolished, leaving Jaffe's addition to stand on its own. The west elevation comprises a series of staggered, angled, and gabled shapes deriving from the tenth letter of the Hebrew alphabet, the "yod." Why use a letter as symbol? The written word, says Jaffe, "is what the Jewish faith is about. The second commandment is very clear about images. While the Greeks were concerned with the holiness of beauty, Jews concentrated on the beauty of holiness."

The synagogue's north and south elevations are simple rectan-

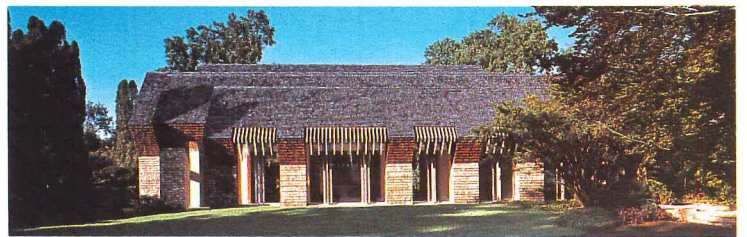

*Facing page: the transparent, welcoming entrance, with dolomite-paved path. Top, west elevation, with roof lines in shape of Hebrew letter 'yod' Above, south entry elevation overlooking street.*

gles, long and narrow to accommodate a grove of young trees planted as memorials in what is now the building's north-facing backyard. Both it and the south-facing entrance elevation are a single story, penetrated by 10 floor-to-ceiling windows.

The window configuration, among other architectural elements, is laden with symbolism. There is the number 10, first of all. Not only are there 10 windows, but the building has 10 slabs and 10 sections, and 10 Hebrew words are carved above seating niches along the building's side walls. In Jewish ritual, 10 males constitute a *minyan* (required for prayer services for the dead); 10 is the number of commandments passed down by Moses; and the 10 branches of the *sofirot* constitute the 10 attributes of God. The *sofirot* is a tree, "the tree of the Kabala, whose roots are in heaven, whose meaning is incomprehensible," says Jaffe, sounding like the verbal equivalent of a Marc Chagall painting.

Jaffe has placed abstracted treelike forms in wood in his expansive windows "to stop the eye and delay it before it goes outside."



Photographs © Jeff Heatley Photography

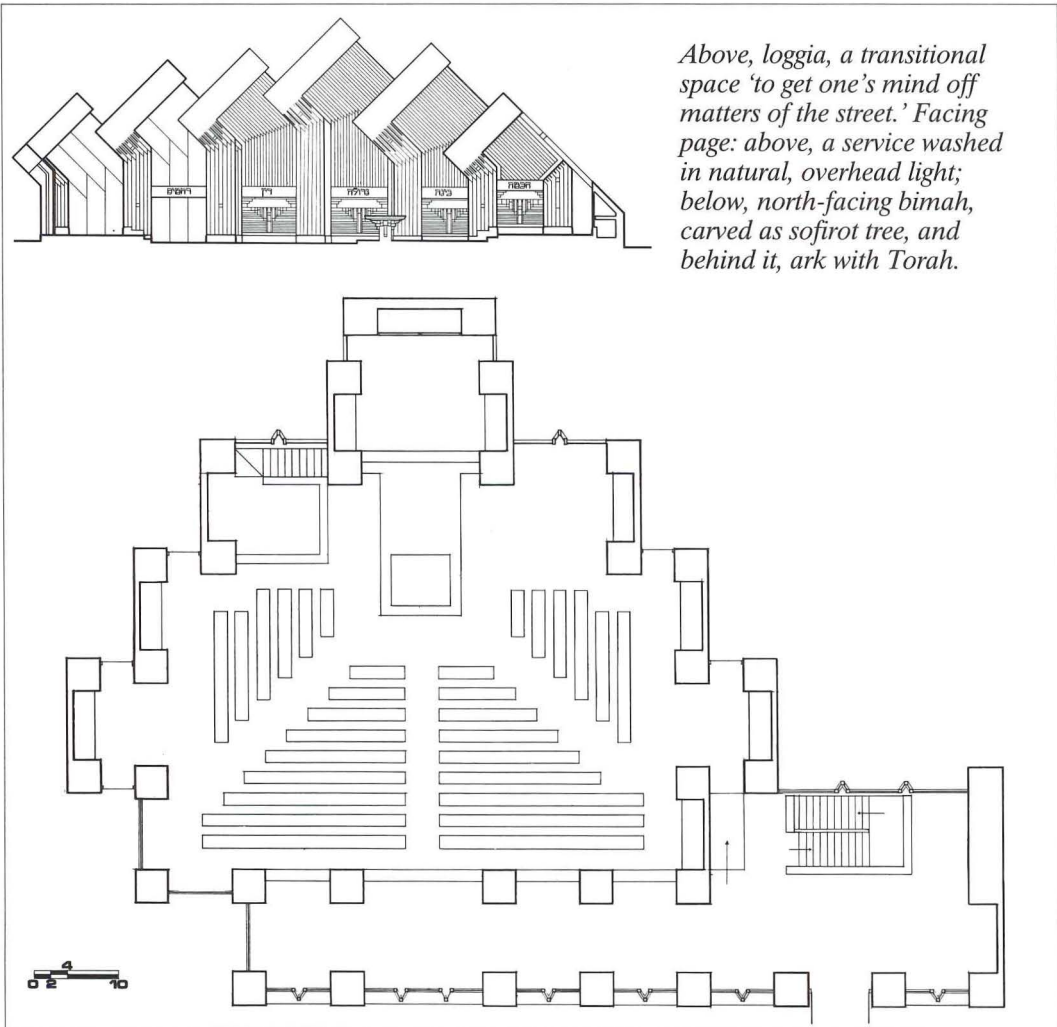
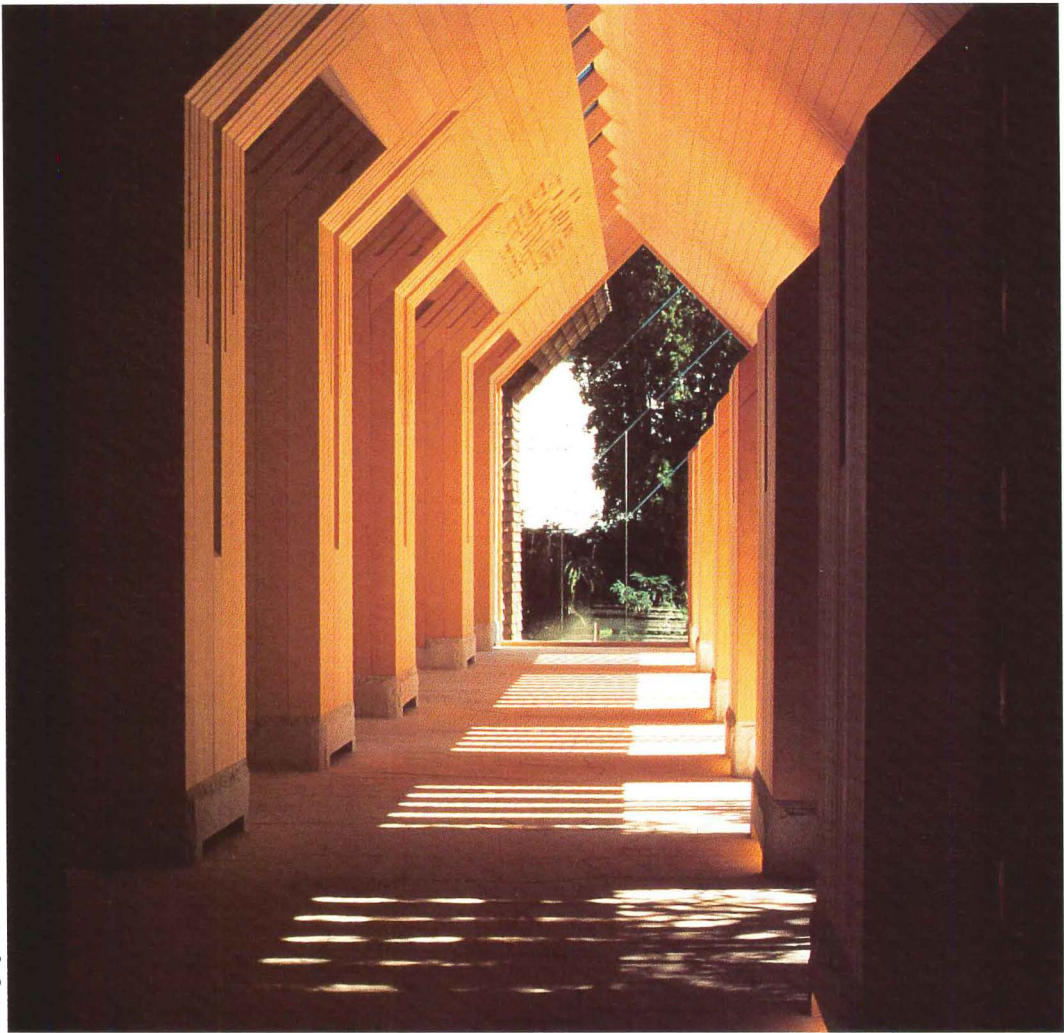

*Above, loggia, a transitional space 'to get one's mind off matters of the street.' Facing page: above, a service washed in natural, overhead light; below, north-facing bimah, carved as sofrot tree, and behind it, ark with Torah.*







This page, southwest corner with arched columns from Jewish wedding chuppe. Facing page, a view from outside of bimah and ark, showing treelike *sofirot* elements veiling windows.

Photographs © Jeff Heatley Photography



He explains, "If you look at early Gothic cathedrals or important mosques, they have something that acts as a veil over the outside, to prevent distraction from the ritual." With the *sofirot* device Jaffe resolves a potential conflict between the clients' desire for a lot of glass and his own wish to concentrate attention on the service and the light and space in its immediate surroundings.

As you approach the synagogue's entrance, you become abruptly aware of a shift, a sense of arrival. The paving changes from an ordinary aggregate to a beautiful, warm-colored dolomite, also used inside for flooring and for dadoes, hammered at their edges where they meet walls of smooth Alaskan cedar.

Just inside the entrance is a long, narrow entry corridor, a somewhat constricted "conditioning space to empty the mind of matters of the street," says Jaffe.

It opens into the light-filled, soaring sanctuary, which uses every possible device to "pull you upward out of your shoes," as Jaffe puts it. Five staggered archlike forms, extending almost the width of the building, reach up 35 feet. Each arch consists of a pair of square pillars that bends like an elbow two-thirds way up and then supports a canted beam, which, in turn, meets a sloping skylight. The ceiling, says Jaffe, is a lesson from the mosques, which use ever-smaller tiled patterns "to pull the congregants into a transcendental state."

His main ally, however, is light, and when Jaffe talks about light he begins to sound like Louis Kahn. Jaffe asks rhetorically, "Which is more important, the light that falls on the *shitel* or on Chartres or Westminster Abbey? The building needs the light to define it. The light doesn't need the building. So if we conceive of a building in terms of things that interrupt light and

space, then the space and light become our media, not the interruptions."

The synagogue's main source of illumination is angled skylights. The light is soft and diffuse, and it intensifies as your eye rises. The only direct light falls on the ark, which contains the Torah and is the focus of attention in all synagogues. Ordinarily, the ark faces east, toward Jerusalem, but since this building's east side is attached to the existing old house, the ark was placed against the north wall, with slits to either side of it admitting light from the east and west to cast shadows on the ark walls and signal the time and type of day. During the service, the rabbi ceremoniously removes the Torah from the ark to a podiumlike table called the *bimah*. From there he reads from the scrolls and delivers his sermon. The *bimah* in this synagogue is configured and carved as a *sofirot*, again the treelike form.

Being inclined toward abstraction and admonished against portraying graven images, Jaffe has detailed the ark and other elements with carved patterns, often adapted from Persian carpets. There are the frequent treelike geometric carvings, and there are patterned incisions above the cabinet in the ark where the Torah is kept as well as in the seating niches that line the synagogue's east and west walls. Detailing and craftsmanship throughout the building are extraordinary.

Jaffe, a natural storyteller, tells how "in Poland the rabbi kept honey in the ark doors, which he gave to little children to create an association of the Torah and sweetness." One can't help but think, how sweet it must be for children to grow up with this synagogue, associating its qualities of transcendence, sophisticated simplicity, and warmth with their faith. □



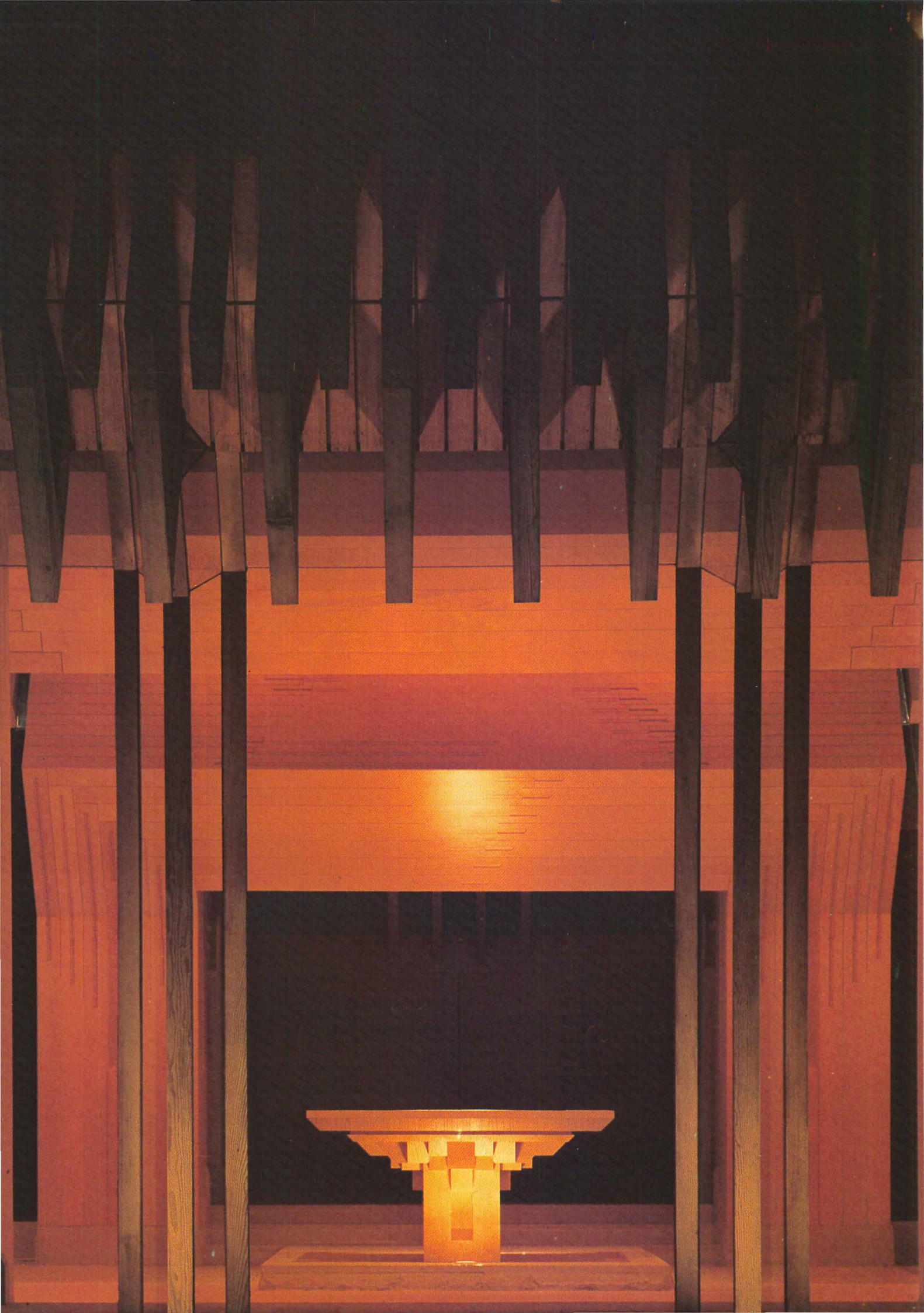



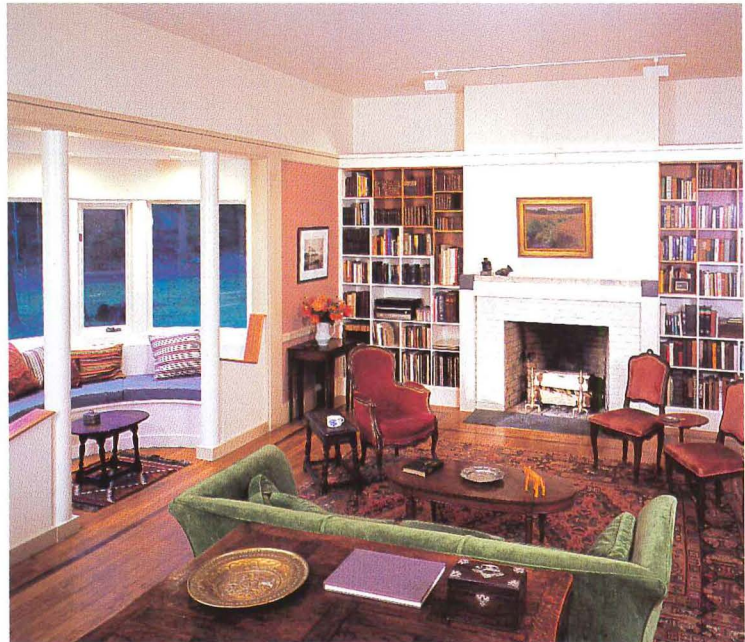
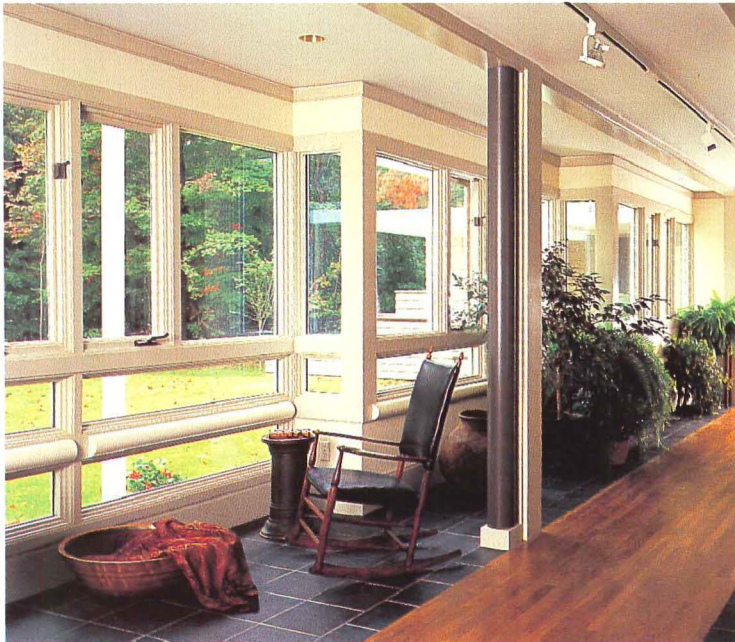



# Architectural Chessboard

*House overlooking the Hudson,*

*Charles A. Platt, architect.*

*By Michael J. Crosbie*



This house for a retired professional couple is sited on a beautiful, wooded plateau overlooking the Hudson River in Palisades, N.Y. Designed by New York City architect Charles A. Platt for his cousin, this commission has a somewhat personal historical precedent. The architect is the grandson of the prolific turn-of-the-century architect of the same name, who designed a house for his own cousin—the grandfather of his grandson's client.

The first house was a stately neo-Georgian manor with white pilasters and red brick. In this house, Platt draws allusions to that earlier house in the white frame that stretches across the building's northeast face, and the brick base with marble accents upon which this house sits. But there the exterior similarity ends, as Platt engages in a game of geometric precision, employing the house's walls as pieces on an architectural chessboard. Layers of grids penetrate through the house, knitting the architectonic elements together. Preventing these layers from extension are two apses on the house's northwest and southeast ends, which contain the grid like bookends.

On the long southwest side, the white frame extends from the house as a vine-covered pergola, stretching out into the landscape and anchoring the house at the woods' edge. On this side the house's boxlike form breaks apart with generous fenestration to capture the sun. Site walls step down from the house and define a quadrangle, a private outdoor space shielded from visitors by a detached garage. Platt articulates these walls as eroding, and he imagines the house as disintegrating into the landscape. The exterior materials of stained cedar and brick are warm and friendly. Platt had wanted to paint the whole exterior white, but the colors selected make this house at home in the woods.

Inside, Platt refers once again to the houses of his grandfather. While the rectilinear and layered exterior might suggest large expanses of uninterrupted space, the interior actually is composed of clearly defined rooms, many with a Georgian sensibility in scale and color. There is a large open staircase in the front hall, a formal fireplace in the apsidal living room, and genteel touches such as a built-in bench in the foyer and a pantry next to the kitchen.

On the first floor the rooms are stretched out along a glazed, south-facing spine that invigorates them with light. Upstairs, the bedrooms are arranged likewise, with clerestory southern lights and views north to the river. At the top of the stair tower is a private study that commands an excellent view of the Tappan Zee Bridge, which unfortunately is interrupted by a horizontal window bar. Such is the price one pays for fenestration patterns generated by relentless architectural grids. Otherwise, Platt has created a warm, comfortable house that is sensitive in its human scale, packed with architectural gamesmanship cultivated by generations of family architects. □

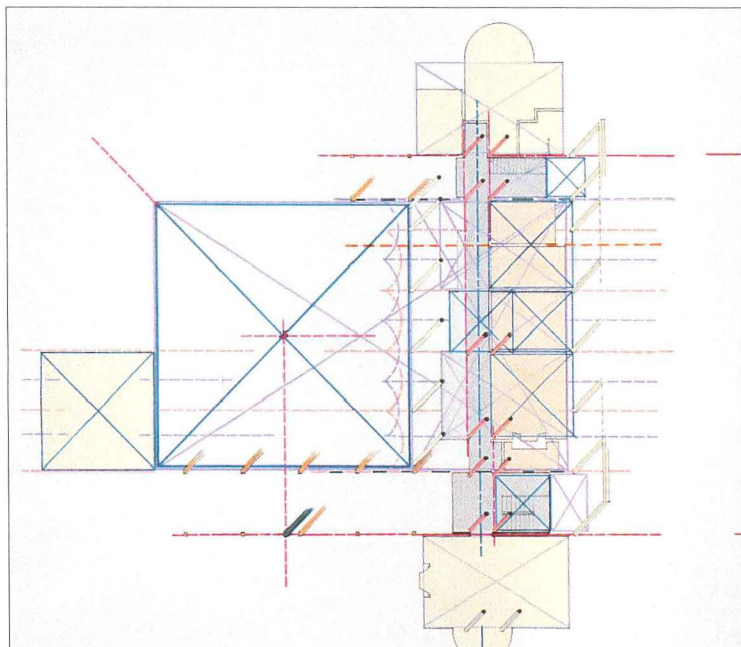

*Top photo, house's northeast exposure as it overlooks the Hudson River and the Tappan Zee Bridge. Far left, a stepped wall extends across the solarium cum circulation spine paved with slate to retain the sun's warmth. Left, the formal living room with fireplace and curved window seat.*







# Glittering And Controversial

*75 State St., Boston,*

*Graham Gund and SOM/Chicago.*

*By Robert Campbell, AIA*

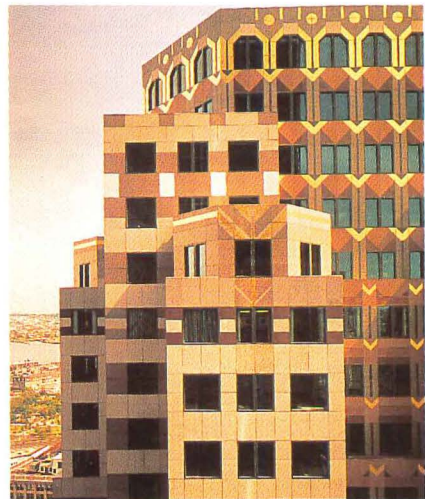

Photographs © Steve Rosenthal

Whatever else it may be, 75 State St. is certainly the most discussed Boston building of its era. To its detractors, this office tower—its facade gleaming in five cosmetic shades of granite, accented with gold leaf—is the Tammy Faye Bakker of architecture. To its admirers, it is a daring attempt to make a building that isn't afraid to stand out boldly on the skyline while fitting in modestly on the street—a building that isn't a box, that has a bottom and a top and real windows and real materials and looks interesting.

One of the detractors is the president of the Boston Society of Architects, Peter Forbes, FAIA. Forbes went on television to denounce it. "I think it's the most vulgar building I've ever seen," says Forbes, who himself designs elegantly minimal rural houses. "Its architects have used rich materials like gold and granite in such a way as to make them look like plastic. They've tried to substitute costly materials for good architecture." The building that draws such fire is a 31-story tower, placed in the middle of a downtown city block with lower wings extending out to the sidewalks. Its most memorable feature is a zigzag pattern of gold leaf at the top. The rest of the exterior, patterned in shades of stone, has something of the look of a showroom display wall of granite samples.

It isn't easy to say who is responsible for 75 State. If a camel is a horse designed by a committee, 75 State is an office tower designed by an entire parliament. It had two architects of record, Graham Gund of Boston and Adrian Smith of the Chicago office of Skidmore, Owings & Merrill. And it had silent designers in the offices of both the Boston Redevelopment Authority and the developer, the Beacon Companies. Looking at the gilded result of all this collaboration, inspired as it is by the deco of the Roaring Twenties, one may be reminded of the strange little poem that the novelist F. Scott Fitzgerald used as a preface to *The Great Gatsby*:

*Left, 75 State from Quincy Market. Above, the crown.*



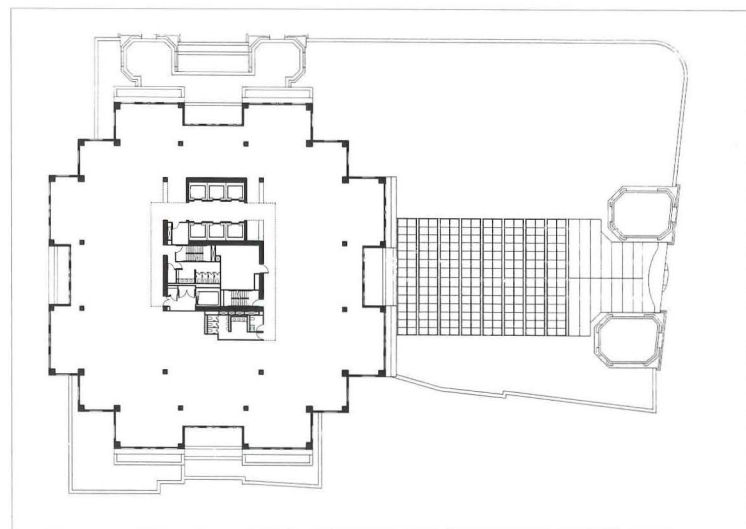
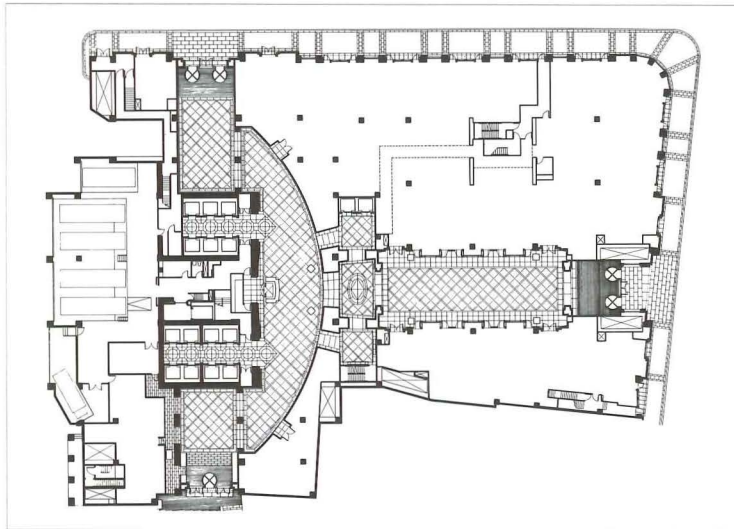
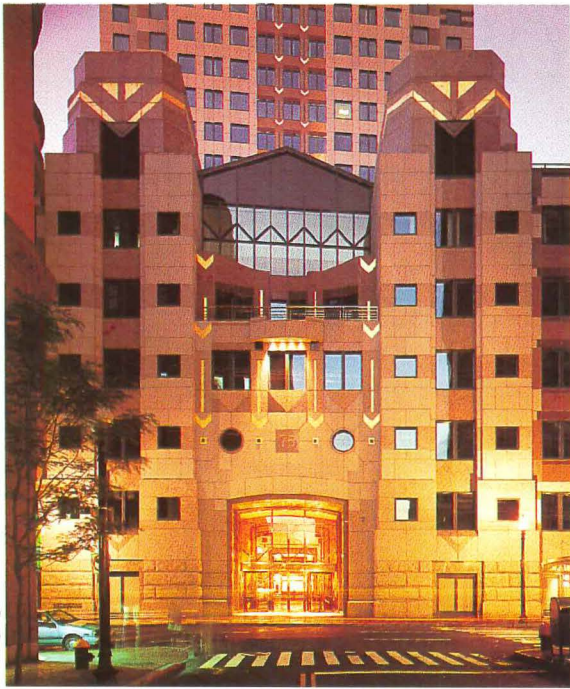

*Then wear the gold hat, if that will move her;  
If you can bounce high, bounce for her, too,  
Till she cry, "Lover, gold-hatted, high-bouncing lover,  
I must have you!"*

Seventy-five State certainly wears a gold hat. And it has some of the American arriviste effrontery of Jay Gatsby. Alas, however, it does not bounce high. It squats. That's the result of so much collaboration. The original design was taller and slimmer and its gold hat shapelier. But the city forced the developer to lower the height, while at the same time the developer forced the architect to maintain the total floor area. Inevitable result: Fat City.

Nevertheless, as urban design, 75 State has major merits. Putting the bulk in the middle of the block permitted a high density without any sense of overwhelming the neighborhood. The low elements that come forward to the sidewalk line up respectfully with older buildings along State Street. There's also an invisible merit: 75 State displaced Boston's single ugliest work of architecture, a 1960s renovation of a once handsome Victorian office block that seemed hung with Miami Beach motel balconies.

At the ground, 75 State is remarkable. An interior arcade-cum-lobby is an amazingly generous public space. Like the arcades of Europe, it extends the sidewalk network into mid-block. It's big and costly but, unlike some other recent postmodern lobbies, it doesn't look or feel like a tomb for Godzilla but instead is alive with shortcutting pedestrians. This arcade was intended to have two levels of retail shops, but that intention has been fulfilled only in part. As a result, like most American attempts at public arcades, this one lacks the magical sense of being a city street brought

*Above, the main entrance and semicircular hall at the end of the arcade/lobby. Right, the arcade, looking toward the entrance.*

indoors. It feels too domestic and too privatized. And there's surely too much marble, seven shades of it, wrapping around you even under your feet, as if you were being swaddled in pink blankets.

The final verdict? Who can say? Sure, the granite and marble look like plastic and the gold leaf looks like Letra-set. There's a lot that's crude. The attempt to remind us of the great deco towers, like the American Radiator in New York City, falls far short because the craft just isn't there. Everything seems to be made of adhesive veneers. There's no sense of something truly built.

But most sane people, one suspects, will prefer this kind of generous and showmanly vulgarity to the kind of office tower that is merely a boxy package of leasable space. Boston, like other cities, has too many buildings that look less like places for human habitation than like an array of abandoned packing crates that the real buildings came in. At 75 State, the architect and the developer—Norman Leventhal of Beacon—have had the nerve to create, like it or not, definite and vivid architecture. It's just as possible to love 75 State for its sheer glitzychutzpah as it is to be grossed out by the same. In its ambitious display of wealth, in its generous gestures to the public realm, 75 State is the high-water mark of the amazing Boston boom of the 1980s—the most intense, probably, in the real-estate history of this venerable city. As that boom now fades, 75 State, by virtue of both its strengths and its weaknesses, can well stand as its emblem. □







# THE CADVANCE/dBASE CONNECTION.

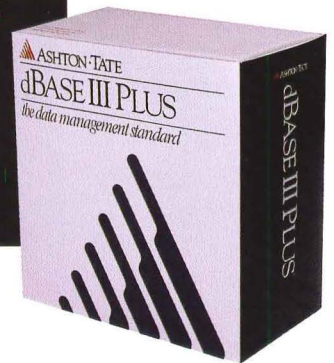
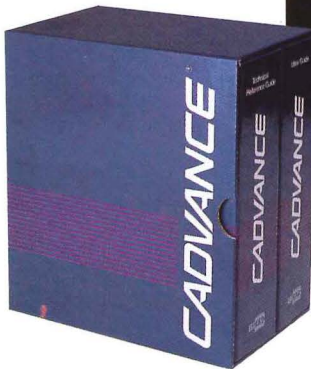
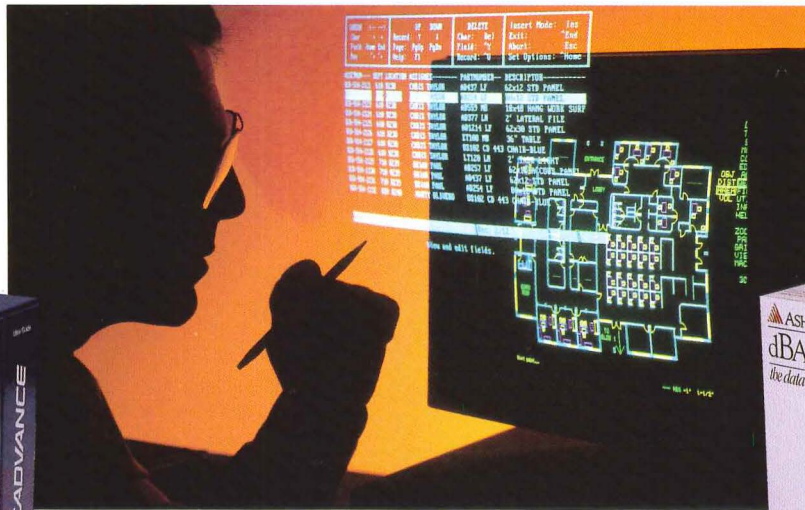

**A NEW MEANING FOR CAD:  
"COMPUTER-AIDED DECISIONS.™"**

## Link Drawings to Data and Data to Drawings.

There's more to CAD than fast drawings. At least at ISICAD there is.

Now you can directly link CADVANCE® PC-CAD drawings with non-graphic information in dBASE® files for a total solution to information management.

## CADVANCE Advances.

CADVANCE goes beyond ordinary computer-aided design and drafting on your PC. It allows you to manage the information behind the pictures, and puts you in total control of your project.

By linking drawings with data in a relational database, you increase the intelligence of your drawings. Keep track of inventories, estimates, costs, locations, schedules—and report on

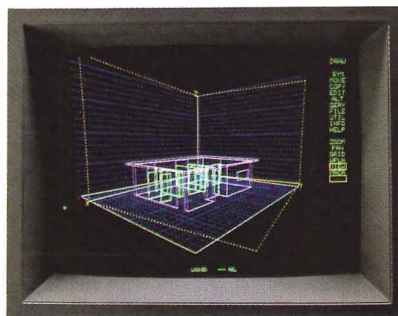

VGS—The new standard in 3D user interfaces.

them easily. Evaluate alternatives quickly, completely and economically. Gain control of project information so you can make better, faster management decisions: "Computer-Aided Decisions."

## Instant Updates.

With the CADVANCE/dBASE connection, your database can be

updated directly from the graphics screen—without exporting, without delay, without repeating steps, and without complication. When you change information in the drawing, it is reflected in your database. And vice versa. Information is always consistent, so you avoid potentially costly errors.

## The Latest in 3D.

In addition to advanced information management capabilities, CADVANCE Version 3.0 offers full 3D drawing and visualization capabilities, including an innovative user interface called the Visual Guidance System (VGS™). The VGS sets a new standard for 3D design and gives you the easiest, most intuitive interaction with 3D available today. See for yourself how easy 3D really can be.

## PC WEEK Poll: High-End CAD Software\*

Overall Performance  
Relative value  
Ease of installation  
Documentation quality  
Product support quality

	CADVANCE	AutoCAD	VersaCAD	MicroStation	CADKEY
Overall Performance	1	3	4	3	2
Relative value	1	4	5	3	2
Ease of installation	1	3	4	4	2
Documentation quality	1	2	4	3	2
Product support quality	1	3	4	2	5

\*Information from "Survey Shows Staff Competition in High-End CAD" from PC WEEK, June 19, 1989. Copyright © 1989, Ziff Communications Company. VersaCAD is a registered trademark of VersaCAD Corp. AutoCAD is a registered trademark of Autodesk, Inc. MicroStation is a registered trademark of Intergraph Corp. CADKEY is a registered trademark of CADKEY, Inc. CADVANCE, Computer-Aided Decisions, and VGS are registered trademarks of ISICAD, Inc. dBASE is a registered trademark of Ashton-Tate.

## TIME FOR DECISION

- Please have a dealer call me
- Please send your free brochure that explains how successful companies are making the CADVANCE/dBASE connection.

For immediate response call  
**800-556-1234 Ext. 281** or  
**800-441-2345 Ext. 281** (In Calif. only). Or send in this coupon

Name ..... Phone ( ..... ) .....

Title .....

Company .....

Address .....

City ..... State ..... Zip .....



ISICAD, Inc. PO. Box 61022, Anaheim, CA 92803-6122



# Practice In the '80s

By Douglas E. Gordon

and M. Stephanie Stubbs

**E**volution, not revolution, has been the watchword of architectural practice during the 1980s. The changes that undoubtedly will shape practice for the future have been taking place quietly but steadily, some controlled by social forces larger than the profession, others brought on by new technologies inevitably making their presence known. Following are sketches of five firms, telling how their practice in the 1980s has evolved into their goals for the 1990s. Although the firms have been chosen deliberately for their differences in size, location, and the types of architecture they practice, similarities in their descriptions of the prime movers of the 1980s give prognostications of what's in store for the profession in the immediate future.

On a societal level, the past decade has brought a greater public awareness of architecture, which has both positive and negative aspects for practice, according to Andrea Leers of Leers Weinzapfel in Boston. "It's extremely healthy that people are interested in and care about architecture—evidenced by, for example, recent public television programs and art studios showing architects' drawings," she says. "The downside of that is that architecture has become a consumer item—Architecture as a style of the moment, to be purchased, collected, and absorbed."

A consequence of public awareness is smarter clients. Arthur Gensler, president of Gensler Associates, says, "Our clients are getting more sophisticated and smarter every day. We're getting better clients than we used to get, and clients themselves are getting better. Where 10 years ago we saw a lot more CEOs—and they either know a lot about design or nothing at all—today, a lot of our clients are facilities managers, real estate people, and

developers who really are getting sensitive and knowledgeable about design. They challenge us more and we can be more rational with them, because they know what they want and demand it."

Client savvy coupled with the weird economy of the 1980s has continued the transformation of the "artiste" architect into the dual-hatted artist/businessperson. "Cost is a major issue. We can't do a project anymore without accurate cost control," says Bruce Tyler, president of Baskervill & Son in Richmond. He also mentions another fact of life in the '80s: "Everyone I know is more conscious of liability and is paying higher costs."

The architect's role is further changing due to a stretching out of services: at the front end of the process, through working more closely with the client and through increased attention to "doing it right" in the programming stage, and at the back end, through more calls for facilities management services. Other service specialties, such as interior design, also play a part. "Traditionally, when there is a downturn in the economy, architects have gone to interiors work, and we're no exception," says John Belle of New York City's Beyer Blinder Belle. "I think our long-term involvement in interiors will be more highly developed as we go after that market," he adds.

Finally, undeniably, the computer is here to stay. Terry Sargent of Lord Aeck & Sargent in Atlanta says, "Even though it takes longer to do anything electronically rather than by hand, computers allow you to deal with a lot more data accurately and effectively. Ten years ago, if anyone worked on a computer at all, he or she was a computer drafter. Now, the project architect and designers are using computers from start to finish."

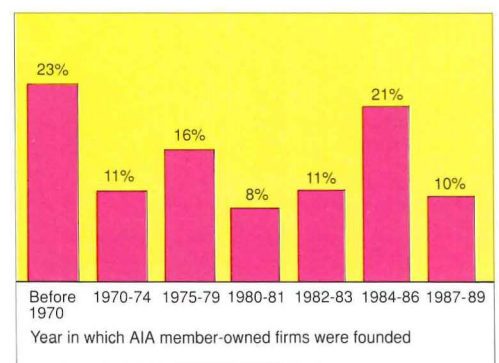
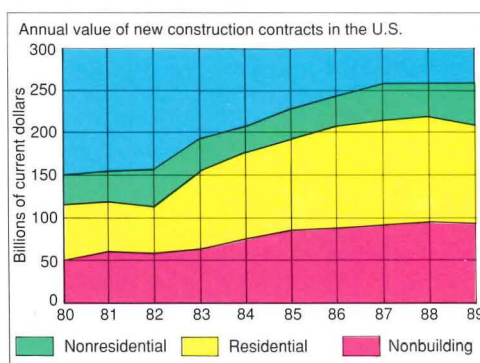
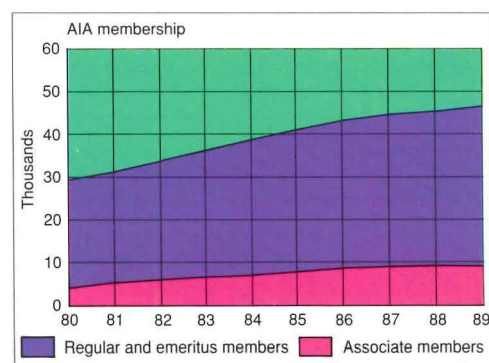





Andy Lautman



## MORE OF A BUSINESS

*for Baskervill and Son, founded in 1897  
and going strong.*

In central Virginia, where respect for tradition runs high, the past decade has brought much change to the Richmond-based firm of Baskervill & Son. The firm itself has a rich tradition, having been founded in 1897 by Henry Baskervill, managed by his son Coleman until 1969, and in the hands of the same principals ever since. "Since 1897, there have been only 25 principals at Baskervill, and today eight of them are active in the firm," says Bruce W. Tyler, AIA, president and one of those eight. "We've always had an in-house training program," adds David C. Smith, AIA, who is chairman of the board. "The firm was a partnership until 1969, and there was a design partner who was in charge of all design. Today, we don't have signature designs. Where up until 1980 it was easier to identify a Baskervill building, today there is a lot more diversity in our designs because owners are more market-driven, and the architectural style reflects the marketplace."

Principal Michael G. Nash, AIA, says the largest change in the firm's design process over the past decade has come from the increasing amount of input from the building owners. "They are playing an intensive role in defining their needs and participating in design aspects, so programming is a very integral part of the process, particularly when we are dealing with the speculative market. It's becoming more of a standard piece of our services." Nash notes further that most clients today, particularly in development projects, have a better appreciation of architecture. They have adopted what he terms "a more European attitude," in that they are more concerned with long-term ownership and life-cycle cost, and want higher quality.

Nash says that another factor contributing to change is the nationwide economic situation along with liability during the '80s, which forced firms to reconsider their business position and to ask whether they were going to specialize. "Consequently," he says, "we have segregated our services for liability purposes. We now look at architecture as a full-service package to clients. Our interior design department is part of that new practice approach. We also have increased our control over construction administration."

Principal C. David Sands Jr., AIA, says that a result of offering full-service architecture is that Baskervill & Son uses more specific types of consultants than ever before. "Today, we do mechanical and electrical design in-house, but will bring on consultants specific to project needs: acoustical, radiological, security, laboratory, fire protection assessments. Using these types of consultants stems from our desire to have that last degree of expertise on the team."

Tyler notices decade-long trends for the firm in that the firm's building projects have gotten smaller and that the firm is doing more repeat business (about 80 percent of its volume). "In 1980, 70 percent of the projects were health care," he says. "Today, we are balanced among health care, corporate, and devel-

opment work, with some special markets, such as interior design. In the early '80s, we did between 50 and 60 projects a year. Today we are doing 120 to 140 projects a year."

While Baskervill & Son's business volume has increased, its geographical area of work has narrowed. Tyler says that in the 1980s half the firm's business was in the Richmond metropolitan area and the rest was in other areas throughout Virginia. Today, 85 percent of the firm's work is in the Richmond area and 15 percent is statewide. Tyler attributes the change to Richmond's being one of the fastest-growing cities in the nation, as well as to the firm's efforts to maintain relationships with existing clients and to diversify its building-type expertise.

Despite the diversification of work, Baskervill & Son has retained its management style of principals working directly with the client on every project. Sands remarks on the changes in staff profile since 1980: "The average age is probably 15 years younger, and we have gone from less than 10 percent to 50 percent female employees. There is more staff participation now, too—we have monthly meetings where we discuss goals and business plans." Growth and management transition also have been carefully planned. The firm has three principals between 50 and 60 years old, three in their mid-40s, and three in their mid-30s. An associate program grooms younger architects for ownership.

With the "new" staff has come a "new" space. The principals all speak enthusiastically about their offices, into which they moved in 1987. Their new home is a turn-of-the-century tobacco warehouse that they renovated for multiple uses: the top two floors contain 32 apartments, and the bottom two floors are the firm's offices. "It gives us a showcase for our abilities and has changed our perception of ourselves by giving us more confidence," says Tyler. "Clients are excited about the space, and they realize what we're about." The open-space plan works well for the firm's studio organization and its "hands-on principals" style.

Businesswise, the principals agree that Baskervill & Son, along with architecture in general, has become more of a business than it was in 1980. The computer has played an enormous role in the firm's development and has become indispensable, Sands says, not only for CADD but also for keeping more accurate records. "Budgeting is more careful, and there is less room for error in project control today," says Smith. CADD also plays a part in the firm's increased marketing effort during the decade.

The principals say that the firm takes its planning for the future very seriously; setting one-year and five-year goals is a common, office-wide activity. Baskervill & Son's goals for the 1990s include improving and expanding the range of services while keeping a high level of design quality; a strong commitment to profitability for its employees and stockholders; and continuing its role as a good corporate citizen in its neighborhood and community. Smith says, "In addition to having fun, we want to be known as one of the top firms in the state of Virginia, and the greatest service we can provide for clients is to be there downstream when they need us."

*The photo on the facing page shows (from left to right): Mike Nash, Bruce Tyler, Irwin McCumber, Dave Smith, Dave Sands, and Brent Farmer, six of the eight principals, all of whom function as project managers in the 47-person firm of Baskervill & Son, founded in 1897. In the early 1980s, the firm diversified from its specialty of health-care design into corporate, development, and interior design work. One of its marketing techniques is handouts of watercolor prints of the firm's hometown, Richmond. Between 1984 and 1988, it provided services for over \$100 million in construction.*



## COMBINING EXPERTISE

*leads to the new firm of Lord Aeck & Sargent in Atlanta.*

**W**ith the ink still wet on the legal papers, the new firm of Lord, Aeck & Sargent faces the 1990s with an economy of scale and a pool of expertise that will allow it to maintain a high-service approach—the watchword for both of its merging components, Lord & Sargent and Aeck Associates.

Larry Lord and Terry Sargent started the decade working at Heery, formed Lord & Sargent five years ago, and built it into a 35-person firm. Tony Aeck, AIA, had a firm of 15 people in 1980, which had grown to 24 by the time the two firms merged this past September.

An early aspiration for Aeck was to be all things to all people. "I haven't lost that interest, but I've learned I can't know everything about everything. With a larger organization I can satisfy my generalist interests by working with many different specialists within the firm," he says. "This merger creates a critical mass of backup that will allow me to focus more on the project and project management relationship with our ongoing clients." The economy of scale also applies to overhead operations, such as accounting, bookkeeping, marketing, and computer management.

"I think computerization has changed architecture in the strategic planning area," Aeck says. "For instance, program development and comparing alternatives with the clients. Now we're getting continuity to things we used to do disparately. As the computer evolves it continues to make tighter and tighter connections to the many processes that produce design."

"We've been using computerized financial management for a number of years," Lord says. "I've gotten into the habit of getting time-spent invoices out every two weeks and fixed-fee billings every four weeks. And we do a lot of work to keep people's time logged right. No matter whether the project is cost-plus or lump-sum, I want to know how much time a project takes. With control of the details, the big picture is easier to see."

Machines may help, but a more important part of growing larger successfully is getting and keeping good people. "The secret to keeping staff over the years, even as project types and levels of complexity change, is to hire people who want to learn and to give them the opportunity to learn," Aeck says.

"We are looking for people like ourselves, with a passionate work ethic and an insatiable desire for more knowledge," Lord continues. "Schools have to instill in students a lifelong interest in learning. Architecture is not a facade; it is a whole dimension—a business, philosophy, and part of our whole lives."

Part of being a good architect is experience, plain and simple, the partners agree. A similar principle applies to clients. Lord, Aeck, and Sargent see a significant increase in client sophistication. "Clients always have been interested in how much a building costs, now they're interested in a holistic look at the building," Lord says. "They want to discuss esthetics, function, engineering, and more."

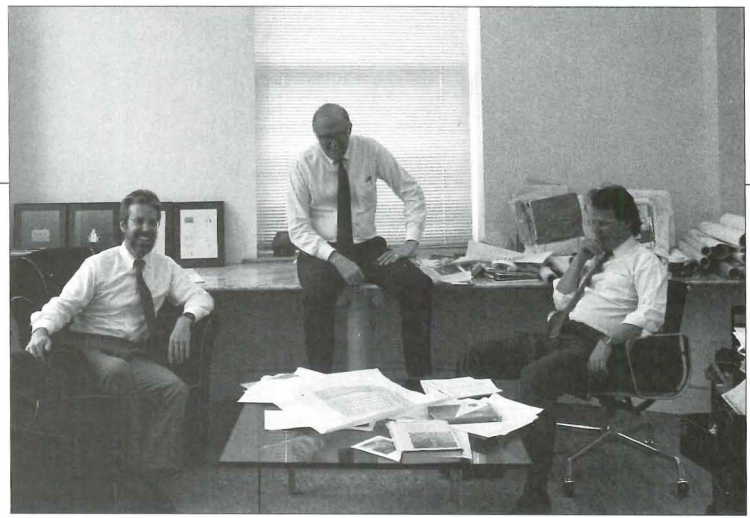

Allen Freeman

"Clients are less self-conscious about discussing design," Aeck agrees. "Ten years ago there might have been discussion about flat roofs, for example, but now we hear clients talking about the feeling a project should have and what kind of expression it has relative to the organization. In fact, we have a number of clients with architects leading their facilities group." One result of the increasing client sophistication, Lord says, is that the proposals he puts together are much more comprehensive than they were in earlier years. Sophisticated clients get architects involved early in project conceptualization and keep them on through construction. "Clients want someone to be accountable," Lord says. "But somewhere along the way, architects gave up some of their territory to developers, construction managers, design/build contractors, and so forth. We are trying to re-establish and broaden what it is that architects should be delivering. We try every day to demonstrate that we have the ability to do more than the client might be used to. One thing we learned from the liability crisis is that, if things get squeaky on a job, you apply grease immediately."

Another lesson of the '80s is that not every client is right for every architect. Liability tends to reside with certain client types and project types, Lord says. Profitability is another issue. "There is a certain threshold we hold to, unless it's part of a bigger picture with an ongoing client," he says. "It's hard to do \$180,000-budget buildings profitably. It drives me insane when I hear an architect say they've done a job at a low fee so he or she can get on board with some client. If our profession would just stand up and say that it costs money to provide good quality services, then the whole profession and the quality of all architecture would go up dramatically."

Design style is not one of the issues that would dissuade Lord, Aeck & Sargent from taking on a client. "Our style is not so much the style of our projects but the style of how we work together and with specialists we bring in," Sargent says.

The specialists the firm brings in have changed some over the past decade. "We consult with environmental psychologists now, which we didn't do much 10 years ago," Lord says. "There also are consultants we are not using now that we used to," Sargent says. "We now do cost consulting, graphics, interior design, and furnishings more comprehensively in-house than 10 years ago."

*Atlanta architects Aeck, Lord, and Sargent, above, have brought together two established firms for the sake of economy of scale and combined expertise. An important factor to them is their shared work ethic and sense of client service. Bringing their CADD systems together, a project Aeck is overseeing, will require significant overhead time. But the principals are committed to it. "The computer is not a way to do things faster—it is a way to do things better," Lord says. The business plan calls for 65 to 70 percent of the firm's work to be for repeat clients. The best marketing technique is to keep clients happy, the principals say.*



## DESIGN PLURALITY

*guides the work and future of Beyer*

*Blinder Belle.*

**R**emember, this firm is 21 years old, and you're asking me to look over half of its existence so far," says John L. Belle, FAIA, of Beyer Blinder Belle. "Ten years ago, we were just at the beginning of major growth, with about 50 people. So the way that practice has changed for us is a matter of the difference between a large small-mom-and-pop office and an organization of some size and of much greater depth of skill and talent."

Having established this framework, Belle comments that the design process has gotten less freewheeling. "It has more respect for the program and budget now," he says. "An architect today can get in trouble quickly by not being concerned about meeting these constraints until design is fairly well developed."

For the architect, tightening up the design process goes hand-in-hand with extension of services, foremost in predesign and postdesign, Belle says. For instance, nowadays the architect is expected to provide a major service in preschematic programming. "In-house client committees will develop a program with space and dollars delineated, but it is often unclear whether these can be achieved," he says. "We will spend six to 12 weeks of intensive testing of the budget and program, helping the client make some tough early decisions. Likewise, the complexity during construction requires much more on-site observation. That is especially true with historic preservation, where a lot of surprises don't reveal themselves until construction begins."

All would agree that New York City is a sophisticated market to begin with. Even so, Belle believes that the firm's clients across the board have gotten more sophisticated over the past decade. "Public clients are very sophisticated these days in their demands, selection process, administration, and programming," Belle says. "The private clients are sophisticated in their selectivity, sense of where to spend money for design, and in their expectations of services from architects and engineers."

While consultants have helped the firm meet those client expectations over the years, on-staff expertise also has increased, Belle says. He cites historic restoration as an example. "In January 1983, we started the Ellis Island restoration in association with Notter Finegold & Alexander. Since then, the in-house ability of our historic preservation staff has grown immensely because of the nature of the historic technology problems that a project of such a complexity makes you face daily."

Public perception is on the rise as well, he says. "I think, with the exception of the press, there is a much better general understanding of the collaborative roles different people play in putting a building together." On the downside, he finds that there is a tremendous emphasis on name recognition, with the public now identifying the work of a small group of architects as representing architecture as a whole.

Considering practice, Belle agrees with the majority opinion of those interviewed that architecture is more of a business than

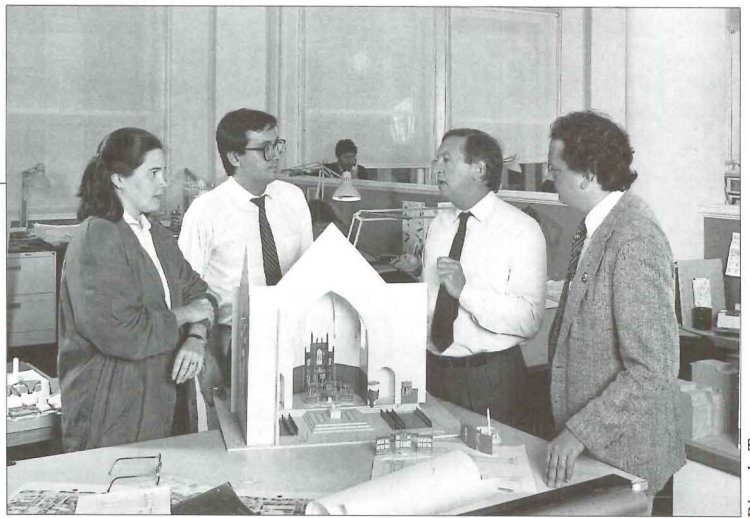

Ricardo Tegre

it was 10 years ago. "I think architects are much more forthright in getting paid, for one thing," he says. "We are more business-like than in 1980 because we have to be."

CADD has played a role in the Beyer Blinder Belle business forum for more than five years. Before that, the firm started with computers for word processing and then for financial and project management. The principals chose a CADD system suitable for a variety of tasks, including design, historic preservation, and interiors work. "We have CADD stations in each of our four studios, and I'd say about a third of our staff are computer-literate," Belle says. Learning the system is "on my list for next year."

Another change over the decade, according to Belle, is that the cost of getting work is now very high. He maintains that, if a firm is to stay in business and not burn up all its potential profits on marketing, the firm must recognize what a reasonable cost for getting work is. Twice a year, Beyer Blinder Belle's principals establish individual/subjective and corporate/objective goals. As an example, five years after winning the Ellis Island restoration job, which catapulted the firm onto the national scene in historic preservation, the principals realized it was time for the next landmark project. When they learned of the Grand Central Terminal restoration, they made a major effort to get recognized, on the list, and selected. "We were successful, in association with Harry Weese Associates and Seelye/Stevenson/Value/Knecht," Belle says. "We are about nine months into the restoration of a wonderful building."

Another major impact on the business of architecture during the decade, especially for a firm known for historic preservation work, was the 1986 tax reform, which narrowed tax benefits for restoration. "Indisputably, this has had a terrible effect," says Belle, "in the sense that through 1986 the tax credits program provided around \$9 billion of construction nationally in about eight years. It accounted for a large part of our construction. When the tax laws changed those tax credits, the active market plummeted because of the constraints in available investment money."

Growth in firm size isn't an objective for the time being, Belle says. "A firm of this size can do almost any project. We provide a high level of personal service with a rounded team of design professionals, and our goal is to do the best work possible in those areas with which we want to be associated."

*John H. Beyer, FAIA, Richard L. Blinder, FAIA, and Belle began Beyer Blinder Belle, New York City, in 1968. Major growth during the '80s has brought the firm to 110 professionals and three more principals: Fred Bland, AIA, Richard Visconti, and Peter DeWitt. Above, Belle (third from left) and associates Page Ayres Colwey, James Czajka, and Timothy Allanbrook, with a model of the Cathedral of the Madeleine, Salt Lake City. Landmark preservation projects have kept the firm in the national spotlight but also have made necessary an effort to maintain client recognition for the firm's work in institutional design, urban design, and waterfront planning.*



## MORE WORK UP FRONT

*for the 650+ and still growing Gensler and Associates.*

**T**oday, before we do anything creative, we have to find out what is permissible," states M. Arthur Gensler Jr., FAIA, president of the firm of Gensler & Associates/ Architects, with 650-plus employees. He finds that the increasingly complex initial public approvals—from neighbors, community, and government officials—that are now part of the design process have had an enormous impact on the way the firm works. "Today," he says, "before we do anything, we race to City Hall and to planning and code sources in order to determine what the limitations and ground rules are going to be. Ten years ago, you did what you thought was right, then negotiated and worked with the officials. I think we have to look at a lot more options than we did in the past, and have a lot more participatory interaction, both with the client and with the community. Certainly the environmental review process has also had a great deal of impact." Gensler believes that many of the projects that now are designated as landmark buildings never would have been built under present conditions.

Stylistically, Gensler & Associates has always objected to the label "signature" design and remains opposed to having a set style as a design philosophy for the firm. "We continually are refining our design approach, and as a result the quality of our projects is continually getting better. However, we have always taken the approach that the site, client, and community dictate the direction of the esthetics, but not the actual esthetics. We try to tailor our services for the specific project. Often we find that what is appropriate for one client or one site probably is not appropriate for another client or site, and that's fine," says Gensler.

However, one distinctive aspect of Gensler & Associates is the way its designers, more than those in most firms, look at the practice of architecture from the inside out. Gensler speculates that this results from the firm's early involvement with mostly interiors projects. Today the firm concentrates on architecture, graphics, and interior design and subs out work that is regional in nature, such as mechanical, structural, and landscape design.

Gensler also notes two other major changes in the firm's scope of services. "First, we're doing a lot more front-end work with clients: strategic planning and determination of long-term needs," he says. "Second, we are doing much more ongoing facilities management after the project is completed. Essentially, we've stretched out the architectural and interior design portions of services a little farther in the front and at the end of a project."

The size of many projects on the Gensler drawing boards is, as one might expect, large and getting larger. "We're now working on \$100 million and \$150 million jobs. In the past we were happy with \$10 million and \$15 million dollar projects. We're seeing more office buildings, and we are more and more involved with transportation and airport work," Gensler says. Still, the firm also does a large number of projects of limited size and budget. Although 65 percent of the firm's work now is interiors, that percentage is decreasing (although the dollar volume is up) as the

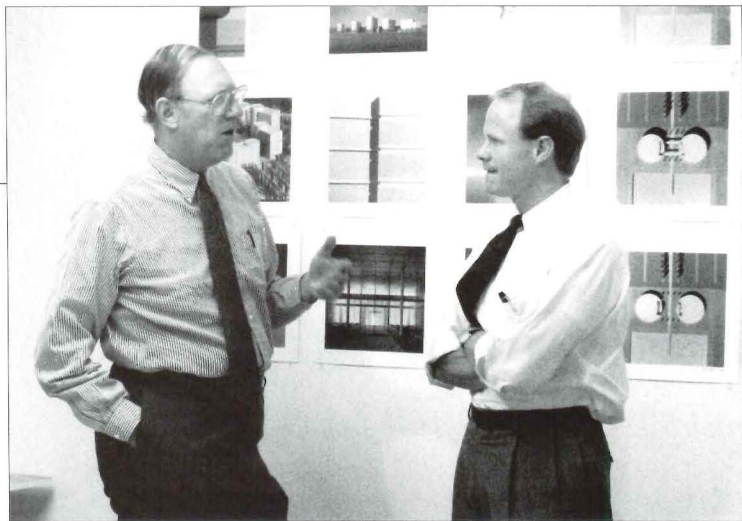

Douglas Sandberg

firm takes on more and more architecture projects.

To handle this volume of work, the staff of Gensler & Associates is big and growing and will continue to grow in the 1990s. When Gensler is asked how one controls 600 people, his answer is, "You don't. We hire and work with people we respect. The success of any organization is the people, and we work very hard at hiring the best and giving them good reason to stay with the firm. The key is that we treat them like professionals and give them opportunities to use their talents in the best way possible. Most people go into this profession not to make a million dollars, but to do great projects. So, one of the firm's responsibilities is to attract great projects to give talented people the chance to demonstrate and develop their skills."

Surprisingly for such a large firm, Gensler & Associates still operates its projects through the studio system instead of separate design and production departments. There is a lot of shifting of personnel among studios and even among the nine offices in the firm, partly on a work assignment basis and partly to give individual staff members a better feel for how the firm operates as a whole.

On the business side, Gensler says the firm's marketing and presentation methods have not changed dramatically over the years, but they have become somewhat more sophisticated. "I think that basically you market by your last job—the quality of work you do and the client relationship you create," he says. Computer use is another story. Gensler & Associates now has more than 100 CADD terminals, and Gensler estimates that about 80 percent of production and 25 percent of design work now are done on CADD. The firm's regional offices are experimenting with some linkups, but so far these have not proven cost-effective.

As far as goals for the 1990s are concerned, Gensler says the firm would like to become a global firm, and it already has taken steps in that direction with a new regional office in London as well as work in Japan, France, and Canada. "This work is an extension of a relationship with our existing American clients, who ask us to go abroad to service them. In the future, we'd like to be able to support our clients wherever they may be. And, just as importantly, we want to keep the best people and improve our design services."

*Arthur Gensler (pictured above, left, with associate Ted Korth) founded Gensler & Associates/Architects in San Francisco in 1965. Today, the firm has more than 650 employees and has offices in Denver, Houston, Los Angeles, New York, and Washington, D.C., as well as in Irvine and San Jose in California. Gensler stresses the importance of well-designed corporate offices for marketing purposes. The firm had over \$61 million dollars in gross revenues in 1988. The size range of the firm's projects is wide: in 1988, Gensler & Associates did work involving over \$25,000 in billings each for 250 clients, and work for less than that amount for 600 clients.*



## TIGHT SCHEDULING

*quickens the pace at Leers, Weinzapfel*

*Associates, Boston*

**A**lmost a decade ago, Andrea P. Leers, AIA, and Jane Weinzapfel, AIA, set off boldly for places where few women (or men, for that matter) had dared to go before. The firm's first public project, the Tobin Bridge Administration Building, was a reconstruction of a building suspended under a major bridge over the Mystic River, 150 feet off the ground. The building (published on the cover of this magazine in January 1982) set the trend for challenging projects that have become a mainstay for the Boston firm of Leers, Weinzapfel. An astronomical observatory and a vertical expansion of the control center for the Boston subway system (which is being built while the building remains in operation) are just two components of their repertoire now under construction.

Leers says, "It's because we see potential in unusual projects, and we're not daunted by the technical difficulties. But we also do more normal projects—we just finished designing a new courthouse, and we're building some wonderful college residence halls." Weinzapfel says another reason for their success on such a wide range of projects is that "we always have high design aspirations for modest, even problematic, projects."

Although the types of projects that Leers, Weinzapfel takes on always have included the unusual, both the range of projects and their size have broadened over the past 10 years. In scope, the architects say, they find themselves doing more and more programming work on a project and have increased their in-house capability for interior design. The geographical area for the firm's work also has broadened, with the Maison Matsuda in Japan (see Jan., page 90) its most far-flung project. "Our work also has come downtown to some visible sites that are very much part of Boston's urban fabric. At the same time, we've gone further afield—we just began work on two large school additions in Columbus, Indiana," says Leers. "And with more building types, we're working with a greater diversity—a greater palette of materials and refinement of each building type and vocabulary."

Leers and Weinzapfel agree that, over the decade, the biggest difference in day-to-day operation of the firm has resulted from a steady but gradual growth in staff. "Where formerly each project was an all-office enterprise, now we often have three project teams," says Weinzapfel. Leers adds that on any given project there are more contributors, discussion, and diversity than in the past.

This slow but steady growth has caused the architects to expand their office space in a large converted warehouse three times. Leers, Weinzapfel, like many firms, has embraced computer use "starting from the front desk out," first for word processing, then scheduling and project management, and now desktop publishing, marketing materials, and specifications and notes for drawings. Although the architects do not yet use the computer for drawings, they are purchasing a CADD system. And, in terms of billing, the firm's process varies by project and by client, although Leers notes that the "per-hour fee" basis is not as



Courtesy of Leers, Weinzapfel

common as it was 10 years ago. "We've found that workable," she says. "We keep good records and we ask for the fee we think we'll really need. Then we have to govern ourselves accordingly." She notes further that clients, on the whole, have become more "professional—they have better information, or they hire it if they don't have it."

The fact that Leers, Weinzapfel is a women-owned, women-operated business is still an issue. "It's always a background issue—it would be foolish to say it's not," says Weinzapfel. "The biggest change is in us," adds Leers. "We're long enough in our profession and set in our roles so that it is not in the forefront of our minds as it was when we were just starting."

Still, the architects agree that clients are now more accustomed to seeing women everywhere and that the balance has been changing gradually over the years ("maybe *too* gradually," they amend). "In a full project meeting, we often see that half of the representatives in the room are women and minorities—that was not the case 10 years ago," says Weinzapfel. Part of the reason for this, she says, is that much of the firm's work is with institutional clients; moreover, much of it is situated in the Northeast. Both those situations are known to be relatively favorable for women. Fifty percent of the Leers, Weinzapfel staff are women. "We don't need to seek out women staff," says Leers. "The associate who does our pre-interviewing has told us that we get most of the men who are applying for jobs in the Boston area, and all of the women."

The past decade has given Leers, Weinzapfel an extensive body of work that the firm can and does use as a point of departure for refining its design approach to future projects. But both architects say they have more fun looking ahead than looking back. For the profession, they see more firms directed by women in the coming decade, more international work with good and provocative results, but perhaps keener competition among firms if leaner times fall upon us. However, Leers says, "What has changed the most and is most likely to change is that the pace and the ante are up—it's the fax machine personified. Everyone wants beautiful and better buildings, but faster and cheaper. We've been asked to do major buildings on time schedules that we wouldn't have dreamed of doing even five years ago, with fee bonuses to prod us along. It's difficult to evolve design ideas; it tends to support non-experimentation. We do it. It's hard."

*Jane Weinzapfel, left, and Andrea Leers incorporated their office in 1983. Before that time, the office was Andrea Leers Browning Associates, which in turn grew out of A&H Browning, formed in 1970. The firm has grown from five ("on a good day") in 1980 to 25 people today. Counted in dollars, a firm project can vary from \$250,000 to over \$20 million, where 10 years ago the top of the range was at \$1 million. In terms of project management, although they look over one another's shoulders constantly, one of the two principals is in charge of each project and there are no projects for which they both are in charge.*



# We've sold enough Fesco® Board to cover Lake Mead.

After three decades of manufacturing Fesco roof insulation board, Manville has sold over six billion square feet of it.

That's enough Fesco to cover Lake Mead. Convincing proof of the popularity of this versatile and reliable board as an excellent built-up and modified bitumen roofing substrate.

Originally, specifiers and installers chose it for thermal efficiency. Today, they appreciate it for its fire resistance, code approvals, rigidity and ability to resist compression.

It can be installed without joint taping. It provides an excellent mopping surface. It's dimensionally stable and it's totally compatible with all conventional bitumens and felts.

Fesco Board is ideal for re-roofing, too. And when used in conjunction with Manville Tapered Fesco Board, it creates an excellent base for a self-draining roof.

To find out more about one of the most popular roof insulation boards ever, contact Manville Product Information Center, P.O. Box 5108, Denver, Colorado 80217-5108 or call 1-800-654-3103. Available for export. TELEX: MANVL DVR.

## Manville

Circle 54 on information card



# Technology in the '80s

By Forrest Wilson

Where architectural form and structural gymnastics directed building technology through the 1950s and 1960s, the driving force of the '70s was energy. By the mid-'80s, architects and engineers had solved all the easy energy problems. About the same time, it was discovered the buildings were working but the workers were not, and "productivity" became the issue of the day. This is appropriate, if our society is indeed predominantly a "service" rather than a manufacturing society. *Scientific American* in December 1987 reported that service industries accounted for 71 percent (\$2,996 billion) of the U.S. gross national product and 75 percent of all jobs.

What are services? "Anything sold in trade that could not be dropped on your foot," says the *London Economist*. This includes all economic activities whose outcome is not a physical product, is consumed at the time it is produced, or provides added value, convenience, amusement, comfort, or health. Large service companies buy technology and play a crucial role in the creation and diffusion of new technologies. These technologies, in turn, precipitate major changes in services and employment. They also demand architectural accommodation. Building form is altered and new building types emerge as a direct response to the service society. We may predict that many—perhaps all—of the technical problems projected to need solutions in the 1990s will be solved. However, we cannot predict the architectural forms those solutions will generate.

What follows is a sampling of technical changes during the 1980s and some predictions by noted experts for the 1990s.

## INTERNATIONALITY

Richard Wright, director of the Center for Building Technology of the National Institute of Standards and Technology (NIST): The unavoidable event of the 1990s will take place in 1992. The European Common Market will effect major changes in the international construction marketplace. It will open up the world. Products and services will respond to internationally accepted standards. Building team participants will come from several countries, and products will come from all over the world. We will need design definitions that are legally recognized, such as, what is a fire-safe building? What products can be used to construct it? And what will be on the label?

Internationally recognized systems of licensing and product testing and approval need agreement. We will need to agree on what standards are appropriate for earthquake and wind forces. The United Nations declared the 1990s the International Decade for Natural Disaster Reduction. It is important that the developed countries provide technical assistance to the Third World, because national disasters can wipe out their economies. The United States must act now if it does not want to be forced to accept European ways of doing things.

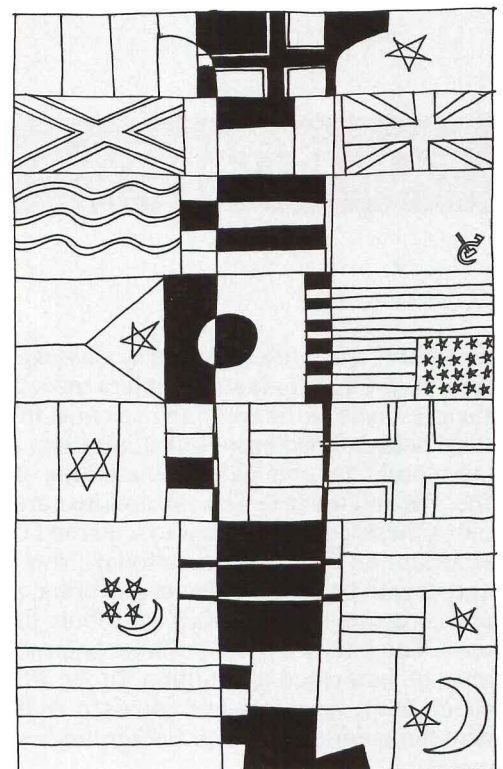



## USERS

*Dr. Arthur Rubin, behavioral psychologist at NIST:* The 1980s have shown that the technology of the workplace is crucial to the institution's function. The way people react to technology determines its success. As a result, ergonomics has increased in importance. However, its technical success depends on the technical ability to employ it to the fullest extent, and this seldom happens. Telecommunications, energy management, and office automation systems are turned over to operators unprepared by experience, education, or training to use them. Where environmental control formerly was managed by janitors opening and closing windows (when not shoveling coal), now the complexity is an order of magnitude greater. Additionally, air quality is as critical an area as noise control and lighting quality, but its research is still primitive [see June, page 95]. Pinpointing and correcting these problems will be a crucial task of the 1990s.

*Mike Demeter, product manager for Johnson Controls' Personal Environments:* Research indicates it is impossible to predict individual comfort. A specific HVAC system will make 80 percent of the people comfortable, but there is no assurance any one of them is comfortable at any given time. Johnson Controls invented and patented the first thermostat in 1885. We have been in the environmental business for 105 years, and in the complaint business for 104. The complaints are not about products—it is not a question of systems operating well or poorly. It's just that every person happens to be different and has different concepts of comfort at different times.

The major change in the 1980s was digital control that made dynamic response possible. More parameters can be sensed and control techniques made more complex. Personal Environments is managed centrally but gives individual control. Each individual environment has a digital interface coordinated with the entire environment.

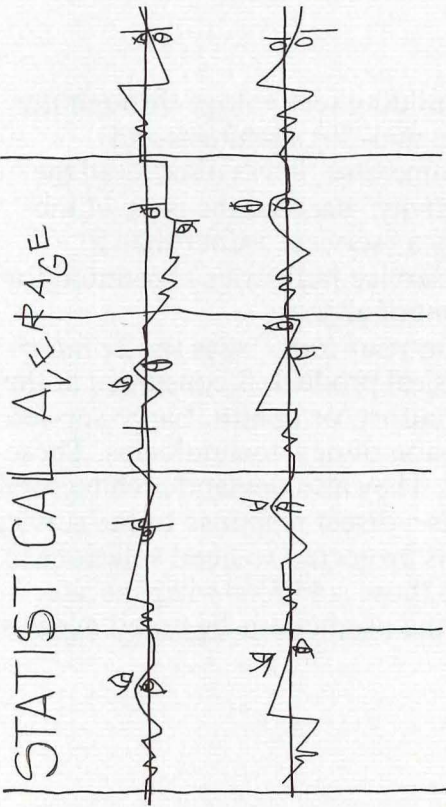

## COMPUTERS

*Thomas V. Mazzotta, president of Computer Aided Systems Inc., New York City:* Computer graphics moved from hacker's turf to the preserves of the computer scientist in the 1980s. Architectural hackers used brute force, intuition, and common sense to solve problems and laid the foundation of computer graphics in the '70s and into the '80s. An architecture student doing a bachelor's thesis could submit it to a learned conference and make a contribution then, but not so today. Now the driving force is scientists with backgrounds in engineering, physics, mathematics, and computer science—they contribute the tools used by architects. The intuitive problems have been solved, and science now must be harnessed to intuition. In the 1990s, architects will be client, critic, visualizer, and end user. Architects will not develop new computer tools—their backgrounds and the time demanded prevent it.

*Wright:* We need a common language to exchange files between computer programs that speak different languages. We are on the verge of computer integration that allows automatic exchange of information. In the 1990s, we will have computer-integrated construction, where the technologies of different manufacturers will be coordinated so that equipment is not restricted to one vendor. Also, each construction team must coordinate with the others. NIST is working on interface standards that allow machines to communicate. The challenge is to set standards for the correct translation of one computer's vision to another. The integration vehicle will be a 3D electronic data base describing the building design, passed from designer to manufacturer to facility operator. It will be used to operate, renovate, and eventually dismantle the structure. The problem is how to put the architect's seal on the data base.



## ENERGY

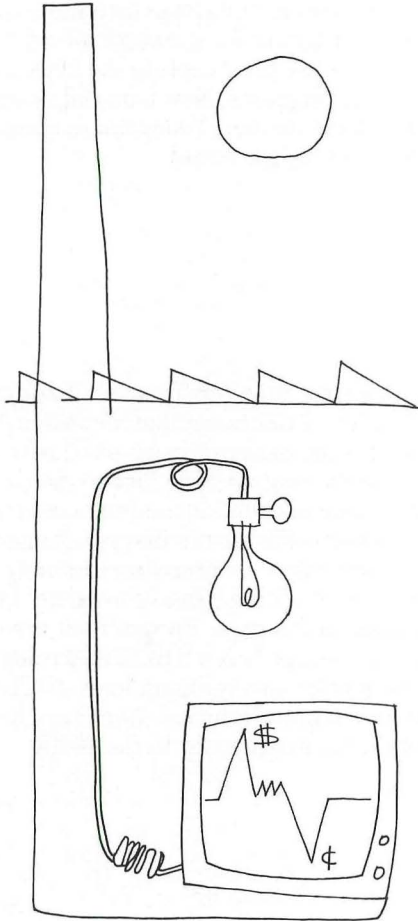

Alan Kaplan, director of engineering, Haines Lundberg Waehler, New York City: The thing that affected us the most in the '80s was the increase of energy costs from the '70s. The '80s were novel—we had to justify and prove to government organizations that our designs would fit within the budget of BTUs allocated per year. It was an architectural problem—you could not do much with fishbowl designs. But extraordinary amounts of energy were consumed, and it had to stop. It did.

However, it takes time to adapt. Nontechnical people were writing technical laws in the '70s. The crisis was resolved in the '80s, when energy codes made sense and we got serious about energy design. But a funny thing happened on the way to conservation—we got PCs. What energy was saved by good design was used up by computers. My fear for the 1990s is that we *think* we have a glut of oil. The truth is that we import more oil today than we did during the energy crisis.

Another crisis is coming. Costs may double in the '90s. All the easy steps—insulation, low-e glass, tighter building skins—have been taken. The next time 'round we will be forced into hard choices, perhaps rationing energy or meters on services, and when the ration is used up, power goes off. There might be a technical breakthrough in energy production, but don't count on it.

*Mike Davis, industrial marketing manager for Oklahoma Gas and Electric Co.:* When the next energy crisis hits, it will cause a change in lifestyle. Off-peak rates at odd hours will force businesses and customers to work and find services at odd hours. Utilities charge by rate class, based on maximum demand, and their peak demand rates are high. Alternatively, utilities give incentives and lower rates for off-hour consumption. Alternative systems, such as thermal storage of chilled water and ice, is becoming increasingly popular. Although conservation, insulation, and double-glazing have paid off, they do not affect peak period usage.

## MATERIALS

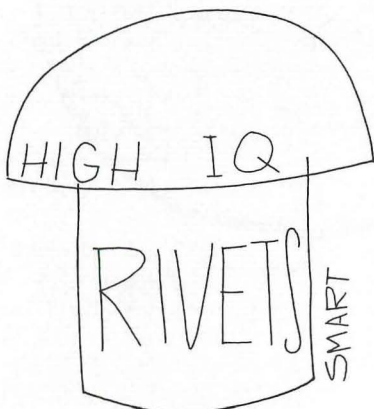

*Wright:* Water-conserving plumbing technology and seismic design are two areas that have advanced substantially and now are incorporated in the model building codes. Concrete technology has advanced in pumping, strength, and forming systems. Many improvements are due to better measuring and control devices. We have higher performance in roofing and cladding surface protection techniques. Higher-strength concrete and high-performance coatings are examples of advances in material science. We now understand the degradation mechanisms and can predict service life in the real building environment.

Construction quality, motivated by serious failures, was another big issue of the 1980s. The ASCE manual on failures was one result. High-tech problems are organizational and procedural, as system changes induced failure modes. There appears to be no single responsibility for the construction pro-



cess, and a search is under way for different ways of organizing it in the 1990s. Considerably smarter sensors are needed for micro-computation and quality assurance. We need a sensing device to analyze concrete as it comes out of the ready mix—one that reads water/cement ratios and one that will tell accurately where the steel is in the column: a “column tomography.” Prototypes can do it now and will be in common use in the '90s.

*Geerhard Haaijer, vice president of technology and research, American Institute of Steel Construction:* In the 1990s, there will be an increased use of higher-strength steels with improved toughness to minimize problems encountered with heavy sections. This includes welded shapes of plates of 100-ksi yield strength. Such

high-performance steel members would be shop-welded with bolted field connections. We will see long-span floor systems through the use of composite steel and concrete construction, including composite trusses and composite columns. There will be more steel research directed toward reducing cost of fabrication, optimizing cost of material and fabrication, and a trend toward pre-engineered connections replacing custom design for specific buildings. Computer programs for connection design will be based on expert systems, and we must capture the knowledge of our best designers for these programs. New materials, such as reinforced plastics, will reach the market. Today, these materials are used for mobile bridges only by the Army.

## WOOD

*Peter Kent, Western Wood Products:* Computers now direct the entire forest industry, from the seedlings to the prongs of the nailing plate. Land managers of industrial and federal forests use data bases that record the tree stand's life history. Foresters project stand growth based on mathematical models, and forests are grown on-screen with computer graphics. The National Forest Service has a complex, integrated modeling system that includes fish in forest streams, wildlife, soil, rain, plants, and wild dogs. This program projects “what if” scenarios, including cutting trees, feeding bears, building trails, and installing outdoor toilets. Comprehensive plans for each of the 126 national forests are under development.

Instead of the traditional “Biltmore” sticks used to estimate

square footage of wood in a tree, foresters now tote hand-held computers to zap the tree with a laser beam that measures diameter and height and translates the measurements into lumber. In the mill, scanners determine the best opening face to cut the log for maximum grade and volume production, and they interface with the computer to position the log for the first cut. Rough-cut boards are guided through the edger for precision trimming. The exact size, grade, and species of each piece of wood are tabulated and displayed on a computer screen. Freight rates are crucial to lumber sales and can make or break a deal, and traders use large data bases to track rates and shipping lines. FAX and on-line printers confirm hard copy in minutes. Bar codes have not yet been put on lumber, but may appear in the 1990s.

## PREMANUFACTURING

*Don Carlson, editor and publisher of Automated Builder magazine:* It used to be that every house builder used a fink truss. Today, everything is custom. Architects continually design new roofs, and component manufacturers tailor truss designs to their design, so what we have is mass production of unique trusses. The people making them call them “nut cases,” or “special,” or “pains,” but the point is that with today's technology it is not difficult to do. One way this happens is that the independent component manufacturer uses the engineering services of a gang-nail plate manufacturer. The plate manufacturer has a computer terminal tied into a huge mainframe and a library of computer tapes with thousands of truss designs—an uncountable number of trusses for special uses. In the '80s, these computers and software became less expensive, allowing component manufacturers to do their own designs with their own systems. A few of the bigger component manufacturers don't want to be tied to a particular plate manufacturer, and so they have their own computer programs. These go far beyond the truss—they can do the entire building, from the footprint up. When the design is input, the program gives a cutting-edge list of materials and tailors the truss design for the part of the country. It also carries zero-defect quality control. The program plays the designs like a flute.

*Arch Farch, component manufacturer, adds:* People love wood because it is a natural material. □

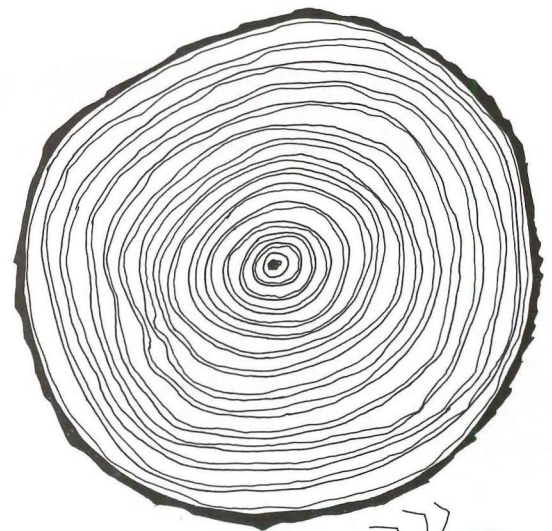

BAR CODED  
TERMITES



## PC's tackle building code research

Five years ago, an Illinois architect came to the conclusion that the tremendous information processing of personal computers should be able to streamline the tedious but necessary task of building code research. That idea gave birth to the "desktop code research" concept, and a powerful new software program called Codebuster.

Codebuster is a stand-alone, PC-based program that allows architects to conduct building code research in a fraction of the time. By answering a few simple on-screen questions about a project, Codebuster can tell the architect what parts of the code do not apply to the project, and why. Even more important, the architect can quickly discover if the design complies with the code, and what areas still need attention.

Codebuster consists of two parts: the actual program, and one or more model building code databases. Versions of BOCA® (Building Officials and Code Administrators International, Inc.) are currently available. The Standard Building Code and the Uniform Building Code™ will be available soon. These databases do not include actual code text. Instead, they consist of carefully phrased statements that allow the user to deal with one code issue at a time.

Because the individual or firm has complete control of Codebuster's database, decisions concerning when, how and to what degree code research should be conducted are placed in the hands of the user. Codebuster streamlines the entire code research process by allowing the user to focus only on the items that are applicable to that particular project.

Codebuster is effective on a broad range of residential, commercial, industrial and institutional projects. The program is easy to learn and easy to use, and the one-time purchase price of under \$1,000 makes it very affordable. There are no user fees, no annual fees, no additional costs.

Codebuster may be used on most IBM PC, XT, AT, PS/2 or 100 percent compatible systems with a minimum 10M hard drive and 640K RAM.

To discover more about how Codebuster is revolutionizing building code research, please call or write: Architech Inc., Post Office Drawer 152, Chillicothe, IL 61523. (309) 274-8187



## Before Codebuster,<sup>®</sup> he conducted building code research after hours.

### Save time and money with the first comprehensive PC-based building code research software.

With Codebuster and a personal computer, you can research the building code in a fraction of the time you're now spending. This affordable, easy-to-use program lets you complete the job faster, and at a lower cost. Codebuster is so efficient, it could pay for itself after just one project!

Codebuster is the only program that gives you total control over computerized building code research. Take advantage of its money-saving efficiency now. And leave the late nights to someone else.

### A complete program for architects, building officials, facility managers and other building professionals.

- Consists of two parts: Codebuster program and the code database\* of your choice (BOCA®, SBC or UBC™)
- Complete documentation, including tutorials
- Conduct code research for any size and type of project
- Simple, menu-driven operation
- Generates hundreds of customized reports

- One-time purchase price . . . no annual fees, no hidden add-ons
- Free program updates with purchase of additional database
- 5¼" or 3½" floppy diskette format
- IBM® PC, XT, AT, PS/2 or 100% compatible with minimum 10M hard drive, 640K RAM

### FREE Zoning Regulations database!

Order Codebuster now and we'll include our own Chapter 99 — Zoning and Miscellaneous — in your code database. It lets you consider zoning regulations at the same time you're conducting code research.

To request additional information on Codebuster, write to the address below, or call (309) 274-8187.



# Architech

Architech, Inc. Post Office Drawer 152  
Chillicothe, IL 61523  
(309) 274-8187

\*Codebuster's database does not include actual code text.



# Sixty second guide to Belden Brick:

## COLORS



Belden Brick is made in over 116 colors that include 2 choices in black, 28 browns, 7 tans, 8 buffs, 3 creams, 18 grays, 16 pinks, 26 reds, and 8 whites. In addition, it is made in 12 different textures, although not all our brick is made in the same range of textures.

Belden also offers a choice of extruded brick or molded brick (with the character of hand-made brick.) Each category includes a wide range of colors and textures providing more than adequate design latitude.

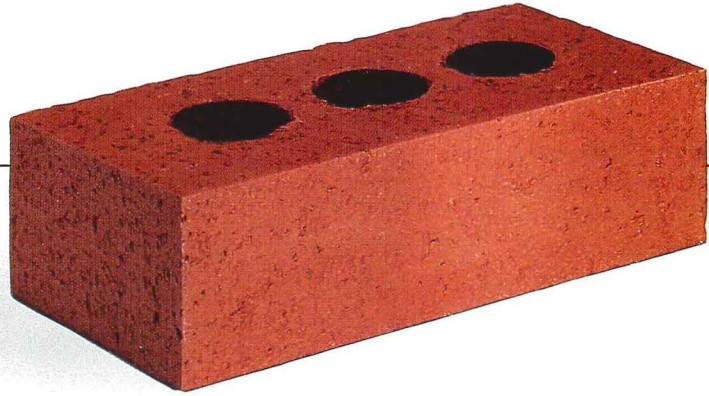

## SIZES



Belden Brick is predominantly made in thirteen different sizes, representing the spectrum of Belden Brick colors and textures. Your design opportunities are broadened by the availability of virtually every Belden Brick color choice as pavers.

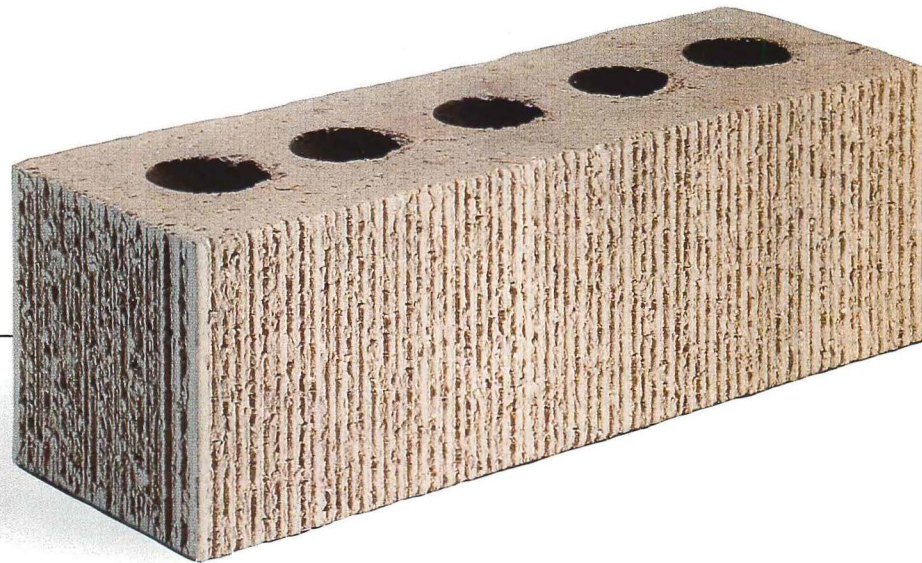

## SHAPES



We've made hundreds of different shapes to provide special structure details, and a week seldom passes without our custom-making a new special shape to meet individual design requirements. If you need an "impossible" special shape to complement the brick structure you're planning, call Belden. We've seen the impossible become reality.



**THE BELDEN BRICK COMPANY**  
700 W. Tuscarawas Canton, OH 44701  
Telephone 216-456-0031

THE **Belden**  
**Brick**  
COMPANY

CANTON, OHIO 44701



# When Will CADD Come of Age?

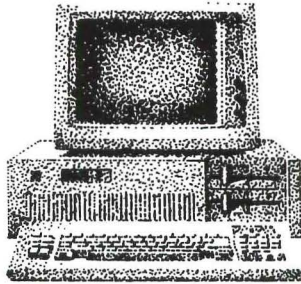

By Douglas E. Gordon

Most architects were unaware of computer-aided design and drafting 10 years ago. It wasn't long after, though, that CADD hit it big at the product shows. The air was thick with promises of automated drafting, paperless offices, instant modeling and mass studies, and foolproof spec writing and materials scheduling. What wasn't mentioned often enough was that automated drafting could cost significantly more than hand drafting, that paper in offices is a matter of spontaneous generation, that the only instant models are the ones at the vendor display booths, and that fools are extremely clever when it comes to getting between you and your construction documents.

Those are old problems now, and long-since solved. Or are they? To get some picture of what architects need most, what is out there on the market, and what the disparity is between the two, ARCHITECTURE asked the opinions of four architects thoroughly versed in the subject and one nonarchitect CADD consultant. Computer-aided drafting is a reality and a recognized boon, they say. Computer-aided design still needs work.

The interviewees are: Dennis Jones, associate professor at Virginia Polytechnic Institute and State University, with 20 years' experience in CADD; Creighton Nolte, AIA, involved with micro-computers, mostly Macintosh, since 1979 in his San Diego office; William Rice, of Norristown, Pa., a technical writer specializing in instructions for computer applications; Ken Sanders, AIA, of Leason Pomeroy Associates, Orange, Calif., with CADD development experience for both architecture firms and system developers; and Terry Schilling, AIA, CADD supervisor for DeRevere Partnership, Newport Beach, Calif.

The first question addressed the price a firm should pay for CADD. "For the base hardware and software system, a small firm should be able to spend \$5,000," Nolte says. According to Sanders, a mainstream CADD workstation for a medium- to small-size firm should cost about \$10,000 for hardware and software. "Below that, you're not buying as much capability or speed as you need," he says. Additional features and utilities also may be justified, according to the needs of the firm. Jones's target for CADD budgeting is based more on value than on first cost. "It isn't unreasonable to budget the same amount for a good

CADD system that you'd pay an architect for a year," he says.

What architects expect for their money is another issue. As the "gee whiz" syndrome wears off, Rice says, architects naturally demand more sophistication. Sanders concurs: "The market's expectations for newer capabilities subtly and automatically ratchet upward as fast as a new technology is developed."

A perfect system for Sanders would let architects define buildings, not just drawings. Now CADD is a means of manipulating geometric shapes. Building design requires CADD modeling of building relationships as well: economic constraints, programmatic requirements, spatial constraints, structural and mechanical considerations, and all those kinds of quantitative things that computers handle well, he says.

Nolte wants more emphasis on building simulation. He also would like to switch immediately from 2D to 3D and back, with changes in one showing automatically in the other. He wants to work with multiple windows, multiple files, and multiple monitors open. And he's intrigued with the potential of animation, although it's an expensive time investment, he says.

Jones would like to see more artificial intelligence, especially in help functions. Menu-driven systems aren't very user friendly, and icon-based command systems require users to waste time windowing between levels. In Jones's ideal system, the computer interface keeps track of how much a user uses and knows about the software and determines whether the user knows what to do next or has to go back through the tree of menus or icons. The interface becomes more sophisticated as the user does. "This hasn't happened yet," Jones says, "because developers have concentrated on functionality and complexity of function and have not been forced to concentrate as yet on user interface."

As development races on, understanding CADD becomes increasingly difficult, Sanders points out. "Within the last two years, I've noticed a dramatic increase in the commitment required to keep up—both with what's on the market today and with what is coming. Realistically, though," he says, "if you want to make a lot of demands on the system, you have to expect a demanding process, with a high threshold of learning."



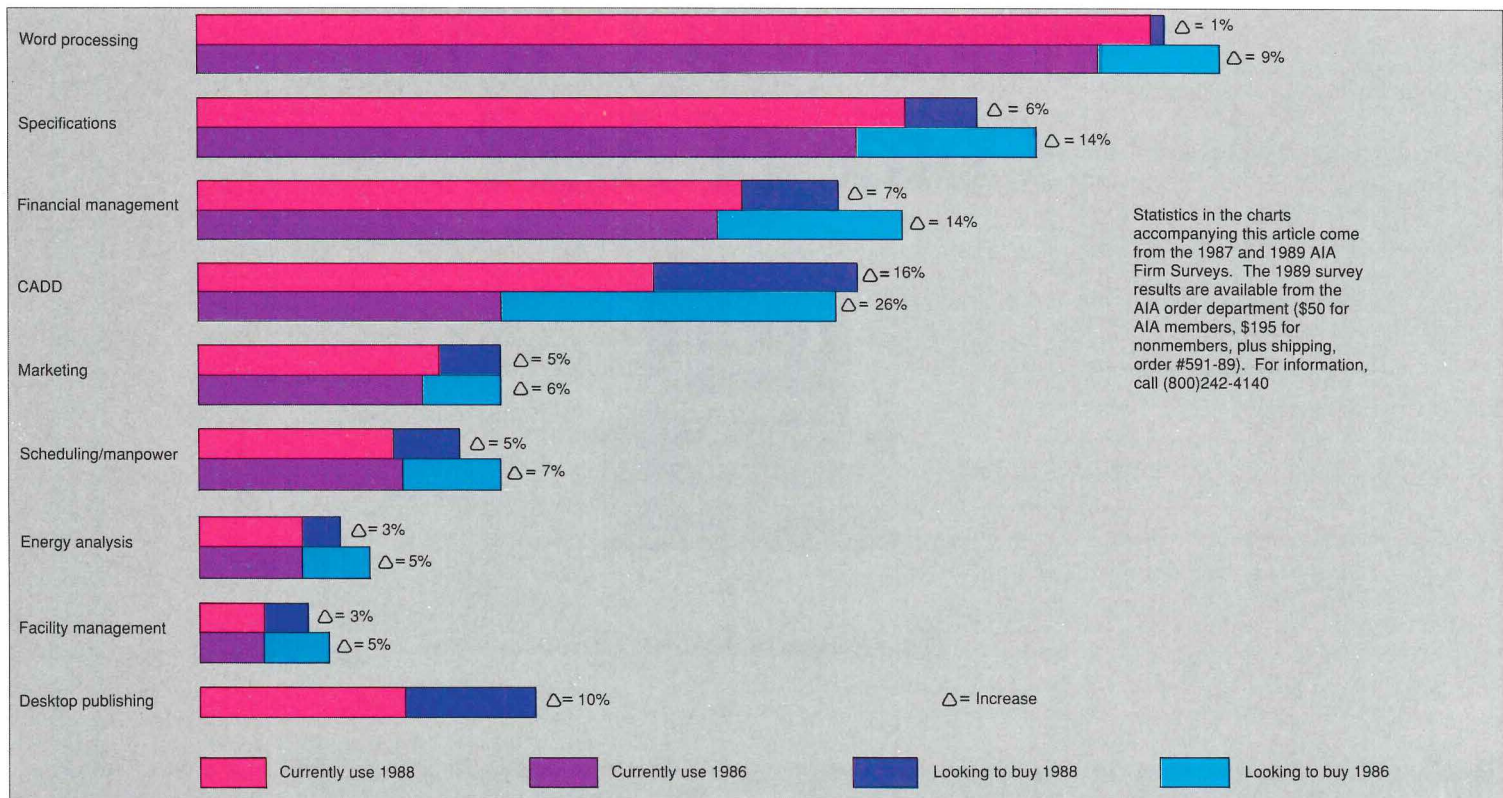

Computer applications in architecture offices

## Fitting CADD to Architecture

A CADD system is immediately useful in an office only if it fits in with the way that office works. The problem for developers is to make CADD fit closely enough to minimize necessary customization, but not to make it so predetermined that the system dictates the design process.

To be able to give architects what they need, Nolte says, manufacturers have to pay attention to the process of architecture. "Many of them think that we sit down right away and start drafting," he says. "They don't really understand that graphics or CADD might be as little as 15 to 30 percent of our work. The job doesn't start with schematic design. It begins with marketing, proposals, contracts, fee negotiations, quantification, and a variety of administrative tasks.

"So far, architects have been limited by CADD. You can't yet design on a drafting program, unless you stretch the limits of the tool. As children, we always drew off the edge of the paper. In elementary school, we learned to stay on the paper. In architecture school, we take our imagination beyond the boundaries of the paper again. Now computers, because of some of the misperceptions of the software developers, have put our imaginations back on the boundaries of that piece of paper."

Off-the-shelf CADD also presents potential operational stress, Sanders says. "Project managers who started as drafters and came up through the ranks are feeling a lot of pressure from computerization. They are used to walking into the drafting room at any point and seeing the drawings being created. Now, if the drawings are in a computer, project managers have to learn CADD or depend on plots that may be outdated before they're delivered. Even if managers know CADD, their system has to have interactive networking before they can hope to see exactly what's going on at a given time."

Part of the problem is that architects are not the CADD vendors' main market. Sanders notes that PC software vendors are tending to imitate the larger vendors, which are more concerned with markets other than architecture. "The facilities management market is driving what little software development that's currently under way," he says. "Further, it's common that marketing representatives stand between the people writing software and those using it."

The complexity of buildings puts architects even further from the CADD-using crowd. "Architectural models tend to be far more complicated than mechanical models," Sanders says. "An assembly of an engine part may have a few hundred polygons. Detailed building models can have hundreds of thousands of polygons."

But a bigger problem to Sanders is the need for a shift in thinking from computer-aided drafting (lines on paper) to computer-aided design (actual buildings). "The basic elements with which CADD drawings are put together—lines, circles, text, etc.—haven't changed in 20 years and are primitive and crude," he says. "Instead of concentrating on conceptually reproducing a building on CADD, software developers have CADD reproducing our drawings, which are only byproducts of architectural services."

The emphasis on documents production annoys Jones as well. "Focusing simply on the technologies of compression of time and dollars doesn't get at the root of what architecture is," he says. "No two buildings are the same, yet we expect every one to work perfectly the first time. The fact is, we make mistakes and we have to live with them. In a society where we test toothpaste, gym shoes, and automobiles, buildings should be the most tested product of all. CADD ought to be helping architects evaluate how a proposed building functions, and how it fits into the existing cultural and contextual infrastructure."



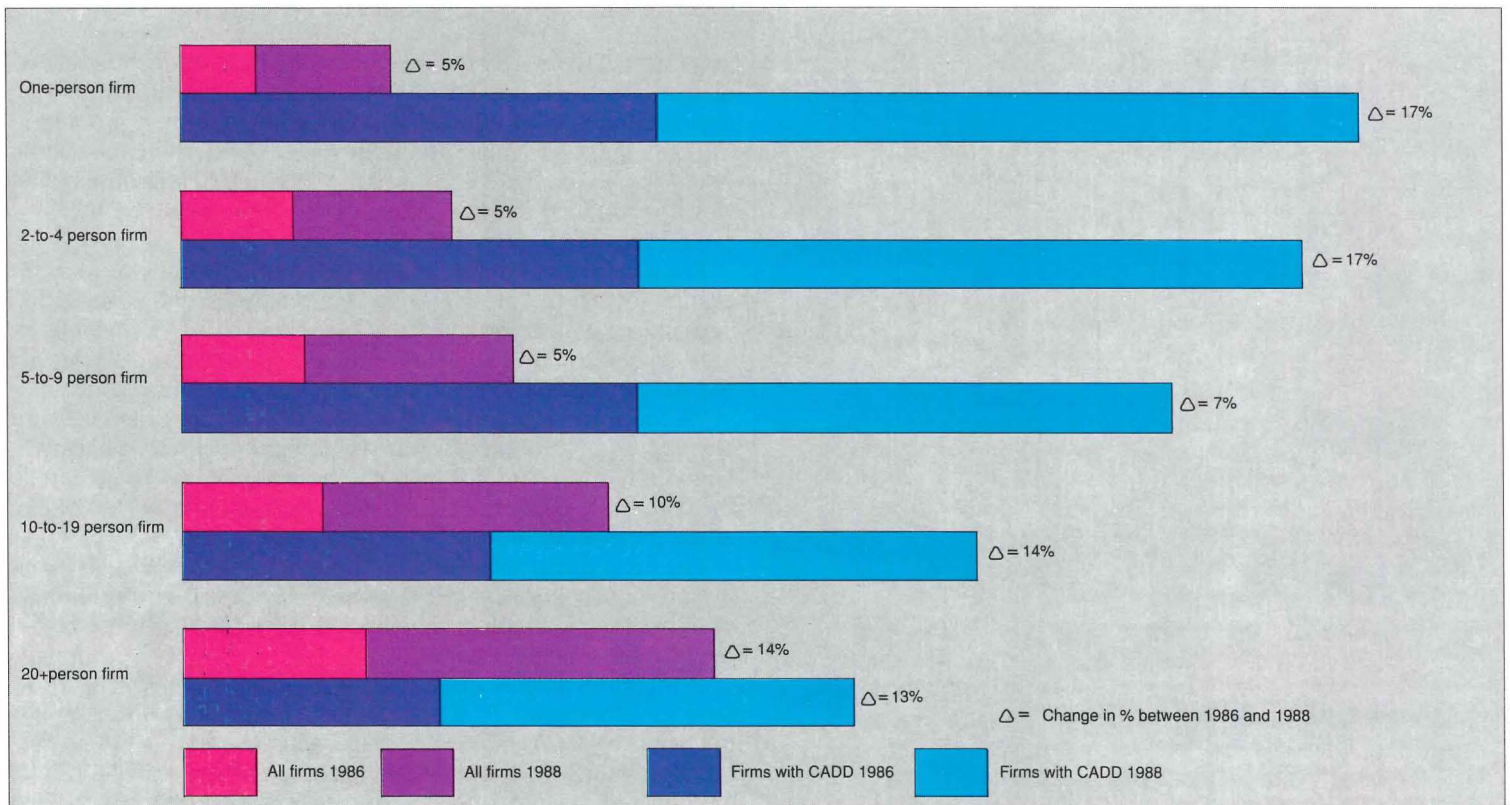

Percent of construction drawings produced on CADD

## Getting CADD on track: define issues

Blame for the gap between CADD and architecture can't be heaped at the door of manufacturers and vendors alone. Architects need to educate themselves as well, most interviewees agreed.

Jones points out, for example, that architects overrate problems such as output-device speed and CADD-file transferring. "People concentrate on the things they understand," he says. "Unfortunately, the areas where most architects feel they have no control ultimately are the most important ones. The real issue to pursue is how to get a CADD system to understand enough of how you work to interact with questions and predetermined actions."

Another exacerbating factor is that software developers pay most attention to what sells, Sanders says. "Architects are buying by the thousands what's out there without learning about CADD and planning for it. A result is that software developers have little incentive to introduce new and better systems. The market success of some leading software packages has nothing to do with innovation. It has more to do with popularity, third-party software, customizing tools, and distribution channels. The architectural market is viewed, and I think correctly so, as being very frugal and naive, and known for displaying lemming-like behavior when it comes to buying systems."

The decision makers in architecture firms need to be aware of the issues, Rice says. It often happens they aren't, and they pay for more power than they ever will need. "The people buying the software don't know they have passed the point of diminishing returns," he says. "They buy whatever promises the most bells and whistles, not realizing all that noise will clutter the program and get in the way of the user's productivity. For every new CADD feature considered, architects should find out what the

chances are it ever will be used, and whether its very presence will get in the way of features used frequently."

For Sanders, a leading issue is a result of the PC CADD revolution. Minicomputer CADD developers are trying to make their systems cheaper and more space-efficient while PC CADD developers try to emulate minicomputer system attributes. "It has really killed software innovation," Sanders says. "Granted, hardware and software have gotten a lot cheaper, and are more accessible. But PC CADD systems are only now catching up with issues we old-timers were raising years ago."

A high-end 386 machine can support a lot more sophisticated software than what is generally available, he continues. "Furthermore, DOS, the operating system for up to 90 percent of the CADD market, is unreasonable for networked CADD because its 640K memory limitation bites you at every turn. I'd like to see architects as a whole take off their DOS blinders—or Macintosh blinders, for that matter—and really get educated about computers and what their ultimate capabilities can be."

Another issue for Sanders is customization. "The most successful installations I've seen are those where the CADD system is specially revised for particular projects and particular clients," he says. "Still, a lot of offices struggle because that level of customizing is forbidding for them. The customizing languages some CADD programs offer, such as Autolisp or User Commands, are designed for programmers, not architects."

A problem Schilling sees, especially with minicomputers, is the age of their software. "Some of it is 10 to 15 years old," he says. "Because PC-based programs have been written more recently than mini software, in most cases, they include features and efficiencies the older systems don't have. Putting old software on new, fast hardware will cover a lot of sins, though. You can now buy so much memory and disk space that you can afford to have very inefficient software."



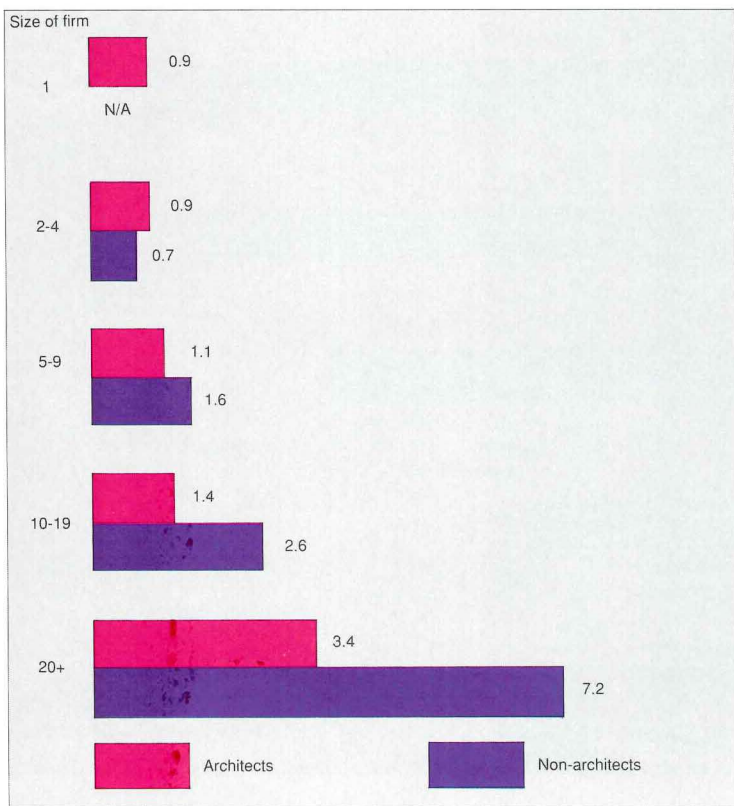

Average number of people proficient in CADD (among firms using CADD)

### Step two: address the issues

The interviewees not only defined a set of issues but also prescribed some strategies for raising CADD awareness in the profession and conveying architects' opinions to vendors.

"Use your dollars to cast votes for the products that increase your productivity the most," Rice advises. "That means actually buying, and not illegally copying, the software that helps you most. And fill out those product surveys that come with every piece of software. Report criticisms and praise to the software manufacturers. In short, make software manufacturers your elected representatives, and keep on top of them to do the job right."

Sanders agrees. "If people are getting fed up with the limitations of the tools today," he says, "they have to speak their minds and put their money where their mouths are. We need to make ourselves heard at the storefront by not buying a CADD system just because our next door neighbor has it."

Architects already have had more impact on the design of CADD systems than most people realize, according to Jones. "We're visual and so have been pushing for a lot of things, such as ray tracing and transparency, that engineers take for granted now. A lot of higher-order CADD features have been pushed along by the architects' desire for visual quality."

"I think there's more progress to be made in the schools in teaching design on CADD as well as general computer applicability to the practice of architecture," Nolte says. "It's a mistake when a school allows the teaching of design to take a back seat to the training of CADD operators. I'm not interested in students whose CADD education left them with blinders on. I look for someone with peripheral imagination."

"A lot of schools, especially community colleges, treat CADD as a vocational skill," Sanders continues. "We often get resumes from people with that kind of education. I've seen floppy-disk

portfolios with CADD drawings showing little understanding of design, construction, or even drafting. As long as that's the approach to CADD education, we're going to have a problem. On the other hand, high-end schools like Cornell turn out students who immediately go into programming or work for Hollywood production studios. Somewhere, there needs to be a middle-ground approach."

For professional development, there are any number of user groups, formal and informal, through vendors, local associations, and among colleagues. Sanders cites these as his main sources for new developments. "Most of the developments in CADD are in software use and not software development," he explains.

"A lot of the input architects have to software and hardware developers," Nolte says, "is through magazine articles, because many practitioners don't have the time to take off to go across the country to conventions. At local shows you don't get the ear of people who are important in the CADD companies."

The most direct involvement, though, is for architects to work in CADD development either as architect-trained programmers or as practicing architects involved in beta testing of the developers' newest achievements.

"I think it would be great for more architects to go into software development," Nolte proclaims. "I think it would be great to have architects go into any profession, whether it's in public service, politics, or sales. Architecture school is a terrific training background. It's probably the most diverse that people get. They learn problem solving, which is a key issue."

But being proficient in both architecture and computer science is a struggle. "I've had less than a dozen students at Virginia Tech and Mississippi State who have been schizophrenic enough to be talented at both," Jones jokes. He himself became involved with computers—in the days before hand-held calculators—as a way of automating specifications. "I thought I was going to make less work for myself by figuring these things out on the computer," he says, laughing.

A somewhat less committed avenue to working directly with CADD development is beta testing, the process by which manufacturers market-test products. At that point of development there isn't a whole lot testers can influence, and there is a possibility a beta tester could set up files using a system or utility that never will make it to market. Still, manufacturers seem to have no trouble finding test subjects, especially among the more experienced CADD users.

"Beta testing almost always is conducted by 'power users,' who know the program inside and out," Rice says. "Since power users often have a natural aptitude for software, though, what works for them may not work for someone who must struggle to learn the same program. Technical proficiency on the part of the testers leads to thorough testing and bug-free programs, but it does not ensure the program will be user friendly."

Whether every architect should become computer literate is another matter. "I don't think every architect has to get excited about CADD," Schilling contends. "One of the nice things about this profession is that it is broad—many people with specialized skills that complement each other. I think it is better to have articulate spokesmen who have some understanding of what the architects' needs are, who get the word out to vendors."

"Every architect ought to be trained to use CADD," Jones says, adding too that there are very few architects who should actually write computer graphics software. "You don't have to be a mechanic, but you should at least know how to drive."



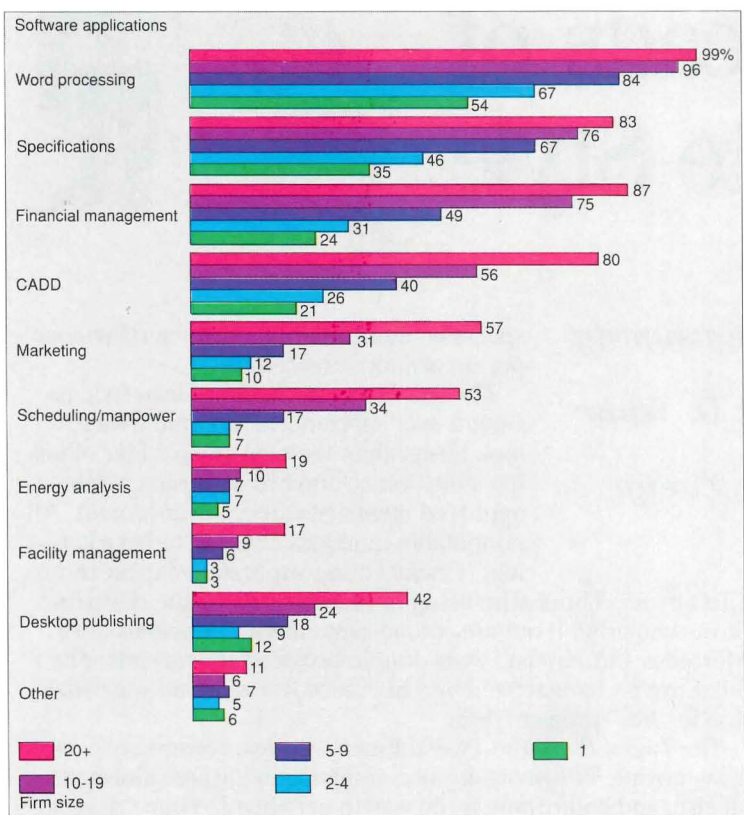

Computer applications by firm size

## What CADD holds for the future

Opinions on what is in store for the future range from very specific features already in the development loop to broad-brush concepts years away from realization. "In the immediate future," Rice says, "we'll see interactively coordinated layers where a change on one drawing layer automatically changes the appropriate items on other layers. Interactive 3D capability on PCs and, eventually, affordable animation, will become possible as chips, coprocessors, and multiprocessors get faster."

"We need to get an interactive CADD display surface that is horizontal," Sanders says. "If you've ever tried to sketch with a mouse, you'll appreciate what an impossible task it is. I think we can expect in the next five years to see a flat-plate liquid crystal or plasma monitor that you could use for digitizing, drawing, or marking up drawings. You'll see a desk. The hardware will be built in and the desktop will be the monitor."

"We're going to end up going back to drawing with pencils and paper," Jones muses, "on something that looks like a light table and allows the computer to track in real time what you draw. You won't need help files because all you have to do is draw it and work back and forth with the computer straightening lines, adding repetitive elements, and so forth. That is when CADD will become invisible."

"I don't see any real need for a horizontal working surface," Nolte counters. "It has to do with hand-eye coordination. The only thing I find discouraging with digitizing tablets is that I don't see a trail of ink on the horizontal surface. Instead, I have to watch the screen. That was a little hard to get used to."

Whatever features are developed to run on increasingly powerful hardware, the next generation of CADD software will not be built on top of an existing generic drafting package, Sanders predicts. "The best system will be developed from scratch," he says. "Layering customized applications on top of a generic

drafting engine leads to inefficient performance and bad user interfaces, and ultimately restricts the quality and intelligence of architectural CADD software. Although standard elements, such as algorithms for displaying 3D geometry, will be pretty much identical from package to package, system data structures and organizational concepts will be different."

Standardization more than likely will remain a bugaboo for developers and users for some time to come. "PCs are upscaling to get more capability while minicomputers are downscaling for affordability," Schilling says. "As the two merge, a major difference that remains is the operating system—DOS versus Unix, for instance. A worst-case scenario is that operating-system standardization never happens and we end up with a new full-time salaried position for an operating-system integration specialist who, we hope, also knows something about architecture."

"I think there will be a universal CADD standard sometime," Nolte says. "Although developers are reluctant to expose the internal logic of their software to one another, some programs now have 'hot links,' which allow other programs—such as utilities to generate bubble diagrams or create schedules—to communicate with that software in a convenient, controlled way."

"System-to-system translation is fairly well standardized already, and is almost a trivial process by now," Sanders says. "The difficulty is dealing with the Tower of Babel of organizational standards that exist on different systems, and within the same system. The layering protocol efforts are good, but to describe a standard that only deals with layers is a little constraining. We really need to deal with the larger problem of building data bases and how we share information between ourselves, consultants, clients, etc."

"I'd like to see holographic imaging of a building, like what Disneyland has been doing for years," Nolte says of CADD for the somewhat-further-out future. "Eventually, the holographic simulation might include participation. Your workroom or office is the 'screen' for the projected holographic image, and as you work from your keyboard or with a 3D DataGlove to manipulate the images or objects, you are viewing and participating in the projected holographic image."

"Real solids modeling is one direction of the future," Jones says. "Three-dimensional modeling, high-definition television, and possibly some of the things they are doing at the media lab up in MIT with large-scale holograms are going to be some things that will drive architects mad because they'll want them bad. And they're going to get them. These aren't so much new things as they are refinements of what's gone on before. There are systems that allow spoken commands, as well as the tactile kinds of things. A lot of this stuff sounds like Buck Rogers in outer space, but it exists."

Jones feels that CADD probably will change the shape of architecture. "The problem is that you can do anything with some of the graphics capabilities. For instance, I once used my modeler program to attach a duck to a pedestal, and it looked feasible. But, of course, there's a difference between looking feasible and being good design. The things a student couldn't visualize and draw before are now possible. On the other hand, with CADD the vignette of drawing to gloss over something we haven't solved doesn't apply. A problem is glaringly apparent on a CADD system when things don't match up or end up floating in space. So, on one level, CADD forces you to deal with the harsh realities of edges and inside and outside. On the other hand, inside and outside can be anything you want them to be." □



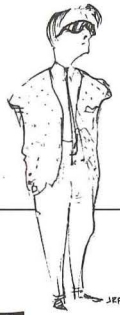

# The Threads of Corporate Style

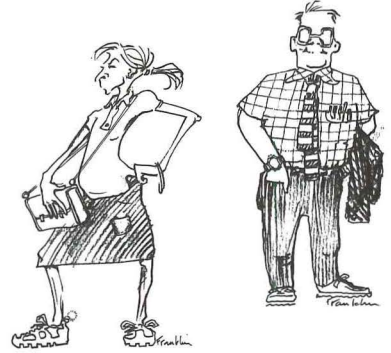

Although corporate culture is one of the hot topics in management literature today, too few design firm owners and managers understand corporate culture or see the implications of their own organizations' cultures for their businesses. The definition we like best comes from Lawrence Peters of the Texas Christian College of Business, who likens corporate culture to the "fabric" of an organization. In other words, culture is made up of the threads that link your staff people. Woven together, these threads form a pattern and a texture consisting of the key values and assumptions of group members—in short, a sense of "the way things are done around here." Our consulting practice takes us into many design firms throughout the United States. We see all sorts of corporate cultures. There are stodgy firms and sloppy firms, nice ones and neurotic ones, square ones and slick ones. Although every situation is unique, we have found some common "threads" that we use here in a lighthearted, albeit serious-minded, characterization of five archetypical, or "off-the-rack," design firm cultures.

**The Polyester Firm:** The Polyester Firm, like the fabric for which it is named, resists change. It is stuck in the mid-70s era of management thought—or worse. The Polyester Firm is a production-oriented workplace, where doing what is technically best is valued over what clients want. Workers frequently pull all-nighters. Flashiness is not rewarded. Everyone drives a practical economy car and sports short-sleeved, wash-and-wear shirts (no jacket in the office). Conflicts are not resolved because confrontations are avoided at all costs. Profit is incidental to doing technically superior work. Typical specialty: environmental engineers or engineers doing work for architects.

**The Blue Jean Firm:** The Blue Jean firm appears laid-back on the surface, and no one gets his or her 100-percent-cotton (preferably pastel) attire into an uproar. People work with and for people they like, not just those they perceive to be on the fast track, and they admire eclectic nontraditionalists and loyal underdogs. Jeep Cherokees with ski racks are the vehicle of choice. People work out their problems by talking, and they favor consensus problem-solving. Working smarter is valued over working harder. Many Blue Jean firms are multidiscipline with a good balance of different specialties.

**The Worsted Wool Firm:** In the Worsted Wool Firm, good technical skills are taken for granted. Academic and experience credentials are outstanding. Good communication and presentation skills are coveted. High-ranking people wear Brooks Brothers suits and drive Black Forest cars. Principals wielding power clearly are at the top of the hierarchy, with all the requisite perks and privileges. Employees are ambitious, but not wildly so, and they concentrate on advancing through the hierarchy: associate by 35, principal by 45, managing partner by 55. Performance expectations are high and client relationships reign supreme. Typical

*And what they signify.*

*By Frederick D. White*

*and Mark Zweig*

specialty: multidiscipline firms serving corporate or industrial clients.

**The Silk Firm:** In the Silk Firm, style is valued over substance. Everyone tries to look busier than the next guy for fear of losing a big bonus, and brown-nosing is the approved means of career advancement. All nonbillable time gets charged to "marketing." Cockey young superstars expect to be

CEO by 35. Those who bring in the work get all the rewards; those who grind it out are second-class citizens. Principals drive Mercedes and Jags and wear double-breasted Italian suits. The Silk Firm is characterized by a high turnover rate and specialization in "hot" project types.

**The Tweed Firm:** the Tweed Firm is stodgy, conservative, and slow-moving. Longevity, loyalty, and punctuality are valued above all else, and conformity is the way to get ahead. Young designers align themselves with an old-timer who knows how to get things done. Old-timers drive a Lincoln or a Cadillac. Dress for all is conservative preppy. Seniority resolves all conflicts. Performance is defined as working long hours and never using sick leave. The Tweed Firm produces the prettiest set of drawings—if not the most inspired designs—because it keeps all the old-line drafters instead of buying CADD. The Tweed Firm is most likely to be in pure architecture or prime basis engineering.

Some corporate cultures are remarkably sturdy; others should be marked "Delicate Cycle Only." But, almost invariably, the most successful and resilient design firms are marked by some kind of strongly defined corporate culture. We do not favor any of these cultures—whatever creates a closely-knit organization is good. On the other hand, a schizophrenic corporate culture can generate internal strife. Silk suits may infiltrate a Worsted Wool Firm and drive away old-line clients. Or, there may be firms within a firm, where each group or department has its own rival culture.

Unfortunately, the firm's corporate culture is not written down in the employee handbook or anywhere else. And often it is not clear, until the firm's corporate culture comes into conflict with its explicit organizational goals (such as making a profit). Then managers begin to take notice. At that point it may be too late, because riding roughshod over existing cultural norms is not likely to improve matters. As an example, we know of one Silk CEO who hired a Worsted Wool executive vice president to get the wrinkles out of his Blue Jean staff. Amazingly, the CEO was surprised when his laid-back staff mutinied under the new regime of law and order.

Take time to assess the weave of your own corporate culture. The sooner design firm management understands the critical importance of self analysis, the better off it will be.

*Mr. Zweig and Mr. White are principals of Mark Zweig & Associates, a Natick, Mass., consulting firm specializing in the architecture/engineering/planning industry.*



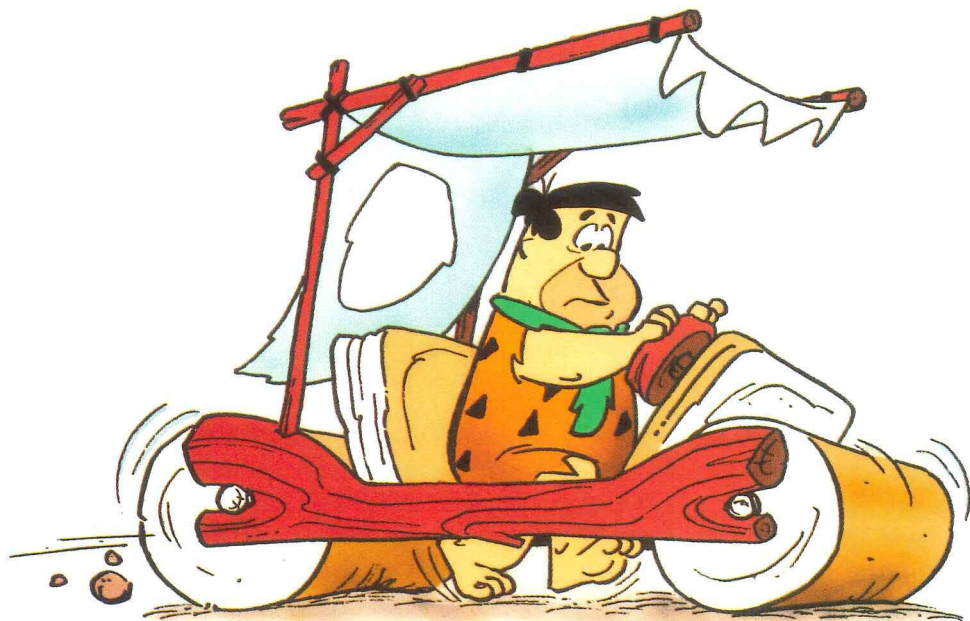

# At last, roof decking so advanced it breaks all the old speed limits.

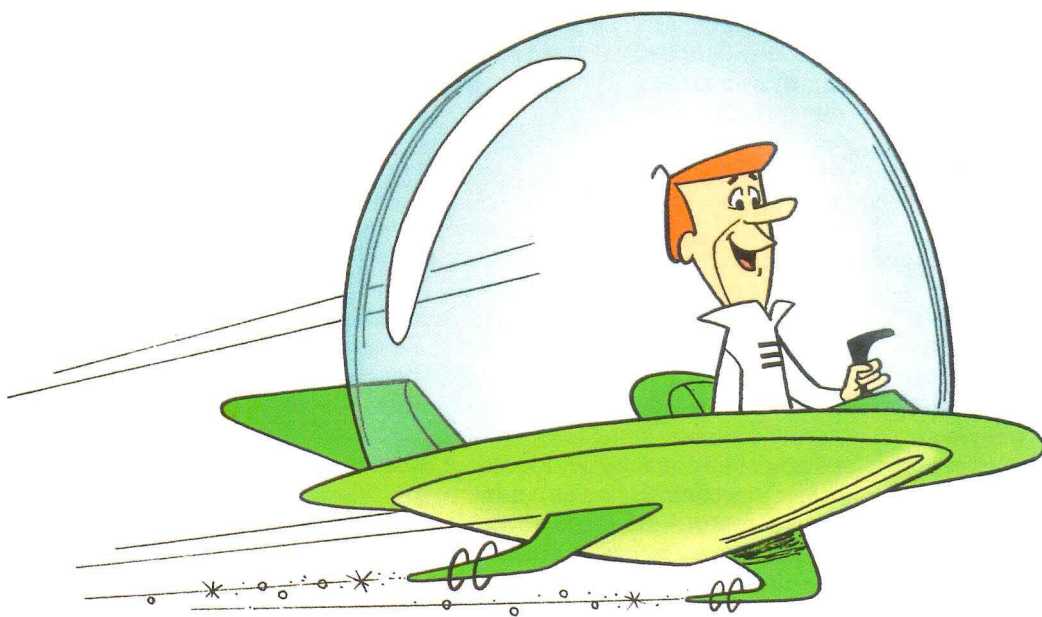

*Rigid polyisocyanurate insulation.*

*Structural decking with tongue and groove.*

*Top nailbase surface.*

It doesn't take a rocket scientist to realize that one-step roof decking is faster and less costly to install than the conventional three-part process. Which is why Homasote designed TUPS™ stress-skin panels. TUPS is structural, insulating roof decking that saves energy, reduces cost, eliminates labor-intensive steps, and shortens installation time.

Make a bold move into the future.

Specify TUPS stress-skin panels from Homasote. We're light years ahead of the competition.

For a free sample and more information, call **800-257-9491, ext. 61** (in NJ, call 609-883-3300, ext. 61).

## **homasote**

C O M P A N Y

P.O. Box 7240, West Trenton, New Jersey 08628-0240

FAX # 609-530-1584

Circle 62 on information card



# The '80s, From the Ground Up

By Timothy B. McDonald

*Defining the Technical Tips column is simple: it's an architect's how-to. It grew out of our perception that the ever-increasing amount of new construction materials and techniques needed some explanation. The explosion of information was such that large portions of the standard architectural manuals and reference books that appear every 10 years or so seemed to be dated before they were in the bookstores. Since 1985, Tips has tried to fill the gap with up-to-date, practical information about new, as well as tried and tested, construction methods and materials. Following is a selection of our favorite Tips topics from the past, starting from the ground (actually below grade) and moving up.*

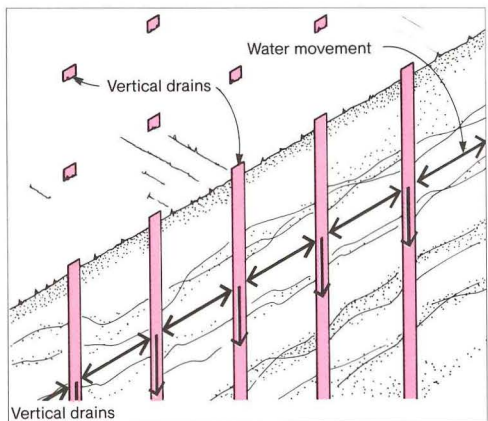

Geotextiles

## Geotextiles

In May 1989 (p. 207) we took a look at geotextiles, a relatively new technology that is changing the way architects address the problem of draining excess water from building sites. The several types of geotextile drains on the market can be divided roughly into three groups: strips of needle-punched, nonwoven fiber or filament material approximately 3/16th-inch thick; a core surrounded by a filter web; and round sand-wick drains, constructed of a geotextile outer casing and stiffener over a center filled with coarse sand. The selection of a filter in a vertical drain is a compromise: the finer the filter, the higher the hydraulic resistance; the coarser the filter, the greater the possibility of clogging the drain.

## Below-grade waterproofing

In the December 1988 issue (p. 135), Tips pointed out the importance of considering hydrostatic pressure as a major criterion for selecting below-grade waterproofing. Even if a project calls for very low levels of water vapor infiltration, materials should not be selected on perm-

rating alone. The amount of hydrostatic pressure expected in a building application also can be critical in material selection. As a building's foundation gets deeper, the hydrostatic pressure it has to withstand increases. Tests should be made to determine the amount of head that can be expected, and the waterproofing manufacturer should be required to submit data showing that its system can withstand those pressures.

## Wood foundations

The November 1986 issue (p. 122) told architects designing wood foundations to pay special attention to ensuring good drainage. It is essential to determine the soil type and its drainage characteristics by using either the U.S. Department of Agriculture's soil conservation maps or a soil test performed by a qualified engineer. A ground surface slope away from the building of half an inch per foot for at least six feet is recommended as a minimum.

Wood footings are made up of a treated wood plate on a gravel or crushed-stone base, the bottom of which must be below the frost line to prevent heaving. The floor—whether concrete or wood—is laid on polyethylene film covering four to six inches of gravel. All basements should have a sump with a positive drain to the sewer or to daylight, which, when combined with the under-floor gravel and gravel footing, will handle the drainage of water from all sources, including those outside the footing.

## Superinsulation

Perhaps because wood foundations (like any framed wall) can be insulated easily, they became an integral part of many super-insulated buildings. However,

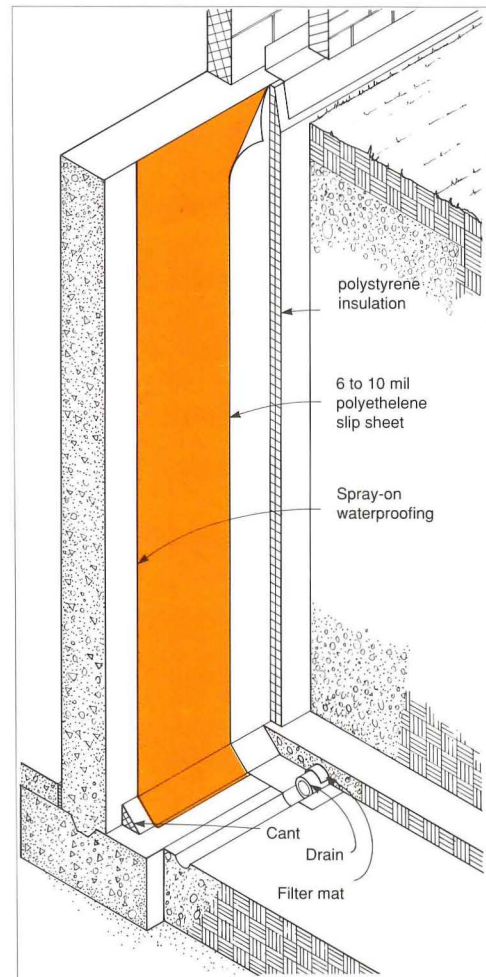

Below grade waterproofing

super-tight construction comes with a built-in problem: indoor air quality. As we pointed out in the June 1987 Tips (p. 122), tight building techniques not only keep out the heat and cold, they trap contaminated air. To eliminate the problem, steer clear of products containing urea formaldehyde, asbestos fibers, mercury, and organic solvents. If building materials



containing these pollutants must be used, steps should be taken to seal them from indoor air. For instance, urea formaldehyde can be sealed with a vapor-barrier paint. This will reduce the amount of moisture that gets to the material and diminish the amount of the urea formaldehyde gas escaping into the building.

Where the presence of radon is suspected, the architect should require testing prior to design. If radon is found in the soil, the building should be sealed from air and water infiltration, especially below grade. A polyethylene moisture barrier around the foundation and basement walls and under the floor will isolate the building from contaminated soil. Groundwater contaminated with radon can be diverted away from the building by means of properly placed drains embedded in gravel.

### Concrete

Although the essential character of concrete construction hasn't changed in the last 10 years, new construction accessories and concrete additives have proliferated. We made some headway in introducing additives in two issues: April '89, "Using Epoxies as Admixtures" (p. 129), and June '89: "Fly Ash as a Concrete Admixture" (p.129). The September '87 (p. 125) and June '88 (p. 125) Tips said that by the time the concrete is delivered to the site,

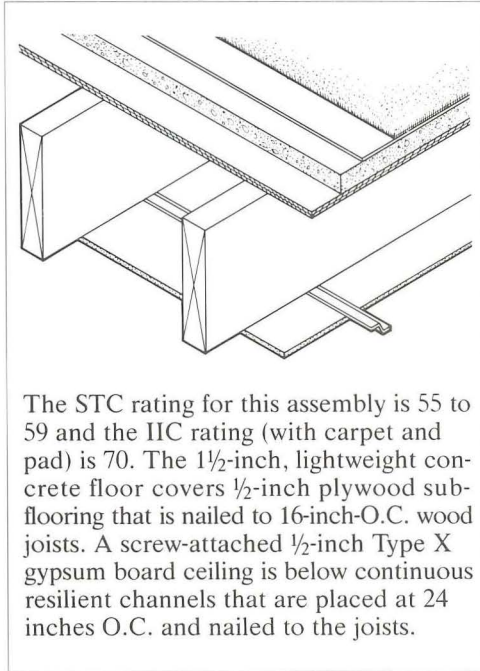

Sound transmission

the architect should have done several inspections—first of the formwork, then of the reinforcing. Although architects generally hire a testing lab rather than take concrete samples themselves, they should be aware of good and bad sampling practice.

### Cleaning stone

Practical information about techniques of cleaning stone building facades and the long-term effects of such techniques appeared in the November '88 Tips (p. 143). For instance, efflorescence, while easy to clean, is not always a simple problem. If the source of water or mineral infiltration is not found and corrected, the efflorescence will return and the cleaning will have to be repeated as additional deposits appear. Furthermore, efflorescence may well be an indication of stone decay, caused by certain minerals. To smooth the cleaning process, it is wise to undertake a complete survey of each stone surface, noting its type and condition. A photo survey is perhaps the best method for making a record of this kind. Coordination of work also is important to avoid impedance of public access and interference with services.

### Powder coatings

In March '87 (p. 78) and again in July of that year (p. 101), Tips surveyed the growing range of paints, coatings, and consolidants. In February '89 (p. 117), we looked at one of the more interesting coatings just beginning to be accepted

here in the United States. Although powder coatings have been in use for several years in Europe, manufacturers in this country still are struggling to establish standard guidelines. When shopping for a powder coating supplier, the architect should ask whether the company has such guidelines. If so, portions of the guidelines can be incorporated into the specifications as performance parameters. The guidelines should include a system of quality management and inspection not only for the coating process itself but also for the aluminum pretreatment; an outline of metal substrate preparation, including the recommended number of pretreatment stages; application procedures; and the kinds of tests and standards the finished coating should meet. (If the architect uses AAMA 605.2 specifications, the supplier's guidelines' standards and test section may be redundant and, if so, need not be included in the architectural specifications.)

### Sound transmission

Quite a number of interior construction materials and techniques were presented in the last five years of Tips columns. In November '87 (p. 107), we covered methods of controlling sound transmission through floor assemblies.

The measured difference between orig-

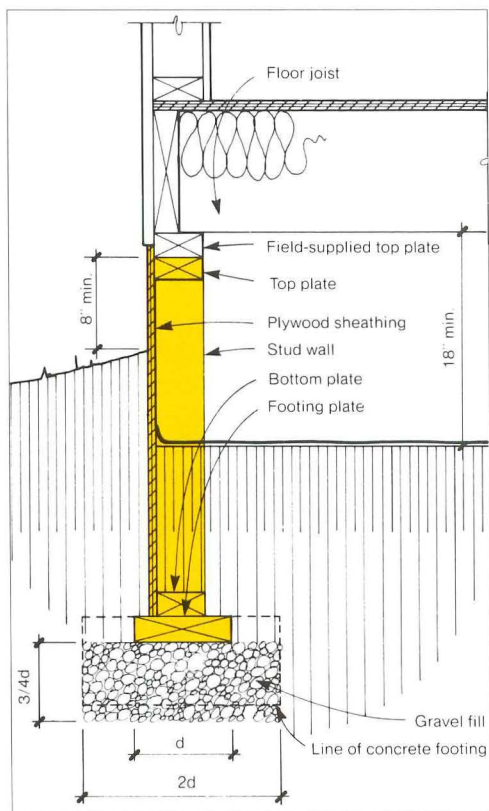

Wood foundations

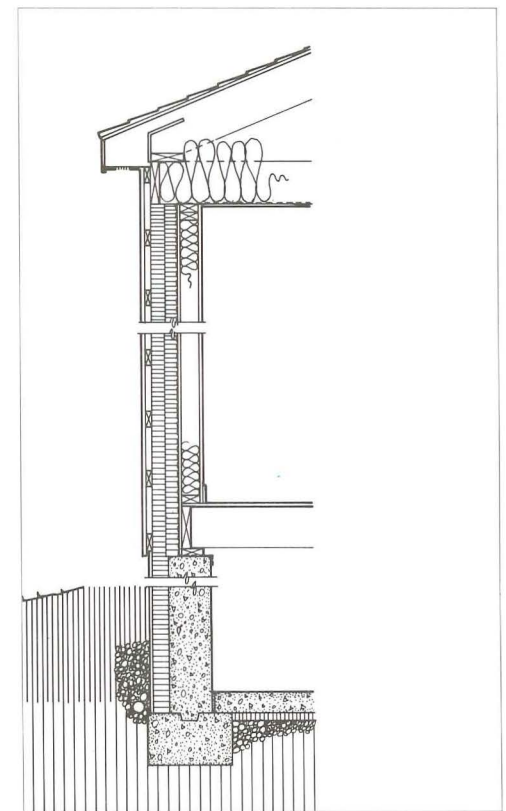

Super insulation



inating sound and air-transmitted sound is translated into an easy-to-use numerical rating, called Sound Transmission Class (STC). The better the sound barrier, the higher the STC number. Impact noise, on the other hand, is a special kind of isolated, structure-borne sound. The measured impact noise of a particular assembly receives a single numerical rating called an Impact Insulation Class (IIC). The IIC rating, which is similar to STC rating, is calculated by comparing measured data with standard criteria.

### Tile

For those interested in a nonflammable floor covering, "Specifying a Ceramic Tile System" in August '87 (p. 97) had a few tips, particularly about substrate preparation. In fact, the most frequent cause of failures and resulting maintenance problems is poorly prepared substrates.

The architect should inspect the substrate for excessive or running cracks that eventually could work through to the tile surface. In order to get a true surface in existing buildings, it may be necessary for the contractor to remove the badly damaged existing substrate and replace it with a new substrate, for example, water-resistant gypsumboard.

When walls serve as the substrate, the architect must consider not only structural loading stiffness and the surface conditions but also the structure on which the wall rests.

Even if the non-load-bearing wall is engineered to support the weight of a thick-bed system, the architect should be careful to check its location relative to the structure in the floor below. Extra supports under tiled walls may be required.

### Paint

The importance of preparing the surface for paint was stressed early on in the July/August '86 issue of ARCHITECTURAL TECHNOLOGY (p. 64).

All too often, definition and specification of surface preparation is not careful or thorough enough or, worse, is completely overlooked, according to Al Blanchard, of Sherwin-Williams Paint Data Bank, who said, "A quality job, for anything from concrete to copper, must begin with a surface that will allow the coating to adhere properly. The spec writer should not take anything for granted in surface preparation specs." The Sherwin-Williams Co. estimated that as many as 80 percent of all coating failures were attributable to inadequate preparation.

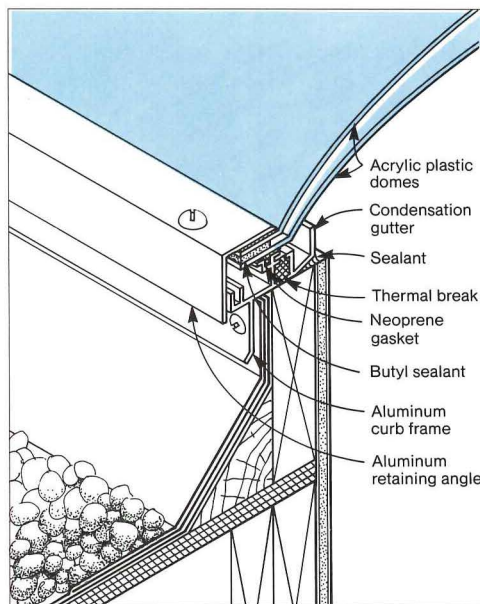

Skylights

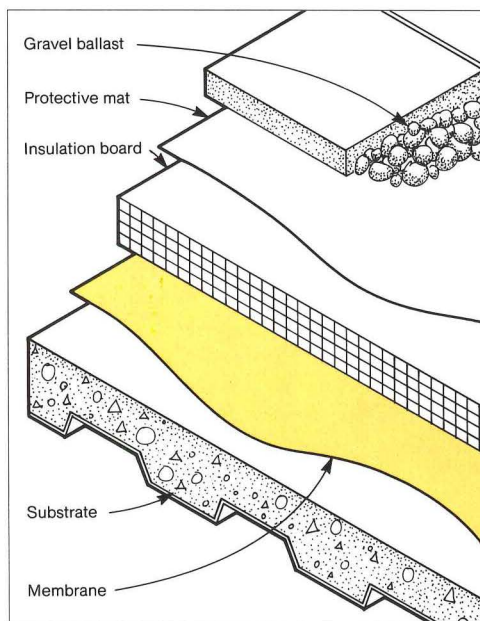

Upside-down roofs

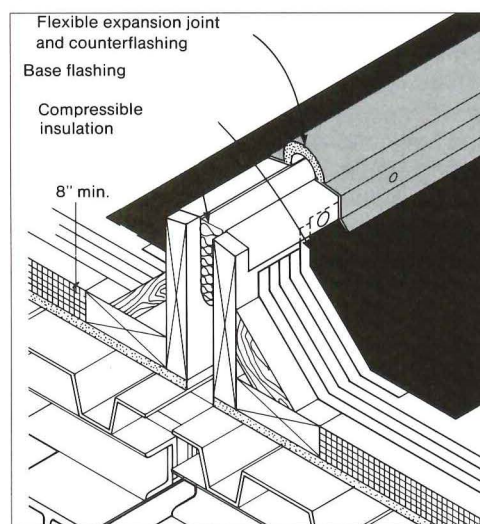

Flashing

### Upside-down roofs

For those keeping track, 1987 was the year ARCHITECTURE ran more than a few roofing-related stories, beginning in January (p. 105) with upside-down roofs, a relatively new technology. Since the start of the decade, upside-down roofs had begun to gain major acceptance by architects. However, like all things turned upside-down, they required some rethinking of traditional ideas. For instance, placing the insulation above the membrane practically eliminates the thermal stress to the membrane. Any thermal bridging that might occur because of loose joints between the insulation boards can be taken care of by using thicker insulation with narrow joints, or by laying two layers of insulation and staggering the joints.

### Flashing

In October '87 (p. 105), we addressed flashing for built-up roofs, not because built-up roofs were a new '80s technology but because good basic construction practice always can stand another review, (particularly when the basics are flashing details). The base/counterflashing combination is perhaps the best flashing system for built-up roofs because it allows both elements to work together. Metal counterflashing, while providing a corrosion-resistant seal over the base flashing, moves when the surface it is attached to moves. The base flashing expands and contracts with the roofing membrane. To achieve a good built-up roof flashing system, consider tips such as this: locate all roof penetrations at least two feet from all vertical surfaces such as walls and parapets to allow enough room for proper flashing around the penetrations and the vertical surface.

### Skylights

Flashing, this time around skylights, was the subject of the January/February '86 Tips in ARCHITECTURAL TECHNOLOGY (p. 56). Later, skylights were covered in the February '87 column (p. 108), which recommended that curbs supporting skylights, air handlers, or other heavy equipment be designed and constructed with two-piece, removable counterflashing. Two-piece counterflashing affords contractors better access to the top of the curve for affixing new base flashing materials—which are often the first parts of a roofing system to fail with normal aging. Wherever a counterflashing is needed, one made of two pieces will serve better than a one-piece type.—TIMOTHY B. McDONALD



# PRODUCTS

## Out on Top

Two outstanding metal roofing projects satisfy requirements of design, durability, performance, and cost



1

Although quite different in design and scope, two projects received the same roofing system because of its ability to form complex configurations and its range of finishes. At Carlson Center, a mixed-use development in Minnetonka, Minn., designed by the local firm BWBR Architects, Bethlehem Steel Corp.'s pre-painted Gal-



2

valume roofing panels were chosen for their 18- and 24-gauge profile panels. The panels had to remain flat, weather-resistant, and able to form the complex shapes needed for the sloped-roofed office towers and connecting rotunda. A similar solution to fabrication and erection was employed by the Atlanta firm Gary B.

Coursey & Associates for the dome over the main entry lobby of the Atlanta Board of Realtors building. This striking element of the Georgian-style building was custom-fitted and custom-colored for the project using Galvalume.

*Products is written by Amy Gray Light*



3

1. Each gently sloping roof of Carlson Center covers 8,000 square feet. The rotunda roof covers 4,000 square feet, and parking ramps are covered with 5,000 square feet of matching Galvalume sheet panels.

2. Architectural details of the Carlson Center roof reveal the gray color that was custom-developed according to the owner's specifications.

3. The Atlanta Board of Realtors originally requested a copper roof because of the antique patina the metal develops when exposed to the elements. The Board chose Galvalume because of its low cost, low maintenance, and durability. Bethlehem Steel Corp. Circle 408 on information card.





# When the Color Choice is Yours—The Color Match is Ours.

## Wide Color Selection

Sonolastic® NP 2 is a two component urethane sealant which is available in over 300 special colors. And, if you specify custom colors, we have **fast** custom color matching service at no additional cost.

## Increased Movement Capability

Now your building joint designs can have an extra margin of safety.

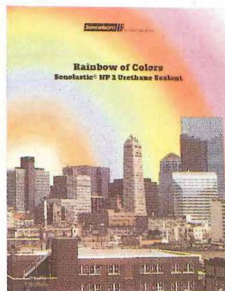

Our Sonolastic® NP 2 has increased joint movement capability of  $\pm 50\%$ , but without a price increase! We offer more benefits without higher prices.

## Specify with Confidence

Sonolastic® NP 2 is a high performance sealant backed by 86 years of Sonneborn Building Products experience. This sealant has excellent adhesion, cohesion and elasticity that resists deterioration caused by weather, stress, movement, water, oils and many chemicals. With appropriate surface preparation, it can bond to many materials such as concrete, masonry, aluminum and glass.

## Free Offer

Call or write to us for the free brochure, "Rainbow of Colors", featuring Sonolastic® NP 2 designer colors. We are listed in Sweets, and complete technical information and expert assistance are available to you on all the Sonneborn products.



**Sonneborn®**

Building Products

**ChemRex Inc.**

7711 Computer Avenue Minneapolis, MN 55435

612/835-3434

Circle 64 on information card

OUR  
**86**<sup>TH</sup>  
YEAR



# PRODUCTS

## Transparent Suggestions



1

New developments in glass provide better performance and esthetic design possibilities

For its design of a subway station in Boston, the local firm CBT/Childs Bertman Tseckares and Casendino Inc. decided to light the entryway with a stained glass effect, in the manner of a cathedral. When the architects discovered that existing glass fabrications didn't meet the range of colors desired, nor local code and the transit authority's standards for heat, impact, and vandal-resistance, they turned to the Lyn Hovey stained glass studio in Cambridge. Working with Artistic Glass Products, a glass fabricator based in Pennsylvania, Hovey developed a new process using the Du Pont Co.'s Butacite polyvinyl butyral resin sheeting. By this method, the stained glass is laminated between outside layers of clear tempered glass and low-emissivity glass to meet code and esthetic requirements.

At Butterfly World Habitat in Vallejo, Calif., design director Glenn Twombly specified Heat Mirror insulating glass from Southwall Technologies to maintain a well-defined temperature range and provide natural light for the butterflies. The 5,500-square-foot habitat is constructed entirely of clear, colorless Heat Mirror glass. In Ohio, Swanton High School was retrofitted by the school district with Heat Mirror windows that resemble the original clear single-pane glass, yet are insulated to block solar heat gain.



2

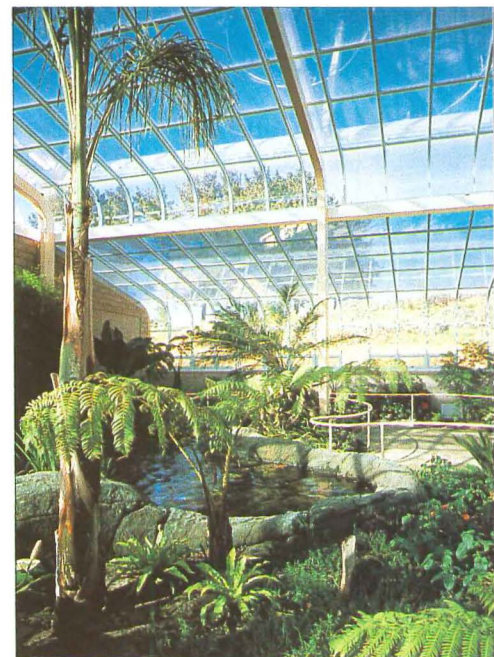

3



4

1. and 2. CBT Inc. used the new Butacite process to create a colorful stained glass canopy that glows at night for Boston's Washington Street station. DuPont Company. Circle 406 on information card.

3. and 4. Heat Mirror acts as a filter to allow light to pass through glass and reflect heat back to its source. A new XUV coating, now standard with the glass of Heat Mirrors 66, 77, and 88, will not alter the glass and is designed to reduce 99.5 percent UV damage to interior furnishings. Southwall Technologies. Circle 407 on information card.



Ask Us About  
the Free Trial Run  
from Apple



# ARCHITRION

## The architectural software you've been waiting for.

Created by architects for architects, Architriton™ is a powerful CAD software package for use on the Macintosh™ computer. Its many features and ease-of-use allows you to maximize your creative abilities at every stage of the design process – from conception to completion. Architriton is available in two versions: the original black

& white version and our advanced full-color Architriton II™ now featuring: create and modify in section; multicolor shading in perspectives and elevations with shadows; and DXF import/export.

**Explore your most complex ideas in minutes.** With Architriton, quickly build your schematics, produce alternative

studies and base your decisions on a realistic 3D representation of your design.

**Experience a better relationship with your clients and consultants.** Architriton allows you to communicate your ideas effectively. Walk throughs, details, modifications or enhancements take shape in a few minutes as you easily produce any interior or exterior perspective, axono or isometric, section or plan.

**Document your design anytime and get take-offs along the way.** While designing, send your automatically generated plans, sections and elevations to the drafting module for further

delineation (before printing or plotting). And, at any moment, check your construction costs with Architriton's estimating module.

**ARCHITRION**  
The essential tool  
for today's architect.

*For more information, or to find out the name of your nearest dealer, contact us today.*

**Gimeor**   
PROGRESSIVE CAD SOFTWARE

420 10th Street S.E.  
Washington, DC 20003  
Telephone: (202) 546-8775

Canadian distributor, B.A.G.H. Consultants, 411 St. Dizier – Suite 104, H2Y2Y1 Montreal P.Q., Telephone: (514) 843-4397

Architriton and Architriton II require a Macintosh Plus, SE or Mac II with a hard disk drive. Architriton and Architriton II are trademarks of Gimeor S.A. Macintosh, Plus, SE and II are registered trademarks of Apple Computer Corp.

Circle 66 on information card



# PRODUCTS

## Better Baths



1



2

Bathroom designs for easier living and barrier-free access



4



5

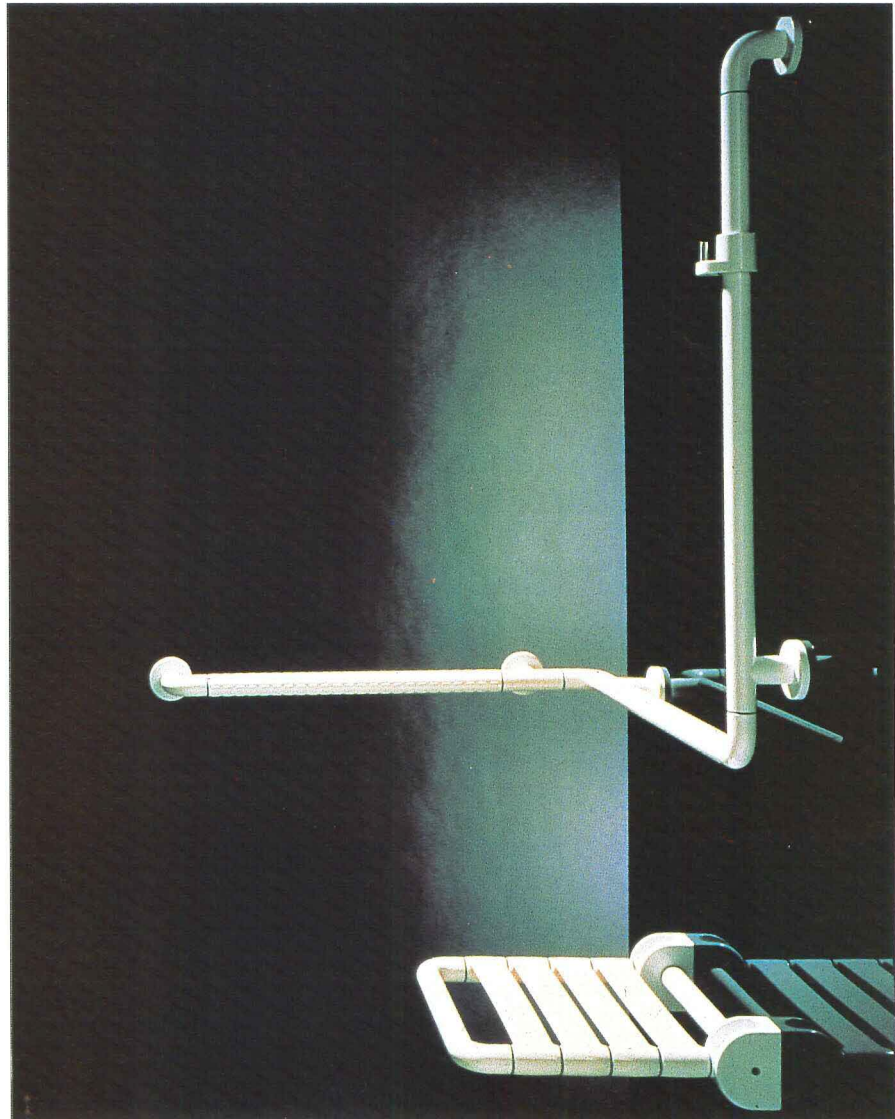

3

According to estimates from a study done for Bobrick Inc., one in every four persons is expected to become temporarily or permanently disabled. All states and the federal government are adopting laws regulating barrier-free access, and many manufacturers are taking an active role in making buildings more accessible to and usable by disabled persons. Some companies, such as Bobrick, find that changing the placement of equipment, rather than the equipment itself, makes the difference in accessibility. Other manufacturers concentrate on faucets and controls that eliminate changes in water temperature, such as Symmons' Temptrol or Porcher Inc.'s Ariane faucet. For easy bath access, Normbau Inc. introduces a textured, nylon grab bar and fold-up shower seat. Alumax's StikStall has a wide door opening, additional floor space, and lowered controls for wheelchair access.

1. Stikstall is available as a corner buttress unit, neo-angle, an island, or a perimeter-sealed steam room. Alumax. Circle 401 on information card.

2. Temptrol automatically adjusts for changes in water pressure. Symmons Inc. Circle 402 on information card.

3. Grab bar and fold-up seat are of tubular nylon with steel inserts for reinforcement and strength. Normbau Inc. Circle 403 on information card.

4. Ariane faucet has a three-setting adjustment to lock out high water temperature. Porcher Inc. Circle 404 on information card.

5. All equipment complies with barrier-free accessibility standards. Bobrick Inc. Circle 405 on information card.





## Light without glare, continued.

This is the new Peerless 7" x 3" Rounded fixture.

It uses the same breakthrough technology that distinguishes our Open Office Fixture, wrapped in a remarkable extrusion.

Note the slim profile, and how it distributes the maximum amount of light from the minimum amount of fixture.

Look around the picture. Try to find any glare or harsh reflections, on the VDT screen or anywhere else. See how smooth the light is on the walls and ceiling.

Then look at the sculptured end cap and the flared lens that gives the 7" x 3" Rounded its unique cross section. The lens gives a continuous line of light—a soft, crystalline glow—that's never darkened by a lamp socket or a fixture butt, never brighter than the ceiling above the fixture, and only available from Peerless.

Practical office lighting never looked so good.

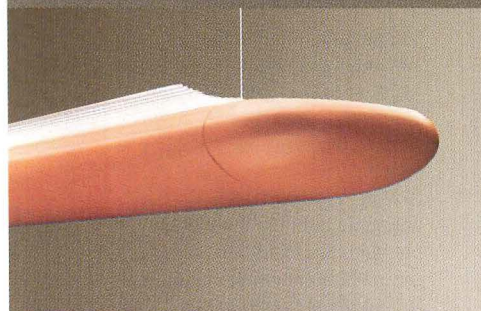

*New optics, new form, new elegance*

 **PEERLESS**

PEERLESS LIGHTING, BOX 2556, BERKELEY CA 94702-0556. (415) 845-2760. FAX (415) 845-2776  
"PEERLESS" IS A REGISTERED TRADEMARK OF PEERLESS LIGHTING CORPORATION. © 1989, PEERLESS LIGHTING CORPORATION.

Circle 68 on information card



# PRODUCTS

## Italian Direction

At this year's Milan Furniture Fair, frivolity and fantasy yield to flexibility and functionalism



1

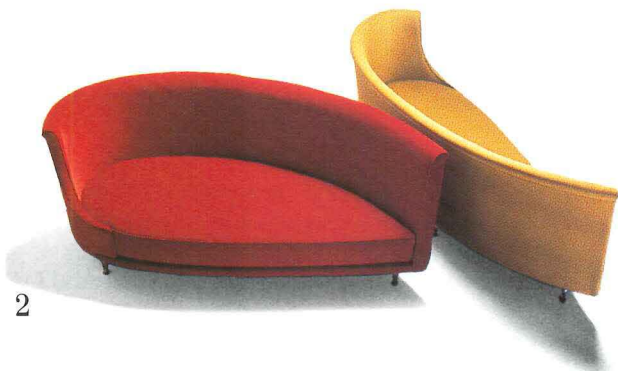

2

1. Forte Ponte high table designed by Paolo Pallucco and Mireille Rivier. Glass top sits upon dismantlable steel structures. Pallucco. Circle 409 on information card.
2. New Tone sofa by Massimo Iosa Ghini. Upholstered in cloth or leather. Moroso. Circle 410 on information card.
3. Titania light by Alberto Meda and Paolo Rizzatto. Interchangeable colored filters of silk-screened polycarbonate enliven the envelope. Luceplan. Circle 411 on information card.
4. The Dada folding chair and 5. Dada T folding table, by Gastone Rinaldi. Both are oval tubular steel frames, epoxy-lacquered. Thema Spa. Circle 412 on information card.
6. Attiva chair by Yaacov Kaufman. Flexible bars are attached to the supporting base and chair back. Seat is beech wood or padded. Seccose. Circle 413 on information card.

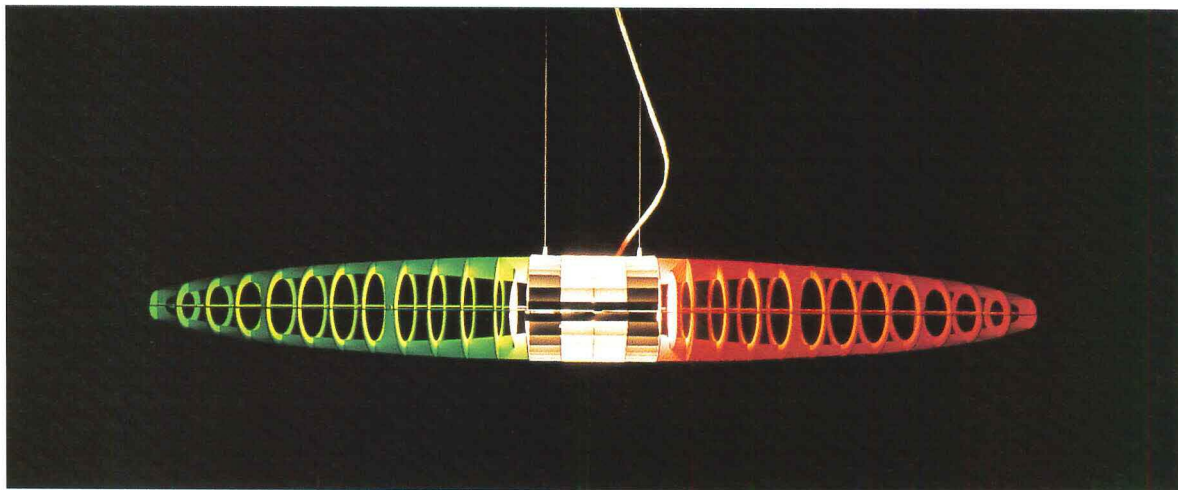

3

At the Salone del Mobile in Milan in September, the whimsical designs of the '80s bowed out in favor of furniture that more assiduously applies to daily living.

In past shows, the design emphasis was on interpreting traditional forms with iconoclastic gestures, but this year's fair suggested that, as designers head into the '90s, trends might not be so easily expressed by historicist formulas. One fairgoer suggested that the new collections

appeared to be inspired by and directed toward the solid bourgeoisie. The designs were cultured but not cerebral, wealthy but not extravagant, refined but not decadent. The furniture and lighting shown on these pages represent the practicality, flexibility, and modernity discernable throughout the show.

—TOM DIPALMA



6



4



5



# PRODUCTS

## Designer's Saturday's Star Productions

Many innovative architect-designed product lines were introduced at Designer's Saturday in New York City last October, blending an historic tone with contemporary style. The three-day show took place at the International Design Center in Long Island City, the A&D Building, the D&D Building, and showrooms scattered throughout Manhattan's East Side. By far, the most exciting offerings were collections designed by two architect "stars"—Robert A.M. Stern and Michael Graves.

Stern's collection of furniture for Hickory Business Furniture demonstrates his architectural philosophy of reworking classical elements to create, in his words, "modern traditionalism" with contemporary flair. The collection's signature piece



1

is a solid cherry wood chair. Called Bodleian, shown left, it features a scroll arm, a contemporary seat and back of graceful and generous proportions, and Georgian-looking "columns" for front legs. Stern's Chandler chair, right on facing page, which he admits is his favorite in the nine-piece collection, pays homage to the novels of Raymond Chandler. Recalling the 1940s, the chair is far more streamlined than its precursors, and a light maple frame contributes to an updated appearance.

Graves continues to demonstrate his prolificacy in furniture and product design with the introduction of the Oculus and Finestra chairs, far right, designed for Atelier International Ltd. The solid beech wood chairs are targeted for the





2

moderately priced, high-volume contract seating market. Oculus features a circular back cutout constructed of multiple wood staves. The Finestra chair, named for the Italian word for window, has a back divided into four window-frame quadrants, with an injection-molded black urethane subframe insert. Both models feature front and rear legs that gently bow outward for stability.



3

1. The Stern Collection consists of nine pieces: three tables, three chairs, and a trio of lounge seating groups. It is the first factory-produced collection Stern has designed. The collection comes in a variety of finishes and may be upholstered in any HBF textile or leather. Hickory Business Furn-

iture. Circle 414 on information card. 2. Finestra and Oculus upholstered seats come in a variety of fabrics, vinyls, and leathers. Finishes include beech wood stained maple, mahogany, oak, walnut, or ebony. Atelier International. Circle 415 on information card.

Everybody knows how destructive hurricanes can be. That's why Risher Hall, a leading glass consultant, specified laminated glass with Saflex® interlayer for the LeParc Condo Project in Naples, Florida.

He knows it can withstand hurricane-force winds; it tends to remain intact if broken, and therefore can continue to offer protection against wind-blown debris; it meets the toughest building codes; and it provides added safety, security and sound control, plus protection against solar heat gain and damaging UV radiation.

## We don't go to pieces in a crisis.

For more information on how well laminated glass stands up in a crisis, send for our free *Guide To The Structural Performance Of Laminated Architectural Glass* and software package. Just complete and mail in the reply card, call 1-800-325-4330, or write Monsanto, Dept. 204, 800 N. Lindbergh Blvd., St. Louis, MO 63167.

**Tough glass for tough problems.**

Circle 70 on information card

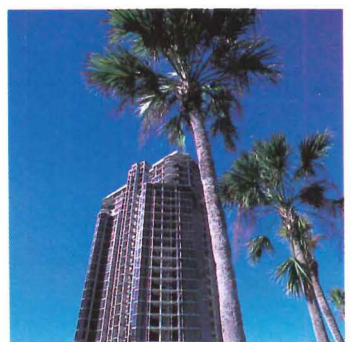

**LAMINATED  
GLASS**  
WITH  
**Saflex**  
BY MONSANTO





## *We won't fade into*

No more faded tans. Or blues that don't stay true. Carpeting made with Marquesa® Lana and Marquesa® Lana/ST polypropylene fiber (also known as olefin) will see to that.

Because unlike fibers dyed at the mill, polypropylene fiber has the color formulated into the yarn. So every stitch stays colorfast no matter what Mother Nature has in store.

Imagine, five years without fading. Without staining. Five full years covered by the PermaColor™ limited warranty from Amoco

**PermaColor™**  
BY AMOCO







***the sunset.***

Fabrics and Fibers. In commercial and residential installations, both.

This remarkable PermaColor warranty is made possible only by years of endeavor at Amoco. From developing new grades of polypropylene. To advancing the technology of face yarns and carpet backing.

Polypropylene yarn is just one of the more than \$4 billion of products that Amoco Chemical makes each year.

And now, the PermaColor warranty is forever changing the landscape of interior design. Call to get complete details. 1-800-292-6626.



Amoco Chemical

Circle 72 on information card



## PRODUCTS

### Report Explains Diffuser Design

United McGill's "Engineering Report No. 153" provides a step-by-step explanation of how to design effective type SP duct diffuser systems. It covers how to determine the diameter and length of perforated duct, as well as how to space orifices and reducers. All the necessary equations are included.  
*United McGill Corporation*  
Circle 419 on information card

### Glass Fiber Duct Liner Guide

Manville Corp. offers its "Top Performer" brochure on Linacoustic glass fiber duct liner products. The color brochure provides a detailed explanation and copy of the new performance oriented ASTM C 1071 Standard Specifications for Thermal and Acoustical Insulation, plus schematic layouts for sound absorption coefficient tests.  
*Manville Corporation*  
Circle 420 on information card

### Repairs on Steam Heating Traps

The "Steam Trap Repair Guide" from Barnes & Jones, Inc., is a cross indexed repair manual for all thermostatic and float and thermostatic traps, as well as the manufacturer's Disc Trap Conversion units for commercial, and industrial steam systems.  
*Burns & Jones, Inc.*  
Circle 421 on information card

### Geoflex PIB Instruction Handbook

Republic Powdered Metals, Inc., announces the availability of their new four-section formatted handbook. The guide explains the installation procedures of the 100 mil white PIB partially adhered membrane with hot asphalt and/or cold adhesive. Also highlighted are various flashing details, including a self-sealing side-lap. All of the details and application procedures are profiled with color-coded drawings and photographs.  
*Republic Powdered Metals Inc.*  
Circle 422 on information card

### Brochure from GE Lighting

A brochure from GE Lighting, the OLP-2403A, gives detailed information about the new decorative Hudson luminaire. The post-top, colonial-style luminaire provides cutoff roadway light distribution patterns and uses high-pressure sodium lamps of 50 through 150 watts. The brochure includes specification features, ordering information, dimensions, ballast and photometric selection tables, and other data.  
*General Electric Company*  
Circle 423 on information card

### Universal Wall Penetration Brochure

A four-page brochure from Omni\*Sleeve describes the features and benefits of the Omni\*Sleeve Universal Wall Penetration. The brochure contains cutaway drawings

of the unit, illustrations detailing its installation and advantages as a wall sleeve or an adjustable waterstop and anchor for a floorpipe, and ordering information, technical data, and specifications.  
*Omni\*Sleeve*  
Circle 424 on information card

### Two Booklets for the Office Environment

Hamilton Sorter Co. offers a 16-page, color booklet created as an application/problem solving guide to the office environment, "Creative Solutions for the Office Environment" illustrates some of the challenges faced by organizations today, such as how to increase productivity, better use floor space, and improve the esthetics of the office. Included with the booklet is an 8-page checklist and exercise pamphlet, which focuses on how to help reduce the stresses of long-term positioning for the VDT screen, keyboard, and chair, and demonstrates exercises that relieve stress for the computer terminal user.  
*Hamilton Sorter Company Inc.*  
Circle 425 on information card

## CREDITS

**Platt House, Snedens Landing, N.Y.** (page 74). *Architect: Charles A. Platt Partners, New York City.* Design team: Charles A. Platt, AIA, and Ray H. Dovell, AIA. Structural engineer: William Atlas. Builder: Seth Glasser Construction.

# LETTER PERFECT.

Here's a quick, economical way to create consistently high-quality lettering for your original drawings or blueprints: the Merlin Express™ Elite Lettering System. It produces professional-looking lettering from 6 to 72 point type on adhesive-backed tape that withstands the high temperatures of diazo reproduction. For details, call toll-free: 1-800-637-5461 (in Minnesota: 612-542-1580). Or send this coupon to Varitronic Systems, Inc., P.O. Box 234, Minneapolis, MN 55440.

Name/Title \_\_\_\_\_  
Company \_\_\_\_\_ Business Phone \_\_\_\_\_  
Business Address \_\_\_\_\_  
City \_\_\_\_\_  
State \_\_\_\_\_ Zip \_\_\_\_\_

 **VARITRONICS**

© Varitronic Systems, Inc., 1989

01241289

# BURNED OUT ON PRODUCING REPORTS?



Could you benefit from a financial management system designed specifically for architects and engineers, that will produce your reports at the touch of a keystroke?

If The Answer Is YES  
Call Now 1-800-77-WIND2



**Wind-2**<sup>®</sup>

The Professional Choice™

1901 Sharp Point Drive, Suite A  
Fort Collins, Colorado 80525



## Books from page 33

believe if not in hierarchy then certainly in plot (presumably in both buildings and books). The problem is that he fails to make the crucial distinction between architects such as Michael Graves, for example, who clearly believe and expect to attract belief in the archetypal fictions (that is to say, myths) that they invoke, and other architects, such as Robert Venturi, who never forget or let their audiences forget the ultimately provisional and even arbitrary status of architectural "fictions." While both may be in some vague sense postmodern, only Venturi is post-Romantic. I would suggest that this will eventually prove to be a more interesting and important distinction than the more familiar grouping of these two architects together, in opposition to modernism.

My point is not that Klotz has not provided some very interesting accounts of some very interesting architects and artists, including some who are not well enough known in this country, such as Walter Pichler, but rather that the depth of his overall account is not sufficient to sustain our interest in the entire project as a history. One can't help feeling that we are at a point where a publication on this scale about recent architecture is either yet another coffee table book (and this book, despite its many excellent illustrations, has higher ambitions) or else it must go beyond the treatment of contemporary

architecture in terms of name-brand architects and projects and cross-grain dualisms and begin to deliver the "history" that is promised. Rather than rehearse yet again the opposition of abstraction and representation, for example, it is high time an architectural historian traced, in the wider context of postwar culture, the way in which representation and its critique have come to be near the top of the agenda for a number of disciplines and discourses.

While Klotz is certainly not a member of the know-nothing school of architectural history, he is not a very persistent intellectual historian. While he makes "fiction," "narrative," and "representation" (which are, by the way, very different concepts not clearly distinguished in this book) central to his account of postmodernism, he does not give the reader much of an idea of the importance of literary and linguistic theory in both the introduction and continuing development of these concepts in architectural theory and criticism. Nor does he deal with the influence of recent philosophy on architectural discussions.

Klotz is better, but still inconsistent, in dealing with what might be called the internal intellectual history of postmodernism. While he, quite correctly I believe, identifies the critique of functionalism as crucial to the theoretical articulation of various postmodern positions, from Venturi to

Rossi, he never mentions Alan Colquhoun's seminal article, "Typology and Design Method." And, surprisingly, his discussion of contextualism never makes explicit the extent to which the attack on zoning by Rossi, Krier, and others is an attack on functionalism as applied to urbanism. A history of postmodern architecture that mentions Colin Rowe only as the source of the "New York Five's" interest in the early work of Le Corbusier risks the accusation so often leveled against the worst aspects of postmodernism: the elevation of image over idea and substance. Indeed, for a book by an eminent historian and critic, this one is altogether too modest about the role of such folk in teaching, practice, and promotion of postmodernism. If Rowe only gets credit for the whiteness of the "Whites," Vincent Scully is noted only as the author of the preface to Venturi's *Complexity and Contradiction*, and Manfredo Tafuri as the source of a quotation about Kahn.

But dropping these names, only in passing, reminds us that history, both intellectual and material, must be rooted finally in the political, social, and economic circumstances of the entire built environment. If this too is ultimately a fiction, then it was one that not only was very persuasive in the 1960s, as postmodernism emerged, but also seems, once again, to put recent developments in a badly need

*continued on page 118*

# Dean School of Architecture

Applications and nominations are sought for the position of Dean of the School of Architecture; the position is available effective July 1, 1990. The School, located in Newark, New Jersey, was established in 1974 and responds to a need for State-supported professional education in architecture. The School offers NAAB-accredited Bachelor of Architecture and Master of Architecture degrees, as well as a Master of Science in Architectural Studies; total enrollment numbers 400 full-time students.

The School is one of four colleges of NJIT, the largest comprehensive technological university in the New Jersey/New York metropolitan area. The Dean is the School's chief administrative officer and reports to the Vice President for Academic Affairs. The Dean will manage the School's resources and administer its institutional, research, service, and development programs.

Qualifications include: professional master's degree in architecture; professional registration; demonstrated executive or administrative capabilities; academic qualifications suitable to the rank of Professor; a demonstrated and active involvement in design through practice, scholarship, or theoretical inquiry.

NJIT does not discriminate on the basis of sex, race, color, religion, handicap, national or ethnic origin or age in employment.

The Committee will begin evaluating candidates by January 31, 1990. Inquiries, nominations, and applications accompanied by detailed resume should be sent to:

Prof. Peter C. Papademetriou, Chair  
School of Architecture Dean Search Committee  
c/o Personnel Box D-SOA

**NJIT** New Jersey  
Institute of Technology  
Newark, New Jersey 07102

## The Wright way of doing things has changed over the years.



Frank Lloyd Wright didn't get to know us. But when granddaughter Elizabeth Wright Ingraham designed Cole Heights, she specified materials as uncompromising as her architectural vision. Including Spectra-Glaze II by Burns & Russell.

Available in 48 standard colors and countless

custom hues, these pre-glazed concrete units offer an exciting alternative to orthodox design solutions. Plus structural strength.

Get the whole story on Spectra-Glaze II's creative options. Call Burns & Russell toll-free at 1-800-638-3188. (In Maryland, 301-837-0720.)



**Spectra-Glaze II**  
CUSTOM PRE-GLAZED CONCRETE MASONRY UNITS

THE BURNS & RUSSELL CO., BOX 6063, BALTIMORE, MD 21231



### Books from page 117

perspective. Lacking this perspective, Klotz can conclude in his "Postscript: Since 1980" that "the American architectural scene is certainly the most interesting in the Western world," without mentioning that behind the "scene" lurks the harsh reality of homelessness and a ruling class that has abandoned the cities. Not having dealt with the emergence of postmodernism as a phenomenon related to the structures of professional practice and patronage, as well as the dialectics of theory and the rhetoric of style, Klotz was not in a position to anticipate the overwhelming reaction against postmodernism that was already beginning, especially in architecture schools. This book is not, therefore, as helpful as one might wish it to be in saving what Klotz himself would surely recognize as the positive, and substantive, contributions of the developments he documents.—ALAN J. PLATTUS

*Mr. Plattus teaches architecture at Yale.*

**The Poetics of Gardens.** Charles Moore, William Mitchell, and William Turnbull Jr. (MIT Press, \$35.)

This is the best book on the history of gardens since Derek Clifford's 1963 *A History of Garden Design*, and it is the best book ever if one wants to get an initiate all worked up about the subject. In many ways it is Clifford's work (especially his

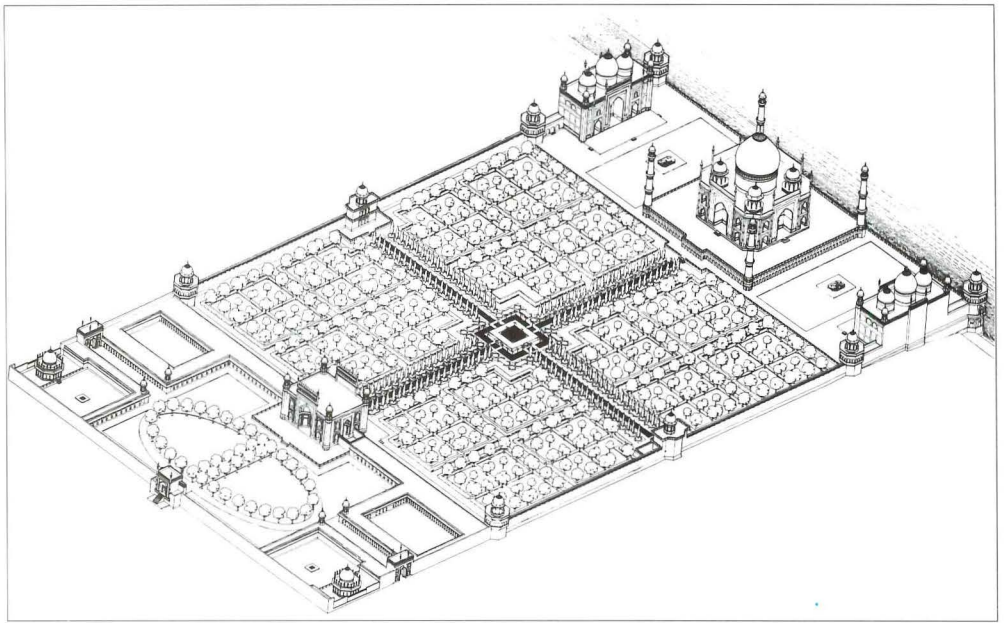

excellent *Britannica* entry on the subject) with a thick patina of Moore-ish magic and the now obligatory addition of items from the inscrutable East, made scrutable. For those whose garden history is shaky, Clifford's *Britannica* précis will get you into this book on a running start. The "poetics" may have problems adhering from time to time if you can't mentally schedule the place and ethos well.

This is an eminently readable book, like Charles Moore's *The Place of Houses*, but about gardens. And this one is better org-

*Plan of Taj Mahal shows four-fold symmetry of gardens that is repeated in the building.*

anized, designed, and written. It is a Hadrian-like travel scrapbook of Moore and his co-authors. They get around. One wonders if Donlyn Lyndon didn't have a small hand in it, having had his Fulbright in India.

There are two irritating problems with this book, and they show up again and again both in Moore's writing and in his architecture. The first is that, while the

### UNIVERSITY OF ILLINOIS AT URBANA-CHAMPAIGN SCHOOL OF ARCHITECTURE

Full-time, 9-mo. faculty positions to begin 8/21/90.

**DESIGN** — Tenure-track Asst Prof(s) and/or tenured Assoc Prof. Highly motivated, dedicated cand. with prof'l, teach and /or research exper in ARCHITECTURE and URBAN DESIGN; THEORY and CRITICISM; HOUSING or CAD, and interested developing and/or pursuing INNOVATIVE approaches to teaching design studios, and lecture/seminar teaching activities. Min require: Arch'l regis plus a Masters or a Ph.D., or similar and equiv exper. Prev exper in teaching, research or nat'l recog for design excel desirable.

**TECHNOLOGY** — Tenure track Asst Prof and/or tenured Assoc Prof. Emphasizes comprehensive bldg del proc, incl: design of bldgs as integrated syst, bldg constr as the design implementation process and proj management as means of design and constr optimization. Must have teach/res competence in Bldg Sci/Tech, particularly in Bldg Constr and in Envir'l Systems. Min qualif: M. Arch or MSAE and prof'l license to practice Arch; or adv degree in Arch or related field, such as CE or MechE. Applic w/o these qualif but a proven record of excellence in teaching, research, or practice also may be considered.

Rank and salary determined by cand qualif and exper. For full consid, C.V., statement expressing educ'l/prof'l philosophy, names of 3 references must be received by **February 1 for Technology** and **February 15, 1990 for Design**.

Send to: R. A. Forrester, Director, School of Architecture  
Design or Technology Search Committee  
608 East Lorado Taft Dr., Champaign, IL 61820  
(217) 333-1330 U of I is an AA/EOE.

## The PAVE-EL® Pedestal System

*The patented system for turning a plain roof into a pedestrian plaza. PAVE-EL reliably protects both roof and paver stone, both membrane and insulation.*

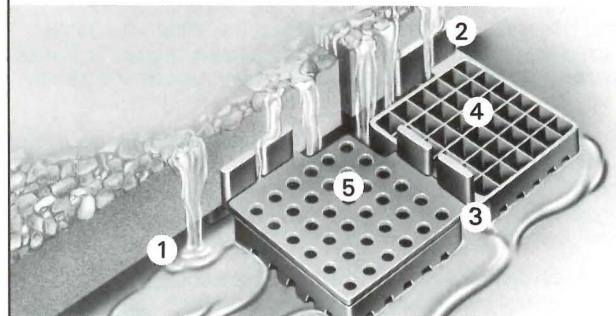

- 1 Paver stones elevated for perfect drainage
- 2 Spacer ribs ensure even joint spacing of pavers
- 3 Pedestals easily sub-divided for corner and edge support of pavers
- 4 Through drainage and aeration eliminates freeze-thaw damage to pavers
- 5 1/8" plates enable perfect levelling of paver

write or call  
for specifications  
brochure

# PAVE-EL®

ENVIROSPEC INCORPORATED

Ellicott Station Box 119, Buffalo, New York 14205 (416) 252-2090



first 217 pages constitute a tour de force essay on gardens of considerable dignity and joy, they are followed by a truly dreadful 22-page fictional dialogue among several landscape greats, which puts phrases into their mouths such as "Have another margarita and mellow out" and "You gotta be kidding. You want that it should look like a Taco Bell?" For those of us who are not as smart as Moore by half, it is irritating to see him play the fool with self-deprecating throwaways. I hope "Amerikanergarten Chats" is excised in future editions.

The other irritation, and again one only Moore can afford, is that he is not judgmental—he apparently loves all gardens equally. It is, like the other irritation, a sin of inclusion and shows an abhorrence of commitment. With his heightened ability to read a culture directly from its gardens as well as its architecture, Moore should have dealt more frankly with the terrible loss of meaning clearly registered in gardens' march through modern history. Think of the Villa Madama's conceit of a progression from the wild to the civilized, of Stourhead's guide to the *Aeneid* (to which Moore does draw attention), of Edmund Wilson's beloved *Bomarzo* based on an epic poem of the period, and then visit the Chelsea Flower Show. Once, amid a sea of blue-haired ladies and men of universally dubious sexuality, all preening over their pretty petunias, I suffered an image: Martians holding a flea market of phonograph records, with furious trading based on jacket design, not one of them realizing that music could be called forth from the artifacts in hand.

Moore has the best mind of a whole generation, perhaps two, of American architects. There is a responsibility inherent in that. American architecture is in desperate need of leadership, which Moore could easily provide. He could be our Petrarch if he wanted. Too often he chooses to fiddle like Nero instead.—DAVID CLARKE, AIA

*Mr. Clarke teaches architecture at the University of Illinois at Carbondale.*

**Designing Dreams: Modern Architecture in the Movies.** Donald Albrecht. (Harper & Row, \$15.95.)

The Fred Astaire-Ginger Rogers movies of the 1930s are among my favorite entertainment, and not least for the sequential photography where dance and settings merge into modern ballet. I have often wondered how these creations were made and who was responsible. Donald Albrecht's book answers a number of these questions, the core of his writing being a history of the "modernist" art directors who dominated Hollywood in the '20s and '30s, illustrated with stills from such classics as "Susan Lenox: Her Fall and Rise" (with Garbo), "Grand Hotel," "Swing Time," "Talk of the Town," and "Top Hat."

The connecting theme is modernism in set design, which leads Albrecht to assume mistakenly that films had a significant role

to play in converting the United States to total acceptance of modern architecture. But the booming '20s brought a scale of urbanization to the United States that had its own momentum independent of Hollywood. One has to agree with Richard Neutra, quoted in one of Albrecht's architectural asides: "Motion picture sets have undoubtedly confused architectural tastes. They may be blamed for many phenomena in this landscape, such as half-timbered English peasant cottages, French provincial and 'mission bell' type adobes, Arabian minarets, Georgian mansions on 50 x 120-foot lots with 'Mexican ranchos' adjoining them on sites of the same size."

Many architects turned to the movies. Albrecht explores this sideline and helps answer my quest for the set designers of the Astaire movies.

"The Fountainhead" (directed by King Vidor in 1949 with Edward Carrere as

art director) is probably the most famous architectural portrayal, as the author of the novel, Ayn Rand, based her story in part on Frank Lloyd Wright's tempestuous career. Wright was asked to handle the sets, but his fee of \$250,000 put him out of the running. Wright's attempt to milk the moviemaking machine had precedent: at that time directors were paying themselves between \$100,000 and \$300,000 per annum, and Hitchcock as producer earned \$2 million for "Psycho."

I found myself wandering off from Albrecht because his literary style was not equal to the scale of the topic. I would recommend that film buffs look at the biography of Hitchcock by Donald Spoto as well as a recent monograph on David O. Selznick. This famous producer directed not only films with modernist settings but also those with historic pastiche such as

*continued on page 120*

## WHY ARE PC GLASSBLOCK® products the choice of America's leading architects?

Because there is a difference  
in glass block quality . . .  
and the service that comes with it.

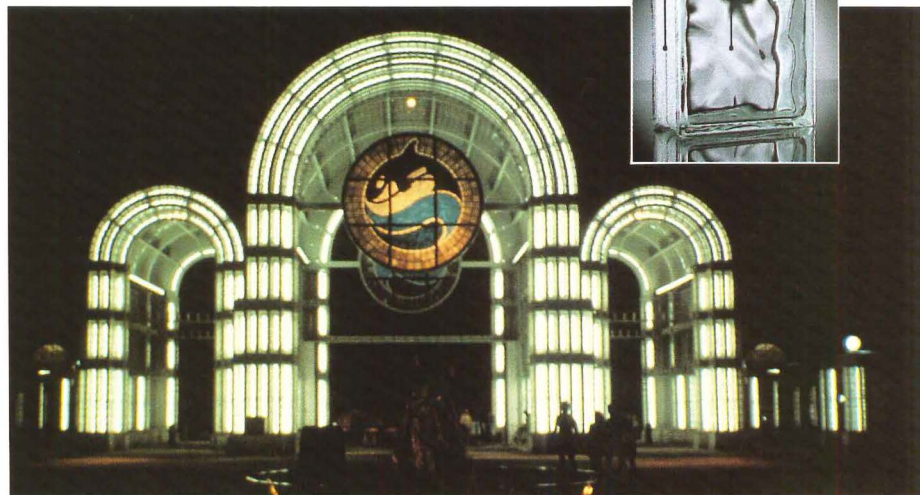

Sea World of Texas, San Antonio • Architect: Sea World of Texas  
Production Architect: Jones & Kell, Inc. • DECORA® Pattern

The clarity and brilliance of PC GlassBlock® products are unmatched, thanks to the exclusive use of low iron-content sand. No recycled glass is ever added because this affects color and clarity. And the unique edge coating on PC GlassBlock® products provides a superior bond with mortar, expediting installation. At Pittsburgh Corning we maintain strict quality control—for example, each block is visually inspected at least once before it's packed. The result: superior, consistent products.

Architects and designers have access to Pittsburgh Corning's drawing review and technical guidance . . . on-site assistance by trained, qualified Pittsburgh Corning representatives . . . full sample selection. And, even after

installation, we stand behind our products.

The Difference—Pittsburgh Corning's quality and service. That's why American-made PC GlassBlock® products are your best choice. For more information, or details on our international distribution, call the PC GlassBlock® Products Hotline.

**800-992-5769**

or write, Pittsburgh Corning Corporation, 800 Presque Isle Drive, Department AGB-9, Pittsburgh, PA 15239. In Canada, call (416) 222-8084.





# FRY IS MOLDING TECHNOLOGY.

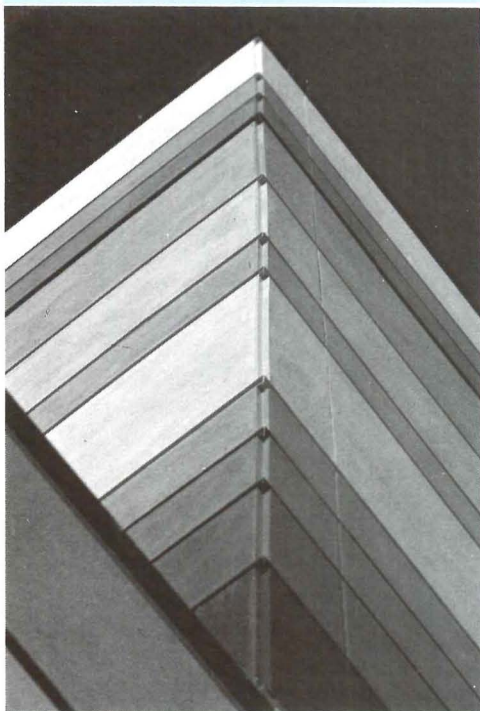

Responding to new trends in architectural design, Fry Reglet has been developing innovative architectural moldings for over twenty years. Our aluminum products are designed to marry form and function, creating surprisingly dramatic results.

Specify Fry — our products are molding technology.



Look for us in Sweets Catalog 09200/FRY.

**FRY REGLET.**

625 S. Palm Ave. • Alhambra, CA 91803 • (818) 289-4744 • Fax (818) 289-0537  
2777 Peterson Place • Norcross, GA 30071 • (404) 441-2337

Circle 88 on information card



**Fusital**

**Valli&Colombo®**

**Forges**

**Make every entrance a command performance.**

Italian designer door lever sets from Valli & Colombo feature over thirty superbly hand-crafted styles with coordinated accessories, deadbolts and mortise locks.

**Valli&Colombo**  
(U.S.A.) Inc.  
P.O. Box 245  
Duarte, CA 91009-0245  
(818) 359-2569

© 1989

**Le maniglie Valli&Colombo**

## Books from page 119

"Gone With the Wind" and "Rebecca," which had as art director the former modernist Lyle Wheeler and shows the flexibility of talent that Hollywood could draw upon.

Some of Albrecht's architectural information is misleading. He singles out glass and concrete for mention, but Neutra's Los Angeles masterpieces were in fact steel stud with rendering or sheet metal facing. Hollywood's back lots and sets were flimsy artifacts of ply and stud, and it is a pity that Albrecht did not draw comparisons with Rudolf Schindler, as his houses for film magnates (including Sam Goldwyn) often were constructed with temporary materials, like back lots. That explains why many of Schindler's designs have fallen apart at the seams.

All in all, the topic of modern architecture in the movies is fascinating, even though it is a cultural cul-de-sac in the general climate of schmaltz that is the real Hollywood.—ALAN BLANC

*Mr. Blanc, an architect and professor, lives in England.*

**The American Design Adventure: 1940-1975.** Arthur J. Pulos. (MIT Press, \$50.)

This chronicle is the sequel to Arthur J. Pulos's *American Design Ethic* of 1983, a chronological and factual overview of American design from the colonial era to 1940. From both books one can readily conclude that American design history is grounded in pragmatism (our only philo-phy) and in the twin forces of democracy and technology, of which John Kouwenhoven has written so eloquently. Architects should be interested in this book because they have played a role in the history of modern design and because most environmental designers rely on industrial design products to characterize contemporary architecture.

Historiographically, Pulos employs an organic model of history—cycles of conception, birth, service, death, and renewal—to frame his discussion. He believes that technological products are transitory in character, "constantly being made obsolete by advancing technology and changes in public need and fancy." Pulos also implies that there is a hierarchical system of values in American design in which "lower order" products evolve into "higher order" ones, with the higher incorporating all the attributes of the lower. The designer's role in this is dual: "as the humane and esthetic conscience of industry" and as a "surrogate for the consumer."

There is, of course, a contradiction in this role in that conscience, in an industry increasingly driven by marketing strategies, is not a high value. In fact, after reading Pulo's account of our design history, one can conclude that conscience and surrogation have as high a profile in industrial design as affordable housing does in architecture. And the esthetic intents of industrial designers, "their aspira-



tions to eternal value," fail to resolve the social contractions inherent in the profession.

Thematically, Pulos's history begins with the pre-World War II context for design and with the designer's role in the war effort; then it moves on to the institutionalization of modernity as our way of life, brought on not only through products but also through an ethos that designers help fabricate, to postwar culture and conspicuous consumption, to the professionalization of design practice and the formal education of designers, to the internationalization of design, and to the role of design in society. Throughout all this Pulos documents the inclusion of human factors in design and the important changes in materials for industrial products.

To blend these themes into a history, Pulos relies on the products themselves, which he sees as mirrors of life, reflecting the spirit of their times. Pulos imagines the products as unique solutions to problems, evolving toward the perfection of "type forms." Categorically, Pulos describes the design characteristics of houses, furniture, large and small appliances, tools, flatware and dinnerware, all kinds of equipment, instrumentation devices, and transportation vehicles.

Based on Pulos's presentation, it seems that the idealism that underwrote a good deal of the origins of modern design practice was relegated to the organizations that were formed to promote or regulate design, and that design practice has been shaped largely by clients and the profit motive. There is no doubt that industrial designers have been partly responsible for the creation of many of the false needs that are so much the concern of advertising and marketing professionals.

American design philosophy is characterized as "combining esthetic principles with empirical exploration and practical experience." This approach has some limitations in practice and in Pulos's accounting of the history of practice. In our time there are the issues of technology transfer to the Third World and the consumer economics and materialism to which such transfers are related. There is no mention of alternative appropriate technology in industrial design, the kind of thing that Victor Papanek advocates.

Pulos, an industrial designer and chairman emeritus of the department of design at Syracuse University, has written a broad-brush history focused on style that no doubt will become the foundation for more specialized studies. The book is clearly written, well illustrated, and finely designed (except for a strange bibliography). However, it is only a first step toward a social history of American design.—HERBERT GOTTFRIED

*Mr. Gottfried teaches at Iowa State University's college of design.*

*Books continued on page 124*

## LIGHTING OUTDOORS

**3-RING REFLECTOR**  
Luminous Acrylic Rings



Cat. No.  
ALL0502

**HEMISPHERE DOME**  
Luminous Acrylic Ring



Cat. No.  
ALL0503

**RADIUS DIFFUSER DOME**  
Luminous Acrylic Ring



Cat. No.  
ALL0504

**CONCRETE BOLLARD**



Cat. No.  
ALC805DW

**CLASSIC LANTERN**



Cat. No.  
ALN441

**WEDGE LUMINAIRE**

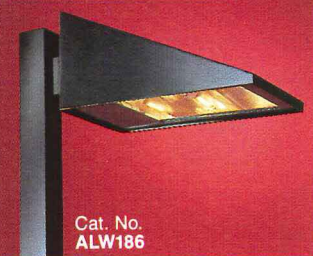

Cat. No.  
ALW186

Introducing a new selection of outdoor lighting products that offers light accents, traditional design, H.I.D. performance, and durable lighting qualities.

### ARCHITECTURAL AREA LIGHTING, INC.

14249 Artesia Blvd., P.O. Box 1869  
La Mirada, California 90637-1869  
(714) 994-2700 Fax (714) 994-0522





# THE AIA PRESS

## 1989 Holiday Selections

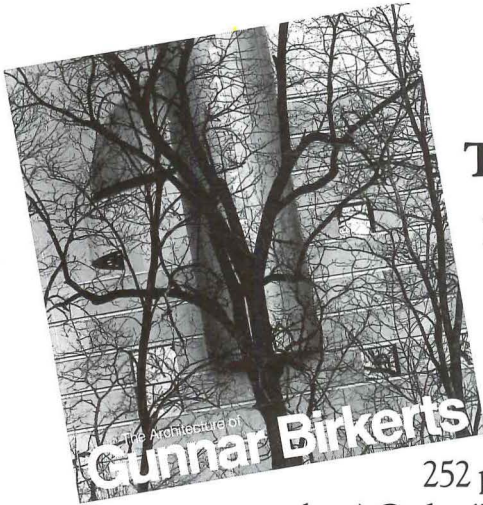

### THE ARCHITECTURE OF GUNNAR BIRKERTS.

Explores the work of this leader of the Modern Movement's second generation designed since 1957. All projects are extensively illustrated with conceptual and design sketches, as well as with color and black-and-white photographs, and are accompanied by a narrative from the architect. Text by Kay Kaiser.

252 pages, 663 illustrations, 171 in color. cloth. \$45 (\$40.50 AIA members) Order #R803

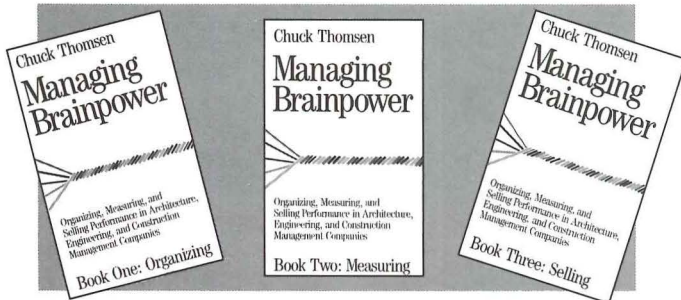

**MANAGING BRAINPOWER.** How to effectively manage, market, and sell the talent and services of an architecture/engineering or construction management firm is the subject of the book, but all information intensive professional firms can adapt the concepts for their use. Hands-on tips to help maximize staff talents and energies are provided by the author.

Set of 3 books contains: Book 1 Organizing • Book 2 Measuring • Book 3 Selling \$24.95 (\$22.50 AIA members) Order #R720

**RECORDING HISTORIC STRUCTURES,** John E. Burns, AIA \$19.95 (\$18.95 AIA members) Order #R743P

**ARCHITECTURAL SHADES AND SHADOWS,** Henry McGoodwin \$32.95 (\$29.75 AIA members) Order #R804

**BUILDING THE OCTAGON,** Orlando Ridout \$16.95 (\$15.25 AIA members) Order #R808

**ROBERT MILLS, ARCHITECT,** John M. Bryan \$39.95 (\$18.95 AIA members) Order #R744

**SIR CHRISTOPHER WREN: The Design of St. Paul's Cathedral,** Kerry Downes \$39.95 (\$36.95 AIA members) Order #R751

**PENNSYLVANIA AVENUE: America's Main Street,** Ted Landphair, photos by Carol Highsmith \$39.95 (\$36.95 AIA members) Order #R718

- Please send me the following 1989 AIA Press selections!  
 Check payable to AIA is enclosed.  
 VISA     MasterCard

Acct. No. \_\_\_\_\_ Exp. Date \_\_\_\_\_  
 Signature \_\_\_\_\_  
 Name \_\_\_\_\_  
 Firm Name \_\_\_\_\_  
 AIA Membership No. (See AIA Executive Card) \_\_\_\_\_  
 Address \_\_\_\_\_  
 City, State, Zip \_\_\_\_\_  
 Telephone \_\_\_\_\_

QTY	ORDER NO.	PRICE		TOTAL
		NONMEMBER	MEMBER	
1	N711	—	—	—

Subtotal \$  
 Shipping \$ 3.00  
 Sales tax: \$  
 DC 6%, MD 5%  
**TOTAL \$**



MAIL TO:  
 AIA Order Dept.  
 9 Jay Gould Court  
 P.O. Box 753  
 Waldorf, MD 20601



# Keep Birds Off Your Structural Designs

Include NIXALITE® Architectural Bird Control from the Start!

Permanent Stainless Steel Strips  
 Does Not Stain Building Materials  
 Adapts To Every Structure Contour  
 Easy Installation  
 Finishing Materials Included  
 Recommended By Bird and Avian Societies  
 Available In Colors!

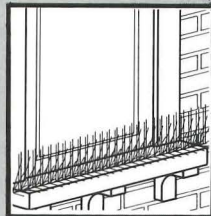
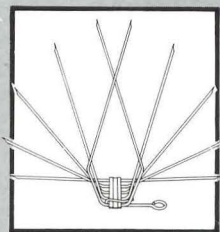

Get Details in Sweet's Section 10290/NIX

Call our Design Department Hotline 800-624-1189 for technical assistance and mounting procedures



**NIXALITE of AMERICA**

1025 • 16th AVE. • EAST MOLINE, ILLINOIS 61244  
 309-755-8771 • 800-624-1189  
 FAX 309-755-0077

SPECIALISTS IN BIRD CONTROL

Circle 108 on information card

NIXALITE® is a federally registered trademark of NIXALITE® of AMERICA.

## PRODUCTS

### Tower and Street Clock Book

A specification book for tower and street clocks is available from the Verdin Co. Three sections of the book detail design drawings, timepiece (motor) details, and clock hand styles for the manufacturer's line of standard tower clocks: surface-mount markers or numerals; surface-mount markers or numerals on acrylic dial faces; and open (hole or recess in wall) markers or numerals on acrylic dial faces. Lighting diagrams also are included for the opening mount clocks.

Other sections of the book cover electrical data, including wiring riser diagrams and clock programmers and controllers. The last section provides design diagrams, including footing details for both two-faced and four-faced street clocks, which are replicas of the turn-of-the-century Victorian post clock.

Verdin's custom design capabilities, general product literature, service information, and instructions for obtaining pricing and proposals conclude the book.

*The Verdin Company*  
 Circle 416 on information card

### Database for Landscape Architecture

A visual data base of plant materials for use with Landcadd's Site Planning and Landscape Design module allows users to view actual photographic images of plants in a Landcadd computerized construction drawing.

Linking CADD drawings to real photographs on either videodisc or floppy disks will be a separate module in the Landcadd system of land planning software. The visual data base of plant materials is being developed with the idea that it may eventually be used in conjunction with Landcadd and Autocad to develop realistic video imaging views of a site. Links will also be provided to the text-based plant data base currently offered with Landcadd.

*Landcadd Inc.*  
 Circle 417 on information card

### Guide Marketing Tool for Architects

*The Greenline Guide to Residential Architects 1990* will be the first visual directory of built projects by U.S. residential architects nationwide. The guide will be distributed in March 1990 and afterward on a yearly basis to custom home builders, developers, and individuals contemplating architectural projects.

The hardcover book displays full color or black and white photographs and drawings of the architect's design with a brief description of the architecture or firm and the services available.

*The Greenline Guide*  
 Circle 418 on information card

# Designing Time

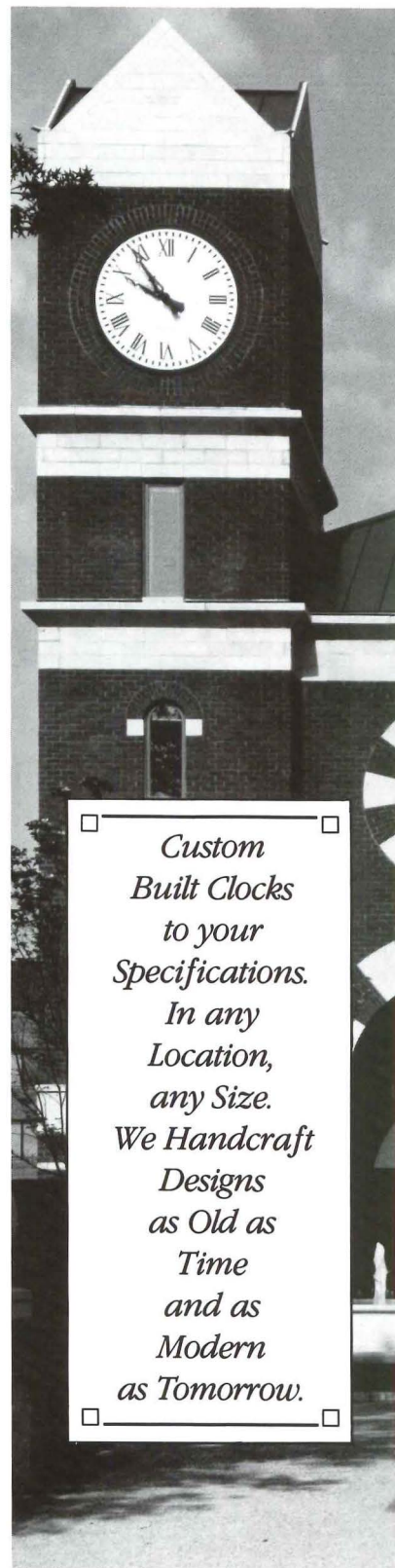

Custom Built Clocks to your Specifications. In any Location, any Size. We Handcraft Designs as Old as Time and as Modern as Tomorrow.

**electric time**  
 company, inc.

45 West St., Medfield, MA 02052 USA  
 Tel: (508) 359-4396 Fax: (508) 359-4482

See Us in Sweets 16730/ELE

Circle 94 on information card



# CULTURED STONE® YOU CAN ACHIEVE THE BEAUTY OF NATURAL STONE AT A FRACTION OF THE COST.

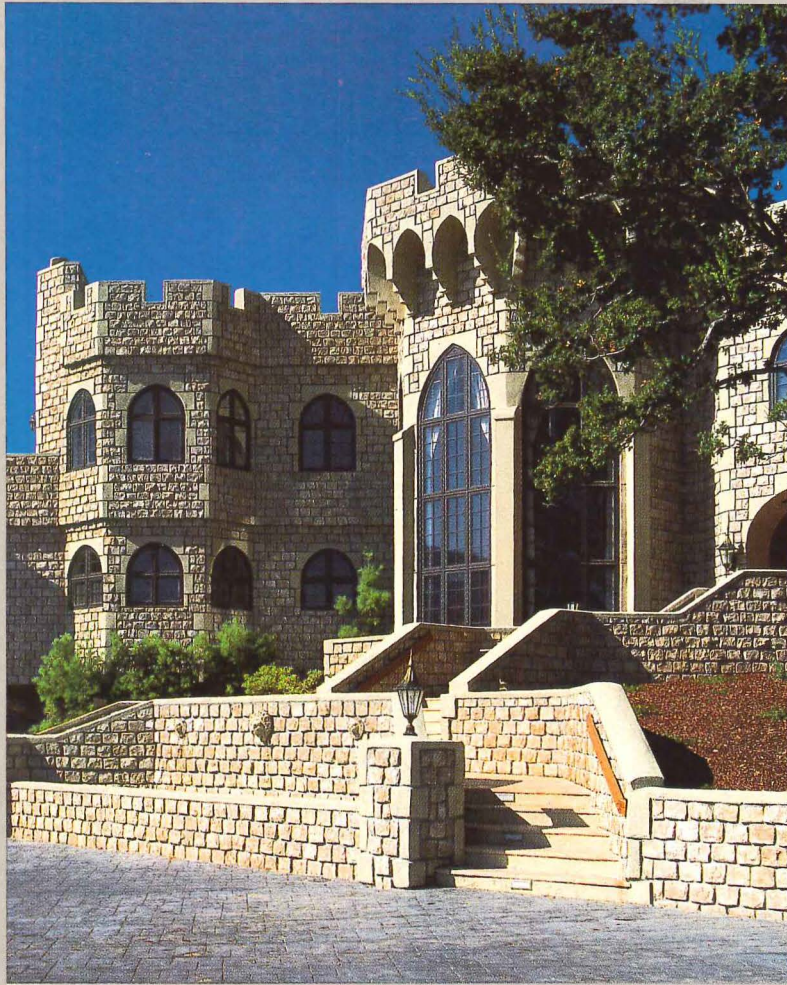

From the Cobblestone Collection: Buff Cobblestone, one of over 50 color and texture choices.

When your clients want the look, feel and durability of natural stone but cost or weight is a problem, consider Cultured Stone®. Its light weight allows for fast and easy installation with no additional foundations or wall ties required.

- listed in Sweet's: 04430/STU
- meets Building Code Specs.
- warranted
- cost effective — no additional foundations or wall ties required
-  Listed — noncombustible

Call or write today for your free Architectural Catalog including: color All Products Brochure, Spec Data, Manu Spec and dealer information. (800) 225-7462. In Calif: (800) 445-9877. P.O. Box 270, Dept. 399, Napa, CA 94559.

# CULTURED STONE®

THE HALLMARK OF EXCELLENCE IN MANUFACTURED STONE

By Stucco Stone Products, Inc.

Circle 06 on information card

**Frank Lloyd Wright: An Index to the Taliesin Correspondence.** Anthony Alofsin, Editor. (Garland Publishing, five volumes, \$800.)

Interest in Frank Lloyd Wright and his architecture has continued to intensify in the United States since his death in 1959. This is evinced, in part, by the popularity of Wright-related building artifacts and decorative arts created by Wright that have been mass-produced for sale. The decorative arts include Wright-designed furniture produced by Atelier International/ Cassina; art glass windows by Oakbrook-Esser Studios; fabric, wall coverings, and rugs by Schumacher; and china, crystal, and silver by Tiffany & Co.

Within the last year there have been two major exhibitions of Wright's work. "Frank Lloyd Wright: In the Realm of Ideas" began its lengthy eight-city tour in 1988 and will conclude in 1991. "Frank Lloyd Wright and Madison: Eight Decades of Artistic and Social Interaction" was at Madison, Wis., in late 1988. These exhibitions included an exquisite display of Wright's drawings, furniture, decorative arts, manuscripts, models, photographs, and other items.

There is also the recent outpouring of books on Wright (some at significant prices) and by Wright himself. Many of the latter are being published for the first time almost 30 years after his death, edited by others into an important, continually growing literary body.

The Wright scholar responsible for much of this outpouring is the eminent Bruce Brooks Pfeiffer, director of archives of the Frank Lloyd Wright Foundation. No other Wright scholar has done so much with such persistence, enthusiasm, care, and fond insight as Pfeiffer. Indeed, his touch is evident also in *Frank Lloyd Wright: An Index to the Taliesin Correspondence*. This is not to diminish the contribution of the editor, Anthony Alofsin, to this important work nor that of the others who participated in the monumental effort.

The five-volume index is awesome not only for its enormous size and breadth as an archival research aid but also for what it represents—virtually the total of Wright's correspondence during his 71-year career in architecture. This is the first published index to the letters of Wright that are housed in the archives of the Frank Lloyd Wright Foundation at Taliesin West. As stated by Pfeiffer in the work: "The plan for the index...was adopted in 1985 by the Getty Center for the History of Art and the Humanities as part of a far-reaching collaboration with the Frank Lloyd Wright Foundation, in which the center would provide access to copies of each principal series in the Frank Lloyd Wright archives," of which Wright's correspondence collection is a part. Indeed, researchers using this index can order copies of any of the correspondence documents from the Getty Center.



The five volumes are organized into seven distinct indexes: the chronological index (Volumes 1 and 2); author index (Volume 3); addressee index (Volume 4); and affiliation, general subject, proper name, and project number indexes (Volume 5). Although quite long, the five volumes contain no illustrative materials and no reproductions of Wright's correspondence. Volume 1, titled "Chronological Index, 1885-1946," serves as the introduction to the entire set. It begins with a short paper by Alofsin, "Frank Lloyd Wright as a Man of Letters," which put both the indexes and the letters into the proper context for study. Then comes a guide to the indexes and archives, describing how the indexes are to be used and listing the 22 subject codes by which all the pieces of correspondence are classified—awards, client, collecting, contract, critical response, exhibition, family, finance, invitations, lecture, materials, office, personal, philosophy, publication of buildings, general publications, specifications, students, and other.

Pfeiffer offers a brief history of the project and also presents the most up-to-date listings of all of Wright's known projects by Frank Lloyd Wright Foundation assigned number as well as in alphabetical order by project name. The introduction to the set concludes with a paper by Nicholas Olsberg, archivist at the Getty Center, titled "A Guide to the Archives of the Frank Lloyd Wright Foundation," which generally describes other holdings of the archives. Volume 1 concludes with a complete chronological listing of the correspondence of Wright from 1885 to 1946, indicating the date of the correspondence, the Getty Center microfiche number, from and to whom the correspondence is associated, affiliation, general subject, proper name, project number, miscellaneous notes, and the total pages of each document.

Volume 2, titled "Chronological Index, 1947-1965," repeats the guide to the indexes and the archives with the 22 subject codes and repeats the two listings of Wright's known projects. Volume 2 ends with a chronological listing of Wright's correspondence from 1947 to 1965.

In Volume 3, titled "Author Index," Alofsin again repeats the guide to the indexes and the archives and follows it with an alphabetically arranged author index to all the correspondence indicating from whom the correspondence was sent, to whom it was sent, the date, and the Getty Center microfiche number.

Volume 4, titled "Addressee Index," includes the guide to the indexes and the archives and an alphabetically arranged addressee index to all the correspondence indicating to whom it was sent, its date, and the Center microfiche number.

Volume 5, titled "Affiliation Index, General Subject Index, Proper Name Index, and Project Number Index," again

*continued on page 128*

# S P A C E S A V E R

## AMERICA'S FIRST CHOICE IN MOBILE FILING AND STORAGE SYSTEMS.



The cost of office space continues to rise.

The "paperless office" has only redefined the needs of filing and storage.

But Spacesaver can help you solve today's growing office space challenges.

Our unique high density mobile storage systems are performing in thousands of office and institution installations both large and small.

They're eliminating wasted aisle space...

Freeing up as much as 50% of existing storage space for more productive use...

Actually doubling existing storage capacity...

Making more room for people...

Ask our filing and storage professionals to conduct a free, no-obligation survey of your record retention needs. We'll work with you to determine the attractive, secure, versatile Spacesaver Systems that are right for *your* specific facility. For the best in local sales, service, and installation, call us today.

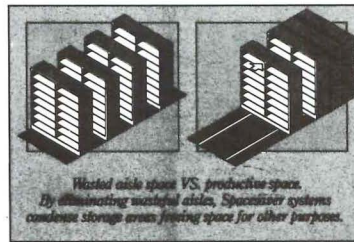

**Spacesaver**   
When Performance Counts.

Spacesaver Corporation, 1450 Janesville Ave., Ft. Atkinson, WI 53538, Tel: 414-563-5546, TWX910-260-3730

Circle 112 on information card

*Discover The Excitement*

Architects Love

**ARCHITECTURE**



# Architects Agree there's no Equal\*

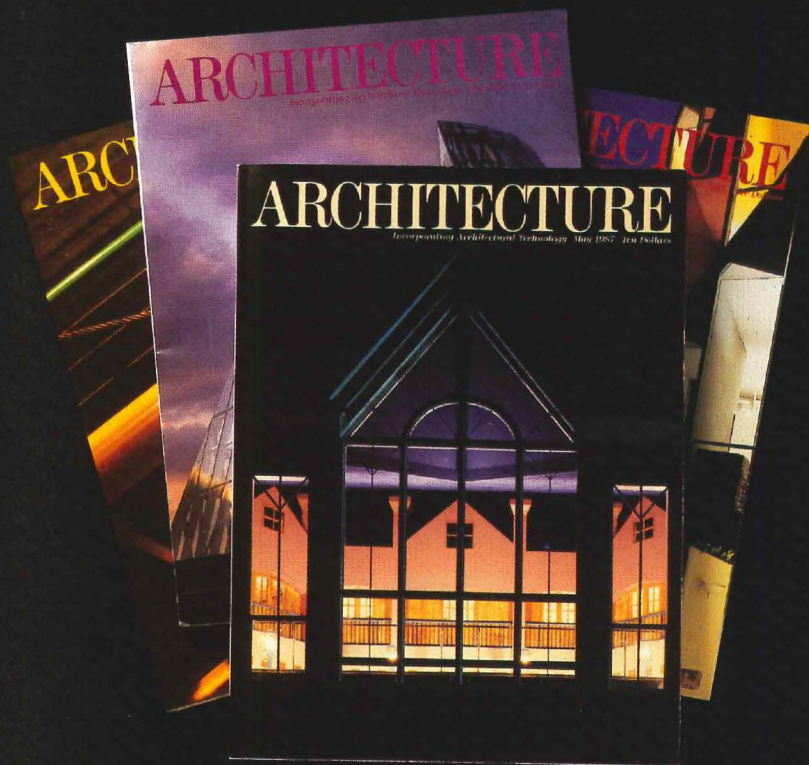

\*Based on the results of the Fourth Annual Study of U.S. Architects  
conducted by Readex, Inc., an independent research company.



**Pozzi Windows.** Over 4,000 windows and doors. Each designed to create the special places that people will remember.

*Circle No. 179*

**ProSoCo Inc.** Masonry restoration treatments are many. But only ProSoCo makes house calls. We are a leader with a trusted name in masonry cleaning. Send today for more information.

*Circle No. 181*

**Raynor Garage Doors.** The Raynor Tri-Core insulated door protects more than the environment inside your building. By not using ozone-destroying chlorofluorocarbons in our Tri-Core doors we're also protecting the environment outside your building.

*Circle No. 263*

**Reynolds Metals.** Our new Reynobond® building panels are everything you'd expect from an aluminum composite: flat, strong, light, and formable. Send for more information including technical literature and color selections.

*Circle No. 229*

**Sloan Valve Co.** Sloan Optima® humanizes electronic faucets with a patented new sensor that welcomes use. Send today for more information.

*Circle No. 185*

**Southwall Technologies.** Send to find out how Heat Mirror™ can open up your design options. For immediate help on a current project, call our Architectural Services Department (800/365-8794).

*Circle No. 191*

**Steelcase.** Steelcase has new choices galore. Fabrics, textures, and colors that are getting rave reviews. More comprehensive, yet easier-to-use planning tools. And a simpler price list in the works. Changes that can be seen in every system Steelcase makes. Send today for more information.

*Circle No. 125*

**Stern Williams Co. Inc.** Specify Williams Corlow corner model service sink with stainless steel Splash Catcher® back panels, and protect the drywall against damage and deterioration.

*Circle No. 259*

**Sternberg Lanterns.** When you consider design options, authentic detailing, structural performance, illumination selections, Sternberg is the outstanding choice! Send for our catalog today.

*Circle No. 243*

**Stucco Stone Products.** With lightweight Cultured Stone® you can achieve the beauty of natural stone at a fraction of the cost.

*Circle No. 255*

**U.S. Aluminum.** United States Aluminum Corp. is now offering the Series SG 450 Structural Silicone Glazing Ribbon system engineered for low and high rise glazing projects.

*Circle No. 137*

**United States Gypsum Co., Durock.** Enduring beauty in stucco-looks or textures in a spectrum of creative colors. Do it all, once and for all with DUROCK™ Exterior Finish Systems.

*Circle No. 223*

**United Technologies.** Cool should whisper. We don't think you should hear it. It's just meant to be felt. Our Carrier subsidiary is a leading company in the building systems industry. Send today for more information.

*Circle No. 131*

**Vinyl Plastics.** Solid vinyl tile floor covering and vinyl and rubber wall base provide innovative answers to flooring needs. Send for our new catalogue.

*Circle No. 219*

---

# SAN DIEGO



# CIVIC CENTER

## • Design/Build Competition •

The City of San Diego announces the opportunity to design a new center of civic government that is the keystone of an overall redevelopment strategy for the creation of a vital and active downtown.

The project will include design and construction of approximately one million square feet of city offices and support facilities, public open space and structured parking. The Civic Center will meet the functional and technical requirements necessary for the effective execution of city government and services, and will be the symbolic center of civic government in the developing city center.

The Design/Build Competition process is comprised of the following phases:

- Phase I: Prequalification of Architects
- Phase II: Formation of Design/Build Teams
- Phase III: Design/Build Competition
- Phase IV: Contract Award
- Phase V: Implementation

The Project Prospectus and Submission Requirements for Architects interested in participating in Phase I of the Design/Build Competition process is available. The deadline Phase I Submissions is January 31, 1990.

Design/Build Teams will be selected through a separate Phase II Request for Qualifications that will be available for interested Teams on February 19, 1990. Design/Build Teams selected to compete in Phase III: Design/Build Competition will be paid an honorarium of \$100,000 upon submission of a proposal in accordance with Competition Regulations. All inquiries should be addressed to the following:

Donald J. Stastny, Professional Advisor  
San Diego Civic Center Design/Build Competition  
C/O Maureen A. Stapleton, Deputy City Manager  
City Administration Building  
202 "C" Street  
San Diego California 92101



**A**  
 AIA. new officers Je 32  
 Allen, Jack & Cottier. Sep 78  
 American Architecture Exhibit. Oct 28  
 American work abroad. Jan issue  
 Archer & Archer. Oct 62  
 Architects and society. Jy 50  
 Architects Collaborative. Nov 54  
 Architecture Bureau. Sep 82  
 Architecture, new American, 12th annual review. May issue  
 Arizona. Patriots Square Feb 20; Red Mountain Ranch Visitors Center Mar 82  
 Arkansas. Rison Villas Jy 58  
 Armenia. U.S. and Soviet architects' collaboration Oct 99  
 Asbestos. Feb 24  
 Astorino, L.D. Associates. Nov 99  
 Australia. Apple Computer headquarters Sep 78; Australian Parliament House at Canberra Jan 52; Overseas Passenger Terminal Sep 76; Sydney Opera House Sep 103  
 Austria. Landerbank Art Gallery Sep 87  
 Awards. AASA excellence in educational facilities Apr 34; ACSA excellence in education Mar 23; AIA gold medal Jan 17; AIA firm Feb 44; AIA honorary fellows Mar 36; AIA honorary members May 33; AIA Institute honors Mar 26; AIA 25 year May 28; American Wood Council Apr 32; Brick Institute of America Jy 28; Building Stone Institute Jy 28; Kemper Feb 18; Praemium Imperiale for architecture Nov 22; Pritzker prize May 23; R.S. Reynolds May 23; Whitney M. Young Feb 18;  
 Ayers Saint Gross. Feb 72

**B**  
 BRW Architects. Mar 107  
 Bacle, Nettie, and Masao Yamada. Aug 78  
 Baker, Josiah R. Oct 54  
 Banta/Collins. Oct 86  
 Barnes, Edward Larrabee. Feb 60, 64; Mar 40  
 Behnisch & Partners. Sep 72  
 Beigel, Florian. Sep 82  
 Bentz Thompson Rietow. Feb 74  
 Beyer Blinder Belle. May 166  
 Binder, Rebecca L. Feb 77  
 Blackwell, Marlon. Oct 76  
 Bodonyi, Csaba. Sep 68  
 Bohlin Powell Larkin Cywinski. Aug 76  
 Book reviews (signed). *The American Design Adventure: 1940-1975* Oct 44; *America's Aging: The Social and Built Environment in an Older Society* Jy 38; *Architectural Practice: A Critical Review* Feb 35; *Balkrishna Doshi: An Architecture for India* Sep 47; *The Battle of St. Barts: A Tale of the Material and the Spiritual* Nov 37; *Best Addresses: A Century of Washington's Distinguished Apartment Houses* Jy 44; *Bourgeois Utopias: The Rise and Fall of Suburbia* Aug 32; *Brat City or Debutante?* Jy 43; *British Piers* Feb 38; *Bruce Goff: Toward Absolute Architecture* Jan 33; *The City that Never Was* Jy 39; *Creativity and Contradiction: European Churches Since 1970* Feb 36; *Density by Design* Apr 51; *Design in Familiar Places: What Makes Home Environments Look Good* Mar 57; *Drawing Instruments 1580-1980* Aug 31; *Energy Design for Architects* Mar 54; *Florentine New Towns: Urban Design in the Late Middle Ages* Nov 160; *George Ranalli: Buildings and Projects* Je 40; *Housing for Elderly People: A Guide for Architects and Clients* Jy 37; *Imagining Tomorrow: History, Technology, and the American Future* Mar 53; *Jefferson and Monticello: The Biography of a Building* Apr 44; *Le Corbusier: The City of Refuge* Aug 32; *The Living City* Sep 49; *The Making of a Modern Japanese Architecture: 1868 to the Present* Apr 43; *The Nature of Frank Lloyd Wright* Feb 38; *Paris 1979-1989* Jan 34; *Parliament House Canberra: A Building for the Nation* Jan 34; *Pleasure Grounds: Andrew Jackson Downing and Montgomery Place* Feb 38; *The Rajput Places: The Development of an Architectural Style* Mar 57; *St. Bartholomew's Church* Nov. 37; *SITE* Oct 41; *The Skyward Trend of Thought: The Metaphysics of the American Skyscraper* Je 39; *The Spirit of H.H. Richardson on the Midland Prairies* Feb 36; *What It Feels Like to Be a Building* Mar 54  
 Building abroad. Jan 87  
 Buildings. failures May 180; skins Mar 66; odor Je 95; power Apr 101; standards research May 177  
 Burdeshaw, Ed. Je 80  
 Burgee/Johnson. Dec 60

**C**  
 CADD. Feb 107; Dec 95; 3D Sep 125; Oct 121; in restoration Nov 115  
 CBT/Childs Bertman Tseckares & Casendino. Feb 88; Nov 68  
 California. Ace Market Place Nov 58; artist's studio Oct 79; Central Housing Office Building, University of California, Irvine May 162; Disney Concert Hall Feb 17; Eats Restaurant Feb 77; Gersch residence Oct 74; Hollis Street Project Oct 89; house at Stinson Beach Oct 86; Maybeck house Jy 84; Monterey Design Conference Je 18; Pacific Design Center May 108; Propaganda Films studio Je 56; San Juan Capistrano Library, Dec 64; Thai

Bar-Be-Que restaurant Feb 76; Veverka-Kruse residence Oct 64; Windward Circle Nov 58  
 Canada. Canadian Centre for Architecture Jy 19; Sep 90; Robson Square Nov 64  
 Cannon. Mar 106  
 Carlhian, Jean Paul. Feb 18  
 Catalano, Eduardo. Nov 19  
 Centerbrook Architects. Feb 87; May 165  
 Chlorofluorocarbons. Mar 125  
 Chrestia, John, and Wellington and Patricia Reiter. Oct 58  
 Clark & Menefee Architects. May 148  
 Clearscapes. Oct 71  
 Climate consulting. May 189  
 Cohousing. Jy 64  
 Colombia. Caldas Institute, visitors settlement Sep 92  
 Color. relation to form Jy 105  
 Colorado. Lovins house Mar 100; vacation house Jy 72  
 Communications Arts Company. Oct 28  
 Components. AIA, awards. May 48  
 Computers. adapter and monitor combinations May 199; behavioral design Je 122; expanding uses Jan 109; use in teaching architecture Aug 91  
 Concrete. behavior Jan 99  
 Control systems. Mar 129  
 Convention, AIA. speakers Apr 41  
 Cook Douglass Farr. Jy 60  
 Cox, David. Je 80  
 Cramer, James P. Jan 18  
 Cromwell Architects Engineers. Mar 103  
 Custer, Betty Lou. Apr 81  
 Cutler, James. Jy 78  
 Czechoslovakia. monument in Dalesice Sep 86

**D**  
 Dean/Wolf Architects. Oct 79  
 Dethrick, Henley & Wilkerson. May 156  
 Design quality. Feb 87  
 Dow Howell Gilmore Associates. Aug 80  
 Druker Company. Nov 54

**E**  
 Education, architecture, Aug issue; symposium Feb 27  
 Educational facilities. Caldas Institute, Bucaramanga, Colombia Sep 92; Central Housing Office Building, University of California, Irvine May 162; Civil/Mineral Engineering Building, University of Minnesota Mar 109; Clemson University, Clemson, S.C. Aug 42; Desert View Elementary School, Sunland Park, N.M. May 139; Education Center, Beke, acute accents over both e's in Beke Hungary Sep 68; Entrepreneurship Development Institute, Ahmedabad, India Sep 88; faculty housing, University of California, Santa Barbara Oct 78; Haystack Mountain School of Crafts, Deer Isle, Me. Feb 60; Mississippi County Community College, Blytheville, Ark. Mar 103; Performing Arts Center, Cornell University, Ithaca, N.Y. Nov 46; Quitman Lower Elementary School, Quitman, Miss. Oct 62; Roger Williams College, Bristol, Vt. Aug 50; Trinity School, Atlanta May 112; University of Washington, Seattle, Wash. Aug 56; Virginia Polytechnic Institute and State University, Blacksburg, Va. Aug 62; Williamson Hall, University of Minnesota Mar 107;  
 Ehrlich, Steven. Nov 58  
 Eisenman Architects. Je 13  
 Energy conservation. Mar 100  
 England. Half Moon theater Sep 82  
 Erickson, Arthur. Nov 64  
 Esherick, Joseph. Jan 17; May 129

**F**  
 Facility management symposium Feb 24  
 Ferenc, Istvan. Sep 68  
 Finland. church complex Sep 58; Heureka Science Center Sep 59  
 Fire codes. Jy 114  
 Firm profiles. Feb issue; Dec 81  
 Florida. Fowler vacation house Aug 78; housing complex Oct 54;  
 Forbes, Peter. 135  
 Foreign investments. Jan 91  
 France. Bouygues world headquarters Jan 48; Grand Louvre pyramid Jan 42; Sep 62  
 Frankeberger, Robert R. Mar 82  
 Frasca, Robert. May 131  
 Freeman, Michael. Oct 85

**G**  
 Gebhard, David. May 130  
 Geddes, Robert. May 136  
 Geddes Brecher Qualls Cunningham. Nov 60  
 Gehry, Frank. Feb 17; May 23; Nov 69  
 Georgia. Butterfly Center, Callaway Gardens Mar 90; Clayton County Library May 158; Georgia Power corporate headquarters Mar 104; High Museum, Dec 50; NAHB model home Je 64; Trinity School May 112  
 Golda, Janos. Sep 70  
 Graves, Michael. Feb 22; Dec 64  
 Gund, Graham, and Adrian Smith (SOM/Chicago). Dec 76  
 Gwathmey Siegel & Associates. Je 74

**H**  
 Haines Lundberg Wachler. Mar 94  
 Halsband, Frances. May 133  
 Hammond Beeby & Babka. May 144  
 Hardy Holzman Pfeiffer Associates. Oct 24  
 Hartman-Cox. May 138; Dec 54  
 Heery & Heery. Mar 104  
 Heikkinen, Mikko. Sep 59  
 Heimstath, Clovis, Architects. Feb 78  
 Hellmuth, Obata & Kassabaum. Apr 83  
 Herbert/Lewis/Kruse/Blunck. Oct 72  
 Heroux, James. Oct 76  
 Hnedak Bobo Group. Nov 78  
 Holl, Steven. May 140  
 Hotz, Theo. May 23  
 House + House Architects. Oct 74  
 Housing, public. Dec 58  
 Hungary. Education Center Sep 68; Roman Catholic church in Vaja Sep 70; Bukkumlaut over u in Bukk National Park Sep 70

**I**  
 IBI Group/L. Paul Zajfen. Oct 78  
 Ibos, Jean-Marc. Sep 32  
 Illinois. Amoco Corporation Oct 26; Hansen house May 144  
 India. American Embassy Jan 76; Entrepreneurship Development Institute Sep 88  
 Indoor pollution. Mar 117  
 Interior acoustics. Mar 78  
 Interior design. title registration Jan 18; new guidelines Aug 20  
 Israel, Franklin D. Je 56  
 Ivy, Robert A. May 137

**J**  
 Jaffee, Norman. Dec XX  
 Japan. architects of the 1970s Sep 52  
 Johnson, E. Verner, & Associates Oct 84  
 Johnston, J.H. Eccleston. Feb 75  
 Jones, E. Fay, + Maurice Jennings Architects. Feb 88  
 Jones & Jones. Mar 86  
 Jova Daniels Busby. Mar 90  
 Jung/Brannen Associates. Je 50

**K**  
 Kallmann, McKinnell & Wood. May 92  
 Kaplan/McLaughlin/Diaz. Je 68  
 Kemp, Jack. Apr 29  
 Keyes Condon Florence. Nov 74  
 Koetter, Kim & Associates. May 156  
 Kohn Pedersen Fox. May 121  
 Komonen, Markku. Sep 59  
 Koonce, Norman L. Apr 38  
 Kopp, Michael. Jan 72  
 Kress Cox Associates. Nov 75

**L**  
 Laboratories. Mar 94  
 Lake/Flato Architects. Oct 71, 72  
 Lambert, Phyllis. Sep 90  
 Landscape architects. working with architects Sep 134  
 Lederer, Arno. Sep 84  
 Legorreta Arquitectos. May 100  
 Leiviska, Juha. Sep 58  
 Lewis, Edward Gardner. Apr 88  
 Liability. Feb 103  
 Libraries. Clayton County Library, Jonesboro, Ga. May 158; Folger Shakespeare Library, Washington, D.C. May 138; Free Public Library, Morristown, N.J. Oct 60; San Juan Capistrano Library, Dec 64  
 Licensing. AIA's revised resolution Je 32  
 Logan, Donn. May 132  
 Lord & Sargent. May 112  
 Louisiana. Arthur Roger Gallery Oct 58; Mer Rouge Villas Jy 58  
 Luyt-de Iong-Abels-Grasveld. Jan 60  
 Lym, Glenn Robert. Feb 76; May 132

**M**  
 Mackey, Eugene. Apr 78  
 Maine. Haystack Mountain School of Crafts Feb 60;  
 Maldonado, Rafael. Sep 92  
 Man, Lawrence K. Oct 84  
 Maryland. boat house Feb 72  
 Masonry and brick. Jan 103  
 Massachusetts. Audubon Court Nov 56; Bennett house addition and renovation Oct 80; Brigham and Women's Hospital Je 68; Charleston Navy Yard Rowhouses Jy 54; garden house and formal garden Oct 76; Heritage on the Garden Nov 54; Herman Miller Office Pavilion Je 50; Hub Club Nov 82; John B. Hynes Veterans Memorial Convention Center May 80;92; Martha's Vineyard residence May 140; Nantucket beach house Oct 82; rooftops Nov 68; 75 State St., Dec 76; Whitney Grove Square Nov 56  
 Massey & Veverka Architects. Oct 64  
 Maybeck, Bernard. Jy 84  
 McCue, George. Apr 77



# ORDER TODAY!

**New for 1989.** . . business planning, project administration, nursing home design, models of excellence. At the 1989 AIA Convention in St. Louis, these four seminars were standing-room-only. But, you can still benefit because all four were captured on videotape. You'll also find seventeen other valuable seminars on videotape—covering all important topics such as marketing, finance, and design. Order now and in a few weeks you'll be learning from the best and brightest in the profession!

All of these seminars were featured at AIA Conventions where the experts share their insights in 1½ to 2 hour seminars, experts like Stu Rose, AIA; David Haviland, AIA; Roger Pickar; John Eberhard, FAIA; Hugh Hochburg; Balthazar Korab; and, Weld Coxé, Hon. AIA.

Return the form below with your payment or call (202) 626-7345 to place your credit card order.

	<b>ORDER NO.</b>
<input type="checkbox"/> (NEW) Nursing Homes for the 90s	VD0891
<input type="checkbox"/> (NEW) Project Administration	VD0892
<input type="checkbox"/> (NEW) Models of Excellence	VD0893
<input type="checkbox"/> (NEW) Business Plans	VD0894
<input type="checkbox"/> Emerging Technologies	VD0881
<input type="checkbox"/> Emerging Markets	VD0882
<input type="checkbox"/> Facilities Management	VD0883
<input type="checkbox"/> Marketing: Madison Avenue View	VD0884
<input type="checkbox"/> 1988 Honor Awards	VD0885
<input type="checkbox"/> Staying Small Successfully	VD0886
<input type="checkbox"/> School Design	VD0887
<input type="checkbox"/> Competing	VD0871
<input type="checkbox"/> Revised Documents	VD0872
<input type="checkbox"/> Personal Financial Planning	VD0873
<input type="checkbox"/> Architectural Photography	VD0874
<input type="checkbox"/> Project Management	VD0875
<input type="checkbox"/> Client-Architect Forum	VD0876
<input type="checkbox"/> Security Issues	VD0877
<input type="checkbox"/> 1987 Honor Awards	VD0878
<input type="checkbox"/> Ownership Transition	VD0879
<input type="checkbox"/> Managing Profitability	VD08710

_____ x \$95 (AIA MEMBER COST)	= \$ _____
_____ x \$135 (NONMEMBER)	= \$ _____
In DC, add 6% sales tax	\$ _____
_____ x \$2.25 per tape shipping	= \$ _____
<b>TOTAL \$ _____</b>	

My check to AIA is enclosed.       VISA       MasterCard

ACCOUNT NO. \_\_\_\_\_ EXP. DATE \_\_\_\_\_

SIGNATURE \_\_\_\_\_

NAME \_\_\_\_\_ MEMBER NO. (See AIA Executive Card)

FIRM \_\_\_\_\_

ADDRESS \_\_\_\_\_

CITY \_\_\_\_\_ STATE \_\_\_\_\_ ZIP \_\_\_\_\_

TELEPHONE \_\_\_\_\_ FAX NUMBER \_\_\_\_\_

# AIA VIDEOTAPE



## The '80s from page 43

interest in Mies; Frank Lloyd Wright, who had never been eclipsed, received abundant attention; and Le Corbusier's centenary was broadly and respectfully celebrated. At least two disciples of Le Corbusier, Richard Meier and Charles Gwathmey, were among the decade's most respected designers.

The single most appreciated talent of the '80s was, arguably, the highly individual, downright quirky Frank Gehry of Los Angeles, whose sensibilities, again, were primarily modern. By 1989, Gehry had been awarded six AIA national honor awards, most accrued in the later years of the decade.

In fact, the decade opened with completion and publication of Gehry's own house in Santa Monica. Brash and startling at first glance, it was really a studied composition of restored and new construction. Oddly shaped and positioned openings in the new parts framed views of the existing structure, and there were ambiguous readings of interior-exterior relationships, colliding forms, and the use of crude materials—including chain link fence, which soon became Gehry's trademark. Architect

Robert Frasca regarded Gehry as "first and foremost a regionalist (some would say a microregionalist whose work thrives in areas with high levels of carbon monoxide)."

Gehry himself has suggested that his work is a commentary on Los Angeles as a banal environment with "bits and pieces of industrial buildings and freeways" and corrugated metal and stud framing. "I have just regurgitated it in another personal way." To *U.S. News and World Report*, Gehry spoke of the affinity of his work with Andy Warhol's soup can paintings, where the use of common cultural artifacts altered the way we looked at things. Gehry also said, "I want to be open-ended. There are no rules, no right or wrong." That could stand as the theme of the 1980s.

By the end of the decade, Gehry was collaborating on designs for mammoth downtown projects with Skidmore, Owings & Merrill, and his colliding, diagonal, asymmetrical, free-flying style had been given a name—deconstructivism. Philip Johnson inspired an exhibition of deconstructivist work at the Museum of Modern Art in the summer of 1988, which featured work by Gehry, Zaha Hadid, Peter Eisen-

man, Rem Koolhaas, Daniel Libeskind, Bernard Tschumi, and the Viennese firm Coop Himmelblau. Some thought it would be the most important such event since the 1932 International Style show. Mark Wigley, author of the catalogue, said of deconstructivism's importance, "Nothing has happened for so long, we are all desperate to talk about something. . . . I guess in a way the show marks the forgetting of postmodernism. . . . It's a very small exhibition with a very narrow agenda about a tight set of ideas."

Well, it was a little more than that. To the extent that it was valid as more than a mind game, deconstructivism posed a direct challenge to the cozy-comfy historicism of the '80s. In January of 1989, the two top annual *Progressive Architecture* design awards went to projects that could only be called deconstructivist. In November of 1989, the first large building by Peter Eisenman, the guru of deconstructivism, opened, and Eisenman had a number of other large commissions in progress that addressed postmodern concerns with history and context in new ways.

Further, in 1989 Frank Gehry was awarded the Pritzker International Architecture award, architecture's closest thing to a Nobel. In commendation the jury praised Gehry's "restless spirit that has made his buildings a unique expression of contemporary society and its ambivalent values."

The Pritzker's first winner, in 1979, was Philip Johnson. Taken together, the work and attitudes of the first and latest Pritzker winners embodied the prevailing design approaches of the '80s. (Premiated between '79 and '89 were Luis Barragán of Mexico '80, James Stirling of Great Britain '81, Kevin Roche '82, I.M. Pei '83, Richard Meier '84, Hans Hollein of Austria '85, Gottfried Böhm of West Germany '86, Kenzo Tange of Japan '87, and Gordon Bunshaft and Oscar Niemeyer of Brazil, both '88.)

Johnson, ever a weather vane for developing design trends, became a barometer of early- and mid-'80s sensibilities, with his wide-ranging eclecticism and historicism. Gehry, by contrast, in remaining aloof from movements and working in a mostly ahistorical, abstract idiom, represented attitudes gaining dominance at the decade's end. As different as these two architects were, however, they shared a view of architecture as first and last a fine art. The result has been a fertile decade that has embraced and refined a range of expression from literal historicism to minimalist architecture, from regionalism to corporate architecture, from organic architecture to high-tech.

Let us hope that

architecture dur

## Alberene Stone is Back!



DIMENSIONAL STONE CUT TO SIZE. FINISHES AVAILABLE ARE GANGED, DIAMOND SURFACE AND HONED. THICKNESSES AVAILABLE ARE 1 1/4", 2 1/2" AND 3 3/4". NATIONAL BUREAU OF STANDARDS RATE HARDNESS OF REGULAR GRADE AT (Ha) 4.50. ALBERENE SOAPSTONE CAN BE USED FOR FLOORING, WALLS, PATIOS, WALKWAYS, etc.

SWEETS CATALOG 0440 / NES Buyline 3133  
0440 / NES Buyline 0864

# TuliKivi



The New Alberene Stone Company, Inc.  
P.O. Box 300, Schuyler, Virginia 22969 USA  
tel: 804-831-2228 Fax # 804-831-2732

Circle 100

