

SEPTEMBER 1990 ■ SIX DOLLARS

ARCHITECTURE

INCORPORATING ARCHITECTURAL TECHNOLOGY

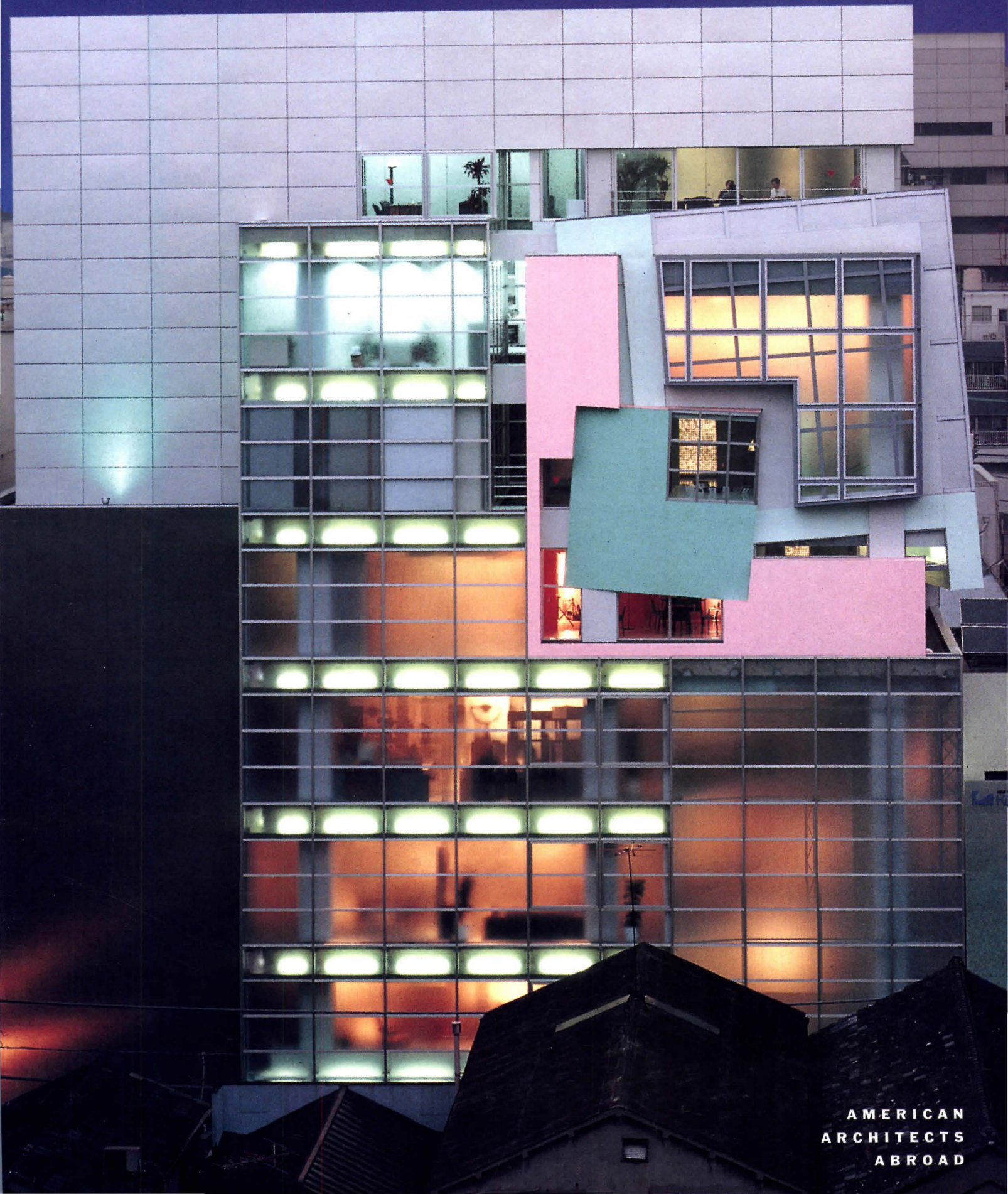

AMERICAN
ARCHITECTS
ABROAD



SUFFIELD™ FLOORS. VARIATIONS IN VINYL.

Multicolored accent chips provide coordinated design options.
Palette of 12 colors. Chemically bonded seams. Easy to clean.
For more information, call 1 800 233-3823 and ask for Vinyl Floors.

EDITOR'S PAGE

Design for Civil Rights

THE AMERICANS WITH DISABILITIES ACT (ADA) has been described as the most significant civil rights bill passed since the Civil Rights Act of 1964. Passed with overwhelming Congressional support and signed by President Bush in July, the new law outlaws discrimination in the workplace on the basis of disabilities. It requires that virtually all new commercial construction be "readily accessible and usable," requiring employers to alter present work sites to accommodate employees, visitors, customers, and clients with physical and mental handicaps.

It's obvious that architects will play a key role in implementing the new federal law. As AIA President Sylvester Damianos notes, "It is the architect who will translate the requirements of the ADA into buildings that are more serviceable, not only for people with disabilities, but for the general public as well." To its credit, the AIA played a significant role in developing the ADA legislation, initiating and shaping a number of provisions that should make the law more workable for architects, employers, and building owners. Those provisions include the treatment of historic properties, alterations to existing buildings, and the alignment of existing state and local building codes with the act.

As a civil rights act, the ADA is not a national building code. It will be enforced, as other civil rights laws are, by action of an aggrieved user, not by local building inspectors, unless a state or locality incorporates the ADA's requirements into its code. Currently, "readily achievable" removal of architectural barriers must be undertaken immediately; major renovation projects for which a permit was

not issued before enactment must comply with the disabilities act; and any new building opened 30 months after enactment must conform to the law. New and altered buildings must also meet new federal regulations, which will be released next July.

In complying with the new law, many architects won't have to start from scratch in designing barrier-free spaces; requirements for renovation and new construction in most states and localities are similar to those set forth by the ADA. In fact, in some states, such as Pennsylvania, laws governing handicapped accessibility in altered structures may be more stringent than the new federal regulations, and in such cases, the previously established laws will continue to apply.

As building owners search for ways to comply with the ADA, architects will be increasingly called upon for advice in devising new ways to design barrier-free spaces. Services related to the new law's requirement offer a potential source of work for the profession. The AIA, for example, is currently assembling a team in its practice division to offer expertise on compliance.

The ADA poses a new challenge for all architects to translate the intent of the law into more accessible buildings, not only for persons with disabilities, but for the rest of the public. Accessibility features must now be considered as natural to buildings as indoor plumbing, air conditioning, and sprinkler systems, not as a resented checklist of requirements to be tacked onto a design.

Congress and the President have done their job for 43 million Americans with disabilities. Now it's the architect's turn. ■

—DEBORAH K. DIETSCH



How prepainted Galvalume[™] sheet solved a top design problem.



When the Atlanta Board of REALTORS[®] wanted a new building, they didn't want yet another glass box clone. They wanted Classic-Style architecture. And the building had to make a statement. Stand out. Impress. But there were a few problems. Like the dome over the building's main entrance. How well could any material be made to fit the complex curvature? Could the owners get the color they wanted for the roof? And would the final design fit the building budget?

Logan Architectural Products Co., Inc., Atlanta, Ga., representative for AEP•SPAN, a division of Dallas Corporation, provided the solution: a prepainted Galvalume sheet standing seam roof. According to the roofing installer, it was easy to fit over the dome's complex shape. Plus, the owners were

able to select the patina green they wanted from a wide variety of available colors. Equally important, the project fit well within the building budget.

In short, prepainted Galvalume sheet more than satisfied the Board's expectations. In addition, they have a product with a proven track record for excellent, long-term corrosion resistance. Results of tough laboratory and atmospheric evaluations attest to this record. And they are comforted by the fact that because of this proven performance, the Galvalume sheet base material is backed by a 20 year warranty.

Prepainted Galvalume sheet is designed with the kind of flexibility that makes any job easier, more efficient. The variety of colors to choose from is as wide as your imagination. Which is important when



Water doesn't have to come in a bottle to be tasteful.

Now, there is a more fashionable way to have your water. Without ever needing a bottle opener again.

It's the Haws' Fashion Plates Collection, of course. Making it easier than ever for you to exhibit such fine taste. With a bounty of colors and designs. In our full line of drinking fountains and water coolers. Which are sure to add new sophistication to the notion of sipping water.

Water any other way will seem tasteless.

Haws

H₂O h h h h h h h.

LETTERS & EVENTS

NEA Debate

Thank you for your wonderful editor's page "In Support of the Arts." When any creative sector of our culture is in danger of being silenced, we are all affected. Though the vision and purpose of an artist or an architect may be challenged, when the line pertaining to freedom of expression and continued federal funding is crossed, it is only a matter of time until a vital part of our cultural essence will be brought to its demise.

*Maxinne Rhea Leighton
Beyer Blinder Belle Architects & Planners
New York, New York*

Thanks for the editorial on the National Endowment for the Arts. Hope it brings a storm of letters from architects. I am on the Texas Commission for the Arts in addition to AIA duties, and just want to say thanks.

*James D. Tittle, FAIA
Tittle Luther Partnership
Abilene, Texas*

The National Endowment for the Arts should not be continued for reasons much larger than the parochial ones you mentioned in your July editorial. The big picture is a complex world of powerful global players in which the United States has a major handicap—an inept national government, a government which has spent the country hopelessly in debt and which exhibits no clue of what to do and no will to address the really important issues facing the nation, starting with fiscal responsibility.

In simple terms, the federal government should get back to doing what the U.S. Constitution intended. Then maybe it could conduct its affairs in something resembling order and discipline. The destiny of the arts should lie with artists, sponsors, and the people at large, not politicians.

In a great, diversified, and generous nation like ours, there will be plenty of room and money for a variety of expression, as there was before the NEA came into existence. Almost every human activity prospers when government disengages itself. Let it happen to the arts.

*Robert W. Dorsey, AIA, FAIC
University of Cincinnati
Cincinnati, Ohio*

Midwest Lament

The issue of unconditional funding for the NEA is not whether the controversial art in question is permissible in our society, but rather whether it should be funded by taxpayer's money. To have my taxes pay for Mapplethorpe's homoerotic photos or Serrano's crucifix in a beaker of urine is an affront to the standards of propriety and the sensibilities of the great majority of Americans, and, it follows, the great cross section of AIA members.

When ARCHITECTURE was handed over to BPI Communications, I received notice from several colleagues that ARCHITECTURE would cease to be an accurate cross section of all American architectural thought, and would instead become a publication catering to the sensibilities of a few "trendy" and politically-liberal East Coast elites. After reading ARCHITECTURE's editorials, I conclude that the warnings of my disenfranchised colleagues may be correct and that we are witnessing the demise of a journal that represents a cross section of all American architecture and the rise of another New York microcosm of intellectual narcissism.

*David F. Schultz, AIA
David F. Schultz Associates, Ltd.
Barrington, Illinois*

Environmental action

The greatest joy in practicing architecture is to contribute to the built environment. The ability to create significant buildings is, in part, the selection of materials to accomplish that goal. As with any diminishing resource, natural materials are fast disappearing.

Since the construction industry is the primary user of redwood, and since it is often at the direction of architect-generated specifications that the use is decreed, I am asking that the AIA and the practicing architects in this country and the world immediately alter specifications to eliminate the use of virgin redwood. It is imperative that this position be taken promptly.

Fellow architects, please help save these splendid redwood trees so that generations to come can enjoy this uniquely American natural wonder.

*Gilbert D. Cooke, AIA
Cooke + Associates Architecture
Baltimore, Maryland*

September 14-November 3: Two exhibitions at Columbia University, New York City: "Emerging Japanese Architects of the 1990s" at Wallach Art Gallery, and "The History of History in American Schools of Architecture, 1865-1975" at Buell Hall.

September 25: AIA professional development workshop "Project Administration" in Dearborn, Michigan. Contact: Brenda Henderson (202) 626-7353.

September 26-28: The University of Wisconsin-Milwaukee offers a "Material Handling Analysis" program. Contact: Roger Hirons (414) 227-3100.

October 4-6: The Chicago Academy of Sciences sponsors the "Sustainable Cities Symposium," including a lecture by William H. Whyte. Contact: Carolyn Bresler (312) 943-7058.

October 4-7: "Interiors and International Markets: Challenge for the '90s," a conference of the AIA Interiors Committee in London. Contact: Christopher Gribbs, AIA (202) 626-7453.

October 5-9: The midyear meeting of the Associated General Contractors of America in Reno, Nevada. Contact: Judy Short, AGCA (202) 393-2040.

October 10-13: "Crosscurrents" during Designer's Saturday in New York City at the IDCNY. Contact: Alexia Lalli, IDCNY (718) 937-7474 or Linda Foa, Designer's Saturday (212) 826-3155.

October 18-21: SpecFair '90, at Moscone Center, San Francisco. Contact: Cindy Noldy (612) 222-2508.

October 27-30: American Society of Landscape Architects annual meeting in San Diego. Contact: (202) 686-2752.

October 28-31: International Facility Management Association conference "A Decade of Leadership" in Baltimore. Contact: IFMA (713) 623-4362.

October 30-31: "Future/Build 2000: The Globalization of Intelligent Buildings" conference in New York City. Contact: Intelligent Buildings Institute (202) 457-1988.

November 15: Deadline for entries for American Academy in Rome Fellowships. Contact: American Academy in Rome (212) 517-4200.

NEWS

AMERICAN DESIGNS FOR EASTERN EUROPE, SOVIET UNION, AND JAPAN

Interior Design Legislation Passed in Two States

THE STATE LEGISLATURES OF NEW YORK and Illinois respectively reached agreements in June on title registration of interior designers. Both bills meet the spirit and intent of the AIA national accord, and will not alter or dilute the practices of architecture or engineering.

The New York bill designates that specific non-loadbearing interior construction remains the responsibility of the architect and engineer. The New York State Association of Architects (NYSAA) and the Interior Designers for Legislation in New York (IDLNY) agreed to common language defining the services of certified interior designers. The bill, signed by Governor Mario

Cuomo on August 1, should go into effect in June, 1991. It contains two different definitions of interior construction: one for interior designers and another for architects and engineers. The bill stipulates that architectural/engineering interior construction is defined as "related to building systems, including any structural, electrical, plumbing, heating, ventilating, air-conditioning, or mechanical system." This reflects the architects' position that full-height partitions define or interrupt ventilation, air-conditioning, sprinkler systems, etc., and that features such as

fire-protected corridors, shaft walls, ceilings, and equipment connected to the structure are further examples of non-loadbearing interior construction that clearly impact structural stability. Thus, the New York bill places the entire responsibility of the building's safety in the hands of the architect and engineer.

The language for interior construction by interior designers is stated as "not materially related to or materially affecting the building systems," reflecting their contention that elements such as shelving, caseworks, and cabinets permanently attached to a building are within the scope of their work. Low partitions or walls also fall into this category. A further aspect of the New York bill is the

statement that drawings produced by a certified interior designer "cannot be construed as those required for submission to the building department." This strengthens the prohibition against the practice of "rubber stamping" (applying an architect's or engineer's seal to the work of others without adequate input on the part of the professional). Addressing the impact of the bill, Randall Croxton, AIA, an NYSAA board member and past president of the NYC/AIA, says, "The bill reflects the strongly held view of New York architects that there is a significant body of work in the area of non-loadbearing interior construction which architects and engineers are uniquely qualified to address."

The Illinois General Assembly passed its title registration of interior designers after a year of negotiations between the Illinois Council of the AIA (ICAIA) and the Illinois Interior Designers Council (IIDC). The bill is expected to be signed by Governor James Thompson in September and to take effect July 1, 1991. The ICAIA withdrew its initial opposition to the bill after substantive amendments changed the legislation from a practice act to a measure restricting the use of the title "interior designer" (i.e., title registration), deletion of a corporate practice section, and other changes to bring the proposal in line with the national accord. In Illinois, interior designers "qualified by education, experience, and examination may offer professional services for any interior design project of non-loadbearing structural elements within and surrounding interior spaces of buildings." This applies only insofar as the projects are exempt from the Illinois Architecture, Professional Engineers, and Structural Engineers' Practice Acts of 1989, which continue to restrict the provision of services related to the professions. As defined by the bill, interior design services exclude mechanical and electrical systems, except for specifications of fixtures and their location within interior spaces.

—A.G.L.

GORDON BUNSHAFT DIES



GEORGE TAMES

**Pritzker Prize winner
Gordon Bunshaft
is remembered for his
skyscraper legacy.**

PAGE 35

A I A B R I E F S

Last year, the AIA's International Relations Committee took a serious look at the growing practice of American architecture abroad and decided to reassess its existing program, realizing that the Institute needed to assume a stronger leadership role. The closed committee will open its doors to new membership and will focus on the global marketplace and international practice. The inaugural meeting will be held November 9-11 in Honolulu.

The decision to increase committee membership is viewed by the Institute as a way of establishing better communication with countries where recent accords on professionalism have been signed, such as Canada, Japan, and the Soviet Union. "Whether or not they are actively engaged in operating in the international marketplace, our members are in competition with international firms because the United States is the largest contiguous market in the world for architects," says resident fellow James Scheeler, FAIA, long active in the AIA's international programs.

The first meeting will establish the committee's priorities and issues affecting individual practitioners and government policy. The committee works closely with the International Union of Architects (UIA), and plans are under way for the AIA to host the 1993 UIA World Congress in Chicago, June 18-21, in conjunction with the AIA convention and Neocon. It is anticipated that the event will produce the largest gathering of architects in the world, according to Scheeler.

The International Relations Committee is chaired by former AIA president Donald Hackl, FAIA. John A. DiNardo, AIA group vice president and general counsel, is responsible for AIA's international programs along with newly hired program director Dena Sollins. Monica Williams assumes the position of assistant program director. For additional information call Ms. Williams, (202) 626-7311.

DETAILS

London is not the only city in the British Isles subject to American redevelopment. In Glasgow, Scotland, Kohn Pedersen Fox is working on a mixed-use project in the Broomielaw district, a former industrial center.

Angeli/Graham Architects of Los Angeles won first prize in a European competition for a new town center near Zurich, Switzerland. The project includes a train station, post office, farmer's market, restaurants, offices, and housing. Gwathmey Siegel & Associates is designing a 10,000-square-foot house in a suburb of Zurich.

Hugh Jacobsen has three houses under construction on the European continent—two adjacent houses on a hillside in Athens and a house in the Netherlands.

Latvian-born Gunnar Birkerts was selected to design the proposed Latvian National Library in Riga, one of the first projects in the Baltic States region of the U.S.S.R. to be awarded to an American architect.

Antoine Predock, Rem Koolhaas, and Roland Simounet were named finalists in a two-stage international competition for the development of the Palm Bay seafont and convention center in Agadir, Morocco. His Majesty Hassan II, King of Morocco, will select the winner later this fall.

Although it is not as hot a marketplace as Europe, American architects are nonetheless active in the Indian subcontinent. Payette Associates, a firm that completed the Aga Khan University Medical College in Karachi, Pakistan, in 1985, is working on a 2-million-square-foot Armed Forces Medical City in Rawalpindi, Pakistan.

Within our hemisphere, Florida-based Spillis Candela & Partners is working on a number of projects, including the Central American Bank for Economic Development in Tegucigalpa, Honduras, and an 800-acre new town resort in Belize. In South America, RTKL Associates has a host of projects under way, with six mixed-use and shopping complexes in São Paulo, Brazil, alone.

Eastern European Projects Proceed Cautiously

SEVERAL PROJECTS BY AMERICAN ARCHITECTS—a tower in Warsaw, Poland, hotels in Budapest, Hungary, and housing in Belgrade, Yugoslavia—are part of the first wave of new construction in Eastern Europe. The fact that developers are courting American firms may appear promising to Westerners hoping for work in the newest free markets, especially since the region's recent architecture has been woefully inadequate and poorly constructed. But reports from the three Americans indicate that others should proceed with caution.

Emery Roth & Sons, New York, is competing to design two hotels in Budapest and has completed working drawings for the Hotel Gresham, a 204-room complex in a Beaux-Arts office building built at the turn of the century. Emery Roth considered investing in a Hungarian architectural firm as a base for these projects, but abandoned the deal when it became unclear whether that firm owned its office space. As in other Eastern European nations, expatriate heads of businesses nationalized by the Communists in the 1940s are returning to stake their claims. "It's not at all clear what you're buying" Chairman Richard Roth, Jr., cautions would-be investors in Hungarian ventures, adding that the "most important thing you can own is space."

When it is completed in 1994, William McDonough's Warsaw Trade Center will be the tallest building in Eastern Europe at 70 stories. In an unusual trade-off, McDonough, a New York architect known for his environmental awareness, has offered to plant 10 square miles of forest somewhere in Poland to compensate for the global warming produced by the skyscraper's construction. McDonough is also involved in designing a hotel in Krakow and housing for a nationwide program, but he says that dismantling the Communist bureaucracy has created another

type of property dispute. In Warsaw, borough presidents are vying with the city government for control of building sites, and "things will take a very long time" as the economy and power structure work their way toward stability.

Recalling Berlin's IBA of the 1980s and the Weissenhof settlement in Stuttgart in 1927 (which united the talents of Mies,

Behrens, Gropius, and Poelzig), Belgrade, Yugoslavia, has invited architects from eight different countries to design housing for its Triennial of World Architecture, to be held June 6-10, 1991. The participants are Justus Dahlinden of Switzerland, Aleksandar Djokić of Yugoslavia, Richard England of Malta, Klaus Kada of Austria, Kisho Kurokawa of Japan, Imre Makovecz of Hungary, Paolo Portoghesi of Italy, and Stanley Tigerman of the U.S. Tigerman's project features two ground-floor units of two bedrooms each, followed by four one-bedroom apartments on floors two through five. He says the international project's consortium of private developers and government agencies is keeping it on schedule, but he is less sanguine about Belgrade's technological expertise: "We send them a lot of faxes and they don't respond."

Although Eastern Europe may appear to be a goldmine, architects should be wary. Leopold Boeckl, vice president of Boeckl-Gates, a Washington, D.C., firm involved in hotel projects in the Soviet Union, says he was contacted by the Czech minister of tourism, but "when we called back, the minister had changed." Economists point out that profits are a virtue of purchasing power, not population. While Eastern Europe's 130 million people may be eager for Western businesses, they may as yet be too poor, their debts too high, and their governments too unstable to afford the construction to house them. —H.L.

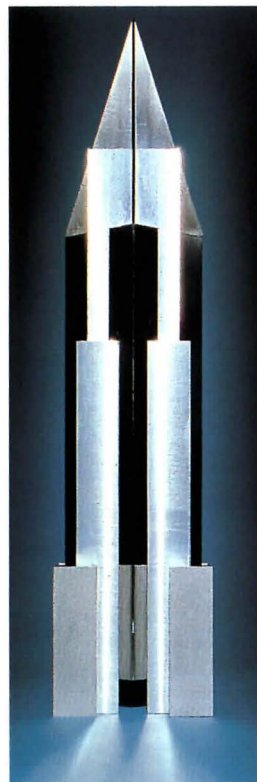

If William McDonough has his way, his Warsaw Trade Center (above) will use recycled glass and aluminum, and its windows will open. The apartment building by Chicago architect Stanley Tigerman (below) will be located five kilometers from the center of Belgrade.





nels, recesses, and corbels are easier to
omplish. That translates into greater
ign flexibility and increased curb appeal.
That's not all. In many markets concrete
ick is less expensive than clay brick.
ontact your nearest member of the
tional Concrete Masonry Associa-
n or send back the
ached coupon for
ore information.



 **NATIONAL
CONCRETE MASONRY
ASSOCIATION**
Horse Pen Road, P.O. Box 781 Herndon, Virginia 22070-0781
Phone (703) 435-4900 FAX (703) 435-9480

Marketing Department
National Concrete Masonry Association
2302 Horse Pen Road, P.O. Box 781
Herndon, Virginia 22070

I'm interested in more information
on the benefits of concrete brick.

Name _____

Title _____

Address _____

City _____

State _____ Zip _____

Telephone _____

AR CBK990

AIA's 20/20 Vision

THE AIA'S REGIONAL & URBAN DESIGN Committee and the Regional/Urban Design Assistance Team task group launched a growth management program in July called 20/20 Vision for America. Director Christopher R. Clark, AIA, explains that 20/20 is an outgrowth of the Vision 2000 program, created to help communities envisage their future growth and its effects.

Clark says the founding committees felt city planning and urban design have taken different paths for too many years, with planning focused on social and economic

concerns, and design addressing only the physical form of communities. The 20/20 program is an effort to bring the two into congruence. Targeting design and planning professionals, community leaders, local developers, and the general public, 20/20 programs will bring national and local experts together in six regional workshops conducted over the next three years around the country. In a process similar to R/UDAT's, sites will be chosen for their growth and development potential, and the workshops will concentrate on identifying local develop-

ment concerns. A national resource book is being developed for workshop participants which will include the results of regional chapters' workshops.

The kick-off meeting for 20/20 is scheduled for October 4-6 in Los Angeles, and will be held in conjunction with a Regional Urban Design Committee session and a meeting of the Los Angeles chapter AIA. Should the program take off in 1991 as expected, regular workshops will be held around the country separate from the Urban Design Committee meetings. —A.G.L.

95%* of architects who use glass block specify

PITTSBURGH CORNING

PC GLASSBLOCK®

PRODUCTS

Because their most important criteria are ours, too!

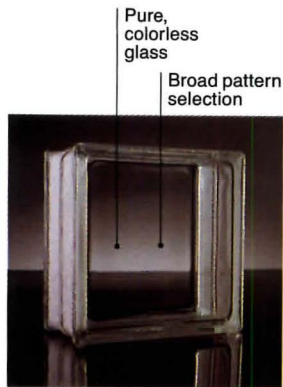

Pure, colorless glass

Broad pattern selection

VUE® Pattern



Liberty Center, Troy, MI • Architect: Rosetti Associates
VUE® and ESSEX® AA Patterns

- **Quality.** Hints of color are often present in some foreign block made with recycled glass or low quality sand. American-made PC GlassBlock® units are always crystal clear because they're pure glass made with only low-iron sand. And, each block is visually inspected at least once before shipment.
- **Selection.** Patterns providing maximum visibility and light... to extreme privacy with reduced light transmission. Products from corner, end-finishing and paving block... to solar reflective, solid, and custom block.
- **Installation.** Options—including traditional mortar or metal frame grid systems—enhance design and application possibilities. Or, consider... our new KWIK'N EZ Silicone System — it's mortar-free and provides an all-glass look. Add the expert assistance of Pittsburgh Corning representatives and our technical services staff, and construction excellence is virtually assured.

Be sure to ask about our new PC GlassBlock® Products Electronic CADalog™. It contains complete design

specifications and detail drawings for mortared applications.

- **Availability.** Thanks to a domestic plant totally dedicated to glass block and an international network of distributors, prompt, on-time deliveries will keep your projects on schedule.

To get all these advantages plus competitive prices, specify PC GlassBlock® products.

For information, call the PC GlassBlock® Products Hotline, Monday through Friday from 8 a.m. to 4:30 p.m. Eastern Time.

800-992-5769

Or contact Pittsburgh Corning Corporation, Marketing Department AGB-90, 800 Presque Isle Drive, Pittsburgh, PA 15239; Tel: (412) 327-6100; or visit the PC GlassBlock® Design Center in the Atlanta Decorative Arts Center. In Canada, 55 Renfrew Drive, Unit 205, Markham, Ontario L3R 8H3; Tel: (416) 222-8084.



*Independent study results available upon request.
© 1990 Pittsburgh Corning Corporation

Los Angeles R/UDAT

LOS ANGELES MAYOR TOM BRADLEY INVITED the local chapter of the AIA to conduct a R/UDAT for the Beverly-Fairfax/Miracle Mile Community. Located midway between downtown and Santa Monica, the site is one of the city's most densely populated areas, comprising shopping districts, residential neighborhoods, the LaBrea tar pits, Farmer's Market, and the Miracle Mile segment of Wilshire Boulevard.

With the help of local design assistance teams (DATs), the chapter issued a report aimed at altering the community's perception of how future urban sites should be developed in the community. The task force urged less commercial development and emphasized the need for more subsidized housing, a senior center, and public parks to serve the area's elderly residents, who constitute approximately 30 percent of the district. Other suggestions include linking open spaces to encourage more pedestrian use, restricting traffic, and retaining historic buildings. Developers for the Farmer's Market originally proposed another 2 million square feet of mixed-use development, but the report's findings warned that "the impact of a shopping center would so severely degrade the character of the area that the proposal must be restructured."

L.A. Urban Design Committee chairman and associate AIA member Marc Futterman says that although the report wasn't part of a regulated city planning process, it is generating serious discussion within the mayor's office and with the city planning board. "The LA/AIA is beginning to have a voice in shaping public policy issues through these DATs," says Futterman. "The mayor's office realized we could visualize the entire scale of an urban plan in a dense area that has been developed piecemeal." —A.G.L.

NEWS

Bunshaft Remembered

GORDON BUNSHAFT, WHOSE DESIGN for Lever House in New York City revolutionized corporate architecture, died in his Manhattan home on August 6. He was 81.

Having joined Skidmore, Owings & Merrill in 1937, after completing his training at MIT, Bunshaft was a partner by the time Lever House was completed in 1952. The building is widely recognized to have launched a new stage in American skyscraper design. Influenced by the International Style, Lever House's thin curtain wall of stainless steel and glass was a harbinger of the glass office towers that were to dominate Modern American architecture.

Although not New York's first glass building (Harrison and Abramovitz's U.N. building preceded it), Lever House was the city's first glass commercial structure, and the first to unite Modern architecture with a thriving corporation (the client was Lever Brothers, manufacturers of household cleaning products). Bunshaft's gift, says a senior SOM partner, "was to take Modern architecture and make it part of the vernacular."

Lever House also symbolized its era, as corporate America emerged in the prosperous decades following World War II, and it paved the way for other significant New York office towers: Mies van der Rohe's Seagram Building in 1954, Bunshaft's own Pepsi-Cola Headquarters (1959), and his Union Carbide building (1961).

When Lever House was awarded the AIA's 25-year Award in 1980, Bunshaft admitted that in 1952 he "knew very little about building an office building," and added, "there must have been a damned good job captain somewhere." Such candor was characteristic of the architect's style, and he was known for his iconoclastic vision. His collaborations with the sculptor Isamu Noguchi on such projects as Yale's Beinecke Library in New Haven and Chase Manhattan Plaza in New York were unusual vehicles for design in the 1950s and '60s.

Bunshaft's later buildings, including the Lyndon Baines Johnson Library in Austin, Texas and the Hirshhorn Museum and Sculpture Garden in Washington, D.C., embody the traditional Modern principles to which the architect aspired. He retired from SOM in 1979 and was awarded the Pritzker Prize in 1988.

—H.L.



EZRA STOLLER/ESTO

Although only 24 stories high, Gordon Bunshaft's Lever House in New York City (above) opened a new era of skyscraper design. The building is protected by the New York City Landmarks Preservation Commission.

Announcing a "New" Architectural Graphic Standards for the 1990s

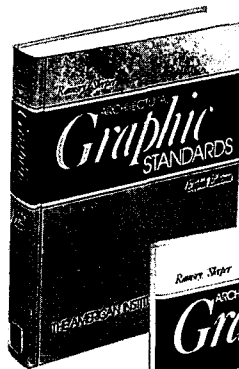

Ramsey & Sleeper's ARCHITECTURAL GRAPHIC STANDARDS 8th Edition

"Just as Vitruvius gives us an understanding of the vocabulary of Renaissance architects, so *Architectural Graphic Standards* will show the future the dizzying speed and expanding horizons of architectural developments and practice in our time."

—Eero Saarinen, on the Fifth Edition

Essential is a claim frequently made for reference books. But very few live up to the billing quite like *Graphic Standards*. If there is one essential book in architectural design and building construction, it's *Graphic Standards*.

No other source provides so much useful data in so easy and convenient a format as *Graphic Standards*. Here are building standards and practices, materials and assemblies, details and specifications. Data is presented graphically in plan/section/elevation, projected or perspective views.

NEW UPDATE SERVICE

Beginning in 1991, *Graphic Standards* will be kept up-to-date through periodic supplementation -- a new service to keep your reference current and to provide even more specialized information, keeping you on the leading edge of your profession.

Already own *Graphic Standards*? You can sign up for the Update Service by checking the appropriate box below.

EXAMINE FREE FOR 30 DAYS!



Clip and mail to:
John Wiley & Sons, Inc.
Att: L. Lee, Dept. 1-0170
605 Third Avenue, NY NY 10158
TOLL-FREE: 1-800-526-5368

Yes! Please send me the Eighth Edition of *Architectural Graphic Standards*, (1-81148-3) at \$160 per copy to examine and use FREE for 30 days. I'll either keep the book and send my check for the purchase price (plus a small charge for postage & handling and local sales tax), or return it within the 30-day examination period and owe nothing. I understand that my reference will be kept current with periodic supplements, related volumes, and future editions sent to me on approval.

Yes! I am a current owner of *Graphic Standards* and would like to receive supplementation. I understand that my reference will be kept current with periodic supplements, related volumes, and future editions sent to me on approval.

Bill me _____ Bill my Firm. PO # _____ Payment enclosed _____
(Prepaid orders shipped postpaid)

Charge to my: _____ Master Card _____ VISA _____ AMEX

Card # _____ Exp. Date _____

Signature _____

Name _____

Firm _____

Address _____

City/State/Zip _____



6 years, 36 months of darkness,

45 snowstorms, 500 inches of snow,

92,000 cups of coffee (24,000 creams),

two polar bears,

one Raynor™ Tri-Core™ Door,

one Raynor Distributor.

RAYNOR GARAGE DOORS

You can't imagine what a garage door goes through over the years. But you don't have to when you specify a Raynor Tri-Core Door, because the only thing more reliable than a Raynor Door is a Raynor Distributor. To locate the one nearest you, call 1-800-545-0455.

Circle 38 on information card

Built in the U.S.S.R.

AS MORE AMERICAN CORPORATIONS open trade with the Soviet Union, the demand grows for housing and office buildings that meet U.S. standards. In one of the first collaborative housing ventures between the U.S. and Soviet Union, Senie Kerschner International Housing of Westport, Connecticut, and the Soviet farm collective Zavet Ilyicha teamed up to build Rosinka, a new 528-unit residential community in a northwestern suburb of Moscow.

Located on an 80-acre site overlooking a lake, the design by Zane Yost & Associates of Bridgeport, Connecticut, will include recreational facilities, shops, restaurants, a

Zane Yost clustered the Rosinka complex (below) into four "villages," each comprising 132 apartment units which range in size from two-bedroom flats to four-bedroom townhouses.

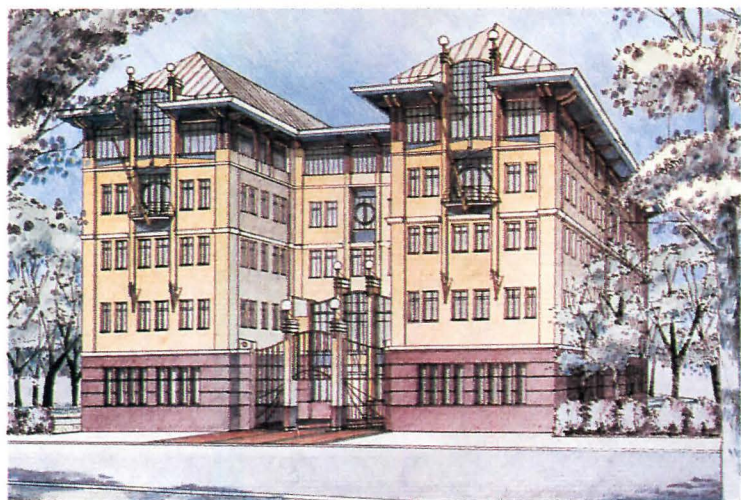

day-care facility, and a conference center. Eighty percent of the units will be leased to foreign companies for hard currency, while 20 percent will be rented for rubles to Soviet citizens associated with foreign firms. Construction is scheduled to begin this fall, with the first apartments completed next year.

In the first wave of capitalist real estate development in downtown Moscow, the Boston-based architecture firm Steffian Bradley Associates is converting an existing apartment building into a commercial office space. The structure, to be known as Borodinskaya Centre, will provide quality interiors for Western corporations in Moscow. —L.N.

Steffian Bradley Associates added two top floors to an existing three-story apartment building (above) to create a 50,000-square-foot "Class A" office building in Moscow.

Design On Peachtree.

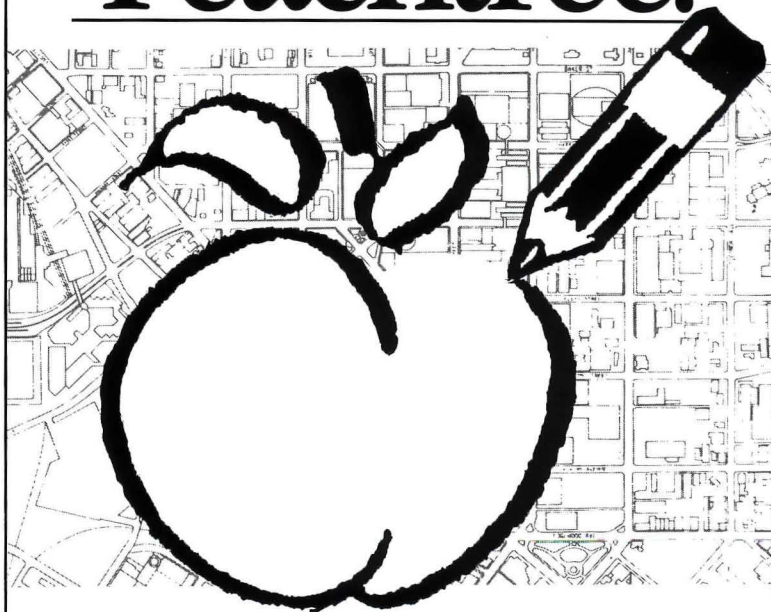

THE CITY OF ATLANTA, GEORGIA
AND
CENTRAL ATLANTA PROGRESS, INC.

ARE PLEASED TO ANNOUNCE AN INTERNATIONAL
TWO-STAGE DESIGN COMPETITION
TO GENERATE DESIGN PROPOSALS FOR
PEACHTREE STREET

THE FINALISTS OF THE FIRST STAGE WILL SHARE
\$100,000 IN CASH PRIZES
AND THE WINNER OF THE SECOND STAGE WILL BE AWARDED A
DESIGN COMMISSION

The Peachtree Street Design Competition is a two-stage competition. Stage 1 is open to all architects, urban designers, landscape architects, planners, engineers and related designers. Registrations with the fee of US\$80 must be postmarked no later than **Wednesday, October 31, 1990**. Checks, money orders or bank drafts must be made payable, in US dollars, to: Peachtree Street Design Competition, and sent to:

Peachtree Street Design Competition
c/o Central Atlanta Progress, Inc.
Grand Lobby, The Hurt Building
50 Hurt Plaza
Atlanta, Georgia USA 30303

First stage submissions, limited to three boards, will be due December 21, 1990. The first stage jury will be conducted during the week of January 13, 1991, and the winners of the first stage will be contacted by January 17, 1991. All requests for further information should be sent to the address above, or telephone 404/658-1877.



THE CITY OF ATLANTA



Central Atlanta Progress, Inc.

WE MAKE WINDOWS WHERE MONEY'S NO OBJECT.



Our best panel ideas good designers.



We're not ashamed to admit it.

Our engineers got the idea for our Alveus™ panels and curtain walls from somewhere else.

They took it from nature.

The honeycomb core in a beehive is a masterpiece of engineering and art. It can support 25 times its weight in spite of its ultra thin shell.

Which is just what we were looking for.

So inside Alveus panel products you'll find a rigid aluminum honeycomb core. Making them lightweight, yet still able to maintain exceptionally high strength-to-weight ratios.

It also gives you surfaces with absolute flatness.

And lets you curve them into almost any configuration you want. From rounded corners to column covers.

So when you need a smooth surface design that blends with glass to create an uninterrupted flush, monolithic surface, look for Alveus panel and curtain wall.

The ones with the honeycomb core. After all, four-hundred million bees can't be wrong.

For complete architectural design specifications, contact Kawneer Company, Inc., Department C, Technology Park - Atlanta, 555 Guthridge Court, Norcross, GA 30092.

Kawneer
Panel Products

Circle 44 on information card

Proposals for a Changing Berlin

ONE OF THE FIRST SECTIONS OF THE Berlin Wall to be demolished revealed a scorched patch of earth that was once Potsdamer Platz, one of Europe's busiest squares. Crossed daily by millions, the plaza was the gateway to the inner city and the hub of its public transportation network. As Berlin grew from city to metropolis around the turn of the century, Potsdamer Platz came to epitomize the modern urban center. Culminating with Erich Mendelsohn's Columbus House (1932), a striking Modernist composition razed in 1959, Potsdamer Platz became a silent document of the early Modern era. The revitalization of this historically important strip of Berlin's inner city presents one of the coming decade's challenging architectural scenarios.

Although German politics must stabilize before decisions can be made, several designs that may define future discussion have surfaced. *Tempo*, a trendy Berlin magazine, invited the Santa Monica-based firm Morphosis, New York-based architect Daniel Libeskind, and Vienna's Coop Himmelblau to submit

proposals for Potsdamer Platz. The resultant visionary designs, though utopian and impractical, have provided impetus for the developing debate.

Morphosis conceived the new Potsdamer Platz as a marked departure from the traditional urban blocks of Berlin's 1980s International Bauausstellung (IBA). The architects envision an oasis of urban green, carved out to reveal the city's historical layers. Rather than seeking to reconstruct "Old Berlin," Morphosis partners Thom Mayne and Michael Rotondi propose a vision of an open city center that makes amenities out of today's scars.

Coop Himmelblau's proposal is a marked contrast to Morphosis's sensitive transformation. The Vienna firm divorces its architecture from the past and strives to create new forms that express the state of contemporary society. The resultant array of prismatic towers oriented around a slanted glass atrium seem poised as if ready to blast off to some distant star. This scheme creates a fitting neighbor for Hans Scharoun's nearby 1960s

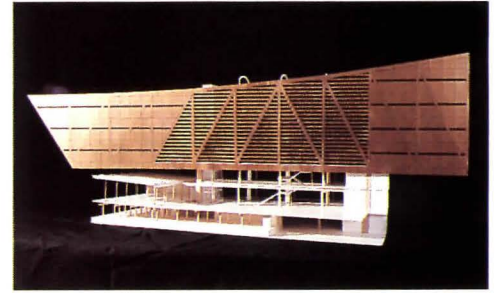

New York architect Karen van Lengen was commissioned to design a 100,000-square-foot addition to the American Memorial Library in Berlin (elevation above, and site plan below), following a three-phase competition.

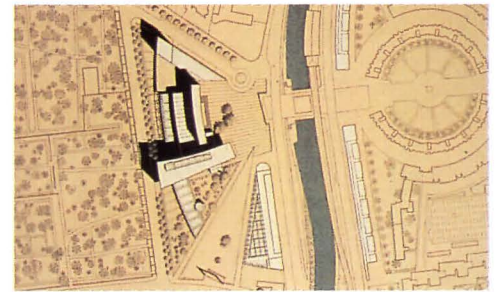

Baron Von Riechoven's bank to the right turned out to be the long way around...

NEWS



Morphosis's design for the Potsdamer Platz (above) seeks to open up the square as a green space. Coop Himmelblau's geometric composition of towers (below) draws on the square's Modernist past.

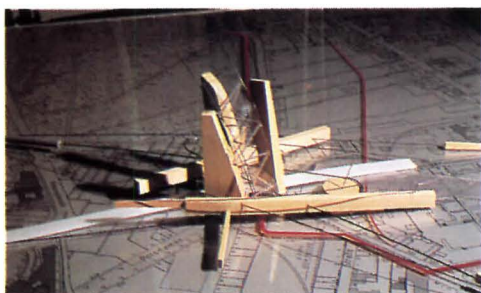

Expressionist "Kulturforum," comprising Philharmonic Hall and the State Library. For better or for worse, the history-negating spirit of Modernism is one of the prime generators of the dynamic energy inherent in Coop Himmelblau's work.

Daniel Libeskind is no stranger to Berlin. "City-Edge," his impossibly expensive IBA housing project, was the focus of much animated debate. His proposal for Potsdamer Platz may be an ironic statement about the future awaiting Berlin's inner city. He proposes four paper-thin towers, their facades serving as over-dimensional projection screens in the sky. At ground level, rectangular and circular slabs form a series of loosely connected urban spaces. While perhaps a valid response to the amount of rental office space Berlin may soon require, this project seems ultimately better suited to Libeskind's New York than to the real scale needed in Berlin.

Josef Paul Kleihues, until 1987 the influential director of the IBA, is critical of these proposals. He envisions a clearly enclosed

traditional urban square that acts as the gate to the adjacent octagon of Leipziger Platz and the city center beyond. Avoiding the superficiality of the recent utopian designs, Kleihues's proposal envisions a synthesis of the traditional urban plan with the needs of today's city.

Whether Berlin's future will be dominated by commercial, ecological, or governmental concerns is as yet unclear, but a period of growth seems inevitable. A few blocks away from Potsdamer Platz in Berlin's Kreuzberg section, New York architect Karen van Lengen's addition to the American Memorial Library is already poised for construction. The world's financial institutions seek to reestablish operations in Berlin, and many Germans favor returning its status as a capital. The opportunity now facing the city is to accommodate these various interests with sensible growth.

—CASEY C.M. MATHEWSON

Casey C.M. Mathewson is an architectural writer living in Berlin.

Sometimes, shortcuts have drawbacks.

Taking shortcuts is something you don't want to do when bringing your designs to life.

Which is why you should consider Olympic. You never have to compromise.

You get the lasting protection that only comes from pure linseed oil. And since our colors are true and consistent, they'll always match your expectations.

With Olympic, your projects will turn out as beautifully as you envisioned.



There's just no way around it.

Circle 46 on information card

Divisional Restructuring

Amended June 5, 1989



Divisional Restructuring

Amended June 5, 1989



Mall Development

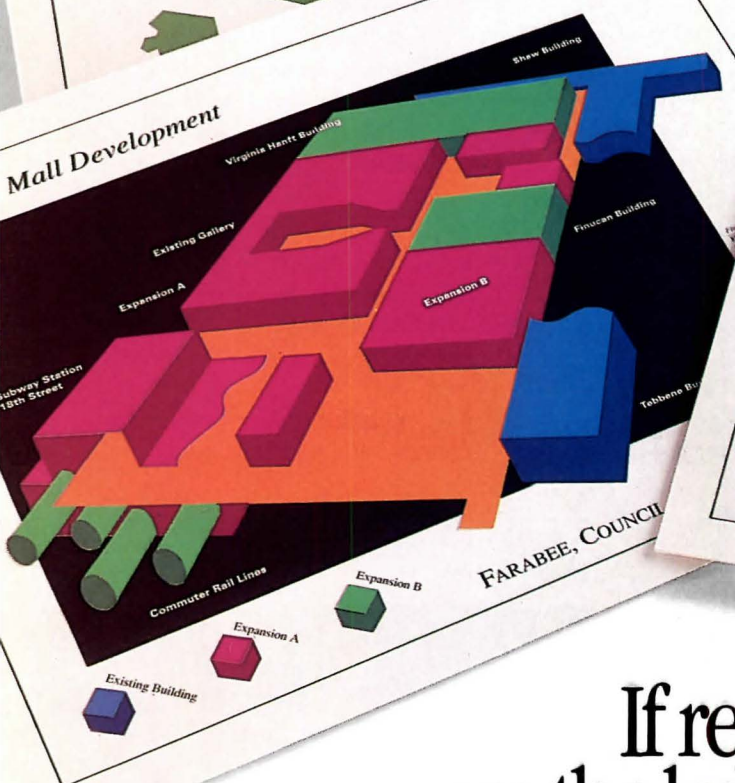

FARABEE, COUNCIL

First City Bank of New York

Loan Portfolio
in billions, average daily basis

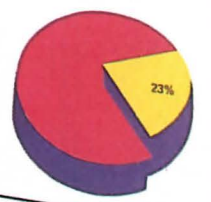
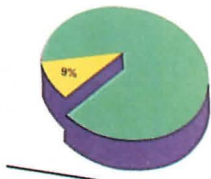
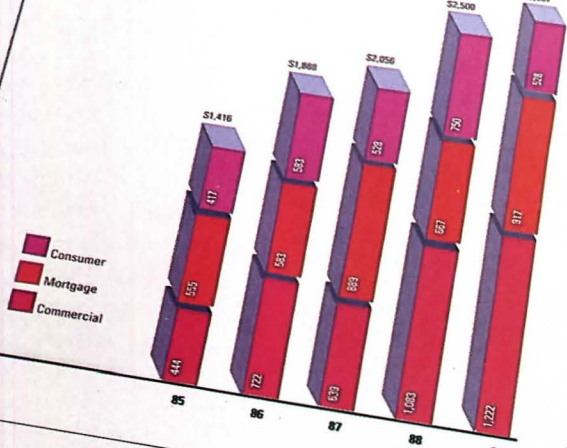

If renderings are the language of your business, how about a color copier that speaks it fluently?

Mastering the nuances of presentation graphics is what the FP-C1 digital color copier does best. It brings color, in all its persuasiveness, to your presentations, proposals, be they documents or overheads. With the optional digital editing board, the FP-C1 becomes a creative assistant. Helping you re-size, re-proportion, even re-color graphs and charts. At 5 full-color copies per minute. And, because there are times when color simply isn't an issue, the FP-C1 is quite comfortable running off



black and whites at a steady 30 copies per minute. Mastering the FP-C1 is so simple, everyone can use it. It requires no dedicated operator. So it goes wherever it's needed.

The Panasonic FP-C1. Color...at your service in the office. For more information, call toll-free 1-800-447-4700.

Copiers, Computers, Printers, Peripherals, Typewriters and Facsimiles.
Panasonic
Office Automation *OA*

CIV-ARC

Circle 48 on information card

NEWS



While viewing the exhibition, President François Mitterrand (below) explained the details of his involvement with each of the 11 *Grands Projets*. Encompassing 7,000 square feet, the show was mounted on a prefabricated exhibition system (left) designed by English architect Mike Dowd, who worked with Piano & Rogers on the Pompidou Center in Paris.



Paris, Texas

DURING THE INTERNATIONAL ECONOMIC summit held in Houston in mid-July, French President François Mitterrand visited the University of Houston to accept an honorary degree and a distinguished professorship of architecture.

In addition, Mitterrand toured the College of Architecture's exhibition "Architectures Capitales à Paris," which traces the French government's ten-year building program of 11 new and renovated public facilities, known as the *Grands Projets*. The major exhibition comprises photographs, models, and drawings of eight completed buildings: Le Musée d'Orsay, Arab Institute, Louvre addition, La Defense, Ministry of Finance, Bastille Opera, and Parc de la Villette and neighboring Center for Music and the Science and Industry Museum. Three future projects were also displayed: International Conference Center, Museum of Natural History, and the French National Library. All the projects were either initiated by or completed during the administration of Mitterrand, who was elected President in 1981.

During his tour of the exhibition, Mitterrand addressed both the form of the different buildings and the impact of the projects on the surrounding neighborhoods. He praised the Louvre and the Arab Institute for their "elegance and imagination" but criticized the opera house for the proportions of its columns and the presence of "too many conflicting elevational themes." (The Bastille Opera was designed by Carlos Ott, a Cana-

dian.) In explaining his administration's goal of revitalizing the entire city, Mitterrand pointed out that important new buildings are located in unfashionable neighborhoods as well as in the traditional heart of Paris.

The exhibition was on display from July 6 to August 16 on the third floor of the university's five-year-old College of Architecture building, Philip Johnson's variation on 18th-century French architect Claude Nicholas Ledoux's "house of education." Three concurrent exhibitions included a display of photographs by Richard Payne of historic monuments in Paris; a computer-generated video animation of Houston, directed by associate architecture professor Elizabeth Bollinger; and a collection of student work.

At the opening of the exhibition, UH architecture professor Thomas Colbert also noted that President Mitterrand is "the only head of state of our time to take a serious interest in architecture and the design of our cities...proving that a program of sensitive and eloquent Modern architecture appropriate to our time is possible." In hopes of bringing this philosophy to Washington, D.C., the American Institute of Architects has invited Mitterrand to speak at the AIA's next Accent on Architecture, which will be held in February, 1991. ■

—L.N.

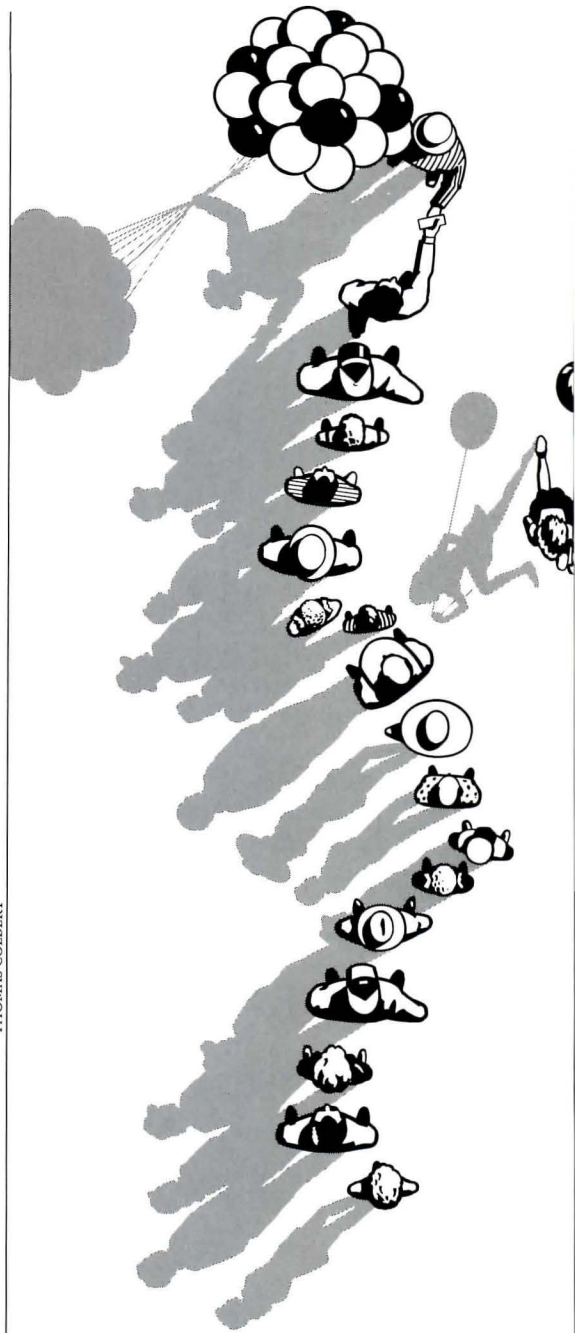

**"Bradley
Accu-Zone™
Washfountains
work so well the
only place we don't
have lines is in
the washroom."**

*David A. Douglas, Design Coordinator
Milwaukee Summerfest Grounds*

Bradley
CORPORATION

We get the job done better.

Box 309, Menomonee Falls, WI 53051 (414) 251-6000
©1990 Bradley Corporation

Circle 54 on information card

Koh-I-Noor plotter supplies provide a full range of products to meet the needs of all plotter applications, including business and technical graphics. You can choose the pens and the media which will give you the best possible hard copy.

Since Koh-I-Noor is a leading supplier to many of the major plotter manufacturers, the pens are designed to function properly on most plotters on the market today. Products are available for Hewlett Packard, Calcomp, Houston Instrument, and many other plotter types.

The Koh-I-Noor plotter supplies offering includes:

DPP® — the *original* disposable liquid-ink pen, designed for the highest quality performance for technical and business presentation plots. Available with a prefilled ink cartridge in black and up to ten colors, six DPP® styles are available in up to five line widths for either paper/vellum or drafting film.

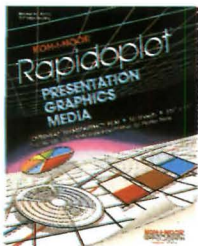

Presentation Graphics Media — 8½ x 11 sheet sizes available in matte chart paper, premium glossy paper and overhead transparency film.

Plotter Inks — formulated for specific plotting applications.



KOH-I-NOOR Rapidograph® PLOTTER SUPPLIES



Refillable Liquid-Ink Pen — offers the greatest versatility, with types for drafting film or paper/vellum in ten precision line widths, and six inks to choose from to meet almost any plotting application.

Fiber-Tip Pen — with a universal ink for paper and overhead transparencies, in ten colors and two line widths. Koh-I-Noor Fiber-Tips provide the highest quality output for business presentation graphics and are economical for use on check plots.

Rapidograph® Presentation Graphics Media — provides outstanding results on matte chart paper, premium glossy paper and overhead transparency film.

For further information and a **FREE** Rapidograph® Plotter Supplies catalog, send in the coupon. Or, call our Plotter Customer Service Department toll free at 800-631-7646. From N.J., collect 201-479-4124. In Canada, 800-268-4961.

Yes Koh-I-Noor. Tell me more. Send your *free* Rapidograph Plotter Supplies catalog.

NAME _____

TITLE _____

FIRM _____

PLOTTER MAKE _____ MODEL _____

ADDRESS _____

CITY _____ STATE _____ ZIP _____ A-9-90

Koh-I-Noor Rapidograph, Inc. 100 North St., Bloomsbury, NJ 08804
In Canada: 1815 Meyerside Dr., Mississauga, Ont. L5T 1G3

KOH-I-NOOR
RAPIDOGRAPH®
a **rotring** company

©1989 Koh-I-Noor Rapidograph, Inc.
All rights reserved.

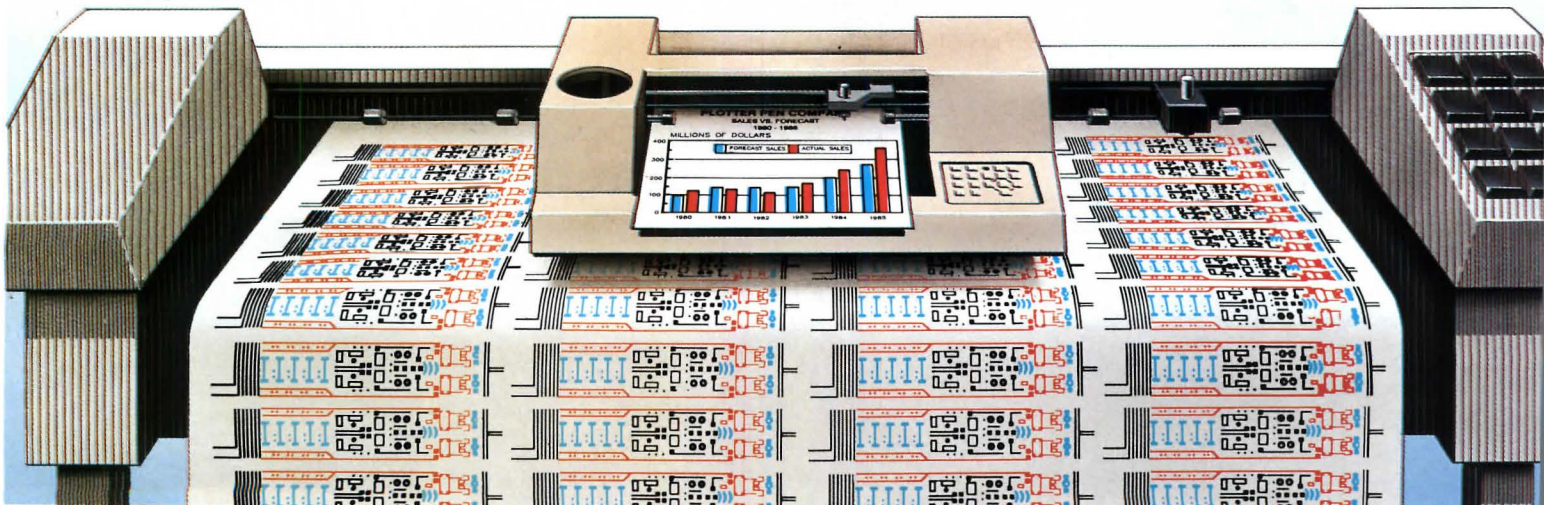

Circle 56 on information card

ON THE BOARDS

Designed to a Tee

JAPANESE GOLFERS TAKE THE ARCHITECTURE of the golf clubhouse as seriously as they do the game. Although Japan sports the highest land prices on the globe, this island nation is experiencing a boom in golf course construction—and American architects are the designers of choice for the lavish country clubs that accompany them. Yet judging by this sampling of American-designed facilities in various stages of development and construction, there is not one preferred stylistic design approach. Each of these very different schemes, however, reflects the strong Japanese tradition of respect for nature and attempts to create an appropriate setting for the competitive game of golf. Drawing inspiration literally from the game, Morphosis says its design is about “movement, the rhythm of walking, the arc of an arm in full swing, the nature and sequence of physical spaces, and the narrative and diversity of place.” ■



Royal Ichikai Golf Club
North of Tokyo, Japan
Michael Graves, Architect

Currently in design development, the Royal Ichikai's 100,000-square-foot complex houses a clubhouse, a 50-room hotel, and dining facilities. Graves clad the exterior in marble and arranged interior public spaces to encourage social interaction.



Karuizawa Golf Club
Tokyo, Japan
RTKL Associates

An 18-hole golf course will serve as the centerpiece of the new Karuizawa resort community west of Tokyo. RTKL Associates is preparing the conceptual designs for a 50-room hotel, recreational facilities, and golf clubhouse, which will span a man-made lake.

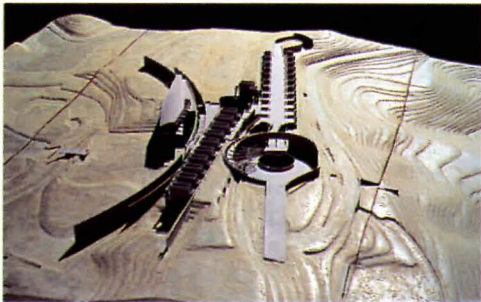

Chiba Golf Club
Chiba, Japan
Morphosis

The Chiba building is made up of four elements: a curved wall that embraces a forecourt; a linear sequence of alternating volumes; a second circular wall that directs movement to the grounds; and a pavilion housing dining and social functions.

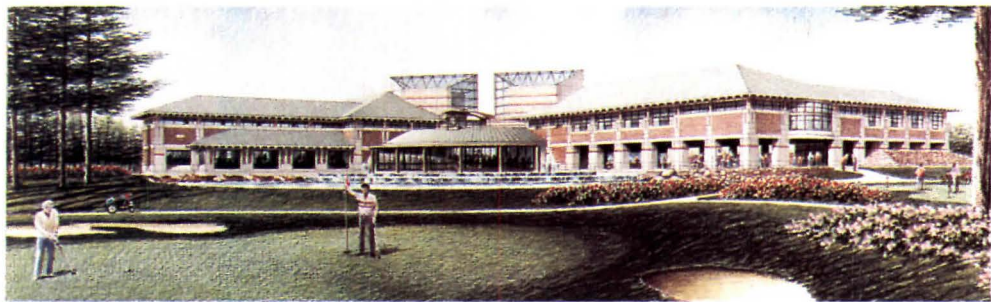

Eniwa Clubhouse
Hokkaido, Japan
The Stubbins Associates

Stubbins alternated buildings and enclosed courtyards to pull a landscaped garden into the center of the facility, while simultaneously projecting a dining hall and terrace onto the golf course. Two glass-enclosed towers mark the intersection of the corners.

*"The SUPERIOR
Glass Block
Alternative"*

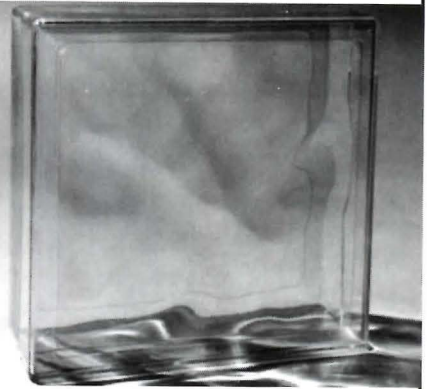

GUARDIAN BLOCK®

GUARDIAN BLOCK® is an impact and ultraviolet resistant acrylic block. It is a superior alternative for all glass block applications.

GUARDIAN BLOCK® is so practical, it can be assembled off-site by unskilled labor, resulting in substantial savings.

- 100 times stronger than glass
- 87% lighter than glass
- impact & abrasion resistant
- will not yellow or fade
- no special tools required for installation
- comes in various colors
- saves time and money

For more information, write or fax:

GUARDIAN BLOCK®
1101 Penn Avenue
Dept. A990
Jeannette, PA 15644-2038

Fax # **412-527-5643**
Or call: **412-527-6160**
(Mr. Pete Moore)

Monogram. A way to avoid some of the complexities that can occur when you build a custom kitchen.



No matter how many times you may have done it before, constructing a kitchen is rarely an entirely smooth process.

Particularly when it comes to selecting the built-in appliances.

At first sight, it might seem

quite logical to specify a refrigerator from one company, a dishwasher from another, and an oven and a cooktop from yet two more.

But anyone who has ever ended up talking to *four* different

people about such important matters as specifications and delivery dates, may well prefer a simpler approach.

Monogram.

It's a complete *line* of built-in appliances.

Which includes the only built-in refrigerator with an electronic monitoring system and dispenser. (It also offers ice and water *through* the door.)

A 5-burner gas cooktop with an exceptionally efficient *retractable* downdraft venting system.

A double oven that possesses the dual blessings of both European good looks and American capacity.

And 10 other innovative appliances.

But, attractive though these products may be, the primary virtue of the Monogram™ line is the fact that it *is* a line.

Which means you only have to deal with *one* company to order it, get it delivered, and have it serviced.

A company that goes just a little further when it comes to service.

Who else offers anything as helpful as the GE Answer Center® service? (Just call 800-626-2000 any hour of the day or night.)

Who else backs their products with such an extensive network of factory service professionals?

No one else.

Only GE.



Monogram.™

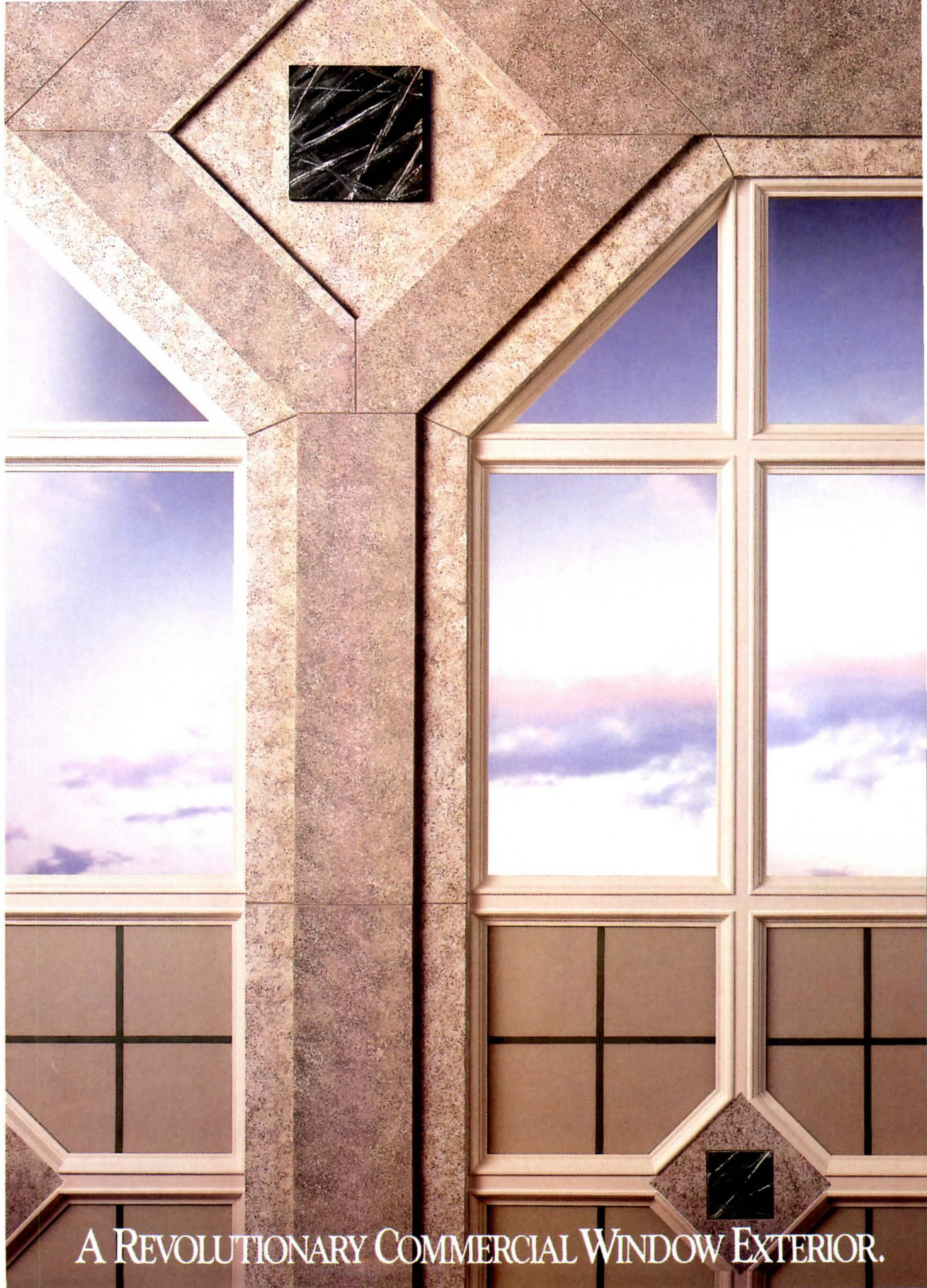

A REVOLUTIONARY COMMERCIAL WINDOW EXTERIOR.

To really appreciate a custom-made Andersen® Flexiframe® window, you have to look at its design potential inside and out.

The exterior is made from a material with a good deal more character than cold aluminum. *It's a glass-fiber-enhanced*

polymer version of our Perma-Shield® System. This polymer is so strong and corrosion-resistant, it's used along the seacoasts as a substitute for steel girders.

On the inside, Flexiframe windows offer another revolutionary material for

commercial windows: rich, warm wood. It gives office interiors a feeling you simply can't get with cold aluminum.

And since Flexiframe windows are custom-made, you even have your choice of almost any glazing option you'd like.

ABOUT THIS ISSUE

American Architects Abroad

A DECADE AGO, ONLY A HANDFUL OF PIONEERING American architects were working abroad on projects in Europe and Japan. Between 1988 and 1989, however, American practitioners reported increasing their foreign billings by 247 percent, from \$17 million to \$59 million. Today, as our economy enters a recession, many more U.S. firms are discovering strong, overseas construction markets that signal more prosperous times.

Firms in the vanguard of this movement have been taking advantage of the affluent Thatcher years, securing commissions in London's new generation of development in the city's easternmost section. The skyline once dominated by St. Paul's Cathedral will soon be punctuated by towers designed by Skidmore, Owings & Merrill, Cesar Pelli & Associates, and Swanke Hayden Connell. For many of these firms, the United Kingdom is a springboard to other European nations, where American know-how is contributing to commercial and mixed-use complexes in cities from Dublin to Lisbon. Architects with good business sense will want to follow the forecast as Europe approaches the integrated market of 1992, and as German reunification carries construction eastward.

American firms have arrived in Japan more recently, but that nation's bullish economy, coupled with cries of unfair trading practices from the West, have encouraged Japanese developers to seek the best in American architectural talent. Many leading U.S. firms have designed housing and office

towers for Japan's last frontier—reclaimed land in major port cities—and other U.S.-designed developments will soon house some of Japan's most successful corporations.

Invited by a Japanese developer, Michael Graves, Stanley Tigerman, and other American architects have designed prototypical housing on urban landfill on the island of Kyushu. An aquarium by Cambridge Seven in Osaka encapsulates the Pacific basin and its rim, and, in Tokyo, an office building/penthouse complex by Robert A.M. Stern Architects marries Western sensibilities with Eastern needs. Exploring the Japanese knack for taking design risks, we examine Peter Eisenman's unusual collaboration with Kojiro Kitayama. The double building designed by the American and Japanese defies the corporate headquarters stereotype.

To provide insight into how U.S. firms are actually coping with foreign markets, we asked eight American principals for tips on working abroad; we also let British architects vent some steam about the U.S. "invasion" of London. A detailed look at the structural-steel artistry of Exchange House, SOM's office complex straddling London's Liverpool Street Station, reveals American engineering and design expertise. We conclude this issue by examining innovative ways of improving long-distance and interoffice communications through computer networks and affordable videoconferencing technology. ■



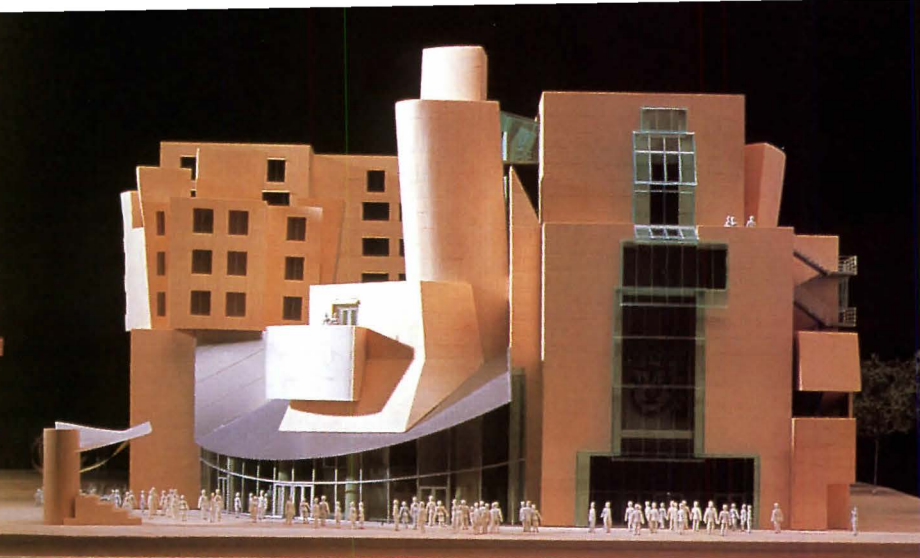

Administrative and Maritime Center
Antwerp, Belgium
Richard Meier & Partners

Meier's mixed-use project of offices, hotel, shops, and restaurants (below) is part of a major public/private redevelopment scheme within Antwerp's waterfront area. In addition to creating the master plan for the 1.2-million-square-foot site, Meier is working on a 16-story headquarters for a major Belgian shipping corporation. Circular in plan, the tower will be clad in glass and white metal panels. Construction is scheduled to begin early next year.

J. SCOTT SMITH

American Center
Paris, France
Frank O. Gehry & Associates

Scheduled to open in 1992, Frank Gehry's 175,000-square-foot cultural center (above) will house the American Center, a nonprofit institution founded in 1941 to assist emerging artists. The \$40-million structure will be located on the southeastern bank of the Seine in a redeveloped cultural district, which will include L'Opéra Bastille, the Ministère des Finances, and the Bibliothèque de France. Facing the entrance to Bercy Park, Gehry's complex is broken into two separate masses, one for the programs of the American Center—galleries, theaters, studios, and a restaurant—and the other for a complex of 27 apartments for visiting artists.

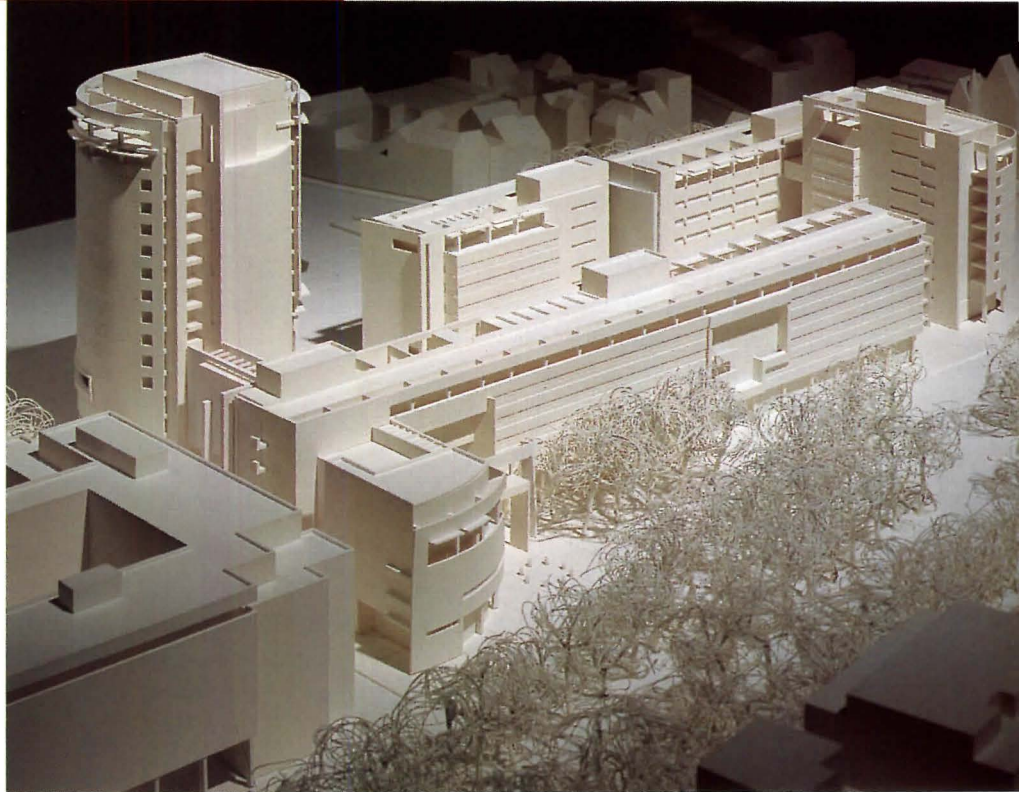

JOCK POITTE/ESTO

European Forecast

BY ANDREA OPPENHEIMER DEAN

AS THE ECONOMIC SUPREMACY OF THE UNITED STATES wanes and architects face a weak construction climate at home, Europe is reshaping itself into a powerful economic giant—a potentially rich source of new work for American architects. In the grip of the "Eurosclerosis" of the 1980s, European economies grew a scant 2 percent, well below Japan's 4.2 percent and America's 2.8 percent during the boom years of the Reagan era. Predictions for the 1990s, by contrast, forecast that Europe's economic growth will be 3 to 5 percent.

Three momentous events have interacted to decalcify and renew Europe: the decision to create a single European market in 1992, the reunification of Germany, and the breakup of Eastern Europe

into sovereign, predominantly pro-Western, democratic nations.

For U.S. architects, entering the European market in 1992 will mean facing an entity composed of 12 nations: Belgium, Denmark, France, Germany, Greece, Ireland, Italy, Luxembourg, the Netherlands, Portugal, Spain, and the United Kingdom. As evidence of Europe's increasing power, Turkey and Austria have applied for associate European Community (EC) membership; Norway, Sweden, Cyprus, and Malta are debating whether to join; and several former Soviet satellites, most notably Hungary and Poland, are also expected to apply soon.

In its present configuration, the EC will constitute an increasingly barrier-free construction market worth \$330 billion, or 25



Messe Frankfurt Complex
Frankfurt, Germany
Murphy/Jahn Architects

In the heart of Frankfurt, a major expansion (right) of the city's existing exhibition complex is composed of an office tower, ceremonial entrance pavilion, and a 750,000-square-foot exhibit hall. Designed to resemble a campanile within a composition of low buildings, Helmut Jahn's freestanding, 825-foot-high tower will be Europe's tallest building when completed later this year. The building is constructed in concrete and finished with polished red granite columns detailed with a striped pattern and profiled with aluminum bands at every floor. The circular entry pavilion (left in model), recently completed, is crowned with a glass pyramid and houses a restaurant and ticketing and registration facilities for the complex.



Mainzer Landstrasse 58
Frankfurt, Germany
Kohn Pedersen Fox

Currently under construction, KPF's complex (right) contains a commercial office tower, a low-rise office building, below-grade parking for 600 cars, and 14 apartments located around a central winter garden. To minimize its impact on the adjacent residential neighborhood, the 648,000-square-foot tower was placed on one side of the site, respecting the existing street wall and with low-rise structures arranged around its mass. Rising from a granite and marble base, the reflective glass and painted steel tower is topped with a two-story loggia and a cantilevered, curving crown.

JOCK POTTLE/PESTO



Housing Tower
Groningen, Netherlands
John Hejduk

To be built under the auspices of the city housing authority, John Hejduk's complex (right) comprises a 16-story apartment building, a clock tower, and a small freestanding residence. Overlooking a canal that runs through Groningen, the tower will border an existing public square in the city's historic quarters. The brick and metal tower, with a floorplate measuring approximately 30 by 40 feet, will feature one large, loft-style apartment per floor. A duplex studio unit with a large skylight will be located on the top floor. The project is to begin construction next year.



Novoli Multi-Use Center
Florence, Italy
Gunnar Birkerts & Associates

Located within the 70-acre site of a former Fiat manufacturing facility, Birkerts's mixed-use project (below) is part of a major redevelopment master plan, developed through a workshop led by landscape architect Lawrence Halprin. The 850,000-square-foot building is designed with clustered masses and inter-connecting pedestrian pathways to reduce its apparent bulk. The development will focus on a public park at its center surrounded by projects by 13 other architects, including Aldo Rossi and Richard Rogers.

Custom House Docks
Dublin, Ireland
Benjamin Thompson & Associates

Based on the firm's winning entry in an international competition, BTA's master plan for a 23-acre waterfront site (bottom) incorporates shops, offices, and housing within the city's historic fabric. The first phase, scheduled for completion in 1993, includes a 300,000-square-foot office building intended to bring four major corporate headquarters to Dublin's center city. The second phase will provide a 6,000-seat arena, a marina and maritime museum, and a major public park.

percent of the world construction market. By last year, in anticipation of the dismantling of trade barriers, Europe had become the most profitable overseas architectural market, and the most lucrative foreign market for Fortune-500-company clients. Between 1987 and 1988, total design billings in Europe tripled; U.S. A/E firm billings rose 28 percent from 1988 to 1989.

Most designers approach the new EC 1992 with caution. "You have to analyze your firm and make sure you have special skills and abilities to sell. Don't be lured by a gold rush mentality," counsels Harold Adams, FAIA, chairman of RTKL, a firm with projects in Amsterdam, Frankfurt, Lisbon, London, and several cities in France and Scotland. Robert Cooke, president of Perkins & Will International, which has work in the United Kingdom and the Netherlands, adds, "This league is mainly for the larger firms. The yellow lights are flashing all along the way for the weaker ones."

European clients look to American firms for prestigious design and managerial ability, and familiarity with large, mixed-use buildings. With land scarcer and pricier and rents higher than in the U.S., some developers gamble that a design by a renowned American architect will enhance a building's value and sell office space. European governments and institutions, meanwhile, appear more interested in, and willing to pay for, distinguished design than are their U.S. counterparts, as evidenced by the widespread use of competitions to select architects. Richard Meier, for instance, has been commissioned to design 18 buildings in nine of the 12 EC countries.

Since most European architecture practices are small, offer few services, and are inexperienced with high-rise design, European clients are receptive to U.S. firms that can manage all phases of design and are familiar with large-scale, complex, and fast-track construction. But, as David Syphard, senior vice president of Houston-based CRSS, Inc. points out, while EC 1992 will give American firms access to a larger market and further economies of scale in the beginning, the American advantage is likely to recede as European firms tool up to compete.

Many American firms entered the European market by following U.S. clients to London during its recent construction boom, and are using the British capital as a springboard to the rest of the continent. Some have opened European offices, others have formed joint ventures with local architects. Virtually all Americans working in Europe stress that success requires making long-term financial commitments. Eugene Kohn of Kohn Pedersen Fox warns that his firm spent \$1.3 million opening a London office. RTKL's Adams points out that "most

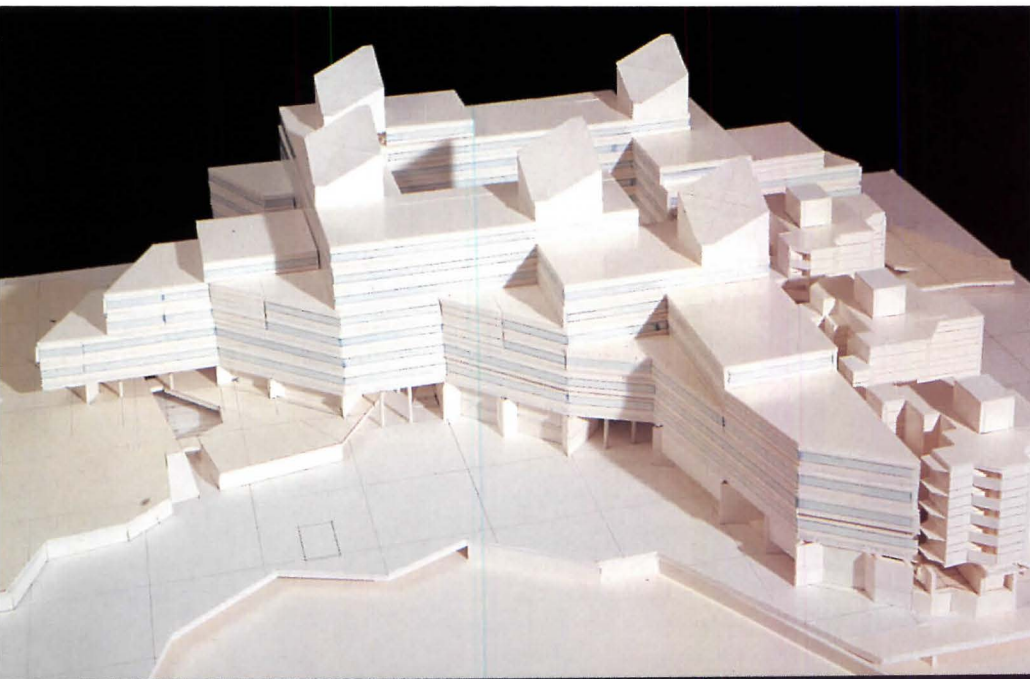

architectural firms that fail abroad do so because they're oblivious to the cultural factors that shape business relationships. You have to be there. You have to be part of a foreign locale's social life and community." Ezra Ehrenkrantz, whose firm Ehrenkrantz, Eckstut & Whitelaw is working for Olympia & York at Canary Wharf in London, adds, "It's all networking, especially since our interest is not just working in London, where the boom has spent itself, but in getting work elsewhere through referrals." Kohn also recommends that U.S. architects align themselves with major engineering and construction companies and with local architectural colleagues who can help pave the way and interpret local codes and customs.

Alliances with local practitioners are all the more important because many European countries (Germany, France, the Netherlands, Spain, and the United Kingdom) protect their own practices through some form of subsidy, risk-sharing, or taxes on foreign firms or imports of goods and services. Additional difficulties for American designers include a diminished dollar that has pumped up the cost of commercial properties and of doing business in Europe. Also, accounting and legal procedures are different from those in the U.S., building densities tend to be lower, and zoning rules are less flexible. Working abroad can also place enormous strains on a firm's home office, since it often siphons off the "most senior, best, and most experienced persons," says Richard Roth, Jr., chairman of Emery Roth & Sons, New York. And it can mean missing work opportunities in the U.S., as Benjamin Thompson & Associates has discovered. The problems and benefits will vary from firm to firm and from one country to the next.

Which countries are the best bets? In England, London's Docklands have been a

booming construction site, with huge new commercial buildings designed by Kohn Pedersen Fox, Cesar Pelli, SOM, and others. But the construction market "is only about six months behind ours," explains Richard Hayden of Swanke Hayden Connell Architects. London has become overbuilt, has high interest rates, and is the most expensive city in Europe. "If you're not over there now, forget it," adds Robert Cooke of Perkins & Will. There are design opportunities in other parts of England and in Scotland, especially for industrial and rehab construction, but the Organization for Economic Cooperation & Development estimates England's economic growth in 1990 at only 1.3 percent.

With reunification under way, Germany is emerging as the economic locomotive of Europe. The financial well-being of other European nations will, therefore, depend considerably on their relationship with Germany, especially since geography and wealth will impel Germany to take the lead in helping to rebuild and develop Eastern Europe. According to *Business Week*, "German reunification and the hint of an era of prosperity in the East are behind a new European investment boom by U.S. companies." According to David Hale, chief economist of Kemper Financial Services in Chicago, reunification will add 16 million to West Germany's population of 62 million, while its GNP of \$1.2 trillion will rise to a possible \$1.6 trillion, 30 percent greater than that of France, Europe's second-largest economy.

Ingeborg Flage of the Bund Deutscher Architekten (West Germany's equivalent of the AIA) writes that even before reunification, West Germany needed about half a million new housing units for refugees. But the nation also has the largest number of architects per capita in the industrialized

**The Colombo
Lisbon, Portugal
RTKL Associates**

Linked to the center of Lisbon with a new highway and served by subway and bus, the Colombo (bottom) will be Portugal's largest mixed-use development when completed in 1993. Designed by the Baltimore firm RTKL Associates, the 2-million-square-foot complex will contain a multilevel shopping center, offices, and a hotel. Three levels of underground parking for 6,000 cars encompass another 2 million square feet. An existing public plaza will be relandscaped to serve as the main entrance to the complex, with a rotunda and curving formal arcades connecting the pair of 17-story office towers, which will feature panoramic views of downtown Lisbon.

Enlivened by interior arcades, the retail component will house approximately 500 specialty shops, movie theaters, health clubs, restaurants, an amusement area, and a landscaped roof garden. The hotel's public spaces will be located on a garden level facing a courtyard of pools and fountains. Building details and graphics (below and inset, left) draw on historic Portuguese and Moorish architecture and incorporate references to the country's nautical past.

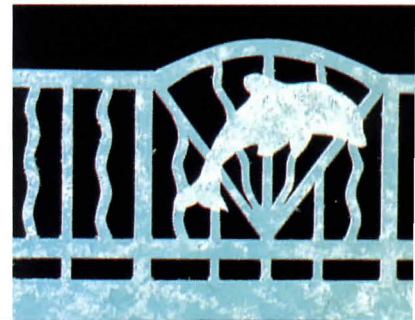
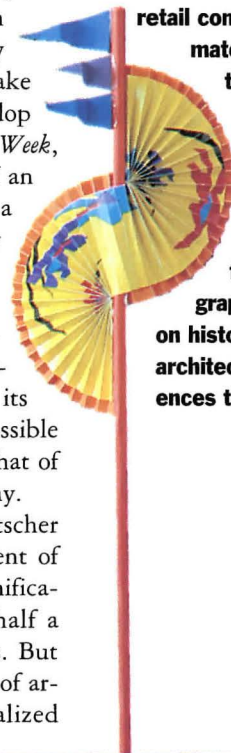

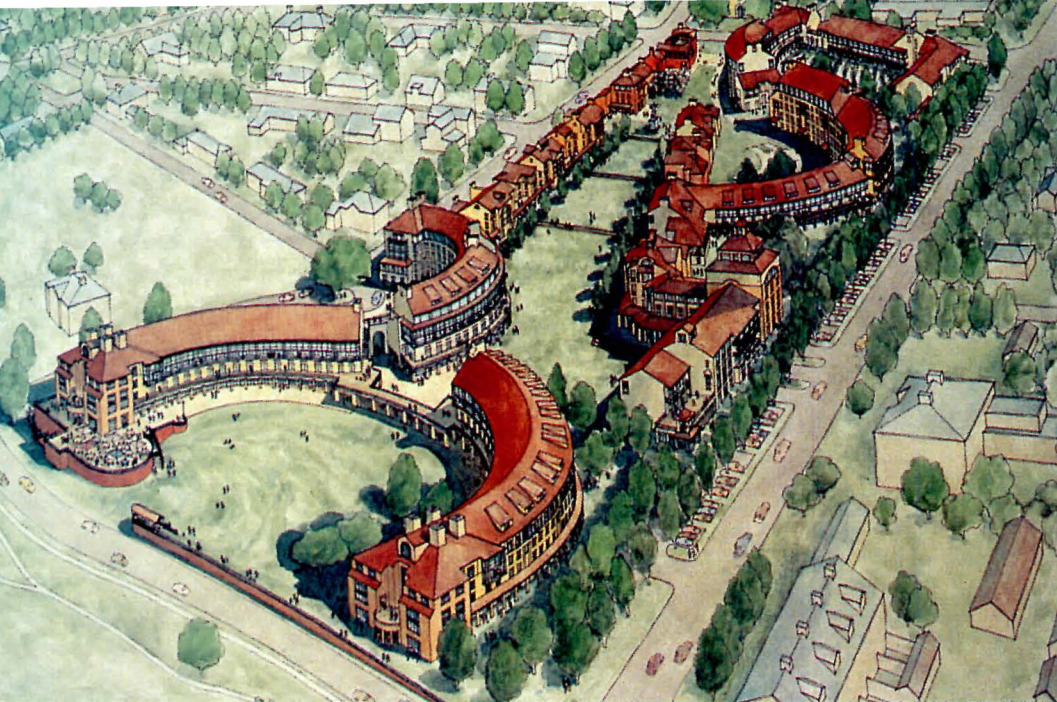

Sundsterrassen
Malmö, Sweden
Moore Ruble Yudell Architects

A large tract of undeveloped land along the sound that separates Sweden and Denmark is now the site of a 500-unit government-subsidized housing project (above). Moore Ruble Yudell arranged apartments within a large crescent-shaped structure facing the water and created a gently sloping lawn bounded by arcades and a series of eight-unit "villas." Simple landscaping takes advantage of mature trees on the site, while a new lawn creates an axis linking the waterfront to a church and neighborhoods beyond. The complex is scheduled for completion in 1993.

Banque de Luxembourg
Luxembourg
Arquitectonica

Arquitectonica's new headquarters for the Banque de Luxembourg (below) is located on a prominent corner site at the focus of Boulevard Royal in the city's downtown financial district. The Miami-based architects combined a glass- and stone-clad six-story structure with a cantilevered limestone block detailed with a grid of square punched windows. The 200,000-square-foot building will include eight levels below grade, which house a banking hall, support facilities, bank safes, and parking. Construction of the project is scheduled to begin early next year.



world, according to Flagege, and expects an influx of architects from other European countries. She warns that American architects would need to "have a good command of the native language, be willing to cooperate, adapt to different working conditions, and accept rules and regulations of the national professional bodies." RTKL's Adams warns, "Barriers in Germany are numerous, codes and regulations are tight, and it's very difficult to break in."

There may be other pitfalls awaiting those who want to enter the West German construction market. East Germany's huge appetite for new equipment and consumer goods may jack up West German growth to 5 or 6 percent, and the fear is that so much money changing hands will create a burst of inflation. To avoid pushing up prices, Germany will have to meet the surge in demand by importing more and exporting less, a boon for Germany's trading partners.

France, as Germany's largest trading partner, will benefit most as Germany draws in imports to meet demand. Because France has one of Europe's lowest inflation rates and a 15 percent annual-corporate-profits growth rate, foreign money is pouring into the French bourse. The rush to invest also stems from docile labor unions and rising productivity, with forecasts of 3.6 percent growth in 1990, according to *Business Week*. For architects, says Harold Adams, "there may be comparable opportunities in France to those in London four years ago." Also, as a result of François Mitterrand's *Grands Projets*, "there is scarcely a mayor who does not dream of erecting some building that will win him fame at home and abroad," writes French critic Jacques Lucan. For less glamorous commercial work, however, France may be less receptive to American architects than the British were.

As Germany's neighbors, Austria, Switzerland, and the Netherlands also stand to gain substantially from reunification and from the rebirth of Eastern Europe. About 22 percent of the Netherlands' exports go to Germany, as do 31 percent of Austria's, according to the *Economist*, which predicts that West Germany, Austria, and Switzerland, followed by the Netherlands and Ireland, would be the five strongest European markets. Ireland's unexpected strength derives from having Europe's largest capital-goods exports as a

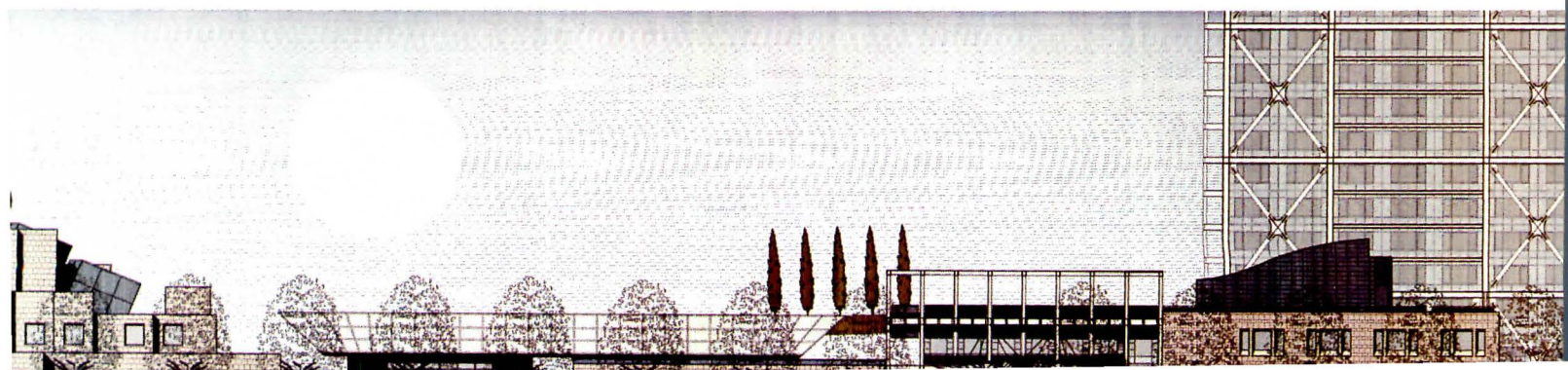

Vila Olimpica
Barcelona, Spain
Skidmore, Owings & Merrill
and Frank O. Gehry & Associates

Responding to the master plan by Martorell, Bohigas & Mackay for the Olympic Village, SOM generated a variety of civic and public spaces for the regatta and sailing events of the 1992 summer games. With its exposed structural system, Bruce Graham's 45-story Hotel of the Arts comprises 600 rooms and 33 luxury apartments and will create a strong visual presence on the city's skyline. A variety of retail, commercial, and maritime elements, including one of Gehry's famous fish, provide points of activity along the waterfront promenades. Section (bottom, these pages) illustrates the diversity of scale.

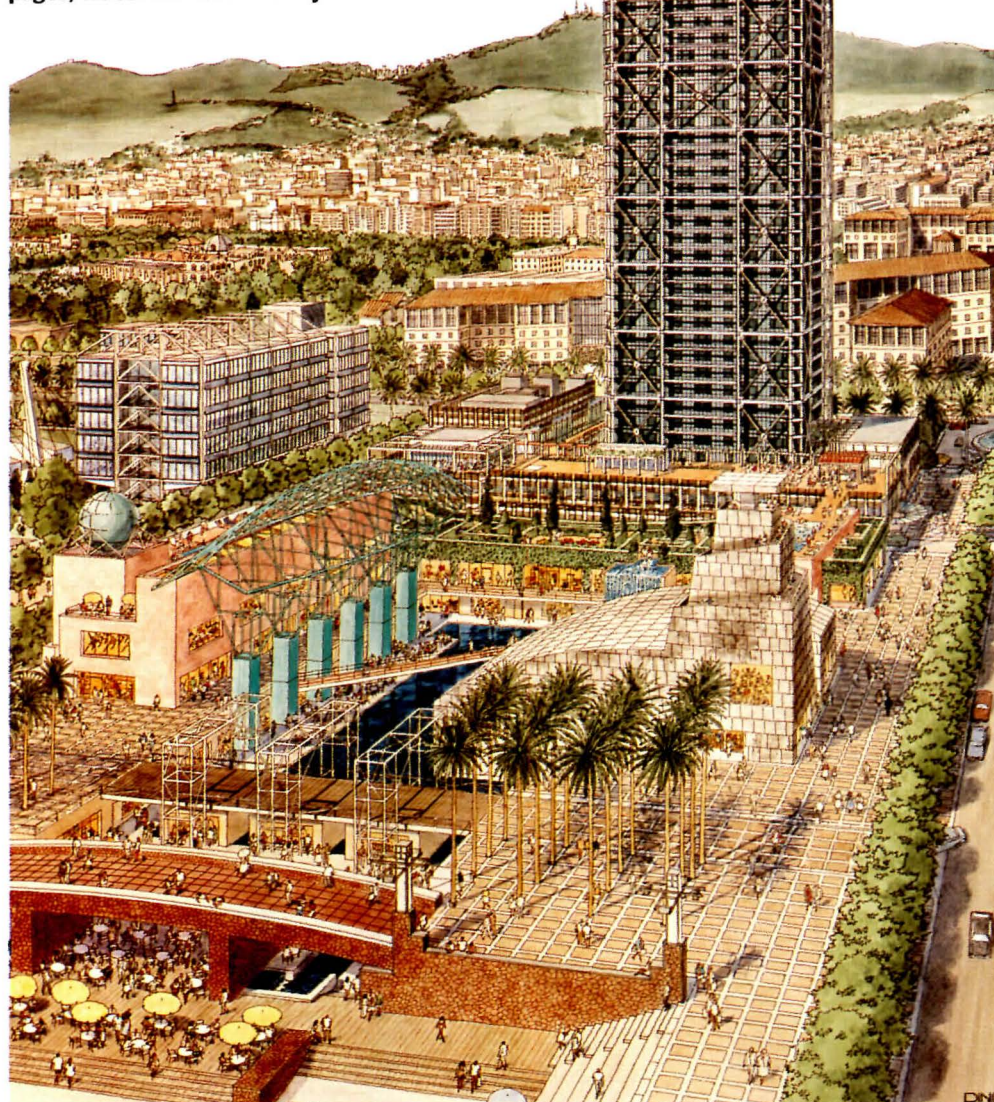

percentage of GNP, and the fourth-lowest wages on the continent.

Low wages have also made Greece, Italy, Portugal, and Spain attractive for investment in labor-intensive industries that provide construction opportunities. But these countries will have to compete with newly liberated, low-wage, Eastern European countries, especially since the four southern European nations have high inflation and high import rates, and Germany accounts for only a small share of their total exports.

In fact, no southern European nation is a reliably promising market for U.S. architects. Italy showed marked entrepreneurial strength in the 1980s, but its chaotic and huge public sector, aging infrastructure, rising inflation and deficit rates, and its still-born attempts to deregulate and privatize state-owned industries are bound to be damaging in the 1990s, according to *Business Week*. Both the Spanish and Portuguese economies have improved since the mid-1980s; Spain is the EC's fifth largest economy, Portugal its 10th largest. But American architectural opportunities in Portugal have not yet materialized, while those in Spain may peak once construction for the 1992 Olympics in Barcelona is complete. The control of design work by architectural colleges makes it difficult for Americans to work in Spain. The relatively few existing opportunities will probably focus on Madrid and favor large corporate firms.

Despite these problems, the benefits to American architects from EC 1992 and German reunification could be prodigious. But the results of reconstituting Eastern Europe into sovereign nations are still unclear. "Although the potential is tremendous, the only enthusiasm I get so far is in the press," says KPF's Eugene Kohn. The problems of working in Eastern Europe seem insurmountable. Currencies, except in Poland and Yugoslavia, are not convertible, which raises the question of how an architect is to be paid. For now, the best answer seems to be an alliance with a developer willing to be paid in bartered goods. Banking systems are crude, accounting systems and laws on repatriation of profits are generally unhelpful, and land ownership is unclear. Houston-based developer Gerald Hines, for one, is waiting until Westerners can own property before moving into Eastern Europe. ■

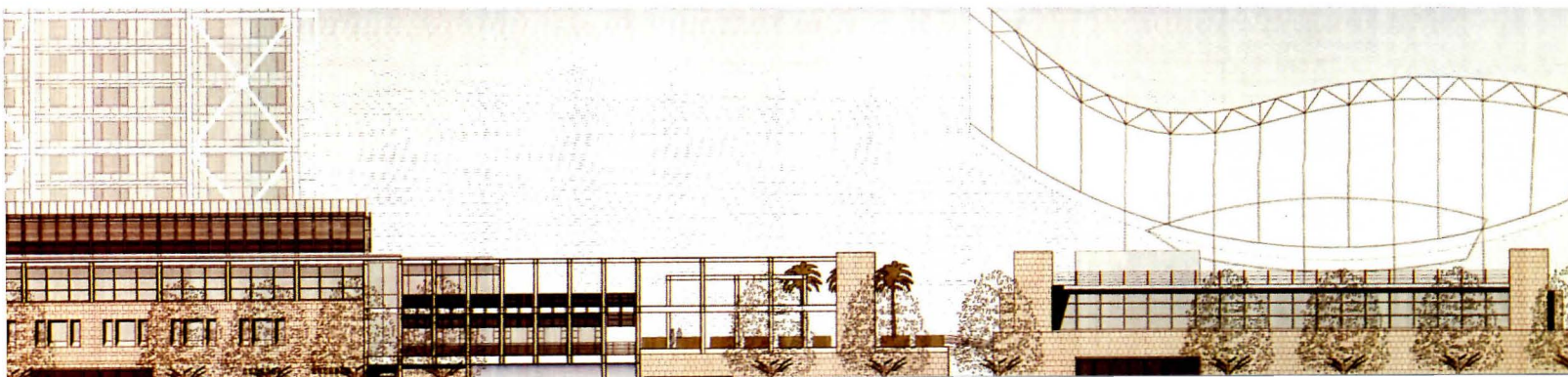

Americans in



London



SPURRED BY THE DEREGULATION OF its stock exchange and Thatcherite incentives for private development, London is undergoing a building boom unprecedented in the city's history since the reconstruction following the Great Fire of 1666. To house increasing numbers of foreign investment banks and British financial institutions in the easternmost areas of the capital, developers have passed over local talent in favor of importing the design expertise of American architects. The reason is based on an immediate need for deep floor plates and efficient layouts—the kind of quality spec office buildings on which practices such as Swanke Hayden Connell Architects, Kohn Pedersen Fox Associates, and Skidmore, Owings & Merrill have built their reputations. Unlike their British counterparts, U.S. architects are accustomed to fast-track scheduling and the organizational and management skills practiced by their corporate clients, many of whom are also Americans. Top firms in the U.K., on the other hand, traditionally have turned their backs on “crass” speculative, commercial development, preferring to concentrate on custom-designed headquarters or public commissions (for more on British practices, turn to page 101).

Over the past five years, America's largest architectural firms have established permanent offices in London, affording them the opportunity to secure additional British and European commissions from these new locations. With a permanent, 305-person office, SOM is the most visible American presence in London, responsible for the city's most expansive projects—the master plan of Canary Wharf in the Docklands (facing and following pages) and Broadgate in the City of London (page 68). Swanke Hayden Connell, with a 64-person London office, has been commissioned to design 21 architectural and interiors projects in the capital, including a 13-acre mixed-use development (page 71), which was originally awarded to a pair of British firms. Other U.S. firms with major commissions in London include Kohn Pedersen Fox Associates; Hellmuth Obata and Kassabaum; Gensler and Associates; Cesar Pelli & Associates; and Pei Cobb Freed & Partners. The need for sophisticated interiors within the first wave of U.S.-designed buildings has also prompted smaller architectural and interior design firms, such as Studios, to join the American invasion, as well as top U.S. electrical and mechanical engineers, and construction managers.

Although confronted by Yankee-bashing critics in the approvals process and the press, the American presence in London has encouraged the local architectural community to become more involved in commercial development and its concomitant disciplines of space planning and facility management. Recently, several British and European firms have been invited to design buildings within American-authored master plans—collaborations which should benefit both sides of the Atlantic.

—DEBORAH K. DIETSCH

Comprising 10 million square feet of office space, Canary Wharf in the Docklands (these pages) is the largest concentration of American design in London. The first phase of SOM's master plan (inset), which includes a 50-story office tower and retail building by Cesar Pelli & Associates, is scheduled for completion in 1991.

Canary Wharf

Docklands

THE LONDON DOCKLANDS WERE DESIGNATED in 1981 as an 8.5-square-mile urban development area east of the city's financial district. Controlled by the London Docklands Development Corporation, the sprawling district of abandoned wharfs and warehouses is freed of traditional planning constraints to encourage private investment. This lack of planning controls, however, has resulted in a jumble of commercial and residential construction of little architectural merit. An exception is Canary Wharf, a 71-acre business complex originally conceived in 1985 by American developer G. Ware Travelstead. The Beaux-Arts inspired ensemble of office buildings, retail spaces, boulevards, and parks is masterplanned by SOM and Hanna/Olin with guidelines for building envelopes, continuity of massing, and ground-floor arcades. Now controlled by Olympia & York, which took over the project in 1987, Canary Wharf is setting new standards for future Docklands development. In addition to the participation of U.S. firms, several of the 27 building sites (plan below) have been designed by British and European firms. Olympia & York is also developing Heron Quays to the south as a residential enclave and an historic warehouse to the north as a retail marketplace.

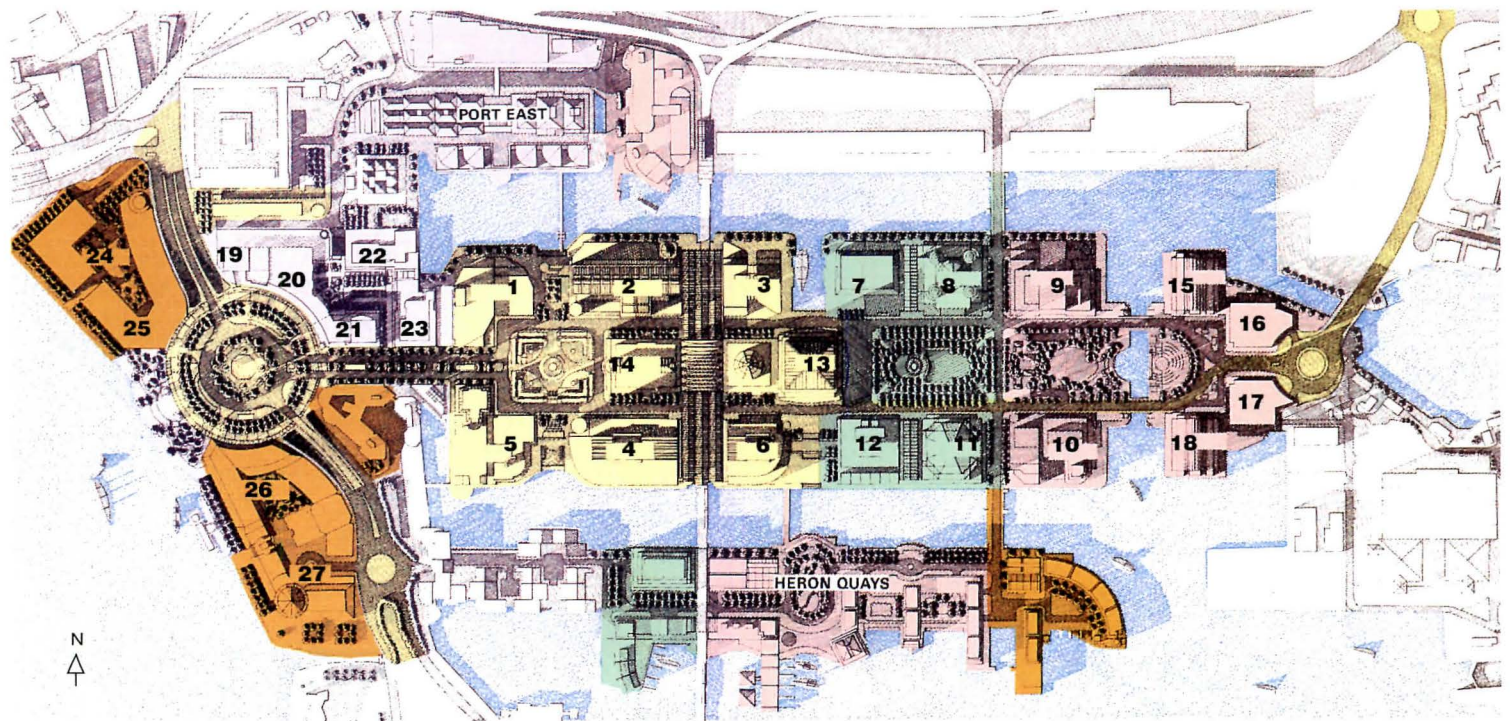

 PHASE I	 PHASE II	1 PEI COBB FREED & PARTNERS	7-11 NOT YET ANNOUNCED	20-21 NOT YET ANNOUNCED
 PHASE III	 PHASE IV	2 SKIDMORE, OWINGS & MERRILL	12 ALLIES MORRISON	22 ALDO ROSSI
 PHASE V		3 TROUGHTON MCASLAN	13 CESAR PELLI & ASSOCIATES	23 ALDO ROSSI
		4 KOHN PEDERSEN FOX ASSOCIATES	14 CESAR PELLI & ASSOCIATES	24-27 NOT YET ANNOUNCED
		5 SKIDMORE, OWINGS & MERRILL	15-18 NOT YET ANNOUNCED	
		6 KOHN PEDERSEN FOX ASSOCIATES	19 SKIDMORE, OWINGS & MERRILL	

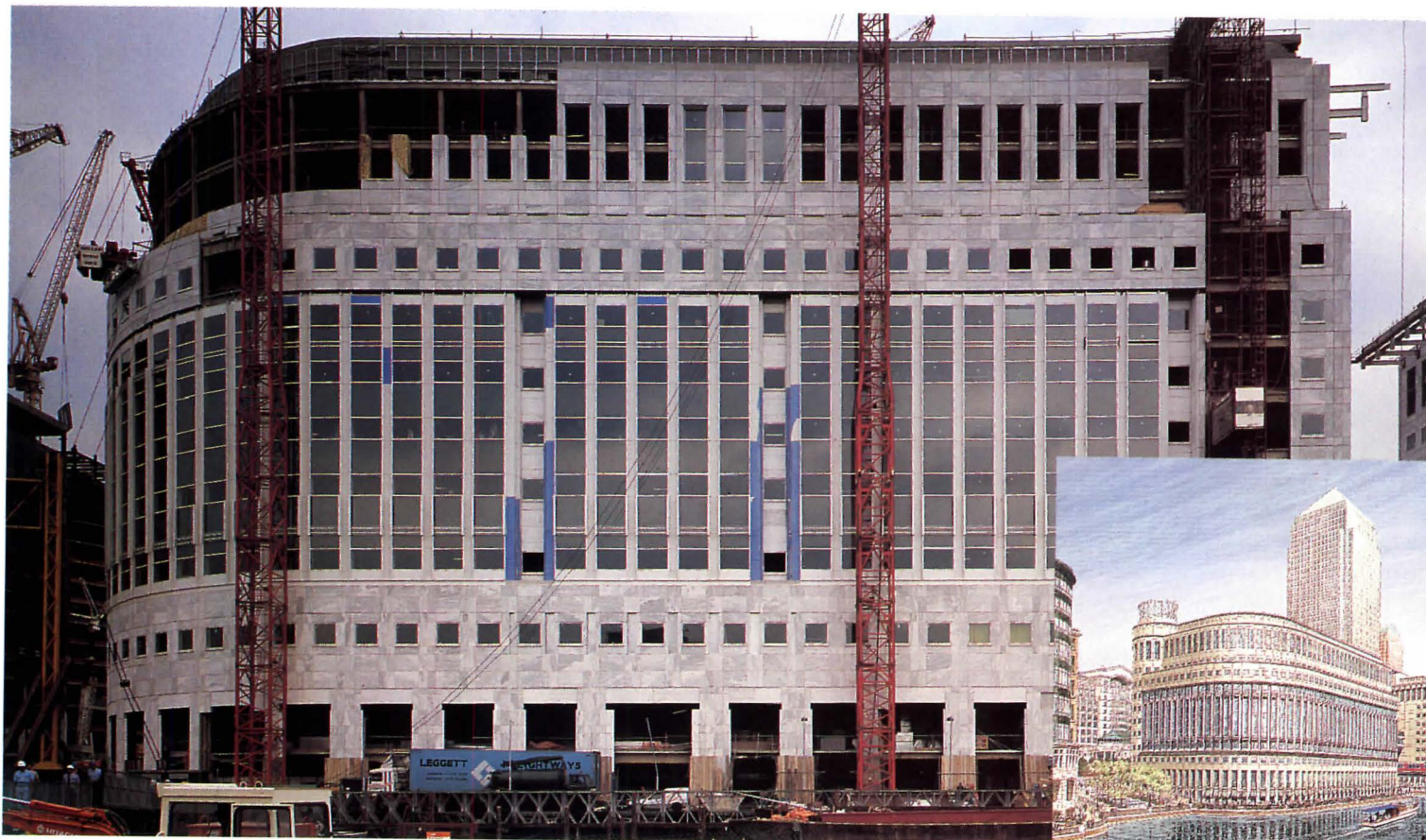

Phase I centers on a 50-story tower (previous pages), retail building, and light railway station designed by Cesar Pelli (facing page), and includes office buildings by KPF (above) and SOM Chicago (right).

Broadgate

City of London

THE FIRST COMPLETED EVIDENCE OF American design in London is a complex of office buildings grouped around Liverpool Street Station. After commissioning the British firm Arup Associates to design the first phase of the 29-acre project, British developers Rosehaugh Stanhope turned to SOM Chicago to add three more buildings, and ultimately commissioned the U.S. architects to design eight more. Compared with the three Arup-designed structures (lower left in site model, below), the SOM ensemble is more historicist in spirit, as exemplified by the entrance arch of the Bankers Trust headquarters (facing page, top right), and by the towers of Hamilton House (facing page, bottom) and Broadwalk House (facing page, top left). Designed by partner Bruce Graham, most of Broadgate's buildings share a palette of granite, limestone, and cast stone, yet each conveys an identity distinct from its neighbors. The most striking structure is Exchange House (right), an engineering tour de force that spans the railroad yard. (For technical details, turn to page 109.)

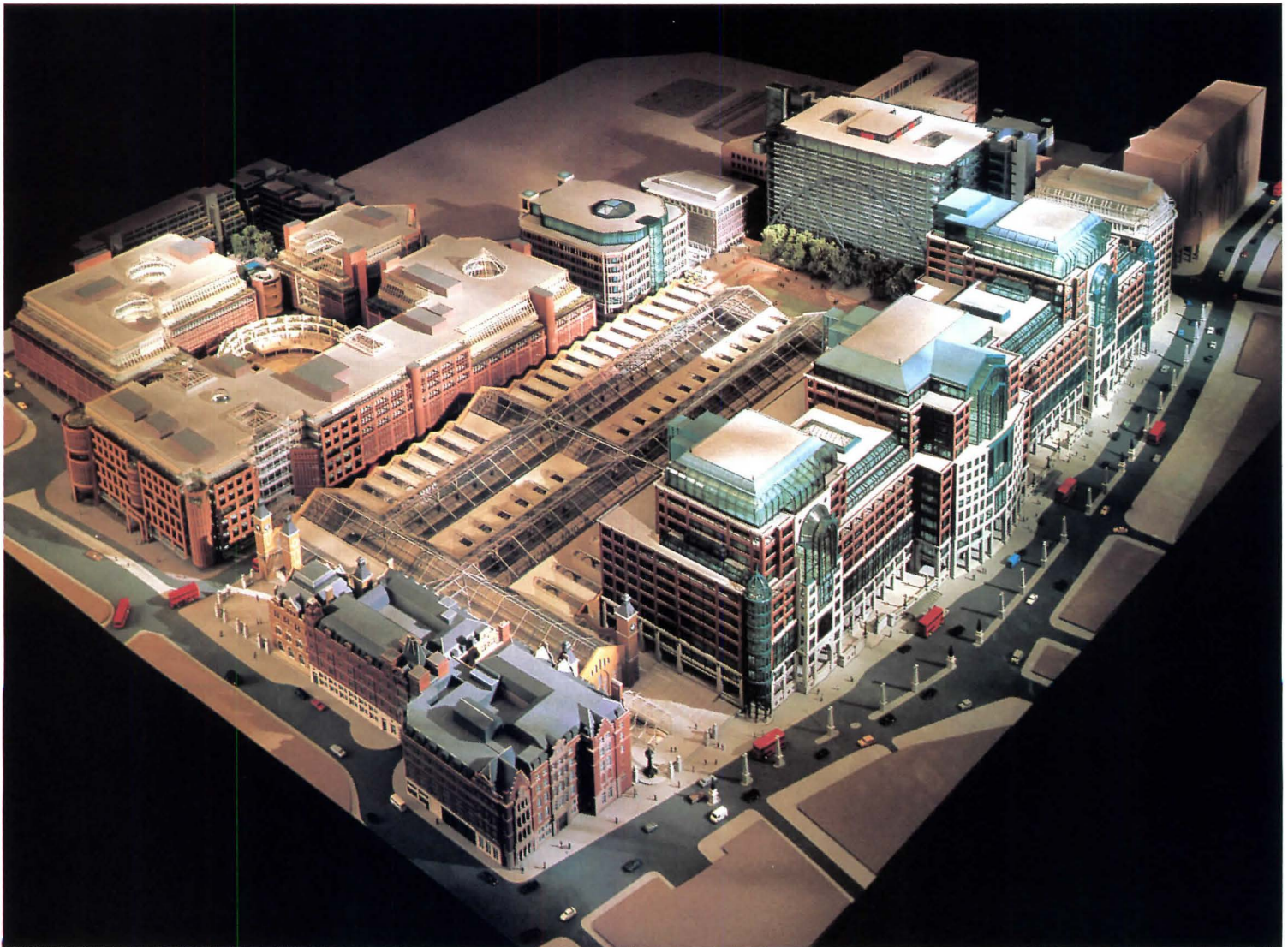
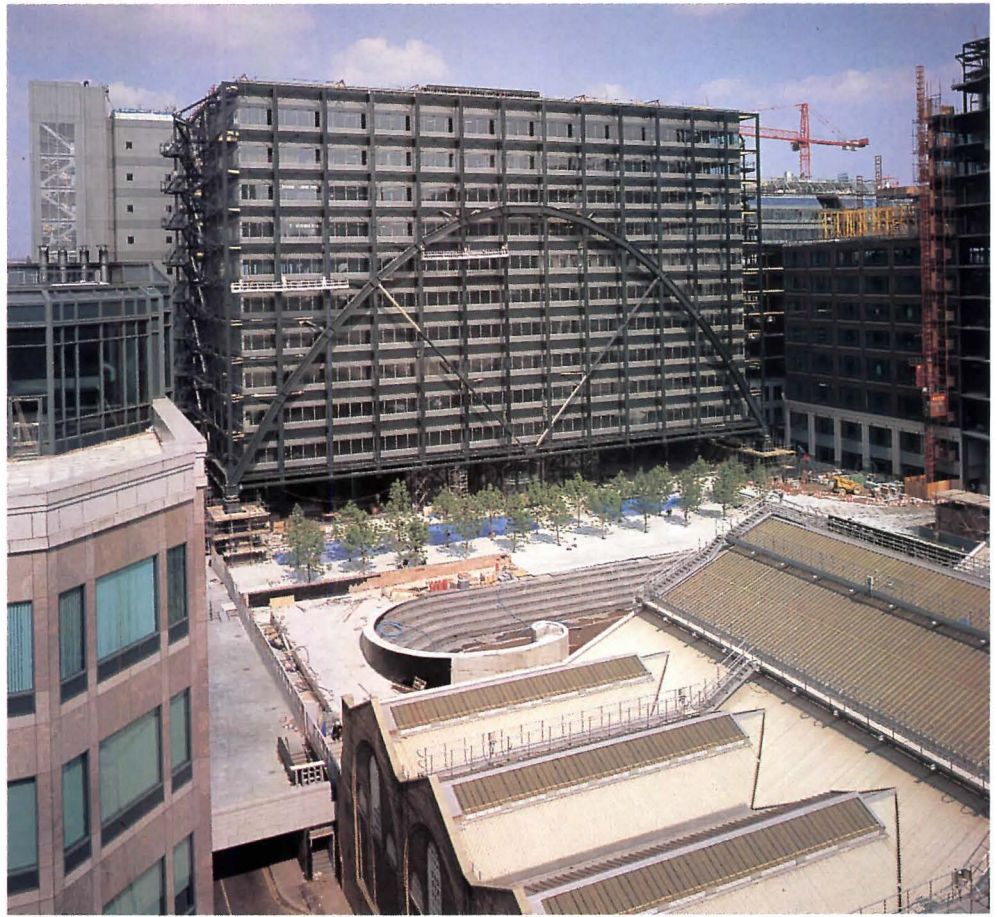



NIALL CLUTTON / ARCAID PHOTOS



Bishopsgate

City of London

LOCATED AT THE EASTERN EDGE OF LIVERPOOL STREET STATION, the largest portion of the SOM-designed Broadgate complex is an ensemble of office buildings totaling 1.5 million square feet. Named Bishopsgate after the street bordering the site, the three buildings were designed in 1986 by Chicago partner Bruce Graham to convey the classically inspired cohesion of John Nash's Regent Street terraces. The 900-foot-long street facade (left) is punctuated by Chicago-style steel windows and granite cladding above a limestone base. A ground-floor arcade lined with mahogany-framed shopfronts (below) is elevated five feet above the street, and a passageway on the western side of the buildings connects Bishopsgate to the train station. The first structure at the southern end of the site opened last year, and is occupied by National Westminster Bank in offices also designed by SOM.



SOM's Bishopsgate complex of three office buildings (above) and shopping arcade (right) is located to the east of Liverpool Street Station (site plan below). Swanke Hayden Connell's Spitalfields development (facing page and site plan below) also borders Bishopsgate site.

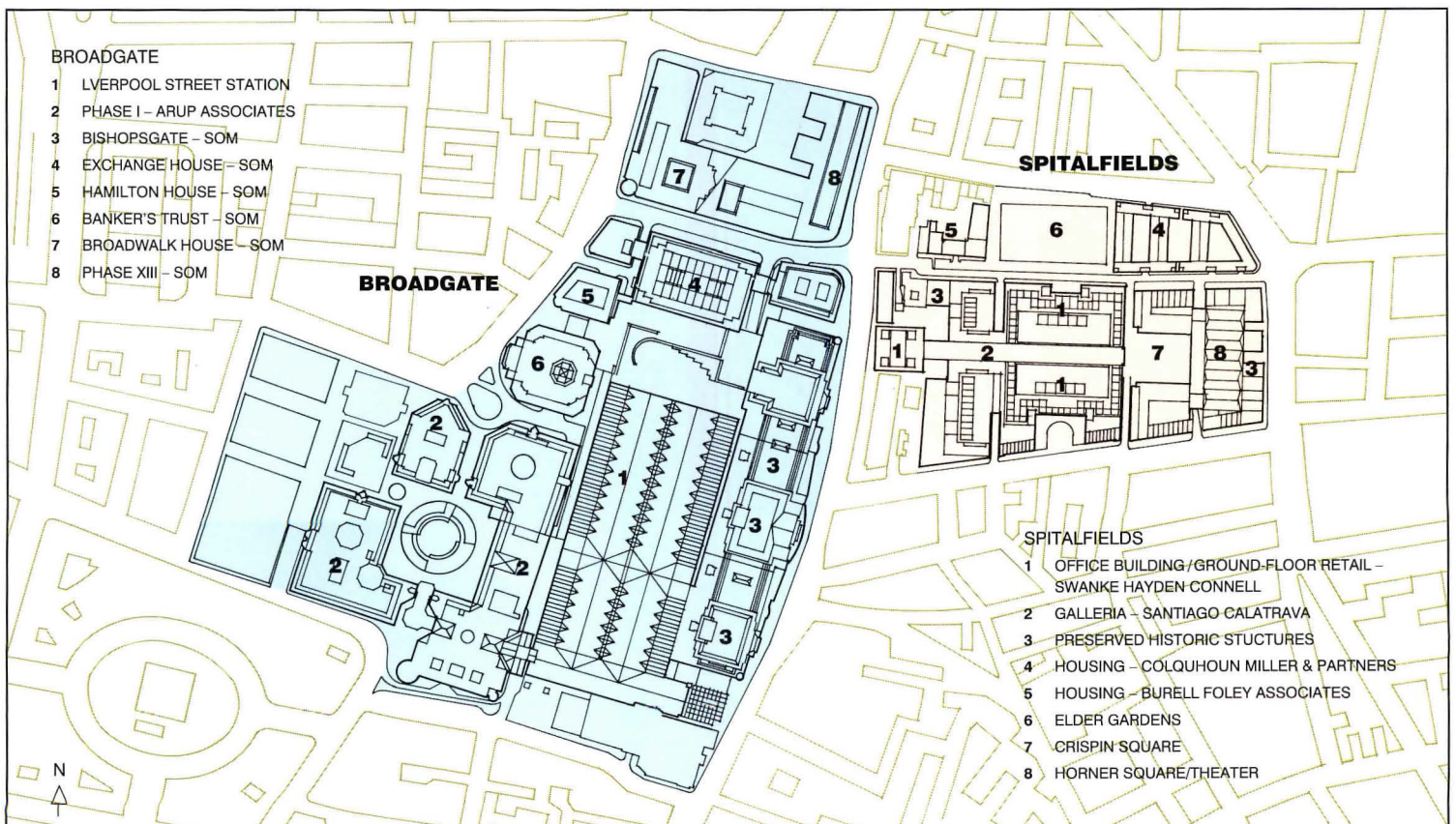



Spitalfields

Tower Hamlets

FORMERLY THE SITE OF A FOOD MARKET in London's East End, Spitalfields will be transformed by Swanke Hayden Connell Architects into a 13-acre mixed-use development when construction begins next year. The project is the result of a design competition held in 1986 that was won by the Spitalfields Development Group, which originally commissioned the British firms of Fitzroy Robinson and Richard MacCormac to conceive an urban design. After a lengthy approvals process, requiring the passage of a Parliamentary bill to relocate the market, the developer decided to replace Fitzroy Robinson with Swanke Hayden Connell (MacCormac subsequently resigned). The 2.5-million-square-foot redevelopment scheme includes office buildings, retail spaces, and housing grouped around traditional squares, as well as a galleria engineered by the Spanish architect Santiago Calatrava, and two apartment blocks designed by the U.K. firms of Burrell Foley Associates and Colquhoun Miller & Partners. The 19th-century buildings of Spitalfields Market will be restored and integrated into the urban design. ■

Spitalfields' office buildings and housing flank public squares (top left). Restored historic townhouses and meeting hall enclose a theater within a glazed-over plaza (top right) that leads beneath apartments to another public square (right). Buildings are highest on the portion of the site nearest Bishopsgate (right in model, below) and step down to the east (bottom left).

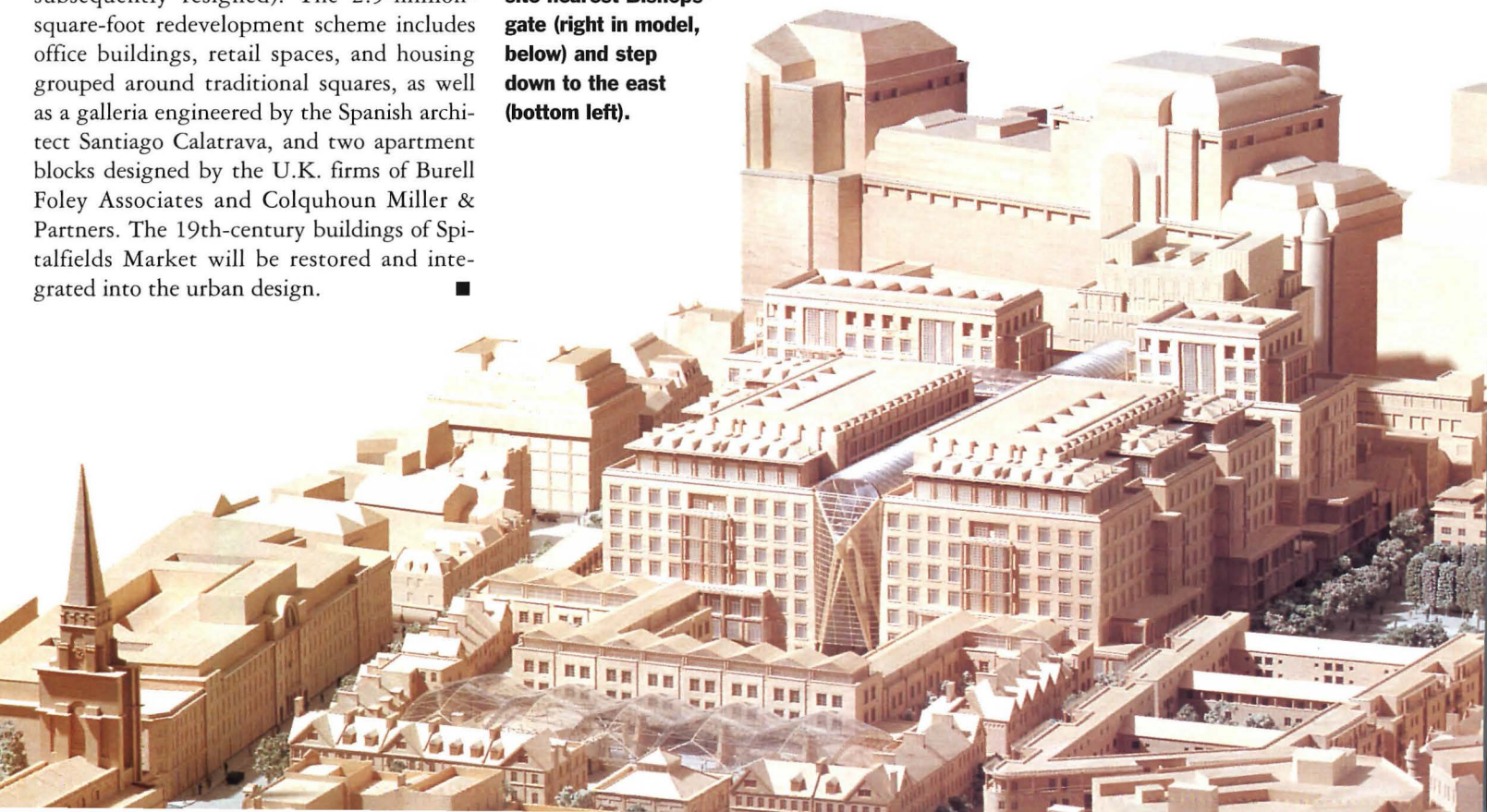
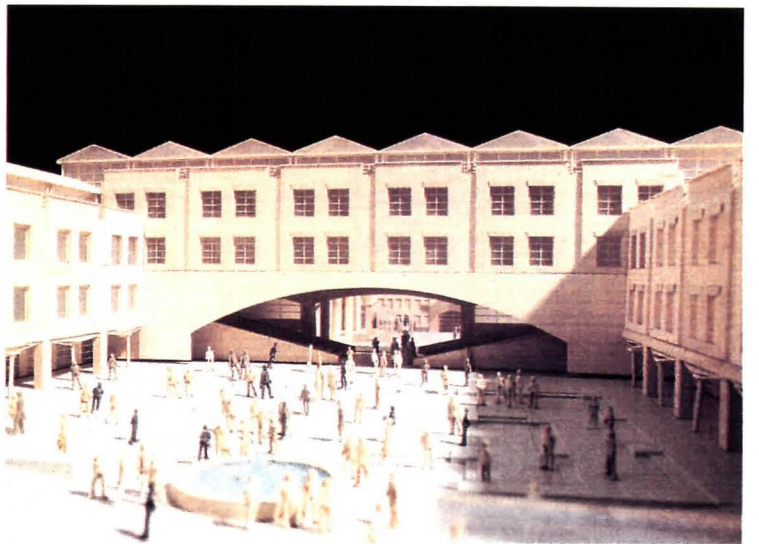

Japanese Imports

BY MILDRED F. SCHMERTZ



STIMULATED BY A BOOMING ECONOMY, THE JAPANESE have been on a global shopping spree over the past few years that has included vast acquisitions of Western artworks. Impressionist paintings have vanished from museum walls only to disappear into private Japanese hands, and America's architectural wonder of the world, Rockefeller Center, is controlled from Tokyo. The Japanese are now steadily acquiring another form of art, the best designs of the world's leading architects.

This trend has been a lifesaver for many American architectural firms unable to find enough work in the troubled U.S. construction market. Today, architectural and design/build firms with offices in Japan have more business than they can handle. Japanese office buildings of the early 1960s, now obsolete in their capacity for large computers, are being torn down and replaced. Other building types offer even more opportunities. The Japanese consumer's demand for better housing, retail, and recreational facilities is finally being met, as the nation recoups the benefits of its postwar dedication

and Kumagai-Gumi. The Kajima Corporation is the best known internationally, and very well connected in the world of American architectural leadership. The CEO of Kajima, Dr. Shoichi Kajima, is an alumnus of Harvard University's Department of Architecture and maintains a strong association with his school. He has been known to fly members of Harvard's design faculty to Tokyo to address Kajima's architectural staff—many of whom also studied at Harvard—on a variety of topics.

The Kajima Corporation's architectural design division has nearly 1,000 licensed architects, including some who are also structural and mechanical engineers. Half of the buildings Kajima erects are designed by in-house architects. The company designs and constructs office buildings, factories, shopping centers, housing, and recreational facilities including golf clubs. Overseas, it is undertaking three hotels in East Berlin and Dresden, and Kajima International has had an office in Los Angeles for 20 years. It is currently building automobile factories in the U.S. for Matsuda and Subaru.

Selecting U.S. architects is part of Japan's effort to redress the balance of trade, thereby reducing the tensions between the two nations. American architects, however, are only one component of this goodwill gesture. Other beneficiaries are U.S. building trades, product manufacturers, and suppliers. Because of the strong yen, American fee structures are very competitive, and Japanese developers have begun to respond to aggressive marketing on the part of U.S. firms.

R.H. Mori, deputy general manager in the real estate and development department of C. Itoh & Company, one of Japan's largest global trading companies, offers additional reasons for buying American architectural talent. "Japanese developers look toward

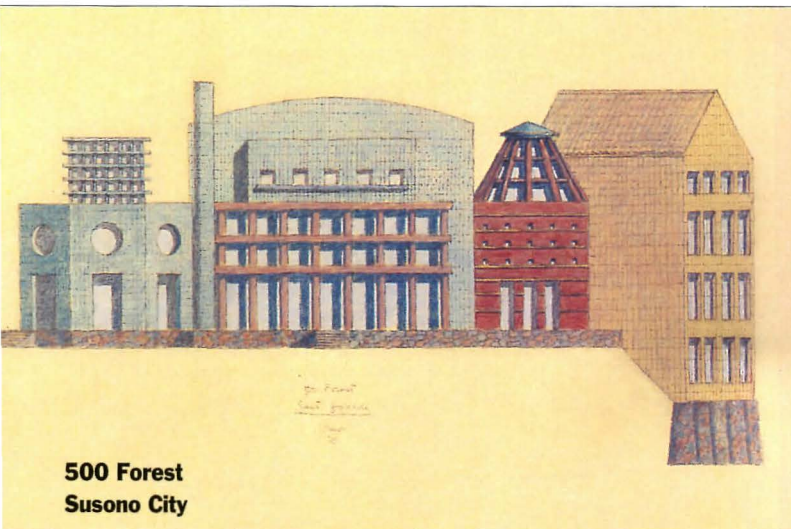

500 Forest
Susono City

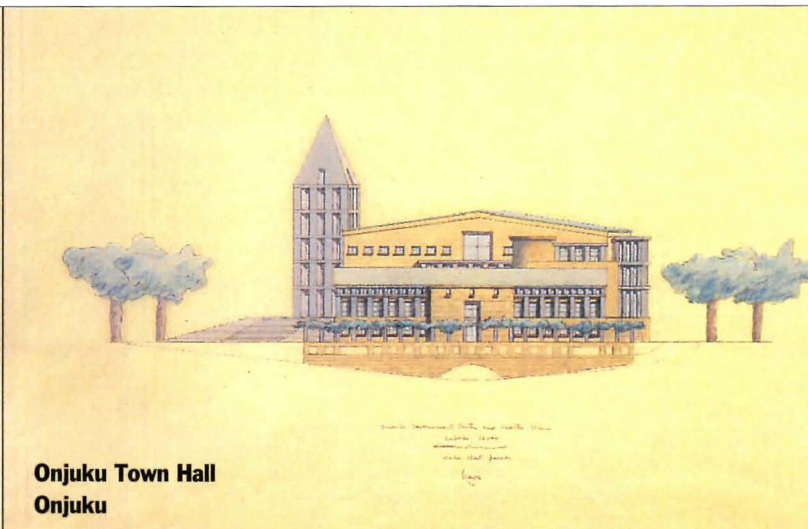

Onjuku Town Hall
Onjuku

to the production of exports.

And there may finally be enough buildable land. Japan is undertaking vast waterfront landfill projects in Tokyo, Yokohama, Osaka, Kobe, and Fukuoka. The Tokyo Bay waterfront has 1,136 acres of landfill areas that will eventually support a population of 120,000 daytime workers. Plans call for 30 to 40 large office buildings and 63,000 new housing units. This single project is twice as large as all of Shinjuku—a rapidly developing Tokyo district of *skyscrapers*, hotels, department stores, the city's most chaotic rail-

giving their projects identity. Just as importantly, we believe that bringing in outside talent will improve our buildings. C. Itoh builds its own projects, including middle- to high-income housing, international hotels, and speculative office buildings." The company engages architectural expertise in the planning and design of shopping centers, housing, and new towns.

Most U.S. architects who fly to and from Tokyo work with one or more of Japan's "Big Six" construction firms: Takenaka, Shimizu, Kajima, Taisei, Obayashi-Gumi,

Among the first American architects to work in Japan, Michael Graves has completed four projects, and 12 others are in various stages of design and construction. They include the five projects shown on these pages: guest houses for a golf club (far left); a new government center for Onjuku (above); the Midousuji Minami, a 10-story office building; (facing page, left), and the nine-story Tajima headquarters (facing page). The 27-story Portside Tower (facing page, center), now under construction, is part of the vast Minato Mirai mixed-use development in Yokohama.

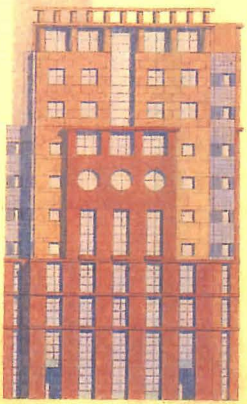

Midousuji Minami Building
Osaka

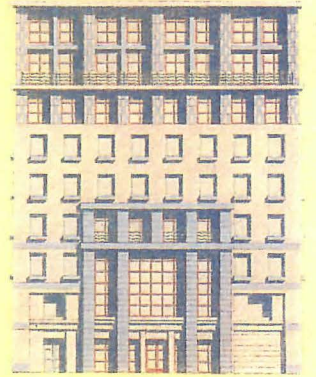

Tajima Building
Tokyo



Portside Tower
Yokohama

American architects working with Kajima or other Big Six firms find that since they have no counterparts in the U.S., architectural life there is not easily comparable to practice here. The Big Six and their close competitors in the design/build industry secure most of the major work in Japan. Most of the best young Japanese architects go to work for these firms to avoid the long hours and low salaries that prevail in the offices of Japanese star architects, where they must follow the master. It is also difficult to move from a master's atelier to a design/build firm that wants its employees to start upon graduation and stay for a lifetime, as do most Japanese corporations. Japanese star architects tend to come from aristocratic families that are powerfully connected with the upper reaches of government and business. Architects from the middle class lack the connections necessary to get major work, and they are fated to run small practices for even lower fees than similar practitioners earn in the United States.

For all these reasons, the big design/build firms tend to be able to hire all the local talent they need. According to architect Osamu Ebata, a young Harvard graduate on the Kajima staff, "Working in a big office like Kajima isn't all that bad. There is more freedom of expression than to be found in working for a star. Ten years ago, very few clients who wanted good design asked Kajima to design for them. Now they engage

our total service from preliminary design studies to construction supervision."

Fortunately for the Big Six and other Japanese client and developer groups, American stars are available as needed. Japanese world-class architects such as Fumihiko Maki, Tadao Ando, and Arata Isozaki, for example, are often too busy working abroad or on major cultural or civic facilities at home to answer the construction firm's call. Not so for the rest of the world's leading designers, including the very best the U.S. has to offer. Getting to know Tokyo better and better are Michael Graves, Robert A.M. Stern, Peter Eisenman, Stanley Tigerman, Steven Holl, Frank Gehry, Michael Rotondi, Cesar Pelli, Kevin Roche, Benjamin and Jane Thompson, Herbert McLaughlin, Emilio Ambasz, Helmut Jahn, Arthur Gensler, Hugh Stubbins, Gyo Obata, Mark Mack, and more. The Architects Collaborative, RTKL, Skidmore, Owings & Merrill, and Kohn Pedersen Fox also have entered the Japanese scene with major planning projects.

Robert A.M. Stern Architects' first finished project in Tokyo is Bancho House, five floors of offices and a two-story penthouse in Ichiban-cho, near the Imperial Gardens and the British embassy (page 76). Stern has also designed a luxury apartment house in Cap d'Akiya, 60 kilometers south of Tokyo in the Hayama district. "I took my cue," he explains, "from the Western architects who have synthesized Classicism and the national

traditions of Asia, such as Frank Lloyd Wright in Japan, and Edwin Lutyens and Herbert Baker in India." Now under construction, the building's classical vocabulary is intended to be enriched by traditional Japanese materials and details. Stern's other projects in Japan include two golf clubs on the Izu Peninsula, and other golf-related facilities in Tochigi prefecture.

Most of Stern's work in Japan is in collaboration with Kajima. According to the architect, it is an efficient process. "We do design and preliminary drawings. Working drawings and engineering are done in Tokyo. Fax machines and computers simplify everything. So does the difference in time. When our workday ends, we fax everything to them as their workday starts. In effect, work goes on for 24 hours." Stern reports that most of his firm's time is spent on design rather than on technology, materials, and costs. "We start out proposing how we would like to construct the building. Kajima then budgets for the whole project. We never go over the budget because we are outsiders to the budgeting process. We do not get into the negotiation of each detail. The Japanese do a lot of private caucusing and politely suggest revisions. They lack the American gift of shooting from the hip."

Eisenman Architects has just completed a 10-story, 50,000-square-foot headquarters for the Koizumi Sangyo Company in the Akihabara district in Tokyo (page 81). It

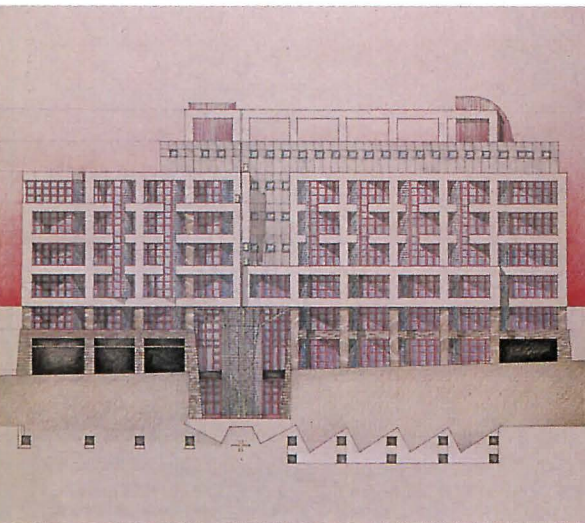

Dai Nippon
Tokyo
RTKL Associates

Located on a narrow street of low-rise buildings, the seven-story headquarters for a large Japanese construction company (above) will feature a massive stone base and a facade detailed with an overscaled, steel structural grid. A curtain wall composed of four types of glazing materials will interlace through the primary grid in a series of angles. Construction is scheduled to begin next year.

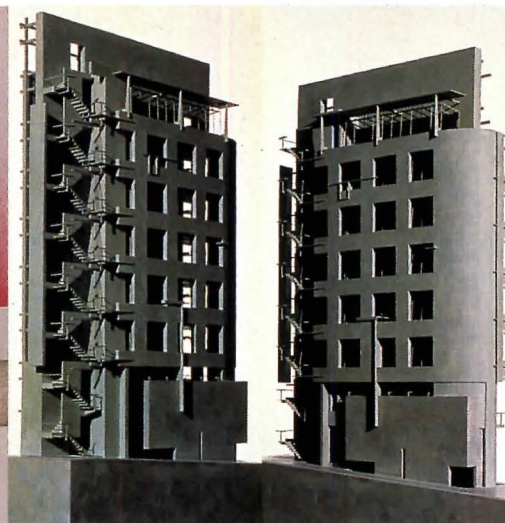

Higashi Azabu Building
Tokyo
Morphosis

Morphosis's slender tower on a corner site in Tokyo (two views, above) will house a restaurant, a two-story gallery space on the ground level, and office space on the upper six floors. The slenderness of the tower is exaggerated through shard-like volumes and a sheer wall bisecting the section, which contains the entrance. Construction of the project is expected to begin in 1991.

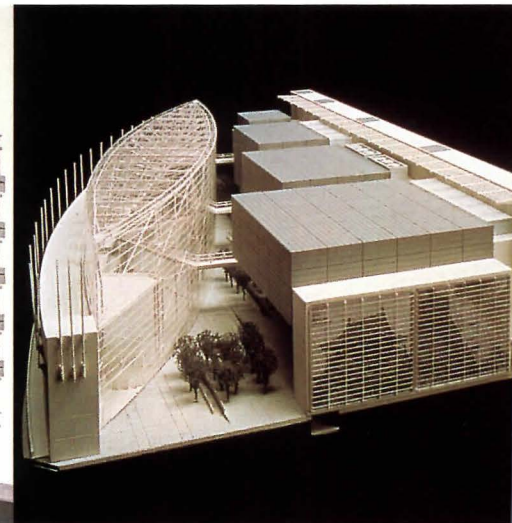

Tokyo International Forum
Tokyo
Rafael Vinoly Architects

The winning scheme in an international competition, Vinoly's \$670-million cultural center (above) will be built on a 6.7-acre parcel in Tokyo's most prestigious business district. The design includes a 5,000-seat theater containing large screens for broadcasting and a curving, glass exhibition hall with an exposed structural-steel frame. The complex is scheduled for completion in 1994.

was built by Taisei Construction with the 10-person firm of Kojiro Kitayama as the local architect. Eisenman is also working on a similarly sized headquarters for Nunotani Corporation in Edogawa, with Zenitaka Construction Company. On the question of technology, materials, and costs, Peter Eisenman agrees with Stern: the construction company sets everything up, and it turns out fine. He adds, "The construction companies take pride in their work and like to do difficult things well. Technologically, the Japanese are more advanced in curtain walls, windows, handrails, elevator cabs, lighting systems, and mechanical equipment. As for costs, tax is a big problem. A value-added tax is taken off the architect's fee." Although Eisenman presently has only two projects in Japan, he hopes for more. "I enjoy working in Japan. They have respect for what you try to do. I was picked because I am a brand-name architect doing quality work. My Japanese clients want high visibility, they want to take design risks. They like my work because it is speculative. I am seen as working in the spirit of the Japanese. Michael Graves, on the other hand, is seen as an exotic."

"Exotic," in this case, means "ahead." Michael Graves discovered and was discovered by the Japanese at least 10 years ago. He has worked on 16 projects there, including two competition entries. Four Graves-designed projects are now complete. A \$4.4-

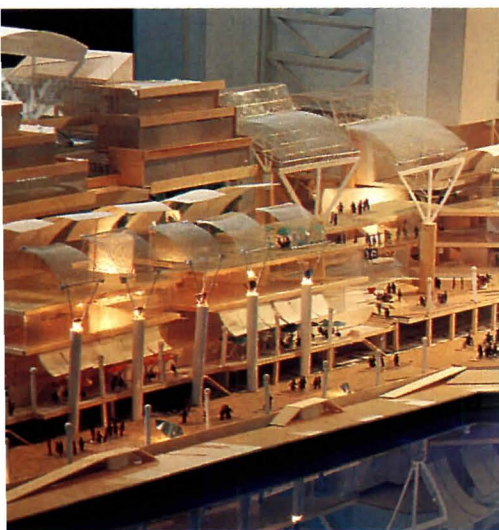

Harumi Waterfront
Tokyo
Benjamin Thompson & Associates

Due to the scarcity of land in Tokyo, developers looked to the surrounding bay for future growth. On an island reached by bridge from downtown, the Harumi project (above) is one of these enormous landfill developments, and construction is scheduled to begin next year. Master-planned by BTA, the 35-acre complex comprises a multilevel retail street, small hotels, and office space.

million, 14,000-square-foot health club for Shiseido, an international cosmetics company, opened in 1986. In 1988, the architect finished the designs for a collection of carpet tiles and vinyl floor tiles for Tajima, Inc. He completed an exterior mural for the IDC office tower in Yokohama in 1989. Graves, along with Stanley Tigerman, was also among a group of internationally noted architects invited by Arata Isozaki to work on the 193-acre model city project in the landfill Momochi district of Fukuoka City, on the island of Kyushu (page 90).

American architects Steven Holl and Mark Mack also designed apartment buildings for another portion of the Fukuoka project. Holl, who worked five months on his structure, with Shimizu completing the working drawings and supervision, admits, "The building was a bit over budget. It was to be \$7 million but became \$8.5 million. We got it down to \$7.8 million and Shimizu swallowed the \$800,000. This would never have happened in America."

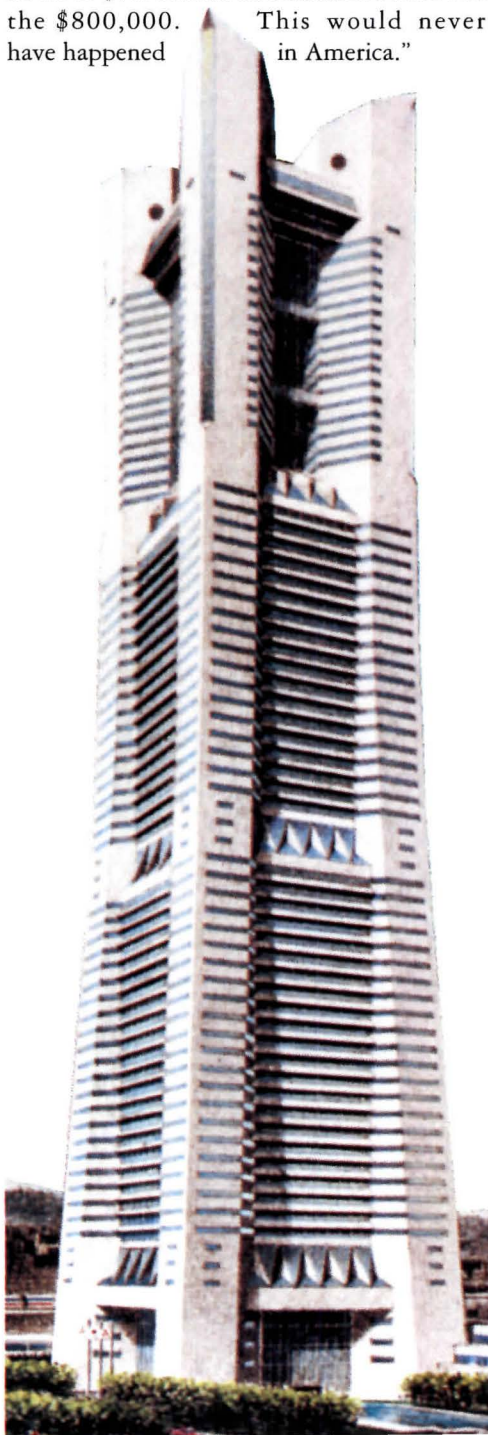

Morphosis is also at work in Japan. The Los Angeles firm was the only one from the U.S. to be selected by Arata Isozaki to join 13 other young firms, each engaged in the act of designing a folly. The program, precisely named "Thirteen Follies," called for the design of that number of objects to be located along the pathways of an exposition held this year on the grounds of the 1970 World's Fair in Osaka.

Morphosis's other client is the industrialist and art collector Fukusabura Maedo, for whom the firm is working on a nine-story office building in Tokyo and a golf club in the Chiba prefecture. On Nipponese golfing, Morphosis principal Michael Rotondi reports: "Japanese do their most serious business on the golf course and in bars. They are now being encouraged by their corporations to do more business on the course for the sake of their health. Because agricultural land is precious and therefore preserved from development, many of the new courses are

Continued on page 154

Minato Mirai
Yokohama
The Stubbins Associates

Stubbins's 75-story Landmark Tower (left), now under construction and scheduled for completion in 1993 and a 80,000-square-meter rounded tower (below right) are part of the massive "Waterfront for the 21st Century" landfill complex in Yokohama (which also includes Michael Graves's Portside Tower, previous page). The \$1 billion complex is intended to serve as the gateway to Yokohama's re-developed waterfront.

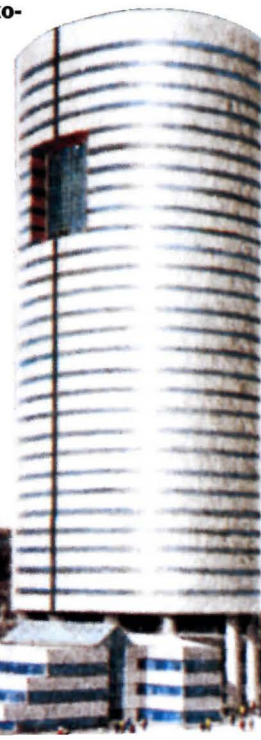

Imperial Quarters



Stern's Tokyo building comprises five floors of offices (above) topped by a two-story penthouse (facing page).



FOR HIS FIRST BUILDING IN JAPAN, ROBERT Stern was initially commissioned to design a penthouse atop a 20,000-square-foot office building already under construction. The Japanese client, who has a penchant for traditional Western architecture, was so taken with Stern's classically inspired penthouse that the firm was asked to redesign the building's facade and lobby. The result is Bancho House, five floors of offices topped by a two-story penthouse. The combination is not unusual in Tokyo, where mixed-use buildings are the norm.

Bancho House is located in the Ichiban-cho, Tokyo's "number-one" neighborhood, named for its prominent inhabitants, Japan's imperial family. Although strict zoning limits the building's height, Stern designed the penthouse to take advantage of spectacular views of the gardens of the Imperial Palace and of the British embassy, located across a narrow street. For inspiration,





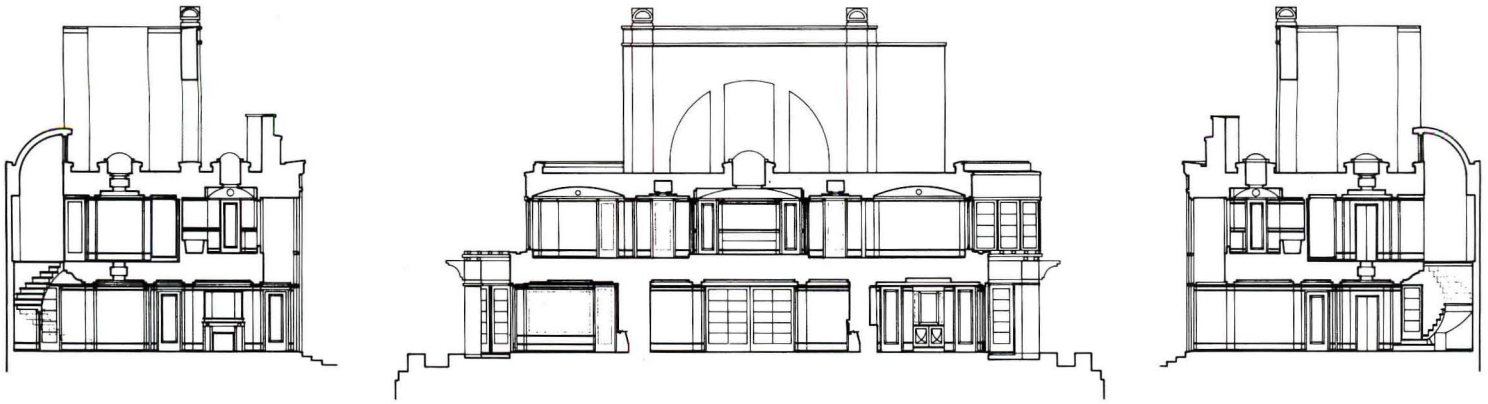

Stern studied the Neoclassical British embassy, which, he says, is eclectic but reflects the spirit of "England in the 1820s." He calls Bancho House an "Anglo-American" building, and its British influences are apparent in the minimal (though for Tokyo, ornate) detailing that recalls the work of John Soane. Its dark granite cladding harmonizes with the color of the nearby embassy, distinguishing Bancho House from Tokyo's more typical white and tan facades.

According to Grant Marani, project architect for Bancho House, working in Japan provided some unexpected differences. "Construction companies are very concerned about what clients think about buildings 10 years down the line. They guarantee their buildings for longer, and they take pride in details like flashing." Marani also found that, although working in stone is a Japanese tradition, elaborate details were impossible due to the shortage of stone masons during Japan's incredible building boom.

The idea of designing contextual architecture is unusual in Tokyo, where towers tend to make their own statements, and most buildings recede into the background. Stern's quiet but expressive ornamentation—granite pilasters, bronze detailing, decorative chimney caps, and urns repeated at roofline and entrance—creates a unique presence in the Tokyo streetscape. Bancho House unifies its imperial neighborhood in a monumental and dignified way. ■

—HEIDI LANDECKER



The principal rooms of the 3,500-square-foot penthouse (sections above and plans below) open onto a garden terrace, screened at either side by heavily planted pergolas. Penthouse windows have painted wood trim (left) for a domestic appearance. Stern sought a fineness of finish that is uncommon in Tokyo; bronze column capitals and stylized bronze acroteria (facing page, top left) decorate the pediment at the office building's entrance. The narrow lobby (below left) is two stories high to create a sense of grandeur in a tight space. Bronze-finished aluminum light fixtures (facing page, top right) flank the public entrance; those gracing the private entrance are slightly more ornate (facing page, bottom left). Urns are constructed of carbon-fiber-reinforced concrete with reveals and caps of stainless-steel-finished aluminum (facing page, bottom right).

BANCHO HOUSE
TOKYO, JAPAN

ARCHITECT: Robert A.M. Stern Architects, New York, New York—Robert A.M. Stern (principal-in-charge); Grant Marani (project architect); W. David Henderson, Mabel O. Wilson (project team); Raul Morillas (project interior designer); Deborah Emery, Sharon Pett (interior design team)
ASSOCIATE ARCHITECT/CONTRACTOR/ENGINEER: Kajima Corporation, Tokyo, Japan—Junzo Munemoto (project architect); Kazuo Yamane (senior designer); Masayoshi Tanabe (assistant)
PHOTOGRAPHER: Peter Aaron/Esto

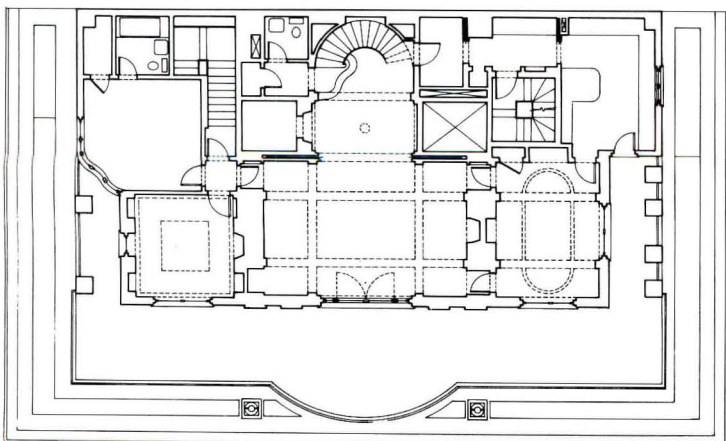

PENTHOUSE – FIRST FLOOR

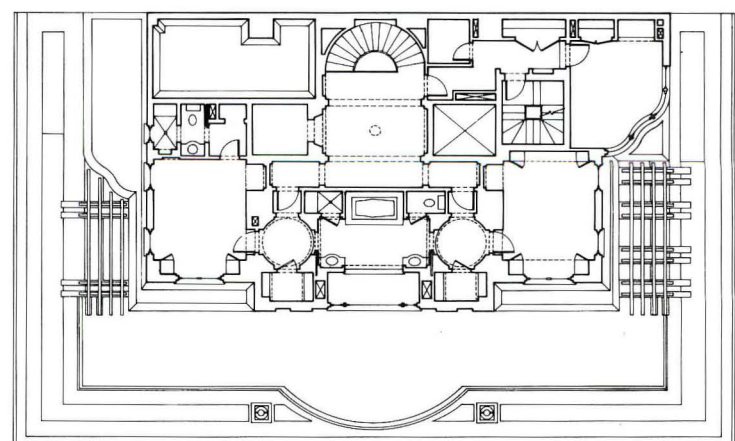

PENTHOUSE – SECOND FLOOR



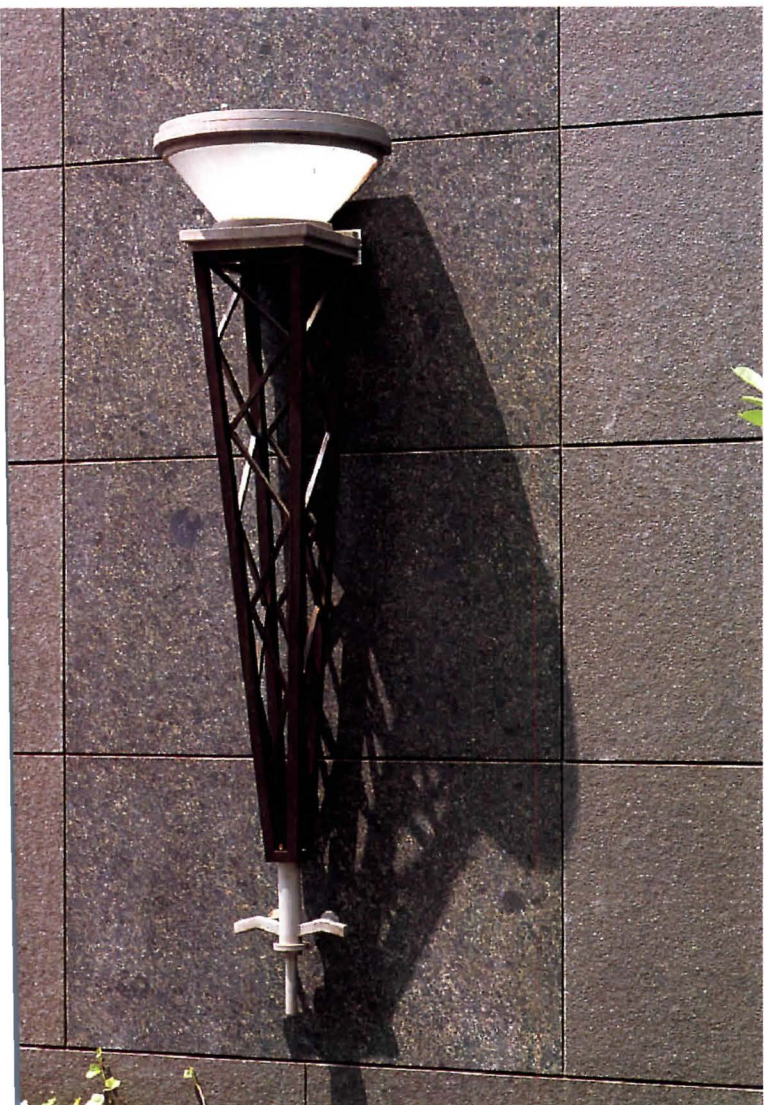
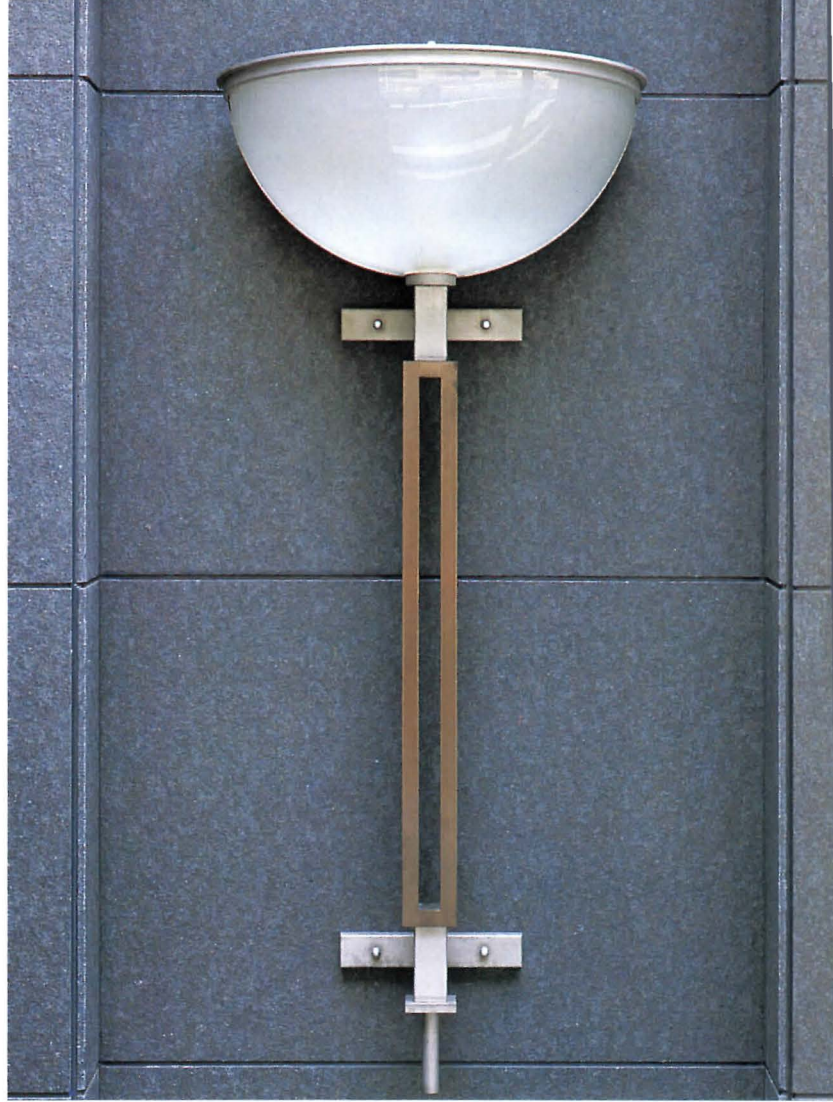

Koizumi Sangyo Building
Tokyo, Japan
Eisenman Architects
K Architects and Associates



Cubic Disturbances

IT IS DIFFICULT FOR A WESTERNER TO PREPARE FOR THE CULTURE shock experienced during a first visit to Japan. But the disorientation that comes with the inability to understand the Japanese language enables one

to slip into a consciousness separate from East or West—an exotic limbo that opens new possibilities for thought and perception.

Appropriately, it is in Japan that Peter Eisenman's ideas of Poststructuralist "weak" form in architecture have achieved their first materiality—in the Koizumi Sangyo Building, which houses corporate offices and showrooms for the company's line of lighting and furnishings. Standing eight stories high in the Akihabara district of Tokyo, the building's striking image stops traffic on the narrow streets that confine it on three sides. Two distorted cubes have attached themselves to an otherwise traditionally Modern office block for no obvious reason. Yet one cannot definitively call these disturbances unreasonable.

This inexplicable relationship (is it intended? is it an accident?) seems at home in Tokyo. The restless compression of the city's density of sounds, lights, and shapes seems to reappear in the Koizumi Building's two fractured cubes. One extends from the fifth through seventh floors, and the other, located in the diagonally opposite corner, projects from the street level to the third floor. The complex, inimitable elevations of these cubes play off the surface of the rectilinear



glass box and invite speculation: Did these angled forms explode from within? Attack from without? What hierarchical system led to their invention? Partial answers are found in the unusual collaboration

of the building's architects, Kojiro Kitayama of K Architects in Tokyo, and Peter Eisenman of Eisenman Architects in New York. The Japanese and American were brought together by Kitayama's brother, the renowned architect Tadao Ando. They agreed to develop separate designs—Kitayama, the basic mid-rise, Eisenman, the cubes—which, when grafted into a single building, would blur the signature of each author, creating an opportunity for a third identity to emerge. This possibility challenges the traditional notion of authorship and introduces the idea of the arbitrary, thereby offering liberation from the limitations associated with conventional architectural design.

The building's cubes are formed by nesting els painted shades of pink and green. The iteration of the els distorts their simple geometry, creating walls of surprise. Set into the building's geometric curtain wall, the facades of the cubes appear to have been shaken by an earthquake. (When a mild earthquake rippled through Tokyo, I half

The nesting els of Eisenman's fractured cubes disturb Kitayama's Modern office block in a way that both pleases and puzzles the eye. The upper cube tilts, rather than towers, over its neighbors (facing page and bottom left). The lower cube (below) simply appears as a facade along the congested street.

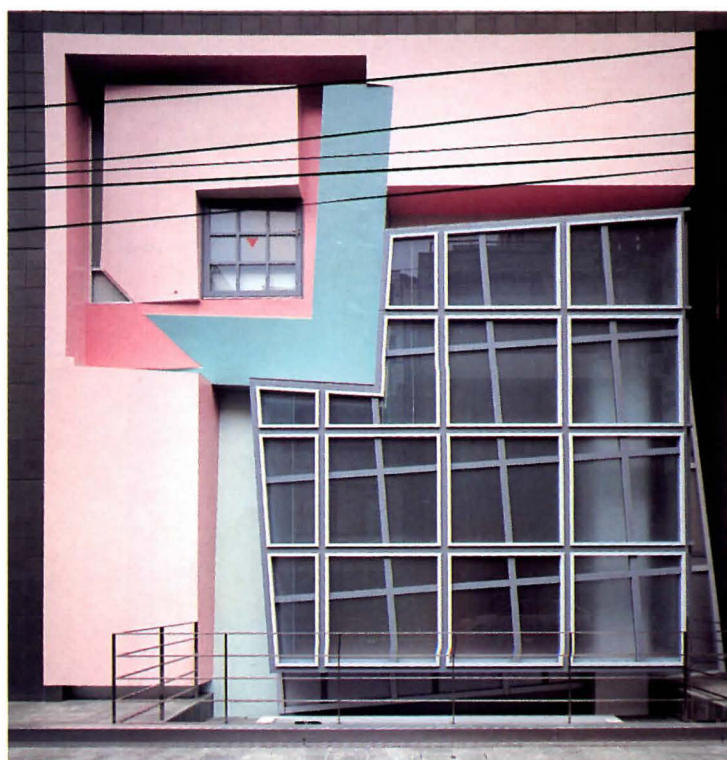

MASAO UEDA



MASAO UEDA

expected to find the facades shifted again.)

Inside the building, the uncanniness of the exterior erupts in tilting ceilings, walls, and floors, in unexpected vertical and horizontal views, and in windows at the floor and ceiling. These conditions redirect the occupants' gaze from customary habits to new patterns that in turn affect behavior and use.

For all the visual discordance of Tokyo, throngs of pedestrians proceed with a quiet purpose that conveys a sure knowledge of their destinations. But the inability of most cab drivers to find a passenger's destination without consulting a thick book of maps cracks the veneer of certainty to reveal the layers of complexity and dislocation that multiply in this city of rapid change. Just as none of my several cab rides to the building retraced any one route through the city, there is no single explanation for the architectural events that have taken place at the Koizumi Building.

While this lack of ability to define is somewhat disconcerting, it also opens possibilities for exploring that which is otherwise repressed beneath the layered conventions of architecture. After Eisenman delivered a lecture at the Koizumi Building in July, a young Japanese architect stood to express what he perceived as the danger of Eisenman's efforts to displace traditional methods of conceiving and executing architecture. But in visiting the New York architect's first Japanese commission, it is difficult to believe that his formal ideas will ever replace—nor are they intended to replace—traditional architectural hierarchies.

When a new building is opened in Japan, Shinto priests perform a ceremony of thanks for its successful completion. Dressed in traditional robes and chanting prayers, the priests at the Koizumi Building solemnly inflected branches and scattered bits of colored paper in a ritual as unfamiliar as the unconventionality that emerges from this work of architecture. Here is a building that successfully challenges methodologies of design, customs of habitation, and preconceptions of accommodation. ■

—CYNTHIA CHAPIN DAVIDSON

Cynthia Davidson is editor of Inland Architect.

Bridges spanning the four-story-high entrance lobby designed by Kitayama (center photos) provide views into the floors used for display of the client's lighting and furniture products (left). The lobby leads into the lower cube (top left and facing page, top), in which parallel corridors lead into a gallery space. The upper cube, which is denoted in the entrance lobby ceiling, contains a fifth-floor office and exhibit space (facing page, bottom) and a two-story volume on the sixth floor.



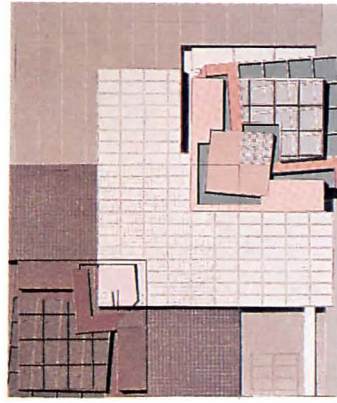

SECTION

Eisenman's cubic insertions disturb the traditional frame building (section, left) and create different plans on every floor. The stepped corridor leading to the gallery (facing page) provides a view through a narrowing volume to the third floor (top left). In the upper cube (bottom left), openings at floor level frame panoramas of Tokyo.

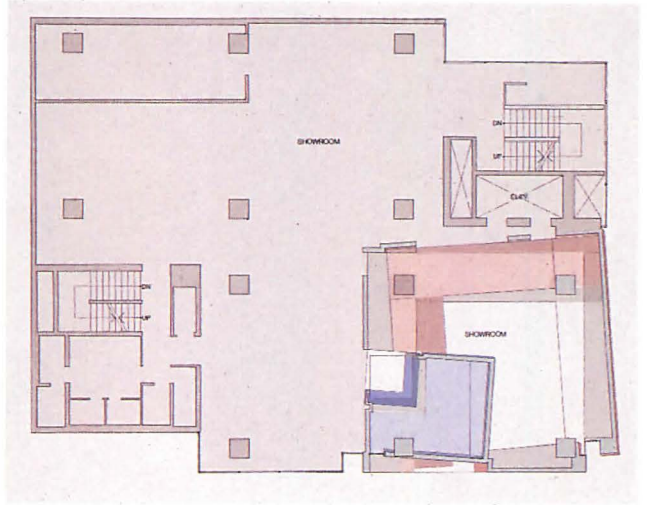

FIFTH FLOOR

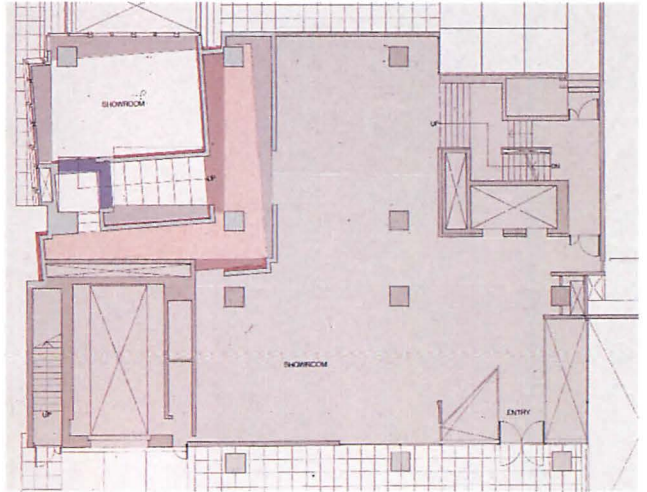

FIRST FLOOR

KOIZUMI SANGYO BUILDING TOKYO, JAPAN

ARCHITECTS: Eisenman Architects, New York—Peter Eisenman (partner-in-charge); George Kewin (associate partner-in-charge); Hiroshi Maruyama (project architect); Lawrence Blough, Robert Choeff, Lise Anne Couture, Begona Fernandez Shaw, Frederic Levrat, Dagmar Schimkus, Julie Shurtz, Mark Wamble (project team); K Architects and Associates, Tokyo—Kojiro Kitayama (partner-in-charge); Minoru Fujii (project architect); Itaru Miyakawa, Tamihito Motozawa, Hiroyuki Kubodera, Kazuhiro Isimaru, Susumu Arasaki, Yujiro Yamasaki (project team)
ENGINEERS: Ascoral Engineering Associates—Shizuo Tonomura, Syuichi Kobayashi (structural)
GENERAL CONTRACTOR: Taisei Corporation
COST: \$13.4 million
PHOTOGRAPHER: Peter Aaron/Esto, except as noted



Osaka Aquarium
Osaka, Japan
Cambridge Seven Associates

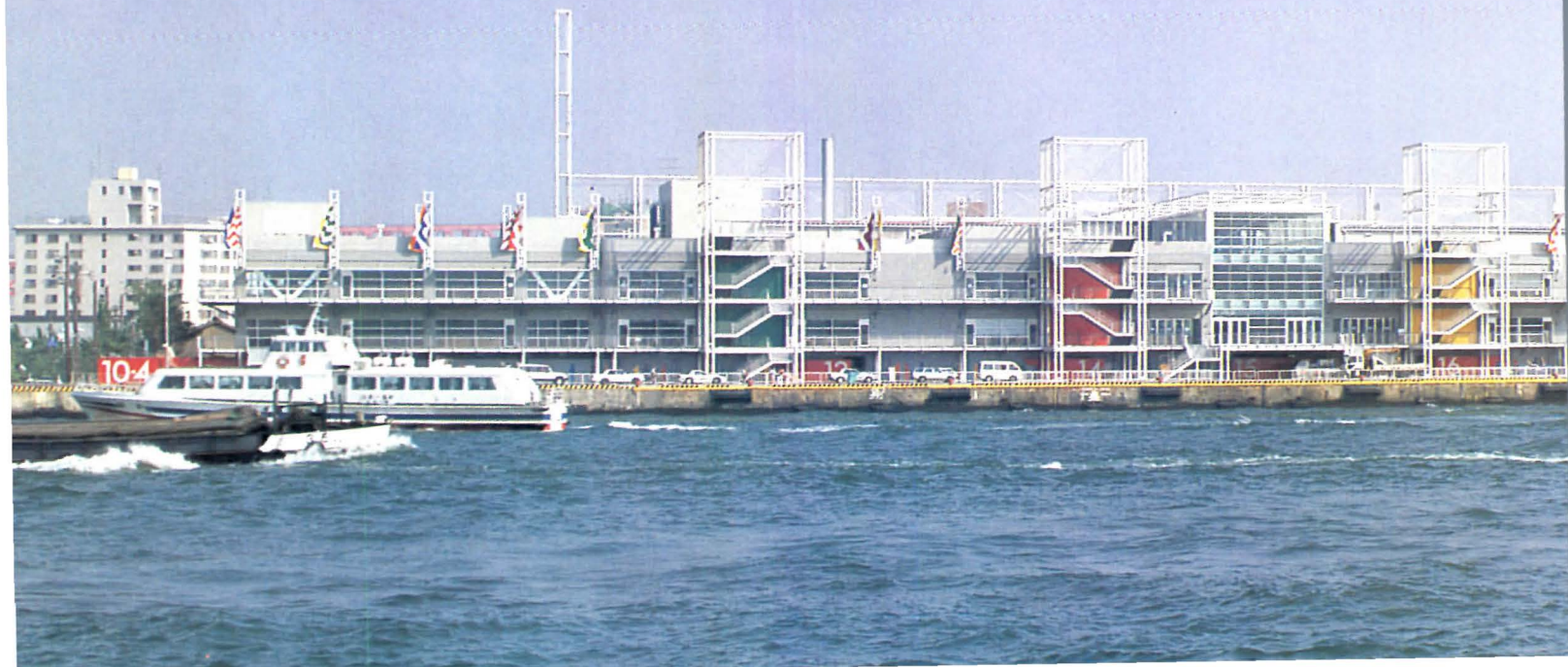

Pacific Overture



OSAKA, JAPAN, AND BALTIMORE, MARYLAND, are worlds apart, but both cities have built world-class aquariums on their waterfronts as instruments of urban revitalization. Baltimore's aquarium has drawn throngs of visitors for nearly a decade, while Osaka opened its new facility in July. The two projects are the work of Cambridge Seven Associates, a firm born out of the commission to design Boston's New England Aquarium in 1962.

Osaka's new aquarium is literally a jewel. Nearly 300,000 square feet, including rain forests under glass, are housed in a faceted cube built on the former site of derelict warehouses in Osaka's inner harbor. As in Baltimore, the Japanese aquarium is accompanied by a 150,000-square-foot festival marketplace with food courts and upscale stores, all part of a \$148-million revitalization package for the city's waterfront. The owners, a consortium of Japanese businessmen and the city of Osaka, hope to attract 2 million vis-

itors yearly at the aquarium alone. On opening day, 15,000 people jammed the new facility; two days later that number had more than doubled.

The new aquarium is filled with nearly 3 million gallons of water and 16,000 fish, marine mammals, birds, and reptiles. The habitats of the Pacific Ocean compose the aquarium's theme, and the architects structured the visitor's experiences of the building into a microcosm of the Pacific's "ring of fire," the zone of volcanic and tectonic activity outlining the Pacific basin. Lava is represented by gas flares arrayed along the exterior facade, and by red neon "flames" within.

This "ring of fire" became the organizing concept for the aquarium, and visitors circulate through the building via a four-story ramp that spirals around gigantic tanks teeming with sea life. Exhibits at the structure's periphery correspond to environments at the edge of the Pacific basin, while at the center of the building, a 1.4-million-gallon cruciform tank represents the Pacific pelagic habitats.



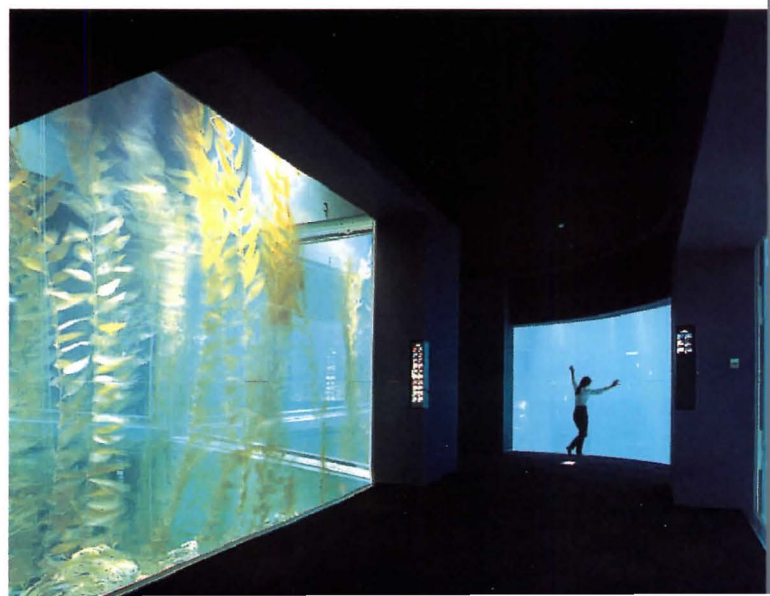

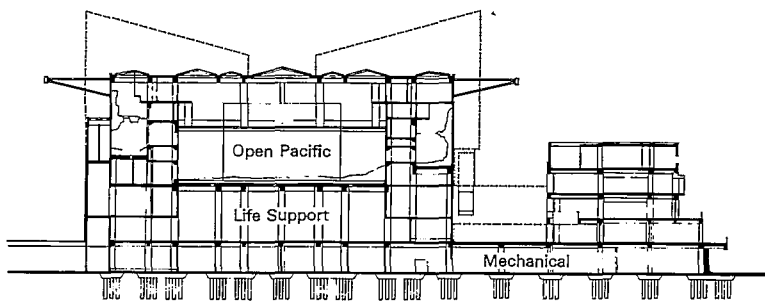

SECTION THROUGH OPEN PACIFIC TANK

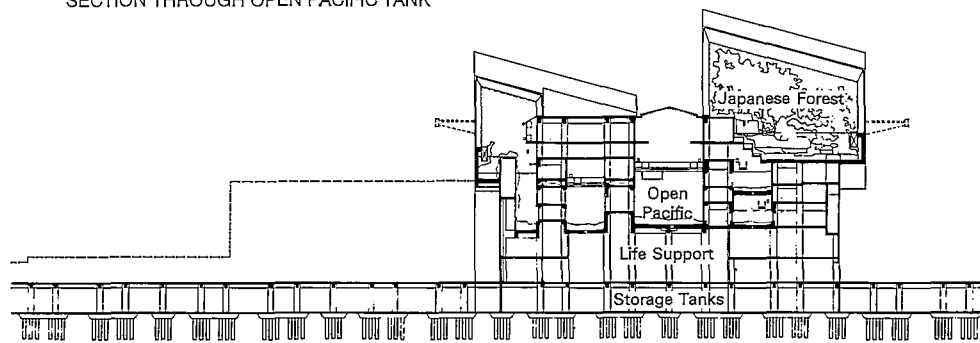

SECTION THROUGH TERRESTRIAL EXHIBITS

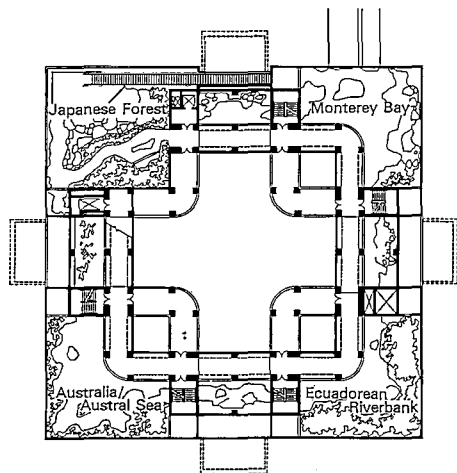

PUBLIC ENTRY LEVEL

The aquarium's exterior color palette (facing page, top left) reinforces its content with blue tile walls symbolizing the water and red glass volumes alluding to the Pacific's volcanoes. Beneath the glass crown thrives a miniature Japanese forest (facing page, bottom left); spiraling ramps offer visitors a sense of underwater life (facing page, bottom right). From Japanese rain forest exhibits (section, above) visitors pass exhibits depicting both sides of the Pacific (plan at left); they descend along ramps to the ocean's depths. Plaza level (below) is devoted to support functions.

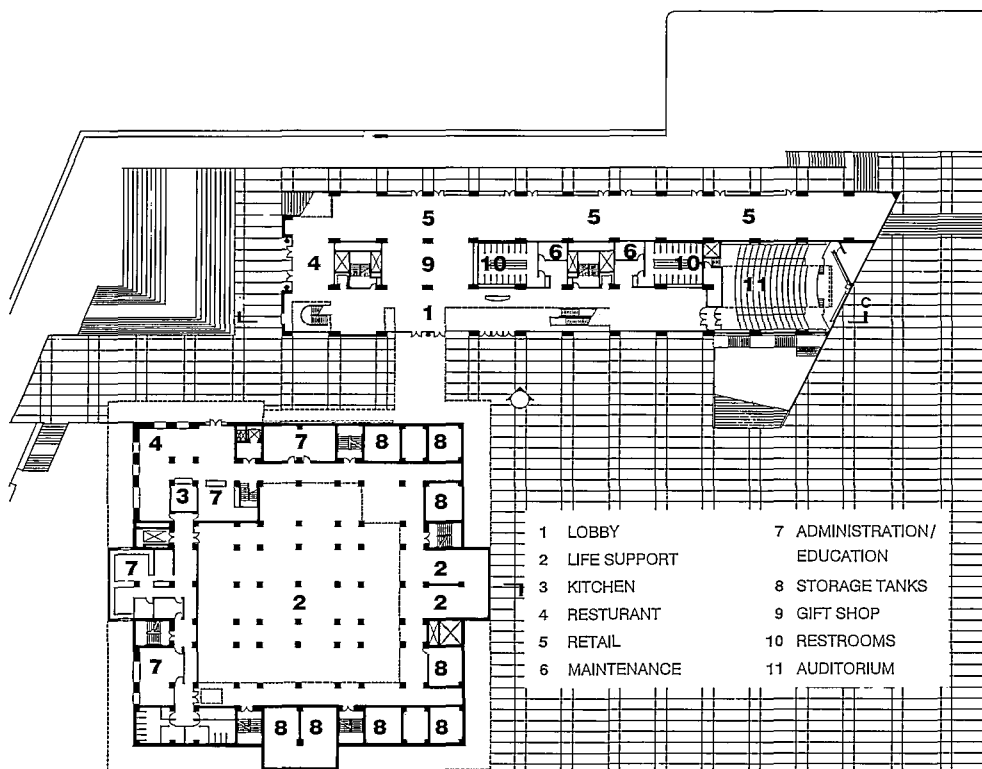

PLAZA LEVEL

A tour of the ring begins at the building's top level, where exhibits explore terrestrial habitats of the Pacific region under the aquarium's glass crown. Visitors with a good sense of geography will discover that exhibits throughout the aquarium are found at their respective compass points. From the Japanese forest at the top of the building's northwest corner, visitors proceed clockwise to the Aleutian islands, the California coast, the Gulf of Panama, an Ecuadorian forest, Antarctica, New Zealand, and Australia's Great Barrier Reef.

After spiraling through nine above-water habitats, visitors take the plunge for a tour of life underwater, where more than 300 species are represented. Cambridge Seven principal Peter Chermayeff (who conceived the idea of an aquarium dedicated to the Pacific region) wanted to create a sense of immersion, so tanks and pathways intertwine, and visitors gaze past the fishes to other humans peering from the opposite sides of tall, columnlike tanks.

Cambridge Seven seems to have cornered the market on aquarium design, having completed planning and feasibility studies for aquariums in at least half a dozen cities and designed operating aquariums in several others. Aquariums designed by the firm are planned for Chattanooga, Toronto, and Genoa, Italy. In fact, Cambridge Seven has created a spin-off company for the Genoa commission that will undertake all facets of the project, from building the exhibits to choosing the fish and training the staff, and will run the aquarium for a year before its operation is taken over by the city.

—MICHAEL J. CROSBIE

OSAKA AQUARIUM
OSAKA, JAPAN

ARCHITECTS: Cambridge Seven Associates, Cambridge, Massachusetts—Peter Chermayeff, Ivan Chermayeff, Peter Sollogub, Bobby Poole, Richard Tuve, Christopher Choa, Louise Hara
ASSOCIATE ARCHITECTS AND ENGINEERS: Environmental Development Research, Osaka—Shingo Yamaguchi, Tatsuo Ino, Masaaki Sugimoto, Teruo Segawa, Tatsuhiko Horiuchi, Toru Mishima, Shoji Kurokawa, Yutaka Yoshida, Toyohiro Matsuo, Akira Matsukuma, Takashi Onishi, Masaharu Akazawa, Toru Hongo
DESIGNERS: Lyons/Zaremba Inc. (exhibit); The Larson Company (exhibit habitat); Chermayeff & Geismar Associates, Ikko Tanaka Design Studio, Studio Ikks (graphics); H.M. Brandston & Partners (lighting)
ENGINEERS: John L. Altieri Consulting Engineers (mechanical/electrical/plumbing); Weidlinger Associates (structural); Enartec (life support)
CONTRACTOR/CONSTRUCTION MANAGER: Takenaka/Obayashi/Konoike Joint Venture
COST: \$107 million
PHOTOGRAPHER: Peter Aaron/Esto

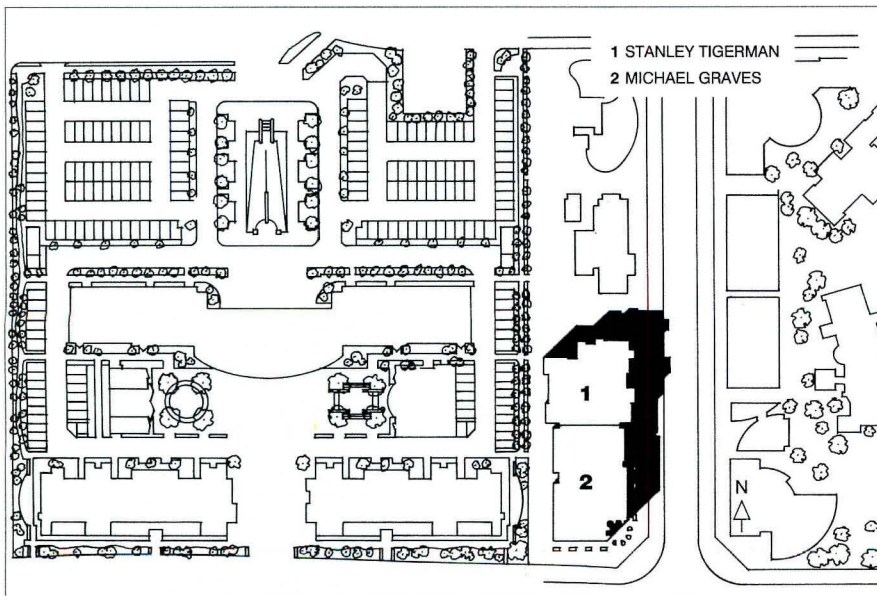

MOMOCHI HOUSING

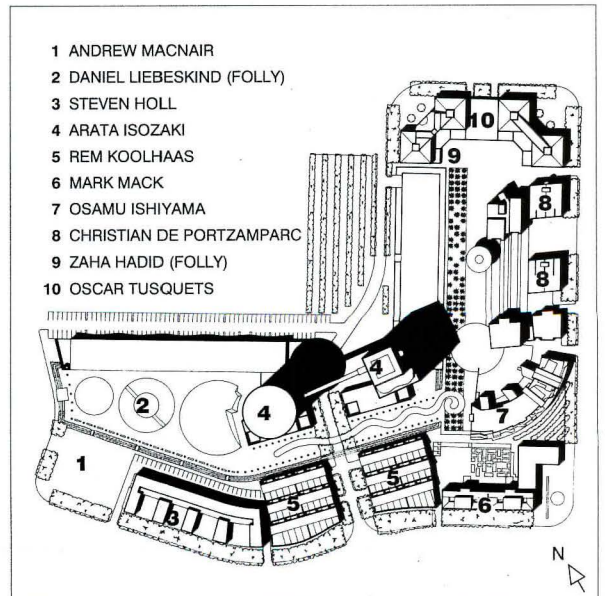

KASHII HOUSING

Model Homes

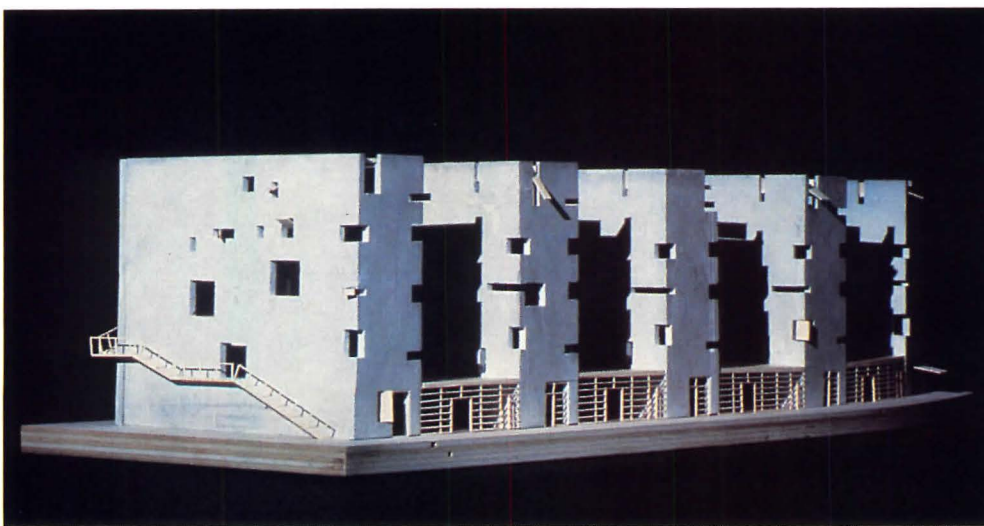
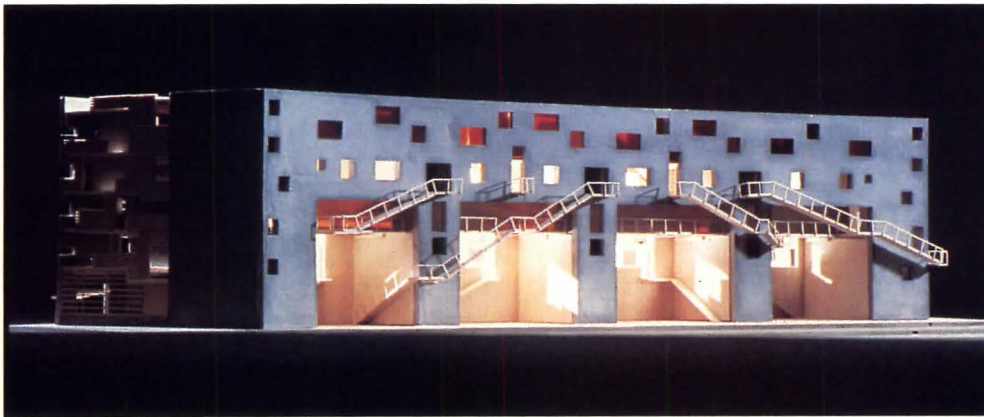

ONE OF THE MAJOR issues facing Japanese cities today, says Arata Isozaki, is whether "traditional Japanese housing with its intimate, private gardens can be replaced by urban housing in a form which offers a panorama instead." Isozaki posed the challenge last May at a highly publicized international conference in Fukuoka, a port city located on the island of Kyushu, at Japan's southwestern tip. Sponsored by Fukuoka Jisho, one of the city's major development companies, the conference brought together seven Western architects recommended by Isozaki to address urban issues and develop innovative housing solutions appropriate for Japan's changing cities.

Inspired in part by Berlin's lauded Internationale Bauausstellung (IBA) housing program established in 1979, Fukuoka Jisho, (which had already constructed 2,500 housing units throughout the city) also sought to build model housing projects by individuals in the forefront of architectural thinking. IBA's ambitious program involved approximately 200 architects from around the world for 3,000 new and 5,500 renovated housing units, on redeveloped land destroyed by war, insensitive urban renewal, and neglect. However in Fukuoka, the developers were charged with extending a cohesive urban fabric on two vast sites of reclaimed land along the waterfront, with the model housing designed by international "name" architects comprising only a small component of the two major developments.

The first completed demonstration housing projects in Fukuoka are mixed-use apartment buildings located adjacent to one another. Designed by Michael Graves and Stanley Tigerman, and built as components of a model city for the 1989 Asia-Pacific Exposition, the Nexus condominiums now serve as the gateway to the 193-acre Momochi development on the west bank of Hakata Harbor.

Kashii is a second waterfront urban development project equal in scope to Momochi, and likewise includes exhibition housing. On a 12-acre site, under the coordination of Arata Isozaki, 10 young architects, including Mark Mack, Steven Holl, Rem Koolhaas, Oscar Tusquets, Christian de Portzamparc, and Osamu Ishiyama, have clustered low structures around two towers by Isozaki. The first buildings are scheduled for completion next year. ■

—LYNN NESMITH

Tigerman's complex abstraction (facing page, right in photo) and Graves's quieter composition (facing page, left in photo) are the first completed components of Fukuoka's Momochi housing project (facing page, left site plan). The second phase in Kashii (facing page, right site plan) comprises Isozaki's two towers and a cluster of six low-rise struc-

tures. For the Kashii corner site, San Francisco architect Mark Mack created two interconnecting buildings (top). The smaller of the two encloses an urban plaza; the larger helps define the commercial street. New York architect Steven Holl's building has a linear spine (above center) with five projecting residential wings (above).

Nexus South

Fukuoka, Japan

"I WANTED TO CREATE A BACKGROUND building," recalls Michael Graves, explaining his Nexus Momochi apartment building in Fukuoka. With its red Indian sandstone cladding and simple, unadorned facades, the five-story structure is certainly one of Graves's more "background" designs. Built as middle-income housing, the condominium complex contains ground-floor retail shops and 10 apartments ranging in size from two- to four-bedroom units.

Addressing the building's prominent location at the intersection of two streets, Graves set an octagon pavilion at the corner. The center of the pavilion serves as the "front door" to apartments on the upper floors, while side entrances provide access to shops. A street-level loggia frames the storefronts and encourages pedestrian activity.

Graves also attempted to compose the structure so that it incorporates a resonance of Eastern influences, rather than purely Western. "In traditional Japanese design, there is an insistence on the frame," Graves points out. Continuous balconies atop the columnar loggia create a gridded facade, which frames the views from the units but also defines views from street to interior. "We tried to make that frame evident," says Graves, "while providing the maximum daylight for each of the apartments."

Furnishing selected units with custom designs allowed Graves to explore, on a more individual level, the concept of housing for a model city. Although the program originally called for American fixtures, as the project developed, the very different requirements for Japanese bathrooms and kitchens ruled out the use of U.S. products. However, Graves did create a collection of tables, armchairs, sofas, chairs, and lamps for the interiors. Recalling the simple exterior, Graves's furniture designs incorporate basic geometric forms in a variety of color combinations: "a notion," he adds, "the Japanese have perfected over the centuries."

ARCHITECT: Michael Graves, Architect, Princeton, New Jersey—Michael Graves (project architect); John Diebboll, Michael Crackel (associates-in-charge); Haruhisa Mikami, Ana Williamson (design team); Wendy Bradford, Stephanie Magdzaik (interiors)
PHOTOGRAPHER: Peter Aaron/Esto

The Nexus tower acts as a corner gateway (facing page, top), providing panoramic views from living rooms (top right). Graves also designed furnishings for the apartments (right). The ground floor (facing page, left) allows for retail space; upper floors are clustered around a service core (facing page, right).



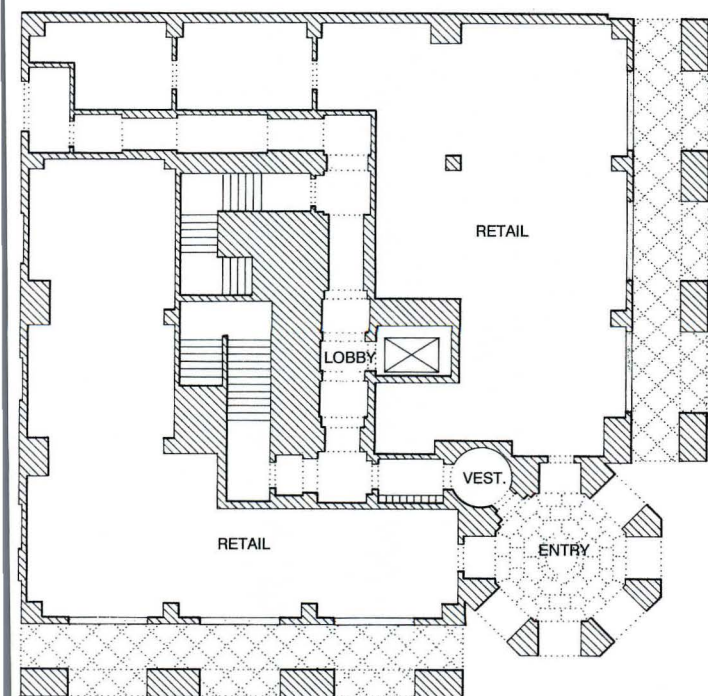

GROUND FLOOR PLAN

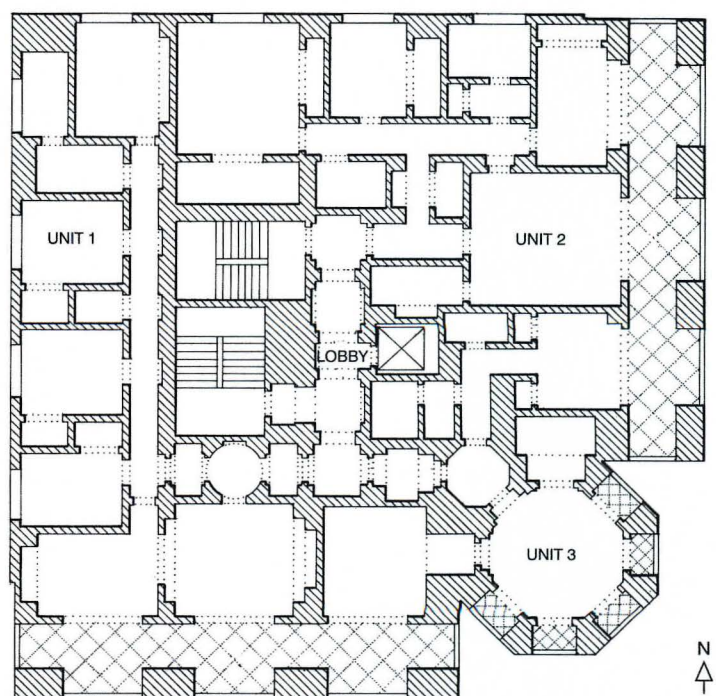

SECOND AND THIRD FLOOR PLAN





Nexus North

Fukuoka, Japan

FOR THE SITE NEXT TO THE GRAVES-designed condominiums, Stanley Tigerman created a building with basically the same size and program as his American colleague's. Tigerman's solution, however, is very different in terms of esthetics and organization. The six-story structure is located along the Momochi district's main commercial street opposite a variety of recently completed buildings by Japanese architects Kisho Kurokawa and Shoen Yoh. Tigerman's ground floor is devoted to retail space, while the upper floors comprise 18 three- to four-bedroom apartment units.

To create a highly articulated street facade, Tigerman manipulated a series of overlaying grids—from a black fiberglass framing system to windows, doorways, balconies, and even the cladding pattern. Individual apartment units are defined within this composition by projecting bays clad in gray ceramic tiles of different sizes. The structure is responsive to the shifting angles of the sun, a high priority in the planning of buildings in Japan. But unlike Graves, who pushed his structure to the street to capture precious light, Tigerman turned his building inward to a central courtyard open to the sky. The lobby provides the only entry to the cubic courtyard. A clean, unbroken white grid, constructed of aluminum, defines the interior courtyard (Tigerman's metaphor for the Garden of Eden), in contrast to the exterior's two-meter-square black grid, which the architect explains "reassembles the disparate elements of the building as an act of reconstruction."

The developer, Fukuoka Jisho, deliberately paired architects for adjacent apartment buildings throughout the Momochi district, and set the program for the "spaces in between." Tigerman's and Graves's buildings join at a low pavilion, the broken tooth that is common in the street wall of Japanese cities, where zoning requires a gap between the buildings. Graves designed this transitional component, but chose to clad it in the gray tile of Tigerman's building.

The American architects speak highly of the design and construction process in Fukuoka, with Tigerman calling it the "best building experience of my life—quality craftsmanship and teamwork operation." Recalling a visit during construction, Tigerman notes, "When the first floor had been poured, I went up and walked on the concrete. I saw that someone had sprung a chalk line revealing that the floor had no camber, no deflection. The concrete was never meant to be exposed, but it had been poured perfectly. My building is not technologically advanced, just perfectly constructed." ■

Fronting a busy street, Tigerman's east elevation (facing page) is a complex overlay of grids, his energetic version of the traditional Japanese frame. Along the north facade (below), Tigerman steps down the black frame and breaks his rigorously geometric composition with a curving fire stair (bottom). A side entrance is announced by a suspended canopy (below), also based on the two-meter-square grid pattern.



ARCHITECTS: Tigerman McCurry Architects, Chicago, Illinois—Stanley Tigerman (principal-in-charge); Paul Gates (project architect); Roger Farris, Adam Koffman, Karen Lillard, Terry Surjan, Constantin Vasiliou (design team)
ASSOCIATE ARCHITECTS: Yoshihide Kato, Zenitaka Corporation
ENGINEER: Zenitaka Corporation
CONTRACTOR: Zenitaka Corporation
PHOTOGRAPHER: Peter Aaron/Esto

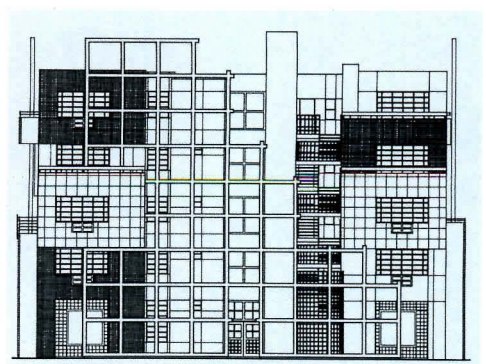

NORTH ELEVATION

Inspired by traditional Japanese proportions, Tigerman uses the square as a recurring theme both inside and outside the Nexus Mochi condominium complex. Large square windows on the ground level (above) provide visual interchange between retail shops and pedestrians, while the black grid meets the street to create a Mondrian-like composition. The north entrance canopy (right), with the same black grid and translucent square panels, is a variation on a hinged, overhead shoji screen. Square ceramic tiles of different sizes and various shades of gray are repeated in the condominium's common elevator lobby (below); the small punched windows open into Tigerman's central courtyard. The interior courtyard is bound by open hallways (facing page, top) that serve as the primary circulation path to the apartments. A continuous white aluminum structure (facing page, bottom) frames a perfect cube to create the literal and figurative heart of Tigerman's building.

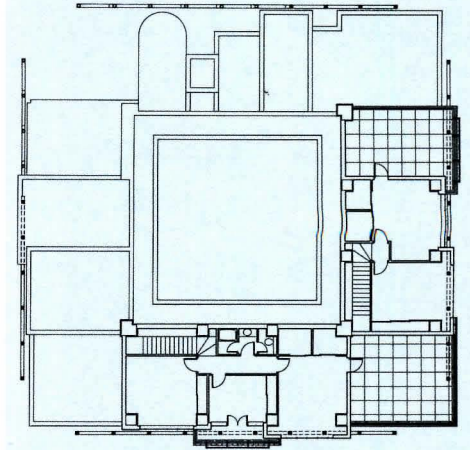

SIXTH FLOOR

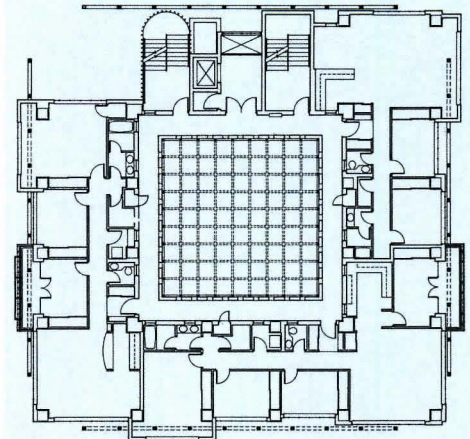

SECOND FLOOR

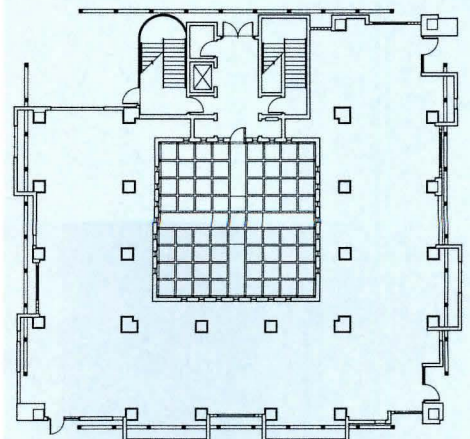
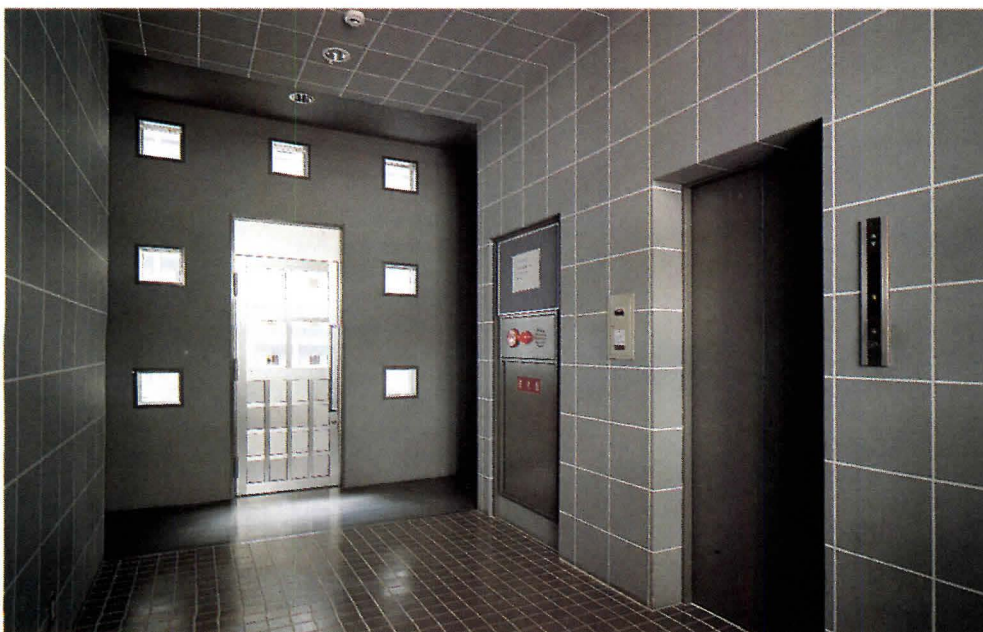

GROUND FLOOR



Hurd InSol-8.™ The biggest news in

The new Hurd InSol-8™ window outperforms any other residential window. It's the only window that insulates to R8 center of glass—R5.5* total unit—and blocks over 99% of the sun's harmful UV rays.

Design freedom without drawbacks.

You don't have to design around the drawbacks of conventional windows anymore. Now you can spec all the windows you want—virtually anywhere you want—without compromising comfort or energy efficiency.

InSol-8 windows are designed to control solar energy without limiting natural light—for any exposure, in any climate.

Heat Mirror XUV™ provides more fading protection than Andersen HP, Pella Heatlock™ and Marvin Low-E windows combined.

InSol-8 windows help protect against fading damage to draperies, furnishings and artwork by blocking over 99% of the sun's invisible UV radiation—without tinting the view.

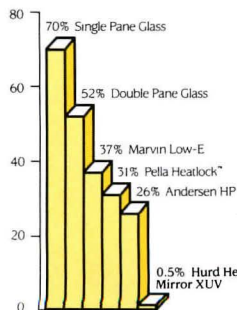

Ultraviolet Transmission Comparison
InSol-8 windows transmit 50 times less UV radiation than ordinary "low-E" and more than 100 times less than double pane glass.

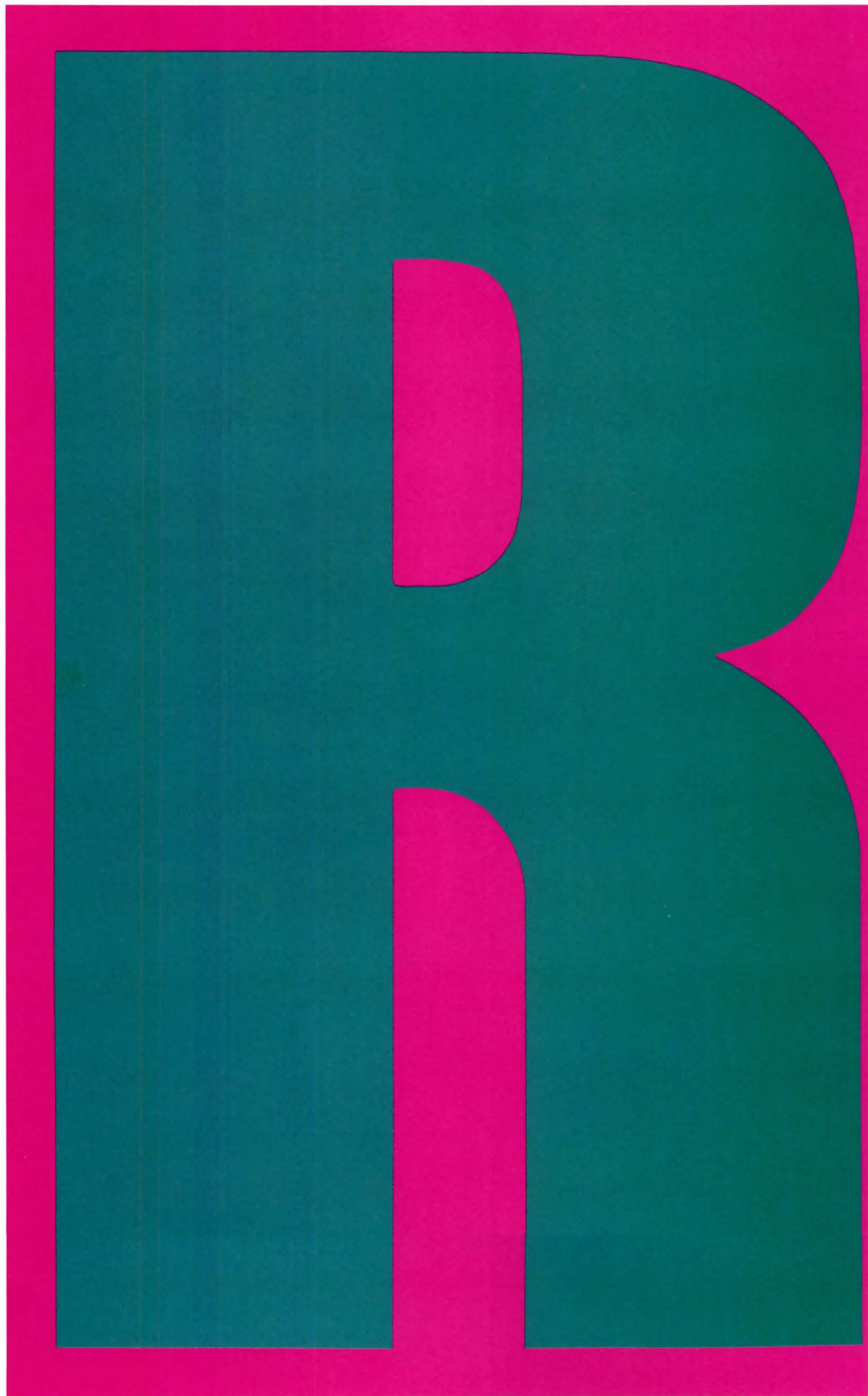

All calculations based on center of glass values for 1" Hurd InSol-8 windows with the Superglass System® with Heat Mirror™ Film. All data were calculated using WINDOW 3.1 Computer Program and standard ASHRAE winter conditions of 0° (F) outdoor and 70° (F) indoor temperatures with a 15 mph outside wind.
*Total unit R value of 5.5 is for commercial size units; 4.6 for residential size units.

Foreign Exchange

**PRACTICE:
WORKING ABROAD**

Architects from the United States offer tips on practicing overseas, while their British counterparts discuss the American presence in London.



NIALL CLUTTON/ARCAID

In July, ARCHITECTURE invited British architects for breakfast at the Design Museum's Blueprint Cafe in London (above) to discuss the American "invasion" (page 104).

WHILE EACH AMERICAN FIRM HAS ITS own strategies for working abroad, practitioners agree on several basic factors, including the timely arrival of the fax machine. Expenditures of time and money are considerable, and so is the stress of global travel. Swanke Hayden Connell Architects, which established its London base in 1987, emphatically urges firms to commit themselves for the long term. "The challenge is to develop a sense of trust, because they're still looking at us with hesitation," notes Richard Carlson, design principal of Swanke Hayden Connell Architects.

Leaders of several U.S. firms working on overseas projects strongly recommend securing expert advice on matters ranging from compensation to national cultures. Diane Barnes of Barnes & Brandt, a New York-based international-marketing consultancy, has several clients anxious to set up practices and design-related businesses in the United Kingdom. For one client, a New York contractor considering expanding to the U.K., Barnes organized three days of conversations in London with experts on labor unions and construction practices; the client decided against the move.

Staffing problems can be avoided by accepting advice from consultants who are familiar with design schools and local firms. RTKL follows the practice of arranging seminars by experts on local culture and history. Forming associations with local architectural professionals is also a must. Local firms offer experience, vital information on local power structures and building codes, and, at the beginning, necessary credentials. They provide an essential operational base—especially in Japan, where clients may select the U.S. architect as lead designer, who then contracts with one of the huge design/build firms. Local firms can also be an invaluable source for understanding contracts. "A local association cures a lot of problems if the project goes bad," says Jeffrey Heller of Heller and Leake Architects of San Francisco, whose project in the Philippines was put on hold after a recently attempted political coup. Heller advises setting up an escrow account in Switzerland, staying current with

billing, and limiting foreign work to a small percentage of the firm's business.

One strength that keeps U.S. firms in good stead in the global arena is their marketing know-how and willingness to set aside substantial budgets for the task. Many architects believe that connections are critical elements of successful marketing. They may be clients, employees and former students from abroad, or corporate associates.

Using the firm's own offices as a marketing tool, while a familiar strategy back home, is rare in the U.K. Richard Carlson and managing principal Richard Hayden, shocked



at the state of British offices in general and architects' quarters in particular, determined that their storefront office in London should serve as an expression of creativity. Designating the ground floor as gallery space, Swanke Hayden Connell now controls its image from the moment a client walks in the door.

Communicating an understanding of foreign custom is vital everywhere. Recognizing the reserved approach of the British, Swanke Hayden Connell replaced its usual recorded slide presentations with conversations supported by portfolio. RTKL marketing vice president Laurin McCracken co-authored a handbook on doing business in Japan, in which he spells out the critical art of exchanging cards and the protocol of conducting business meetings (the average meeting lasts one hour; punctuality is imperative).

Diane Barnes recommends employing a European graphic designer to produce a brochure that does not look American. Country telephone codes and locations of projects should be included. Books containing illustrations of projects are often well received and help potential clients remember a firm's work. (More tips from architects follow on the next two pages.)

Clearly, global practice in all its variety is here to stay. The benefits are considerable, from improving profits to gaining insight on practice at home—all of which, in the long run, can lead to better buildings everywhere.

—KARIN TETLOW

Karin Tetlow is a New York-based writer.

Advice from the Experts

To understand the complexities of working abroad, ARCHITECTURE interviewed principals of eight U.S. firms about their experiences practicing in Europe and Asia.

Participants included **Harold L. Adams**, chairman of RTKL; **Richard Hayden**, managing principal of Swanke Hayden Connell; **Cesar Pelli**, principal of Cesar Pelli & Associates; **Charles Redmon**, managing principal of Cambridge Seven; **Erik Sueberkrop**, principal of Studios; **Benjamin and Jane Thompson**, partners of Benjamin Thompson & Associates; **Stanley Tigerman**, principal of Tigerman McCurry Architects; and **Carolina Woo**, partner of Skidmore, Owings & Merrill.

How easy was it to set up an overseas office and recruit foreign personnel? How did immigration laws affect your practice?

HAROLD L. ADAMS: Opening a new office anywhere, whether abroad or down the street, is no easy task. The secret of our success has been obtaining outstanding legal, financial, and other professional advice.

Immigration laws have not adversely affected our practice. Once we decided to move abroad, we knew there would be certain requirements and restrictions. British immigration laws state that you cannot be in the country while your work permit is being processed, something that takes a few weeks. Our office directors had to leave the country while the projects were just beginning. Fortunately, we were able to serve the client in the interim.

In our first office abroad—London—we decided to form a partnership with an existing U.K.-based firm. Though we've been working on many international projects, we felt the partnership would make our first step a little easier. One of the reasons for this is that it avoided what can be a very frustrating endeavor—recruiting foreign personnel. When we cannot supply the appropriate personnel from the U.S., we tap into our partner's resources.

ERIK SUEBERKROP: Immigration laws were not a critical issue for us in London, although they are for many firms. Our London office is managed on a day-to-day basis by a British citizen who had worked for Studios in the United States.

All of our London staff are legal residents. There is quite a large pool of American-trained interior designers and architects in London, and we have been fortunate to find new staff members from this group. Opening an office in Paris, on the other hand, is somewhat more restrictive.

BENJAMIN AND JANE THOMPSON: Our firm is currently working in nine foreign cities. We maintain a single, centralized design/production organization in the U.S., and we do not set up satellite offices, preferring to work in close association with an architect in each location. Nevertheless, we set up a four-man project office in Dublin, for coordination and supervision, due to the speed and complexity of our redevelopment project there. In transferring personnel, we obtained temporary work permits without difficulty. However, all salaries are subject to Irish income taxes and value-added taxes, and that amount is greater than what we pay in the U.S. There is also a corporate tax on fees for the work done there. In addition, there is a 25 percent tax on all supplies purchased in the country. It is certainly more expensive than working in the U.S.

RICHARD HAYDEN:

We have found it no more difficult to establish an office in London than to establish an office in Chicago. Our offices are always set up with a major project as the impetus and are staffed by our own people. The immigration laws had a very modest impact on us since they recognize specialized and experienced talents and allow them to relocate. No one dictated the percentage of local people we needed to have, but we did not wish to have a "carpet-bagger" presence and looked forward to building a permanent staff incorporating local practitioners. We recruited through acquaintances, agencies, and a modest use of local classified ads. At present, 10 percent of the staff is American.

CAROLINA WOO: Setting up an office in the U.K. was really no different from setting up any other office in a foreign country. The immigration laws in the U.K. are very similar to those of the U.S. It is important to seek legal advice to tackle such problems as immigration and taxation laws, which are very complex. At present, 15 percent of our employees in the U.K. are American.

CHARLES REDMON: In most cases, we did not set up an overseas office largely because of foreign taxes. We have entered associations

with local design firms to facilitate getting the project done. We have also been sending our own staff members abroad for extended working periods, working out of our associates' offices.

What are the procedures for getting a project approved by planning commissions and local authorities?

SUEBERKROP: In Switzerland, France, and Japan, there are specific codes; however, they are often subject to discussion and interpretation. As you might imagine in a city with the long history of London, there are many and various codes. In the Docklands, however, new codes being written for getting projects through aren't subject to borough approval. It is not as difficult a review process as it is in the rest of London.



Richard Hayden

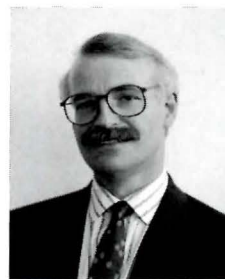

Erik Sueberkrop



Benjamin Thompson

THOMPSON: In Britain there seem to be more layers of approval than in the U.S. The process is more systematic and appears more bureaucratic than political—except when royalty intervenes. In Ireland, the codes are more general, with less specific requirements of how life-safety issues (fire egress and access, for example) must be resolved. Architects tend to ignore the codes and resort to negotiation when there is a specific design. Because of our collaboration with resident architectural firms, most of the process is handled and understood by designated technicians in those offices.

HAYDEN: The approval processes in the U.K. are very similar to the variance-procedure methods in New York and other major cities. The major difference is derived from the philosophical difference between British common law and American statute law. In Britain, there are no clearly stated administrative codes governing building-design issues, but there are guidelines that are interpreted through agency staff with final decisions being made by the legislative body or elected

council. The major difference is that in the U.S. there is always the opportunity to test out an "as-of-right" approach, which doesn't exist in the U.K. In England, the number of agencies involved in the process is never quantified. In addition to actual government agencies, special-interest groups, such as preservation societies, are consulted by local authorities.

CESAR PELLI: The review and approval process by British public authorities is more interactive and subjective in nature. For example, an inspector here in the U.S. reviews a set of drawings for compliance to a clearly defined set of standards mandated in the applicable building code, and then issues a building permit to allow construction to commence. In the U.K., however, a district surveyor (the equivalent of our building inspector) addresses specific health and safety issues as they are raised by the architect throughout both the design and construction process. Instead of referring to a building code, the district surveyor will render judgment based on his experience with similar issues on previous projects.



Harold L. Adams



Cesar Pelli

How do foreign construction methods differ from those in the U.S.?

ADAMS: In general, the architect abroad has far less control over the construction process than here in the U.S. The process is closer to the design/build format, where the contractor has broader responsibilities.

SUEBERKROP: In countries such as France, Switzerland, and Japan, a large proportion of the construction pricing and contractor selection is based on what would be considered a detailed design development set of drawings in the U.S. There is, however, a lot of maneuvering room for both the contractor and the architect in the final execution of the work. In Europe, the architect is frequently the construction manager. Contractors in the U.K. are not as familiar as American firms with the concept of fast-track scheduling.

THOMPSON: The significant difference between the U.S. and U.K. is the presence of the quantity surveyor as a key player in the team process. Working directly for the

client, the quantity surveyor estimates costs, controls the specifications and bid documents, receives and evaluates bids, selects subs, negotiates all contracts and extras, and seeks the best value for the price. This process provides the client with an independent view. But, because the quantity surveyor doesn't work for the architect, there is often little input on important issues like material quality, and substitutions can be made without the architect's approval or knowledge. The architects, nonetheless, are responsible for supervision.

HAYDEN: For large-scale projects the systems, methods and procedures are quite similar in the U.K., though more detail is expected from architects than from contractors and suppliers.

STANLEY TIGERMAN: Technological differentiation between the U.S. and other countries is minimal. What can be different is the level of craftsmanship. Having worked in Berlin, for example, the well-known German craftsmanship is a bit of a myth. On the other hand, my experience in Japan was extraordinary, producing the best building I have ever been part of.

PELLI: Construction methods and systems are similar to those in the U.S. However, builders in the U.K. support a systems approach to construction more than U.S. builders do. For example, bathrooms in high-rise buildings are prefabricated in modules and lifted, complete with accessories, into place by crane. However, there is less of a reliance on mass production—there is no such thing as a hollow metal or wood door-frame profile.

REDMON: Quantity surveyors and construction involvement in the U.K., and "director of works" roles in Italy, are quite different and have significant impact on fees.

Are you importing materials and furnishings from the U.S. for your projects abroad?

ADAMS: Work abroad carries with it certain restrictions and expectations, one of them being that you don't rely too heavily on the crutch of American materials. Why use an American curtain wall system for a project in Germany when a German curtain wall system is every bit as acceptable?

SUEBERKROP: Although we import some materials and furnishings from the U.S., we tend to use only manufacturers that also have outlets in Europe. We are intrigued by the materials that are available to us in Europe, and think it makes good sense to use those materials from the point of view of cost and service. We find, for instance, a much better selection of light fixtures in Europe.

HAYDEN: Within the European Community there is little need to import products except for highly specialized materials. Already a number of American contract furniture companies such as Knoll, Herman Miller, and Steelcase are manufacturing in Europe, and we have purchased from them for many years. We have always purchased our marble and stone from Europe for buildings both here and abroad, and of course continue to do so.

PELLI: Most of the materials and furnishings for our projects come out of Europe, not the United States.

WOO: We are importing some materials such as precast curtain walls, systems furniture, and carpet tiles.

How often do your principals travel abroad to supervise overseas operations?

ADAMS: The people we've positioned abroad are all competent professionals, each offering the skills necessary to make the venture a success. When our principals travel abroad, it is not to supervise operations, but to attend board meetings, deliver formal presentations, and explore other types of marketing opportunities.

THOMPSON: We find that travel abroad is required monthly or bimonthly during the planning and presentation phases of each project, which often extend for several years. This schedule continues during construction even though we make supervision arrangements with associated architects.

Overseas travel is a special cost of this long-distance work—not only travel time and jet lag, but planning, arranging, and accounting of such trips. We feel it justifies a 10 percent surcharge on our fees and are attempting to implement this increase.

HAYDEN: Travel is required on a biweekly basis. We have a principal and associates in charge of the London office; this arrangement is similar to the relationship between offices in the United States.

TIGERMAN: The fax machine has greatly reduced overseas travel. My associates and I traveled to Japan five or six times. Our Japanese associates and clients took two or three trips to Chicago. There were also thousands of faxes between us.

WOO: So far we have six full-time principals stationed in the U.K. Some principals travel abroad on specific projects all the time.

REDMON: Hardly a week passes without a principal traveling abroad.

British Reaction

In London, millions of square feet of office buildings and interiors are being designed by U.S. architects. How do local firms feel about this American invasion? To find out, ARCHITECTURE invited a group of British architects to express their opinions at a roundtable held at the Design Museum in London.

Participants included **Francis Duffy**, chairman of DEGWA, a 100-person firm in London with offices in Glasgow, Paris, Milan, and Madrid; **Piers Gough**, partner in CZWG, a 40-person office that designs commercial, residential, and institutional buildings; **Eva Jiricna**, a Czech architect working in Britain for the past 22 years and principal of a 12-person firm that specializes in retail interiors and small-scale commercial work; **Rick Mather**, an American living in Britain for the past 25 years and principal of a 15-person firm known for university, residential, and commercial buildings; **Ian Ritchie**, principal of Ian Ritchie Architects, a 19-person firm specializing in both commercial and residential work with offices in London and Paris; **Julyan Wickham**, partner of Wickham & Associates, a six-person firm that specializes in residential and commercial buildings.

Millions of square feet of development have been taken from British architects by U.S. firms. Why are the Americans so successful?

JULYAN WICKHAM: It's not so much the American firms, but their size. The Americans are no better than big British firms: they are businesses doing architecture rather than architects being businesslike. I've nothing against them except the product. It's a cynical type of architecture.

RICK MATHER: The developers at Canary Wharf are North American. They're used to working with Americans, so they go to what they know. The British process is slower. Americans can come up with an image, a design package, in days. They know how to present very quickly, offering lots of variations. The British, on the other hand, want to be thoughtful and serious, not so fast or superficial.

IAN RITCHIE: Another reason is greed. The British are not so good at putting so many square feet on a site. That's why Stanhope Properties asked SOM to design the second phase of Broadgate [page 68]. They started with a gentlemanly British practice, Arup Associates, putting up sophisticated buildings, but because of their greed and time scale, they moved to Americans.

WICKHAM: Broadgate was just too big for most British firms. That's why SOM got the commission.

How are the British influenced by American developments in terms of work methods and esthetics?

FRANCIS DUFFY: Americans from the Beaux-Arts tradition find it possible to split off design from production. That's enormously at-

tractive to developers. It looks decisive and clear. The British think small because of the Arts and Crafts tradition. We worry about every detail. It's limited our scale of operations and imagination.

PIERS GOUGH: There's a generosity of space at Broadgate which the Americans have taught us. They may design appalling Edwardian pastiche facades, but there is an incredible richness to their buildings.

Is it true that part of the American success is due to office interiors?

RITCHIE: Yes. One reason Stuart Lipton goes to SOM is because he gets the whole lot—right down to services, engineers, interiors.

DUFFY: Broadgate's office interiors cost at least as much as the shell, because sophisticated, international tenants have asked for them that way.

RITCHIE: But is architecture exportable in cultural terms? American architects think you can drop in the American product, maybe round off the corners.

DUFFY: I think the opposite. I think architecture is very site-dependent, very local. What has recently happened is the result of



DEGWA conducts research on office environments, as well as designing interiors and buildings, such as the 9,000-square-foot Willow House in London.

CZWG's Cascades housing complex, completed last year, is located near Olympia & York's Canary Wharf development in London's Docklands.

Jiricna Associates has built its reputation on precisely crafted office and retail interiors, such as those designed for Jardine's Insurance Services.



Francis Duffy

Piers Gough

Eva Jiricna

strong economic forces making the local product inadequate for the aspirations of the user. It's a failure of the profession in this country.

GOUGH: We should have the wit to learn from the Americans who are here. British commercial architecture is pretty dire.

EVA JIRICNA: But I don't think good architects could survive at SOM. I've interviewed people from there, and it's so commercial they kill the idea of good architecture. There's huge money spent on presentations that the client can see and understand. There are models worth £25,000 that they give to the client. No Briton can compete. I saw the SOM presentation for a development in London. They didn't understand the existing architecture.

RITCHIE: SOM flew in with 600 renderings and models to show to British Rail and Stanhope for the King's Cross presentation. A British Rail director asked, "Where's the railway?" SOM asked, "What railway?" Now an English architect would have caved in at that point. But they went into a huddle, came back and said, "We'll raise the whole thing a floor." That's the ability of the Americans.

DUFFY: SOM's presentation skills are formidable. They're skilled politically, intellectually, and graphically. Their ideas can be grasped by people who don't come from their background. I've worked with a dozen other American firms like that.

MATHER: Yes, they are much more professional in their communication skills.



Mather has moved from small-scale projects such as interiors to designing 2 Pennington Street, a 100,000-square-foot office complex in the City of London.

Rick Mather

JIRICNA: They are trained for it and take it very seriously.

MATHER: Norman Foster said the greatest thing he learned as a student at Yale was how to relate to other people, and he's supremely successful at communicating when he presents projects.

RITCHIE: British architects are not that keen to do commercial work. We need work to fund the projects on which we don't make a profit, but where we enjoy the architecture. We're happy to do a commercial project like we have for Stanhope at Stockley Park. But we don't want to be saturated with "skin" projects—empty shells with no feeling. We're arguing with Olympia & York because we think they shouldn't put in air-conditioning without knowing the tenant. We're concerned about the human context. We were asked to design a 250,000-square-foot building at Canary Wharf. We questioned it, and produced a master plan which we're about to show to the client. Meantime, recognizing they had a problem, they employed Fred Koetter [principal of Koetter, Kim & Associates, Boston].

How would you characterize the American sensibility?

DUFFY: Americans are eclectic. They use a dozen different styles.

RITCHIE: Yes, they ask a developer what style he wants—high-tech, modern, traditional.

WICKHAM: That's my point. They're not architects.

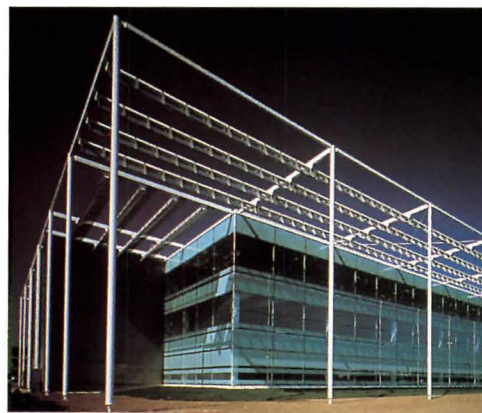

Ritchie Architects' office facility in Stockley Park was commissioned by Stanhope Properties, a British developer known for patronage of high design.

Ian Ritchie

RITCHIE: American architects don't ask the same sort of questions we do. They accept the client's instructions more easily.

DUFFY: It's an architect's job to influence the processes that are going on.

JIRICNA: It's a problem of how much architects respect what they are asked to do. That applies to Americans, Italians, British. It doesn't matter what nationality you are.

What do Americans have to learn from British architects?

RITCHIE: It's important for them to understand about not having power.

DUFFY: There is a tradition of user research and public concern coming from the great social programs of the 1950s, which Americans tend to skip.

MATHER: Americans will learn from controls, planning restrictions, and local participation in England.

RITCHIE: Americans assume that having answered what they consider to be all the questions, they can draw a scheme, and that's it. The English mind carries on thinking and then makes the next series of comments.

JIRICNA: Americans tend to sweep aside things that get in their way.

RITCHIE: There's a difficulty in transferring architectural cultures. Americans assume you can embrace Englishness. ■

Jose Manser contributed to this article.



Horselydown, a housing block recently completed by Wickham & Associates, is located on a re-developed wharf on the south bank of the River Thames.

Julyan Wickham



St. Joseph Hall, erected in 1884, is the University of Dayton's most revered landmark.

Replacing the windows in this historic structure would be as much an intellectual challenge as a physical one.

The form, detail and soul of the original wood windows had

REPLACING THE WINDOWS IN THIS UNIVERSITY MATH, SCIENCE AND HISTORY. NOT TO MENTION

to be perfectly preserved. Yet brought into the 20th century with low maintenance and energy efficiency.

The university chose Pella[®] for this project. Smart.

Pella's exclusive custom capabilities enabled us to perfectly match the color, style and sight lines of the 250 original windows. Using actual pieces of the old wood trim,



BUILT TO IMPOSSIBLY HIGH STANDARDS. OUR OWN.™

London Bridge

**ENGINEERING:
STRUCTURAL STEEL**

Spanning a railway, a 200-foot high office building in London links engineering demands and architectural expression.

ARTISTRY AND STRUCTURE ARE JUST AS intricately meshed in Skidmore, Owings & Merrill's Exchange House as the building is woven into its congested location within the City of London. Sympathetic to a long British tradition of exposed steel, iron, and glass construction, the 550,000-square-foot structure cleverly solves the problems imposed by its site, which spans a network of functioning railroad tracks from Liverpool Street Station. To sidestep the tracks, the building's foundation had to be strategically placed, requiring a clear span of 256 feet between support piers. The successful resolution of both the building's design and its structure was achieved through the ingenious manipulation of bridge technology and exposed structural steel.

One-story trusses support a plaza over an

intermediate floor level between tracks and office floors. Structural engineer Hal Iyengar and principal architect Bruce Graham, both of SOM's Chicago office, which designed and engineered the project, explored several structural systems for supporting the building above the plaza level. Combining formal dynamism, efficiency of materials, and ease of erection, the resulting structure is

based on four segmented parabolic arches that span the railroad tracks. Ten floors of offices and trading space are supported by these seven-story arches, allowing for column-free floors divided into a central 49-foot-wide bay flanked by a pair of 60-foot-wide bays. Floor loads are transferred to the arches by open-web steel trusses that span the bays. The floor trusses connect directly to columns attached to the arches. The two



Exchange House's 10 stories of office and trading space are suspended over a plaza concealing train tracks below. The exposed structural-steel framework of the southern facade (right) reveals the means of support almost as clearly as a structural diagram (below).

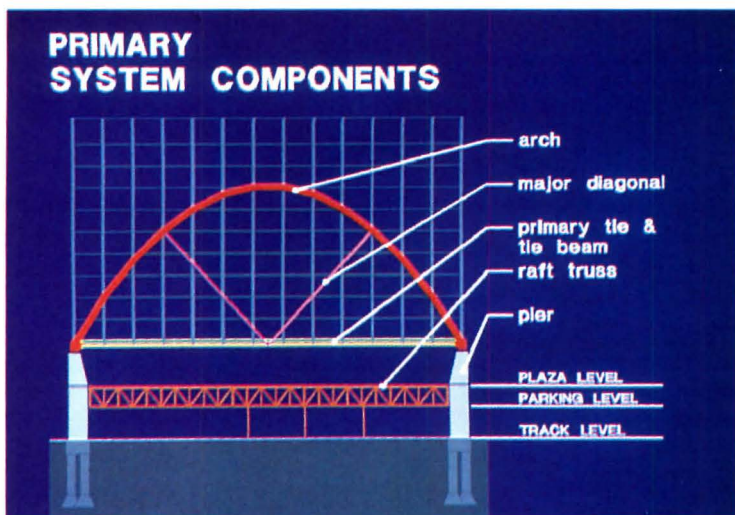



Floor trusses span the bays within the building and connect either to girders or directly to the exterior columns. The arches are constructed of parallel steel channels (above) with an intermediate space to allow the columns to pass through the arch (facing page, top left).

perimeter arches and their connecting columns, beams, and struts are entirely exposed on the exterior, and project approximately six feet beyond the wall face to display the form, connections, and function of each structural member. Diagonal struts at each floor level, constructed of steel pipes, tie back the exposed frame to end girders at the floor edges, providing lateral stiffness for the exterior columns.

Concealed behind the exterior glass face, the girders are connected to the outside arches by larger diagonal struts that allow the girders to function as intermediate ties, preventing lateral spread of the arches. For the interior arches, a girder within the plane of each arch acts as an intermediate tie. The girders and arches also function to provide lateral stiffness for the entire building in the direction of the arches. For lateral resistance against wind loads on the broad side of the building, vertical trusses constructed of cross-shaped diagonal members are located on each of the shorter building ends. These trusses are also exposed, continuing the projected-steel perimeter.

The arches are constructed of straight steel channels that are connected at nodes, which join the angled linear pieces to form a parabolic curve. These nodes also mark where the I-beam columns connect to the arches. The columns are evenly spaced, approximately 20 feet on center, to apply *uniform point* loads on the arch. This condition allows the

applied loads to be transferred as compressive forces, limiting flexural bending of the arch. Since the arches are built up from channel segments paired back to back with an intermediate space, the columns can attach to the arch at the nodes and pass through the arch uninterrupted.

To define the edges of the arches, the flanges of the channel segments are oriented outward to create a continuous reveal. The only part of the structure to intersect the continuous lines of the arches are the transverse flanges of the nodes, also constructed of steel channels, which accent the connection points between the arch and the rest of the structure. Regularly spaced batten plates between channel members tie the separate parallel pieces of the arch together. Two major diagonal members provide lateral stiffness and resistance to buckling within the plane of each arch, in case of unsymmetrical loading. Placed on either side of the columns, each major diagonal is constructed of two parallel pipes that radiate upward from a midpoint pin connection at the primary tie to upper pin connections located on the arch. The use of built-up parallel members in the construction of the arch and its major diagonals animates the steel framework by creating multiple layers of intersecting members that overlap and slip between one another.

Exposed primary and secondary ties resist the outward lateral thrusts created at the

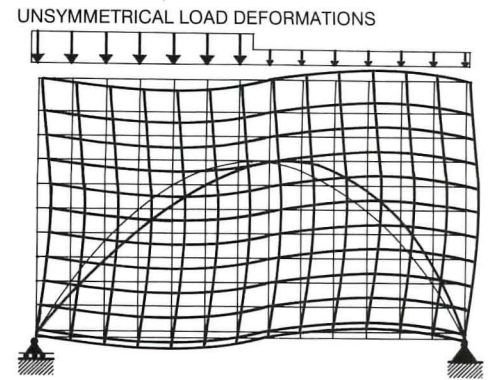

UNBRACED ARCH

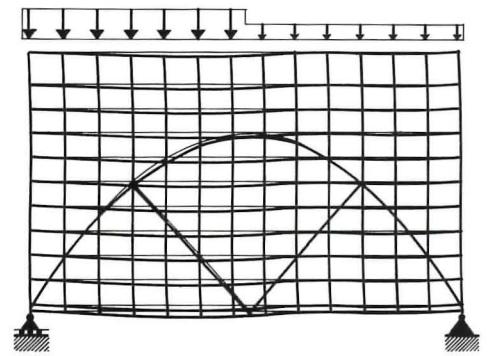

BRACED ARCH

Columns are evenly spaced to apply equally distributed point loads on the arches. If unsymmetrical loading were to occur, however, the unbraced arch would buckle (top). To prevent buckling, two major diagonal members are placed within the plane of each arch (above).

base of each arch and transfer the load to nodes where columns, arches, primary ties, secondary ties, and foundation piers all meet. Polished stainless steel caps detail the pin connections at the base node and the splice connections joining the multiple plate sections of the primary ties, accentuating the primary ties' resistance in tension. Bearings formed by alternate layers of rubber and stainless steel plates act as springs to allow for limited vertical and rotational movement of the superstructure. The bearings on the east side are fixed to restrict lateral movement, while the opposite end permits several inches of lateral arch expansion through deformation of the rubber in the bearings. The imposed loads from the arches and ties are transferred through the bearings to above-grade concrete piers. The piers' buttress-like forms express their function in resisting the outward thrust of the arches.

Structural expression is also given free rein inside the building. The two inner arches are partially visible as they pass through two atriums located at each side of the mechanical and elevator cores. Vertically staggered in section, the atriums cascade outward from the core as they descend from the top floor, following the lines of the vaulted arch forms. In addition to exposing the structural members, the architects located modular bathrooms and fire stairs in two ancillary towers on either side of the main structure. An open fire stair is held a slight distance from



NIAL CLUTTON / ARCAID

Struts (left) provide lateral support to the exterior frame by tying it back to interior girders. At the base of each arch the major structural elements join at a node (bottom left and below). Loads are then transferred to buttressed piers (above).

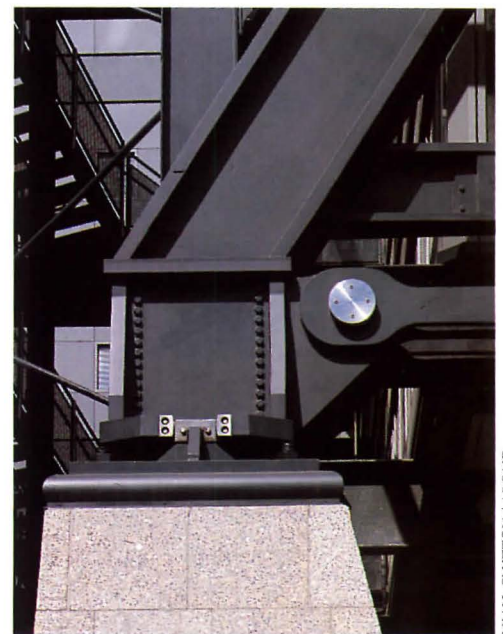
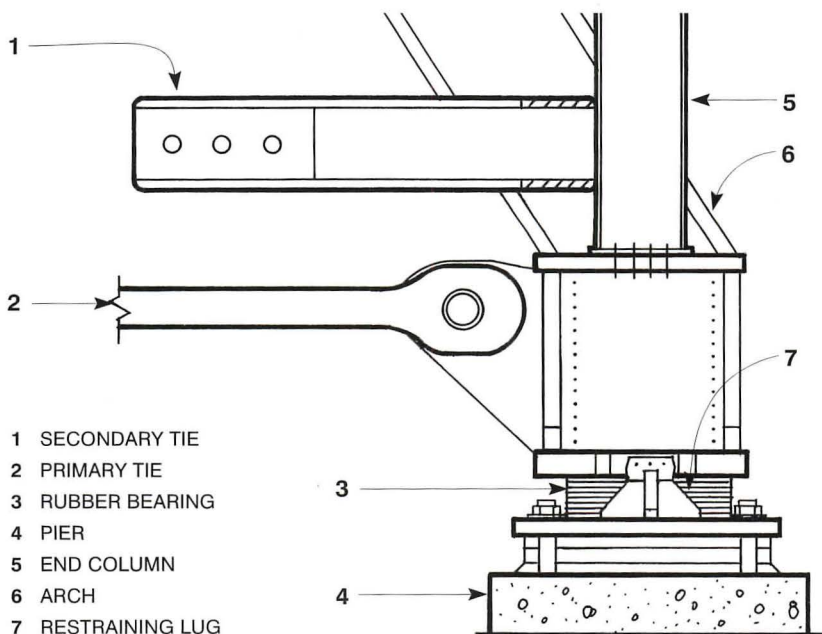

NIAL CLUTTON / ARCAID

the main structure and suspended from the roof rather than contained within the core of the building.

To take full advantage of the architectural possibilities of exposed structural steel, SOM devised a means of fire protection that would not conceal the revealed members. Rather than adding sheet-metal flame shields to the surface of the exposed steel, which would be unsightly and reduce the purity of structural expression, SOM used state-of-the-art fire analysis techniques to convince local fire code officials that the glass sheathing could serve a combined safety and architectural purpose. Composed of a chemically tempered fire-resistant glass of normal thickness, the dual-glazed window wall creates a fire-rated barrier, protecting the exterior steel members from the thermal stresses of heat and flames. Clear glass also aids in delineating the design's structural clarity by limiting the use of solid elements to those that serve a structural function.

By sheathing the curved lobby in glass, the granite-clad concrete piers appear to be the only solid portions of the building to touch the ground. Although the lobby seems to rest on the plaza, it does not aid in support of the building but is hung from the structure above, and adjusts vertically and horizontally accordingly to movement differentials between the independent plaza and building structures. A reveal where the edge of the lobby meets the plaza delineates its ability to move independently. Ramps to the lobby, able to adjust in slope, allow for any height differences between the lobby floor and the plaza level.

By articulating structural engineering design principles through exposed structural steel, the American-designed Exchange House elaborates a tradition of British engineering, represented by the train sheds of Liverpool Street Station. The building's architectural image is as easily followed as are the loads it transfers through its tracery of steel.

—MARC S. HARRIMAN



NIALL CLUTTON / ARCAID

NIALL CLUTTON / ARCAID

The lobby and elevators are enclosed in glass to create a sense of transparency (above), in contrast to the solid structural members. Interior arches are partially revealed in two

atriums (section below). Fire stairs and bathrooms are placed in towers located at either side of the structure, rather than as service cores within the building (plan).

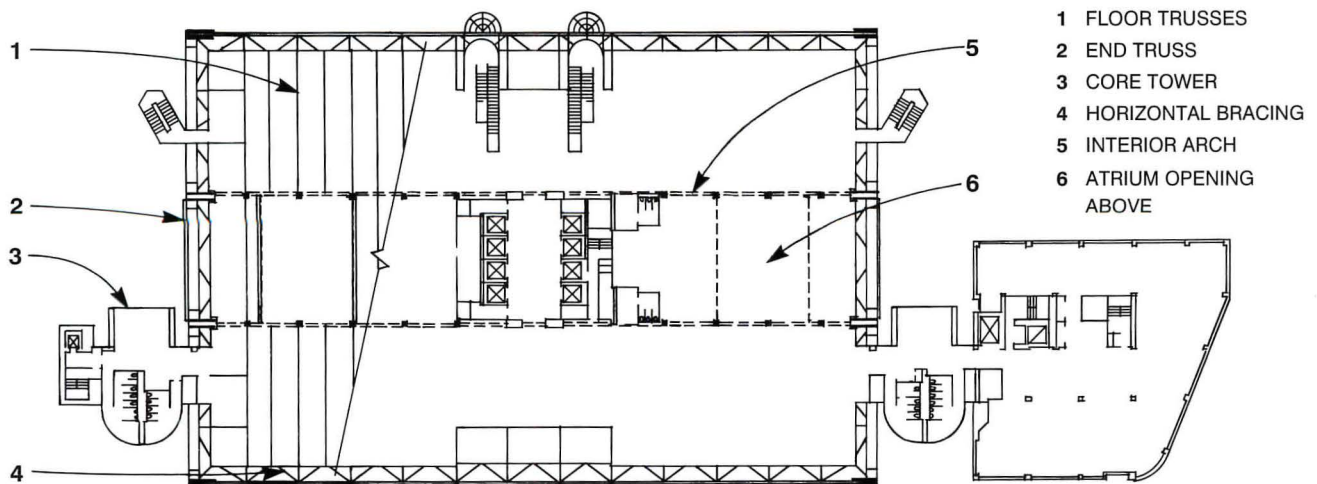
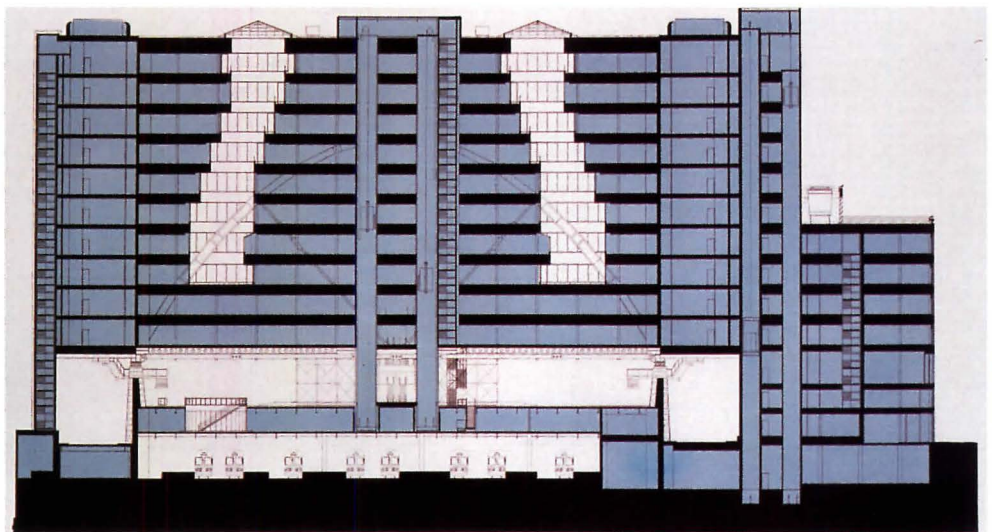

FIRST LEVEL

Pooling Resources

COMPUTERS: NETWORK SYSTEMS

Communication between offices, departments, and individuals is enhanced by linking computers.



Eos Architecture, a firm based in Excelsior, Minnesota (top), networks Cadvance with Novell 286, enabling job captains to merge ideas with designers. The Boston firm of Shepley Bulfinch Richardson and Abbott Architects integrates the computer into a studio setting (above). Associate Michael W. Schunk, AIA, claims that the dispersal of computers within the design studio gives every member of the firm a chance to contribute. The firm runs its Arris CADD program on Sparcstation 1 computers from Sun. Other networks involve IBM and Macintosh computers.

SINCE ALL BUT THE SMALLEST FIRMS require teamwork to share information, ideas, and other resources, the next big improvement in computer-related productivity is likely to come from networking. Major research and development efforts today are being directed at issues of connectivity, workgroup computing, and networks. Almost every CADD vendor is working on a new generation of programs that will make interaction between individuals, departments, and offices more effective. Firms that want to make better use of their human and computer resources must consider two options: either replace their PCs and Macintoshes with mini- or workstation computers, or connect them.

Exchanging information

TO EMPLOY HUMAN AND COMPUTING resources most efficiently within the DOS and Macintosh families, architects have three levels of options: peripheral sharing, file-exchange systems, and networks.

Peripheral sharing employs devices as simple as switch boxes. A manual switch box incorporates input cables from each computer and an output cable to the printer or plotter. Users simply turn a knob on the switch box to connect their computer to the output device. Intelligent switch boxes accept input from all users and queue up the jobs. Prices start at \$50.

Plotting is a little more complex than printing, particularly if the plotter uses pens and cut sheets. A user typically must prepare the plotter individually. For unattended plotting, some manufacturers are adding roll feeders and automatic take-up. CalComp, for example, has developed a thermal plotter with four input ports for direct support of up to four computers and a 25-megabyte hard disk for automatic queuing.

The simplest method of file exchange is called the "sneaker net." Copies of data files are made on a diskette and carried to another computer. But the sneaker net won't work when computers have dissimilar disk drives, and CADD drawings often become too large to fit on a floppy disk, even after file compression.

A slightly less cumbersome technique re-

quires connecting the serial ports of two computers with a null modem cable. Files are transferred with communication software such as ChipChat, HyperAccess, or MicroPhone. Some, such as ProComm, are shareware and offer a free trial.

The same communication software also connects a computer with a modem, but modems use phone lines and thus work best when transferring files to distant offices. An extra advantage of a modem is that it gives access to bulletin boards, commercial data banks, and information services such as the Source and CompuServe. Another class of communication software, which includes Timbuktu Remote and Carbon Copy, offers the advantage of permitting each user to take charge of another user's computer, so that the same image appears on both monitors. This is very useful when communicating between branch offices, with consultants, or with clients. The software costs less than \$300, but works best with high-speed modems such as the U.S. Robotics Courier HST, priced at \$995.

LapLink, from Traveling Software, will transfer files over parallel ports with software that permits one user to control both computers. It also works between PC and Macintosh computers and between portable and desktop computers. It will not connect some computers with hard disk partitions larger than 32 megabytes. The price, including cable, is less than \$200.

Sharing information

A TRUE NETWORK, HOWEVER, PERMITS computer users to share files, not just exchange them. Networks also allow users to share all computer resources of the office, including hard disks, printers, and plotters. Local-area networks (LAN) connect computers within an office; wide-area networks connect distant offices.

Prices for complete networks are dropping so fast that they are cutting into the market for peripheral-sharing and file-exchange products. A two-station network lists for as little as \$1,000. Although only 15 percent of PCs are networked today, market researchers estimate that 50 percent will be networked within five years.

Gene L. Montgomery, AIA, principal of Jack Train Associates in Chicago, cites his firm's continuing restoration of the Wrigley Building (below) as an example of cost savings through workgroup computing on an Intergraph CADD program. According to Montgomery, a network is important for jobs requiring more than one person, and represents a vast improvement over stand-alone personal computers in office productivity.

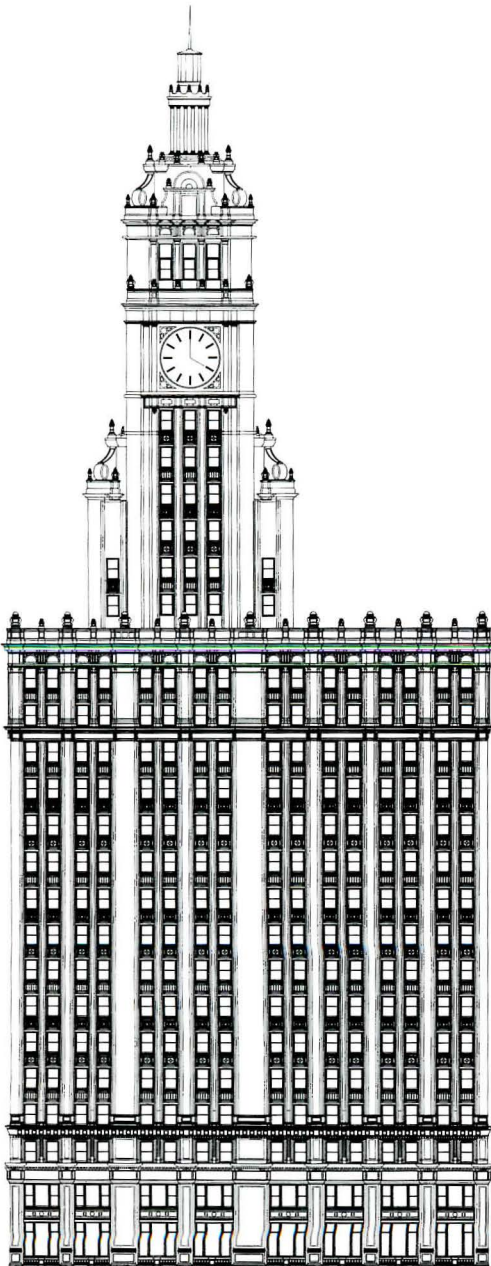

A network is often so complex that firms need an administrator to manage it. Even Apple Computer, the apostle of access, defines the problem as ease of use. "There are more acronyms per square inch in networking and communications than in any other area of data processing," says Donald P. Casey, Apple's vice president of networking. Until recently, MacProject would not run on a Sitka (formerly TOPS) network, although it would run on an AppleShare network. Copy-protected programs are especially balky, and DOS-based CADD programs were written to be run on stand-alone personal computers. They work awkwardly on a network or not at all.

After ease of installation and use, architects should consider cost, speed, applications to be used, computers and peripherals to be networked, random-access memory (RAM) required for client stations, and volume of traffic. The office environment—including electrical interference, existing equipment, and wiring—as well as distances between computers are also critical factors.

Components

A LOCAL-AREA NETWORK IN THE PC world consists of a network operating system, an interface card, and cabling. Choices must also be made regarding the type of network and its topology, and should be considered together, not in any particular order.

The interface card sits inside a PC and acts as gateway to the network. The most common types of cards are Ethernet, ArcNet, and Token Ring. The fastest is Token Ring and the slowest is ArcNet, but specified speeds might not equal installed speeds. Several companies make cards with proprietary protocols. For example, Apple Computer sells a LocalTalk interface card that enables PCs to connect to Apple's LocalTalk network.

The choice of interface card influences the choice of cabling medium. The most popular options are twisted pair (similar to telephone wiring) and coaxial cable (used for cable TV), which is faster but more expensive. Ethernet and ArcNet typically employ coaxial cable. Optical fiber, still more expensive, is reserved for high-security, high-interference situations. New wireless options are recommended in specialized cases such as historic preservation: Photonics uses infrared waves that work well in open offices or through windows of nearby buildings.

Local-area networks are either host-based or peer-to-peer. Host-based networks are divided into those that have one computer dedicated solely to administrative functions as a file server, and those with a non-dedicated file server that handles both administrative and client (also called requester) functions. A host-based network is highly efficient and makes backups easily, but it means purchasing

an extra computer. On the other hand, asking a computer to do double duty as both server and requester degrades its performance. In a peer-to-peer network, all resources on the network are available to all users. With the absence of central management, crucial tasks such as file backup are delegated to individual users.

AppleShare, which is Apple Computer's proprietary network system, requires a dedicated server. Novell's ELS, which supports four computers, is usually configured with a non-dedicated server. Artisoft's Lantastic is normally configured as peer-to-peer.

The specific configuration of the system is its topology, and will consist of either a bus, ring, or star arrangement. A bus structure is linear, with two ends, and data is broadcast to the entire network. Bus topology offers the least disruptive way of adding or removing computers from the network. (Most Ethernet installations use the bus.) In a ring structure, computers are added in a closed loop, and data is passed from node to node. In a star configuration, each computer is connected directly to a file server.

Vendors

MINICOMPUTERS WERE INTENDED TO operate in a networked environment, usually employing "dumb" terminals—those without a computing chip. Workstation-class computers also were intended to be networked, but with "smart" terminals. Both integrate an operating system such as Unix and software designed for a workgroup environment.

Intergraph, one of the first generation of CADD vendors, bundles all these elements, including CADD, into a unified system, increasingly based on workstation-class computers and Unix. According to Christopher L. Barron, AIA, marketing manager for Intergraph, these computers are based on "powerful microprocessors, and were designed to share data among several workstations." But Barron adds that it takes more than networking to make this hybrid system effectively integrated. With network file-management software and network application software, it is possible to establish a continuous flow of information among all team members, allowing each to refer instantaneously to the designs of other team members and witness changes on screen as soon as they occur. Intergraph calls this technique a reference file, which is dynamic and unique to network programs, in contrast to a copied file, which is static and will not change until another copy is made.

Other workstation vendors include IBM, which bundles its Architecture and Engineering Series CADD program on an RT (and soon on a System 6000) workstation under IBM's version of Unix, called AIX. Accu-

graph's architectural system, MountainTop, also runs on the RT under AIX, as well as on Hewlett-Packard computers. Arris, a CADD program by Sigma Design, runs on Sun workstations as well as on other Unix-based computers. HOK of St. Louis still sells its CADD program, HOK Draw, on VAX computers by Digital Equipment Corporation, but the firm has recently been talking about porting to the Macintosh.

File locking

ONE OF THE MAIN PROBLEMS OF NETWORKING can be solved by file locking, which prevents more than one user at a time from accessing data. The purpose is to avoid having multiple versions of the file, none of which is current because each contains revisions made by someone else.

But networks are intended to give people access, not lock them out. In a database program, this is handled by leaving the file open and locking only the single document being changed. However CADD files are not like database files; few programs lock the layer but not the drawing. Even the most sophisticated network CADD programs vary on their treatment of this problem, although they seem to agree that the solution is creating a separate but linked file for each layer.

Once file-sharing is permitted, issues such as security, drawing-file management, and data integrity must be considered. Those were precisely the issues addressed by Isicad and Novell when they announced a cross-certification program for Cadvance and NetWare. In addition, the new network version of Cadvance will permit computing-intensive tasks such as shading and hidden-line removal to be redirected to the file server so the client-workstation user can continue with other work.

Start-up costs

DOS AND MACINTOSH VENDORS REQUIRE that users buy separate licenses, usually at full price, for each computer on which the software is installed. However, network versions of CADD programs now in development will permit the program to be accessed by a specified number of stations, without regard to which station will run it. Network users will get a discount for buying multiple licenses.

Offices that were skirting the law by buying only one copy of the program and installing it on more than one computer will now have to pay for every copy they use simultaneously, or forgo the advantages of workgroup computing.

Autocad and Cadvance have announced network versions for release this fall, although prices are still undetermined. Microstation, at \$3,300, already offers reference files, a benefit of its close ties to Intergraph.

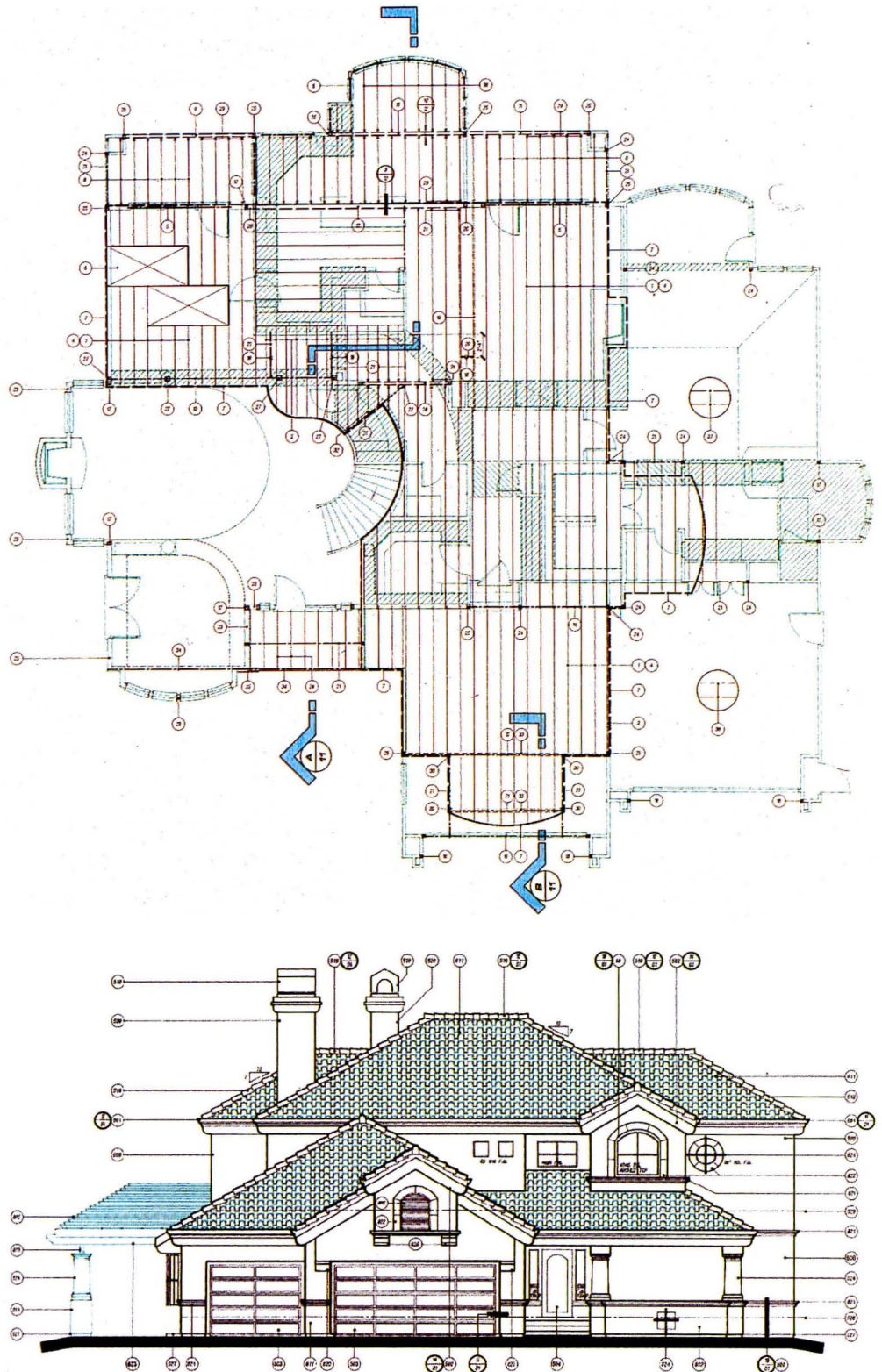

Kenton C. Russell, AIA, principal of Studio Four in Sacramento, California, stresses the importance of computer networks in achieving consistent office standards and clearer construction documents. His firm uses Arris on Personal Iris workstations by Silicon Graphics. Russell has discovered that the color of a plotted drawing affects the apparent boldness of a line when reproduced as a blueprint. Black reproduces darkly, green is lighter, and blue is relatively faint. Thus, colored lines can be manipulated to represent different planes and distances.

The perimeter of a house (top), for example, is drawn with a 1.2 black pen, while

major beams and other components of the framing system are rendered with a .8 black pen. The floor below is represented in green lines while section cuts, soffit framing, and minor elements, such as reference numbers (above), are drawn in blue.

By maintaining office drawing standards in a central library accessible to all designers and drafters over the computer network, Studio Four achieves personality and graphic punch in its plotted drawings without sacrificing clarity and consistency. The firm now produces entire projects on CADD, beginning as early as design development. The plots were produced on a Hewlett-Packard DraftMaster.

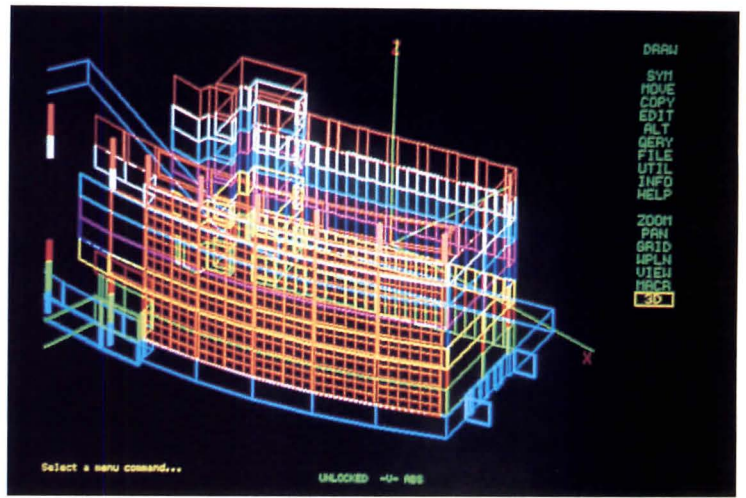
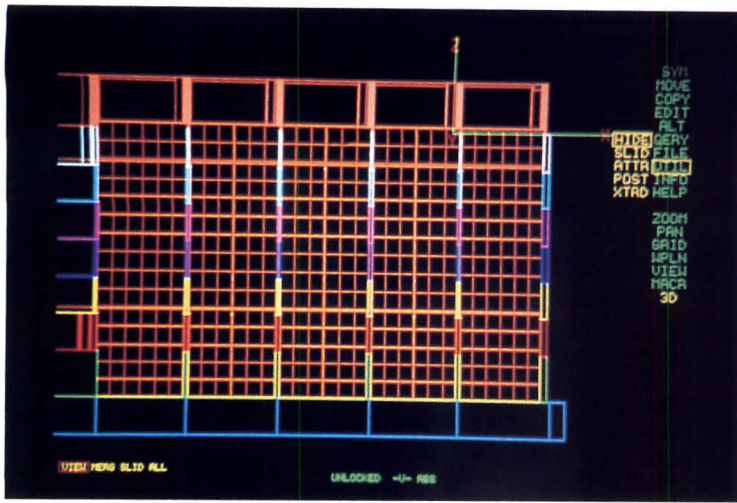

Holabird & Root in Chicago employs Cadvance software on a Lantastic network to combine information developed by architects, structural and electrical engineers, and interior designers onto one set of drawings (facing page, top). Four images of interiors studies (facing page, center), for example, were developed from floor plans drawn on

the computer and made available to other designers over the network. Three-dimensional models (facing page, bottom) are drawn from previously created studies and are critiqued over the network. Elevations produced on the system (above left and right) eliminate guesswork over projection angles for a curved wall.

Network successes

AT SHEPLEY BULFINCH RICHARDSON AND Abbott, a 150-member firm in Boston, networks of 11 Sun workstations run CADD using Arris, and 14 Macintoshes handle spreadsheets and project management under AppleShare. Accounting is done on an IBM System 36, and four pre-DOS computers perform word processing, according to associate architect Michael W. Schunk, AIA. In 1987, Shepley Bulfinch began decentralizing its CADD resources, but Schunk believes four different kinds of networks are too many. "We could get by with two: Sun for CADD, and Macintosh for the rest."

A different approach is taken by Jack Train Associates of Chicago. The firm continues to concentrate its computer resources in a designated room. "We're not ready for floor time yet," contends Gene L. Montgomery, AIA, principal of the firm and CADD manager. The firm, with 25 employees, uses an Intergraph system, upgraded six months ago with an Interpro 225. Montgomery emphasizes the competitive advantages of a good network in developing speed and synergy. He adds, "Intergraph's reference files enable as many designers and drafters as necessary to work on the same project without copying files." Several team members are currently benefiting from the networked arrangement while restoring the Wrigley Building in Chicago.

One of the hottest new CADD platforms is the Personal Iris by Silicon Graphics. Studio Four Architects, a 13-member residential design firm in Sacramento, California, bought three Iris workstations last year for \$25,000 each, including Arris. Kenton C. Russell, AIA, principal of the firm, describes the Personal Iris as the best and fastest available because it offers separate graphics processing.

Russell says his applications are primarily production and modeling. Studio Four uses a peer-to-peer network, with both programs and drawings maintained at each workstation, as required by Arris. Drawings are directed to a plotter through a switch box to avoid slowing down the workstations to which the switch box is attached. The firm's strategy was to hire its computer managers and operators first, then buy the system.

Eastlake Studio was formed in 1988, and installed TOPS (now Sitka) when the partners bought their second computer. The firm kept expanding the network so that each of its 10 employees' Macintoshes were linked, but their office was only 1,300 square feet and the firm kept growing. Originally intended as a convenience in transferring files, the network proved invaluable when the firm expanded into a second office on another floor. David J. Johnson, AIA, a principal in the firm, says the problem of two people accessing the same file at the same time is rare. The risk is minimized by file-naming conventions, specific job assignments, and locking those files that are in use.

One of the objectives in installing a network in the offices of Peckham & Wright, Columbia, Missouri, was to link the front office, where word processing and specifications are carried out, with the back office, where the design and drafting were done on Datacad, a DOS-based CADD program. The firm had been moving files on floppy disks, making it impossible to locate the current version. When SweetSpec was installed, a modem was attached to an IBM Model 80 CADD station, and problems intensified. Nicholas Peckham, AIA, selected a Lantastic network because, he says, it was the best for \$800, and he hired a top-notch consultant to install it late last year. "We just plugged

it in and turned it on." Because the firm did not want to dedicate a computer as file server, it selected a peer-to-peer network. Although Peckham recognizes the risk of two people accessing the same drawing at the same time, he said it has never happened. All drawing files are maintained on an Acer 33-megahertz computer. Plotting is done through a switch box to which all CADD stations are attached, avoiding tying up one computer.

Architects at Johnson Fain and Pereira of Los Angeles have an unusual perspective on networks, because the firm automated its design staff before its production staff. Some 90 percent of all design work is now done on the computer, compared with 50 percent of the production work, according to Daniel J. Janotta, AIA, senior designer. He doubts that the firm is saving any time by using computers; the benefit is being able to produce a better product in the same amount of time. The payback, thus, is not in faster drafting, but in more refined concepts and more realistic images that the client finds easier to understand, finance, and market.

One of the first architects to select OS/2 is Zeidler Roberts Partnership, Toronto. The new operating system runs the file server of the firm's 3Com network. Zeidler Roberts chose 3Com's 3+Open LAN Manager, which runs with OS/2, because it was fast, according to F. Lyndon Devaney, an associate. The firm uses Autocad 386, which is installed on each client workstation, and to avoid the problem of two people working on the same file simultaneously, the firm wrote an Autocad Lisp routine that warns other users when the file is in use. Says Devaney, "CADD was an interesting toy for us, but it didn't become a tool until we tied it together in a network."

Network alternatives

CREIGHTON C. NOLTE, AIA, WHO RUNS A small office in San Diego, concedes the benefits of a network but suggests that many architects would be better off with simpler, less expensive solutions. "If all you want to do is share peripherals or transfer files, there may be a better way while still avoiding the floppy shuffle," Nolte says. When he wants to move files from one Macintosh to another, he uses Traveling Software's Lap-Link. It's just like copying files, he says, and formatting is retained in most cases, even when copying from PC to Macintosh.

Two similar products for the personal computer did not fare as well in the hands of Michael D. Goff, director of information services, Holabird & Root, Chicago. The firm has a branch office in Rochester, Minnesota, and the prospect of exchanging ideas and files dynamically and delivering computer support over phone lines was exciting. Goff tried two programs, Microcom's Carbon Copy Plus, which didn't work with DOS Version 4.01, and Norton-Lambert's Close-Up, which supports obsolete CGA monitors but not current VGA monitors.

For Steven Langford Architects, a 12-person firm in Irvine, California, PC-Anywhere by DMA performed better, but not with graphics. Office administrator Betsy Nickless took maternity leave last fall and credited the program with enabling her to keep up her work while she was away. With PC-Anywhere and a modem, she controlled her computer at work from a computer at home as if she were sitting at the work computer's keyboard. Once a week she came into the office to pick up paperwork, but everything else was accomplished over phone lines.

The western division of United Engineers in Denver uses PC-Anywhere for troubleshooting computer problems in remote offices. "I just take over the remote PC from my computer in my office in Denver and make the needed fixes," says Frederic P. Cubbage, administrator of CADD systems. "It saves travel expenses and my time." He described the program as "really cheap (less than \$100) and easy to use."

Cubbage's assistant, William S. Mizer, says PC-Anywhere locks up occasionally when connecting dissimilar computers and video cards. He is exploring Takeover, by Soft Klone, which supports VGA monitors but requires that monitors at both ends be of the same type. It does not support remote control of graphics. The price is \$295, which includes software for both ends and a guarantee. As an alternative to a true network, however, Goff contends that "these products are not there yet."

—OLIVER R. WITTE

Kristin M. Fox contributed to this article.

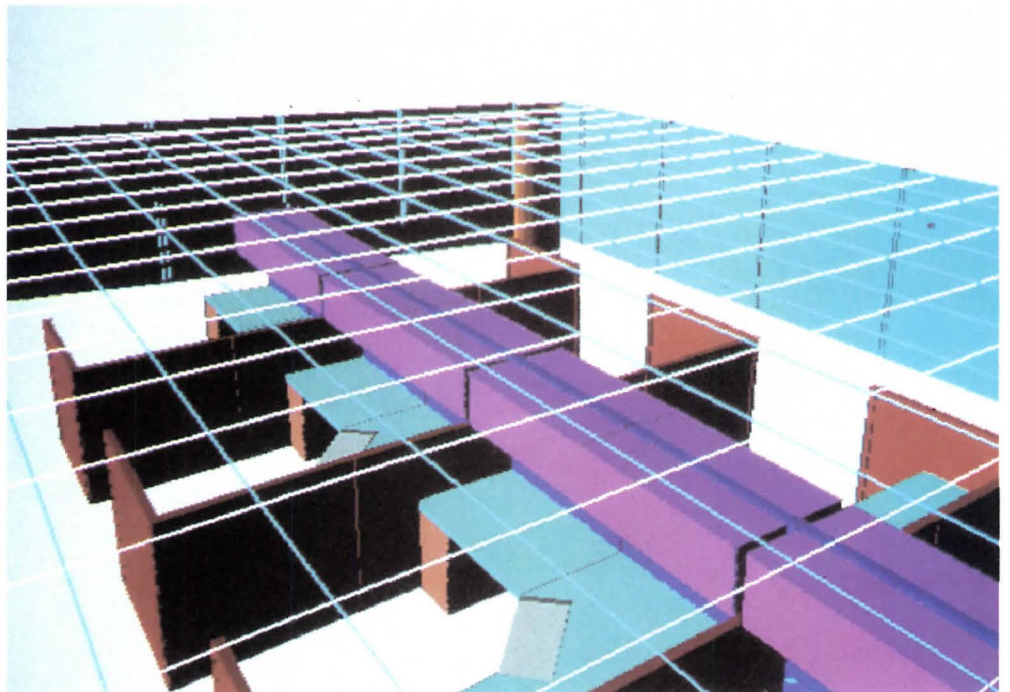
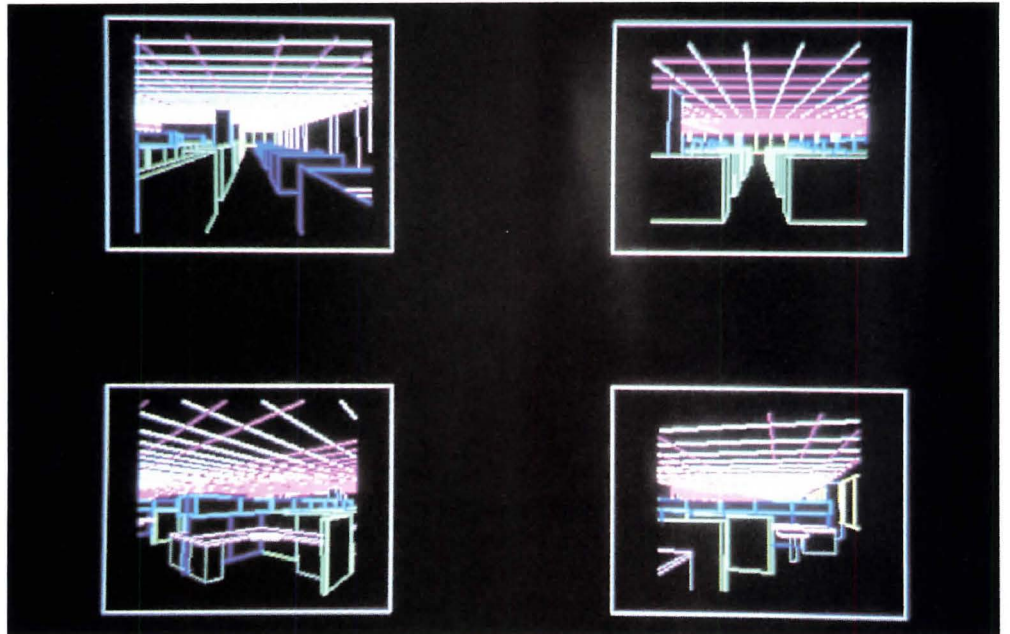
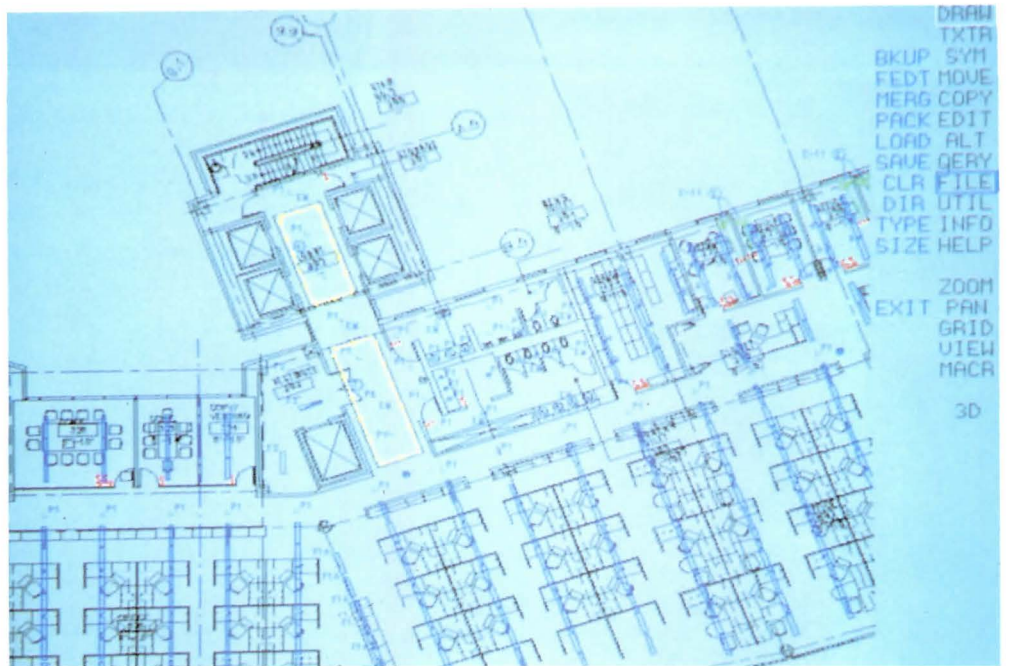



Empire Bank, Springfield, MO
Distributor: Midwest Metal
Fabricators, Inc.
New Haven, MO

Face to Face

**TECHNOLOGY:
VIDEOCONFERENCING**

New transmission methods and affordable equipment are revolutionizing long-distance meetings.



AS INTERNATIONAL EXCHANGE BETWEEN U.S. and foreign businesses increases, videoconferencing is destined to provide the greatest communications breakthrough since the introduction of the fax machine. Until now, economic and technological hurdles have prevented its widespread acceptance, but a 20-by-40-foot booth specially created at the AIA Convention in May by ARCHITECTURE convinced those who watched a live videoconference of its viability.

The demonstration was conducted between the Expo Center in Houston and Westinghouse Furniture Systems headquarters in Grand Rapids, Michigan, and AIA conventioners rated it the second most informative exhibit after the newly inaugurated Book Fair. Particularly interested in the demonstration was a contingent of Japanese architects, who photographed both inside and outside the booth, clearly convinced of videoconferencing's future.

Economic feasibility

IN DECIDING TO CREATE A PROTOTYPE for the AIA convention, ARCHITECTURE's goal was to demonstrate the low cost and flexibility of videoconferencing resulting from recent developments in the technology. Just a few years ago, videoconferencing

was an expensive proposition that few corporations could realistically afford, costing anywhere from \$110,000 to \$1 million, depending on sophistication. But, like so many other technologies, research and development for space exploration and defense have improved videoconferencing systems and dramatically reduced costs. Today, the basic equipment—a camera, a codec (a device that compresses video information at 1-1/2 million bits per second for digital transmission over communication links), and an audio system—may cost as little as \$60,000. Peirce-Phelps, a Philadelphia-based company that has designed and installed more videoconferencing systems for corporate and government customers than any other supplier, manufactures videoconference systems in a variety of configurations, with its top of the line equipment selling for \$200,000, including on-site installation and operator training.

In addition to lower prices for the hardware, common carriers have expanded to include many transmission options, including satellite link, microwave link, and fiber-optic land lines. Of these techniques, a new technology called switched-56 offers the greatest possibility for affordable videoconferencing, because it permits dial-up videoconferencing

"Meeting the Future Now" videoconferencing exhibit (above) provided a demonstration of state-of-the-art technology, courtesy of Westinghouse. Because of recent developments, live conferences are now priced as low as twice the cost of a telephone call.



From the options available for transmission (right), the exhibit utilized affordable fiber-optic land lines between Westinghouse Furniture Systems in Grand Rapids (above), and the Expo Center in Houston (far right) during the demonstration in May.

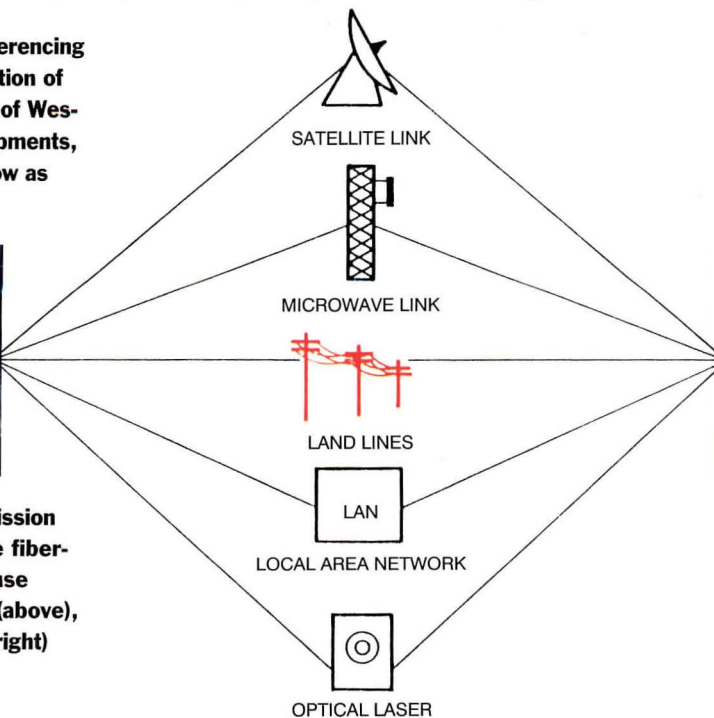



for about \$35 per hour per line—about twice the cost of an ordinary conference phone call.

At its 1990 convention, held in Washington, D.C., the International Teleconferencing Association (ITCA), noted that the fastest growing segment of the telecommunications industry is two-way video, which grew 65 percent in 1989, to post overall revenues of \$202 million—more than double the industry's \$86 million business in 1987. Today, there are more than 1,200 video rooms in operation across the country, in such Fortune-500 corporations as IBM, General Electric, Sears, Bank of America, United Technologies, AT&T, Xerox, and Bell Laboratories. (Pei Cobb Freed & Partners has completed a dozen videoconferencing rooms for IBM.) Based on this growth, the ITCA projects that the two-way video market will have revenues of \$335 million in 1990.

Expert coordination

UNLIKE THE FAX MACHINE, WHICH CAN be simply plugged into a telephone jack, new videoconferencing technology requires the coordination of architects and engineers to provide an appropriate environment. The space housing the equipment not only has to be designed for esthetics, but because it demands careful and precise integration of acoustics, lighting, and audiovisual technology, it must be thoroughly engineered. Acoustical considerations are particularly important, since the critical audio component of the videoconference decreases in quality with noise interference. HVAC upgrades are also typical necessities, along with electrical power improvements and capacity, plus conduits, ducts, or trenches for the cables that run from the control panel to all the components. For product manufacturers, the videoconferencing room requires specialized and custom-

designed furniture to suit individual circumstances (see page 141).

To demonstrate this new dial-up videoconferencing coordination at the AIA convention, ARCHITECTURE and INTERIORS magazines orchestrated collaboration among more than 20 companies and individuals who are experts in the communications, computer, and architectural fields. Beginning with the design team, we invited the Houston offices of Gensler & Associates, The Whitney Group, the Douglas Harding Group, and Pran, Inc., to develop the program. Principals of each firm had specific responsibilities: Charles Kifer, vice president of Gensler, worked out the concept of the shell, the lighting, and the storage units for electronic equipment; Gary Whitney, president of the Whitney Group, produced the design of the videoconferencing work-surface modules; Frank Douglas, principal of Douglas Harding, was responsible for coordination of the exhibition design team and the graphic design of the booth; and John Whitcomb, principal of Pran, Inc., acted as the audiovisual consultant and electronic-equipment systems integrator.

Initially, Whitcomb stressed the need to integrate electronic support systems into the room in order to maximize videoconferencing capability. The state-of-the-art systems necessary included a monitor with scanner for instant transmission of graphic information (photographs, drawings, charts); a large electronic whiteboard capable of receiving faxed information and magnifying it for instant reading by participants; and a laser-writer device tied to a monitor that enables participants to write or draw directly into the computer.

Breaking out of established conference-room conventions, the design team evaluated user requirements to determine design

alternatives. They questioned the need for a massive conference table, for example, pointing out that such a large piece of furniture restricted camera angles and the number of people in the room. Gary Whitney devised a solution comprising a mobile module with articulated keyboard arms that supported movable work surfaces. Two of these modules may accommodate eight people sitting comfortably in roll-about armchairs. After experiencing the videoconferencing environment, all participants believed that an informal atmosphere was preferable to a stark, TV-studiolike space. When more people are required at a meeting, the modules can be replaced with auditorium-style seating.

Charles Kifer investigated lighting, suggesting that the conventional fluorescent overhead troughs did not produce particularly flattering lighting of people on camera. And since he was also mindful of the technical objectives, he opted for MR 16 lamps to secure glare-free lighting at minimum light levels for a picture with adequate depth of focus, as well as the right color temperature and color balance for light distribution without shadows. The lamps were spaced evenly within the ceiling grid for distribution of light, and to allow participants to walk around the booth without falling into shadowed recesses.

While conventional teleconference rooms feature built-in electronic components, requiring a deep wall and shelving to support monitors and cameras, Kifer felt that roll-around cabinetry was more flexible and appropriate for the AIA exhibit. Identifying one long wall as the "mother wall," he designed five storage units to house the electronic equipment. The largest contained a twin-monitor videoconferencing unit with camera and codec, connected to dedicated telephone wires.

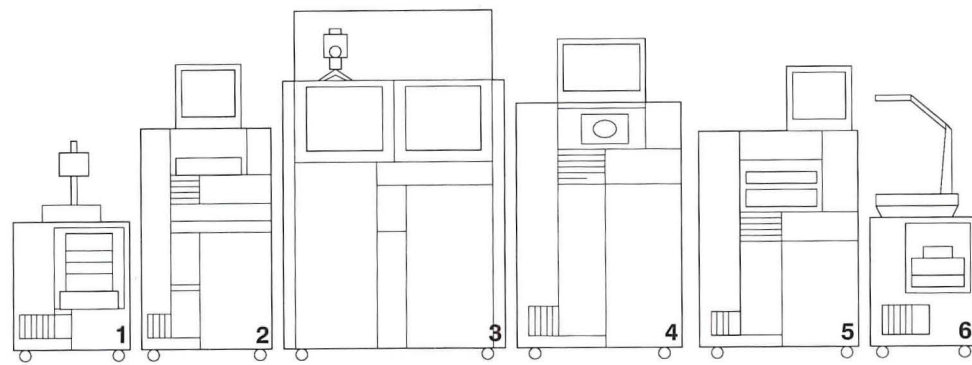
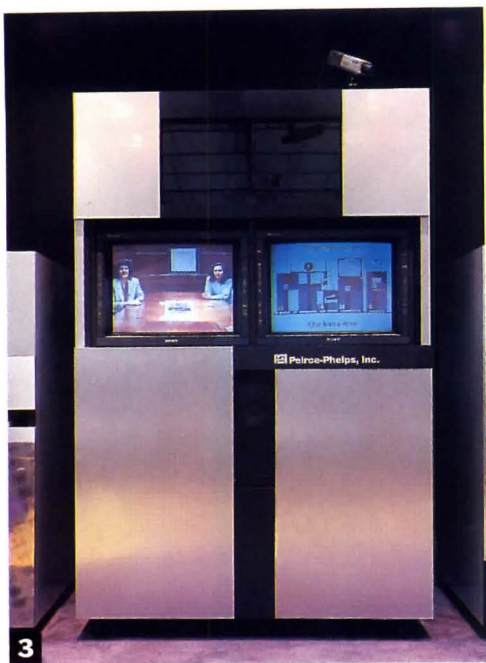

In the AIA videoconferencing exhibition (below left), comfortable executive chairs are grouped around two four-sided mobile work-surface units. The atmosphere is more like a lounge than a TV studio or high-tech lab. Grouped along the "mother wall" (rear in photo, below left, and drawing, left) are:

1. Wolf visualizer, a multipurpose device, consisting of video camera and light source on a copy stand connected to video monitors, for transmission to big screen for general viewing. Laserex. Circle 428 on information card.
2. An electronic notepad, comprising laser pen and sensitized board connected to a monitor, which transmits freehand writing or drawings to monitor for general viewing or video transmission. Personal Writer. Circle 429 on information card.
3. Videoconferencing unit, consisting of twin monitors, camera in top, and codec "black box" underneath (facing page). Technology by Westinghouse and Peirce-Phelps. Circle 430 on information card. Videoconferencing unit with doors closed (top left), indicating transmission is in progress. The housing for all storage units—new, metallic textured laminates from Europe—was donated by Formica Corporation. Circle 431 on information card.
4. Used in government defense labs, a high-tech scanner and monitor transmits documents, photos, and drawings to the computer and relays them by phone lines to remote locations; it also delivers hard copies. Data-beam. Circle 432 on information card.
5. The Sony multiscan TV monitor displays video and computer images and is linked to an NEC audioconference system. Darome. Circle 433 on information card.
6. The still video system produces 1-1/2-inch discs to be scanned, recorded, or played, plus color printouts. Sony. Circle 434 on information card.



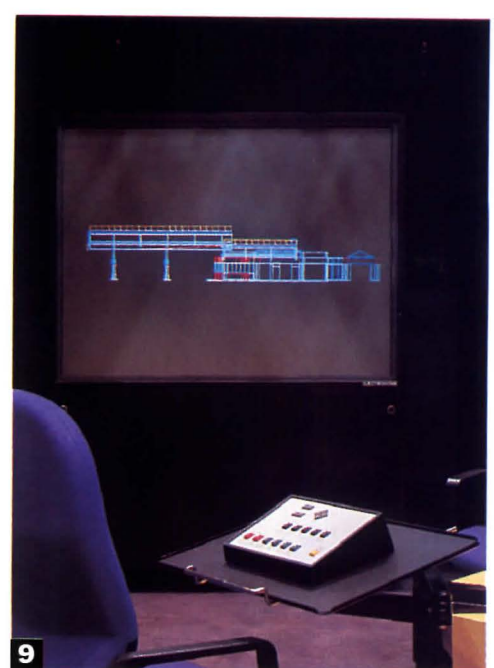

System components

THE VIDEOCONFERENCE SYSTEM SELECTED by ARCHITECTURE for the project is a mid-range unit supplied by Peirce-Phelps, with two 25-inch monitors (one showing incoming picture and the other showing outgoing picture or graphics), a camera with pan/tilt/zoom/focus, codec, video switchers, and table-top control panel. The heart of the system is a microprocessor-based controller, which allows the user to control all functions of the system including audio, preview all input sources, manually control the camera, switch video inputs, select auxiliary input, and send graphics. More sophisticated systems manufactured by Peirce-Phelps include a unit with dual 35-inch monitors that display regular video as well as PC graphics and text, along with smaller 13-inch monitors that display outgoing motion video. As with all video-imaging technology, the higher the graphics resolution, the more expensive the system.

Continued on page 153

7. The menu-driven AMX Touchscreen control panel and hand-held laser pointer by Peirce-Phelps allow users to control and annotate all displays along the mother wall, as well as operate the Yamaha audio system. Peirce-Phelps. Circle 435 on information card. Yamaha. Circle 436 on information card.

8. Electronic whiteboard is useful to magnify documents transmitted by fax to meeting participants. It can also display on-the-spot drawings or messages. Canon. Circle 437 on information card.

9. The self-contained rear-projection TV system enables easy viewing with large displays of video- and computer-generated images in the fully lighted room. Electrohome. Circle 438 on information card. Close-up of the work module (below) shows articulated arms from Westinghouse that hold the latest notebook-size computer with full PC capability. Westinghouse Furniture Systems. Circle 401 on information card. Compaq. Circle 439 on information card.

MEETING THE FUTURE NOW
1990 AIA CONVENTION
HOUSTON, TEXAS

DESIGN TEAM: Douglas Harding Group, Houston, Texas—Frank Douglas, FAIA (president), Angi Riley (designer); Gensler & Associates, Architects, Houston, Texas—Charles Kifer (designer), Lonny Doyle (project architect), Elyse Dobson, Lynn Langston (interior designers); The Whitney Group, Houston, Texas—Gary Whitney (president); Pran, Inc., The AV Innovators, Houston, Texas—John G. Whitcomb (principal)

CONSULTANTS: Dr. Leonard Kruk, adjunct professor, University of Georgia, Department of Business Education (director of office syntonics research, The Shaw-Walker Co.); Lynn Billings & Co.—Lynn Billings, principal (coordinator of information and public relations)

CONSTRUCTION: Armstrong World Industries (exhibition construction); Johns & Hausmann (work surface and storage unit fabrication); Linbeck Construction & Carpet Services (installation and dismantling)

TRANSPORTATION: Assistance by McCoy, Inc. SYSTEM COMPONENTS: Architectural Signing, Inc. (graphic display panels); Armstrong World Industries (Soundsoak wall panels and Sonotrol ceiling baffles); Compaq Computer (laptop computers); Flos Inc. (lighting); Formica Corporation (laminates); ICF/Unika Vaev (upholstery fabric); Karastan/Bigelow (carpet); Peirce-Phelps (videoconferencing system); Shaw/Walker (ergonomic seating and stacking chairs); Sony (professional video monitors); Westinghouse Communications (videoconferencing fiber-optic network); Westinghouse Furniture Systems (keypads)

PHOTOGRAPHER: Peter Aaron / Esto



PRODUCTS



1



2

1. Westinghouse work module with articulated arms holds Compaq notebook computers and an electronic-pen notebook from Personal Writer. Shaw/Walker's Paragon chairs upholstered in Annapolis tweed from Unika Vaev/ICF. Westinghouse Corporation. Circle 401 on information card. Shaw/Walker. Circle 402 on information card. Unika Vaev/ICF. Circle 403 on information card. 2. Armstrong wall panels with Carina Zircon fabric. Shaw/Walker's Multi-Chairs in ICF's Annapolis fabric. Armstrong. Circle 404 on information card. Shaw/Walker. Circle 405 on information card.

LIGHTS, CAMERA, ACOUSTICS

Close-up on products for videoconferencing.

ARCHITECTURE'S VIDEOCONFERENCING ROOM AT THE AIA convention (page 129) was not designed as a TV studio and did not require a noise reduction coefficient (NRC) rating of .20 to .25. But such facilities for the business environment should be as quiet as possible. Reverberations from adjacent spaces or HVAC systems can be reduced with prudent selection of noise-control products. Fabric-covered fiberglass panels with an NRC of .40 to .45 provide a sound-absorbent and esthetically pleasing background. Fire-resistant and easily installed on splines, some of the latest acoustic wall surfaces not only absorb noise but add an interesting textural backdrop to the room. They should be complemented with acoustical ceiling treatments and good quality carpeting for further noise reduction. Lighting requires some careful analysis. The TV-studio type of glare is uncomfortable to participants, unflattering, and unnecessary. However, a fixture's footcandle power must adequately illuminate participants to ensure a clear image at the receiving end of a video transmission. Fixtures must be installed out of camera range for consistent lighting color and optimal visibility of conference participants. Comfortable seating ensures a relaxed environment ideal for this type of business meeting, which is more effective if conducted in a clublike atmosphere.

—AMY GRAY LIGHT



3

3. Custom shelving units, fabricated by Johns & Hausmann in silver Brushed Aluminum, Aluminum Footplate, and Two-Tone Black Checkerboard Formica laminates, support a phone from Houston Cellular, a Compaq computer, and a Sony video camera. Floor covering is Antron fiber from Karastan/Bigelow. Formica Corporation. Circle 406 on information

card. Karastan/Bigelow. Circle 407 on information card. 4. Ceiling grid is composed of Sonotrol baffles covered in Carina Zircon fabric. Tor and Lucy light fixtures are available from Flos. Each holds a 50-watt MR16 halogen lamp. Armstrong World Industries. Circle 427 on information card. Flos Inc. Circle 408 on information card.



4

Bungalows, Camps and Mountain Houses

William P. Comstock
NEW and Clarence E. Schermerhorn
 A resource guide for architects, historians, and homeowners on the bungalow style and its characteristic plan. 125 pp., R847, \$19.95 pb. (\$17.95 AIA members)

Fanlights: A Visual Architectural History
Text by Alexander Stuart Gray
NEW and John Sambrook. *Drawings* by Charlotte Halliday
 Everything you need to know about the history and restoration of fanlights (or overdoor) in Georgian homes. 160 pp., R846, \$21.95 hardcover (\$19.75 AIA members)

Sir Christopher Wren
Kerry Downes, editor
 An annotated and well-illustrated catalog of surviving drawings for the design of St. Paul's Cathedral. 190 pp., R751, \$39.95 cloth (\$35.95 AIA members); R751P, \$29.95 pb. (\$26.95 AIA members)

Architectural Shades and Shadows
Henry McGoodwin
 A complete course in the technique of shadow casting used by architecture professionals. 120 pp., R804, \$32.95 cloth (\$29.65 AIA members)

The Architecture of Gunnar Birkerts
Text by Kay Kaiser
 A Pulitzer prize nominee explores a world-renowned architect's personal history, design philosophy, and building methodology. 252 pp., R803, \$45 cloth (\$40.50 AIA members); R803P, \$30 pb. (\$27 AIA members)

Human Resources Management for Design Professionals
NEW *Cynthia A. Woodward, AIA*
 A guide to hiring and keeping talented people, for design firms of all sizes. 130 pp., R805, \$24.95 pb. (\$22.50 AIA members)

American Architecture of the 1980s
Foreword by Donald Canty, Hon. AIA
NEW *Introduction by Andrea Oppenheimer Dean*
 Presents a retrospective from the magazine's coverage of the period. The selection represents the best of contemporary American architecture as well as outstanding architectural journalism and photography. 352 pp., R807, \$60 cloth (\$54 AIA members)



Hugh Newell Jacobsen, Architect
Designed and edited by Massimo Vignelli.
Photographs by Robert Lautman.
Introduction by Vincent Scully
 A volume brimming with the beauty and magnificence of great architecture brought to life by splendid photography. 352 pp., R719, \$50 cloth (\$45 AIA members); R719P, \$35 paper (\$31.50 AIA members)

THE AIA PRESS

Special Bonus Offer!
 If you purchase 3 or more books, *Pennsylvania Avenue* is yours for only \$19.95 (a \$29.95 value)!
 Order number (R718P)
 "The authors have assembled a compelling collection of illustrations and anecdotes documenting the history of the avenue... Highly recommended for those interested in Washingtoniana." —Library Journal

Order Form	Qty	Title	Order #	Price	Total
Name _____ Phone () _____					
Address _____					
City/State/Zip _____					
AIA Membership No. (See AIA Exec. Card)		<i>Pennsylvania Avenue</i>	R718P	\$19.95	
Special Bonus Offer –				Sub-total	
			Sales tax: MD 5%; DC 6%		
			Shipping		\$4.00
			Total		

Check payable to AIA is enclosed VISA MasterCard Account # _____

Signature _____ Exp. Date _____

Mail to: AIA Press Order Dept., 9 Jay Gould Court, P.O. Box 1886, Waldorf, MD 20640

ENERGY CONSCIOUS CONSTRUCTION: BECAUSE THERE ARE TWO SIDES TO EVERY STORY.

Occupant:
"I want a comfortable building with low operating costs."



The Building Team:
"We want that, too. But without increasing first cost."

With Energy Conscious Construction (ECC), both sides get what they need. For occupants — a comfortable, productive work environment. For the owner, architect and engineer — improved energy efficiency *without expensive change orders or unnecessary construction delays.*

ECC is a program with monetary incentives and free consultation from The Connecticut Light and Power Company (CL&P) and Western Massachusetts Electric Company (WMECO). Its aim is to encourage additional energy-saving measures in new, nonresidential construction projects in the CL&P and WMECO service territories. *Typically, the incentives for the energy-saving measures in ECC can cover the incremental cost — with the added reward of lower electric bills from the day the building is occupied.*

For more information and a free copy of our ECC guidebook *Energy and Economics: Strategies for Office Building Design*, simply fill out the coupon. Or call 800-545-0663.

YES, I'm interested in ECC. Please send me more information. Also, send me the free guidebook *Energy and Economics: Strategies for Office Building Design*.

I'm an architect or engineer. I'm an owner or developer.

Name _____

Title _____

Company _____

Address _____

City _____ State _____ Zip _____



Please have a representative contact me

Mail Coupon to: Northeast Utilities,
P.O. Box 3023, Wallingford, CT. 06492-3023



THE CONNECTICUT LIGHT AND POWER COMPANY
WESTERN MASSACHUSETTS ELECTRIC COMPANY • HOLYOKE WATER POWER COMPANY
NORTHEAST UTILITIES SERVICE COMPANY • NORTHEAST NUCLEAR ENERGY COMPANY

THIS ENERGY CONSERVATION MESSAGE IS PAID FOR BY CL&P AND WMECO CUSTOMERS.

Circle 104 for more information

Circle 106 to have a CL&P/WMECO representative call.

0NA000UEXXC

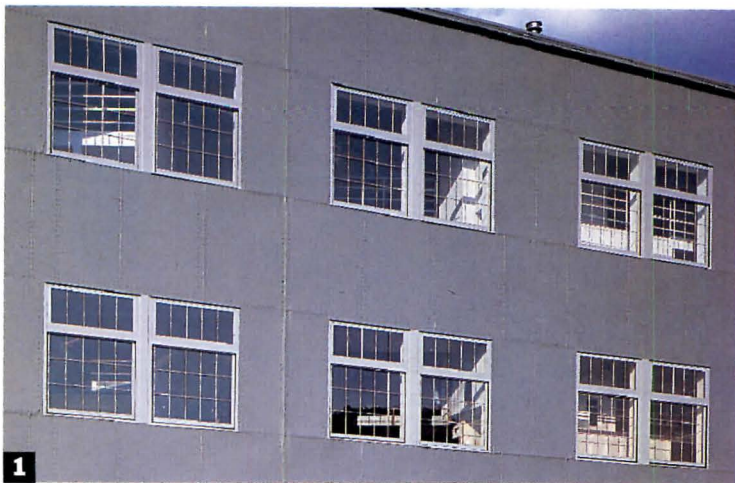

WINDOWS OF OPPORTUNITY

New fenestration alternatives boost energy.

The U.S. currently faces critical energy shortages and other environmental challenges not unlike the energy crisis of the 1970s. "Architects in the 1970s were timid about specifying large expanses of glass," says William Anton, executive director of the American Architectural Manufacturers Association (AAMA). "The difference today is that manufacturers are turning their attention to producing better, more energy-efficient windows. Windows are becoming a primary architectural element again, and are not being phased out of the design process." Anton bases his remarks on entries for "Great American Facades," an AAMA-sponsored design competition that recognizes outstanding and imaginative uses of windows, skylights, sloped glazing, storefronts and entrances, curtain walls, and siding. The competition is open to architects, builders, and remodelers of low-rise projects that will be completed by December 31, 1990, the competition deadline. For further information, contact AAMA, 2700 River Road, Suite 118, Des Plaines, Illinois, 60018. —A.G.L.



1. New heavy commercial aluminum windows are advantageous where monumental glazing is required, or where the size and weight of a window sash may affect operation. Season-all Windows, Inc. Circle 409 on information card.

2. Equa-Vu window features a projected system and the uniform appearance of equal sight-lines, which prompted Daniel, Mann, Johnson & Mendenhall, Architects, to specify the product for their San Francisco Marriott Hotel (top right). Equa-Vu's top-hinged in-swing vent or in-swing casement facilitates cleaning from inside. Efco Corporation. Circle 410 on information card.



3. CommercialLine Windows are offered in six models in thermal and non-thermal frame sections and a variety of operable and fixed types. All models conform to AAMA commercial ratings. Kawneer Company. Circle 411 on information card.

4. The Corner Window features glass bent to a 90 degree angle and energy-efficient 1-inch insulating glass. Marvin Windows. Circle 412 on information card.

5. Perma-Shield Awning windows with Terratone exteriors provide energy-efficiency and the appearance of a small-pane window while actually comprising a large expanse of glass. A recently introduced software program, CADD 2.0, helps in the selection process and specification of the manufacturer's windows. Andersen Corporation. Circle 1 on information card.



Long after everything else has gone to ruins,
it's worth noting that the entrance still makes
a monumental impression.



Kawneer has a complete line of
aluminum entrance systems,
each a timeless classic in its own right.

Kawneer
The designer's element.

Circle 108 on information card

RESIDENTIAL VISTAS

Windows for houses offer energy-efficient variety.

The residential window market has increased significantly since 1982, reaching almost 39 million units in 1988, according to the American Architectural Manufacturers Association's annual report. Two of the largest growing markets are vinyl- and wood-framed products. The National Wood Window and Door Association (NWWDA) notes a 20 percent increase in total window and door sales over the past year, and NWWDA president Robert A. Carlson predicts that wood-framed windows may outperform the insulating capabilities of walls and roofs in which they are installed in the coming decade. "In terms of energy efficiency, windows now have R-values of six to eight, and glass is being created to change from clear to reflective to curb solar gain." Vinyl-framed windows are also rising within the total market share, now accounting for 30 percent of all residential replacement window installations. Aside from the advantage of easy maintenance, their fusion-welded sashes and frames also help eliminate air and water infiltration. —A.G.L.



3



4



1



2

1. The Architect Series of divided-light windows features a narrow 7/8-inch wood profile, supporting insulated glass without wide muntin bars. Pella/Rolscreen Company. Circle 414 on information card.

2. Aluminum extrusions are combined with a wood frame and sash for reputedly the lowest air-infiltration ratings in the industry. Eagle Window & Door, Inc. Circle 415 on information card.

3. The Vinylweld Model 335 provides weather-stripping protection. Season-all Industries, Inc. Circle 416 on information card.

4. Full-circle, quarter rounds, half rounds, and other models are available in two-, three-, and four-foot diameters. Hurd Millwork Company. Circle 417 on information card.

5. Wood-window replacement systems are available in a variety of styles, with double-paned insulating glass. Caradco, an Alcoa Company. Circle 418 on information card.

6. The Ariel double-hung, insulated window features an easily removable wood sash liner. Peachtree Doors Inc. Circle 419 on information card.



5



6

**Artistry is what transforms an entrance from
a passage through a building into
a passage through time.**

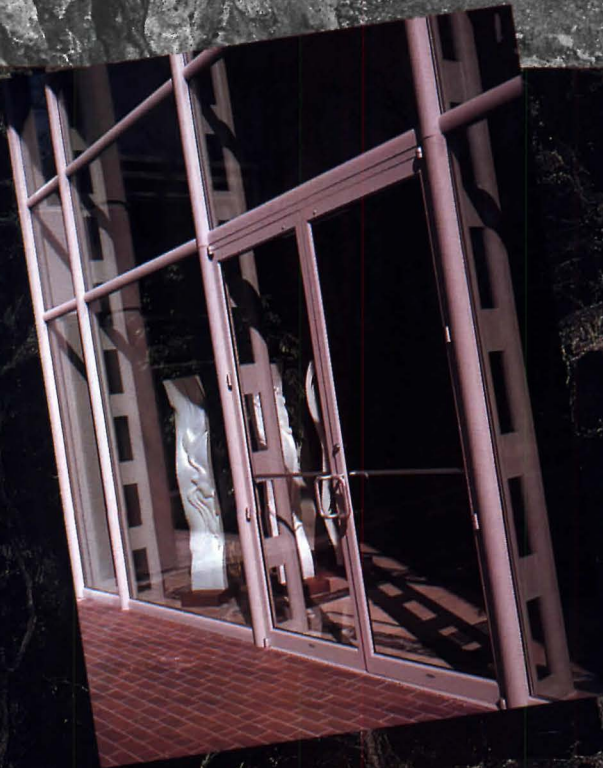

No matter what design statement you're making, Kawneer has an aluminum entrance system to help make it immortal.

Kawneer
The designer's element.

Circle 112 on information card

SURFACE TREATMENTS

Screening windows from the sun's rays.

Once a window, skylight, or other glazed unit is specified and installed, many innovative products can be applied to glass to control sunlight and heat gain.

Conventional window treatments such as blinds and drapes can be manipulated with electric motors and remote-control accessories, eliminating problems of accessibility. Window treatment products manufactured with new materials—such as synthetic shade fabrics and heat-reflective coatings applied to venetian blinds—address specific requirements of heat and light transmission dictated by window placement. For instance, a shade for a south-facing window needs to keep heat gain to a minimum, whereas a north-facing window might use a shade admitting as much heat and sunlight as possible while maintaining privacy.

Pressure-sensitive films are another way of screening glazed areas. These invisible coatings are applied directly to glass and are designed to afford heightened thermal efficiency values and safety from shattered glass. Still another kind of pressure-sensitive film is decidedly visible. 3M has developed a removable plastic sheet targeted to replace acid-etched decorations and signage on glass. A design created with this product can be pulled off and replaced by a new one without affecting the glass itself.

—RANDALL MASON

1. For creating designs on glass, 3M's Dusted Crystal Film is reputedly more versatile and economical than traditional acid etching. Designs on this pressure-sensitive film can simply be peeled off and new ones applied. Circle 420 on information card.

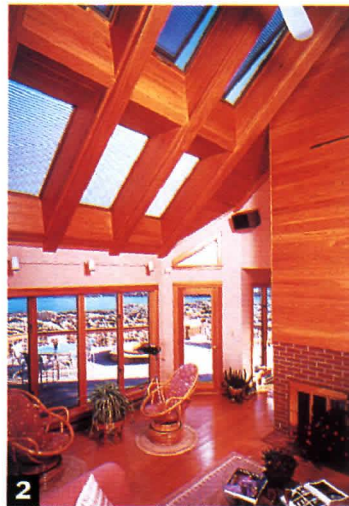
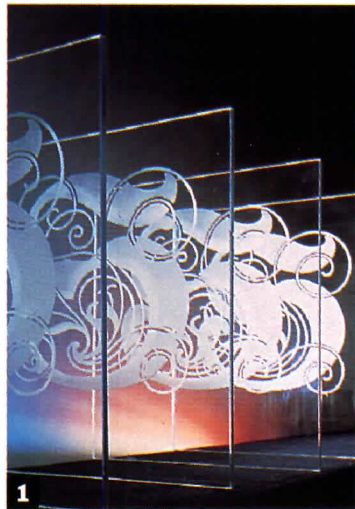

2. Velux skylights can be operated by pole or electric motor with remote control. Both the fixed FS and adjustable VS models are fitted with coated interior venetian blinds to control sunlight and reduce heat gain. Circle 421 on information card.

Idea File: Recessed wall systems for stores, offices, libraries, hospitals, etc.

CORNICE BRACKET

FACE OUT

STUD-EZE®
hidden standard mounts between 2 metal studs.

A clothing store in Indiana is shown here as an effective use of Crown Metal studs and hardware.

U.S.G. METAL STUDS 24" ON CENTER

LAMINATED WOOD SHELF

SHELF BRACKET

Crown Metal

FOR MORE INFORMATION:
CROWN METAL MFG. CO., INC.
5925 SOUTH LOWE AVENUE
CHICAGO, ILLINOIS 60621-2896
TELEPHONE: 312 873-3833 FAX NUMBER: 312 873-8878

Circle 114 on information card

BOSTON • ARCHITECTURAL • CENTER



The Boston Architectural Center (BAC) invites nominations and expressions of interest for the position of PRESIDENT. The President, as CEO, is responsible for developing, recommending, articulating and implementing policies approved by the Board of Trustees, and is to provide the leadership and management essential to achieve the school's mission.

In its 101st year, the BAC is the Nation's only accredited degree-granting, concurrent work curriculum program in architecture. Almost all teaching for its 800 students is done in the evening by a volunteer faculty drawn from the practicing design community. Its enrollment policy remains essentially open. Occupying its own buildings in the heart of the Back Bay, the Center also offers a program in interior design and a wide range of continuing education classes.

The BAC seeks an outstanding individual to lead the school into the next century inspiring a new level of excellence in design education - an individual with vision and energy, demonstrated leadership, administrative and educational abilities who is sympathetic with the Center's principles. She or he should possess qualities necessary to work with all constituencies within the Center, including highly motivated students, faculty and staff, while strengthening the BAC's links with the practicing profession and the community at large.

While an understanding of and dedication to the architectural and design professions are important, the BAC is sincerely interested in persons with ability regardless of their field of specialization.

Nominations and expressions of interest should be forwarded to:
Maurice N. Finegold, AIA, Chair
Presidential Search Committee
Boston Architectural Center
320 Newbury Street
Boston, Massachusetts 02115

The committee will begin consideration of applicants in mid-October and will accept inquiries until December 31, 1990. The President is to be selected in early 1991 and is to assume the office on July 1, 1991.

The Boston Architectural Center is an equal employment affirmative action employer and encourages women and under-represented minorities to submit nominations and expressions of interest.

3. The Kirsch X-10 Powerhouse System can control up to 16 drapery motors, lamps, and other appliances. The motor can be operated directly or from several different types of remote controls, and can be programmed with an optional timer. Circle 422 on information card.



4. Profilon Plus polyester and nylon window-safety film protects against shattered glass while acting as a solar screen. Martin Processing. Circle 423 on information card.



5. Ventarama's skylights can be adjusted with a motorized skylight system that is easily concealed in a standard 2-by-6-foot rafter space. It is useful where handicapped accessibility is a concern. Circle 424 on information card.

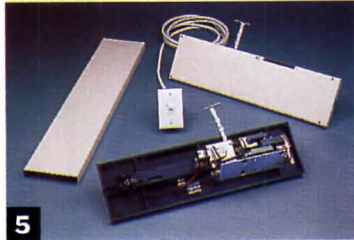

6. Levolor's Tech Shade fabric blinds act as solar screens. They are available in many colors and in weaves of varying openness to provide appropriate heat and light control for any window placement. Tech Shades can be operated manually by beaded chain or by a motor drive that is enclosed in the shade's roller. Options include wireless remote control and automated sun sensor control. Circle 425 on information card.

7. Awning and casement windows from SSI/Sunshine Rooms are used to fabricate solariums and pool rooms. The windows feature built-in tracks for internal shade systems. Exterior shading systems are also available. New glazing support components allow room depths up to 22 feet. Available in a number of colors and fabrics, the shades efficiently control heat and provide privacy. Circle 426 on information card.

CITY OF RANCHO MIRAGE



CIVIC CENTER DESIGN COMPETITION

The City of Rancho Mirage, California, a country club and resort city in the Coachella Valley, in the heart of Riverside County.....the fastest growing county in Southern California, is sponsoring an open two stage competition to develop a master plan for the City's proposed \$20 million Civic Center.

When completed, the Civic Center will contain governmental functions, together with cultural facilities of the community. The Civic Center is an integral part of an adjacent large commercial redevelopment project. The architect selected will be awarded the opportunity to negotiate a contract to provide architectural services for the first element of the Civic Center, the estimated \$10 million City Hall and its related parking facilities, which are scheduled to begin construction in 1992.

The competition program is scheduled for distribution on November 1, 1990. First stage design competition submissions (which will be anonymous) will be due on January 4, 1991. For additional information and registration forms, write to:

William H. Liskamm, FAIA, Competition Advisor
 Rancho Mirage Civic Center Design Competition
 c/o Rancho Mirage City Hall
 69-825 Highway 111
 Rancho Mirage, CA 92270

....Or phone Marilyn Brockman, Competition Secretary, at Rancho Mirage City Hall, (619) 324-4511. Architects who are interested in participating in the competition are invited to contact either Mr. Liskamm or Ms. Brockman.

Circle 116 on information card



© 1990 CYRO Industries

POZZI

Energy-efficient Pozzi Wood Windows are manufactured in over 4,000 designs ranging from double-hung windows to patio doors, to suit any architectural specifications, from restoration projects to contemporary homes. Special options include custom-shaping, True Divided Lite construction, double glazing, and low-E glass. Bend Millwork Systems. *Circle 440 on information card.*

WWDA Directory

The National Wood Window and Door Association's directory lists manufacturers, their product lines, and services offered.

Circle 441 on information card.

Daylighting Document

The Illuminating Engineering Society of North America (IES) has issued a calculations document on the recommended practice for the lumen method of daylighting. The paper was prepared by the IES Calculation Procedures Committee to provide a simple way to predict interior illumination through skylights and windows. The lumen method calculates interior lighting levels through coefficient utilization tables.

Circle 442 on information card.

Weather Shield

Supersmart Wood Windows yield high energy-efficiency ratings by employing low-E glass coatings, triple glazing with argon gas between panes, and a dual-sealing process for the entire unit. Weather Shield Manufacturing.

Circle 443 on information card.

LouverDrape

The newest product in LouverDrape's line of vertical blinds is the Perspectives model. Available in a number of striking, sculpted shapes, Perspectives blinds offer efficient control of heat and light.

Circle 444 on information card.

Window Film Detailed

All aspects of window film for retro-fit applications of residential and commercial buildings are discussed in a brochure from Gila River Products, a division of Courtaulds Performance Films. In addition to detailing construction and application techniques, a specifications chart is provided that compares solar reflectance, solar transmission, absorbance, reflection, as well as summer and winter U-values, K-cal design, shading coefficients, and emissivity.

Circle 445 on information card.

Malta Windows

Malta's Classic View replacement windows are constructed of solid wood and customized to accommodate any size opening. Features include exteriors clad in vinyl and aluminum and unfinished wood interiors.

Circle 446 on information card.

Bali Blinds

Carey McFall Corporation's line of Bali Blinds are specified for both residential and commercial uses. They are manufactured in vertical or horizontal configurations, 50 shapes, various sizes, and over 300 colors.

Circle 447 on information card.

Wood Window Line

The JX-7 line of clad wood and wood products is listed in two catalogs detailing all the JX-7 products and their styles, sizes, energy performance data, features, colors, options, and warranties. Wenco Windows, div. of Jeld-Wen.

Circle 448 on information card.

Architectural Supply Catalog

The Dataprint 25th Anniversary Catalog offers a complete selection of brand name drafting, print, and plotter supplies at significant discounts. *Circle 449 on information card.* ■

AT YOU THROUGH

ACRYLITE

ACRYLIC SHEET

CYROLON ZX

POLYCARBONATE SHEET

OPTICAL CLARITY, SAFETY, DURABILITY

If you demand superior performance in your specialty glazing application, specify superior ACRYLITE acrylic or CYROLON ZX polycarbonate sheet. For maximum weatherability combined with outstanding light transmission characteristics, ACRYLITE acrylic sheet is unsurpassed. When an added measure of security is a must, our CYROLON polycarbonate sheet delivers the impact resistance you need.

Both ACRYLITE and CYROLON sheet comply with material requirements of AAMA's voluntary specifications for skylights, No. 1600-86 and both are manufactured by CYRO Industries, North America's largest producer of acrylic sheet. We use statistical process control to ensure the highest quality sheet, provide technical and fabrication support, and our nationwide network of distributors stands ready to fill your orders promptly and efficiently. For walkways, atriums, skylights, solariums, staircase treatments and specialty glazing, ACRYLITE and CYROLON sheet are without equals. For informative literature, write D. Artz, CYRO Industries, P.O. Box 950, 100 Valley Road, Mt. Arlington, NJ 07856.

SEE US IN SWEET'S CATALOG FILE, REFERENCE NO. 08840 CYR, OR CALL

1-800-631-5384.



QUALITY PRODUCTS · INNOVATIVE TECHNOLOGIES · CARING PEOPLE

Circle 118 on information card



Videoconferencing from page 132

The key to affordable videoconferencing is the codec, which performs two vital functions in the transmission process. First, it compresses the data taken in from the camera by predicting the next frame, and transmitting only those pixels that have changed since the last frame was taken. This eliminates more than half the data needed for a single frame. Secondly, it converts the analog input from the camera into digital information for transmission. For highly sensitive conferences, an encrypter can also be added for privacy.

Applications

ACCORDING TO PEIRCE-PHELPS, VIDEOCONFERENCING creates a communications conduit that addresses two of the most important business trends in the past decade. One is the progressive reduction of middle managers, and the other is the explosion of information that results in greater need for connecting management to key personnel. Furthermore, videoconferencing reduces costly business travel, allows rapid changes in plans, aids decision-making, shortens product-development cycles by instantly connecting all the players in a loop, and helps in crisis management

Peirce-Phelps vice president Henry Grove also points out that the new CCITT (Consultative Committee of International Telephone and Telegraph) worldwide standard—H.261 for codecs—"is bound to increase interest in the technology, since it will be possible to have global, spontaneous, dial-up conferencing just like the telephone." He expects the standard to promote dramatic growth, just as the Group 3 standard fostered explosive growth in fax.

During a demonstration at the AIA convention moderated by Arny Hooton, Westinghouse information and technology service manager and his colleagues from Grand Rapids, participants were intrigued with the way Westinghouse, which has a network of videoconferencing facilities across the country, employs the technology. The firm has found videoconferencing particularly useful for product development, when instant reaction is needed to judge a prototype. A full-sized product was introduced to the Houston audience, with the camera zooming in to explain specific details. Such applications can be helpful for architects in explaining a design scheme or in planning a complex installation of furniture systems for a corporation, for example. Models and drawings

can also be reviewed without assembling a team of people in one location.

To illustrate how the technology makes sense for architects, Denis Moncion, project manager, WBDC Group in Grand Rapids, made an appointment for a videoconference with his project manager for Toys "R" Us in Houston. They went over the architecture firm's plans for toy stores across the country. During Designer's Saturday, October 11-13, at the International Design Center in Long Island City, New York, architects can witness a videoconference demonstration, as well as all the equipment and furnishings that were donated to the AIA exhibition.

While installations such as the AIA's videoconferencing rooms may for now be restricted to major corporations, the Westinghouse demonstration team emphasized the room's value and usefulness for designers and architects. Close-ups of three-dimensional models, products, plans, and drawings were shown on screen during transmissions, and graphics were clear and readable. As Gensler's Charles Kifer notes, "We have pushed the limits of communication. What we thought was the future has invaded the present, and I can't wait to be part of it." ■

—GREGORY LITTLETON

DEAN

College of Engineering, Computer Sciences and Architecture

Applications and nominations are invited for the position of Dean of the College of Engineering, Computer Sciences and Architecture at Temple University.

The dean is the chief executive officer of the college. In administering the college, the dean interacts with the faculty who govern the academic aspects of the college. The dean is an advocate for the college and faculty.

Temple University is a member of the Pennsylvania Commonwealth System of Higher Education and presently has an enrollment of more than 34,000 students in 14 schools and colleges. Located in Philadelphia, at the heart of the northeast corridor, Temple offers a broad range of quality academic programs that attract students from all over the United States and from more than 60 foreign nations.

The College of Engineering, Computer Sciences and Architecture is comprised of 71 full-time faculty who, in conjunction with adjunct faculty, serve an enrollment of more than 1900 undergraduates and 200 graduate students. The College is strongly oriented towards professional studies, graduate work and research activities, with programs offered in architecture, civil engineering, computer and information sciences, electrical engineering and mechanical engineering.

Applicants must have a proven record of scholarship or professional recognition and have had significant management experience. An advanced degree and experience in university management are important assets but are not required. Applicants should have demonstrated expertise in managing resources, especially people, in an organization of shared authority and responsibility. The applicant must be an innovative leader capable of taking the initiative and promoting new ideas. At the same time, the applicant must understand the nature of the university, academics and scholarship, and the balance of authority and responsibility between the faculty and the administration.

Applicants or nominators should submit a letter summarizing qualifications, a current vita, and the names, addresses and telephone numbers of at least three references to:

Leonard J. Garrett
Chairperson, Dean Search Committee
Computer and Information Sciences
(038-24)
College of Engineering, Computer
Sciences and Architecture
Temple University
Philadelphia, PA 19122

A review of applications and nominations will begin September 1990.

Temple University is an affirmative action, equal opportunity employer serving over 34,000 students.

Choose
TEMPLE

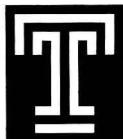

UNIVERSITY

Japanese from page 75

being built in the mountains. Conveyor belts move the players up and down the steep terrains from hole to hole. Robots, moving along separate pathways, carry the clubs."

Japanese construction companies do most of the hiring of U.S. architects, and they are clearly attracted to the American vanguard. The work of Graves, Stern, Eisenman, Tigerman, Holl, and Rotondi is as exotic and wonderful to them as that of Maki, Ando, and Isozaki is to us. But *A+U* and *Process Architecture* publish the work of the more conservative American architects as well as that of the design radicals, and globe-trotting Japanese architects travel to the U.S. to learn from both, forming valuable associations with their American counterparts. For example, Takenaka Corporation, one of the Big Six, needed to find its way into the U.S. design community. Last year it formed a partnership with The Architects Collaborative, creating a jointly-owned firm called TAC International. Takenaka chose TAC because Walter Gropius continues to be widely revered in Japan, and because of TAC's broad experience in West Germany, Saudi Arabia, Iraq, Kuwait, Bahrain, and Algeria. The new company's first project is a high-rise office building in downtown Los Angeles, which is being developed by Takenaka and the Mitsubishi Trust Group.

Kevin Roche John Dinkeloo & Associates is working with Shimizu to complete an office tower addition to two adjoining venerable buildings in the heart of Tokyo, opposite the Imperial Palace Garden. Roche finds his Japanese clients to be similar to those he deals with at home. "Putting the cultural differences aside—formality of meetings, entertainment, customs and so on—working in Japan is much the same as working in the U.S. Some Americans get hung up on the cultural differences. They either ignore them completely—a big mistake—or they come super-armed with knowledge of local customs and folkways. Because most of my clients are corporate, I bring a decision-making process and a working relationship with which the Japanese are familiar."

Like all architectural compatriots fortunate enough to be working in Japan, Roche extols the virtues of Japanese construction. "Pride of workmanship induces the Japanese to spend money. Both the construction firm and the owner want to do a good building, and neither will take advantage of the other. Only fools would attempt to operate at this level of trust in the United States."

Cesar Pelli & Associates was engaged to build in Japan because the client group is directly familiar with the firm's work. Pelli is designing the 32-story, 900,000-square-foot headquarters for Nippon Telephone and Telegraph (NTT), the largest corporation in

the world, to be constructed in Shinjuku. Yamashita Sekkei, a purely architectural firm of 500 employees, invited Pelli to submit a proposal with them because they admire the American embassy in Tokyo that he designed, as well as the World Financial Center in Battery Park City and the Pacific Center in Los Angeles. In the typical Japanese way, NTT would have had the building designed by its huge staff of 2,000 architects and built by one of the large contracting firms. Because of the importance, however, of opening Japanese construction markets to competition from foreign builders, NTT sought a collaboration between a foreign architect and a Japanese architectural firm. The construction contract will be open for foreign bidding, and American suppliers and contractors will be invited to participate.

Most foreign architects working in Japan are designing single buildings or planning for various mixes of building types on relatively small sites. Not many are yet planning on the scale demanded by Japan's vast waterfront landfill and rust-belt sites. Few Japanese architects are trained in land planning. Most have never dealt with large space problems, because until now they have lacked large spaces to consider. Realizing the need for expertise at megascale design, the Japanese architectural firm Nikken Sekkei invited Benjamin Thompson & Associates to collaborate on two projects with budgets in the billions. Both are large retail and residential projects that incorporate towers designed by Japanese firms, and both are on sites within commuting distance to downtown Tokyo. Ben and Jane Thompson and their team enjoy working with the Japanese, and echo other American architects in describing how BTA is treated by them. In the give and take of work, Jane Thompson finds that, for the Japanese, "personal opinion counts for very little. They caucus, talk it over among themselves, and decide what they like and don't like. They then present their conclusions to us." She finds them sensitive about requesting changes. "They don't make you feel that you have failed. You simply figure out the aspects that don't meet the requirements and fix them."

BTA is finding that work in Japan is challenging. "The Japanese are not interested in preservation or looking back," Jane Thompson adds. "They like novelty and ideas for their own sake. The work designed by the Japanese architects themselves is stimulating and contagious. We are learning from it. We are on a frontier there. It is a lot better than working in London and having your designs vetoed by Prince Charles." ■

Mildred F. Schmertz, FAIA, is a journalist and member of the New York City Landmarks Preservation Commission.

Did you miss valuable information offered by advertisers in last month's issue of ARCHITECTURE?

The manufacturers listed below and on the following page were advertisers in last month's issue who are anxious to provide you with their latest product information and literature for your planning needs. To receive this helpful information, just circle the appropriate numbers on the self-addressed, postage-paid response card. For product information and literature from advertisers in this issue of ARCHITECTURE, circle the appropriate numbers appearing on the advertisements.

Advance Lifts, Inc. "The Disappearing Dock" replaces dangerous concrete ramps. Advance Superdok. *Circle No. 103*

Advance Lifts, Inc. If you don't have a loading dock because space or cost is a problem, you need an Advance Superdok. *Circle No. 105*

Advance Lifts, Inc. If you can't safely load and unload all trucks at your loading dock, you need a versatile Advance Superdok. Call 1-800-THE-DOCK. *Circle No. 107*

Alucobond Technologies. Alucobond's technical experts demonstrate the service that makes Alucobond material your best curtain wall value. *Circle No. 31*

American Olean Tile. No one offers as many textures, colors, and styles of quality ceramic tile. *Circle No. 11*

American Stair-Glide Corp. PORCH-LIFT vertical wheelchair lift is a safe, simple solution to architectural barriers. Send for a free brochure. *Circle No. 47*

Andersen Corp. Presenting Flexiframe® windows. The custom-made commercial window from the company you may have thought didn't even make one.

Andersen Corp. We offer custom-made windows to fit any frame of mind. Our Flexiframe® windows are custom-made to almost any shape or size.

Andersen Corp. All things considered, there's nothing quite like one of our Flexiframe® windows. No matter how you look at it—a revolutionary commercial window, exterior and interior.

Andersen Corp. Thanks to Andersen CADD-I™ technology, architects are suddenly able to express themselves like never before. The Andersen CADD-I program is IBM-PC compatible and now runs with dozens of different computer-aided design packages.

Brick Institute of America. Brick is unique in that it is an extremely handsome material whether you look at it from up close or far away. Brick's design flexibility helps you meet the diverse needs of all your clients. *Circle No. 25*

Burns & Russell. Spectra-Glaze® II—because of the unique formulation and patented process, the sealed, smooth surface is practically wear resistant and can't be permanently marred or gouged. *Circle No. 57*

UNIVERSITY OF CALIFORNIA, IRVINE

Associate or Full Professor, and Assistant Professor (two positions)—Environmental Analysis and Design

The Program in Social Ecology at the University of California, Irvine, is recruiting for two positions in the area of Environmental Analysis and Design: a full or associate professor, and an assistant professor. Candidates for the senior or associate position must have achieved international recognition for outstanding scholarship in one or more of the following fields: urban and regional planning, environmental planning, facility planning, public health, and/or environmental design research. Candidates for the assistant professor position must have outstanding potential for scholarship and research in any one of these fields. Salary and benefits competitive with the best research universities.

The Program in Social Ecology grants B.A., M.A., and Ph.D. degrees, with over 100 Ph.D. students and approximately 1200 undergraduate majors. The 35 full-time faculty have multi-disciplinary interests and include urban planners, architects, environmental health specialists, psychologists, sociologists, demographers, urban and regional specialists, criminologists, and lawyers. The Program offers a Ph.D. concentration in Environmental Analysis and Design and M.A. concentrations in Urban and Regional Planning and Facility Planning and Management. The elected senior candidate will be expected to provide leadership in the development of these areas of the Program. The Social Ecology Building houses a full-scale environmental simulation laboratory, as well as environmental health and behavioral observation laboratories. As the nation's largest planned community, Irvine offers one of the most interesting settings for the study of planned environments. Orange County is one of the most rapidly urbanizing areas in the nation and has one of the largest concentrations of high technology industries in the world. The Irvine campus of the University of California presently enrolls approximately 17,000 students and is expected to expand to 28,000 by the end of the decade.

Submit letter of application and curriculum vita to:

Professor Daniel Stokols, Director
Program in Social Ecology
University of California, Irvine, CA 92717

In addition, each candidate should arrange for 3-5 letters of recommendation to be sent directly by each referee before the closing deadline. Closing date for applications is January 3, 1991. The University of California is an equal opportunity, affirmative action employer.

"THE DISAPPEARING DOCK"

At a ground level building . . .

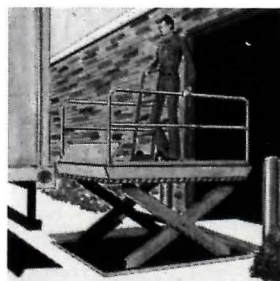

Now you see it

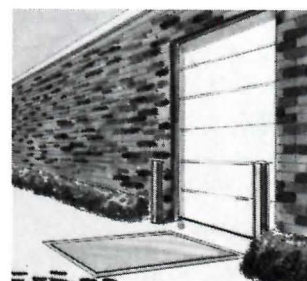

Now you don't



If you don't have a loading dock because space or cost is a problem, you need a versatile Advance Superdok. Call 1-800-THE DOCK for FREE information.

We're here to help.



Advance Lifts, Inc., 3575 Stern Avenue, St. Charles, IL 60174 (708) 584-9881

Circle 120 on information card

Superior communications products specially discounted for Members only.

Save up to 40%

Your membership is your key to special savings on office equipment and long distance service. Through Member Communications Plus you'll always receive prompt, personal attention from expert member sales agents or dedicated customer service personnel.

US Sprint, Long Distance Special member discounts let you save even more off everyday low US Sprint long distance rates. And you'll enjoy unsurpassed sound quality via their 100% fiber optic network.

Call 1-800-669-8585

Panafax 750D A new, high speed performance *plain paper fax* that uses plain bond sheet-fed paper and holds 500 standard and legal-sized sheets. Letter quality, archival production via laser printing. Other units available.

Fax Paper Why risk damaging your valuable fax machine with inferior fax paper? Now you can get the best—ultra-sensitive Jujo paper—and get sharp, long lasting image quality at a terrific price.

Panasonic Copier FP-820 Panasonic's FP-820 Personal/Desktop Copier fits anywhere, yet delivers full-sized features and performance.

Panasonic Laser Printer P4420 It's compact, reliable and twice as fast as any model in its price range, and gives you letter-quality printing. Works with 'IBM compatibles.'

Panasonic Laptop Computer CF-150B This highly-rated laptop offers the optimum combination of power, features and price. It weighs just 6.2 lbs., yet has all the power to run your desktop programs and its backlit screen is easy on your eyes.

To order equipment or fax paper call:
1-800-289-2776

For discounted US Sprint service call:
1-800-669-8585

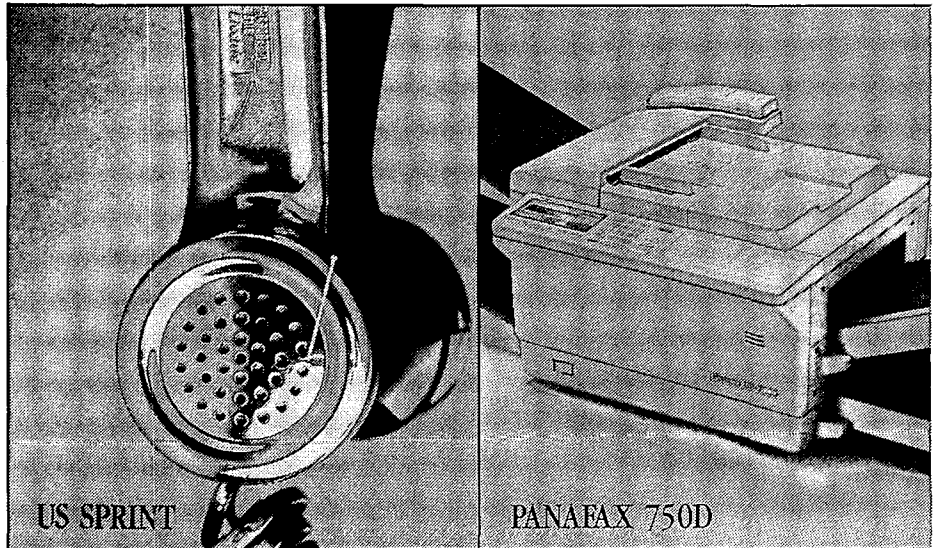

US SPRINT

PANAFAX 750D

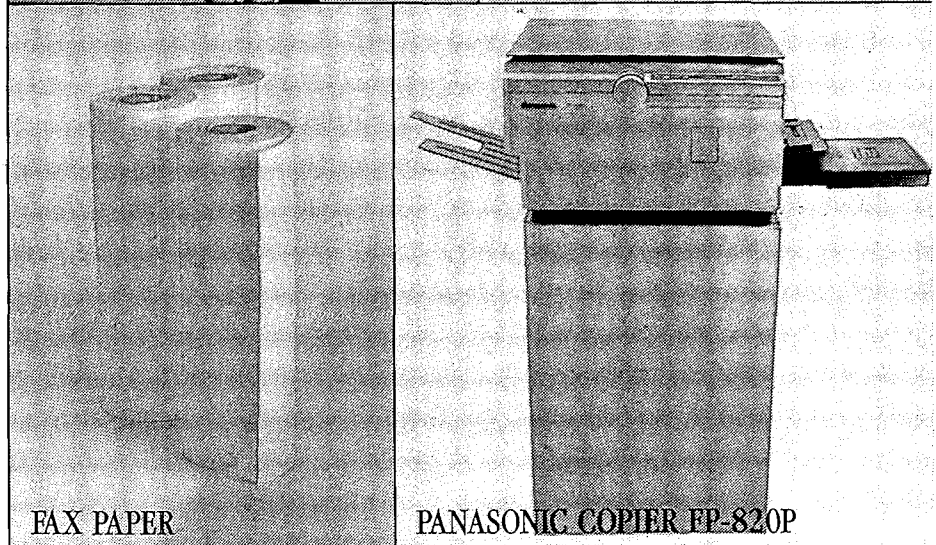

FAX PAPER

PANASONIC COPIER FP-820P

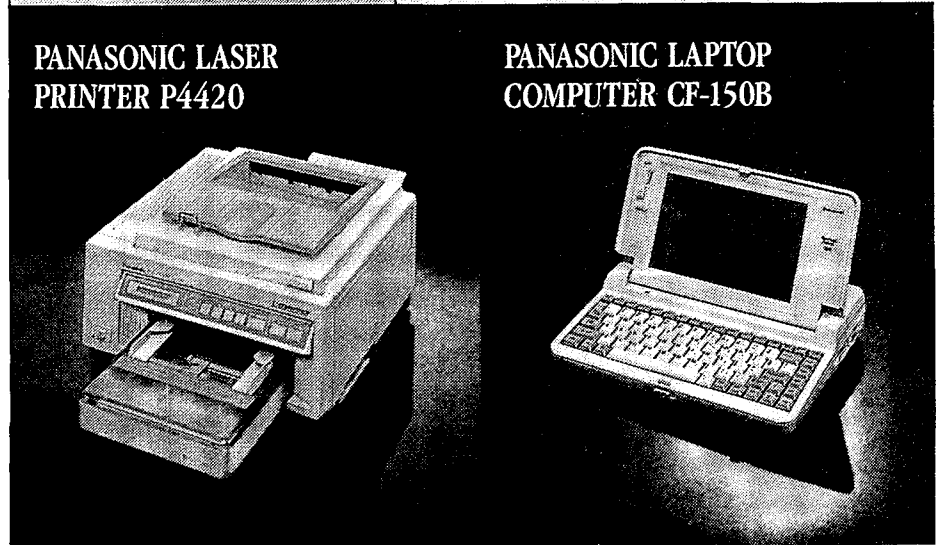

PANASONIC LASER
PRINTER P4420

PANASONIC LAPTOP
COMPUTER CF-150B

CalComp. There are six different sized tablets in CalComp's DrawingBoard® line so you're sure to get one that measures up to your projects. *Circle No. 125*

California Redwood Assoc. Natural beauty, durability, and stability make redwood the natural choice for designs that endure. *Circle No. 41*

Carlisle Syntec Systems. Carlisle has a roofing system to meet your every need in black or white, reinforced or non-reinforced, EPDM or CSPE services. *Circle No. 19*

CNA Insurance. Now you can earn premium credits for longevity and loss prevention with a CNA/Schinnerer professional liability insurance program. *Circle No. 87*

Computervision. Many of you know us as a "big CAD" vendor. The fact is, we're also a leader in micro-based CAD/CAM. If you're looking for a microbased CAD/CAM solution, be sure to consider Computervision software. *Circle No. 9*

Cyro Industries. Look to Cyro for superior acrylic and polycarbonate sheet for framing, displays, functional panels, glazing, skylights, and other applications. *Circle No. 89*

Electric Time. Custom Built Tower and Street Clocks of all kinds. We can handcraft replicas or assist in a new design. *Circle No. 7*

Fry Reglet. The finest products available and caring professional people are behind every Fry molding. *Circle No. 45*

General Felt Ind. Veelock carpet is 100% water resistant. There's no sprayed-on coating to wear away, no backing to disintegrate, no chance of mildew. *Circle No. 23*

Grace, W.R. Grace's new Bituthene System 4000 is based on 25 years of proven Bituthene technology, and it complies with existing and anticipated VOC regulations. *Circle No. 95*

Haws Drinking Faucet Co. Haws has a full line of outdoor drinking fountains in a melange of textures and styles. *Circle No. 43*

Homasote. New DesignWall™ panels combine superior tackability with the elegant appearance of textured fabric. *Circle No. 83*

Hurd Millwork Co. New Hurd InSol-8™ windows are remarkable. No other residential window insulates to #8 and blocks over 99% of the UV rays. *Circle No. 21*

Lehigh Portland Cement Co. Lehigh White Cement is manufactured under precise, rigidly controlled conditions to assure a uniform whiteness, consistent performance, and reliable strength. *Circle No. 79*

LPS Paving. LPS Pavement Company installs confidence. Modular paving casts a powerful image of unmatched prestige, wealth, and impeccable style. *Circle No. 71*

Marvin Windows. We make windows to order. We don't build and warehouse a few popular shapes and sizes or limit our line to a few standard feature packages. *Circle No. 63*

Marvin Windows. We make windows for imaginations that have no limit and budgets that do. Just because you have to think with your wallet doesn't mean your imagination has to take a back seat. *Circle No. 85*

Medart, Inc. Discover Medart for the 1990's customized designs for standard prices. Dollar for dollar, Medart lockers make a good deal a good deal better. *Circle No. 67*

Mutoh Ind. LTD. The new Mutoh F-920AR keeps your plotting on a roll, all night long. Find out more about plotter automation with the F-920 series. *Circle No. 33*

Harvard University
Graduate School of Design

FACULTY POSITIONS BEGINNING ACADEMIC YEAR 1991-92

ARCHITECTURE

Senior Academic Positions in Architectural Design

Senior faculty positions are available for persons qualified to offer graduate-level instruction in architectural design. Full-time positions as professor may be filled for a fixed term or "without limit of time" (tenure). Responsibilities include teaching, scholarship, and administration. The teaching includes design studios, plus courses in a secondary specialty such as visual studies, design theory, or construction technology. Part-time positions as adjunct professor may be filled for a fixed term and normally would include responsibilities for teaching design studios only. Candidates should be qualified through advanced academic study and/or professional practice and should be experienced teachers of design studio with records of distinguished achievement in design or related scholarship.

Full-time positions as assistant or associate professor may be filled for fixed terms with responsibilities for teaching design studios, plus courses in a secondary specialty such as visual studies, design theory, or construction technology. Candidates for these positions should have experience in teaching design and achievement in design or related scholarship.

Academic Position in Building Science/Environmental Systems

A faculty position is available for a person qualified to offer graduate-level instruction in building science with a focus on environmental influences on building design and environmental systems. A full-time position as assistant or associate professor may be filled for a fixed term with responsibilities for teaching required lecture courses and offering seminars in specialty areas such as lighting, mechanical systems, or acoustics. In addition to teaching, the person holding this position would be expected to discuss research in the GSD Laboratory for Construction Technology. Candidates should have a doctoral degree or equivalent with research experience in engineering, design, or a related field. Preference will be given to candidates with advanced academic preparation, experience in teaching environmental systems, and a demonstrated achievement in scholarship or professional practice.

APPLICATIONS

Position descriptions and application forms are available at the address listed below. Applicants should *not* send portfolios or dossiers with their initial applications and completed applications should be received by 1 November 1990 at the following address:

Appointments Committees
Graduate School of Design
Gund Hall 305
48 Quincy Street
Cambridge, MA 02138

Harvard is an equal opportunity/affirmative action employer.

"THE DISAPPEARING DOCK"

At a raised concrete dock . . .

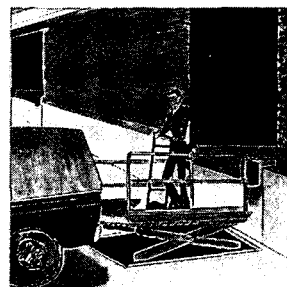

Now you see it

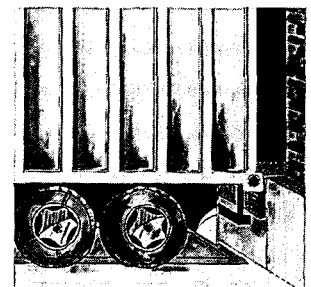

Now you don't

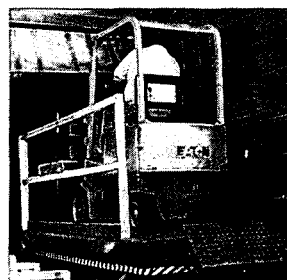

If you can't safely load and unload all trucks at your loading dock, you need a versatile Advance Superdok. Call 1-800-THE DOCK for FREE information.

We're here to help.



Advance Lifts, Inc., 3575 Stern Avenue, St. Charles, IL 60174 (708) 584-9881

Circle 122 on information card

Everybody
knows what you
can build with
steel joists.

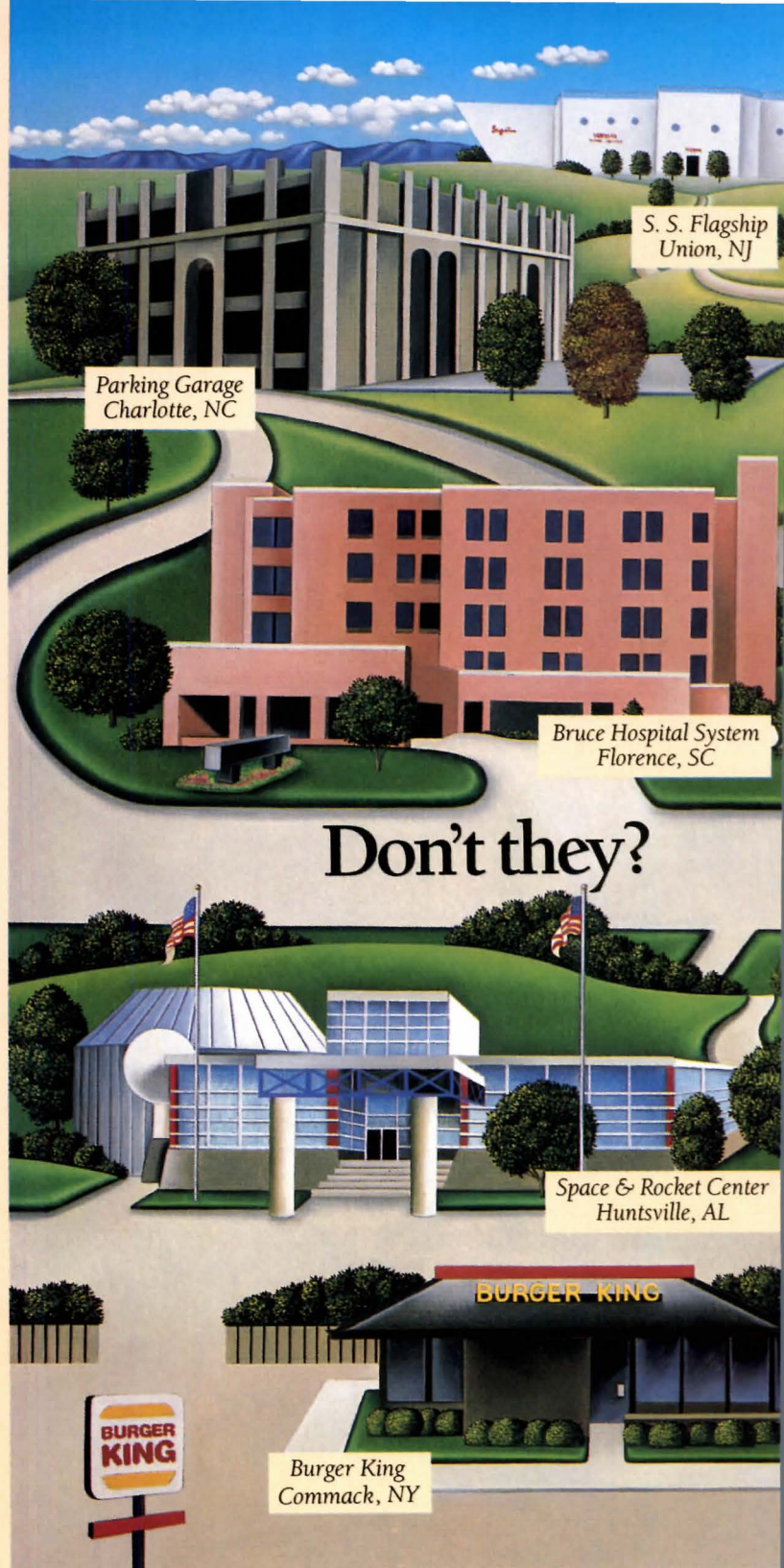
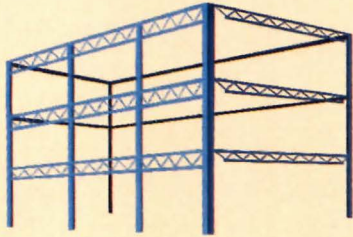

Don't they?

If you have a steel joist building you're proud of, drop us a line or send us a photo.

Don't stop with the first picture that comes into your mind. Instead, take a look all over town.

For instance, that new corporate headquarters downtown. Maybe that dramatic suburban condo complex everybody's been talking about. Or a very

interesting new grouping in that west side office park.

That's the steel joist picture today. Beautiful stores, auditoriums, hospitals, churches, motels—because using steel joist construction is an idea that's catching on everywhere. You get complete design flexibility—the freedom to do

exactly what you want. And steel joist construction is a great time saver, too, with the economics all in your favor.

But then all you have to do is start building your own beautiful ideas with steel joist construction. And you'll get the picture.



1205 48th Avenue North
Suite A
Myrtle Beach,
South Carolina 29577

Nichimen. Elmes® Doorhandles—standard and custom—the eloquent expression of time and space. *Circle No. 65*

Nucor Corp. Before you start your next project, consider Vulcraft composite deck. It's strong, it's economical. And it beats poured-in-place concrete to finish every time. *Circle No. 37*

Panasonic Copiers. Mastering the nuances of presentation graphics is what the FP-C1 digital color copier does best. *Circle No. 69*

Peachtree Windows and Doors. Introducing the Peachtree Newport door. It looks like expensive oak but is actually an advanced composite material that's fully insulated, easy to finish and guaranteed for as long as your client owns it. *Circle No. 73*

Pittsburgh Corning. 95% of architects who use glass block specify Pittsburgh Corning PC GlassBlock® products because their most important criteria are ours, too! Quality—Installation—Availability. *Circle No. 39*

Plan Hold/CPG. Affordable. Plan CADD™ Creativity Centers for architects. Build a creativity center to fit your personal needs. *Circle No. 61*

Pozzi Windows. Pozzi Wood Windows offer advantages an architect can appreciate. Windows as distinct as your signature. *Circle No. 77*

PPG Industries. Azurlite™, the new aquamarine-tinted float glass that allows the designer to realize all the openness, esthetics, and efficiencies of daylighting with 72% light transmission. *Circle No. 75*

Rite Hite Corp. Specify Dual-Dok.™ It's two docks in one. *Circle No. 3*

Sloan Valve Co. Introducing the On-Q Electronic Faucet. An solution to everything no-hands faucets should be. *Circle No. 35*

Spacesaver Corp. High-density mobile storage systems increase storage capacity, eliminate off-site storage, and make room for growth. *Circle Nos. 109, 111, 113, 115, 117, 119, 121, & 123*

Steel Joist Institute. Steel joist construction is an idea whose time has come—an idea that's catching on everywhere. Send today for more information. *Circle No. 17*

Stereo Graphics. Leadership in creating visual reality. Dramatic, stereo 3D depth perception lets them see your design as they normally see things. *Circle No. 51*

Stucco Stone Products. With lightweight Cultured Stone® you can achieve the beauty of natural stone at a fraction of the cost. *Circle No. 55*

Titus Products. New Titus® Omni diffuser: Smooth, clean lines with anti-smudge performance. *Circle No. 53*

United States Aluminum. United States Aluminum's Series 3300 Slope Glazing is tops in its class. Send for complete information. *Circle No. 81*

Wilson Plastics Co. Don't take cover in a safe place...propel your wildest brainstorm into reality with SOLICOR Colorthrough Laminates. *Circle No. 5*

Wind-2 Software Inc. Using only three main types of input, the Wind-2 system produces project cost, budget, and profit analysis, plus company financial and cash flow reports. *Circle No. 101*

DON'T KEEP IT
TO YOURSELF!

ORDER
REPRINTS

of articles that have appeared in

ARCHITECTURE.

Minimum Print Order:

100 copies

Call or write for a price quotation:

(215) 254-9800

Penny Jenkins
994 Old Eagle School Rd.
Suite 1010
Wayne, PA 19087

"THE DISAPPEARING DOCK"

Replaces expensive truck wells . . .

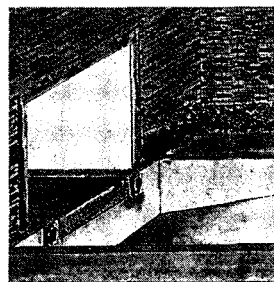

The costly way

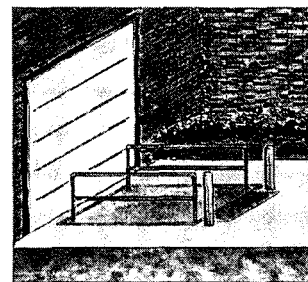

The economical way

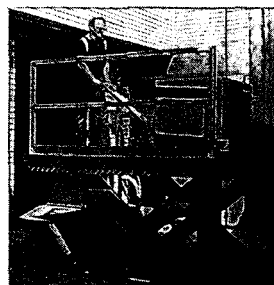

For half the cost of a truck well loading dock, you can have a versatile Advance Superdok.
Call 1-800-THE DOCK for FREE information.

We're here to help.



ADVANCE LIFTS

Advance Lifts, Inc., 3575 Stern Avenue, St. Charles, IL 60174 (708) 584-9881

Circle 124 on information card

ADVERTISERS

EDITORIAL OFFICE

1130 Connecticut Avenue, N.W., Suite 625
Washington, D.C. 20036
(202) 828-0993

EXECUTIVE OFFICE

994 Old Eagle School Road, Suite 1010
Wayne, Pa. 19087
(215) 254-9800

Robert Hoover
Production Director

Maggie Cuomo
Circulation Manager

Nancy A. Perri
Assistant to the Publisher

Robert G. Kliesch
Publisher

ADVERTISING SALES OFFICES

New York/Connecticut (215) 935-8522

D. Douglas Johnson

P.O. Box 199

Devon, Pa. 19333

New England (617) 242-3042

Joan Donahue

31 Shipway Place

Charlestown, Mass. 02129

Philadelphia/Pittsburgh (215) 254-9800

George T. Broskey, Eastern Sales Manager

994 Old Eagle School Rd., Suite 1010

Wayne, Pa. 19087

Southeast (215) 935-8552

D. Douglas Johnson

P.O. Box 199

Devon, Pa. 19333

Midwest (312) 527-1055

Jack E. Bergren

Robert G. Hatfield

1337 The Merchandise Mart

Chicago, Ill. 60654

Jack E. Bergren (414) 786-4286

2530 Coach House Dr.

Brookfield, (Milwaukee) Wi. 53005

Edward R. Novak (708) 658-7133

E.R. & J. Assoc., Inc.

P.O. Box 348

Algonquin, Ill. 60102

Southwest (314) 569-3210

Richard Grater

1466 Summerhaven

St. Louis, Mo. 63146

West/Northwest (619) 451-9782

James A. Anderson

Western Sales Manager

11858 Bernardo Plaza Court, Suite 240-C

San Diego, Calif. 92128

Canada (416) 833-6200

Donald C. Fenn

148 King Road E.

King City, Ontario L0G 1K0 CANADA

Italy 9-20135 Milano (02) 54.00.757

Cesare Fiorucci, Viale Sabotino

Telex: 326559 Timas; Fax: 5451526

Circle No.	Page No.	Circle No.	Page No.
120	Advance Lifts155	22	ISICAD21
122	Advance Lifts157	80	JDL/U.S. Sales Division124
124	Advance Lifts159	108	Kawneer Company145
—	AIA Member Communications156	110	Kawneer Company147
—	AIA Press142	112	Kawneer Company149
32	Alply33	44	Kawneer Company40-41
78	Alucobond Technologies122-123	82	Kawneer Company125
12	American Olean Tile10-11	14	Knoll International12-13
1	Andersen Corp.52-53	56	Koh-I-Noor48
2	Armstrong World Industries...C2, p.1	70	LCN Closers100
4	Armstrong World Industries2-3	26	LOF Glass27-29
6	Armstrong World Industries4-5	16	Lorin Industries14
84	ASG127	42	Marvin Windows38-39
102	Bell Atlantic (East Reg.)148	90	Marvin Windows134-135
18	Bethlehem Steel Corporation16-17	98	MUTOH Industries Ltd.140
74	Bobrick Washroom Equipment108	8	Nixalite of America6
—	Boston Architectural Center150	104	Northeast Utilities (East Reg.)143
52	Bradley Corporation46	106	Northeast Utilities (East Reg.)143
54	Bradley Corporation47	28	N.C.M.A.30-31
25	Brick Institute48A-H	46	Olympic Stain42-43
92	California Redwood137	—	Osram Corporation22-23
86	Chicago Faucet128	48	Panasonic Copiers44
34	Clearprint34	40	Peachtree Design Competition37
132	CNA Insurance126	72	Pella Windows106-107
114	Crown Metal Mfg. Co.150	30	Pittsburgh Corning32
24	Curries Company24	94	Ralph Wilson Plastics138
118	CYRO Industries152-153	116	Rancho Mirage Competition151
10	Domtar Gypsum7	38	Raynor Garage Door36
—	Dover Elevator Systems Inc.136	128	Rite Hite Corp.C3
66	Fry Reglet56	88	Semaphore133
60	General Electric Monogram50-51	100	So. California Edison (West Reg.) .143
130	Georgia-PacificC4	126	Steel Joist Institute158
58	Guardian Block49	76	Steelcase113-116
64	Hansgrohe, Inc.55	—	Temple University154
—	Harvard University157	—	University of Cal./Irvine155
20	Haws Faucet18-19	62	U.S. Aluminum54
96	Homasote139	36	John Wiley & Sons35
50	Houston Instrument45		
68	Hurd Millwork98-99		

Everyday enemies of a soft foam stucco system.

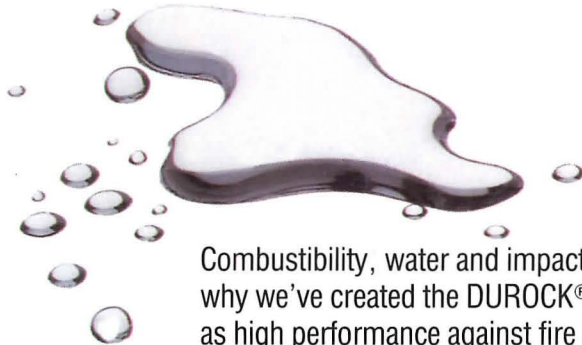
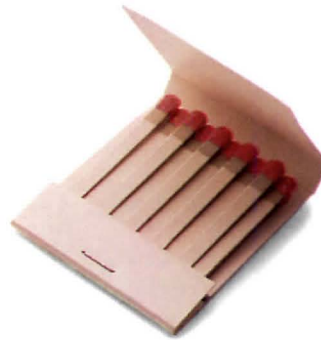

Combustibility, water and impact damage are threats you can't take lightly. That's why we've created the DUROCK® Exterior Cement Board System for beauty as well as high performance against fire and damage. You'll find the complete system marketed under the name DUROCK—cement board, screws, tape, basecoat and crack-resistant finishes.

Performance . . . it's an everyday event for United States Gypsum Company. Please call or write for information and technical support:

1-800-347-1345

101 S. Wacker Drive, Chicago, IL 60606-4385. Dept. PA690

DUROCK®

Exterior Cement Board System

USG

United States Gypsum Company

Copyright 1989, United States Gypsum Company.
DUROCK is a registered trademark of United States Gypsum Company.

Circle No. 397 on Reader Service Card

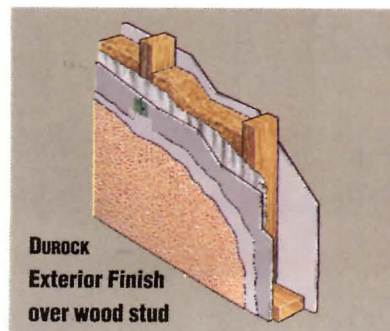

Durock
Exterior Finish
over wood stud

TAKE THE K-THERM™ QUIZ AND WIN A GOLD CUP!

Kinnear K-Therm is the world's toughest 1 $\frac{5}{8}$ " high-efficiency, money-saving sectional door. To win a gold cup, correctly identify what makes K-Therm so good! Just match the numbered features to the listed benefits. Then send in your entry. (Original entry form only. No copies, please.) Supplies of prizes are limited, so enter today!

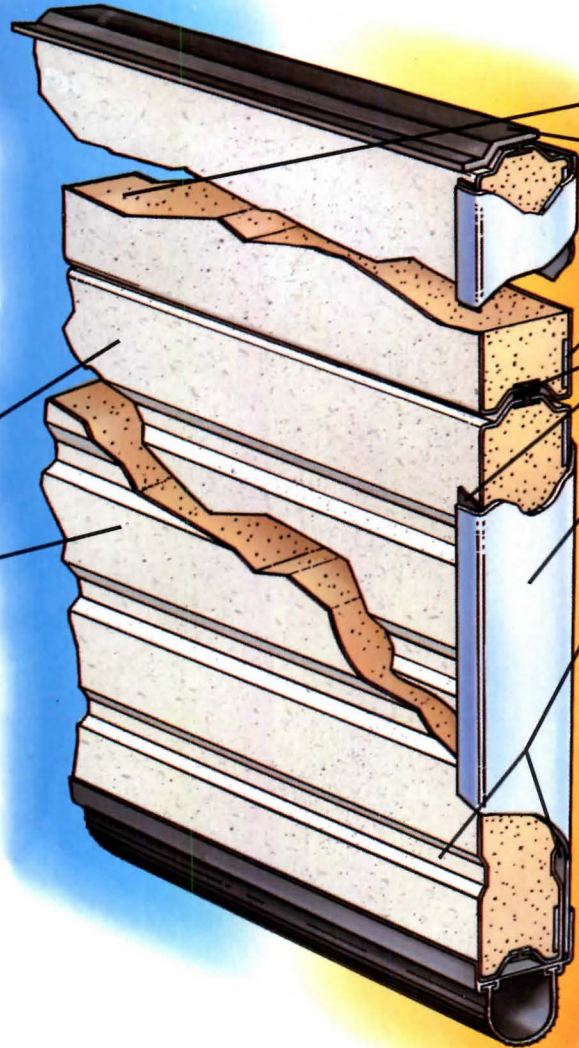

1 Stucco-embossed steel.

2 Hot-dipped galvanized steel with epoxy paint finish.

3 2.5 Density polyurethane.

4 Optional self-adjusting vinyl header seal.

5 20-gauge backup plate.

6 Complete thermal breaks.

7 16-gauge galvanized steel end caps.

8 Ribbed steel front and back.

9 Manufactured by Kinnear for high-energy efficiency money-saving applications.

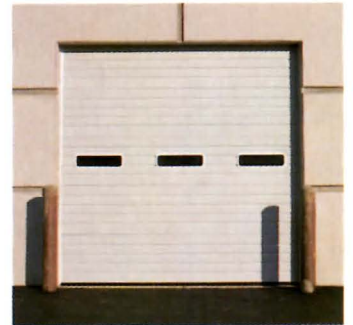

DOOR
WAYS TO **KINNEAR**
THE DIVISION OF WAYNE-DALTON CORP.
FUTURE

K-Therm benefits:

- Provides hinge reinforcement to add strength and make it easy to fit odd-size doors.
- Eliminates "oil canning" and provides attractive appearance.
- Adds superior vertical strength.
- Provides elegant overall design and additional horizontal strength.
- Protects against corrosion.
- Stops conductive heat loss.
- Provides maximum strength and insulation over full door area.
- Increases energy efficiency by blocking air infiltration.
- 9 Provides superb quality assurance. (This one's free!)

That wasn't so tough. Send me my Gold Cup and complete K-Therm information!

Name _____
Title _____
Company _____
Address _____
City _____ State _____ Zip _____
Phone () _____

Mail to: Kinnear Gold Cup Winner, 1191 Fields Ave., Columbus, OH 43216. For K-Therm information only, call (614) 294-4451.