

OCTOBER 1990 • SIX DOLLARS

# ARCHITECTURE

INCORPORATING ARCHITECTURAL TECHNOLOGY

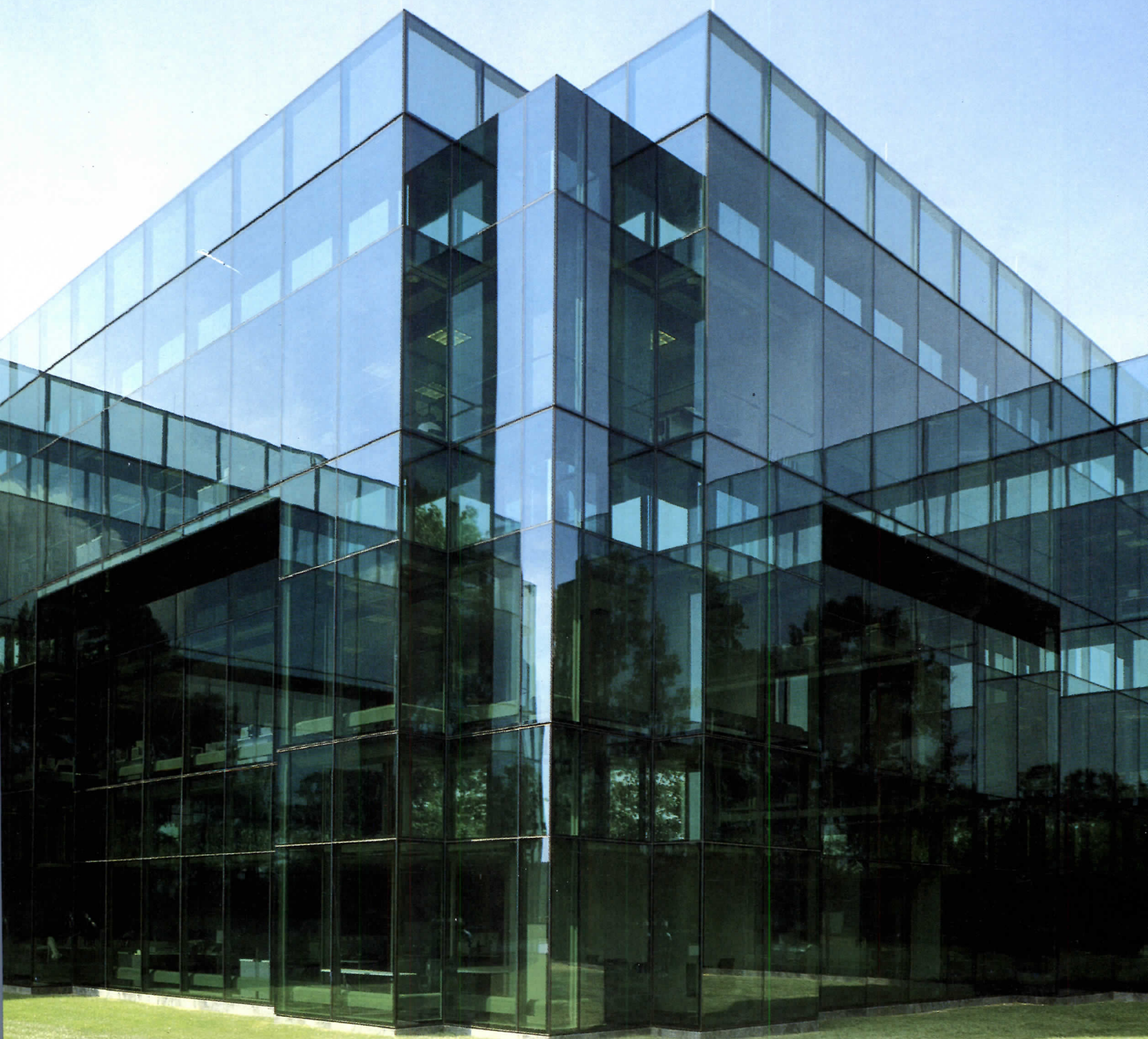

RELEARNING FROM LAS VEGAS • ENRICHING THE GLASS BOX



*"They are all so tacky."*

*"There is-a no load limit."*



*"There is-a paper catcher, so you can't lose important papers even if you wanted to."*

*The new Steelcase Avenir™ system.*



## Renewing Energy Conservation

WITH PUBLIC ATTENTION FOCUSED ON THE Middle East, we decided to examine how the political turmoil has affected several U.S. architectural firms with projects in Kuwait (page 21). More important to architects than the loss of work, however, is the effect of the current oil crisis on the future of building design. Are we destined to replay the 1970s, searching for new ways to incorporate alternative energy sources in buildings? Will such strategies mesh with current design attitudes? How will the building industry respond?

Looking back at the 1970s offers important lessons in the pitfalls of energy conservation. It's no secret that many energy-saving practices during this period clearly did not go hand in hand with environmental quality. Tight building

envelopes turned out to be primary causes of sick-building syndrome. For many architects, energy-saving features also proved to be antithetical to Postmodern design; solar panels and Neoclassical pediments simply did not mix.

Ironically, the energy consciousness of the 1970s left an indelible mark at the state and local level. Around the country, building codes were transformed in the 1980s to mandate energy conservation features. Performance specifications in several states now control the ratio of glazed to opaque surfaces in walls and roofs, and electrical and mechanical system design.

Building standards have also changed to reflect more realistic methods of complying with energy-efficiency requirements. Earlier this year the American Society of Heating, Refrigerating and Air-Conditioning Engineers (ASHRAE)

published a new 147-page standard for the energy-efficient design of all new buildings, except low-rise residential buildings. ASHRAE/IES Standard 90.1-1989 sets minimum, energy-saving requirements for HVAC systems and equipment, water heating, lighting, and energy management. What is significant about the new standard is its consideration of building components as interrelated systems in improving energy savings. According to the standard, energy use in a building may be determined

through either prescribed values assigned to lighting, envelope, HVAC systems, or through the application of energy unit costs to proposed design elements, allowing the architect to evaluate the most cost-effective conservation method.

Building products manufacturers have also developed new ways of achieving energy efficiency through design options. Window manufacturers, for example, now offer low-emissivity coatings on glass and other innovations that increase opportunities for passive solar design (ARCHITECTURE, August, 1990, page 95).

Although energy-conscious design still faces an esthetic stigma, this prejudice may be fading with a renewed interest in Modernism. With more products at their disposal and a new awareness that energy conservation is part of the total design process, architects have greater options in controlling heating, cooling, and air circulation. Compared with the 1970s, architects in the 1990s have no excuses for failing to integrate energy-saving measures into their designs.

—DEBORAH K. DIETSCH



ILLUSTRATION BY PETER HOEY

# CREATIVE



**EIFS (Exterior Insulation and Finish Systems) using Rohm and Haas 100% acrylic polymers help imagination take shape.** Because they give you design flexibility superior to brick, stucco, and pre-cast concrete. Flexibility that's unique in decorative capabilities. You can create columns, cornices, reveals, arches, pediments, keystones, spandrels, and quoins. And you can inventively blend a multitude of textures with an unlimited array of colors. This is just a sampling of the choices you acquire by requesting Rohm and Haas 100% acrylic polymers when you specify EIFS.

**Now, the sky's the limit for the creative side of your brain.**

**EIFS—Appealing to Both**



# LOGICAL

**EIFS (Exterior Insulation and Finish Systems) using Rohm and Haas 100% acrylic polymers make perfect sense.**

Because EIFS that incorporate Rohm and Haas 100% acrylic polymers can deliver long-term resistance to the elements and long-term retention of textures and colors. Our polymers protect the aesthetics of your design against ultraviolet degradation, moisture, and environmental pollutants. Quality performance based on our decades of EIFS industry experience and commitment to EIMA's (Exterior Insulation Manufacturers Association) high standards.

**Now, that's a rational set of benefits  
for the logical side of your brain.**

For more information, write our  
Marketing Services Dept.,  
Independence Mall West,  
Philadelphia, PA 19105.

**ROHM  
AND  
HAAS**   
PHILADELPHIA, PA. 19105

## ides of Your Brain

# LETTERS & EVENTS

## Small is beautiful

Two recent AIA publications call for an increased focus on small project methods by our organization. One is the small projects article in the July, 1990 issue of ARCHITECTURE and the other is the recent AIA publication *Architecture Factbook of Industry Statistics*.

As a practitioner involved with small projects, I found the sketch of the outcome of the roundtable discussions on small project methods very accurate. In reading the factbook I found that 58 percent of firms owned by AIA members have fewer than five employees. Further study led me to find that this majority of our membership is focused on small projects (much of which is housing).

I urge the AIA to recognize these conditions and respond with more support for small projects and small practices. Thank you for these enlightening publications.

*Ralph Rorem*  
Ralph Rorem Architect Ltd.  
Orland Park, Illinois

## Humane housing

I was delighted that your July, 1990 issue focused on affordable housing design. As a housing practitioner and advocate, I would have been pleased by such coverage of this important issue even if two properties my company co-developed had not been featured—Battle Road Farm (page 56) and Harbor Point (page 64).

Unfortunately, we will not be able to proudly display reprints of these articles in our marketing efforts. The photographic presentations are exquisite, but the accompanying story lines are deadly. It conjures up the very images the design of this successful housing has worked to overcome, referring to "projects" and "places for poor people."

The essence of mixed-income housing is to create economically and racially integrated new neighborhoods where residents all sense a value in their new homes. That value is created by good design combined with innovative financing and public funding. However, these ingredients should not be highlighted for their own sake; rather, the resulting housing should be judged on the merits of the living environment created. Prospective new residents are not looking for some self-conscious architectural exercise or social engineering experiment, but only that basic American dream of a dignified home.

If ARCHITECTURE and other professional journals adopt a more positive attitude, perhaps then we can expose your articles to the general public who can share in the pride by making that housing their new home.

*Robert H. Kuehn, Jr.*  
Keen Development Corporation  
Cambridge, Massachusetts

Maybe I missed something, but the De-Queen Villas (July, 1990) appear to be woefully lacking in windows. In the typical first floor units illustrated, none of the living, dining, or kitchen areas have a single window except for an ornamental fan light in the entry door. I am sure that this reduces the life-cycle heating costs, but I fail to understand how anyone could accept these units as being suitable for human habitation.

*David W. Moore*  
David W. Moore, Architect  
Woodbridge, Connecticut

## Reader survey

I wonder how much longer you will continue to publish projects like The Aventine (August, 1990) as laudable examples of architecture, representative of "Italianate Postmodernism" or not. I do not have \$150 million projects, but I would be ashamed to associate my name with such design, or a host of others of recent vintage. Postmodernism, constructivism, deconstructivism. No ivy grows big enough to hide them.

Perhaps you could initiate a survey and let your readers provide insight into what they think of current buildings.

*Ludwig Spiessl, AIA*  
Ludwig Spiessl Architect  
Lakeland, Florida

*Editor's note: Good idea. We plan on conducting a reader preference survey on design and technology, and publishing the results next year. Stay tuned.*

## Corrections

The Bank One Tower in Indianapolis (August, page 65) was designed by Hugh Stubbins, not Cesar Pelli.

The CN/Royal Trust Development in Toronto (August, page 46) was a joint venture between Dunlop Farrow Architects in Toronto and Ellerbe Becket in New York City.

**October 6-14:** Austin Architecture Week in Texas, a week-long celebration including a number of events. Contact: Deb Duval (512) 458-8191.

**October 25-26:** The Second International Cubit Symposium on Architecture and Culture: "Places Between Here and There: Emerging Patterns in City and Suburb," at The Woodlands, Texas, sponsored by Texas A&M University and the University of Houston. Contact: Patti Rogers (409) 845-3942.

**October 31:** Registration deadline for the Peachtree Street/Auburn Avenue Design Competition in Atlanta. Contact: Carol Hassell (404) 873-1711.

**Through November 30:** "Architectural Brochures: History, Hype, and Graphic Design," at Carnegie Mellon University, Pittsburgh, Pennsylvania. Contact: Martin Aurand (412) 268-2451.

**November 2-3:** Conference of the AIA Committee on Public Architecture, Washington, D.C. Contact: Elizabeth White (202) 626-7539.

**November 4:** "A Day in the Country at Auldbrass Plantation," a tour of a Frank Lloyd Wright house near Yemasee, South Carolina. Contact: (803) 524-8600.

**November 5-7:** TeleCon X, conference on teleconferencing, business television, and distance learning, in San Jose, California. Contact: (800) 829-3400.

**November 5-9:** "Value Engineered Design and Construction," an extension course offered at U. C. Berkeley, California. Contact: (415) 642-4151.

**November 7:** "Facilities Management Critical Strategies: The Human Aspect," an executive program of the MIT Office of Facilities Management in Scottsdale, Arizona. Contact: MIT (617) 253-0595.

**November 9-January 6:** "Frank Lloyd Wright: Facets of Design" exhibition at the Chrysler Museum, Norfolk, Virginia.

**November 13:** "Crossroads: Architects and the Environment," an AIA-sponsored symposium at the Mayflower Hotel in Washington, D.C. Contact: Patrick Lally (202) 626-7449.

**November 15-18:** "Breakthroughs in Health Care Design," the Third Symposium on Health Care Interior Design, in San Francisco. Contact: (415) 370-0345.

# NEWS

WRIGHT HOUSE RESTORED • NATIONAL CONSTRUCTION SLOWDOWN • NIAE ACTIVITIES

## Iraqi Invasion Stalls Projects in Kuwait

SEVERAL ARCHITECTURAL OFFICES AROUND the country have put hoped-for projects in the Middle East on hold since the Iraqi invasion of Kuwait in August. The firm with the largest stakes in Kuwait itself is The Architects Collaborative in Cambridge, Massachusetts, with 2.7 million square feet worth of projects in design and about 1 million square feet under construction.

TAC's interrupted projects in the New Jersey-sized nation include large office buildings to house the ministries of water and public

Frank Lloyd Wright, and Walter Gropius to design important public buildings in Baghdad. Gropius's designs for the University of Iraq in Baghdad led to ongoing campus commissions for TAC. The company's Baghdad office remained open during the Iran-Iraq war, but TAC had sent Moncef Eladhari, a Tunisian-born engineer, to close the office in August.

Finding himself in Baghdad at the time of the invasion, Eladhari, an American citizen fluent in Arabic, employed company evacuation procedures established especially for politically volatile parts of the world. Drawing upon a large cash reserve and the exit visa he kept on hand, Eladhari commandeered a taxi for a 400-mile trek to the Jordanian border, where he bought all the seats on the next bus to Amman. He flew to Paris and then to Boston just as other U.S. citizens were being detained.

Despite such dramatic departures, Raad Al-Mumayiz foresees a political solution to the conflict and is optimistic about the firm's projects. "Coming out of the recession caused by the Iran-Iraq war, there was a boom atmosphere in Kuwait," he says. "I am hopeful that the situation will normalize.

Then the government will inject money into construction. That's how the Kuwaitis create confidence in their economy."

But architects at other companies are less confident that they will see their Kuwaiti projects come to fruition. HOK's Health Sciences Center on the Jabriyah Hospital Campus of the University of Kuwait was in the first stage of programming when the invasion occurred, and one HOK employee remains in hiding. Skidmore, Owings & Merrill and Tippetts Abbott McCarthy Stratton (TAMS) of Boston were among six international firms shortlisted for a new international airport for the country, which would have transformed an obsolete Kenzo Tange-designed building into a domestic terminal. "I would certainly like to see a political solution," says Senior Vice President Dan Remeta of TAMS, which was collaborating with TAC for the airport expansion. "But for now, we have folded our tent."

—HEIDI LANDECKER



**TAC's Kuwait Ministries office complex was under construction at the time of the August invasion by Iraq.**

works, headquarters for the country's press club, an engineering college, a national postal facility, and interiors for the offices of the Emir of Kuwait. Until the surprise invasion, work was conducted from a four-person office in Kuwait City that the firm established in 1973. The projects represent a majority of TAC's overseas work.

Raad Al-Mumayiz, an American citizen and manager of TAC's Kuwait office, left the Persian Gulf nation for the United States two days before Iraqi soldiers overran the port city. He says "no one had any notion whatsoever" that the attack would occur, and adds that the company's other three employees—two Indian citizens and one Canadian—are all Kuwait residents and are safe.

TAC's involvement in the Middle East began in 1957 when the Iraqi government capitalized on its newfound oil profits to ask internationally known architects Le Corbusier,

## A I A B R I E F S

AIA's newly formed **Committee on the Environment** will hold its inaugural conference, a symposium entitled "Crossroads: Architects and the Environment," on November 13 in Washington, D.C. Environmentalist Amory Lovins, cofounder of the Rocky Mountain Institute, will deliver the keynote address. Other invited panelists include U. S. Senator Alan Simpson (R-Wyoming); Representative John Dingell (D-Michigan); and former Senator Gaylord Nelson, now head of the Wilderness Society. Experts from the federal government, environmental groups, professional associations, and the private sector will discuss the **AIA Environmental Resource Guide**, a new resource to evaluate the environmental impact of common building materials. The conference will also address the 1991 legislative agenda for environmental issues. For more information, contact Patrick Lally at the AIA (202) 626-7449.

The AIA has developed an informational packet to help architects respond to changes in the laws following passage of the **Americans With Disabilities Act**. The accessibility kit is available to AIA members for \$9.95 and non-members for \$16.95. For more information, contact Elizabeth Wainger (202) 626-7411.

As part of AIA's Vision 2020 Growth Management program, the Institute's **Regional Urban Design Committee** is distributing a handbook to help local AIA components develop their own design assistance teams (DATs). For more information, contact Charles Zucker (202) 626-7532.

"Architecture in Atlanta," is a new program sponsored by the **Atlanta Chapter/AIA**, that offers tours of architecturally significant landmarks each month. The program gives the public an opportunity to visit historic and contemporary buildings that have contributed to the fabric of Atlanta. For more information, contact the Atlanta chapter office at (404) 873-3207.

## DETAILS

**Norman DeHaan, FAIA, FASID, died on August 24. DeHaan, former president of the AIA/Chicago chapter, studied under Mies van der Rohe at the Illinois Institute of Technology and went on to distinguish himself in both the architecture and interior design professions.**

**British architect Max Gordon, internationally recognized for designing museum exhibitions and houses, also died on August 24. He was the architect for New Scotland Yard from 1962 to 1966.**

**Noted Spanish architect, author, and lecturer Javier Cenicacelaya was appointed dean of the University of Miami School of Architecture in June.**

**Frank Lloyd Wright's Guggenheim Museum was declared a landmark by the New York City Landmarks Preservation Commission in August. A new addition to the museum, designed by Gwathmey Siegel & Associates, will open to the public next spring.**

**The Architectural Foundation of San Francisco was formed by the San Francisco AIA Chapter in August to enhance local awareness of architecture in the community.**

**The 52,000-square-foot National Aviation Hall of Fame located in Dayton, Ohio, the birthplace of aviation, is being designed by the local firm Lorenz & Williams, Inc. The three-level, skylit facility is distinguished by a 100-foot-tall glass and steel obelisk (bottom left and center) and an exhibit gallery located 30 feet beneath street level that will feature six major exhibits (bottom right). Senator John Glenn (D-Ohio) launched a campaign in June to raise \$12 million for the facility.**

## Hard Times Ahead for Firms Nationwide

ARCHITECTURE FIRMS ACROSS THE COUNTRY are feeling the pinch as the construction boom of the roaring 1980s has yielded to a "revolving" recession. "Large, diversified firms seem to be suffering the least, mid-size offices focused on a single market are the worst off, while small practices are scrambling," observes Lizbeth Quebe, vice president and marketing director at Perkins & Will. The recession is tightening its grip on the Northeast while loosening its hold on the Southwest, but no region is immune from construction-industry jitters.

The slump is being fueled by reduced or stalled business expansion; years of commercial overbuilding; a growing federal budget deficit that has reduced government spending and clamped a tight lid on public works projects; a downturn in real estate prices; and the disappearance of the stream of ready cash that nourished the construction industry in the '80s. The passage last fall of the Financial Institutions Reform, Recovery, and Enforcement Act has made it virtually impossible for many builders to roll over existing loans or get new ones, and the Savings & Loan industry crisis is creating fears that the Resolution Trust Corporation will dump additional defunct thrift assets on already depressed markets at drastically reduced prices.

## East Coast

In hard-hit Boston, Richard Fitzgerald, executive director of the Massachusetts State Association of Architects/AIA, says that cutbacks by large firms have been as high as 60 percent, while mid-size firms that concentrate on commercial construction are the most deeply affected. Fitzgerald knows of six practices, all small, that have gone under. On the positive side, he says, is a collegial "we'll-make-do" spirit, which finds architects sharing information about how to survive.

In New York, "everyone is slowing down," according to Lenore Lucey, executive director of the New York AIA Chapter. "Or, if they're busy now, they are looking at slowing down by the end of the year." Richard Roth, Jr., chairman of Emery Roth & Sons, adds, "I would guess that there are more unemployed architects in New York than there were in the 1970s." Emery Roth has cut its staff from 100 to 55, Swanke Hayden Connell is down from 220 to 160, and SOM/ New York is at 380 from 425.

Washington, D.C., previously regarded as recession-proof, is proving vulnerable. Hartman Cox Architects laid off five out of 30 architects according to George Hartman, who adds that "everyone is scrambling, especially in the suburbs," where office vacancy rates nationwide are higher than in metropolitan downtowns. Craig Hartman of SOM/Washington says the firm has cut 35 of 100 architects as part of a reorganization that focuses the firm's attention on three offices: New York, Chicago, and San Francisco. Keyes Condon Florance and Partners has furloughed close to 15 percent.

## South and Midwest

*The Atlanta Constitution* reports a worsening office glut in its home city. Lenders recently asked office and hotel developer John Portman, Jr., to provide collateral on previously unsecured lines of credit, an indication that no one is immune to the tight money squeeze. Jeff Floyd, president of the Georgia Association/AIA, says that even institutional work is declining because the state, with revenues 5 to 8 percent lower than expected, has frozen new construction contracts, and that several firms have reduced their size by a third or a half from three years ago. Henri Jova of Jova/Daniels/Busby, which has cut its

*Continued on page 24*

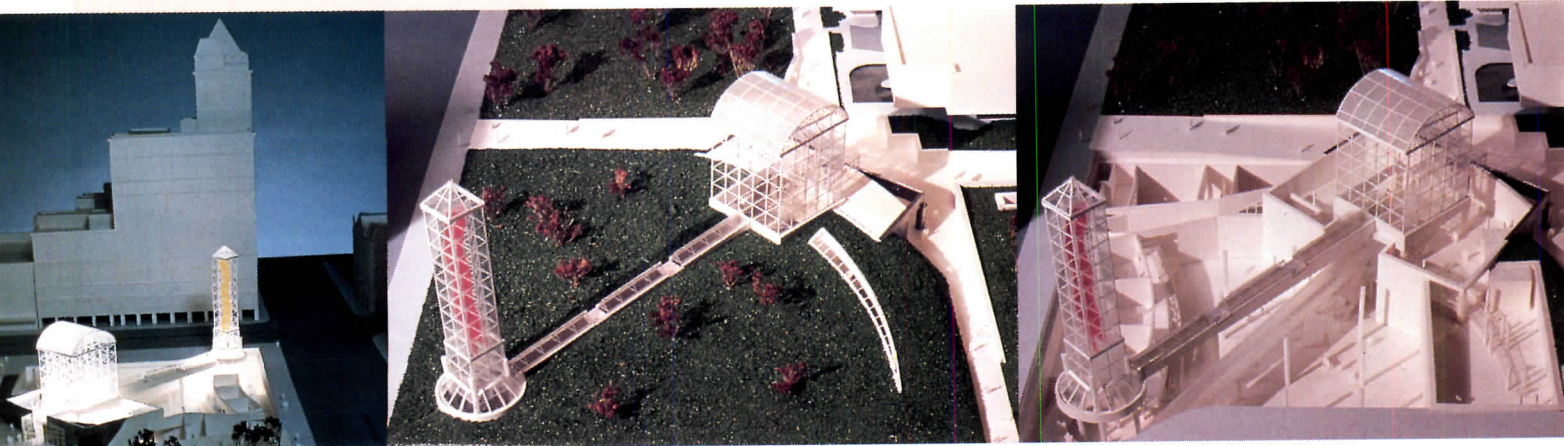



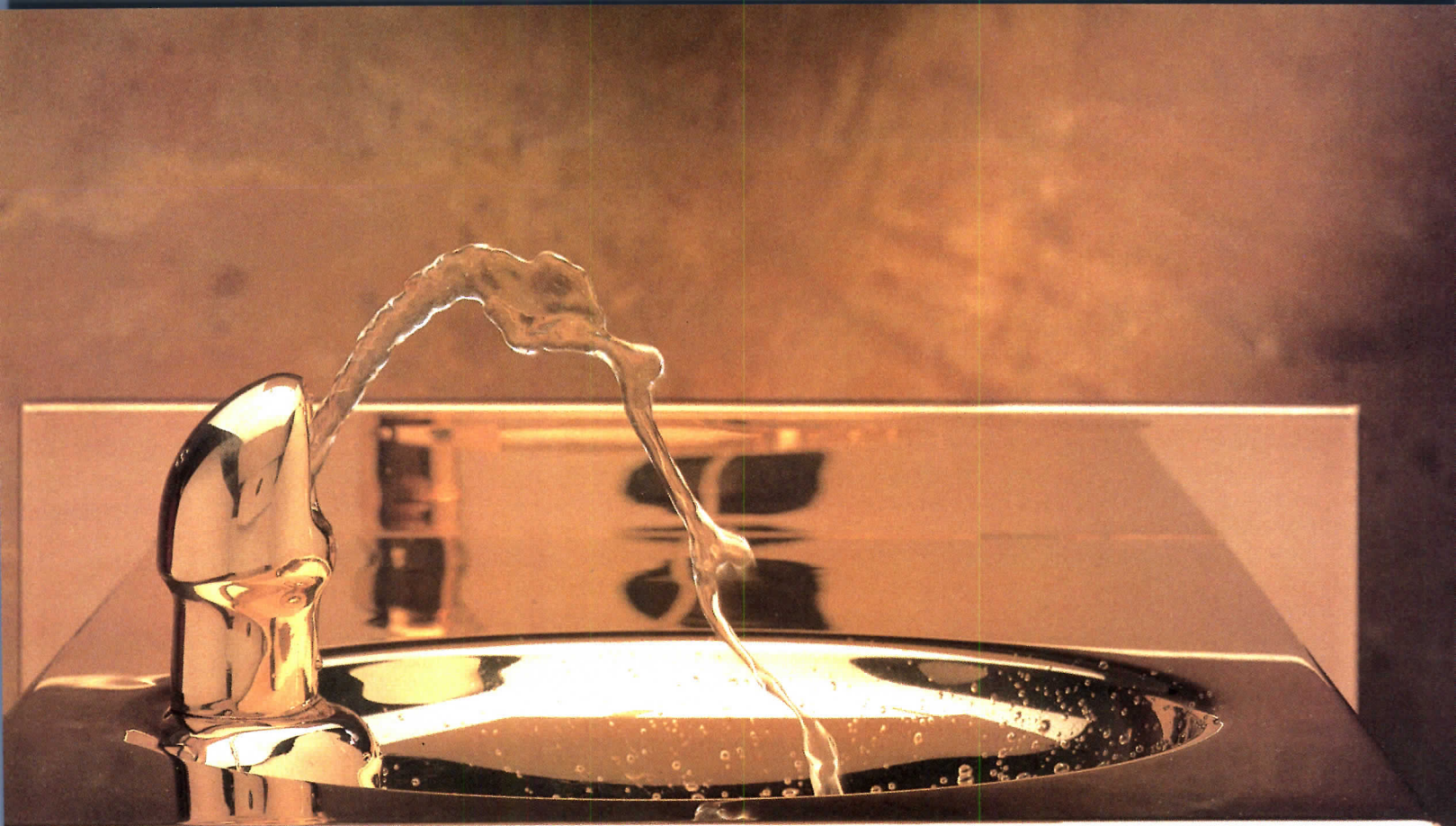

## You don't need crystal glasses to serve water in style.

Even if you're serving a large group of people.  
It's still quite easy to impress them.

Because the Haws Fashion Plates  
Collection allows you to impress  
anybody. With a full line of drink-  
ing fountains and water coolers.  
Specially designed to enhance your  
every creation. Making it easy to add  
elegance to any scene.

Incidentally, a twist of lime is optional.

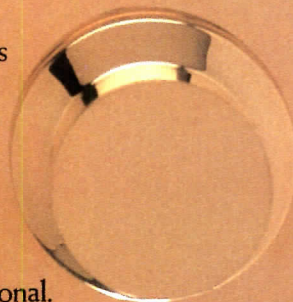

**Haws**

H<sub>2</sub>O h h h h h h h h.

## Hard Times Ahead

*Continued from page 22*

staff from 55 to 40, points out that in the past, Atlanta has rebounded quickly, "but the unknown now is what effect the Mideast crisis will have."

David Johnson, president of the Miami Chapter/AIA, reports that his home city "hasn't seen it this bad in years. Permits are slow for the first time in seven years, and it's tough to get a bank loan unless you promise your first born."

In the Midwest, the construction decline has been less steep because there was less

overbuilding in the '80s. But Detroit is suffering from a slump in U.S. auto sales, while Chicago is undergoing layoffs at big department stores, banks, and other financial institutions. But Alan Hinklin, managing partner at SOM/Chicago, says his office has not yet reduced its staff "because there's been a lot of overseas work." But he cautions, "that's beginning to lag too."

Although Dallas, Austin, Houston, and San Antonio all still have higher than 20 percent vacancy rates, Texas seems to be on the rebound. Houston is among a small number

of cities—including Las Vegas, San Francisco, and Denver—reporting a decrease in vacancies. Martha Murphree, executive director of the Houston Chapter/AIA, observes that some firms have been looking for new hires and there is a cautious expansion.

In Dallas, construction remains weak, though oil-field equipment sales are picking up, as are orders for glass and steel. San Antonio remains slow, while Fort Worth is picking up slightly with help from justice facilities design work.

### West Coast

Seattle is turning into a high-growth area. To protect itself, the city has put a cap on downtown construction and down-zoned many of its residential areas. Thom Emrich, a principal in Methun Partners, remains sanguine but wary. Architects are busy, he says, but since the Kuwait crisis, bankers have "changed their tune. No one wants to finance commercial projects." Although the housing market remains strong, there are indications, as Emrich says, that "there's a fallback ahead."

San Francisco's 1986 cap on new downtown office construction protected the city from overbuilding, compelling many firms to cut back and shift their focus to smaller buildings, interiors, and renovations. Richard Bender, a professor at the School for Environmental Studies, University of California, Berkeley, points out that expansion of California's state universities continues to provide many architects with work, and adds, "people are trying to rush to Asia for business. The results will be similar to 15 years ago when everyone was rushing to Saudi Arabia. The rich pickings will prove to be an illusion."

A number of Los Angeles office towers are being topped off when there is already a surplus of commercial space; housing demand is soft and money is hard to get. The Jerde Partnership has reduced its staff from 93 to 83, and SOM/Los Angeles is down to 63 from 100, according to a source within the firm. Raymond Kuca of SOM adds, "Architects here are thinking of new strategies."

Suzanne DiGeronimo, chairman of AIA's practice committee, has outlined a number of markets that remain strong nationwide. They are health care and elderly housing, affordable housing, justice facilities, neighborhood family services (drug rehabilitation centers, halfway houses), criminal facilities and "build-to-suit" spaces such as research centers, manufacturing plants, and distribution centers. —ANDREA OPPENHEIMER DEAN

Charlotte chose Masonry  
with DRY-BLOCK®  
for their Jewel.  
Would you consider anything less  
for your masterpiece?

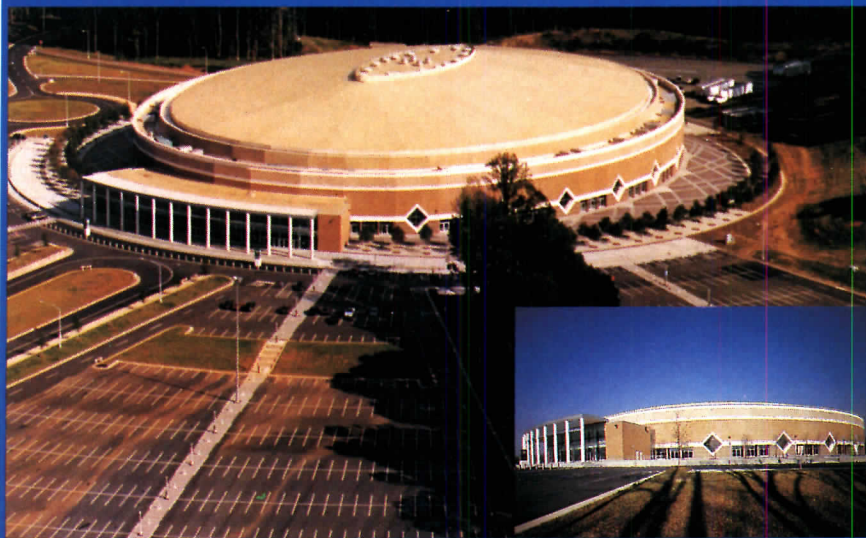

### Over 700,000 DRY-BLOCK® units used in the Charlotte Coliseum

The beautiful, split-face masonry units making up the walls of the fabulous Charlotte Coliseum are protected from the elements by the DRY-BLOCK® System.

Depend on DRY-BLOCK® the original, integral water-repellent system for lasting beauty that stands up to whatever Mother Nature dishes out.

For the full story on the Charlotte Coliseum, just drop us a line.



7221 West Parkland Court  
Milwaukee, WI 53223  
(414) 354-4400  
1 (800) 558-7066  
A UNIT OF W.R. GRACE & CO.



Circle 23 on information card

# NEWS



DAVID BLANCHETTE / IHPA

## Wright's Legacy

THE DANA-THOMAS HOUSE, DESIGNED BY Frank Lloyd Wright in 1904, reopened to the public last month after undergoing an extensive three-year renovation. A September reception held at the Springfield, Illinois, house was sponsored by the Illinois Historic Preservation Agency (IHPA).

The state of Illinois purchased the house in 1981 from its second owner, the Charles Thomas Publishing Company, after recognizing the building as one of Wright's most significant commissions. The Prairie Style structure incorporates many design elements elaborated in the architect's subsequent projects, as well as the largest original collection of Wright-designed furniture and art glass.

Built for wealthy socialite Sarah Lawrence Dana, the 15,700-square-foot house was designed by Wright for entertaining, and is organized with his characteristic open spaces, a large dining hall, and surrounding balconies. In 1944, the Thomas Publishing Company purchased the house for use as offices. But the house remained relatively free of major architectural alterations. The most significant feature of the structure, however, an exterior decorative frieze adorning the second story, was removed during this period.

In 1987, the IHPA determined that renovations were necessary, and closed the house for repairs. On the exterior, the decorative frieze was reinstated by replicating the original casting. Distinctive horizontal brick joints, which had disappeared due to haphazard repointing, were also replaced. The interior was stripped of many layers of paint, and new equipment and climate-

*Continued on page 28*

**The Dana-Thomas House (above) reopened last month. IHPA chose 1910 as the restoration period. The Romeo and Juliet Windmill at Taliesin (below) built in 1896, will be reconstructed (bottom).**



FRANK LLOYD WRIGHT FOUNDATION



FRANK LLOYD WRIGHT FOUNDATION

# ETERNIT SLATES

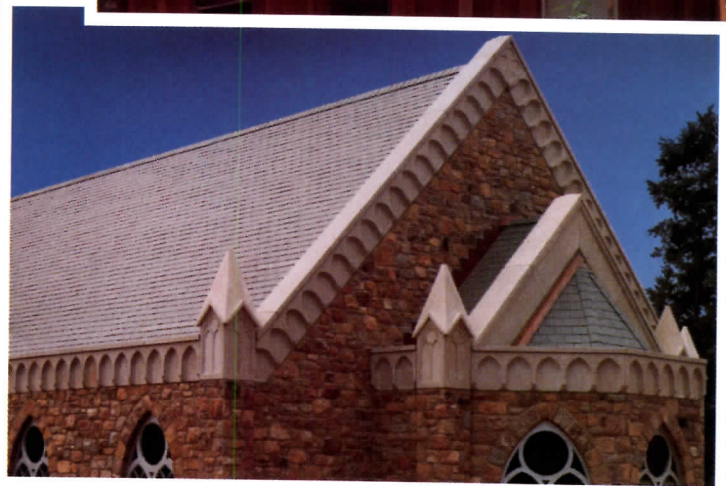

## ARCHITECTURAL ROOFING SHINGLES

What makes Eternit Slates the number one choice in fiber reinforced cement shingles?

Architects, contractors, and owners say, "Durability, authenticity, fire protection, a 30 year non-prorated warranty, and they do not contain asbestos".

Eternit Slates are designed for long-term performance in the sun, the rain, and snow. They are made to resist storms and high winds and to provide total water integrity.



Eternit Inc. • Excelsior Industrial Park  
P.O. Box 679 • Blandon, PA 19510-0679  
(215) 926-0100 • 800-233-3155  
FAX (215) 926-9232

World's Largest Manufacturer of Fiber Reinforced Cement Products  
Circle 29 on information card

WITH LIGHT WEIGHT  
CULTURED STONE® YOU CAN  
ACHIEVE THE BEAUTY OF  
NATURAL STONE AT  
A FRACTION OF THE COST.



From the Cobblestone Collection: Buff Cobblestone, one of over 50 color and texture choices.

When your clients want the look, feel and durability of natural stone but cost or weight is a problem, consider Cultured Stone®. Its light weight allows for fast and easy installation with no additional foundations or wall ties required.

- listed in Sweet's: 04430/STU
- meets Building Code Specs.
- warranted
- cost effective — no additional foundations or wall ties required
-  Listed — noncombustible

Call or write today for your free Architectural Catalog including: color All Products Brochure, Spec Data, Manu Spec and dealer information. (800) 225-7462. In Calif: (800) 445-9877. P.O. Box 270, Dept. 399, Napa, CA 94559.

**CULTURED STONE®**

THE HALLMARK OF EXCELLENCE IN MANUFACTURED STONE  
By Stucco Stone Products, Inc.

## NEWS

### Wright's Legacy

*Continued from page 27*

control systems were tucked into existing basement crawl spaces, closets, and original radiator cabinets. The furniture was also extensively restored, and the original materials preserved as much as possible. Taking advantage of photographic documentation, the IHPA restored the woodwork, interior paint, and frieze to the colors Wright had personally selected.

In August, the formation of a Taliesin Preservation Commission was announced by members of the Frank Lloyd Wright Foundation in Spring Green, Wisconsin. The local organization will work in partnership with the Foundation to preserve Taliesin, Wright's home, and other buildings comprising the complex—Hillside Home School, Romeo and Juliet Windmill, Midway Farm, and Tan-y-deri. The commission will also oversee the addition of visitor facilities at an adjacent site.

—AMY GRAY LIGHT

### Prairie Style Preserved



Another Prairie Style house, designed by two contemporaries of Frank Lloyd Wright, opened to the public in September. The Purcell-Cutts house (above), located near a lake in Minneapolis, Minnesota, was designed in 1913 by architects William Gray Purcell and George Grant Elmslie as a family home for Purcell. The house was sold to the Cutts family in 1919, who bequeathed it in 1985 to the Minneapolis Institute of Arts. Guided by drawings and letters housed at the Northwest Architectural Archives in Minneapolis, the Institute restored the house to its appearance during the years 1913-1917, when Purcell lived there. Purcell and Elmslie began their careers under Chicago architect Louis Sullivan.

## NIAE Plans for the Future

FOR NEARLY A CENTURY, THE NATIONAL INSTITUTE for Architectural Education has promoted excellence in architectural education and attempted to bridge the gap between the academic and professional worlds. As Joan Bassin, Executive Director of NIAE for the past year, notes "NIAE is not beholden to any one group or individual for support, which allows us to maintain our independence."

Founded in 1894 as the Society of Beaux-Arts Architects, the organization changed its name to NIAE in 1956 and expanded to hold lectures and competitions and offer fellowships. The organization is also taking a more active role in sponsoring exhibitions. Opening November 14 in its New York headquarters is an exhibition on Italian Rationalist architect



SCOTT FRANCIS / ESTO

On view this summer at NIAE, "Competition x 3" presented entries to the Korean War Veterans, National Peace Garden, and Women in Military Service memorial competitions. The New York firm Weiss/Manfredi Architects designed the exhibit display (above). The Arnold Arbeit prize was awarded to Cornell student Todd Fulshaw for his scheme for a memorial at the United Nations Plaza (below).

Franco Albini. Next year NIAE will present "Theaters Under Siege," an exhibition of photographs by Maggie Hopp of New York City theaters endangered by the proposed Times Square redevelopment.

NIAE has expanded its student competitions to encourage a more international response. Competition information was sent to more than 900 international schools, according to Bassin, and this year's program for a memorial at the United Nations Plaza drew entries from 15 countries. Zainie Zainul, a graduate student of architecture at Columbia University was awarded the 77th Paris prize, which includes the \$10,000 Lloyd Warren fellowship. Second and third place were awarded to Lisa K. Ingler of Ball State University and Yoshiko Sato of Cooper Union.

First prize in the William Van Alen fellowship, which also carries a \$10,000 prize, was presented to Alexey A. Kozyr, a fourth-year student at the Moscow Architectural Institute. Second place was awarded to Jill MacCartie from Queensland University in Australia and third place went to Kirill A. Gorodov, also a student at the Moscow Architectural Institute. The competition program called for a hotel and museum complex at Cambodia's Angkor Wat.

Caleb Crawford of Southern California Institute of Architecture, Johannes M. Knoops of Pratt Institute, and Laurie Perriello-Sharon of the University of Arkansas were awarded John Dinkeloo Traveling Fellowships.

The winning schemes of the 1990 design competitions and fellowships are on view through October 26 at NIAE headquarters at 30 West 22 Street in New York City. ■

—LYNN NESMITH

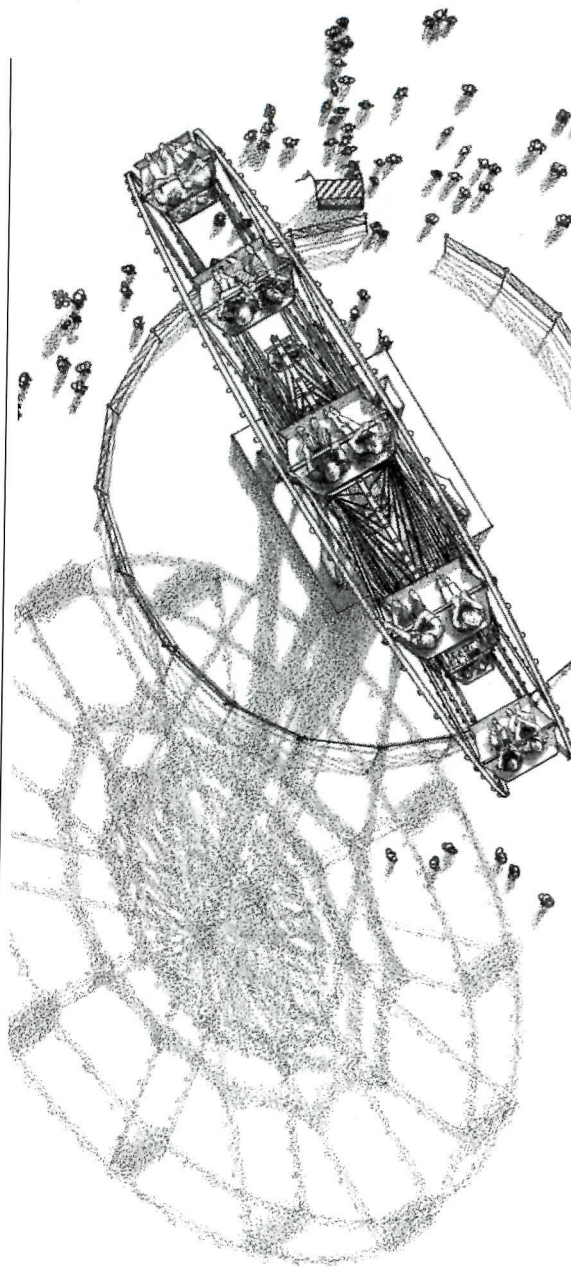

**"We tested other no-touch faucets against Bradley's Futura.™ It ran circles around them."**

*Bill Alvey, Plumbing Shop Leadman  
Six Flags Over Georgia*

**Bradley** CORPORATION

We get the job done better.

Box 309, Menomonee Falls, WI 53051 (414) 251-6000  
©1990 Bradley Corporation

Circle 37 on information card

## AND YOU THOUGHT ANDERSEN WAS JUST A HOUSEHOLD NAME.

Presenting Flexiframe® windows. The custom-made commercial window from the company you may have thought didn't even make one: Andersen.

Flexiframe windows offer a nice change from common aluminum. They're made with a glass-fiber-enhanced polymer, a version of our Perma-Shield® window.

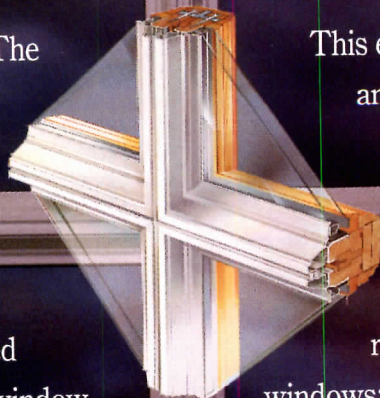

This enhanced polymer material is so strong and corrosion-resistant, it's actually used along the seacoasts as a substitute for structural steel.

On the inside, Flexiframe windows offer yet another revolutionary material you don't usually find in commercial windows: wood. Our warm Ponderosa pine gives

# DESIGN IS ONE OF THE CORE ELEMENTARY SCHOOL.

Bow string steel joists were the order of the day for the designers of Desertaire Elementary School. They wanted a multi-purpose room that was not only functional but architecturally interesting and attractive as well.

We filled the order for those joists. We're the largest supplier of steel joists in the country and we provide more than a dozen nonstandard designs, the most in the industry.

That's a lot. But then we've been making nonstandard joists for a long time. And the manufacturing expertise we've developed over the years, plus our large inventory of steel, enables us to make them quickly and economically.

And the earlier we get involved in the design stages the better for the project. Because our experienced engineers can assist the building's designers, and bring the end product in at less cost and more quickly than could be done with traditional methods.

So when you're designing your next project, think of Vulcraft nonstandard joists. They give you the opportunity to expand your design possibilities while retaining the advantages of steel joist construction. And those advantages are many.

Vulcraft joists are strong, yet lightweight and easy to erect. And they can be delivered to your site when you need them. In short, they meet all the requirements for a truly outstanding product.

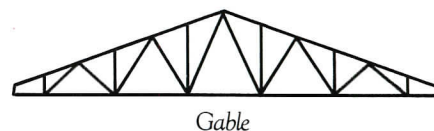

Gable

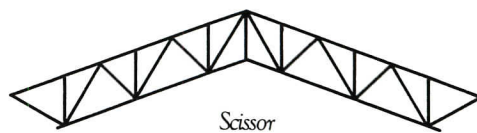

Scissor

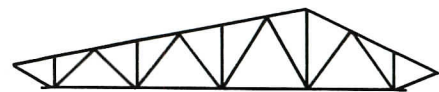

Offset Double Pitch



Arched Chords

**VULCRAFT**

A Division of Nucor Corporation

PO Box 637, Brigham City UT 84302 801/734-9433; PO Box F-2, Florence, SC 29502 803/662-0381; PO Box 169, Fort Payne, AL 35967 205/845-2460; PO Box 186, Grapeland, TX 75844 409/687-4665; PO Box 59, Norfolk, NE 68701 402/644-8500; PO Box 1000, St. Joe, IN 46785 219/337-5411. Architect: Alvidrez Associates, Inc., Structural Engineer: Robert Navarro and Associates; General Contractor: Arrow Building Corporation. Steel Fabricator: Ramsey Steel; Steel Erector: River Bend Crane & Rigging, Inc.

Circle 39 on information card

## ON THE BOARDS

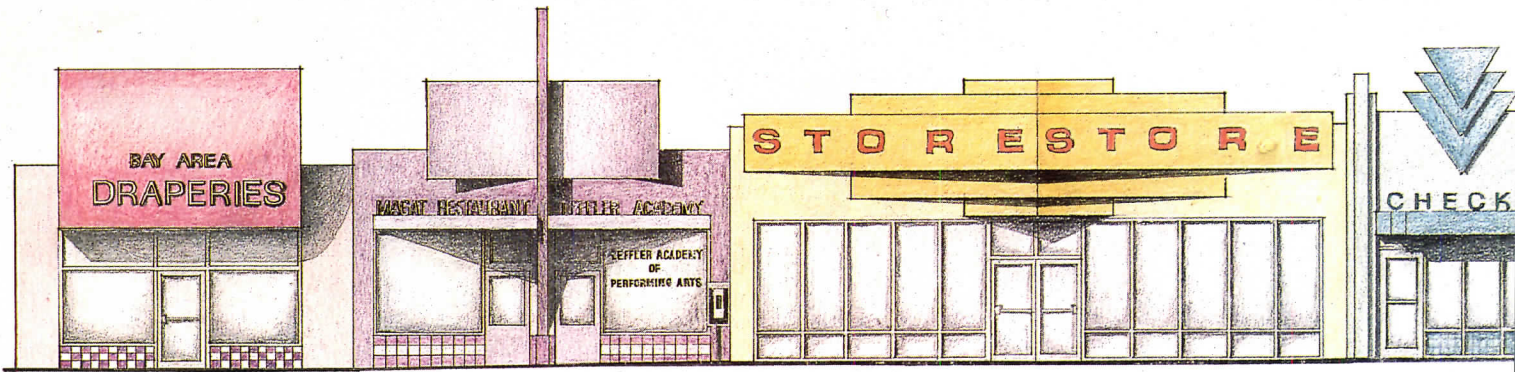

**Alum Rock Village  
San Jose, California  
Ace Architects**

TO RENOVATE THE FACADES OF A ROW OF RETAIL BUILDINGS CON-  
structed in the 1940s, Ace Architects of San Francisco treated the  
block as five separate buildings. Rendering the facades in character-  
istic Depression Modern colors, the architects emphasized existing de-  
tails to highlight the buildings' original simple lines. The stucco and  
tile storefronts are punctuated by large awnings constructed of perfo-  
rated steel. Neon ornamentation, tile patterns, pylons, and signage  
are employed in a vocabulary consistent with the period. The project,

to be completed this fall, is the terminus of a 4.5-mile Facade Im-  
provement Grant Program, administered by the San Jose Redevelo-  
ment Agency.

Under the program, each building owner or retailer receives grants  
of \$3,000 to \$10,000 for facade improvements, and Ace Architects  
provides its services free of charge. The grant program was designed  
to renovate retail buildings in San Jose's business district, where ar-  
chitectural styles range from Victorian to Modern.

# AMERICA, LET

Circle 41 on information card



## ON THE BOARDS

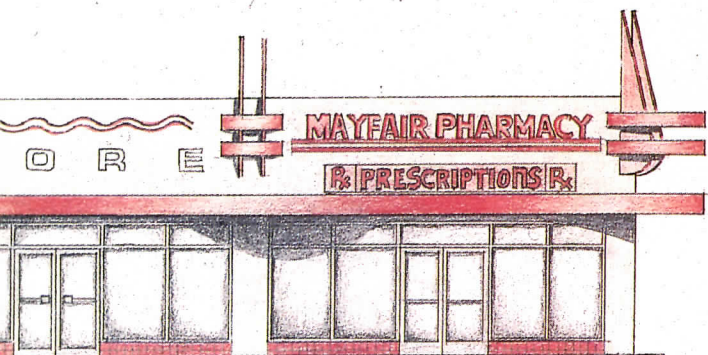

**JJ & Company Restaurant**  
Kent, Washington  
Levy Design Partners

THE UNDULATED ROOF OF A 6,500-SQUARE-FOOT RESTAURANT CREATED FOR CHINESE OWNERS SUGGESTS THE FORM OF A DRAGON, THE CHINESE SYMBOL FOR GOOD LUCK. THE DESIGN ALSO INCORPORATES ANCIENT FENG SHUI BELIEFS, BY SEEKING TO CAPTURE "GOOD SPIRITS" THAT COME FROM THE SOUTH AND DEFLECT "BAD ENERGY" FROM THE NORTH. THE ANCIENT LORE SUGGESTS MANY FORMAL CONTRASTS THAT SEEM APPROPRIATE FOR THIS COMMERCIAL EATERY IN A RECENTLY AGRICULTURAL BUT RAPIDLY-GROWING INDUSTRIAL AREA. THE BUILDING WILL BE COMPLETED NEXT SUMMER.

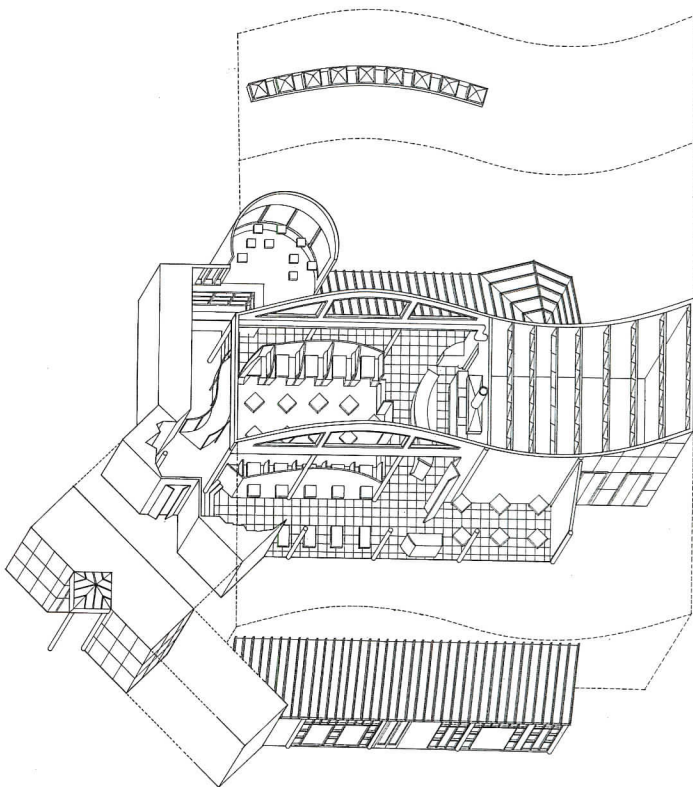

# THERE BE LIGHT...

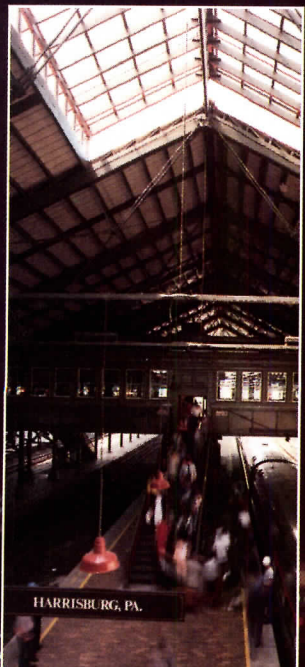

# EXOLITE<sup>®</sup>

NO DRIP<sup>®</sup> double-skinned acrylic sheet

# CYROFLEX<sup>®</sup>

NO DRIP<sup>™</sup> double-skinned polycarbonate sheet

## INSULATION, SAFETY AND STRENGTH

When your specialty glazing application also calls for insulating values or sound attenuation, specify the best -- EXOLITE NO DRIP double-skinned acrylic or CYROFLEX NO DRIP double-skinned polycarbonate sheet. Both of these unique constructions deliver insulation values superior to single-paned glass, proprietary condensation control and both comply with material requirements of AAMA's voluntary specifications for skylights, No. 1600-86.

EXOLITE NO DRIP acrylic sheet combines excellent light transmission characteristics with superior weatherability. Where added impact resistance is a requirement, select CYROFLEX NO DRIP polycarbonate sheet. Both are ideal for walkways, skylights, atriums, roof glazing, pool enclosures, solariums, and more. EXOLITE and CYROFLEX sheet -- for quality, performance and service, there simply are no equals. From CYRO, North America's largest producer of acrylic sheet.

For informative literature write D. Artz, CYRO Industries, P.O. Box 950, 100 Valley Road, Mt. Arlington, NJ 07856.

SEE US IN SWEET'S CATALOG FILE, REFERENCE NO. 08840/CYR, OR CALL

**1-800-631-5384.**

**CYRO**

QUALITY PRODUCTS. INNOVATIVE TECHNOLOGIES. CARING PEOPLE.

## ON THE BOARDS

**Turtle Wax Car Wash &  
Auto Appearance Center  
Bloomington, Illinois  
Perkins & Will,  
Architects**

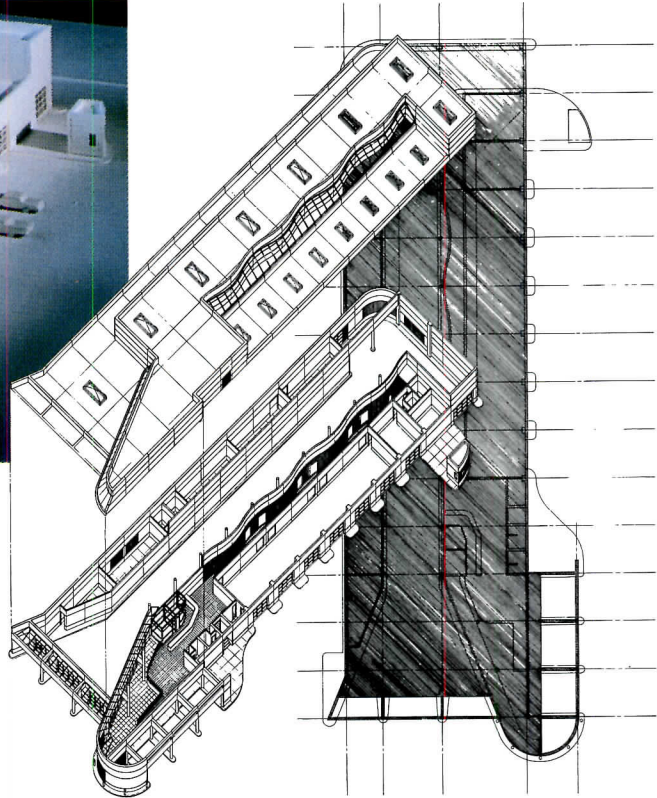
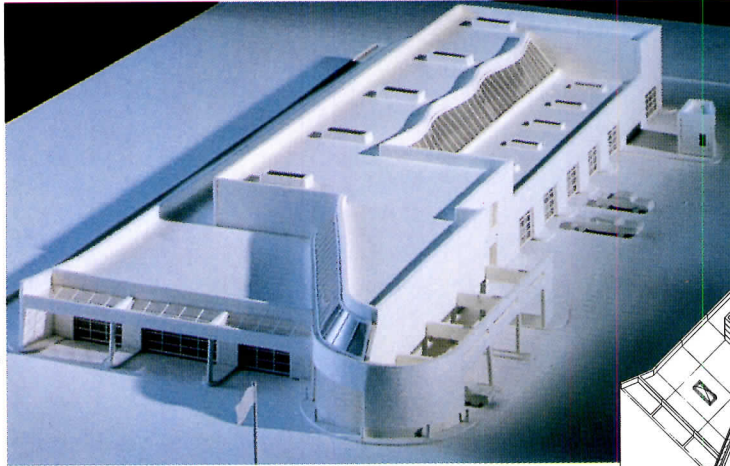

THE SUBURBAN CHICAGO FACILITY IS A PROTOTYPE FOR ADDITIONAL CENTERS designed to revolutionize the car wash industry that Turtle Wax, Inc., plans to build across the nation. The 15,000-square-foot facility, which features computerized, high-pressure washing equipment and gentle "soft-cloth" polishing, is organized as a series of stages along a conveyor. The main wash tunnel is visually reinforced by a 25-foot-high linear roof. A raised observation walkway for customers and a two-story skylit waiting lounge are flanked by an automated wash tunnel and hand-detailing bays. The building's exterior features glass block, white fiberglass panels, and gray-glazed openings with painted metal frames. Construction will be completed later this year.

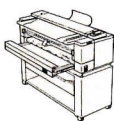

The Mita DC-3648 Plain Paper Copier gives a much sharper, cleaner image than any blueprint could. But to fully understand its advantages over diazo copying, you need more than good eyesight.

You need the vision to see how it could revolutionize your business.

For one thing, it's able to make copies from originals that measure up to a huge 36" x 78". And can produce up to 19 continuous copies from either 24" x 36" or 18" x 24" originals.

Mita's plain paper copier reproduces virtually any type of original, too. Without chemicals or the need for translucent or



## ON THE BOARDS

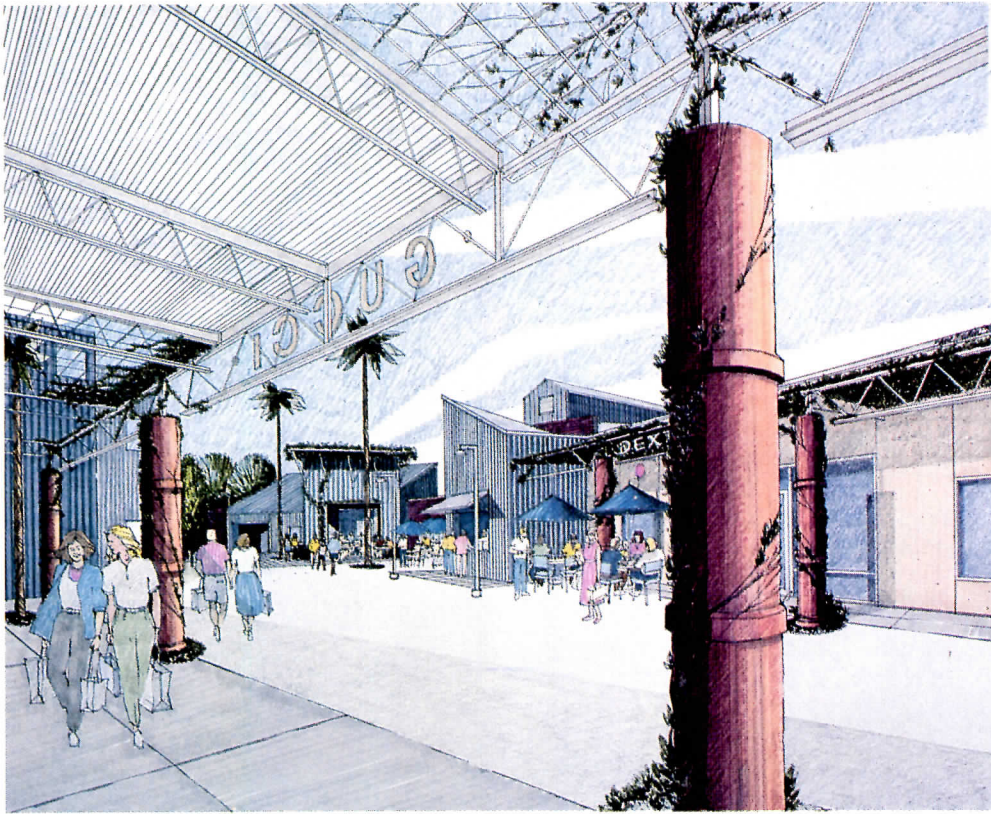

**Petaluma Factory Outlet Town**  
**Petaluma, California**  
**Carlson/Ferrin Architects**

A FACTORY OUTLET CENTER DESIGNED BY Seattle architects Carlson/Ferrin is arranged as a village, with courtyards and plazas connected by narrow shopping streets. Flexible spaces will be provided in the approximately 200,000-square-foot center to accommodate a variety of manufacturers' retail outlets. The steel-frame buildings are clad in a combination of red brick, galvanized corrugated metal, and plaster. Colonnades formed by terra cotta columns and woven-wire trellises will support bougainvillea and other climbing plants. Since many customers will come from great distances to spend the day at the center, the project will provide a variety of restaurants and places for resting, entertainment, and relaxation. The 25-acre site is 40 miles north of San Francisco, located between Highway 101 and the Petaluma River. The project is to be developed in three stages and construction of the first phase will be completed in mid-1991. ■



transparent base materials. Everything from bluelines to CAD-plotted originals come out beautifully, even if the originals are faded or worn. (Our auto-exposure sees to that.)

Plus you can copy on more than plain paper. Choose bond. Or translucent bond. Vellum. Erasable vellum. Or film. They all come out oil free. So you can make notations just like on plain paper. There's even a feature that enlarges margins to give you more room to write on.

If you're still uncertain about switching to Mita's plain paper copier, give us a call at 1-800-ABC-MITA.

And let us put things into proper focus.

**All we make  
are great copiers.™**

# AWARDS

## Wisconsin Society of Architects 1990 Design Awards

RANGING FROM A RESTORATION to a new airport, 8 diverse projects received 1990 design awards from the Wisconsin Society of Architects' 36th annual design competition held last March. The jurors were ARCHITECTURE's editor-in-chief, Deborah K. Dietsch; Milo Thompson, FAIA, of Frederick Bentz/Milo Thompson/Robert Rietow, Minneapolis; and Kate Diamond, AIA, of Siegel Diamond Architects, Los Angeles.

The awards recognized a wide range of building types, new construction, and preservation projects. Honor awards were presented for an indoor football practice facility with a columnless, naturally lit playing field of artificial turf; a clothing shop in a mall that creates thematic repetition through rows of attenuated columns; a 19th-century house transformed into a period bed-and-breakfast inn; and a retail/office center that draws upon the 19th-century vernacular architecture of the region. Merit awards were given to a theater that occupies the shell of a 100-year-old power plant; an aerodynamic airport; an addition to a mansion-style museum; and a 1914 Carnegie library addition.



ERIC OXENDORF

**McClain Athletic Facility**  
Bowen Williamson Zimmermann Architects



DALE HALL

**Baraboo Public Library**  
Strang, Inc.



STEVE POAST

**Riversite**  
Kubala Washatko Architects, Inc.



MICK HALES PHOTOGRAPHY

**La Crosse Airport Terminal**  
HSR Associates, Inc.

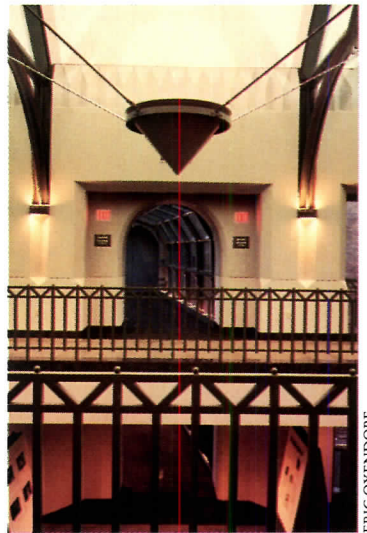

ERIC OXENDORF

**The Milwaukee Repertory Theater**  
Beckley/Myers Architects



HARRY VAN OUDENALLEN, AIA

**Majolie/Garcon, Bayshore Mall**  
JVOS Architects



MARK HEFFRON

**The Inn at Pine Terrace**  
Kubala Washatko Architects, Inc., and Zimmerman Design Group



ED PURCELL / PURCELL IMAGING

**Leigh Yawkey Woodson Art Museum**  
Heike/Design Associates, Inc.

# ABOUT THIS ISSUE

## Of Sheds and Ducks

IN 1972, ROBERT VENTURI PUBLISHED HIS NOW famous polemic on “decorated sheds” versus “ducks.” The merits of utilitarian structures ornamented with explicit signage (sheds) over buildings designed as unitary, sculptural forms (ducks) formed the thesis for *Learning from Las Vegas* and set the stage for Postmodern architecture. Venturi and coauthors Denise Scott Brown and Steven Izenour insisted that by designing buildings concerned only with the Miesian severities of space, form, and structure, architects were out of touch with the meaning and visual richness of our automobile-based culture. “If we learn our lessons correctly from the strip,” they concluded, “the Flamingo sign will be the model to shock our sensibilities toward a new architecture.”

Returning to Las Vegas 22 years after the initial visit, Steven Izenour reports that the Flamingo Hotel sign is still there, but recent

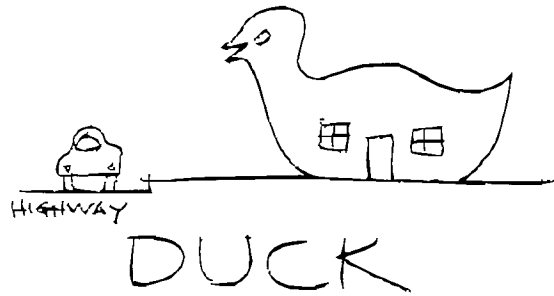

steel shed with Art-Deco-inspired details houses an off-beat supermarket, and in Oklahoma, the strong forms of a sunscreen and skylight call attention to a drive-through bank. While most buildings along American highways tend to be trendy rather than timeless, this sample exemplifies the vision of Arizona architect Will Bruder, designer of the carwash, who says, “The strip doesn’t deserve second-class architecture.”

*Learning from Las Vegas* also chastised Modernists for rejecting symbolism in favor of expression based on function and structure, for “distorting the whole building into one big ornament...a duck.” Today, architects have gone beyond the empty expression of the glass box to blend Modern simplicity with contextual references and site-specific imagery. We illustrate three examples, including a Miesian ideal—the all-glass building—that achieve human scale through historical precedent.

Recent advances in the compressive strength of concrete have produced buildings on the cutting edge of current technology, as our portraits of three office towers demonstrate. The merits of sharing talents and resources between firms—through compatible CAD formats and outright mergers—are reviewed in our practice section. And an article on the latest developments in photogrammetry reveals new ways of recording existing buildings—whether they are sheds or ducks. ■

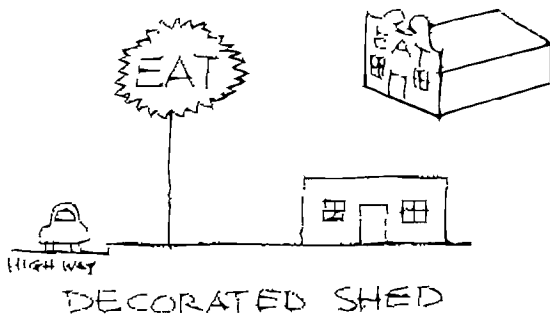

development has besieged the strip with new urban complexities and vexations. He proposes solutions to the city’s street and pedestrian problems that will retain the strip’s character. In our design section, we move from the Vegas archetype to its progeny, featuring some unusual buildings from commercial strips in four Western states. A Los Angeles fast-food restaurant offers a much-needed facelift of the prototype, while sweeping curves imbue a Phoenix car wash with motion. In Seattle, a corrugated

# relearning from las vegas

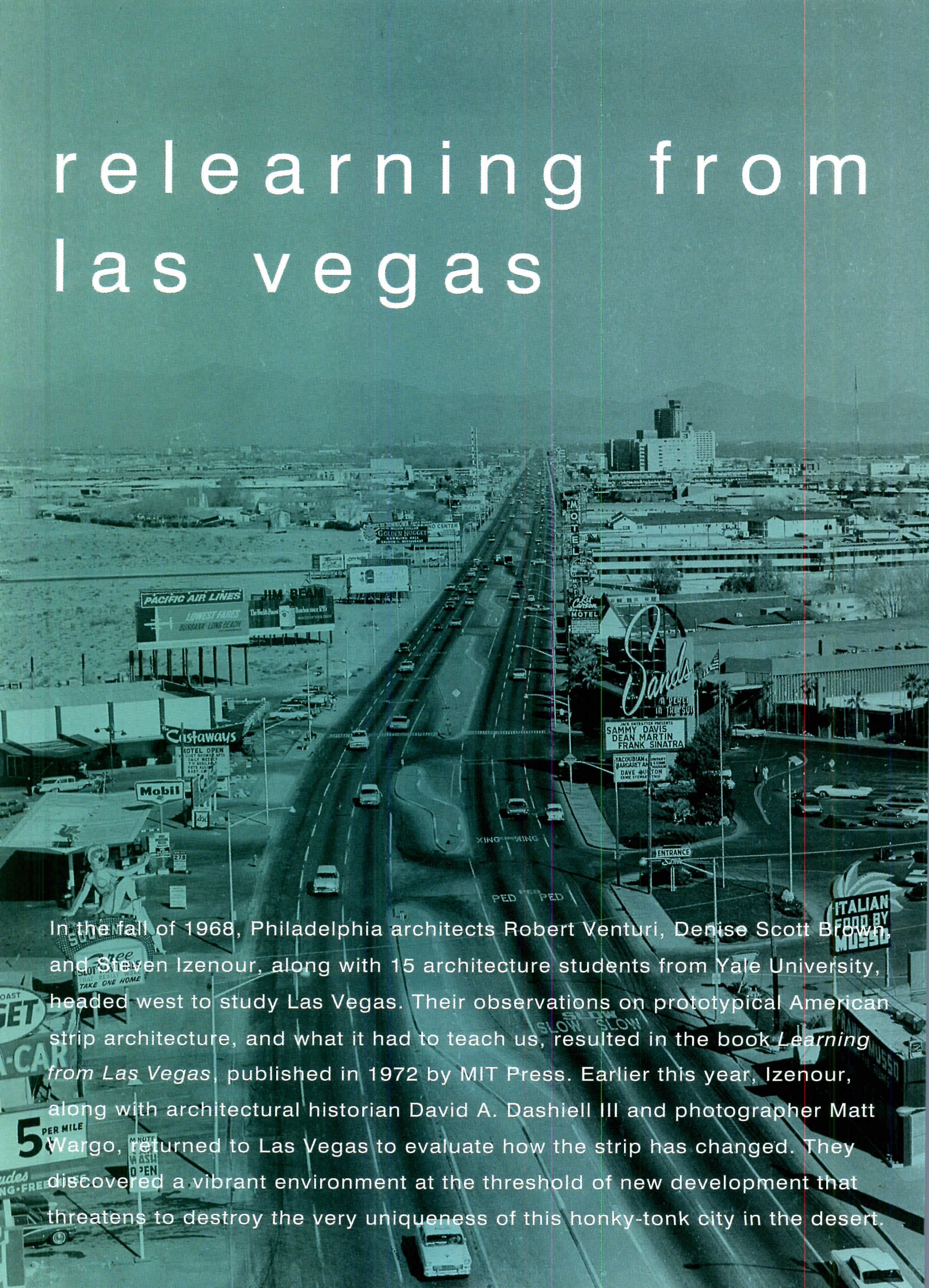
An aerial photograph of the Las Vegas Strip, showing a wide multi-lane highway with traffic. The landscape is dotted with numerous signs and buildings. On the left side, there are signs for 'Pacific Air Lines' with 'Lowest Fares' and 'Burbank - Long Beach', 'Custaways' hotel, a 'Mobil' gas station, and a 'Free Motel' sign. On the right side, there are signs for 'Sands' casino, 'Italian Food by Mussi', and a '5 PER MILE' sign. The city skyline is visible in the background under a clear sky.

In the fall of 1968, Philadelphia architects Robert Venturi, Denise Scott Brown, and Steven Izenour, along with 15 architecture students from Yale University, headed west to study Las Vegas. Their observations on prototypical American strip architecture, and what it had to teach us, resulted in the book *Learning from Las Vegas*, published in 1972 by MIT Press. Earlier this year, Izenour, along with architectural historian David A. Dashiell III and photographer Matt Wargo, returned to Las Vegas to evaluate how the strip has changed. They discovered a vibrant environment at the threshold of new development that threatens to destroy the very uniqueness of this honky-tonk city in the desert.



**O**UR PILGRIMAGE TO LAS VEGAS, NEVADA, 22 YEARS AGO was propelled by the notion (which everyone thought was crazy at the time) that Las Vegas just might have something to teach “serious” designers. We were interested in relearning how to use signs and explicit symbols as architectural tools, and the strip, with its color and decorative richness, beckoned like an oasis in the desert. To architects like us, who had been trained in the hermetic, hard-edged, black-and-white, concrete-and-steel vocabulary of Modernism, downtown Las Vegas was liberating. It became our classroom.

We thought it would be fascinating to see how the strip has evolved and changed in the intervening years. We were pleased to find that the Las Vegas of 1990 is still a brash and lively place, but we also sensed that the strip may be in danger of losing some of the qualities that make it unique and wonderful. It occurs to us that Las Vegas now has an excellent opportunity to learn some valuable lessons from itself.



ment was designed in the classic American mode. Individual entrepreneurs staked a claim in the desert along Las Vegas Boulevard and, with the help of architects, interior designers, and sign companies, created their own very personal and fantastic expressions of the Great American Resort. The results were the Roman splendors of Caesars Palace, the Arabian delights of the Alladin, the tropical fantasies of the Flamingo, and the three-ring big top of the Circus Circus casino.

The particular images and symbols weren’t necessarily new or different—we’d seen similar images in Atlantic City and Miami Beach a generation or two before. What was new and different about Las Vegas was the gambling, and the excess of neon and lights. Every surface became an excuse for neon decoration in every phosphorescent color imaginable, all of it animated and flickering in the dark of the desert night. This “old” Las Vegas might have been tacky in architectural terms, but it was certainly turned-on tacky, so bright and excessive that it became beautiful and seductive.

### the strip then

THE STRIP LANDSCAPE WE DISCOVERED IN 1968 WAS DICTATED almost entirely by the automobile. It had sprung up, as ordinary strips do, along the road to somewhere else, in this case the road from California to an older gambling district in downtown Las Vegas. The highway was a multilane thoroughfare, with turning lanes directing traffic into major parking lots in front or to the side of each establishment. All travel was by car. There was almost no pedestrian traffic.

The buildings themselves were ordinary—gas stations, motels, hamburger stands, casinos—that were, architecturally, little more than utilitarian sheds. What was extraordinary was the sheer number, size, and brightness of the surrounding signs and facades. The fierce competition to catch the traveler’s eye had led to ever larger, brighter, more animated extravaganzas.

But even though the strip was structurally an automobile strip—a “passing-through” place—the casino owners intended it to be a destination in itself, or more precisely, each intended his own casino to be a traveler’s only destination. Capturing the visitor was the motivation for both the visual richness of the competing signs and the spatial fragmentation of the strip. Owners wanted to make it easy to come to their establishment and difficult to go on to another.

The result of this business imperative, which we found ourselves documenting 22 years ago, was the strip’s first great entrepreneurial building boom. Its develop-

### the strip now

OF COURSE, THE STRIP HAS CONTINUED TO EVOLVE AND GROW over the two succeeding decades since our first visit. The two biggest changes we noticed involve scale of development and transportation. The strip we analyzed in 1968 was a rich mix of major casinos juxtaposed with small-scale commercial establishments such as gas stations, motels, and souvenir shops.

In more recent years, development on the strip has paralleled that



**Las Vegas in 1968 (facing page and center right) and today (bottom right and top). Caesars Palace and the Flamingo now dominate gas stations and fast food chains.**

The strip is evolving from a purely auto-driven thoroughfare to a classic American Main Street, depending equally on cars and pedestrians. Strip businesses have responded to this change in a variety of ways, all of which address the pedestrian at the sidewalk's edge. For some of the older casinos, the strategy involves drawing the pedestrian into the complex.







Classical icons at Caesars (above and below) dominate Las Vegas in 1990 (facing page).

of the typical American strip, which has evolved into ever larger centers culminating in major regional shopping malls of multimillion square feet. New casino hotels like the Excalibur, Mirage, and the planned MGM development have many thousands of rooms and dominate thousands of linear feet of street frontage on the strip. The Shell station no longer lives cheek-by-jowl with Caesars.

## main street on the strip

IN A SENSE, THE STRIP IS EVOLVING FROM A PURELY AUTO-driven thoroughfare to a classic American Main Street, depending equally on cars and pedestrians. In *Learning from Las Vegas* we contrasted the strip of the '60s with the older gambling district on Fremont Street, which is historically the actual Main Street of Las Vegas.

On Fremont Street, the casinos are part of the sidewalk, as the stores on any American Main Street would be. Like a bazaar, the casinos present open, inviting faces to the street, encouraging pedestrians to wander in and drop a few coins in the slots. Larger signs projecting from the facades of the buildings appeal to drivers in downtown traffic.

There is a much greater density of signs on Fremont than on the strip, but the traffic is much slower, so the passing driver has more time to take it all in.

The strip of the '60s had few pedestrians or amenities, such as continuous sidewalks, to accommodate them. This has changed dramatically, and great numbers of pedestrians

now stroll the strip day and night. The strip businesses have responded to this change in a variety of ways, all of which address the pedestrian at the sidewalk's edge.

For some of the older casinos, which have big investments in complexes set back from the street, the strategy involves drawing the pedestrian from the sidewalk to the complex. The most dramatic example is Caesars, which has constructed an elaborate system of moving walkways to carry customers from the street across a large expanse of open parking lots. Pedestrians enter the walkways from three fantastic architectural confections that are designed in the spirit of excess that gives Las Vegas its unique flavor. One, at the northern edge of the property, carries the visitor through a procession of five closely-spaced triumphal arches, past a glittering Classical temple and rows of trumpet-blowing angels perched on columns. Even more impressive is a circular temple halfway down the sidewalk that is a riot of gilded columns, obelisks, urns, big-breasted sphinxes, and brightly colored marble.

Once they arrive on the moving walkway, visitors are welcomed by disembodied voices and are directed to move past holographic projections of orgiastic Romans. The walkway carries them into the casino at the second-floor level, affording the sensation of flying above the gaming floor. It is a very effective introduction to Caesars world.

Another strategy that has been employed is to move the casino front itself up to the street, a solution more closely analogous to conventional Main Street commercial buildings. Some, like the Flamingo Hilton, come right up to the edge of the sidewalk. The Flamingo is set ablaze with neon at night, but this decoration is kept low and close to the street—clearly aimed more at the pedestrian than the approaching driver.

The Stardust has moved its facade closer to the boulevard, but left space for a wide pedestrian plaza that is a real amenity on a street where the sidewalks are sometimes too narrow. Although the Stardust's facade is a pale shadow of its '60s predecessor, the plaza, with its amusing fountains and places to pause and rest, is a positive addition to the strip and should be emulated.

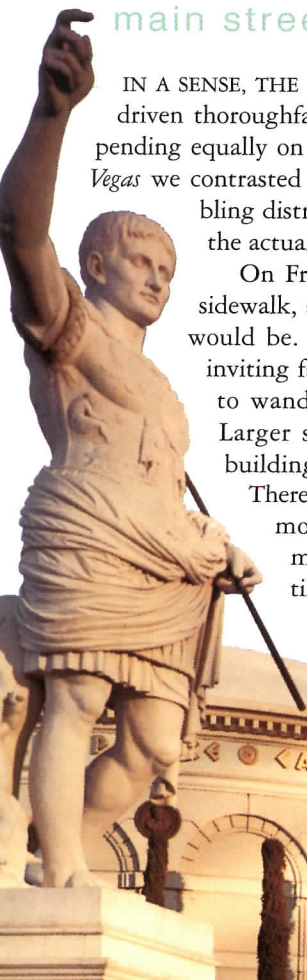

## gridlock on the strip

YET ALONG WITH MANY POSITIVE CHANGES, recent growth in Las Vegas has brought some serious problems that threaten the viability of the strip as an attraction. At periods of peak activity, the strip suffers from severe congestion and gridlock. On a typical weekend evening, it can take an hour or more to drive the length of the strip, and walking can be difficult on the narrow sidewalks, which are clogged in many places by “news-stands” advertising various illicit titillations. The strip in 1990 has become a victim of its own success.

Any solutions to this very real problem should take into account the practical and symbolic need for auto access to the casinos, and other businesses, but these solutions should also address the strip’s added role as both a pedestrian and automobile promenade. Potential solutions should also evoke images powerful enough to capture the imagination of the tourist. Las Vegas Boulevard is not just a dysfunctional county road, but a classic street in the American experience.

## solutions for the strip

BECAUSE RECENT TRAFFIC PROBLEMS ARE SO DISTURBING, IT IS tempting to look for massive solutions to the strip’s gridlock that might solve everything in one bold stroke. The reality is, however, that such overwhelming interventions rarely achieve what they intend, and inevitably alter the surrounding environment beyond recognition.

In a recent example of such potential intervention, proposals have been advanced for building an elevated train down the center of the strip. At first glance, such a scheme might be appealing for its novelty as a tourist attraction. However, on closer examination, its few questionable benefits are far outweighed by the potential for harm. In their renderings, developers illustrate massive structures and stations blocking views of the strip on both sides along the railway’s length. All of the previous 30 years’ investment in signs, facades, volcanoes, and castles would become irrelevant when covered over by these structures. Putting aside the practical and economic problems of such proposed transportation systems, the most tragic consequence would be the esthetic destruction of the strip.

Las Vegas needs to protect the qualities that provide its unique identity, and developers must solve the city’s problems in well-reasoned, incremental steps. The search for more appropriate solutions might be carried out in the following areas:



Recent views of the Flamingo entrance (above) and Blinko the clown at Circus Circus (below).

- A systematic analysis of changing Las Vegas Boulevard, Paradise Road, and Industrial Road into linked parallel routes by means of one-way loops, offering rear access to the major casinos and thus relieving pressure on the strip;
- A study of one-way systems, depressed cross-streets, and/or elimination of left-turn lanes, both onto and within the strip. The goal would be to minimize starts and stops and maximize available through-traffic lanes;
- A total redesign of the sidewalk and curb lane to allow for easy pedestrian movement and continuous jitney service on the strip;
- Learning from the Atlantic City Boardwalk and Disney World, where immense numbers of tourists are handled efficiently with a combination of surface jitneys and “shanks’ mare;”
- Exploring ideas of limiting—but not eliminating—automobile access to the strip during peak hours. A potential prototype is the system used by some national parks of issuing free access tickets during peak periods. When the tickets are gone, access is cut off. It is important, though, to keep cars on the strip. Turning the strip into a pedestrian mall would certainly destroy its uniqueness.

Real solutions will be found only after serious study of all the issues, and with a commitment from all parties to cooperate in the eventual implementation. The strip businesses are much more obviously interdependent than 20 years ago. They need to work together—while still maintaining their individuality—to effect lasting solutions of benefit to all.

## disney world vs. the strip

A USEFUL WAY TO UNDERSTAND THE PROBLEMS AND opportunities facing the strip in the last decade of the 20th century is to compare Las Vegas with Disney World. Both have become popular destination resorts for millions of people each year. More and more, they are competing with each other for the same tourist dollar.

Disney offers the American family an idealized vision of a 19th-century American town, one without cars, dirt, graffiti, or social and economic strife—a romanticized ideal of the American Main Street with a dash of movie fantasy and sanitized “future world” thrown in for spice. It is the ultimate G-rated resort environment.

The Las Vegas strip has always been part of a real city with real cars and gambling, a PG-13 (and sometimes R-rated) resort. This gives it a striking advantage over Disney. However skillful the



designers at Disney are, they are inevitably limited by the fact that their client is a single corporate hierarchy, and this too often results in a sameness, an overly homogenized image in danger of becoming boring, as only paradise can be. The Disney attractions are very sophisticated in execution, but we suspect as the population grows older and more sophisticated, tourists will become jaded with the paradise that says little about our everyday world. (Disney is obviously aware of this problem and is trying to broaden its appeal for a more adult and sophisticated audience by developing more conventional resort venues that will be in direct competition with Las Vegas for the convention-goer and tourist.)

In Las Vegas, for better or worse, there are multiple owners operating in a highly competitive business environment. Each casino has its own market niche and crafts its own special image to differentiate its product from that of its competitors. This ad hoc competitive environment has resulted in a visual and economic diversity that has been one of Las Vegas's greatest strengths, saving it from the blandly homogenized good taste of Disney World. As Las Vegas casinos get larger and larger, the challenge will be to avoid losing the colorful excitement of the myriad signs and facades competing for the tourist's dollar. A "good taste" Las Vegas could become its own worst enemy.

## glimpses of the future?

IT IS ALWAYS DANGEROUS TO PREDICT WHAT THE FUTURE OF such a diverse and changing environment will be. But it is possible to identify trends, and the obvious trend on the strip is toward ever greater size and scale.

The Mirage, for example, greatly increases the stakes for those on the established areas of the strip. The hotel itself is large, and with its very high sign, it is a prominent feature of the strip, but still very much in the tradition of what has gone before. The new element is an extensive "jungle" along the edge of Las Vegas Boulevard. But because it incorporates trees and waterfalls, it was impossible to overscale the elements that constitute this oasis fantasy—a real palm tree is a real palm tree. The strategy instead was to use quantity instead of real size—more trees and copious amounts of water, with its accompanying sounds. This is an effective strategy for the pedestrian on the strip, but not quite so dramatic from the car; as one approaches this

prominent bend in the strip by vehicle from the south, it seems almost empty.

Perhaps the biggest disappointment in this context is The Mirage's much-ballyhooed volcano. Because it is, in reality, a waterfall with "fire" and lighting effects, it isn't even perceptible as a volcano during the day, and somewhat anticlimactic at night. It is our impression that the volcano should have been designed more dramatically, higher, and larger.

The designers of the new Excalibur more clearly understand the relationship between size and scale. On the strip, where there are real cars, gas stations, and vast vistas, Excalibur's architects realize that building features need to be bigger than life to be effective, just as the original signs had to be the biggest and brightest ever. The immense castle that rises out of the Excalibur's hotel wings is exaggerated in size and scale in order to be read from a car barreling down the interstate, or as viewed from the north. Bigger is definitely better, particularly at the underdeveloped south end of the strip. (Unfortunately, the architects did not carry this appreciation of scale throughout the building; certain features of the two massive hotel towers, such as the corner turrets and mansard roof, appear underscaled and puny.)

But not only is Excalibur huge, it will also be the most complete excursion into the fully themed environment yet on the strip. Themed casinos, of course, are not new, but in most, the themes are largely decorative settings for the gambling areas. Drawing on the more involving experience at Circus Circus, where circus acts go on above the gamblers' heads, Excalibur will immerse the visitor in its fantasy-castle world. This is clearly being viewed as a potential trend for other future developments, and all eyes will be on Excalibur to see how the public responds.

The main lesson we learned from the strip today (and this lesson hasn't changed in 22 years) is *vive la difference!* As long as the casinos continue to develop in their own idiosyncratic and individual ways, the result for the strip and Las Vegas as a culture will be salutary. Conformity and "good taste" would kill the strip quicker than an invasion of gamblers with second sight.

—STEVEN IZENOUR AND  
DAVID A. DASHIELL III

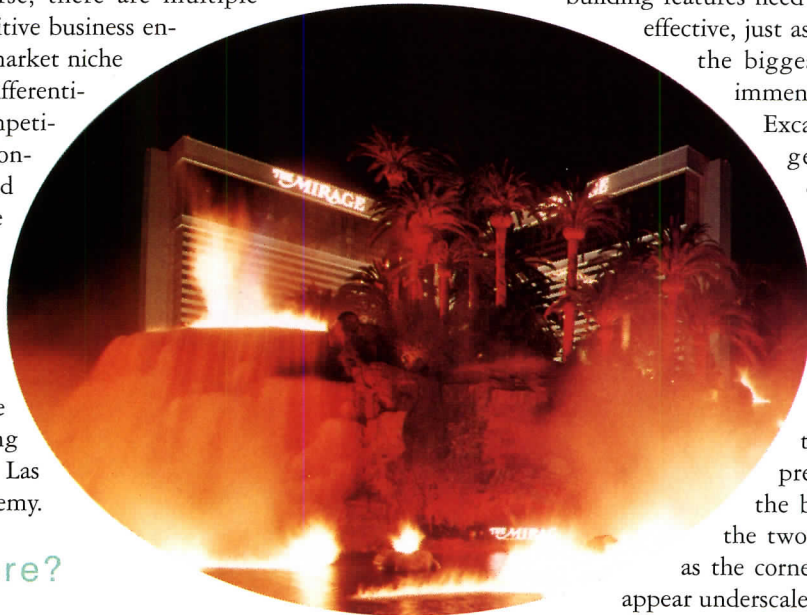

The Mirage's water-and-fire volcano (above); Excalibur's castle (below).







# Kentucky Home

FEW OF AMERICA'S NATIONAL FAST-FOOD chains are housed in buildings as boring as the ones favored by the Kentucky Fried Chicken (KFC) franchise. Featuring fake mansard roofs topped by an outsize Colonel Sanders-emblazoned bucket, KFC restaurants fill the urban landscape with a lifeless imagery that seems to lack the courage of its own vulgarity.

The new KFC outlet in midtown Los Angeles is a radical break with the chain's usual visual boredom. Commissioned by franchisee Jack Wilke, the Los Angeles firm Grinstein/Daniels reshaped the standard concept of the fast-food restaurant from the ground up, creating the first architecturally avant-garde Kentucky Fried Chicken outlet in the U.S.

"I convinced the chain's national headquarters in Louisville that something different was needed on this stretch of Western Avenue, which is recovering from a long period of decline," Wilke says. "The new management was sympathetic, if skeptical, but they like it fine now."

Situated on the corner of Western and Oakwood Avenues, the new building replaces a conventional, 25-year-old KFC restaurant on the same site, one of three franchises operated by Wilke. Set in the midst of a typical L.A. strip of minimalls and small stores backed by low-rise residential streets, the Western Avenue KFC is radical in layout as well as in style.

Elyse Grinstein and Jeffrey Daniels, both alumni of Frank Gehry's Santa Monica office, have created several high-profile, upscale Los Angeles restaurants, including Chaya Brasserie and Chaya Venice. The Western Avenue KFC, their first venture in the design of a "downscale" eatery, derives much of its inspiration from the famed 1950s coffee shops that once dotted the L.A. landscape from the Sunset Strip to Long Beach. Known as the "Googie" style, from the cafeteria chain of that name, the '50s restaurants with their dramatic, sweeping roofs, tilted glass walls, and glittering neon design made Modern architecture popular.

"Jack [Wilke] had in mind to do an updated Googie KFC," Daniels said, "but we convinced him to take it one step further and reinterpret the 1950s coffee-shop style in a '90s idiom. In this way, we acknowledge the

commonplace commercial vernacular of the surrounding strip while heightening its sophistication and theatricality."

To make room for a large parking lot and a drive-through window, the building is crammed into a two-story structure on the edge of Western Avenue. Customers place their orders on a ground-floor counter and then march upstairs past a big picture window to an airy, high-ceiling room topped by a large skylight. Here they wait for their food to be delivered by dumbwaiter from the kitchen below.

The 50-seat dining room, lit by a big curving glass wall shaded by tapered solar fins, is the largest segment in Grinstein/Daniels's eccentric composition, which resembles a pile of children's building blocks. Its curved front wall, which turns the corner of Western and Oakwood, looks like part of the chain's signature bucket of chicken. From the upstairs dining room, patrons may munch their chicken parts and watch the busy Western Avenue scene below, while their kids play on an adjacent terrace filled with swings and slides.

"We wanted to make the whole operation look as theatrical as possible," says Jeffrey Daniels, KFC's principal designer. "From outside, passers-by can see customers climbing the stairs to the dining room or seated at their tables eating. From inside, the patrons can watch the theater of the street."

To emphasize the theatricality of the design, Daniels clad the building in a mixture of light gray and green stucco, and ribbed metal siding capped by sloping zinc roofs painted in primary reds and blues. Exposed ventilating ducts and bright yellow balcony railings emphasize the makeshift, muscular mannerism pioneered by architect Frank Gehry in such local landmarks as Santa Monica's Edgemar complex.

Now, the bearded image of Colonel Sanders beams down on the avenue from a skewed perch, signalling to the neighborhood with his familiar string tie that this strange structure is indeed the home of his popular, finger-lickin' goodies. ■

—LEON WHITESON

*Leon Whiteson is the architecture critic of The Los Angeles Times.*

**Situated on a corner in a typical stretch of L.A. strip shops and stores (below), the Western Avenue Kentucky Fried Chicken attracts the eye with an eccentric composition that radically breaks with the chain's standard architectural formula. A curved wall with louvers (facing page, top) shields the dining room (facing page, bottom), which opens onto a terrace.**

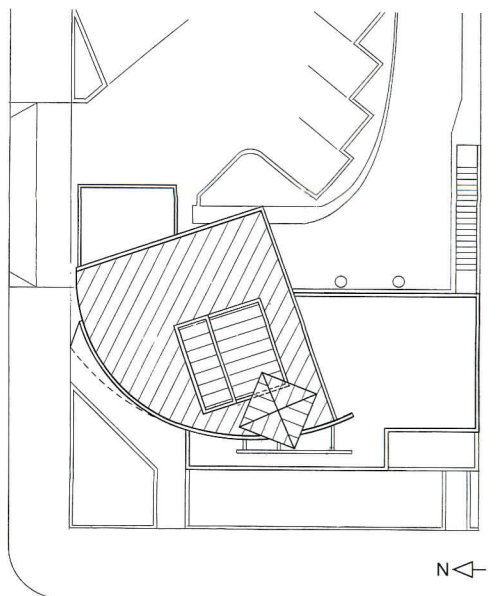

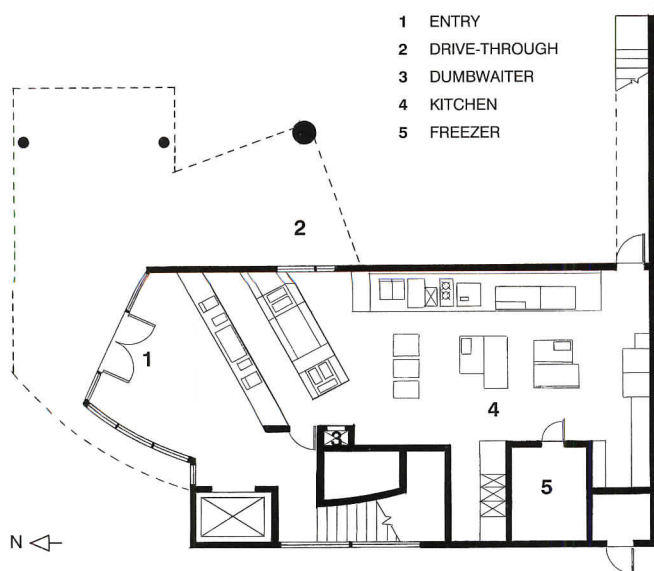

- 1 ENTRY
- 2 DRIVE-THROUGH
- 3 DUMBWAITER
- 4 KITCHEN
- 5 FREEZER

GROUND FLOOR

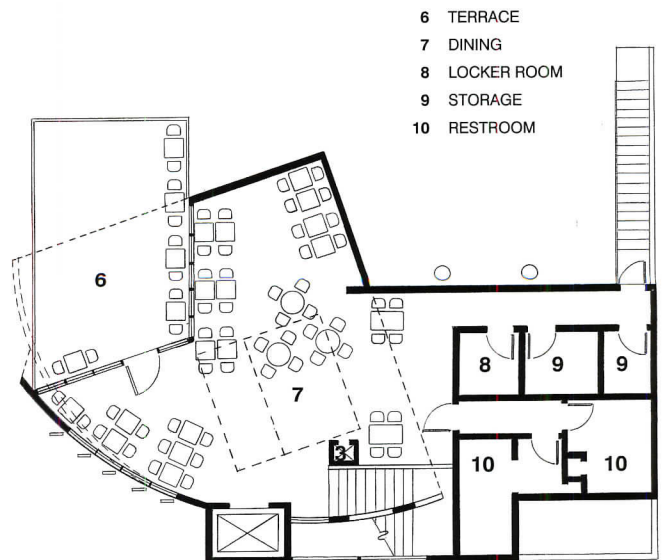

- 6 TERRACE
- 7 DINING
- 8 LOCKER ROOM
- 9 STORAGE
- 10 RESTROOM

SECOND FLOOR



The fast-food restaurant is organized with a dining room on the second floor (facing page), above kitchen and ordering counter. Patrons ascend the stairs (bottom left) and wait for their food to be delivered by dumb-waiter. The airy, high-ceiling dining room (left) overlooks busy Western Avenue through a window wall shielded by tapered solar fins. A big skylight, adjacent to the Colonel Sanders sign (bottom right and sections below), floods the dining room with cheerful sunshine.

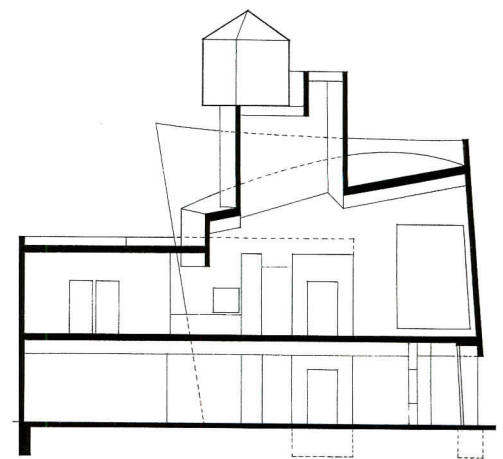

SECTION LOOKING WEST

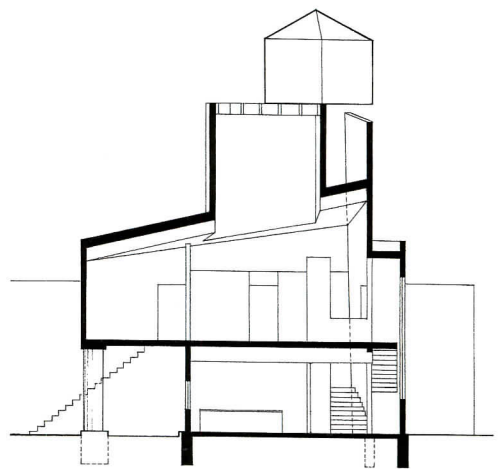

SECTION LOOKING SOUTH



**KENTUCKY FRIED CHICKEN  
LOS ANGELES, CALIFORNIA**

ARCHITECT: Grinstein/Daniels, Inc.—Jeffrey Daniels (partner-in-charge); Elyse Grinstein, Iris Steinbeck, Harry Harris (project team)  
ENGINEERS: Erdelyi-Mezey and Associates (structural); Comeau Engineers Inc. (mechanical); Mirahmadi and Associates (electrical)  
CONTRACTOR: 2M Construction; Carlson Design (kitchen)  
PHOTOGRAPHER: Grant Mudford



# Clean Sweep

WEDGED INTO A COMMERCIAL STRIP AT THE edge of Phoenix, Weiss Guys Carwash occupies a narrow site where dusty vehicles make a U-turn as they sweep from vacuum area into wash tunnel. Arizona architect Will Bruder's graceful steel roofs echo that curve. The architect designed a clean, vaulted form, whose purity and curves hark back to sleek automobile forms of the 1950s. As Bruder notes, "This building could have had wheels."

The architect chose galvanized steel because it provides cool expanses of shade and weathers well in the desert, and sandblasted concrete blocks because they are both inexpensive and durable. Steel columns and beams with a natural rust patina support the roofs. Within, customers can view their automobiles from a smooth uninterrupted glazed

area, and a razorlike shaft of pure daylight captures the car as it emerges glistening from the washing machinery.

Bruder has spent a lifetime studying the work of Frank Lloyd Wright, Paolo Soleri, Carlo Scarpa, and others. He especially admires Scarpa's respect for the integrity of simple materials, and finds them particularly appropriate for the strip, where budgets are always low. "A lot of what is on the strip has to do with economic practicality," Bruder contends. He thinks the strip doesn't deserve second-class architecture. "We're all captivated by Europe and the pedestrian scale, but America is about the car, so you need a dynamic architecture. This building is almost in motion." ■

—HEIDI LANDECKER

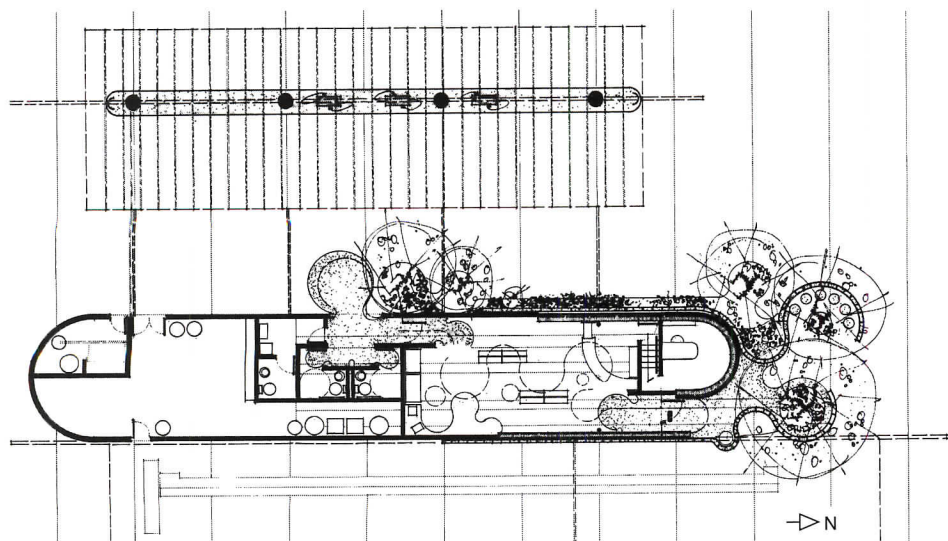
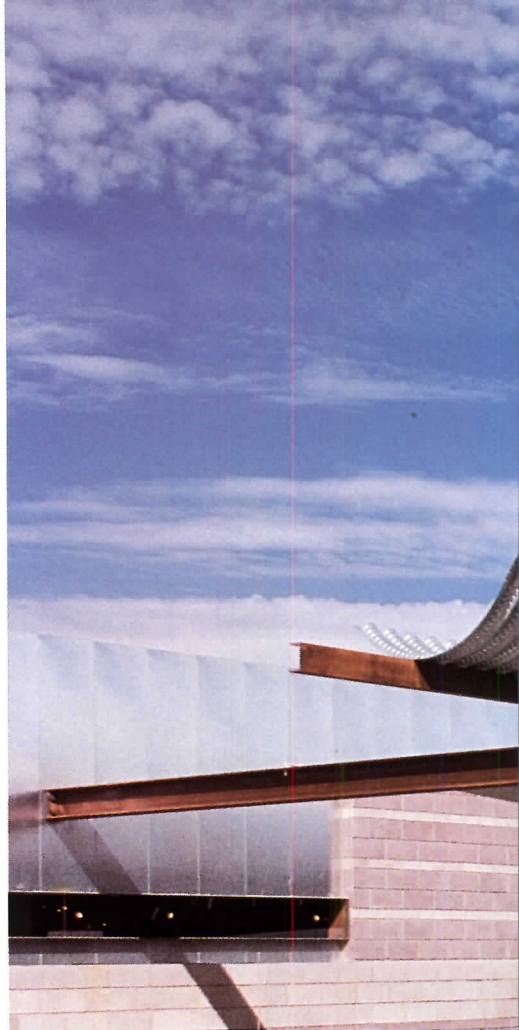

WEISS GUYS CAR WASH  
PHOENIX, ARIZONA

ARCHITECT: William P. Bruder Architect, Ltd. William Bruder (principal in charge); Wendell Burnett, Tyler Green, Peter Rott (design team)  
ENGINEERS: J.T. Engineering (structural); Roy Otterbein, P.E. (mechanical); CA Energy Designs (electrical); William J. Norman (civil)  
CONSULTANTS: Lighting Dynamics (lighting)  
CONTRACTOR: Weiss Guys Carwash, Howard Kemper (construction superintendent)  
PHOTOGRAPHER: Scot Zimmerman, except as noted





Above the vacuum area, a trellis of galvanized steel creates shade and a latticework pattern on the ground (above). Steel beams with a natural rust patina support wash tunnel (far left, facing page). Galvanized steel panels clad curved element over entry to retail pavilion (facing page, center), where clerestory admits light into sales area (facing page, right). Retail area, snack machines, manager's office, and seating are arranged in a linear structure between the wash tunnel and vacuum/gas pump area (plan, facing page).

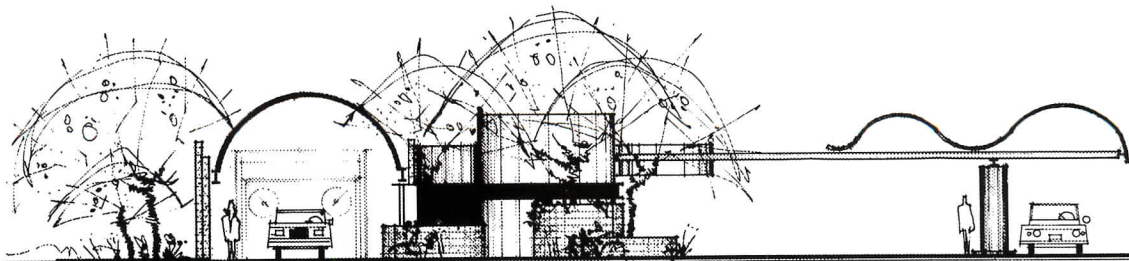

Bank of Oklahoma  
Yukon, Oklahoma  
Elliott + Associates Architects

# On the Corner

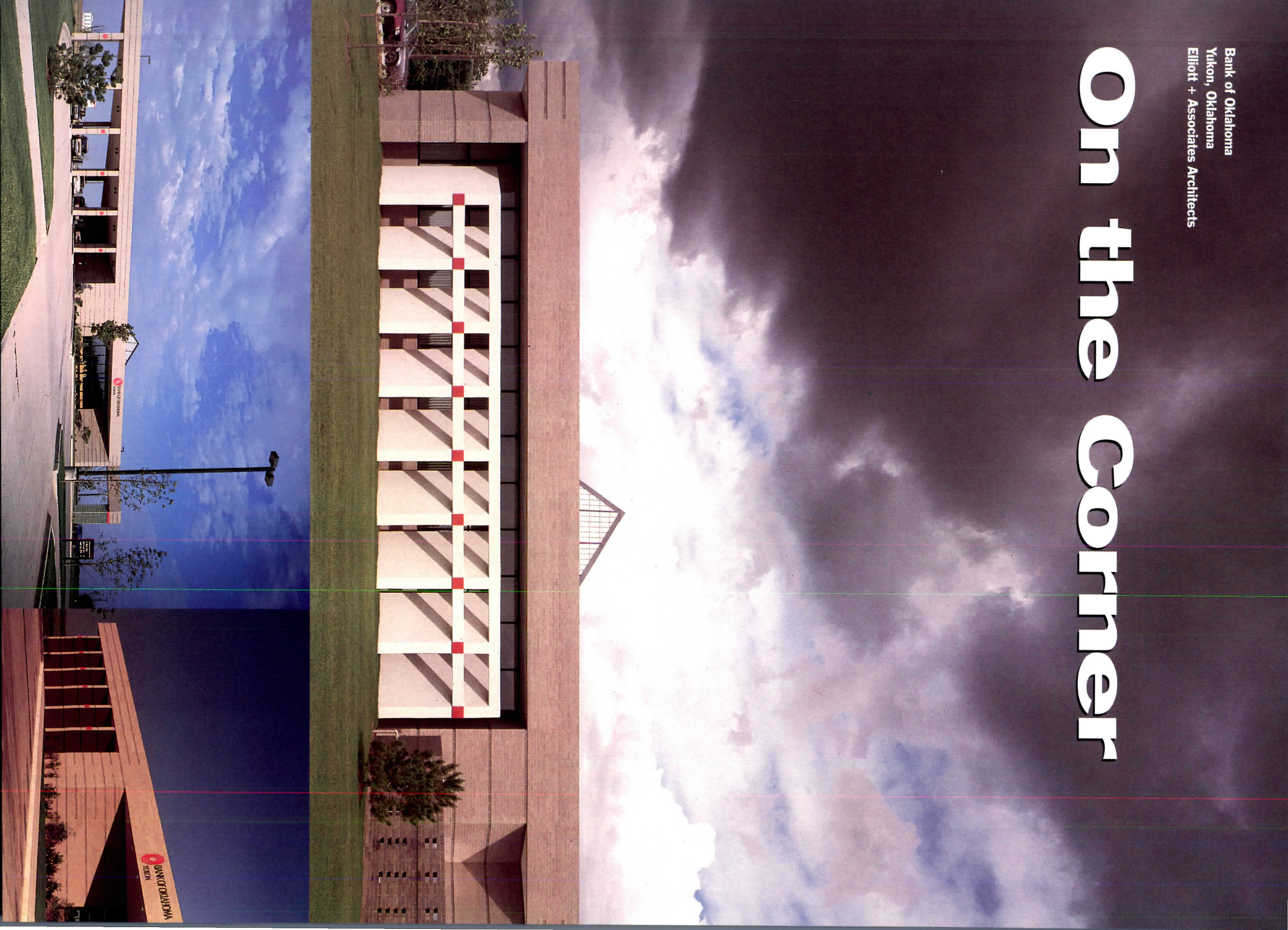



IN 1987, THE BANK OF OKLAHOMA ACQUIRED the failed assets of a smaller financial institution in Yukon, a rural town west of Oklahoma City. After opening this branch, however, the Tulsa-based bank soon discovered that its headquarters was too large for its needs, and decided to build a smaller, drive-through facility across the street. The site selected was the corner of a wheat field bordering a commercial strip between a major highway and the center of town.

In designing the new bank, the Oklahoma City firm of Elliott + Associates capitalized on the corner location with angular geometries and bold forms that are unusual for such a mundane building type on the strip. In organizing the simple, one-story structure, the architects directed circulation diagonally across the interior, from a corner entrance marked by a glass-block-clad sign to a bank vault, which is articulated as an angular, rear projection. To maximize daylight and views, they lined the perimeter with offices and service counters, and defined the open, central space with a daylit, triangular waiting area and seating that encourages social interaction.

Principal Rand Elliott explains that the 6,000-square-foot building is intended "to feel big." He infused the small structure with a sense of monumentality through passive solar elements that create a strong, graphic image. Sun angles plotted and calculated for

each side of the building resulted in a site-specific profile: a deep overhang on the east, a drive-through canopy on the south, and a curtain wall on the north. The western facade is shielded from bright daylight by a plaster-covered sunscreen of angled fins that appears from a distance as a Classically inspired arcade. Similarly, a pyramidal skylight placed over the center of the interior creates a recognizable silhouette on the flat plains. The corners of the bank are further accentuated with variegated courses of Texas brick.

Elliott says he didn't have to convince his client to accept a Modern-inspired vocabulary, since the Bank of Oklahoma's previous headquarters in Yukon was a stripped down, flat-topped, 1970s box. "A bank must call attention to itself like any other chain on the strip to attract business," the young architect notes. "Good design is certainly one way of achieving that goal."

—DEBORAH K. DIETSCH

ARCHITECT: Elliott + Associates Architects, Oklahoma City, Oklahoma—Rand Elliott, AIA (principal-in-charge); David Foutz, AIA (project architect)  
 ENGINEERS: Eudaley Engineers (structural); Cooper Engineering (mechanical and electrical); Grossman Keith Engineers (civil)  
 CONTRACTOR: Ward Construction  
 COST: \$600,000—\$95/square foot  
 PHOTOGRAPHER: Bob Shimer/Hedrich Blessing

**A drive-through on the southern edge (facing page, bottom) and a lantern on the northeast corner (bottom left) define the Yukon branch bank. A sunscreen (facing page, top) protects the western window wall from the sun's rays.**

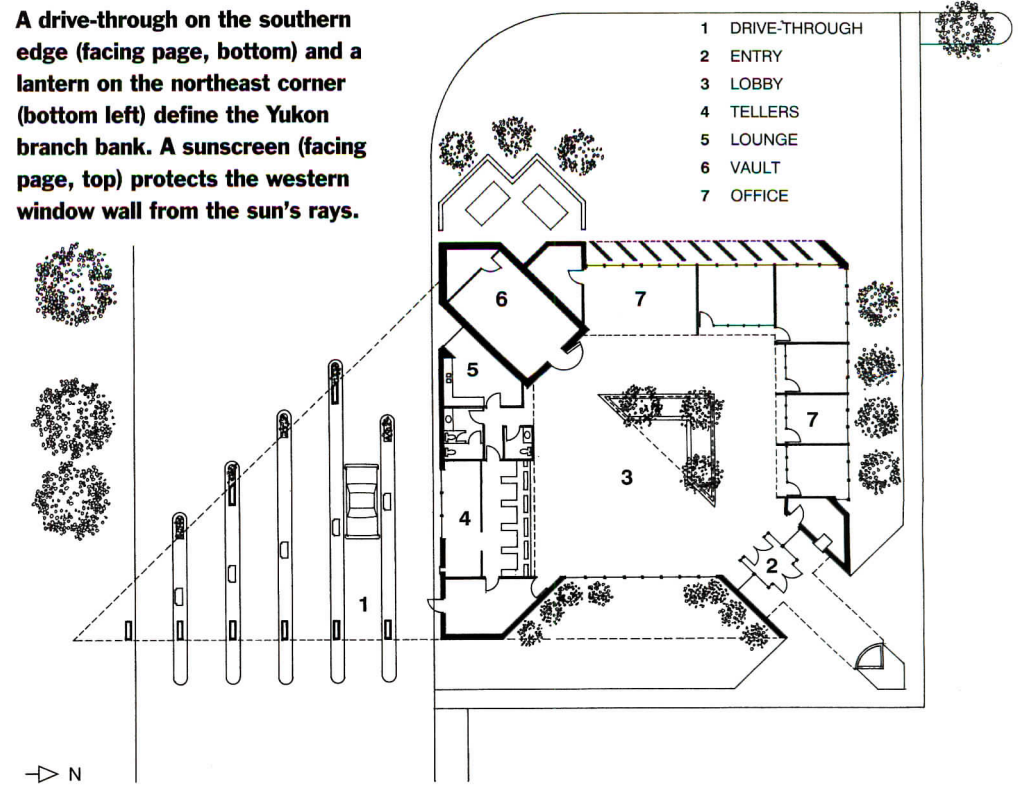

**The Shops at Larry's Market**  
Bellevue, Washington  
Carlson/Ferrin Architects



# Food Chain

LARRY'S MARKET, AN UNUSUAL SEVEN-supermarket chain in Seattle, features upscale cuisine prepared on the premises while offering ordinary food and household products at reasonable prices. Each market is situated to attract suburban shoppers, and the recently opened Larry's in Bellevue shares a parking lot with eight shops, forming a minimall known thus far as the Shops at Larry's.

The chain's three newest stores and the shops are housed in no-nonsense buildings designed by Carlson/Ferrin Architects, a 17-person Seattle firm begun five years ago by Don Carlson, an architect who spent five years in Frank Gehry's office, and who has practiced in Seattle since 1977. The buildings are constructed of industrial materials—corrugated steel and concrete—that are remarkable along the strip for their sheer simplicity. Even though the program included neon signage and obligatory billboards, Carlson/Ferrin Architects has succeeded in supplanting turnpike tackiness with a measure of elegance.

Unlike ordinary supermarkets, Larry's Markets contain a cafe, numerous food kiosks for quick snacks or espresso, and display kitchens where customers can watch food preparation. These amenities, as well as a more traditional produce section, seafood section, wine department, and stacks of shelving (piled high with boxes of products in storage, as in thrift supermarkets) are enclosed in great, airy, shedlike spaces.

The North Seattle store, which opened in 1986, was the first building Carlson/Ferrin designed for owner Larry McKinney, a grocer's son who inherited his first store from his father in the 1960s. Although McKinney and his wife, Suzi, an interior designer, make most of the decisions about food locations and design within the buildings, it was Carlson/Ferrin who suggested moving the flower stalls from the back of the North Seattle store to an entry kiosk. This arrangement proved so popular that the flower supply overran the kiosk, and the subsequent Kirkland and Bellevue stores are also marked by a profusion of vegetation at their entrances. "When customers drive up," says McKinney, "they don't feel like they're arriving at a supermarket. That was one of our goals." The architects designed translucent fiberglass

canopies to protect the flowers from the elements at the two newest markets.

Carlson/Ferrin also convinced the client that clerestories would add to the grandeur of the high, warehouselike spaces and lighten the burden of food-shopping. (Most food retailers eschew natural sunlight; they don't want to have to protect perishable products from the sun's warm rays.) Each of the three stores contains more natural light than the last, and the Bellevue market's clerestory windows completely surround its two-story volume. Industrial lamps that reflect upward, another novelty in supermarkets, create an environment compatible with classical music and display kitchens where customers can watch employees make chocolates and sushi.

The Bellevue Larry's is the largest of the three markets at 75,000 square feet, and it is the best example of what both client and architects were trying to create—the ambience of the high, daylight arcades that house indoor markets in European cities. That they have succeeded in establishing that aura is all the more remarkable given Don Carlson's use of completely contemporary materials.

The walls of the Bellevue store are inexpensive glazed concrete block alternated with waterproof concrete block that has a texture and irregularity that resembles cut stone. Upper walls and roof are galvanized corrugated steel à la Gehry—"he's my mentor, I'll admit it," says Carlson—supported by exposed trusses and girders. Beams and ceilings in the two-story central space are painted white, while the one-story perimeter areas (containing produce, seafood department, wine cellar, frozen foods) are painted dark green, accentuating the higher, clerestoried center.

In this newest structure, Carlson/Ferrin responded to the art deco detailing that Suzi McKinney introduced in the North Seattle store and then used boldly inside the Kirkland market. The Bellevue market therefore sports a wide glass-block expanse that runs the length of the cashier area, sweeping steel curves, and a glazed octagonal cafe. Across the parking lot, one of the shops wears a steel crown. In contrast with the colorful sawtooth roofline that distinguishes the Kirkland market from its lowly brethren (a Motel 6 is on one side, a freeway on the other), these Mod-



**A steel crown tops the northernmost shop at Larry's Market in Bellevue (facing page). A glass-walled cafe and a neon apple adorn the North Seattle store (above). Artist Buster Simpson created windvanes over the entrance of Larry's in Kirkland (below), where the cafe has a sawtooth roof (bottom).**



JAMES F. HOUSEL

JAMES F. HOUSEL

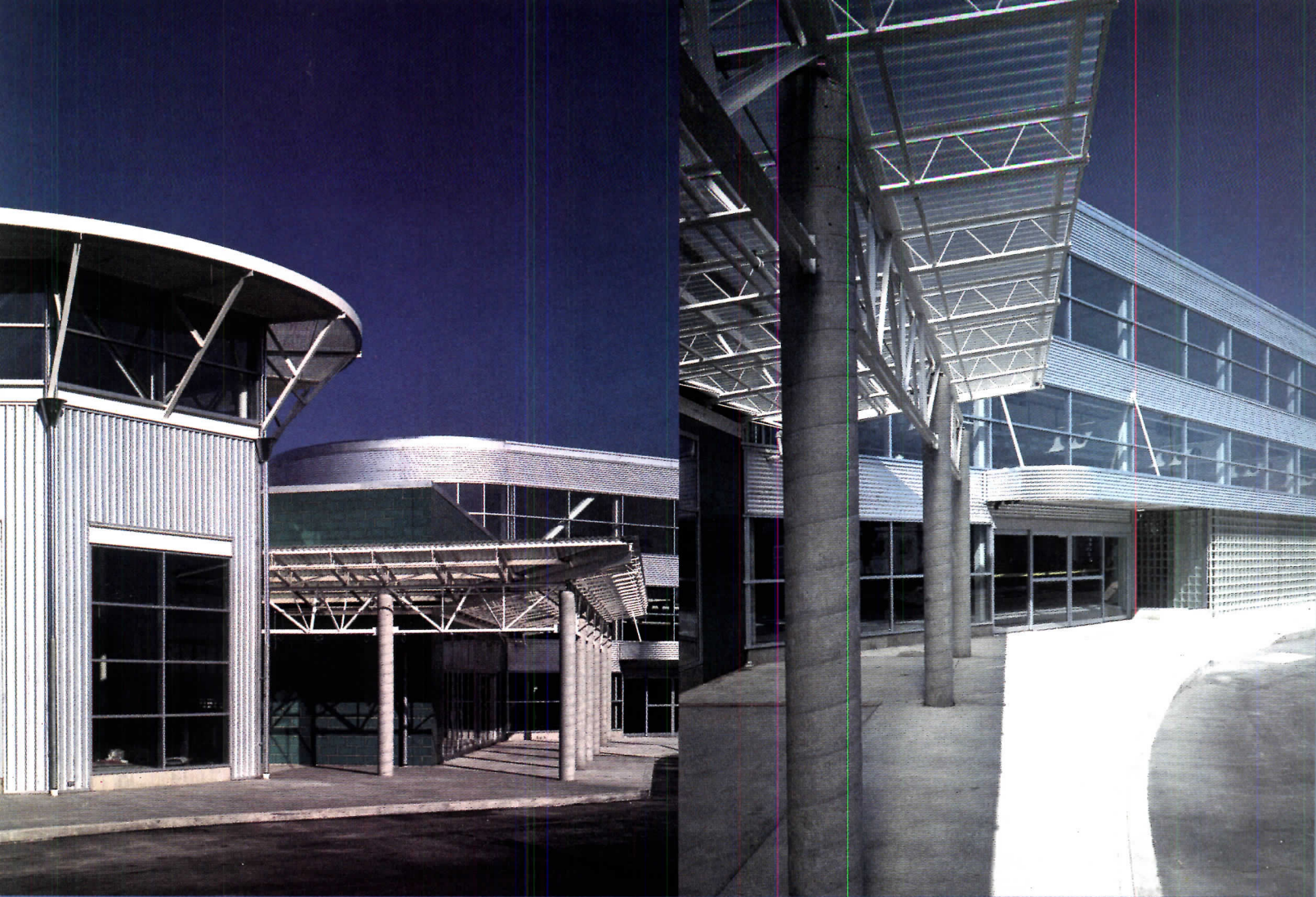

The new Larry's in Bellevue includes an octagonal cafe (above left and below) and a glass-block wall (above right). Fiberglass canopies shield the entrance (this page). A balcony connects offices and a cooking school (sections), and steel beams create simple patterns (photo, facing page).

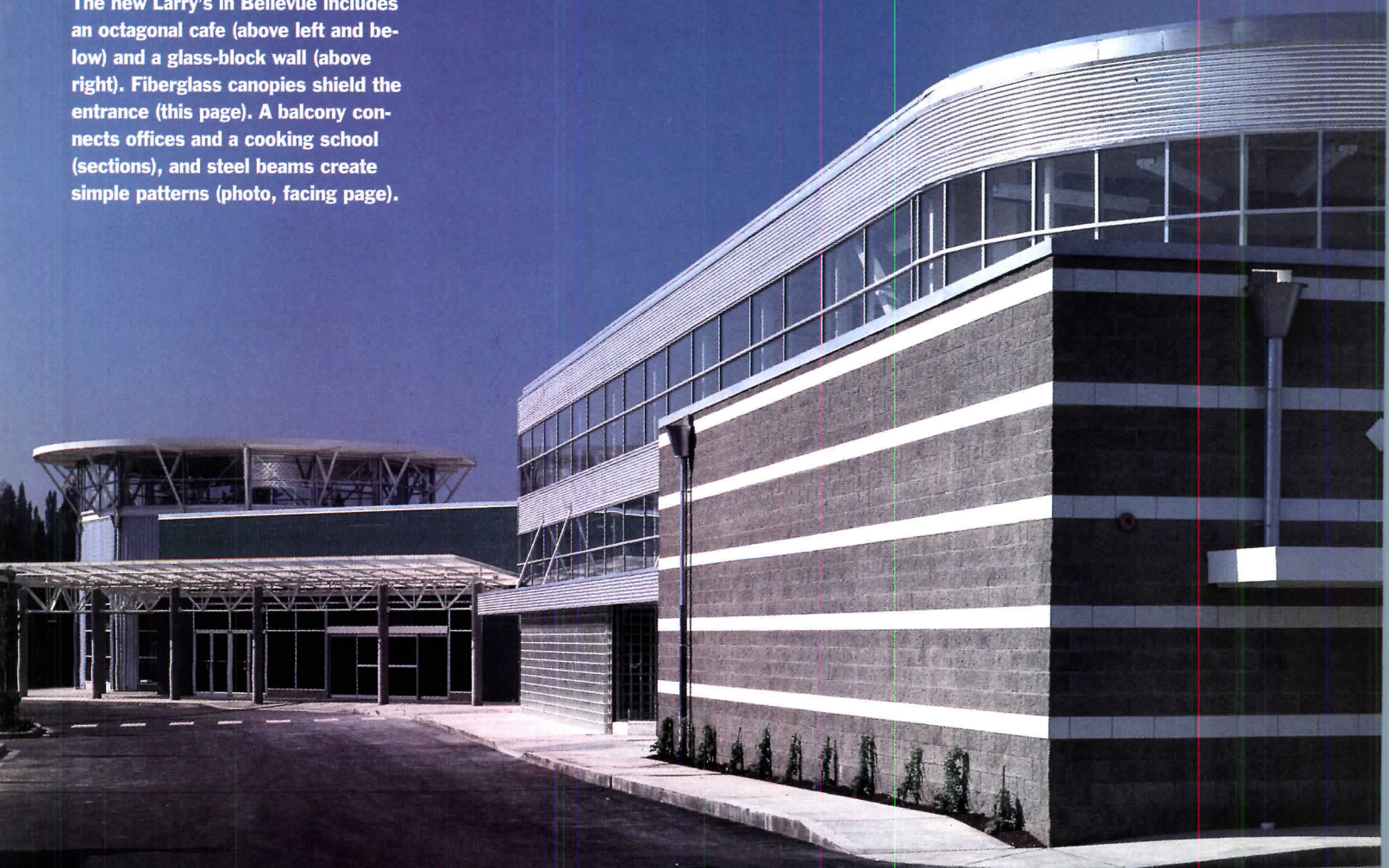

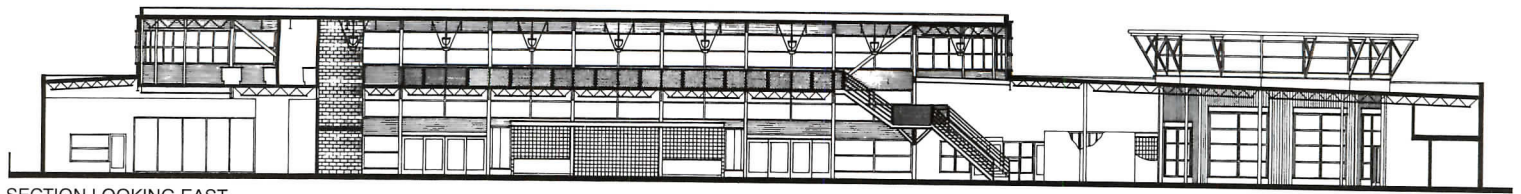

SECTION LOOKING EAST

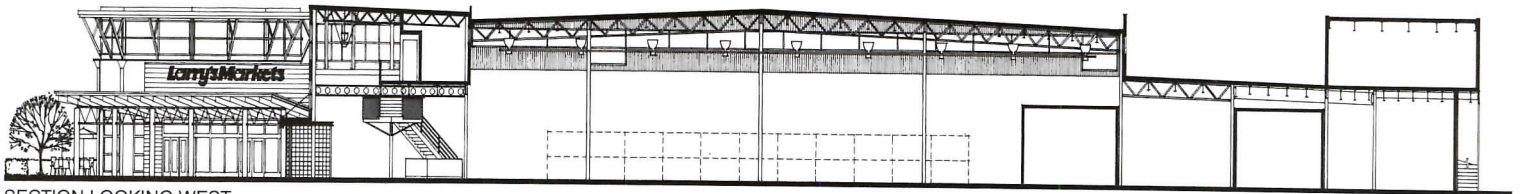

SECTION LOOKING WEST

erne details are a bit of a cliché, and Carlson admits that he prefers the Kirkland market's more up-to-date, honest forms. However, the architects had their way inside the newest store, where castellated wide-flange beams and simple galvanized steel ducts create their own modest patterns.

Seattle, with its bounty from the sea and its international influence, is a city that prides itself on cuisine; the community may well support more espresso bars per capita than, for instance, Bologna. By offering such culinary delicacies along the strip, Larry's Market has brought these food traditions out of the inner city and into the heart of America. For the three newest stores, the architects were thus faced with creating buildings to meld cultures, by introducing sashimi and caffè latte to turnpike shoppers more accustomed to the fare of Denny's and McDonalds.

If retail success is a measure of the achievements of architecture, Carlson/Ferrin has done a remarkable job: Larry's Markets are immensely popular, and the architects are currently designing a new building to house the original store. Other supermarkets have begun copying McKinney's food-oriented innovations, and, if Seattle residents are fortunate, Carlson/Ferrin's pure, industrially clad buildings and scrutable, clean lines will likewise be emulated along the strips and suburban malls of this expanding city.

—HEIDI LANDECKER

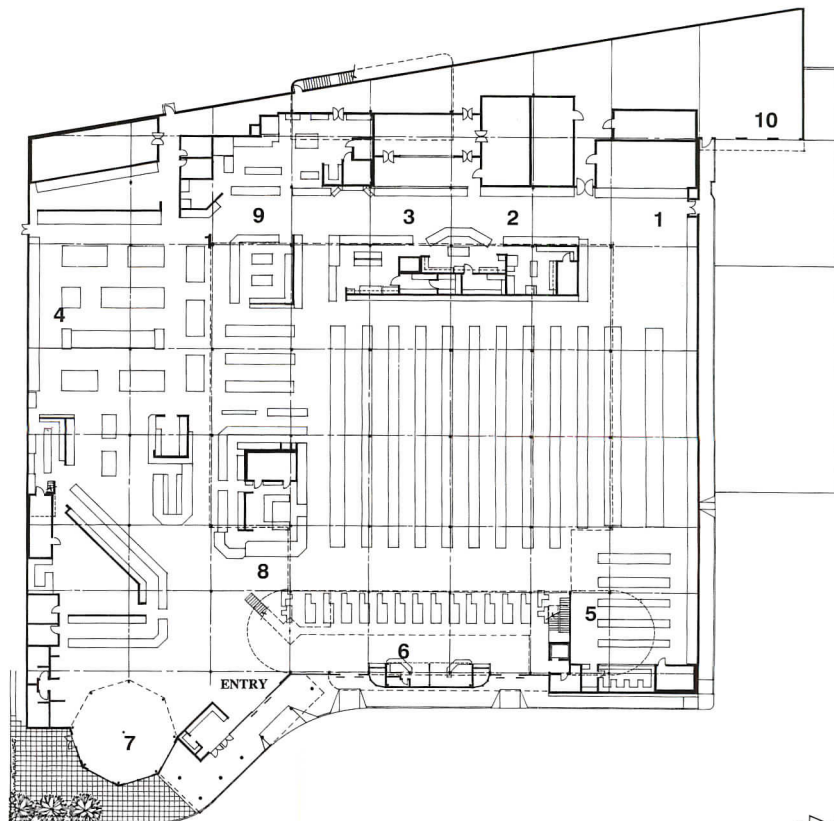

- 1 DAIRY
- 2 MEAT
- 3 FISH
- 4 PRODUCE
- 5 WINE
- 6 CASHIER
- 7 CAFE
- 8 DELI
- 9 BAKERY
- 10 RECEIVING

THE SHOPS AT LARRY'S MARKET  
SEATTLE, WASHINGTON

ARCHITECTS: Carlson/Ferrin Architects, Seattle, Washington—Donald E. Carlson (principal-in-charge); Terre Meinershagen (project architect, market); Tom Morris; Gail Wong (project architect, shops); David Boyd  
CONSULTANTS: Engineers Northwest (structural); Ed Sider and Associates (mechanical); Wieland Lindgren and Associates/AER (electrical); Bush Roed and Hitchings (civil); Bleeker Brumbaugh Associates (landscape); Suzi McKinney Design (interiors)  
CONTRACTOR: R.G. Leary Construction (Larry's Market); Abbott Construction (site and shops)  
PHOTOGRAPHER: Michael Shopenn, except as noted



Fidelity & Guaranty Life Insurance  
Company Headquarters  
Baltimore, Maryland  
Peterson and Brickbauer  
Emery Roth & Sons, Architects

# Essential Baroque

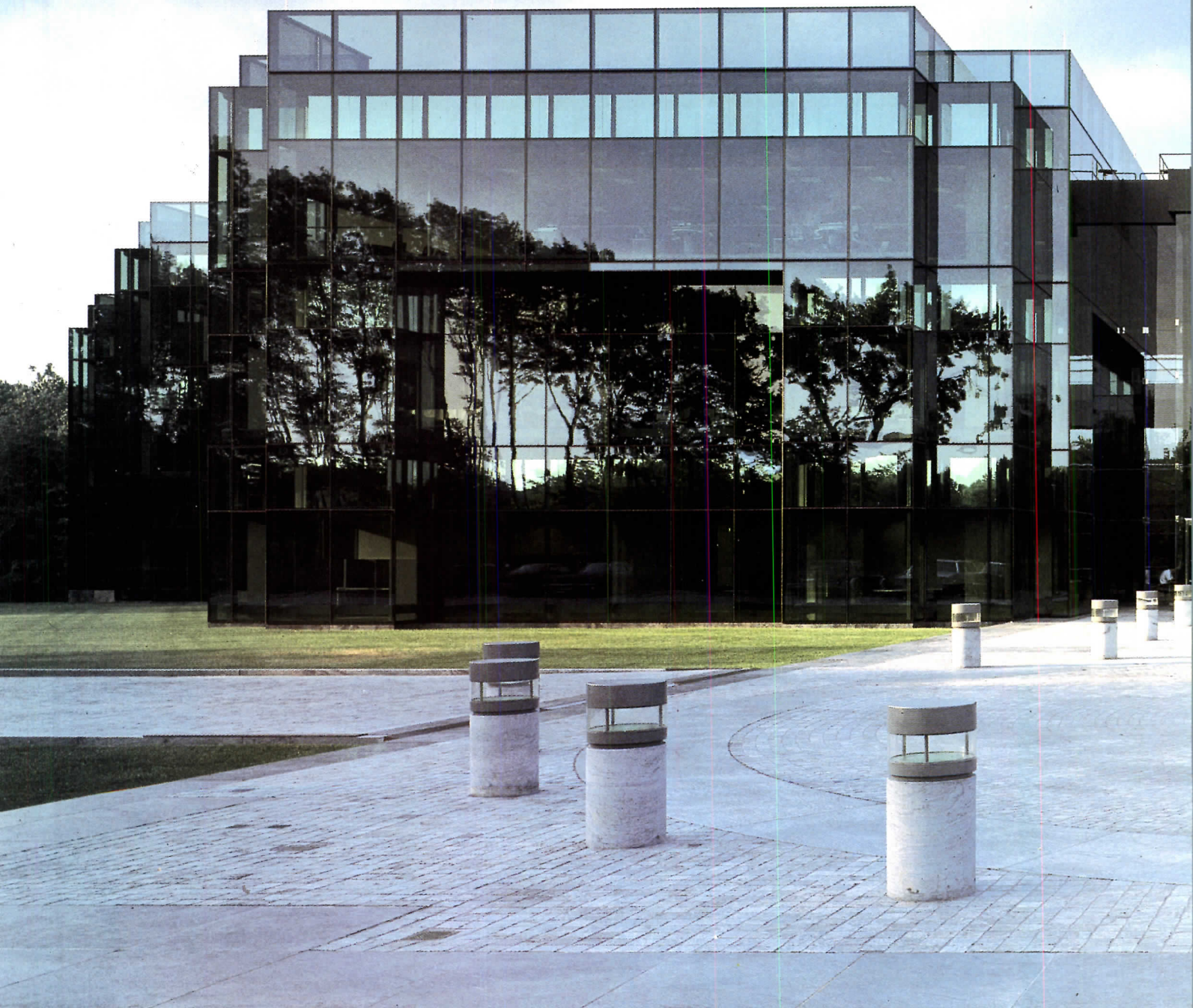





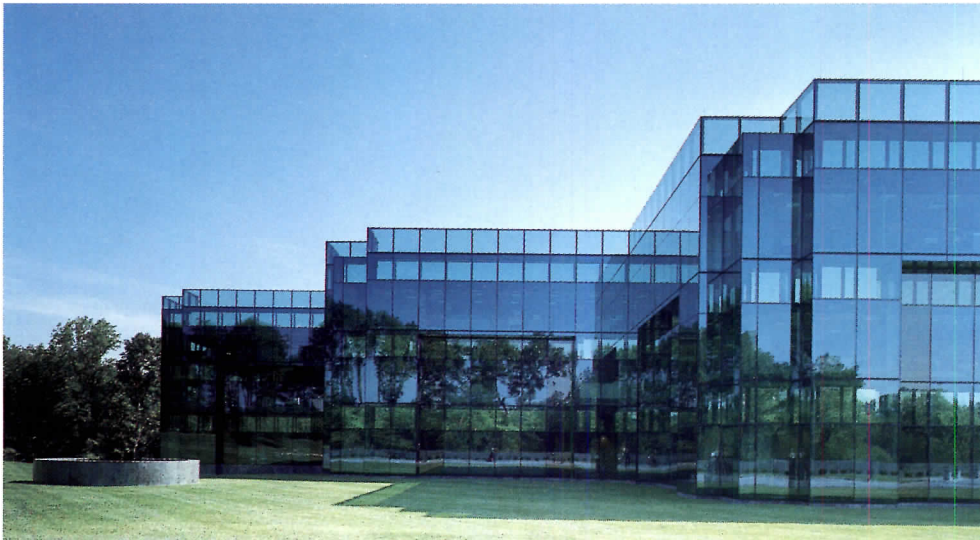
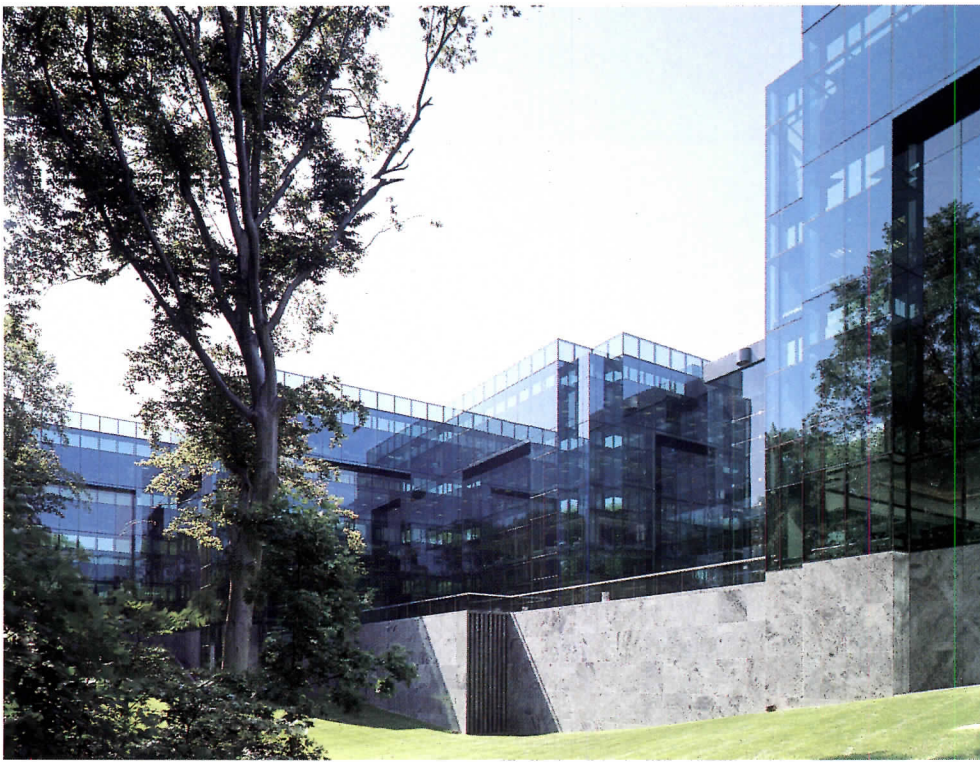

**Straddling a ravine (top), Fidelity & Guaranty Life was conceived according to Charles Brickbauer as “an exercise in transparencies and color.” At different times of the day, its**

**sculptural surfaces may be reflective, mirroring the wooded surroundings (center and facing page), or transparent, allowing views of the offices inside (above).**

THE ALL-GLASS BUILDING HAS TANTALIZED architects since the 1920s, when Ludwig Mies van der Rohe unveiled plans for two crystalline skyscrapers in Berlin. Construction technology had not yet advanced enough for either of them to be built, and decades passed before any of Mies’s glass and steel towers became a reality.

An architect who worked briefly with Mies in the 1950s, Charles Brickbauer of the Baltimore firm Peterson and Brickbauer, has recently designed a glass-clad office building that is on the threshold of current advances in glass technology, just as Mies’s early towers were advanced in their day.

Shimmering in the woods eight miles north of downtown Baltimore, the Fidelity & Guaranty Life Insurance Company Headquarters is enclosed by an all-glass skin without metal mullions or other visible means of fastening the glazed panels to the building frame. A new structural glazing system freed the designers to employ expanses of apparently uninterrupted glass. Structural adhesives allow the glazing to be affixed from the inside, and joints are minimized to the limits of construction tolerances.

But there is far more to this faceted gem than its glistening technological achievements. The Baltimore insurance headquarters represents an effort to reinvigorate Modernism by infusing it with historic nuances unknown in most glass-clad office buildings today. Brickbauer worked with Mies and associate Philip Johnson on the Seagram Building before moving to Baltimore and joining forces with Warren Peterson in 1963. And though Miesian ideas serve as a starting point for Fidelity and Guaranty Life, the design is founded on a combination of contemporary technology and historical forms that Brickbauer calls “essential Baroque.” Brickbauer says he wanted to go further than Mies and create a highly sculptural glass building, shaped as though made of stone but clad in nothing but glass. The architect also sought to overcome what he views as a deficiency of Mies’s designs—their sterility. “I always felt that Mies’s buildings were stillborn, static. The orderliness was wonderful, but they didn’t lead to anything else. They were ends in themselves.” By exploring the color, transparency, and three-dimensional possibilities of glass, Brickbauer’s firm, in collaboration with Emery Roth & Sons, elevated the much-derided suburban glass box and made it worthy of renewed attention.

With three-and-a-half levels of office space, the 615,500-square-foot building straddles a deep ravine on the Mt. Washington Center campus of U.S. Fidelity & Guaranty Corporation, parent company of Fidelity & Guaranty Life. A 600-car, two-and-a-half-story garage, clad in Brazilian granite, serves as the building’s base. The spaces above are





divided into two buildings joined by a four-story atrium. Offices are arranged in a rectangular grid, with 60-by-60-foot bays spaced in an irregular configuration that follows the sloping terrain. The module is further broken down both in plan and in section into a series of mathematically related squares, double squares, and rectangles, based on traditional harmonic proportioning systems. The face of each office bay is sculpted with a rectangular arch in both glass and granite. The architects also shifted the buildings slightly out of alignment, creating a dynamic relationship between the paired structures.

From the terrace up, the building is clad in green-tinted transparent glass that is layered to create a variety of shadings and patterns. The curtain wall is constructed of one-inch-thick insulation units composed of two 1/4-inch-thick sheets of tinted glass with a non-reflective, low-emissivity, and high-transmittance coating, spaced one-half inch apart. A darker shade is applied inside the facades' arches to set them in greater relief, while a clear suspended glass system encloses the entrance atrium. In order to maintain the continuity of transparency, spandrels are deeply recessed and faced with mirrored glass behind the glass curtain wall.

In addition to establishing a dialogue between the landscape and people inside, Brickbauer's design is rich with allusions to specific architectural precedents. Inside the atrium, the main stairway draws on the proportions of the stair fronting John Russell Pope's National Gallery of Art in Washington. Another staircase, positioned to the west of the building that leads to the garage, is an homage to Louis Kahn's triangular stair-within-a-cylinder in the art gallery at Yale University, where Brickbauer studied architecture. Rectangular arches define the scale of the facades and add a sense of Beaux-Arts formality, evoking the work of the French-born architect Paul Phillipe Cret.

Unlike Mies, who kept his buildings as spare and simple as possible, Brickbauer has intentionally interjected his Modernist composition with sculptural richness and architectural references. He says the process is similar to that employed by 17th- and 18th-century architects, who aspired to the ideal of fusing the arts. In the case of Fidelity & Guaranty Life, however, technology is treated as one of the arts. "We are not borrowing elements from the past and using them ornamentally," says Brickbauer. "The ornament is intrinsic in concept rather than applied. The geometry, the forms, the richness—all spring from precedent. There's really nothing new here." ■

—EDWARD GUNTS

*Edward Gunts is the architecture critic of The Baltimore Sun.*

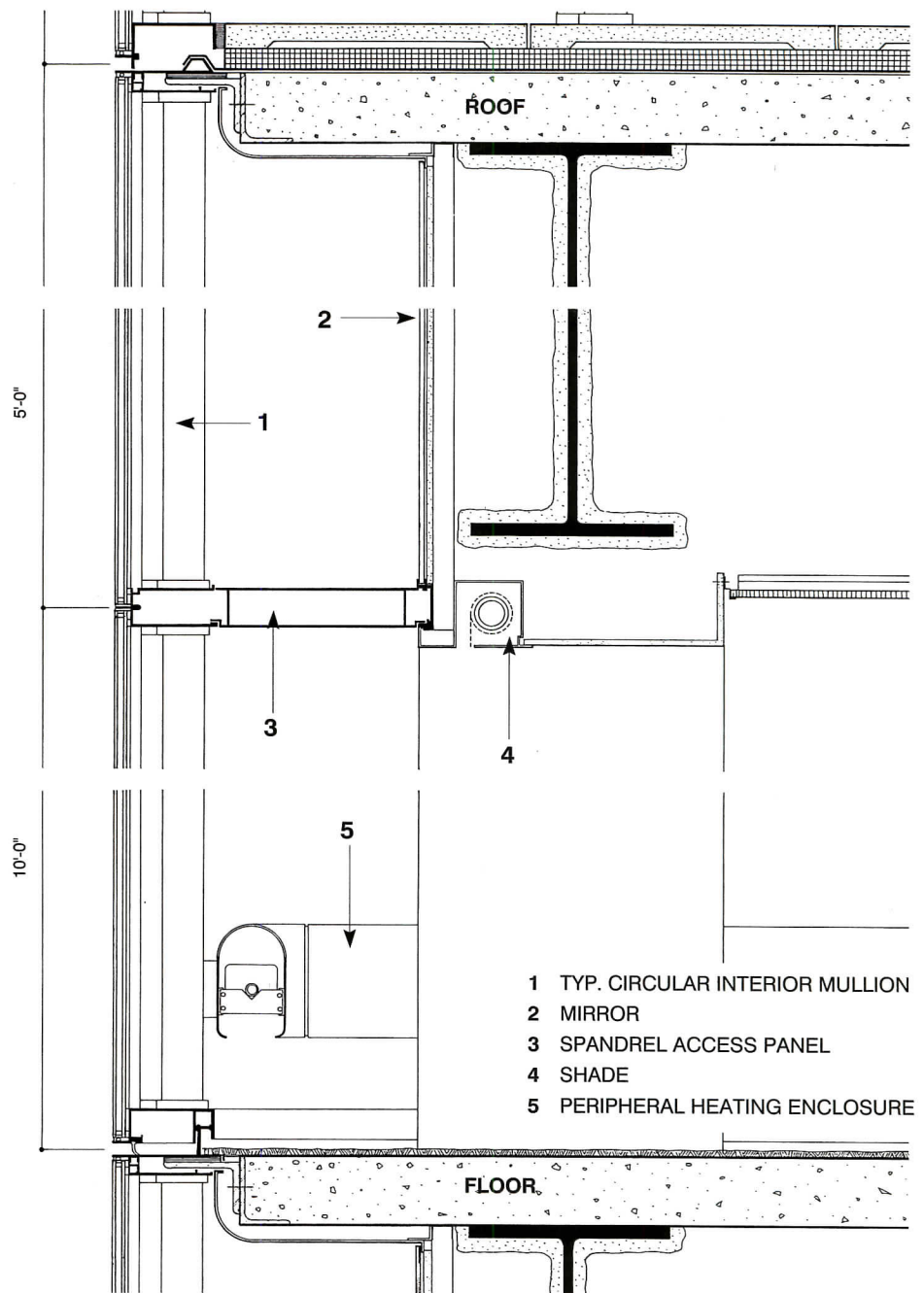

WALL SECTION

**Transparent parapets and precise detailing create a building that appears monumental yet evanescent. In section (above), spandrels are deeply recessed and faced with mirrored glass to maintain continuity of transparency. A 24-inch air space between mirrored and transparent glass allows interior surfaces to be cleaned. Glazed panels are cantilevered vertically to create a transparent parapet (left) and rest on a stainless steel base (below). The atrium (facing page) is clad in a suspended system of clear glass without frames or mullions.**

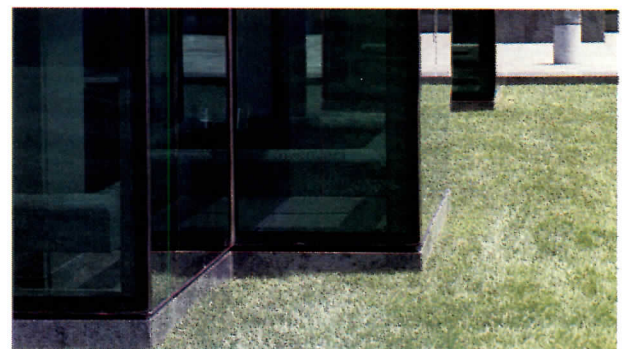

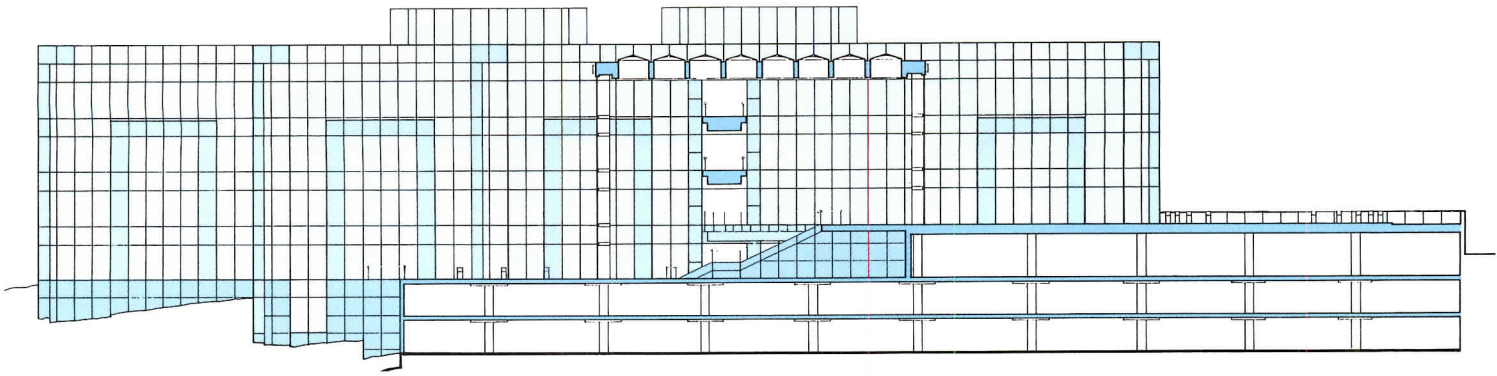

CROSS SECTION THROUGH ATRIUM

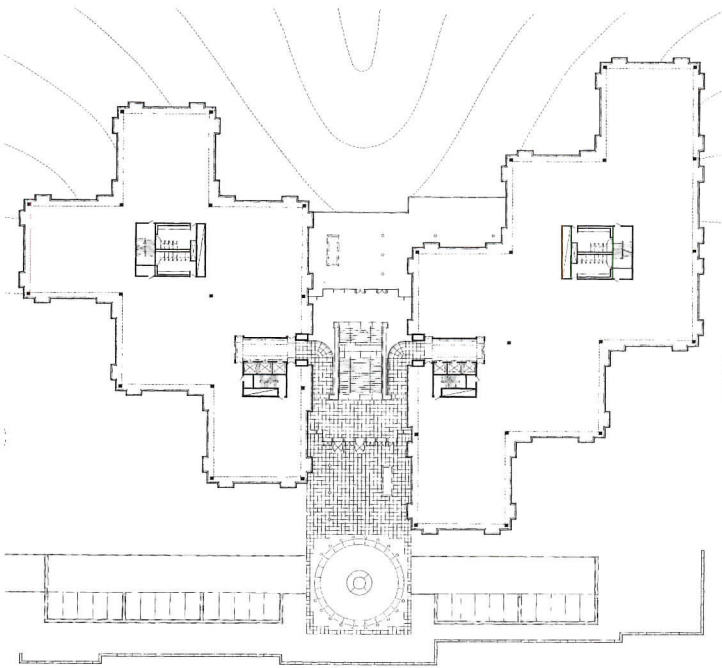

FIRST FLOOR PLAN - ENTRANCE LEVEL

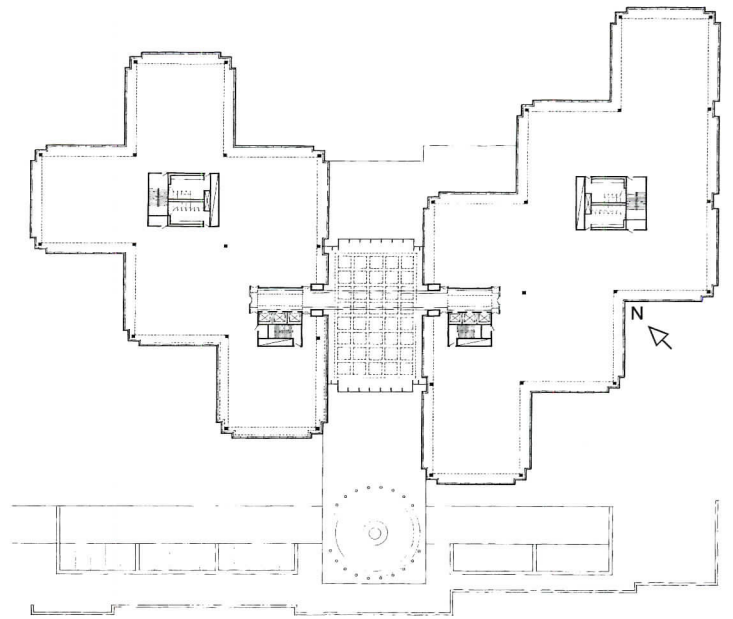

THIRD FLOOR PLAN



FIDELITY & GUARANTY LIFE INSURANCE  
COMPANY HEADQUARTERS  
BALTIMORE, MARYLAND

ARCHITECTS: Peterson and Brickbauer, Inc., Baltimore, Maryland—Charles Brickbauer (partner-in-charge of design); Robert Wong, Hugh P. McCormick, III (project managers); Emery Roth & Sons, P.C., New York, New York—Richard Roth, Jr. (partner-in-charge of administration); John Secreti (project manager)  
INTERIOR DESIGN: ISD, Inc., New York, New York—John Lijewski



(officer-in-charge); Richard Kaling (project manager); Elizabeth Doland (project designer)

LANDSCAPE ARCHITECTS: Daft, McCune, Walker; Sasaki Associates  
ENGINEERS: Thornton-Tomasetti (structural); Syska and Hennessy (mechanical/electrical)  
LIGHTING CONSULTANT: Jules Fisher & Paul Marantz, Inc.  
ARCHITECTURAL GRAPHICS: Jane Davis Doggett  
OWNER'S REPRESENTATIVE: Yetter and Associates  
CONSTRUCTION MANAGEMENT: The Whiting-Turner Contracting Co.  
PHOTOGRAPHER: Peter Aaron / Esto



From inside the building, including employees' cafeteria (facing page, left) and atrium (this page), the glass exterior and wooded surroundings are visible. Typical office floors (facing page, right) comprise an open plan, with circulation relegated to the perimeter, permitting views of the landscape.

**Southern Progress Corporation**  
**Birmingham, Alabama**  
**Jova/Daniels/Busby & Kidd/Plosser/Sprague, Architects**

# Into the Woods

"FOR OVER A CENTURY OUR COMPANY HAS advocated responsible and enlightened use of the land," says Southern Progress President Don Logan. "We wanted a new headquarters that blends with the landscape, not destroys it." Logan's philosophy is reflected in the company's new headquarters, a pristine glass box anchored to the landscape by a base of local sandstone.

The new headquarters was driven by the desire to consolidate staff into a single new facility. As the largest publisher of books and magazines for and about the South, the company's rapid growth in the past two decades had forced many departments to locate outside of their existing facility, a beloved 46,000-square-foot building designed by Jova/Busby/Daniels of Atlanta in the early 1970s. Reminiscent of Eero Saarinen's John Deere facility, the older headquarters, with its lacy exterior of Cor-Ten steel, sunshades, and brown glass, had become a local architectural landmark. "It was our benchmark," recalls Gray Plosser, whose Birmingham firm, Kidd/Plosser/Sprague teamed up with Jova/Busby/Daniels for the new facility. "The challenge was to design a building more than

three times as large that retains the sensitivity and intimacy of the original Southern Progress headquarters."

Located on a heavily wooded, 27-acre site, the new 150,000-square-foot headquarters appears to grow out of a foundation of native Alabama fieldstone. The structure bridges a 35-foot-deep ravine to create a dramatic lobby, which appears to float in the treetops, and contains a monumental staircase legible both inside and out. Rising from the lobby to the fourth floor, the stairway follows the stepped pattern of the rustic stone podium as it ascends the contour of the landscape.

Supported by a poured-in-place concrete frame, the structure is expressed like a skeleton—exposed inside and outside where the building is carved out from its basic rectangular form. A recessed curtain wall of clear glass articulates the public spaces while the bulk of the building is clad in a dark bronze, reflective glass curtain wall, with its horizontal extrusions accentuated by a matte finish to define the upper office floors.

Sheltered by a canopy of trees, this self-effacing, suburban office building is barely visible from the main road. A driveway lined

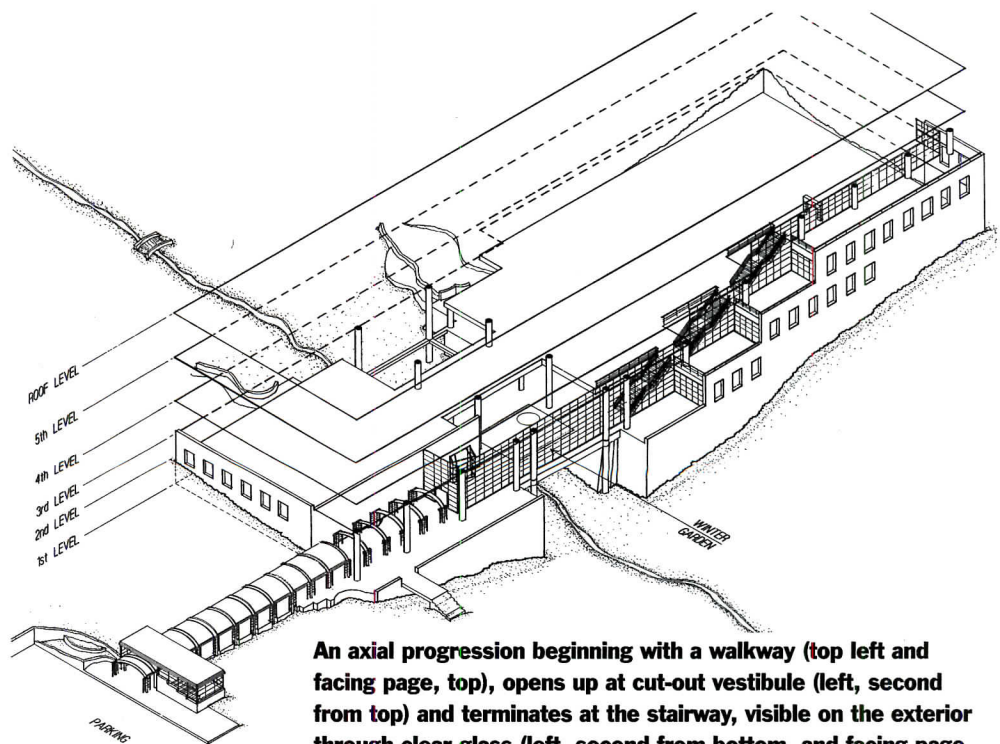

An axial progression beginning with a walkway (top left and facing page, top), opens up at cut-out vestibule (left, second from top) and terminates at the stairway, visible on the exterior through clear glass (left, second from bottom, and facing page, bottom). The north elevation is less articulated (left, bottom).







with the same sandstone of the building winds along the perimeter of the site to a tiered parking structure discreetly tucked in the landscape southwest of the building. "Although our first inclination was to bring cars right up the ravine to give visitors dramatic vistas of the building, the client specifically requested that cars were to be kept as inconspicuous as possible," says Henri Jova.

The formal procession to the headquarters really begins after leaving the car. A rectangular stone-clad headhouse at the terminus of parking structure leads to a steel-framed canopy that is slowly being covered with vines. The walkway extends under an overscaled, cut-out corner of the building, as a transitional zone between the exterior and the main lobby, a 3,000-square-foot atrium set atop the axis of the ravine.

In addition to office space for the company's magazines, which include *Southern Living*, *Southern Accents*, and *Progressive Farmer*, the headquarters houses a 100-seat auditorium, a library, staff lounge, photography studios and labs, and 13 individual, residential-scaled kitchens for testing recipes published in their books and magazines. The architect inserted a series of stepped terraces along both the north and south facades as the building climbs the ridge. These exterior "rooms" are used as conference areas, lunch spots, and spaces for testing outdoor cooking.

In accordance with the company's emphasis on environmental conservation, the sandstone base was built by hand and the glass curtain-wall system was installed from the interior of the building to reduce the impact of construction on the surrounding wildlife. ■

—LYNN NESMITH

**The lobby, with its double-height volume and clear glazing, functions like a winter garden (facing page, top and bottom). As part of Southern Progress's arts program, a site-specific sculpture by Doug McLean enlivens the 3,000-square-foot space (facing page, top). The fieldstone base continues into the lobby with a projecting glass storefront that interrupts the wall just off the main entrance (right) to allow views into a bookstore. Balconies and a bridge allow the lobby to be used for spontaneous meetings as well as formal staff gatherings (facing page, bottom). The monumental stairway, which features oversized landings at each floor, rises along the southern elevation's clear glass wall (below, right). The first floor is cut away with the structure exposed as the building spans the ravine (plan).**

SOUTHERN PROGRESS CORPORATION  
BIRMINGHAM, ALABAMA

ARCHITECT: Jova/Daniels/Busby & Kidd/Plosser/Sprague (joint venture), Atlanta, Georgia, and Birmingham, Alabama—Gray Plosser and Henri Jova (principals); Rick Davidson and Mack Cunningham (project management); Richard Allen, Rob Montgomery, Doug Kleppin (building design/production); Karen League (interiors principal); Mike Rice and Linda Rathje (interior design and production)

LANDSCAPE ARCHITECT: Robert E. Marvin & Associates

ENGINEERS: Lane Bishop York Delahay, Inc. (structural); B & A Consulting (mechanical and electrical); Walter Schoel Engineering Co. (civil)

CONTRACTOR: Brice Building Company, Inc.

PHOTOGRAPHER: Timothy Hursley / The Arkansas Office

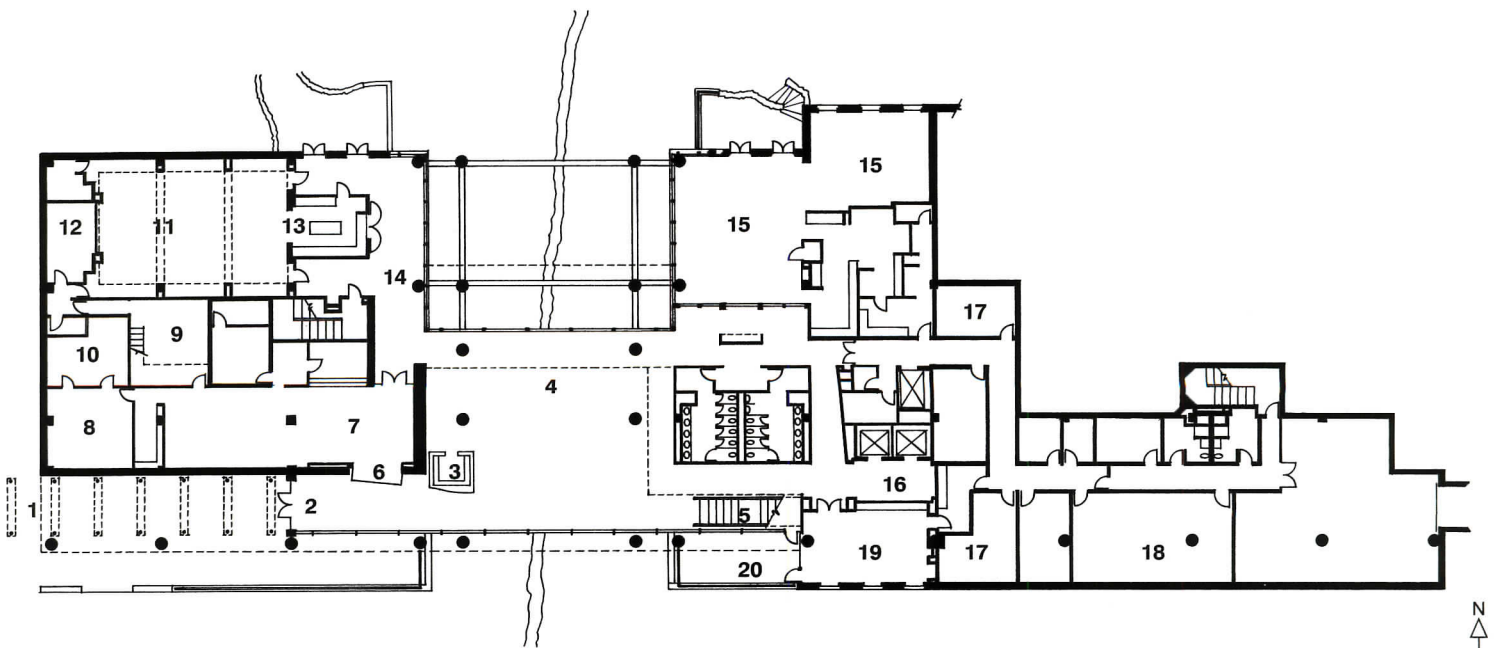

- |                  |                   |                 |                     |               |
|------------------|-------------------|-----------------|---------------------|---------------|
| 1 WALKWAY        | 5 GRAND STAIRWAY  | 9 PHOTO LAB     | 13 CATERING KITCHEN | 17 MECHANICAL |
| 2 ENTRY          | 6 DISPLAY AREA    | 10 ARCHIVES     | 14 PRE-FUNCTION     | 18 STORAGE    |
| 3 RECEPTION DESK | 7 CENTRAL LIBRARY | 11 MULTIPURPOSE | 15 STAFF LOUNGE     | 19 DINING     |
| 4 WINTER GARDEN  | 8 PHOTO / FILES   | 12 PROJECTION   | 16 ELEVATOR LOBBY   | 20 TERRACE    |

Thiele Kaolin Headquarters  
Sandersville, Georgia  
Lord Aeck & Sargent, Architects

# Industrial Complex



THIELE KAOLIN IS A VAST 35-ACRE INDUSTRIAL complex that processes kaolin, a white chalky clay used in coated paper, ceramics, pharmaceutical products, and plastics. Located on the outskirts of rural Sandersville, Georgia, the factory is one of several kaolin processing plants in the center of the state, where a large and pure deposit of kaolin is located. Approximately 60 percent of the world's supply of the product is mined from a narrow strip of land known as the Tuscaloosa Fall Line, which cuts across Georgia about 100 miles south and east of Atlanta. Referred to as "white gold" by the locals, kaolin has transformed the area's main economic base from agriculture to industry.

The company's administrative functions were previously housed in three simple, one-story brick buildings constructed over the

past 35 years. When the growing company previously required more space, the owners hired an architect to design another brick building similar to their original 4,000-square-foot headquarters.

But in 1986, Thiele Kaolin took a different direction. Although the client didn't deliberately search out a high profile designer, the company ultimately commissioned Lord Aeck & Sargent, a progressive Atlanta firm whose Delta Training Center in Salt Lake City and AIA honor-award-winning Trinity School in Atlanta reveal a knack for innovative architecture despite budgetary constraints. When the program grew from 4,000 square feet to 13,000 square feet, and finally to 23,000 square feet, the manufacturer realized this building could create a whole new corporate identity.

Rather than literally translating surroundings into high-tech imagery, Lord Aeck & Sargent designed the new headquarters as a highly articulated box enlivened with a trio of bold geometric forms, which subtly reiterate the company's brawny manufacturing structures. As Terry Sargent recalls, "we were immediately taken by the overwhelming scale of Thiele's manufacturing complex. During our early discussions, the client agreed that this context should be reflected in their new building." While the Thiele officials took this to mean unpretentious, businesslike offices, the architects designed a building whose actual forms and materials mirrored the manufacturer's massive storage structures and processing components. "Our first scheme was a 400-foot-long concrete and steel structure with executive offices and

**Seen from the main driveway (right), a glazed pavilion and drum define the headquarter's main entrance. Looming beyond is one of the company's massive processing components (facing page). Fire stairs are located on either end of the building and are flooded with natural light from tall, narrow windows (below). A metal-roofed walkway (left in photograph below) connects the new building to three existing office structures. The headquarters terminates a 35-acre industrial site with railroad access (site plan, bottom right).**

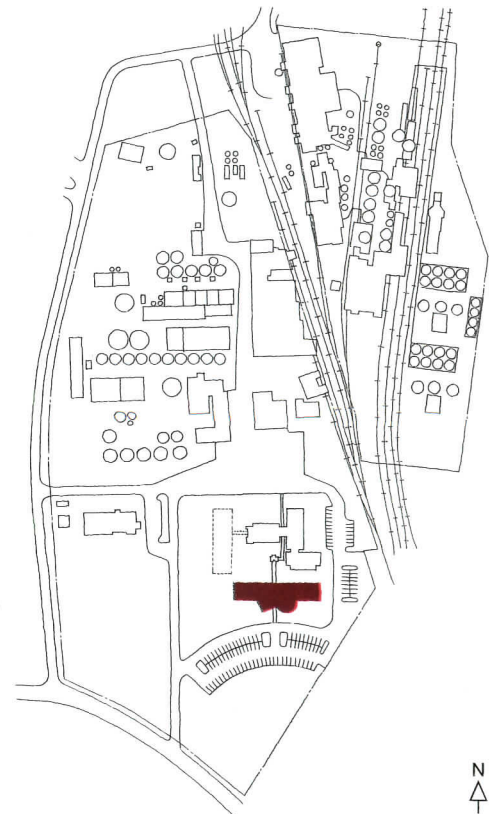

exposed mechanical system stacked on top," says Sargent. "During the presentation, it was obvious our more literal translation of their context was not what the client had in mind. We finally agreed on a brick building."

The Thiele Company got its brick box and a lot more. The new headquarters comprises three simple forms (rectangle, triangle, and cylinder) rendered in three basic materials (brick, precast concrete, and glass). Repeating the brick of the adjacent buildings, the architects enlivened the two-story rectangular structure with square windows, continuous bands of precast sills and lintels, and tiled insets.

Abutting the front elevation of the main structure, the architect placed a one-story, drumlike component housing a conference room. Reversing the material patterning of the main building, the cylindrical form is constructed of precast concrete with bands of brick, and detailed with the same blue tiles and slit windows.

To further relieve the building's boxiness, the entrance foyer and main reception area

are set askew in a triangular, gable-roofed glass structure, which in profile recalls the roof lines of the ubiquitous metal sheds scattered around the site. Rising up through the building is the architect's most direct industrial quotation—a white brick-clad cylinder that houses an elevator.

Thiele Kaolin's new headquarters houses a mix of open and closed spaces. The circular conference room within the precast drum opens onto two smaller meeting rooms to accommodate larger gatherings. An employee lounge is located near the rear entrance to encourage interaction with employees in the company's three existing office buildings.

Combining geometrical complexity with simple materials, Lord Aeck & Sargent imparted character and a bold identity for the new Thiele Kaolin headquarters. Their approach has already proven to be a success—in terms of both function and form—based on the rave reviews of employees, who brag that their new facility is almost as valuable as the company's "white gold." ■

—LYNN NESMITH

## THIELE KAOLIN CORPORATE HEADQUARTERS SANDERSVILLE, GEORGIA

ARCHITECT: Lord Aeck & Sargent, Atlanta, Georgia—Larry Lord, Terrance E. Sargent (principals-in-charge); Jeff Bureson, Laura Kelterborn, Mike LeFevre, Chip Bullock, Jane Seville, Keith Weiland, Doug Cofer, Pamela Crockett, Allen Duncan, Bennett Wiggins, Diane Barfield (design team)

LANDSCAPE ARCHITECT: Lester C. Helm  
ENGINEERS: Case Engineering (structural); Newcomb & Boyd (mechanical and electrical); Tribble & Richardson (civil)

CONSULTANTS: Total Audio Visual Systems  
GENERAL CONTRACTOR: R. W. Allen & Associates

COST: \$1.65 million—\$72/square foot  
PHOTOGRAPHER: Jonathan Hillyer

**A drumlike projection, banded in brick, reverses the material patterning of the main building. It extends inside the lobby and defines the conference room's main entrance (bottom left). Gabled roofs of the entrance lobby counter the cylindrical elevator shaft (facing page). A finely crafted stairway of wood and painted metal rises up through the lobby (bottom right); overhead, a wooden ceiling follows the gabled roof lines. The floor plan illustrates the building's axial circulation and office arrangement.**

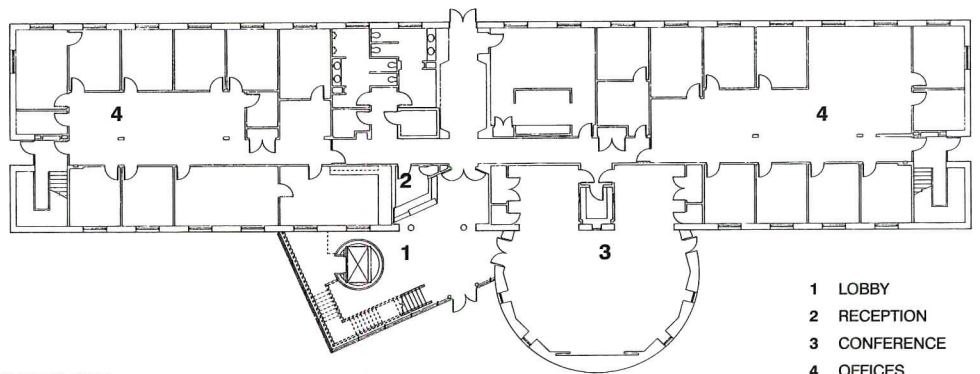

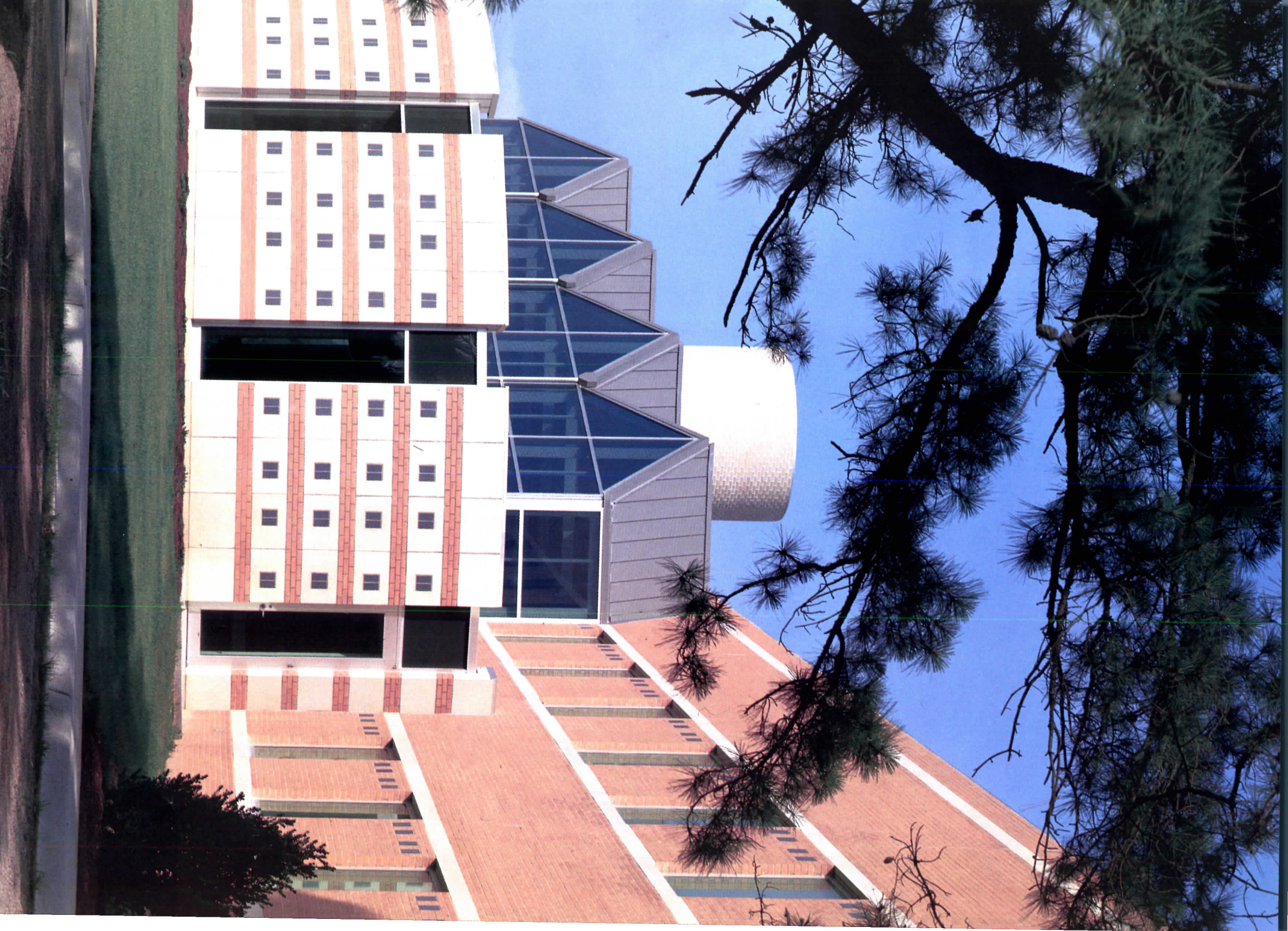

# “Carolyn’s been w

Carolyn and Gordon met in 1977. “I was new and he was new,” she says, “and we sort of grew together.” Perhaps all clients don’t take advantage of Carolyn’s brand of thorough service, but Gordon does. “He’s cautious,” she says. “He tends to call us before he starts a project or gets into certain areas. He might say, ‘We’re thinking about a joint venture with another firm. How will that impact our insurance?’ Then our contract analyst and I work together to give him some advice on short and long-term consequences.”

On the account management side, Carolyn doesn’t just wait for the renewal quote to come in. She’s on the phone with DPIC—dealing with the underwriters, pointing out her clients’ strengths, negotiating for the terms she needs. And she’s persuasive.

“I expect a high quality of service for him—I want to be as professional as Gordon is. He

emphasizes high standards in serving his clients. And we feel the same way.” Carolyn also works hard to keep Gordon H. Chong + Associates informed about the many premium reduction opportunities available from the DPIC program.

Carolyn has a master’s degree in education and began her working life as a teacher. The teacher in her still comes out when she’s conducting a workshop panel on liability issues for one of the Bay Area AIA chapters or a brownbag seminar for one of her clients. “I love to see the light bulb go on in someone’s head,” she says. “The ‘oh, now I know what you’re talking about.’ I think that’s what I like about this job: I’m always teaching and getting close to people who, I think, appreciate what I have to tell them. They all have the same interests—they want to better their practice in a professional way.”

*Gordon Chong is the owner of Gordon H. Chong + Associates, a 45-person architectural practice located in San Francisco, California. He is president of the San Francisco Chapter of the AIA for 1991, and has been a director of the California Council of the AIA and president of Asian American Architects and Engineers.*



*Carolyn Isseks is vice president of Dealey, Renton & Associates, an independent insurance agency based in Oakland, California. She has represented DPIC’s unique insurance program of education and loss prevention services for over thirteen years. She is also a member of the Professional Liability Agents Network (PLAN), a nationwide group that specializes in serving the risk management needs of design professionals.*



**Professional Liability Insurance  
for Design Professionals**



**The Professional Liability Specialist  
of the Orion Capital Companies**

Design Professionals Insurance Company • Security Insurance Company of Hartford • The Connecticut Indemnity Company • Guaranty National Insurance Company • Landmark American Insurance Company

Available through an exclusive network of independent agents. Please call 1 (800) 227-8533 for the agent serving your area.

DPIC Companies, Inc.  
2959 Monterey-Salinas Highway  
Monterey, California 93940



## High Strength

### MATERIALS: STRUCTURAL CONCRETE

*Recently constructed office towers in Chicago and Seattle point to advances in concrete technology.*

**Increasing heights of residential and commercial towers over the last 30 years (below) parallel technological innovations in the strength of concrete.**

SINCE THE 1950s, RESEARCH AND DEVELOPMENT have led to a steady increase in the strength of commercially obtainable concrete. Progressively taller concrete buildings have mirrored the strength gains, but for the last 15 years, Chicago's 869-foot-high Water Tower Place stood as the tallest reinforced concrete building in the world. Columns in the lower stories have compressive strengths up to 9,000 psi, pushing the limits of concrete available when the building was completed in 1975.

Over the last year, two concrete buildings, also located in Chicago, have surpassed Water Tower Place. Two Prudential, a 64-story, 900-foot-tall high rise was first, but it was soon surpassed by the 70-story, 969-foot-tall 311 South Wacker. Both are constructed of concrete with a compressive strength up to

12,000 psi. In Seattle this year, however, a new concrete-strength record was set. The 56-story Two Union Square boasts concrete capable of bearing 19,000 psi, the highest strength concrete ever used in a building.

New records in concrete strength and building height are an indication of an increased use of concrete stronger than the 3,000- to 5,000-psi range of conventional ready-mix concrete. Seattle building code officials, for example, report that small amounts of 8,000- to 10,000-psi concrete are being specified for particular applications in five- to 25-story buildings, where it would not have been considered two years ago. Anticipating the increased interest and demand during the last decade for high-strength concrete in buildings, the American Concrete Institute (ACI) formed a committee on the subject in

### High-Strength Concrete in High-Rise Construction

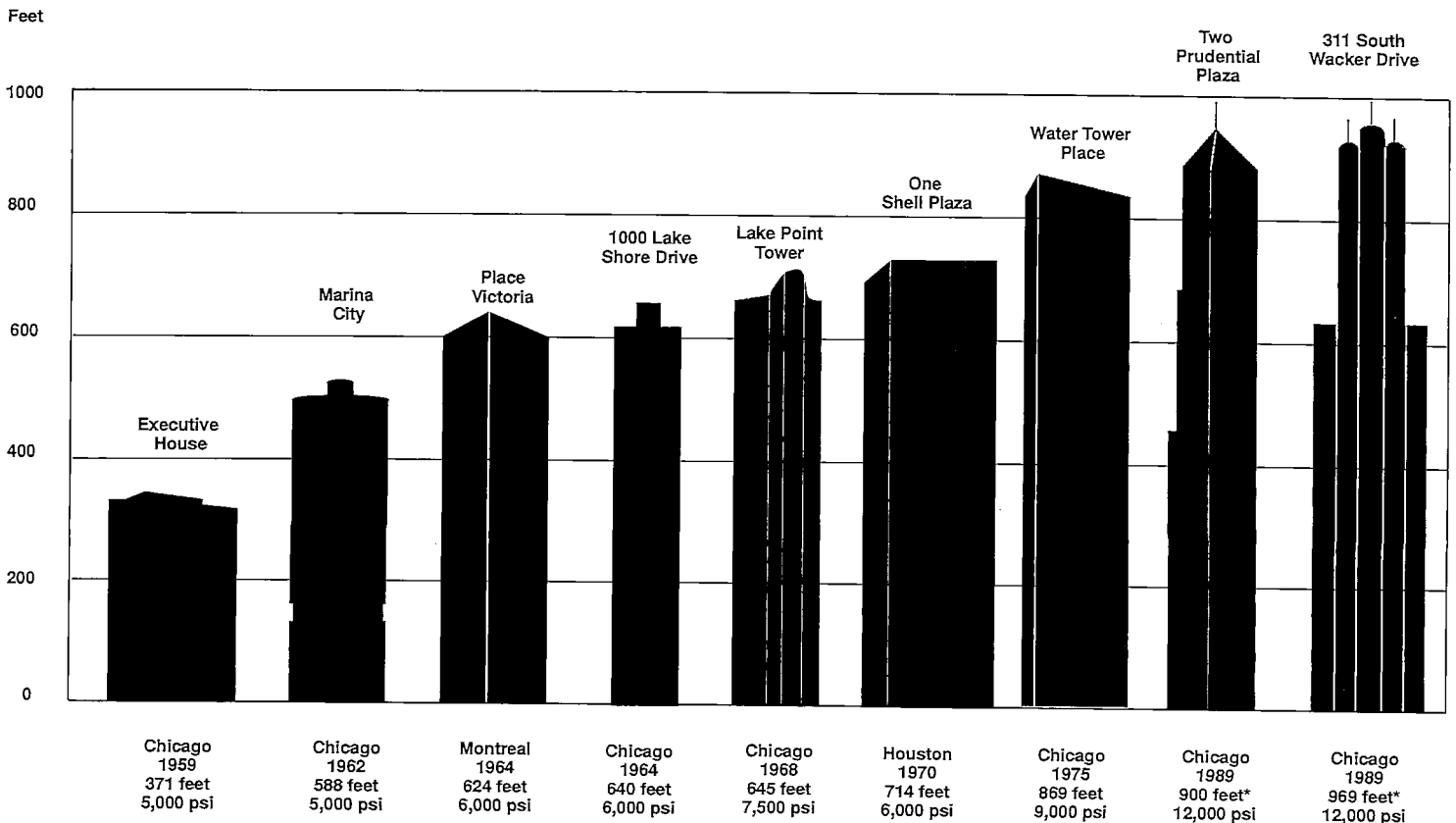

\* Height from street level to top concrete plate

Source: Portland Cement Association

1979. They chose to define high-strength concrete as any normal-weight concrete over 6,000 psi since, at the time, production of concrete strengths above that level was extremely limited.

However, because the development of high-strength concrete requires a stricter selection in the material mix, its definition varies relative to region due to the quality of locally available aggregates. Local manufacturers' experience in producing such concrete is also a determining factor. But regardless of location, decreasing the ratio of water to cement in the mix is essential to gaining strength. The mix proportions of high-strength concrete vary widely, but increasing strength also usually relies on liquid chemical admixtures that compensate for reduced water in the mix and allow denser concrete to remain workable. Conventional water reducers can eliminate up to 10 percent of water content. More recently, high-range water reducers or "superplasticizers" have been added, which can decrease the volume of water by up to 25 percent.

Carefully selected aggregates and a greater volume of portland cement can increase concrete strength to a point, but water reducers are also frequently used in combination with supplementary cementitious materials that can replace from 10 to 40 percent of the portland cement. Compared with standard cement, these materials offer a finer mix consistency, which limits water-filled voids and

increases strength. Fly ash, a coal derivative, produces a slight reduction in water, thus making it a popular substitute admixture. Slag, an iron by-product, is also used. Silica fume, the latest and finest concrete admixture, allows for even denser concrete pastes, and has proven to be an integral part of mix designs achieving greater than 10,000 psi. Silica fume and slag both demand substantial increases in water to form cement, making superplasticizers essential to reduce the additional water required for workability and placement. High-range and conventional water reducers have both been commonly added to the same mix, reducing the rate of slump loss. Retarding the slump loss can allow water reducers to be mixed at the plant before the concrete is transported, assisting in quality control. Otherwise, the very limited time period in which these liquid chemicals react with the cement requires them to be applied at the site to produce easily worked concrete.

Due to the variable quantity and possible combinations of admixture materials to achieve high strengths, several trial batches are often needed to determine optimal mix proportions. Compared with conventional-strength concrete, additional testing for high-strength concrete is also required because of its different strength-gain characteristics. Standard concrete achieves full strength at 28 days, while high-strength concrete exhibits high-strength gains in the first several days, and often continues to gain considerable

strength for 56 and up to 90 days. In office towers, where high-strength concrete is most commonly used, the final strengths are not needed until later, since full loading will not occur until the structural frame is completed. Early testing in the first week is conducted to predict final strengths, which proves beneficial for detecting deficiencies before the 56- or 90-day tests determine its full strength.

High-strength concrete has been primarily specified for interior structural members, especially to reduce the size of lower-story columns, increasing available floor area and design flexibility for interiors. By varying concrete strengths, uniform column dimensions throughout a building can be maintained. Smaller concrete members also diminish dead loads, allowing for longer spans and reduced overall structural frames. Greater compressive strength, however, does not fully describe the properties of high-strength concrete.

Concrete's modulus of elasticity rises in direct proportion to increased compressive strength, improving stiffness and resistance to bending stresses. Bracing against wind loads is a critical factor in structural design of tall buildings, and much of the structural members' size is determined by the need for rigidity. The improved stiffness of high-strength concrete compared to lower strengths limits differential shortening in columns and shear walls, which causes uneven floors. Compared with conventional concrete, high-



GEORGE LAMBROS



WAYNE CABLE / CABLE STUDIOS

strength concrete exhibits greater durability and improved resistance against spalling from freeze-thaw cycles, chemicals, and abrasion because of its lower permeability due to reduced water content.

Experts in the concrete industry stress the need for stricter monitoring of the testing and production of higher strengths to ensure consistent, high-quality concrete that meets specifications. The technology to produce the highest strength concretes can strain testing laboratories' ability to verify the highest compressive strengths, since much of the equipment predates the need to measure strengths achievable today. To compensate, the 6-inch-diameter by 12-inch-long cylinders typically used to test compressive strength have been scaled down to 4-by-8 inches. Smaller samples, type of cylinder mold used (plastic, cardboard, or steel), curing procedures, and sample capping methods all create variations in measured strengths. The same percentage discrepancies that are negligible in testing normal strengths become magnified with higher strength samples.

For structural design, performance is largely based on data extrapolated from testing on concrete with strengths up to 6,000 psi. To meet ACI code requirements and ensure the adequate transfer of floor loads to columns, high-strength concrete in a floor slab is placed around a column, provided the column strength is 40 percent or greater than the slab strength. This is a common construc-

tion detail of high-strength concrete buildings, since conventional strengths are often specified for floor slabs, while high-strength concrete is usually limited to columns. If structural members are exposed, esthetic concerns arise, since silica fume admixtures create a material that is darker gray in color than normal-strength concrete.

High-strength concrete is still a premium material used for specific needs and is not likely to supplant the use of conventional concrete. The supplementary admixtures and increased need for testing and quality control add considerable cost to high-strength concrete, which is often not warranted. However, the material has proven economically beneficial in tall buildings by substantially increasing the rentable floor area. The increased unit cost is offset by a reduction in the total volume of concrete and the amount of reinforcing steel required. Additionally, the early high strength and stiffness allows for quicker form stripping, thereby reducing construction time.

However, as architects, engineers, and manufacturers become more familiar with the production and properties of the material, specification of high-strength concrete is on the rise for both its economic and design advantages. To illustrate the latest innovations in this growing technology, we feature three buildings on the following pages that have pushed the limits of concrete to new heights.

—MARC S. HARRIMAN

Currently, the tallest concrete buildings are **Two Prudential** (facing page, left) and **311 South Wacker** (facing page, right). **Two Union in Seattle** (bottom left), boasts the highest strength concrete ever applied in a building. Admixtures reduce water content to increase strength (table, bottom). High-strength concrete is usually specified for columns, requiring a high-strength cap in the surrounding slab above (photo and diagram below).

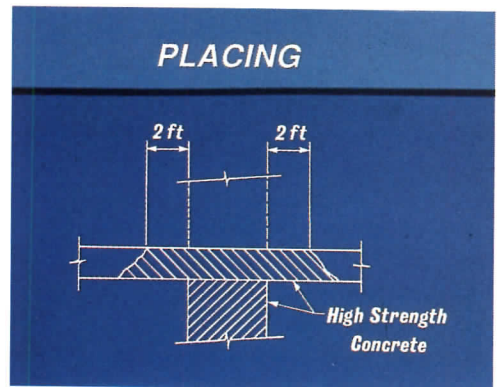

TIMOTHY HURSELEY

## SAMPLE CONCRETE MIX DESIGNS

### Conventional 5,000-psi mix

MATERIAL (lb/yd <sup>3</sup> )	
Type I cement.....	561
Coarse aggregate (1" max).....	1,750
Sand.....	1,416
Water.....	299
ADMIXTURE (fl. oz/yd <sup>3</sup> )	
Accelerator.....	60
WATER/CEMENT RATIO: 0.53	

### High-Strength 14,000-psi mix

MATERIAL (lb/yd <sup>3</sup> )	
Type I Cement.....	800
Silica fume.....	120
Coarse aggregate (3/8" max).....	1,703
Sand.....	1,242
Water.....	266
ADMIXTURES FL. (fl. oz/yd <sup>3</sup> )	
Superplasticizer.....	138
Retarder.....	29
WATER/CEMENT RATIO: 0.29	

STEINKAMP & BALLOGG



STEINKAMP & BALLOGG



**Two Prudential Plaza**  
Chicago, Illinois  
Loebl Schlossman and Hackl

Two Prudential Plaza is a 64-story successor to the existing One Prudential Center, which in the early 1960s was the tallest building in Chicago. Currently, the new office tower represents the second-tallest reinforced concrete building in the world. Stepped vertically and horizontally (below right), the tower's massing includes telescoping projections on the north and south facades that reflect the outline of the walls behind. The forms diminish in width and height as they extend from the center, creating notched building corners (plans at left). The top stories recede diagonally back from the serrated tops of the walls to a central spire (top left). This complex exterior articulation limited structural resistance to bending stresses on the perimeter, where bracing is frequently placed to counter wind loading.

To provide the required rigidity, the Chicago firm Loebl Schlossman and Hackl instead relied on four 12,000-psi-concrete shear walls at the building core, tied to the perimeter columns by perpendicular structural walls on mechanical floors. The floor slabs act as lateral diaphragms on each level to reduce the size of the necessary spandrel beams and columns. The building corners and projections cantilever up to 15 feet beyond girders to limit support columns at the setbacks (top right). According to Joe Colaco of CBM Engineers, the chief structural engineer on the project, the height of concrete buildings with conventional concrete strengths is limited by undesirably large structural columns necessary in the lower stories.

For Two Prudential Plaza, concrete up to 12,000 psi was specified to reduce the size of the columns required to transfer the loads through the first 20 stories, providing support for 1.2 million square feet of office space. From the 21st level to the top floor, the concrete columns and shear walls decrease in strength, from 10,000 psi to 6,000 psi.



WAYNE CABLE / CABLE STUDIOS

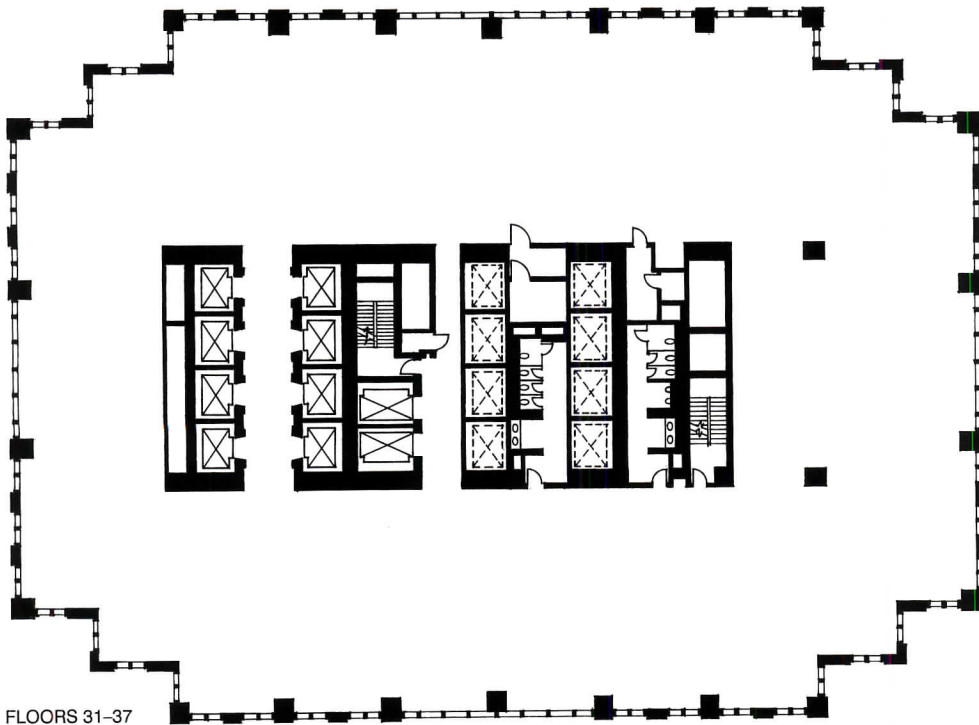

FLOORS 31-37

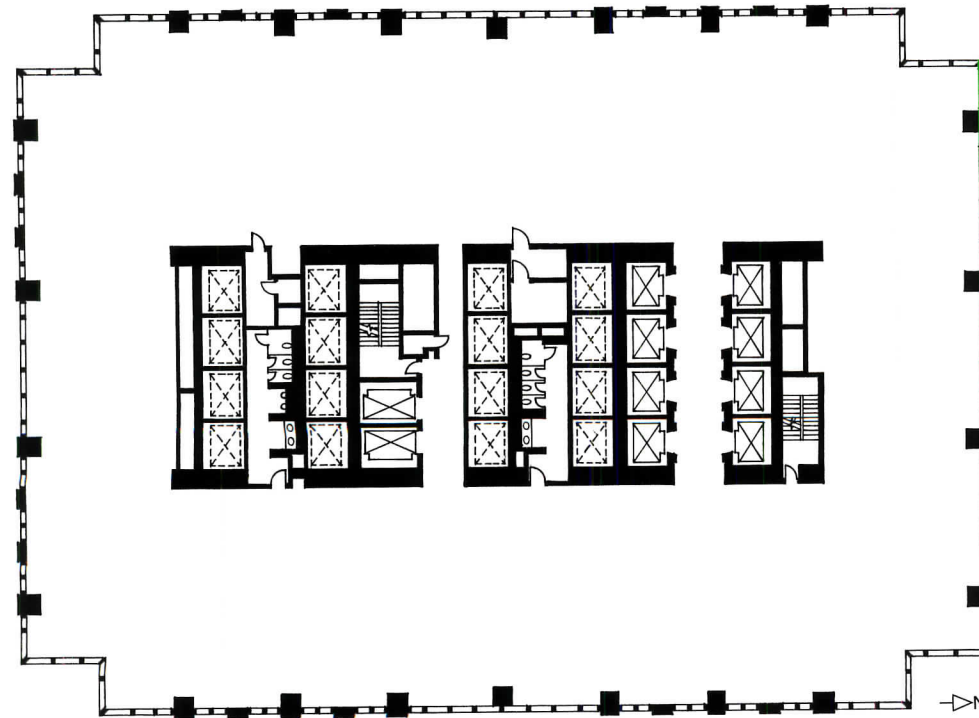

FLOORS 13-16

# THE • OPTIMA • ADVANTAGE



## Quality and performance no one can touch.

Sloan continues its tradition of leadership with the Optima® line of faucets and soap dispensers...

Impeccably crafted, incorporating the latest in solid state technologies, Optima faucets and soap dispensers bring form and function together in the kind of benefits that both accountants and architects love:

- Sensor-operated Optima ensures efficiency—water and energy resources are only used when needed, and the waste cycling of products is eliminated.
- Optima products are designed with both the user and owner in

mind. They respond instantly upon demand, and their modular design greatly reduces maintenance. • They make for a more healthful world. As hands need never touch an Optima product, general environmental hygiene is improved.

Contact your Sloan representative today for more information on why the Optima product line is the hands-down choice among new washroom fixtures. Sloan Valve Company, 10500 Seymour Avenue, Franklin Park, IL 60131.

# SLOAN



Optima faucet with integral base



Optima deck mounted soap dispenser



Optima faucet/soap dispenser with integral base

Circle 55 on information card

**311 South Wacker**  
Chicago, Illinois  
Kohn Pedersen Fox Associates

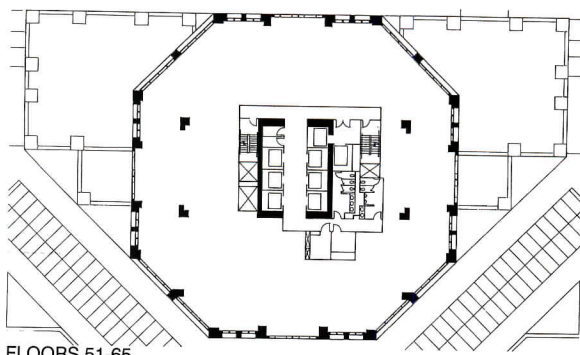

FLOORS 51-65

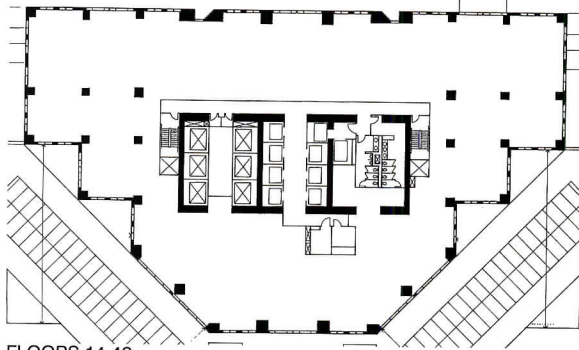

FLOORS 14-46

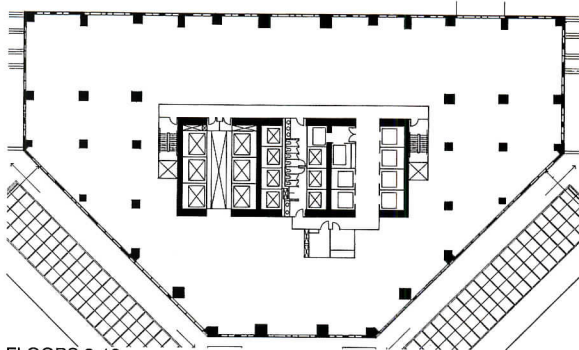

FLOORS 3-13

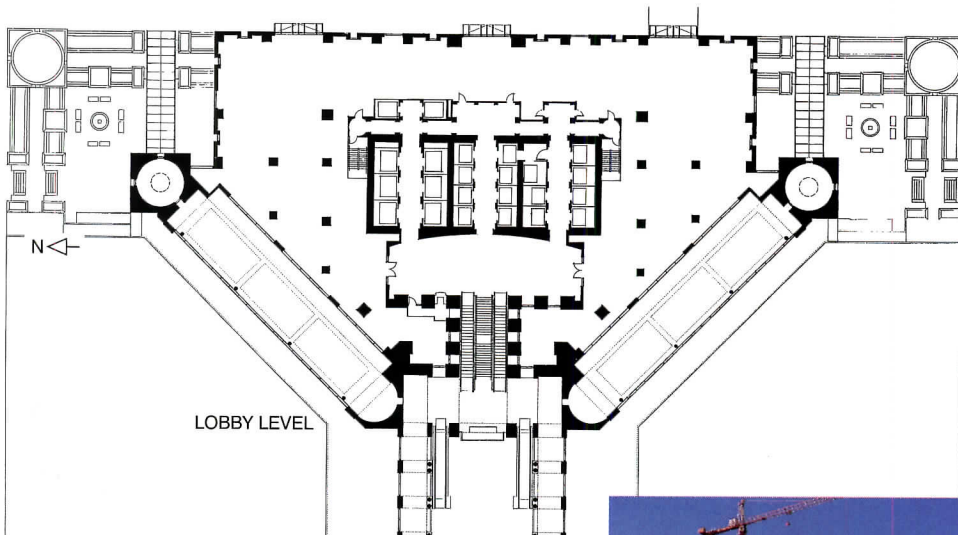

LOBBY LEVEL

On the east facade (far right), columns are placed to divide one side of the octagon from the wider building face below, creating continuous vertical lines through the buildings. Interior columns of various sizes are needed to transfer the loads from the setbacks as the building rises (plans). Column spacing and sizes were structurally achieved through high-strength concrete.



WAYNE CABLE / CABLE STUDIOS

The first phase of a three-tower development in downtown Chicago stands as the tallest concrete building in the world. Designed by Kohn Pedersen Fox Associates' New York office, the 70-story building rises from a 13-story, six-sided base through a series of setbacks at the 14th and 47th floors to an octagonal tower crowned by a five-story, glass-enclosed cylinder. On the east side of the building, a solid wall extends from the street level until the 52nd floor, where it narrows to form one side of the octagon.

The slender horizontal and vertical banding of the facades delineates the granite-clad concrete beam and column framework. According to project architect Rick Del Monte, the exterior fenestration is designed to align through the shifting building forms to create a continuous vertical ladder element. With the facades dictating the spacing and approximate size of the columns, the range available to Brockette Davis Drake engineers for adjusting the column dimensions of the structure was limited. The columns are designed to support approximately equal loading to limit uneven creep and shrinkage, a common problem in tall concrete buildings.

To meet structural and architectural design requirements, concrete strengths range from 6,000 psi on the top floor to 12,000 psi in the lower 13 stories, allowing the columns to stay within the desired dimensions. Concrete shear walls form the building core and are tied to exterior columns and spandrel beams by girders, allowing clear spans up to 48 feet from the core to the perimeter.

Two of the core walls drop away at the 52nd floor, where only the octagon soars upward. As the building rises, the shear walls decrease in strength from 12,000 psi to 8,000 psi. At the 52nd floor, two of these walls drop away entirely, and only the octagon soars upward.



WAYNE CABLE / CABLE STUDIOS

# THE NEW MUTOH F-920AR KEEPS YOUR PLOTTING ON A ROLL, ALL NIGHT LONG.

ft to its own devices, the new Mutoh F-920AR can plot all night long, and have your plot ready first thing in the morning.

Only the F-920AR pen/pencil plotter offers genuine plotter automation, with roll-media feed/take-up and an auto-feed 260 lead reel for the ability to batch plot and run long X-axis plots — all without babysitting.

And by mixing leads of various thickness and hardness, it can output complex plots with stunning visual detail. Of course, not only does it know when it's time to reload,

it also knows exactly where to continue plotting after refilling.

Also available is the F-920A cut-sheet model. Like the F-920AR, it features 0.0004" resolution, pen/vector sorting, 44.5 ips top speed and 5.7 G acceleration for astonishingly fast plotting. Plus, a 1 MB buffer that quickly frees your computer for the next job.

Find out more about plotter automation with the F-920 series from Mutoh or your Mutoh dealer.

PROFESSIONAL PLOTTER **F-920AR**

**MUTOH AMERICA INC.** 895 Cambridge Drive, Elk Grove Village, Illinois 60007 Tel: 708/952-8880. Fax: 708/952-8808.

**Western Office:** 4883 East La Palma Avenue, Suite 505, Anaheim California 92807 Tel: 714/779-2326. Fax: 714/779-0185.

**Eastern Office:** 23 Walkers Brook Drive, Reading, Massachusetts 01867 Tel: 617/942-2442

**TOLL FREE FOR WESTERN CANADA:** 1-800-663-6001. **FOR ONTARIO, QUEBEC & ATLANTIC CANADA:** 1-800-465-0164.

**MUTOH EUROPE GmbH.** Klosterstrasse 112, 4000 Düsseldorf 1 F.R. Germany Tel: 0211/3613095. Fax: 211-362128

**MUTOH INDUSTRIES LTD.** 1-3, Ikejiri 3-chome, Setagaya-ku, Tokyo 154 Japan. Tel: (03) 5486-1111. Telex: 2422575 DRAMUT J Fax: (03) 5486-1133 Cable Add: DRAFTERMUTOH.

# MUTOH

Japan's No.1 Name in Professional Plotters

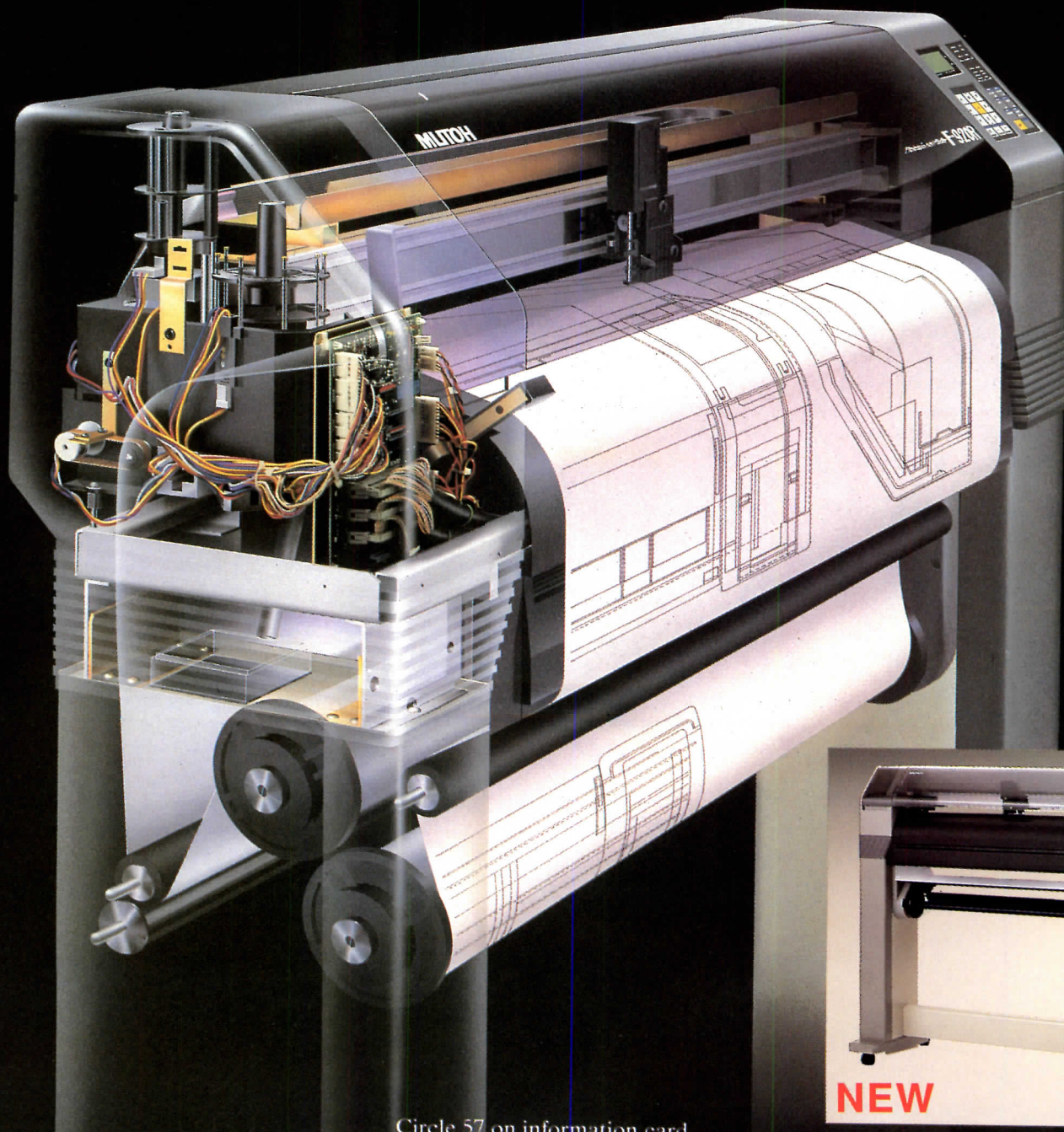

Circle 57 on information card



TIMOTHY HURSLEY

Free of exterior structural constraints, each of Two Union Square's fluid and open facades is designed to be different (above and far right). To eliminate exterior diagonal bracing, a stiff core of four concrete columns encased in steel (below) provides rigidity against wind loads. On the interior, structural walls were avoided between core and building perimeter (plan), which would have divided the open floor areas. Record strength concrete aided in keeping the size of the perimeter columns to a minimum and prevented the need for intermediate support columns (plan and section).

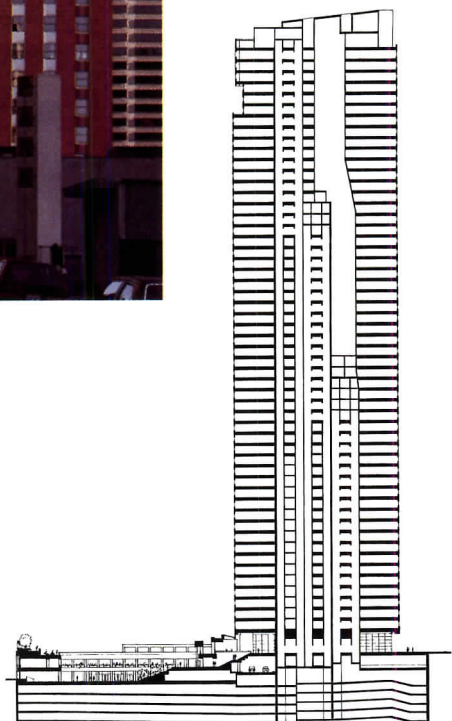

TOWER SECTION

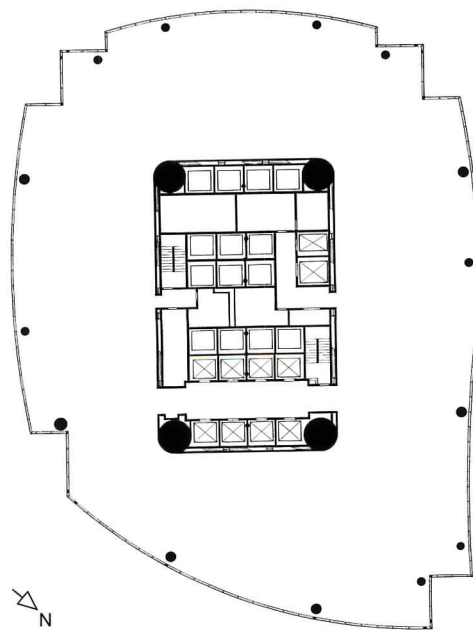

TOWER PLAN

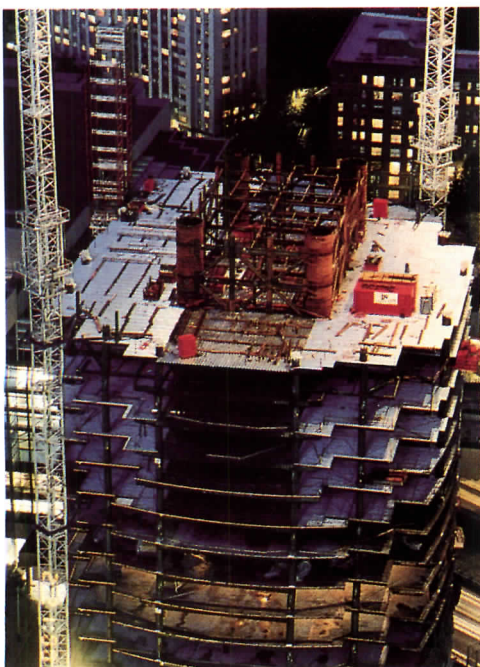

**Two Union Square**  
Seattle, Washington  
NBBJ Group

At 743 feet high, Two Union Square is Seattle's second-tallest building. Many of its contemporary high-rise rivals within the city feature diagonal bracing either at the perimeter or inside the structure, extending perpendicularly from the core to the exterior.

The developer of Two Union Square, however, did not want exterior bracing to obstruct views or interior structural walls or columns to limit space-planning flexibility for the over 1 million square feet of office space. Additionally, NBBJ's Seattle office wanted to create a tower with glazed corners free of structure, to reflect the open edges of its neighboring predecessor, One Union. To meet architectural design objectives, an innovative structural solution devised by the engineering firm Skilling Ward Magnusson Barkshire required the specification and production of the highest strength concrete ever to be employed in a building.

The fluid lines of Two Union Square's curved metal-and-glass-panel curtain wall exterior conceal a very stiff, internal composite concrete and steel structure. Defining the building core, the structure relies on four 10-foot-diameter steel cylinders. To support nearly half of the floor loads on each level, the cylinders are filled with 19,000-psi concrete throughout the entire 56 stories. The tubes are connected by composite spandrel beams to 14 concrete columns along the perimeter of the building.

These columns, which receive the rest of the floor loads, are also constructed of 19,000-psi concrete on all floors to reduce their size, and eliminate the need for intermediate columns. A concrete strength capacity of 14,000 psi was required for compressive loads, a level already pushing the upper end of obtainable strength. The additional 5,000 psi was used to gain the stiffness needed to limit motion from wind loads.



TIMOTHY HURSLEY



## Mutual Benefits

**PRACTICE:  
FIRM MERGERS**

*From meetings to joint ventures, firms gain diversity and new projects in combining talents and resources.*

INFORMAL NETWORKS, PEER REVIEWS, AND associations are just some of the ways architects are joining forces for mutual gain. By combining resources, firms can leverage their strengths to improve the quality of their services and profits. The benefits can be even more dramatic when such short-term tactics lead to long-term mergers.

In many cities, groups of solo practitioners band together in offices to share the cost of support staff, computers, reception room, printers, and the like. The model is similar to doctors sharing space in a clinic. Reported spin-off benefits include the appearance of a larger firm when clients visit, the ability to broker hours among the group, second opinions when you want them, and having someone to cover for you when you take time off.

In another version of mutual support, solo practitioners, who are not physically under the same roof, help each other through peer review of working drawings and specs. They messenger review sets across town and routinely red-line documents for each other. Instead of invoicing each other, at year-end they get together for lunch, compare hours, and settle up. In between times, they are available to each other for advice and production help during crunches. However project peer review is not limited to production quality assurance. A growing number of firms interested in improving their design quality report inviting architects from other firms or nearby schools to serve as visiting critics at in-house juries.

### Discussion groups

IN MANY CITIES, ARCHITECTS WITH MID-SIZE firms form luncheon clubs to discuss management issues. The conversations can be wide-ranging, although some subjects are off limits for legal reasons, like fees, salaries, divying up projects, or boycotts. Usually, the only prerequisites are that participants are meeting a payroll and that they buy their own lunch. Studies reveal that architects prefer to learn from each other rather than by reading or listening to lectures. The most frequently listed benefit of the AIA Small Firm Management workshops is "networking with others like myself."

These luncheon clubs are fairly easy to set

up or break down. None of the participants risks a great deal if the discussion doesn't teach them useful things to apply in their own practices. Instead, they are rather like singles clubs for those architects who didn't find a partner during school or intern days, when most of the lasting partnerships seem to form. Ideally, of course, participants discover shared values and complementary skills.

### Sister firms

A CONCEPT FOR MORE IN-DEPTH INFORMATION sharing and support among larger firms is the AIA "Sister Firms" initiative begun in the mid-1980s. The program encourages getting together firms that have shared concerns, similar size and firm culture, and that are non-competing because of different locations and/or project specialties. Usually, sister firms select each other simply because their principals have established a strong, respectful, and trusting relationship at AIA or professional development events.

Typically, sister firms are remote from each other. Their principals meet several times a year at a location midway between the two offices. They spend the day comparing management problems and solutions to personnel problems, insurance issues, computer software—day-to-day management concerns. The objective of these meetings is to help the participants become more competitive, rather than less. Sister firms often end up collaborating on designs for projects they would not be able to get separately. If a big local project is within the expertise of your sister firm but not your own, it's natural to market the project as a joint venture. When that marketing effort is successful, the relationship between the firms undergoes an abrupt change.

Depending on the outcome of the competition, it can begin a new phase or bring an abrupt end to the relationship. The deciding factors will most often depend on the extent and ability of the participating principals to communicate, and the extent to which they feel the relationship has been equitable. In this case, equity depends not only on how the fee and work loads are allocated, but also on how credit is shared, and how attribution and respect are awarded.

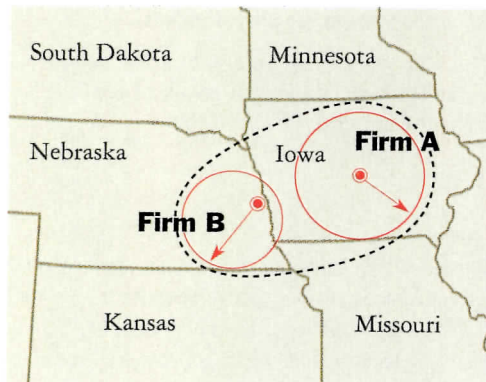

**John Birge of Omaha, Nebraska (below left), and Ken Bussard of Des Moines, Iowa (below right), worked together as AIA board members for several years. Their firms (above), Wilsam Birge and Associates (B) and Bussard/Dikis Associates (A), subsequently merged in order to increase their geographic reach (dotted oval). Their new firm is named the Renaissance Design Group.**

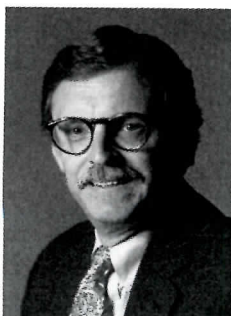
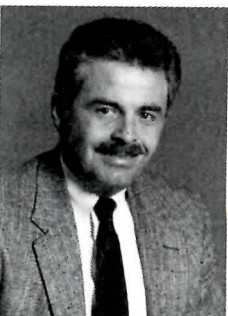

## Merger models

A GENERALIZED MODEL OF A MERGER BETWEEN firms can be drawn from a merger that evolved from a sister-firm relationship. The principals involved cite Norm Wirkler, FAIA, and the Durrant Group of Dubuque, Madison, Denver, Colorado Springs, and Phoenix as the model they followed. In this case, two architects—Ken Bussard, FAIA, and John Birge, AIA—socialized, traveled, and worked together for several years from 1985 to 1986 as AIA board members.

During the process they found that they shared similar professional values and that their firms were complementary in many ways. Each talked about merging the two firms with other principals and middle management. Confirming the potential for mutual support and benefit, they progressed carefully through sister-firm status, then to joint-venture partnerships, and finally to a merger of the two companies. A major, two-year project was required to create a holding company that now owns the two parent firms.

Why go through all that just to give up autonomy and personal ownership of your own firm? There probably isn't any one reason compelling enough to initiate such an undertaking. Rather, it's when several of the following reasons coincide that you may want to consider a merger:

- **Family Growth.** You've hired and trained a trusted "family" of middle management but, by reason of age, skills, or motivation, they are unable to take over more leadership. Hiring anyone above them would destroy what you've built together, yet the firm is stagnating with you as the only rainmaker.
- **Golden Parachute.** You have painstakingly built up an equity value in your present firm. You want to get paid for it while you're still productive enough to assure that the profits necessary to fund that process can be earned.
- **Golden Handcuffs.** There are key people who should be awarded stock and given the incentives and the shared vision to keep them with the firm for the long-term.
- **Diversification.** You feel typecast by the market—locked into certain project types—and want both the economic stability and the self-fulfillment that the merger can bring.
- **Expanded Services.** The partner firm brings related design disciplines (planning, interiors, engineering, etc.) to the merger—*expertise that you lack and need in order to broaden the scope of the firm.*
- **Geographic expansion.** Your practice is locked into a limited political and geographic area that won't support your ambitions.
- **Staff Stability.** It's important that certain experienced staff have a clear picture of the firm's future and their place in it—the benefits and stability that will accrue through staying with the firm as a steady and productive employee.

## MODEL OF A MERGER

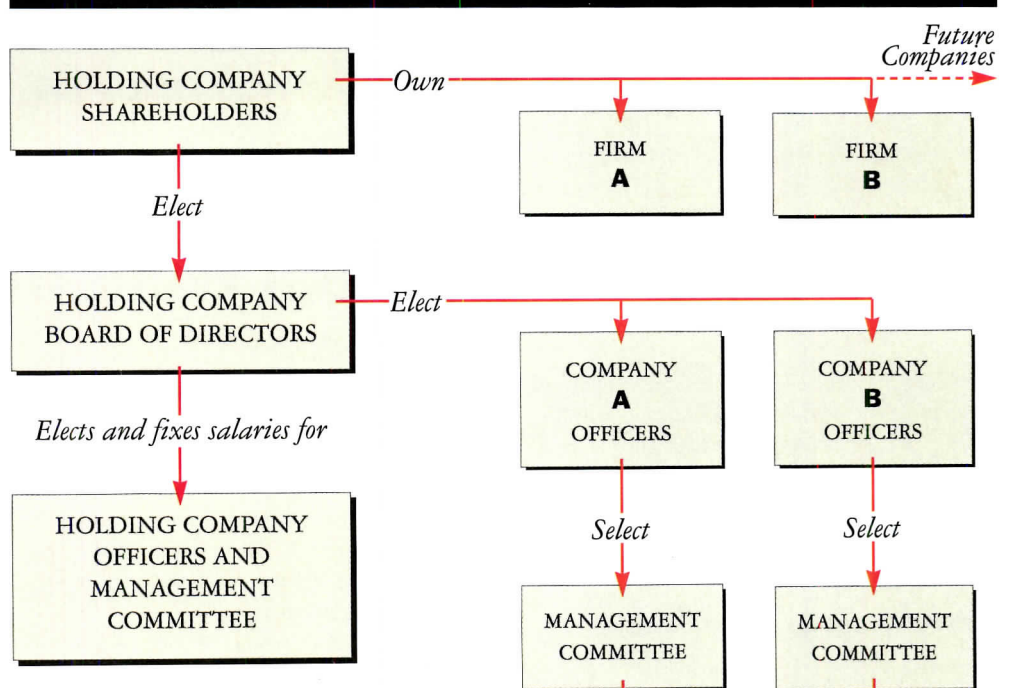

### The holding company provides:

- E&O insurance
- Employee benefits
- Bookkeeping
- Accounting
- Payroll
- Project records and database
- Cross-marketing
- Joint-marketing
- Tax preparation/reporting
- Return on investment for its owners.

**The idea is that companies A and B retain everything to do with being architects on projects. The holding company does almost everything else needed to make a profit.**

**Each subsidiary firm markets, negotiates, contracts, staffs, designs, produces, bills, and collects for its own projects.**

**Each subsidiary firm pays the holding company a percentage of net fees for administration, as well as an agreed-upon amount to provide the targeted return on investment to holding company shareholders.**

**The idea is that companies A and B decide on and achieve their own levels of profitability independently of each other.**

- **Clear Division of Responsibility.** You are tired of trying to be all things to all people and want a more focused role—either as a manager or as a project-focused architect.
- **Money.** You feel there are economies of scale and efficiencies in administration and accounting that will provide a sizable savings in indirect expense over time.
- **Bottom Line.** Many of the reasons above may apply, but the truth is, you're tired of feeling like you're being recycled. You're competing in the same market for the same client with the same problems against the same competition. It's not as much fun as it was the first three times around, and you want to transcend all of it and take the practice into a new dimension.

With enough of those reasons tugging at them, Bussard/Dikis Associates of Des Moines and Wilscam Birge and Associates of Omaha merged their firms in 1989. Last July they formed the Renaissance Design Group. The owners of each of the original firms traded that ownership for controlling interest in the new firm. It's still in the early stages, but

Bussard feels many of the potential improvements are already becoming reality.

He sums up the chief advantage of the new organization as having provided not just for ownership transition, but for leadership transition as well. Bussard contends that commitment and motivation are an inherent aspect of "being owned by something bigger than yourself—it gets your attention." As with most things, the greater the reward, the greater the risk. There is a lot invested here, and a lot at stake.

His advice? Go slow. Date before you marry. Network, share information, try to do at least *three or four* projects together as an association or joint venture. It's important that you share far more than a set of complementary needs. Shared values, work ethic, firm culture, mutual respect—these are essentials that can only be developed and evaluated over time.

—JAMES R. FRANKLIN, FAIA

*James Franklin is a resident fellow of the American Institute of Architects.*

## Image Builder

### COMPUTERS: SCANNERS

*Conversion of text and visual images into computer-recognizable formats are changing design methods.*



**Hewlett Packard's Scanning Gallery Plus 5.0 software (above), introduced in September, offers greater image manipulation options for HP ScanJet Plus users. The Benham Group presented the proposed design for the Iberaki Prefecture Hotel to its Japanese client by superimposing project models on the site (below left). The photos were scanned with a Howtek color scanner and merged with a 3D modeling program (below right).**

COMPUTERS PROCESS DATA QUICKLY, BUT entering information into them can be tedious and slow. One of the most helpful new devices for speeding up data entry is the scanner. Scanning is essentially the process of converting images and information on paper or film into a format that can be recognized by the computer. While the human eye and the camera see images in analog format, with varying shades and levels of brightness, the computer recognizes images in digital form as dots or picture elements (pixels).

Developed more than 10 years ago, scanners are just now beginning to find a place in architects' offices. "It's interesting how the scanner is affecting our design process," says N. Ross Bell, AIA, vice president and principal for design at the Benham Group, a 600-member firm in Oklahoma City, Oklahoma. "Before, we would prepare a rendering at the end of schematic design or design development. Now we're completing renderings at the concept stage, when we're still scratching on canary paper. It's easy to generate photo-quality images, and get the client into the process visually. For us, renderings have become as much a valuable design tool as a presentation tool."

Bell scans color photographs of sites to form the background and foreground for highly realistic computer models of projects designed by the firm. He uses a \$6,000 Howtek color scanner, but other architects are finding that they can pay much less or

much more. ECD Associates in Oak Park, Illinois, for example, selected a \$339 hand-held Logitech scanner to capture details from magazines and catalogs for insertion directly into construction documents without redrawing. Du Pont's Fast Trax document-management system, on the other hand, starts at \$40,000 plus scanner.

Other types of scanner applications that are beginning to change the way architects conceive of a project visually include:

- Capturing details that are drawn by hand or that appear in magazines or manufacturers' literature;
- Capturing blueprints of old architectural drawings, either to preserve them or to rework them as part of a renovation project;
- Converting hand-typed specifications into a computerized format so they can be revised with word-processing software;
- Converting text supplied by client for insertion into presentation documents;
- Collecting small graphic elements, such as a client's logo, for use in visual presentations to that client;
- Enhancing computer-generated 3D models of proposed buildings with photographs of landscaping, people, and cars;
- Illustrating newsletters and other documents with photographs;
- Enhancing photographs by retouching them or by inserting models of buildings in photos of existing sites;
- Creating a graphic database and archiving



a slide collection into it;

■ Transmitting drawings, photographs, and other images over a modem.

### Capturing images

THE SCANNER WORKS BY PROJECTING A bright light against an image and detecting how much is reflected back. At each sampling point, the reflected light is read as a dot, converted into digital form, and sent to the computer. The number of sampling points in the scanner is important because this controls resolution. If there are 2,450 elements in an 8.5-inch linear array of sampling points, the potential resolution is 300 dots per inch, which is the typical resolution of desktop scanners today.

**Isicad's new software, Scan-In, allows the user to scan images in a raster format and either convert portions of those images into vector format or combine additional vector images in the same drawing. The software, which runs on a UNIX-based system 5000, offers the following options:**

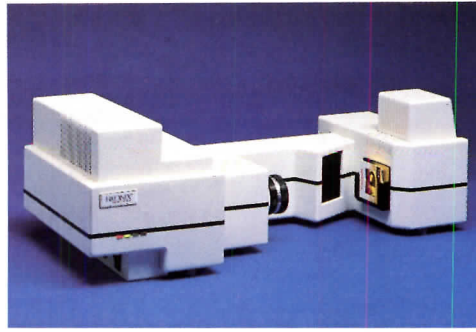

**The Eikonix 1435 Slide Scanner (above) weighs only 15 pounds and is designed for scanning 35mm slides. It will also scan negatives, film strips, and aperture cards.**

Another way to distinguish between scanners is by data type: bilevel, grayscale, or color. In a bilevel scanner, a dot is either black or white. Bilevel scanners are adequate for line art and text. Since only one bit of data is required to record the signal of each scanned pixel, file sizes are small. Grayscale scanners can read a dot as a shade of gray. Eight-bit scanners can read 256 shades of gray. Six-bit

Should an architect buy a color or black-and-white scanner? If color output is required, the choice is easy. Even handheld scanners are available now for color scanning. But be prepared to pay more for the color scanner than for a black-and-white scanner of comparable size, resolution, and quality. Working with color scans may also require the purchase of a larger hard disk, since the amount of storage needed increases proportionately with the larger size of color files.

### Image options

ONCE AN IMAGE HAS BEEN CAPTURED, IT can be saved in a variety of formats. Several file formats are currently available and the number keeps growing. One of the most common is the tagged-image file format, or TIFF file. Others include encapsulated PostScript (EPS), run-length code (RLC) and picture (PICT, which supports bilevel data, and PICT2, which supports gray scale and color data). The format choice usually depends on the type of software in which the image will be used. If the destination is Aldus Page-

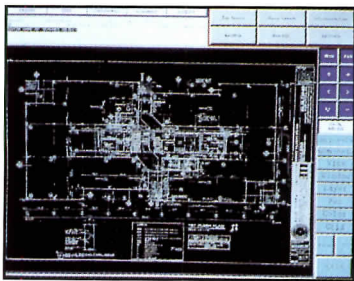

**An entire drawing can be scanned into the system as a raster image.**

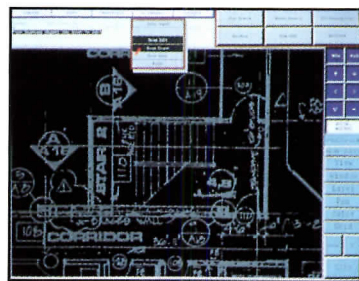

**A zoom-in view allows a closer look at isolated details of the same raster image.**

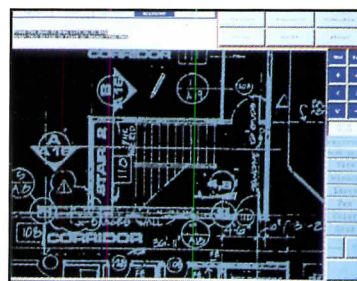

**Vector images can be added to the raster image using the pencil icon (top center).**

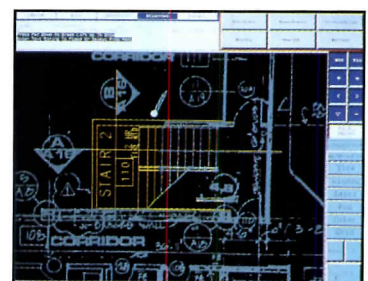

**Raster image is cleaned up under newly drawn vectors using a pencil/eraser icon.**

The four basic types of scanners are flatbed, sheetfed, handheld, and slide. Flatbed scanners look and work like desktop photocopiers. Documents are placed face down on a glass plate and covered with a plastic lid. Most flatbed scanners accept pages 8.5-by-11 or 8.5-by-14 inches, but sizes up to 11-by-17 inches are also available. Although flatbed scanners take only a single page at a time, they can accept books as well as oddly sized and shaped documents. Some flatbed scanners even have an optional automatic document feeder that permits rapid scanning of multiple pages.

Sheetfed scanners move a sheet of paper past the light, and typically accept up to D- or E-size documents. Handheld units, which look like the head of a vacuum cleaner, usually scan a swath about four inches wide. With handheld scanners, the entire unit is moved past a stationary document.

Slide scanners capture images from 35mm transparencies or negatives. Some models also accept 2 1/4-by-2 1/4-inch and 4-by-5-inch film. Prices for these machines generally start at about \$8,000.

scanners can read 64 shades of gray, and four-bit scanners can read 16 shades of gray. File sizes get considerably larger with the extra information about the dots, but the tones in a photograph look more realistic when scanned in grayscale and printed on a high-resolution printer, such as a Linotronics. Color scanners must sense each dot three times, increasing the size of the file still more and raising the price of the unit.



**Fora's IMG-311 flatbed scanner (above) is for PC compatibles, and represents up to 145 levels of gray. The scanner comes with MicroArt Image Editor editing software.**

Maker for output on a Linotronics typesetter, for example, service bureaus often recommend TIFF files.

Neither word-processing programs nor CADD programs can understand these formats because they represent only dots, not characters or geometry. This is because a CADD program constructs images as vectors—that is, two points connected by a line. Effective and affordable software that can transform images from the dots produced by a scanner into vectors, text, or smooth tones is just now becoming available. Converting the dots into actual words is the job of software programs that perform a function called optical character recognition (OCR). Converting the dots to geometry is called vectorizing, which another class of software performs. When the time comes to print a CADD drawing on an electrostatic or similar kind of plotter, the lines must be converted back to dots by a process called rasterizing. Drawings output to a pen plotter do not need to be rasterized because pen plotters can draw lines and arcs. However any image that has been converted to dots is

called "bitmapped," because it is comprised of a basic map of dots, or bits of information.

Scanners are capable of handling three kinds of images: line art, continuous tones, and halftones. Construction documents, including the drawings and text, are considered line art. They may be called one-bit images because only one bit of data is stored for each dot scanned. Photographs consist of continuous tones. The tiny silver particles in photographic film can represent almost any shade of gray. The problem with a photograph's gray tones is that most printers cannot reproduce them properly (a copy machine reproduces photos as blotches of black and white). To give the illusion of tonal continuity, newspapers and magazines traditionally have created a halftone image, which consists of tiny dots. In light areas, the dots are very small, whereas in dark areas the dots are large. The varying dot sizes look to the eye like continuous gray shades. Photographically, a halftone is created by placing a glass screen between a camera and the image, but a scanner can produce the same effect.

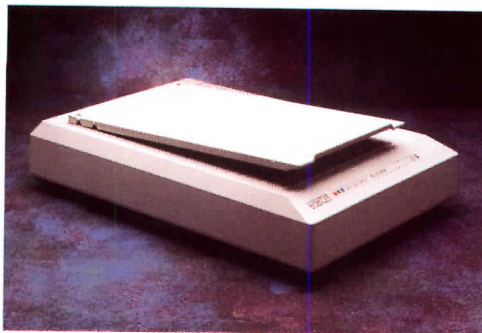

**Microtek's MSF-300Z scanner (above) captures 16.8 million colors and 256 shades of gray. The flatbed scanner can be used with PC compatibles, Macintosh, or Sun stations.**

DOS-based computers is expected to be introduced in the immediate future.

Although most scanner manufacturers support both DOS-based and Macintosh computers, most users agree that the image-enhancement software available on the Macintosh is superior. The leading software is Digital Darkroom by Silicon Beach, Color Studio by Letraset, and Enhance by

rection, montages, collages, paint capability for original art, and even color separations.

Several new scanning products are expected to be available in late 1990. Mouse Systems is introducing a handheld mouse that can scan documents of unlimited size by moving the mouse randomly across the page. It will not be necessary to piece together 4-inch-wide swaths, which most handheld scanners produce.

**Systems' cost**

THE COST OF THE SCANNER VARIES GREATLY from one manufacturer to another. Chinon has built a color scanner that will sell for less than \$1,000. Microtek's RV Master will turn paper drawings into CADD drawings automatically with RV Master, priced at \$1,995. At MacWorld Expo in August, Caere announced a handheld scanner, the Typist, that converts text on the fly, placing it on the computer monitor at a rate of 500 words per minute as the scanner passes over the page. The price is \$695 for the Macintosh version, \$595 for the DOS version.

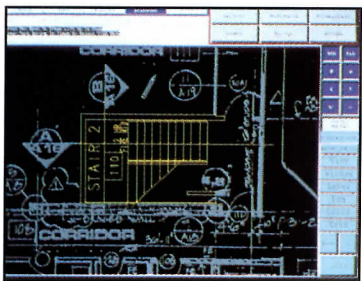

**Clean-up of the new vector image has been completed during this process.**

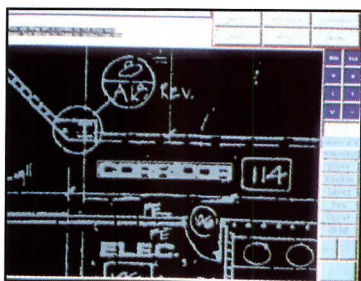

**Shown close-up, text to be replaced is "boxed-in" to indicate size and positioning of new type.**

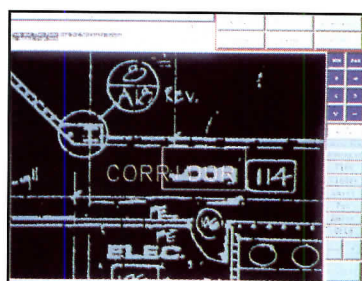

**Other raster images underneath the type can also be "boxed-in" and erased.**

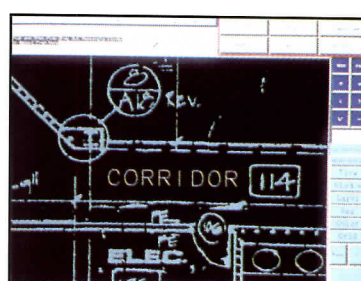

**Cleaned-up vector text replaces raster images for more easily legible plans.**

Dots produced by a laser printer are not the same as halftone dots. The size of printer dots is fixed at the resolution of the printer—300 dots per inch for the typical desktop laser printer. Laser printers achieve the effect of variable-size dots by dithering, which is a process of interpolation involving clusters of miniature dots. Currently under development are new controllers that break the rules about dot sizes and permit LaserJet-class printers to produce 64 levels of gray at 70 lines per inch.

Most scanning software controls brightness, contrast, resolution, scaling, and halftone dot pattern. The brightness control makes the entire image lighter or darker. Set too high, details wash out. Set too low, black blotches appear. Contrast adjusts the distinction between light and dark areas. Low contrast images look washed out; high contrast images lack normal tonal variation. For example, the software that controls Hewlett Packard's ScanJet Plus with Macintosh computers permits users to preview the effect of changes to brightness and contrast on the screen. A similar product for

MicroFrontier. Silicon Beach has created an enduring impression by showing how the Leaning Tower of Pisa can be straightened with a half-dozen clicks of a mouse button. All three programs run on the Macintosh.

Adobe's new Photoshop, also a Macintosh program, provides both creative and production tools, including retouching, color cor-

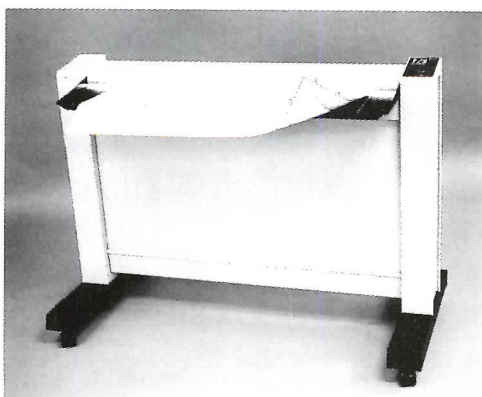

**Houston Instrument's wide-format LDS-4000 scanner (above) accepts up to E-size and DIN A0 Oversize documents. The stand-alone scanner offers a resolution of 300 dpi.**

Scan-In, for Isicad's System 5000, permits photographs to be merged with architectural drawings. "Renovation instructions can be much clearer if the architect can show what needs to be removed or changed by drawing directly on a photograph and including it as part of the construction documents," says Yoav Etiel, manager of personal systems marketing. Accugraph also offers a scanner interface module that converts scanned images into CADD format. Numerous vendors offer software aimed specifically at bringing scanned images into Autocad.

In May, Houston Instrument began shipping its LDS-4000 scanner. Priced at \$13,995 including software, it can scan 36-inch-wide drawings in 23 file formats. The software permits the drawing to appear on the screen as it is scanned. Its chief competitor is the Contex 400T, sold in the United States by Vemco and Ideal for \$13,900 plus software. The Contex 400D, which accepts a sheet 24 inches wide, sells for \$9,900 plus software.

One of the lowest-priced programs that will convert a bitmapped image to a vector

image without user intervention is the Scan-Pro at \$495 from American Small Business Computers. For power users, the SRV 386 is priced at \$18,000 from Scorpion Technologies. In the middle is Visus VIP from Visual Understanding Systems for \$4,200. All three run on PCs.

Automated Digital Recognition (Audre) specializes in turnkey scanning systems using its software and hardware from outside sources. Prices range anywhere from \$30,000 to \$100,000.

### Scanning hurdles

ALTHOUGH SCANNING IS IMPROVING AT A rapid pace, several problems remain with the technology. Storage is one problem, since file sizes tend to be enormous—a small photo or drawing may consume half a megabyte. File compression software is getting better, but small disks may still be overwhelmed.

Most affordable scanners today are too small to handle D- and E-size drawings. The drawings can be cut before scanning, but then the pieces must be reattached in the CADD program. One solution is to use a service bureau's scanner, but prices paid by sources interviewed for this article range from \$6 to \$100 a sheet.

Tracing or vectorizing of scanned drawings can be completed by the architecture firm on its own computer system, but speed can be a major hurdle. Vendors quote times of one-and-a-half to three hours for D- to E-size drawings, depending on density of lines. Then the task of cleaning up the drawing begins. Few vendors claim greater than 70 percent accuracy for drawings. Except in scanning systems costing more than \$50,000, no attempt is made simultaneously to vectorize drawings and recognize text.

Automatic vectorizing software converts



**Chinon's inexpensive, lightweight DS 3000 overhead scanner (above) offers 300 dpi and will run on both PCs and Macintoshes.**

everything to lines, even coffee stains. Satisfaction depends, in part, on expectations. Vendors complain that some architects expect the scanned and vectorized drawing to be better than the original, even joining lines that were not closed on the original.

"If it's 'not to scale' on the print, it's going to be 'not to scale' on the scanned image," says scanning skeptic Robert Hartman, AIA, Bellevue, Washington. "Scanning may be appropriate for other graphic applications, but for A/E work, 'building' the building, via CADD, is far more accurate."

Architects interviewed for this article gave much lower estimates of success at text recognition than vendors claim. As with drawings, much depends on the quality of the original text. The old proverb applies: garbage in, garbage out. Typewriter text is much easier for OCR software to understand than hand lettering or type fonts.

Accuracy of conversion software is improving, but it remains disappointing. Still, architects interviewed for this article said the result was much better than reentering the text or drawings from scratch. New federal and state regulations are requiring more as-built information than ever before, notes Michael F. Hamman, Intergraph's AEC marketing manager for core products. Previously, the architect had to work with a blank screen, redrawing everything—even parts of the building that will not change. Intergraph's scanning system allows architects to remove only what will be changed and to begin drawing immediately to show new or expanded facilities.

In using a scanner, architects should not expect even automatically vectorized drawings to have much intelligence. The data imported from a scanner consists of one layer with one line width and style. All text and dimensions must be reentered manually. Remember, too, that hybrid files that combine raster and vector data cannot be plotted with pens. An electrostatic, thermal, or laser plotter will be needed. Even vectorized files that have not been fully cleaned up may be impractical on a pen plotter because of the many very short line segments created in the vectorizing process. Further, file formats have not been standardized. If vectorizing software is adopted for a system, make sure it can understand the formats in which the scanner can save the file.

Still, the benefits are worth the trouble, maintain architects who are experimenting with scanning technology. They cite significant gains in productivity, accessibility, and convenience. Information stored in digital format is more useful, more durable, and infinitely more versatile.

—OLIVER R. WITTE

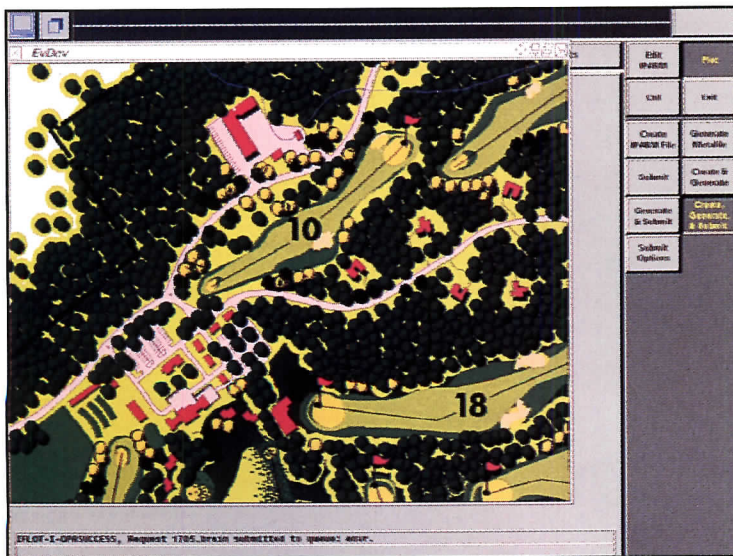

**Intergraph's I/Plot Finisher was used to produce a color-filled image (above). The raster symbols for trees and other elements were added during the drawing display, but do not take up space in the actual computer file.**

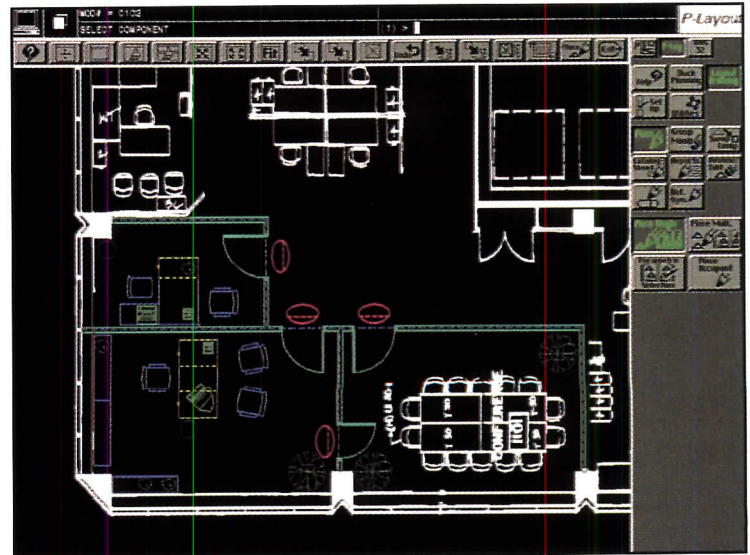

**Scanned data can be erased and elements added by using Intergraph's Project Architect and Project Layout application systems. Screen shot of a furniture plan (above) indicates original drawing in white lines and raster data in colored lines.**

## Layers of Meaning

**COMPUTERS:  
CAD GUIDELINES**

*Organizational strategies for CAD files maximize communication and efficiency of working drawings.*

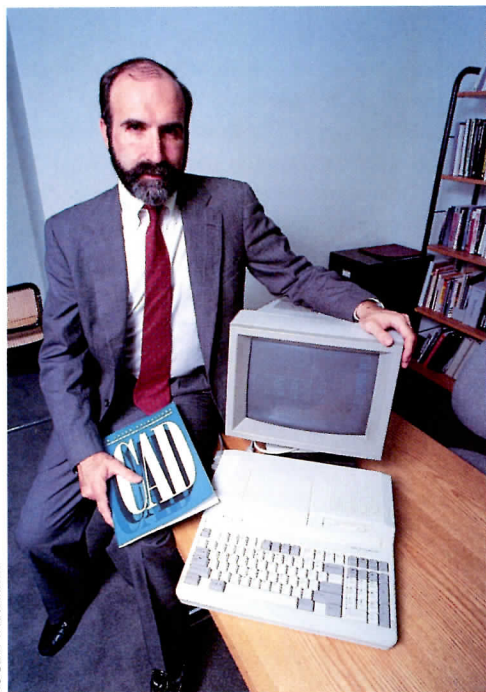

**Michael K. Schley, AIA (above), is chair of the Task Force on CAD Layer Guidelines. The first version of these guidelines was issued in May, 1990. The task force welcomes comments from users, which will be taken into consideration as the guidelines are further refined.**

WHILE CAD SYSTEMS HAVE INCREASINGLY eased many aspects of working drawing production, they have also introduced new challenges. CAD files, if organized unsystematically, could seriously impede communication between architect, consultant, and client. The Task Force on CAD Layer Guidelines, co-sponsored by the AIA, has proposed a method of managing graphic data files within all CAD systems in a new booklet entitled *CAD Layer Guidelines: Recommended Designations for Architecture, Engineering, and Facility Management Computer-Aided Design*. Members of the task force hope that these guidelines will become the industry standard.

Most CAD programs employ a technique known as layering to store and manipulate visual information. This process is analogous to overlay drafting, with each layer representing a separate sheet of mylar. A layer is not a complete drawing, but rather a set of specific graphic data, whether it represents walls or furniture. The final working drawing is a composite of all appropriate layers. As an example, a first floor plan may be produced by plotting four CAD layers: a wall layer, a partition layer, a door-swing layer, and a flooring layer.

Separating building components by layers offers a number of benefits. For one, the graphic image of each layer is uncluttered by unnecessary information, so reviewing the data pertinent to the layer becomes much easier. Certain layers can be manipulated to create a number of different drawings for the same project, or they can be saved for future projects without having to be redrawn or cleaned up. If, for instance, a lighting engineer draws fixtures on one layer and circuits on a second, the fixture layer can be reused by the architect to plot a reflected ceiling plan without having to delete circuit notations.

CAD systems typically allow users to name and file layers as they see fit. Formatting, therefore, has generally been developed in-house by each office that uses CAD, with little regard for formats established in other offices. This ad hoc approach to layer management has sufficed up until now largely because the transfer of information among offices has been primarily through hard copies such as prints and mylars. But as CAD sys-

tems become more prevalent in the industry, the need to dispense information electronically will increase. An engineer, for instance, will need to access an architect's database to obtain floor plans on which to lay out mechanical systems; a client will require "as-builts" on floppy disks for ongoing use in facility management.

With architect, consultant, and client each accustomed to a unique format, information transfer could become a future Tower of Babel. Communication could be stymied because one party would have no idea how to locate information on another's database.

Michael K. Schley, AIA, founder of the Raleigh, North Carolina-based firm FM:Systems, which develops and markets software for facility management needs, recognized the potential seriousness of this problem in 1988 when, as a member of the steering group for the AIA Committee on Practice, he was charged with the responsibility of investigating current computer issues in architecture. Believing that a professional organization like the AIA was best suited to address the problems of industry standards, Schley organized the Task Force for CAD Layer Guidelines to develop a common, consistent terminology for CAD users. Chaired by Schley, this committee was sponsored by the AIA, the International Facility Management Association, the American Consulting Engineers Council, the American Society of Civil Engineers, the United States Army Corps of Engineers, the Naval Facility Engineering Command, and the Department of Veterans Affairs.

CAD vendors were not appointed to the task force, Schley explains, because "we couldn't invite all of them to participate and it would have been unfair to ask some and not others." Instead, the task force communicated informally with vendors and invited them to review the first draft of the guidelines and to participate in a meeting at the June, 1989, A/E/C Systems Conference in Anaheim, California. Though he actively sought input from the vendors, Schley did not believe it was the responsibility of CAD vendors, whose markets are broader than the construction community, to establish the industry standard for architectural CAD users.

The task force reviewed several existing

format systems, including the Construction Specifications Institute's Masterformat, before deciding to develop a new one tailored to the particular needs of CAD layering. "It would have been great," admits Schley, "to have found an existing format on which to base the CAD layer names." None of them, however, combined the necessary features. The new format uses an alphanumeric index that takes into account construction disciplines (architecture, structural, electrical); construction systems (walls, doors); and drawing types (plans, sections, elevations). The letter abbreviations are "user friendly" mnemonic devices to help the CAD operator remember layer names.

Some current CAD programs have only numeric layer designations. While the task force urges CAD vendors to provide named layers where possible, the booklet includes some recommendations on how best to apply the guidelines to numbered layers.

The proposed layer names have four components; the first two are mandatory and the second two are optional. The first component describes the major group code: A (Architecture, Interiors and Facilities Management); S (Structural); M (Mechanical); P (Plumbing); F (Fire Protection); E (Electrical); C (Civil Engineering and Site Work); and L (Landscape Architecture). The second component, called the minor group code, indicates different construction systems: WALL; DOOR; ROOF; FURN (furniture); etc. The third is an optional modifier to separate related minor groups: for example, the layer for full-height walls (A-WALL-FULL) can be distinguished from the layer for partial-height walls (A-WALL-PRHT). The fourth is an optional user-defined code to clarify even further the difference between two assemblies: A-WALL-FULL-01 may designate first-floor full-height walls while A-WALL-FULL-02 defines full-height walls on the second floor. For a simple project, the user may forgo any modifier or user code, and simply have a layer called A-WALL for all walls.

The committee actually developed two naming systems: a long format, with 6 to 16 characters for greater readability; and a short format with 3 to 8 characters for quicker use. The short version of A-WALL-FULL-02 would be AWAFU-02.

Over the last five years, a significant increase in the use of CAD systems has occurred in architecture firms. In 1985, very few firms had automated their drawing production, but according to the AIA's most recent survey 80 percent of offices with 20 or more people used CAD by 1988. Spurred by the dramatic decrease in the cost of setting up computer work stations, this growth has generated the need for industry standards. And, because further growth in use and technology is expected, the guidelines were

purposely organized to allow for flexibility and future modifications. According to Schley, "Standards need to be a half-step behind technology. It doesn't make sense for someone to devise the standards before the practitioner can work with the technology in the field. But standards must closely follow, or else the practitioners go their own way—at which point it becomes difficult to establish an industry standard."

Schley believes the guidelines have been issued at an appropriate time. Gregg Kendrick, executive director of Republic Research Training Centers in Charlottesville, Virginia, concurs: "It's great timing. I don't see how it could have been done before now." Kendrick is impressed with the guidelines and the fact that the task force represented a variety of construction-related organizations. His firm, which provides training seminars on a number of CAD systems to architects and others, includes the guidelines in its workshops as an example of how to organize CAD work in any type of firm. "Up until now, there has been no industry standard for CAD. It is most important for architects and engineers because of their great need for information sharing, but all CAD users can benefit from this approach. Overall, the guidelines have been very well received—particularly by those who have already confronted the problem of layer management in their work and are therefore aware of the difficulties."

Kendrick has found that the "bulk of firms do not have any standards, or at least not enough to accommodate the full range of issues facing the building industry." He believes that those firms that already have an

in-house standard will not find it difficult to convert to the new one because "you can always make some kind of correspondence between one standard and another." He has found many users to be particularly happy with the short format since some systems cannot accommodate more than eight characters to a name.

Knipper Dunn Franklund, located in Yakima, Washington, had developed its own in-house format since the firm began using CAD four years ago. But, according to partner David Franklund, AIA, the architects recently converted to the CAD layer guidelines. "We reviewed both the AIA format, which is based on construction systems, and another, material-based approach that uses the CSI numbering system. We found that the numeric format generated too many layers and did not correlate as well to the drawings, which are organized around con-

**Graphic data is stored on different layers within most CAD systems. Firms should adopt a layering strategy that avoids repetitive information. In one method (below), all layers for a project are stored within a single file. Drawings are plotted by turning on the appropriate layers. The floor plan, therefore, consists of a wall layer, a door layer, and a layer of notes and dimensions. The project can also be contained in multiple files (facing page). This works best if the system is equipped with a reference file feature, so that one file can refer to another for certain layers. File 5 contains the floor plan layer for border and notes, but looks to File 1 for walls and to File 2 for structure.**

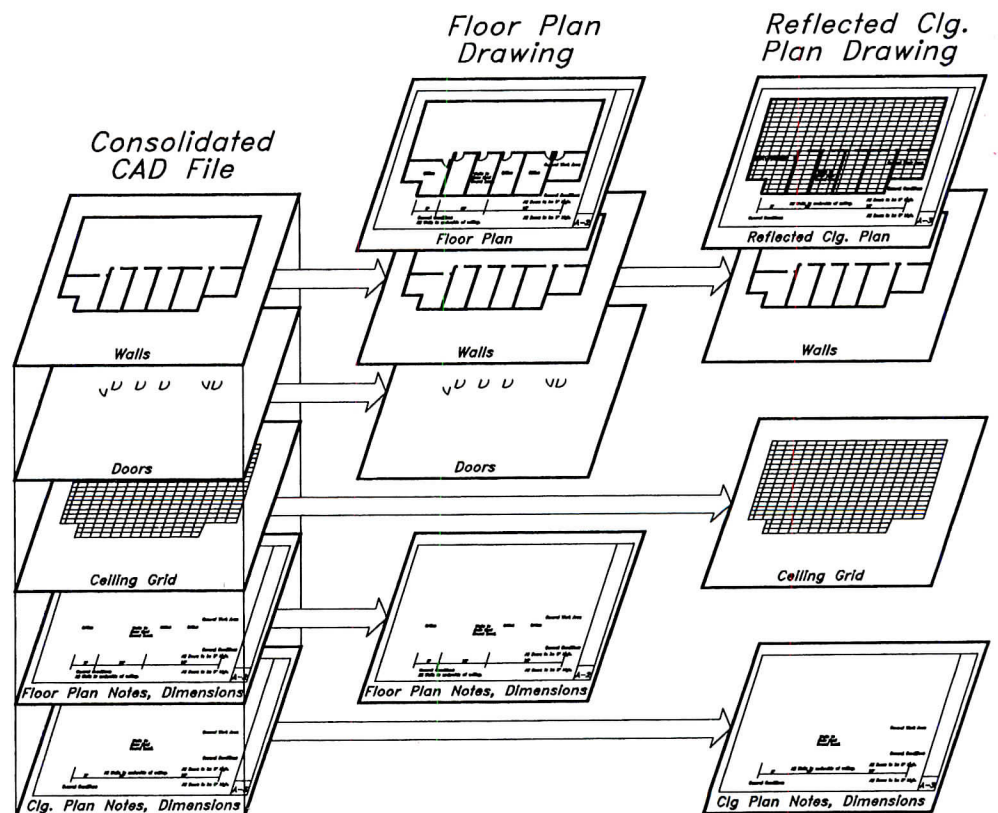



struction systems rather than materials. And the AIA names are easier for a new person to learn and remember.”

Frank Heitzman, AIA, principal of Heitzman Architects in Oak Park, Illinois, has had firsthand experience with the current problems of sharing CAD files. As he points out, “Getting a drawing from other architects with different layering systems can be very confusing. It takes time to convert to your own.” Heitzman also likes basing the format on construction systems rather than materials, but he has other concerns. “Any universal system is of limited value until template companies like ASG or Vertex allow for user-defined names.” If they do not, the operator is forced into using the program-supplied list. Heitzman is slightly puzzled by the long format. “I don’t see why you would ever use it.” He prefers the short names.

Along with the master list of layer names,

the AIA guidelines contain some general CAD tips, which Schley describes as “an attempt to encourage architects to draw smart with CAD.” The task force suggests that CAD users think not only about the kinds of drawings the project requires, but also how they will be organized into files and in what sequence they will be produced. The AIA booklet presents a number of possible strategies, all of which minimize redundancies and maximize coordination. The simplest, most straightforward approach is to keep all layers for a project within one file. Selected layers are to be turned on, and others turned off, to plot a particular working drawing. Because there is only one file, only one person at a time can be working on that project’s drawings—even if the computer is part of a network (ARCHITECTURE, September 1990, page 117). This single-file strategy ensures project control, but inhibits multiple users.

The layers of a project can also be stored in multiple files so that more than one person can work on different aspects at the same time. This strategy is best employed if the system has a reference file feature, which lets a CAD user display other files as background information in a “read only” mode. The file for the first floor plan, for example, may contain the layer for walls. The file for the reflected ceiling plan can reference the wall layer in the first floor plan file rather than duplicate the wall layer for itself. If the walls change, the CAD user makes the correction only once—in the floor plan file. The next time the reflected ceiling plan file is opened, it will refer to the corrected wall layer. Several users, therefore, can have read-access to the most recent version of the first floor plan file without disturbing the original.

It is only recently that some PC-CAD software programs have begun to offer this reference file feature. The architect can combine aspects of single- and multiple-file strategies in one project, or develop other methods as necessary. In any case, layering should be done efficiently, avoiding the duplication problems inherent in hand drafting.

The committee members describe and recommend using a CAD layer matrix to keep track of the various layers. The relationship among layers, files, and drawings is complex (left), but will ultimately help in plotting the final working drawings.

In a section of the booklet directed at CAD vendors, the task force discusses specific features that it finds particularly useful for architects. These include: named layers (or at least a method of mapping numbered layers to named ones); user-defined layers; the ability to save plot settings; reference file capability; text and symbols sized according to plot scale; and full control and display of line weights. Currently, not all CAD systems on the market incorporate every one of these features.

A universal naming system will by no means overcome every communication barrier within the CAD world. The architect, engineer, and client of a particular project may not, for instance, be equipped with the same CAD system. Exchanging information between two different systems can be problematic, since each CAD system stores data in its own proprietary format. The two most commonly used methods for translation are Autodesk’s DXF format and IGES (International Graphic Exchange Standard). The DXF format was developed to translate to or from AutoCad drawing files. IGES was developed by an open committee under the auspices of the American National Standards Institute (ANSI). Both methods work reasonably well for basic graphic information, but graphic elements such as complex curves, dimension strings, dashed lines, and attributes

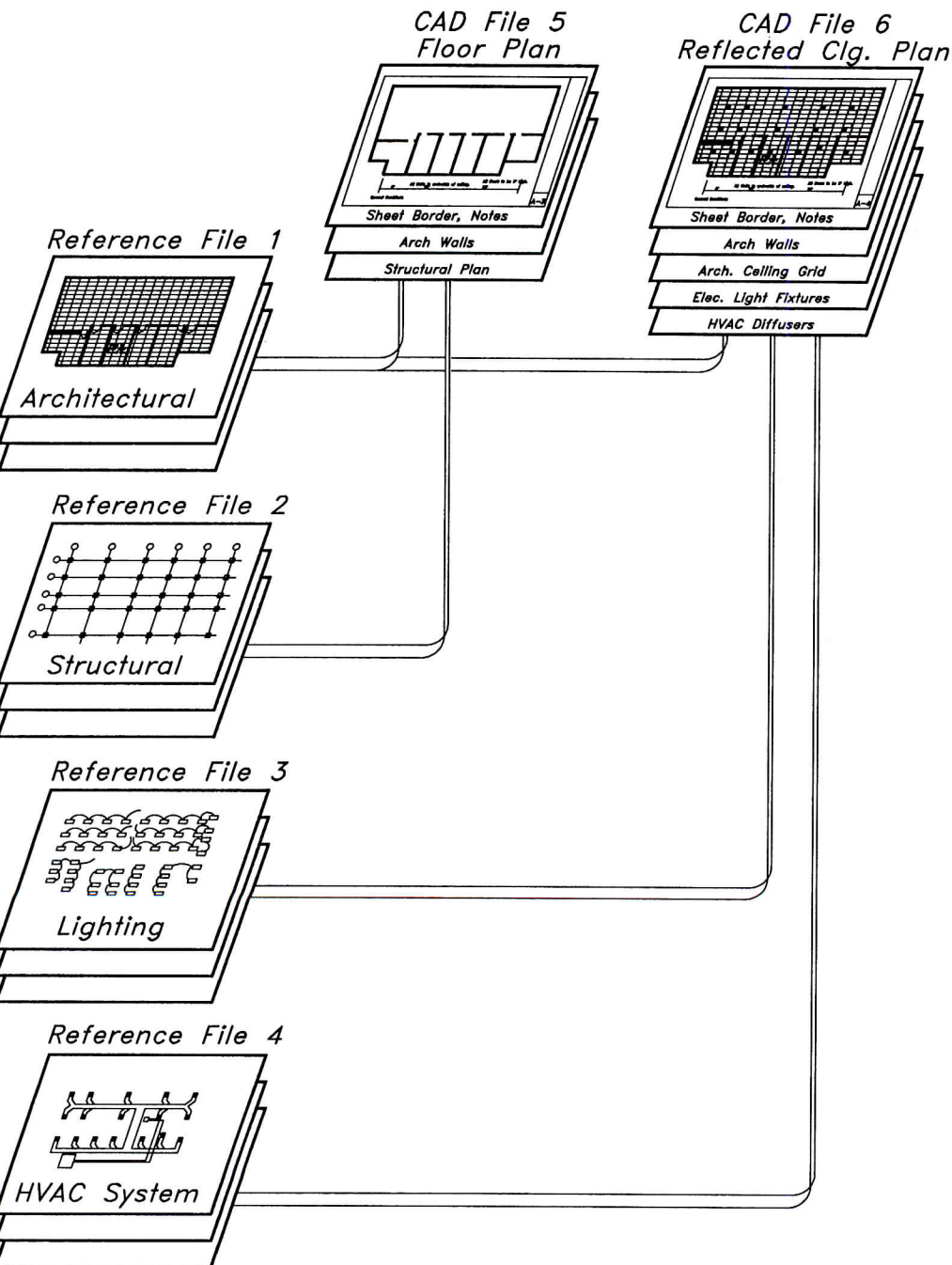

(text or numeric data attached to symbols) will not always be properly translated from one system into another. Dashed lines representing walls to be demolished, for example, may be depicted as solid lines in the translated version.

Schley views the CAD layer guidelines and the translation of CAD drawings between systems as parallel efforts, equally important but independent of one another. The former addresses a management issue, the latter a technical one. "It's comparable to developing a worldwide telecommunication system. The ability to make a direct-dial phone call to the Soviet Union won't do you any good if you don't speak Russian. We are addressing the language component." Schley is confident that the technical requirements will eventually be solved. But in the meantime he feels the industry must begin to organize all CAD work in a manner that allows users to share information between similar programs now on the market and, in the future as technological issues are solved, among all programs. The issue of translation—along with

### Architecture, Interiors, and Facilities

Long Format Layer Name	Short Format Layer Name	Layer Description
		<b>Building Information Layers</b>
A-WALL	AWA	<b>Walls</b>
A-WALL-FULL	AWAFU	Full Height Walls, Stair and Shaft Walls, and Walls to Structure
A-WALL-PRHT	AWAPR	Partial Height Walls (Not on Reflected Ceiling Plans)
A-WALL-MOVE	AWAMO	Movable Partitions
A-WALL-HEAD	AWAHE	Door and Window Headers (Shown on Reflected Ceiling Plans)
A-WALL-JAMB	AWAJA	Door and Window Jambs (Not on Reflected Ceiling Plans)
A-WALL-PATT	AWAPA	Wall Insulation, Hatching and Fill
A-WALL-ELEV	AWAEL	Wall Surfaces (3D Views)
A-DOOR	ADO	<b>Doors</b>
A-DOOR-FULL	ADOFU	Full Height (to Ceiling) Door: Swing and Leaf
A-DOOR-PRHT	ADOPR	Partial Height Door: Swing and Leaf
A-DOOR-IDEN	ADOID	Door Number, Hardware Group, etc.
		<b>Doors (3D Views)</b>

### Architecture, Interiors, and Facilities (continued)

Long Format Layer Name	Short Format Layer Name	Layer Description
A-FLOR	AFL	<b>Floor Information</b>
A-FLOR-OTLN	AFLOT	Floor or Building Outline
A-FLOR-LEVL	AFLLE	Level Changes, Ramps, Pits, and Depressions
A-FLOR-STRS	AFLST	Stair Treads, Escalators, and Ladders
A-FLOR-RISR	AFLRI	Stair Risers
A-FLOR-HRAL	AFLHR	Stair and Balcony Handrails and Guard Rails
A-FLOR-EVTR	AFLEV	Elevator Cars and Equipment
A-FLOR-TPTN	AFLRP	Toilet Partitions
A-FLOR-SPCL	AFLSP	Architectural Specialties (Toilet Room Accessories, Display Cases)
A-FLOR-WDWK	AFLWD	Architectural Woodwork (Field-Built Cabinets and Counters)
A-FLOR-CASE	AFLCA	Casework (Manufactured Cabinets)
A-FLOR-APPL	AFLAP	Appliances
A-FLOR-OVHD	AFLOV	Overhead Skylights and Overhangs (Usually Dashed Lines)
A-FLOR-RAIS	AFLRA	Raised Floors
A-FLOR-IDEN	AFLID	Room Numbers, Names, Targets, etc.
A-FLOR-PATT	AFLPA	Paving, Tile, and Carpet Patterns
A-EQPM	AEQ	<b>Equipment</b>
A-EQPM-FIXD	AEQFI	Fixed Equipment
A-EQPM-MOVE	AEQMO	Movable Equipment
A-EQPM-NICN	AEQNI	Equipment Not in Contract
A-EQPM-ACCS	AEQAC	Equipment Access
A-EQPM-IDEN	AEQID	Equipment Identification Numbers
A-EQPM-ELEV	AEQEL	Equipment Surfaces (3D Views)
		<b>Windows, Window Walls, Curtain Walls, Glazed Partitions</b>
		Full Height Glazed Walls and Partitions
		Windows and Partial Height Glazed Partitions
		Window Sills
		Window Number
		Glazing and Mullions (Elevation Views)
A-EQPM	AEQ	<b>Equipment</b>
A-EQPM-FIXD	AEQFI	Fixed Equipment
A-EQPM-MOVE	AEQMO	Movable Equipment
A-EQPM-NICN	AEQNI	Equipment Not in Contract
A-EQPM-ACCS	AEQAC	Equipment Access
A-EQPM-IDEN	AEQID	Equipment Identification Numbers
A-EQPM-ELEV	AEQEL	Equipment Surfaces (3D Views)

22 Copyright 1990 The American Institute of Architects

Layer Name	Drawing (Output Plot)	CAD File
A1.1 Floor Plan	8951A1	
A1.2 Reflected Clg. Plan		
A1.3 Furniture Plan		
A1.4 Finish Plan		
A2.1 Arch. Details	8951A2	
A3.1 Section/Elevations	8951A3	
A4.1 Room & Door Schdl	8951A4	
M1.1 HVAC Ductwork Plan	8951M1	
M1.2 HVAC Equip. Plan		
M1.3 Chld Water Pnng Plan		
M2.1 Equip. Schedule	8951M2	
E1.1 Elec. Power Plan	8951E1	
E1.2 Elec. Lighting Plan		
E1.3 Telephone/Data Plan		
E2.1 Circuit Schedules	8951E2	
A-WALL	●	
A-WALL-PRHT	○	
A-DOOR	●	
A-GLAZ	○	
A-FLOR	●	
A-FLOR-WDWK	○	
A-FURN	●	
A-CLNG	○	
A-ELEV	●	
A-SECT	●	
A-PFLR	●	
A-PCLG	●	
A-PMFN	●	
A-PXFU	●	
M-HVAC-CDFF	○	
M-HVAC-DUCT	●	
M-HVAC-EQPM	○	
M-CWAT	●	
M-SCHD	●	
M-PDUC	●	
M-PHVA	●	
M-PLCW	●	
M-SCHD	●	
E-POWR	●	
E-LITE-CLNG	○	
E-LITE-CIRC	●	
E-LITE-PANL	○	
E-COMM	●	
E-SCHD	●	
E-PPOW	●	
E-PLIT	●	
E-PCOM	●	
E-SCHD	●	

LEGEND ● Active Layer ○ Referenced Layer

The recommended names (above) have both long and short forms and are grouped by discipline. They begin with "A" in the architecture, interiors, and facilities division. A CAD layer matrix (left) shows the relationship among layers, files, and drawings. The A-WALL layer, located in CAD File 8951A1, is used to plot 10 drawings. A solid dot denotes the layer originates. A hollow dot indicates the layer is used for plotting but comes from another file.

other computer-related topics—is being studied by a new AIA Task Force on Computerized Practice. The six designated participants, including Chairman Schley, met for the first time in September.

Of course, the Task Force on CAD Layer Guidelines still has more work ahead. The members are actively trying to enlist organizations and agencies to accept their format so that it truly becomes a universal naming system for CAD layering. And they will be modifying the first edition of the guidelines—largely in response to comments by professionals who are now implementing the ideas—when they reconvene in 1991. CAD Layer Guidelines can be obtained from the AIA Press by calling 800-242-4140. The cost for the booklet is \$13.50 for AIA members (\$15.00 for non-members), plus \$4.00 for shipping.

—NANCY B. SOLOMON

Nancy Solomon is a Washington, D.C.-based architect and freelance writer.

## A Measured Perspective

### TECHNIQUES: PHOTOGRAMMETRY

*Computerized photographic survey methods are easing the process of recording existing structures.*

AS LONG AS THERE HAVE BEEN CAMERAS, photographs have been used by architects as reference tools for documenting existing buildings. For the purposes of producing measured drawings, however, they have served primarily as supplements to manually recorded dimensions. Less familiar to architects is photogrammetry, a method of determining measurements from photographs. The process differs from typical surveying techniques by relying on very few field measurements. Instead, dimensions are derived from specialized photographic equipment.

Extracting measurements from photographs is superior to hand measuring in several ways. One benefit is the ability to record inaccessible and difficult-to-reach areas such as tall buildings or towers—an ornate church spire, for example. When measuring by hand, it is also difficult to establish reference points for measuring intricate details or irregular shapes lacking geometric form. Photographs, on the other hand, can document a complex form quickly, without requiring contact with a structure.

Photographic techniques are particularly

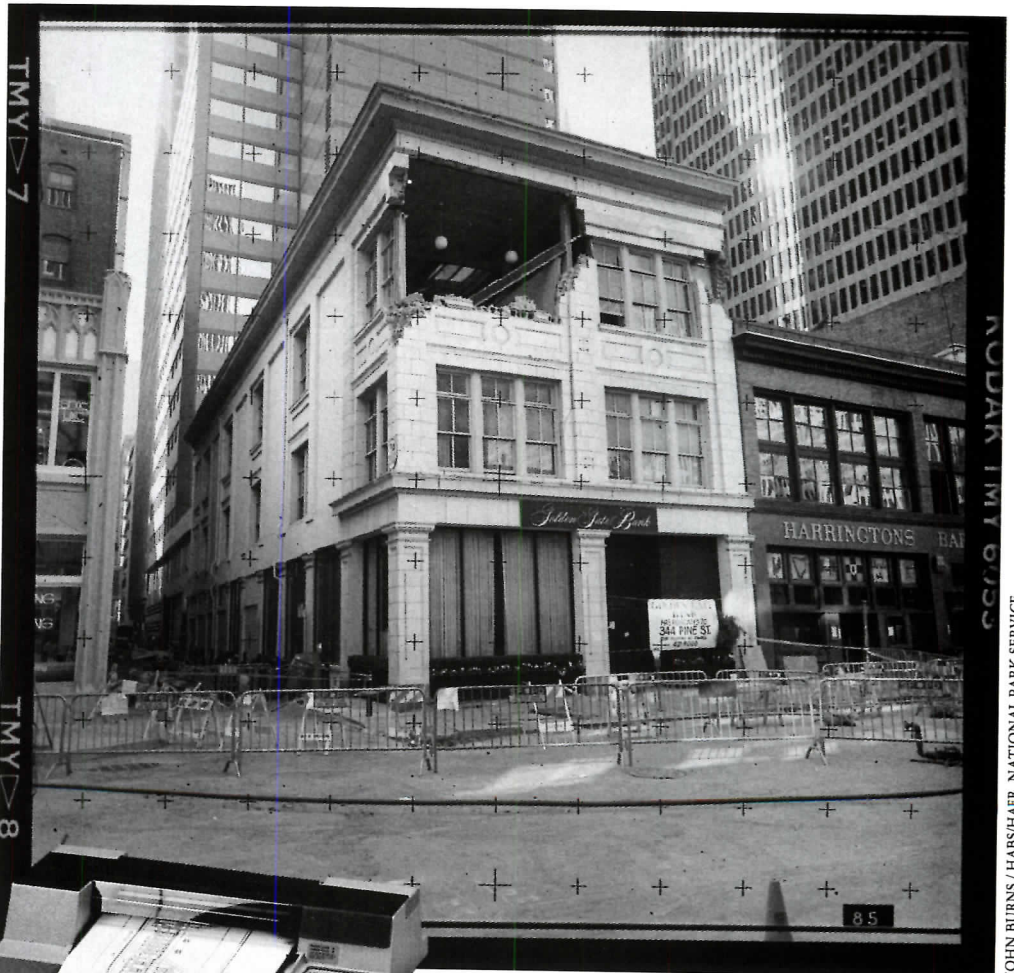
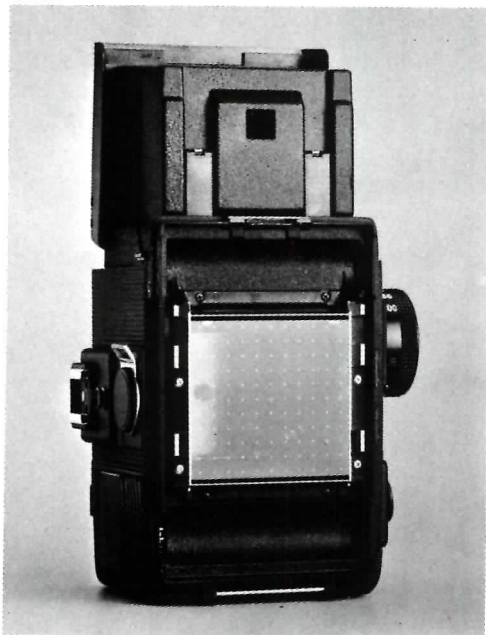

To avoid dangerous physical contact required to measure a damaged structure by hand (above), accurate drawings can be created from photographs taken with a hand-held camera. The required tools are a personal computer, specialized software, a plotter, and a digitizing tablet (top left to bottom right).



Methods for obtaining precise results from photographs were previously limited to specialized equipment. A fixed-position set of calibrated cameras (near right) capture a pair of overlapping images (above). These images are then projected to create a single three-dimensional or stereo model (far right), which can be measured and plotted to create dimensioned drawings.

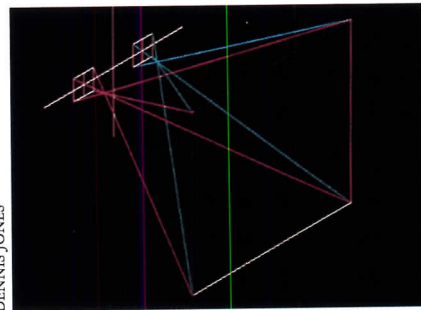

advantageous if a building is in danger of collapsing or scheduled for demolition. The Historic American Building Survey (HABS) and the Historic American Engineering Record (HAER), divisions of the National Park Service, have found photogrammetry an appropriate technique in recording landmark structures in otherwise difficult-to-document locations. Recently, John Burns, deputy chief of HABS/HAER, applied new photogrammetric techniques as part of an emergency response team recording historic buildings damaged by the 1989 San Francisco earthquake before they were demolished or repaired. Photographs provide a permanent record with detail that can later be extracted. Photogrammetry also offers the ability to monitor building deformations, such as structural movements and facade deterioration, by comparing the same reference points in photographs taken at different times.

#### Evolution of the technology

SINCE PHOTOGRAPHY WAS FIRST AVAILABLE in the 1830s, photogrammetry has been applied to land surveying, and, with the development of aircraft, its application has grown to encompass nearly all large-scale topographic mapping. Photogrammetric applications in architecture have previously been limited to the same principles and tech-

niques used to create topographic maps.

Aerial photogrammetry depends on two closely spaced mounted cameras that take sequential photos of overlapping images. Similarly, earlier types of architectural photogrammetric evaluation required two cameras positioned precise distances from each other and from the building. The resulting negatives created a stereo pair that was viewed as an overlapping, three-dimensional image, which was then plotted manually or electronically to produce a measured drawing.

An electronically rectified photograph, known as an orthophoto, can also be derived from the stereo pair. The orthophoto is created from the stereo pair to produce a two-dimensional image print that can be directly scaled. However, the orthophoto can only be used to draw elevations, since the depth of building elements cannot be obtained by correcting for perspective.

Unfortunately, the equipment needed for stereo photogrammetry approaches the cost of a mainframe computer, limiting access to a few specialized firms. As a result, its application has been prohibitively expensive for all but the most historically significant structures, with costs for contract services frequently paid by local and federal government agencies. And, although they are experts in analyzing dimensions from photographs, photogram-

metric-service firms are not the best qualified to interpret elements significant to architectural documentation.

#### New techniques

PERSONAL COMPUTERS WITH CADD CAPABILITIES have influenced photogrammetry, combining the advantages of photographic documentation with the benefits of CADD systems in facilitating drafting. By applying the analytical capabilities of a personal computer, innovations in the field are making it possible for a novice in photogrammetry to walk around an existing building with a hand-held camera and extract accurate dimensions from the resulting photographs. Detailed elevations and three-dimensional drawings, such as isometrics or perspectives, can be produced to articulate windows, doors, trim, and brick coursing, as well as depicting areas where a damaged surface material is scheduled for repair or replacement.

By applying a combination of standard and specialized tools, architectural firms now have the capability of multi-image restitution, a technique comparable in accuracy but less demanding in equipment and expertise than stereo-photogrammetry.

Determining measurements from standard

photographs taken by uncalibrated cameras (thereby avoiding the complex procedure required for stereo photogrammetry) has traditionally been limited by several factors. Distortions created by buckled film and by lack of precise lens optics (in both the camera and enlargement process), for example, can bow an image. These inaccuracies are variable and inconsistent throughout a photograph and are therefore difficult to correct. With a PC, however, the photographic distortion can be compensated, eliminating the need for calibrated cameras. Instead, modified versions of ordinary cameras, known as semi-metric cameras, can be used.

Conventional 35mm or 6cm-by-6cm (2 1/4-inch) camera bodies and lenses are retrofitted by the manufacturer with a gridded plate (properly called a "reseau") of fixed-positioned crosshairs permanently mounted just in front of the film plane. The gridded reseau points appear on each negative and reproduction so that by digitizing the points from the enlargement, their location can be compared with the known, calibrated positions programmed in the software. The software can then correct for discrepancies between the digitized and calibrated points due to film or lens inaccuracies.

To capitalize on semi-metric cameras for measured drawings, architects need a digitiz-

ing tablet, an IBM-XT-compatible desktop computer with a math coprocessor, a plotter, AutoCad software, and the necessary photogrammetric software. The German-based manufacturer Rollei has produced a system integrating the camera and software based on the principle of multi-image photography, and is designed to be accessible to the inexperienced photogrammetrist.

Jim Williamson, an experienced close-range photogrammetrist, has developed his own software for correcting photographic distortions. He explains that the principles of eliminating variations in measurements caused by photographic perspective are similar to drawing architectural perspectives from plans and elevations—except that the process is reversed. Reverse-perspective analysis relies on first determining the location of the camera relative to the photographed object. Based on trigonometric equations derived from the geometric relationship of the camera to the building, the distance of the object points can then be triangulated by photogrammetric software.

The software is first oriented by digitizing a sketch of the rough location of each photograph. The exact location is fine-tuned by digitizing common points in each of those photographs. This process requires enlargements of the exposures, which are mounted on a digitizing tablet that can accommodate up to four 8-by-10-inch prints, allowing common views to be observed simultaneously. The reference points, located by targets placed on the building during the field phase, are manually digitized with a movable sensor similar to a mouse. Once the camera position is established, the software traces a line from each of the points back to their convergence at the camera. Since a point can exist anywhere along the line, with more than one photograph capturing the point, it is more precisely located in three-dimensional space by the intersection of another line traced from a different angle.

The result is a file of established points and lines creating a three-dimensional wire-frame model that can be transferred into AutoCad. Elevations, isometrics, and perspectives can all be plotted from this model. Improvements to the final drawing, such as applying material delineation, depend on the sophistication of the CADD program. Once an "as-built" model is created, it can be manipulated to illustrate proposed rehabilitation and renovation work for presentation and working drawings.

### Field survey

IN MULTI-IMAGE PHOTOGRAMMETRY, CONDUCTING a field survey is relatively simple, with only a few guidelines to consider. Unlike precisely calibrated cameras which are cumbersome and require a carefully positioned

fixed station point, the multi-image process achieves its accuracy and camera orientation by relying on several photographs taken from widely separated vantage points. A rough, hand-drawn sketch of the site, outlining the building perimeter and identifying the approximate locations of the camera for each photograph, is necessary for software evaluation at the desktop work station.

To identify a precise point for later comparative reference in enlarged exposures, targets are placed on the building surface. The photographs must capture a minimum of five points on the structure and one measured

vantage in a constricted site, where obstructed views can otherwise severely limit information obtained by photographically documenting a building.

The accuracy of multi-image photogrammetry depends on several factors, including the precision of manually aligning the digitizer to pinpoint common locations on separate photographs, the number of points on the object established, and the number of common points used to cross reference a location. The distance from which photographs are taken and the amount of detail captured by photographs also influence accuracy. If rec-



**Accurate measurements equal to those obtained from calibrated cameras can be made from standard film exposures (above). Using the Rollei system, a grid of points is superimposed on the image, which can be taken from any angle, and a computer program will compensate for film and perspective distortions by digitizing the points.**

distance to provide scale. These points also need to appear in at least two, and, ideally, in three or more photographs. Accuracy of the final drawings improves with an increase in the number of points identified on the structure and with more points that can be cross referenced in additional photographs. Otherwise, the position of the camera relative to the building is unimportant, enabling the photographer to move freely around the building. In addition to the time saved over establishing a fixed camera location, flexibility in choosing vantage points is a considerable ad-

commended procedures are followed, dimensions with a standard deviation of one part in 2,000 (+/- 1/4-inch over a 41-foot measured distance) can be achieved. If this degree of accuracy is not required, 35mm cameras can be used. Harrison Eiteljorg, director of the Center for the Study of Architecture in Bryn Mawr, Pennsylvania, has compared semi-metric and 35mm cameras, achieving nearly equal results. However, he cautions that self-calibrating a camera and interpreting the results requires considerable photogrammetric expertise.

COURTESY OF TERRA METRIC, INC.

## Limitations

ONE IMPORTANT POINT TO REMEMBER IN USING photogrammetry is that only the portion of the building photographed can be recorded later, and a building must be photographed at least twice for accurate measurements. Architects who intend to use Rollei's system should have experience with AutoCad, since Rollei's data files can only be interpreted by that specific software. The process of translating photographs to drawings is not yet automatic. Although the outline of all the building details reproduced does not have to be digitized (only the common points and reseau crosses are necessary) the orientation phase, the evaluation phase, and the plotting each take several hours, depending on the level of detail, scope and size of the project, and number of drawings.

Rollei's software acts independently of AutoCad and lacks graphics, making it difficult to check the developing model except by periodically importing the data into AutoCad and plotting results. Producing three-dimensional drawings uses the program to the best advantage in terms of time savings, since the same number of points have to be entered to create orthographic elevations. Currently, Rollei's software costs about \$15,000. Semi-metric cameras are available from several

manufacturers, with prices starting at several thousand dollars. Although the equipment is far less expensive and requires less expertise than previous methods, photogrammetric-service firms are still the primary purchasers.

To eliminate the tedious and time-consuming steps of manually digitizing points, still-video cameras present a possible option for the future. These are equipped with a charged-couple-device (CCD) sensor instead of film—a chip that captures images electronically. The images can then be input directly to computer programs for dimensional analysis, reducing inaccuracies from

the digitizing process. Currently, however, the resolution of video equipment limits the accuracy of derived measurements in comparison with higher resolution film exposures.

The merits of architectural photogrammetry relative to time, expense, speed of recording, and needed accuracy, must be weighed in comparison with other survey techniques. However, new photographic equipment and computer software are transforming the previously limited architectural applications of photogrammetry into a more feasible, efficient alternative to traditional methods. ■

—MARC S. HARRIMAN

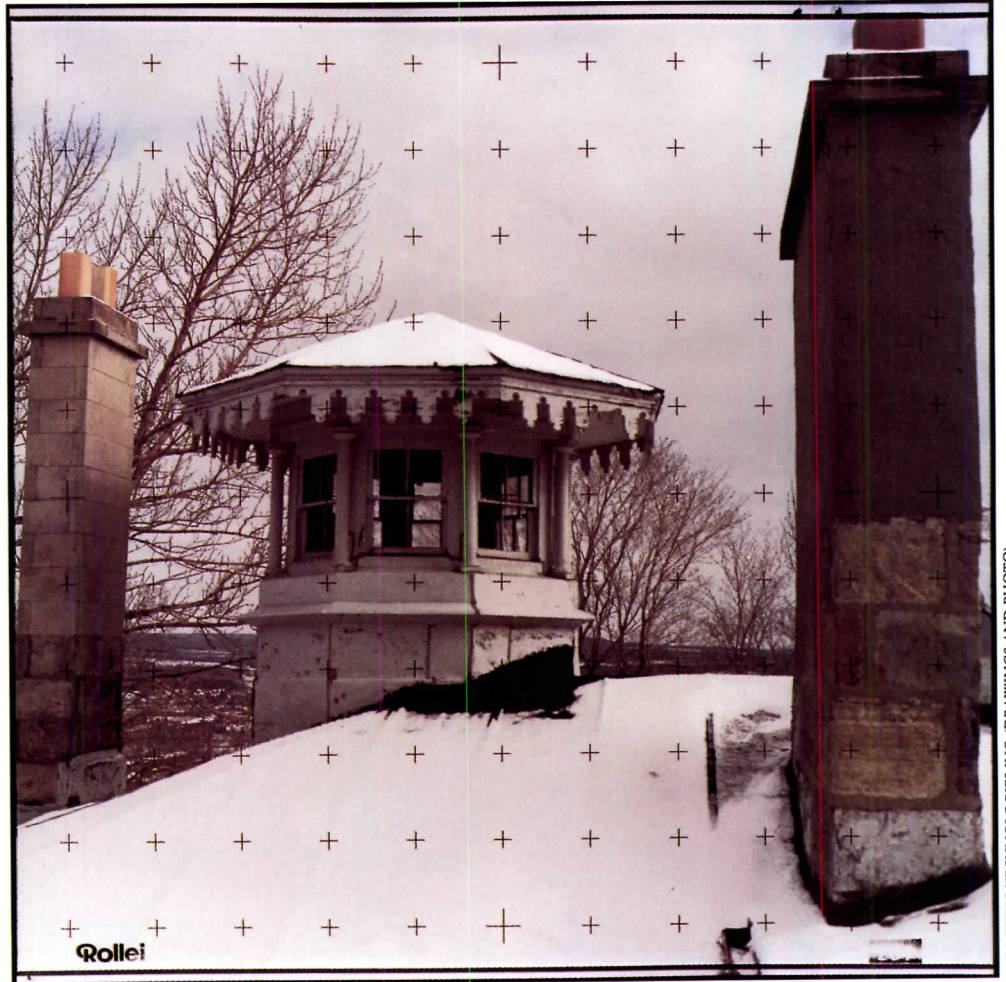
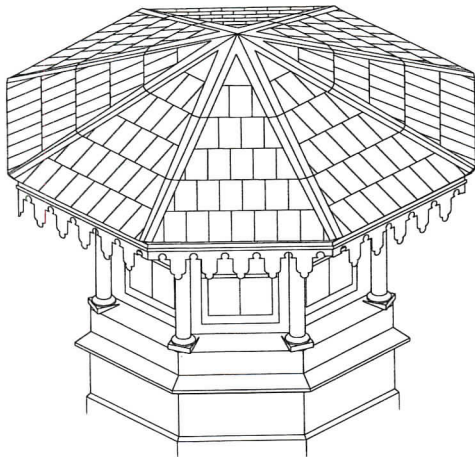

PROMETRIC TECHNOLOGIES INC. (DRAWINGS AND PHOTO)



**Intricate architectural details that are difficult to measure by hand can be photographed as isolated elements (above), translated into CADD elevations (bottom left), and plotted as three-dimensional drawings (above left).**

# New TITUS® air diffuser harmonizes with your ceiling



**C**onventional air conditioning diffusers can fill the ceiling with protruding louvers or large expanses of perforated metal. But here is a diffuser that is visually smooth *and* superior in performance.

The TITUS® Modu-Bloc diffuser (foreground in ceiling at left) gives you clean, unobtrusive lines, flush with the ceiling. The diffuser blends with whatever ceiling system you have selected, because a piece of the actual ceiling material becomes the diffuser's center panel. This material can be acoustic tile, texture coated sheet rock, or anything that can be formed or cut into a square panel. The mounting can be standard tee-bar, narrow tee or surface.

## Performance and layout flexibility

Designed for use in modern variable air volume systems, the Modu-Bloc diffuser projects a tight, horizontal blanket of air across the ceiling for draft-free comfort — *plus protection against ceiling smudging.*

All four outlet slots are individually adjustable for both angle and volume of air flow. This means you can be flexible in your layout; you can locate diffusers with an eye to both aesthetics and structural realities, and still maximize heating and cooling comfort.

Call today for data on Modu-Bloc, the design-conscious diffuser.

TITUS Modu-Bloc diffusers are installed throughout the IBM National Marketing and Technical Support Center at Solana, in Southlake, Texas. Joint venture of IBM Corporation and Maguire Thomas Partners. Design architect: Legorreta Arquitectos. Architects of record: LPA. Mechanical engineers: Carter & Burgess Inc. General contractor: HCB Contractors. Mechanical contractor: Brandt Engineering Company Inc.

*Above:* Employee entrance lobby. The ceiling diffuser in the foreground is a 24" x 24" TITUS Modu-Bloc, installed in a plaster frame. The center panel of the diffuser consists of the same material as the ceiling.

*Right:* View near the main entrance.

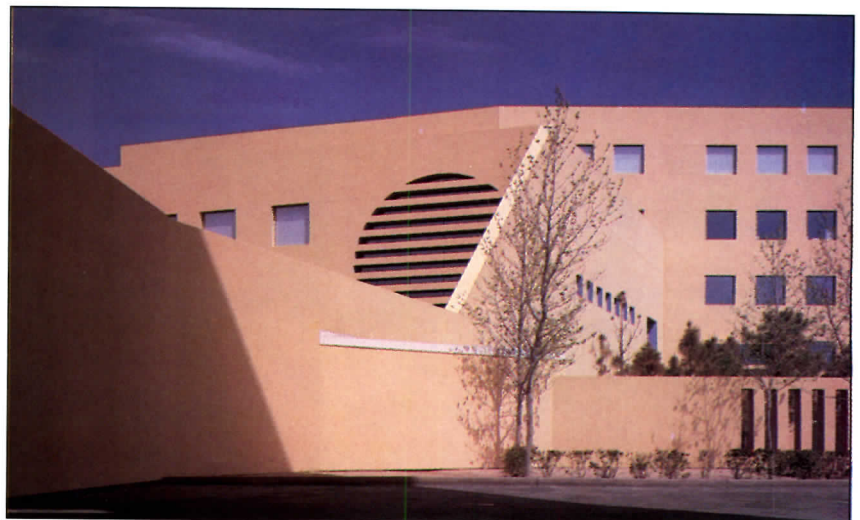

990 Security Row  
Richardson, Texas  
Phone 214-699-1030  
FAX 214-644-4953

# THE QATRA™ DIFFERENCE

LOOKING FOR A *NEW*  
EXTERIOR INSULATION  
FINISH SYSTEM?

WHY?

TRY THE QATRA  
DIFFERENCE INSTEAD.

## QATRA IS NOT EIFS

- No Gypsum Board
- No EPS Foam
- No Brittle Cement Base Coat

## QATRA IS

An elastomeric synthetic  
stucco finish applied *directly to*  
*Eterspan*, a hard fiber rein-  
forced cement substrate.

- Noncombustible
- Highly Impact Resistant
- Completely Water Resistant
- About The Same Price  
As EIFS

## DURABILITY AND STABILITY . . .

Because of QATRA's excep-  
tional dimensional stability,  
'jointless' runs up to 25 feet can  
be made to a max. of 250 sf.

Call us for more information,  
samples and budget pricing on  
QATRA, The *Hard System*,  
800-233-3155.



# Eternit®

Eternit Inc.  
Excelsior Industrial Park  
P.O. Box 679  
Blandon, PA 19510-0679  
800-233-3155  
(215) 926-0100





# PRODUCTS

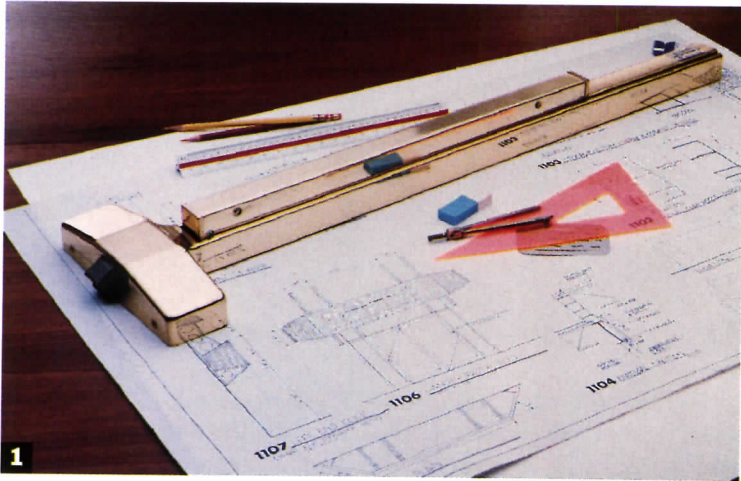

1



2

**1. Monarch 17 and 18 Series exit devices are specified for heavily trafficked openings. Circle 401 on information card.**

**2. The Best Lock 35H Series mortise lockset allows master-keying with other systems. Circle 402 on information card.**

**3. Von Duprin's 99EL exit device is paired with Digital Scrambler access-control keypads. Circle 403 on information card.**

**4. Dorma 7800 closer has high-security valve and screw features. Circle 404 on information card.**

## PLAYING IT SAFE

Sophisticated security and dependable hardware.

DURABLE SECURITY HARDWARE AND AUTOMATED MONITORING SYSTEMS have become standard elements in commercial building programs. In urban, suburban, and rural settings alike, extensive security measures are routine for ensuring safety and privacy. But with the recent passing of the Americans With Disabilities Act, accessibility has become as important an issue as protection for designers of commercial and public spaces. New security hardware products thus address the improvement of accessibility while ensuring safety in security-sensitive buildings, such as corporate headquarters and prisons.

Some innovative products have been introduced that support the use of commonplace security hardware such as locks, closers, and panic bars. Newest among these products are umbrella systems like the Schlage SE6000, developed with Basic Applications, Inc., and Hewlett Packard. The system combines entry/exit hardware with powerful computers to control access and record information at thousands of points in many locations. The 6000 Series is designed for maximum flexibility, building on existing Schlage monitoring hardware and using existing conduits for wiring. In addition to monitoring information at entry/exit points, this system can control elevator operations and keep employees' time and attendance records. —RANDALL MASON



3



4

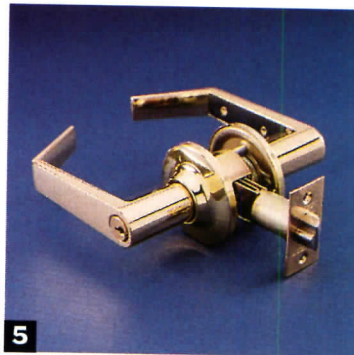

5



6

**5. Falcon's F Series locksets conform to state accessibility codes. Circle 405 on information card.**

**6. The SE6000 access control network monitors thousands of access points. Schlage. Circle 406 on information card.**

**7. LCN Closers feature tamper-resistant components. Circle 407 on information card.**

**8. The 7500 closer is activated by scanner or gentle shove. Norton, division of Yale Security. Circle 408 on information card.**



7



8



1

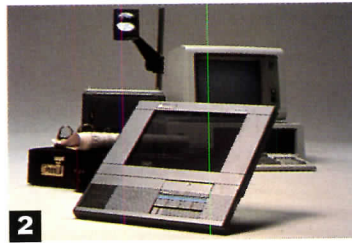

2



3



4

## WHITE-COLLAR REALITY

Cost-saving systems for the modern office.

IN THE 1970s, IT WAS PREDICTED THAT IN A MATTER OF DECADES THE modern office would be paperless and completely automated. In 1990, however, paper remains the preeminent business medium despite continual advances in technology and communications. In today's office environments, computers, communications equipment, and conventional furnishings all vie for valuable space.

A decade ago, videoconferencing was also predicted to be the next revolution in communications, but its high costs proved prohibitive for most businesses. Recent developments, however, are now making affordable videoconferencing a reality. Computers, graphics, video, and audio devices—the next generation of office machinery and furniture—are easing live face-to-face links between individuals at remote locations (ARCHITECTURE, September 1990, pages 129-132, 141).

Nevertheless, managing paper is still the most challenging task of most offices. Intelligent new filing components from Spacesaver and Meridian acknowledge that offices continue to be paper-filled, even with more space dedicated to computers. —R.M.

**1.** Peirce-Phelps, Inc. designs, manufactures, and installs this videoconferencing environment. The state-of-the-art system includes cameras, video monitors, audio systems, codecs, computers, and furniture. Circle 409 on information card.

**2.** Wired to a computer and placed on an overhead projector, Dukane's MagniView LCD Panels enlarge and project computer images (either graphics or text) onto screens for presentation. Circle 410 on information card.

**3.** Electrohome ECP 4000 three-bus graphics and video projection system is controlled through an internal microprocessor and operated by infrared remote control. Circle 411 on information card.

**4.** FlutterFree acoustical moulding from RPG Diffuser Systems improves the sound environment for videoconferencing, as well as a variety of other applications. Circle 412 on information card.

**5.** Meridian modular lateral files allow efficient storage of paper in various arrangements and come in 44 standard colors. Innovative electronic locking systems are also available. Circle 413 on information card.

**6.** Mobile storage and filing systems from Spacesaver allow high-density storage in a minimum of space. Options include custom graphics for unit ends. Circle 414 on information card.

**7.** Meridian's Electronic Support Systems feature flexible components, articulating keyboard pads, 18 printer-table configurations, and textured steel matte finishes. Circle 415 on information card.



6



5



7



# YES. AGELESS DESIGN TO STAND THE TEST OF TIME.

**L**ike the pyramids, the YES Entrance System provides durability, timeless design and more. Much more. You'll find no other manufacturer provides as many standard features. And you get all the extras without added costs.

Compare the standard features of Yes Entrance System and select its distinctive quality for your next ageless design.



**Versajamb™**  
Our unique tubular frame with snap-in filler for added frame strength and rigidity for greater windload capacity, without exposed fasteners.

YES ENTRANCE SYSTEM	STANDARD FEATURES
<b>Door/Frame</b>	
Accented pull handles (all exposed surfaces fully anodized)	Yes
Accented push bar with end caps	Yes
Adjustable levelizer	Yes
Anodized Plus™	Yes
Combination mechanical and welded corners	Yes
Flush bolt trim plate	Yes
Heavy-duty flush bolts	Yes
Lock strike trim plate	Yes
Maximum security hook bolt	Yes
No exposed fasteners	Yes
Non-removable adjustable bottom pivots	Yes
Spring-loaded top pivots	Yes
Thermoplastic elastomer weather stripping	Yes
Unique Versajamb™ construction	Yes

**YKK®**  
Architectural Products Division  
Framing Systems for Innovative Designs

5610 Gwaltney Drive  
Atlanta, GA 30336  
(404) 344-2981  
YKK, AP International: Tokyo, Singapore,  
Taipei, Hong Kong, Jakarta, Melbourne  
and Sao Paulo.

Circle 93 on information card

# PRODUCTS

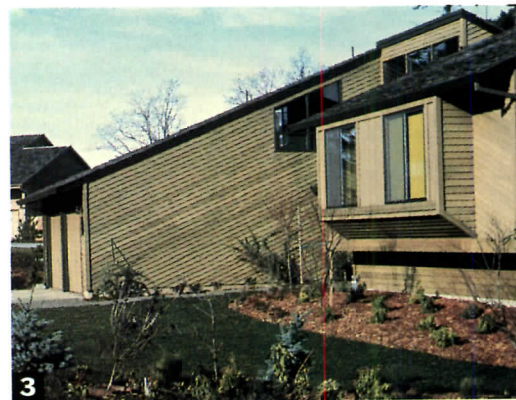

## SIDE BY SIDE

Recladding exteriors in wood, metal, and synthetics.

FOR THE FIRST TIME IN HISTORY, AMERICANS ARE SPENDING MORE money on remodeling and home improvements than on buying new houses, according to the American Homeowners Foundation (AHF). This trend has been steadily on the rise since 1985, and according to AHF vice president John Prufrock, is due to the fact that remodeling is simply "less disruptive and expensive." One type of residential remodeling that is straightforward and cost-effective is the application of exterior siding. There are many choices on today's market, from wood paneling to aluminum cladding and synthetics such as vinyl. Updated palettes offer a varied selection of colors from which to choose, and synthetics resembling textured wood grain have also been recently introduced. Durable, easy to maintain finishes are more available thanks to technological advances in coatings and sealants. Special formulas enable surfaces and edges of wood siding to resist warping, buckling, and delaminating. Fiberglass composites in metals and synthetics help prevent scratches, dents, and corrosion in metal panels.

—AMY GRAY LIGHT

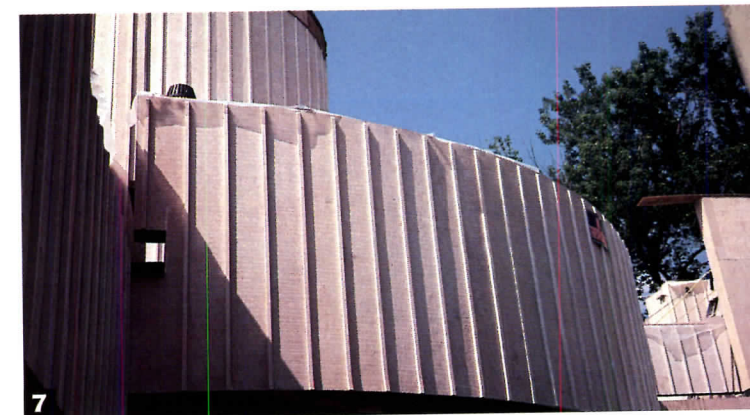

**1.** The Monogram vinyl siding line includes 12 siding colors and 15 matching or contrasting trim colors. Complements, a line of decorative accessories, is also available. CertainTeed Corporation. Circle 416 on information card.

**2.** Alcoa Building Products' new dentil molding of white PVC trim in 12-foot lengths can be painted and nailed. A new line of aluminum siding called Horizon, with five neutral colors, is also available. Circle 417 on information card.

**3.** Clear cedar bevel siding is offered in widths from 4 to 12 inches. Western Red Cedar Lumber Association. Circle 418 on information card.

**4.** Smooth L-P Inner Seal is a 7/16-inch oriented strand board that resists warping, buckling, splintering, or delaminating. Louisiana-Pacific Corporation. Circle 419 on information card.

**5.** PrimeTrim from Georgia-Pacific is a high-resin, high-temperature-cured, all-wood fiber composite panel. Circle 420 on information card.



**6.** Redwood heartwood siding resists decay, insects, and fire. Weather-tight joints help prevent warping. California Redwood Association. Circle 421 on information card.

**7.** APA-rated siding 303 Rough Sawn is available in a variety of lengths, sizes, and surface treatments. American Plywood Association. Circle 422 on information card.

# Now you can earn premium credits for longevity & loss prevention.



Now there are even more ways to save money under the CNA/Schinnerer professional liability insurance program\* for architects and engineers. We give

- A 5% credit for firms with acceptable claims experience that have been CNA/Schinnerer policyholders for three to four years

*or,*

- A 10% credit for firms with acceptable claims experience that have been CNA/Schinnerer policyholders for five or more years

*plus,*

- A 5% credit for firms with acceptable claims experience that implement loss prevention programs.

All this is in addition to our traditional underwriting credits for firms with acceptable claims experience.

You work hard to manage your risks—both professional and financial. Let CNA/Schinnerer support your efforts. These new credits join our many loss prevention programs to help you where it counts—on your bottom line.

\*CNA/Schinnerer is proud to have earned the commendation of the AIA and NSPE/PEPP.

Victor O.

**Schinnerer**  
& Company, Inc.

Underwriting Manager  
Two Wisconsin Circle  
Chevy Chase, MD 20815-7003  
(301) 961-9800, Telex 892340

Chicago, (312) 565-2424  
New York, (212) 344-1000  
San Francisco, (415) 495-3444

**CNA**

For All the Commitments You Make®

Note: Credits apply to limits up to \$1,000,000 and are subject to approval by your state insurance department.

Coverage for this program is provided by Continental Casualty Company, one of the  
CNA Insurance Companies/CNA Plaza/Chicago, IL 60685

Circle 95 on information card

## ON THE BALL

A new table captures the kineticism of dance.

AWARD-WINNING DESIGNER DOUGLAS BALL BEGAN HIS LATEST FINISHED design for Vecta by sketching on paper napkins while traveling. Upon reaching his Quebec office, Ball transferred the designs for his new Vecta table onto a three-dimensional computer system, his principal sketching and design tool. The resulting table was built entirely off computer-generated data, simplifying the design process. On screen, the designer twisted and rotated the table in synchronized movement, reminding him that an earlier sketch had suggested a dancer in full flight. The table's anthropomorphic base also recalls a dancer's sweeping lines. Thus, the series was named Ballet.

The Ballet Table premiered at Neocon 22 in June, generating enthusiasm for its clean lines and the ease with which it could be folded and carried. Ball achieved his desire to create a multiple-use piece of furniture without the constraints of a full-length table. The designer so enjoyed working with Vecta, a "company with spirit and energy," that he is working on an accompanying folding chair. ■

—A.G.L.

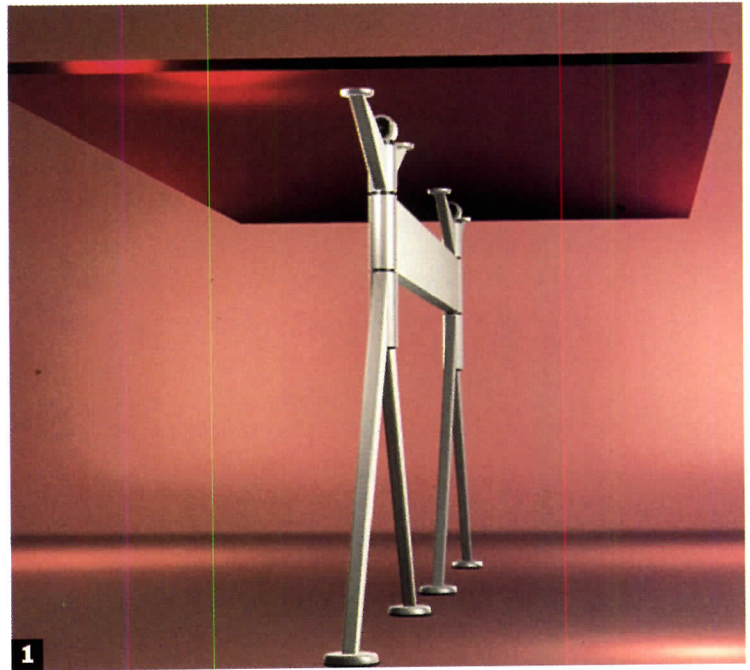

The Ballet Table series epitomizes Vecta's reputation for industrial elegance. Two base options, "X" and "K," are available. The X base (1) supports a variety of rectangular table tops 30, 36, and 42 inches wide to be used for conference, dining, and work surfaces. All models but the 42-inch version are available in 60-, 72-, 84-, and 96-inch lengths (the 42-inch model does not offer a 60-inch length). The K base is primarily recommended for training/seminar tables and is 24 inches wide in 48-, 60-, 72-, and 84-inch lengths. The base can be finished in 29 thermoset colors. The laminated table top (2) is

available in 30 colors and has a custom-designed, ribbed vinyl edge with corner inset bands. Wood veneer tops in 10 choices have a tapered self edge. Both variations convert easily into folding tables by a pivot and fold action (3). Ball designed the table so that one person can easily hoist and carry it (4). Says Ball, "I wanted to design a simple work table with many functional uses; a table that doesn't appear full-length but can be altered as needed." Ball points out that today's furniture market offers few tables as basic or as adaptable as this one. Vecta. Circle 423 on information card.

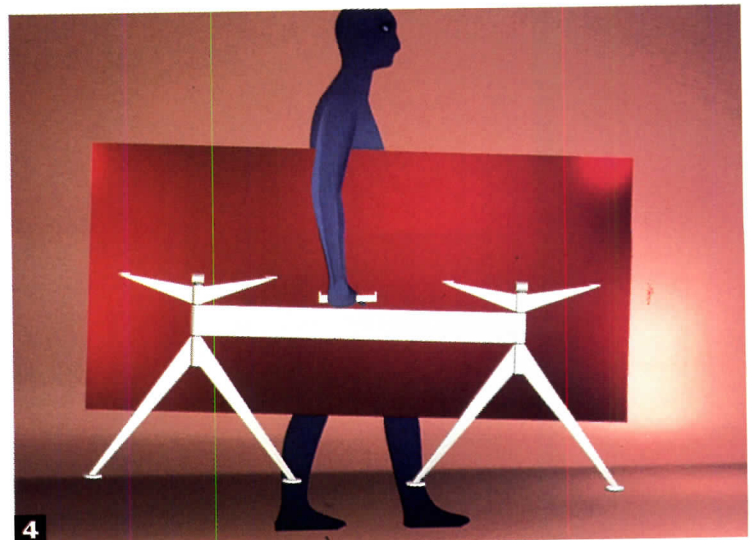
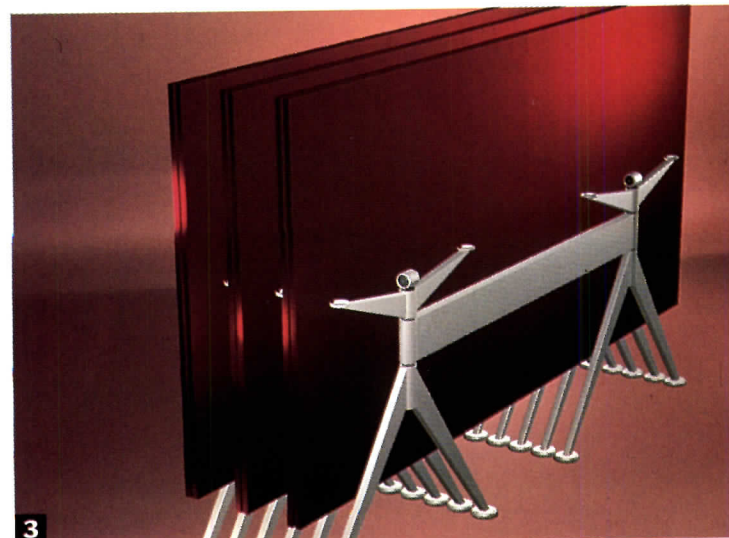

# PRODUCTS

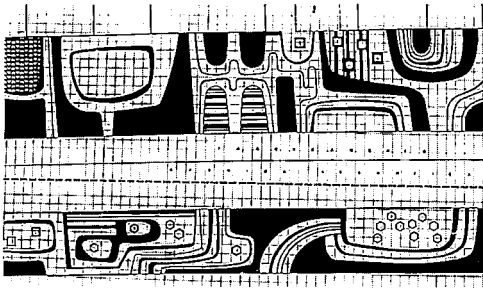

## Master Design Series

THE LANDSCAPE ARCHITECTURE OF ROBERTO Burle Marx is the first documentary in a Master Design Series recently introduced by landscape architect and former professor of landscape architecture, Zara Muren. The one-hour film explores the work and ideas of the Brazilian designer, whose striking compositions and use of indigenous plant materials revolutionized the treatment of urban open spaces.

Marx, 1985 recipient of the American Society of Landscape Architects' highest honor, the A.S.L.A. medal, reveals his creative approach as he discusses a diverse selection of his most famous projects.

Shown are the three-mile-long Copacabana Promenade in Rio de Janeiro, (illustrated at left as a conceptual drawing); IBM plaza; Itamaraty Palace, and Monterio Residence. The film ends at Burle Marx's home, site of a garden and nursery that contain his design experiments and some of his most perfectly realized work. Shown at several landscape design conferences this year, the film is available in both VHS or 3/4-inch video tape. Inquiries may be sent to Master Design Series, 200 Crescent Road, San Anselmo, California, 94960, or telephone (415) 459-2255.

## Single-Lever Kitchen Mixer

A NEW LINE OF SINGLE-LEVER MIXERS for high-end kitchen design has received approval for installation in all areas of the country from IAPMO, a West Coast code certification plumbing organization. The Allegro line of kitchen mixers is available in chrome, white, almond, satin chrome,

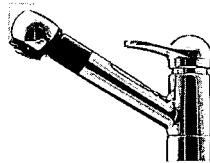

and polished brass from Hansgrohe, Inc.

*Circle 424 on information card.*

## New Service for Architects

CONCEPTUAL DESIGN ANALYSIS IS A COMPUTERIZED construction database that provides construction estimates from anywhere in the United States and Canada. The service compares the cost of more than 12,000 materials, and 22 local construction firms individualized for more than 700 zip codes. The service is available from Marshall & Swift, a leading supplier of cost data in the construction industry.

*Circle 425 on information card.*

## Masonry Wall System Guide

A BROCHURE PROVIDING SPECIFICATIONS for Spectra-Glaze's factory-glazed masonry wall systems explains wall details and provides technical data, product descriptions, and installation methods. Information for both exterior and interior walls, construction details and the shapes, sizes, and colors of the masonry systems is also provided. The Burns & Russell Company.

*Circle 426 on information card.*

## UNIVERSITY OF ILLINOIS AT URBANA-CHAMPAIGN SCHOOL OF ARCHITECTURE

DESIGN Teaching Division seeks applicants for two or more full-time nine-month tenured Associate Professor/tenure-track Assistant Professor or Instructor faculty level positions to begin August 21, 1991.

Candidates should be highly motivated and dedicated individuals who can take advantage of the unique resources at the University of Illinois for teaching and research. These resources include personal-computer-based studios, a major reference library, and access to associated research programs (Housing Research & Development Program, Building Research Council, The U.S. Army Construction Engineering Research Laboratory). These positions will involve both studio and lecture/seminar teaching activities. Applicants with professional, teaching and/or research experience in ARCHITECTURE and URBAN DESIGN; THEORY and CRITICISM; HOUSING or CAD, and who are interested in developing and/or pursuing INNOVATIVE approaches to design studio teaching, are especially encouraged to apply.

Rank and salary will be determined by candidates qualifications and experience. Requirements for Associate and Assistant Professors are: Architectural registration plus a Masters Degree or a Ph.D., or similar and equivalent experience. Requirement for Instructor rank is a professional Masters Degree with demonstrated design accomplishment. Previous experience in teaching, research or recognition for design excellence is desirable.

To receive full consideration, Curriculum Vitae, including a statement expressing educational/professional philosophy, and the names of three references must be received by December 3, 1990. Send to: R. Alan Forrester, Director, School of Architecture, Design Search Committee, 608 East Lorado Taft Drive, Champaign, IL 61820 / (217) 333-1330.

The University of Illinois is an Equal Opportunity/Affirmative Action Employer.

## "THE DISAPPEARING DOCK"

Replaces expensive truck wells . . .

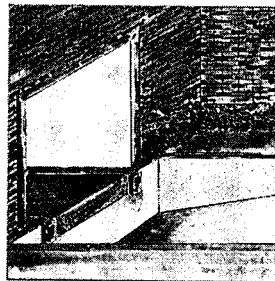

The costly way

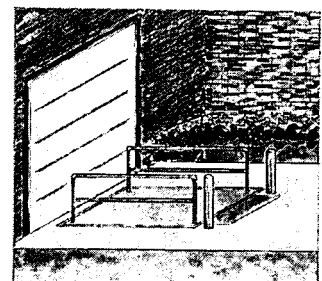

The economical way

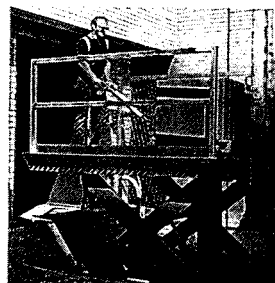

For half the cost of a truck well loading dock, you can have a versatile Advance Superdok.

Call 1-800-THE DOCK for FREE information.

We're here to help.

**ADVANCE LIFTS**

Advance Lifts, Inc., 3575 Stern Avenue, St. Charles, IL 60174 (708) 584-9881

Circle 97 on information card

## Cedar Siding Brochure

A CATALOG DETAILING THE FULL LINE OF western red cedar siding from Shakertown Corporation includes photographs of product applications as well as close-up photographs of the options available, including exposure, shingle spacing, and butt-line applications. Shakertown Corporation.

Circle 427 on information card.

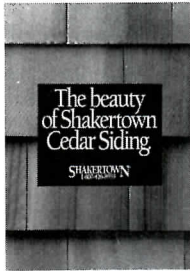

material. The literature includes information on lumber grades as they apply to siding, pattern selection, moisture content, priming, finishes, pre-finishes, and nailing. According to Victor Riolo, WWPA's director of field services, problems with siding represent the main reason for telephone calls received by WWPA's field representatives across the country. The comprehensive package is an attempt to deal with many of these problems before they arise. Western Wood Products Association.

Circle 428 on information card.

## Video and Literature on Wood Siding

A 40-MINUTE VIDEO AND BOOK ON THE USE of natural wood siding is produced by the Western Wood Products Association (WWPA) and the Western Red Cedar Lumber Association. Both are entitled "Natural Wood Siding," and explain how to select, install, and finish the ma-

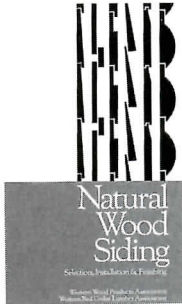

## 1989 Architectural Index

AN INDISPENSABLE OFFICE TOOL FOR KEEPING abreast of current design and research in architecture, urban design, interior design, and landscape architecture is the *Architectural Index*, developed by architect Ervin J. Bell, AIA, its publisher for over forty years. The index contains a complete guide to the 1989 back issues of ARCHITECTURE, *Architectural Record*, *Progressive Architecture*, *Interiors*, *Interior Design*, *Landscape Architecture*, *Builder*, *Custom Builder*, and *Journal of Architectural*

*Education*. Articles on a building or design project are listed under general building type, the location of the project, and the architect or designer. General articles are entered under subject headings. Current issues are \$22, and back issues to 1950 are available. A hardboard binder holding four to five issues is also sold. Contact The Architectural Index, P.O. Box 1168, Boulder, Colorado 80306, or telephone (303) 443-5354.

## Sport Court

THE MINI SPORT COURT FROM SPORT COURT OF America is designed to fill the need for a complete backyard recreation center. The most basic court model includes a surface of shock-absorbing, interlocking plastic tiles; an adjustable net for a variety of racket games; an adjustable hoop; a lighting system; and a rebounder wall for solo practices. The durable grid tile surface is designed to generate the same ball bounce as a conventional court. For games such as tennis, a special ball and racquet that absorbs energy compensates for the smaller playing area. This equipment permits the player a full tennis stroke without over-

## What's behind every Fry molding?



**Our people.** You'll find them behind every Fry architectural molding. Fry is with you from product selection to installation and beyond.

**Our team of product specialists.** Fry will assist with product selection supported by samples and detailed technical information.

**Our quality products and dependability.**

For thirty years contractors have relied on Fry. Our network of distributors. Fry products are readily available for fast, dependable service.

What's behind every molding? The finest products available and caring professional people who will be with you every step of the way.



First Interstate World Center

Fry representative consults on site of First Interstate World Center project, Los Angeles. I.M. Pei & Partners, Design Architect. Ellebe Bechet, Executive Architect.

**FRY REGLET®**  
Aluminum Architectural Moldings

625 South Palm Avenue • Alhambra, CA 91803 • (818) 289-4744 • Fax (818) 289-0537  
2777 Peterson Place • Norcross, GA 30071 • (404) 441-2337 • Fax (404) 441-3194  
Look for us in Sweets catalogue 09200/Fry

Circle 103 on information card

## UNIVERSITY OF CALIFORNIA, IRVINE

### Associate or Full Professor, and Assistant Professor (two positions)—Environmental Analysis and Design

The Program in Social Ecology at the University of California, Irvine, is recruiting for two positions in the area of Environmental Analysis and Design: a full or associate professor, and an assistant professor. Candidates for the senior or associate position must have achieved international recognition for outstanding scholarship in one or more of the following fields: urban and regional planning, environmental planning, facility planning, public health, and/or environmental design research. Candidates for the assistant professor position must have outstanding potential for scholarship and research in any one of these fields. Salary and benefits competitive with the best research universities.

The Program in Social Ecology grants B.A., M.A., and Ph.D. degrees, with over 100 Ph.D. students and approximately 1200 undergraduate majors. The 35 full-time faculty have multi-disciplinary interests and include urban planners, architects, environmental health specialists, psychologists, sociologists, demographers, urban and regional specialists, criminologists, and lawyers. The Program offers a Ph.D. concentration in Environmental Analysis and Design and M.A. concentrations in Urban and Regional Planning and Facility Planning and Management. The selected senior candidate will be expected to provide leadership in the development of these areas of the Program. The Social Ecology Building houses a full-scale environmental simulation laboratory, as well as environmental health and behavioral observation laboratories. As the nation's largest planned community, Irvine offers one of the most interesting settings for the study of planned environments. Orange County is one of the most rapidly urbanizing areas in the nation and has one of the largest concentrations of high technology industries in the world. The Irvine campus of the University of California presently enrolls approximately 17,000 students and is expected to expand to 28,000 by the end of the decade.

Submit letter of application and curriculum vita to:

**Professor Daniel Stokols, Director**  
Program in Social Ecology  
University of California, Irvine, CA 92717

In addition, each candidate should arrange for 3-5 letters of recommendation to be sent directly by each referee before the closing deadline. Closing date for applications is **January 3, 1991**. The University of California is an equal opportunity, affirmative action employer.



# PRODUCTS

playing the court size. The courts range in dimension from 30-by-70-feet to 25-by-52-feet.

*Circle 429 on information card.*

## Roof Systems Brochure

KALWALL CORPORATION'S INSULATING, light-transmitting building system for roofs, both exterior and interior walls, and skylights is described in the company's latest brochure. The system's combined light transmission and high degree of insulation is designed to reduce energy consumption in a building.

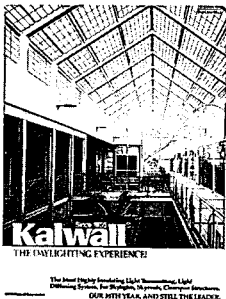

*Circle 430 on information card.*

## Skylighting Metal Buildings

A TRANSLUCENT SKYLIGHT SYSTEM FOR metal buildings is featured in a brochure that covers a variety of applications, including gyms, warehouses, schools, plants, shopping

centers, and other low-profile rooflines. Custom Curb Inc. *Circle 431 on information card.*

## Custom Porch Enclosures

A PORCH-ENCLOSURE SYSTEM FROM SEASON-All features tempered glass; deluxe hardware with deadbolt option; a four-point locking corner gusset system; silicone-treated weatherstripping; a limited warranty; and an option of either Lexan, Sunscreen, or aluminum screens. Season-all Inc.

*Circle 432 on information card.*

## Metal Ceiling Panels

THE CLASSIQUE LINE OF LAY-IN CEILING-panels from Chicago Metallic Corporation is designed for high-traffic areas or dust-free clean rooms. Available in both flat and reveal-edge styles, the panels are stamped from commercial grade steel or aluminum.

*Circle 433 on information card.*

## Acoustical Wall and Ceiling Brochure

THE CONWED LINE OF CUSTOM INTERIOR acoustical products offers a range of wall and ceiling panels and special acoustical and dec-

orative interior solutions. Product descriptions include acoustical properties, construction, sizes, installation options, and sample specifications. Conwed Designscape.

*Circle 434 on information card.*

## Brochure Details Fiberglass Duct Systems

A NEW FOLDER FROM MANVILLE CORPORATION outlines three steps to effective and reliable medium pressure fiberglass duct systems, and shows how the Manville fiberglass duct board is supported by the company's other line of products. For a copy of "Right Ducts," (No. AHS-129-1-90), write Manville, Product Information Center, P.O. Box 5108, Denver, Colorado 80217-5108 or telephone (800) 654-3101.

## Marketing Brochure

A BROCHURE FROM FLYNN-HEAPES CONSULTING lists 50 strategies for coming out ahead in the design professions. "Strategies for Surviving a Tough Economy" includes ideas for marketing, project operation, personnel, finance, and firm administration.

*Circle 435 on information card.*

# BURNED OUT ON PRODUCING REPORTS?



Could you benefit from a financial management system designed specifically for architects and engineers, that will produce your reports at the touch of a keystroke?

If The Answer Is YES  
Call Now 1-800-77-WIND2

**Wind<sup>2</sup>**  
The Professional Choice™

1901 Sharp Point Drive, Suite A  
Fort Collins, Colorado 80525

## "THE DISAPPEARING DOCK" At a raised concrete dock . . .



Now you see it

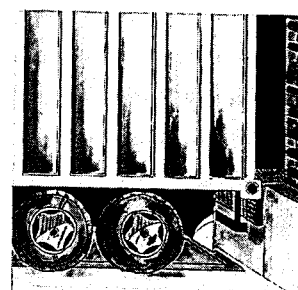

Now you don't



If you can't safely load and unload all trucks at your loading dock, you need a versatile Advance Superdok. Call 1-800-THE DOCK for FREE information.

We're here to help.

**ADVANCE LIFTS**

Advance Lifts, Inc., 3575 Stern Avenue, St. Charles, IL 60174 (708) 584-9881

*Circle 99 on information card*

*Circle 105 on information card*

On the one hand, progress in business technology is always making things easier for us. On the other, constant rewiring just to keep up with these changes is costly and time consuming. But now there's Bell Atlantic® Transpath<sup>SM</sup> Service, the premises transport system that's designed to adapt to the innovations of tomorrow without costly rewiring. Transpath can



One day, you will be able to smell a rose growing 3,000 miles away. Most people will be completely unprepared.



handle voice, data and video through both central-office and premises based equipment. In the future, it will be able to handle things as wondrous as transmitting smell. A unique combination of fiber optics and twisted-pair wiring brings you accuracy, speed and flexibility. Transpath is modular, so it will always be able to link all your systems, including terminals, telephones, networks and computers. Customizing is easy. So if you're not into antiques, call (800) 456-6934. Prepare yourself now with Transpath Service.

**© Bell Atlantic**  
We're More Than Just Talk<sup>®</sup>

© Bell Atlantic

Circle 115 on information card

# PRODUCTS

## Estimating & Design Tool Catalog

EMERLING & COMPANY/CALHOOK OFFERS A catalog on space-planning systems, template sets, color reference materials, sketch collections, style references for furniture and window treatments, and fabric-estimating tools. Also available for order are tapes and books on improving business operations, sales management, and business promotion.

Circle 436 on information card.

## Earthquake Preparedness Checklist

THE NATIONAL CONFERENCE OF STATES ON Building Codes and Standards Inc. (NCS-BCS) offers a planning guide for what to do before, during, and after a major earthquake. The brochure contains tips on how to identify potential dangers in the home, how to conduct a family earthquake drill, and how to survive an actual quake.

Circle 437 on information card.

## Custom and Specialty Stairs

AN INSTRUCTIONAL VIDEOTAPE DESCRIBES the manufacturer's line of stainless steel and aluminum stairs and the detailing of various

installations. Monumental and apartment stairs are the company's specialty. J. Toce Spiral Stairs International.

Circle 438 on information card.

## Noise, Impact, and Vibration Controls

A REFERENCE GUIDE AND PRODUCT CATALOG from Mason Industries introduces the basics of the vibration isolator function and describes light-duty neoprene and spring mounts, hangers, flexible connectors, and the manufacturer's seismic mounts.

Circle 439 on information card.

## Protection from Power Surges

PROMIXA BY COMPUTER ACCESSORIES PROTECTS against power surges that can damage computer systems. Bell Laboratories estimates 97 percent of all AC outlets in America are subject to such surges each year. "The majority of all desktop micro-computers are unprotected by surge-suppression devices, and an estimated 95 percent aren't supported by battery-backup systems," says John Thomas, Promixa Power business unit manager. The company offers a lifetime equip-

ment protection policy for selected Promixa power protection devices.

Circle 440 on information card.

## New Book Available from ASTM

ASTM STANDARDS ON BUILDING ECONOMICS is a comprehensive resource document from the American Standards for Materials, Products, Systems & Services organization on evaluating the economic performance of building investments. The book helps recognize whether to accept or reject a given investment; how to design and size building systems; and how to establish a priority when budgets are limited.

In addition, sections are included on selecting economic methods, practices for measuring life-cycle costs, payback for investments in building and building terms, standard definitions of terms used in standards, and more. These standards are endorsed by the American Association of Cost Engineers. For information, contact ASTM Customer Service, 1916 Race Street, Philadelphia, Pennsylvania 19103, or FAX (215) 977-9679.

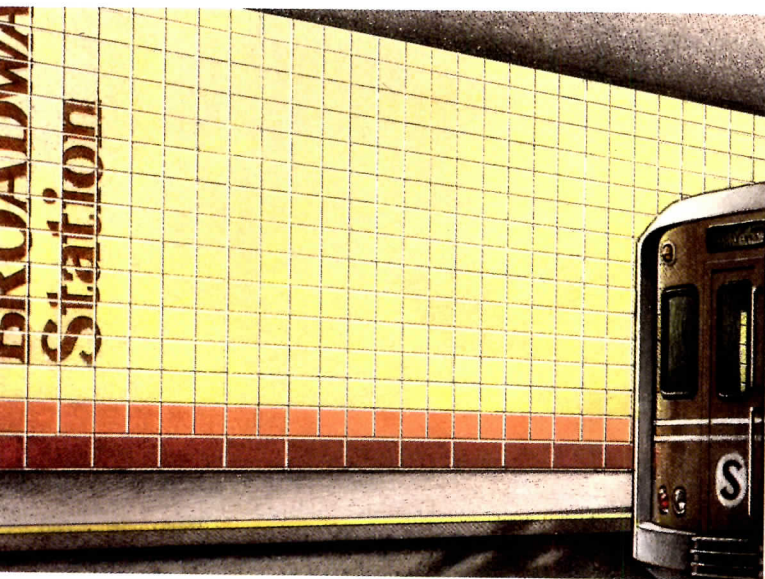

## Attractive solutions to a tough problem.

SPECTRA-GLAZE® II units are tough as well as good looking. That's why they are ideal for high traffic areas such as subway, bus and train stations. Because of the unique formulation and patented process, the sealed, smooth surface is practically wear resistant and can't be permanently marred or gouged. Even the most persistent grime and



graffiti can be easily removed without damage to the factory applied glaze. Choose from a rainbow of 80 standard colors and countless custom hues.

For more details about this unique finish for your next building project, call Burns & Russell toll free 1-800-638-3188 (in Maryland 301-837-0720).

**Spectra-Glaze® II**  
CUSTOM PRE-GLAZED CONCRETE MASONRY UNITS

The Burns & Russell Co., Box 6063, Baltimore, MD 21231 FAX: 301-837-9498 TELEX: 87-791 ©1990, all rights reserved, and ®Reg. U.S. Pat. Off., Canada and other countries by The Burns and Russell Co.

Circle 107 on information card

## "THE DISAPPEARING DOCK" Replaces expensive truck wells . . .

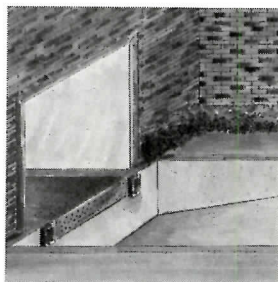

The costly way

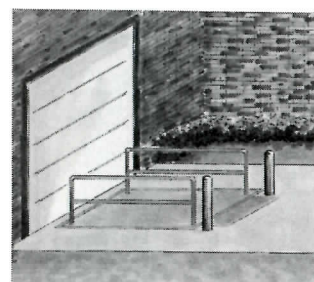

The economical way

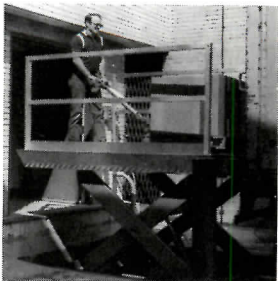

For half the cost of a truck well loading dock, you can have a versatile Advance Superdok.

Call 1-800-THE DOCK for FREE information.

We're here to help.



Advance Lifts, Inc., 3575 Stern Avenue, St. Charles, IL 60174 (708) 584-9881

Circle 101 on information card

# YOU'RE INVITED...



C R O S S R O A D S :  
A R C H I T E C T S  
A N D T H E  
E N V I R O N M E N T

A Symposium Sponsored by  
The American Institute of Architects  
Committee on the Environment



Tuesday, November 13, 1990  
12:30 p.m. - 5:30 p.m.  
Luncheon and Keynote Address, 12:30 p.m.  
Reception, 5:30 p.m.



The Mayflower Hotel  
1127 Connecticut Avenue, NW  
Washington, DC



Keynote Speaker  
Amory Lovins, Vice President and cofounder  
The Rocky Mountain Institute

This symposium will follow the inaugural meeting of the AIA's new Committee on the Environment, which begins at the *Mayflower Hotel* at 9:00 A.M. on November 17. Noted environmentalist Amory Lovins will deliver the keynote address. Topics to be discussed include: a forecast of environmental issues on the 1991 federal legislative agenda; an update on the state of the tropical rainforest; and the introduction of the AIA Environmental Resource Guide. General registration fee is \$225; \$175 for AIA members; \$35 for students. For more information and a brochure, contact Doug Greenwood at the AIA, (202) 626-7463.

# Did you miss valuable information offered by advertisers in last month's issue of ARCHITECTURE?

The manufacturers listed below and on the following page were advertisers in last month's issue who are anxious to provide you with their latest product information and literature for your planning needs. To receive this helpful information, just circle the appropriate numbers on the self-addressed, postage-paid response card. For product information and literature from advertisers in this issue of ARCHITECTURE, circle the appropriate numbers appearing on the advertisements.

**Advance Lifts, Inc.** If you don't have a loading dock because space or cost is a problem, you need a versatile Advance Superdok.  
*Circle No. 120*

**Advance Lifts, Inc.** If you can't safely load and unload all trucks at your loading dock, you need a versatile Advance Superdok.  
*Circle No. 122*

**Advance Lifts, Inc.** For half the cost of a truck well loading dock, you can have a versatile Advance Superdok.  
*Circle No. 124*

**Alply Inc.** Custom architectural insulated metal panels—Alply specializes in custom fabrication for creative projects.  
*Circle No. 32*

**Alucobond Technologies.** Alucobond's technical experts demonstrate the service that makes Alucobond material your best curtain wall value.  
*Circle No. 78.*

**American Olean Tile.** No one else offers as many textures, colors, and styles of ceramic tile as American Olean.  
*Circle No. 12*

**Andersen Corp.** All things considered, there's nothing quite like one of our Flexiframe® windows. No matter how you look at it—a revolutionary commercial window, exterior and interior.

**Armstrong World Ind.** Suffield™ floors. Variations in vinyl. Palette in 12 colors. Chemically bonded seams. Easy to clean.  
*Circle No. 2*

**Armstrong World Ind.** Soundsoak™ Mezzo—our new sculpted wall treatments. Fabric-covered acoustical wall panels with a unique dimensional visual.  
*Circle No. 4*

**Armstrong World Ind.** New Cirrus™ Classical Motifs—The only lightly textured ceiling panels available in two classically ornate patterns.  
*Circle No. 6*

**ASG.** Send today for more information on our improved ASG Architectural, the best architectural package yet.  
*Circle No. 84*

**Bethlehem Steel Corp.** The next time you have a challenging design problem to solve, consider the advantages of prepainted Galvalume™ sheet.  
*Circle No. 18*

**Bobrick Washroom Equipment Co.** When you specify Bobrick washroom accessories and toilet compartments, there's never a need to compromise one of your most important tenant-user amenities.  
*Circle No. 74*

**Bradley Corp.** The many advantages of Bradley's new ACCU-ZONE™ infrared activation control for plumbing fixtures are described in their free four-color brochure.  
*Circle No. 52*

**Bradley Corp.** The design coordinator for the Milwaukee Summerfest Grounds says, "Bradley ACCU-ZONE™ washfountains work so well the only place we don't have lines is in the washroom."  
*Circle No. 54*

**Brick Institute.** Building with brick represents a wide spectrum of sensibilities...and possibilities. A limitless horizon of shapes, details, and colors...that is the promise of brick that has made it a favorite building material of architects everywhere.  
*Circle No. 25*

**California Redwood Assn.** Natural beauty, durability, and stability make it the natural choice for creative designs that endure. Send for a copy of the Redwood Architectural Guide today.  
*Circle No. 92*

**Chicago Faucet Co.** The Legacy Collection—the new standard of beauty...a bequeathed legacy of quality.  
*Circle No. 86*

**Clearprint.** Clearprint Xerographic media...100% solvent-free—Environmentally safe.  
*Circle No. 34*

**CNA Insurance.** Now you can earn premium credits for longevity and loss prevention with a CNA/Schinnerer professional liability insurance program.  
*Circle No. 132*

**Crown Metal Mfg. Co.** Recessed wall systems for stores, offices, libraries, hospitals, etc.  
*Circle No. 114*

**Curries Co.** You can't knock our selection of metal doors. Send for more information today.  
*Circle No. 24*

**Cyrolon Industries.** If you demand superior performance in your glazing application, specify superior Acrylite® acrylic or Cyrolon™ ZX polycarbonate sheet  
*Circle No. 118*

**Domtar Gypsum.** Send today for more information about distinctive new Eurostone all-environment ceiling panels.  
*Circle No. 10*

**Fry Reglet.** Fry moldings, which for over 20 years have added function and design to exteriors, are now enhancing interiors as well.  
*Circle No. 66*

**GE Monogram.** Monogram—a complete line of built-in appliances. A way to avoid some of the complexities that can occur when you build a custom kitchen.  
*Circle No. 60*

**Georgia-Pacific.** Dens-Shield tile backer from Georgia-Pacific gives you the assurance of high quality and exceptional reliability.  
*Circle No. 130*

**Guardian Block.** Guardian Block® is an impact and ultraviolet resistant acrylic block. It is a superior alternative for all glass block applications.  
*Circle No. 58.*

**Hansgrohe Inc.** Send today to find out more about our new Shower Pavilion where multiple massaging sprays and soft halogen lamps are electronically regulated from integral control panels.  
*Circle No. 64*

**Haws Drinking Faucet.** Water doesn't have to come in a bottle to be tasteful. Now there's a more fashionable way to have your water. It's the Haws Fashion Plates Collection.

*Circle No. 20*

**Homasote.** When you recommend a layer of ComfortBase between the carpet and a concrete slab floor, your clients will never complain about cold floors.

*Circle No. 96*

**Houston Instrument.** Check out HI's new DL Series. Large format, big features, small price. Send today for more information.

*Circle No. 50*

**Hurd Millwork Co.** New Hurd InSol-8™ windows are a remarkable achievement. No other residential window insulates to #8 and blocks over 99% of the UV rays.

*Circle No. 68*

**ISICAD.** CADVANCE for Workgroups is a revolutionary concept in PC-CAD networking.

*Circle No. 22*

**JDL.** JDL's OmniPlotter™ is the first plotter with the speed, convenience, and reliability you need for continuous, unattended operation.

*Circle No. 80*

**Kawneer Co. Inc.** We borrowed one of our best panel ideas from some very good designers—the honeycomb core in a beehive. Send for complete architectural design specifications.

*Circle No. 44*

**Kawneer Co. Inc.** 350 Tuffline entrances are all their name says they are. For new and replacement doors in high-traffic and abuse-prone installations.

*Circle No. 82*

**Kawneer Co. Inc.** Kawneer aluminum entrance systems are part of the world's most memorable architecture. They make a building extraordinary.

*Circle No. 108*

**Kawneer Co. Inc.** Kawneer has a complete line of aluminum entrance systems, each a timeless classic in its own right. Send today for more information.

*Circle No. 110*

**Kawneer Co. Inc.** No matter what design statement you're making, Kawneer has an aluminum entrance system to make it immortal.

*Circle No. 112*

**Knoll International.** At Knoll you can choose between a wide array of systems, desks, files, and chairs... they're practical and affordable.

*Circle No. 14*

**Koh-I-Noor.** Koh-I-Noor plotter supplies provide a full range of products to meet the needs of all plotter applications.

*Circle No. 56*

**LCN Closers.** LCN supplies Liquid Z hydraulic fluid in heavy-duty and exterior door closers as standard equipment. We are too firmly committed to quality to take any shortcuts in our materials or the way we put them together.

*Circle No. 70*

**LOF Glass.** EverGreen Glass—A soothing green tint that blocks 78% of UV light, lets in 66% of visible light, yet offers nearly 20% less solar heat gain than other tinted glasses on the market today.

*Circle No. 26*

**Lorin Ind.** Specify the rich look of metal for creating art with real luster...specify Lorin's "Finished First" metal.

*Circle No. 16*

**Marvin Windows.** We make windows where money's no object and where money's precisely the point. We make the industry's broadest and most versatile line of standard shapes and sizes.

*Circle No. 42*

**Marvin Windows.** We supplied the made-to-order Magnum windows used to renovate a 93-year-old elementary school. Our made-to-order approach meant our windows fit better. And, we were able to deliver on schedule.

*Circle No. 90*

**MUTOH Ind. LTD.** The new MUTOH F-920AR keeps your plotting on a roll, all night long. Find out more about plotter automation with the F-920 Series.

*Circle No. 98*

**Nixalite of America.** Keep birds off your structural designs—include Nixalite® Architectural Bird Control from the start! Send for information.

*Circle No. 8*

**National Concrete Masonry Assn.** Concrete brick performs as well as it looks. It won't burn, rot, rust, melt, or dent.

*Circle No. 28*

**Olympic Stain.** With Olympic you never have to compromise. Our colors are true and consistent, they'll always match your expectations.

*Circle No. 46*

**Panasonic O/A.** Mastering the nuances of presentation graphics is what the FP-C1 digital color copier does best.

*Circle No. 48*

**PELLA Rollscreen.** Pella's exclusive custom capabilities enable us to match the color, style, and sight lines of windows no matter what the age of the building.

*Circle No. 72*

**Pittsburgh Corning.** Ninety-five percent of architects who use glass block specify Pittsburgh Corning PC GlassBlock® products because their most important criteria are ours, too.

*Circle No. 30*

**Wilson Plastics Co.** All you need to escape the visual boundaries of design is an untamed imagination and the right material, like Solar Colorthrough Laminates.

*Circle No. 94*

**Raynor Garage Door.** When you specify a Raynor Tri-Core Garage Door, the only thing more reliable is your Raynor distributor.

*Circle No. 38*

**Rite Hite Corp.** Specify the vehicle restraint that helps prevent accidents for 98% of the top 300 U.S. companies. Dok-Lok®.

*Circle No. 128*

**Semaphore.** Designed by an architectural firm, SEMA4 will immediately adapt to your business and provide critical project and financial controls.

*Circle No. 88*

**Steel Joist Institute.** With steel joists you get complete design flexibility—the freedom to do exactly what you want. It's a great time saver and the economics are all in your favor.

*Circle No. 126*

**Steelcase.** Paper hood, 10-year warranty, door equalizer, over-head storage, no assembly required and tackable panels...all "little miracles" that show why, if you're not buying Steelcase, you're not getting your money's worth.

*Circle No. 76*

**U.S. Aluminum.** The 3600 Curtain Wall is designed to meet the most demanding performance specifications for today's construction market.

*Circle No. 62*

**John Wiley & Sons.** Announcing a "new" architectural graphic standards for the 1990s—Ramsey and Sleeper's ARCHITECTURAL GRAPHIC STANDARDS, 8th Edition.

*Circle No. 36*