

# ARCHITECTURE

OCTOBER 1991



PAGE 58



PAGE 50



PAGE 40

## DESIGN

### Women in Architecture

- 39 **A FIRM OF ONE'S OWN** Across the country, an increasing number of women are heading up their own offices to design public and private commissions in this country and abroad.
- 40 **MODERN SCIENCE** Los Angeles architect Rebecca L. Binder hones her bold esthetic for an engineering/computer science facility at the University of California, Irvine.  
BY LYNN NESMITH
- 46 **PHILADELPHIA STORY** AIA President-elect Susan Maxman values the diversity of her clients in designing contextual projects, such as a house on an abandoned estate in Philadelphia.  
BY HEIDI LANDECKER
- 50 **MARK OF THE HAND** Bausman-Gill Associates' deft manipulation of crafted materials is typified by Electra Entertainment's corporate offices in New York City.  
BY MICHAEL J. CROSBIE
- 54 **URBAN PRIZE** The competition-winning design of the American Memorial Library by New York architect Karen Van Lengen reestablishes urban order in reunified Berlin.  
BY VERNON MAYS
- 58 **TEXAS PIONEERS** Carrie Glassman Shoemake, Val Glitsch, and Heather H. McKinney represent Lone Star State independence as sole practitioners in Houston and Austin.  
BY RAY DON TILLEY
- 68 **YANKEE DUET** The Newburyport District Court and Grainger Observatory illustrate how Leers, Weinzapfel Associates tempers Modernism with regional influences.  
BY MICHAEL J. CROSBIE

# Nobody offers you more ways to control losses.

Pre-claim Assistance

Free Contract Review

Professional Liability Courses

Office For Professional Liability Research

Loss Control Video Tapes

Guidelines For Improving Practice

Liability Update

Invited Attorneys Seminars

1-800-CNA-A55T

AEGIS

Tort Reform Support

Invited Broker Seminars

A/E Claims Specialists

Construction Claims Seminars

Working closely with architects and engineers for 35 years has helped us to understand the liability risks you face in your daily practice. This experience enables us to respond to your requests for effective and innovative ways to help recognize liability and control losses. In fact, our program gives you more ways and choices to do that than any other in the market.

Our insureds tell us they benefit from that flexibility. They have seen their efforts in loss control succeed in reducing claims frequency. From 1985 through 1990 alone, the number of claims per 100 insured firms dropped by 30%. And that's good news for everyone.

To learn more about the CNA/Schinnerer Architects and Engineers Professional Liability Insurance Program,\* have your independent insurance agent or broker call Schinnerer at (301) 961-9800.

\*The CNA Insurance Companies and Victor O. Schinnerer & Company, Inc. are proud to have earned the commendation of the AIA and NSPE/PEPP.

And, CNA, a multi-line insurance group, has over \$9 billion in revenue, over \$30 billion in assets, \$4.5 billion in stockholders' equity and consistently high ratings.\*\*

\*\*A.M. Best, Standard & Poor's, Moody's, Duff & Phelps

Victor O.  
**Schinnerer**  
& Company, Inc.

Underwriting Manager  
Two Wisconsin Circle  
Chevy Chase, MD 20815-7003  
(301) 961-9800, Telex 892340

Chicago, (312) 565-2424  
New York, (212) 344-1000  
San Francisco, (415) 495-3444

**CNA**

For All the Commitments You Make®

Coverage for this program is provided by Continental Casualty Company, one of the CNA Insurance Companies/CNA Plaza/Chicago, IL 60685.

Circle 19 on information card

## TECHNOLOGY & PRACTICE

- 79 **WOMEN IN CORPORATE FIRMS** Eight female practitioners discuss their progress within the country's largest offices.  
BY NANCY B. SOLOMON
- 89 **DEVELOPMENTS IN PLASTICS** New structural possibilities and decorative applications are available with synthetic materials.  
BY PATRICK TUCKER
- 93 **WHAT DO ARCHITECTS REALLY EARN?** Surveys by the AIA and PSMJ reveal compensation levels and the effect of the recession on salaries.  
BY ANDREA OPPENHEIMER DEAN
- 97 **INSULATED PANEL CONSTRUCTION** Prefabricated components provide resource-efficient alternatives to wood-frame construction.  
BY ALEX WILSON
- 103 **PROJECT MANAGEMENT SOFTWARE** Computer programs offer architects assistance in developing schedules and tracking budgets.  
BY B.J. NOVITSKI



PAGE 79



PAGE 89



PAGE 97

## DEPARTMENTS

- 13 EDITOR'S PAGE
- 16 LETTERS & EVENTS
- 21 NEWS
- 23 EDUCATION
- 29 ON THE BOARDS
- 77 INFO
- 109 PRODUCTS
- 120 NEAT FILE

**COVER:** Computer Sciences/Engineering Research Facility, University of California, Irvine, designed by R.L. Binder, Architecture and Planning (page 40). Photograph by Jeff Goldberg/Esto

**NEXT MONTH'S ISSUE:** Old buildings, new additions  
Replacement materials  
Working with preservation commissions  
Retrofitting buildings for computers

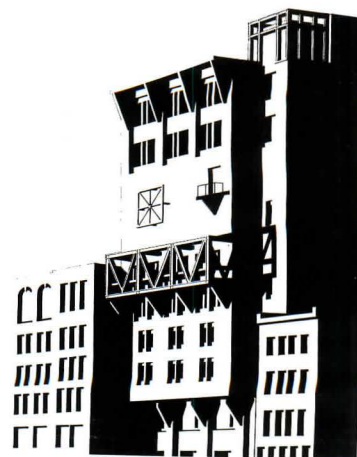

PAGE 29



# Why an Issue on Women Architects?

IT ALL STARTED AT LAST YEAR'S AIA CONVENTION DURING a meeting of the AIA Committee on Women in Architecture. We agreed that it was time to take another look at women architects, who have gained considerably more influence in the profession since the magazine last focused on their accomplishments in January 1982. Women have been entering the profession in increasing numbers (see statistics at right); at least three architecture schools have recently appointed female deans (pages 23-25), and the AIA has just elected its first woman president, Susan Maxman (pages 46-49). However, after deciding to devote an entire issue to women in architecture, we were met with a far less than enthusiastic response from our very subjects: "Why ghettoize women in a special issue?" "Why can't we be considered architects, rather than female architects?" "Just publish my work in a regular issue!"

However, given women architects' slow progress in academia and practice, we felt a special issue examining their current status would be valuable for all our readers. Moreover, our primary focus in this issue is on design, since women are rarely, if ever, considered the design "stars" in the field. For example, the majority of women working in offices are not partners or associates responsible for design. Most tenured women faculty in architecture schools do not teach design studios. And even some of the most prominent female architects are eclipsed by their male partners in receiving credit for design. This point was brought home to the editorial staff in planning this issue, when we pondered the question: can you think of a new building solely designed by a woman? While the work of two Washington, D.C., architects immediately came to mind—Amy Weinstein (*ARCHITECTURE*, April 1991, pages 82-87) and Chloethiel Woodard Smith—we were at a loss to name many other female sole practitioners.

To gain a better perspective, we decided to invite female architects from around the country to submit portfolios of their work. After a preliminary review by the AIA Committee on Women in Architecture, we examined over 200 submissions and decided to focus on the work of female sole practitioners

and women in partnership with other women. Why such an exclusive policy? The obvious answer is that the work of these firms is indisputably female-authored, and therefore the truest indication of women's design abilities. Women-owned firms, although increasing in number, have received little attention in the press, as compared with women architects in partnership with men, especially celebrated husband-and-wife teams. And while it is certainly more difficult for women than men to secure prominent, large-scale commissions, this issue finds that some women-owned firms are beating the odds, designing significant civic and institutional buildings in this country and abroad. In other words, the stereotype that women architects design only houses and interiors no longer applies.

Do women design buildings differently than men? While several architects interviewed for this issue bristled at the very question, many stressed the important role played by staff, consultants, and even clients during the design process. Their comments indicate that architects can no longer model themselves on Howard Roark in Ayn Rand's *The Fountainhead*, an artistic rebel isolated from the world. Women recognize the need

for collaboration in order to meet the increasingly complex challenges of practice today. Such an approach signals a fundamental change in how buildings will be created in the future as more women reach positions of power. This inclusive way of designing should benefit us all. ■

—DEBORAH K. DIETSCH

**There are more than 12 times as many female architects as there were in 1970, but there are currently more than five times as many male architects as female.**

■  
**Women constitute 9.1 percent of all AIA members; 5,003 out of 55,036.**

■  
**The AIA has bestowed Fellowship on 1,880 architects; 66 of them women.**

■  
**AIA's 1991 Firm Survey reveals that 9 percent of all sole practitioners are women; women head up 3 percent of firms with 2 to 9 employees; and more women are employed in firms owned by women than in other firms.**

■  
**71 percent of women in architecture firms hold nontechnical and administrative positions.**

■  
**West Coast firms employ more female interns than anywhere in the country, but New England firms have the highest percentage of licensed women architects, and the West South Central has the fewest women overall.**

■  
**Women architects earn approximately 72 cents for every dollar earned by their male colleagues.**



# AN AWARD FOR PEOPLE WHO MADE SOLID USE OF LIGHT, WATER AND AIR.

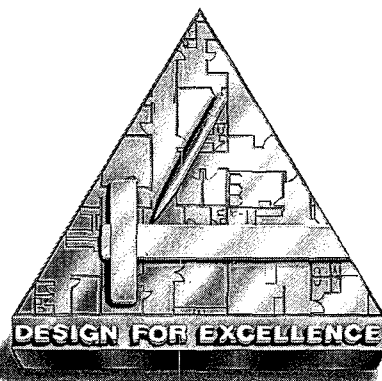

Instead of relying on the usual building materials, three extraordinary design teams harnessed the power of the elements. And ended up creating the ultimate in energy-efficient construction.

Their ingenious use of technologies such as daylighting, space conditioning or thermal energy storage systems is a testament to civic responsibility. And will go on to save the owners of these new buildings countless thousands of dollars in operating expenses and retrofitting.

Such creativity could only be honored with the prestigious Design For Excellence Award sponsored by both Southern California Edison and the California Energy Commission.

If you too can prove that light, water and air are stronger than concrete and steel, your chance to do so is coming up. For details about the next Design For Excellence competition, please call your Edison New Construction Representative or the Action Line at 1-800-952-5062.

The rest is elementary.



Circle 25 on information card



## JUDGES

Gregg D. Ander, AIA  
Southern California Edison  
Rosemead, CA

J. Marx Ayres, PE  
Ayres, Ezer, Lau  
Los Angeles, CA

Charles N. Eley, FAIA  
Charles Eley Assoc.  
San Francisco, CA

John K. Holton, AIA, PE  
Burt, Hill, Kosar, Rittleman Assoc.  
Houston, TX

James T. Kelly, MIES  
California Energy Commission  
Sacramento, CA

Douglas E. Mahone, AIA  
ADM Assoc.  
Sacramento, CA

Bruce A. Wilcox  
Berkeley Solar Group  
Oakland, CA

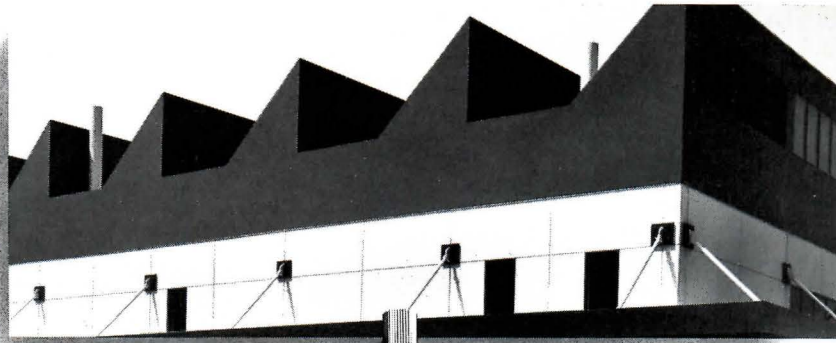

Winner: Commercial Category  
South Coast Air Quality Management  
District Headquarters Building  
Diamond Bar, CA  
Owner: South Coast Air Quality  
Management District  
Architect: Meyer & Allen Assoc.  
Engineer: Hayakawa Assoc.  
Engineer: Johnson & Nielsen  
Consultant: Wheeler & Gray  
Consultant: Fluor Daniel

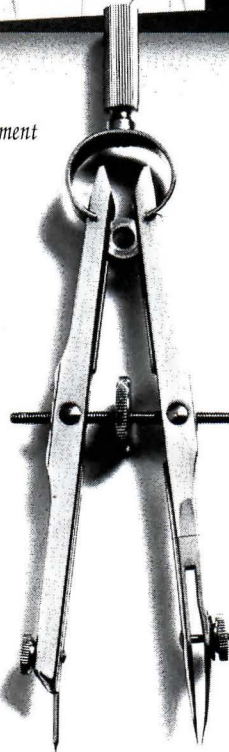

Winner: Institutional Category  
Emilie Ritchen Elementary School\*  
Oxnard, CA  
Owner: Oxnard School District  
Architect: BFGC Architects Planners, Inc.  
Engineer: Charles Mistretta & Assoc.  
Engineer: Kurily Szymanski Tchirkow  
Consultant: Santa Barbara Electrical  
Design Group  
Consultant: TECH 5 Corporation  
\*Scheduled for completion December 1991.

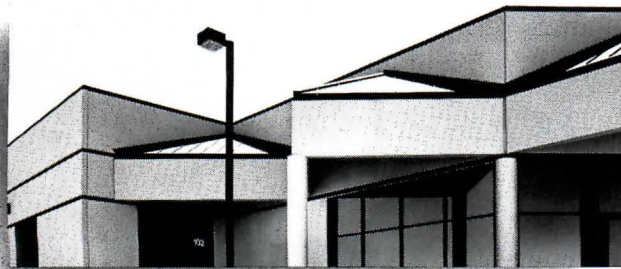

Winner: Industrial Category  
Lark Industrial Park  
Lancaster, CA  
Owner: Richard Kravitz  
Architect: Scott Ellimwood & Assoc.  
Engineer: John D. Oeltman  
Engineer: Cushman & Assoc.  
Consultant: Robert Bein, William Frost & Assoc.  
Consultant: Pacific Coast Land Design



# LETTERS & EVENTS

## Code Satisfaction

I felt a deep level of inner satisfaction reading John Hogan's letter and Robert Harding's NEAT file on code compliance (June 1991, pages 16, 136). Documents containing basic information on code compliance greatly improve the plan review and permit issuance processes, and eliminate many costly oversights. In cooperation with the Raleigh, North Carolina, AIA chapter and North Carolina chapter of professional engineers, our city has recently broadened local requirements for a code data summary sheet to a statewide requirement. I feel ours goes further in requiring specific data, including graphic identification on building floor plans of all fire-rated partitioning, wall and ceiling penetrations, and special rated assemblies. I also read with delight that the three national model code agencies have been included by the National Council of Architectural Registration Boards in the development of the national examination. The next step is to include codes in the formal education of aspiring architects. Until that occurs, few architects will venture into the code and its research, development, and promulgation, and a narrow vision of the building law and its impact on architects will prevail.

*James J. Tschupp*  
Assistant Inspections Director, City of Raleigh  
Raleigh, North Carolina

## Turning Back the Clock

Your recent article regarding the shortcomings of CADD for preliminary drawings (August 1991, pages 97-99) touches on an opinion I have long held. I feel CADD makes a cold, two-dimensional graph of a creative concept. However, my argument with CADD is the use to which it is put.

In a day when architects have turned back the esthetic clock to anachronistic, 16th- and 17th-century takeoffs of Roman takeoffs of Greek takeoffs of wood architecture, the use of 21st-century tools seems out of place. Perhaps it would be more consistent for architects to hold quill pens under the flickering light of candelabras. Or at least sleeve garters and green eyeshades under gas lamps. In this way, contemporary architects might be better equipped to copy the works of Vitruvius, Wren, or even Richardson.

*Edmond Pachner*  
Kensington, Maryland

## Regionalism Reminder

While welcoming the attention to alternative voices, I find puzzling the statement, "No region in the U.S. has been as fertile ground for regionalism as the Southwest" (August 1991, page 51). What about the Bay Area, with its legacy of Bernard Maybeck, Willis Polk, and Greene and Greene, or the Pacific Northwest, with its architecture of simple, economical, wood-framed structures open to the fresh breezes and spectacular views? Both regions, and no doubt others throughout the U.S., have spawned a plethora of built forms, both elite and vernacular, which remain in wide use today.

Short memories, or have I missed something?

*Meredith L. Clausen*  
Associate Professor, Architectural History  
University of Washington  
Seattle, Washington

## R/UDAT Redux

We are delighted to see the NYC/AIA Penn Yards Urban Design Review Workshop featured in your August news section (page 21). However, we are also anxious to set the record straight.

The workshop was sponsored by the New York Chapter AIA, in collaboration with Manhattan Borough President Ruth Messinger and Community Board 7. It was not an official R/UDAT and was not sponsored by the national AIA, although Charles Zucker of AIA provided useful guidance. The workshop was different in format from a R/UDAT, as noted in the article, in that we reviewed an existing design concept and we organized the entire event in only six weeks, thanks to the expert professional help of Lance Brown.

We are pleased to see that so many of the ideas proposed by the workshop have been incorporated into the Riverside South design and we look forward to an ongoing relationship with our collaborators.

*Frances Halsband*  
President, New York Chapter AIA  
New York City

## Correction

Brooks/Collier in Houston, Texas, should have been credited as the healthcare/interior architects of the St. Luke's Medical Tower (July 1991, pages 42-45).

**October 3-December 31:** Exhibition of models, drawings, and sketches of architect Tadao Ando at the Museum of Modern Art in New York City.

**October 14-15:** Clean rooms will be the topic of the UC Berkeley course "Clean Rooms, Microenvironments, and Automation for Semiconductor Manufacturing." Contact: (415) 642-4151.

**October 16-18:** 1991 MetalCon International conference and exhibition in Washington, D.C. Contact: Claire Kilcoyne (800) 526-5455.

**October 17-19:** "The Greening of Design" at Designer's Saturday, International Design Center New York and throughout Manhattan. Contact: (718) 937-7474.

**October 17-18:** 1991 Housing & Society Trust Conference in Chicago will focus on the problems and promise of mixed-income housing. Cosponsored by the Chicago Dwellings Association. Contact: (617) 328-3100.

**October 20-January 5:** "Louis I. Kahn: In the Realm of Architecture," at the Philadelphia Museum of Art. Contact: (215) 787-5431.

**October 28-31:** A/E/C Systems fall conference and exhibit in Nashville. Contact: Sharon Price (800) 451-1196.

**November 8-9:** International Trends in World Markets Conference in San Francisco, California, sponsored by the AIA International Committee. Architects, developers, and executives will examine business and construction trends in global markets. Contact: Elizabeth Wainger (202) 626-7411.

**November 12-15:** First International Design for Extreme Environments Assembly in Houston, hosted by the Sasakawa International Center for Space Architecture and the University of Houston. Contact: (713) 749-1181.

**November 14-17:** Fourth Healthcare Design Symposium in Boston, Massachusetts, sponsored by the National Symposium on Healthcare Design. Contact: (415) 370-0345.

**November 16-19:** The 68th Annual Conference of The Council of Educational Facility Planners International in Atlanta. Contact: (614) 442-1811.



# NEWS

Women in Architecture Events ■ Women in Academia ■ Projects by Women-Owned Firms

## Exhibitions Highlight Architecture by Women

THE 1990s MAY BE THE DECADE OF THE woman architect. This year alone, the number of female AIA chapter presidents reached 27 compared to 11 in 1985; 20 new AIA Women in Architecture Committees have emerged; and a series of exhibitions and events are being held across the country to celebrate women's accomplishments at every level of the profession.

This fall, a variety of AIA-sponsored exhibitions document work by contemporary women architects and designers. At the Baltimore and San Francisco AIA chapters, projects by women will be on display through the end of the month. Later in the year, the Connecticut, Boston, Virginia, and Puerto Rico components will host similar exhibitions. In February 1992, the Santa Barbara Museum of Art will exhibit original drawings by 1920s-era architect Lulah Maria Riggs illustrating her interpretation of Southern California Spanish Colonial Revival style. And the Portland, Oregon, AIA chapter plans to open the first of a series of traveling exhibitions, "MatriArchs: Pioneering Women Architects," next July.

The crop of regional shows follows the close of the 3-year traveling exhibition "That Exceptional One: Women in American Architecture 1888-1988," which ended its national tour in Phoenix last July. The exhibition, which was the first to tell the story of American women in the profession, set out to counter the once widely-held view that only an extraordinary woman was capable of succeeding as an architect.

Principal of Ace Architects in Oakland, California, and exhibition juror Lucia Howard hopes that "Women's Work," a collection of drawings and photographs of projects by California architects and designers, will help debunk some of the myths associated with today's female architects: that they rely upon curvilinear forms; shy away from establishing hierarchy; and focus on details at the expense of larger concepts. The San Francisco exhibition includes Cathy Simon's design of the city's main library,

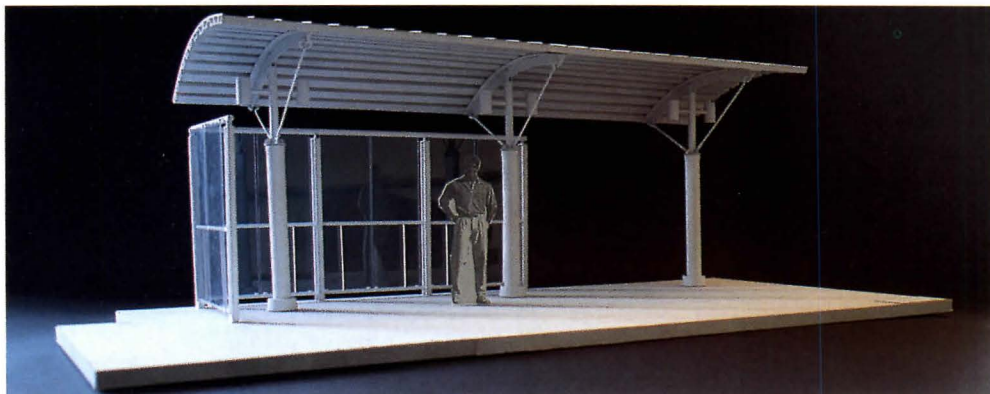

**Barbara Wilks and Diane Cho of Cho, Wilks & Benn, a Baltimore firm responsible for new light rail stations (above), are exhibiting projects at the Baltimore chapter AIA this month. The San Francisco AIA chapter's "Women's Work" exhibition will feature San Francisco's main library (below), designed**

**by Cathy Simon of Simon Martin-Vegue Winkelstein Moris in conjunction with Pei Cobb Freed & Partners. Also included are Toby Levy's proposed renovation of the San Francisco Examiner building (bottom right) and a garden folly designed by landscape architect Lori Pottinger (bottom left).**

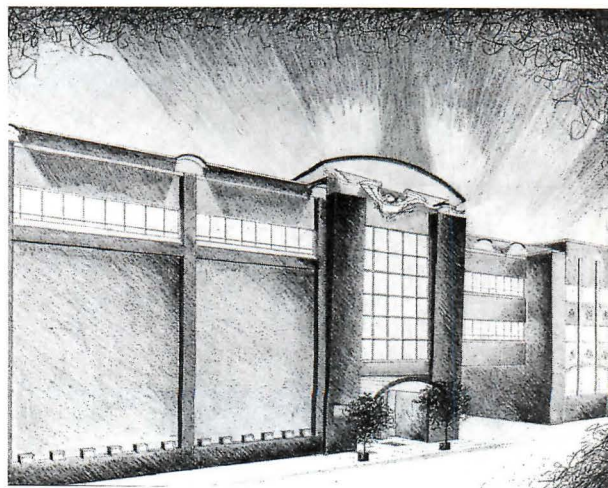
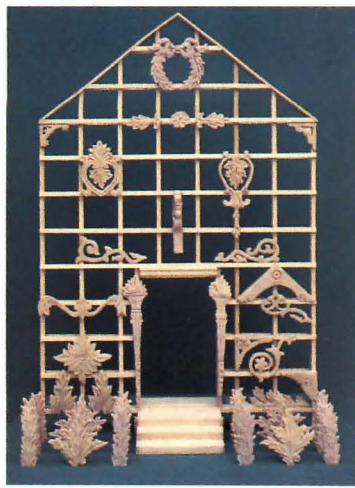
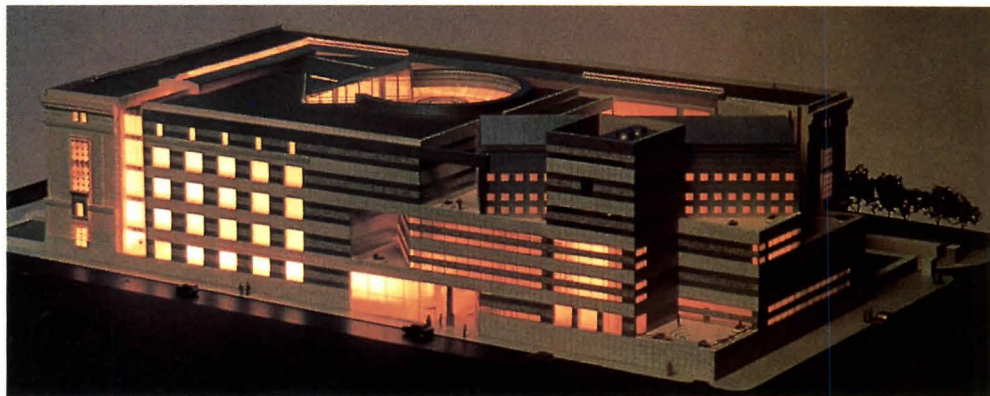

## D E T A I L S

The California team of **Bernardo Urquieta** and **Renzo Zecchetto** has been selected the winner in a two-stage competition to design a new \$35 million city hall building for Santa Clarita, California. **Adele Naude Santos** won a design competition for the civic center in Perris, California. Finalists included **Studio Works**; **William Turnbull Associates**; and **Anderson/Schwartz** in joint venture with **Venturi, Scott Brown & Associates**. **Hewitt/Isley Architects**, in association with **Jones & Jones**, has been selected by the Port of Seattle to design an 18-acre mixed-use waterfront project from a short list that included **Charles Moore**, **Robert A.M. Stern**, **Esherick Homsey Dodge & Davis**, and **Zimmer Gunsul Frasca**. The New York office of **Hellmuth, Obata & Kassabaum** has been selected to restore the Kuwait Parliament/National Assembly Building. **Thom Mayne** and **Michael Rotondi**, partners since 1975 of the Los Angeles-based **Morphosis**, have decided to pursue individual practices. **Thom Mayne** remains principal of **Morphosis**; **Michael Rotondi's** new firm will be called **Rotondi**. The Texas Rangers have named **David Schwarz Architectural Services** of Washington, D.C., to design a new stadium in Arlington, Texas (below). Schwarz will collaborate with sports architect **HNTB** and managing architect **HKS**. Schwarz was selected from a field of 17 firms, which included **Antoine Predock**; **Michael Graves**; **Kohn Pedersen Fox**; **Charles Moore/Arthur Andersen**; **Keating, Mann, Jernigan, Rottet**; **Hammond Beeby & Babka**; **Hardy Holzman Pfeiffer**; and **Lake/Flato**.

Women in Architecture Exhibit *continued from page 21*

and a church and AIDS memorial wall in Marina Del Ray by Diane Caughey.

Architect Rebecca Swanston, who curated the Baltimore show on display this month, expects "Women in Architecture" to attract public interest. The display includes projects by Cass Gottlieb, principal of G+F Architects, and Jo Anne Murray of Murray & Associates. Barbara Wilks and Diane Cho of the Baltimore firm Cho, Wilks & Benn will exhibit a housing project and a building housing their own offices.

Echoing this year's theme for the Puerto Rico AIA chapter's annual assembly, entitled "Women's Roles in Architecture," an exhibition will feature more than 40 projects by women practicing in Puerto Rico, the Caribbean, and Florida. Beatriz del Cueto, first woman president of the 25-year-old component, explained that the November 14-17 conference will examine why women rarely reach top positions. According to Del Cueto, who heads a 4-person firm specializing in historic preservation, women comprise the majority of students in Puerto Rican architecture schools, but after graduating "remain behind closed doors."

Rather than exhibit projects by local women, the New York AIA chapter's new Women in Architecture Leadership Network (WALN) will launch a program to identify and enhance areas of Manhattan in need of improvement. WALN will present its list to a panel of women experts in government, planning, and construction at the group's kickoff meeting on October 24.

"I think that we have not passed the point where we need to recognize women in architecture as a separate element," asserts Los Angeles architect Kate Diamond, who will moderate a panel on feminism and architectural values at the third annual Julia Morgan colloquium in Los Angeles on October 26. The event will also feature projects by women students at five Los Angeles architecture schools. In Diamond's view, the student exhibition plays a vital part in writing a "herstory" to parallel traditional architectural history. "We act like we are the first women architects that ever existed...most of us don't know how long and how rich a history of women architects there is, because they generally haven't made it into the mainstream architectural press."—KAREN SALMON



1



2



3



4

**Iris González-Alfonzo of Marvel, Flores, Cobian & Associates** will oversee construction of a 1-million-square-foot office/housing complex in San Juan's business district (1). **Maria Chalgub and Hortensia Lanio of St. Croix** designed the 187,000-square-foot Ensenada Resort Condominiums (2) for a beachfront site on the island's southwestern shore. Puerto Rican preservation architect **Beatriz del Cueto** restored a 19th-century Spanish lighthouse in Fajardo (3) and designed the entrance pavilion for the Las Cabezas de San Juan Nature Reserve (4).

## Why Aren't More Women Teaching Architecture?

ARCHITECTURE IS STILL A MALE DOMAIN. And nowhere is this more pronounced than in architecture academia, where men dominate by a staggering percentage. Nationwide, full-time male professors of architecture make up 19.5 percent of all architecture faculty as compared with a paltry .8 percent of female full-time faculty. Of course, the truest measure of academic power lies in the percentage of tenured professorships; here, men make up 33 percent of total architecture faculty versus women at 2.8 percent. The groundwork has been laid, however, for a palace coup. Women are attending architecture schools in increasing numbers and asking, with more clout than ever before, "Why aren't more women teaching?"

Recent statistics on the status of women in architecture schools have been compiled by the Association of Collegiate Schools of Architecture (ACSA) and were published last year. One of the more encouraging signs of change noted in the ACSA report is that 19 percent of last year's master's degrees in architecture were earned by female students, and many schools reported that 1991 entering classes are half women. Not only are women proliferating, they are also excelling, often beyond their male peers. "Based on the portfolios we see," says Patricia Conway, principal of Kohn Pedersen Fox Conway and newly appointed dean of the University of Pennsylvania's Graduate School of Fine Arts, "the women are taking all the prizes."

Furthermore, the percentage of AIA women members who own their own firms increased from 24 to 27 percent between 1990 and 1991. And this year, women captured a handful of significant leadership roles in the field. Susan Maxman was voted presi-

dent-elect of the AIA, and three women deans have recently been appointed in architecture programs: Conway at Penn in Philadelphia, Frances Halsband at Pratt Institute in Brooklyn, and Adele Naude Santos at the University of Southern California, San Diego. At Parsons School of Design in New York, Susana Torre has been named chair of the architecture program.

These positions are important because women who teach architecture believe that until leadership is granted them, their status as professors, and, indeed, the profession of

**"There's never an excuse anymore not to hire women, because the women in academia are proving to be excellent."**

—ADELE SANTOS

architecture as a whole, will not change. "At my school, we have on paper what looks like a pretty good percentage of women," observes Sharon Sutton, an associate professor at the University of Michigan in Ann Arbor. "But they are all junior faculty who only stay for a year. They have absolutely no power to affect policy." Sutton, who arrived at Michigan in 1984, received tenure in 1987. The faculty of the architecture department had never before included a woman.

Similarly, most tenured women architecture professors teach history, planning, or even behavioral psychology rather than design. When they do teach design, women tend to teach the extremely intensive and de-

manding first-year design studios. "Women are the workhorses, the good guys, the teachers, the ones who put in endless hours with the students rather than tending their own work," says Linda Jewell, an architect and landscape architect who recently left a non-tenured position as chairperson of the landscape architecture department at Harvard's Graduate School of Design for a tenured spot at Berkeley. And often, because they are underrepresented within architecture departments, women are asked to serve on committees and find themselves beset with administrative tasks as well. The process frequently overworks the small numbers of women in architecture programs, cutting into the time for their own scholarly or professional work. For many, the question of tenure produces a conflict between practice and teaching. "Women are particularly loathe to let go of their practice, because they know of the difficulty of getting tenure," says Sandra Howell, a behavioral psychologist who has taught in the architecture department at the Massachusetts Institute of Technology for 17 years. "They don't want to risk the loss of their professional activity by throwing everything into the academic hopper."

The tenure issue can be a doubled-edged sword for both male and female professors. Historically, architecture has held an uneasy place in some academic institutions. How does the publish-or-perish mandate apply to a designer of buildings? Different universities have different methods for evaluating built work, competition-winning designs, research, or buildings published in the architectural press. Tenure committees beyond the department level, accustomed to evaluating publi-

*continued on page 24*



PATRICIA CONWAY  
Dean  
Graduate School of Fine Arts  
University of Pennsylvania



FRANCES HALSBAND  
Dean  
School of Architecture  
Pratt Institute



DOLORES HAYDEN  
Professor  
School of Architecture  
Yale University



ADELE SANTOS  
Dean  
School of Architecture  
University of California, San Diego



SHARON SUTTON  
Associate Professor, College of  
Architecture and Urban Planning  
University of Michigan, Ann Arbor



SUSANA TORRE  
Chair, Department of  
Environmental Design  
Parsons School of Design

## Women in Academia *continued from page 23*

cations and research, have little experience judging design. Many schools deal with this situation by offering adjunct status, visiting professorships, or one- to five-year appointments to architects who wish to practice part-time. For those with thriving practices, these arrangements can be very satisfying, but for those primarily interested in academic careers, the system creates a revolving door. More often than not, as the numbers show,

that door closes on woman after woman.

To say that women professors encounter discrimination in schools of architecture is perhaps an understatement, but there are many who refrain from putting the problem into simple terms. "It's not just a matter of tenure itself," says Carol Burns, a tenure-track associate professor at Harvard's GSD, which has yet to offer tenure to a woman. Society as a whole, she points out, discrimi-

nates against women, and schools don't stand outside of society. "Tenure is just the outward manifestation of other barriers." Unfortunately, the way most universities—especially the public institutions—are organized, only those professors who have tenure can influence curriculum, hiring choices, and, in some schools, even admissions. Says Adele Santos, dean of UCSD's newly created architecture school, "If you're not tenured, you don't have power."

Now that Santos has power, she has created four tenured positions at San Diego, and two of them went to women. "It's not as if we were looking for a needle in a haystack—half the applicants were women!" Santos exclaims, adding that she simply chose the best people. One of these female professors will teach building technology, typically a male bastion. "There's never an excuse anymore not to hire women, because the women in academia are proving to be excellent." If there are few tenured women faculty now, Santos believes, it is simply because they are younger and inexperienced, but their numbers will grow as the numbers of women students increase. She adds, "Women excel at every level in the profession, and I think the future is rosy. Architecture went from a male-dominated profession to one in which half the graduates are women; the transformation over the next decade is inevitable."

At UCLA, Dean Richard Weinstein concurs. "When I became dean here six years ago, I discovered that there was only one tenure-track woman faculty member, and well over 40 percent of the student body were women." Faculty and administration agreed to begin recruiting women to fill positions as they became available. Now UCLA has three tenure-track women, one of whom teaches design.

However, Susana Torre of Parsons contends that merely increasing the volume of women teaching is not enough. Torre, who was denied tenure at Columbia three years ago after overwhelming recommendations from her department (she is appealing the decision), says that female students are beginning to acquire a sense of equality with their male classmates, but when they look around, they still see far too few women in positions of authority. "Many signs tell you you can do it; other signs tell you that no



**6** years, 36 months of darkness,

45 snowstorms, 500 inches of snow,

92,000 cups of coffee (24,000 creams),

two polar bears,

one Raynor Tri-Core Door,

one Raynor Distributor.

### **RAYNOR GARAGE DOORS**

You can't imagine what a garage door goes through over the years. But you don't have to when you specify a Raynor Tri-Core Garage Door, because the only thing as reliable as a Raynor Door is a Raynor Distributor. To locate the one nearest you, call 1-800-545-0455.

Circle 3 on information card

matter how hard you try, there is a glass ceiling." Torre sees top-notch students she taught five or six years ago who have now gone through their first few years of entry-level positions. Many of these women are beginning to realize that the promotions went to their male colleagues instead of to them. "The most shocking realization for a young woman who was considered a 'brilliant' designer in academia is that the designation is much more difficult to receive in an office," Torre explains. "The young, upcoming designer is more likely to be a man."

To change the boys-only nature of ascension, Torre argues, the "male persona" of the architect must change, beginning in the classroom. She and many women professors believe that the Beaux-Arts style of instruction—the jury process and intense loyalty to a male mentor that is a holdover from the atelier—is an anachronistic practice ill-suited to architectural pedagogy for the 1990s. Today's students, they believe, require new approaches to problem-solving in order to tackle contemporary urban issues.

For example, Frances Halsband, principal of New York-based R.M. Kliment & Frances Halsband Associates, and now dean of architecture at Pratt, cites the problem of building daycare into office buildings in Manhattan. Rather than simply obey zoning ordinances that prohibit children in certain downtown workplaces, Halsband says architects should challenge them. To take on such complex tasks, she maintains, tomorrow's architects will have to be community oriented, working with numerous consultants on a collaborative basis. Notes Halsband, "Women work much more easily in groups, and we tend to listen better." MIT's Sandra Howell, who has served as a consultant on several Boston housing projects, agrees. "Men don't have the patience and they don't know how to deal with human relationships."

And Dolores Hayden, who taught history of the built environment for 11 years in the planning department at UCLA and has just moved to Yale, believes that gender will be a significant issue in terms of what people build and how they organize space within the city. "It goes beyond the question of equal pay and equal ranks for individuals, to the whole society, to how everything we do will affect women and children, as well as men."

In Hayden's view, the profession should focus less on an individual building and more on the city as a process.

The focus on the individual "star" designer and his or her building—the goal of most architectural curriculums—precludes both Halsband's and Hayden's approaches, which require a broader set of intellectual and collaborative responses. Clearly, these women and many others are concerned about

changing more than the opportunities for advancement in academia for *others of their* sex. They want to transform the very nature of pedagogy, and with it, the way architects approach and think about the built environment. "And maybe," muses Susana Torre, "there will come a time when we no longer have separate and different voices, but a richness of discourse that is not exclusionary." ■

—HEIDI LANDECKER

## Lighting the private office...



Elliptipar's high-powered Ensonce® series provides all the benefits of indirect lighting without overhead obstructions. Even with relatively low ceiling heights the surface appears evenly luminous, and the space free of harsh glare. Wall mounting enables concealment within decorative sconces from Elliptipar or others.

**elliptipar inc.**  
Performance in and From Lighting

145 Orange Avenue, West Haven,  
Connecticut 06516 (203) 932-2266

Circle 5 on information card

Sylvan R. Shemitz® Designs  
© elliptipar, inc. 1988

## IN JAPAN, ANDERSEN HELPS AN ARCHITECT

"In designing this office building/restaurant/showroom, we imported many Western ingredients," said architect Yuji Noga. "Andersen supplied us with the windows and engineering data. The wood interiors of their products worked well with the masonry structure."

And the engineering data? "Osaka city building codes are very strict," continued Noga. "Andersen Corporation's windloading and other performance data helped us install the three-story Andersen curtain walls securely and aesthetically."



Andersen® window materials compatibility, structural integrity and commercial viability. Solutions worth remembering whichever hemisphere you design in.

For the name of your Andersen representative, call 1-800-426-7691. Or write Andersen Commercial Group,<sup>SM</sup> Box 12, Bayport, MN 55003.

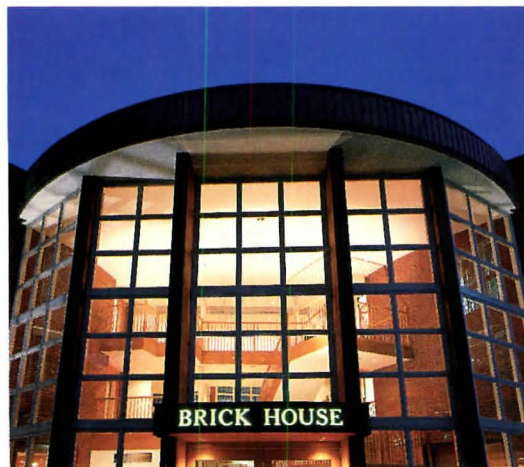

BRICK HOUSE, OSAKA, JAPAN. ARCHITECT: YUJI NOGA. ISSIKI ARCHITECTS & PARTNERS CO., LTD. TOKYO, JAPAN.

Designed to a "T"

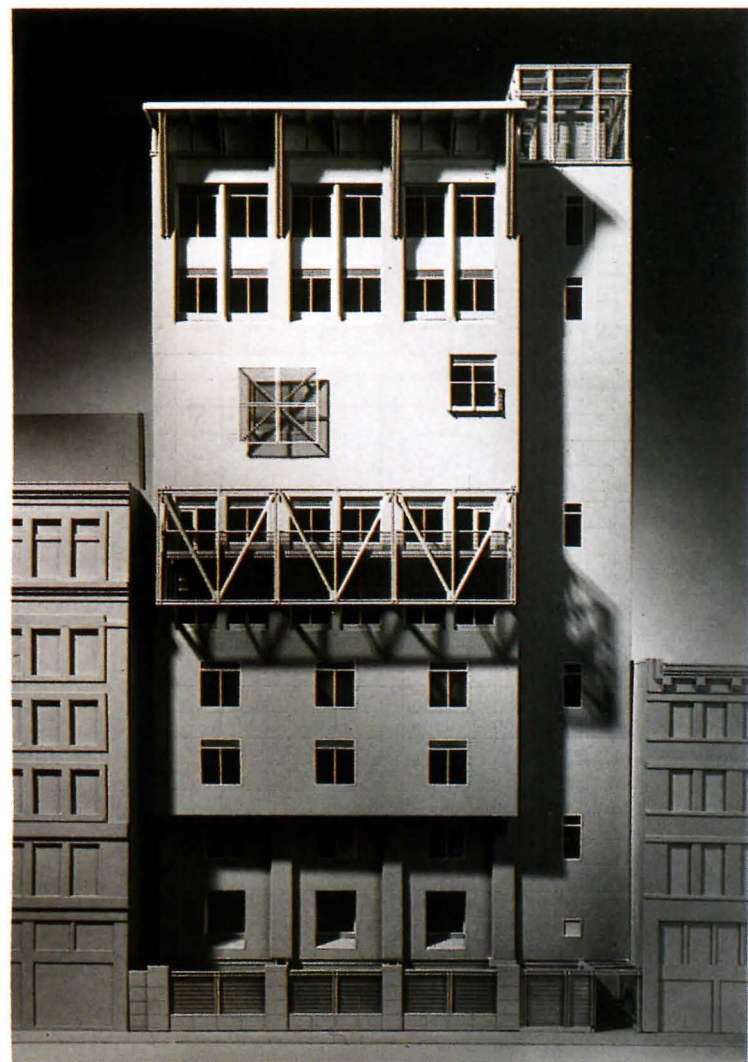

Leers, Weinzapfel defined Purchase Street facade (far left and bottom), fronting Central Artery, with overscaled cornice and balconies. More subdued High Street elevation (left) responds to neighboring buildings.

**MBTA Operations Control Center  
Boston, Massachusetts  
Leers, Weinzapfel Associates**

LOCATED ON THE EDGE OF BOSTON'S DOWNTOWN, the 10-story Massachusetts Bay Transportation Authority Operations Control Center is designed to mediate between neighboring 4- to 6-story older commercial buildings and new highrises. The architects incorporated the structural system and service core of the MBTA's existing 5-story building into the design, which features granite panels, steel balconies, and a highly articulated stair-tower. Both facades of the through-block building reestablish a pedestrian scale and reflect the functional zones of the center. The architects marked the entrance with an arcade and echoed the attic stories of the adjacent buildings with a cantilevered balcony. A nearly windowless zone on the fifth and sixth floors houses a state-of-the-art operations center that will direct all MBTA trains and trolleys. The top two floors contain executive offices. The existing facility will remain in operation during the renovation, which is expected to be completed in 1994. —L.N.



# ON THE BOARDS

## Community Amenity

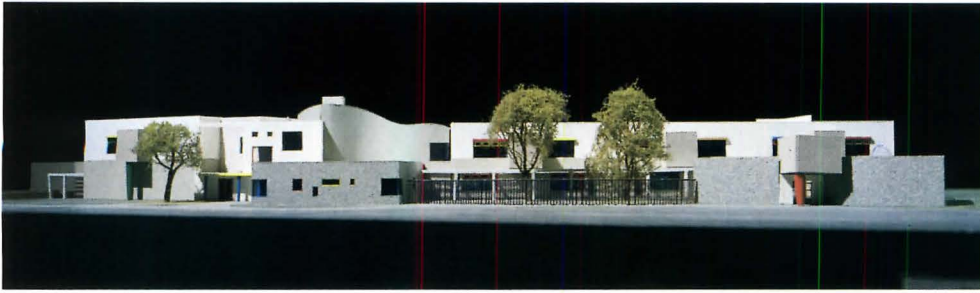

**Jefferson Elementary School**  
**Los Angeles, California**  
**Siegel Diamond Architects**

SIEGEL DIAMOND ARCHITECTS, A LOS ANGELES-based firm headed by Margot Siegel and Kate Diamond, designed a two-story school (left) with a public library (foreground in bottom photo) to offer a low-income neighborhood in south central Los Angeles new public amenities. The 51,000-square-foot elementary school will join an existing community meeting hall, a mental health facility, a senior citizens center (now under construction), and a public park on 20 acres. Principal Kate Diamond arrived at the fractured plan in order to shorten corridors for small children and to preserve existing trees. She created a double-height lobby with a curved, stucco facade at the center of the building to separate classrooms from auditorium, lunch porch, and upper-level classrooms to the east. At the western edge of the site, the library, punctuated by a rotated cube and a column, encloses a kindergarten play area. A rear playground for older students opens to the public after school. To establish individual classroom identities, Diamond devised different color schemes for window and door overhangs, visible from both exterior and interior corridors. To minimize vandalism, she covered the building base with graffiti-proof ceramic tile, and applied stucco on the second level. Pull-down security grills, to be installed outside glazed areas, act as sun shades during the day. Construction of the \$7.6 million facility will begin in June 1993. —K.S.

## AGGLOSIMPLEX

**For the look and prestige of marble**



A time tested and proven large chip marble agglomerate of unsurpassed quality. Agglosimplex offers the beauty and durability of marble at savings of 30 to 60 percent over quarried marble. Outstanding for commercial use as well as personal residences. Available in tiles and slabs, and a choice of two finishes in 21 colors.



Produced by  
Santa Margherita  
in Italy since  
1974. Sold  
exclusively in the  
U.S. through  
Verona Marble Co.



**Verona Marble Company**  
8484 Endicott Lane  
Dallas, TX 75227  
(214) 381-8405 FAX (214) 381-8333





## Los Angeles Houses



**Sarli House**  
**Juniper Hills, California**  
**Judith Sheine, Architect**

JUDITH SHEINE DIVIDED THE LIVING/DINING area (foreground, top left) and the master bedroom (top right) of a 1,300-square-foot residence into a pair of vaulted volumes. The curved, corrugated-steel roofs, which echo the surrounding San Gabriel foothills, allow for two mezzanines inside the double-height volumes. Above a one-story hall, a kitchen, and a bathroom is a roof-level deck offering views of the Mojave Desert. High winds and extreme temperatures led Sheine to design a cavity wall of concrete block at the base and metal stud walls covered with corrugated steel on the exterior and plywood inside. The project on five acres is scheduled to break ground later this year.

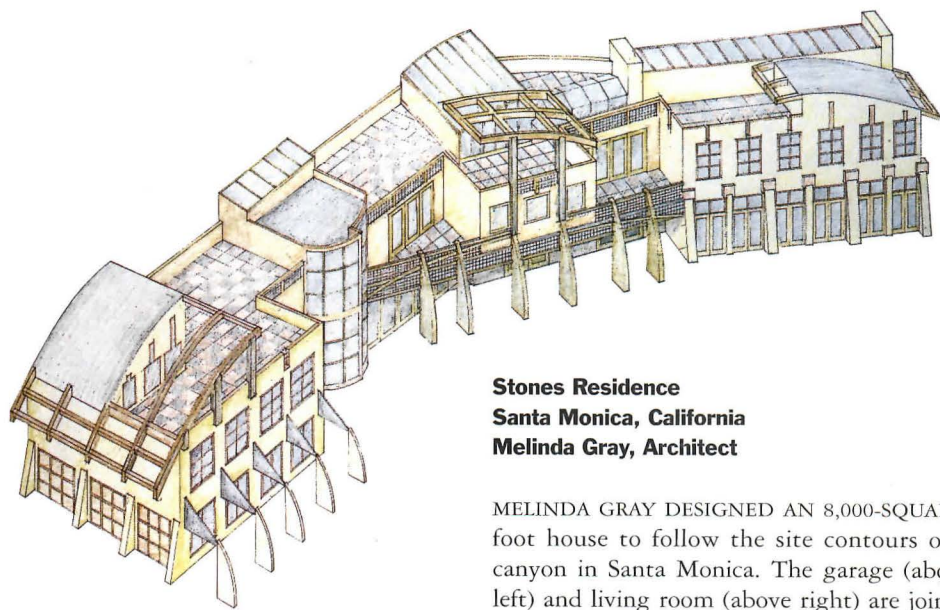

**Stones Residence**  
**Santa Monica, California**  
**Melinda Gray, Architect**

MELINDA GRAY DESIGNED AN 8,000-SQUARE-foot house to follow the site contours of a canyon in Santa Monica. The garage (above left) and living room (above right) are joined by a kitchen/breakfast room housed in a semi-cylindrical volume, a ground-level dining room, and a study. Two of five upper-level bedrooms open onto balconies overlooking 30-foot trees and the Pacific Ocean. Sheltered in part by a wood-framed canopy, a roof terrace also provides ocean views. Protruding fin-shaped columns attached to a metal railing create an entrance portico; similarly shaped structures establish a colonnade alongside the garage. The \$1.5 million house will begin construction by year's end.

**3.5 Houses**  
**Riverside, California**  
**Sigrid Miller Pollin, Architect**

INFLUENCED BY THE MODERN HOUSES OF Rudolf Schindler, Sigrid Miller Pollin designed a trio of residences and a guest house on a 10-acre site in Riverside's foothills. One of the residences, House 3 (right), typifies Miller Pollin's designs: each building incorporates a wood and glass living room "cube," and 30-foot-high reinforced-concrete walls. Designed to shelter the building from high winds and brush fires, the protective walls of House 3 enclose a circulation spine that provides access to south-facing rooms. A cantilevered living room (right in bottom photo) affords views of the Riverside valley. The three houses will be completed in February 1992. —K.S.

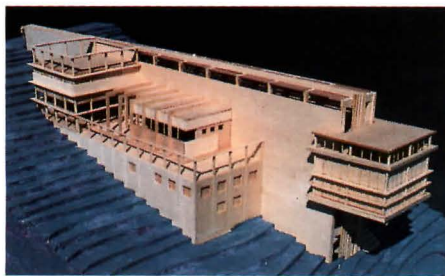

# ON THE BOARDS

## Everglades Visitors Center

Sawgrass Education Complex

Coral Springs, Florida

Marilyn Nepomechie with Sasaki Associates

IN 1987, THE CITY OF CORAL SPRINGS BEGAN assembling a 180-acre site at the northern tip of Everglades National Park for an educational facility focusing on the surrounding swampland. Two years later, Marilyn Nepomechie of Miami translated the program requirements into three discrete structures: a vaulted visitor's center flanked by an elevator/stairtower to the south and an aluminum-capped observation tower to the north. From the 75-foot tower (far right), visitors will view 3 million acres of protected everglades. A raised steel deck links the structures, which rest on concrete piles to preserve undergrowth. The project's axial alignment and colorful finishes acknowledge the project as a built intrusion on an undeveloped landscape. The \$1 million scheme currently awaits city approval. —K.S.

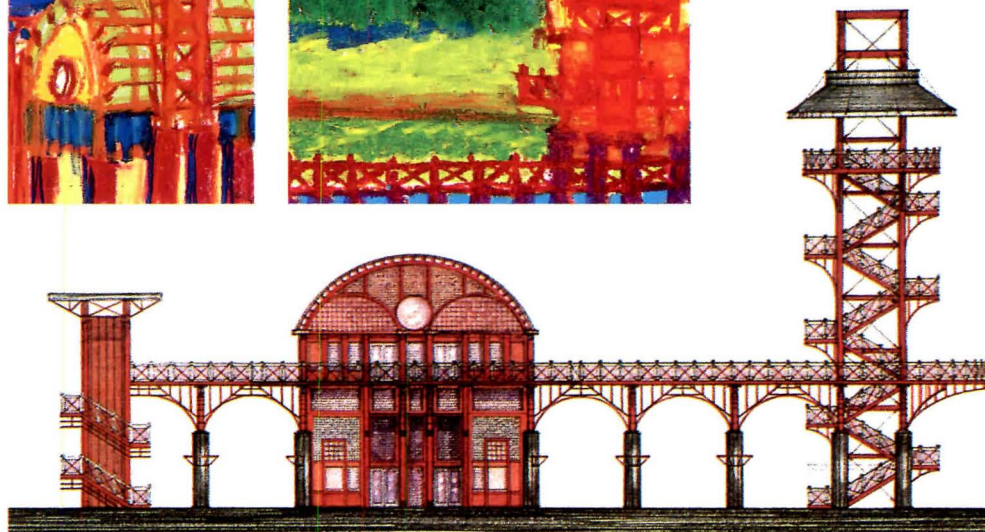

## Technician™ Mechanical Pencil

**Perfection from Beginning To End!**

You'll have a smooth beginning with Technician's fixed metal sleeve that protects lead and glides along template and ruler - precision engineered for drawing and drafting work. And, as you make changes, Technician™ offers you the perfect ending - Unique New **TUFF STUFF™** Eraser. Available now through your local office supply dealer.

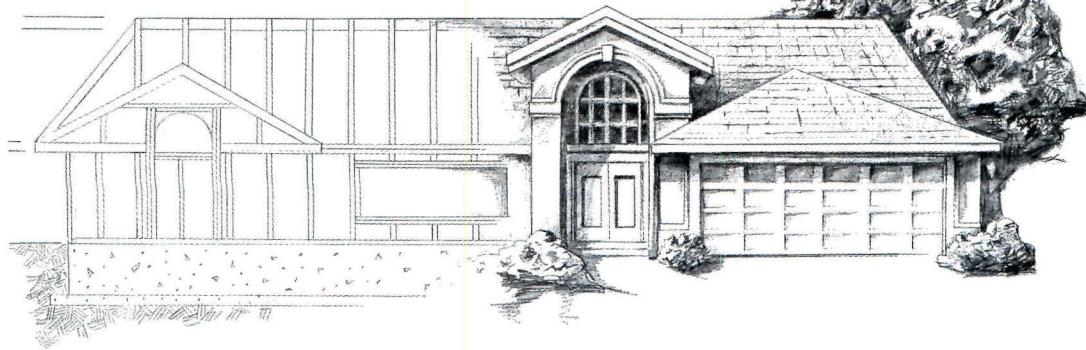
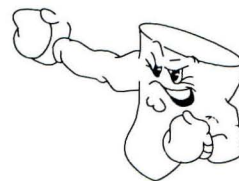

Technician™  
Mechanical  
Pencil  
Now With  
**TUFF STUFF™**  
Eraser!!  
Lasts ten times  
longer than  
standard  
erasers.

Technician™, *Perfection From Beginning To End!*

**SANFORD** CORPORATION  
Bellwood, IL 60104

Circle 57 on information card

Florida Boating Village



**Goodland Marina**  
**Marco Island, Florida**  
**Andrea Clark Brown, Architect**

ANDREA CLARK BROWN DESIGNED A MARINA near her 5-person office in Naples, Florida, to incorporate 25,000 square feet of retail spaces, including a showroom, offices, and a boat parts and services building. Faced in cedar board and batten siding, the complex respects a local fishing village esthetic, while intersecting volumes at the western edge of the complex establish a contemporary precedent. Brown inserted a narrow corridor along the west wall of the 260-boat storage facility to create an internal arcade that captures breezes from the south. From a plaza at the waterfront (center in elevation, top), boaters can enter a garden walkway along the marina's west facade or ascend a stair to reach upper-level shops. The project is expected to begin construction next spring. —K.S.



**Sloped, metal roofs and board and batten siding recall fishing village vernacular (top left). Pedestrian breezeway alongside shops (left) leads to waterfront. Garden walkway adjoins parking area (bottom).**



# ON THE BOARDS

## Church and State

**New Hope Church of Christ  
Duarte, California**

**Rebecca L. Binder, Architecture and Planning**

FOR A 15,000-SQUARE-FOOT RELIGIOUS COMPLEX on a two-acre site, Rebecca Binder clustered a sanctuary, multipurpose room, classrooms, and offices around a courtyard. This cloistered arrangement satisfies the congregation's need for a private outdoor space sheltered from a busy intersection adjacent to the site and allows the project to be constructed in phases due to budget limitations. Classrooms and offices will be housed in a pair of simple sheds that flank the entry facade of the multipurpose building (inset). In contrast to the support buildings, the sanctuary features an abstracted Romanesque facade and a distinctive roof line accented by a skeletal steeple (right). The first phase of the project, the multipurpose wing, is scheduled to begin construction next year. —L.N.

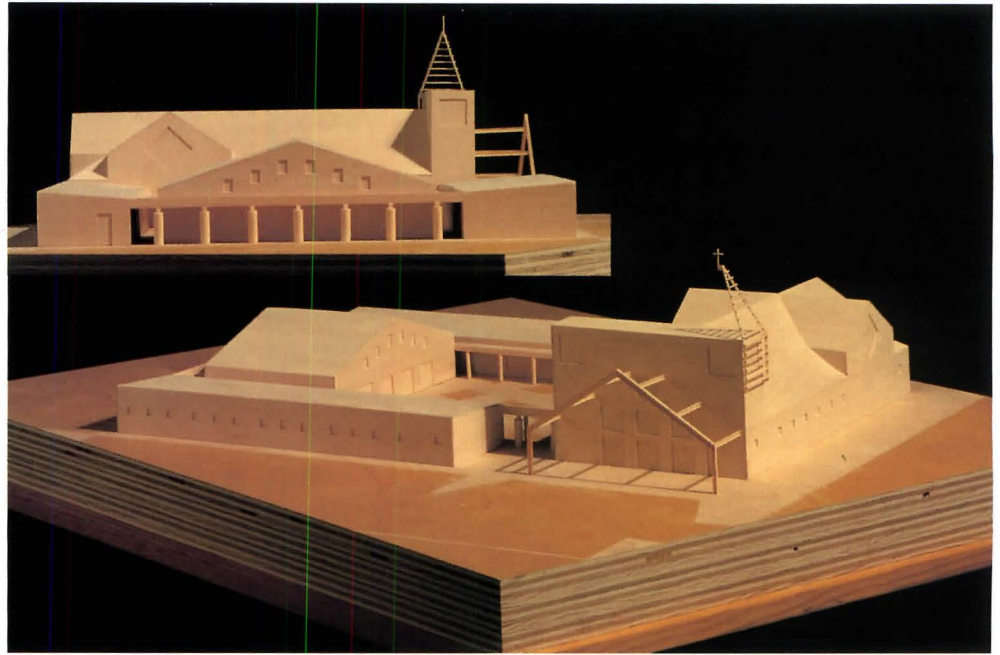

# AMERICA, HERE'S LOOKING

# ON THE BOARDS

**Visual Arts Facility**  
**University of California, San Diego**  
**Rebecca L. Binder and**  
**Neptune Thomas Davis, Architects**

IN ADDITION TO A PAIR OF COMPLETED buildings at University of California, Irvine (pages 40-45), Rebecca Binder has designed projects for other branches of the state university system. A 71,000-square-foot, two-story visual arts center (right) at UCSD began construction this month and will be the first building in UCSD's fifth college, a newly master-planned campus precinct. The villagelike complex linked by walkways and courtyards focuses on a central block housing art studios, galleries, and performance spaces. Binder is also designing a \$15 million addition/renovation to UCLA's Ackerman Student Union, scheduled to start construction next year, and the firm was recently short-listed for a chemistry building at UC Santa Cruz. ■



## AT YOU THROUGH

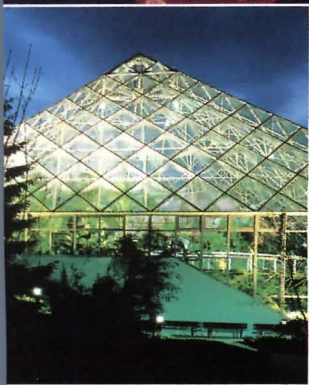

# ACRYLITE<sup>®</sup>

ACRYLIC SHEET

# CYROLON<sup>™</sup> ZX

POLYCARBONATE SHEET

### OPTICAL CLARITY, SAFETY, DURABILITY

If you demand superior performance in your specialty glazing application, specify superior ACRYLITE acrylic or CYROLON ZX polycarbonate sheet. For maximum weatherability combined with outstanding light transmission characteristics, ACRYLITE acrylic sheet is unsurpassed. When an added measure of security is a must, our CYROLON polycarbonate sheet delivers the impact resistance you need.

Both ACRYLITE and CYROLON sheet comply with material requirements of AAMA's voluntary specifications for skylights, No. 1600-86 and both are manufactured by CYRO Industries, North America's largest producer of acrylic sheet. We use statistical process control to ensure the highest quality sheet, provide technical and fabrication support, and our nationwide network of distributors stands ready to fill your orders promptly and efficiently. For walkways, atriums, skylights, solariums, staircase treatments and specialty glazing, ACRYLITE and CYROLON sheet are without equals. For informative literature, write D. Artz, CYRO Industries, P.O. Box 950, 100 Valley Road, Mt. Arlington, NJ 07856.

SEE US IN SWEET'S CATALOG FILE, REFERENCE NO. 08840/CYR, OR CALL

**1-800-631-5384.**



QUALITY PRODUCTS • INNOVATIVE TECHNOLOGIES • CARING PEOPLE

Circle 11 on information card

# “Joe is very availa

*T. Graham Bradley is a principal of Bradley Likins Dillow Drayton, AIA, a 60-year-old firm located in Decatur, Illinois. He is a Fellow of the AIA and a past director of the national AIA. He is also past president of both the Central Illinois Chapter of the AIA and the Illinois Council of the AIA.*

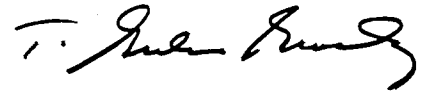

*Joe Murphy is president of Insurance Designers, an independent insurance agency based in Petersburg, Illinois. He is a member of the Professional Liability Agents Network (PLAN), a nationwide group that specializes in serving the risk management needs of design professionals.*



There's no typical day for Joe Murphy, but at least a couple of days a week you'll find him driving 250 or so miles in several different directions to: spend two hours discussing loss prevention with an architect and helping him fill out a DPIC application, two hours talking about a structural engineer's changing practice and completing a renewal application, another hour talking about project insurance with another architect, and more time with another renewal application. He met Graham on a trip like that about eight years ago. Graham had a problem on his professional liability policy and Joe helped straighten it out.

Joe says, "I don't think you have to come on strong—I think it's just being there when they need you. You finally get to the place where, when they think they have a problem, they call you—they just plain can't think of anyone else to call."

Joe's spent over 20 years in the insurance business, and nearly ten representing DPIC. Today he can hardly remember the days before he knew about professional liability for design professionals: almost 100% of his time is spent with architects and engineers. Because of his expertise and his proximity to the state capitol, he works with Graham and other design professionals to provide input to policymakers, working with government bodies like the state Capital Development Board, which handles all renovations and new buildings for the state. He's a "reference point" for them—their sounding board on what the insurance industry thinks about contractual clauses under discussion with the AIA, ACEC and others. If you're a design professional in central Illinois, you'll see Joe Murphy.

Professional Liability Insurance  
for Design Professionals



The Professional Liability Specialist  
of the Orion Capital Companies

Design Professionals Insurance Company • Security  
Insurance Company of Hartford • The Connecticut  
Indemnity Company • Guaranty National Insurance  
Company • Landmark American Insurance Company

Available through an exclusive network of independent  
agents. Please call 1 (800) 227-4284 for the agent  
serving your area.

DPIC Companies, Inc.  
2959 Monterey-Salinas Highway  
Monterey, California 93940

Circle 31 on information card

# ARCHITECTURE

## A Firm of One's Own

IN HER 1928 ESSAY "A ROOM OF ONE'S OWN," VIRGINIA Woolf outlines the prerequisites necessary for a woman to best express her creativity. Topping the list are independence and solitude, a sanctum that none can intrude. When Louise Bethune, the first woman member of the AIA, set out to practice architecture in 1881, it is doubtful she had such creative freedom. Although Bethune did indeed become successful designing commercial, institutional, and residential buildings in Buffalo, New York, she shared a partnership with her husband. She was an early pioneer in an era that witnessed only a trickle of women into the profession, most of whom found themselves relegated to the sidelines. Today, that trickle is a steady stream: in many architecture schools half the entering students are women; and professionally, women no longer require a man's name on the door to win clients. Our design section this month focuses on talented women who are flourishing away from the restrictions of male-owned practices, in firms of their own.

On the West Coast, Rebecca Binder completes the University of California, Irvine's computer sciences/engineering quadrangle, designed in two earlier phases by Frank Gehry. On a campus that features work by many "star" architects, Binder is one of the few to receive a second commission. In Philadelphia, AIA President-elect Susan Maxman has earned a reputation as a tal-

ented mediator of clients and context, as shown in her design for a residence that balances the expanse of a romantic garden with the density of a neighboring apartment complex. In New York City, Karen Bausman and Leslie Gill negotiate problems of space and materials in artistic constructions before tackling design commissions, such as Electra Entertainment's corporate offices. After some lean years of solo practice, New York architect Karen Van Lengen enters the big leagues with the coveted commission for a 150,000-square-foot addition to the American Memorial Library in Berlin. In Texas, Carrie Glassman Shoemake, Heather McKinney, and Val Glitsch are blazing new trails in design and professional leadership. With complementary talents, Boston architects Andrea Leers and Jane Weinzapfel excel in designing public and private institutions, including a recent courthouse in Newburyport, Massachusetts, and a teaching observatory in Exeter, New Hampshire.

Not every female architect has chosen to go it alone or in partnership with other women. As our roundtable discussion on women in large firms demonstrates, sometimes it takes even more courage to fight the battles within the system (pages 79-87). And our status check on women in architecture academia (pages 23-25) proves that women still have a long way to go before reaching parity with men in the higher ranks of the profession—both on and off campus. ■

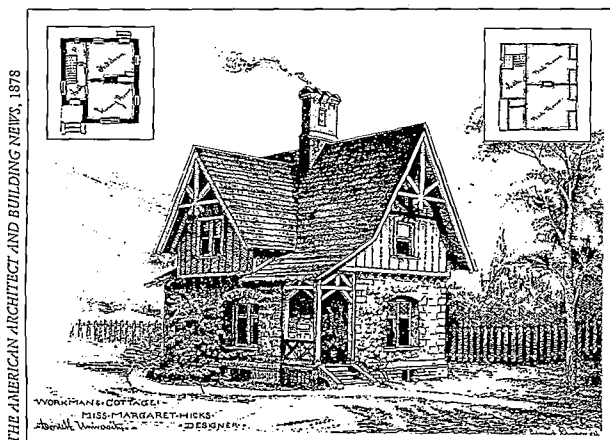

The earliest existing published sketch by a woman architect is Margaret Hicks's student project at Cornell, an 1878 rendering for a workman's cottage (above left). While Susan Maxman's sketch for an upcoming

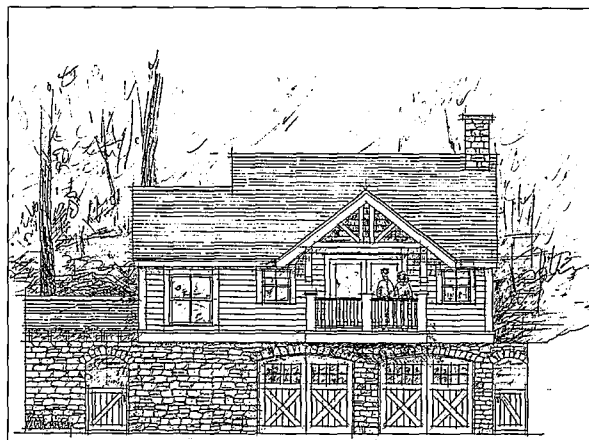

garage addition in Philadelphia (above right) bears a striking resemblance to Hicks's drawing, her recent election as president of the AIA demonstrates how far women have progressed within the profession.

# Modern Science

IN 1979, REBECCA L. BINDER DECIDED TO ESTABLISH HER OWN practice. Fortunately she didn't have to search long to find a commission, it turned out to be in her own backyard. With her husband as co-developer, she tore down their house in Santa Monica to design a four-unit condominium, the Pacific Townhouse, which won a national AIA honor award in 1985.

Binder has since moved on to other people's backyards, designing her share of houses, restaurants, and apartments. Often working with tight sites and limited budgets, she exploits banal materials and abstracted forms to pack visual punch into a range of modest projects. Acknowledging a deep respect for "strong, simple, and pragmatic Modernist precedents," Binder views her work as "basically an evolution of Modernism turned into the next generation." Over the last five years, Binder's practice has grown to support a range of institutional projects (pages 34-35), which has allowed the 40-year old architect to hone her esthetic.

An East Coast native with an English degree from the University of Pennsylvania, Binder received a master's of architecture from UCLA in 1975, and stayed in Los Angeles to work for several

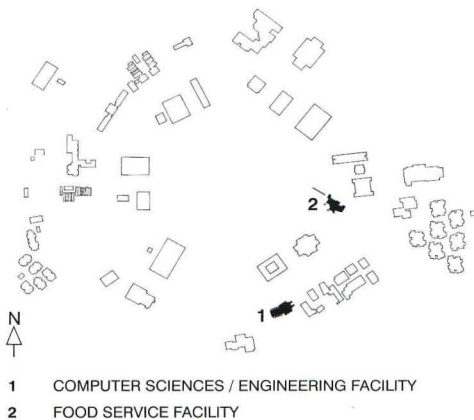

**Bordering UC Irvine's pedestrian ring mall (top and site plan), Binder's engineering building (facing page and right in photo below) completes the quad started by Frank Gehry.**









“Regardless of advantages or constraints, you either design good buildings or you don’t. The architecture speaks for itself.”

—REBECCA L. BINDER



corporate offices over the next five years. From 1977 to 1987, she taught a design studio at Southern California Institute of Architecture. Last month after single-handedly directing a firm that has grown to ten, Binder named her first partner, Kim A. Walsh.

Within the past 11 years, the firm has amassed a significant repertoire of built work. A food service building at the University of California, Irvine, (*ARCHITECTURE*, January 1990, pages 76-77) is one of the more successful examples of signature buildings on campus by architects such as Robert Stern, Charles Moore, Robert Venturi, and Eric Owen Moss. One of the few “stars” asked to design a second building on the campus, Binder’s encore structure is a 16,000-square-foot facility that completes the campus’s computer sciences/engineering quadrangle designed in two earlier phases by Frank Gehry. While some young Los Angeles architects might have been intimidated by the proximity to Gehry, Binder holds her own with a bold design that makes the most of its minimal mass and mundane materials.

Binder divided the program of labs and offices into paired blocks and responded to new campus planning guidelines that require buildings along the William Pereira-designed circular pedestrian path to incorporate arcades. A three-story stuccoed volume with a grand entrance stairway defines the quad’s orthogonally planted olive grove, and the torqued “tail” of the building follows the arc of the ring mall.

While indisputably influenced by Gehry, Binder’s composition of simple volumes provides an appropriate counterpoint to his neighboring complex of variegated forms. Moreover, her addition strengthens the role of the engineering compound as a cohesive hinge between the central ring mall at UC Irvine and one of the emerging spokes in the campus master plan. ■

—LYNN NESMITH

**Facing the quad, the entrance is defined by a ceremonial stairway (left). The skewed, darker volume with a pitched roof and timber pergola (facing page) responds to the geometry of the ring mall and parking lot (top left).**



A mahogany-clad stairway (below right) rises along the building's west elevation (facing page). The cathedral-like scheme (plans) affords flexibility with large bays and small offices. Without grand lobbies, the stairway and heavy timber arcades (below left) function as a transition between indoors and out.

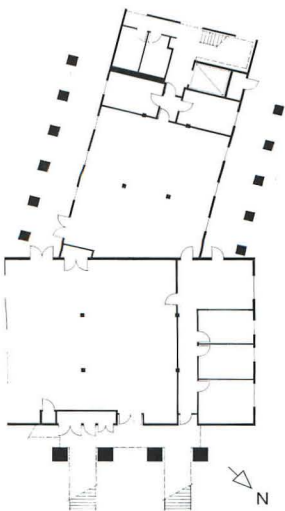

FIRST FLOOR

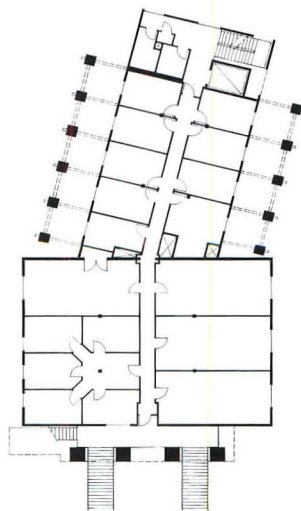

SECOND FLOOR

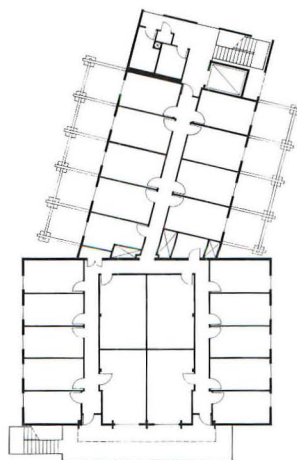

THIRD FLOOR

**INFORMATION COMPUTER SCIENCES/  
ENGINEERING RESEARCH FACILITY  
UNIVERSITY OF CALIFORNIA, IRVINE**

**CLIENT REPRESENTATIVES:** Chuck Powers (associate vice chancellor); Rebekah Gladson (director of architecture)

**ARCHITECTS:** R.L. Binder, Architecture & Planning, Playa del Rey, California—Rebecca L. Binder, FAIA, Kim A. Walsh, Kevin Shibata, Paul Harney (project team)

**LANDSCAPE ARCHITECTS:** Emmet L. Wemple & Associates—Peter Brandow (principal)

**ENGINEERS:** KPFF Consulting Engineers (structural); Tsuchiyama & Kaino (mechanical); Mirahmadi & Associates (electrical); Arthur R. Leatores & Associates (civil)

**GENERAL CONTRACTOR:** A.R. Willinger

**COST:** \$2.2 million—\$125 square foot

**PHOTOGRAPHER:** Jeff Goldberg/Esto



# Philadelphia Story

AT A RECENT DINNER HONORING AIA PRESIDENT-ELECT SUSAN Maxman in Philadelphia, one of the architect's former professors at the University of Pennsylvania came over to shake her hand. "Susan," he said, "I'll never forget the time you came to me and said, 'Listen John, you just have to give me a crit earlier—I have to get home to feed all my kids!'"

A mother of six, Maxman went back to school in 1974 to get a master's degree in architecture. It didn't matter that the 35-year-old housewife never received a bachelor's degree, or that, in 1958, when she had tried to transfer into Penn's architecture program from Smith College, she was told "it's no place for women." It didn't matter that she would first have to take calculus and physics alongside Penn's pre-med students, or that her physics professor told her she'd flunk, because "women can't do physics." Maxman got an "A" in physics, and, as her AIA accolades—including a 1991 national honor award for Camp Tweedale—clearly demonstrate, she's been getting "A's" ever since.

Maxman recalls another Penn professor telling her class that it takes 20 years to become a good architect. She thought, "I haven't got that long!" Today, 11 years after passing her registration exam, Maxman runs a 13-person firm that specializes in renovating Philadelphia houses. She also designs Girl Scout camps, updates 1970s-era municipal buildings, and builds bridges—both real ones, like the Strawberry Mansion bridge across the Schuylkill River, for which her firm is designing an observation deck; and interpersonal ones, like the coalition she forged when renovating Vernon House. Financed by the Philadelphia Redevelopment Authority and owned by the city's department of recreation, the early 19th-century residence was restored as offices for the Central Germantown Council, a nonprofit organization trying to stimulate growth. Because it is located in the gentrified Vernon Park neighborhood, Friends of Vernon Park was active in its rejuvenation,

**Chestnut Hill residence faces an early 20th-century garden ruin (top right). Living quarters (facing page and section) take in the outdoors.**

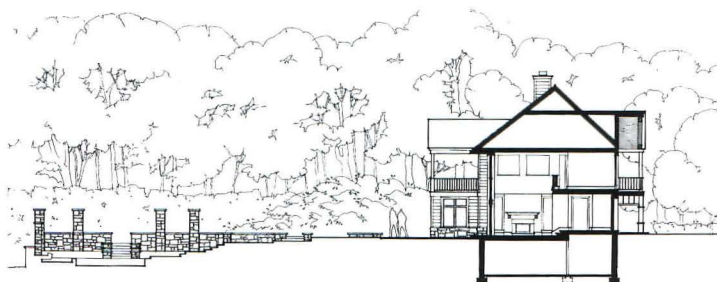





“I went into architecture to solve problems for people. I will never sacrifice a client’s program for my design objectives.”

—SUSAN MAXMAN

and the Philadelphia Historical Commission reviewed every detail. “It’s a challenge to work with all these groups,” Maxman observes. “Many architects are very possessive of keeping control. The challenge is to include everybody, and still keep control. You can do that by being upfront, direct, and a good listener.”

Direct she is. A client who commissioned Maxman to remodel a bland, 1950s-era ranch house once asked the architect what she liked about the house. “Not much,” Maxman snapped. That client has become one of the architect’s biggest supporters, and the house, now an airy brick and clapboard cottage lit by clerestories and dormers, is her firm’s best word-of-mouth marketing tool. Despite her frankness, Maxman contends that she never sacrifices a client’s program for her design ob-

jectives. “We provide a service for our clients, and I very much respect what they want.”

For a private residence in Philadelphia’s Chestnut Hill (these pages), the clients requested a design reminiscent of a carriage house for their abandoned estate property with its spectacular garden ruin. On a bluff above the site, where an early 20th-century mansion once stood, is an apartment complex, so Maxman organized the house around a long circulation spine that buffers the living quarters from the nearby buildings. Kitchen, living/dining area, study, and upstairs sleeping quarters all face the garden and woods below. Most of the base of the house is clad in Wissahickon schist salvaged from the site, a reminder of neighboring stone mansions. “I’m basically a contextual

architect,” Maxman reasons.

On the boards at her firm are two more Girl Scout camps, an agricultural history museum, a master plan for a humane society—which includes a wetland interpretive program suggested by the architect—a garage and studio for the Chestnut Hill residence, and renovations of two 18th-century houses. Maxman admits that her office handles a “crazy diversity” of projects, but treats every commission as a special opportunity, not only for design, but for good client relationships. Although the clarity of her architecture is evidence of her straightforward design principles, Maxman maintains that all she really cares about is happy clients: “I don’t care if my work wins awards.” ■

—HEIDI LANDECKER





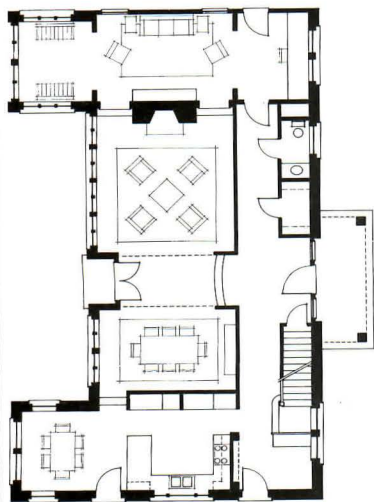

FIRST FLOOR PLAN

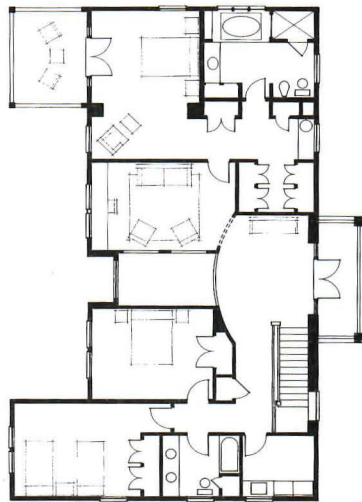

SECOND FLOOR PLAN

By arranging circulation at the rear of the house (plans and facing page, right), the architect focused living areas and bedrooms on the landscape (facing page left). Balconies off master bedroom and above living area (below) afford garden views. Stair trellis (facing page, right) is signature Maxman.

**CHESTNUT HILL RESIDENCE  
PHILADELPHIA, PENNSYLVANIA**

**ARCHITECT:** Susan Maxman Architects, Philadelphia, Pennsylvania—Susan Maxman, FAIA (principal-in-charge); Thomas D. Hecht, AIA (project architect)

**LANDSCAPE ARCHITECTS:** Shusterman & Steiger

**ENGINEERS:** Ortega Consulting (structural); Bruce E. Brooks & Associates (mechanical/electrical)

**GENERAL CONTRACTOR:** Cornerstone Construction

**PHOTOGRAPHER:** Tom Bernard Photography



# Mark of the Hand

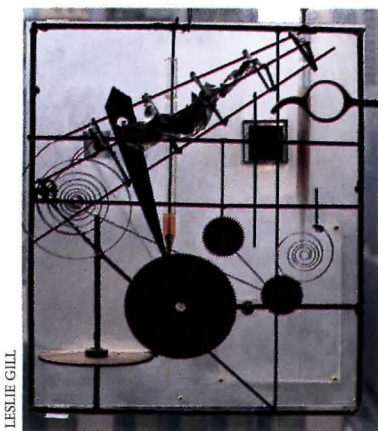

LESLIE GILL

1

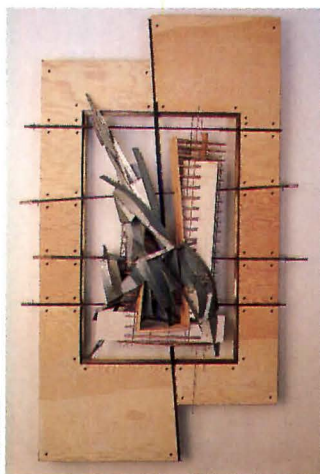

LESLIE GILL

2



LESLIE GILL

3



ELLIOTT KAUFMAN

4

**Electra Entertainment (facing page) reveals manipulation of space and materials evident in Bausman and Gill's collaborations with Alison Berger, *Homage to the Turntable* (1); with James Hicks, *Wall Relief II* (2); and in their own *Landscape V* (3) and *Barn Box* (4).**

THE PHONE IS ANSWERED AT THE FIRM OF BAUSMAN-GILL ASSOCIATES in New York City with a single word: "studio." It is clear evidence that Karen Bausman and Leslie Gill have managed to keep alive the intensity of spatial investigation that they first discovered as architecture students in the late 1970s. The young partners are indebted to Cooper Union and its dean, John Hejduk, for igniting a passion for the poetic implications of architecture that has yet to abate. Space, and its material definition, is at the center of education at Cooper, complemented by one of the most rigorous programs in building science of any architecture school in the country. The school also emphasizes mixing the discipline of architecture with painting, sculpture, literature, and music, which Bausman and Gill continue to carry out in their work. "In almost every project," says Gill, "there are pieces that we construct ourselves or in cooperation with artists."

Some of the artworks created by Bausman and Gill (left) serve as sketches for further spatial investigations. Both designers often fill shadow boxes with layers of material, color, and pockets of space to explore concepts that are later translated into architecture. Unlike scaled architectural models that literally represent space, "our shadow boxes can be understood at the size at which they exist, or on various scales," explains Gill, from a single room to an urban region. Bausman adds that the boxes "allow us to explore space and viewpoints at a very personal scale: the texture and density of materials, methods of containment. You can also suspend gravity within the boxes. They're our most experimental medium." The designers liken their miniature constructions to Gothic paintings, which are distinguished in their compression of space and shifts of scale between subject matter. Bausman and Gill have also built wall reliefs and room-size installations, which approach full-scale architecture. Their artworks have been shown at the John Nichols Gallery and Artist's Space in New York City, at Princeton University, and in several traveling exhibits.

Bausman and Gill started their own firm in 1982, a few months after graduating from Cooper. While students, they

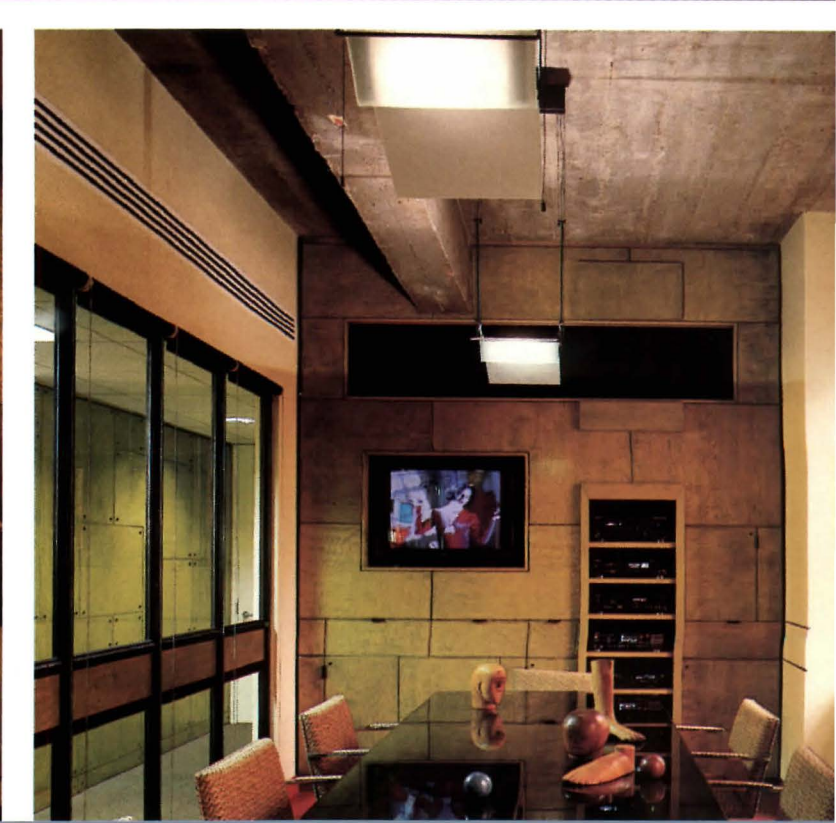



“The intangible in both art and architecture motivates our work, which expresses the mark of the human hand in its search for order.”

—LESLIE GILL AND KAREN BAUSMAN

worked in several New York offices: Bausman at I.M. Pei & Partners; Gill at Kohn Pedersen Fox Associates and Chermayeff and Geismar Associates, a graphic design firm. After completing several commissions for office interiors in New York City high-rises over the past four years, Bausman and Gill have identified a provincial characteristic of their practice. “We call it New York City regionalism,” explains Gill. “We’re supplied with an interior shell and all of the supplies: electricity, heating, ventilation, plumbing, structure, circulation, fenestration. The sectional biases in these shells are planar, horizontal cuts through space, rather than vertical.” Within the shell, the architects attempt to create a depth of field, a compression of materials and space similar to their shadow boxes: architectural elements are layered, solids are silhouetted against light, and long vistas cut through the interior to windows where a horizon line is established.

Because these internalized spaces lack conventional exterior architectural elements, such as windows, doorways, and roof profiles, human scale is defined through what Bausman and Gill refer to as the “mark of the hand.” The trace of human movement, they feel, makes the scale of their interiors intelligible. The size of a wall panel, for example, is understood in relation to the evidence of human movement on that panel—the imprint of a hand, or the sweep of an arm in applying paint or plaster.

Bausman-Gill’s design for Electra Entertainment’s corporate offices, on the 15th and 16th floors of a 32-story tower at New York City’s Rockefeller Plaza, extends the architects’ shadow box investigations and reveals their manipulation of scale through human craft. Screens, sliding walls, overlapping panels, and free-standing frescoes, crafted by the designers with artist collaborators, provide the music company headquarters with spaces that are multilayered, rendered in brushed metal, birch plywood, plaster, and leather. “We used materials that will age with a patina,” notes Gill, “so that the character of the interior will evolve over time, showing the imprint of human use.” ■

—MICHAEL J. CROSBIE

**Stair at Electra Entertainment (right and section) communicates a skeletal quality, with overlapping struts, rails, wall panels, and shadows. A similar metal system was installed for filing cabinets and mounting fresco panels (previous page and axonometric, bottom). Frescoed sliding walls and doors in a round conference room (facing page) were painted by the designers. Stained birch plywood panels (previous page) divide workstations and define support spaces.**

**ELECTRA ENTERTAINMENT  
NEW YORK CITY**

**ARCHITECT:** Bausman-Gill Associates, New York City—Karen Bausman, Leslie Gill (partners-in-charge); Adi Shamir (designer); Bryce T. Sanders (project architect); Alison Berger, John Blackmon, James Hicks, Tim Lenahan, Clarissa Matthews, Bette Miller, Jackie Pillicotti, Tim Schollaert, Gary Shoemaker, Homa Sojaie, Mabel Wilson, Dan Wood (project team)  
**ENGINEERS:** Edwards & Hjorth (structural); Hartmann & Concessi (mechanical/electrical); RAH Associates (acoustical)  
**CONSULTANTS:** Audio-Video Crafts (audio/video)  
**GENERAL CONTRACTOR:** Clark Construction  
**FRESCO PANELS:** Lucinda and Robert Wallace  
**PHOTOGRAPHER:** Peter Mauss/Esto, except as noted

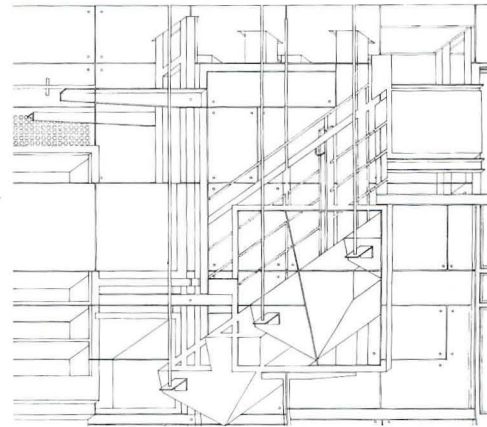

STAIR SECTION

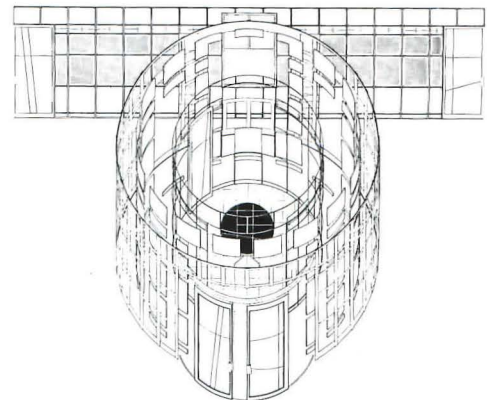

CONFERENCE ROOM AXONOMETRIC



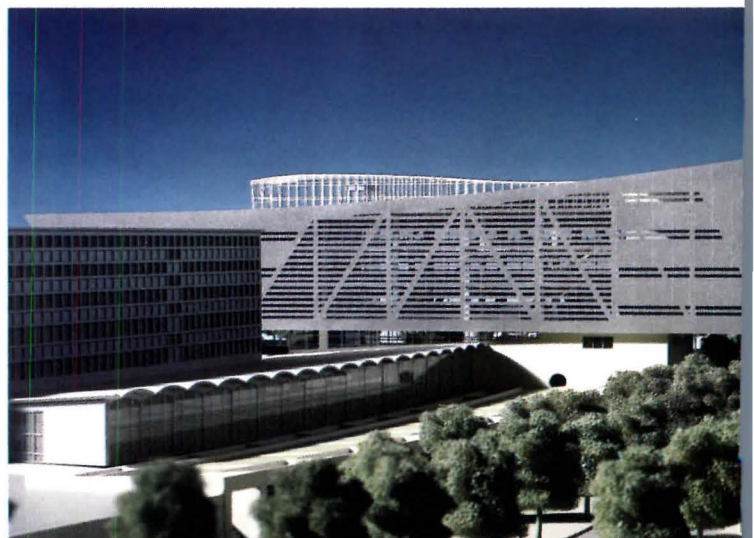
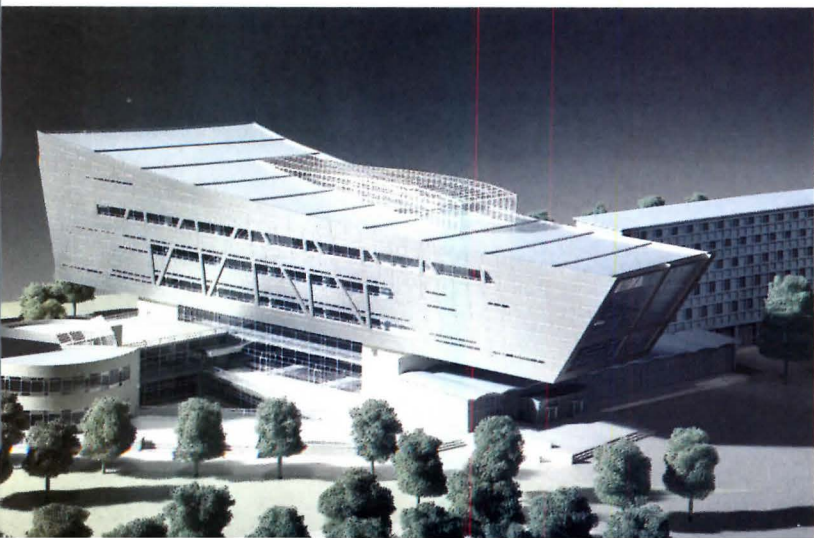
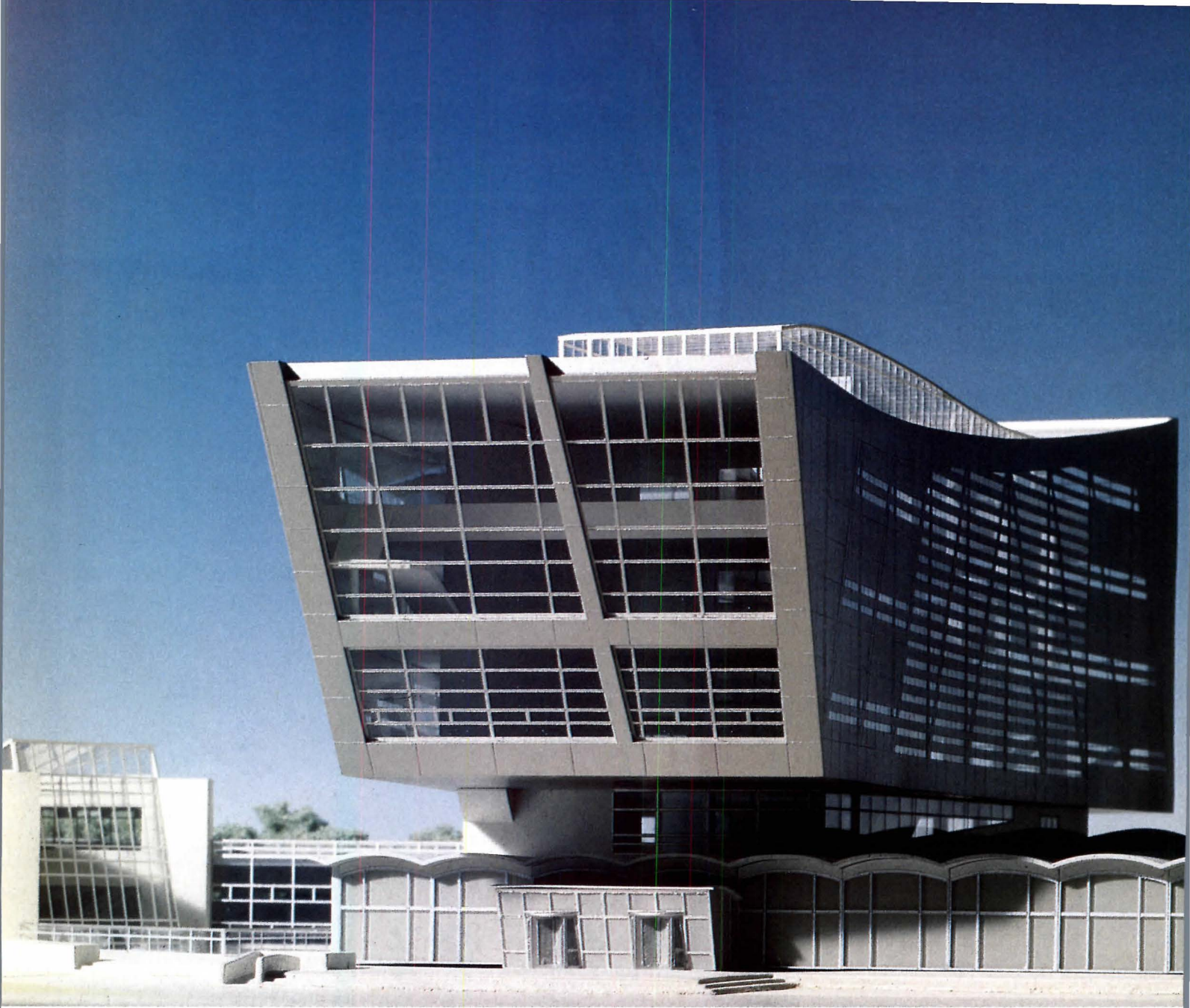

# Urban Prize

KAREN VAN LENGEN CUT HER PROFESSIONAL TEETH DESIGNING large buildings under the gaze of mentors I.M. Pei and James Freed. After opening her own practice seven years ago, she ended up with projects typical of a struggling young firm in New York City—houses, small renovations, and the occasional design competition. Two years ago, however, Van Lengen walked off with a prize for an international competition—the coveted commission for a 150,000-square-foot addition to the American Memorial Library in Berlin. It is the type of project that makes careers, and the 40-year-old architect is paying it due heed. “I decided that as a woman in this profession, I might never get another chance like this. So I am giving it everything,” she says.

For over two years, Van Lengen and her staff have done little else but labor in a small SoHo loft to resolve the library’s idiosyncratic details. Even with the Berlin library commission, she has resisted expanding her firm: “in a smaller office, you can control the project more carefully.” Meanwhile, the circumstances of the architect’s selection have lent the project a certain notoriety. A jury first selected New York architect Steven Holl among the competition’s three first-place winners—Van Lengen and Lars Lerup of Berkeley, California. But when political winds shifted in West Berlin, a powerful new minister of construction emerged, demanding revised proposals from the trio. In late 1989, more than a year after the first-round submissions were reviewed, Van Lengen won the endorsement of a committee composed of government officials, library personnel, and the chairman of the competition jury.

Her scheme was lauded for its sensitivity to context. And no wonder. Van Lengen developed a penchant for studied site analysis at I.M. Pei & Partners, where she worked for six years after completing a master’s degree in architecture at Columbia University. She credits the years in Pei’s office—where, among other things, she worked on the 1984 AIA honor award-winning, 350-room Fragrant Hill Hotel in Beijing, China, and a million-square-foot office/retail center—with teaching her to integrate building and landscape. A Fulbright grant in 1982 took her to Rome for a year, and

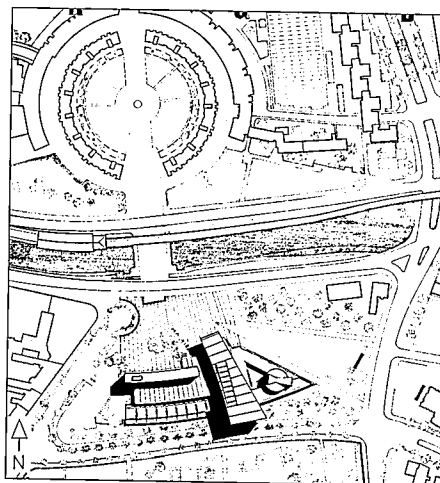

SITE PLAN

Van Lengen's addition to the American Memorial Library in Berlin (facing page) reinforces urban connections between existing (left in plans) and new (right in plans) wings, and circular Mehringplatz and Landwehrkanal (top and middle of site plan).

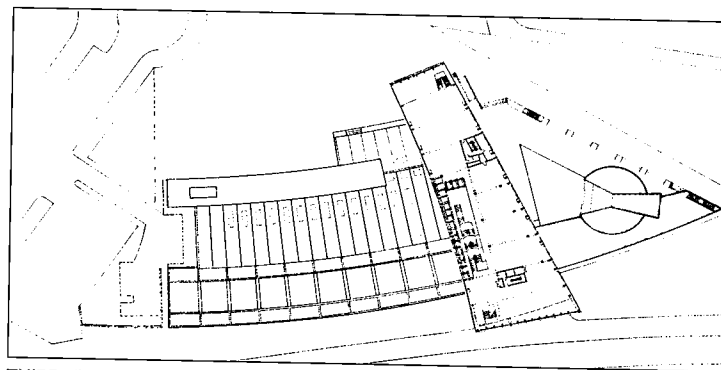

THIRD FLOOR PLAN

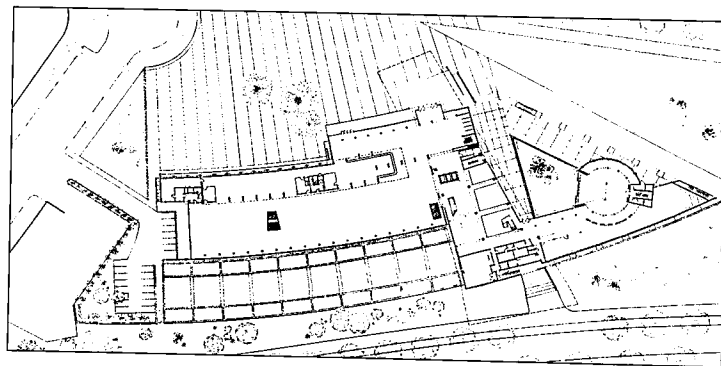

GROUND FLOOR PLAN

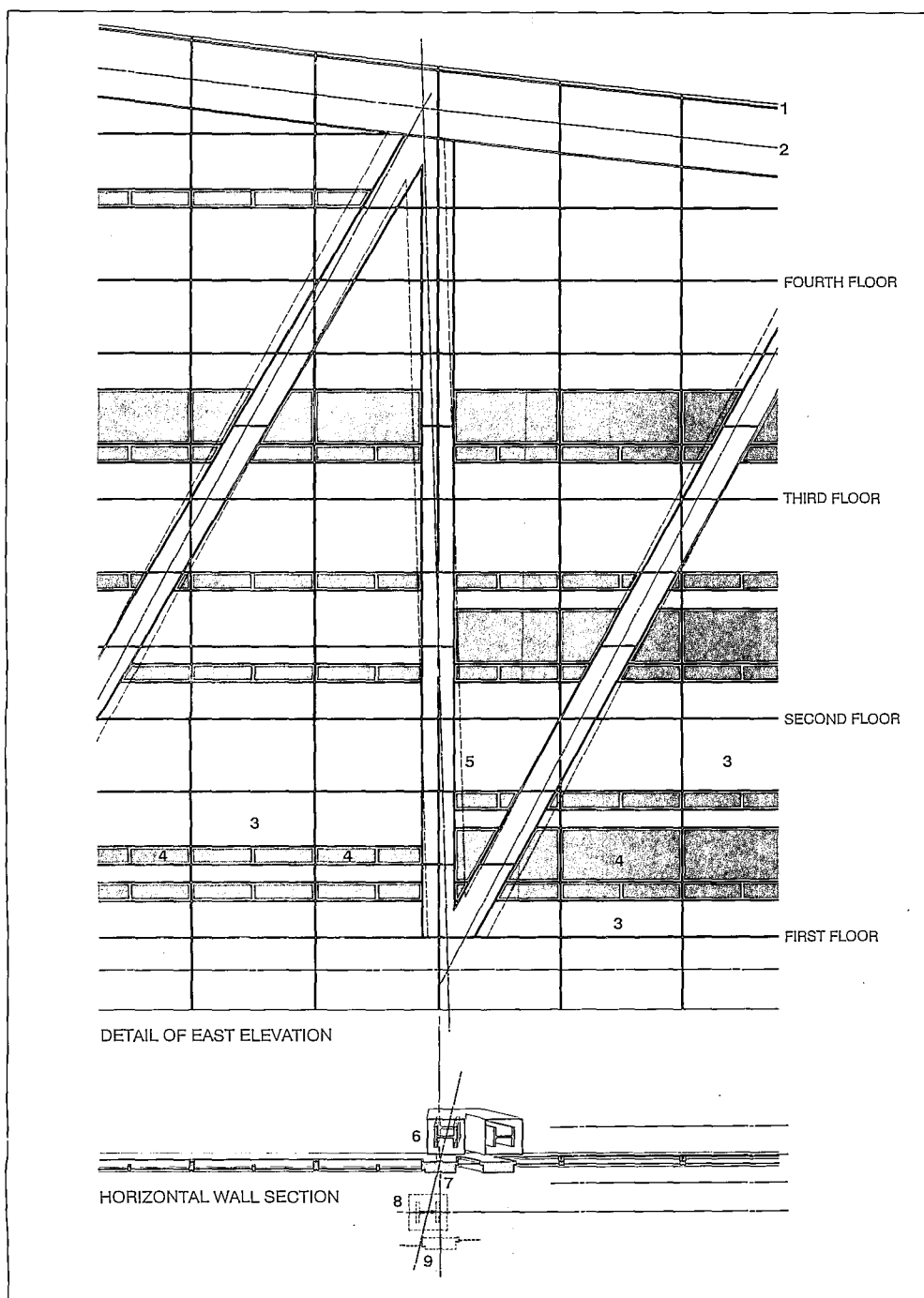

- |  |                                       |
|--|---------------------------------------|
| 1 PARAPET                              | 6 COLUMN TRUSS MEMBER AT FIRST FLOOR  |
| 2 CENTERLINE OF TOP CHORD TRUSS MEMBER | 7 COLUMN COVER AT FIRST FLOOR         |
| 3 ALUMINUM PANEL                       | 8 COLUMN TRUSS MEMBER AT FOURTH FLOOR |
| 4 GLASS PANEL                          | 9 COLUMN COVER AT FOURTH FLOOR        |
| 5 EDGE OF INTERIOR COLUMN ENCLOSURE    |                                       |

she stayed another year to teach in Notre Dame's study abroad program. When she returned to New York in 1984, Van Lengen was faced with the choice of going back to Pei's office or striking out on her own. She took the more uncertain course, and today recounts lean years of practice supplemented by teaching stints at Columbia and Parsons School of Design.

Van Lengen's first solo commission was a master plan study for a factory in New York, and in 1987 she developed a competition scheme for the Battery Park City waterfront. So she was primed to tackle the American Memorial Library—built in 1954 with U.S. funds—and a competition that stressed urban design and the accommodation of a half-million new books. Van Lengen envisioned the library as a new subcenter in Berlin, a first gesture toward reestablishing the physical order of a city ravaged by war and Communist building programs. She proposed a raised plaza on the northern edge of the site that links the existing structure and new wings, including community facilities, to the nearby Landwehrkanal, Mehringplatz, and the surrounding Kreuzberg district. The new library thrusts into the plaza while hovering over it, creating a dynamic architectural composition that rejuvenates the dated original to the west.

Van Lengen pictures the addition as "a building that floats." That perception is encouraged by two giant structural trusses that support the overhanging floors and dominate the long facades of the building. Each truss rests on two large columns, while the building cores absorb the eccentricities of the asymmetrical form. An atrium draws light into the heart of the building and heightens the sense of transparency, while providing a place for vertical circulation.

The library has rekindled in Van Lengen an interest in public architecture. But winning public commissions, she says, is often thwarted by prejudice against small firms. "Clients always say, 'You haven't built a large building.' Now I can say, 'Yes I have.'" ■

—VERNON MAYS

*Vernon Mays is editor of Inform, published by the Virginia Society AIA.*





“I decided that as a woman in this profession, I might never get another chance like this library commission. So I am giving it everything.”

—KAREN VAN LENGEN

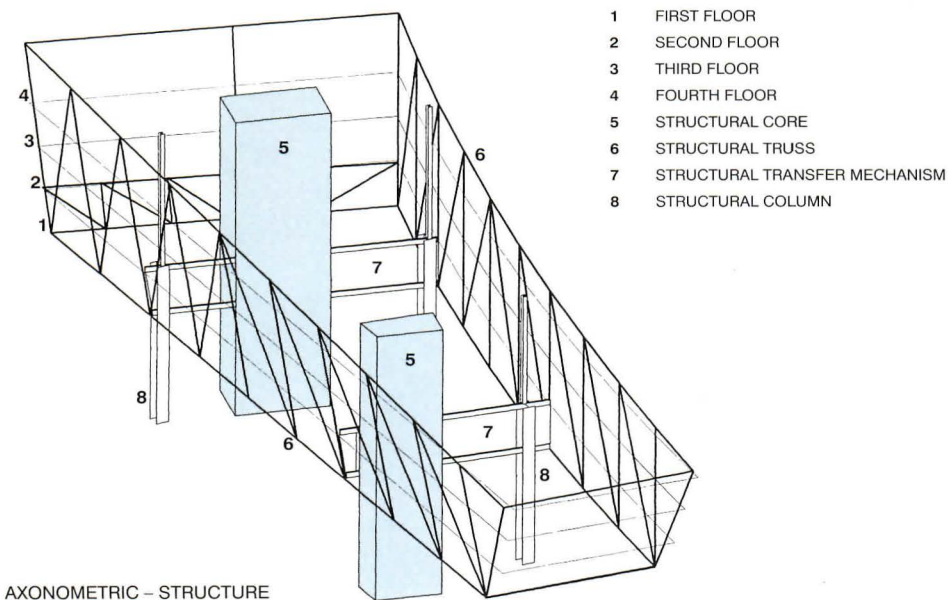

The library's east facade (elevation below and detail, facing page) presented a conflict of geometries between the radially organized structure and canted wall. To avoid custom-cutting each panel and pane of glass, column covers on the outside wall (facing page) were adjusted to the structural truss behind. Floors extending up to 100 feet from the supporting structure are carried by two large trusses on the long facades (axonometric, left); uneven loads caused by the library's asymmetry are absorbed by double cores.

**AMERICAN MEMORIAL LIBRARY**  
BERLIN, GERMANY

**ARCHITECTS:** Karen Van Lengen Architects, New York, New York—Karen Van Lengen (principal-in-charge); Michael Gorski (associate); Peter Thurlimann (project architect); Sigi Sliwinski, Max Cardillo, Peter Wowkowych, Leslie Shih, Petra Konig, Donald Baumann (design team)

**ASSOCIATE ARCHITECT:** Inken Baller, Berlin

**LANDSCAPE ARCHITECTS:** Becker Giseke Mohren Richard

**ENGINEERS:** Weidlinger Associates, Pichler (structural); Integ (mechanical)

**CONSULTANTS:** Carlton Rochell (library); Robert Heintges (curtain wall)

**PHOTOGRAPHER:** Jock Pottle/Esto

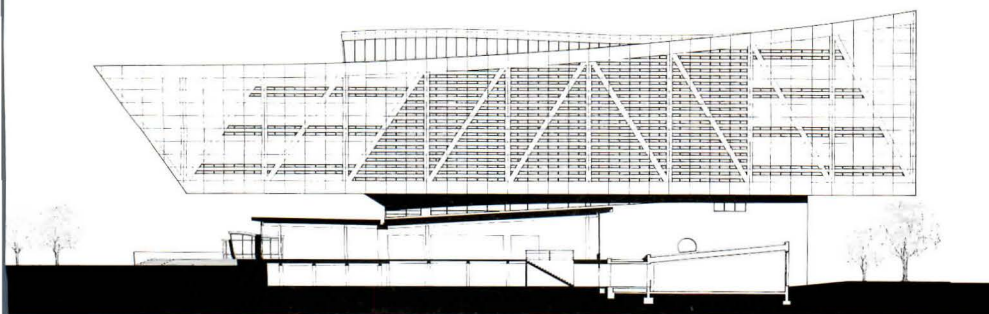
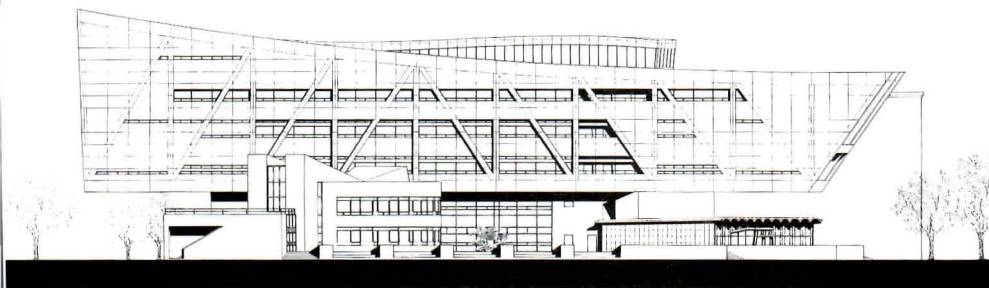

# Texas Pioneers

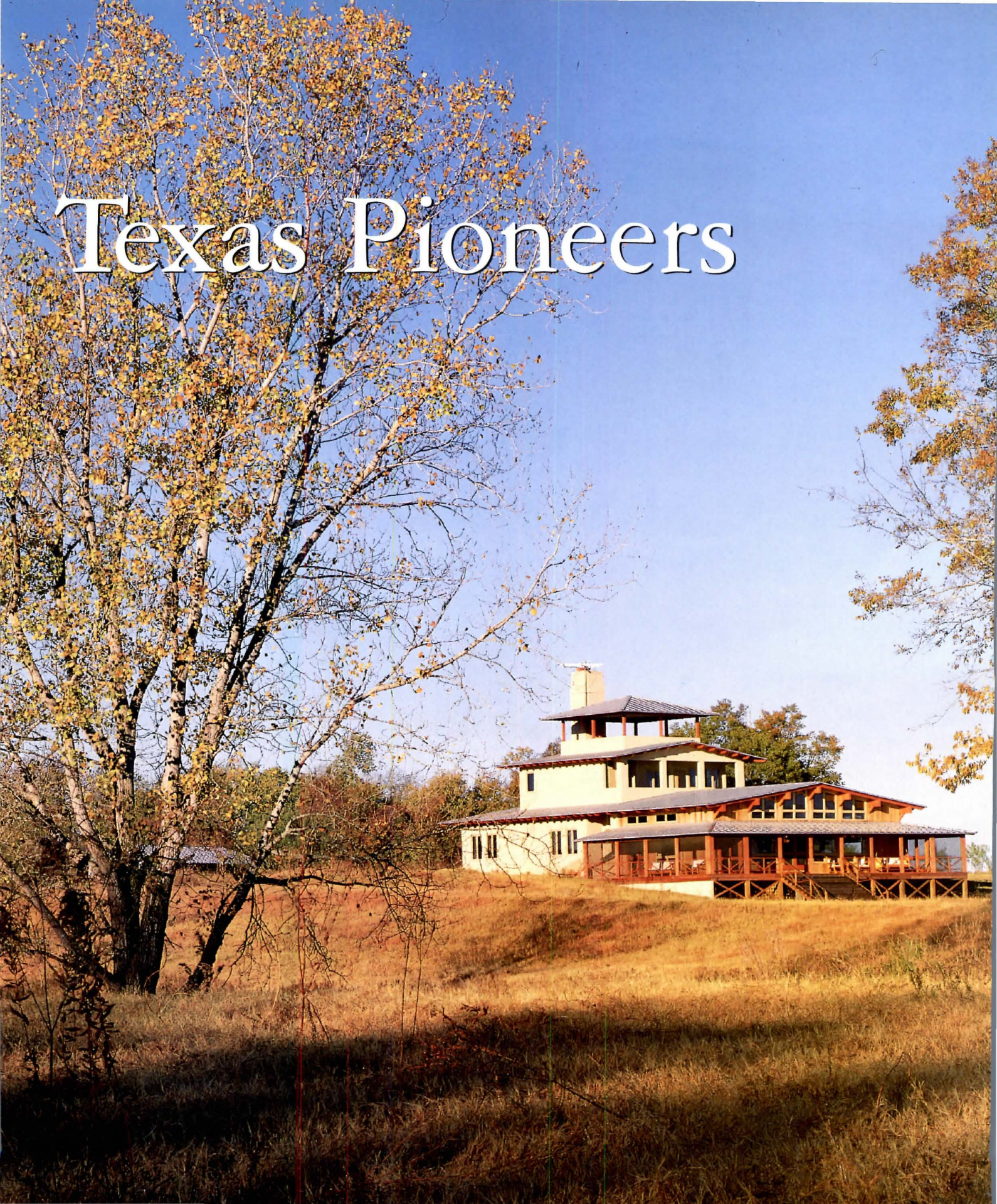

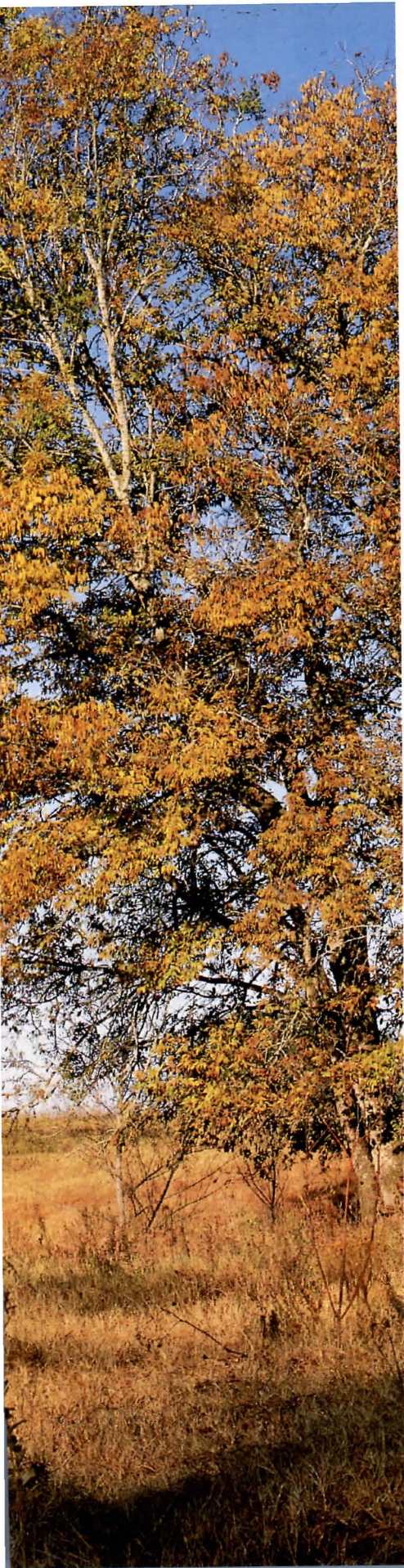

**The McCurdy Lodge outside Austin (these pages) is designed by Carrie Glassman Shoemake, an architect based in Houston.**

**C**ONVENTIONAL WISDOM CLAIMS TEXAS AS A DEFIANT “good ole boy” domain. But that’s old news to Governor Ann Richards, Houston Mayor Kathy Whitmire, Dallas Mayor Annette Strauss, Fort Worth Mayor Kay Granger, and former San Antonio Mayor Lila Cockrell. This republic is, as Richards proclaimed at her inauguration in January, the “New Texas.”

In architecture, as in politics, Texas women are blazing new trails. Carolyn Peterson, FAIA, a principal of Ford, Powell and Carson in San Antonio, is heading the \$90 million restoration of the State Capitol in Austin. Dallas architect Jane Landry, FAIA, has designed influential churches since 1976 with a care for materials, light, ventilation, and strong geometry. And Natalie de Blois, who until recently taught at the University of Texas at Austin, played a vital role for 30 years at Skidmore, Owings & Merrill, designing many of the firm’s best-known buildings.

While Peterson, Landry, and de Blois have worked within the system, today’s Texas pioneers—Carrie Glassman Shoemake, Val Glitsch, and Heather H. McKinney—are going it alone. Part of the early 1970s influx of women into architecture schools, the three paid their dues at large firms through the early 1980s. Each now heads her own firm, concentrating on small-scale architecture—Shoemake and Glitsch in Houston, McKinney in Austin.

What unites their work is a regionalist sensibility. Shoemake, Glitsch, and McKinney respond to the expanse of Texas with projects sited to catch views, daylight, natural ventilation, and even the character of suburban locations, where neighborhood cohesiveness quickly dissipates to rural separation. While responding to the landscape, their projects maintain a strong internal order: Glitsch plumbs for Modernist resolve, designing houses with geometric components; Shoemake and McKinney dig to the roots of local precedents to create simple, unified images.

Each architect has made a name for herself by cutting her own path in the rich landscape of the Lone Star State. Like Governor Richards, they have beaten the odds to become design leaders and active participants in the profession. As president-elect of the Austin chapter AIA, Heather McKinney hopes to revitalize the organization by supporting students and young practices instead of catering to established firms. “The old guard is still there,” McKinney says, “but now *I’m* considered one of the ‘good ole boys.’”

—RAY DON TILLEY



PAUL HESTER



PAUL HESTER

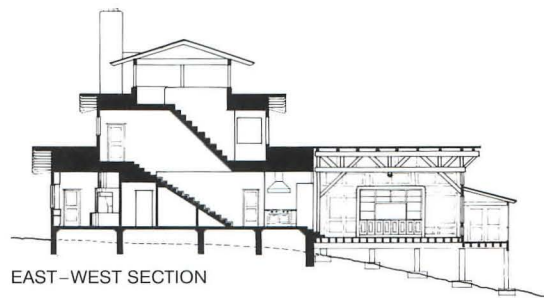

EAST-WEST SECTION

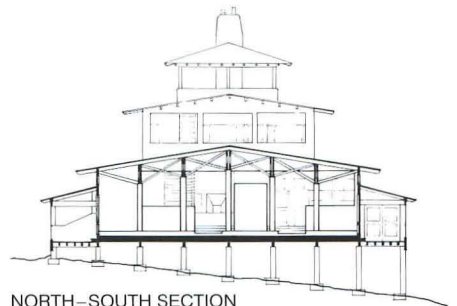

NORTH-SOUTH SECTION



“I’m not interested in developing a signature style. Every project is an adventure and each client opens new avenues.”

—CARRIE GLASSMAN SHOEMAKE

**McCurdy Lodge**  
**Hills Prairie, Texas**  
**Carrie Glassman Shoemake, Architect**

FOR CARRIE GLASSMAN SHOEMAKE, DESIGN is a solitary pursuit. A 1976 graduate of the University of Texas at Austin, Shoemake worked in her native Houston before opening a commercial interiors partnership in Austin in 1981. But she became frustrated with the firm’s success. “I was managing much more than designing,” says the 39-year-old architect, so she dissolved the partnership in 1985.

The 4,000-square-foot McCurdy Lodge near Austin is Shoemake’s first solo commission. The house reflects sensitivity to its site through simple organization and common-sense ventilation. The architect drew upon the client’s love of adobe dwellings, Nantucket widow’s walks, and South Texas ranches and hunting lodges, unifying the design by studying the houses of California architects Charles and Henry Greene, with their deep overhangs and delight in wood structure. The house’s telescoping form is arranged from public to private: first-floor living spaces, second-level bedrooms, and an observation deck, perched high above a river and 50 acres of rolling prairie. An airy, screened great room at ground level opens to views on three sides. Enriching the simple spaces of the house are pieces of Arts and Crafts-inspired furniture, designed by a team of four local craftspeople.

Shoemake, who has practiced in Houston since 1988, shuns a regionalist label despite her adeptness with its many forms. “I love Modernist architecture,” she admits, describing a recent unbuilt house that, while thoroughly spare, still manages to be comfortable. “I’m sensitive to the way clients use buildings. I want people to sit down, enjoy the space, and feel good.”

**OWNER:** Robert McCurdy  
**ASSOCIATE ARCHITECT:** Mike Petty  
**STRUCTURAL ENGINEER:** Jaster-Quintanilla  
**CONSULTANTS:** Dunne Company (septic system)  
**GENERAL CONTRACTOR:** Don B. Crowell  
**PHOTOGRAPHER:** Matthew Fuller, except as noted



The lodge’s wood-framed tiers (facing page, top) separate functions into vertical zones (facing page, bottom), public to private, from first-floor living and dining spaces (left) to an observation deck (top left).



**West facade (above) is shaded by a skewed canopy; punched openings delineate east elevation (right and far right). Entry (facing page) punctuates slim north facade.**



“God is not *only* in the details. The magic of architecture cannot happen without a strong initial concept.”

—VAL GLITSCH

**Schiebl House**  
**Houston, Texas**  
**Val Glitsch, Architect**

HOUSTON ARCHITECT VAL GLITSCH ESTABLISHED her practice eight years ago while on maternity leave awaiting her son's birth. “A contractor recommended me to a client and I was hired for the project. I never looked back.” Forty houses later, Glitsch's chance beginning seems more like fate.

The Dallas native, who earned degrees from Rice University and Harvard's Graduate School of Design before returning to Houston in 1979, gained professional recognition soon after opening her firm for designs that capture the particulars of place. Glitsch's historically allusive early projects, however, are anachronistic compared to a recently completed house in west Houston. Stripped to a pair of bold volumes with restrained details, the Schiebl House marks a concerted effort on the part of the architect to simplify her buildings.

Sited on a long streetfront in an undistinguished Houston suburb, the residence is divided into two discrete volumes. A tall, narrow white house, placed perpendicular to the street, contains kitchen, bathrooms, and laundry, while spaces for living, dining, and sleeping fill a larger, interlocking gray volume, shifted five degrees away from the street's axis. By slightly angling this wing of the house, Glitsch created privacy on the west elevation and introduced subtle drama to the daylit interiors.

The architect currently shares office space with 33-year-old architect Natalye L. Appel (ARCHITECTURE, April 1990, pages 58–61), and looks forward to tackling diverse buildings, perhaps with Appel. But the firm must remain small, Glitsch reaffirms. “The ‘business’ of architecture doesn't interest me. I love the studio setting and the work it produces.”

**OWNER:** Paul and Gina Schiebl

**ARCHITECT:** Val Glitsch, AIA (principal-in-charge), Elizabeth Weedman (assistant)

**STRUCTURAL ENGINEER:** Peter Hurley

**GENERAL CONTRACTOR:** Trentham Contractors, Inc.

**PHOTOGRAPHER:** Paul Hester



**Stairway (right and below) in narrow wing of house (center in section, plans) echoes splay in plan, demarcated by columns in open living area (facing page, top) and a south-facing window in the second-floor bedroom (facing page, bottom).**



**EAST-WEST SECTION**



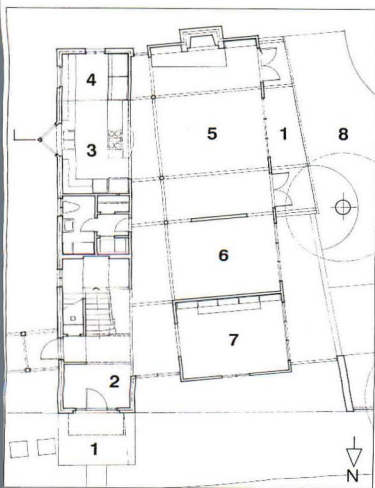

FIRST FLOOR

- |   |         |   |         |
|---|---------|---|---------|
| 1 | PORCH   | 5 | DEN     |
| 2 | ENTRY   | 6 | DINING  |
| 3 | KITCHEN | 7 | LIBRARY |
| 4 | PANTRY  | 8 | TERRACE |

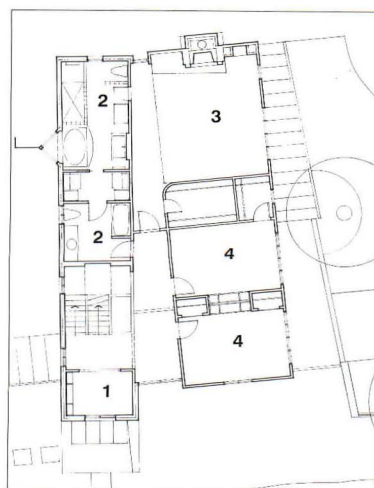

SECOND FLOOR

- |   |                |
|---|----------------|
| 1 | STUDY          |
| 2 | BATH           |
| 3 | MASTER BEDROOM |
| 4 | BEDROOM        |





“If buildings always flex their muscles, all you get is Muscle Beach. When humbled to fit in, they achieve an indescribable strength.”

—HEATHER H. MCKINNEY

**Jester Estates Club**  
**Austin, Texas**  
**Heather H. McKinney Architects**

WORKING IN THE DENSE FABRIC OF Philadelphia and Boston from the mid-1970s to the early 1980s, Heather H. McKinney gained perspective on the loosely knit landscape of her native Texas. “I respect the profound sense of community in the buildings in the Northeast,” says 39-year-old McKinney, who earned a master’s degree in 1976 from the University of Pennsylvania. In 1983, she returned to Texas to oversee construction of a friend’s house and soon opened her own office, adding other residences, and small public projects to her portfolio.

McKinney’s civic-mindedness is evident in a recreation center for Jester Estates, a remote suburb of Austin. Opening the southeast face to prevailing breezes, she sited a trio of structures—bathhouse, shade pavilion, and pergola—around a swimming pool. Like early Texas ranch buildings, the stuccoed dressing rooms and pavilion block the summer sun and permit breezes to waft through their screened enclosures. Strengthened by the landscape, these structures create a communal outdoor room.

Bathhouse complexes have become a minor specialty for McKinney, who has designed two others in Austin’s suburbs. Punctuated by glass block, the largest is inspired by dog-trot farmhouses that incorporate generous porches. Another pool complex combines entry and bathhouse into a sentinel-like gateway tower.

In addition to her design work, McKinney is a leader in the profession. After serving as an officer in a local women in architecture group, she was elected president of the Austin chapter AIA and will take office next year. ■

**OWNER:** Jester Land Management  
**ARCHITECT:** Heather McKinney, Tommy Kosarek, Dianne Mullen (design team)  
**LANDSCAPE ARCHITECT:** P&D Technology  
**ENGINEERS:** Lester Germanio (structural); Tom Green and Co. (mechanical/electrical); Fred Lockwood (civil)  
**GENERAL CONTRACTOR:** Canyon Corporation  
**PHOTOGRAPHER:** Greg Hursley, except as noted



MATTHEW FULLER

Shade pavilion occupies northwestern corner of site (left and bottom left). This structure, bathhouse, and pergola (facing page) create an outdoor room (plan below).

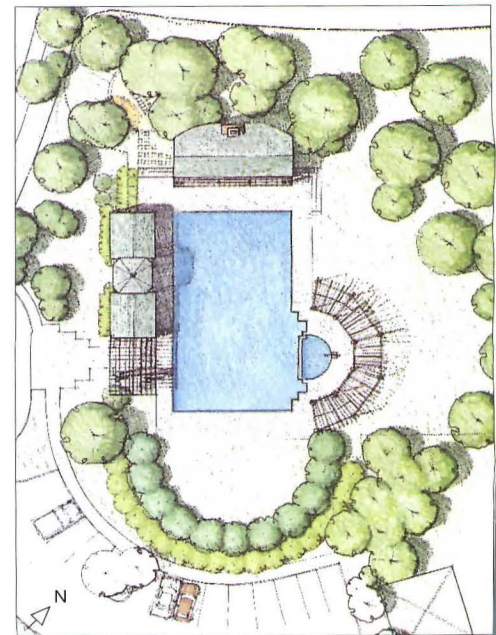



# Yankee Duet

ONE OF THE BEST WAYS FOR TWO ARCHITECTS TO RUIN A friendship is to start a practice together. That fear, fortunately, has proved unfounded for Boston architects Andrea Leers and Jane Weinzapfel, who joined forces in 1982 and have fruitfully collaborated ever since. The two partners, five associates, and 13 architects of Leers, Weinzapfel Associates form an industrious, upbeat practice, an exception in recession-torn Boston. “We’re different than most firms in this city in that we haven’t relied on commercial work,” points out Weinzapfel, a factor that has helped carry the firm through tough economic times. “We like to work with clients who share our values, such as universities, public entities, or arts institutions,” adds Leers. “They understand the importance of creating architecture for the long run.”

In working on these projects, Leers and Weinzapfel encourage a collaborative effort. “Often we’ll start a project with an office-wide sketch problem,” explains Leers, “just to get the ideas flowing.” Weinzapfel adds that projects are often reviewed by the entire design team with a staff member who hasn’t worked on the project “to generate fresh ideas and new energy.” Leers traces this method of working to the partners’ experiences in academe. “It grows out of teaching. We look at the work together, talk about it, debate the ideas, clarify them. Neither Jane nor I sit alone in our offices and make sketches for other people to develop.” This process also works in reverse: Leers often introduces architectural problems that the firm is grappling with into her design studio at Harvard or Yale to stimulate ideas. Although Leers and Weinzapfel each has her own interests and clients, the partners share an office, desks side by side, overlooking Boston’s Fort Point Channel district. “It’s important that we overhear each other’s conversations,” notes Leers. “There’s a seamlessness between what we know about each other’s work.”

The partners met at the office of Boston architect Earl Flansburgh in 1966—Leers

**Thin granite planes modulate the south facade of Newburyport District Court (right). Details of west facade’s south edge (facing page) reveal granite’s applied quality.**





fresh out the University of Pennsylvania's architecture program, Weinzapfel continent-jumping from San Francisco, where she worked after graduating from the University of Arizona. In 1970 their paths diverged as Leers set up a practice with her former husband, and began teaching at Harvard University's Graduate School of Design. Weinzapfel worked for the Boston architecture and planning firm Wallace Floyd Ellenzweig Moore, where she concentrated on transportation design, and taught at MIT's architecture school. In 1982, the two architects, friends since their Flansburgh days, began discussing the prospect of partnership. "Through the years of working separately we had developed different strengths, skills, client access, and approaches to design," says Leers. "We really complemented each other."

Weinzapfel concentrates on urban design and transportation. Her work for the Massachusetts Bay Transportation Authority ranges from the design of individual subway stations to an operations control center for the city's public transit (page 29).

Having studied at the University of Pennsylvania under Louis Kahn, Leers pursues a passion for the unity of form and structure. For the past decade she has also studied Japanese architecture. "Travel and research in Japan has made me more attuned to the esthetic of construction and the intimate relationship between building and landscape," says Leers, who this fall will be the first American architect to teach a design studio at the Tokyo Institute of Technology.

As a result of their complementary talents and experiences, Leers and Weinzapfel have excelled at work for public and private institutions, distinguishing them from most women-owned practices that concentrate on residential projects. "Our institutional work grew quite naturally from our experiences at other firms before starting our own," observes Leers, who points out that Flansburgh's practice was built on educational and public buildings. This background helped Weinzapfel and Leers garner the Tobin Bridge project for Massport, the first public work of their young practice. Projects for the MBTA, including glass-block-clad subway sta-



**Newburyport District Court  
Newburyport, Massachusetts**

**"This project raises the issue of how Modernism can express civic architecture without a sentimental return to the past," explains Andrea Leers of the recently completed courthouse in Newburyport. Uncompromisingly Modern, the building is articulated to reveal that the masonry is veneered, not load-bearing (previous pages), and the thin metal-frame windows appear as though they are applied to the masonry surface. But the courthouse's siting and composition recall Beaux-Arts Classicism: its symmetrical facade is entered on a central axis, which Leers likens to the Boston Public Library. The arrangement of interior spaces is also classically inspired: a central staircase (top left) rises from a public lobby to the second floor courtrooms (top right), which are balanced in plan and surrounded by support spaces. Across the building's front extend seminar rooms (facing page) and a library to house the very instruments of law.**

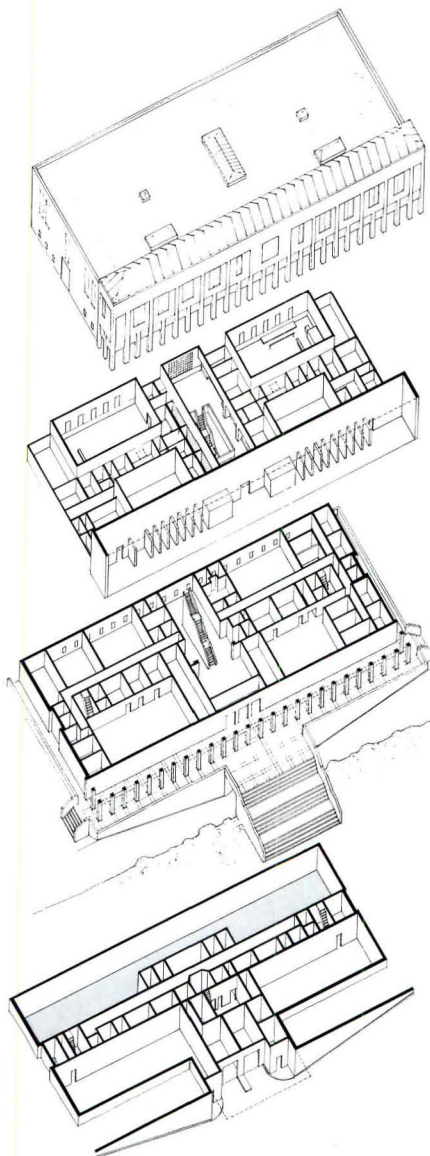

**ARCHITECT:** Leers, Weinzapfel Associates, Boston, Massachusetts—Andrea P. Leers (principal-in-charge); Jane Weinzapfel (consulting principal); Karen Moore, Josiah Stevenson (project architects); Renee Mierzejewski, Sabir Kahn, Bradley Johnson, Teresa Griffin, Richard Alvord, Alex Adkins, Ellen Altman (design team); James Vogel (construction administration)

**COURT CONSULTANT:** Walter H. Sobel & Associates  
**LANDSCAPE ARCHITECTS:** Carol R. Johnson & Associates

**ENGINEERS:** Construction Engineering Services (civil); LeMessurier Consultants (structural); SAR Engineering (mechanical/electrical)

**GENERAL CONTRACTOR:** Eckman Construction  
**PHOTOGRAPHER:** Michael Moran



“We are interested in architecture as real buildings—not polemics or abstractions, but ideas that take form as a tangible presence.”

—ANDREA LEERS AND JANE WEINZAPFEL



tion entrances in Boston and Cambridge, are durable designs that relate to their urban contexts. Similarly, government projects such as the South Boston Neighborhood Police Station and the Newburyport District Courthouse convey a tough-minded, civic profile. Even the firm's Cabot Stains Headquarters in Newburyport, designed in a more historicist vein to display the company's wood products, evokes a deep-rooted solidity.

The stripped-down esthetic of Leers and Weinzapfel serves them well in a region where Puritan temperance has colored even the architecture. As Leers explains, "There's restraint in the palette of materials and the decoration of the buildings. That's been true from Charles Bulfinch and Alexander Parris on down." Yet elements of the firm's work break from the taciturn Yankee tradition. Their buildings have a strong envelope—ordered and rigorous—but also a playful refinement of details, use of color, and treatment of light that is not protective and buttoned-up.

Two recent projects by Leers, Weinzapfel in New England illustrate regional influences tempered with a purity of form, a refinement of detail, and a kinder, gentler Modernism. The exterior of the Newburyport District Courthouse (pages 68-71) is every inch a sober, civic monument—clad in a tight skin of granite detailed to reveal the material as veneer. But the interior is softened by natural light and wood paneling. At the Grainger Observatory at Phillips Exeter Academy (these pages), a windowless teaching block exudes architectural introspection, balanced against the graceful arc of an observation deck, which reaches out across the landscape like two arms to embrace the heavens.

While debate of architectural ideas is central to their practice, the built reality of their designs remains the critical test of those ideas for Weinzapfel and Leers. "Jane and I share an interest in the fundamental relationship between form and construction, between form and material," says Leers. "We are interested in the tangible presence of buildings, what it feels like to be in them, how they exist in the natural or urban landscape. That's where ideas blossom." ■

—MICHAEL J. CROSBIE

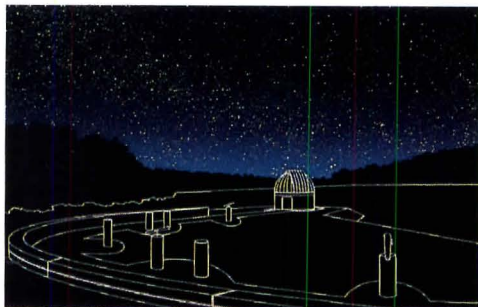

**Grainger Observatory  
Phillips Exeter Academy  
Exeter, New Hampshire**

**Leers, Weinzapfel unified outdoor and indoor viewing areas of Exeter's teaching observatory by orienting the site in a configuration based loosely on the stars and planets. They arranged a chart house, two telescopes, and a concrete observation deck on a small arc-shaped plateau, which slopes gently at the perimeter to define its earthly boundaries and those of an adjacent playing field. The architects traced the arc with a low concrete wall and walk that open to the southern sky, and distributed eight concrete posts along the curve for students to mount their telescopes. At the ends of the arc, like planets sharing the same orbit, are two telescope domes, kept low to avoid rising above a distant horizon of trees. The vault-roofed chart house at the northwest curve of the arc (facing page, left inset), clad in tongue-and-groove cedar siding (facing page, right inset), contains spaces for studying the night sky through slides and charts. The windowless rooms are lit indirectly with artificial light to allow for adjustment to night vision. The building also holds photo darkrooms and telescope storage facilities.**

**ARCHITECTS:** Leers, Weinzapfel Associates, Boston, Massachusetts—Jane Weinzapfel (principal-in-charge); Andrea P. Leers (consulting principal); David Buchanan (project architect); Eric Gresla (designer)

**LANDSCAPE ARCHITECTS:** Michael Van Valkenburgh Associates

**ENGINEERS:** LeMessurier Consultants (structural); SAR Engineering (mechanical/electrical)

**GENERAL CONTRACTOR:** Sullivan Construction

**PHOTOGRAPHER:** Steve Rosenthal

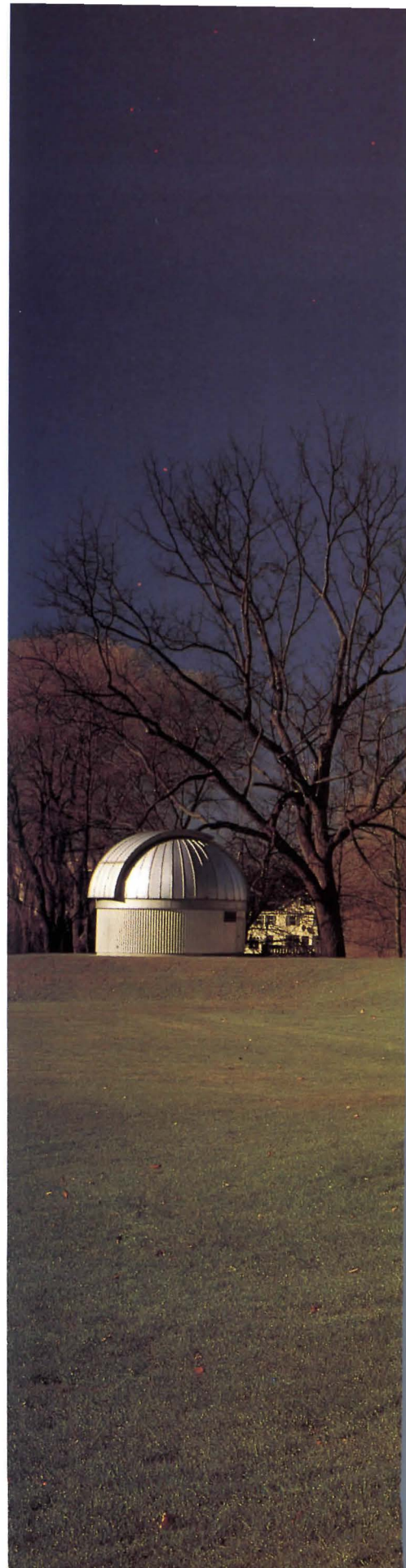



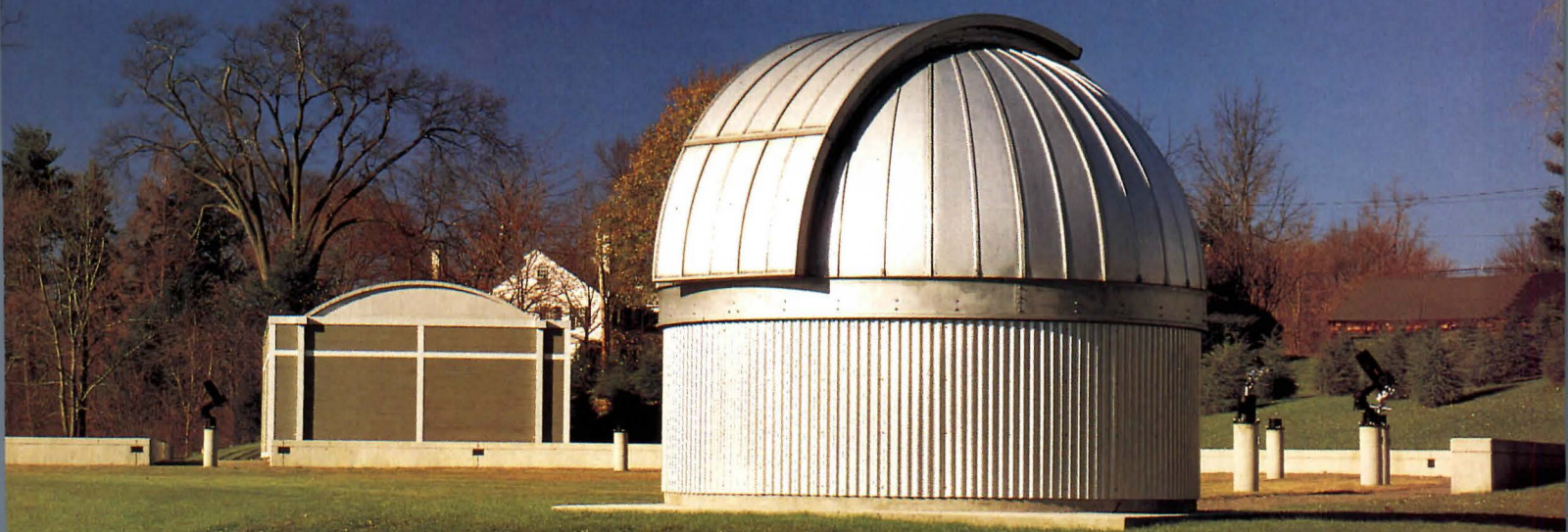

# The Advantages of Thermal Mass

The ability of certain types of building materials to store energy has been used for thousands of years. Since primitive times man has built homes to take advantage of thermal mass. In North America some of the finest examples come from Indians of the southwest who created adobe dwellings that evened out the daily temperature swings to remain comfortable all day. Early pioneers built homes with massive masonry fireplaces using interior mass to work on the same principle.

Somewhere along the line our building technology neglected the advantages of thermal mass. Perhaps, in the rush to embrace insulation as the main factor in determining energy efficiency, we forgot what our forefathers practiced. The simplified techniques for calculating thermal resistance ignored the effects of thermal mass. Now that has changed. With the new ASHRAE Standard 90.1 designers and engineers can



incorporate the benefits of thermal mass in walls constructed with almost any building material.

The old way of calculating the thermal properties of concrete masonry walls was to assign a U or R value to each of the parts, then combine them. This provided an estimate of the insulating value, or the rate at which heat passes through the building envelope. The higher the R-value, the greater the insulating power.

Now, thanks to ASHRAE 90.1, we can incorporate easily the advantage of concrete masonry to store and release valuable energy back into the living or work space. We can now practice what our forefathers taught us—that thermal mass provides a valuable function.

Let's look at the thermal performance of several common masonry wall sections and their performance in several areas of the country. Because concrete masonry delays the impact of outdoor temperature swings on indoor comfort, the effects of thermal mass vary with the climate. All calculations are based on the new ASHRAE/IES Standard 90.1—1989, "Energy Efficient Design of New Buildings, Except New Low Rise Residential Buildings."

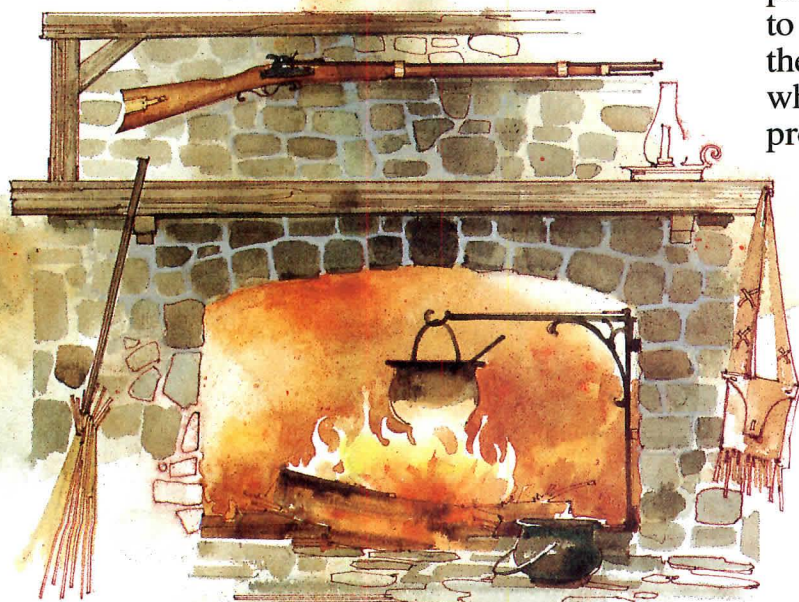

### Update on the Americans with Disabilities Act

AFTER REVIEWING THOUSANDS OF PAGES OF public commentary, the five federal agencies responsible for implementing the Americans with Disabilities Act (ADA) issued regulations for the enforcement of the law this summer. The new legislation prohibits discrimination within the workplace, state and local government buildings, public accommodations, commercial facilities, and telecommunication services. As designers of such environments, architects must now understand what constitute physical barriers and how they can be eliminated. In addition, practitioners who head offices must also become familiar with the law's employment provisions.

While the ADA was signed into law on July 26, 1990, portions of the legislation do not immediately go into effect. For instance,

the "readily achievable" removal of existing architectural barriers must occur by January 26, 1992. Some of these changes include installing ramps and bathroom grab bars, and widening doors. Newly constructed buildings to be occupied after January 26, 1993, must be "readily accessible and usable."

To help architects understand the complexities of the law, code-related organizations, government agencies, and the AIA are developing training programs. One such event was held in August as part of the National Conference of States on Building Codes & Standards' 24th Annual Conference. Discussions focused on the architect's responsibility in determining what constitutes "readily achievable" removal of barriers. The relationship between local codes and federal legisla-

tion, and the differences between their respective enforcement was also explored. Several participants stressed the importance of the certification process—a voluntary program through which a local jurisdiction presents its building code to the U.S. Department of Justice to determine its compliance with the ADA. Application for certification commences January 26, 1992.

All federal government agencies involved in the ADA legislation—the Equal Employment Opportunity Commission, Department of Justice, Department of Transportation, Federal Communications Commission, and the Architectural and Transportation Barrier Compliance Board—are now developing technical assistance programs. Architects can obtain information from the Justice Department (voice: 202/514-0301, TDD: 202/514-0383) and the Architectural and Transportation Barrier Compliance Board (800/872-2253).

The national AIA is also developing a series of training seminars on the ADA, including workshops on the law itself, the technical requirements of accessibility design, and a class for principals on teaching clients about the ADA and barrier-free architectural offices. A pilot workshop takes place in San Francisco on October 5. AIA members are encouraged to contact their local component chapters to request a program in their area. Members can also contact AIA's Public Affairs Department (202/626-7461) in Washington, D.C., to obtain highlights of the regulations, ADA accessibility guidelines, and related information. ■

—N.B.S.

### Precast Concrete Awards Announced

The Precast/Prestressed Concrete Institute's (PCI) 1991 design award winners selected in August reflect the growing sophistication of structures built in precast concrete. Winners ranged from an office tower designed to sympathize with its historic terra-cotta-clad neighbor to a soaring bell tower that doubles as a cellular telephone communications transmitter. The awards were selected by a jury comprised of AIA President C. James Lawler; *Architecture* Editor-in-chief Deborah K. Dietsch; *Engineering News Record* Executive Editor Janice L. Tuchman; Royal Architectural Institute of Canada President-elect David Edwards; and Consulting Engineering Group principal Thomas D'Arcy. The award-winning buildings and architects

are: Minneapolis Convention Center by Convention Center Design Group; Washington State Convention & Trade Center by TRA; Jefferson-Pilot Headquarters by Smallwood, Reynolds, Stewart, Stewart & Associates; Limon Correctional Facility by Clifford S. Nakata & Associates; AARP Headquarters by Kohn Pedersen Fox Associates; School Street Deck by LZT Associates; Peter J. Shields Library by Simon Martin-Vegue Winkelstein Moris; Southern New England Telephone Data Center by Rose, Beaton + Rose Architects and Engineers; Citrus Bowl Stadium by HNTB; All Saints Catholic Church Bell Steeple by Slater Paull & Associates. For information on PCI's 1992 design awards, contact (312) 786-0300. —M.S.H.



All Saints Catholic Church



Jefferson-Pilot Headquarters



Minneapolis Convention Center



Peter J. Shields Library



Limon Correctional Facility

Show & Conference

**AEC**  
EXPO

JAVITS CONVENTION CENTER NOVEMBER 19-21, 1991 NEW YORK CITY

# BEYOND CAD

THROUGH INTEGRATED SYSTEMS  
TOWARD THE BEST SOLUTION

COMPUTING A PATH FOR SURVIVAL...AND SUCCESS! Special programs for design, construction, management, and marketing.

50+ SESSIONS & HANDS-ON WORKSHOPS. Guidance on CAD, CAFM, construction computing, project management, marketing graphics and networking. • Authorized AutoCAD Training by N. Y. University • ASCE (metropolitan section) Civil Engineering Computing Conference • Regional IGUG Meeting for Intergraph users.

PREVIEW 1992 TECHNOLOGY SOLUTIONS. See 10,000+ products. Compete in Top Gun: AutoCAD Olympics sponsored by CADENCE • *Enhancement Center for AutoCAD\* Users* • *MicroStation Solutions* by Intergraph • Imaging ideas at Ideal Scanner Solutions Expo

WORLD'S 1<sup>ST</sup> AEC INTEGRATION CENTER coordinated by ASG

*featuring a dozen multi-discipline applications*

NYC/AIA DESIGN COMPETITION...*Explore the interface of imagination and automation*

Organized by Expocorsul International, Inc., 500 College Road East, Princeton, NJ 08540

AEC EXPO is not affiliated with the A/E/C Systems show or its sponsors. \*The Enhancement Center for AutoCAD Users\* is not sponsored by or affiliated with Autodesk, Inc. \*AutoCAD is a registered trademark of Autodesk, Inc.

**FREE SHOW TICKETS  
CALL 800-766-EXPO**

# Women in Corporate Firms

The top positions in large offices aren't just for men anymore.

AS IN OTHER SECTORS OF THE PROFESSION, women are gaining ground within the country's largest architecture firms. Many corporate practices report an increase in the number of women applying for entry-level work and point to the successes of experienced female practitioners in middle and senior management. Nonetheless, the number of women who have attained top positions in large firms is proportionately small. An informal survey of AIA's Large Firm Roundtable members, conducted by ARCHITECTURE last August, underscores women's limited stature within the corporate hierarchy (see chart below). On average, women represent 11 percent of all registered architects on staff, but only 2 percent have achieved principal or partner status.

This gap has not gone unnoticed. Some of the large firms contacted for the survey agreed to participate only when assured that their employment statistics would not be singled out. They were concerned that the data would paint a poor picture of hiring practices, despite the fact that many are genuinely trying to recruit more female architects. Interviews with principals and human resource directors of several respected firms indicate a sensitivity to sexism and a sincere desire to combat it. In acknowledging the poor representation of women in top positions in New York-based Kohn Pedersen Fox Associates, for example, principal Gene Kohn expressed his own frustration over the situation. "The partners here want women at the top of this firm—I just don't think that we understand how best to make it happen," Kohn explains. "Perhaps we haven't spent enough time coaching talented young women, or perhaps men have been trained early on to feel more comfortable competing for recognition."

The most obvious—and least threatening—explanation for the lack of women at the top is sheer numbers. Women have only recently entered the profession in significant numbers, so the supply of entry-level female architects is much greater than experienced ones. The majority of women now practicing

have not been in the field long enough to attain partnerships, which are usually earned, if at all, only after 10 to 20 years of hard work. "I think it is a numbers game," notes John Mahon, human resource director of HOK in St. Louis, Missouri. "It's easier to find talented women at the entry level because there are just more of them. But I just don't think there is the availability of really top-notch designers and project managers at the more experienced level." ARCHITECTURE's survey supports Mahon's contention: only 2 percent of the principal positions are held by

**Entry-level women cooperate in a team environment and are frequently more able communicators than their male counterparts.**



**RTKL associate principal Geraldine Pontius (far right) discusses projects with principal David Hudson (standing) and design team.**

women, while 11 percent of the associates and 27 percent of intern-architects are women. The current percentage of women in associate and intern positions in these firms, in fact, exceeds that of women holding regular memberships in AIA this year—roughly 7 percent.

Duane Roggow, Hansen Lind Meyer's director for human resources, has found that entry-level women are well-prepared graduates, cooperate in a team environment, and are frequently more able communicators than their male counterparts. But, at the upper levels, he sees the ranks of women thin out as many of the more experienced female practitioners settle into smaller firms or open their own offices. The long hours and frequent travel demanded of architects working for large firms can take a toll on women, who continue to bear greater family responsibilities as compared to their male colleagues.

Despite the odds, some women have managed to rise to the top. We invited eight such practitioners from large, nationally recognized firms around the country to participate in a roundtable discussion of issues facing women in architecture. While their comments acknowledge discrimination, they demonstrate a reluctance to speak out on controversial subjects such as equal compensation and promotion practices. Such reticence is understandable for women working within the system, where efforts at change must be handled with diplomacy and patience. Having shattered a few glass ceilings themselves, these female architects are paving the way for others to join them.

—NANCY B. SOLOMON

## Staff positions occupied by women and men in selected large firms

Staff position	Total	Percent women	Percent men
<b>Registered architects</b>	<b>1,511</b>	<b>11</b>	<b>89</b>
<b>Registered principals/partners</b>	<b>329</b>	<b>2</b>	<b>98</b>
<b>Registered associates</b>	<b>801</b>	<b>11</b>	<b>89</b>
<b>Intern-architects</b>	<b>452</b>	<b>27</b>	<b>73</b>

Data based on a survey of 20 members of AIA Large Firm Roundtable.

CAROLINA WOO

PARTNER

Skidmore, Owings & Merrill



EDUCATED IN ARCHITECTURE AT RHODE Island School of Design and in business policy at Columbia University, Carolina Woo has been with SOM for 22 years. She is currently based in the firm's San Francisco office, and is registered to practice in four states and Great Britain. As partner-in-charge of administration, Woo is responsible for the coordination of all professional disciplines participating on a specific project, such as the redevelopment of London's Canary Wharf (below), a multi-use complex occupying 71 acres. SOM established development guidelines for the entire area, designed the infrastructure, and provided architectural and engineering services for projects on two of 26 building sites. In 1988, the New York City Art Commission presented Woo with an award for excellence in design for a transitional housing project for the homeless. She has held positions within the Royal Institute of British Architects and National Council of Architectural Registration Boards, among other professional organizations, and is a member of the AIA's College of Fellows.

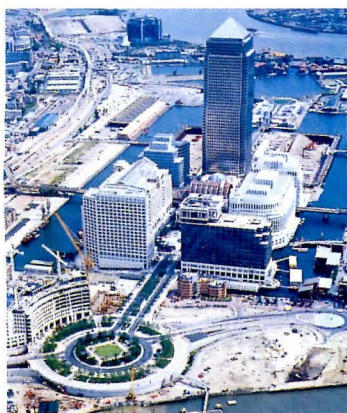

CANARY WHARF  
LONDON, ENGLAND

### What changes have you witnessed over recent years in regard to female practitioners?

**Geraldine C. Pontius:** There are more women teaching architecture, in private practice, and in large offices than ever before. Although women make up a larger percentage of the work force, there still are very few women at the principal level in large offices. Unless a female architect is also an entrepreneur, it seems that the top management is still primarily controlled by men.

**Molly Hester:** When I was in school in the 1970s, only 10 to 15 percent of the first-year architecture class was women, and the percentage of women who graduated was even lower due to attrition. From my undergraduate class, I know of only three women who are registered architects. Now, women see architecture as a viable career, and the number of women who graduate annually from architecture school is much higher.

**Marcel Quimby:** When I first started working 13 years ago, there was only a handful of female architects in Dallas. Currently, the number of female architects in the city is at the national norm—8 percent of registered architects and 25 percent of intern-architects—so a lot of progress has been made since 1978. Women are taking a very active role in local AIA activities, creating the perception that there are many more female members than there really are.

**Carolina Woo:** It depends on where you are in the country. In my experience, the Northeast corridor is the most advanced. Women are more generally accepted in interior design, but still face an uphill climb in architecture.

**Elizabeth S. Ericson:** There are more of us practicing architecture. More women are having children and continuing their architecture practice at the same time. More women are filling more diverse positions, such as field work, engineering, and marketing.

**Deborah L. Booher:** The most interesting recent changes are in how women are working. A significant number of women are opening their own firms, working as freelance consultants, and teaching in our architecture schools. In other words, they are discovering successful alternatives to working in male-dominated situations.

**Ruth M. Gless:** The people in our industry—clients, contractors, engineers, and sales representatives—are growing more accustomed to working with women. Time is a great equalizer; the longer women are in the profession and the more experience they gain, the more people will think of them as archi-

tecs rather than as women. The goal is to think of women as professionals, not as women professionals.

### Do you feel women have made progress within your firm or other firms over the last few years?

**Quimby:** I think women have made great progress over the last few years but there is a very long way to go. The profession is very short on women at middle- and upper-management positions and as partners.

**Booher:** Some women have made progress, but not as many as should have in ratio to their male counterparts. As things operate today, only those women who are aggressive enough to actively compete with the men at their level will make significant forward progress. Unfortunately, I believe this applies no matter how talented a woman may be.

**Gless:** My perception is that there are more women in positions of authority and more female partners in large firms than a few years ago. Female architecture students number around 40 percent or more in most schools, and hiring practices in most firms have kept pace.

**Hester:** Within HLM, there are a lot more women in responsible positions. There are 17 female associates, 63 female professionals/managers, 20 female technical staff, two female construction administrators, as well as female directors and managers of personnel, interiors, environmental graphics, public relations, and marketing.

**Ericson:** Women have not gained greater authority, nor made a greater impact on the decision-making process, unless they own their own firm.

**Norma Sklarek:** The progress has been slow.

**Pontius:** Prior to the recession, women had attained a certain amount of leverage. There was enough quality work available such that talented architects could negotiate better positions for themselves. In general, women seem to progress through the ranks at a slower pace, so given the current economy, the progress may slow even more.

### Do you feel you have progressed and been compensated at the same rate as your male colleagues from architecture school?

**Booher:** No, I have not. I take a portion of the blame for this myself. While I am aggressive and able, and have progressed very well into new roles and responsibilities, I did not understand until the past few years that

these qualities are not always enough. Different abilities are required to gain the recognition and compensation that one would naively expect to follow this sort of growth.

**Woo:** Ten years ago, I would have said no. Today, looking at SOM, I would answer yes. This does not mean that women and men are at parity in every firm—I know examples to the contrary. But the situation for women improved markedly during the 1980s.

**Ericson:** I recently attended my 25th reunion at Columbia's School of Architecture and was surprised at the diversity of achievements of my male and female classmates. Many of them have turned their energies to construction companies, academic careers, regulatory agencies, and other associated fields. Those who started their own firms early on have experienced unpredictable profitability. A few of us joined larger firms and are partners with—I am guessing—about the same pay and status as each other.

**Pontius:** Measurements for progress are very elusive. It's true that some men seem to progress at a more rapid rate than some women. I feel fortunate in that I have been challenged with many splendid opportunities. Commonly, the compensation for design-oriented architects is less than for project managers regardless of gender.

**Gless:** I have not always felt well compensated, but I never thought it was because I was female; I thought it was because I was an architect. I think women suffer from unequal compensation because they are more reticent about their abilities and less likely to complain if they think they are being underpaid. I also believe that this situation is exacerbated by the precariousness of the profession during an economic downturn. My perception is that the people in charge are really trying to be fair and non-sexist.

#### **What has been the most difficult stage in your professional career?**

**Pontius:** I completed my master's in architecture at a time when jobs were scarce. After months of searching unsuccessfully for an architecture job, I found work as a systems computer programmer in my former field. My first long-term architecture job was for a husband and wife partnership. I probably would not have gotten started except for the female partner's determination to hire a woman. Her company policy was specifically aimed at maintaining an equal number of male and female employees.

**Woo:** I joined SOM in 1969, and became an

associate in 1974. The next eight years until I became an associate partner were the most difficult. The "old boy" network was still largely in force, and though a woman's ability might be recognized, there was still a reluctance to advance her based on capabilities. This situation made for a lot of frustration.

#### **Have you experienced discrimination in the profession?**

**Ericson:** Indirectly. I find that we do not easily gain the trust of our male peers that we need to be fully expressed in our work. Women have to prove themselves constantly in the workplace, whereas men tend to give each other room to make mistakes.

**Woo:** I have been in practice for about 25 years. For the first 15 years, I experienced a lot of discrimination, beginning with advice not to enter the field because I was a woman. Gradually, things improved. Working in our London office put me face to face with English cultural behavior—or "institutionalized sexism"—as feminists call it. Often I was the only woman at meetings of 25 or 30 people. Questions I posed would be answered—but the answer would be directed to the man sitting to my right or left. Like Margaret Thatcher, however, I persevered.

**Booher:** I have never felt any discrimination as far as job assignments or responsibility are concerned. I have been given major responsibilities on many large, complex projects with no reservations on the part of my employers or project ownerships. I cannot say whether the same applies to disbursement of recognition and compensation.

**Gless:** Today, professionals are too well educated and too sensitized to engage in overt discrimination. Occasionally I have encountered a subtle attitude among professionals about what women can do best, and any such attitude is limiting. I have seen an office where women were channeled in the direction of design because technology was the road to management, and management was not considered in the purview of women. In that office, women did not do construction administration. Unfortunately, this attitude also limits men. They complained about not being involved in design and honestly felt it was because they were not women.

**Hester:** I think both men and women experience some discrimination. Sometimes, there is a concern about a woman's ability to lead in a technical field. You don't have to let that dictate the direction of your career. You simply analyze the situation, make adjustments,

ELIZABETH S. ERICSON  
PRINCIPAL

*Shepley Bulfinch Richardson and Abbott*



ELIZABETH ERICSON JOINED SHEPLEY Bulfinch Richardson and Abbott as an associate in 1981 and was promoted to principal in 1983. She maintains an active role in the design of the firm's medical and institutional projects. Ericson is particularly committed to improving the design of hospitals, a building type she feels is the most challenging to shape into architecture. Her design for Brown University's Biomedical Research Laboratory (below), completed in 1989, integrates classrooms, offices, and laboratories. Ericson is currently working on two projects for New England Deaconess Hospital in Boston, a macromolecular research facility at Case Western Reserve in Cleveland, a library addition at the University of Oregon in Eugene, and a renovation of a performing arts center at Worcester Polytechnic Institute in Worcester, Massachusetts. Educated at Columbia University, Ericson has taught at Massachusetts Institute of Technology and Boston Architectural Center, and recently served as secretary of the Boston Society of Architects.



BIOMEDICAL RESEARCH LABORATORY  
PROVIDENCE, RHODE ISLAND

NICK WHEELER

NORMA SKLAREK  
PRINCIPAL  
*Jerde Partnership*



ANA DANIEL

TRAINED AT COLUMBIA UNIVERSITY, Norma Sklarek became the first registered black female architect in New York (1954) and California (1962). As director of architecture at Gruen Associates from 1960 to 1980, Sklarek was responsible for the technical aspects of such projects as the Fox Plaza in San Francisco, the Pacific Design Center in West Hollywood, and the U.S. Embassy in Tokyo. From 1980 to 1985, Sklarek was vice president of Welton Becket Associates and project director for Terminal One at Los Angeles International Airport and Wilshire La Brea Metro Rail Station. She was a partner in the firm Siegel-Sklarek-Diamond from 1985 to 1989. Now a principal of the Jerde Partnership, Sklarek completed the Fashion Institute of Design & Merchandizing (below) in 1990. Sklarek, the only black woman to be elected to the AIA's College of Fellows, is also director of the LA/AIA, commissioner on the California Board of Architectural Examiners, faculty member at UCLA, and technical adviser to Architectural Graphic Standards.



FASHION INSTITUTE  
LOS ANGELES, CALIFORNIA

and move forward.

**Pontius:** Of course, everyone who is different experiences discrimination. It is always easier for “likes” to work with “likes,” but the world is filled with variety and so we are all struggling with discrimination in some way.

**Do you perceive a so-called “glass ceiling”—an invisible barrier just below the top tier of a firm—for women in architecture?**

**Quimby:** There used to be concerns about how women would “fit in” in the drafting room, now there are similar apprehensions about women “fitting in” at upper-management levels. It may not be openly discussed, but many men in management have such concerns and are slow to promote women.

One obstacle for professional women is “gender bias,” where men simply feel more comfortable working with other men. This is illustrated by men in management or senior positions who prefer to have men as their top people; women are then excluded from the opportunity to work closely with these senior men, earn their trust, and develop relationships that would benefit them in the future.

**Booher:** This glass ceiling is a result of so many years of an exclusively male profession and the remnants of the “old boy” system. This exists throughout our culture. Improvements have obviously been made but much more needs to be done. Each new generation deals better with these problems and, hopefully, they will eventually cease to exist.

**Hester:** Glass ceilings exist in some firms and they have been broken in others. Women need to seek out firms in which they can reach their career goals—firms that offer equal opportunity in compensation, in professional development, and in corporate participation.

**Sklarek:** If a woman is considerably better and more productive than her male counterpart, she can rise close to the top.

**Woo:** Some firms have a glass ceiling—occasionally a very low one. If there is one at SOM, I managed to pass through it. I believe that I am a partner based on my abilities, not because of “tokenism.” There are not very many female partners in SOM at present, but this reflects the fact that, for my generation, there are fewer women in general in the profession. When our associates are promoted to partners, there will be many more women, perhaps even more women than men.

**Pontius:** The number of female principals in firms around the country would indicate that there is some resistance. RTKL has expressed an interest in having a female partner and, in

fact, has a number of minority partners.

However, the economy may adversely affect promotions of any kind. Also, a number of women leave the corporate practices at about the time they might be eligible for partnership because of a common perception among senior women that opportunities for advancement do not exist.

**Gless:** As more and more women open their own practices, I wonder if a glass ceiling will continue to be a factor.

**Ericson:** I do not believe women fit comfortably within the hierarchically based organizational pyramid so typical of male-dominated firms. The office ambience is a contest as to who gets to be “The One at the Top.” Success is about winning. The glass ceiling is the barrier between those people who want to compete to get to the top, and others who want to collectively support each other in their self-expression. I call this latter an “umbrella concept” of organization. Success is about personal fulfillment, and the success of the firm directly results from the fulfillment of not one but many people.

**Are there certain aspects of an architect's work, such as visits to construction sites, that are made more difficult for a female practitioner?**

**Ericson:** There is no substitute for knowledge as a way to gain respect. If you know your stuff in the field, you are accepted. If you don't know something, admit it. Humility and a sense of humor can get you out of almost any difficulty.

**Gless:** Once construction crews realize that a female architect has the same architectural ability as a man, they forget about gender. The best way to handle difficult situations is to be competent, professional, and well prepared for any meeting.

**Booher:** My favorite stage of a project is the building process—solving the day to day problems on site, coordinating with the consultants and subcontractors, punchlisting, essentially getting it done right. Most construction workers have an innate mistrust of architects, male or female. However, once they understand that you know what you're talking about, can handle yourself on a construction site, take your work seriously, and, very importantly, have a sense of humor, their respect for both you and the work grows rapidly. This phase of first getting to know each other may take longer for a woman and not all women have the kind of personality required to achieve this level of rapport—but



then again, neither do most men.

**Hester:** Frankly, from a woman's point of view, I have had very few problems. I love construction sites and like talking to people in the field. Early in my career, I became a licensed general contractor. Having that license has been a decided advantage.

**Woo:** In the U.S., visits to construction sites are no longer a problem for female architects. When the problem has arisen, my approach has always been to brush it off and move on to the task at hand.

**Sklarek:** Frequent trips to out-of-town sites can present a greater problem for women with young children than for their male counterparts.

**Have you ever perceived any reservation—on the part of a colleague, client, contractor, or subcontractor—that you could not handle the job because you are a woman? How was this communicated?**

**Booher:** At one time I was led to believe, in an indirect way, that I was slated to work on a very difficult upcoming job. But a man was assigned the project. I will probably never know if this was a result of cross-communication, personal preference on the part of the partner-in-charge, lack of ability, or discrimination. I was given no real explanation.

**Woo:** Once at SOM I was passed over as job captain for a large project because I was a woman, although it was clear that I could handle it. Once I was given the U.S. component of a large project because the country in which it was located does not accept women in positions of authority. I have sometimes declined to work on projects for this reason. I may regret their attitude, but I don't feel these countries are obliged to alter their culture on my behalf.

**Gless:** Discrimination is usually subtle. For example, contractors and clients might prefer to deal with a male colleague. Once I had a client who often observed that I was smart or knowledgeable "for a woman."

**Hester:** Occasionally, some clients have expressed initial reservations. That has meant that I have had to work harder to win them over. Those same men have become some of my best clients.

**Sklarek:** In a previous office, one major project overseas was assigned to me on a Monday and unassigned on Wednesday. The Korean client would not accept a woman in such a position of responsibility.

**Pontius:** In the business world, you are always proving yourself to someone. It is incessant,

sometimes emotionally draining. But you keep working because it is what you have chosen to do. When I am challenged professionally, I don't take it personally. Actually, I enjoy the competitive atmosphere.

**What are the advantages and disadvantages for women working within large corporate firms in comparison to those who have started their own office?**

**Quimby:** Large firms offer the opportunity to work on large-scale, unique, and high-profile projects. One disadvantage, however, is that large firms are often so rigidly structured that they have difficulty capitalizing on the talents of those employees whose experience and interests are slightly different from the mainstream. In contrast, principals of small firms know their staff better and, therefore, may be able to provide them with opportunities well-suited to their unique capabilities. Single practitioners typically may have more flexibility and control over their own time. This may be a great way to practice when you have young children and need such flexibility. But when 60 hours a week are required at work, there may not be anyone else to help you as there would be in a large firm.

**Ericson:** The character of a large practice tends to be diverse, with a wide range of building types—libraries, laboratories, performing arts centers, hospitals, offices—and budgets. The human resources are just as diverse: specification writers, technical detailers, designers, managers, marketers. The staff is a mix of young, and old, with architectural education and heritages from all over the world. The downside is that a person can become too specialized within a large office, and, ironically, lose touch with all this enriching diversity.

**Booher:** The clear advantage to owning one's own firm is control; the major disadvantages are the pressures of getting work and being responsible for the financial side of the business. In most large corporate firms, very few women have yet achieved serious design or administrative control. On the other hand, I have had the advantage of being able to work on very large, impressive buildings that I would not have had in my own or a smaller firm.

**Woo:** Large firms—SOM, at least—expose people to different aspects of practice and provide a level of internal competition that I think is healthy for women. They also free people to find and concentrate on their strengths. Having your own practice has one

GERALDINE C. PONTIUS  
ASSOCIATE PRINCIPAL  
RTKL



EDUCATED AT COLUMBIA UNIVERSITY, Geraldine Pontius worked at the New York firms of James Stewart Polshek & Partners, John Young/Urban Deadline, I.M. Pei & Partners, and Kohn Pedersen Fox Associates before opening her own practice in 1986. She subsequently joined the Baltimore office of RTKL as associate principal in 1989. Working on a range of building types—including office high-rises, educational facilities, cultural institutions, and corporate headquarters—

Pontius continually searches for forms and materials that reflect the character of each project's location. At I.M. Pei & Partners, she was a designer of the Portland Museum of Art, which won an AIA Honor Award in 1985. At KPF, she was a member of the design team for the Proctor & Gamble Corporate Headquarters in Cincinnati, which was also recognized by an AIA Honor Award in 1987. At RTKL, Pontius is the project architect for Commerce Place (below) in Baltimore, Maryland, and a department store in Long Island, New York, both scheduled for completion in late 1992.



COMMERCE PLACE  
BALTIMORE, MARYLAND

RUTH M. GLESS  
SENIOR ASSOCIATE  
*Perkins & Will*



RUTH GLESS GRADUATED FROM THE UNIVERSITY OF NEBRASKA IN 1969 WITH A MAJOR IN ENGLISH, TAUGHT HIGH SCHOOL, AND WORKED AS A POTTER BEFORE ENTERING THE GRADUATE ARCHITECTURE PROGRAM AT THE UNIVERSITY OF VIRGINIA IN 1976. SHE JOINED THE WASHINGTON, D.C., OFFICE OF PERKINS & WILL IN 1982, BECAME REGISTERED TO PRACTICE IN THE DISTRICT OF COLUMBIA IN 1988, TRANSFERRED TO THE FIRM'S CHICAGO LOCATION IN 1990, AND WAS APPOINTED SENIOR ASSOCIATE IN 1991. AS A SENIOR PROJECT ARCHITECT, GLESS HAS BEEN INSTRUMENTAL IN THE DESIGN OF MANY BUILDING TYPES, INCLUDING EDUCATION FACILITIES, RESEARCH LABORATORIES, HEALTHCARE PROJECTS, CORPORATE HEADQUARTERS, AND MIXED-USE DEVELOPMENTS. THE COLLEGE OF AMERICAN PATHOLOGY (BELOW) IS A RECENT EXAMPLE OF HER AWARD-WINNING WORK. IN 1990, HER DESIGN FOR THE WESTFIELDS INTERNATIONAL CONFERENCE CENTER IN CHANTILLY, VIRGINIA, WAS ACCORDED THE FAIRFAX COUNTY EXCEPTIONAL DESIGN AWARD, THE BEST LUXURY HOTEL AWARD BY THE BUILDING INDUSTRY ASSOCIATION, AND THE FIRST AWARD FROM THE MASONRY INSTITUTE.



COLLEGE OF AMERICAN PATHOLOGY  
NORTHFIELD, ILLINOIS

enormous advantage—no one within the firm can tell you what to do. But it can be limiting in other ways.

**Gless:** Women who have started their own practices are in control of their own careers. The decisions are theirs, the successes and failures are theirs, and if they suffer from sexism, it is from sources outside the firm. This is both liberating and frightening. The advantages of practicing in a large firm are many. There are the teams of talented young architects and the support systems such as accounting, marketing, and supply and mail rooms. Without these support systems, architects have less time to spend on aspects of projects that interest them most. Being in a large firm allows one to specialize. For me, the most exciting quality of a large firm is that the scale and variety of projects is so great.

**Sklarek:** In large firms we are able to work on larger and more exciting projects. But very often women are not given the opportunity to do challenging work, thereby hindering their advancement within the profession.

**Pontius:** A corporate firm provides a higher degree of financial security, but it often gives you less control over the ultimate quality of the product. A small practice allows you the freedom to foster your own esthetic goals.

**Have you ever experienced conflicts between your career and personal life? Are these different in degree or kind from your male counterparts?**

**Quimby:** All architects experience such conflicts—it's inherent in any business that frequently demands more than 40-hour weeks. I would like to see the entire profession become more cognizant of the quality of life of their employees, and work to positively address this issue. A firm needs to consider the affects of schedule and fee decisions on the quality of life of its employees prior to making unreasonable commitments.

**Ericson:** I don't think it's possible to devote enough energy to raising children and to creating architecture, and do both equally well. Today's women are encouraged to do both, and I hope it works for them. With or without children, female architects typically are expected to take care of the house and family members, yet devote the same amount of time to their jobs as do their male colleagues.

**Sklarek:** My career has caused some degree of conflict with the needs of my family, especially when my children were young. I believe that women, especially those in single-parent

households, experience such problems to a greater extent than male counterparts.

**Booher:** Women in our current culture are much more understanding of a man putting in long hours and spending time traveling. I do believe this is one problem that is improving as our culture changes and women are more visible in all professions.

**Pontius:** From my perspective, both men and women in American business are asked to place work first and private life second. The time commitment is enormous and business schedules change at a moment's notice. Conflict between career and personal life is a fact, for better or worse. One learns to juggle and balance. It pays to be very well organized and have a clear sense of direction.

**Gless:** I do think men and women of the current generation share a need for more balance within their lives. Architecture has historically been one of the passion professions requiring devotion to perfection and intense work, often late into the night. Architecture involves a transformation of identity; it is part of what one becomes. The conflicts arise between the desire for development of the self through professional success and the desire for fulfillment through human relationships. Since the nurturing of these human relationships traditionally belongs to women, I believe it is they who suffer most from personal conflicts.

**Has your firm established methods of accommodating family-related concerns by implementing such policies as parental leave, leaves of absence, and part-time or flex-time options?**

**Quimby:** HOK has a maternity-leave policy, and an individual may work out extended maternity leave, part-time schedules, and leaves of absence for family reasons. The firm has been good about accommodating such requests, if the situation and project are not adversely affected.

**Ericson:** SBRA is doing quite a lot to accommodate the family. Women have maternity leave and men paternity leave. Employees can return part-time and be treated as equal participants on a project. And they can return full-time when they wish, assuming there is the work load at the time.

**Woo:** SOM is "old-line" in the sense of being quite family-oriented. If an individual's situation calls for a solution, the firm will take the time and make the effort to work it out. This applies to women as well as men.

**Gless:** My firm does not have any established

maternity-leave policies separate from the legally defined disability leave. However, I have never known any female employee who was unable to work out satisfactory additional leave arrangements. Special family or health problems of all employees are addressed on an individual, more flexible basis.

**Hester:** HLM does provide various family-leave programs, flexible hours, and/or altered work hours to allow employees to tend to the illness or disability of a child, parent, or spouse. Maternity leave is also included under a family-leave policy.

**Pontius:** RTKL provides benefits comparable to other firms in the industry—standard maternity leave and some part-time arrangements—but no unusual solutions.

**Sklarek:** Whenever jobs are plentiful and employees are in demand, more policies on women's issues are implemented by firms.

**Do women bring insights to an architectural practice that are not commonly associated with this male-dominated profession?**

**Quimby:** Definitely! I think the typical female architect is likely to contribute to the profession by having a more varied background and bringing a wider range of experiences to the firm than the typical male architect, and can be more sensitive to clients and users. Women are excellent organizers and managers, and this is of real value for women in management positions.

**Ericson:** Women tend to be inclusive of ideas, jump easily between scales of thinking, and seek possibilities within constraints. Men tend to seek closure, take a step-by-step, sequential approach to their thinking, and build results from facts rather than possibilities.

**Woo:** I do think that women generally understand the needs of women (and children) better than men do. This has been an advantage in the design of housing. Today, with more women in the workforce, it may be a more general advantage in practice.

**Sklarek:** I think that women are more sensitive to the needs of facility users than to the superficial, personal ego issues.

**Pontius:** Women are often more skillful communicators and this makes them stronger managers. As the profession becomes ever more team-oriented, women will become increasingly valuable in management roles.

**Booher:** No two, three, or ten men respond to architecture with the same insights. Any good female architect can offer as much to the profession as any good male architect. I believe a good architect is a good architect.

**Hester:** Input from both genders is beneficial to any project. As more women enter the profession, it has become evident that there is the same diversity among women as there is among men. Some women are more technically oriented, some are more design oriented, and some have the ability to do both.

**Gless:** In terms of talent and intelligence, women as a group have neither less nor more than men or than dark-haired people from Texas. There is an occasional brilliant female architect just as there is an occasional brilliant male one, so to exclude women or men as a group is to exclude potential greatness in the profession. Brilliance aside, it takes competence, cleverness, and hard work to get a project out, and the talent pool for this needs to be as inclusive as possible.

**Do you receive support from other women in your firm, or from professional women's groups? Do you see a continued need for such groups?**

**Quimby:** I think such focus groups are vital. Women in our profession are constantly breaking new ground as individuals, and the opportunity to discuss this with other women and find out what others have done is very important. This doesn't need to be done formally, but can be done by phone, lunch, or at chance meetings. I envision such a need until women comprise a much larger percentage of the architectural profession.

**Ericson:** The Boston Society of Architects has been very supportive of its Women in Architecture Committee, which sponsors its own exhibition of women's work throughout the area and focuses on women's issues through meetings and lectures. Such consciousness-raising about the competency and imagination of women practicing today, demonstrated with current examples of women's work, builds credibility in the community. This committee serves as a network for job hunting and builds professional relationships.

**Booher:** The support in my firm is there, but not in any organized way. In the early spring of this year a brochure and memo discussing a professional group was circulated to the women in the firm, asking for feedback. I do not know how much feedback was returned but nothing has come of it as yet. I believe a program of this sort would be of definite benefit to both women and men, and therefore the firm as a whole.

**Woo:** SOM treads a fine line between collegiality and competitiveness. I don't think being a man or a woman particularly enters

MOLLY HESTER  
ASSOCIATE  
*Hansen Lind Meyer*



A PROJECT ARCHITECT FOR THE PAST two-and-a-half years in Hansen Lind Meyer's Orlando, Florida, office, Molly Hester specializes in government and commercial buildings. She has full responsibility for projects such as the Orange County State's Attorney and Public Defender Buildings (below), anticipated to begin construction in 1992. This project received a 1991/92 ACA/AIA Architecture for Justice citation for excellence.

Hester is also currently providing program management services for a new government operations facility in Brevard County, Florida. In addition to studying architecture at the University of Florida, she took courses in building construction, which helped her qualify in 1977 for a general contractor's license in Florida. Hester went on to complete a master's degree in architecture with a minor in historic preservation at North Carolina State University in 1979. Active in issues regarding women in the profession, she is this year's chairperson of the mid-Florida AIA chapter's Women in Architecture Committee.



ORANGE COUNTY BUILDINGS  
ORLANDO, FLORIDA

## MARCEL QUIMBY

ASSOCIATE

*Hellmuth, Obata & Kassabaum*



MARCEL QUIMBY BEGAN AS AN INTERN-architect in the design department of HOK's Dallas, Texas, office after earning a Bachelor of Architecture degree from the University of Southwestern Louisiana in 1978. Intrigued by the technical aspects of the profession, she transferred to the production department in 1982 and undertook some management duties beginning in 1989. Quimby has worked on mixed-use developments, corporate facilities, and educational buildings. Most recently she has undertaken the design of correctional facilities. She was project architect of the MCI Campbell Creek engineering facility (below) in Richardson, Texas, which won a Texas Society of Architects Honor Award in 1990, and project manager of the Federal Bureau of Prison's San Juan Metropolitan Detention Center in Puerto Rico, which is scheduled for completion in 1992. Quimby served on the Dallas Landmark Commission from 1987 to 1989, chaired the national AIA Women in Architecture Committee in 1990, and will be vice president/secretary of AIA's Dallas chapter in 1992.



MCI CAMPBELL CREEK  
RICHARDSON, TEXAS

into it at this point. I believe in equality. If focusing on women's role in the profession will help to achieve that, so much the better. But I hope that at some point the focus will no longer be needed.

**Gless:** I have always had the luck to be surrounded by intelligent and supportive women in a number of professions. Consequently, I have not needed organized professional groups. The fact that women are involved in them is evidence of a continued need for such groups. Women will know they are fully integrated into the profession when they no longer need the groups.

**Hester:** The mid-Florida AIA chapter's recently formed Women in Architecture Committee allows interested women to network and talk informally several times a year, which is positive. There is a continued need for those groups. I frequently talk with non-architect friends who are businesswomen and find their insights valuable. I also find reading general business books and attending management seminars helpful.

**Pontius:** The women in my firm are supportive—when you can find them. Our numbers are few and everyone who is working is doing so very hard these days. Over the years, I have found it useful to spend time with women from other professions formally and informally. I was active with Barnard's professional women's organization in New York and my sister, highly successful in her own, non-architectural career, has been a great source of support and information, particularly regarding the business world. As long as business is male-dominated, I believe women's groups offer a useful forum.

### **Have female role models made a difference in your professional development?**

**Ericson:** Knowing what women are doing and which buildings they have worked on establishes standards to which other women can aspire. For me, Sally Harkness, partner of The Architect's Collaborative and former president of the Boston Society of Architecture, has done a great deal to open up opportunities for women in the field. Zaha Hadid, with her bold, Deconstructivist ideas and beautiful drawings, has pushed all of us into new design perceptions. Teaching and working with graduates in the intern-architect development program are ways that I have been a mentor to other women.

**Booher:** As a young architect I was always delighted to hear of a successful woman, but at the time I chose my career, I did not know

of any. I have worked with several younger women or summer students who have told me, gratifyingly, that working with me has taught them many technical and managerial specifics, and also that success as a female architect is achievable.

**Woo:** Given the nature of the profession at the time, my own role models were all men. I do think some women benefit from having other women as role models. In my case, I don't think it would have made much difference. While I am both a role model and a mentor, men and women alike learn and benefit from that. My task as a partner is, after all, to encourage both sexes.

**Gless:** In the offices in which I have worked, I have either been the only woman or one of the most experienced architects. Consequently, I have found myself being a role model for younger women, which I accept as an important responsibility. I like to think of myself as a mentor for any young architect.

**Hester:** Having female role models would be helpful, but they are virtually non-existent in Orlando, Florida, so I have male role models. I try to help younger women in the office by explaining project goals and processes. I offer advice when I become aware of problems that arise within the office.

**Sklarek:** Since I was one of the pioneer female architects, there were not many female role models for me. I am a mentor to several women in the design fields.

**Pontius:** My mother had a successful career as a medical researcher. She always worked, so I knew I would, too. While I don't feel I had female mentors, I greatly admire artists Georgia O'Keeffe and Louise Nevelson. As an associate principal, part of my job involves training younger staff.

**Quimby:** Female role models are vital. Firms with very few women in leadership positions send a strong signal that such positions are only open to men. Having women in upper-level positions acting as role models lets you know that reaching that level is achievable, and provides much-needed encouragement. In recent years, I've tried to be a mentor to other women—both at the office and outside—and enjoy the fact that I'm now at a level where I can be of some help.

### **How can architecture schools better prepare women for the profession?**

**Quimby:** Female architecture students need to have a greater understanding of the profession and the building process than male students, so they can effectively combat the

mistaken perception that they are less suited to the profession. I'm not sure how this can be done; possibly by having strong female faculty who take an interest in the issue and act as mentors for the female students.

**Ericson:** Attention needs to be paid to the accomplishments of female architects. Furthermore, architecture schools should hire more female professors and support the female professionals of today.

**Sklarek:** Institutions should provide courses on design from the feminist viewpoint and provide preparation for the reality of discrimination against women in the field and how to overcome it.

**Pontius:** The schools need to be more direct about what is attainable in the profession; they tend to promote an idealized view and that makes it harder when the graduates—male or female—enter the profession and realize not everyone is going to be a “star.”

**Woo:** Architecture schools should make no distinction between men and women in preparing people for the profession.

**Booher:** I don't think architecture schools' attitudes towards women can have much impact on the conditions in the profession today. By the time someone, male or female, has graduated from a four- or five-year architectural curriculum, they will have decided whether or not to enter the profession. Being an architect requires desire and dedication. These cannot be taught to anyone but must come from within each individual.

**Gless:** The question should be, “How can schools of architecture prepare students to be architects?” Besides being well-trained architecturally, architects need to be confident, assertive, articulate, adaptable, hard-working, and realistic. Of these qualities, the schools only address hard-working.

#### **Is the current economic recession hitting woman architects more, less, or the same as their male counterparts.**

**Gless:** The recession appears to be hitting every group equally. In most cases, it is the least talented, least hard-working who disappear from the studio.

**Booher:** We have felt the economic crunch and have lost some employees because of it. It seems the ratio of men to women recently laid off is proportionally equivalent to the ratio of men to women in the firm.

**Quimby:** It seems that women are being hit particularly hard by this recession. A large number of women architects in the Southwest are younger, and many firms tend to keep

their more experienced staff and release their younger personnel when times are bad. Consequently, there is a large number of female intern-architects and architects who have been affected by layoffs.

#### **What advice would you give to women entering the profession?**

**Quimby:** First of all, I'm very positive about the profession and would heartily encourage women to enter it. Women should do so with both eyes open, and be aware of their talents, position, and worth. Women tend to undervalue themselves and this is of no benefit to them, other women, or the profession. Secondly, be as prepared as you possibly can to identify your assets and capitalize on them.

**Ericson:** Architecture is an avocation; not a skill. Long-term commitment, talent, and experience is required to become accomplished. If you love it, do it—you'll never be bored!

**Booher:** I would suggest that a young woman be absolutely sure she wants to become an architect. Be prepared to dedicate long hours and a lot of energy to a career from which it may take a long time to reap the rewards.

**Woo:** When asked for my advice, I would tell anyone, man or woman, to think twice before entering a field in which the work is long and hard, the job security so questionable, and the financial rewards so often negligible. Architecture is really a “calling,” something people do because it's in their blood. You could almost say that if you have to ask, it's not worth pursuing.

**Gless:** I would tell women the same things I would tell men considering the profession. Besides marrying well, visit with an architect and observe whether your preconceptions about what it means to be an architect mesh with the day-to-day realities.

**Hester:** I would tell them that there is diversity within the profession. There are many ways to be a valuable asset to a firm other than being a star designer. Stay in school long enough to meet the educational requirements for registration. Take the exam and pass it as soon as possible. Don't be afraid to try unfamiliar things. Find a mentor.

**Pontius:** Understand the depth of commitment it takes to succeed. This is a low-paying, detail-oriented, and slow-moving profession. Architecture requires some talent, but mostly endless endurance.

**Sklarek:** Be prepared for the discrimination factor and never let it cause you to give up. Persevere, persevere, persevere. ■

DEBORAH L. BOOHER  
ASSOCIATE

*Kohn Pedersen Fox Associates*



EDUCATED AT THE UNIVERSITY OF TENNESSEE IN KNOXVILLE, TENNESSEE, DEBORAH

BOOHER BEGAN TACKLING LARGE-SCALE PROJECTS EARLY IN HER CAREER. SHE SPENT SIX YEARS IN THE NEW YORK OFFICE OF I.M.

PEI & PARTNERS WORKING ON THE DESIGN OF FACILITIES SUCH AS RAFFLES INTERNATIONAL CENTER AND RAFFLES CITY IN SINGAPORE;

JOHNSON & JOHNSON BABY PRODUCTS HEADQUARTERS IN MONTGOMERY TOWNSHIP, NEW JERSEY; SUNNING PLAZA IN HONG KONG; WARWICK HOTEL IN HOUSTON,

TEXAS; AND NESTLE CORPORATE HEADQUARTERS IN WHITE PLAINS, NEW YORK. IN 1980, BOOHER JOINED KOHN PEDERSEN FOX ASSOCIATES WHERE SHE DEVELOPED DETAILS FOR

ONE LOGAN SQUARE IN PHILADELPHIA; SERVED AS JOB CAPTAIN FOR GENERAL REINSURANCE BUILDING IN STAMFORD, CONNECTICUT, AND 712 FIFTH AVENUE IN NEW YORK CITY; AND UNDERTOOK THE ROLE OF BOTH JOB

CAPTAIN AND PROJECT MANAGER FOR THE RECENTLY COMPLETED MELLON BANK CENTER

(BELOW) IN PHILADELPHIA. AS A PROJECT MANAGER, BOOHER SUPERVISES ALL ASPECTS OF THE BUILDING PROCESS, FROM ZONING ANALYSIS AND DESIGN THROUGH CONSTRUCTION.



MELLON BANK CENTER  
PHILADELPHIA, PENNSYLVANIA

# Clad for Elegance by Brite Vue



## Full-framed aluminum doors clad in brass or stainless steel

Now you can design monumental entrances at an affordable price! Brite Vue clad doors are produced with narrow, medium or wide stiles. Stile widths are fixed but top and bottom rails



A. Freedom Square Building  
Cleveland, Ohio  
Architect: Ross C. Farro  
Glazing Contractor: Lorain Glass Co., Inc.



can vary in height. The unique design, with the stiles being of minimal greater thickness than the rails, eliminates visible glass stops, creating unusually clean lines. Brass or stainless steel cladding can be mirror or satin

B. 160 Pine Street Building  
San Francisco, CA  
Architect: Robinson, Mills & Williams  
Glazing Contractor:  
Carlson/Wyseth Glass Co.

polished. Brass cladding can also be satin oxidized and oil rubbed or clear baked enamel. For entrances of exceptional beauty and structural integrity...Brite Vue brass or stainless steel clad doors.

Write or call today for complete information. Costs are lower than you think.

**BRITE  
VUE**

**Glass Systems, Inc.**

A Kawneer Company

Contact Kawneer,  
Department C,  
Technology Park-Atlanta  
555 Guthridge Court,  
Norcross, GA 30092  
404-449-5555

Circle 39 on information card

C. Thomas Jefferson Building  
Washington, D.C.  
Designer & Glazing Contractor:  
Capitol City Glass Co., Inc.

# Developments in Plastics

Expanding applications of synthetic materials include new structural possibilities.

"I JUST WANT TO SAY ONE WORD TO YOU... plastics." The spirit of the best-known line from the 1967 film, *The Graduate*, illustrates the mixed perceptions the plastics industry has long generated—even in architecture.

A vague term, plastic is a label applied to the broad range of synthetic polymers made from petroleum and various chemicals. In its many forms, plastic has changed the way we live—but with some serious side effects. In the headlines most recently is the proliferation of inexpensive, disposable containers accompanied by the environmental nightmare of landfills burgeoning with non-biodegradable plastic bags and bottles.

As a medium for builder and architect, plastic has offered similarly mixed results. Despite the best efforts of many scientists, all-plastic buildings will not cover the landscape in the near future due to the serious limitations of structural applications and high costs. Plastics, however, solve major problems posed by chemical corrosion and electroconductivity, and, combined with wood, metal, and concrete, increase strength and durability of these traditional building materials.

Plastics have been most successfully applied for nonstructural purposes, as exemplified by such tried-and-true components as PVC piping, vinyl windows and siding, and

plastic foam insulation. The annual use of plastics in new house construction tripled between 1970 and 1991 to 11.9 billion pounds, according to data published last March by *Modern Plastics*. The vast majority of these synthetics are found in nonstructural materials where they have proven effective and economical. And as development continues, plastics should offer increasingly innovative building and design options. Some of the more recently manufactured products, such as a new roofing system and a brand of plastic lumber, address environmental concerns by employing recycled materials.

## Structural applications

TO DATE, THERE HAS BEEN LITTLE APPLICATION of plastics for load-bearing purposes. That's because the strongest plastic structural components, namely fiberglass-reinforced plastic (FRP) beams, reinforcing bar (rebar), and panels formed in a process called "pultrusion" are prohibitively expensive. In pultrusion, reinforcing fibers of glass, graphite, or carbon are pulled through a resin bath, then through a heated die, where the resin cures. Its use has been curtailed, however,

**Box-shaped beams and reinforcing fibers help overcome the inherent flexibility of plastic members (left). Such beams were used to construct AT&T's electromagnetic capability test facility in Oklahoma City (below left and bottom right). Plastic paneling also encases the structure (below right).**

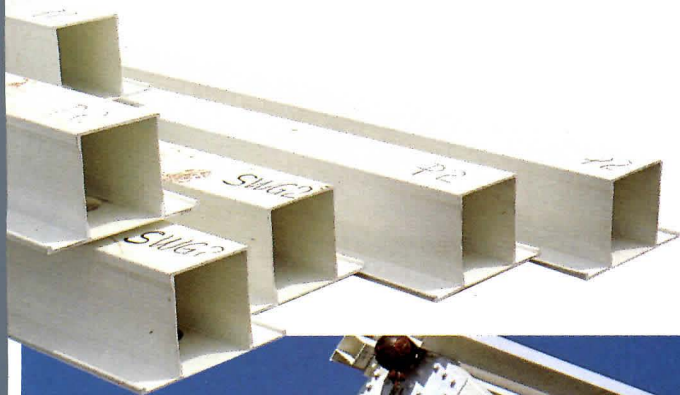

COURTESY OF GE PLASTICS



VAN TUIJL



VAN TUIJL

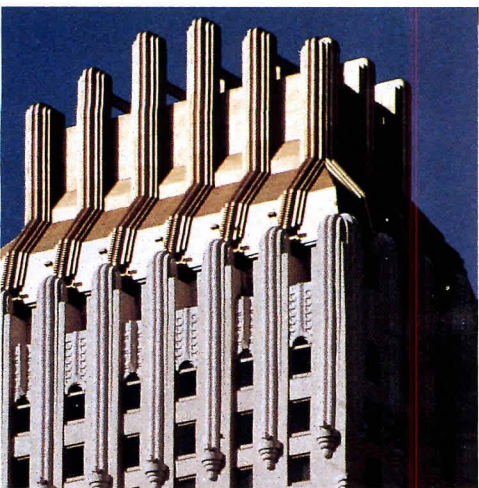

Architectural elements now constructed from plastic include roofing panels made from recycled plastic to simulate the appearance of flammable cedar shakes (top), wooden columns (above center), and terra-cotta cornices (above). Foam plastic blocks (right) serve as formwork for combining the strengths of concrete and polystyrene. After concrete is poured into the form, the assembled blocks are left in place (far right) to provide better curing and insulation. Cladding can also be applied directly to the form.

due to the high cost of the process and the product's lack of rigidity compared with vastly cheaper conventional materials such as wood and steel. According to Eric Balinski, market development manager at Dow, "With [FRP], you get a modulus of elasticity of approximately 6 million pounds per square inch. With wood you're at 10 million, and steel, 37 million. So you have to find special applications for FRP." For architects, pultruded plastics could be considered for the design of paper mills, chemical plants, computer installations, telephone facilities, or other buildings where standard structural wood or steel would be vulnerable to corrosion or cause electromagnetic interference.

Composite Technology, a division of W.R. Grace & Co. in Fort Worth, Texas, has developed a series of advanced pultruded structural members called "Tuff-Span." Incorporating continuous, high-strength reinforcing fibers and new beam shapes, the company enhances the stiffness of pultruded plastic beams. "We found that using the traditional I-beam shape was the wrong way to go," says Dave Goodwin of Composite Technology. By employing a box configuration, the company achieves longer spans, including an 18-inch-deep beam on a 40-foot clear span at the Tennessee Eastman Wastewater Treatment Plant in Kingsport, Tennessee.

One project employing Tuff-Span is AT&T's electromagnetic capability (EMC) testing facility completed two years ago in Oklahoma City, Oklahoma. Within the building, scientists test the electromagnetic emissions of manufactured products for compliance with FCC standards. Such structures are also known as open-air test sites, because at one time such testing could only be done outdoors to avoid interference caused by metal fasteners and moisture retention in wood components. AT&T's in-house engineering, design, and construction department specified pultruded plastic beams and panels to duplicate the interference-free, open-air envi-

ronment while providing weather protection.

Pultruded plastic rebar may be specified to reinforce concrete slabs in projects where conductivity and corrosion are a problem. It has been applied in the construction of radar installations, electricity generating- and transmission stations, and chemical facilities. David Ratchford, president of Vega Technologies in Marshall, Arkansas, explains that the largest use for his company's plastic rebar lately has been in hospitals, where structural steel poses a risk of interfering with magnetic resonance imaging diagnostic equipment. Plastic rebar may also be used to reinforce concrete exteriors in which rusting steel rebar might discolor the surface.

Plastics can be used for a wider range of structural applications when employed with other materials, as exemplified by foam-core panels and foam concrete forms. Foam-core or stress-skin structural panels consist of a polystyrene or polyurethane foam insulation core sandwiched between panels of wood, metal, or concrete. The mix of these materials furnishes panels with energy efficiency, ease of assembly, and greater strength, allowing construction of a building without a structural frame (pages 97-100).

Foam plastic forms used for setting concrete also perform with strength. Made from the same polystyrene as standard foam insulation panels, the forms offer fire retardance and insulation while taking the place of wood or steel concrete forms. The hollowed-center blocks are stacked together to create formwork for a wall. Concrete is poured into the form and the formwork is left in place after the concrete dries. The extra curing time increases strength; consequently, a foam-formed wall requires up to 1/4 less concrete than a conventionally poured wall. The insular qualities of the polystyrene offer R values in the low 20s. Cladding can be applied directly to the form and the overall time savings afforded by the forms' light weight and easy assembly is impressive. 3.10 Insulated Forms of

LARSH K. BRISTOL



LARSH K. BRISTOL





Omaha, Nebraska, for example, has supplied plastic forms to a wide variety of projects in the last three years, including apartment buildings, resort houses, and office buildings. BASF also offers a building form made from its Styropor EPS.

Increased application of foam-core panels and plastic concrete forms exemplifies an overall trend. According to Dow Chemical's Balinski, "I think that plastics used in conjunction with other materials...will be the real future of plastics in general, as well as in structural applications."

### Nonstructural plastic

A NEW VARIETY OF DECORATIVE PRODUCTS is expanding the use of nonstructural plastics beyond doors, siding, plumbing, and windows while also improving upon traditional materials in cost, weight, and durability. Prefabricated and custom-built plastic cornices, railings, columns, and millwork are barely distinguishable from plaster or wood. Made of high-density polymers and fiberglass-reinforced polyester, details can be custom-fabricated or chosen from a selection of pre-fabricated components.

Plastic ornamentation is fire-retardant, durable, and considerably cheaper than traditional materials and craftsmanship. These intricate, authentic-looking elements have been used widely for restoration, and Focal Point of Atlanta, Georgia, offers several product lines under license from such organizations as the Colonial Williamsburg Foundation, the National Trust for Historic Preservation, and the Historic Natchez Foundation.

Drew Mager, of Molded Fiber Glass Companies of Union City, Pennsylvania, points out that such technology has replaced the exterior ornamentation once achieved by terracotta craftsmen. "Those craftsmen are gone. And we're able to achieve the same affects at only a pound or two per square foot."

Ever since polyvinyl resins were incorporated into safety glass in the early part of this century, plastics have been employed widely in reinforcing glass. Continuing that trend in a decorative vein, Glass Alternatives Corporation of Petoskey, Michigan, markets Deco Bloc, a lightweight plastic alternative to traditional glass block for many interior and exterior applications. Each plastic block weighs 50 percent less than its glass counterpart; provides greater thermal efficiency; responds well to temperature variations; and is coated with a special scratch-resistant material. A snap-lock feature eliminates the need for a bricklayer.

Plastics are key ingredients in oriented-strand board and other types of engineered lumber in which wood is reinforced with resins. As an alternative to pressure-treated lumber, Eaglebrook Products of Chicago has developed an all-plastic, extruded lumber product that offers the appearance of wood with greater durability. Durawood lumber is heat-molded from high-density polyethylene recycled from discarded plastic milk jugs. The product may be specified for exterior applications, mainly in fencing, decking, and marine docks, and is available in several wood colors and sizes. Durawood simulates wood grain but not its stiffness; it therefore requires a closer spacing of support beams, particularly in decking applications. While initially more expensive than wood, Durawood is not susceptible to rotting, splitting, or splintering.

A new roofing system made of recycled material takes advantage of plastics' light weight, durability, fire-retardance, and insulation characteristics, while also offering the look of wood. In collaboration with General Electric, Nailite of Sacramento, California, developed an injection-molded, simulated cedar-shake shingle called the Roofvantage, which was featured as part of the GE plastics house (ARCHITECTURE, March 1990, pages 165-168). The panels have found a strong market in California, where some communities have banned the flammable cedar shake.

Nailite and GE plan to offer the same product using 52 percent recycled plastic. This summer, the panels are being tested on the roofs of two Chicago-area McDonald's restaurants. With its multi-tile panel configuration and light weight, a Nailite roof requires roughly half the installation time of conventional systems. Made of 21-by-42-inch panels containing 13 "shingle" units, Nailite is virtually impervious to heat, cold, water, fire, and termites.

The science of plastics is focusing not only on areas of proven performance but also on finding new ways to solve its shortcomings through combinations with other materials. Additionally, new strides in the use of recycled plastics will help stem the landfill overflow while preserving the non-renewable petroleum reserves from which they are made. Plastics will never be the only word in an architect's vocabulary, but increasingly, it is a material to be taken seriously. ■

—PATRICK TUCKER

*Patrick Tucker is a freelance writer based in Washington, D.C.*



COURTESY OF FOCAL POINT



COURTESY OF FOCAL POINT

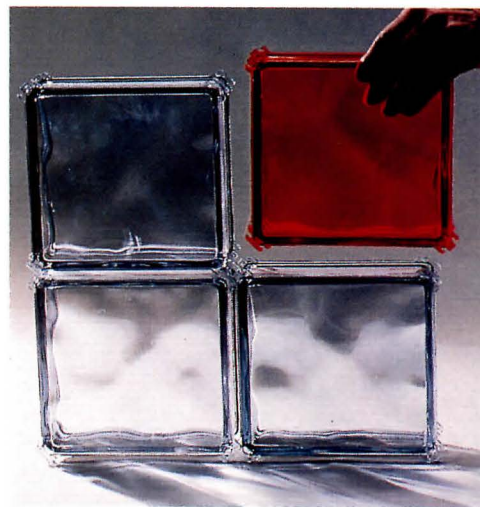

COURTESY OF GLASS ALTERNATIVES

**Plastic can be a great imitator. Molded polymer rosettes (top) and cornices (above center) are capable of duplicating the authenticity of historical details traditionally constructed of wood or plaster. For exterior and interior applications, highly durable plastic blocks (above) look exactly like glass block, but are only half the weight of their authentic counterparts. Such blocks require substantially less time and effort to install since snap-lock connections eliminate the need for grouting joints.**



# LOCK, STOCK & BARREL.

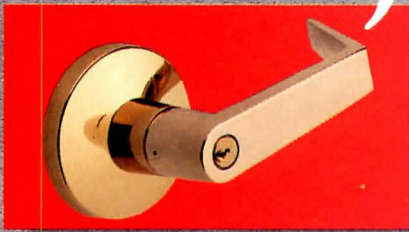

## Yale's 5400L: The Best Lock Got Better

The best lockset on the market is now a series of locksets. Two additional handle designs offer you more flexibility and greater compatibility with existing hardware. Each is self-aligning and now incorporates a key demountable handle to make re-keying quick and simple. Plus, the non-handed 5400L gives you the proven benefits of independent return springs to eliminate sag and droop, through-bolting for strength and security, and a free-turning handle to deter break-ins.

## Always In Stock For Quick Ship

The heavy duty 5400L Series is part of Yale's industry-leading Warehouse Program. Available in a variety of architectural finishes, the 5400L Series locksets are available door to door in seven days or less, to keep your job schedule running smoothly.

## Expanded Cylinder Compatibility

In addition to accepting Yale cylinders, the 5400L Series is available for use with Schlage cylindrical lock cylinders. And if you need to use Best, Falcon or Arrow interchangeable cores, the 5400L accepts these as well. Now the best lockset on the market can be installed without changing the current key system—easy for you, and your customer.

And because the 5400L Series retrofits into existing cylindrical lock cutouts, you can bring a building up to handicap codes without a major rework. To find out more about the 5400L Series, call Yale or your local Yale sales representative today.

Circle 41 on information card



# Yale®

YALE SECURITY INC.

Yale® Locks And Hardware, A Division of Yale Security Inc.  
US(800)438-1951 Canada(800)461-3007

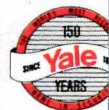

# What Do Architects Really Earn?

Surveys reveal compensation levels and the recession's effect on salaries.

ARCHITECTS ARE THE FIRST TO ADMIT THAT they are inadequately paid for the highly skilled work they perform. They are, for the most part, the most poorly compensated of their professional brethren, earning less than doctors, lawyers, and, in many cases, engineers. Unfortunately, the downturn in the economy is only widening the gap, as many architects find themselves with shrinking client rosters. Released in early August, the *1991 AIA Salary Report for Architectural Design Firms*, which compares 1990 and 1988 compensation, illustrates the preliminary effects of the recession. The biennial survey, in which the most recent figures are from the last quarter of 1990, analyzes 2,778 completed questionnaires, representing 16 percent of all firms owned by AIA members, and includes data on bonuses, benefits, and profit-sharing. Another salary survey, the annual *Executive Management Salary Survey*, is published by the Practice Services Management Journal (PSMJ), an arm of Practice Management Associates, a Newton, Massachusetts, consulting firm. The latest edition gives 1991 figures based on data from the first quarter of this year.

The PSMJ report surveys primarily medium- and large-size design firms, including engineering firms. For the analysis, questionnaire responses are tallied from 7,901 designers working in 308 practices with a total of 40,049 employees. In contrast, the AIA salary report surveys only AIA member-owned practices. Of these 17,000 firms, 10,000 have only one architect, and 86 percent of those surveyed by the AIA have less than 10 full-time staff members. Even with its small sample size, however, the PSMJ survey cannot be discounted since architectural practice is dominated in many respects by 1,000 firms with 20 or more people, as the AIA salary report points out.

The principal differences between the AIA salary report and the PSMJ survey, therefore, lie in the differences in compensation at large and small firms. According to the AIA salary report, whose respondents tend to practice in smaller firms, the mean national compensa-

tion for principals and partners was \$67,100 in 1990. The figure ranged from less than \$50,000 for sole proprietors to more than \$100,000 for principals/partners in firms with 20 or more employees. In the AIA survey, the national average is pulled down by small firms, since the mean partner salary in firms with more than 20 employees is \$107,200. In contrast, the mean total compensation for principals listed in the 1990 PSMJ survey ranges from \$161,060 (chairman of the board) to \$78,105 (principals below senior vice president).

**The best-paid practitioners are specialists with a marketable expertise, while the most poorly compensated tend to be generalists working for small firms.**



ED CASTLE

## Average compensation by position

	1988 mean	1990 mean
<b>Principal/Partner</b>	<b>\$62,100</b>	<b>\$67,100</b>
<b>Associate</b>	<b>42,000</b>	<b>47,600</b>
<b>Manager</b>	<b>39,900</b>	<b>43,400</b>
<b>Architect III</b>	<b>35,000</b>	<b>38,000</b>
<b>Architect II</b>	<b>31,100</b>	<b>33,800</b>
<b>Architect I</b>	<b>28,200</b>	<b>30,000</b>
<b>Intern</b>	<b>23,400</b>	<b>24,200</b>

Source: 1991 AIA Salary Report for Architectural Design Firms

The AIA salary report shows the mean compensation for associates (\$47,600) rising with firm size, together with that of all positions except recently licensed architects. Their salaries varied little with size of practice. The mean 1990 salary for "managers," defined as designers with 10 or more years of experience, was \$43,400; for architects with eight to 10 years experience, usually with project management duties, mean earnings were \$38,000; for architects with six to eight years experience, usually responsible for design and/or technical development of one or more projects, average compensation was \$33,800; recently licensed architects, usually with three to six years experience, earned an average of \$30,000; and the mean income for interns was \$24,200. The 1990 PSMJ survey lists the mean compensation for senior project managers at \$52,617; for junior project managers at \$42,055.

The best-paid practitioners are specialists with a marketable expertise, while the most poorly compensated tend to be generalists working for small firms. In most cases, a young practitioner's salary will increase rapidly during the first five years, then level off. Peter Piven, president of the Coxe Group in Philadelphia, explains that the reason many principals earn far more than even the most valued employees is that they usually own the practice and therefore assume all the risks inherent in ownership.

When a firm reaches a certain size, the practice becomes increasingly businesslike, and "with that comes a more business-type set of salaries and benefits," notes Andrea Leers of Boston-based Leers, Weinzapfel & Associates. According to Piven, large, service-oriented firms working on complex projects tend to be the most successful and therefore pay the highest salaries. Louis Marines, president of the Advanced Management Institute in Corte Madera, California, explains, "Larger firms that are clear about themselves as service-providing collaborators, rather than seeing clients and construction firms as adversaries, are willing to ask for what they're worth." The firms in the best position to pay

## The firms in the best position to pay competitive salaries are large, service-oriented firms with one or more niches that are not dependent upon cyclical economic swings.

competitive salaries, adds Ellen Flynn-Heapes of Flynn-Heapes Consultants in Alexandria, Virginia, are large firms with one or more niches that are not dependent upon cyclical economic swings.

Even the most successful architects have a difficult time competing with the salaries that physicians and attorneys earn. The mean pre-tax net income for all physicians in 1990-1991 was \$155,800, according to the American Medical Association. As with architects, the most poorly remunerated physicians were general practitioners. They earned \$95,900 a year, while surgeons were the most generously paid at \$220,500. The salaries of attorneys vary greatly from city to city and firm to firm. According to the *National Law Journal* of May 6, 1991, starting-salary offers to law school graduates ranged from \$46,193 in the South to \$55,875 in California. A sample of national practices surveyed by the journal found first-year law associates were paid no less than \$50,000 and as much as \$83,000 a year; the average income for sole practitioners was \$90,924; and, in firms of six to 12 lawyers, the average salary was \$101,263—roughly comparable to the average salary of an architectural principal or partner of a large firm.

Architects' earnings fail to outpace related disciplines. According to the AIA survey, median (which is generally lower than the mean) 1990 incomes of mechanical, electrical, and structural engineers working for architecture firms were in the low \$40,000s. Considerably higher, at \$57,000, was the median income reported by the National Society of Professional Engineers in its *1991 Income and Salary Survey*. The median ranged from \$32,500 for engineers with less than one year experience to \$72,156 for engineers with 30 or more years experience.

There is no independent salary survey for interior designers, but Jack McNichol of McNichol Associates, a Philadelphia search firm for architects and engineers, postulates that "reputed interior designers can earn more than architects, because their projects turn over faster, there are more jobs, and decisions are made more quickly." According to the AIA salary report, average earnings for interior designers were only \$28,000 in 1990, but McNichol estimates that interior designers working on their own or for firms earn between \$35,000 and \$50,000.

Of design professionals, only landscape architects earn consistently less than architects. The AIA salary report found that the mean 1990 income for landscape architects was \$33,400, while the 1989 *National Salary Survey of Landscape Architects* claimed designers in private practice earned a mean gross income of \$37,500—which still doesn't compare to a seasoned architect's earnings.

It is unlikely that architects' compensation will improve in the near future. The recession has affected nearly every region and every firm in the country (ARCHITECTURE, September 1991, pages 91-94). Virtually all principals interviewed for this article maintain, however, that when faced with economic survival, they cut staff members rather than salaries, though several reduce benefits and raises. Most report that they refrain from cutting salaries to avoid jeopardizing the morale of their remaining employees, and that even during hard times, the best people are always in demand. According to Piven, "To obtain competitive fees, firms must remain competitive for talent, which means paying what the market pays."

The hardest hit by the recession so far, according to the 1991 AIA salary report, are principals and interns. The overall number

of interns has dropped 20 percent since 1988, and their earnings have risen only 3 percent. Many principals, especially on the East Coast, have cut their own earnings or reduced their raises. According to the AIA report, sole proprietors saw their compensation fall in 1990—by 3 percent since 1988 to \$46,000. This figure is more significant than it might appear, since the number of sole-practitioner firms grew in all sections of the country except in the East North Central region (Illinois, Indiana, Michigan, Ohio, Wisconsin). The greatest increase in one-person firms—from 25 percent in 1989 to 42 percent in 1991—occurred in New England. Compensation for all principals increased by 8 percent nationwide, less than that of other professional staff, according to the AIA report.

Firms owned by AIA members employ an estimated 130,000 full-time employees, a 5 percent decline since 1988. Most of this decline is concentrated among intern architects and technical staff positions, which have suffered a 10 percent decrease. However, average compensation for all architects increased 9 percent from 1988 to 1990, slightly less than the 10 percent rise in the consumer price index. Associates' earnings jumped 13 percent on average.

Although previous AIA surveys documented strong regional differences in compensation, the salary report of 1991 shows that the current recession has significantly modified these differences. The sharpest drop in compensation occurred among principals and partners in New England, where the 1990 mean income of \$61,600 was nearly 8 percent below that of 1988. The nation's highest paid principals were in the Mid-Atlantic region, despite its 5 percent drop in earnings. Firms in this area also reported the highest mean salaries for five of six architectural positions listed in the AIA salary report. The lowest average compensation in eight of the 20 identified positions was reported in the Pacific Northwest, where principals/partners also had the lowest average earnings in the nation: \$51,000. In every region, compensation for staff architects increased faster than it did for principals, with the strongest gains of 11 percent in the western North Central and Pacific Southwest regions.

In New York City, principals' earnings dropped 10 percent between 1988 and 1990

### Average compensation by firm size (1990 mean)

	Sole practitioner	2-4 persons	5-9 persons	10-19 persons	20+ persons
<b>Principal/Partner</b>	<b>\$46,300</b>	<b>\$56,100</b>	<b>\$71,800</b>	<b>\$92,300</b>	<b>\$107,200</b>
<b>Associate</b>	—	<b>38,800</b>	<b>44,100</b>	<b>47,900</b>	<b>55,800</b>
<b>Manager</b>	—	<b>38,500</b>	<b>41,800</b>	<b>42,400</b>	<b>46,100</b>
<b>Architect III</b>	—	<b>33,800</b>	<b>37,700</b>	<b>37,400</b>	<b>40,300</b>
<b>Architect II</b>	—	<b>33,600</b>	<b>32,500</b>	<b>33,500</b>	<b>35,000</b>
<b>Architect I</b>	—	<b>29,100</b>	<b>30,000</b>	<b>30,300</b>	<b>30,100</b>
<b>Intern</b>	—	<b>23,200</b>	<b>25,000</b>	<b>24,700</b>	<b>24,500</b>

Source: 1991 AIA Salary Report for Architectural Design Firms

## Although the downturn in the construction market has caused principals and partners to cut their own compensation, they are striving to keep their employees' salaries competitive.

placing them fifth nationwide behind principals in Miami, Chicago, Los Angeles, and Atlanta. However, for those positions below principal, New York still reported the highest average compensation in the nation.

The slightly more up-to-date trends indicated by the 1991 PSMJ survey also tend to be somewhat less encouraging than those elaborated by the AIA salary report. Like the AIA survey, the PSMJ study finds architects more deeply affected by the recession than engineers. The PSMJ survey states that the analysis "clearly shows the effects of the recession, with fewer managers receiving bonuses, lower raises and retirement contributions, and much lower optimism levels for 1991." According to PSMJ, retirement contributions "fell substantially from the levels of a year ago," and fully 25 percent of architects expect lower bonuses in 1991, compared to only 17 percent who expected lower bonuses last year. Average salary increases, however, are still projected at 5 percent, although 10 percent of architectural firms expect staff levels to drop by 11 percent or more in 1991. Smaller firms reported that they would retain staff at reduced hours, while larger practices claimed they were more likely to lay off employees in the future.

While the PSMJ survey confirms that the recession is having the most impact on firms in the Northeast serving private-sector clients, it finds that Midwestern firms with government clients are feeling little pain. More encouraging amid a flurry of discouraging news is the 1991 AIA salary report suggestion that although the downturn in the construction market has caused principals of East Coast firms to reduce their own compensation, they are striving to keep employees' salaries competitive across the board.

While it's clear the recession has nega-

tively affected most of the profession, it doesn't explain why architects are underpaid in the first place. One of the most obvious answers is supply and demand. With 33,800 students in accredited architecture schools and a comparable number in unaccredited programs, there are almost as many architecture students today as there are practicing architects. According to the National Architectural Accrediting Board, the number of students in architecture schools has not increased appreciably since 1983, although it is expected to rise soon due to three new programs granted accreditation this year, and four that have applied for review next year.

Although some architects favor tightening architecture schools' admission requirements and academic standards to reduce the numbers of novice practitioners, most oppose limiting access to architectural education. They argue that, in fairness, the market should be allowed to winnow the successful from those who are less so. Rose Anthony, vice president of Management Design Consultants in San Francisco, adds that two years ago there was a shortage of architects. "We couldn't find enough designers to fill many offices," she recalls. There is, moreover, no demonstrable relationship between the supply of architects and their incomes. Italian architects, for instance, earn no less than their U.S. counterparts despite their greater number per capita.

Stuart Rose, executive director of Professional Development Resources in Washington, D.C., contends that architects don't believe in their abilities, and therefore sell themselves short to clients. "You have to have the confidence to walk away," he advises.

Robert Gutman, a sociologist and author of *Architectural Practice: A Critical View* (Princeton Architectural Press, 1988), is conducting studies on remuneration and reward levels in

different professions. He observes that the public perceives the services of an architect who designs a beautiful house to be less critical—and therefore less valuable monetarily—than those of a physician who saves lives, or a lawyer who saves a client money or staves off a conviction. Gutman explains that it is harder to judge the merit of an architect's work than an attorney's because the criteria for judging a successful house is a matter of opinion. The results of a lawyer's work, on the other hand, are measurable in dollars and documented in court records. Washington, D.C., architect Hugh Jacobsen, however, takes issue with that valuation: "Most people don't know the bar exam is a Boy Scout picnic compared to an architectural registration exam. We've never been able to get the message out to the world that we are responsible for a building, that we put our heads on the line."

The architect's situation is further complicated, Gutman adds, by the fact that construction managers hired by clients are providing many of the services traditionally furnished by architects, while high-profile firms are increasingly becoming consultants who guide and plan design that is executed by someone else.

According to Gutman, many people enter the architectural profession because it is the most secure and best paid of the visual arts. "A lot of designers would feel much better about their level of remuneration if they compared their situation to that of painters and sculptors."

The AIA salary report, which highlights salaries in 19 cities across the country, is available for \$50 (\$30 for AIA members) plus \$5 shipping by calling (800) 242-4140 and ordering publication R648-91.

—ANDREA OPPENHEIMER DEAN

### Average compensation by region (1990 mean)

	New England	Mid-Atlantic	South Atlantic	East South Central	West South Central	East North Central	West North Central	Pacific Northwest	Pacific Southwest
<b>Principal/Partner</b>	<b>\$61,600</b>	<b>\$66,100</b>	<b>\$62,400</b>	<b>\$64,000</b>	<b>\$57,500</b>	<b>\$65,500</b>	<b>\$57,000</b>	<b>\$51,000</b>	<b>\$65,800</b>
<b>Associate</b>	<b>46,500</b>	<b>52,800</b>	<b>45,300</b>	<b>42,200</b>	<b>42,800</b>	<b>46,400</b>	<b>46,100</b>	<b>40,300</b>	<b>50,100</b>
<b>Manager</b>	<b>43,200</b>	<b>47,700</b>	<b>41,800</b>	<b>37,300</b>	<b>41,000</b>	<b>43,300</b>	<b>41,000</b>	<b>40,900</b>	<b>45,200</b>
<b>Architect III</b>	<b>38,200</b>	<b>41,400</b>	<b>38,300</b>	<b>35,600</b>	<b>33,800</b>	<b>37,300</b>	<b>34,300</b>	<b>32,600</b>	<b>39,900</b>
<b>Architect II</b>	<b>35,600</b>	<b>36,100</b>	<b>32,300</b>	<b>29,300</b>	<b>30,500</b>	<b>33,500</b>	<b>31,600</b>	<b>32,100</b>	<b>36,300</b>
<b>Architect I</b>	<b>31,400</b>	<b>33,000</b>	<b>28,800</b>	<b>27,900</b>	<b>26,900</b>	<b>28,800</b>	<b>27,000</b>	<b>29,100</b>	<b>31,300</b>
<b>Intern</b>	<b>26,000</b>	<b>26,200</b>	<b>23,800</b>	<b>23,000</b>	<b>21,900</b>	<b>22,800</b>	<b>22,300</b>	<b>23,400</b>	<b>25,000</b>

Source: 1991 AIA Salary Report for Architectural Design Firms



# Major flaws

Even the best plans can fail if your phone system's capabilities are in question. So the companies of Bell Atlantic have developed some customized phone solutions to help keep your firm's valuable time and money from slipping through the cracks.

## found in

By providing 'call accounting' capabilities, Bell Atlantic was able to help Hankins and Anderson Inc. track the length of their client calls. This permitted billable hours to be accurately evaluated and invoiced. And for Bernardon & Associates, Bell Atlantic

## architectural

added 'voice paging,' allowing the staff to get their calls quickly and easily. To get the phone system that's right for you, call your representative at Bell of Pennsylvania, Diamond State Telephone, New Jersey Bell or The C&P Telephone companies.

## firm.

Let Bell Atlantic help your company build a better foundation. 1-800-843-2255.

# Insulated Panel Construction

Modular units offer resource- and energy-efficient alternatives to wood framing.



**Structural foam-core panels, comprised of rigid insulation between layers of wood sheathing (top), offer quick assembly without a structural frame (second from top). Once enclosed (second from bottom), an exterior finish can be added to resemble a wood frame house (bottom). The panels are also available with pre-assembled interior drywall finish and exterior finish (far right).**

OVER THE PAST 30 YEARS, ONE OF THE MOST significant advances in building technology has been the development of foam-core panels—insulation sandwiched between inner and outer wall surfaces. The first stress-skin panels, manufactured in the 1950s, originated with the design of refrigerated buildings and were covered in metal. In the early 1970s, the American Plywood Association began investigating the idea of substituting plywood for metal cladding around rigid foam insulation, and suggested that in ten years time wood studs might be obsolete.

This application was initially adapted to timber-frame houses in the 1970s by companies such as Atlas Industries of Ayer, Massachusetts, and Winter Panel Corporation of Brattleboro, Vermont. These companies manufactured insulated panels with drywall on the inside and waferboard sheathing on the outside to close in wood-framed buildings in a quick, one-step process. The manufactured panels provide a finished interior, an excellent insulation system, and exterior sheathing ready for siding. And because the entire panel is installed outside the timber frame, the attractive wood frame remains exposed on the interior. Today, an estimated 80 percent of timber-framed buildings are clad in foam-core panels.

This application was taken a step further in the 1980s with the development of structural foam-core panels that could be joined together into walls and roof without a frame. A number of foam-core panel manufacturers began packaging panelized, pre-cut homes from structural foam-core panels to produce energy-efficient structures that could be erected very quickly. These buildings range from simple modular houses to large, custom-designed houses and light commercial buildings. Some of the larger, foam-core panel manufacturers are equipped with sophisticated CADD systems to speed building design and panel layout for pre-cutting. When possible, building designs are optimized to conform with standard panel dimensions, generally produced in 4-foot widths and even-foot-length increments.

## Panel performance

STRUCTURAL STRESS-SKIN PANELS ARE COMPRISED OF two layers of waferboard, oriented-strand board (OSB), or plywood, surrounding a core of rigid foam insulation. In some products, an additional facing of tongue-and-groove wood or drywall is applied to the inner waferboard skin to provide a finished wall or ceiling surface. Structurally, these skins act like the chords or flanges of an I-beam, while the lower-strength foam functions as the web. The combined system provides a very strong and rigid assembly—considerably stronger than a conventional 2-by-4 wall system. A 4½-inch-thick, urethane-core panel used in a roof application has a horizontal span limit of about 8 feet. Equivalent panels with EPS foam have somewhat lower span limits which can be offset

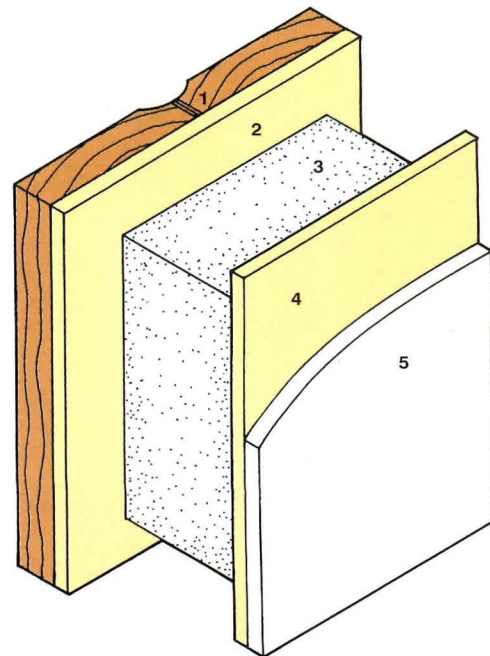

INSULATED PANEL

- 1 EXTERIOR FINISH
- 2 EXTERIOR SHEATHING
- 3 FOAM CORE
- 4 INTERIOR SHEATHING
- 5 DRYWALL

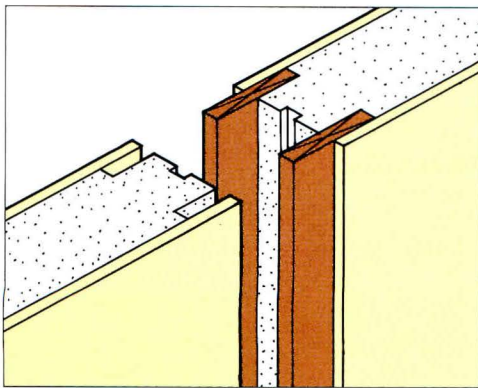

DUAL-SPLINE PANEL CONNECTION

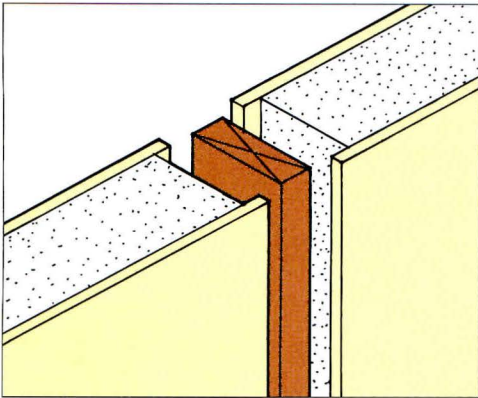

STUD-PANEL CONNECTION

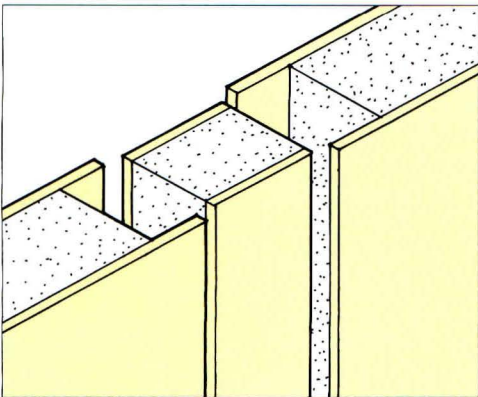

FOAM-CORE INFILL-PANEL CONNECTION

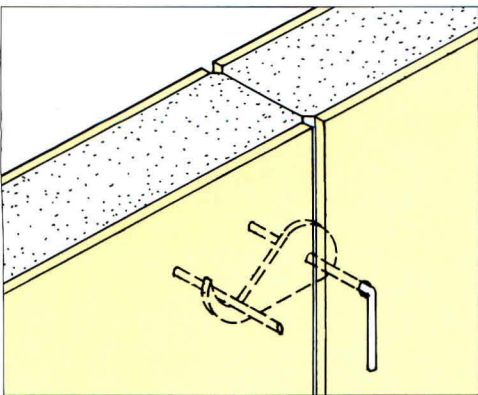

CAM-ACTION LOCKING-ARM PANEL CONNECTION

by increasing the foam thickness.

Because the nominal insulation value of panels ranges from R-14 to over R-26 for the foam (plus about R-2 for other components and air films), buildings constructed of structural foam-core panels are generally energy-efficient. And since the panels feature far fewer interruptions in the insulation, their actual average R-value is almost as high as the listed value for the panels; whereas in conventional wood framing, the studs or ceiling joists significantly reduce the average insulation values because of higher thermal conductivity through the wood members. Even more importantly, because a properly erected structural foam-core-panel wall system is significantly more airtight than a conventionally framed building, heat loss resulting from infiltration is considerably lower.

Two types of insulation are commonly incorporated into foam-core panels: expanded polystyrene (EPS) and urethane (or polyisocyanurate). EPS is used by many more manufacturers than urethane, but many of these manufacturers are small companies with relatively low output. EPS panels have the advantage of lower cost compared with urethane panels, but because the R-value is lower, EPS panels must be made thicker to provide an R-value equal to the urethane panels. Even thicker EPS panels, however, are usually less expensive on a dollar-per-R-value basis. And while EPS panels have the same Class I fire rating as urethane panels, some argue they are not as safe because the melting EPS contributes fuel for the flames.

Urethane panels are generally stronger than EPS panels; they have a higher R-value (about R-6 per inch); and because they do not melt, they will contribute less to flamespread. However, urethane may release more toxic combustion products during a fire than EPS, since urethane insulation is made with chlorofluorocarbons (CFCs), which deplete the

**Foam-core panels offer a wide range of rigid insulation and sheathing options. The greatest difference between available panel types is the way in which they are assembled to each other. The most common technique for joining panels is a dual-spline connection (top left). A channel in the insulation provides room for an expandable sealant. Other manufactured options include an inset stud (left, second from top) or foam-core panel section (left, second from bottom). A fourth alternative requires locking an integral cam arm over a pin with a wrench inserted in a pre-drilled hole (left).**

Earth's protective ozone layer. One of the largest urethane structural foam-core panel manufacturers, Winter Panel Corporation, has reduced its use of CFC-11 by approximately 40 percent and expects to convert to a less destructive hydro-chlorofluorocarbon foaming agent within two years. Hydro-chlorofluorocarbons, while far safer than chlorofluorocarbons, still deplete ozone to some extent and are slated for elimination by the year 2030 under international agreement (ARCHITECTURE, February 1991, page 77).

#### Foam-core panel construction

STRUCTURAL FOAM-CORE PANELS ARE ASSEMBLED in a very different way from conventional 2-by-4 or 2-by-6 construction. The panels provide a complete, preassembled, all-in-one wall system, and as a result, their installation is quite rapid. Using a crane to lift panels into place, a crew can erect an entire house frame in just a few days.

One of the biggest differences among manufacturers is the way in which panels are joined—obviously an important structural consideration in a panel wall or roof system without framing. The most common system for joining panels is to apply dual plywood splines that fit into pre-routed grooves in the panel edge next to both the inner and outer waferboard skins. This system is used by Winter Panel Corporation, AFM Corporation and their 35 associated manufacturers that produce the R-Control EPS panels, and several additional manufacturers that produce Insulspan panels.

Atlas Industries and Thermpan Industries rout out more foam from the panel edges and join panels with a 3-inch strip of thinner panel. Cheney Building Systems employs a patented cam-action locking arm and integral hardware to join panels, and a number of manufacturers inset full studs (2-by-4s, 2-by-6s, or 2-by-8s),  $\frac{3}{4}$  of an inch into each panel, to provide a secure joint. While the latter system was at one time the most common, most manufacturers have resorted to alternative methods to reduce heat loss through studs and minimize air leakage around the studs.

With the dual-spline system connection and inset-panel joint, manufacturers recommend installing a bead of expanding foam sealant into the joint before sliding the panels together to provide a tight seal. Some manufacturers provide a pre-routed groove for the sealant, which is applied just before the panels are joined together and expands to fill the channel formed by the routed grooves.



Another important foam-core panel detail that varies among manufacturers is the joint between the panels and floor systems. Some manufacturers employ a platform-frame system in which upper-floor decks are supported on the top of a wall of panels; others suspend upper-floor joists on joist hangers hung over the top of the wall panels, thus keeping the joists entirely within the insulated building envelope. Details for joining wall panels to roof panels and joining roof panels at the roof peak also vary considerably. Purlin and ridge beams are often required to support the roof panels.

Electrical wiring details also differ among panel manufacturers. Some supply panels that are pre-routed with vertical wiring chases every 16 or 24 inches or customized channels to meet an architect's design. Other panel systems require pushing wires through foam by hand without special chases, or running surface-mounted wiring in wire mold. No matter which approach is used, it is important with foam-core panels to plan out fixture and receptacle location and wiring carefully during design.

Most structural foam-core panels are finished in oriented-strand board. With these products, an inner layer of drywall or another fire-rated wall surface must be added to meet fire code requirements. Some panels are available with drywall bonded to the inner oriented-strand board skin, eliminating a step in the finishing process. By adding the drywall after the shell is completed and running the drywall sheets horizontally, cracking at panel joints can be minimized. As a result, some manufacturers recommend against installing panels that include the inner drywall skin.

Because each manufacturer has its own quite specific and unique installation procedures—including fastener sizes and spacing—it is very important that installation guidelines be followed closely so that the panels perform as designed. In drawing up specifications for structural foam-core paneled buildings, architects should work closely with the manufacturer's representatives and their respective technical literature.

#### Future of foam-core panels

A CHIEF ADVANTAGE OF STRUCTURAL FOAM-core panel construction is speed of construction. A skilled crew with a crane can erect an entire house frame in just a few days, while framing the same building out of lumber might take three times as long. As a result, foam-panel construction would at first

## Wall Construction

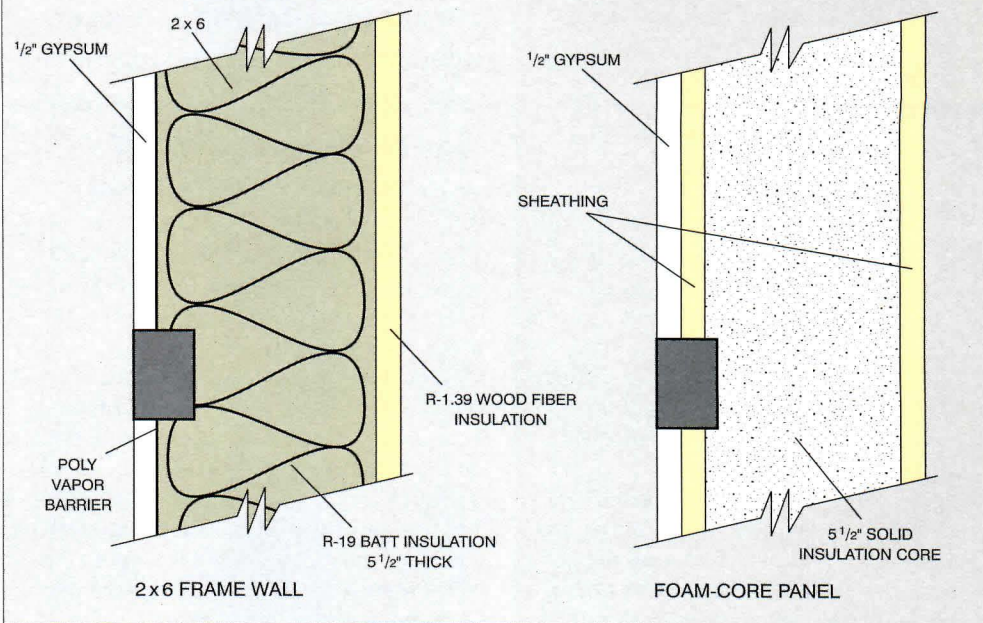

## Insulative Properties

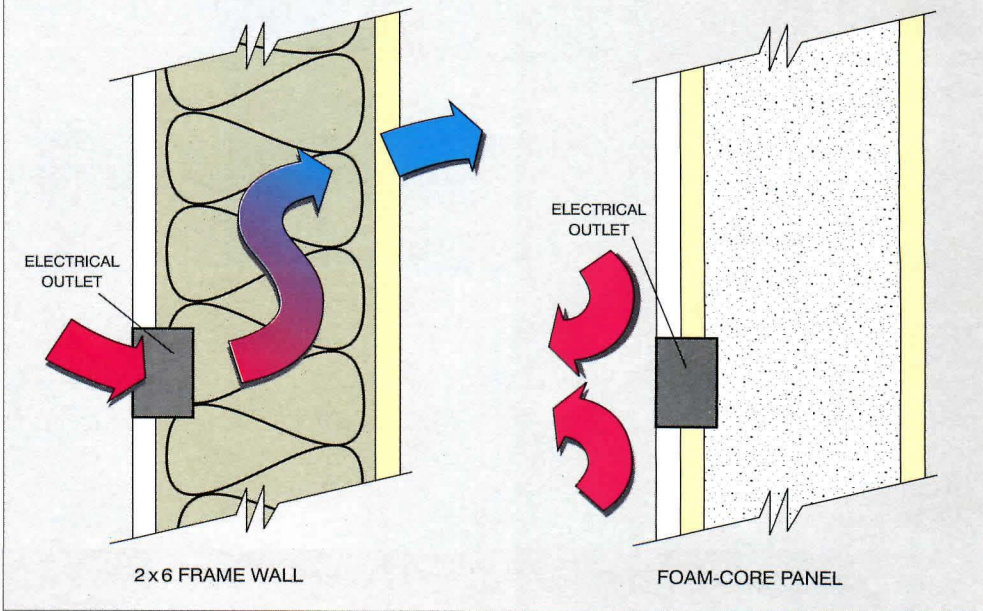

COURTESY OF DUPONT

Comparison shows how solid insulation of a foam-core panel, built to the same dimensions and finish as a frame wall (top), provides a superior thermal barrier by preventing heat from escaping through studs and openings such as electrical outlets (above). In a thermographic image of a conventionally framed house (left), dark blue areas indicate thermal efficiency; light blue reveals heat lost through the roof and walls.

appear to cost less; that is not usually the case. Although labor costs of framing can be significantly reduced, the materials are more expensive, balancing out the labor savings.

AFM Corporation's structural foam-core panels are recognized by Building Officials and Code Administrators International (BOCA), International Conference of Building Code Officials (ICBO), and Southern Building Code Congress International (SBCCI), but many other foam-core panels are not currently recognized by all these building code organizations. The lack of acceptance by some local building code officials continues to be a stumbling block to expanded use. Before designing with structural foam-core panels, architects should check with a building official and find out which, if any, listings are

**In addition to providing superior insulation, the simple, one-step process of joining and sealing structural foam-core panels to one another (bottom left), is equivalent to the more complex and labor-intensive steps of cutting and assembling wall studs and roof joists, installing insulation, and attaching sheathing and drywall (bottom right).**

## As high-quality lumber and a skilled labor force of carpenters becomes more scarce, stress-skin panels will increase as an appealing alternative to conventional wood-frame construction.

required, and then determine from the manufacturer if their panels have completed the necessary testing.

One drawback to foam-core panels, especially in rural areas, is the affinity carpenters have for them. Like rotted wood, both urethane and EPS foam provide an ideal nesting substrate for ants—it's easy to dig out and well-insulated. Some manufacturers have added a borate material to the foam to discourage ants, which seems to be effective.

A much greater impediment to more widespread use of panels continues to be architects' and builders' unfamiliarity with their design and structural potential. Few ar-

chitects want to be first to try this new technology: they would rather let others make the mistakes that inevitably occur when moving up the learning curve. The adoption of this new technology—as with any new idea—will just take time. But certain trends seem to be encouraging the growth of foam-core panel construction applications.

As high-quality lumber and a skilled labor force of carpenters becomes more scarce, stress-skin panels will increase as an appealing alternative to conventional wood-frame construction. So far, the big companies—DOW Chemical, Weyerhaeuser, Louisiana Pacific—have kept on the sidelines of panel production, letting smaller, start-up companies take the risks. With the relatively weak economy, companies like Weyerhaeuser are pulling in the reins and concentrating on the conventional products they know will sell. If economic conditions change, however, these companies could jump into panel manufacturing, both increasing the scale of production and reducing costs. If and when that happens, the shift away from conventional framing is likely to accelerate rapidly. ■

—ALEX WILSON

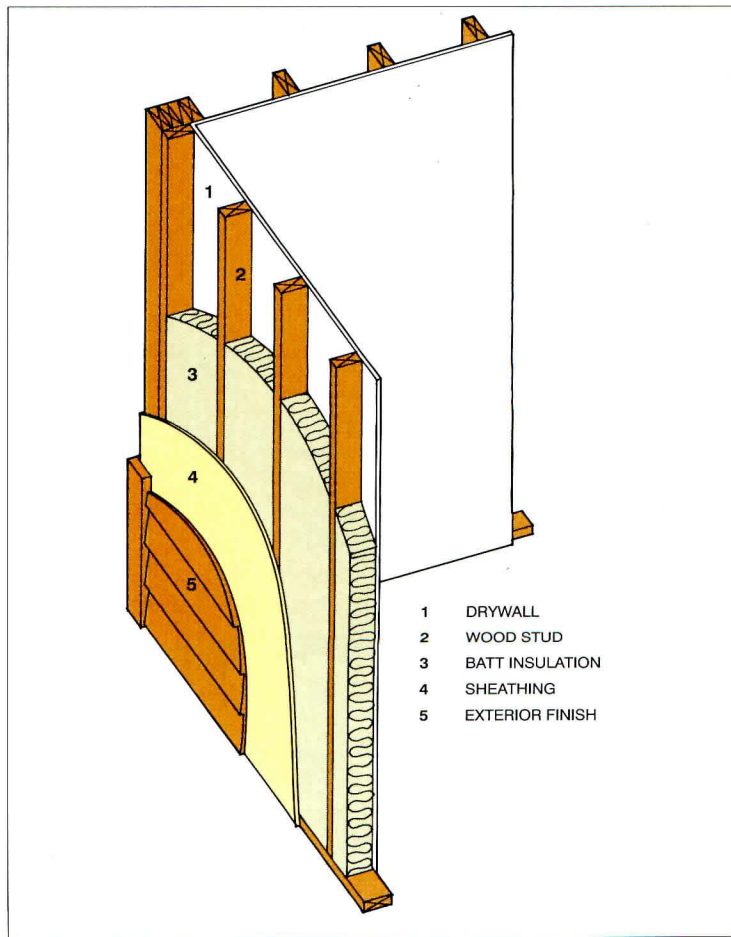
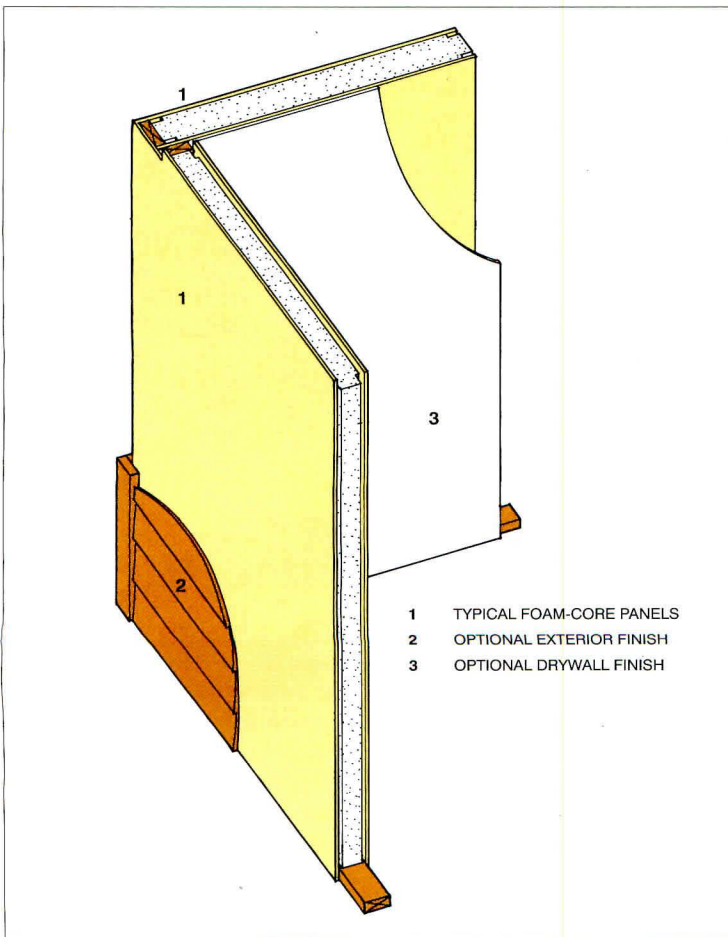

# Project Management Software

Computerized office procedures help architects balance schedules and finances.

DETERMINING PROJECT SCHEDULES, BUDGETS, and personnel allocation are the biggest headaches any business faces. In architectural firms, where miscommunication and delay can cause expensive mistakes, the advantages of project management software are invaluable. Automated project management was first developed by the federal government in the 1950s, when the progress of military contract work began to be tracked by mainframe computers. Only in the last few years has such software been commercially available for small computers. As it has gained popularity in architectural and engineering firms, the umbrella term "project management" has come to mean not only scheduling but also monitoring costs and keeping track of the multitude of tasks and documents needed to run an office effectively. These automated procedures free architects from the more mundane yet complex aspects of running an architectural practice.

## Scheduling procedures

PROJECT MANAGEMENT IS STILL MOST COMMONLY thought of as a collection of scheduling procedures that facilitates the breakdown of long-term projects into well-defined tasks. These tasks are shorter-term activities with associated attributes such as cost, duration, and personnel resources.

One of the most important forms of output from scheduling software is the Program Evaluation and Review Technique (PERT) chart, which graphically displays task dependencies of a project—illustrating which items of work must be completed before others can begin. A manager enters information about a project, including how long each task will take, who will do it, with what equipment, at what cost, and in what order. Then, given a project's start date or desired completion date, the computer calculates a schedule. The chart displays the whole network of responsibilities, so all team members can see how their jobs fit into the overall project. The resulting schedule is useful not only for internal project management, but also for clients who require a careful accounting of the process and its deadlines.

PERT charts are commonly required now for architectural proposals on government building contracts. These charts highlight tasks on a so-called "critical path." This unique sequence of steps through the project requires the most time to develop. Any delays along this path, which the computer calculates from job duration and dependencies among project tasks, can create delays in a project's final completion. Project managers can closely monitor activities on the critical path to identify scheduling problems before

they become serious.

Other common scheduling displays are the Gantt chart, which shows the progression of a project over time, but not task dependencies, and the resource histogram, a bar chart that shows the allocation of resources (people and equipment). These histograms facilitate "resource leveling," or the reassignment of workers when individuals are under- or over-allocated. Most project management software also allows managers to assign cost and income amounts to activities, providing an ongoing assessment of project expenses and warning of potential cost overruns.

Commercial software packages that perform some or all of these functions include Accent Vue, AlderGraf Scheduling System, MacProject II, MacSchedule Plus, Open Plan, Primavera Project Planner, Microsoft Project for Windows, Microsoft Project for Macintosh, Project Workbench, Syzygy, and ViewPoint (see page 106 for sources).

**The Primavera Project Planner provides up to five levels of detail for project activities, allowing a global project overview or an inspection of specific tasks (bottom left). The resource-comparative profile shows which personnel resources are overloaded and which are underused (below), enabling managers to reallocate assignments.**

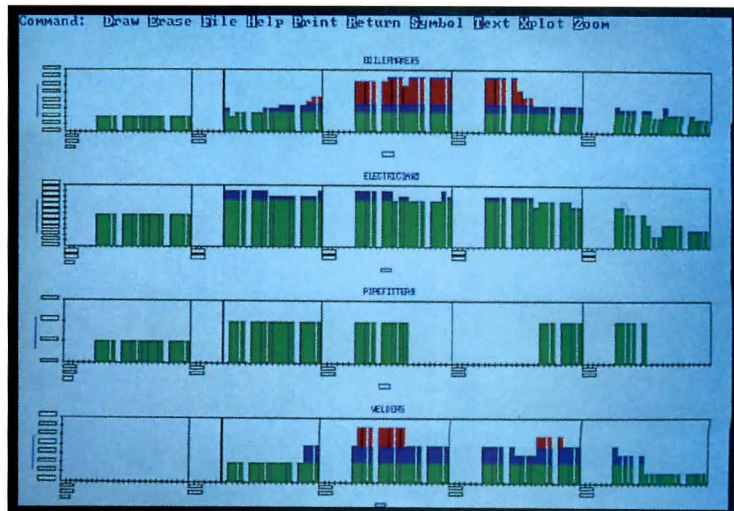
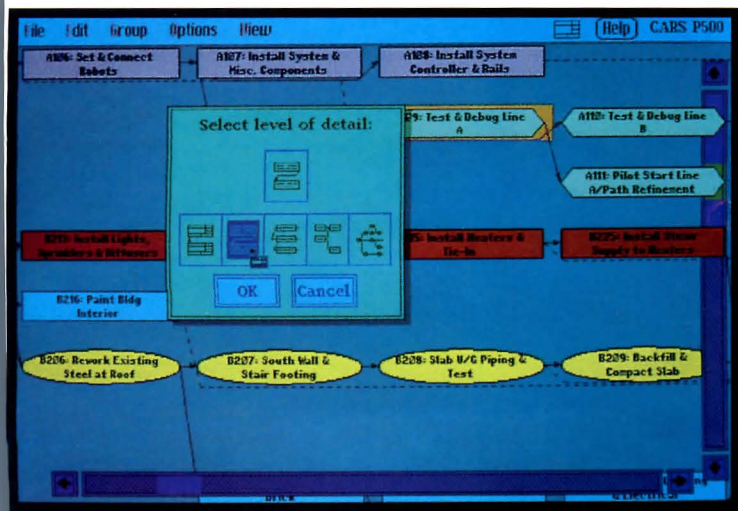

Applying these tools requires more than simply knowing how to plug numbers into a computer. Basic management skills and practices are also needed to set goals and define specific time and cost objectives and to apply previous experience to estimates of task durations and costs. Also necessary are skills in contingency planning, diligent consulting with the project team, and continuous updating of the project plan for comparison with the original goals and schedules.

The benefits derived from the appropriate application of these programs can be well worth the effort it takes to submit to their discipline. Gary Szydelko, the supervising architect for the City of Sacramento, California, has benefited in several ways since his staff began using a customized combination of software, including MacProject, to set up design and construction schedules. Szydelko's office now supervises five times more construction dollar volume per person than before automation. "After we set up a schedule," he explains, "we monitor it constantly to see where we are, and to help our clients in other city departments understand how the construction process works, why it takes so long, and when they can realistically expect to have their facility available."

Another important benefit, according to Jim Martin, a senior associate of Hellmuth, Obata & Kassabaum (HOK) in St. Louis, is

**Common formats for project management software output, shown in MacProject II by Claris, are PERT charts revealing critical path of activities (below, top half), Gantt charts displaying project time lines (below, lower half), and displays of associated project costs (bottom right); together, these charts help a manager stay on schedule and on budget.**

the improved credibility with clients as a result of efficient management. "When we interview for a job, we provide a project schedule that extends from signing the contract through ribbon cutting," Martin explains. "The clients appreciate this because it helps them plan and organize their resources." With Primavera Project Planner, HOK develops detailed schedules, sometimes going so far as to determine when specific sheets are to be drawn and by whom. Martin contends the biggest advantage of the software is the ability to present information at varying levels of detail for varying audiences. The software is similar to an outline that can contain a large hierarchy of detailed subheadings yet be abbreviated to a few major headings. "For example," he says, "now I'm developing a schedule that contains many places where the client must make decisions. I can look at the schedule in detail to see if I have enough draftspeople, or I can present a chart to the client with only the required decision points."

According to Martin, design firms traditionally have not undertaken such thorough planning. "But," he claims, "once upper management sees how it can assist them in presentations to clients and construction managers, it will be applied much more."

An important advantage in automating project management for firms with offices nationwide is the ability to share resources and coordinate dispersed staff. Robert Danowski is a systems analyst at Malcolm Pirnie, an environmental engineering firm headquartered in White Plains, New York. His firm chose Open Plan because of its flexibility and ability to coordinate multiple projects. "Working with a coast-to-coast staff is already complicated," he explains, "but we're also diversifying the kinds of work we do, so we

need a system that will help us coordinate the efforts of all these different people."

### Financial project management

THE SECOND MAJOR CATEGORY OF PROJECT management software focuses on finances. Like conventional accounting methods, these programs have integrated functions for general ledger, payroll, accounts payable, and accounts receivable. But they extend further to features designed specifically for architectural and engineering firms. For example, with information from time sheets, the software generates job-costing reports that provide continually updated information about the budget spent by a design team compared to the amount allocated for a given phase of work. This allows a firm to monitor project progress and be forewarned of cost overruns.

Developers of such financial project management software realize that most firms, before they automate, develop their own manual accounting methods. Therefore, they make the software adaptable to a firm's established practices. Most of these programs have flexible database retrieval and reporting capabilities, so budgeting information can be produced in a variety of formats, at any level of detail, and for a variety of audiences. Some software also generates information for financial statements, tax forms, or other special purposes. Commercial software in this category includes the AEasy series, Aegis, AEMAS Plus, Clerk of the Works, Micro/CFMS, Sema4, and Wind-2 systems.

Long before this financial software was commercially available for small computers, mainframe project management software was being developed by and for Skidmore, Owings & Merrill. Their software has continuously evolved for 25 years, according to

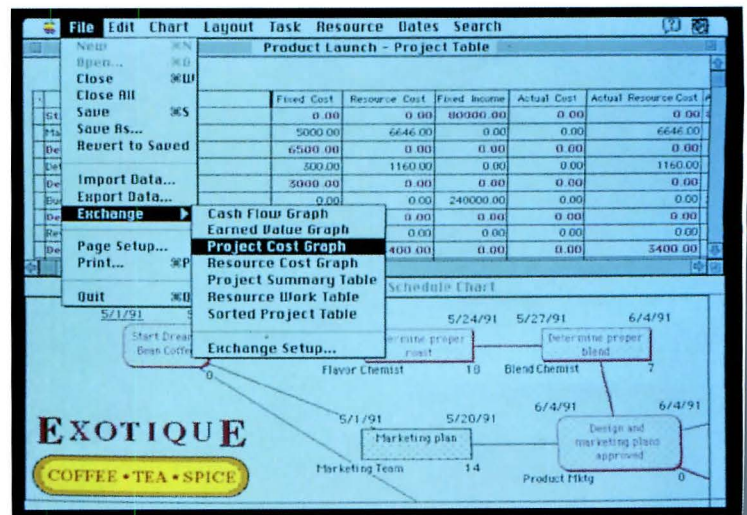
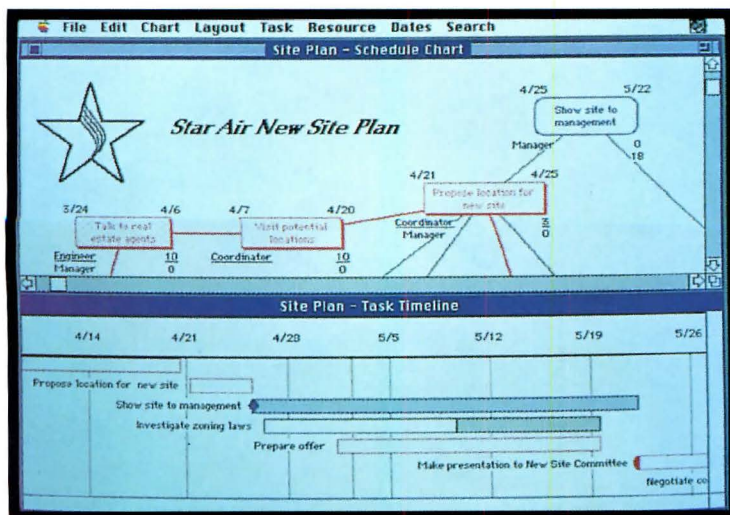

Michael Keselica, an associate partner in SOM's New York office. The software gives project managers accurate data on the current level of staff effort and cost relative to established budgets. "If something seems awry," Keselica explains, "the project manager can contact staff members and discuss any problems so adjustments can be made to accomplish work tasks and financial objectives. This allows the project manager to control resources as the work proceeds, leading to greater efficiency. It gives us a better database for future proposals, and it puts us in the best possible competitive position."

These benefits are also cited by Janet Perkins, chief financial officer of the Atlanta architecture firm Richard Rothman & Associates, who uses AEasy to manage the firm's finances. She collects information from time sheets and consultant invoices and gives project architects weekly project summaries, outlining how much of their budget is spent, who spent it, and how much they have left. "They know how much work still needs to be done," she points out, "so they can compare that with the budget they have left. Without this feedback, most architects underestimate the amount of time they've put into something." This weekly feedback also gives architects instant status reports in preparation for client meetings.

One of the strongest aspects of her financial project management software, Perkins believes, is its flexibility in extracting information from the database. As an example, she cites summarizing a firm's financial history for professional liability applications. "Those things are ghastly to prepare," she says, "and they're getting more complicated every year. When I collected that information by hand, it was a two-week nightmare. With a com-

puter and the right software, you can request information in almost any configuration, and get it immediately."

Perkins explains how software designed for an A/E firm differs from conventional financial packages. "Architects and engineers need to know how much of an individual's time was spent on project-related work. Unless you can split out your costs by direct and indirect, you won't know the overhead factors, which are critical in setting fees." She concludes with advice for firms just beginning project management. "Many times people start slowly, automating only one thing," she says. "Then they discover how wonderful it is, and they want to automate more. Therefore, it's important to anticipate this and get modular software so you can keep fitting pieces together as you grow into it."

### Tailored applications

SOME PROJECT MANAGEMENT SOFTWARE, designed specifically for architectural and engineering firms, defies categorization. These programs may include scheduling or financial analysis, but each is unique in its approach and individual features.

For example, the AEC Information Manager, though it can produce Gantt charts that combine multiple projects within an office, is more of a database manager than a full-featured scheduler. It specializes in tracking time- and status-dependent information such as submittals, approvals, and staff promotions. Sporting a mini word-processor, a flexible and graphic report generator, and an alarm system, it tames the paperwork of a design practice.

The Architect's Office is a collection of documents and checklists of design activities, from preliminary feasibility studies to con-

struction documents submission. Its network of information, analogous to the paper typically scattered over an architect's desk, includes phone memos, field reports, project manuals, and transmittal forms.

A program specifically designed for tracking submittals, change orders, and other construction paperwork is Expedition, from Primavera. Originally designed for contractors, it is a helpful construction management tool for architects, especially those already using Primavera Project Planner for scheduling.

Sagacity is new software that applies a rule-based "expert system" to help managers allocate assignments, matching resources to tasks. Well-suited for multidisciplinary firms, Sagacity considers many variables, including skill level, project priorities, due dates, existing assignments, costs, and downtime.

Resources and Projects Manager, unlike many programs that provide great detail for one project at a time, is a simple scheduler that presents an overview of an architectural staff working on multiple projects. This helps a manager reassign personnel when problems threaten to delay a project.

Star-Watch integrates many A/E management tasks, including scheduling, risk analysis, take-offs for cost estimating, and maintaining drawing lists. A new version is specifically designed for computer networks, allowing a user to perform "what-if" analyses

**AEasy, from Timberline Software (bottom left), displays a "budget remaining report" for several projects in progress. A similar display can show earnings, billings, costs, or hours. The Resources and Projects Manager from South Pointe Software (below) displays a Gantt chart with a resource histogram indicating a form's staff allocations.**

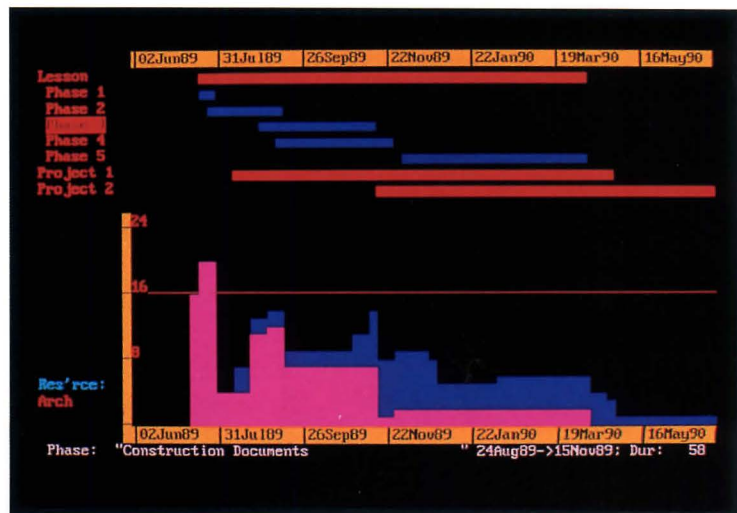
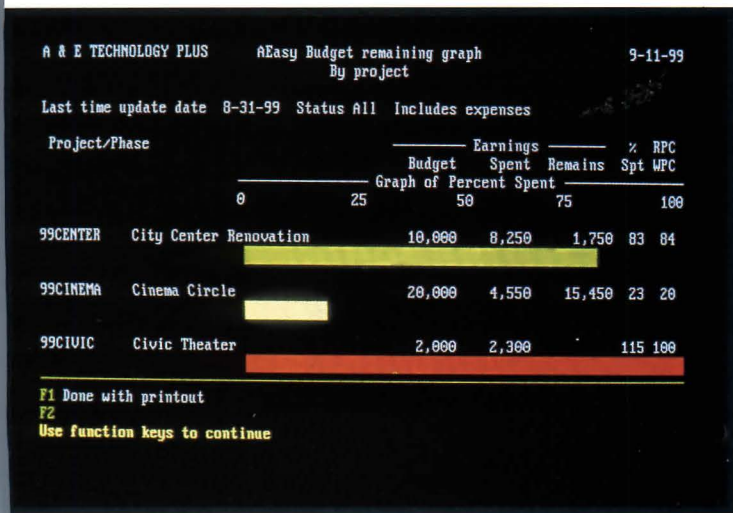

without affecting the shared database.

The Knowledge Worker System is a prototype developed by researchers at Georgia Institute of Technology working with the U.S. Army's Construction Engineering Research Laboratory (CERL). According to the project's manager, Beverly Thomas, this system captures an institution's or a firm's knowledge base and distributes it on a network to a wide, possibly dispersed, community of office workers. Thus, when individuals depart from a firm, they do not leave an information vacuum in their wake. A master calendar alerts workers to deadlines for a report or submittal, for example, and provides the responsible individual with supporting material such as databases, previous reports, and programs that calculate related statistics.

#### **Benefits of automation**

PEGGY J. DAY, A PROJECT MANAGEMENT CONSULTANT in Portland, Oregon, and author of *Getting Organized with MacProject II*, helps architects and other professionals break into project management on both Macintosh and DOS platforms. She maintains many architects get interested when they learn that PERT charts are required for government proposals. Others are motivated by private clients who require automated planning in the event the project ends in litigation: the paper trail provided by project management software could prove in court whether or not a piece of work was planned, budgeted, or completed on time.

Once lured into project management by client requirements, an architectural firm can become hooked and reap many benefits. For example, a firm can anticipate and smooth uneven workloads and decide whether to hire temporary staff. Better job estimates can improve both a firm's profitability and its credibility among clients. "Staff members are going to feel like they're in control of the project," Day points out, "and not like the project is pushing them around. Project management software gives you the information needed to make decisions." Until automated project management becomes commonplace, architectural firms already benefiting from its increased efficiency may well enjoy a significant competitive advantage.

For more information on project management, contact the Project Management Institute, (215) 622-1796, or the American Association of Cost Engineers, (304) 296-8444. These nonprofit organizations offer publications, seminars, and certification programs. ■

—B.J. NOVITSKI

## **Project Management Software Suppliers**

#### **Accent Vue (minis and mainframes)**

National Information Systems, Inc.  
4040 Moorpark Avenue, Suite 200  
San Jose, California 95117-1852

#### **AEasy, AEasy Plus (DOS)**

Timberline Software Corporation  
P.O. Box 728  
Beaverton, Oregon 97075-0728

#### **AEC Information Manager (Mac)**

**FastTrack Schedule (Mac)**  
AEC Software  
22611 Markey Court, Bldg. 113  
Sterling, Virginia 22170

#### **Aegis (UNIX)**

Sota Software Inc.  
15310 Amberly Drive, Suite 115  
Tampa, Florida 33647

#### **AEMAS Plus (DOS)**

Data-Basics, Inc.  
11000 Cedar Road  
Cleveland, Ohio 44106

#### **AlderGraf Scheduling System (DOS)**

AlderGraf Systems, Inc.  
10810 Old Katy Road, Suite 102  
Houston, Texas 77043-5013

#### **Architect's Office (Mac)**

Collaborative Design Group  
345 E. Toole Avenue, Suite 202  
Tucson, Arizona 85701

#### **Clerk of the Works (Mac)**

Samsara  
Box 222  
Spring House, Pennsylvania 19477

#### **MacProject II (Mac)**

Claris Corporation  
5201 Patrick Henry Drive, Box 58168  
Santa Clara, California 95052-8168

#### **MacSchedule Plus (Mac)**

Mainstay  
5311-B Derry Avenue  
Agoura Hills, California 91301

#### **Micro/CFMS (DOS)**

Harper and Shuman, Inc.  
68 Moulton Street  
Cambridge, Massachusetts 02138

#### **Microsoft Project (DOS, Mac)**

Microsoft Corporation  
Redmond, Washington 98052

#### **Open Plan (DOS, Mac, UNIX, VAX)**

Welcom Software Technology  
15995 North Barkers Landing, Suite 275  
Houston, Texas 77079

#### **Primavera Project Planner (DOS) Expedition (DOS)**

Primavera Systems, Inc.  
Two Bala Plaza  
Bala Cynwyd, Pennsylvania 19004

#### **Project Workbench (DOS)**

Applied Business Technology Corporation  
361 Broadway  
New York, New York 10013

#### **Resources and Projects Manager (DOS)**

South Pointe Software  
810 Peace Portal Way, Suite 175  
Blaine, Washington 98230

#### **Sagacity (DOS)**

Erudite Corporation  
533 Airport Boulevard, Suite 400  
Burlingame, California 94010

#### **Sema4 (DOS, Mac)**

Semaphore, Inc.  
3 East 28th Street, 11th Floor  
New York, New York 10016

#### **Star-Watch (DOS)**

Pathfinder, Inc.  
11 Allison Drive, Box 5027  
Cherry Hill, New Jersey 08034

#### **Syzygy (DOS, Mac)**

Syzygy Development, Inc.  
5555 Triangle Parkway, Suite 320  
Norcross, Georgia 30092

#### **Total Trak (DOS)**

Wind-2 Financial Management System  
Wind-2 Research, Inc.  
1901 Sharp Point Drive, Suite A  
Fort Collins, Colorado 80525

#### **ViewPoint (DOS)**

Computer Aided Management  
1318 Redwood Way, Suite 110  
Petaluma, California 94954

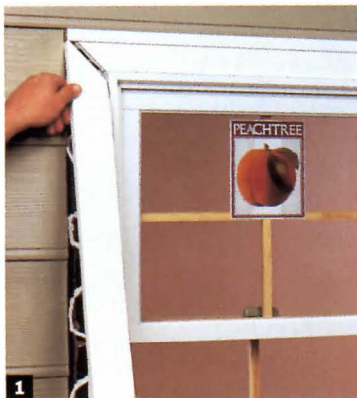

## Framing Options

Window finishes promote thermal efficiency.

WHILE WOOD REMAINS A POPULAR WINDOW FRAMING MATERIAL FOR its flexibility and esthetic qualities, vinyl- and aluminum-framed windows have become increasingly popular for commercial and residential renovation projects due to their low cost and low maintenance requirements. First manufactured in Europe and introduced to the U.S. in the 1970s, vinyl-covered windows are specified for their thermal efficiency and resistance to swelling and shrinkage. Unless supported by steel or wood, however, some synthetic frames can lose rigidity when exposed to intense sunlight. Like vinyl, aluminum does not expand or contract, rust, crack, or chip at low temperatures, making it a logical exterior cladding material for wood windows. Manufacturers produce enamel-coated, extruded aluminum fittings to match interior muntins and protect wood underneath the metal from harsh weather elements. Compared to vinyl and wood, aluminum demonstrates the greatest strength as a window framing material; aluminum members resist distortion caused by structural movement, thereby minimizing air and water leakage. In order to match the insulative properties of vinyl or wood, aluminum windows require a thermal barrier—a core of insulating material, often vinyl or polyurethane, placed between the inner and outer extruded frame.

—KAREN SALMON



1. Peachtree introduces a retrofit kit that provides composite casing components for its aluminum-frame Ariel windows. Circle 401 on information card.
2. Finished in metal or wood, Loewen Windows' traditional double-hung window can be specified in double- or triple-

- glazed units. Circle 402 on information card.
3. Pella's Architect series is available in four styles with the option of aluminum cladding. Circle 403 on information card.
4. Hurd Millwork Company manufacturers InSol-8, an insulating window that is purported to block more than 99 percent of the sun's ultraviolet rays. Circle 404 on information card.
5. Andersen's Flexiframe wood and fiberglass windows can be customized according to color, size, and dimension. Circle 405 on information card.
6. Season-All offers the vinyl Performer sliding patio door for new or renovation projects. Circle 406 on information card.
7. Caradco's Spandrel windows are available in a variety of geometric shapes. Circle 407 on information card.



# Meet Mark Kalin.

Mark Kalin earns his living by knowing specifications systems. As a leading expert on specifications systems, he works with architects, engineers, designers and a host of other professionals to manage their specifications systems for virtually every type of architectural and engineering project. Mark has seen a wide variety of specifications systems, from the "home-grown" versions to sophisticated electronic systems; he knows what's available, what's needed and what works. As a member of the MASTERSPEC Review Committee, Mark works to ensure the profession's current and *future* needs are reflected in the MASTERSPEC Specifications System and that it's the most comprehensive and reliable master specifications reference service available. Using MASTERSPEC makes sense to Mark, and it can make your specifications writing job easier, more cost-effective and a lot less risky.



—Mark J. Kalin, AIA CCS  
Member, MASTERSPEC Review Committee

***“Trying to write specifications without MASTERSPEC® is like a pilot not using a checklist before take-off. It's risky at best.”***

The distinct MASTERSPEC Libraries cover architectural, engineering and interiors applications.

Written and reviewed by professionals, the MASTERSPEC Libraries are continually updated and expanded to reflect current practice, and each Library is available in a printed form and on diskettes compatible with PC-based systems. The MASTERSPEC service also includes quarterly updates and newsletters with helpful information about using MASTERSPEC specifications. Plus, you can call our specifications writers toll-free to talk about your specifications problems.

Find out more about the MASTERSPEC Specifications System and discover why so many of your fellow professionals make it their system of choice for specifications writing. Call toll-free, 1-800-424-5080 for full details and ordering information.

*MASTERSPEC—The Expert Specifications System For Professionals Like You.*

*I want to know more about MASTERSPEC—The Expert Specifications System For Professionals.*

Please send me the complete MASTERSPEC information kit on:

- Architecture/Structural/Civil Specifications System
- Mechanical/Electrical Specifications System
- Structural/Civil Specifications System
- Interiors Specifications System

Reason for Inquiry:

- Current Project  Future Project
- Do you write Project Specifications?  Yes  No
- Please have a MASTERSPEC Representative call me.

NAME \_\_\_\_\_ ( ) \_\_\_\_\_ PHONE \_\_\_\_\_  
TITLE \_\_\_\_\_  
ORGANIZATION \_\_\_\_\_  
ADDRESS \_\_\_\_\_  
CITY/STATE/ZIP \_\_\_\_\_

**Member:**

- AIA  NSPE
- IBD  ACEC

**Organization Type:**

- Architecture
- Engineering
- A/E  E/A
- Health
- Government
- Education
- Interior Design
- Finance  Banking
- Insurance
- Other \_\_\_\_\_



A Division of The American  
Institute of Architects

## AIA Master Systems

1735 New York Avenue, N.W.  
Washington, DC 20006  
Telephone: (202) 626-7584  
Toll-Free: (800) 424-5080, x7584



# Resilient Coverings

Vinyl and rubber flooring promote longevity.

NEW FLOORING IS ENGINEERED TO MEET TOUGH DURABILITY AND maintenance standards while catering to architects' esthetic demands. Responding to the current trend toward customized work environments, manufacturers are turning commercial sheet vinyl into an effective design tool with softer colors and varied textures. An alternative to carpet is textured resilient flooring, which is purported to resist soil and bacteria and is therefore well-suited for institutional settings. In specifying floor materials supporting a high volume of circulation or heavy, static objects, architects must address durability. With a life expectancy of ten years, sheet vinyl and rubber surfacing products generally offer greater longevity than carpeting. Like carpet, textured resilient materials diminish glare caused by overhead lighting on reflective surfaces. Popular in schools and industrial applications, rubber products resist staining, decrease noise transmission, and minimize slippage. While rubber and vinyl surfaces are not as effective as carpet in reducing leg fatigue, they create less resistance when carts or objects are pushed across the floor. The third Surfaces '92 trade show, to be held February 14-16 in Las Vegas, will address technological advances and trends in vinyl flooring as well as carpet, ceramic tile, wood flooring, and window and wall coverings. Contact the Western Floor Covering Association at (800) 624-6880 for information. ■

—K.S.

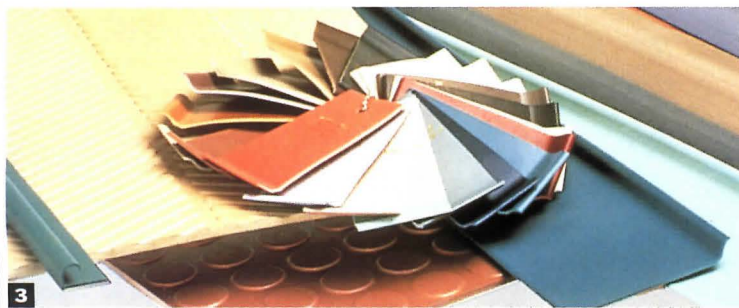
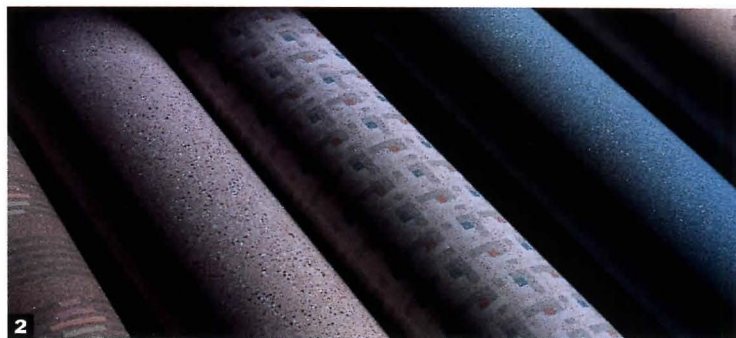

1. Freudenberg Building Systems manufactures Norament Duo, a two-toned rubber flooring with raised circular or square treads to reduce slippage. Circle 414 on information card.
2. Mannington Mills introduces Fields and Forms, two lines of inlaid sheet vinyl for commercial applications. Circle 415 on information card.
3. Johnsonite offers its rubber and vinyl floorcoverings and accessories in 16 colors. Circle

- 416 on information card.
4. Tarkett manufactures Eminent Acoustiflor for high-traffic areas. Circle 417 on information card.
5. Vinyl Plastics adds a granite pattern to its solid vinyl tile flooring. Circle 418 on information card.
6. Available in 17 colors and patterns, J.R. Musson's 2-foot-square rubber tiles incorporate raised circular discs for added tread. Circle 419 on information card.

# Your Holiday Presents Will Get A Stamp Of Approval, And Thanks, With These Practical Gift Ideas...

Coffee mugs with commemorative architectural stamps ... guides to great architecture ... tote bags, the architects and designers diary ... these and other practical, reasonably-priced, and intriguing items make perfect selections for your holiday gift giving. Call toll-free (1-800-242-4140) or use the coupon below.

## Architecture Stamp Coffee Mugs (New)

American Architecture was celebrated by the U.S. Postal Service in the early 1980s with commemorative stamps depicting our most treasured designs. These beautiful, sharp engravings are reproduced in sepia tones on cream colored coffee mugs with descriptions in red lettering.

For the Student of History—

### Jefferson/University of Virginia Rotunda

R109 \$10/\$7.50 (AIA Mbrs.)

For the "Gentleman" Architect—

### Richard Morris Hunt/Biltmore

R107 \$10/\$7.50 (AIA Mbrs.)

For the Museum-Going Architect—

### Renwick/Smithsonian Castle

R105 \$10/\$7.50 (AIA Mbrs.)

For the Frequent-Traveler Architect—

### Eero Saarinen/Dulles

R104 \$10/\$7.50 (AIA Mbrs.)

### Set of Four (one each)—20% Off!

R104-4 \$32/\$24 (AIA Mbrs.)

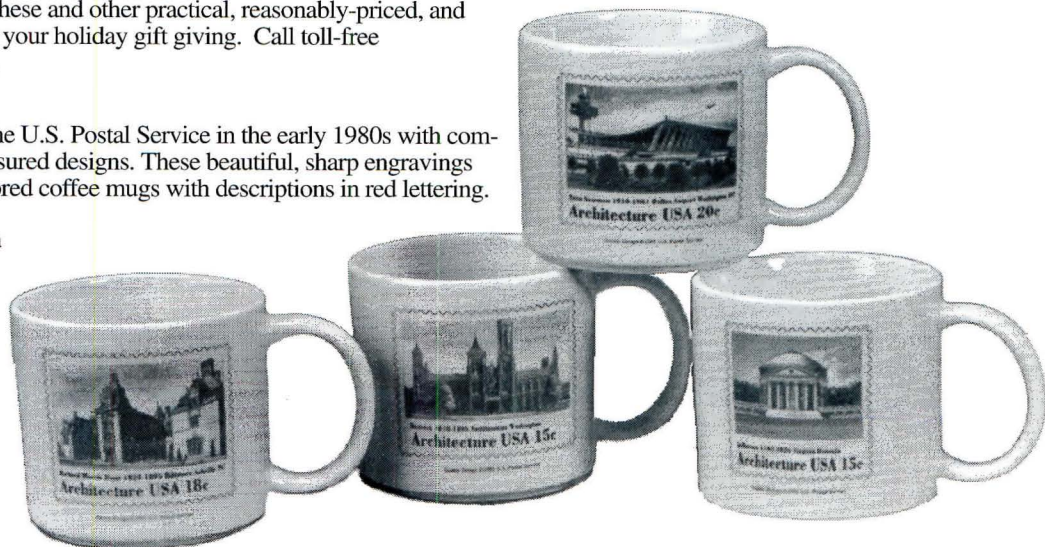

**Modern Architecture in Europe**—A comprehensive practical guide to the most important, innovative, and interesting Western European architecture of the past two centuries. More than 500 buildings are fully listed and another 500 buildings of related interest are included.

Dennis J. De Witt and Elizabeth R. De Witt 355 pp R494 1987  
Formerly \$19.95 **Sale Price \$5.98** Van Nostrand Reinhold

### Richard Morris Hunt Beaux-Arts Drawings Portfolio

**The Octagon Museum/Pomegranate**—Eight selected prints from the heart of the Prints and Drawings Collection of the Octagon Museum are now available in an attractive portfolio. These full-color prints of Richard Morris Hunt's Beaux-Arts drawings include the "Theatre for a Small City" and "A Winter Garden."

15" x 13" J102 \$14.95/\$14.25 (AIA Mbrs.)

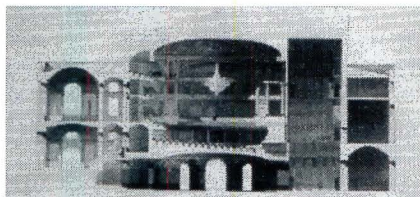
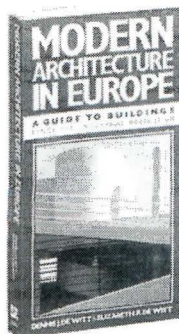

**AIA Tote Bags**—Sporting the new AIA logo, the lunch bag size is natural canvas, black trim and red eagle, with waterproof lining; the larger size is 100% canvas, black with red trim and logo.

Small AIA Tote Bag 9" x 8" x 4" R989 \$15/\$12 (AIA Mbrs.)

Large AIA Tote Bag 15" x 13" x 8" R990 \$20/\$17 (AIA Mbrs.)

**Architects and Designs Diary 1992**—Clothbound yearly planner from England.

Para/Graf M592 \$19.95/\$19 (AIA Mbrs.)

**Elements of Architecture T-Shirt**—Depicts acroteria, clathri, and rosettes, in pink, purple, and gray details; 100% pre-shrunk cotton; kids love them! Order by size. \$12/\$10 (AIA Mbrs.)

Children S (6-8) M (10-12) L (14-16) R882C

Adults S, M, L, XL R882A

**Frank Lloyd Wright Drawings**—Unparalleled beauty captured in 309 illustrations by the master architect.

Bruce Brooks Pfeiffer 304 pp R902 1990  
\$65/\$61.75 (AIA Mbrs.) Abrams

**At Home**—For ages 1-4, sized for tiny hands to open doors and investigate where people and animals feel at home.

Tony Tallarico 12 board pgs. M674P 1983 pbk \$3.50 Tuffy Books

I Want My Standards To Be Current And Classic. Please send me these selections.

Check payable to AIA is enclosed.  VISA  MasterCard

ACCT. NO.

Exp. Date

NAME

AIA MBR. NO.

SIGNATURE

FIRM NAME

ADDRESS

CITY

STATE

ZIP

Please send a list of additional standards.

QTY	ORDER NO.	TITLE	PRICE	TOTAL
1	N711	Bookstore Catalog	-0-	-0-

### MAIL TO:

AIA Order Dept.  
9 Jay Gould Court  
P.O. Box 753  
Waldorf, MD 20604  
1-800-242-4140

### Shipping Charges

Pre-Tax Total	Shipping Charges	Pre-Tax Total	Shipping Charges
\$0-5	\$3	\$51-150	\$7
\$6-50	\$5	\$151+	\$8

Subtotal \$  
Shipping \$  
(See Box)  
Sales Tax  
DC 6%, MD 5%  
Total





## Carpet Conservation

Manufacturers strive for healthier interiors.

LAST YEAR, AFTER A GROUP OF ENVIRONMENTAL PROTECTION Agency employees filed a petition protesting poor air quality in their offices, the agency began working with the carpet industry to examine the nature of volatile organic compounds (VOCs) in all carpet materials and develop a standard testing method for measuring total VOC emissions. Ultimately, the EPA hopes companies will voluntarily evaluate or engineer changes in manufacturing processes to reduce toxic VOC emissions. While actual emission levels and related health risks remain in question, some manufacturers have responded to the nationwide spirit of environmental conservation through technological developments. Public concern over indoor and outdoor air quality has encouraged the creation of low-emission adhesives for flooring and wallcovering products. Manufacturers have tried to sidestep state-mandated building vacancy periods following carpet installation by eliminating wet glues from the process, or by avoiding adhesives altogether. Interface's carpet tiles, for example, do not require a chemical bonding substrate; the tile's concave shape helps suction each square to the floor. Yet until the Carpet and Rug Institute issues an industry profile listing VOC emission levels in carpet components, it remains unclear which flooring products are safer than others. —K.S.



**1. Lowe's velvet square carpet tile is available in 24 colors. Circle 408 on information card.**

**2. Collins & Aikman manufactures Velvabond carpet tile in three patterns. Circle 409 on information card.**

**3. Interface's Studio Collection is constructed from Monsanto's Ultron 3-D nylon. Interface Flooring Systems. Circle 410 on information card.**

**4. Renaissance cut pile carpeting is intended for commercial applications. J&J Industries. Circle 411 on information card.**

**5. Opening Night, by Mohawk Carpets, is coated with BASF Stain Protector. Mohawk Carpets. Circle 412 on information card.**

**6. Atlas produces commercial carpet from Allied's Anso IV HP nylon. Allied Fibers. Circle 413 on information card.**



# ADVERTISERS INDEX

Circle Number	Page Number
—	AIA Bookstore .....107
—	AIA Bookstore .....112
—	AIA Masterspec.....110
15	American Olean Tile .....4-5
1	Andersen Windows, Inc .....26-27
—	Apple Computer, Inc.....2-3
43	Bell Atlantic (East Reg.) .....96
51	Brickyard Graphics.....117
39	Brite Vue.....88
—	Canadian Wood Council .....20
—	Canadian Wood Council .....28
19	CNA Insurance .....7
11	CYRO Industries .....34-35
31	DPIC .....36-37
5	Elliptipar Lighting.....25
—	Expoconsul International, Inc. ....78
13	Fry Reglet.....115
47	Gold Bond Building Products.....101
29	Hewlett Packard .....18-19
17	Hurd Millwork Co. ....C.2,p.1
49	Intergraph Corp. ....102
37	ISICAD, Inc. ....76
7	Kalwall Corp. ....115
21	Kawneer Company, Inc. ....10-11
27	Kawneer Company, Inc. ....17
—	Monsanto Chemical Co. ....C.3
59	N.C.E.C. '92.....108
35	N.C.M.A. ....74-75
23	N.E.G. America.....12
33	Peerless Lighting .....38
3	Raynor Garage Doors .....24
57	Sanford Corporation .....32
45	Southern Calif. Edison (West Region).....96
25	Southern Calif. Edison.....14-15
55	Steel Joist Institute.....C.4
9	Verona Marble Co.....30
53	Wire Crafters, Inc.....117
41	Yale Security, Inc. ....92

## EDITORIAL OFFICE

1130 Connecticut Avenue, N.W., Suite 625  
Washington, D.C. 20036  
(202) 828-0993

## EXECUTIVE OFFICE

994 Old Eagle School Road, Suite 1010  
Wayne, Pennsylvania 19087  
(215) 254-9800

Robert Hoover  
Production Director  
Phyllis Josselson  
Group Circulation Director  
Nancy A. Perri  
Assistant to the Publisher  
Robert G. Kliesch  
Publisher

## ADVERTISING SALES OFFICES

New York/Connecticut (215) 935-8522  
D. Douglas Johnson  
P.O. Box 199  
Devon, Pennsylvania 19333  
New England (617) 242-3042  
Joan Donahue  
31 Shipway Place  
Charlestown, Massachusetts 02129  
Philadelphia/Pittsburgh (215) 254-9800  
George T. Broskey, Eastern Sales Manager  
994 Old Eagle School Rd., Suite 1010  
Wayne, Pennsylvania 19087  
Southeast (215) 935-8522  
D. Douglas Johnson  
P.O. Box 199  
Devon, Pennsylvania 19333  
Midwest (312) 527-1055  
Jack E. Bergren  
Robert G. Hatfield  
1337 The Merchandise Mart  
Chicago, Illinois 60654  
Jack E. Bergren (414) 786-4286  
2530 Coach House Dr.  
Brookfield, (Milwaukee) Wisconsin 53005  
Edward R. Novak (708) 658-7133  
E.R. & J. Assoc., Inc.  
P.O. Box 648  
Algonquin, Illinois 60102  
Southwest (314) 569-3210  
Richard Grater  
1466 Summerhaven  
St. Louis, Missouri 63146  
West/Northwest (619) 451-9782  
James A. Anderson  
Western Sales Manager  
11858 Bernardo Plaza Court, Suite 240-C  
San Diego, California 92128  
Canada (416) 833-6200  
Donald C. Fenn  
148 King Road E.  
King City, Ontario L0G 1K0 CANADA  
Italy 9-20135 Milano (02) 54.00.757  
Cesare Fiorucci, Viale Sabotino  
Telex: 326559 Timas; Fax: 5451526

## Preservation Politics

IN THIS ISSUE, WE FOCUS ON THE WAYS IN WHICH ARCHITECTS preserve, expand, and restore landmarks in various parts of the country. Through these projects, we also laud the local individuals and agencies that safeguard historic structures and encourage creative amalgams of old and new. Although such preservation efforts are now taken for granted in this country, it has only been 25 years since the federal government officially recognized the importance of protecting our architectural and cultural heritage. This recognition was initiated by President Lyndon B. Johnson, who signed into law the National Historic Preservation Act in 1966. The original objectives of the act were to provide funding for preservation projects, to place a scientific emphasis on restoration methods and classification, and to increase public awareness of preservation issues. Although these goals form the backbone of preservation practice today, they seem simple compared to the complexity that now characterizes the preservation field.

Last month, a conference was held in San Francisco, cosponsored by the National Trust, the National Park Service, and the Advisory Council on Historic Preservation, to celebrate the anniversary of the Historic Preservation Act. The event not only revealed just how specialized the preservation movement has become, but how far it must progress in developing new ways of saving landmarks. For example, investors' use of tax credits for certified rehabilitation of historic structures has dramatically declined over the past five years, from \$2.4 billion in 1985 to \$750 million in 1990. As a result, preservationists continue to lobby for a federal law that would allow investors to take advantage of less restrictive federal tax credits in financing the rehabilitation of older structures.

A group of amendments that would strengthen and expand the scope of the original preservation act has also been introduced in Congress, and the AIA is playing an active role in supporting this legislation. One proposal that would especially benefit architects is the establishment of a federally sponsored National Center for Preservation Technology. The center would act as a clearinghouse for research on state-of-the-art preservation technology

and would be accessible to both the private and public sectors.

While not directly focused on historic preservation, the surface transportation legislation recently passed by the House of Representatives and the Senate could provide billions of dollars in federal funding for "enhancement activities" that will promote the rehabilitation of older structures as well as the purchase of scenic and historic easements. Incorporating the AIA's "livable communities" concepts, the bill could significantly increase government spending on "bricks and mortar" projects for architects to restore.

But such funding cannot save historic buildings in those states in which landmark status is being called into question. In July, the Pennsylvania Supreme Court issued a severe blow to preservationists across the country in deciding that Philadelphia's historic buildings law resulted in the unconstitutional taking of private property. The decision, which involved the Art Deco Boyd Theater in downtown Philadelphia, suspended the authority throughout the state to prevent the demolition or alteration of landmarks by private owners. At risk are more than 15,000 landmarks in Philadelphia alone. The ruling, which favors private rights over public values, undercuts the 1978 landmark decision by the U.S. Supreme Court that upheld New York City's historic preservation law and halted construction of a skyscraper over Grand Central Station. At the time, the Supreme Court justices concluded that designation of historic structures and districts was constitutional as long as affected property owners retained a reasonable economic use of their property.

Although professional and public awareness of historic preservation has expanded over the past 25 years, the Pennsylvania court decision (now under appeal) indicates that our landmarks are by no means secure. Popular support of preservation has waned over the past five years under languishing governmental support, and has shifted to conserving the natural, rather than the built, environment. Reinvigorating public interest through continued political action and education is the preservation movement's next challenge. ■

—DEBORAH K. DIETSCH

# Attila



While the engineering and architectural disciplines have always prized the elegant solution, there are times when brute strength is imperative. Introducing the Apple® Macintosh® Quadra™ 700 and Quadra 900 computers.

*So much power in so little space. The Quadra 900 is just 18.6" high and fits comfortably next to your desk. The Quadra 700 fits comfortably on top of it.*

Ferociously fast. Awesomely powerful. But each is still very much a Macintosh.

Up to twice as swift as any of their forebears, they're the first Macintosh computers to be built around the Motorola 68040, rated at 20 MIPS and running at 25 MHz.

A highly integrated design, the 040 combines the processor, math coprocessor, memory controller, and cache memory all onto one chip.

More important than merely technical measurements, the Macintosh Quadra computers are totally harmonized systems. The hardware architecture, operating system, interface, peripherals, and networking were all designed from the start to optimize the 040's power and work together smoothly as a single integrated system.

Anyone using compute-intensive applications — like 3-D modeling and stress analysis — will immediately appreciate the difference.

Popular software packages like MicroStation Mac, Virtus WalkThrough, and Infini-D perform more nimbly and responsively than they ever did before.

*Big just got bigger. The new Macintosh 21" Color Display gives you a lot more drawing board to work on. Colors are vivid, focus is crisp, brightness and contrast are high.*

