

MARCH 1993 • SIX DOLLARS

# ARCHITECTURE

INCORPORATING ARCHITECTURAL TECHNOLOGY





ASID AWARD WINNER

## CREATING A NEW PATH IN VINYL

Possibilities™ vinyl sheet flooring features three fabric-like visuals designed to work together. Heathered pattern in 2' width serves as a border or accent for dot or weave visuals.

All available in 10 contract colors.

For more information, call 1 800 233-3823 and ask for Possibilities.

## Design Envy

*As the recession narrows opportunities, architects should broaden the applications of design.*

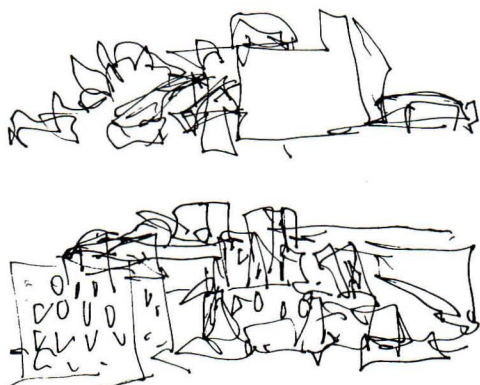

**ABOVE:** Frank Gehry's sketches of the Iowa Advanced Technology Laboratories at the University of Iowa.

Whenever we publish a provocative project by a high profile architect, such as our cover story on Frank Gehry's new laboratory for the University of Iowa, readers accuse us of catering to the "stars." This reaction is due, in part, to professional jealousy toward those few architects who are now afforded the opportunity to design, given the current economy. Design is no longer perceived as a team-oriented process, but an image-oriented commodity produced by an architectural elite. Increasingly, large-scale institutional buildings, especially public projects, are being developed by joint ventures between a design architect and a production firm. This paired arrangement not only fuels design envy, but widens the gap between a project's conception and execution. Many medium-sized practices that have built strong reputations as generalists, for example, are increasingly called upon to produce working drawings for local projects designed by out-of-town firms. Such arrangements diminish the local firms' stature; in many cases, these associate architects are just as capable of producing quality design as the imported "star." The real culprit in this situation, however, is not the pairing of firms, but a narrow definition of design that continues to be accepted by the profession and promoted to the client.

This narrow definition starts in architecture school, with a design studio-focused curriculum that fosters unrealistic expectations about the complexities of today's practice. One way of broadening the definition of design is to change the way architecture is taught. In addition to encouraging the individual designer, schools should instruct architecture students about the interdisciplinary nature of the profession and the application of an architectural education to careers in government or corporations, beyond the boundaries of the private firm. Another way to broaden the definition of design is to abolish the design committee of the AIA as a separate entity and reintegrate its ideals into other committees and professional activities. Design should be held up as a model of teamwork in those areas of architecture that really need it, such as affordable housing, hospitals, and prisons.

Architects also need to get the word out to the public that design, in the broadest sense of the word, is a participatory process involving more than specific physical improvements. More architects should get involved in policy-making through public forums, in which community members recommend ways to make their cities and neighborhoods more livable. We need more "stars" attuned to an expanded definition of design, as well as architects open to visions as imaginative as Gehry's Iowa laboratory. It's time for architects to change their role from design specialists to problem-solvers. It's time to turn envy into advocacy.

Deborah K. Dietz



# FOR THE ARCHITECT ON THIS PROJECT, THERE WERE A LOT OF TOUGH DECISIONS. AND THEN THERE WAS ANDERSEN.

According to the Design-Build team of OPUS Corporation and Hammel Green and Abrahamson, there were "special problems" building St. Therese, an enhanced retirement facility in Hopkins, Minnesota.

For one, there was concern about putting a 228-unit project in a suburban neighborhood. They wanted to do it in a

"sympathetic fashion." Part of which was to create a warm, home-like feeling.

Other considerations were a tight budget and what Larry Everson of OPUS described as an "incredibly demanding" 15-month schedule.

Fortunately, architect Johnson didn't worry about selecting the right windows. Thanks to their reputation, "Andersen was a given when I came onto the project."

Johnson claimed Andersen® windows were chosen because "there's never a question about the quality. Plus, they came through and delivered to our rigorous schedule."

To find out more about using Andersen® windows and patio doors in your next commercial project, call 1-800-426-7691 for the name of your local Andersen Commercial Representative. Or write Andersen Commercial Group, Box 12, Bayport, Minnesota 55003.

ST. THERESE CARE CENTER, HOPKINS, MINNESOTA  
ARCHITECT: DUANE JOHNSON, HAMMEL GREEN AND ABRAHAMSON  
MINNEAPOLIS, MINNESOTA  
DESIGN-BUILD CONTRACTOR: OPUS CORPORATION, LARRY EVERSON, AIA  
MINNETONKA, MINNESOTA

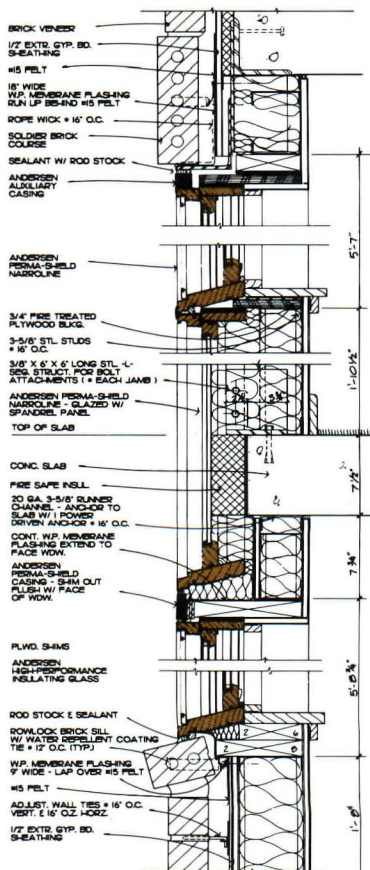
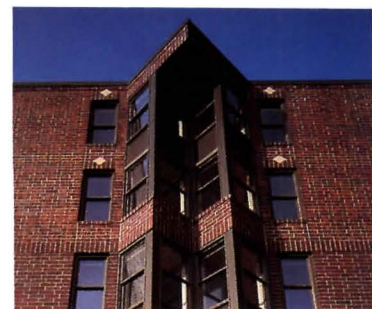

Circle 1 on information card

**Susan Maxman's vision: pro . . .**  
 What a refreshing new spirit in the message from AIA President Susan Maxman. I have been an AIA member since 1947 and have never seen architects so directly challenged to take up a position of leadership and put vitality back into our cities.

For too many years, the message coming from all levels of the AIA has been that architects must become businessmen first and professionals second. What a destructive lesson to teach the young people who enter schools full of dreams and ideals: that the most important part of their future is landing a job; that the most important skill they must acquire is self-promotion.

The tragedy is that while we have been busy teaching architects how to be good businessmen, the profession has lost a tremendous amount of ground and public respect. I'm not sure that Susan Maxman is right when she says that architects "are trained to be professional visionaries," but they used to be, and could be again. I think it will take unusual courage for individual architects and local chapters of the AIA to start leading the way in

imaginative urban redevelopment and neighborhood revitalization, instead of continuing their present course of "following behind our former patrons, the developers" and supporting suburban explosion. But Susan Maxman, as well as President Bill Clinton, may be offering us a chance to take a new direction. Let's not miss the opportunity.

*Eugene D. Sternberg, AIA  
 Eugene D. Sternberg and Associates  
 Evergreen, Colorado*

Thanks to AIA President Susan Maxman for imploring us to make a difference by focusing on leadership and vision. Our newly inaugurated president also reminded us that our greatest strengths are our ideas. President Clinton asked us to re-create the "idea of America," and "act on our idealism."

As architects around the country struggle in an environment overbuilt by greed and limited vision, we should consider President Clinton's words and the challenge of his season of change. I hope, as this new season blossoms, that substantive issues, such as housing and the ability of architects to be responsible for the

built environment, will be uppermost in our minds and our pursuit of professional practice.

*Steven H. Logan, AIA  
 Steven H. Logan, Architect  
 Indianapolis, Indiana*

The design of the suburbs since World War II has caused serious social problems. Nearly all architects have abdicated their role as experts on the planning of growth and have allowed planners to take over instead. Where have all the architects gone? No group of professionals is better trained to make new development and construction livable and sustainable. Don't you, as design professionals, feel insulted when bureaucrats tell you what density is proper for a given site? Architects must step forward and engage the political system.

*Barry LeClair  
 Hillsborough Development Department  
 Tampa, Florida*

**. . . and con**  
 Susan Maxman claims that the "overriding challenge facing American architects . . . is the revitalization of our urban centers." In fact,

*The Propane Gallery  
 of Architectural Design  
 Winners*

**H O M E S F O R  
 TODAY &**

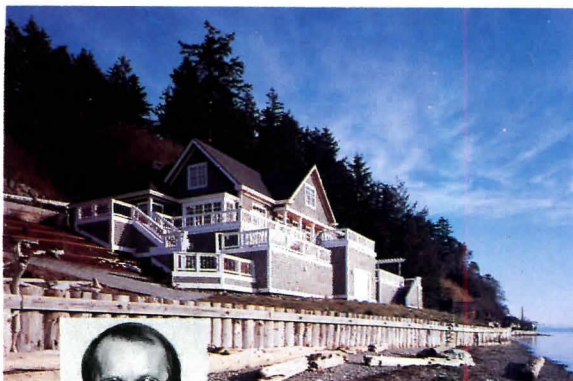

*The Grand Prize "Home of Today" was designed and built by Ronald J. Wainhouse of Canon Design Group in Redmond, Washington.*

*In 1992, the National Propane Gas Association launched a competition to promote and encourage the design and building of homes that protect the environment and conserve our natural resources—today and in the future. We now proudly present the two great propane gas homes that took top honors in the first Propane Gallery of Architectural Design:*

A distinguished panel of judges were unanimous in their selection of this wonderfully cozy, multi-tiered waterfront home on Camano Island, Washington. Positioned to welcome glorious views through every window, its rustic, natural materials and lines evoke the nostalgia and whimsy of a 19<sup>th</sup> century beach cottage. Inside, the 21<sup>st</sup> century has already arrived in a complete complement of high-tech appliances and energy systems. They blend perfectly with the huge stone fireplace, gleaming wood floors and soaring sun-swept spaces, which all seem to speak of quieter, gentler times.

***We salute these winners and all the designers and builders of the many fine homes entered in the 1992 competition!***

**1992 Appliance Donors:** Bradford-White Water Heaters • Controlled Energy Corp. • DESA International • The Domestic Corp. • Empire Comfort Systems, Inc. •  
**1993 Appliance Donors:** Arklia Products Co. • Consolidated Industries • Ducane Co. • Empire Comfort Systems • Enerco Technical Products •  
**1993 Tuition Donors:** Auxier Gas Inc. • Centex Butane • Commonwealth Propane • Green Mountain Propane • Loggins Supply •

she goes as far as to state that "if we allow our metropolitan areas to die, we will never be able to sustain life on this planet." That's a profound statement from the president of an organization that represents a largely conservative membership.

Maxman certainly does not see the problems that real-life architects face. The ever-increasing overregulation of the industry is a far greater threat than running out of land. Jurisdictions at every level are passing restrictive laws faster than architects can comprehend them.

Clients are being forced to tear down buildings that no longer comply with new, stiffer codes. Stairways, doors, ramps, exits, and hallways keep getting wider. Nowadays, you can hardly build anything without rated corridors, a sprinkler system, and wired glass.

Codes used to be written and passed to protect life safety. Now we have codes coddling every conceivable special-interest group. We don't need more liability; we need less legislation and a national life-safety-based building code.

*Peter B. Holz, AIA  
Lansing, Michigan*

#### Modern dilemma

As an architect involved with historic structures, I found your November 1992 issue on Modern landmarks right on target. Preservation of Modern buildings is a problem both because of the 50-year age requirement for listing on the National Register and the imprecise ways stylistic criteria are applied to buildings by the public review boards that often decide their fates. We can only hope that the public will become more inventive about how to preserve and re-adapt historic structures.

*Scott Johnson, AIA  
Johnson Fain and Pereira Associates  
Los Angeles, California*

#### Corrections

Grover Harrison Harrison master-planned the Birmingham, Alabama, Civil Rights District (January 1993, page 24). Ryder Associates designed the Civil Rights Institute.

Ben Thompson & Associates is designing the landscape for the New Jersey Performing Arts Center (February 1993, page 23). Barton Myers Associates with Wilson Woodridge Architects is designing the center.

#### March 17

Deadline for the New England Healthcare Facilities Design Awards. Contact: (800) 662-1235.

#### March 17-19

WestWeek '93, sponsored by the Pacific Design Center in Los Angeles. Contact: (310) 657-0800.

#### March 20

Deadline for the International Forum of Young Architects international design competition. Contact: (301) 405-6297.

#### April 13

Deadline for The Electric Vehicle and the American Community. Contact: (617) 267-9035.

#### April 21-23

Indoor Environment '93, conference and exhibition in Baltimore. Contact: (301) 913-0115.

#### April 22

AIA's final teleconference of Building Connections: Linking Economy and Ecology for New Prosperity. Contact: (800) 365-ARCH (2724); to register, call (800) 677-2111.

#### April 23

Passive Solar Design Strategies workshop in Washington, D.C. Contact: (202) 628-7400.

#### April 24

Creating the Classical Interior Today, a seminar at the New York Academy of Art sponsored by the Institute for the Study of Classical Architecture. Contact: (212) 941-8088.

#### May 10-12

Lightfair International in San Francisco, sponsored by Illuminating Engineering Society of North America and the International Association of Lighting Designers. Contact: (404) 220-2115.

#### May 15-21

American Industrial Hygiene Conference and Exposition in New Orleans. Contact: (703) 849-8888.

#### June 1

Deadline for Lakeview Visions, a design competition in Chicago sponsored by Lakeview Neighborhood Development Corporation. Contact: (312) 281-5492.

# TOMORROW

Great imagination and awareness of developing technologies were united in this design for quality living in tomorrow's world. It is a sprawling, futuristic glass, steel and concrete berm house featuring a giant central greenhouse, passive solar system, pools, ponds, fountains and roof plantings. Developed for a Midwest site, the Romanesque design is especially adaptable to warmer climates where the roof gardens would also be equipped for solar water heating.

#### **The 1993 Propane Gallery of Architectural Design Competition**

*Builder and architect entries for the second year of this competition will be accepted from February 19, 1993 until August 31, 1993. Prizes for the winning "Home of Today" will include national publicity, a replica of the enviro-flame sculpture award, an original painting of the winning home and a full complement of the latest technology propane gas appliances for the winner's next home. • Student entries will be accepted only until June 15, 1993. The winning architecture student will receive up to \$5,000 tuition. • All winners will be announced at the 1994 National Association of Home Builders (NAHB) Show. For complete information and a 1993 entry form packet, call the National Propane Gas Association at 1-800-4LP-GAS2.*

Heatmaster Gas Logs • Humphrey Products • Myson, Inc. • Robert H. Peterson Co. • Temtex Products • Trianco-Heatmaker, Inc. • U.S. Gaslight Flame Engineering Co. • Heat-N-Glo Fireplace Products • Martin Industries • Robert H. Peterson Co. • Temtex Products • U.S. Gaslight North Carolina Propane Gas Co. • Pearce Bottled Gas • Squibb-Taylor • Suburban Propane



*The Grand Prize "Home of the Future" was designed by Timothy F. Macy, an architecture student at Ball State University in Muncie, Indiana.*

Circle 4 on information card

# ***The Honesty of Natural Stone. The Serenity of Contemporary Color: Dolomiti by Marazzi.***

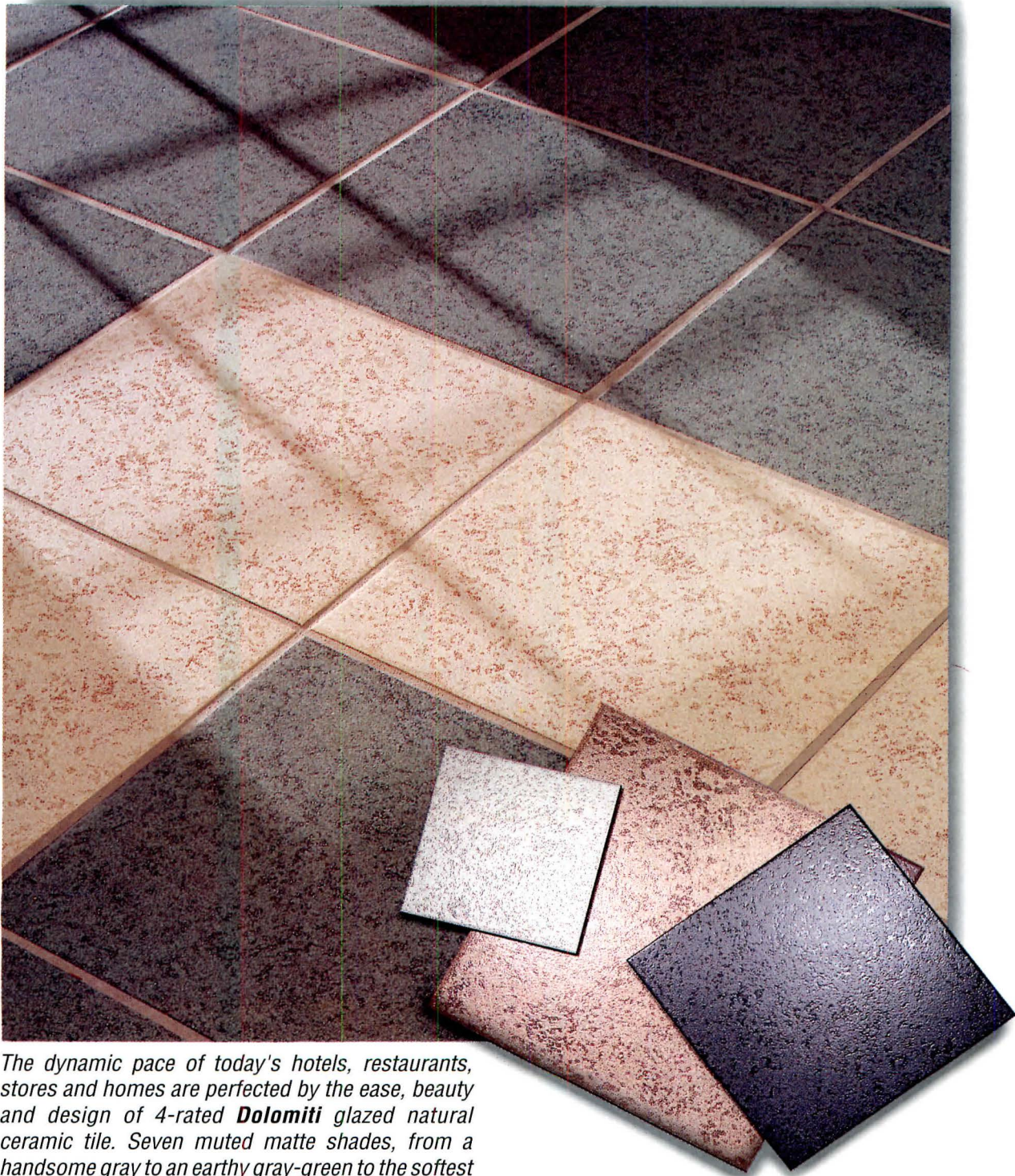

© 1992 American Marazzi Tile, Inc. Dolomiti Ad

*The dynamic pace of today's hotels, restaurants, stores and homes are perfected by the ease, beauty and design of 4-rated **Dolomiti** glazed natural ceramic tile. Seven muted matte shades, from a handsome gray to an earthy gray-green to the softest dove rose, are single-fired for great strength and textured for resistance and durability. Scratch and frost-resistant for outdoor patio, **Dolomiti's** gentle tones are pure naturals. Available in 8"x8", 12"x12", and 16"x16". For more information on your nearest distributor, call **Customer Service at (214) 226-0110.***

Circle 28 on information card

 AMERICAN  
**MARAZZI TILE**  
**The Fine Art of Ceramic Tile.**

**See you in Miami! International Tile & Stone Exposition, April 21 / 24, 1993 Booth 2700**



## AIA Accents Livable Communities

The AIA is taking President Clinton's "rebuild America" rhetoric seriously. During the Institute's annual Grassroots leadership training conference in January, some 650 AIA officers and chapter executives lobbied Congress for urban aid and investment. They asked senators and representatives to approve enterprise zones, to permanently extend low-income housing tax credits and tax-exempt mortgage revenue bonds, and to fully fund the \$151 billion Intermodal Surface Transportation Efficiency Act, enacted last October.

The 103rd Congress offers hope for more livable communities because of representatives like Norman Mineta (D-CA), chairman of the House Public Works and Transportation Committee. During Grassroots' Government Affairs Day, Mineta argued that investing in roads and transit could kick-start the economy. "We have neglected these public lifelines for too long," he added, noting that infrastructure only accounts for .4 percent of our gross national product.

Culminating the four-day conference was the annual Accent on Architecture awards gala, held at the National Building Museum. This year's Gold Medalist, Kevin Roche, who received his honor from President Clinton at the White House, criticized our country's blindness to the urban crisis in his acceptance speech. "If cities are a record of our civilization," Roche asked the audience, "what is being said about us?"

## New Urban Visions for Philadelphia

To Edmund N. Bacon, Philadelphia has always been the center of the universe. The former executive director of Philadelphia's Planning Commission is still working to reinvigorate his hometown, and recently set forth ideas that could help the city better realize its development potential—if not as the center of the universe, then at least as the center of the Boston-Washington megalopolis.

A recent exhibit at the Mellon Bank Center, "New Visions for Philadelphia," documents Bacon's strategy for expanding commercial and cultural development beyond Philadelphia's downtown core. Bacon advocates moving westward along Market Street and then leaping across



**GOLD MEDAL:** Clinton and Roche.

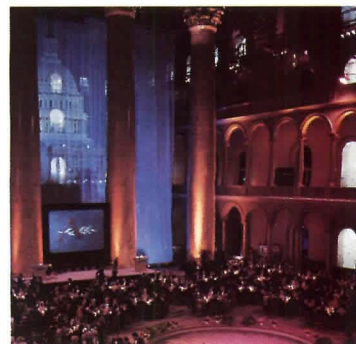

**ACCENT:** Building Museum awards gala.



**NEW VISIONS:** Himel-designed towers in Philadelphia flank Schuylkill River.

the Schuylkill River to a 65-acre parcel that is ripe for development. The magnets drawing development across the Schuylkill, according to Bacon, are the recently refurbished 30th Street Station and the promise of high-speed rail from Boston to Washington. Once these new trains are running, Philadelphia will be poised for a resurgence of commercial activity because of its central location along the northeast corridor.

To symbolize this leap across the river, Bacon and local architect Bernard Himel propose erecting two office towers, one on either bank. As designed by Himel, the towers would be identical, and arranged so that one faces north and the other south; they would be joined by a suspension bridge for pedestrians. Bacon explains that the idea for the complex, called River Scenario, came from developer H. Leonard Fruchter of Penn Center West Associates, the group that controls the eastern bank of the Schuylkill and is negotiating with Amtrak for development rights to the west side. Bacon believes River Scenario could provide a symbol for the new devel-

opment and make Philadelphians more conscious of the rail corridor's significance to the city's economic future in a post-petroleum era.

The "New Visions" exhibit also includes Bacon's ideas for a monument at Penn's Landing, commemorating the arrival of William Penn, and a permanent laser display to reestablish the dominance of City Hall. The mayor of Philadelphia, Edward G. Rendell, admits Bacon's visions won't materialize until the real estate market improves significantly, but he is happy to promote discussion about the city's future. "We hope the economy turns around so some of it can become a reality," Rendell notes.

For many, the show serves as a fitting tribute to the indefatigable Bacon and his provocative images for growth. Bacon says he merely sought to build on the work of William Penn, whose 1682 plan still serves as the guiding force for Philadelphia's urban growth. "William Penn had a vision," Bacon says. "I've spent most of my life just basking in Penn's vision and trying to keep it alive."

—Edward Guntz

- 24 **Ponti in Denver**
- 25 **Women in Design**
- 25 **Details**
- 27 **Oakland Houses**
- 29 **AIA Housing Forum**
- 33 **On the Boards**

## Ponti in Denver

The Denver Art Museum marked its 100th anniversary last month by unveiling a \$9 million renovation of its galleries and an exhibition celebrating its Modern building. Founded in 1893, the museum's collections were displayed in a variety of spaces around the city until 1971, when they gained a permanent home. This building, designed by Italian architect Gio Ponti in collaboration with Denver architect James Sudler, broke new ground in its arrangement of open, loftlike galleries within a pair of tile-clad towers; the design grew out of former museum director Otto Bach's belief that the average visitor could only see 10,000 square feet of galleries in one hour. But the unconventional nature of the gallery-in-a-tower design, Ponti's only building in the United States, confounded curators and visitors alike, resulting in clumsy renovations and the museum's undeserving reputation as a forbidding fortress within the Beaux-Arts Classicism of Denver's Civic Center.

Now, under the watchful eye of museum director Lewis Sharp, Ponti's original vision is being revived through sympathetic renovations of galleries and public spaces. "The museum is our most important acquisition," asserts Sharp. To convey this view to the public, the museum has mounted an exhibition, "The Art of Architecture: The Denver Art Museum Reconsidered," now on view through February 1994. Curated by R. Craig Miller, head of the museum's newly created Design and Architecture Department, and designed by Denver architect Anthony Pellechia and graphic designer Kathy Wesselman, the small show reveals the beauty of Ponti's sculptural building through a walk-through collage.

Architects hoping for a Ponti retrospective will be disappointed by the Denver show, but they will be inspired to learn more about the Italian



**NEO GIO:** Pellechia-designed exhibition at Denver Art Museum is introduced by Ponti-inspired obelisks, striped walls, and text.

architect. The installation is announced by references to Ponti's own exhibition design: a cluster of obelisks echoes the Italian architect's 1965 display for the Ideal Standard showroom in Milan. From the entrance, a metal path leads to an introductory text about the museum design, which is presented in cursive script as if written by Ponti himself. The exhibition also reflects the decorative nature of Ponti's early work, inspired by the Vienna School. Black-and-white striped walls, and repetitive photographs of the museum, superimposed over 10-foot-square portraits of Ponti and Sudler, echo the architect's interiors of the 1930s. Unfortunately, these references are not explained within the exhibition and require some knowledge of the Italian master's work to be fully appreciated.

Most of the Denver exhibit focuses on the remarkable, light-reflective details of the museum. Local photographer Thomas Arledge's grainy images of the building's exterior and its tubular entrance are reproduced on translucent sheets and suspended as freestanding objects. Partitions within the installation are cut out to resemble Ponti's narrow windows and accented by the Italian architect's palette of primary colors, which is slowly being reinstated

throughout the museum. A videotape, created by filmmakers Amie Knox and Tom Neff, presents a brief, poetic tour of the museum exterior.

The historical importance of Ponti's building is stressed through a comparison with plans and photographs of the National Gallery in Washington, D.C., and the Museum of Modern Art in New York. The most significant development in the Denver Art Museum's history, however, still lies ahead. As part of Denver's Civic Center Cultural Complex, the museum is now working with its neighbors, the Colorado Historical Society and Denver Public Library, to develop a master plan, designed by Denise Scott Brown, for the three-block area.

A few intriguing sketches of this plan are displayed in the show. In addition to proposing a plaza to be shared by the three institutions, the drawings reveal the scale of the library's expansion, designed by Michael Graves. For those who dismiss Ponti's museum as a fortress within Denver's Civic Center, Graves's design should change their minds. The massive, polychromed library promises to dwarf the museum and make the 1971 building appear as the enchanted castle Ponti always meant it to be.

—D.K.D.



**DETAILS:** Suspended photos.



**MUSEUM:** Ponti's tile-clad castle.

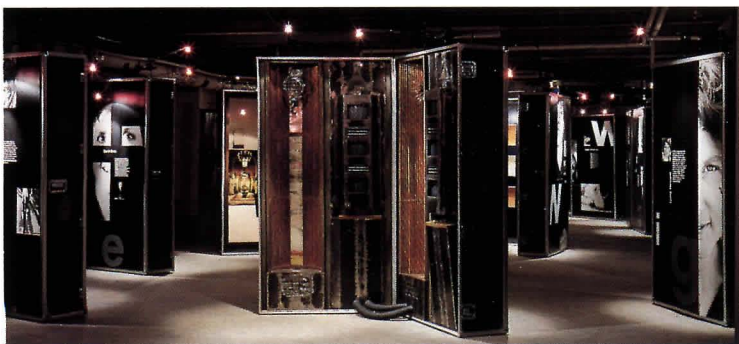

**WOMEN OF DESIGN:** Trunk show of 33 American architects and interior designers.



**MALLIS:** Work and leisure.



**MCCLINTOCK:** Foldout living.

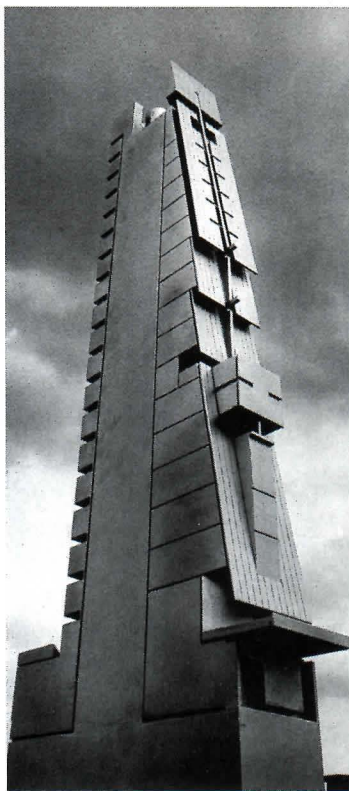

**CULTURAL INSTITUTE:** Abraham's wedge.

## Designing Women in Washington

"Women of Design," an exhibition open through May 9 at the National Building Museum, is a long overdue introduction to the best female architects and interior designers working in this country today. Although the format has potential—33 women each received a 7-foot-high steamer trunk to outfit—the result is an uneven assemblage of esthetic viewpoints and career histories.

The exhibition, sponsored by the Steelcase Design Partnership, is a three-dimensional version of Beverly Russell's recently published book *Women of Design*. The star of the show is a foldout apartment with chaise longue, steel basin, and tensile canopy, conceived by Elizabeth McClintock of MGS Architects in New York. In a more conservative, but no less successful interpretation, interior designer Stephanie Mallis converted her trunk into a sophisticated storage chest; one-half holds drawings, models, and photographs of her work, while the other half displays personal treasures.

Collectively, the trunks tell us that design is a deeply personal, problem-solving process. For Lucia Howard of Oakland-based Ace Ar-

chitects, design is an act of magic. She depicts herself as a wizard who pulls designs out of her cap.

Except for isolated references, the show does not directly address the idea of gender-specific design. It does, however, capitalize on the symbolism of the trunk as a repository of female keepsakes. Several designers, for example, included photographs of friends and family. Unfortunately, some exhibitors turned their trunks into firm advertisements, rather than creative expressions.

The most significant trunk was designed by New York architect Frances Halsband, who treated her trunk as a frame for photographs of female design students at Pratt Institute, where she is dean. Each student holds a printed card bearing her own definition of design.

With the number of women enrolled in architecture programs on the rise, Halsband and her colleagues will be joined by a new generation of designing women. "Women of Design," which opened in New York last fall and will travel to Chicago, Miami, Dallas, and San Francisco, is an inspirational overview for young architects and designers. One only wishes the accomplishments of its role models were portrayed with more substance. —K.S.

## Austrian Institute Competition Winner

A 20-story glass, steel, and concrete building, described as a metronome, will house New York's new Austrian Cultural Institute when it is completed in 1995. Designed by Raimund Abraham, an architecture professor at Cooper Union, the wedge-shaped scheme was selected from among 226 entries during a design competition held last December that was limited to Austrian-born architects.

The building comprises a glass-and-metal facade (above), a concrete-enclosed core, and an exposed stair tower to the rear. The \$7 million structure will contain four floors of commercial space and seven floors of apartments, in addition to galleries and offices for the Austrian Cultural Institute.

Distinguished by stepped layers of glass and steel protrusions, the facade was varied to indicate the mixture of uses within the building. The high rise is the 59-year-old architect's first major commission. The jury, which included Charles Gwathmey, Richard Meier, and Kenneth Frampton, praised Abraham's scheme for its innovative relationship to adjacent buildings. —K.S.

**Cesar Pelli & Associates**, in association with Yamashita Sekkei, is designing a new laboratory for the Radiation Effects Research Foundation in Hiroshima, Japan. Pelli is also designing the corporate headquarters for Wachovia Corporation in Winston-Salem, North Carolina, and the renovation of One Market, a 1.4 million-square-foot commercial office complex in San Francisco. London-based **James Stirling Michael Wolford and Associates** has been selected to design the Singapore Cultural Center. Finalists included **Hardy Holzman Pfeiffer Associates**, **Kohn Pedersen Fox Associates**, and the team of **Mitchell/Giurgola and Thorp Architects**. In Japan, **Hellmuth, Obata & Kassabaum** won a competition to design a \$280 million passenger terminal building for Fukuoka International Airport. This summer, a 490,000-square-foot state office building designed by **Graeber, Simmons & Cowan** will begin construction on an Austin, Texas, site originally intended for **Venturi, Scott Brown's** 20,000-square-foot Laguna Gloria museum. **Engberg Anderson** of Milwaukee, Wisconsin, won a competition for the redevelopment of an eight-block neighborhood in Peoria, Illinois. **Lars Lerup** has been appointed dean of Rice University's School of Architecture, while **Stanley Tigerman** has been ousted from his position as director of the University of Illinois, Chicago's School of Architecture. **Alan Schwartzman** of New York-based **Davis, Brody & Associates** will open the firm's new office in Paris, France. **Jeff Olson** has left Denver-based **Pellechia Olson Architects** to join **C.W. Fentress J.H. Bradburn and Associates**. Film director Bernardo Bertolucci is shooting his new movie, *Little Buddha*, in a Seattle, Washington house designed by local architect **Larry Rouch**. The National Park Service has hired **Backen Arrigoni & Ross** to assess structures on San Francisco's former Presidio military base that will be incorporated into the Golden Gate recreation area. **Mark Robbins**, assistant professor of architecture at Ohio State University, has been named the first curator of architecture for the university's Wexner Center for the Arts. **Joseph Pell Lombardi & Associates** of New York is working with the World Monuments Fund to convert an 18th-century Hungarian castle into a music academy.

# Input

800-445-6515

# Output

## A big company image on a small company budget.



### THINK BIG, SPEND SMALL

For only \$1,992, DesignMate has everything you'd expect in a world-class pen plotter – except the high price. Crisp plots in up to 8 colors or pen widths. A full range of output sizes from A-D and 1-4. Precise .0005" resolution. Compatibility with all popular platforms and software – including Windows™ and AutoCAD®. Plus a 1-year warranty and 30-day money-back guarantee.

**\$1,992**

### SUPPLIES & SERVICE

CalComp offers a full line of supplies designed by CalComp engineers to give you the best output possible from your DesignMate. Plus excellent technical support and rapid response to our warranty and service contract customers.

### BUY DEALER OR DIRECT

To order, or to see DesignMate at a CalComp dealer near you, call CalComp Direct toll free. We accept MasterCard and Visa, or open an account over the phone. Leasing program available.

**DesignMate™**  
**The first personal 8-pen, A-D size design powerhouse for under \$2,000.**

**CALL CALCOMP DIRECT 800-445-6515 Ext. 361**



Ordering hours are from 7:30 am to 4:30 pm PST. Price is in United States Dollars, does not include applicable sales tax or delivery charges and is subject to change without notice. Leasing program available in continental U.S. only, through third party. For return or repair call 800-CALCOMP for terms and instructions. All products are trademarks or registered trademarks of their respective manufacturers. Plot courtesy of AutoDesk, Inc. DesignMate pictured with optional stand and dust cover.  
© 1993 CalComp Inc. All rights reserved.



Oakland Hills, curator Meredith Tromble intended the show to document the experience of the fire survivors. A video recording survivors' comments (a collaborative effort by Tromble and independent producer Rick English) runs continuously alongside the architectural displays.

Typical is the story of Oakland residents Jay and Judy Espovich who had been accustomed to living on a heavily wooded hillside. When they surveyed the devastation wrought by the fire, they realized the landscape would never be the same. Working with architect Heidi Richardson of San Francisco, they settled on a design combining some qualities of their old "cottage in the woods" with an internal courtyard. In place of the house in nature—a key feature of the Bay Area style—the new house builds nature into the house.

Another fire survivor, Katherine Adcock, found the neighborliness of her old street to be its most charming feature. Many property owners view the fire as a chance to build bigger houses, and a predictable rancor has broken out over issues of scale and access to \$100,000 views. But in a moment of inspiration, Adcock arranged with the couple next door, Kevin and Lovella Barney, to hire the same architect, Robert Swatt. Working together, the two families managed to maintain views and create a shared backyard.

At the opposite end of the spectrum is a house designed by Ace Architects of Oakland for Dixie and Jenny Jordan, a mother and daughter. With wry satisfaction, Dixie Jordan explains on the video how the highly idiosyncratic structure, partially clad in metal shingles, has already been dubbed the "fish house." The house's hall-and-tower composition was also inspired by the Bay Area style—a fanciful clubhouse Maybeck designed for renowned patron Phoebe Hearst.

Tromble says she deliberately picked projects for the show that represented a variety of client situations and architectural approaches. For some clients, the chance to undertake the design process with an architect was an opportunity to preserve only cherished aspects of their former dwellings; for others, to strike out in bold new directions. Such variety of intent might not bode well for the continued existence of a "style" if it were understood in clearly defined terms. But the Bay Area style has always mani-

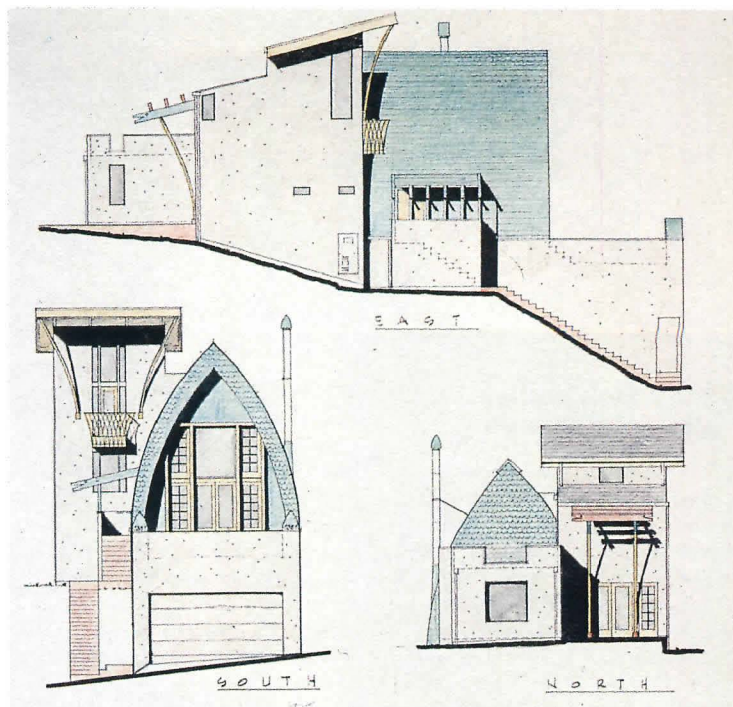

ACE ARCHITECTS: Shingled "fish" house inspired by Maybeck.

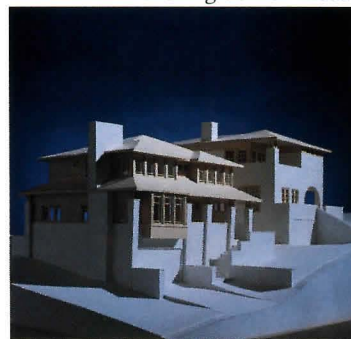

SWATT ARCHITECTS: Shared backyard.

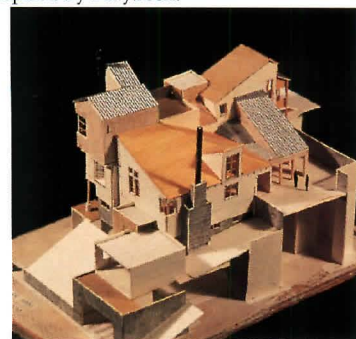

GRAY/LANGENBACH: Shed roofs.



RICHARDSON ARCHITECTS: Cottage with courtyard.

fested itself more as an attitude toward natural setting than as a compendium of specific forms. In this sense, the houses in the show illustrate a continued concern for local issues of climate, topography, and materials. What is forgotten,

Tromble points out, is that houses in the hills before the fire addressed these issues in a variety of ways. "New Architecture in Oakland" reveals how such diversity will continue in the fire's aftermath.

—David Moffat



## New Houses for Oakland Hills

An exhibition of new house designs for the fire-ravaged hills around Oakland, California, is again raising the question of whether a distinctive San Francisco Bay Area style still exists. "New Architecture in Oakland," on view at the Limn Furniture showroom in San Francisco through March, features drawings and models of houses by 13 California architects.

The Bay Area style was developed by turn-of-the-century architects such as Bernard Maybeck as a reaction to the region's ornate Victorianism. Its simplicity emphasized a respect for landscape and a casual blending of indoor and outdoor living. Contemporary versions of this style have been criticized for their easy formulas and pastiche. But proof that Bay-Area-style houses are still captivating was clearly shown by the estimated 1,200 people who tried to squeeze through the Limn showroom doors opening night.

The exhibit focuses on designs by principals of small Bay Area and Los Angeles firms—Ace Architects, David Baker, Timothy Gray/Randolph Langenbach, DeCredico/Sergent, Jim Gillam, Mark Horton, House + House, Frank Israel, Jim Jennings, Steve McCracken, Heidi Richardson, Stanley Saitowitz, and Robert Swatt. In addition to sampling the best new houses for the

buildings. Graves also draws upon the campus vocabulary of overhanging red-tile roofs and marble, and extends the new building eastward from Hornbostel's structure to define the main quadrangle's southern edge. As the anchor of the quad's central cross-axis, the new addition, with its grand staircase and colonnade, will become the focal point of the campus.

The new museum's prominent location also creates a primary point of contact between the university and the local community. To foster this relationship, Graves incorporates an entrance along the south facade, which will encompass a ceremonial portal and a pedestrian bridge over a wooded ravine.

Graves designed the addition's interiors to blend seamlessly with the original. The museum's 29 permanent galleries are arranged in an enfilade connecting the old with the new. In addition to temporary and permanent exhibition space, the new facility will house a 2,080-square-foot reception hall on the fourth floor, offices, a boardroom, and a restaurant. —L.N.

## Emory University Museum Expands

In Atlanta, Emory University's expanded Michael C. Carlos Museum, designed by Michael Graves, will open to the public on May 11. The 45,000-square-foot addition adjoins the existing museum, a 1916 Henry Hornbostel-designed law school, renovated by Graves in 1985 to house Emory's art and archaeological collections. Graves's new scheme, a contemporary interpretation of Hornbostel's Beaux-Arts Classicism, will maintain the proportions and symmetry of the surrounding historic

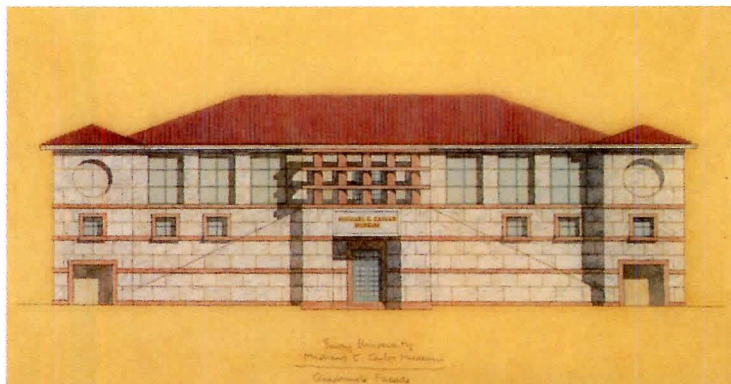

**MUSEUM ADDITION:** Graves's facade interprets Hornbostel's Beaux-Arts Classicism.

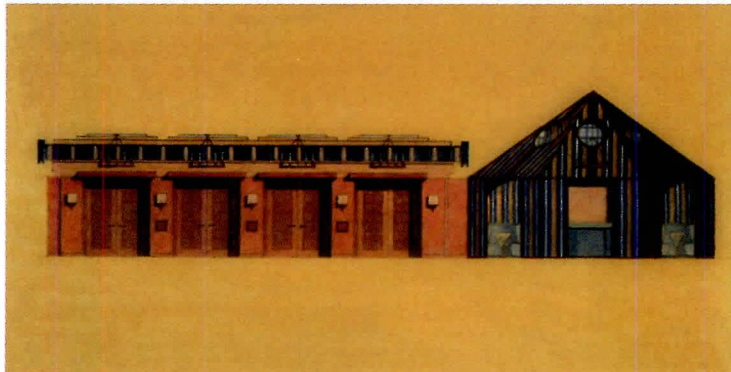

**SECTION:** Reception hall and fabric-tented restaurant.

## ELIASON® CUSTOM BUILT EASY SWING® DOUBLE ACTION DOORS

### MINIMAL MAINTENANCE INTERIOR PARTITION DOORS

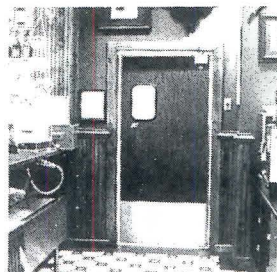
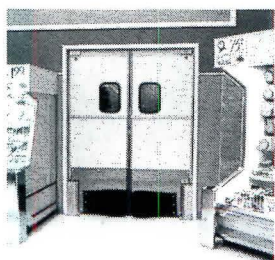
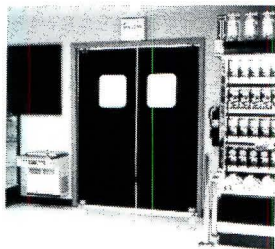

for use in...

- STORES
- SUPERMARKETS
- RESTAURANTS
- FOOD SERVICE
- DRUG
- DEPARTMENT
- SHOPPING MALLS
- HOTELS
- HEALTHCARE FACILITIES

ALL ELIASON EASY SWING® DOORS COMPLY WITH THE NEW ADA RECOMMENDATIONS FOR SAFETY AND CONVENIENCE.

Eliason Easy Swing® doors utilize gravity and offset pivots to facilitate a safe, gentle swinging action. Just a light nudge opens the door and the closing action is automatic with a slight time delay. No springs, no cam castings, no mechanical devices to fail. Doors can be specified in a variety of lightweight tempered aluminum, rigid polymer core, solid core or foam insulated models. Use in light, medium or heavy traffic doorways. Many decor options and sizes available.

**PURCHASE DIRECT  
CALL TOLL FREE 1-800-828-3655**

OR SEND FOR YOUR NEW FREE  
PRICE/SPEC CATALOG

**ELIASON®**  
CORPORATION

P.O. BOX 2128, KALAMAZOO, MI 49003, Ph: 616-327-7003, FAX 616-327-7006  
P.O. BOX 1026, WOODLAND, CA 95776, Ph: 916-662-5494, FAX 916-662-5192

Circle 6 on information card

## Housing Forums Teach Value of Design

The AIA, the American Architectural Foundation, and the National Endowment for the Arts (NEA) are proving that well-designed, affordable housing is critical for neighborhood stability. Since 1990, these groups have sponsored six Design for Housing forums to mobilize civic leaders, nonprofit developers, and financial institutions.

The two-day regional workshops center on case studies of neglected residential areas presented by teams of housing professionals from cities selected by the AIA and NEA. The program's mission is to debunk the mystery of design and to teach its long-term value. It is also designed to spark rebuilding by convening housing players from targeted communities.

So far, the forum's message has been paying off. William Edwards, director of Community Service Programs of West Alabama, admits that before he attended a housing forum in Miami last May, his organization focused on maximizing housing production rather than on design quality.

"When the budget got tight, the first things to go were the frills," says Edwards. At the Miami workshop he learned, however, that design is not a frill and, for the first time, he hired an architect to design a 16-unit project.

Mayor Joann Smith of Helena, Arkansas, who also attended the Miami workshop, has turned her attention to the redesign of her city's rental housing. Smith's participation in the Miami forum led to an AIA-sponsored housing charette in Helena last fall (ARCHITECTURE, November 1992, page 25), where a team of architects, planners, developers, public officials, and bankers helped the city devise a neighborhood rebuilding strategy. Since then, the city has reconfigured a concrete block triplex according to the team's suggestions, and architect Billy Wenzel of Tunica, Mississippi, has begun to transform the recommendations into a set of working drawings.

During the most recent Design for Housing forum, held in mid-January, Mayor Robert Markel of Springfield, Massachusetts, joined a team of housing advocates, bankers, and developers in New Haven, Connecticut,

to analyze a neglected Springfield neighborhood cut off from the city by a freeway. A graduate of the Mayors' Institute for City Design, another NEA-sponsored educational program, Markel hopes that by participating in the rebuilding process from the start, he can avoid repeating the mistakes of his predecessors.

Forum organizers Charles Zucker and Charles Buki of the AIA's Community Design and Development department stress the importance of including public officials in the workshops to pinpoint resources and develop revitalization strategies. To help sell participants on the benefits of good design, the forums feature presentations by architects such as Joan Goody of Boston-based Goody, Clancy & Associates, Michael Pyatok of Pyatok Associates in Oakland, California, and San Francisco's Tom Jones of Asian Neighborhood Design Center, who underscore the fact that good housing is not cheap, and that success depends upon knowing residents' needs. These architects have battled planning departments, stretched budgets, and earned citizen support to create model projects.

A survey by the National Congress for Community Economic Development indicates a 39 percent increase in the number of low-income housing units produced by community-based developers in the past seven years. As community groups become increasingly responsible for producing affordable housing, the forum's message will become more critical to ensuring the long-term success of neighborhoods. But only a handful of the nation's architects currently promote well-designed, affordable housing, underscoring the difficulties architects face in being taken seriously by developers and lenders.

By assembling these forums, the AIA is encouraging an effective low-income-housing delivery system that relies upon teamwork. According to Michael Zbailey, vice president of Fleet Bank in Hartford, Connecticut, who attended the New Haven forum, "Design is an effective way to bring people together." By asking questions like "How can we pay for new housing?" and "What will it look like?" Zbailey explains, housing advocates are ensuring a secure future for their communities. —K.S.

# Elegant. Affordable. Granite.



Granite has long been perceived as one of the most beautiful and spectacular elements an architect or designer can employ. Often overlooked, however, is its remarkable *cost-efficiency*.

Minimal maintenance and repair expense mean granite simply cannot be beaten in the context of life cycle cost over a typical 20-year span.

Whether for new construction, modernization or renovation, Granite cladding will add elegance and endurance to both the client's image and your design. Affordably.

If you are interested in the latest innovations in Granite construction technologies, call 1-800-551-7502.

COLD SPRING

202 South Third Avenue Cold Spring, MN 56320 • 1-612-259-3400 • FAX 612-259-3452

Circle 8 on information card

# If you think prepaint is just for roofs, take a

The building is Honolulu's spectacular Honfed Tower. Its curtainwalls are produced from Bethlehem's prepainted Galvalume® sheet. And the response from the business community, regarding the building's aesthetics, has been overwhelmingly positive.

But instead of us telling you why our prepainted Galvalume sheet was chosen for the curtainwalls, we'll let the architect in charge tell you. Say aloha to James R. Combs, AIA, Leo A. Daly & Associates. "We required a maintenance-free material that would stand up to the ocean environment. And since the building's appearance had to reflect the strength and stability of its corporate tenants, it was necessary for the facade to be lasting and attractive.

"We had a strict set of design criteria to be met, including color, size, flatness, finish, water tightness and detail of construction. [The panels are finished with a bright metallic silver, four-coat, 70% fluorocarbon paint system.] A mock-up panel was also required so we could test all design criteria.

"Protean Construction Products Procon™ brand panel system, fabricated from Bethlehem's prepainted Galvalume sheet, was selected because it met all criteria,





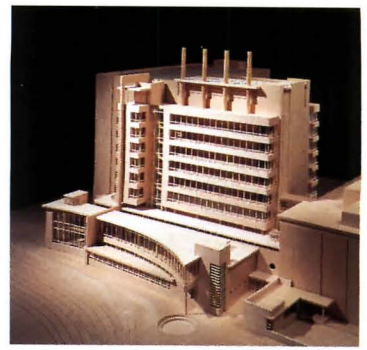

**BIOSCIENCE ADDITION:** North elevation.

**BioScience/Parks Hall Addition  
Ohio State University  
Columbus, Ohio  
Perkins & Will and  
Burgess & Niple, Architects**

A 120,000-square-foot addition to a pair of existing laboratories is designed to unify Ohio State University's biological sciences research campus. "Our objective was to solve the programmatic requirements of a major research facility," explains Perkins & Will Design Principal Ralph Johnson, "while adding a strong urban element to this part of the OSU campus." The complex will front a large intramural athletic field and a highly traveled pedestrian path that connects dormitories in the northwest portion of the campus with the medical school to the south.

To form a new northern edge to the campus, the architects set the building atop a two-story, brick podium that contains a 25,000-square-foot library and a skylit lobby. They angled the first floor to align

with the existing pedestrian route and curved the second floor to echo the concave line of the horseshoe-shaped football stadium across the field. Along the complex's new north elevation, the architects projected a tower, accented with a prominent brick fin, to house an elevator core and lounges on each floor. For the main laboratory block, they wrapped new construction around the north and east elevations of an existing nine-story building and incorporated a pedestrian bridge to link the labs to an existing four-story building to the west.

This main lab component, comprising floors four through nine, is organized with perimeter offices along a new glass-and-aluminum curtain wall that faces north. To service the labs, the architects incorporated a central mechanical core and ganged the four exhaust stacks along an equipment penthouse, shielded behind aluminum louvers. "Our intention was to treat the mechanical systems as a decorative system," maintains Johnson. The building is scheduled for completion next spring. —Lynn Nesmitb



## On the Boards

### **New York Psychiatric Institute New York City Ellerbe Becket, Architects**

Designed by Senior Vice President and Design Principal Peter Pran of the New York office of Ellerbe Becket, the 312,000-square-foot Psychiatric Institute is organized with a laboratory-research wing to the north and an inpatient-outpatient wing to the south. Pran unified the components with a sweeping glass curtain wall along the west facade and a six-story, skylit atrium at the juncture of the two wings. He divided the circulation system to take advantage of the site: vehicles enter a motor court and landscaped plaza directly east of the building, and pedestrians enter via elevated bridges that connect the building with the adjacent Columbia-Presbyterian Medical Center. The \$84 million complex is scheduled for completion in 1997.

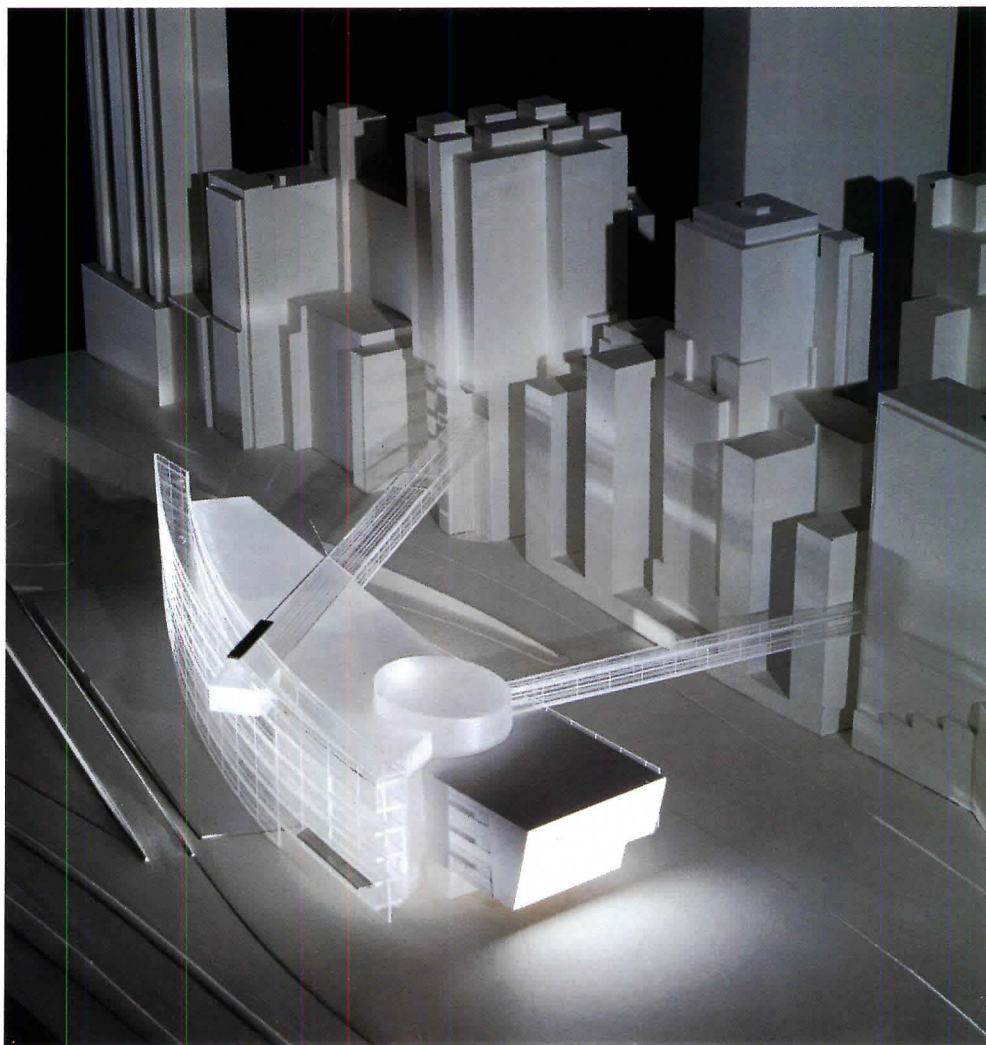

**NEW YORK PSYCHIATRIC INSTITUTE:** Pran-designed complex connects to medical center by pedestrian bridges.

### **Cayman Islands Hospital Grand Cayman Island Ellerbe Becket, Architects**

The new, 100,000-square-foot hospital was designed by John Michael Currie of Ellerbe Becket's Washington, D.C. office. He organized the facility along two main corridors—one for the staff and patients, and another for the public, which is expressed by an undulating roof line (model, bottom right). From this spine, three curved wings extend northward to house 90 patient rooms and public spaces, including a dining area and lobby. A rectilinear wing to the south contains clinical, administrative, and service functions. Indigenous materials will be utilized throughout, including corrugated-metal roofs and walls, concrete block, stucco, and masonry. The hospital is scheduled for completion in late 1993.

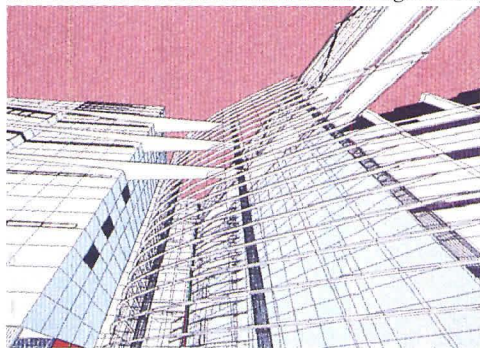

**PSYCHIATRIC INSTITUTE:** Detail of bridge connection.

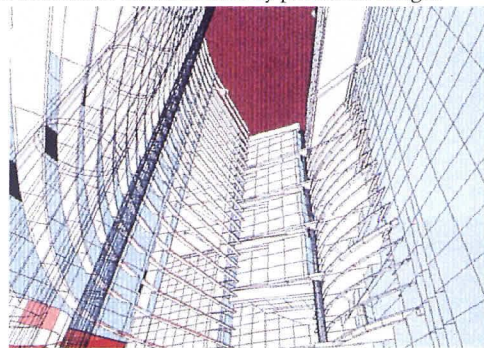

**PSYCHIATRIC INSTITUTE:** Central atrium rises six stories.

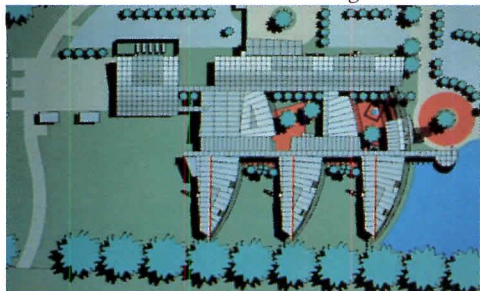

**CAYMAN ISLANDS HOSPITAL:** Plan reveals patient wings.

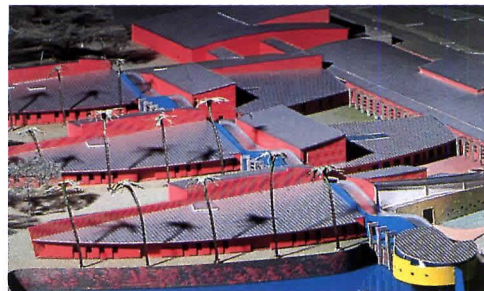

**CAYMAN ISLANDS HOSPITAL:** Undulating public corridor.

## Hospitals of the Future

*A healthcare consultant predicts that hospitals in the 21st century will change from megacampuses to community-based facilities.*

Health insurance is not the only part of the healthcare system that should be reformed. The organization and structure of the hospital are in need of a complete overhaul. Over the next two decades, architects are likely to find clients on the cusp of change, for whom a new building may be a great opportunity to create a new environment for healthcare work.

But healthcare providers aren't in the business of building hospitals all the time. Most will be involved in designing a new building only once or twice in their entire careers. So it is no wonder that they want to build a hospital that looks like the one they presently manage. That is, an imposing structure with patient beds in towers and diagnostic and treatment services on lower floors. But this model causes patients to move to services, fostering inefficiency.

In hospitals designed around the needs of the patient, routine diagnoses and treatments—70 percent of all services—are decentralized to the patient floor, suite, or room. Lab tests in this patient-focused arrangement require seven minutes to process, instead of the current two hours. Clinical pharmacies are located on the patient floor, as are radiology labs and operating suites.

Such decentralization produces savings for the whole hospital. In fact, some departments, such as admitting and discharge planning, disappear as nursing staff and program administrators on each floor take responsibility for the care management of their patients through bedside computing.

Hospital interiors will need to accommodate these changes by providing space for a professional and support core on each floor. Wherever site permits, low, broad structures should replace tall, slim buildings. Outpatient services should be organized adjacent to the hospital; they may also take over much of the area originally designed as diagnostic and treatment spaces for inpatients.

The hospital of the future must also make site-related changes. The current megacampus paradigm implies certain assumptions: that all patients, no matter how well or ill, should come to the same place because that is where the doctors are; they should come only when they are ill, rather than when they want help in not becoming ill; they should arrive by automobile or bus, rather than on

foot; and they should merely look at the green, un-built part of the campus, rather than make use of it. All of these assumptions are wrong, and they lead to an unfortunate alienation of the urban hospital from its surrounding community.

To make hospitals more hospitable, the edges of their campuses should be like live coral reefs—full of energy and activity, pulling neighborhood residents in rather than shutting them out. Restaurants, day care, communal dining rooms (with food-service training), home repair businesses, schools for disabled children, combined welfare and Medicaid offices are all elements that can be included.

In the January issue of ARCHITECTURE (pages 37, 39), AIA President Susan Maxman encouraged architects to address the inner city, where crime and violence are endemic. Add the problem of illness: most inner-city residents have more than their share, from childhood diseases to the maladies of the elderly. So in addition to offering traditional treatment, healthcare providers in the city have a public health role to play. Community-based planning should be utilized to produce hospital programs and services that address what ails the community, and not merely what physicians and healthcare administrators know how to do.

It is clear that, in the future, hospitals will no longer be healthcare's "main event." The main event will be outpatient services and associated case management systems for patients with chronic illnesses. What an opportunity for architects! They can help their clients to design delivery systems, not just hospitals; community-service networks, not just campuses; and new patient-focused operating systems, not just sets of rooms and spaces for equipment.

The patient-focused concept (pages 99-105, this issue) is a powerful idea that carries the seeds of a solution to a host of problems within the old base-and-tower hospital structure. Now we need a breakthrough for the hospital site itself. Architects who are prepared to offer this kind of visionary leadership will produce something much more meaningful than a beautiful building.

—Wanda J. Jones

*Wanda J. Jones is president of the San Francisco-based New Century Healthcare Institute.*

**YOU'LL FIND SUNBRELLA® HANGING  
AROUND ALL THE BEST PLACES.**



The Phoenician Resort, Scottsdale, Arizona

## High-Tech Humanism

*Hospitals and laboratories are elevated by amenable design.*



PAUL WARCHOL

The architecture of hospitals and laboratories seldom elicits more than a yawn from editors and critics. Mercifully, architects are now shunning cold and sterile imagery, epitomized by the futuristic hospital depicted in Woody Allen's 1973 film *Sleeper*, and looking instead to more noble precedents. One Modernist example is Cité du Refuge, the Salvation Army shelter in Paris by Le Corbusier, who charged the spatial procession from street to building with restorative power. Kahn too, working with a very different program for the Salk Institute in LaJolla, manipulated relationships among ocean, light, and building to achieve similarly potent effects.

The five projects we present this month discredit the popular complaint that the contemporary demands of stringent building codes, review boards, and limited budgets make it too difficult to move beyond the mere resolution of program. We feature two hospitals and three research laboratories that take on broader agendas. For the design of the Guggenheim Pavilion, an addition to New York's Mount Sinai Medical Center, Pei Cobb Freed & Partners manifest the firm's belief in the healing power of nature and architecture: patient rooms command the magnificent sweep of Central Park in a city where light and air are precious real estate commodities. Across the continent in San Diego, a city that takes sun and breezes for granted, Kaplan McLaughlin Diaz refurbished and expanded the 30-year-old University of California San Diego Medical Center. The scheme incorporates a drab tower into a new collage, with a cylindrical lobby that reorients the center away from the suburbs and toward downtown. Our technology and practice section elaborates these growing improvements in patient services, with particular emphasis on what the healthcare industry terms "patient-focused care."

We also feature three centers for research where architecture aspires to nurture ideas. In each case, the architects encourage social interaction among different users of the building by the placement of public rooms at strategic locations in plan; design strategies differ in the adaptation of new buildings to existing contexts. Frank Gehry & Associates, master of form and collage, unifies the University of Iowa's fragmented campus with a forcefully composed laboratory complex that beckons the viewer's touch. In Portland, Boucher Mouchka Larson Architects designed a metal-clad Science Center that defines a new image for the Oregon Graduate Institute, where the existing campus of demure wood-clad, shed-roof buildings will undergo a dramatic expansion. So too will the facilities at the Loudoun County, Virginia, campus of George Washington University: Florance Eichbaum Esocoff King Architects combines technology and artifice in the design of a Graduate Research and Teaching Center well suited to the pastoral Virginia landscape. In each project, a skillful balance of forces—those of the building and its context, of architectural tradition and up-to-the-minute *technology*, and of *public gathering* spaces and private facilities—reaffirms the capacity of architecture to promote good health and to generate creative ideas.

# MEDICAL TURNAROUND

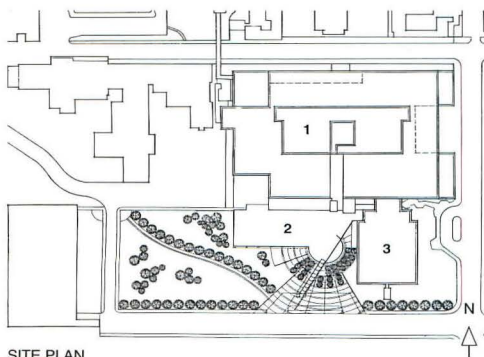

SITE PLAN

- 1 EXISTING HOSPITAL
- 2 NEW ADDITION
- 3 EXISTING CLINIC

**SITE PLAN:** Medical center's 90,000-square-foot addition is inserted between original 1962 hospital and south-facing clinic wing added in the 1970s. Expansion houses new main entrance and outpatient surgery center.

**TOP:** Entrance rotunda reaches to street with granite-clad screen wall.

**BOTTOM:** South-facing, four-story outpatient surgery addition is clad in painted steel panels and stucco. Sunlight is filtered by steel sunscreens and fritted glass. Curved bay projecting from building's west end houses recovery area for bronchoscopy patients.

**FACING PAGE:** Futuristic stucco and glass-clad spires top new elevator tower, which serves as a link between outpatient addition and existing patient tower, visible at far right in photo.

When architects at San Francisco-based Kaplan McLaughlin Diaz (KMD) first began designing hospitals in the 1960s, they assumed that patients preferred a traditional medical environment, which at the time comprised ground-floor reception, diagnostic, and treatment areas, with patient floors stacked in a tower above. Hospital lobbies, the architects believed, should be comfortable, like the waiting rooms in doctors' offices. To check their assumptions, KMD combined forces in the mid-1970s with a group of architecture students at the University of California, Los Angeles to conduct a survey of patient attitudes. Their research revealed some surprising information: instead of serving as waiting areas, the architects discovered, hospital lobbies functioned primarily as highly trafficked reception areas, where patients formed their first impressions of the institutions. And rather than seeking comfort and tradition, patients preferred hospitals to project a high-tech, medically advanced image. Not surprisingly, the public wants a hospital to inspire confidence and appear as state-of-the-art as possible.

With these findings in mind, Principal Herbert McLaughlin designed an addition to the University of California, San Diego (UCSD) Medical Center that completely revamps the 30-year-old institution's image, from a drab general hospital to a progressive healthcare facility for teaching and research. Built in 1962 as a county hospital that served San Diego's most indigent population, the facility added



an outpatient clinic wing a decade later; the complex was then purchased in 1981 by UCSD for its medical school. Although the hospital is located in a medical enclave just north of downtown San Diego, 13 miles from the university's La Jolla campus, its new owners enhanced its reputation by adding regional trauma and burn centers, a dialysis unit, a neonatal intensive care unit, a heart and lung transplant center, and a cancer research and treatment center. Today, the hospital not only serves as a classroom for UCSD's third- and fourth-year medical students, but has evolved into one of the top biomedical research institutions in the United States.

In the late 1980s, reflecting current trends in healthcare toward cost-effective, home-based recovery, UCSD decided to add a new wing to house outpatient surgery and to upgrade the building's 11-story tower to meet current seismic standards. Shepherded by then-campus architect Charles Powers, the university awarded the project to the team of local architects Neptune-Thomas-Davis and KMD. The latter's student center and School of International Relations and Pacific Studies were already under way on the UCSD campus, and the firm's reputation for successfully renovating older hospitals, including Brigham and Women's Hospital in Boston (ARCHITECTURE, June 1989, pages 68-69), was well established. The architects' practical task was fourfold: seismically brace the existing inpatient tower; add the new wing; improve vertical circulation for the hospital, whose population had







**ABOVE:** To comply with seismic codes, 1962 tower is braced by steel tie rods that span two floors. Mirrored-glass-and stucco-clad tower houses classrooms and four new elevators and links existing hospital with new addition.

**BOTTOM:** Three-tiered steel canopy reaches across main vehicular route to hospital entrance and shelters arriving patients. Fluorescent fixtures in canopy direct after-dark arrivals.

**FACING PAGE:** Glass-and-steel entrance rotunda, which faces due south, is shielded by three gracefully curved sunscreens fabricated of perforated steel.

grown from about 2,000 to more than 6,000; and design a new lobby.

The architects' boldest gesture was to reorient the hospital's main entrance from the north, where it faced the San Diego suburbs, to the south, addressing downtown. McLaughlin offers a practical explanation for this medical turnaround: "We had more room back there." Facing ancillary trailers, support buildings, and a neighborhood of tiny bungalows, the northern elevation indeed offered no space for expansion. And besides, hospital staff wanted to keep their teaching and healing activities up and running while construction was under way. By building the addition and new lobby behind the existing hospital, then linking new and old with an 11-story elevator tower, KMD's solution allowed the practice of medicine to continue apace.

Although tucked between the east-west slab of the original hospital and the south-facing clinic wing, the stucco, steel, and glass-clad addition begins at a lobby that is hardly a reticent, doctor's-office-style waiting room. Instead, a grand, daylit, three-story entrance rotunda addresses the hospital's new vehicular approach with a steel canopy, and a punched, granite-clad screen wall marches out of the lobby and onto the sidewalk. Inside, rather than seating, the sunscreened rotunda houses an airy, uplifting 45-foot-high room that grandly directs newcomers to an admissions area, gift shop, and medical departments. Referring to the contemporary image projected by this entrance, McLaughlin explains, "With the rapid-fire changes in medicine, hospitals are frequently in need of restating what they are about." UCSD Campus Architect Boone Hellmann characterizes the change in the medical center as a dramatic transformation. "If you were used to the old environment," Hellmann advises, "your first reaction might be that you've gone to the wrong hospital."

The born-again image wrought by KMD and Neptune-Thomas-Davis doesn't stop at the door. The new outpatient surgery wing,

which includes suites for bronchoscopy and pulmonary operations, is housed in a four-story rectangular volume that projects from the rotunda's northwest quadrant, parallel to the Modernist tower of the 1962 building. Linking this new wing and rotunda to the existing building is an 11-story tower that houses four new elevators and classrooms serving the university's teaching physicians. Topped by jaunty, futuristic spires, the center's new tower invigorates the medical enclave's skyline much as its lobby enlivens the street. This contemporary montage of new volumes—rectangular surgery wing, cylindrical lobby, and twin-spired elevator tower—is a far cry from the relentlessly Modernist slab of the original 1962 hospital.

And even the old building has a new look: steel cross-braces tied into the existing columns of the steel-framed building achieve a shear wall for seismic stability. More than merely structural, these tie-rods are articulated to emphasize the diagonal. The stucco cladding the mechanical ducts on the tower's west elevation is embossed to carry the "X" pattern around the building.

In devising a practical scheme to link inpatient and outpatient services in one building, KMD may also have developed a proto-









**ABOVE:** New 45-foot-high lobby is finished in terrazzo floors and pierced by 218-foot-long, granite-clad screen wall that continues onto the street.

**PLANS:** New addition fills a niche between rectilinear main hospital and south-facing clinic wing. Wall through lobby emerges outside at drop-off area, directing patients from parking toward entrance.

**FACING PAGE:** Tucked within second- and third-floor mezzanines, curved classrooms and conference rooms overlook main lobby above reception desk, softening lobby's stark formality.

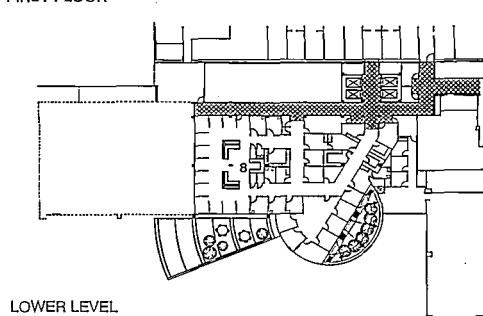
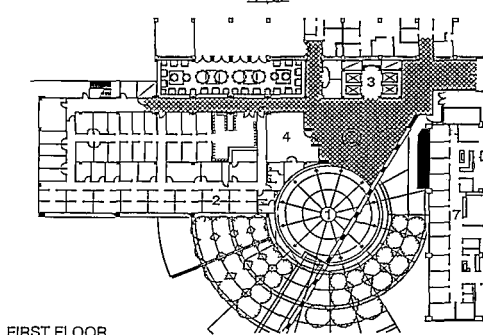
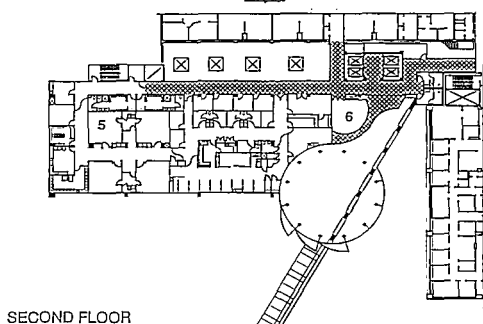
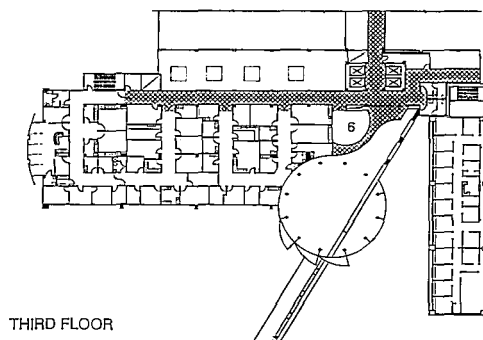

- |              |                      |
|--------------|----------------------|
| 1 LOBBY      | 5 OUTPATIENT SURGERY |
| 2 ADMISSIONS | 6 CONFERENCE ROOM    |
| 3 NEW TOWER  | 7 EXISTING CLINIC    |
| 4 GIFT SHOP  | 8 DIALYSIS           |

type for bringing postwar teaching hospitals into the 21st century. Dr. David Ward, the hospital's chief of clinical nephrology and UCSD professor of clinical medicine, explains that medical students have traditionally learned by participating in inpatient procedures. But as hospital stays become shorter, some of today's most important cases involve outpatient surgery. UCSD Medical Center's classrooms in the new tower, intelligently juxtaposed between out- and inpatient wings, allow students to observe both types of procedures and meet with professors in the center.

Practical solutions aside, the hospital's new addition succeeds because, though ambitiously progressive, its round lobby adds a romantic element to the stark linearity of the existing complex. "Patients need architecture that is both high-tech and humane," asserts McLaughlin. While its modernity inspires confidence in the state-of-the-art of medicine, UCSD Medical Center now welcomes and uplifts both patients and staff. "Architecture creates emotions," McLaughlin explains, "and that is as functional a part of building as keeping the rain out and meeting the codes." ■

—Heidi Landecker

UNIVERSITY OF CALIFORNIA, SAN DIEGO  
MEDICAL CENTER  
SAN DIEGO, CALIFORNIA

CLIENT: University of California

ARCHITECTS: Kaplan McLaughlin Diaz, San Francisco, California—Herbert McLaughlin (partner-in-charge of design); Neptune-Thomas-Davis, San Diego, California—Grover L. Starr (principal-in-charge); James Meyerhoff (project manager); Mark Thomas (construction administration)

LANDSCAPE ARCHITECT: KTU + A

ENGINEERS: Brandow & Johnston Associates (structural); Merle Strum and Associates (mechanical); Randall Lamb Associates (electrical); Barrett Consulting Group (civil)

CONSULTANTS: Anshen + Allen (interiors); Sussman/Prejza & Company (exterior colors and graphics)

GENERAL CONTRACTOR: Blake Construction Co.

COST: \$32 million

PHOTOGRAPHER: David Hewitt and Anne Garrison



# CAMPUS GENERATOR

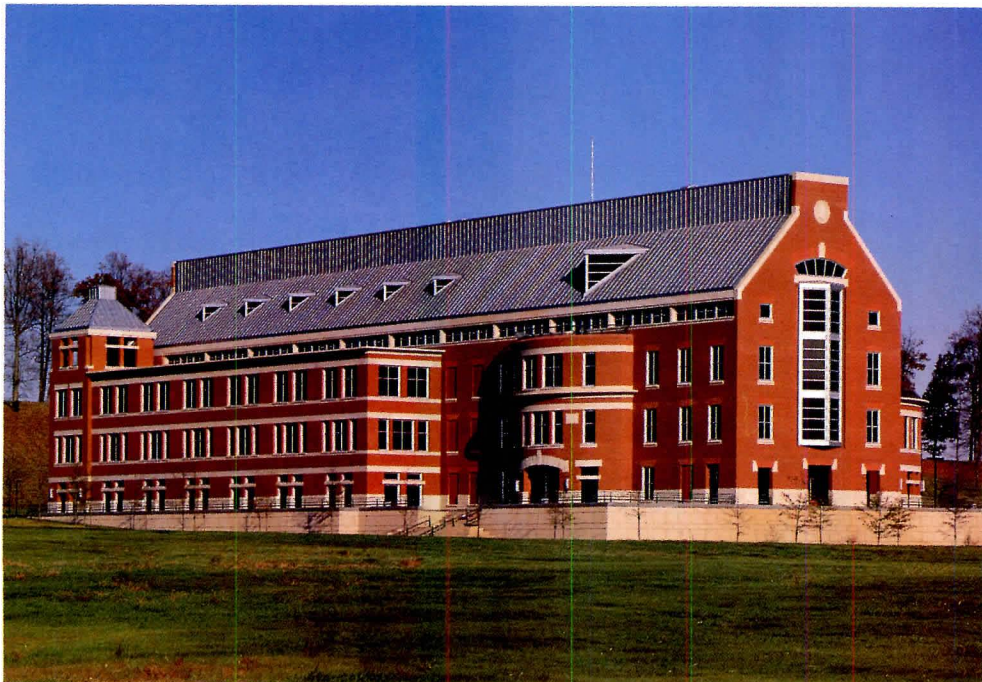

**ABOVE:** West elevation offers the most prominent entrance, in anticipation of further development of the campus.

**SITE PLAN:** George Washington University's Virginia campus comprises a complex of buildings enclosing a tree-lined mall that steps uphill. FEEK's new Graduate Research and Teaching Center is shown east of the mall.

**FACING PAGE:** Traditional elements such as gabled south end, jack arches above windows, and brick walls laid in Flemish bond are updated with modern windows and customized precast concrete sills.

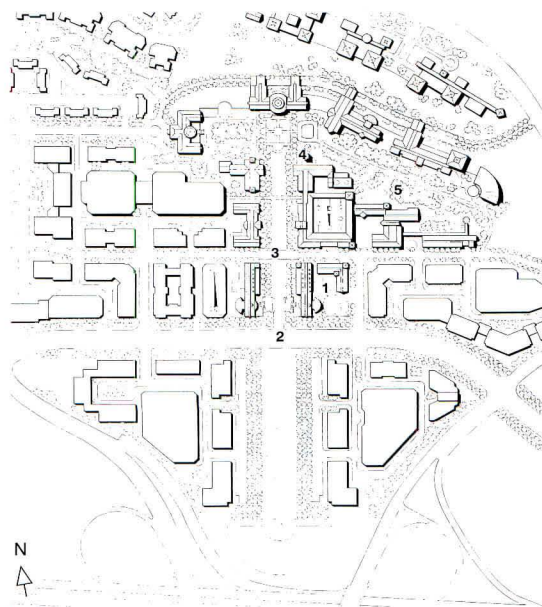

SITE PLAN

- |                                       |                 |
|---------------------------------------|-----------------|
| 1 GRADUATE RESEARCH & TEACHING CENTER | 3 MAIN STREET   |
| 2 CAMPUS MALL                         | 4 HILLTOP GREEN |
|                                       | 5 CAMPUS WALK   |

Rarely does an architect get the chance to design the first building on a new college campus. Yet for Florance Eichbaum Esocoff King Architects of Washington, D.C., the commission for just such a project was a mixed blessing. The artistic freedom to design a high-profile research and teaching center that would set the tone for later development at the Loudoun County, Virginia, campus of George Washington University (GWU) was immensely exhilarating. But tempering the opportunity to create a potential regional landmark was a complex program that demanded a hodgepodge of functions under one roof.

To attract greater numbers of part-time, and specifically night, students to the building's five academic departments, the University required the building to house varied, often conflicting uses—research and computer laboratories, classrooms, lecture halls, library, conference rooms, executive training center, faculty offices, and administrative suite. "It's a campus in a building," explains Principal Philip Esocoff. Although the center is isolated now, it will someday be surrounded by suburban-style development, if current plans are realized. Situated just a few miles from Washington's Dulles International Airport, the campus will be the centerpiece of a planned 576-acre, high-technology office and research park, featuring acres of housing already taking shape.

Poised on a slight rise hundreds of yards from its nearest neighbor, the GWU Graduate Center has all the presence of a barn commanding its piece of Virginia landscape. Rooted on a plinth of bush-hammered concrete scored to resemble stone, the center's brick facades, accented with precast sills and lintels, convey permanence. But closer inspection reveals the architect's Modern attitude in detailing of windows and openings and in an organization that segregates laboratories from public functions.

Details of the development's overall master plan, designed by RTKL Associates of Balti-

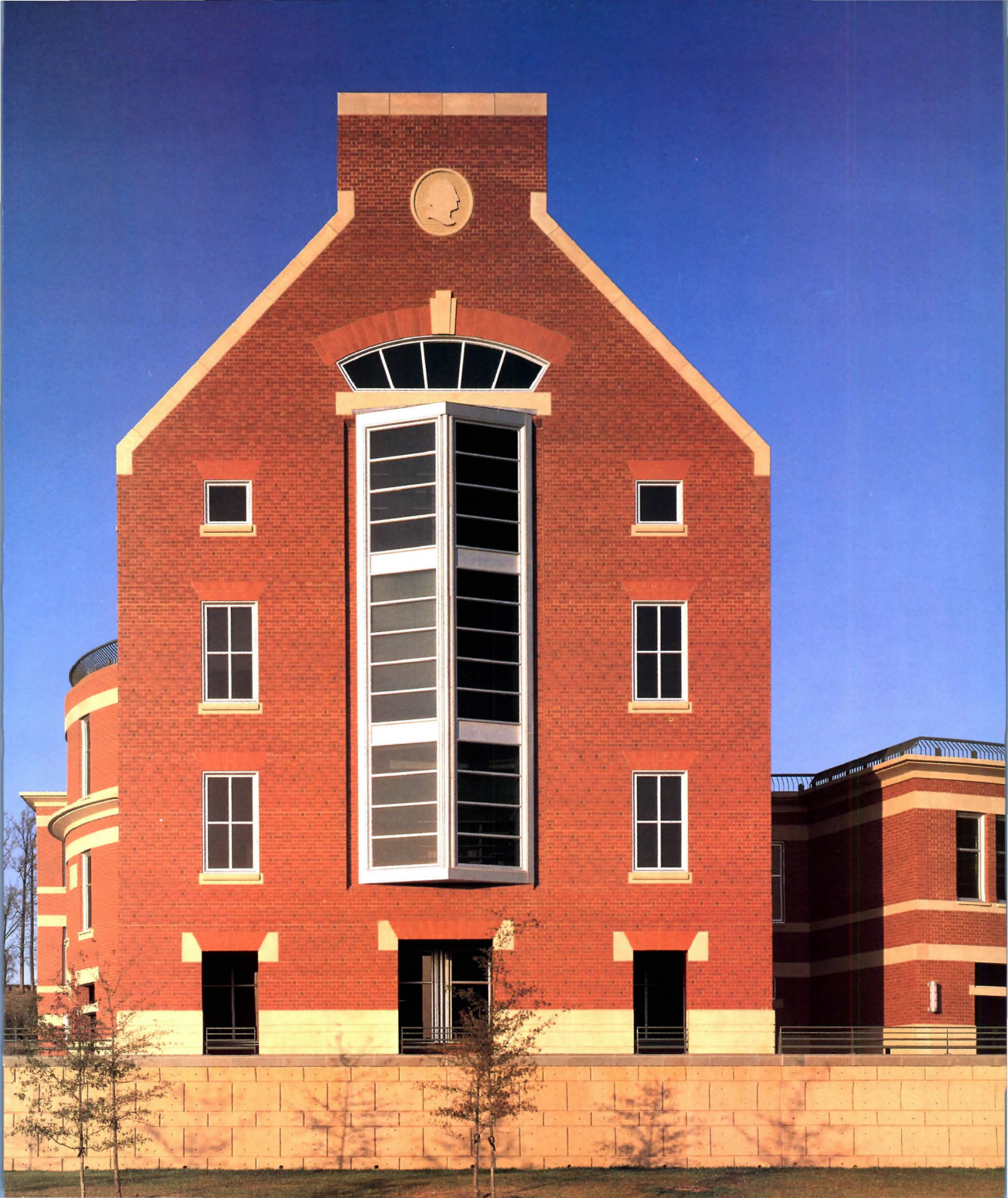



more and Land Design/Research of Columbia, Maryland, provided many design cues for Esocoff and influenced the form and placement of the building's three entrances. Plans for a 200-foot-wide grassy mall just west of the building dictated the location of the main entrance, with a bowed ceremonial doorway atop a wide set of stairs that splays outward as it meets the ground. Wedged into the side of a curved wing that extends from the east facade, the "front door" is announced by a sprawling stair that flattens toward the parking lot like a concrete glacier. A third entry, placed beneath the square tower at the building's north end, opens toward a small parking lot that in time will become the development's Main Street.

From the east and west entrances, visitors proceed to the "greeting hall," a three-story shaft paneled in sections of warm-hued Danish beech detailed to resemble blocks of stone. The rusticated walls, like the oval oculus two stories overhead, take their inspiration from Mount Vernon. Only 15 by 21 feet in size, the space nonetheless serves as the social heart of the building. "It's like the great old stair hall, the indoor plaza for the campus," Esocoff says. Seating niches carved out of the beech-paneled walls on the upper levels offer places to rest and afford views across the space and below.

Hints of Modernity on the building's exterior are more exaggerated in the greeting hall and surrounding spaces. A vaulted ceiling of machine-brushed stainless steel, triangular sconces with halogen lights, perforated metal railings, and adjacent concrete and concrete-block walls introduce a multiplicity of elements to the formal composition.

Technology dominates the linear laboratory and office wing at the north end of the building. Galvanized metal ducts carrying supply and return air pierce the space from above, reinforcing the rhythm established by exposed concrete columns and industrial-style lighting fixtures. Anticipated changes in the use of lab spaces raised many questions about future technical needs, so Esocoff fitted each pair of labs with a 3-by-10-foot service

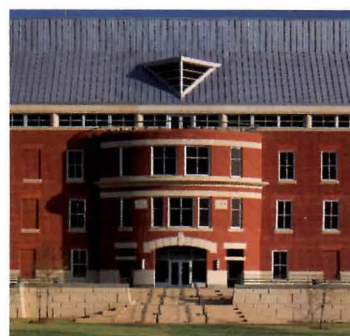

**TOP:** East facade functions as service side, with a large loading bay and removable ground-floor windows that allow delivery of lab equipment.

**ABOVE:** Oval grille on north end vents mechanical penthouse located beneath standing-seam metal roof.

**LEFT:** Curved bay containing teleconference center and library extends from flat wall of east facade.

**BOTTOM:** West entrance facing future campus mall leads to a monumental stair that took its cues from Stratford Hall Plantation in Virginia.

**FACING PAGE:** Symmetry is broken on the north wall by stacked windows that illuminate a fire stair. Tower shelters ground-floor entrance and fourth-floor terrace.

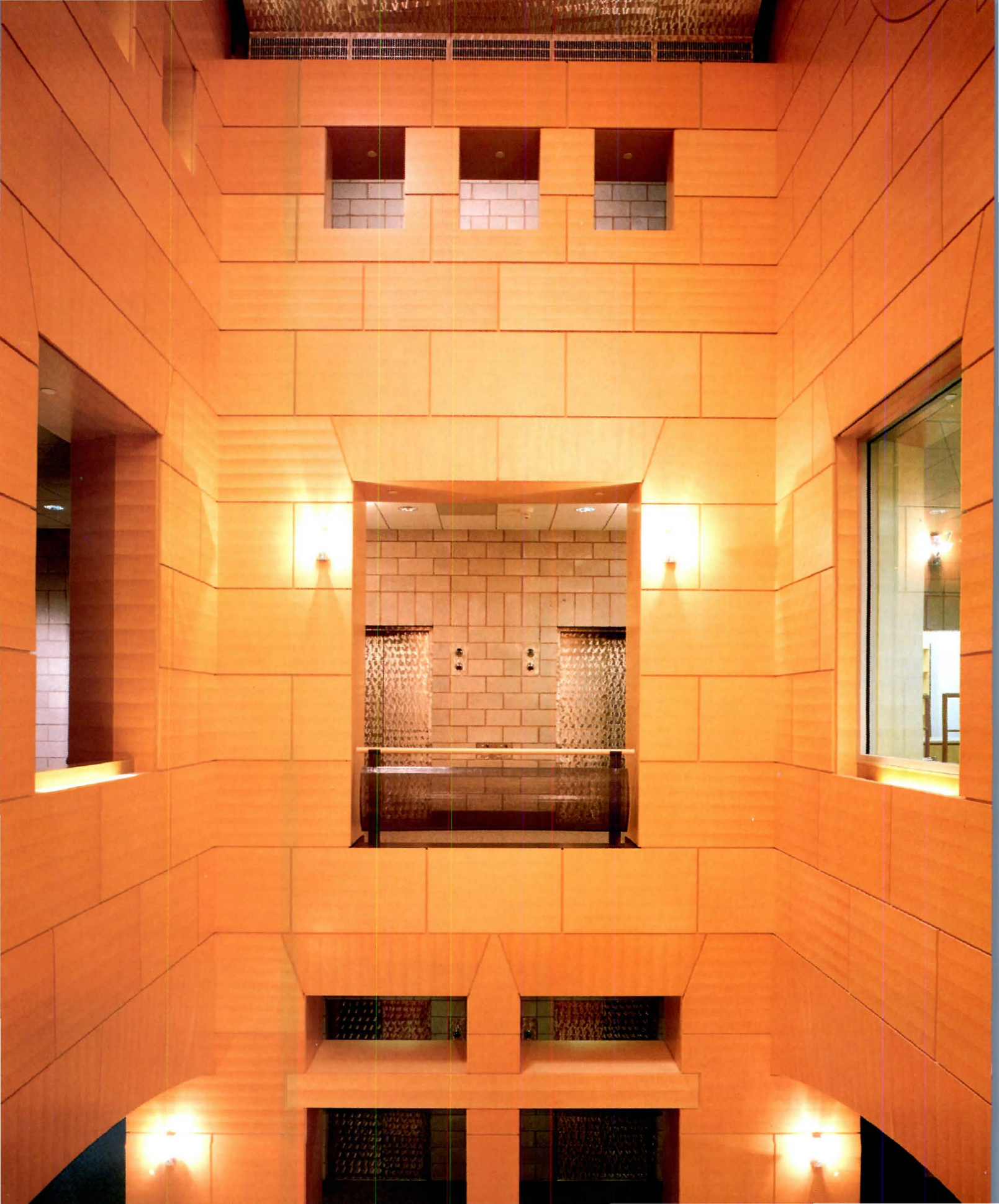



closet of perforated metal through which mechanical systems can later be fed vertically. The closets also contain the base building's plumbing and electrical systems. This planning strategy allowed for the elimination of the expensive interstitial mechanical corridor found in many lab buildings; it also provided a chance to place the labs on the building's perimeter, where they receive natural light and can be converted into future classrooms.

Esocoff also anticipated changes in the use of the building by providing a 15-foot floor-to-floor height; generous structural capacity (150 psf live load, which allowed a last-minute relocation of the library without requiring redesign); and flexible lab space within a 24-by-32-foot planning module. "If you design a building with generosity in those three areas, you design a building that can hold a wide variety of human activities," Esocoff maintains. The research activities housed within the new center already run the gamut from magnetics to paleoanthropology.

The center, which is electronically linked to GWU's downtown Washington campus, incorporates the latest in instructional technology. Adjacent to the greeting hall is a multimedia theater equipped with teleconferencing facilities; this allows students in Virginia to "attend" classes being conducted 30 miles away.

One of the graduate center's highest-profile offerings is its executive training program, located in a fourth-floor suite dedicated to that purpose. Its tiered, 45-seat lecture hall is surrounded by four seminar rooms and a paneled dining room that matches the greeting hall's high level of finish. Natural light spills into the dining room through two large dormers that jut prominently from the rooftop. University officials wanted a building based on Georgian tradition, says Esocoff, "but didn't want it to look like Ye Olde University." For anyone who takes more than a passing glance at the graduate center, its inventive, Modern expression conveys a sensibility that respects tradition but stays true to the present. ■

—Vernon Mays



**TOP:** Oval window at top of hall admits light from east facade window beyond.

**LEFT:** View through the greeting hall reveals juxtaposition of wood and metal finishes and concrete-block walls.

**BELOW:** Greeting hall and reception area floors mix wood, slate, and carpet.

**BOTTOM:** View toward laboratory wing shows green-stained beech applied to outer surfaces of greeting hall.

**FACING PAGE:** Beech in greeting hall is detailed to resemble stone. Steel vaulted ceiling is echoed in elevator doors.

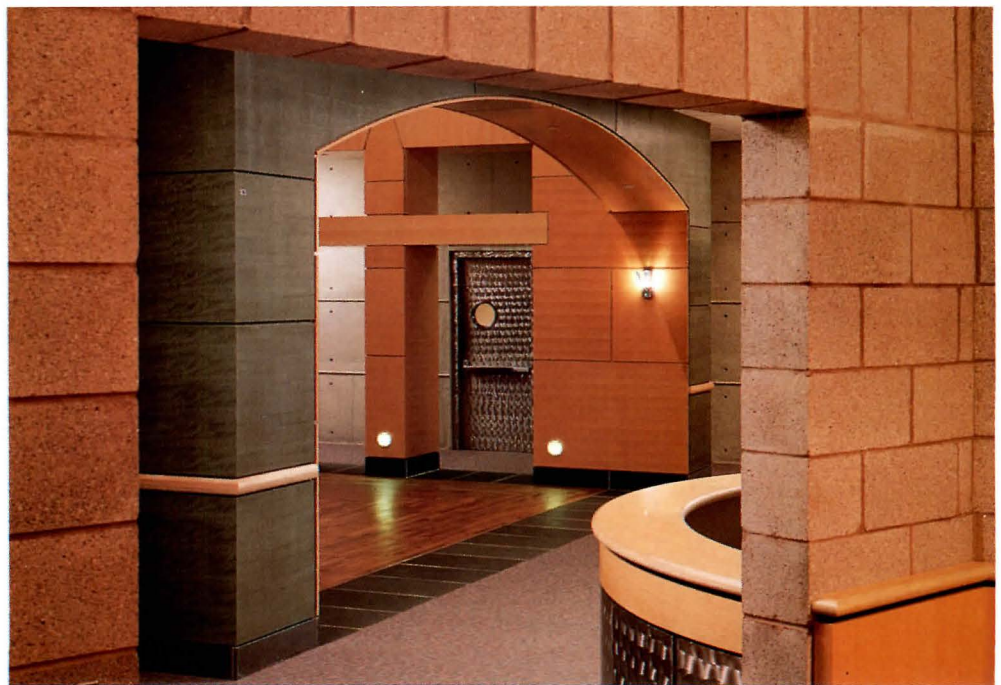

**BELOW:** FEEK encouraged everyday use of building's fire stairs by installing colorful railings and carpet runners.

**FACING PAGE:** Repetition of structural columns, red service closets, industrial lighting, and galvanized ducts in the corridor between laboratory and office wings heighten a sense of technology.

**PLANS:** Public functions are contained within southern wing, and laboratories and offices in northern portion.

**SECTION:** Mechanical corridor divides laboratories on left from offices on right.

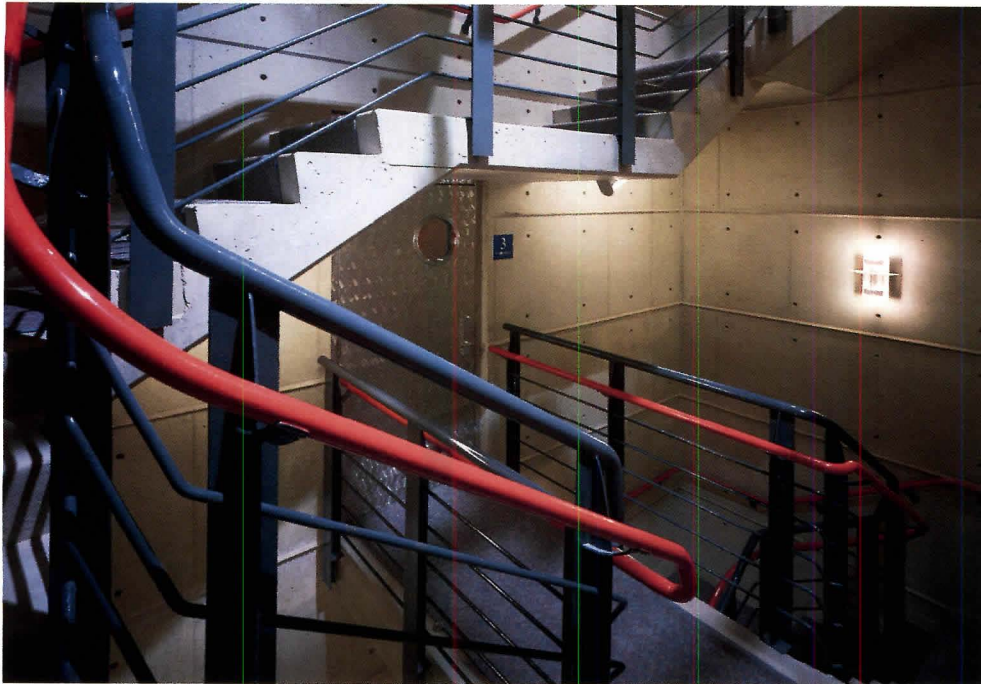

**GEORGE WASHINGTON UNIVERSITY  
GRADUATE RESEARCH AND TEACHING CENTER  
LOUDOUN COUNTY, VIRGINIA**

**ARCHITECT:** Florance Eichbaum Esocoff King Architects, Washington, D.C.—Philip A. Esocoff (principal-in-charge); Martin Denholm (project manager); David Greenbaum (project architect); Guillermo Rueda, Steve Lauria, Greer Maneval, Charles Szoradi, Hugh Randolph, Eugene Stolzhus (design team)

**LANDSCAPE ARCHITECT:** Florance Eichbaum Esocoff King Architects

**ENGINEERS:** James Madison Cutts (structural); Girard Engineering (mechanical); Patton Harris Rust & Associates (civil)

**CONSULTANTS:** Kendall Associates (acoustics); Wheel Gersztzoff Friedman Shankar (lighting); Heller & Metzger (specifications); Red Walther's Plan Room (cost-estimating)

**GENERAL CONTRACTOR:** OMNI Construction

**COST:** \$11.7 million—\$151/square foot

**PHOTOGRAPHER:** Maxwell MacKenzie

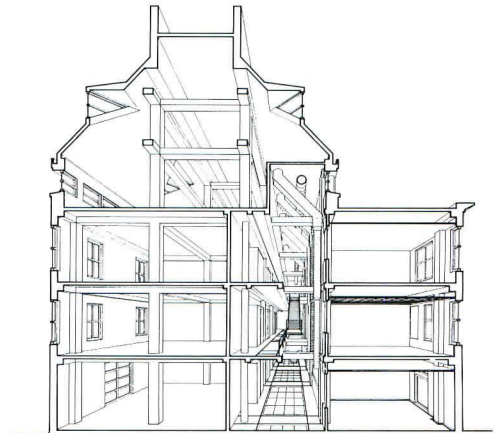

WEST-EAST SECTION

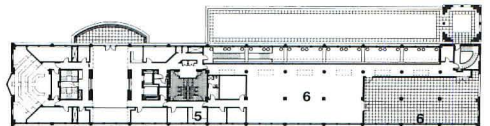

FOURTH FLOOR

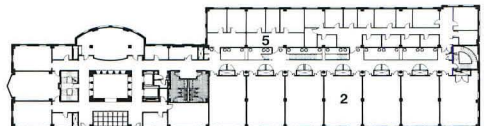

THIRD FLOOR



SECOND FLOOR



GROUND FLOOR

- |                 |                   |
|-----------------|-------------------|
| 1 GREETING HALL | 4 LIBRARY         |
| 2 LABORATORY    | 5 FACULTY OFFICE  |
| 3 CLASSROOM     | 6 MECHANICAL ROOM |



Iowa Advanced Technology Laboratories  
Iowa City, Iowa  
Frank Gehry & Associates, Architects

# IOWA ENLIGHTENMENT



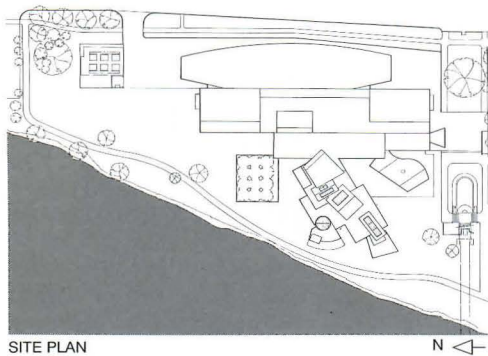

SITE PLAN



Lack of a coherent urban fabric would lead some architects to abandon the search for site-sensitive solutions. Frank Gehry chooses instead to redefine the context. The Iowa Advanced Technology Laboratories (IATL), which houses the University of Iowa's new laser research program, is the fullest embodiment to date of the alternative contextualism that Gehry has been developing since he clothed his own Santa Monica house in chain-link fencing and corrugated steel in 1978.

Spectacular among the undistinguished structures on the university's east campus, the metal and stone collage rises like a new leader determined to break with the past. Instead of snubbing its surroundings, however, the 136,000-square-foot building engages and modifies its context by reinterpreting and recombining salient features of neighboring buildings into a dynamic whole. Gehry's design thus strengthens the tentative personalities of existing structures while serving as a magnetic center in which their disparate elements are molded into a common expression.

The creation of the IATL is a direct result of the University of Iowa's commitment to move into the forefront of high-technology research over the next century. In addition to laser research, the building supports interdisciplinary teams that are studying acid rain and developing computer-aided design software. The university's architectural selection committee chose Gehry because its members felt he would not impose an alien structure on the campus. "He was a low-key salesman," notes Wallace Tomasini, director of the School of Art and Art History, who was on the selection committee. "He came by himself, not with an entourage like the other architects we were considering."

**FACING PAGE:** IATL comprises steel-clad offices and limestone-and-copper-faced labs on banks of Iowa River. Powerhouse inspired structure's geometric forms.

**SITE PLAN:** Rectangular and boat-shaped laboratory structures to the east fit into campus grid; office cubes to the west follow diagonal line of river.

Designed by Gehry in conjunction with the Des Moines firm of Herbert Lewis Kruse Blunck, the IATL shares a plaza with the Iowa Memorial Union, built in 1925, at the entrance to a pedestrian bridge over the Iowa River between the university's east and west campuses. Setting up a conceptual tug-of-war between unity and fragmentation, the design combines five structures whose contrasting forms and materials suggest their distinct functions: an entrance pavilion, a conference space, two laboratory buildings, and an office block. Jogs, inserts, and cutouts between the disparate volumes emphasize the building's three-dimensionality and mask the points of connection among its parts.

Gehry anchored the building to the campus with a monolithic, four-story, limestone-clad laboratory wing, devoid of fenestration on three sides to provide a controlled environment for laser research. The rectilinear mass of this stone block places the building firmly within the campus's orthogonal street grid and serves as a stabilizing foil for the more volatile elements to the east and west. On the east face of the limestone wing, Gehry designed a curved, copper-clad structure that slips past the stone facade like the hull of an upside-down boat. On the west side, offices are housed in discrete pavilions that collide and tumble in a flash of stainless steel toward the river.

The stainless-steel panels of the office cubes point up the full intensity of Iowa's most dramatic natural phenomena—its huge sky, intense light, violent and rapidly changing weather, and flying clouds that move swaths of light and dark across the site. At sunset, the stone and the steel reflect golden light, blurring the distinctions between them. In the rain, the steel panels darken like the river, while the stone remains light-colored. Folded at the edges and overlapped to create a pillowed effect that reflects light unevenly and mitigates the metal's harshness, the lower panels are already marked with the fingerprints of people who have been drawn to touch their

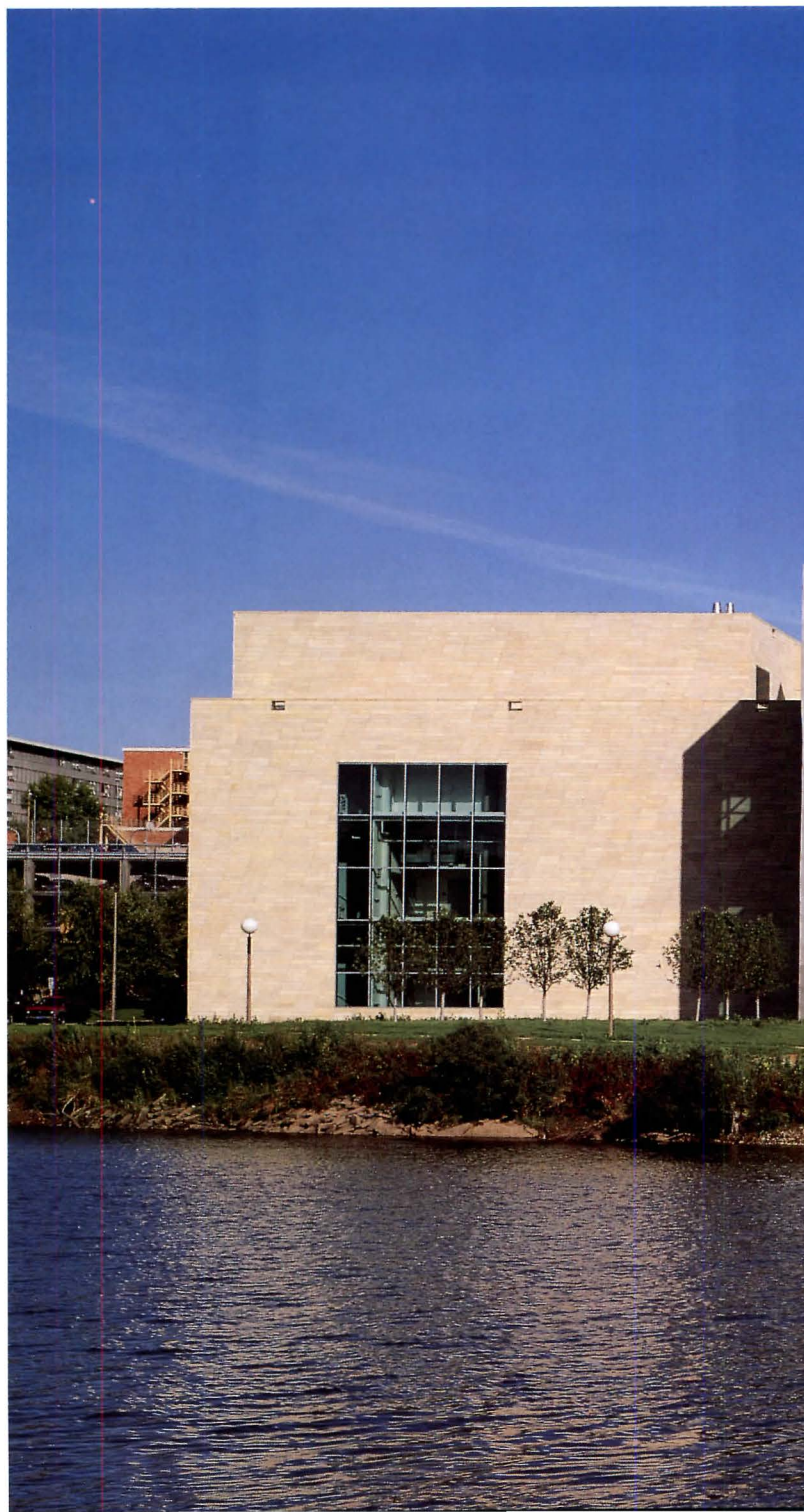



**FACING PAGE, TOP:** Roof of Iowa Memorial Union inspired copper cladding of boat-shaped laboratory and steel-faced wedge atop stone lab.

**LEFT:** West facade contains offices with river views. Foundation of second office building, eliminated by budget cuts, is visible near river promenade.

**BELOW:** Steel-clad forms of office structure suggest crystals relevant to laser technology. Expansive glazing provides daylight and views.



mysterious surfaces. Sun alternately highlights the panels' long vertical seams, emphasizing the structure's upward thrust, or the panels' short horizontal seams, bringing out zigzag patterns. If the constant transformation in intensity, pattern, and color of the steel surfaces expresses the volatility of the natural elements, the slow oxidation of the lab's copper cladding suggests a longer evolution.

During design development, the Gehry-led team built not only 30 models of the building, but a detailed model of the campus as well, resulting in subtle correspondences between the laboratory and its surroundings that are fully revealed only from certain vantage points. A wedge-shaped, stainless-steel clerestory sliding off the office structure, for example, was inspired by the clerestory wedges of the university's Music Building downriver; a cutout at one end of the laboratory reinterprets the uneven roofs of dormitories on the west campus.

Gehry conceptually bracketed the campus by pairing the IATL with the 1936 brick powerhouse upriver, which he termed the most "animated and gutsy" structure on campus. The energetic compactness and vertical emphasis of Gehry's colliding, overlapping cubes and cylindrical light well reinterpret the power plant's craggy planes and tall smokestacks. The cylinder also refers to the ubiquitous silos on the farms just outside Iowa City. These multilayered references surpass simple story-telling, fostering a fresh view of the built surroundings as a collage of abstract, corresponding geometries.

Gehry's exploration of context releases the expressive potential of existing forms. The architect refers to the hipped roof of the nearby Iowa Memorial Union in a steel-clad wedge atop his stone laboratory and echoes the roof's copper sheathing by enrobing his boat-shaped lab in copper. Thus, Gehry releases the copper material from its conventional application and defeats the hierarchical distinction between roof and walls. Crouched at the foot of the lab's limestone cliff, the copper-sheathed form reveals the intrinsic beauty of its material.

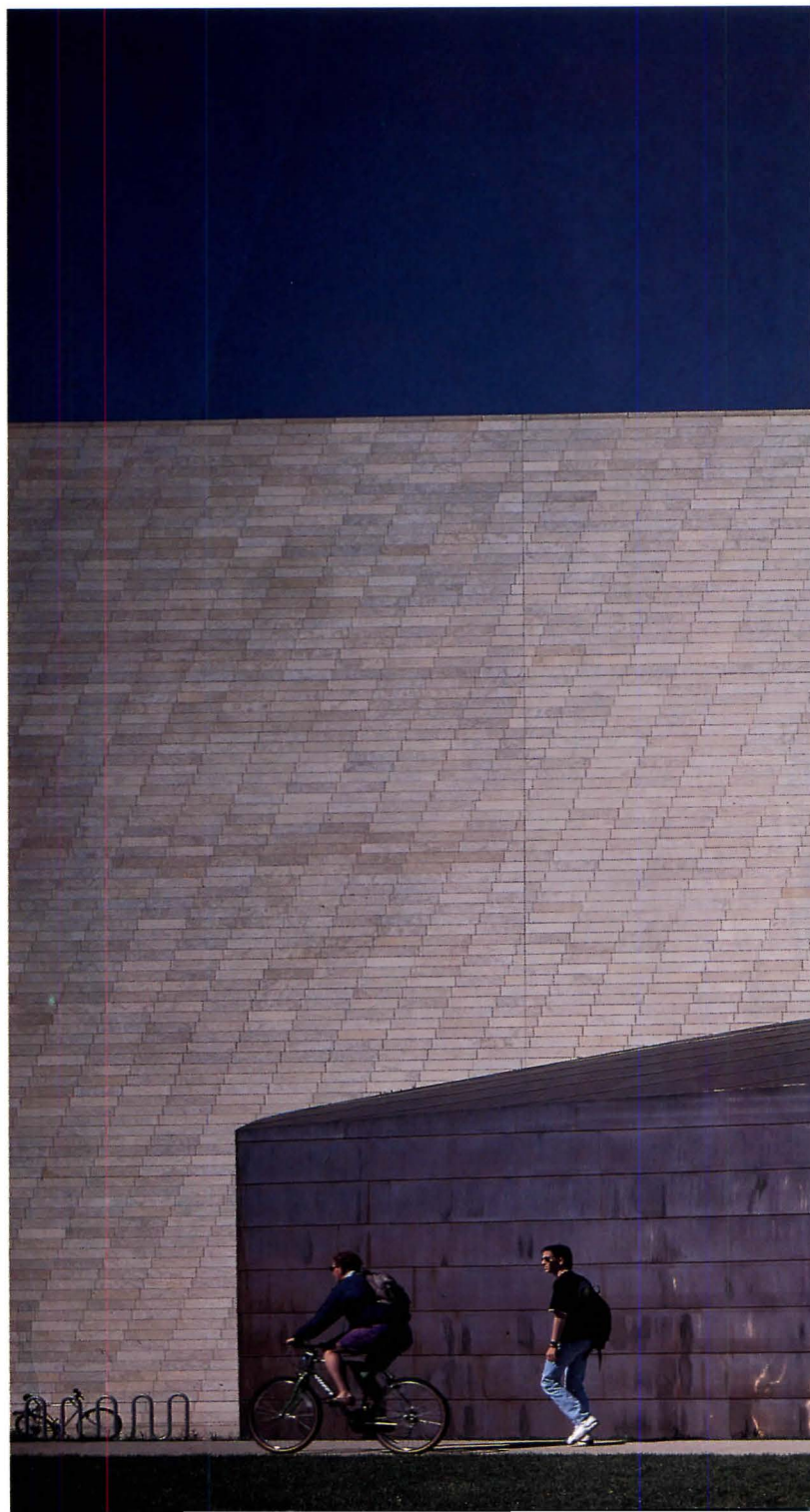
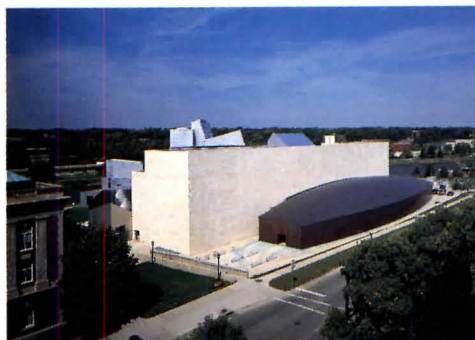



**FACING PAGE, TOP:** Complex shares an entrance plaza with Iowa Memorial Union. Limestone volume relates to Art Building across the river; copper-clad structure will house future labs.

**RIGHT:** Lack of fenestration in two lab blocks provides ideal environment for laser research and fosters shifting perceptions of building's scale.

**BELOW:** Cladding materials are unified by diagonal pattern formed by shifting successive rows of copper and steel panels and stone blocks in small increments.





**FAR LEFT AND LEFT:** Entrance pavilion is positioned next to lab block.

**BELOW:** Conference room is contained within reflective-metal-clad pavilion.

**PLANS:** Main stone-clad lab is flanked by boat-shaped lab building and offices.

**FACING PAGE, TOP:** Facade of conference structure mirrors form of fountain wall at steps to pedestrian bridge.

**FACING PAGE, BOTTOM:** Windows repeat proportions of openings in other campus buildings.

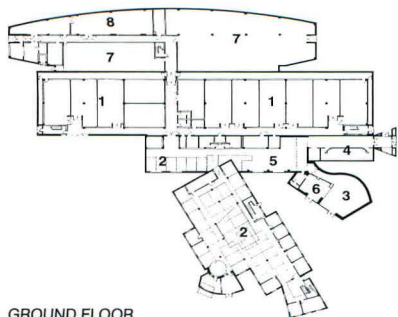

GROUND FLOOR

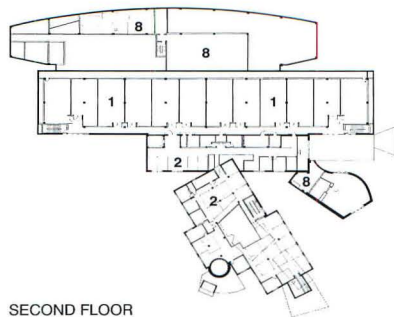

SECOND FLOOR

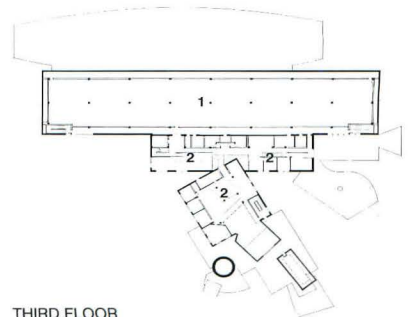

THIRD FLOOR



- 1 LABORATORY
- 2 OFFICE
- 3 CONFERENCE
- 4 DISPLAY
- 5 RECEPTION
- 6 LOUNGE
- 7 STORAGE
- 8 MECHANICAL

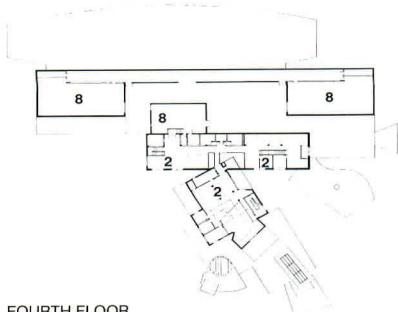

FOURTH FLOOR

The IATL, like much of Gehry's work, is truly sculptural in its egalitarian circularity that refuses to privilege a single viewpoint. The building has no front or back; each facade resolutely faces in its own direction, proclaiming in turn its preponderance. Successive vantage points reveal new angles, shapes, and volumetric relationships, so that fixing the whole at any one moment is impossible. Gehry's games with shifting scale relationships and forced perspective also hinder definition. As one descends the hill toward the building's east face, the dark copper arc flanking the stone monolith rises up through the trees like newly plowed earth against a light sky, greatly magnifying the perceived size of each structure. Lack of fenestration and the similar patterning of the stone and copper surfaces contribute to this momentary misperception of scale: with no clues as to where the descending curve of copper joins the vertical plane, the stone blocks appear farther from the copper panels than they really are. Not wholly predetermined, the building allows the viewer to participate in its conceptual creation.

Inside the building, private offices fill the cubes' outer extremities, while four levels of open-plan offices in the center adjoin a four-story-high atrium whose jutting overhangs suggest the corners of the cubes piercing through from the outside. Bars of light and shadow from mullioned windows and clerestories sweep in jagged lines across the broken surfaces. The labs are connected to the offices by a narrow rectangular building; a four-story-high corridor that joins the two lab structures contains more than nine miles of pipes supplying natural gas, deionized water, compressed air, and nitrogen to lab bench tops.

Gehry manipulates scale within the interior to pit context against abstraction, providing close-up views of the building's varied elements through every window. The effect can be shocking: reduced to pure light and texture, the reflective wall of the conference center, for example, looms through the enor-

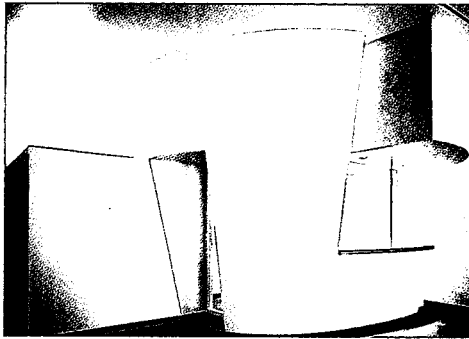

mous window of a small office. One step to the side, however, reveals the structure's edge against the river beyond, reintegrating the building with the landscape.

In addition to the IATL, other recent projects demonstrate Gehry's masterful molding of eclectic forms and materials into rhythmic, site-specific compositions. For the just completed University of Toledo Center for the Arts, for example, the architect translated the stone-faced Neoclassicism of an abutting museum into copper-clad, heavily massed geometries. He oriented windows so that no two openings frame the building's surroundings alike, initiating a lively interaction between students and landscape. Even in downtown Los Angeles, Gehry is attempting to create an accessible landmark. His Disney Concert Hall, now under construction, is intended to fluidly commingle interior and exterior, inviting the community inside. The Iowa Advanced Technology Laboratories similarly boasts an interactive agenda that bonds the research center to the community. Gehry, with this building, has realized his most convincing example of alternative contextualism to date. ■

—Andrea Truppin

**IOWA ADVANCED TECHNOLOGY LABORATORIES**  
UNIVERSITY OF IOWA  
IOWA CITY, IOWA

**ARCHITECTS:** Frank O. Gehry & Associates, Santa Monica, California—Frank O. Gehry (principal/design); David Denton (principal/management); Bruce Biesman-Simons (senior associate/management); Roberta Weisner, Thomas J. Hoos (project architects); C. Gregory Walsh (project designer); Tom Buresh, Edwin Chan, Kevin Daly, Tom Duley, Alex Meconi, David Pakshong, Carroll Stockard (project team); Herbert Lewis Kruse Blunck, Des Moines, Iowa—Charles Herbert, Rod Kruse, Jim Dwinell, Rick Seely, Kevin White, Jeff Morgan, Mark Schmidt (project team)

**ENGINEERS:** Structural Consultants (structural); Kimmell Jensen Wegerer Wray (mechanical/electrical)

**CONSTRUCTION MANAGER:** Cost-Planning Management International

**COST:** \$17.5 million

**PHOTOGRAPHER:** Erich Ansel Koyama



**RIGHT:** Flowing lines guide visitors from narrow entrance off lobby into conference room.

**FACING PAGE, TOP:** Gehry-designed reception center, containing mailboxes and office services, fills entrance lobby. Its curve channels circulation to conference structure and offices.

**BELOW:** Four levels of offices open onto light-filled atrium in center of metal-clad structure. Jutting angles express corners of office pavilions inside.



# METROPOLITAN HEALTH



**ABOVE:** Pei Cobb Freed's 11-story Guggenheim Pavilion complements the scale and street wall of Fifth Avenue—unlike its neighbor, the towering Annenberg Building.

**FACING PAGE:** Triangular incisions into the hospital define the patient towers and reduce the building's bulk. Inside the building, the towers are defined by skylighted triangular atriums.

City planning is a complicated business, as is hospital design; together, the two demand a daunting array of deliberations and decisions. For the Guggenheim Pavilion—a 900,000-square-foot addition to New York's Mount Sinai Medical Center on a prime Fifth Avenue site facing Central Park—Pei Cobb Freed & Partners had to address medical facility programming, then tackle master planning and urban design throughout the four-city-block complex. The architects were also compelled to consider how the new medical pavilion would relate to Manhattan's Upper East Side. And at each stage of the project, they were confronted by the special interests of the hospital's constituencies.

The complex project began 12 years ago when the Mount Sinai Medical Center decided to replace 11 buildings on a square-block site between 100th and 101st streets and Madison and Fifth avenues with one facility that would not only consolidate medical departments but increase the number of patient beds; provide state-of-the-art treatment capabilities; supply additional space for Mount Sinai's medical school; clarify the circulation and organization of the entire center; and remain flexible for future change and adaptation. Pei Cobb Freed, in association with Ellerbe Becket, responded with the Guggenheim Pavilion, which began construction in June 1986 and was completed last year. The \$218 million hospital is cleanly and clearly designed and successfully meets Mount Sinai's requirements, but just misses integrating its program within the site.

Pei Cobb Freed simplified the organization by designing three patient towers atop a four-story podium that faces Fifth Avenue: administration, admitting, and a cafeteria are on the first floor; a small auditorium, physicians' lounge, and family waiting area, on the second; and operating rooms and support, on the third and fourth. The towers are defined by large triangular incisions cut into the building's rectangular bulk that create matching triangular atriums inside. In the towers, two floors of intensive care and five of patient

rooms are arranged to offer daylight and views. Adjoining the south corners of the towers is a narrow service block; further south, a three-story enclosed plaza along the path of 100th Street connects the new hospital to two other Mount Sinai buildings and leads to the Madison Avenue entrance. On the Fifth Avenue side, the plaza is set back by an L-shaped exterior courtyard.

The Guggenheim Pavilion's mass fits surprisingly well into the cityscape; juxtaposed against Mount Sinai's behemoth Annenberg Building, designed by Skidmore, Owings & Merrill in 1976, the scale of the new hospital seems almost demure. Pei Cobb Freed's intrusion is also minimized by sensitive massing and materials. Facades, on the exterior and inside the atriums, are neutrally clad in extra-long, light-colored, iron-spotted brick, and enlivened by regular, square windows and vaguely Classical limestone trim. The taut, two-tone composition recalls the works of Louis Kahn; structural and architectural elements are expressed in a combination of stone and brick patterning. Along the avenues, small triangular niches cut into the facade from the fifth floor upward visually separate the service block from the westernmost patient tower, which also lessens the impact of the mass. The unadorned windows of the service block and the third floor, however, do not achieve the same effect, instead lending the exterior an odd and uneven asymmetry. The 101st Street facade is the least successful; broken only by overscaled vehicular entrances, its brick expanse is stark and forbidding.

Inside, Pei Cobb Freed's most dramatic flourishes are reserved for public spaces. Two triangular atriums are formed from the spaces between the towers: one serves as part of the main lobby, rising the full 11 stories of the building, while the other functions as a super-scaled dayroom, starting at the seventh level. Lined on two sides by facades that mirror the exterior, and on the third by open corridors of the service block, the atriums create urban courtyards that allow the dense project to





**TOP:** Windows are framed in bronze and crisply detailed in limestone.  
**CENTER:** Limestone trim highlights both the faceted elevations of the patient towers. On Madison Avenue facade (left), a triangular niche separates rear service block from patient towers.  
**ABOVE:** Enclosed plaza joins pavilion to Annenberg Building and Klingenstein Clinical Center.  
**FACING PAGE:** Fifth Avenue entrance is topped by deeply coffered ceiling and leads into cavernous atrium.

breathe. They also offer patients access to natural light, open space, and greenery. While striking, the atriums vary in success; the smaller one achieves a more intimate scale than its canyonlike, full-height counterpart.

Another special feature is a service block, containing conference rooms and storage, that provides a two-tier circulation system: a set of corridors and elevators along the atriums are reserved for visitors and ambulatory patients, while corridors and elevators along the south side of the block are reserved for medical staff.

The most successful public space of the new building is the enclosed plaza between the Guggenheim Pavilion and the other buildings on the plot. As a piece of urbanism within its context—it connects two-thirds of the medical center—it is essential to the pavilion's success. The second-floor balconies, Madison Avenue entrance, well-chosen art, and confluence of doors and stairs, all contained under a sloping glass roof, create a well-scaled and lively area that completes the progression from the Fifth Avenue lobby through the building to Madison. Unfortunately, this public connection also compromises the main lobby, since the city's traffic networks conspire to make the Madison Avenue side far more important. While it is natural that the hospital and the architects would want to create a grand entrance along Fifth Avenue, the overscaled doorway and cavernous entry pale in comparison to the energetic plaza at the heart of Mount Sinai.

In a building of this size and complexity, it is not surprising that there are a few misses. For the most part, though, the Guggenheim Pavilion is a large and complicated hospital that, through careful planning and design, conveys a surprising simplicity. As in the best city planning, Pei Cobb Freed has produced an urban project that performs well both within Mount Sinai's sprawling complex and within Manhattan's Upper East Side. ■

—*Andrea E. Monfried*

*Andrea E. Monfried is associate editor at Rizzoli International Publications.*





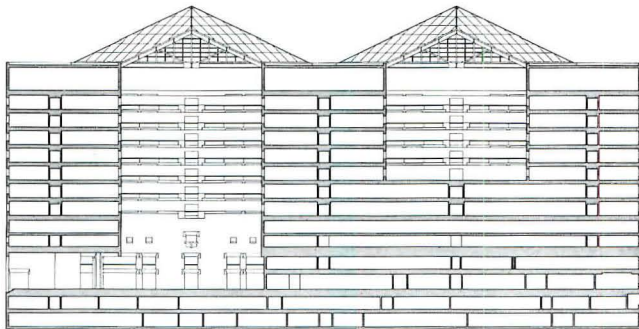
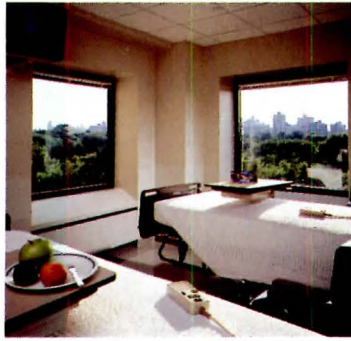

WEST-EAST SECTION

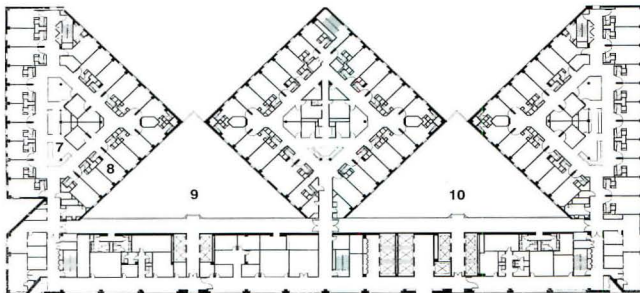

FLOORS 7-11

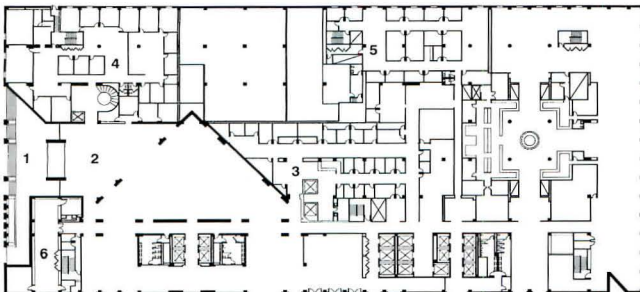

PLAZA LEVEL

- 1 ENTRANCE
- 2 LOBBY
- 3 ADMITTING
- 4 ADMINISTRATION
- 5 OFFICE
- 6 CHAPEL
- 7 NURSING POD
- 8 PATIENT ROOM
- 9 11-STORY ATRIUM
- 10 FIVE-STORY ATRIUM

**TOP:** Patient rooms offer stunning views of Central Park.

**SECTION:** Main lobby leads to 11-story atrium; five-story atrium fills levels seven to 11 between east and center towers.

**PLANS:** Pavilion is organized around triangular patient towers formed around atriums; narrow south block houses services.

**FACING PAGE:** Five-story atrium serves as patient dayroom; open corridors are reserved for visitors. Glazed slot frames north-facing view over city.

**GUGGENHEIM PAVILION  
MOUNT SINAI MEDICAL CENTER  
NEW YORK CITY**

**ARCHITECT:** Pei Cobb Freed & Partners, New York City—I.M. Pei (design partner); Eason H. Leonard, Leonard Jacobson, Werner Wandelmaier (administration partners); C.C. Pei, Allen Terry (design architects); Richard Cutter (project architect); Michael Vissichelli (production manager); Fritz Sulzer (curtain wall/skylight); Ian Bader, Richard Diamond, Richard Dunham, Ellen Friedman, Michaela Haberland, Dorothy Hill, Tatiana Kasnar, Louis Kaufman, Stephanie Mallis, Andrzej Morawski, Jean-Pierre Mutin, Steve Nakada, Gianni Neri, Michael Ngu, Armando Rose, Stephen Rustow, Jeff Stumacher, Simon Thackdurian, Jose Valdes, Jorg Weinbrenner, King Wong, W. Stephen Wood, Steve Yabon, Michael Zakian (design team)

**ASSOCIATE ARCHITECT/MEDICAL PLANNING:** Ellerbe Becket, Architects, New York City—John Gaunt, Ellis Hansen, Duane Ramseth, Bill Kidd

**ENGINEERS:** Weiskopf & Pickworth (structural); Syska and Hennessy (mechanical/electrical)

**CONSULTANTS:** Mason DaSilva (master planning); Howard Brandston Lighting Design (lighting); Cerami and Associates (acoustical); Rolf Jensen & Associates (life safety); Robert Schwartz (specifications); Kowalski/Dickow Associates (materials handling); Charles A. Broutman (communications); Allee King Rosen Fleming (environmental); Travers Associates (traffic); Cole-Gillman Associates (codes); Christopher Klumb Associates (graphics); Museser Rutledge (soils); Marriott Corporation (food service); Mitchell International (equipment); Morse/Diesel (construction)

**GENERAL CONTRACTOR:** Turner Construction Company

**COST:** \$218 million

**PHOTOGRAPHER:** Paul Warchol



# SCIENTIFIC BREAKTHROUGH

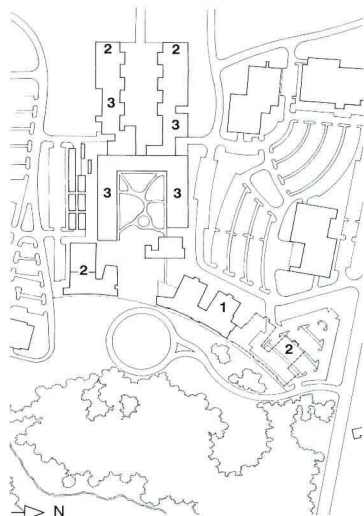

SITE PLAN

- 1 COOLEY CENTER
- 2 FUTURE BUILDINGS
- 3 EXISTING BUILDINGS



**SITE PLAN:** Original campus featured a central quadrangle. New plan reorients traffic and creates a circular courtyard with Cooley Center at its edge.

**ABOVE:** Transparent lobby anchors the science center's southern edge.

**FACING PAGE, TOP:** Along the building's curving east facade, an outdoor walkway serves as a main campus artery.

**FACING PAGE, BOTTOM:** Two-story glass wall marks central administrative spaces; aluminum cladding is articulated with a brise-soleil.

The Oregon Graduate Institute (OGI) was established in 1963 as the first private graduate school of science and engineering in the Pacific Northwest. Its original campus, master-planned by the Portland firm of Wolf Zimmer Gunsul Frasca (with Pietro Belluschi as a design consultant), comprised a series of low, wood-clad buildings with simple shed roofs. But by the late 1980s, OGI had evolved into an internationally respected institution and was ready to shake its unassuming image. When the university commissioned BOOR/A in 1989 to develop a comprehensive master plan, the Portland architecture firm recommended extending the campus to the east with a new vehicular approach. BOOR/A also advised OGI to develop future buildings with a more high-tech profile that would befit the Institute's scientific mission and its growing student body and faculty.

The new Cooley Science Center supports state-of-the-art research, such as the creation of synthetic enzymes to destroy environmental toxins, as well as laboratories and classrooms for the chemistry, biology, and environmental engineering departments. Accordingly, Boucher Mouchka Larson (BML) designed a progressive, metal-clad structure—the first evidence of the Institute's three-stage construction program that is designed to carry out BOOR/A's mandate.

At 67,000 square feet, the Cooley Center is the largest building on the OGI campus and sharply contrasts with its restrained neighbors. Rather than attempt to reduce its apparent mass, BML capitalized on the center's size to create a bold marker at the northeast corner of the campus, where a new entrance roadway will be built in the second phase of OGI's construction. Responding to the new master plan, the architects gently curved the building's east facade to define a future vehicular rotary and to frame a creek valley to the southeast. Departing from the campus's original material palette of cedar siding and shakes, Boucher Mouchka Larson

clad the building in aluminum panels; pent-house mechanical equipment is shielded behind stainless-steel screens.

The architects crowned the facility with a pair of symmetrically placed skylights that rise above the roof line. Expressing the building's engineering purpose, these rooftop light wells feature exposed painted-steel trusses and slanting walls of transparent glass detailed with a ceramic frit pattern. Flanking either side of the pair of skylights are the center's requisite exhaust stacks that serve two floors of labs below.

At the midpoint of the science center's curving east facade, the architects inserted a two-story wall of dark-gray tinted glass. The southern end of the building is anchored by a two-story glazed lobby. This 2,000-square-foot foyer, enlivened by a grand stainless-steel-and-glass stairway, also functions as a ceremonial space for campus activities. Within the existing pedestrian and vehicular circulation patterns, the main lobby is now located slightly off the most direct path of traffic. When the new master plan is fully realized, however, it will occupy a more significant location; it will also serve to bracket a proposed landscaped courtyard and a planned auditorium building farther to the south.

Although the architects strived to develop an exterior expression that responded to OGI's master plan, the building's footprint was actually derived from its programmatic requirements. To meet chemists' and biologists' demands for traditional labs with individual workstations and environmental engineers' preference for a more collective research arrangement, BML Design Principal Gary Larson developed an all-purpose, square lab wing, whose sides measure approximately 95 feet. The architects then repeated this configuration four times—stacking two levels of laboratories in a pair of wings that extend from an administrative block.

To ensure some degree of departmental autonomy, the architects devoted the entire first floor of the building to the chemistry



**BELOW:** Skylight is tilted at an 11-degree angle to crown a stairway.

**CENTER:** Secondary entrance is located between two lab wings that extend westward to a parking lot.

**SECTIONS:** Labs are designed for flexibility—with the upper floor divided into four bays, and the ground floor comprising three bays (top). Mechanical equipment is stacked above the administrative wing (bottom).

**FACING PAGE:** Roof line is enlivened by east-facing skylights and exhaust stacks.

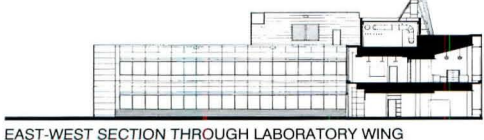
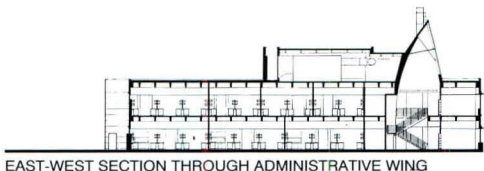

and biology departments. The environmental science and engineering departments are housed on the second floor. This arrangement results in a floor plate that is organized into a double-T configuration, with two distinct laboratory wings that extend to the west from a linear north-south office spine.

In addition to creating a very efficient floor plan, Larson and his team designed the four laboratory blocks to be easily modified. Each block is organized on 10-foot-6-inch modules within three bays that measure approximately 30 feet each. To meet strict HVAC requirements, the laboratories are served by ganged mechanical vents along a manifold that is connected to four stacks on the roof; the stacks are outfitted with powerful fans that shoot exhaust up and out. This stacked laboratory space, which was designed to be easily customized to meet diverse functions, proved amenable to all departments, and provided approximately 8,000 square feet of space beyond the program requirements.

The architects created a decidedly different environment for the office wing that forms the building's eastern edge. "Our footprint deliberately separates lab and research support spaces from primary building circulation and administrative activity," explains Larson. The building's main north-south axis follows the gentle curve of the administrative offices and becomes a social corridor. Embodying the flexibility the architects designed into the lab wings, the administrative wing provides each department with the leeway to customize support spaces.

On the ground level, two conference rooms flank the building's secondary entrance, which opens onto a landscaped courtyard defined by the two research wings. A large conference room, an open work space for support staff, student study carrels, and a row of computer terminals are clustered at the center of the administrative wing on the second floor to further encourage interdepartmental communication. Most universities recognize that research depends on interdisciplinary contacts, and a



**BELOW:** Lobby's horizontal bands of gray-tinted windows accentuate views out to adjacent wetlands.

**CENTER:** Ground-floor library and conference room flank building's secondary entrance corridor.

**PLANS:** Laboratories form two wings that extend from the spine of offices; second-floor labs within the north wing will be outfitted in the future.

**FACING PAGE:** Main lobby with steel staircase anchors southern end of building and doubles as a ceremonial space.



- 1 LOBBY
- 2 COMPUTER ROOM
- 3 LABORATORY
- 4 INSTRUMENT ROOM
- 5 INCUBATION/  
REFRIGERATION ROOM
- 6 OFFICE
- 7 CONFERENCE ROOM
- 8 DEPARTMENT CENTER
- 9 CLASSROOM
- 10 LIBRARY
- 11 LOADING DOCK
- 12 MECHANICAL ROOM

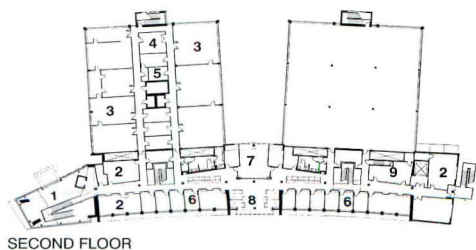

SECOND FLOOR

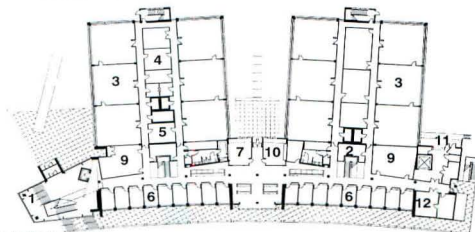

FIRST FLOOR

building that fosters such sharing will prove successful in the long run. With this spirit of camaraderie in mind, the architects inserted two skylit stairways at the juncture of the laboratory and administrative wings to encourage interaction between the researchers from the various departments.

Breaking with the architectural tradition of a campus is risky business. But with the support of a dynamic college administration, Boucher Mouchka Larson eschewed shrouding the Cooley Center's technologically advanced laboratories in a traditional wrapping that would have receded into the campus setting. Instead, they designed an arresting exterior that sets a new standard for the campus. Larson views this stylistic departure as a deliberate way to express the Institute's goal to remain at the forefront of scientific research. And so does his client. At the building's dedication in October, OGI President Dwight Sangrey stated, "OGI is well on its way to becoming one of the world's outstanding graduate schools in science and engineering. Our transformation begins with this new building."

—Lynn Nesmith

**COOLEY SCIENCE CENTER  
OREGON GRADUATE INSTITUTE  
PORTLAND, OREGON**

**ARCHITECTS:** Boucher Mouchka Larson Architects, Portland, Oregon—Ray Boucher (principal-in-charge); Gary Larson (project designer); Ken Mouchka (project manager); James Meyer (project architect); Bill Hutchinson, Nancy Hiss, Inara Beitlers, John Holmes, Burt Ewart, Robert Thrapp, David Morey (design team)

**LANDSCAPE ARCHITECTS:** David Evans and Associates; Mayer/Reed

**ENGINEERS:** KPFF Consulting Engineers (structural); PAE Consulting Engineers (mechanical/electrical); David Evans and Associates, Thomas Wright (civil)

**CONSULTANTS:** Earl Walls Associates and The Estimate Group (laboratory design); Ventilation Engineering (ventilation)

**OWNER'S REPRESENTATIVE:** FMCI, Bob Broberg

**GENERAL CONTRACTOR:** Hoffman Construction Co.

**COST:** \$10.5 million—\$156/square foot

**PHOTOGRAPHER:** Strode Eckert Photographics





**In 1906, an architectural  
aluminum company was founded by  
an architect who believed that  
only an architect could know  
what an architect needs.**



**FRANCIS J. PLYM.**

**ARCHITECT.**

**KANSAS CITY, MO.**

**KEMPER BLDG.**



# Technology & Practice

- 87 Info
- 91 Healthy Trends
- 99 Patients First
- 111 Venting the Laboratory
- 123 Laboratory Innovations
- 144 Neat File

In this month's technology and practice section, we extend our coverage of hospitals and laboratories to examine how the evolution of the two building types is responding to changes in healthcare services and research methods. A radical notion is beginning to spread through the healthcare industry: Hospitals should be more hospitable to their patients. Many facilities, now in the financial equivalent of cardiac arrest, will have to adapt in order to survive in an increasingly competitive market.

■ As our article on healthcare trends (pages 91-93) suggests, some hospitals are beginning to reflect the familiar atmosphere of the shopping mall, adding restaurants and retail shops to walk-in diagnostic and treatment centers, all combined under one roof.

■ Many hospital administrators are realizing that to compete with other medical facilities their buildings must be designed for the comfort of patients, rather than for the convenience of medical staff. Such hospitals employ interdisciplinary medical teams to diagnose and assist patients within private rooms, rather than wheeling them through an endless maze of hallways to specialists and technicians. Healing techniques rooted in environmental design, such as providing patients with outdoor views and daylight, are increasingly being recognized as sound therapy for quick recuperation. As our article on patient-focused care (pages 99-105) illustrates, these changes in the delivery of healthcare services profoundly alter previous facility-planning concepts and programming assumptions.

■ Provisions for the health and safety of scientists and technicians working in research laboratories have also changed. Concerns about health hazards are vastly magnified in such environments, where contact with high doses of potentially hazardous chemicals is an everyday occurrence. As illustrated in an article on mechanical systems for laboratories (pages 111-117), improving indoor air quality, as well as limiting the discharge of contaminants to the surrounding environment, is driving architects to integrate HVAC services in research laboratories at an early stage of design in order to accommodate ever-increasing equipment and duct-distribution requirements.

■ Likewise, the research laboratory must itself be more flexible to respond to the changing nature of scientific study. Increasing reliance on computers to record experiments requires more ancillary office and support space, often blurring the distinction between bench tops and desktops. An article on laboratory programming (pages 123-127) outlines ways of encouraging interaction between researchers to provide fertile ground for sharing and testing new ideas.

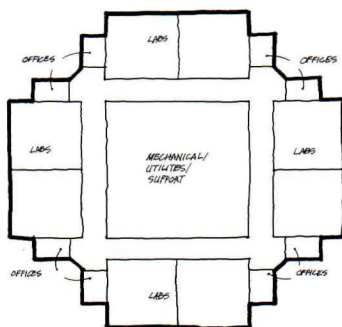
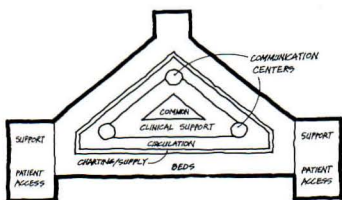

**TOP:** Organizational diagram of prototypical patient-focused hospital wing.

**ABOVE:** Organizational model of laboratory, office, and support module.

# THE OSRAM HQI-DE LAMP PUTS UNION STATION ON THE FAST TRACK TO BIG SAVINGS.

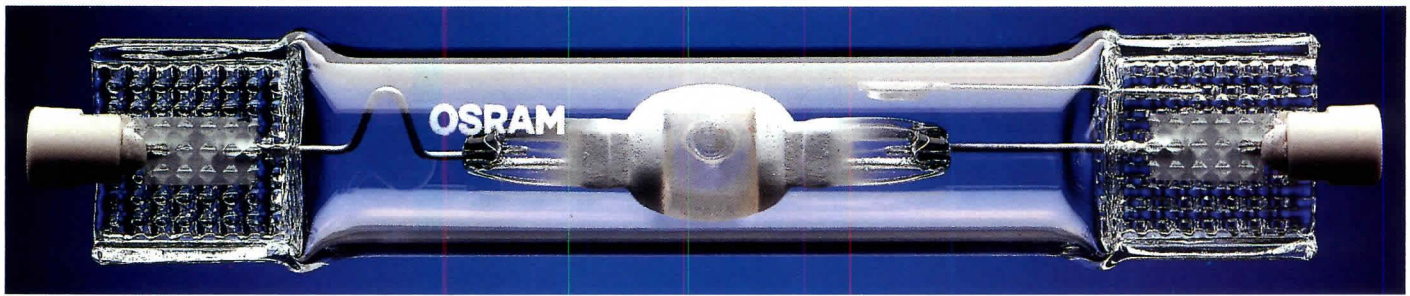

**With the OSRAM HQI-DE lamp, Washington D.C.'s Union Station now has energy cost savings that would make any President proud.**

After its non-Congressionally funded, \$160 million restoration and renovation, Union Station has a lot more going for it than a facelift. It has a future.

And to ensure the brightest future possible, the designers of the new Union Station specified the OSRAM HQI-DE lamp.

## **Better performance. With bigger savings.**

The OSRAM HQI-DE metal halide lamp far outshines all other PAR incandescents and metal halides. It provides extraordinary color rendition and luminous efficacy for accent and display lighting. And when used together with the new OSRAM POWERTRONIC electronic ballast, the already energy efficient HQI-DE lamp delivers even greater performance, a 20% longer life and increased savings.

Producing more light than PAR lamps while using less wattage and emitting less heat, the new OSRAM HQI-DE lamp offers a service life that is five times that of PAR incandescents. This means big reductions on energy and maintenance—and a fast return on your investment—usually within the first year of use.

## **A clear favorite.**

Compact and versatile, the OSRAM HQI-DE lamp is available in 70 and 150 watt sizes and in two color temperatures. So no matter who or what you're spotlighting, the OSRAM HQI-DE is the bright choice.

How long can you afford to stay in the dark about the OSRAM HQI-DE lamp and the new POWERTRONIC electronic ballast?

For more information call **1-800-338-2542**.



## Super Collider Moves Ahead

A group of modest buildings in Waxahachie, Texas, indicates substantial progress in the Department of Energy's enormous \$8 billion superconducting super collider project, scheduled for completion in 1996. To study the basic physics of energy and matter, magnets ringing a 54-mile-long elliptical tunnel will guide proton beams on a collision course with one another at nearly the speed of light. Within the new Magnet Development Laboratory, the first of these particle-smashing magnets is now being assembled and tested. The 109,000-square-foot laboratory is located to the north-west of the main campus, which will include research labs, conference centers, and other facilities; it sits over the first access shaft to be excavated for lowering the 3-foot-diameter, 54-foot-long magnets into the underground tunnel.

To visually tie the development laboratory to its site, Houston-based CRSS Architects designed the building in precast concrete made of an indigenous limestone aggregate similar to the stone excavated from the site. Glass-enclosed stair towers were erected at the corners of the building to allow views of the central bay where the magnets are assembled.

Also completed in January were three buildings for simulating the magnets' performance when they are strung together, and a group of three laboratories for testing individual magnets. Since the magnets must be cooled to 0 degrees Kelvin in order to prevent them from being destroyed by the tremendous amount of electricity—approximately 20 trillion volts—required to power them, both test areas are equipped with mechanical systems capable of producing such exacting, extreme temperatures.

Nearby, a linear accelerator for generating the particle beams' speed is scheduled for completion this fall. Two massive detector halls—each measuring approximately the size of a football field—for monitoring the collision of protons will be built by 1996. In addition, the many utility and other access points interspersed above the tunnel remain to be built before the massive complex is completed. The entire superconducting super collider project is scheduled to be operational by the turn of the century.



**SUPER COLLIDER:** West campus.

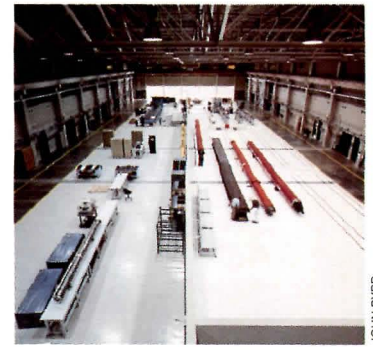

**LABORATORY:** Magnet assembly.

JOHN BYRD



**AWARD-WINNER:** Stamford Hospital's Bennett Cancer Center, by Geddis Partnership.

## Environmental Videoconference

Too often architects sitting in their offices lose sight of the effect they have on the world. By capitalizing on video technology, the AIA has dramatized the profession's global environmental responsibilities in a three-part series entitled "Building Connections." The first segment, which aired January 14 at 180 sites around the country, opens with an architect specifying mahogany paneling for a project. Seconds later, the camera cuts to a rain forest, where buzzing saws are felling trees and destroying a vital source of our planet's oxygen and potential medicines. Back in the office, the architect continues her work, unaware of the destruction she is encouraging.

Today's architects cannot afford to remain so oblivious. Improved lighting and glazing technologies, more sophisticated clients, expanding utility rebate programs, and increasingly stringent environmental regulations mean that architects have no excuse for being environmentally insensitive. Through tours of environmentally sensitive projects, such as the Way Station in Frederick, Maryland (ARCHITECTURE, pages 92-93), a bank in the

Netherlands, and the Rocky Mountain Institute in Snowmass, Colorado, and discussions with industry experts, the first videoconference outlines the benefits of resource-efficient design. The second program, entitled "Healthy Buildings and Materials," airs March 4. The third, called "Land, Resources, and the Urban Ecology," is scheduled for April 22. For more information, call (800) 365-ARCH.

## Healthcare Design Awards

The Symposium on Healthcare Design, a California-based organization promoting improvements to hospital environments, has announced the results of its fifth annual Healthcare Design Competition. Barbara Geddis, partner of the Stamford, Connecticut-based Geddis Partnership, received the award for the firm's design of the Bennett Cancer Center at Stamford Hospital. The jury commended the project's innovative use of an atrium and entry garden. Two students from Arizona State University received awards for patient-operated lighting and bed control designs. The deadline for next year's awards is October 8, 1993. Contact: (510) 370-0345.

# It's no illusion AutoCAD users But don't get

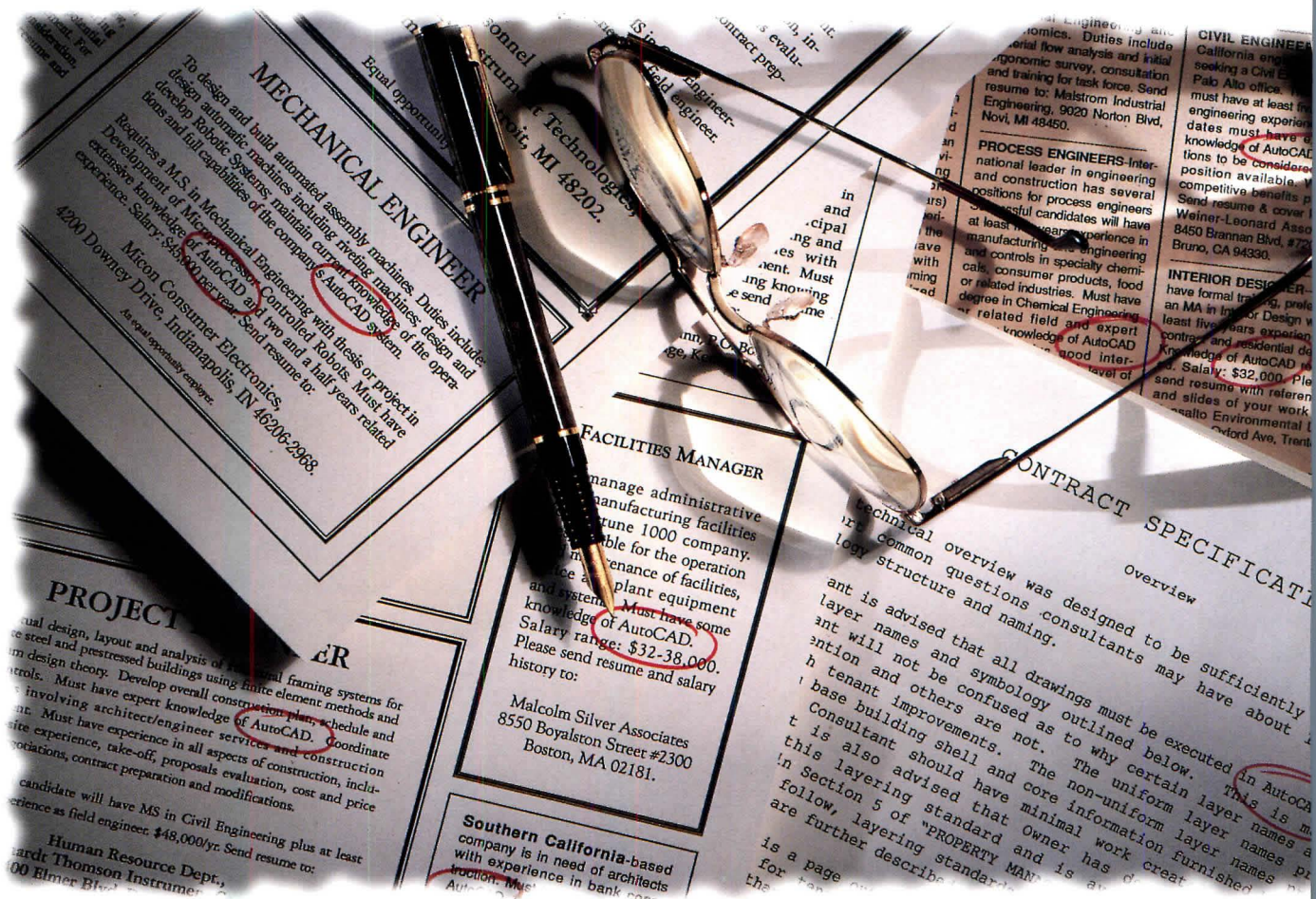

## Introducing new easy-to-learn AutoCAD® for Windows.

If you're annoyed by all the advantages AutoCAD users have been getting, this is your chance to get even. You can learn AutoCAD software faster than they ever did, thanks to new AutoCAD for Windows.

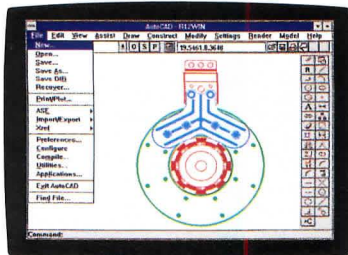

*Learning AutoCAD is easier  
than ever with  
AutoCAD Release 12 for Windows.*

With AutoCAD for Windows you can create your drawings by using simple tools and icons. So you'll quickly regain the productivity and artistry you enjoyed on the drafting board.

The intuitive Windows™ interface eliminates a lot of the repetitive keyboard work that makes computers seem confining. You can work the way that comes most naturally to you. Whenever you need assistance, just push the *Help* button. Exactly the information you need appears on the screen. There's no searching through the manual.

## Healthy Trends

*The increasing popularity of outpatient and ambulatory care is producing more flexible healthcare facilities.*



**ABOVE RIGHT:** A new, patient-focused “front door” will be created at the Swedish Medical Center in Seattle with the addition of a 671,000-square-foot wing, designed to bring diagnostic services to the patient and make a positive first impression.

When officials of the Genesys Health System began planning a new hospital to replace four existing hospitals in Flint, Michigan, they knew the time had come to make a break with traditional, physician-centered, hospital design and its strict separation of medical departments. Studies undertaken by Genesys and the state of Michigan revealed that only half of the system’s 908 existing inpatient beds would be needed by the year 2000. The healthcare company decided to seek a new paradigm for the hospital designed around the patient, rather than the staff.

The resulting Genesys Hospital, designed by Seattle-based NBBJ, will be one of the first healthcare facilities in the country to depart from an organization focused on traditional medical departments. The \$90 million facility will consist of seven patient-care centers that officials expect to function as independent profit centers. Under the patient-focused care approach, the same interdisciplinary, cross-

trained team of nurses, therapists, and technicians care for individual patients from admittance to release. Testing and surgical facilities will be located within each care center to reduce the need to move patients from one department to another. At the same time, the hospital will strive for “physician integration,” according to Timothy J. Keener, Genesys’s director of planning. Genesys hopes to draw independent doctors to practice at the hospital by providing 100,000 square feet of office space for private practitioners adjacent to inpatient and ambulatory patient centers.

Other hospitals are similarly undertaking extensive renovations and additions with an eye to patient needs. One such project is the Swedish Medical Center in Seattle, which is adding a 671,000-square-foot wing to create a new entrance to the existing facility. The addition, also designed by NBBJ, is expected to bring doctors and diagnostic services right to the patient entrance, eliminating the need to move patients between departments.

## Ambulatory care centers

During the past decade, healthcare providers seized the opportunity to provide less expensive outpatient care by building freestanding ambulatory care centers away from existing hospitals. These centers usually contain both offices and surgical facilities, and are often organized around a single medical specialty. Because such outpatient centers do not need to meet the same strict building codes that hospitals must comply with, they are less expensive to construct. In California, for example, a hospital may cost \$200 a square foot to build, while an ambulatory care center might cost just \$120 a square foot, according to James R. Diaz, principal of San Francisco-based Kaplan McLaughlin Diaz.

An emerging trend in the design of these ambulatory care centers is to construct them closer to existing hospitals, often as new wings. "Hospitals are going to great lengths to get physicians to nestle in close to them," explains Thomas H. Bast, healthcare marketing director at Anderson DeBartolo Pan in Tucson, Arizona. The firm recently designed a two-story ambulatory care center for three groups of orthopedic doctors, located on the grounds of the 700-bed Tucson Medical Center. The doctors are not hospital staff members, but because of their new proximity they will probably get referrals from and make referrals to the hospital. Some hospitals are also building ambulatory care facilities away from their own campuses but near competing hospitals to develop new business.

Although ambulatory care centers were regarded as very different from traditional hospitals when they first began to appear 20 years ago, the line between inpatient and outpatient services is becoming increasingly blurred. An innovation that involves adding a small number of recovery beds to ambulatory care facilities, which began in California as a demonstration project several years ago, has now spread to several other states.

## More humane environments

To make patients feel more comfortable in a hospital setting, healthcare providers are increasingly turning to familiar building prototypes, such as the shopping mall, as organizational tools. Boston-based Shepley Bulfinch Richardson and Abbott Architects, for example, drew upon the mall concept to organize the \$163.5 million Dartmouth Hitchcock Medical Center in Lebanon, New Hampshire.

The facility, which opened in early 1992, organizes a 328-bed inpatient section, a diagnostic and treatment facility (including a



**LEFT:** The Swedish Medical Center's new southeast wing is organized around a central rotunda that serves as a lobby and marks major circulation paths within the hospital.

**PLAN:** The new wing is expected to become an "access center" that will allow the hospital staff to bring required services to the patient at the hospital's entrance and avoid unnecessary patient movement. New wing includes exam/interview rooms and private patient rooms.

**AXONOMETRIC:** Waiting room off rotunda is shared by radiology, laboratory, and pharmacy units.

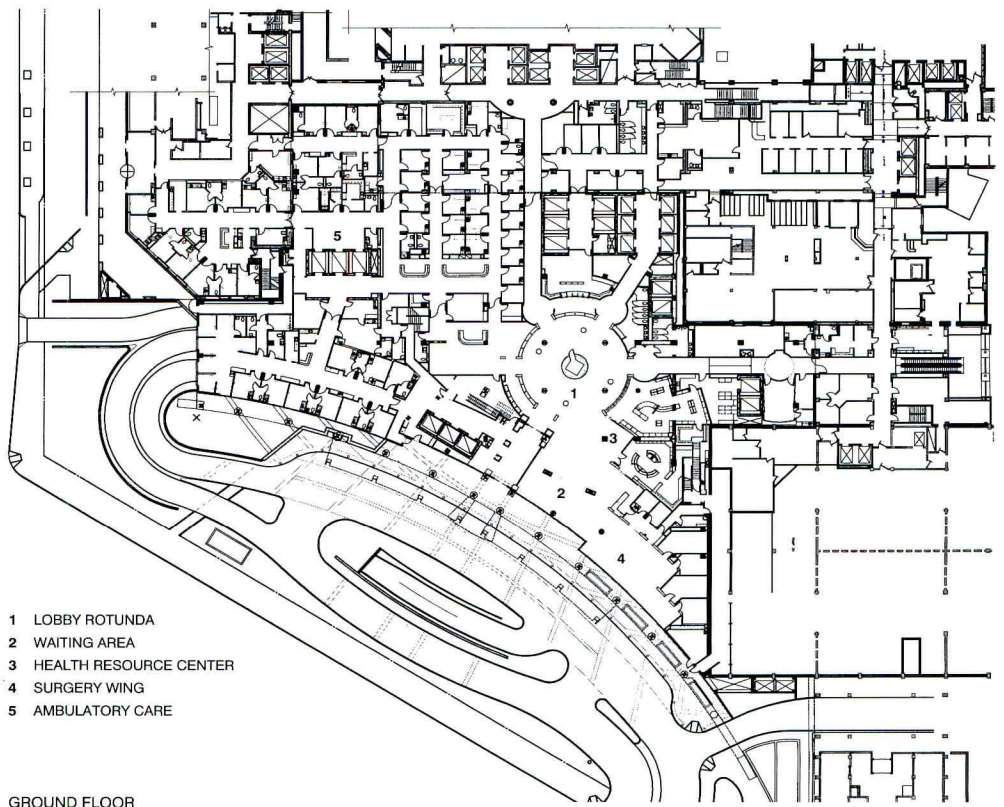

GROUND FLOOR

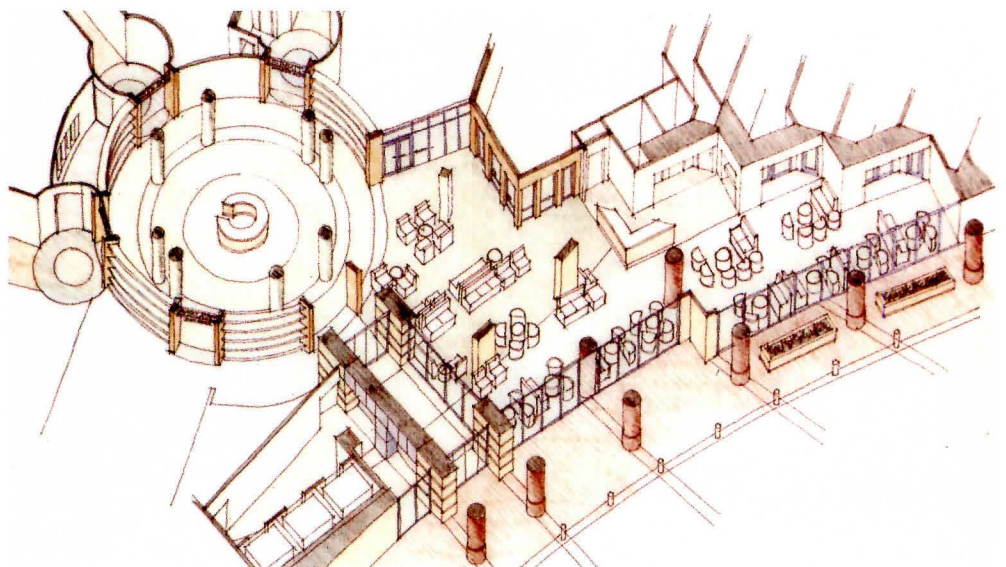

AXONOMETRIC OF SOUTHEAST WING



**RIGHT:** Shepley Bulfinch Richardson and Abbott drew upon the shopping mall to organize the Dartmouth Hitchcock Medical Center and to create an inviting environment for patients and staff.

**BELOW LEFT:** Skylit interior "street," divided into 30-foot bays, connects inpatient, diagnostic, ambulatory, and academic areas of the complex.

**BELOW RIGHT:** Street is flanked by shops, restaurants, and other medical and nonmedical services, and culminates in a 70-foot-high rotunda that serves as an entrance to the entire complex.

**PLAN:** Central mall connects inpatient care wing to the research and medical school wing.

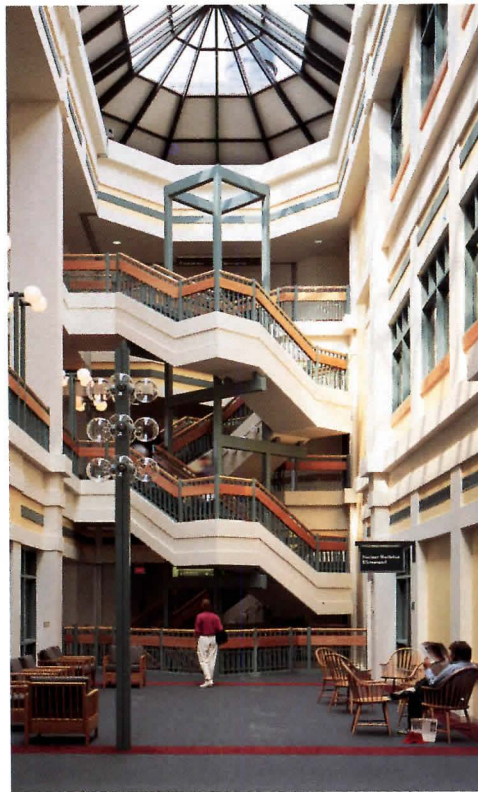

birthing center), doctors' offices, a medical school, and a research building along a 390-foot-long skylit circulation space. To further serve patients and visitors, the complex contains retail shops and restaurants. Views of the hospital's wooded, 200-acre site are offered throughout the building from patient rooms, hallways, offices, and even surgical suites.

Medical centers like Dartmouth Hitchcock are paying increased attention to providing patients with natural views as evidence mounts about their therapeutic value. Studies conducted during the past decade by behavioral scientists such as Professor Roger S. Ulrich of Texas A&M University have shown that patients who were exposed to pictures of nature in the hospital suffered fewer signs of stress; patients who could look through a window at trees rather than at a brick wall were able to leave the hospital faster and suffered fewer complications. "The building becomes part of the healing process, and it doesn't have to cost more to do it right," says Mo Stein, principal of The Stein/Cox Group of Phoenix, Arizona.

Such concepts are gaining mainstream acceptance. "There is a new emphasis on natural light and natural materials," says Leanne Kaiser Carlson, an associate with healthcare consultant Kaiser & Associates, which operates a computer bulletin board for the exchange of healing healthcare design strategies.

### Hospitals of the future

Future developments in healthcare design remain a wide-open topic, especially in light of President Clinton's vow to provide Americans with universal health insurance—a promise that could bring 34 million people who are now uninsured into the system. Many architects, including W. H. Tusler, a senior vice president of San Francisco-based Stone Marzaccini and Patterson, Architects, anticipate that the ability of a larger group of people to select healthcare services will have a Darwinian effect, weeding out the weak medical centers and ensuring that the strong survive.

Others predict a shift in the perception of hospitals, essentially redefining their place in the community. "We associate hospitals with sick care, and they are often sick, painful, and insufferable-looking buildings," notes Donald C. McKahan, a healthcare planner with Lennon Associates in Del Mar, California. "What we are understanding is that buildings talk, and the hospitals of the future need to send the message that they are healing institutions, not just structures based on power." ■

—Virginia Kent Dorris

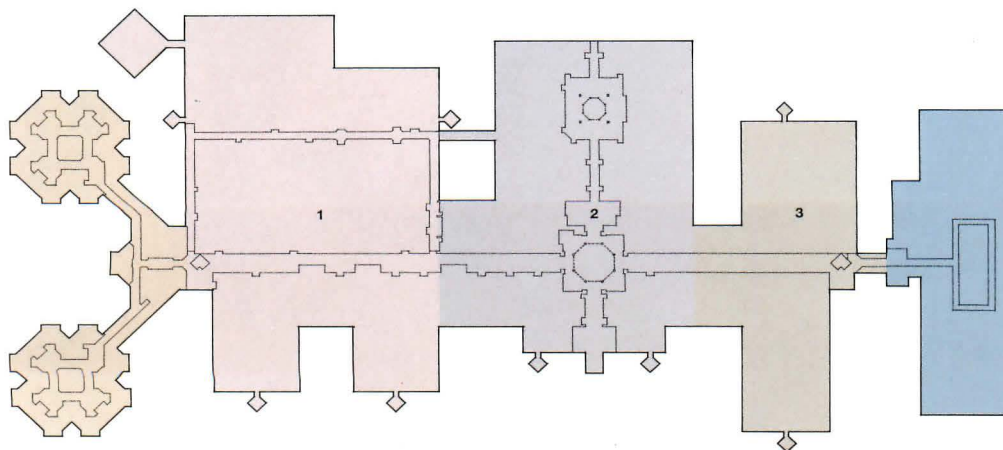

FIRST FLOOR

- 1 MARY HITCHCOCK HOSPITAL
- 2 HITCHCOCK CLINIC
- 3 DARTMOUTH MEDICAL SCHOOL

- INPATIENT CARE
- DIAGNOSTIC TREATMENT
- AMBULATORY CARE
- CONFERENCE/ACADEMIC
- RESEARCH

JEAN M. SMITH PHOTOS



"I find it easier to get to see my colleague from Barcelona in Milan than in Madrid."

"He said that if we got to we'd meet Eurocucina. But he never said which of the four pavilions he meant."

"Italy is the world's leading furniture exporter."

"Shame we can't take the exhibits from the Furnishing Accessories Exhibition with us."



Cosmit, Organizing Committee of the Italian Furniture Exhibition. 20123 Milano, Corso Magenta 96, Tel. 02/48008716, Fax 02/4813580, Telex 334394 Cosmit I.



Salone del Mobile di Milano  
Furnishing Accessories Exhibition  
20-25 April 1993  
Eurocucina  
19-25 April 1993  
Milan Fairgrounds

Circle 60 on information card

How come  
the world



## Patients First

*Hospitals are increasingly being designed to accommodate patients rather than the physicians who treat them.*



**TOP LEFT AND RIGHT:** HLM Architects organized Berry Women's Health Pavilion at Miami Valley Hospital in Dayton, Ohio around a three-story rotunda that eases orientation.

**ABOVE LEFT AND RIGHT:** Obstetrical suite includes multifunction rooms that allow mothers to remain in one setting throughout delivery and hospital stays.

For all the furor over upwardly spiraling healthcare costs, which last year soared to 14 percent of national economic output, hospitals are not coining money. Government programs, such as Medicare and Medicaid—and, increasingly, private insurers—are placing caps on reimbursement for a wide range of healthcare services. Shortages of qualified professional and technical support personnel are driving wages higher. New medical technologies can be near-miraculous but extremely costly in terms of both capital expenditure and labor.

Ironically, the same technologies are allowing services that once required hospitalization to be performed in doctors' offices or outpatient clinics. Hospitals that respond by expanding ambulatory care are in effect competing with their own acute-care facilities. Add a better-informed and less complaisant consumer to the equation, and you get hospital systems that consider themselves lucky to operate on a break-even basis.

Thus, hospitals are under intense pressure to control costs, improve quality, and compete for paying customers. The movement to what is known as patient-focused or patient-centered care is attracting wide attention because it addresses these issues at the root by reexamining the way hospitals do business.

In marketing hospitals, it is axiomatic that women do the family's shopping for medical care. The past decade has accordingly witnessed a burgeoning of women's centers, birthing centers, and other freestanding vari-

ations on the onetime maternity ward, driven by the assumption that the happy experience of childbirth will engender a "brand loyalty" that will carry over to the chosen hospital's other medical services.

### Women and infants

The sharpened focus on this special patient group of mothers and babies, combined with advances in obstetrics, has led providers to question the arbitrary fragmentation of the natural, continuous—and often brief—process of birth: labor in one place with one set of monitors; a wheeled dash down the hall for delivery by a new corps of attendants; and a brief interlude in a recovery area before the new mother is finally ensconced in a patient room for a day or two of postpartum care. The result has been the development of single settings in which a coordinated medical team attends to the patient throughout labor, delivery, and recovery (LDR) and increasingly through a few hours of postpartum recuperation as well (LDRP).

Instead of moving the patient, any special equipment needed to augment the hospital room's customary array of built-in services is brought to the bedside, minimizing stress and assuring continuity of care.

In addition, LDRP units woo patients by making the multipurpose room as homelike as possible, *comfortable for the new mother* and inviting to family and friends. Medical apparatus is hidden or disguised; carpet and drapes are musts; and residential-type seating

DON DUBROFF, SAGIN PHOTO GROUP, LTD.

often doubles as sleeping accommodations for the father or other overnight visitors.

### Diagnosing the sick hospital

The immediate impetus for the constellation of strategies that have come to constitute patient-focused care was an analysis of hospital operations begun in 1988 by healthcare consultants Booz, Allen, Hamilton for Florida's Lakeland Regional Medical Center, later joined by a consortium of five like-minded institutions. The findings were discouraging: the hospital's operations were out of touch with the needs of its customers (staff as well as patients), bound up in rigid specialization, burdened by an unwieldy bureaucracy, and helpless to control costs.

Labor, according to Booz, Allen, accounts for half of a typical hospital's budget. But only 16 percent of every wage dollar is spent on medical services—assessing patients, giving injections, performing surgery. Almost as much (14 percent) is spent on efforts to schedule and coordinate those services; even more (19 percent) is spent on built-in idle time. Medical documentation consumes an astonishing 30 percent of labor costs. The remaining 21 percent buys personal services, transportation, and management and supervision. The bottom line is that for every hospital dollar spent directly on clinical care, two or three are spent to arrange for it or write it down.

### Resuscitation by restructuring

The counterattack launched by a dozen or so hospitals over the past several years is to reverse the decades-long drive toward departmental orientation of hospital operations. The specific initiatives undertaken, for the most part on a pilot basis, vary from institution to institution and are still evolving. But they share at least three components—decentralization of services, despecialization of staff, and streamlined documentation of paperwork.

Instead of bringing the patient to the service (one hospital discovered that a single stroke patient had been shuttled 8 miles during a six-day stay), the service is brought to the patient. By redeploying appropriate equipment, routine procedures can be performed within the patient-care unit. So can most pharmaceutical dispensing and the often exasperating paperwork.

Responsibility for each patient is assigned to a small team of staff members (two or three per shift) who are drawn from varied backgrounds, including technicians as well as nurses, and cross-trained to integrate their

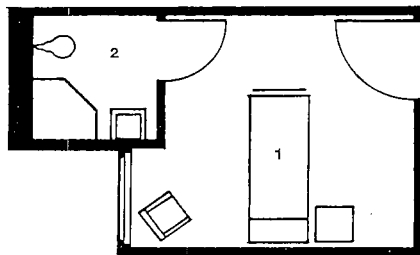

PREVIOUS TYPICAL ROOM PLAN

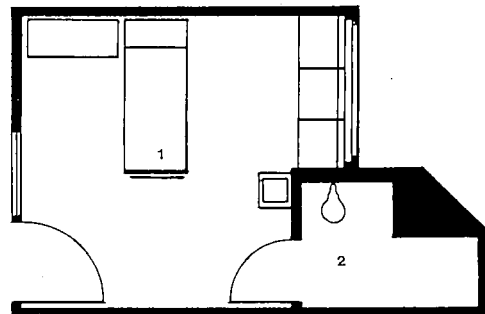

NEW TYPICAL ROOM PLAN

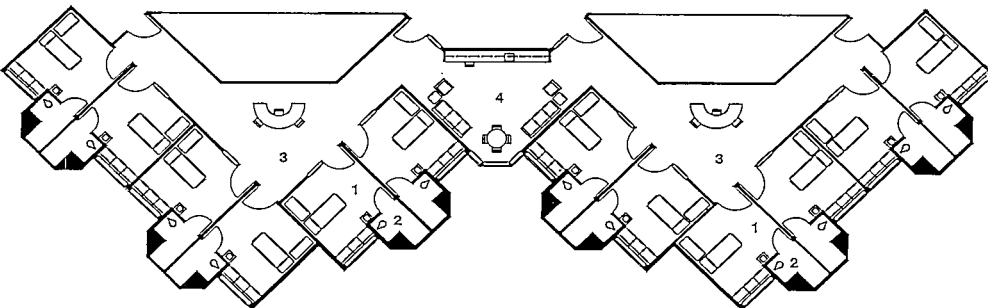

TYPICAL FLOOR PLAN

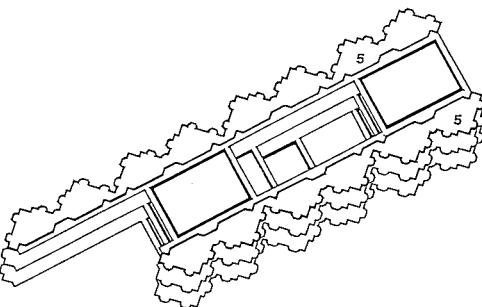

DIAGRAM OF PROTOTYPICAL HOSPITAL WING

- 1 PRIVATE ROOM
- 2 BATHROOM
- 3 NURSES' STATION
- 4 WAITING AREA
- 5 PATIENT WING

### Hospital Prototype The Ratcliff Architects

Close study of patient-focused-care prototypes persuaded The Ratcliff Architects that such programs predicted the future of the hospital. It is these ground-breaking projects that inspired the firm to explore their implications for physical planning through a model program for a representative 295-bed community hospital. Developed in concert with the San Francisco-based HOM Group's healthcare consultants, the prototype takes as its basic building block a V-shaped cluster of six patient rooms. All rooms are single: "Semiprivacy means no privacy," asserts Ratcliff planner Milton Bullard. They also provide for disabled access, family rooming-in, and a full complement of telemetry and bedside support functions, as well as increasing the bedroom-bathroom area by about a third. To accommodate staffing shifts, six-

bed suites are paired, with a shared living room that includes a small kitchenette, lounge and dining areas, and a compact library. Shifting activities to this common space or to the patient rooms reduces the traditional nurses' station to little more than a reception desk and consulting area. Decentralized support facilities for the 14 care suites that constitute each nursing floor distinguish between relatively fixed service cores, which contain such functions as administration and accounting, housekeeping, and staff facilities, and more flexible professional cores which may vary in response to specific patient needs. A floor that includes intensive and cardiac care, for example, might contain more clinical support spaces and fewer suites for use by patients recovering from same-day surgery.



**Greater Baltimore Medical Center  
Baltimore, Maryland  
RTKL Associates, Architect**

The showpiece of the Greater Baltimore Medical Center's recently completed obstetrics and acute-care addition. The first major expansion of the center since it was designed by RTKL Associates in 1964, the project consists of 170,000 square feet of new construction to house critical care and diagnostic and treatment facilities and 95,000 square feet of renovated space for related facilities.

The larger component is a nursing pavilion with cardiac, medical, and surgery units on three floors above a 17-room labor-delivery-recovery (LDR) suite, which adjoins facilities for high-risk births and cesarean sections. (Sixty postpartum beds remain in the existing hospital, as do well-baby and intensive-care nurseries.) Although almost all the patient rooms are singles (largely to appeal

to the upscale population the center serves), the 32-bed acute-care floors defy the trend to universal rooms. Instead, each of the three floors is joined by an interior bridge to a corresponding 12-bed intensive-care floor in a separate tower with parking at its base (left in photo of exterior.)

Between the two new elements lies a skylit and balconied atrium courtyard that is the core of the women's center and its principal public space. At the outer end, a glass-cornered, building-high lobby, dominated by a handsome, wood-encased stair (above right), meets the entry portico that introduces the updated complex. In the more private inner courtyard (top right), comfortable seating, natural brick, and wood grillework, panels, and louvers enhance a waiting lounge for families and visitors.

The richness and warmth of wood, which also echoes the interiors of the original hospital, is carried through to the LDR rooms (above left). To fine-tune their design, the architects replicated the rooms in a mock-up that also afforded a chance to test such finishes and materials as the vinyl-infused wood-plank flooring and fabric wall coverings. The head wall is fitted with oak-trimmed cherry cabinetry focused on a central arch, whose engaged columns and integral lighting sconces conceal doors that open to outlets for gases, power, and telemetry. Opposite the bed, the foot wall features similar cabinetwork. An overhead ceiling recess with a drop-down panel contains a powerful surgical lamp. Invisible when not in use, the lamp lowers on an articulated frame similar to an aircraft's landing gear.

skills. The resulting continuity of care across shifts and throughout a patient's stay is more satisfying to staff as well as to patients, who might be "serviced" by a bewildering stream of caregivers under the usual system; one hospital counted 55 employees who dealt with a typical patient over a three-day stay.

Although the paperless hospital has not yet arrived, reducing paperwork is a key element of patient-focused services. Typically such units introduce "charting by exception," employing protocols that define the plan of care and anticipated responses over a given length of stay. Instead of immortalizing such inanities as "patient slept well," staff then record only departures from the expected course of treatment and recovery. Inch-thick charts shrink to a few pages—or a few screens on a computer link that allows for the immediate exchange and management of information.

### Patient-focused planning

Because operating experience with patient-focused care dates back only two years, and most programs were launched with only ad hoc renovations, the planning implications of this new approach have not been fully explored. An obvious issue, however, is the introduction of more ancillary services to the nursing unit and the impact of their redeployment on the central departments they spin off from. To support unit-based services cost-effectively suggests nursing wings somewhat larger than the recent range of 45 to 64 patient beds. But the concept of care teams suggests organizing the rooms into smaller clusters of six to nine beds, depending in part on the nurse-patient ratio deemed acceptable during the minimally staffed night shift. With record-keeping automated and dispersed, care teams spend most of their working hours moving among patient rooms; the role of the nursing station, once the hub of floor activities, becomes vestigial. What nurses in such units need most, they say, are quiet niches where they can confer with patients and their families or other staff.

Appropriately, patient-focused care is also forcing a sharper focus on the patient room itself. In addition to a wide range of activities and support services, patient rooms are expected to accommodate a higher level of amenities for the patient and more family participation and rooming-in. They are also subject to the Americans with Disabilities Act. To the extent that added functions are accommodated, space requirements in patient rooms and bathrooms may as much as double. An-

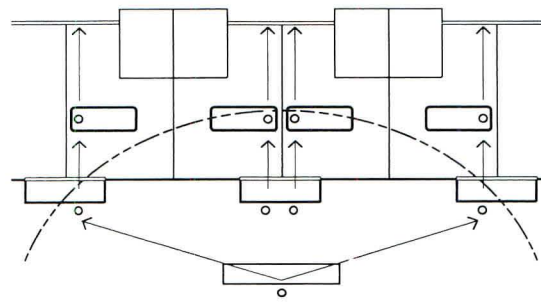

UNIT ORGANIZATIONAL DIAGRAM

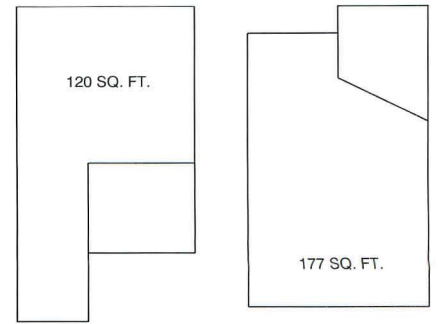

SQUARE-FOOT COMPARISON BETWEEN PATIENT ROOMS

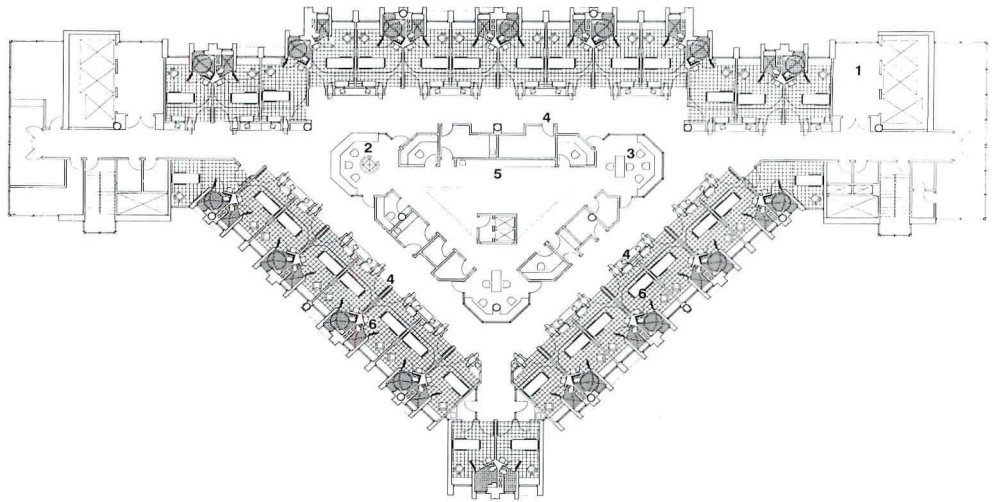

ORIGINAL SCHEME

- 1 LOBBY
- 2 COMMUNICATION CENTER
- 3 WORKROOM
- 4 NURSE SUBSTATION
- 5 COMMON AREA
- 6 PATIENT ROOM

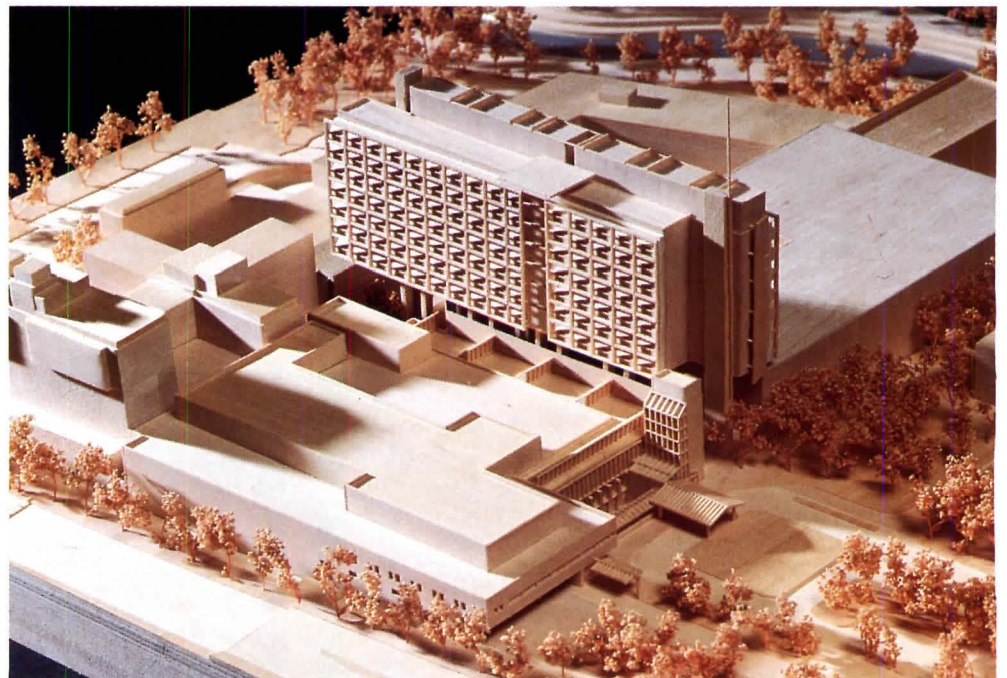



TYPICAL FLOOR PLAN

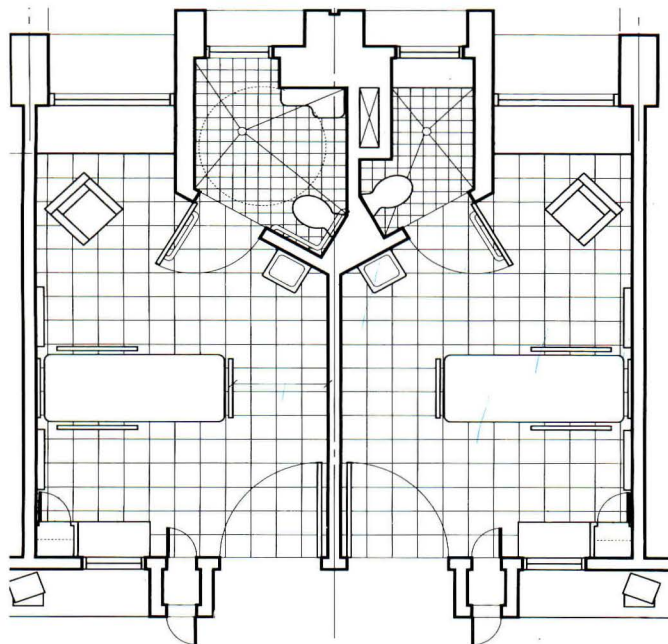

ORIGINAL ROOM SCHEME

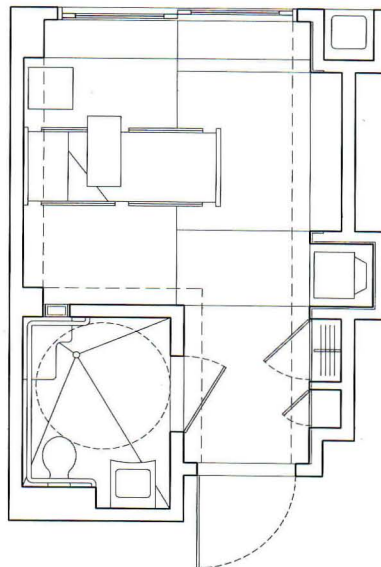

REVISED ROOM SCHEME

- 1 PATIENT ROOM
- 2 LOBBY
- 3 NURSES' STATION
- 4 WAITING AREA
- 5 TECHNICIANS' CORRIDOR

**St. Luke's Medical Center**  
**Milwaukee, Wisconsin**  
**Bobrow/Thomas & Associates, Architect**

Although St. Luke's has not yet decided to what extent—or whether—it will embrace the operational shifts prescribed by patient-focused care, the sophisticated design proposed for its new cardiac patient tower is tailor-made to advance the concept. BTA presented the hospital with a choice between two well-developed schemes. The first was a traditional, triangular “racetrack” unit (facing page), with 32 patient rooms arranged around a central support core and nurses’ stations at each angle. Though efficient, the triangular plan limited the unit’s bed capacity: as the number of patient rooms expanded, the core might become too large and the distance from nursing station to bedside too long. The architects’ linear scheme (top), by contrast, allows great initial flexibility and can be easily extended along

its long axis—a key consideration given St. Luke’s tight site for the tower and accompanying ground-floor outpatient facility.

Julia Thomas and Michael Bobrow observe that the overall size of the typical nursing floor may increase to as many as 70 to 100 beds to optimize the use of on-floor diagnostic and other decentralized support services. The larger scale will be offset by cross-training and paperless record-keeping, which permit greater freedom in adjusting staffing ratios. For now, however, the St. Luke’s scheme calls for 48 single bedrooms sandwiched between inner and outer corridors. At the center of the floor, a “technicians’ corridor” devoted to back-of-the-house activities—circulation, distribution, supplies, house-keeping—also includes “soft” spaces for such services as lab, pharmacy, and radiology.

Rooms (above) are sized to accommodate even intensive-care requirements, and can continue to serve patient needs throughout the hospital stay. Each room backs on to the technicians’ corridor for ease of supply and fronts on a peripheral solarium, from which it borrows light through a large but screenable window to augment light funneled through an overhead clerestory. The solarium, the scheme’s most radical departure from conventional hospitals, is at once a lounge space for patients and their visitors, a conference area for nurses and clinicians, and a necklace of nursing substations supported by computer terminals between each pair of rooms. The inherent flexibility allows fine adjustments in staffing ratios, from one patient to one staff member in intensive-care, to a skeletal 12:1 during the night.

other unresolved question in planning patient-focused units is how patients are to be gathered. Current projects, without exception, have followed the lead of women's centers in organizing around a specific clinical service: surgery, oncology, orthopedics. Advantages include easing the program into an established operating entity and to a lesser degree capitalizing on specialized technology and staff. Milton Bullard of The Ratcliff Architects in San Francisco disagrees. Ratcliff's design for a prototypical hospital proposes to gather patients by the severity of their illness and the consequent extent of the nursing care they require—from critical care to skilled nursing functions or outpatient recovery—and to allot support facilities accordingly. Hospital-wide, Bullard believes, such an arrangement would greatly increase both space utilization and flexibility.

### Privacy and the generic room

The quest for flexibility is also pointing toward providing the prime amenity: a private room. Although hospitals have long rejected private rooms on grounds of cost, particularly the expense of installing extra bathrooms and the increased distance nurses would be required to walk, many now believe private rooms have advantages that might offset the additional costs. A key argument is the fact that patients would remain in the same room throughout their stay, from near-intensive care, which requires a private room, through recovery. The concept of the "universal room" enhances flexibility within and among nursing units and also fits the small-team nursing approach of patient-focused care, which obviates the problem of supervision from a central nurse station. (Moving patients, even from bed to bed in the same room, also entails administrative costs approaching those of initial admission and increases the risk of treatment errors.)

Finally, though, the most persuasive argument for private rooms may be that the shared patient room is what most hospital consumers most deplore. For a decade, hospitals have sought to compete by upgrading public spaces like lobbies to the level of mid-priced chain hotels; now they'd like to make their patient rooms look more like hotels too. As hospitals reinvent the way they care for customers, architects are ready to reinvent the hospital environments the patient experiences most intimately. ■

—Margaret Gaskie

Margaret Gaskie is a New York-based writer.

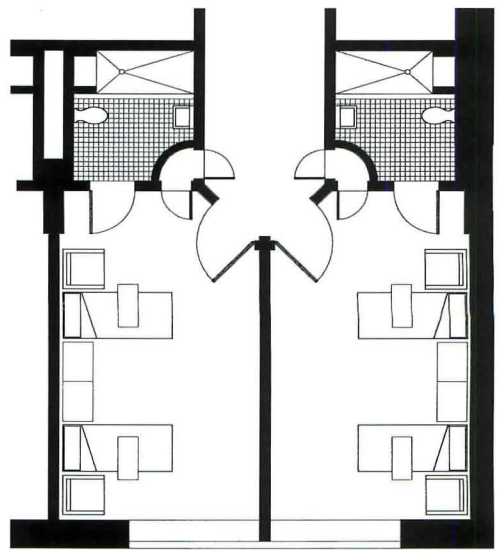
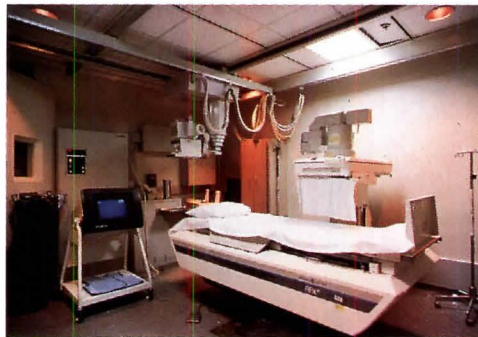
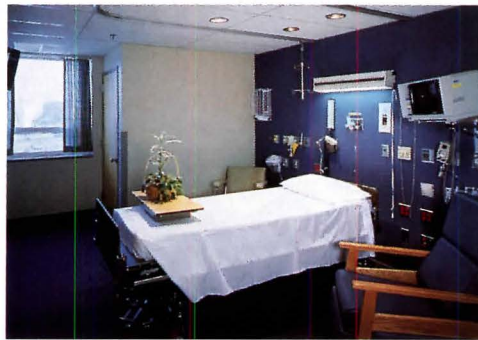

TYPICAL ROOM PLAN

- 1 SEMIPRIVATE ROOM
- 2 CARE STATION
- 3 PRIVATE ROOM
- 4 ELEVATOR LOBBY

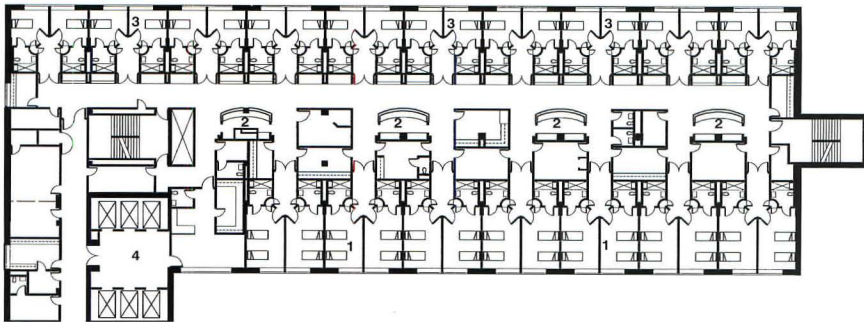

TYPICAL FLOOR PLAN

### Lakeland Regional Medical Center Lakeland, Florida HDR, Architect

Lakeland was one of the nation's first hospitals to adopt patient-centered care, and began planning for its pilot project in 1989. The center and its longstanding architect, HDR, are now old hands at fitting the square pegs of obsolete facilities into the round holes needed to accommodate the operational restructuring that patient-focused care requires and the attendant shifts to intensive computerization and decentralized technological support. The gynecological/urological unit (photos) is the third floor that HDR has converted, and the firm is currently engaged in the process of extending the concept to other areas of the center.

Beginning with a typical racetrack layout, HDR gutted the floor, replaced all mechanical and electrical systems, and reconfigured the space into a self-contained minihospital.

The unit, for example, conducts its own admitting and discharge procedures—drawing on the services of a floor-based financial counselor and a social worker—from a suite near the visitor's lounge. In addition to pharmacy, lab, and radiology areas, support facilities include a large staff conference room and a central suite equipped for performing special procedures.

Patient rooms (top plan) are arranged in six-bed pods on either side of nursing workstations (plan above)—which in future layouts will be even further diminished in size. Lakeland opted for a mix of single and double rooms, in part to balance fluctuations in occupancy. In practice, however, the unit operates at peak capacity year-round—and is besieged by requests for patient admissions from other clinical services.





**Pomona Valley Hospital and Medical Center  
Pomona, California  
NBBJ, Architect**

The new women's center (top), the first element in Pomona Valley Hospital's long-range replacement and expansion plan, includes well-baby and neonatal intensive-care nurseries, special procedure rooms, an ob-gyn floor and ICU unit, and the usual support areas. But the second-floor birthing center and 26 labor-delivery-recovery-postpartum (LDRP) rooms became the point of departure for the building's overall design. In addition to the main birthing area, each LDRP room (above right) contains a small "inglenook" for a sociable gathering to celebrate the birth. Beneath a broad window is a sofa that doubles as a bed and a retractable dining table that folds into the surrounding woodwork—a comfortable setting for the complimentary festive dinners for two that the hospital offers new parents. The patient

bed can be curtained off for privacy and is fully but unobtrusively equipped for birthing. Vinyl-infused fabric paneling with cherry trim covers the head wall, in which sliding panels give access to gases, power, and telemetry connections. Special features include a pair of ceiling-mounted, "bull's-eye" strobe lamps that the obstetrician can direct and focus with remote-control wands.

An extensive perimeter area was needed to provide the generous windows in the LDRP suites. The design solution was to place patient rooms around double courtyards with support services in between. Main public circulation paths are typically located along outside walls, enhancing overall orientation while providing daylight and views. The central nursing control point is near visitor waiting areas and elevator lobbies, which are orga-

nized to separate staff and service circulation from public circulation. Nursing substations (top right), however, were shifted to the corners of the building, where they open to two-story "gazebos" that bring in daylight and provide outdoor spaces for staff and visitors.

The landscaped courtyards play a similar role. One, which adjoins the neonatal intensive-care unit, is relatively private to provide respite for ICU nurses and worried parents. The other (above left), more closely associated with the main entrance lobby, is an exuberant social space in which fountains provide natural focal points for family get-togethers—and occasionally serve as settings for baptisms. In the lobby (top center), sandstone walls complemented by a floor of brass-inlaid quartzite echo the red sandstone base that anchors the building's precast-concrete exterior.

**Problem:** Your client wants lots of windows to enjoy a stunning view—on a site that's within earshot of a noisy freeway.

**Solution:**

**Hurd InSol-8™ windows. With the most advanced glazing system available, you can reduce outside noise by up to 95 percent.**

Compare any leading window—Andersen, Pella or Marvin. You'll find Hurd windows give you more performance solutions.

From the best residential noise reduction, the highest R value and UV fading protection to maintenance-free extruded aluminum cladding, Hurd performance means you really have more design freedom—in most any size or shape.

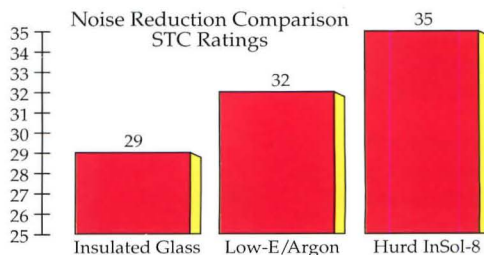

*Hurd windows reduce outside noise by up to 95%. That's 53% better than double pane and 24% better than Low-E/Argon.*

Hurd gives you a choice of windows that offer the option to tune a building for the most energy efficiency possible—even reduce the HVAC investment—without compromising comfort or design.

Find out more. See your Hurd distributor or call 1-800-2BE-HURD. Or write Hurd Millwork Co., 575 South Whelen Ave., Medford, Wisconsin 54451. Circle 68 on information card



**When You're Serious  
About Windows.™**

Hurd windows look good in line print and even better up close. See for yourself. Noise comparison data were based on independent testing by Riverbank Acoustical Laboratories. InSol-8 is a trademark of Hurd Millwork Co. Hurd InSol-8 windows use the Superglass System with Heat Mirror Film. Superglass System® Heat Mirror™ and Heat Mirror Film are trademarks of Southwall Technologies. ©1992 Hurd Millwork Company, Medford, Wisconsin 54451.

## Venting the Laboratory

*Improving air quality in laboratories requires integration of mechanical and structural systems.*

**ABOVE LEFT:** Placement of HVAC services affects even the rooftop, where exhaust fans and stacks are located.

**ABOVE RIGHT:** Basement-level air handlers in the University of Georgia Biological Sciences complex reveal the tremendous space required by mechanical equipment to provide fresh air.



FRED MARTIN, JR.

It acts as a giant lung.” That is how Vice President Howard Weiss characterizes Anshen + Allen’s new laboratory addition to California State University, Fullerton’s sciences building (page 115). Weiss’s metaphor aptly describes what is required of mechanical systems installed in research laboratories today. Forty to 50 percent of the total design and construction budget of a laboratory is typically dedicated to HVAC equipment, in order to ensure a healthy environment for scientific researchers who must work with toxic substances.

According to Eugene Bard, principal of the Boston-based mechanical engineering firm BR+A, greater public awareness about airborne contaminants and stringent regulations restricting their discharge are prompting the installation of improved air-filtration systems. Such measures require more space dedicated to air-handling services in laboratories.

### Fumes and heat

Likewise, researchers’ concerns for their own safety while working with hazardous airborne toxins is leading architects to increase the number of internal fume hoods; these separately ventilated, negatively pressurized cabinets limit the spread of unwanted toxins and exhaust them away from bench tops. Fume hoods are now commonly installed at individual workstations, further increasing the rate of air exchange within laboratories. As a consequence, added fume hood duct and sash requirements have elevated floor-to-floor heights in laboratories.

While such mechanical systems successfully boost the volume of air to better dilute toxins, the ever-increasing number of computers and electronic instruments necessary for recording and analyzing lab data generate large quantities of heat. Since air-handling systems consume energy and produce the lion’s share of operating expenses, a greater number of efficient heat-recovery systems are being added to HVAC equipment in order to offset increasing loads.

The demand for mechanical services has heightened the need for architects to consider how they will integrate such equipment into a building structure at the conceptual design stage. They are learning to take better advantage of ceiling plenums, to avoid overlapping separate supply and return air ducts that could cause cross-contamination; and to limit critical floor-to-floor dimensions, especially for projects restricted in height by local zoning regulations.

### Distribution diversity

Horizontal distribution is the most economical air-circulation solution since a low-rise structure—three stories or less—offers the advantage of a higher roof-to-floor-area ratio, allowing greater freedom in locating and routing mechanical penthouses and exhaust stacks. Vertical shafts punched through floors, on the other hand, consume valuable square footage that could be devoted to labs. An exoskeletal approach, permitting ventilation shafts to be pulled outside the building envelope, also reduces the space requirements of mechanical systems, as illustrated by the University of Arizona’s agriculture school (pages 116-117).

Another height-reducing approach is exemplified by Haines Lundberg Waehler’s new Drug Discovery Facility in New Jersey, in which labs are serviced by a central corridor. Such a strategy requires a larger building footprint, but physically separates waste, supplies, and utility services from the actual lab and allows for changes and maintenance of HVAC systems with far less disruption than if these services were located in the ceiling plenum. Some buildings devote an entire floor to utility services between or above lab levels; this interstitial approach offers the most flexibility in changing lab configurations, but is usually reserved for those buildings in which the demand for frequent mechanical system alterations overrides concerns about height limitations and added costs.

Intake and exhaust distribution routes are primary considerations in determining a

lab facility's eventual structure and expression. Hansen Lind Meyer Principal Martin Meisel reveals that when designing a lab project, "My closest associate is a mechanical engineer." Even a lab's initial siting and orientation have implications for locating stacks, thereby influencing the eventual profile of the roof line. Flad & Associates Vice President Ralph Jackson explains that such decisions determine the direction and height at which fumes are discharged. Air exhaust tends to roll back down the sides of the building, producing a "wake cavity" effect. Fumes must therefore be exhausted away from and above adjacent structures to avoid reintrainment. Architects must also decide early in the design process where fresh-air intake grills are best placed, ensuring that they are sufficiently below rooftop exhaust and away from potential polluting vehicle emissions at ground level.

### Modeling systems

In addition to early consultation with mechanical engineers, architects involved in lab projects must work closely with owners and users during design development. The complexity of integrating mechanical and utility services within equipment-intensive buildings makes the three-dimensional modeling of proposed projects vital for conveying design strategies to clients and for eliciting decisions from owners, who often cannot visualize plans. Full-scale mock-ups of a typical lab station are frequently constructed. But the rendering capabilities and sophisticated graphics of computer-aided design systems are proving a faster, more effective tool for communicating three-dimensional ideas at earlier stages in the design process.

In designing the University of Maryland at Baltimore's new health research facility, for example, CUH2A and Ayers Saint Gross created a series of computer-generated lab perspectives (right), which convinced their skeptical clients of the scheme's flexibility.

Client demands for better air quality with more adaptable mechanical services are therefore fueling the increased role of HVAC systems in the earliest stages of the design process. The examples on the following pages illustrate the dictum of Stanley Stark, a principal at Haines Lundberg Waehler: "The configuration of the air-handling system has its own 'architecture' in the way that it is delivered, strongly influencing the architecture of the laboratory as a whole." ■

—Marc S. Harriman



**University of Maryland at Baltimore  
Health Sciences Facility  
Baltimore, Maryland  
CUH2A and Ayers Saint Gross, Architects**

A new, 200,000-square-foot facility for conducting biomedical research will serve as the hub of the University of Maryland at Baltimore's medical center when completed in 1995. Constructed on an urban site in downtown Baltimore, the building will connect the hospital, adjacent medical research and teaching facilities, and a shock trauma center to encourage the collaboration of specialists from the medical, nursing, pharmacy, and dental schools. Baltimore-based Ayers Saint Gross and Princeton-based CUH2A therefore designed the building to accommodate biomedical research laboratories in flexible spaces. The six-story building's attachment to adjoining facilities at each floor level dictated a lower-than-optimal, 13-foot, floor-to-floor height. To maintain ceiling clearances, the architects minimized overhead mechanical services by routing supply and exhaust ducts from the labs to vertical shafts that run to a rooftop penthouse, where system control elements are located. Polluted air from a nearby incinerator and downdrafts from helicopters arriving and departing from the adjacent shock trauma center placed additional burdens on the building's exhaust system. Such constraints led the architects to design a brick-clad tower stretching above the northwest corner of the building to house exhaust stacks. This tower not only discharges toxins, but creates an architectural marker to enhance the school's previously undistinguished presence on the cityscape.

**TOP LEFT:** Proposed Health Sciences Facility  
**RIGHT AND FACING PAGE:** Computer images of the Health Sciences Facility depict location of separate building systems—structural (top row, left to right), HVAC (second row), electrical (third row), plumbing (fourth row)—and their integration (bottom row). The drawings allow clients to envision the organization of each system and the design of individual laboratories (facing page, far right, top to bottom).

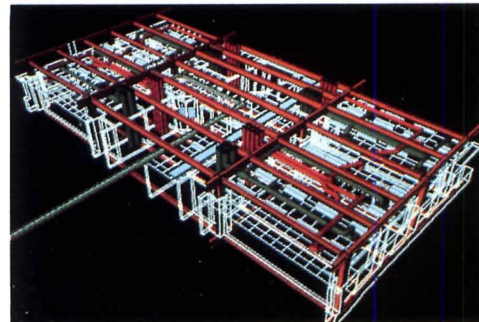
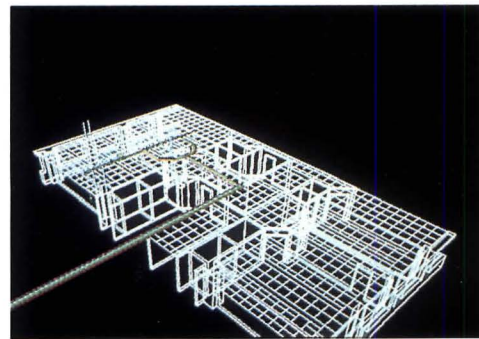
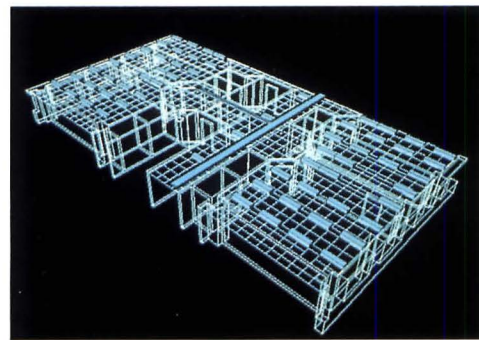
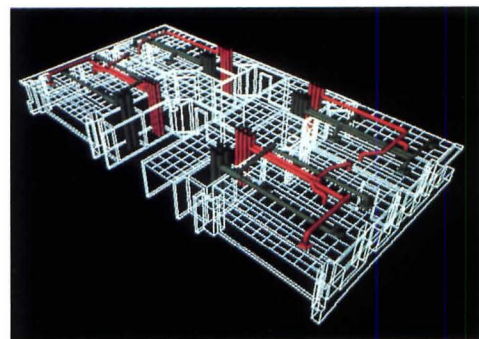
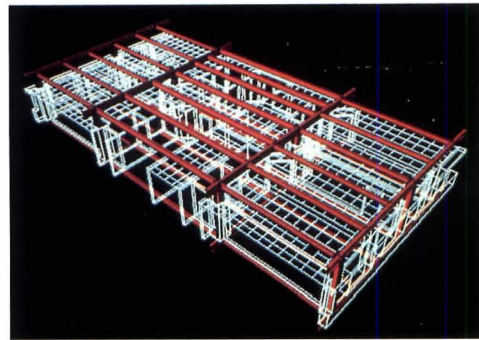

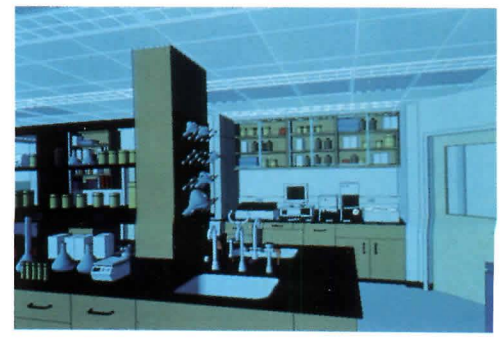
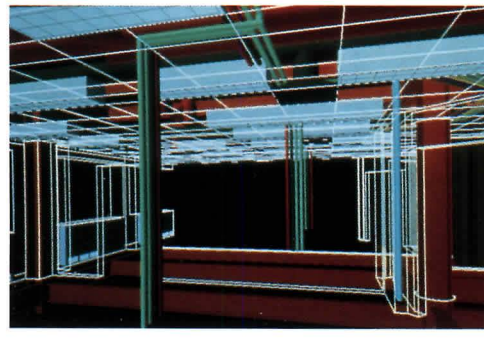
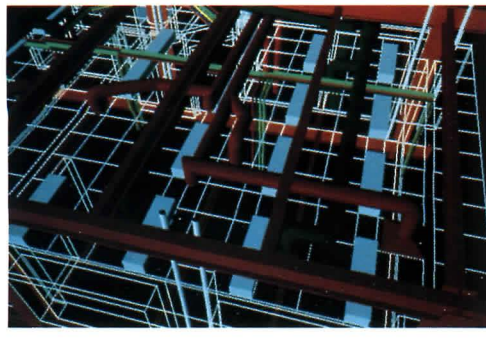
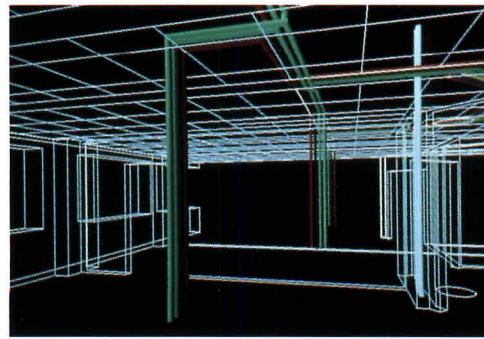
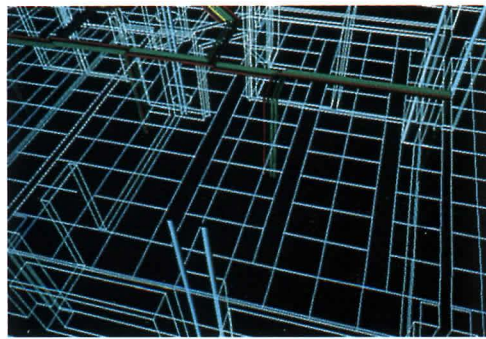
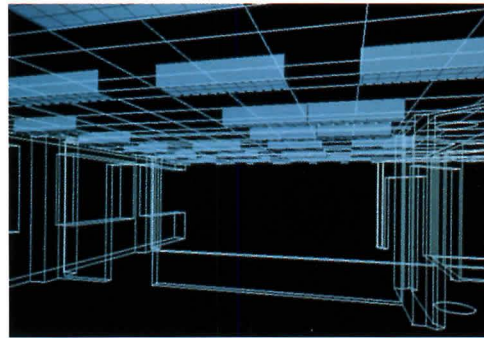
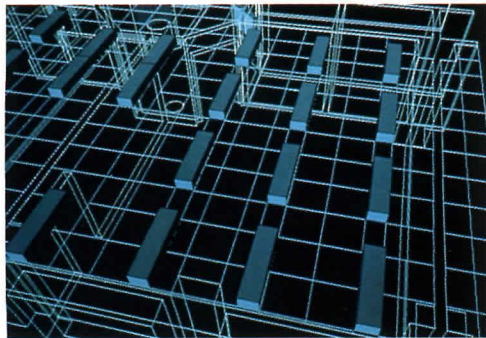
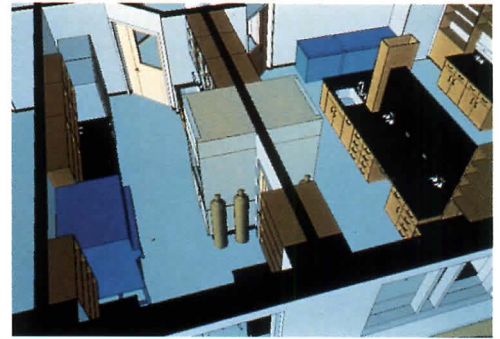
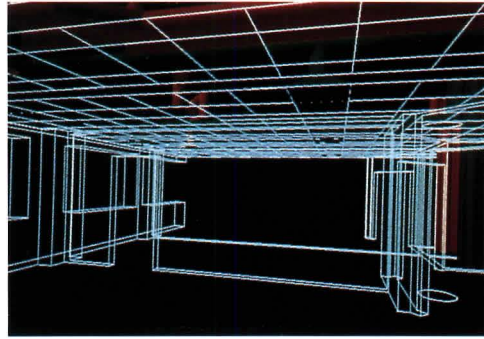
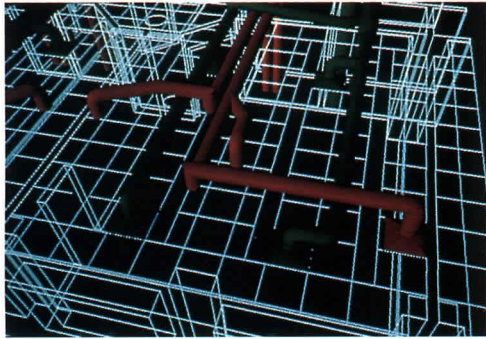
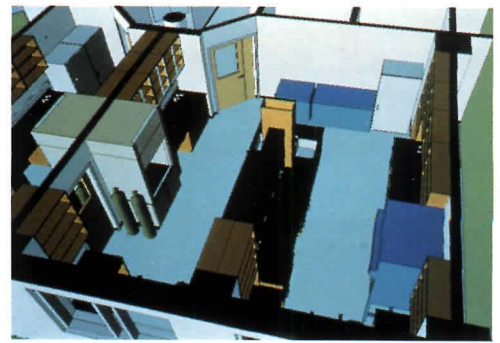
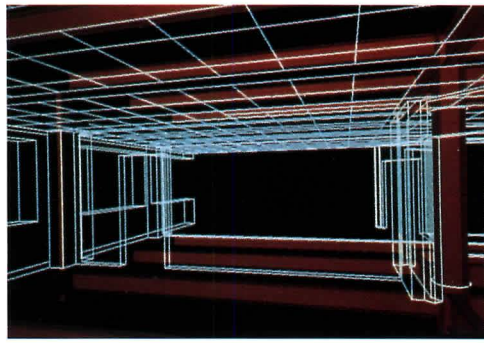
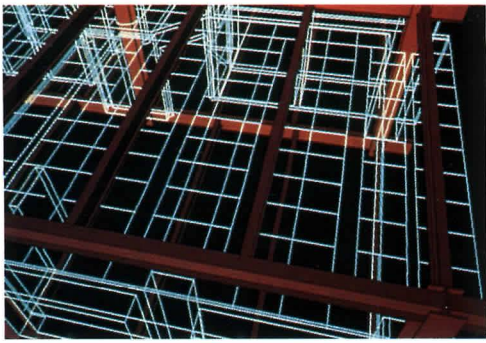



STEVE TURNER

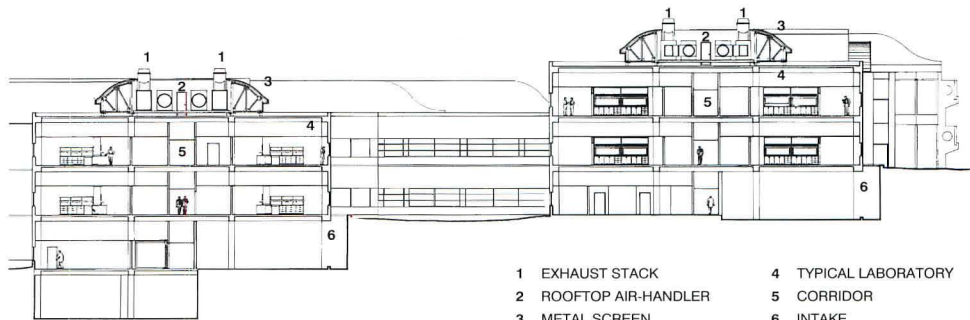

EAST-WEST SECTION

- |                       |                      |
|-----------------------|----------------------|
| 1 EXHAUST STACK       | 4 TYPICAL LABORATORY |
| 2 ROOFTOP AIR-HANDLER | 5 CORRIDOR           |
| 3 METAL SCREEN        | 6 INTAKE             |

**Boehringer Ingelheim Pharmaceuticals  
Ridgefield, Connecticut  
Flad & Associates, Architects**

Two linear laboratory wings added to the south end of Boehringer Ingelheim Pharmaceuticals' 20-year-old campus in rural Connecticut mark the completion of a second construction phase for the German-based company's growing North American headquarters. The new buildings provide an additional 100,000 square feet of chemistry- and biology-based research space for developing new drugs. In the new labs, Flad & Associates distributed mechanical equipment along double-loaded service corridors that continue the circulation spine established by the original structures. The architects maintained the three-story height of the existing research facilities and extended supply ductwork from basement air-handlers through two fresh-air supply shafts flanking one end of the hallway. Two more shafts flanking the opposite end of the corridor remove fume hood exhaust. Ducts then branch out laterally from the central corridor to individual labs; this main hallway efficiently doubles as circulation for occupants and as a plenum for overhead air-handling services. The wind-tunnel-tested, aerodynamic profiles of curved, perforated metal screens atop the buildings' flat roofs shield penthouse mechanical equipment from view and from prevailing winds. Their sloped configuration, engineered so that the path of airflow closely follows the panels' streamlined contours, limits the deflection of swirling outside air from the building facades and permits rooftop exhaust to be discharged from relatively short stacks without risk of reintraintment.

- TOP:** Aerial view of two new laboratory wings.
- SECTION:** Profile of metal-panel windscreens for rooftop exhaust stacks.
- ABOVE RIGHT:** Typical laboratory with fume hoods along rear wall.
- BOTTOM RIGHT:** Basement-level air-handlers.

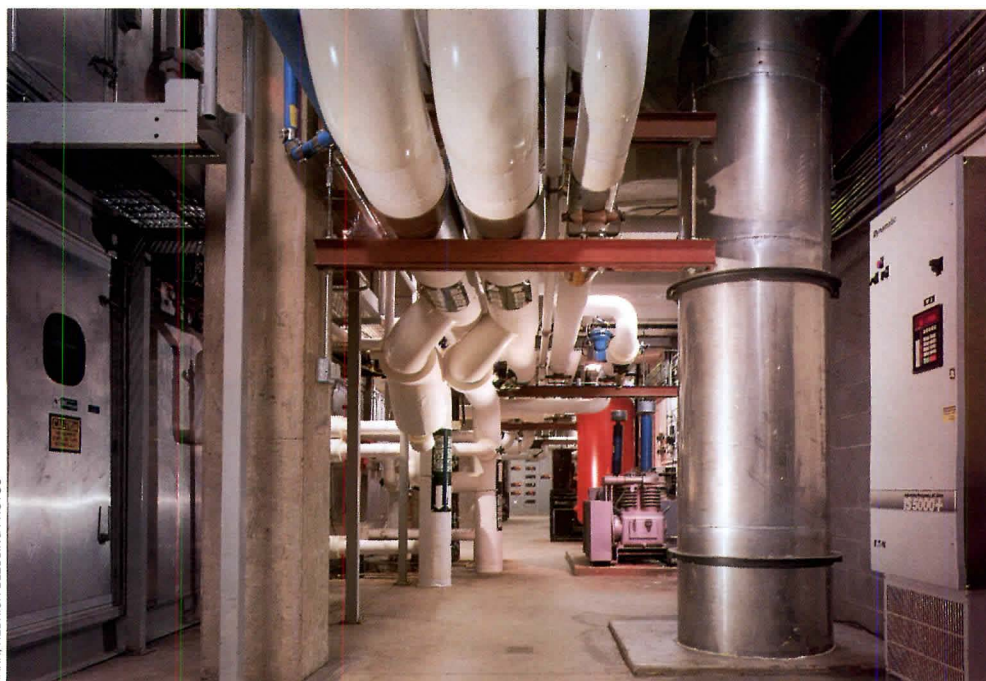

HARR, HEDRICH-BLESSING PHOTOS

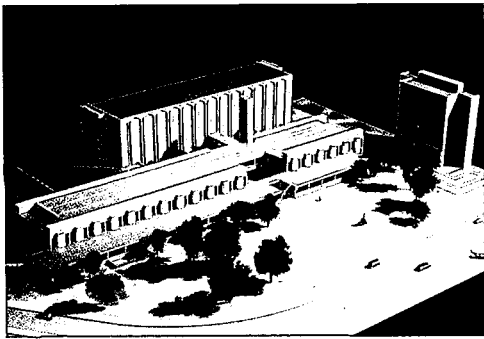

**Sciences Building Addition**  
**California State University, Fullerton**  
**Fullerton, California**  
**Anshen + Allen, Architects**

A new addition to California State University, Fullerton's School of Natural Sciences and Mathematics building now provides the faculty with improved indoor air quality and an additional 60,000 square feet of teaching and research laboratories. Anshen + Allen's linear, two-story structure allows support spaces and equipment to be shared by the university's biology, chemistry, geology, and physics departments. The architects specified 16-foot floor-to-floor heights to accommodate the air-handling services required in each of the department's labs. To conserve interior space, they pulled fume hood exhaust ducts from each lab to the outside of the building at every 22-foot-wide structural bay and extended them upward to a rooftop plenum above the building's central circulation spine. Since the university did not want mechanical services to be visible, the architects wrapped exterior ductwork, rooftop equipment, and exhaust stacks within an uninsulated, metal-paneled shell. A previous retrofit of the original labs, but also expelled exhaust too close to existing intake grills, causing reintraintment of chemicals previously discharged into the atmosphere. To correct the situation, Anshen + Allen located the new structure's fresh-air supply at the southwest corner of the building, as far as possible from the original laboratories. Furthermore, aeronautical engineering studies of wind patterns helped the architects determine that new stacks must force exhaust upward at least 25 percent above the original six-story structure to avoid possible reintraintment; this led Anshen + Allen to house the stacks within a single, 100-foot-tall chimney.

**MODEL:** Addition with 100-foot-tall exhaust chimney.  
**DRAWING:** Mechanical system distribution.

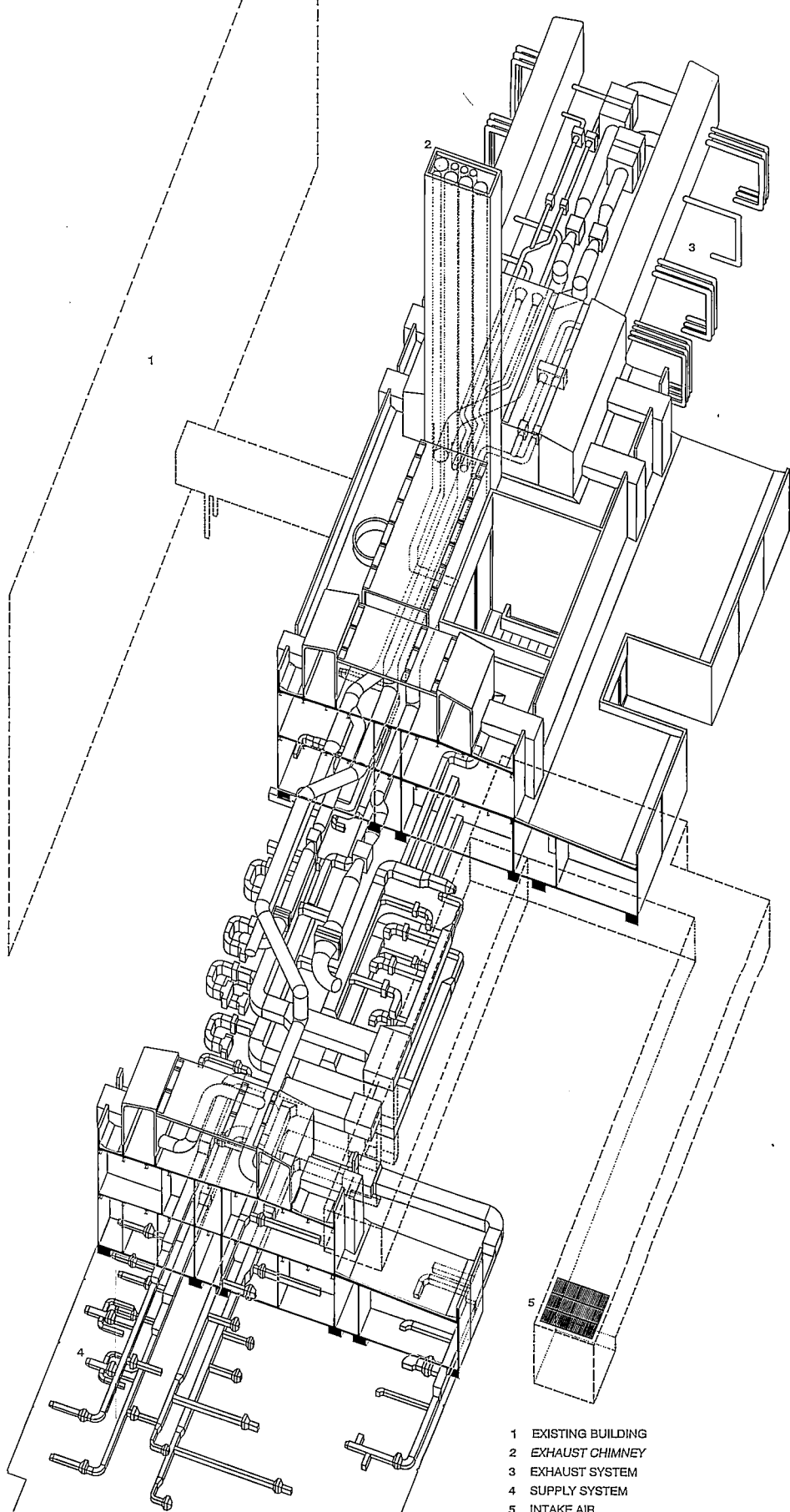

- 1 EXISTING BUILDING
- 2 EXHAUST CHIMNEY
- 3 EXHAUST SYSTEM
- 4 SUPPLY SYSTEM
- 5 INTAKE AIR

MECHANICAL SERVICES DISTRIBUTION



**Marley Agricultural Laboratory**  
**University of Arizona**  
**Tucson, Arizona**  
**Anshen + Allen, Architects**

A new, seven-story research and teaching facility for the University of Arizona's plant sciences, plant pathology, entomology, and biotechnology departments greatly expands the school's agricultural college. Sited between adjacent one- and three-story buildings, the 123,000-square-foot Marley Agricultural Laboratory was designed by Anshen + Allen with carefully threaded mechanical and utility systems to minimize its imposing height. Basement-level air-handlers take in fresh air at ground level, supplying it to the labs through two vertical risers within the core of the building. The architects specified poured-in-place concrete slabs above the central corridors and support areas to provide room for deep horizontal distribution trunks overhead. These ducts then branch into supply ducts running between precast-concrete, double-T members to lab stations, providing ample 10-foot-6-inch effective ceiling heights within shallow, 13-foot-6-inch floor-to-floor dimensions. Exhaust ducts run between alternate precast-concrete T-beams to avoid crossovers with supply services; exhaust ducts also lead from each of the 11-by-33-foot lab module fume hoods to seven metal-clad vertical shrouds running lengthwise up the east- and west-facing exterior walls. These risers then feed into a single rooftop plenum, where frames are expelled through shared stacks. By interlocking supply and exhaust ducts within the structure, Anshen + Allen clearly relegates HVAC services to distinctly separate zones, facilitating their installation, future adaptation, and maintenance.

**MODEL AND FACING PAGE:** Duct risers run up facade.  
**TOP RIGHT:** Typical concrete T-beam.  
**ABOVE RIGHT:** Utilities placed within structure.  
**ISOMETRIC, RIGHT:** Duct distribution.  
**ISOMETRIC, FACING PAGE:** Integration of mechanical and structural systems on typical floor.

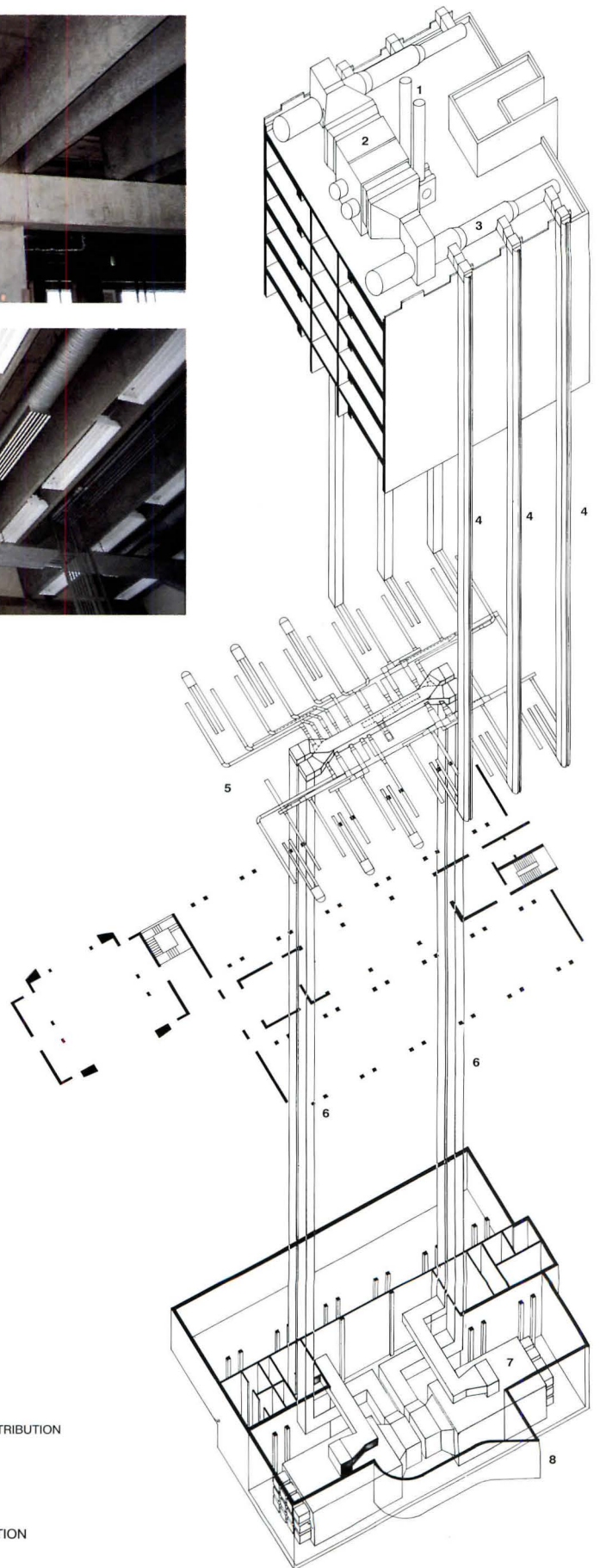

- 1 EXHAUST STACK
- 2 EXHAUST PLENUM
- 3 EXHAUST MANIFOLD
- 4 EXHAUST RISER
- 5 TYPICAL HORIZONTAL FLOOR DISTRIBUTION
- 6 SUPPLY RISER
- 7 BASEMENT AIR-HANDLING UNIT
- 8 GROUND-LEVEL INTAKE

MECHANICAL SERVICES DISTRIBUTION



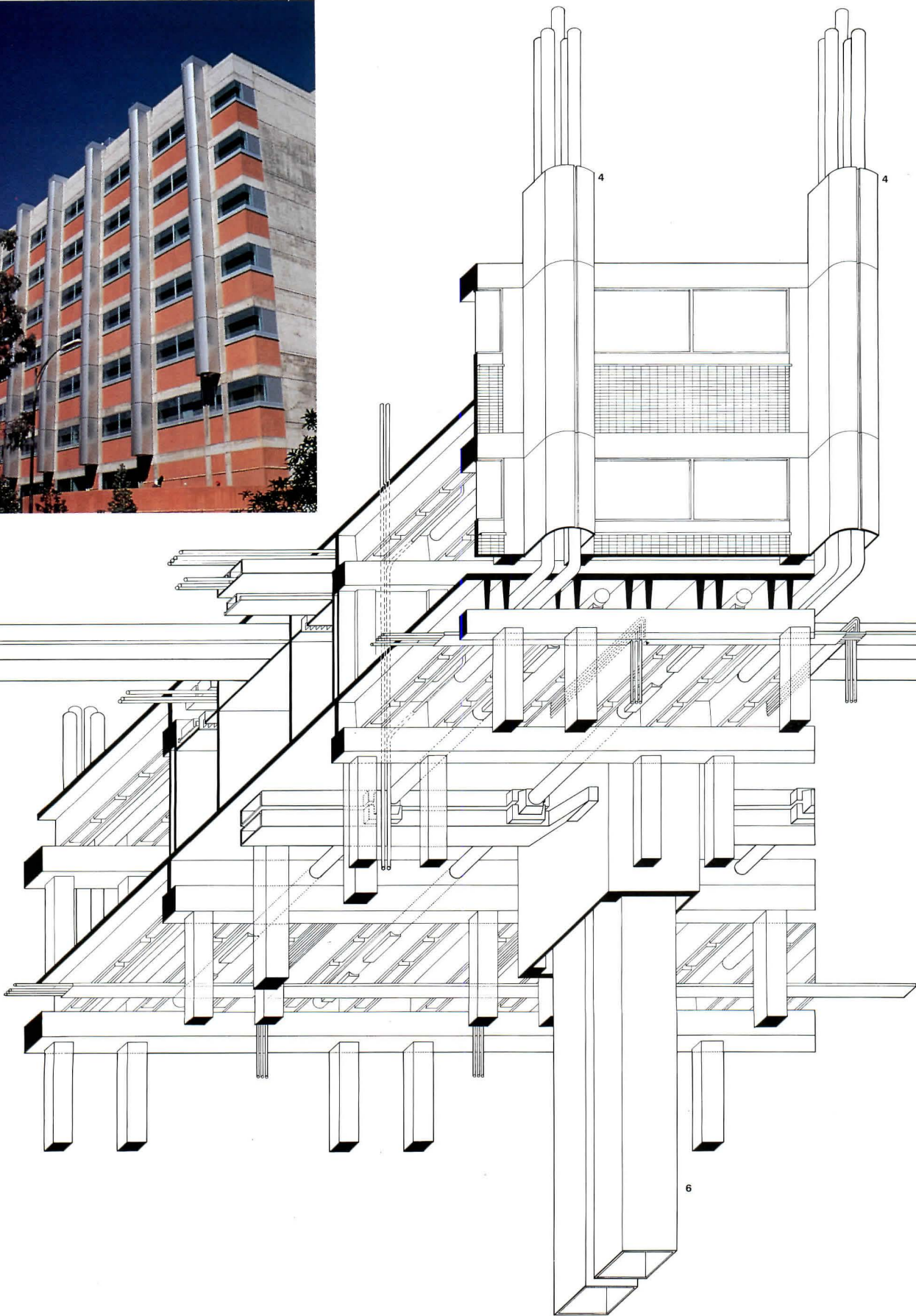

The American Architectural Foundation and The Octagon wish to thank the following major donors for enabling success of "Challenge '92," the \$4 million capital campaign for the restoration of the historic Octagon in Washington, D.C.

# RESTORING THE OCTAGON: BUILDING ON EXCELLENCE

## Leadership Donors

\$100,000 & above

The American Institute of Architects  
The Lynde and Harry Bradley Foundation  
The Temple Hoyne Buell Foundation  
Mr. & Mrs. Leo A. Daly III  
The Getty Grant Program  
The Kresge Foundation  
The National Endowment for the Humanities  
Otis Elevator Company

## William Thornton Circle

\$50,000 & above

Anderson DeBartolo Pan, Inc.  
Billboard Publications, Inc.  
The College of Fellows Fund  
DPIC Companies, Inc.  
Ellerbe Becket, Inc.  
HKS Architects  
Kohn Pedersen Fox Associates  
National Association of Home Builders  
RTKL Associates, Inc.

## John Tayloe III Circle

\$25,000 & above

The William H. Brady Foundation  
CNA Insurance Companies/  
Victor O. Schinnerer, Inc.  
Mr. & Mrs. Thomas J. Eyerman  
Gensler and Associates/Architects  
Hellmuth, Obata & Kassabaum, Inc.  
Henningson, Durham & Richardson, Inc.  
The Kling-Lindquist Partnership, Inc.  
Lightolier  
Paul Mellon  
NBBJ  
Odell Associates Inc.  
Queene Ferry Coonley Foundation, Inc.  
Smith, Hinchman & Grylls Associates, Inc.

## Glenn Brown Circle

\$10,000 & above

Harold L. Adams, FAIA, RIBA  
Anonymous  
The Architects Collaborative, Inc.  
Richard G. Boxall

Ronald M. Brame, AIA

C. Joe Buskuhl, AIA

Carrier Corporation

The Clark Construction Group/

The George Hyman

Construction Company/

OMNI Construction, Inc.

Committee for Historic Resources

CRSS Architects, Inc.

Ehrlich • Rominger Architects

Robert Elkington, FAIA

Florance Eichbaum Esocoff King

Architects

Haines Lundberg Waehler

Hansen Lind Meyer, Inc.

Alice & Allan Kaplan

Kevin Roche/John Dinkeloo

and Associates

Karl J. Krapek

Loomis Sayles & Company, Inc.

Marpat Foundation

Sue Ann & Terrence M. McDermott

Elizabeth & John Merrill

Notter + Associates PC

Mr. & Mrs. Philip W. Pillsbury Jr.

Rose, Beaton + Rose

Russell Gibson von Dohlen Architects

Sasaki Associates, Inc.

Ronald L. Skaggs, FAIA

Swanke Hayden Connell Architects

Paul M. Terrill Jr., AIA

Zimmer-Gunsul-Frasca Partnership

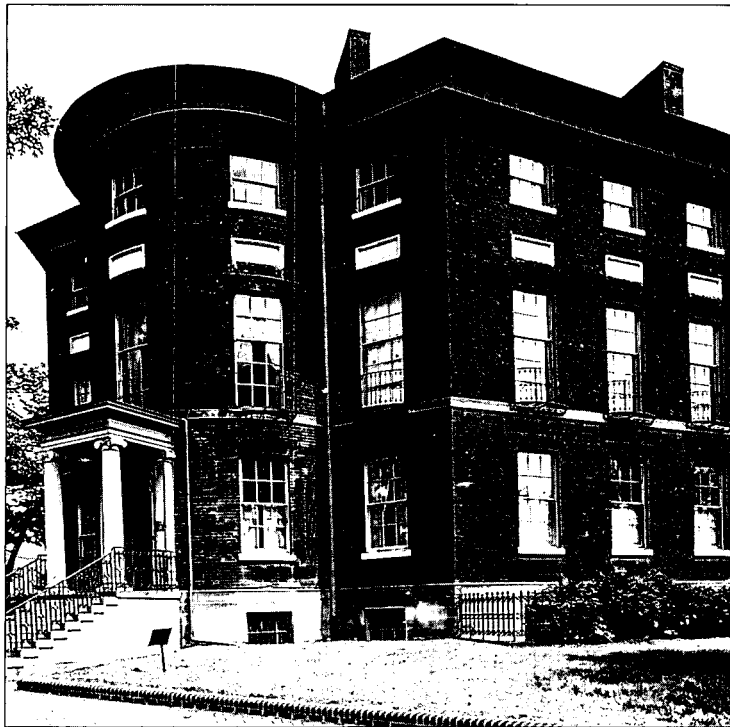

## Richard Morris Hunt Circle

\$5,000 & above

Albert Kahn Associates, Inc.  
Andersen Windows, Inc.  
Anshen + Allen Architects  
Architecture Magazine  
Carolyn Brewer & Benjamin E. Brewer Jr., FAIA  
Mr. & Mrs. S. Allen Chambers  
Ellen MacNeille Charles  
Corinne Aaker Cramer and James P. Cramer, Hon. AIA  
Daniel, Mann, Johnson & Mendenhall  
Davis/Fenton/Stange/Darling Architects Engineers  
Flad & Associates  
Robert V. M. Harrison, FAIA, FCSI  
Mones E. Hawley  
Lawrence N. Hawthorne, AIA  
HTB, Inc.  
The Kiplinger Foundation  
Luckman Management Company  
Media Five Limited  
Moore Ruble Yudell  
Pennsylvania Society of Architects/AIA  
Progressive Architecture  
Reese, Lower, Patrick & Scott  
Robert Lehman Foundation  
Shearson Lehman Brothers Inc.  
Thompson, Ventulett, Stainback & Associates, Inc.  
The WBDC Group

It is not too late to join this list of major donors who will be recognized in a permanent installation at The Octagon and in the "Challenge '92" Capital Campaign Donor Book. Please call (202) 626-7564 for more information.



THE AMERICAN  
ARCHITECTURAL FOUNDATION

## Laboratory Innovations

*As corporations and universities race for new ideas, architects experiment with interactive formulas for research facilities.*

Bell Laboratories in bucolic Murray Hill, New Jersey, was for decades the paradigm of laboratory design. Conceived in the late 1930s by Voorhees, Walker, Foley and Smith of New York, the research complex consisted of repetitive laboratory modules flanked by shared corridors. Within the discrete laboratories, senior scientists, supported by small teams of junior investigators, independently pursued their research. The building's organization did little to encourage interaction among scientists or between scientists and corporate management. In essence, "AT&T allowed very intelligent scientists to think interesting thoughts, hoping new products might evolve from them," explains Janet M. Brown, director of facility planning at CUH2A, a Princeton-based specialist in laboratory design.

If Bell Labs represents the first generation of modern American laboratories, then Louis Kahn's Salk Institute, completed in 1965, represents the second. According to Stanley Stark, partner of New York-based Haines Lundberg Waehler (HLW), "Although most remembered for its majestic siting, Salk's fundamental contribution to laboratory design was its introduction of interstitial space." By routing utilities through an intermediary level between laboratory floors, rather than through wall cavities, Kahn freed up the plan. Salk's labs were still primarily laid out along corridors in repetitive units, but they could be expanded or contracted to meet the changing nature of research. This more flexible approach has dominated lab design for the past 30 years.

### New research models

Bell Labs and the Salk Institute advanced scientific knowledge and spurred other corporate and institutional clients to follow suit; but rapidly changing economic, cultural, and technological conditions have conspired to shape a new research model for the 1990s and beyond. "Today, there is a much tighter relationship between science and business," contends Brown. Corporations are asking researchers to develop ideas that can be converted into marketable products more quickly; universities are tailoring their research toward applied, rather than theoretical, work in order to receive private funding; and campus laboratories are being sponsored and occupied by private companies, so that the distinction between academic and corporate labs is becoming blurred.

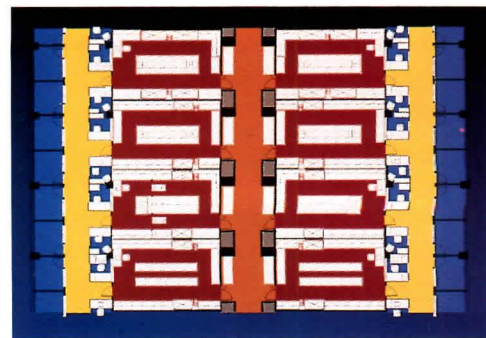

DEPARTMENTAL CONFIGURATION

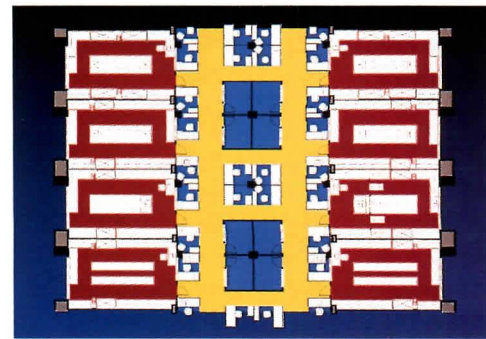

TEAM CONFIGURATION

- |                      |  |
|----------------------|--|
| ■ MECHANICAL SPACE   | 1 ENCLOSED OFFICE FOR SENIOR SCIENTIST |
| ■ PERSONNEL CORRIDOR | 2 WORKSTATION FOR JUNIOR SCIENTIST     |
| ■ SERVICE CORRIDOR   |  |
| ■ RESEARCH OFFICE    |  |
| ■ LAB OR LAB SUPPORT |  |

**TOP:** By introducing two secondary corridors between the labs and enclosed offices, architects retain a traditional departmental configuration while separating staff from hazardous materials.

**ABOVE:** By inverting the plan, architects cluster scientists' offices together. This arrangement encourages interaction among different disciplines, an important ingredient as research becomes more multidisciplinary.

The pressure to produce profitable ideas, coupled with the complexities of today's research, is forcing scientists to interact with their peers, with scientists from other disciplines, and with the business world at large. Such increased interaction means that the research laboratory of the future, whether industrial or academic, may more closely resemble a corporate beehive than a monastic retreat. And this shift is already evident on every scale—from the basic lab module to the overall building program.

#### Office versus lab

Traditionally, a scientist and a technician worked together in the lab; the senior investigator would be assigned an enclosed office at the far end of the room, while the technician would be allocated a few linear feet of bench space near the experiment. Essentially all aspects of their work took place in this laboratory—from running experiments to analyzing results over a cup of coffee.

Today, scientists spend more time in an office environment, simulating experiments on computers. Hypotheses are often tested electronically before experiments are conducted in real life. And more often than not, the actual experiment is undertaken by specialized equipment, rather than by human hands. "You don't even have to go to the lab to get your results," explains Brown. "They appear on your computer screen."

This automated research, coupled with a concern for worker safety, has prompted architects to pull scientists' offices out of the lab so that researchers need not walk through experiments to get to their desks. In separating office and lab spaces, architects now have the opportunity to congregate scientists more closely to encourage the exchange of ideas.

Not only are offices being removed from the generic lab, so is sophisticated analytical equipment. Architect Mariano Rodriguez of The Hillier Group in Princeton estimates that the amount of instrumentation in research facilities is doubling every seven years. Because today's high-tech instruments are expensive and require special placement, most complex machinery, such as mass spectrometers and electron microscopes, are being located in dedicated labs, to be shared by a specific group of investigators. Even less complicated processes, such as glass washing, are located in shared support rooms. In addition to saving the cost of duplicating equipment and space, these dedicated areas free up the lab module so that it can remain as generic, and therefore as flexible, as possible.



JEFF GOLDBERG/ESTO

#### U.S. Headquarters Rhone-Poulenc Rorer Collegeville, Pennsylvania CUH2A, Architect

Rhone-Poulenc Rorer was formed in July 1991 as an alliance between the United States-based Rorer Group and the French pharmaceutical and chemical company Rhone-Poulenc. The new company quickly set out to assemble 2,000 researchers, managers, and support personnel—formerly located at dispersed sites—within a new, 1.1 million-square-foot headquarters (site plan). The client believes that combining the corporation's scientific, business, and marketing divisions will spark creativity.

Princeton-based CUH2A designed the U.S. Research and Development Center and Administrative Offices as a series of laboratory and office pavilions linked by a curved circulation spine. The connecting zone includes common functions such as the library, auditorium, and fitness center. The architects provided opportunities for casual interaction both within hallways in the spine (center left) and in the laboratory block (plan). Natural light is emphasized throughout the facility. An atrium in a lab wing illuminates interior research spaces (top left).



TYPICAL LABORATORY FLOOR

- |                   |                   |
|-------------------|-------------------|
| ■ LABORATORY      | 1 SKYLIT ATRIUM   |
| ■ LAB SUPPORT     | 2 CONFERENCE ROOM |
| ■ RESEARCH OFFICE | 3 BREAK-OUT AREA  |
| ■ ADMINISTRATION  |                   |
| ■ MEETING AREA    |                   |

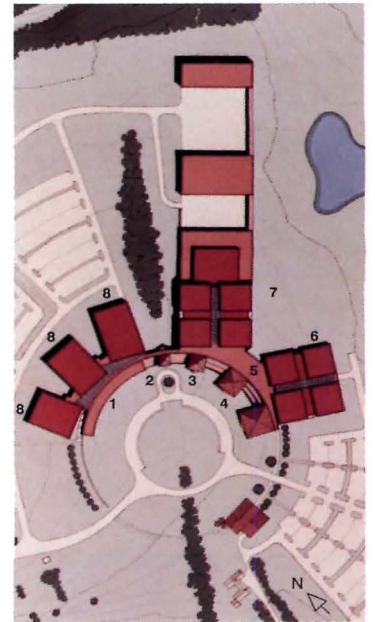

SITE PLAN

- |                    |
|--------------------|
| 1 FITNESS CENTER   |
| 2 LOBBY            |
| 3 AUDITORIUM       |
| 4 LIBRARY          |
| 5 DINING           |
| 6 CHEMISTRY        |
| 7 BIOLOGY          |
| 8 CORPORATE OFFICE |

**Biological Sciences Complex**  
**University of Georgia**  
**Athens, Georgia**  
**CRSS Architects**

Eager to be part of the state's emerging biotechnology industry, the University of Georgia constructed the Biological Sciences Complex (top right) in 1991 to house both biochemical and genetic research. The Houston-based firm of CRSS designed the 250,000-square-foot building as three interconnected octagonal blocks (plan). Within each block, the architects placed laboratories and offices on the building perimeter to maximize natural light; support spaces are clustered at the center. The architects also designed a flexible floor plan to promote interaction among project team members while preserving a sense of individual territory within particular departments. Discussions among faculty and research assistants, for example, can take place within centrally located instrumentation rooms or adjacent to corner offices. The laboratories (center right) can be subdivided into a number of configurations. Technician workstations (bottom right), generously sized to accommodate complex computer equipment, are positioned next to windows, far away from fume hoods (below).



FRED MARTIN, JR. PHOTOS

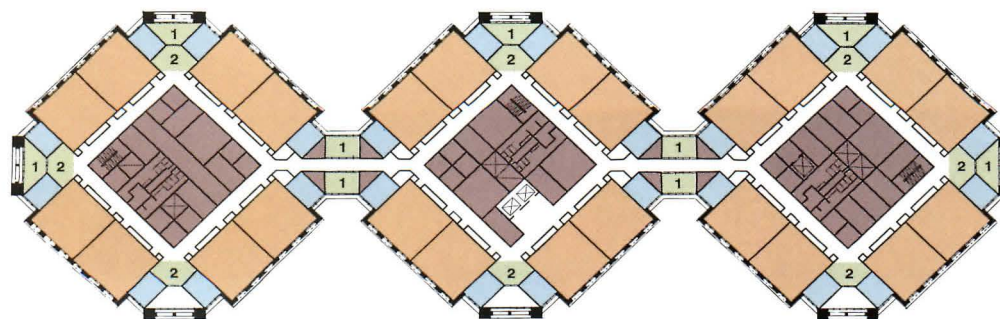

SECOND FLOOR

- LABORATORY
- LAB SUPPORT
- RESEARCH OFFICE
- MEETING AREA
- 1 CONFERENCE ROOM
- 2 BREAK-OUT AREA

**Break-out areas**

Because of the complexity of today's research, interaction among scientists is critical. Many researchers are working in multidisciplinary teams; the more ideas are shared, the more likely these joint projects will bear fruit. "Architects and managers must be very sensitive to the need for cross-fertilization," explains HLW's Stark. But the solid walls required for shelving and utilities, the protected areas for hazardous materials, and the hard surfaces for cleanliness typical of most labs are not conducive to such socialization. To overcome these barriers, architects are emphasizing shared functions through staircases and atriums that invite exchanges between floors, glazing between labs that promote interior views of research activity, and carefully placed conference areas to facilitate both scheduled and casual discussions.

Today's laboratory designers are quick to distinguish these informal meeting spaces from the "interaction spaces" popular during the 1970s and 1980s. Many of these earlier attempts took the form of lounges tacked onto the ends of corridors in out-of-the-way places. Instead, the most forward-thinking designers subtly weave these kinds of spaces—now often referred to as "break-out areas"—into the normal work flow. "The best exchange of information often happens in or near work areas," observes Chris Cowansage, director of laboratory planning at the Washington, D.C., office of CRSS. Architects can encourage this communication by strategically locating a blackboard, bulletin board, coffee pot, or mailbox outside an office or lab as a magnet to attract discussions.

**Adaptable lab modules**

Scientific research is changing so rapidly—responding virtually daily to new diseases, new discoveries, fluctuating funding, business priorities, and staff mobility—that academic and corporate clients want some assurance that a building will meet their needs into the next century. "I see more and more clients saying that flexibility is now a big issue, given the first costs of the projects," observes Cowansage. "They are taking a longer-term view, even if it does cost a little more money upfront."

One response to this demand for flexibility is the generic lab module. Architects develop such units from a basic geometry that can accommodate a variety of configurations—from a hood-intensive chemistry lab, for example, to an instrument-intensive electronics lab. Typically, the width of a standard module is based on a 10-foot dimension to ac-

commodate 30-inch-deep casework and 5-foot-wide aisles. The length of a lab module depends upon the specific work being undertaken by the researchers. Architects frequently work with manufacturers to develop casework and bench “kits-of-parts” so that layouts can be easily removed or reassembled.

While an architect will always strive to develop a lab module from which to organize a coherent plan, Stark predicts even greater flexibility in the near future. “In older labs, a lot of time went into creating the perfect module, and then it was repeated ad infinitum,” explains Stark. “In the future, we will see more forgiveness in the base module; it will be invested with qualities that allow it to grow and change.” This ability to adapt the laboratory is critical if facilities are to accommodate the organizational volatility inherent in research. “Teams are reconstituted with remarkable rapidity during projects,” Stark observes. “They need to be able to create dedicated support or additional office space to accommodate these changes. We have come to expect this in general office environments. The same pressures exist in labs.”

The fact that architects are frequently being called upon to design lab space for an unidentified tenant is symptomatic of this volatility. “There are instances,” describes Cowansage, “when management says they are not going to assign a user to the space during design because they want a generic lab. They want to be able to decide three years from now who is going into it.”

### Organizing the team

Once the lab module, support space, and office needs are defined, the architect must develop the research block according to an organizational strategy based either on departments, such as biology and chemistry, or on the project team. Ideally, the two approaches are carefully balanced. According to CUH2A’s CEO Ronald A. Thompson, “A critical mass is needed within each discipline—there needs to be enough of a coalition between people of similar specialties so that they can talk to each other in a way that only they can understand—but there also needs to be a connection between different disciplines working on joint projects.”

But achieving the correct mix of labs and offices, of generic and dedicated spaces, and of departmental and team areas is no longer enough for the most up-to-date research labs. Today, architects are also being asked to integrate research and business functions under the same roof to foster *closer ties between sci-*

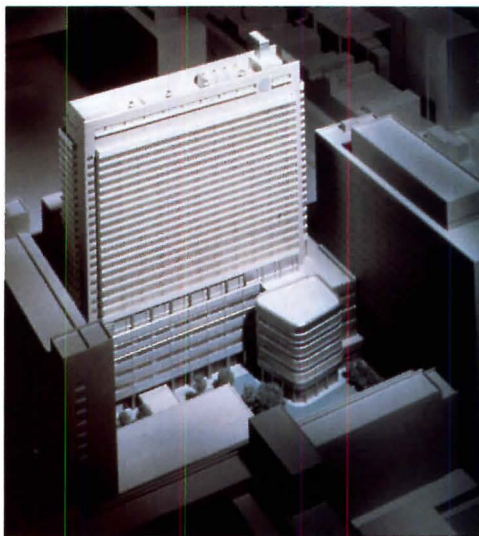

**Skirball Institute and Residential Tower**  
**New York University Medical Center**  
**New York City**  
**Polshek/Payette Associates**

Inserted between two buildings on New York University’s urban medical campus, the new 23-story building (top left) comprises an institutional and residential enclave. The lower five stories, known as the Skirball Institute of Biomolecular Medicine, house research labs and faculty offices, while the upper levels provide apartments and medical offices. A curved, five-story pavilion containing research administration, conference rooms, and lounges (center left, bottom left, and below) will connect the institute to Tisch Hospital. By locating an open staircase within this pavilion, and alternating shared instrumentation and conference rooms between floors, the architects invite scientists to socialize within this public element.

The laboratories are organized along a double-loaded corridor (plan). The lab module is divided into a primary bench and desk zone along the perimeter wall, and a secondary support zone along the corridor. Between the zones lies a “ghost corridor”—an aisle that runs continuously between adjacent labs to provide a second means of egress.

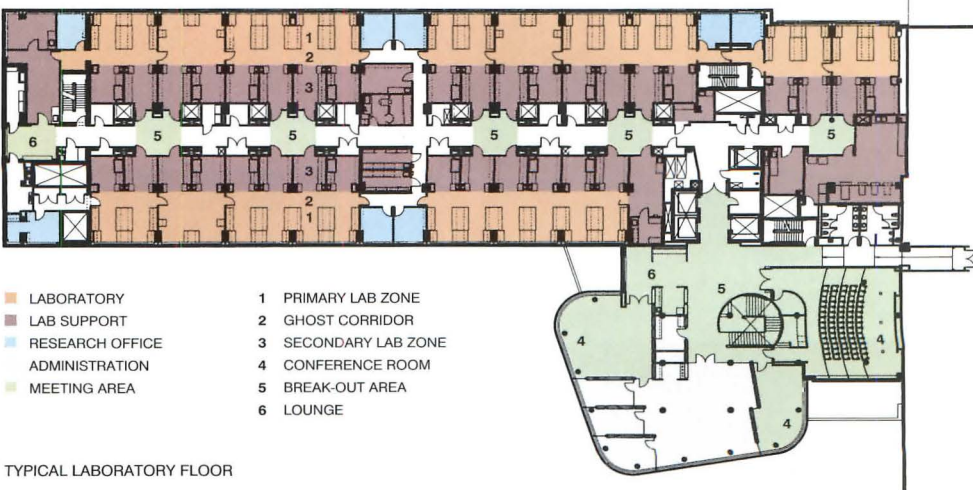
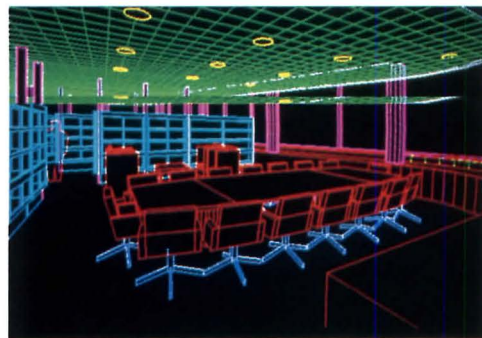
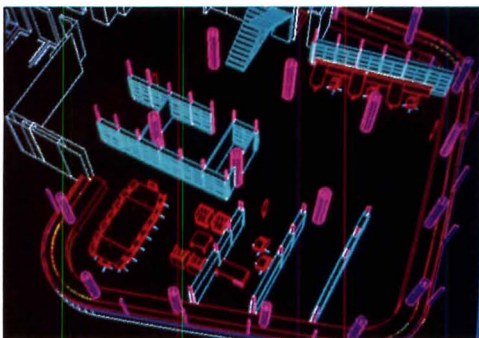
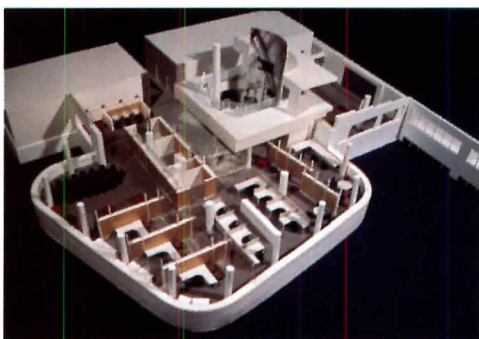

JOCK POTTLESTO

**Walter Reed Army Institute  
of Research**  
Forest Glen, Maryland  
Haines Lundberg Waehler, Architect

Like many older, urban research centers, Walter Reed Army Institute of Research had long outgrown its Washington, D.C., headquarters. Having relied on satellite campuses for years, Walter Reed is now consolidating its services within one state-of-the-art building in suburban Maryland. Construction of the 485,000-square-foot building and adjacent parking garage will begin this year.

The new facility (below) is divided among seven departments that focus on viruses, bacteria, parasites, medicine and surgery, psychology, animal care, and vaccine and drug development respectively. Research conducted at Walter Reed primarily involves infectious diseases, so HLW developed a basic repetitive laboratory module that can be easily reconfigured as one division expands and another contracts (plan). In addition, the architects provided a large central zone of support space that's accessible to all the labs.

Administrative offices ring the three-story building's atrium, which marks the crossing of the two wings, and encourages communication between division chiefs and researchers.

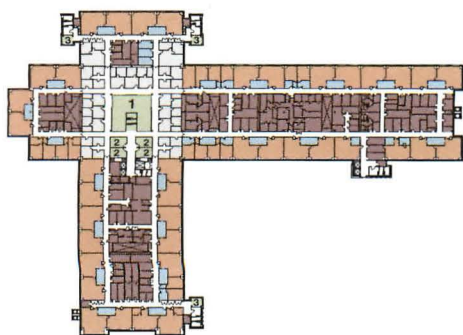

TYPICAL LABORATORY FLOOR

- LABORATORY
- LAB SUPPORT
- RESEARCH OFFICE
- ADMINISTRATION
- MEETING AREA
- 1 SKYLIT ATRIUM
- 2 CONFERENCE ROOM
- 3 LOUNGE

**Walter E. Foran Hall**  
Rutgers University  
New Brunswick, New Jersey  
Haines Lundberg Waehler, Architect

As science becomes more sophisticated, financing research facilities is becoming more complicated. Rutgers University, for example, is relying on a trio of sponsors to pay for the construction of Foran Hall on the shared campus of Cook and Douglass colleges. Each of the funding sources is tied to a specific portion of the building. A state revenue bond administered by the State Commission on Science and Technology will pay for the Center for Agricultural Molecular Biology. Federal grants from the U.S. Department of Agriculture will finance the Plant Science Department. And money appropriated by the New Jersey legislature will cover the shared research and teaching portion of the building, Cook/Douglass Science Center.

Because construction money was tied to specific entities, and funding commitments were uncertain, HLW Architects designed the building so that certain functions could be added or eliminated as necessary. Fortunately, all three portions of the building are now funded, and the entire 140,000-square-foot facility (below) will be completed in 1994.

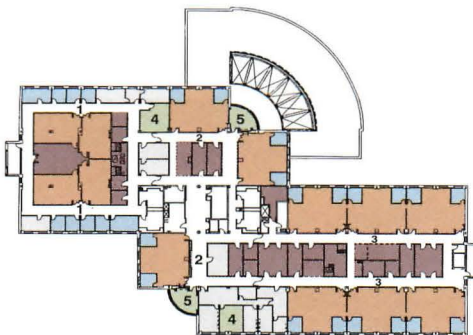

TYPICAL LABORATORY FLOOR

- LABORATORY
- LAB SUPPORT
- RESEARCH OFFICE
- ADMINISTRATION
- MEETING AREA
- 1 PLANT SCIENCE
- 2 SCIENCE CENTER
- 3 MOLECULAR BIOLOGY
- 4 CONFERENCE ROOM
- 5 BREAK-OUT AREA

ence and business in the corporate environment. Explains Thompson: "The research team has dramatically expanded to include not just the scientists but the whole business team." This change can be seen in the size of new research facilities: 10 years ago, the average industrial complex might have been 300,000 square feet; today, many are 1 million square feet. And new university facilities are often strategically positioned to link a vast array of existing laboratory spaces together into one dynamic complex.

**Research amenities**

Nonlaboratory facilities that serve all of a complex's tenants are also receiving increased scrutiny. As scientists spend less time in the lab, they are required to spend more time in meetings—so seminar rooms, auditoriums, conference areas, and high-tech training rooms are taking on greater significance.

Connections to the outside are also being strengthened. The library, always an important ceremonial space in a research facility, is increasing in size and usefulness—and tying scientists electronically to new research being developed around the world. "Today, with the globalization of knowledge, no single research entity can do everything on its own. There is a good deal of collaboration and sharing of information," explains Stark.

To recruit and retain well-qualified staff, a critical issue for both academic and corporate laboratories, research clients have broadened their program requirements. Large-scale research complexes are incorporating consumer services, such as newsstands, cash machines, food carts, dry cleaners, and video rentals. On-site day-care centers are becoming commonplace. Fitness centers, which were integrated into the corporate environment several years ago, are now considered essential to research facilities.

These amenities are not just altruistic gestures on the part of management. While employees may appreciate the convenience, corporate strategists recognize that they keep scientists more focused on their research. And many of these functions encourage conversation that leads to scientific breakthroughs. According to Peter Hoyt, CUH2A's director of design, scientists will not share technological or business knowledge until and unless a social relationship is established.

"There is nothing like scientists spending 20 minutes next to each other on the Stairmaster to help break the ice in a meeting later that day," Hoyt says with a laugh.

—Nancy B. Solomon

# Member Communications Plus

## Exclusive Member Savings

### Faxes . . .



Over 20 Models available—thermal and plain paper. Super low prices on superior-quality thermal fax paper.

### Copiers . . .

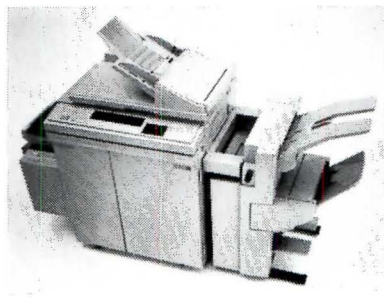

Models for all needs from 500 to 100,000+ copies per month with guaranteed factory authorized local service support.

### Panaboard & More!



Electronic print board—makes copies of whatever is written, drawn or taped to it.

***Call about fax paper, laser printers, and laptop computers, too!***

- Guaranteed lowest prices
- Service support available nationwide
- Free shipping on most items
- No sales tax charge except in Md, Va & Washington, DC

**A Member Sales Agent is standing by to assist you.**

# Call 1-800-289-2776

Monday–Friday 8 am–8 pm EST



## Products

*Healthcare environments are humanized by fabrics, furniture, and flooring.*



**TOP:** Congoleum introduces two designs to its Flor-Ever series of flooring. The sheet vinyl can be cut and inlaid to create borders and patterns. *Circle 401 on information card.*

**ABOVE:** Milcare manufactures the Cambio low-back chair that echoes the curve of the spine to provide lumbar and upper-back support. Upholstered seat pads are optional and zip off for cleaning or replacement. *Circle 402 on information card.*

**TOP:** Maharam Vertical Surfaces offers 44 fabrics suitable for cubicle curtains, bedspreads, and draperies in healthcare facilities. Manufactured entirely of Trevira FR polyester, the collection includes solid, geometric, and traditional designs. *Circle 403 on information card.*

**ABOVE:** Mini Sensor by Steelcase is an ergonomic chair designed for tight laboratory spaces. The chair's height and tension may be adjusted mechanically or with a pneumatic device. Fabric can be specified from four Steelcase textile lines. *Circle 404 on information card.*

**TOP:** Claiespan seating by ADD Interior Systems comprises up to four modules that are connected by steel plates, thereby reducing the number of floor supports for easier cleaning. It is designed for highly trafficked areas such as emergency and waiting rooms. *Circle 405 on information card.*

**ABOVE:** Adden Furniture offers the solid wood Roommate 2 series, including a desk, bookcases, shelves, a headboard, and a freestanding wardrobe with radiused edges and corners. *Circle 406 on information card.*



### Cubicle fabrics

DesignTex offers Envirotex 5, a collection of flame-retardant cubicle curtain fabrics (above) that are reversible and available in 17 styles. A set of pediatric textiles is designed to educate children.

Circle 407 on information card.

### Exterior insulation

Senergy manufactures the QRsystem, an exterior insulation and finish system that can be installed without plywood or gypsum board. The system accommodates columns, quoins, and trim, and is available in a range of colors.

Circle 408 on information card.

### Residential siding

Dryvit Systems offers a brochure that describes the energy efficiency, design flexibility, and maintenance characteristics of the company's residential siding systems. The line includes Sprint, Outsulation, and Fasttrak 4000, suitable for mild climates.

Circle 409 on information card.

### ADA hardware

The Jackson Exit Device division of the Builders Brass Works Corporation produces a series of door control devices designed to meet Americans with Disabilities Act (ADA) requirements. The line includes a slim-profiled panic bar, a lever-operated door latch, and concealed door closers.

Circle 410 on information card.

### Detectable paver

Cushwa Brick has developed the Guardian Paver in accordance with the Americans with Disabilities Act (ADA) to make crosswalks, curb cuts, ramps, and entrances easy to detect. Each brick paver has eight small projections that contrast with adjoining surfaces. The product is available in a variety of colors.

Circle 411 on information card.



### Healthcare flooring

Smaragd is a sheet-vinyl flooring manufactured by Forbo Industries for healthcare facilities, operating suites, and laboratories (above).

Available in 20 colors, the product is designed to resist staining and withstand heavy traffic. Forbo also produces wall coverings, linoleum, and acoustical panel systems suitable for healthcare applications.

Circle 412 on information card.

### Accessible shower

Aqua Glass designs its Special Care showers to accommodate the disabled. The 4-foot-square shower includes a fold-down seat, a textured

floor surface, and a horizontal grab bar along two walls. Fixture options include pressure-balanced valves by Grohe or Delta/Alson. In addition to showers, the company produces acrylic and gel-coated fiberglass bathtubs and whirlpools.

Circle 413 on information card.

### Hardware literature

Hewi offers a 12-page product brochure that outlines the installation and design of the company's nylon-and-steel handrails and balustrades. Available in 13 colors, the components are designed to work within a wide range of structural applications.

Circle 414 on information card.

### Woodlike vinyl

TOLI International manufactures Mature, sheet-vinyl flooring that simulates natural wood. The material can be heat-sealed or chemically welded at the seams, making it suitable for healthcare applications, and is available in eight colors, and six plank and two parquet styles. In addition to a seven-year warranty, Mature offers stain resistance.

Circle 415 on information card.

## "THE DISAPPEARING DOCK" Replaces dangerous concrete ramps

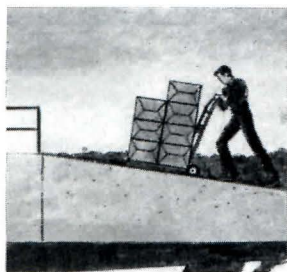

The hard way

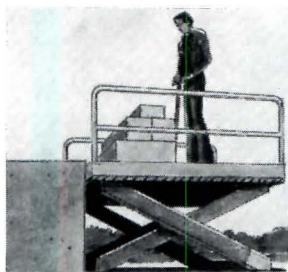

The safe way

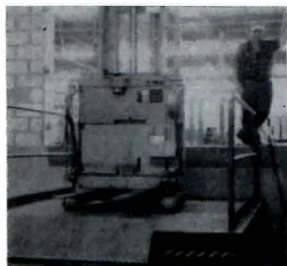

You can avoid accidents and the high cost of ramps by using a versatile Advance Superdok. Call 1-800-THE DOCK for FREE information. We're here to help.

Circle 90 on information card



Advance Lifts, Inc., 3575 Stern Avenue, St. Charles, IL 60174 (708) 584-9881

## When Barriers Prohibit Wheelchair Traffic:

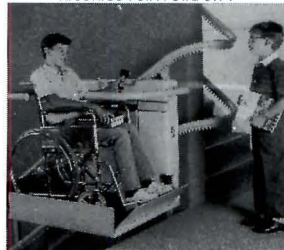

Look to the Accessibility products from American Stair-Glide.

The ideal solution to barriers imposed by stairs, the CARRIER-LIFT Inclined Platform Lift carries a seated passenger or person in a wheelchair up or down straight run stairways or around corners between two or more levels of stairs.



We offer a wide range of PORCH-LIFT Vertical Platform Lifts. Our nineteen models are the largest and most versatile line-up in the industry. We offer 5 different product groups with lifting heights up to 12 feet. They are the alternative to low-rise elevators and ramps.



Dept. #AIA 0393

4001 E. 138 th Street • Grandview, MO 64030  
816-763-3100  
FAX 816-763-4467 • TOLL FREE 1-800-925-3100

Circle 92 on information card

### Insulation information

A new 20-page catalog of Certain-Teed Corporation's fiberglass insulation products provides installation information for thermal and acoustical applications in residential and commercial settings. The literature includes information on the company's standard and high-performance lines.

Circle 416 on information card.

### Nonreflective glass

Amiran nonreflective glass by Schott is intended for interior and exterior showroom and street-front windows, galleries, museums, and restaurants. The weather-resistant material purportedly reduces reflected light to less than 1 percent. Amiran also absorbs UV radiation to protect display items and interior finishes from fading.

Circle 417 on information card.

### Courtyard seating

Landscape Forms produces the Traverse Chair for indoor and outdoor food courts and courtyards. The chair can be specified with or without armrests, and seat panels are available in gridded or perforated metal patterns. All metal is finished in the company's Pangard II powder-coat system, which is designed to resist rusting, chipping, peeling, and fading, and is available in a range of colors.

Circle 418 on information card.

### Metal windows

Wausau Metals manufactures a line of aluminum windows for schools, hospitals, office complexes, and other low-rise buildings. The product's 10-year warranty applies to corner joinery, glass and glazing, weather stripping, hardware, hinges, and structural performance.

Circle 419 on information card.

### Ceramic tile

Cactus International offers Marmol, a ceramic tile manufactured by Vitromex that is designed to emulate marble. The series, which is intended for residential applications, includes three natural stone colors including black, jade, and salmon.

Circle 420 on information card.

### Roof decking

Eternit introduces a four-page brochure describing its Promadeck roof-decking material, a fiber-reinforced cement sheathing that purportedly will not deteriorate during a fire.

Circle 421 on information card.

### Suspended tables

Spiros Industries has released a four-page brochure that illustrates how the company's ceiling-suspended tables can help convert a dining room into a multipurpose area. The tables are 60 inches in diameter and can accommodate up to eight people. Using the system's electronic controls, tables can be raised or lowered in approximately 15 seconds.

Circle 422 on information card.

### Service door

The Screenguard perforated metal service door, manufactured by Cornell Iron Works, allows air to circulate and provides visual access to interior spaces. Available in 186 colors, the door may be specified in either 22- or 20-gauge galvanized steel. The product is suitable for storefronts, parking garages, food-service areas, and industrial and recycling facilities.

Circle 423 on information card.

### Masonry video

The Burns & Russell Company offers a seven-minute video—"A Mason's Guide"—that presents installation guidelines for the company's Spectra-glaze concrete masonry units.

Circle 424 on information card.

### Girsberger chair

Girsberger Industries introduces the Girsberger 91 chair in honor of Switzerland's 700th anniversary. Constructed from chrome and beech wood, the chair is available with back and seat upholstered in fabric or leather, or with a perforated aluminum backrest and upholstered seat. The model is suitable as a side, occasional, or conference chair.

Circle 425 on information card.

### Masonry blocks

Best Block Company manufactures the Optimum series of split-face masonry blocks in a range of sizes. The units are suitable for indoor or outdoor applications.

Circle 426 on information card.

### Flexible lock set

Suitable for closets, bedrooms, and bathrooms, the Weiser Lock Saratoga lever is available in a variety of finishes and includes a lifetime warranty. The unit can also be used on exterior doors when combined with a Weiser Lock keyed entry knob.

Circle 427 on information card.

## EXIT DEVICE FOR THE 21st CENTURY

The 2100 Series from Jackson is the perfect mating of form and function. These are the only ADA compliant exit devices available with such a narrow profile.

The 2100 Series models include rim, concealed and exposed vertical rod devices. The concealed rod is also available in an electrified version.

Enduring beauty for the next millennium. For more information call 800-533-6229 - 800-585-6533 in CA.

Patent Pending

THOMAS  
INDUSTRIES, INC.

  
**jackson**  
EXIT DEVICE

Circle 94 on information card



### Low-ceiling lighting

SPI Lighting offers the Options series (above) for low ceilings. Available in 30 colors, the model's reflector system offers indirect light and eliminates glare. The series includes wall and ceiling fixtures, in addition to sconce and pier-mounted models. Twin-tube fluorescent lamps between 27 and 50 watts provide the Options light source.

Circle 428 on information card.

### Vinyl wall coverings

The Breckenridge collection of vinyl wall coverings by Koroseal incorporates geometric patterns, is available in 35 colors, and is suitable for hos-

pitality settings. The line is treated with antimicrobials to resist mildew and bacteria; it also contains an ingredient designed, in the presence of heat, to trigger smoke alarms before a fire ignites. The company also manufactures 27-inch and 54-inch vinyl and textile wall coverings for the commercial market.

Circle 429 on information card.

### Doors and frames

Benchmark produces two brochures that include product illustrations, applications, and specifications for the company's commercial door line and door-frame systems. The company offers four galvanized-steel frame systems: Universal Commercial Frames can be used with drywall or masonry construction; the Adjusta-Trim series is a prehung steel door and frame system with built-in trim; Adjusta-Fit is a prehung, fire-rated steel frame system for commercial installations; and Secura-Fit is a steel frame system intended for remodeled buildings. All frames are sealed with a dry powder paint that is thicker than conventionally applied wet paint.

Circle 430 on information card.



### Hardwood flooring

An acrylic-impregnated, unaxed hardwood floor by Mannington Wood Floors (above) is intended to resemble natural wood. Designed for commercial and retail applications, the floor is purported to resist water penetration. The line is available in six finishes: natural, natural oak, maple, bordeaux maple, honeytone oak, and sienna ash.

Circle 431 on information card.

### Kitchen sink

Briggs Industries introduces the Ultra Tuff Boston kitchen sink, which is divided into two compartments and is constructed of

polyurethane and porcelain. The main basin measures 32 by 21 inches. In addition to its line of sinks, Briggs manufactures toilets, lavatories, enameled steel bathtubs, bidets, brass fixtures, and whirlpool baths for residential, institutional, and commercial use.

Circle 432 on information card.

### Bathroom sinks

Swanstone produces lavatory bowls in a range of shapes and sizes, and in five solid and 10 aggregate colors. The aggregate is intended to look like pearl-finished granite. The units can be installed with Swanstone vanity tops. Minor scratches can be removed by using abrasive pads and cleaners or fine sandpaper.

Circle 433 on information card.

### Plastic laminates

Laminart offers three new decorative plastic laminates. The Illusion series incorporates an abstract pattern of gold and blue lines and geometric shapes; the Lustre series offers a brushed-metal appearance; and Architectural Maple offers a natural, woodlike appearance.

Circle 434 on information card.

## MUSSON Fluff Cord Tile

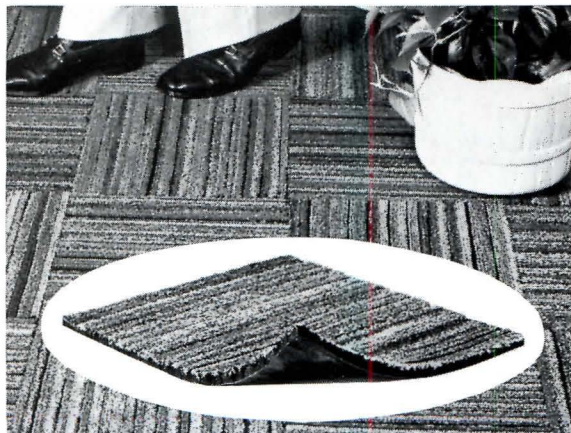

Exceptionally durable in heavy wear areas such as the entrances, lobbies and ramps of airports, theaters, factories and shopping centers. The carpet-like surface is made of heavy-duty tire stock, bonded to a flexible backing, installed with non-flammable adhesive and laid in a beautiful parquet pattern. Tiles are 3/8" thick and 12" x 12" square. (Also golf spike resistant.)



For Free Brochure & Samples, write:

**MUSSON RUBBER CO.**

P.O. Box 7038 • Akron, Ohio 44306

Circle 98 on information card



**Architectural Binder**

**Product and Color Samples**

**HANDRAILS • WALL GUARDS • CORNER GUARDS**

 **UL CLASSIFIED**

To receive your Architectural Binder or Product and Color Samples, call toll free:  
**Nationwide: 1-800-543-1729 FAX: 1-414-679-9127**

**IPC Door and Wall Protection Systems**

Circle 96 on information card



#### Antiscald valve

The SafeTemp tub-and-shower valve by Gerber Plumbing Fixtures Corporation (above) is designed to keep water temperature within 3 degrees of its setting and establish hot water limits. The valve automatically adjusts in the event of systematic hot or cold water loss.

Circle 435 on information card.

#### Wool fabrics

F. Schumacher and Co. offers six new textiles. Grassweave is a blend of 89 percent wool and 11 percent nylon for strength. Parquetry was designed to emulate intricate parquetry flooring and is a combination of

36 percent wool and 64 percent nylon. Available in 18 colors, Mohair Velvet is a durable, 100 percent wool fabric. Quill Weave is constructed of 90 percent wool and 10 percent nylon and is designed to resist wear. Needlepoint Leaf, which is offered in nine colors, is a contemporary interpretation of a classic tapestry from the Schumacher archives. Pique is made from 100 percent wool and is available in 10 colors.

Circle 436 on information card.

#### Classic laminates

In February, the Ralph Wilson Plastics Company introduced 10 new variations of solid black and white decorative laminates.

Circle 437 on information card.

#### Steel joist vibration

The Steel Joist Institute offers "Technical Digest #5" to help architects and contractors select a steel joist and concrete slab design with appropriate vibration characteristics. The 44-page guide includes information on how running, dancing, and aerobics affect steel-joist-and-concrete-slab floor construction.

Circle 438 on information card.



#### Wood chair

The DeTriana chair by Atelier International (above) is manufactured from beech wood and includes an upholstered seat. Wood finishes can be customized or selected from the following colors: natural, mahogany, pear, honey, and ebony.

Circle 439 on information card.

#### Access flooring

The Selvo-Combi access flooring system was developed by CTA Boden Systeme AG in Switzerland to offer a high level of durability and access to electrical, telephone, and computer installations at low cost. The system comprises prefabricated panels that

are installed over a concrete floor; synthetic anhydrite is then poured into the formwork elements. Cavity clearance ranges from 1½ to 7 inches high, with total floor height measuring 2½ to 8 inches.

Circle 440 on information card.

#### Color palette

Pantone and International Color Standard are planning to establish the first global plastic color reference system. The Pantone Plastic Color System will allow architects, manufacturers, and suppliers to select, specify, and produce more than 2,800 colors through a system of opaque and transparent color chips.

Circle 441 on information card.

#### Cabinet hardware

Valli & Valli offers a collection of Italian-designed hardware for the Valli & Columbo, Forges, and Fusital lines of cabinetry. The collection, constructed of solid brass, includes cabinet pulls, knobs, and hooks. Finishes include brass, chrome, white, dull black, light black, and gold to coordinate with the company's door lever sets.

Circle 442 on information card.

## Woven Wire Partition



**Meets D.E.A. Approval**  
for secured storage of Class III, IV, & V  
controlled substances

- Wall panels mount flush to floor and ceiling
- Clear spanned ceilings up to 35' available
- Self closing/locking doors
- No exposed mounting hardware

## WireCrafters

6208 Strawberry Lane, Louisville, KY 40214  
Call Toll Free 1-800-626-1816 • 502-363-6691

Circle 100 on information card

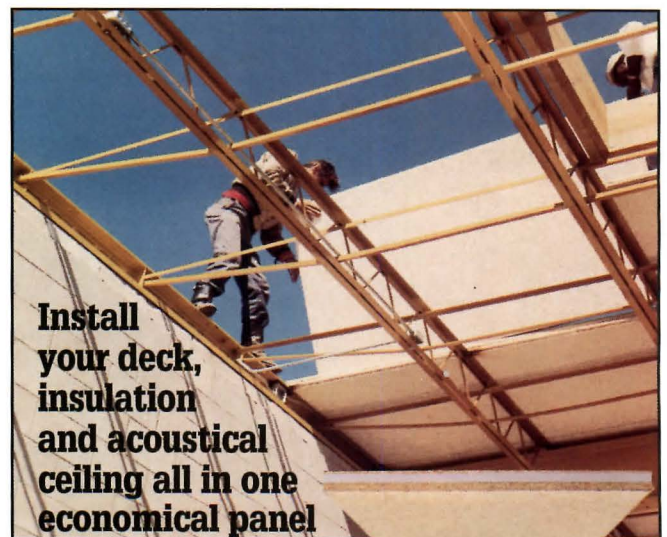

**Install  
your deck,  
insulation  
and acoustical  
ceiling all in one  
economical panel**

### Tectum III



...and get actual field performance far superior to so-called acoustical metal decking, because Tectum III absorbs specular sound not accounted for in laboratory tests.

Fully warranted Tectum III Roof Deck panels are a composite of a Tectum acoustical panel, Styrofoam® brand insulation in various thicknesses, and OSB. Long spans, T&G, light weight, nailable surface approved for single ply. Past one-trade installation.

\*Trademark of The Dow Chemical Co.



### TECTUM INC.

P.O. Box 920 • Newark, OH 43058  
614/345-9691 • FAX 1-800-TECTUM-9

Circle 102 on information card

# Advertisers Index

Circle number		Page number
44	ACI Glass Products	37
90	Advance Lifts, Inc.	132
62	A/E/C Systems '93 (East reg.)	96
128	AFM Corp.	122
—	AIA Bookstore	97
—	AIA Bookstore	129
—	AIA Convention	137
—	AIA Documents	139
—	AIA Mastersystems	129
12	American Olean Tile	2-3
28	American Marazzi Tile	20
92	American Stair-Glide	132
1	Andersen Windows	16-17
10	Armstrong World Industries	C2,p.1
104	Artifice	141
64	ASC Pacific, Inc. (West reg.)	96
130	ASC Pacific, Inc.	122
30	ASG	21
126	ASG Vertex	122
112	Autodesk, Inc.	88-89
36	Bethlehem Steel	30-31
46	Bobrick Washroom Equipment	38
58	Bradley Corp.	90
—	Builder Magazine	96A-D
—	Calcomp, Inc.	26
18	Cedar Shake & Shingle Bureau	8
88	Chicago Faucet	130
8	Cold Spring Granite	29
60	Cosmit	94-95
26	Dorma Door	14
76	DPIC Companies	110
6	Eliason Corp.	28
134	Finestone—Simplex	
—	Products Division	122
86	Follansbee Steel	C3
70	Forbo Industries	107
110	Georgia Pacific	C4
48	Glen Raven Mills	40-41
38	Gold Bond Building Products	32
66	Grohe America, Inc.	98
42	Haws Drinking Faucet	36
32	Homasote Company	22
68	Hurd Millwork Co.	106
96	Institutional Products Corp.	134
94	Jackson Exit Device	133
132	JPS Elastomerics Corp.	122
52	Kawneer Company, Inc.	80-81
16	Kim Lighting	7
54	LCN Closers	82
80	Louisiana-Pacific	119
22	Merchandise Mart	10
78	Milgard Mfg., Inc. (West reg.)	118
56	Mitsubishi Electronics America, Inc.	86
98	Musson Rubber Co.	134
4	National Propane Gas Assoc.	18-19
2	Nixalite of America	6
—	Osram Corporation	84-85
20	Pella Corporation	9
74	Pemko	109
40	Petersen Aluminum Corp.	35
50	Robertson, H.H.	42
136	Ruskin Manufacturing	122
84	Schlage Lock Co.	121
72	Sloan Valve Co.	108
82	Southern California Gas (West reg.)	120
106	Spiros	141
102	Tectrum, Inc.	135
24	Vulcraft	12-13
14	Weather Shield Mfg., Inc.	4-5
100	Wirecrafters Inc.	135

## EDITORIAL OFFICE

1130 Connecticut Avenue, N.W., Suite 625  
Washington, D.C. 20036  
(202) 828-0993

## EXECUTIVE OFFICE

994 Old Eagle School Road, Suite 1010  
Wayne, Pennsylvania 19087  
(215) 254-9800

Robert Hoover Production Director  
Christopher Wessel Circulation Manager  
Nancy A. Perri Assistant to the Publisher  
Robert G. Kliesch Publisher

## ADVERTISING SALES OFFICES

New York/Connecticut (215) 935-8522  
D. Douglas Johnson  
1625 Oak Hill Road  
Chester Springs, Pennsylvania 19425

PA/VA/MD/New England (215) 254-9800  
George T. Broskey, Eastern Sales Manager  
994 Old Eagle School Rd., Suite 1010  
Wayne, Pennsylvania 19087

Southeast (215) 935-8522

D. Douglas Johnson  
1625 Oak Hill Road  
Chester Springs, Pennsylvania 19425

Midwest (312) 464-8505

Jack E. Bergren  
Robert G. Hatfield  
936 The Merchandise Mart  
Chicago, Illinois 60654

Jack E. Bergren (414) 786-4286  
2530 Coach House Dr.  
Brookfield, (Milwaukee) Wisconsin 53005

Edward R. Novak (708) 658-7133  
E.R.&J. Assoc., Inc.  
P.O. Box 648  
Algonquin, Illinois 60102

Southwest (314) 569-3210

Richard Grater  
1466 Summerhaven  
St. Louis, Missouri 63146

West/Northwest

James A. Anderson (619) 451-9782  
Western Sales Manager  
11858 Bernardo Plaza Court, Suite 240-C  
San Diego, California 92128

James D. Anderson (714) 855-0808  
23591 El Toro Rd., #209  
El Toro, California 92630

Canada (416) 833-6200

Donald C. Fenn  
Tony Hyland  
148 King Road E.  
King City, Ontario L0G 1K0 CANADA

Italy (02) 58.31.02.19

Cesare Fiorucci  
Viale Sabotino, 9  
20135 MILANO  
Fax: (02) 58.31.57.10

**“Our great rates will get you started.  
Our member benefits  
will keep you going.”**



Avis Employee-Owner  
Suzanne Jacinto  
Rental Sales Agent

The employee-owners of Avis value your association membership. And we're ready to give you the money-saving and time-saving benefits you deserve. You're entitled to special low rates, many with free unlimited mileage, on a wide variety of GM and other fine cars whenever you use your Avis Worldwide Discount (AWD) number. And we give you special express services to help you rent and return your Avis car as quickly as possible.

With an advance reservation and a Wizard® Number, Avis Express® lets you bypass the rental counter at over 60 U.S. and Canada airport locations. In Canada, bypass the in-terminal rental counter and go directly to the Avis Express Booth. And Roving Rapid Return® makes returning your car fast and easy. Our quick car return service is available to charge card customers with no modifications to their rental charges.

For more information and reservations, call your travel consultant or Avis toll free at **1-800-331-1212**.

And be sure to mention your Avis Worldwide Discount (AWD) number: **A991400**

**AVIS**®

**We try harder.®**



THE AMERICAN  
INSTITUTE  
OF ARCHITECTS



Avis features GM cars.  
Pontiac Bonneville.

©1998 Wizard Co., Inc. 6/92/CR

DON'T  
KEEP IT  
TO  
YOURSELF!

## ORDER REPRINTS

*of articles  
that have  
appeared in*  
ARCHITECTURE

Minimum Order:  
100 Copies

Call or write  
for a price  
quotation:

**(215) 254-9800**

Nancy Perri  
994 Old Eagle School Rd.  
Suite 1010  
Wayne, PA 19087

## Last Chance

*Did you miss valuable information offered by advertisers in last month's issue of ARCHITECTURE?*

The manufacturers listed below were advertisers in last month's issue. They are anxious to provide you with their latest product information and literature for your planning needs. To receive this information, circle the appropriate numbers on the self-addressed, postage-paid response card. For product literature from advertisers in this issue, circle the appropriate numbers shown on the advertisements.

### Access Industries

Find out about our VPL™ Series 2000 Vertical Platform Lift.

Circle No. 7

### Advance Lifts Inc.

Send for more information on Advance Superdok.

Circle No. 3

### AFM Corp.

Our R Control building panel electronic CADalog is free to qualified professionals

Circle No. 128

### Andersen Corporation

In today's designs, it's the brand that helps architects take value to new heights.

### Armstrong World Industries

Grand Openings—Hardware friendly openings can now be ordered in dimensions from 1" to 16".

Circle No. 23

### Art Directions Inc.

Get the details on the Original Cast™ Lighting.

Circle No. 5

### ASC Pacific Inc.

Our steel roofing systems electronic CADalog available to qualified professionals.

Circle No. 130

### ASG Vertex

Get details on our Electronic CADalogs™—the intelligent building product catalogs.

Circle No. 126

### Autodesk, Inc.

Ask for our AutoCAD brochure for the architecture, building-services and construction industry.

Circle No. 25

### Azon Corporation

Introducing a new line of ink jet plotter vellums, films and bonds that dry faster than any others on the market.

Circle No. 33

### Bradley Corporation

Whatever your high-usage shower room needs, you can count on Bradley.

Circle No. 39

### Certaineed Corporation

Send for a brochure on our Grand Manor Shingle.

Circle No. 43

### Chicago Faucet Company

Our faucets are engineered to last...and made to order.

Circle No. 73

### Endicott Clay

Get the visual introduction to our products—send for your free VHS tape today.

Circle No. 57

### Finestone-Simplex Products Div.

Our exterior insulation and finish systems electronic CADalog is available to qualified professionals.

Circle No. 134

### Follansbee Steel

Send for our substantiating transcript on our terne-coated stainless steel, TCS®.

Circle No. 77

### Forbo Industries

Introducing Marmoleum—the new standard in linoleum.

Circle No. 83

### Haws Drinking Faucet

We offer more exciting styles, enduring finishes and a stronger reputation for quality.

Circle No. 41

### ICBO

The current 1991 edition of the Uniform Building Code™ is now available.

Circle No. 11



### Institutional Products Corp.

Write to receive your Architectural Binder or Product and Color Samples. *Circle No. 9*

### JPS Elastomerics Corp.

Our roofing systems electronic CADalog is available to qualified professionals. *Circle No. 132*

### Kawneer Company, Inc.

Send for details on our Lifetime Warranty on door corners. *Circle No. 61*

### Kim Lighting

Our AFL Series excels in design, engineering and performance. *Circle No. 27*

### Lin-El Inc.

LinEl Wall 1000 is a new metal wall panel system designed to solve every wall panel problem. *Circle No. 19*

### Louisiana Pacific

L-P's I-Joists and Gang-Lam® LVL beams will give you all the support you need. *Circle No. 45*

### Ludowici Celadon

The Ludowici roof is the lowest-cost roofing material over a structure's life cycle. *Circle No. 37*

### NCJJ

Send for our sourcebook for juvenile and family court design. *Circle No. 85*

### Neste/Thermo

Our technologically advanced roofing systems are more reliable than ever. *Circle No. 59*

### Nucor Vulcraft Div.

If you're wondering whether steel joists are the answer, remember the Alamodome. *Circle No. 31*

### Phoenix Products Co.

Send for our free brochure on the new Phoenix Projection 100™ Luminaire. *Circle No. 17*

### Pittsburgh Corning Corp.

PC Glassblock® products express multiple design possibilities. *Circle No. 47*

### Robertson, H. H.

The heart of our roof is our Versacor® PF high-build coating system. *Circle No. 35*

### Ruskin Manufacturing

Our electronic CADalog on louvers, screens and grilles is available to qualified professionals. *Circle No. 136*

### Schlage Lock Co.

Specify Primus and add ultimate key control and high security solutions to your project. *Circle No. 79*

### Sloan Valve Co.

Find out more about our Optima Plus Retrofit Kit. *Circle No. 69*

### Steelcraft

No other door manufacturer has made such a total commitment to distributor success. *Circle No. 49*

### Sternberg Lanterns

Send for our 1993, 64-page, full color catalog. *Circle No. 15*

### Tectum, Inc.

Install your deck, insulation and acoustical ceiling all in one economical panel. *Circle No. 13*

### Velux America Inc.

The new VELCAD™ software is not only easy to use, but also quick, efficient and flexible. *Circle No. 71*

### Visionwall Technologies

Get all the information on the proven technology of the Visionwall System. *Circle No. 81*

### Weather Shield Mfg. Inc.

The end of washing windows is finally in sight. *Circle No. 29*

### Xerox Engineering

We have the product selection and the service support to help architects streamline their document production. *Circle No. 67*

### YKK AP America Inc.

Our Anodized Plus™ finishes add protective coating to the anodized surface. *Circle No. 55*

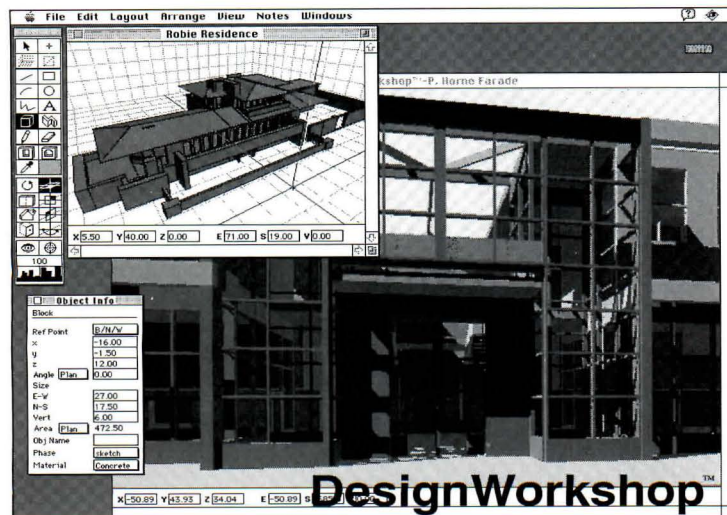

**DesignWorkshop**

**Intuitive 3D CAD**

"With DesignWorkshop, the computer interface no longer gets in the way of the creative process. This is the program for the architect who swore he or she would never use the computer."

Neil Kleinman, Editor  
Macintosh Scientific & Engineering Report

Sketch solid models in live 3D perspective • dynamic 3D viewing, fast shading, poched sections • 3D direct manipulation means 75% fewer commands • floating-point precision with Mac-style ease of use • create, move & resize openings as easily as rectangles • import/export Claris CAD, DXF, Architrion 3D, and more • 32 bit color, QuickTime™ sun studies, walkthroughs • only \$895, with 90 day satisfaction guarantee • call 503-345-7421, or fax:

**Artifice, Inc.** Box 1588, Eugene, OR 97440 • 503-345-7421 • 503-346-3626 fax

Circle 104 on information card

**Suspended Tables...**

**More space to do more things**

Convert your long-term care facility dining room into a multi-purpose area by simply retracting dining tables to ceiling automatically. Once tables are up and out of the way, quickly set up for a recreation center, therapy room, chapel or visitors lounge. Get more space instantly by the flip of a switch without adding to brick and mortar, or construction expenses.

Housekeeping and maintenance are easier, faster and less costly, too. And wheelchair residents and attendants appreciate the legless tables because there's no bumping or cramming. Call toll free for illustrated brochure.

**SPIROS INDUSTRIES**

**1-800-972-8235**

P.O. Box 917, 7666 Highway WW, West Bend, WI 53095, Phone/Fax (414) 629-5285

Circle 106 on information card

Architects  
agree there's  
no equal.

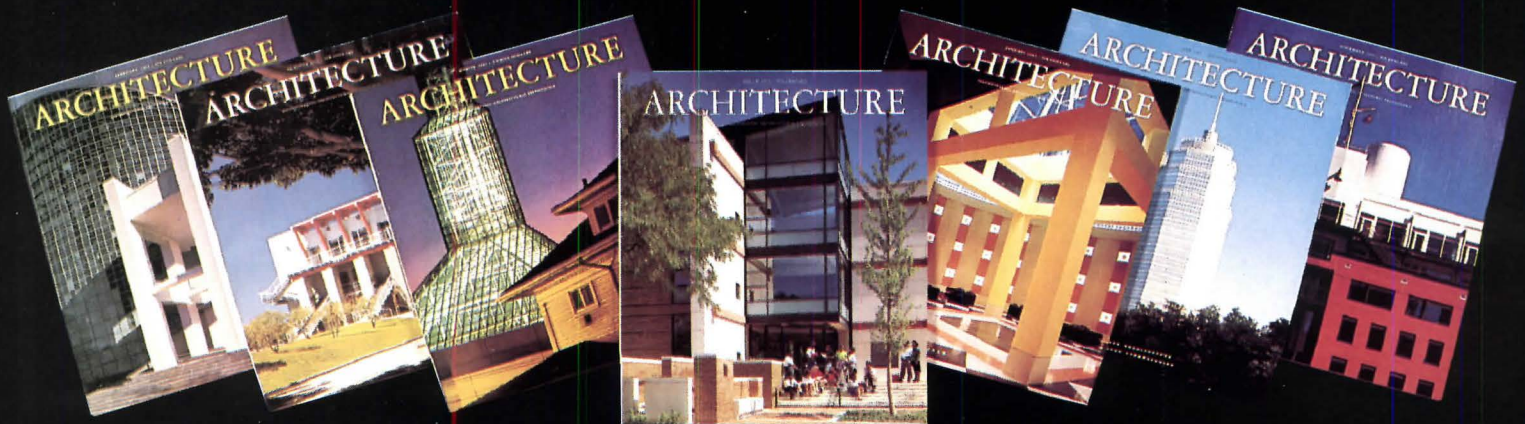

# ARCHITECTURE is the leading publication in the profession—and independent research by Simmons\* in October 1991 proves it!

## Preference

of a vast majority of architects for useful technical information.

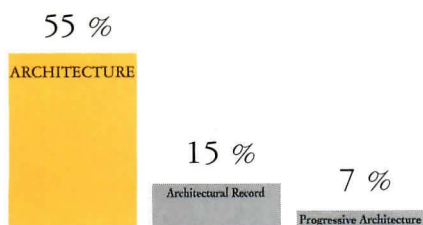

## Choice

of a majority of architects for useful professional practice information

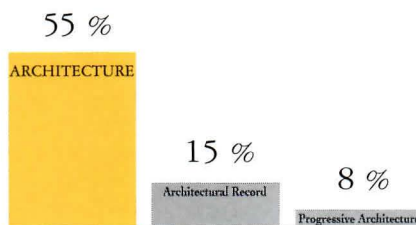

## Leader

for useful design information

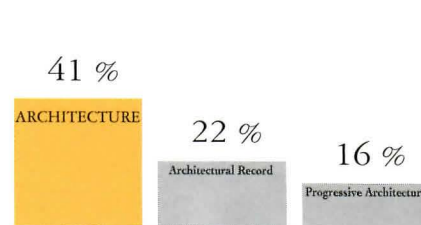

## Most helpful

magazine to a majority of architects in their work

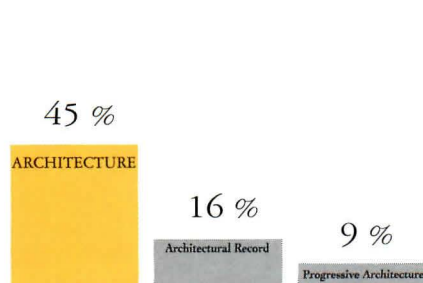

## Most respected

and valued magazine in the industry

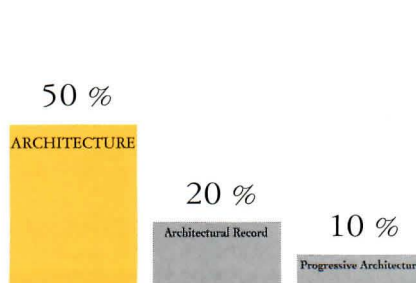

## Best read

with the greatest readership among a majority of U.S. architects

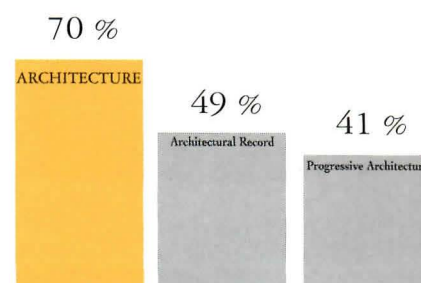

ARCHITECTURE continues to build excitement by providing editorial coverage of both the design, practice, and technological aspects of architecture to a degree unequalled by any other magazine in the architectural field.

**ARCHITECTURE**

\* Based on the results of the Sixth Annual Study of U.S. Architects conducted by Simmons Market Research Bureau, Inc., an independent research company.

*No Excuses After This information exchange*



**LAB INTERIOR:** View of bench top.

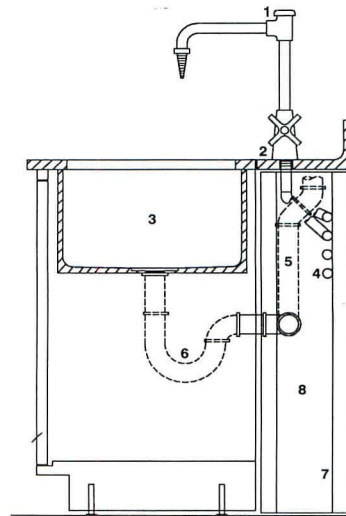

**TYPICAL SECTION AT SINK**

- |                               |                 |
|-------------------------------|-----------------|
| 1 BENCH-MOUNTED WATER FIXTURE | 4 VENT          |
| 2 TYPICAL JOINT AT COUNTERTOP | 5 PIPING        |
| 3 SINK                        | 6 DRAIN         |
|                               | 7 SUPPORT FRAME |
|                               | 8 PIPE SPACE    |

## Lab Equipment

*CSI Section 11600*

### Lab benches

When a recessed hot water bath is required at a lab bench, blending equipment suspended over the bath is often required. Our client had been using a stainless-steel bar frame, 1 inch high by 2 inches wide, which was drilled to accept threaded rods for supporting the blending equipment and sat on top of the bench. Working with a casework equipment installer, we came up with a detail for recessing the stainless-steel frame into the bench top. The frame's profile is rabbeted to accept the rim of the bath unit, so the unit sits flush with the bench top. The result is a clean surface that makes working with hot water baths more convenient.

*Caroline Hancock, AIA  
CUH2A  
Princeton, New Jersey*

### Bench-top installation

Installing laboratory services can be improved by allowing lab fixtures and piping to be installed along with other plumbing work. To ease the process, suspended casework bench tops and their support frames can be erected without base cabinets, or bench tops can be installed before more conventional, floor-mounted casework. An epoxy-resin or stone top, for example, may be cut to allow the back portion to be installed on a separate frame that supports all service fixtures and piping without the need for base cabinets; the remainder of the bench top, the base

cabinets, and the sinks can then be installed at a later date. The joint between the front and back portions of the top should be finished with an acid-resistant sealant flush with the face of the top. The contractor must take care in setting the height of the back top so that it aligns with the face of the front top. The location and size of the sink and the size of the faucet must be coordinated to determine the proper extension of the faucet over the sink.

*Charles Garnett  
Flad & Associates  
Madison, Wisconsin*

### Split-bench arrangement

With the profusion of equipment in research labs, the servicing of these tools has become increasingly important. Most laboratories now require some form of electrical or piped utility service hookup. In the past, much of the equipment was relegated to the rear of a traditional research bench, which is difficult to service. A split-bench arrangement is an excellent solution to the problem. Space is provided down the middle of two benches to provide easy access to the back of the equipment and to make room for special gas cylinders where needed. Electrical and piped services—such as gas and water lines—are located along the back side of each row of base cabinets to allow for multiple hookups. This arrangement is particularly useful in analytical areas, where equipment density is high.

*Alex Shirshun  
Harley Ellington Pierce Yee Associates  
Southfield, Michigan*

### Gas cylinders

Good laboratory design facilitates research by anticipating all kinds of functional requirements. A common oversight that can cause researchers frustration is a lack of dedicated space for specialty gas cylinders. A blocked aisle or a cylinder at risk of being knocked over is unacceptable. But it is common to see these large, heavy, and potentially dangerous containers strapped or chained, sometimes leaning, against laboratory casework. For the University of Georgia's Biological Sciences complex, we solved the problem with a special alcove in the casework to house cylinders safely out of the way of staff traffic while affording accessibility. The alcove, designed for one or several cylinders, improves lab operations and solves a potential safety hazard.

*Chris Cowansage, AIA  
CRSS Discovery Center  
Washington, D.C.*

*Architects are encouraged to contribute their practical suggestions about specifications and detailing, including drawings, for publication. Send submissions to:*

**ARCHITECTURE**  
1130 Connecticut Avenue, N.W.  
Washington, D.C. 20036  
or by fax (202) 828-0825

# FOLLANSBEE Roofing Metals

## enviable records of longevity and beauty.

Today, re-roofing costs are a major consideration in the design of all types of structures. TERNE, the old "tin" roof, and TCS<sup>®</sup>, terne-coated stainless steel, are establishing enviable records of longevity... adding a gracious beauty to outstanding function, at a cost competitive in value with other roofing materials.

**62 years in place... the charm and durability of a TERNE roof!**



This house, near Pittsburgh, PA was originally roofed with TERNE in 1929. Painted several times since, the roof remains as testimony to the durability of TERNE and a perfect complement to the charm and beauty of the residence.

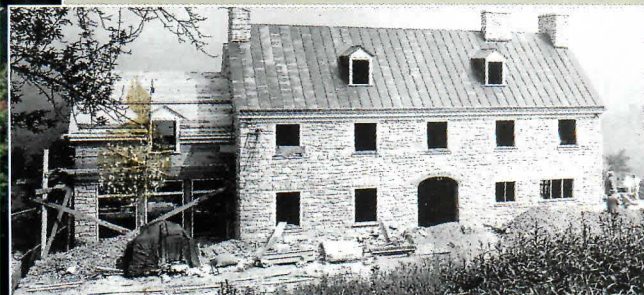

*A standing seam roof of Follansbee Terne with over 62 years of service... still performing its designed function.*

## TCS and a roofing lesson... weathering to beauty and generations of service

Hinsdale High School, Hinsdale, Illinois, was built in 1977 and roofed with TCS. Requiring no painting, it has weathered to a soft gray and will stay that way through generations of service. TCS, introduced by Follansbee in the 1960's, gains its finest testimonials from a distinguished roster of architects who continue to specify it for major projects.

See our catalog in Sweets and Sweets Canada



*Now weathered to an attractive, warm gray, the standing seam roof on Hinsdale High School will remain beautiful without painting.*

**TERNE...the beauty of color**  
**TCS...beauty by mother nature**

# FOLLANSBEE

FOLLANSBEE STEEL • FOLLANSBEE, WV 26037

Call us toll-free 800-624-6906

Circle 86 on information card



MADE IN U.S.A.  
and available



in the UK and in Europe  
through  
FOLLANSBEE UK, Ltd.  
44-81-367-6463  
and  
BRODERICK STRUCTURES  
44-483-750-207



in the Pacific Rim  
through  
SUMITOMO  
CORP.  
(03) 3237-4134

# GAMBLE



**Paper-faced exterior gypsum sheathing**

Let's face it. With ordinary paper-faced gypsum sheathing, there's no guarantee that it will stand up to problems like rain, wind, snow or humidity. In the face of adversity, it can sag, buckle, warp and delaminate. Which can create adversity for you.

Georgia-Pacific presents an innovation in sheathing: G-P Dens-Glass® Gold. Named for its unique gold alkali-resistant coating, Dens-Glass Gold is truly the next generation in sheathing. Superior performance proves it. And a remarkable warranty backs it up.

**THE WINNING NUMBERS** What do we mean by "superior performance?" Check the box and compare the numbers. At about the same weight as ordinary gypsum sheathing, Dens-Glass Gold is a heavyweight in performance. Twice the flexural strength, in the 4' direction. Five times better in humidified deflection. Half the susceptibility to water absorption.\* Pick any number: Dens-Glass Gold outperforms the ordinary every time.

**MULTIPLE APPLICATIONS, MULTIPLE ADVANTAGES** Unlike paper-faced gypsum, Dens-Glass Gold is ideal for exterior finish systems with or without insulation. In EIFS applications, the unique gold coating eliminates the need for primer, and enhances the bonding of the system. On exteriors such as wood, brick, stucco and others, the use of building felt is normally unnecessary (unless local building codes indicate otherwise). Fiberglass mats front and back and a silicone-treated core enhance its weather-resistance, allowing interior work to proceed, rain or shine. All in all, Dens-Glass Gold saves money, labor, time and aggravation.

# GUARANTEE

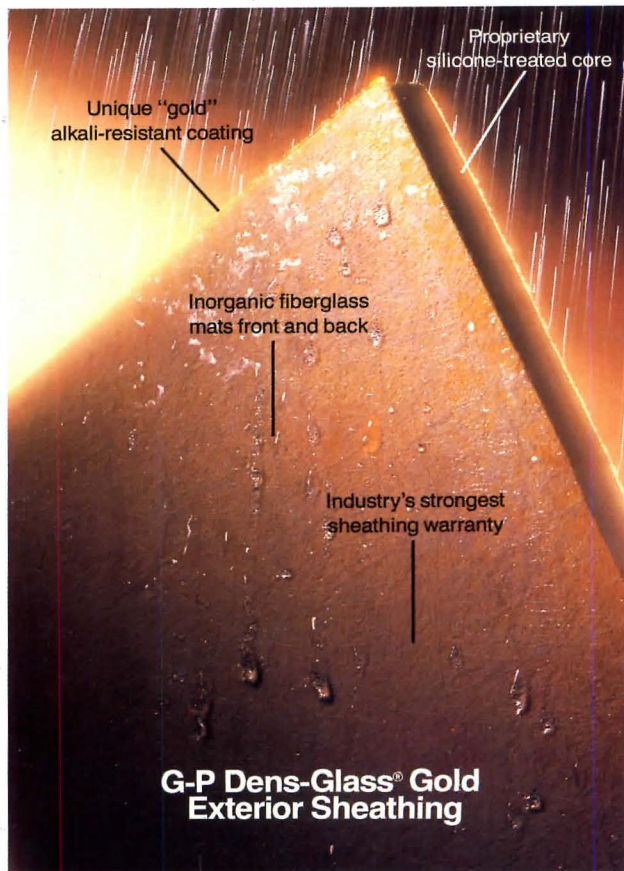

**G-P Dens-Glass® Gold Exterior Sheathing**

## THE WORLD'S STRONGEST SHEATHING GUARANTEE

G-P offers the industry's strongest sheathing warranty. Dens-Glass Gold is warranted against delamination, warping and related moisture damage for up to six months of continuous exposure to weather—plus a five-year limited warranty against manufacturing defects. In other words, if Dens-Glass Gold does not perform, G-P will replace it.\*

If you've been gambling on ordinary paper-faced sheathing, it's time you did an about-face. Ask for G-P Dens-Glass Gold. Sheathing made extraordinary.

Properties	1/2" Dens-Glass Gold® Gypsum Sheathing	1/2" Regular Gypsum Sheathing
Flexural Strength, parallel, lbs.		
face up	100	40 <sup>1</sup>
face down	94	40 <sup>1</sup>
Flexural Strength, Perpendicular lbs		
face up	141	110 <sup>1</sup>
face down	151	110 <sup>1</sup>
Hardness, lbs. core	29	15 <sup>1</sup>
end	25	15 <sup>1</sup>
edge	41	15 <sup>1</sup>
Water Absorption, % by weight	5.0	10.0 <sup>2</sup>
Surface Water Absorption	.83	1.6
Humidified Deflection, inches	1/4"	10/8"
Flamespread	0	15

NOTE: Tests conducted in accordance with ASTM guidelines.

<sup>1</sup> Minimum requirements for ASTM C-79 standards specification.

<sup>2</sup> Maximum requirements for ASTM C-79 standards specification.

\* For a free 20-page brochure including warranty information, specifications and physical properties, call Georgia-Pacific: **1-800-447-2882**, Operator #731. Look for us in Sweet's Section #09250 GEN.

"Dens-Glass" is a registered trademark and "Georgia-Pacific. Ask for it" is a trademark of Georgia-Pacific Corporation. ©1990, Georgia-Pacific Corporation. All rights reserved. Simulation of actual test.

**Georgia-Pacific**



**GEORGIA-PACIFIC. ASK FOR IT.™**