

architecture February 1998 \$8.95 usa \$11.00 canada

# architecture

## TRANSFORMATIONS

RoTo's Urban Recharge  
Weiss/Manfredi Salutes Military Women  
Preservation Roundtable: Back to the Future

A world of new colors to help



At Armstrong, we feel limits shouldn't be placed on your vision. That's why we now offer the widest array of vinyl flooring colors and designs – including 81 new colors across 10 product lines. Plus, our Custom Concepts service helps bring your most unique ideas to reality. And since our colors are coordinated across sheet,

bring your vision to life.



tile and accessories, the entire floor becomes a single system. Of course, it all comes with our legendary performance, durability and service. To receive a free, four-color, 74-page Commercial Floors Catalog, call 1-800-292-6308. And let your vision take flight.

Circle 13 on information card



# teetury

## DESIGN

15  
Editorial

19  
Letters

23  
Calendar

28  
News

37  
Review

40  
City

46  
On the Boards

49  
Interview

55  
Protest

57

### Transformations

The past need not constrain the future in contemporary architectural renovations.

58

### Pickling the Past

Preservationists should treat the past progressively—not succumb to misty-eyed nostalgia.

*By Paul Spencer Byard*

64

### Powered Up!

RoTo Architects rewires an old electrical plant and creates a dynamic L.A. loft residence.

*By Joseph Giovannini*

74

### Industrial Film

Edits to an abandoned warehouse in Cincinnati produce a flexible headquarters for a high-tech film company.

*By Edward Keegan*

78

### The Future of Preservation

A group of leading architects and preservationists surveys the state of the movement and its horizons.

84

### Ruin Rehab

Fisher Friedman Associates forges high-tech lofts from the ravaged remains of a San Francisco warehouse.

*By Aaron Belsky*

90

### Remembering Women

Carved from the earth of Arlington National Cemetery, a new memorial by Weiss/Manfredi Architects salutes America's servicewomen.

*By Donald Albrecht*

# e

## TECHNOLOGY + PRACTICE

89

### Introduction

100

### Drawing on the Past

A unique National Park Service program immortalizes historic buildings through meticulous documentation.

*By Michael Maynard*

104

### Raising the Roof

SOM hits a high note at Chicago's Symphony Center by raising the historic concert hall's roof to upgrade acoustics.

*By Eric Adams*

110

### Writing a Winning Proposal

Project proposals should be concise—and tailored to your client's needs.

*By Elizabeth Padjen*

114

### Better, Faster, Stronger Output

The latest printers and plotters offer high-resolution drawings at lower cost.

*By Patrick Mays*

120

### Fire Drills

Performance-based fire codes increase safety while boosting design flexibility.

*By Jack Klein*

129

### Products

124

### Ad Index

134

### Last Word

#### NEXT ISSUE

Performing arts centers  
Koolhaas schoolhouse  
Teleconferencing

#### COVER

Carlson-Reges House, Los Angeles, by RoTo Architects. Photograph by Assassi Productions.

#### TABLE OF CONTENTS

Carlson-Reges House, Los Angeles, by RoTo Architects. Photograph by Benny Chan/Fotoworks.

# We Protect Architectural Legacies From Unhealthy Embarrassments

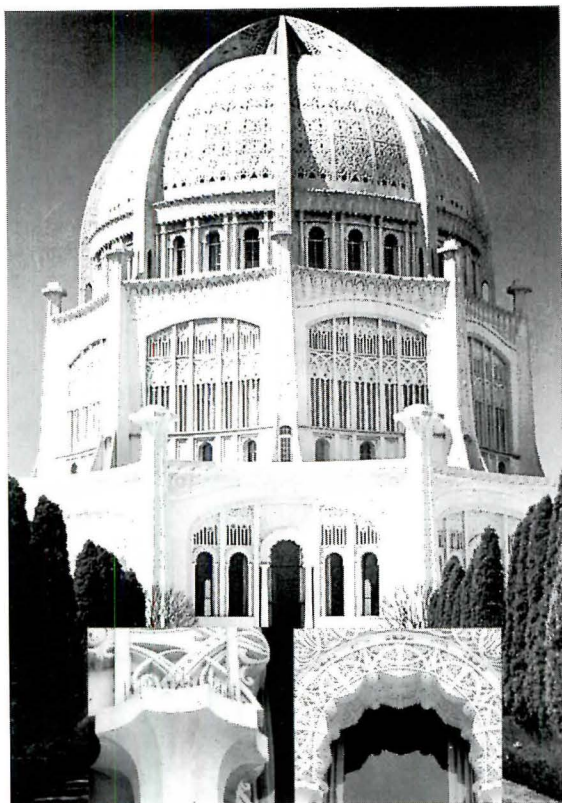

Photo courtesy of Bahai National Center, Wilmette, Illinois

Nixalite, the original custom crafted, stainless steel architectural bird barrier has protected and preserved many architectural legacies for almost 50 years, including:

- Disneyland
- Ford Motor Co.
- Mc Donalds
- General Motors
- KFC
- Mc Cormick Place
- Sea World
- Indianapolis Zoo
- Opryland
- Harvard University
- UCLA
- Holiday Inn

We can also protect yours.

## For more information:

Ph:800/624-1189 Fax:800/624-1196

Ph:309/755-8771 Fax:309/755-0077

Internet: <http://www.nixalite.com>

E-mail: [nixalite@qconline.com](mailto:nixalite@qconline.com)

Sweets 10290/NIX

Circle 15 on information card



1025 16th Ave - ARCH  
East Moline, IL 61244

# archi

## PUBLISHER

**Stephen B. Donohue**  
[sdonohue@ix.netcom.com](mailto:sdonohue@ix.netcom.com)

## ART DIRECTION AND DESIGN

**Samuel G. Shelton**  
**Scott Rier**  
**Scott Allison**  
Kinetik Communication Graphics, Inc.

## SENIOR EDITORS

**Bradford McKee**  
[bmckee@architecturemag.com](mailto:bmckee@architecturemag.com)  
**Raul A. Barreneche**  
[rbarreneche@architecturemag.com](mailto:rbarreneche@architecturemag.com)  
**Reed Kroloff**  
[rkroloff@architecturemag.com](mailto:rkroloff@architecturemag.com)

## MANAGING EDITOR

**Samuel W. Barry**  
[sbarry@architecturemag.com](mailto:sbarry@architecturemag.com)

## ASSOCIATE EDITORS

**Eric Adams**  
[eadams@architecturemag.com](mailto:eadams@architecturemag.com)  
**Michael Maynard**  
[mmaynard@architecturemag.com](mailto:mmaynard@architecturemag.com)  
**Ned Cramer**  
[ncramer@architecturemag.com](mailto:ncramer@architecturemag.com)

## COPY EDITOR

**Michael J. O'Connor**  
[mo'connor@architecturemag.com](mailto:mo'connor@architecturemag.com)

## ASSOCIATE ART DIRECTOR

**Lara Anita Behnert**  
[lbehnert@architecturemag.com](mailto:lbehnert@architecturemag.com)

## ART ASSISTANT

**Douglas McLennan Thom**  
[dthom@architecturemag.com](mailto:dthom@architecturemag.com)

## EDITORIAL ASSISTANT

**Jessica Barrow Dawson**  
[jdawson@architecturemag.com](mailto:jdawson@architecturemag.com)

## TECHNICAL ILLUSTRATOR

**Christine Malecki West**

## CONTRIBUTING EDITORS

**Sarah Amelar**  
**Aaron Betsky**  
**Peter Buchanan**  
**Colin Davies**  
**Joseph Giovannini**  
**Edward Gunts**  
**Richard Ingersoll**  
**Edward Keegan**  
**Barry B. LePatner**  
**Steven Litt**  
**Vernon Mays**  
**Morris Newman**  
**Elizabeth Padjen**

Architecture® (VOL. 87, no. 2), incorporating Architectural Technology, publication number ISSN 0746-0554, is published monthly by BPI Communications, Inc., 1515 Broadway, New York, NY 10036. Editorial offices are located at 1130 Connecticut Ave., N.W., Suite 625, Washington, D.C. 20036. Postmaster, please send changes of address to Architecture, P.O. Box 2063, Marion, OH 43305-2063. Individual subscriptions: U.S. and its possessions: \$55 for 1 year, \$105 for 2 years, \$155 for 3 years. Canada: \$64 for 1 year. Foreign: \$85 for 1 year. Single copies: U.S. and its possessions: \$8.95 each; Canada: \$11.00 each. For subscription matters, write: Circulation Department, Architecture, P.O. Box 2063, Marion, OH 43305-2063; (800) 745-8922; outside U.S. (614) 382-3322. Periodicals postage paid at New York, NY, and additional mailing offices. Canadian Post International Mail Product (Canadian Distribution) Sales Agreement No. 0877859. Printed in USA.

Architecture Access Benefit Plan Membership is available for \$10; please call: (800)745-8922.

The contents of this publication may not be reproduced in whole or in part without the consent of the copyright owner, BPI Communications Inc. Chairman: Gerald S. Hobbs; President and CEO: John B. Babcock, Jr.; Executive Vice Presidents: Robert J. Dowling, Martin R. Feely, Howard Lander; Senior Vice Presidents: Georgina Challis, Paul Curran, Mark Dacey, Ann Haire, Rosalee Lovett; Vice President: Glenn Heffernan.

[www.architecturemag.com](http://www.architecturemag.com)

Countless historic treasures would have been lost in this country since the 1960s were it not for the ardent voices and growing political savvy of preservationists. But, in recent years, the preservation movement has become a parody of itself and its old enemies. Its champions have conflated the cause of protecting historic artifacts with the folly of contriving history itself. Thus, the mainstream preservation movement is in danger of becoming a reactionary caucus, or worse, another branch of paleontology, fascinated with the past for its own sake rather than as a font of wisdom for future generations.

Look, for example, down 42nd Street in New York's Times Square. The street holds glorious recent examples of preservation's virtues, such as the New Amsterdam and New Victory theaters, both restored by Hardy Holzman Pfeiffer Associates, along

cynical attempt to short-circuit reality. One might guess that today's impresarios vested on 42nd Street—big companies like Disney and Livent—would appreciate the legacy of the theater district's lights enough to illuminate the street to the hilt. But if new tenants aren't interested, they shouldn't be forced into such high-wattage forms of expression on a public street simply because Stern, Kalman, and a clutch of officious bureaucrats command it.

The line between descriptive and prescriptive preservation is fine. The signage requirements for Times Square are a pedantic contrivance, a mockery of the freewheeling bravado that once made the district dazzling. Worse, such rules infringe on the pursuit of free enterprise and the protection of free expression by compelling a specific form of expression as a prerequisite for setting up shop.

# Preservation's Tyranny

**Architects should protect the past, not re-create it.**

with Beyer Blinder Belle's transformation of the Lyric and Apollo theaters into the new Ford Center for the Performing Arts. Each of these projects faithfully steers a historic cultural asset in a new direction.

But on the street, the story is much different. In 42nd Street's heyday, bright, flashing signs defined this unique block by trying to outshine one another in a spectacular display of capitalist brio. The post-war demise of the 42nd Street theater strip darkened many signs, but now the city is determined to bring them back by regulatory writ. The joint city-state redevelopment authority running the show on 42nd Street hired architect Robert A.M. Stern and graphic designer Tibor Kalman to draft planning standards requiring specific types of lighted signs across the 34 buildings surrounding Times Square—with special emphasis on redecorating 42nd Street. The rules take effect later this year, aiming to re-create the street's lost bazaar of incandescence.

Mandates like this represent preservation gone overboard. The rules sound harmless and fun, but they're actually a

But the 42nd Street signage police are all of a piece with meddlesome design cops and historic review boards everywhere. For example, new development on the island of Nantucket is so strictly coded for lockstep conformity to its historic architecture that, as Boston architect Pamela Hawkes notes, "it's hard to figure out what's real there. Everything looks exactly the same." New Urbanists share a lot of the blame too, for the exhaustive, trifling covenants—dictating every dimension, material, and color down to the width of wooden fence pickets—they impose on new neighborhoods that don't have a history.

A number of smart preservationists continue to fight the good fight to protect our built history from philistine development across the country (pages 76-81, this issue). But serious preservationists should be wary of historicist hacks overstepping their territory for the sake of nostalgia, damaging the movement's credibility in the process. Because nostalgia, as French actress Simone Signoret once mused, is not what it used to be.

*The Editors*

The Engineering Enterprise: Year 2, Day 95, 6 pm

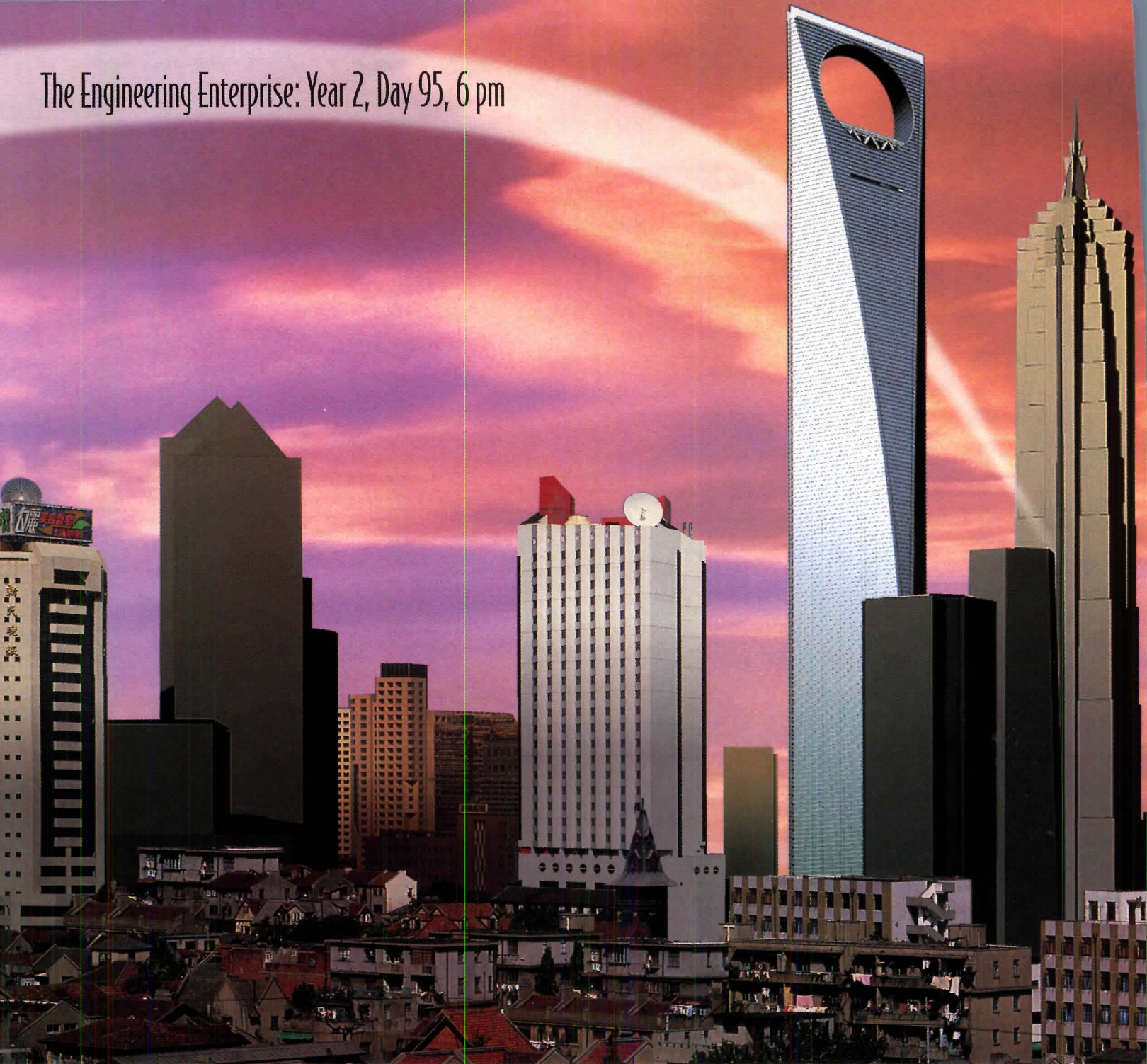

## How Do You Design More Value Into The World's Tallest Building?

Get the most value from your architectural designs and data with the Bentley Continuum, our unique approach to enterprise engineering for the life cycle.

The Bentley Continuum is our comprehensive offering of software products and support services, plus best-in-class solutions from our Strategic Affiliate,

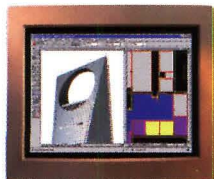

WorkPlace System Solutions, Inc.

The MicroStation® TriForma™ product family provides high-performance architectural, HVAC, plumbing and landscape modeling, creating a single 3D building model from which 2D drawings are automatically generated. Yet it also includes ActiveAsset Planner™, ActiveAsset Manager™ and ActiveAsset Inquirer™ from WorkPlace, for enterprise-wide management of



## Shame in Spain

Either Frank Gehry's Guggenheim Museum Bilbao (*Architecture*, December 1997, pages 60-77) is a great building or its critics aren't getting much press. It looks like a giant, chain mail-clad hand slapping the face of Basque tradition. Gehry has imposed his selfish vision without any regard for regional architectural precedent. Is this building the greatest of the century or just a giant crumpled aluminum can littering the streets of a provincial Spanish city?

*Richard Battaglia  
Portland, Oregon*

## They are out there

Krista Becker is an owner of the Landau Partnership, and like most owners, she can at any time commit the resources of the Landau Partnership and does so with intelligence, force, and intuition. She has overseen the design of the largest privately financed office tower to be built in California since the 1994 Northridge earthquake and the first fully integrated movie studio to be built in 80 years. You ask, "Where are the women?" I submit that they are alive and well here in Southern California.

*Thomas H. Landau  
President, The Landau Partnership  
Santa Monica, California*

When I first came to The Hillier Group, I was concerned about the lack of women in the firm. Since then, I have noticed some important changes in how women are perceived and the opportunities that are created for them. More project managers, project architects, associates, and senior associates are women. At our most recent annual meeting, almost half the employees recognized with stock options and other incentives were women. Two new studio principals—both female—were named. I hope this is only the beginning.

*Nikki Stern  
The Hillier Group  
Princeton, New Jersey*

Perhaps Gensler's success is due to the many women partners in the firm: Four women are permanent members of the firm's management committee; one woman sits on the Board of Directors; 29 percent of the firm's 72 partners, 38 percent

of the senior associates, and 49 percent of the associates are women. Chairman Arthur Gensler, Jr., was ahead of his time—promotions here are gender-blind.

*Margo Grant Walsh  
Robin Klehr Avia  
Managing Principals, Gensler  
New York City*

## KPF's bank-ruptcies

I would like to take issue with your article on Kohn Pedersen Fox Associates' new World Bank headquarters in Washington, D.C. (*Architecture*, November 1997, pages 100-107). As a recently retired World Bank staff member who had the responsibility of planning the new building, I feel your article has misinterpreted, misrepresented, and distorted the facts.

The basic concept of the atrium space and the retention of the two existing buildings was prepared by Paul Spreiregen, the World Bank's competition advisor. KPF's building—which came in 70 percent over budget—is generally recognized by the bank's staff as an overpriced architectural ego trip that poorly reflects the bank's mission. The building provides a very poor image of the World Bank as it moves into the 21st century and confronts the needs of the developing world. I don't think we do architecture justice when we distort the facts.

*John M. Courtney  
Chevy Chase, Maryland*

As a Honolulu resident, I feel the need to respond to the assertions made in your article about KPF's First Hawaiian Bank building (*Architecture*, November 1997, pages 108-113). The building is not a welcome addition to the community, nor is it representative of the diverse local culture. The building is a superficial colonial sculpture imposed on the city by Honolulu's elite.

The building insults local culture with its sealed spaces, artificial lighting, materials, details, and forms. This homogenized design seems to be KPF's standard: All those elements you describe as Hawaiian can be seen in almost every other of the firm's buildings. The firm hardly merits the fawning attention you gave it in your November issue.

*David M. Ansberry  
Honolulu, Hawaii*

## Add to the unique character of your homes

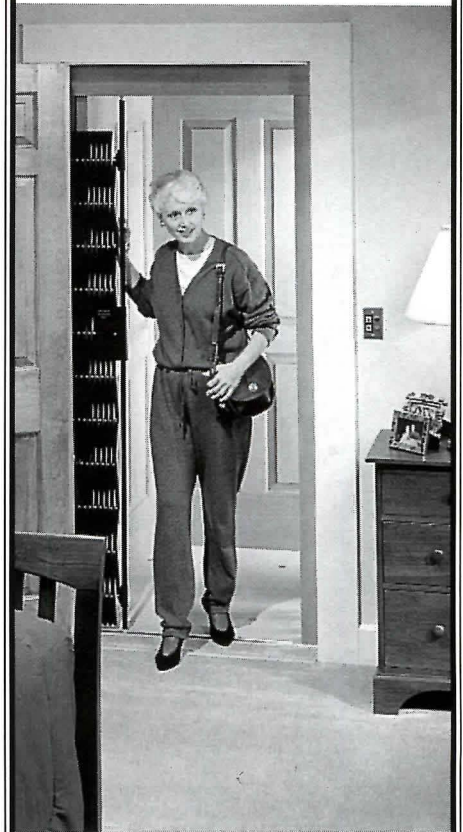

The "Elevette®" provides luxury and practical convenience for upscale home owners. That's why today's designers provide space in their plans for this residential elevator.

The custom-built "Elevette" is available in many configurations and interior finish options. It fits easily into new construction or renovations. Today's upscale homes are not complete without elevator service.

For more information refer to:  
*Sweet's 1998 General Building & Renovation  
File 1423/INC*

For free literature illustrating car designs and options, contact:

**INCLINATOR**  
COMPANY OF AMERICA

Dept. 96  
PO Box 1557  
Harrisburg, PA 17105-1557  
Phone 717-234-8065

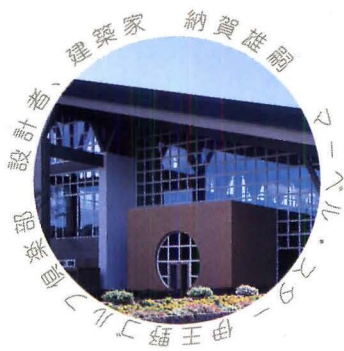

*"We considered other windows. But to get what we wanted"*



MARVEL STAR IOHNO GOLF CLUB, NASU, JAPAN  
ARCHITECTS: ISSIKI ARCHITECTS & PARTNERS, INC., TOKYO  
PRESIDENT & PRINCIPAL ARCHITECT: YUJI NOGA  
CONTRACTORS: OBAYASHI CORPORATION  
IOHNO PROJECT MANAGER: KAZUO SAITOH

## exhibitions

city	dates	exhibition	contact
Milwaukee	through February 21	<b>The Kubala Washatko Architects Studio</b> at the Milwaukee Institute of Art & Design	(414) 276-7889
New York	February 17-May 10	<b>Arquitectonica: The Times Square Project</b> at the Cooper-Hewitt, National Design Museum	(212) 849-8400
	February 19-May 26	<b>Alvar Aalto: Between Humanism and Materialism</b> at the Museum of Modern Art	(212) 708-9400
Pittsburgh	through March 22	<b>A. James Speyer: Architect, Curator, Exhibition Designer</b> at the Carnegie Museum of Art	(412) 622-3131
	through April 18	<b>Fresh Furniture</b> at The Society for Contemporary Crafts	(412) 261-7003
Washington, D.C.	February 26- November 8	<b>Breaking Through: The Creative Engineer</b> at the National Building Museum	(202) 272-2448

Cooper-Hewitt exhibition examines Miami-based Arquitectonica's 47-story Times Square hotel.



## The fastest, easiest way for architects to buy professional liability insurance

### THE SMALL FIRM PROGRAM

**T**ime is money when you're a small firm. That's why you need the Small Firm Program from CNA/Schinnerer, sponsored by the AIA Trust. It's the fastest, easiest way to buy professional liability insurance. Just give us a call and we'll give you a free quote.

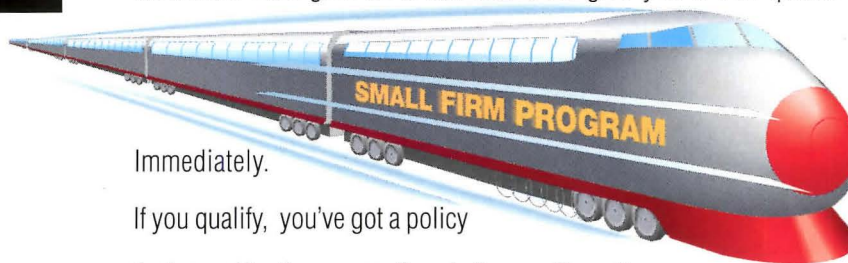

Immediately.

If you qualify, you've got a policy

that's good for three years. Even better, you'll pay the same

premium all three years. So call your broker or **1-800-762-5534**.

Ask for special policy SF8A. And put your firm on the fast track.

[www.PlanetAEC.com](http://www.PlanetAEC.com)

The interactive resource guide for architects, engineers and contractors.

CNA is a registered service mark of the CNA Financial Corporation. Coverage is provided by Continental Casualty Company, one of the property-casualty companies of CNA. This advertisement is not a contract. Only the policy can give you the actual description of terms, coverages, amounts, conditions and exclusions.



Victor O.  
**Schinnerer**  
& Company, Inc.



## conferences

city	dates	conference	contact
Boston	March 5-6	<b>Architecture of Segregation symposium</b> , sponsored by the Harvard University Graduate School of Design	(617) 496-0291
	March 12-14	<b>Restoration</b>	(978) 664-6455
Las Vegas	May 26-29	<b>Lightfair International</b> , sponsored by the International Association of Lighting Designers and the Illuminating Engineering Society of North America	(800) 856-0327
Los Angeles	March 18-20	<b>WestWeek</b>	(310) 657-0800
	March 19-20	<b>NeoCon West</b>	(800) 677-6278
San Francisco	May 14-17	<b>AIA National Convention and Expo</b>	(202) 626-7395



Segregation symposium at Harvard examines such buildings as this Durham, North Carolina, café that had separate "colored" and "white" entrances.

**A Hole New Concept**

If you can imagine it, we can custom-perforate it. We specialize in decorative and functional perforated metals for today's architects and designers. And we also offer you the world's largest library of archive patterns.

Call for our **free** architect source book:  
**800-621-3869**

**HK Harrington & King PERFORATING COMPANY**

5655 W. Fillmore St.  
 Chicago, IL 60644  
 Fax: 773-261-1686  
 www.hkperf.com • e-mail: sales@hkperf.com

The world's best architectural books  
all in one collection.

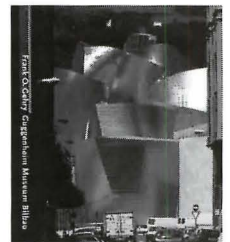

**Frank O Gehry:  
Guggenheim Museum  
Bilbao**

Hailed as one of this century's most amazing constructs, the Guggenheim Museum in Bilbao already holds a place in the history of architecture. Gehry sees the process from first sketch into building as an evolution: "In the first sketch I put a bunch of principles down. Then I become self-critical of those images and those principles, and they evoke the next set of responses, and as each piece unfolds, I make the models bigger, and bigger, brining into focus more elements and more pieces of the puzzle..." This book traces the design process as well as the construction of the museum through text, drawings and color photographs. A necessary book for any interested in Gehry's design strategy and the museum's entire building process.

Cloth \$55.00 USD  
 Paper \$27.50 USD

## FORM ZERO ARCHITECTURAL BOOKS

Edgemar 2433 Main Street  
 Santa Monica, CA 90405 USA  
 T: 310.450.0222 F: 310.450.0071  
 E: info@formzero.com

Tue - Thu 10:30 - 7:00  
 Fri, Sat 10:30 - 9:00  
 Sun 11:30 - 6:00

**FULL ON-LINE SERVICE WITH  
CATALOG & SECURE ORDERING:**  
<http://www.formzero.com>

# competitions

competition	deadline	contact
<b>Alvar Aalto Centennial Student Competition</b> for expansion of Seinäjoki Library, Finland	March 2 (registration)	(35) (814) 619-009 fax
<b>Independent Project Grants,</b> sponsored by the Architecture, Planning, and Design Program of the New York State Council on the Arts	March 2	(212) 387-7013
<b>New American Architecture Awards,</b> sponsored by the Chicago Athenaeum	March 2	(312) 251-0175
<b>DuPont Benedictus Awards for Innovation in Architectural Laminated Glass</b>	March 9	(202) 393-5247
<b>Van Alen Prize in Public Architecture</b>	April 8	(212) 366-5836 fax
<b>J.B. Jackson and American Landscape conference</b> call for presentations, sponsored by the University of New Mexico School of Architecture and Planning	April 15	(505) 277-2053

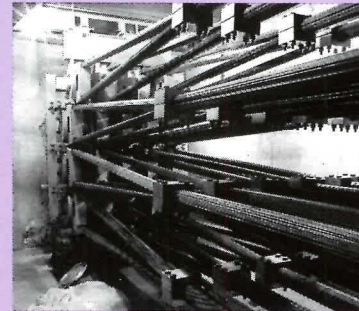
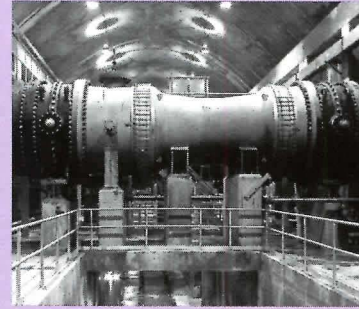

Johns Hopkins University Press will publish Stanley Greenberg's photographs of New York City infrastructure, for which he received a grant from the New York State Council on the Arts.

## PEMKO Fire Life Safety Solutions.



**Problem:** Deadly Smoke Transferring From Room To Room In a Fire.

**Solution:** Pemko's Intumescent Fire Life Safety Product, HSS2000, HotSmokeSeal™ - Fire Labeled (UL10B, UBC7.2 Positive Pressure).



**Problem:** The Infiltration of Sound, Smoke, Drafts, and Light.

**Solution:** Pemko's State of the Art, Self-Adhesive Door Gasketing, SiliconSeal™ and PemkoPrene™ - Fire Labeled (UL10B, UBC7.2 Positive Pressure) and Smoke Labeled.



4226 Transport St., Ventura, CA 93003  
5535 Distribution Dr., Memphis, TN 38141  
www.pemko.com @ Pemko Mfg. Co. 2/98

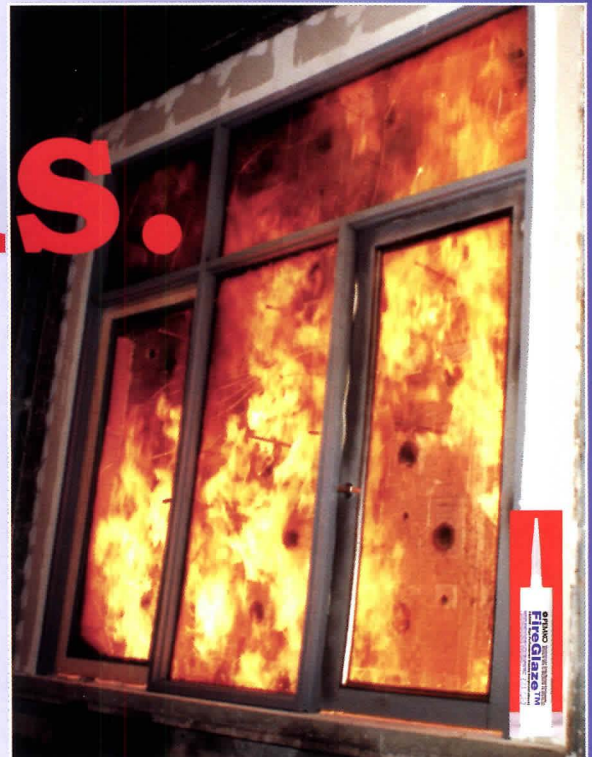

**Problem:** Limited Visibility, Light and Safety In Fire Rated Doors and Screens Due To Previous Code Restrictions.

**Solution:** Pemko's Revolutionary FG3000, Fire Glazing Compound and PLK Lite Kits Allow For Much Larger Lites In 20, 45, 60 and 90 Minute Doors and 45 Minute Screens.

# Found in no forest on earth.

Don't be deceived by its beauty.  
Our Grain-Tech™ series of stainable steel doors, frames  
and trim has a look that says wood. A feel that says wood.  
But a strength and fire rating that scream steel.

**INGERSOLL-RAND**  
ARCHITECTURAL HARDWARE

**STEELCRAFT**

Ingersoll-Rand Architectural Hardware Group, Steelcraft, 9017 Blue Ash Road, Cincinnati, Ohio 45242  
(513)745-6400 <http://www.steelcraft.com> ©1997 Ingersoll-Rand

Circle 43 on information card



# SKIDMORE SWEEPS AIA AWARDS, AGAIN

In January, the American Institute of Architects (AIA) announced that 28 projects will receive Honor Awards for Architecture, Interiors, and Urban Design this year. Skidmore, Owings & Merrill captured a total of five awards in all three categories, echoing the firm's outstanding performance in 1996, when it received the Architecture Firm Award, the 25 Year Award, and an Honor Award. The 1998 Honor Awards will be presented in May at the AIA National Convention in San Francisco. *Ned Cramer*



PETER VAN DER WAMPEN

**ARCHITECTURE**  
**Becton Dickinson and Company, Building Two** • Franklin Lakes, New Jersey • Kallmann, McKinnell & Wood Architects;  
**Chapel of St.**

**Ignatius at Seattle University** • Seattle, Washington • Steven Holl Architects with Olson Sundberg Architects; **Type/Variant House** • Wisconsin • Vincent James Associates (project initiated by James/Snow Architects); **Brandenburg's Ravenwood Studio** • Ely, Minnesota • Salmela Architect; **Powell Library Renovation, University of California, Los Angeles** • Moore Ruble Yudell Architects & Planners; **Ventilation Building # 7, Logan Airport** • Boston • TAMS Consultants with Wallace, Floyd, Associates

and Stull & Lee; **U.S. Court of Appeals** • San Francisco • Skidmore, Owings & Merrill; **St. Andrew Presbyterian Church** • Sonoma, California • Turnbull Griffin Haesloop; **Orange Place Cooperative** • Escondido, California • Studio E Architects; **The Atlantic Center for the Arts** • New Smyrna Beach, Florida • Thompson and Rose Architects

## INTERIORS

**101 Cityfood Cafe** • New York City • Westfourth Architecture; **Civic Opera House Renovation** • Chicago • Skidmore, Owings & Merrill; **The Helen & Harry Gray Court, Wadsworth Atheneum** • Hartford, Connecticut • Tai Soo Kim Partners; **Rooftop Residence** • New York City • Shelton, Mindel & Associates with Reed Morrison, Architect; **Massachusetts Institute of Technology, School of Architecture and Planning** • Cambridge, Massachusetts • Leers, Weinzapfel Associates Architects; **Neisser Residence** • Chicago • Tigerman McCurry Architects; **New Amsterdam Theater** • New York City • Hardy Holzman Pfeiffer Associates;



CHRISTIAN RICHTERS FOTOGRAF

**New Hearth Showroom** • New York City • Mark Simon of Centerbrook Architects and Planners; **Park**

**Avenue Apartment** • New York City • Frank Lupo/Daniel Rowen, Architects; **The Salad Bowl** • New York City • Hugh A. Boyd, Architects; **Wilkahn North America Showroom** • New York City • Skidmore, Owings & Merrill; **U.S. Court of Appeals** • San Francisco • Skidmore, Owings & Merrill

## URBAN DESIGN

**Beursplein** • Rotterdam, The Netherlands • The Jerde Partnership International; **The City Campus of The Savannah College of Art and Design** • Savannah, Georgia • Lee Meyer & Company, Architects; **Ellen Wilson Neighborhood Redevelopment** • Washington, D.C. • Weinstein Associates Architects with Oehme, Van



HEIDRICH BLESSING PHOTOGRAPHERS

Sweden and Associates; **Jamaica Market** • Queens, New York • James McCullar & Associates; **Robert F. Wagner, Jr. Park, Battery Park City** • New York City • Machado and Silvetti

Associates with Olin Partners and Lyndon B. Miller; **State Street Renovation Project** • Chicago • Skidmore, Owings & Merrill

**Jerde's Beursplein** (above); **SOM's Wilkahn North America Showroom** (left); **Ventilation Building # 7** by TAMS Consultants with Wallace, Floyd, Associates and Stull & Lee (far left)

## MAYA LIN'S GREEN MACHINE

"A monument to the environment" is how Vietnam Veterans Memorial designer Maya Lin describes her latest project, a \$370 million, 350,000-square-foot recycling plant in the former Harlem River Rail Yard in the South Bronx, New York. The Bronx Community Paper Company is the brainchild of the nonprofit Natural Resources Defense Council and the Banana Kelly Community Improvement Association, the struggling neighborhood's development corporation. It was designed by Lin with project architect HLW International. The plant will recycle 280,000 metric tons of wastepaper—one-quarter of New York City's total annual consumption—into 220,000 metric tons of newsprint each year. Unveiled in December at an exhibit at the Municipal Art Society in Manhattan, the plant is scheduled to begin construction this fall. N.C.





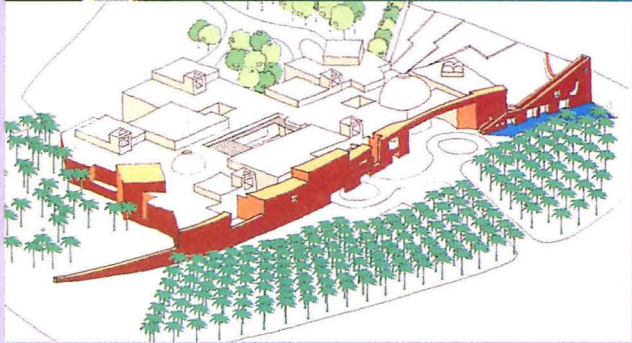
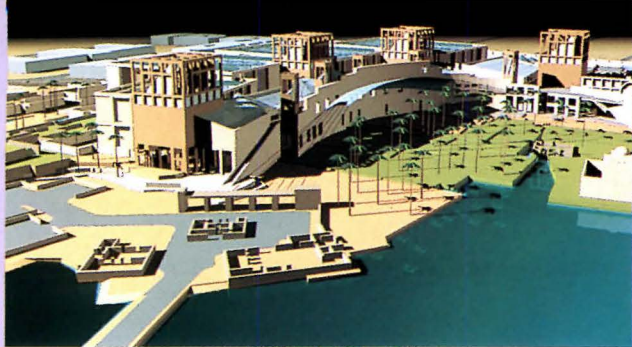

## SHEIKH OVERTURNS JURY IN QATAR

Little-known in the U.S., Jordanian architect Rasem Badran bested a shortlist of stars to design the Museum of Islamic Arts in Doha, Qatar (top). The jury for the invited competition, organized by The Aga Khan Trust for Culture, originally selected a proposal by Charles Correa of India (above), ranking Badran's second. However, Sheikh Saud Bin Mohammad Al-Thani, ruler of Qatar, overturned the jury's decision in favor of Badran. Other participants in the competition were Oriol Bohigas of Barcelona, Zaha Hadid and Richard Rogers of London, and James Wines of New York City. The jury comprised archi-

itects Ricardo Legorreta, Fumihiko Maki, Luis Monreal, Domenico Negri, and Ali Schuaibi.

The 270,000-square-foot museum will house the collection of Qatar's royal family on a waterfront site in the capital city. According to the Trust, Al-Thani placed great emphasis on the context's "cultural, environmental, and historical values" in selecting an architect. Badran's scheme incorporates internal courtyards and streets to reflect the urban fabric of Arab cities; the jury originally passed it over for its inability to expand "due to the formal rigidity of the proposal." The museum is scheduled to open in 2000. *N.C.*

## ISRAEL MUSEUM ANNOUNCES EXPANSION

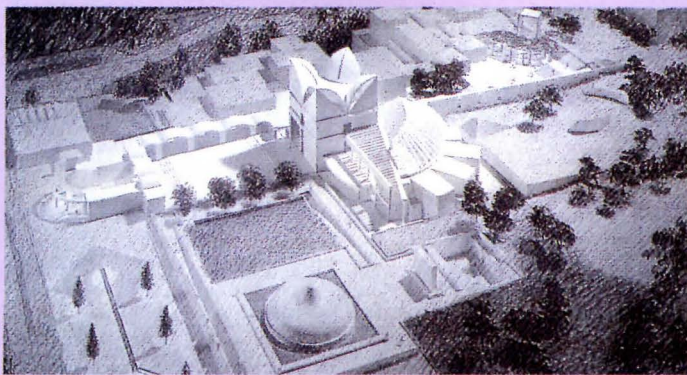

Thanks to a \$42 million gift from the late Caroline and Joseph Gruss of New York City, construction can now begin on a new visitor center at the Israel Museum in Jerusalem, designed by architect James Ingo Freed of Pei Cobb Freed & Partners. An additional \$8 million from the Israeli government fulfills the project's \$50 million budget. The 130,000-square-foot addition will consolidate the existing 500,000-square-foot museum complex, located south of the Israeli parliament.

Originally designed by the Modernist Israeli firm Mansfeld-Gad in the 1950s, the sprawling museum was subsequently added to by Jurgen Bo, architect of the Louisiana Museum in Denmark. A pavilion designed by Surrealist architect Frederick Kiesler to house the Dead Sea Scrolls and a 6-acre sculpture garden designed by artist Isamu Noguchi both opened in 1965. The project faces a lengthy approval process, but groundbreaking is anticipated by 1999. *N.C.*



AP/WIDEWORLD PHOTOS

## BRENDAN GILL 1914-1997

He once observed that humanity is divided between the lovers and the haters. The indefatigable, irrepressible, and incorrigible Brendan Gill—effervescent during a toast, wicked in a tête-à-tête, adept at dipping into two or three receptions before the main event of a Manhattan evening—was clearly a lover: His life, like his works, brimmed infectiously with curiosity and brio. He was a writer who read the world around him as avidly as he devoured words, and he pried open its secrets using his disciplined wit as the crowbar. It is difficult to believe that he died on December 27, because, at the age of 83, Gill was still a life force.

Architects knew Gill best for his book *Many Masks: A Life of Frank Lloyd Wright* (1987) and for "Skyline," the column in *The New Yorker* that he resurrected 10 years ago. But his career as architecture critic was merely the last turn in his six decades at *The New Yorker*, years that embraced biography, journalism, poetry, fiction, and his particular love, preservation. New York was his oyster, and Gill relished the fray—the battle over the soul of Times Square, the Supreme Court's rescue of Grand Central. He championed and protected the city with his particular combination of savvy, glee, and mischief. *Joseph Giovannini*



Unless by some freak of  
nature it starts raining manhole covers,  
our roof insulation will  
probably never need replacing.

## LIGHTWEIGHT INSULATING CONCRETE SYSTEMS FROM SIPLAST.

Outside of the Apocalypse, our Siplast Roof System is designed to stand up to whatever nature throws at it. In fact, we're the only commercial manufacturer to offer a *complete* package that combines the unparalleled quality of an SBS-modified bitumen membrane with the added benefits of lightweight insulating concretes. The result is a longer-lasting roof with the ability to

economically create slope-to-drain, excellent fire and wind resistance, and stable R-values. And since the Siplast Roof System virtually eliminates the need to replace the insulation when it's time to reroof, the cost savings over the life of the building will be outstanding. For more information, call us toll-free at 1-800-922-8800. Our roofs are ready for just about anything.

NOTHING STANDS UP TO THE ELEMENTS LIKE A SIPLAST ROOF™

 **siplast**®

Circle 77 on information card

## THE BUZZ

California's Department of Transportation (Caltrans) has approached a joint venture team comprising San Francisco engineer **T. Y. Lin International** and **Moffatt & Nichol** to design a new eastern span for San Francisco's Bay Bridge, which was damaged in the 1989 Loma Prieta earthquake. No contract has yet been signed. Caltrans faced significant opposition for its initial intent to design a replacement span using an in-house design team. (*Architecture*, June 1997, page 34).

New York City-based architect **Gruzen Samton** recently won a competition for the Chung Dong Integrated School in Seoul, South Korea. And Munich, Germany-based **Lauber + Wehr Architects** was selected over **Gensler, The Hillier**

**Group, Kohn Pedersen Fox, and Murphy/Jahn** to design a new U.S. headquarters for Mercedes-Benz of North America. Meanwhile, Gensler has opened a 25-person office in Chicago, bringing the total number of the firm's offices to 16.

Don't miss the U.S. Postal Service's new Robie House stamp, which honors **Frank Lloyd Wright** as part of a new series commemorating significant people and events of the 20th century. Wright's successor firm, **Taliesin Architects**, is now working with Chicago-based **Eifler & Associates** to restore the Studio and Kiva Theater at Taliesin West.

Several new international museum commissions were awarded recently: British architect **David Chipperfield** bested **Frank Gehry** for the commission to design the \$150 million New Museum on an island

in Berlin's Spree River. The Photographer's Gallery has selected Dutch architect **Erick Van Egeraat** to design its new facility in London over **Van Berkel and Bos** and **Nicholas Grimshaw and Partners**. **Hodgetts + Fung** is renovating a turn-of-the-century electrical plant in Kirchleugern, Germany, into a 60,000-square-foot science museum. And **Wood and Zapata** is designing the Tsumarigo Art Necklace museum in Nigata, Japan, as well as the Sterling Hotel in Miami's South Beach.

From architect to innkeeper: **Michael Rotondi** and designer **April Greiman** have opened Miracle Manor, a renovated 1950s motel in Desert Hot Springs, California.

Arts and architecture patron **Dominique De Menil** (*Architecture*, April 1997, pages 49-53) died on December 31, 1997, at the age of 89 at her home in Houston. And **Lillian Bounds Disney**, the 98-year-old widow of Walt Disney, died in Los Angeles on December 15. Disney sparked the effort to build the Walt Disney Concert Hall, designed by Frank Gehry, with a \$50 million donation in 1987.

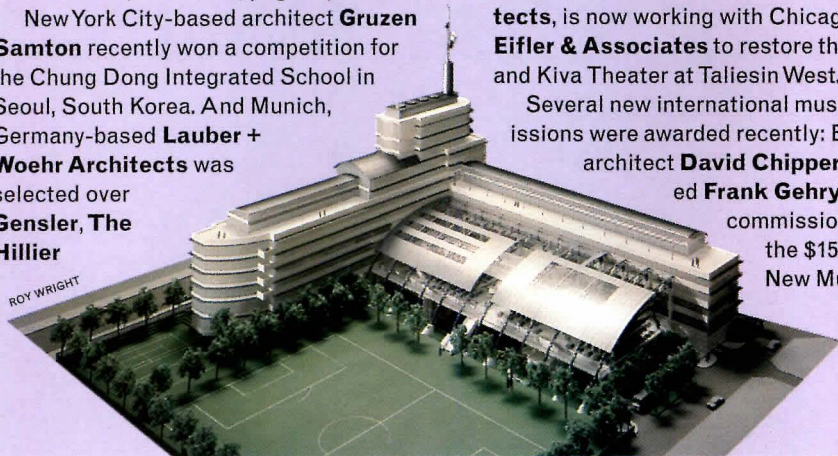

Gruzen Samton's Seoul school (left); Robie House stamp (above)

# HOW WOULD YOU LIKE IT IF NOBODY PAID YOU FOR YOUR DRAWINGS?



It wouldn't be fair. In fact, it would be wrong. And like stealing drawings, stealing software is something that not only sacrifices your professional integrity but also could put you in a heap of legal trouble. Bringing copied software into the workplace is a crime punishable with up to 5 years in prison or a \$250,000 fine. So, prevent damaging your reputation by bringing the same set of ethics to your software as you do to your work.

▶ CALL 1-800-NO-COPIES FOR MORE INFORMATION  
OR TO REPORT INSTANCES OF AUTODESK SOFTWARE PIRACY.

 Autodesk®

DESIGN  
YOUR  
WORLD™

# DesignIntelligence™

---

## Sharing Ideas That Work

The trends, research, and strategies newsletter from the Design Futures Council  
Published 24 times a year

### Top 10 Reasons to Subscribe to DI:

1. To find out how other firms are achieving success—new insights in every issue
2. Full membership in the Design Futures Council—includes invitations to annual conferences
3. The very latest financial benchmarks—24 times a year
4. New research on key trends and issues in the design professions
5. Discounts on in-depth “white papers” on the future of the profession
6. Exclusive rankings of top firms, collegiate design programs, and emerging design technology
7. Innovative communications and marketing strategies that get your firm noticed
8. The best source for executive career postings in the \$68,000-300,000+ range
9. The most sought after clients tell why certain firms are selected over others
10. Top leadership and profitability strategies revealed by today’s most successful firms

**You get all this and more when you subscribe to DI for just \$149 a year. That’s almost 30% off the cover price (regularly \$199), and less than half of what you’d pay for just one hour of a top consultant’s time!**

**You’ve got the talent.  
DI brings you fresh strategies for success.**

**Call 800/726-8603 to subscribe today.**



KEVIN BERNE

Many architects doubted the staying power of Zaha Hadid's iconoclastic vision when the Iraqi-born British architect first gained international attention with her winning entry to the Hong Kong Peak competition in 1983. But a new exhibition, *Constructed Landscapes: Projects by Zaha Hadid*, on view until March 10 at the San Francisco Museum of Modern Art (SFMOMA), proves that her early visionary impulses have not diminished—in fact, they have gained strength, maturity, and clarity. Concisely selected and assembled in two galleries by Aaron Betsky, curator of architecture and design at SFMOMA, are large paintings, models, computer-generated fly-throughs, and drawings dating as far back as Hadid's 1976 thesis project at the Architectural Association in London.

In the first gallery, exploratory drawings and relief models for three recent building projects demonstrate the discipline with

# Hadid Delivers

**At SFMOMA, a Zaha Hadid retrospective fulfills the architect's early promise.**

which Hadid maintains her ideas as they move from her imagination into the material world. This is not an easy process: The requirements of structure and technical and programmatic performance drag at her gravity-defying spaces. And yet Hadid persists in keeping the buildings afloat. The paper-relief explorations of elevations and perspective views are particularly compelling. "My work has to be explored three-dimensionally," Hadid explains. "These elevation studies become more volumetric. They become landscapes in a gentle way."

On the walls of the second gallery are arrayed two dozen of Hadid's arresting paintings of projects, conceptual studies, and competition entries. It is an indication of the influence Hadid and the Deconstructivists have had over the past decade that their "slash-and-crash" esthetic no longer seems violent. Now that our eyes are familiar with such forms, Hadid's paintings reveal sublime, carefully rendered images of an alternative built world. She challenges traditional architecture using visual, rather than verbal, means. In these paintings and models, gravity appears to have new rules. Sometimes buildings become landscape, sometimes clouds. Surfaces fold, Escher-like, from wall to floor to ceiling. Hadid reinterprets architecture's role as mediator between ground and sky,

While each painting is engaging on its own, the suite of these works documents the evolution of Hadid into an architect who builds. The models and videos in the second gallery show that this shift toward buildability has not diminished the disturbing beauty of Hadid's work. Indeed, structural necessity seems only to add another layer of poetry to these representations of buildings. While some viewers will remain skeptical until they have experienced Hadid's buildings, this sampling of projects suggests that her early architectural promise is being fulfilled. *L.R. Findley*

*Oakland-based architect L.R. Findley teaches at the University of California, Berkeley, and the California College of Arts and Crafts.*

Show incorporates paintings, models, and computer-generated fly-throughs (top), including paper relief of 1993 Vitra fire station (right) and 1992 painting, *Tatlin Tower* and *Tektonik Whirlwind* (below).

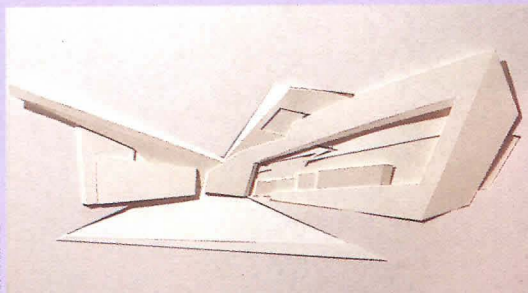

KEVIN BERNE

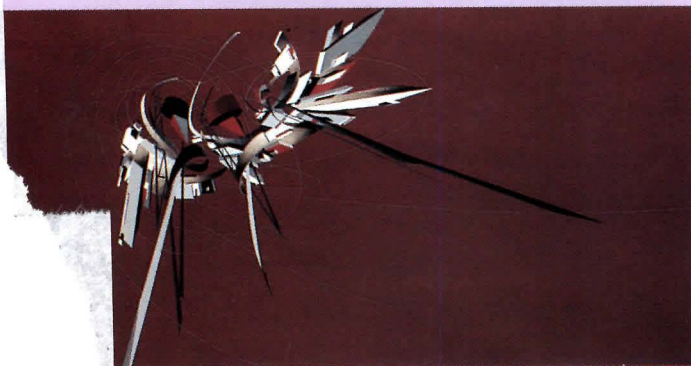

The Engineering Enterprise: Year 1, Day 1, 6:00 am Eastern



## Where Does A Continuum Begin?

The Bentley Continuum begins with a comprehensive understanding of your business dynamics coupled with our unique business philosophy and total approach to enterprise engineering



throughout the life cycle. It encompasses everything from software like MicroStation® and the new ModelServer™ family of products for sharing engineering

documents over the WWW, to solutions and project services from Bentley Strategic Affiliates, to continuous technology and service subscription programs like Bentley SELECT™ and the MicroStation Institute for professional

The Bentley Continuum maximizes the effectiveness of your most complex engineering for the life of your engineered assets. It works



## The Continuum

from design through construction, to operational output, performance and maintenance, while reducing the risk of ownership and helping you get a longer-lasting asset to market faster.

To learn how your organization will benefit from the Bentley Continuum, call us at 1-800-BENTLEY or visit us on the WWW.



### FREE! Bentley Continuum White Paper

Maximize the value of your engineering enterprise with the Bentley Continuum:

[www.bentley.com/continuum/10a.htm](http://www.bentley.com/continuum/10a.htm)



**BENTLEY**

*Engineering the future together*

1-800-BENTLEY  
In Europe/Middle East/Africa call +31 23 556 0560  
In Asia-Pacific call +61 3 9699 8699

There's a loud rumbling in San Francisco, and it's not the sound of the fault lines acting up. It's the din of construction. The city is experiencing a building boom that makes memories of the late-1980s glut and slump seem foggier than the coast. The convergence of a robust economy, the legacy of the 1989 Loma Prieta earthquake, the latest round of military-base closures, and a development-minded mayor with Hausmannesque ambitions explains why the Urban Land Institute has named San Francisco the hottest real estate market in the United States.

Sizable sections of the city are undergoing substantial overhaul, from the Civic Center's quake-damaged Beaux-Arts ensemble to the now freeway-free Embarcadero waterfront, to the long-stagnant Mission Bay district, the site of HOK Sport's new Giants baseball stadium now under construction in China Basin. However, the city's most visibly changed quarter continues

## San Francisco

# Shake-Up

**Entire neighborhoods are under construction, brimming with new cultural facilities, a new campus—and controversy.**

to be the 87-acre area around Yerba Buena Gardens (YBG) in the South of Market neighborhood, a civic centerpiece several decades in the making.

The city's gamble on converting this skid-row area into a cultural arts district is just now paying off. Public and private interests alike, bolstered by the economy's bullishness, are vying for property near the YBG Center for the Arts Theater by James Stewart Polshek and Partners (*Architecture*, February 1994, pages 58-67), the Visual Arts Gallery by Fumihiko Maki, and Mitchell Giurgola's esplanade, which opened in mid-1994, shortly before Mario Botta's San Francisco Museum of Modern Art (SFMOMA) opened across the street.

Across another street, Yerba Buena's final cultural component, the \$56 million Children's Center designed by Adele Naudé Santos and Associates, is now nearing completion on the roof of the Moscone Convention Center. The Children's Center features a glassed-in historic carousel on one corner, as well as a studio, theater, day-care center, ice rink, and bowling alley within a series of highly articulated volumes arranged around a park.

The deal-making behind Yerba Buena's costly cultural facilities is worth noting because it is being repeated in the city's other redevelopment areas. Huge public investments in YBG were subsidized by a lease agreement with the neighboring Marriott Hotel, a colossal eyesore that looks like the offspring of a Wurlitzer and a wedding cake. Though crucial to realizing the now-thriving arts center, the hotel serves as a glaring reminder of the price the San Francisco's Redevelopment Agency is willing to pay to guarantee prolonged funding for its building projects.

The western edge of the YBG block, opposite the Polshek and Maki buildings, was always intended for commercial use, though it



Culture and commerce are vying for control of San Francisco's undeveloped lands.

RICHARD BARNES

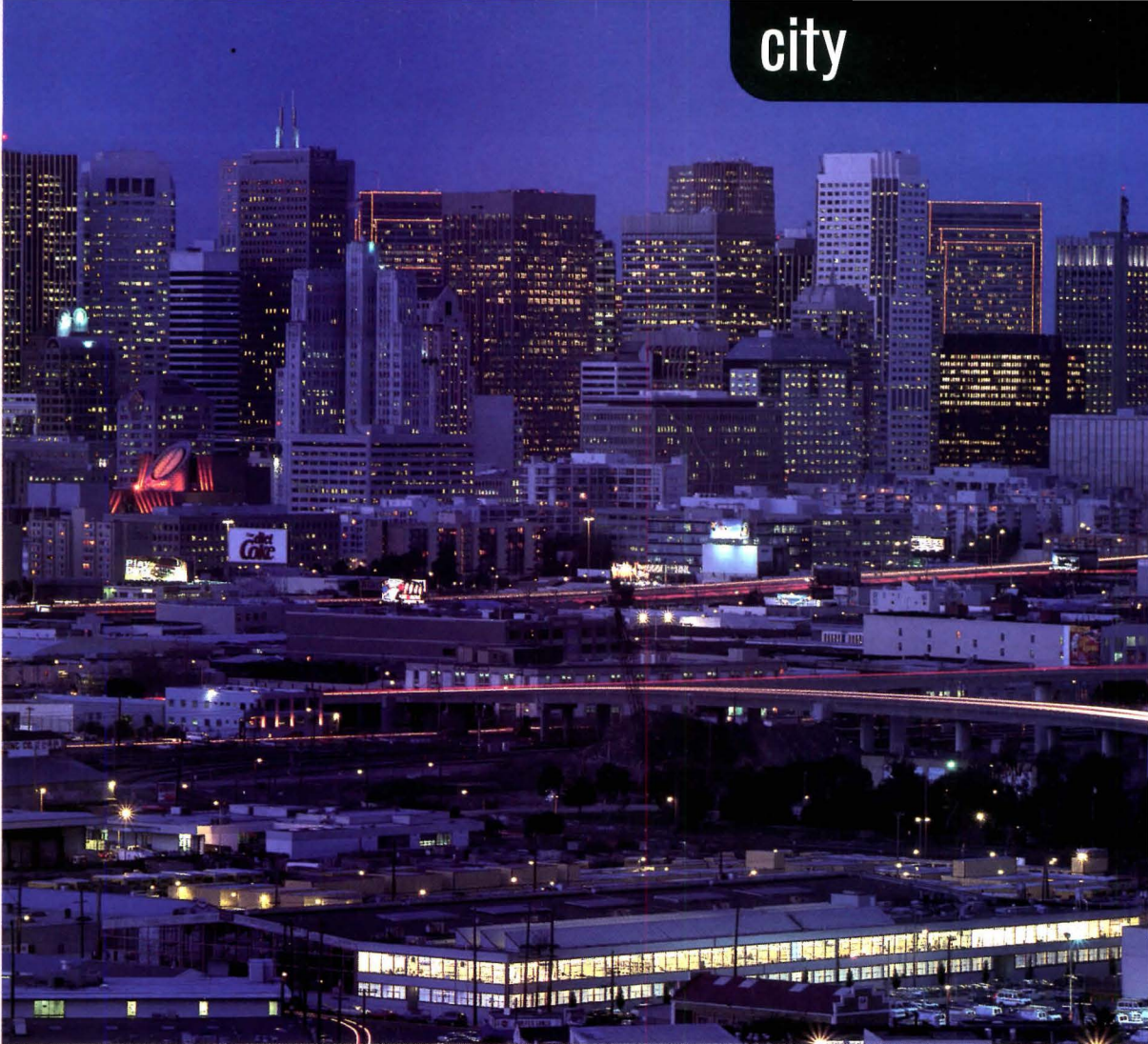

was not until 1994, with the upturn in the economy, that the city finally signed a similar lease with joint developers Millennium Partners of New York (responsible for the Lincoln Square complex in Manhattan) and the local WDG Group. The development team, in turn, will lease a new 200,000-square-foot building to the Sony Entertainment Group, for its Metreon "urban entertainment center" comprising a 15-screen theater, a 120-foot-high 3-D IMAX theater, and other themed retail attractions.

Local architect Simon Martin-Vegue Winkelstein Morris (SMWM) designed the core and shell, which complements the Polshek and Maki buildings in terms of scale, massing, and color. Spanning the width of the block, Sony's Metreon, scheduled to open at the end of the year, features a 60-foot-high curtain-walled atrium and an upper-level outdoor terrace that both open toward YBG's esplanade. The Metreon is designed to amend some of the art park's problems, such as its alienating perimeter and poor accessibility. Both Polshek's and Maki's buildings turn their backs to Third Street; by contrast, SMWM's scheme promises to enliven Fourth Street with a retail arcade flanked by prominent entrances at the corners.

Millennium Partners has also revived an underutilized site adjacent to the Marriott on Market Street, and is now narrowing a list of top-tier architects to build a luxury hotel-apartment-club, aiming to break ground early this year. The most anticipated feature of this development is a 50-foot-wide, shop-lined allée con-

necting Market Street and Yerba Buena, bordering the future Jewish Museum and a plaza to be shared with the planned Mexican Museum. The Jewish Museum, having dropped Peter Eisenman as its architect last year, is moving ahead with new candidates Enrique Norten, Eric Owen Moss, and the local firm Studios Architecture, though museum officials have been stalling for months on announcing the commission. Though the Mexican Museum's funding remains shaky, it recently unveiled a revised design by Ricardo Legorreta that moves its café and store from the building's interior to streetside, taking cues from SFMOMA's lucrative configuration of retail functions.

Interestingly, many of the projects now under way in South of Market and downtown are reincarnations of plans that were approved in the 1980s before the market bottomed out. A 400-plus-room hotel designed by local firm Hornberger + Worstell is now under construction next to SFMOMA, as is a 350,000-square-foot office tower by Skidmore, Owings & Merrill around the corner on Second Street. Several other significant projects, such as an office and retail building on Third and Mission and an expansion of the Moscone Center, are in the works.

Just below South of Market lies San Francisco's next real estate hotbed, the Mission Bay district, which has endured a succession of schemes, from John Carl Warnecke's 1970s master plan to another proposal by Pei Cobb Freed & Partners in the early 1980s, both of which reflected their times with dense office

# PAC-CLAD®

## Petersen Aluminum

1005 Tonne Road • Elk Grove Village, IL 60007  
1-800-PAC-CLAD • FAX: 1-800-722-7150 or  
1-847-956-7968

Other Plant Locations:  
Annapolis Junction, MD: 1-800-344-1400  
Tyler, TX: 1-800-441-8661

<http://www.pac-clad.com>

# PAC-CLAD® Flush Panels

for soffit & fascia applications

**P**AC-CLAD Flush Panels have been designed for wall, fascia and soffit applications where a flush or flat appearance is desired. Our Flush Panels are formed on precision roll-forming equipment that includes in-line Herr Voss corrective levelers. Corrective leveling works to remove typical metal conditions including "oil-canning", coil set and edge wave. The result is a panel that exhibits **superior flatness**. A rounded interlock leg acts to improve the flush appearance while adding torsional strength.

The Capitol City Airport in Lansing, Michigan, designed by Greiner Inc., included more than 50,000 square feet of PAC-CLAD Flush Panels installed as soffit. The Rubenzer residence designed by Bruce Lehrer, Architect, is an example of our panel used in a wall panel application.

For more information regarding the wide variety of PAC-CLAD Flush Panels, please contact Petersen Aluminum Corp. at **1-800-PAC-CLAD** or visit our web site @ <http://www.pac-clad.com>

Circle 45 on information card

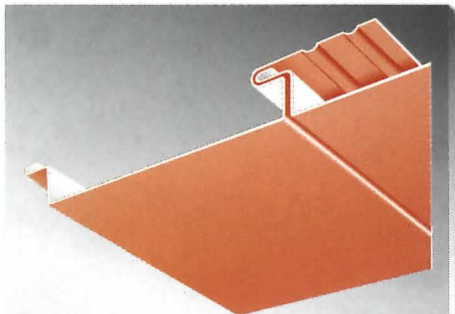

### Flush Panel

7" or 11" O.C.  
1" high

.032 aluminum  
22 gauge steel  
24 gauge steel

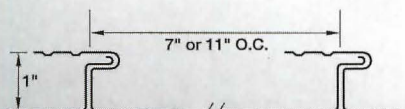

### Features

- Herr-Voss corrective leveled
- Rounded interlock leg provides improved flush fit
- 1-1/2" reveal profile available
- Available with up to 3 stiffener beads
- PAC-CLAD finish
- 20-year non-prorated finish warranty
- 25 standard colors (24 ga. steel)
- 10 standard colors (22 ga. steel)
- 16 standard colors (.032 aluminum)

**NEW**

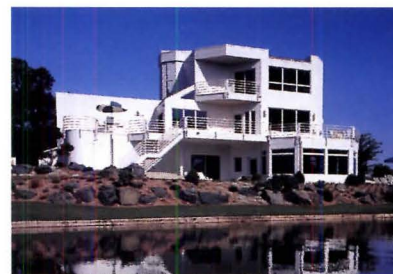

*The Capital City Airport  
Lansing, MI  
Architect: Greiner, Inc.  
Roofing Contractor: Metal Building  
Specialties  
Color: Sandstone  
Profile: Flush Panel*

*Rubenzer Residence  
Prior Lake, MN  
Architect: Bruce Lehrer Architect  
Roofing Contractor: D.H. Nygren/  
Specialty Systems  
Color: Stone White  
Profile: Flush Panel*

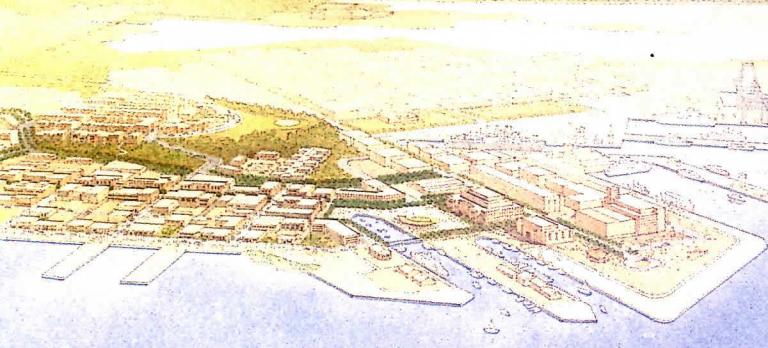

Hunter's Point Naval yard (above) will become neighborhood. Legorreta recently revised Mexican Museum scheme (left). Machado and Silvetti's UCSF campus (below, left and right) moves into Mission Bay. Sony entertainment complex (bottom, at center) completes Yerba Buena Gardens.



developments fashioned after Los Angeles's Century City. Later plans led by EDAW (1987) and Skidmore, Owings & Merrill (1990) signaled the community's growing role in city planning, as local activists lobbied successfully for a reduced-scale "urban village," emphasizing housing with a mix of commercial and open space. But nothing ever materialized because the cost of developing this marshy former railyard and warehouse wasteland exceeded its profit potential, according to primary property owner Catellus, a real estate offshoot of the Southern Pacific Railroad Company.

The 1996 approval to build a 42,000-seat stadium for the Giants and the extension of the Muni transit line south along the newly beautified Embarcadero to China Basin have already lured a range of developments to the area, which includes several piers. (The recently revised Waterfront Land-Use Plan limits pier developments to retail, cultural, maritime activities, such as ferry tours, and other recreational uses, and excludes residential and office space, pointing the entire waterfront in the direction of a tourist zone similar to Fisherman's Wharf.) The Giants' Pacific Bell Park, designed by HOK Sport and set to open in 2000, squeaked by skeptical voters after numerous defeats primarily because backers promised that its \$262 million price tag would be privately funded.

Last year, the Redevelopment Agency gave Mission Bay another shot of adrenaline with its 11th-hour bid to keep the University of California San Francisco (UCSF) from building its new multimillion-dollar biomedical research campus outside the city. The agency convinced Catellus to give the university 43 acres, nearly one-fourth of its total property. Catellus's gift was motivated by its awareness that the campus will catalyze interest in the site, attracting, for example, other biotech research centers and companies. And UCSF's new campus will finally jump-start the area's residential development: Catellus has immediate plans to build 2,000 units of market-rate condominiums and apartments, while 1,000 units of low-income housing will be open to nonprofit developers for bid.

A new entity called the Bay Area Life Sciences Alliance (BALSA) was established to expedite the campus design process. Local biotechnology giant Chiron (whose monumental headquarters by Legorreta is taking shape as a landmark of Emeryville, the East Bay's biotech ghetto) was the primary funder of the design competition held last fall. Machado and Silvetti's conservative, Classical campus plan, developed in collaboration with landscape architect Laurie Olin and local architect Gordon H. Chong and Associates, bested wide-ranging proposals by Steven Holl, Dan Solomon, Shin Takamatsu, and Studios. The Redevelopment Agency is now working with SMWM to revamp the Mission Bay Master Plan to take into consideration the UCSF campus as well as the ballpark.

The 1996 ballpark initiative was the city's most expensive ballot campaign—it cost \$1.2 million—until last year, when the DeBartolo family, owners of the '49ers, spent \$2.5 million to win citizen approval to build a fancier stadium to replace 3Com (formerly Candlestick) Park. San Francisco must now contribute \$100 million toward a \$525 million deal that includes a 1.4 million-square-foot shopping mall attached to the new stadium. The public funds will be drawn from lease revenues from the stadium and mall, which will be otherwise financed by the DeBartolos and mall maven Mills Corporation. Described by developers as a

# Wausau Tile

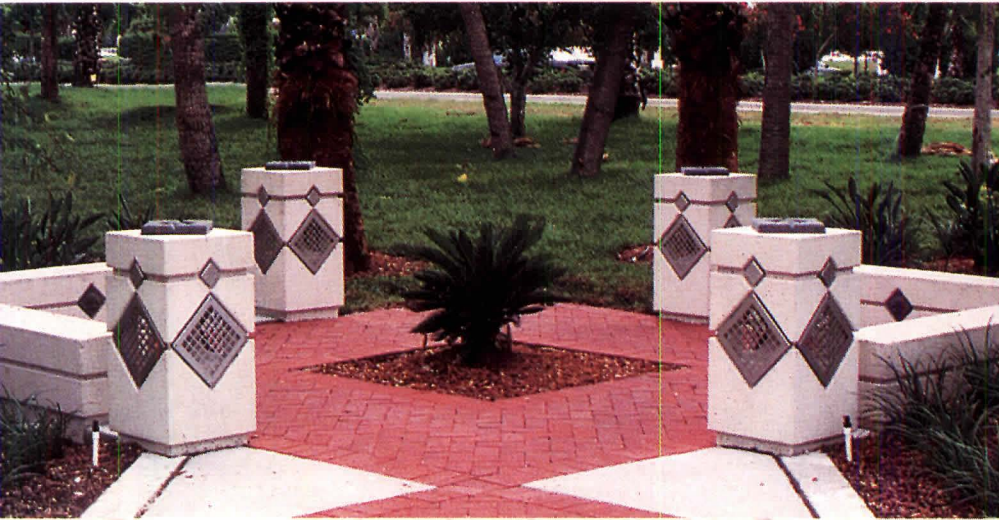

From Conception to Completion Your  
One Source for Custom Precast Concrete Products



**WAUSAU TILE**

P.O. Box 1520  
Wausau, WI 54402-1520  
(800) 388-8728  
(715) 359-3121  
Fax (715) 355-4627

Circle 47 on information card

city

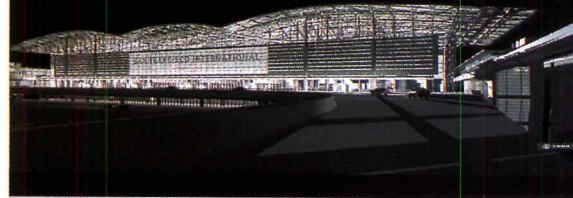

City still seeks funding for transit line to link SOM's new airport terminal (above) to downtown.

"super-regional, value-oriented megamall," the Candlestick Mills project—similar to megamalls outside Miami, Philadelphia, and Washington, D.C.—will contain a 30-screen cinema, chains like J.C. Penney, Virgin Megastore, Nordstrom Rack, and other discount outlets, as well as themed restaurants including an NFL restaurant-arcade-museum. Nearly 160 acres of the 200-acre complex will be devoted to parking.

The mall addition was Mayor Willie Brown's own brainstorm. He sees it as an opportunity to generate jobs for nearby Bayview-Hunter's Point, which suffers a higher unemployment rate than any area in the city. The military's departure from the Hunter's Point Naval Shipyard 20 years ago hurt the neighborhood deeply, as did poor transportation links. This month, the Redevelopment Agency gains ownership of the 600-acre base, and will begin implementing a land-use plan, conceptualized by SMWM, that encourages a wide development mix. The first step in revitalizing the area, already approved by the agency, is a \$300 million extension of the Muni line from China Basin through Mission Bay to Hunter's Point. Brown has even proposed building a bridge to cross the inlet between Hunter's Point and Candlestick Point.

The coincidence of so many big-ticket items in San Francisco begs the question: How is the city going to pay for all this? Despite promises of private financing, both stadiums will cost the public dearly, in financial and physical terms. Infrastructure improvements such as road widening and transit links, for example, will require millions of dollars, and will likely compete for funding with other urgent projects: Among the city's other priorities are repairing the last of the quake-damaged freeways, the Central Freeway, and the Transbay Terminal, the seismically unsafe downtown regional bus station whose repairs have been put on hold due to disputes between the city and the Metropolitan Transit Authority.

over who should pay for the \$125 million problem. A \$1.2 billion extension of the BART subway to the San Francisco International Airport, as called for in Skidmore, Owings & Merrill's elegant expansion scheme, will receive only \$29.9 million from Congress in the next fiscal year; the remainder must come from state or regional coffers.

A review of other major projects in the city reveals similarly staggering price tags. City Hall's \$224 million seismic retrofit and facelift is \$30 million short. Civic Center Plaza badly needs a redesign to accommodate its many changes, such as the building of the New Main Library, the expansion of the State Office Building, the construction of the Federal Plaza, and the conversion of the Old Main Library into the new Asian Arts Museum. And the fate of the M.H. DeYoung Museum remains undetermined, since voters last year rejected a \$73 million bond for seismic improvements of its Golden Gate Park facility. The museum has proposed relocating to almost every eligible site in the city, including the barely functioning Ferry Building, the boarded-up Old Mint, the promising Transbay area, and the contested Embarcadero piers.

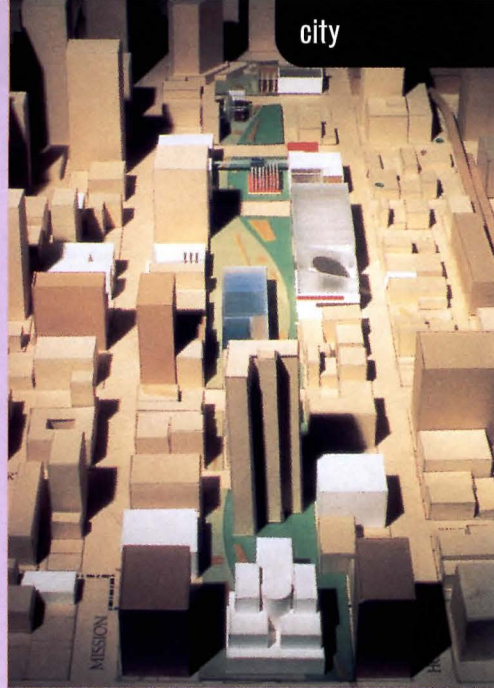
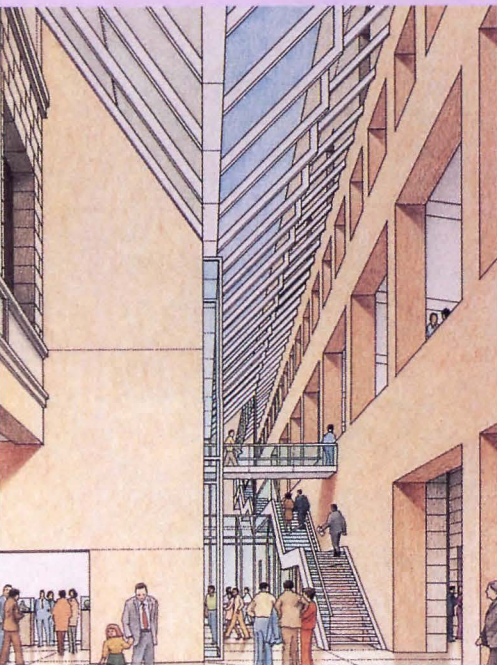

Many of the decisions being made in this heady time will affect the city's form, and hence its character, in ways that may make the economic gains seem paltry compensation in the future. Focused heavily on the art of the deal, Brown and his aides have yet to display any interest in broader coordination—that is, how the deals add up and contribute to the city as a whole. While building *grands projets* is perhaps part of every mayor's ambition, the city's long-term health requires that these projects are appropriate, desirable, and in balance with the broad needs of San Francisco. For instance, how many franchise-filled, mega-movieplexed, entertainment-themed malls does a city like this need? With vibrant storefront strips from one end of its 7-mile square to the other, does San Francisco really need any at all?

No doubt, the amount and pace of building activity in the city is exciting, particularly given its fitful development history, with bickering interest groups frequently delaying the moment of action (or rendering it more mediocre than need be). But speed can be as powerful as sloth in blinding visions of how great a city can be. *Cathy Lang Ho*

*Cathy Lang Ho is editor of Design Book Review in Berkeley, California.*

**New Asian Art Museum (above left) by Gae Aulenti and HOK will occupy renovated Old Main Library (left). SMWM's proposal to relocate DeYoung Museum brings it to Transbay Terminal area (top) behind SFMOMA.**

city

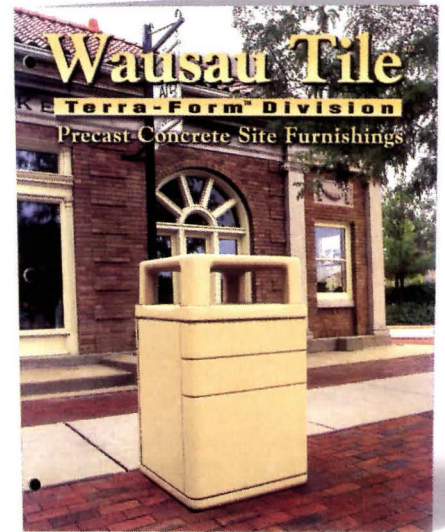

**Wausau Tile Terra-Form**  
Complete Line of  
Precast Concrete  
Site Furnishings

Circle 49 on information card

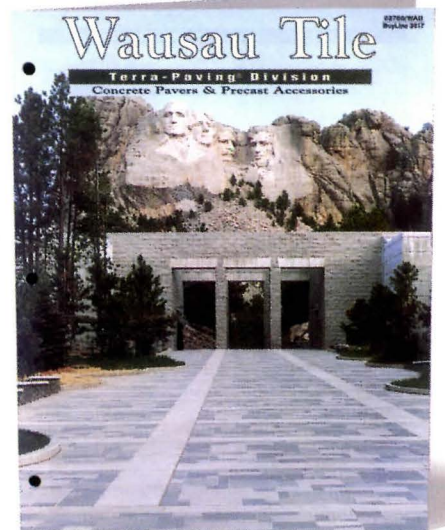

**Wausau Tile Terra-Paving**  
Complete Line of  
Concrete Pavers & Precast  
Concrete Accessories

Circle 51 on information card

**WAUSAU TILE**

(800) 388-8728

## Project Portfolio, Perkins & Will

Architect Ralph Johnson is sitting in a corporate catbird seat. As design director of Chicago-based Perkins & Will, he's one of a handful of forward-looking American designers with the imprimatur of a large firm. Johnson occupies the cutting edge of corporate architecture, along with such colleagues as Mehrdad Yazdani of Dworsky Associates (*Architecture*, July 1997, pages 51-53) and William Pedersen of Kohn Pedersen Fox Associates (*Architecture*, November 1997, pages 93-135), thanks to his reconciliation of Modern form and the particulars of site. In Johnson's latest projects—a museum in Chicago, an office tower in Manila, and schools across the Pacific Rim—local context informs the architect's gestural arcs and wedges. These highly personal, abstract forms become catholic.

In designing the 153,000-square-

Chicago Academy of Sciences Nature Museum, Chicago

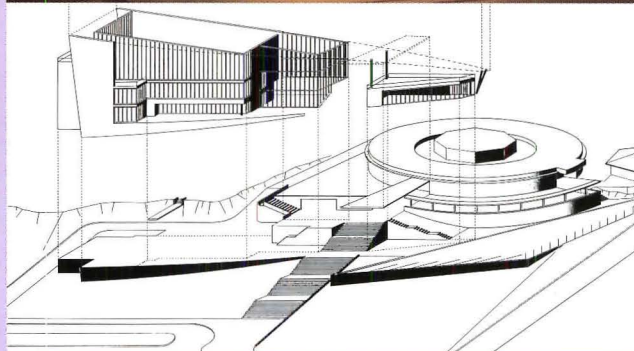
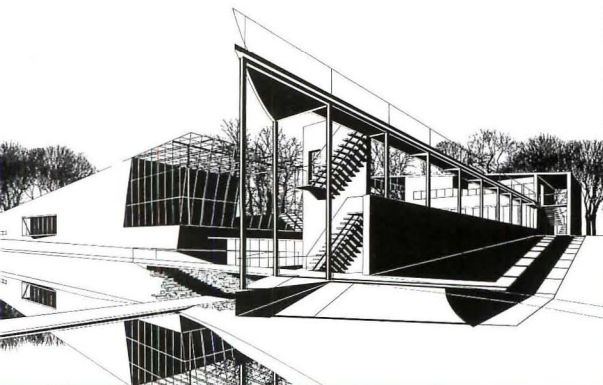
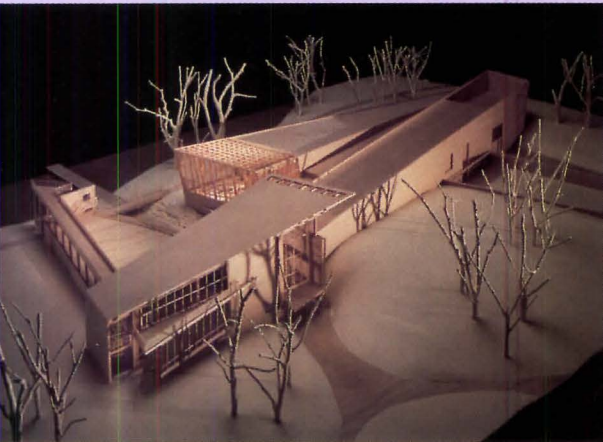

Nagoya International School, Nagoya, Japan

foot J. L. Stanford Middle School in Palo Alto, California, scheduled to begin construction next January, Johnson was inspired by the surrounding neighborhood, largely built in the 1950s by noted Modernist developer Joseph Eichler. A semicircular classroom block recalls Eichler's roundabout street patterns; its covered walkways enclose a courtyard, taking advantage of the warm California climate. Shared functions such as the library are located in a curving wing that intersects the courtyard, and serves as a focus for the school.

Johnson contended with another Modernist context in designing a new 21,000-square-foot administration, physical education, and fine arts building for an international school in Nagoya, Japan. Frank Lloyd Wright disciple Antonin Raymond designed the existing campus buildings, a pair of hexagonal and circular pavilions, in the 1960s. Scheduled for groundbreaking later this year, Johnson's freestanding, wedge-shaped addition extends the current collage



of platonic forms, and rectifies Raymond's omission of definitive exterior and interior gathering spaces. A cluster of distinct forms, housing a double-height lobby and gymnasium, as well as offices and classrooms, are intersected by grand public stairs and an entrance plaza. This entire ensemble is gathered under a vast sloping roof, forming a monumental new gateway to the campus.

Even when working on a generic former military base on the outskirts of Manila, Philippines, Johnson carefully considers local architectural precedent. His 592,000-square-foot international school takes cues from a local 19th-century monastery. Johnson created cloisterlike courtyards between a large curving bar housing individual classrooms and a rectilinear block for public spaces such as a gymnasium and cafeteria. Shared classrooms occupy

three short wings connecting the two larger blocks. Construction begins next January.

For Johnson, the curving north facade of his 37-story AMA Tower in

**AMA Tower, Manila, Philippines**

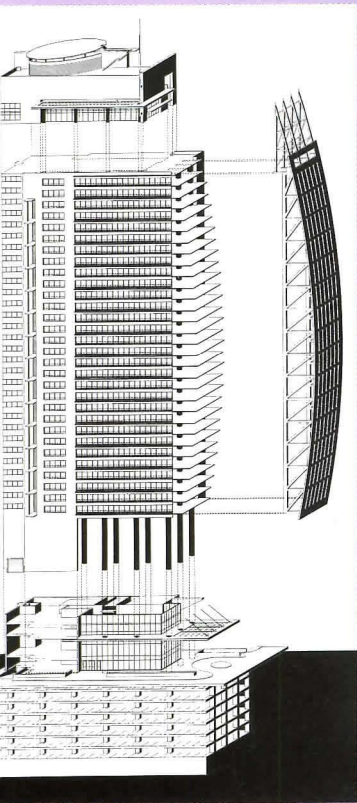

**International School Manila, Manila, Philippines**

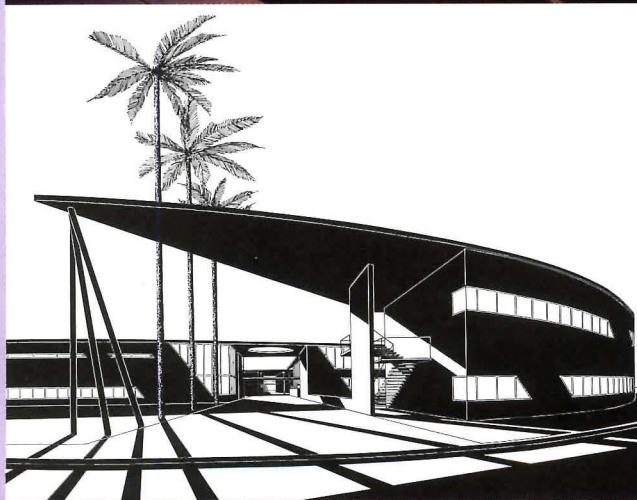

**J.L. Stanford Middle School, Palo Alto, California**

Manila, designed with local firm Luis & Associates and now under construction, evokes a wind-filled sail. This nautical reference winks at the 441,000-square-foot residential and office condominium tower's

suburban site, which Johnson describes as "a sea of asphalt."

Of all his current projects, the context of the 73,000-square-foot Chicago Academy of Sciences Nature Museum in Lincoln Park is closest to Johnson's heart: The architect lives nearby. "I used to jog by the site everyday," he says, "but I never thought I'd be building there." The museum specializes in the natural history of the Midwest. Correspondingly, Johnson designed the cluster of wedge-shaped blocks as an abstraction of the dunes that used to cover the site. The building, which is slated for completion in 1999, is bisected by a glazed lobby; to the north lie galleries, to the south, an auditorium and classrooms. *Ned Cramer*

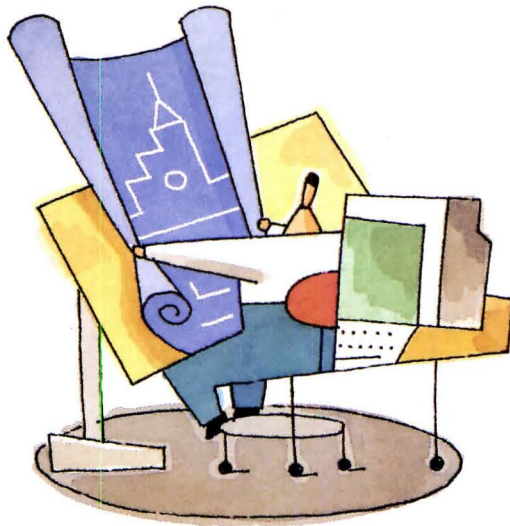

*The architect had big plans—but his client's wallet had other ideas.*

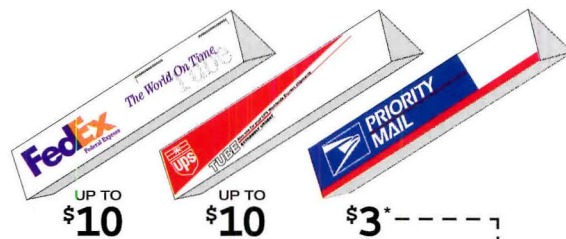

**What's Your Priority?™** ←

FB20

Switch to Priority Mail™ and you can save money even when sending the largest drafts. Mailing tubes are free.

1-800-THE-USPS ext. 2003 <http://www.usps.gov>



*We deliver.*

\*Priority Mail average delivery of 2-3 days. Price comparisons based on Priority Mail up to 2 lbs. vs. 2-lb. published rates for FedEx 2Day<sup>SM</sup> from \$7.25 to \$10.25 and UPS 2nd Day Air<sup>SM</sup> from \$7.25 to \$10.50. ©1998 U.S. Postal Service

**Circle 53 on information card**



The Washington, D.C.-based National Trust for Historic Preservation, chartered by Congress in 1949, is a nonprofit organization charged with providing leadership, education, and advocacy on behalf of the nation's historic places and communities. Since he was named president of the Trust in 1993, Richard Moe has worked to broaden the mandate of the organization to advocate for the control of sprawl. He is the coauthor (with Carter Wilkie) of *Changing Places: Rebuilding Community in the Age of Sprawl*, published in December by Henry Holt.

# Leading the Trust

**Richard Moe heads an organization best known for preserving historic houses. So why is he worried about the suburbs?**



BILL GEIGER

**ARCHITECTURE:** You say sprawl is as great a threat to the preservation movement as urban renewal was a generation ago. How is the Trust addressing this threat?

**RICHARD MOE:** First, through land-use mechanisms that manage growth more successfully and, second, we're using preservation as a tool to revitalize older communities. That's really what preservation has become over the last couple of decades. *Changing Places* is designed to talk about how preservation is being used to reinvent downtowns, to revitalize smaller towns through our Main Street program, and to revitalize older, inner-city neighborhoods at the grassroots level. There are marvelous success stories.

**Is sprawl something that Americans recognize as a problem?**

Yes, increasingly, although they don't yet connect it with the totality of what's going on in any given metropolitan area. They recognize it when they're stopped in traffic or when they see an ugly strip mall, but a lot of this becomes part of their daily routine. Sprawl is very much on people's minds.

**Do you think the goals of the preservation movement resonate with many Americans?**

More and more they do. Preservation used to be defined by what Ann Pamela Cunningham did when she saved Mount Vernon—that is, saving single, significant houses, mansions for the most part. But in the last half-century, especially the last several decades, preservation evolved as society changed. It's had to. We learned that we couldn't save single buildings in isolation; we had to look at them in context, whether that context was a block or a neighborhood or a whole community. So we began developing strategies to save, preserve, and revitalize larger areas—whole neighborhoods and communities. This has led to the use of preservation as a tool for community revitalization. We will always be saving the Mount Vernons and significant old structures, but preservation has become a multifaceted kind of activity. Our goal in the preservation movement is to persuade Americans that the built environment is as important to them and their welfare as the natural environment is. The environmental movement has done a



Construction in Atlanta's Martin Luther King, Jr. Historic District received a 1997 National Trust preservation award.

marvelous job of inculcating environmentalism as an ethic or value for the American people. That's our goal, too, but we're about 30 years behind them. We hope that people will see the value of the built environment to their family, their daily lives, and their community—and increasingly they are. There's no question that progress is being made.

**How did Disney's failed attempt to build a theme park near the Manassas Battlefield affect the preservation movement?**

It galvanized the preservation community for about a year. It wasn't just a local issue: People from all over the country responded in a very positive way. That experience was totally about sprawl. There was nothing historically significant about the land on which they were going to build the theme park. And there were no structures there of any kind. So this was not your traditional preservation fight. Rather, it was an issue

of the collateral sprawl and development that would have emanated from the theme park and overwhelmed these fragile battlefields and historic communities for miles around. People saw that. Of course, it helped to get [prominent historian] David McCollough on our side. When people saw some of their most sacred historic landscapes at risk, it all came together. It was a great object lesson in what sprawl can do.

**Should government play a more active role in preservation?**

This is a complicated issue. Government does have a role. Governments can be the stewards of historic properties. The question is: What kind of stewards are they? I think government has an additional responsibility to offer support and encouragement for the preservation of historic structures. And that can happen through tax credits: The Federal Rehabilitation Tax Credit has been responsible for attracting

LUTE BONISE

## We Stand Behind Our Products

Polygal Polycarbonate Sheet is your logical choice for outdoor and indoor glazing and covering applications requiring light weight, exceptional strength, maximum light transmission, outstanding insulation characteristics and fire safety.



We offer the widest range of thicknesses, colors and multi-wall construction styles in the industry, along with a proprietary line of custom profiles to join, cap and trim panels . . . all backed by a 10 year non-prorated warranty!\*

For more information, see your POLYGAL Distributor, call 1-800-537-0095, or visit us on the web at [www.polygalusa.com](http://www.polygalusa.com)

\*Warranty details available upon request



**POLYGAL®**  
The Leading Supplier of Quality Glazing Alternatives Since 1983

Circle 55 on information card

## We're Here to EARN Your Business...

*with exactly the connector you need, on spec and on time – every time!*

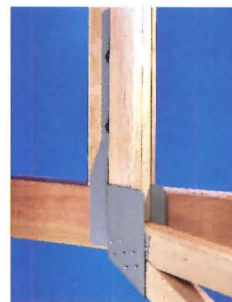

### Greatest Design Flexibility

More options on more hangers than any other manufacturer. Skewed or sloped seat, sloped top flange, offset top flange, concealed flange –, we can modify our hangers to meet your need.

### Exclusive Computerized Manufacturing

Catalog hanger specials are produced precisely to *your* specs. Cost is lower; quality is higher; installation is easier and delivery can be accurately forecast.



Call 800/999-5099 for a catalog or answers to connector design questions. Let us earn your business and show you why we deserve our No Equal reputation.

**SIMPSON**

**Strong-Tie**  
CONNECTORS

**SIMPSON STRONG-TIE® CO., INC.**

The World's "No-Equal" Structural Connector Company

California ■ Florida ■ Ohio ■ Texas ■ Canada ■ UK

Circle 57 on information card

more than \$17 billion in private capital to income-producing buildings that are either on the National Register or are contributing buildings to a National Register District. Although it was largely eviscerated in 1986, it's still on the books. It's a little harder to access, but it's still being used. Our top priority now is to persuade Congress to enact what we call the Historic Homeowner Assistance Act. This would include a 20 percent federal tax credit for investment in historic homes on the Register. This would do more to preserve historic structures all over this country than any single thing we could do. And it would stabilize neighborhoods, particularly low- and lower-middle-income neighborhoods in older cities. It has strong bipartisan support on Capitol Hill. There are state tax credits that do the same sort of thing. Some states have tax-abatement provisions whereby if you invest in your historic house, your real estate taxes will be frozen for a period of years. I think

the underlying premise is the recognition that historic structures deserve special treatment as part of our common heritage and they often require special incentives for restoration and maintenance.

**What's your read on the New Urbanist movement? Are they allies in the preservation movement?**

For the most part, I think they are. Some of the most talented urban planners in America are New Urbanists. I'm all for using traditional principles in building communities. My quarrel with the New Urbanist movement is that they don't devote enough of their talents and energies to existing communities. They could be major players in the restoration and revival of older communities. But for the most part, they're only building new ones. I'm not a no-growth person, and while New Urbanist communities are better than what has traditionally been built, they could do even greater work



National Trust awarded Deland, Florida, its 1997 Great American Main Street Award for preserving its downtown.

if they found ways to work within existing communities—older cities and towns of all kinds. In fairness, some of them are—Peter Calthorpe, for example, is doing that. I wish more of his colleagues were.

**What role have architects played in the preservation movement?**

I don't think we could have gotten anything



**ARCHITECTURAL DESIGN FACULTY  
WITH PARALLEL EXPERTISE**  
Tenure Track Faculty Positions  
Beginning Fall 1998  
**CARNEGIE MELLON UNIVERSITY**  
School of Architecture

The School of Architecture of Carnegie Mellon University's College of Fine Arts announces faculty positions for teaching in an accredited program for the first professional B.Arch. degree, as well as for teaching and research in a graduate program. The Faculty of the School of Architecture at Carnegie Mellon are seeking Design Studio Faculty with Parallel Expertise in one of the following areas:

**Tenure Track position in Computational Design and Simulation, focused on:**

The development and use of innovative computational tools for visualization, simulation, prediction and analysis; multimedia technologies and their application to design education and practice; building product modeling & design databases.

**Tenure Track position in Building Economics, Life Cycle Assessment, and Environmental Sustainability, focused on:**

The development of innovative approaches to building and design economics, real estate/facilities management, life cycle assessment, and environmental sustainability. The candidate is expected to teach and conduct research in the core areas of building and design life cycle economics, including issues of environmental impact and eco-balances as relevant to the construction and operation of buildings.

**Tenure Track position in the Performance of Complex Buildings and Advanced Building Technologies, focused on:**

The development of advanced building materials, components, assemblies, and construction technology, including innovative structures, enclosures, mechanical, networking, lighting and interior systems – to enhance the integration of building systems and the corresponding performance quality of complex or innovative building designs.

The School is seeking innovative teaching methods for bringing practice and research into professional education. Persons who have experience in the practice of architecture, construction or engineering are encouraged to apply. The appointment will be to the rank of Assistant or Associate Professor, in a tenure track appointment.

An application is invited wherein goals for teaching and research are enumerated, a resume is included, as well as three references along with the address and telephone number of each. Except for full time practitioners who have not previously taught, experience in studio teaching should be demonstrated through course descriptions, assignments, examples of student work and student evaluations. Parallel expertise should be demonstrated by professional practice accomplishment or by research publications and funding. Applications should be sent to Associate Head Bruce Lindsey, 201 College of Fine Arts, Carnegie Mellon University, Pittsburgh, PA 15213, USA, no later than March 15, 1998. Carnegie Mellon University is an Equal Opportunity Employer.

# Archiflash®

The only architectural FLASHCARD study system.

"Passed First Time!  
Your system is great."  
— Randy Rice



"Great product!  
Best study tool I have found."  
— Molly Scanlon

**new edition**

Give yourself an edge. Familiarize yourself with the necessary information to pass the Architectural Registration Exam. Archiflash® contains over 1,100 expertly written flashcards covering information on all seven written divisions of the A.R.E. Learning is easier with time saving charts, essential definitions, clarifying diagrams, and questions & answers. More information than you ever thought possible in an easy to use flashcard format. Deal yourself a winning hand—study with Archiflash®.

**PAY ONLY \$89<sup>95</sup>** for the entire set. Individual divisions available at \$21.50 ea. (plus S&H)

**ORDER YOURS TODAY!**  
**800-411-7314**

Circle 59 on information card

NEW VERSION!

# MiniCAD<sup>®</sup> 7

Windows<sup>®</sup>/Macintosh<sup>®</sup>

The Easiest, Most Cost-Effective Way to Design

For more than a decade, architects seeking an out-of-box CAD solution have selected the award-winning MiniCAD. This stand-alone program lets you create everything from precise working drawings to sophisticated client presentations to extensive materials lists and cost estimates.

As always, MiniCAD 7 offers the same core features that have made it the program of choice



for builders in more than 80 countries—multi-decimal accuracy for precise drafting, a built-in database/spreadsheet to track costs and materials, cross-platform compatibility (Mac and Windows), and a macro programming language for automating complex and routine tasks.

Now this total CAD solution speeds your design process with these new features:

- True 3D Boolean Solid Modeling
- DWG and DXF Import/Export
- Dual-Unit Dimensioning
- Auto Wall Framing
- QuickDraw 3D Rendering
- Associative Hatching

- Automatic Wall Joining
- Next-Generation SmartCursor
- Precise Sun Positioning
- Expression Evaluation Inside Textboxes
- Automated Databases/Spreadsheets
- Multi-Decimal Dimensioning
- Rotatable Grid and Customizable Coordinate System
- Plus Dozens of Performance and Interface Enhancements

To learn more about MiniCAD's extensive feature set and why the program was voted "the easiest, most cost-effective way to design" by your peers at

the first CAD Shoot-Out, visit our Web site [www.diehlgraphsoft.com](http://www.diehlgraphsoft.com) or call 1-888-MiniCAD.

**Special offer for Architecture readers:**  
Save \$200 by buying MiniCAD direct for \$595. Includes 18 months' FREE tech support and 90-Day Money-Back Guarantee.

Diehl Graphsoft, Inc.  
1-888-MiniCAD  
[www.diehlgraphsoft.com](http://www.diehlgraphsoft.com)

Circle 61 on information card

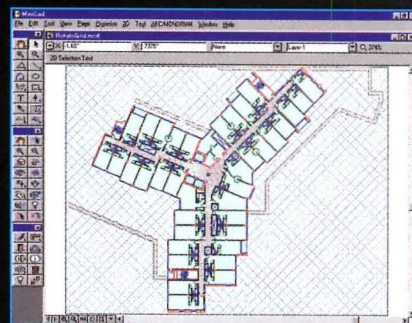
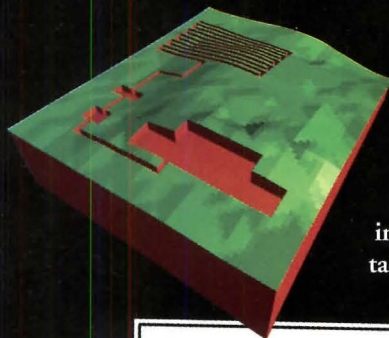

FINISH SCHEDULE										
#	Room Name	NEW	EXIST.	Floor Fin.	Walls	Columns	Roof	Stairs	Windows / Finish	Notes
101	Plant Workshop	CC		1/2" Solid Concrete	1/2" 1/2" 1/2" 1/2"	1/2"	1/2"	1/2"	1/2"	1/2"
102	Plant Office	CC		1/2" Solid Concrete	1/2" 1/2" 1/2" 1/2"	1/2"	1/2"	1/2"	1/2"	1/2"
103	Building Area	CC		1/2" Solid Concrete	1/2" 1/2" 1/2" 1/2"	1/2"	1/2"	1/2"	1/2"	1/2"
104	Plant Area	CC		1/2" Solid Concrete	1/2" 1/2" 1/2" 1/2"	1/2"	1/2"	1/2"	1/2"	1/2"
105	Plant	CC		1/2" Solid Concrete	1/2" 1/2" 1/2" 1/2"	1/2"	1/2"	1/2"	1/2"	1/2"
106	Plant Room	CC		1/2" Solid Concrete	1/2" 1/2" 1/2" 1/2"	1/2"	1/2"	1/2"	1/2"	1/2"
107	Plant Office	CC		1/2" Solid Concrete	1/2" 1/2" 1/2" 1/2"	1/2"	1/2"	1/2"	1/2"	1/2"
108	Plant Office	CC		1/2" Solid Concrete	1/2" 1/2" 1/2" 1/2"	1/2"	1/2"	1/2"	1/2"	1/2"
109	Plant Office	CC		1/2" Solid Concrete	1/2" 1/2" 1/2" 1/2"	1/2"	1/2"	1/2"	1/2"	1/2"
110	Plant Office	CC		1/2" Solid Concrete	1/2" 1/2" 1/2" 1/2"	1/2"	1/2"	1/2"	1/2"	1/2"
111	Plant Office	CC		1/2" Solid Concrete	1/2" 1/2" 1/2" 1/2"	1/2"	1/2"	1/2"	1/2"	1/2"
112	Plant Office	CC		1/2" Solid Concrete	1/2" 1/2" 1/2" 1/2"	1/2"	1/2"	1/2"	1/2"	1/2"
113	Plant Office	CC		1/2" Solid Concrete	1/2" 1/2" 1/2" 1/2"	1/2"	1/2"	1/2"	1/2"	1/2"
114	Plant Office	CC		1/2" Solid Concrete	1/2" 1/2" 1/2" 1/2"	1/2"	1/2"	1/2"	1/2"	1/2"
115	Plant Office	CC		1/2" Solid Concrete	1/2" 1/2" 1/2" 1/2"	1/2"	1/2"	1/2"	1/2"	1/2"
116	Plant Office	CC		1/2" Solid Concrete	1/2" 1/2" 1/2" 1/2"	1/2"	1/2"	1/2"	1/2"	1/2"
117	Plant Office	CC		1/2" Solid Concrete	1/2" 1/2" 1/2" 1/2"	1/2"	1/2"	1/2"	1/2"	1/2"
118	Plant Office	CC		1/2" Solid Concrete	1/2" 1/2" 1/2" 1/2"	1/2"	1/2"	1/2"	1/2"	1/2"
119	Plant Office	CC		1/2" Solid Concrete	1/2" 1/2" 1/2" 1/2"	1/2"	1/2"	1/2"	1/2"	1/2"
120	Plant Office	CC		1/2" Solid Concrete	1/2" 1/2" 1/2" 1/2"	1/2"	1/2"	1/2"	1/2"	1/2"
121	Plant Office	CC		1/2" Solid Concrete	1/2" 1/2" 1/2" 1/2"	1/2"	1/2"	1/2"	1/2"	1/2"
122	Plant Office	CC		1/2" Solid Concrete	1/2" 1/2" 1/2" 1/2"	1/2"	1/2"	1/2"	1/2"	1/2"
123	Plant Office	CC		1/2" Solid Concrete	1/2" 1/2" 1/2" 1/2"	1/2"	1/2"	1/2"	1/2"	1/2"
124	Plant Office	CC		1/2" Solid Concrete	1/2" 1/2" 1/2" 1/2"	1/2"	1/2"	1/2"	1/2"	1/2"
125	Plant Office	CC		1/2" Solid Concrete	1/2" 1/2" 1/2" 1/2"	1/2"	1/2"	1/2"	1/2"	1/2"
126	Plant Office	CC		1/2" Solid Concrete	1/2" 1/2" 1/2" 1/2"	1/2"	1/2"	1/2"	1/2"	1/2"
127	Plant Office	CC		1/2" Solid Concrete	1/2" 1/2" 1/2" 1/2"	1/2"	1/2"	1/2"	1/2"	1/2"
128	Plant Office	CC		1/2" Solid Concrete	1/2" 1/2" 1/2" 1/2"	1/2"	1/2"	1/2"	1/2"	1/2"
129	Plant Office	CC		1/2" Solid Concrete	1/2" 1/2" 1/2" 1/2"	1/2"	1/2"	1/2"	1/2"	1/2"
130	Plant Office	CC		1/2" Solid Concrete	1/2" 1/2" 1/2" 1/2"	1/2"	1/2"	1/2"	1/2"	1/2"
131	Plant Office	CC		1/2" Solid Concrete	1/2" 1/2" 1/2" 1/2"	1/2"	1/2"	1/2"	1/2"	1/2"
132	Plant Office	CC		1/2" Solid Concrete	1/2" 1/2" 1/2" 1/2"	1/2"	1/2"	1/2"	1/2"	1/2"
133	Plant Office	CC		1/2" Solid Concrete	1/2" 1/2" 1/2" 1/2"	1/2"	1/2"	1/2"	1/2"	1/2"
134	Plant Office	CC		1/2" Solid Concrete	1/2" 1/2" 1/2" 1/2"	1/2"	1/2"	1/2"	1/2"	1/2"
135	Plant Office	CC		1/2" Solid Concrete	1/2" 1/2" 1/2" 1/2"	1/2"	1/2"	1/2"	1/2"	1/2"
136	Plant Office	CC		1/2" Solid Concrete	1/2" 1/2" 1/2" 1/2"	1/2"	1/2"	1/2"	1/2"	1/2"
137	Plant Office	CC		1/2" Solid Concrete	1/2" 1/2" 1/2" 1/2"	1/2"	1/2"	1/2"	1/2"	1/2"
138	Plant Office	CC		1/2" Solid Concrete	1/2" 1/2" 1/2" 1/2"	1/2"	1/2"	1/2"	1/2"	1/2"
139	Plant Office	CC		1/2" Solid Concrete	1/2" 1/2" 1/2" 1/2"	1/2"	1/2"	1/2"	1/2"	1/2"
140	Plant Office	CC		1/2" Solid Concrete	1/2" 1/2" 1/2" 1/2"	1/2"	1/2"	1/2"	1/2"	1/2"
141	Plant Office	CC		1/2" Solid Concrete	1/2" 1/2" 1/2" 1/2"	1/2"	1/2"	1/2"	1/2"	1/2"
142	Plant Office	CC		1/2" Solid Concrete	1/2" 1/2" 1/2" 1/2"	1/2"	1/2"	1/2"	1/2"	1/2"
143	Plant Office	CC		1/2" Solid Concrete	1/2" 1/2" 1/2" 1/2"	1/2"	1/2"	1/2"	1/2"	1/2"
144	Plant Office	CC		1/2" Solid Concrete	1/2" 1/2" 1/2" 1/2"	1/2"	1/2"	1/2"	1/2"	1/2"
145	Plant Office	CC		1/2" Solid Concrete	1/2" 1/2" 1/2" 1/2"	1/2"	1/2"	1/2"	1/2"	1/2"
146	Plant Office	CC		1/2" Solid Concrete	1/2" 1/2" 1/2" 1/2"	1/2"	1/2"	1/2"	1/2"	1/2"
147	Plant Office	CC		1/2" Solid Concrete	1/2" 1/2" 1/2" 1/2"	1/2"	1/2"	1/2"	1/2"	1/2"
148	Plant Office	CC		1/2" Solid Concrete	1/2" 1/2" 1/2" 1/2"	1/2"	1/2"	1/2"	1/2"	1/2"
149	Plant Office	CC		1/2" Solid Concrete	1/2" 1/2" 1/2" 1/2"	1/2"	1/2"	1/2"	1/2"	1/2"
150	Plant Office	CC		1/2" Solid Concrete	1/2" 1/2" 1/2" 1/2"	1/2"	1/2"	1/2"	1/2"	1/2"

**MiniCAD 7—  
The only thing  
small is the price.**



done over the years without committed preservation architects. Preservation architects taught us the concepts of adaptive reuse and preservation. Some of the most exciting rehabs I've seen have been done by creative architects, whether it's a church in Lawrence, Kansas, that's been converted into law offices, or an old school in Baltimore now used for senior citizen housing, or an old warehouse in St. Paul reconfigured as studio space for low-income artists. The possibilities here are endless. And, happily, there are more and more really talented architects devoting their energies to these kinds of projects.

**What about designating urban neighborhoods as historic sites?**

Historic designation can be very helpful to a community. It gives a community economic benefits and a sense of identity that it may not have had before. Don Rypkema, a real estate consultant who does a lot of

preservation work, found that historic designation usually improves or stabilizes property values. He never found an instance in which property values declined.

**In *Changing Places*, you touch on the notion of the limitless American frontier. Do we still believe in that?**

There are certain American attitudes that have served us well historically, but can conflict with some preservation issues. One of them is the quest for open space. We have a finite amount of it, we're using it up pretty rapidly, and we simply have to find strategies to deal with it more effectively. We're beginning to do that. There's also this notion that we're a young country, that we don't have a lot of history worth saving. Totally wrong! The other attitude that gets in our way is that, traditionally, we've been a disposable culture. But even that's beginning to change. Again, this is thanks to the environmental movement, which encour-

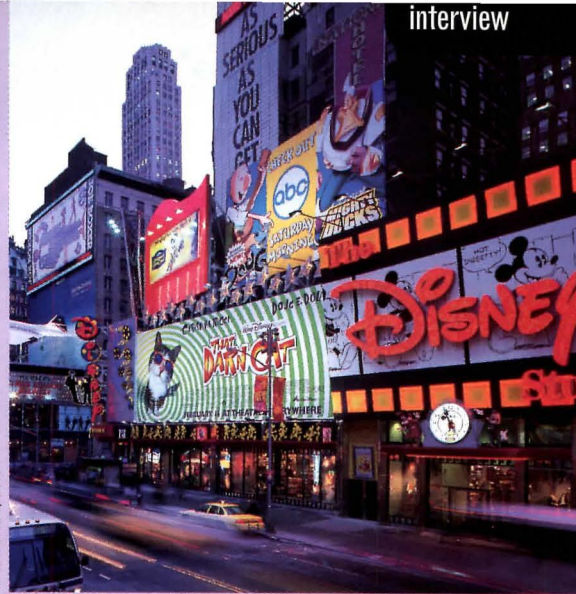

PETER AARON / ESTO

**Revival of Times Square demonstrates that private investment coupled with public policies that encourage redevelopment can make urban areas safe and attractive.**

ages us to recycle everything from aluminum cans to cars. In the preservation movement, we are in the community recycling business.

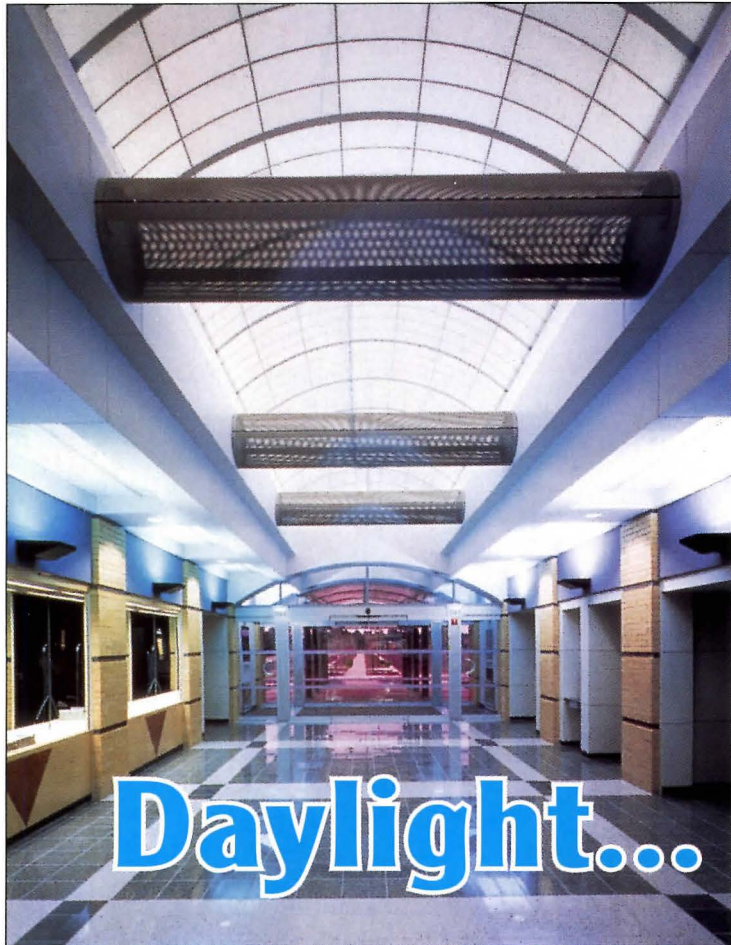

People thrive on daylight. Electrical energy is at a premium. It's no wonder that buildings of the 21<sup>st</sup> century will incorporate more natural light into their designs.

Since 1955, Kalwall has led the world in the innovation and perfection of museum-quality, natural daylight. Time-proven performance of a true structural sandwich panel and total design flexibility yield the most highly insulating, diffuse-light-transmitting technology in the world.

Are your designs and buildings ready for the next millennium? Kalwall has been for more than 40 years! **Kalwall's 8 Systems** can be a part or all of the walls and roof of any building, or even an entire structure!

**High-tech building systems... light-years ahead!**

Since 1955  
**Kalwall**<sup>®</sup>

800-258-9777 [www.kalwall.com](http://www.kalwall.com)  
1111 Candia Rd., Box 237, Manchester, NH 03105

**Daylight... 21<sup>st</sup> Century**

East Columbia Library, Columbia, MD Architects: Grimm & Parker



*Bold Colors. Classic Lines. Perfect Fit.*

It's the timeless look of an EFCO® storefront. Take your pick of 21 standard colors or unlimited custom shades. Coordinate with your EFCO windows and doors. And enjoy the advantages of easy-care aluminum for years of wear. We'll match your specifications exactly to achieve the best possible custom fit.

Contact us at 1-800-221-4169 or <http://www.efcocorp.com> on the Web for information on storefronts and other aluminum glazing systems that flatter your design.



WINDOWS  
CURTAIN WALLS  
ENTRANCES  
STOREFRONTS

*AIA Continuing Education Provider*

# Failing the Course

**The centerpiece of a downtown campus in San Antonio gives lessons in how not to make a building.**

A new downtown campus for the University of Texas at San Antonio (UTSA) symbolizes educational opportunity in a neighborhood decimated by urban renewal. The new 11-acre campus, located within sight of San Antonio's historic West Side barrio, was created in response to an early 1990s court settlement that found the University of Texas historically neglected South Texas minorities. However, the first of at least three buildings to be built on the campus doesn't live up to the promise of the enterprise. The Frio Street Building, designed by local architect Humberto Saldaña and Associates and completed last July, comprises classrooms, lecture halls, a student center, and a library, but makes a disappointing centerpiece for an important institution.

The building is a jumble of arbitrary forms that only occasionally correspond to interior spaces, an expression of *rascuachismo*, according to the architect. This Spanish term refers to the vernacular tradition of adding to a building as needed, usually without

regard to the original form or materials. Such modifications generally are made in stages, however, and the buildings retain a strong formal identity. The Frio Street Building, with its palette of cladding materials and colors, lacks any unifying formal gesture. And since it's new, the building has no history to present.

The Frio Street Building's exterior materials are meant to suggest a mixing of regional precedents: Beige limestone recalls San Antonio's Spanish missions, while glazed tile and aluminum windows refer to European Modernism. But clumsy detailing is obviously inspired less by local vernacular than by a tight budget.

The street elevation is overly monumental, with the formal play of exterior volumes doing little to break up the sheer four-story mass. The Frio Street Building is divided into two blocks that define a passage intended to symbolize the role of the new institution in linking downtown San Antonio—and its economic and cultural opportunities—to the neglected communities on its West Side. But this portal is a stark and uncomfortable shaft capped by a clumsy glass pyramid. Although it is the only shaded public space at street level, the passage is devoid even of seating.

The goal of regionally inflected, inclusive architecture is a noble one, and San Antonio has a rich cultural and architectural legacy from which designers can draw inspiration. Very little of that is visible in UTSA's Frio Street Building. It is merely a conventional classroom building in a gaudy wrapper.  
*Darryl Ohlenbusch*

*Darryl Ohlenbusch is an architectural designer and educator in San Antonio.*





## *Durable Beauty At A More Competitive Price.*

If an architect could create the ideal wood flooring for a commercial project, the floor's wearability would be guaranteed for 25 years. It would have color and tough acrylic forced through the wear layer, so restaining would never be required for the life of the floor.

An architect's ideal floor would come in a broad color palette, and would offer easy-to-achieve custom-look designs by mixing lengths, widths, colors and species.

The ideal wood floor would be readily available, would look like a custom floor, and would be priced more affordably than custom floors.

And it would come with the manufacturer's expert sales and support system, for smooth and timely completion of the project.

This dream floor exists, but only at Hartco. Take a look today. You'll be floored by Hartco's durability, design capabilities, colors and remarkable price advantage.

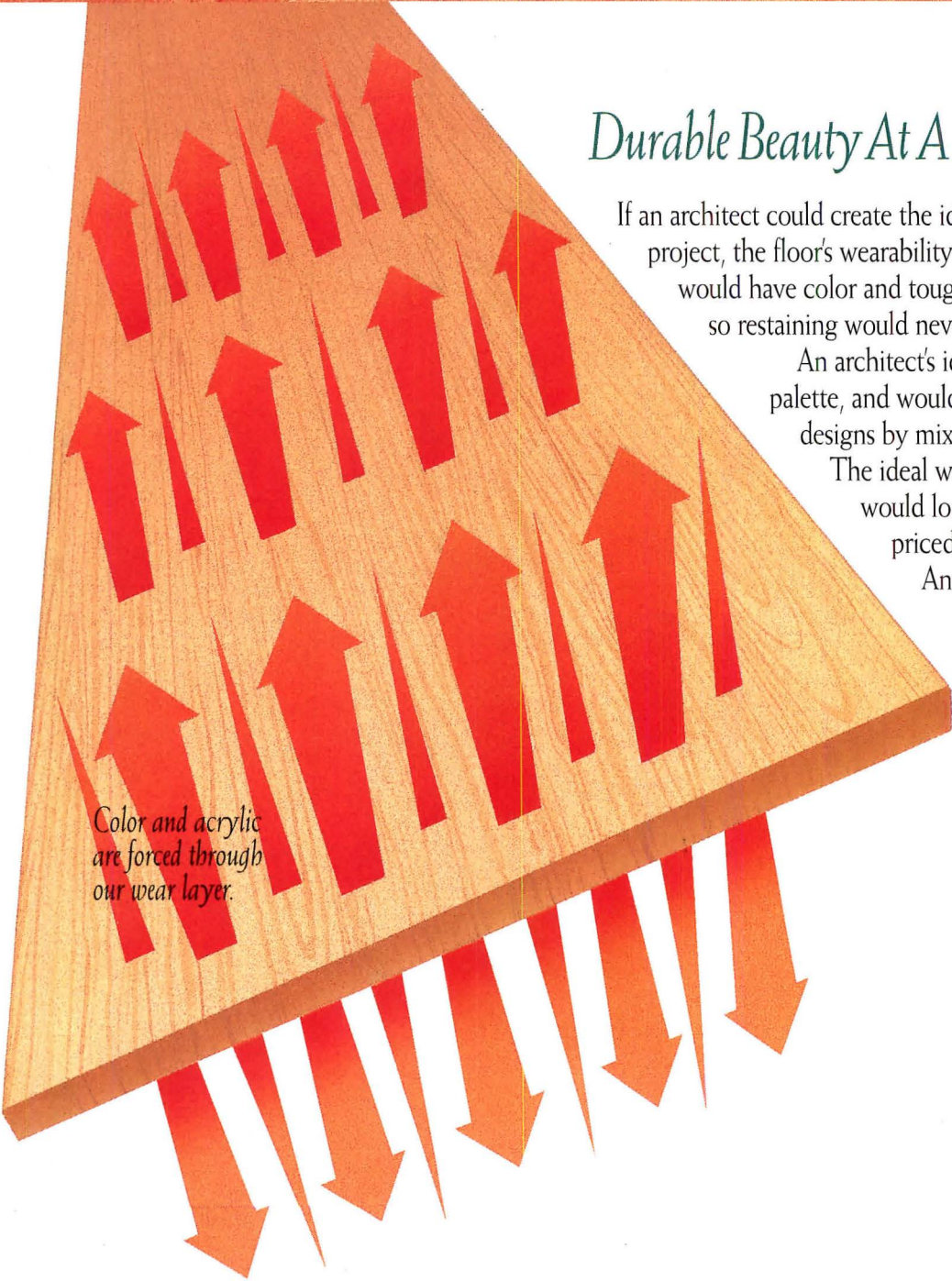

*Color and acrylic  
are forced through  
our wear layer.*

**Hartco**<sup>®</sup>  
Quality Wood Flooring  
a subsidiary of Triangle Pacific Corp.

Circle 67 on information card

# The Strongest Survive.





# architect

## TRANSFORMATIONS

“Nostalgia is the enemy of progress,” avows architect Paul Westlake. It’s a sentiment shared by many of the country’s leading preservationists, as *Architecture* discovered when we convened a roundtable of experts to discuss the state of historic preservation. The buildings in this issue demonstrate that many architects agree. They aren’t content to treat warehouses, power plants, and even solemn monuments like precious relics, but they are careful not to drown out the past with the energy of their additions. New materials, forms, and functions reinforce the old by asserting their difference. Good design respects the past, but isn’t mired in it.

Thirty years into their ascendancy, advocates of preservation need to acknowledge that they are responsible for at least as many bad buildings as were ever laid at the door of the Modern movement. The phenomenon is national and pervasive. It stretches from the masterworks of imitation—Colonial Williamsburg, Las Vegas, and Disney's town of Celebration, Florida—to the little plastic roof peaks of the nation's myriad roadside ducks and sheds. It shows in the seductive fictions of New Urbanism and America's now-ubiquitous green-boutique downtowns. The ethical core of preservation is, like the core of Modernism at a similar stage, dissolving in a bath of popular success.

The problem lies not inherently with preservation. Like every architectural agenda, preservation is an expression of preference of the society that invests in it. Architects' heroic outrage at the demolition of New York's Pennsylvania Station in 1962 set in motion something that fit perfectly with the needs of a society that was losing confidence in the new. Thereafter, the ascending old—and imitation old—offered comfort to people seeking reassurance, and opened new territory for the exercise of its righteous energies. Just as Modernism expressed and served ambitious meliorists ready to start fresh early in the century, preservation shores up a culture that is losing its nerve.

In its success, preservation made its own contributions to the proliferation of its problem. It retreated from larger questions about its purposes and limitations to concentrate on small ones of technique. It seemed to authorize, welcome even, a historicist "contextual" architecture stuck on buildings like bubble gum. It allowed its issues to be decided not so much by thought as by appeals to authority. Like the conflicted, wealthy, self-absorbed society around it, it became dogmatic and imposing.

**The preservation movement has become a victim of its own success.**

*pickling*

**By Paul Spencer Byard**

# THE PAST



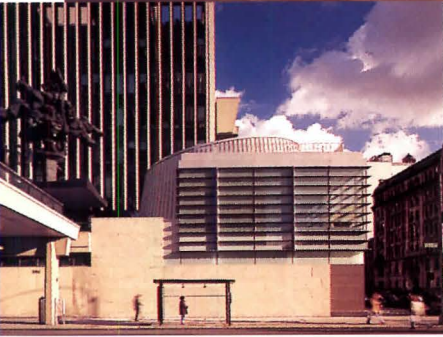

**Polshak and Partners' streamlined addition enlivens ribbed box of Harrison & Abramowitz-designed Columbia Law School. Louvered, glass-and-steel entrance pavilion, placed atop inhospitable concrete plinth of original building, re-engages school with street grid, and provides clearly defined entrance to building.**

In this state, preservation seemed to lose touch with its ethical core. It lost sight of the fact that it is about reality, about the survival of real things and the lessons inherent in them, who we have been, and who we are as we try to make something of our lives. It treated its old buildings as artifacts to be coddled even at the expense of the truth, rather than works of art that make the truth accessible. It forsook its unique critical significance as a device to show difference, not to obscure it.

Preservation lapsed into this state because of an ambiguity about the nature of its work: It had difficulty embracing its entanglement with the present and the new. The field has always been troubled by the fact that its interventions, even in the strictest restoration, are all contemporary expressive choices, showing what we want to think of old things now, not what they immutably are. Preservationists now need to forget this hesitation and acknowledge that the movement's architects, scholars, and advocates are unavoidably engaged with the new in the great and difficult public art of architecture, helping new architecture use old buildings and their meanings to speak accurately about our times. As such, its highest concern is not so much the safety of the old as the quality and validity of the new. What matters most is not what the old thing is, but what new architecture makes of its meaning. An acknowledgement of the cardinal importance of the new—indeed a cheerful embrace of its wonderful possibilities—will not necessarily be popular in a society that likes to pretend, one that has difficulty with reality and with difference. But it should be helpful in getting out of the current imitative morass, particularly in addressing the most important piece of business now facing preservation: buildings from the mid-20th century. The monuments of Modernism—many of them deeply unpopular—make the difference that preservation exists to serve particularly vivid.

Modernism was important exactly because it did not do what popular preservation might do. Modernists thought things were different in the early 20th century, that we could change and do things for our own good that were unheard of in the past. Embracing abstraction like the other arts of its time, Modernism showed off its confidence in the new, spoke for its times, and in the process, opened limitless and extra-

ordinary expressive possibilities. It also got into serious trouble as its ideas became simplistic dogma and were widely and destructively imposed.

The mixture of wonders and troubles in these buildings—their obdurate reality and irreducible difference—puts the question of what to do with them happily beyond pastiche. Furthermore, some first-class examples of what can be done with them—the understanding they require and the possibilities they offer when engaged in serious new architecture—are already on hand to see and indeed to celebrate. These have nothing to do with preservation as we have come to know it; however, their treatment of historic buildings makes us reconsider the expressive potential of inventive presentation. Gifted architects are using older 20th-century buildings to say something about where we are as we approach the millennium.

Columbia University's Jerome S. Greene Hall (facing page) is a fine example of the redemptive powers of new architecture added onto the old. The object of Polshek and Partners' work was a tough one: expanding Harrison & Abramowitz's easy-to-hate Columbia Law School (1963). The famous toaster on 116th Street in New York City embodied lumpish versions of important ideas of its time—notably, in its siting back and up from the street on a raised base. The ideas were our ideas, however much we now think we know better. They differed only in ambition and method from what we wish we could do today. And this is what Polshek's addition acknowledges.

Polshek respectfully applies what we have learned since the 1960s to humanize the law school. Thus, by its placement, the addition ties the school back into the city grid from which the original architects thought they should remove it. It breaks into the old base to unite and dignify the split entries that were the exasperating consequence of the raised plaza. It refines the original uniform stockade of concrete and glass into an elegant horizontal block of clear glass and light metal that engages the contemporary school with the street, animating the transition from the old vertical blocks of McKim, Mead & White's campus to the horizon beyond the cliffs of Morningside Heights. Making a satisfying three-part composition out of the base and tower that is still faithful to Harrison & Abramowitz's original architecture, Greene Hall transforms the school into the work of art it wished to be.

Foster and Partners' Cambridge University Law Faculty Building (right) had a happier object to address: James Stirling's adjacent History Faculty Building (1964), an important building less in need of redemption than moral support. Stirling's History Faculty was a pioneer in the possibilities of tectonic architecture—both as a piece of art and as a representation of the capabilities and resources of its society. The History Faculty regrettably demanded too much of its own technology: It leaked and overheated, becoming unpopular and escaping demolition only with the help of an immovable Tudor historian. Laid down in obvious homage to Stirling, Foster's new neighbor ends the History Faculty's isolation at the edge of the university's campus and vindicates Stirling's ideas in a strong display of what can be made of them given current technical capacities. Where Stirling's library-as-greenhouse fought gravity as it hung down over its historians, Foster's truncated glass quarter-cylinder balloons as it hung down over its historians, Foster's truncated glass quarter-cylinder balloons

Sleek forms of Norman Foster's new Law Faculty at Cambridge University salute adjacent History Faculty Building, designed by James Stirling. Glazed west facade reflects Stirling structure, creating visual and symbolic link between buildings.

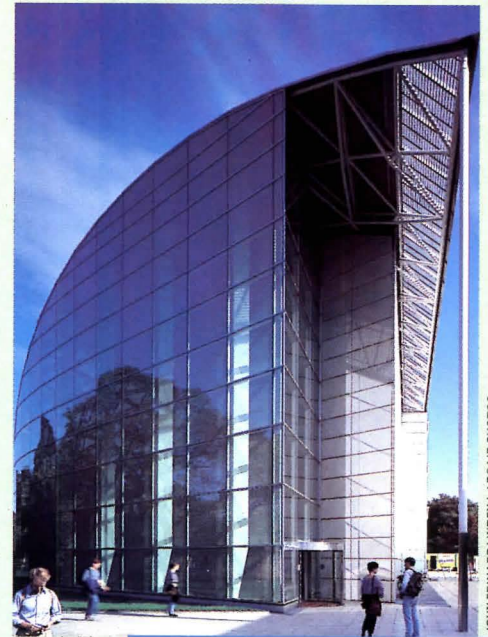

JOHN EDWARD LINDEN / ARCAID PHOTOS



From some views, architect Bernard Tschumi's addition to Le Fresnoy National Studio for Contemporary Arts in Tourcoing, France, creates aggressively new and Modern image (below left and right); from others, it cradles turn-of-the-century structures with new lightweight roof (bottom).

over its trays of lawyers as if with endless energy. His sliced-off main facade, beautifully curved in deference to an historic tree, reflects Stirling's rough glass assembles in an infinitely smooth surface. The facade is freely scored with horizontal offshoots of its accelerating curve, uplifting the adjacent plazas and *pilotis* of Hugh Casson's 1961 Modern Languages Building in the process. Foster's Law Faculty makes Stirling's once-strange portent the lead player in a live demonstration of the possibilities of 20th-century architecture. Foster, on behalf of the university, salutes Stirling, like a cheerful, old-radical professor acknowledged at last for his early work.

Demonstrating the most daring new approach toward preservation, Bernard Tschumi's National Studio for Contemporary Arts in Tourcoing, France, is much more disturbing. Tschumi began with three elderly, turn-of-the-century arenas for popular entertainment like wrestling and animal acts. Recognizing the buildings' value as forebears of the "popular" high-tech media arts to be taught at the school, the architect shelters them under a gigantic roof that feeds technical services from above. Lit through cutouts in the roof decking, the zone between the roof and the old spaces is filled with columns, rods, ducts, catwalks, and stairs that Tschumi adds to make it read as the meaning of the combination of old and new. What he makes and celebrates in this zone, we realize, is a built rendering from the computer screen, made accessible by an extraordinary vertiginous grand stair that makes getting there like falling through the looking glass. Playing with the stair's scale, Tschumi lands the beguiling folly of the studio amid the scraggly trees of its site like a visitation from another order of imagination, adapting the old arenas for the play of the virtual monsters of our mind.

These three aggressive, confident additions give some sense of the pleasures of a renewed attention to the ultimate business of preservation: making the most of the meanings of old buildings with discipline, faithfulness, insight, and imagination. Each addition treats its old building respectfully, like a collaborator, and works out insights of real value. They make clear what we are doing as preservationists and why we are doing it—and why it is an unambiguously worthwhile task.

*Paul Spencer Byard is principal of New York City-based Platt Byard Dovell Architects.*





At Le Fresnoy, Tschumi shelters existing buildings beneath new umbrellalike roof. Tschumi celebrates zone between new roof, containing high-tech services, and renovated sheds below.



PETER MAUSS / ESTO PHOTOS

# POWERED



ASSASSI PRODUCTIONS

By Joseph Giovannini

House reclaims former electrical station in revitalized industrial zone now filled with live-work studios (above). Site borders railyards on northeast edge of downtown Los Angeles (right).





**ROTO RECHARGES A DERELICT POWER  
STATION WITH AN ELECTRIFYING LOFT  
CONVERSION.**

**UP!**



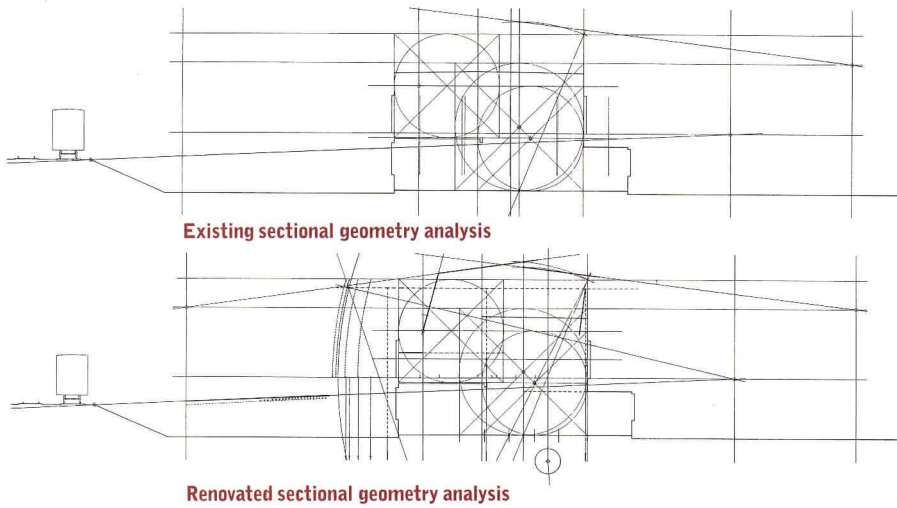

Every six years or so, a breakout house gives the architectural profession pause. In the early 1970s, it was the Douglas House by Richard Meier, perched in solitary white splendor on a steep, wooded hillside overlooking Lake Michigan; later in the decade, it was Frank Gehry's reinterpretation of his own plain and ordinary bungalow as an open-air, live-in installation. In the mid-1980s, the Austrian firm Coop Himmelblau plumbed the potential of chaos with a flurry of lines conceived as a storm of glass and steel in Malibu. All were houses that precipitated an esthetic, and the Gehry and Himmelblau designs, in particular, shifted the architectural paradigm to a wilder place. Houses, after all, color practice, make reputations, and sometimes pivot architectural history.

After a long dry spell, a new house by Partners Michael Rotondi and Clark Stevens of Los Angeles-based RoTo Architects, has emerged as the next significant notch in the architectural timeline. The form of the complex, hybrid structure reflects an unusual genesis, based in a peculiar site and nurtured by clients who almost seem invented themselves.

RoTo's commission involved remodeling the machine shop of L.A.'s first electrical power station in a former industrial belt near downtown. The building, adjacent to the street and surrounded by a parking lot, was already being used as a loft by Kathy Reges, an art collector, and Richard Carlson, a demolition contractor who specializes in dismantling industrial buildings. The couple wanted more comfort from their unusual house, while retaining the structure's raw, open nature. The steel-framed, concrete-clad building—styled in 1915 as a two-story, Neoclassical pavilion—overlooks the main railyards leading into downtown L.A.; a major freeway; the city's skyline; and the Santa Monica and San Gabriel mountains. With long trains locomoting along a web of tracks, the surrounding landscape moves—accompanied by riffs of train whistles—to unstructured, percussive beats of steel against steel.

What seemed at first like a forbidding industrial wasteland proved a real-life Tinkertoy quarry that RoTo culled to produce one of the most compelling architectural visions since Gehry combed the thoroughfares of L.A. for his own street-smart house: A steel-girder depot, like a lawn surrounding the old



ASSASSI PRODUCTIONS



RoTo's geometric analysis determined reconfigured section (diagrams, facing page). Steel shell atop existing concrete-and-steel pavilion (facing page, top and above) contains bedroom annex. Angular steel panels supported by rooftop beams buffer south side of house (top left and left). Walkway between steel cladding and original structure wraps southwest corner of house (facing page, bottom).

Solid steel door on south flank of house (below) leads to private entrance. Stairway (right) leads to kitchen. Stairs are finished in cherry wood; small desk flanking kitchen (facing page) is crafted of beech.





machine shop, offered the architects a trove of material with which to build their invention. Cranes and forklifts were already on site, and a full-time steel fabricator was brought in to provide expertise.

The clients were game for the adventure: “Kathy and I figured Michael was very talented, and if you’re going to commission an architect to build something, you might as well let him have a free hand. We knew that trying to fit into a three-bedroom, two-bath real estate sheet wasn’t going to work,” says Carlson, who served as general contractor for the three years of construction.

RoTo’s domestic transformation grew out of the surrounding rail and recycled-materials yards as organically as any house Frank Lloyd Wright built into a bucolic slope. The serene idealism of a Petit Trianon confronted the powerful metallic materiality of the industrial landscape in a roiling composite of the cooked and the raw. The architects began by reorganizing the building’s section. The vertiginous 36-foot-tall living room on the ground floor of the existing loft became a semiprivate gallery, while the upper floor emerged as a more intimate, but still soaring, living and dining area. Steel shells were added

to the roof to enclose a new master bedroom and a mezzanine-level guest room above the living room. A corrugated metal shield was added on the railyard side of the house to mitigate sound and diesel fumes, creating a tall perimeter wall at grade to invert the site adjacent to the structure. The yard was lushly planted as a rain-forest garden, and an old gas tank was halved and welded together end-to-end to form a lap pool elevated above the garden on metal struts.

Rotondi and Stevens foraged in the adjacent depot to find cast-off trusses, beams, and staircases. Their fundamental insight was to subvert the repetitive character of these industrial parts by reassembling them in nonstandardized ways—“to end up with spatial configurations that weren’t merely rectilinear and repetitive,” explains Stevens. But the architects did not simply create an architectural collage of found parts. They extrapolated lines from significant moments in the surrounding landscape—the neighboring towers of downtown, various mountain peaks, and Dodger Stadium—into the building to create geometries that organized the recycled members that were worked through the structure.

- ① entrance
- ② studio
- ③ storage
- ④ garden
- ⑤ kitchen
- ⑥ living
- ⑦ open to below
- ⑧ deck
- ⑨ pool
- ⑩ bedroom
- ⑪ wardrobe

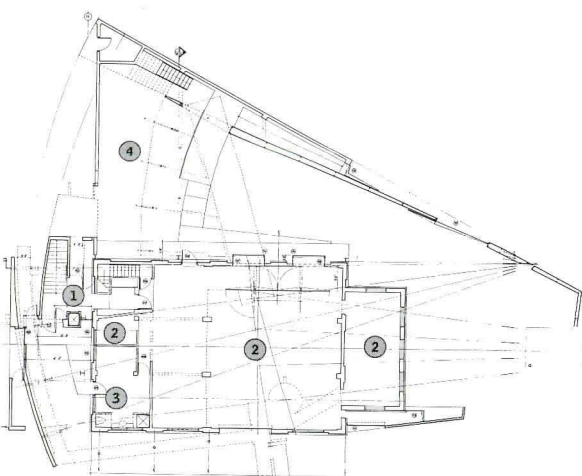

First-floor plan 1" = 20'/6m ⊙

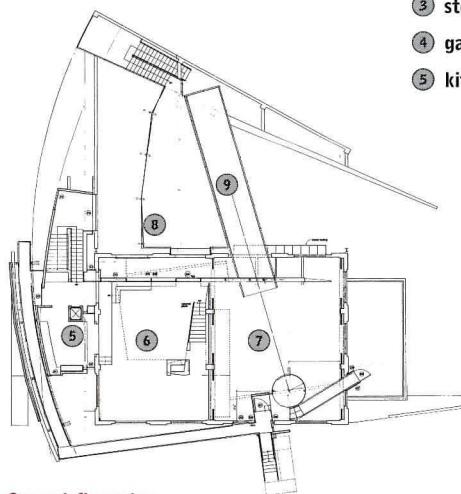

Second-floor plan

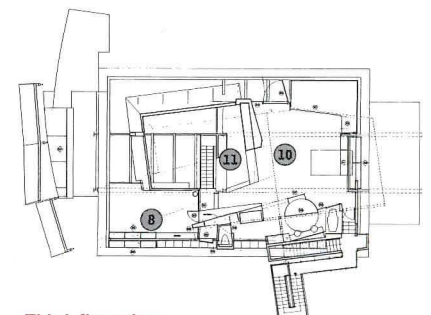

Third-floor plan



New steel armature supports corrugated metal shell crowning soaring second-floor living and dining areas (facing page and right). Windows along living room's south wall (above) overlook double-height gallery. Stair behind drywall-encased fireplace stack leads to third-floor master bedroom with panoramic views (top right).



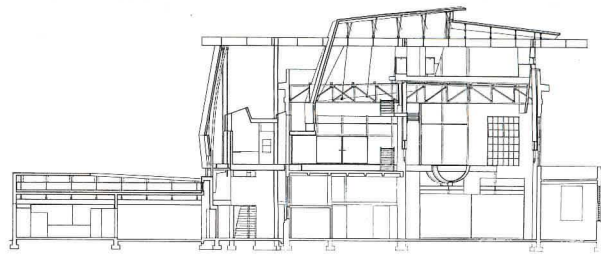

North-south section looking west

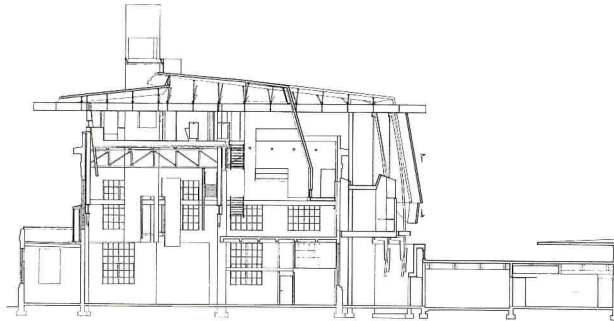

North-south section looking east

"We've been influenced by the relationship American Indians have to the land, and we're always thinking about how to bring physical and spiritual geographies into a project," says Stevens. "We analyzed the building through drawings to understand the internal relationships. It's like a Rorschach test: You look at something and things start to emerge—you see potential volumes."

With sight lines converging inside, the architects cultivated a reciprocal relationship between the building and the near and distant landscapes. Instead of one geometric center, there are several centers of several arcs. "We found a secondary geometry with multiple centers, and their radii generated the building's form," explains Rotondi. In plan, pie-shaped wedges radiate lines past the outside walls to points in the landscape. This new geometry gives the structure a dynamic secondary language of incomplete, non-Euclidean forms that contrast with the serene simplicity of the original structure. Neither the absolute world of the original Classical shell nor the dynamic world of RoTo's abstract interventions dominates, leaving the house in a tense state of ambiguity between the certainty of the old and the uncertainty of the new. The overlapping geometries generate small-scale terraces, landings, and overlooks that are subsumed within the larger program.

Just as the architects opened the structure to the environment with radiating sight lines, they also opened the design process to other participants—contractor, fabricators, and consultants—in a drawn-out jam session verging on improvisation. Rotondi does not believe that the architect should dominate other actors in the building process: He relaxes the grip over design exercised by so many architects, enriching the building with different disciplines and thought systems. This brand of "open practice" was especially productive in the Carlson-Reges project because the location of RoTo's studio—a stone's throw from the house—allowed frequent discussions with carpenters and steel fabricators. "We told each tradesman our design intentions so we could hear their advice," recalls Rotondi. "We wanted what the steel guy does in an ordinary industrial building. I learned that an industrial building is an additive system. You don't weave things together; you add layers." Rotondi decided to live with any mistakes,





Architect RoTo transformed rusted steel gasoline tank found on site into lap pool attached to west side of living room (far right). Supported on steel struts, pool shades lushly planted private garden (right).

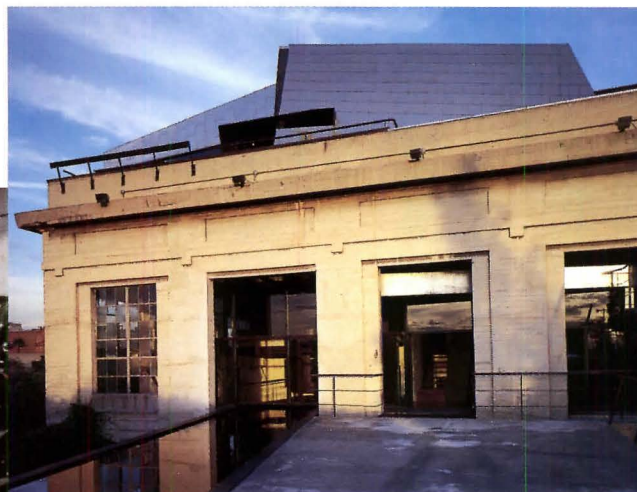

“even if it looked bad.” The architect was secure enough with the process to simply let things happen. Instead of typical working drawings, Rotondi and Stevens improvised hardlined sketches on 8½-by-11-inch sheets. “We kept ourselves in a realm of uncertainty as long as we could, taking a higher degree of comfort in the unpredictable. We were trying to capture uncertainty itself in this building,” Rotondi suggests. The architects walked the thin line between coherence and incoherence—“that turbulent moment when matter transforms from one state to another, all the parts interacting,” says Rotondi.

The architects didn’t cut into the existing structure, but simply removed windows and door frames to allow pieces of the new steel armature to penetrate open expanses in the original pavilion enclosure. With outside spaces moving inside the shell and interior spaces flowing outside, the architects blurred boundaries of spatial divisions with membranes that jump back and forth between old and new. A redwood deck inside the original concrete frame, for example, lies outside the two new bedroom areas but within the corrugated metal enclosures, creating an in-between space.

Each new piece of the house has a memory of other geometries. It anticipates the next, and the metamorphosing forms are always in a state of self-mutation. Each piece, such as the hovering plaster volumes in the living room, is experienced in different ways from different angles, and nothing is revealed from a single point of view. The building’s spaces and forms unfold unpredictably, especially where the old and new geometries and languages collide to shape hybrid spatial pockets. The architects have created a building with an underlying composite order that does not easily reveal itself. This complexity has coherence, however; the building may be segmented, but it is not fragmented. “We were not interested in creating alienation and fragmentation, but wholes,” explains Rotondi.

The Carlson-Reges House accomplishes the rare feat of displaying sophisticated tectonic expression without being merely technological. In a dance that seems to flirt with both the rational and irrational, the architects have enchanted a serene, Classical structure into a state of wonder with hard-nosed logic and a heavy dose of heavy metal.

**CARLSON-REGES HOUSE**  
LOS ANGELES, CALIFORNIA

**CLIENTS:** Richard Carlson and Kathy Reges **ARCHITECT:** RoTo Architects, Los Angeles—Michael Rotondi, Clark Stevens (principals), Angela Hiltz, Kenneth Kim, Yusuke Obuchi, Brian Reiff, Craig Scott (project team), Michael Brandes, Peggy Bunn, Carrie Jordan, Bader Kassim, James Keyhani, Gregory Kight, Thorsten Kraft, Qu H. Kim, Tracy Loeffler, Liana Sipelis, Caroline Spigelski, James Malloch Taylor (project assistants) **ENGINEERS:** Peter S. Higgins and Associates (structural) **CONSULTANTS:** Donald T. Griggs (structural steel fabrication); Richard Reyes; Arkkit-forms (furniture) **GENERAL CONTRACTOR:** Richard Carlson **COST:** Withheld at owner’s request **PHOTOGRAPHER:** Benny Chan/Fotoworks, except as noted



At east end of gallery, new structural frame supports second reconfigured steel tank, housing contemplative space, portion of master bathroom, and rooftop belvedere (below left). Enclosed by glass wall, pool scupper projects into upper reaches of gallery (below).



BY EDWARD KEEGAN



A FORMER WAREHOUSE IN CINCINNATI TAKES  
ON NEW LIFE AS A VIDEO-PRODUCTION STUDIO.

INDUSTRIAL

FILM





Curving concrete ramp in lobby leads visitors past reception desk to video viewing area (facing page, top). Two-story brick addition (left) continues concrete sill course of existing warehouse (at right). Clerestory between new and old buildings (above) brings daylight to stairwell. Clear glass and translucent acrylic panels enclose mechanical room.

An esthetic derived from glass, steel, and exposed utilities can be labeled “high-tech” architecture. But when compared with cutting-edge computer technologies like those used at Cincinnati’s Lightborne Communications for video production and editing, even a sophisticated architectural expression of polished materials can seem downright primitive.

“There’s nothing high-tech about the architecture here,” asserts Argentine-born architect José Garcia, describing the elaborately layered renovation and addition located in Back of the Rhine—a neighborhood of solid immigrant-built masonry structures. Garcia and codesigner Terry Boling began the project in collaboration with Ken Jones—a Cincinnati-based architect whose preservation expertise proved critical in restoring portions of the original building—and during the process, founded their own four-person firm named VOX Architects. The team of Garcia, Boling, and Jones inserted an assembly of metal-and-glass volumes, exposed mechanical and electrical services, and a sculptural concrete stair into a late-1930s warehouse. Each of these additions physically supports Lightborne’s innovative digital technologies, and visually emphasizes the high-tech nature of the enterprise.

The existing five-story, open-loft, concrete-framed warehouse had a simple three-bay brick facade that concealed a two-bay-wide interior organization. The building’s top three floors set back to create a towerlike profile. The team

transformed the overall massing by extending the third floor to house video-editing suites and building a two-story addition to the west that contains a double-height video-production studio on the ground floor, editing suites on the second floor, and a rooftop terrace.

The structure of the addition echoes the detailing of the original building’s concrete frame, which is fully exposed along a side alley but concealed by buff-colored brick on the street facade. Unlike the original building’s brick front, however, the new elevation is clearly expressed as a veneer that sits atop a steel shelf angle. The architects visually extend an existing limestone sill at the second floor along the new elevation with a precast concrete replica of the original that floats free of the wall and is supported by a new concrete beam. The suspended nature of the new construction is expressed further through the complicated composition of the new windows where cross-sections of structural steel appear to float in front of the glazing.

The entrance reveals the spare, luminous qualities of the reconfigured loft interior. Original concrete floors, columns, and ceilings are

- ① entrance
- ② lobby
- ③ video viewing area
- ④ kitchen
- ⑤ restroom
- ⑥ studio
- ⑦ vehicle access
- ⑧ equipment storage

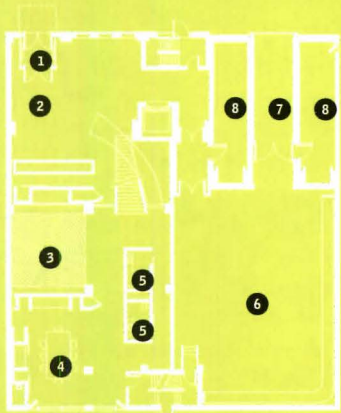

First-floor plan 20'/6m



East-west section

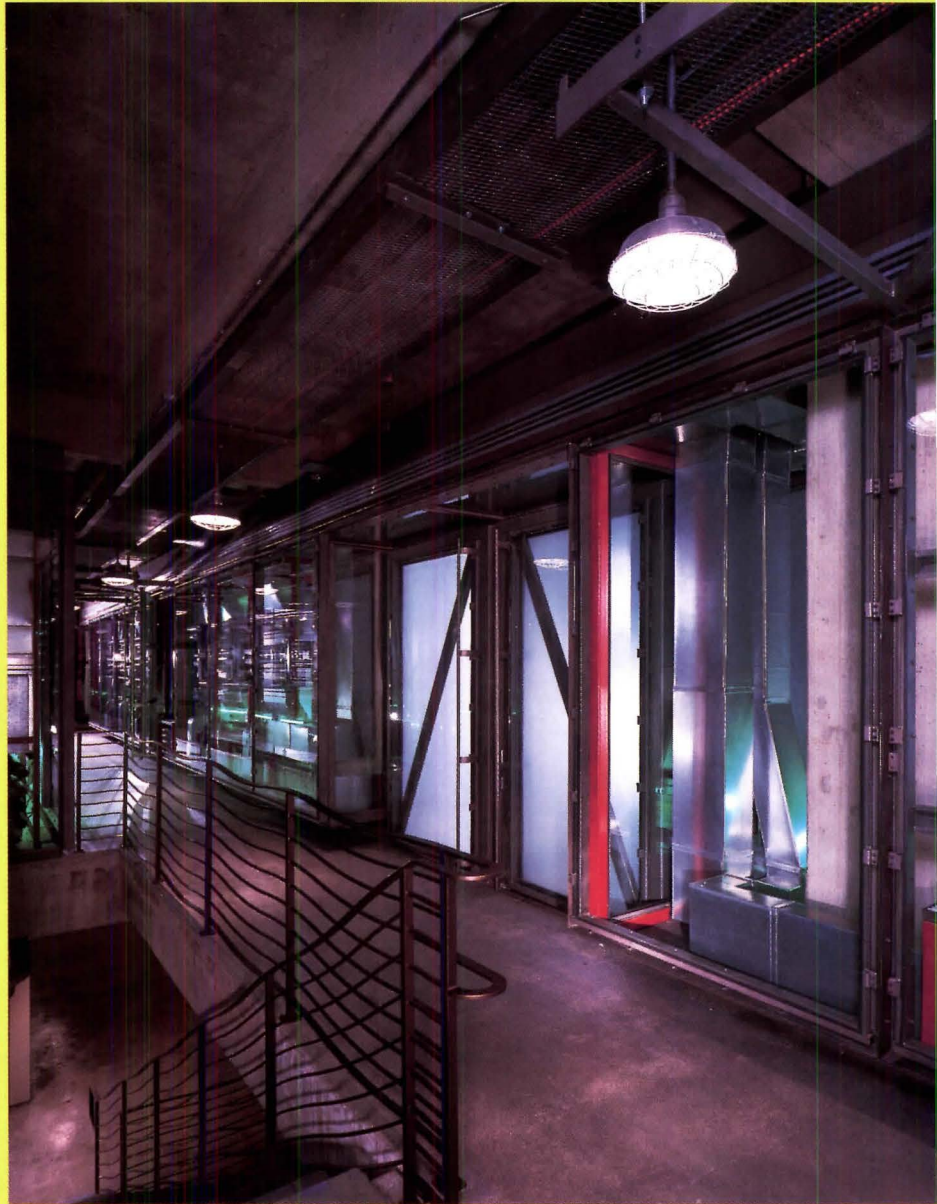

**LIGHTBORNE COMMUNICATIONS  
CINCINNATI, OHIO**

**CLIENT:** Lightborne Communications **PROJECT DESIGNERS:** Terry Boling, José Garcia (team leader), Ken Jones **ARCHITECT:** Ken Jones and Associates, Cincinnati, Ohio—Ken Jones (design principal), Michelle Avery, Dan Batt, Shawn Duffy, Tobias Hasselgren, Josh Predovich, Marc Swackhammer (project team), Miranda Mote, Terri Treinen, Karl Wallick (project assistants) **ENGINEERS:** Steven Schaefer Associates (structural); Maxfield, Schwartz, Lonnemann & Kohrs (mechanical, electrical, plumbing) **CONSULTANTS:** Mark Adler (audiovisual); Daniel W. Martin (acoustics) **GENERAL CONTRACTORS:** Turner Special Projects Division; Pilot Contracting **COST:** Withheld at owner's request **PHOTOGRAPHER:** J. Miles Wolf

left exposed, while new woodwork cuts the space into reception, video viewing, and service areas. A lyrically curving ramp moves visitors across an existing level change and leads to a dramatic, sculpted concrete stair, an organic form that resembles a spinal column.

The building's second and third floors contain video-editing suites that require ample power and data connections and large volumes of conditioned air. A series of thick walls separate these workrooms while framing the hodgepodge of ductwork, fan-coil units, wiring, and cabling within intricately detailed steel-and-glass cases. These elements are displayed in the public corridor behind panes of clear glass, while neon-green acrylic and translucent laminated glass panels line the workspaces to create luminous privacy screens.

The presentation of the mechanical and electrical systems provides a powerful esthetic that reinforces the "backstage" nature of Lightborne's business. (Most of their work involves postproduction editing and mixing.) But there's also a practical side to this industrial language: Readily accessible interstitial spaces can easily be modified to adapt to the rapid changes in the technology that Lightborne utilizes.

The architects transformed the old building by layering elements, and then separating them from the existing structure. Unlike the original building, whose depth results from its masonry mass, the new interventions develop their richness through thoughtful composition.

"We're bound to images of the Industrial Revolution. That is how we picture technology," says Garcia. But as the silicon era of bits and bytes supersedes the industrial era that produced the original warehouse, Lightborne's new insertions defer to its new machinery—although with a nostalgic deployment of old high-tech metaphors. Garcia is unapologetic about the irony: "The technology in the computers is not reflected in the architecture."

Building services are displayed behind metal-and-glass cases screening private work areas from hallway (facing page). Editing suite (below) is enclosed by opaque, backlit Plexiglas walls. Large metal-and-glass doors (bottom), guided by curved tracks suspended from ceiling, swing open to provide access to mechanical and electrical equipment.



# The FUTURE of Preservation

**Is the debate over preserving structures that aren't typically considered historically valuable date-related or more of a cultural issue?**

**PAUL WESTLAKE:** If a building is important to the character of a community and if it's beloved and recognized as a symbol, then it's a landmark. The 50-year date that is often used to establish landmark status isn't critical. What's important is that it defines a community's traditions and culture. This idea is especially relevant in the Western United States, where 80 percent of the buildings have been built since World War II. That whole landscape falls outside the norms of what we think of in the East as historic fabric.

**GEORGE SKARMEAS:** The 50-year mark has been debated very seriously lately, and the National Park Service is in the process of revising its standards. This is primarily because of Dulles Airport [in Washington, D.C.]. The issue there was the restoration, expansion, and modification of a building that was landmarked even though it was only about 30 years old. In the past, we lost a lot of important buildings because they were not on some list.

**PAUL BYARD:** As for the underlying objective, age is probably unimportant. It's a question of what you can learn from a building. To a degree, the date question is a way of getting around the popularity issue.

**DIANE KAESE:** Popularity is something that I'd like to take out of the picture because a landmark isn't necessarily popular architecturally. The Edward Durell Stone building on Columbus Circle in New York City is a classic case. My first reaction to it, which is still my reaction today, was "Who let that get built here?" But I now realize that there is a lot to that building.

**BYARD:** We only progress when we get away from likes and dislikes. We have to get to some substantive point about the quality of the building and what you learn from it. We also have to be reminded of the cyclical nature of preference. We are now realizing how fine things are that we hated for the past 15 years.

**PAMELA HAWKES:** People think there's a scientific approach to preservation that will always field the right answer. But the more I do it, the more difficult the answers seem to be. The easy buildings have been dealt with. Now we're dealing with the ones that are more marginal.

**BYARD:** They're not necessarily more marginal; they're just newer. We haven't thought about them in the same way. We've been through a period of not feeling good about the buildings of the 1960s and 1970s because they were out of tune with the conservative, disappointed world in which we've been living lately. But it's conceivable that this, too, shall pass.

**The Secretary of the Interior's Standards for the Treatment of Historic Properties stipulate that additions must be different, yet compatible with historic structures. How do you combine old architecture with new construction?**

**HUGH HARDY:** The purpose of these guidelines is to challenge people to think about what's at stake in ways they never had before.

**KAESE:** I disagree. "Tell me what I have to do!"—that's what architects want. When you hand an architect the Secretary of the Interior's standards, they baffle them because there's so much interpretation necessary.

**HARDY:** That's really horrifying.

**WESTLAKE:** Maybe architects are too timid. My experience is that those involved in

In December, Architecture convened a roundtable of noted historic preservation architects at the Cooper-Hewitt, National Design Museum in New York City. The group's animated debate ran the spectrum of current concerns: what makes a building historically significant, the public's role in preservation, the importance of technology, and the future of the field.



JIMMY COHRSEN PHOTOS

state historic preservation offices and with the Department of the Interior are actually open to strong change and contemporary solutions.

**SKARMEAS:** The question is: Can you legislate sensibility, sensitivity, and design talent? You can't. I think the standards are an attempt to protect buildings. When we're dealing with new construction and additions to historic buildings, we need to figure out ways of managing egos. Generally, the underlying assumption is that we can improve on the past. But that's not necessarily the case, and the standards attempt to control change and put it on a manageable course. I'm not sure that's the right approach. But it certainly makes us think about these issues. First, we need to understand what the building means, its significance and character. Then we must figure out our relationship to that.

**HARDY:** It's difficult to generalize a way in which it ought to be done. But context has a lot to do with it and the materials make an enormous difference.

**WESTLAKE:** The key is to find something to transform the original principles into new vocabularies. Often, we think it's better to stand as far away from the original as possible, to understand the original not through its details and materials, but through the spirit of the composition. Too much confusion is created by weak attempts to conform to historic work.

**JOHN MILNER:** I got a lesson from Bob Venturi 20 years ago when we were working on the Franklin Court Project in Philadelphia, which involved the restoration of

*There's been confusion between authenticity and nostalgia. There's so much emphasis on celebrating preservation that it's difficult to get the public to accept contemporary work in an historic context. Nostalgia is the enemy of progress.*

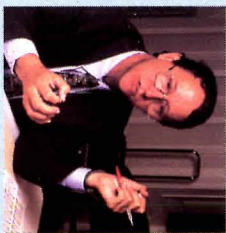

James Rhodes  
Beyer Blinder Belle Architects & Planners  
New York City

five rowhouses, one of which was totally gone and had to be reconstructed. These houses were to commemorate Benjamin Franklin and to screen his house, which was built on the courtyard behind it. The question was, What do we do with this missing tooth? And I said, "Well, for sure it should be a very different, contemporary building." And Bob Venturi said, "No, it shouldn't. It should be another rowhouse." Looking back, if we had done a contemporary building, it wouldn't have been right.

**BYARD:** Venturi was on the cutting edge at that time.

**JAMES RHODES:** Rule-making, whether it's the Secretary's standards or preservation law, seems to serve two functions. One is to express some element of consensus, that this is the best we could come up with together. The other is that if you do it this way, you won't get into trouble. But you can always come in if you've got something different. Defining design excellence is impossible. That's why the people who interpret the standards must be well-chosen and responsible. As society changes, the rules may be interpreted differently.

**BYARD:** The key words within the standards are very generous. I mean, "appropriately" gives you all the room in the world.

**RHODES:** It's a wonderful word, isn't it?

**BYARD:** So is "compatibility." It depends on what you bring to it, and that is what the word is supposed to do. It's supposed to leave room for your work.

### How has the public's perception of preservation evolved over time?

**WESTLAKE:** The public, including developers, has gotten very involved in the review process. There's been confusion between authenticity and nostalgia. There's so much emphasis on celebrating preservation that it's difficult to get the public to accept contemporary work in an historic context. I like Garrison Keillor's quote that says, "The past was copied, quoted, and constantly looked at until one day, the country looked more like it used to than it ever had before." This kind of nostalgia is the enemy of progress.

**HARDY:** The public seems to be frightened by the enormity of change. Consumerism is at an all-time high, and now the wealthy can possess the past. They can live in a Park Avenue apartment the same way people did in 1930. New York has become a time machine. All cities are time machines that way. The middle class wants to possess history, too, and that's where you get into nostalgia.

**HAWKES:** Or you get Nantucket, which has become economically viable simply

*If a building is important to the character of a community and if it's beloved and recognized as a symbol, then it's a landmark. The 50-year date isn't as important. What's important is that it defines a community's traditions and culture.*

because it's a preservation area. Last summer, *The Boston Globe* quoted citizens saying, "If you change it, no one will come." Now people come in droves, building subdivisions of little Nantucket houses. What was originally a very thoughtful and well-developed design review now deals with trophy houses. It's hard to figure out what's real there, because everything you see looks exactly the same.

**WESTLAKE:** It might be uniquely American to prize nostalgia. Europeans don't operate that way. There's always been a healthier attitude there about change. In this country, we don't understand the difference between conformity—which is what these trophy houses are, and what so many architectural guidelines deal with—and the impact of new work on tradition. In other arts, there isn't this obsession with history. The whole history of music, for example, is one of continuous change, part of a continuum. We don't have that attitude about architecture.

**HAWKES:** Time affects us in a much more physical way than it does the other arts, though. You can lose the music, but if you build something and it's not great, it's there with you for a long time.

**MILNER:** The more I work in this field, the more weary I get of the notion that we have to establish a cutoff date for a restoration, or we have to freeze time at 1853 and the colors all have to be what was there in 1853, and the furniture all has to be the same. It deprives the public of the notion of change. The public certainly is able to understand change and deal with it.

**BYARD:** If we are really showing people anything, it is difference, not sameness. The whole point of having an old thing is that it's different.

**HARDY:** This is the first time the public has been involved actively with the re-creation of the past in architecture. History was like some wonderful trunk in the attic and you'd go root around in it and it was something you played with, but it wasn't this serious endeavor to try to restore something.



Diane Kaese  
Miss Janney Elstner Engineers and Architects  
Princeton Junction, New Jersey

**John Milner:** A project we worked on a few years back illustrates the dilemma here. It's the Jared Coffin House in Nantucket, which is a 17th-century house that was restored in the 19th century and again in the early 20th century.

**Hugh Hardy:** Each with a different point of view. I'm sure.

**Milner:** Yes. The problem was that the building was struck by lightning and basically blown apart. We had 17th-century framing, adapted in the 19th century and again in the early 20th century. There were several approaches we could take. One was to design a new, visible structural system. Another was to build a new building, or half of it, and take away the weather

problem—wind and snow loads—and interpret it as an artifact. The decision was made to use new fiberglass reinforcing and epoxy consolidation to reconstitute the original frame and preserve as much of it as we possibly could, which allowed the building to be interpreted the way it had been intended—as a house museum.



## A warning



Hugh Hardy  
Hardy Holzman Pfeiffer Associates  
New York City

**Paul Byard:** We have to acknowledge the degree to which we're in trouble—we're just too much in a bath of success. The initiative consequences are a serious thing. We need to begin to rebuild our capacity to be comfortable with the new. I hope we will begin to see the accommodation of old things with much more adventurous

new things. We shouldn't be driven back or allow ourselves to seek a derivative of what we've come to call contextual. We need to find some way to revivify a more valid and authentic response to old buildings. We've lost our way a little bit because the times are really, in some ways, too good.

**BYARD:** The very notion that you could even think you could is wonderfully naive.

### At Frank Lloyd Wright's Wingspread in Racine, Wisconsin, engineer Robert Silman Associates used high-tech composite materials to strengthen the roof. Was this a suitable preservation strategy?

**HAWKES:** It's not that radical. The best preservation approach is always to use tried-and-true materials in a way that's reversible so that if doesn't quite work out, the next set of repairs will be just as easy. There were some catastrophic failures of materials used in the 1970s and 1980s from which there was almost no way out.

**BYARD:** Wingspread got right to the issue. When you put it back together, are you trying to make a perfect artifact, or are you looking at it as a work of art that has a certain effect? I don't care if you repair it with carbon fiber or with 2-by-4s; the point is to be able to learn from it what you can.

**HARDY:** All restoration has to be an interpretation because it's basically impossible to restore anything. You cannot turn the clock back; you can't re-create the people who lived in the society that built a building. Preservation is one matter; restoration is something totally different. The museum psychology would have

*When we're dealing with new construction and additions to historic buildings, we need to figure out ways of managing egos. Generally, the underlying assumption is that we can improve on the past. But that's not necessarily the case.*



Paul Westlake  
Van Dijk Pace Westlake Architects  
Cleveland, Ohio

you believe that you can take buildings and freeze them in time. But we all know you can't do that. You can reveal the interventions, making clear that this is something new. The opposite approach is that it should be sympathetic. If you can't tell, if it's seamless, that's fakery.

**BYARD:** It's very interesting that one has to be convinced of the only thing that is an inescapable truth: Change is simply one of the things about us. But it's still a way of going at the same set of issues.

### What new technologies do you find most useful in historic preservation?

**RHODES:** I see computers and digital media affecting all levels, from documentation through building maintenance and operations. At St. Thomas Church in New York, we recently coupled the latest digital camera and notebook-computer technologies with old-fashioned steeplejacking—jumping off buildings. Workers jumped off the steeples on a rope armed with a camera and we sat up in the bell tower to see the flaws of the building without having to erect expensive scaffolding. The documents for that building were scanned in New York and drafted by skilled persons in Europe, who sent us back digital files.

**BYARD:** My eyes have just been opened to the benefits of radar, which we've been using on the restoration of Cooper Union. It is absolutely magical that it can tell you the location of every anchor.

**RHODES:** The computer has allowed us to develop a system of keynoting digital drawings and scanned photographs that creates stronger document sets. That allows us to go from the field, where we can apply keynotes to the documents, to

translating them into remedial drawings and, after scanning historical details and documents, to seeing what lies behind a wall.

**SKARMEAS:** We have to use technology appropriately, as in the medical profession. I just hope we don't go through the same process that physicians went through where they started prescribing MRIs [magnetic-resonance imaging] for every patient. We've got data loggers now, but do we need to monitor every building and become saturated with a lot of information? New technology will add a cost to our services that, at some level, may create problems with clients.

**MILNER:** I lament the loss of the skill of hand-drafting. A lot of the projects we do are very individual and require hand-drafting. It's difficult nowadays to interview potential employees and find any but a few who have hand-drafting skills, particularly younger ones.

*Midwestern culture is out there by the freeway, in the shopping center, in the housing development, and there isn't an old building anywhere. To the general public, this whole conversation would be meaningless.*

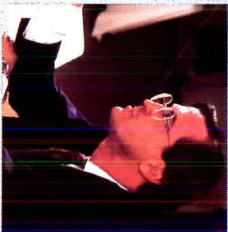

George Skarmas  
The Hillier Group  
Princeton, New Jersey

**WESTLAKE:** Photography can capture many aspects of restoration work far better than drawings. So the application of digital photography to the final contract documents is a great tool. It saves us from trying to look at fairly complex things and figure out how to draw them just to make a few simple notes on selected areas. The same details can be captured very well in photographs.

**Are there new players on the design team? Do they have changing roles and new responsibilities?**

**SKARMEAS:** There's an interesting situation we're facing at the University of Pennsylvania. The school dismantled the physical-plant department and hired property manager Trammell Crow. This is a new reality—a developer who thinks in terms of a building's depreciation cycles and return on investment, not years of history. Trammell Crow has become the lead in everything that happens on Penn's campus.

**WESTLAKE:** Design-build changes the makeup of teams. We have done restoration and preservation design-build projects where clients let you negotiate relationships with artisans, for example, so you can work together closely. You can select teams and put them on board in the beginning—within a negotiated framework. That is a major change in the way we work and the way we interact with trades.

**RHODES:** Preservation is drawing the architect back to the field. Most contemporary architects trust the construction managers to do their bidding. At most, the architect checks shop drawings.

**WESTLAKE:** The way we're forming teams in the restoration and preservation projects we do is very different from our new work. Our preservation clients demand that we function more in the role that architects did when the buildings were created—as generalists with some broad control, which is pretty healthy. They're often seeking—and we're seeking, too—negotiated relationships with teams of artisans, for example.

**James Rhodes:** There are certain sensitivities that a preservation architect has had traditionally whether it's sniffing for mildew, or being able to sketch and convey an idea, and bring it back from the field and put it onto computer. I've found that the best computer to interpret what people see in the field is the

person who saw it in the field to begin with. The transfer of data from the field to the computer is still a very personal relationship. But if a person is a bad draftsman, very often they are not going to be much better on CAD.

Pamela Hawkes  
Ann Beha Associates  
Boston, Massachusetts



Many forecasters predict that by 2010, preservation and renovation will amount to between 30 percent and 50 percent of all architectural building services in the United States. Where do you see preservation headed in the next decade?

**MILNER:** I hope that as the tax-abatement programs kick in to encourage revitalization, most preservation work will focus on urban areas or small communities.

**RHODES:** Attention will also shift from just the monuments of our past, as people realize that recycling buildings of only moderate historical value is good practice.

**HARDY:** The point about urban context is well-taken because most old buildings are in cities. We are in a minority: Mainstream culture is out there by the freeway, in the shopping center, in the housing development, and there isn't an old building anywhere. To the general public, this whole conversation would be meaningless. That is the American culture. I think everything hinges on whether the cities continue to come back to life.

**KAESE:** Not only is the preservation of architectural infrastructure key, but so is how we deal with bridges, tunnels, and subways.

**WESTLAKE:** When considering infrastructure, we will have to ask: What makes towns and communities vital? I'm not talking about the visual character, but the decisions to route around towns and take traffic off Main Street. This has hurt many communities. Infrastructure is an area where preservation can have an extraordinary impact. There is also now a market in converting big office buildings to residences. We're seeing this, surprisingly, in Southwestern cities like Dallas. It's not like the old industrial buildings and warehouses becoming housing—these are big office buildings. In places where people traditionally commuted into cities from the suburbs, they can now live in these rehabilitated office buildings and work there, too.

**HARDY:** Cities could be in good shape in the future. It takes public-private partnerships to make these things work.

**WESTLAKE:** That may be increasing with the strain on public budgets.

**HARDY:** True. Beyer Blinder Belle's renovation of Grand Central Terminal couldn't

*I lament the loss of the skill of hand-drafting. A lot of the projects we do are very individual and require hand-drafting. It's difficult to interview potential employees and find any but a few who have hand-drafting skills, particularly younger ones.*

happen if it weren't for the marketplace justifying all that public investment. And our 42nd Street Theater would not have happened were it not for the private marketplace, which is going to make it work and inflate the land values.

**RHODES:** It's not only due to the private sector, but some local, state, and federal programs, as well. You're finding some money going into efforts like the Legacy Program, which funds Department of Defense projects that bring architects from the public and private sector together. The restoration of Ellis Island wouldn't have happened so successfully without public and private cooperation. It's healthy for the architecture profession to develop these relationships.

Paul Byard  
Platt Byard Dovel  
Architects  
New York City



PHOTOGRAPH BY WESLEY WATSON FOR ARCHITECTURE

**Paul Westlake:**

Look at the projects that emerged during the recent Santa Fe Conference of the National Trust for Historic Preservation. One of the 10 awards went to one of the original McDonald's buildings—a piece of franchise architecture in Los Angeles. That said a lot. Another award went

to a book on the preservation of rural landscapes in Pennsylvania. Another went to a more architecturally anonymous but historically significant African-American neighborhood in Atlanta, which had to do with revitalization and the preservation of urban vitality. The paradigm will continue to shift from

pre-1930s landmarks to post-World War II buildings. We'll be dealing with more industrial stock and older office buildings, even common housing from original subdivisions, such as Levittown.

# RUIN



# REHAB

Fisher Friedman fills a ravaged San Francisco warehouse with urban lofts.

By Aaron Betsky

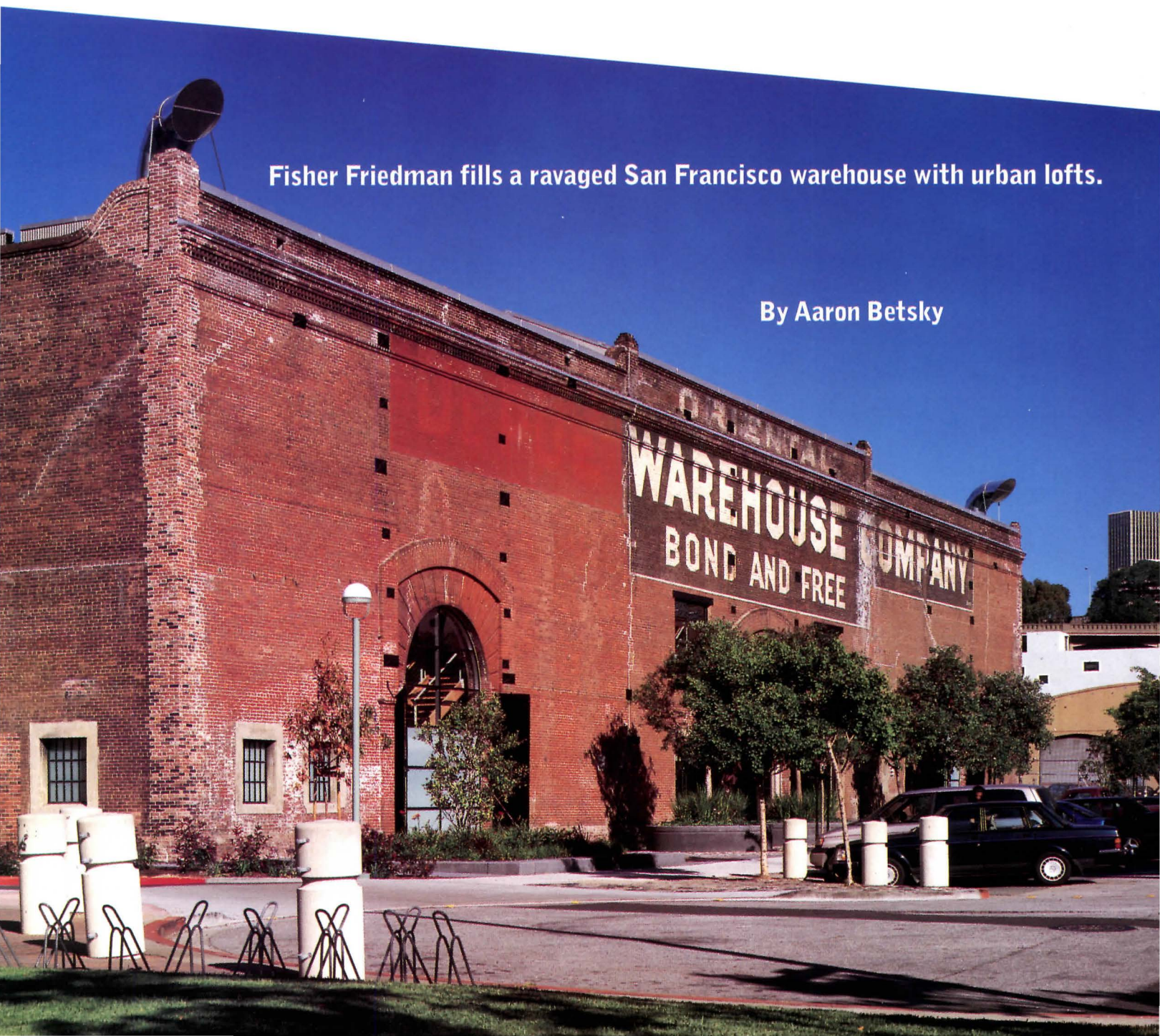

Architect left warehouse's original signage above new steel-and-glass entrance (right). New corrugated metal-clad lofts rise from stabilized ruins of brick wall (below). Steel trusses brace living units against original brick wall (facing page).

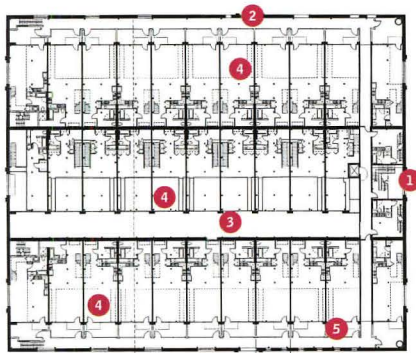
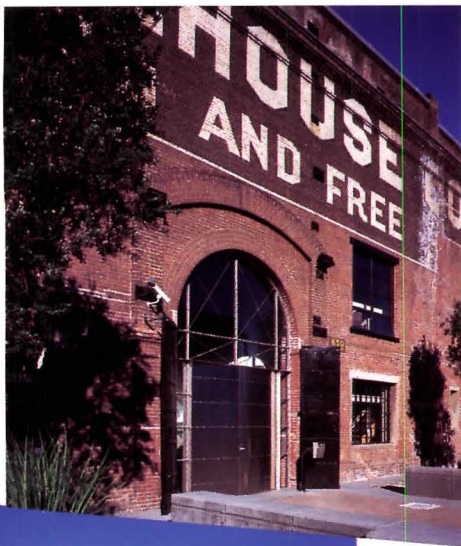

Second-floor plan

50'/15m

- 1 entrance
- 2 perimeter light court
- 3 mews
- 4 loft units
- 5 private patio

The Oriental Warehouse, a squat, 200-foot-square block in San Francisco's South of Market district, is a great repository of memories. Originally constructed in 1868 as a bonded warehouse for trade goods from Asia, the building also housed immigrants for several decades. It fell into disrepair between the two world wars and in the 1960s, was finally abandoned by the Southern Pacific Railroad. Scheme after scheme for reusing the massive brick structure appeared, but none was pursued. Principal Rodney Friedman of Fisher Friedman Associates worked on one such proposal, for retail and office space, as early as 1976.

Then came a series of disasters. Two fires, one in 1988 and one in 1994, gutted two-thirds of the structure. The 1989 Loma Prieta earthquake further destabilized the building, toppling a large section of the north wall. Meanwhile, the warehouse changed hands several times as the formerly light-industrial South of Market area began filling up with increasingly expensive live-work lofts. Friedman continued to track the project and was finally hired by the building's current owner, developer Reliance Properties, in 1988.

Now, this ghost of a building has been transformed into a metal "warehouse for the 21st century in a 19th-century shell," says Friedman. But the past still exerts such a strong presence on the building's present that some owners of these new lofts asked a medium to put them in touch with the spirits of past occupants.

The latest incarnation of the Oriental Warehouse is an inwardly turned building that not only looks back in history, but literally at the back of the old walls. Friedman and Project Architect David Tritt kept what was left of the structure's exterior intact "as a statement that this renovation was just another stage in the building's ruination, only a partial reconstruction," as Tritt puts it.

Fisher Friedman began by stabilizing what remained of the warehouse. They stripped off unstable brick, rebuilt several small areas, and braced the remaining walls. Into this more secure shell, the architects inserted 66 new 1,400-square-foot, metal-clad lofts in three rows along the length of the building. The central row of double-height units looks out at a 15-foot-long open mews, the literal and conceptual heart of the building. The two outer rows of units, meanwhile, look across similar gaps at the back of the exterior brick walls. Large openings in the outside walls allow views of the surrounding neighborhood through these brick ruins. The northwest corner even has unobstructed views of downtown San Francisco beyond the stabilized remnants of the north wall.

One understands the relation between the remnants of the Oriental Warehouse and the new construction by Fisher Friedman's treatment of the exterior openings: The architects set frosted glass into the existing ground-floor openings that let daylight into a new underground parking garage, while dividing the upper-level windows of residences into grids of clear glass set into black metal frames. Where new meets old, as on the west facade, one can see the clear distinction between the glass and steel the architects inserted and the brick they simply cleaned and stabilized.

These efforts create a dynamic tension between old and new. The Oriental Warehouse looks like a reinhabited ruin, especially as the galvanized metal of the new structure suggests that the new building is only a temporary, vaguely industrial inhabitation of the older volume. The white-painted steel trusses that brace the original structure enhance the impression that one is witnessing an unstable situation about to change. In this manner, the renovation maintains the spirit of the loft as the ultimate Modernist space: a functional readaptation of an industrial structure that is as malleable and temporary as the lives it houses.

Friedman and Tritt extend this sensibility through the detailing of some of the building's public spaces. Friedman claims that they wanted to "include the same things Le Corbusier would have in 1928." To that end, the firm engaged local metal-



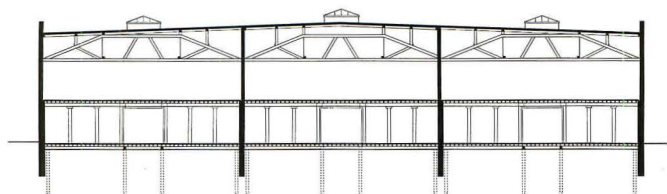

Original north-south section

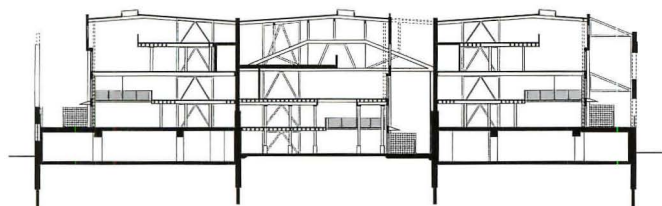

Renovated north-south section

Original brick walls and wooden trusses punctuate loft interiors (below and right). Steel beams, columns, and braces criss-cross spaces once supported by wood columns and trusses (facing page). Windows overlook restored brick wall of original warehouse.



working wizard Larissa Sands of South Park Fabricators to outfit the lobby with aluminum-and-steel doors in the shape of airplane wings, as well as a concrete stair that rises past glass balustrades and hangs with a spider's web of honed and polished steel. Sands continued this esthetic in awnings and fences she designed to define small individual "gardens" facing the mews. Inside the lofts, exposed ducts, structural steel beams, columns, and braces, and high-tech appliances inhabit the otherwise neutral brick-, wood-, and drywall-finished spaces.

Not all the Oriental Warehouse's interiors give technology such an appropriate expression. Corridors are minimal, fluorescent-lit spaces that exude a low-budget, institutional flavor. There are no communal areas in this high-priced loft development. Nevertheless, the light and scale of the units makes one forget that there are few exterior views and the spaces are repetitive. The careful detailing of the building makes the promise of the exterior into a livable reality.

The Oriental Warehouse stands in contrast to other recent work by Fisher Friedman, some of which abuts the Oriental Warehouse site. These are stuccoed monstrosities that attempt to abstract traditional forms through the strainer of the vocabulary Friedman's mentor Charles Moore developed in the 1960s and 1970s. In contrast

to these, the Oriental Warehouse proposes that the way in which buildings are put together can be extrapolated and used as the starting point for their reconstruction. The result, for all of its internal contrasts, looks more natural in its setting than the firm's other efforts. Fortunately, Fisher Friedman promises more work in this industrial vein. Friedman notes that loft clients prefer "the ultra-techie look" of the Oriental Warehouse, and the project's success has led to several new ground-up loft commissions in nearby Mission Bay and a new city hall for Emeryville across the bay.

To Friedman, the firm is reviving the lessons of Erich Mendelsohn and Charles Eames, his teachers at the University of California at Berkeley. For Tritt, the Oriental Warehouse is a chance to put into practice the concepts he learned from Robert Mangurian and Craig Hodgetts 20 years ago: how to create a collaged sense of order out of the new and the old, the precious and the cast-off. The result is a building that reinhabits a structure that evokes a palpable past with a stage set for modern living. The Oriental Warehouse embraces the way technology itself has transformed that former world into a lighter, more open, and flexible space.

**ORIENTAL WAREHOUSE LIVE/WORK CONDOMINIUMS  
SAN FRANCISCO, CALIFORNIA**

**CLIENT:** Reliance Development Group **ARCHITECT:** Fisher Friedman Associates, San Francisco—Rodney Friedman (partner-in-charge), David Tritt (project designer)  
**ASSOCIATE ARCHITECT:** Loving and Campos, Walnut Creek, California **LANDSCAPE ARCHITECT:** Guzzardo Associates  
**ENGINEERS:** Culley Associates (structural); Marion Cerbatos; Tomasi (mechanical, electrical); Harding Lawson (geotechnical) **CONSULTANTS:** Architectural Resources Group (historical); South Park Fabricators (metal fabrication); Larry Pace (construction management) **GENERAL CONTRACTOR:** Swinerton & Walberg **COST:** Withheld at owner's request **PHOTOGRAPHER:** Charles Callister, Jr.







STEVE GOTTLIEB

# women

*A new memorial at Arlington National Cemetery  
honors females in America's armed forces.*

*By Donald Albrecht*

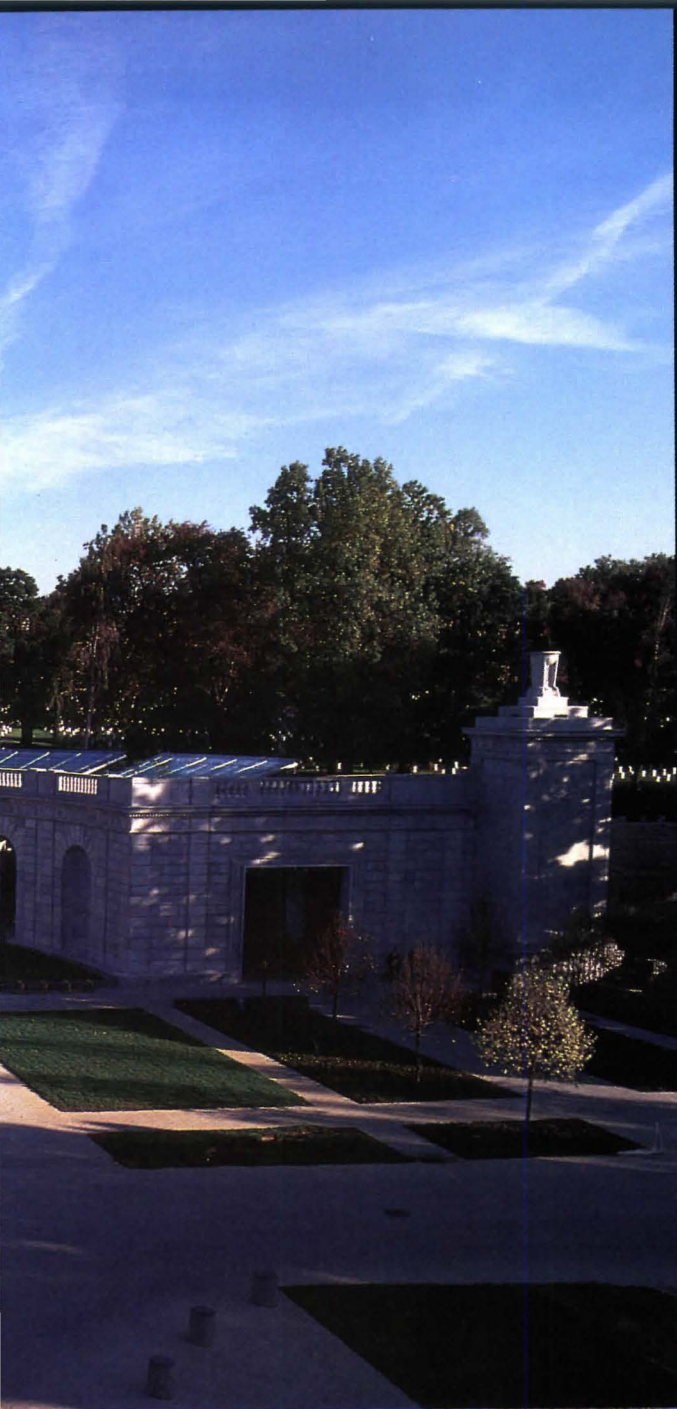

STEVE GOTTLIB



Within hemicycle's central niche (above left), fountain with 200 water jets flows into 80-foot-diameter circular reflecting pool. Restored and expanded hemicycle visually connects Arlington National Cemetery with Washington's monuments (above). Stairs connect memorial's rooftop terrace with field of gravestones (left).

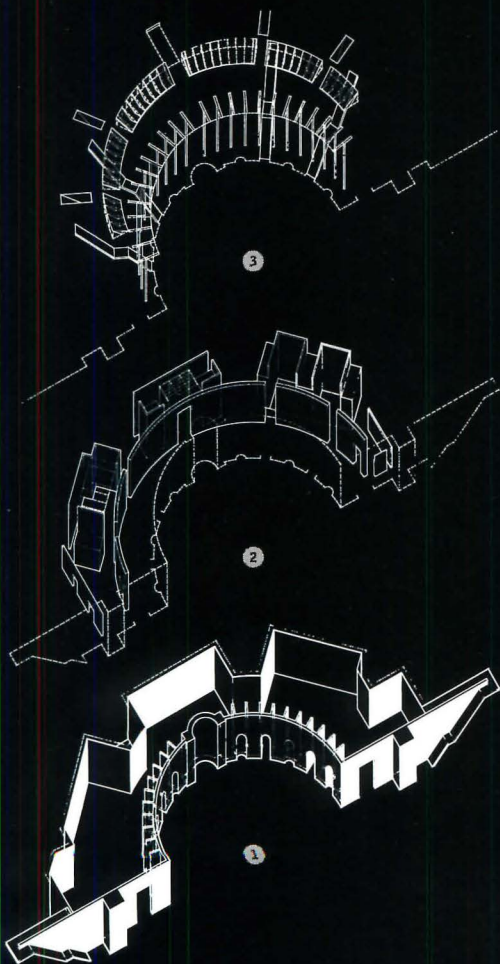
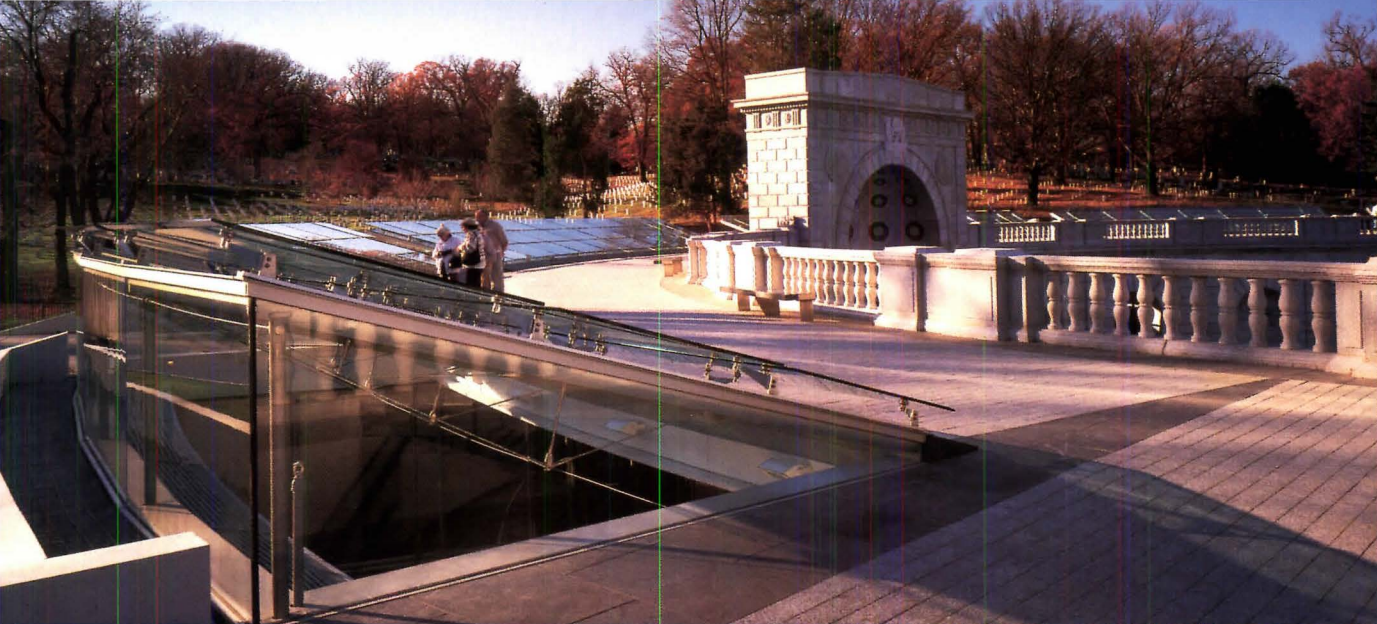

Axonometric

- ① existing walls and new excavation
- ② public spaces
- ③ glass tablets and stairs



TODAY YOU MAKE  
FROM PEACE  
TO WARTIME TASKS.  
COMFORTABLE  
POSITIONS. LEISURE  
OFF SILK AND  
YOU HAVE  
A DEBT TO  
A

Angled skylight on upper-level terrace supports 138 glass tablets inscribed with quotes from servicewomen (left). Stainless steel clamps support tablets atop canted skylight (below).



In designing the recently dedicated Women's Memorial at Arlington National Cemetery, New York City-based Weiss/Manfredi Architects practiced architecture as creative archaeology. The memorial, sponsored by the Women in Military Service for America Memorial Foundation, was created by excavating an historic landscape and constructing new spaces where the unearthed stories of female members of the armed forces are brought to light. Weiss/Manfredi's design was selected over nearly 150 submissions in a 1989 competition.

"In our work," asserts Principal Marion Weiss, "we try to enhance the continuity of the natural, social, and cultural processes of the site." Continues Principal Michael Manfredi, "We search for a method of adapting and intensifying both natural and cultural information." The 37,000-square-foot memorial sits at the cemetery's ceremonial entrance behind a 180-foot-diameter granite hemicycle—a grandiose retaining wall completing a monumental urban axis—designed by McKim, Mead & White in 1927.

Visitors enter the new memorial through large glazed portals at the north and south flanks of the granite wall. Inside is an exhibition gallery, a 196-seat theater, a computerized register where visitors can retrieve information about individual servicewomen, and a Hall of Honor dedicated to women who were prisoners of war, died in service, or received military awards. Glass-enclosed interior stairways connect the hemicycle to a new upper-level terrace defined by a curving glass skylight. Text drawn from military speeches and personal wartime journals of servicewomen is carved into glass panels mounted above the 220-foot-diameter skylight.

The architects' reductivist esthetic sets the tone for the memorial's interior, which was built by excavating the earth behind the hemicycle and constructing new spaces bermed into the hillside. Weiss/Manfredi revealed the site's history by removing existing layers of clay tiles and asphalt waterproofing to expose the hemicycle's original reinforced-concrete retaining wall and powerful, buttresslike counterforts. The resulting series of 22 alcoves houses an exhibition, designed by Washington-based Staples & Charles, that showcases the achievements of servicewomen throughout American history. Beyond the counterforts, a row of new steel columns that support the curved terrace above runs parallel to the interior's major architectural feature: a new curving wall of white Imperial Danby marble. This wall reinforces the skylit space as the memorial's circulation spine, and is cut with openings that lead to the theater, register, and Hall of Honor.

Weiss/Manfredi's design employs subtle yet compelling metaphors to convey the legacy of the more than 2 million women who have served in the military since the country's founding. For example, the four glass-enclosed stairways that lead visitors from the hemicycle to the rooftop terrace evoke the passage of servicewomen breaking through the military's male hierarchy. The stairs replace blank niches in the original hemicycle, beckoning visitors like glistening shafts of light piercing the solid granite wall. They then rise into the memorial's interior,



Skylights along rooftop terrace illuminate memorial's interior circulation spine (above). Belvedere provides views across Potomac River to Lincoln Memorial. Shadows cast by inscriptions on tablets animate curved marble wall below (right).

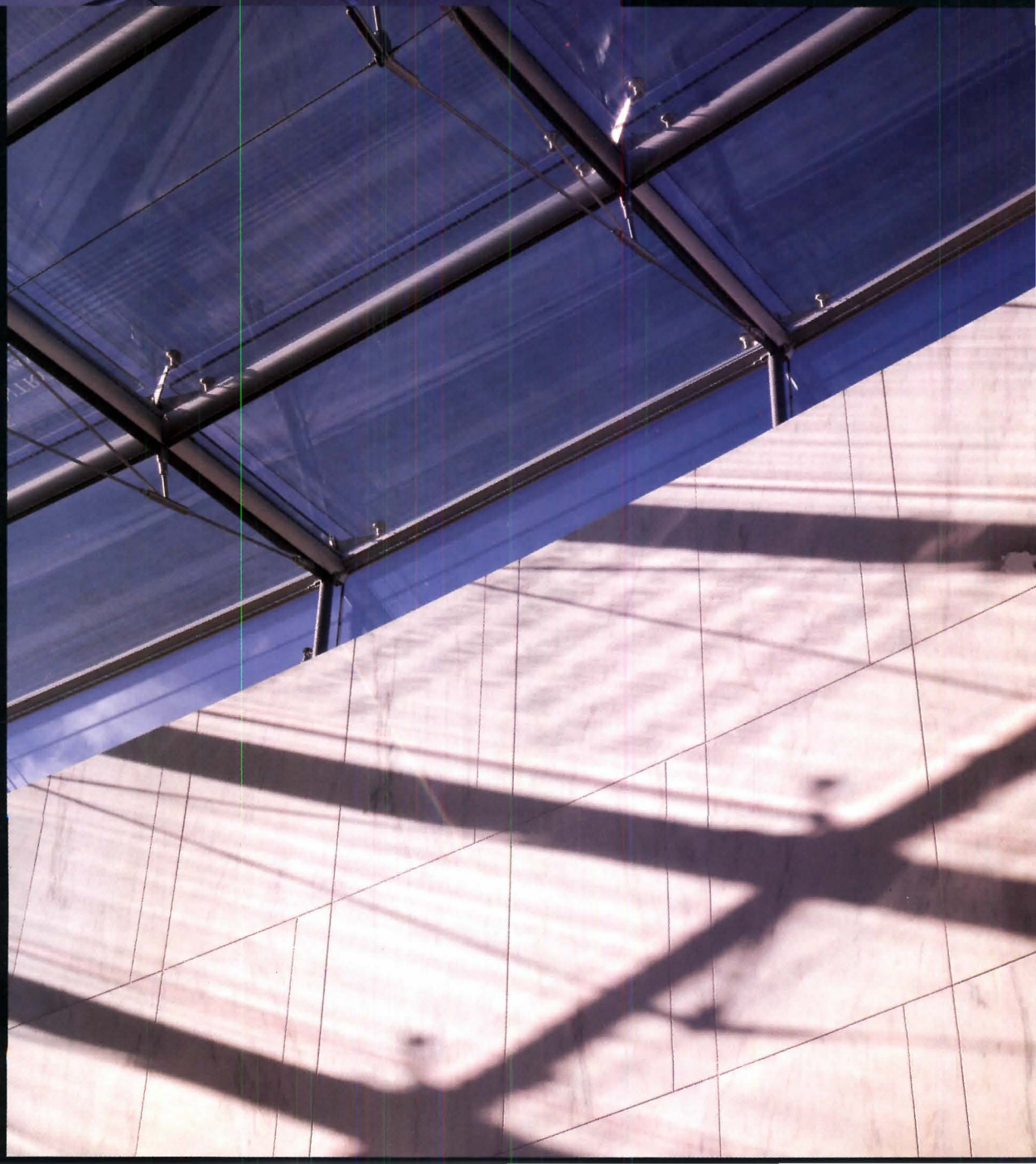

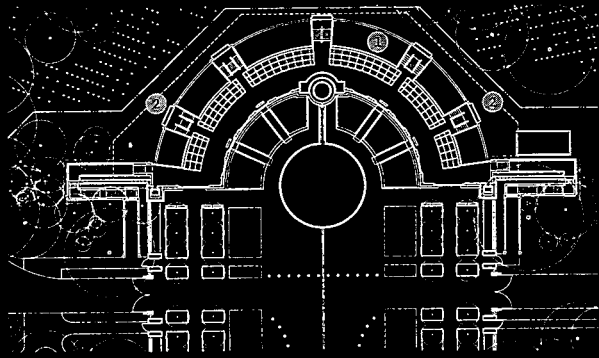

Ground-level plan

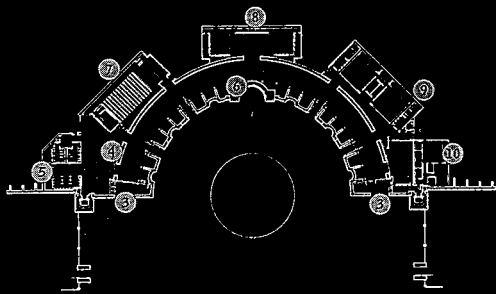

Lower-level plan

- ① skylight
- ② glazed stairway
- ③ entrance
- ④ foyer
- ⑤ gift shop
- ⑥ gallery
- ⑦ theater
- ⑧ register
- ⑨ conference room
- ⑩ honor hall

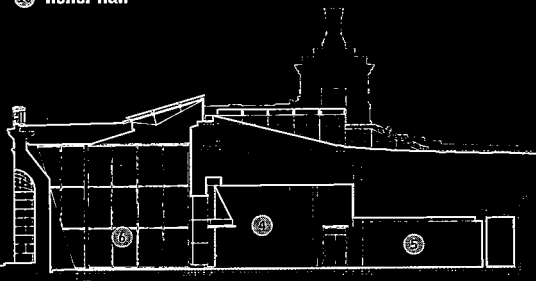

North-south section

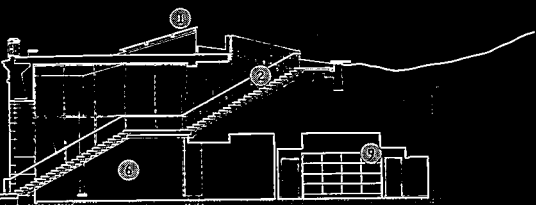

East-west section

passing through openings in the marble wall, and onto the terrace between the angled skylights—a reminder, perhaps, of women's quest to shatter the "glass ceiling" encountered in professional advancement.

Glass as a symbol of enlightenment is the terrace's most dramatic motif. Wrapping the full curve of the hemicycle are 138 tablets made of  $\frac{3}{4}$ -inch-thick glass, held aloft by jewel-like, stainless steel mounts. Quotations from servicewomen are carved into the tablets like a diary. Throughout the day, changing shadows cast by the skylight's inscribed texts animate the wall below with words in motion. An inherent problem of the interior's minimalist aesthetic, however, is that without these lively shadow-plays, the memorial loses much of its drama.

Angled toward the city, the floating rows of tablets seem to join the servicewomen's words to those inscribed on Washington's historic monuments. Arranged in military formation, the tablets—thick enough to read like transparent stone—echo the cemetery's orderly rows of marble gravemarkers; they visually integrate servicewomen into Arlington's larger community of honor and remembrance. This new public belvedere also knits the Women's Memorial into one of the capital's grand, symbolic axes, which stretches from the Lincoln Memorial across the Potomac River to the John F. Kennedy grave site and Arlington House atop the cemetery's highest promontory. It highlights the hemicycle's function as a retaining wall negotiating a change of level between the land of the living and that of the dead.

Materials and details throughout the memorial are crisp and pared down, contrasting with the decorative nature of McKim, Mead & White's Classical Revival hemicycle. The essentially monochromatic interior palette includes polished concrete floors inlaid with black granite to designate important zones such as the entrance, the register, and the Hall of Honor. Strips of the same polished granite, which are inserted into the floor from behind the hemicycle's large central niche into the register, attempt to visually link the interior to the axis of Washington's National Mall. Though this subtle material change may seem logical in the architect's plans, Weiss/Manfredi's intent is hard to read on-site. A more significant gesture is the symbolic use of white Colorado Yule marble for the ceremonial tablets in the Hall of Honor. These stone panels were cut from the same block of marble from which the nearby Tomb of the Unknown Soldier was originally carved.

McKim, Mead & White's concept for the hemicycle stopped short of providing iconographic elements: Inscriptions and statuary would have given their wall specific meaning. Weiss/Manfredi, however, have completed this unfinished Beaux-Arts composition with a quietly dignified and restrained Modern vocabulary. Through physical and cultural excavation, they have added new meaning to the historic structure, bringing to light an untold chapter of American history.

*Donald Albrecht is a New York City-based curator, architect, and writer.*



**WOMEN'S MEMORIAL AND EDUCATION CENTER  
ARLINGTON, VIRGINIA**

**CLIENT:** Women in Military Service For America Foundation—Brigadier General Wilma Vaught (president), John Carr (project director) **ARCHITECT:** Weiss/Manfredi Architects, New York City—Marion Weiss, Michael A. Manfredi (design partners), Michael DeCandia (managing partner), Charles Wahl (project architect), Christopher Ballentine, Jennifer Graessle, Karl Lehrke, Stephen Moser (project team) **LANDSCAPE ARCHITECT:** EDAW **ENGINEERS:** Weidlinger Associates (structural); Cosentini Associates (mechanical); Wiles Mensch (civil); Mueser Rutledge Consulting Engineers (geotechnical) **CONSULTANTS:** Staples & Charles (exhibit design); H.M. Brandston & Partners (lighting); R.A. Heintges Consultants (glazing); Shen Milsom & Wilke (audiovisual, acoustics); Oehrlein & Associates (preservation); AMIS (cost); Rolf Jensen & Associates (codes); Lehrer McGovern Bovis (program manager) **GENERAL CONTRACTOR:** Clark Construction **COST:** \$16 million **PHOTOGRAPHER:** Jeff Goldberg/Esto, except as noted







Openings in curved marble wall and glazed stairways (above) link ground level of hemicycle with upper-level terrace. Hall of Honor (facing page, top), computerized register (facing page, center), and foyer (facing page, bottom) compose underground memorial.

# Formglas Design Catalog

60 PAGES OF INTERIOR COMPONENTS



- COLUMNS • PILASTERS • MOULDINGS
  - VAULTS • DOMES • LIGHTCOVES
  - RAILINGS • BALUSTERS • PEDIMENTS
- IN
- FORMGLAS® G.R.G (GYPSUM)
  - QUARRYCAST® (MOLDED STONE)
  - METALCAST® (CAST METAL POWDERS)

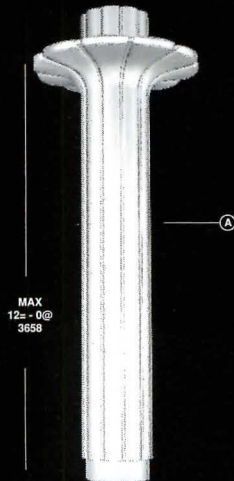

MAX  
12-0@  
3658

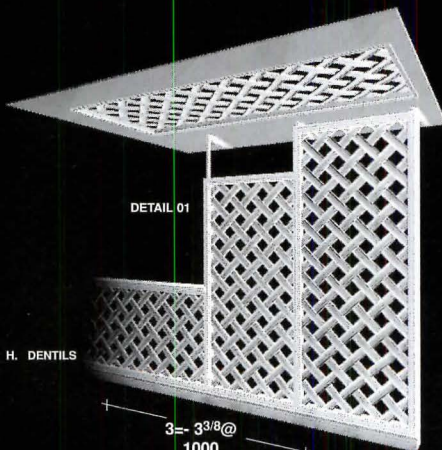

6@ H. DENTILS

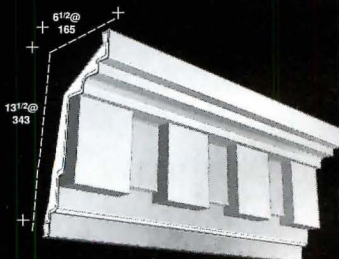

13 1/2@  
343

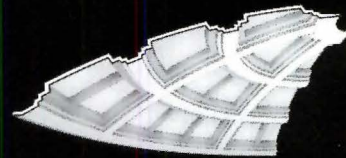

+ 8@  
203 +

+ 8@  
203

+ 12@  
304 +

+ 6 1/2@  
165

#63409



+ 13 1/4@44

+ 6 1/4@  
159

#44006

**Formglas**

Formglas Inc.  
20 Toro Road, North York, ON  
CANADA M3J 2A7  
Tel: (416) 635-8030  
Fax: (416) 635-6588  
Web Site: <http://www.formglas.com>

Circle 69 on information card

# ecture

TECHNOLOGY  
+ PRACTICE



PRESERVATION  
TECHNOLOGY

100  
**Drawing on the Past**

PRACTICE

104  
**Raising the Roof**

COMPUTERS

110  
**Writing a Winning Proposal**

TECHNOLOGY

114  
**Better, Faster, Stronger Output**

120  
**Fire Drills**

# Drawing on the Past

Two National Park Service programs train students to document historic structures through richly detailed drawings.

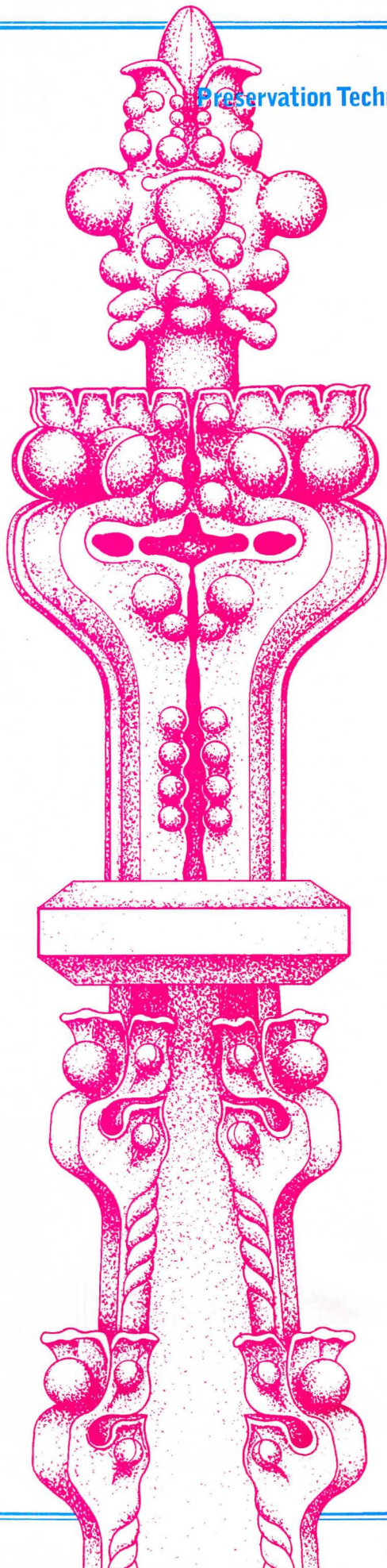

*By Michael Maynard*

With its marble columns and limestone interior, the Lincoln Memorial is one of Washington, D.C.'s most recognizable landmarks. But in 1991, National Park Service (NPS) architects found that the 75-year-old structure lacked detailed building drawings that would aid them in future renovations or repairs.

To solve the problem, the architects called upon the Historic American Buildings Survey (HABS), a small division within the NPS that specializes in developing and creating architectural drawings and renderings for historic buildings and structures. In some instances, the structures documented by HABS and its counterpart, the Historic American Engineering Record (HAER), are on the verge of oblivion or have been forgotten by all but the most committed preservationists. In other cases, such as the Lincoln Memorial, existing design drawings do not reflect what was actually built, requiring the creation of an accurate set of building documents.

HABS and HAER are charged with recording the architectural history of

these buildings for future generations. Annually, each program relies on 80 to 120 undergraduate and graduate students in architecture and related disciplines to spend the summer conducting detailed analyses of historic sites around the country.

These students produce beautifully detailed architectural drawings of houses, bridges, factories, and other structures that are then catalogued in the prints and photographs collection of the Library of Congress. Knowing that their work will be preserved in perpetuity gives the job "a sense of better purpose," says Elizabeth Milnarik, a master's degree candidate in architecture at the University of Illinois, Urbana-Champaign, who worked on a HAER team in Pennsylvania last summer.

### **Multidisciplinary approach**

The HABS program, established as a federal public-works program for jobless architects during the Depression, and the HAER program, established in 1969 by Congress as a parallel program emphasizing engineering, have evolved into two of the largest summer internship programs

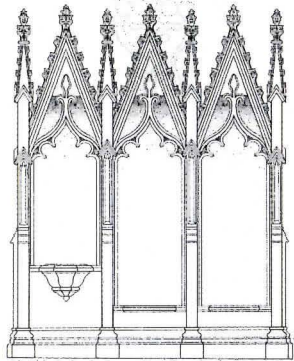
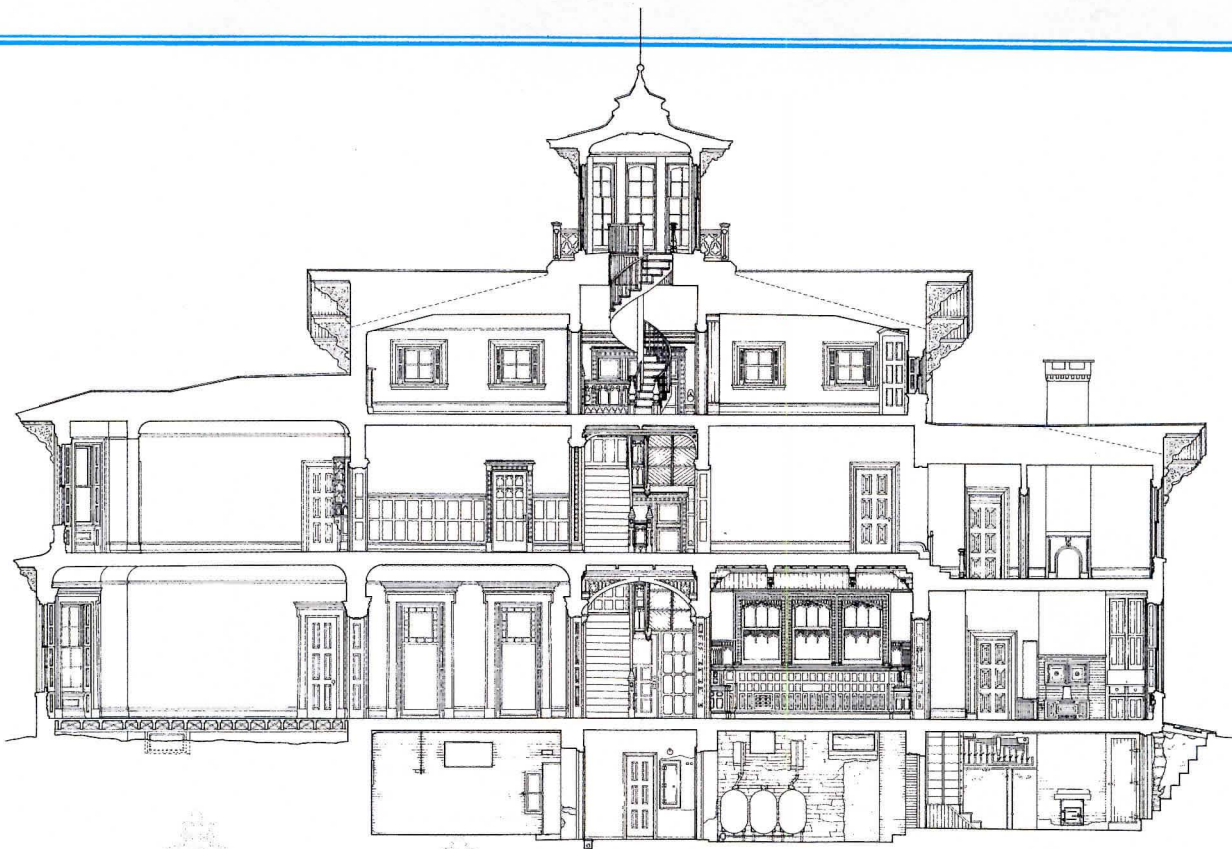

Longitudinal section (top) of Asa Packer Mansion in Jim Thorpe, Pennsylvania; drawing of sedilia (above) at Stateburg, South Carolina, church with detail of sedilia post (facing page) shows intricate woodwork.

in the federal government. Each summer, 12 to 24 HABS and HAER teams, under the supervision of professors, architects, and historians, fan out to sites selected by program officials. Each team spends 12 weeks documenting the project's history through written research and drawings. Students receive an additional crash course in architectural history and drawing using measurements and photographs. Both programs require students to submit a portfolio of their work as part of the application.

Some students are hired to draw, while others are hired to conduct research. Students like Milnarik measured two bridges in Pennsylvania on-site and then drew their various components in a field office. In some cases, students also work from old photographs or other documents to complete their record.

The detailed nature of the drawings sets the work of HABS and HAER apart from more banal documentation. Dolinsky compares the programs' emphasis on drawing to a young pianist who must first learn the scales and rote exercises before he or she can excel. The student

architects in these summer programs "develop techniques and the ability to work with the building and to learn how to draw," comments Paul Dolinsky, the chief of the HABS program. "Knowing how to draw must become second nature."

To appreciate the total architectural history of a site requires a multidisciplinary approach, asserts Eric DeLony, chief of the HAER program. Mark Brown, a Earlham College professor who worked for HAER as a student and later as a full-time employee, recognizes the value of such a comprehensive approach. Although he is an architectural historian, Brown says he makes it a rule to survey bridges with the architects so that they can compare its features together, utilizing the strengths that each discipline brings to the project.

Local publicity given to the HABS/HAER projects often encourages residents to become involved. "That usually happens when a national program comes in and looks at a building in a different way," maintains Dolinsky.

While the HABS program has primarily focused on historic buildings,

DESIGNED BY CHRISTOPHER B. BROWN, 1997  
 MARISCAL QUICKSILVER MINE & REDUCTION  
 WORKS RECORDING PROJECT  
 MARISCAL MOUNTAIN

MARISCAL QUICKSILVER MINE & REDUCTION WORKS 1916-19, 1919-23, 1942-43  
 BIG BEND NATIONAL PARK  
 BREWSTER COUNTY  
 TEXAS

SHEET  
 11-16  
 HISTORIC AMERICAN  
 ENGINEERING RECORD  
 TX-72

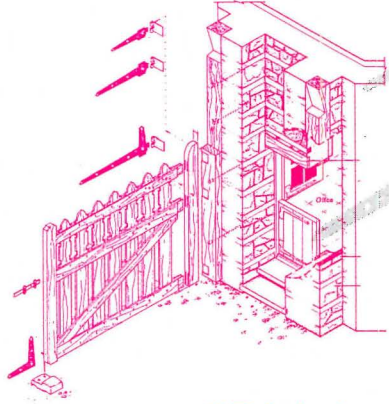
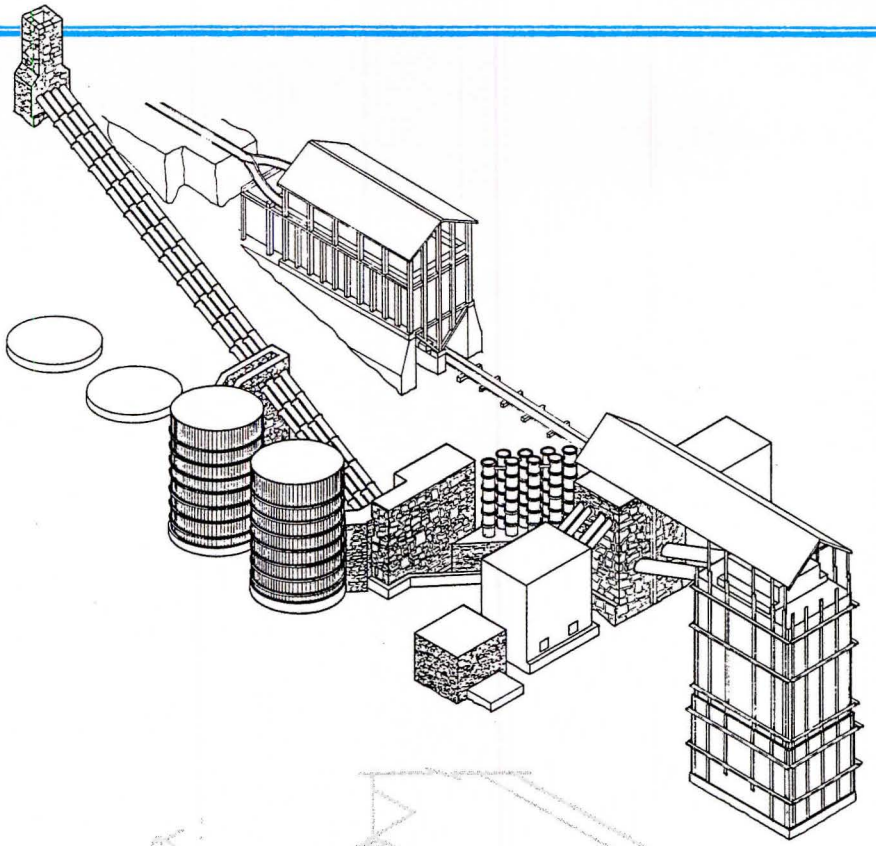

HAER drawing of Mariscal Condensing System (top) documents early system of releasing mercuric gas from ore mine in Big Bend National Park in Texas. Axonometric (above) details post-and-beam construction of Brown Mountain Gate House in Acadia National Park in Maine.

the HAER program has added a new dimension to the notion of preservation: HAER students record the roads, bridges, and industrial factories of earlier eras. Measured drawings and written histories of the textile mills of southern New England, the steel mills of Pittsburgh, and the coal mines of West Virginia and southwestern Pennsylvania completed by HAER are now catalogued at the Library of Congress alongside their HABS counterparts.

Students are capturing the industries and technologies that powered the country in the 19th and 20th centuries. DeLony asserts that the HAER program has carved out a niche within the preservation community, demonstrating that machinery, such as that used in the steel and mining industries, are important components of American history.

Instead of waiting for an object to become "historic," DeLony must sometimes act quickly to document it if a newer technology threatens its obsolescence. For example, HAER teams spent two summers at the Marshall Space Flight Center in

Huntsville, Alabama, recording many of the static-testing rocket stands that launched the first rockets.

**Reaching out**

With government funding for these two NPS programs barely enough to cover the salaries of the approximately 25 full-time HABS and HAER employees, Dolinsky and DeLony are relying more and more on private sources for funding. DeLony recently forged a partnership with mining company executives to document historic mining camps.

Organizations such as the Historic Charleston Foundation have had an ongoing relationship with HABS. With 8,000 historic buildings in the coastal South Carolina city, most of them lacking building plans, HABS is playing a significant role in the documentation of its history, according to Carter Hudgins, the foundation's executive director.

*The deadline for the 1998 summer program is March 7. For an application, call (202) 343-9626 or visit the Park Service's Web site at [www.cr.nps.gov/habshaer/jobscomp.htm](http://www.cr.nps.gov/habshaer/jobscomp.htm).*

# Ellison's Balanced Door. Greater Than The Sum Of Its Parts.

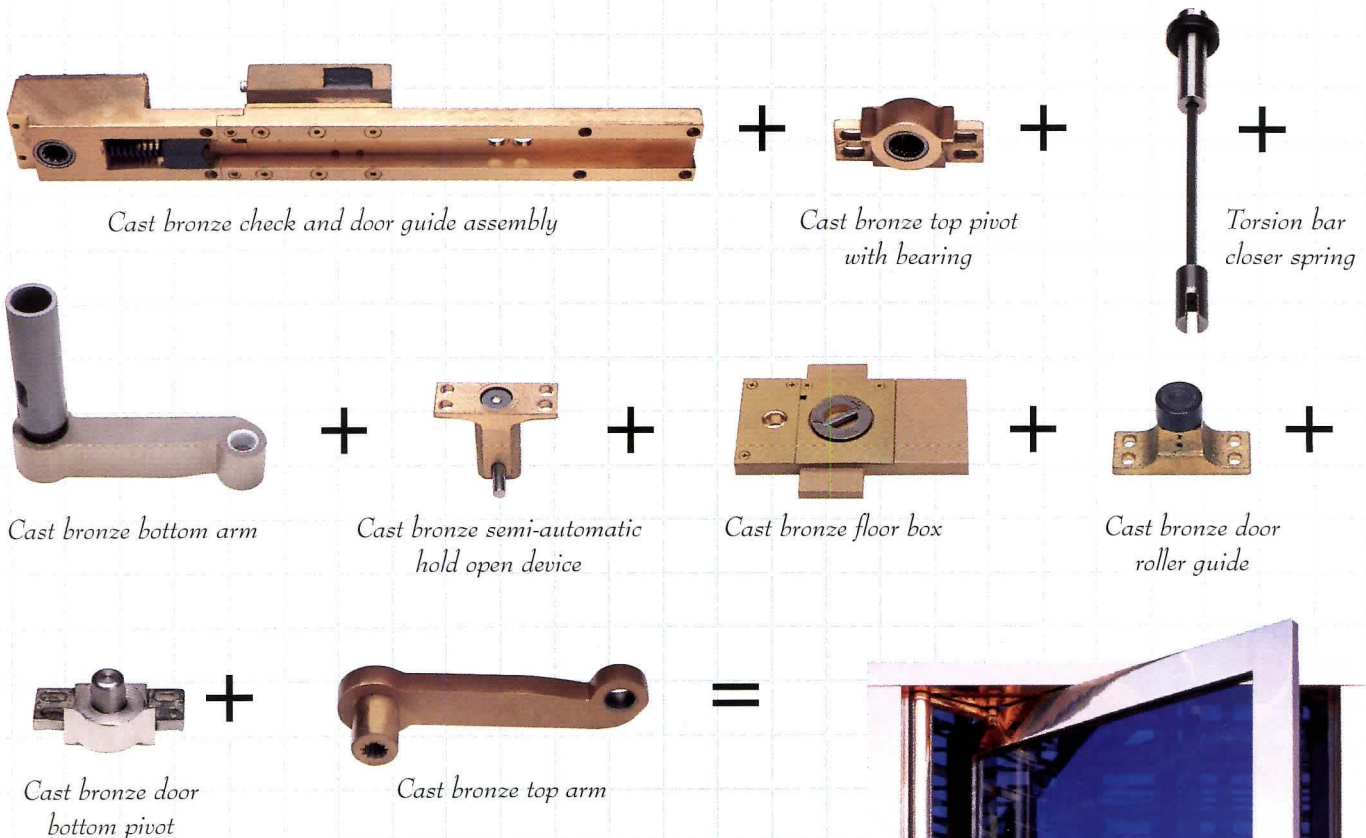

**Y**ou can open it with one finger in a heavy wind. It meets ADA requirements without additional hardware, and will operate dependably decade after decade. The construction and finish are meticulous, and the door comes with a no-hassle "bumper to bumper" ten year warranty. It is the unique Ellison Balanced Door, a system of components engineered to produce flawless operation and headache free maintenance.

Ellison makes everything—from the overhead check and guide assembly to the cast bronze top and bottom arms—in one manufacturing facility which includes a bronze casting foundry. Others have attempted to duplicate our hardware, and mimic our old-world craftsmanship. None have succeeded. Fast comparisons show major differences:

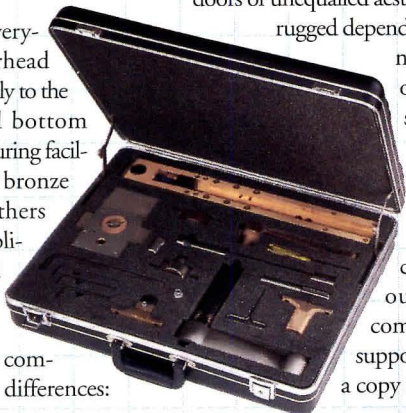

.09" thick stainless steel or bronze sheets are welded directly to an interior-tied subframe to form an impressive 2" thick door; our one piece arms are cast from molten bronze and then machined in our own shop; our exclusive concealed overhead check component provides easy routine maintenance.

While the others experiment with a part bought here, a part made there, Ellison continues to design and build doors of unequalled aesthetic appeal and rugged dependability. If you've never had the opportunity to see or feel the parts that make the whole, let us bring our case to you. Or, call and request our package of complete technical support literature and a copy of our video.



## ellison

Ellison Bronze, A Division of Dowcraft Corporation  
125 West Main Street / Falconer, New York 14733  
716-665-6522 / Fax: 716-665-5552

## Preservation Technology Raising the Roof

To improve acoustics and functionality at Chicago's historic Symphony Center, SOM adds volume in all the right places.



Addition of six-story, 20-foot-wide arcade (above, at right) is most visible change on Symphony Center's Michigan Avenue facade. Before and after drawings of main hall (right) reveal how designers reshaped hall to add space and better deflect sound.

By Eric Adams

In the world of concert hall acoustics, milliseconds of sound travel can mean the difference between an aria and an earache. Sadly, architect Daniel Burnham's 1905 Orchestra Hall, a Beaux-Arts jewel on Chicago's Michigan Avenue, has for most of its life been known as a mediocre space for sound. The hall's short sound-wave reverberation time—longer times create richer, fuller sounds—made it difficult for performers to hear each other and prevented the hometown audiences of the world-renowned Chicago Symphony Orchestra (CSO) from fully appreciating its talents.

Now Chicagoans can hear the CSO bright and clear. A three-year, \$110 million renovation and expansion by Skidmore, Owings & Merrill (SOM) and acoustician Kirkegaard and Associates completed last October has vastly improved sound quality by literally raising the roof to allow for longer reverberation times. SOM also expanded the historic facility to meet the demands of a modern

performance hall. The firm's work includes renovations throughout the building and the addition of new rehearsal and chamber music spaces, offices, redesigned public spaces, and an arcade designed to improve circulation. The new spaces are contained in two buildings—the Education and Administration Wing, housed in the renovated Chapin and Gore Building, and the new Artistic Support Wing—connected to each other and Orchestra Hall by a modern six-story skylit rotunda. The new complex has been renamed Symphony Center.

### Improvements and additions

SOM had been a pro bono consultant for the CSO for about 20 years when the firm was hired in 1990 to execute minor repairs and develop a master plan for a new performance hall at a new location. Ultimately, the firm persuaded the CSO that Burnham's Georgian Revival building on Michigan Avenue could, with improvements, work just as well and retain its historic value.

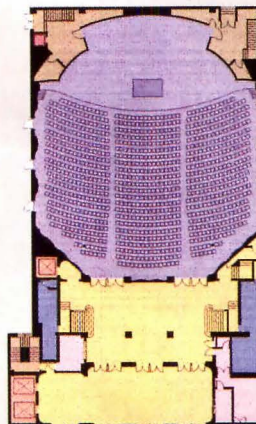

Existing auditorium

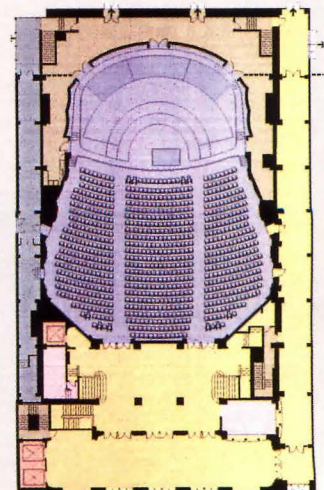

Restored auditorium





Controversial additions of adjustable acoustical canopy and terrace seating behind stage change character of attending symphony.

In 1993, when the firm was officially hired as architect and engineer for the restoration and new construction, SOM started talking at length with the CSO's board members, performers, and Conductor Daniel Barenboim. They discovered, among other things, that the stage was too shallow for a modern orchestra, there was little support space, no rehearsal facility, poor rest rooms, and uncomfortable seating.

But SOM Partner-in-Charge Robert Wesley says the facility's worst problem centered around its acoustics: "Not only were the orchestra members not able to hear each other, which was significantly affecting their ability to perform, but the audience was hearing a much drier, weaker sound than they would if conditions were optimal."

The building had been renovated and otherwise tinkered with numerous times in its history, and it did have some merits acoustically. The plaster wall coatings reflected sound well, as did the thick masonry walls. The hall's layout is a credit to Burnham's talents as a performance

hall designer. "Despite the difficulties and problems, the fact is that Symphony Center is a beautiful building with a warm, intimate performance hall," says Project Manager Brian Jack. "Our challenge was to make the necessary improvements but keep that original character."

#### Increasing volume

The thrust of the acoustical problem centered on low reverberation times caused by inadequate interior volume. "This causes music to arrive at the audience too soon," explains Dawn Schuette, Kirkegaard's project manager, "so the individual sounds don't blend well together."

Acoustician Larry Kirkegaard determined that the reverberation time within the hall—the amount of time sound takes to bounce off the roof and arrive at the audience—was 1.2 seconds and that it needed to be at least 1.8 seconds, which is an average for most modern concert halls. To get that time, more volume had to be added. The two design firms decided that the best way to do that would be to raise the roof.

The original roof only rose 10 feet above the stage shell, which is built of perforated metal to allow sound transmission. To increase the hall's volume, SOM designed a new roof 20 feet, at its highest, above the finished ceiling, which remained at the same height. A new truss system supplements the existing truss and roof support system, but old heating, ventilation, and air-conditioning (HVAC) equipment was removed and new systems were installed in the adjacent support building.

This relocation also solved the problem of noise from the mechanical systems hampering acoustical performance. Fans and a cooling tower above the stage, for example, had to be shut down during recordings, but had to keep running during performances because the hall became too hot. When SOM and Kirkegaard relocated all HVAC equipment to the renovated support building behind the main hall, the structurally independent building absorbed nearly all vibration and sound from the mechanical systems. Extra-large, 6-foot-diameter primary

Stage increased in depth by 35 feet to accommodate larger modern orchestras. Other interior dimensions were unchanged, although roomier seating arrangements increase comfort levels.



ducts circulate air noiselessly at low velocity into the truss space above the performance hall.

Challenges faced by the design team, which included Senior Designer Leigh Breslau and Senior Technical Architect Nancy Carreon, were as much about schedule as they were structure. The CSO's season could not be shortened or interrupted, so when the symphony wasn't performing, the construction team built the new roof over the existing roof. Then, last summer, just months prior to the hall's reopening, the newly covered old roof was finally taken down.

Other factors affecting sound quality within the hall were addressed. After increasing the volume, the designers turned to side and rear wall shapes, which they "pinched" to reflect sound better. Materials selection also played a critical role. "Every detail for every surface has a reason for being what it is because of acoustics," Wesley says. Plaster ornamental wreaths on the proscenium arch were recast in perforated aluminum to reflect sound better, seat cushion fabric

and thicknesses were adjusted, and the plaster depth on exposed wall surfaces was increased to between 2 inches and 4 inches.

Among the main hall's most visible interventions was the addition of a 7-ton steel and glass acoustical canopy above the stage. The canopy was designed to deflect sound back onto the orchestra and out into the audience. The 40-foot-wide, 30-foot-deep structure relies on clear, laminated acoustical glass reflectors to control sound direction. It can be raised or lowered, as required by different types of performances, by a complex winch system above the stage. During jazz performances, for example, the canopy can be raised almost to the ceiling because the music is already very loud and clear. For a string quartet or a solo vocalist, the canopy will hover only a few meters above the stage.

The board was at first concerned with the visual impact of the canopy and was hesitant to approve it. But when they did and heard the difference after the hall's October 4 reopening, their opinions changed. "After they saw how well the canopy

worked, the board became its biggest fan," Wesley says.

#### **Other improvements**

The center also had a reputation for being uncomfortable for its patrons. The chairs were too narrow and leg room was minimal. SOM increased chair widths from 19 inches to 21 inches, on average, throughout the hall and added up to 4 inches between rows.

These added dimensions, however, cut the number of seats in the hall from 2,310 to 2,110. To compensate for lost seats, which could have represented major revenue losses, the designers added a terrace behind the main stage for an additional 200 patrons and the occasional chorus. Although such terraces are rare in the United States, they are common in Europe. "There was a lot of debate over this," Wesley says. "The board didn't want the audience being so close to the orchestra and the conductor, who might become nervous because of this proximity."

In the lobby areas on each of six floors, the architect refurbished carpeting, all wood detailing, and re-cre-

ated brass lighting fixtures that had deteriorated beyond repair. A top-floor social room belonging to the famous, recently folded Cliff Dwellers Club was converted to pre-concert space for the conductor, featured performer, and guests. On the second floor, a ballroom was also restored to be used for small performances and lectures.

Throughout the building, all of Burnham's original structure was retained. Structural engineer Stan Korista attributes this to the strength of the original design. "The hall was built at a time when people were transitioning from all masonry to a mix of steel and masonry," Korista explains. "We found things to be in quite good shape and were able to retain all the original foundations. The new roof work, however, stands on new foundations."

### More support spaces

Orchestra Hall has historically lacked adequate support space and room for other music-related activities. SOM's 250,000-square-foot addition to the facility, however, nearly

triples the center's usable space. To the west of Orchestra Hall is the six-story, 138,000-square-foot Artistic Support Wing, which includes the 300-seat Buntrock Hall for chamber music. The wing also houses the relocated mechanical equipment in the top two floors, storage and archive rooms, and offices. The adjacent six-story rotunda, finished in white and dominated by an atrium with a curved stair reaching from the first to the second floor, provides circulation between the three main structures.

The Education and Administration Wing to the north of the rotunda is housed in the fully renovated 62,000-square-foot Chapin and Gore Building, a dark red brick landmarked structure designed in 1904 by Richard E. Schmidt and Hugh M.G. Garden. The building originally held a wholesale and retail liquor distributor. The CSO annexed the building in 1991 to house the Eloise W. Martin Center (an educational center also known as Echo), a restaurant, and staff offices.

The additions are all situated behind Orchestra Hall and don't detract from the historic Michigan

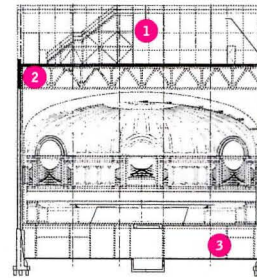

Existing east-west section through main hall

- 1 mechanical systems
- 2 truss zone
- 3 support space
- 4 stage shell
- 5 acoustical canopy
- 6 stage
- 7 arcade
- 8 offices
- 9 lobbies
- 10 roof
- 11 cooling tower
- 12 donors' club
- 13 rehearsal space

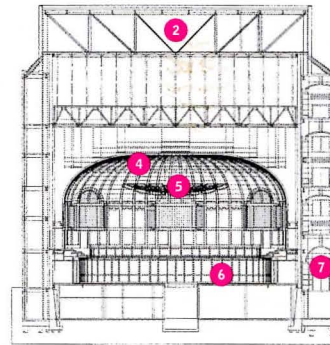

Renovated east-west section through main hall

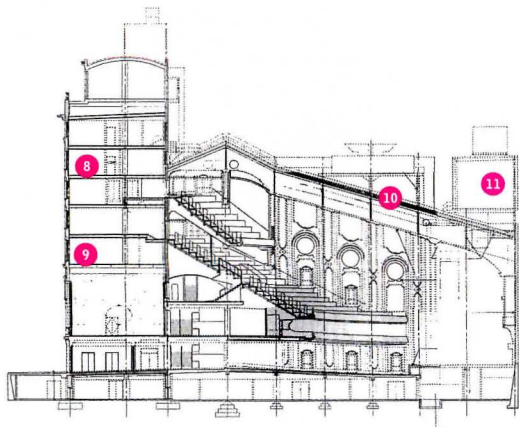

Existing north-south section through lobbies and main hall

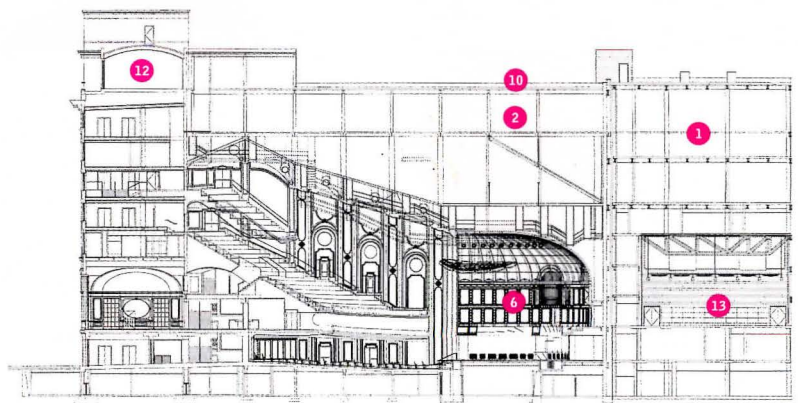

Renovated north-south section through lobbies, main hall, and new support spaces

New six-story skylit rotunda (right) connects Orchestra Hall to support spaces and education and administration functions; new arcade (below right) fills gap between orchestra hall and adjacent building to north and improves circulation; Buntrock Hall (bottom) was created in support wing for rehearsals and chamber music performances.

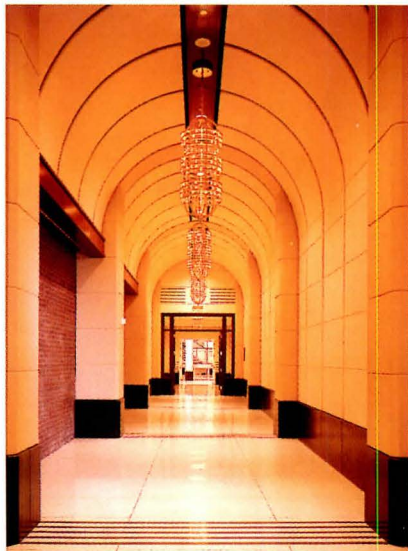
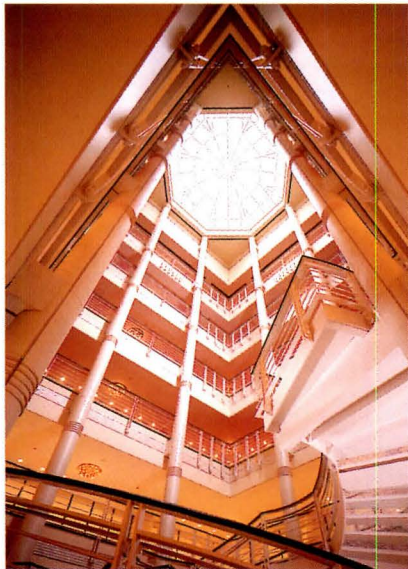

Avenue facade. The only change visible from that side is a new 20-foot-wide, six-story arcade, which connects to the Borg-Warner Building to the north and which matches Burnham's original red-brick facade. The arcade allows for more circulation during intermissions and before and after performances.

### Much fanfare

Construction continued until the day of the first performance on October 4, but Symphony Center opened on time and to much acclaim. Though all involved seem satisfied with the result, more improvements are desired. The city has already offered funds to fully restore the cornice and the terra-cotta decoration of the Chapin and Gore Building, which could only be given remedial attention during the last restoration phase. Additionally, the orchestra hopes to raise another \$35 million for an additional performance hall to be built in place of the adjacent Borg-Warner Building.

But until that time, Chicagoans will certainly be satisfied with what they have: a performance hall that has been upgraded from mediocre to one of the world's finest.

### SYMPHONY CENTER CHICAGO, ILLINOIS

**CLIENT:** Chicago Symphony Orchestra  
**ARCHITECT:** Skidmore, Owings & Merrill, Chicago—Robert L. Wesley (project partner), Brian M. Jack (project manager), Nancy S. Carreon (senior technical architect), Leigh S. Breslau (senior designer), D. Stanton Korista (director of structural engineering), Ray J. Clark (engineering partner), Ron Johnson (project structural engineer)  
**CONSULTANTS:** LaSalle Partners (program manager); Kirkegaard & Associates (acoustics); Claude Engle & Associates; Jules Fisher/Joshua Dachs Associates (lighting); Soil Testing Services (geotechnics); SAKO & Associates (security); Hygienetics Environmental (environmental); Patrick Monahan & Associates (communications); Carbone Smolan & Associates (signage and graphics); Blue Plate Catering (catering); Jeff Weiler (organ); Country Roads (seating)  
**GENERAL CONTRACTOR:** Turner Construction  
**COST:** \$70 million  
**PHOTOGRAPHER:** Jon Miller, Hedrich Blessing

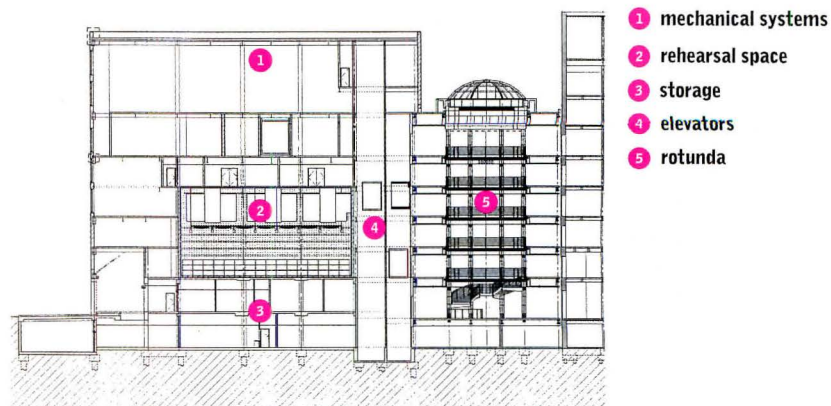

East-west section through support spaces and rotunda

**U.S. Fish & Wildlife Service  
NATIONAL CONSERVATION  
TRAINING CENTER**



An investment in beauty and long life

**TCS<sup>®</sup>**

terne-coated stainless steel roofs  
helping create a farm-like environment

More than 310,000 square feet of TCS – terne-coated stainless steel roofing cover the 22 buildings of the new U.S. Fish & Wildlife Service.

This National Conservation Center, designed to be an exceptional learning place for the natural resource conservation professional, is located on a 538-acre campus 4 miles outside Shepherdstown, West Virginia.

KCF-SHG Architects modeled the buildings after local farm buildings so that they blended with the rolling countryside as a partner to it. Aiding this partnership is the dull gray finish which the TCS will weather to — a surface which will never require painting.

This Follansbee metal offers not only beauty but the promise of longevity unmatched by any other roofing metal. We will be happy to send you substantiating evidence.

Call us toll-free at 1-800-624-6906.

Follansbee also produces  
**TERNE II<sup>®</sup> – ZT<sup>®</sup>-coated carbon steel  
(VIROTIN<sup>®</sup>)**

**TCS II<sup>®</sup> – ZT<sup>®</sup>-coated stainless steel  
(VIROMET<sup>®</sup>)**

*Job Site Architects:*  
KCF-SHG Architects, Washington, D.C.  
*General Contractors:*  
West Virginia Corps of Engineers and  
Centex Construction Company  
*Roofing Contractor:*  
James Myers Roofing Company,  
Beltsville, MD

*creating outstanding roofing metals for more than a century*

**FOLLANSBEE<sup>®</sup>**

FOLLANSBEE STEEL • FOLLANSBEE, WV 26037

Circle 73 on information card

Visit our Website:  
folrfg.lbcorp.com

Our E-Mail address:  
folrfg@lbcorp.com

## Practice Writing a Winning Proposal

Show your prospective clients you know what they need—without going overboard.

*By Elizabeth Padjen*

Proposal: The very word conjures a state of combined stress and optimism—and a financial hit roughly equivalent to the cost of a good diamond. How can you be sure that your firm's overtures will be accepted?

Proposals today are far more sophisticated than they were even five years ago, reflecting trends toward keener competition, cheap desktop technology, and smarter clients. And while some marketing departments in architectural firms view proposals as an end in themselves, it's important to remember their real purpose: to secure an

Holmes. "If you don't address the specific needs of the client, you're wasting your time," he adds. The degree to which a proposal responds to client concerns and shows a grasp of their unique issues will determine success. The architect's task is to identify those needs, not only in the building project, but also in the proposal itself. Unsophisticated clients embarking on their first construction project may respond favorably to proposals that educate them on the process, and they are more likely to be swayed by flashy graphics. More experienced clients can be sensitive to condescension and are more likely

**YADDA, YADDA, YADDA—the things architects say that breath—they've heard it all before: "We enjoy working  
"We listen to what you need."... "We love collaboration."...**

invitation to an interview. "You don't win a project with a proposal," notes Richard Holmes, vice president of The Hillier Group in Princeton, New Jersey. "You win a place at the interview table." A proposal may be a client's first introduction to your firm, and resources spent on producing a superior document can pay off.

"It's a little test," says Allison Hecht, marketing manager of Kohn Pedersen Fox Associates in New York City, where clients ask: "Can you respond quickly with a good product? Can you follow directions?" Ellen Watts, marketing director of Tsoi/Kobus & Associates in Cambridge, Massachusetts, believes that proposals also have long-term importance: "Whether you win the job or not, you are building the foundation for a future relationship."

What is the key to success? "One word: customizing," answers

to focus on the design and construction process.

Public-sector clients are accountable to the public, which will affect how they scrutinize proposals. "Government selection is biased toward a conservative viewpoint," notes management consultant Paul Nakazawa of Pearson Egan Nakazawa, who has served on several public selection boards. "Experience and competence are germane to the selection."

Among the most significant trends affecting clients' reception of proposals is the emergence of professional project managers, on staff and especially as outside consultants. "The audience for a proposal is no longer just the end user," observes Mitchell Cohen, senior vice president of Griswold, Heckel & Kelly Associates (GHK) in Chicago. Cohen finds that good client advisors effec-

