

Architecture® May 1998 \$8.95 usa \$11.00 canada

Architecture

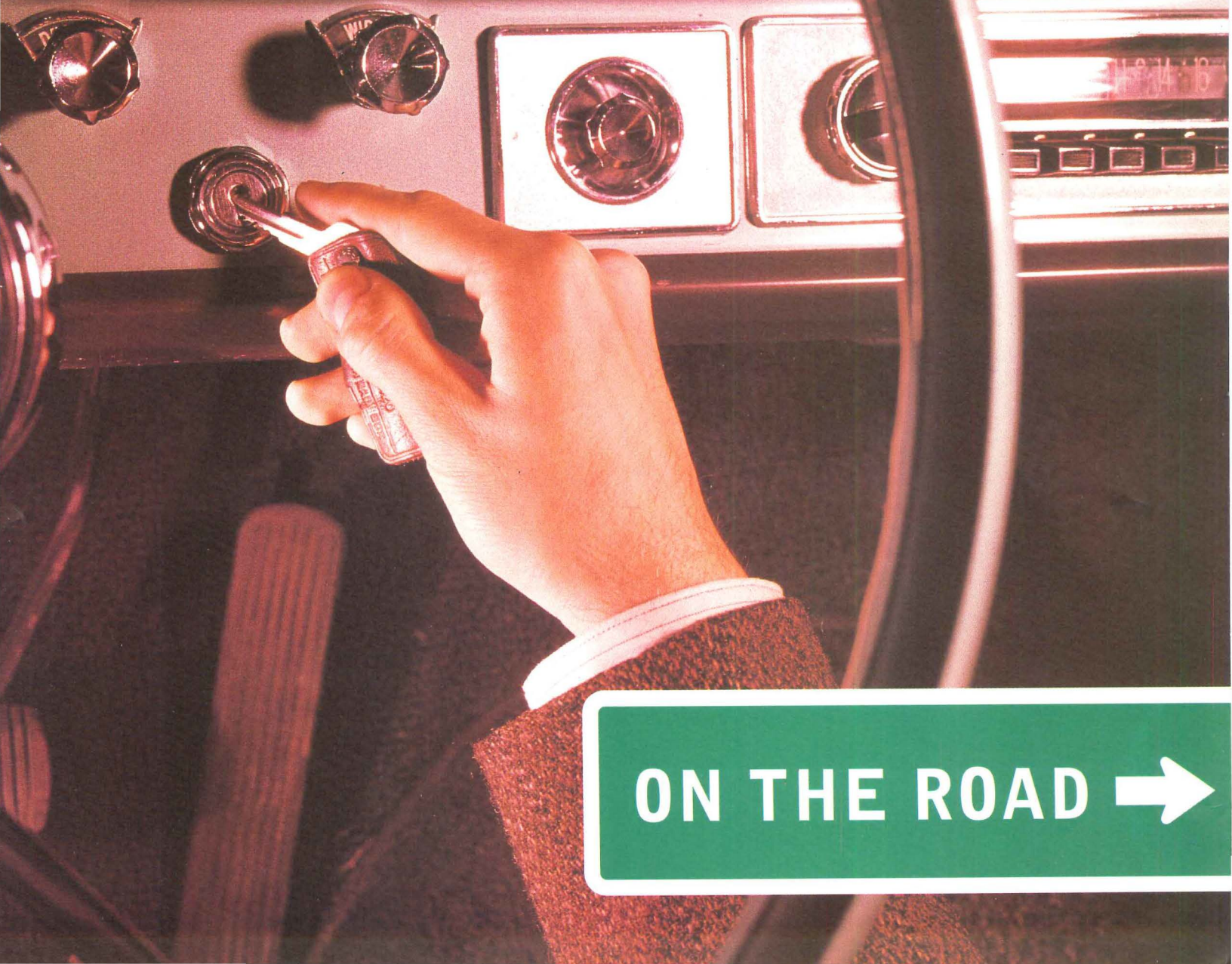

ON THE ROAD →

A silhouette of a human head is centered against a dark, gradient background. The head is mostly black, but the two ears are highlighted with a bright, glowing red-orange light, giving them a three-dimensional appearance. The text is overlaid on the forehead and upper face area of the silhouette.

Up until now,

these were

the two best ways

to determine

noise reduction.

The road is our quintessential national icon: Jack Kerouac wrote about it; Willie Nelson sings about it; all Americans dream about it. Yet we are torn between a visceral embrace of its power and an impassioned rejection of its depredations. We throw billions of dollars at roads every year: The notoriously pork-laden transportation bill currently rolling through Congress targets most of its \$200 billion-plus appropriation toward highway construction. Then we chain ourselves to lawyers—trees having proved much less effective—to stop the building of new roads.

Twentieth-century architects are no less divided. Only eight years after lining the road with his theoretical *Ville Contemporaine*, Le Corbusier subsumed the city beneath the freeway altogether in his 1930 plan for Algiers. Almost four decades later,

which they had long ago handed over to builders and plan services. To be sure, architecture offices still produce roadside buildings, but most of them are unremarkable, or worse.

What a waste. Architects wring their hands about losing relevance in the public eye. But in the two places people know best—their homes and their cars—architecture is very hard to find.

That's not the way it should be. As Jane Holtz Kay points out (pages 138-139), America's driving environment is increasingly congested and hazardous. She exhorts architects to play a more active role in ameliorating those conditions. At one level, that effort revolves around planning, where the New Urbanists have at least been successful in reactivating public debate about autocentric urban design.

Road Hazards

Architects need to improve their on-the-road performance.

Robert Venturi, Denise Scott Brown, and Steven Izenour argued in *Learning from Las Vegas* that road culture and American culture are the same. In this issue, Venturi argues further that today's roadside advertising will inspire tomorrow's artistic visions (page 228).

At the opposite pole is Venturi's mentor Vincent Scully, who, along with Jane Jacobs, decried autoculture before such attacks were popular. Today, architects from across the spectrum have joined the critical chorus. The Congress for the New Urbanism, for instance, couches its anti-automobilism in a thoughtful, if treacly, rejection of Modernist paradigms.

Between the extremes lies a respectable heritage of roadside buildings, from the regional picturesque of the 1930s to the flight-inspired Futurism of the late 1950s. But by the 1970s, the fanciful roadside design bubble had burst. McDonald's traded its golden arches for a mansard hut, and homogeneity blanketed the land. Architects all but abandoned the road as a field of creative endeavor, apparently satisfied to see it go the way of production housing—

Building design is equally important. Roadside architecture is generally the result of market forces, not tight planning controls. And after decades of a me-too mentality, American business has finally begun to understand that brand identity and physical identity are linked: That's the impetus behind Machado and Silvetti Associates' new Sonic drive-in (pages 104-107) and BOORA Architects' Auto Bistro (page 63). More broadly, it's the inspiration for this year's annual review of American architecture: Architects can do better by the road, and can reclaim a market doing it.

This issue assembles nearly a dozen buildings that belie the musty argument that banal programs and intransigent clients make good roadside architecture impossible. Here are fast-food joints, a drive-thru bank, a car wash, and a department store, executed for conservative corporate behemoths—including McDonald's itself. Each respects the client, the context, and the bottom line. And without fail, each of these buildings stylishly drop-kicks the sickly status quo of roadside design.

Reed Kroloff



©1998 The Carpet and Rug Institute 1-800-682-8846 or www.carpet-rug.com
© Kari Alberg 1996

The new Newark

While I applaud Mayor Sharpe James's efforts to revitalize Newark (*Architecture*, March 1998, pages 69-73), he should not forget what distinguishes a city from just another suburb. In his zealous effort to build, he has forgotten to rebuild. Many outstanding buildings have gone under the wrecking ball and have been replaced by inferior buildings or, worse, by parking lots, without considering the needs of the community.

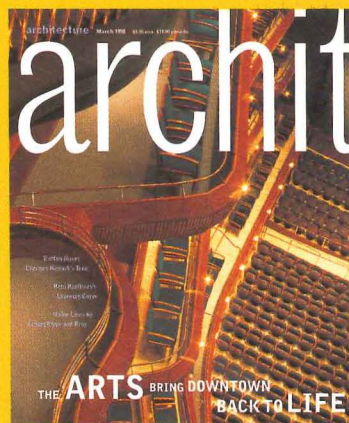

Newark doesn't have enough open public space for passive recreation. The Wilson Avenue Bath House, a beautiful building and public swimming pool, was demolished and replaced by a privately owned apartment building. Also, while there is a strong need for public housing, Mayor James's concept for "horizontal growth" in the city's core destroys the possibility for a tight urban fabric.

Before Newark embarks on a building spree, let's restore and preserve the building stock that we have inherited. Now that the city is creating a master plan, new ideas on how to better utilize our acres of parking lots and derelict buildings without suburbanizing our city should be incorporated.
Ada R. Caro
David Smotrich & Partners
Newark, New Jersey

Gund undone

Your review of the North Shore Center for the Performing Arts in Skokie, Illinois (*Architecture*, March 1998, pages 110-113), intimates that a difficult site and stringent budget make good architecture impossible—a belief which, if held by all architects, would

seriously harm public buildings.

Part of the excitement of architecture is to improve challenging sites and neighborhoods. Your article neglected to note that others [in the neighborhood] are upgrading their properties. The "undistinguished hotel" adjacent to the center has begun improvements and has been repainted using a palette similar to that of the North Shore Center. The supermarket loading dock will soon be screened by a planned addition and the Village of Skokie has required additional plantings to screen it entirely.

Graham Gund Architects (GGA) believes that buildings do not need expensive details and materials to be successful. In this building, materials do double duty: The structure holds up the building, is the acoustic enclosure, and defines the space. Given the budget, the client, their patrons, and our firm feel that the material esthetic is quite successful.
Graham Gund, President
Graham Gund Architects
Cambridge, Massachusetts

Preserving the truth

Contrary to the opinions presented in the February 1998 issue of *Architecture*, preservation is a complex phenomenon that has brought back the issues of continuity, memory, and group identity into architectural discourse and practice. While many preservation projects are driven by nostalgia, it is equally true that progress, the antithesis of nostalgia, uses a seductive fiction to invalidate the past as irrelevant and harmful.

Preservation began in the 1960s as a public response to the social failure of the Modern movement and has evolved into an academic field of study with its own history and theories. But to call preservation a reactive "architectural agenda," as author Paul Spencer Byard does, neglects the complex history of its concerns over time.

Preservation responds to the built environment and focuses on maintaining contact with works of the past. The process by which this is done is neither vague nor new. Preservation asserts a fundamental and primary concern for the existing context. It finds its outlet in minimal but opportune interventions. It avoids a generalized, irrational renewal of form and

materials and addresses complex cultural questions.

Everything has a history, thus it is the obligation of preservation to provide the means by which those stories can be made relevant to the present through the built environment. Buildings and places transform with or without our professional input. Controlling change, therefore, remains the primary responsibility of preservation, and one which will become of increasing importance as architects and planners turn their attention toward working with existing buildings and places.
Frank Matero
Associate Professor of Architecture
University of Pennsylvania
Philadelphia

NPS responds

In response to "Battle of Gettysburg" (*Architecture*, January 1998, page 59), author Ned Cramer confuses or takes several issues out of context. The Gettysburg National Military Park is planning to rehabilitate key areas of the battlefield by removing modern intrusions, restoring essential 1863 features, and building a new visitor center and museum through a public-private partnership.

Two years of planning a new visitor center and producing a General Management Plan have included extensive public meetings and review. The National Park Service (NPS) has clearly stated its goals: to provide storage for priceless Civil War artifacts and archives; to preserve the Cyclorama painting; to rehabilitate Ziegler's Grove and the High Water Mark battle areas; and to provide high-quality educational opportunities for visitors.

The latter goal involves removing the 1959 Richard Neutra-designed visitor center and Cyclorama center because it sits on one of the most sacred areas of the battlefield. The Advisory Council on Historic Preservation, established by the National Historic Preservation Act of 1966, stated in its June 1977 report that both buildings should be removed. The Gettysburg National Military Park has evaluated their significance through appropriate assessments and has consulted with the Pennsylvania State Historic Preservation Officer, who concurred with the park's finding.

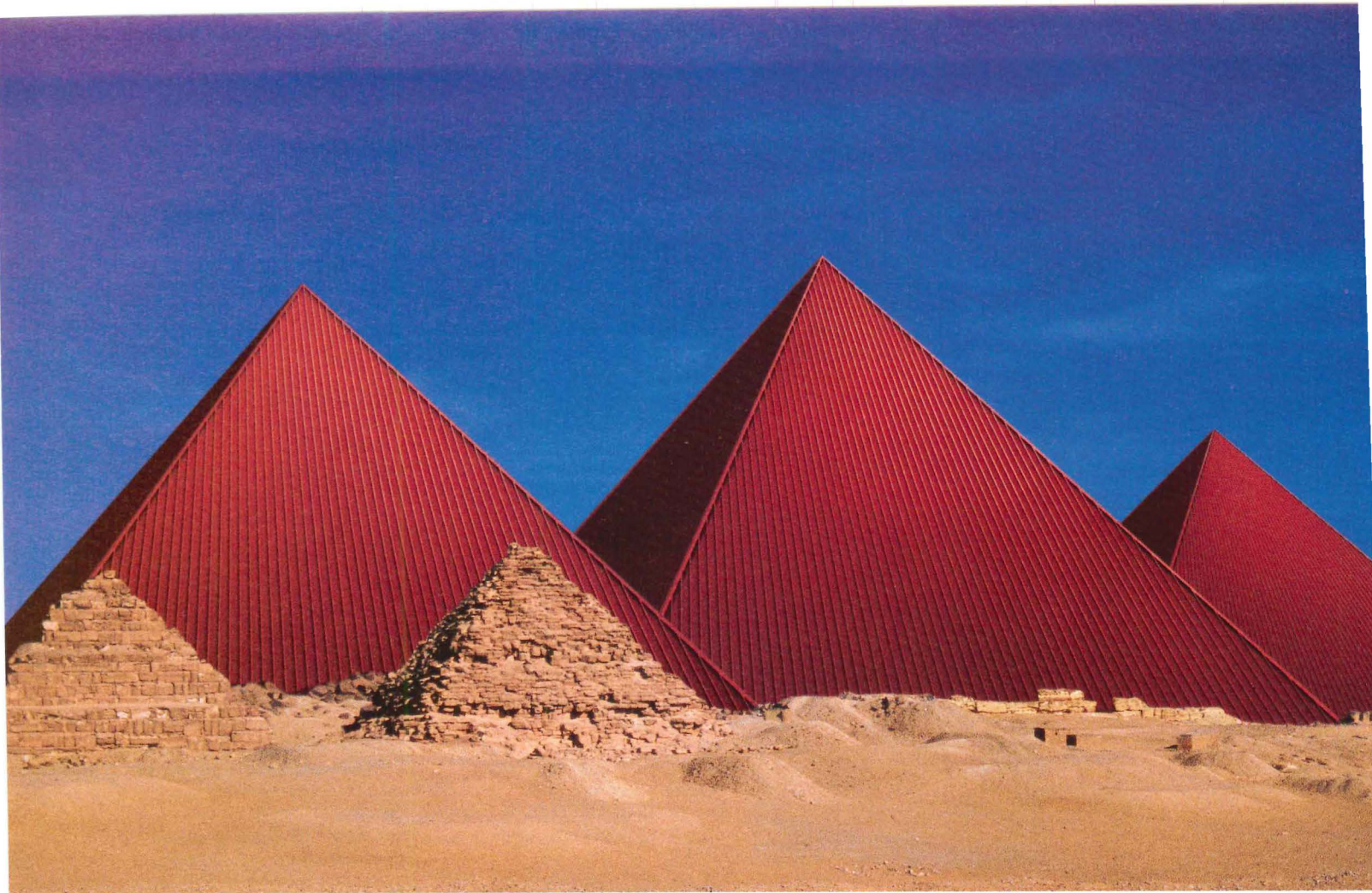

OK, the tourists wouldn't like it as well, but the architects would have been amazed and inspired.

If the Egyptians had invented UC-4 in 3000 B.C., the ancient world would have looked very different. Today, you can discover a new world of design flexibility and durability that would have made you the envy of the pyramid builders. All they had to work with was stone and wood. You can choose UC-4 in long-lasting steel, aluminum or copper. All are UL-90 rated. It's available in an almost unlimited range

of durable colors. And clipless installation means UC-4 will save your clients' time and labor. The aesthetic appeal, durability and efficiency of UC-4 combine to offer you an exciting world of design options just waiting to be explored on your next project. Call 1-800-426-7737 to discover the creative possibilities of UC-4 and a full line of metal roof, wall panel and column cover products.



Circle 22 on information card

The NPS and the development team are negotiating the final program. It may include an interpretive film, expanded museum exhibits, a bookstore or museum shop, and food service. It would therefore not be a "mall," but would include functions found in major museums across the country.

Richard W. Segars
Historical Architect
Gettysburg National Military Park
Gettysburg, Pennsylvania

Hejduk review

I was very interested in Ned Cramer's review of the John Hejduk retrospective at the Canadian Centre for Architecture (*Architecture*, December 1997, page 33). Although the piece is titled "Masked Intentions" and Cramer refers to it as "intellectual hide-and-seek," I found it stimulating and reachable compared to the bombastic works by Frank Gehry and Richard Meier presented in the same issue.

Rod Knox
Professor of Architecture
The Cooper Union
New York City

CORRECTIONS

The Hillier Group designed the New Jersey Institute of Technology's School of Architecture (*Architecture*, March 1998, page 71). The Newark Center for Commerce and Education (*Architecture*, March 1998, page 71) was designed by Vladimir Arsene when he was project designer for Grad Associates.

San Francisco's SONY Metreon project (*Architecture*, February 1998, pages 40-45) was designed by Simon Martin-Vegue Winkelstein Moris and Gary Edward Handel Associates. Johnson Fain Partners is the lead designer of Catellus's Mission Bay master plan.

The Phillips Group is the architect of the Cemex video-teleconferencing boardroom (*Architecture*, March 1998, pages 158-162).

WE WANT TO HEAR FROM YOU!

Please mail (*Architecture*, 1515 Broadway, New York, NY 10036), fax (212 / 382-6016), or e-mail (info@architecturemag.com) your letters to the editor. Please include your name, address, and daytime telephone number. Letters may be edited for clarity or length.

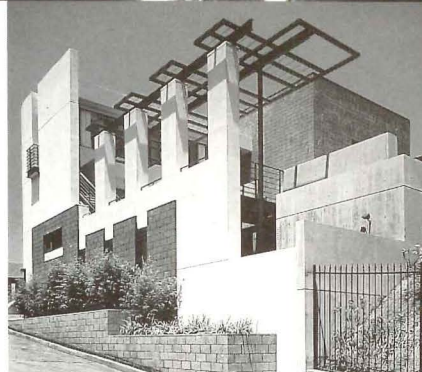
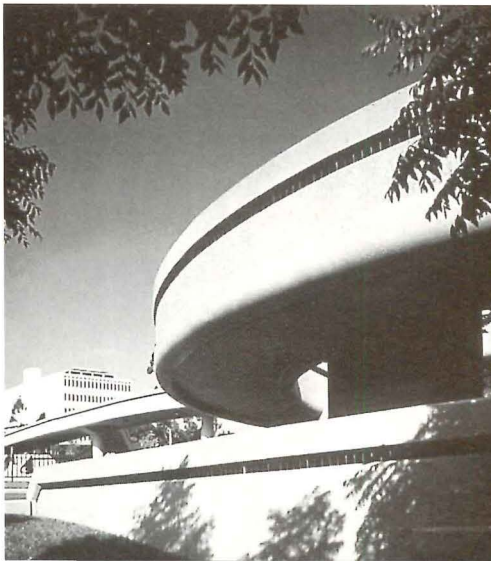

Reinforced concrete gives you decisive advantages . . .

and, Award Winning Design possibilities

. . . lower costs and cash flow savings . . . shorter completion schedules . . . cast-in-place flexibility for unusual, dramatic shapes . . . durability . . . natural, aesthetically-pleasing finish . . . greater fire-resistance . . . thermal mass advantages . . . and reinforced concrete allows architects to be creative.

These important advantages enable owners to build award winning facilities that are cost efficient and distinctive. Whether it's institutional, commercial, educational, residential or healthcare structures, *reinforced concrete provides the cost-effective, creative solution.*

Find out more about award winning design using reinforced concrete. Call or fax for the *1998 Design Awards Brochure* from CRSI.

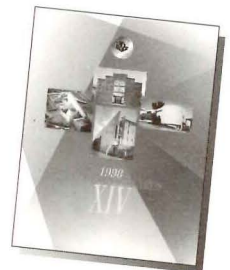

Concrete Reinforcing Steel Institute

933 N. Plum Grove Road
Schaumburg, Illinois 60173-4758
847/517-1200 Fax: 847/517-1206
Website: www.crsi.org
Circle 24 on information card

WHEN IT CAME TO RENOVATING THIS HISTORIC COURTHOUSE, EVEN THE

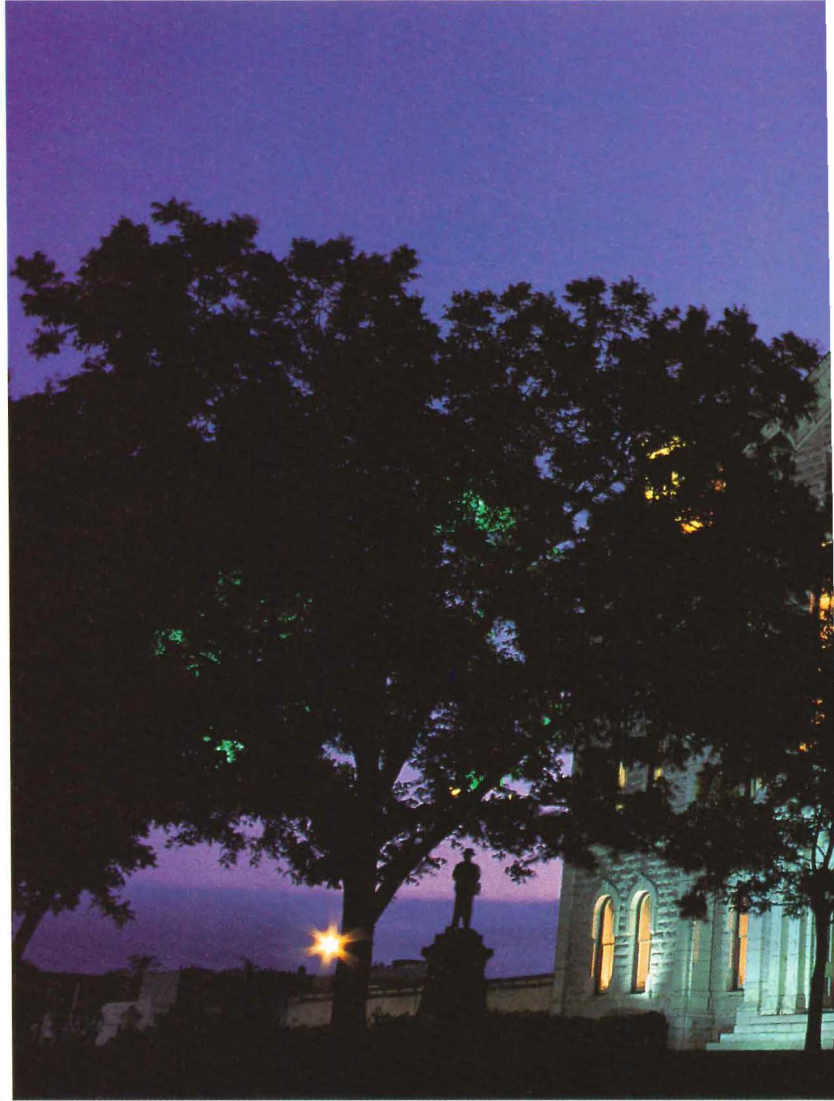

In 1964, The Parker County Courthouse in Weatherford, Texas was designated a Texas Historic Landmark. And thus began the slow, methodical process of restoring it. First to receive attention was the structure's limestone stonework. Later, the roof was replaced. Then came the windows, which proved to be one of the most challenging aspects of the project.

The Historical Survey Committee mandates that if nothing remains of a historic building's original windows, the new ones must be faithful reproductions, right down to the last detail. Since the courthouse's original wood windows had been replaced by aluminum ones some years back, that meant that all 105 of the new windows had to be virtually identical to those made and installed over a century ago.

Bids were sought, but only two manufacturers felt qualified to respond. One of them, Marvin Windows & Doors, had actually been recommended by a company that was asked to bid but declined.

Though underbid by the other finalist, Marvin's figures were based on building the largest windows with structural muntin bars to withstand the winds that buffeted the building's hilltop site. Intrigued, the architect asked each company to build a sample window. One look at the prototypes and the job was immediately awarded to Marvin.

For the next several weeks, Marvin's architectural department busied itself recreating the past. Working from turn-of-the-century photographs



exhibitions

city	dates	exhibition	contact
Boston	June 3-August 31	Art by Architects at the Boston Society of Architects	(617) 951-1433
Chicago	through June 4	Invisible New York: The Hidden Infrastructure of the City at the Graham Foundation	(312) 787-4071
New York	through June 19	Dream Houses: Three Latino Constructions at the Hostos Center for Art and Culture	(718) 518-4455
	through June 30	The Technology Series I: Titanium! at the Material Connexion	(212) 445-8924
Washington, D.C.	through July 5	Architecture in Perspective 12 at the Octagon	(202) 638-3221
	through September 27	Completing the Federal Triangle: The Ronald Reagan Building and International Trade Center at the National Building Museum	(202) 272-2448



Art by Architects includes "Construction," a drawing by Principal Robert J. Miklos of Schwartz/Silver Architects.

Success Story.

It's always the same story – traditional butt hinges cause doors to sag or to bind and eventually to fail. PemkoHinge™ continuous geared hinges replace this problem with a guaranteed successful solution:

The architect of this new high school chose PemkoHinge™ for its quality, clean aesthetics, and smooth-acting functionality.

The contractor loves the ease of installation and the "Life of the Opening" guarantee.

The school district and facility manager appreciate the durability, safety, privacy and security provided by PemkoHinge™.

ASK FOR IT BY NAME.



P.O. Box 18966, Memphis, TN 38181
 Ph: (901) 365-2160 or (800) 824-3018
 Fax: (901) 365-1354 or (800) 243-3656
 P.O. Box 3780, Ventura, CA 93006
 Ph: (805) 642-2600 or (800) 283-9988
 Fax: (805) 642-4109 or (800) 283-4050

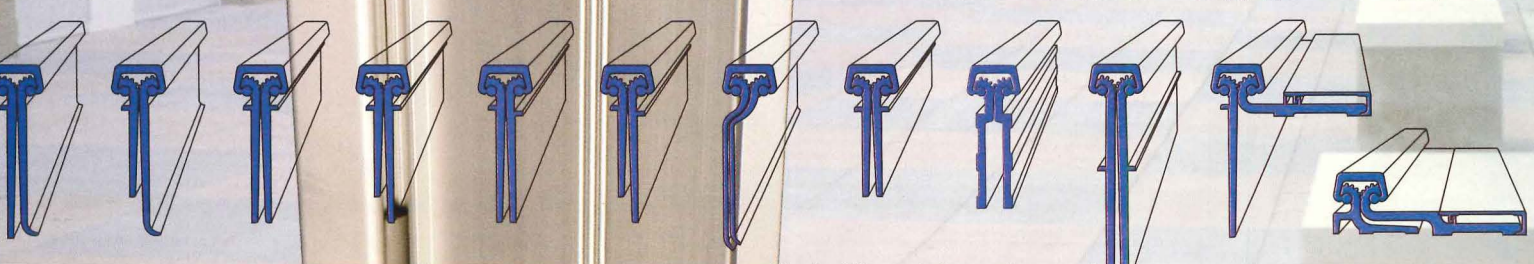

conferences

city	dates	conference	contact
Baltimore	June 25-28	Construction Specifications Institute Convention and Exhibit	(800) 689-2900, ext. 772
Chicago	June 7-10	Decorex USA	(800) 677-6278
	June 8-10	NeoCon	(800) 677-6278
	June 2-5	A/E/C Systems '98	(800) 451-1196
Las Vegas	May 26-29	Lightfair International , sponsored by the International Association of Lighting Designers and the Illuminating Engineering Society of North America	(800) 856-0327
Philadelphia	June 21-23	The Building Owners and Managers Association International Convention	(202) 326-6331
Washington, D.C.	June 25	Do It Yourself: Home Improvement in 20th Century America Panel Discussion at the National Building Museum	(202) 272-2448

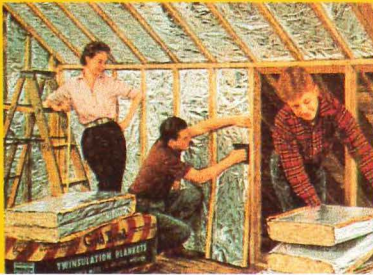

National Building Museum celebrates publication of Carolyn M. Goldstein's new book, **Do It Yourself: Home Improvement in 20th Century America** (Princeton Architectural Press).

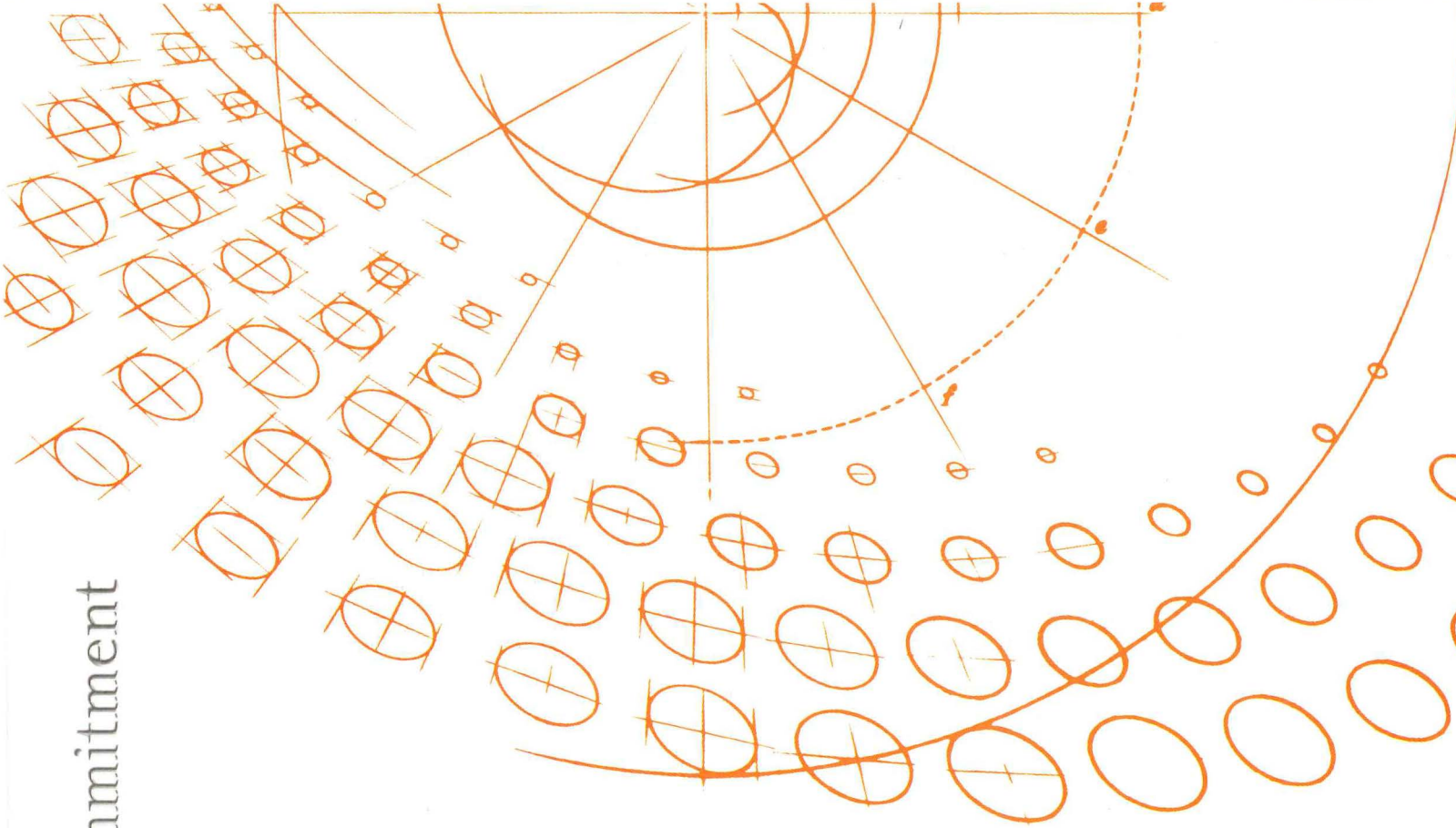

Commitment

competitions

competition	deadline	contact
1998 National Marketing Communications Awards , sponsored by the Society for Marketing Professional Services	May 15	(703) 549-6117
National Art & Design Competition for Street Trees , sponsored by the City University of New York and the Cooper-Hewitt, National Design Museum	June 5	(212) 642-2970
1998 Van Alen Prize in Public Architecture: Design Ideas for New York's Other River	June 5 (revised deadline)	(212) 924-7000
Student Case Study Competition , sponsored by the University of California, Berkeley	June 15	(510) 642-1696
Good Design awards program , sponsored by the Chicago Athenaeum	July 1	(312) 251-0175
Unbuilt Architecture Design Awards , sponsored by the Boston Society of Architects	August 17	(617) 951-0845 fax
Johannesburg, South Africa, Constitutional Court Competition	August 25 (registration)	(27) (12) 325-8095 fax

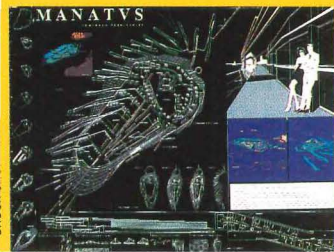

Governor's Island proposal by Winka Dubbeldam received honorable mention in 1996 Van Alen Prize competition.

Allow us to illustrate why we should be a part of your plans.

Introducing something better in the world of float glass—Visteon. Where you'll find the performance you've been looking for in our people as well as our product. At Visteon, we've invested \$60 million updating our float glass facilities. Combine this commitment

with the customer-conscious focus of our people and the result is quality product, color choices and reliable service to back them. Take for instance, our new Visteon Versalux™ Blue 2000 coated and uncoated glass. Improved performance characteristics and richer color

make it a blue like never before. Making it an excellent addition to our bronze, grey and green glass offerings. And another reason why you should consider us in your plans. Visteon. Call us at 1-800-521-6346 to find out more. And visit our web site at <http://floatglass.visteonet.com>.

See the possibilities™



Circle 32 on information card

An Enterprise of *Ford Motor Company*

Architectour

1998 Tours & Events

Architectour Berlin 98

(with optional 3-day extension to Prague)

July 14-20

Architectour Spain 98

(with optional 4-day extension to Portugal)

September 13-28

Architectour Japan 98

(with optional 3-day extension to Hong Kong)

Oct. 29-Nov. 13

Architectour Thailand 98

(with optional 3-day extension to Singapore)

Dec. 20-Jan. 2



▲ Schneider + Schumacher, Info Box, Berlin

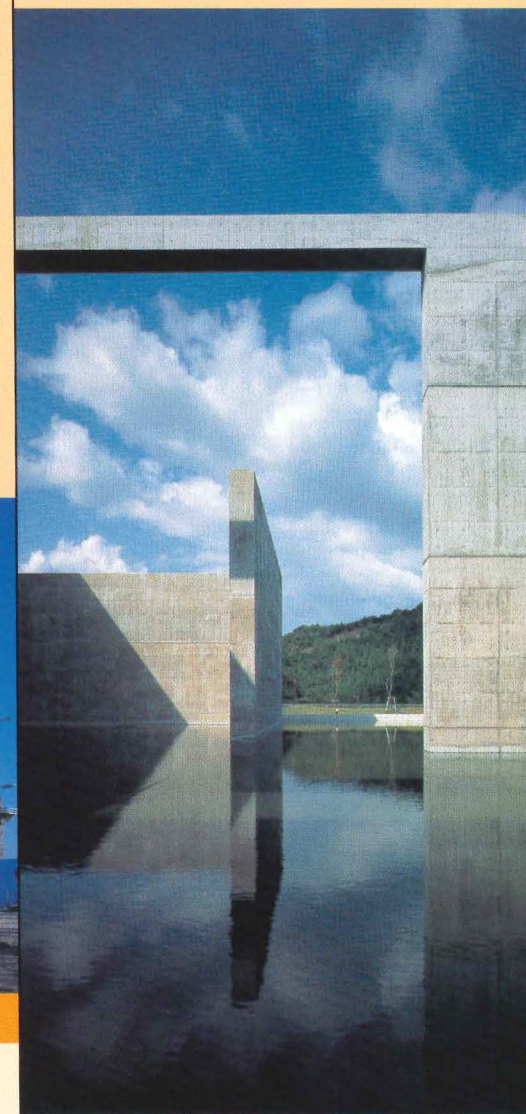

Tadao Ando - Himeji Children's Museum, Japan ▲

"I could have booked a trip, made my own arrangements, spent six months there, and still not have seen or heard about one-quarter of what I was able to experience on Architectour."

Michael N. Schuster, AIA, Cincinnati, Ohio

Architectour 98 is made possible with the assistance of:

BSA
The Boston Society
of Architects

JIA
Japan
Institute of
Architects

**ARCHITECTURE INTERIOR
DESIGN**

COAC
Col.legi
d'Arquitectes de
Catalunya

**MUSEU D'ART CONTEMPORANI
MAC
BARCELONA**
Fundación Cultural
de Colegio de
Architectos de Madrid

Places are limited!

Tax Deduction

Participating architects, interior designers and other design professionals are entitled to a full tax deduction for all expenses.

Architectour conforms to Learning Unit requirements of the AIA (American Institute of Architects) and ASID (American Society of Interior Designers).

Architectour was a deeply emotional and penetrating experience. I came away with a deeper love and appreciation of architecture."

Frank O. Gehry, Architect, NYC, NY



Frank O. Gehry - Bilbao Guggenheim Museum, Spain

All Architectour programs include:

- > Presentations on-site by the most important architects and designers.
- > Access to places impossible to reach on your own.
- > Visits to the best works of contemporary and historical architecture and interior design.
- > A daily 'menu' of tours and events to suit particular interests.
- > A delightful blend of cultural and social activities.
- > *Special discounts for companions.*

✓ *The Amanpuri, The Island of Phuket, Thailand*



For your free brochure and for more information on Architectour programs, schedules, rates, installments plans, Early Booking Bonuses, call Architects Abroad, toll free number:

1-800-272-8808

or, for calls from outside the USA and Canada, 1(415)955-2753 or fax 1(415)955-2754
Website: <http://www.arctour.com>
E-Mail: info@arctour.com

Architectour is a registered trade name of Architects Abroad, Inc.
44 Montgomery St. Suite 500, San Francisco, CA 94104, USA

Circle 34 on information card

NEW AIA CHIEF **CLEANS HOUSE**

When *Fortune* magazine published its list of the top 120 lobbyists in Washington, D.C., last December, it included everyone from the American Medical Association to the Associated General Contractors of America to the Beer Institute. The American Institute of Architects (AIA), though housed less than a block from the White House, was nowhere to be found.

Clearly aware of the AIA's lackluster lobbying efforts, and tuned into complaints from both members and staff about service and management deficiencies, the Institute's new executive vice president and CEO, Mark Hurwitz, is cleaning house. Taking cues from his predecessor, Terry McDermott (who left the AIA for the National Association of Realtors in Chicago last July, after a three-year tenure that began with drastic downsizing), Hurwitz has dramatically restructured management to streamline operations. Most significantly, the new boss eliminated the positions of vice president of federal affairs, held by Stuart Binstock, and vice president of member communications, held by Philip

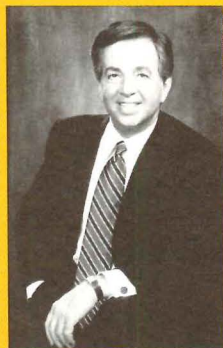

Schreiner—both considered ineffective McDermott hires. Hurwitz created a new vice presidential position overseeing all local, state, and federal government affairs and hired James C. Dinegar, previously a business manager for Washington, D.C., architect Atelier Design and a lobbyist for the Building Owners and Managers Association International and the American Society of Association Executives.

All outreach efforts were consolidated under Vice President of Communications Charles E. Hamlin, who will still oversee public relations, advertising, and the honors and awards programs, but will also take over AIAOnline, *AIArchitect*—both previously under Schreiner—and the AIA Press. In addition, Hurwitz transferred the AIA's general counsel duties to an outside law firm, eliminating the position held by John DiNardo; named former State

Government Affairs Director Nancy Somerville vice president of component affairs; and promoted Chief Financial Officer Fred R. Deluca to senior vice president and chief operating officer. Several departments were consolidated under newly appointed Vice President of Human Resources and Administration Ronald Dias. A new chief technology officer is being recruited, as is a new library manager.

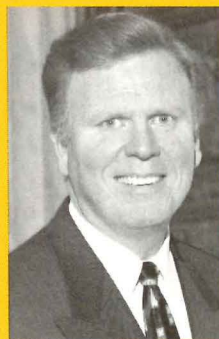

Hamlin says the changes, all effective May 1, reflect the Institute's desire to improve member communication through increased chapter support and investment in information technology. A lobbying boost is critical, as well, he maintains: "The AIA's advocacy role in public policy and regulation is about to get a real shot in the arm."

Hurwitz obviously doesn't want any grass to grow under his or the Institute's feet: "It is my goal to move quickly and create a truly unified, collaborative orga-

New AIA CEO Mark Hurwitz (above left); new government affairs Vice President James C. Dinegar (left)

AMERICAN INDIAN MUSEUM OUSTS ARCHITECT

In politically correct Washington, D.C., it seemed like a perfect assignment. Canadian architect Douglas Cardinal, part Ojibwa, part Mohawk, was hired to design the Smithsonian's National Museum of the American Indian (NMAI). The building, to open in 2002, will stand prominently on the Mall near the Capitol. Cardinal's organic structure is, he says, intended to celebrate American Indian culture.

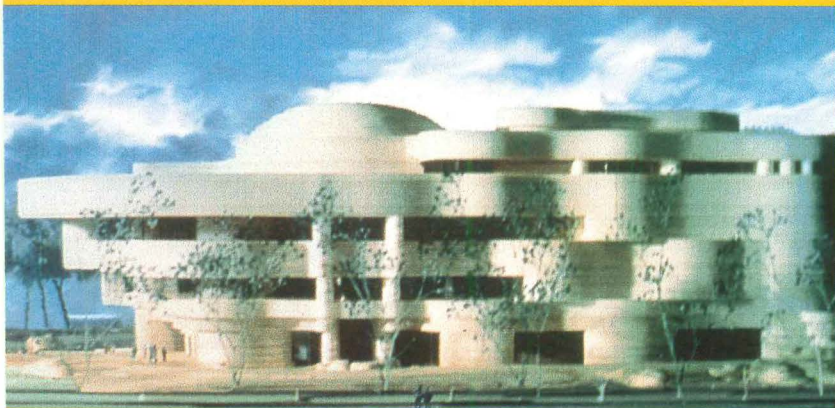

Cardinal's curvaceous American Indian Museum faces Pei's National Gallery East Wing.

But in late March, the Smithsonian fired Cardinal and GBQC Architects, the prime contractor with whom Cardinal is associated. Citing the architects' failure to deliver drawings on time as stipulated by contract, Smithsonian Director of Communications David Umansky explained that Cardinal's acclaimed design will be built without its architect. Since September, Cardinal has withheld design-development drawings, which he says are "35 percent complete," because he feels the Smithsonian required "exhaustive" extra work for which he was not paid. "They want to build my building; they just don't want to pay me for it," Cardinal grumbles.

NMAI Director Richard West claims the two halves of the architectural team divided over the fees. GBQC Principal James Snyder admits, "We've been trying to work this out with Doug" and feels confident that an appeal of the firing will resolve in the team's favor. (A decision is due at the end of May.) Meanwhile, West and Umansky appear divided over the role of James Stewart Polshek, architect of a separate, nearly completed storehouse for the museum in Suitland, Maryland, whom the Smithsonian retained on the heels of Cardinal's dismissal. Says Umansky: Polshek is "only doing a survey and giving a plan for how to proceed." Says West: Polshek is "overseeing completion of the building." Polshek, for his part, says he has "not been officially hired to complete the building," but only to conduct a peer review of the limited drawings the Smithsonian has. "We hope they'll work this out with Cardinal," Polshek adds. *Heidi Landecker*

Heidi Landecker is a Silver Spring, Maryland-based freelance writer.

PIANO TAKES PRITZKER

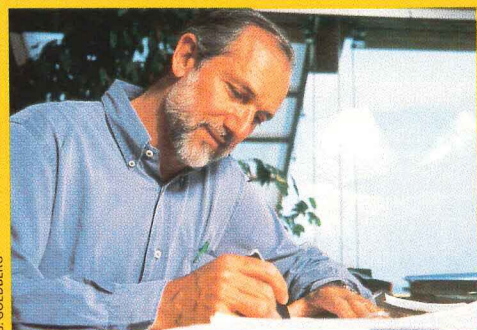

Italian architect Renzo Piano, whose fame was initiated with the construction of the Georges Pompidou Center in Paris (1976, with Richard Rogers), and deepened with the success of The Menil Collection in Houston (1987), has been awarded official star status with the 1998 Pritzker Architecture Prize.

The difference between most star architects and Renzo Piano, however, is his refreshing independence from preconceived notions and styles. Each project is approached as a unique collective voyage in which there will be discoveries of technical solutions, adjustments to historical and natural conditions, and above all, a meaningful dialogue with all sorts of participants. Clients, engineers, contractors, and designers will all have an equal voice as Piano sits back and lights up a cigar, absorbing all that is being said, convinced that good listening is the basis of good design.

Piano's rapport with the late engineer Peter Rice inspired fantastic structural solutions such as the flower-petal concept for the Bari Stadium (1990). Piano's drawings, passed on to long-time associates in his firm, Renzo Piano Building Workshop (RPBW), are like artless, thumbnail maps that serve as the catalysts to creative dialogue in a genuinely lateral design process.

Initially considered a High Tech architect because of his emphasis on innovative and expressed structure, Piano's work has evolved into a rich assembly of experimental engineering, sensitive programming, and a stylistic respect for place. His recent output ranges from subtle background buildings

such the Rue De Meaux apartments in Paris (1991), clad with dry-mounted terra-cotta panels, to projects of high presence such as the ship-shape new Metropolis Science Center (*Architecture*, September 1997, pages 128-135) in Amsterdam harbor.

For Piano to call his office a "building workshop" rings as idealistic as Walter Gropius's choice of the name "bauhaus" and implies a similar ethic of craft and collaboration. After 30 years of practice and an unflinching commitment to inductive reasoning, Piano, who just turned 60, has recognized the pedagogical value of his experience. His new book, *Renzo Piano's Logbook* (Rizzoli), abounds in lessons about how to achieve transparency amid the different circumstances of each project. He has recently promised to establish a school at his Genoa office, populated mostly with students from lesser developed countries.

The 1990s have been extremely active years for RPBW, with the completion of one of the world's largest buildings, the Kansai Airport in Japan; the retrofitting of the mammoth Lingotto FIAT factory in Turin; and the production of significant pieces in European cities, such as Rome's Auditorium complex, the Lyon convention center, and the master plan of Potsdamer Platz with the Daimler Benz tower in Berlin. Piano's says his mission at all scales is to achieve transparency: "The unexpected, the unfinished, the transparent processes are needed to recuperate the complexity of an urban place."
Richard Ingersoll

Projects include (top to bottom): Georges Pompidou Center, Paris (1977); Renzo Piano Building Workshop, Genoa, Italy (1989); Tjibaou Cultural Center, Nouméa, New Caledonia (1998); Daimler Benz tower, Berlin (1998).



MICHEL DENANCE/ARCHIPRESS



MICHEL DENANCE/ARCHIPRESS



GOLLINGS



MICHEL DENANCE/ARCHIPRESS

OLYMPIC PARK REOPENED

The 1996 Olympic Games gave Atlanta a much-needed infrastructural jump-start with the creation of several parks, stadiums, and public art installations (*Architecture*, September 1996, pages 40-41). Now, Atlantans wait to see if post-Olympic conversion plans promised by investors will actually come to fruition. One of these projects, the 107,000-square-foot Centennial Olympic Park—the controversial site of a still-unsolved July 27, 1996, pipe bombing—represents a promise kept: The redesigned plaza reopened on March 28.

Originally designed for the Games by San Francisco-based landscape architect EDAW, the plaza's post-Games incarnation, also by EDAW, retains the popular interactive Olympic Rings Fountain and Light Towers, and features five new commemorative plazas linked by an organic, granite-framed piedmont stream. Called "quilts" in con-

junction with the theme chosen by the Atlanta Committee for the Olympic Games, four of the plazas honor those people who made the Centennial Games

a reality, including Atlantan Olympic booster Billy Payne, the Ancient Greeks, the participating nations, and the Olympians themselves. The fifth plaza eulogizes the two victims of the bombing. Existing street patterns extend through the pedestrian park, connecting such adjacent destinations as Coca Cola headquarters, the Georgia Institute of Technology, CNN Center, and the Atlanta Underground shopping mall. *Michael J. O'Connor*

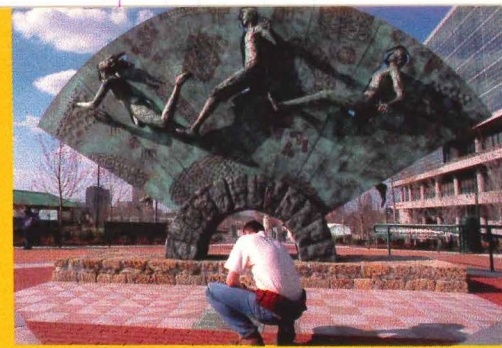

Atlanta's renovated plaza (above) honors Ancient Greeks.

VIÑOLY'S TWO-PART HARMONY

New York City-based Rafael Viñoly Architects is following up its Tokyo International Forum (*Architecture*, October 1996, pages 110-161) with another civic-minded performing arts center in Philadelphia. Released last month, Viñoly's design for the Regional Performing Arts Center (RPAC) replaces a decade-old Venturi Scott Brown Associates proposal.

Viñoly's roughly 400,000-square-foot scheme will boast two auditoriums: a 2,500-seat concert hall and a 650-seat theater for chamber-music recitals and plays. Viñoly, a cello enthusiast, likens the acoustically precise curves of RPAC's larger hall to a well-tuned instrument. "The interior of a cello is pretty much the same as [that of] a concert hall," the architect explains. The smaller hall also takes its form from music: Its stage platform features a revolving turntable that accommodates varying performance sizes and acoustic needs.

A 150-foot-high glazed canopy crowns the two theaters and a 21,800-square-foot public lobby. Viñoly chose the canopy's barrel-vaulted profile to harmonize with the vaulted windows and domes of nearby landmark buildings. Stepped balconies containing restaurants and retail will ring the lobby and an indoor garden will sit on the recital theater's roof.

Of the project's estimated \$245 million price tag, \$166 million has been pledged by public and private donations. Groundbreaking is scheduled for November, and should open in time for the 2001 season. *Michael J. O'Connor*

Viñoly's Regional Performing Arts Center

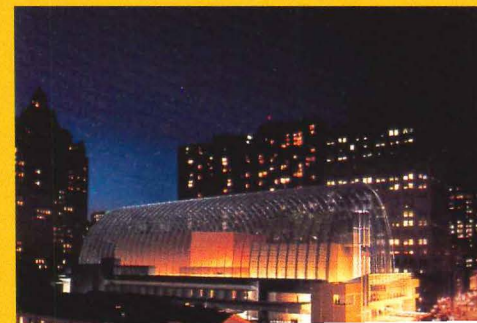

**INNOVATIVE
INSURANCE
THAT STANDS
THE TEST
OF TIME**

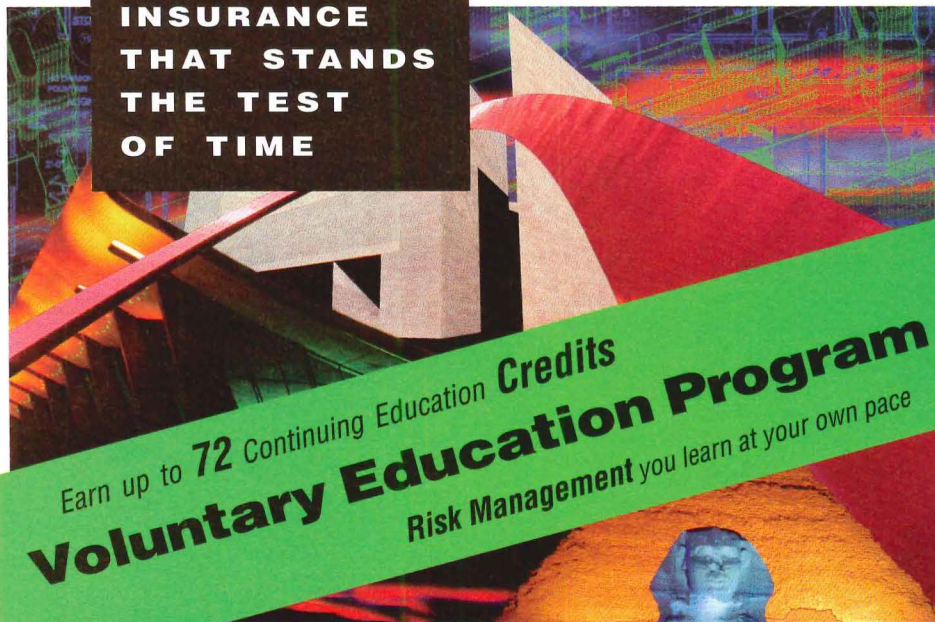

Earn up to **72** Continuing Education Credits
Voluntary Education Program
Risk Management you learn at your own pace

Innovation comes in many shapes and sizes. From the ancient pyramids to your newest project, innovation is one of the keys to **successful** design. • When CNA/Schinnerer designs your professional liability insurance program, we put innovation into **practice**. Our A/E Practice Program helps you meet the changing needs of your firm. And after 40 years, we continue to be the market **leader** with features that include coverage for design-build, a self-study Voluntary Education Program and COMMITMENT PLUS®, our

universal **profit sharing** plan. • To learn more about the A/E Practice Program, which has earned the commendation of the AIA, **call** your local independent agent or broker.

Victor O.
Schinnerer
& Company, Inc.

CNA

Victor O. Schinnerer & Company, Inc., Two Wisconsin Circle, Chevy Chase, MD 20815-7022. Phone: (301) 961-9800. Fax: (301) 951-5444. Coverage provided by Continental Casualty Company, one of the property-casualty companies of CNA. CNA is a registered service mark and trade name of the CNA Financial Corporation. This advertisement is not a contract. Only the policy can provide the actual description of terms, coverages, amounts, conditions and exclusions.

THE BUZZ

It seems that nothing is sacred in Boston. If the mayor's proposal to abandon city hall wasn't enough (page 40), the **Red Sox** are reportedly considering offing the city's beloved Fenway Park as well. The 86-year-old baseball stadium may be demolished and the remains, including the famous "Green Monster" rear wall, incorporated into a larger, and—the owners hope—more profitable facility along the lines of Baltimore's Camden Yards. The Red Sox have reportedly consulted architects **HOK Sport** and **Chan Krieger & Associates** on the replacement scheme. According to a Sox spokesman, "We're definitely looking to build a new park, but we're not making any specific statements yet." And last month, days before *The Boston Globe* disclosed the Red Sox proposal, a steel beam collapsed at 75-year-old Yankee Stadium in the Bronx (fortunately while the stadium was unoccupied), calling into question that ballpark's future.

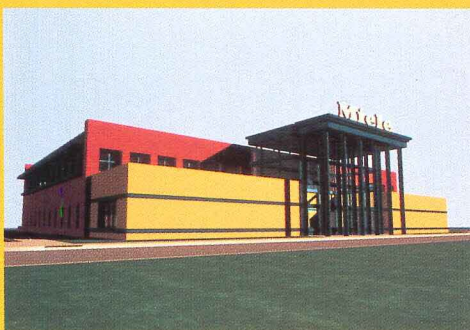

In April, the University of Texas announced its shortlist for the new Jack S. Blanton Museum of Art: Swiss architect **Herzog and De Meuron**, Norwegian architect **Snøhetta**, and Americans **Steven Holl**, **Antoine Predock**, **Thompson and Rose**, **Rafael Viñoly**, and **Tod Williams and Billie Tsien**. Predock is also designing a new art museum in Tacoma, Washington.

As construction draws to a close on **Daniel Libeskind's** long-awaited Jewish Museum in Berlin, the architect nabbed the commission for another Jewish museum, in San Francisco's Yerba Buena cultural district. New York City architect **Bernard Tschumi** won an invited competition for a new exhibition center and 7,000-seat concert hall in Rouen, France. Ground broke last month on appliance manufacturer **Miele's** new 31,000-square-foot headquarters, designed by architect **Michael Graves** in his hometown of Princeton, New Jersey. Graves (with **Thomas Miller & Partners**) is also one of three architects invited to compete for Nashville's new downtown public library.

His competition is **Hardy Holzman Pfeiffer Associates** with **Gould Turner Group** and **Robert A.M. Stern Architects** with **Hart Freeland Roberts**.

America's Interstate Highway System tops the **Construction Specifications Institute's** (CSI) list of the five most significant construction achievements of the last half-century. The announcement helps mark CSI's own 50th anniversary. The other four projects are **Eero Saarinen's** St. Louis Arch; the Washington, D.C., subway system, by **Harry Weese and Associates**; the space shuttle and its launching pad; and **Skidmore, Owings & Merrill's** Lever House in New York City. They were selected by CSI's members.



Bernard Tschumi's competition-winning exhibition center and concert hall in Rouen, France (above); Michael Graves's Miele headquarters in Princeton, New Jersey (below left)

The Most Sensitive, Reliable, Rolling Door or Grille Failsafe Safetyedge is Now CORDLESS and Available Only on Cookson Doors.

The purpose of a safetyedge is to reverse the closing action of a door or grille when it touches an obstruction. The Cookson Company introduces a new wave in safetyedge design - Phantom Featheredge™ - the very first device using air wave technology. And, it's cordless! The fail-safe Phantom Featheredge will function properly even if punctured or torn, it has no contacts to corrode, variations in temperature will not effect its performance, and it does not require a power cord to operate.

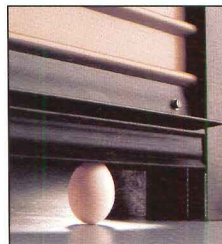

Can you afford to take a chance with safety? Of course you can't. Always specify Cookson rolling doors and grilles with the fail-safe Phantom Featheredge. The only safetyedge with air wave technology that does not require a connecting power cord.

For More Information and a FREE Educational Video

PHANTOM FEATHEREDGE™



Fax your business card to
800-277-2576



Rolling Doors

The Cookson Company

2417 S. 50th Avenue • Phoenix, AZ 85043
Phone (800) 390-8590 • Fax (800) 866-2132
www.cooksondoor.com

Circle 38 on information card



THE MOST INNOVATIVE
LIGHTING IS FOUND
BEHIND THE MOST
INNOVATIVE DESIGNS.



At Philips Lighting Company, we design to maximize the visual experience. Our innovative **MasterLine™** halogen and **MasterColor®** lamps provide superior control and color consistency. Of course, we also consider the environment a partner in our vision. Our acclaimed **ALTO™** lamps revolutionized fluorescent technology with low mercury content. The **Earth Light®** collection is uniquely designed to conserve electricity. For information, call 1-800-631-1259 or e-mail us at plc.lit@salessupport.com or visit our Web site at www.lighting.philips.com/nam

Dress Courtesy of AmericasMart•Atlanta ©1998 Philips Electronics North America Corporation



PHILIPS

Let's make things better.

Circle 40 on information card

MENINO SNUBS CITY HALL



PETER VANDERWARKER

Once again, Boston Mayor Thomas M. Menino is trying to abandon Kallmann McKinnell & Wood's iconic city hall (1968). Even with ambitious plans for improving the barren plaza surrounding the Brutalist icon (pages 52-61), Menino's newly

released budget proposal for fiscal year 1999 includes \$250,000 to study the logistics of building a replacement city hall on a different downtown site.

The mayor apparently hopes to sell the current city hall site, and gut the building's interior for commercial tenants. "I don't know what it could be used for. Some parts of it would make a great handball court," *The Boston Globe* quoted Menino as saying. The mayor is also considering another, more drastic option: demolishing City Hall altogether to make way for a new office and hotel complex built by private developers.

Menino shares many Bostonians' discontent with City Hall. The building has been widely criticized for its severe architecture and its inability to house all the city's offices. Two years ago, the mayor unsuccessfully approached the U.S. General Services Administration about moving into Boston's Art Deco district courthouse, which the agency was vacating for Pei Cobb Freed & Partners' new facility on Fan Pier (*Architecture*, March 1996, page 43). *Ned Cramer*

FREED AT LAST IN D.C.

They call it a white elephant, but at least it's a well-trained one: After a 10-year period of design and construction, the \$720 million Ronald Reagan Building and International Trade Center opens this month in the massive Federal Triangle district of downtown Washington, D.C.

The 7.7-acre project, designed by James Ingo Freed of Pei Cobb Freed & Partners, represents the final piece of Federal Triangle, for which a City Beautiful plan was launched in 1926. It is also the last hurrah for the now-disbanded Pennsylvania Avenue Development Corporation, which first proposed the project 30 years ago to help revive America's Main Street.

On the outside of the Reagan Building, Freed works the limestone Classicism of Federal Triangle to its most abstract conclusion yet while inside, the Modernist in him goes to town with a 125-foot-high

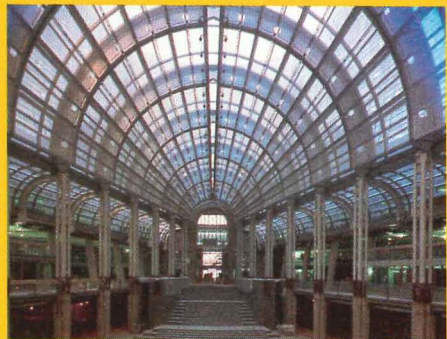

TIMOTHY HORSLEY

glass-and-steel atrium, structural columns that thrust and lean dramatically, and profuse daylighting.

During its long gestation, the project—which holds offices for the Environmental Protection Agency and the Agency for International Development, among others—withstood death threats from Congressional conservatives who made it a symbol of government waste. Critics quickly noted the irony of such an extravagant sum being spent to honor a president known for a gospel of government thrift. *Bradford McKee*

Vaulted atrium (above) cuts through Classical Reagan Building (left).

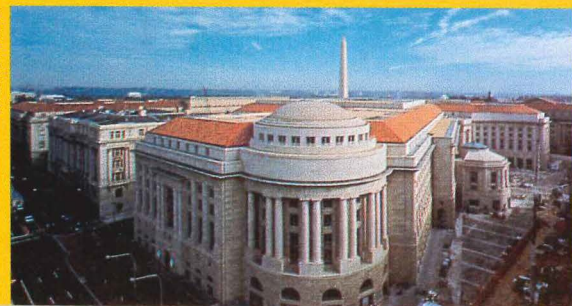

What's in a name?

NAAMM

NAAMM is the benchmark against which architects and other specifiers confidently measure their own plans and obtain precise information on the design, manufacture and installation of superior products. The Association offers the most comprehensive guide specifications in the industry. Today's architects, engineers, other designers and contractors look to NAAMM to ensure the highest standards and quality.

NAAMM makes it easy for you to get this information by providing a series of targeted manuals, with all the codes, facts and specifications you need, including:

Architectural Metal Products

- Metal Stairs and Railings
- Metal Finishes
- Metal Flagpoles

Hollow Metal Doors and Frames

Aluminum and Steel

Bar Grating

Steel Framing Systems/

Metal Lathing and Furring

Steel Cell Systems

Expanded Metal

Consider taking advantage of all the benefits in our name.

Contact your one-stop resource for specification and technical information about:

Architectural Metal Products 150 Metal Bar Grating 156

Hollow Metal Doors/Frames 152 Metal Lath/Steel Framing 158

Expanded Metal Products 154 Steel Cell Systems 160

NAAMM

National Association of
Architectural Metal Manufacturers

8 South Michigan Avenue
Suite 1000
Chicago, IL 60603
312/332-0405
FAX: 312/332-0706
E-mail: naamm@gss.net
<http://www.gss.net/naamm>

ERICKSON'S DIVERSIFIED
CORPORATION, HUDSON, WI
ARCHITECTS AND ENGINEERS:
BOARMAN-KROOS-PEISTER-VOGEL
& ASSOCIATES, MPLS., MN
CONTRACTOR: MATSON, FORSBERG
COMPANY, ST. LOUIS PARK, MN
INTERIOR DESIGN: DESIGN
SYNDICATE, INC., MPLS., MN
FENESTRATION: ANDERSEN
FLEXIFRAME AND AWNING
WINDOWS WITH GREEN-
TINTED TEMPERED
LOW-E GLASS.





New J.B. Jackson anthology reproduces the writer's evocative photographs of small-town parades.

In 1951, John Brinckerhoff Jackson (1909-1996), a Harvard-educated war veteran, novelist, artist, and rancher, issued the first edition of a one-man magazine called *Landscape* from his rural New Mexico outpost. Writing as J.B. Jackson, H.G. West, or simply Ajax, his essays raised the flag for such movements as Postmodernism and the study of roadside "ducks and diners." *Landscape in Sight: Looking at America* (Yale University Press) is a posthumous anthology assembled from 200 essays and other writings from Jackson's 45-year career.

Editor and Smith College Professor Helen Lefkowitz Horowitz organized this overview around seven topics, such as the perception of landscape, the evolution of the

dwelling, and the shortcomings of Modern architecture. Horowitz's introduction combines clarity, narrative, and colorful detail—the subject's own strengths as a writer.

Jackson blended the cultural geographer's eye with the novelist's ear and the critic's dart. Quietly iconoclastic, he lambasted Modern architecture as it was still ascendant. Years before Robert Venturi's *Learning from Las Vegas*, he wrote appreciatively of the 1950s neon-clad strip. Both a patrician and a populist, Jackson could become as absorbed by the study of a Baroque town plan as he was by a city's tenderloin district.

About a third of these essays might be called architectural criticism, to which Jackson's approach was unconventional. He refused to address esthetic theories or the use of materials, preferring to discuss buildings in the context of culture and landscape.

Jackson's Last Stand

A new, posthumous J.B. Jackson anthology affirms his influence on ideas about the American landscape.

Rather than writing a scathing critique, he skewered the Modernist glass house in a parody of *House Beautiful*. In "Living Outdoors with Mrs. Panther," a socialite clad in a linen top, toreador tights, and ballet slippers patrols a fictive Ludwig Mies Van Der Rohe box. "You see," says Mrs. Panther, "the house is temperatrolled."

At his best, Jackson employed such fiction-writing skills to construct compelling, hypothetical models of cities and their buildings. One was Optimo City ("the Overalls Capital of the Southwest"), a composite industrial town on the Texas prairie, where the reader can almost smell the sorghum. In the "Westward-Moving House," Jackson weaves architectural history into a fictional family saga, as three generations move from a Colonial farmhouse to a balloon-frame Victorian to a 1950s ranch. His point: Americans always prefer flexibility to architectural dogma.

Architects should study Jackson's prose. He avoided jargon and abstractions, embraced observation and humor, and proffered fresh ideas that incited discourse, not controversy. Although his ideas aren't as startling today, Jackson remains a model for civil discussion of architecture and the landscape. *Michael Leccese*

Michael Leccese is editor-at-large of Landscape Architecture.

BEGA

Low level directional luminaires
for above grade illumination
of paving surfaces

180° or 360° lighting distribution.
Extremely rugged, small scale with
a precise optical system.

Available with low wattage H.I.D.
or incandescent lamps.

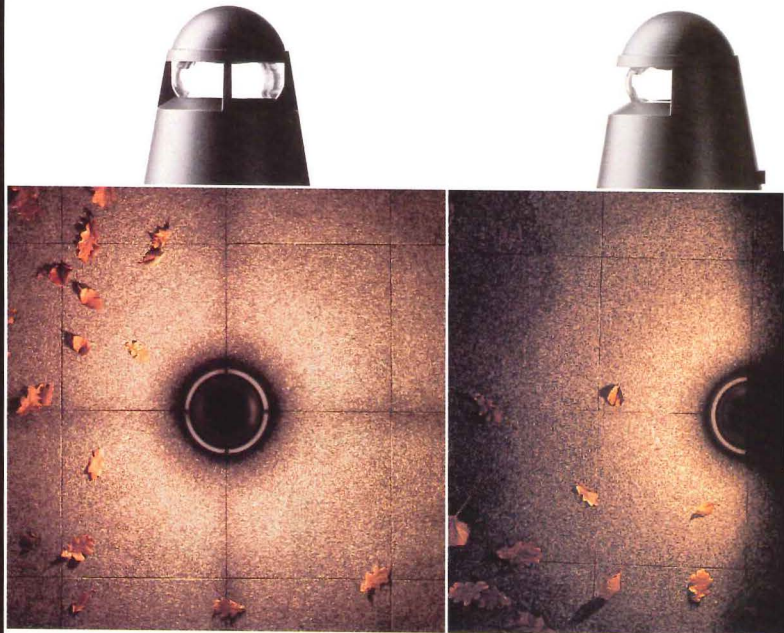

BEGA 1005 Mark Avenue, Carpinteria, CA 93013
[P] 805-684-0533 • [F] 805-684-6682

Circle 46 on information card

Introducing EcoSystem™ ...

Notebook computers replaced digital dinosaurs. Now EcoSystem™ is replacing conventional elevators. It makes fast, quiet AC gearless elevator performance affordable where it wasn't before – for low- and mid-rise buildings • Why more affordable? Because it needs no penthouse or large machine room, reducing building construction costs. Because it streamlines installation, allowing faster building completion. • And because, as its name suggests, EcoSystem™ is ecologically responsible. It uses less electricity and has no hydraulic fluid that can contaminate the environment. • To Reach Higher, call 1-800-956-KONE (5663) or visit our Web site at <http://www.montgomery-kone.com>. Ask for a free CD-ROM about EcoSystem™ and see history repeat itself.

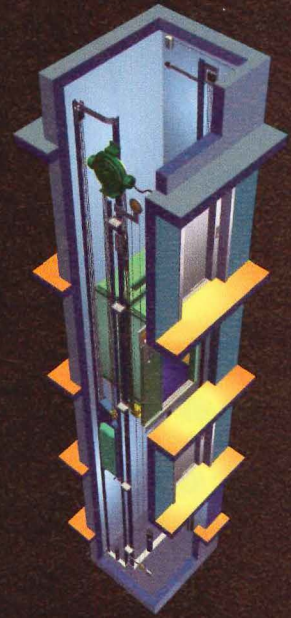

A new kind of AC gearless elevator. A new kind of affordability.

Montgomery KONE

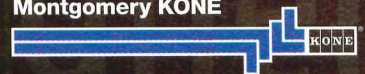

Circle 50 on information card

Bostonians just can't escape history. Real estate development in Boston is still shaped by two decisions made centuries ago. The first was founder John Winthrop's now-famous notion about establishing a city on a hill—a hill that happened to be on a scrawny peninsula without much room to grow. The second was to designate the region's largest city and economic center as state capital—the only such major city in the continental United States. Today, the city's 560,000 residents are still skirmishing over turf, while the overlap of government and commerce means big business mixes with big politics.

Boston is certainly a busy place right now. The city's architectural community, hard-hit by the recession that was well under way in 1989, is enjoying a recovery begun two years ago. The recent economic expansion, driven by the high-tech and financial services industries, has led to one of the lowest office-vacancy rates in the country—approximately 4.4 percent, compared to a national average of 9.6 percent. Cranes are seemingly at work everywhere, and construction barriers and heavy equipment are having a diabolical effect on an already arcane street system.

Boston

In a heady economy, renovation and infill rule a city with few remaining open spaces.

But the presence of construction equipment and the city's low vacancy rate have little relationship. The city's developers and lenders are still shaken by the trauma of the last real estate downturn, returning to the market gingerly, and investing in relatively low-risk rehabs. Despite an array of proposed and approved projects, no new office tower has broken ground since the late 1980s.

Instead, Boston's impressive fleet of cranes are mostly deployed in the construction of one of the largest public works projects in American history: the depression of the Central Artery, locally dubbed the "Big Dig." Roughly 40 percent completed, the entire project, including the new Ted Williams Tunnel that crosses under the harbor to Logan Airport, is expected to open in 2003 at a projected cost of \$10.8 billion. The new eight-to-10-

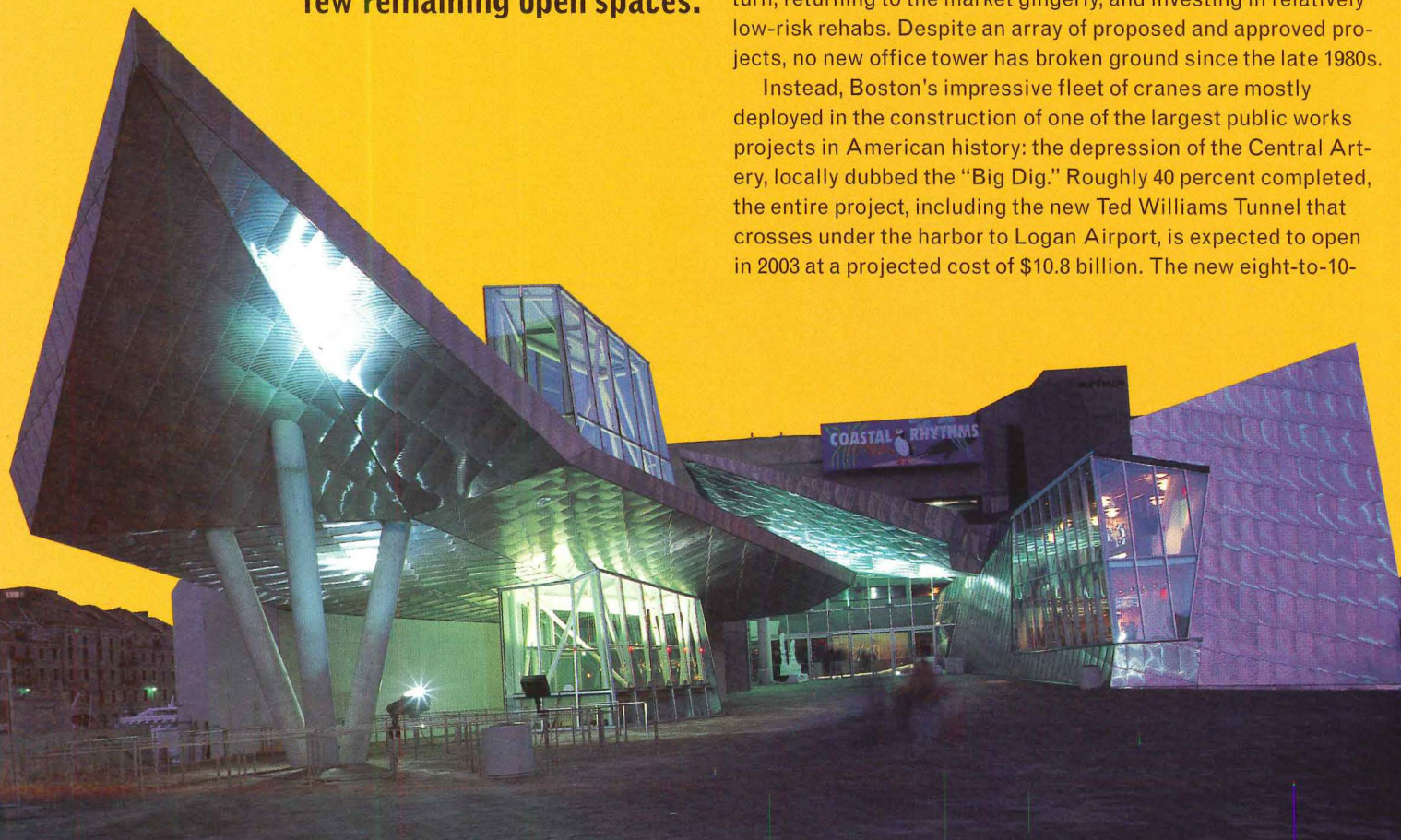

lane underground roadway will replace a deteriorating, six-lane elevated highway (dubbed the "Skyway" at its 1959 opening), thus sparing Bostonians the 16-hour traffic jams predicted by transportation planners. Demolishing the present structure will open 27 acres of land along the project's 7.5-mile length. Current plans dictate that the majority will remain open space, with only one-quarter of the area designated for modest development.

Even though civil engineers appear to be doing more than architects to change the face of the city, the trend toward rehabs is in many ways just as significant. One of the best lessons in the ability of modest, incremental development to influence change is the Midtown Cultural District—the new moniker shared by three established districts near the financial core: the theater district, the Downtown Crossing retail center, and the adult-entertainment precinct known as the Combat Zone. Three years ago, Emerson College, located in a genteel section of the Back Bay, acquired the Little Building, an office building at the edge of the decidedly ungentle Combat Zone, with plans to convert the building for

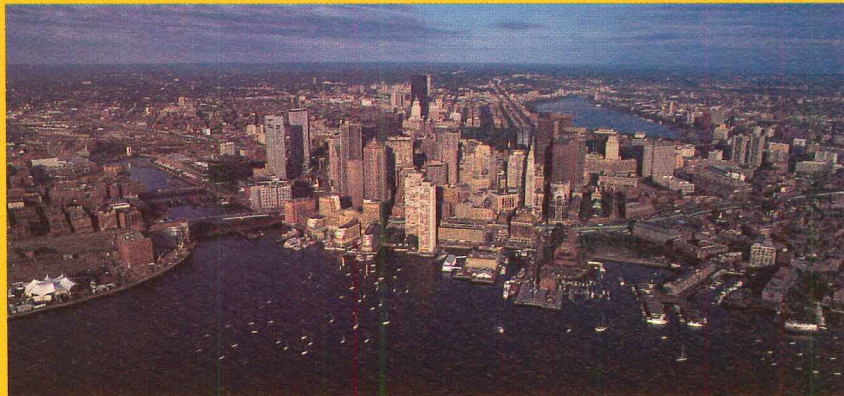

ALEXS. MACLEAN

Pops

dormitory use. Emerson's institutional support and the 24-hour presence of students contributed to the now-certain revitalization of a seedy area that has defied improvement for nearly three decades. This spring, the Registry of Motor Vehicles will move into the newly renovated Liberty Tree Building just two blocks away. The recent restoration of the nearby Shubert Theater added another performance space to the district's list of active theaters which are fostering new restaurants and a growing club scene.

Three blocks away, Mitchell/Giurgola's 1982 Lafayette Place shopping mall is getting a makeover. This mall, located at the edge of Boston's core retail district, was despised for its featureless, block-long facade, and considered by many urbanists to be the final blow to this fragile part of the city, destroying all hope of restoring an historically lively streetscape. The mall's ultimate failure was even more devastating, as the city's hopes of redeveloping the site were alternately raised and dashed for nearly a decade. Now renamed Lafayette Corporate Center, the \$85 million renovation by ADD, Inc. of Cambridge, Massachusetts, will include 75,000 square feet of street-level retail and 500,000 square feet of new office space—a major boost to the economic health of the district and the vitality of its streets.

Other parts of the city are also benefiting from this hermit-crab approach to development, as new tenants move into sometimes

Schwartz/Silver Architects' addition to New England Aquarium (facing page); South Boston Seaport district (above, at left) capitalizes on its proximity to downtown.

THE **BIG KAHUNA** IN METAL COATINGS.



KYNAR 500® PVDF RESIN. ASK FOR IT BY NAME.

There's only one #1. Only one original. Only one industry

Only one standard by which all other architectural metal coatings are measured. KYNAR 500® resin-based coatings.

For the past thirty years, architects have been specifying metal coatings based on KYNAR 500 resin for their extraordinary ability to retain color and gloss by resisting ultraviolet degradation, chalking and pollutants, including acid rain.

You'll find coatings based on KYNAR 500 resin at airports in Chicago and Singapore, on skyscrapers in New York and Hong Kong, beach houses in Florida and condominiums in Boston.

KYNAR 500 resin-based coatings consistently exceed the stringent industry requirements including the AAMA 605.2 Specification and the most demanding ASCA '96 Voluntary Specification for Superior Performance of Organic Coatings.

To get the long-lasting protection you need, be sure to specify KYNAR 500 resin-based coatings by name.

For a copy of a CSI SPEC-DATA® sheet, call 1-800-KYNAR 500.

Elf Atochem North America
2000 Market Street
Philadelphia, PA 19103-3222

<http://www.elf-atochem.com>

elf atochem
ATO

Circle 52 on information

1 - 8 0 0 - K Y N A R 5 0 0

unlikely shells. The 1915 Custom House tower, a 16-story structure near the waterfront that for many years defined Boston's skyline, reopened in 1997 as time-share residences operated by Marriott Vacation Club International; the adjacent Board of Trade Building now houses corporate apartments—furnished units leased for short-term stays. Construction starts this spring on Landmark Center in the Fenway, west of Back Bay, where Cambridge architects Bruner/Cott will convert a 1.4 million-square-foot distribution warehouse into an office and retail facility featuring a multiplex cinema with 14 to 18 screens.

Not all of Boston's construction is focused on renovation. The institutional and public sectors, more recession-tolerant than the real estate development community, have been responsible for most of the city's handful of new buildings, some of which are long-awaited infills. Kallmann McKinnell & Wood's Suffolk County Courthouse, which will open this summer at the edge of the Government Center

PETER VANDERWARKER

Ted Williams Tunnel travels under Boston Harbor, cutting commute between southern suburbs and Logan Airport.

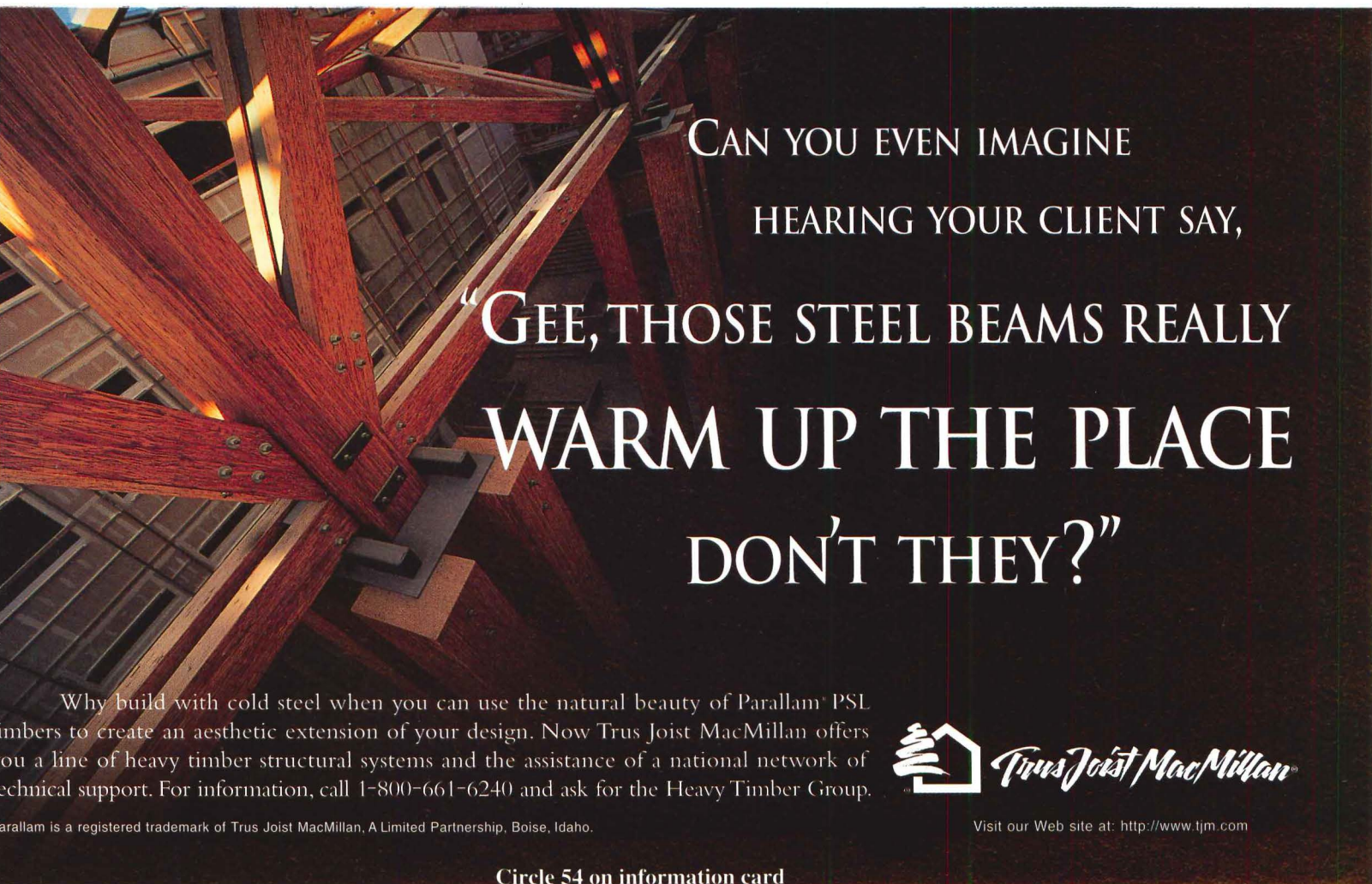

CAN YOU EVEN IMAGINE
HEARING YOUR CLIENT SAY,
“GEE, THOSE STEEL BEAMS REALLY
WARM UP THE PLACE
DON'T THEY?”

Why build with cold steel when you can use the natural beauty of Parallam® PSL timbers to create an aesthetic extension of your design. Now Trus Joist MacMillan offers you a line of heavy timber structural systems and the assistance of a national network of technical support. For information, call 1-800-661-6240 and ask for the Heavy Timber Group.

Parallam is a registered trademark of Trus Joist MacMillan, A Limited Partnership, Boise, Idaho.



Visit our Web site at: <http://www.tjm.com>

Circle 54 on information card

Carlisle's **Sure-Weld™** gives you the design options you need.



SURE-WELD HEAT WELDED MEMBRANE

For a roofing system that looks as great as it performs, choose Carlisle's Sure-Weld.

When aesthetics are as important as durability, Carlisle's Sure-Weld is the choice of architects and specifiers. Sure-Weld not only offers installation expediency and seam integrity, it is also available in two color options for reflectivity and a consistent, monolithic appearance.

Sure-Weld Offers Flexible Design Options:

- Offered in white or gray
- Can be mechanically fastened or fully adhered
- Available in .045" and .060" thicknesses
- Polyester reinforcement provides added breaking and tearing strength and puncture resistance
- Provides long term UV and ozone resistance and is environmentally friendly because it is compounded without chlorine or plasticizers

Sure-Weld Systems Speed Application Time:

- Seams can be welded at 10–15' per minute
- Heat welding fuses splices together, creating a smooth, seamless appearance

Sure-Weld membrane from Carlisle increases your design options.

For nearly 40 years, Carlisle has provided specifiers with

LEADERSHIP • INNOVATION • TECHNOLOGY • EXPERIENCE

CARLISLE
LEADERSHIP

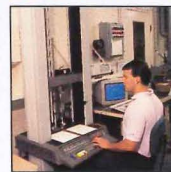

Industry-leading research assures product performance.

I **NNOVATION**

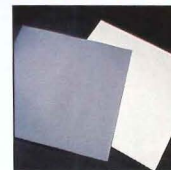

Innovative white and gray membranes resist biological defacement.

T **ECHNOLOGY**

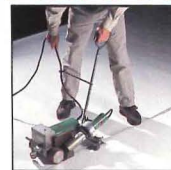

Heat-welding produces a visually seamless system.

E **XPERIENCE**

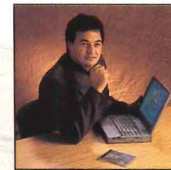

Carlisle's experienced design experts can help develop the right Sure-Weld system for your roofing challenges.

CARLISLE

Carlisle SynTec Incorporated

P.O. Box 7000 • Carlisle, PA 17013

Phone (toll free): 1-800-4-SYNTEC

Fax: 717-245-7143

<http://www.carlisle-syntec.com>

Circle 56 on information card

Sure-Weld is a trademark of Carlisle SynTec Incorporated.
©1998 Carlisle Corporation
Printed in U.S.A. 855034

YOUR
Single-PLY
SOLUTION™

district, completes the unfinished arc of Paul Rudolph's 1970 Lindemann Building. The New England Aquarium recently opened a new addition designed by Schwartz/Silver Architects as the first phase of an expansion of Cambridge Seven Associates' 1969 waterfront landmark. A new seven-story, 250,000-square-foot building for Suffolk University Law School, designed by Tsoi/Kobus & Associates of Cambridge, will open in 1999 across from the historic Old Granary Burial Ground in the Midtown Cultural District.

The Midtown Cultural District seems to be the target of developers' growing confidence. A 31-story, \$150 million office tower designed by New York's Thomas Phifer is expected to win city approval easily and will start construction later this year. The district's anchor project, Millennium Place, breaks ground this spring on one of the city's most visible sites, abutting Boston Common. Designed by Gary Handel & Associates of New York, Millennium Place will be Boston's first

major mixed-use project in nearly 10 years. The project sailed through Boston's approval process by taking advantage of permits secured in the 1980s for a now-defunct proposal. Replacing the large floor plates of the earlier project's office towers with the narrow floor plates of residential uses, Millennium Place will include 400 condominiums, a 300-room hotel, a 4,700-seat Sony movie multiplex, and a Reebok sports club.

Although the Millennium project and its mix of uses are generally welcomed on the Washington Street site, a similar proposal for the Back Bay has met with vehement opposition. There, the city's geographic and political legacies have set the stage for a classic Boston confrontation. The Massachusetts Turnpike Authority, faced with the challenge to find funding for the Big Dig, has entered into negotiations with developer Millennium Partners for the air rights to a section of the depressed Turnpike highway—the most significant potential development parcel

left in this venerable part of the city. Noise levels are high as residents voice concerns about traffic, density, parking, and shadows, and the city tries to exert control over decisions that would affect an already-congested neighborhood.

The din of controversy is also deafening thanks to the proposed redesign of City Hall Plaza, the brick tundra that surrounds Kallmann, McKinnell & Knowles' 1968 Brutalist landmark in the heart of Government Center. The nonprofit Trust for City Hall Plaza, which Mayor Thomas Menino established to develop a plan and identify funding sources, is fighting the perception that its process has been closed. This charge was first levied when the Trust unveiled its proposal to build a hotel on the plaza and subsequently designated a developer for the project. The hotel proposal is not without logic: Its restaurants and cafés and 18-hour-a-day activity would bring social life to the plaza, and a funding agreement would ensure both construction dollars and money for the

AMERICAN MARAZZI TILE
The Fine Art of Ceramic Tile.

CORTI ANTICHE BY MARAZZI.

For more information about American Marazzi Tile products or to locate the Distributor nearest you, contact Customer Service at (972) 226-0110 or FAX your request to (972) 226-5629 or Email Marazzi01@aol.com. Circle 58 on information card

C/S Expansion Joints at



Architects: Pei Cobb Freed & Partners, NYC, in association with SMWM, SF

For nearly forty years, leading architects and engineers have challenged the C/S Group with complex expansion joint problems.

The spectacular San Francisco Library is just such a case. A base isolated design, the entire structure is separated from adjacent areas with a "moat" type expansion joint.

Specifications called for a flush, virtually invisible, joint cover capable of allowing for an incredible 18" of movement in any direction without destruction to the covers or plaza.

C/S answered the San Francisco Library challenge with an imaginative, custom designed and fabricated solution so complete, the covers actually reset themselves after cycling.

We can do the same for you. Because at C/S, our expertise is impossible to imitate. For free literature call

800.233.8493

The San Francisco Library

Circle 60 on information card

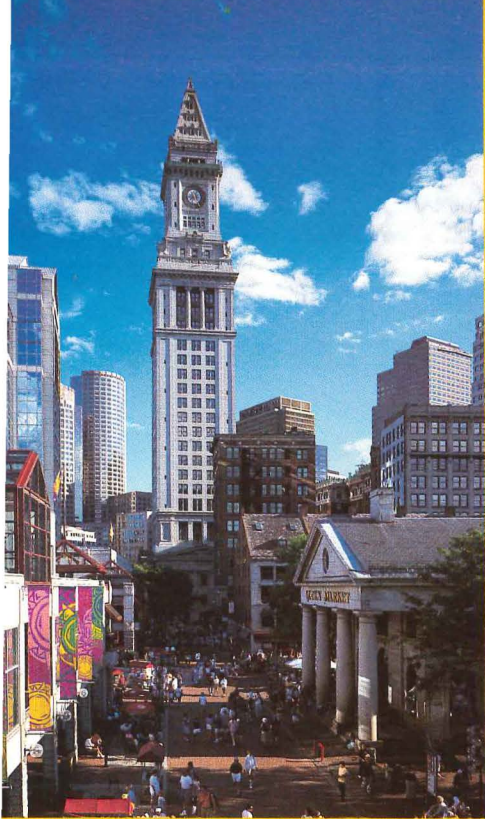

PETER VANDERWARKER

plaza's long-term maintenance. But there are logical arguments against the scheme, too. Some citizens are concerned about the loss of public space to private use, and the U.S. General Services Administration (GSA), owner of the adjacent John F. Kennedy Federal Building, would lose its plaza frontage to the hotel. GSA's worries about security threats and the loss of views and property value are hard to deny. Mayor Menino has recently tried to break through the logjam of conflicting opinion by appointing a panel to examine the proposal, although the panel's ultimate authority is still unclear. Meanwhile, the beleaguered project team, including urban designer Alex Krieger and landscape architect George Hargreaves, continue to make presentations to interest groups, and the Trust has launched a new public-information effort, including a poster of the proposed design. Trust officials worry that if the process is delayed too long, the hotel may miss a critical moment in the city's economic cycle and will no longer be feasible,

even if it ultimately wins public support.

The city is currently suffering a severe shortage of hotel rooms. Several hotels are proceeding with additions, and proposals for another eight to 10 new hotels are moving through the approval process as developers try to fill the current shortfall of 1,800 rooms. Even greater demand will come with the proposed construction of a new 600,000-square-foot convention center, which will require 3,800 additional rooms.

The convention center, projected to open in 2003, will be the keystone of Boston's new frontier: the South Boston Seaport district. With barely a half-dozen significant building sites left in the city's financial core, planners and developers have been focusing on the 1,000 acres of underutilized land connected to downtown by four bridges that span the Fort Point Channel. The area has long been Boston's ignored outback, characterized by turn-of-the-century industrial buildings, pier structures, and vast vacant lots. With the opening of the Big Dig's new Ted Williams

Historic Custom House, adjacent to Quincy Market and Faneuil Hall, is retrofitted with time-share apartments.

January 1998
January 1998

architecture

AMERICAN EXPORTS
I.M. PEI'S SHANGRI-LA

HOLL'S NORTHERN LIGHTS IN HELSINKI
PACIFIC OVERTURES BY MORPHOSIS
AMERICAN DESIGN: A FOREIGN APPRAISAL

AMERICAN EXPORTS | PEI | MORPHOSIS | HOLL

Architecture
Magazine On-Line:

Special Features
Technology & Practice
Calendar
Protest
Pierpoint
Resources
Reader Support
SEARCH

Morphosis I.M. Pei Holl

www.architecturmag.com

SEE

- Architecture highlights from current issue
- Enhanced industry calendar
- The Protest Column with "Talkback" feature
- Technology & Practice articles

FREE

- Listings in our Architectural Firm Database

PLUS

- Search manufacturer's Web sites with PIERPOINT database organizer
- Virtual Reader Service Card
- New products on-line

A resource for the
architectural community

architecture



Dulux® PAINTS



DULUX: Dulux is the world's leading brand of premium quality paint designed to deliver the highest level of performance.



INDUSTRIAL: ICI Devoe Coatings is a complete line of protective maintenance and heavy-duty coatings with an established reputation for surface-tolerant technology.

SEE US AT AIA BOOTH #1328

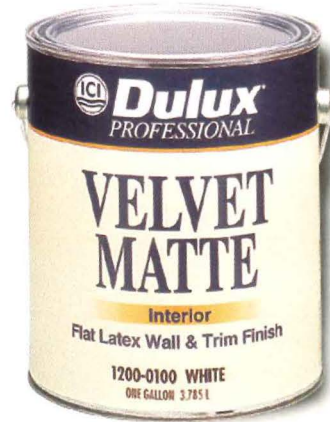

DULUX PROFESSIONAL: High-quality commercial and custom jobs demand superior performance.

A COMPREHENSIVE PRODUCT RANGE BUILT FOR THE PROFESSIONAL MARKET

ULTRA-HIDE: Our complete offering of wall and trim finishes, primers, block fillers, stain killers and dryfalls.

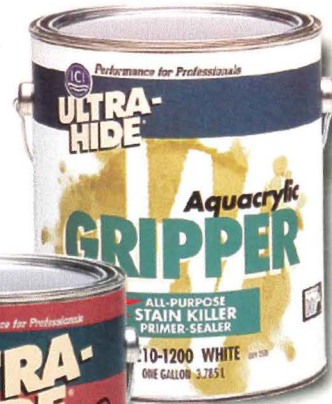

SPEED-WALL: Interior and exterior products for high volume commercial repaint and new construction.



SPECIALTY: Special products for specific applications – WoodPride Interior and Exterior wood finishes, and Decra-Flex elastomerics.

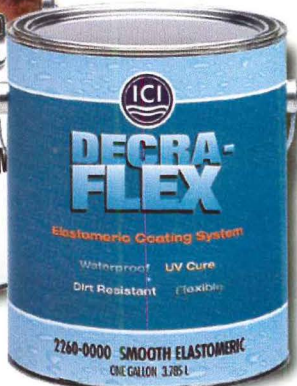

Product breadth, performance and quality. The product range from ICI can handle a full range of applications and challenges. For your nearest ICI Dulux Paints store call: 1-800-984-5444 or Fax: 216-344-8883



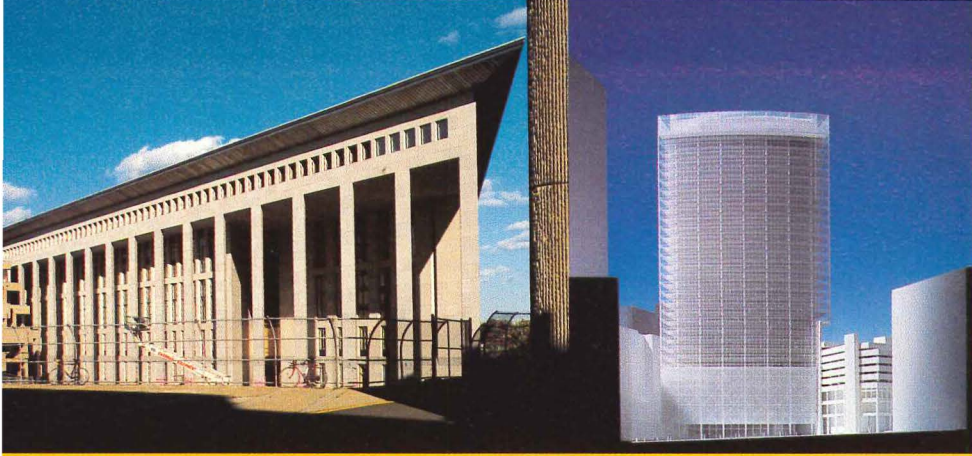

Kallman McKinnell & Wood's Suffolk County Courthouse abuts Paul Rudolph's 1970 Lindemann building (above left). Thirty-one story office tower is architect Thomas Phifer's second high-rise scheme for downtown Boston.

Tunnel, the district is now only five minutes from Logan Airport and is within walking distance of the Financial District, with access to two interstate highways and direct frontage on a major deep-water port. Interest in the area's development potential has coincided with increased public interest in the harbor itself and new state and city regulations mandating greater public access to the waterfront. The city is working feverishly to develop a master

plan for the area, but development has already begun with the construction of the new Federal Courthouse, designed by Henry Cobb, and a new 425-room hotel next to the World Trade Center on Commonwealth Pier by The Stubbins Associates.

In a welcome—and smart—move, the city recently applied a temporary height limit of 150 feet to the area, which allows a cooling-off period while planning proceeds and gives hope to critics of the interim

master plan, who feared that the district would become "Manhattan-by-the-Sea." Shortly after the announcement, the Pritzker family of Chicago withdrew its proposal for a widely criticized 250-foot-tall hotel and office complex on the water.

In the meantime, the Seaport planning process has begun to attract an unprecedented omnium-gatherum of activists, neighborhood groups, property owners, and regulators—even the Federal Aviation Administration is watching with interest, because of the proximity of Logan Airport and potential conflicts with flight paths. With relatively few precedents, the sheer scale of the undertaking is formidable, a test of all that the city has learned about the urban environment.

The Seaport District plan serves as the epilogue to the story of Boston's development at the end of the 20th century, a reprise of familiar characters, torrid themes, and intriguing subplots. Let's hope this titanic undertaking does well at the box office. *Elizabeth Pajden*

We're Here to EARN Your Business...

With exactly the connector you need, on spec and on time – every time!



Greatest Design Flexibility

More options on more hangers than any other manufacturer. Skewed or sloped seat, sloped top flange, offset top flange, concealed flange – we can modify our hangers to meet your need.

Exclusive Computerized Manufacturing

Catalog hanger specials are produced precisely to *your* specs. Cost is lower; quality is higher; installation is easier and delivery can be accurately forecast.

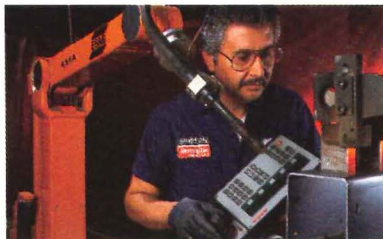

Call 800/999-5099 for a catalog or answers to connector design questions. Let us earn your business and show you why we deserve our No Equal reputation.

SIMPSON

Strong-Tie
CONNECTORS

SIMPSON STRONG-TIE® CO., INC.

The World's "No-Equal" Structural Connector Company

California ■ Florida ■ Ohio ■ Texas ■ Canada ■ UK

Circle 62 on information card

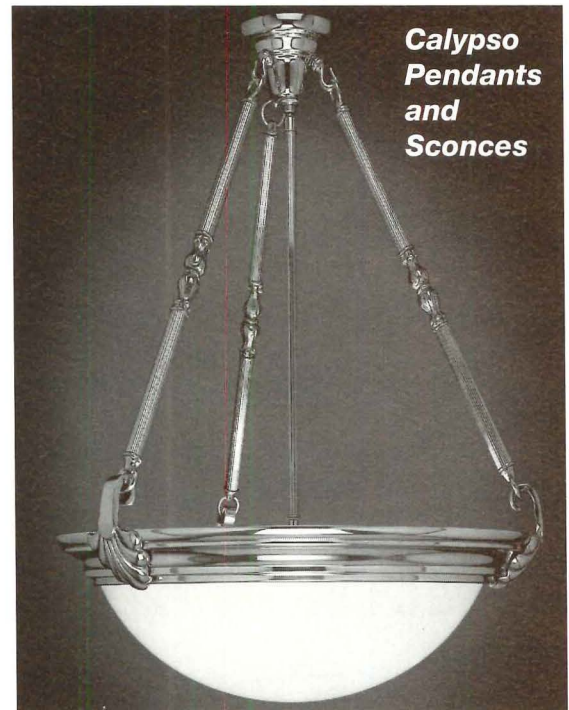

**Calypso
Pendants
and
Sconces**

**THE ORIGINAL CAST™
LIGHTING**



6120 DELMAR BLVD • ST. LOUIS, MO 63112
314.863.1895 • FAX 314.863.3278

www.theOCL.com

Circle 64 on information card

PAC-CLAD®

Petersen Aluminum

1005 Tonne Road • Elk Grove Village, IL 60007
1-800-PAC-CLAD • FAX: 1-800-722-7150 or
1-847-956-7968

Other Plant Locations:
Annapolis Junction, MD: 1-800-344-1400
Tyler, TX: 1-800-441-8661
<http://www.pac-clad.com>

SNAP-CLAD™

Metal Roofing Panels

Petersen Aluminum Corporation's SNAP-CLAD Panels feature architectural panel aesthetics as well as structural panel performance. SNAP-CLAD Panels are corrective leveled to provide superior flatness and feature an optional factory-applied sealant bead for improved weather resistance. In addition, SNAP-CLAD Panels carry a UL 90 rating for wind uplift.

SNAP-CLAD Panels feature a 1-3/4" leg height and a continuous interlock for improved structural performance and wind resistance. A concealed fastener clip system has been designed to allow for thermal expansion/contraction while providing excellent hold-down strength.

SNAP-CLAD Panels feature our full-strength PAC-CLAD® finish and are available in a variety of on-center dimensions, fabricated from either .032 aluminum, 24 ga. steel or 22 ga. steel. For more information on SNAP-CLAD Panels, please contact Petersen Aluminum Corporation, **1-800-PAC-CLAD** or visit our web site @ <http://www.pac-clad.com>

Circle 66 on information card



SNAP-CLAD™

10", 12", 16", or 18" O.C. .032 aluminum
1-3/4" high 22 gauge steel
24 gauge steel

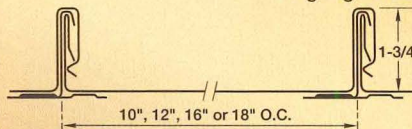

Features

- Herr-Voss corrective leveled
- UL 90 rated
- Factory-applied sealant
- Continuous interlock
- Labor-saving one-piece design
- 20-year non-prorated finish warranty
- 25 standard colors (24 ga. steel)
- 10 standard colors (22 ga. steel)
- 16 standard colors (.032 aluminum)

NEW



Dental Offices of Manassas
Architect: Robert Loveless
General Contractor: Rector Construction
Roofing Contractor: GRC Roofing Inc.
Color: Forest Green
Profile: 24 ga. SNAP-CLAD

Auto Bistro Prototype, BOORA Architects

"Revolutionize quick food service," three ambitious entrepreneurs instructed the experts they hired to help develop a new drive-thru restaurant chain, named Auto Bistro. Appropriately, Portland, Oregon-based BOORA Architects' prototype for the outfit takes stylistic, if not ideological, cues from Russian Constructivism—the official, aggressively tectonic idiom of the early Soviet Union. "It's an expressive, optimistic take on technology," explains BOORA

Principal Stanton Bowles about the firm's esthetic and organizational improvements to standard fast-food design.

With the other advisors to the budding restauranteurs—including financial, operations, marketing, and public relations consultants—BOORA decided to overturn the conventional fast-food delivery process. The team opted for a drive-thru, not an eat-in restaurant, emphasizing a healthy menu and streamlined, personalized service: A "motor d" hands menus out to cars as they pull into the drive-thru entrance. Rather than talk to a squawking box, customers give orders to waiters stationed under a plasticized fabric canopy that is supported by a freestanding steel frame. To speed up delivery time, food can be served to several cars at once, from three perforated, stainless steel-clad "vittleveyor" chutes that hang beneath an elevated food-preparation area.

The restaurant's form, too, is a far cry from fast-food conventions: A giant, angled truss worthy of Constructivist master Vladimir Tatlin spans the width of the Auto Bistro site, and simultaneously serves as the drive-thru entrance, structural support for the food-preparation area, and an eye-catching icon for the chain. A bold monochromatic color scheme—periwinkle blue in the first project, now under construction along the Pacific Coast Highway in Newport Beach, California—allows the 1,800-square-foot prototype to act as its own billboard. *Ned Cramer*

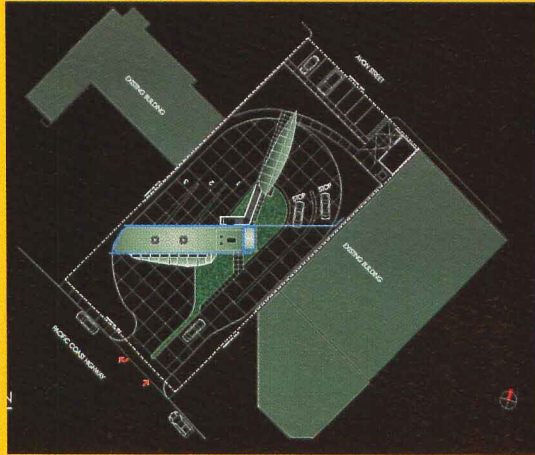

Giant truss (bottom) spans width of site. Plan (left) demonstrates vehicular circulation pattern: Customers receive menus under truss, place orders beneath canopy, and pick up meals below food preparation area. "Vittleveyors" (below) bring food from steel panel-clad kitchen above directly to customers waiting in cars.

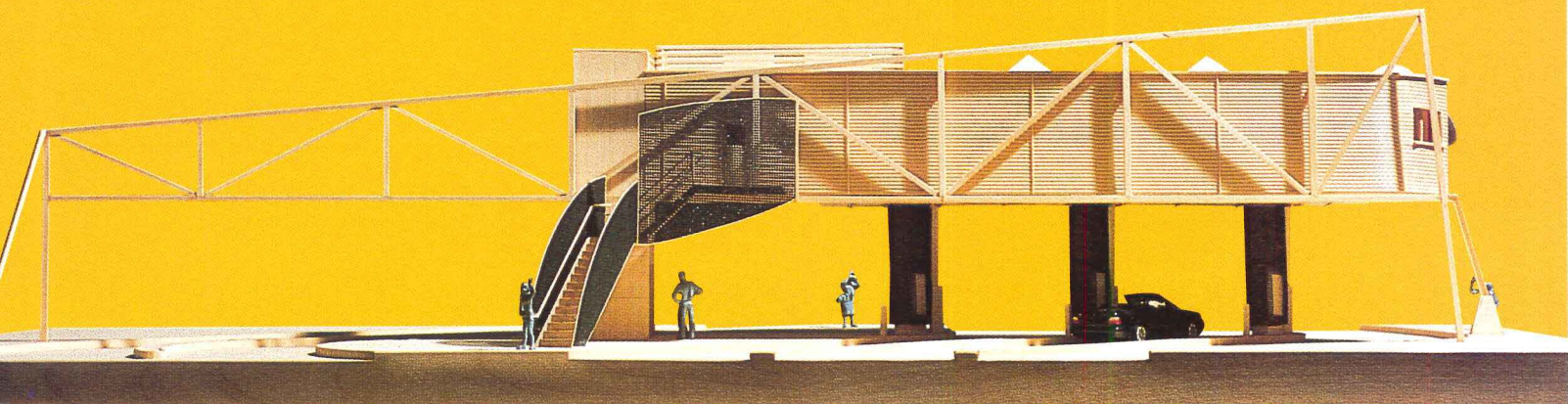

These doors ain't wood.
But that's okay, this ain't Texas.



Texas Station Gambling Hall. Architects: Anthony A. Marnell II, Chtd. Structural Engineers: Martin & Peltyn, Inc.
Main Contractor: Marnell Corrao Associates—Las Vegas, NV. Steelcraft Distributors: Berger Building Supply Inc.—Sparks, NV.

At Texas Station Gambling Hall in Las Vegas, wood doors just wouldn't have cut it. Because, each day, thousands of tough customers come a knockin'. Not to mention a hostile desert sun.

But what a fine place for the Grain-Tech™ series from Steelcraft.

The Grain-Tech™ series is steel, like the nerves 'round the poker table. Yet its resemblance to wood is uncanny, in both look and feel. It can even be stained to match existing wood treatments.

The Grain-Tech™ series of doors, frames and trim. Cold, hard steel in the spitting image of wood.

INGERSOLL-RAND
ARCHITECTURAL HARDWARE

STEELCRAFT

Ingersoll-Rand Architectural Hardware Group, Steelcraft, 9017 Blue Ash Road, Cincinnati, Ohio 45242 ©1997 Ingersoll-Rand Website <http://www.steelcraft.com>

Acura Dealership Prototype Oliver + Ray Architects with Deiss & Associates

In 1996, to combat a sagging market share and perceived identity crisis in the luxury car market, Honda launched a major revamping of its 250 Acura dealerships in the U.S. The Japanese manufacturer commissioned Oliver + Ray Architects of Houston and St. Helena, California-based automotive consultant Deiss & Associates to breathe new life into the high-end brand through a standardized refurbishment of existing interiors.

Now that renovations are under way in almost half of the company's franchises, Honda is taking the rehab one step further: designing prototypes for new dealerships. Oliver + Ray and Deiss & Associates' design will replace the standard-issue sheds that dot suburban auto malls with considered Modernist buildings finished in edgy industrial materials.

The typical building will consolidate a dealer's complete inventory into a four-story garage attached to a separate lobby and sales area. Display models will be parked on the ground floor of the garage; a suite of small offices flanks the parked cars behind a glazed wall. Behind the lobby block will be a service area, accessed beneath a porte cochere of exposed steel beams. The second floor of the lobby and service blocks will house administrative offices, a lounge, and a multipurpose room.

The building's materials display a tough, machine esthetic: The middle floors of the parking structure will be wrapped in a scrim of metallic louvers; the top floor will remain exposed, to create what Principal Douglas Oliver describes as "a cornice of cars." Delicate, glazed clerestory lanterns will crown the blocky lobby and service bays, both of which will be finished in synthetic stucco. Honda expects to begin construction on the first of its new prototypes early next year. *Raul A. Barreneche*

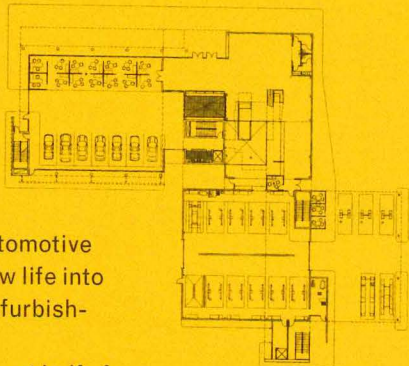

Two-story block housing lobby and sales area joins service bay (at left) with metal-sheathed storage garage (at right).



Ceiling
system
solutions
from the
experts.

TECHLINE™

ACOUSTICS

How can we make an open-plan office less noisy and distracting for employees?

There are several ways to make an open-plan office quieter and more effective:

- Choose a ceiling with a high Articulation Class (AC) rating (minimal 170, optimum 210). AC is the primary measure of acoustics in an open-plan office. It indicates a ceiling's ability to absorb the angled sound that travels over cubicles.
- Choose a ceiling system with a high NRC (noise reduction coefficient), the measure of a material's ability to absorb sound. The higher the NRC the better. NRC 0.70 or higher is best for open plans.
- Choose cubicle partitions that are at least 60" high and stagger openings to reduce direct lines of sight and sound.
- Use a sound masking system to cover unabsorbed noise.
- Use indirect lighting or flush fixtures with louvered lenses, and avoid using air diffusers larger than 2'x2'.

Get expert solutions to your questions about ceiling systems. Our technical staff is standing by from 8 a.m. to 7 p.m. (EST).

1-888-CEILINGS (option 3)
(888-234-5464)

www.ceiling.com.

Email: techline@armstrong.com

Armstrong

CEILINGS, SUSPENSION SYSTEMS AND ACOUSTICAL WALLS

The solutions you need, the performance you can trust™

©1998 Armstrong World Industries, Inc.

Circle 70 on information card

STONE - THE FIRST BUILDING MATERIAL...

LONG TREASURED FOR ITS ARCHITECTURAL

REPRESENTATION, AND MORE PRACTICALLY,

RECONSTRUCTED

DURABILITY, AND STRENGTH.

STONE

UNFORTUNATELY, COST AND AVAILABILITY

LIMIT THE USE OF NATURAL STONE.



WE'D LIKE YOU TO TAKE OUR WALL PANELS FOR GRANITE.

Now, HANOVER® INTRODUCES A LINE OF

EXTERIOR WALL PANELS WHICH BRINGS THE

PERFORMANCE OF STONE INTO A HIGH

STRENGTH CONCRETE PRODUCT. THE WALL

PANELS CAN BE PREPARED TO ACCOMMODATE

A VARIETY OF ANCHORING SYSTEMS.

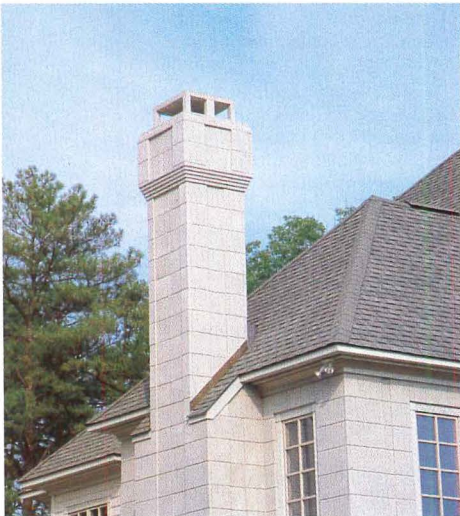

 HANOVER®
Architectural Products

Where Concrete and Imagination Meet

240 BENDER Road, HANOVER, PA 17331
(VOICE) 717-637-0500 (FAX) 717-637-7145
<http://www.hanoverpavers.com>

Circle 72 on information card

Vertical Auto Mall Kanner Architects

It's ironic, but in autocentric Los Angeles, shoppers have to travel to distant suburbs to buy a new car. No more: Ira Smedra of the L.A.-based Arba Group is developing a vertical auto mall in the middle of town, in which individual car dealerships will be housed on separate floors instead of freestanding buildings. Designed by the local firm Kanner Architects, the facility will occupy a renovated 1960s office building located just north of Wilshire Boulevard's fabled Miracle Mile.

Kanner will remove the existing curtain wall along the south and west edges of the tower and expose the structure to the outdoors, like a parking garage, with glass panels wrapping the perimeter. At the southeast corner, glass-enclosed bays cantilevered from the structure will showcase the latest model cars in floor-to-floor vitrines. A five-story-high screen mounted to the building's core on the east facade will display videos of automobile advertising, enhancing the role of the building as a giant billboard.

The shell of the original 11-story building won't require structural upgrades, since the concrete frame is strong enough to support the added loads of automobiles.

On each floor, individual dealerships will display cars around an elliptical pod enclosing sales offices and a small meeting area. A new elevator will transport two vehicles at a time up to the dealerships; two additional banks of elevators will carry shoppers up to the sales floors after leaving their cars on the roof of a two-level parking deck behind the building. (The first level will provide storage for additional car inventories.) Construction of the project will start early next year. *Raul A. Barreneche*

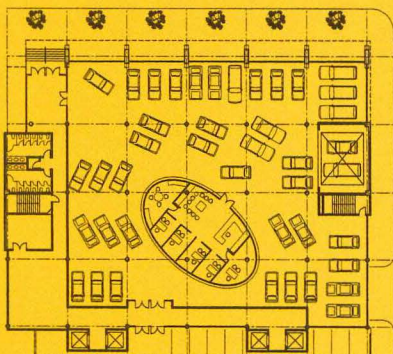

Boldly colored butterfly roof and giant video screen will transform 1960s office building into vertical auto mall.

"It's Simply Indispensable"

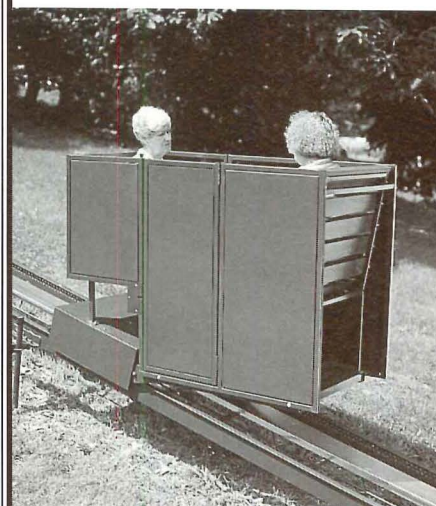

That's what you hear owners say about **Hill/Climber**, the personal outdoor transportation system.

Wherever activities exist on multiple levels or things have to be carried up steps.

Wherever easy access is needed to a cabin, boat dock or parking area. Hill/Climber provides the reliable, easily-installed solution.

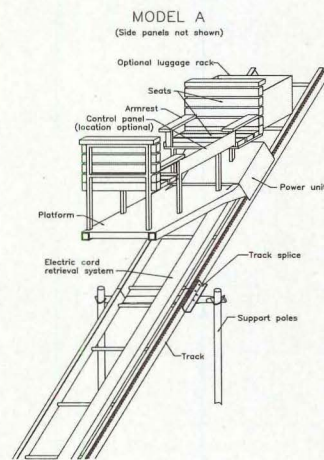

For more information refer to:
Sweet's 1998 General Building & Renovation
File 1423/INC

For free literature, contact:

INCLINATOR
COMPANY OF AMERICA
Dept. 96
PO Box 1557
Harrisburg, PA 17105-1557
Phone 717-234-8065

Circle 74 on information card

THE INTELLIGENT CHOICE.

**316L
STAINLESS STEEL**



**STSBB1391
4.5 x 4.5 US32D**

THE STSBB1391... 316L STAINLESS STEEL, CONCEALED STAINLESS STEEL BALL BEARINGS IN A 3 KNUCKLE HINGE EXCLUSIVELY FROM MONT-HARD.

Mont-Hard offers a complete line of Architectural Grade Commercial and Residential Hinges Manufactured to ANSI/BHMA Standards. Hinges recognized by Architects throughout the World for their quality and excellence.

A company with two manufacturing plants and seven distribution centers in North America, Proudly bearing the Mont-Hard name.

Mont-Hard has been manufacturing hinges in Canada for 107 years Fanal has been Manufacturing hinges in Mexico for 51 years. A successful union that provides 158 years of High-quality products.

Call or fax us now! U.S.A. & Canada: SAME DAY SHIPMENTS FROM STOCK.

CANADA
Mont Hard (CAN) Inc.
Contact: Andre Lopez
Tel: 800 363-6120
Fax: 514 641-4290
e-mail: monthard@aol.com
Lang.: Français, English
Espanol, Italiano

U.S.A.
Mont Hard Corp.
Contact: Jesse Noriega
Tel: 800 892-7902
Fax: 800 892-7916
e-mail: mhhinges@aol.com
Lang.: English, Espanol

MEXICO
Fanal, S.A. de C.V.
Contact: Pedro Ledezma
Tel: 01 (8) 350-4250
Fax: 01 (8) 350-6198
e-mail: fanalmt@infosel.net.mx
Lang.: Espanol, English



Lincoln Street Garage Brian Healy Architects

The ornate ceremonial gateway to Boston's Chinatown long faced the neighboring Leather District across a barricade of concrete and steel called the Central Artery. But the city is depressing this elevated freeway, narrowing the newly uncovered surface roads, and lining them with trees (this issue, pages 52-61). Now the only obstacle remaining between Chinatown and the Leather District is the banal Lincoln Street Garage, built across the Artery from the Chinatown gate in the 1950s.

Fortunately, the five-story garage is getting a facelift from local architect Brian Healy Architects that promises to transform it from a gritty liability into a good neighbor. The concrete-framed building already has one significant advantage: The original design incorporated pedestrian-friendly retail on the ground floor. Four steel-framed stories were added above the ground floor in 1959, with offices and parking on the second floor, parking on the third and fourth, and additional offices on the fifth.

Healy's renovation, which begins this summer, will retain this mixed-use configuration and the existing asbestos-panel cladding system. A new concrete-panel rain screen and galvanized standing-seam metal will add humanizing texture and depth to the facade. To further integrate the garage with the turn-of-the-century warehouses of the Leather District, Healy plans a parapet on the north side of the garage that will match the height of adjacent buildings. The gate to Chinatown will also get its due: A new balcony on the garage's fifth floor extends out to face the portal from across the street. *Ned Cramer*



KIMBERLY HOLCOMBE

Lincoln Street Garage curves along Central Artery (above) and faces Chinatown gate (below).

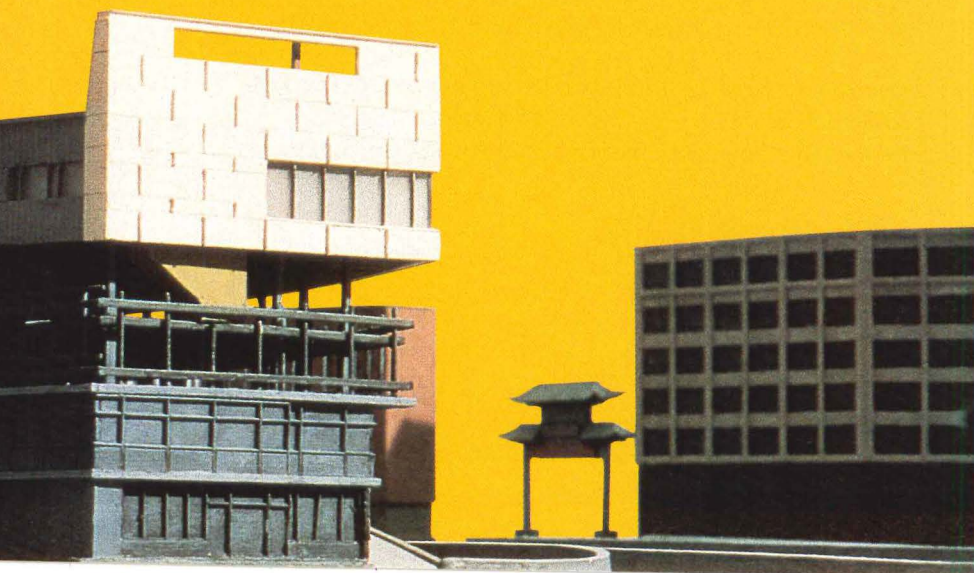

the Designer is in



Neil Frankel
Carpet and Rug
Industry Master
Designer and
President-elect of
the International
Interior Design
Association
(IIDA)

Beginning this month, Architecture will feature "The Designer Is In," a column on the latest design trends, written by Carpet and Rug Industry Master Designer Neil Frankel, AIA/FIIDA.

In addition to sharing design trends, Frankel will answer questions that you – our readers – submit. The answers may be provided in a future column.

Q: How is the way we work today influencing your approach to design?

Frankel: Today's work environment has changed dramatically from the traditional workplace. One predominant goal of today's commercial interiors is to promote team-building, and one design element that helps serve team identities and relationships is carpet. Since our clients are asking us to make the workspace informal and comfortable to encourage interaction, we are using carpet that's more texturally inviting in team areas – such as conference rooms and collaborative work areas – while carpet in work areas could provide a more structured look. This juxtaposition creates balance and plays to the space's architecture.

To submit your question, please write to:
"The Designer Is In" - Architecture
1355 Peachtree Street, NE
Suite 700, South Tower
Atlanta, GA 30309



www.carpet-rug.com
800-882-8846

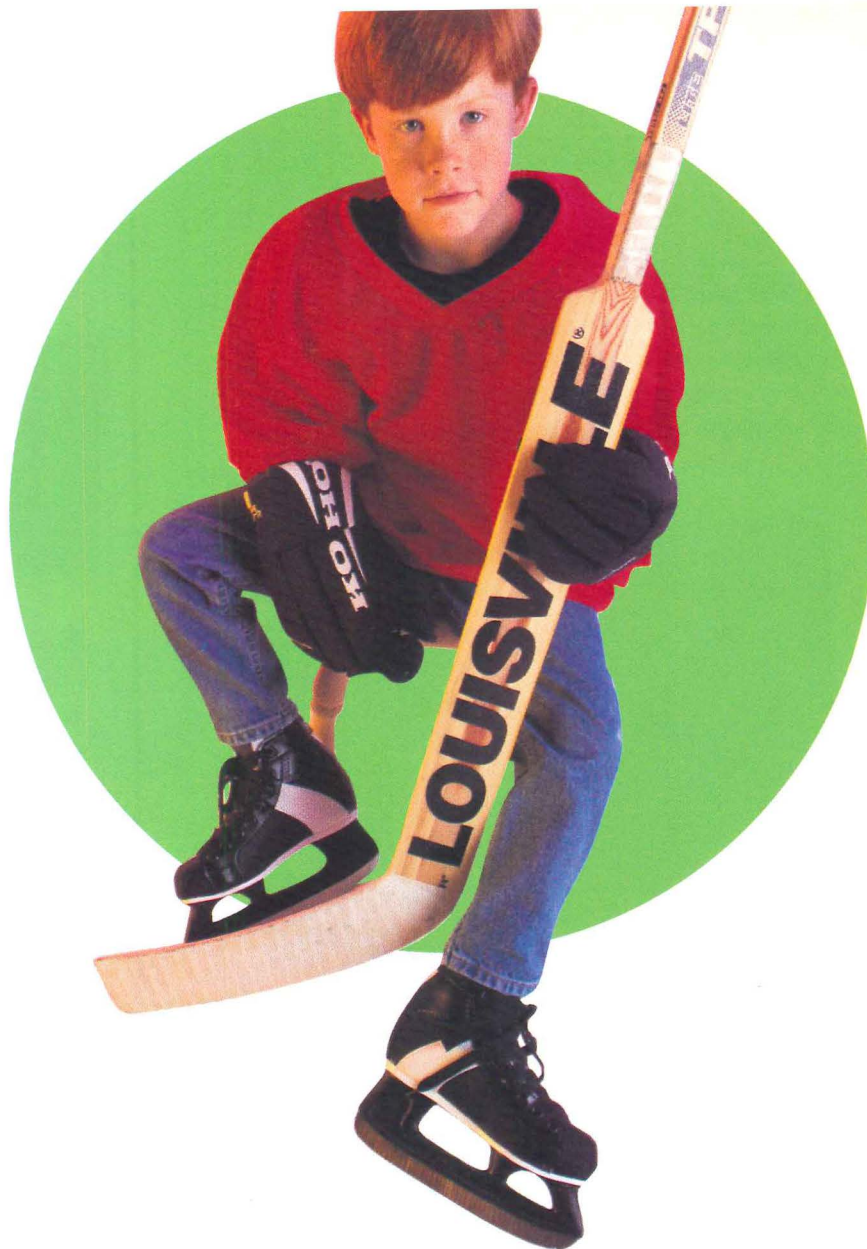

New Hi-Abuse™ Wallboard Ensures Tommy Makes His Mark In The World. Not On Your Walls.

If you need gypsum panels that are specially designed for high-traffic areas like classrooms, dormitories and day-care centers, you can't beat Gold Bond Hi-Abuse wallboard. It's ideally suited for use anywhere surface durability and impact-resistance are major concerns.

Hi-Abuse wallboard combines a specially formulated fire-resistive core with a scuff-resistant face paper to protect against surface indentation and impact. So if you're looking for a versatile alternative to fiber-reinforced gypsum panels, you can't beat Hi-Abuse wallboard.

National 
Gypsum
COMPANY

GOLD BOND® BUILDING PRODUCTS

2001 Rexford Road, Charlotte, North Carolina 28211
For technical information, call 1-800-NATIONAL or fax 1-800-FAX-NGC1

www.national-gypsum.com

Circle 80 on information card

Light Projects Pittsburgh Gluckman Mayner Architects and Robert Wilson

Pittsburgh's skyline will be transformed this fall when the city flips the switch on a series of monumental lighting displays by artist and stage director Robert Wilson and Gluckman Mayner Architects (the recently changed moniker of Richard Gluckman Architects that acknowledges longtime collaborator David Mayner). The first three installations—abstract, computer-controlled projections on

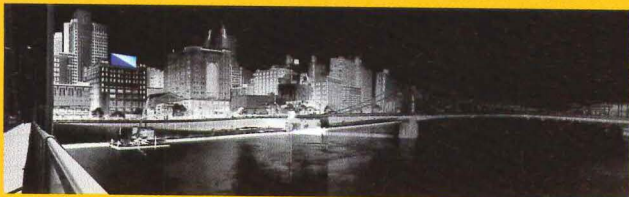

a riverside billboard, a theater rooftop, and the wall of a parking lot—are part of a master plan by the architect and artist team to enliven a 14-block historic district along the Allegheny River. The Pittsburgh Cultural Trust, a local nonprofit cultural and economic development group, assembled the team. Other Pittsburgh Trust initiatives include a new downtown plaza and theater by architect Michael Graves, landscape architect Daniel Urban Kiley, and sculptor Louise Bourgeois and a riverfront park (*Architecture*, January 1997, pages 92-93) by landscape architect Michael Van Valkenburgh and artists Ann Hamilton and Michael Mercil. According to Trust Director Carol Brown, Gluckman Mayner and Wilson will also serve as consultants to other artists and architects on subsequent lighting installations. *Ned Cramer*

Changing abstract lighting patterns (below) will be projected on billboards and walls of downtown Pittsburgh (above and bottom).

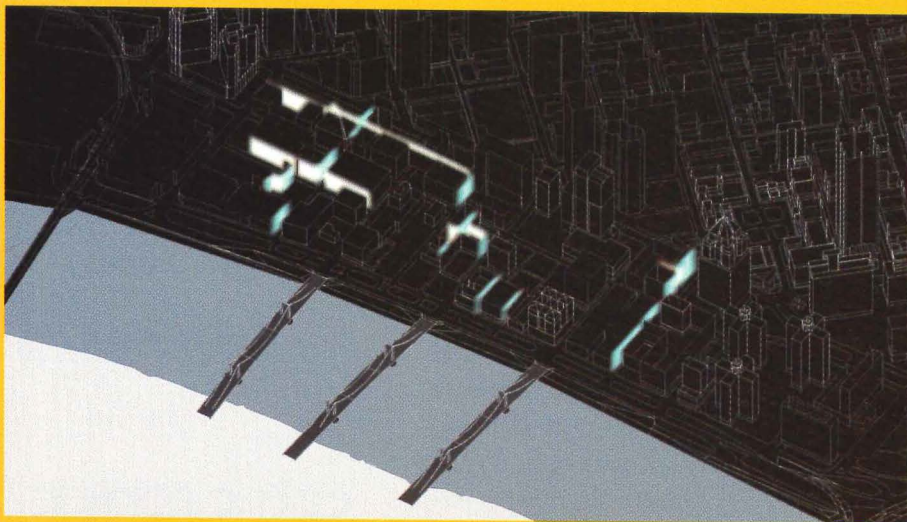
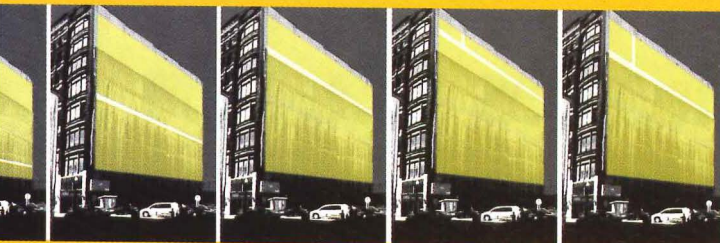

GENERAL SERVICES ADMINISTRATION

Excellence in Public Architecture

A/E Services are being solicited for a new U.S. Mission to the United Nations, 799 United Nations Plaza, New York, New York. The existing Mission will be demolished and a new building will be constructed at this location. The existing site is 9 059 square meters and the estimated range of costs for demolition is between 3 and 4 million dollars. General Services Administration desires this facility be constructed on this site, within the context of the existing community. It should reflect an appropriate expression of the American architectural tradition; while being visual testimony to the dignity, enterprise, vigor and stability of the United States of America. The proposed United States Mission will contain an occupiable area of 9 986 square meters and a gross area of 13 128 square meters. The estimated cost of construction for this facility ranges between 38 and 41 million dollars. A two-stage selection process will be used for the selection of a Design Team.

Stage I: Initial Selection

Submission of Designers Portfolio.

Submissions will be evaluated on their design merits. The designers will provide evidence of their capabilities to deliver design excellence and express their design philosophy. The submission will be evaluated and short-listed in this stage by the following criteria:

- Past Performance
- Philosophy of Design Intent
- Lead Designers Architectural Profiles

Stage II: Final Selection

Submission of the Design Teams Qualifications.

The short-listed design firms from *Stage I* will submit their A/E team qualifications for review. The teams are to include designated lead designers and all consultants who will work on the project. The A/E design firms will submit Standard Forms 254 and 255's which reflect the entire team. GSA will establish the criteria and the date these submittals are due and provide the selection criteria for the interviews and final selection process at the time of the *Stage I* short-list announcement published in the *Commerce Business Daily*.

Qualifications: Details of this solicitation have been defined in the *Commerce Business Daily* advertisement which appeared on March 31, 1998 @ <http://cbdnet.access.gpo.gov>. Designer Profiles for *Stage I* are due June 9, 1998.

Limitations: The Principal designer's office must be located within a seventy-five (75) mile radial distance from Columbus Circle, New York City.

Details of this solicitation may be obtained through:

Ms. Gayle Schuster, Contract Specialist
212-264-2825



Architecture Loves Design



More apartments or offices
- more call buttons.
The Siedle Vario system
adapts to the needs.



The internal call station:
The Siedle in-house tele-
phone. For table, wall sur-
face or flush mounting.
In black or white.

Sophisticated architecture
demands the right ma-
terials. The Siedle Vario
system has character and
style. Its form reflects its
function.

The Siedle Vario is mo-
dularly constructed. The
illustrated basic elements,
call buttons, loudspeaker
and house number, are all
integrated into a frame to
give a complete harmo-
nious design. Accessory
modules, such as move-
ment sensors, code locks or
video monitoring cameras
are easy to add.

More information:
Siedle Communication Systems
of America, Inc.
750 Parkway, Broomall, PA 19008

Call: 800 874 3353
Fax: 610 353 9716
<http://www.siedle.de>

And finally, the colors,
titanium, white and brown,
ensure that, wherever it is,
Siedle Vario looks good.

Circle 82 on information card

SSS SIEDLE

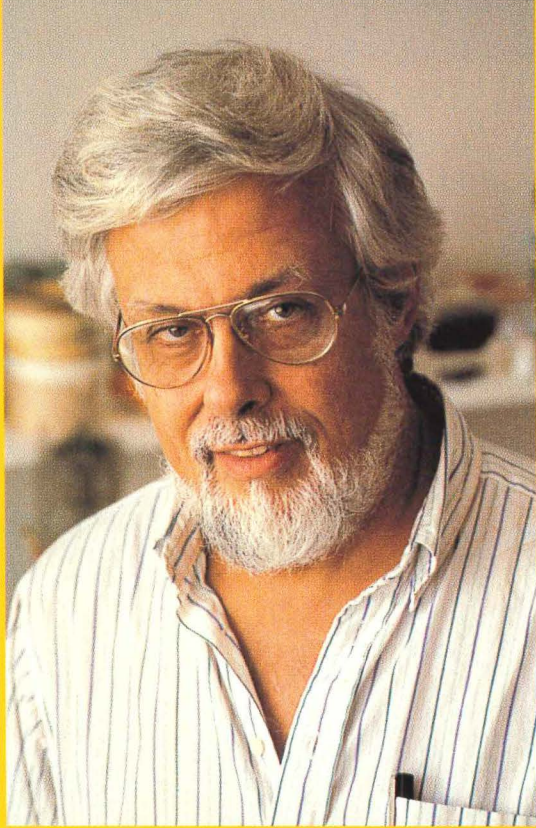

In the 1970s, James Wines put his New York City-based firm, SITE, on the architectural map with his iconoclastic designs for showrooms of the Best Products Company. These notorious buildings—part sculpture, part billboard—made SITE a household name. But the firm's star began to fade in the late 1980s, at least at home: It's been six years since Wines completed a project in this country—Ross's Landing park in Chattanooga, Tennessee—but his popularity never waned abroad. The firm has completed projects in Europe, Asia, and the Middle East, including the U.S. pavilion at the 1992 World's Fair in Seville, Spain, and a series of parks in Japan.

After this long absence, SITE is again working in the U.S. The firm is currently designing new prototypes for two restaurant chains, Chili's and Carrabba's. Last month, SITE was awarded the commission to design the U.S. pavilion at Expo 2000, to be held in Hanover, Germany. And Wines is busy finishing a new book on sustainability, to be published by Taschen in this fall.

ARCHITECTURE: What has become of the buildings you designed for the Best company?

JAMES WINES: Most of them have been destroyed. They were mowed down to make way for shopping centers. The "Forest" building in Richmond is being made into a church and religious center. Someone bought the one in Houston and put neon all over it—it's awful. The owner really loved one of the buildings in California. He's an art collector himself so he really appreciated it and has kept it in good condition.

SITE Survey

James Wines argues for sustainable buildings that don't forget about design.

The others didn't have to be destroyed—they could have been converted. I suggested to Best that they donate the buildings to community organizations. But these guys come in and buy the real estate and bulldoze everything that's there, no matter what. That's very bad for the environment: constantly getting rid of buildings that are perfectly serviceable.

Society has to say that there are things worth preserving. Italy is the best example. The country makes something like \$54 billion a year from tourism because they kept a lot of their old buildings around. It pays off, but there has to be a commitment from our government and society.

Do you think you've been branded the Best showroom guy?

That happens to every artist: Jasper Johns is the guy who painted the American flag. Andy Warhol did the Campbell's soup cans. I still live with the Best showrooms. I think we've built some of the most photographically reproduced buildings of the 20th century. We know of at least 3,000 instances in which images of the Best



10
MILLION

THE LEADING CAST

Heavy duty, cast iron closers. There's not a stronger, better performing door closer. LCN puts its cast iron closers through independent tests and publishes the results: over 10 million cycles! No other closer has been able to come close. No other closer can match the power and longevity of LCN cast iron closers. No other closer can meet the high standard of quality set by LCN.

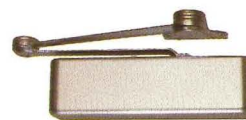

THE BEST CLOSERS. THE BEST VALUE. WORLDWIDE.

INGERSOLL-RAND
ARCHITECTURAL HARDWARE

LCN

LCN Division, P.O. Box 100, Princeton, IL 61356-0100 Phone: 800/526-2400 Fax: 800/248-1460

buildings have been printed. One is even included in H.W. Jansen's *History of World Art* now.

What projects have you built abroad?

We did five projects in Japan, including two children's parks. We also worked in Spain on the Avenue Five project in Seville and the U.S. pavilion for Expo '92. And we worked on the decommissioning of a nuclear power plant in Wales, which was a weird project. We suggested gradually curing these places through a new process called phytoremediation, where certain kinds of ivies and vines are used to cleanse nuclear waste. We also submitted designs for two museums in Riyadh, Saudi Arabia, and Doha, Qatar. Neither has been built.

Do you think there's a difference between foreign clients—European governments, for example—and American clients?

I think so. Foreign governments are much more committed. In the U.S., it's always a problem: It's like pulling teeth to get people to do anything.

What's your academic training?

My father was an engineer, and when I was young, I was always building stuff. I didn't really go to architecture school; I kind of got into architecture through the back door: I studied art history at Syracuse University. I started out as a sculptor and went to Italy and lived there a long time and that's where I got into architecture.

Do you teach?

Currently, I'm teaching an environmental workshop at the University of Pennsylvania. It's a collaborative studio that combines artists, architects, and landscape architects. The students are designing schemes for [Manhattan's] Hudson River Park.

How have you been perceived by other architects?

Five or six years ago, I was on a panel with a number of prominent architects, and they were laughing at me—like I was some kind of tree-hugger or something! Then, I was on another panel about two

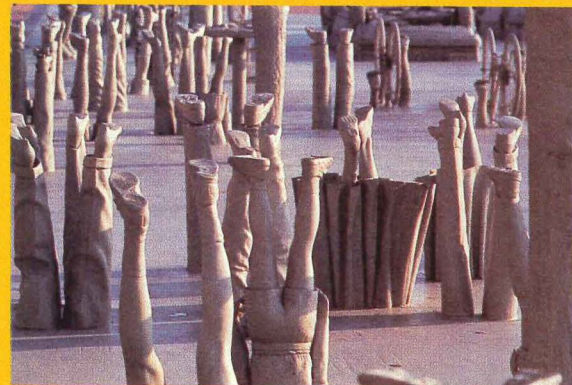

At Atsuzu space station park in Yokohama, Japan (1989), SITE embedded painted mannequins, bicycles, and cars into paved plaza.



ARCHITECTURAL
Drawing
EXHIBITION

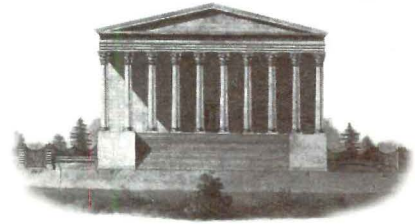

FRONT ELEVATION.

Though the reputation of Girard College and its alumni is widespread, less is known of the extraordinary story behind the design and construction of its first buildings.

The competition for the architectural commission to plan Girard College attracted the most accomplished architects of the day. One hundred and seventy drawings were displayed in Independence Hall and the winner was Philadelphia Architect Thomas U. Walter, who later went on to complete work on the United States Capitol.

After the College opened in 1848, more than 200 of the competition drawings were placed in the third floor of Founder's Hall, where they remained undisturbed, unnoticed and unappreciated for more than a century.

These magnificent drawings have been rediscovered and 60 of them are on display for all to see in Girard College's legendary Founder's Hall.

**The Exhibition runs from
May 10 - October 23,
Tuesday - Sunday,
11 a.m. - 4 p.m.**

**Admission is free to
the general public.**

**Large Groups are asked
to please call in advance.**



2101 South College Avenue
Philadelphia, PA 19121-4897
telephone: 888-447-2731

What's behind the Look?



Look beyond the stunning curb appeal of Senturion Wall Systems. Underneath the exciting shapes, colors, and textures lies a tested moisture drainage system. Senturion Residential Wall Systems* will keep water out, and also accommodate incidental moisture that might enter a wall around windows, doors, decks and other wall penetrations. Only CDsystems by Senergy provide an unobstructed drainage plane over the entire secondary moisture barrier.

With warranties up to ten years, Senturion Wall Systems deliver the look home buyers want and the assurance they demand.

SENTURION™ RESIDENTIAL WALL SYSTEMS

Senergy®

HARRIS SPECIALTY CHEMICALS, INC.

10245 Centurion Parkway North
Jacksonville, FL 32256-0565
☎ 800/221-9255

Fax: 904/996-6056

Visit our web site: www.hsc-ss.com

Circle 90 on information card



100% ACRYLIC POLYMER

*Contact Senergy for information on the Senturion Wall System.

years ago and the whole audience of young people was trashing those same architects, calling them goddamned stylists and their work egocentric crap! It was a complete reversal of attitude in less than three or four years.

How do you think your work has been received by the sustainable architecture movement?

They think I'm way out there. It's divisive like everything else. And it's sad because the point of ecology is that nature works together; only the things we impose on it destroy those systems. The "green" movement is factionalized into groups that don't speak to each other. I guess I'm in the esthetic camp, which is frowned upon by the [University of Virginia School of Architecture Dean] Bill McDonough camp. I occasionally find myself at conferences on sustainability, but I have the feeling that other architects look down on me. Like I'm not holy or orthodox enough.

Do you think green architecture is divorced from esthetics?

My take on esthetics is that if it isn't interesting, nobody's going to keep the building around anyway. So what's the point of the sustainable movement? It doesn't mean anything. If the building's ugly, they're going to get rid of it at some point.

How do your buildings differ from those structures designed by other "green" advocates?

Our designs are not prescriptive or formulaic. We're trying to give an esthetic dimension to environmental issues by expressing technological functions. For example, at Chattanooga's Ross's Landing park (1992, below), we designed buildings sheltered with earth. The U.S. pavilion for the Seville World's Fair (1992) was a big piece of bioclimatic art: The columns were framed in wire, filled with earth, and seeded with plants. These projects express environmental innovation and say something about their context.

How large is your office?

About 10, plus two people working in Germany now. We're kind of like a film company: We change our setup for each job. Then we usually get a local architect in the country where we're working. We create a temporary company and then dismantle it when the work is over. We used to have about 40 people working in

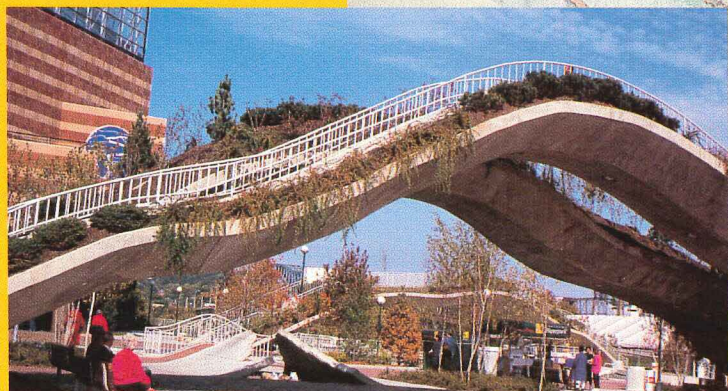
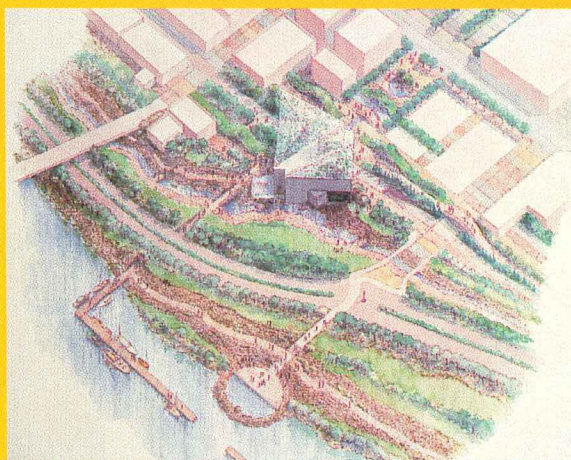

Sinewy concrete ribbons support bridges and plantings at Ross's Landing park in Chattanooga, Tennessee (1990).

SUSTAINABLE Design and Development

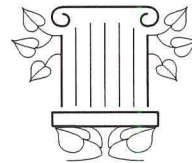

Joslyn Castle Institute
for Sustainable Communities

in affiliation with the
College of Architecture,
University of Nebraska

JCI provides information, research, continuing education programs, professional round tables, and access to the United Nations Best Practices Network. The Institute promotes

- integrated approaches to sustainable development;
- models which balance human systems and the natural environment;
- communication with regional, national, and global partners for the development of sustainable communities.

Now receiving applications for individual, firm and organizational memberships and sponsorships.

Contact:
Catherine McGuire, AIA
Executive Director
Joslyn Castle Institute
for Sustainable Communities
3902 Davenport Street,
Omaha, Nebraska 68131
Ph (402) 595-1902
FAX (402) 595-1007
<http://www.unl.edu/JCI/>



our old office. We were doing a lot of work, and we were doing more things in the U.S., like interiors and shopping centers.

Is your office computerized?

We start our projects by hand because it's fast. Every time I ask for something on the computer it takes days for it to appear. So I draw. Often clients expect that there'll be some kind of artwork [as part of a project]. If I don't draw, they wonder if I'm really working on the job.

Do you think your work engages people and makes the public more interested in architecture?

Historically, I think so. They've noticed it, that's for sure.

You've always positioned yourself as an artist as much as an architect. Which artists were particularly influential to you?

Gordon Matta-Clark, Bob Smithson, and Vito Acconci are still good friends of mine. I know all the environmental artists like Mary Miss. I've always loved the Surrealists and Dadaists. I've been more influenced by literary figures—playwrights, maybe—and visual artists than architects. I like Samuel Beckett's absurdist, serious, and ironic commentary. You know—it's serious, but then it's also sort of funny and it makes you nervous. I like that.

Do you think there's a sense of humor to your architecture?

From the very beginning, we felt that architecture had become a little dull, primarily because it was so rigorous and everything was focused on design and how you put forms together. There are always little inci-

Horoscope Ring park (above) in Toyama, Japan (1992), features segmented plantings. Museum of Islamic Arts in Qatar (below) and Saudi Arabian National Museum in Riyadh (bottom) remain unbuilt.



METALCAST® or QUARRYCAST® ?

MetalCast®

By combining metal powders, minerals and glassfibers, MetalCast® elements equal or surpass the elegant beauty of conventional castings.

The 1/4" (6mm) thick copper, brass, bronze and nickel-silver elements have an uneven buffed / burnished appearance that is enhanced by reveals or similar relief. It is not available in a bright polished finish.

For interior use only, typical applications are mouldings, door surrounds, columns and panels.

QuarryCast®

A combination of natural aggregates, minerals and glassfibers, it has the distinctive appearance of lime / sand stone. Between 1/4" and 3/8" thick (6 - 8mm) it is light weight, available in both standard and custom colors and cut with standard carpenter tools.

For interior use only, it is used for columns, mouldings, wall panels and other decorative elements, but it is not suitable for floors.

Note: MetalCast® & QuarryCast® meet the most stringent fire codes anywhere in the world.

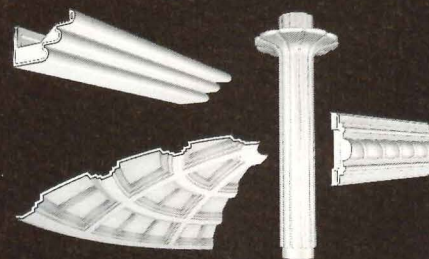

Design 1 is Formglas' new 60 page catalog showing architectural components with existing molds, including columns, capitals, domes ceiling & wall panels, etc. All items available in Formglas G.R.G (gypsum) QuarryCast® and MetalCast®. Catalog can be sent by mail or viewed at www.formglas.com

Formglas

Formglas Inc.
 20 Toro Road, Toronto, ON CANADA M3J 2A7
 Tel: (416) 635-8030 Fax: (416) 635-6588
 Web Site: <http://www.formglas.com>
 Canada • Japan • Malaysia

Circle 92 on information card

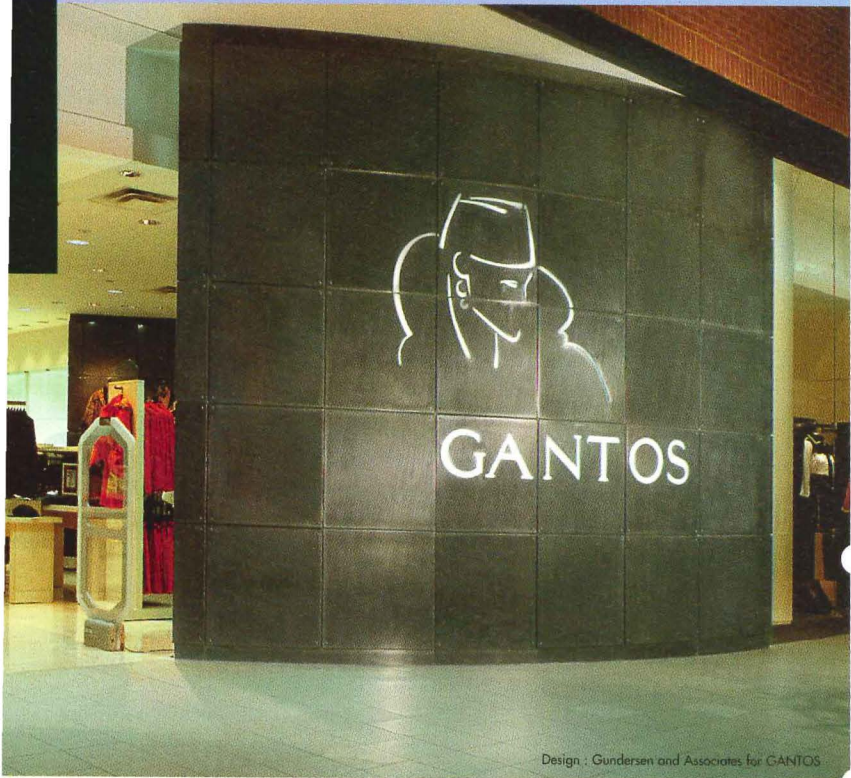

Design : Gundersen and Associates for GANTOS

METALCAST[®] BY FORMGLAS

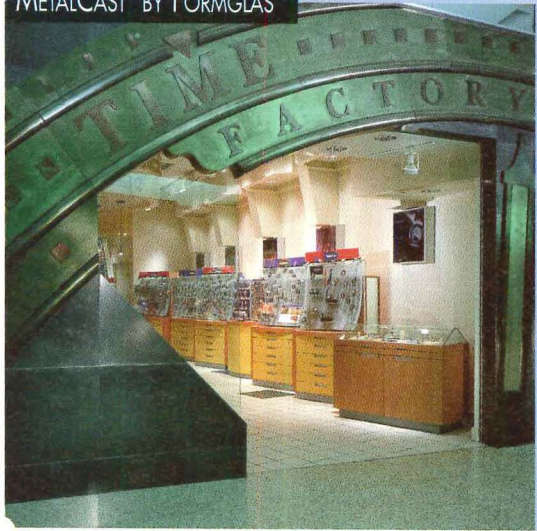

Design : M.C.M. Inc. for TIMEEX



CAST ARCHITECTURAL SHAPES

"...CONSIDERED ACTUAL
[BRONZE] CASTING BUT IT
WAS NO CONTEST."

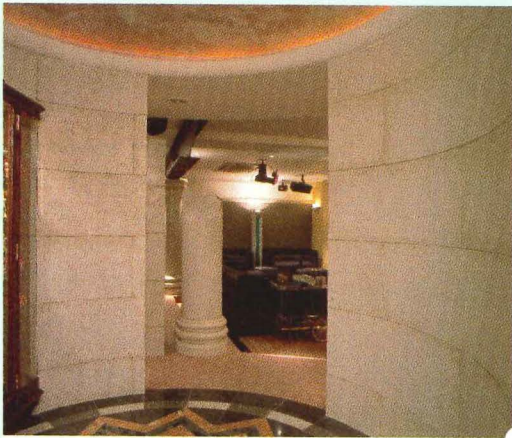
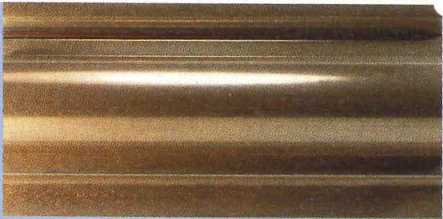

"REGULAR STONE WOULD
HAVE TAKEN 3 TO 4 TIMES
LONGER TO INSTALL..."

QUARRYCAST[®] BY FORMGLAS



"... COULD NOT TELL THE
DIFFERENCE BUT SO MUCH MORE
VERSATILE [THAN STONE]."



Wausau Tile



Design - Beauty - Durability

Choose Precast Terrazzo



N.T.M.A. MEMBER

WAUSAU TILE

P.O. Box 1520

Wausau, WI 54402-1520

Circle 94 on information card

(800) 388-8728

(715) 359-3121

Fax (715) 359-7456

www.wausautile.com

INTERVIEW

dents in our work that are plays on situations, or metaphors, or puns. It depends on the project. We've done children's parks in Japan, which are very funny. There are funny things in my new book, too; it has some really sardonic edges. Humor is always good, but you need a little more than that.

Tell us about your upcoming book.

I'm doing a book for Taschen about the environmental design movement called *Architecture in the Age of Ecology*. We're trying to think of a livelier title that doesn't sound so academic, but basically that's the theme. The point of the book is to get the green movement off this finger-wagging, to get away from that reprimanding tone.

You're challenging that tone.

I'm challenging those awful buildings done by most of the "greenies." It's bad, uninteresting design. That's the point of the book: Philosophy, esthetics, and technology go together. In a way, this publication is both too early and too late. From a design perspective, it's too early: While there's brilliant work being done today that qualifies as sustainable, most architects' choices of visual interpretation are still locked into time-warped, 20th-century stylistic idioms, which tend to confuse rather than reinforce progressive images of earth-friendly architecture.

On the other hand, from the standpoint of advocating much-needed environmental reforms in the building arts, this book is too late. A good portion of the architecture profession has remained oblivious to the magnitude of its irresponsible assaults on resources and the land. Given the longstanding need for an environmentally oriented philosophy, the main message of the book is actually a half-century overdue. It's part apology and part getting ourselves to think about being responsible.

What is your opinion of contemporary architecture?

Look at the most prominent new building: Frank Gehry's Guggenheim Museum [in Bilbao, Spain]. It's the most anti-ecological building that could possibly be built. Titanium is one of the



Overscaled brick chili pepper dominates roadside facade of Chili's prototype.

most toxic materials there is in terms of manufacturing it and the waste it creates.

Do you think such an attitude toward construction is a purely modern problem?

The Greeks really destroyed their environment, and ultimately their economy with it. They defoliated all their hillsides and cut down all the trees. It was one of the first real environmental and economic destructions. The Egyptians were the best [keepers of the environment]. For almost 3,000 years, they didn't fool around with it. I'm sure had they been able to build dams or had modern technology they would have done the same stupid things we do. But they didn't. They actually understood wetlands and the overflow of the rivers, how important they were, and how you accommodate them.

Our attitude is insane: You pave over everything. A river overflows and everything washes away. And you blame the government. You call it a natural disaster! That's ironic. It's a totally man-made disaster! I've heard scientists say that in the last 90 years, we've done more irreparable and catastrophic damage to the air, land, and sea than everything that has occurred on the earth in the last 60 million years. So we are primarily the cause of the next extinction. Isn't that unbelievable? It's staggering.

Tell us about your designs for prototypes for Chili's restaurants (above). How did you secure the commission?

The president of the company knew our work pretty well. And the architects on staff had all studied our work in school so they were very excited about working with us.

The facade is in the shape of a big chili pepper that you see from the highway. The whole interior is made out of the same exact materials and has the same iconography as the exterior: The two match up. The design is like an assemblage of cultural icons, subliminally or otherwise associated with the roadhouse and driving on the all-American strip. The restaurant had no existing image; they had no archetype to work with. There were so many stylistic references in the average Chili's restaurant: Mexican border station, Alpine chalet, Lombardy stone village, biker's hangout, Parisian café, Texas ranchhouse, Tex-Mex roadhouse, Provençal farmhouse, Irish tavern, sports bar, and suburban Colonial. I said, "That's why no one remembers your restaurant—you've become a composite." So we had to think one up. We went through this ritual of looking up all the images that would be associated with a roadhouse without building a mock roadhouse.

NEW

WAUSAU TILE

TT6050 w/ Light Option

TT6093 Custom Bollard

TT6099 Shown w/ optional "candle" light

TT6091 Shown in Polished Terrazzo

Wausau Tile introduces "LAPA-Z" bollard, a beacon of light to control traffic, provide security and accent lighting. The Lapa-Z bollard is steel reinforced concrete designed to provide years of dependable service.

Wausau Tile manufactures many standard precast concrete bollards or can custom design to meet your specific needs.

WAUSAU TILE
Call 800-388-8728

Wausau Tile Precast Bollards "Protective Beauty"

Control traffic and provide security choose from 38 standard designs or create your own. Circle 96 on information card

NEW

WAUSAU TILE
STONE CREEK SERIES
Terra-Paving Division

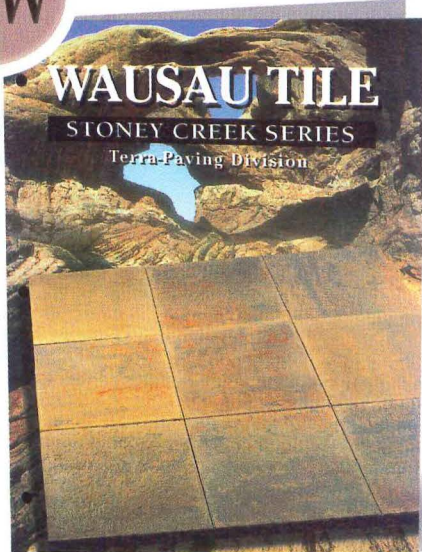

Stoney Creek Series
concrete pavers are of a natural stone texture with beautiful color ranges to match or blend with most types of stone. Request our new catalog for information.

Circle 98 on information card

WAUSAU TILE

(800) 388-8728

It had all the potential to be brilliant. But they just didn't quite get it.

Suddenly, compromises had to be made. But not everywhere. The saving grace

was the windows. Because there's a kindred soul that shares your passion for

t h e o n l y t h i n g s c a r i e r

fine detail. From 7/8" TDL, five hardwood interiors, all the way to the only

vinyl window you would ever specify with confi-

dence. Unlike so many others...they get it.

Circle 100 on information card

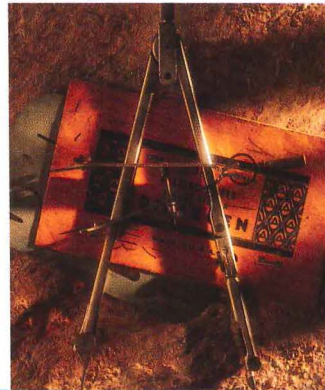

*T h e r e ' s m o r e
t o s e e i n a
W e a t h e r S h i e l d
w i n d o w TM*

Weather Shield
Windows & Doors



t h a n a b l a n k s h e e t o f p a p e r



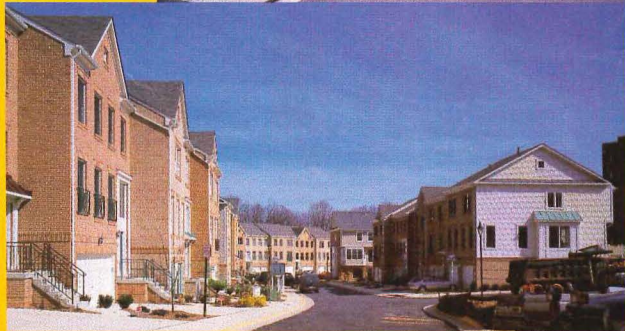

Unrest in Reston

New automobile-oriented development in Reston, Virginia, betrays the spirit of the community's original plan.

Reston's residential neighborhoods have gone from intimate and green (top) to big and bland (above). Shopping centers that once favored pedestrians (right) now cater to automobiles (below).

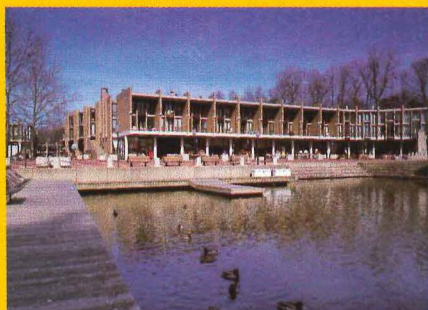

The problem with success is that everyone wants a piece of it. Hence the runaway development in Reston, Virginia, a planned community created in the mid-1960s by developer Robert E. Simon. The 7,400-acre city near Washington, D.C., originated as walkable residential and commercial clusters sited around four lakes and separated by wooded spaces. Since then, hundreds of new businesses and thousands of new residents, both led by eager developers, have surrounded these clusters in an attempt to monopolize on Reston's success as an intimate and livable community.

Even though this recent development follows Simon's plan for Reston's growth, it fails miserably in spirit. The original neighborhoods remain inviting environments: Modernist apartments crown inward-facing retail stores and there's plenty of greenery integrated into a comfortably high-density community. But Reston's current developers, planners, and architects, all controlled by landowner Westbrook Communities, apparently saw none of this. They're instead building bland strip malls, office parks, and housing—all designed for volume rather than quality of life.

Consider Reston Town Center. Phase one of this mixed-use development, now 25 percent complete, consists of an office, hotel,

and outdoor mall complex designed by RTKL and opened in 1992. Surrounded by parking lots, a busy parkway, and sites for two future office buildings, the project was the first large-scale development to break the pedestrian-oriented pattern. It lies within walking distance to nothing in particular and is not the center of any town in the traditional sense. Nor is it likely to be: The remaining 75 percent promises more parking-oriented development.

Nearby, several new strip shopping centers, all facing the parkway instead of engaging residential neighborhoods, offer ominous signs of decline in design quality. Even more ominous is the fact that two of the original village centers, Tall Oaks and Hunters Woods, will soon be replaced with outward-facing strip malls, complete with drive-thru fast-food restaurants.

The prognosis for Reston's residential areas is equally grim. While older neighborhoods feature closely spaced houses, high trees, and de-emphasized roads, the rest are standard suburban fare: wide streets, abundant acreage between properties, pastel-colored garden apartments, enormous single-family houses, and assorted "historic-looking" townhouses.

Many residents oppose the apparent break from Reston's original patterns. Others find Barnes & Noble and Best Buy superstores hard to resist. Resident opinions, however, mean little here: Reston is not an incorporated town, so there is no government at the community level. Instead, decisions are made by Fairfax County officials and Reston's elected supervisor, Robert Dix. As a result, development proceeds according to developer interest and what county officials think is best. For Reston, such shortsighted goals spell a sad end to an otherwise honorable beginning. *Eric Adams*

The **AIA** National Convention & Expo

Moscone Convention Center

San Francisco

May 14-17, 1998

B R I D G E S
bridges

to education
to leadership in the community
to the global marketplace
to sustainable values

98
SAN FRANCISCO

CONVENTION
AIA 
EX PO 98
SAN FRANCISCO

- Over 110 new products and services at AIA Expo98
- Networking with industry colleagues
- View over 450 exhibitors' products and services
- 36 LUs in one convention

For more information
call 617 859.4475
or fax this request
to 617 859.4354

Please send me information about

- Attendance at AIA98
 Exhibiting opportunities
 Other

Name _____

Company _____

Address _____

Phone _____

Fax _____

You can learn more about the Convention and Expo
at the AIA Convention website, www.aiaonline.com.

archit

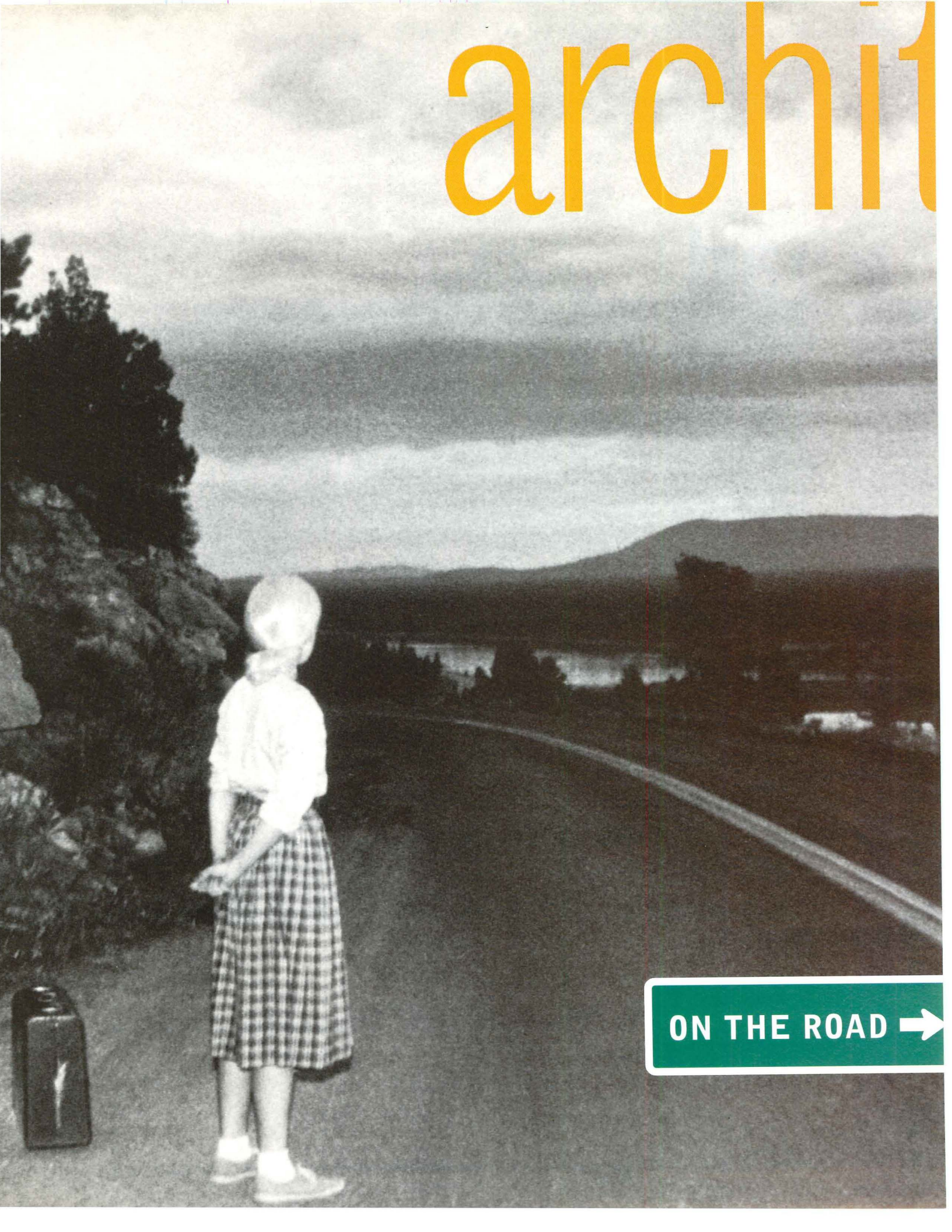

ON THE ROAD →

By Andrei Codrescu

Road trip



JOE SCHERSCHEL

A road scholar laments the death of the American highway as narrative.

Sequential Burma Shave billboards lured motorists down mid-century American roads (facing page); Free-wheeling McDonald's museum celebrates the chain's roots (right).



Roads are intrinsically narrative, a concept that was fleetingly grasped by the Burma Shave billboards of the 1950s, which told a story that compelled you to follow it from one sign to the next. On a Pennsylvania state road, I once saw a similar series of religious billboards that began with the hugely lettered question: "After life, what?" About 5 miles later, the answer, in similar gigantism: "Death." Another 5 miles, another question: "After death, what?" I gladly went 5 miles out of my way for that answer: "The resurrection." Was there more? Five miles later, I found out. There was: "Resurrection for whom?" At this point, I had the feeling that I was following a crumb trail left by the wicked witch to lure me into the oven. I was impressed enough, however, to dream up a billboard novel stretching over a thousand miles of road, each installment ending in a cliffhanger that would take people out of their way, divert them from their plans, and drive them mad with literature.

Most roadside architecture does not exploit the narrative nature of the road. McDonald's' arches repeat like an idiot mantra, assuring the traveler of the opposite of adventure: Nothing weird will happen. We are your guarantee that you actually never left home. You are not on a road: You inhabit the afterlife by crossing through the arches into a sky of fluffy clouds, double-patty putti, and bun-soft music. This was confirmed by a manager of the first McDonald's near Chicago, who told me that the vast numbers of hamburgers sold have made it necessary to abandon astronomical metaphors, such as "the number of burgers sold equals x trips to the moon," for something more metaphysical. He then played a tape of McDonald's founder Ray Kroc, who spoke from beyond the grave on the virtues of perseverance. (And redundancy.)

The Burma Shave billboards and McDonald's belong to two different generations of roads. The first, which lasted roughly from the mid-1920s to the mid-1960s, was a giddy and adventurous enterprise that legitimized the new freedom of the automobile. Route 66, America's "main street," "the mother road," was dedicated at the height of the roaring '20s, and it allowed Americans to roar from Chicago to Los Angeles across three time zones and eight states. Route 66 and its surging tributaries had nothing of the straight-arrow, steely resolve of the railroad, which had conquered and unified the American continent. These motoring roads were a haphazard collection of local and state interests that bent, curved, looped, and backtracked at the whim of a thousand commissions, merchants' associations, and land speculators. Not even federal will could impose strict order on roads that promised—and delivered—unprecedented individual freedom.

For a time, roadside architecture flourished unregulated along Route 66. Gas stations, motor courts, drive-in restaurants, curio shops, homemade "museums," and idiosyncratic "monuments" did their garish best to entice the motorist. Regions capitalized on their folk myths and local legends: There were giant jack rabbits in Oklahoma, Indian teepees in Arizona, huge cowboys over inns in Texas, and early neon in California. The sign for The Snow Cap restaurant in Seligman, Arizona, is shaped like an oversized striped drink cup with a straw that contains some swirly float called the "HumDinger." The menu recommends "dead chicken with all the trimmings." American earnestness, hucksterism, buoyancy, and good humor burst along this road with all their mixed messages, from the statue of the Virgin Mary, "the queen of



Detroit's Uniroyal tire embodied urban roadside iconography (left); religious signage (facing page) promises drivers roadside redemption.

the roads," just below Springfield, Illinois (a Carrara marble statue bought by farm kids in 1959) to The World's Largest Totem Pole, outside Foyil, Oklahoma.

In 1957, when Jack Kerouac's novel *On the Road* appeared, roadside America was at its peak, although there were hints that it wasn't long for this world. Kerouac's title articulated a new mid-century American philosophy, namely that the road was no longer simply a means to get from one place to another, but a state of being, a symbolic way to view existence itself. The road was a place, one that had its own residents: drifters and wanderers made ill by the advent of the suburb, a quickly metastasizing megamonster. This incarnation of nowhere, neither city nor country, was already reducing late-1950s Americans to appendages of their automobiles that went nowhere and saw nothing.

I like to think that Kerouac's road as we know it ended in 1966, when I first gazed on the gigantic Uniroyal tire near a Detroit airport. My first glimpse of America from a car became one of the steady images in my newborn immigrant brain. "It's big enough to live in, have a couple of kids there," the poet Jeffrey Miller said about the tire. By 1968, aggressive federal highway policy was already rendering such landmarks merely quaint. The federal government used highways to make social policy (destroying entire "trouble" neighborhoods following the riots of 1967 and 1968) and by providing entertainment-free four- and six-lane ribbons of interstate road. The coming superhighway had palliative repetitions dispensed with roadside attractions; its exits led only to oases of pure pragmatism: gas, food, lodging.

Today, there are two nervous systems that go by the name "road" in America: the vestigial, nostalgic one that

connotes the instinctual urges of wandering and freedom, and the neocortexlike network that sucks people in at one end and spews them out at the other at great speed. The old system was fragmented, narrative, homey. Its greatest consumers were families out for an after-church Sunday drive. With the advent of the superhighway, the traditional Sunday drive got longer and longer, eventually replacing the church service itself. Instead of church, families headed for Disneyland. In the 1970s, being "on the road" became mainstream, and roads lost much of their narrative, initiatory sense. Disneyland was not a place to which one needed to go: It was an imaginary destination like "the road" itself, though an end product, not a process of self-invention.

Americans have been "on the road" since the founding of the republic, moving faster and faster every decade. Westbound settlers in the 19th century literally hacked their own roads through the wilderness. You can still see the ruts of wagon wheels on the Oregon Trail today. Only a relatively short time elapsed from that epic-heroic endeavor to the federally funded highway projects that today inscribe the face of North America. An even shorter time is now elapsing between the disappearance of roads altogether and the triumph of another road ideology: virtual highways. In the process, the utopian projections of dreamers blossom and fail in rapid succession, leaving behind the detritus of a bizarre archeology. The American road makes the best and the fastest ruins.

Andrei Codrescu's film Road Scholar (1993) features a journey across America. His latest book, to be published by St. Martin's Press this month, is Hail, Babylon! Looking for the American City at the End of the Millennium.

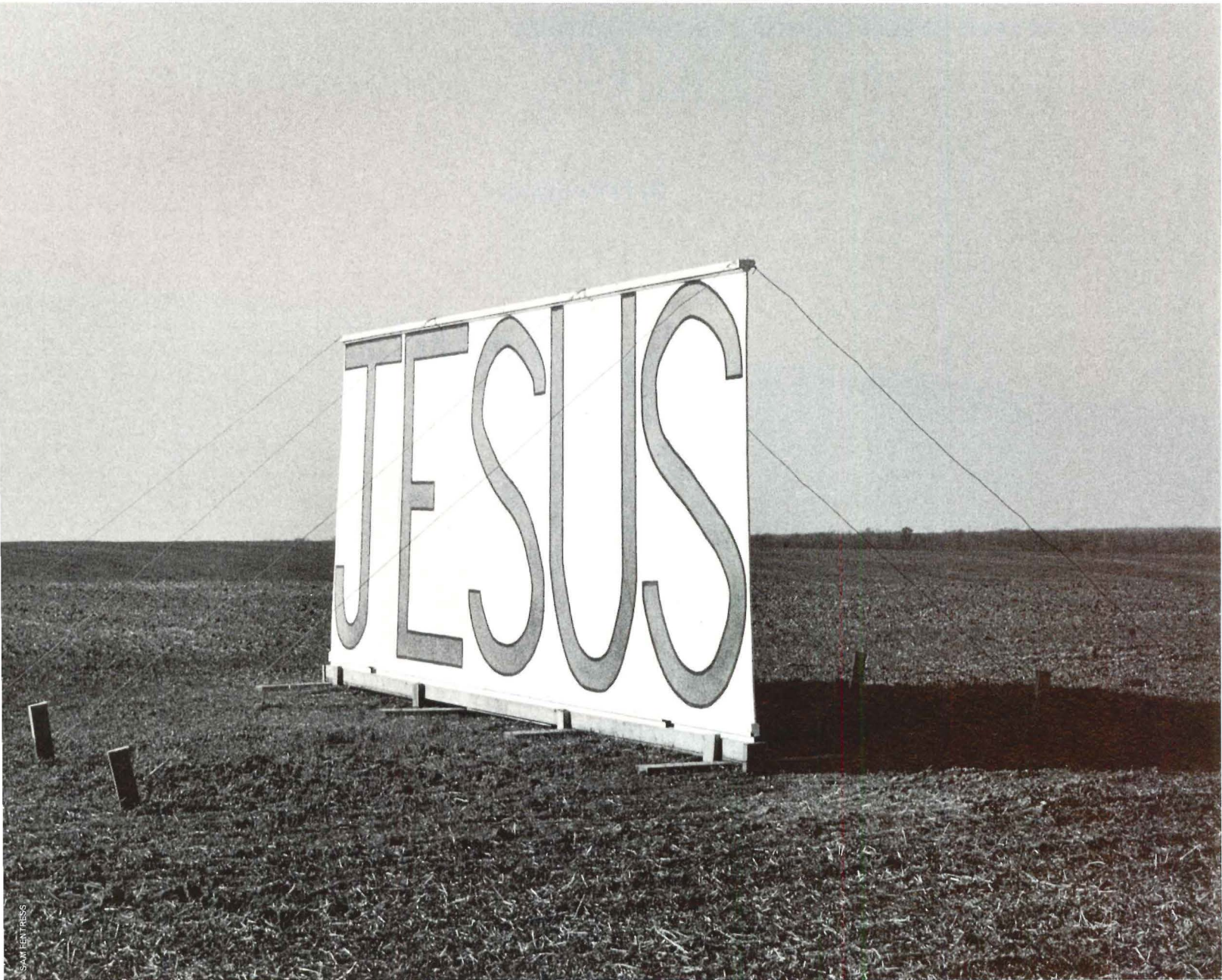

SAM FEATRESS

happy meals

Gensler reinterprets the Golden Arches with fresh new ingredients.

By Edward Keegan



Dining room of Darien, Illinois, store pays tribute to Chicago's architectural history with Miesian glass box and Wright-inspired wood-sided mass (facing page). Drive-thru is contained within rounded brick shell, detailed with horizontal bands reminiscent of Prairie Style. Dining room features window alcove seats that sit beneath canted soffits (bottom).



It's easy to forget that McDonald's' ubiquitous golden arches are derived from the double-arched, canted-roofed structures that the company constructed across the country in the 1950s and 1960s. While those perky red-and white-striped hang-outs still inspire Baby Boomer sentimentality, there's scarce nostalgia for the thousands of squat, mansard-roofed boxes that McDonald's has built in strip locales since 1968. However, two new restaurants in Colorado Springs, Colorado, and Darien, Illinois, suggest that McDonald's may be ready to atone for three decades of architectural junk food. San Francisco-based Gensler has produced kindred buildings that slickly integrate architecture, interior design, and graphics, while reinvigorating the fast-food form with wit and function.

McDonald's' Customer Oriented Restaurant Experience (CORE) team tutored Gensler on the inner workings of a typical shop. The architect then divided these functions into distinct programmatic elements: entrance vestibule, service area, dining area, kitchen, and drive-thru. Conceptually defining these pieces as discrete architectural masses and volumes, Gensler manipulated their configuration and articulation to fit the different sites. "Modularity was very important," explains Gensler Project Director Dian Duvall.

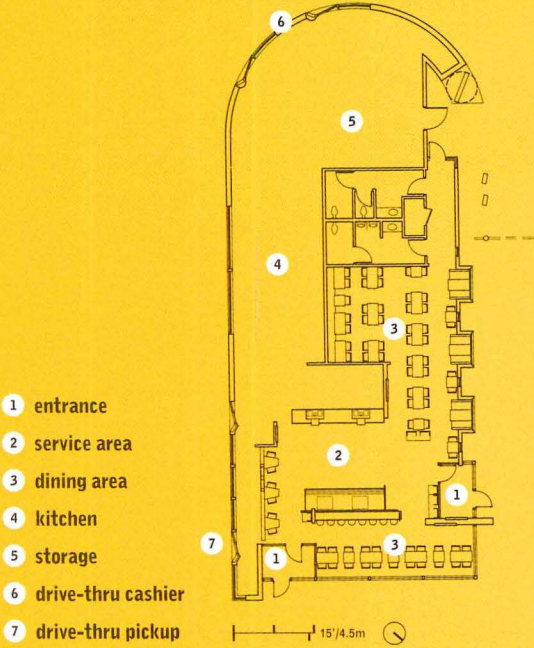
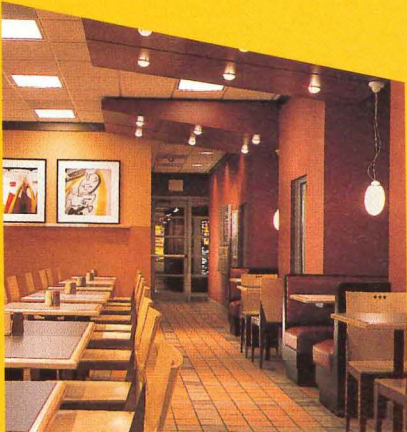

MCDONALD'S RESTAURANT
DARIEN, ILLINOIS

CLIENT: McDonald's Corporation **ARCHITECT:** Gensler, San Francisco—Charlie Kridler (principal-in-charge), Kourosh Baradaran, Kevin Hart, John Ishihara, Jean Lavan, Andrew Meagher (design team), Jane Brady, Dian Duvall, Julie Tashima (graphics and signage), Michael Bodziner, Dana Frost, Jeff Henry, Katie Price, Chris Seager (interiors) **ASSOCIATE ARCHITECT:** McDonald's Customer-Oriented Restaurant Experience (CORE) Team, Oak Brook, Illinois **ENGINEERS:** DASSE Design (structural); ENCON Energy Conservation Company (mechanical, electrical) **CONSULTANTS:** Doblin Group (customer research); Frankel & Company (signage); Auerbach + Glasow (lighting) **GENERAL CONTRACTOR:** Schwabe **COST:** Withheld at owners' request **PHOTOGRAPHER:** Chris Barrett, Hedrich-Blessing

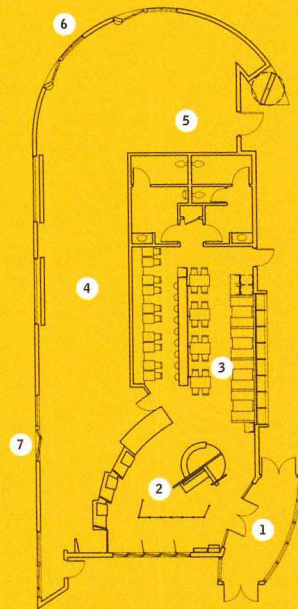

15' / 4.5m

- 1 entrance
- 2 service area
- 3 dining area
- 4 kitchen
- 5 storage
- 6 drive-thru cashier
- 7 drive-thru pickup

The complexity of forms reflects the restaurants' site constraints and building sizes. The 64-seat Colorado Springs restaurant occupies a narrow suburban site with a clear front-and-rear orientation. The 100-seat Darien store sits at an acute angle to the intersection of two commercial thoroughfares. This siting and the need for more dining space dictated two distinct entrances and warranted more elaborate glass and wood volumes.

The interiors of the Colorado Springs restaurant are more fully resolved. A segmented service counter sits under a broadly arced soffit, providing a well-defined hinge between the verticality of the double-height vestibule and the horizontal thrust of the dining room. In Colorado, witty elements such as a sculptural sleeve of french fries hang from the vestibule ceiling and canted windows in the dining room—a conscious evocation of 1950s McDonald's—enliven the interior without distracting from the streamlined process-oriented organization. Darien's interiors are less clearly organized, with multiple dining areas interrupted by the food service area.

Gensler also developed the bold graphics that complement the new designs. Menus sit in front of the counter—where they're most visible to customers—instead of behind it. The most dramatic new signage occurs at the drive-thru lane, where a large pivoting menu board sits beneath a broad cantilever.

Gensler's two McDonald's display how flexible a well-conceived design concept can be, since their shared pedigree isn't obvious. They dramatically raise the level of architectural sophistication for an American icon—one whose esthetic credibility ended three decades ago with the demise of its road-tested architecture.

Double-height entrance vestibule of Colorado Springs restaurant houses oversized french fry sculpture (facing page). Stucco-clad drive-thru wraps around back of building. Located in foothills of Rocky Mountains, restaurant recalls detailing of McDonald's' early restaurants of 1950s and 1960s (bottom left). Menus sit in front of counters for easier viewing (below).

**MCDONALD'S RESTAURANT
COLORADO SPRINGS, COLORADO**

CLIENT: McDonald's Corporation—Mickey and Wilene Maize (owners) **ARCHITECT:** Gensler, San Francisco—Charlie Kridler (principal-in-charge), Todd Davis, Kevin Hart, John Ishihara, Jean Lavan, Andrew Meagher, Jung Suh (architecture), Jane Brady, Dian Duvall, Chris Seager, Julie Tashima, Lisa Van Zandt (graphics and signage), Michael Bodziner, Dana Frost, Jeff Henry, Suzanne Korock, Julie Lochowski-Haney, Katie Price, Luke Sheridan (retail and interiors) **ASSOCIATE ARCHITECT:** McDonald's Customer-Oriented Restaurant Experience (CORE) Team, Oak Brook, Illinois **ENGINEERS:** DASSE Design (structural); ENCON Energy Conservation Company (mechanical, electrical) **CONSULTANTS:** Doblin Group (customer research); Frankel & Company (graphics and signage); Auerbach + Glasow (lighting) **GENERAL CONTRACTOR:** Christofferson Commercial Builders **CONSTRUCTION MANAGEMENT:** McDonald's Denver Region **COST:** Withheld at owners' request **PHOTOGRAPHER:** Chris Barrett, Hedrich-Blessing, except as noted

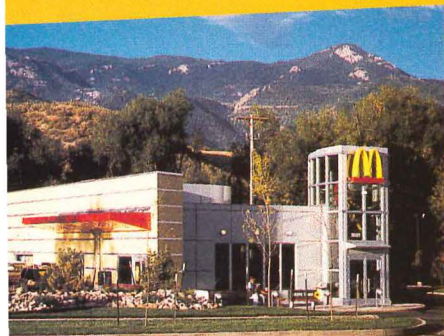

ANDREW MEAGHER / GENSLER

By Richard Ingersoll

Neon-trimmed oval canopy (below) crowns corrugated aluminum kitchen. Kitchen sits at center of oval (plan) surrounded by drive-thru, picnic tables, and parking. Canopy along site's southern edge (facing page, bottom) shields additional parking spaces, from which customers can place orders.



super sonic

The American drive-in restaurant, invented in the 1920s and mass-marketed in the 1950s, is now a relic of the great age of vernacular Futurism. Filippo Marinetti's wildest invocations of the synthesis of man and machine could never have anticipated the drive-in's unself-conscious perversity: eating in the intimacy of one's own car while being served by roller-skating waitresses. The drive-in became one of the typical elements of the post-urban, automobile-based environment, where big signs and bright lights formed the crass but majestic axis of the commercial strip. Cheap food, cooked in substances that resemble the fuel of the preferred means of transportation, and low wages for working in conditions similar to a factory pump room, characterize this motorized world beyond the scrutiny of the civic realm.

Sonic, the country's largest drive-in chain, engaged Boston-based Machado and Silvetti Associates and the corporate identity company Lippincott & Margulies in 1995 to design a new prototype for its outmoded roadside image. The involvement of such a highbrow architect in the conception of a fast-food outlet might seem incongruous, but a common interest in exploiting architecture as a system of communication forged a creative bond between client and firm. "Corporate identity consultants and graphic designers," says Partner-in-Charge Rodolfo Machado, "deal more directly than most architects with the cultural readings, allusions, and analogies possible with a specific visual language. We think that architectural invention results not from the development of a universal architectural language (like late Mies) but from the way a language is deployed (like Eero Saarinen)."

To appeal to potential customers traveling at a variety of speeds, businesses along the strip frequently deploy a graphic logo on a mast set against a prefabricated box supporting an iconic roof, just as McDonald's' golden parabolas are juxtaposed against homey mansards. Rather than pursuing such pseudo-domestic imagery,

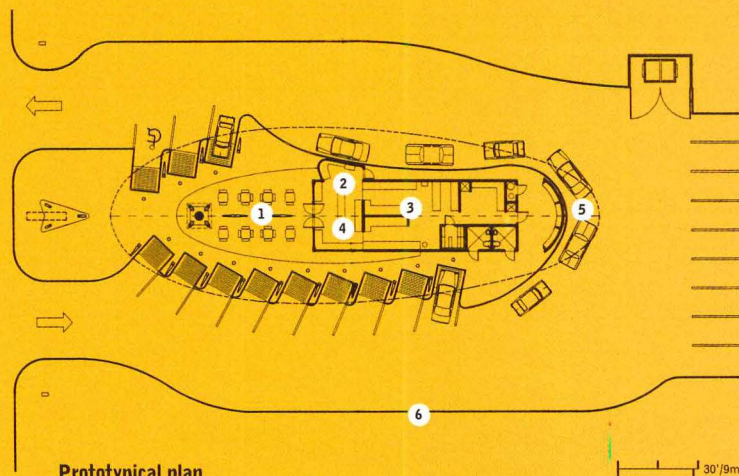

Prototypical plan

- 1 outdoor dining
- 2 drive-thru
- 3 kitchen
- 4 food preparation
- 5 order station
- 6 car service

Machado and Silvetti's space-age prototype for a chain of drive-in restaurants takes Texas back to the future.

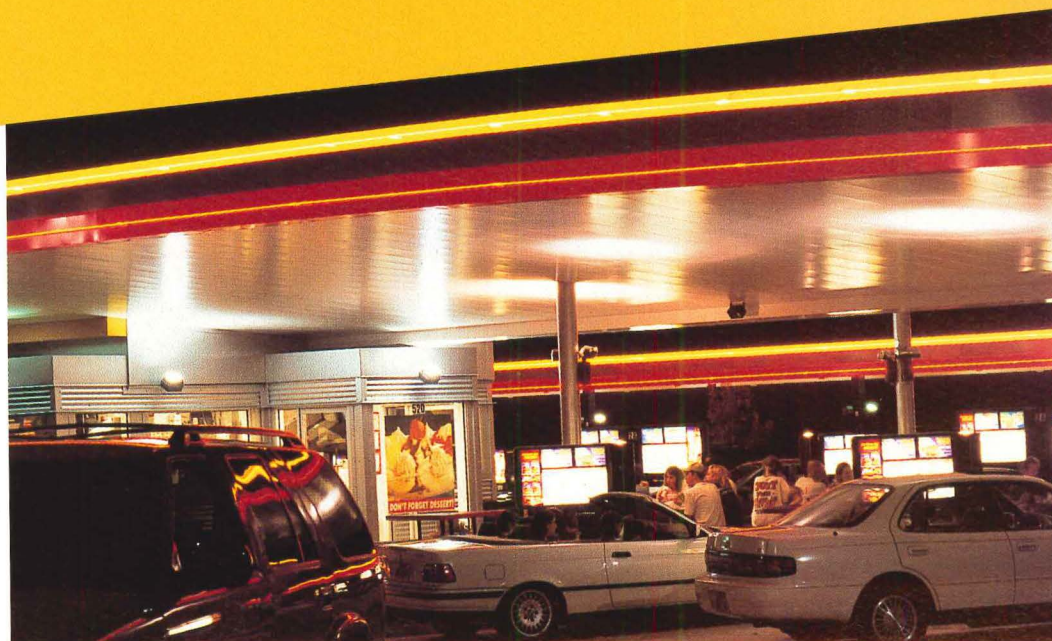

Painted steel cone penetrates oval canopy, creating additional signage for building (below left and facing page, top). Diners can order meals through intercoms mounted to menu boards at individual parking spaces (facing page, bottom).

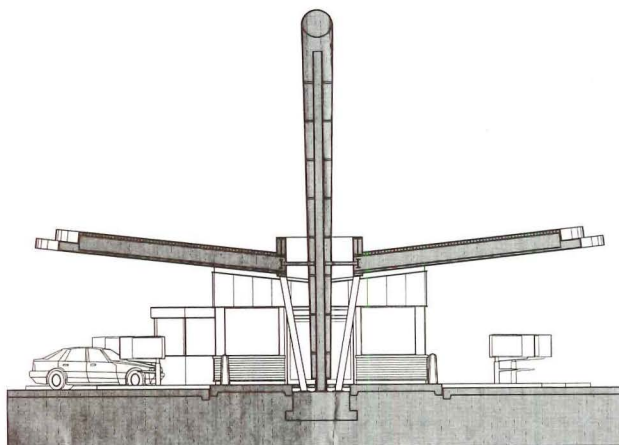

Prototypical section through outdoor dining area



Sonic's new strategy revives the streamlined look of the golden age of automobility.

The restaurant's new logo of intersecting chevrons—developed by Lippincott & Margulies—graces a sign-pole on the road. The restaurant draws in all of the programmatic elements—kitchen, parking, drive-thru, and seating—under a gigantic oval canopy. To enhance the legibility of the roof's folded surfboard shape, a continuous frieze of red and yellow neon stripes lines its contours, while ambient lighting illuminates its flaring underbelly. A red cone pierces the canopy's front end like a toothpick run through a hamburger, and projects blue light into the sky. The tiny kitchen, which occupies the back third under the oval, is clad in corrugated aluminum and exposed by large windows on three sides.

Cars can either pull up to diagonal parking slots under the perimeter of the canopy to place their orders or circumnavigate its edge and pick up the food from a drive-thru window on the far side. Sonic's milkshakes, fries, and burgers are ordered over intercoms at each parking station and transmitted to the cooks on video screens to ensure service at "the speed of sound." An exposed veranda under the canopy allows the option of eating at a table, but as most patrons come to Sonic for the experience of dining in their cars, this well-lit void generates an uncanny sense of expectation like an empty stage.

By simplifying the restaurant's image into a single oval form, Machado and Silvetti have introduced a salient new icon to pick out amid the clutter of commercial effluvia lining the road. The unifying canopy creates an integrated haven for automobiles and hamburgers that indulges the nostalgic, space-age aspirations of a '57 Chevy and the hula hoop. While such an exercise in style cannot compensate for concerns about dubious nutrition and underemployment, it contributes a graceful inflection to the uniquely American landscape of the strip.



SONIC 2000 PROTOTYPE
RICHARDSON, TEXAS

CLIENT: Lippincott & Margulies (image and identity consultant to Sonic Restaurants)
ARCHITECT: Machado and Silvetti Associates, Boston—Rodolfo Machado (partner-in-charge), Timothy Love (project director), Nader Tehrani, Rusty Walker (design team), Ben Karty, David Lee (computer modeling)
ARCHITECT OF RECORD: Boice-Raidl-Rhea Architects, Merriam, Kansas—John E. Quinton, Jr., Boyd W. Rau (project team)
ENGINEERS: Johnston Burkholder Associates (structural); Henderson Engineers (mechanical, electrical); Gonzalez & Schneeberg (civil) **GENERAL CONTRACTOR:** Stovall Construction **COST:** Withheld at owner's request **PHOTOGRAPHER:** Frederick Charles



By Raul A. Barreneche



fast food forward

Glazed facade of west-facing entrance (facing page) exposes dining area to street. Plaster-finished canopy shields outdoor dining terrace. Boomerang-shaped volumes at corner (right) house kitchen and drive-thru window. Metal louvers (bottom) conceal exhaust fans over kitchen.



A kinetic L.A. burger joint blurs the line between billboard and building.

IN-N-OUT Burger is a Los Angeles institution, but not your typical fast-food joint. Launched by Harry and Esther Snyder in 1948, the hamburger shop that introduced the drive-thru window to California is still owned by the Snyder family, who insists that the food on the tiny menu be fresh and cooked to order. To wit, there's not a single heat lamp or microwave oven in sight in their restaurants. Any customers skeptical of this pledge of freshness can watch from the counter as cooks turn real, whole potatoes into french fries and cook burgers on spec. The company now boasts over 125 restaurants, but because it requires its outposts to stay close to their central meat packing plant in Baldwin Park, IN-N-OUT Burger has remained primarily an L.A. phenomenon.

Kanner Architects, the designers of an IN-N-OUT branch in L.A.'s Westwood district, are an Angeleno tradition of similar vintage. The firm, founded in 1953 by the late Herman Kanner, is now headed by his son Charles and grandson Stephen, who are continuing the patriarch's strong Modernist heritage and rekindling the optimistic spirit of postwar California architecture (*Architecture*, April 1994, pages 82-89). The Kanners' exuberant recent work is part Schindler and Neutra, part Googie coffee shop and the Jetsons. The new Westwood branch of IN-N-OUT Burger could only be the offspring of such a quirky design talent and fastidious client—a playful yet rigorous building that reconsiders just about every aspect of fast-food culture.

The 4,500-square-foot restaurant fills a crowded, tiny site just one block west of the Kanners' office, on the southern edge of the campus of the University of California, Los Angeles. The building replaces two existing fast-food restaurants with a radical departure from Westwood's standard fare of Spanish Colonial Revival





architecture. "But the building wasn't a hard sell to the community," admits Principal Stephen Kanner. "In fact, it was one of the least controversial projects we've built."

Kanner's restaurant is pure Pop. The genesis of its form is the bent yellow arrow of IN-N-OUT's logo, which the architect exaggerated in scale and extruded into a three-dimensional jigsaw puzzle of interlocking boomerang shapes. The vibrant plaster volumes extend the logo's red, white, and yellow palette into a dervish of primary colors and razor-sharp forms. "Making a sign into a building and blowing it up in scale is very much an element of roadside architecture," Kanner suggests.

The building breaks open the dingy box that houses most fast-food restaurants and replaces it with a light, transparent enclosure. The west-facing entrance facade, for example, boasts a giant glazed wall shaded by an angular canopy, which is punctured by circular cutouts. Along the length of the north wall, a bank of picture windows give drive-thru customers a clear view of the kitchen, which is placed between the drive-thru and the service counter. Inside, 4-foot-tall plastic letters divide the large, open dining area into smaller zones.

IN-N-OUT Burger captures the boldness and giddy energy of 1950s roadside dining, but tames it with clarity and restraint. Despite its exaggerated forms and strident colors, the building never feels cartoonish. The iconography is distilled and abstracted into a more measured—though no less lively—composition that reveals the Kanners at their Pop best.

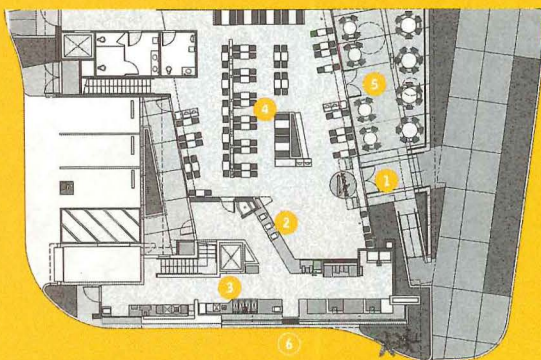

Plan | 15' / 4.5m

- 1 entrance
- 2 service area
- 3 kitchen
- 4 dining
- 5 outdoor dining
- 6 drive-thru

Palm trees penetrate cutout in canopy (facing page) outside glazed open kitchen. Oversized sign (bottom) divides indoor dining area. Skylights cover circular cutouts over outdoor dining area (right).

**IN-N-OUT BURGER
LOS ANGELES**

CLIENT: IN-N-OUT Burger
ARCHITECT: Kanner Architects, Los Angeles—Charles G. Kanner (partner-in-charge), Stephen H. Kanner (design partner), Keith Coffman, Michael Wojtkielewicz (project architects), Brant Gordon, Suzana Gussman (project team)
LANDSCAPE ARCHITECT: Environmental Landscape Concepts
ENGINEERS: E & A Engineers (structural); All Trade Engineering Corporation (mechanical, electrical); Carl W. Donmoyer & Associates (civil); Hollins Engineering Company (HVAC)
CONSULTANTS: Young Electrical Sign Company (signage); Chino Glass & Glazing System (storefront system); Industrial Louvers (louvers); Restaurant Equipment Fabricators (food service)
GENERAL CONTRACTOR: IN-N-OUT Facilities Design
PHOTOGRAPHER: Mark Lohman



BOXES

The sleek, layered skin of a Florida department store elevates shopping mall design. By Sarah Amelar





Aluminum fins and steel channels distinguish Bloomingdale's windowless south facade (facing page) from conventional department store. Perforated stainless steel panels project from curtain wall mullions (above). Modernist store (right) contrasts with adjacent Disneyesque food court building.



THOMAS DELBECK

While most department stores are asleep for the evening, Bloomingdale's in Aventura, Florida, sparks to life. At night, the building, designed by Kohn Pedersen Fox Associates (KPF), becomes a glowing lantern, its layered skin delicately revealed and its inner workings glimmering behind a veil of perforated stainless steel. Images of merchandise flash across the facade's projection screen (or, at least, they will once the media system is up and running). From the causeway that sweeps past the Aventura Mall, the view is fleeting—like a stolen glimpse of a drive-in movie. But this flickering teaser lasts just long enough to convey the message: “buy.”

The message is subtle, as is the facade: a stark contrast to the neighboring food court, a Disneyesque extravaganza of ersatz Spanish roof tiles, stucco, stained glass, and a seahorse-crowned campanile. The west facade of Bloomingdale's is a rarity in suburban malls: Its hard-edged materials—glass, aluminum, steel, and concrete—create a tempered composition in silver, gray, black, and white.

Whereas typical mall department stores are virtually windowless monoliths, KPF's Bloomingdale's emporiums (the firm has also designed four California branches) buck the conventional wisdom of store design. “We wanted to create translucency to bring daylight into the building,” explains Design Principal Kevin Kennon, “letting customers see the true colors of apparel and capitalizing on the after-hours illumination of department stores.” The little-known fact that sales floors often remain brightly lit all night (mainly for security reasons) suggested an architectural opportunity, especially given the continuous stream of traffic that speeds past the site.

Prevailing retail philosophy has been ruled by a strategy that minimizes point-of-sale-to-inventory distances. In standard department store layouts, a windowless ring of inventory surrounds clustered departments, centered on escalators. Encouraged by two visionary Bloomingdale's executives, KPF devised a more harmonious scheme: two light-filtering exterior walls, with back-of-the-house func-



tions doubled against the two elevations facing the mall. The translucent west and south facades are intended to be inviting and dynamic, animated by activities behind them. These glazed walls make billboard-scale gestures toward the curving causeway; mannequin-inhabited display windows address the pedestrian.

With a Deconstructivist sense of skews, and implied speed and collision, horizontal aluminum fins join the translucent volume to a canted wall of precast black concrete. Steel channels cut bold diagonals across the grid of precast panels. From the west parking lot, drivers approach the viewing screen head-on, beckoned by rear-projected "previews" of merchandise.

The architect discovered that fixed panels of perforated stainless steel over a curtain wall (wrapping the west facade and southwest corner) could be visually elegant, and also solve practical problems: taming the harsh Florida sun and meeting stringent building

At southwest corner (above and below), perforated steel panels yield gauzy moiré effect. West facade (facing page) incorporates tilted precast black concrete panels inset with steel channels and a point grid of step lights. Perforated panels double as shading devices and hurricane shutters.

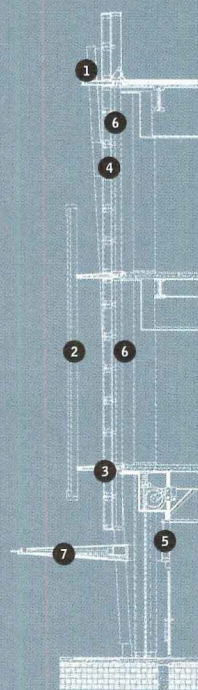
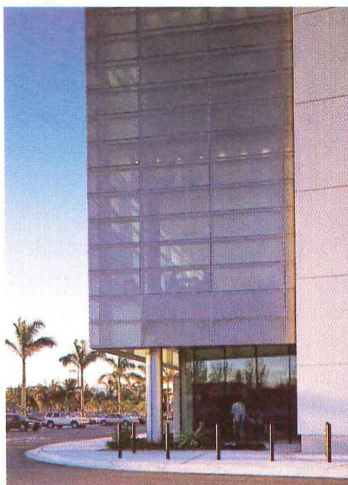

Wall section detail

- 1 precast concrete panels
- 2 projection screen
- 3 aluminum fins
- 4 perforated stainless steel panels
- 5 low-e insulating glass
- 6 sandblasted glass
- 7 fiberglass canopy
- 8 entrance
- 9 escalators

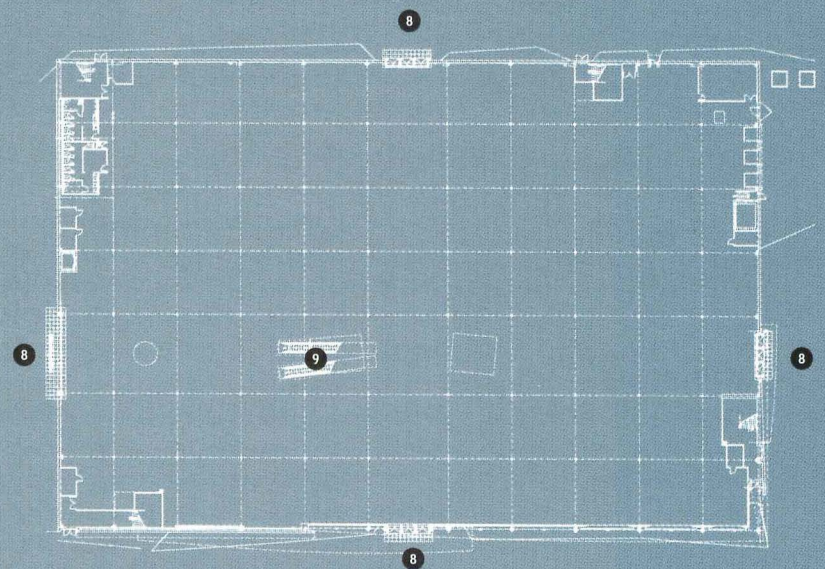

First-floor plan

40'/12m



bloomingdale's



**BLOOMINGDALE'S
AVENTURA, FLORIDA**

CLIENT: Federated Department Stores, Inc. **ARCHITECT:** Kohn Pedersen Fox Associates, New York City—Kevin Kennon (design principal), Marianne Kwok, Nicola Wallter (design team leaders), Nathan Clark Corser, Andreas Haulser, David Weinberg (project managers), Angeline Ho, David Kaplan (coordination leaders), Elina Cardet, Luke Fox, Tomas Hernandez, Michael Marcolini, Widia Ranti, Lisa Ross, Aida Saleh (project team) **INTERIORS ARCHITECT:** Robert Young Associates, Dallas **ENGINEERS:** Shenberger & Associates (structural); Cosentini Associates (mechanical, electrical); LAW Engineering (civil) **CONSULTANTS:** Heitmann & Associates (exterior wall) **GENERAL CONTRACTOR:** Whiting-Turner **COST:** Withheld at owner's request **PHOTOGRAPHER:** Timothy Hursley



Pedestrian-level vitrines mediate billboard-scale gestures of west facade (facing page). Café (above) provides views of surrounding palm trees. Dressing rooms (right) permit customers to view merchandise colors in natural light. Luminous wall offers long, continuous views.



codes fortified after 1992's Hurricane Andrew. Mounted on aluminum struts fixed to the mullions, the perforated panels stand 9 inches off the face of the glass. This outer skin changes over the course of the day, from opaque matte gray to shimmering and lightly translucent. Set against sandblasted glass interspersed with double panes of clear, low-e glass, the screens diffuse light gently into the store. Recalling the work of architects Peter Zumthor and Herzog & De Meuron, this layering combines visible thickness with extraordinary lightness. "The light is soft," remarks Kennon, "as if passing through a silk stocking."

But visitors to the building's east side (across a narrow street from the parking garage) might assume they've arrived at a conventionally hermetic white-box department store. The east and part of the south elevations are vast and windowless, clad in low-maintenance synthetic stucco. Though somewhat sculptural and punctuated with inset steel channels and aluminum fins, these faces nonetheless lack the west wall's refinement.

The sales floors, by Dallas-based Robert Young Associates, are ordinary in comparison with the more daring facades. Certain displays are shoved indiscriminately near the windows, but the glazed wall's continuity is consistently respected. More inspired are the dressing rooms and café, also by Young. Across a narrow passageway from the milky sandblasted glass, the changing rooms successfully balance needs for privacy and daylight. And the luminous café on the second floor offers surprisingly calming corner views through veiled, clear glass of the palm tree-lined roadway.

KPF considers the Aventura Bloomingdale's one evolutionary phase in their attempt to transform the department store typology. And the store's design is certainly a refreshing change from the glitzy sights of typical strip retail. From the causeway, it flashes into view for just a few seconds, but long enough for drivers to grasp an ephemeral beauty that dematerializes by night. And, Bloomingdale's hopes, just long enough to lure them back for more.

Rios Associates' new gateway to Universal Studios greets visitors with a riot of color and form.

By Morris Newman

POP PORTAL

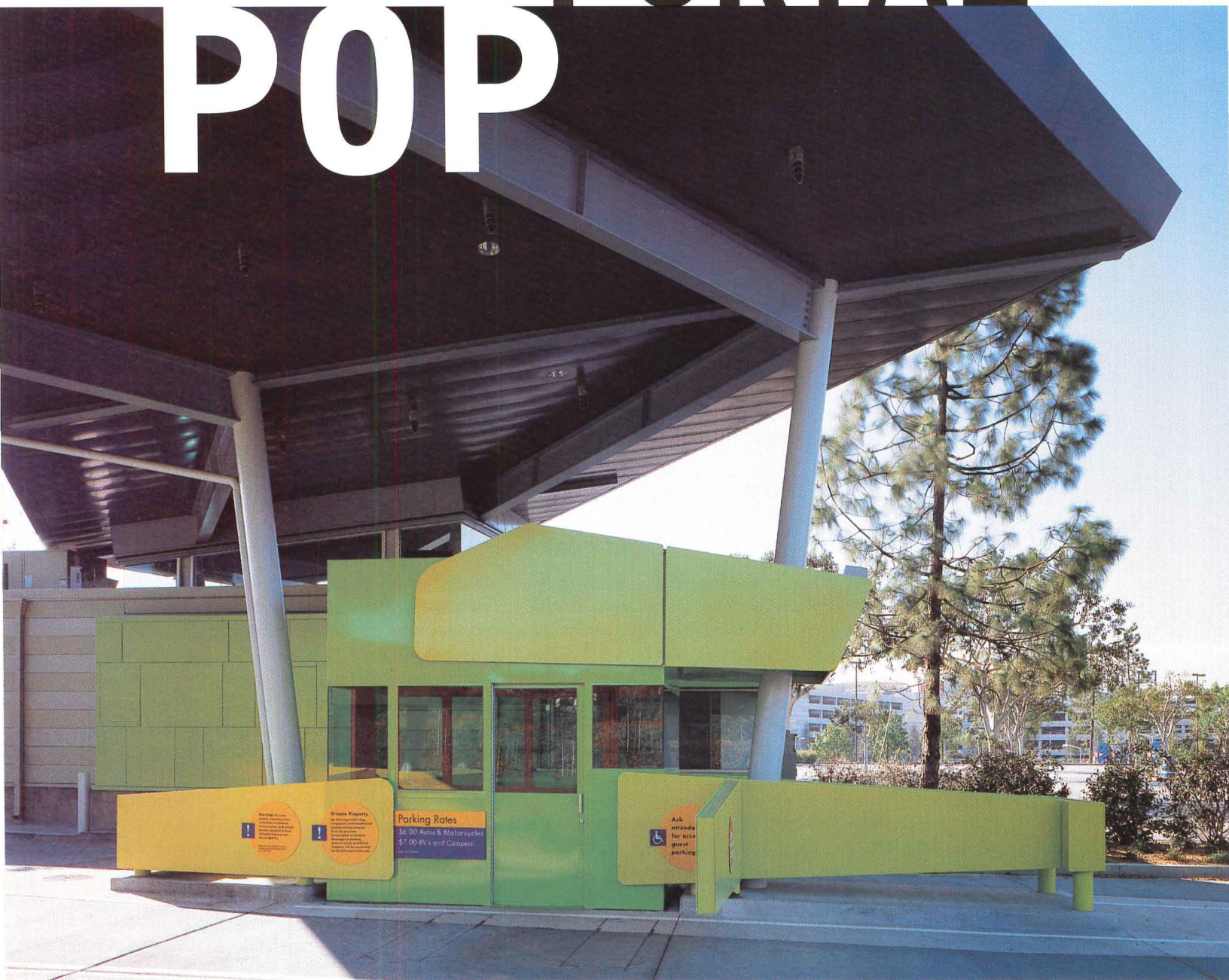

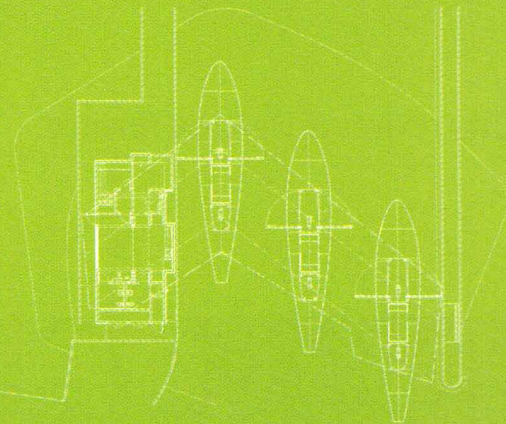

Plan

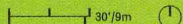

For motorists climbing the hill to Universal Studios in Los Angeles, the first glimpse of the park is that of three fanciful booths and a toll house painted in shades of chartreuse, crossed by traffic gates of exaggerated size and shape. This small, 1,800-square-foot ensemble is the work of L.A.-based Rios Associates, a firm that combines architecture and landscape design with an emphasis on structural integrity and an aggressive use of color.

The firm's designers take pride in the tough functionality of the plaza, which sits atop a concrete base. The three booths are actually prefabricated units onto which Rios has added a steel roof, a front wall containing the traffic gate mechanism, and a rear "tail piece" incorporating bollards that direct traffic away from the plaza. The flamboyant floating steel canopy, supported by large steel beams, was inspired by Albert Frey's Tramway Gas Station in Palm Springs, California (1963). The guard-house is straightforward, but manages to be whimsical.

Principal Mark Rios has transformed an anonymous traffic control element into a giant transformer toy. The design reflects what Rios describes as the basic premise of theme parks: "an exaggeration and an accentuation of experience." At the same time, he doesn't try to make the toll plaza into a themed attraction in its own right: Restraint keeps whimsy and functionality in proper balance, proving that simple infrastructure can provide sophisticated pleasure.

Painted steel wraps prefabricated toll booths marking entrance to Universal Studios parking lot (these pages). Horizontal slots above toll houses will hold LED signs that display visitor information (above left and right).

**TOLL PLAZA
UNIVERSAL CITY, CALIFORNIA**

CLIENT: Universal Creative—Bob Ward (senior vice president, design and planning), Bob Hale (vice president, design and planning), Ed Borrego (design director), Jim Matson (hilltop operations), Randy Fulton (project manager) **ARCHITECT:** Rios Associates, Los Angeles—Mark Rios (principal), Jonathan Black (senior designer), David Montalba, Stephanie Savage, Julie Smith (project team) **EXECUTIVE ARCHITECT:** IWA Engineers, Orange, California—Mark Bogh (principal), Matt Kirk (project engineer) **LANDSCAPE ARCHITECT:** Nancy Goslee Powers and Associates **ENGINEERS:** Freet, Yeh & Rosenbach Associates (structural); Mike Salazar & Associates (mechanical); VIRTEC Engineering (electrical) **CONSULTANT:** Francis Krahe & Associates (lighting) **GENERAL CONTRACTOR:** G.B. Cooke **COST:** Withheld at owner's request **PHOTOGRAPHER:** Tom Bonner

A new branch bank outside Kansas City revives drive-thru finance.



EXACT CHANGE

Bank's steel-crowned concrete drum grounds flaring steel canopy (above). Light sanding preserves concrete's irregular texture (right). Skewed columns delineate teller lanes (facing page, bottom).

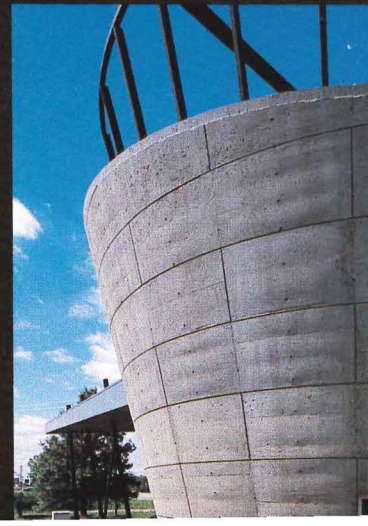

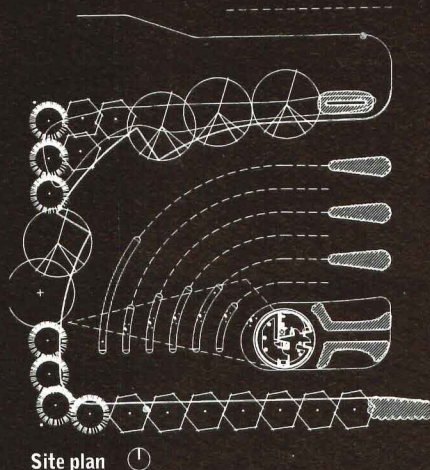
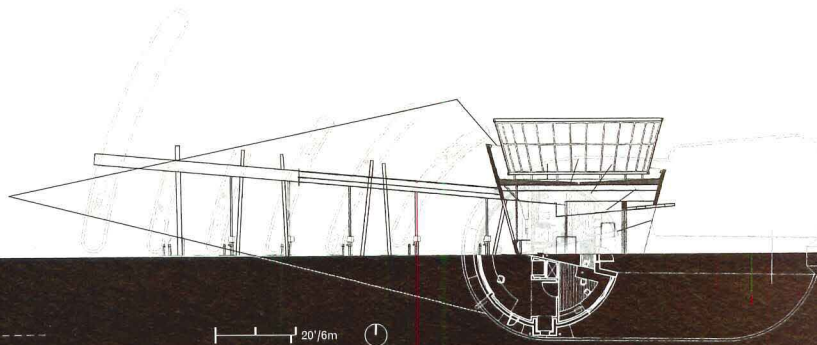

Forget conservative investing. The new drive-up branch of UMB Bank by International Architects Atelier of Kansas City, Missouri, subverts financiers' drab reserve and their obsessions with blue suits, balance sheets, and the bottom line. UMB's new building whirls in place on a leftover strip between highways in Overland Park, Kansas, defying the codified banality of a suburb that enforces the esthetic of the nondescript.

The bank is only slightly bigger than a bread box. The 600-square-foot teller building is an arch little upside-down cone of cast-in-place concrete, topped by a translucent glass-and-steel crown. Its compact interior holds counter space for seven tellers, a vault, break room, and rest room. The concrete drum, the top of which is sloped to imply eccentric rotation, anchors a severe angular steel canopy. This light canopy sits atop a series of splayed steel columns that appear randomly placed, though they are in fact artfully load-calculated and detailed. Seven lanes for drive-up banking, defined by concrete curbs of varying lengths, curve cleverly under the canopy from the parking lot. The organic forms of the sitework help create a milieu of humor for the bank itself.

The sense of past futures that encircles the building is poignant too because drive-thru banking is probably headed in the direction of drive-in movies. It's become increasingly outmoded by direct deposit and "bank-in-your-bathrobe" software for depositors. The UMB Bank, however, takes us back to the heady days when it seemed the car could solve everything.

**UMB BANK-KANSAS DRIVE-UP FACILITY
OVERLAND PARK, KANSAS**

CLIENT: UMB Bank—Kansas **ARCHITECT:** International Architects Atelier, Kansas City, Missouri—Elizabeth K. Amirahmadi, Majid Amirahmadi (principals), Chris Akers, Matthew Walters (project team) **ARCHITECT OF RECORD:** John Lawrence Daw & Associates, Kansas City, Missouri—John Lawrence Daw (principal) **LANDSCAPE ARCHITECT:** Shafer, Kline and Warren **ENGINEERS:** Bob D. Campbell & Company (structural); Smith & Boucher (mechanical, electrical); Shafer, Kline and Warren (civil) **GENERAL CONTRACTOR:** Winn-Senter Construction Company **COST:** Withheld at owner's request **PHOTOGRAPHER:** Farshid Assassi, Assassi Productions



construction a h

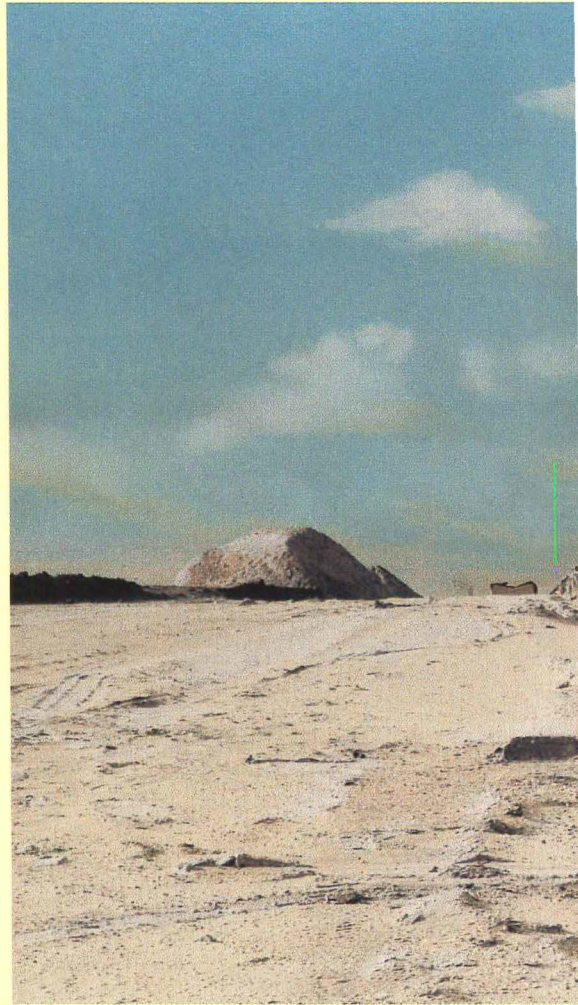

Photographs by Silvia Lizama

A Florida photographer unearths the raw power of highway building.

e a d

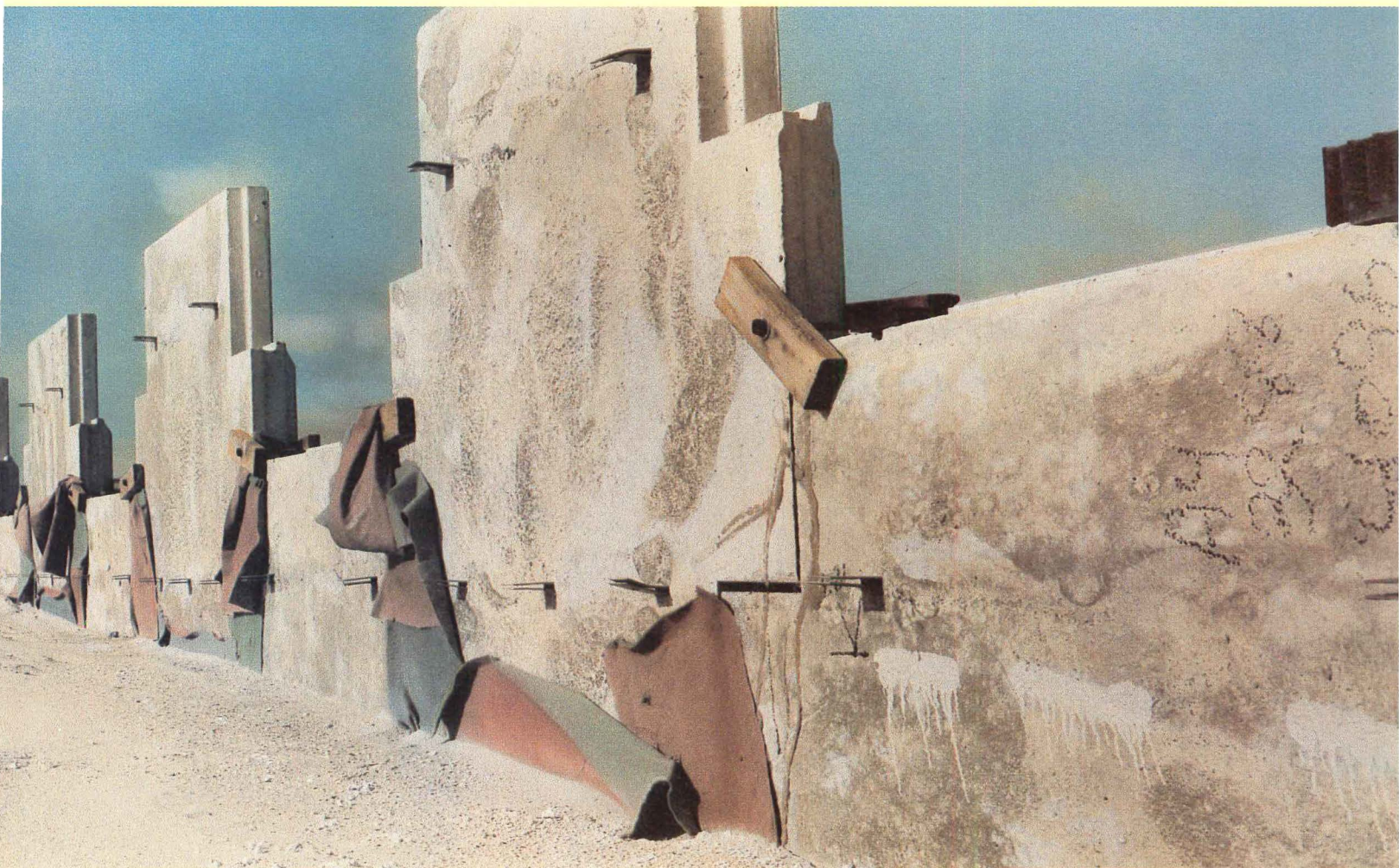

As fiber-optic cables supplant dams and rail lines in an age of increasingly ephemeral infrastructures, roads remain one of the few public works that exude a palpable physical presence. Cuban-born artist Silvia Lizama's black-and-white photographs of highway construction sites, shot along Interstate 95 near her South Florida home, fix the evolving concrete forms at moments of raw grandeur. But unlike the propagandistic photojournalism of the 1930s, when America proved its prowess through the heroic labors of building the Hoover Dam and Empire State Building, there's no bustle of workers or cranes swinging overhead in Lizama's photographs. Instead, on-ramps, retaining walls, and overpasses take on a ruinous air, surrounded by the detritus of their creation. Oil tints impart an apocalyptic afterglow to these scenes, furthering the confusion between conception and decay.

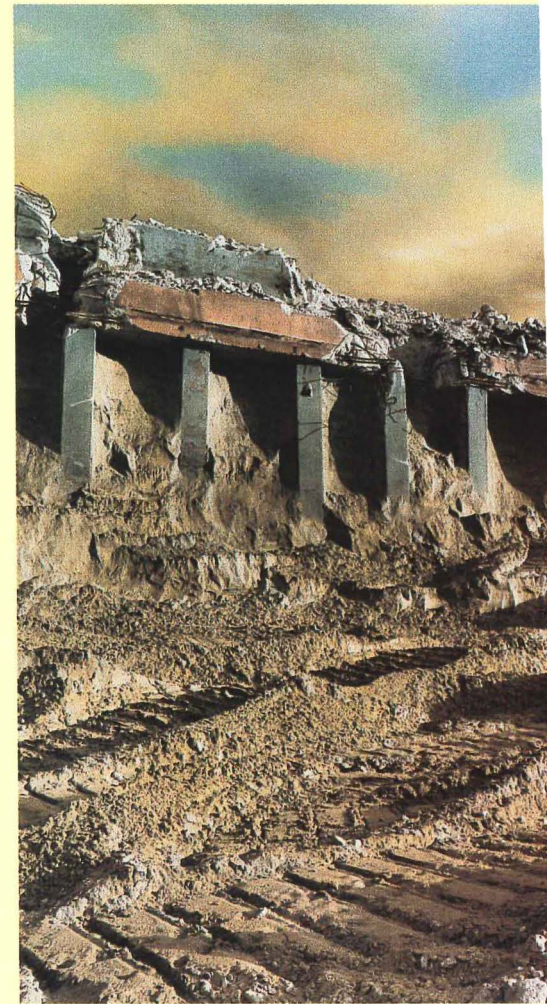

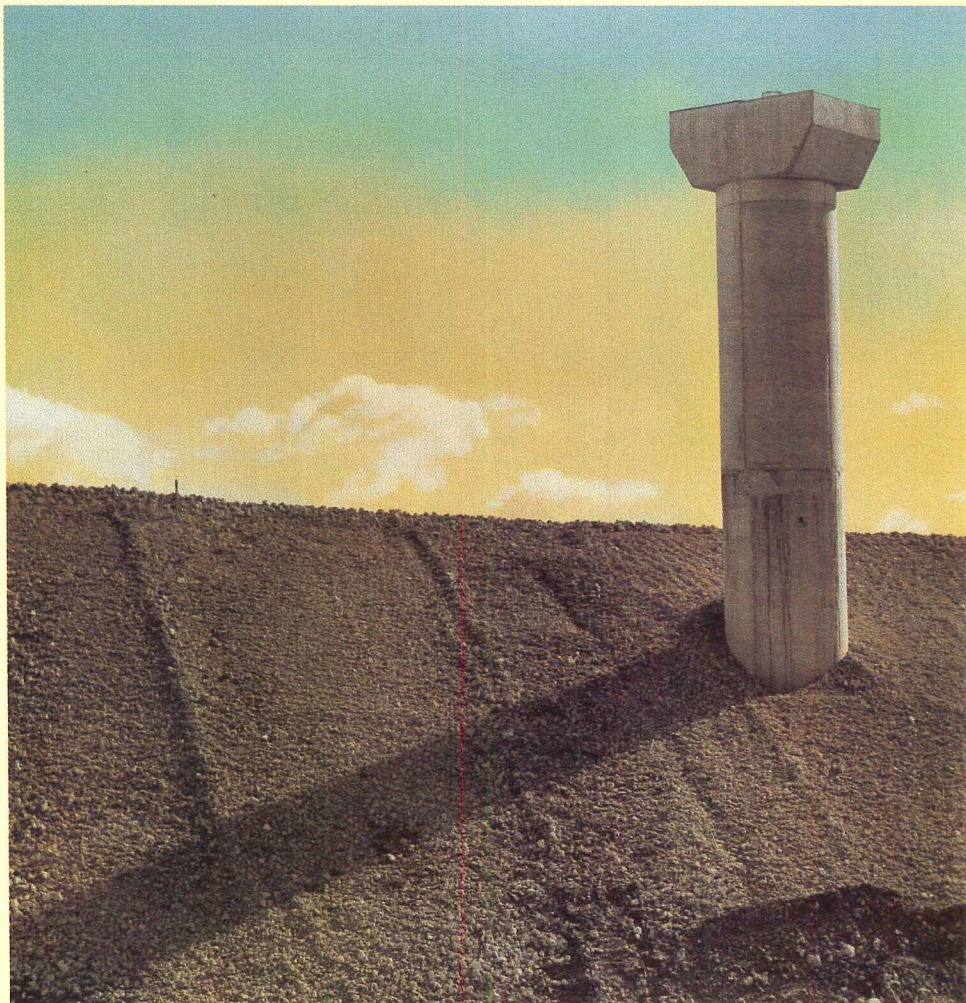

Steven Ehrlich builds a billboard-sized library on a commercial strip in L.A.

Reading

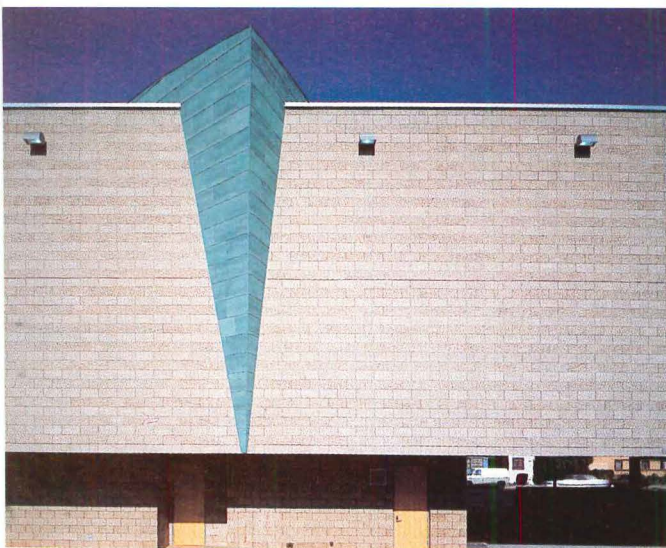
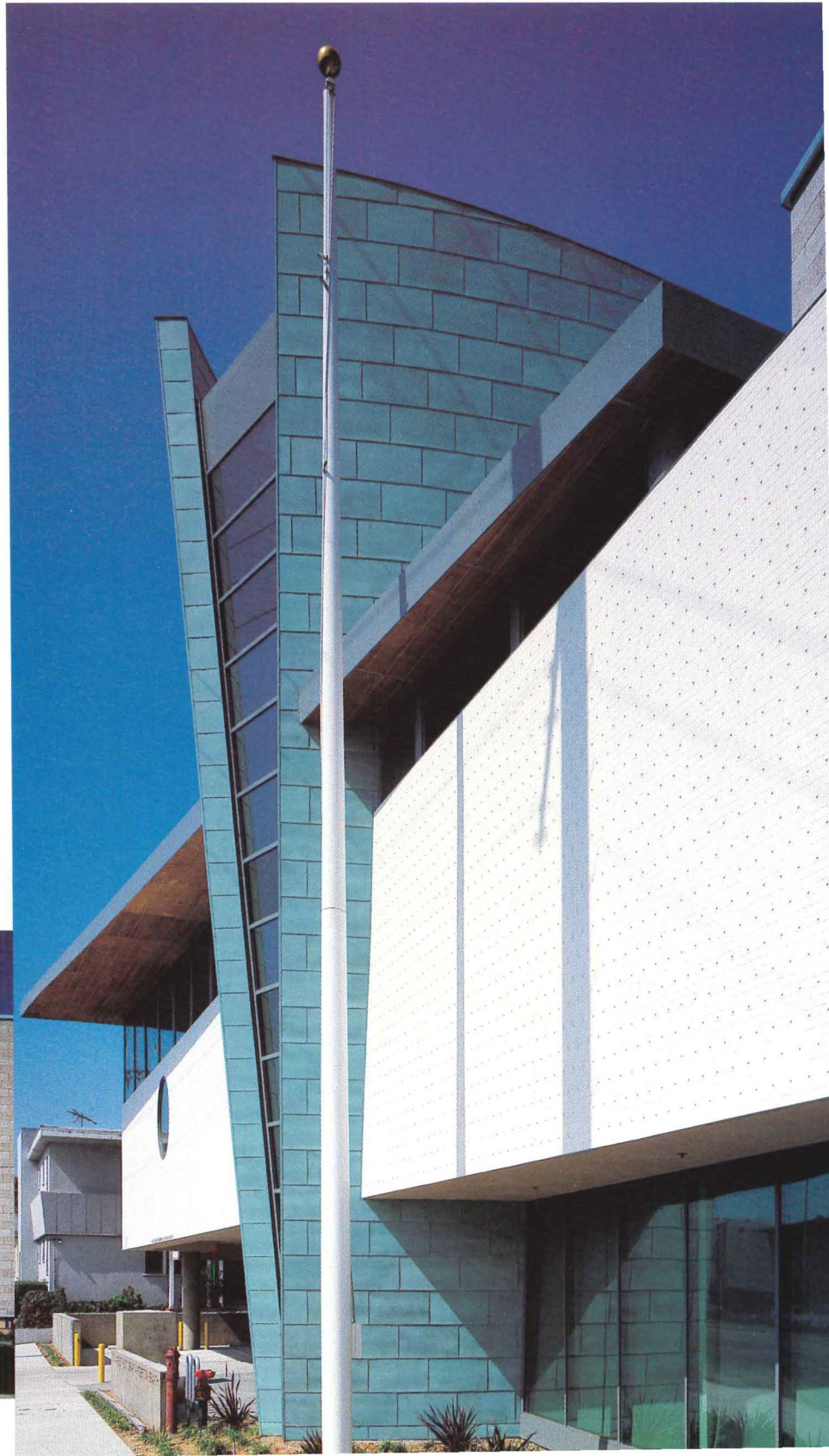

Architect Steven Ehrlich explains that his intent in designing the new Robertson Branch Library in Los Angeles was to create an emblem for the MTV generation, the wayward lambs who have forsaken books for "Baywatch." Ehrlich figured a library could convince dispassionate young people to substitute lines of resolution for lines of text by seducing them with a chromatic, somewhat unstable icon. For better or worse, kids hooked on television respond to eye candy like nothing else.

Far be it from Ehrlich to erect a stern, sober box for books anyway: His work is too good-humored for that. Besides, such a building wouldn't read well, so to speak, along the crowded storefront strip of West L.A.'s Robertson Boulevard, where stuccoed, flat-roofed SROs mingle with "pre-owned" car dealerships, Al's Sandwich Shop, and the occasional huckster clairvoyant. Cheap signage is rife on Robertson, which is why it made sense to Ehrlich to design the library as a billboard for books.

"It says 'Library—here!'" Ehrlich suggests. From a block away, you see the building's icon—a looming, glowing, patinated-copper-clad atrium—before you see the library itself. The rest of the building becomes clear as you pull into its tiny driveway between two smooth, low concrete walls marking the entrance, and motor under the library's raised mass to the rear parking lot.

The building is an embellished two-story box of smooth-sanded concrete block, through which the copper vessel primitively plunges. The 10,000-square-foot library's reading room and stacks occupy the second floor, which is jacked up on a transparent storefront podium containing offices, a meeting room, and a staff lounge.

The broad, white billboard facade—clashed between two concrete book-ends beneath a subtly sloping roof—is clad in a rubbery, studded material

By Bradford McKee

& Riding



Rear facade (facing page, left) reveals tenuous intersection of copper panels and concrete block. Splayed edge of copper-clad atrium slices through main facade of Robertson Branch Library (facing page, right). Library's chromatic forms and aggressive scale address ersatz character of busy Robertson Boulevard (above).

typically used for non-slip floors. The texture of fine, raised dots, barely visible until you get up close, casts small shadows like little sundials. Ehrlich has been infatuated with surface texture since his travels throughout the countries of the Sahara Desert in the 1970s, where vernacular architecture commonly exalts the chiaroscuro play of sunlight. Otherwise, the facade is largely blank, except for an outsized ocular window punched just off center into the reading room in a flash of 1950s Futurism. In a few simple strokes, the library's roadside personality becomes a hybrid of Irving Gill-meets-Google, with the big copper can crashing through like a Fauvist anomaly.

The copper element is the punch line in Ehrlich's composition: "I wanted it to lean out to the sidewalk and be in your face." The blue-green volume doubles as main entrance, stair hall, and skylit atrium. It is the only remarkable feature one confronts in the library's otherwise plainclothes interior. The floors in the small lobby are tiled in rich bluestone, and the walls are clad inside as out with patinated copper shingles that overlap coarsely. When visitors surmount the sinuous, bluestone-treaded stair to the mouth of the reading room and look back toward the front of the building, they see that the copper surface cleaves to reveal a canted vertical window trained on the skyline of downtown Los Angeles. Across the front end of the atrium, a bridge connects a small reading area to the larger one.

The reading room's open plan fuses with the copper can in a huge cutaway scheme, allowing the two spaces to penetrate each other. Spatially, the rest of the library is a relative letdown. On either side of the copper piece, in the reading room, a series of outsized glulam beams run beneath the sloped ceiling about 65 feet from end to end, as if in a gigantic bungalow. Circular skylights march across the center of the room between the beams. Bookcases and ban-

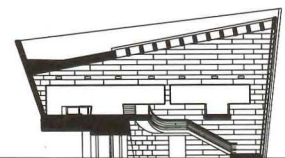
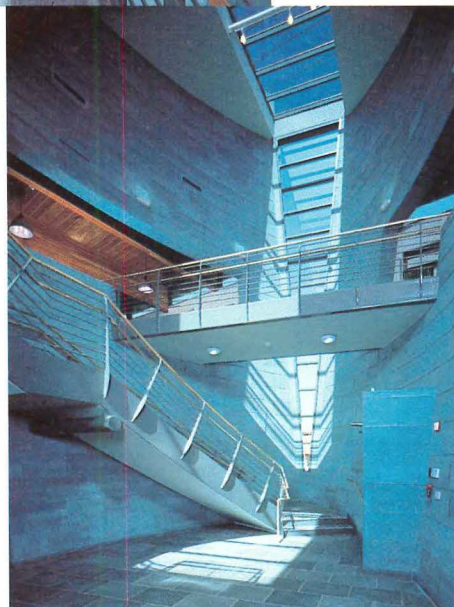

East-west section

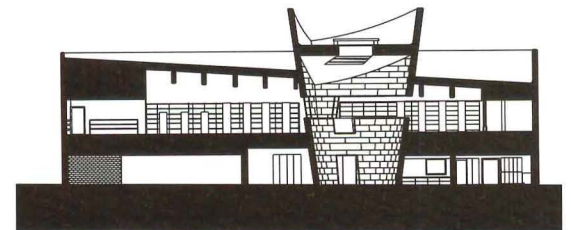

North-south section

- 1 entrance lobby
- 2 multipurpose room
- 3 workroom
- 4 office
- 5 staff lounge
- 6 stacks
- 7 circulation
- 8 computer room
- 9 reference
- 10 children's library

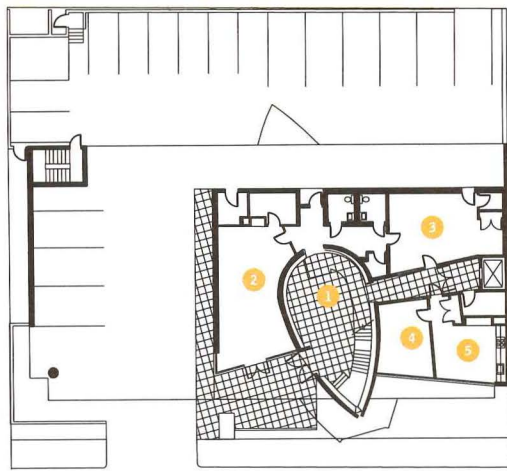

Ground-floor plan

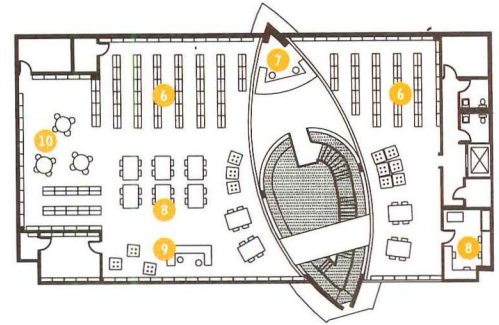

Second-floor plan

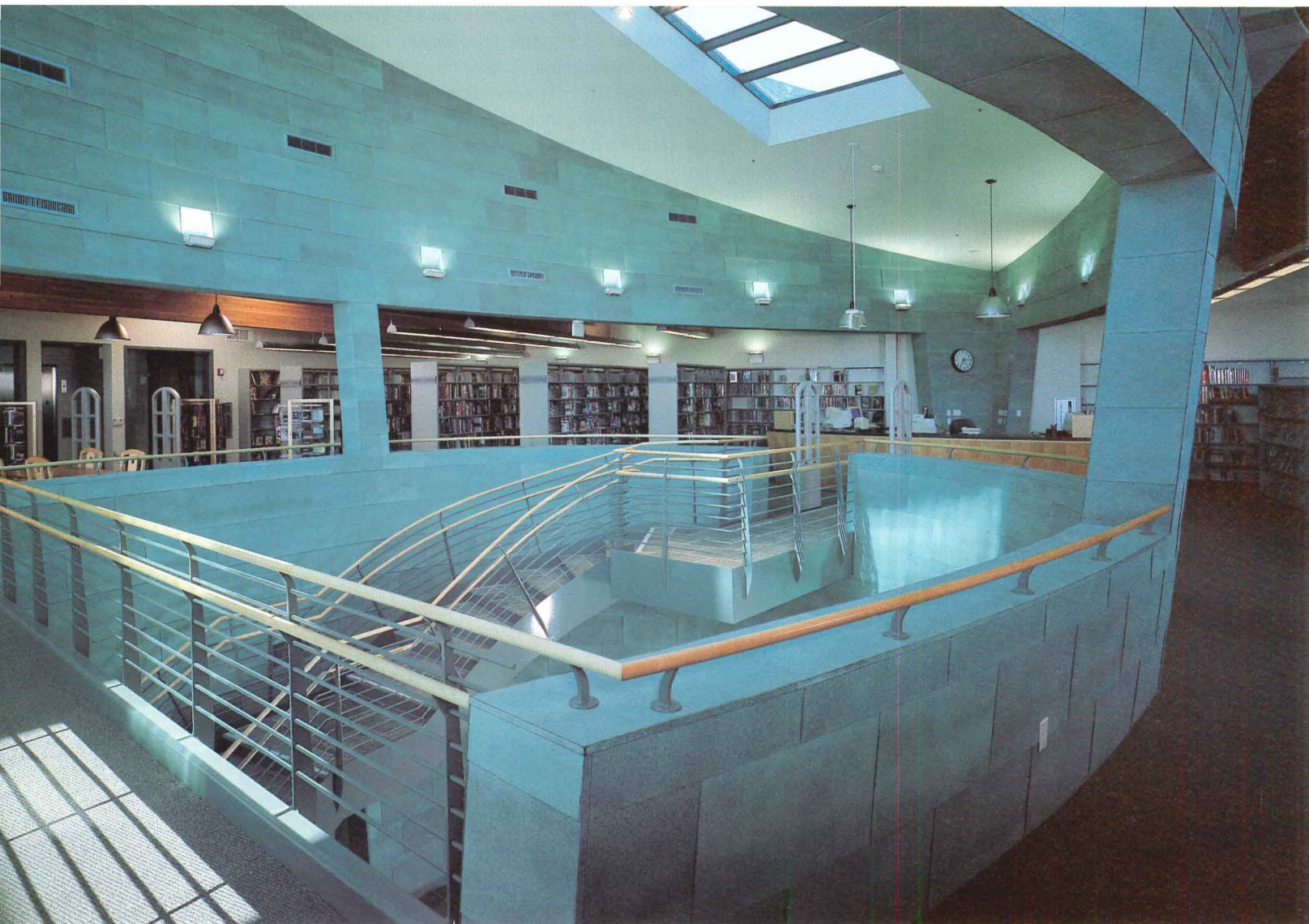

Atrium cleaves to frame view of downtown L.A. (facing page, top). Steel stair and bridge (facing page, bottom) float through copper atrium. Plans (top) reveal how lozenge-shaped atrium bisects reading room.

and banisters are uniformly wrought in maple.

In comparison to the chromatic saturation and volumetric charge of the copper vessel, the reading room is static and bland. It raises the question of whether the hierarchy of the library's visual energy is correct. The copper vortex swirls and rocks violently, then delivers visitors to the washed khaki environment of the reading room. Despite its plastic, polyrhythmic reaching, and dangerous mixing of dynamic textures and geometries, the library's principal space remains its least interesting one, which is too bad; what should have been the main event—the reading room—is in fact the sideshow.

This is not to say that people in the neighborhood don't like the library. They love it. The community had long ago tired of the elderly, one-story brick building that formerly housed the library, and the new facility has pumped up the interest level considerably. "Everybody wants to come," a senior librarian confirmed, and as evidence, cited a spike in requests for library cards at the Robertson Branch. Kids mob the computers, read to themselves in peace, and enjoy the drama of crossing the bridge.

Libraries are, above all, intellectual retreats, full of curious, subtle discoveries. It seems cynical to have to bait children with trendy imagery to excite their supposedly flaccid gray matter. But there's always the alternative: The library's circular front window looks out across Robertson Boulevard into the window of an apartment where multiple televisions crackle—the death of reading incarnate! Nonetheless, Ehrlich's library is more enjoyable as a billboard than as a bibliothèque. By the time you've reached the card catalog, you feel as if your biggest find is already behind you.

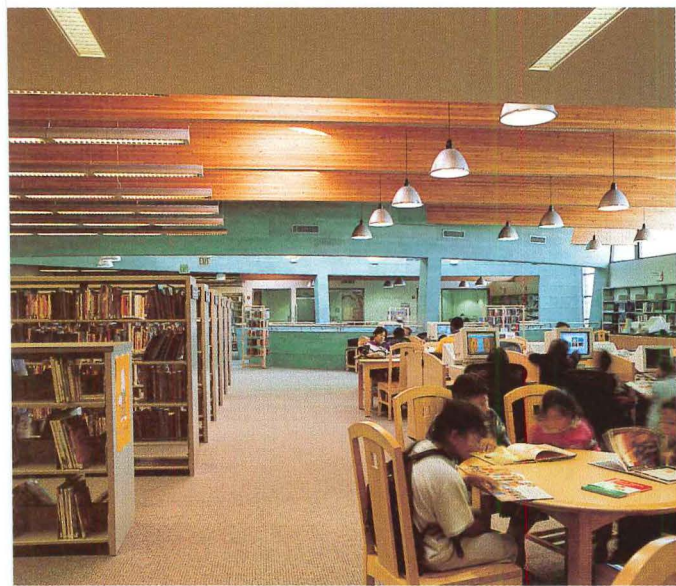



**ROBERTSON BRANCH LIBRARY
LOS ANGELES**

CLIENT: City of Los Angeles—William Holland (city architect), Connie Gacad, May Woo (bureau of engineering, architectural division), Fontayne Holmes, Carmen Martinez, Leslie Norby (library branch services) **ARCHITECT:** Steven Ehrlich Architects, Culver City, California—Steven Ehrlich (principal), Gary Alzona (project manager), Gantcho Batchkarov, Melvyn Bernstein, Carlos Kitzinger, Nick Seierup, Tom Zahlten (project team) **LANDSCAPE ARCHITECT:** BLS Environmental Design **ENGINEERS:** William Koh (structural); Kim, Casey & Harase (mechanical, electrical); Ashba Engineers (civil) **CONSULTANTS:** PHA Lighting Design (lighting); Erika Rothenberg (artist) **GENERAL CONTRACTOR:** Allee Construction **COST:** \$3.1 million **PHOTOGRAPHER:** Tom Bonner

Open-plan reading room (facing page, left) sits beneath skylights and glulam beams of sloped roof. Natural light floods clerestory and ocular window that fronts boulevard (facing page, right). Maple-and-steel bridge (above) crosses daylight atrium above main entrance.

AT THE

In a land where the automobile is king and dust settles thickly during 10 rain-free months each year, car washes abound. At the Dolphin Car Wash, however, cleaning off the desert is an event rather than a chore. This new auto oasis in Mesa, Arizona, at the dry brown edge of the Phoenix metropolitan area, sits beside a gas station, off one of the city's ubiquitous strip-mall-lined roads. Designed by Tempe, Arizona-based Architekton, the Dolphin is a hybrid of self-service and automated car washes: It has five self-serve wash bays, one tall bay for recreational vehicles and tractor trailers, 10 self-serve detailing bays, and an automated wash line with a 400-car-per-day capacity. An enclosed two-bay building where Dolphin employees hand-detail cars is tucked at the back of the triangular, 1.25-acre site. The \$650,000 facility is a prototype that creates an identity for the new Dolphin Car Wash Company. A 36-foot-tall, perforated metal-clad, dorsal fin-shaped tower draws customers to the ticket booth of the automated line and has become the company's logo.

Customers pull their dirty cars in off the main drag that forms the western edge of the site. The drive between self-serve washing and detailing forms an open-ended court. The self-serve wash bays line the southern edge of the court; the detailing bays are located to the north, backing onto the long side of the automated wash line. The contained space of the court invites customers to linger rather than rush. Casual car-motivated conversations can arise between bays about horsepower, four-wheeling adventures, gas mileage, car safety seats, and commute times. It is a social space where customers check out each others' cars, and a stage where car detailing becomes a performance for passersby.

The stage effect is heightened by a steel-framed proscenium arch that connects the two sides of the court

By **L.R. Findley**

Washing and detailing court, framed by car wash's proscenium sign, creates a social space. Horizontal roof canopies shade bays and evoke 1950s car culture (right).

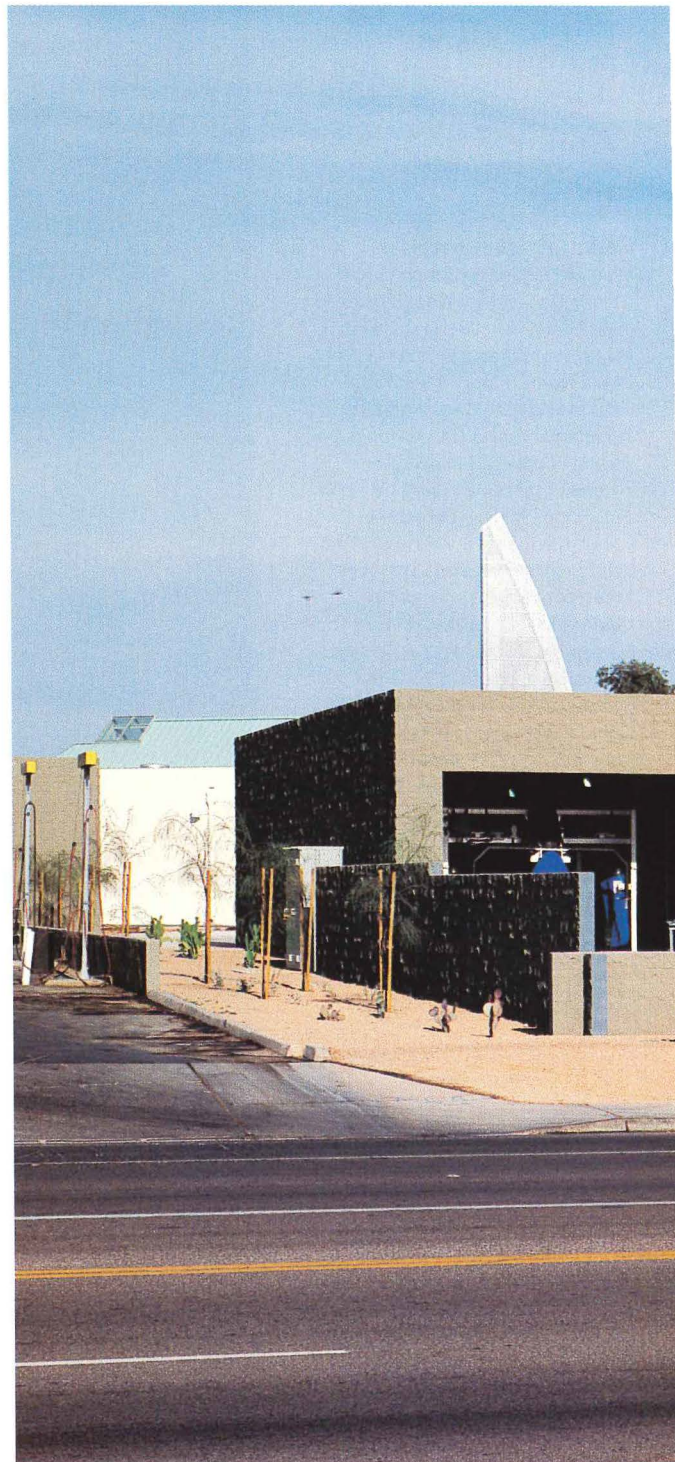

Architekton cleans up the car wash with a new prototype.

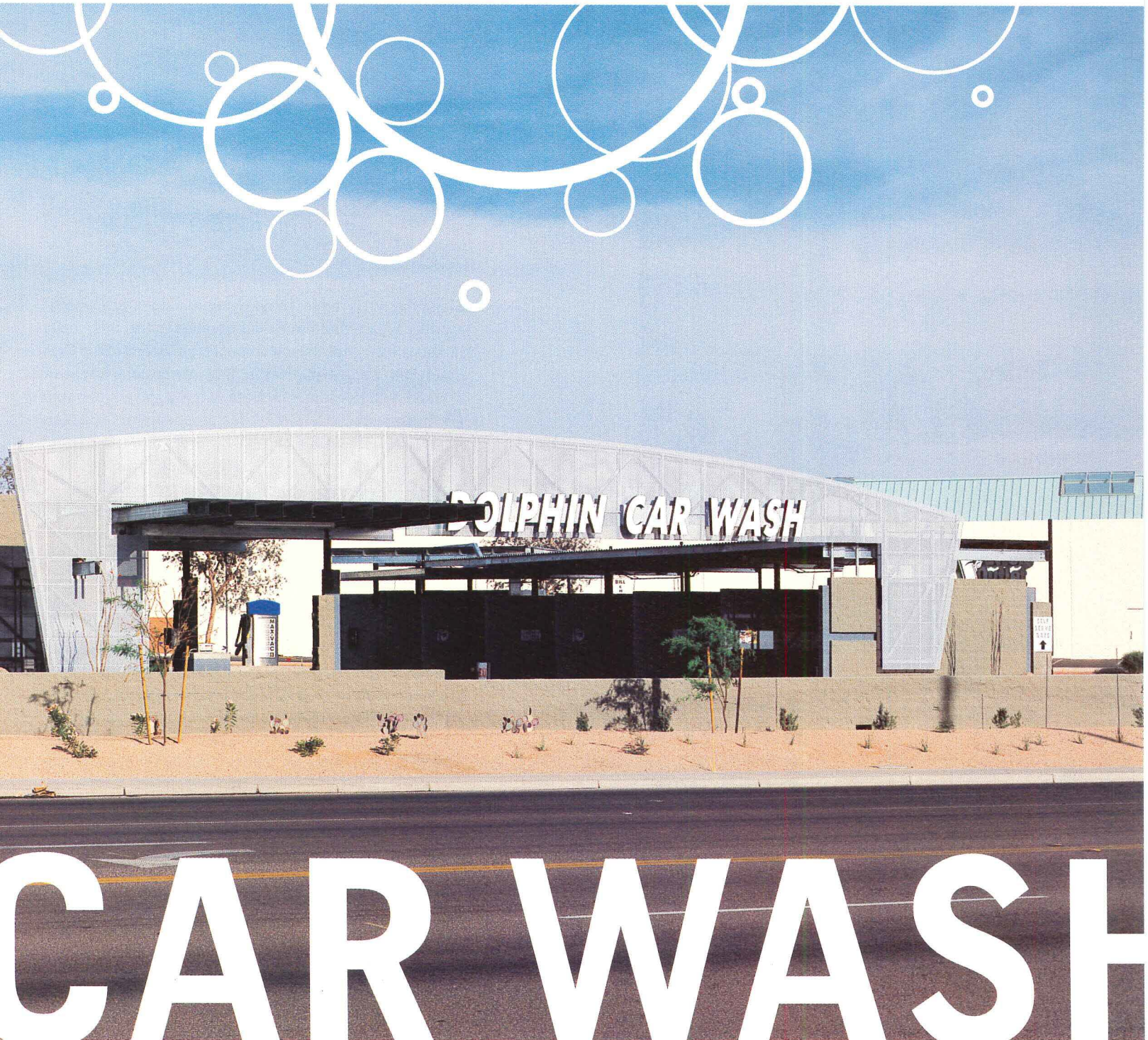

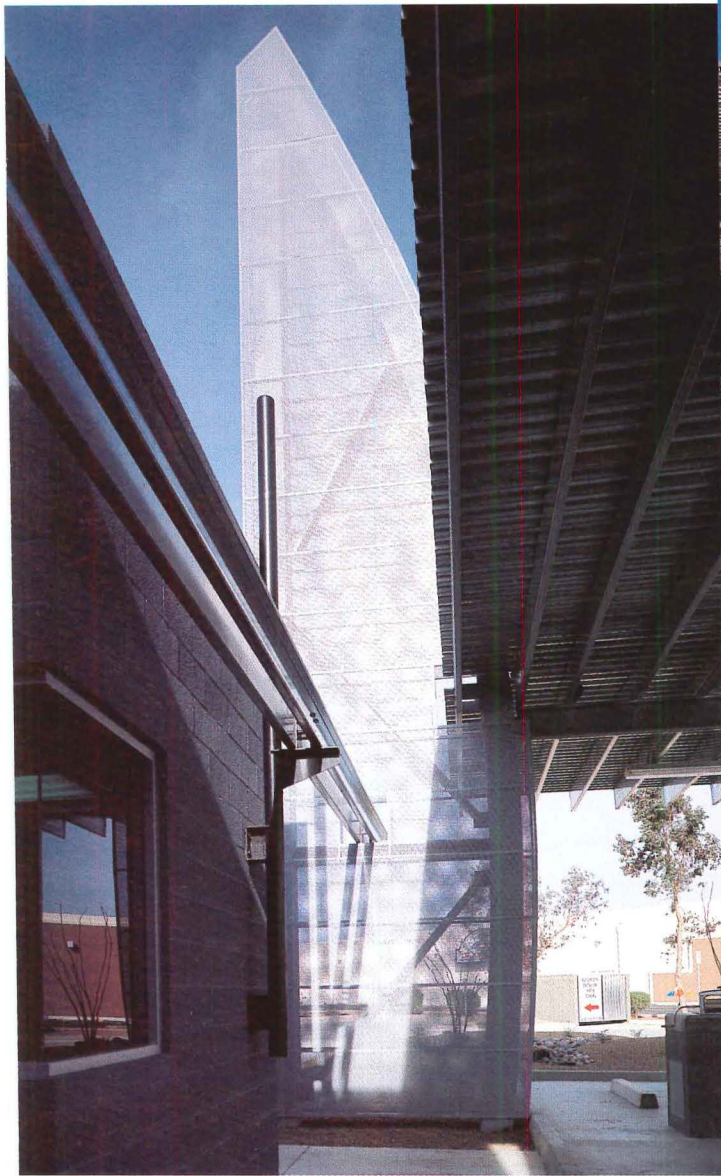
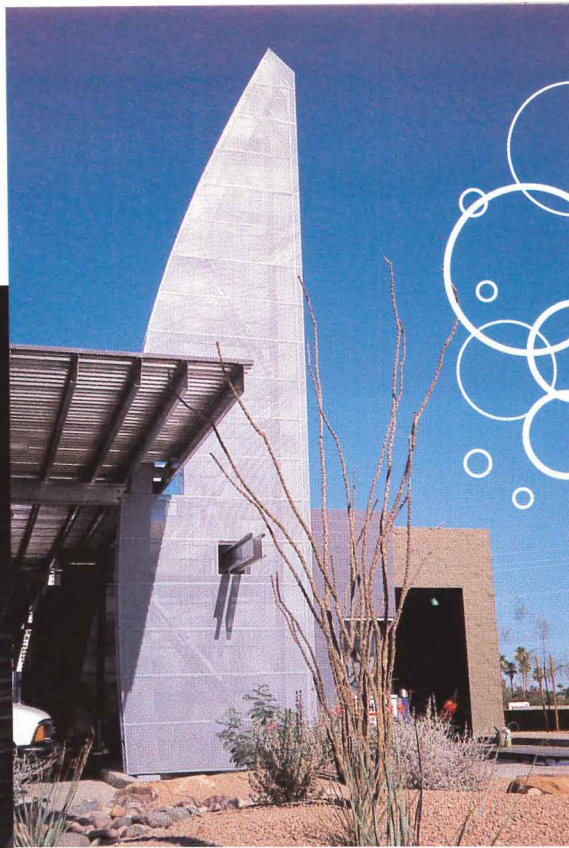

along the street edge. The proscenium doubles as both a utility bridge that brings water pipes to the wash bays and as a frame for the car wash's sign. Architekton Principal John Kane explains that the incongruous image of a dolphin in the desert is created with two layers of painted perforated steel that sheath the proscenium: "The resulting moiré pattern shimmers like water as one drives past, while the slowly curving top suggests a dolphin's back breaking the surface of the waves."

Architekton's building evokes the optimism of the car-culture buildings of the 1950s that celebrated the road with sweeping horizontal roof planes and opportunities to display the car, yet its rigorous planning and crisply detailed concrete-and-steel structure place it squarely in the architectural present. A simple palette of split-face and smooth concrete block is used metaphorically: The rough split-face block of the hot, dry exterior protects the smooth dolphin-gray blocks on the cool, wet interior. At the wash bays, metal deck roof canopies float above masonry walls, supported by tubular steel brackets. The resulting space between wall and roof provides daylight and ventilates the heat from the wash bays.

Architekton has made something more of the utilitarian car wash program by creating a playful celebration of water in the desert and a place for social interaction in a city where few such places exist. Their refreshing transformation of the mundane delights the eye, raises the stakes for strip architecture, and makes one believe again in the joyous potentials of the road.

Oakland-based architect L.R. Findley teaches at the California College of Arts and Crafts.

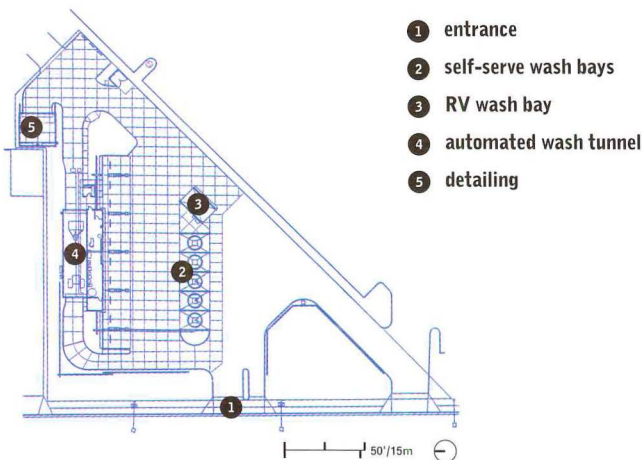

Thin roof canopy soars above walls to let in light and ventilate heat (facing page, left). Dorsal fin-shaped tower marks entrance to automatic wash line and serves as logo for Dolpin Car Wash Company (facing page, right). Two layers of perforated steel create moiré pattern, turning proscenium into a shimmering, waterlike surface (right).



**DOLPHIN CAR WASH
MESA, ARIZONA**

CLIENTS: Terry Johnson and Steve Scholnik **ARCHITECT:** Architekton, Tempe, Arizona—John Kane (principal-in-charge), Chris Kelly (project architect), Tony Amidei (project team) **LANDSCAPE ARCHITECT:** Moore/Swick **ENGINEERS:** Brickey Rudow & Berry (structural); Anderson Engineering (mechanical); SW Engineering (electrical); Dibble & Associates (civil) **CONSULTANT:** Pete Wareing, Copperstate Carwash Systems (car wash) **GENERAL CONTRACTOR:** SMW Contracting **COST:** \$650,000 **PHOTOGRAPHER:** Walt Saadus

M O V I E N G

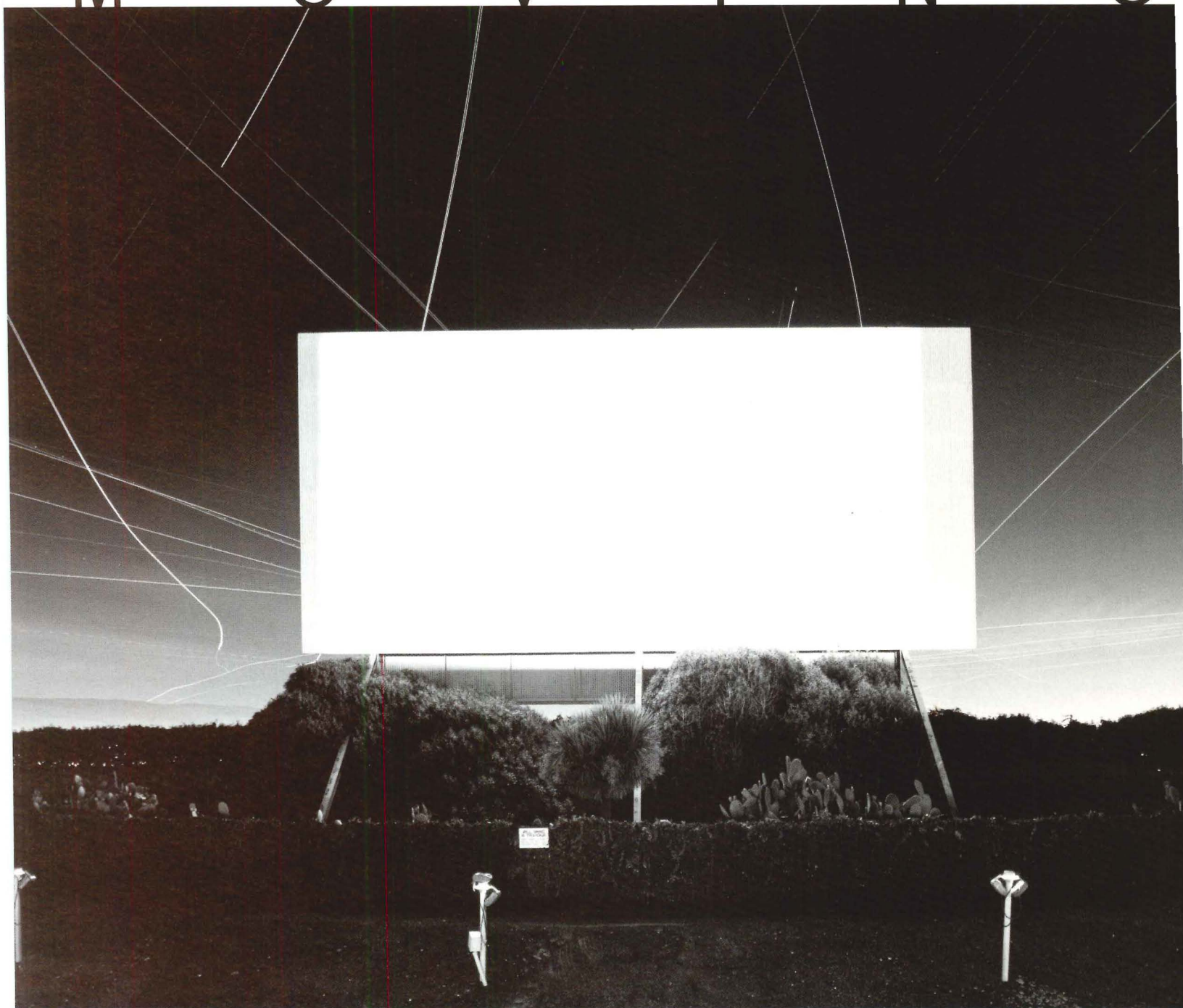

There's no smell of buttered popcorn here, no sticky warm vinyl, or giggles from the back seat. New York City artist Hiroshi Sugimoto's photographs of Southern California drive-ins abandon 1950s poodle-skirt sentimentality for a transcendent view of time and place. His long exposures capture the luminescence of an entire movie, the whited-out accumulation of projected images. These ghostly lit screens sit front and center—stately voids framed by an active night of stars, wind-blown trees, and power lines—in a quiet elegy for the chrome age. HIROSHI SUGIMOTO'S PHOTOGRAPHS APPEAR COURTESY OF THE SONNABEND GALLERY.

PICTURES

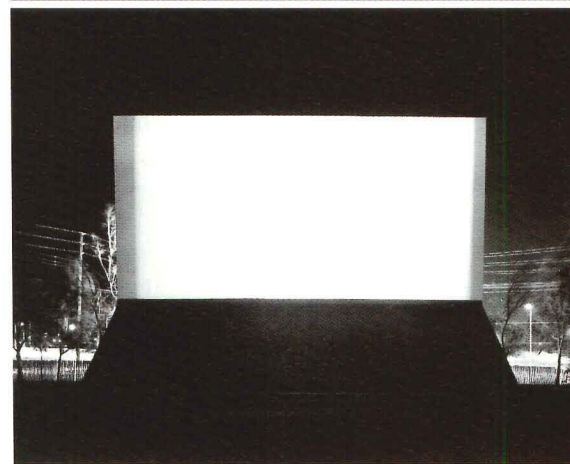
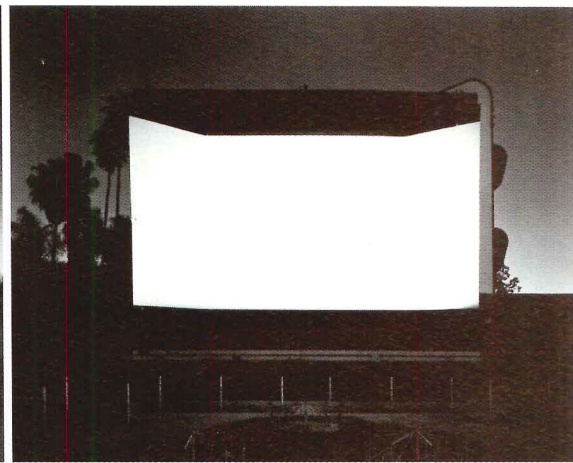
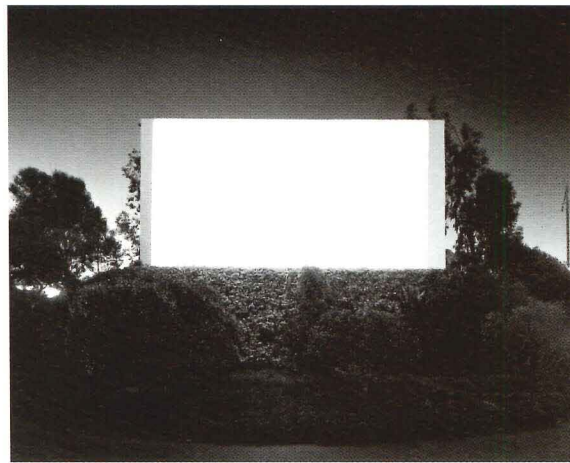
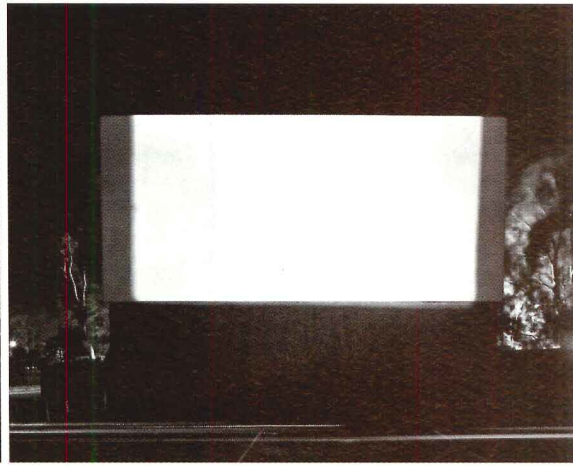
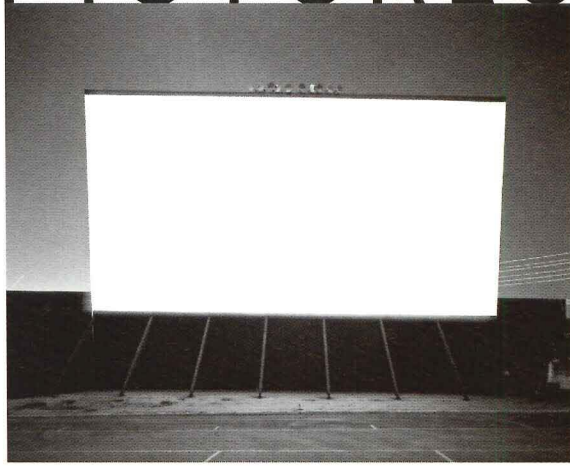

Photographs by Hiroshi Sugimoto

By Jane Holtz Kay

Motion Sickness

"The shortest distance between two points is always under construction" ... "At the end of every on-ramp is a 12-ton air horn" ... "Careful, you may run out of planet."

These are the signs of the times on the map of America, the offspring of those Burma Shave billboards that once meant happy motoring along U.S. highways and byways. And who has written the new signs? Is it Hunter S. Thompson railing against the great American dream machine? "Doonesbury"'s Uncle Duke stuck in traffic? Or architects who've come upon some freshly minted Shangri-La encased in a 5-acre parking lot? None of the above. These menacing words are, in fact, advertisements from the car industry. The message behind the negativism is clear: The size, comfort, or flexibility of their vehicle will overcome the worsening conditions behind the wheel that driving it causes.

Where, then, have all the flowers, the Chevys-to-the-levees, gone? Gone to junkyards every one? Not exactly. The romance with the automobile is still here. In early spring, Ferdinand Porsche received a half-page obituary in *The New York Times* that featured a photograph of the car magnate standing beside his father ("a friend and

confidant of Hitler"). Meanwhile, Volkswagen has released a new version of Porsche's Beetle—the "people's car"—whose Mickey Mouse buoyancy would put a smile on even the most tight-lipped environmentalist. And yet, as gas prices descend and driving miles increase, as sprawl creeps across the landscape, the bloom may not be off the Beetle, but the thorns are there.

Stuck an average of 73 minutes a day behind the wheel, driving 12,000 miles a year, suffering increasing traffic jams and congested lives, Americans question the car's dominance. Even as the nation (barely) skirted its second oil war in the Persian Gulf this winter and the highway-friendly transportation bill (most recently dubbed BESTEA) sailed through Congress with just enough crumbs to muffle public-transit folks, a new constituency has emerged.

For instance, the transportation bill managed to rouse C-SPAN's usually somnolent bastion of callers to "Washington Journal." One phone-in excoriated the \$41 million airport built near the home of Bud Shuster (R-Pennsylvania), chairman of the House Transportation and Infrastructure Committee; another was irate about "just slapping down more asphalt." Representative James Moran (D-Virginia) uttered

phrases on transit-oriented development and compact communities that might have been mouthed at a New Urbanist Congress.

When not only the people but the politicians are ahead of the architects in dashing the excesses of the auto age, it is time to reconsider the love affair with 90-mile-an-hour architecture. Not only have stewards like the National Trust for Historic Preservation assumed a strong position against the road-induced sprawl, but the Surface Transportation Policy Project, an umbrella group of architects, environmentalists, and alternate transportation supporters, now lists 200 advocate groups of road warriors.

Beyond the traffic-calmer, greeners, and communitarians, a vast chorus voices disenchantment with the reality behind the romance. In Washington, D.C., activists downed a multibillion-dollar plan to replace the Wilson Bridge over the Potomac; others fight Interstate 710 in South Pasadena; and in the Midwest, CARR (Citizens for Appropriate Rural Roads) battle a rural highway. Still others confront the 16 ring roads proposed for U.S. metropolises, insisting we shouldn't spend seven times more for highways than for public transit.

The cost of our supposed mobility has begun to enter the national consciousness.

Whether economists or the conservative Taxpayers for Common Sense, many tally the pricey path of accessibility: the \$93 billion spent on federal, state, and local roads; the \$80 billion a year for time lost in traffic; the price of accidents and ill health, global warming, and environmental exactions. Instead of mending potholes, new roads—destined to become traffic-laden—now take 44 percent of our highway dollars. The facts provoke questions on the lifestyle this perpetual automotion promotes.

Ask a driver—ask half our households that now have two or three of the nation's 200 million cars—why they drive. Vacations are one answer; to get to work the other. Neither reflect the odometer. According to the U.S. Department of Transportation's Nationwide Personal Transportation Study, only 22 percent of our driving is to work, only 8 percent on leisure trips. The other two-thirds? One-third for soccer mom to chauffeur the nation's 55 million school-age children and an expanding portion of the 60 million immobilized elderly; the other one-third to shuttle a \$6,500-a-year ton or two of wheel and steel to buy a popsicle or save a dollar on a hammer at the Home Depot.

Populist discontent has, and hasn't, reached architects. It hasn't quite convinced the New Urbanists, who clearly sign and often spirit the movement to compact communities, yet too often cater to auto-

dependent, developer-driven planning. Architects have, however, produced transit-oriented projects in states from New Jersey to California, and infill designs that encourage walkable communities.

Once, architects attempted to curb the car, shaping buildings and communities to reduce their impact. From the corridors that funneled walkers to work to the back-door loading docks where trucks slid inconspicuously into the cellar, Rockefeller Center was a masterwork of both architecture and movement. Architect Percival Goodman wrote the enlightened *Communitas* with his brother Paul. Even Victor Gruen tried to fight before he went over to the other side. Today, too many architects just cave—creating an emperor's-new-clothes architecture adrift in brutal asphalt, ignoring architecture's role as the couturier of civic space.

To be sure, architects hate running interference with highways, intersections, and parking lots. It is they who know how to make the one-third of our trips under a mile a civilized experience; they intuit the fact that asphalt islands do not make for good design. Yet whatever they understand, they should do far more within and without their communities to advocate the urban design, zoning, and land-use policies to shape car-free cities and retain unpaved road.

For one, Anton Nelessen, a New Jersey planner and Rutgers professor, has become a spearhead for charting the potential

patrons of an alternate design paradigm. Juxtaposing slides of sprawling ranch-burgers on wide arterials with dense, traditional neighborhoods, his visual-preference surveys in several hundred cities show how audiences endorse the latter: replacing a 30-tentacle Milwaukee interchange with downtown boulevards, or choosing to infill and tree-line Athens, Georgia. "Transportation is the DNA of design," says Nelessen. And the first level of transportation is walking. Architect and writer-activist Peter Calthorpe calls for "pedestrian pockets." Local grassroots and neighborhood groups boast architects and landscape architects on their boards to three-dimensionalize their dreams.

Someone once said that war is too important to be left to the generals. So, too, transportation is too sensitive to be left to engineers. Architects can be the "generals" and "engineers." They can transform vague longings for a car-free landscape into real plans. Instead of penning the fin de siècle drive-ins and hard-topped Taj Mahals shown in this issue, they should garage the pedal-to-the-metal fantasies from Frank Lloyd Wright and Le Corbusier. If architects want to do more than shuffle deck chairs on the *Titanic*, let them help transform the highwayscape into a human one.

Jane Holtz Kay is architecture and planning critic for The Nation and author of Asphalt Nation (Crown Publishers, 1997).

Architects should help America get over its love affair with the automobile.

On the Canadian frontier, Miller | Hull bridges two countries with a tectonic border station.

BORDER





Dynamic cant and slopes define border crossing at Point Roberts, Washington (these pages). Cable-stayed steel canopies hover above inspection areas in counterpoint to main building. Concrete, steel, and glass booths (left) match material patterns of frontispiece.

LINE S

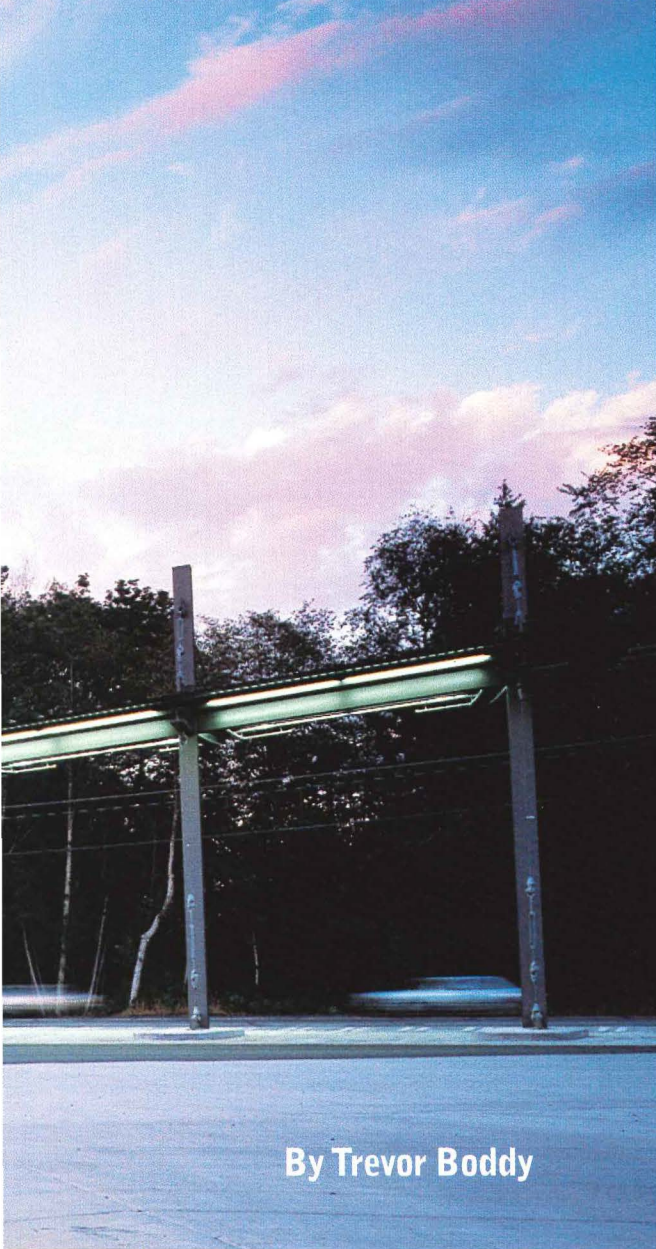

By Trevor Boddy

The U.S. Port of Entry at Point Roberts, Washington, lies at the end of the American road, at the conclusion of the 3,000-mile-long boundary between the U.S. and Canada drawn at the 49th parallel. The crossing itself has recently become far more interesting with the addition of a new border station “porthouse” designed by The Miller | Hull Partnership of Seattle. The client, the U.S. General Services Administration, commissioned the project as part of its Design Excellence Program for new government buildings, launched by the agency’s Chief Architect Edward Feiner in 1994 (*Architecture*, January 1996, pages 59-63). In the case of the Point Roberts station, the GSA made an inspired choice by commissioning Miller | Hull, whose building shows passionate conviction about public-minded urbanism, and whose rain-coast construction vocabulary insists upon dialogue between natural and built tectonics.

The porthouse extends Miller | Hull’s ideas about “an architecture of roofs”; aggressively exposed, thrusting structure; the contemporary Northwestern language of expressive details; and a thirst for natural light. Point Roberts embodies a hybrid, transnational personality peculiar to an American town where 70 percent of its 12,000 people are Canadian commuters.

Principal David Miller forms a dramatic gateway between sympathetic nations. The station is defined by the angular silhouettes of two cable-stayed canopies, covering primary and secondary inspection areas that adjoin a pair of cedar-clad boxes aligned lengthwise north to south to form the main porthouse. The constructivist

canopies, inspired by the boats of the nearby Point Roberts marina, anchor visually to the porthouse, and are placed to allow easy visual surveillance of the outside inspection areas from within. The sloped roof of the larger cedar box, which holds secure offices for customs and immigration authorities, intersects with the flat roof of the smaller wooden building via continuous skylights that illuminate the heavy-duty steel joinery framing the open, airy interior.

The public portions of the interior are distinguished by the layered geometries of steel structure and tubular air ducts. These mechanical tubes create an angular, tectonic enfilade running between the wood-paneled walls of the main building and the more lightly built curtain wall of the frontispiece. Sober Modernism merges with the sylvan of the region in contrasting materials and dramatic cutaways in the lobby, denoting a spirit of openness at this guarded outpost along the international fence. On the northeast corner, a glazed, canted cube protrudes to permit views of the wooded grounds.

Both the interior and exterior orientations of the building respond poignantly to the ecology of its forested green backdrop: To be sure, construction of the building in 1996 could not begin until the end of the blue heron's early summer nesting season. Miller | Hull 's design successfully mixes respect for the abundant wildlife with sensitivity to the rarefied rain-coast climate. The architect imbues the building with the voice of authority required by a remote sentinel of national identity.

Trevor Boddy is an architecture critic and historian based in Vancouver, British Columbia.

- 1 lobby
- 2 customs
- 3 offices
- 4 conference room
- 5 drive-thru inspection

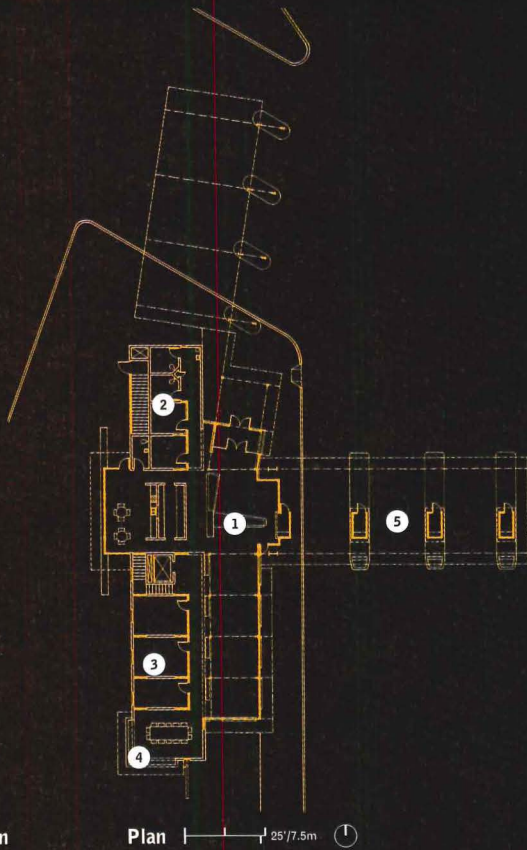

Plan | 25' / 7.5m

East-west section

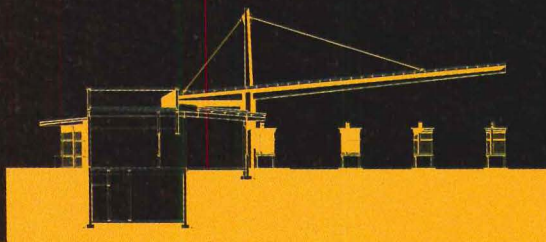

Site plan exploits wooded views (facing page, top). Compact organization ensures security (section). Exposed ducts and steel framing delineate light-filled lobby (facing page, bottom). Steel cables (right) anchor canopy of inspection area.



POINT ROBERTS INTERNATIONAL BORDER STATION
POINT ROBERTS, WASHINGTON

CLIENT: U.S. General Services Administration **ARCHITECT:** The Miller|Hull Partnership, Seattle—David Miller (design lead), Craig Curtis (partner-in-charge), Christine Arthur, Scott Wolf (project managers), Carla Allbee, Gabriel Hajjani, Annie Han, Chris Patano, Peter Wolff (design team) **LANDSCAPE ARCHITECT:** EDAW **ENGINEERS:** KPFF Consulting Engineers (structural); Wood Harbinger (mechanical); Sparling (electrical); GeoEngineers (geotechnical) **GENERAL CONTRACTOR:** Arango Construction **CONSULTANTS:** Ackroyd (cost control); Specifications NW (specifications); Art Anderson Associates (construction management) **COST:** \$3.2 million **PHOTOGRAPHER:** Fred Housel

INFORMATION HIGHWAY

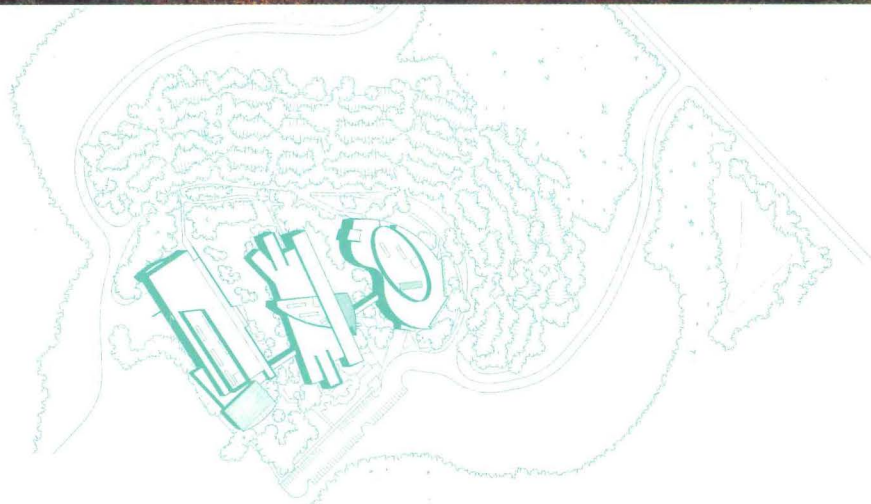
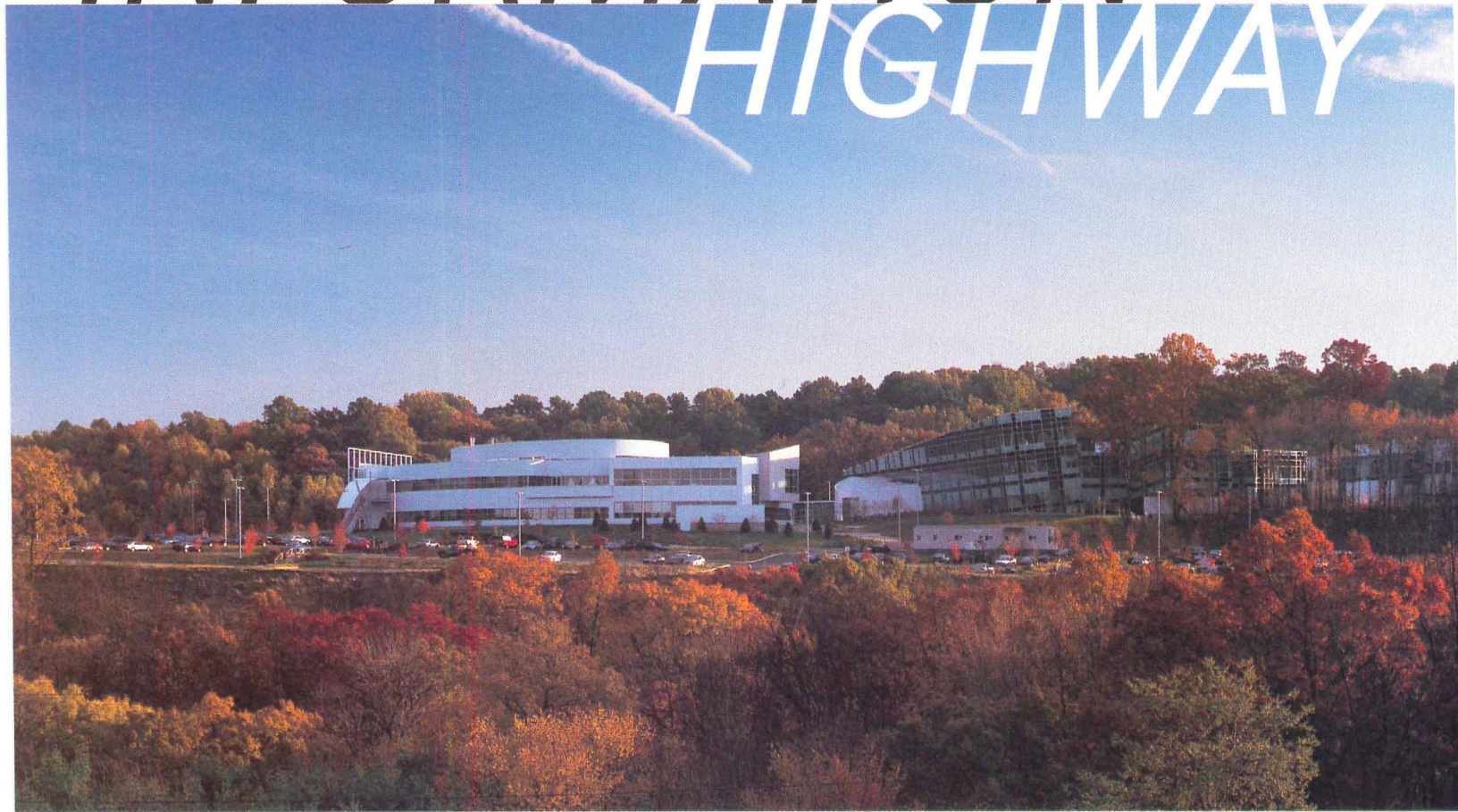

Site plan

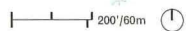

FORE Systems headquarters (these pages) dominates hillside in western Pennsylvania. Building 1, clad in white corrugated steel panels, houses customer service and sales offices. Building 2, with slanting glass curtain wall, houses engineering labs and offices.

BY STEVEN LITT



*A HIGH-TECH HEADQUARTERS IN WESTERN
PENNSYLVANIA FLIRTS WITH THE FREEWAY.*

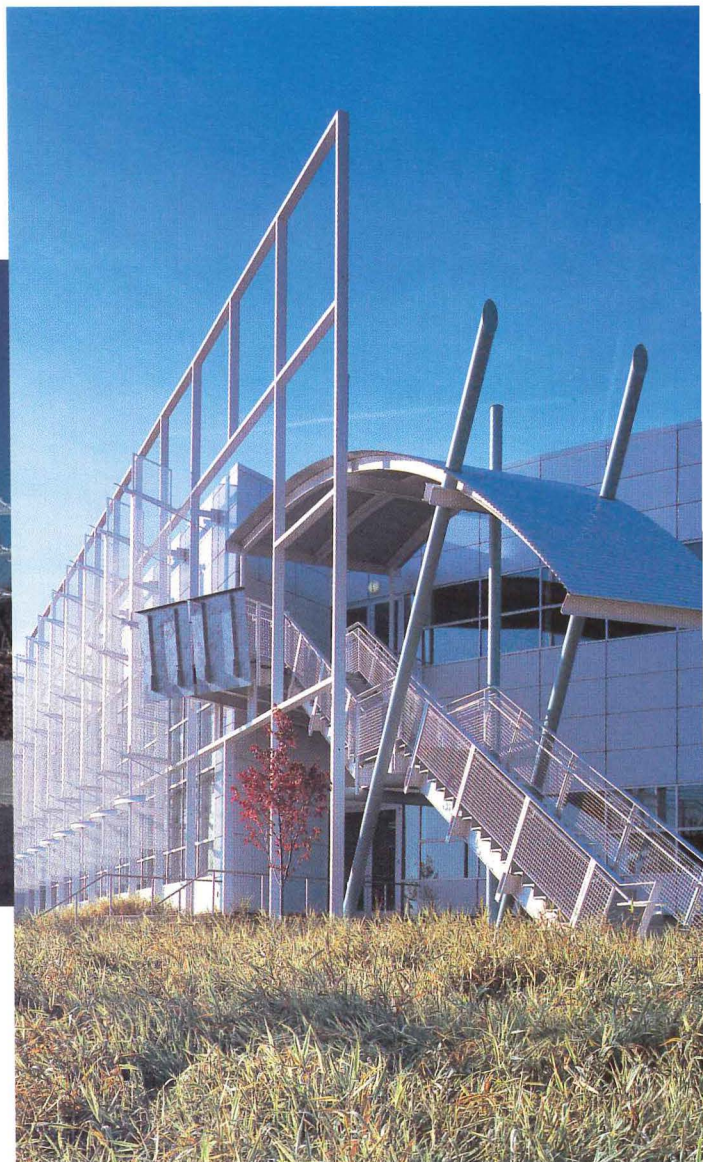

Most suburban office complexes springing up along the outer loops and outer, outer loops of America are brain-dead boxes set adrift amid parking lots and vapid landscaping. Thus, southbound motorists on Route 19 in Warrendale, Pennsylvania, could be forgiven for rubbernecking as they speed past the dynamic new headquarters of FORE Systems, a maker of high-speed computer networking hardware and software located 25 miles north of Pittsburgh. The FORE Systems headquarters has a story to tell. It attempts nothing less than to embody the sometimes rambunctious, caffeine-fueled search for innovation in the volatile high-tech computer industry. Through unusual building forms, clever use of exposed mechanical elements, and office layouts that boast a spirit of rambling informality, the complex strives to flout expectations and encourage creative teamwork among the 900 employees housed on-site.

Designed by San Francisco-based STUDIOS Architecture in a skin-and-bones Modernist style, the \$40 million, 300,000-square-foot complex consists of three buildings with a few Deconstructivist deformations that make them dance across a hillside west of the highway. Building 1, which conceals a honeycomb of office cubicles behind curving, corrugated steel facades, rises above the trees on the hilltop like an ocean liner or a giant Corbusian villa. Building 2, which houses engineering labs, catches the eye with a tartan grid of slanting green and black glass curtain walls that refer to the layers of shale exposed by highway cuts throughout the region.

Building 3, which occupies the highest ground and lies farthest from Route 19, is a manufacturing plant clad in a relatively sober rectangular grid of precast concrete panels. Not to be outshone by its neighbors, however, Building 3 includes a barrel-roofed cafeteria wing with



- 1 entrance
- 2 conference
- 3 laboratory
- 4 offices
- 5 lounge

Building 1 plan 40'/12m



Canted glazed foyer (facing page, left) bisects curving, corrugated steel facade of Building 1. Slanting steel columns (facing page, right) support steel canopy over employee entrance. Public lobby (above left) features wood-paneled walls, exposed HVAC, and slate floors. Steel-framed elevator cage in Building 1 (above right) resembles coal-hauling structure called tippie.

a steel lattice sunscreen that sweeps down like the brim of a baseball hat worn low over the eyes. Despite their differences, the FORE Systems buildings relate to each other by collaging materials. For example, the glass-enclosed engineering lab (Building 2) has an entrance pavilion clad in a curving swath of the same white corrugated steel that wraps the main mass of Building 1 across the way.

William Bates, director of real estate and corporate services for FORE Systems, explains that the company's founders wanted to emulate the laid-back intensity of the headquarters of 3Com, a competitor based in Santa Clara, California, also by STUDIOS. FORE Systems is thus an outpost of California high-tech culture in the Rust Belt. It is also vastly superior to typical suburban office design in the area; the standard is represented by the adjacent U.S. Postal Service bunker, which FORE Systems can look down on in more ways than one.

Until last October, FORE Systems had labored in two nondescript buildings located miles apart from each other in the hills north of Pittsburgh. Company executives considered relocating to a high-tech office park downtown, but chose a 96-acre hilltop site in Marshall Township, which offered high visibility, ample room to grow, and, most importantly, easy access for its largely suburban workforce.

Despite its formal complexity, the design parti is actually quite simple. A glassy circulation spine connects the three buildings in the complex (two more are planned) and creates an all-weather main street that facilitates easy movement for employees. Elevators, stairwells, kitchens, snack bars, and other amenities are clustered around the spine, where exposed utility trays overhead carry electrical wiring that plays a central role in FORE Systems products. Lighting conduits reveal their connections with the stark hanging fixtures. The look is





East facades of Building 2 (facing page) lean seven degrees off horizontal. Building 2's entrance (below left) is clad in corrugated steel panels. Circulation spine (below) runs northeast to southwest through complex, with exposed HVAC ducts and cable trays overhead.

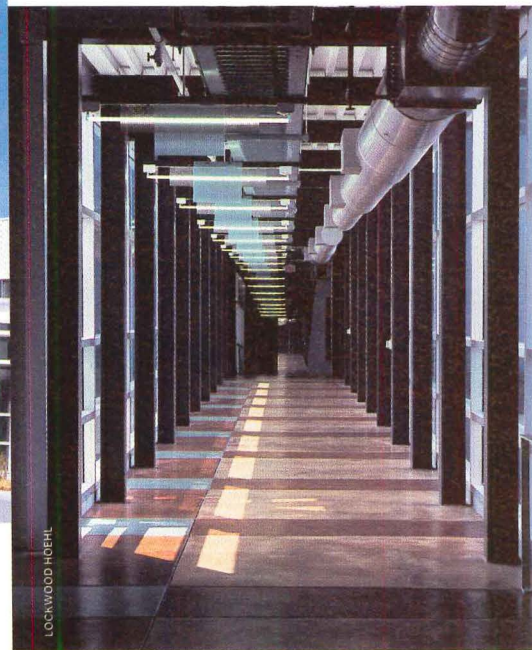

Building 2 plan | 40'/12m

- 1 entrance
- 2 conference
- 3 laboratory
- 4 offices
- 5 lounge



- 1 entrance
- 2 conference
- 3 laboratory
- 4 office
- 5 lounge
- 6 manufacturing
- 7 fitness center
- 8 kitchen
- 9 cafeteria

Building 3 plan

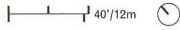

raw and finished at the same time, giving the headquarters a wealth of ornamentation derived from clever deployment of the building's functional parts. "People go to great extremes in Postmodern design to get a lot of detail in their buildings, but we believe the detail is inherent in the structure itself," says Erik Sueberkrop, principal-in-charge at STUDIOS.

The diversity of expression among the buildings is intended to represent the company's interest in individuality as well as STUDIOS' respect for the hilltop site and the region. Building 1, for example, borrows its curve from the contours of the hillside, and from the dramatic approach road that climbs up the flank of the slope below. Visitors enter the complex through this building, where a transparent glass foyer seems to crash out of the corrugated steel facade like a coal-mine chute. The complex's elevators, which ride up and down in steel-framed towers, approximate "tipples," mineshaft head structures common in Appalachian coal country. Office areas are tight clusters of cubicles, punctuated at regular intervals by conference areas with sweeping views of the surrounding hills.

FORE Systems hopes that its new headquarters will promote corporate esprit, increase efficiency, and attract new hires with its airy work spaces, sociable atmosphere, and amenities, including basketball and volleyball courts and a cafeteria. It's too soon to say whether such perks will boost the bottom line. But it's hard to argue against giving workers a bright, stimulating environment. In that sense, FORE Systems is exemplary. The project also succeeds in adapting a breezy, California-style Modernism to the emerging high-tech corridor north of Pittsburgh. It may be in the Rust Belt, but the building buzzes with all the optimism and energy of Silicon Valley.

FORE SYSTEMS
WARRENDALE, PENNSYLVANIA

CLIENT: FORE Systems—Thomas Gill (president), William Bates (facilities director); The Gustine Company (developer) **ARCHITECT:** STUDIOS Architecture, San Francisco—Erik Sueberkrop (principal-in charge), Jerry Griffin (project architect), Stuart MacDonald (project manager), Karyn Gabriel, Philip Luo, John Mulcahy, Jacek Ostoya, Bradley Skaggs (project team) **ASSOCIATE ARCHITECT:** Perfido Weiskopf Architects, Pittsburgh—Alan Weiskopf (principal) **LANDSCAPE ARCHITECT:** GWSM **ENGINEERS:** Gensert Brettnall Associates (structural); Civil & Environmental Consultants (civil) **CONSULTANTS:** Architecture & Light (lighting) **GENERAL CONTRACTOR:** Mascaro **COST:** \$32.5 million **PHOTOGRAPHER:** Richard Barnes, except as noted



Cafeteria roof (facing page, left) curves over south end of Building 3. South entrance to Building 3 (facing page, right) combines material palettes of Buildings 1 and 2. Cafeteria interior (above left) features open web trusses, exposed HVAC, and abundant daylight. Open steel lattice sunshade on south facade of Building 3 (above right) screens cafeteria from direct sunlight.

A world of new colors to help



At Armstrong, we feel limits shouldn't be placed on your vision. That's why we now offer the widest array of vinyl flooring colors and designs – including 81 new colors across 10 product lines. Plus, our Custom Concepts service helps bring your most unique ideas to reality. And since our colors are coordinated across sheet,

ecture

TECHNOLOGY
+ PRACTICE

PRESERVATION TECHNOLOGY 196
A Union Divided

TECHNOLOGY 202
Academic Initiative

PRACTICE 208
Taking Charge

COMPUTERS 212
Urban Simulations

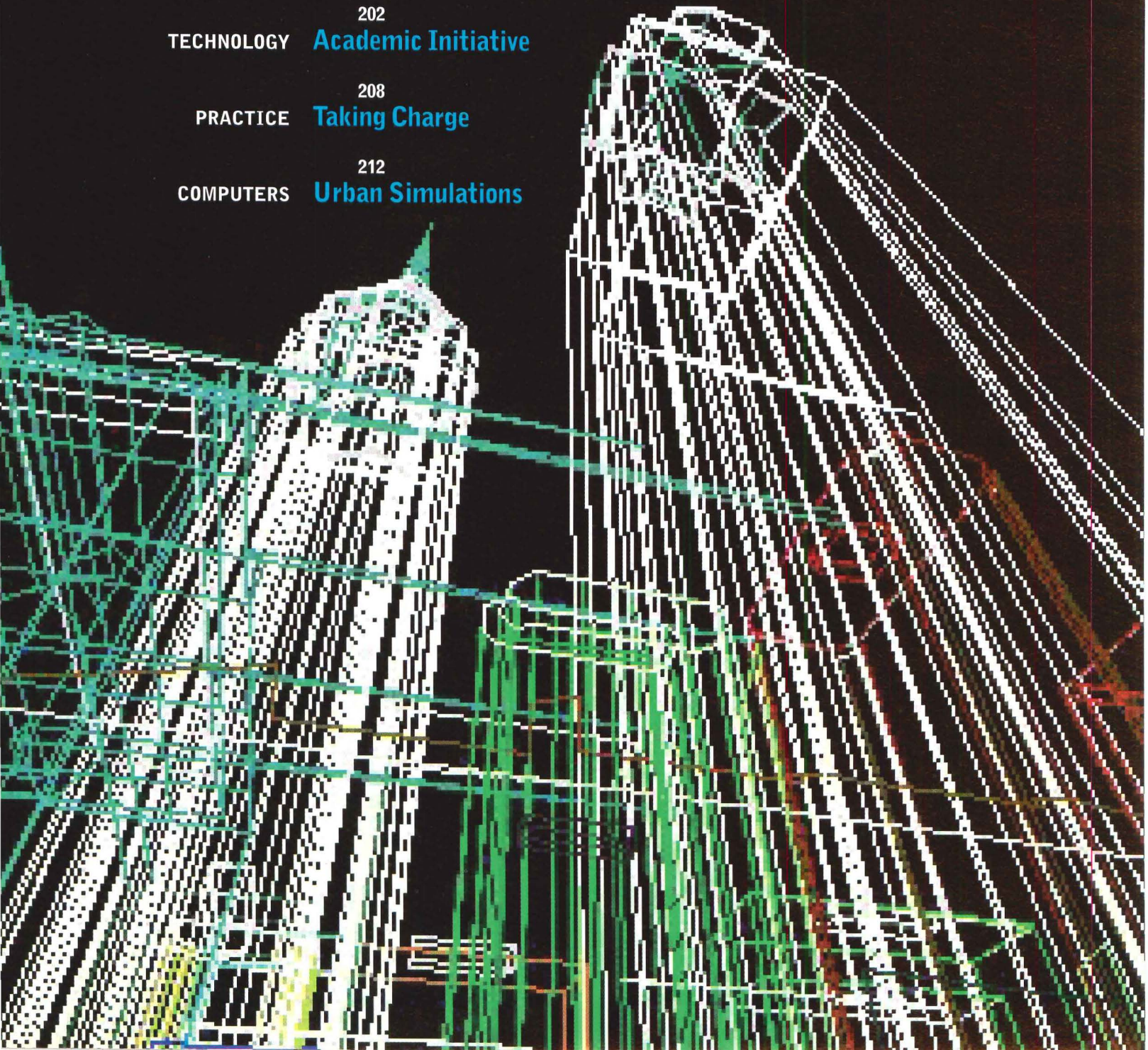

A Union Divided

Goody, Clancy & Associates transforms McKim, Mead & White's obsolete but symbolic Harvard Union into dynamic, usable space.



Before opening of adjacent Memorial Hall, Harvard Union's main hall served as freshman cafeteria. Goody, Clancy & Associates inserted skylit stairwell into hall and created five habitable floors.

By Sarah Amelar

In a vast oak-paneled hall, beneath elk-antler chandeliers, Harvard freshmen took their meals in McKim, Mead & White's 1901 Georgian-style Union Building for nearly seven decades. Here, between 1929 and 1996, the tradition evolved of flipping pats of butter upward from knife ends to strike the 34-foot-high bowed ceiling embossed with the university's insignia. The 94-foot-long hall, dubbed the "Living Room" by its designers, was the Union's centerpiece. But by the mid-1990s, the University deemed this cavernous space obsolete. When the far grander Memorial Hall, a cathedral-like, 1874 Ruskinian Gothic extravaganza only two blocks away, was restored in 1996 to its original function as a dining hall, the Union lost its main purpose.

University planners envisioned subdividing the hall and converting the building into an interdisciplinary humanities center with faculty

offices and seminar rooms for 13 departments. But a room so immense, so saturated with lore, and designed by so prominent an architect as Charles Follen McKim was not easily wrested from alumni and preservationists. The contentious battle that ensued ended with the hall's conversion by Boston architect Goody, Clancy & Associates—a dramatic interior reconfiguration that raised important questions about what to preserve when a space's symbolic weight outlives its usefulness.

A democratic solution

The building's original function dates back to the 1890s, when graduate Henry Lee Higginson donated \$150,000 for a "meeting-house for all Harvard men—alumni, students, teachers," regardless of financial or social status. The hall was designed like a gentlemen's clubroom, with imposing, 14-foot-high limestone fireplaces at either end, and such

Adirondack touches as the rustic antler chandeliers, probably gifts of President Theodore Roosevelt (Class of 1880). In the Union's early decades, speakers included Bertrand Russell and Count Ilya Tolstoy. But by the 1920s, membership dwindled, and the university appropriated the hall for freshman dining.

In the late 1980s, as many aging campuses faced heavy costs of deferred maintenance, Harvard adopted a policy that generally favored reprogramming underutilized spaces rather than commissioning new buildings. Philip Parsons, former director of planning for Harvard's Faculty of Arts and Sciences, proposed clustering 17 humanities departments (previously scattered around campus) in the Union/Burr Hall building and neighboring Warren House. This spatial consolidation would heighten the humanities' visibility and encourage cross-pollination among such diverse disciplines as history and literature, religion, Afro-American studies, women's studies, and folklore and mythology.

Initially, university planners and Goody, Clancy & Associates considered schemes that would retain the Union's central hall. But according to Parsons, many students and humanities faculty members objected, expressing an aversion to the huge, gloomy interior. "The space was so dark and big," agrees Principal Joan Goody, "you couldn't get a critical mass. The room seemed to suck life out of the building rather than energize it." The architects suggested filling the hall with library carrels, but students opposed it and the university had no program for a new library. The room was especially dark because McKim had placed exterior windows on only one side, and the plaster bas-relief ceiling, once a golden cream color, had been painted brown.

Rather than faithfully re-create the 1901 Harvard Union, Goody, Clancy focused on reinvigorating its program and function—leading to a radical spatial intervention. The firm proposed inserting a great skylit stairway and light well down the cen-

ter of the former dining hall, leaving an ample first-floor seminar room and a 1,443-square-foot lounge flanking the new vertical elements.

By dropping the ceilings in these first-floor rooms from 34 feet to 16 feet, extending the atrium down to the basement, and reclaiming two stories of attic space, the architect could generate five habitable floors from two-and-a-half in the original Union building. (Scissor trusses supporting the central hall's tremendous clear span had occupied one-and-a-half stories above the 34-foot-high ceiling). All five levels could potentially house communal rooms distributed near the center with departmental offices and seminar rooms further from the core.

Ideally, the central stairway and atrium lighting would spark chance encounters, encourage interaction between departments, and generate a sense of community—a modern take on Higginson's turn-of-the-cen-



McKim's Neo-Georgian design features a play on classic limestone quoins (above), which are repeated across facade. Union building is entered from recently landscaped courtyard. Brickwork and limestone (left) were cleaned and restored; enclosed porch was converted to coffee bar; and slate roof and dormers were replaced.

tury vision. "By adding a vertical axis to the existing north-south axis," explains Goody, "we intended to override the horizontal, highly stratified 19th-century organization—upstairs-downstairs or served-versus-service spaces—and make the whole building more democratic."

Radical and conservative

But many partisans saw the project in less glowing terms. Just before construction began, alarm bells suddenly went off, pitting alumni against alumni, faculty against faculty, and drawing a fleet of architects and preservationists into the fray. A group of alumni, led by Tweed Roosevelt (a descendent of Teddy), formed the Committee to Save the Great Hall. Such illustrious figures as architectural historians James Ackerman of Harvard and Vincent Scully of Yale and Harvard architecture chair Jorge Silvetti defended the endangered room. "The loss of the

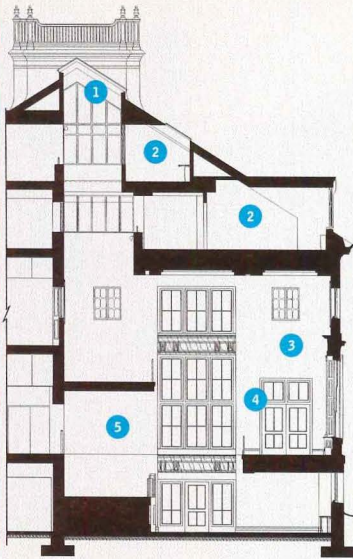

North-south section

- 1 new skylight and light well
- 2 offices
- 3 new floor
- 4 atrium
- 5 stair
- 6 café
- 7 seminar room
- 8 lounge
- 9 entrance

Neutral stairwell and skylights (right) contrast with historic spaces. Limestone pavers in entrance hall (below) were restored and walls were repainted Harvard crimson. New stair hall (bottom) incorporates original artifacts restored by Fogg Museum, including plaques, clocks, and Sargent portrait of donor Henry Lee Higginson.

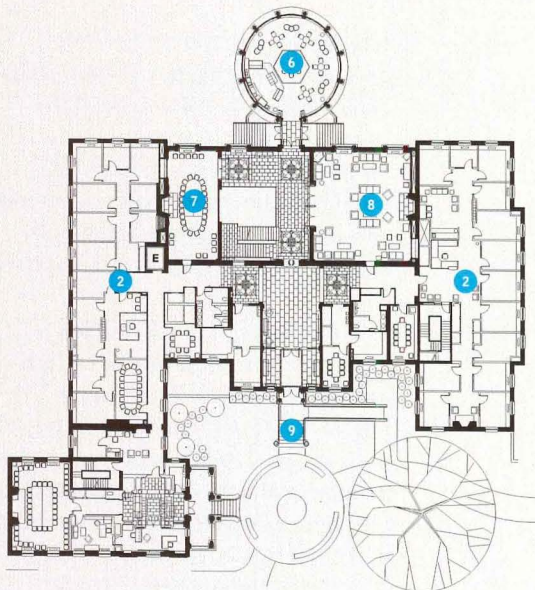

First-floor plan



Great Hall," wrote Palladian scholar Ackerman in a letter to the *New York Times*, "is the equivalent of the loss of a novel by Henry James or a painting by John Singer Sargent." Petitions circulated, and a court order halted construction. Ultimately, Harvard's administrators won the right to proceed as planned.

The deed has been done—with the renovation completed last fall—and a new calm has settled over the old Union (now part of the two-building Barker Center for the Humanities). As Goody points out, McKim's exterior—the only part of the building listed on the National Register of Historic Places—was meticulously restored. The architect reconstructed the crowning widow's-walk-style cupola. Long overrun by exposed vents, it now conceals skylights and an emergency smoke exhaust system. A barnaclelike 1960s addition—a kitchen vestibule and loading dock—is gone, bringing back the building's clean lines. With its pale gray limestone and red brickwork cleaned, repointed, and replaced, the facade's rich playfulness snaps into focus. McKim parodied the classic limestone quoins by rhythmically repeating them across the facade, punctuating the brickwork with flat, dashlike stones. The diaper pattern of the gable brickwork is newly legible and subtly textured.

The entrance hall, with its creamy limestone floor, is airy and flooded with light—and, yes, people actually stop to chat on the great stairway. On axis with the main entrance, a coffee bar occupies the sunny south-facing rotunda (formerly a porch that was enclosed in 1930). "We asked faculty members what would draw them out of their offices," recalls Goody, "and many answered 'a really good cup of coffee.'" Sure enough, the café scarcely has a free seat.

Recalling the openness and spatial continuity of McKim's Living Room, floor-to-ceiling windows separate the central stair hall from the flanking lounge and seminar room. Oak carvings and paneling (mostly plywood veneer) were stripped, restored, and matched in the frames and mullions of the new interior win-



Once an open porch, this light-flooded room (left) now houses coffee bar. In former main hall (below), oak carvings and wall paneling, limestone mantel, and wrought-iron andirons were fully restored. Thirty-four-foot ceiling was dropped to 16 feet for more intimate proportions.

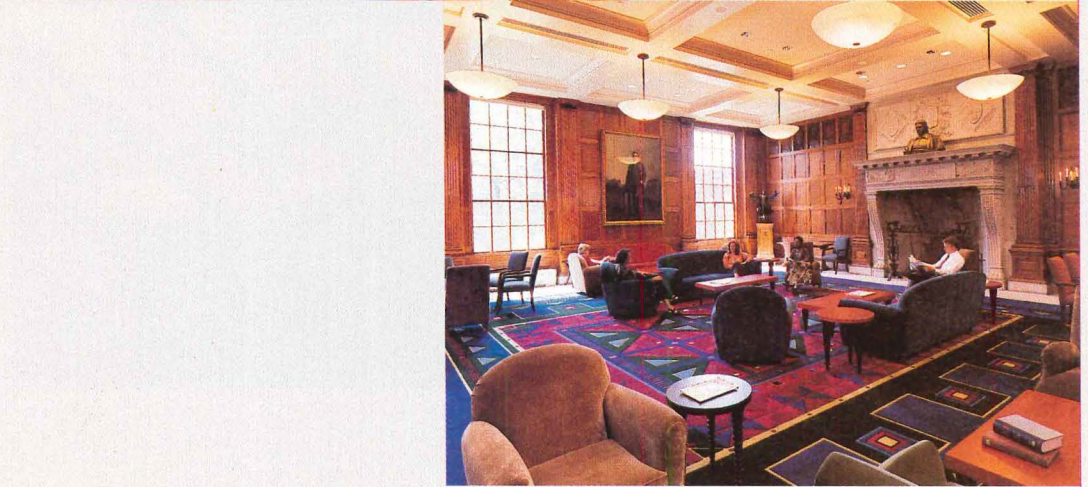

dows. Gray limestone pavers, door surrounds, and mantelpieces were also cleaned and revived.

Modern additions

Though the spatial intervention was radical, much of the surface treatment—both new and adapted—is intentionally conservative. "We wanted to preserve the memory of the original place," Goody emphasizes. "We kept many artifacts of the old Union and though we distinguished between old and new, we tried to respect the original character and texture—its sense of materials, color, warmth, and reflectivity." The approach was not a "steel-and-glass intervention," Partner John Clancy points out. The architect got daring only with the first-floor carpet—a jazzy, geometrically syncopated design (a riff on the Union's Oriental rugs) that enlivens its contrasting setting. Goody, Clancy also chose curvy furniture, modern variations on

Burr Hall's 1911 chairs, rather than attempt to re-create the overstuffed leather men's club armchairs of 1901.

Curiously, the new spatial configuration often rejuvenates the relics. The huge, sumptuously carved fireplaces, once bookends to the vast hall, are now wonderfully oversized in the first-floor seminar room and parlor. An elk-horn chandelier suspended over the light well becomes a focal point, newly visible from above. But other artifacts do not fit the new proportions as well. Though rich and warm, the original oak paneling now joins squarely with the ceiling—visually compressing this wood surface—eliminating wall space above it to soar or "breathe."

Structural solution

The facade's window placements, however, limited ceiling heights and floor-slab thickness, posing an intriguing structural dilemma. To avoid obstructing windows, the slabs

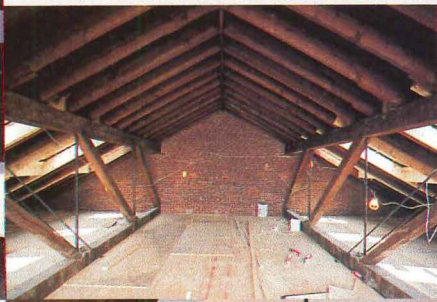

Attic space (above and above right) contained ductwork and operable skylights. Skylights were replaced and space now houses seminar room (right). Original suspension structural system is intact; floor hangs by tension rods from timber roof trusses.

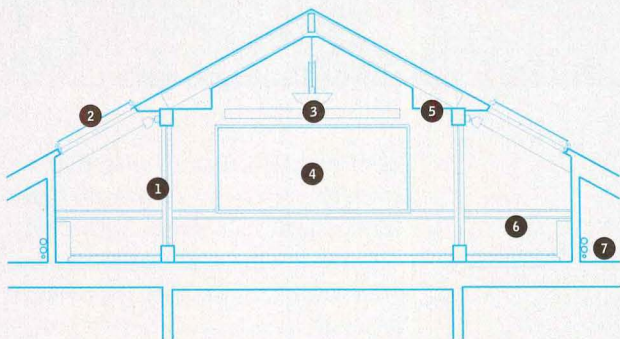

East-west section through seminar room

- 1 existing truss
- 2 skylight
- 3 direct/indirect pendant
- 4 blackboard
- 5 dimmable downlight
- 6 chair rail
- 7 fan unit

BARKER CENTER, HARVARD UNIVERSITY
CAMBRIDGE, MASSACHUSETTS

CLIENT: Harvard University—Elizabeth Randall (project manager)
ARCHITECT: Goody, Clancy & Associates, Boston—John Clancy, Joan Goody (principals-in-charge), Randi Holland, Jean Lawrence, Victor Ortale (associates), Martin Deluga, Christine Toupin Hoelter, Cindy Lee, Tom O'Brien, Eve Schlapik, Robert Turano (project team)
LANDSCAPE ARCHITECT: Carol Johnson Associates, Cambridge, Massachusetts
ENGINEERS: Ocmulgee Associates (structural); Cosentini Associates (mechanical, electrical, plumbing)
CONSULTANTS: Berg-Howland Associates (lighting); Preservation Technology Associates (historic stone and masonry); Falk Associates (specifications) **GENERAL CONTRACTOR:** Shawmut Design and Construction **COST:** \$18.5 million **PHOTOGRAPHER:** Steve Rosenthal

had to be thin and the beams shallow. But the architect was committed to retaining column-free 40-foot spans across the first-floor rooms. McKim's massive scissor trusses had permitted clear spans throughout his central hall, but to create habitable space above the former Living Room, Goody, Clancy needed to replace the one-and-a-half-story members with more efficient steel roof beams. The firm ultimately solved the problem with a variant on one of the building's original structural systems, suspending the second floor from tension rods held by the structure above.

To further enhance the floor slab's thinness, they also ran air-supply ducts down from above. Poché spaces in this Beaux-Arts-era building frequently conceal new mechanical ducts without destroying the original fabric. The architect also cleverly converted unused chimneys into toilet and elevator exhausts. By

moving some mechanical systems from attic to basement and adding 25 operable skylights and 15 dormers, they increased occupiable upper-floor space. Although the new dormers altered the building's exterior, Goody, Clancy discovered more dormers in McKim's original sketches. After restructuring the roof, the architect replaced its thinned, porous, and cracked slate shingles. Air conditioning was installed (a new sub-basement transformer and emergency generator meet modern electrical and computer needs) and the Union was brought up to code with wheelchair-access ramps, an elevator, and automatic fire shutters.

Goody, Clancy & Associates ushered light into the building and, in the spirit of 20th-century Modernism, made vertical circulation a focus. Their inviting, more intimately scaled parlor is well-lit, naturally and artificially, and functions more comfortably as a living room. By contrast, McKim's hall seemed too vast and intimidating for casual lounging, yet lacked the grandeur of some of his more magnificent interiors (such as Boston's Main Library and New York's University Club). In an era of interdisciplinary academia, the new architecture has successfully lured faculty members into the paths of students and other faculty. But sadly, one of the room's most prominent features, its once-light-colored plaster bas-relief ceiling, is gone, surviving only as a casting on display at the Barker Center.

The architectural changes infused new life and spirit into an old dysfunctional building. Change is not always bad—nor always progressive. Fortunately, the Pantheon and the Parthenon were not reshaped to greater efficiency or demolished when their primary purposes vanished. But should we embalm every old space that's stagnating in obsolescence? The Union hall was not among McKim's greatest interiors, nor Harvard's most glorious spaces. Its demise was undeniably a loss, but—unlike the tragic and senseless demolition of McKim, Mead & White's Pennsylvania Station—this change also brought true gain.

FOCAL

designed by architects

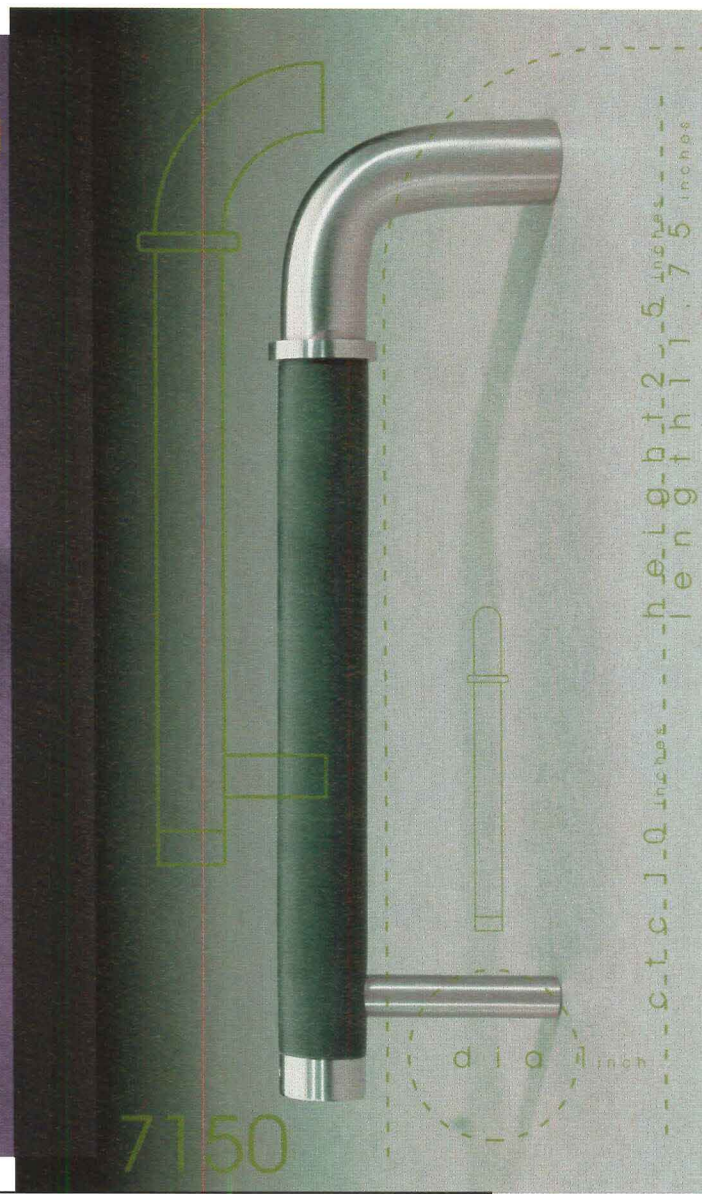
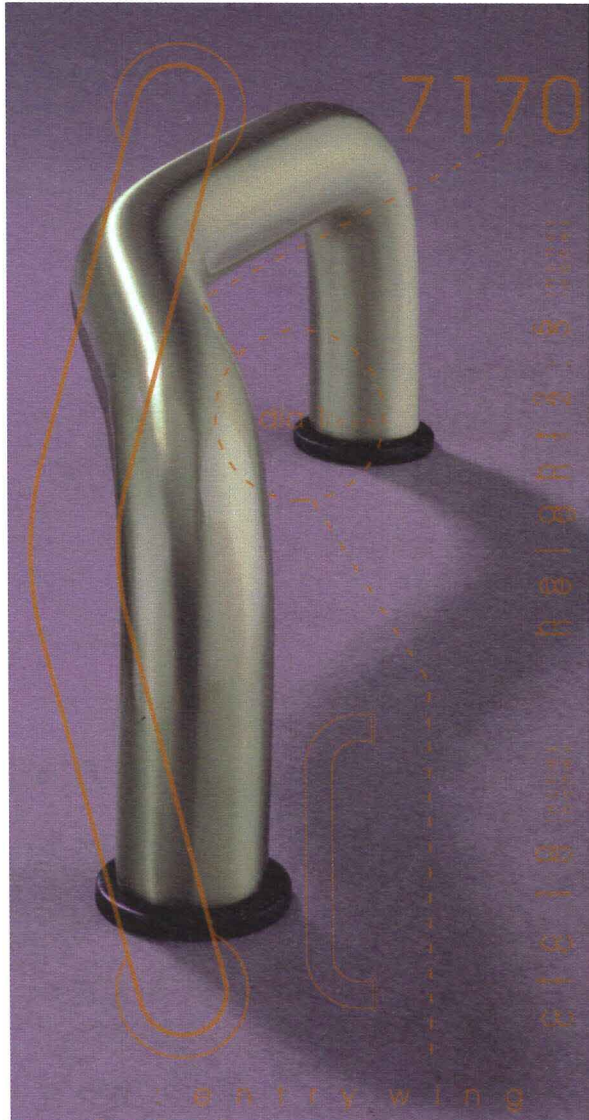
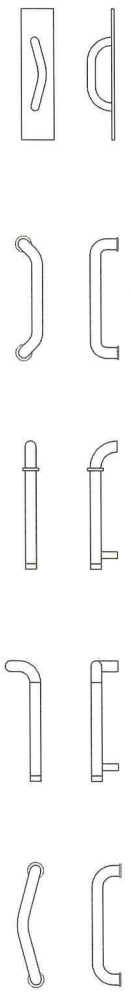

for architects



fOCAL, a full line of affordable architectural door hardware. Since good hardware is essential and cost important, the fOCAL Series is manufactured to be the very best value in the industry.



Custom entry pulls for Getty Center made by TRIMCO/BBW.

TRIMCO/BBW offers the broadest range of sturdy and tasteful accessory door products. For additional information see us in the SweetSource CD and at the SWEETS web site: www.sweets.com

In a variety of fashionings and in all standard finishes, *fOCAL* solves the problem of having to choose between generic and extravagantly priced hardware.

Circle 132 on information card

CALL US AT 213/262-4191 OR TOLL FREE 800/637-8746

Technology **Academic Initiative**

The Intelligent Workplace demonstrates that office construction needn't be oppressive to its occupants.

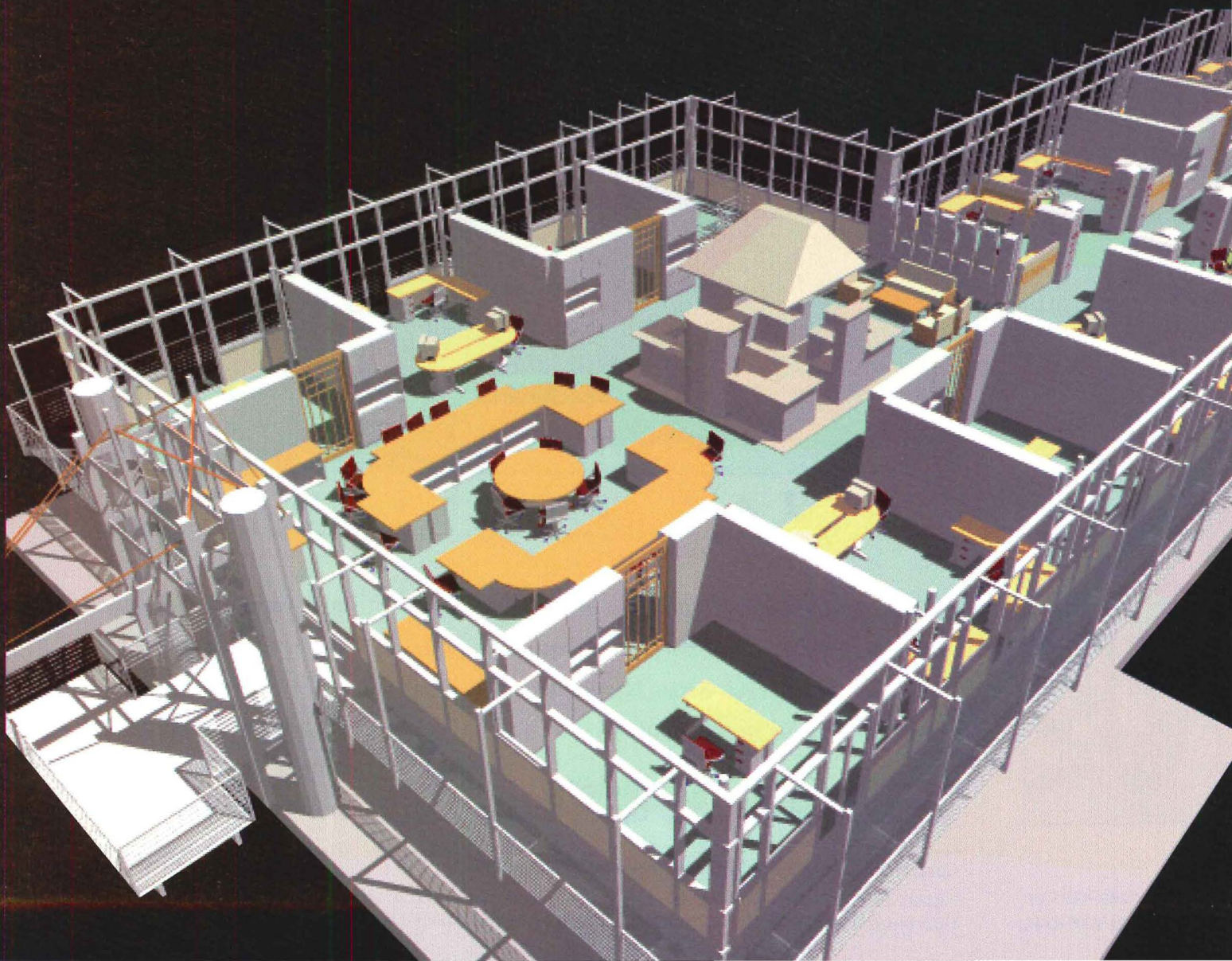

By Ann C. Sullivan

In their daily commutes, those of America's 50 million office workers with new cars enjoy individual control over the temperature, direction, and velocity of heated, cooled, and fresh air. The Lincoln Town Car, for instance, has dedicated rear vents, while the Saab 9-5 and Buick Park Avenue offer dual heating and cooling options. If the driver likes a toasty 74-degree cab while a passenger prefers cooler temperatures, both can ride in climatic comfort. Yet the same employees can't exercise this level of environmental control at work. Office residents usually can't even open a window, let alone adjust a thermostat or redirect a vent.

Lack of climate control is only one shortcoming of the standard-issue office building that designers tried to eliminate in the Robert L. Preger Intelligent Workplace, a 7,000-square-foot working laboratory spearheaded by faculty at Carnegie Mellon University's Center for Building Performance and Diagnostics (CBPD). The designers also attacked the inefficient mechanical systems, poor telecommunication strategies, and generally inflexible interiors that unfortunately characterize most office construction in this country.

Live-in laboratory

The Intelligent Workplace is the brainchild of CBPD Director Volker Hartkopf and Vivian Loftness, head of the Carnegie Mellon's architecture department. Hartkopf traces the inspiration for the Intelligent Workplace to research that he and Loftness conducted in Canada in the early 1980s. Hired by the Canadian government to evaluate office building performance, the husband-and-wife team examined structural, mechanical, and ventilation systems in a number of existing offices. "The surprise to us as architects was how inadequate these buildings were if they were measured through the eyes, noses, and ears of the occupants; how inadequate they were in terms of organizational requirements; and how completely ill-prepared they were to accept new

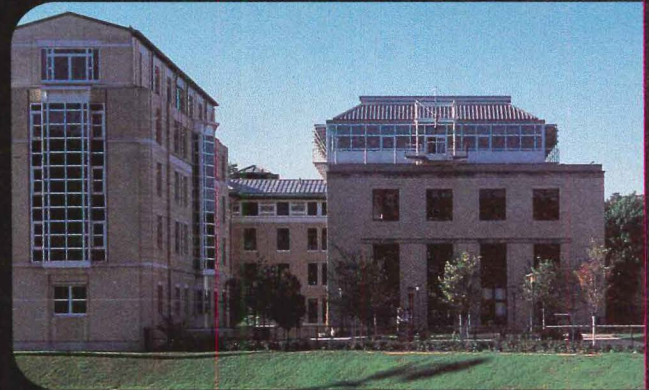
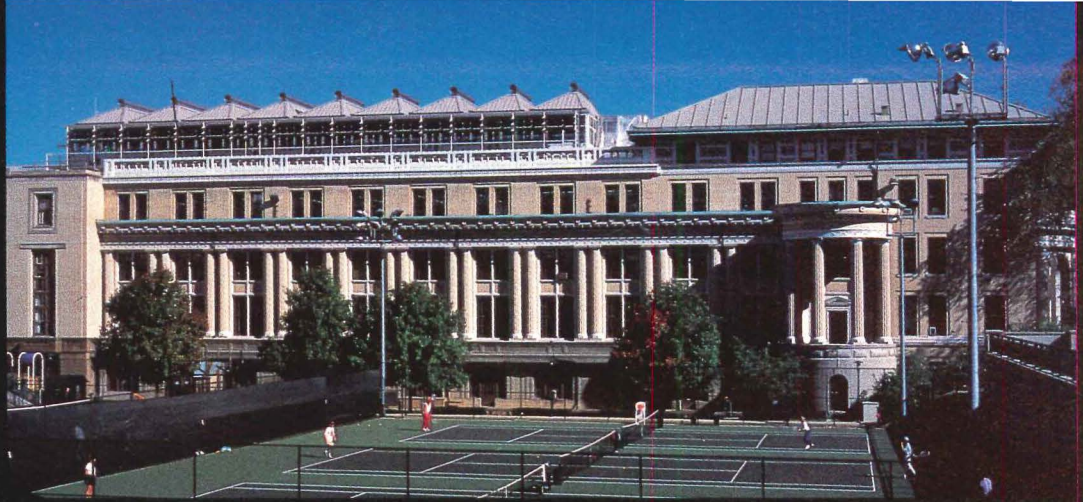

technology," explains Hartkopf, noting that the personal-computer revolution was gathering speed at the time of this research.

Writing proposals wasn't a sufficient conclusion to their studies, the pair decided, "because the problem was so large and so intractable," Hartkopf says. **They decided that a demonstration project was the best way to show designers and the public that buildings can be designed more efficiently.** Hartkopf championed a "living laboratory" dedicated to the research, development, and integration of building systems. "Early on, we formulated the idea of building a demonstration project on campus," recalls Hartkopf. "The university was willing to entertain the idea as long as we were able to raise the funds outside."

CBPD's efforts to solicit external support were formalized in 1988 with the founding of the Advanced Building Systems Integration Consortium (ABSIC). The first big player to join this university-industry-government alliance, which today carries a \$50,000 annual corporate

Comfort and flexibility drove interior design of Intelligent Workplace (facing page). Raised floor and modular carpet tiles make it easy to relocate diffusers and access data, power, voice, and video lines. Ergonomic chairs from Grahl and Steelcase desks are joined by modular storage walls. Modest structural enhancements to the existing Beaux-Arts building (top and above) were made to the floor below the penthouse addition.

membership fee, was Johnson Controls, whose personal environment system delivers individual, desktop climate control to the deskbound masses. After curtain-wall manufacturer Josef Gartner & Company agreed to donate a facade, the project gained momentum and the CBPD approached Swiss architect and former CMU Visiting Professor Pierre Zoelly with the idea of designing a rooftop addition to a classroom and studio building.

The Intelligent Workplace, a shining steel, aluminum, and glass structure, sits atop architect Henry Hornbostel's 1904 Margaret Morrison Carnegie Hall on Carnegie Mellon's Pittsburgh campus. Its exposed

1 Doors and fixed windows are glazed with Viracon low-E, argon-filled glass. Recycled steel and aluminum frame all modular units. Occupants can reconfigure facade and interchange doors and windows as needed.



2 Recycled steel trusses and columns were pre-fabricated to reduce on-site waste and accelerate workplace's construction time.

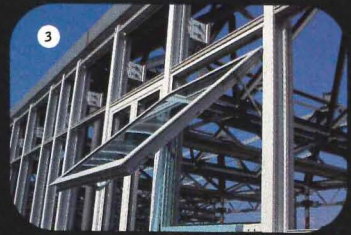

3 Interpane's PPG Hestron Sungate and Azurlite glazing creates blue tint. Fixed windows by Viracon, which were ordered later in schedule, eliminate this tint, but meet same performance specifications.

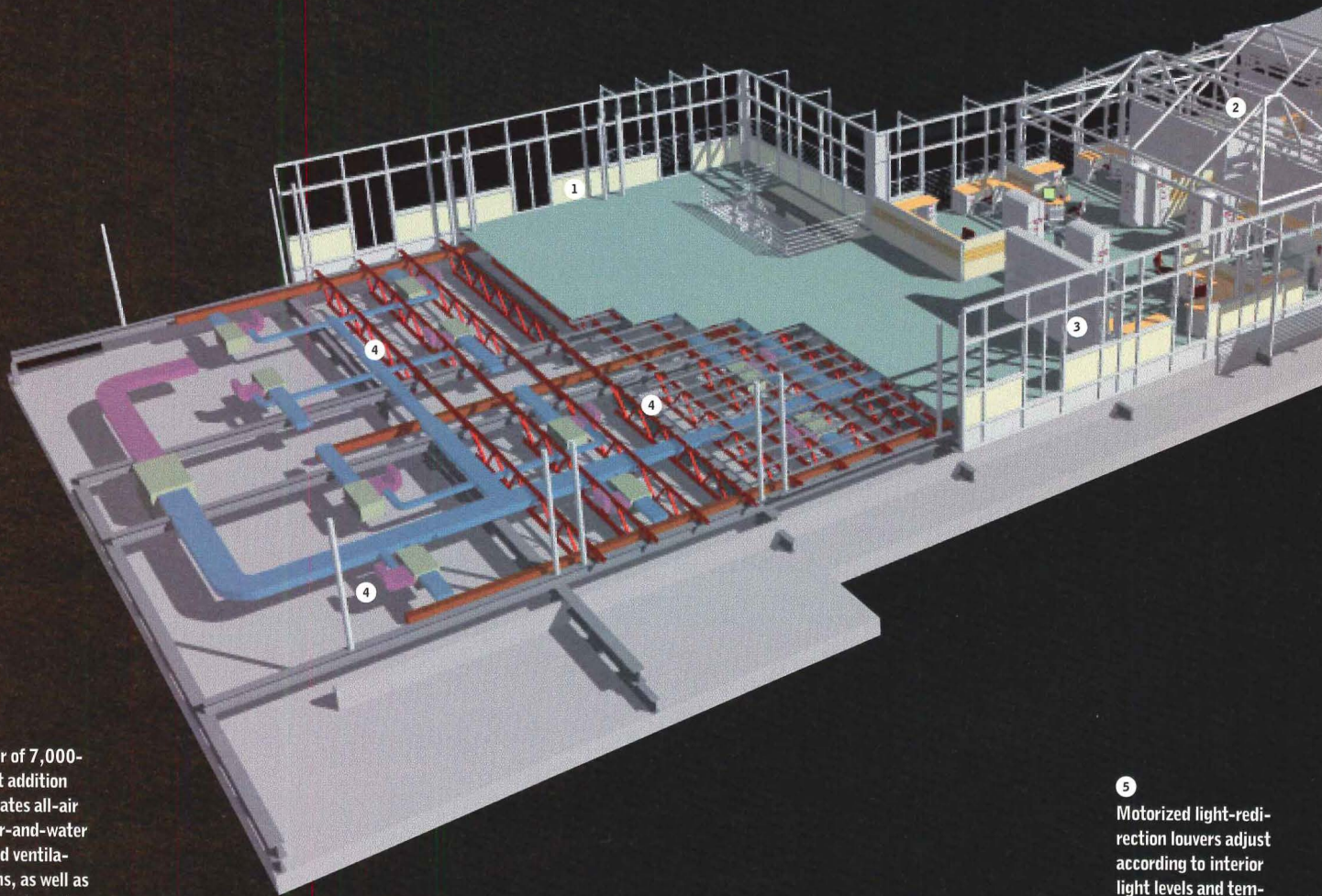

4 Raised floor of 7,000-square-foot addition accommodates all-air and split air-and-water thermal and ventilation systems, as well as central computer network supplying power, data, voice, and fiber connections.

5 Motorized light-redirecting louvers adjust according to interior light levels and temperature and reflect light to ceiling; interior diffusing shades control glare.

modular structural bays and highly articulated glazed facade stand out in contrast to the staid base of Hornbostel's building.

When the center announced its intentions to build atop Margaret Morrison Carnegie Hall, "everybody thought we were crazy," laughs Hartkopf. "But I knew we couldn't go for a piece of land that everybody else wanted. We had to get something that nobody else thought about." On campus, the scheme was referred to as "Volker's Folly," he boasts with the assurance of someone who has silenced his skeptics.

The solution

The Intelligent Workplace was designed to maximize passive conditioning, or "comfort without a plug," asserts Loftness, referring to low-tech strategies that rely on daylight, shading, and fresh air for economical environmental control. The building's narrow section and open plan facilitate natural ventilation, since fresh air can flow unimpeded from one side to the other; rooftop ventilators induce stack-effect cooling by drawing warm air that has risen to the ceiling outdoors.

The Intelligent Workplace breaks many cardinal rules of conventional office design: Most noticeably, it eschews common forced-air mechanical systems that avoid expanses of glass and operable windows. Yet the designers of the workplace insist that natural ventilation, radiant heating and desiccant cooling, and photovoltaic panels can reduce energy costs by 50 percent over conventional systems.

The Intelligent Workplace's modular raised floor takes wiring and

ductwork out of ceilings and walls and allows workers to relocate and replace telephones, computers, power outlets, and floor diffusers with minimal effort. Users can also control air temperature around their personal workstations, which can be rearranged as needed in the open-plan layout. **Keeping tabs on all the mechanical components and environmental conditions is a network of sensors that monitor everything from air temperature and humidity to light levels and occupancy status.**

Prefabricated recycled steel components and bolted connections are the defining features of the one-story project's structure. Rectangular bays form the shell of the 7,000-square-foot, L-shaped space. Two-foot-deep open-web trusses accommodate mechanical ducts and support lighting, cooling components, and the electronic sensors that measure air quality and lighting. Perimeter columns allow an open floor plan. The modular steel skeleton, facade, and flooring system—all designed by Zoelly—can be quickly disassembled and reconfigured if necessary.

A design team consisting of CBPD faculty, architects of record Zoelly and Bohlin Cywinski Jackson, and structural, mechanical, and electrical engineers refined the scheme and saw it through to the project's completion. Design authorship is graciously shared: "It's an antiquated idea that there is a single name behind a building," notes Loftness, who speaks highly of the design team's collaborative approach.

Members of the consortium, too, contributed more than just money to the design effort. They brought ideas and new products designed to improve the building envelope, acoustics, and HVAC, lighting, and telecommunication systems. The layered facade engineered by Josef Gartner & Company, for example, incorporates computer-controlled shading and reflective louvers that respond to changes in daylight levels and temperature. Water circulates within the aluminum-encased steel mullions for radiant heating, and Pilkington Flachglas photovoltaic



panels generate enough electricity to power blinds, fans, and heat pumps.

Inside, Johnson Controls' Personal Environments Module allows an occupant to regulate air flow and temperature in his or her immediate area—and turn on white noise to create privacy—from a small control module, a pair of desktop vents, and an under-desk mixing unit. Occupants can control Zumtobel's LaTrave indirect-direct luminaires and recessed perimeter uplights with manual switches or by remote control. Otherwise, a computer program adjusts artificial lighting on the basis of occupancy and daylight levels, which helps to minimize energy consumption throughout the workplace.

Artificial intelligence

The common denominator among these automated products and systems is artificial intelligence: Each responds to environmental conditions as measured by a fleet of sensors mounted inside and outside the structure. Air-quality sensors monitor indoor and outdoor air temperatures, wind speed, humidity, heated or chilled-water temperature, and carbon dioxide levels. Motion detectors keep track of occupants, and lighting sensors monitor daylight and indoor light levels. These sensors feed information to computerized facility-management systems, including the Metasys System from Johnson Controls and the Instabus lighting control system from Siemens Energy & Automation. The hardware for these systems is displayed in glazed containers resembling china cabinets that occupy a prominent location in the center of the workplace floor as an educational tool, Loftness explains.

Money remains the greatest obstacle to widespread adoption of systems applied in the Intelligent Workplace. Loftness estimates that incorporating these systems in a new building could run up to 50 percent over standard construction costs, or an additional \$5,000 to \$10,000 per occupant, on average. Yet that high number sounds more reasonable when one considers that many

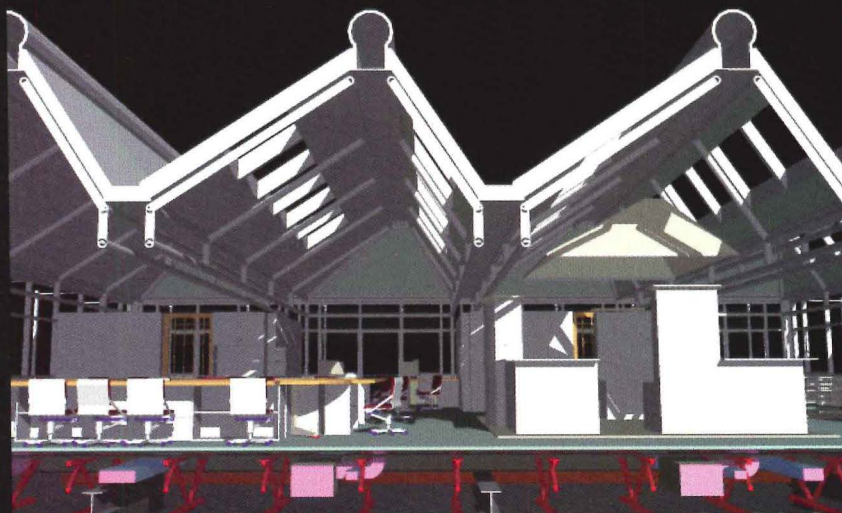

companies spend that amount and more annually just to arm employees with the latest in computer hardware and software. Further, the increased initial cost will be offset by reduced energy consumption and increased comfort and productivity. Still, Loftness admits that it's a tough sell when most clients are thinking, "How cheaply can I house my workforce?"

The prevailing attitude—keep start-up costs down—hurts building research efforts, which suffered a symbolic blow when the American Institute of Architects reduced its three-year-old internal research division, AIA Research, to a single staff member. The end is near for the program, which the AIA usurped from the ACSA in 1995. To compensate, the AIA is planning a spring debut for its own Center for Building Performance, which will fall under the jurisdiction of the Building Codes and Standards Professional Interest Area. However, no clear mission has emerged and Loftness remains dissatisfied with the AIA's efforts. "Not to be engaged in research is ludicrous," she admonishes, citing

Roof-mounted daylight sensor by Zumtobel continually measures workplace's daylight level. Manufacturer's LaTrave luminaires and perimeter uplighting illuminate when interior light levels drop below predetermined level.

the American Society of Civil Engineers as an example of a professional organization that supports a vibrant research agenda.

Nonetheless, the CBPD remains committed to its cause. The Intelligent Workplace challenges people to look at buildings as sustainable and renewable assets, rather than depreciating and inevitably obsolete containers. Otherwise, architects, engineers, building developers, and owners will continue to deem a 20-year life cycle as acceptable performance—and occupants will continue to suffer the consequences.

Ann C. Sullivan is a freelance writer based in Framingham, Massachusetts.



Product:
 EFCO Series 5800 Silicone
 Gasket Curtain Wall System
 (formerly Don Reynolds
 Curtain Wall System)
 Building:
 Kemper Arena,
 Kansas City, MO
 Architect:
 H.N.T.B. Architects
 Erector:
 Building Erection Services Co.

SILICONE GASKET CURTAIN WALL

THAT GIVES FLEXIBILITY OF DESIGN
 WITHOUT PERFORMANCE CONCERNS.

FLEXIBILITY

It's our silicone gasket that makes the difference.

In fact, EFCO™ Series 5800 (formerly Don Reynolds) structural exterior-glazed curtain wall is the only system with a durable silicone gasket that is impervious to harmful U.V. rays, water, temperatures, and atmospheric pollutants for the lifetime of the building. And Series 5800 delivers a superefficient seal with zero water infiltration.

Our gasket comes in 21 standard colorfast shades, or specify custom colors. With this narrow sightline system, you can design curved walls using flat infills up to 7° off-axis, or create slopes down to 20° from horizontal. You'll even save labor since the factory-fabricated continuous gasket is easy to install in any weather, with no sealants required. Plus there are no internal frame or joint seals, plugs, or pressure plates, and no snap covers are needed. And Series 5800 is ideal for new construction or retrofit.

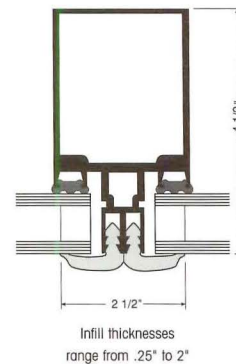

All of these benefits—combined with EFCO's engineering and manufacturing expertise—made Series 5800 the choice for Kemper Arena. Discover the system that's been a proven performer in hundreds of installations. Ask your EFCO representative about Series 5800, call 1-800-221-4169, or visit our Web site at www.efcocorp.com. Circle 134 on information card



WINDOWS
 CURTAIN WALLS
 ENTRANCES
 STOREFRONTS

SEE US AT AIA BOOTH 1634

Practice Taking Charge

With management consulting firms expanding into real estate and design issues, architects could be squeezed out.

By Michael Maynard

Architects have watched fretfully in recent years as major chunks of their business slip away to other professions. But now some practitioners are trying to win back full project control by selling their expertise as a broader array of consulting services: from aiding with real estate decisions to troubleshooting and improving the workflow among employees in a clients' operations. Whether firms view these expanded services as a more holistic, client-driven approach to architecture or simply imaginative ways to keep busy, the fact is that consulting can be very profitable.

It is also quite competitive, especially as architects begin to overlap with big-name management consulting firms in meeting clients' needs. Consulting also creates an identity question for architects who want to keep their franchise in design, but see the earnings potential of moving beyond it as well.

Many forward-thinking firms are dropping the architecture, planning, and engineering tag lines, says Mark Zweig of Zweig, White & Associates, a Natick, Massachusetts-based consulting firm. "They're saying, 'We'll consider any service we can make a profit on that doesn't detract from our image as architects.'"

Knowing the client

Both design firms and management consultants are competing in a business climate where flexibility

is the operative word. "The client demands people that understand their business," observes Zweig. For example, an architect with a pharmaceutical client should be keeping up to date on healthcare issues.

When principals of Washington, D.C.-based Greenwell Goetz Architects saw an opportunity in the early 1990s to go beyond design work to serve clients in new ways, such as managing a corporate reorganization, they concentrated on learning a client's business. Today, the 55-person firm, which specializes in corporate interior architecture, puts together teams of programmers, human resources specialists, or other types of facilitators for clients who want to change their workplaces, whether it's to create a better image or to enhance efficiency. Drawing on the recommendations of the consultants it brings aboard, Greenwell Goetz will implement a design that incorporates the client's goals.

Such an approach, suggests Principal Lewis J. Goetz, is "integrated." That is, the architect addresses multiple issues related to how a business functions instead of merely creating an attractive environment. When Greenwell Goetz redesigned the Marriott Corporation's headquarters in Bethesda,

Maryland, it brought in Watson Wyatt, a human resources firm, to help transform the building from private offices to an open plan. In developing a building for Manor Care, a healthcare organization, the firm chose to work with the client's human resources staff to implement the new floor plans.

But just as Greenwell Goetz wields its design credentials to overhaul the workplaces of clients, large, well-established management and accounting firms are using their business credentials to establish inroads into the design world. Such worldwide consultants as Booz-Allen & Hamilton and Arthur Andersen have established dedicated facilities planning and management divisions to program, design, and manage properties for their corporate clients.

At Booz-Allen & Hamilton, a management consulting firm based in McLean, Virginia, a "facilities and infrastructure management team" advertises its ability to "provide preliminary space-plan concepts, facility designs, construction documents, design management, [and] construction management and scheduling." It sounds like a line from an architecture firm's marketing brochure. Increasingly, these management consultants have been making the case that, rather than architecture firms, they are better equipped to meet their clients' needs.

The real issue is "behavioral," says Peter Miscovich, who trained as an architect and engineer and now heads the "workplace transition group" in New York City for Arthur Andersen, the worldwide consulting firm. Miscovich contends that architectural solutions alone do not solve a client's workplace problems.

Miscovich argues that Andersen, with a cadre of architects, interior designers, workplace strategists, and an organizational psychologist in the workplace transition group, can address a host of sophisticated client

Large, well-established management and accounting firms are using their business credentials to establish inroads into the design world.

Consulting opportunities for architects span the entire life cycle of a project or series of projects, from management and facility planning to construction and building operation.

challenges that integrate technology, layout or floor plans, and employee dynamics. Looking at the situation architecturally would be limiting, he says. With a consulting firm, "we're taking this to another level."

Booz-Allen & Hamilton, too, counts as its strength a diversity of employees who can analyze client needs. "To do this correctly, you need a real breadth of skill sets," asserts Mike Craig, a principal in the company's facilities strategies and operations team. Booz-Allen employs only a "token" number of designers because its interior design services represent a small subset of its work. "We're really focused heavily in that longer piece of the facilities life cycle, which is to operate and maintain" clients' buildings.

Still, architecture firms with a specialty, be it retail, management, or educational facilities, see them-

selves as equally if not more qualified to do this work. That was the view of principals at Bergmeyer Associates of Boston, which was established as an architecture firm in 1973, but developed a new mission statement in the early 1990s when the principals broadened their perspective. "In the mission statement was a key phrase that said we're a consulting firm that specializes in architecture and design," remarks Principal Joseph P. Nevin. Such flexibility has allowed the firm to pursue opportunities such as pulling together consumer research, and retaining marketing consultants and graphic designers to advise on ways to increase amenities for museum visitors. "One part of what we do is bring a team together that's tailored to the specific needs of the client and the project," Nevin says. With this strategy, Bergmeyer's retail division has become specialized in marketing and merchandising as well as design.

Selling business smarts

Architectural giant HOK recognized in the early 1980s that a consulting arm could be a valuable asset to its design work, in terms of both dollars and prestige. The work of HOK Consulting (HOKC) evolved from the predesign services that the firm provided its corporate clients. "That work has continued to expand as clients redefine what the workplace should be," Steve Parshall, HOKC's practice director. As customers asked for more services, "conventional answers to office spaces, research, and design weren't valid anymore," he says.

Industry analysts say that HOK had the foresight to forge new paths

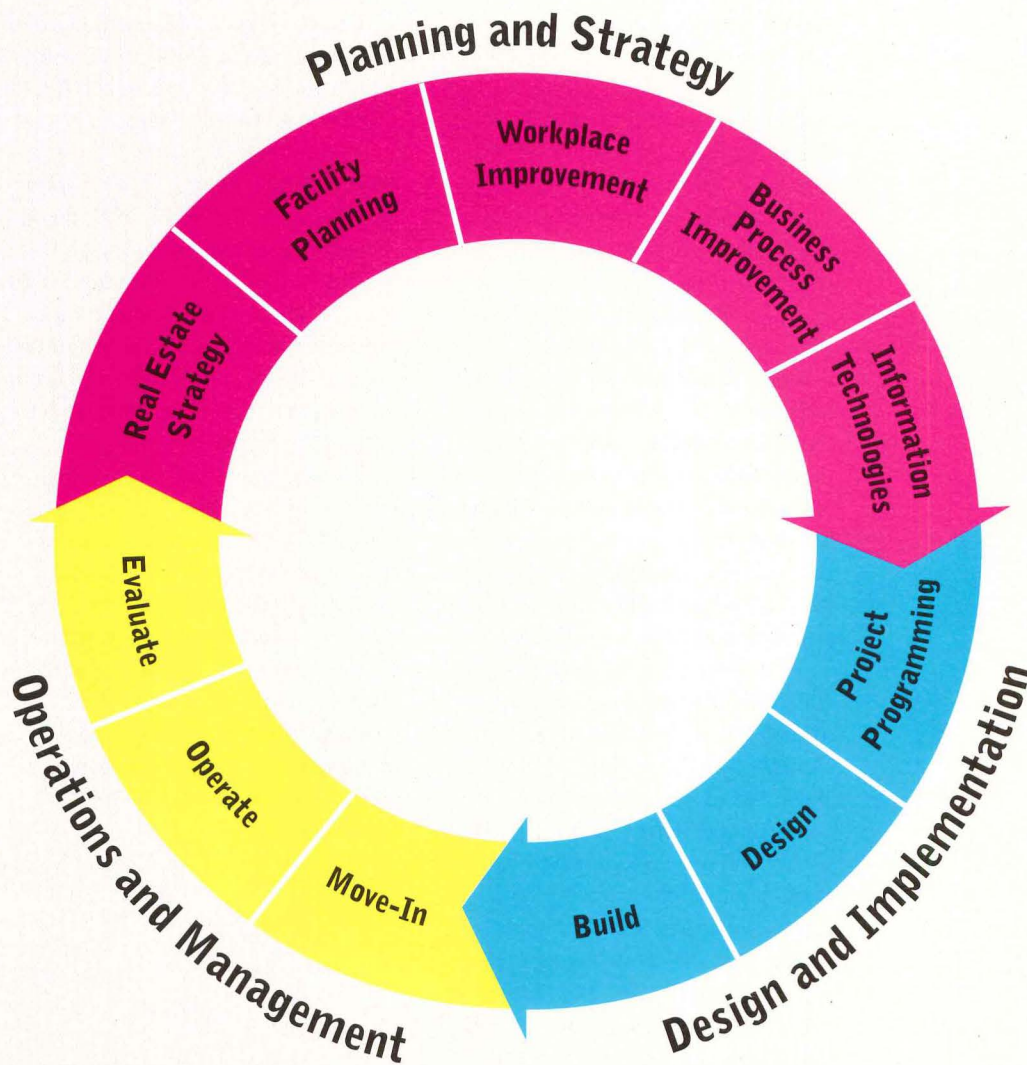

into strategic planning and management consulting instead of becoming locked into strictly architecture and engineering. Architecture firms can play a large role in helping clients "redefine" the workplace. Gene Kolstad, the president of CTA Architects in Billings, Montana, calls it the client's "latent needs." About four years ago, as the result of a strategic planning session, CTA decided to undertake a range of services that stood apart from its traditional A/E work.

CTA has expanded into facility management, recently landing a contract with Billings-based First Interstate Bank to maintain 40 banking facilities in a two-state area. The consulting work will involve assessing the bank's facilities, including its energy needs, workspaces, and the condition of everything from its computer systems to its carpeting. "My guess is that through the course of doing all this we're going to identify \$500,000 in yearly savings" for the client, Kolstad says.

As firms successfully branch out, both clients and architects discover new opportunities for collaboration. Architecture "is not just about architects creating spaces," says Nevin. "As you climb up the ladder in prominence, [clients] are expecting much more of you. The saying that 'architects don't do that' doesn't really apply in my book." And most architects who continue to recite from that book "will go broke," predicts Zweig. Firms that are going beyond design work is why architecture as an industry "is not doomed," he observes, adding that the best architecture firms "are more willing to combine these other services."

Most design firms still do not separate out revenues for consulting and design work. Goetz says that the work is so interrelated that it would be difficult to distinguish the revenues, although he does not rule it

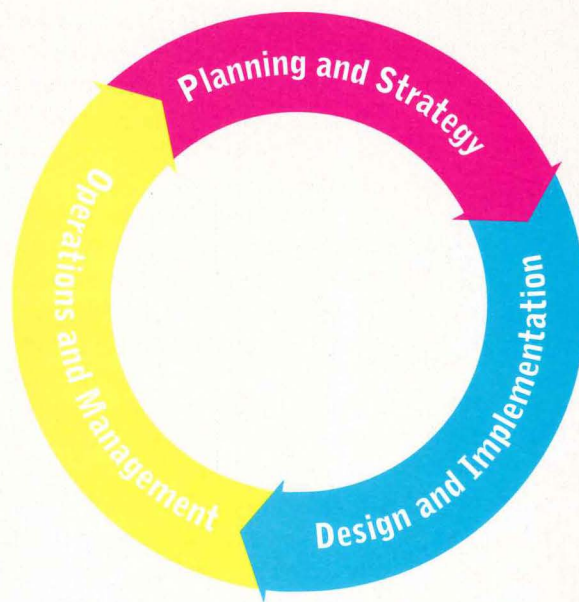

out in the future. Bergmeyer's Nevin, too, says that each division within the firm does not differentiate between design fees and the other work that it produces. As such firms become more established in related fields, however, it seems likely that such fees will be separated.

Architects such as Kolstad are taking advantage of what consultants like Zweig and Hugh Hochberg of Seattle, Washington-based Coxe Group say should be an integral part of any firm practice: identifying with the client. "Firms that have a strong marketing bent or better client rapport are more likely to be tuned into what the clients are looking for and are likely to get into a broader service base earlier," comments Hochberg. And those firms will influence future planning and design decisions.

Nevin relates a job interview in which Bergmeyer was one of the firms bidding to design a prototype store. Instead of touting his firm, Nevin asked why a new store was necessary. When he was told that the parent company was demanding a greater return on its investment, Nevin responded with a focused strategy for the store based on the company's goals. "We addressed the things that really mattered to them," Nevin explains. They got the job.

Maintaining objectivity

While a firm's consulting arm may result in future design work, architects must be careful to remain objective in their assessments of what a client should do—for instance, either build a new facility, remodel, or do nothing. "We work quite separately from the design piece of HOK so that clients can come to us for an objective view," says John Francis, a senior associate for HOKC in St. Louis.

Miscovich of Arthur Andersen, though, says his firm brings a third-party objectivity to its recommendations. "We're really in an advisory role to clients," he says. The firm will assist in the selection of architects, vendors, and manufacturers to a project. By getting inside an organization and understanding its development and behavior, Miscovich says that his firm can work with the employees to adapt them to new environments and the integration of new technologies. "It's a much more complex challenge than developing a plan, designing a space, and hoping that it works out," he adds.

The consultative role of such firms worries architects, who then become once- (or sometimes twice-) removed from the client. That can lead to its own set of misunderstandings. "There could be a disconnect between the consulting side and the implementor," says Goetz. The architect may not understand the issues behind the decision-making.

Leading teams and integrating services is not a new concept, however, as Goetz points out. "It used to be that the master builder was in charge of the whole process," he says. Architects have had pieces of the master building process taken away from them over time. And Goetz worries that if they do not respond to the changing corporate culture, architects may be shut out altogether.

Ellison's Balanced Door. Greater Than The Sum Of Its Parts.

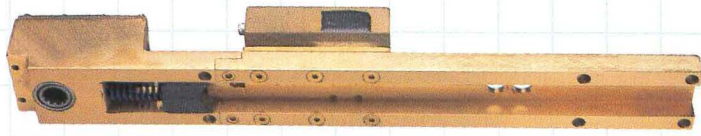

Cast bronze check and door guide assembly

+



Cast bronze top pivot with bearing

+



Torsion bar closer spring

+



Cast bronze bottom arm

+



Cast bronze semi-automatic hold open device

+

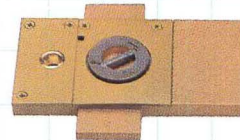

Cast bronze floor box

+

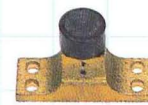

Cast bronze door roller guide

+



Cast bronze door bottom pivot

+



Cast bronze top arm

=

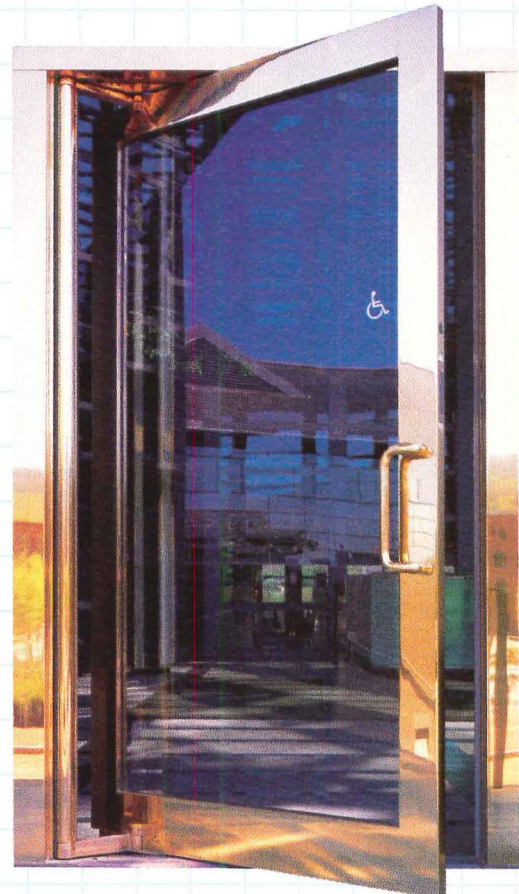

You can open it with one finger in a heavy wind. It meets ADA requirements without additional hardware, and will operate dependably decade after decade. The construction and finish are meticulous, and the door comes with a no-hassle "bumper to bumper" ten year warranty. It is the unique Ellison Balanced Door, a system of components engineered to produce flawless operation and headache free maintenance.

Ellison makes everything—from the overhead check and guide assembly to the cast bronze top and bottom arms—in one manufacturing facility which includes a bronze casting foundry. Others have attempted to duplicate our hardware, and mimic our old-world craftsmanship. None have succeeded. Fast comparisons show major differences:

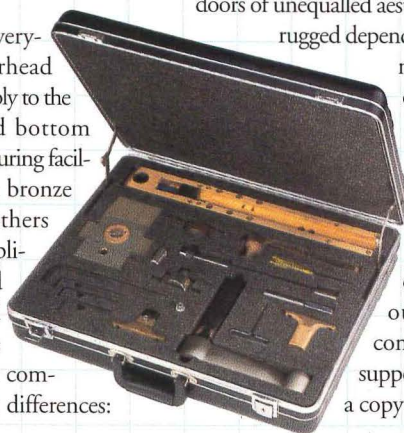

Circle 136 on information card

.09" thick stainless steel or bronze sheets are welded directly to an interior-tied subframe to form an impressive 2" thick door; our one piece arms are cast from molten bronze and then machined in our own shop; our exclusive concealed overhead check component provides easy routine maintenance.

While the others experiment with a part bought here, a part made there, Ellison continues to design and build doors of unequalled aesthetic appeal and rugged dependability. If you've

never had the opportunity to see or feel the parts that make the whole, let us bring our case to you. Or, call and request our package of complete technical support literature and a copy of our video.

ellison

Ellison Bronze, A Division of Dowcraft Corporation
125 West Main Street / Falconer, New York 14733
716-665-6522 / Fax: 716-665-5552
www.ellison-bronze.com

Computers

Urban Simulations

Hybrid CAD and GIS applications help architects and planners predict the impact of their work.

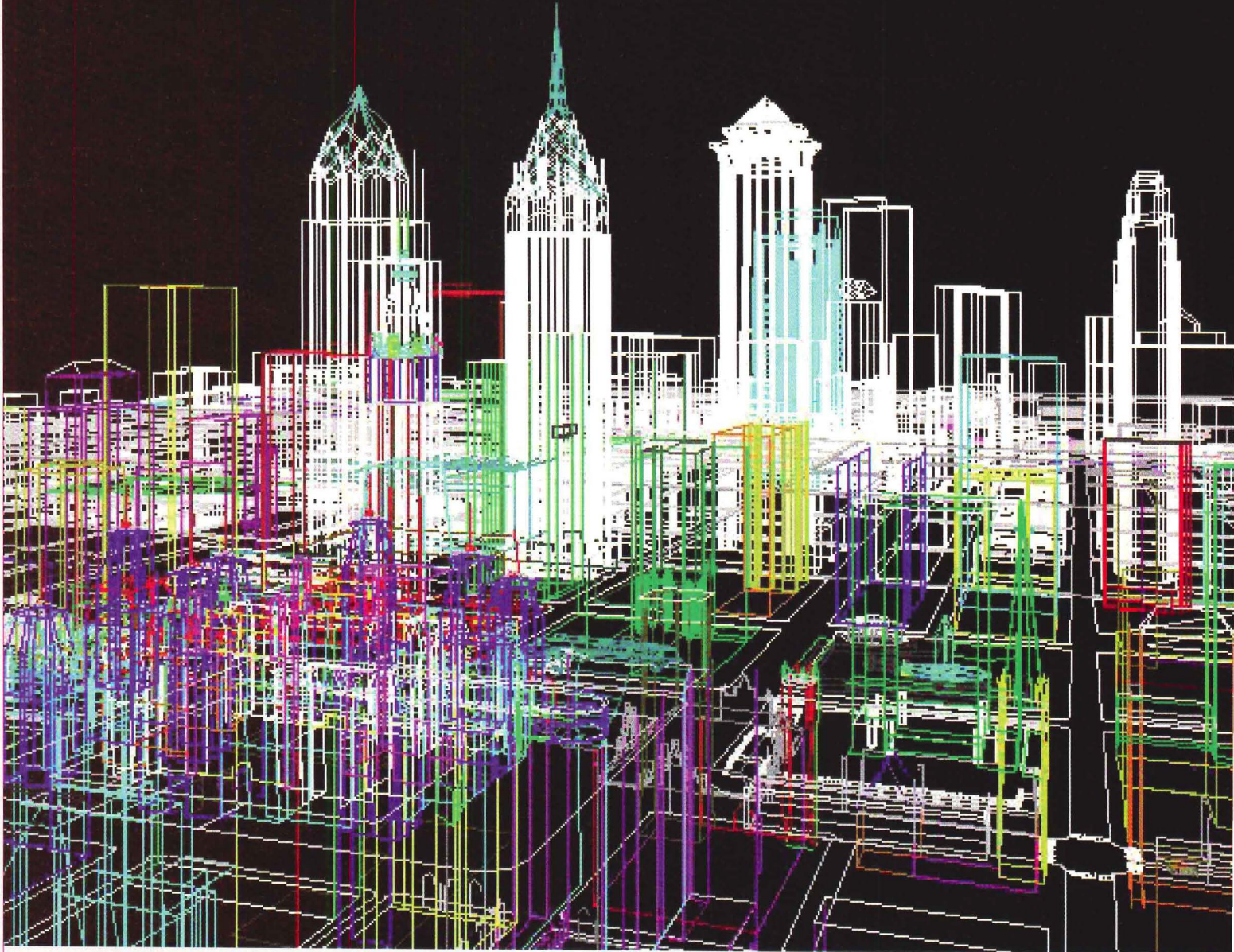

Wire-frame model reveals skeleton of Model City Philadelphia (above), an urban simulation initiated by Bentley Systems. Developers modeled streets and buildings of downtown core (facing page, left). Plans, sections, and elevations can be extracted from three-dimensional volumes (facing page, right).



By Ann C. Sullivan

Last summer, Boston Mayor Thomas Menino and Linda Haar, of the Boston Redevelopment Authority, took a break from their duties to play a computer game. The game was SimCity, which challenges players to design and build a functional, fictional metropolis from scratch.

Since SimCity debuted in 1987, millions of copies of the urban planning game have been sold to children, adults, and teachers. It has also gotten the attention of public officials and city planners like Menino and Haar, who find it interesting because it links architectural and environmental data to urban design efforts. Every decision a SimCity player makes has an immediate effect on fiscal conditions, and every operational decision influences regional demographics.

If SimCity's formulas could be applied to a real city, a mayor might visualize the impact that a new waterfront stadium, for example, would have on traffic patterns, crime, population, employment, and income. Then, urban-scale models could test designers' instincts before cities spend millions on construction.

Combining CAD and GIS

Today, architects and software developers are working on just such urban-simulation applications for real-world uses. But it isn't as easy a task as the game might suggest. While design and geographical analysis frequently go hand-in-hand in urban planning, it's nearly impossible to find both sets of tools in a single software application. What makes it so difficult is that the two types of analysis rely on distinct

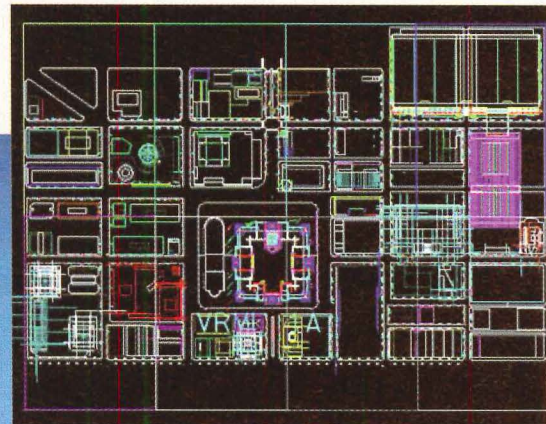

technologies that, for the most part, have always operated independently of each other: computer-aided design (CAD) and geographical information system (GIS) applications.

In the construction industries, CAD has made it easier for architects, engineers, and developers to model structures and evaluate building designs in the context of their sites. But physical modeling is not sufficient for an urban simulation. If a virtual city is to be more than just a glitzy visual presentation, it must be linked to intelligent data that contributes to its design and operation.

Referencing data to CAD files isn't new. In the last decade, CAD building components have evolved from static collections of lines representing windows, doors, and walls to three-dimensional objects with attributes such as size, weight, material, and fire rating contained in their codes. Urban models demand similarly enhanced figures that estimate gas, electricity, and water loads for each new structure, and take into account the burdens that occupants will place on parking, traffic, and public transportation.

This is where CAD packages yield to GIS applications. Retrieving and organizing data is the hallmark of GIS technology, which stores environmental, topographical, and demographic information in layers linked by geographic reference points.

The merging of these two tech-

nologies promises to revolutionize urban design. In two cities, such a merger is taking place. And with new software products about to hit the market, architects and urban planners no longer have any excuses for failing to look at the big picture.

Integrating design and data

Architect and virtual reality specialist Mike Rosen heads the Philadelphia Virtual Reality Center (PVRC), a consortium of utility companies, city planners, and government agencies that is developing ModelCity Philadelphia. This virtual model will ultimately include all of the city's streets, buildings, and public works in an interactive three-dimensional environment that users can navigate in real time.

The project was initiated by CAD developer Bentley Systems.

The company reverse-engineered a several square-block section of the city and created a virtual model. After developing the architectural shell, Bentley Systems turned control over to Rosen through a limited licensing agreement. His \$1.5 million center, which opened in January, is a joint venture between Philadelphia-based RWZ, Inc.—a virtual-reality spin-off of Rosen's architectural practice, Rosen & Associates—and the Swedish firm Prosolvia, which owns and operates virtual-reality centers around the world.

PVRC's goal is to create a central resource for engineering data, including physical structures such as buildings and streets, public transportation routes, and underlying infrastructure like the location of utility, phone, and cable lines. Architects will be able to design buildings

UCLA's real-time simulations allow users to navigate enormous visual databases using gamelike interface. The Virtual Los Angeles database covers more than 20 square miles of downtown L.A. (facing page, bottom left and below).



Los Angeles city planners and community members use technologies adapted from military flight simulations to envision redevelopment projects in South Central, the Pico-Union district (far right), Playa Del Rey, and the Vermont Avenue subway station area (right).



laid aerial photographs that reveal building footprints. Architecture students are photographing the facades of every building and using these images to build three-dimensional geometries for each. Eventually, the model will cover more than 10,000 square miles.

Proprietary software drawn from military flight-simulation programs allows users to “walk” through individual neighborhoods as well as fly overhead and experience satellite views. But UCLA’s intention is not to produce high-quality presentation renderings, Jepson points out. The primary benefit of the model is the ability to navigate the city in real time, at a rate of about 30 frames per second. Users can see what a proposed building would look like on its site, change the cladding material, and witness in an instant what 15 years of growth will do to a sapling.

within the context of the greater metropolitan area, and city engineers will have access to accurate measurements of land and city infrastructure.

For this to happen, the virtual-reality center must collect enormous amounts of data. The group plans to recoup expenses by charging architects and city planners for using the high-tech model and by contracting other virtual-reality services.

“We see architects using the model for all different things, such as making presentations to neighborhood committees, zoning hearing boards, and financial institutions,” Rosen predicts. The center will give architects access to the technology, which Rosen admits is out of the technical range of most firms.

Virtual Los Angeles

Meanwhile, architects in Los

Angeles have already put more than three years of effort into a virtual model of their city. The project is spearheaded by Bill Jepson, director of computing for the University of California, Los Angeles (UCLA) Department of Architecture and Urban Design. Jepson manages the school’s Urban Simulation Laboratory and is project director for the City Simulator project, a real-time virtual-reality system that lets users explore visual databases using a gamelike interface.

Virtual Los Angeles combines three-dimensional models generated in standard CAD applications with aerial photographs and street-level videos. Project developers created a digital-terrain model from city engineering data, determined street widths and alignments through a global coordinate system, and over-

Common ground

The Philadelphia and Los Angeles urban models are massive endeavors. The Virtual Los Angeles database is dozens of gigabytes in size. Within three to five years, the team expects that it will exceed one terabyte. To handle this enormous volume of data, Jepson and his team developed the Virtual World Data Server, a large, multiclient server that will allow multiple users to access the virtual model at once.

For the rest of the design world,

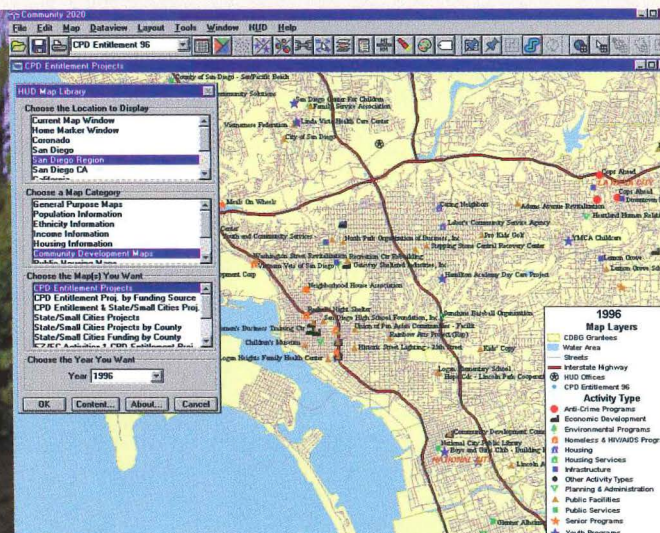
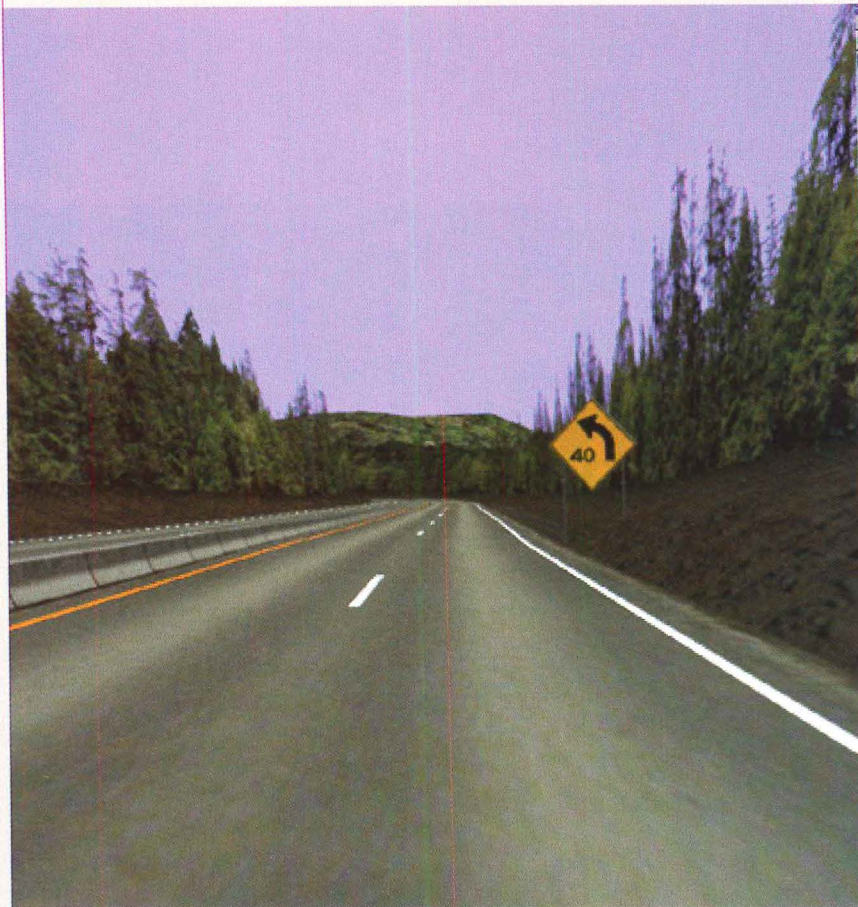

Coryphaeus markets integrated software suites for aircraft, automotive (above), and urban simulations. Community 2020 Version 2.0 (above right) displays HUD program locations, 1990 Census data, demographic estimates and projections, and in-house design projects.

software developers are working to bridge the gap between CAD and GIS at the desktop level. CAD manufacturers have added database-management functionality to programs and GIS developers have added three-dimensional projection facilities to their applications. Major CAD vendors are working to introduce programs that combine the best of both.

Autodesk's newest product, Autodesk World, purports to integrate CAD, GIS and database technology into a single, non-proprietary environment within which users can create, edit, and query geographic-based data from any source—a DWG format or a competitive file format—without conversion.

Bentley has focused its efforts on what it has dubbed "geoengineering," the integration of CAD and GIS. The company's MicroStation

Geographics is a GIS-enhanced CAD product that relies on a translator called MicroStation GeoExchange to import data. Geographics allows MicroStation CAD and GIS files to merge, and preserves their intelligence in the new linked package.

Small firm solutions

While Autodesk and Bentley have combined CAD and GIS data, their solutions still don't address the small architecture firm that may not have the resources to generate GIS data. Fortunately, programs exist that have already done the work. Architects and planners can purchase basic desktop GIS programs such as ArcView from ERSI and Maptitude from Caliper Corporation. These mapping programs read and display geographic data and incorporate a drawing module so that users

can add freehand annotations to maps. World maps, census data, and street listings are included. While ArcView and Maptitude are not design applications, they graphically reveal development trends.

Caliper Corporation also markets Community 2020, a community-planning software package from the U.S. Department of Housing and Urban Development (HUD). Community 2020 is a special edition of Caliper's Maptitude GIS product for Windows. For \$299, the program creates maps that display community housing conditions, economic indicators, and population characteristics.

Caliper devised special add-on tools for the basic program for HUD, including a library of maps, data access, and presentation options. In the new release of Community 2020, due out this summer, users will be able to store imagery, video, and multimedia files and relate them to a geographic location. Scanned images, for example, can be referenced to a map and stored.

Future planning

Whether on a small or a large scale, GIS makes it possible to manage and visualize the spatial properties of data. When combined with modeling and navigation capabilities, visualization through GIS can bring a new level of intelligence to urban simulations.

Ann C. Sullivan is a Framingham, Massachusetts-based writer.



1

1 Pendant Fixture

Six new drum-shaped pendant luminaires were recently added to d'ac Lighting's Soft Industrial fixture collection. Each aluminum shell has a 5-inch-diameter opening; finishes include polished aluminum and baked enamel. Custom finishes are also available. The fixture is compatible with incandescent, halogen, compact-fluorescent, and metal-halide lamps. *Circle 291 on information card.*

2 Castiglioni Reissue

Flos Lighting recently reintroduced the Toio fixture created by Italian designer Achille Castiglioni and his brother Pier Giacomo Castiglione in 1962. Flos replicates the Castiglioni's original construction, which attached a car headlight, electrical wire, and fishing line guides to a metal shaft to create the adjustable-height floor lamp that provides indirect uplight. The fixture adjusts from 67 to 79 inches and requires a 300-watt, 120-volt PAR lamp. *Circle 292 on information card.*

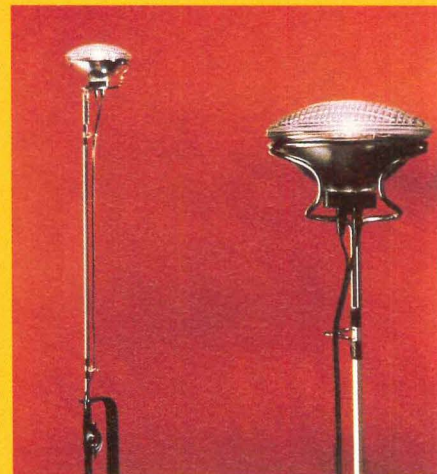

2

Bright

Ideas

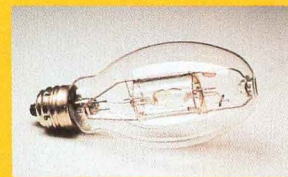

3

New and reissued fixtures cut dashing profiles—and your electric bill.

3 Long-Life Lamp

Venture Lighting redesigned its 200-watt metal-halide lamp, called UNI FORM Pulse Start, to offer illumination equal to a 250-watt lamp less expensively. The company lengthened and recontoured the arc tube to produce more lumens and claims to burn 50 percent longer than other metal-halide lamps. The company offers similarly constructed lamps from 50 to 400 watts. *Circle 293 on information card.*

4 Ethereal Shades

The folded acrylic shades of Japanese designer Shiro Kuramata's K-series lamps float ghostlike above floors and tabletops. The lamps, originally designed in 1972 and rereleased and distributed in America by Yamagiwa, create atmospheric ambient light. The floor model measures 23 inches high; the table version is 14 1/2 inches high. Both models are compatible with standard 40- and 60-watt incandescent bulbs. *Circle 294 on information card.*

5 Cable Fixture

Bruck Lighting combines alderwood, aluminum, and opaque glass in its new Shou lighting system. Fixtures can be suspended every 3 feet along a conduit; additional ceiling supports for cables longer than 40 feet are available. The fixture requires standard bi-pin or MR16 halogen lamps. *Circle 295 on information card.*

5

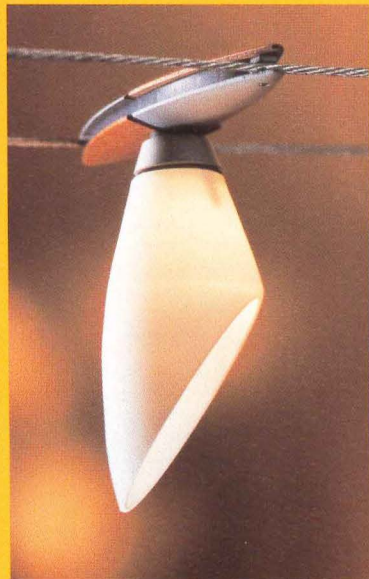

4



THE BEST JUST GOT BETTER

Introducing the NEW Sloan Royal® Flushometer

ATTENTION ALL ARCHITECTS AND SPECIFIERS!

Sloan has raised the performance bar once again. Introducing the latest engineered improvement to the Sloan Royal® Flushometer — the Dual Filtered By-Pass.

- Helps prevent valve run-on
- Ensures extended performance even in water conditions with high contents of sand and other particulates
- New diaphragm molded from Sloan's Permex® rubber to withstand deteriorating effects of ammonia and chloramine used in water treatment facilities

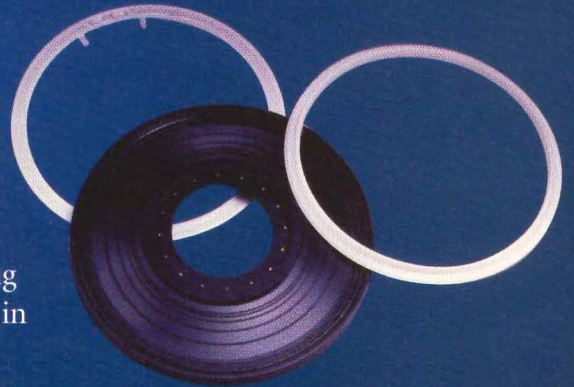

The fact is, the Dual Filtered By-Pass reaffirms the Royal as the true leader in Flushometer design. To ensure that your projects incorporate the latest in Flushometer design, get a copy of the new Royal Master Specification by calling 1-800-745-0800.

THE SLOAN ROYAL® FLUSHOMETER — THERE IS “NO KNOWN EQUALSM”



SLOAN

Sloan Valve Company
10500 Seymour Ave.
Franklin Park, IL 60131
1-800-745-0800
847-671-4300
FAX 847-671-6944
<http://www.sloanvalve.com>

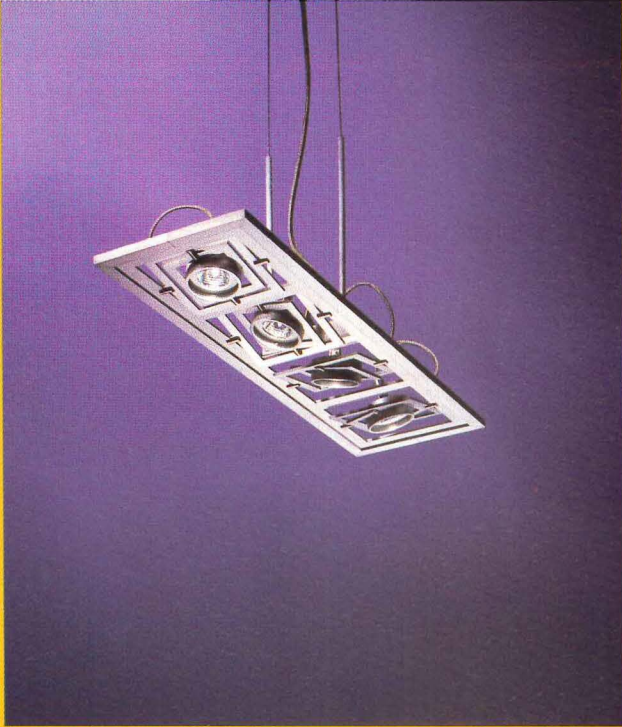

1 Modular Pendant

Lightframes, a multicell aluminum pendant fixture manufactured by Loomis, can be suspended from the ceiling with stainless steel cables. Individual cells, offered as 8- and 12-inch squares, can be combined in linear and clustered configurations to create gridded fixtures up to three cells deep and six cells high. Lightframes are compatible with incandescent, low voltage, and metal-halide lamps; units are available in 10 different finishes. *Circle 296 on information card.*

2 Electrodeless Bulb

Osram Sylvania will introduce its Icteron electrodeless fluorescent lamp at Lightfair this month. The lamp uses radio waves instead of electrodes, which the company claims extends lamp life to 60,000 hours. Units are available in 100- and 150-watt models. *Circle 297 on information card.*



1

2

Lights Fantastic

Innovative fixtures and lamps feature advanced components for expanded application and energy efficiency.

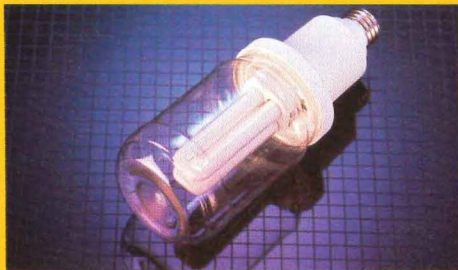

4

3 Adjustable Spotlight

Mondial 50 is the latest addition to Italian manufacturer Targetti's line of recessed lighting, distributed in America by Tivoli. The adjustable lamp allows the base to extend or retract up to 5 inches to concentrate light on objects below. Aluminum fins inside the housing distribute heat. The fixture is available in five standard finishes and requires a 20- to 50-watt halogen lamp. *Circle 298 on information card.*

3

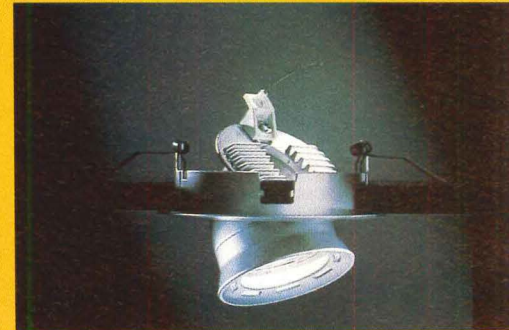

5

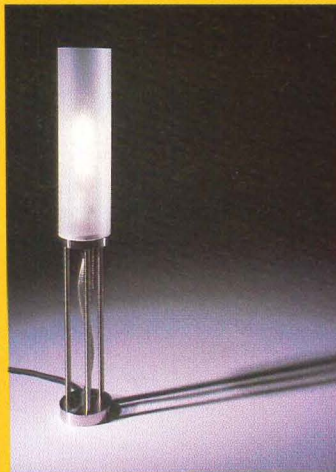
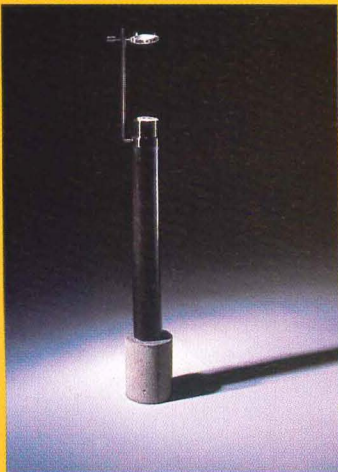

4 Waterproof Lamp

Lumatech's Microlamp compact-fluorescent lamps are now housed in a clear acrylic waterproof cylinder that enables the unit to be used outdoors, in areas with high humidity, and in extreme temperatures. The manufacturer claims their lamps use 80 percent less energy than comparable incandescent lamps. Five-, 9-, and 13-watt versions are available. *Circle 299 on information card.*

5 Adjustable-Focus Fixtures

Colorado-based Makela introduces sleek new lighting fixtures. The L1 steel fixture (far left), which features an adjustable mirror to focus light, is offered with a concrete or resin base and requires a 12-volt MR-11 halogen lamp. The unit is also compatible with a 120-volt incandescent bulb. The frosted glass shade of the L2 fixture (left) diffuses light for softer illumination. Both models measure 24 inches high. *Circle 300 on information card.*

17,000 ARCHITECTURAL FIRMS AT ONE ADDRESS



Have you
moved
in yet?

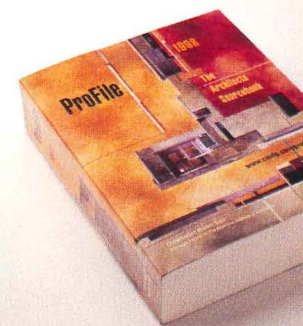

Only one place has in-depth information on the nation's architectural firms — **ProFile: The Architects Sourcebook.™**

ProFile is more than a listing of firms. This valuable resource describes your key personnel, current and recent projects, architectural service specialties, and more for prospective clients. And *ProFile* is available both in print and on the Internet (www.cmdg.com/profile).

ProFile is the only comprehensive and detailed directory of its kind in the U.S. To find out how to move into this prime location (rent free!), or to do some remodeling of your current listing, call **1-800-949-0276** today.

The new 13th edition is available now.

Published by Construction Market Data, a business partner of The American Institute of Architects.

A complimentary copy of *ProFile* is provided to each firm that updates its listing and to all newly-listed firms. If you missed the deadline for the 1998 book, update now to receive your copy (while supplies last).

ProFile, Construction Market Data
30 Technology Parkway South
Norcross, GA 30092
1-800-949-0276
www.cmdg.com/profile

CONSTRUCTION COST COMPARISONS PER SQUARE FOOT • MAY 1998



DEPARTMENT STORE, 3 STORY

Face brick with concrete block back-up on a steel frame

APARTMENT BUILDING, 1-3 STORY

Face brick with concrete block back-up with steel joint

PARKING GARAGE

Face brick with concrete block back-up on a reinforced concrete frame

	2nd Q 1998	2nd Q 1997	2nd Q 1998	2nd Q 1997	2nd Q 1998	2nd Q 1997
Atlanta	\$60.94	60.88	78.30	77.16	23.13	22.61
Boston	80.96	81.19	102.84	102.26	30.77	30.18
Chicago	76.73	76.98	97.80	94.35	28.89	27.65
Dallas	60.02	60.13	76.38	75.66	22.58	22.17
Kansas City	66.13	66.43	83.71	81.96	24.87	24.15
Los Angeles	77.13	77.43	98.09	96.66	29.19	28.61
New York City	93.21	93.40	119.07	117.73	35.38	34.50
Phoenix	62.26	62.36	79.18	78.69	23.72	23.21
St. Louis	70.93	71.11	90.27	88.78	26.69	26.01
San Francisco	86.34	86.68	109.72	109.26	32.67	31.99
Seattle	72.97	73.36	92.98	91.85	27.50	26.92
Washington, D.C.	66.34	66.48	84.75	83.33	25.18	24.42

Each month Architecture takes a snapshot of U.S. construction – looking at average costs and actual upcoming projects for different building types on a rotating basis. News on projects is provided by Construction Market Data (CMD). Costs are supplied by R.S. Means Co.

NOTE: Cost comparisons shown here are for the basic building without sitework, development, land, specialty finishes or equipment. Actual square foot costs vary significantly from project to project based on quality, complexity and local economy.

©1998, R.S. Means, A Construction Market Data Group Company. For more cost information, contact Means at 800.448.8182.

UPCOMING PROJECTS

Lord & Taylor Retail Store

Location: 5000 Shelbyville Road, Louisville, Jefferson County, KY

Project Value: \$10 million

Size: 130,000 sq ft, 2 floors above grade, 1 structure

Contract Type: Invited Bidders

Current Project Stage: Planning; Masterplanning

Status: Masterplanning in Progress; Bid Schedule Not Set

Project Scope: Upscale Department Store

Owner: May Company; Chris Weyman; 611 Olive Street 12th Floor; St. Louis, MO 63101

Phone: 314.342.6300; **Fax:** 314.342.4394

Architect: Kenneth Balk & Associates; Kenneth Balk; 1066 Executive Parkway; St. Louis, MO 63141

Phone: 314.576.2021; **Fax:** 314.576.2075

Queens Retail Store

Location: 119-02 Rockaway Boulevard, Queens, Queens County, NY

Project Value: \$1.5 - \$2 million

Size: 20,500 sq ft, 1 floor above grade, 1 floor below grade, 1 structure, 14 parking spaces

Contract Type: Invited Bidders

Current Project Stage: Planning; Schematics
Status: Schematics Complete; Bid Schedule Not Set

Project Scope: Retail Store with Storage in Cellar, One Loading Berth

Owner: Mark Investments Inc.; 199 Wells Avenue; Newton, MA 02159

Phone: 617.332.8140

Architect: Asfour Associates; 100 Medway Road, Suite 301; Milford, MA 01757

Phone: 508.478.0826; **Fax:** 508.478.1065

Clear Lake Apartments

Location: Site not selected, Galveston, Galveston County, TX

Project Value: \$25 million

Size: 15 acres, 2 floors above grade, 1 structure

Contract Type: Invited Bidders

Current Project Stage: Planning; Masterplanning

Status: Masterplanning in Progress; Bid Schedule Not Set

Project Scope: Apartments

Architect: James W. Coit, AIA; James Coit; 7026 Old Katy Road, Suite 296; Houston, TX 77024

Phone: 713.880.9491; **Fax:** 713.864.4475

Dupont Lakes Phase 2

Location: 69th & Dupont Road, Fort Wayne, Allen County, IN

Project Value: \$2,307,500 - \$3,120,000

Size: 32,500 sq ft, 3 floors above grade, 3 structures

Contract Type: Negotiated

Current Project Stage: Planning; Working Drawings

Status: Working Drawings in Progress; GC To Take Subbids Approx. 4/98

Project Scope: Eleven Building Apartment Complex, Each Building Contains 24, 30 or 36 Units

Developer: Edward Rose of Indiana; Mike Peterson; 6100 Newport Road, PO Box 3015; Kalamazoo, MI 49003

Phone: 616.323.9484; **Fax:** 616.321.7884

Architect: Eckert-Wordell Architects; David Jarl; 225 West Walnut Street; Kalamazoo, MI 49007

Phone: 616.388.7313

Jackson Parking Structure

Location: Main Street, Jackson, Amador County, CA

Project Value: \$3 million

Size: 2 floors above grade, 1 structure, 240 parking spaces

Contract Type: Invited Bidders

Current Project Stage: Planning; Preliminary Plans

Status: Preliminary Plans in Progress; Bid Schedule Not Set

Owner: Jacob Strohm; PO Box 725; Jackson, CA 95642

Phone: 209.223.3443; **Fax:** 209.223.5243

Architect: Watry Design; Nicholas Watry; 1500 Fashion Island Blvd.; San Mateo, CA 94404

Phone: 415.349.1546; **Fax:** 415.349.1384

Capitol Complex Parking Garage, Part 36

Location: 3rd & 4th Avenues, Baton Rouge, East Baton Rouge County, LA

Project Value: \$10,588,698

Size: 1 structure

Contract Type: Open Bidding

Current Project Stage: Planning; Masterplanning

Status: Masterplanning in Progress; Bid Schedule Not Set

Owner: Louisiana Division of Administration-Facilities; Roger Magendie; 1051 N. 3rd Street, PO Box 94095; Baton Rouge, LA 70804-9095

Phone: 504.342.0820; **Fax:** 504.342.7624

Architect: Kessels Diboll Kessels; Mr. Piet Kessels; 305 Barrone Street, Suite 200; New Orleans, LA 70112

Phone: 504.522.8625; **Fax:** 504.522.8628

©1998, CMD, A Construction Market Data Group Company. Additional project details can be obtained from CMD at 800.928.4530, or from the Web at www.cmdg.com.

Our landscape is no longer that of the Romantic English garden, of suburban sanctity, or the idealistic *Ville Radieuse*. It's the product of the American genius for the everyday way. Why do we Americans continue to be ashamed of advertising? It's always been part of the architectural scene, just as hieroglyphics appeared on Egyptian pylons, gods on Classical pediments, and Christian ads via mosaics have communicated specific and persuasive messages. And think what those Medieval stained glass exploiters would have done if they had blinking neon and LED boards!

shocking idea of adapting American industrial vernacular architecture in the early 20th century worked for the International Style—so that CEOs in pin-striped suits could come to inhabit Mies's glorified high-rise factory on Park Avenue—then why couldn't American commercial vernacular architecture become a source of inspiration in the late 20th century?

Besides our politely contextual university work, we have built projects embracing iconographic imagery inspired by commercial roadside signage, employing what Kenneth Frampton has recently decried

Off Ramp

Almost 30 years after Learning from Las Vegas, Robert Venturi still thinks the road is all right.

Denise Scott Brown and I have long proclaimed the significance of commercial vernacular architecture in terms of setting—the strip or the road—and its vocabulary—form generated through iconographic signage. In *Complexity and Contradiction in Architecture* (1966), we avowed that “Main Street is almost all right,” and compared Times Square favorably with Piazza San Marco. Unity derives not from minimalist, motival consistency but from messy, rich diversity!

In *Learning from Las Vegas* (1972), we proclaimed the “decorated shed” and the “duck” and reintroduced “meaning” and “symbolism” (rather than expression) into an architecture that had safely excluded everything but space and abstraction, while admitting unadmittedly its symbolic industrial vocabulary. We acknowledged a real architecture seen from moving cars beyond parking lots in an automobile age, and acknowledged urban sprawl as a fact of life—rather than the deadly ideals of *Ville Radieuse*, Broadacre City, or the Garden City.

In *Iconography and Electronics upon a Generic Architecture* (1996), we reconsidered the current commercial vernacular of the American roadside as the significant source for architectural iconography of our time. I also predicted American billboards would be exhibited beside American patchwork quilts in craft museums in the next century. I pointed out that if the then-

as the “sophistry (rather than the sophistication!) of scenographic populism.” Our Kirifuri Hotel complex in Japan, for example, teems with iconographic signage and symbolism derived from the everyday commercial streets of Japan.

Other projects have been inspired by the street and have incorporated its symbolism (more or less commercial in reference), including the Seattle Art Museum, the Sainsbury Wing of the British National Gallery in London, the Trabant Student Center at the University of Delaware, and the Hôtel du Département de la Haute Garonne in Toulouse, France.

This is the postindustrial age and everyday commercial vernacular and electronic technology are for us today the source for an iconographic/electronic architecture. (Employing a historical industrial vocabulary today is no different from employing a historical Renaissance vocabulary.) Viva the roadside as a source for architectural imagery that engages commercial advertising, accommodates scenographic diversity, and embraces a bold scale through bold signage—as you ride through Main Street, the strip, or the interstate. The vernacular road is a true vehicle for contemporary architecture, one that looks to advertising as a source for an architecture of iconography. *Robert Venturi*

Robert Venturi is principal of Philadelphia-based Venturi Scott Brown Associates.