

chitecture®

February 2000

\$8.95 usa \$11.00 canada

architecture

SELL THE U.N. NOW? p.166
POLITICS: WILL LIVABILITY
PLAY IN PEORIA? p.37
AMERICA'S NEXT DRUG
PROBLEM p.50

Thom Mayne's Perceptual Shift

and introducing:





**Spot the two terms
that don't go together:**

1. Suspended Ceiling
2. Grid-hiding Visual

Until now.

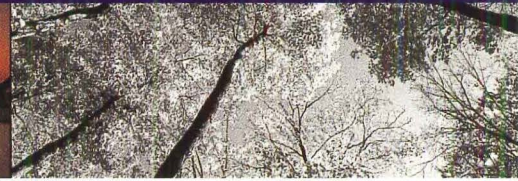
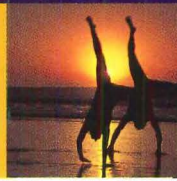
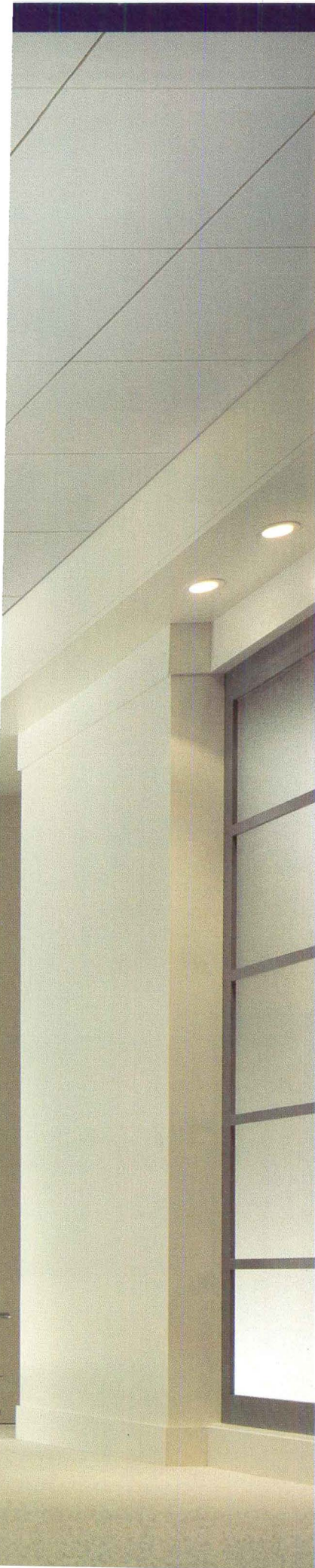

CEILING SYSTEMS

[Between us, ideas become reality.®]

Introducing Optima Vector™, the revolutionary new acoustical ceiling with virtually no visible grid.

With Optima Vector, now you can achieve a clean, nearly monolithic look in a downward access suspended ceiling. That's because the unique Vector* edge detail provides a sleek 1/4" reveal that minimizes the existing grid. In fact, the larger the expanse of open plan ceiling, the more effectively the grid disappears, leaving you with a grid-hiding, upscale visual. It works with existing standard 15/16" grid systems, which makes it perfect for renovations – avoiding costly, time-consuming grid removal, replacement or repainting. And because Optima Vector is a high performance open plan ceiling, you can count on superior sound absorption, light reflection and durability.

Suspended ceiling. Grid-hiding visual.
Now together, from Armstrong.

*Patent Pending

Armstrong

Circle 3 on information card

teectury

10
Contributors

15
Editorial

19
Letters

160
Ad Index

166
Protest

NEWS

21

Another New Guggenheim

Plus: Bruno Zevi remembered; the Pompidou reopens. *Edited by Michael J. O'Connor*

31

Calendar

The Cooper-Hewitt debuts its triennial, more.

32

On the Boards

Winners of the Times Square TKTS competition.

PRACTICE

37

It's Livability, Stupid!

Al Gore put sprawl and other livability issues on the political map. Can he ride that message to the White House? *By Michael Cannell*

40

Modernville, U.S.A.

Columbus, Indiana, is known for its collection of modern architecture. Now the city fathers want federal landmark protection for it. *By Steven Litt*

42

21st-Century Alchemist

Engineer Tom Barker is creating sustainable new building materials by pushing the limits of old ones. *By Sara Hart*

CULTURE

47

Eyes Wide Open

The MoMA exhibition *ModernStarts: People, Places, Things* examines modernism's fitful beginnings and enduring legacy. *By Marisa Bartolucci*

50

The Drugstore Invasion

The return of chain pharmacies to American Main Streets is creating headaches for some small towns. *By Christopher Hawthorne*

54

A World Less Ordinary

The everyday is funky, spontaneous, unself-conscious. It also offers valuable lessons for professionals. *By Dell Upton*

56

Robert Wilson Sees the Light

Leading avant-garde theater director Robert Wilson transforms downtown Pittsburgh into a City of Light. *Interview by Cathy Lang Ho*

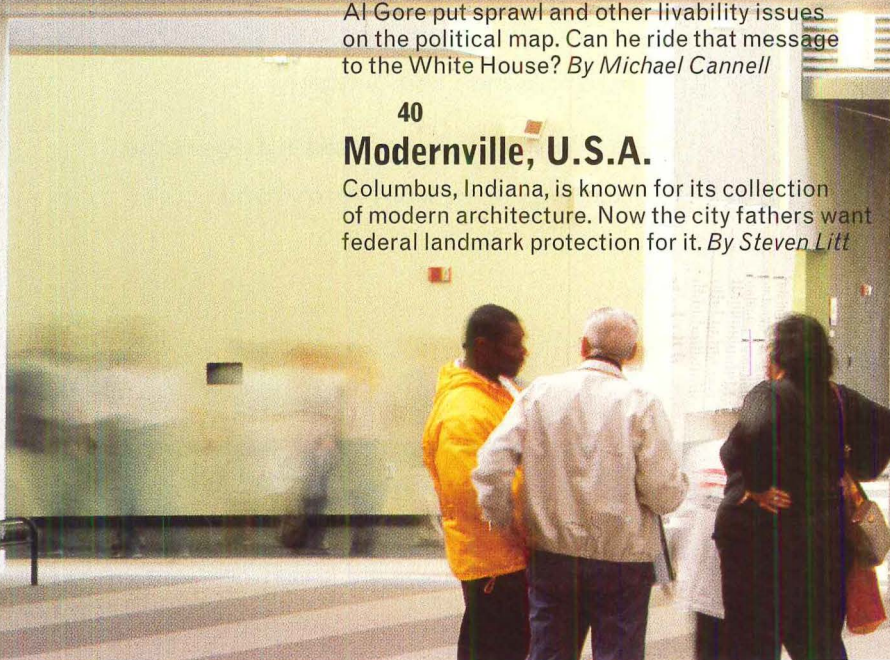

DESIGN

59

Perceptual Shift

Perception and reality collide, in projects that range from the rational to the expressionist.

60

Containment Strategy

Bernard Tschumi's architecture school outside Paris makes an event out of architectural education.
By Catherine Slessor

70

The Science of Entertainment

A monolithic science museum by Arata Isozaki sits like a cipher in downtown Columbus, Ohio. *By Aaron Betsky*

78

Heavy Metal

A Beirut nightclub by Bernard Khoury evokes Lebanon's belligerent past. *By Farès el-Dahdah*

86

A Visit to the Ice Palace

UN Studio strikes a new balance between classicism and modernity in their Het Valkhof Museum. *By Aaron Betsky*

94

Tight Bookkeeping

For a branch library in suburban Atlanta, Scogin Elam and Bray makes the most of a tight budget and a conservative brief. *By Vernon Mays*

100

Hidden Assets

Thom Mayne demonstrates a modernist maturity in a new, kinetic bank headquarters in Austria. *By Joseph Giovannini*

113

house

NEXT ISSUE

Eric Owen Moss' Umbrella Building

Jane Jacobs returns to the city

Radio City Music Hall restoration

COVER

The Hypo Alpe-Adria-Center in Klagenfurt, Austria, by Morphosis. Photograph by Christian Richters. See story, page 100.

TABLE OF CONTENTS

Hall of the Center of Science & Industry, Columbus, Ohio, by Arata Isozaki with NBBJ. Photograph by Timothy Hursley. See story, page 70.

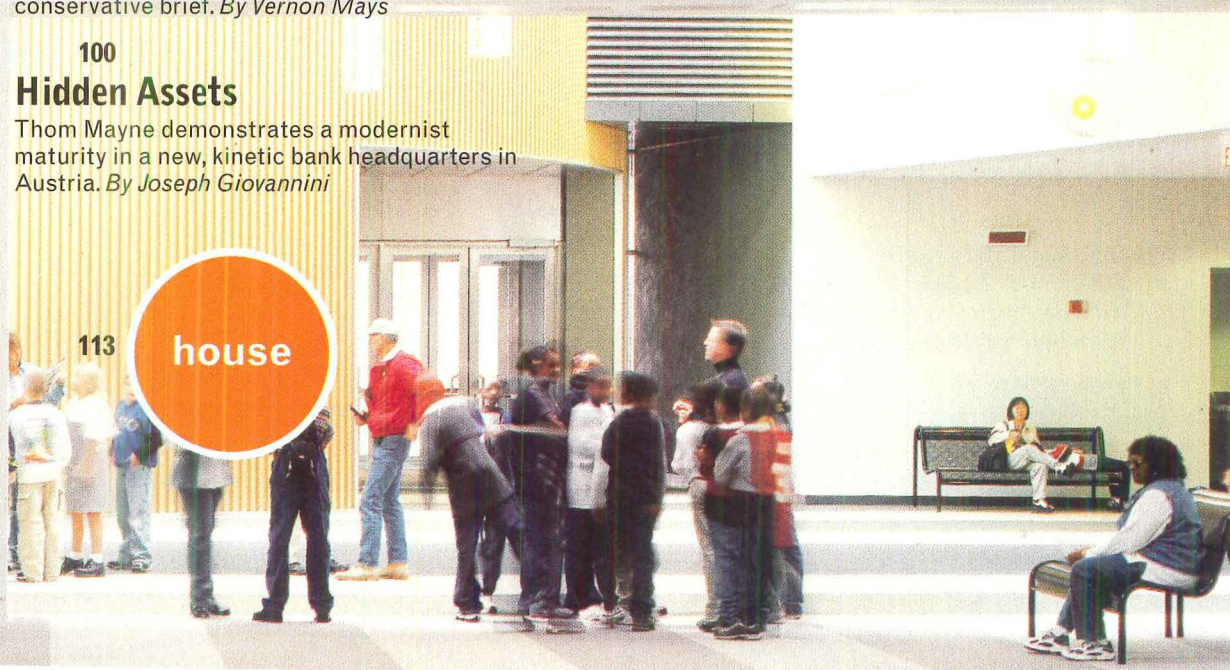

Architectural Bird Control

from **Nixalite®**

Nixalite Stainless
Steel Bird
Barrier

Protect and
preserve
architectural

treasures from pest birds and their unhealthy habits with **Nixalite Stainless Steel Bird Barriers**. Nixalite eliminates the endless maintenance and cleaning that is associated with pest birds.

Inconspicuous and long lasting, Nixalite is effective, humane and affordable. The available ColorCoat™ process applies a wide range of durable colors to the needle strips, making them virtually invisible.



Let Nixalite submit a comprehensive bird control plan for your next project. With nearly 50 years experience in bird control, we have what it takes to solve the toughest pest bird problems. This service is free, you have nothing to lose except the birds.

Ph: 800/624-1189 Fax: 800/624-1196

Ph: 309/755-8771 Fax: 309/755-0077

Website: <http://www.nixalite.com>

E-mail: nixalite@qonline.com

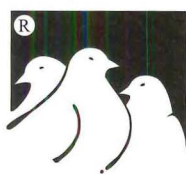

Nixalite®
of America Inc
1025 16th Avenue ARCH
East Moline, IL 61244

Experts in bird control since 1950

Circle 5 on information card

archi

EDITOR-IN-CHIEF

Reed Kroloff

rkroloff@architecturemag.com

ART DIRECTOR

Lisa Naftolin

lnaftolin@architecturemag.com

MANAGING EDITOR

Joelle Byrer

jbyrer@architecturemag.com

SENIOR EDITOR

Raul A. Barreneche

rbarreneche@architecturemag.com

ASSOCIATE EDITORS

Michael Cannell

mcannell@architecturemag.com

Ned Cramer

ncramer@architecturemag.com

Sara Hart

shart@architecturemag.com

Cathy Lang Ho

cho@architecturemag.com

ASSISTANT EDITOR

Michael J. O'Connor

moconnor@architecturemag.com

COPY EDITOR

Iris Becker

ibecker@architecturemag.com

ASSOCIATE ART DIRECTOR

Claudia Brandenburg

cbrandenburg@architecturemag.com

PHOTO EDITOR

Alexandra Brez

abrez@architecturemag.com

EDITORIAL ASSISTANT

Sarah Palmer

spalmer@architecturemag.com

TECHNICAL ILLUSTRATOR

Christine Malecki West

EDITORS-AT-LARGE

Aaron Betsky

Joseph Giovannini

Bradford McKee

PRESIDENT/DESIGN GROUP

Craig Reiss

creiss@architecturemag.com

CIRCULATION MANAGER

Barbara Falk

bfalk@bpicomm.com

VICE PRESIDENT/PRODUCTION

Robert M. Hoover

rhoover@architecturemag.com

PRODUCTION MANAGERS

Helen Koh

hkoh@architecturemag.com

Randell Scherer

rscherer@architecturemag.com

VICE PRESIDENT/MARKETING SERVICES

Deborah Patton

dpattson@bpicomm.com

BUSINESS MANAGER

Richard Francois

rfrancois@bpicomm.com

ASSISTANT TO THE GROUP PRESIDENT

Marilyn Alba

malba@architecturemag.com

EDITORIAL

(212) 536-6221

(212) 382-6016 fax

info@architecturemag.com

ADVERTISING/MEDIA KITS

(212) 536-5236

SUBSCRIPTIONS

(800) 745-8922

REPRINTS

(212) 536-5137

BACK ISSUES

(212) 536-5083

CONTRIBUTING EDITORS

Peter Blake

Lawrence W. Cheek

Andrei Codrescu

Colin Davies

Richard Ingersoll

Edward Keegan

Alex Krieger

Barry B. LePatner

Steven Litt

Vernon Mays

Elizabeth Padjen

Steven S. Ross

Catherine Slessor

Architecture®

(vol. 89, no. 2), publication number ISSN 0746-0554, is published monthly by BPI Communications, Inc., 1515 Broadway, New York, NY 10036. Postmaster, please send changes of address to Architecture, P.O. Box 2063, Marion, OH 43305-2063.

Individual subscriptions: U.S. and its possessions: \$55 for 1 year, \$105 for 2 years, \$155 for 3 years. Canada: \$64 for 1 year. Foreign: \$85 for 1 year. Single copies: U.S. and its possessions: \$8.95 each; Canada: \$11.00 each. For subscription matters, write: Circulation Department, Architecture, P.O. Box 2063, Marion, OH 43305-2063; (800) 745-8922; outside U.S. (740) 382-3322. Periodicals postage paid at New York, NY, and additional mailing offices. Canadian Post International Mail Product (Canadian Distribution) Sales Agreement No. 0877859. Printed in USA.

© 2000 by BPI Communications Inc. No part of this publication may be reproduced, stored in any retrieval system, or transmitted in any form or by any means, electronic, mechanical, photocopying, recording, or otherwise without the publisher's prior written permission. Chairman: Gerald S. Hobbs; President and CEO: John B. Babcock, Jr.; Executive Vice Presidents: Mark Dacey, Robert J. Dowling, Howard Lander; Senior Vice Presidents: Paul Curran, Ann Haire, Rosalee Lovett, Craig Reiss; Vice President: Glenn Heffernan; Chairman Emeritus: W. D. Littleford

www.architecturemag.com

February 2000

architecture

house

EDITOR-IN-CHIEF
Reed Kroloff
rkroloff@architecturemag.com

EXECUTIVE EDITOR
Raul A. Barreneche
rbarreneche@architecturemag.com

CREATIVE DIRECTOR
Lisa Naftolin
lnaftolin@architecturemag.com

ART DIRECTOR
Claudia Brandenburg
cbrandenburg@architecturemag.com

MANAGING EDITOR
Joelle Byrer
jbyrer@architecturemag.com

COPY EDITOR
Iris Becker
ibecker@architecturemag.com

PRESIDENT/DESIGN GROUP
Craig Reiss
creiss@architecturemag.com

VICE PRESIDENT/PRODUCTION
Robert Hoover
rhoover@architecturemag.com

VICE PRESIDENT/MARKETING SERVICES
Deborah Patton
dpattton@bpicomm.com

EDITORIAL
(212) 536-6221
(212) 382-6016 fax
info@architecturemag.com

ADVERTISING/MEDIA KITS
(212) 536-5236

REPRINTS
(212) 536-5137

details

117

Editorial

Welcome to *Architecture House*.
By *Raul A. Barreneche*

118

News + Products

The latest housing starts and interest rates; architect-designed home furniture; Philippe Starck goes residential; architects finally tune into feng shui.

122

Home, Home on the Web

A scan of top home-design websites helps architects navigate uncharted waters. By *Lauren Neefe*

124

Everything and the Kitchen Sink

Smart designers are going to great lengths to deliver completely furnished houses—and boosting their fees in the process.
By *Edward Keegan*

houses

127

New Directions

128

House South

In suburban Mexico City, Alberto Kallach anchors a domestic ensemble to its hillside perch.
By *Raul A. Barreneche*

136

House East

Steven Holl gives new shape to a family retreat in New York's Catskill Mountains.
By *Karen Stein*

142

House West

Anne Fougeron spins polished materials into a sleek, sensuous home in Northern California.
By *Aaron Betsky*

Cover

Y-House, Catskills, New York,
by Steven Holl Architects.
Photograph by Paul Warchol.

“I’ve never had my first sketch
built before.”

Steven Holl, page 136

PAVESTONE
CO.

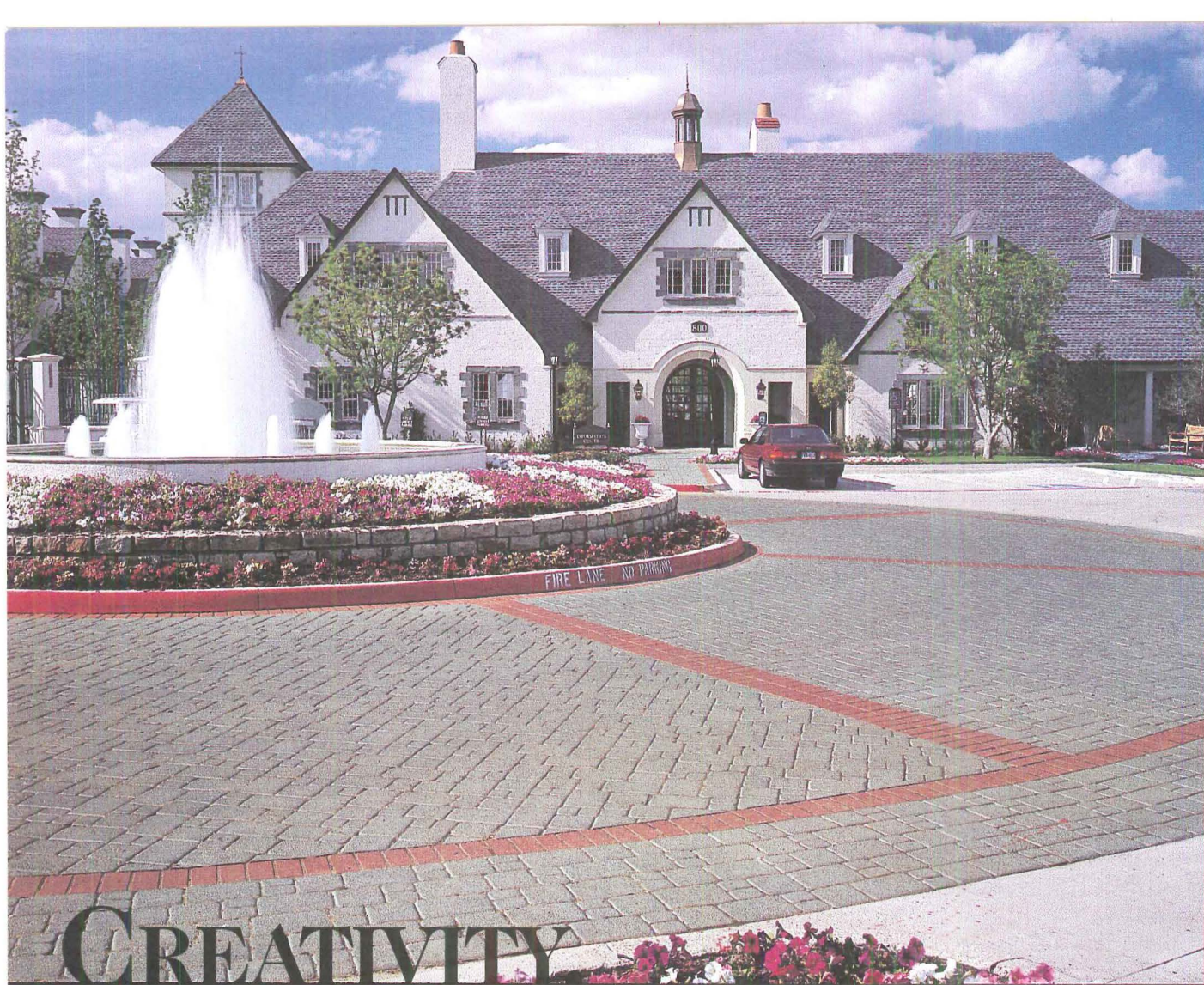

CREATIVITY

EVERY JOB IS AN ORIGINAL WORK OF ART.

Your work is your signature. With Pavestone you can create an original masterpiece with our extensive paver product line, custom color palette and the versatility of our patented pavers. From traditional to modernism to the classics, our pavers have developed quite a loyal following. In fact, our products are permanently on display at Friends University, The Mansion on Turtle Creek, and Phoenix City Square...just to name a few. And since your work is your signature, shouldn't it be etched in Pavestone?

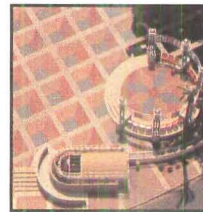
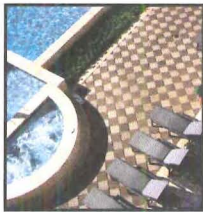

Circle 61 on information card

SALES & MANUFACTURING:

Austin, TX...(512) 346-7245
Chattanooga, TN...(423) 855-1899
Cincinnati, OH...(513) 474-3783
D/FW, TX...(817) 481-5802
Denver, CO...(303) 287-3700
Houston, TX...(281) 391-7283

Kansas City, MO...(816) 524-9900
Lafayette, LA...(318) 234-8312
Las Vegas, NV...(702) 221-2700
New Orleans, LA...(504) 882-9111
Phoenix, AZ...(602) 257-4588
San Antonio, TX (512) 558-7283

CONCRETE BEA

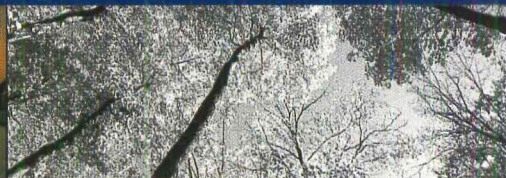
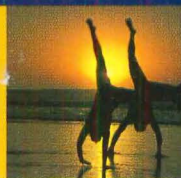
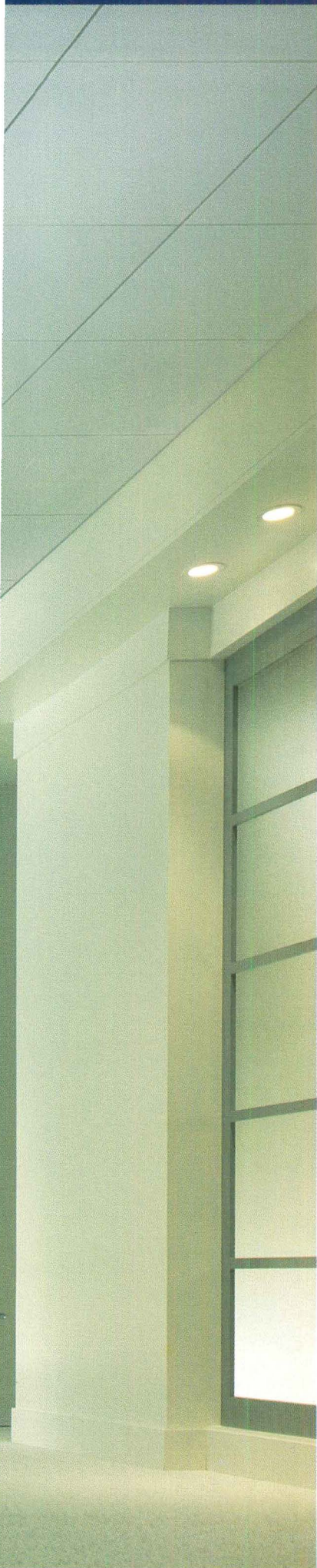

CEILING SYSTEMS

[Between us, ideas become reality.]

Introducing Optima Vector™, the revolutionary new acoustical ceiling with virtually no visible grid.

With Optima Vector, now you can achieve a clean, nearly monolithic look in a downward access suspended ceiling. That's because the unique Vector* edge detail provides a sleek 1/4" reveal that minimizes the existing grid. In fact, the larger the expanse of open plan ceiling, the more effectively the grid disappears, leaving you with a grid-hiding, upscale visual. It works with existing standard 15/16" grid systems, which makes it perfect for renovations – avoiding costly, time-consuming grid removal, replacement or repainting. And because Optima Vector is a high performance open plan ceiling, you can count on superior sound absorption, light reflection and durability.

Suspended ceiling. Grid-hiding visual.
Now together, from Armstrong.

*Patent Pending

Armstrong

Circle 44 on information card

tectur

10
Contributors

15
Editorial

29
Letters

136
Ad Index

150
Protest

NEWS

33

Clinton Puts Design on the Agenda

Plus: Alien invades Fallingwater; AIA Awards; plastic made from plants; and more.
Edited by Mickey O'Connor

49

Calendar

52

On the Boards

PRACTICE

59

Star Treatment

Radio City Music Hall is high-kicking again after a meticulous renovation by Hardy Holzman Pfeiffer Associates. *By Christopher Hawthorne*

68

Interior Motives

The cold war between architects and interior designers heats up again. *By Bradford McKee*

CULTURE

71

Jane Jacobs, Urban Agitator

In her sixth book, the homespun urban theorist posits the natural world as a model for sound urban development. *By Adele Freedman*

74

New Urbanism Sees Green

Civano is ambitious: Not only does it demand front-porch friendliness, it asks builders for a 50 percent reduction in water and energy consumption. *By Lawrence W. Cheek*

76

A Portrait in Stone

New York architect Michael McDonough assembles 34 anecdotal reflections of Casa Malaparte, the house that Italy's avant-garde built. *By Cathy Lang Ho*

78

Too Close For Comfort?

Where do you draw the line between community and privacy in an age that dances nervously between globalization and regionalism, historicism and innovation? *By David Harvey*

80

Picture Window

Photographer Vera Lutter uses space as her instrument, creating pinhole cameras out of entire rooms to capture the density and scale of her urban subjects. *By Cathy Lang Ho*

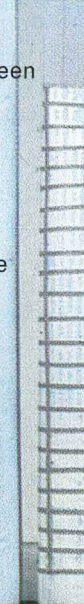
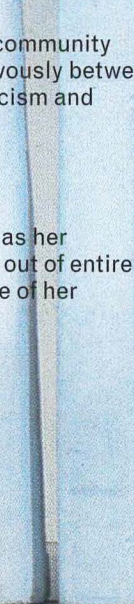
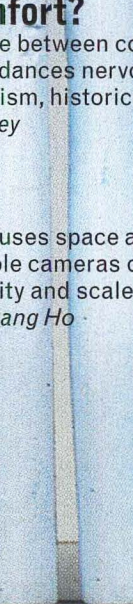
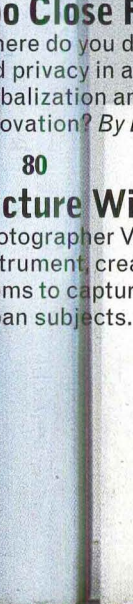
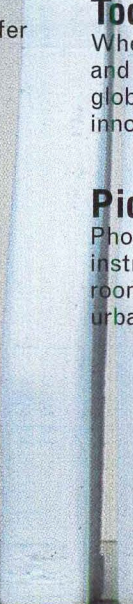
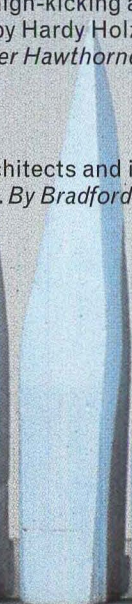
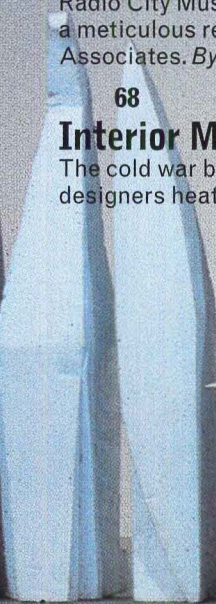
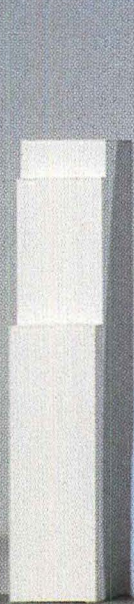

E

DESIGN

83

Ready-to-Wear

Buildings can be fashionable without being thin.

84

Twenty-Five Floors of Glamour

Christian de Portzamparc dresses an elegant New York City high-rise in arresting folds of faceted glass.

By *Raul A. Barreneche*

92

Palazzo Beck

José Rafael Moneo contends with predecessors Mies van der Rohe and William Ward Watkin in building a new pavilion for the Museum of Fine Arts in Houston.

By *Ned Cramer*

104

The Glass Fantastic

With his latest addition to Culver City, Eric Owen Moss uses cascades of clear glass to blur the division between public and private. By *Aaron Betsky*

116

Laser Sharp

A new factory by P/A Award-winner Barkow Leibinger refashions Miesian modernism for a suburban office park.

Photographs by *Paul Warchol*

122

Nordic Diplomacy

Behind an intriguing serpentine wall, six Scandinavian architects author embassy pavilions in Berlin that favor the whole over the individual parts.

By *Catherine Slessor*

NEXT ISSUE

47th Annual P/A Awards
Whither the AIA?
Redesigning Gotham City

COVER

LVMH Tower, New York City,
by Atelier Christian
de Portzamparc.

Photograph and digital
imaging by Jill Greenberg.
Study-model photograph

by Nicolas Borel,
courtesy Atelier
Christian de Portzamparc.

Hair and makeup by
Matthew Monzon.

Styling by Franciscus Ankone
at Julian Meijer.

Model: Giedre from Karin

Models. Dress by John
Galliano for Christian Dior.

TABLE OF CONTENTS

Study models for LVMH Tower,
New York City, by Atelier
Christian de Portzamparc.
Photograph by Nicolas Borel,
courtesy Atelier
Christian de Portzamparc.

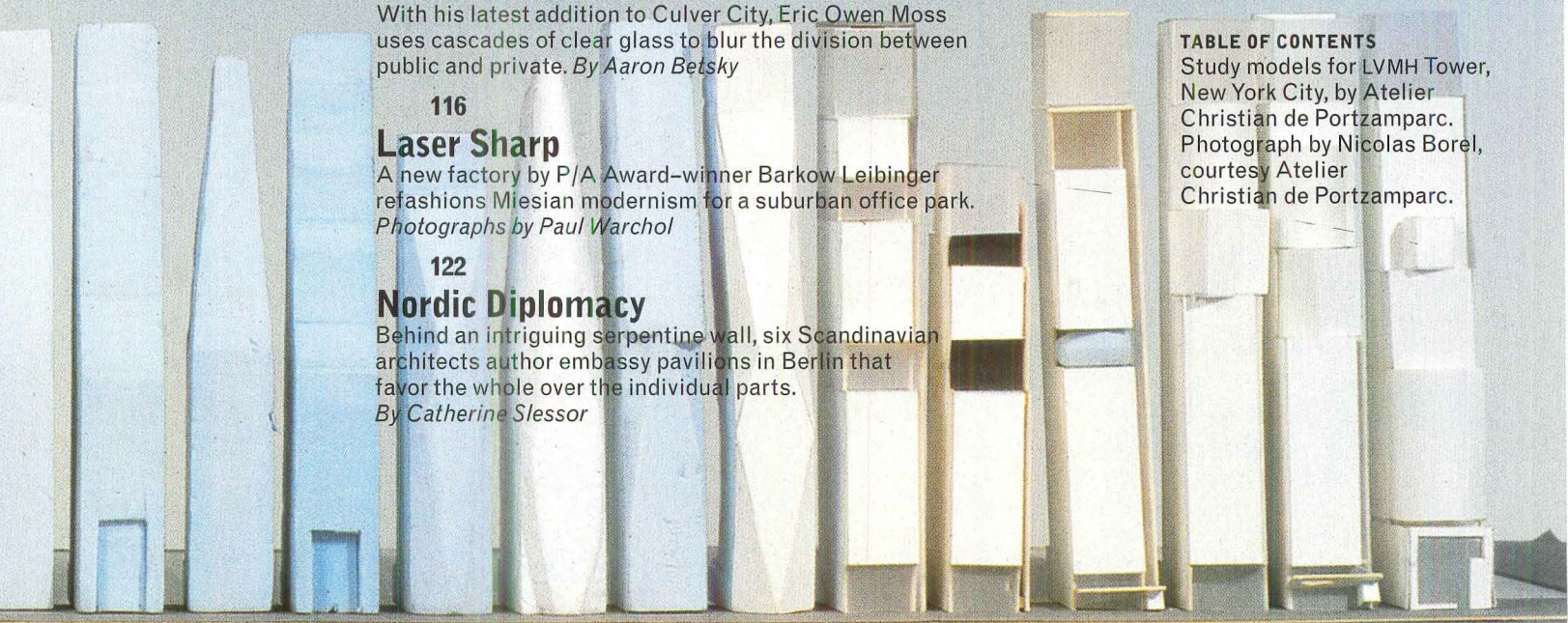

Architectural Bird Control

from **Nixalite**[®]

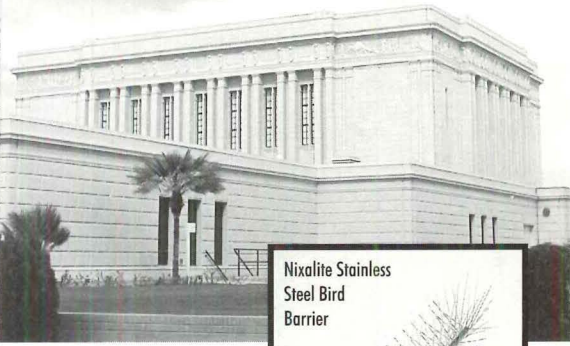

Nixalite Stainless
Steel Bird
Barrier

Protect and
preserve
architectural

treasures from pest birds and their unhealthy habits with **Nixalite Stainless Steel Bird Barriers**. Nixalite eliminates the endless maintenance and cleaning that is associated with pest birds.

Inconspicuous and long lasting, Nixalite is effective, humane and affordable. The available ColorCoat[™] process applies a wide range of durable colors to the needle strips, making them virtually invisible.



Let Nixalite submit a comprehensive bird control plan for your next project. With nearly 50 years experience in bird control, we have what it takes to solve the toughest pest bird problems. This service is free, you have nothing to lose except the birds.

Ph: 800/624-1189 Fax: 800/624-1196

Ph: 309/755-8771 Fax: 309/755-0077

Website: <http://www.nixalite.com>

E-mail: nixalite@qconline.com



Nixalite[®]
of America Inc
1025 16th Avenue ARCH
East Moline, IL 61244

Experts in bird control since 1950

Circle 46 on information card

archi

EDITOR-IN-CHIEF

Reed Kroloff
rkroloff@architecturemag.com

ART DIRECTOR

Lisa Naftolin
lnaftolin@architecturemag.com

MANAGING EDITOR

Joelle Byrer
jbyrer@architecturemag.com

SENIOR EDITOR

Raul A. Barreneche
rbarreneche@architecturemag.com

ASSOCIATE EDITORS

Michael Cannell
mcannell@architecturemag.com

Ned Cramer
ncramer@architecturemag.com

Sara Hart
shart@architecturemag.com

Cathy Lang Ho
cho@architecturemag.com

ASSISTANT EDITOR

Mickey O'Connor
moconnor@architecturemag.com

COPY EDITOR

Iris Becker
ibecker@architecturemag.com

ASSOCIATE ART DIRECTOR

Claudia Brandenburg
cbrandenburg@architecturemag.com

PHOTO EDITOR

Alexandra Brez
abrez@architecturemag.com

EDITORIAL ASSISTANT

Sarah Palmer
spalmer@architecturemag.com

TECHNICAL ILLUSTRATOR

Christine Malecki West

CONTRIBUTING DESIGNER

Martin Perrin

EDITORS-AT-LARGE

Aaron Betsky
Joseph Giovannini
Bradford McKee

GROUP PUBLISHER

Jill Bokor
jbokor@bpicomm.com

ASSISTANT TO THE GROUP PUBLISHER

Marilyn Alba
malba@architecturemag.com

VICE PRESIDENT/MARKETING SERVICES

Deborah Patton
dpatton@bpicomm.com

EVENTS MANAGER

Rory Sullivan
rsullivan@bpicomm.com

VICE PRESIDENT/PRODUCTION

Robert M. Hoover
rhoover@architecturemag.com

PRODUCTION MANAGERS

Helen Koh
hkoh@architecturemag.com

Randell Scherer
rscherer@architecturemag.com

CIRCULATION MANAGER

Barbara Falk
bfalk@bpicomm.com

EDITORIAL

(212) 536-6221
(212) 382-6016 fax
info@architecturemag.com

ADVERTISING INQUIRIES

(212) 536-5236

SUBSCRIPTIONS

(800) 745-8922

REPRINTS

(212) 536-5137

BACK ISSUES

(212) 536-5083

PRESIDENT/DESIGN GROUP

Craig Reiss
creiss@architecturemag.com

CONTRIBUTING EDITORS

Peter Blake
Lawrence W. Cheek
Andrei Codrescu
Colin Davies
Richard Ingersoll
Edward Keegan
Alex Krieger
Barry B. LePatner
Steven Litt
Vernon Mays
Elizabeth Padjen
Steven S. Ross
Catherine Slessor

Architecture[®]
(VOL. 89, NO. 3), publication number ISSN 0746-0554, is published monthly by BPI Communications, Inc., 1515 Broadway, New York, NY 10036. Postmaster, please send changes of address to Architecture, P.O. Box 2063, Marion, OH 43305-2063. Individual subscriptions: U.S. and its possessions: \$55 for 1 year, \$105 for 2 years, \$155 for 3 years. Canada: \$64 for 1 year. Foreign: \$85 for 1 year. Single copies: U.S. and its possessions: \$8.95 each; Canada: \$11.00 each. For subscription matters, write: Circulation Department, Architecture, P.O. Box 2063, Marion, OH 43305-2063; (800) 745-8922; outside U.S. (740) 382-3322. Periodicals postage paid at New York, NY, and additional mailing offices. Canadian Post International Mail Product (Canadian Distribution) Sales Agreement No. 0877859. Printed in U.S.A.

© 2000 by BPI Communications Inc. No part of this publication may be reproduced, stored in any retrieval system, or transmitted in any form or by any means, electronic, mechanical, photocopying, recording, or otherwise without the publisher's prior written permission. Chairman: Gerald S. Hobbs; President and CEO: John B. Babcock, Jr.; Executive Vice Presidents: Mark Dacey, Robert J. Dowling, Howard Lander; Senior Vice Presidents: Paul Curran, Ann Haire, Rosalee Lovett, Craig Reiss; Vice President: Glenn Heffernan; Chairman Emeritus: W. D. Littleford

www.architecturemag.com

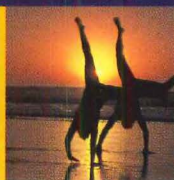
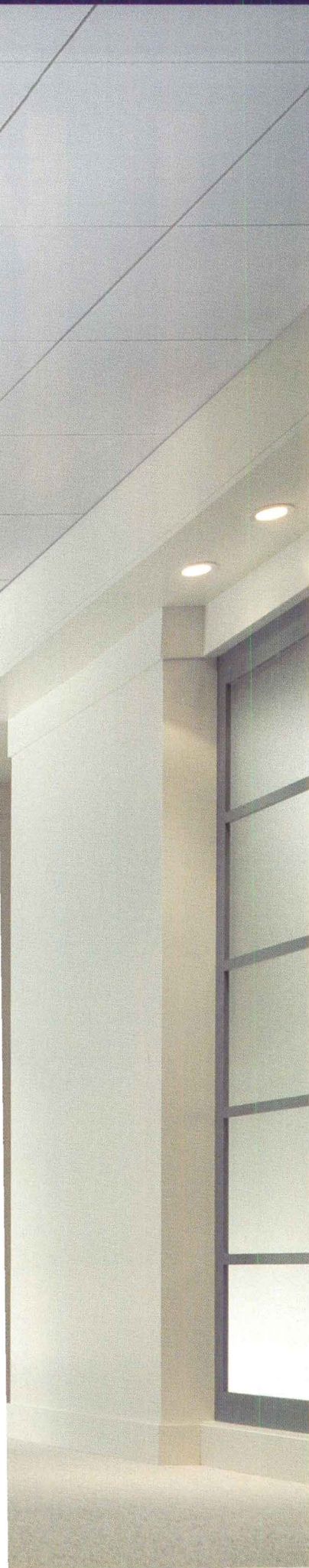

CEILING SYSTEMS

[Between us, ideas become reality.™]

Introducing Optima Vector™, the revolutionary new acoustical ceiling with virtually no visible grid.

With Optima Vector, now you can achieve a clean, nearly monolithic look in a downward access suspended ceiling. That's because the unique Vector* edge detail provides a sleek 1/4" reveal that minimizes the existing grid. In fact, the larger the expanse of open plan ceiling, the more effectively the grid disappears, leaving you with a grid-hiding, upscale visual. It works with existing standard 15/16" grid systems, which makes it perfect for renovations – avoiding costly, time-consuming grid removal, replacement or repainting. And because Optima Vector is a high performance open plan ceiling, you can count on superior sound absorption, light reflectance and durability.

Suspended ceiling. Grid-hiding visual.
Now together, from Armstrong.

For more information, call 1-888-CEILINGS
or visit our website at www.ceiling.com

*Patent Pending

Armstrong

Circle 3 on information card

teectury

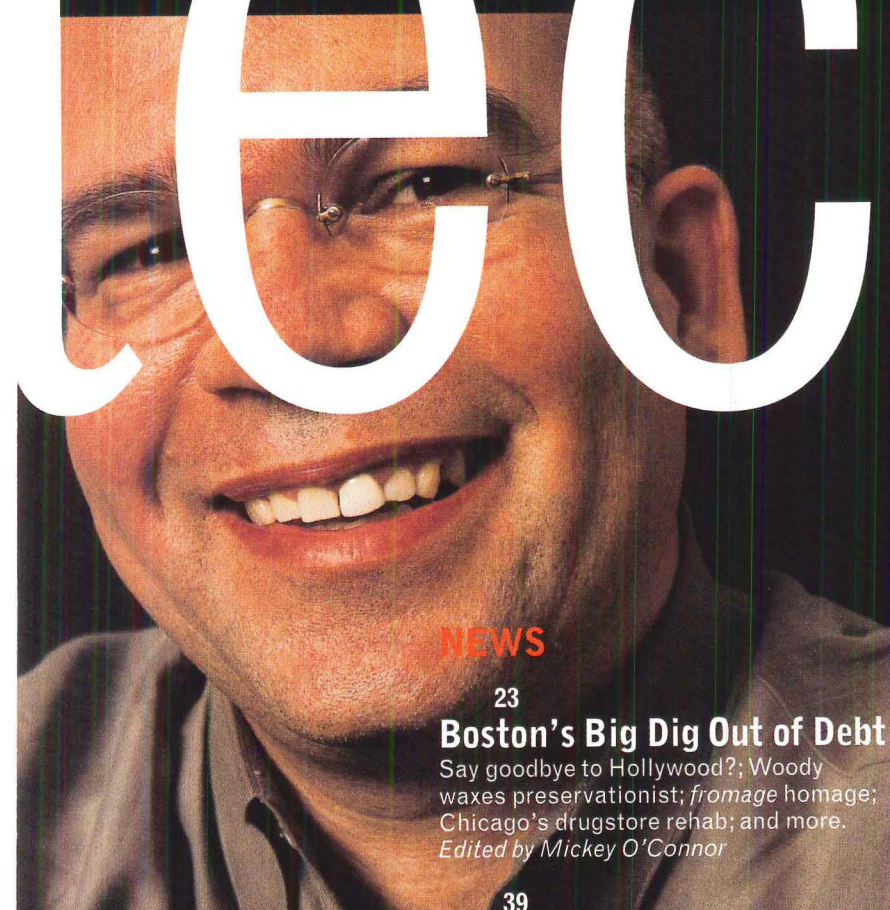

NEWS

23
Boston's Big Dig Out of Debt
Say goodbye to Hollywood?; Woody waxes preservationist; *fromage* homage; Chicago's drugstore rehab; and more.
Edited by Mickey O'Connor



60
KAL's Big Moment (Diagram)

SOM builds a gracefully engineered airplane hangar for Korean Airlines. *By Sara Hart*

CULTURE

65
A Street for All Seasons
To be a pedestrian would be a pleasure, if cities hadn't abandoned the arcade. *By Peter Blake*

70
Housing's Early Advocate
Catherine Bauer cowrote the Housing Reform Act of 1937 and advised five U.S. presidents on urban strategies. A new biography traces the lively life and career of this pioneering woman. *By Gwendolyn Wright*

74
Miscellany, by Design
Architecture, products, and graphics overwhelm the Smithsonian Cooper-Hewitt, National Design Museum in the country's first design triennial. *By Peter Hall*

78
Holy Redesign, Batman!
Gotham gets a facelift that leaves it cleaner and more streamlined, setting the stage for Batman's newest battles, against "everyday" villains. *By Bradford McKee*

- 10 Contributors
- 14 Editorial
- 19 Letters
- 142 Ad Index
- 154 Protest

39
Calendar

43
On the Boards
Hollywood-Orange Building, by RoTo Architects

PRACTICE

47
Meet the New AIA (Same as the Old AIA?)
Architecture's troubled professional organization tries to remake itself as a responsive, forward-looking enterprise. *By Christopher Hawthorne*

51
The Big Schmooze
Architects take their agenda to Capitol Hill. Are lawmakers listening? *By Michael Cannell*

56
Global Gardening
The world's largest terrarium takes shape on 100 acres of England's Cornish countryside. *By Sara Hart*

April 2000

E

DESIGN

87

Annual Awards Issue

- 88 **The Spirit of the New**
- 90 **Diller + Scofidio** Blur Building
- 96 **Steven Holl Architects** M.I.T. Residence 2001
- 102 **Preston Scott Cohen** Torus House and Studio for Eric Wolf
- 108 **Eskew+** A Shroud for Bathing
- 112 **Steven Holl Architects** Nelson-Atkins Museum of Art Expansion
- 118 **Michael Maltzan Architecture** Inner City Arts Addition and Renovation
- 120 **William E. Massie** Big Belt House
- 122 **Morphosis** MTA 101 Pedestrian Bridge
- 126 **Vincent James Associates** Tulane University Center Addition and Remodel
- 130 **Eric Owen Moss Architects** SPA
- 132 **TEN Arquitectos** JVC Convention and Exhibition Center
- 134 **Studio Works** InSideOutSide House
- 138 **Brown & Storey Architects** Dundas Square
- 140 **Skidmore, Owings & Merrill** Pennsylvania Station Redevelopment Project

TABLE OF CONTENTS

P/A Award-winners Steve Dumez, Allen Eskew, Steven Holl, and Preston Scott Cohen (from left to right), photographed by Steve Pyke/Matrix.

COVER

Ricardo Scofidio and Elizabeth Diller, photographed by Steve Pyke/Matrix on February 24.

NEXT ISSUE

The Power List: Ten Phone Calls You'll Want to Take
A Visit to the Glass House
Herzog & de Meuron's Tate Gallery
Architectural IPOs
More *Architecture House*

Architectural Bird Control

from **Nixalite®**

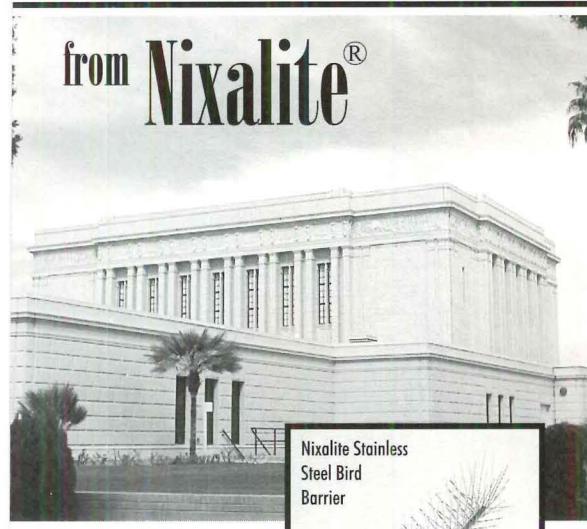

Nixalite Stainless
Steel Bird
Barrier

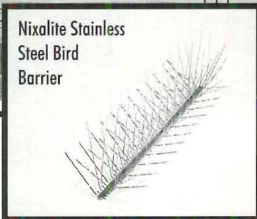

Protect and
preserve
architectural

treasures from pest birds and their unhealthy habits with **Nixalite Stainless Steel Bird Barriers**. Nixalite eliminates the endless maintenance and cleaning that is associated with pest birds.

Inconspicuous and long lasting, Nixalite is effective, humane and affordable. The available ColorCoat™ process applies a wide range of durable colors to the needle strips, making them virtually invisible.

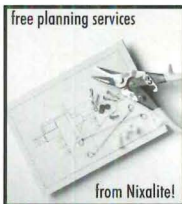

free planning services

from Nixalite!

Let Nixalite submit a comprehensive bird control plan for your next project. With nearly 50 years experience in bird control, we have what it takes to solve the toughest pest bird problems. This service is free, you have nothing to lose except the birds.

Ph: 800/624-1189 Fax: 800/624-1196

Ph: 309/755-8771 Fax: 309/755-0077

Website: <http://www.nixalite.com>

E-mail: nixalite@qconline.com

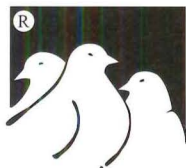

Nixalite®
of America Inc
1025 16th Avenue ARCH
East Moline, IL 61244

Experts in bird control since 1950

Circle 5 on information card

archi

EDITOR-IN-CHIEF

Reed Kroloff
rkroloff@architecturemag.com

ART DIRECTOR

Lisa Naftolin
linaftolin@architecturemag.com

MANAGING EDITOR

Joelle Byrer
jbyrer@architecturemag.com

SENIOR EDITORS

Raul A. Barreneche
rbarreneche@architecturemag.com
Michael Cannell
mcannell@architecturemag.com
Ned Cramer
ncramer@architecturemag.com

ASSOCIATE EDITORS

Sara Hart
shart@architecturemag.com
Cathy Lang Ho
cho@architecturemag.com

ASSISTANT EDITOR

Mickey O'Connor
moconnor@architecturemag.com

COPY EDITOR

Iris Becker
ibecker@architecturemag.com

ASSOCIATE ART DIRECTOR

Claudia Brandenburg
cbrandenburg@architecturemag.com

PHOTO EDITOR

Alexandra Brez
abrez@architecturemag.com

EDITORIAL ASSISTANT

Sarah Palmer
spalmer@architecturemag.com

TECHNICAL ILLUSTRATOR

Christine Malecki West

EDITORS-AT-LARGE

Aaron Betsy
Joseph Giovannini
Bradford McKee

GROUP PUBLISHER

Jill Bokor
jbokor@bpicomm.com

ASSISTANT TO THE GROUP PUBLISHER

Marilyn Alba
malba@architecturemag.com

VICE PRESIDENT/MARKETING SERVICES

Deborah Patton
dpattson@bpicomm.com

EVENTS MANAGER

Rory Sullivan
rsullivan@bpicomm.com

VICE PRESIDENT/PRODUCTION

Robert M. Hoover
rhoover@architecturemag.com

PRODUCTION MANAGERS

Helen Koh
hkoh@architecturemag.com
Randell Scherer
rscherer@architecturemag.com

CIRCULATION MANAGER

Barbara Falk
bfalk@bpicomm.com

EDITORIAL

(212) 536-6221
(212) 382-6016 fax
info@architecturemag.com

ADVERTISING INQUIRIES

(212) 536-5236

SUBSCRIPTIONS

(800) 745-8922

REPRINTS

(212) 536-5137

BACK ISSUES

(212) 536-5083

PRESIDENT/DESIGN GROUP

Craig Reiss
creiss@architecturemag.com

CONTRIBUTING EDITORS

Peter Blake
Lawrence W. Cheek
Andrei Codrescu
Colin Davies
Richard Ingersoll
Edward Keegan
Alex Krieger
Barry B. LePatner
Steven Litt
Vernon Mays
Elizabeth Padjen
Steven S. Ross
Catherine Slessor

Architecture®
(VOL. 89, No. 4), publication
number ISSN 0746-0554, is pub-
lished monthly by BPI Commu-
nications, Inc., 1515 Broadway,
New York, NY 10036. Postmaster,
please send changes of address to
Architecture, P.O. Box 2063,
Marion, OH 43305-2063.
Individual subscriptions:
U.S. and its possessions: \$55
for 1 year, \$105 for 2 years, \$155
for 3 years. Canada: \$64 for 1 year.
Foreign: \$85 for 1 year. Single
copies: U.S. and its possessions:
\$8.95 each; Canada: \$11.00 each.
For subscription matters,
write: Circulation Department,
Architecture, P.O. Box 2063,
Marion, OH 43305-2063;
(800) 745-8922; outside U.S.
(740) 382-3322. Periodicals
postage paid at New York, NY,
and additional mailing offices.
Canadian Post International
Mail Product (Canadian
Distribution) Sales Agreement
No. 0877859. Printed in USA.

© 2000 by BPI Communications
Inc. No part of this publication
may be reproduced, stored
in any retrieval system, or trans-
mitted in any form or by any
means, electronic, mechanical,
photocopying, recording, or
otherwise without the publisher's
prior written permission.
Chairman: Gerald S. Hobbs;
President and CEO: John B.
Babcock, Jr.; Executive Vice
Presidents: Mark Dacey,
Robert J. Dowling, Howard
Lander; Senior Vice Presidents:
Paul Curran, Ann Haire,
Rosalee Lovett, Craig Reiss;
Vice President: Glenn
Heffernan; Chairman Emeritus:
W. D. Littleford

www.architecturemag.com

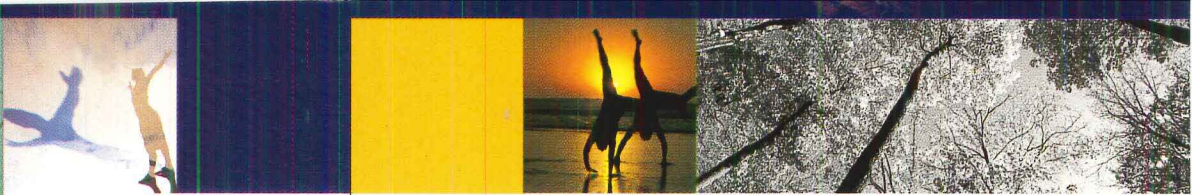
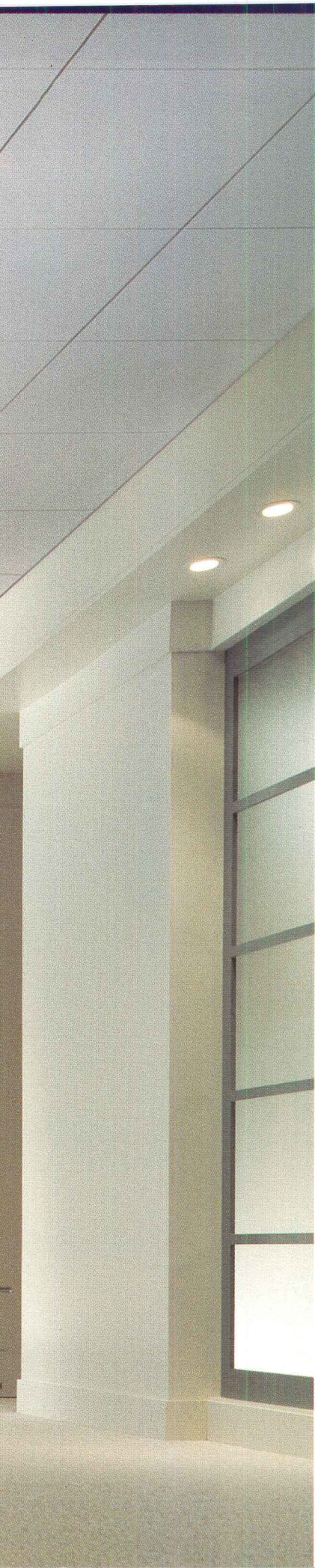

CEILING SYSTEMS

[Between us, ideas become reality.™]

Introducing Optima Vector™, the revolutionary new acoustical ceiling with virtually no visible grid.

With Optima Vector, now you can achieve a clean, nearly monolithic look in a downward access suspended ceiling. That's because the unique Vector* edge detail provides a sleek 1/4" reveal that minimizes the existing grid. In fact, the larger the expanse of open plan ceiling, the more effectively the grid disappears, leaving you with a grid-hiding, upscale visual. It works with existing standard 15/16" grid systems, which makes it perfect for renovations - avoiding costly, time-consuming grid removal, replacement or repainting. And because Optima Vector is a high performance open plan ceiling, you can count on superior sound absorption, light reflectance and durability.

Suspended ceiling. Grid-hiding visual.
Now together, from Armstrong.

For more information, call 1-888-CEILINGS
or visit our website at www.ceiling.com

*Patent Pending

Armstrong

Circle 52 on information card

teectury

11
Contributors

15
Editorial

28
Letters

220
Ad Index

230
Protest

NEWS

37

Koolhaas Wins Pritzker Prize

Guggenheim gets Gehry; Olympics in the Big Apple?; Zaha shows us her moves; Architects show us their underwear; and more.
Edited by Mickey O'Connor

63

Calendar

68

On the Boards

Chicago condominium tower, by Perkins & Will; Madison, Wisconsin office building, by Valerio Dewalt Train.
By Anne Guiney

PRACTICE

75

Turning Kyoto Into Kindling

Japan's ancient cultural capital is abandoning its exquisite wooden townhouses to the wrecking ball. Preservationists are struggling to stop the demolition. *By Marc Peter Keane*

82

Easy Money

Champagne is flowing from Main Street to Wall Street as IPO's turn businesspeople into millionaires. So why are architects watching from the sidelines? *By Christopher Hawthorne*

CULTURE

91

Pilgrim's Progress

Architects may be the nearest thing in our secular world to medieval pilgrims. *By Robert Harbison*

98

For Sale: Life-size Aquarium

The line between public and private life remains contested, as a glass house in Santiago, Chile, reveals. *By Robert Gonzales*

102

The Triumph of the Baroque

The baroque dazzled and impressed the society of its day—and continues to do so today. *By Richard Ingersoll*

108

Unfashionable Fashion

Rei Kawakubo's conceptual clothing for Comme des Garçons earns kudos from the architectural world. *By Ned Cramer*

May 2000

E

DESIGN

113

Power Inventory

Our registry of powerful people and places.

114

The Power List

The Most Powerful People in American Architecture.

130

Buildings Under Power

Santiago Calatrava builds poetry in motion.
By Sara Hart and Raul Barreneche

138

Power Outage

Venturi, Scott Brown and Associates isn't hip anymore, which is what makes its new Toulouse provincial capitol so interesting. *By Ned Cramer*

146

Power Station

Light is the language of Herzog & de Meuron's renovation of the Bankside Power Station into the Tate Modern, London.
By Nina Rappaport and Sara Hart

156

Computer Power

Coming to a laptop near you: the next branch of the Guggenheim Museum. *By Cathy Lang Ho*

162

The Seat of Power

There's more to Philip Johnson's New Canaan estate than the Glass House. *By Hilary Lewis*

162

house

TABLE OF CONTENTS

Herzog & de Meuron's luminous Tate Modern, London, photographed by H el ene Binet, March 7, 2000.

NEXT ISSUE

Albert Speer, Junior

A summer reading roundup

Modernism, Diller + Scofidio-style

Say hello to the new tenants



"It's perfect honey, nice neighborhood, lots of space and NO NIXALITE!"

Specify Nixalite and send them packing

Specifying Nixalite Bird Control ensures a lifetime of effective, inconspicuous and humane control for all types of birds on all kinds of architectural surfaces.

For 50 years, architects and engineers have trusted Nixalite to solve their pest bird problems. Our reputation for quality and reliability is unsurpassed.

Call now to get your free planning guide.



Ph:800-624-1189 Fax:800-624-1196
Email: birdcontrol@nixalite.com
Website: www.nixalite.com

Nixalite[®]
Architectural Bird Control
1025 16th Ave, ARCH, East Moline, IL. 61244
Ph: 309-755-8771 Fax: 309-755-0077

Circle 54 on information card

archi

EDITOR-IN-CHIEF

Reed Kroloff
rkroloff@architecturemag.com

ART DIRECTOR

Lisa Naftolin
lnaftolin@architecturemag.com

MANAGING EDITOR

Joelle Byrer
jbyrer@architecturemag.com

SENIOR EDITORS

Raul A. Barreneche
rbarreneche@architecturemag.com

Michael Cannell
mcannell@architecturemag.com

Ned Cramer
ncramer@architecturemag.com

ASSOCIATE EDITORS

Anne Guiney
aguiney@architecturemag.com

Sara Hart
shart@architecturemag.com

Cathy Lang Ho
cho@architecturemag.com

ASSISTANT EDITOR

Mickey O'Connor
moconnor@architecturemag.com

COPY EDITOR

Iris Becker
ibecker@architecturemag.com

ASSOCIATE ART DIRECTOR

Claudia Brandenburg
cbrandenburg@architecturemag.com

PHOTO EDITOR

Alexandra Brez
abrez@architecturemag.com

EDITORIAL ASSISTANT

Sarah Palmer
spalmer@architecturemag.com

INTERN

Alan G. Brake

TECHNICAL ILLUSTRATOR

Christine Malecki West

EDITORS-AT-LARGE

Aaron Betsky
Joseph Giovannini
Bradford McKee

GROUP PUBLISHER

Jill Bokor
jbokor@bpicomm.com

ASSISTANT TO THE GROUP PUBLISHER

Marilyn Alba
malba@architecturemag.com

VICE PRESIDENT/MARKETING SERVICES

Deborah Patton
dpatton@bpicomm.com

EVENTS MANAGER

Rory Sullivan
rsullivan@bpicomm.com

VICE PRESIDENT/PRODUCTION

Robert M. Hoover
rhoover@architecturemag.com

PRODUCTION MANAGER

Randell Scherer
rscherer@architecturemag.com

CIRCULATION MANAGER

Barbara Falk
bfalk@bpicomm.com

EDITORIAL

(212) 536-6221
(212) 382-6016 fax
info@architecturemag.com

ADVERTISING INQUIRIES

(212) 536-5236

SUBSCRIPTIONS

(800) 745-8922

REPRINTS

(212) 536-5194

BACK ISSUES

(212) 536-5083

PRESIDENT/DESIGN GROUP

Craig Reiss
creiss@architecturemag.com

CONTRIBUTING EDITORS

Peter Blake
Lawrence W. Cheek
Andrei Codrescu
Colin Davies
Richard Ingersoll
Edward Keegan
Alex Krieger
Barry B. LePatner
Steven Litt
Vernon Mays
Elizabeth Padjen
Steven S. Ross
Catherine Slessor

Architecture® (VOL. 89, NO. 5), publication number ISSN 0746-0554, is published monthly by BPI Communications, Inc., 1515 Broadway, New York, NY 10036. Postmaster, please send changes of address to Architecture, P.O. Box 2063, Marion, OH 43305-2063. Individual subscriptions: U.S. and its possessions: \$55 for 1 year, \$105 for 2 years, \$155 for 3 years. Canada: \$64 for 1 year. Foreign: \$85 for 1 year. Single copies: U.S. and its possessions: \$8.95 each; Canada: \$11.00 each. For subscription matters, write: Circulation Department, Architecture, P.O. Box 2063, Marion, OH 43305-2063; (800) 745-8922; outside U.S. (740) 382-3322. Periodicals postage paid at New York, NY, and additional mailing offices. Canadian Post International Mail Product (Canadian Distribution) Sales Agreement No. 0877859. Printed in USA.

© 2000 by BPI Communications Inc. No part of this publication may be reproduced, stored in any retrieval system, or transmitted in any form or by any means, electronic, mechanical, photocopying, recording, or otherwise without the publisher's prior written permission. Chairman: Gerald S. Hobbs; President and CEO: John B. Babcock, Jr.; Executive Vice Presidents: Mark Dacey, Robert J. Dowling, Howard Lander; Senior Vice Presidents: Paul Curran, Ann Haire, Rosalee Lovett, Craig Reiss; Vice President: Glenn Heffernan; Chairman Emeritus: W. D. Littleford

www.architecturemag.com

May 2000

architecture

house

EDITOR-IN-CHIEF
Reed Kroloff
rkroloff@architecturemag.com

EXECUTIVE EDITOR
Raul A. Barreneche
rbarreneche@architecturemag.com

CREATIVE DIRECTOR
Lisa Naftolin
lnaftolin@architecturemag.com

ART DIRECTOR
Claudia Brandenburg
cbrandenburg@architecturemag.com

MANAGING EDITOR
Joelle Byrer
jbyrer@architecturemag.com

COPY EDITOR
Iris Becker
ibecker@architecturemag.com

PRESIDENT/DESIGN GROUP
Craig Reiss
creiss@architecturemag.com

VICE PRESIDENT/PRODUCTION
Robert Hoover
rhoover@architecturemag.com

VICE PRESIDENT/MARKETING SERVICES
Deborah Patton
dpattson@bpicomm.com

EDITORIAL
(212) 536-6221
(212) 382-6016 fax
info@architecturemag.com

ADVERTISING/MEDIA KITS
(212) 536-5236

REPRINTS
(212) 536-5137

details

177

News + Products

The biggest house in the U.S. takes shape; fiberglass puts a new spin on house building; interior designers are eyeing your job; plus the latest facts and figures on housing starts and mortgage rates.

180

How Many Consultants Does It Take to Change a Light Bulb?

Clients demand high-tech home automation; architects don't know a thing about it. How to stay on top of the curve?
By Edward Keegan

184

Recipe for Success

A Bay Area entrepreneur translates kitchen design expertise into a full-fledged business.
By Aaron Betsky

houses

187

Beyond the Box

188

The Shape of Things to Come?

Designer Michael Jantzen builds his eye-popping vision of flexible housing.
By Ann Jarmusch

192

The Super Shed: Not Your Typical Dorm

Auburn University architecture students get a mandate in designing shelter: Do it yourself.
By Vernon Mays

200

Labs for Living

Industry and academia help future-thinking architects build the houses of tomorrow—today.
By Nina Rappaport

206

Boxed Up, But Not Boxed In

An addition to an off-the-rack suburban ranch proves anything but ordinary.
By Lawrence W. Cheek

“We’re still building houses the way we first built cars—by hand.”

M.I.T. professor Kent Larsen, page 200

Cover

Drawing of Su Mei Yu
Addition, La Jolla,
California, by Public

LEHIGH CEMENTS

Engineered for Quality. Specified for Creativity.

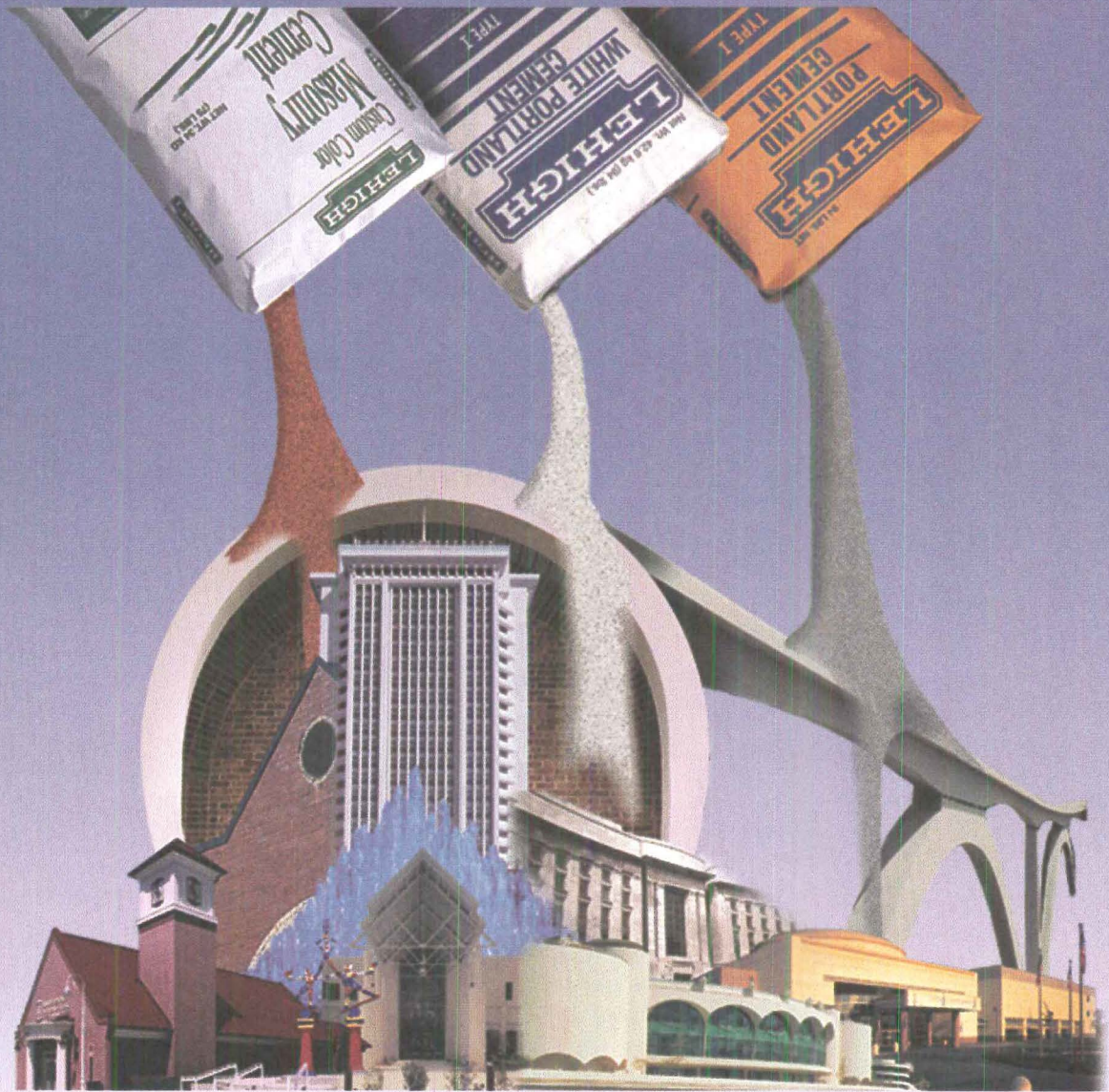

For over 100 years, Lehigh Gray, White, and Custom Color Portland and Masonry Cements have been used in concrete to create architectural masterpieces. With Lehigh products, architects are given the freedom to choose a multitude of applications to achieve an unlimited range of color, texture, shape, size and pattern. Our versatile quality cements are uniquely transformed through your imagination and creativity. Contact us today or visit us on the web.



Since 1897

7660 Imperial Way, Allentown, PA 18195
800-523-5488 610-366-4600 Fax: 610-366-4638
www.lehighcement.com



Visit us at Booth #2107
at AIA Expo 2000

Circle 156 on information card

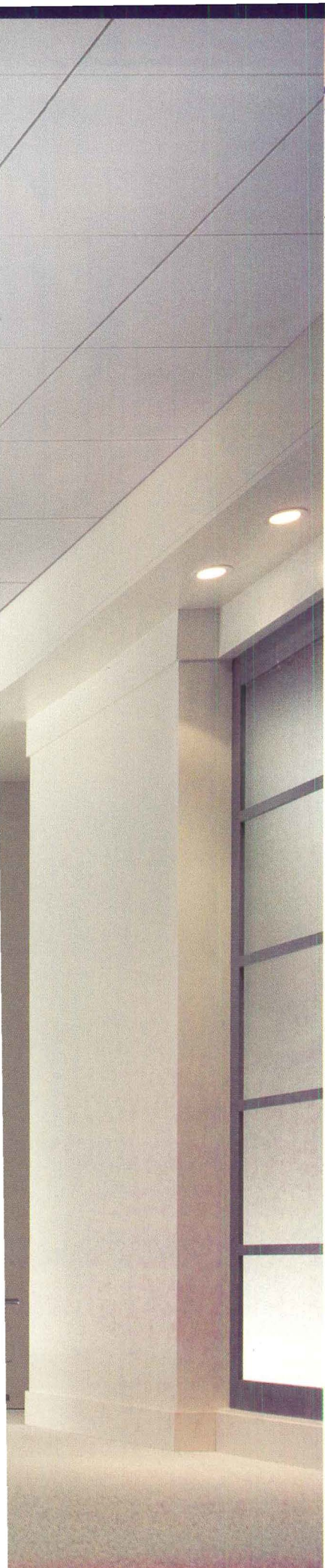

CEILING SYSTEMS

[Between us, ideas become reality.™]

Introducing Optima Vector™, the revolutionary new acoustical ceiling with virtually no visible grid.

With Optima Vector, now you can achieve a clean, nearly monolithic look in a downward access suspended ceiling. That's because the unique Vector* edge detail provides a sleek 1/4" reveal that minimizes the existing grid. In fact, the larger the expanse of open plan ceiling, the more effectively the grid disappears, leaving you with a grid-hiding, upscale visual. It works with existing standard 15/16" grid systems, which makes it perfect for renovations – avoiding costly, time-consuming grid removal, replacement or repainting. And because Optima Vector is a high performance open plan ceiling, you can count on superior sound absorption, light reflectance and durability.

Suspended ceiling. Grid-hiding visual.
Now together, from Armstrong.

For more information, call 1-888-CEILINGS
or visit our website at www.ceilings.com

*Patent Pending

Armstrong

Circle 3 on information card

teetury

11
Contributors

15
Editorial

23
Letters

150
Ad Index

160
Protest

NEWS

31

Chutzpah, Thy Name Is Zaha

OK City dedicates memorial; Little Rock's land grab; Condé Nast's new lunch spot; Pisa's Leaning Tower sits up straighter; and more. Edited by Mickey O'Connor

49

Calendar

53

On the Boards

Cincinnati Country Day School by Michael McInturf Architects. By Anne Guiney

PRACTICE

59

Prairie Revolution

The U.S. heartland feeds the world even as its own hard-luck farm towns vanish. Can the wild prairie inspire a comeback? By Michael Cannell

68

Loophole Masters

Smart growth is spawning a new kind of architecture firm that sees income in infill. By Lawrence W. Cheek

72

Here Comes the Sun

A giant new heliodon helps architects preview the behavior of light. By Sara Hart

CULTURE

77

The Burden of History

If modern architecture ever had a villain, it would be Albert Speer, chief architect of the Third Reich. How did his son and namesake cope with his father's legacy—and manage to practice architecture in postwar Germany? By Michael Z. Wise

82

'Less Aesthetics, More Ethics'

Massimiliano Fuksas, director of the Venice Biennale, opening this month, proposes a new agenda for architecture: a return of substance over style. By Richard Ingersoll

86

Paper Bound

The Museum of Modern Art's latest acquisition is a piece of paper architecture: a latticed cardboard roof for its sculpture garden, by Japanese architect Shigeru Ban. By Anne Guiney

90

Summer Reading

Not all architecture books fall into the coffee-table category. Here's a handful of titles that will keep you occupied (and edified) this summer. Edited by Cathy Lang Ho

June 2000

E

“Elizabeth Diller and Ricardo Scofidio are architects. It just happens that they haven’t designed much that their colleagues would recognize as buildings.”

from *Diller + Scofidio: Under Surveillance*, p. 128

DESIGN

97

Theory into Practice

Architecture is smarter than ever.

98

Urban Geography

Della Valle + Bernheimer creates a topography of concrete plates for San Francisco’s Federal Plaza. *By Lisa Findley*

104

Creative Space

Allied Works brings urbanity to the office in its renovation of a Portland, Oregon, warehouse. *By Adele Freedman*

116

The Montessori Method

Los Angeles-based architect Studio Works imparts its smart sense of humor to a Milwaukee school. *By Joseph Giovannini*

122

The Piggyback Building

Canadian architect LWPAC lands a modernist architecture school atop a neo-Gothic campus. *By Julie Lasky*

128

Diller + Scofidio

Under surveillance. *By Aaron Betsky*

TABLE OF CONTENTS

Image from Diller + Scofidio’s video installation *Travelogues*.

COVER

One frame of a 3D x-ray image from *Travelogues*. Assembly by Matthew Johnson and Deane Simpson, with the assistance of Doshi Diagnostics. See story, page 128.

NEXT ISSUE

Breaking into the Box
The American Indian Museum Controversy
Mies’ Missing Drive-In

Say hello to the new tenants



"It's perfect honey, nice neighborhood, lots of space and NO NIXALITE!"

Specify Nixalite and send them packing

Specifying Nixalite Bird Control ensures a lifetime of effective, inconspicuous and humane control for all types of birds on all kinds of architectural surfaces.

For 50 years, architects and engineers have trusted Nixalite to solve their pest bird problems. Our reputation for quality and reliability is unsurpassed.

Call now to get your free planning guide.

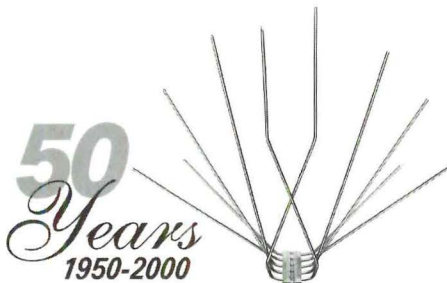

Ph: 800-624-1189 Fax: 800-624-1196

Email: birdcontrol@nixalite.com

Website: www.nixalite.com

 **Nixalite**[®]
Architectural Bird Control
1025 16th Ave, ARCH, East Moline, IL. 61244
Ph: 309-755-8771 Fax: 309-755-0077

Circle 5 on information card

archi

EDITOR-IN-CHIEF

Reed Kroloff
rkroloff@architecturemag.com

ART DIRECTOR

Lisa Naftolin
lnaftolin@architecturemag.com

MANAGING EDITOR

Joelle Byrer
jbyrer@architecturemag.com

SENIOR EDITORS

Michael Cannell
mcannell@architecturemag.com
Ned Cramer
ncramer@architecturemag.com

ASSOCIATE EDITORS

Anne Guiney
aguiney@architecturemag.com
Sara Hart
shart@architecturemag.com
Cathy Lang Ho
cho@architecturemag.com

ASSISTANT EDITOR

Mickey O'Connor
moconnor@architecturemag.com

COPY EDITOR

Iris Becker
ibecker@architecturemag.com

ASSOCIATE ART DIRECTOR

Claudia Brandenburg
cbrandenburg@architecturemag.com

PHOTO EDITOR

Alexandra Brez
abrez@architecturemag.com

EDITORIAL ASSISTANT

Sarah Palmer
spalmer@architecturemag.com

INTERN

Alan G. Brake

TECHNICAL ILLUSTRATOR

Christine Malecki West

EDITORS-AT-LARGE

Aaron Betsky
Joseph Giovannini
Bradford McKee

GROUP PUBLISHER

Jill Bokor
jbokor@bpicomm.com

ASSISTANT TO THE GROUP PUBLISHER

Marilyn Alba
malba@architecturemag.com

VICE PRESIDENT/MARKETING SERVICES

Deborah Patton
dpatton@bpicomm.com

EVENTS MANAGER

Rory Sullivan
rsullivan@bpicomm.com

VICE PRESIDENT/PRODUCTION

Robert M. Hoover
rhoover@architecturemag.com

PRODUCTION MANAGER

Randell Scherer
rscherer@architecturemag.com

CIRCULATION MANAGER

Barbara Falk
bfalk@bpicomm.com

EDITORIAL

(212) 536-6221
(212) 382-6016 fax
info@architecturemag.com

ADVERTISING INQUIRIES

(212) 536-5236

SUBSCRIPTIONS

(800) 745-8922

REPRINTS

(212) 536-5194

BACK ISSUES

(212) 536-5083

PRESIDENT/DESIGN GROUP

Craig Reiss
creiss@architecturemag.com

CONTRIBUTING EDITORS

Peter Blake
Lawrence W. Cheek
Andrei Codrescu
Colin Davies
Richard Ingersoll
Edward Keegan
Alex Krieger
Barry B. LePatner
Steven Litt
Vernon Mays
Elizabeth Padjen
Steven S. Ross
Catherine Slessor

Architecture® (VOL. 89, no. 6), publication number ISSN 0746-0554, is published monthly by BPI Communications, Inc., 1515 Broadway, New York, NY 10036. Postmaster, please send changes of address to Architecture, P.O. Box 2063, Marion, OH 43305-2063. Individual subscriptions: U.S. and its possessions: \$55 for 1 year, \$105 for 2 years, \$155 for 3 years. Canada: \$64 for 1 year. Foreign: \$85 for 1 year. Single copies: U.S. and its possessions: \$8.95 each; Canada: \$11.00 each. For subscription matters, write: Circulation Department, Architecture, P.O. Box 2063, Marion, OH 43305-2063; (800) 745-8922; outside U.S. (740) 382-3322. Periodicals postage paid at New York, NY, and additional mailing offices. Canadian Post International Mail Product (Canadian Distribution) Sales Agreement No. 0877859. Printed in USA.

© 2000 by BPI Communications Inc. No part of this publication may be reproduced, stored in any retrieval system, or transmitted in any form or by any means, electronic, mechanical, photocopying, recording, or otherwise without the publisher's prior written permission. Chairman: Gerald S. Hobbs; President and CEO: John B. Babcock, Jr.; Executive Vice Presidents: Mark Dacey, Robert J. Dowling, Howard Lander; Senior Vice Presidents: Paul Curran, Ann Haire, Rosalee Lovett, Craig Reiss; Vice President: Glenn Heffernan; Chairman Emeritus: W. D. Littleford

www.architecturemag.com

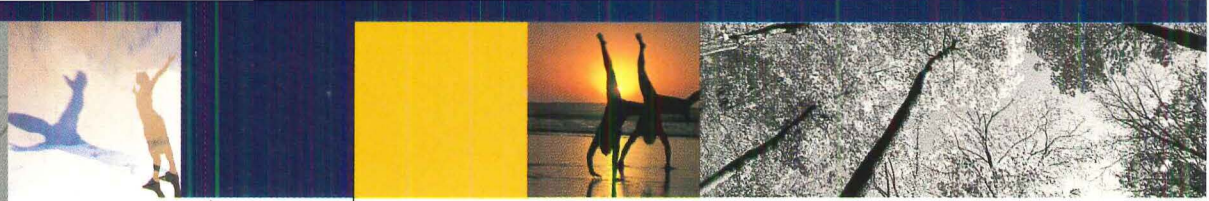

CEILING SYSTEMS

[Between us, ideas become reality.™]

Introducing Optima Vector™, the revolutionary new acoustical ceiling with virtually no visible grid.

With Optima Vector, now you can achieve a clean, nearly monolithic look in a downward access suspended ceiling. That's because the unique Vector* edge detail provides a sleek 1/4" reveal that minimizes the existing grid. In fact, the larger the expanse of open plan ceiling, the more effectively the grid disappears, leaving you with a grid-hiding, upscale visual. It works with existing standard 15/16" grid systems, which makes it perfect for renovations – avoiding costly, time-consuming grid removal, replacement or repainting. And because Optima Vector is a high performance open plan ceiling, you can count on superior sound absorption, light reflectance and durability.

Suspended ceiling. Grid-hiding visual. Now together, from Armstrong.

For more information, call 1-888-CEILINGS or visit our website at www.ceilings.com

*Patent Pending

Armstrong

Circle 48 on information card

tectury

11
Contributors

15
Editorial

27
Letters

144
Ad Index

150
Protest

NEWS

39

Billings, Profits Looking Up

The unretiring Hejduk retires; (school) size doesn't matter; neo-Corbusians, beware!; having a bang-up time in Times Square; Johnson Wax nostalgia; and more. *Edited by Mickey O'Connor*

51

Calendar

52

On the Boards

School of Architecture and Planning at the University of New Mexico, by Antoine Predock, Architect. *By Anne Guiney*

PRACTICE

55

The View from the Hill

As his January retirement approaches, Senator Daniel Patrick Moynihan reflects on a long career as architecture's Beltway backer. *By Mickey O'Connor*

58

The Screens of Summer

Pull up to the speaker, put the car in 'park,' and recline your seat. After years of decline, drive-in theaters are coming back. *By Michelle Patient*

60

Cardinal Rules

Can a building heal old wounds? The National Museum of the American Indian is meant to be part-Louvre, part-holocaust memorial. *By Michael Cannell*

CULTURE

67

Burgers, Fries, and a Side Order of Mies

How did an American roadside diner—designed by Mies van der Rohe—manage to slip from the annals of architecture? *By Liane Lefavre*

72

Desperately Seeking Saarinen

A little-known college in a little-known town turns out to be a pivotal project in the American practice of Finnish father-and-son team Eliel and Eero Saarinen. *By Peter Papademetriou*

74

Architecture, To Go

At the annual Milan Furniture Fair, architects' works are strictly prêt-à-porter. *By Cathy Lang Ho*

78

Taken for Granted

Though artists pursue grant money as a matter of course, every year grant money for architects goes unclaimed. *By Christopher Hawthorne*

July 2000

E

DESIGN

83

Living with the B

84

Building a Better

The modernist box is open
By Aaron Betsky

90

Wiel Arets

Lensvelt Factory and Office

96

Artifact Design

Sauna Pavilion

102

The Steel Cage

Criticism and fiction collide in a three-part account of the famous, tempestuous relationship between Ludwig Mies van der Rohe and his client Edith Farnsworth. By Farès el-Dahdah

104

Maya Lin Studio

Langston Hughes Library

114

Angélil/Graham/Pfenninger/Scholl Architecture

Esslingen Market

122

Valerio Olgiati Architecture

Paspels Schoolhouse

130

RCR Architects, Aranda Pigem Vilalta

Social Center

TABLE OF CONTENTS

Saturday night at Becky's Drive-In in Berlinsville, Pa. Photographed by Jason Fulford, May 20, 2000. See story, page 58.

COVER

Caged bird: Mies boxes-in client Edith Farnsworth. Illustration by Zohar Lazar. See story, page 102.

NEXT ISSUE

Spectacle: Frank Gehry, Jon Jerde, and the Hannover Expo

Was ANYbody Listening ANYway?

Will Britain Lose Its Elgin Marbles?

Say hello to the new tenants



"It's perfect honey, nice neighborhood, lots of space and NO NIXALITE!"

Specify Nixalite and send them packing

Specifying Nixalite Bird Control ensures a lifetime of effective, inconspicuous and humane control for all types of birds on all kinds of architectural surfaces.

For 50 years, architects and engineers have trusted Nixalite to solve their pest bird problems. Our reputation for quality and reliability is unsurpassed.

Call now to get your free planning guide.

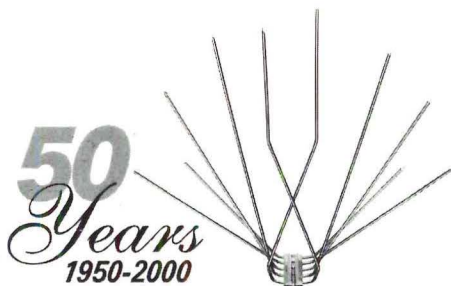

Ph: 800-624-1189 Fax: 800-624-1196
 Email: birdcontrol@nixalite.com
 Website: www.nixalite.com

Nixalite[®]
 Architectural Bird Control
 1025 16th Ave, ARCH, East Moline, IL. 61244
 Ph: 309-755-8771 Fax: 309-755-0077

Circle 50 on information card

archi

EDITOR-IN-CHIEF

Reed Kroloff
rkroloff@architecturemag.com

ART DIRECTOR

Lisa Naftolin
lnaftolin@architecturemag.com

MANAGING EDITOR

Joelle Byrer
jbyrer@architecturemag.com

SENIOR EDITORS

Michael Cannell
mcannell@architecturemag.com
Ned Cramer
ncramer@architecturemag.com
Cathy Lang Ho
cho@architecturemag.com

ASSOCIATE EDITORS

Anne Guiney
aguiney@architecturemag.com
Sara Hart
shart@architecturemag.com

ASSISTANT EDITOR

Mickey O'Connor
mo'connor@architecturemag.com

COPY EDITORS

Iris Becker
ibecker@architecturemag.com
Lauren Wolfe

ASSOCIATE ART DIRECTOR

Claudia Brandenburg
cbrandenburg@architecturemag.com

PHOTO EDITOR

Alexandra Brez
abrez@architecturemag.com

EDITORIAL ASSISTANT

Sarah Palmer
spalmer@architecturemag.com

PHOTO INTERN

Carrie Levy

TECHNICAL ILLUSTRATOR

Christine Malecki West

EDITORS-AT-LARGE

Aaron Betsky
Joseph Giovanni
Bradford McKee

GROUP PUBLISHER

Jill Bokor
jbokor@bpicomm.com

ASSISTANT TO THE GROUP PUBLISHER

Marilyn Alba
malba@architecturemag.com

VICE PRESIDENT/MARKETING SERVICES

Deborah Patton
dpattson@bpicomm.com

EVENTS MANAGER

Rory Sullivan
rsullivan@bpicomm.com

VICE PRESIDENT/PRODUCTION

Robert M. Hoover
rhoover@architecturemag.com

PRODUCTION MANAGER

Randell Scherer
rscherer@architecturemag.com

CIRCULATION MANAGER

Barbara Falk
bfalk@bpicomm.com

EDITORIAL

(646) 654-5766
 (646) 654-5817 fax
info@architecturemag.com

ADVERTISING INQUIRIES

(646) 654-5760

SUBSCRIPTIONS

(800) 745-8922

REPRINTS

(646) 654-5763

BACK ISSUES

(646) 654-5871

PRESIDENT/DESIGN GROUP

Craig Reiss
creiss@architecturemag.com

CONTRIBUTING EDITORS

Peter Blake
Lawrence W. Cheek
Andrei Codrescu
Colin Davies
Richard Ingersoll
Edward Keegan
Alex Krieger
Barry B. LePatner
Steven Litt
Vernon Mays
Elizabeth Padjen
Steven S. Ross
Catherine Slessor

Architecture®

(VOL. 89, NO. 7), publication number ISSN 0746-0554, is published monthly by BPI Communications, Inc., 770 Broadway, New York, NY 10003. Postmaster, please send changes of address to Architecture, P.O. Box 2063, Marion, OH 43305-2063. Individual subscriptions: U.S. and its possessions: \$55 for 1 year, \$105 for 2 years, \$155 for 3 years. Canada: \$64 for 1 year. Foreign: \$85 for 1 year. Single copies: U.S. and its possessions: \$8.95 each; Canada: \$11.00 each. For subscription matters, write: Circulation Department, Architecture, P.O. Box 2063, Marion, OH 43305-2063; (800) 745-8922; outside U.S. (740) 382-3322. Periodicals postage paid at New York, NY, and additional mailing offices. Canadian Post International Mail Product (Canadian Distribution) Sales Agreement No. 0877859. Printed in U.S.A.

© 2000 by BPI Communications Inc. No part of this publication may be reproduced, stored in any retrieval system, or transmitted in any form or by any means, electronic, mechanical, photocopying, recording, or otherwise without the publisher's prior written permission. Chairman: Gerald S. Hobbs; President and CEO: John B. Babcock, Jr.; Executive Vice Presidents: Mark Dacey, Robert J. Dowling, Howard Lander; Senior Vice Presidents: Paul Curran, Ann Haire, Rosalee Lovett, Craig Reiss; Vice President: Glenn Heffernan; Chairman Emeritus: W. D. Littleford

www.architecturemag.com

After 70 years in business we're happy to report:

So far so good.

Meticulous craftsmanship produces doors so durable most will outlive the buildings in which they're installed. What makes Ellison Doors virtually indestructible is a unitized superstructure created by welding a .09" continuous frame right through the .09" door face — rather than just tacking channel to the door edge. Seams between stiles and rails are also welded and then, in a painstaking process, ground and finished until welds and joints are invisible. Top rails and stiles are a minimum of 2-3/4" wide. Bottom rails are at least 6" deep. The specs on our glass doors and aluminum doors are equally impressive. And all of our balanced hardware is manufactured in our shop, so replacement components are available for every door we've ever made. Contact us today for complete information and technical support.

ellison
Ellison Bronze
A Division of Dowcraft Corporation



800-665-6445 • www.ellison-bronze.com

Circle 3 on information card

teectury

8
Contributors

13
Editorial

23
Letters

180
Ad Index

186
Protest

NEWS

27
**Samuel Mockbee:
Reluctant Genius**

London bridge, falling down; Andres Duany broadens his horizons; the most recent battle of Gettysburg; Swiss take sides; Tributes: John Hejduk and Enric Miralles; and more. Edited by Mickey O'Connor

37
Calendar

38
On the Boards

Theater renovation and addition, Minneapolis, Minnesota; University of Alaska Museum, Fairbanks, Alaska, by Hammel Green, and Abrahamson Shubert. By Anne Guiney

PRACTICE

41
Thawing the Frieze

The 2,500-year-old Elgin Marbles are a Greek national treasure. So why are they on display at the British Museum? By Christopher Hawthorne

46
Sea Change

The Salton Sea is a ghost town of mid-century modern resort structures. The 1950s yacht clubs and googie-style motels may soon come back to life. By Alan Hess

50
Measuring the Globe

A replica of Shakespeare's Globe Theatre is London's most popular playhouse. Controversial new evidence casts doubt on its authenticity. By Christopher Hawthorne

CULTURE

55
Constant Appeal

Dutch artist Constant Nieuwenhuys' New Babylon offered the 1960s counterculture a critique of the society of the spectacle. It also elucidates today's architecture and cities. By Mark Wigley

60
ANYthing Went

ANY broke new ground in packaging haute architectural culture and mastering the media event. Its 10-year project comes to an end. By Joan Ockman

62
That's Entertainment

Entertainment used to be a part of culture; now it is culture. What happens when art and museums adopt the blockbuster ethic? By Frank Edgerton Martin

64
The New Glocalism

Armed with 3-D Studio, splines, berms, and blobs, ArchiLab is the new avant-garde. By Aaron Betsky

August 2000

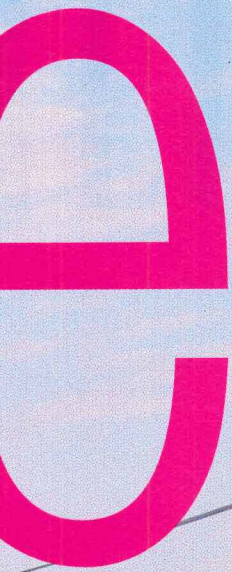

DESIGN

67

Life's Guilty Pleasures

68

The Venetian

Introduction: *Ned Cramer* Photographs: *Richard Barnes*

78

All the World's a Stage: Architecture and Spectacle

Text: *Richard Ingersoll*

80

The Experience Music Project

Text: *Joseph Giovannini* Photographs: *Timothy Hursley*

92

Expo 2000 Hannover

Text: *Ned Cramer* Photographs: *Christian Richters*

112

Jon Jerde: Neon Urbanist

Text: *Michael Cannell* Portrait: *Gail Albert Halaban*

116

Burj al Arab

Text: *Edward McBride* Photographs: *Robert Polidori*

141



house

TABLE OF CONTENTS

Expo 2000 Hannover, Hannover, Germany. Photograph by Christian Richters. See story, page 92.

COVER

The Experience Music Project, Seattle, by Frank O. Gehry & Associates. Photograph by Timothy Hursley. See story, page 80.

NEXT ISSUE

Building the Perfect Blob
The Best Places to Work
Education: Legendary Design Studios



Say hello to the new tenants



"It's perfect honey, nice neighborhood, lots of space and NO NIXALITE!"

Specify Nixalite and send them packing

Specifying Nixalite Bird Control ensures a lifetime of effective, inconspicuous and humane control for all types of birds on all kinds of architectural surfaces.

For 50 years, architects and engineers have trusted Nixalite to solve their pest bird problems. Our reputation for quality and reliability is unsurpassed.

Call now to get your free planning guide.

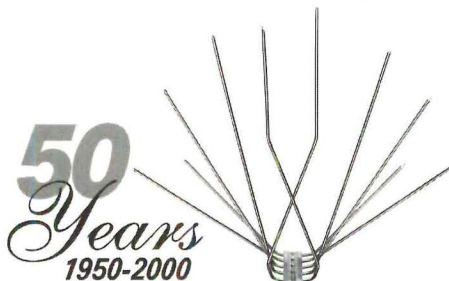

Ph:800-624-1189 Fax:800-624-1196
Email: birdcontrol@nixalite.com
Website: www.nixalite.com

 **Nixalite**[®]
Architectural Bird Control
1025 16th Ave, ARCH, East Moline, IL. 61244
Ph: 309-755-8771 Fax: 309-755-0077

Circle 5 on information card

archi

EDITOR-IN-CHIEF

Reed Kroloff
rkroloff@architecturemag.com

ART DIRECTOR

Lisa Naftolin
lnaftolin@architecturemag.com

MANAGING EDITOR

Joelle Byrer
jbyrer@architecturemag.com

SENIOR EDITORS

Michael Cannell
mcannell@architecturemag.com

Ned Cramer
ncramer@architecturemag.com

Cathy Lang Ho
cho@architecturemag.com

ASSOCIATE EDITORS

Anne Guiney
aguiney@architecturemag.com

Sara Hart
shart@architecturemag.com

ASSISTANT EDITOR

Mickey O'Connor
moconnor@architecturemag.com

COPY EDITOR

Lauren Wolfe

ASSOCIATE ART DIRECTOR

Claudia Brandenburg
cbrandenburg@architecturemag.com

PHOTO EDITOR

Alexandra Brez
abrez@architecturemag.com

EDITORIAL ASSISTANT

Sarah Palmer
spalmer@architecturemag.com

PHOTO INTERN

Carrie Levy

TECHNICAL ILLUSTRATOR

Christine Malecki West

EDITORS-AT-LARGE

Aaron Betsky
Joseph Giovannini
Bradford McKee

GROUP PUBLISHER

Jill Bokor
jbokor@bpicomm.com

ASSISTANT TO THE GROUP PUBLISHER

Marilyn Alba
malba@architecturemag.com

VICE PRESIDENT/MARKETING SERVICES

Deborah Patton
dpatton@bpicomm.com

EVENTS MANAGER

Rory Sullivan
rsullivan@bpicomm.com

VICE PRESIDENT/PRODUCTION

Robert M. Hoover
rhoover@architecturemag.com

PRODUCTION MANAGER

Randell Scherer
rscherer@architecturemag.com

CIRCULATION MANAGER

Barbara Falk
bfalk@bpicomm.com

EDITORIAL

(646) 654-5766
(646) 654-5817 fax
info@architecturemag.com

ADVERTISING INQUIRIES

(646) 654-5760

SUBSCRIPTIONS

(800) 745-8922

REPRINTS

(646) 654-5763

BACK ISSUES

(646) 654-5871

PRESIDENT/DESIGN GROUP

Craig Reiss
creiss@architecturemag.com

CONTRIBUTING EDITORS

Peter Blake
Lawrence W. Cheek
Andrei Codrescu
Colin Davies
Richard Ingersoll
Edward Keegan
Alex Krieger
Barry B. LePatron
Steven Litt
Vernon Mays
Elizabeth Padjen
Steven S. Ross
Catherine Slessor

Architecture® (vol. 89, no. 8), publication number ISSN 0746-0554, is published monthly by BPI Communications, Inc., 770 Broadway, New York, NY 10003. Postmaster, please send changes of address to Architecture, P.O. Box 2063, Marion, OH 43305-2063. Individual subscriptions: U.S. and its possessions: \$55 for 1 year, \$105 for 2 years, \$155 for 3 years. Canada: \$64 for 1 year. Foreign: \$85 for 1 year. Single copies: U.S. and its possessions: \$8.95 each; Canada: \$11.00 each. For subscription matters, write: Circulation Department, Architecture, P.O. Box 2063, Marion, OH 43305-2063; (800) 745-8922; outside U.S. (740) 382-3322. Periodicals postage paid at New York, NY, and additional mailing offices. Canadian Post International Mail Product (Canadian Distribution) Sales Agreement No. 0877859. Printed in USA.

© 2000 by BPI Communications Inc. No part of this publication may be reproduced, stored in any retrieval system, or transmitted in any form or by any means, electronic, mechanical, photocopying, recording, or otherwise without the publisher's prior written permission. Chairman: Gerald S. Hobbs; President and CEO: John B. Babcock, Jr.; Executive Vice Presidents: Mark Dacey, Robert J. Dowling, Howard Lander; Senior Vice Presidents: Paul Curran, Ann Haire, Rosalee Lovett, Craig Reiss; Vice President: Glenn Heffernan; Chairman Emeritus: W. D. Littleford

www.architecturemag.com

August 2000

architecture

house

EDITOR-IN-CHIEF

Reed Kroloff
rkroloff@architecturemag.com

CREATIVE DIRECTOR

Lisa Naftolin
lnaftolin@architecturemag.com

ART DIRECTOR

Claudia Brandenburg
cbrandenburg@architecturemag.com

CONTRIBUTING EDITORS

Samuel W. Barry
Sara Hart
shart@architecturemag.com

MANAGING EDITOR

Joelle Byrer
jbyrer@architecturemag.com

COPY EDITOR

Lauren Wolfe
lwolfe@architecturemag.com

PRESIDENT/DESIGN GROUP

Craig Reiss
creiss@architecturemag.com

PUBLISHER

Jill Bokor
jbokor@architecturemag.com

VICE PRESIDENT/PRODUCTION

Robert Hoover
rhoover@architecturemag.com

EDITORIAL

(646) 654-5766
(646) 654-5817 fax
info@architecturemag.com

ADVERTISING/MEDIA KITS

(646) 654-5760

REPRINTS

(646) 654-5763

details

145

Luxury in a Box

Prefab construction comes of age in the form of swank condominiums now appearing on London rooftops. *By Sara Hart*

146

News + Products

John Pawson designs kitchens for uncluttered minimalists; funky furnishings emerge at ICFF 2000; Georgia Tech wires a house for aging baby boomers; HUD approves accessibility codes; the housing boom slows down as interest rates go up; a superhero generator promises fuel efficiency for the home; a book about townhouses gives new life to an old building type. *Compiled by Samuel W. Barry and Sara Hart*

houses

151

Less Can Be More

152
Country House
Designer Jerry Waters debuts a small house brimming with big ideas. *By Lawrence W. Cheek*

158

Town House

Architectural alchemists Kuth/Ranieri transform a run-down San Francisco garage into an elegant house. *By Aaron Betsky*

164

Suburban House

A new house by Nagle Hartray proves the modern tradition is alive and well in Chicago. *By Ed Keegan*

168

Vacation House

A guest house by Toshiko Mori respects and updates Paul Rudolph's Sarasota school. *By Joseph Giovannini*

“Historic precedents may be an endangered species, but you have to push forward from them to the next round of evolution.” Architect Toshiko Mori, page 168

Cover

Giving small house a hand
Photograph by
Anne Katrine Senstad

LEHIGH CEMENTS

Engineered for Quality. Specified for Creativity.

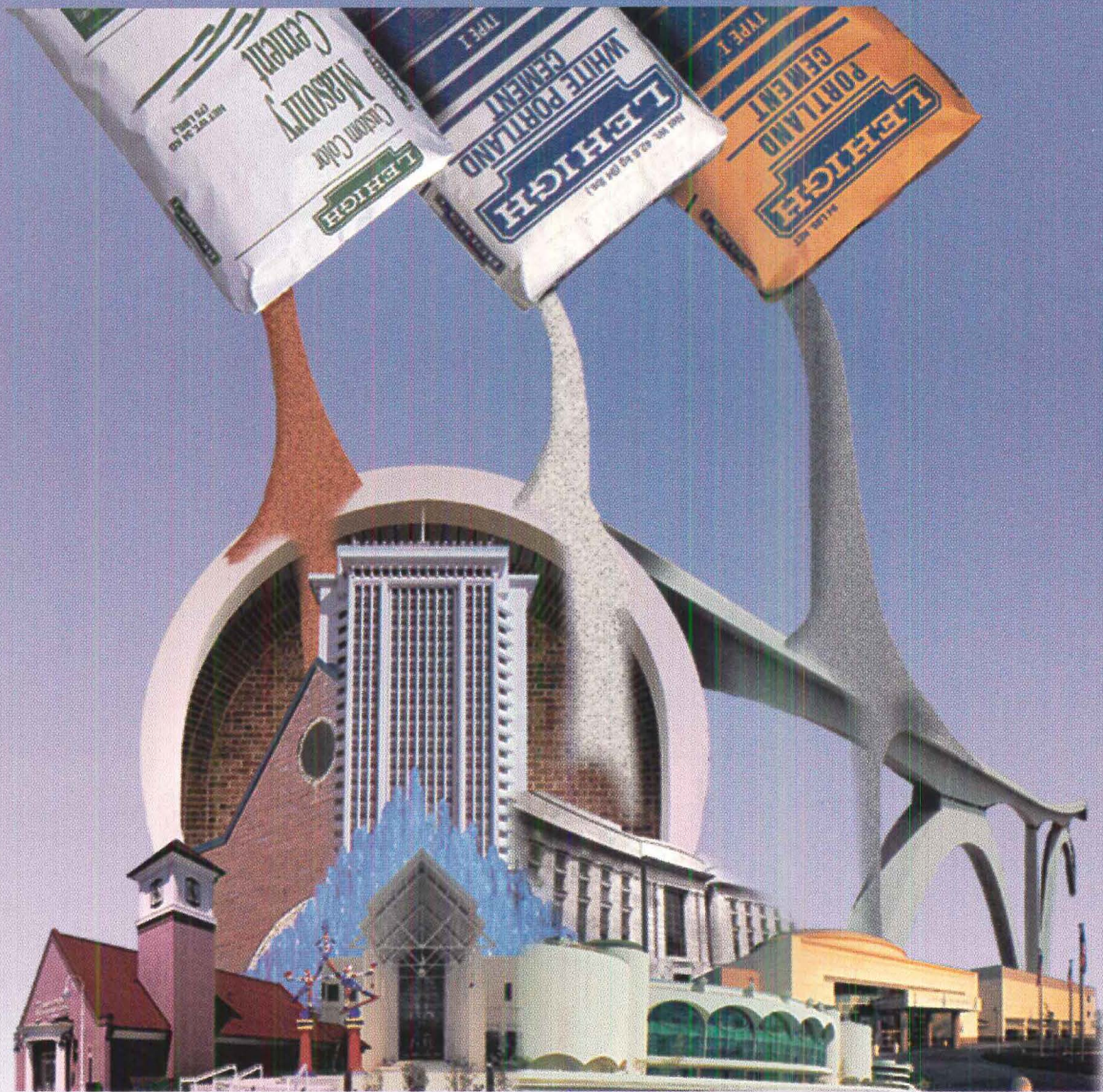

For over 100 years, Lehigh Gray, White, and Custom Color Portland and Masonry Cements have been used in concrete to create architectural masterpieces. With Lehigh products, architects are given the freedom to choose a multitude of applications to achieve an unlimited range of color, texture, shape, size and pattern. Our versatile quality cements are uniquely transformed through your imagination and creativity. Contact us today or visit us on the web.



LEHIGH

Since 1897

7660 Imperial Way, Allentown, PA 18195
800-523-5488 610-366-4600 Fax: 610-366-4638
www.lehighcement.com

Circle 59 on information card



CEILING SYSTEMS

[Between us, ideas become reality.™]

Introducing Optima Vector™, the revolutionary new acoustical ceiling with virtually no visible grid.

With Optima Vector, now you can achieve a clean, nearly monolithic look in a downward access suspended ceiling. That's because the unique Vector* edge detail provides a sleek 1/4" reveal that minimizes the existing grid. In fact, the larger the expanse of open plan ceiling, the more effectively the grid disappears, leaving you with a grid-hiding, upscale visual. It works with existing standard 15/16" grid systems, which makes it perfect for renovations – avoiding costly, time-consuming grid removal, replacement or repainting. And because Optima Vector is a high performance open plan ceiling, you can count on superior sound absorption, light reflectance and durability.

Suspended ceiling. Grid-hiding visual. Now together, from Armstrong.

For more information, call 1-888-CEILINGS or visit our website at www.ceilings.com

*Patent Pending



Armstrong

Circle 60 on information card

teetalk

9
Contributors

13
Editorial

27
Letters

144
Ad Index

158
Protest

NEWS

33

FEMA: 87,000 Structures Threatened by Erosion

Green for green; the *Times* it is a-changin'; Scotch red tape; bugs funny; Bland-ton's shortlist; Beantown's frozen smile; and more.
Edited by Mickey O'Connor

49

Calendar

50

On the Boards

The Norwegian National Opera House
by Snøhetta. *By Anne Guiney*

PRACTICE

53

Upcycling the World

German chemist and former Greenpeace protestor Michael Braungart wants architects to adopt nature as their guide. Are corporations listening?
By Michael Cannell

58

Route Structure

Congress is acting to preserve Route 66 and its neglected roadside culture.
By Alan Hess

62

Going Dotty

Will young Information Age moguls grow up to be the next great architectural patrons? *By Michael Cannell*

CULTURE

67

Drawing New Conclusions

With never-before-seen drawings, an exhibition on Luis Barragán sheds new light on the old master. *By Richard Ingersoll*

70

The Electric Cool-CAD Auto Test

At the 7th Venice Architecture Biennale, architects draft diverse methods and media to express this year's theme, "*Città: Less Aesthetics, More Ethics.*" *By Cathy Lang Ho*

73

Event City

The 2000 Olympics offered Sydney a chance to jump-start urban development. Did it work?
By Christopher Procter

76

Studio Crit

The studio is the heart of the architect's education, but it may be time for a checkup.
By Dana Cuff

E

DESIGN

93

**DIGITAL ARCHITECTURE:
BETWEEN WORLDS**

94

THE COMPUTER SCHOOL

How Columbia University helped launch a digital revolution.
By Ned Cramer and Anne Guiney

108

FAST COMPANIES

NBBJ polishes Reebok's corporate image with a sleek new headquarters in suburban Massachusetts.
By Sara Hart

118

DIGITIZING DÜSSELDORF

Frank Gehry pushes the (building) envelope again with three towers in Germany. *By Catherine Slessor*

126

BUILDING A BETTER BLOB

The virtual becomes physical as architects begin to build their digital dreams. *By Joseph Giovannini*

130

A Clean, Well-Lighted Space

Tampa's new art center by Thompson & Rose basks in the Florida sun. *By Anne Guiney*

136

THE PECKHAM EFFECT

Aisop & Störmer's Peckham Library gives hope to a depressed London suburb. *By Catherine Slessor*

TABLE OF CONTENTS

Coming to a neighborhood near you. Image from *Housings*, by Kolatan/MacDonald Studio. See story, page 94.

COVER

Digital image of the *Hot Tub House*, by Kolatan/MacDonald Studio.

NEXT ISSUE

Architecture in Motion

Athens Prepares for the Olympics

Extracting the Future of Extranets

Say hello to the new tenants



"It's perfect honey, nice neighborhood, lots of space and NO NIXALITE!"

Specify Nixalite and send them packing

Specifying Nixalite Bird Control ensures a lifetime of effective, inconspicuous and humane control for all types of birds on all kinds of architectural surfaces.

For 50 years, architects and engineers have trusted Nixalite to solve their pest bird problems. Our reputation for quality and reliability is unsurpassed.

Call now to get your free planning guide.

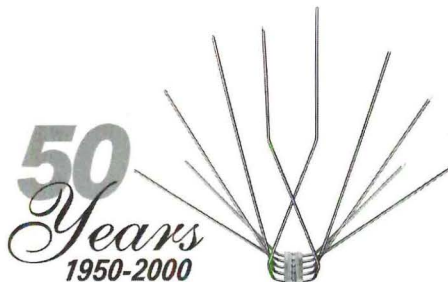

Ph: 800-624-1189 Fax: 800-624-1196
Email: birdcontrol@nixalite.com
Website: www.nixalite.com

Nixalite[®]
Architectural Bird Control
1025 16th Ave, ARCH, East Moline, IL 61244
Ph: 309-755-8771 Fax: 309-755-0077
Circle 62 on information card

archi

EDITOR-IN-CHIEF

Reed Kroloff
rkroloff@architecturemag.com

MANAGING EDITOR

Joelle Byrer
jbyrer@architecturemag.com

SENIOR EDITORS

Michael Cannell
mcannell@architecturemag.com
Ned Cramer
ncramer@architecturemag.com
Cathy Lang Ho
cho@architecturemag.com

ASSOCIATE EDITORS

Anne Guiney
aguiney@architecturemag.com
Sara Hart
shart@architecturemag.com

ASSISTANT EDITOR

Mickey O'Connor
moconnor@architecturemag.com

COPY EDITOR

Lauren Wolfe
lwolfe@architecturemag.com

EDITORIAL ASSISTANT

Sarah Palmer
spalmer@architecturemag.com

EDITORS-AT-LARGE

Aaron Betsky
Joseph Giovannini
Bradford McKee

CONTRIBUTING EDITORS

Peter Blake
Lawrence W. Cheek
Andrei Codrescu
Colin Davies
Richard Ingersoll
Edward Keegan
Alex Krieger
Liane Lefavre
Steven Litt
Vernon Mays
Elizabeth Padjen
Steven S. Ross
Catherine Slessor
Lawrence W. Speck
Anthony Vidler

GROUP PUBLISHER

Jill Bokor
jbokor@bpicomm.com

ASSISTANT TO THE GROUP PUBLISHER

Marilyn Alba
malba@architecturemag.com

VICE PRESIDENT/MARKETING SERVICES

Deborah Patton
dpatton@bpicomm.com

EVENTS MANAGER

Rory Sullivan
rsullivan@bpicomm.com

VICE PRESIDENT/PRODUCTION

Robert M. Hoover
rhoover@architecturemag.com

PRODUCTION MANAGER

Randell Scherer
rscherer@architecturemag.com

CIRCULATION MANAGER

Barbara Falk
bfalk@bpicomm.com

EDITORIAL

(646) 654-5766
(646) 654-5817 fax
info@architecturemag.com

ADVERTISING INQUIRIES

(646) 654-5760

SUBSCRIPTIONS

(800) 745-8922

REPRINTS

(646) 654-5763

BACK ISSUES

(646) 654-5871

PRESIDENT/DESIGN GROUP

Craig Reiss
creiss@architecturemag.com

ART DIRECTOR

Lisa Naftolin
lnaftolin@architecturemag.com

ASSOCIATE ART DIRECTOR

Claudia Brandenburg
cbrandenburg@architecturemag.com

ASSISTANT ART DIRECTOR

Lynn Yeo
lyeo@architecturemag.com

PHOTO EDITOR

Alexandra Brez
abrez@architecturemag.com

PHOTO INTERN

Carrie Levy

TECHNICAL ILLUSTRATOR

Christine Malecki West

Architecture® (vol. 89, no. 9), publication number ISSN 0746-0554, is published monthly by BPI Communications, Inc., 770 Broadway, New York, NY 10003. Postmaster, please send changes of address to Architecture, P.O. Box 2063, Marion, OH 43305-2063. Individual subscriptions: U.S. and its possessions: \$55 for 1 year, \$105 for 2 years, \$155 for 3 years. Canada: \$64 for 1 year. Foreign: \$85 for 1 year. Single copies: U.S. and its possessions: \$8.95 each; Canada: \$11.00 each. For subscription matters, write: Circulation Department, Architecture, P.O. Box 2063, Marion, OH 43305-2063; (800) 745-8922; outside U.S. (740) 382-3322. Periodicals postage paid at New York, NY, and additional mailing offices. Canadian Post International Mail Product (Canadian Distribution) Sales Agreement No. 0877859. Printed in U.S.A.

© 2000 by BPI Communications Inc. No part of this publication may be reproduced, stored in any retrieval system, or transmitted in any form or by any means, electronic, mechanical, photocopying, recording, or otherwise without the publisher's prior written permission. Chairman: Gerald S. Hobbs; President and CEO: John B. Babcock, Jr.; Executive Vice Presidents: Mark Dacey, Robert J. Dowling, Howard Lander; Senior Vice Presidents: Paul Curran, Ann Haire, Rosalee Lovett, Craig Reiss; Vice President: Glenn Heffernan; Chairman Emeritus: W. D. Littleford

www.architecturemag.com



Birdair

x 4

Four technologies converge to create tensioned membrane structures for a new millennium.

The result: dramatic and versatile permanent membrane structures of Teflon® coated woven Beta® glassfiber yarns. This building product works. It survives winds, snow, heat. It performs for decades. Design a roof, an amphitheater, an airport. The membrane is Sheerfill®, the resource is Birdair. Advanced engineering, exceptional quality control, dedicated team effort. Call, visit our website, or write for comprehensive technical support.



BIRDAR

Circle 3 on information card

CHEMFAB

Teflon®
Only by DuPont

ADVANCED
GLASSFIBER YARNS LLC

Birdair, Inc. 65 Lawrence Bell Drive, Amherst, New York 14221 USA 716-633-9500 • 800-622-2246 • www.birdair.com

Teflon® is a registered trademark of DuPont Corporation. Beta® is a registered trademark of Advanced Glassfiber Yarns LLC. SHEERFILL® Architectural Membrane is a registered trademark of Chemfab Corporation.

teectury



11
Contributors

15
Editorial

18
Letters

144
Ad Index

150
Protest

NEWS

27

Why Is This Man Smiling?

Richard Rogers grins and bears it; poll positions; less is more than \$350 million; preservation news from Maui and Tijuana; sunset over Stiltsville; oh, Mickey, you're so fined; is Bilbao rusting?; and more. *Edited by Mickey O'Connor*

45

Calendar

50

On the Boards

Central Library of Quebec by Patkau Architects (with Croft-Pelletier and Gilles Guité)
By Anne Guiney

PRACTICE

55

Laying Down Arms

With a cease-fire in place, the British army is gradually dismantling Northern Ireland's menacing military structures. *By Michael Cannell*

60

What Has Your Firm Done For You Lately?

With today's sustained prosperity offering architects' employees a wealth of job options, firms must devise new enticements to keep their staffs intact. *By Mickey O'Connor*

66

Net Effect

Construction management will never be the same after the introduction of extranets. But are they good for architects? *By Andrew Cocke*

CULTURE

71

Rubble-Rousing

To prepare for the Olympics in 2004, Athens embarked on a major subway expansion. It soon began to become the largest archaeological dig in the world. *By Alexander Tzonis and Alkistis Rodi*

76

Pooled Cars

Car sharing has thrived in Europe for years, but will it succeed with car-loving Americans? *By Cathy Lang Ho*

80

The Last Frontier

Space stations might represent "giant steps for mankind"—but are they bringing us closer to utopia or dystopia? *By Andrei Codrescu*

84

It's a Jungle Out There

In an advertising-saturated world, companies must go to extremes to attract attention. Station Domination is the latest strategy. *By Sarah Palmer*

October 2000

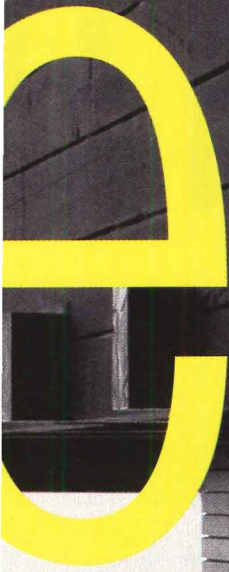

DESIGN

87

Slow Motion

88

Chelsea Carwash

Cybul & Cybul Architects and Christopher K. Grabé

By Anne Guiney

92

Muskoka Boathouse

Shim-Sutcliffe Architects

By Raul A. Barreneche

100

Science City at Union Station

Ehrenkrantz Eckstut & Kuhn Architects/SmithGroup

By Lawrence W. Cheek

108

Suransuns Footbridge

Conzett, Bronzini, Gartmann

By Nina Rappaport

112

Trailers

Photographs by Victoria Sambunaris

118

Williams Natatorium

Tod Williams Billie Tsien and Associates

By Ned Cramer

130

La Granja Escalator

José Antonio Martínez Lapeña & Elías Torres Tur, Architects

By Paloma Acuña

TABLE OF CONTENTS

A summer afternoon at Shim-Sutcliffe's Lake Muskoka boathouse. Photograph by Edward Burtynsky. See story, page 92.

COVER

Photograph by Michael Moran.

NEXT ISSUE

Germany Cleans Up Its Dirty Past

Architecture and Landscape

Paul Allen, Billionaire Benefactor

Say hello to the new tenants



"It's perfect honey, nice neighborhood, lots of space and NO NIXALITE!"

Specify Nixalite and send them packing

Specifying Nixalite Bird Control ensures a lifetime of effective, inconspicuous and humane control for all types of birds on all kinds of architectural surfaces.

For 50 years, architects and engineers have trusted Nixalite to solve their pest bird problems. Our reputation for quality and reliability is unsurpassed.

Call now to get your free planning guide.

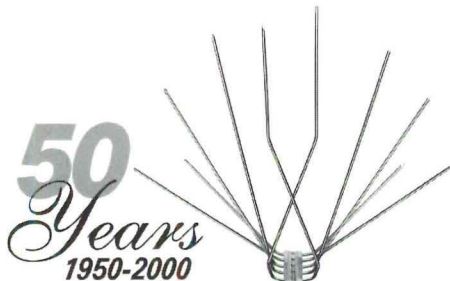

Ph:800-624-1189 Fax:800-624-1196
Email: birdcontrol@nixalite.com
Website: www.nixalite.com

Nixalite®
Architectural Bird Control

1025 16th Ave, ARCH, East Moline, IL. 61244
Ph: 309-755-8771 Fax: 309-755-0077
Circle 5 on information card

archi

EDITOR-IN-CHIEF

Reed Kroloff
rkroloff@architecturemag.com

MANAGING EDITOR

Joelle Byrer
jbyrer@architecturemag.com

SENIOR EDITORS

Michael Cannell
mcannell@architecturemag.com
Ned Cramer
ncramer@architecturemag.com
Cathy Lang Ho
cho@architecturemag.com

ASSOCIATE EDITORS

Anne Guiney
aguiney@architecturemag.com
Sara Hart
shart@architecturemag.com

ASSISTANT EDITOR

Mickey O'Connor
moconnor@architecturemag.com

COPY EDITOR

Lauren Wolfe
lwolfe@architecturemag.com

EDITORIAL ASSISTANT

Sarah Palmer
spalmer@architecturemag.com

EDITORIAL RESEARCHER

Sara Moss

EDITORS-AT-LARGE

Aaron Betsy
Joseph Giovannini
Bradford McKee

CONTRIBUTING EDITORS

Peter Blake
Lawrence W. Cheek
Andrei Codrescu
Colin Davies
Thomas Fisher
Richard Ingersoll
Edward Keegan
Alex Krieger
Liane Lefavre
Steven Litt
Vernon Mays
Elizabeth Padjen
Steven S. Ross
Catherine Slessor
Lawrence W. Speck
Anthony Vidler

PUBLISHER

Suzanne Tron Haber
sthaber@bpicomm.com

GROUP PUBLISHER

Jill Bokor
jbokor@bpicomm.com

ASSISTANT TO THE GROUP PUBLISHER

Marilyn Alba
malba@architecturemag.com

VICE PRESIDENT/MARKETING SERVICES

Deborah Patton
dpatton@bpicomm.com

EVENTS MANAGER

Rory Sullivan
rsullivan@bpicomm.com

VICE PRESIDENT/PRODUCTION

Robert M. Hoover
rhoover@architecturemag.com

PRODUCTION MANAGER

Randell Scherer
rscherer@architecturemag.com

CIRCULATION MANAGER

Barbara Falk
bfalk@bpicomm.com

EDITORIAL

(646) 654-5766
(646) 654-5817 fax
info@architecturemag.com

ADVERTISING INQUIRIES

(646) 654-5760

SUBSCRIPTIONS

(800) 745-8922

REPRINTS

(646) 654-5763

BACK ISSUES

(646) 654-5871

PRESIDENT/DESIGN GROUP

Craig Reiss
creiss@architecturemag.com

ART DIRECTOR

Lisa Naftolin
linaftolin@architecturemag.com

ASSOCIATE ART DIRECTOR

Claudia Brandenburg
cbrandenburg@architecturemag.com

ASSISTANT ART DIRECTOR

Lynn Yeo
lyeo@architecturemag.com

PHOTO EDITOR

Alexandra Brez
abrez@architecturemag.com

PHOTO INTERN

Janna Johansson Pereira

TECHNICAL ILLUSTRATOR

Christine Malecki West

Architecture® (vol. 89, no. 10), publication number ISSN 0746-0554, is published monthly by BPI Communications, Inc., 770 Broadway, New York, NY 10003. Postmaster, please send changes of address to Architecture, P.O. Box 2063, Marion, OH 43305-2063. Individual subscriptions: U.S. and its possessions: \$55 for 1 year, \$105 for 2 years, \$155 for 3 years. Canada: \$64 for 1 year. Foreign: \$85 for 1 year. Single copies: U.S. and its possessions: \$8.95 each; Canada: \$11.00 each. For subscription matters, write: Circulation Department, Architecture, P.O. Box 2063, Marion, OH 43305-2063; (800) 745-8922; outside U.S. (740) 382-3322. Periodicals postage paid at New York, NY, and additional mailing offices. Canadian Post International Mail Product (Canadian Distribution) Sales Agreement No. 0877859. Printed in USA.

© 2000 by BPI Communications Inc. No part of this publication may be reproduced, stored in any retrieval system, or transmitted in any form or by any means, electronic, mechanical, photocopying, recording, or otherwise without the publisher's prior written permission. Chairman: Gerald S. Hobbs; President and CEO: John B. Babcock, Jr.; Executive Vice Presidents: Mark Dacey, Robert J. Dowling, Howard Lander; Senior Vice Presidents: Paul Curran, Rosalee Lovett, Craig Reiss; Vice President: Glenn Heffernan; Chairman Emeritus: W. D. Littleford

www.architecturemag.com



years Dens-Glass Gold has been proven in places like this?

course there's also the fact that Dens-Glass Gold is lightweight and easy to cut with a utility
So next time you find yourself wondering which exterior sheathing product would best suit
needs, think about the options. Then think Dens-Glass Gold. Proven. Reliable. And simply superior.



Circle 48 on information card

TECHNICAL

11
Contributors

15
Editorial

29
Letters

152
Ad Index

158
Protest

NEWS

35

Paul Warwick Thompson New Cooper-Hewitt Head

Austria's hills are alive with the schemes of Hollein; reopening Pennsylvania Avenue; Clint Eastwood, lucky punk; is Kansai sinking?; Fung's sway in Washington; and more. *Edited by Mickey O'Connor*

53

Calendar

56

On the Boards

The Potsdam Biosphere, by Barkow Leibinger Architects; Museum of the Earth, by Weiss/Manfredi Architects. *By Anne Guiney*

PRACTICE

63

Allen's Town

Microsoft mogul Paul Allen has the ambition—and the money—to redraw the cultural map of Seattle. Will his largesse produce an important architectural landscape? *By Lawrence W. Cheek*

67

Steelcase House

Long a leader in furniture systems, Steelcase is branching out into something bigger: architecture. *By Christopher Hawthorne*

70

Concrete for a Sustainable Future

New methods of composition promise to green an ancient building technology. *By Jim Parsons*

CULTURE

75

Paradise Found

Once a postindustrial wasteland, Emscher Valley in Germany's Ruhr region is now a cultural promise land. *By Sebastiano Brandolini*

80

Waste Not, Want Not

The United States is not short of damaged landscapes or strategies to reclaim them. *By Cathy Lang Ho*

84

Memory-Building

Photographer Hiroshi Sugimoto transforms famous buildings into abstract glyphs. *By Paolo Polledri*

89

Making a High-Rise out of a Termite Hill

Zimbabwean architect Mick Pearce gleans architectural lessons from insects. *By Liane Lefavre*

November 2000

DESIGN

93

Landforms

94

Tulach a' tSolais

Scott Tallon Walker *By Catherine Slessor*

98

Exploration Place Science Center and Children's Museum

Moshe Safdie and Associates *By Lawrence W. Speck*

106

Peggy Notebaert Nature Museum, Chicago Academy of Sciences

Perkins & Will *By Edward Keegan*

112

Secrets of the Pyramids

Photographs and text by Thomas Miller

118

McNamara Alumni Center, University of Minnesota Gateway

Antoine Predock, Architect *By Lawrence W. Cheek*

126

Woman Suffrage Memorial

Loom *By Thomas Fisher*

132

Diamond Ranch High School

Morphosis with Thomas Blurock Architects
By Aaron Betsky

TABLE OF CONTENTS

The entrance stair to Morphosis' Diamond Ranch High School in Diamond Bar, California. Photograph by Timothy Hursley. See story, page 132.

COVER

The defunct industrial monuments of the Emscher Valley (in Germany's Ruhr region) have been reborn as land-art projects. London artist Jonathan Park has transformed the Zollverein coke plant in Essen into a mammoth light sculpture. Photograph by Thomas Pflaum / Visum

NEXT ISSUE

Toys for Architects:
A Holiday Gift List

Loudoun County,
Maryland, Says No
to Sprawl

Surface Treatment: Veils,
Skins, and Wrappers

Say hello to the new tenants



"It's perfect honey, nice neighborhood, lots of space and NO NIXALITE!"

Specify Nixalite and send them packing

Specifying Nixalite Bird Control ensures a lifetime of effective, inconspicuous and humane control for all types of birds on all kinds of architectural surfaces.

For 50 years, architects and engineers have trusted Nixalite to solve their pest bird problems. Our reputation for quality and reliability is unsurpassed.

Call now to get your free planning guide.



Ph:800-624-1189 Fax:800-624-1196
Email: birdcontrol@nixalite.com
Website: www.nixalite.com

Nixalite[®]
Architectural Bird Control
1025 16th Ave, ARCH, East Moline, IL. 61244
Ph: 309-755-8771 Fax: 309-755-0077
Circle 50 on information card

archi

EDITOR-IN-CHIEF
Reed Kroloff
rkroloff@architecturemag.com

MANAGING EDITOR
Joelle Byrer
jbyrer@architecturemag.com

SENIOR EDITORS
Michael Cannell
mcannell@architecturemag.com
Ned Cramer
ncramer@architecturemag.com
Cathy Lang Ho
cho@architecturemag.com

ASSOCIATE EDITOR
Anne Guiney
aguiney@architecturemag.com

ASSISTANT EDITOR
Mickey O'Connor
moconnor@architecturemag.com

COPY EDITOR
Lauren Wolfe
lwolfe@architecturemag.com

EDITORIAL ASSISTANT
Sarah Palmer
spalmer@architecturemag.com

EDITORIAL RESEARCHER
Sara Moss

EDITORS-AT-LARGE
Aaron Betsky
Joseph Giovannini
Bradford McKee

CONTRIBUTING EDITORS
Peter Blake
Lawrence W. Cheek
Andrei Codrescu
Colin Davies
Thomas Fisher
Richard Ingersoll
Edward Keegan
Alex Krieger
Liane Lefaivre
Steven Litt
Vernon Mays
Elizabeth Padjen
Steven S. Ross
Catherine Slessor
Lawrence W. Speck
Anthony Vidler

PUBLISHER
Suzanne Tron Haber
sthaber@bpicomm.com

GROUP PUBLISHER
Jill Bokor
jbokor@bpicomm.com

ASSISTANT TO THE GROUP PUBLISHER
Marilyn Alba
malba@architecturemag.com

VICE PRESIDENT/MARKETING SERVICES
Deborah Patton
dpatton@bpicomm.com

EVENTS MANAGER
Rory Sullivan
rsullivan@bpicomm.com

VICE PRESIDENT/PRODUCTION
Robert M. Hoover
rhoover@architecturemag.com

PRODUCTION MANAGER
Randell Scherer
rscherer@architecturemag.com

CIRCULATION DIRECTOR
Barbara Falk
bfalk@bpicomm.com

EDITORIAL
(646) 654-5766
(646) 654-5817 fax
info@architecturemag.com

ADVERTISING INQUIRIES
(646) 654-5760

SUBSCRIPTIONS
(800) 745-8922

REPRINTS
(646) 654-5763

BACK ISSUES
(646) 654-5871

PRESIDENT/DESIGN GROUP
Craig Reiss
creiss@architecturemag.com

ART DIRECTOR
Lisa Naftolin
lnaftolin@architecturemag.com

ASSOCIATE ART DIRECTOR
Claudia Brandenburg
cbrandenburg@architecturemag.com

ASSISTANT ART DIRECTOR
Lynn Yeo
lyeo@architecturemag.com

PHOTO EDITOR
Alexandra Brez
abrez@architecturemag.com

PHOTO INTERN
Janna Johansson Pereira

TECHNICAL ILLUSTRATOR
Christine Malecki West

Architecture®
(VOL. 89, NO. 11), publication number ISSN 0746-0554, is published monthly by BPI Communications, Inc., 770 Broadway, New York, NY 10003. Postmaster, please send changes of address to Architecture, P.O. Box 2063, Marion, OH 43305-2063. Individual subscriptions: U.S. and its possessions: \$55 for 1 year, \$105 for 2 years, \$155 for 3 years. Canada: \$64 for 1 year. Foreign: \$85 for 1 year. Single copies: U.S. and its possessions: \$8.95 each; Canada: \$11.00 each. For subscription matters, write: Circulation Department, Architecture, P.O. Box 2063, Marion, OH 43305-2063; (800) 745-8922; outside U.S. (740) 382-3322. Periodicals postage paid at New York, NY, and additional mailing offices. Canadian Post International Mail Product (Canadian Distribution) Sales Agreement No. 0877859. Printed in USA.

© 2000 by BPI Communications Inc. No part of this publication may be reproduced, stored in any retrieval system, or transmitted in any form or by any means, electronic, mechanical, photocopying, recording, or otherwise without the publisher's prior written permission. Chairman: Gerald S. Hobbs; President and CEO: John B. Babcock, Jr.; Executive Vice Presidents: Mark Dacey, Robert J. Dowling, Howard Lander; Senior Vice Presidents: Paul Curran, Robert Montemayor, Rosalee Lovett, Craig Reiss; Vice President: Glenn Heffernan; Chairman Emeritus: W. D. Littleford

www.architecturemag.com

**And the HR guy, and the
accounting guy, and...**

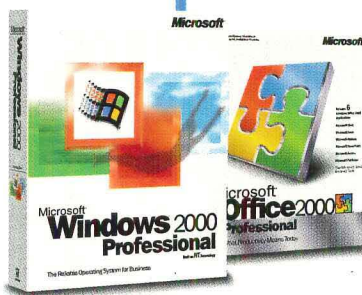

As the guy running your small business, your IT decisions should make your many jobs easier. That's why choosing new PCs that are preinstalled with Microsoft® Windows® 2000 Professional and Office 2000 is the simple and smart software solution. Running the 2000 generation of software from Microsoft ensures your PCs are powered by the most reliable Windows operating system. And you'll be able to tackle all your tasks with the power of the world's leading productivity suite—complete with tools* specially designed to help smaller companies better manage their finances, serve their customers, and reach new markets. Choose Windows 2000 Professional and Office 2000. It's the easiest executive decision you'll ever make.

To learn more, visit www.microsoft.com/businessdesktop

Where do you want to go today?

Microsoft®

Architecture

12
Contributors

17
Editorial

21
Letters

120
Ad Index

134
Protest

NEWS

23
Jane Jacobs Lauded by National Building Museum

Savannah sees through fake bricks; Prop 35 opens public doors to private firms; place your bets on banking in Las Vegas; GSD grads take paths less traveled—and strike gold; Philippe Starck's latest rawks. *Edited by Anthony Mariani*

35
Calendar

36
On the Boards

Bayer Headquarters in Leverkusen, Germany; Deutsche Post Headquarters in Bonn, Germany, by Murphy/Jahn Architects. *By Anne Guiney*

PRACTICE

41
Land's Sakes

The frontline of the battle between growth control and property rights moves to suburban Maryland. *By Bradford McKee*

48
Pier Review

SMWM architects breathes new life into one of San Francisco's derelict historic piers. *By Alfredo Botello*

54
The Business of Complex Curves

Frank Gehry's CATIA guru Jim Glymph argues that architects must take control of the software design process or be relegated to the sidelines. *By Andrew Cocke*

CULTURE

57
Curtain Call

Dutch designer Petra Blaisse changes how we look at curtains, walls, indoors, outdoors, and the spaces in between. *By Paul A. Barreche*

60
The Future of the Modern

DOCOMOMO members, guardians of the Modern Movement, convene in Brasília and debate the fate of their cause. *By Jean-Louis Cohen*

64
Holiday Wish List

What could be harder than buying a gift for a designer? We've done the legwork for you. *By Susanna Sirefman*

E

DESIGN

67

SURFACE TENSION

68

KOHN SHNIER

Umbra World Headquarters
By Adele Freedman

74

MECANOO

National Heritage Museum
By Liane Lefavre

84

**LEERS WEINZAPFEL
ASSOCIATES**

Modular VII Chiller Plant
By Vernon Mays

92

ESSAY

The Disappearing Façade, and
Other Architectural Sleights-of-Hand
By Aaron Betsky

94

**ENRIQUE CARBONELL
WITH ADHOC MSL AND
SALVADOR MORENO**

Faculty of Economics and Business,
University of Murcia
By Catherine Slessor

104

**HEIKKINEN-KOMONEN
ARCHITECTS**

Lume, Media Center
By Cathy Lang Ho

TABLE OF CONTENTS

The National Heritage
Museum in Arnhem,
The Netherlands, by
Mecanoo. Photograph by
Christian Richters.

COVER

A graphic rendering of the
freestanding perforated-
metal façade of Leers
Weinzapfel Associates'
Modular VII Chiller Plant
for the University of
Pennsylvania in
Philadelphia, taken from a
photograph by Peter
Aaron/Esto. See story,
page 84.

NEXT ISSUE

2001 Construction
Forecast

The Changing Face of
Federal Architecture
Vito Acconci Sounds Off

Say hello to the new tenants



"It's perfect honey, nice neighborhood, lots of space and NO NIXALITE!"

Specify Nixalite and send them packing

Specifying Nixalite Bird Control ensures a lifetime of effective, inconspicuous and humane control for all types of birds on all kinds of architectural surfaces.

For 50 years, architects and engineers have trusted Nixalite to solve their pest bird problems. Our reputation for quality and reliability is unsurpassed.

Call now to get your free planning guide.

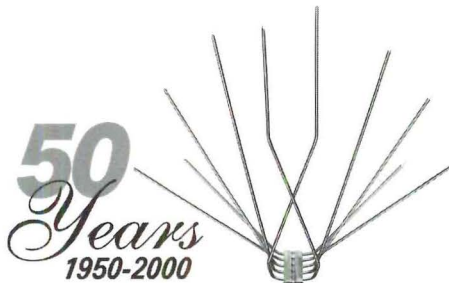

Ph: 800-624-1189 Fax: 800-624-1196
Email: birdcontrol@nixalite.com
Website: www.nixalite.com

Nixalite[®]
Architectural Bird Control

1025 16th Ave, ARCH, East Moline, IL. 61244
Ph: 309-755-8771 Fax: 309-755-0077
Circle 7 on information card

archi

EDITOR-IN-CHIEF

Reed Kroloff
rkroloff@architecturemag.com

MANAGING EDITOR

Joelle Byrer
jbyrer@architecturemag.com

SENIOR EDITORS

Ned Cramer
ncramer@architecturemag.com
Cathy Lang Ho
cho@architecturemag.com

ASSOCIATE EDITOR

Anne Guiney
aguiney@architecturemag.com

ASSISTANT EDITORS

Anthony Mariani
amariani@architecturemag.com
Mickey O'Connor
moconnor@architecturemag.com

COPY EDITOR

Lauren Wolfe
lwolfe@architecturemag.com

EDITORIAL ASSISTANT

Sarah Palmer
spalmer@architecturemag.com

EDITORIAL RESEARCHER

Sara Moss

EDITORS-AT-LARGE

Aaron Betsky
Joseph Giovannini
Bradford McKee

CONTRIBUTING EDITORS

Peter Blake
Lawrence W. Cheek
Andrei Codrescu
Colin Davies
Thomas Fisher
Richard Ingersoll
Edward Keegan
Alex Krieger
Liane Lafavre
Steven Litt
Vernon Mays
Elizabeth Padjen
Steven S. Ross
Catherine Slessor
Lawrence W. Speck
Anthony Vidler

PUBLISHER

Suzanne Tron Haber
sthaber@bpicomm.com

GROUP PUBLISHER

Jill Bokor
jbokor@bpicomm.com

ASSISTANT TO THE GROUP PUBLISHER

Marilyn Alba
malba@architecturemag.com

VICE PRESIDENT/MARKETING SERVICES

Deborah Patton
dpatton@bpicomm.com

EVENTS MANAGER

Rory Sullivan
rsullivan@bpicomm.com

VICE PRESIDENT/PRODUCTION

Robert M. Hoover
rhoover@architecturemag.com

PRODUCTION MANAGER

Randell Scherer
rscherer@architecturemag.com

CIRCULATION DIRECTOR

Barbara Falk
bfalk@bpicomm.com

EDITORIAL

(646) 654-5766
(646) 654-5817 fax
info@architecturemag.com

ADVERTISING INQUIRIES

(646) 654-5760

SUBSCRIPTIONS

(800) 745-8922

REPRINTS

(646) 654-5763

BACK ISSUES

(646) 654-5871

PRESIDENT/DESIGN GROUP

Craig Reiss
creiss@architecturemag.com

ART DIRECTOR

Lisa Naftolin
linaftolin@architecturemag.com

ASSOCIATE ART DIRECTOR

Claudia Brandenburg
cbrandenburg@architecturemag.com

ASSISTANT ART DIRECTOR

Lynn Yeo
lyeo@architecturemag.com

PHOTO EDITOR

Alexandra Brez
abrez@architecturemag.com

PHOTO INTERN

Janna Johansson Pereira

TECHNICAL ILLUSTRATOR

Christine Malecki West

Architecture® (vol. 89, no. 12), publication number ISSN 0746-0554, is published monthly by BPI Communications, Inc., 770 Broadway, New York, NY 10003. Postmaster, please send changes of address to Architecture, P.O. Box 2063, Marion, OH 43305-2063. Individual subscriptions: U.S. and its possessions: \$55 for 1 year, \$105 for 2 years, \$155 for 3 years. Canada: \$64 for 1 year. Foreign: \$85 for 1 year. Single copies: U.S. and its possessions: \$8.95 each; Canada: \$11.00 each. For subscription matters, write: Circulation Department, Architecture, P.O. Box 2063, Marion, OH 43305-2063; (800) 745-8922; outside U.S. (740) 382-3322. Periodicals postage paid at New York, NY, and additional mailing offices. Canadian Post International Mail Product (Canadian Distribution) Sales Agreement No. 0877859. Printed in USA.

© 2000 by BPI Communications Inc. No part of this publication may be reproduced, stored in any retrieval system, or transmitted in any form or by any means, electronic, mechanical, photocopying, recording, or otherwise without the publisher's prior written permission. Chairman: Gerald S. Hobbs; President and CEO: John B. Babcock, Jr.; Executive Vice Presidents: Mark Dacey, Robert J. Dowling, Howard Lander; Senior Vice Presidents: Paul Curran, Robert Montemayor, Rosalee Lovett, Craig Reiss; Vice President: Glenn Heffernan; Chairman Emeritus: W. D. Littleford

www.architecturemag.com



Roppe

Some “rubber” base products are up to 97% vinyl. But Roppe real Rubber Wall Base (type TS) is 100% vulcanized rubber. It won't shrink and doesn't need to be acclimated to building conditions prior to installation. So you can use it with confidence. Rely on Roppe rubber base for years of worry-free wear. Because nothing performs like rubber. And nobody knows rubber like Roppe.

Fax: 419-435-1056 internet: www.roppe.com e-mail: sales@roppe.com For free samples call toll free 1-877-SAMPLE-4

Circle 9 on information card

contributors



Silvia Otte

New York City-based **Joseph Giovannini** is an editor-at-large at *Architecture* and writes for other publications ranging from *The New York Times* to *Vanity Fair*. He is also the principal of the eponymous architectural practice Giovannini Associates. This month he evaluates Thom Mayne's gestural Hypo Alpe-Adria-Bank in Klagenfurt, Austria (page 100), a study in "architectural Realpolitik."

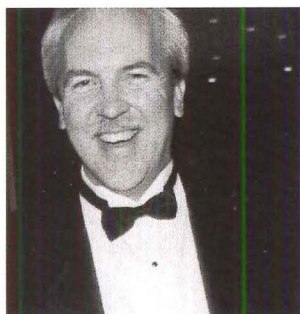

Vernon Mays

The curator of architecture and design at the San Francisco Museum of Modern Art, **Aaron Betsky** has published eight books and is an editor-at-large at *Architecture*. His new book, *Architecture Must Burn*, will be published by Thames and Hudson in the U.K. in March and by Ginko Press in the United States in May. In this issue, he explores both the "enigmatic form" of Arata Isozaki's Center of Science & Industry (page 70) in Columbus, Ohio, and Ben van Berkel's Het Valkhof Museum (page 86) in the Netherlands.

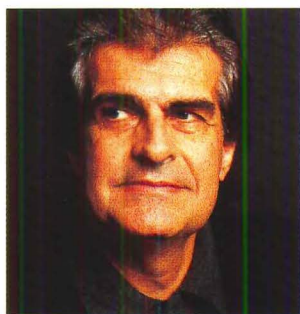

Joseph Giovannini

Dell Upton is a professor of architectural history at the University of California at Berkeley and the author of *Architecture in the United States* in the *Oxford History of Art* series. In this issue of *Architecture*, he weighs in on the everyday with a review of two books on the subject (page 54).

Formerly the executive editor of *Metropolis*, **Marisa Bartolucci** is currently working on a book about the effect of Frank Gehry's Guggenheim Bilbao on the Basque country. She reviews the new *MoMA2000: ModernStarts* show (page 47) at New York's Museum of Modern Art for our February issue.



Marissa Bartolucci

Vernon Mays is the editor of *Inform*, the magazine of the Virginia Society of the AIA, as well as a contributing editor for *Architecture*. He discovers this month how Scogin Elam and Bray create space and tranquillity in an atmosphere of suburban chaos with their third library in Atlanta (page 94).

Manhattan-based **Silvia Otte** was born in Germany and works as a commercial photographer. For our Culture section, she shoots John Burd, of Shamokin, Pennsylvania, for Christopher Hawthorne's story on drugstores and downtowns (page 50).

METALCAST® or QUARRYCAST® ?

MetalCast®

By combining metal powders, minerals and glassfibers, MetalCast® elements equal or surpass the elegant beauty of conventional castings.

The 1/4" (6mm) thick copper, brass, bronze and nickel-silver elements have an uneven buffed / burnished appearance that is enhanced by reveals or similar relief. It is not available in a bright polished finish.

For interior use only, typical applications are mouldings, door surrounds, columns and panels.

QuarryCast®

A combination of natural aggregates, minerals and glassfibers, it has the distinctive appearance of lime / sand stone. Between 1/4" and 3/8" thick (6 - 8mm) it is light weight, available in both standard and custom colors and cut with standard carpenter tools.

For interior use only, it is used for columns, mouldings, wall panels and other decorative elements, but it is not suitable for floors.

Note: MetalCast® & QuarryCast® meet the most stringent fire codes anywhere in the world.



Design 1 is Formglas' new 60 page catalog showing architectural components with existing molds, including columns, capitals, domes ceiling & wall panels, etc. All items available in Formglas G.R.G (gypsum) QuarryCast® and MetalCast®. Catalog can be sent by mail or viewed at www.formglas.com

Formglas

Formglas Inc.
20 Toro Road, Toronto, ON CANADA M3J 2A7
Tel: (416) 635-8030 Fax: (416) 635-6588
Email : enquiries@formglas.com
Web Site: <http://www.formglas.com>
Canada • USA • Japan • Malaysia

Circle 11 on information card



Why the AOL/Time Warner deal matters to architects

By Reed Kroloff

Consider for a moment the staggering capitalization of the recent America Online (AOL)/Time Warner merger: AOL will shell out \$167 billion for its new partner. That sticker price amounts to more than 10 times the value of all U.S. architectural billings last year. Though architecture is unlikely to be the next dotcom darling, the transaction offers important lessons for the profession.

Pundits heralded the takeover as a triumph of new media over old. In fact, AOL was never tempted by HBO or *Sports Illustrated*. Instead, it coveted Time Warner's least glamorous asset: coaxial cable. Turns out that cable transmits data with far greater speed and capacity than telephone lines, and AOL had no cable system. Time Warner came late to the Internet ball, but it does own the nation's second-largest cable system. Break out the champagne, I hear a wedding.

Why should an architect care (unless they own stock)? First consider AOL's challenge in the Internet wars. Like architects, AOL had no exclusive technology. It faced fierce competition and price-cutting. And it offered a product that consumers didn't understand or think they needed. AOL prevailed, and today it is an icon of our new business culture. Granted, design isn't a commodity, at least not one that reasonably can be peddled for \$19.95 per month. Nevertheless, the rise of AOL is a textbook example of how to capture a market; the kind of case study that should be required reading in architecture school business classes. Except that—oh, yeah—most architecture schools don't teach business.

Equally significant for architects is how Stephen Case, CEO of AOL, and Gerald Levin, chairman and

CEO of Time Warner, saw beyond their core enterprises. AOL has a commanding market share and a high-flying stock. Case nevertheless understood that his portal's popularity was no insurance policy. Though Time Warner was profitable, Levin recognized that the Internet spelled big trouble for his media empire. Both men knew that preconceived notions of how to do business, no matter how prosperous, would ill serve them in an economy that demands instant flexibility.

Why shouldn't architects make the same leap? After all, who better to think beyond the box? Yes, architects design buildings, and they will continue to do so. But they can—and should—design much more: This profession must seize design opportunities at all scales and in all spheres. Ask the hundreds of young architecture school graduates who are now earning fortunes designing websites and video games (*Architecture*, December 1999, page 125), or the gurus at Pentagram, the star-studded, 150-person international design firm stocked with 10 architects. Pentagram designs everything from CD cases for Pet Shop Boys to graphics packages for the AIA (they also do architecture, interiors, and exhibitions). Do they wring their hands over disciplinary purity? All the way to the bank (and the awards programs).

Arthur Gensler doesn't fret about it either. He's toying with transforming his behemoth interiors and architecture firm (1999 billings totaled more than \$242 million) into a Pentagram-like general design practice. If Gensler can pull it off (and it will require significantly stepping up the firm's design profile), architecture may have its first AOL—a corporate giant that can convince the public that good design is in their interest and price range. I say, bravo Art—and where can I buy stock?

Architecture House

This month *Architecture* launches a quarterly sibling, *Architecture House*, beginning on page 113. Created with both the residential architect and client in mind, *House* will feature extraordinary architect-designed houses, along with the technical, business, and product information necessary to run a successful residential practice. And it will do all this with the award-winning writing and graphics you've come to expect from *Architecture*. *House* is another of the changes we inaugurated with our January redesign, and there are more coming. Stay tuned and enjoy! ■



BUILD SPEED.

move it.

Sometimes it's not a luxury.

ProjectCenter® is the most widely-used project management Website in the building industry, and has made the definitive difference in the success of projects of every size and scope, in nearly every corner of the world. The reason it works is simple — ProjectCenter gives team members immediate access to mission-critical information, streamlining work flow, reducing project schedules, improving time to market, and minimizing the risk of miscommunication along the way. And because it's so easy to use, team members are up and running in no time at all.

ProjectCenter is a service of Bricnet.com, the e-marketplace for the building industry. It's available for only \$259 per project per month, which allows you an unlimited number of team members. To see a demo or receive more information, visit www.bricnet.com today.

bricnet.com

Bricnet.com is the most comprehensive e-marketplace for the building industry. A place where every part of the building process gets equal attention, so that someday the world's second largest economy will also be the world's most efficient.

BUILD on

Circle 19 on information card

ProjectCenter is a registered trademark and Bricnet is a trademark of Bricnet N.V.

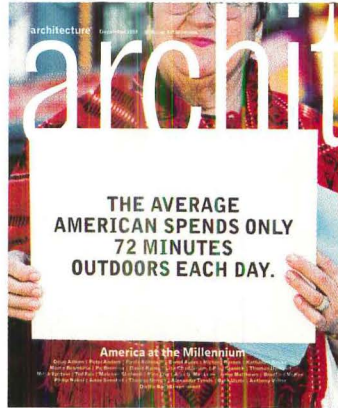

Y2Kudos

As a reader of both *Architecture* and *Architectural Record* for a third of a century, I would like to comment on your respective millennium issues. How different their explicit and implicit messages are.

Record's parade of visionary projects is too much about talent and not enough about ideas. There is insufficient new substance in this string of what-ifs, with vacuous and shopworn subtitles. I can't imagine anything as tedious or empty as another 100 years of endless formal and technical invention driven by raw capability, blind technology, esthetic boredom, media vanity, and envy of other fields. Compared to the last century, the average modern building simply sucks.

Architecture's December issue is innovative rather than merely about innovation. And it's not modernist innovation for its own sake. Provocative, insightful essays by Michael Benedikt, Alexander Tzonis, Anthony Vidler, and some new extramural voices, as well as a sobering statistical portrait of end-of-century America, seem more millennial than Y2K. It is good to see editorial perspective that is more international at the end of the "American Century." It also seems appropriate that no design projects per se were trotted out to capture or usher in a moment as big as this one. As an aside, thank you for heralding biomorphic forms, which

potentially represent a more soothing architectural and urban language than rough-hewn deconstructivist fractals.

History will register which new work will have lasting effect and influence. It will of course depend on who's writing it for whom, but Tzonis' comments (pages 78–79) about how "the computer-driven proliferation of forms at the end of the millennium" has "spilled over to the level of the self-indulgent and hedonistic" are telling. He describes how Gehry uses the computer to "ease" the design and construction of buildings conceived with traditional sketches and models, while Calatrava uses them "to empower design vision." It's differences like this that may prove to be prophetic.

As life becomes faster and architecture more mediated by magazines like yours, it won't take a third of a century to see the differences emerge. Thanks for helping us get this far.

Doug Kelbaugh
Dean, Taubman College of
Architecture and Urban Planning
University of Michigan
Ann Arbor, Michigan

cc: Robert Ivy, Editor-in-Chief,
Architectural Record

I feel like *Architecture* has been building to this point for some time—in your editorials and, obviously, in the content. What better time than the passing of the century to finally hit us over the head with it: WAKE UP! Architecture is important and we need to believe that and act like we believe it. I was shocked to learn recently that the top recruiter of architecture students in this country is Andersen Consulting—apparently it recognizes the broad-based problem-solving skills that this education instills. Of course, Andersen retrain recent grads and then pays them twice as much.

I am only about halfway through the December issue, but dealing with architectural issues at the

level of cultural reality is a welcome departure from the tradition of style versus practice that is typical in architectural magazines. I look forward to the changes you mentioned in the coming months.

E. Tim Carl
Hammel, Green and Abrahamson
Minneapolis

Your December cover reports that Americans spend a daily average of only 72 minutes outdoors. This represents less the success of architecture, as you imply, than the failure of urbanism. In the throes of modernist planning, our public realm has become both dysfunctional and unpleasant.

Andres Duany
Miami

Brain Drain

Let the young architects flee (December 1999, pages 125–127). Architecture is more than imagery. It's brick and mortar. It's contracts and litigation. It's knowing how to build the vision. The profession is missing out on some potential design talent. However, design vision is only part of the mix. I would guess that those who leave real architecture for virtual would never pass the exam or become contributing professionals anyway. The final line of the article tells it all: They want to strike it rich, then play at architecture. They might be able to talk the talk, but they can't walk the walk. Game Boy, anyone?

Eric Kuritzky
Orlando, Florida

WE WANT TO HEAR FROM YOU!
Mail your letters to the editor to:
Architecture, 1515 Broadway,
New York, NY 10036.
Or fax to: 212/382-6016. Or e-mail us at: info@architecturemag.com.
Include your name, address, and daytime phone number. Letters may be edited for clarity or length.

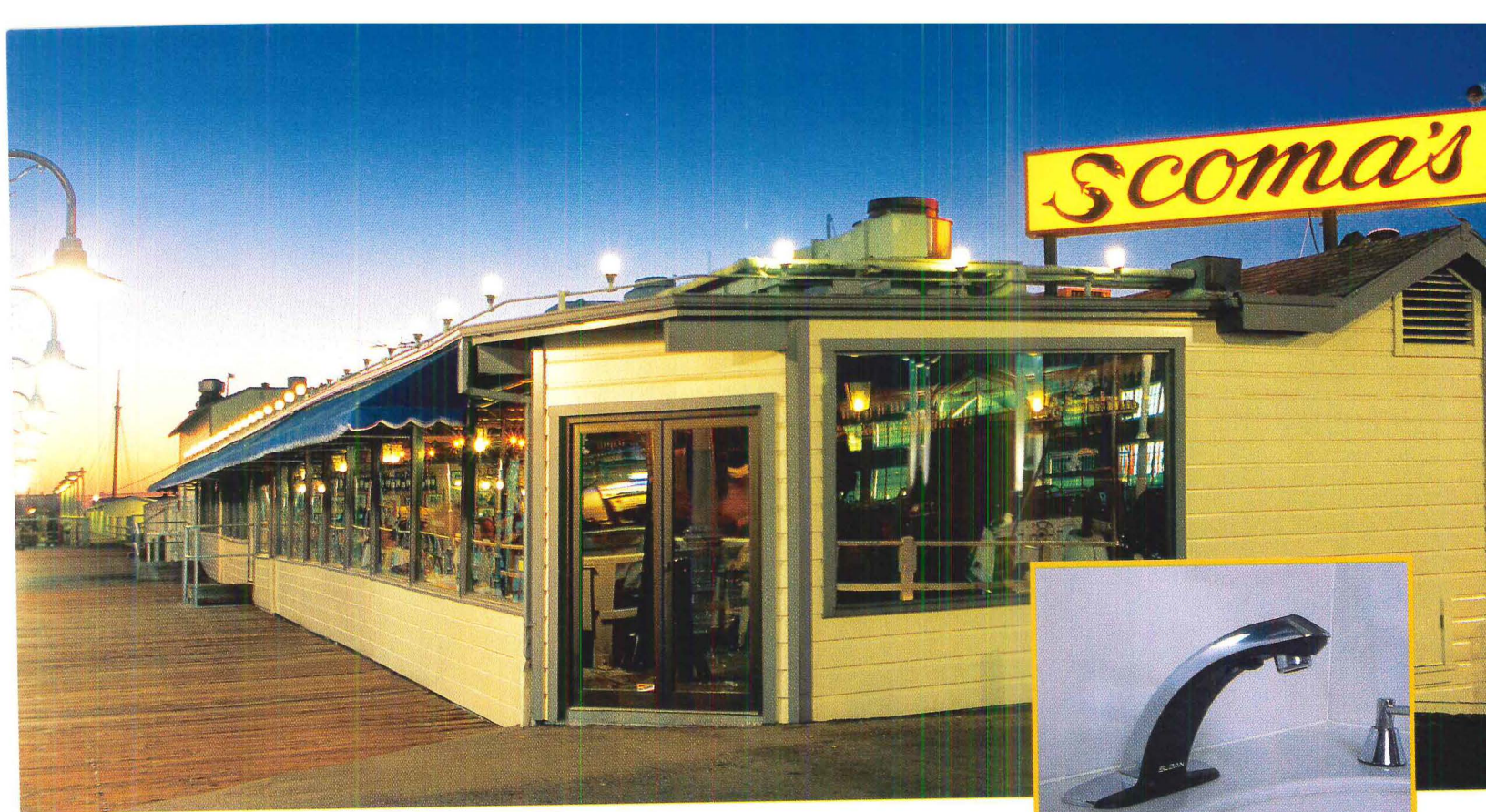

WHY SCOMA'S RESTAURANT ON PIER 47 RELIES ON SLOAN OPTIMA FAUCETS

"When you're pressed for space and have one of the most popular restaurants in the area, you have to find faucets that perform AND maintain your image under heavy usage," says Tom Creedon, President of Scoma's Restaurant in San Francisco.

In addition, water savings are realized with Optima's adjustable hand washing time-out settings that meet Scoma's and California's stringent water conservation practices.

"We are on the pier in San Francisco Bay and practice strict water conservation at Scoma's," Creedon says. "I'd recommend Sloan's water-saving faucets to any restaurateur because they save water and have other features important to restaurants."

- *Easy maintenance for continued top performance*
- *Water-resistant and splash-proof circuit housings to protect critical components*
- *Sleek styling for design conscious, upscale new or remodeling applications*
- *Timeless craftsmanship embodying elegance without sacrificing performance*

"That's why we chose SLOAN'S Optima® ETF-80, ADA compliant electronic faucets."

Sloan Optima designer styled, hands-free electronic faucets' provided the space-savings and good looks that Creedon wanted in the restrooms of his world-famous restaurant. The faucets are mounted on the sink basin where the back and side splashguards intersect, providing a unique, hygiene-rich installation that projects a positive image to customers.

Learn more about why Tom Creedon also recommends Sloan's Optima Flushometers and why more restaurants and owners rely on the performance of Sloan. Call **800-745-0800** or circle the number below for a copy of our full-line catalog/CD-ROM.

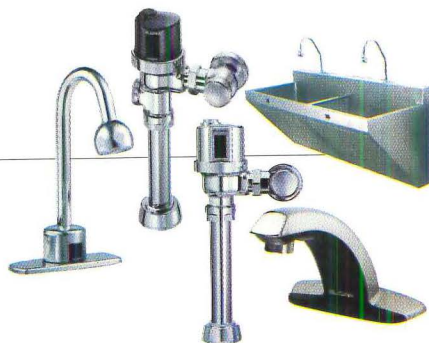

SLOAN®

Sloan Valve Company
10500 Seymour Avenue • Franklin Park, IL 60131
Phone: 800-745-0800 • Fax: 800-447-8329
www.sloanvalve.com
Circle 25 on information card

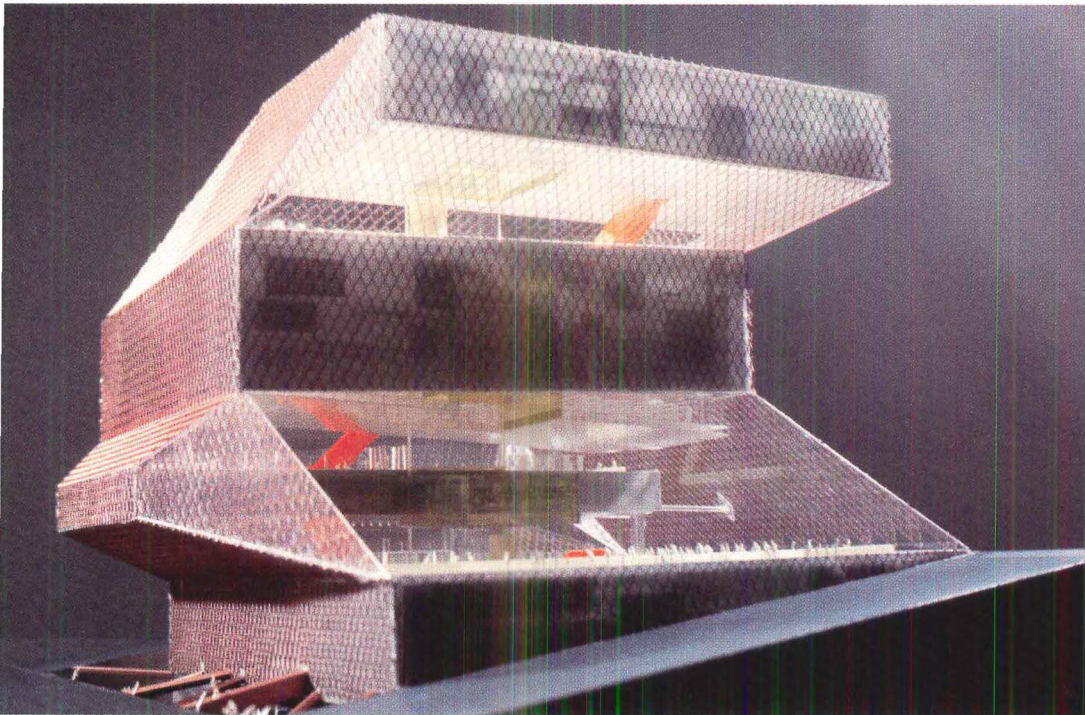

Locals have likened Koolhaas' design to stack of shoe boxes, but the architect emphasizes integration of programmatic flexibility.

Seattle Gives Koolhaas the Cold Shoulder

Opening It wasn't conceived as a controversial knockout punch for Seattle's sedate downtown, but Rem Koolhaas' design for a new 355,000-square-foot central library, unveiled December 15, has inspired at least as much local furor as Frank Gehry's Experience Music museum, now taking its convoluted form beneath the Space Needle.

Koolhaas' building is "bold, fascinating, cerebral, exciting, cutting edge," gushed the *Seattle Times* as outraged letters rained down. "The design is pure ugliness and stupidity cloaked in a honeycomb of elitist self-importance," wrote one reader. Another: "Seattle's effort to become a 'world-class' city puts it in danger of alienating the public it supposedly represents." Koolhaas' firm, Office of Metropolitan Architecture, associated with Seattle's Loschky Marquardt & Nesholm, is scheduled to complete a

schematic design in May. Construction will begin mid-2001 with completion in mid-2003.

The new building is a stack of five irregular platforms with curtain walls and an exoskeleton of steel tubing that serves as the primary structural system, suspends the glass envelope, and circulates air in place of conventional ducting. Public spaces such as the children's library and a community "living room" are wedged between the platforms, which contain stacks, education facilities, and operations.

Koolhaas described it as "five solid elements that float in a cloud of more improvised activities." Project architect Joshua Ramus said the configuration avoids what other libraries are doing: planning the obsolescence of public spaces as books overflow into them. Here, the wedges will morph as technology and library usage change.

Ramus said provocation wasn't intended; the program elements simply were sized and stacked onto the squeezed, sloping site in a way that made sense, and "it became a sculptural form." But library trustee Gilbert Anderson said the board wanted a landmark and loves Koolhaas' "wild building." Said the 70-year-old Seattle native, "Seattle is tired of these gray buildings we keep getting." *Lawrence W. Cheek*

Buzz

The **Getty Institute** has founded **Preserve L.A.**, an organization that will assist nonprofit preservation ventures in the city.

Rockwell Group principal **David Rockwell** is rumored to be talking to **Target Stores** about a housewares deal; ditto for **Philippe Starck**.

Boston's **Ann Beha & Associates** is designing a new master plan for that city's First Church of Christ, Scientist complex, which was partially designed by **I.M. Pei**.

Further German penance—in the form of historic preservation: After **Norman Foster** reconfigured Berlin's Reichstag, renovations are currently under way to convert the Reichsbank (gold looted from Holocaust victims was once hidden in its basement) into a new foreign ministry, and the Luftwaffe building into a new labor ministry.

Daniel Libeskind's Jewish Museum in Berlin, scheduled to open in October 2000, has postponed its opening for at least a year. It seems that primary inspections found the building unsuitable to accommodate the projected 600,000 annual visitors.

Hardy Holzman Pfeiffer Associates (HHPA) is working on the renovation of Griffith Observatory in Los Angeles, made famous by the **James Dean** classic *Rebel Without a Cause*.

The **Future Systems**—designed media center at the Lord's cricket grounds has received the £20,000 Stirling Prize for this year's best building in the U.K.



Zevi (seen here in 1986) led revolutions against Fascism and for organic architecture.

Bruno Zevi, 81

Theoretician and Activist

Tribute

There was no greater defender of the organic tradition in 20th-century architecture than Bruno Zevi, who died on January 9 in Rome. This remained both his most enduring contribution and deepest flaw, creating at once an optimistic anti-classical agenda for design that necessarily prejudiced everything he observed.

Born into Rome's Jewish community, Zevi left Italy with the publication of the Fascist racial laws in 1938. He attended Harvard, studying with Walter Gropius and Sigfried Giedion, and graduated in 1943, in time to return home to join the Resistance. His important role as a coordinator in the anti-Fascist movement is still much admired.

His American sojourn also brought him in direct contact with Frank Lloyd Wright, whom he never ceased to admire and promote. The author of more than 30 books—*Towards an*

Organic Architecture (1949), *The History of Modern Architecture* (1950), *Architecture as Space* (1960), and *The Modern Language of Architecture* (1973) among them—Zevi's works were regularly translated into a dozen languages and have been among the most influential texts of their times.

A brilliant teacher whose lectures ignited the enthusiasm of several generations of students, the scope of his activities seemed boundless. He ran a small architecture office (designing the Italian pavilion in the 1967 Montreal Expo), was editor-in-chief for 45 years of the monthly *Architettura—cronache e storia*, penned a weekly column for *Espresso* (the Italian equivalent of *Newsweek*), and wrote regularly for the daily newspapers. In addition, he represented the Radical Party in Italy's parliament from 1987 until his death. The recent triumph of organic style, found in such works as Frank Gehry's Guggenheim Museum in Bilbao, is no small vindication of Zevi's lifetime campaign against the straight line. *Richard Ingersoll*

As a **child** you always **loved** working with **colors**.

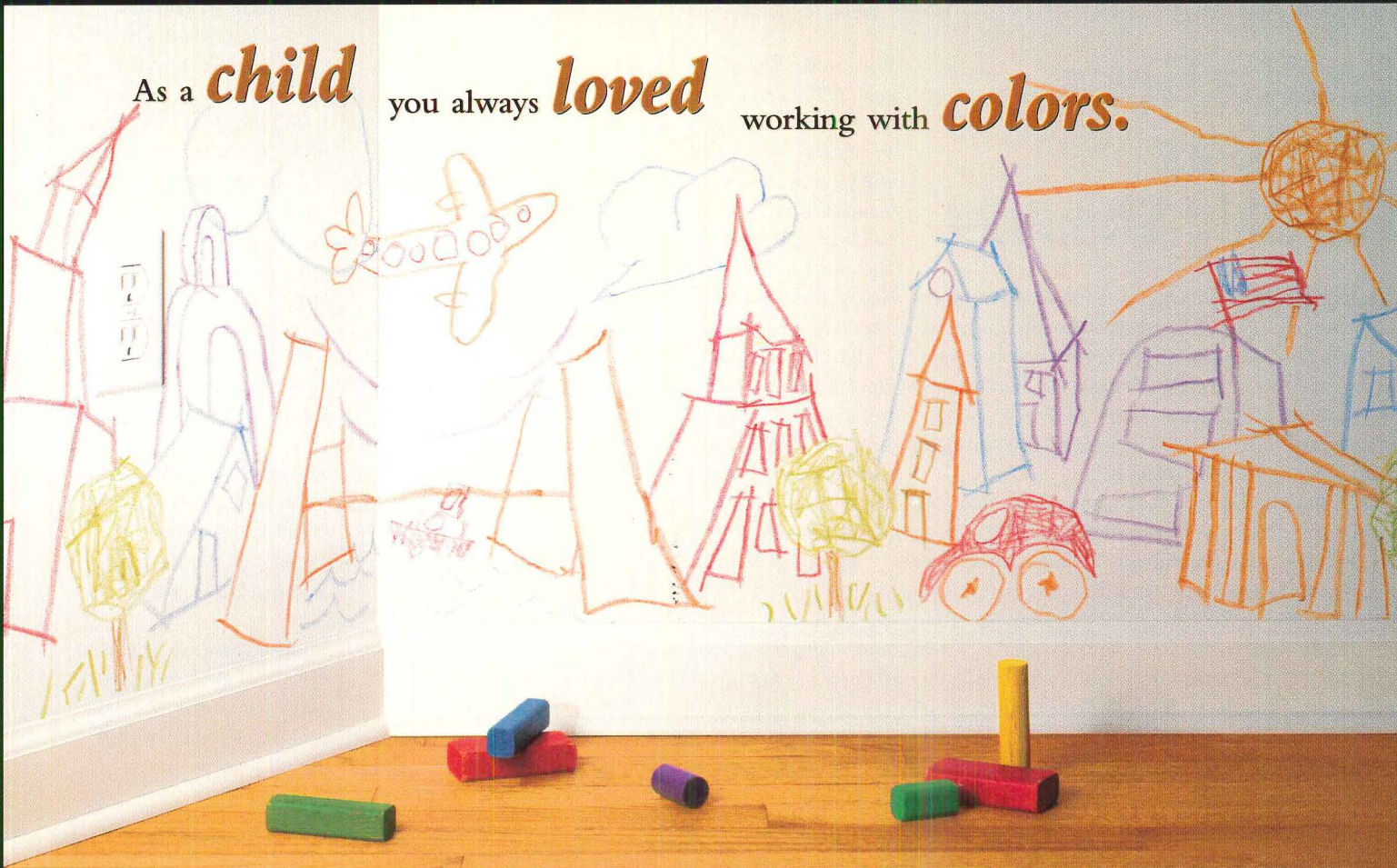

Johnson Rings Stock Exchange's Bell

Bullish Pulpit In his latest public appearance in which he stands officiously behind a podium, architect Philip Johnson (shown with NYSE COO William R. Johnston, left, and SOM's David Childs, right) rang the bell to open the day's trading on the New York Stock Exchange on January 5. Part of a program called Bridging the Millennium, Johnson is one of several luminaries—also including slugger Hank Aaron, newsman Walter Cronkite, and author John Updike—to receive the honor. *M.J.O.*

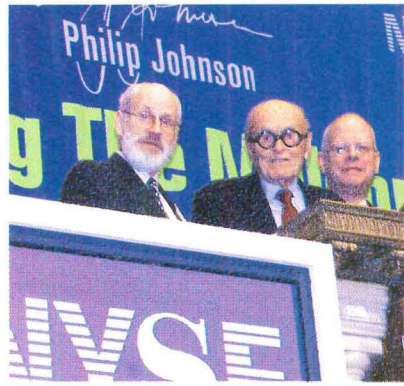

NCARB Launches Uniform Registration

NCARB (The National Council of Architectural Registration Boards) has recognized the frustration of becoming registered in multiple states and has begun a program to standardize all the necessary forms. Taking a cue from higher education, which allows applicants to use a common form to apply to hundreds of different colleges and universities, NCARB has introduced its Uniform Application. With the new form, architects can apply for certification in 17 states and all 10 Canadian provinces. Further, you can get the form (and information about applying in 36 U.S. jurisdictions) online at www.ncarb.org/forms/req_tran.html. Next up: NCARB will attempt to expand this coverage nationwide. *M.J.O.*

Ground Control to Anyone: **Wimberly Allison Tong Goo** is purportedly working on a gravity-free hotel for outer space scheduled to be operational by 2017! This timetable also includes the possibility of short space flights for civilians in just four years!

What a capital pain in the neck! **RTKL Associates'** underground Capitol visitors center has been delayed yet again as Congress discusses the security ramifications of connecting the complex to the Library of Congress via subterranean tunnel.

Five people have been indicted in the collapse of a hotel in Taiwan during last September's earthquake, including a prominent National Party politician (who promptly had a stroke) and

Copper lets you feel like a **kid** again.

From rich, natural earth tones to bright blue-greens to shimmering silvers and elegant grays, copper comes in a full pallet of colors, textures and finishes. And the Copper Development Association provides the design assistance, information resources and technical specifications to help you use them.

Discover the unique colors of copper. And rediscover the thrill of opening that *big* box of crayons. For supplier information or help on a specific project, call 888-427-2411. Visit us on the Web at <http://architecture.copper.org>.

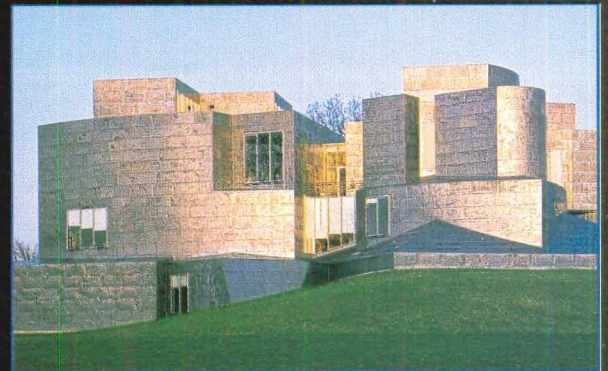

Project: University of Toledo — Center for the Visual Arts
Architect: Frank O. Gehry Associates



Unique. Beautiful. Enduring.

Circle 29 on information card



Hays Appointed Whitney's First Architecture Curator

New Hire

New York City's Whitney Museum of American Art, which is housed in a landmark Brutalist building designed by Marcel Breuer (1966), recently appointed its first adjunct curator of architecture: theorist and historian K. Michael Hays. The founding editor of the critical journal *assemblage* and editor of *Architecture Theory Since 1968*, Hays will keep his day job at Harvard's Graduate School of Design, where he has taught since 1988. "The Whitney's decision to start an architecture program indicates that architecture is now clearly understood—by institutions as well as the lay public—as an important part of culture, not just something that keeps the rain out," comments Hays.

His first curatorial projects include the exhibition "Mies in America," scheduled for the summer of 2001, and a conference and exhibition about the Whitney building itself, on the occasion of its expansion. "There's no reason why museums shouldn't be able to help repartition the field, which is still stuck in these old categories, like formalism, expressionism, and so on," says Hays, who will also organize exhibitions on contemporary architecture. *Cathy Lang Ho*

Maryland Passes Mortgage Credit Act

With significant historic Maryland sites, such as downtown Baltimore and the battlefield at Antietam, popping up repeatedly on the National Trust's most-endangered lists, it seemed as though the Free State was headed straight for preservation's hall of shame.

But state lawmakers made good when they passed the country's first-ever mortgage credit certificate option for utilizers of Maryland's Heritage Preservation Tax Credit Program.

Under this new option, which became effective last October, historic-property owners can transfer a tax credit of 25 percent of qualified rehab expenditures to their lender to reduce either the loan's principal or interest rate.

Maryland's program is modeled after the federal Historic Homeownership Assistance Act, which provides a 20 percent federal tax deduction for owners of historic homes. It was included in the Republican-led Taxpayer Refund and Relief Act of 1999, which Congress passed but President Clinton vetoed. Preservationists, however, remain optimistic that the bill has a fighting chance for passage this year. *Michelle Patient*

Michelle Patient is a New York City-based freelance writer.

Indoors or out: warm and friendly... or wet and wild. Mixes equally well with ballgowns or blue jeans. Sealed and open reflectors; four sizes and countless variations optimize up to 400 watts of lighting. Envirogard™... new from Guth.
T 314 533-3200
F 314 533-9127



GUTH

A JJI Lighting Group Company
www.guth.com

Circle 31 on information card

Ponte fuses form with function: subtle pathway illumination and separate-source, fully adjustable uplighting... both embodied in its own sensuous art form.
.hessamerica
T 704 471-2211
F 704 471-2255



hessamerica

A JJI Lighting Group Company
www.hessamerica.com

Circle 33 on information card

The Guggenheim Spreads Out

Urban Legend While developing a global chain of contemporary art museums, New York City's Solomon R. Guggenheim Museum has spawned a new kind of urban myth. Since the museum made Bilbao, Spain, the toast of the European tourist trade, rumors have persisted of new Guggenheims in Lyons, France, Johannesburg, or most recently, anywhere in Australia.

One venue has been confirmed. The Guggenheim Museum Venice of Contemporary and Modern Art will be housed in the Punta della Dogana (above), a 17th-century former customs house on the Grand Canal. Italian architect Vittorio Gregotti will restore and convert the building, but as yet there is no projected opening date.

Back across the pond, Guggenheim has gotten some ink in New York papers for expressing interest in sites in Brooklyn and on Governors Island. Guggenheim remains mum about their allegedly



grand expansion plans, but—with a wink—supplied *Architecture* with a recent article from *ARTNews* that details their current ambitions. The piece describes an \$850 million scheme for a building on the East River by Frank Gehry that connects and floats above four existing piers. The proposed complex will house a library, educational facilities, a theater, a skating rink, and a park in addition to extensive exhibition spaces. Gehry's office also refused comment.

Susanna Sirefman

Susanna Sirefman is the author of New York: A Guide to Recent Architecture (Ellipsis, 1997).

news

the building's builders and architects. The structural columns were found to be too small and inadequately reinforced. Each person faces five years in prison.

The National Association of Home Builders has released a completely, totally, incontestably unbiased report that reminds us that only 1/10 of 1 percent of the available land in the U.S. is occupied by housing.

The reopening of the quake-battered Assisi Cathedral was overshadowed by the fact that 10,000 people remain homeless and are facing their third winter in boxlike temporary housing.

The National Capital Planning Commission has chosen a site for a

After dark —
Enter on the kilowatt
Make the most of up
illuminating watts
Landscape's SL-35
Discover your
get the Catalog.
Landscape
68-3660
68-1107

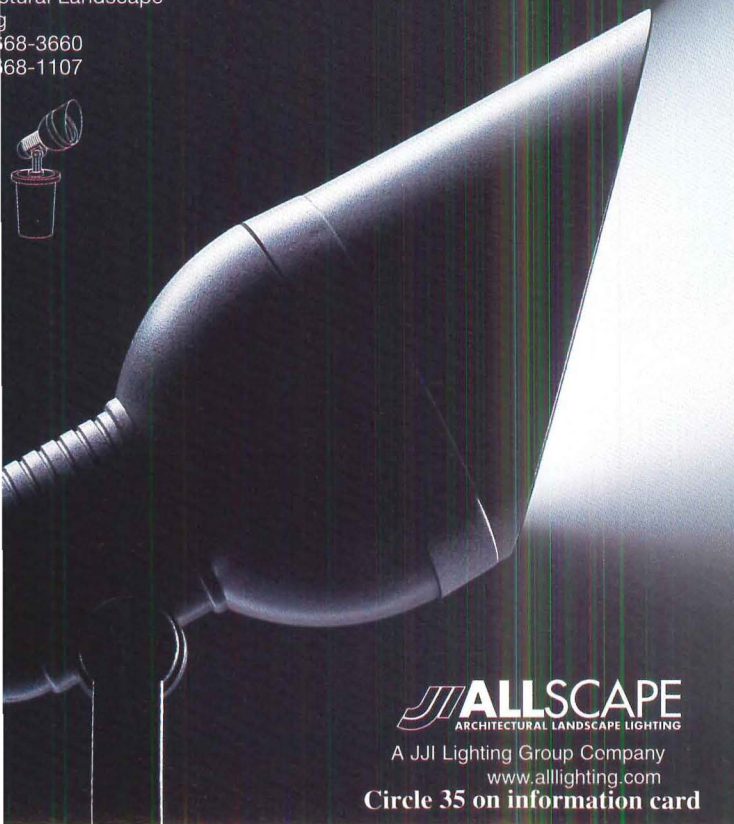

ALLSCAPE
ARCHITECTURAL LANDSCAPE LIGHTING

A JJI Lighting Group Company
www.alllighting.com

Circle 35 on information card

Beware the Domino effect: fall for one, fall for all. Stylish Domino sconces artfully conceived by Peter Wooding Design Associates. ADA compliant, color and finish options to suit.
d'ac Lighting
T 914 698-7799
F 914 698-5577

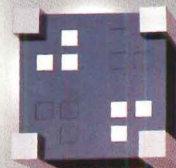
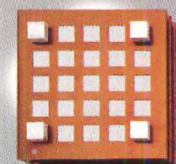
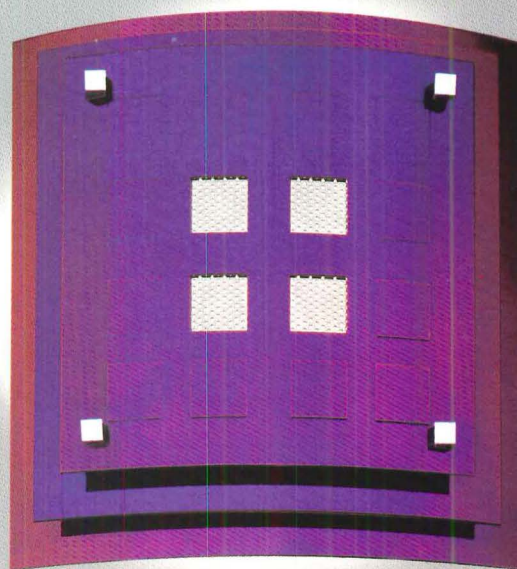

d'ac

A JJI Lighting Group Company
www.daclighting.com

Circle 37 on information card

Bonus Questions

A survey by PSMJ Resources tracks the bonus-giving practices of 67 A/E firms last year.



WHO'S GIVING THEM? 100% OF FIRMS SURVEYED	
---	--

HOW DO THEY COMPARE TO LAST YEAR'S? HIGHER 59.3% SAME 33.3% LOWER 7.4%	WHO'S GETTING THEM? 100% OF PRINCIPALS 92.6% OF ASSOCIATES 92.6% OF PROJECT MANAGERS 85.2% OF ADMINISTRATIVE STAFF	HOW ARE THEY GETTING THEM? 87.5% IN CASH 0.2% IN STOCK 12.3% IN QUALIFIED RETIREMENT PLANS
--	---	--

SOURCE: PSMJ RESOURCES

Downtown Hosts First Autodesk Retail Outlet

Brand Management Following on the heels of the recently spawned Gateway Country, a new AutoCAD Store opened in Boston in December. Such high-visibility companies as Disney or the National Basketball Association believe retail ventures solidify brand loyalty among consumers. But a boutique that sells only drafting software for architects?

"I haven't heard about a retail store," remarked a surprised Richard Koch, Autodesk's public relations manager. Rest easy, Dick, the Boston store is not an Autodesk-sponsored effort. The store belongs to Beantown's Consulting for Architects (CFA), a company that offers staffing placement and CAD training. Add to that its plum location in the Architects Building—also the home of the Boston Society of Architects—and it starts to make a little more sense. Just in case the store doesn't work out, CFA is also launching a related website (www.cadstoreonline.com). M.J.O.

Consider the possibilities... for each new ModuleX™ low voltage downlight shown here actual size, over 100 more adaptations are at your call. It's the decorative and functional downlighting system you design. Ardee Lighting
 T 704 482-2811
 F 800 275-1544



shown actual size, 3.9" diam.

Circle 39 on information card

ARDEE
 A JJI Lighting Group Co.
www.ardeelightir

Nuclear Family Fission

Survey: Only 26% of U.S. Homes Comprise Married Couples With Children

The number of American married couples with kids continues its decline, according to a new study. The General Social Survey, recently completed by the University of Chicago's National Opinion Research Center, finds that only 26 percent of households consist of a married couple with children. In the early 1970s, that figure stood at 45 percent. "People marry later and divorce and cohabitate more," says Tom W. Smith, director of the survey. Plus, he says, "a growing proportion of children have been born outside of marriage."

For architects serving the housing market, the surprising statistic affects both the number and type of new houses needed. Demand in the housing market typically begins with first-time homebuyers, whose numbers will likely decline from their levels of the 1970s and 1980s, notes Kermit Baker, chief economist for the American Institute of Architects. "With an older population spending more money on homes, there's more activity in the custom and luxury side of the market."

There's a darker side to the new statistics, suggests Oakland, California-based architect Michael Pyatok, who specializes in affordable housing. There's a much higher incidence of poverty among families with children than among singles and childless couples, Pyatok notes, and the Center on Budget and Policy Priorities, a Washington, D.C., think tank, concurs. The center estimates that 55 percent of related children under 6 in female-headed families lived in poverty last year. "Firms doing market-rate housing are basically serving singles, couples, and seniors," says Pyatok. "Those of us serving nonprofits are designing primarily for families, seniors, and low-income singles." *Bradford McKee*

NEWS

new memorial to **Martin Luther King, Jr.**, on the tidal basin near the new Franklin Delano Roosevelt Memorial and on axis with the Lincoln and Jefferson Memorials.

Ronald L. Skaggs, CEO of IKS Architects in Dallas, has assumed the presidency of the American Institute of Architects for 2000.

Raze, burn, and pillage: After leveling a Richard Neutra-designed visitors center at Gettysburg because it sat on a battlefield, the National Park Service has decided to condemn a 310-foot-tall observation tower in Gettysburg that also sits on the battlefield—this time, however, with the endorsement of the National Trust for Historic Preservation.

the light. Not the
s. With new ceiling-
ealed Recessed-
M. Aim and rotate...
r a dead spot.
sely accent, highlight,
ot and wallwash.
Alkco.
7 451-0700
7 451-7512

German
engineering.
At its most brilliant.
Coordinated collections
of spots, tracks, recessed
and surface mounts...
state-of-the-art light
sources and reflector
technology.
The Hoffmeister line
by Alkco.
T 847 451-0700
F 847 451-7512



ALKCO

A JJI Lighting Group Company
www.alkco.com

Circle 41 on information card

ALKCO

A JJI Lighting Group Company
www.alkco.com

Circle 43 on information card

Sprawl Watch

Filling the Great Wide Open

A recent report by the United States Agriculture Department, released by campaign hopeful Vice President Al Gore (this issue, page 37), chronicles the loss of cropland, forests, and other open-space acreage in each of the 50 states and Puerto Rico between 1992 and 1997. (Figures were unavailable for Alaska.)

Open Acreage Developed 1992-1997

TX	1,219,500	OK	224,500
PA	1,123,200	MD	222,300
GA	1,053,200	AZ	199,400
FL	945,300	KS	192,500
NC	781,500	LA	172,100
CA	694,800	ME	167,800
TN	611,600	PR	153,100
MI	550,800	OR	150,400
SC	539,700	MT	122,700
OH	521,200	ID	120,800
NY	492,400	CO	120,300
VA	467,200	NH	107,300
AL	445,300	UT	105,100
KY	354,100	IA	102,900
WA	350,000	NE	81,200
NM	348,500	SD	76,700
MS	312,600	CT	63,400
MN	311,300	WY	52,700
MO	310,500	ND	49,700
IL	292,200	NV	41,500
NJ	283,200	DE	35,100
WI	282,800	VT	26,000
MA	281,500	RI	11,200
WV	275,600	HI	8,700
IN	274,400		
AR	237,200	Total	15,966,000

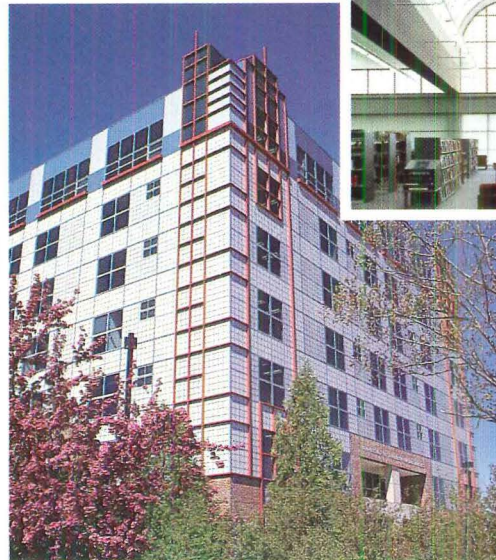
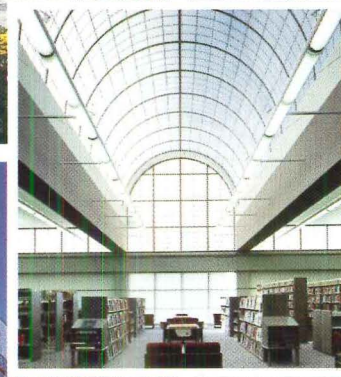
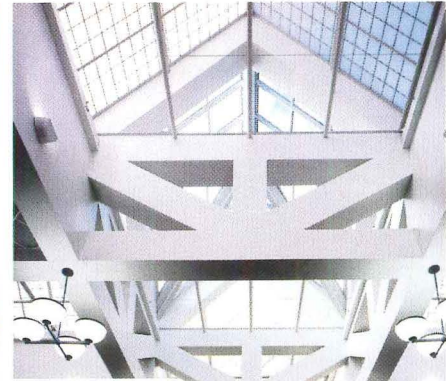
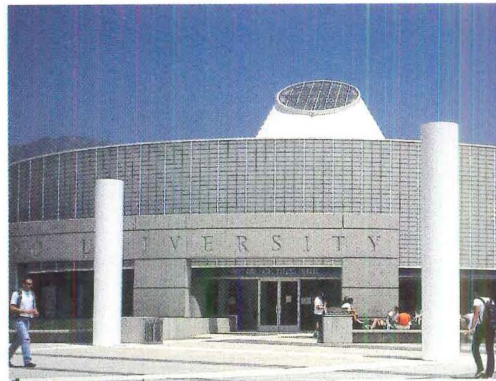

**Finally...
a Web site
filled with
bright ideas.
www.kalwall.com**

Now you can view the work of some of the world's most renowned architects...

See for yourself the practical solutions to realizing your own design dreams...

Quickly explore unlimited daylighting alternatives...

Learn how building owners are turning "green" and realizing major HVAC savings using the most highly insulating, translucent technologies the world has ever seen...

Since 1955
Kalwall®

PO Box 237, Manchester, NH 03105 **800-258-9777**

Calendar

Exhibitions

Berkeley, California

Equal Partners: Men and Women Principals in Contemporary Architectural Practice at the UC Berkeley Art Museum through March 19 (510) 643-6494

London

Art Nouveau 1890–1914 at the Victoria and Albert Museum April 6–July 30 www.vam.ac.uk

Los Angeles

At the End of the Century: One Hundred Years of Architecture at the Museum of Contemporary Art April 16–September 24 (213) 621-2766

Montreal

Visions and Views: The Architecture of Borromini in the Photographs of Edward Burtynsky at the Canadian Centre for Architecture; March 8–May 7 (514) 939-7000

New York City

Coming into Fashion: The Architecture and History of the Garment District at the Municipal Arts Society through March 15 (212) 935-3960

Capturing Time: The New York Times Capsule at the American Museum of Natural History through March 26 www.amnh.org

The New York Century World Capital Home Town, 1900–2000 at the Museum of the City of New York through July 9 (212) 534-1672

National Design Triennial: Design Culture Now at the Cooper-Hewitt National Design Museum March 7–August 6 (212) 849-8400

Philadelphia

Rome in the 18th Century at the Philadelphia Museum of Art March 16–May 28 (215) 684-7860

Pittsburgh

The Pritzker Architecture Prize 1979–1999 at the Carnegie Museum of Art through February 27 (412) 622-3288

Washington, D.C.

The Corner Store at the National Building Museum through March 6 (202) 272-2448

See the U.S.A.: Automobile Travel and the American Landscape at the National Building Museum through May 7 (202) 272-2448

Ralph Rapson: Sixty Years of Modernism at the Octagon Museum through May 28 (202) 638-3221

Conferences

WestWeek 2000
Los Angeles
March 29–31 (310) 360-6423

2000 National Planning Conference sponsored by the American Planning Association
New York City; April 15–19 (202) 872-0611

Hospitality Design 2000 Expo and Conference Las Vegas
April 27–29 www.hdexpo.com

Coverings 2000 Orlando, Florida
May 2–5 www.coverings.com

AIA 2000 National Convention and Exposition Philadelphia
May 4–6 (202) 626-7395

A/E/C Systems
Washington, D.C.; June 5–8
www.aecsystems.com

53rd Annual Meeting of the Society of Architectural Historians
Miami; June 14–18 www.sah.org

Construction Specifications Institute Atlanta
June 21–25 www.csinet.org



In New York City: The Cooper-Hewitt National Design Museum presents its first design triennial, "Design Culture Now." Curated by Donald Albrecht and Ellen Lupton, the triennial's sweeping narrative showcases 83 designers working in various fields, from architecture to graphic design to new media. Among the offerings is Boym Design Studio's cheeky Strap Furniture. Mocking the now-cliché midcentury webbed designs of Jens Risom and Alvar Aalto, principals Constantin Boym and Laurene Leon Boym "upholstered" a simple wooden frame with standard-issue strapping tape. Albeit designed with tongue firmly planted in cheek, the yellow- and black-painted furniture line is completely functional (strong tape).

Competitions

The Vincent Scully Research Grant is a \$10,000 award to facilitate publication of a monograph on American architecture; offered by the Architectural History Foundation; deadline February 28 (516) 944-5961 fax

Charles E. Peterson Research Fellowships & Summer Internships 2000–2001 to study American architecture prior to 1860; sponsored by the Athenaeum of Philadelphia deadline March 1 www.libertynet.org/~athena

Ceramic Tiles of Italy Design Competition for projects completed before February 28 that use Italian ceramic tiles in innovative commercial and residential settings; carries a \$20,000 prize; deadline March 15 (212) 980-1500

UC Berkeley AIDS Memorial Design Competition deadline March 24 <http://campus.chance.berkeley.edu/BAMC>

Preserve L.A. Grants of up to \$75,000 sponsored by the J. Paul Getty Trust; deadline March 31 www.getty.edu/grant/preservela

Martin Luther King, Jr. National Memorial Project Design Competition deadline April 1 (410) 554-0040, ext. 110

The MacDowell Colony offers eight-week residencies to architects deadline April 15 www.macdowellcolony.org

2000 National Preservation Awards sponsored by the National Trust for Historic Preservation; deadline May 1 (202) 588-6236

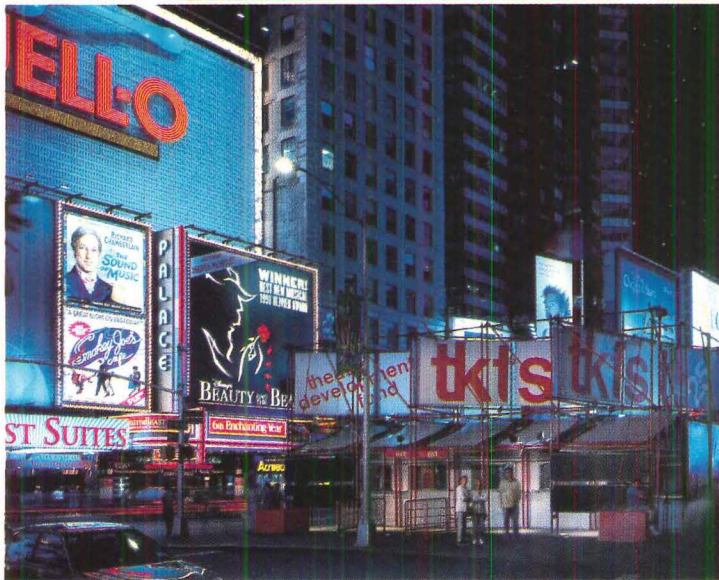
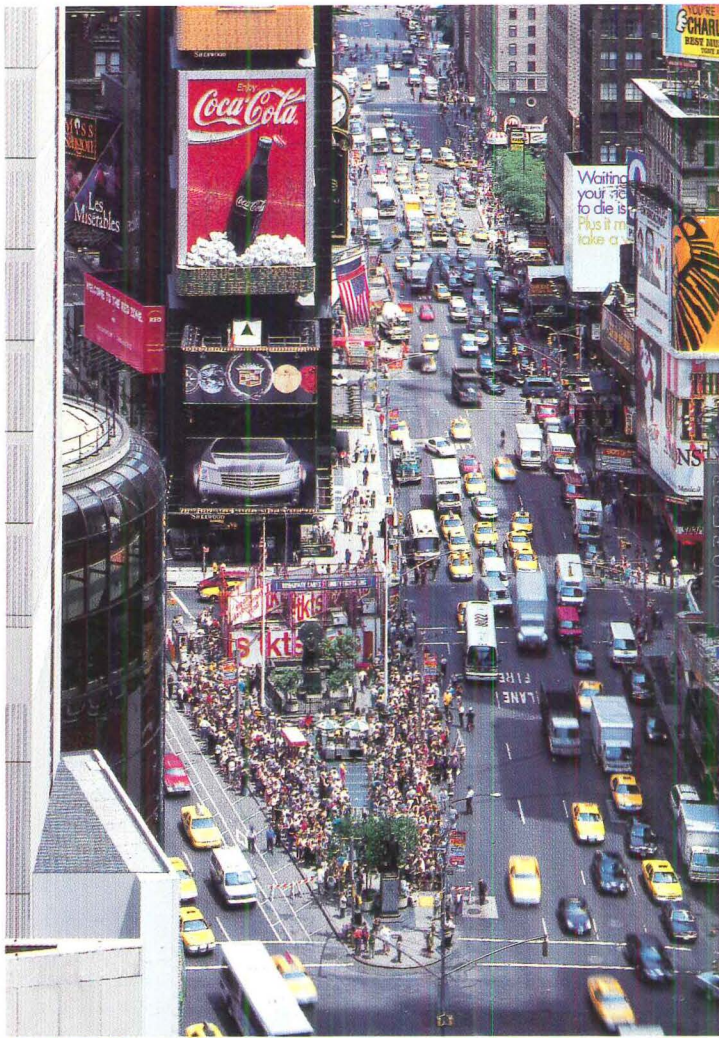

The site of the current and future TKTS booth is a wedge-shaped traffic island on the north end of Times Square (top). At the center of the island rises a 1937 monument to Father Francis P. Duffy, a World War I chaplain who was later pastor of a church on nearby West 42nd Street, and achieved lasting fame thanks to his portrayal in the 1940 James Cagney film, *The Fighting 69th*. The statue must remain in any scheme to replace the 1973 booth designed by Mayers & Schiff (above), as must a second, smaller statue of famed Broadway composer George M. Cohan at the southern tip of the traffic island.

On the Boards

Eight winners have been named in the international competition to redesign the TKTS booth in New York City's Times Square.

FIRST PRIZE

John Choi and Tai Ropiha, Sydney, Australia

SECOND PRIZE

Ove Arup & Partners/Thomas Phifer and Partners, New York City

THIRD PRIZE (tie)

Lisoni Associates, Milan, Italy

Leo Miele, Toronto, Canada

HONORABLE MENTION

Byron Terrell and Rahmon Polk, Chicago

Mauk Design, San Francisco

Lippincott & Margulies, New York City

U-Arc Studio, Seattle

Despite all the talented architects who practice in New York City, few buildings and public places of distinction get built there. Developers' bottom lines, byzantine zoning regulations and building codes, intensive involvement of community and special-interest groups, and politics can blur the clearest of visions, making the realization of an intelligent, forward-looking project such as the new Times Square Recruiting Station seem like a miracle on 43rd Street (January 2000, page 96). The implausible may happen again, however if the host of organizations behind a proposed replacement for the TKTS ticket booth on the opposite, north side of the square stay the course.

In this case, esthetics met necessity in the selection of a design for the booth (where discount tick-

ets to Broadway shows are sold) thanks in part to the involvement of the city's Van Alen Institute, a nonprofit with a 100-year history of supporting architecture. The Institute directed a design competition at the invitation of the booth's proprietor, the Theatre Development Fund, which attracted nearly 700 entries by the October 1999 deadline. An 11-person jury met later that month; it included architects Marion Weiss and Enrique Norten, as well as such local power brokers as Brendan Sexton, president of the Times Square Business Improvement District. According to Van Alen president Raymond Gastil, "Our political skills were put to the test making sure that the jury saw a common mission."

Mayor Rudolph Giuliani named the initiative an official project of NYC 2000, the New York City Millennium

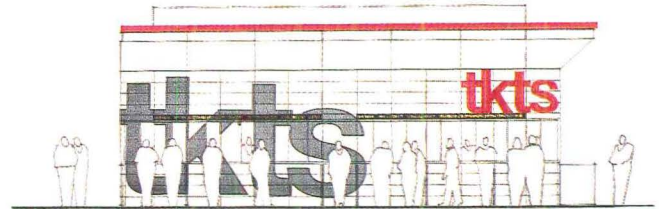
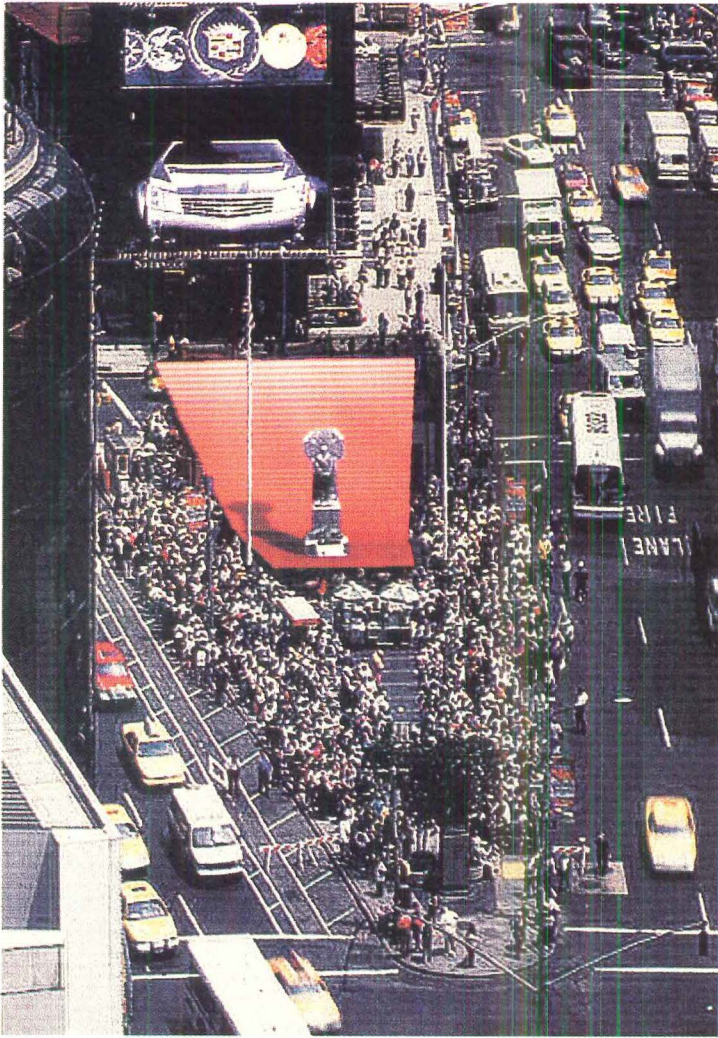

North elevation

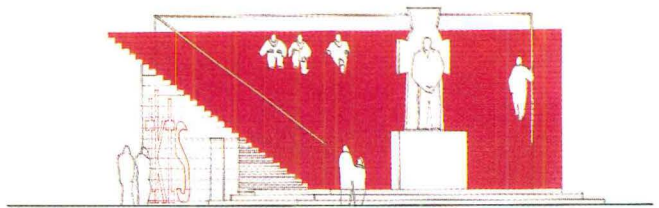

South elevation

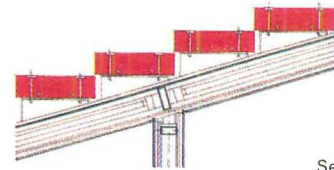

Section detail

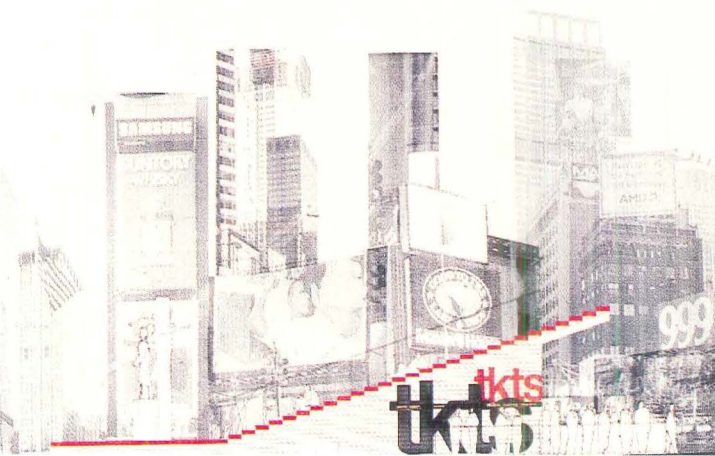

East elevation

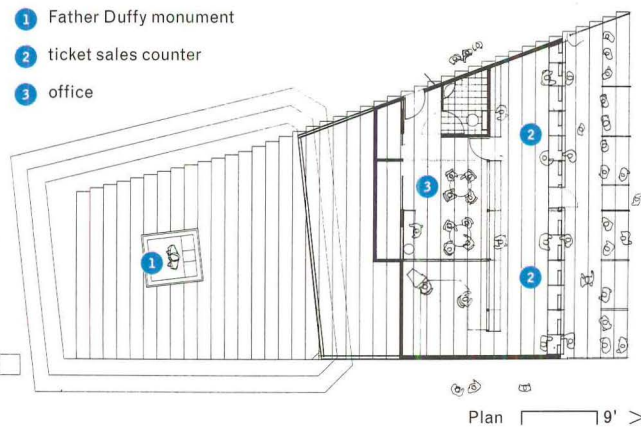

Plan 9' >

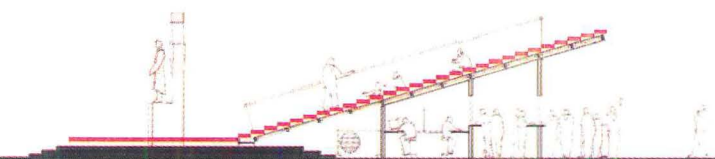

North-south section 9' <

First prize went to a team from Sydney, Australia, John Choi and Tai Ropiha, who proposed a large amphitheater-like staircase, with the statue of Duffy rising from the stage at its south end (top left). The higher, north end of the stair shelters the ticket booth proper (left), while supergraphics herald its name (top). The proposal cleverly elevates a commercial concern into a public amenity, and returns to the existing monument some of its original prominence.

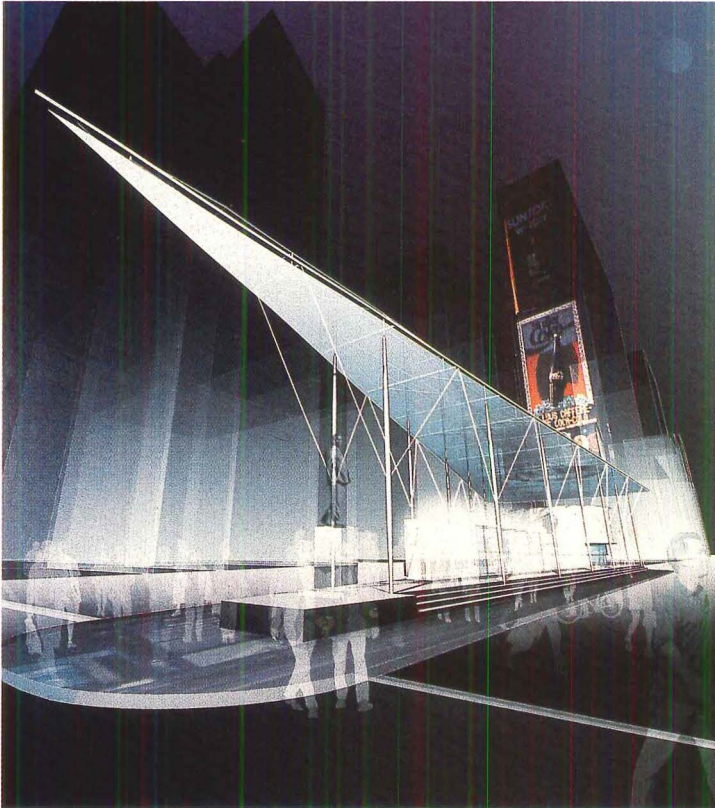
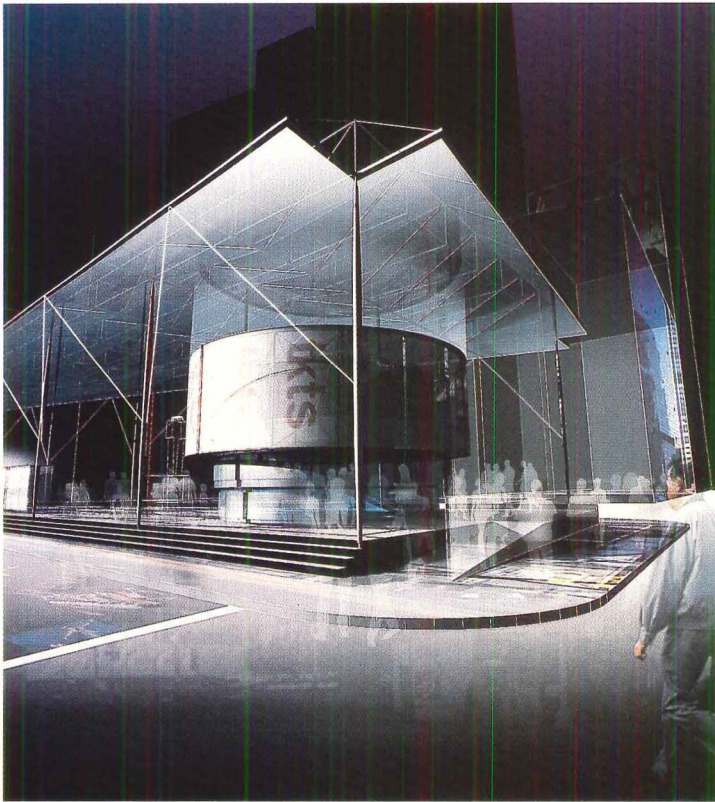

New York City architect Thomas Phifer and Partners collaborated with engineer Ove Arup & Partners on a translucent arrowhead-shaped canopy that would cover nearly the entire traffic island (above). The scheme, which took second prize, accommodates the ticket booth in a circular pavilion at the north end of the canopy (top).

Committee in charge of the city's celebration, and he is expected to have announced the winners of the competition in late January. John Choi and Tai Ropiha of Sydney, Australia, took first prize with an urban interpretation of Casa Malaparte: a giant red staircase that faces south across the square and doubles as the roof of the booth. The jury recognized seven other teams with second and third prizes, and honorable mentions—sparse modern boxes, for the most part, incorporating the red TKTS logo at giant scale. "Simplicity in the face of the signage and animation of Times Square stood out more than something that enters the fray," says Weiss of the jury's selections.

There are no guarantees that the first-place winner will be built; the Theatre Development Fund can opt to build one of the seven

other schemes. And several city departments, commissions, boards, and committees have jurisdiction over the project and may block the approval of whichever design the client chooses to pursue. But, as Weiss notes, the competition organizers were clear about potential political and technical loopholes from the outset of the competition process in order to forest all potential snafus. Hopes for the project's realization are high; says Gastil, "It seems unique to have this many players, from so many arenas, enthusiastic about a project like this."

Ned Cramer

Architecture provided significant in-kind support to this competition.

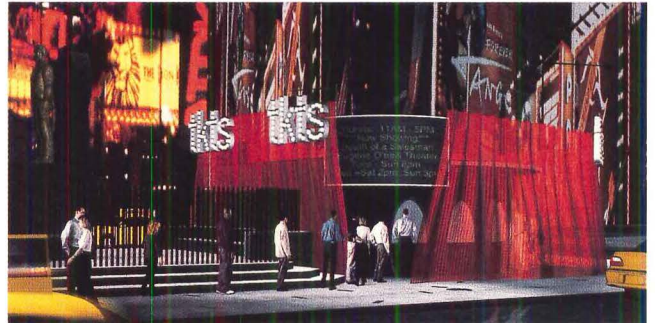
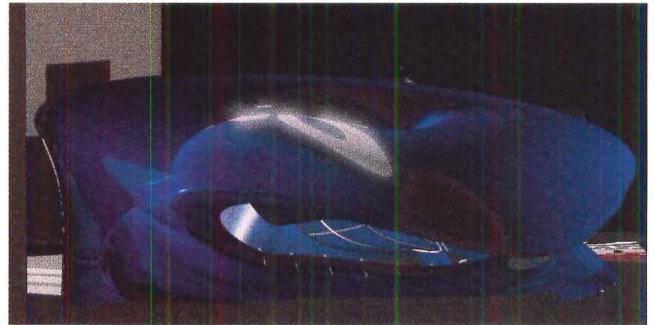
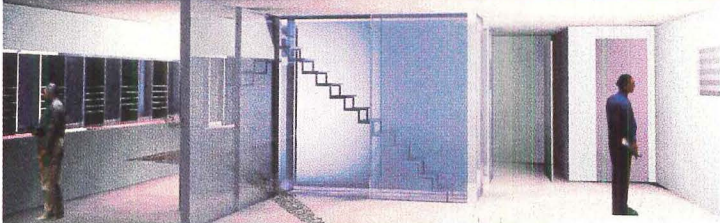

One of the two third-prize winners, a scheme by Toronto-based Leo Miele, proposes a cubic structure with ticket windows along its west face (top). Electronic signage along the north face would display information about available shows and ticket prices. A demountable open steel structure (above) at the top of the booth, clad in woven-metal mesh, offers a venue for performances, while creating a calm visual barrier against the surrounding advertisements.

Four schemes won honorable mentions (from top to bottom): Colorful light projections and graphics enliven New York City-based Lippincott & Margulies' simple glass-and-steel pavilion. Byron Terrell and Rahman Polk of Chicago propose an amorphous blue booth that incorporates the distinctive, lower-case TKTS logo on its roof. A red, perforated-aluminum curtain wraps the booth designed by San Francisco-based Mauk Design. Giant letters envelope a quiet glass-and-metal box designed by Seattle-based U-Arc Studio.

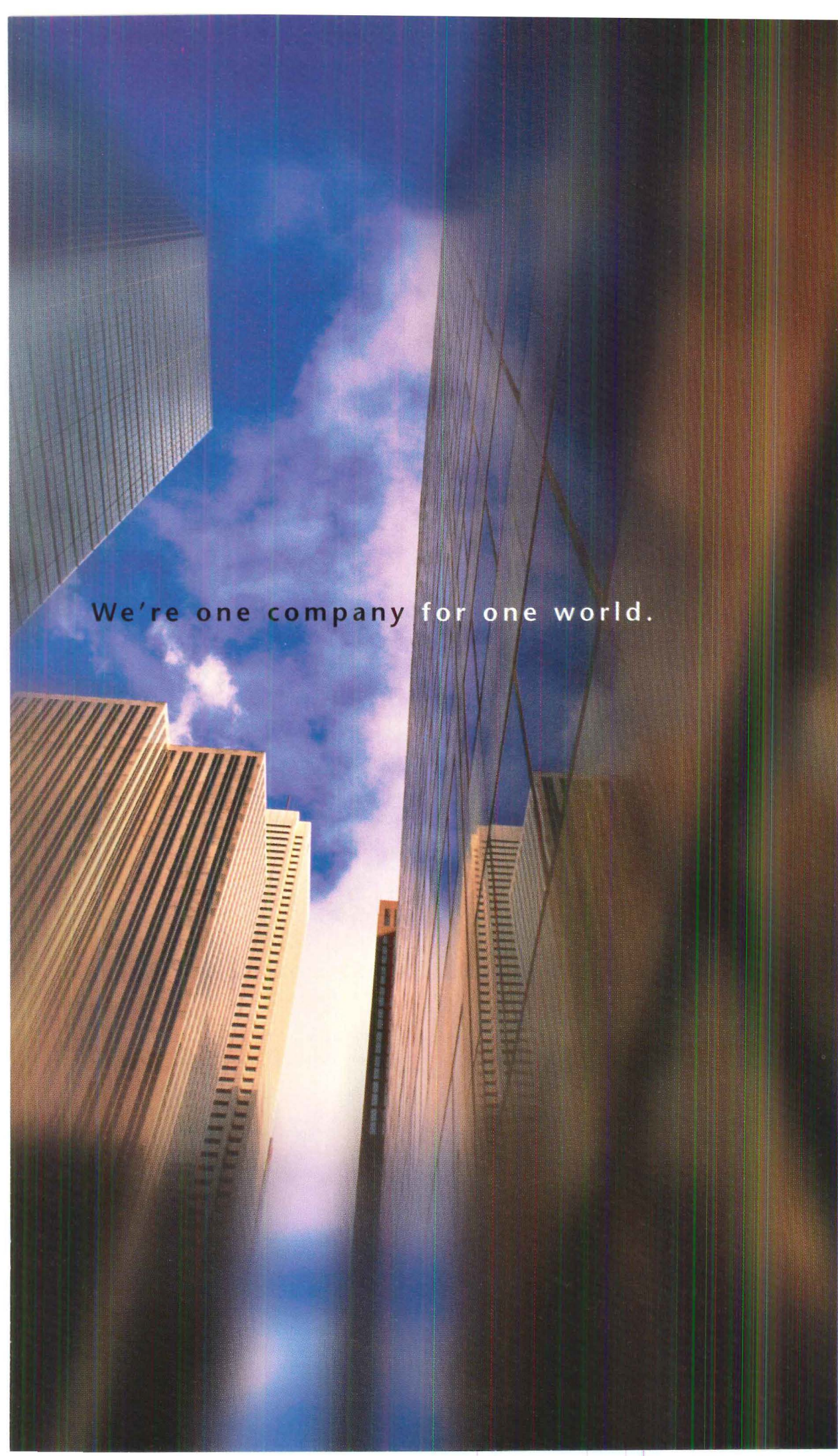

We're one company for one world.

Montgomery KONE is now KONE.

One company dedicated to innovative and reliable vertical transportation worldwide. Keeping people circulating efficiently, safely and dependably in buildings like yours. Creating elevators and escalators that set new standards. Making sure that the pulse of your building never skips a beat. That's who we've been for more than 100 years. It's the way we'll continue to serve.

To learn more about KONE and our innovative vertical transportation solutions, give us a call at 1-800-956-KONE (5663). Or visit us on-line at www.us.kone.com.

Circle 49 on information card

The heart of your building™

KONE Elevators
Escalators

practice

“The intention is to raise awareness about the need for further conservation of these buildings.”
From “Modernville, U.S.A.”
Preservation p. 40

“I envisioned a structure made of waste.”
From “21st-Century Alchemist”
Technology p. 42

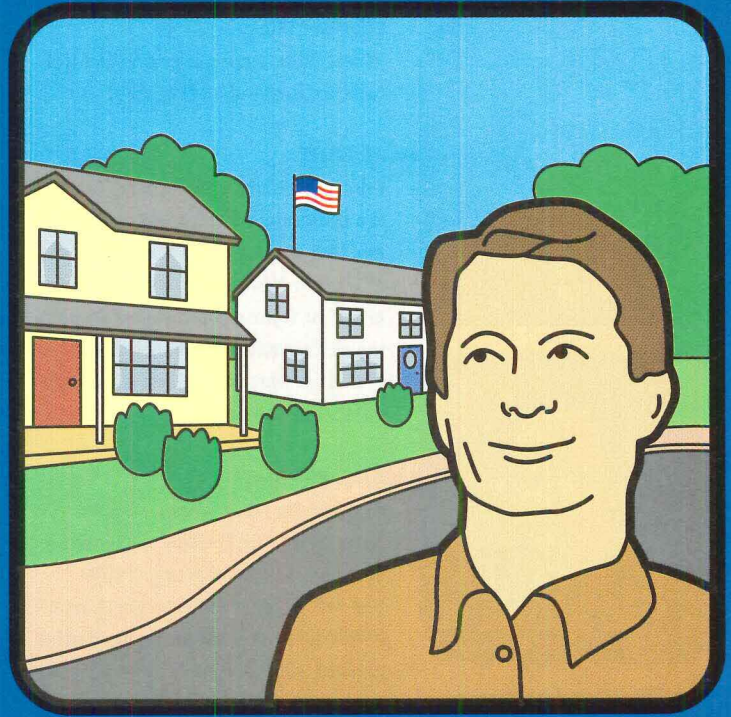

It's Livability, Stupid!

For the first time in decades, the design of cities is a hot political issue. **Michael Cannell** investigates how sprawl and smart growth will play on the campaign trail.

Politics In September 1998, while all of Washington, D.C., prattled over the lurid details of Monica's Big Adventure, Vice President Al Gore delivered a speech on the dangers of sprawl and other livability issues at the Brookings Institute, a Washington think tank. What initially shaped up as a forgettably wonkish policy address actually proved to be the first stop on Gore's presidential campaign. Although the earliest primaries were still 17 months off, Gore's speech marked the beginning of his bid to stake out his own agenda and to distinguish himself from his disgraced boss. "The ill-thought-out sprawl hastily developed around our nation's cities has turned what used to be friendly, easy Vice President Al Gore (above) bet that livability would engage angry suburban voters.



LIVABILITY

Where do the four major presidential candidates stand on the issue?

AL GORE

Gore is livability's poster boy. He made it a centerpiece of his early campaign, and last year he announced a parcel of Clinton Administration programs aimed at fighting sprawl and promoting sustainable growth. But would President Gore live up to the candidate's soaring rhetoric?

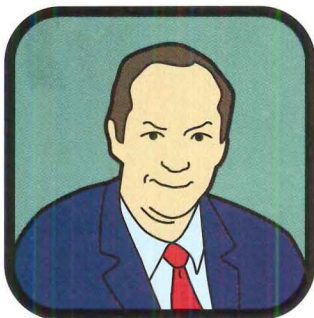

BILL BRADLEY

As a senator from sprawl-plagued New Jersey, Bill Bradley consistently voted against pro-developer bills. But don't expect much leadership on this issue from Bradley. He has distinguished himself from his Democratic rival by dismissing livability as an issue best handled by state and local governments.



GEORGE W. BUSH

Bush opposes any federal efforts to curb sprawl. Since Bush took office as Texas governor, Houston has replaced Los Angeles as the smoggiest U.S. city and three Texas cities have fallen out of compliance with the Clean Air Act—largely because of unchecked sprawl. His record speaks for itself.

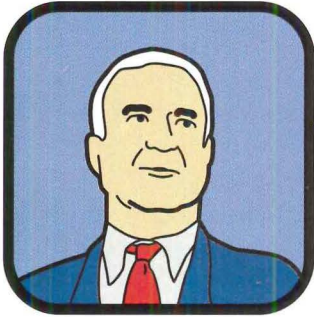

JOHN McCAIN

McCain is the least sympathetic to livability measures. His home state of Arizona is a strong property-rights state wallowing in suburbs, and McCain is expected to toe that line. In 1998, he voted for a measure on the Senate floor that would have helped developers overcome local anti-sprawl measures.

suburbs into lonely cul-de-sacs," he said, "so distant from the city center that if a family wants to buy an affordable house they have to drive so far that parents get home too late to read a bedtime story."

As Gore-the-Candidate traversed the country over the following months (making the compulsory stop in Portland, Oregon, the acknowledged Mecca of smart growth), a national effort to control suburban sprawl and build livable cities emerged as a cornerstone of his gathering campaign. "A gallon of gas can be used up just driving to get a gallon of milk," he told audiences from the stump. Aides described livability as a logical extension of his long-held environmental convictions.

Maybe so. But Gore has always lofted an astute finger to the political wind. As early as the summer of 1998, he and his revolving cadre of strategists shrewdly identified livability as a stealth issue, one with surging appeal to harried suburbanites distressed by interminable traffic tie-ups and a bulldozer blitzkrieg that threatened to convert every last piece of open land into endless cookie-cutter subdivisions. By adopting livability as a signature cause, the veep's brain trust hoped to invade stalwart Republican suburbs, not just in the East, but in the West and Southeast. Moreover, they bet on its appeal to college-educated suburban women, the soccer mom voting bloc that helped send Bill Clinton to the White House in 1992.

Livability's drawing power was confirmed when it proved a big player in the 1998 midterm elections. Voters across the nation encountered some 240 state and local ballot initiatives designed to preserve open space and limit sprawl, and they approved more than 70 percent of them. In New Jersey, for example, suburbanites who had electeded Republican governor Christine Todd Whitman in 1993 on her pledge to cut taxes overwhelmingly endorsed her proposal to devote some \$1 billion a year to preserve half of the state's 2 million acres of open space. Two months after the 1998 midterm elections, Gore appeared at the American Institute of Architects (AIA) to formally unveil the administration's livability agenda, which would make \$2 billion in federal funds available to buy undeveloped land, create parks, and protect green spaces. "The federal government's role should never be that of commissar," Gore said. "But it is our job to amplify citizens' voices and make it easier for communities to get their hands on the tools they need to build the way they want. It is our job to keep learning from community successes and do what we can to support them."

It is the inexorable way of Washington: What the Democrats espouse the Republicans bash, and vice versa. So it came as no surprise when the opposition started blasting Gore's pet issue. Conservative columnist George Will led the way by dismissing livability as a manufactured campaign issue in a February 1999 issue of *Newsweek*. He cited the candidate's focus on sprawl as "fresh evidence of Gore's propensity for muddy, hackneyed, and semihysterical thinking."

"Now he wants government, the author of the disaster known cheerily as 'urban renewal,' to inflict suburban renewal," Will sneered.

Four months later, House Majority Leader Dick Armey, (R-Texas) circulated a memo to Republican colleagues urging them to deride Gore's

livability agenda as a big-government infringement on individual property rights. "We have to look comprehensively at quality-of-life issues," he wrote, "focusing on freedom and individual choice over Washington intervention and mandates." In other words: Let the 85 percent of Americans who say they want to live in a freestanding suburban home fulfill their wish. Let government confine itself to policing and quality-of-life enforcement, as New York mayor Rudy Giuliani did in Times Square.

Enter Jim Dinegar, a tall, red-haired lobbyist hired two years ago by the AIA (now chief operating officer). Dinegar recognized that the Republican leadership on Capitol Hill would, as a matter of course, shoot down Gore's pet issue—unless the AIA could demonstrate that livability issues have broad public support. Here was the rare opportunity for the AIA to inject itself into prominent national discourse and offer its expertise as a bipartisan resource to policymakers. To that end, Dinegar and then-AIA president Michael Stanton met last spring with Jim Nicholson, chairman of the Republican National Committee. "We warned him that the head-in-the-sand approach to livability wasn't

By adopting livability as a signature cause, the veep's brain trust hoped to invade Republican suburbs, not just in the East, but in the West and Southeast.

going to work," Dinegar says. "Politics is blinding Republicans from a winning issue. They'd be foolhardy to pass it up."

As a former Colorado homebuilder with close ties to construction and development, Nicholson might easily have ignored Dinegar's pitch. But he agreed to give Dinegar a letter of introduction to all seven Republican presidential hopefuls. Dinegar was already briefing the Democratic candidates. He then scheduled meetings with their Republican counterparts, with varying degrees of success. The most receptive was George W. Bush, who had already appointed progressive Indianapolis mayor Stephen Goldsmith as his consultant on the issue. Least responsive was Steven Forbes, who, as the standard-bearer of fiscal conservatism, condemns most ambitious government interventions. "The presidential candidates are slower to get it," Dinegar says. "We impressed on them that livability is an issue they're going to have to face."

To demonstrate that livability plays well on the local level, the AIA conducted a survey: 68 percent of state and local executives and policymakers responded that they believe concern over livable communities is growing. Nearly two-thirds said they were involved in measures to control sprawl and congestion.

So far, only Gore has pushed livability, with Republicans and his Democratic opponent, Bill Bradley, dismissing it as a subject better left to state and local officials. "We see livability and sprawl as significant issues emerging on the community level," says Linda DiVall, president of American Viewpoint, a Republican polling *continued on page 153*

Computers

Why 2K for Windows?

Windows 2000, Microsoft's replacement for Windows NT 4.0, went on sale February 17. While most of the consumer buzz has centered on the Professional version for desktops, the big news for architectural offices is in the two server versions. They run faster than NT Server 4.0 and are significantly easier to administer.

The Server version comes with 10 client access licenses and sells for \$1,199. The upgrade price from NT Server is \$599. The Advanced Server version is quite a bit more expensive at \$3,999 (\$1,999 for the upgrade), but 25 workstations can access the server at once. Advanced Server looks like a winner even in smaller offices that don't need 25 workstations connected. It has what Microsoft calls "two-mode failover," where one server can take over automatically if the other fails. It also supports faster computers with up to eight CPUs. The regular Server version supports only four CPUs.

Desktop performance is mixed. Windows 2000 is certainly easier to install and maintain than NT 4.0. It is

much more stable than Windows 98. It also accesses large amounts of memory more efficiently. Those running Windows 98 with 64 or 128 MB of RAM in a workstation should see a modest speed improvement. On the other hand, Windows 98 is 20 to 30 percent slower than NT 4.0, so some users may see a slight degradation in performance with Windows 2000. The upgrade from Windows 95 or 98 costs \$219 per machine; from NT 4.0 the upgrade price is \$149 (all these prices are list and will be discounted a bit over time).

Users should consider upgrading their servers fairly quickly, but hold off on the workstations until vendors of CAD and other applications assure consumers that drivers are available. Those with workstations that are not 300 MHz with 128 MB of RAM or better shouldn't bother putting Windows 2000 on them, even if their servers have been upgraded. *Steven S. Ross*

Modernville, U.S.A.

Steven Litt reports that a small Midwestern town is seeking landmark status for its big-city modern architecture.

Preservation Columbus, Indiana, 45 miles south of Indianapolis, boasts one of the largest collections of buildings by important modern architects anywhere in the United States. And if the town of 35,000 has its way, it will soon enjoy special government recognition for that. In January, local citizens applied to the National Park Service to have several of the city's buildings designated as the first modern architecture district to win National Historic Landmark status. Advocates hope to have six individual buildings listed as contributing structures. If they succeed, more Columbus buildings may be added in the future.

Columbus began to emerge as a modernist Mecca in 1942, with the completion of First Christian Church, designed by Eliel Saarinen. In 1957, Cummins Engine Company chairman J. Irwin Miller directed the company's philanthropic arm, the Cummins Engine Foundation, to pay architectural fees for any new public buildings in Columbus if the clients chose designers from a list of leading architects compiled by an independent panel of accomplished architects. The program took off slowly, but today the city has 65 notable buildings by such architects as Eero Saarinen, I.M. Pei, Kevin Roche, Harry Weese, and Richard Meier, among many others. Some, such as Robert Venturi's Fire Station No. 4, are seminal pieces of modern design.

Normally, buildings are eligible for federal historic landmark status—which forbids alteration or demolition without extensive review—only after they are 50 years old. What's more, the landmarks commission rarely lists the work of living architects, which leaves many midcentury modern masterpieces unprotected. Sponsors of the Columbus buildings hope the National Park Service will bend the rules on behalf of such a notable group. They expect a ruling by May. "The intention," says Columbus architect Louis Joyner, who helped prepare the historic landmark nominations, "is to raise awareness about the need for further conservation of these buildings." ■

The low, glass-walled Irwin Union Bank designed by Eero Saarinen in 1954 was among the first of some 65 modern buildings erected in Columbus, Indiana.





21st-Century Alchemist

New materials are sometimes just old ones made better. Sara Hart reports on British industrial designer Tom Barker's innovative building products for two Millennium Dome exhibitions.

Technology On January 1, the Millennium Dome opened to the public and to the relief of thousands of construction workers, project managers, technicians, engineers, architects, and, of course, politicians. The controversial tensile-membrane structure is the United Kingdom's \$1.2 billion arena for a yearlong extravaganza of multimedia and interactive exhibitions, celebrating all things U.K. (January 1999, pages 108–113). Designed by the Richard Rogers Partnership and engineered by Buro Happold, the 20-acre dome hosts 14 themed zones, or exhibition buildings. Beneath the excessive hype and visual overload, two of these spaces stand out for their conceptual finesse and material innovation: Zaha Hadid's Mind zone and Gumuchdjian + Spence's Shared Ground zone.

With the dome as a laboratory, both architects enlisted Tom Barker, a young, imaginative engineer and industrial designer whose multidisciplinary design company, DCA-b, pushes the limits of existing building materials and, in the process, strives to create new ones. "Most things are possible," states Barker with an alchemist's optimism, while explaining the process of turning recycled cardboard into a fire-resistant, structural building material for Shared Ground and creating what he calls "Zaha's Brick" for the Mind.

Hadid (July 1999, pages 70–77) has created a dramatic place for a collection of high-tech exhibits exploring the mysteries of the mind. While

most of the other zones treat the dome's surface as an invisible *Truman Show*-type protective covering, the Mind zone celebrates the volumetric grandeur of Rogers' dome with dramatic cantilevers that poke up and out from the exhibit's upper levels. The drama of it all suggests that Hadid garnered more terrain than the other exhibits, but she didn't. The structure's apparent bulk is a clever illusion used to reinforce the zone's message that the mind is a mysterious world of shifting perceptions. Hadid has designed a stage rather than a building, upon which visitors will interact with a variety of quasi-scientific games and machines as they ascend along ramps, up staircases, across cantilevered decks, and through a darkened sound chamber.

Hadid and Barker borrowed some of the technologies from one of the zone's sponsors, British Aerospace, including the translucent, glowing floors and walls of the zone that give the entire structure an otherworldly, greenish cast. The overall structure is a steel frame, engineered by Ove Arup, with the floor and walls clad in a version of "Zaha's Brick," not an invention so much as a permutation of the fiberglass and aluminum panels used in the floors of airplanes. The floor cladding is a series of composite 1-by-3 meter panels made of a glass-fiber reinforced polymer (GRP) skin on an aluminum honeycomb core with a thin polymer backing. These panels are fixed to rubber-padded pedestals at 500-millimeter intervals. Fluorescent lights sit between the pedestals, and

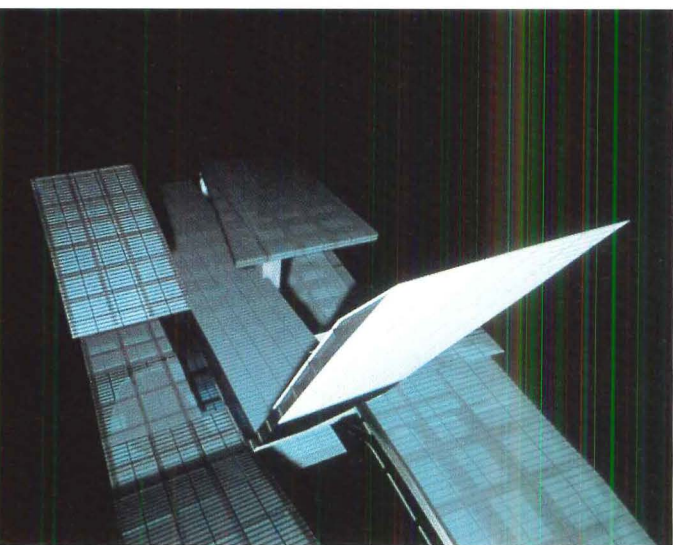
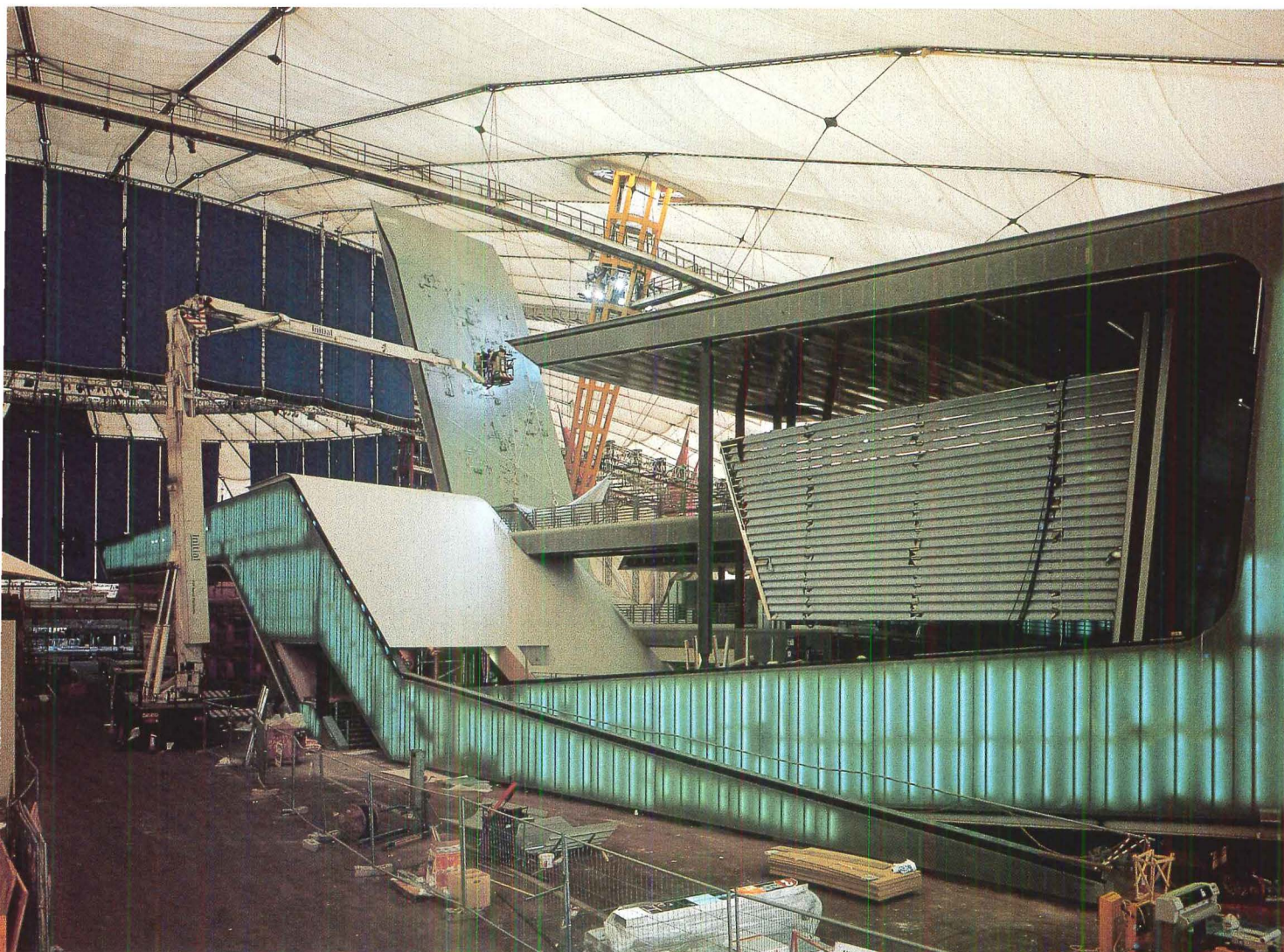

The Mind zone (under construction, top) is approximately 21,500 square feet divided into three long sections ending in dramatic cantilevers. The largest cantilever angles steeply 100 feet above the dome floor. Fiber-optic cables are bonded to areas of the steelwork to provide information about stress levels, which is then displayed on a screen as part of the exhibition.

the whole system is supported by a timber-and-pressed-metal truss on the steel frame. With a transparency of 20 percent and a load capacity of 5kn/m^2 (0.725 psi), the floor passed British Aerospace's "walking wheel" test used to determine endurance against foot traffic, especially high heels, earning the system a 20-year wear certification.

"I envisioned a structure made of waste," says Philip Gumuchdjian about his original concept for Shared Ground, a zone exploring the connection between people and cities. A former associate at Richard Rogers Partnership, he worked extensively on the master plan for the dome and shares Rogers' commitment to sustainability. But he and partner Stephen Spence also saw an opportunity to show visitors to the zone that architects can take ordinary, even unrefined, materials and make something extraordinary with them.

Realizing that the schedule was too tight for him to develop a system for using various kinds of discarded or recycled materials, Gumuchdjian reduced his palette to just recycled cardboard. Having edited Rogers' 1998 book, *Cities for a Small Planet* (Westview Press), he was familiar with Japanese architect Shigeru Ban's paper-tube structures. He enlisted Ban to act as design consultant, figuring correctly that the Japanese architect's paper precedents would reassure the client, the government-appointed New Millennium Experience Company (NMEC), panicked by visions of a rickety, combustible three-story structure. Then, in a pub-

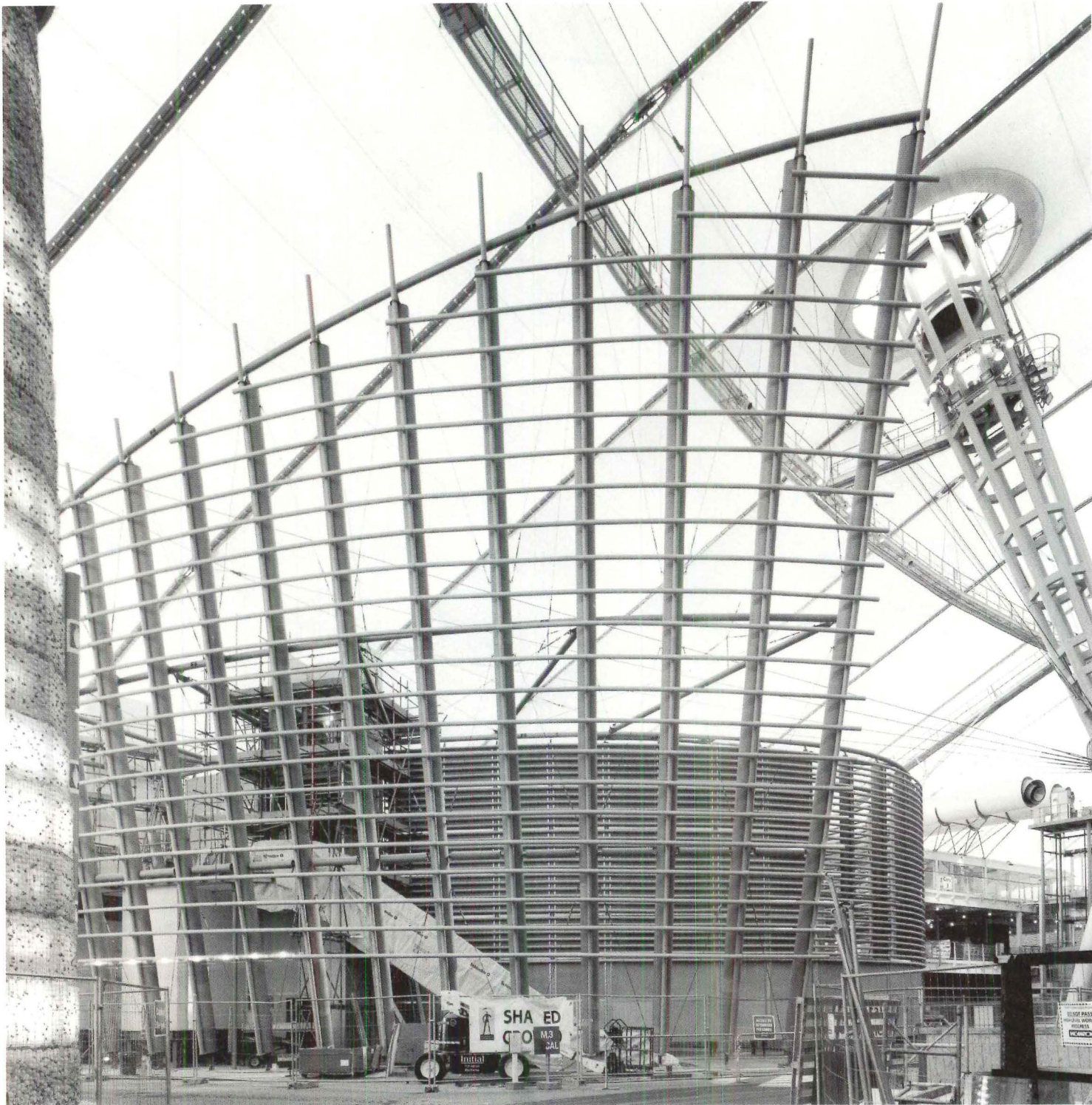

Gumuchdjian and Spence saw an opportunity to show visitors that architects take ordinary, even unrefined materials and make something extraordinary with them.

lic-relations coup, Gumuchdjian unveiled his plan to young viewers on a children's television show and invited them to help build the zone by mailing 5-inch squares of discarded cardboard directly to the paper mill chosen as the project's materials manufacturer.

Barker was undeterred by cardboard's image problem. Indeed, it is a cheap, disposable packing material, apparently lacking both the sta-

mina and visual appeal of even the most modest building materials. It falls apart when wet. It creeps when loaded, and its adhesives pollute. The most discouraging liability, of course, is its propensity to burn briskly when set on fire.

Barker worked for six months at DCA-b to uncover the attributes and eliminate the liabilities of the material. *continued on page 154*

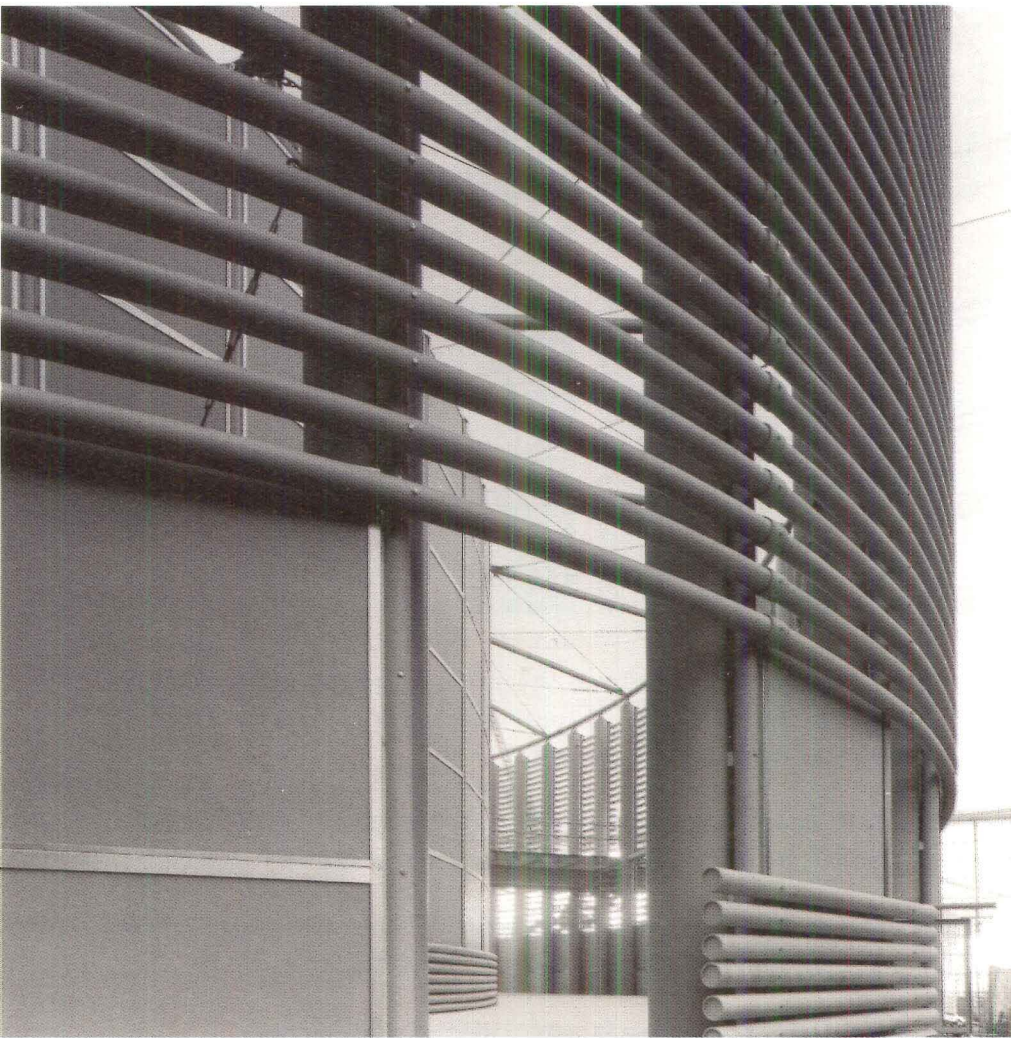

The Shared Ground zone (shown under construction, facing page, above, and in model below) is an exhibition building of over 16,000 square feet, made almost entirely of recycled cardboard. The building system (diagrammed at right) consists of 100 columns, ranging from 30 to 60 feet in height, connected by 6-inch-diameter mullions bolted to 4-by-6-foot panels. These 3-inch-thick panels are made of two exterior cardboard sheets adhered to corrugated cores, separated by foam insulation. Cables transfer axial loads from the leaning columns, which are reinforced internally with timber fins, to the supporting columns anchored to concrete pilings.

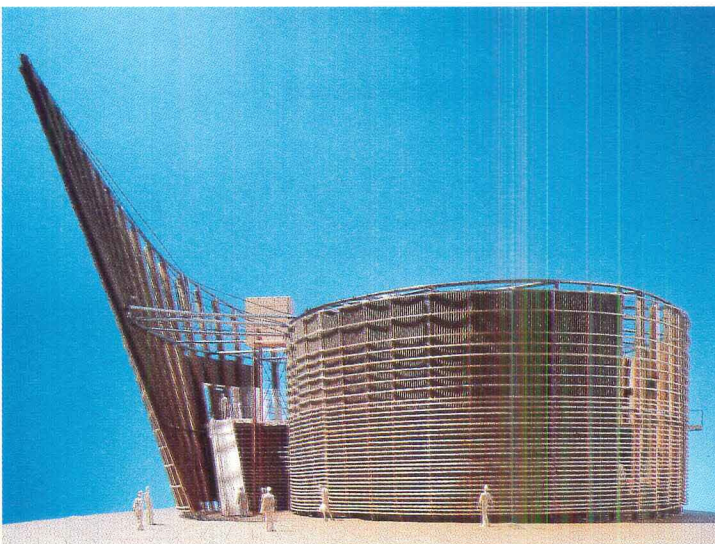
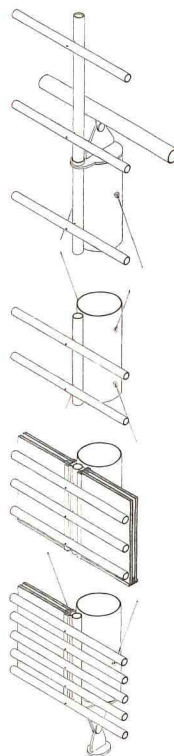

Computers

Autodesk Bounces Back

Autodesk, which fired 10 percent of its workforce last fall in the wake of disappointing earnings for the quarter that ended in August, seems to have recovered somewhat. The firm, whose flagship product AutoCAD is used by half of all American architects, saw its stock plummet to a low of \$17 a share in late October. Autodesk also considers itself the world's largest supplier of software for creating digital content on the Web. Several new product introductions that had been expected during the summer had been delayed until September 1. But with the new products finally shipping, revenue began to rise. So did the stock price, doubling before falling back to about \$31 a share in late December.

But that's still well below the 52-week high in 1999 of almost \$50 a share. Revenue still lags the previous year, and net income for the nine months ending October 31 is only a third of the income for the corresponding period in 1998 on a pro forma basis (after taking away the effects of one-time financial dealings). So don't expect Autodesk to be hiring any time soon. *Steven S. Ross*

ordinary

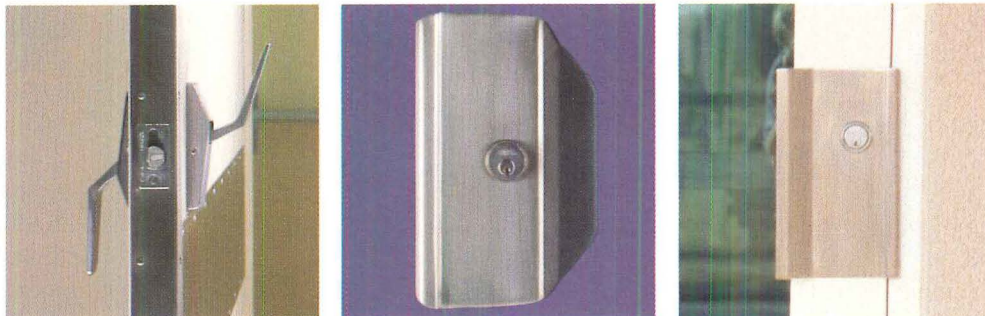

TRIMCO has a unique line of quality hardware products from the ordinary to the extraordinary. Our *MasterCraft*, *Modern Masterpieces* and architect-designed *Focal* lines give you a wide range of exquisite, handcrafted door pulls and tasteful contemporary door trim.

We also offer a complete line of Life Safety Products including Push/Pull Latches, Auto Flush Bolts, Door Coordinators and others as well as Anti-Vandal and Heavy Duty Products for schools and public buildings.

Our in-plant capabilities and award winning design and engineering departments enable TRIMCO/BBW to take your idea, implement your concept, and then manufacture it to your specifications.

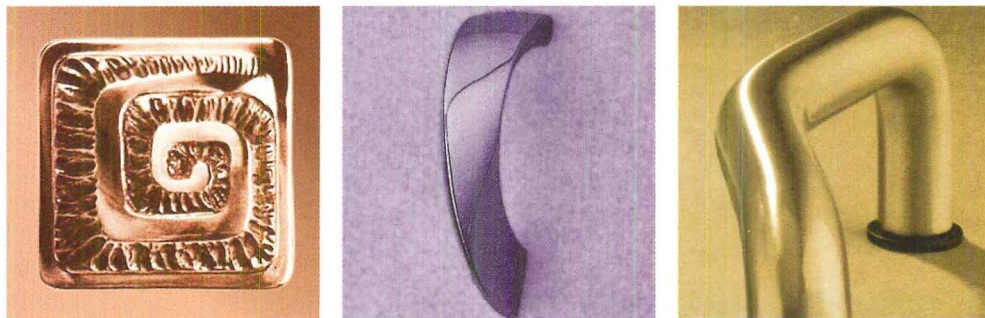

CALL US AT 323/262-4191 OR FAX TOLL FREE 800/637-8746 EMAIL: TRIMCOBBW@AOL.COM



TRIMCO offers the broadest range of sturdy and tasteful accessory door products. For additional information see website at www.trimcobbw.com or in the SweetSource CD and at the SWEETS web site: www.sweets.co

Circle 51 on information

EXTRAORDINARY

culture

Christopher Hawthorne
on Main Streets
p. 50

Dell Upton
on the Everyday
p. 54

Cathy Lang Ho
interviews
Robert Wilson
p. 56



Eyes Wide Open

The lens of modernism changed our perception of life in the 20th century. **Marisa Bartolucci** observes it also sharpens our view of the 21st.

Review Modernism's relevance to this post-postmodern age might seem tenuous. However, the Museum of Modern Art makes a provocative case for its ongoing influence with the first of the three-part MoMA2000 exhibition, entitled *Modern Starts* (1880–1920). The show examines not only modernism's but also the museum's own evolving definition and purpose. (Next year, it will embark on a major expansion, which, if this exhibit is to be understood as a foretasting, will involve displaying its collection in an entirely new, interdisciplinary way.) The fates of both movement and museum have always been intertwined. Since

Sven Wingquist's self-aligning ball bearing (1929) shows how an industrial object could become a thing of beauty; Marcel Duchamp combined everyday industrial objects, as in *Bicycle Wheel* (1951, after lost 1913 original), tweaking conceptions of art.



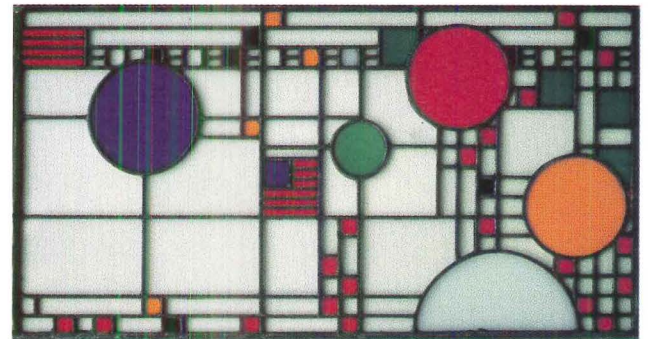
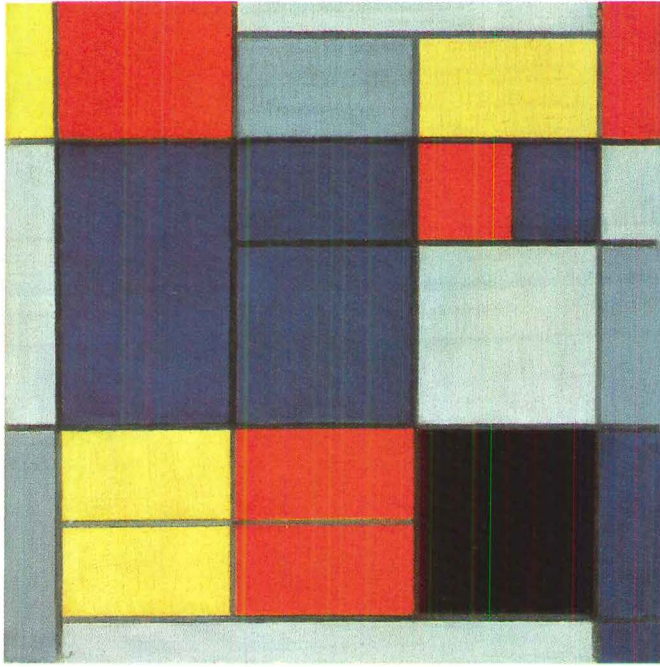

Piet Mondrian's *Composition C* (1920, above), Gerrit Rietveld's Red Blue Chair (1929, top right), and Frank Lloyd Wright's clerestory window (bottom right) from the Avery Coonley Playhouse in Riverside, Illinois (1912) reveal the interest of early modernists, across genres, in geometric abstraction.

MoMA's own avant-garde beginnings in 1929, when it started to assemble what has become the world's most comprehensive collection of modern art, it has been the principal author of the modernist canon.

Now with this bracingly imaginative show, it turns that official narrative on its head, exploring the many conjunctions and disjunctions within modernism's own advent and the past from which it ruptured forth. Employing inspired juxtapositions of art, sculpture, design, and architecture from different places and periods—works by Kandinsky, Monet, Miró, Steiglitz, and Viola keep company in one room, while Picasso, Wright, Rodchenko, Matisse, and Gaudí hang side by side in another—the curators rescue the movement from creaky historicism. They provide electrifying glimpses of the shift in consciousness that precipitated and defined that revolutionary period and continues to shape our own.

What initiated this shift? Virginia Woolf asserted there was a change in human nature. There was certainly a change in the nature of the Western world. The Industrial Revolution and the Great War eroded hierarchies, boundaries, bonds, and sentiments. The modern city—anonymous, complex, frenetic—emerged as the new locus, indeed the new medium, for the Industrial Revolution's "culture of invention." Such physical and social upheaval altered not only the way artists saw the

world, but also how they envisioned it. The show's three sections, "People," "Places," and "Things," reveal how the relationship of artists to their classical subjects—figure, landscape, and still life—was irrevocably transformed.

This altered vision had enormous consequences for architecture as well, but alas they're not addressed seriously in this installment of MoMA2000, although product and graphic design play a key role in the "Things" section. It's a curious omission since architecture has always been an important part of MoMA's purview. There are exceptional architectural elements on view from MoMA's collection: a grille from Gaudí's Casa Milá, a spandrel from Louis Sullivan's Gage Building, and a stained-glass window from Frank Lloyd Wright's Avery Coonley Playhouse. While these pieces demonstrate architecture's new fascination with the organic and geometric, and resonate with the forms and intentions of the industrial and decorative products and sculpture displayed nearby, they only hint at the astonishing new structures and environments that arose during this time. As marvelous as the contributions of this period's painters and sculptors, it was the creations of Gaudí, Sullivan, and Wright that would directly impact the public's perception of modernism. But here their ideas are reduced to mere decorative art.

The era's visual disorientation proved liberating for artists, who withdrew from their suddenly anomalous surroundings to explore and depict the realms of the psyche. Illustration was abandoned; the evocation of impression and sensation pursued. Stripped of narrative associations, the human figure and landscape were employed to suggest naked emotion, or were put to more formal exercises and pushed to the limits of abstraction. The figure, depersonalized, would become machinelike in the works of Fernand Léger and Eadweard Muybridge. Later, this transfigured being would come to intellectual life as socialism's New Man and Le Corbusier's Modulor Man, a rational creature conceived to inhabit what promised to be a newly rationalized world.

Mechanical creations captivated and fired artists' imaginations, with the airplane literally revealing new horizons. The advent of the cam-

Since MoMA's inception it has been the principal author of the modernist canon. Now it turns that narrative on its head.

era expanded possibilities for visual representation while adding a new, vicarious dimension to our relationship with objects and places.

Even the furniture of the era was blurring perceptions. Displayed in the "Things" section are 10 chairs from the period, including those by Adolf Loos, Charles Rennie Macintosh, Josef Hoffmann, and Gebrüder Thonet. On one hand they approximate sculpture with their spare, expressive wood forms and tradition in craft, while on the other, the chairs hint at the industrial, being produced, at least in part, by machine. Hoffmann actually called his armchair the *Sitzmaschine*—a machine for sitting. In this new world, the mass-produced object had itself become a work of art.

Among the first to address the radical implications of this development was Marcel Duchamp, who upon seeing a propeller as sensuous as any Brancusi, despaired for the future of art. His response to this aesthetic dilemma was a series of "readymades," everyday objects that by being slightly twisted in form and placed in a gallery setting became works of art. Challenging conceptions of art and creative production, Duchamp's witty conceit would alter the course of art theory.

None of the early moderns could have predicted how powerful the reverberations of their extraordinary perceptual revolution might be. While we may be in the midst of digital and molecular revolutions, the iconic expressions of our own age—Frank Gehry's Guggenheim Bilbao, the formaldehyde-preserved animals of Damien Hirst, Apple's iMac—all derive from modernism's liberating vision. Indeed, it was Brancusi, not Gehry, who declared, "True architecture is sculpture." As this first installment of the MoMA2000 series reminds us, we may have traveled far this century, but we still see the world through modern eyes. ■

MoMA2000: Modern Starts, People, Places, Things, 1880–1920, through March 14; **Making Choices, 1920–1960**, March 16–September 12; and **Open Ends, 1960–Present**, September 14–February 13, 2001.



Bringing the War Home (1967–72) by Martha Rosler. The image shows a modernist interior with large windows overlooking a war-torn landscape. The scene is a composite of various images, including soldiers, tanks, and destroyed buildings, which are viewed through the glass walls of the room from a seated position in the foreground.

Art

Martha Rosler:
Positions in the Life World,
edited by Catherine de
Zegher (MIT Press, 1999).

Exhibition: New Museum of
Contemporary Art, New York
June 13–October 18, 2000.

"The familiar is not necessarily the known," said Hegel. Artist Martha Rosler has long recognized that everyday objects, ordinary places, and popular imagery are rich with clues about who we are. Since the 1960s, she has been using them to examine and critique daily life and the complex forces underlying it. The lush, intelligent catalog, *Martha Rosler: Positions in the Life World*, accompanies the first major retrospective of her suggestive multimedia work.

Rosler's *Bringing the War Home* series (1967–72) juxtaposed troubling photos from the Vietnam War front and innocuous spreads from design magazines depicting idealized domestic life—

startling representations of "the war abroad, the war at home" (above).

The public arena also falls under Rosler's scrutiny: Her exhibition *If You Lived Here...* (1989) addressed homelessness and the geopolitics of urban space. More recently, *In the Place of the Public* (1993) documents the transitional, anonymous space of airports which have redefined the world as a massive network, with people no longer constituting communities but flows.

Her 1993 video work *How Do We Know What a Home Looks Like?* reflects upon Le Corbusier's *Unité d'Habitation* (1967), refuting attacks on this modernist milestone as repressive. One interviewed tenant appreciates how the place "prevents you from consuming like idiots." Rosler poses questions about people's real interaction with built forms, and how design's grandeurs, banalities, hierarchies, and more, inform daily life. *Cathy Lang Ho*

The Drugstore Invasion

Chain pharmacies are returning to Downtown America. They're also destroying it. Christopher Hawthorne sifts through the rubble.

City John Burd makes an unlikely champion for historic preservation. The 30-year-old part-time electrician, who lives with his mother in a nondescript two-story house just outside Shamokin, Pennsylvania, has no formal design training. Even calling him an architecture buff would be a stretch.

Over the summer, though, Burd found himself fighting a lonely battle to save a cluster of buildings in Shamokin, a sleepy town of about 20,000 residents nestled in central Pennsylvania's once-prosperous coal valley. His appropriately Goliath-sized opponent was Rite Aid, the quickly expanding drugstore chain whose corporate headquarters are located about 50 miles south of Shamokin in Camp Hill, Pennsylvania.

Early in 1999, Rite Aid announced plans to put up a new store at the corner of Independence and Diamond Streets, in the heart of Shamokin's stately, if aging, downtown. To make way for the new building—plus an attached parking lot for 40 cars—Rite Aid purchased and then demolished four adjacent commercial buildings on Independence. Most prominent among them was the 81-year-old Victoria Theatre, a 1,700-seat movie palace designed by the prolific Pennsylvania architect William H. Lee.

From its perch at the busiest intersection in town, the theater lent Shamokin a touch of beaux-arts grandeur. It opened to the public in January 1918 with a mixed bill of movies and vaudeville shows. Since 1985, it had been listed on the National Register of Historic Places. For a time it ranked as the oldest continually operating theater in the coun-

try, but went vacant in the early 1990s and began to deteriorate in the absence of regular upkeep. By the time Rite Aid bought the theater in 1998, it was in need of significant repair. "Quite simply, it was falling apart," says Jody Cook, a Rite Aid spokesperson.

Demolition began on July 8. "It was extremely difficult organizing folks in Shamokin against Rite Aid," Burd told me. "I mean, we've heard about the economic prosperity that's going on in the rest of America. But too many people in this town are living hand-to-mouth to get really riled up about an old building." For a brief time he had some allies in town, including an ad hoc group called the Restore the Victoria Theater Committee. But in the end their scattered efforts were no match for expansionist Rite Aid. Civic leaders maintain that there was little they could have done to stop the demolition. "Everyone, including me, hated to see the theater demolished," says councilmember R. Craig Rhoades, "but it was private enterprise at work. The city did not own any of the buildings involved. There was no official action we could have taken—no zoning, no ordinances in place that would have prevented it."

Of course, as is often the case, the politicians' inaction was itself a choice. By not mounting any opposition to Rite Aid, Shamokin officials betrayed a policy preference, a feeling that the presence of a successful national chain on Independence Street was ultimately more valuable to Shamokin than a handful of handsome but empty storefronts.

That calculus is hardly unique to Pennsylvania's coal country. What happened last summer in Shamokin is part of a national trend in which



John Burd stands on the former site of Shamokin, Pennsylvania's Victoria Theatre with scavenged remnants of the demolished 1918 beaux-arts landmark.



City

House Arrest

"Smart growth" has become a buzz issue in cities large and small, a centerpiece on the agenda of politicians and planners intent on preserving "livability" and countering the horrors of sprawl. To each city its own: For Portland, growth limits are the solution, while restrictions on big-box retail are the fix in Rockville, Maryland (December 1999, p. 29). South Kingstown, Rhode Island, saw a building type—single-family homes—as an appropriate target for mitigating growth. In 1996, the town of 29,000 capped housing starts at 160 per year (starts in the state rose by 25 percent between 1995 and 1998), recognizing the inability of its schools to accommodate a population surge.

Charging discrimination, the Rhode Island Builders' Association sued the town, lost, and is now appealing. Initiative supporters are growth-wary, citing as concerns the loss of greenbelts, preservation of the town's character, and fear of higher taxes. Says John G. Picerne, president of the Builders' Association, "They're complaining because they got their piece and they don't want anybody else to get theirs." *Barbara Knecht*



City

Business Plan

Taking advantage of generous new property tax breaks, in 1994 industry giant Intel expanded its facilities in Washington County, outside Portland, Oregon.

Last year Intel, which now employs 4,000 locals, went to the county with a plan to invest an additional \$12.5 billion in facility upgrades and equipment over the next 15 years. The county again granted property tax breaks, but also negotiated terms with the company that are intended to mitigate, rather than encourage, growth. If Intel exceeds its projected job growth of 1,000 employees over the term of the agreement, it will pay a \$1,000 fee per new person. The company will pay an \$86 million Community Service fee up front, which will be applied to community and infrastructure improvements, such as bike lanes and light rail.

Some think it's a mistake for the county to fine big businesses for growth, while contend that land-use policies are overly pro-business and environmentally irresponsible. Intel is staying quiet: Despite the fees, it's still paying about 40 percent less than it would under standard tax law. *B.K.*

chains, particularly drugstores, are returning to the Main Streets of older American downtowns, territory they once shunned in favor of locations on the outskirts of cities that offered easy highway access and oceans of parking.

At first, the chain stores' rekindled love affair with Main Street sounds like nothing but good news for the struggling towns of America—the kind of shift urban theorists such as the leaders of the Congress for a New Urbanism have been promoting for years. The cruel twist is that the chains are generally unwilling to give up the architectural elbow room they grew accustomed to in their strip mall and suburban locations. Indeed, they are now building bigger outlets than ever: As they return to the downtowns of places like Shamokin, they are demanding stores as large as 15,000 square feet, on-site, above-ground parking for as many as 60 cars, and space for drive-through pharmacy windows. In the place of older structures whose floor plans don't suit their strict design criteria,

"We've heard about the prosperity in the rest of America. But too many people in this town are living hand-to-mouth to get riled up about an old building."

companies are erecting freestanding, usually one-story buildings meant to stand noticeably aloof from the surrounding architecture.

The list of notable buildings that have fallen prey to the drugstore invasion is long. Sixteen "important structures" have been razed in New York state alone in the past two years to make way for drugstores, according to the National Trust for Historic Preservation, which called attention to the trend by including what it calls "The Corner of Main and Main" on its 1999 list of Endangered Historic Places.

Though they are not the only national businesses making a return to Main Street, drugstores have led the charge. Driven by the HMO boom and the bottomless pharmaceutical appetites of a rapidly graying population, drugstores have become the fastest-growing chain business in America, sprouting up at a pace of three new buildings per day. Though that growth has finally begun to slow, each of three leading chains—Walgreen, CVS, and Rite Aid—has been expanding at a rapid clip since the mid-1990s, essentially doubling its number of stores in the last four or five years. Rite Aid alone has built more than 1,000 new outlets since 1995, mostly in the East and Northeast.

As they expand, drug chains are finding the strip mall locations where they set up shop in the 1970s and 1980s less appealing. Those settings too often contain a jumble of commercial storefronts that share parking, and the supermarkets that anchor such developments are opening their own in-house pharmacies. As a result, drug giants are deciding to build their new stores at the most trafficked intersections of older downtown commercial centers. And they are quite picky about exactly where. "If a location doesn't meet our criteria," Walgreen president Dave Bernauer wrote in the company's *continued on page 156*



PARTNERSHIP

EFCO™ ON YOUR TEAM MEANS
A STRONG PARTNERSHIP FOR
EFFECTIVE PROJECT DELIVERY.

As the industry increases demands for faster, better, and less expensive projects, you need an edge to keep you competitive in the market.

Discover the power of a partnership with EFCO.

Involve EFCO in the early stages of your project, and you're getting a valuable consultant. Look to EFCO for innovative design solutions, cost-effective products, and technical support at every stage of the project. EFCO brings experience working with all types of delivery teams—design-build, construction management or design-bid-build—to help you achieve optimum results. You'll work with a single-source manufacturer who offers a complete line of compatible products,

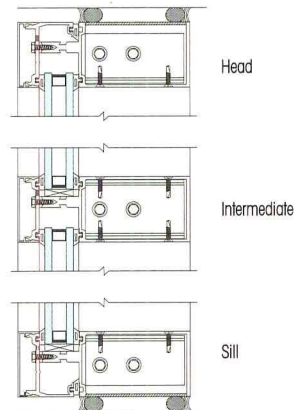

including windows, storefronts, curtain walls, and entrances.

Make EFCO your project partner from design to completion. Contact your EFCO representative, call EFCO direct at 1-800-221-4169, or visit our Web site at www.efcocorp.com.

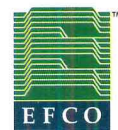

WINDOWS
CURTAIN WALLS
ENTRANCES
STOREFRONTS



Products: EFCO Series 5600 Curtain Wall System, Series D-300 Entrances, Series D1 and 403 Storefronts, Series 660 Hung Windows, QuickSet™ Storefront Ribbon System, and Custom Steel Curtain Wall
Building: Johnston Professional Building, Baltimore, MD
Design/Build Team: DiAleo & Associates, L.C. (architect) and The Mullan Contracting Company (general contractor)
Contractor: Custom Walls and Windows
NOTE: Custom curtain wall on this design-build project has all-steel interior mullions that span 32 feet in height in a 72-foot radius with exterior aluminum covers.

THE DRIVE-IN,
THE SUPERMARKET,
AND THE TRANSFORMATION
OF COMMERCIAL SPACE
IN LOS ANGELES,
1914–1941



RICHARD LONGSTRETH

Review

City Center to Regional Mall: Architecture, the Automobile, and Retailing in Los Angeles, 1920–1950,

by Richard Longstreth
(MIT Press, 1997)

The Drive-In, the Supermarket, and the Transformation of Commercial Space in Los Angeles, 1914–1941,

by Richard Longstreth
(MIT Press, 1999)

So ubiquitous are supermarkets, service stations, strip malls, and shopping centers, we often forget that they—and other familiar building forms—evolved specifically in response to the automobile. Now Richard Longstreth has produced a landmark pair of books addressing this important yet neglected chapter of architectural history.

City Center to Regional Mall meticulously traces the out-migration of retail activity from downtowns to the regional malls of the 1950s, while *The Drive-In, the Supermarket, and the*

Transformation of Commercial Space in Los Angeles follows up by examining other auto-centric building types. The dilemma of what to do with cars when not in use—yes, parking—emerges as the fundamental form-driver, Longstreth reveals, changing not only the way buildings address the street but the organization of interior spaces, reflecting drastic shifts in retail practices. For example, supermarkets assumed open, self-service plans with nonhierarchical aisle arrangements and minimal contact with staff; like their exteriors, they were geared for efficiency and convenience.

While many books have chronicled car culture's decentralizing effect on cities, Longstreth's detailed analyses of how cars precipitated architectural transformations offer a deeper understanding of the genesis of the multicentric city and its dependence on the auto.

With the blossoming of e-commerce, cities today are poised for yet another revolution. Some, like Joel Garreau, foresee that big boxes and large-scale retailers will be the first casualty, and others, like William Mitchell, see recent shifts in retail activity as a signal for the resurgence of the street. Longstreth's books offer powerful insight into the transformations of commercial space, past and future. *Jonathan Ian Mason*

A World Less Ordinary

Everyday, quotidian, banal—these aren't usually considered compliments, but, as **Dell Upton** notes, the ordinary can be quite extraordinary indeed.

Everyday Urbanism, edited by John Chase, Margaret Crawford, and John Kaliski (Monacelli Press, 1999)

Architecture of the Everyday, edited by Steven Harris and Deborah Berke (Princeton Architectural Press, 1997)

Review

In 1947, French theorist Henri Lefebvre published his epic *Critique of Everyday Life*, an examination of the alienation from self and society that seemed to pervade modern life. Lefebvre thought the antidote lay in an appreciation of the ordinary, of “real life” in the “here and now,” which might be transformed by a “dramatic attitude” and a “lyrical tone” into a more satisfying existence. Although critical of daily life in the industrial era, he thought many of the daily actions of ordinary people demonstrated a healthy resistance to overbearing authority.

Lefebvre's ideas provide the authors of two recent essay collections with a starting point for imagining the future of professional architecture and urban design. *Everyday Urbanism* seeks to counter the monotony, authoritarian politics, and growing inequality of globalized cities by studying the lessons that might be learned from the ad hoc, sometimes illegal, urban spaces created by ordinary people—median-strip vendors, garage-sale entrepreneurs, recyclers. The essays are careful, unromantic, and for the most part, sensitive to the difficulties that such a strategy might present even to the best-intentioned people.

John Chase's “Curmudgeon's Guide to the Wide World of Trash” ponders the conflicting territorial behavior of the housed and houseless residents of one alley in Venice, California. Chase frankly discusses of the ambivalence of a middle-class urbanite whose abstract social sympathies clash with his annoyance at his poorer neighbors. The essay reveals a problem with the Lefebvrian resistance model: Academics and professionals might celebrate “subversion” in their writings, but, as this example makes clear, they reside, nevertheless, on the side of authority.

The difficulties inherent in using the resistance model as an approach to design are even more evident when *Everyday Urbanism* considers the role of professionals. John Kaliski's “The Present City and the Practice of Urban Design” perceptively exposes the shortcomings of urban



Part of photographer and sociologist Camilo José Vergara's series on the barrios of Los Angeles, this shot is in a neighborhood in Watts, where the homeowner Juan and his son, Tony, sell mattresses from their front yard.

design work, from Le Corbusier to Rem Koolhaas—but does so in such a manner that no room seems left for any appropriate professional role. Kaliski attempts to salvage one. He presents the planner as a facilitator who provides open-ended alternatives that express “the many voices, dreams, and desires of existing situations,” while also arguing that urban design “engages the daily without abandoning interest in structure, form, typology, light, material, and the histories of the art.”

Not surprisingly, when the contributors to *Everyday Urbanism* try to design the ordinary, the results are disappointingly one-dimensional. For example, Phoebe Wall Wilson’s “neighborhood place” offers a bland middle-class vision of New Urbanism. One major problem is that architecture is by nature on the side of those seeking to impose more and simpler order; meanwhile, at its most vital, the everyday works against all imposed orders. The point is made most starkly in landscape architect Walter Hood’s design for a park that anticipates a full range of urban activities, such as yard sales, children’s play, and romantic trysts, as well as sidewalk drinking and prostitution. But learning from Chase’s alley study, the park’s neighbors are unlikely to be as nonjudgmental as Hood.

Architecture of the Everyday takes a different tack, using Lefebvre’s concept of the ordinary to challenge heroic formalism and abstruse design theory. Deborah Fausch’s essay explores the controversy surrounding Robert Venturi and Denise Scott Brown’s 1976 exhibition *Signs of Life*. That debate implicitly interrogated the profession’s political

position: Is the architect to be the unquestioning handmaiden of consumer capitalism, the advocate of high culture, or (as Venturi and Scott Brown appeared to argue) a more flexible, more pragmatic, less easily categorized—and thus more effective—protagonist in society?

Joan Ockman advocates the creation of “minor” architecture that might perform the subversive function that Lefebvre assigns to everyday life. Women and other marginalized groups might be particularly effective in doing this, Ockman suggests. By small, subtle infusions of their own ordinary but distinctive experiences into the high architecture shaped by white men, they could effect a transformation of architecture that would be gradual and incremental but more radical than anything achievable through strident avant-gardism or high theory.

These volumes offer sound critiques of the grandiosity of the high-style architecture of the 1980s and 1990s, the solipsistic abstraction of contemporary architectural theory, and the unquestioning acceptance of top-down planning and development practices. Yet it remains unclear what might replace them. Ultimately, these anthologies are best read as essays in architectural ethics, meant to sensitize designers to the intellectual and political contradictions inherent in their professional positions rather than to recommend specific design practices. ■

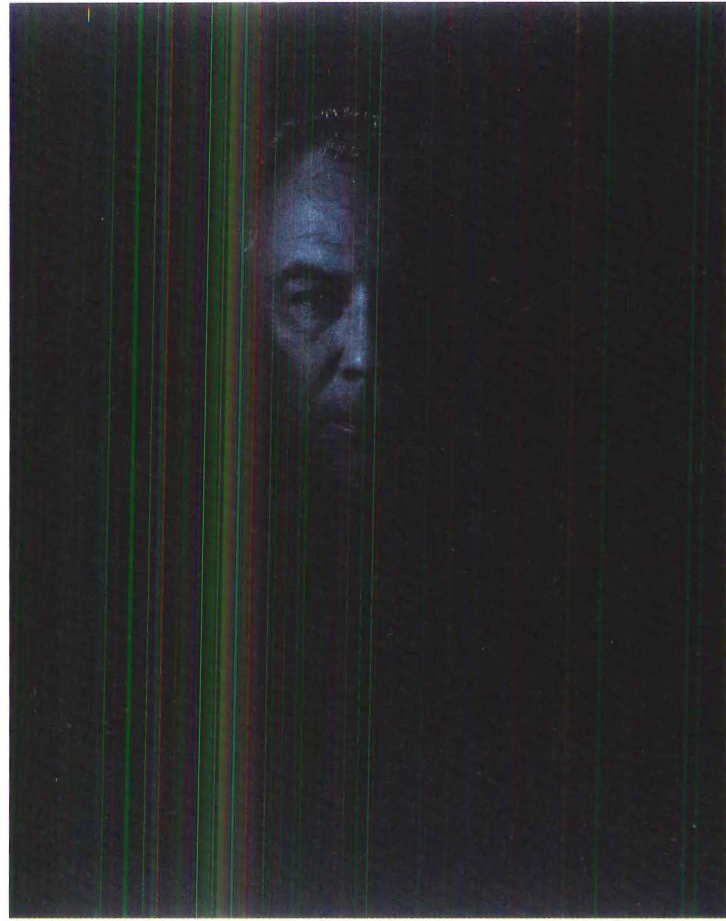
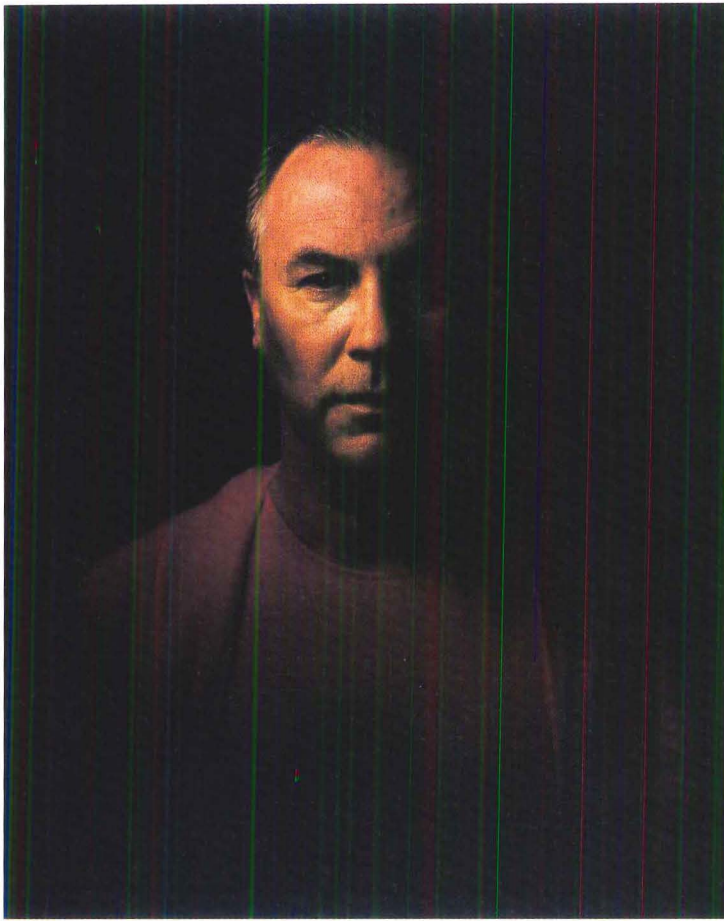

Robert Wilson Sees the Light

The world's leading avant-garde theater director studied architecture and worked with Paolo Soleri. He tells **Cathy Lang Ho** about his latest endeavor: to lighten up downtown Pittsburgh.

Interview Space speaks to Robert Wilson. If he had become an architect (he studied architecture at Pratt Institute in the 1960s), his buildings would likely be imbued with the balance and tension, calmness and drama that characterize his revolutionary stage productions. Wilson's latest theatrical work is the city of Pittsburgh. Collaborating with New York architect Richard Gluckman, he devised a multidimensional, multiscaled light installation as part of a larger program commissioned by the Pittsburgh Cultural Trust to breathe new life into the city's historic downtown.

Cathy Lang Ho: You've been called one of the most architectural of directors. What does your work share with that of architects?

Robert Wilson: Well, everything begins with light—without light there's no space. And space can't exist without time: They are part of one thing. For me, time is a vertical line that goes to the center of the earth and to the heavens, and space is a horizontal line. This cross of time and space is the basic architecture of everything. It's in a painting by Barnett Newman or Vermeer, it's in a drop of water, in Mozart, in the chair you're sitting on, and the building you're in.

So you use the word "architecture" as a metaphor for basic structure. It's a way of constructing time and space. It's a decision you make. There can be more or less tension between the vertical and the horizontal, but it exists in everything.

Architects design buildings and cities—megastructures—but I'm more interested how you fill in those megastructures. Filling in the form is what you experience, which, to me, is the most important thing.



What did you learn from working with Paolo Soleri?

Soleri was a dreamer. Sometimes he'd take a stick and draw in the sand and no one knew what it was going to be—I don't think he knew himself. That was fascinating to me, that he started with a blank book and that his making of things was the actual experience of doing it. He wasn't building a model—he was carving into the earth what he was about to make, whether a wall or a foundation or a form to cast something that might be moved someplace else. One reason we work as artists is to ask "What is it?" rather than to say what something is. Too often we are too intellectual, trying to explain instead of experience what things are. Experiencing things is a way of thinking.

For your recent Pittsburgh project, you extend your ideas beyond the controlled interior of a theater to the street and the city.

It's all about light. It's trying to establish a coherence through a district that consists of many different esthetics and ideas. Many people view Pittsburgh as a cold mining town, a rather dark image. We are giving the community a new symbol. There is a 20-by-40-foot light billboard on top of a building, which is readily recognized and identifiable—you can see it from the ballpark or as you're flying in on an airplane.

Some of the light reflections are almost imperceptible—it might be a pattern moving across the side of a wall, or a triangle moving within a frame of a billboard. We're doing a facade with vertical bars of light that scan across a building, but very slowly, with delicate and light colors. If you're walking by it you might barely notice it.

We also have lighting ideas for alleyways, roofs, and facades, to enhance what is there or to mask what is temporary or a work in progress. We have modular scaffolding and lit scrims that can be moved from building to building or construction site to construction site, spot-lighting or shielding whatever we want to see or not see.

What from your architecture education stands out?

The best class I ever had was from Sibel Moholy-Nagy. She said one day, "Students, you have three minutes to design a city. Ready, go!" I drew an apple and inside the apple I put a crystal cube. She asked, "What is that?" I said, "A plan for a city, like a medieval village where you had a cathedral in the center." The crystal cube was the core and could reflect the universe. I've often gone back to think about that, about how our cities need centers where people can go for enlightenment, education, pleasure. The most important thing I learned from this class was how to see the big picture quickly. Theater, like design, has to be about one thing first, and then it can be about a million other things. ■

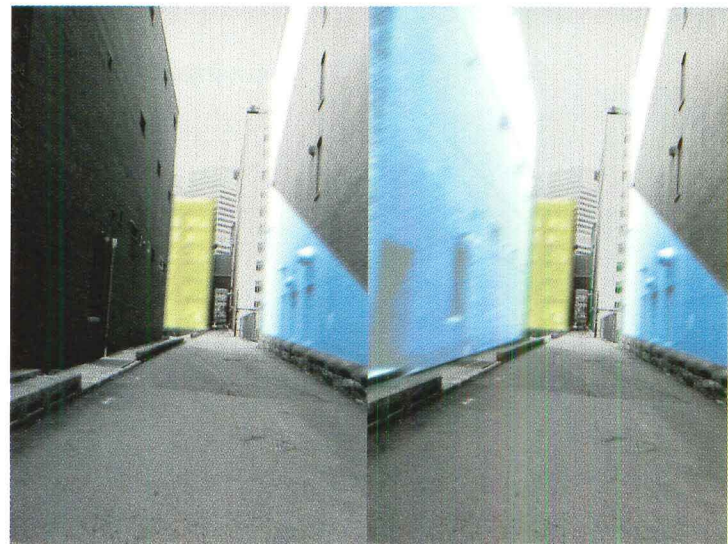
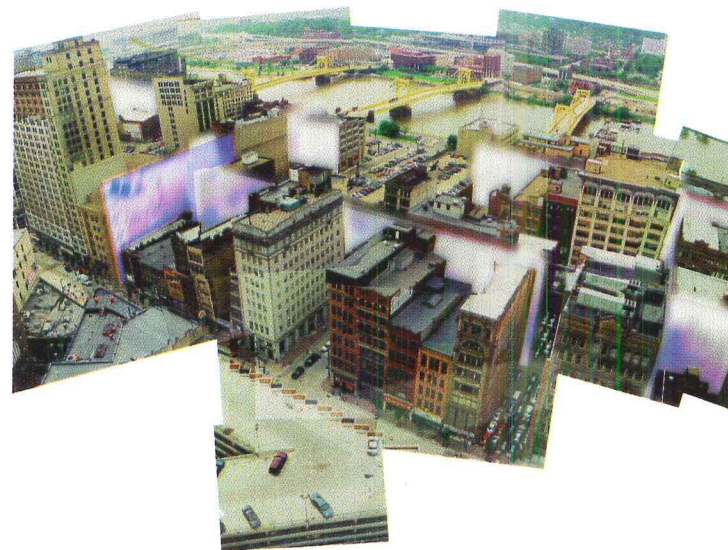

To give downtown Pittsburgh a brighter identity, Robert Wilson (self-portrait diptych, facing page) and Richard Gluckman devised installations that transform streets and buildings into backdrops for abstract plays of light. The furniture Wilson has designed for his productions, such as the *Meek Girl Chair* (1994, above left) and *Parzival: A Chair With a Shadow* (1987, above right), are more than props, becoming actors in his plays.

From Now On...

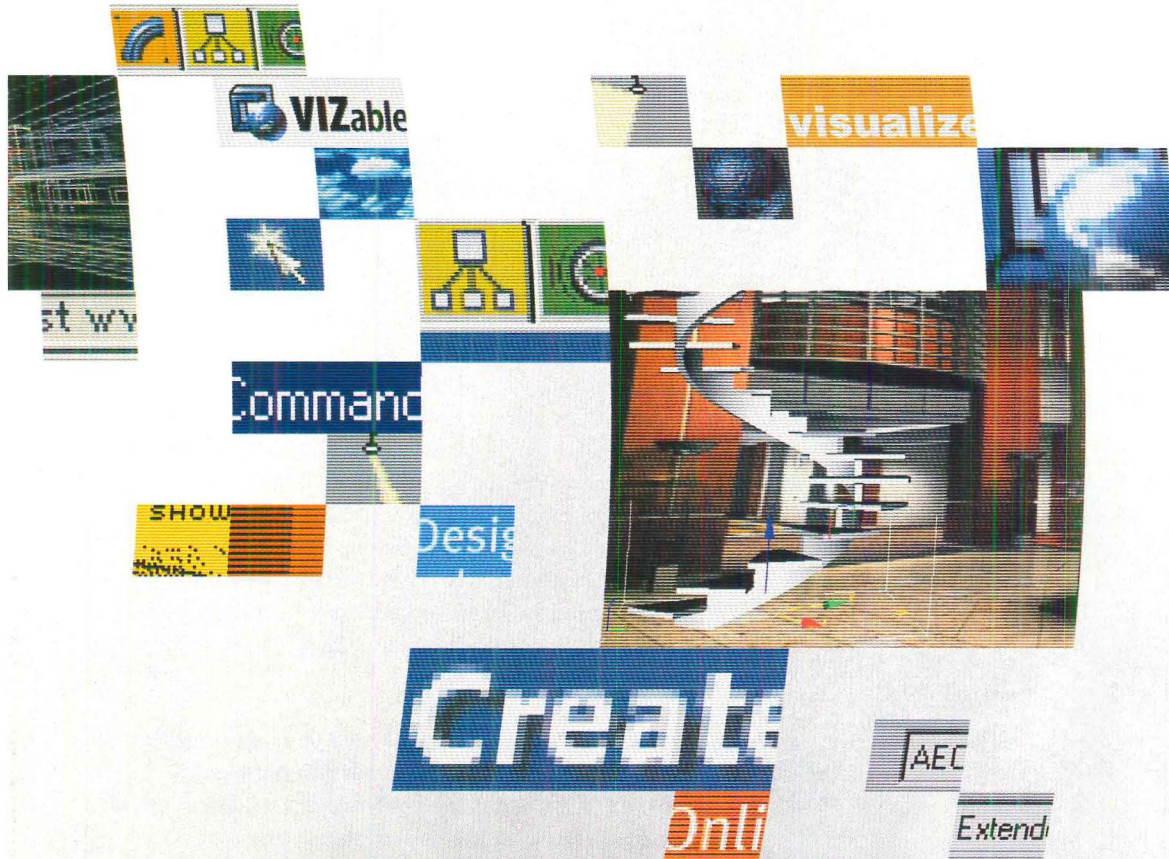

...You'll sharpen your imagination, instead of pencils.

...You'll use the web as a tool, instead of a toy.

...You'll communicate more, and clarify less.

3D Studio VIZ™ R3

The leading design visualization tool now has an innovative, web-enabled Asset Browser. For the first time you can drag and drop manufacturers' content directly into your designs.

To learn more visit us at www.autodesk.com/vizr3

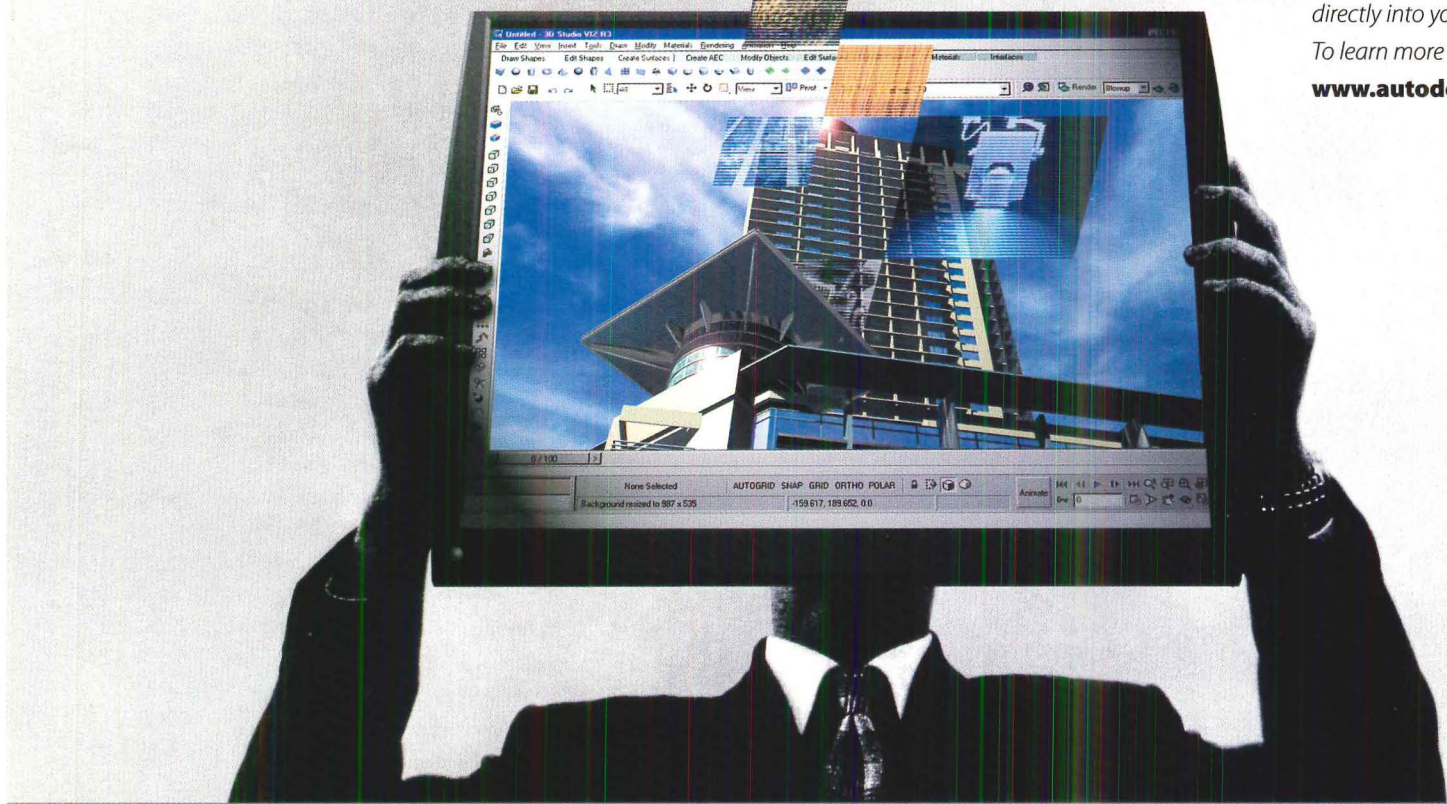

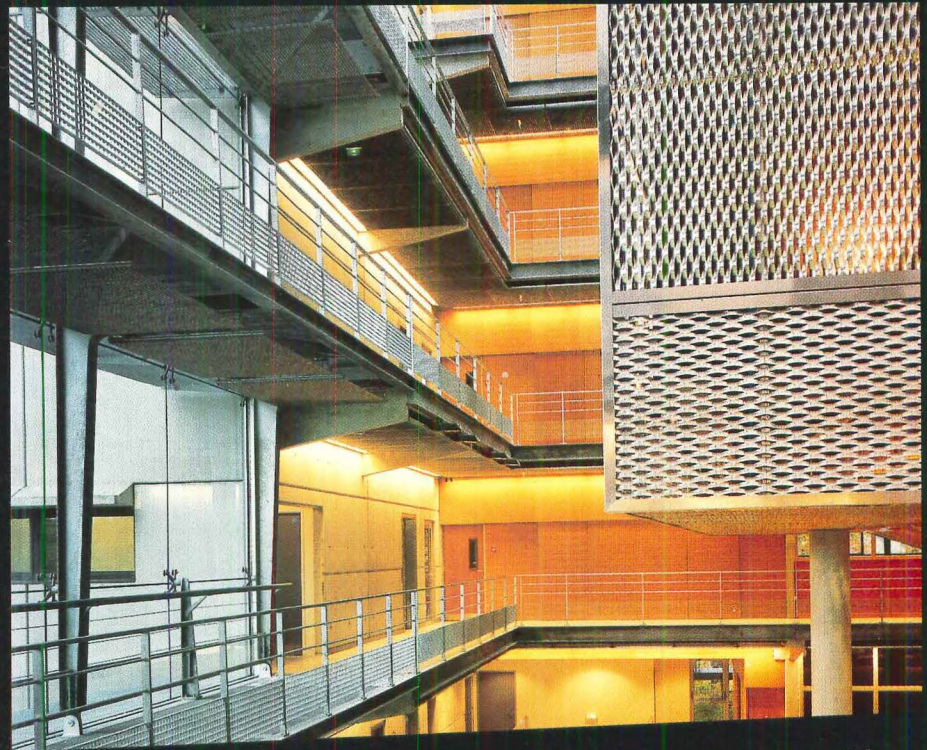

Perceptual Shift

At the beginning of the 21st century, modern architecture has shifted from an ostensibly neutral assemblage of architectural forms and building types to an idiom fraught with meaning and association. Thom Mayne's new Hypo Alpe-Adria-Center and Bernard Tschumi's Paris architecture school exploit—and upset—the conventions of modernism: Mayne tilts, breaks, and layers his architecture in order to express contemporary ideas of indeterminacy; Tschumi encourages a different kind of complexity—human interaction—with layered bridges, catwalks, and stairs. Arata Isozaki's Center for Science & Industry in Columbus, Ohio, is, by contrast, a cipher—a closed, monumental form that denies easy physical or intellectual comprehension. Modern architecture has entered a delightfully difficult age.

Tschumi's Chinese puzzle box of a building toys with the viewer's perception of inside and out.





An architecture school outside Paris illuminates Bernard Tschumi's strategies for layering space and motion. By Catherine Slessor

Containment Strategy

An elevated auditorium dominates the building's large central atrium, hovering over a café and gallery.

Cantilevered balconies line the atrium (below left), running along the quadruple-height, glazed entrance in the school's west facade toward a metal panel-clad office wing. Catwalks (right and below right) connect internal corridors to the floating auditorium and the terrace on its roof. On the west facade (facing page), the metal panel-clad office block and the concrete studio block flank the glazed entrance. A partly glazed sawtooth roof admits northern light into the atrium.





Once the corsets of beaux-arts architectural education were finally loosened, the founding of modern schools of architecture often provided a catalyst for the construction of such radical buildings as Ludwig Mies van der Rohe's Crown Hall at IIT or, more recently, Peter Eisenman's Aronoff Center at the University of Cincinnati (August 1996, pages 114–125). With the completion of an unself-conscious school of architecture in the new Parisian suburb of Marne-la-Vallée, New York City-based Swiss architect Bernard Tschumi quietly joins this influential coterie. Acutely aware of the pitfalls of employing a star architect to design an architecture school, Tschumi observes, "Designing an architecture school was a challenge for me, because I run the school of architecture at Columbia [University in New York City]. I had the impression that I knew too much. I also found it difficult because once the project is finished, it will be criticized by the architecture students."

Tschumi's own student career was spent at London's Architectural Association, which occupies the labyrinthine confines of an 18th-century Georgian terrace. This cultivated his recognition of the importance of informal "in-between spaces," where students meet, talk, and exchange views. At Marne-la-Vallée, Tschumi has endeavored to create a humane, flexible educational environment where architecture forms an adaptable armature for activities that foster both intellectual and social development.

A 20-minute drive east of Paris, Marne-la-Vallée is a soulless conurbation grafted onto the suburban plain. The town's state university campus occupies a series of buildings in a nondescript landscape of spindly trees and parking lots. The new architecture school terminates the eastern fringe of the campus; its immediate neighbor is a large geography and civil engineering building, soberly executed in steel and glass by the French partnership of Chaix and Morel. Housing 500

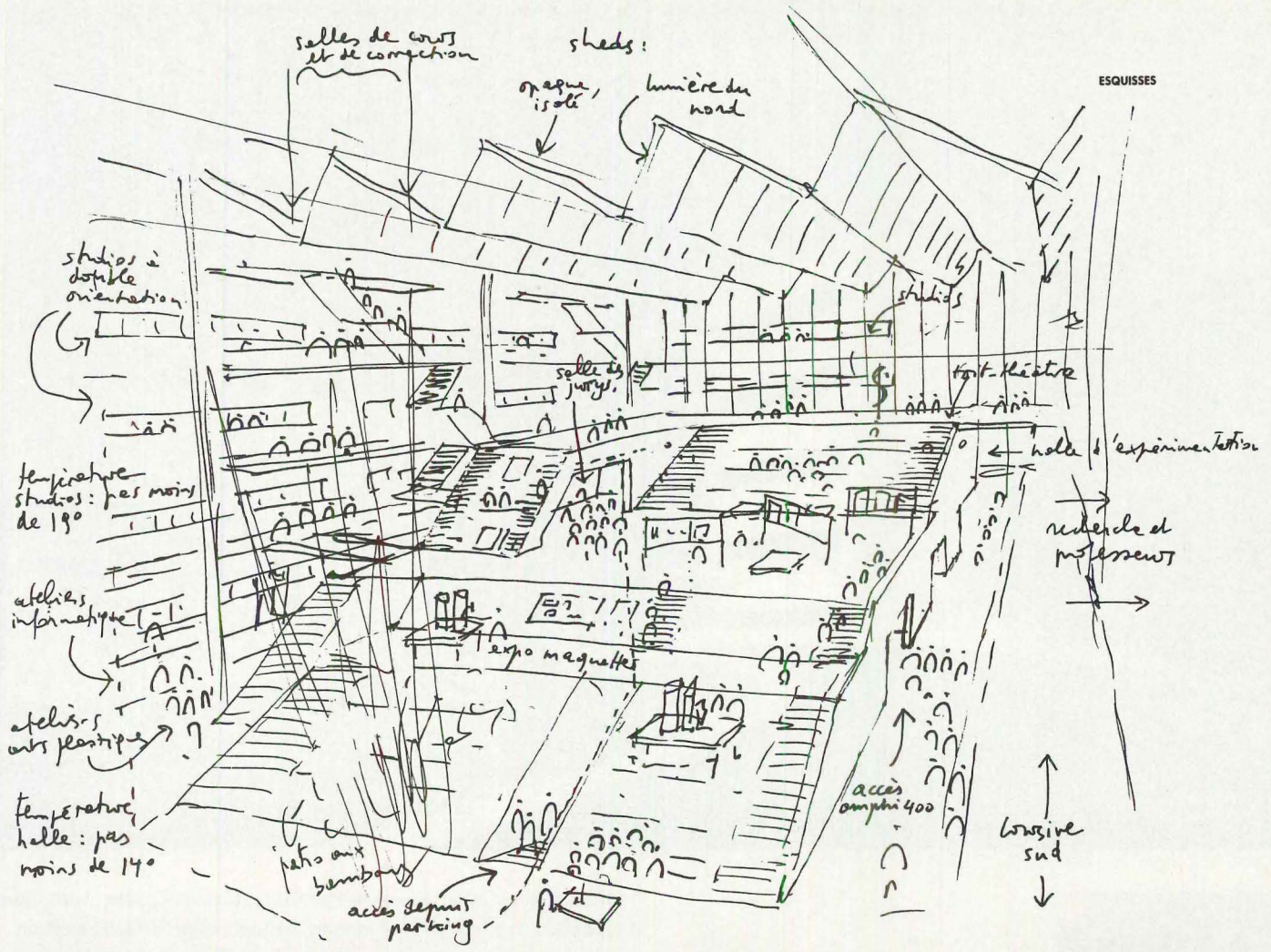

Tschumi designed the architecture school to expand to the east. A giant staircase with terraced seating (above), part of which is already built outside (page 66), will eventually provide the focal point of the enlarged atrium.

- 1 entrance
- 2 café
- 3 gallery
- 4 studio
- 5 classroom
- 6 auditorium
- 7 offices
- 8 media library

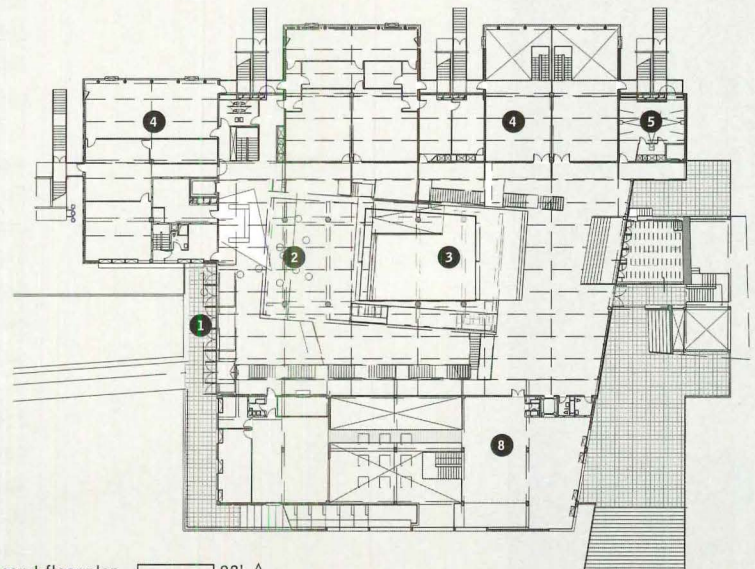

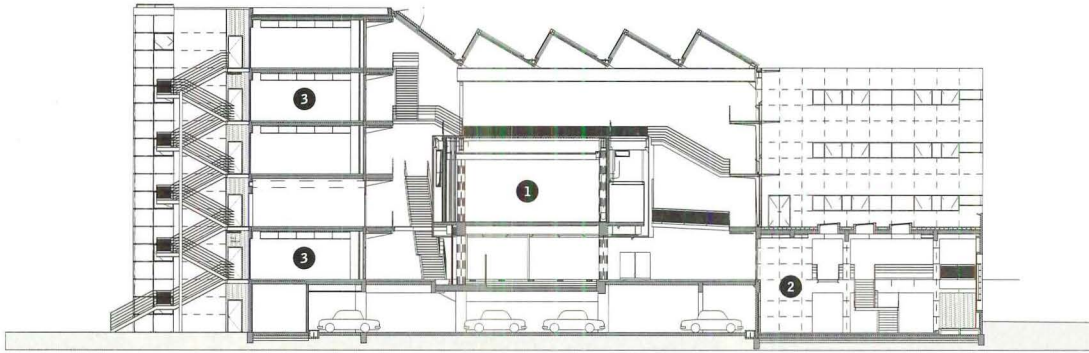

North-south section

- ① auditorium
- ② library
- ③ classroom

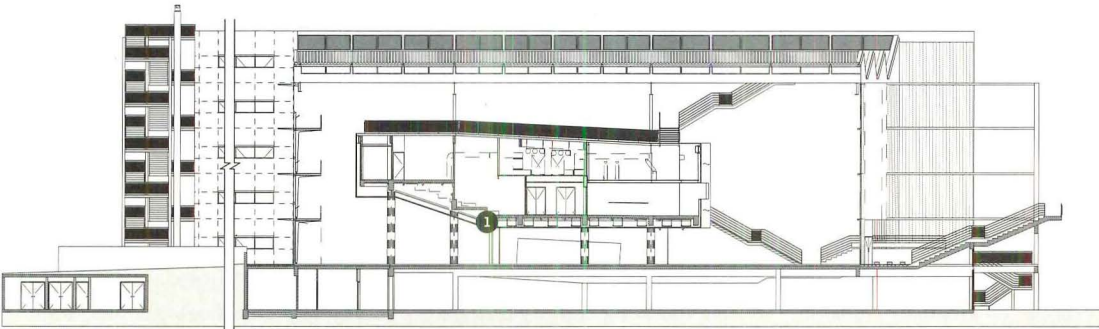

East-west section 13'

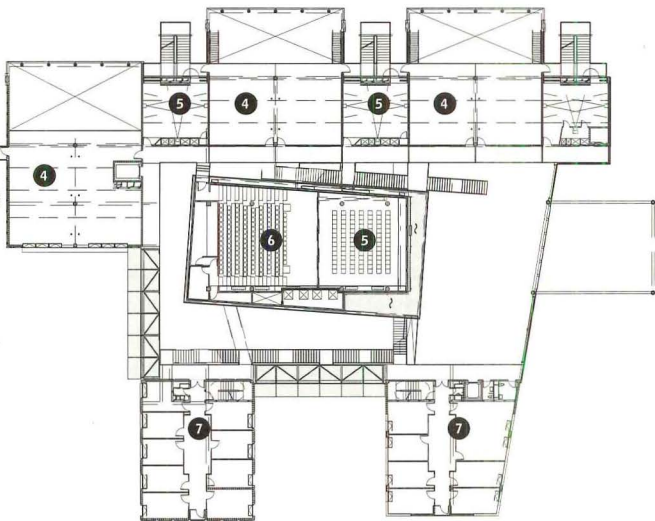

Fourth-floor plan

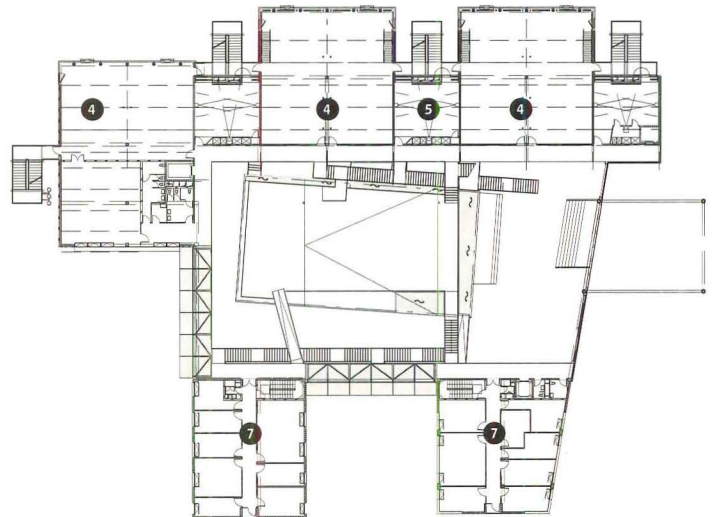

Fifth-floor plan



students, the first phase of the architecture school is complete and the inaugural academic year underway. The second, final phase will add 700 to the roll, but its timing has yet to be decided. Tschumi's building therefore forms part of a much larger complex, and its existing east wall of vertical translucent glass panels will eventually be dismantled to receive the second phase.

The plan has elegant simplicity and economy: two parallel wings flanking a cavernous central atrium. Studios and seminar rooms are located along the north side of the atrium, with office and staff facilities to the south. Crisscrossed by walkways and staircases and teeming with student activity, the luminous central hall forms the building's social and spatial fulcrum. Light pours in from its glazed east and west ends and also diffuses down through rows of sawtooth skylights and nautical portholes punched into the roof. Suspended in this heroically scaled space is the lecture hall, its sides clad in expanded-mesh panels so it resembles a giant, glinting cheese grater. Services are concealed behind the rippling, corrugated skin, and light percolates through the mesh, softening and sensualizing the auditorium's monolithic bulk.

From the approach road along the building's southern edge, the school appears as a chunky, interlocking composition of opaque and transparent blocks. The offices along the south side are crisp, cuboid volumes clad alternately in fairfaced concrete and metal panels. Custom built for this project, each double-skinned aluminum panel is incised with a raised diamond pattern. Throughout the building, the intricacies of construction are lucidly and literally expressed, giving the school a muscular, industrial quality, like a factory or oil rig. "It's not an esthetic decision," Tschumi cautions. "I always want to keep the concept as the important thing, and the use of materials at a basic minimum."



Along the north elevation rise the sheer, six-story flanks of the three main studio blocks, their sleek horizontal glazing reminiscent of Walter Gropius' Dessau Bauhaus. Commanding uninterrupted views of the surrounding countryside, each double-height studio has a mezzanine level, and can accommodate individual study and more public group crits. Interspersed between the studio blocks are smaller cellular seminar rooms. The school's lowest level houses car parking and the intimate, subterranean spaces of the library. Partially embedded in the ground, this level acts as a podium, elevating the building above its featureless surroundings. A gently sloping path provides transition from street to entrance: It winds up to the glazed west end of the central hall, generating a sense of arrival and discovery.

Other spaces around the school are appropriated and colonized as Tschumi hoped they would be—for formal and informal study. Walkways are bustling with students clustered around drawings and models. During my visit, the panoramic roof of the lecture hall had been taken over for a crit, with drawings stuck on improvised display panels attached to roof beams. Architecture students inevitably generate a great deal of clutter, yet the building seems tough enough to withstand the rigors of daily use.

Tschumi consciously resisted the temptation toward bombast. Instead, the quietly radical themes of social interaction and the exchange of ideas—at the heart of any educational institution—find resonant expression in his straightforward architecture, which delights in organizational clarity and an inventive approach to materials. More importantly, Tschumi creates a robust stage set for the dramas and distractions of student life. Marne-la-Vallée is that rare commission where the users are as informed—and opinionated—about how buildings are made as the designer, and, in this case, the students appear to relish their lively new home. ■



Glazed curtain walls admit light to two north-facing studio blocks (left). Each studio is double-height (below left). A mezzanine at the rear of each studio serves for informal reviews (below right). A library occupies the concrete plinth on the school's south facade (facing page, right). The building's future expansion to the east is indicated by the exposed steel framework and staircase rising to nowhere (facing page, right, at right). A cluster of nine skylights (facing page, left) brings daylight from the south-facing courtyard to the library below.



Tschumi's subtly rich material palette (below) incorporates translucent and transparent glass to the outside, perforated-wood paneling along the outside wall of the studios, and an expanded-metal mesh cladding the auditorium. The glazed east face (facing page) will eventually be removed to make way for the school's expansion, and the atrium will enclose the exterior staircase and terraced seating (foreground).

SCHOOL OF ARCHITECTURE, MARNE-LA-VALLÉE, FRANCE

CLIENT: French Ministry of Culture **ARCHITECT:** Bernard Tschumi Architects, New York City and Paris—Bernard Tschumi (principal-in-charge); Véronique Descharrières, Alex Reid, Kevin Collins, Gregory Merryweather, Rhett Russo, Frederick Norman (design team) **ENGINEERS:** RFR (structural); Choulet (MEP); CIAL (acoustical); Fouché (cost estimating); SETEC TP (infrastructures) **CONSULTANTS:** Hugh Dutton Associates (facade); Ursula Kurz (landscape) **GENERAL CONTRACTOR:** Campenon Bernard **COST:** \$26 million **PHOTOGRAPHER:** Peter Mauss/Esto; Robert Cesar/Archipress







The Science of Entertainment

Arata Isozaki creates an enigmatic container

A photograph of the Center of Science and Industry building in Columbus, Ohio. The building's exterior is a large, curved, blue-tinted concrete structure, which is the focus of the image. The structure is composed of many vertical panels that curve in two directions, creating a complex, abstract form. The building is set against a clear blue sky with some light clouds. In the background, a cityscape is visible, including a prominent building with a dome and other structures. The foreground shows a paved area and some trees with autumn foliage.

Columbus, Ohio's Center of Science and Industry. By Aaron Betsky

Isozaki's oblong, abstract Center of Science and Industry forms a new frontispiece for a 1920s neoclassical building that originally served as a high school (facing page, at right). The Japanese architect clad his arced exterior (above), technically a clothoid curve, in 6-by-62-foot precast concrete panels. Each panel curves in two directions.



The pure 1,000-foot-long concrete curve of the science center addition (above) provides a horizontal, monumental foil to downtown high-rises. The former high school (below) at the rear of Isozaki's new wing faces downtown Columbus to the east across the Scioto River.

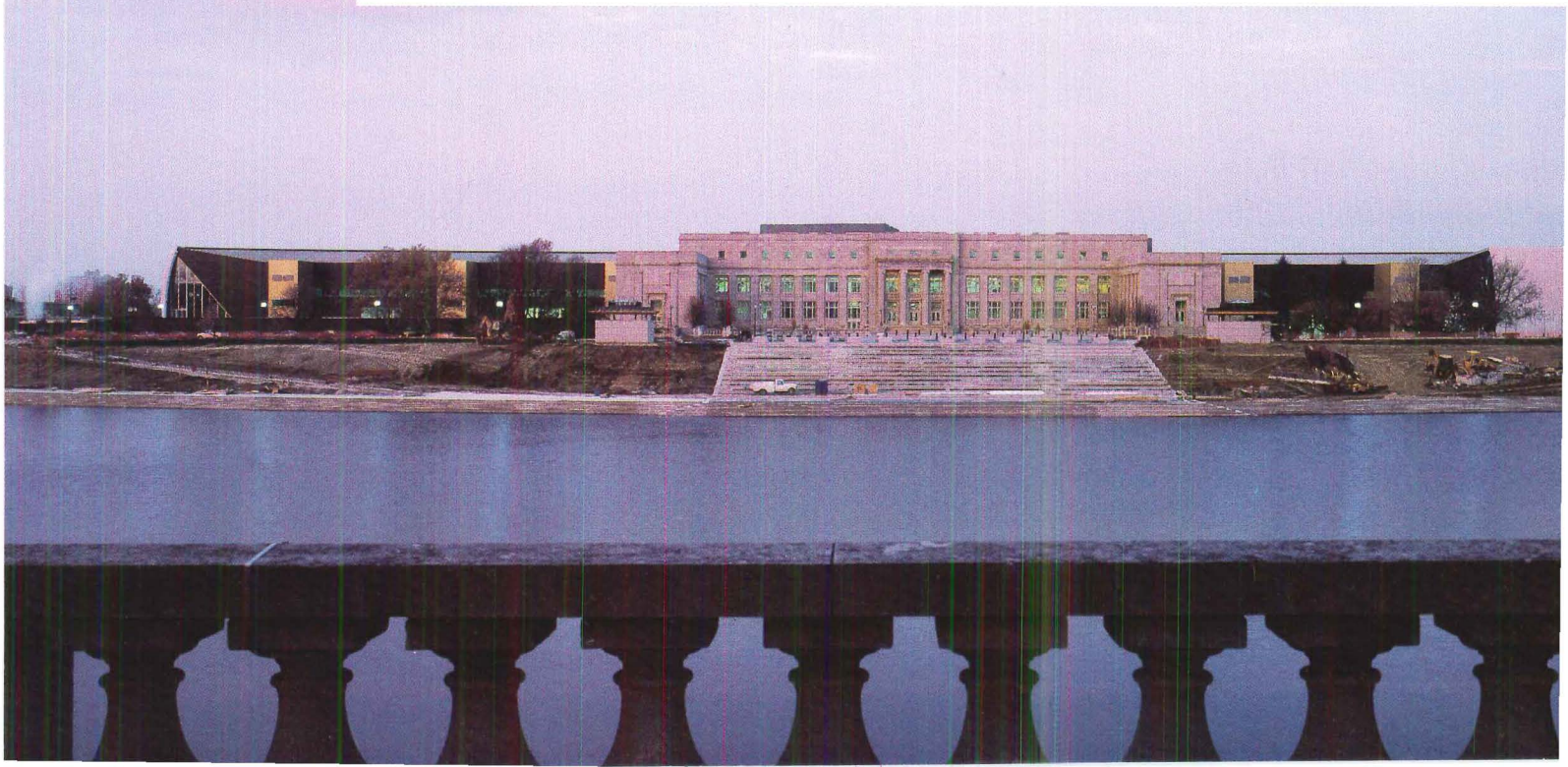

Arata Isozaki's design for the Center of Science and Industry (COSI) in Columbus, Ohio, raises the question of whether architecture can be both universal in form and address local conditions. The zeppelin-like shape of his hangar for science exhibitions is loosely related to its riverfront site, yet it appears as a closed, mysterious, and imposing presence in Columbus' otherwise rather homogenous landscape. A large collaborative crew of exhibition designers, technical consultants, and graphic artists filled the gaps between his big forms and the way the building is used.

The tensions between form and content, and between form and place, were inherent both in the way the institution's director, former NASA astronaut Katherine Sullivan, sees COSI, and in the choice of Isozaki as its architect. Sullivan states, "Our heart and soul is in Columbus, but science is not a local issue." She wanted exhibitions that would "let visitors experience the global threads that run through every American's life."

Isozaki, meanwhile, is a Japan-based architect as interested in universal issues as in the specific concerns of a site. Like many architects, Isozaki uses certain forms repeatedly: The curved form he decreed for COSI is similar to shapes that house his Nara Convention Center (1999) and Domus Interactive Museum (1997) in La Coruna, Spain. All shapes are abstract, incomplete, and in search of a perfection Isozaki knows and deliberately shows he cannot achieve.

COSI's site is formed by a bend in the Scioto River that separates it from downtown Columbus. Isozaki played his \$125 million design against the brick neoclassical forms of the Central High School (1924), to which the museum was technically an addition. "The new building looks west to the future, while the high school looks east to the past," he claims.

The new building, which houses 140,000 of COSI's 230,000 square feet, indeed looks like a futuristic monument and was constructed like a science experiment. Its west facade is a 1,000-foot-long "clothoid curve," a lozenge-like shape with sharp ends that tapers both horizontally and vertically. Six-foot-wide and 62-foot-high precast concrete panels, each of which curves in two dimensions, make up this smooth surface. On the east side, where his addition plugs into the U-shaped high school, Isozaki carved out the back of the lozenge and plugged in a row of stair towers clad in black-painted corrugated-metal panels. A plinth intersects the building's ground floor on the south side and contains the service functions that, because of the museum's position on the Scioto's floodplain, cannot be placed in the basement. Two rectangular boxes protruding from the west wall and a cylindrical entrance rotunda in that facade's center complete the interruptions to the pavilion's sweeping envelope. The power of the addition's overall shape, which seems to change continually while maintaining an overall form, is strong enough to subsume these breaks. Symmetrical yet interrupted,

clearly articulated yet sweeping, singular yet always moving away from what the eye and the mind can comprehend, COSI's west facade is one of Isozaki's most successful recent designs.

Isozaki tried a similar tactic of forceful form-making on COSI's interior by designing a cube at the core of the addition to contain the museum's main public spaces. Light enters through skylights, the back facade of the high school forms a stage set at the space's eastern end, the lozenge's entrance rotunda plays off against the cube's orthogonal frame, and most of COSI's program elements open up to this grand lobby. Here, one can understand the building's pieces and its construction.

All that clarity disappears, however, as soon as one enters any of the exhibits. COSI is not just a museum, but a collection of "Learning Worlds"—scientifically thematized fantasy environments—that occupy Isozaki's 27-foot-high interiors: an underwater world complete with waterfalls and faux submarines, 19th- and 20th-century evocations of a "typical" Main Street, and a gadget-filled room meant to look like a laboratory. To tell a story here, the client depended on an exhibition team rather than the architect to frame, validate, or otherwise place its functions. Sadly, these exhibit environments are nearly indistinguishable from their more commercial equivalents in shopping malls or amusement parks.

Director Sullivan claims there is a relationship between the exhibitions and the architecture: "This is a place where you learn through constructed fun and playful experience," she says, "and those moments of delight in discovery resonate with the building." Unfortunately, her sense of play and discovery makes little use of architecture to provide a critical or contextualizing framework.

Isozaki's task, then, has been reduced to this: He has created a building whose abstract, highly seductive appearance makes one understand that this is an important place where perhaps strange and unknowable things occur. His interior space sets forth an order in which the journey of discovery can take place. Yet as is the case in most of our recent cultural institutions, the actual exhibits are so hyperactively thematized, so concerned with telling a story, that the architecture disappears. For the client this may be enough. Unfortunately, for those of us who admire Isozaki, and expect more from our architecture, COSI is a disappointment. ■

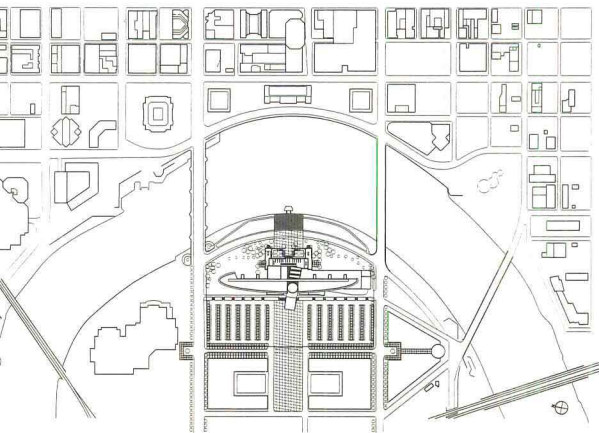

the plan | 1470' <

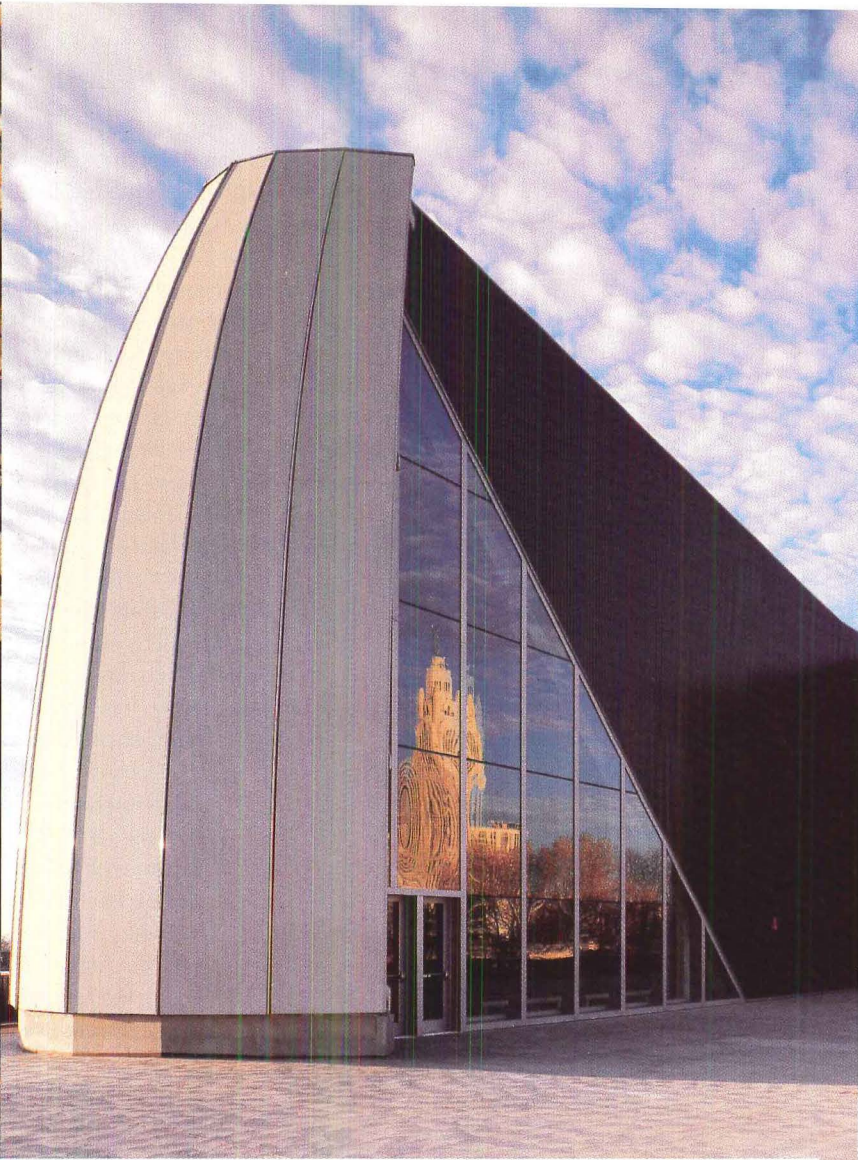
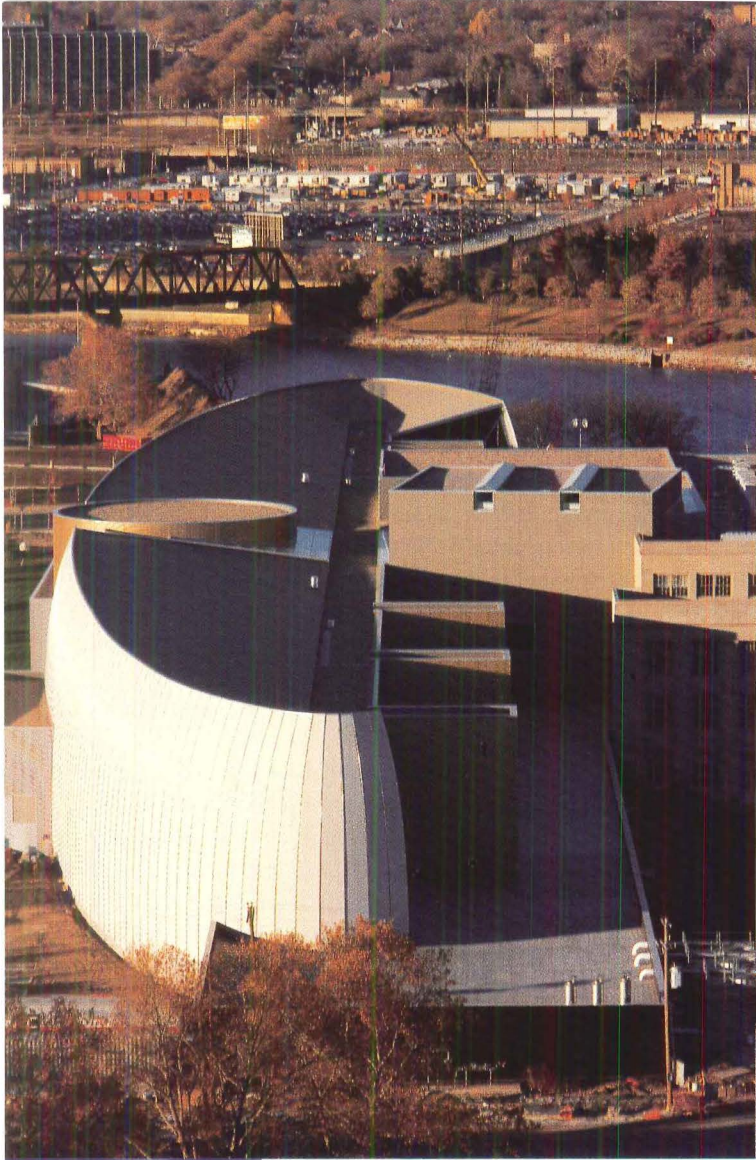

The rotated cube (above left, at center) serves as the science center's circulation hub. A plinth houses services (foreground). The cylindrical form (below left) on the principal, west facade (below right) houses the entrance rotunda and a planetarium called the "space theater" above. Isozaki's curve gives way to corrugated-metal stair towers (above) on the east elevation. The large triangular window illuminates an exhibition space.

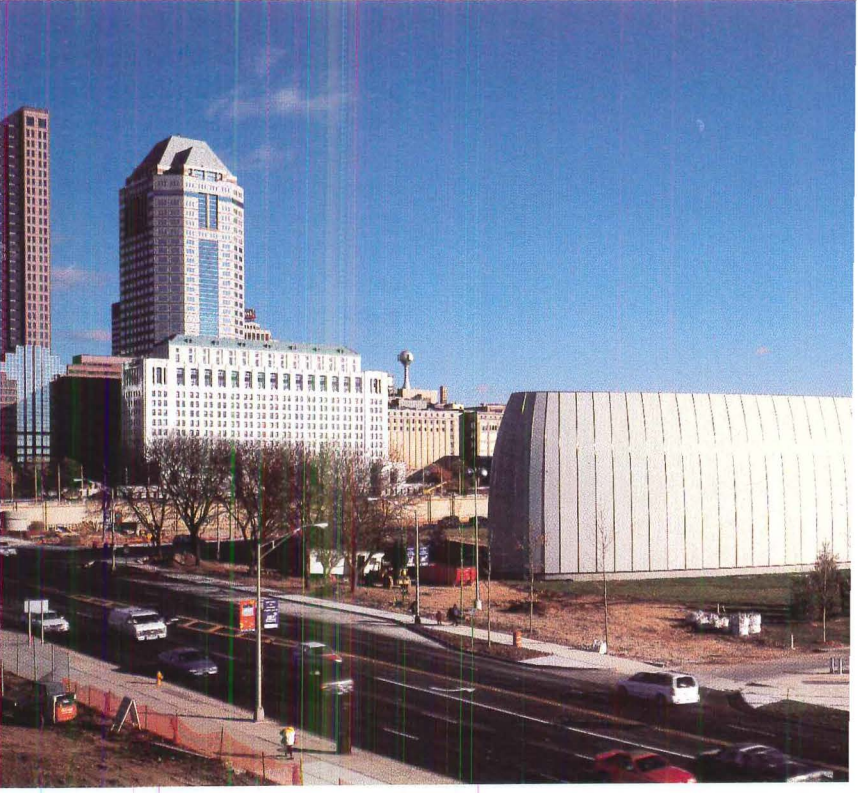
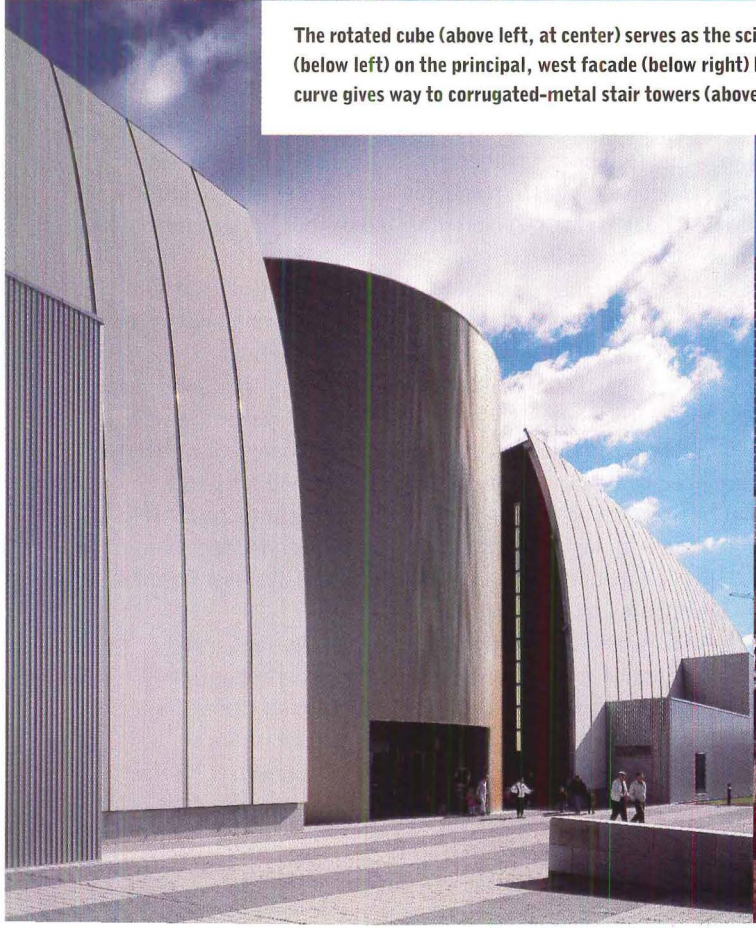

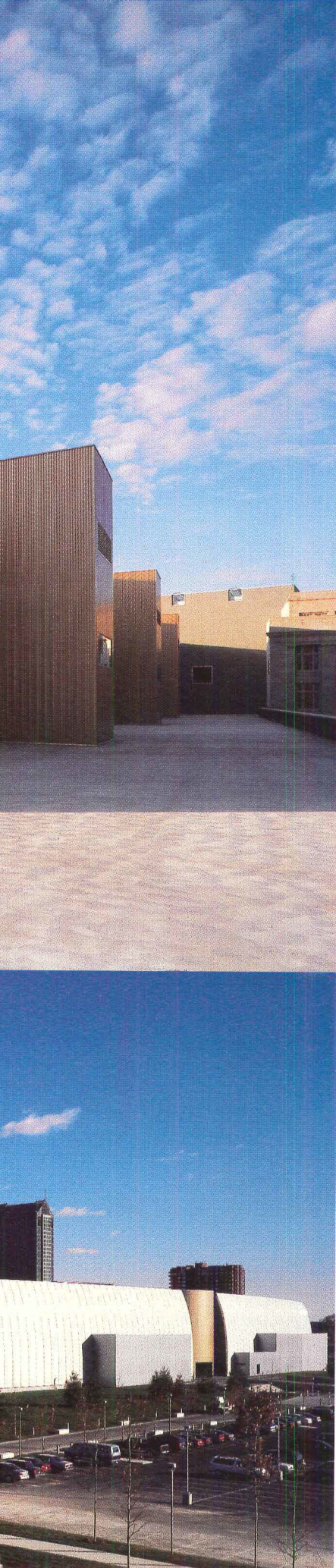

- 1 entrance
- 2 lobby
- 3 exhibits
- 4 planetarium
- 5 large-format 3D theater
- 6 restaurant
- 7 offices

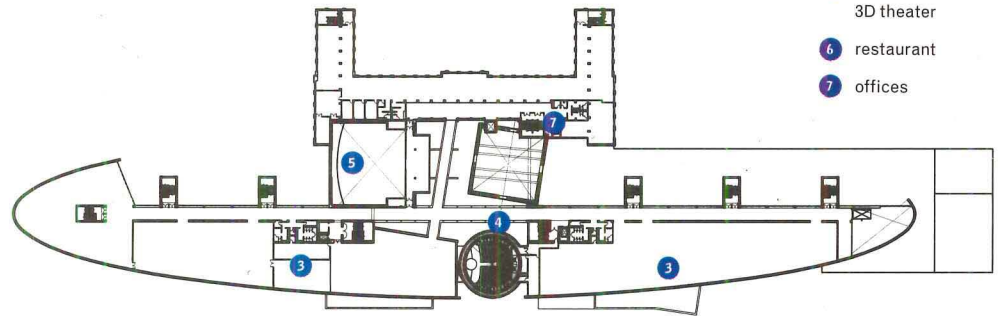

Second-floor plan

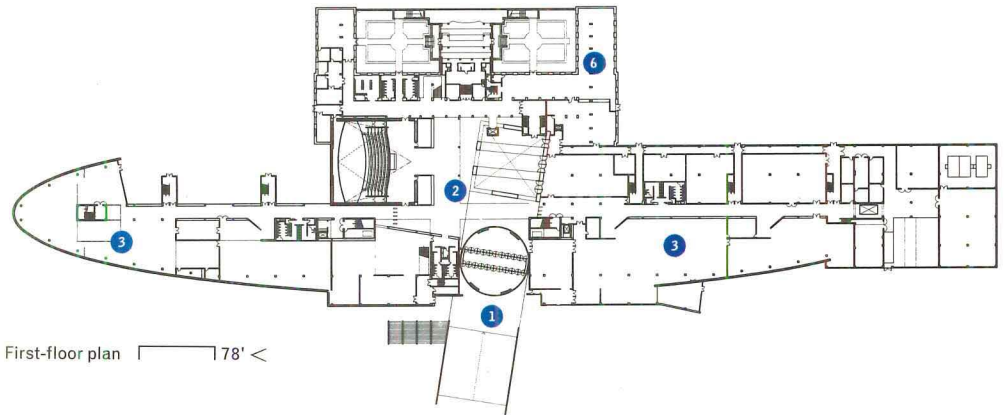

First-floor plan 78' <

- 1 entrance
- 2 foyer
- 3 theater
- 4 exhibitions
- 5 restaurant
- 6 offices

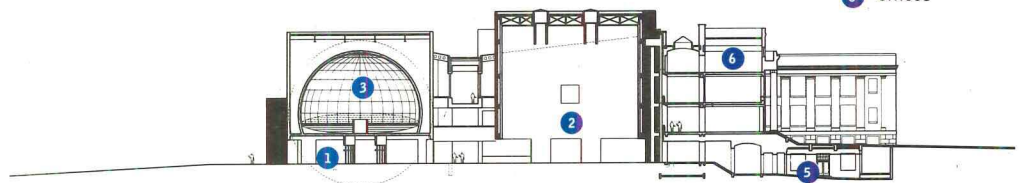

East-west section



East-west section 35'





In the cubic pavilion at the center of Isozaki's addition (facing page), linear waterfalls designed by the late artist Eric Orr inscribe the center of each wall. A carpeted, 1,000-foot circulation spine (above and below) runs the length of the addition, bypassing the corrugated-metal entrance rotunda (below, at right) and the central cubic pavilion (below, at left). Hanging columns in the hallway are light fixtures (above and below).



CENTER OF SCIENCE & INDUSTRY, COLUMBUS, OHIO

CLIENT: State of Ohio/Center of Science & Industry, Columbus, Ohio—John W. Kessler (chair, Ohio Arts & Sports Facilities Commission); Katherine D. Sullivan (president and CEO, COSI)

ARCHITECTS: Arata Isozaki & Associates, Tokyo—Arata Isozaki (principal-in-charge); Yasuyori Yada, David Gauld, Fumio Matsumoto, Atsushi Aiba, John Bohn (project team); NBBJ, Columbus, Ohio—Bernard Costantino (principal-in-charge); Jerome Scott (project architect); Kathy Kelly, Jim Lenhart, Steve Rice, Ed Mendelson, Ray Skonce, A.J. Montero (project team) **LANDSCAPE ARCHITECTS:** Sasaki Associates; Peter Walker and Partners; NBBJ

ENGINEERS: Moody/Nolan (civil); Korda Nemeth Engineering (structural); HAWA (mechanical, electrical, HVAC)

CONSULTANTS: Acoustic Dimensions (acoustics); William Caruso & Associates (food service); Fisher Marantz Stone (lighting) **GENERAL CONTRACTOR:** Ruscilli Construction **COST:** \$125 million **PHOTOGRAPHER:** Timothy Hursley

A YOUNG ARCHITECT EVOKES LEBANON'S BELLIGERENT PAST IN AN UNDERGROUND BEIRUT NIGHTSPOT. BY FARÈS EL-DADAH

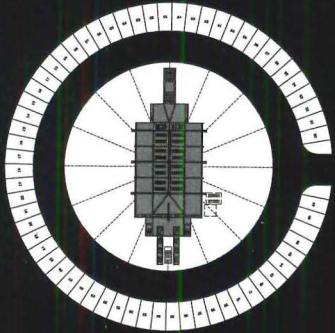
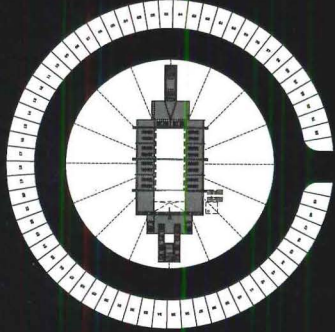

Site plans

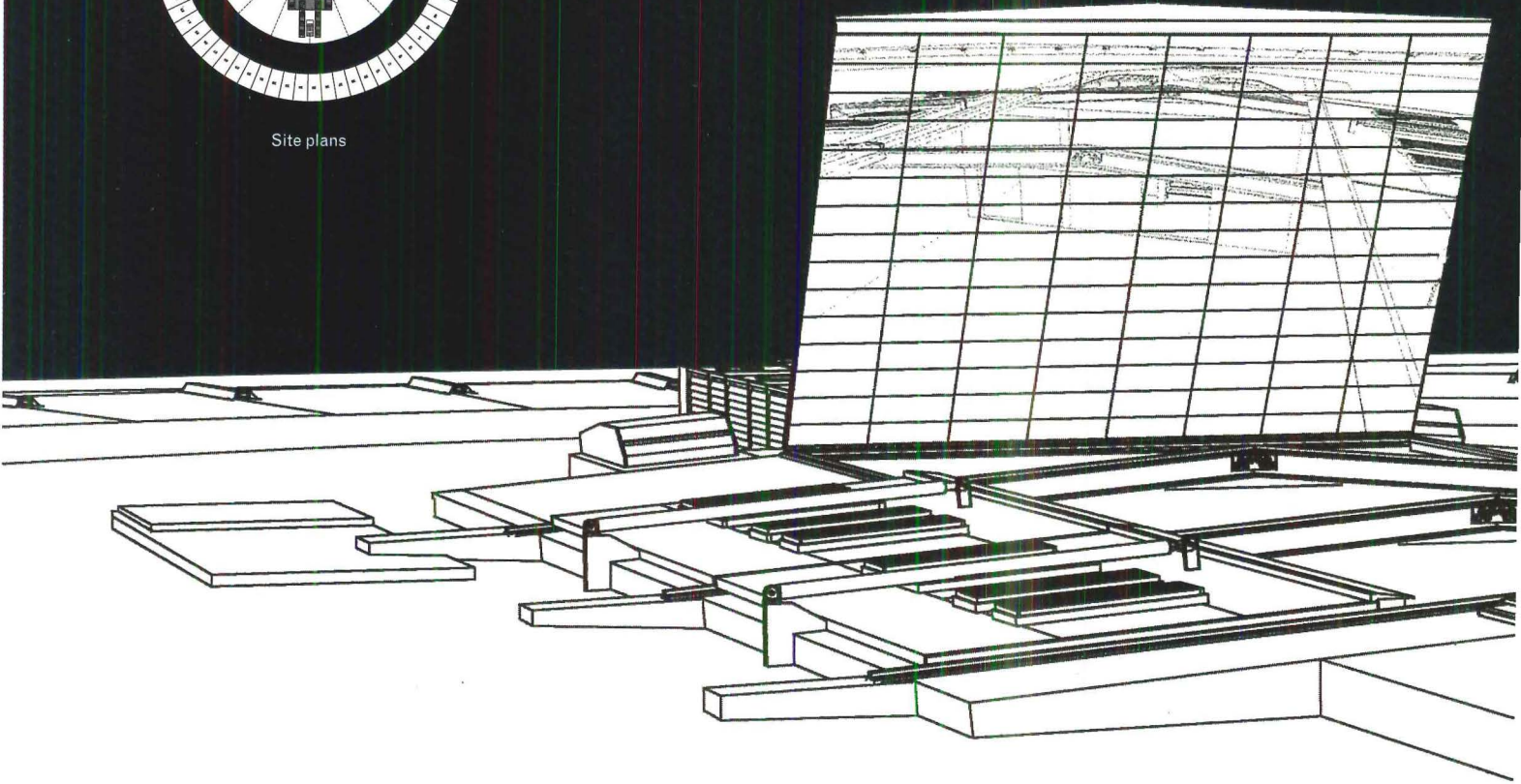

NAVY METAL

B 018 began as the number of an apartment famous for its parties. It has since developed into the trendiest bar in Beirut—with nonetheless a morbid twist. In its new location, one now literally dances on the site of the city harbor's former quarantine station, which in 1939 was transformed into a refugee camp for Armenians fleeing Turkish persecution. It later became home to exiled Palestinians who, in the mid-1970s, were forcibly evicted by Lebanese militias. The site's belligerent history aside, the form of the bar itself is riddled with military associations that operate on all possible levels.

On a field of concrete, cars are parked in a carousel formation, headlights pointing toward a low-lying metal contraption with exposed pistons. A stair at the south end of the structure leads to two successive underground "airlock" spaces manned by scowling (yet fashionably dressed) bouncers. A gunner's slit provides an eye-level glimpse of what lies beyond: a 60-by-40-foot room lined with scarlet-colored velvet drapes that could well be the set of an early James Bond movie (a 1950s martini lounge also comes to mind). Strewn across the floor are a series of fixed-in-place sofas with collapsible backs that, when closed, serve as elevated dancing surfaces. Drinks sit nearby on monolithic marble shrines appointed with pictures of dead

The bar's steel-roof structure recalls a bunker or missile silo. As shown in the site plans (facing page), it lifts open on its north end, and slides open to the south.

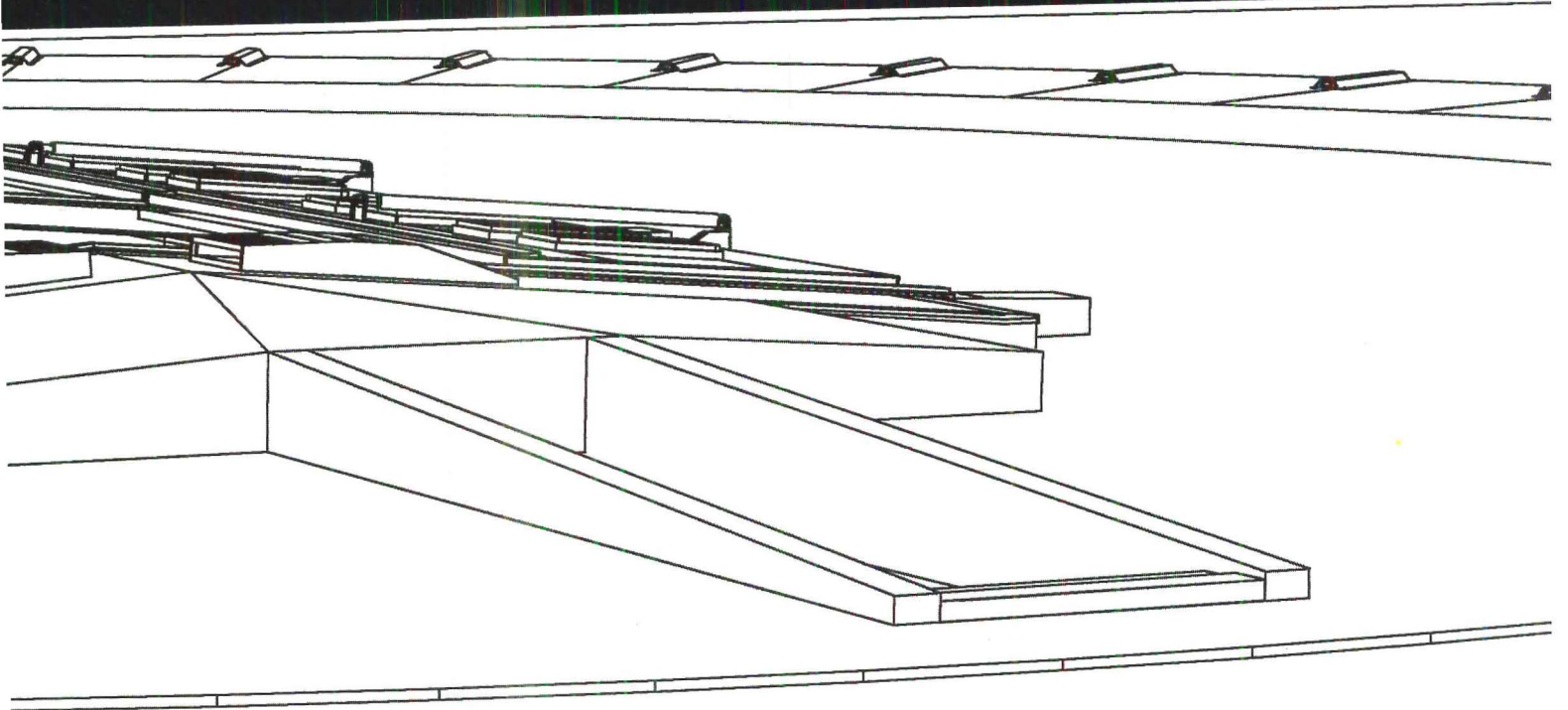

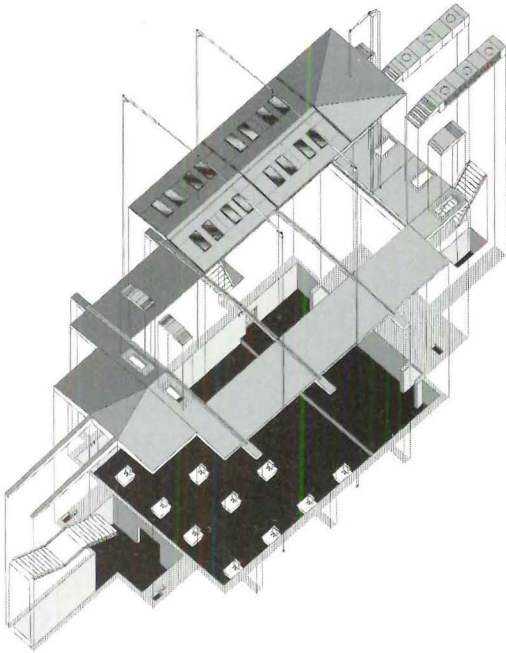

Exploded axonometric

An ominous staircase (below) at the south end of the structure leads down to the bar proper—a 40-by-60-foot underground room. The roof slides open on pistons for most of the length of the room (right). At the north end, the roof opens like a hatch; a mirror on its underside offers patrons a blurred vision of the world above.

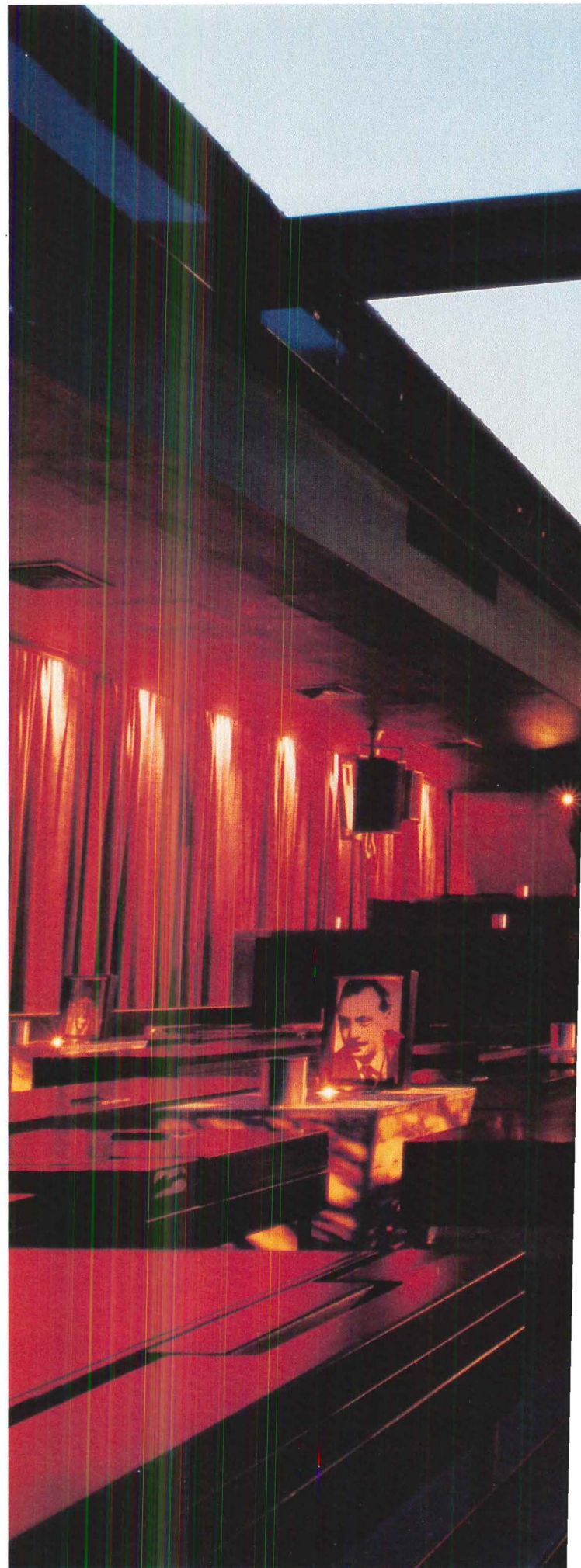
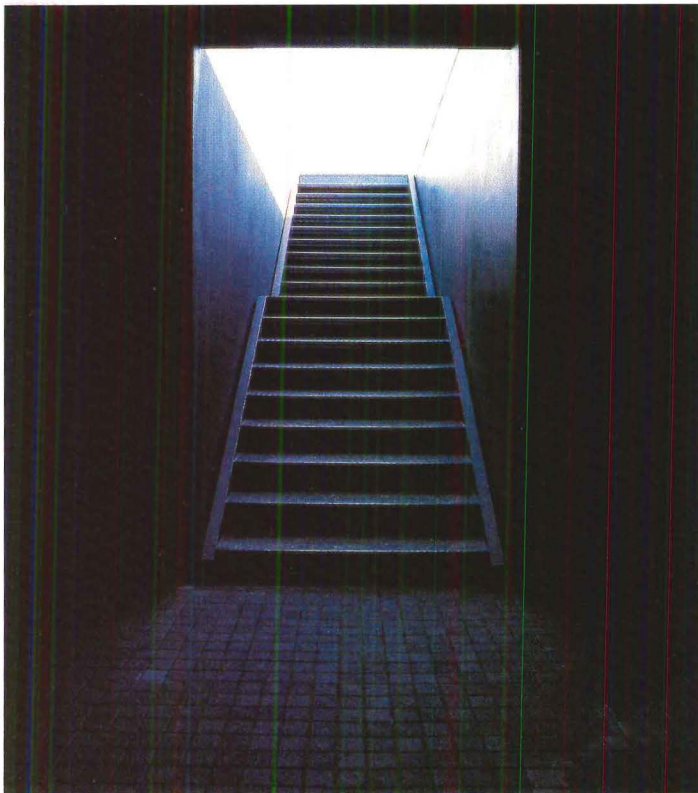







Red velvet curtains (facing page) line the walls; fixed-in-place sofas with collapsible backs double as platforms for dancing when closed. Skylights illuminate the bar when the ceiling is closed (above right). Photographs of dead pop stars (right) sit on marble tables at the center of each seating arrangement. At night, the tables glow from within (below right), and light bounces off the red curtains.

(jazz great Louis Armstrong and Egyptian chanteuse Umm Kulthum, among others). Along the bar at the far end of the room, high-back stools are equipped with projector lights aimed at the room behind (the scope of the lights is controlled by swiveling the seats). The roof retracts in three parts, two of which slide out. A hatchlike third over the bar is covered on the inside with mirrors, which when open works much like a periscope that reveals a blurry composition of the world above to those dancing beneath (and vice versa).

War is something to which B 018, designed by Lebanese architect Bernard Khoury, never ceases to allude. While it may look like a bunker or an underground silo, it also belongs to a particular “esthetic” of war best represented by protective measures produced during Beirut’s 17 years of civil warfare (1975–1992). Black drapes, eight stories high, were drawn across gaps between buildings to veil one warring faction from another and thereby shield pedestrians from a sniper’s predatory gaze. Building entrances were blocked by neatly arranged stacks of concrete blocks that left a space just wide enough for one to slither in obliquely, while keeping shrapnel at bay. Such grim installations were dismantled at war’s end and are understandably not remembered as having any esthetic value, just a functionally vital one.

At B 018, one has no choice but to dance on tables: Decadence is required. To insist, however, on military connotations—not to mention dancing on the allegorical graves of musicians or “undesirables” who previously occupied the spot—is at best decadent in the literary sense of the term. Much like late-19th-century French novelists who reacted against romanticist trends, B 018 also refuses to participate in the naive amnesia that governs all other Lebanese postwar reconstruction efforts. These recent building campaigns myopically reproduce the region’s colonial urbanism without acknowledging what the young republic has since gone through, both architecturally and socially. ■

Lebanese architect Farès el-Dahdah is an assistant professor and Chairman of Graduate Affairs at the Rice University School of Architecture in Houston.

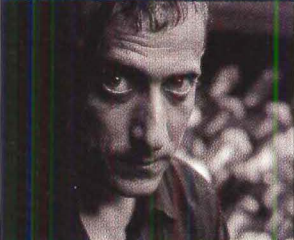

Exposed pistons (above) indicate the roof's retractability; cars park around it in radial formation. The bar appears poised for attack (right) at the edge of dense downtown Beirut, on a site that once served as the city harbor's quarantine station.

Debut	Bernard Khoury
	Beirut, Lebanon
<p>Architect Bernard Khoury was born in Beirut in 1968, and studied architecture in the United States—first at the Rhode Island School of Design and later at the Harvard University Graduate School of Design. Khoury returned to Beirut to establish an architecture and furniture-design practice in 1994. He taught an experimental studio at the American University from 1995 to 1996.</p>	

B 018, BEIRUT, LEBANON

CLIENT: B A 4 **ARCHITECT:** Bernard Khoury Architects, Beirut, Lebanon—Bernard Khoury (project architect); Richard Saad (project assistant) **ENGINEERS:** R.A.A. (structural); Nagib Nabhan (mechanical); Antoine Yazigi (electrical); Nadim Honein (civil); Ohanian (HVAC) **CONSULTANTS:** Interdesign (furniture manufacturer); Mitsulift (hydraulic systems) **GENERAL CONTRACTOR:** Ayoub Contracting **COST:** \$460,000 **PHOTOGRAPHER:** Anne Françoise Pellisier, except as noted

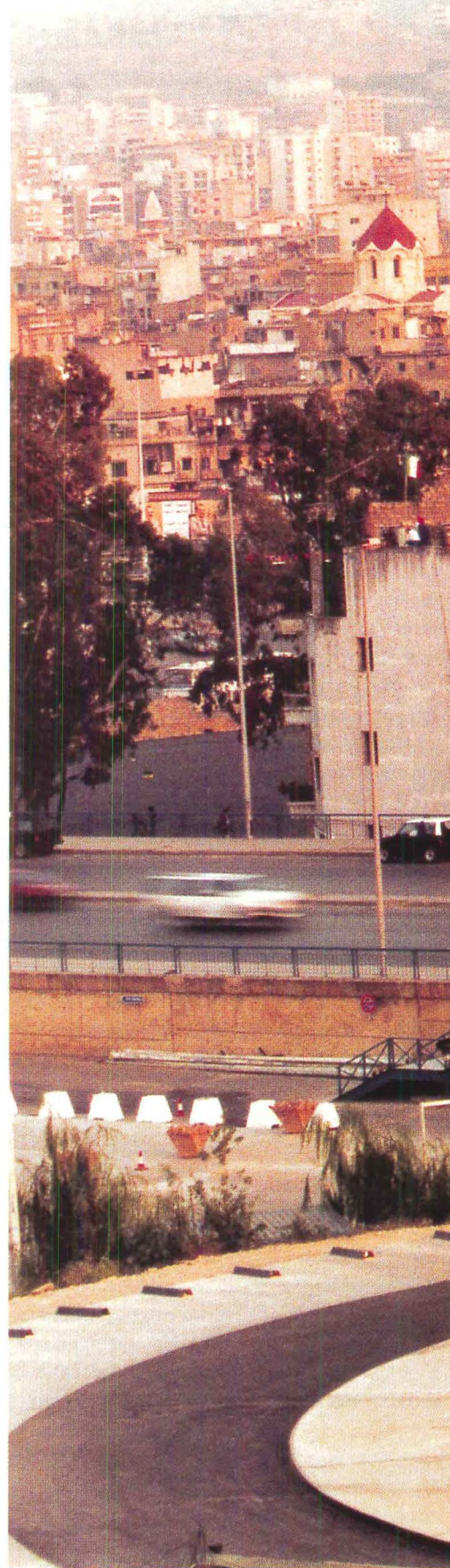



A sleek museum by UN Studio houses Hol

A Visit to th



archaeological past. By Aaron Belsky

Ice Palace



UN Studio's new museum in the ancient Dutch town of Nijmegen operates in a gray area between classical ordinance and modernist complexity. On its west plaza front (above), streamlined ribbons of glass play tricks of scale: What appears to be a four-story facade actually fronts only two levels.



From the principal entrance (above), the museum's main staircase at the rear of the ground-floor lobby leads to galleries above (facing page, top). An undulated aluminum ceiling conceals lighting and other services (facing page, bottom right). The fins along the museum's east facade give way to larger panes of glass, where the windows overlook a large park (facing page, bottom left).

They call it the Ice Palace. "I think they mean it as an insult, but once they come inside, they see why it makes sense," says the director of the "Ice Palace," Antoinette Gerhartl. Her domain is actually the Het Valkhof Museum in the Dutch town of Nijmegen. An amalgamation of three pre-existing institutions (museums of archaeology, modern art, and pre-20th-century art), the new building had to find a way to house its disparate collections on a historically sensitive site. Architect Ben van Berkel's solution was to "suspend space between archaeology and the future." Hence the frozen aspect of the museum: Here time and space hang in the preservative of an architecture as cool as ice.

The Het Valkhof Museum is a two-story rectangular block sitting on the edge of a market square at the edge of a hill. The site is historically significant: It is adjacent to the location of the ancient Romans' first settlement in Nijmegen. It is also one of the few towns in the country with a change of height: From the museum, visitors can glimpse the Waal River running below. "We had to play a game not just between the past and the future, but between the city and the landscape, the flat and the vertical, and the open and the closed," says van Berkel.

That the architect plays this topographic game with such a simple shape reflects architecture's current state as much as it does his site and program. After decorating buildings, breaking them apart, or elongating them into expressive snakes, designers of van Berkel's generation are returning to the box. For UN Studio, the office established by van Berkel and his wife, art historian Caroline Bos, deceptively simple shapes are deformed by what the partners call "data streams": everything from site coordinates to building program to lighting requirements.

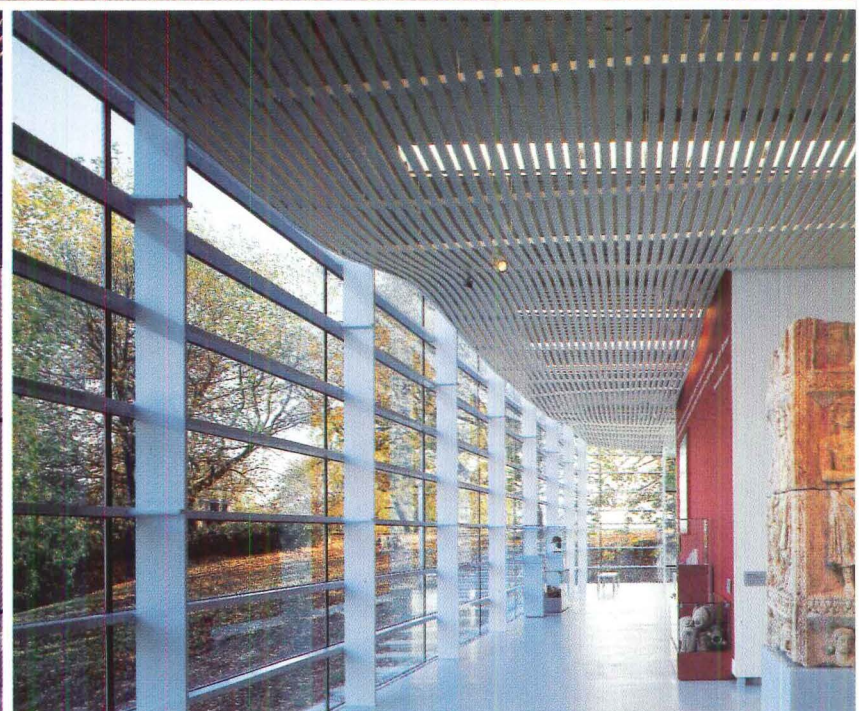



The pine-wood-paneled staircase at the center of the museum (above) leads from the ground-floor lobby to galleries above.

The result is an abstraction, yet the final form also has direct references to the monumental tradition of public architecture. This is not so strange: The strength of the classical tradition was its ability to absorb a variety of different contexts and programs into a highly regularized, abstract, yet flexible and responsive language of forms. So it is here. The Het Valkhof Museum frames the east side of its square like Schinkel's Altes Museum in Berlin or the Boston Public Library by McKim, Mead & White. But it is also specific to its site.

Van Berkel achieved this specificity by covering the building with thin strips of glass that, though at first glance appear to be parallel, undulate and bow ever so slightly. To make this possible, UN Studio developed a flexible joint attached to the steel substructure from which the strips of glass hang in different alignments. The pieces fan out and up along the length of the facade, making the museum appear thinner and more compressed at the southeast corner, more transparent and larger at the corner closest to the river. The changing distance between facade and structure also alters one's perception of the glass color from a deep aquamarine to a light green. Like a block of ice, the museum hints at frozen depth and suspended flows beneath an elusive surface. UN Studio plays with our perceptions by subtly altering the appearance of what seems like a straightforward box. They do not simply affirm the building's scale and placement, as a classicist would. Nor do they make it appear to defy rules of perspective or gravity, as a modernist would. Instead, they make a building that slips and slides away from true—in both senses of the word.

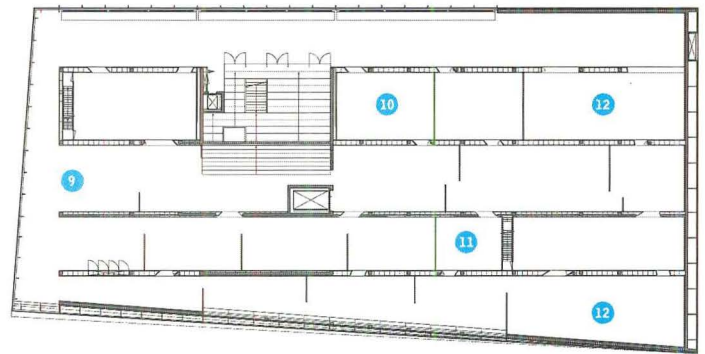
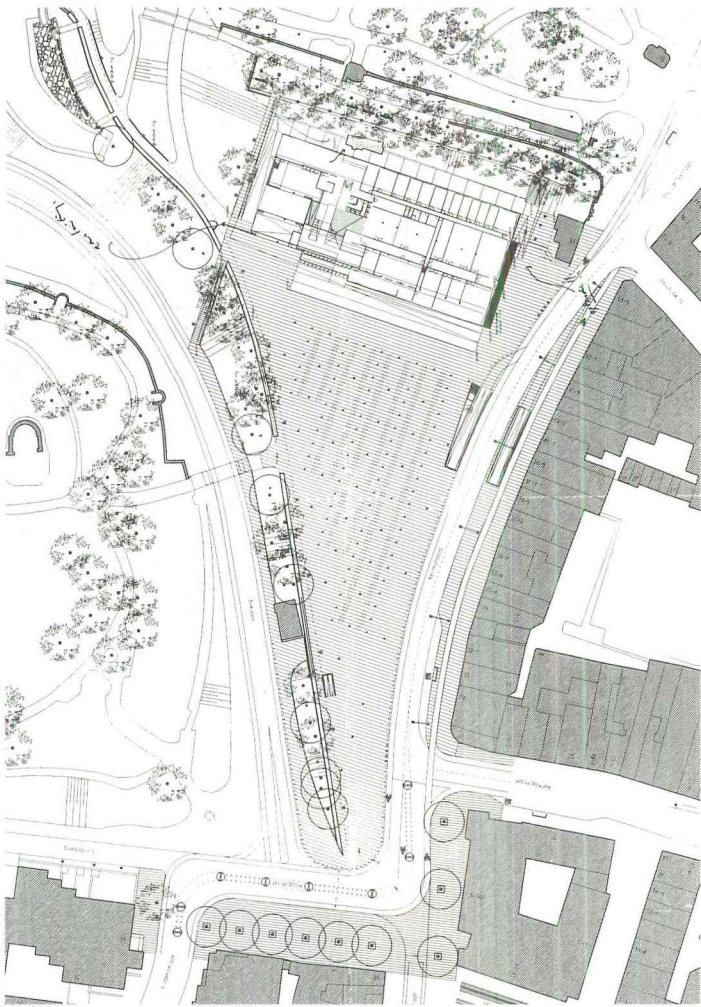

Second-floor plan

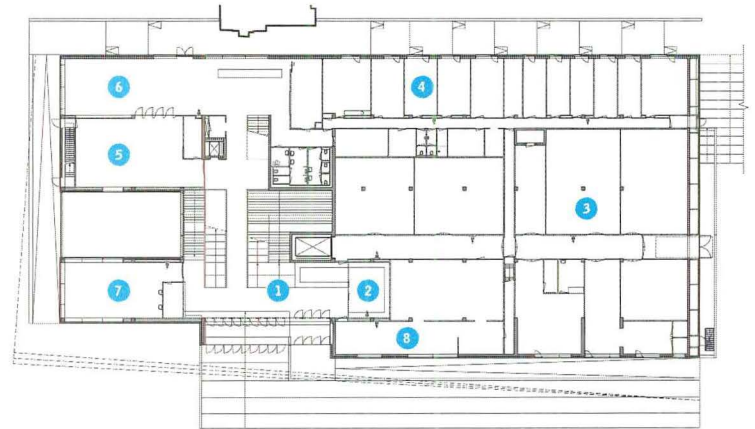

First-floor plan

- 1 entrance
- 2 store
- 3 art storage
- 4 offices
- 5 auditorium
- 6 café
- 7 education room
- 8 archives
- 9 archaeology gallery
- 10 Old Masters gallery
- 11 modern-art gallery
- 12 changing exhibition gallery
- 13 gallery
- 14 archaeology courtyard
- 15 installation shop
- 16 future expansion space

Site plan 68'

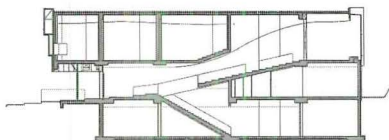

Section 27'

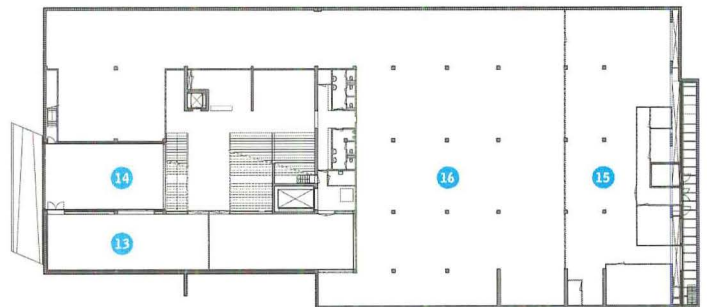

Basement-floor plan 27'

The plays between classical formality and modern complexity continue on the inside. A central stair takes the visitor directly from the entrance level, which is given over to services, offices, and educational functions, up to the piano nobile overlooking the square. Yet what appears to be a single flight of steps offers eight different routes up, down, and straight across the museum. While the broadest flight leads to the galleries on the second floor, one can also exit directly back outside, where the remains of a medieval wall back up onto the rear of the museum, or go down into the basement, or across into the support spaces. Moreover, major sections of the roof are cantilevered off the stair's concrete walls. Thus the stair hall is not just a void, but a major structural element at the museum's very core.

Upstairs, the galleries unfold in spaces van Berkel says were "inspired by New York loft galleries," but they also suggest a classical enfilade. Once again, there is a twist: The galleries are arranged in parallel "streets" through which diagonal pathways cut from one corner of the building to the other. By following a zigzag route, the visitor can watch art and craft unfold in time from the Roman era to the present. By cutting across the streets and moving toward the corner windows, the visitor can observe a collage of art objects from different eras and of different media.

"We believe that a living tradition is the wellspring for the new," says museum director Gerhartl. Recognizing that architecture always encases traditions, since that is its task, van Berkel and his team have chosen to present those traditions as if they were frozen. Suspended in their forms are both the canon of architecture and new ways of seeing. ■

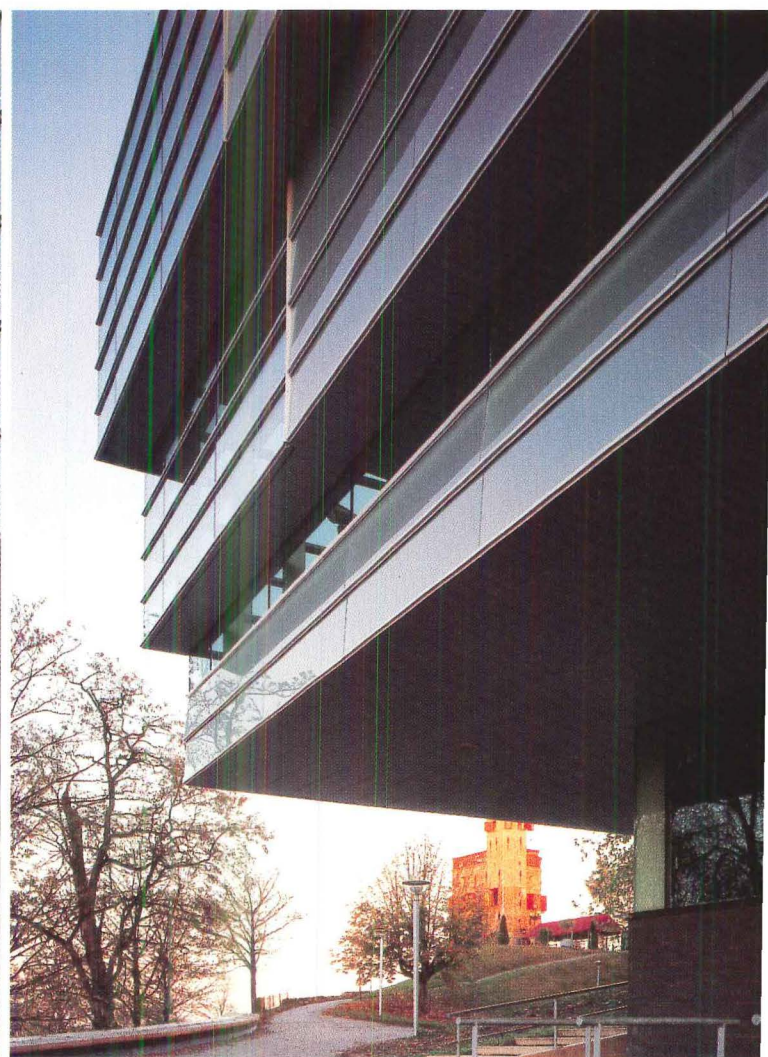

HET VALKHOF MUSEUM, KELFKENSBOS NIJMEGEN, NETHERLANDS

CLIENT: Stichting Museum Het Valkhof

ARCHITECT: UN Studio/Van Berkel & Bos, Amsterdam—Ben van Berkel (principal); Henri Snel, Rob Hootsmans (coordination); Remco Briggink (interior); Hugo Beschoor Plug, Walther Kloet, Marc Dijkman, Jacco van Wengerden, Luc Veeger, Florian Fischer, Carsten Kiselowsky (project team)

LANDSCAPE ARCHITECTS: Bureau B&B; Gemeente Nijmegen

ENGINEER: Ketel Raadgevende Engineering (technical installations)

GENERAL CONTRACTOR: Nelissen van Egteren Bow Zuid

COST: \$6 million **PHOTOGRAPHER:** Christian Richters



The glass facades of UN Studio's seemingly monolithic box are surprisingly varied. The plaza front transforms from a continuous surface to a striated one (above). Two layers of glass, the inner one sandblasted, sandwich a blue-green-tinted laminate. At the northeast corner of the museum (facing page, right), where the plaza meets the park to the north, the striated facade dramatically cantilevers. Transparent glass allows views into and out of galleries and offices facing the park along the east facade (facing page, left).



Architect Scogin Elam and Bray carved away the southwest corner of their Philmon Branch Library in Atlanta to serve as a covered entrance porch (above). Librarians' offices lie immediately behind, and the front door is to the right. The projecting steel member and slanted ceiling of the canopy prefigure the suspended light fixtures and undulated ceiling of the interior (facing page).

Scogin Elam and Bray transforms a spartan budget into a serene library.



Tight Bookkeeping

By Vernon Mays

After completing two libraries for the Clayton County Library System in suburban Atlanta, Scogin Elam and Bray Architects found their reputation preceding them when they began work on a third. What had changed since they built the Carol Cobb Turner Library in 1991 (May 1993, page 104) was the makeup of the system's board of trustees, which had taken a more conservative tilt. Principal Merrill Elam recalls, "They said, 'Maybe this building could be a little quieter.'"

Elam and partners Mack Scogin and Lloyd Bray accepted that remark as their marching orders and set to work defining just what "quiet" could mean, esthetically speaking. "We also talked a lot about trying to create the new library within the milieu of the nearby suburban strip and all the automobile traffic passing by—to make it a quiet place."

That discussion soon led to ideas of garden, the metaphor that began to inform their design studies. But while the new Philmon Branch Library embraces the idea literally with a small outdoor space, nonliteral notions of garden did more to

germinate this inventive building's abstract qualities as a salve for the sensory whipping delivered by its suburban context.

In much the same way Olmsted anticipated that his rural Central Park would someday be surrounded by Manhattan, Elam predicts that the \$1.3 million Philmon Library, which opened in January 1998, will be engulfed by a hodgepodge of gas stations, convenience stores, muffler shops, and big-box retail centers. For now, its most visible neighbor is an inelegant pair of metal sheds that house the Living Waters Assembly of God church. "The idea was to let people get away from the rattle of the outside world," Elam explains.



The architect exposed the library's steel frame on its south face (above). The curved form (at right) houses a meeting room that can be accessed through the lobby for after-hours events. The fiber-cement panel-clad lower half of the library's lean east side (below) extends to enclose a north-facing garden (facing page, below). The zigzag profile of the roof trusses (section, facing page, center) echoes in the scissor pattern of the clerestory windows on the west facade (facing page, above).

LEE B. PHILMON BRANCH LIBRARY, RIVERDALE, GEORGIA

CLIENT: Clayton County Library System **ARCHITECT:** Scogin Elam and Bray Architects, Atlanta—Merrill Elam (principal-in-charge); Mack Scogin, Lloyd Bray (principals); Tim Harrison, Denise Dumais, Ned Frazer, Jeff Atwood, Martha Henderson-Bennett, Dustin Lindblad, Beth Morris, Cecilia Tham, Kathy Wright (project team) **LANDSCAPE ARCHITECT:** Michael Van Valkenburgh Associates **ENGINEERS:** Uzon and Case Engineers (structural); Arthur Vanderhoogt (mechanical); Beaudry Tankersley Associates (electrical); Jefferson Consultants (civil); Minick Engineers (plumbing) **CONSULTANTS:** Construction Industry Service Associates with Lusk & Associates (cost); Ramon Luminance Design (lighting); Soorikian Furniture, Motheius (casework fabrication); Evan Levy Sculpture and Design (signage); Starry Night Designs (furniture) **GENERAL CONTRACTOR:** Van Winkle and Company **COST:** \$1.3 million **PHOTOGRAPHER:** Timothy Hursley



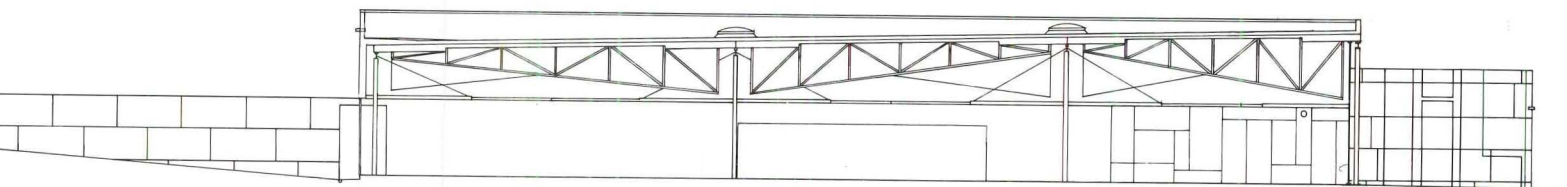

North-south section 1/4" = 1'-0"





- 1 entrance
- 2 meeting room
- 3 stacks
- 4 reading area
- 5 offices

Clayton County's program for the 12,000-square-foot building was not unlike the other libraries Scogin Elam and Bray has completed for the client, especially in requiring a meeting room available for public use after library hours. Most of its functions—adult stacks, children's collections, and staff workspaces—fit neatly in the uncomplicated wedge-shaped plan. Only the meeting room—an egg-shaped volume grafted to the front facade—announces itself as special.

The building's main event is inside: an undulated landscape of zigzag ceiling planes. Activated by shadow and sunlight, angled up and down, the ceiling was inspired by the architects' recollections of garden trellises. "Our premise was to take that idea and enlarge it as a kind of megatrellis," Elam relates.

By inverting the long-span trusses and reversing their direction so the undersides rise and fall, the architects created an alternating rhythm of angled surfaces to

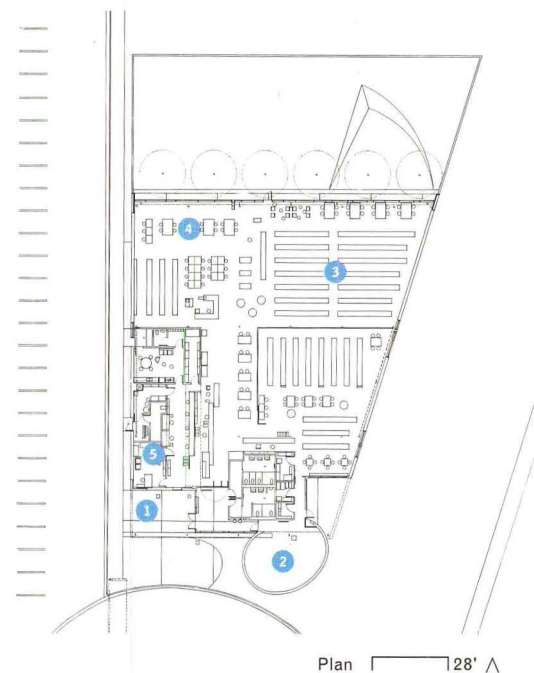



Full-height windows at floor level illuminate reading areas on the perimeter of the library (above). Light from skylights and the triangular clerestory windows washes across the ceiling (facing page).

bounce light and disperse sound. “For economy’s sake, we used the same length and depth everywhere,” Elam points out. The net effect is an ever-changing play of diffused light coming from skylights, windows, and a mixture of warm and cool artificial lamps suspended overhead in 40-foot-long steel fixtures.

Not unlike its kin on the suburban strip, the library’s architecture is pieced together from thin walls and flat facades. By the time a visitor sees the volumes that compose the ceiling inside, the triangular clerestories strung along the sides of the building can be appreciated for their cleverness. Complementing the building’s crisply detailed windows is exterior cladding of unpainted fiber-cement panels attached with exposed fasteners.

Tables in the reading area along the north facade line a glass curtain wall that overlooks the sloped reading garden. Library director Carol Stewart had long wanted

to include a garden space in one of the branches. But in this case, the sparsely landscaped lawn, enclosed by a monolithic fence and a row of evergreens, was justified primarily as a way to buffer the noise, both aural and visual, that is certain to kick in when the adjacent corner lot becomes a gas station or convenience store.

In that regard, the new Philmon Branch Library is an impulsive brushstroke on a canvas of predictability. Overscaled but delicate, provocative yet serene, a concoction of opposites—this urbane container for books and media both celebrates and rejects its place in the matrix of time, space, and commercial culture. ■



HIDDEN ASSETS

Morphosis weaves industrial materials into a kinetic ensemble of bank buildings.



The perforated columns and slipped skins of Thom Mayne's Hypo Alpe-Adria-Center (this page) seemingly defy orthogonal logic. The entrance to the banking hall (facing page, at year) is in a courtyard at the western end of the complex.

By Joseph Giovannini



Few American architects have searched more intensely for a voice and direction than Thom Mayne, whose intellectual and graphic ruminations have amounted to a public diary of personal growth for two restless decades. But although site-specific, highly crafted modernism earned Morphosis a stream of P/A Awards, relatively few designs were built. The opening of the Hypo Alpe-Adria-Center this September in Klagenfurt, Austria, marks a significant change. Aware, no doubt, of Frank Gehry's path to Bilbao (the two practice in the same Santa Monica zip code), Mayne has undergone an epiphany over the last several years and now practices an architectural *realpolitik*. The Hypo Bank is one of the first fruits of a new strategy based in gesture rather than detail. The forms are big and powerful, they are feasible, and they are now standing rather apocalyptically at the corner of the Südring and Volkemarkter Strasse. The 100,000-square-foot bank headquarters marks the passage from a promising but protracted architectural adolescence to adulthood. The talent and technical virtuosity Mayne so conspicuously displayed for many years now embodies a convincing structure of ideas.

The timing and nature of the Hypo Bank commission were fortuitous in bringing Mayne's career to its next level. Conservative by nature and practice, banks typically want to project an image of stability and wealth through static design and rich materials, but the Hypo Bank restructured itself in

the early 1990s from a sleepy, state-oriented, politically dependent institution to a financial motor, expanding into markets across national borders. It needed to consolidate scattered offices in a large, single structure that would confer international cachet and the image of dynamism and size.

The opening this September marks the completion of the first phase of the bank headquarters and performance hall. Mayne brought in the five-story, 110,000-square-foot building for \$13.7 million (\$125 per square foot), the going Austrian price for conventional office buildings. The 65,000-square-foot second phase of offices is already under construction and nearly finished. A 100,000-square-foot phase three will include offices as well as business and residential components, and will be finished in 2001. The ensemble is a P/A Award-winning design (January 1997, pages 62–65).

The site just outside Klagenfurt, a baroque town marked by storybook towers with onion domes, was a sprawling, featureless drive-by corner at an intersection of a suburban thoroughfare lined with car dealerships. One geologically contoured part of the building heaves up from the site like surrounding pre-Alpine hills rising out of the valley, while another part thrusts toward the intersection in an eruption of angled volumes caught in seismic upheaval. "A thickening of the earth's surface...is the zone of occupation," says Mayne. "We wanted to come out of the ground and go into it, always breaking its surface."

A view of the center from the southwest (this page) includes three of Mayne's principal compositional elements: two office blocks (at center and right) and the inverse V-shaped roof of the restaurant (at left). The small pavilion (foreground) houses an automated teller machine. On the south facade (facing page), an outer layer of aluminum fins runs at an angle to the glazing pattern behind. A giant sunshade shelters the roof terrace; the balcony of an exterior stair projects over the fins at the top of the facade. Its railing creates another angle in the composition at the bottom of the facade.



The low roof of the partly submerged restaurant and meeting hall sharply angles upward (this page); its structure is revealed behind perforated metal panels. Maybe likened the form to a bird's wing. Where the roof approaches the adjacent office block (facing page) at the entrance to the meeting hall, the office block's profile deflects, creating a tense slit of space between them.







Aerial view looking west shows all three project phases

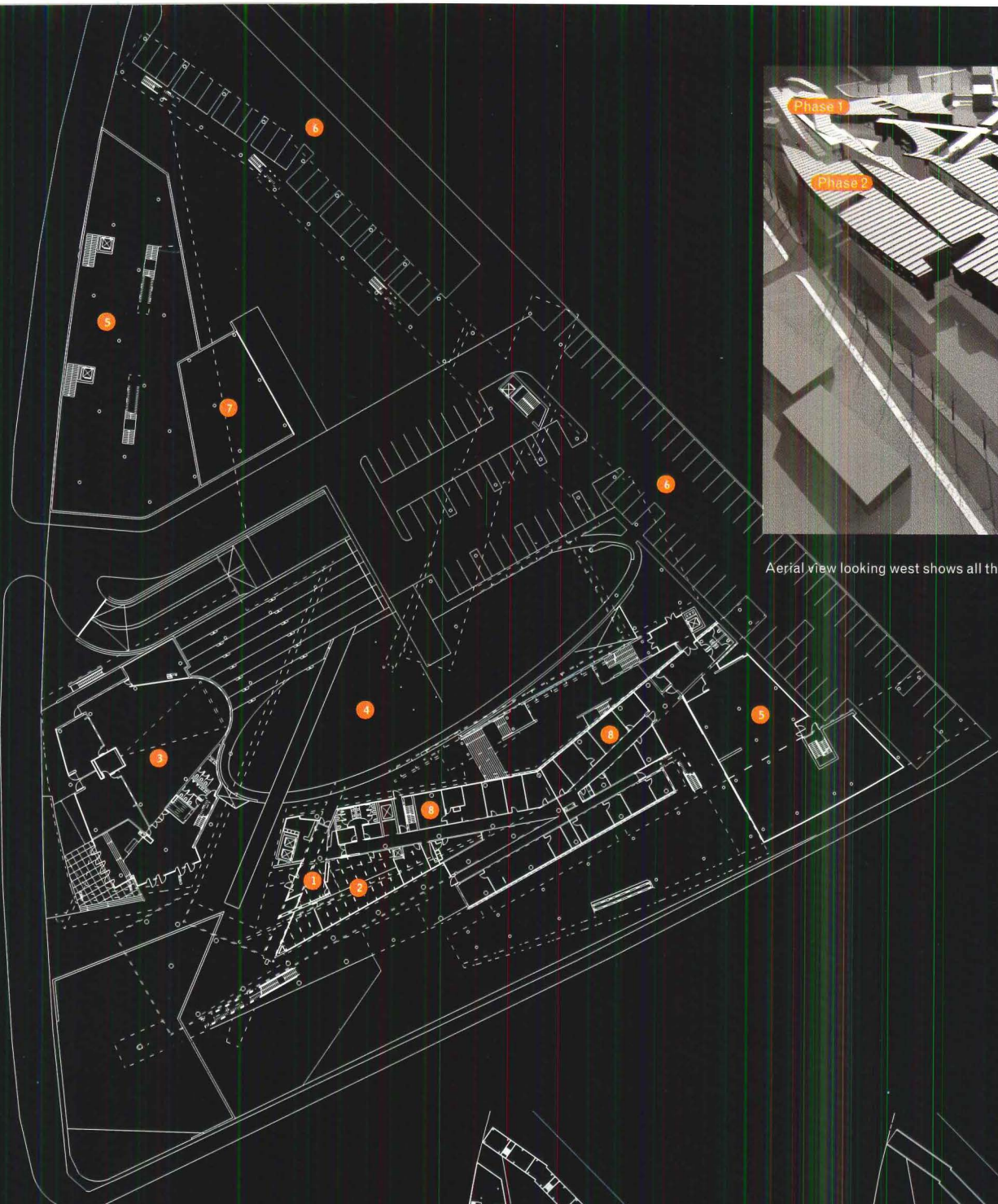

- 1 entrance
- 2 branch bank
- 3 event center
- 4 courtyard
- 5 retail
- 6 parking
- 7 kindergarten
- 8 offices
- 9 housing

First-floor plan 34' ^



Second-floor plan 82' ^



Fifth-floor plan

Apart from a single three-story box elevated on leaning pilotis, the shapes do not evoke other buildings, but reference the landscape and inspire descriptive terms borrowed from geology and nature: turbulent space, peninsular masses, crevassed sections, geological strata, geothermal plumes. The architectural upheaval throws off the horizon line and thwarts perspective from ordering the fragments into a whole. Often the anomie, or just the landscaping, of suburban space devours buildings, rendering them secondary and insignificant, but here, seven-year-olds on mountain bikes brake in their tracks to look at the structure.

Mayne is now, and always has been, an architect of complexity and intensity, but the nature of the work has changed. Fifteen years ago the complexity originated largely within the systems of the building; the architectural expression grew out of structure, repetitive rhythms, and an emphatic materiality, with expressed joinery that declared the fixity of the parts. Morphosis devised Newtonian constellations in which things knew their place.

Mayne's personal paradigm has now shifted from the static to the dynamic, and from equilibrium to a state between balance and imbalance; unique conditions are the rule and even the ideal. Mayne has always articulated the architectural

Often the anomie, or just the landscaping, of suburban space devours buildings, rendering them secondary and insignificant, but here, seven-year-olds on mountain bikes brake in their tracks to look at the structure.

parts, but at the Hypo Bank the parts are not locked into a binding orthogonal syntax: Instead, they move within a field of agitation generated by the intersection of separate systems. The several volumes that compose the five-story bank are separate; each is characterized by the high ratio of surface to volume typical of narrow European floor plates. Within each volume, the glass curtain walls are independent of their respective volumes, and the perforated-metal brise-soleils, which wrap the structure in many veils, are separate and geometrically distinct from the curtain walls. Sunbreaks migrate episodically over the facades, screening southern light, opening northern views, then rising to create a Gaudiesque roofscape made magical by the moiré effect of perforations registering against perforations. The almost gaseous materiality reflects the distance Mayne has come since the heavy-metal days in the 1980s, when his Schwarzenegger display of steel implied permanence and a form of unyielding truth in construction. "The whole idea," says Mayne, "is to instill a

series of transparencies, and a constantly shifting sense of what's inside and outside that engages people with the building, site, and views."

Despite the external complexity, the basic part of the bank building is a three-sided doughnut, with corridors that triangulate around a light well that is glazed at the bottom to illuminate a small banking chamber on the ground floor. "You're always moving across bridges, through thresholds. From one building to another, you're experiencing movement as part of a journey," claims the architect, who always deploys orientation devices—views, openings, corridors—to make the path of the constantly changing officescape self-guiding and cogent.

Yet Mayne notes that even the typology and program of the office building proved malleable. "Every office is different," he says. "I was interested in abstractly translating the narrow, twisting passage and plazas of Klagenfurt into the building. The result is a collection of episodes where things break down into smaller, idiosyncratic pieces." With highly differentiated perimeters that demand varied office configurations inside, the interiors are unique (though surprisingly sedate given the visual commotion outside).

The design is nevertheless simple at the level of the office building part, the materials, and the details; the simplicity accounts for Mayne's ability

to control price. The architect has found other ways to economize too. The structure is a straightforward post-and-beam system built in concrete. Inexpensive expanded-metal panels cover more than half the facade, masking inexpensive, unfinished surfaces punctured by operable windows.

Glazing is minimal; the perforated galvanized metal and its supporting armature are cheap. "It is difficult to convey that buildings like this are not expensive," he states. Mayne also admits that the computer has been instrumental in realizing this vision: "I can't draw by hand anything I'm interested in now."

Like the Guggenheim Bilbao, the image of the exterior is so strong that it carries over into the perception of the interiors; the afterimage convinces the mind that the interiors are equally radical. But like the Guggenheim, the interior, despite the individuality of many spaces, is much more conventional than the exteriors would lead visitors to expect. For such a visually topographical building that grows thematically from the earth, there is, surprisingly, no topography inside, just conventionally stacked floor plates. This is difficult to understand because Mayne, with the computer, could easily visualize the section three-dimensionally. The space of flowing relativity he cultivates so beautifully in plan, elevation, and volume

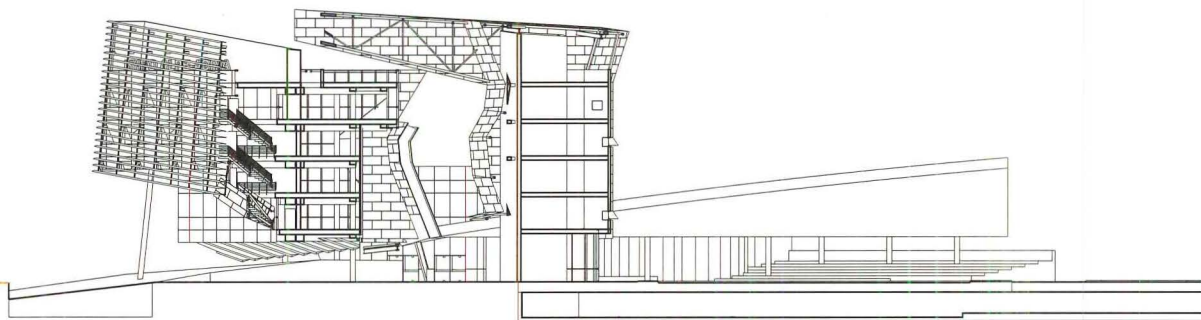

North-south section through offices 23'

hardly affects the way the sections are conceived.

Without the “geological” dislocation of interior floor plates, the exteriors and interiors seem spatially dissociated: The facades may be sculpturally and spatially rich and complex, but they remain an exoskeleton. The same might be said of the interior materiality: If Mayne used an inexpensive palette of industrial materials to transform the usual pinstriped curtain wall, he could have brought an equivalent palette inside, where a more standard range of corporate finishes now prevail.

This literal superficiality of the facade is reinforced by the visual rhetoric of forms that are not sustained by a convincing function or idea. The grandiloquent cloudlike vapors of expanded metal on the roof don’t have a function, not even as a trellis. A decorative bent column and structural armature on the west facade (its only function is to extend an interior form to the outside) might have

been better spent over the entrance, to give the self-effacing doorway and lobby greater presence.

Still, this is a building of tremendous power and persuasion. The bankers who commissioned the design are well aware that they have earned a building that, like any number of palaces and Catholic churches in this part of the world, defines the institution itself. The structure also reinforces the so-called Bilbao effect, which has expanded expectations about how a building can exceed its immediate job to assume an important civic role. An effort of great scope and ambition, executed with dazzling skill and ingenuity, Hypo Bank is a building capable of affecting Austria’s entire building culture, one that will make the arguments of the next architect easier in Austria, and, for that matter, in the rest of Europe and America. There are other Bilbaos and Klagenfurts in the offing for the knowing clients who dare. ■

Mayne designed interiors that seem conservative in light of the radical exterior (facing page, clockwise from top left). Window frames and shifted exterior fins create dynamic patterning in the offices. An enclosed bridge connects north and south office wings, and overlooks a triangular courtyard between the two wings. A rooftop conference room opens onto a terrace. A skylit banking hall fills the ground floor of the central courtyard.



In the U-shaped entrance courtyard, perforated-metal panels clad offices and lift like shutters to reveal strip windows behind. The glazed facade (at left) opens onto the ground-floor banking hall within.

HYPO ALPE-ADRIA-CENTER, KLAGENFURT, AUSTRIA

CLIENT: Hypo Alpe-Adria-Bank—Wolfgang Kulterer (director); Jörg Schuster (director); Erwin Sucher (procurist) **ARCHITECT:** Morphosis, Santa Monica, California—Thom Mayne (principal); John Enright (project architect); Martin Krammer (site supervisor); David Grant, Fabian Kremkus, Sylvia Kuhle, Ung Joo Scott Lee, Brian Parish, David Plotkin, Robyn Sambo, Stephen Slaughter, Brandon Welling, Marion Wicher, Eui-Sung Yi (project team); Michael Folwell, Eugene Lee, Thomas Lenzen, Juliana Morais, Ulrike Nemeth, Janice Shimizu, Bart Tucker, Ingo Waegner, Oliver Winkler (project assistants) **ENGINEERS:** Klaus Gelbmann, Richard Kuglitsch (structural); Robert Sorz (mechanical); A. Gregoritsch, Fritz Aufschlager (electrical) **CONSULTANTS:** Zolestin Thomas Stich (construction management); Reinhold Sventina, Werner Schusser (specifications); Alfred Lengger (local supervision); Herbert Sammer (survey); Gerhard Tomberger (building physic) **COST:** \$13 million (phase 1) **PHOTOGRAPHER:** Christian Richters

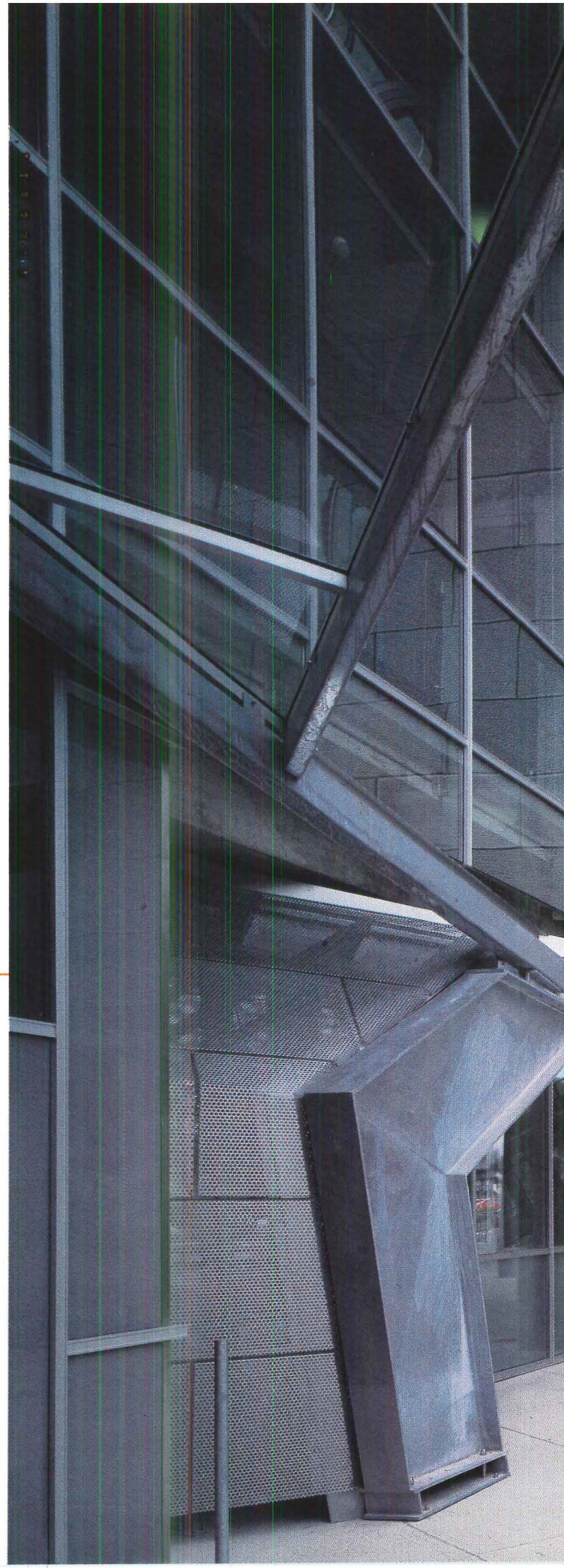



WE'RE ALL YOU NEED TO KNOW

FOR THE FINEST IN HARDWOOD, LAMINATE, CERAMIC AND VINYL FLOORING



hoboken[®]
FLOORS □□□

THE NATION'S LARGEST DISTRIBUTOR OF HARD SURFACE FLOORING

CORPORATE OFFICES: 70 DEMAREST DRIVE, WAYNE, NEW JERSEY 07470 • 201.694.2888 / 1 800. 222.1068

SHOWROOMS: NEW YORK D&D BUILDING: TEL: 212.759.5917 • BOSTON DESIGN CENTER: TEL 617.426.4343

OTHER LOCATIONS: ALBANY, NY • ATLANTA, GA • EAST BRUNSWICK, NJ • NEWARK, DE • OAKVILLE, CT • ORLANDO, FL
POMPANO BEACH, FL • ROCHESTER, NY • STOUGHTON, MA • WESTBROOK, ME

www.hobokenfloors.com

Circle 57 on information card

architecture house™ February 2000

archi[®] t

house

HOME, HOME ON
THE WEB

MASTER BUILDERS
OR MASTER SHOPPERS?
ARCHITECTS TACKLE
TURNKEY SERVICES

HOUSES BY
ANNE FOUGERON AND
ALBERTO KALACH

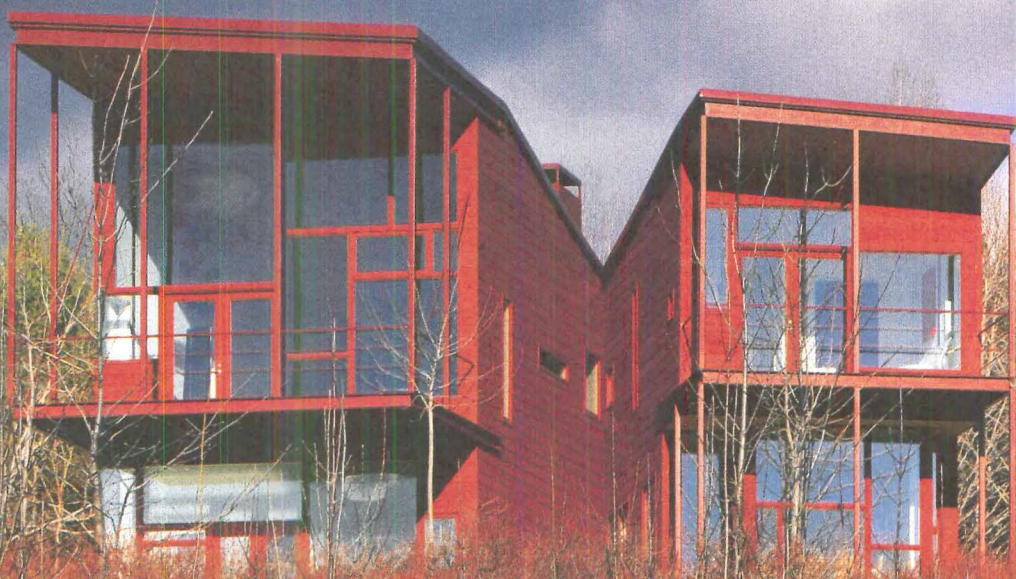

New Houses, New Directions

THE HOW AND "Y"
OF STEVEN HOLL'S
LATEST HOUSE

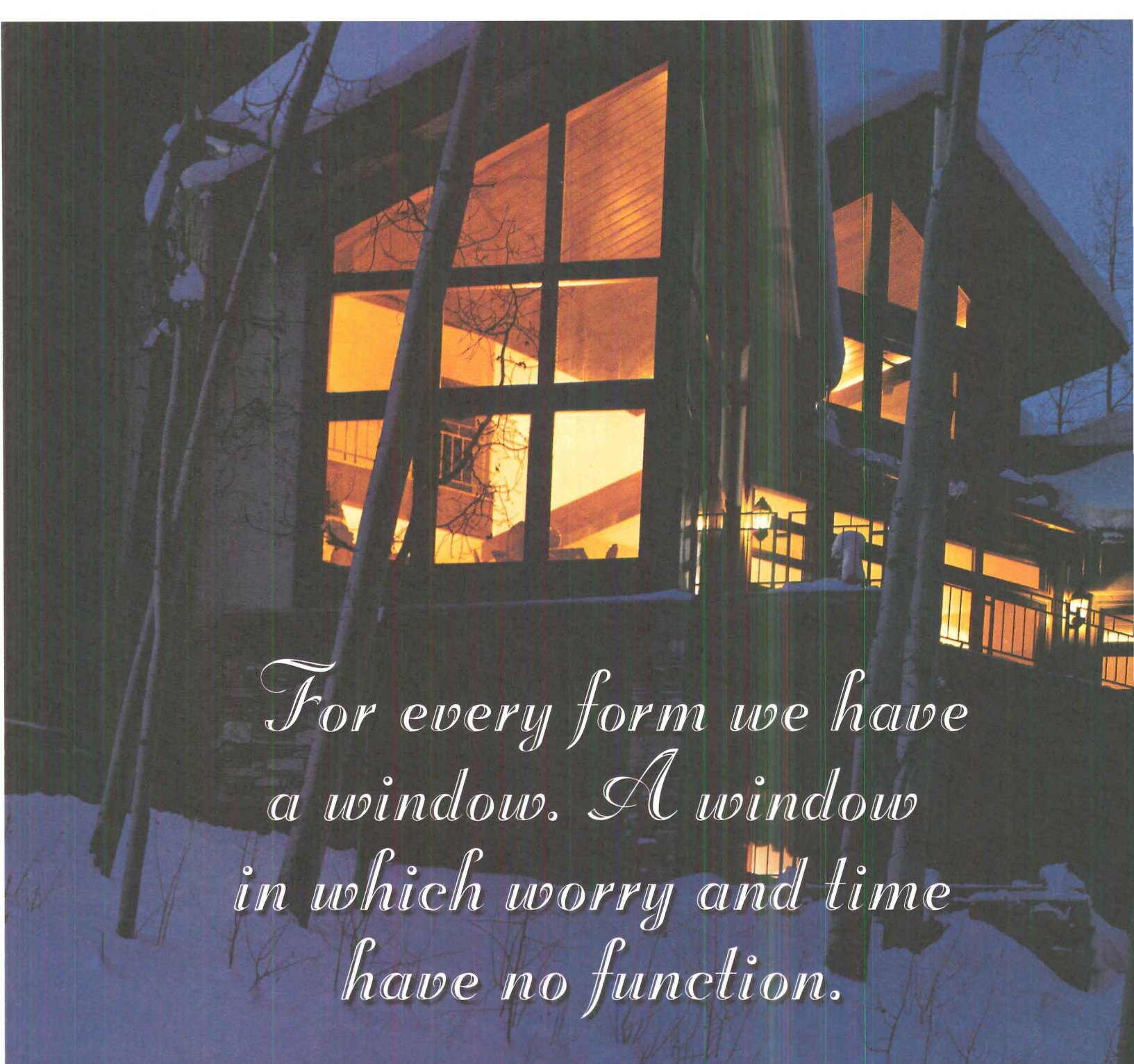

*For every form we have
a window. A window
in which worry and time
have no function.*

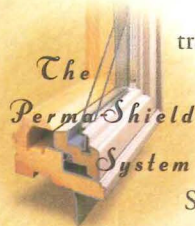

*The
PermaShield
System*

You can use Andersen® windows in virtually any form imaginable. Hexagons, octagons, pentagons, trapezoids, triangles, diamonds, circles, ovals and, of course, squares and rectangles. In fact, we sell 200,000+ shapes and sizes. In combinations beyond belief. 1,000,000 bay-bow choices alone. And each window offers you unique profiles, dramatic shadow lines and slender frames. Each offers your clients the Perma-Shield® System: products so solidly built, backed and serviced, that window worry has no place to reside. Today or tomorrow. To learn more, call 1-800-426-4261, ext.3176.

Worryproof. Timeproof. Andersen Windows®.

www.andersenwindows.com Circle 59 on information card

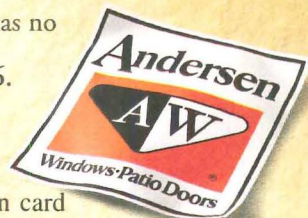

Welcome. By Raul A. Barreneche



For years, *Architecture* has been bringing you the best houses in the United States and abroad. We've shown you residences designed by such masters as Richard Meier and Rem Koolhaas and emerging talents like Rick Joy and Vincent James, edgy iconoclasts like Scogin Elam and Bray and Dan Rockhill, and contemporary regionalists such as Miller/Hull and David Salmela. But with the exception of a few special issues, we've had to sprinkle these houses among larger buildings. We think the houses we bring you are important; they deserve their own publication.

Welcome to *Architecture House*, the magazine-within-a-magazine created specifically for residential architects and their clients. Four times a year, *House* will explore the one building type that exerts an equally powerful hold over architects and the general public. Designers have always had a fondness for houses and the unequalled freedom to experiment they allow. The public, meanwhile, loves houses because they embody the American Dream. People spend their lives fantasizing about a home of their own—starter homes, dream homes, second homes. The house is the one kind of architecture that lay people truly understand. *House*, the magazine, will speak to this common passion for house, the building type.

The heart of *House* will be design features—the sort of stories with rich photography and intelligent, critical writing that appear each month in *Architecture*. And *House's* format will allow us to give you more information than before: bigger drawings, more details, sidebars on innovative technical solutions, and, in the future, comprehensive lists of product sources. We'll also introduce you to the architects behind the projects and tell you a bit about their practices—whether established names or unknown talents—and their design philosophies.

House will kick off each issue with a news section geared toward residential designers but informative for all architects. We'll show you the latest industry statistics, tell practitioners how to put more money in their pocket, explain new software and building technologies, share what clients look for from their architects, and give you the first look at hot new home products. These pages will talk about everything that goes into creating houses, to give you a snapshot of the state of residential architecture.

We hope you find *House* both informative and inspiring. Most importantly, we hope that *House* rekindles your own passion for that most simple yet meaningful of buildings—the house. Join us again in May.

Tell us about houses you've designed and share your story ideas. Drop me a line at rbarreneche@architecturemag.com, or send information to *Architecture's* editorial offices at 1515 Broadway, New York, NY 10036; fax (212) 382-6016.



Facts and Figures

Housing and Interest Rate 2000 Forecast

Here are the National Association of Home Builders' downward-looking predictions for the residential construction market this year, compared with 1999.



	1999	2000
Total housing starts	1,666,000	1,536,000
Single-family starts	1,329,000	1,225,000
New home sales	935,000	881,000
Existing home sales	4,945,000	4,527,000
Fixed-rate mortgage rates	7.4%	7.9%
ARM mortgage rates	5.9%	6.2%

Department of Hype

Tuning in to Feng Shui

Feng shui, the Asian philosophy of creating positive energy flow through the placement of objects, colors, and natural elements, is proving to be more than just a passing fad. Architects are starting to take this much-hyped but ancient tradition more seriously, hiring consultants and reading the countless new how-to books to make sure their room layouts and furniture arrangements maximize harmony and prosperity.

"Ninety percent of my jobs come from clients who want me to work with their architect or designer," says R.D. Chin, a New York-based feng shui consultant, author of *Feng Shui Revealed* (Clarkson Potter, 1998), and an architect who formerly worked with Paul Rudolph. "But a lot of architects aren't into it," adds Chin, implying that they are threatened by the prospect of new-age mystics modifying their designs.

More and more clients are asking their architects to follow feng shui principles, especially when designing new homes or renovating existing ones. "I had a client who was obsessed with it," says Lee Mindel of Shelton Mindel Associates. "I think if you are a responsible architect and you respect light, axis, view, and site, then feng shui takes care of itself."

Even the cautious AIA is getting in on the act: Chin was recently invited to speak to the Brooklyn chapter of the AIA on feng shui techniques. "It was the largest turnout they've ever had for a lecture," says Chin. "But the fascinating thing was that nobody asked any questions." *Rima Suqi*

Rima Suqi is a New York-based freelance writer.

Who Knew?

Ever wonder what went into building a house, besides 90 percent perspiration and 10 percent inspiration? Some figures on what it takes to make a run-of-the-mill 2,100-square-foot house:

OUTSIDE: 13,127 board feet of framing lumber + 6,212 square feet of sheathing + 13.97 tons of concrete + 2,325 square feet of exterior siding + 3,100 square feet of roofing + 3,061 square feet of insulation + 6,144 square feet of interior wall material + 120 linear feet of ductwork.

INSIDE: 2,085 square feet of flooring (carpet, tile, or wood) + 15 windows + 13 kitchen cabinets + 12 interior doors + 7 closet doors + 3 exterior doors + 2 garage doors.



Now You Know the Secret!

For Lasting Protection, Specify Tyvek® CommercialWrap™

It's no secret, Tyvek® protects! Tyvek® CommercialWrap™ offers strength, performance, and ease of handling for breathable membranes in light commercial construction. Its spunbonded polyolefin resists air and water penetration with a non-perforated continuous microfiber web, which has microscopic pores large enough for moisture vapor to pass through, but small enough to resist air and liquid water. For more information, or to speak with a DuPont Tyvek® Specialist, call 1 800-44-TYVEK® (1 800-448-9835).

www.tyvekconstruction.com
Circle 63 on information card

DuPont Tyvek® CommercialWrap™ Performance:

- Protects installed R-value
- Superior moisture vapor transmission
- Water holdout 2 1/2x to 3x better vs. 10- and 60-minute building papers
- 2x better than #15 felt and almost 1 1/2x better than building paper during wind load testing



Tyvek®

CommercialWrap™

© 1999 DuPont. Tyvek® is a DuPont registered trademark for its brand of spunbonded olefin. CommercialWrap™ is a DuPont trademark for its brand of weatherization system.



Gracious Living

YOO Who?

Philippe Starck, the brand-name king of 1990s commercial design, is kicking off the millennium with a residential venture called YOO. Starck founded the London-based property company with John Hitchcox, the developer who brought New York-style loft living to London with the successful Manhattan Loft Company in the early 1990s. YOO's concept is simple and broad: Buy an apartment in a Starck-designed YOO building and have the option to buy one of four Starck templates for fitting out your flat: classic, minimal, nature, or culture. A YOO design team—but not Starck himself—will assist you in picking furniture, fixtures, and colors to create a complete Starck-inspired environment.

Starck living doesn't come cheap: 800-square-foot apartments in the flagship London development start at \$600,000. Buyers wanting their apartment interiors designed by the YOO team will have the fee included in the purchase agreement. For more information, call (44) (207) 266-2244, or visit YOO's website at www.yooarehere.com. *Sara Hart*

Facts and Figures

The U.S. Commerce Department reported last month that November 1999 sales of single-family homes dropped 7 percent from October to a seasonally adjusted annual rate of 865,000. The monthly figure was down sharply compared to the previous year—a drop of 12 percent from November 1998. This is the biggest percentage decrease in almost two years, a sign that higher interest rates are starting to discourage home shoppers. The average home sales price rose in November, however, up to \$209,700 from \$201,300 in October.

Products

Architects At Home

The TERRA table, created by James Wines of SITE for Saporiti Italia's collection of architect-designed furniture, is made of solid cherry. Its base is divided into a grid of cubicles and is covered by a glass tabletop.



Parisian architect Jean Nouvel has designed a sleek, elegant bathroom unit for Italian manufacturer Zeritalia. A stainless-steel frame supports transparent, adjustable glass shelves, as well as mirrors, acrylic drawers, toothbrush holders, and soap dishes.

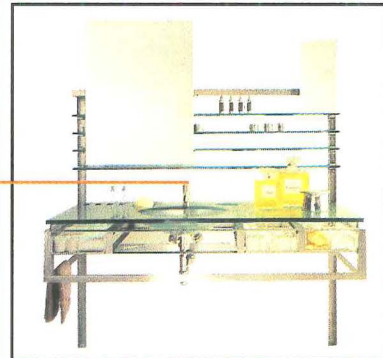

San Francisco architect Bruce Tomb's new company, Infinite Fitting, developed the X Basin, a simple oval sink with an X-shaped drain. The basin is available in white bronze, silicon bronze, brass, or aluminum, and can be ordered in either a smooth or satin-polished finish.



John Portman's Sling chair, also for Saporiti Italia, echoes Le Corbusier's furniture in its simple forms and materials. Sling, which can be used as an office or dining chair, has a steel frame and a natural hide seat and back, which is available in a range of colors.

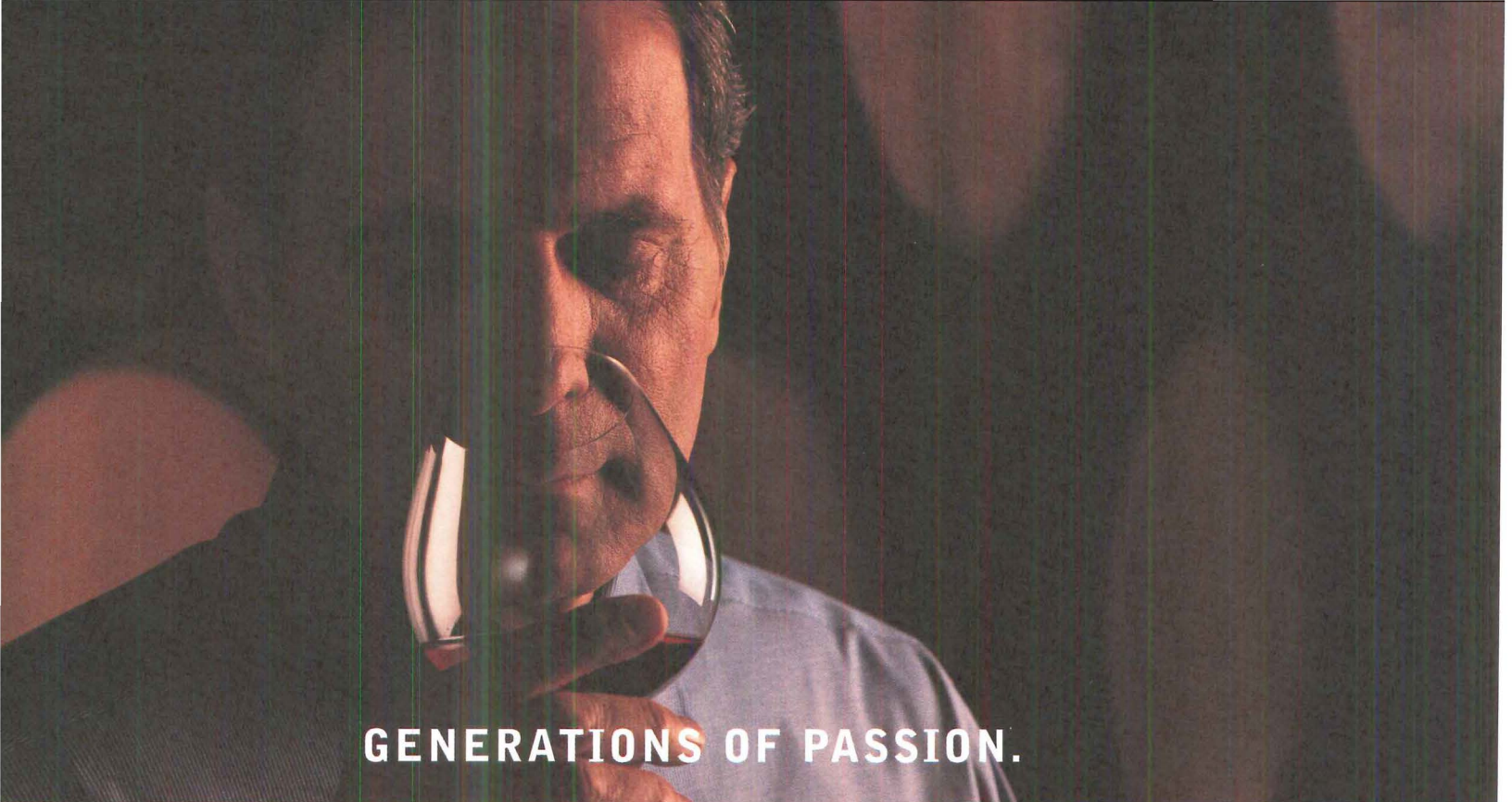

GENERATIONS OF PASSION.

AND A NEW PLACE TO PRESERVE THEM.



Introducing wine storage as only Sub-Zero could make it. Four models, each with two distinct temperature zones, provide the ultimate storage conditions for 46 to 147 bottles. Choose stainless steel door styles or match your cabinetry beautifully. For a free catalog: 1-800-444-7820 or www.subzero.com



Circle 65 on information card

Home, Home on the Web

Architects afraid that the boom of online commerce might hurt their residential business can rest easy—for now. A survey of existing sites reveals that some make it easy and cheap for anyone to purchase high-end design objects and furniture directly from the Web. But they offer only a small selection of what's available to design professionals—meaning architects still have the best access to home furnishings. More importantly, many home-related sites are developing services targeted directly at architects, such as posting portfolios online and creating databases that match potential clients with architects. Following are a few sites that give a range of what's available. *Lauren Neefe*

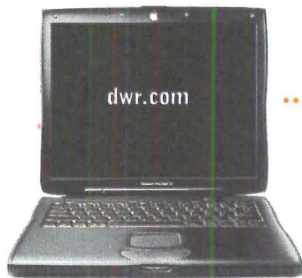

Since **dwr.com** (Design Within Reach) is a direct source of classic modern and contemporary furniture, architects and the public alike can enjoy the company's preferred rates, sometimes saving hundreds of dollars off the list price. For the moment, the company has postponed the launch of an online Registry for Architects and Designers, where prospective clients will be able to browse through the portfolios of architects and designers approved by DWR's in-house selection committee. Other services scheduled to debut in the near future include tools for viewing products in simulated environments, testing fabrics and finishes, and overnight shipping of swatches and chips.



Homeportfolio.com is geared more to the general public than other sites, but it does have features that appeal specifically to professionals, including online design discussion groups, "shopping carts" that allow designers to save favorite products, and e-mail links that let them send images of products to clients and consultants. Some items are marked "trade only." For professional users, the site boasts links to other useful sites such as AIA Access, where prospective clients can track down an architect in their area. In March, the site will launch the first of its two-part Interior Design Portfolio Program, a free service similar to DWR's registry. The service will be offered initially only to interior designers, but will eventually expand to include other design professionals.



The **realfurniture.com** team, led by architect Abby Suckle, Pei Cobb Freed's former head of interiors, presents the furniture it sells like a carefully curated gallery that changes periodically. Currently for sale are a collection of Alvar Aalto furniture and a few pieces by Ron Arad and Robert Bliss; Hoffman furniture will fill the online gallery by the end of February. Future selections will be related to themes like minimalism, ergonomics, home offices, and outdoor furniture. *Realfurniture.com* also hosts online events developed with the AIA, for which AIA members can earn learning units to meet continuing education requirements. The first event, "So, You've Always Wanted to Design a Chair," was held in September (you can still earn AIA credit by purchasing a videotape of the event from the site); a seminar on office planning for small companies will follow soon.



You can't buy anything on **interiortrade.com**, but you can certainly learn a lot. Prospective clients can search a directory of architecture, interior, and landscape design firms to find designers according to project type and geographic location. Professionals, meanwhile, can browse directories of suppliers and services organized by specialty: construction systems, furnishings and finishes, lighting, even business supplies. The listings in these directories offer links to manufacturers' websites and e-mail addresses to request product information. The site also offers a useful calendar of industry trade shows and links to design publications and business news wires.

Lauren Neefe is an editor at ID magazine in New York City.

NIMA® CANYON
 IN MARIGOLD
 AND RED.
 ALSO AVAILABLE
 IN TOMATO AND
 BRONZE, LEMON,
 AQUA, AND SAGE.
 STANDARD SIZES
 4'x6' TO 10'x14'.
 CUSTOM SIZES
 ALSO AVAILABLE
 TO 20'x28'.

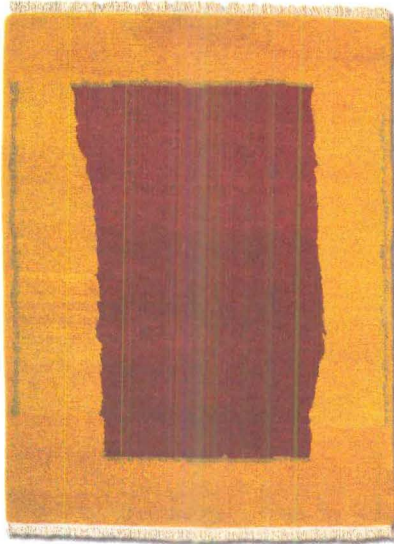

NIMA TASHI® GOYOE
 IN BRONZE.
 ALSO AVAILABLE
 IN RED.
 STANDARD SIZES
 4'x6' TO 9'x12'.
 CUSTOM SIZES
 AND RUNNERS TO
 20'x28'.

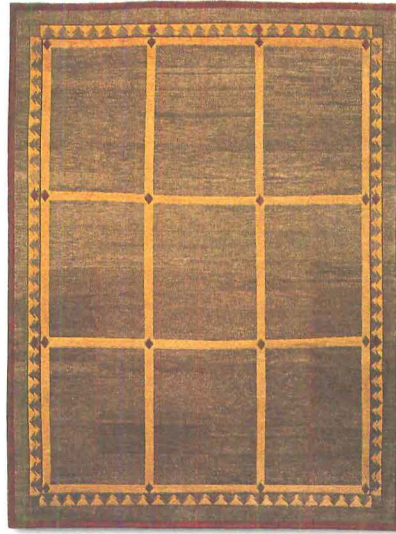

NIMA® ECLIPSE
 IN MARIGOLD
 ALSO AVAILABLE
 IN TOMATO,
 MARINE BLUE,
 YELLOW AND TAUPE.
 STANDARD SIZES
 4'x6' TO 10'x14'.
 CUSTOM SIZES
 AND RUNNERS TO
 20'x28'.

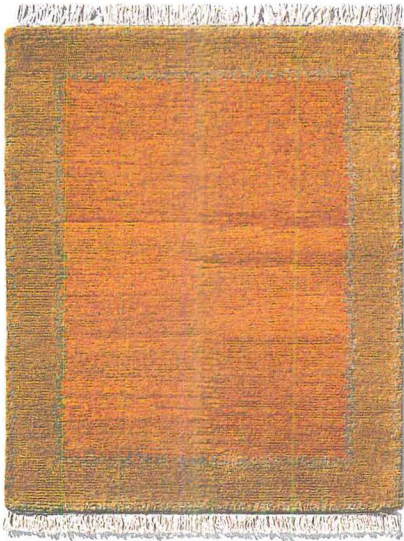

NIMA® TUNDRA
 IN TOMATO.
 ALSO AVAILABLE
 IN GRASS GREEN,
 PLUM AND
 TURQUOISE.
 STANDARD SIZES
 4'x4' TO 10'x14'.
 CUSTOM SIZES
 AND RUNNERS TO
 20'x28'.

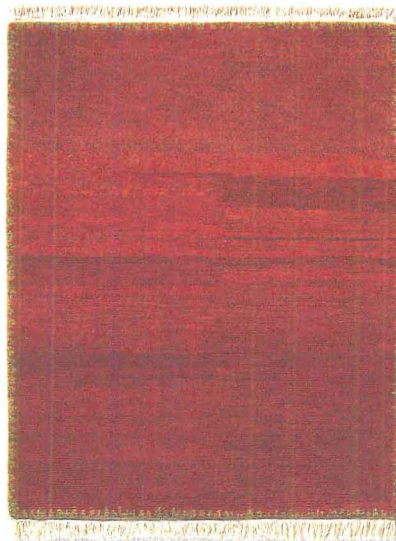

YOU CAN SEE THEM IN OUR SHOWROOMS. OR AT THE GETTY.

THE GETTY MUSEUM. RESTAURANT DANIEL. ODEGARD IS NOW DOING SOME
 OF THE MOST EXCLUSIVE INTERIORS IN AMERICA. IF YOU ARE TOO, PERHAPS WE SHOULD TALK.

ODEGARD®
 Rare & Original Carpets

Circle 67 on information card

THE NEW YORK DESIGN CENTER 200 LEXINGTON AVENUE, SUITE 1206 PHONE 212 545-0069 FAX 212 545-0298
 THE WASHINGTON DESIGN CENTER 300 D STREET SW SUITE 519 PHONE 202 484-5888 FAX 202 484-6077
 THE CHICAGO MERCHANDISE MART 200 WORLD TRADE CENTER SPACE 1828 PHONE 312 644-9638 FAX 312 644-9639





Soup to Nuts

Everything *and* the Kitchen Sink

Stanford White did it. So did Frank Lloyd Wright. Now Michael Graves does it, too. Architects have always enjoyed playing master builder, designing houses down to the dishes. Nowadays, designers call this “turnkey service,” and some architects are going to great lengths for residential clients who want one-stop shopping—with their architect providing every last furnishing.

For instance, Alison Smith, a partner in La Jolla, California-based Bennett + Smith, has found herself specifying 400-thread-count bed linens, fogless shaving mirrors, toothbrush holders, and antique wastepaper baskets for her clients. Tannys Langdon’s eponymous Chicago firm has designed Q-tip drawers and storage units for toilet paper and cotton balls. And Michael Graham (pictured) of Liederbach & Graham, also in Chicago, has even picked out dogs for two

clients. Are these cases of lazy owners, controlling designers, or just resourceful architects bolstering their fees with extra services?

It comes down to the bottom line: Delivering complete interiors packages as part of architectural commissions is a moneymaker. “We charge higher design fees for these kinds of projects because there’s a lot of handholding,” explains Philip Durham of Saint Louis-based Rubio/Durham, who framed the family portraits in a house he designed.

Each of these architects uses slightly different billing strategies for their interior design services, though they all separate interiors and architectural agreements. Smith refers to her firm’s documents as “skin” (interiors) and “bones” (architecture). Interestingly, Smith, Graham, and Rubio all keep their markups on furnishings lower than the notoriously high add-ons of interior designers. “We’re not retailers,” says Rubio. Langdon dispenses with markups altogether; he bills procurement services on a straight hourly basis and sells the items to clients at cost.

Just being a great shopper won’t make you a successful practitioner in the rarified air of integrated design. “When you’re purchasing items, it’s up to you to make sure they work together; there’s no general contractor to put all the pieces together,” cautions Durham. “Unless you understand all the pros and cons, it can be a real trap.”

These pampering services might seem a byproduct of today’s prosperous times, but when work slows down, they can keep a firm afloat. “During the last recession, it really helped to have an interiors practice,” Langdon recalls. The market may be softening, but, as Landon suggests, “People will always pay for shopping.”

Edward Keegan

Pooches on a punch list? Golden retrievers were part of Michael Graham’s house design.

New Directions It's no surprise that architects love the freedom that **house** commissions give them. Where else can they experiment so freely, at such a controllable scale? The houses in our

debut issue offer startling solutions to the age-old task of creating a home. Their architects test new approaches to circulation and massing, how to pull the indoors out and bring “public materials into private space,” as the client of Anne Fougeron’s California glass house (page 142) requested. The house is the most accessible building type because it’s the one with which we’re all intimately familiar; it’s one place where architects and the public have much to talk to each other about.

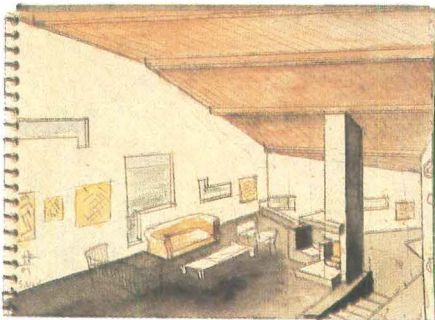

Watercolor sketch by Steven Holl depicts homey yet unconventional interior of Y-House.



On a steep site outside Mexico City, Alberto Kalach weaves a house into a hillside promenade.

CASA NEGRO, CONTADERO, MEXICO CITY

CLIENTS: Alejandro and María Eladia González

ARCHITECT: Alberto Kalach and Daniel Alvarez, Mexico City—Alberto Kalach (principal-in-charge); Gustavo Lipkau, Rosa López (project team)

LANDSCAPE ARCHITECT: Tonatiuh Martínez

ENGINEER: Guillermo Tena (structural)

CONSULTANTS: Jorge Segura (ironwork); María Eladia Haggerman (interiors); Sergio Valdez (carpentry)

GENERAL CONTRACTOR: Daniel Alvarez **COST:** Withheld at owner's request

By Raul A. Barreneche

Just a few miles outside its almost unbearable congestion and smog, Mexico City's sprawl gives way to green hills thick with oak and tepozan trees. These lush hillsides conceal the Mexican capital's bedroom communities and weekend getaways, places where outdoor living—a challenge in urban neighborhoods—is not only possible but downright pleasant given the breathable air, shade, and lakes. One of these secluded hillside communities is Contadero, where local architect Alberto Kalach weaves together a powerful sequence of inside and out to form a house where being outdoors is almost mandatory. In fact, it's the only way to get from one wing of the building to another.

Kalach designed the 7,530-square-foot home for a television executive and his young family, with former partner Daniel Alvarez, who acted as the project's general contractor. Kalach separated the house's

functions into five individual volumes and set the pieces tumbling down a steep, south-facing slope, like fingers scratching into the hillside, being careful not to disrupt the thicket of trees. One enters the uppermost volume unaware of the sprawling ensemble to come, and moves into a long hallway leading to living and dining rooms; off to the north is a tall, narrow box containing the kitchen with servants' quarters below. Just downhill, the third and largest volume contains a suite of bedrooms; farther down is a double-height study and exercise room; and, finally, a 25-meter-long lap pool that terminates the ensemble.

Kalach dug deep into the hillside to install massive concrete walls to support the structure, stabilize the hillside, and minimize damage to the roots of the existing trees. These deep foundations, which eliminate the need for retaining walls on the site, frame large cisterns in the earth that collect rain to supply the



Architect carefully sited the house's individual volumes to preserve existing oak and tepozan trees. The roofs of the bedroom wing (above) act as terraces accessed by a stepped path from the living wing just uphill (in background). The glass-enclosed dining room (below left) cantilevers out beyond the concrete foundations, which penetrate deep into the steep hillside. Kafach alternated exposed concrete walls with ochre-tinted soil excavated from the site. The towering volume at rear contains a kitchen with servants' quarters below. The outdoor hill sequence winds down a concrete staircase, then winds back to access the two-story studio (below right) through a large wooden portal.

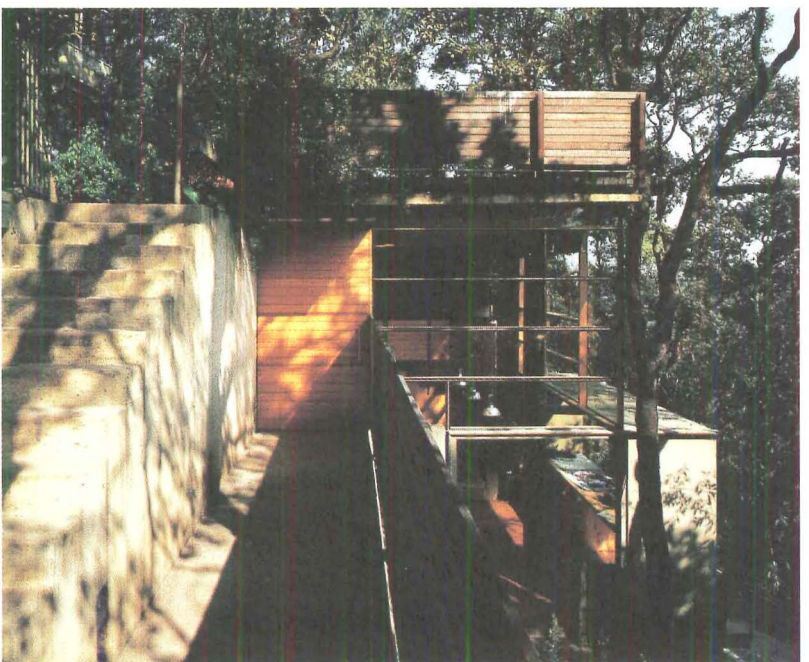





The path down to the pool continues through the woods to a wooden walkway (left page). Above the studio is a terrace accessed from the bedroom wing above. Kalach wrapped wood-framed glazing panels are used to connect the main living (above). The near-to-ceiling glazed panel breaks down virtually all barriers between inside and out; the wooden floor is made of teak, and the walls are made of concrete. The structure is built on a hillside, offering a panoramic view of the surrounding forest, emphasizing the connection between interior and exterior.

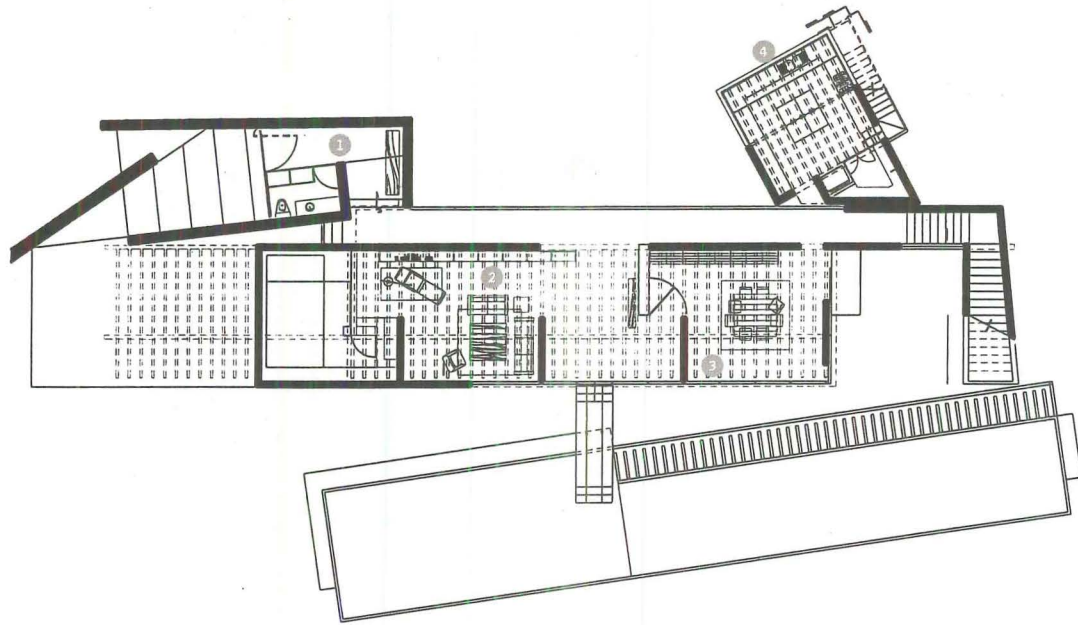

Entry-level plan 10' ^

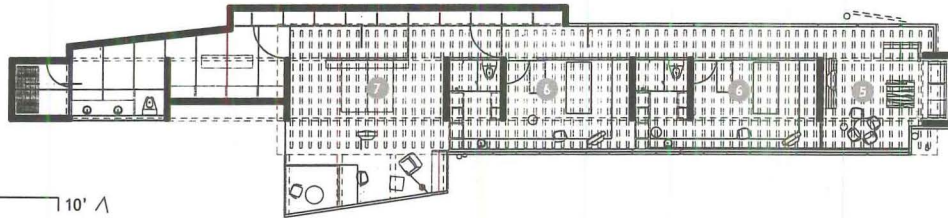

Bedroom-level plan 10' ^

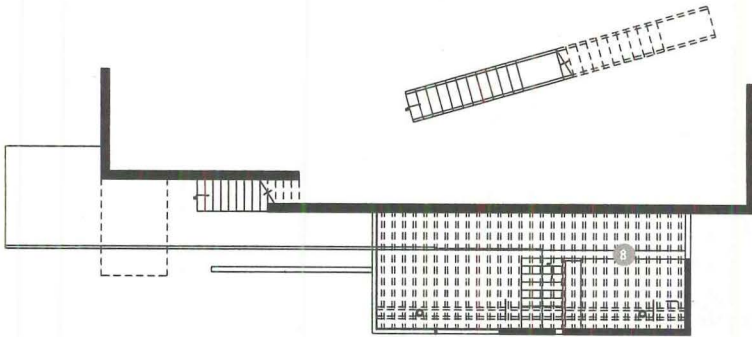

Studio-level plan 10' ^

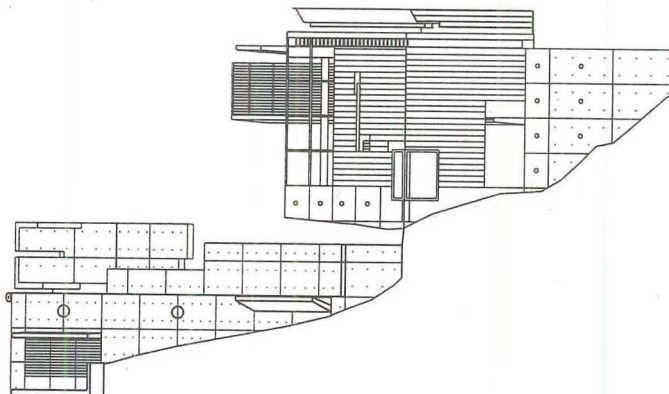
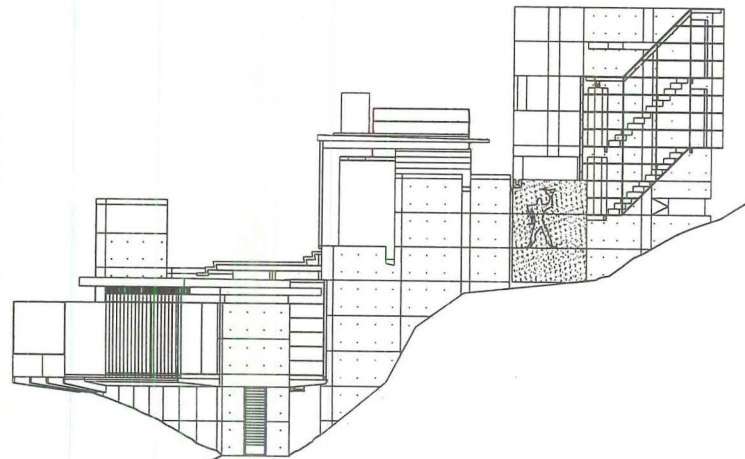

- ① entry foyer
- ② living room
- ③ dining room
- ④ kitchen
- ⑤ family room
- ⑥ children's bedroom
- ⑦ master bedroom
- ⑧ study

Site elevation 10'

- 1 living wing
- 2 kitchen wing
- 3 bedroom wing
- 4 studio
- 4 pool

house with water. Above the earth, the pavilions take on a feeling of lightness that makes the structures read “like large platforms floating in the landscape,” as Kalach describes them.

The brilliance of the plan is the simultaneous independence and interconnectedness of the five pieces that together create a hillside promenade. Moving through the pieces of the house, one always sees the site’s dense vegetation through broad expanses of glass—and then is thrust outdoors to walk among the trees. Interior circulation takes place along narrow, sunlit corridors on the north flank of each volume, leading to lofty rooms that open onto the valley. The connections between the bars are mostly external, across flying bridges or down earthbound staircases. (The only interior link is a staircase connecting the main living wing to the bedroom block below.) The path from the living quarters to the pool takes guests zigzagging down the hill along a series of bridges and walkways that weave indoors and out: from a terrace flanking the bedrooms; into the top of the two-story studio and out the bottom level; and finally to the flared aquamarine trough that holds the pool deep down the forested slope.

Since the house faces outward into the dense valley, there is no vantage point from which to understand the entire composition of stacked boxes on a hill; one can only grasp the volumes one piece at a time. From close range, the house seems light and immaterial despite its concrete construction. Above ground, the boxes become lighter as Kalach cuts away concrete planes where

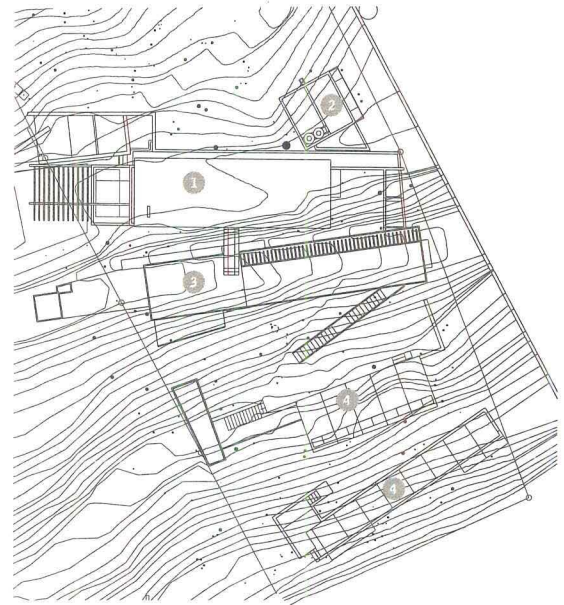

Site plan 22' 1

they’re not structurally necessary and replaces them with non-load-bearing walls of tawny *tepate* soil excavated from the site. Above the masonry, the walls disappear altogether, replaced by bands of glass. The other exterior materials—limestone, steel, glass, and marble—are hard, but Kalach treats them so they never feel edgy or opulent.

Inside the house, the architect opens rooms to the outdoors with seamless expanses of floor-to-ceiling glazing. He wraps the corners of the living room with horizontal bands of wood-framed glass and then erodes the corners by removing the mullions, invoking a favorite detail of Frank Lloyd Wright. Wooden joist ceilings above the living and dining areas, supported on hefty exposed steel beams, stop just short of the glass curtain wall—a trick emphasized along the bedroom corridor, where the glass wall wraps up and onto the roof. Polished wood floors and walls painted dark green have a double effect: They warm up the interior and pull in the outdoors with a palette that mimics the hues of the forest outside.

Kalach’s house is hard to place in the rich canon of Mexican modernism. It’s abstract, but not sentimental like Ricardo Legorreta’s colorful mastabas; it’s structurally sophisticated, but not as precocious as Enrique Norten’s expressive high-tech idiom (*Architecture*, September 1996, pages 78–83). Kalach’s house is sensuous and earthy, yet rational and hard-edged. This house is not a machine for living; it’s a comfortable hammock stretched among the trees. ■

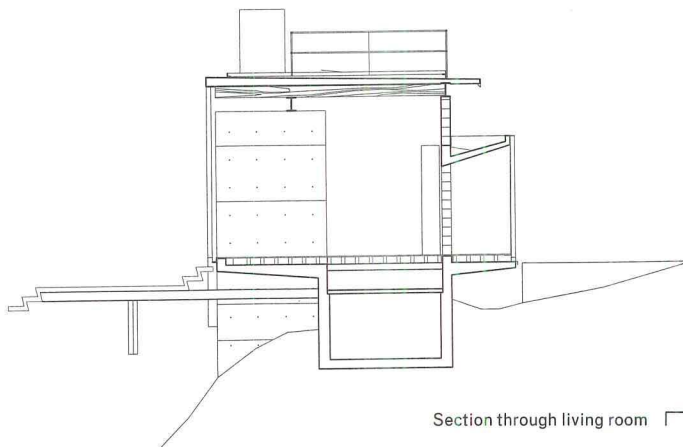

Section through living room 16'

Debut

Alberto Kalach

Mexico City

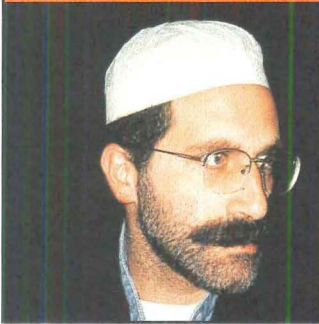

Alberto Kalach is Mexico's new master of modernism. The rebellious 40-year-old architect, now working without longtime partner Daniel Alvarez, with whom he started a practice in 1981, studied at the Universidad Iberoamericana in Mexico City and later at Cornell University. Kalach has spent much of his career teaching at universities throughout Mexico, as well as the University of Houston, the University of Southern California, and most recently Harvard University, where he held the Eliot Noyes Chair at the Graduate School of Design in 1998. His built work—all in Mexico—ranges from office interiors and private homes to subway stations and urban-scale housing projects. In addition to directing the "Mexico City Studio" at the Universidad Nacional Autonoma de México, Kalach is currently completing a house and a residential tower, both in Mexico City.

Principal: Alberto Kalach

Continuing the exterior promenade, a walkway and staircase hang from the limestone-and-glass facade of the bedroom wing (below left). The staircase connecting the living wing with the bedrooms (below right) is the only internal link between volumes. The stairs open into an informal family room flanked by a glazed corridor leading to bedrooms. Wooden joists atop an exposed steel beam stop just short of the glass wall that wraps up into the ceiling plane, visible from a deck off the living room (facing page, top). Flanking the glass strip is a shallow reflecting pool (at right); a short bridge connects the living room to the rooftop terrace above the bedrooms. Inside the loftlike living room (facing page, bottom right) and dining room (facing page, bottom left), Kalach's clearly articulated structural system reveals itself: Load-bearing concrete panels support steel girders with wooden joists.

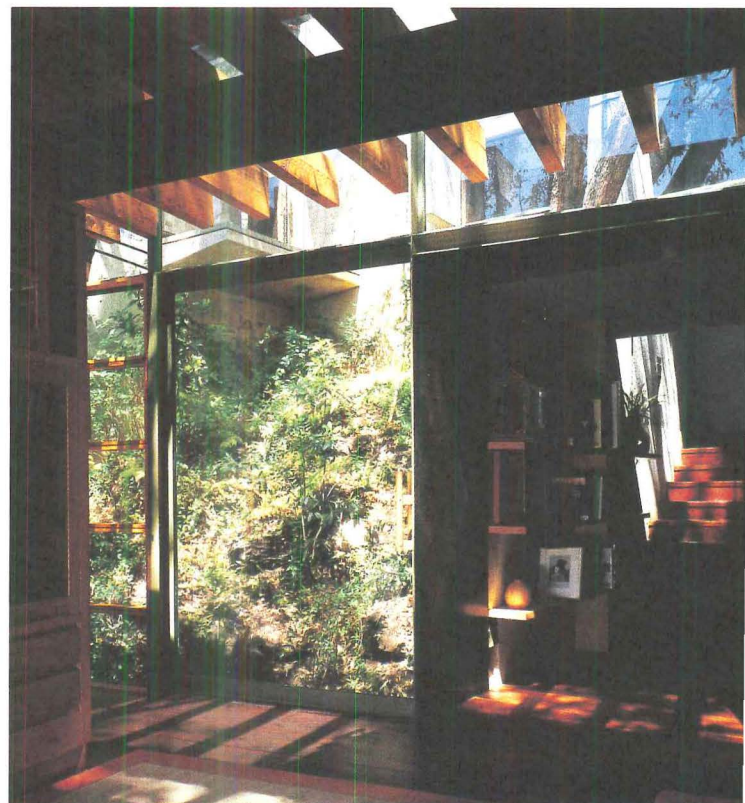
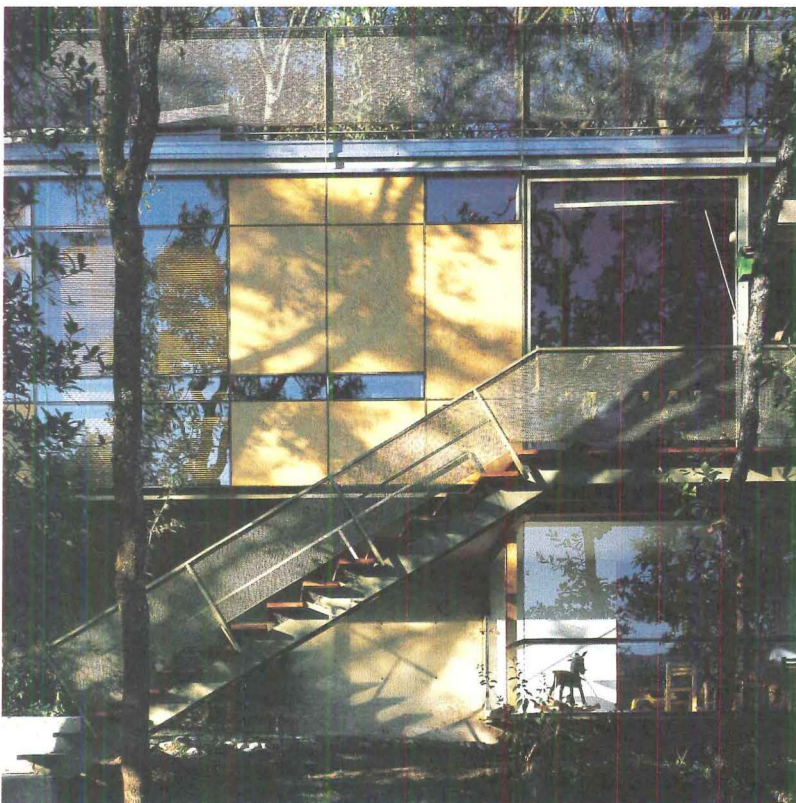





house east

In the Catskill Mountains, Steven Holl reconfigures living patterns.

By Karen Stein

Y-HOUSE, CATSKILLS, NEW YORK

CLIENT: Withheld at owner's request

ARCHITECT: Steven Holl Architects, New York City— Steven Holl (principal); Erik F. Langdalen (project architect); Annette Goderbauer, Brad Kelley, Justin Korhammer, Yoh Hanaoka, Jennifer Lee, Chris McVoy (project team)

ENGINEER: Robert Silman Associates (structural)

CONSULTANT: L'Observatoire International (lighting) **GENERAL CONTRACTOR:** Dick Dougherty

COST: Withheld at owner's request **PHOTOGRAPHER:** Paul Warchol, except as noted

-house

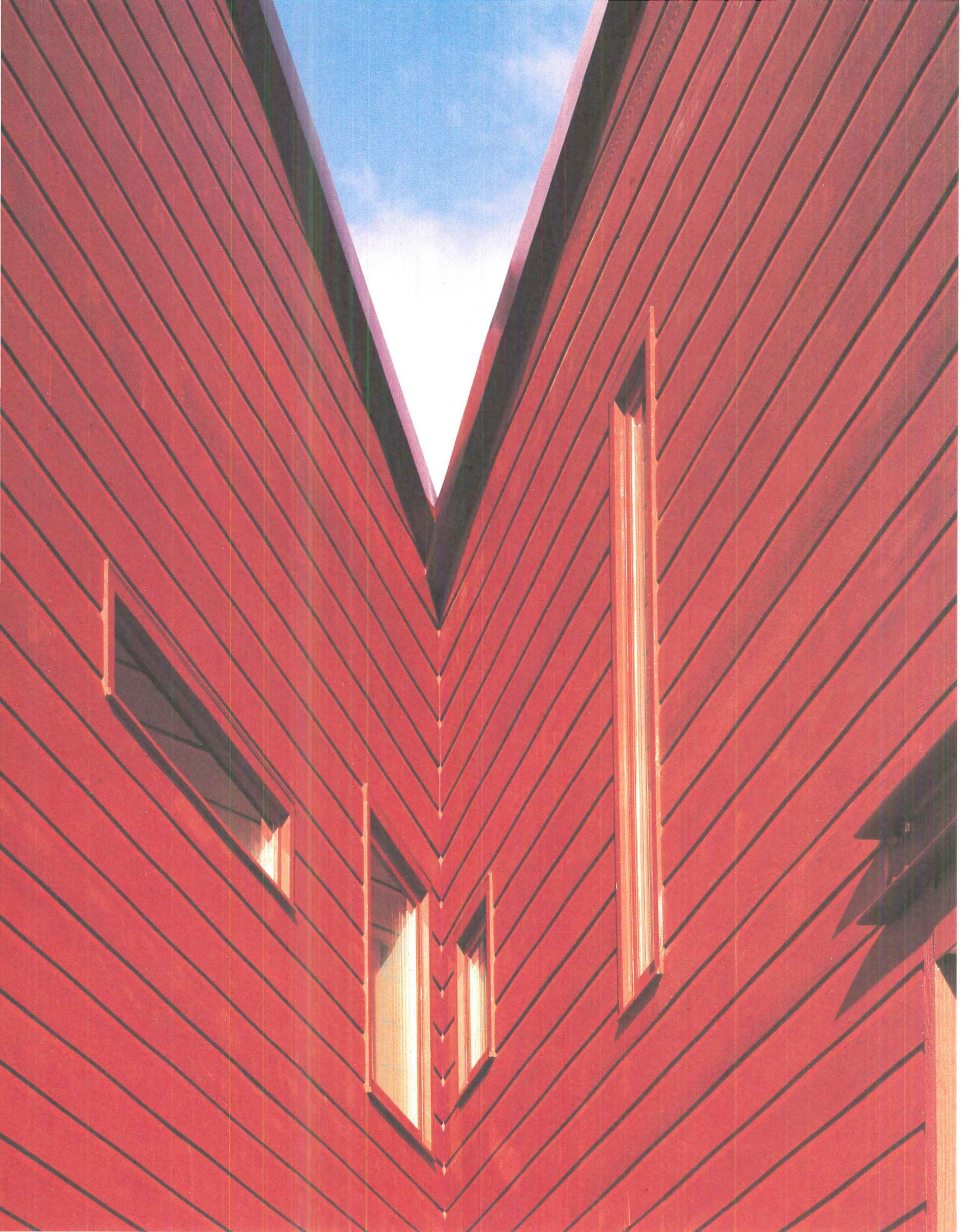

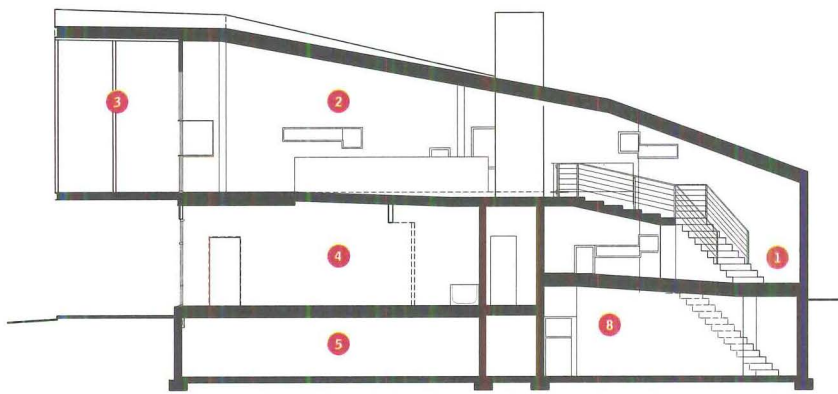

East-west section

- 1 entry foyer
- 2 living room
- 3 terrace
- 4 bedroom
- 5 basement
- 6 master bedroom
- 7 dining room
- 8 wine cellar

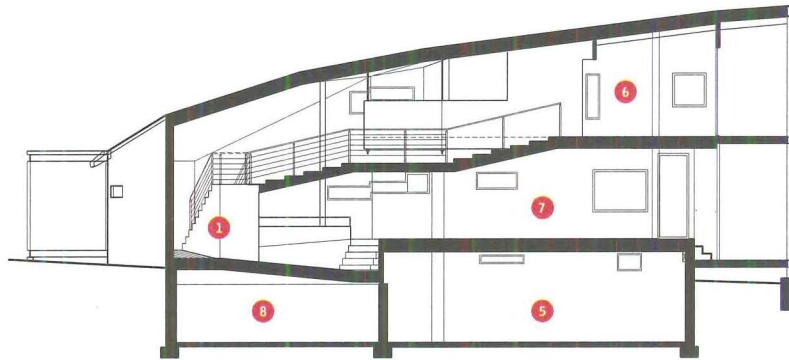

East-west section 7'

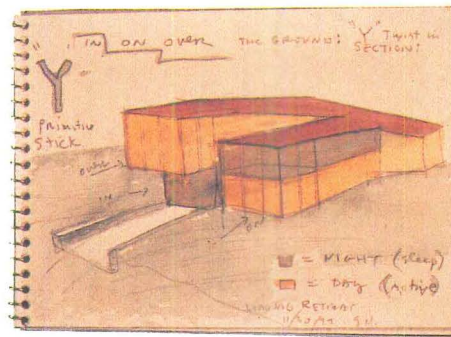

"I could have done anything," says Steven Holl of his design for what he calls the Y-House. Anything, that is, within the project's size limitations—3,500 square feet—and budget constraints (the amount is withheld at the client's request). The house, located in Schoharie County in New York's Catskill Mountains, is a retreat for an Austrian couple and their grown children, who approached the project as if it were an art commission. The family admired Holl's architecture and, in effect, asked him for a piece to add to their existing collection of art and architectural drawings. For Holl, the absence of client interaction in the design process allowed him to quickly gauge his responses to the landscape and proceed with a solution.

Just moments after his first visit to the site, a grassy plateau with commanding mountain vistas, Holl sketched a scheme of conjoined rectangular volumes that split into two branches to accommodate two generations of family members and their communal daytime and separate nighttime activities, while maximizing the views. Holl brought these double-height volumes together in a Y-shaped mass resembling a partially

open zipper; the rows of "teeth" along the inside of the Y serve as circulation, leaving the exteriors open to the views. The peculiar Y form underscores the idea that the two wings stem from a single source; it also emphasizes the diagonal motion across the building section, and allows the house to focus on two slightly offset views of different valleys. Less than two months after his initial sketch, the architect presented a model of this strategy to his client, who immediately accepted the design. "I've never had my first sketch built before," Holl marvels.

Nothing in its surroundings visually prepares you for the unusual form of the house. While its red-painted wood cladding is clearly a nod to the dairy barns that dot neighboring farms, the attenuated forms—elongated by the thin steel members of cantilevered outdoor balconies—and the irregularly patterned windows make it a hybrid of the known and the invented. For Holl, the massing was influenced not by specific houses or vernacular buildings in general, but rather by his response to the contours of the site. "It's not typological, it's topological," the architect emphasizes. Toward that end, the winding



Holl's early sketch of the project (facing page, bottom) and the finished house (above) reveal his clear concept of a split volume. As revealed in sections (facing page, top), Holl located the bedrooms for two generations of family members in separate branches and on separate levels to maximize privacy (below left). On the west-facing ends of the blocks, slender steel members support balconies (facing page, center) facing mountain views. The balconies' horizontal members continue the banding of the painted cedar siding (below center). Seen from the east (below right), the house flares upward and out from its low entry facade.

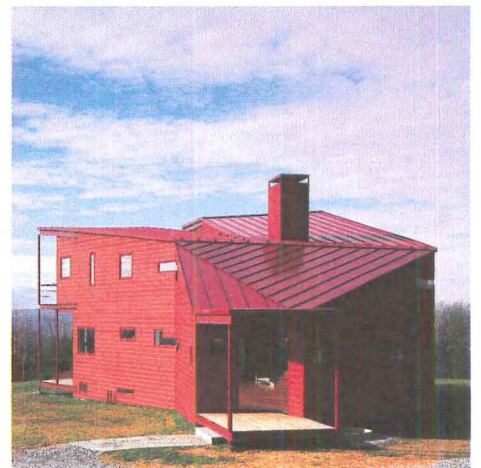
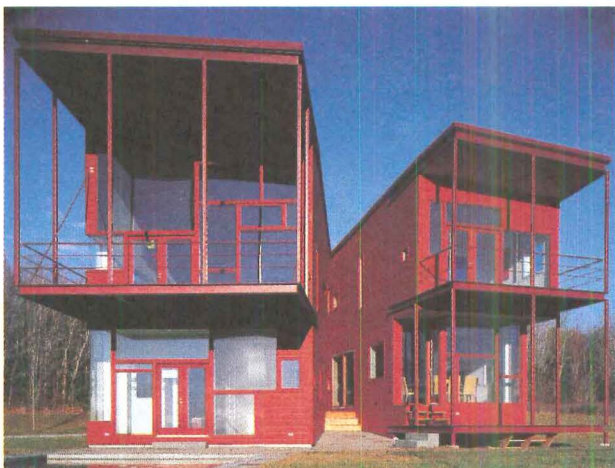

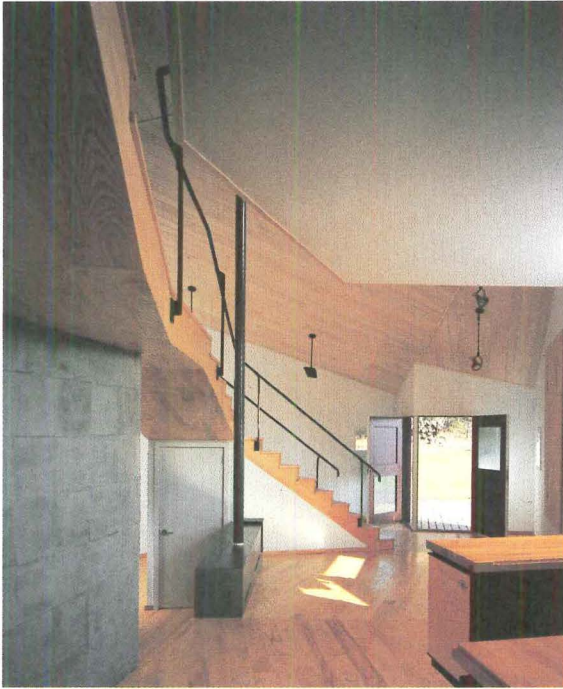

The two branches of the Y are joined by a staircase that generates circulation up, down, and across the house (above right). At left is the kitchen and dining area with the master bedroom suite above, overlooking the entry foyer. As it rises to a second-floor living room, the stair (above left) defines the edge between the two branches of the Y form, like teeth in a zipper. Throughout the house, custom cabinetry—by New York architects and longtime Holl collaborators FACE Design (*Architecture*, May 1999, pages 104–109)—defines the outlines of communal rooms without obstructing views (facing page, top left). The seam between the wings of the house (facing page, top right) expresses itself as splayed walls between the second-floor living room at right and master suite at left, both opening onto expansive window-walls open to views.

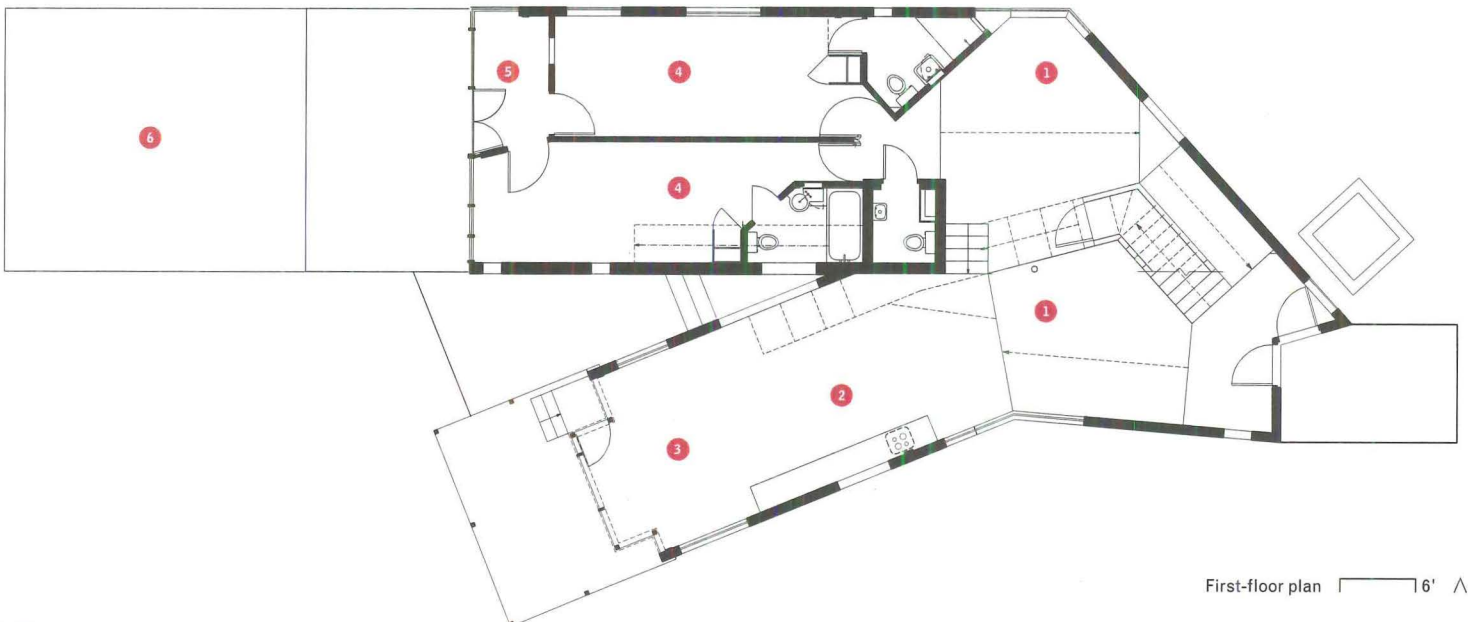
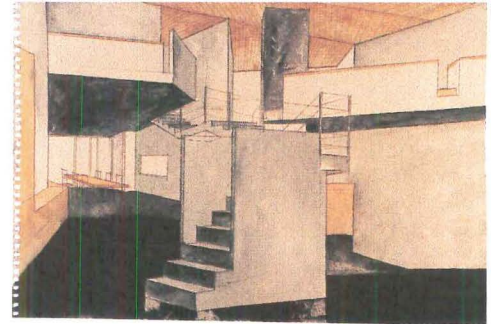

First-floor plan 6' ^



route up densely forested back roads to a clearing on the property is echoed in the house's spatial experience: One moves through it from a confined lower level upward to an airy, column-free space that cantilevers beyond the foundations.

Holl's segregation of the family's two generations into separate volumes with their own "day" and "night," or public and private, spaces was influenced by Marcel Breuer's houses of the 1960s, which have become icons of informal living in their arrangement of overlapping spaces. In Holl's case, separating different activities into zones with distinct daylight and view requirements allowed him to further activate the interiors. The kitchen and adjacent dining room, located on the lower level of the southern branch of the Y, are open to the loftlike living

room on the upper level of the adjacent west-facing branch, allowing for fluid movement up, down, and across the house. Sleeping areas are sheltered: The master bedroom sits behind a study on the upper level of the southern block while children's bedrooms are tucked beneath the living room on the opposite flank, shaded by a balcony off the living room.

Holl describes the overall effect of the interior space as "flying," which is certainly an apt metaphor for how quickly his design progressed from concept to finished product. As a result, perhaps, the house projects a sense of immediacy that belies its unusual form. ■

New York City-based Karen Stein, a former senior editor of Architectural Record, is Editorial Director of Architecture at Phaidon Press.

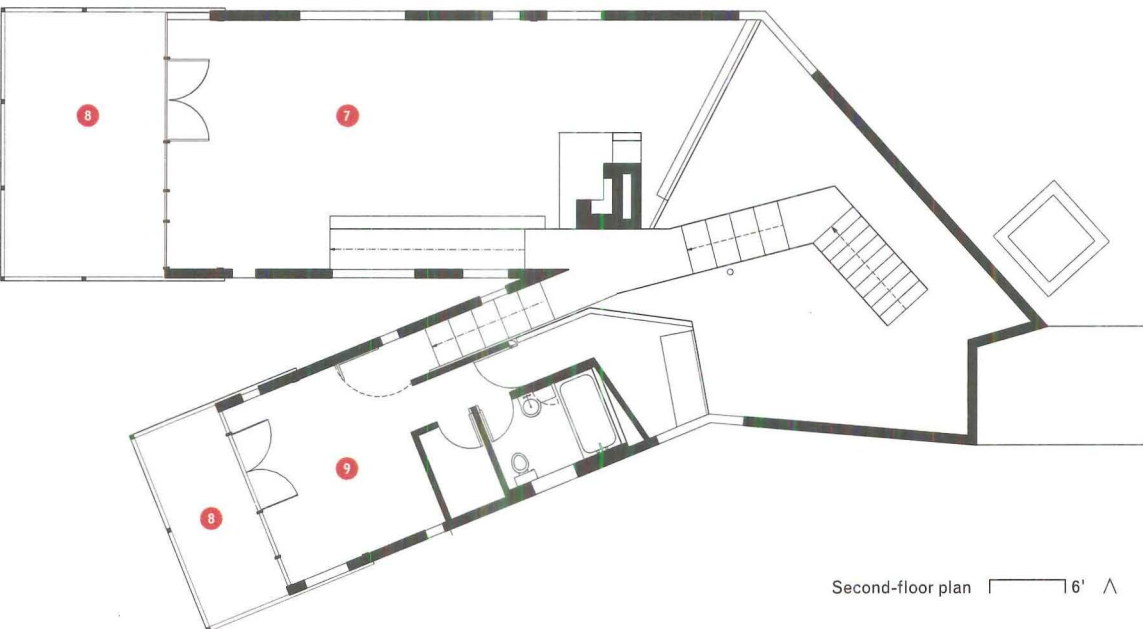

- 1 entry foyer
- 2 kitchen
- 3 dining room
- 4 bedroom
- 5 enclosed porch
- 6 reflecting pool
- 7 living room
- 8 terrace
- 9 master bedroom

Second-floor plan 16' ^



A glass house by Anne Fougeron emphasizes modernism's sensual side

440 RESIDENCE, PALO ALTO, CALIFORNIA

CLIENT: Withheld at owner's request **ARCHITECT:** Fougeron Architecture, San Francisco—Anne Fougeron (principal); Russell Sherman (project architect); Cathleen Chua Schulte, Addison Strong, Christine Keisling, Elizabeth Garcia, Todd Aranz (design team)

LANDSCAPE ARCHITECT: Topher Delaney **ENGINEER:** Endres Ware Consulting Engineers (structural)

GENERAL CONTRACTOR: Young & Burton **COST:** Withheld at owner's request **PHOTOGRAPHER:** Richard Barnes

By Aaron Betsky

A new house in Palo Alto, California, by San Francisco architect Anne Fougeron is a study in luscious surfaces. Its facade boasts French limestone, steel, glass, and cedar slats. The main staircase has sandblasted glass treads and moves along a structural glass wall made of self-supporting channels. The floor that extends into the house from the entry path and out again into the backyard is black polished granite; the upstairs floors are finished in a hardwood called garrah. The living room sports pear wood and plaster walls that are hand-rubbed to a satiny texture. The steel-fronted cabinets in the kitchen have a spidery angel-hair finish. Every surface, in other words, is luxurious. "We went completely over the edge with the finishes and the details," admits Fougeron. "We did full-scale mock-ups of everything, chose the most sensual finishes, and hid all the connections. It was insane, but the client wouldn't stand for anything less than perfection." The result is a house that is minimal in form and maximal in surface. "It's modern, but tactile and crafted," says Fougeron.

Given these conditions, it's surprising that the house does not appear as a collection of planes sliding past each other, as one might expect from a modern home that pays such close attention to the skin of things. Instead, in Fougeron's view, it is made up of "different masses with their corners eroded that come together into an open composition." The house is fluid and permeable, yet monumental. "The clients wanted this place to look like it was going to last, because they intend to stay here until they die," Fougeron explains. This is monumentality without references to chateaux or palaces.



Red-granite entry walk (above) extends past the French limestone-clad guest bedroom and office at left, into the soaring glass-enclosed family room, and outside again, defining a paved terrace (below). Flanking the entry path is a garden of pebbles and crushed glass bits. The rear facade (below) reveals the kitchen to the left of the family room, with the master bedroom above, and an exercise room to the right with an office above.





A custom glass curtain wall shaded by a steel brise-soleil encloses the house's rear facade (above). The glazed volume enclosing the circulation spine (see sidebar, facing page) projects beyond the patio facade, revealing the structure of load-bearing glass channels. The architect leaves all joints between manmade materials exposed, as with the steel frame and C-shaped channel glass.

Detailing the Channel Glass

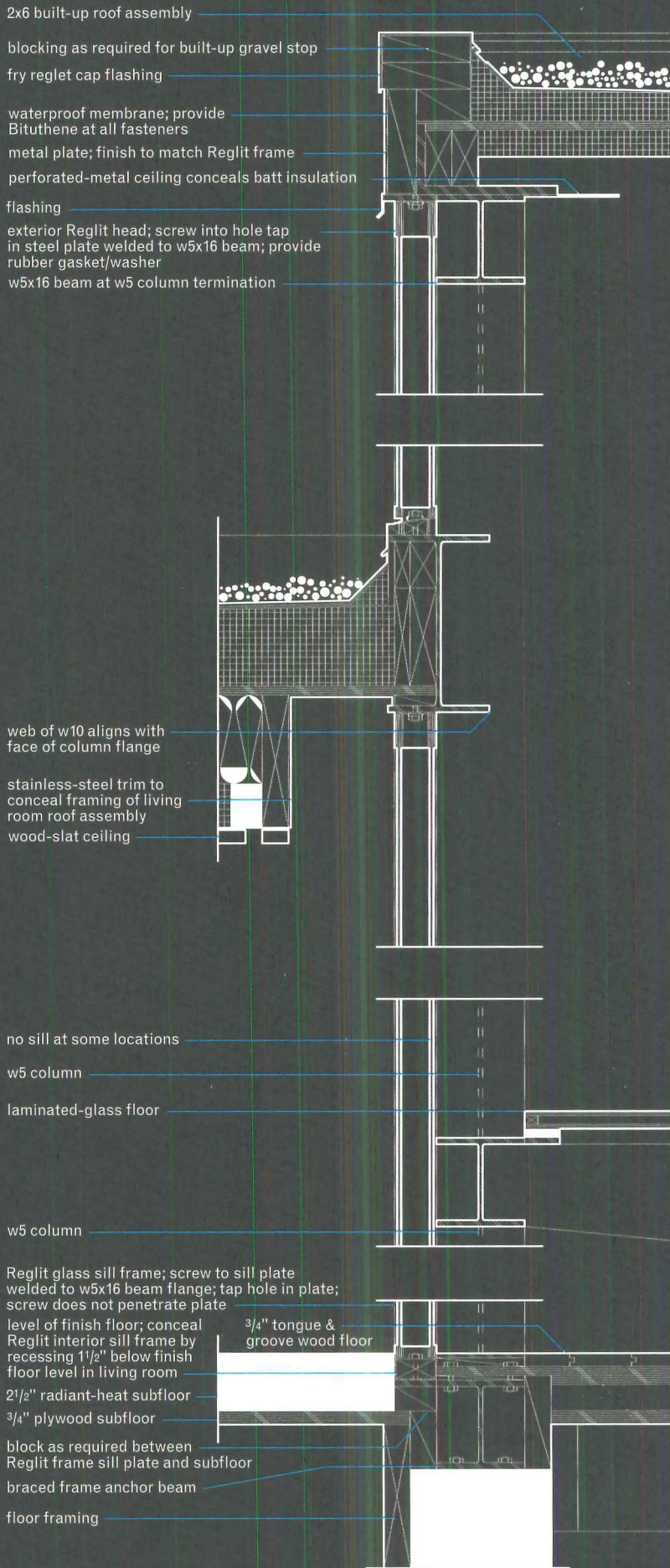

Architect Anne Fougeron was looking for a glass to enclose the house's stair tower that would give the stairs a soft light without being transparent; did not have too many mullions; and could be used indoors and outdoors, since the stairs penetrated the house's skin. The architect chose Reglit, a channel-glass cladding system—also known as Profilite—that has been manufactured in Germany since the 1920s and is now distributed by the British company Pennington. "I first saw the product in a magazine article on a low-income housing project in Australia," Fougeron recalls, "and knew it was going to be right for this house."

The self-supporting, C-shaped channels are held in an aluminum peripheral clip that comes in lengths of up to 15 feet. The outer surface of the glass is cast to give it a milky appearance, but with the green tint found in the skins of so many classic modernist buildings. In detailing the stair volume, Fougeron doubled the C-channels, overlapping them to create a double-walled glass construction with added depth and a higher insulating value than a single layer of glass channels. She cut the glass on-site, diagonally, so each channel lines up seamlessly with the stair stringer. *A.B.*

Section through glass wall 4'

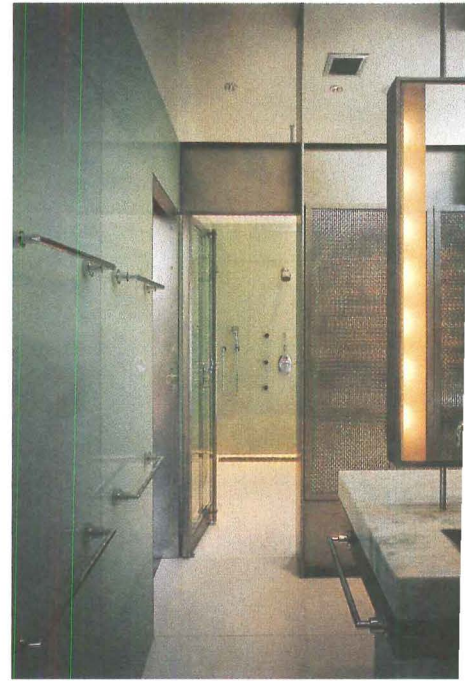
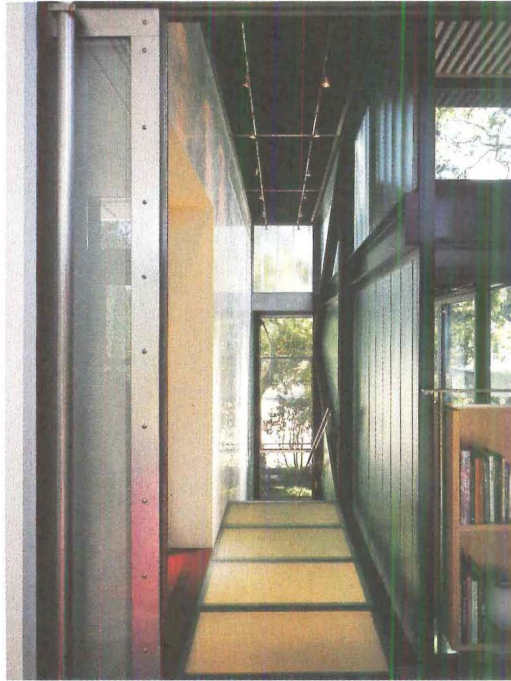
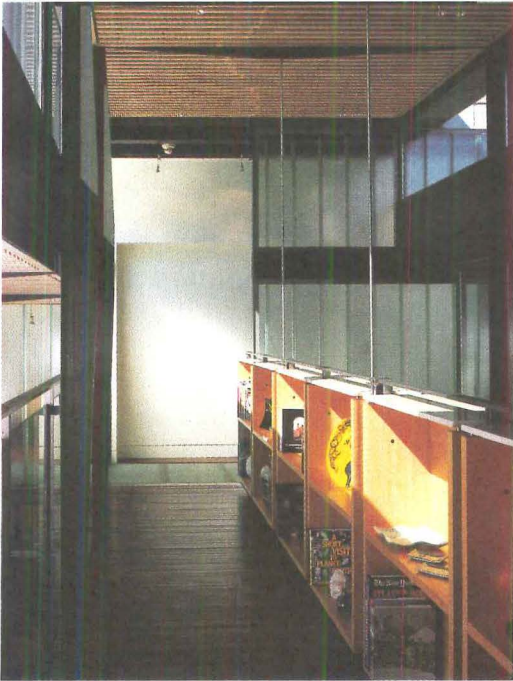

Top, left to right: A limestone-wrapped fireplace separates the soaring family room from the dining room; a glass bridge on the second floor overlooks the living room; seen from beneath the bridge, the glass stair volume extends beyond the entrance doors. Above, left to right: Bookshelves line the bridge connecting the master bedroom with an office and exercise room; the glass walkway extends into the glass stair volume; in the master bathroom, materials include white marble, Panama granite, woven metal, and glass. The channel wall extends into the house, partially screening the dining room with a diaphanous glass veil.

The architect's enthusiastic response to the project has much to do with the fact that this is her first major residential project. The house is sited within the footprint of an existing one-story "ranchburger" on a constricted lot in Palo Alto. The technology boom has driven real-estate prices in this community into the stratosphere, while the city and neighborhood groups have fought attempts to "mansionize" what land is still available. Fougerson's clients wanted a mansion—without looking like one. "We weren't interested in faux chateaux," says the wife. "We wanted something pure and modern." The architect explains that the client wanted to "go up and out, making a house that was as big and open to the outside as possible." She managed to convince the city that the design was a remodel by keeping to the footprint of the existing house—but gutting it, opening up its geometry, and extruding it up to two stories.

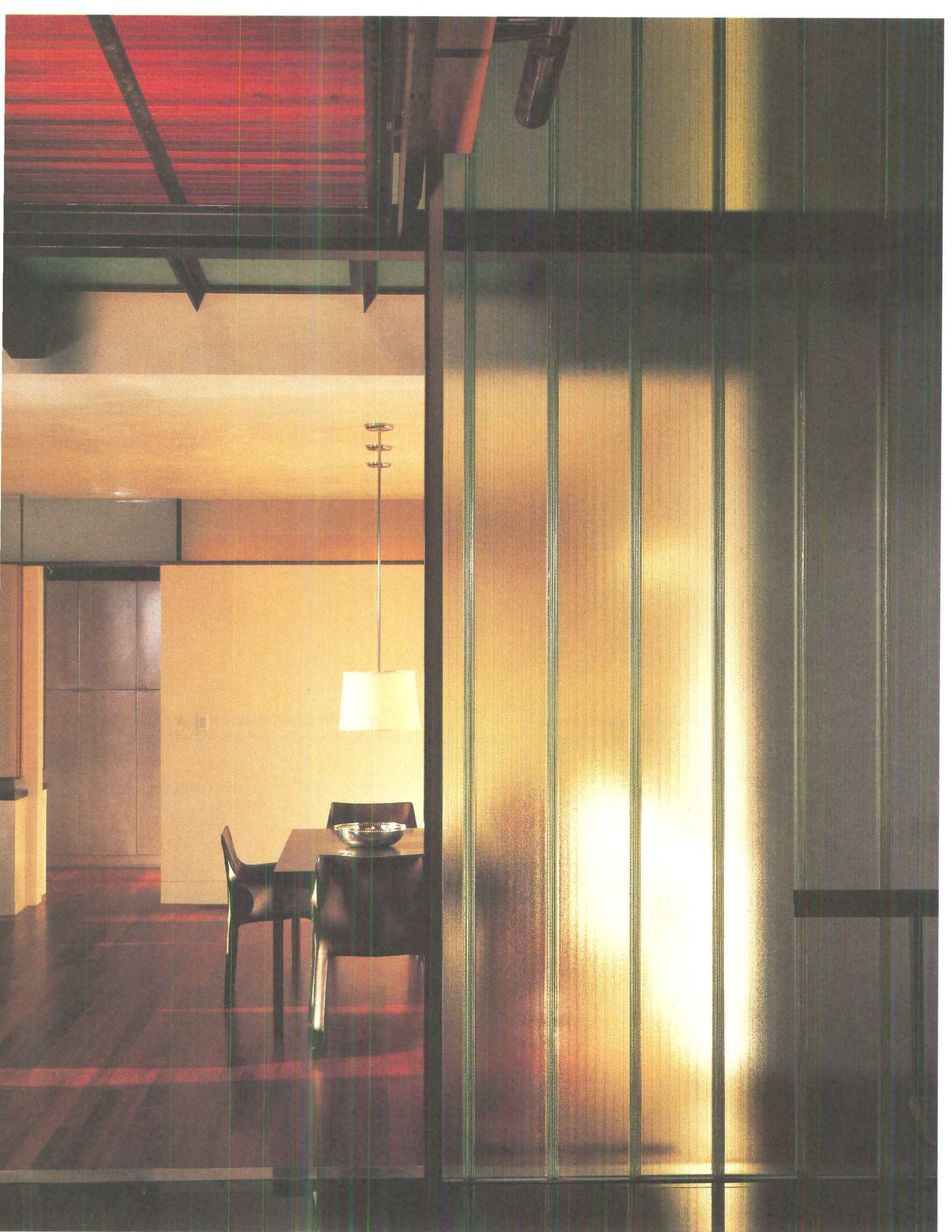

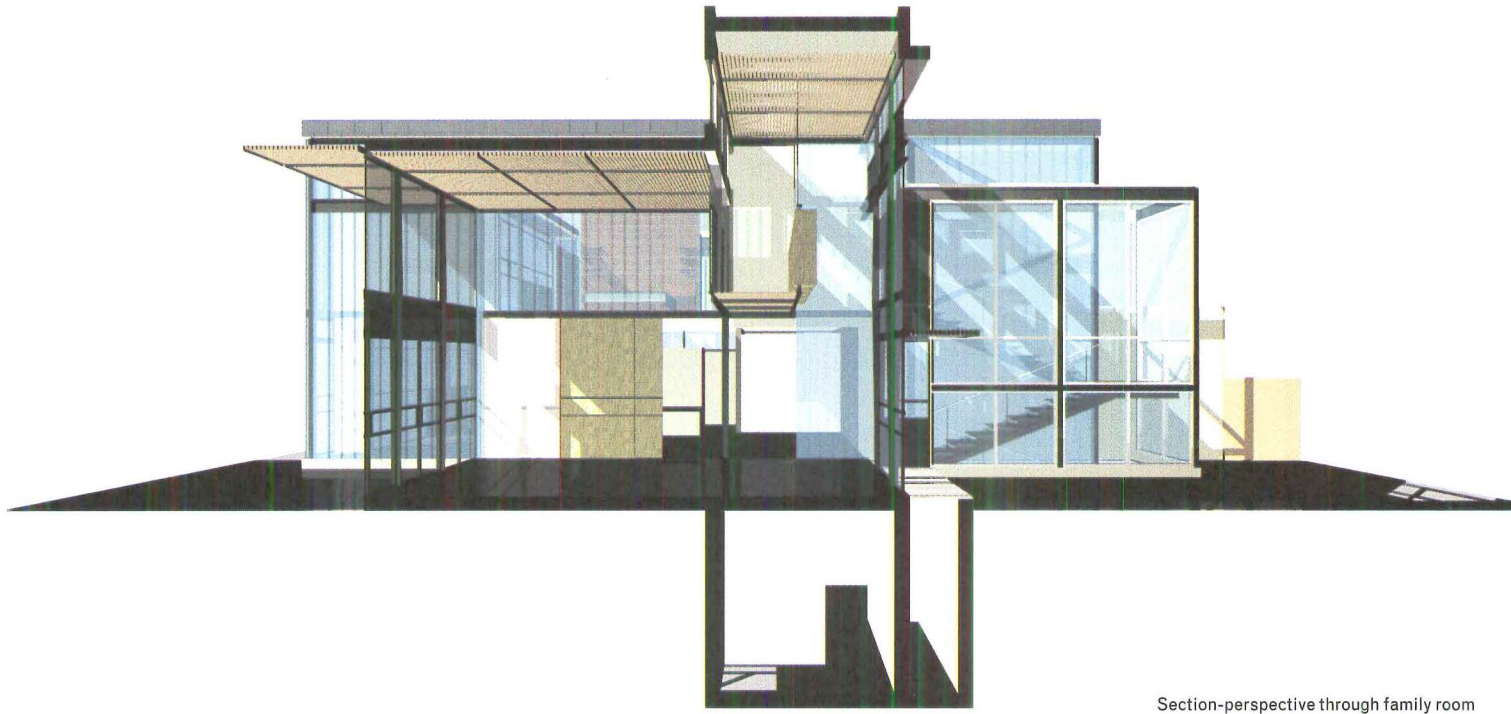

Section-perspective through family room



Section-perspective through stair tower

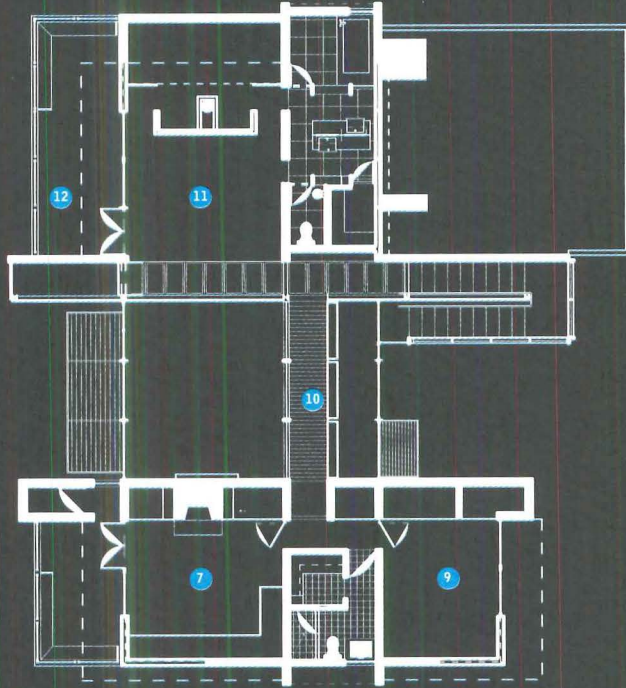

- 1 entrance
- 2 family room
- 3 living room
- 4 dining room
- 5 kitchen
- 6 garage
- 7 office
- 8 guest room
- 9 exercise room
- 10 bridge
- 11 main bedroom
- 12 deck

Second-floor plan

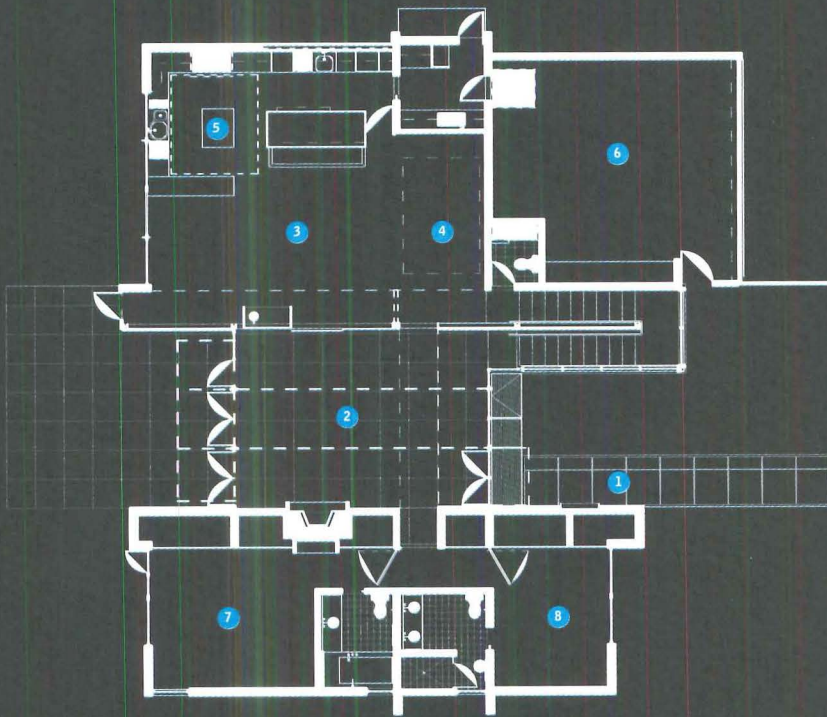

First-floor plan 17' >

Debut	Fougeron Architecture	San Francisco
	<p>"I started my own office because I was interested in housing," says Anne Fougeron of the five-person firm she founded in 1986. Fougeron, who was born and raised in Paris, emigrated to the United States to attend Wellesley College and later received an architecture degree from the University of California, Berkeley. After graduation, she spent five years working for Bay Area housing specialist Dan Solomon. Since founding her own firm, she has developed "a bit of a split practice," concentrating on both residential and medical projects. "We do a lot of work for Planned Parenthood, which is our favorite client because of their political and social agenda," she explains. Her work for the organization has led to other hospital projects, but Fougeron plans on expanding her portfolio with more residential projects. <i>A.B.</i></p>	

Flanking the entrance path, a steel-and-glass cage encloses the stairs that wrap around the channel-glass wall. A series of operable stainless steel-mesh panels screen the bays of the outermost enclosure, adding another layer to the composition of clear and translucent skins.

Fougeron's clients desired as much space as possible. These two professionals with no children each needed a study in addition to an ample master bedroom suite and an exercise room. A guest bedroom, wine cellar, and plenty of room to entertain filled out the requirements for the 5,000-square-foot house. Fougeron gave them that space in two closed wings sliding past a central living space. Like the grandest of homes, this one is organized around a great hall—a two-story living room that opens to the street-side entrance foyer and the garden in the rear and also bleeds into the dining and kitchen area. The only thing that defines the living room, beyond the limestone fireplace wall, is an exposed cage of structural steel.

Circulation takes place through this exposed moment frame that intersects the central living space, creating a web of slender steel members that stand against the solidity of the finished walls that define the bedrooms. Against this network of open space and structure, the southern wing—containing the two studies, exercise room, and guest bedroom—appears as a block of discrete spaces. The master bedroom suite occupies the entire second floor of the north wing, with the kitchen, dining area, and garage on the ground floor.

Fougeron makes no clear distinctions between programmatic zones and structure. The steel moment frame appears in the main living spaces and again in the master bedroom. The circulation wing continues beyond the bedrooms, breaking any sense of symmetry. "We wanted regularity without symmetry," says the husband. Program, space, and form bleed both laterally and vertically, and the eye follows a hopscotch of forms. Finishes are what hold the composition together.

Fougeron has figured out how to make a mansion that it is not monumental, a grand house that is not static, and a collection of skins that do not seem draped on some invisible structure. Her loose yet complex composition makes for a livable piece of strong, self-conscious architecture. This is a house that gives us the modern mansion as a box full of space—the greatest luxury of all—and beautiful materials. What stands out most in this environment is the body as it mirrors itself in the walls past which it moves, and to which the architect has given a sense of solidity and composition. In a sterile, digitized world, devoid of tactile experiences, this is a house for the lush life. ■



The Biggest GlobalShop Expo & Conference Ever!

5 Shows in 1 • 1,200+ Exhibits • 200+ New Exhibitors
 40+ Educational Seminars • "Stores of the Future" Centerpiece
 "100 Years of Store Design" Gallery • 1,000,000+ sq. ft. of Show
 420,000+ net sq. ft. of Exhibits

GLOBALSHOP®

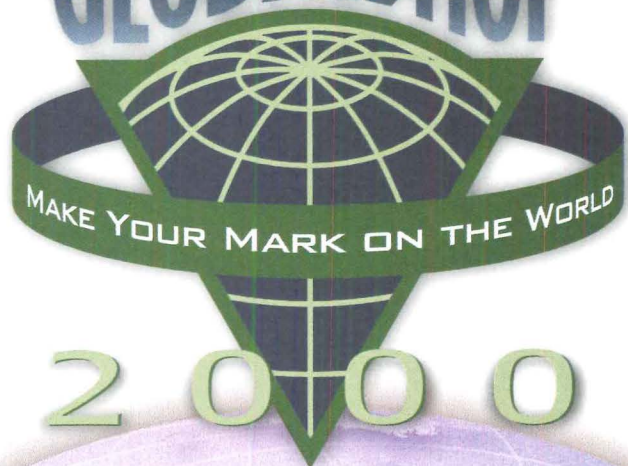

SPONSORED BY

nasfm

NATIONAL ASSOCIATION OF STORE FIXTURE MANUFACTURERS

Where retailers, store designers/planners, brand marketers, and architects go for resources and concepts to create sales-enhancing retail environments.

McCormick Place • Chicago
 March 25-27, 2000

Register Today!

Visit www.globalshop.org to register online

For more information call the FAX-back line at 1-800-646-0091, toll-free 1-877-835-7236, or international callers 703-318-0300. For discount travel and hotel accommodations, call 1-800-508-8000. Circle 71 on information card

From new store construction to chainwide renovation and maintenance — find your solutions here!

GlobalShop includes:

Retail Operations & Construction Expo®
 SPECIALIZED MATERIALS, PRODUCTS AND SERVICES

SPONSORED BY

RCA
RETAIL CONTRACTORS ASSOCIATION

Retail Operations & Construction Expo is your most important source for the products, services, systems, and expertise to make better planning and purchasing decisions for your stores.

All retail architects, store planners, construction professionals, retail contractors, and facilities and operations managers must attend GlobalShop this year!

It's here you'll find the latest resources for retail planning, construction, renovation, facilities management, and preventive maintenance — everything you need to achieve more efficient and productive retail environments.

Stores that stand apart get their edge here.

FREE

exhibit hall admission
 (\$35 value)
 and seminar discounts
 if you register by February 26, 2000!

GLOBALSHOP 2000 INCLUDES:

The **Store Fixturing Show**
 The Exhibition & Conference For The Retail Design Professional

SPONSORED BY

nasfm

The **Visual Merchandising Show**
 Tradeshow & Seminars for Visual Merchandisers

SPONSORED BY

NADI
 National Association of Display Industries, Inc.

Retail Operations & Construction Expo
 SPECIALIZED MATERIALS, PRODUCTS AND SERVICES

SPONSORED BY

RCA

3
 In-store Interactive Ideas

SPONSORED BY

nasfm POPAI

Now part of GlobalShop!
POP MARKETPLACE

SPONSORED BY

POPAI

Plus, 2000's exciting centerpiece

STORES OF THE FUTURE

AND
100 YEARS OF STORE DESIGN

It's Livability, Stupid

continued from page 39

group. "We feel they're most appropriately handled by planning commissions and zoning boards in partnership with business." Forty percent of state legislative officials surveyed by the AIA agree that the federal government should play no role.

On the other hand, Gore backers claim that decades of federal subsidies pushed development on the fringes of central cities, so it's only right that Uncle Sam should enlist in the fight to solve sprawl, preserve open space, and promote smart growth. Livability advocates were perturbed by an 11-month

report issued last April by the General Accounting Office (GAO), the research arm of Congress, which found scant evidence that federal policies encourage sprawl. Senators Carl Levin (D-Michigan) and James Jeffords (R-Vermont) asked the GAO to prepare a second, more detailed report due by the end of July. "Nobody who has looked at the urban landscape over the past 20 years can escape the fact that the federal government has sadly contributed to its deterioration," says Rep. Earl Blumenauer (D-Oregon). "It tilted the playing field in favor of new development. Massive investments such as federal highway programs dropped down on communities without any consideration for their local effect."

In any case, the Republican spin has made it hard for candidates to push intrusive big-government solutions. "It's had a chilling effect," says Debra Knopman, director of the Pro-

gressive Policy Institute's Center for Innovation and the Environment. "They've tempered Gore's inclination to talk about livability. And other candidates are now less likely to ride the bandwagon."

"Nobody who has looked at the urban landscape can escape the fact that the federal government has sadly contributed to its deterioration."

gressive Policy Institute's Center for Innovation and the Environment. "They've tempered Gore's inclination to talk about livability. And other candidates are now less likely to ride the bandwagon."

The AIA's Jim Dinegar has lobbied the League of Women Voters to include livability questions in

one voice can't generate the kind of spirited debate that captures public attention. "It's hard to have a food fight when there's no one else in the room," says Sierra Club executive director Carl Pope. "The Republicans know the best way to make the issue disappear is not to engage in it." ■

Amazing Architectural Opportunity

Why work in an architectural firm as one of many when you could work for an individual patron? This sensational opportunity is for someone who has creativity and refinement with a minimum of 5 years of luxury house building experience. This full time position is to design and build and oversee 3 extraordinary and unique residences in 3 diverse and challenging environments. Each project is over 30,000 square feet.

**Please fax resume to Ms. Galindo at
212-371-8042.**

Circle 75 on information card

THE UNIVERSITY OF TENNESSEE: Assistant or Associate Professor Interior Design Program Tenure-Track Design Faculty Positions

THE UNIVERSITY OF TENNESSEE, KNOXVILLE — The College of Architecture and Design seeks candidates for at least one anticipated full-time tenure track position in the Interior Design Program, at either the Assistant or Associate Professor rank, commencing Fall 2000. Candidates should be qualified to teach design studios at all levels in the professionally accredited undergraduate program. Additional teaching should be related to curricular areas such as furniture design, textiles, lighting, materials, color theory, computing, or professional practice. Prior to appointment, applicants should possess a Master's degree in Interior Design, or a related field (e.g., M.S., M.F.A., or M. Arch). At least one degree must be in Interior Design from an accredited program. NCIDO certification or eligibility for certification preferred. Substantial teaching experience is valued. Experience in distinguished practice is desirable. Candidates are expected to pursue self-defined intellectual objectives through teaching, research, scholarship, creative work, and service, leading to concrete, recognized accomplishments.

Candidates should submit a letter of interest and objectives, a curriculum vitae, photocopied select examples of design work (non-returnable), and the names of three references by February 15, 2000 to: Chair, Interior Design Search Committee, Interior Design Program, The University of Tennessee, 217 Art and Architecture Building, Knoxville, TN 37996-2400. Applications will be accepted until the position(s) is (are) filled.

U T Knoxville is an EEO/AA/Title VI/Title IX/Section 504/ADA/ADEA institution in the provision of its education and employment programs and services.

21st-Century Alchemist

continued from page 44

The most obvious problem was combustibility. The NMEC regulations stated that exhibit surfaces cannot be made of flammable materials. Barker conducted a variety of fire tests—including surface and furnace certified tests—on a typical hollow column (14 inches in diameter and one-half inch thick) varnished with intumescent paint (a compound that expands into a fire-resistant foam when exposed to extreme heat). The column scorched and smoldered a bit but never caught fire. Consequently, the material received a 90-minute rating.

Each column is spun from 32 layers of paperboard. Using pulp made from the donated scraps, the manufacturer added longer fibers from industrial-grade recycled cardboard for strength. Humidity levels within the dome fluctuate, so the cardboard had to be treated to resist moisture for at least one year. The third layer from the exterior

of each is a polymer that acts as a vapor barrier. Strength in compression of a cardboard column is not unlike that of wood, as both are made of cellulose, so structural engineers at Buro Happold determined load capacity in a way similar to how they would for a timber column.

From both the cardboard and GRP experiments, it is clear that Barker's solutions are evolutionary rather than revolutionary, meaning that his innovations are more likely to evolve from tweaking the chemistry of an existing material or transferring the technology of one industry to another. Like an alchemist spinning base materials into gold, Barker works his magic in messy trial-and-error experiments performed in a workshop and has documented his syndetic method in a new book, *b is for building*, published this month by O'Mahony Press (London). In a future issue, *Architecture* will report on how Barker is evolving his clever one-offs for the Millennium Dome into cost-effective and sustainable building products for the rest of the world. ■

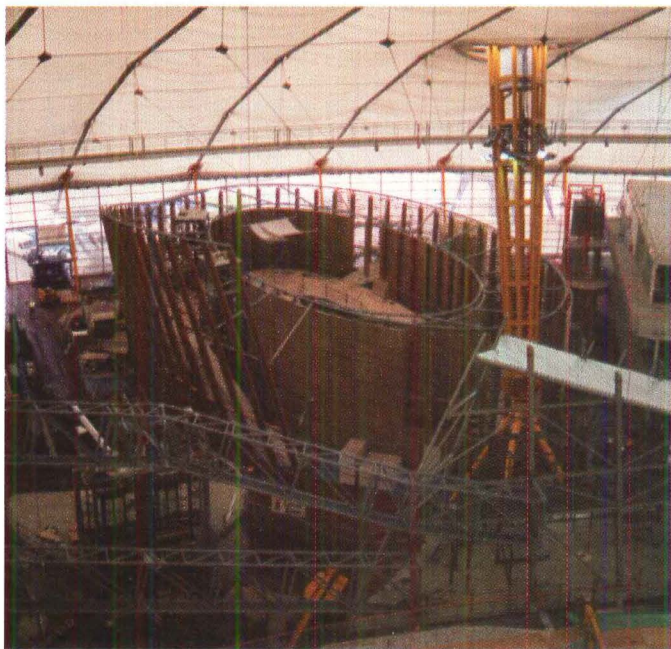

The Shared Ground zone's cardboard structure nears completion.

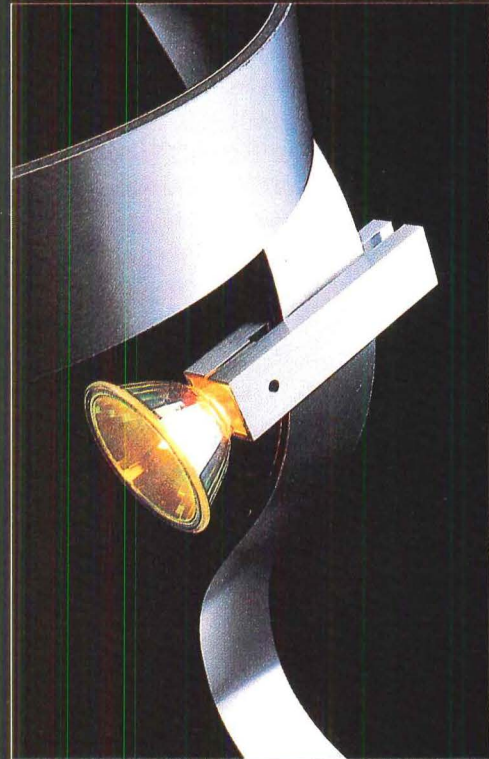

idl

Industry & Design Light

BERLIN • MUNICH • MINNEAPOLIS

fon 612-673-9213

fax 612-673-9217

lightfair 1998 • booth no. 2050

Circle 73 on information card

the many colors of accountability

BASF CONTRACT NYLON FIBERS

At BASF, we don't make the carpet, we make it better.

We make it better with the finest premium branded nylon fiber systems available.

We make it better with the finest pigmentation process and color direction in the contract marketplace.

We make it better with a dedication and resolve to keep it from our landfills.

And above all, we make it better by standing behind it with the contract floorcovering industry's most meaningful warranty.

No rhetoric: just 10 years of absolute accountability. Now that's better.

We don't make the carpet. We make it better.®



Circle 77 on information card

BASF

The Drugstore Invasion

continued from page 52

1998 annual report, "we won't take it just to be there. For example, we have a pin on the map for Paducah, Kentucky. There's only one intersection where we want to go. We might have to wait several years, but we're not going to Paducah unless we can be on that corner."

Walgreen has pioneered this "prominent corner" approach with great success. The company is putting up buildings in these new locations that are generally larger than their strip mall stores, with average square footage of about 14,000. Relying on a rigid formula

that combines roomier floor plans with conspicuous downtown locations and parking lots oversized enough to be invitingly half-empty at even the busiest hour, Walgreen earns the largest drugstore revenues in the nation—with only the third-most outlets. The other chains have followed its lead.

"The problem, of course, is that those corners tend to be occupied already—and occupied by distinctive historic buildings," says Anne Stillman, author of *Better Models for Chain Drugstores*, a booklet published by the National Trust. She suggests that many of the towns that have welcomed new drugstores are blinded by a desire to rebuild their commercial cores at any cost. "Certainly towns want economic development; it's only

natural," she says. "But they shouldn't have to forfeit their community character for it."

Jeffrey Harris, program associate in the Northeast office of the National Trust, agrees: "What we're saying is that communities need to realize they have a choice, they can control this growth, and they can take steps to ensure that these stores come in on [the communities'] terms."

In a sense, the chain-store explosion—and the way some civic leaders have embraced it—represents a second wave of urban renewal, one that targets towns and small cities instead of population centers. Then as now, buildings from the late 19th and early 20th centuries were picked for demolition because they were

said to be decrepit roadblocks in the way of economic growth. The new architecture may have a more benign face this time around, but the language used to justify leveling older buildings to revive struggling neighborhoods hasn't changed in 25 years.

The words of Shamokin's code enforcement officer, Michael Templar, who oversaw the demolition of the Victoria Theatre, ring like an echo of classic urban-renewal thinking. "This is a blessing," he told Shamokin's local paper, the *News-Item*. "It's sad to see a landmark being torn down, but that building has been in deplorable condition for quite some time and needs to be demolished because it has become a health *continued on page 157*

Discover the New World of code uniformity with the 2000 International Codes

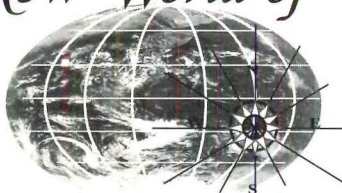

The *International Codes*, are a complete family of coordinated, comprehensive codes, which include: *Building, Fire, Residential, Plumbing, Mechanical, Fuel Gas, Private Sewage Disposal, Property Maintenance, Energy Conservation, Zoning and Electrical*. You can purchase the *2000 International Codes* individually, or save money with our specially priced *International Code Book Bundles*.

Call BOCA toll-free

1-800-214-4321, ext. 768

To see all of BOCA's products and services, visit our web site at www.bocai.org



Photograph by Timothy White



Which one would you choose?

The elephants? The whales? The clean air we breathe? Maybe the choice isn't so clear. Maybe you'd like a way to keep them all. Now the world's leading environmental groups are working together. To find out how you can help, look for us at www.earthshare.org.

One environment. One simple way to care for it.



Earth Share

The Drugstore Invasion

continued from page 156

hazard and an eyesore in the community."

The threat posed by drugstores may be peaking, according to some observers. Chastened by a glut of drugstores in some regions, falling stock prices, and the rise of online pharmacies, the leading chains are beginning to implement slightly more modest expansion plans. But other chains are ready to pick up the ambitious pace—most notably 24-hour convenience stores such as Wawa, which is expanding rapidly into older downtown Main Streets. What's the best way for towns to

protect their older buildings? The key, says Stillman, is to have zoning protections on the books before a chain decides to build. "It's sometimes possible to obtain a better design through negotiation, but it absolutely cannot be counted on," she says.

Rite Aid, for one, confirms that it has modified its approach. "Because of our negotiations with the National Trust," Jody Cook says, "it is now our policy not to demolish any buildings that are listed on the National Register."

Back in Shamokin, those words are little comfort to Burd, who seems reluctant to let go of his memories of the Victoria Theatre. When I visited Pennsylvania at the end of the summer, he drove me out to his house, which is in Coal

Township, just across the Shamokin border, to show me some architectural remnants he managed to pull from the theater's wreckage. Atop a plastic picnic table in his backyard, he carefully peeled back two blankets to reveal a large piece of cracked terracotta ornament from the building's facade. He also showed me shards of the large wooden letters that once spelled out "Victoria Theatre" across the top of the building.

Talking to Burd, it's impossible not to wonder how this effort wound up falling to him. What about the town's older residents, those who remember the theater in its heyday, who saw Ray Bolger or Pablo Casals perform on its stage, or witnessed the celluloid

images of early film stars flickering across its huge screen? When we returned downtown to the old Victoria Theatre site, soon to be paved over to create a parking lot, I asked him that question. "For these older folks," he said, "the town was at its height when they were young, and it's been slowly downhill ever since. They've seen so much deterioration around here that they saw the theater as just another eyesore." His foot poked at the rubble still filling the lot. "But to me that theater was the nicest thing in this town—probably the nicest thing that ever will be in this town." ■

Brooklyn-based Christopher Hawthorne writes frequently about architecture and design.

157

We Stand Behind Our Products

Polygal Polycarbonate Sheet is your logical choice for outdoor and indoor glazing and covering applications requiring light weight, exceptional strength, maximum light transmission, outstanding insulation characteristics and fire safety.

We offer the widest product range in the industry, including double- and triple-wall construction configurations from 4mm (5/32") to 25mm (1") . . . two styles of corrugated sheet . . . flat sheet . . . a proprietary line of custom profiles to join, cap and trim panels . . . all in a variety of standard and custom sizes and colors . . . *all backed by standard-setting performance warranties*!*

For more information, contact your POLYGAL Distributor, call 1-800-537-0095, or visit us on the web at www.polygalusa.com

**Warranty details available upon request*

POLYGAL®
The Leading Supplier
of Quality Glazing
Alternatives Since 1983

Circle 81 on information card

PASS THE BAR!

get

Archiflash®

- PRE-DESIGN**
"Makes studying fun."
- SITE PLANNING REVIEW**
"I love them."
- LATERAL FORCES**
"Very educational tool."
- GENERAL STRUCTURES**
"Helped me pass the first time!"
- MECHANICAL SYSTEMS**
"The cards are great."
- MATERIALS & METHODS**
"Straight forward, easy to use."
- CONSTRUCTION DOCUMENTS**

3rd Edition
OVER 1,100 CARDS

Prepare for the computerized Architect Registration Exam with Archiflash®. Each set contains over 1,100 expertly written flashcards covering all six multiple choice tests, plus a review section on Site Planning. Learning is easy with timesaving charts, essential definitions, concise diagrams, true-false and multiple choice Q & A. More info than you ever thought possible in an easy-to-use flashcard format. **COMPLETE SET ONLY \$89.95**

Individual sections available for \$21.50 each + S&H.

www.archiflash.com
1 800 411 7314

Circle 83 on information card

B E L D E N B R I C K



**DIVERSITY AND
VERSATILITY AT WORK.**

BELDEN
THE BELDEN BRICK COMPANY

Canton, Ohio 44701-0910
<http://www.beldenbrick.com>

AN ISO 9002 REGISTERED COMPANY

Circle 85 on information card

ZERO[®] *Panels*

Design: De Pas, D'Urbino, Lomazzi
Cameo Carlo Poggio



A S Y O U L I K E I T

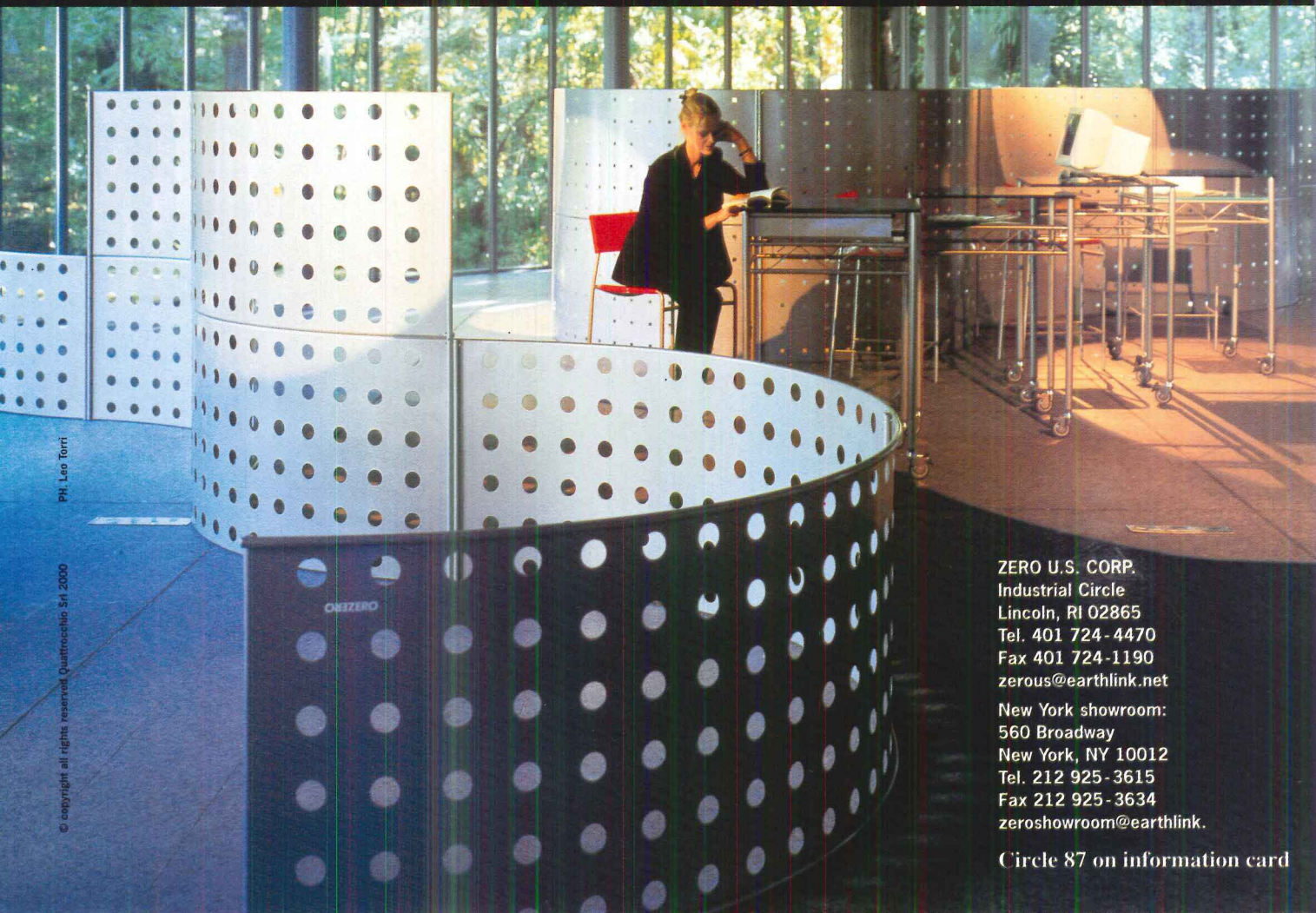

PH. Leo Torri

© copyright all rights reserved Quattrocchi Srl 2000

ZERO U.S. CORP.
Industrial Circle
Lincoln, RI 02865
Tel. 401 724-4470
Fax 401 724-1190
zerous@earthlink.net
New York showroom:
560 Broadway
New York, NY 10012
Tel. 212 925-3615
Fax 212 925-3634
zeroshowroom@earthlink.

Circle 87 on information card

Product Information for February 2000 Advertisers

RS#	—	AIA Convention/p164	
41		Alkco Lighting/p29	83
43		Alkco Lighting/p29	5
1		Andersen Windows/p6-7	67
59		Andersen Windows/p114	61
35		Architectural Landscape Lighting/p27	81
39		Ardee Lighting/p28	69
3		Armstrong Ceilings/C2,1	27
—		Autodesk/p58	9
77		BASF/p155	17
85		Belden Brick/p158 (East, Midwest region)	25
71		Billcom/p152	65
79		BOCA International/p156	21
19		Bricsnet/p16	51
7		Buzzsaw/p5	—
29		Copper Development Association/p24-25	87
37		D'ac Lighting/p27	
91		Diehl Graphsoft/pC3	
63		Dupont Tyvek/p119	
53		EFCO Corporation/p53	
23		Ellison Bronze/p18	
89		Florida International University/p165	
93		Follansbee Steel/pC4	
11		Formglas/p10-11	
31		Guth/p26	
33		.hessamerica/p26	
57		Hoboken Floors/p112	
73		Industry Design & Light/p154	
75		J. Epstein/p153	
47		Kalwall/p30	
49		Kone/p36	
13		LCN Closers/p12-13	
45		Marvin Window/p126	
		NALSA/p157	
		Nixalite of America/p4	
		Odegard/p123	
		Pavestone/p116	
		Polygal USA/p157	
		Portland Cement/p125	
		Quartzitec/p22	
		Roppe Corporation/p8-9	
		Schott Corporation/p14	
		Sloan Valve/p20	
		Sub-Zero/p121	
		Timely Corporation/p17	
		Trimco/p46	
		University of Tennessee/p153	
		Zero Corporation/p159	

Advertising Sales Offices

ADVERTISING SALES HEADQUARTERS

Craig Reiss
Group President
(212) 536-6570 fax (212) 536-5357

Robert M. Hoover
Vice President / Production
(212) 536-5234 fax (212) 536-5357
1515 Broadway
New York, NY 10036

MIDWEST

Jack E. Bergren
Midwestern Sales Manager
(312) 583-5505 fax (312) 583-5501
200 W. Jackson Blvd., Suite 2700
Chicago, IL 60606

John W. Maisel
(630) 416-0780 fax (630) 416-0793
Maisel Media Associates
1928 Pleasant Hill Lane
Lisle, IL 60532

Rick Novak
(773) 832-0798 fax (773) 832-0799
Natural Resources Inc.
711 Gordon Terrace, #321
Chicago, IL 60613

SOUTHEAST

Holly Fisher
Southeastern Sales Manager
(404) 249-9915 fax (404) 249-9916
hfisher@architecturemag.com

MID-ATLANTIC / UPSTATE NEW YORK

George T. Broskey
Eastern Sales Manager
(610) 640-3123 fax (610) 722-9266
301 Lindenwood Drive
Suite One
Malvern, PA 19355

NEW ENGLAND / NEW YORK CITY

Richard J. Ancas
Joseph E. Sraeel
(732) 450-9791 fax (732) 450-9793
Ancas & Associates, Inc.
P.O. Box 7951
Shrewsbury, NJ 07702

LITERATURE & PRODUCT PORTFOLIO / REPRINTS

Danny Lee
Portfolio / Reprints Manager
(212) 536-5137 fax (212) 536-5357
1515 Broadway
New York, NY 10036

For additional information from our advertisers, circle the corresponding number on the Free Product Information Card. **You may also get information online at www.architecturemag.com.** First, click on Reader Support, then Product Info to reach our electronic reader service card.

Did you miss valuable information offered by advertisers in last month's issue of architecture?

The manufacturers listed below were advertisers in last month's issue. They are anxious to provide you with their latest product information and literature for your planning needs. To receive this information, fill in the appropriate numbers on the self-addressed, postage-paid response card. For product literature from advertisers in this issue, fill in the appropriate numbers shown on the advertisements.

ALKCO

Get the facts on Lincs® under-cabinet modules.
Circle No. 82

ALUMINUM ANODIZERS COUNCIL

Anodizing offers the look that lasts; contact us for information.
Circle No. 62

AMERICAN SLATE

Contact us for more information; the timeless beauty of natural slate.
Circle No. 124

ANDERSEN WINDOWS

In today's designs, it's the brand that helps architects take value to new heights.
Circle No. 1

ARCHITECTURAL AREA LIGHTING

Find out more about our new MITRE series.
Circle No. 118

ARCHITECTURAL LANDSCAPE LIGHTING

Contact us for a copy of our new portfolio.
Circle No. 86

ARDEE

Call us for more information on Matrex™.
Circle No. 90

AUTODESSYS

Call for information or visit us at www.formz.com to download a free demo.
Circle No. 98

BALDINGER LIGHTING

The possibilities are endless! Contact us for information.
Circle No. 114

BILLCOM

The three most important days for your store and brand success—Globalshop 2000.
Circle No. 102

BIRDAIR

Tensioned Membrane, a technological vision that works—contact us for information.
Circle No. 132

BOBRICK WASHROOM EQUIPMENT, INC.

Accessories and partitions for buildings from one source; contact us for information.
Circle No. 15

THE COOKSON COMPANY

A rolling fire door for every occasion—contact us for information.
Circle No. 126

d'ac LIGHTING

Call us for more information on Corcovado.
Circle No. 92

DESIGN-BUILD INSTITUTE OF AMERICA

Send for a full-color print of our limited edition art poster.
Circle No. 104

DIEHL GRAPHISOFT, INC.

Introducing VectorWorks, a better way to design.
Circle No. 128

EFCO CORPORATION

Contact us for innovative green solutions in windows, curtain walls, entrances, or storefronts.
Circle No. 68

FOLLANSBEE STEEL

Contact us for information on our environmentally friendly roofing metals: TCS II and Terne II.
Circle No. 78

GLOBALTECH

Introducing Referee™ insulating concrete forms—contact us for information.
Circle No. 76

.hessamerica

Call us for more information on our fully adjustable uplighting.
Circle No. 80

HANOVER ARCHITECTURAL PRODUCTS

Contact us for more information on Chapel Stone™ garden walling and edging.
Circle No. 72

KALWALL CORPORATION

Finally...a website filled with bright ideas.
Circle No. 74

KONE, INC.

Call us to learn more about KONE and our innovative vertical transportation solutions.
Circle No. 54

LAM LIGHTING SYSTEMS

Call us for more information on our lighting systems.
Circle Nos. 88, 94

LCN CLOSERS

Introducing the advanced LCN 4040 and 1460 series closers.
Circle No. 70

MARVIN WINDOWS AND DOORS

Contact us for more information on our windows and doors.
Circle No. 66

MASLAND CONTRACT

130 years of dedication, innovation, and creative integrity.
Circle No. 56

NESSEN LIGHTING

Call us for more information on Starfish: a stunning solid-brass pendant.
Circle No. 84

NIXALITE OF AMERICA, INC.

Contact us for more information on our stainless-steel bird barriers.
Circle No. 52

NOVAWALL SYSTEMS, INC.

Contact us for more information on our fabric wall and ceiling systems.
Circle No. 106

ROPPE CORPORATION

Call us for free samples; nobody knows rubber like Roppe.
Circle No. 58

SOMERSET DOOR & COLUMN COMPANY

Contact us for information on our architectural columns in wood or composite.
Circle No. 122

SPACESAVER

Call us for innovative solutions to your storage problems.
Circle No. 2

SPI LIGHTING GROUP

SPI takes a new direction: Innovative Performance System.
Circle No. 112

TANGO LIGHTING

Call or fax for our catalog.
Circle No. 60

USG CORPORATION

Call us for more information on USG® Fiberock™ abuse-resistant panels.
Circle No. 130

WAUSAU WINDOW & WALL SYSTEMS

Contact us today for more information on our window and wall systems.
Circle No. 96

For additional information from our advertisers, circle the corresponding number on the Free Product Information Card. **You may also get information online at** www.architecturemag.com. First click on Reader Support, then Product Info to reach our electronic reader service card.

MUST ATTEND



AIA 2000 NATIONAL CONVENTION AND EXPOSITION

**MAY 4-6, 2000 • PHILADELPHIA, PA
PENNSYLVANIA CONVENTION CENTER**

NEW CENTURY

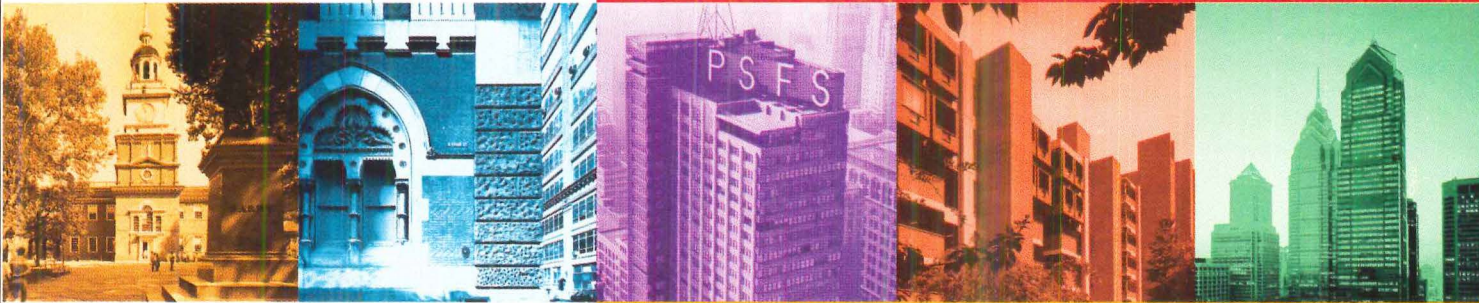

NEW VISION

For complete convention and expo information and to attend the full convention program, register online at www.aiaconvention2000.com

FOR INFORMATION ON EXHIBITING, CALL 617 859.4475 OR CALL THE AIA CONVENTION HOTLINE AT 202 626.7395. FAX YOUR REQUEST TO 617 859.4354. EMAIL YOUR REQUEST TO AIAEXPO@HHCC.COM

LIVABLE COMMUNITIES FOR AMERICA'S FUTURE

- View over 550 exhibitors' products and services
- Earn 36 CES hours/LUs in one convention
- Over 60 new product and service introductions at AIA Expo2000
- Network with industry colleagues

To gain free admission to the AIA Expo2000 just fill out this short form and present it at the Exhibits Only Registration Desk or mail to AIA Registration Agent, CompuSystems Inc., P.O. Box 465, Brookfield, IL 60513-0465 or fax to 708-344-4444.

Pre-Registration deadline is April 7, 2000.

AIA FAIA Assoc.AIA Hon.AIA Hon. FAIA Please Print or type clearly.

NAME _____		TITLE _____	
COMPANY _____			
ADDRESS _____			
CITY _____		STATE _____	ZIP _____
PHONE _____		FAX _____	E-MAIL _____
AIA MEMBERSHIP NUMBER _____		AFFILIATION _____	

Please note: this registration does not include admission to conference sessions. Please extend this invitation to colleagues by duplicating this form.

Please complete to help AIA plan future conventions.

Title/Job Function (check one)

BA Principal/Partner/President
 BB VP/Associate/Project Manager
 BC Project Architect/Architect
 BD Interior Designer/Space Planner
 BE Draftsperson
 BF Engineer
 BG Specifier/Cost Estimator
 BH Landscape Architect
 BI Facility Manager
 BJ Administrator/Office Manager
 BK Educator/ Student
 BL Other

Type of Firm

CA Architecture
 CB A/E or E/A
 CC Interiors/Space Planning
 CD Contractor/Builder
 CE Construction Management
 CF Facility Management/Development
 CG Government
 CH Educational
 CI Consulting
 CJ Other

Firm Employees (all offices)

DA 1
 DB 2 - 9
 DC 10 - 49
 DD 50 - 100
 DE More than 100

Buying Influence

EA Final Decision
 EB Specify
 EC Recommend
 ED No Role

Location of Firm's Work

FA Local
 FB Regional
 FC National
 FD International

Primary Type of Work

GA Commercial
 GB Institutional
 GC Residential
 GD Industrial

Reasons for attending the AIA Convention (check three that are most important to you)

AA Complete continuing Education Requirements
 AB Products and Services in AIA Expo2000
 AC Networking with Colleagues
 AD General Session Topics and Speakers
 AE Convention City
 AF Delegate to AIA Business Sessions

HERE'S OUR **NEW** BUILDING. **MAKE IT YOURS**

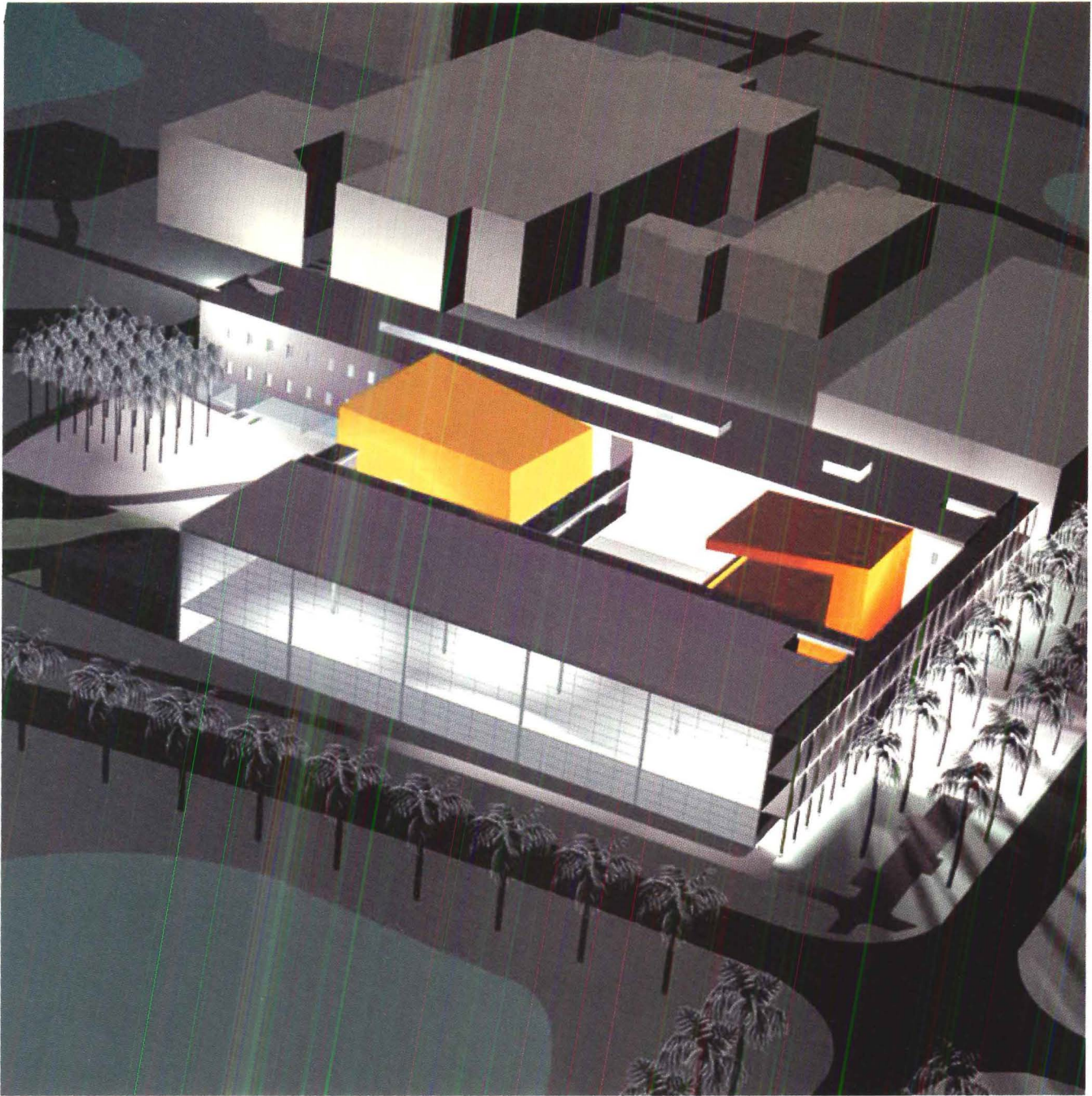

Bernard Tschumi Architects / Bruno-Elias and Associates, Joint Venture

FLORIDA INTERNATIONAL UNIVERSITY PRESENTS A **NEW SCHOOL OF**
ARCHITECTURE
IN MIAMI

Circle 89 on information card

ARCHITECTURE, INTERIOR DESIGN AND LANDSCAPE ARCHITECTURE
VH 216 • Miami, Florida 33199 • T: 305.348.3181 • F: 305.348.2650 • www.fiu.edu/~soa

The United Nations headquarters complex is falling down. Some of the problems at the 50-year-old buildings—leaking roofs, crumbling walls, failing HVAC—result from age. Others persist as side-effects of the U.N.'s immunity from New York City building codes: Asbestos remains throughout, there are no sprinklers, and wheelchair access is poor. According to an October 24 article in *The New York Times*, published on the eve of a congressional debate on U.N. funding, saving the property could cost \$800 million.

The complex, designed in 1947 by Wallace Harrison with input from a gang of international architects that included Le Corbusier, is the foremost masterpiece of midcentury modern architecture in this country. The Secretariat's glittering curtain wall—the first in New York City—and the low, domed swoosh of the General Assembly building are peerless

A Diplomatic Solution for the U.N.

Philip Nobel suggests an island locale to replace the United Nations' crumbling world headquarters.



You could live here: What if an inspired developer made a vacated U.N. (seen here before its 1950 opening) into funky riverside condos?

expressions of the optimism and formal exuberance of the best postwar design. It should, of course, be saved at all costs.

But how? The buildings have come to their current sad state through simple poverty, not willful neglect; most years, the U.N. has other priorities for its shoestring budget—like saving the world. The U.S. government, which stiffed the U.N. for over \$1.5 billion in dues in recent years, is the next obvious culprit. Only in November did our cranky Congress approve \$926 million for the organization, some of which could go to stopgap measures. As the other 187 members would argue, we lured the U.N. here, we derive the political and economic benefits of having the organization on our soil, the least we can do is help fix the buildings.

There is an alternative: Build a new U.N. on Governors Island, just across from the Statue of Liberty. Relocating there would give the U.N. a secure, 175-acre campus away from its decrepit old buildings, the controversial 90-story Trump residential tower, and the Midtown parking frenzy that once prompted Mayor Rudolph Giuliani to suggest that U.N. delegates could shove their diplomatic plates.

That deal would rescue the island from the banal mixed uses currently planned for it and could save the original buildings. As soon as the U.N. vacates, the complex would fall into the protective embrace of the city's Landmarks Preservation Commission. Then it can safely be sold to the highest bidder; a smaller adjacent site is on the market for \$500 million. Let Donald Trump remove the asbestos and rework the Secretariat into pricey river-view condos for the *Wallpaper* set. The globocrats could set sail for United Nations Island with enough spare change to build something new and wonderful. ■

Philip Nobel is a Brooklyn, New York–based freelance writer.



Bronskill & Co., Rendered with RenderWorks

Introducing VectorWorks A Better Way to Design

After 14 years of constant research and development, Diehl Graphsoft is proud to introduce VectorWorks—the next generation of MiniCAD. VectorWorks improves MiniCAD's proven CAD technology and merges new state of the art Object-Based design philosophy. This integration makes you more productive without sacrificing flexibility and control.

Increased Productivity with Object-Based Design

VectorWorks' state of the art Object Technology helps streamline the design process by making it easy to create common design elements. Now, Objects like doors, windows, roofs and stairs, can be created and edited with a click of the mouse, making it easy to explore design alternatives, consider "what if" scenarios, and handle last-minute client changes.

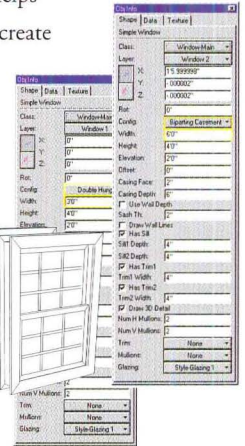

The Strength of a Proven CAD Technology

VectorWorks offers a solid foundation based on proven CAD technology—giving you the power and flexibility to tackle any design problem. New features such as Workgroup Referencing, DWG (v.14), Round Walls, Multiple Undo/Redo and an improved scripting language, strengthen VectorWorks' core CAD capabilities. And, with RenderWorks, VectorWorks' new photo-realistic rendering plug-in, you can bring your designs to life with textures, shadows and dramatic lighting.

The VectorWorks Advantage

With VectorWorks, you get it all—the flexibility and control of proven CAD technology and the productivity benefits of Object-Based design. VectorWorks ships FREE solutions for Architecture, Landscape Design, DTM and HVAC among others. Best of all, you aren't limited to the solutions we provide. VectorWorks is completely customizable allowing you to create your own custom business solutions.

Special Offer to Readers of Architecture Magazine

Save \$134 by purchasing VectorWorks with photorealistic rendering direct for \$1061 or, without rendering for only \$795. Includes FREE Tech Support and a 90-Day Money-Back Guarantee.

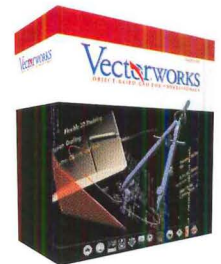

Diehl Graphsoft Inc
Software for Today's Professional

1-888-646-4223

Circle 91 on information card

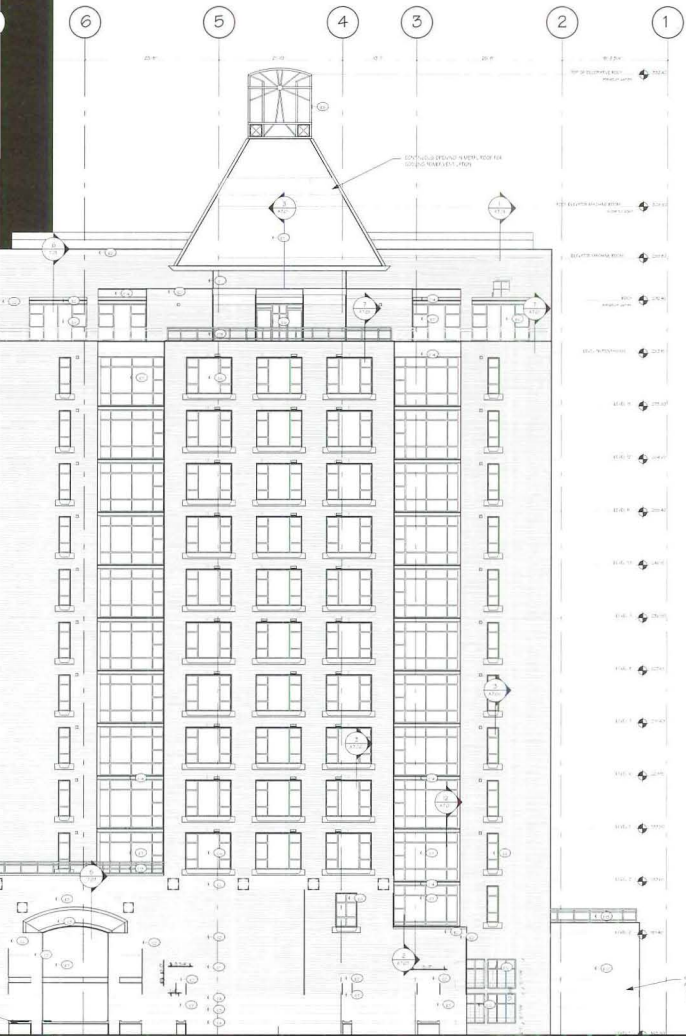

Mike Huggins, Burrows Huggins Architects - Vancouver, Canada



the BEST in ROOFING METALS

**TCS[®]
AND
TERNE**

just
got
better!

Newly developed TCS II[®] and TERNE II[®] offer better corrosion resistance than Follansbee's original TCS and Terne. Coated with a new, revolutionary alloy of zinc and tin, these new environmentally-friendly roofing metals are oxygen-reactive, enhancing their performance in all atmospheres including those in marine areas.

The new alloy, while retaining solderability, is substantially more abrasion and smudge resistant. TCS II does not require painting and transforms its color to an earth-gray oxide as it weathers. TERNE II requires painting and its surface has an excellent affinity to paint.

Follansbee offers you these two outstanding roofing metals-combining many of the time-tested characteristics of the original metals with metallurgical and production improvements which answer the demanding needs of the next century.

We'll be happy to send you substantiating evidence of the excellence of TCS II and TERNE II. Call us toll-free at 1-800-624-6906.

*Creating outstanding roofing metals
for more than a century*

FOLLANSBEE
FOLLANSBEE STEEL • FOLLANSBEE, WV 26037
FAX 1-304-527-1269

Visit us on the Website:
www.follansbeeroofing.com

Our E-Mail address
folrfg@lbcorp.com

TCS II[®] and TERNE II[®]

for enhanced corrosion resistance
in marine and chemical atmospheres

Circle 93 on information card