

architecture®

March 2000

\$8.95 usa \$11.00 canada

architecture™

## 25 Floors of Glamour

Christian de Portzamparc rewrites the rules to build the LVMH Tower,  
Manhattan's best new high-rise in twenty years.



**Spot the two terms  
that don't go together:**

1. Suspended Ceiling
2. Grid-hiding Visual

**Until now.**

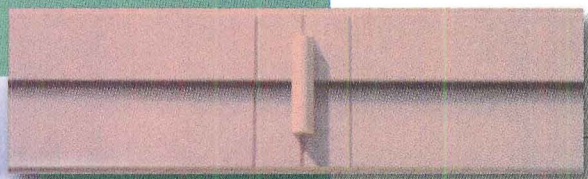

VARIABLE  
THICKNESSES

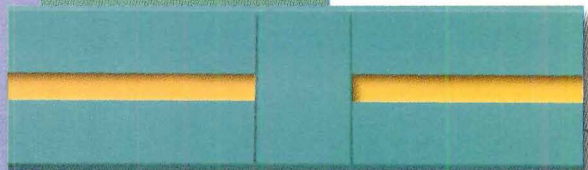

VARIABLE  
REVEALS

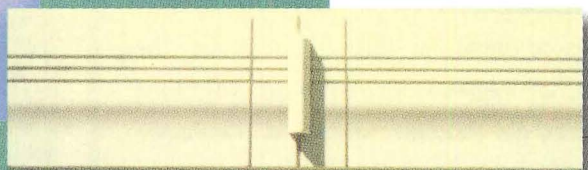

VARIABLE  
PROFILES

## CENTRIA's New Formawall® Dimension® Series

### A r c h i t e c t u r a l M e t a l P a n e l s

CENTRIA's new Dimension Series panels are more attractive, colorful, and versatile — and you can get them now without waiting! Dimension Series panels give you everything precast doesn't. Like lower installed cost. Brilliant palette of over 100 colors. Integral insulation. Lightweight, weathertight construction. And a wide range of thicknesses, profiles and reveals that give you virtually limitless design freedom. So quit stonewalling. Contact CENTRIA today for your personal presentation and add new Dimension to your designs.

**You've settled for precast long enough.**



**CENTRIA**

CENTRIA Architectural Systems

1.800.752.0549  
www.centria.com

Circle 48 on information card



The **Pilkington Profilit™** structural glazing system provides the architect with the **freedom to design**.

Whether you are creating curved form in glazing, achieving difficult shapes or details in glass, or utilizing the properties of light, we believe our expertise combined with the simplicity of the **Profilit™** system will enhance your design concepts.



**WESTCROWNS INC.**

CALL FOR OUR NEW BROHCURE

910-579-4441 Phone 910-575-3203 Fax

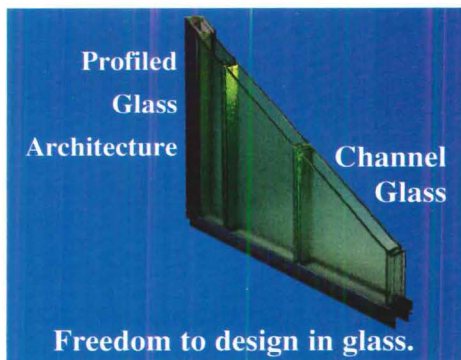

[www.westcrowns.com](http://www.westcrowns.com)

Circle 50 on information card

## contributors

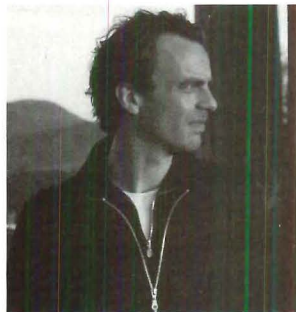

Bradford McKee



Arnaud Maggs



Adele Freedman

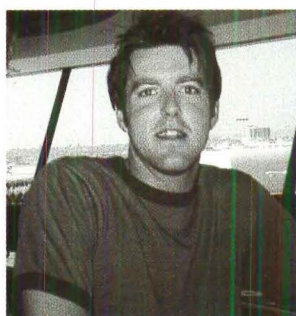

Christopher Hawthorne

Contributing editor **Lawrence W. Cheek** is the former architecture critic for the *Tucson Citizen* and *New Times* of Phoenix. Now living in Seattle, he has written nine books on Arizona and New Mexico, including *Photographing Arizona* and *A.D. 125: Ancient Peoples of the Southwest*. For our City section, he takes on Civano, Tucson's foray into "sustainable" New Urbanism (page 74).

One of Canada's leading architecture critics, **Adele Freedman** has won numerous awards for her coverage of architecture and the arts. She is the author of *Sight Lines: Looking at Architecture and Design in Canada* (Oxford University Press, 1990). This month she interviews fellow Canadian and legendary urban critic Jane Jacobs (page 71).

**Christopher Hawthorne**, a contributing editor with *Metropolis*, studied architectural theory, among other subjects, last year as a fellow at the National Arts Journalism Program at Columbia University. Beginning on page 59, he uncovers the nitty-gritty of Radio City Music Hall's resurrection.

Canadian photographer **Arnaud Maggs** has had more than 70 solo and group exhibitions over the past 20 years. His portrait of Jane Jacobs (page 71) is from his series *48 Views*, courtesy of the Susan Hobbs Gallery in Toronto. Here, Maggs stands in front of *Notification XIII, 1996*, which is composed of 192 color photographs of 19th-century mourning envelopes.

Editor-at-large **Bradford McKee** began writing for *Architecture* in 1993. He is now the arts editor of the *Washington City Paper*, in Washington, D.C., where he has written extensively about architecture's thorny professional politics. In this issue, McKee moderates the ongoing struggle between the American Institute of Architects and the American Society of Interior Designers (page 68).



# Architects Could Win the Next Election— if Only They'd Try

By Reed Kroloff

Architects may not realize it, but for the first time in decades, they have the opportunity to play a meaningful role in electoral politics. Al Gore has made livability a central plank of his campaign platform (February 2000, page 37), and suddenly terms like smart growth, planning, and—dare I say it—design are voiced on the hustings. If architects get on the stick, they could leverage this renewed interest into political muscle.

Democrats are betting that livability—a fuzzy conflation of sprawl-busting, environmentalism, and good old-fashioned pork barrel politics—is a bullet-proof issue: Who could oppose building better communities? Republicans have been caught off guard, left to splutter platitudes about big-government interference in local affairs and sinister threats to property rights. Meanwhile, polls show the electorate squarely behind Gore's position. Case in point: President Clinton's designation last January of several new national monuments in Arizona and California (page 34, this issue). The smallest of the three parks is the most politically charged: a 70,000-acre preserve called Agua Fria that is clearly situated to frustrate the ravenous sprawl of suburban Phoenix. Local Republican officials are howling about a politically motivated federal land grab, but the public approves overwhelmingly.

Could there be a political issue more perfectly suited for architects than livability? Al Gore is a bright guy, but architects know much more about urban design than the Vice President. Certainly, the

collective expertise of the profession would be a valuable asset for candidates seeking voter-friendly proposals for the built environment. If ever there were a time to step up public relations, this is it: Let the candidates—and voters—know that architects have the answers to livability questions, and that the profession is ready, willing, and able to ride to the rescue.

This is not a public service announcement. While good citizenship matters, politics is ultimately a game of money and numbers. Therefore, if architects want to translate their knowledge into tangible gains for the profession, they must also demonstrate the electoral and financial savvy necessary to influence a campaign.

American Institute of Architects (AIA) chief operating officer Jim Dinegar understands that. He is trying to convince the organization to take lobbying seriously by supporting its political action committee (PAC)—as successful industries do. (Construction, for instance, spent \$22.3 million on lobbying in 1998. The AIA spent \$42,000. And we wonder why contractors always seem to have the upper hand?) Thus last year, for the first time, the AIA solicited PAC donations from the rank and file. But should members have to shell out for political representation? Isn't that included in their already pricey dues? Passing the hat is particularly outrageous in light of the astonishing figures the AIA squanders on Board retreats and paying off the contracts of failed chief executives.

Besides, the AIA already has the resources for formidable political clout. If the organization devoted just 5 percent of its annual budget to a lobbying war chest, Jim Dinegar could shower politicians with more than \$1.5 million every year (more than \$2,500 annually for each representative and senator on the hill, or even larger contributions to targeted candidates). Another 5 percent could make an equal amount available for local elections, where the biggest practice battles are fought anyway.

We are entering an election in which architects can make a difference—for themselves and their fellow citizens. But it will take institutional leadership—and money—to make that happen. Jim Dinegar notwithstanding, AIA national may not be up to the task. Call your local office. California's chapter raised \$2.8 million two years ago and whipped Proposition 224. They say all politics is local, so let's start there. ■

# BUILD BY THE RULES.

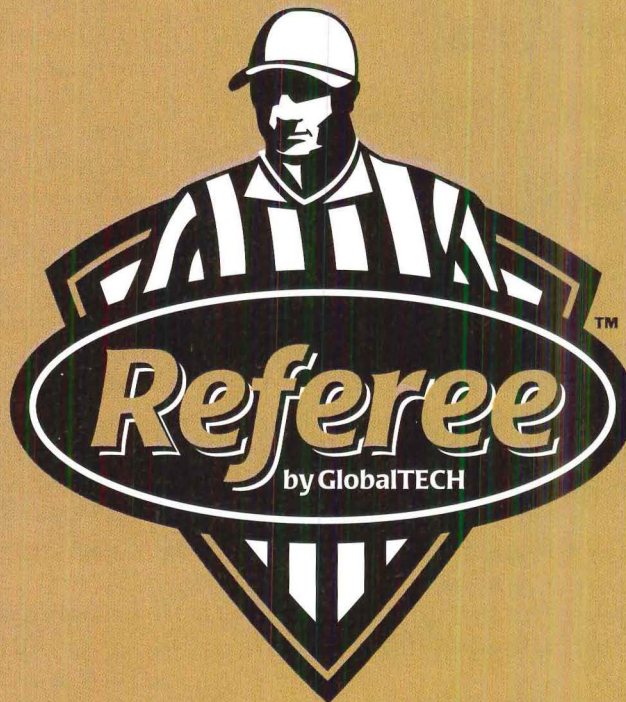

*The Authority in Insulating Concrete Forms.*

## Introducing Referee™ Insulating Concrete Forms...only from GlobalTECH.

In the construction game, the key to victory is to build by the rules. So to help you stay in the game and win, GlobalTECH introduces Referee...the authority in Insulating Concrete Forms. Made to be lightweight and easy to handle, Referee offers today's cost-conscious builders the advantages of:

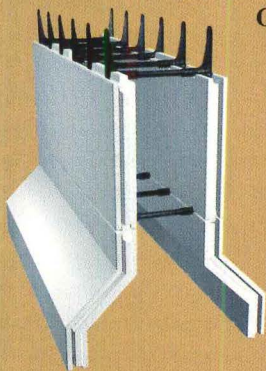

- Customized wall size and thickness – ranging from 3.5" to 8.0"
- High-precision, high-quality, high-strength walls
  - Simple, fast and reliable field installation
  - Superior-engineered tongue-and-groove system
  - Unique corner detail
    - All-season construction capability
    - Design flexibility
    - Disaster resistance
  - Ships flat for substantial cost savings

Referee provides all these benefits, backed by GlobalTECH's leading experience in construction and the latest ICF techniques, commitment to service and training, along with competitive pricing. If you want to build the right way, Referee will show you how to build by the rules...and win. For more information, you make the call – 1.877.888.8182 – or visit [www.globaltechbsi.com](http://www.globaltechbsi.com).

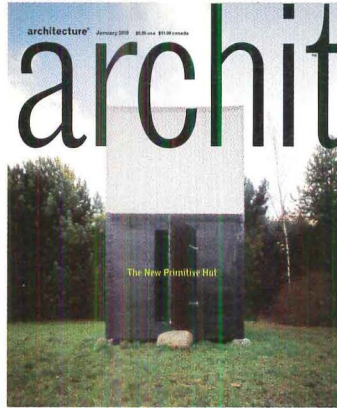

## Speck Appeal

I've been in architecture for almost 30 years and have followed all the major publications. However, until now I have not experienced, and with such great delight, editorials such as yours. With regard to the January editorial (page 13), I am amazed that a design selection committee could knowingly hire a firm such as Herzog & de Meuron and not expect the product it delivered. If they wanted something more traditional, why did they go to such an incredible length to hire this firm? For that matter, why is this scenario repeated across the architectural community? There is clearly a communication canyon that needs to be filled. If the profession is going to sit on its thumbs and let this continue, I've got other things I want to do in my life.

Bob Elmore  
Santa Cruz, California

Lawrence Speck is indeed a hero. This profession is severely in need of principled professionals like Mr. Speck to set examples and reflect the honor and dignity once held by architects. Instead, we are surrounded by slaves to the "almighty dollar" who are too shortsighted to establish benchmarks commensurate with the risk, liability, and abuse we take on a daily basis.

Though there are still some of us who cherish the ethics, professionalism, and practices of old, few

and far between is the individual who will stand up for the rights of the profession. Kudos to you, Mr. Speck. You have my respect and admiration and I suspect that of many others. I also laud Mr. Kroloff for his courage in publishing such an honest editorial.

Anthony C. Mussachio  
Amherst, New York

The University of Texas completed a very thorough and costly master plan, produced by Cesar Pelli and Associates, for development of the campus. It advised the school to return to its roots: elegant stone and brick buildings by Cass Gilbert and Paul Cret, set on the terraces, lawns, and malls of Cret's 1933 plan, each view framed by allées of native live oak trees and punctuated by fountains. The Pelli master plan was produced by consensus with the participation of the School of Architecture, clearly with the knowledge of Dean Speck. Instead of lionizing the dean for resigning in protest of the treatment of Herzog & de Meuron, perhaps you should question his promotion of a firm whose design disregarded the university's vision for its future growth. I applaud the Board of Regents for not being bullied into a building they could not support.

Jeffery Povero  
New York City

As a native Texan, a graduate of the University of Texas, and a former student of Larry Speck, I eagerly read your spin on the recent incidents in Austin. I agree that the architects were treated disrespectfully by the regents, but this story is much more complex than your editorial and Protest article (January 2000, page 154) describe. I was amazed when the "design-savvy" selection committee made its choice. The comparison that came to mind was placing a work by Andy Warhol in a gallery filled with works by Andrew Wyeth. Austin is not Bilbao. Why did the committee select an avant-garde firm for a

project in such a conservative environment?

I question Speck's decision to resign for the very fact that he is a great dean. The Architecture School students are the ultimate losers. The school needs a steady, articulate leader such as Speck, but now it is adrift.

Laurie Dwyer Ansley  
Baltimore

## Call Paul Harvey

Over the years, I have admired many projects in your magazine, but I have wondered why projects depict conditions that are contrary to known codes and ADA requirements. Rick Joy's beautiful office in the January issue (page 78) has a new building and toilet room that is not accessible because it is technically a studio residence, or a "home occupation" in a residential neighborhood. The construction cost is also deceiving because it includes a lot of volunteer labor. (A call to their office confirmed all this.) I admire the creativity in the design and bending the rules to establish an office economically. However, it would be more informative and responsible for your magazine to tell the architects reading any project article "the rest of the story."

David E. Christensen  
Bellingham, Washington

### CORRECTION

In Joan Ockman's "Paper Architecture" (January 2000, page 59), the author writes that *Harvard Design Magazine* is "edited by William Saunders with Nancy Levinson." Ms. Levinson is in fact coeditor of the magazine.

### WE WANT TO HEAR FROM YOU!

Send your letters to the editor to: *Architecture*, 1515 Broadway, New York, NY 10036. Or fax to: 212/382-6016. Or e-mail us at: [info@architecturemag.com](mailto:info@architecturemag.com). Include your name, address, and daytime phone number. Letters may be edited for clarity or length.

**OUR DOORS ARE BUILT**

**TO LAST A CENTURY**





**Clinton Protects  
1 Million+  
Acres in the West**  
p. 34

**2000 AIA National  
Honor Awards**  
p. 35

**Satellite Keeps an  
Eye on Fallingwater**  
p. 37

**Corn-Derived  
Plastic Invented**  
p. 41

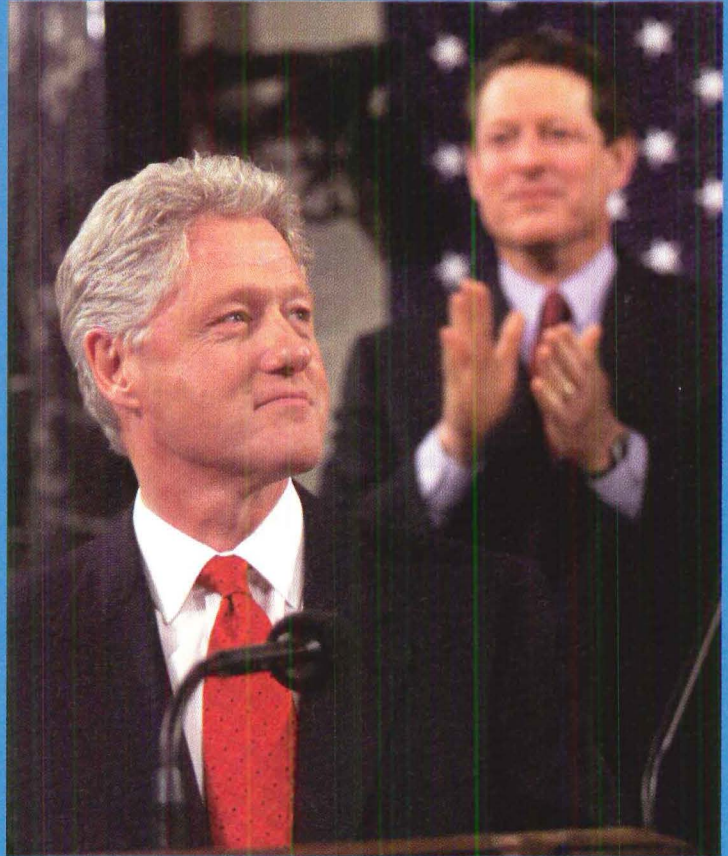

## Clinton Puts Design on Agenda

**State of the Union** *Following is an excerpt from President Clinton's January 27, 2000, State of the Union address:*

We know we must connect all our classrooms to the Internet, and we're getting there... But we cannot finish the job when a third of all our schools are in serious disrepair. Many of them have walls and wires so old, they're too old for the Internet. So tonight, I propose to help 5,000 schools a year make immediate and urgent repairs; and again, to help build or modernize 6,000 more, to get students out of trailers and into high-tech classrooms. **(APPLAUSE.)** Now, to keep our historic economic expansion going—the subject of a lot of discussion in this community and others—I believe we need a 21st-century revolution to open new markets, start new businesses, hire new workers right here in

In his last State of the Union address, Clinton makes miles of promises that Gore may have to keep.

America—in our inner cities, poor rural areas, and Native American reservations. (APPLAUSE.) Our nation’s prosperity hasn’t yet reached these places. Over the last six months, I’ve traveled to a lot of them, joined by many of you, and many far-sighted business people, to shine a spotlight on the enormous potential in communities from Appalachia to the Mississippi Delta, from Watts to the Pine Ridge Reservation. . . . Tonight, I propose a large new markets tax credit and other incentives to spur \$22 billion in private-sector capital to create new businesses and new investments in our inner cities and rural areas. (APPLAUSE.) Because empowerment zones have been creating these opportunities for five years now, I also ask you to increase incentives to invest in them and to create more of them. (APPLAUSE.) . . . As our communities grow, our commitment to conservation must continue to grow. Tonight, I propose creating a permanent conservation fund, to restore wildlife, protect coastlines, save natural treasures, from the California redwoods to the Florida Everglades. (APPLAUSE.) This Lands Legacy endowment would represent by far the most enduring investment in land preservation ever proposed in this House. . . . Last year, the Vice President launched a new effort to make communities more liberal—livable—(LAUGHTER.)—liberal, I know. (LAUGHTER AND APPLAUSE.) Wait a minute, I’ve got a punch line now. That’s this year’s agenda; last year was livable, right? (LAUGHTER.) That’s what Senator Lott is going to say in the commentary afterwards. (LAUGHTER.) To make our communities more livable. This is big business. This is a big issue. What does that mean? You ask anybody that lives in an unlivable community, and they’ll tell you. They want their kids to grow up next to parks, not parking lots; the parents don’t want to spend all their time stalled in traffic when they could be home with their children. . . . I want you to help us to do three things. We need more funding for advanced transit systems. (APPLAUSE.) We need more funding for saving open spaces in places of heavy development. (APPLAUSE.) And we need more funding—this ought to have bipartisan appeal—we need more funding for helping major cities around the Great Lakes protect their waterways and enhance their quality of life. We need these things and I want you to help us. (APPLAUSE.)

# Clinton Protects 1 Million+ Acres in the West

## Sprawl Watch

In January, far from the madding crowd (except for the ubiquitous media), President Clinton sat outdoors near the Grand Canyon’s south rim and declared two enormous national monuments in Arizona, designated another along California’s coastline, and expanded a fourth, also in California, all according to the 1906 Antiquities Act. Exactly 92 years after President Teddy Roosevelt designated the Grand Canyon (left) a national monument, Clinton acted to protect more than a million acres north of the 1.1 million-acre national park, to be known as the Grand Canyon-Parashant National Monument.

However, when Clinton also designated Agua Fria National Monument, 71,000 acres of public land about 40 miles north of Phoenix, he was taking aim at that city’s unbridled sprawl. “This is about freeing up [lands] . . . from the pressures of development and the threat of sprawl,” Clinton intoned pointedly.

Although Clinton’s action affects only public land, Arizona state and local leaders objected to the proposed designations (including Governor Jane Hull, and presidential hopeful Senator John McCain, both Republicans), accusing Clinton and Interior Department secretary and former Arizona governor Bruce Babbitt of making a “land grab” without local or congressional consent. Public opinion polls, however, showed otherwise. *The Arizona Republic*, the state’s largest paper, found nearly 80 percent of local residents in favor of protecting the two areas from future development, mining, and timber cutting.

The third new national monument embraces countless small islands and rocks along California’s coast, where sea otters, birds, and seals take refuge. The federally protected zone extends 12 miles out to sea. In addition, Clinton added 8,000 acres to the 16,265-acre Pinnacles National Monument, south of San Jose, to protect soaring rock spires and surrounding wildlife habitat from commercial development. *Ann Jarmusch*

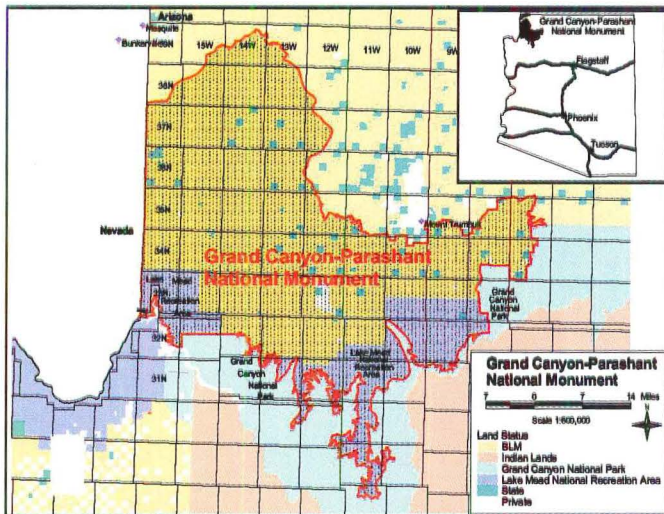

*Ann Jarmusch is the architecture critic for The San Diego Union-Tribune.*

## Buzz

London officials are planning a memorial park near Kensington Palace to be dedicated to the late **Diana, Princess of Wales**.

In the wake of November's disastrous resignation scandal at UT-Austin involving architects **Herzog & de Meuron** (January 2000, pages 13, 154), the university has formed a new architect advisory committee that—inexplicably—includes Regent **Tony Sanchez**. (Sanchez is the regent who hired another architect behind de Meuron's back to take a stab at the Blanton Museum, basically forcing the Swiss designers to resign.)

Three strikes, you're out: Boston architect **Graham Gund** has applied for a second demolition permit to yet again dig up the foundation of his planned dream house in Cambridge, Massachusetts, so he can start from scratch. Apparently, Gund and his wife have decided to go back to their original design concept, which they demolished about a year ago.

The University of Chicago has selected New York City's **Rafael Viñoly Associates** to design a new facility for its graduate school of business.

After seven years as editor-in-chief of *J.D.* magazine, **Chee Pearlman** has left to edit an Internet-based magazine start-up. The yet-to-be-named venture, the baby of a computer concern called **One Ventures**, will be based in San Francisco and New York City. (One Ventures was founded by **Dana Lyon**, formerly of *Wired* magazine.)

Golden boy: 2000 AIA Gold Medalist **Ricardo Legorreta** is also the

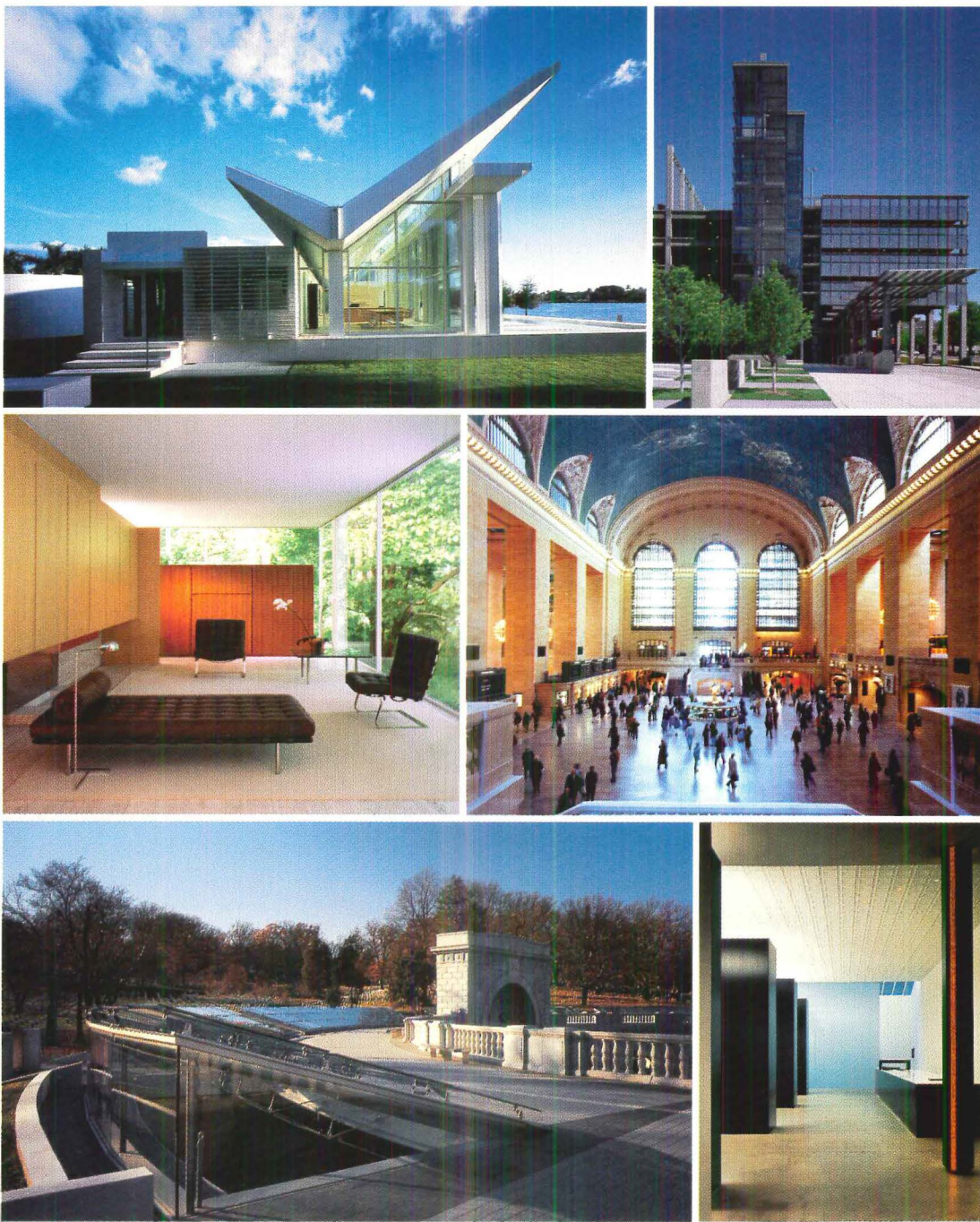

## 2000 AIA National Honor Awards

### Awards

For its 2000 AIA National Honor Awards, which recognize excellence in architecture, interiors, and urban design, the American Institute of Architects has cited 38 projects, 11 of which you've seen already in *Architecture*. This year's projects range from the preservation of a Mies van der Rohe–designed house to the development of low-income housing for senior citizens, and shift in scale from a small Catholic sanctuary to the world's tallest high-rise. The awards will be presented in early May at the AIA National Convention and Expo in Philadelphia. *Sarah Palmer*

Neugebauer House, Naples, Florida, Richard Meier & Partners (top left); Center Street Park and Ride, Des Moines, Iowa, Herbert Lewis Kruse Blunck Architecture (top right); Kaufmann House Restoration, Palm Springs, California, Marmol and Radziner Architects (center left); Grand Central Terminal Restoration, New York City, Beyer Blinder Belle Architects and Planners (center right); St. Jean Vianney Catholic Church Sanctuary, Baton Rouge, Louisiana, Trahan Architects (bottom left); Kuala Lumpur City Centre, Phase I, Kuala Lumpur, Malaysia, Cesar Pelli & Associates (bottom center); Helmut Lang Flagship Retail Boutique, New York City, Gluckman Mayner Architects (bottom right).

## THE CHALLENGE

Create a new generation coating alloy which will outperform the much heralded Follansbee metal roofing products Terne and TCS; meet and exceed all performance and environmental criteria anticipated for the next century; maintain price

## THE PLAN

Engage a top team of metallurgical and chemical engineers to develop and independently test hundreds of alloys both in the laboratory and through natural exposure to all conceivable atmospheres

## THE OUTCOME:

After seven years of rigorous testing, Follansbee creates a patented ZT<sup>®</sup> Alloy. Applied to both stainless steel and prime carbon steel, it exceeds all anticipated objectives.

## THE RESULT:

Announcing a new generation of Follansbee roofing metals which will meet your highest performance and environmental requirements. We are proud to offer these products under the trade names:



# ENVIROMETALS<sup>®</sup> TCS II<sup>®</sup> and Terne II<sup>®</sup>

Created to meet the increasing demands of an environmentally conscious new century



Visit us on the Website:  
folrfg.lbcorp.com

**FOLLANSBEE<sup>®</sup>**

Our E-Mail address:  
folrfg@lbcorp.com

FOLLANSBEE STEEL • FOLLANSBEE, WV 26037  
CALL US TOLL-FREE 1-800-624-6906 or FAX 1-304-527-1269

Circle 66 on information card

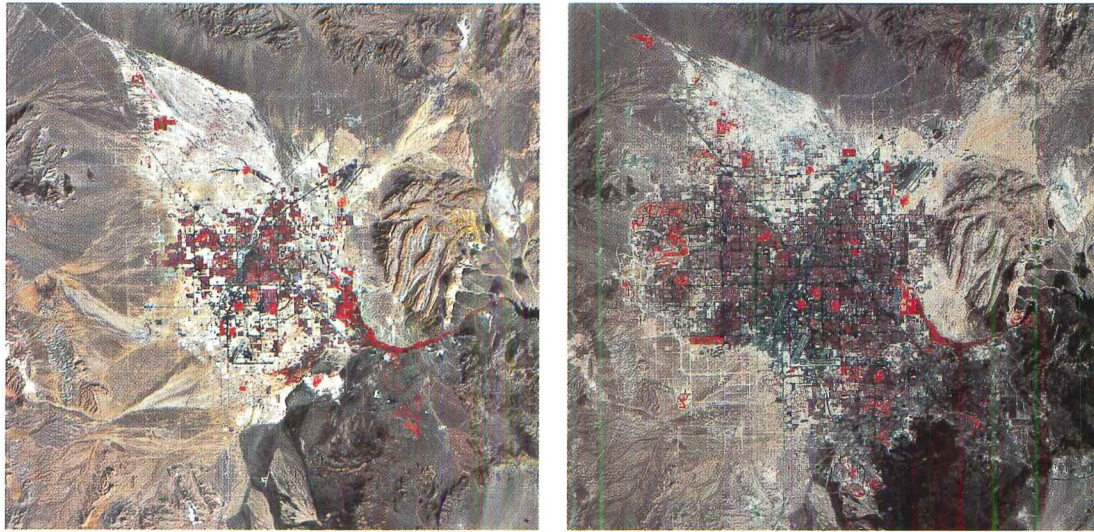

Dramatic satellite footage shows Las Vegas' unchecked sprawl between 1972 and 1999.

## As Vegas Sprawls, EPA Sanctions

### Desert Justice

In December 1999, the U.S. Census Bureau announced that Las Vegas was leading the country as the fastest-growing metropolitan area. And, as usual, environmental controls are struggling to keep up with the boom. Since 1990, the city's population has swelled a staggering 55 percent, adding almost half a million people to a region that already leads the country in new-housing starts. On January 10, the Las Vegas Business Press reported that the Bureau of Land Management was planning to auction off the largest contiguous piece of public land in the valley to the highest bidders. The question is, then, how much growth can an area sustain before it must impose restrictions?

When Las Vegas earned the ignoble distinction of placing eighth in a Natural Resources Defense Council air pollution study, county officials were moved to action. Subsequently, the Clark County Health District's Air Pollution Control Division has begun to enforce stricter regulations to keep pace with the area's rapid growth, including, ironically, blacktopping many unpaved roads to minimize airborne dust. *S.P.*

## Satellite Keeps an Eye on Fallingwater

Fallingwater has an alien in residence. When Frank Lloyd Wright's 1936 masterpiece started living up to its name last year—specifically, the cantilevered balconies were sagging—the Western Pennsylvania Conservancy looked to the outer reaches of space for assistance.

The "alien," as staffers have nicknamed it, is a small global positioning system (GPS) transmitter that officials from the National Oceanic and Atmospheric Administration have attached to the underside of the recently shored-up terraces. When preservationists replace the temporary steel

crutches that are currently supporting the weakened cantilevers with permanent structural supports this spring, the GPS tracker will ensure that they're doing their job.

In short, GPS is a system that uses measurements from satellites to fix an object's position on the earth in three dimensions. Shockingly, this technology is accurate to within a centimeter. Therefore, should Fallingwater's old bones ever slump again, annual check-ins with the GPS tracker will alert caretakers before the problem asserts itself in dramatic or dangerous ways. *Mickey O'Connor*

recipient of the Union of International Architects' gold medal.

Follicles, testicles, keys, wallet: In Rome, **Pope John Paul II** gave his blessings (literally) to a new, controversial parking garage the Vatican paid \$40 million to build to accommodate Jubilee Year pilgrims.

**Einhorn Yaffee Prescott** is renovating the **Eero Saarinen**-designed U.S. Chancery in London.

**Erdy McHenry Architecture** will develop a strategic master plan for The Enterprise Center mixed-use complex (the original home of *Dick Clark's American Bandstand*) in West Philadelphia.

A popular Taiwan restaurant called The Jail—Taiwanese TV star **Jacky Wu** is part owner!—has removed photos of concentration camp victims from its walls after complaints from German and Jewish patrons. (The restaurant also features a sign that hangs over the rest room entrances that reads "Gas Chamber.")

The Cooper Union for the Advancement of the Arts and Sciences has chosen **Rem Koolhaas** and **Herzog & de Meuron Architects** to design an **Ian Schrager** hotel on a parcel of Cooper Union-owned land in New York City's Greenwich Village. The complex will also feature street-level retail and a Robert DeNiro-backed independent film center.

Hooray for Hollywood! In an oddly motivated preservation effort, film distributor **Artisan Entertainment** has paid an undisclosed sum to save Baltimore County's Griggs House. The 200+-year-old Federal home was made famous by its inclusion in last



relax.

## kaleidoscope™

Whether you're designing a transit stop or a rest stop, Kaleidoscope provides just the right amount of shade.

**the project:** When Bal Harbour, Florida, wanted to replace its existing transit seating, the village turned to Kaleidoscope as an elegant, durable, and speedy solution. Modular and pre-finished, Kaleidoscope provides a comfortable respite from the elements.

## landscapeforms™

[www.landscapeforms.com](http://www.landscapeforms.com)  
1.800.430.6201

Circle 68 on information card

Kaleidoscope is designed by Robert Chipman, ASLA; Brian Kane, IDSA; and Arno Yurk, AIA, ILL. Kaleidoscope design is patent pending. Landscape Forms supports the Landscape Architect Foundation at the Second Century level.

## Vitals

## Environmental Sustainability Index

A new report, released in January at the World Economic Forum in Davos, Switzerland, ranks countries by the success of their sustainability policies. Using a base of 100, the study measures such criteria as how well their green laws are flourishing and their comanagement of environmental problems with other countries.

Norway	76
Iceland	75
Switzerland	75
Sweden	75
Canada	72
France	71
Britain	70
Netherlands	70
Germany	67
United States	67
Japan	66
Israel	65
Spain	65
Russia	62
Argentina	61
Belgium	61
Italy	61
Brazil	59
Poland	58
South Korea	57
Malaysia	55
Greece	55
Singapore	54
Thailand	52
Turkey	52
Mexico	51
India	50
Egypt	48
Philippines	47
Vietnam	44

SOURCE: YALE CENTER FOR ENVIRONMENTAL LAW AND POLICY

## Get Your Hands Caught in These



Emma and Sam,  
Stanley Tigerman



Palazzo,  
Michael Graves



Stealth,  
Antoine Predock



The White Chocolate Chip  
Cookie Jar, Richard Meier



Volcano,  
Cesar Pelli



Inside the White Cube,  
Richard Gluckman

### Commerce

As Michael Graves stumps for Target and Terence Conran hocks dishtowels and paella to the masses, it's clear that the esthetic advice of an architect is still a draw in fields other than their own. But Jack Markuse already knows that. For more than 15 years, Markuse, president of the Woburn, Massachusetts-based Products, has been the exclusive American distributor for Alessi. In the past, the Italian home-products manufacturer has tapped such architects as Ettore Sottsass, Philippe Starck, and Graves to create everything from flatware to small appliances.

Since 1990, Markuse has also developed and sold several lines of architect-designed products under his own label, including mailboxes and timepieces. At last month's Gift Show in New York City, he debuted a line architect-designed cookie jars. He chose cookie jars because they are distinctly American and often collected and displayed as domestic art.

The nine porcelain prototypes seen here will begin appearing in specialty housewares shops and museum stores next month (priced between \$40 and \$60), but will also be available on Project's website at [www.projects-us.com](http://www.projects-us.com). In the future, Markuse is negotiating with a major cookie manufacturer to license the jars and has his eyes on cocktail culture, contemplating a line of architect-designed barware. *M.O.*

year's runaway independent hit *The Blair Witch Project*.

Graphic designers at **Pentagram** had the honor of designing the National Millennium Time Capsule. **President and Mrs. Clinton** unveiled the flag-inspired capsule, which will be permanently housed at the National Archives, during Washington, D.C.'s millennium celebration.

Preservationists in Los Angeles have formed the **John Lautner Foundation** to celebrate and maintain the results of the modernist architect's five-decade-plus career. Check out their efforts at [www.johnlautner.org](http://www.johnlautner.org).

Tax preparers: New York City's **Swanke Hayden Connell** is overseeing a \$50 million renovation of the 1.4 million-square-foot headquarters of the **Internal Revenue Service** in Washington, D.C.

**Voorsanger & Associates** are working on a \$30 million renovation of the **Edward Larabee Barnes**-designed Asia Society in New York City.

Los Angeles-based firm **AREA** is undertaking a renovation of **Cesar Pelli & Associates'** 16-acre Pacific Design Center.

San Francisco's **Michael Willis Architects** is converting the 17,000-square-foot, former Oakland, California, public library into a new African-American museum.

A recent survey by the **National Association of Home Builders** says people in Denver, Atlanta, San Diego, Minneapolis/St. Paul, and Washington, D.C., are concerned about the rate of housing growth, but think that business is at the right

"The One That Got Away," a semiregular feature, will chronicle those public figures who began their education and/or careers in architecture before veering off into very different territory. Please send your nomination to "The One That Got Away," Architecture, 1515 Broadway, New York, NY 10036.



Queen Noor at last year's commencement ceremonies at Brown University.

## Her Majesty Queen Noor of Jordan

**The One That Got Away** Since the highly publicized death of His Majesty King Hussein I of Jordan in February 1999, his widow, Her Majesty Queen Noor, has gradually heightened her public profile stateside. Most recently, the queen grabbed headlines when she replaced the late Diana, Princess of Wales, as the patron of the Nobel Peace Prize-winning International Campaign to Ban Landmines. Stints on MSNBC, in *Vanity Fair*, and a chummy friendship with the Clintons have practically made "Noor" a household name.

But who knew she was an architect? Her Majesty (née Lisa Najeeb Halaby, an American of Arab descent) received a degree in architecture and urban planning from Princeton University's first coeducational class in 1974. Her first international planning projects brought her to Australia, Iran, the United States, and Jordan, where she designed the master plan for an aviation training facility at Arab Air University. In the late 1970s, she moved to Jordan to become the director of planning and design projects for Royal Jordanian Airlines, where she worked full time before her June 15, 1978, marriage to the king.

Becoming the queen of Jordan galvanized Noor's involvement in architecture. She persuaded the then-minister of public works and housing to adopt the first national professional building code, and in the early 1980s, she established the National Committee for Public Buildings and Architectural Heritage to record, preserve, and rehabilitate Jordan's unique architectural legacy. First on her list were the Middle Eastern nation's unique religious pilgrimage sites at Petra and the ancient port of Aqaba. She is a proponent of sustainable tourism and development at these archaeological sites to promote economic growth and business ownership. *M.O.*

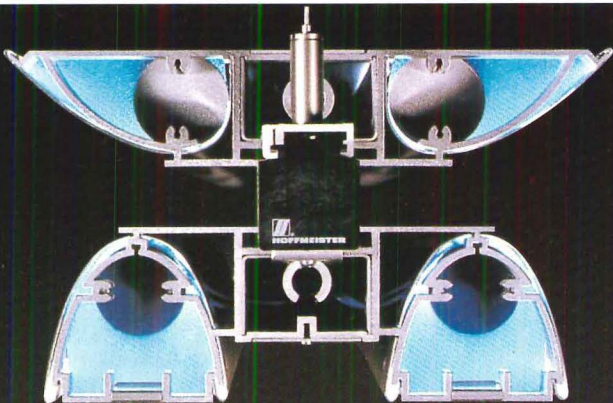

The suspense is thrilling – from a single hanging track, movable direct and indirect lighting, accents, spots and wallwashing, you decide. Just think of a system that's truly Mobilē™ and you've got our number. LAM Lighting Systems  
T 800 732-5213  
F 714 662-4515



**LAM**

A JJI Lighting Group Company  
www.lamlighting.com

Circle 70 on information card



It's the fine line between poise and pretense... the design eloquence that transforms contemporary into timeless Amalfi. Thematically matched pole, bollard and wall mount luminaires. hessamerica  
Shelby NC  
T 704 471-2211  
F 704 471-2255

**hessamerica**

A JJI Lighting Group Company  
www.hessamerica.com

Circle 72 on information card



# Corn-Derived Plastic Invented

**Technology** A collaboration between giants in the agricultural and chemical fields has produced a plastic derived from corn and wheat. The product, called polylactide (PLA) and branded NatureWorks by the company, is the result of a partnership between grain processor Cargill of Minnetonka, Minnesota, and Midland, Michigan-based Dow Chemical.

The new company, called Cargill Dow Chemical, is building a manufacturing facility in Blair, Nebraska, which is projected to produce 300 million pounds of the material annually. It is the first company to bring such a product to commercial production. Similar efforts to create a PLA-like plastic at Monsanto and DuPont fell victim to budget cuts or are years away from production, respectively.

Making plastic from a natural source frees its production from the volatility of the crude oil market; moreover, Cargill Dow is claiming that PLA, unlike petroleum-based plastics, is made entirely from renewable resources and is biodegradable. Further, the company asserts, it isn't necessary to genetically engineer the plastic's plant source; the needed chemicals are present in existing species. Although it's admittedly early in the game, Cargill Dow has already identified marketable applications for the plastic, including carpet fibers, packaging, and clothing. *M.O.*

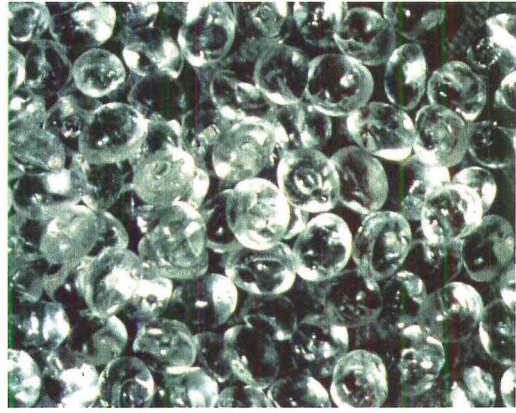

These plastic pellets are the rough form of naturally derived PLA, which can be used to make carpets, packaging—even clothing.

## news

pace. This is ironic—they say—considering the implied “relationship between business growth and the need for new housing.”

**Bohlin Cywinski Jackson**, of Seattle and Wilkes Barre, Pennsylvania, have designed a new 12,000-square-foot, \$11.2 million shelter for Philadelphia’s Liberty Bell to better accommodate the bell’s 1.6 million annual visitors.

In a city better known for horizontal expansion, there’s a shortlist for a new, city-funded, \$100 million office building in downtown Denver. The chosen ones for the 15-story, 680,000-square-foot tower are: **Gensler and Gwathmey Siegel & Associates; HumphriesPoli Architects** and **Kuwabara Payne**

handles one to eight  
 on, barely audible  
 compact fluorescents. Sealed  
 open, goes indoors or out,  
 dry or hostile environs  
 ambient heat to 104F!  
 countless size, finish and  
 mounting options including  
 incandescent and metal  
 halide. Envirogard™... new  
 everywhere lighting  
 Guth.  
 T 533-3200  
 F 533-9127

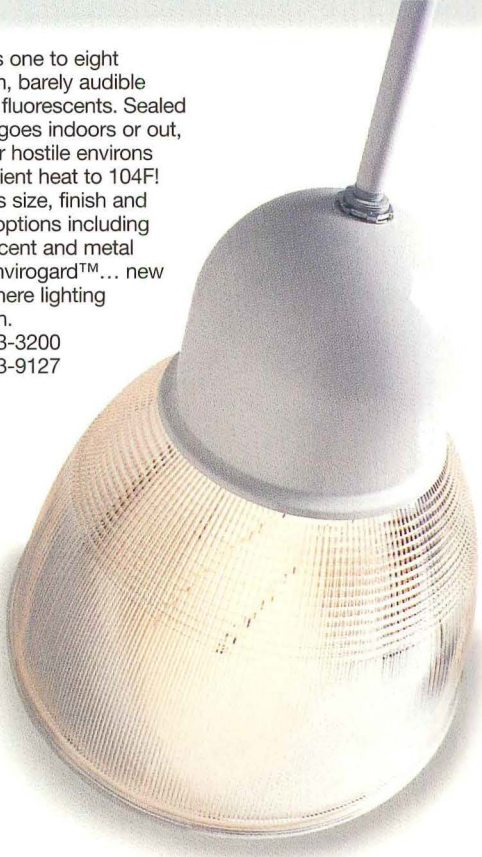

**GUTH**  
 A JJI Lighting Group Company  
 www.guth.com  
 Circle 74 on information card

This is the incredible Alkco low voltage, wet location, 2 1/2" mini-aperture downlight. Select a larger housing, choose an interchangeable trim ring, opt for a lens or louver and *voila* – a full, commercial-scale fixture boasting the latest PL lamping technology. Hundreds of matching and contrasting adaptations plus the quality you expect from Alkco.  
 T 847 451-0700  
 F 847 451-7512



**ALKCO**  
 A JJI Lighting Group Company  
 www.alkco.com  
 Circle 76 on information card

# Polshek-Designed Planetarium Opens

## Opening

In an effort to reinvent its musty image, the American Museum of Natural History just opened the \$210 million Rose Center for Earth and Space (right). Six years in the making, the completed exhibition, education, and research facility was designed by Polshek Partnership Architects with exhibit designer Ralph Appelbaum Associates. Inverting traditional notions of display and making the architecture itself an exhibit, the Rose Center is essentially an inhabitable display case. The 120-foot-high, 333,500-square-foot glazed cube contains an enormous sphere, the global symbol of astronomy. Transcending its controversial theme-park connotations, architect James Stewart Polshek intended the structure to be "a cosmic cathedral." Indeed, its vast size and elegance are an engineering tour de force that rivals Chartres. The cube's diaphanous exterior walls—the building's west and north facades—are the largest suspended glass curtain wall in the United States. "Water-white" glass panes, held in place by spider fittings and braced by steel wall trusses and tension cables, provide a spectacular view of the surrounding cityscape without any greenish tint.

The 2,000-ton, 87-foot-diameter, aluminum-clad sphere is supported by three pairs of tilted steel columns, and houses the Space Theatre, a



new state-of-the-art planetarium. Visitors digest the overwhelming display of scientific facts that surround the cube as they traverse the space via multiple horizontal and vertical circulation routes. These include a sloping 360-foot-long walkway called the Cosmic Pathway, which is cantilevered from a 30-inch-diameter steel torsion tube to provide vertical access to the sphere—and a 13 billion-year journey through cosmic history. *Susanna Sirefman*

*Susanna Sirefman teaches architectural design at New York City College and is the author of several books on contemporary architecture.*

Consider the possibilities...  
for each new ModuleX™  
low voltage downlight shown  
here actual size, over 100  
more adaptations are at  
your call. It's the decorative  
and functional downlighting  
system you design.  
Ardee Lighting  
T 704 482-2811  
F 800 275-1544



**ARDEE**

A JJI Lighting Group Company  
www.ardeelighting.com

Circle 80 on information card

# APA Advocates Smart Growth

The American Planning Association (APA) recently published "Planning Communities for the 21st Century," part of APA's long-term "Growing Smart" project, which provides a report card on planning initiatives in each of the 50 states.

The APA is looking to fill an obvious gap. Planning in many American states is still driven by land-use laws that predate the interstate highway system and the proliferation of suburban sprawl development. The current study profiles programs in six states that the APA considers success stories: Maryland, New Jersey, Oregon, Rhode Island, Tennessee, and Washington. Each of these states has implemented some form of smart-growth strategies that the APA considers essential to a modernized approach to planning. These initiatives include protections against increased sprawl, better coordination of regional transportation systems, provisions for affordable housing, and the inclusion of economic development within the scope of planning strategies.

Planners seem to have learned lessons from their failures in the second half of the 20th century. Most important is their embrace of flexibility within comprehensive plans and the understanding that state-level, top-down plans can't succeed without grassroots involvement and support at the local level. The current study is a solid document and clearly delineates how retrograde most planning remains in this country. But the study's most important contribution is how it carefully situates itself as part of a larger initiative to develop new model laws. These still-evolving documents, fueled by intelligent background studies like this report, have the potential to change the character of planning legislation for the next 50 years. Ultimately, the current effort's low point may prove to be its disingenuous language. It's easy to remain skeptical of a program that alternately touts its initiatives as either "sensible" or "smart." Cloaking itself behind these terms can stifle reasonable debate among intelligent dissenters. *Edward Keegan*

## news

McKenna Blumberg Architects of Toronto; and locals David Tryba Architects and RNL Design

TAMS Consultants have snagged the commissions to design new terminals at the airports in Westerly and on Block Island, Rhode Island.

New Orleans' Eskew+ is designing a 100,000-square-foot Louisiana State Museum in Baton Rouge.

The clamshell-on-a-pedestal house that inspired director Woody Allen to create the "Orgasmatron" for his 1973 time-travel comedy *Sleeper* will be an actual residence for the first time in more than three decades. John Huggins, a Denver-based Internet entrepreneur, purchased the dilapidated house, which was

...me is as venerable  
...torch. Yet how rarely  
...ried out this closely  
...ection? Helping  
...ne case for absolute  
...gn excellence: the  
...ty sponse by  
...Mindel & Associates  
...rass, nickel satin  
...er finishes  
...essen Lighting  
...98-7799  
...98-5577

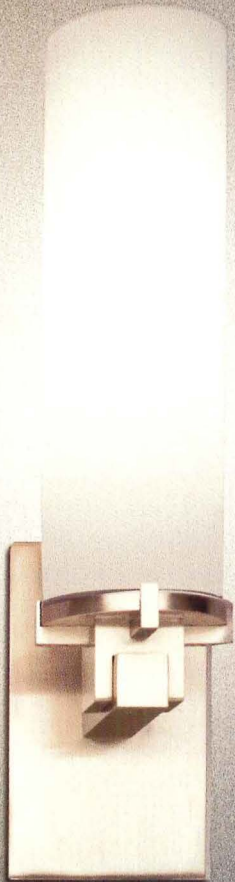

**Nessen**

A JJI Lighting Group Company  
www.nessenlighting.com

Circle 82 on information card

Get lighter after dark – and lighter on the kilowatt hours. Make the most of up to 175 illuminating watts with ALLscape's SL-35 Bullets. Discover your options, get the Catalog. Architectural Landscape Lighting  
T 714 668-3660  
F 714 668-1107

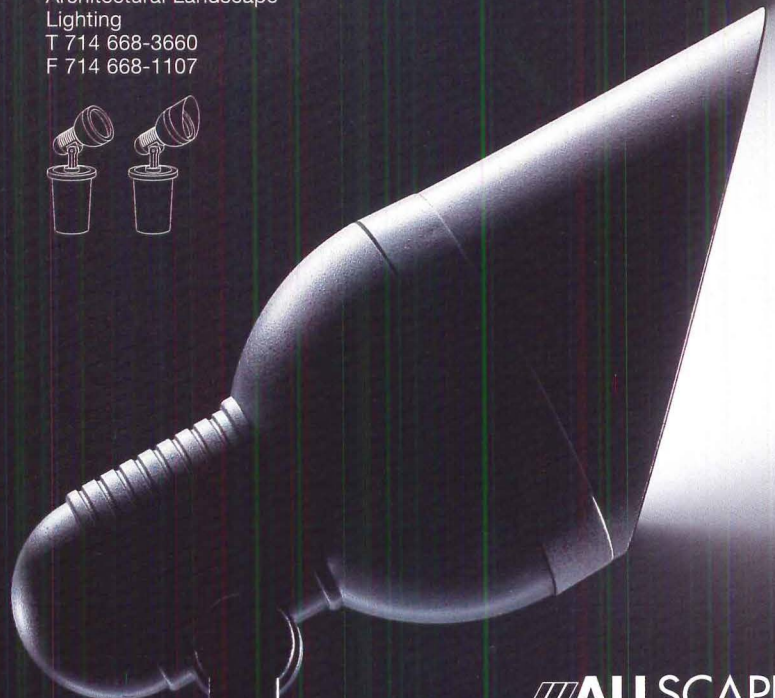

**ALLSCAPE**  
ARCHITECTURAL LANDSCAPE LIGHTING

A JJI Lighting Group Company  
www.alllighting.com

Circle 84 on information card



How is it possible for a stone floor tile to attain mythic status? Well, it helps to start at rock bottom. In a rare quartz deposit to be precise. With pure, white, naturally occurring crushed quartz which is then bound with the highest grade of white portland cement. It also helps to know a thing or two about history. You see, the Venetians recognized the virtues of agglomerate floors centuries ago. What we at Quartzitec have done is to perfect the technology. The result is QuartzStone – floor tile and paving stones that have

*Medusa got a pretty  
bad rap for turning  
people to stone.*

*We, on the other hand,  
have had nothing  
but compliments.*

stunned the architectural and design communities. For one thing, quartz is more durable than either marble or granite. But remarkably, the price is far more attractive. What's more, these lightweight tiles can be installed with simple mortar, and once installed, never require polish or wax. Nor will they harm the environment. To see the many benefits of QuartzStone for yourself, visit our website or give us a call. We expect you'll be riveted by what we have to say. In the nicest possible way of course.

**QUARTZITEC®**

Circle 88 on information card

**THE NEXT GENERATION OF TILE. MADE NATURALLY. TEL: 1-877-255-9600 FAX: 506-433-9610 WWW.QUARTZITEC.CO**

NATURAL

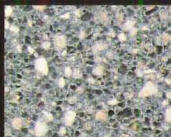

AFFORDABLE

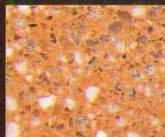

QUARTZ  
STONE

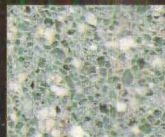

COLORFUL

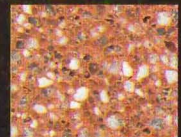

DURABLE

# Obelisk Course

## Is It Art?

There's been plenty of love lost since the scaffolding started coming down from the Washington Monument in January. The nearly 40 miles of aluminum tubes, which were covered in blue nylon panels patterned after masonry mortar, simply electrified the people of D.C. and the city's millions of tourists since it first appeared around the Robert Mills and Thomas Casey-designed obelisk in 1998. But as the monument's restoration winds down, it seems that the \$1 million temporary structure may get a second life—in a Minneapolis park.

Minneapolis-based Target Stores paid most of the cost of the scaffolding designed by architect Michael Graves, who also designs housewares for the retail chain. Now Target is helping to lead a campaign to buy the scaffold structure and re-erect it in Washburn Fair Oaks Park, just north of the Minneapolis Institute of Arts. "We're very interested" in the prospect, says Target spokeswoman Patty Morris. "But it's all still in the talk phase."

They can talk all they want to, but residents of the surrounding Whittier neighborhood aren't so keen on the idea. Brad Canham, editor of a neighborhood newspaper, The Whittier Globe, says that with so many turn-of-the-century mansions in the community, some worry whether the imported scaffold-cum-sculpture will relate architecturally to its environment. "The question is, what are we gonna do with it once it's here?" he wonders. "And what does it mean to the neighborhood?" *Bradford McKee*

## news

completed in 1963 by late architect **Charles Deaton** but never occupied, for \$1.3 million. Huggins plans to renovate and add on to the boarded-up house with the help of Deaton's daughter, interior designer **Charlee Deaton**, and her husband, architect **Nick Antonopoulos**

Houston-based **Morris Architects** will design a 110,000-square-foot, \$49 million facility for Moody Gardens Aquarium on Galveston Island, Texas.

**OBITUARY:** **Edward Logue**, former director of the Boston Redevelopment Authority, whose efforts pushed through the completion of that city's Government Center, the Prudential Center, and the restoration of Quincy Market-Faneuil Hall, 78.

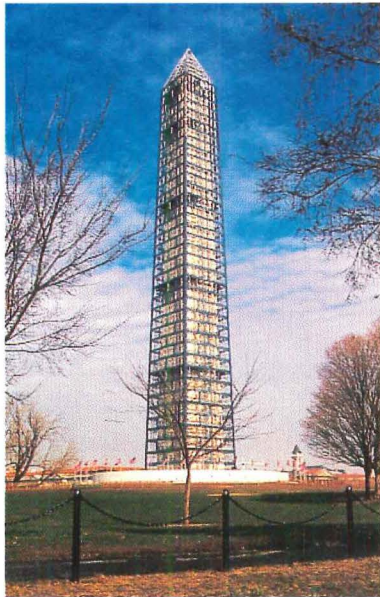

It's a simple rule. And it applies to your software tools. Using a pirated copy of a program like AutoCAD® is wrong. It hurts the people who work hard to make your software better, and it hurts you. Because without a valid license, you can't get the service and support you deserve. Even if it's not your fault,

**1-800-NO-COPIES**

you can do something about it. Don't fall for it. Report pirated Autodesk software. All calls 100% confidential. [Call 1-800-NO-COPIES.](http://1-800-NO-COPIES)



Lighting the architecture and design of the 21st century

North America's Largest  
Architectural and Commercial  
Lighting Trade Show

The World's Largest Architectural  
and Commercial Lighting Conference

Pre-Conference:  
May 8, 2000

Trade Show & Conference  
May 9-11, 2000

Javits Convention Center  
New York, NY

visit our website: [www.lightfair.com](http://www.lightfair.com)

# Light fair international 2000

## year 2000: where will you be?

The Year 2000 marks the emergence of LIGHTFAIR INTERNATIONAL's new global position as the architectural and commercial lighting industry's **WORLD EVENT**. Recent changes in other International lighting events has established LIGHTFAIR INTERNATIONAL as the **global leader** in the lighting component of the building, construction and design industry. Make plans **NOW** to join your industry colleagues from around the world.

- More than **17,000** architectural, engineering and design professionals will be in attendance representing the top firms in their industries;
- Over **400** leading industry manufacturers will occupy over 1100 booths;
- An **expanded** Exhibit Hall featuring over **110,000** net square feet of the newest products, latest technology, and most up-to-date information;
- The world's largest architectural and commercial lighting Conference will take place over four days, encompassing **six intensive Workshops** and **31 seminars**, with most providing AIA, ASID, IESNA, and IIDA accreditation, and NCQLP Lighting Education Units. Seminar Tracks include: Design in the Built Environment; Urban Lighting: City Lights (Sponsored by LD+A); Entertainment Architecture (Sponsored by Phoenix Products Company); Energy & Technology (Sponsored by Energy User News); and Business Practices;
- The multi-media **New Product Showcase & Awards Presentation** will feature more products than ever;
- Other exciting awards ceremonies and the **BEST** industry association events will coincide with the largest LIGHTFAIR INTERNATIONAL, ever!

## make it happen!

**YES!** I want to be in New York at **LIGHTFAIR INTERNATIONAL 2000**

Name \_\_\_\_\_

Title \_\_\_\_\_

Company \_\_\_\_\_

Address \_\_\_\_\_

City \_\_\_\_\_ State \_\_\_\_\_ Zip \_\_\_\_\_

Country \_\_\_\_\_

Email: \_\_\_\_\_

Phone (\_\_\_\_) \_\_\_\_\_ Fax (\_\_\_\_) \_\_\_\_\_

### CODE (P)

Contact us in one of the following ways and your name will be added to mailing list to receive complete program information in February 2000.



Visit our Website at [www.lightfair.com](http://www.lightfair.com), go to Attendee Inform and fill out form



Return this card by **fax** to 708-344-4444



**Call** 1-800-450-1106 (US & Canada) or 708-786-4120 (Int)



Return **Mail** to: LIGHTFAIR INTERNATIONAL 2000  
c/o CompuSystems Inc.  
P.O. Box 614  
Brookfield, IL 60155-4531



Sponsored by The International Association of Lighting Designers



Sponsored by The Illuminating Engineering Society of North America and The New York Section, IESNA



Produced and Managed by AMC, Inc.



Official On-Site Event Directory

FOR INFORMATION ON EXHIBITING, PLEASE CALL 404-220-2215.

## Calendar

## Exhibitions

**Berkeley, California**

Roma/Pacifica: The Phoebe Hearst International Architectural Competition and the Berkeley Campus, 1896–1930 through April 23 at the UC Berkeley Art Museum (510) 643-6494

**Chicago**

Bilbao: The Transformation of a City at the Art Institute of Chicago April 7–July 16 (312) 443-3600

Tibetan Modern: The Architects' Collection at the Athenaeum Museum of Architecture & Design through April 10 (312) 251-0175

**Los Angeles**

At the End of the Century: One Hundred Years of Architecture at the Museum of Contemporary Art; April 16–September 24 (213) 621-2766

**Montreal**

En Chantier: The Collections of the CCA, 1989–1999 at the Canadian Centre for Architecture through April 30 (514) 939-7000

Visions and Views: The Architecture of Borromini in the Photographs of Edward Burtynsky at the Canadian Centre for Architecture; March 8–May 7 (514) 939-7000

**New York City**

The New York Century World Capital Home Town, 1900–2000 at the Museum of the City of New York through July 9 (212) 534-1672

National Design Triennial: Design Culture Now at the Cooper-Hewitt National Design Museum March 7–August 6 (212) 849-8400

Making Choices: Modern Living 1 at the Museum of Modern Art March 16–July 26 (212) 708-9400

A Century of Design, Part I: 1900–1925 at the Metropolitan Museum of Art through March 26 (212) 535-7710

**Philadelphia**

Rome in the 18th Century at the Philadelphia Museum of Art March 16–May 28 (215) 684-7860

**Washington, D.C.**

See the U.S.A.: Automobile Travel and the American Landscape at the National Building Museum through May 7 (202) 272-2448

Ralph Rapson: Sixty Years of Modernism at the Octagon Museum through May 28 (202) 638-3221

Reinvigorating the Cities: Smart Growth and Choices for Change at the National Building Museum April 19–September 6 (202) 272-2448

## Conferences

2000 National Planning Conference, sponsored by the American Planning Association New York City; April 15–19 (202) 872-0611

AIA 2000 National Convention and Exposition Philadelphia; May 4–6 (202) 626-7395

A/E/C Systems Washington, D.C. June 5–8 [www.aecsystems.com](http://www.aecsystems.com)

53rd Annual Meeting of the Society of Architectural Historians Miami; June 14–18 [www.sah.org](http://www.sah.org)

Construction Specifications Institute Atlanta; June 21–25 [www.csinet.org](http://www.csinet.org)

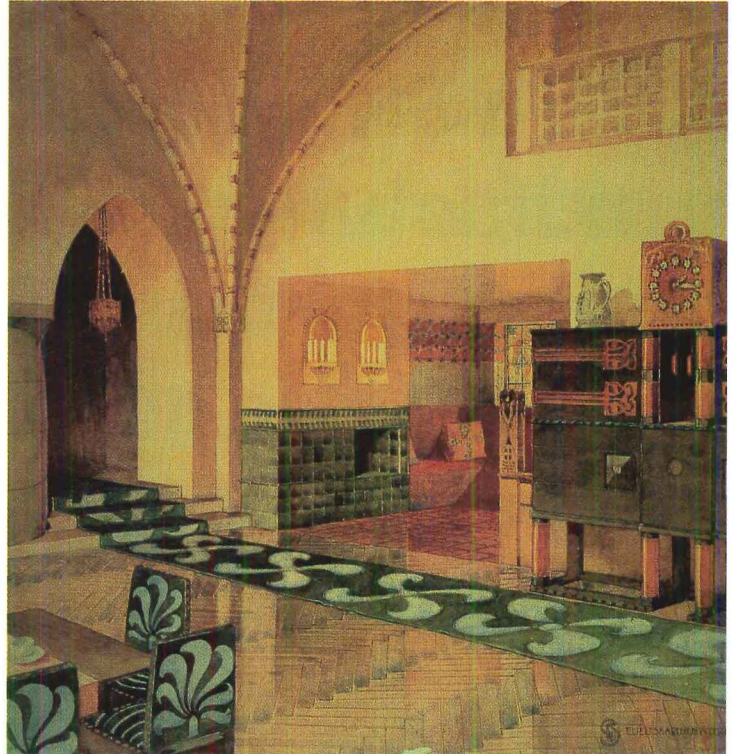

**Art Nouveau 1890–1914**, which opens next month at London's Victoria and Albert Museum, entwines visitors in an ornate narrative of the movement that cross-references geography—the show sweeps through Paris, Brussels, Glasgow, Munich, Vienna, New York, and Budapest—and three organizing principles: nature, the creation of meaning, and the metropolis and the designer. This 1903 watercolor by Eliel Saarinen of the interiors of the Suur-Merijoki country house near Viipuri, Finland (now Russia) shows that even the reserved Scandinavians dressed up their designs during this period. April 6 through July 30. For more information, see [www.vam.ac.uk](http://www.vam.ac.uk).

## Competitions

**Preserve L.A. Grants** of up to \$75,000; sponsored by the J. Paul Getty Trust deadline March 31 [www.getty.edu/grant/preservela](http://www.getty.edu/grant/preservela)

**Martin Luther King, Jr. National Memorial Project Design Competition** registration deadline April 1 (410) 554-0040, ext. 110

**The MacDowell Colony** offers eight-week residences to architects deadline April 15 [www.macdowellcolony.org](http://www.macdowellcolony.org)

**2000 National Preservation Awards** sponsored by the National Trust for Historic Preservation deadline May 1 (202) 588-6236

**Frate Sole Foundation International Prize for Sacred Architecture** carries a 300 million-lire (approx. \$190,000) prize deadline May 31 fax (39) (0382) 301-413

**Palos Verdes Art Center International Architectural Design Competition** registration deadline April 30 [www.pvartcenter.org](http://www.pvartcenter.org)

**The James Marston Fitch Charitable Foundation Mid-Career Grants** of up to \$10,000 deadline September 1 (212) 777-7800

**Haller Systems is a USM product line and a worldwide classic for the office and home.**

**USM, a Swiss company, has been manufacturing Haller Systems modular furniture for over 30 years. USM is committed to good design, high quality products and maintaining long-term customer partnerships.**

**We are now proud to offer our products and services under the original name of USM, U. Schaerer Sons, Inc. in the United States.**

USM modular furniture is available in the following countries:

Andorra, United Arab Emirates, Austria, Belgium, Bermuda, Brazil, China, Czech Republic, Denmark, England, Estonia, Finland, France, Germany, Greece, Hong Kong, Hungary, Ireland, Iceland, Italy, Japan, Latvia, Lithuania, Malaysia, Mexico, The Netherlands, Norway, The Philippines, Poland, Russia, Singapore, Slovakia, Spain, Sweden, Switzerland, Taiwan, Thailand, Turkey, USA and Vietnam.

**USM**  
Modular Furniture





Haller Systems

## Timelessness

Time is the ultimate test of form and function.

Times are changing and USM's Haller Systems change with them.

Ask for detailed documentation.

USM U. Schaerer Sons, Inc., 150 East 58th Street, New York, NY 10155  
Phone 212-371-1230, 1-800-4-Haller, [www.usm.com](http://www.usm.com)  
Showrooms: Chicago Phone 312-527-2901, San Francisco Phone 415-490-4990

Circle 94 on information card

**USM**  
Modular Furniture

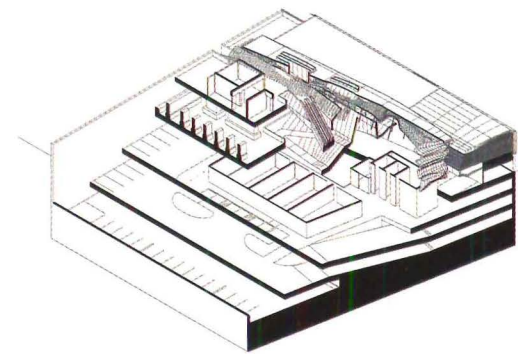
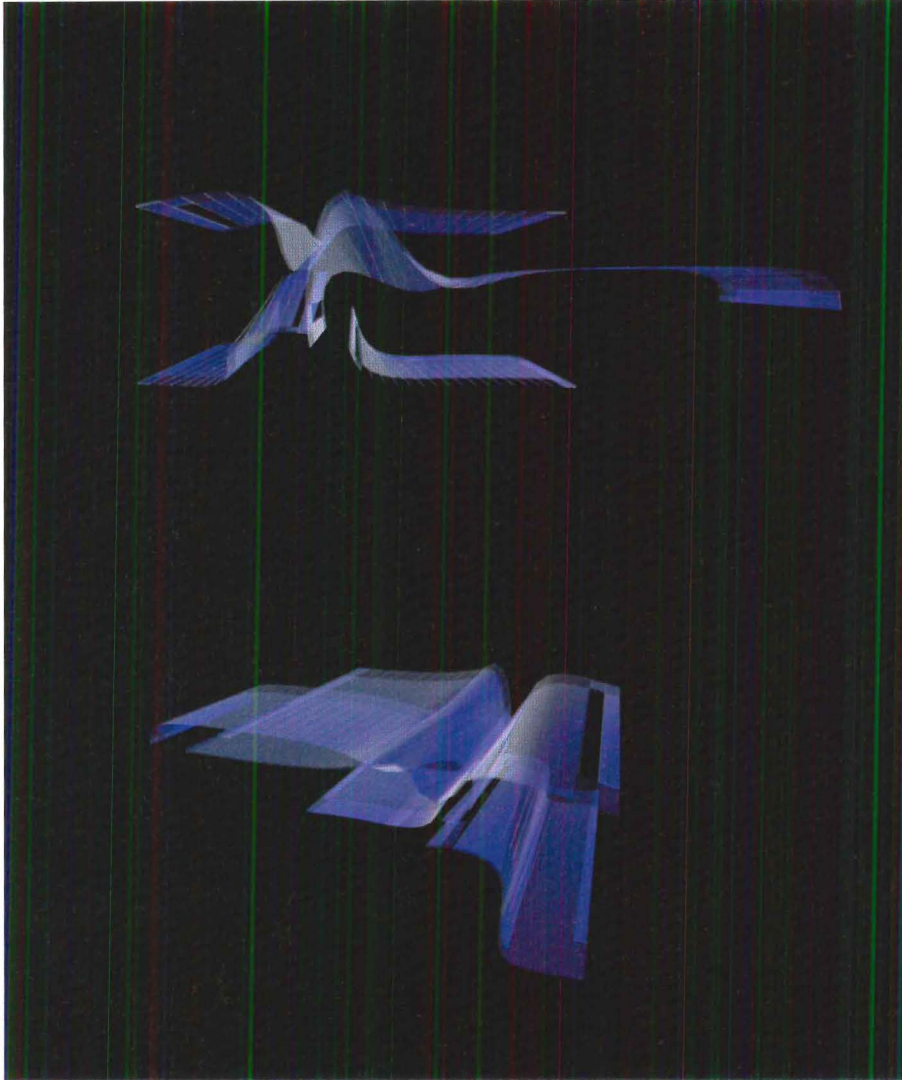

Cut-away axonometric

## On the Boards

SHoP architects hotwire the traditional strip mall.

**SHoP/Sharples Holden Pasquarelli**  
VMall, New York City

SHoP/Sharples Holden Pasquarelli is the architectural equivalent of a dotcom— young, forward thinking, and inseparable from the computer. The New York City-based practice's first major commission, the as-yet-unbuilt Museum of Sex, earned notoriety (and a citation in the 1999 P/A Awards), not only for its erotic program, but for the smart sensuousness of its undulated glass skin. In the firm's latest project, SHoP applies its avant-garde, digitally enabled conception of space and form to a more pragmatic place and purpose—a strip mall in Queens, New York.

The SHoP architects have nicknamed the project the VMall, a name with which they intend to imply such design concepts as virtuality, variability, and verticality. But some very pragmatic issues also informed the design. Local zoning ordinances determined that only 76,000 square feet of the shopping center's 203,000 square feet of parking and retail (including a 30,000-square-foot Asian supermarket) could be built above ground. The site slopes down 10 feet from back to front, and SHoP accordingly buried most of the building, so that two levels appear above grade on the street and one at the rear.

Parking consumes two basement levels; a combination of parking, ramps, and retail fill the middle three floors; retail occupies the fifth floor; and a miniature golf course covers the roof. A skylit atrium bisects the shopping center to provide visual and physical continuity between the retail floors. Its bent and folded planes of titanium, clear polycarbonate, rubber, and perforated metal dynamically envelop and incorporate hallways, escalators, and pedestrian and vehicular ramps, so that shoppers climbing from floor to floor can see cars drive past to basement parking. *Ned Cramer*

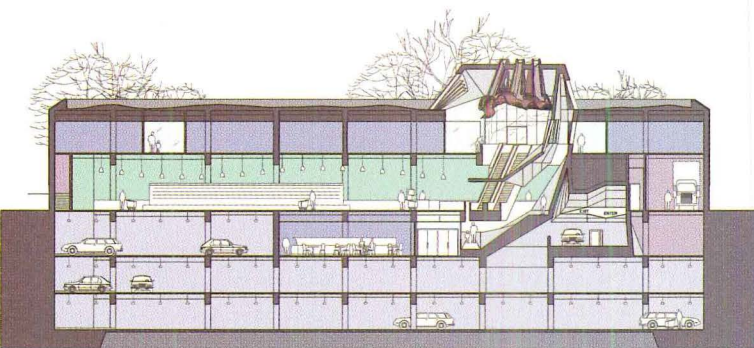
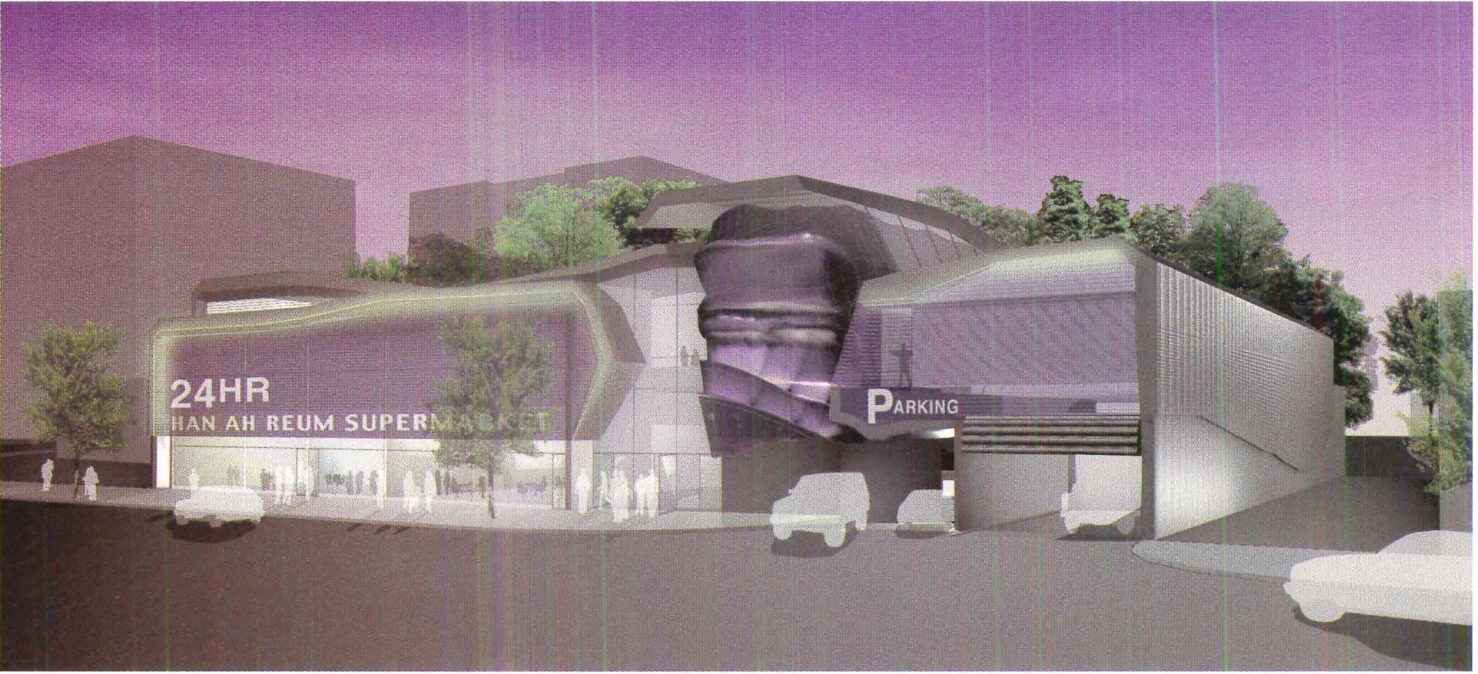

East-west section

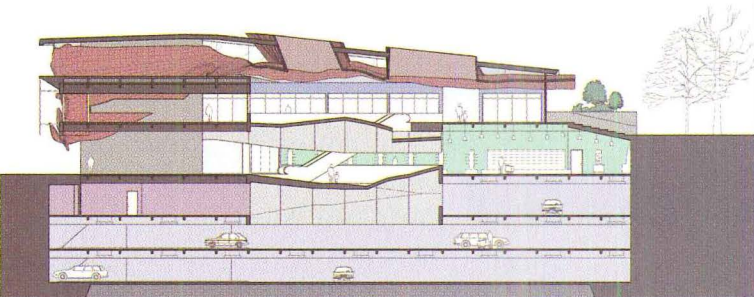

North-south section

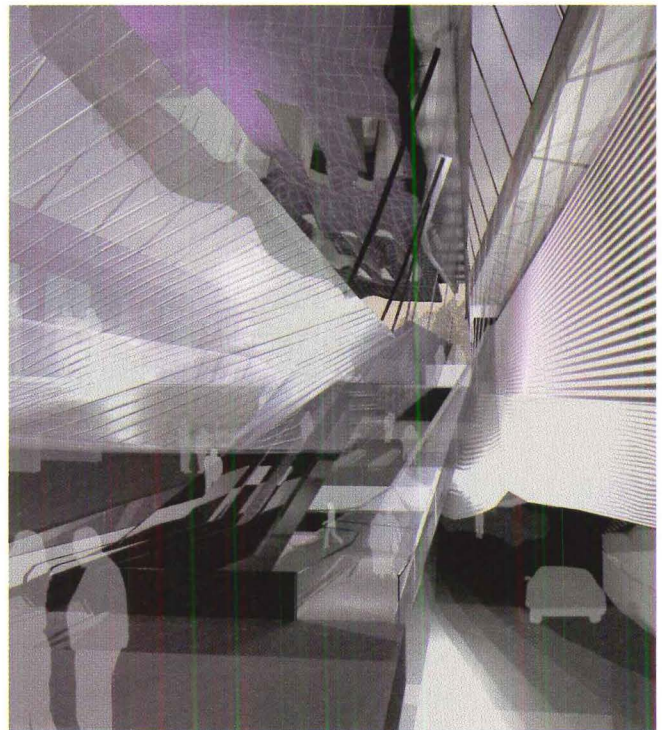

The partners of SHoP—Kimberly Holden, Gregg Pasquarelli, Christopher Sharples, William Sharples, and Coren Sharples—conceived the VMall as a series of overlapped and intersecting surfaces (facing page, far left). A central atrium, where the surfaces most dramatically interact, breaks the entrance facade (top) and runs to the rear of the building. Within the atrium (above right), a tangle of escalators and ramps create dynamic interactions between cars and people.

BOLD STYLE. MINIMAL LINES. INN



INTRODUCING Sometimes the real work of art  
**INPACT**<sup>™</sup> isn't on the wall.  
It's on the door. That's the  
case with Von Duprin's new streamlined  
**INPACT** recessed exit device. **INPACT** is fully  
integrated within a door and combines a



clean, tasteful appearance with Von Duprin  
unmatched standards of reliability  
durability. Available in a variety  
of finishes, **INPACT** is adaptable to virtual  
any application, from healthcare facilities  
to schools, hotels, office buildings, even mu

“There’s a fear that interior designers are going to take work away from architects. The reality is that it’s already happened.”  
From “Interior Motives”  
**Business p. 68**



## Star Treatment

It's show time at Radio City Music Hall after a \$70 million renovation. **Christopher Hawthorne** inspects the deco diva's face-lift.

**Preservation** In December 1932, Radio City Music Hall (designed by a collaborative known as The Associated Architects, led by Wallace K. Harrison) opened to the public on the western edge of an unfinished Rockefeller Center. The soaring art deco interiors of this new entertainment palace, the brainchild of John D. Rockefeller and the impresario S.L. “Roxy” Rothafel, provided a much-needed visual palliative for a country slipping into the fourth year of its Great Depression. The artistic team assembled by interior designer Donald Deskey crammed every inch of the 6,200-seat theater with color and texture, from 24-karat-gold-backed mirrors as tall as trees to lounge chairs of aluminum and patent leather. Onstage, too, beneath the highest proscenium arch in the world, Rothafel made sure that grandiosity was the rule: The opening-night gala didn’t wind down until 2:30 in the morning.

Now, more than 67 years later, Radio City is again showing a gleaming face to the public after an exhaustive seven-month, \$70 million renovation overseen by Hugh Hardy of New York- and Los Angeles-based Hardy Holzman Pfeiffer Associates (and paid for by Cablevision, which now owns the building).

The Sixth Avenue “E1” train was demolished seven years after Radio City opened, leaving the main entrance and marquee clearly visible. The designers wanted visitors to feel the theater’s spell long before reaching their seats.





The ticket lobby opens onto the elliptical Grand Foyer. A restored version of Ezra Winter's *The Fountain of Youth* dominates the north wall above the stripped and repolished marble-and-bronze staircase (facing page). Six miles of new red, blue, and gold neon tubing was added to the legendary marquee (above).

How could a Radio City Music Hall past retirement age—even after a series of architectural lifts and tucks—compete with the high-volume culture around it? Would out-of-town visitors, who make up 80 percent of Radio City patrons, still find a trip to the theater thrilling if it were sandwiched between a stroll through a high-wattage, Disneyfied Times Square and an IMAX screening? During the years before the renovation the answer to that question was simple: Radio City couldn't keep up. Inside, the building had lost much of its luster, decaying into a still impressive but thoroughly earthbound version of its former self. Wallpaper and carpets, dirtied by years of cigarette smoke and trampling feet, had begun to fade to the same muddy brown color. Artwork was carted off to museums, or closed off from view.

But the story of Radio City is no simple narrative of long decline finally reversed. Desperation and failure have alternated with comebacks and surprise victories since the hall originally opened. Since before it opened, actually: Deskey, at that point a relative unknown, drained his entire life savings of \$5,000 to put together his original scheme for the interior design. Rothafel, who insisted on opening the theater with a program of traditional vaudeville—even as that style of performance was fading from fashion—collapsed after the final curtain on opening night and left the building on a stretcher. Radio City lost nearly \$200,000 in its first two weeks of operation, and Rothafel was forced into retirement a few months later. Turning the theater into a

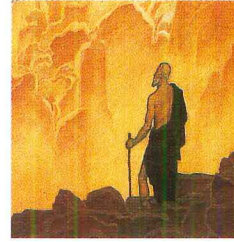

#### Youth Renewed

The Grand Staircase in the foyer, which rises to the mezzanine level, is wrapped with a mural 60 feet long and 40 feet tall. *The Fountain of Youth*, by Ezra Winter, represents an Indian legend of mankind's search for the fountain across a bridge to a mountaintop. Over the years, several coats of varnish were painted over the mural, dramatically darkening and yellowing the colors. As part of the restoration, conservation experts painstakingly removed the layers, readhering flaking paint, and repainting areas where paint was lost. This mural is one of the most visible symbols of Radio City's renewal. **Sara Hart**

high-end movie house helped turn things around in the 1940s and '50s, but by the 1970s, Radio City was again running a severe deficit. Filling just a tenth of its seats on some nights, it escaped demolition only after the city designated the theater's interior a landmark in 1978.

In a sense, the building's spotted history only made the job of Hardy, who pulled off similar resuscitations of Manhattan's New Victory and New Amsterdam Theaters, more difficult. Because most people knew the original Radio City only from old photographs filled with stylish, smiling celebrities, their memories of it perhaps possessed even more glamour than the original hall ever did. When Hardy first inspected

#### RADIO CITY MUSIC HALL RENOVATION, NEW YORK CITY

**CLIENT:** Cablevision/Madison Square Garden and Radio City Productions, New York City **ARCHITECT:** Hardy Holzman Pfeiffer Associates, New York City—Hugh Hardy (partner-in-charge); Stewart Jones (project director); Jonathan Schloss (project manager); Caroline Bertrand (project interior designer); David Andreini (project field representative); Carey Press, Serge Demerjian, Nina Freedman (project architects); Winslow Wu, Hyungsup Sim, Steve Benesh, Marcelo Mendez, Arturo Padilla, Doug Pearl, Kari Overvik, Chris Kaiser (design team); Ryoko Okado (interiors) **ENGINEERS:** Robert Silman Associates (structural); Meyer Strong and Jones Engineers (MEP) **CONSULTANTS:** Fisher Dachs Associates (theater); Fisher Marantz Stone (lighting); Jaffe Holden Scarbrough (acoustics); Building Conservation Associates (historic preservation); 212 Associates (graphics and signage) **CONSTRUCTION MANAGER:** Barr & Barr, Inc. Builders **COST:** \$70 million **PHOTOGRAPHER:** Whitney Cox, except as noted







A newly woven, 112-foot-wide gold curtain hangs from 13 motorized cables concealed behind the restored proscenium's overlapping arches (facing page). All 5,910 original seats in the 450,000-square-foot auditorium were replaced (below). The ceiling was resurfaced with coats of metallic speckled paint (above).



Radio City after he won the renovation contract in 1998, he says, "I couldn't believe how dowdy it had become." That Hardy has banished dowdiness becomes clear as soon as you leave the low-ceilinged ticket lobby and enter the Grand

Foyer, which can once again take its place among the nation's most impressive rooms. As the renovation makes plain, it was here that Deskey most successfully married the opposing themes of lushness and speed, creating a streamlined opulence.

"We touched every surface in this space," says HHPA project manager Jonathan Schloss of the Grand Foyer. Its ceiling, which rises more than 61 feet overhead, has had its gold-tinted aluminum leaf completely replaced and reglazed. A new version of the foyer's carpet, a geometric, almost cubist swirl of musical instruments designed by artist Ruth Reeves was hand-woven by restorers working from her original watercolor rendering of its design. On the northern wall, Ezra Winter's three-story-high mural, *The Fountain of Youth*, has regained its position as the unifying piece in this gigantic space. A thick layer of varnish applied to the mural in the 1960s had yellowed with age, darkening Winter's work; restorers cleaned it to the level of raw paint, applied touch-ups by hand, and then covered the whole surface with a non-discoloring protective coating.

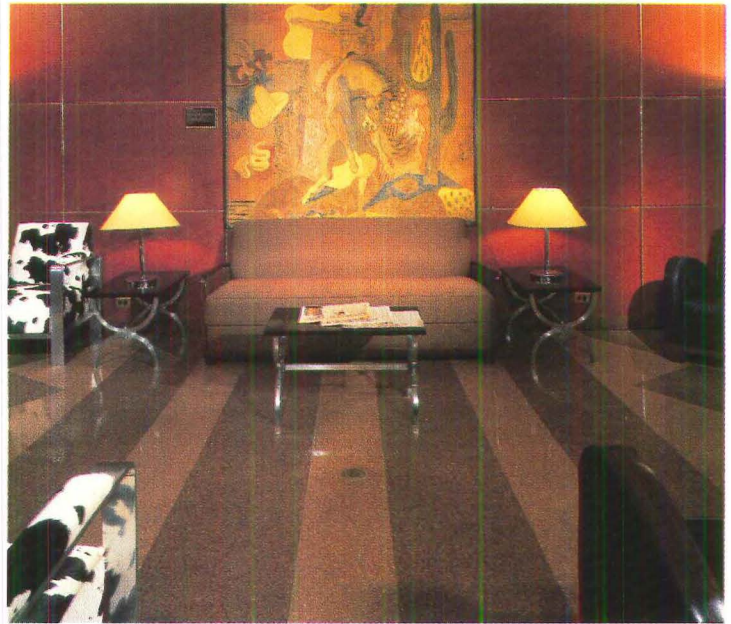

The original men's smoking room on the third mezzanine was based on a Western theme featuring a wall painting titled *Wild West*, by Buk Ulreich (below). HHPA replaced the leather wall panels and reproduced the brown-and-white cowhide chairs. The terrazzo floor was patched and refinished (above).



It is still the auditorium, though, that stands as Radio City's most eye-popping feature. Its 60-foot-high proscenium arch—designed by a 30-year-old Edward Durell Stone to resemble a setting or rising sun—shifts imper-

ceptibly from wall to ceiling as it radiates outward above spectators' heads. The recovery work here was among the most extensive in the theater. Each of the seats, which fill a broad orchestra level and three shallow mezzanines, was replaced and upholstered with a plush salmon-pink fabric. There are 5,910 of them, some removable to accommodate television cameras and wheelchairs. The theater's mechanical and electrical systems have been brought up to date as well. New speakers hang from the balconies, which have also gained structural supports for new lighting and had their facings replaced to improve acoustics. And the theater is now wired to broadcast its highest-profile events, such as the Emmy Awards, in HDTV format, with three dozen new camera positions connected to a television control room on the 51st Street side of the building.

The original Radio City's smoking rooms, lounges, and powder rooms that led to the men's and women's restrooms on each floor were like sumptuous worlds unto themselves. Each had a theme, from tobacco

# From Now On...

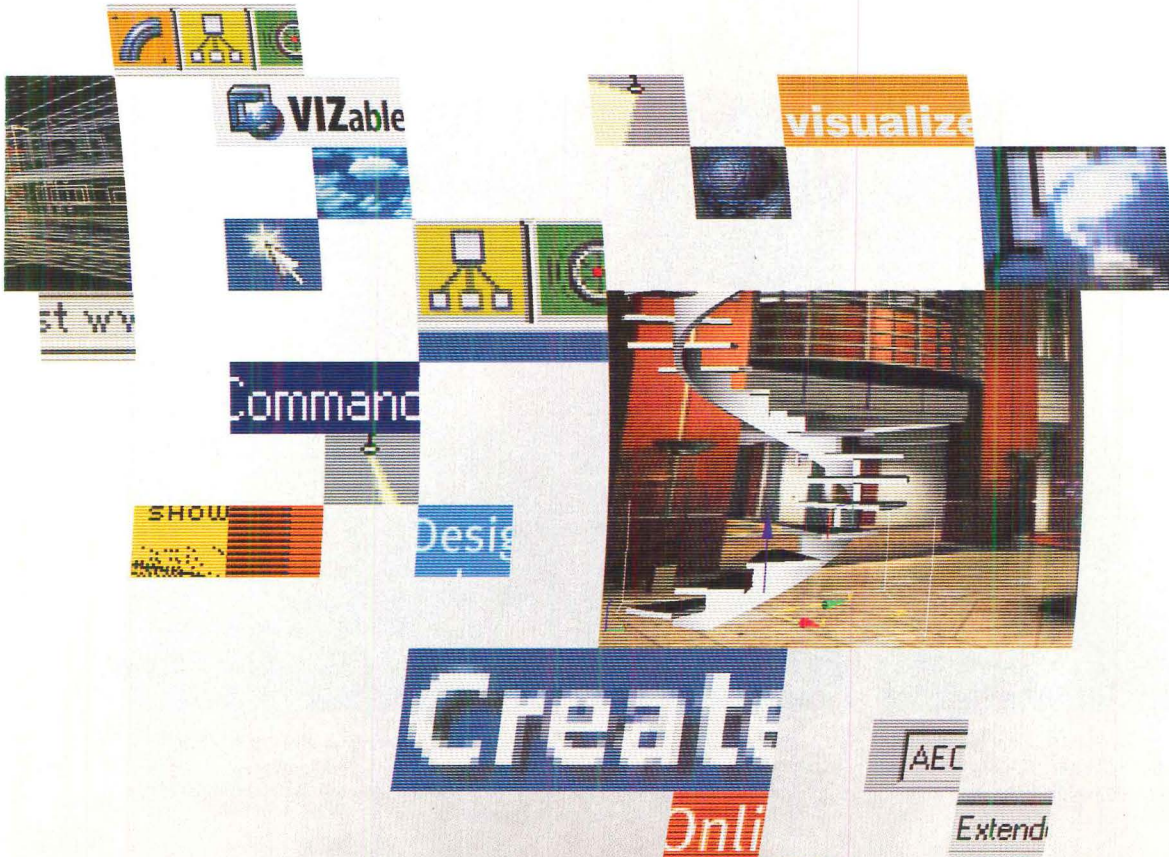

...You'll sharpen your imagination, instead of pencils.

...You'll use the web as a tool, instead of a toy.

...You'll communicate more, and clarify less.

## 3D Studio VIZ™ R3

The leading design visualization tool now has an innovative, web-enabled Asset Browser. For the first time you can drag and drop manufacturers' content directly into your designs.

To learn more visit us at

[www.autodesk.com/vizr3](http://www.autodesk.com/vizr3)





The men's smoking room off the Grand Lounge was converted to storage in 1978. HHPA reinstalled the Stuart Davis mural *Men Without Women* and refinished the walls in waxed-cork tiles (top). The 16-sided women's powder room on the first mezzanine contains white-lacquered wood stools designed by Donald Deskey (bottom).

to the Wild West to the history of cosmetics, with murals and furniture to match. But over time they lost some of their great appeal. Yasuo Kuniyoshi's mural in the women's lounge on the second mezzanine was painted over completely in 1963. Artist Stuart Davis' wall panel, *Men Without Women*, was exiled to the Museum of Modern Art a decade later, and the smoking lounge that had displayed it became a makeshift storage closet, piled high with packing boxes. Now the Kuniyoshi has been re-created, and the Davis is back in its original spot, flanked by shining cork wall panels. (At first the architects thought the cork had been completely removed from the room over the years. But they found a bit of it hiding behind a mirror, and from

*continued on page 134*

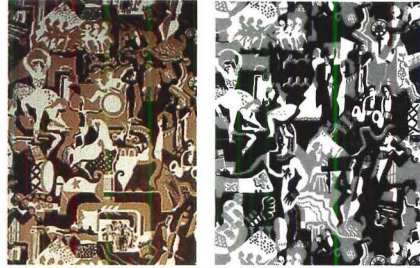

More than 40 years of cigarette smoke had badly discolored Ruth Reeves' *History of Theater* (top left). HHPA reproduced her design (top right). The reinstalled fabric covering the back walls of the auditorium and mezzanines acts as an acoustical buffer (bottom).

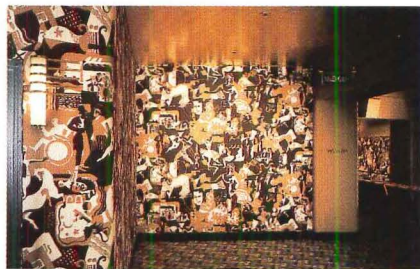

#### Up Against the Wall

Textile designer and artist Ruth Reeves (1892–1966) designed Radio City's *History of Theater* linen wall hanging to cover the entire back wall in the orchestra section and mezzanine levels of the auditorium. Her two-panel design used abstracted images of acrobats, ballet dancers, and circus clowns rendered in shades of brown, caramel, and tan.

By the 1970s, the linen had torn and the colors had degenerated into a dull, monochromatic brown. Members of a misguided renovation team in 1979 cannibalized the original design by patching together images from both panels into a single incoherent reproduction, which they then printed onto heavy canvas in colors that imitated the existing dark brown hues, rather than the original ones.

Caroline Bertrand, design director of HHPA's interiors department, spent 2½ years scouring newspaper articles and old black-and-white photographs in search of clues to the original design and color scheme. Combining intuition, assumption, and analysis, Bertrand and her team re-created Reeves' product with as much verisimilitude as possible and commissioned dozens of paint samples until she was satisfied with the tones and hues. Because the fabric also had to act as an acoustical buffer, cotton samples were examined until one was found with a weave dense enough for silk-screening, but loose enough to absorb sound and satisfy updated acoustical requirements. Finally, the panels were hand-printed at Scalamandré Studios imitating the exact method used by Reeves and her team in 1932. To Bertrand's delight, small remnants of the original panels were uncovered during demolition for the renovation. The eggplant, caramel, and cream colors that she had so painstakingly mixed and remixed turned out to be dead ringers of the original. **Sara Hart**



## MEMBERSHIP MAKES A MONUMENTAL DIFFERENCE.

About 100 years ago, John Muir and his small group known as the Sierra Club worked to make Yosemite a national park, to preserve it for generations to come. Since then, the Sierra Club has helped to protect 100 million acres of wilderness areas, 8,000 miles of wild and scenic rivers, and national treasures like the Grand Canyon and America's newest monument: the Grand Staircase-Escalante. Our proven track record and diverse following have made us the largest grassroots environmental organization. And the most effective. But today we're facing greater challenges than ever before. So if you'd like to make a lasting difference for generations to come, please join us.



SIERRA  
CLUB  
FOUNDED 1892

Protect America's Environment: For Our Families, For Our Future.

85 Second Street, San Francisco, CA 94105 • (415) 977-5653

Or visit our website at: [www.sierraclub.org](http://www.sierraclub.org)

Email us at: [information@sierraclub.org](mailto:information@sierraclub.org)

The #1 Global Marketplace for  
Ceramic Tile and Natural Stone

# World Wide

# WOW



## DISCOVER

thousands of hot new products  
-10 miles of aisles!

## SOURCE

from every major  
manufacturer and  
supplier in the world

## PROFIT

from opportunities you'll  
find only here at the  
#1 industry marketplace

## WIN

Watch your mail  
for Advantage  
Cards from  
Coverings 2000  
exhibitors.



Then, bring the Cards when you visit  
those exhibitors. You might win a trip  
to Bora Bora, a car lease, \$5,000 in  
cash or other exciting prizes.

PLUS, Advantage Cards are your key  
to special discounts and free gifts.



# coverings 2000<sup>sm</sup>

*The International Tile & Stone Exposition*

**May 2-5**

**Orlando, Florida USA**



561.747.9400  
800.881.9400



561.747.9466  
800.883.9466



info@coverings.com  
www.coverings.com

# Interior Motives

Bradford McKee reports from the front lines of the never-ending border war between architects and interior designers.

## Business

Interior designer John Arabolos, of West Haven, Connecticut, knows there's a war brewing out there between architects and interior designers. But you wouldn't know it to judge by the daily practice of his four-person firm. Arabolos Design Associates works with architects on about half of its projects—whenever he needs structural help, the principal says, and the relationship is almost always simpatico. The battle, in case you can't hear the rumble, is being waged between the American Society of Interior Designers (ASID) and the American Institute of Architects (AIA) in statehouses across the country. It's a turf war provoked by the separatism of interior designers, who want their own profession distinct from, not subordinate to, architecture.

Architects, you can bet, would prefer that interior designers remain in a lower caste, as this conflict goes beyond the question of who is qualified to move a wall and who is merely allowed to specify wallpaper. It concerns who holds the power and esteem in the allied design industries. And in no small way, it is about who makes the money.

This is a long, cold war dating back more than 20 years. But the battle cry between ASID and the AIA sounded again last spring, when ASID's board of directors backed out of a dubious treaty the two groups signed in 1989, in which each pledged to help the other up the economic ladder. It was not to last, for obvious reasons. "I work with architects all the time and never have a problem," Arabolos says. "But there's a fear [among architects] that interior designers are going to take work away from them. The reality is that it's already happened."

If architects fear losing work to interior designers, then interior designers have their own nervous perch on the food chain: directly below them are the hordes of semi-professionals known as "interior decorators"—often caricatured as ragpickers and furniture salesmen. Thus, since the late 1970s, interior designers, mainly through their lobbyists at ASID, have been gunning to get state legislatures to treat them

as a bona fide profession, much as they treat architects, engineers, doctors, and lawyers.

Architects, through the AIA, have fought them at every turn, maintaining that, philosophically at least, "professional" status is only necessary for occupations affecting the health, safety, and welfare of the public. Only architects, they argue, are sufficiently educated, trained, examined, and, ultimately, licensed to make such crucial decisions. The common interior-design curriculum doesn't—and shouldn't—carry such a burden, insists a report issued last September by an AIA task force on interior design. The AIA concludes that the need for a new regulatory infrastructure for interior design at the state level is imaginary—and also highly wasteful.

"We see the proposed [interior] designer laws as diluting protection to the public as well as diluting the resources to enforce the architecture and engineering [laws]," contends Shirley Norvell, executive vice president of AIA Illinois, who has fought the interior designers' legislation for 11 years at the state capitol in Springfield.

The legislative debate began in 1979, when interior-design lobbyists in New York state tried unsuccessfully to persuade lawmakers to pass what is known as a "right-to-practice" act, which essentially attempted to establish a formal regulatory apparatus for a profession. In this case, the statute would have defined what degree of education and training is required of anyone who wishes to assume the title of "interior designer" and perform routine interiors services such as installing partitions and specifying seating.

Interior-design lobbyists pushed on, to no avail, for legal protections until 1982, when they scored their first victory in Alabama, where the legislature passed what is known as a "title act." A title act simply says one can't call oneself an interior designer without satisfying a bare minimum of requirements and registering one's name with the state. Only the appellation is off-limits. One can still *continued on page 135*

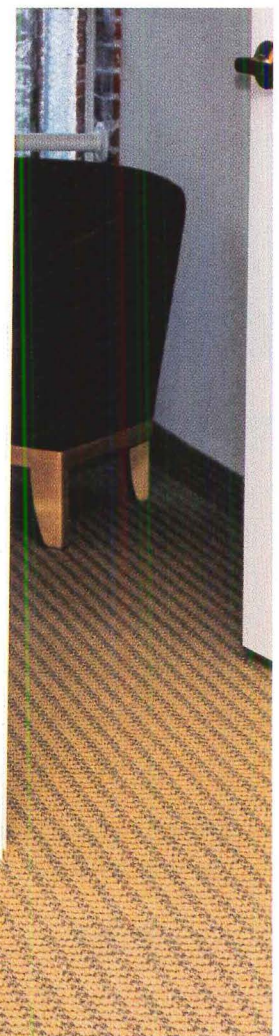
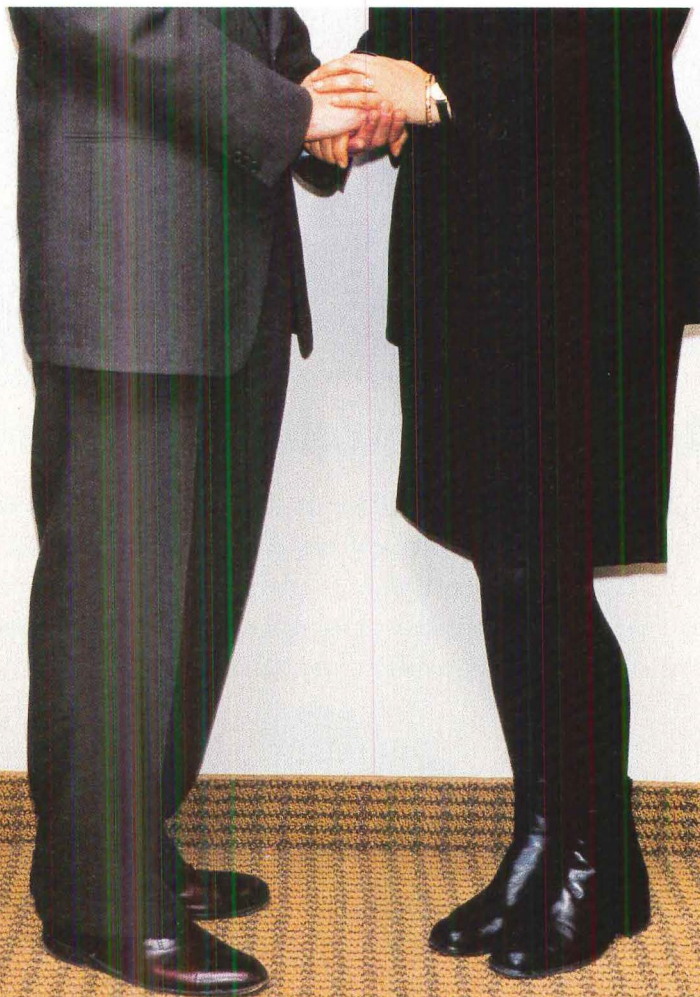

Border war:  
Former AIA president  
Michael Stanton  
and ASID president  
Rosalyn A. Cama.

# formz

## 3D FORM SYNTHESIZER

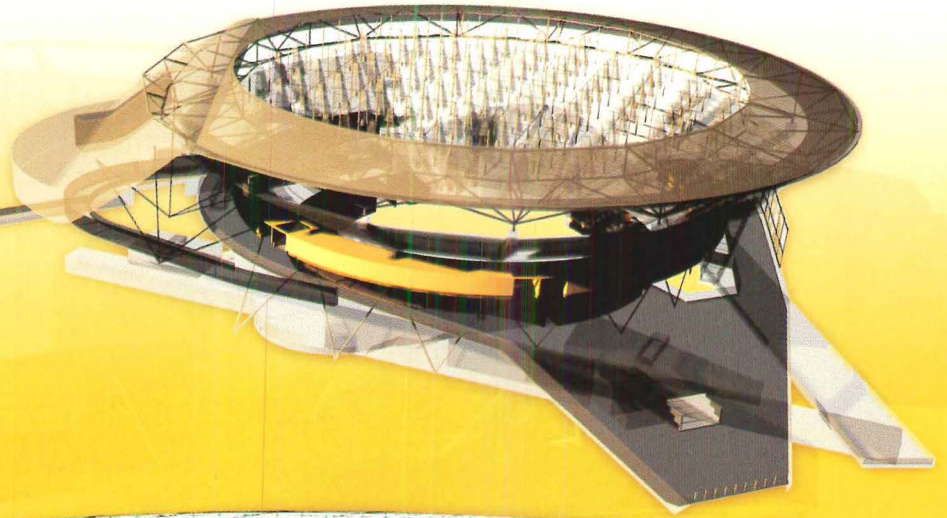

A multi-use stadium located in Guadalajara, Mexico, by Morphosis, Santa Monica, California. All modeling and rendering by Ung Joo Scott Lee.

## The most complete set of modeling tools for 3D design.

**Thom Mayne**, Principal of **Morphosis**: "One of the most significant benefits derived from the integration of computer technology in the design studio is the ability to create both presentation material and construction documents out of the same epigenetic material. The 3D model utilizing **formz** is the initial departure point of the design process. A continual refinement of the 3D model both informs the design and brings another level of precision and coherence to the project. It's a tool which assists us greatly with the issues of simultaneity, which might be seen as the consistently singular issue of the 20th century."

3D solid and surface modeling software at its best, with  
Visit us at [www.formz.com](http://www.formz.com) to download a free demo.



photorealistic rendering, radiosity, and animation.  
Call (614) 488-8838 or fax (614) 488-0848 for information.



Circle 104 on information card



# culture

**Lawrence W. Cheek**  
on Green New Urbanism  
p. 74

**David Harvey**  
on the Politics of Propinquity  
p. 78

**Cathy Lang Ho**  
on Rooms with Views  
p. 80

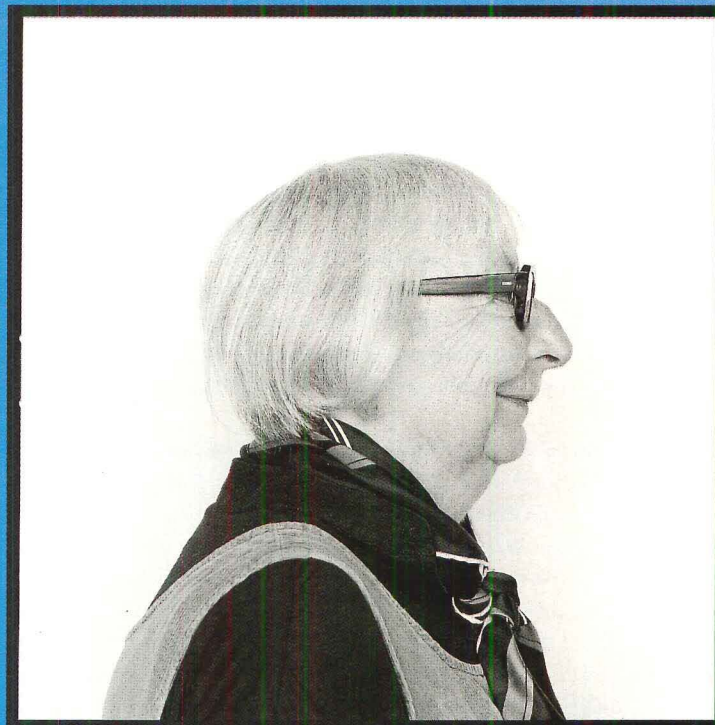

## Jane Jacobs, Urban Agitator

Cities keep making the same mistakes, but Jane Jacobs hasn't given up on them. **Adele Freedman** speaks to her about her latest book.

**Interview** At 83, an amazing 40 years after the publication of *The Death and Life of Great American Cities*, Jane Jacobs is still searching for new ways to think about “the whole precarious contraption,” her homespun term for economic life. Jacobs has always been fascinated by the hows and whys of our doings and strivings, of our prosperity or failure to prosper. The fact that economies flourish most vigorously in cities has been a lifelong theme and provocation for her work. In the just-published *The Nature of Economies* (Modern Library)—her sixth book, not counting an edition of her grandmother’s journals and a children’s book—Jacobs arrives at economics via an analysis of the lives

Photographer Arnaud Maggs' 1983 portrait of Jane Jacobs, from his series *48 Views*.

of plants and animals, her assertion being that all ecologies, including human settlements, operate on the same universal principles.

This interview took place last October in Toronto, where Jacobs and her family moved from New York in 1968 after both her sons decided they would not serve in Vietnam. Her three-story Queen Anne is in a leafy downtown neighborhood of the sort she praised in *Death and Life*. With a career laudable for its courage as much as its longevity, Jacobs began by taking a position on the edge and has remained there ever since—marching to the beat of her own curiosity and intellect. Revered in her adopted city, she is often seen about her neighborhood in her woolen poncho and Adidas sneakers—a disarming brand of bohemian chic, about which, like everything she stands for, she is thoroughly unapologetic.

**Adele Freedman: In your books something always set you off, whether it was the stupidity of modern planning in *The Death and Life of Great American Cities* or the number-crunching economists in *The Economy of Cities*. What sparked *The Nature of Economies*?**

Jane Jacobs: An interest in process. All living things, including things we would regard as inanimate, like communities, form and re-form themselves and become what they are, and then become something else, and so on, because of process. I don't think this is as understood or acknowledged as it should be. In my book, I mention the fallacious "Thing Theory"—of development, of community, of everything—which pervades far too much of our thinking. Look at city planning. The idea we encounter so often is that things can be made perfect; you try to make a thing, and that's it. Whereas at best, all you can make is the site for processes to happen, and the processes will inevitably affect the thing, too. I wonder a little about why *Architecture* readers would be interested in this, but I'm glad if they are, because my book is concerned with building habitations for processes.

**The imaginary characters in *The Nature of Economies*, which was written in the form of a symposium, describe settlements in terms of energy flows and discharge, webs, feedback loops, fractals, bifurcations. It's a far cry from *Death and Life's* safe sidewalks and short blocks. Are you still as interested in cities as you used to be?**

Oh yes. They're all part of the same thing. Streets are involved in energy flows and in webs. Cities are the locus of processes and, of especial interest to human beings, they're the locus of most of our economic processes. That still interests me. Really what I've been doing is the same book all along, with new chapters.

**Are the enemies still the same?**

I think now the enemies are ignorance and lack of awareness. Take the recent changes in zoning in Toronto's old industrial district to permit mixed-use development: It was so hard to do, even though there was a strong leader—former mayor Barbara Hall—with a lot of backing by entrepreneurs and people who love the city. It was the same in the 1970s, when people fought to make infill happen. The reason this doesn't hap-

pen naturally and exuberantly is all the regulations and bylaws constructed for a different vision that still stand. I get very irked that the people who preside over these bylaws and regulations are not taking it on themselves to dispose of them. It irks me that, while today's planners talk a much better line than they used to, and have better ideas, they haven't done this hard work of dismantling that old debris. Who's going to do it if they don't? This should have been one of their biggest tasks.

**There's movement in planning, if not in the planning bureaucracy. What did you think of Seaside? How significant is New Urbanism?**

When I first heard about Seaside, I thought of it as a copy of small towns, but its meaning is a lot larger than that. It has been extended into cities,

**I don't think architects are aware enough of context, that everything they do is in a context—even when it stands out from the context.**

and it embodies, when it's allowed to, a lot of the principles that work in cities. But you notice how much it follows project planning, which is not organic. It still has that foundation—that structure—of segregated uses. And that is built into it by the bureaucratic context. It is not the wish of New Urbanists, however. They tell me of the obstacles that stand in their way, and how hard it is, very often, to get permission and cooperation to try out their ideas. It's heartbreaking to want to do something like this and to be stifled. There's a fear of evolution.

**How do architects fit into the picture? You count many architects among your friends—your late husband Robert Jacobs was one—yet you can be quite hard on architects, to say the least.**

Maybe what bothers me the most is architectural education. It encourages a kind of unfortunate self-sorting in which—how shall I put it?—students are encouraged to think of Things, to be showy about a Thing, to be interested in Things and not in processes. That's why I liked Stewart Brand's *How Buildings Learn*. He addressed this straight on by showing how buildings change and learn. It's much the same as what I'm saying. I'm not against architects. I think many do beautiful and sensible things, and they often do it against great odds. But their training—well, there are two kinds of training. One comes down the line of architecture as a fine art—the cathedral-makers. And the other one is architecture as mundane engineering. I don't think either is an adequate expression of what architecture should be. I don't think architects come out of school aware enough of context, that everything they do is in a context—even when it stands out from the context—like Frank Gehry's much-admired things, especially the museum in Bilbao. If [works like that] were up in a field somewhere, or with a collection of other such things, they wouldn't work. Gehry is very *continued on page 142*



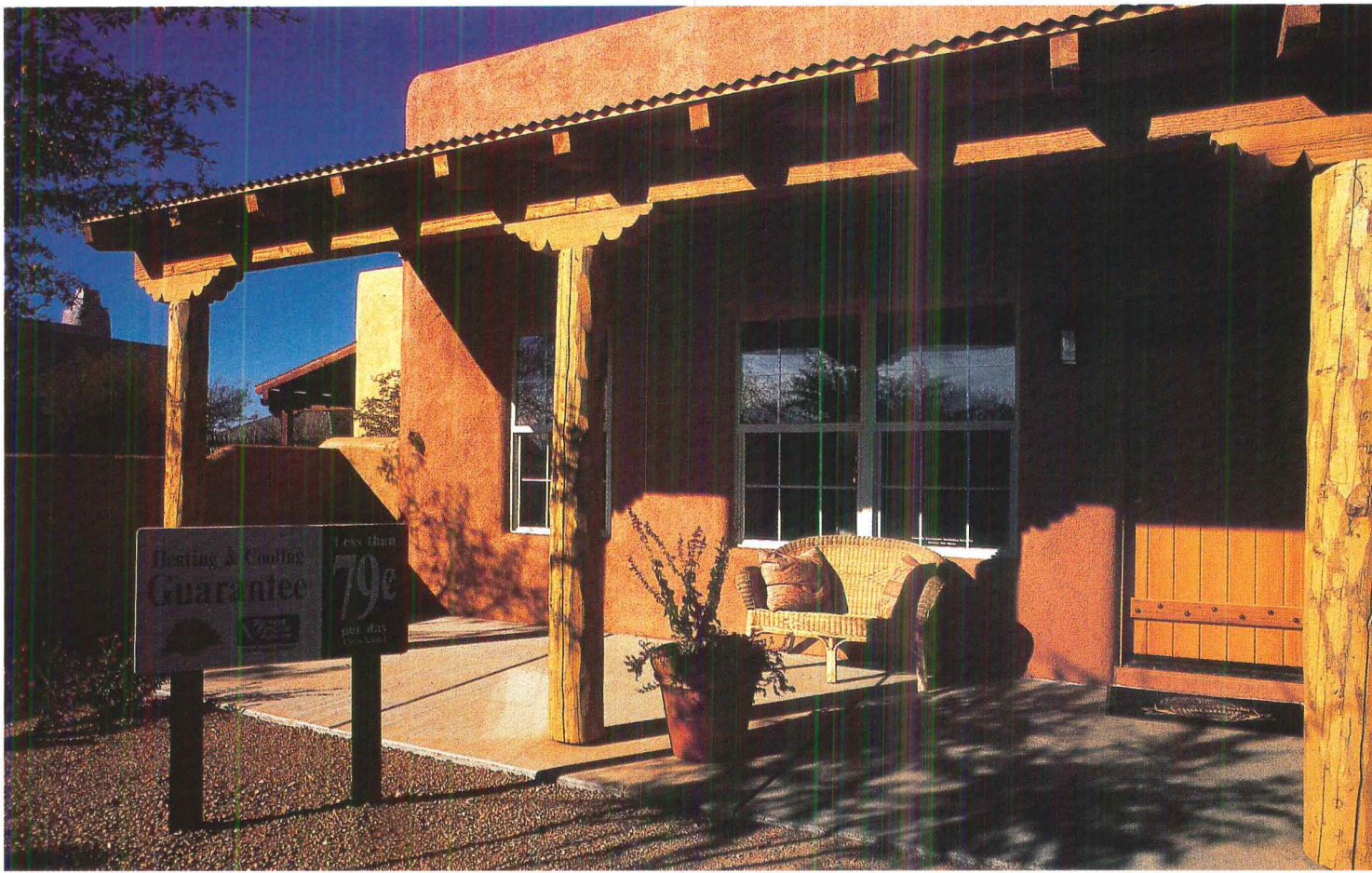

# New Urbanism Sees Green

Civano mixes New Urbanism with green design. Lawrence W. Cheek tests the results.

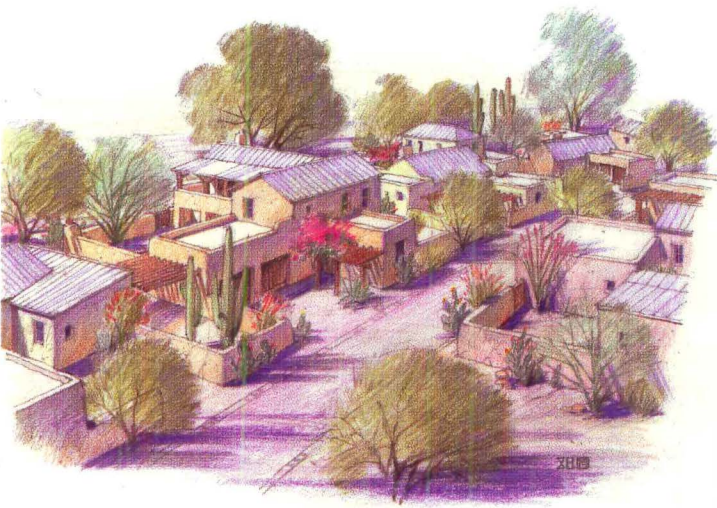

**City** Over the quarter-century I lived in Tucson, the city doubled in size and died by a thousand cuts. Mindless development ransacked its two great natural resources—a prodigious aquifer and the lavish Sonoran Desert landscape—generating monsoons of protest but little innovative planning or enlightened housing. Unless you had an environmental conscience and a mountain of money—hard to come by legally in low-wage Tucson—you bought a production house on a swath of bladed desert, sited with no concern for sun or view, and then swallowed hard when the utility bills slammed home.

A year ago, Civano, the city's first large-scale “sustainable” housing development, opened for business. It had been ridiculously long in gestation—20 years, battered by public carping and nearly killed by numerous close City Council votes. (Critics were chary of the city subsidizing a “sustainable” development that appeared to gobble pristine desert and promote sprawl.) But buyers have descended like locusts. Despite a remote location and a cost premium of 12 to 15 percent over comparable square footage, 120 houses were sold in the first seven months.

The reason for Civano's success, believes John Laswick, Tucson's sustainable-communities program manager, is that “it takes the green soul of sustainable development and puts some curb appeal on it.” That “green soul” is cached in a set of resource conservation standards that the city has imposed on the developer, Civano Development Company (CDC), in exchange for \$3 million worth of subsidized infrastructure. Civano's 2,600 eventual households must use 50 percent less energy

than specified in the 1995 Model Energy Code; use 54 percent less potable water than Tucson's baseline 1990 residential average; generate 30 percent less solid waste than the local average; and generate 40 percent fewer trip miles than the local average.

Builders must certify that their houses will meet the energy conservation standards before being granted building permits. The other goals, Laswick admits, lean heavily on household ethics and individual enterprise. He's optimistic that the community will incubate a culture of conservation. "A lot of the people I know who've moved in already were drawn to Civano because of conservation," he says. "Over the long run, I think it will not only meet but exceed the standards."

Some local critics don't think so. Former city councilwoman Molly McKasson, who voted against the project, complained at the opening, "It's so far out [about 15 miles east of downtown Tucson] that everything you save on heating your house is going to be burned in your gas tank." Councilman Steve Leal said that while Civano is using all the right buzzwords, it's hardly "sustainable" if it had to engorge millions of dollars in subsidies in order to exist.

But at the very least, Civano is a dramatic departure from business as usual. The community plan, developed by Pasadena, California-based Moule & Polyzoides Architects & Planners (which also designed many of the house models), adheres to the New Urbanist agenda, which is new to Tucson. Usable porches peer over narrow streets; garages and mother-in-law apartments open to paved alleys. Home businesses are encouraged. A café already has opened in the community center, although hungry Civanoans still have to drive eight to 10 miles to reach any serious dining because a commercial core has yet to evolve. Location, location, and *continued on page 144*

Five different developers offer a range of house models: The "adobe look" of TJ Bednar's The Villas (top left and bottom right), designed by Moule & Polyzoides, comes in RASTRA block. First Homes' Village Center model (bottom left), designed by Paul Weiner, is a live-work layout with zero lot line and courtyard. Another First Homes model, Desert Ranch (top right), by Moule & Polyzoides, is a straw-bale construction.

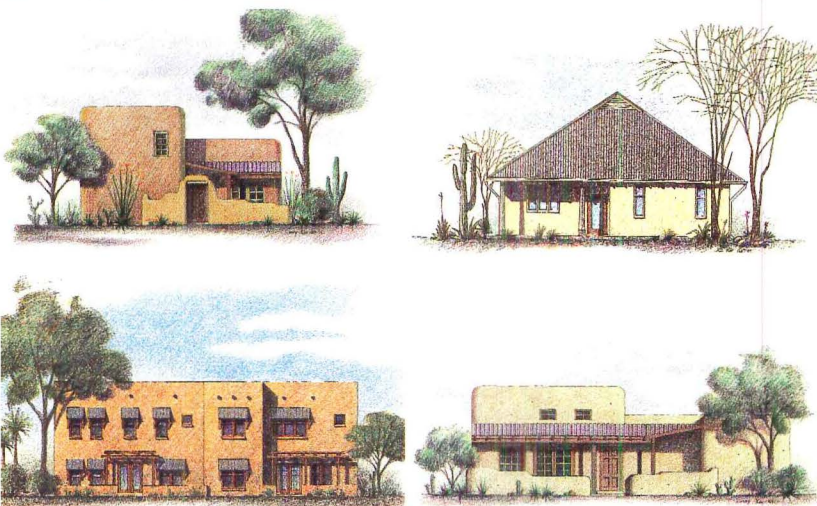

### Green House Effect

Even in a desert with sunshine to burn, solar energy remains a tough sell. So does conservation—if the cost-benefit scenario sprawls over the horizon.

A real-world example from Civano: Developer TJ Bednar's Cielo model is a 1,227-square-foot house normally built with 2-by-6 wood-frame construction (base price: \$111,300). Walls are rated R24 and the ceiling R38. RASTRA-block construction, which takes walls to R37, is an option that adds \$13,000 to the price tag. The sales agent tells prospective buyers that this might cut the projected monthly heating and cooling cost, already low at \$24, in half. Do the math: If you live in the house for 90 years, it would begin to pay off.

"I wouldn't do it," the agent confides. So despite builders' offerings of green alternatives such as RASTRA block and straw bale, most of the houses in Civano that have been sold are framed conventionally in 2-by-6 fir. With today's moderate energy costs, anything else is a spiritual commitment, not a checkbook decision. Browsers are already pleasantly startled by three-year heating/cooling guarantees, developed in cooperation with the city's electric utility—no more than 79 cents per day for that 1,227-square-foot house, for example. Only six homes built so far at Civano have photovoltaic power bars on the roof, and four of those are models. A 1-kilowatt grid-tied photovoltaic system costs \$8,000, thus keeping this option in the realm of the demo. Of the five builders currently active at Civano, only SolarBuilt has a standard-equipment photovoltaic power supplement—and its 1,951-square-foot model, at \$225,000, is priced high in the Civano stratosphere.

Still, many of Civano's homes do offer, as a matter of routine, cost-effective and common-sense green features, such as recycled steel studs and stained concrete floors in place of wood products, built-in kitchen recycling cabinets, and wiring for ceiling fans in every room. Some, though certainly not all, are sited for passive solar heating; there's a trade-off between squeezing lot sizes and throwing southern exposures open to the winter sun. More aggressive conservation practices will await harder times—ironically, when we can least afford it. *L. W.C.*

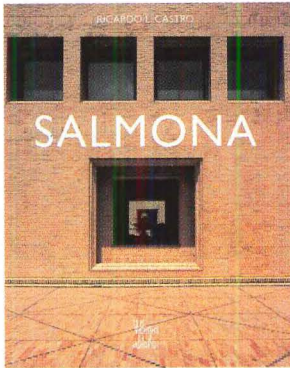

#### Bibliofile

**Salmona**, by Ricardo Castro (Villegas Editores, 1999; distributed in the U.S. by Rizzoli International)

Like many of his Latin American counterparts, Colombian architect Rogelio Salmona, now 70, spent his early 20s apprenticing in Le Corbusier's Paris atelier. This direct experience with European modernism left a lasting imprint on his work, yet did not stop him from developing a highly personal style rooted in diverse sources, ranging from Spain to North Africa, the Middle East to Latin America.

In the lush new monograph *Salmona*, author Ricardo Castro invokes poetry and literature, rather than architectural theory, to understand the architect's work. He links him to such Latin American writers as Gabriel García Márquez and the literary genre he popularized, magical realism, basing his comparisons mostly on what he perceives as similar,

extraordinary ways of looking at and experiencing nature. This perspective, however, while offering rich, metaphorical readings of the architecture, focuses overly on sensation and the sensory experience of architecture, leaving unexplained questions on the complex political, intellectual, and esthetic context of Salmona's work.

Upon returning to Colombia in 1958, Salmona found himself in a place undergoing profound transformations. With his regionally responsive work, he (with the most gifted of his colleagues) was responsible for creating an architectural context that dominates present-day Bogotá, where he and most of his work is based.

Salmona's affinity for natural materials shapes his entire oeuvre. With few exceptions, every project employs clay brick and water, both of which figure strongly in local building traditions. Salmona has extended the formal vocabulary of these materials to new realms, such as high-rises. A recurring feature of his works are patios carved with canals, which act as decoration, a cooling element, a soothing sound sculpture, and a reference to the ways that pre-Columbian populations and the Spanish after them obtained and channeled water. This beautiful book showcases the architectural wonderment that can be achieved with the most elemental of ingredients. *Odile Hénault*

# A Portrait in Stone

Casa Malaparte is more than an architectural icon—it's a literary masterpiece, a political manifesto, and an autobiography of its owner. **Cathy Lang Ho** reads between the lines.

**Malaparte: A House Like Me**, by Michael McDonough, foreword by Tom Wolfe (Clarkson Potter Publishers, 2000)

**History** All buildings tell stories, but some have juicier tales than others. The power of Casa Malaparte in Capri (1938, facing page), home of writer Curzio Malaparte, is rooted in far more than the breathtaking rocky outcrop that serves as its foundation: It is built upon a convoluted set of cultural circumstances, symbolizing a historical moment that is as complex as its owner. An early Fascist activist and journalist, later a novelist and poet, the controversial Malaparte's shifting politics led him to embrace communism, Catholicism, Maoism, and other extreme stances during his lifetime. Concurrently with the construction of the house (initially attributed to Italian rationalist Adalberto Libera though now believed to have been designed by Malaparte himself working with a local mason), he edited the cultural journal *Prospettive*, which published the work of leading Italian thinkers in addition to André Breton, Martin Heidegger, James Joyce, and Pablo Picasso. Casa Malaparte was a meeting ground for this important avant-garde community in the midst of war-era Italy.

It was important to Malaparte that the house be considered equally alongside his literary, journalistic, political, and other activities. He spoke about the house as his "portrait in stone," describing it proudly as "a house like me." Paying homage to this unique architectural autobiography, New York architect Michael McDonough has assembled 34 essays, including accounts on the political climate in Italy in the first half of the century, firsthand recollections about Malaparte, excerpts from his novels and letters, mixed with popular images of the house, such as stills of Bridgette Bardot sunbathing on the roof in Jean-Luc Godard's 1963 romantic-tragic film, *The Contempt*. The architect teams responsible for the house's recent restoration provide details of the work done to its exterior and interior, which deteriorated significantly after Malaparte's death in 1957. (Descendants of Malaparte recently established the Casa Malaparte Foundation to oversee the long-needed repairs and develop the house as a writers' and artists' retreat and cultural center.)



Architects all over the world regard the work as a touchstone, inspiring for its mythology and magic, its bold, elemental form, and its demonstration of the stunning marriage that can be made between architecture and site. Some of their impressions are included here:

**JOHN HEJDUK:** “It is a house of rituals and rites, it is a house of mysteries, it at once brings forth the chill of the Aegean on the horn head of past sacrifices, it is an ancient play placed in an Italian light. It has to do with the primitive gods and their unrelenting demands. . . . It has to do with the abandonment of abstraction and the seduction of the lyrical.”

**JAMES WINES:** “Malaparte faced the challenge of finding a relevant imagery in an era devoid of social and religious accord—a time of cynicism, unrest, pluralism, chaos. . . . Beyond his self-possessed and maverick persona, Malaparte intuitively sensed that this dwelling place must serve as a contextual sponge, absorbing and disseminating ideas of a multidimensional nature.”

**ARATA ISOZAKI:** “When asked whether he had bought the house or made it himself, Malaparte answered, ‘The severe cliffs of Matromania, the three giant rocks of Faraglioni, Penisola Sorrentitna, the Isola del Sirente, the blue of the far Amalfi beach, the shore of Paestum shining behind it—all the scenes are what I designed.’”

**ETTORE SOTTASS:** “The wildness [of the site] helps us understand the relationship between architecture and nature more precisely, because it helps us define nature. It also prompts us to ask why architecture should disappear in nature or be eaten by nature. It helps nature, it gives it a meaning and an explanation.”

**EMILIO AMBASZ:** “Who remembers the house’s four facades? Knowing a four-sided house would not withstand a critical observer’s close analysis of its theatrical underpinnings, Malaparte invented the roof-facade. Was this stepped roof-facade designed to connect earth to the hopelessness of ever reaching the sky, or was it a melancholy device to evoke the precipitous end lurching behind the last step?” ■



The world is increasingly shaped by the homogenizing forces of globalization—as well as ethnic revivalism and identity politics. To reconcile the differing needs of different groups, we all need to “give ground.”

## Too Close for Comfort?

Physical proximity is a defining feature of cities, yet it also brings conflict and contradiction into high relief. **David Harvey** interprets the politics of propinquity.

### Review

#### **Giving Ground: The Politics of Propinquity**

edited by Joan Copjec and Michael Sorkin (Verso, 1999)

How can we live together with openness and decency, under the rule of law, but with a semblance of civility and democracy, in a world where propinquity—closeness—with everybody else is unavoidable? Can propinquity be understood as a virtue rather than a threat? And how might we better orchestrate our actions, planning, design, architecture, and, above all, our legal practices, in support of such ends?

These are the questions that permeate *Giving Ground: The Politics of Propinquity*, edited by Joan Copjec and Michael Sorkin. They are pertinent questions in a world at once dominated by globalization and racked by ethnic and intercommunal strife. The book's contributors analyze different facets of cultural, political, and economic life in their attempts to offer answers. Such an enterprise is fraught with dangers, but the risk is worth it: This collection of essays has something to say.

The dangers and virtues are best illustrated in the last two chapters, both of which use Sophocles' *Antigone* as a reference point.

*Antigone*, daughter of Oedipus, is put to death when she defies her uncle Creon's orders and gives a proper burial to the body of her brother Polynices, who has broken the law. Copjec contrasts Creon, with his fixation on an idealized, dead past, capable of producing only an accumulation of more and more of the same (architects, beware!); and Antigone, who pursues new ways of thinking without necessarily losing faith in the past. Antigone can “give ground” (hence the title of the volume) whereas Creon cannot. The opposition between Creon and Antigone highlights a tension between the desire to preserve the past as urban virtue and the endless pursuit of novelty in current modes of urban living.

What does this have to do with contemporary urban life? Several essays cast New York mayor Rudy Guiliani and architects such as Robert A.M. Stern as Creon figures, preoccupied with stability and trapped within nostalgia for the city as it once was. These essays raise the issue of how to construct a future that incorporates difference, openness, the unexpected, and dialogue between individuals and groups with seemingly disparate or even incommunicable values. This question takes a particularly dark turn in Thomas Elsaesser's telling of how the



Antigone myth has been played out in recent history. In West Germany in the 1970s, the extremist “urban guerilla” group Red Army Faction (RAF) engaged in numerous acts of terrorism, including bombings, kidnappings, and a hijacking, in its quest to “tear the mask off” official authority and establish a role for populations they believed to be excluded (they appealed to young people in particular). The tale illustrates the violent consequences that can result when an unyielding state and rigid forces of law and convention—solidified into alienating built environments—finds itself unable to “give ground” in the face of a population’s burgeoning discontent or desire for difference.

But where does this take us in terms of architectural and urban practices? According to coeditor Sorkin, living closely together does not mean that we should submerge or erase our differences. Conceptions of neighborhood, circulation, and urban living must be expanded to encompass the unplanned, or accidental. Homogeneity, order, and boundedness (e.g., gated communities) are bad. Heterogeneity, openness, porosity, and a modicum of chaos and confusion are not only inevitable, but good. Sadly, Sorkin leaves these themes dangling when they cry out for elaboration and critical scrutiny.

Subsequent essays offer a mix of illumination and obfuscation. Rosalyn Deutsche, who wanders aimlessly from one philosophical authority to another, wins the prize for obfuscation. Ariella Azoulay has a firmer grasp on reality and confronts the dilemma of Jewish-Palestinian propinquity in Jerusalem, a wonderful terrain on which to explore how difference and propinquity collide in an urban setting. But she, too, loses her way in a philosophical dead-end. She appeals to French philosopher Michel Foucault’s concept of heterotopia—an idealized conception of diverse communities flourishing independently—to help her argument. The problem is, of course, that Jerusalem cannot be so easily partitioned. This is a case of good analysis gone awry in Foucauldian trendiness.

Other essays do better. Disney’s Celebration, along with New Urbanism, come in for a critical roasting by Dean MacCannell, and the redesign of Times Square forms a central motif in a wonderfully evocative essay by Samuel Delany (alas poor Robert Stern, the architectural consultant in both cases!). Delany brings all manner of different themes into focus—the hidden homophobia, the persistence of “family values” as an ideology, the capitalist logic of real-estate development with its Creonic desire for seriality, and the failure to distinguish between networking (usually purposeful activity) and contact (accidental events). Delany’s outrage at the systematic erasure of contact zones in the redesign of Times Square deserves a hearing. The meanings and possibilities of propinquity in relation to people’s needs and desires come to life here in tangible form, albeit in controversial ways. ■

*David Harvey is professor of geography at Johns Hopkins University, and the author of Justice, Nature, and the Geography of Difference (Blackwells, 1996) and Spaces of Hope (University of California Press, 2000).*

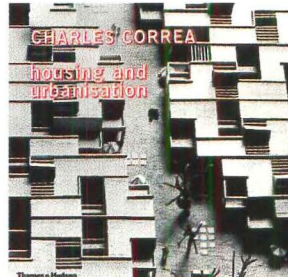

#### Bibliofile

##### Housing & Urbanisation

by Charles Correa  
(Thames & Hudson, 2000)

Throughout his 40-year career, Indian architect Charles Correa has devoted himself to addressing his country’s severe housing problem, investigating solutions which, to him, go hand in hand with sustainable urbanism.

*Housing & Urbanisation* is a collection of over 40 residential projects and a dozen city plans, and his own writings outlining his theories of urban development. He advances the same basic principles across a range of project types. For a squatter housing project in Bombay, for example, he clusters basic units around private and shared courtyards, which function as additional rooms; the same premium on centrality and open-to-sky spaces also shape his designs of middle-class subdivisions, college dormitories, and vacation homes. His is a distinct Indian modernism that deftly reconciles economic, ecological, and cultural issues.

*Cathy Lang Ho*

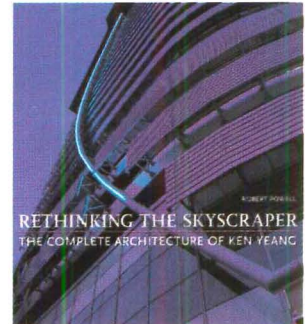

#### Bibliofile

##### Rethinking the Skyscraper: The Complete Architecture of Ken Yeang

by Robert Powell (Whitney Library of Design, 1999)

Malaysian-born, Architectural Association-educated architect Ken Yeang is one of the pioneers of the green skyscraper, resuscitating old—and innovating new—technologies to enable this complex building type to conserve energy and be more responsive to its specific bioclimate. His new monograph, *Rethinking the Skyscraper*, includes both realized work—such as the Menara UNMO Tower in Penang—and unrealized projects, documenting very real research and strategies for the further development of smart skyscrapers. As many Asian countries are only now recognizing the high ecological costs of vertical (Western) urbanism, one hopes they won’t be forced to repeat the same mistakes that skyscraper builders elsewhere in the world have already made. *Cathy Lang Ho*

# Picture Window

Photographer Vera Lutter is constantly searching for a room with a view. **Cathy Lang Ho** finds out why.

Exhibition: *Time Traced*, Dia Center for the Arts, New York City, through June 18, 2000

**Art** Rooms are German photographer Vera Lutter's instrument, and cityscapes her subject. Offices, airport lounges, trailers, metal construction containers, even a women welders' changing room at a shipyard, have all doubled as pinhole cameras for Lutter, who, upon finding a photo-worthy site, searches for a building or structure nearby that she can convert into a camera obscura. She exposes the desired view directly onto a large sheet of photographic paper stretched across one wall, and, from within the camera, watches the image take its negative shape. (She "feels" the length of the exposures, which may last several hours.) The view from the room—the picture-window view—is exactly the view that is captured on the wall-sized prints, each an original, a direct impression.

She began making on-site pinhole camera photographs when she arrived in New York seven years ago. Inspired by the density of visual information in the cityscape and the ever changing quality of light, she turned both into tools for her art. Many artists speak of how essential natural light is to their work, but Lutter's desire to use it as an artistic medium meant her work had to occur outdoors. Moreover, she states, "It's important to me that buildings aren't just things that appear in the photographs, but actually make it possible for the photos to be made."

Lutter grew up in Bochum, close to Düsseldorf (where photographers Bernd and Hilla Becher also live), in the industrial corridor along the Ruhr River. Her recent photographs of a dry dock, airport runway, marina, and abandoned factories show that she is drawn to industrial landscapes in her new home. She comments, "Time seems to have stopped in these places." Ironically, the time warp is traced in her work, a result of a patient process and the incessant passing of the light of the day. ■

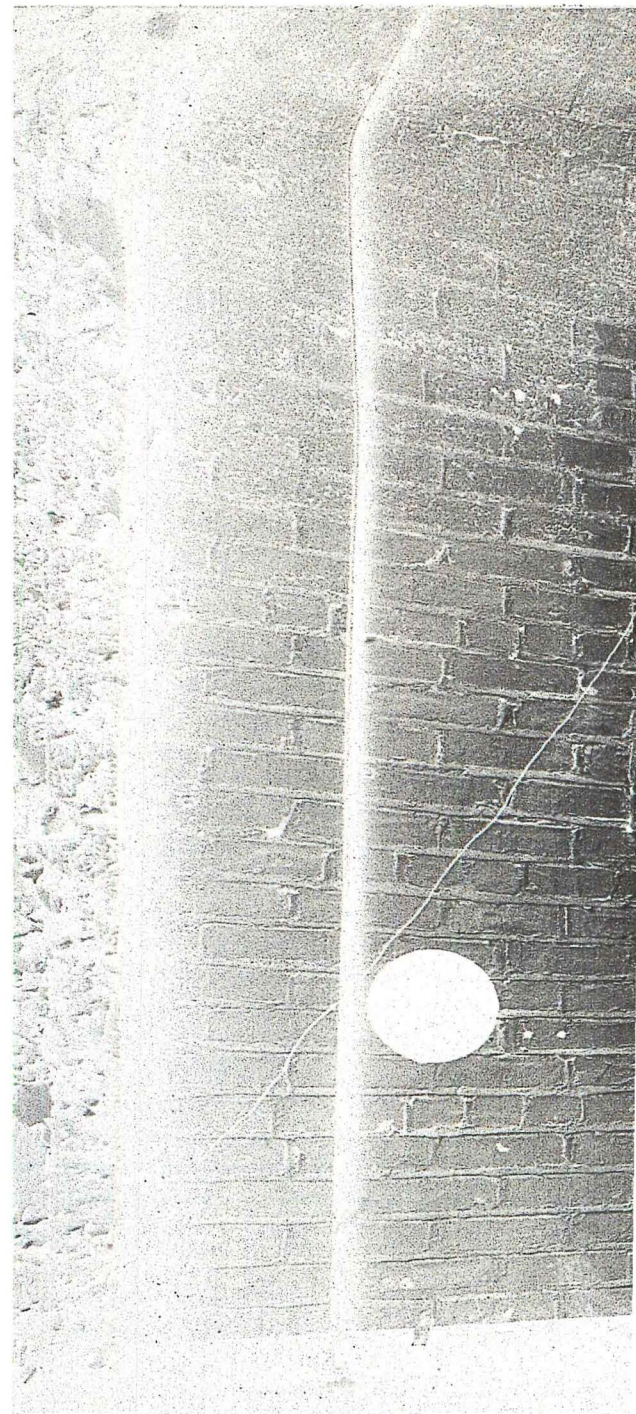

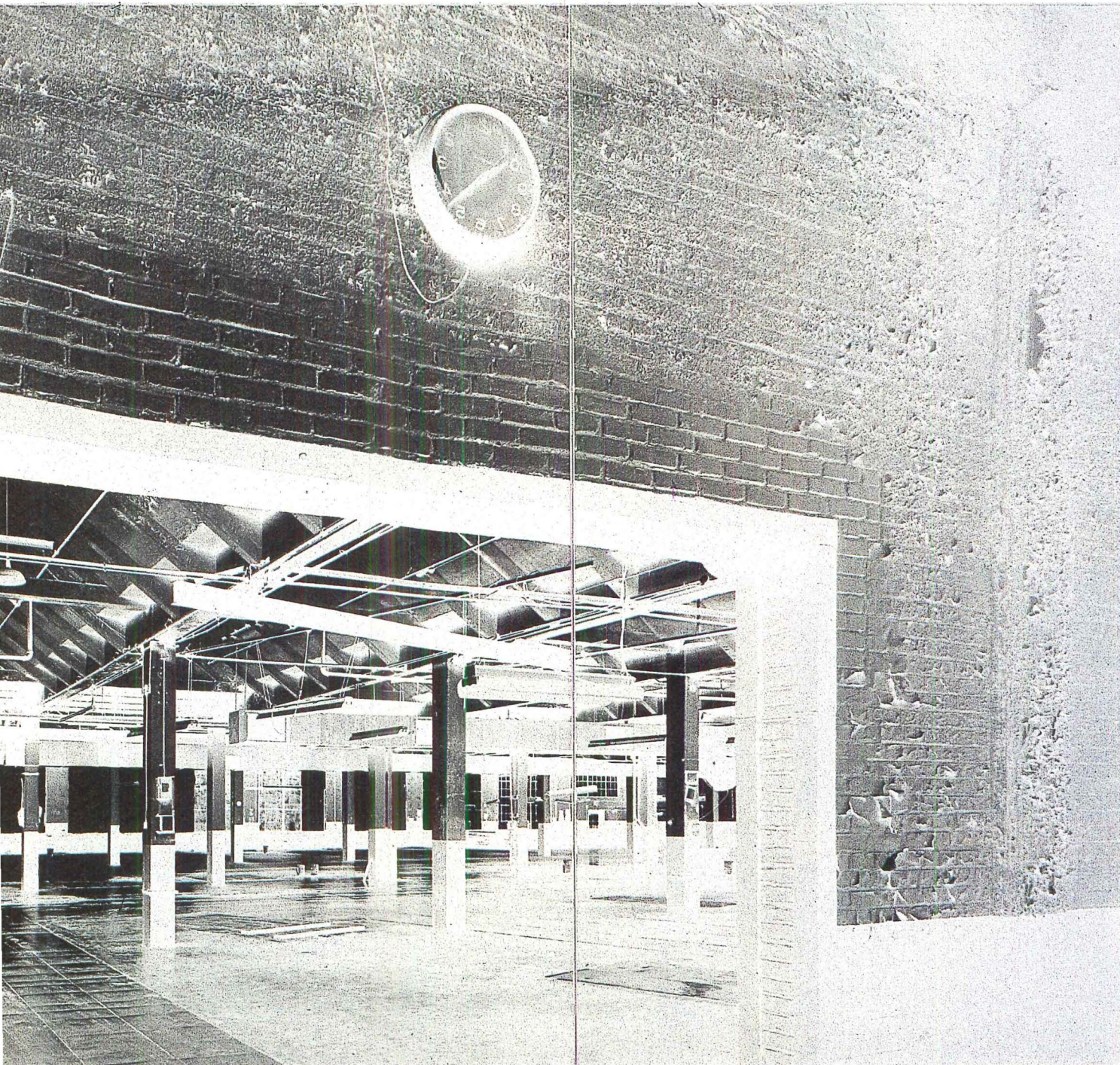

Vera Lutter's *Nabisco Factory, Beacon IV: September 14–19, 1999* (above).

The Nabisco box factory in Beacon, New York, which closed in 1994, is currently being converted by the Dia Center for the Arts into its new gallery to show its extensive collection of large site installations. Lutter's camera obscura cabin is situated in one building, and shooting toward another. A selection of Lutter's photographs will be on view at the Fraenkel Gallery in San Francisco, March 30 to April 13, 2000.

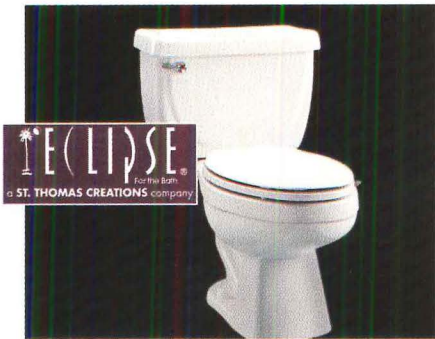

**ECLIPSE**  
 For the Bath  
 a ST. THOMAS CREATIONS company

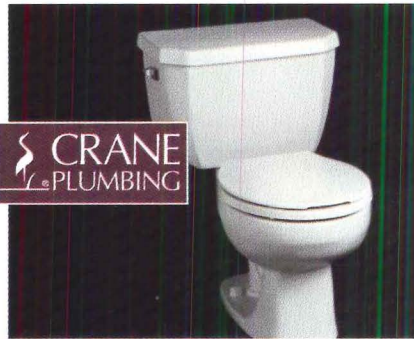

**CRANE**  
 PLUMBING

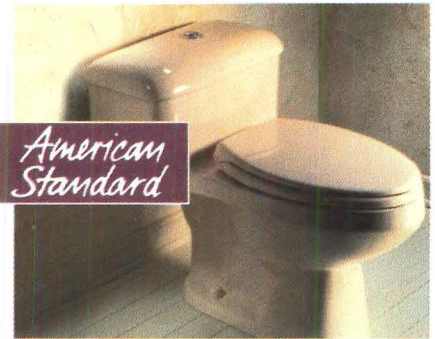

*American Standard*

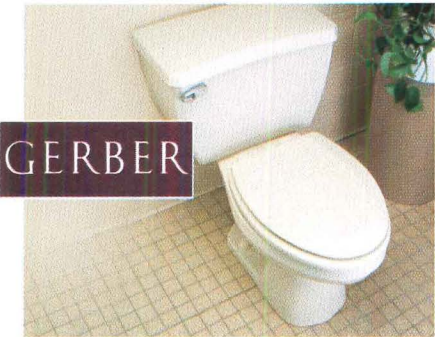

**GERBER**

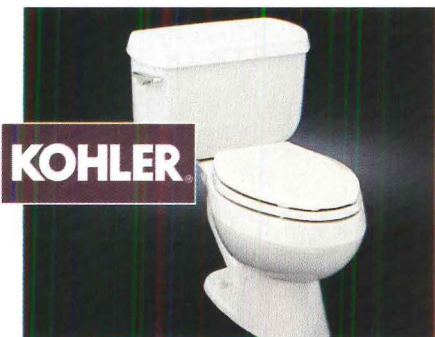

**KOHLER**



*Mansfield*

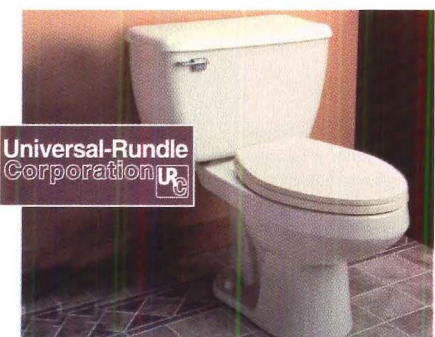

**Universal-Rundle Corporation**

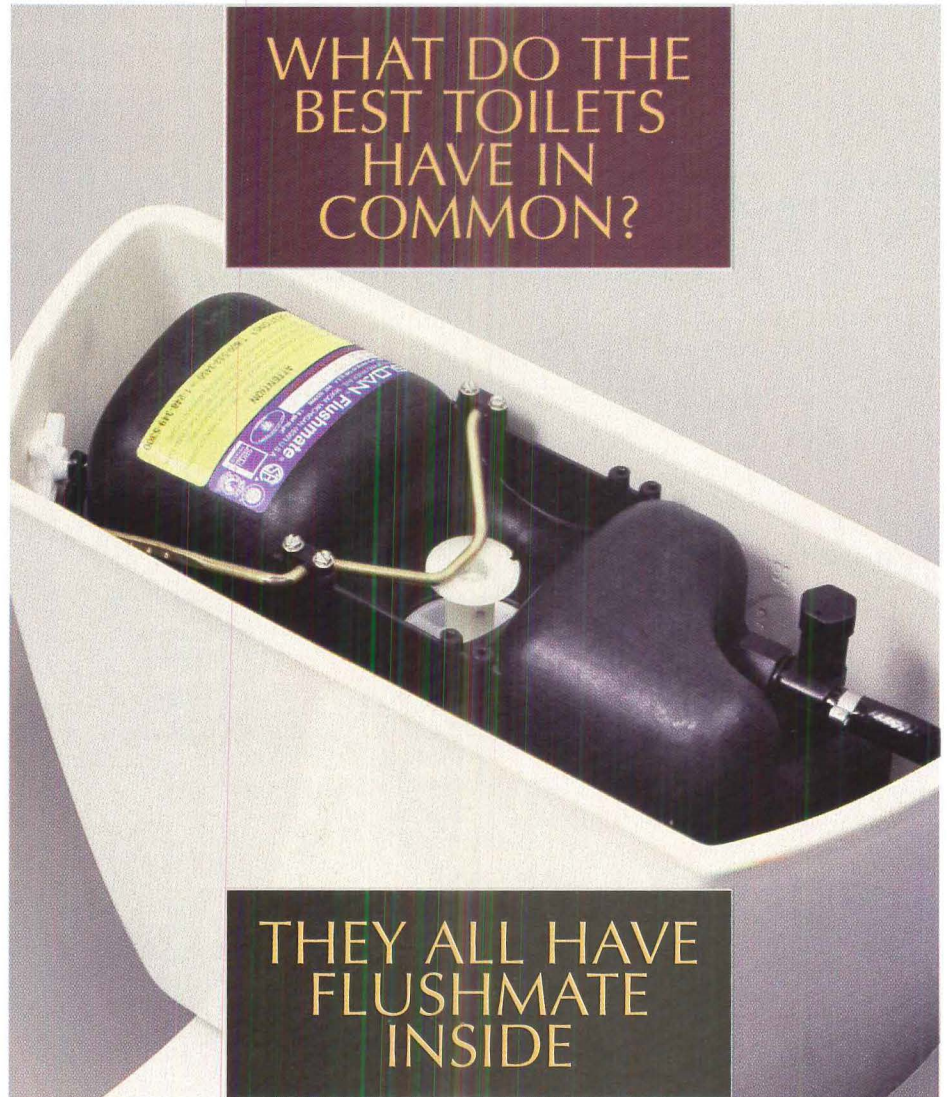

WHAT DO THE BEST TOILETS HAVE IN COMMON?

THEY ALL HAVE FLUSHMATE INSIDE

- Superior Performance** through pressure instead of gravity to eliminate the need to double flush
- Advanced Bowl Design** using hydraulically designed jets to "push" contents out of the trapway
- Largest Trapway** with a less complicated trapway, pressure-assist toilets have less twists and turns so there's less chance of clogging
- Largest Water Surface Area** offering the largest water surface area at 10"x12" to keep bowl cleaner
- Non-Sweating Tank** because water is contained in the FLUSHMATE vessel, so floors stay dry
- Conventional Installation** in the same standard dimensional area as any conventional toilet, with no special tools required

Find out for yourself why toilets with FLUSHMATE inside are fast becoming the preferred toilets by engineers. For a full color brochure of makes and models and complete specifications, call 800-875-9116, circle the number below or visit our website at <http://www.flushmate.com>.



**FLUSHMATE**  
 A Division of Sloan Valve Company  
 10500 Seymour Avenue • Franklin Park, IL 60131  
**800-875-9116**

ISO 9001 Quality System Certified

Circle 106 on information card

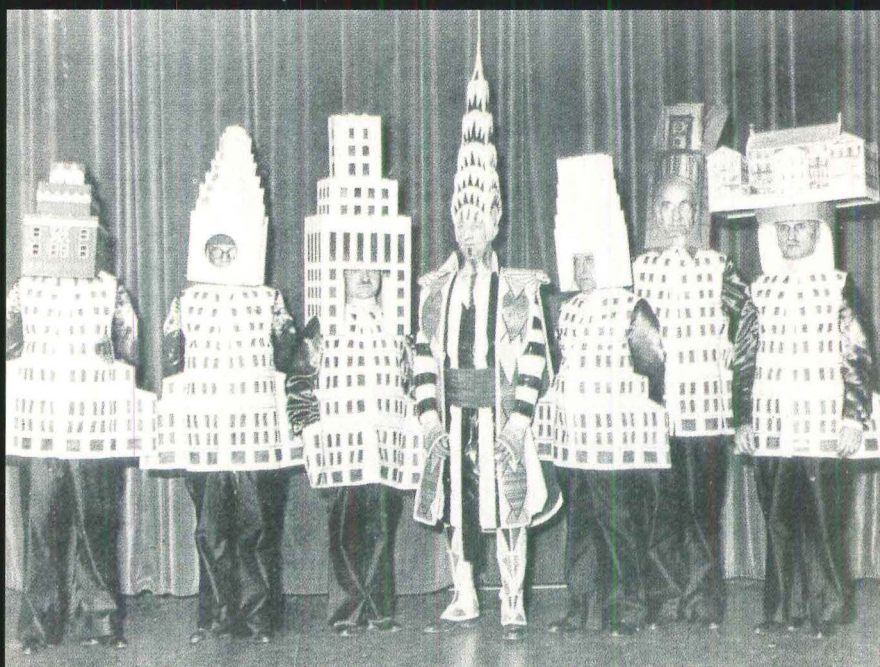

## Ready-to-Wear

Buildings and fashion have suffered an uneasy relationship ever since theoretician Gottfried Semper proclaimed that architecture was merely clothing. Architecture still scorns fashion for its ephemeral pursuit of surface and frill. The world of fashion, in turn, appropriates architecture's substance and permanence in cautious, conservative stores, and quiet classical backgrounds for glossy advertising.

The two realms intertwine more provocatively in Christian de Portzamparc's new tower for French luxury-goods purveyor LVMH. The U.S. home of the world's most powerful fashion empire is an angular, self-consciously feminine form clothed in an elegant sheath. What's more, the party celebrating the building's December opening became a star-studded gala of famous designers, supermodels, movie stars, even the First Lady. But beneath the hype and style lies substance. De Portzamparc generated the building's form by cleverly interpreting the century-old setback laws that have shaped Manhattan's skyscrapers into masculine, stepped boxes. De Portzamparc proves that fashionable architecture can amount to more than just a fashion statement.

*For architects at the fabled 1931 Beaux-Arts Ball in New York, costumes were serious business. The iconic image above is a lineup of Gotham's grandest gentlemen architects festooned as their creations: Ely Jacques Kahn attired as the Squibb Building, Leonard Schultze dolled up as the Waldorf-Astoria, and William Van Alen capped with the spire of his Chrysler Building, towering above his peers, so to speak. The architects' earnest, almost grim expressions suggest an uneasiness with the prospect of reducing their monuments to frivolous party wear—hats, really, since their gridded frocks, the bases of their buildings, are all the same.*

# Twenty-Five Floors of Glamour

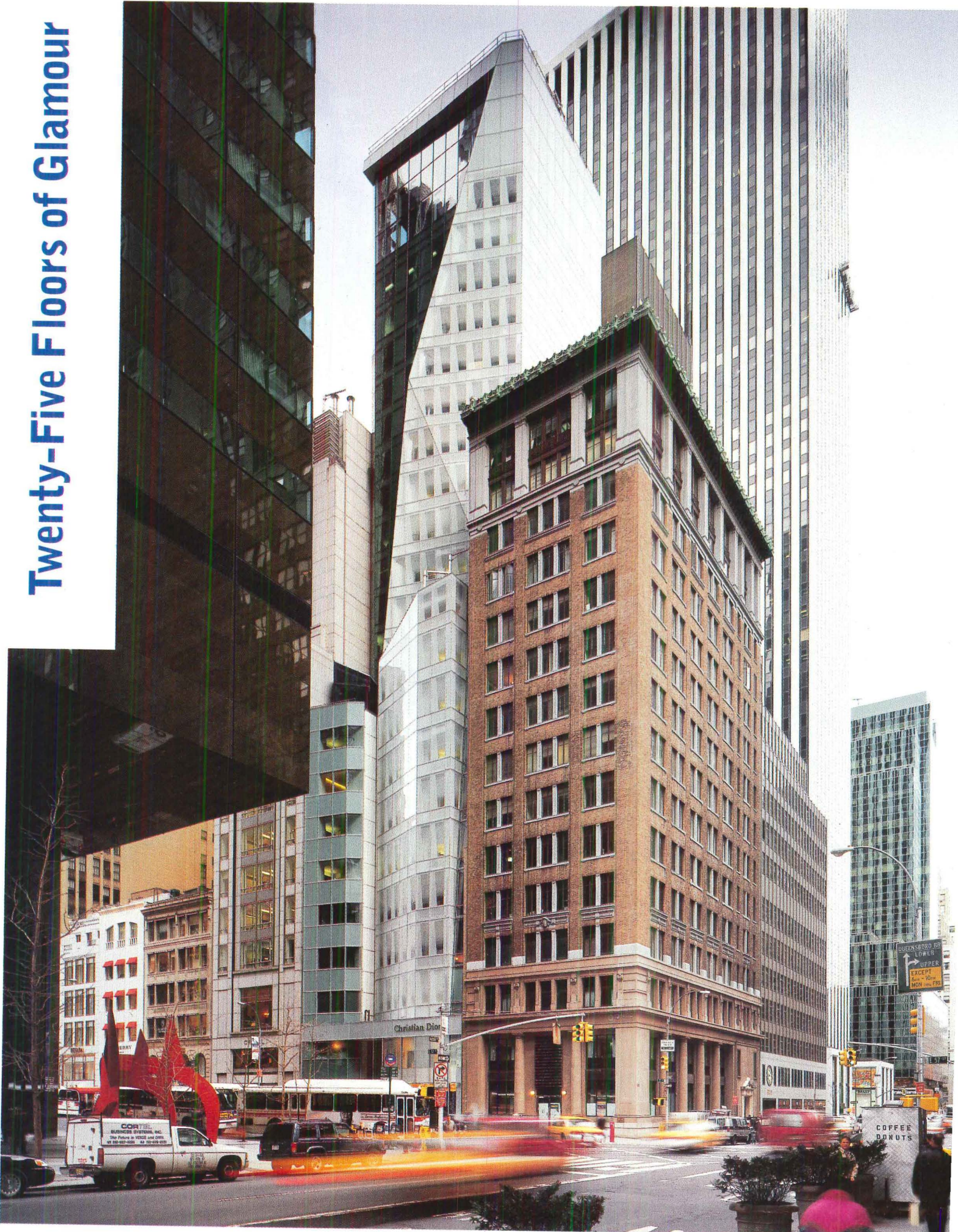



**Christian de Portzamparc fashions a new look  
for New York skyscrapers and the LVMH luxury-goods empire.  
By Raul A. Barreneche**

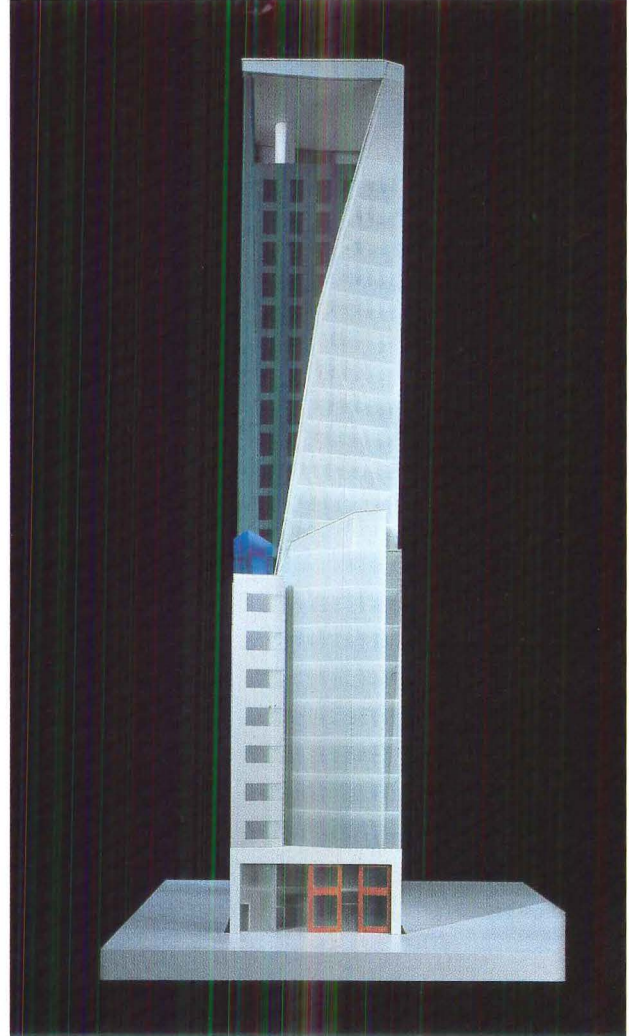
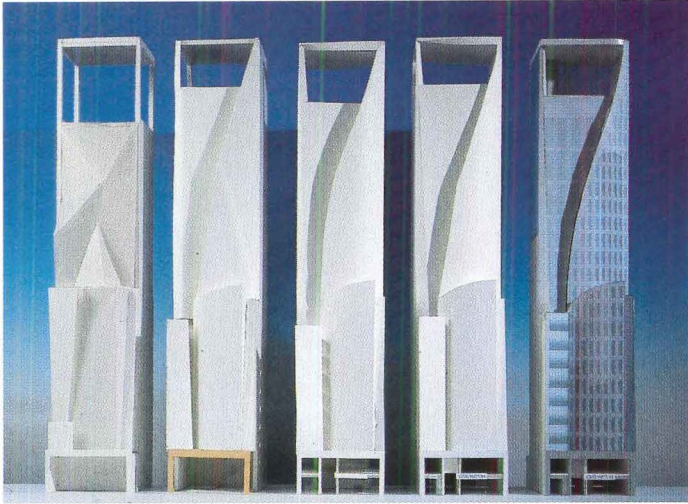

**De Portzamparc's original massing strategies (above) of stacked cylinders that reminded the architect of perfume bottles evolved into the final solution of fluid folds (top and right). The original design was much narrower because a tiny five-story gallery—which was ultimately demolished—filled a slot between the LVMH Tower and the existing Chanel building to the west.**

New York City didn't invent the skyscraper, but it certainly perfected it. Peering out above Manhattan's crowded streets are the icons of the high-rise era, some topped with gilded crowns, others with hushed, dark slabs, but all designed to convey power above all else. These days, there are few high-rises going up in New York, and those that are being built are more concerned with efficiency and speedy construction than creating a lasting, attractive presence on the skyline and the street. Just visit Times Square to see what skyscraper building has been reduced to. The two new towers soaring above 42nd Street are little more than expensive scaffolds for enormous billboards and building-sized electronica; the new Reuters tower is being built so quickly that the curtain wall is going up on the lower floors before the entire steel skeleton is even erected.

So whenever a new high-rise goes up in Manhattan, expectations are high that it might break the mold of developer-driven dross and join the pantheon of great Gotham towers. The new U.S. headquarters of Parisian luxury-goods empire LVMH (Moët Hennessy Louis Vuitton) may not qualify as a skyscraper—it's only 25 stories tall—but it does weigh in as one of the most serious and significant structures in the city in recent years. And it took a French client, the glambitious billionaire Bernard Arnault, and a French architect, Pritzker-laureate Christian de Portzamparc, to teach New York how to do a skyscraper right.

The LVMH Tower fills a narrow, 60-by-100-foot sliver on tony East 57th Street tucked between the 17-story headquarters of rival Chanel and a beaux-arts brick office block. As if squeezing 25 floors of corporate offices and retail space weren't difficult enough on this tiny plot, de Portzamparc had to face the stringent, if somewhat vague, setback requirements that created the familiar stepped profile of New York City's most famous buildings, including the mighty Chrysler and Empire State Buildings. This tangle of regulations forced him to maintain a strong street edge along the ground and then pull back from the street on upper floors.



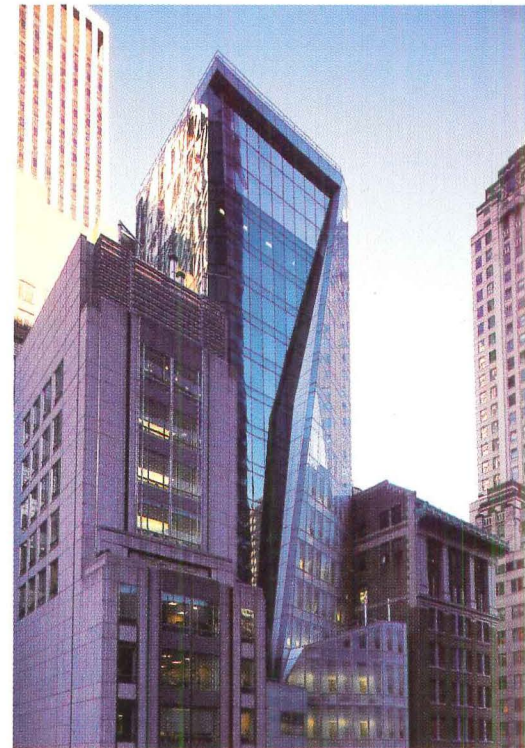

Seen from across 57th Street, the angled facade's outermost skin inflects outward (above and right). At night, tubes of fiber-optic lighting tucked beneath the edge of the angular facade (right) streak a strip of light along the reflective surface. Computerized controls change the colors in an almost infinite number of patterns.

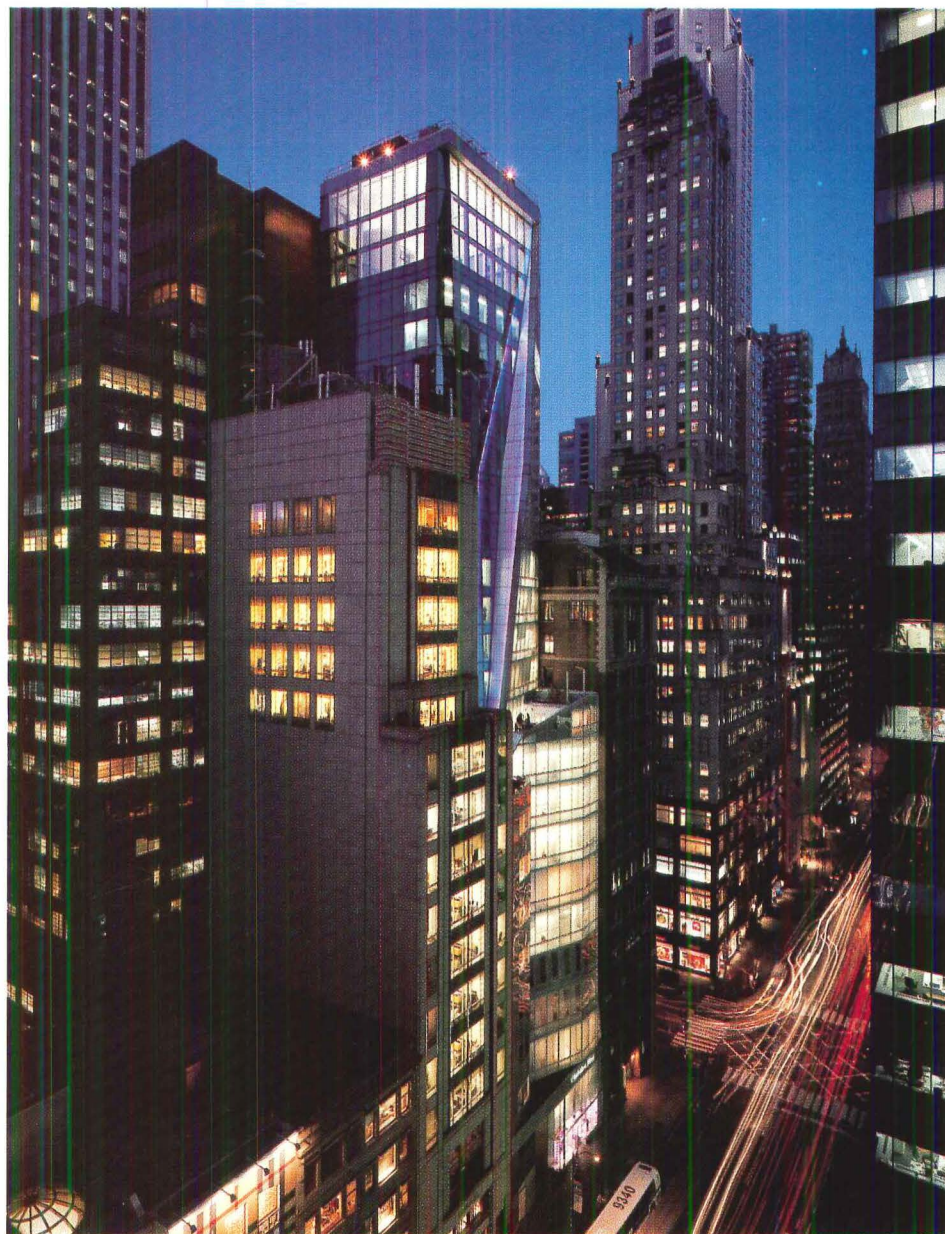

De Portzamparc and architect-of-record Hillier Group pushed and pulled the tower's massing to meet the letter of the law, if not quite the spirit. Instead of stacking the building blocks wedding cake-style, de Portzamparc chamfered them, pinched them, skewed them, and sloped them, discovering a few tricks along the way. "We learned that once you meet a setback, the zoning law doesn't say you can't come back out toward the street," explains Hillier's project architect, John Mulliken. But no architect had ever tried this loophole. So de Portzamparc pulled the surface of the tower's tallest volume outward from its 11th-floor setback to the 18th floor and then pushed it in again up to the roof level, giving the volume an angular profile. This prismatic shape "looked sharper and more Manhattan" to de Portzamparc than his earlier schemes of stacked cylinders, "which were more mannerist and unlike New York." The architect also learned that he could leave a percentage of the building volume open, so he created a void in the lower parts of the facade.

De Portzamparc dressed the tower's faceted facade in a sexy ensemble of green and white glass. To the east of the angled line that clefs the tower in two, the architect draped a veil of pure white glass sandblasted with shadowbox patterns (see page 89); to the west of the seam he switched to a gauzy green glass speckled with an almost invisible grid of fritted dots. The glass skin, aside from softening reflections of the ominous monolith of Edward Larrabee Barnes's 1983 IBM Building across the street, becomes a luminous folded and pleated sheath. Like a sexily dressed woman, the building reveals glimpses of itself through the fabric of its enclosure. It doesn't demand to be looked at and understood all at once, as a monument, but slowly and seductively.

Inside, the tower's outward image of stylish complexity is dimmed by the reality of its tiny floor plates. Though claustrophobic, the lobby's elegant palette of burlwood, tawny sandstone, and illuminated glass creates a suitably luxurious foyer for the owner of such haute fashion houses as Dior, Givenchy, Guerlain, and Vuitton. But once the doors of the three minuscule elevators close

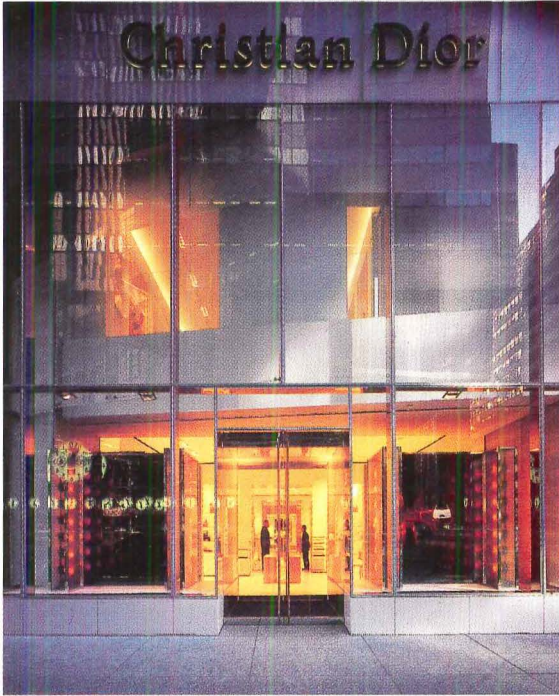

The facade of the two-story Dior flagship store on street level (above left) shows how the glass softens reflections of the IBM tower across 57th Street. New York fashion architect Peter Marino designed the store's interiors and also helped detail the tower's tiny lobby (above right). The lobby's palette of tile and backlit glass walls, Indian sandstone floors, and burled particle-board elevator enclosures are a neutral entrée to the offices of LVMH and six of its companies.

- 1 lobby
- 2 Dior boutique
- 3 future retail
- 4 offices
- 5 Magic Room

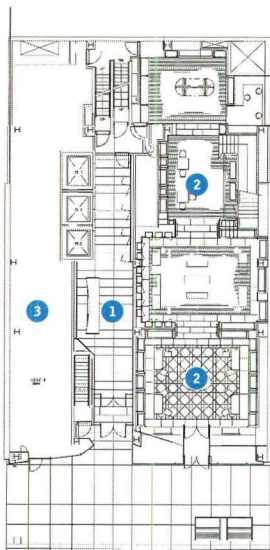

Ground-floor plan 17' ^



Third-floor plan



19th-floor plan



23rd-floor plan



LVMH

## MAKING THINGS PERFECTLY CLEAR

Christian de Portzamparc envisioned a pristine, uninterrupted surface for the south facade of his LVMH Tower. To get it, the architect opted for low-iron, heat-strengthened vision glass for his veneer, etched with an elegant angled pattern that reinforces the building's rakish profile. Low-iron glass is the clearest, if not the most economical, material available. John Pachuta of RA Heintges, curtain-wall consultant on the project, explains its benefits: "Low-iron glass is increasingly fashionable because it is completely colorless, unlike typical float glass, which has a faint greenish tint caused by its iron content. On the other hand, low-iron is a specialty product that generates more waste than float and therefore can cost from 30 to 50 percent more." In this case, a supply wasn't available domestically, so Paris-based Saint-Gobain manufactured it for Guardian Glass in Toronto, fabricator of the building's insulating window units for which the low-iron glass was one of the two lites.

At Guardian Glass, fabricators of the building's dual-lite window assemblies sandblasted the decorative, nonreflective line pattern onto the number two surface of the vision glass. Because low-iron glass allows high levels of light transmission, the second lite of the insulating unit is tempered float glass with a low-e coating. The green window units that clad the upper levels of the building's tower are designed to compensate for the energy inefficiency of the low-iron units. These units are covered with a dot pattern made by silk-screening and then baking a light-reflecting ceramic frit onto the number two surface. The number three surface received a low-e coating. Together, the green units and the low-iron units meet the state's energy requirements.

Typically, New York curtain walls must provide a 36-inch vertical fire separation between floors, usually expressed on the exterior by an opaque spandrel. De Portzamparc avoided a jarring disruption of his continuous white facade by reaching an agreement with the city in which he was allowed to substitute sprinklers at the perimeter of each floor, five feet on center, which will produce a water curtain in the event of a fire. By negotiating his way through all the thorny bureaucracies that control the building process, de Portzamparc set a precedent for other designers by demonstrating that one can finesse the rules without breaking them. *Sara Hart*



The soaring, 30-foot-high Magic Room, site of parties, product launches, photo shoots, and fashion shows, fills the tower's top two levels (left and below left). Floor-to-ceiling windows open onto views of Midtown Manhattan landmarks. De Portzamparc orchestrated a sweeping entry promenade from elevators that open onto an elliptical mezzanine, down a curving stair. By night, the Magic Room is a glowing lantern atop the pleated, luminous facade.

#### LVMH TOWER, NEW YORK CITY

**CLIENT:** LVMH—Moët Hennessy Louis Vuitton—NTX Interiors (owner's representative); Franklin Dickinson (project director)

**ARCHITECT:** Atelier Christian de Portzamparc, Paris—Christian de Portzamparc (principal-in-charge, design); Bruno Durbecq (project architect); Wilfred Bellecour, Etienne Pierres, Isabelle Ragot (project team)

**ASSOCIATE ARCHITECT:** The Hillier Group, New York City—Gerard F.X. Geier II, James Greenberg (principals-in-charge); John Mulliken (project architect); Marty Bloomenthal, Metin Celik, Jimmy Dumas, Zigmund Rubel, Philip Toussaint (project team)

**ENGINEERS:** Weiskopf & Pickworth (structural); Lilker Associates (MEP)

**CONSULTANTS:** RA Heintges Architects (curtain wall); Fisher, Marantz, Stone (lighting); Cerami Associates (acoustics); Development Consulting Services (zoning); Outsource (expediter); VDA (elevators); Federman (cost estimating)

**CURTAIN WALL MANUFACTURER:** GlassAlum International Corporation

**CONSTRUCTION MANAGER:** Tishman Construction

**COST:** Withheld at client's request

**PHOTOGRAPHER:** Peter Mauss / Esto, except as noted



behind you—there's not even room for a separate freight elevator—the glamour ends abruptly; cram, not glam, becomes the operative word. The office floors, which Hillier designed to mimic the look of each label's stores, are stuffed to capacity with showrooms, conference rooms, and cubicles. The private offices lining the street facade aren't particularly grand, and they bear the brunt of the facade's geometric irregularities, like a sliver of a window that tapers to a ridiculously small point.

The one great interior is what LVMH calls its "Magic Room," a 30-foot-high, 60-foot-square space for parties and fashion shows that fills the tower's top two floors. De Portzamparc choreographed an elegant promenade into the space: Elevators deposit partygoers onto a mezzanine, then they descend a curving stair as dramatic—if not as grand—as the staircases of Technicolor musicals. From this perch 25 stories above Midtown Manhattan, you can marvel at the sliced crown of the Citicorp Center, peer into a corner of Central Park, and gaze down on 57th Street, past Tiffany's storied vitrines, all the way across the Hudson River to New Jersey.

De Portzamparc's U.S. debut has proven itself suitably edgy and glamorous for the home of LVMH. This is the empire of Arnault, the man who turned the fashion establishment on its ear by installing iconoclastic designers John Galliano and Alexander McQueen as creative heads of the venerable houses of Dior and Givenchy. Arnault's power base is luxury; his building conveys a sense of power with its style, not the cold dominion of such modern high-rises as Saarinen's CBS Building, unaffectionately nicknamed "Black Rock," or the impersonal IBM building. De Portzamparc's tower says a lot about the company's esthetic philosophy, too. While the Chanel building next door is elegant in an orderly, uptight way—like a Chanel suit—LVMH's tower has a loose, imprecise, and forward-looking sense of style. That style is its power—and its challenge to the status quo of the American high-rise. ■

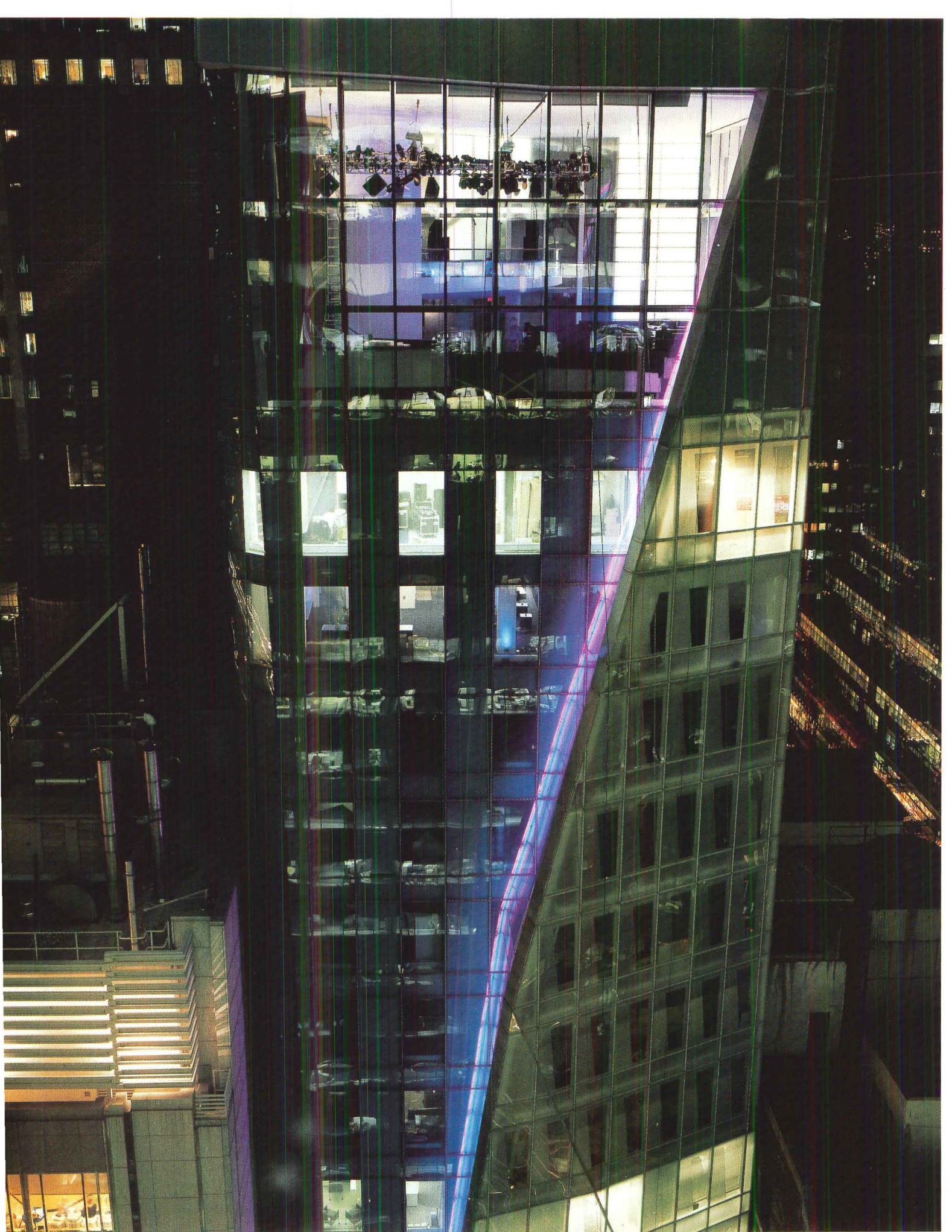

# Palazzo Beck

José Rafael Moneo  
builds an arts palace for  
the people in Houston.  
By Ned Cramer

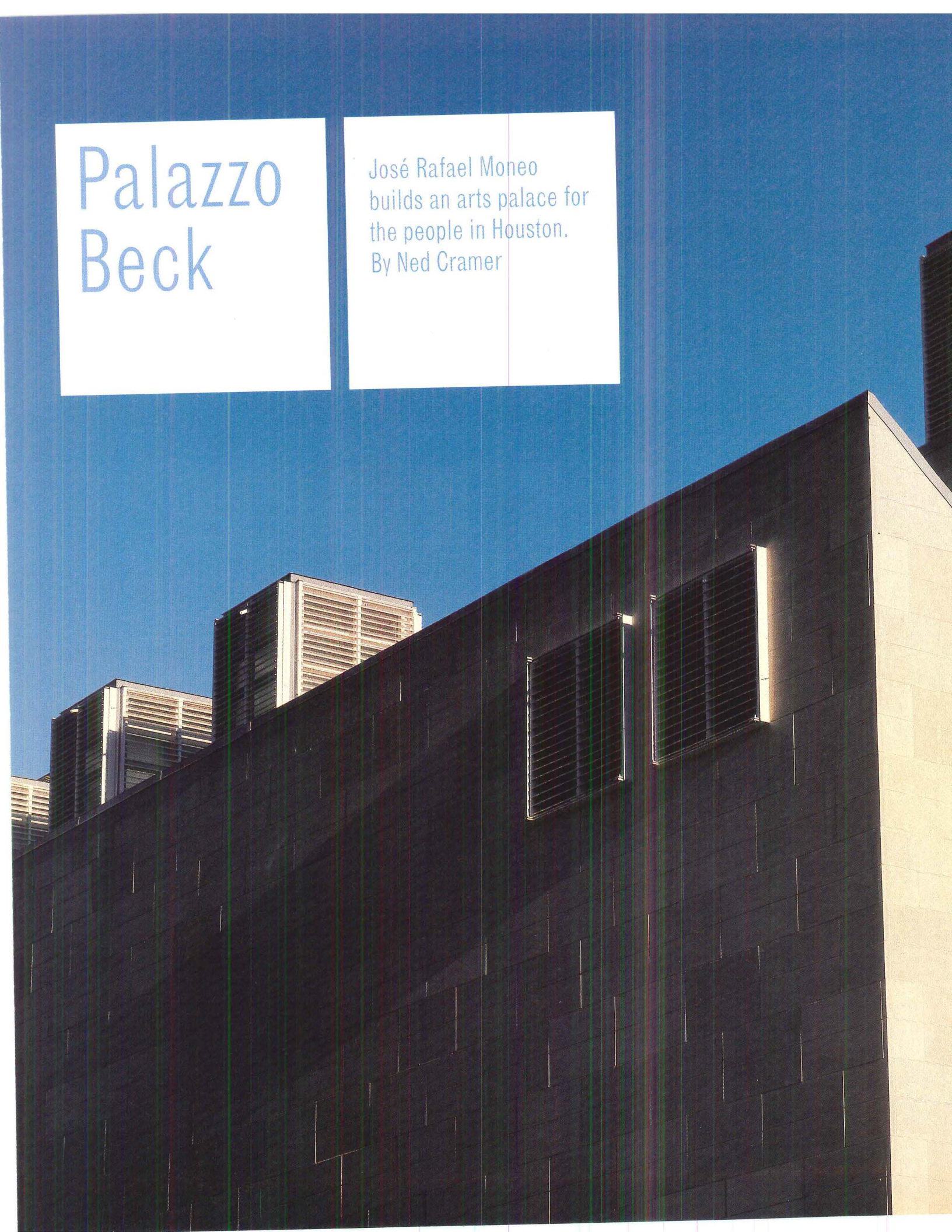



Moneo's Audrey Jones Beck Building (left), an annex for pre-World War II European and American art, occupies a full block to the east of the original Museum of Fine Arts, Houston, which William Ward Watkin designed in 1924, and Ludwig Mies van der Rohe twice expanded. Louvered windows and skylights at the top of Moneo's spare limestone building illuminate third-floor galleries.

José Rafael Moneo describes a building as achieving beauty when it "enjoys being itself," which is a lot to expect of an inanimate object. Whether his statement sounds like claptrap or scripture, there's no mistaking what Moneo's getting at: the seemingly effortless, ineffable rightness of certain buildings, their clarity of purpose and construction, deftness of light and materials, and suitability to locale. On these terms, Moneo's new Audrey Jones Beck Building at the Museum of Fine Arts, Houston (MFAH) should be very pleased with itself, but doesn't seem comfortable with the company it keeps.

MFAH director Peter Marzio commissioned the 192,000-square-foot Beck as a freestanding annex for the institution's encyclopedic holdings of old-master, impressionist, and pre-World War II American art. For years, the works were lost in the antiseptic vastness of Ludwig Mies van der Rohe's Cullinan and Brown Pavilions across the street, contiguous 1958 and 1974 additions to a colonnaded 1924 block by beaux-arts architect William Ward Watkin. If the wide-open Mies interior proved to be as proscriptive a setting for art as Watkin's original, cramped galleries, the bowfronted steel, glass, and stone exterior unashamedly reconciled tradition and the avant-garde.

Moneo and Mies both began with Watkin in their work for MFAH, but where Mies concluded with the column, Moneo contradicts him with an architecture of enclosure, of thick walls and clearly bounded volumes. Within the Beck's regular limestone shell, the Spanish architect has created an ingenious three-dimensional cluster of rectilinear rooms that would make Adolf Loos proud. An office mezzanine sits beneath skylit European art galleries on the third floor, in the leftover space around double-height American and changing exhibition galleries on the first floor. Axes connect the galleries horizontally, and a giant rectangular entrance hall and shaftlike sculpture court rise the full height of the building.

"Every now and then, I'd like to stack the paintings," salon-style, Marzio enthuses, and now there's nothing to stop him. The Beck's skylit top-floor galleries, with their beaux-arts proportions, enfilade arrangement, and cove ceilings, are like remembrances of rooms past—in the Uffizi, say, or the Louvre—and the paintings feel right at home, safe (hidden, some might say) from the self-consciousness that ironic or dismissive architectural attitudes toward the past would impose.





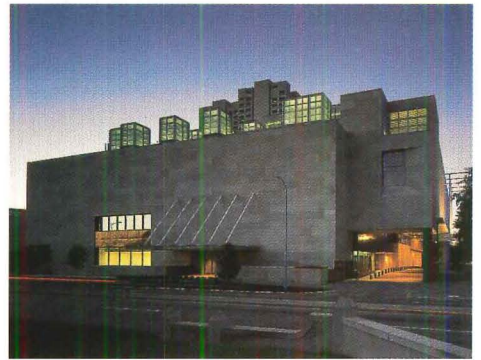

Moneo deliberately kept the Beck's exteriors simple: The west-facing entrance facade (top left), opposite the original museum, incorporates banners, a cantilevered canopy, and granite-clad drive-through. The east and south facades (top right and above left) are the museum's simplest, with only bronze service doors and louvered windows to relieve the expanses of stone. Street-level windows on the north facade (above right) look into the museum store, next to a canopied secondary entrance. The Beck's roofscape of skylights and lanterns are breathtaking when illuminated at night (left); unfortunately, the roof is not open to the public.

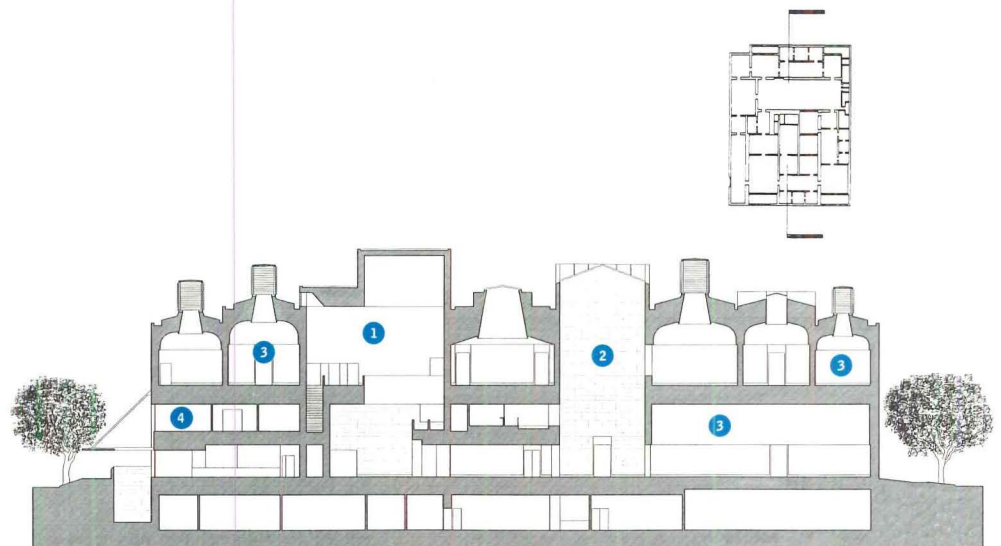

North-south section | 30'

- ① entrance hall
- ② sculpture court
- ③ gallery
- ④ office mezzanine

The photograph captures the exterior of the Museum of Fine Arts, Houston (MFAH) building during the "blue hour" of dusk. The building's facade is composed of large, rectangular stone panels. Three prominent, white, diagonal structural beams extend from the top left towards the center, casting long, parallel shadows across the stone surface. A dark, cantilevered overhang is visible below these beams. In the lower portion of the image, a dark glass entrance is partially illuminated from within, revealing a warm, orange-red interior. The text "MFA H The Museum of Fine Arts, Houston" is engraved in a serif font on the stone wall above the entrance. The overall lighting is dramatic, with strong contrasts between the dark shadows and the warm, golden light of the setting sun.

MFA H *The Museum of Fine Arts, Houston*

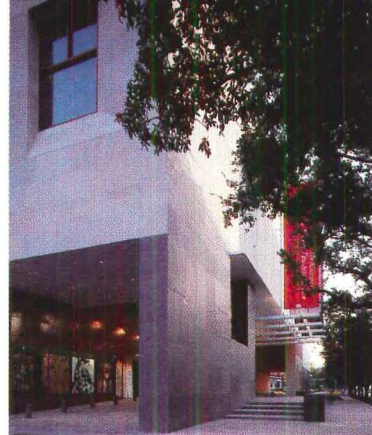

Moneo's sumptuous bronze door and Portuguese limestone-and-red oak floors heighten the reverie, as do lantern skylights derived from John Soane's 1814 Dulwich Art Gallery. The type, size, and number of skylights varies from room to room, and the ratio of artificial to natural light subtly varies accordingly, with the welcome effect of keeping the eye alert.

The Beck's galleries are such seemingly natural habitats for a Bellini or a van Dyck that Moneo has to recall museumgoers to the modern age with oblique views through doorways, in addition to the axial ones; detailing, as opposed to ornament; and overscaled windows carefully trained on views of Houston. More dramatically, if singularly, Moneo indents the Beck's northeast corner to break the regularity of the room within—and on the outside, appropriately enough, to momentarily bring the building's profile down to Mies' size. The entrance hall's enormous S-curved light scoops and diagonal composition of stairs and escalators take abstraction even further, but the room itself is nonetheless rectilinear and rich in materials, providing a smooth transition between the nearly traditional galleries and the nearly modern exterior.

The Beck's proudly spartan facades fill a city block to capacity, giving a slight impression of distaste for their German neighbor, and of passive aggression about the building's own secondary role as an annex. "The architecture of Mies has prevailed," Moneo writes in a statement about the project, and "the modest and dignified architecture of the first museum has been absorbed in the severe and dark metal framework of the German master." Determined to give Mies a lesson in civility he doesn't need, Moneo presumably hoped to evoke Watkin's earnest pavilion. But the Beck can get so wrapped up in its own noblesse oblige that true modesty rarely enters the equation.

Taken out of context, the Beck's monumental, subtly modulated form—like a stripped-down Renaissance palazzo—supremely suits its purpose. Moneo deliberately kept things simple on the outside, preferring to create "an architecture whose substance is found in the interior space." A building of such scarcely relieved grandeur would be marvelous in a city like Madrid, with the population density to absorb it, or a shopping mall, where cars could fill in the blanks. But Houston's leafy, eclectic Museum District, where the MFAH campus is located, is built on a 1915 City Beautiful plan. Designed in a temporal and conceptual middle ground between



The canopied north entrance (facing page) bridges another entrance below grade. A waterfall (top left) mirrors exterior stairs that lead to the basement entrance. The granite-clad drive-through (top right) on the west facade also serves as an arcade sheltering the main entrance. Moneo surrounded the front door (above) with bronze panels and a curtainlike sculpture by Joseph Havel.

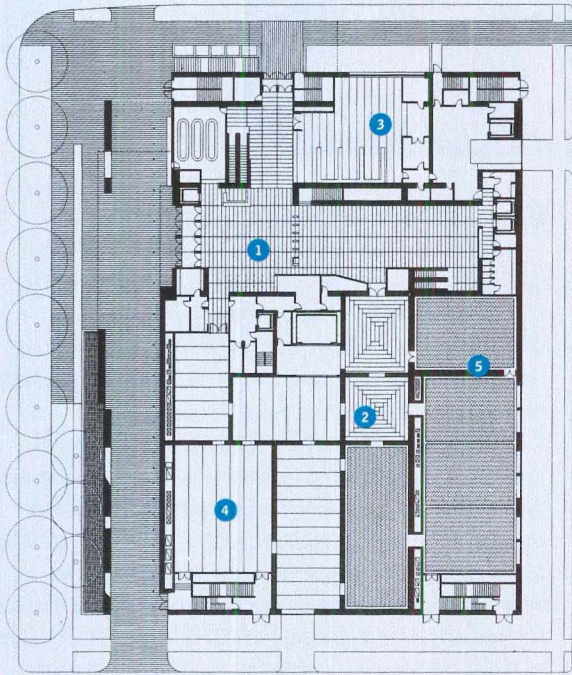

First-floor plan 42'  $\Delta$

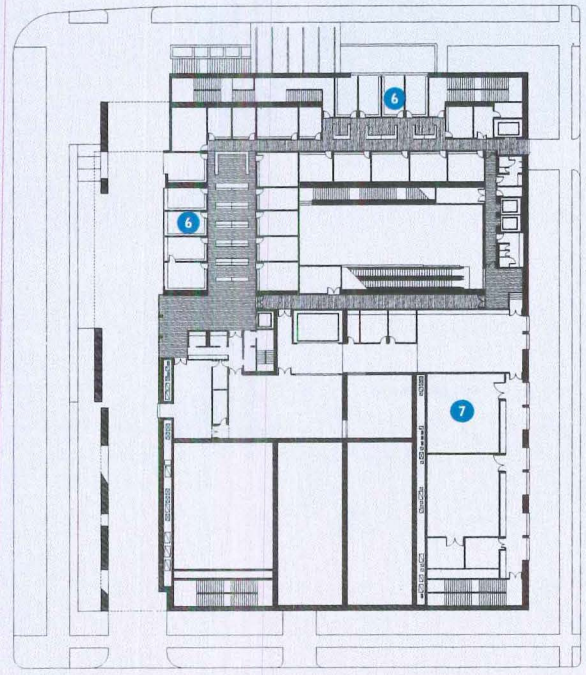

Second-floor plan

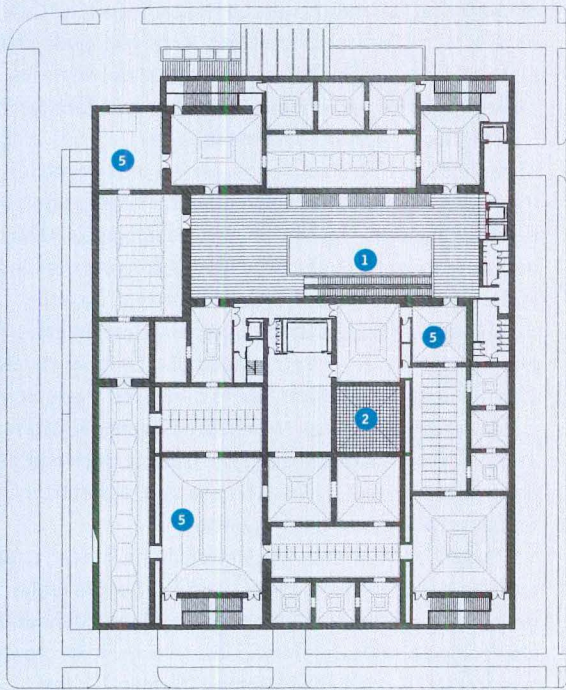

Third-floor plan

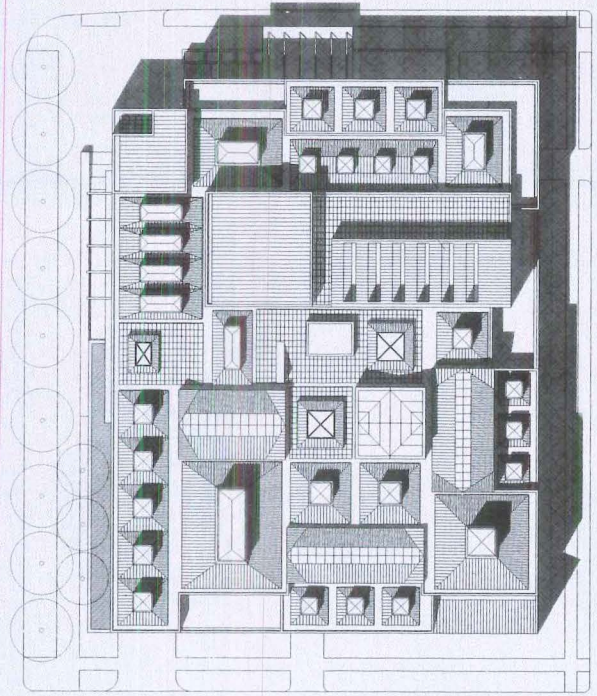

Roof plan



Moneo's freestanding annex (left) rises much higher than Mies van der Rohe's bowfronted addition (at right) and Watkin's original neoclassical building (at right, rear), effectively blocking the MFAH campus from a group of high-rises to the east. Moneo also had a hand in the design of the low parking garage to the east of the Beck Building (at left, rear).

compact historic urbanism and sparse contemporary suburbanism, it's one of the few places in Houston where people actually walk, and the overscaled Beck is simply too big for it.

Moneo, like most newcomers, saw the splendors of Houston's sprawl at 75 miles per hour, believing that its "buildings are perceived from the automobile." His overall acceptance of Houston's car culture and the magnitude he thinks it demands undermine concessions he makes to pedestrians and context, and the superb tone of tradition he establishes on the interior stretches thin outside. For instance, in a brief but strategic moment of exuberance, supple bronze panels and a curtainlike sculptural relief by local artist Joseph Havel surround the Beck's main entrance—a broad bank of doors that deferentially aligns with a side entrance to the original museum—from underneath a granite-clad arcade that lines the west facade. But the arcade is really a drive-through, and while it rises to the same height as the limestone base of the Mies expansion across the street, the rest of the Beck is much taller than Mies' piano nobile, and it overwhelms, rather than matches, the scale of the original museum.

Pedestrians might prefer the building's secondary, north entrance, where a low-slung canopy beckons anyone walking from Moneo's new parking garage, on a block east of the Beck, to the front of the original museum. Then again, pedestrians might skip the street altogether. In typical Houston fashion, an underground passage follows the same path. And Moneo's east and south facades are relieved only by bronze service doors and windows high on the wall. From a distance, driving down the street, these elevations are starkly beautiful; up close, they're just stark. The varied roofscape of lantern skylights—the Beck's chief exterior grace note—is breathtaking at night, when it is illuminated from within, but is so far above the street that it, too, can only be appreciated from afar.

Houston is a forgiving host. Development occurs there with remarkable speed and sometimes-surreal direction, aided by a complete lack of zoning restrictions. High-rises already encroach to the east of the MFAH campus, against which Moneo provides a transition to the lower scale and looser density of the Museum District. So as the Beck's neighbors grow, its size may cease to matter. In the meantime, appreciate the building for its inner beauty. ■

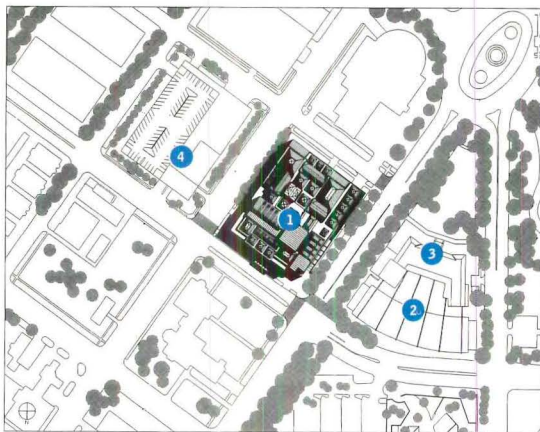

Site plan ▾

- 1 entrance hall
- 2 sculpture court
- 3 retail
- 4 changing exhibitions
- 5 gallery
- 6 offices
- 7 storage

- 1 Beck Building
- 2 Mies wing
- 3 Watkin wing
- 4 garage



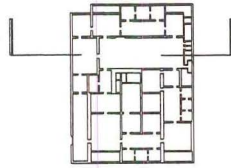
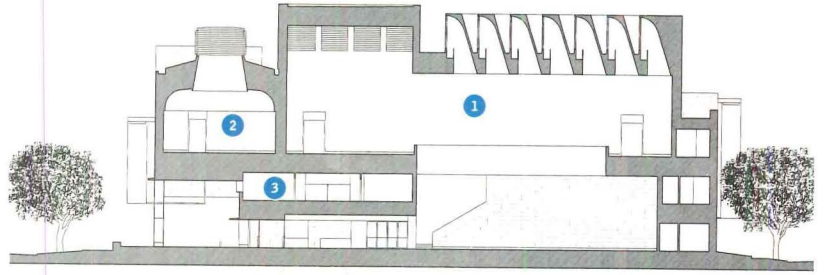

East-west section | 27'

- 1 entrance hall
- 2 gallery
- 3 office mezzanine

Moneo employs a rich material palette—Indiana limestone, white marble, and bronze—on the lower level of the entrance hall (facing page); a staircase and escalators create a strong diagonal composition. The upper level of the entrance hall (below left) is finished in white drywall. Clerestories (below right) and light scoops (section, above) illuminate the hall.

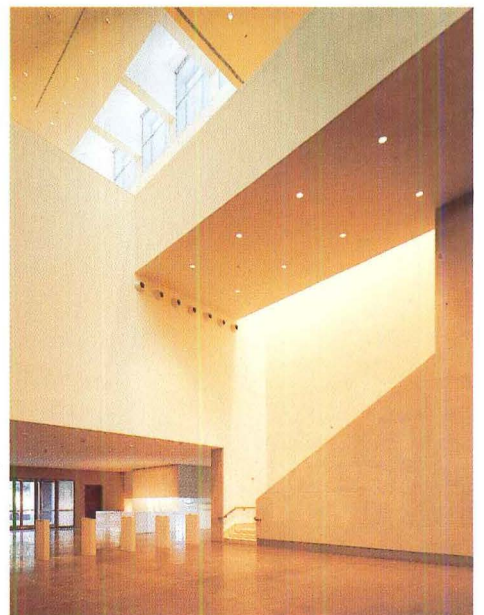
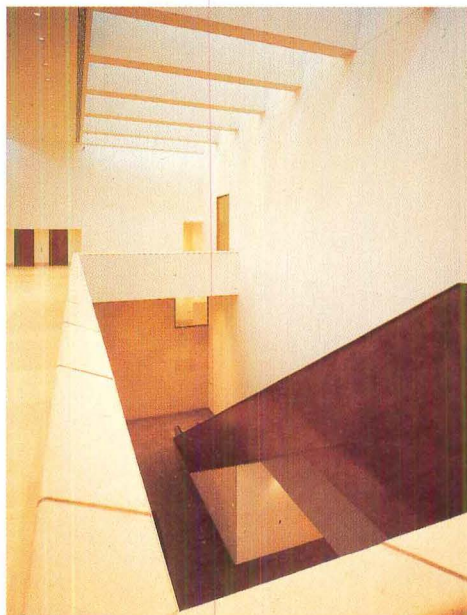







Moneo's details in the galleries (facing page) strike a careful balance between modernity and tradition: Bronze panels surround the doorways; ventilation grilles double as baseboards. In the top-floor galleries, Moneo incorporates a limited, varying set of skylight conditions: Light from a conventional skylight bounces off a row of fins (above left); exterior louvers and a long neck deflect light from a large lantern skylight (above center); and the angled bases of a line of smaller lantern skylights create an overhead rhythm echoed in the floor pattern (above right).

**AUDREY JONES BECK BUILDING, THE MUSEUM OF FINE ARTS, HOUSTON**

**CLIENT:** The Museum of Fine Arts, Houston—Peter Marzio (director)

**ARCHITECT:** José Rafael Moneo Architect, Madrid—José Rafael Moneo (principal-in-charge); Emilio Tuñón (preliminary design phase); Eduardo Miralles (project architect); Hayden Salter, José Luis Gahona (project team)

**ASSOCIATE ARCHITECT:** Kendall/Heaton Associates—Larry Burns (project architect)

**ENGINEERS:** CBM Engineers (structural); Altieri Sebor Wieber (mechanical)

**CONSULTANT:** Fischer Marantz Renfro Stone (lighting design)

**COST:** \$60 million **PHOTOGRAPHER:** Richard Barnes, except as noted

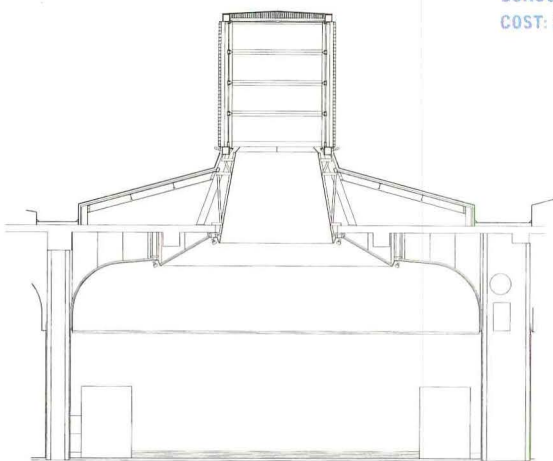

Gallery section 9'

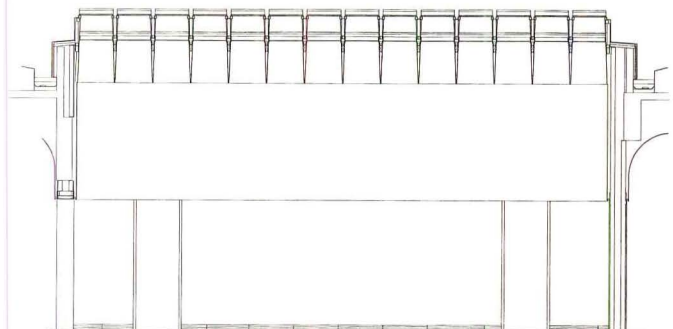
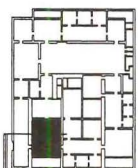

Gallery section

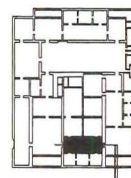

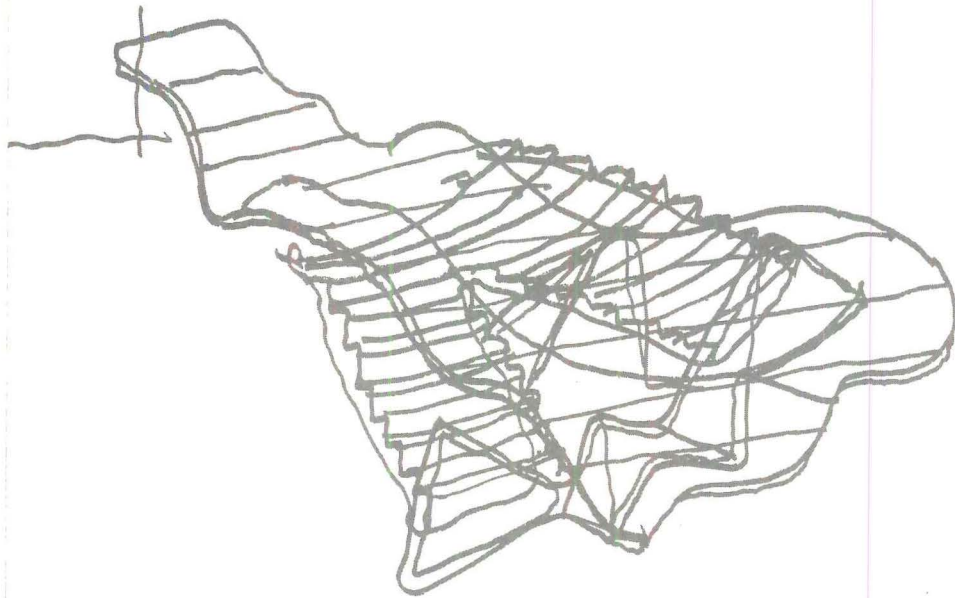
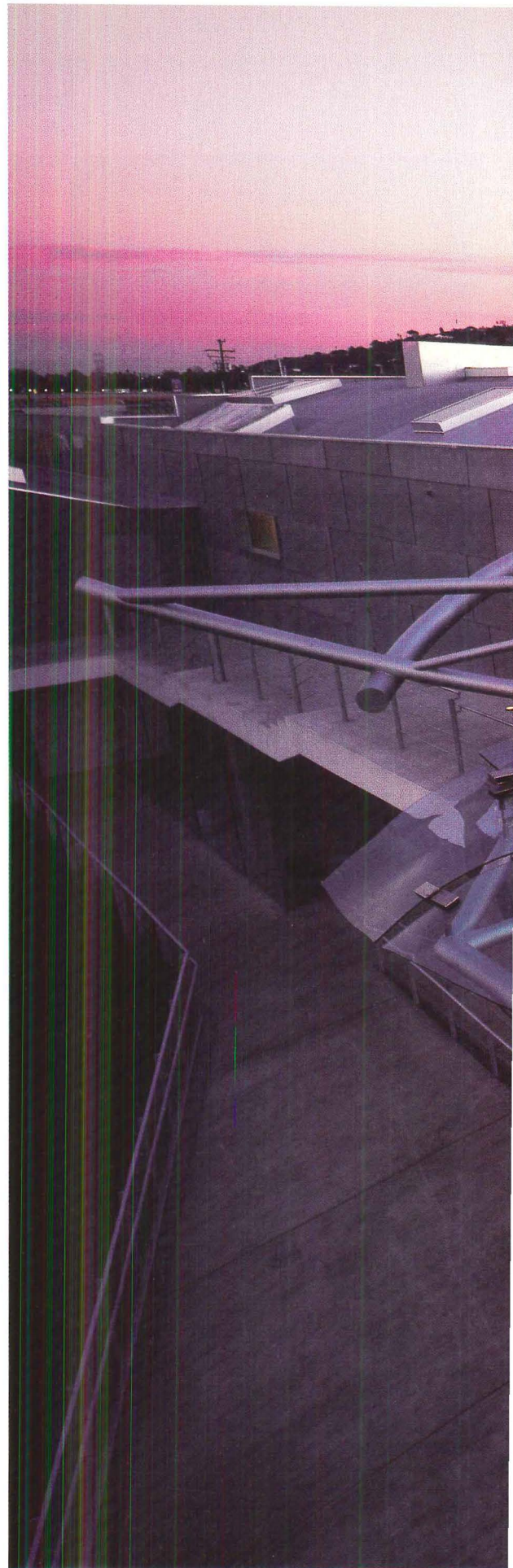
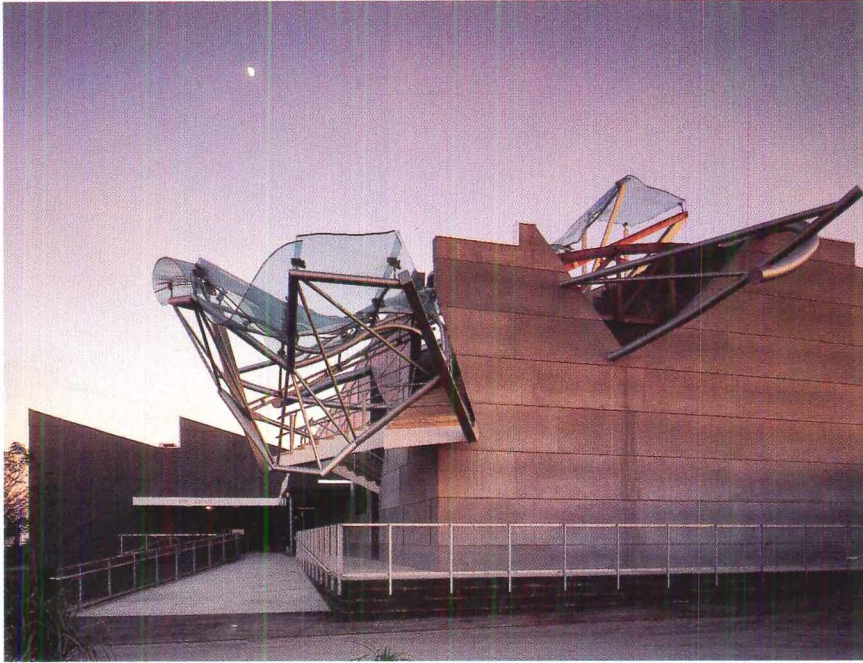

**Sheets of undulated glass (right) cascade from the corner of a reclad industrial shed in Culver City, California. To support the glass, Moss created a complex structure (top) of inverted steel and wood bow trusses, as well as other members. A sketch by the architect (above) explains how the complex glass surfaces serve as a canopy for a stepped terrace.**

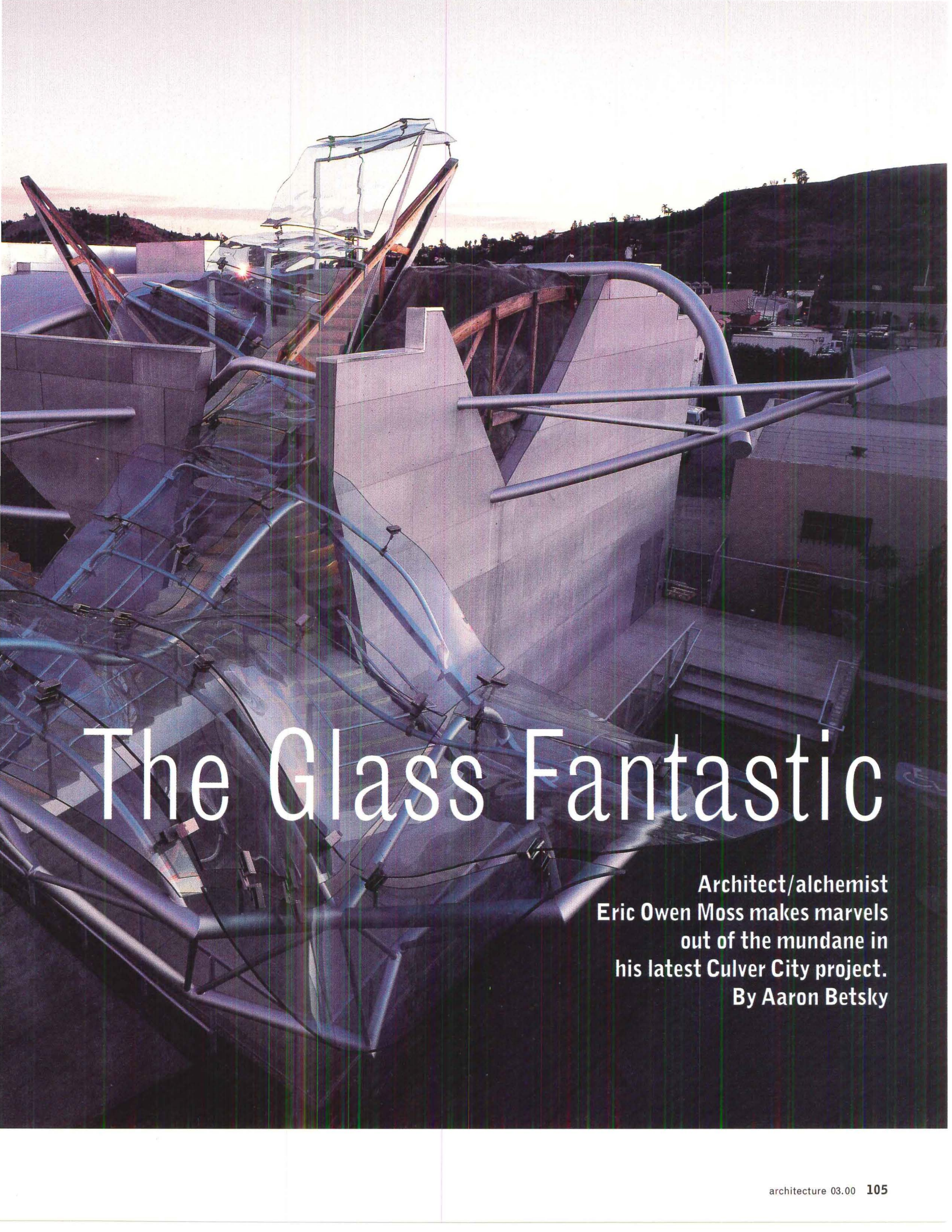

# The Glass Fantastic

Architect/alchemist  
Eric Owen Moss makes marvels  
out of the mundane in  
his latest Culver City project.  
By Aaron Betsky

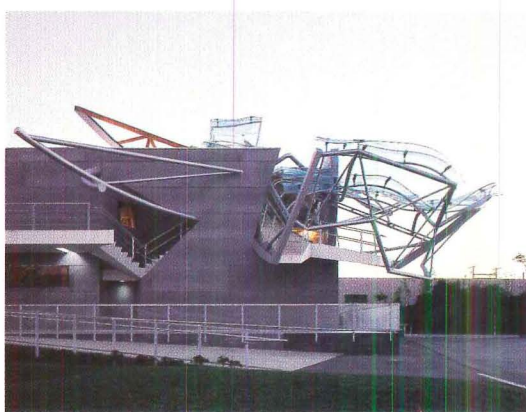

The irregular steel frame for the canopy (left and far left), which Moss calls **The Umbrella**, projects from the shed building's eroded northwest corner. Moss tucked the entrance (above) between the legs of the L-shaped building, and beneath a low, cantilevered overhang. Lapped sheets of glass enclose part of the lobby (facing page, bottom right).

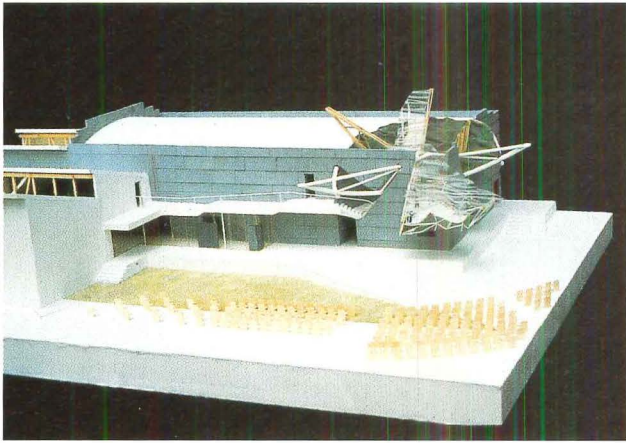

The building was originally intended as a rehearsal space for the Los Angeles Philharmonic, and the corner canopy as a stage for the Philharmonic's "Green Umbrella" music series. The model (above) shows how seats would fill the adjacent parking lot during performances.

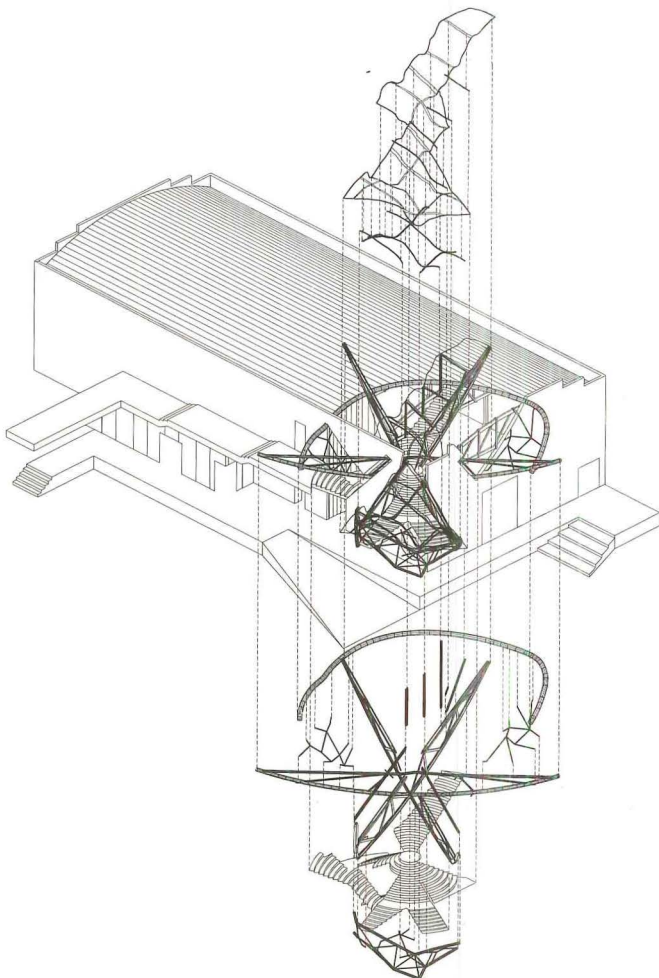

Exploded axonometric

Eric Owen Moss, the architectural alchemist who turns base buildings into sites of revelation, has conducted another brilliant experiment in Culver City, California. Working with his long-term patrons, the developers Frederick and Laurie Samitaur Smith, Moss has rescued yet another warehouse building from the sea of anonymity that stretches across the southern part of the Los Angeles basin. In this case, the architect and his clients have tried to, as Moss puts it, "cross the boundaries of architecture into music" with a fantastic glazed canopy called The Umbrella that blasts out from the corner of the building like some great, unfurling, expanding force. Intended for outdoor performances, the Umbrella sums up their reinvention of the basic warehouse, while pointing the way, Moss claims, "to something we cannot know."

For almost two decades, Moss and the Smiths have been transforming warehouses in Culver City's Hayden Tract, once home to many defense-related industries, into the workshop for Los Angeles' visual culture. The place has become a Mecca for the small production companies, consultancies, and effects designers who make the magic of film and television happen. Though the area's success has much to do with its location—it is one of the most affordable sites left near Hollywood—Moss' improvements have helped draw attention and clients. To expose the slicing, selective preservation and almost baroque additions of these mainly interior renovations, Moss has built a series of small additions to the otherwise relatively anonymous warehouses: the tilting "Box" of 1994, a spiraling blob in 1997, and now the Umbrella.

The Umbrella started as a direct reference to the Los Angeles Philharmonic's "Green Umbrella" series. The Smiths had hoped to lure these experimental music concerts to their development by giving the orchestra a practice site. They offered to cut a corner off one of their buildings, insert a raised stage, and configure the parking lot in front of the building so it could be used for outdoor concerts. The Philharmonic decided instead to concentrate on the construction of Frank Gehry's design for their new downtown home and on Hodgetts and Fung's renovation of the Hollywood Bowl.

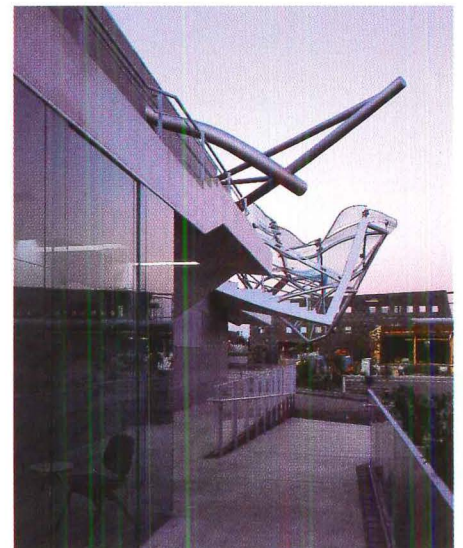

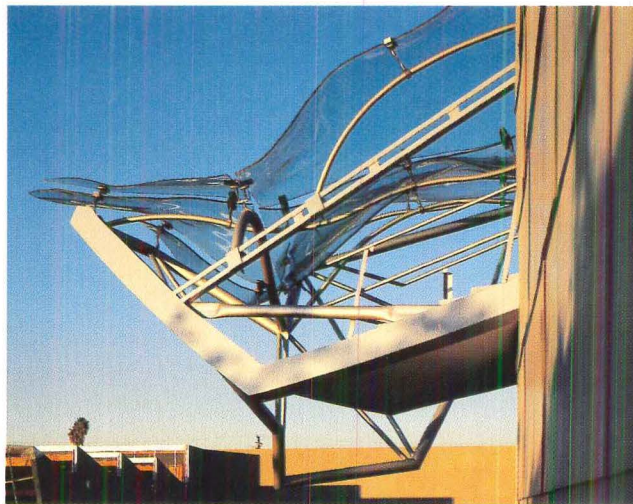
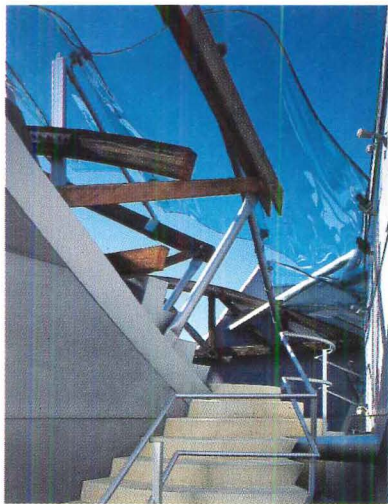

Moss conceived the structure supporting the canopy as an inverted umbrella (sketch, facing page). As realized, the structure is far less regular than the spines of an umbrella (facing page, top). A concrete stair (above) weaves between the structural supports and an undulated gunnite roof. The stair culminates in a balcony overlooking the parking lot (left), and doubles back to the interior of the shed building (far left).

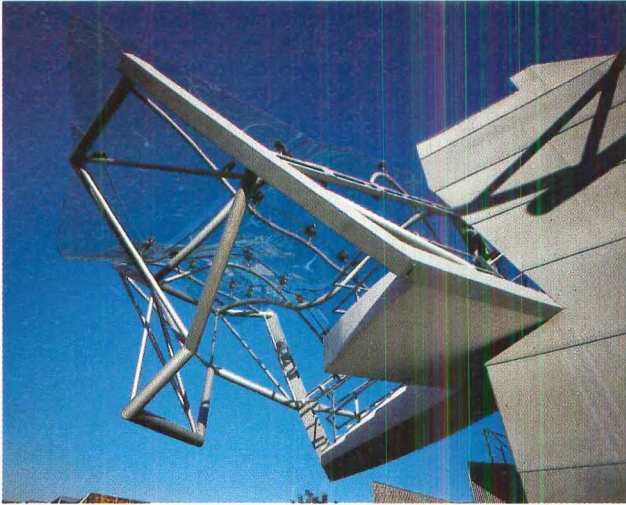

From Umbrella Crest



The Smiths, who are eager to give their development a strong cultural component, went ahead with the construction of the stage while renting the rest of the building to the production company T Minus 30 Films. It took many trials and errors to build the Umbrella. “Nothing you see today is exactly as we drew it,” Moss admits. The basic structure “started with a bowstring truss we took out of the building, turned upside down, and turned into the base of the bowl on which the stage sits,” the architect explains. “The truss cut through the existing building, and we inserted a new pipe structure above to tie it back.” The pipe structure becomes the steel mirror of the wood truss. Its undulations pick up connections to a web of structural support to become the Umbrella’s spine. On top of this assemblage of old and new parts, Moss then built a small amphitheater. He covered the whole structure with sections of undulated glass that cascade from the back of the roof to the open corner. “Mies in the microwave” is how Moss describes this tour de force of glass construction, which shattered several times before the laminated pieces actually held their form (see page 112). “It was a nightmare,” admits Frederick Smith, “but we had to see it through.” “It is the focal point for a whole dream community,” adds Laurie Smith.

The Umbrella does serve to focus a plaza-like parking area the Smiths and Moss created by cutting away surrounding buildings, opening up the backs of what was left, and framing them with two pieces of large new construction. One of the latter is a parking garage. The other is the “Stealth Building,” the first ground-up office building the Smiths are developing (and Moss is designing) in the area. The drainage slopes of the parking lot indicate an amphitheater-like arrangement that fans out from the base of the Umbrella.

The Umbrella is, for all its ability to catch the eye, not the only part of the 20,000-square-foot renovation worth noting. Moss covered the building with cement-board panels whose roughness emphasizes the crystalline nature of the glass-and-steel construction. A glass entry piece in the northern section of the L-shaped building answers the Umbrella’s complexity with its own, calmer collage of sliding, orthogonal planes. One enters a two-story space where selective elements of the existing building—a wood beam here, a truss there—intersect a composition of white volumes that house private offices.

Instead of the standard arrangement of outer offices and open desk areas in the middle (or its reverse), Moss devised a labyrinth of open and closed, one- and two-story, separate and connected spaces that offer the spatial equivalent of the Umbrella’s structural gymnastics. “This is a place with no hierarchy, but of fluid and flexible spaces,” he claims. For an industry in which tenants and uses change frequently, this variety also makes economic sense. “The tenants already are in here in ways they never anticipated, and they’ll change again,” Moss explains as he surveys the seemingly haphazard landscape of desks, gaming tables, and equipment scattered around the building’s interior.

If there is one focal point to this interior, it is the two-story conference room underneath the Umbrella. Here, walls are made of laminated-wood slats between overlapping sheets of glass. One can look up at the underside of the amphitheater steps, or out into the assembly of spatial volumes that make up the office space. The occupant is suspended between the articulation of the elements of architecture—



The building houses the production company T Minus 30 Films with an irregular plan of enclosed offices and open floor space (above and left).

- 1 lobby
- 2 conference room
- 3 office
- 4 open floor
- 5 lounge
- 6 kitchen

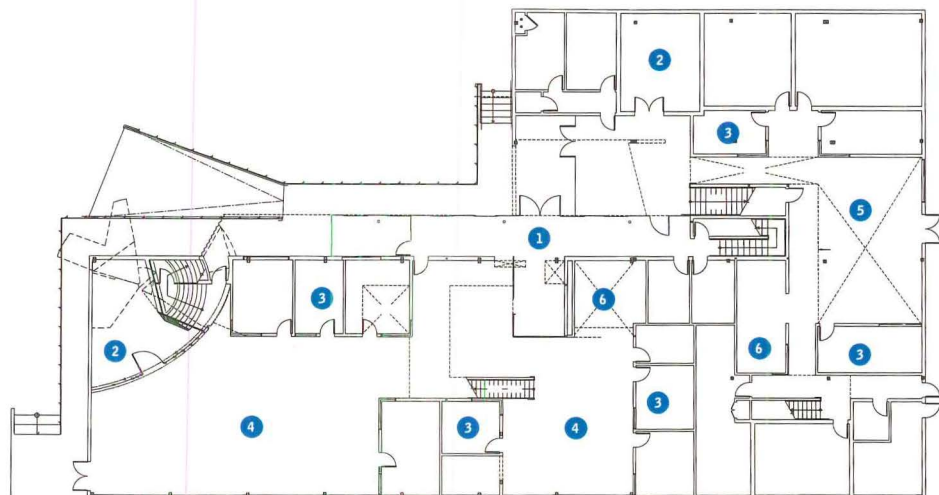

First-floor plan 15' ^





whether they are fragments of construction, pieces of abstract geometry, or strange ideas about place-making—and the actual open spaces that all this messy work makes possible.

Because of its complexity and its lack of rational function, the Umbrella is an oddity. It is, as a matter of fact, the official artwork that the developers had to deliver at the cost of one percent of their construction budget in order to receive Culver City tax breaks. It works, like all public art should, to sum up, clarify, and transform its site. If it has no particular function beyond the few days it may be used for concerts, it serves as “a fossil,” as Moss asserts, to remind us of his aspirations to make an architecture that is as “strange, fantastic, and almost impossible” as any Pre-Cambrian life-form. It also makes visible the experiments in sound and form that are embedded in the ad hoc, slice-and-dice urbanism the Smiths and Moss are creating in Culver City. It is the crystal made by crunching together all the construction already on the site. Out of it a whole new universe of forms can grow. ■

**THE UMBRELLA, 3542 HAYDEN, CULVER CITY, CALIFORNIA**

**CLIENT:** Samitaur Constructs, Culver City, California—Frederick and Laurie Samitaur Smith

**ARCHITECT:** Eric Owen Moss Architects, Culver City, California—Eric Owen Moss (principal-in-charge); John Bencher (project associate); Paul Groh (project architect—glass canopy); Christine Lawson, Scott Nakao, Austin Kelly, Augis Gedgaudas, Tim Burnett, Holly Deichmann, Dolan Daggett, Don Dimster, Stuart Magruder, Emil Mertz, Iris Regn, Scott Hunter, David Wick, Sharon Judelman, Gevik Hovsepian, Mark Prezkop, Curt Simmons, Hao Ko, Joseph Tiu, Juan Garcia, Francisco Delgado, Jay Vanos, Gudrun Wiedemer, Simon Businger (project team)

**ENGINEERS:** Englekirk and Sabol (structural); Silver, Roth, and Associates (electrical); Fruchtman and Associates (mechanical, plumbing, fire); Advanced Structures Incorporated (structural analysis, glass installation); California Glass Bending (glass fabrication)

**CONSULTANTS:** Nick Weinstein, Guy Nordensen (glass)

**GENERAL CONTRACTOR:** Samitaur Constructs

**COST:** Withheld at client’s request **PHOTOGRAPHER:** Tom Bonner

A conference room (far left) sits immediately beneath the Umbrella canopy, at one end of an open work floor (left). Lapped sheets of glass in a wood frame enclose the conference room (above left); the underside of the concrete stairs and gunnite roof form its ceiling.



## TECHNOLOGY

# MAKING GLASS FLY AT T MINUS 30

An owner's patience, a fabricator's poise, an engineer's ingenuity, and one architect's resolve were the defining attributes that levitated a gravity-defying glass umbrella to the top of a film studio in Culver City, California. Four years in planning and a year in execution, Eric Owen Moss' much anticipated crystal canopy, originally intended to cover an amphitheater for concerts, was, until its completion in December, a symphony of shattering glass.

For months before fabrication began, Moss and project architect Paul Groh studied the canopy idea in great detail: sketching, making physical models, scanning the models into the computer, tweaking them, making more cardboard models, and eventually turning the design over to L.A.-based Advanced Structures Incorporated (ASI) for engineering. ASI produced the shop drawings for a structure made of 17 unique, undulating glass panels, which it then turned over to Kelly Green, owner of California Glass Bending in Wilmington, for fabrication.

Until Moss drew him into his dreamworld of bizarrely cascading glass moguls suspended in the air with a minimum of point supports, Green was known for creating flawless glazing for high-end clients in need of simple, but perfect, radial bends. When he received the drawings, Green admits, "It was hard to reconcile the design elements with the technology. The design was overly ambitious for the bending process. Glass is not that malleable." The architect was well aware of the limitations while, at the same time, he embraced the risk. "There were no antecedents for this," explains Moss. "In principal, if you solve the issues of one panel, you solve them for all. But we found that what worked for one didn't necessarily work for the next. You have to have the attitude that you'll figure it out."

First of all, Green simplified the drawings into workable profiles. He successfully conducted several experiments bending 3-foot sections made of 1/2-inch-thick laminated units. But when he tried to fabricate the panels as designed—8 to 10 feet wide and 8 to 12 feet long, it became apparent that at 1/2 inch, the panels could not support their own weight.

**The Umbrella (below and right) consists of 17 unique panels of slumped, laminated glass, attached to a steel and wood structure by stainless-steel clips.**

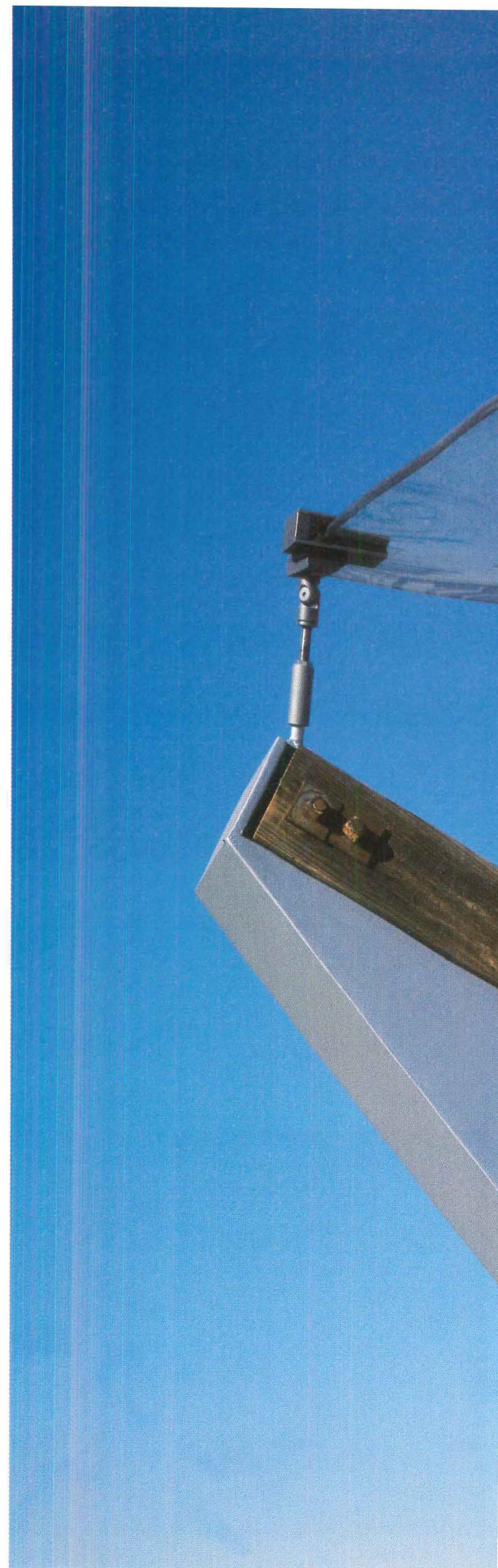





The panels were formed by slumping two sheets of tempered glass over a steel mold. A fiberglass blanket between the glass and the steel (top) prevented the two materials from sticking together in the 1,200-degree oven. Before installation, the panels were loaded with sandbags (center) to check deflection and verify live loads. Finished panels were carefully lifted (above) and loaded on a flatbed truck for delivery to the site. Each panel is dramatically different from any other one. Computer renderings (right) reveal the range of undulations in panels 1 through 5.

With simpler profiles and an increased panel thickness of  $\frac{3}{8}$  inch, production began. The glass was bent by a process called slumping. For each panel, two sheets of  $\frac{3}{8}$ -inch tempered glass were stacked on a steel mold created by ASI. Each mold was unique but all were constructed by vertical steel rods cut to match the intended contour of the glass and mounted on a steel plate. The assemblage was then heated in an oven at 1,200 degrees Fahrenheit until the sheets softened and slumped over the mold. “The glass never gets so soft that the two sheets fuse. It’s not like cheese in a microwave,” explains Green. After cooling, he laminated the two identically bent sheets with a sheet of polyvinyl butyral (PVB) in a giant autoclave that uses pressurized steam to bind the layers together.

Preparation, slumping, cooling, and lamination took about 18 hours per panel. Several panels were broken in the shop for reasons having less to do with mishandling than with the unstable nature of such eccentric, fragile shapes. But it was only when the panels were transported to the site that the real problems began. They were to be held in place by S-shaped stainless-steel clips, lined with silicone and rubber, and connected to a latticework of pipes, which was, in turn, connected to the building’s perimeter structure. In theory, the clips should have supported the glass panels. However, in application, they were too rigid to adjust to a seemingly infinite range of bends in the glass. The diagram was right, but the devil was in the details. The stresses inflicted by the clips caused repeated and dramatic glass failures over the course of several months. Half to three-quarters of the panels had to be replaced, many more than once.

Frustration ebbed and flowed. Because of the experimental nature of the process, there was no way to tell either how far the team was from reconciling the details, or if the whole proposition was impossible to realize at any cost. “I had to decide how dogmatic I was going to be about the rules,” Moss recounts. “I was not interested in the clips as pieces of jewelry. The idea was to minimize support while maximizing the visual effects of a rolling glass canopy.”

ASI reengineered the clips to be more dexterous; Moss submitted to the laws of physics and added clips wherever more support was needed. Failures became less frequent until the last panel was installed, six months behind schedule. Today, the Umbrella appears stable and imposing. Was it worth the enormous effort? Moss says yes. “Architecture is fundamentally about control, and we had to give up a certain amount in the investigation. It’s the only way you learn anything new. Otherwise, you just rerun what everybody already knows. I hope other people will look at it and see a new venue for using glass.” *Sara Hart*

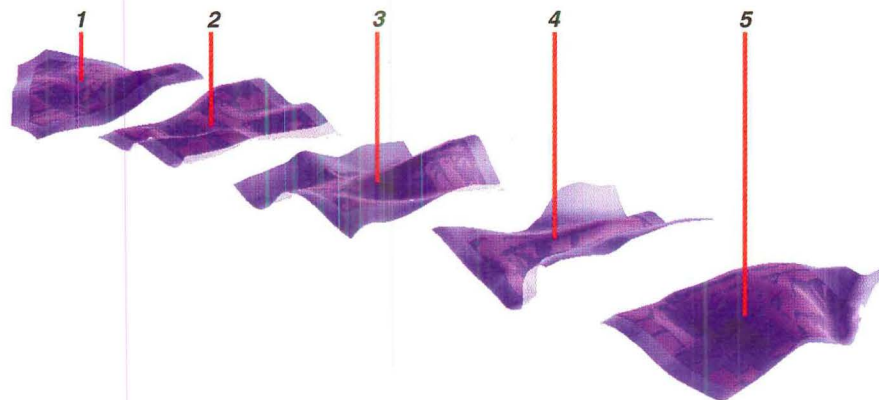

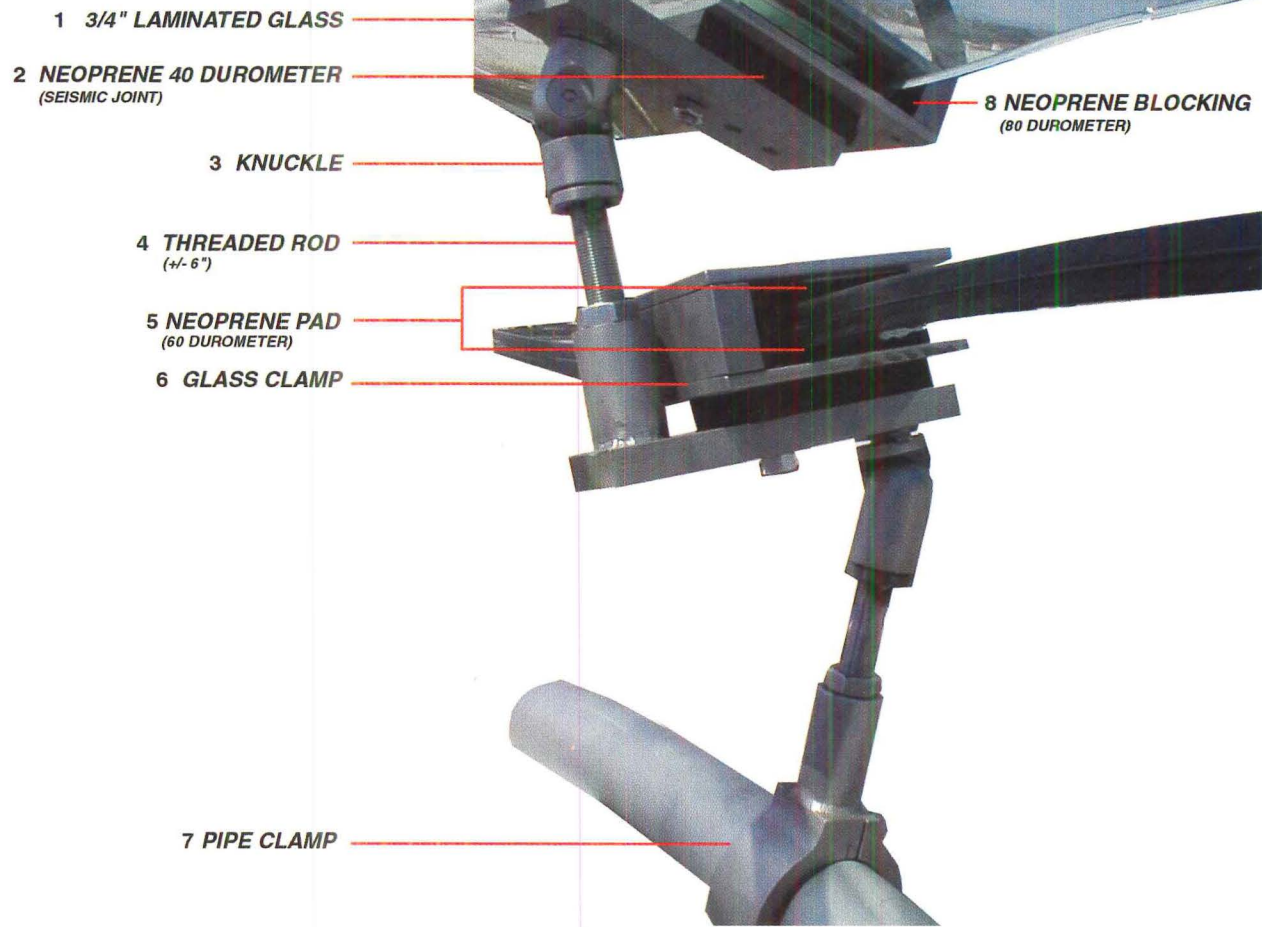

Advanced Structures Incorporated (ASI) engineered the clips that hold the glass panels (above), making a number of adjustments over the course of the installation process to accommodate bends in the glass panels. Cranes lifted each panel to its approximate location (below left), then workmen carefully maneuvered the panels into position. Most failures (below right) occurred when the clips, which originally were too rigid to accommodate the uneven glass, were fastened onto the panels.





Barkow Leibinger  
revisits  
Mies with a  
clean-cut  
testing center  
in rural  
Connecticut.

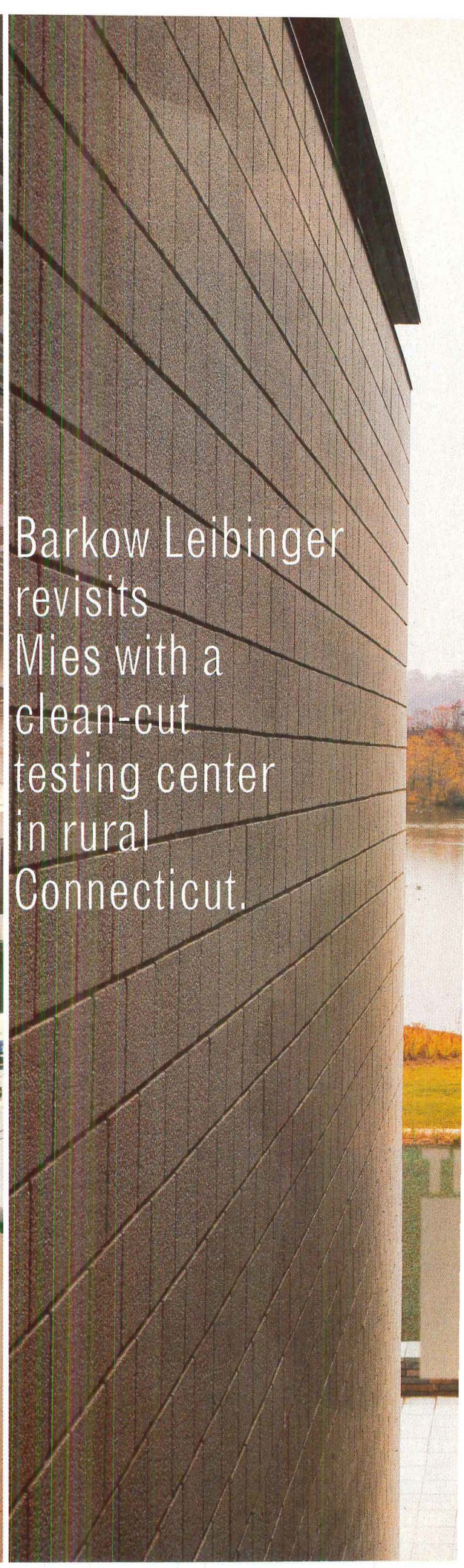



# LASER SHARP



From the mid-1960s to the early 1980s, a little-known Connecticut architect named Skip Green set a modernist tone at the Farmington Industrial Park near Hartford, Connecticut. Instead of the park's standard fare of dreary suburban dross, Green created light yet forceful offices and factories with simple steel frames, brick infill, and abundant daylighting. His buildings proved to be an inspiring precedent for Berlin architects Frank Barkow and Regine Leibinger, who designed Farmington's newest building: an office and production facility for the German laser-tool company Trumpf. Their 36,000-square-foot addition to existing Trumpf facilities also looks to more noble predecessors, such as Mies' Illinois Institute of Technology campus (1940) and Peter and Allison Smithson's Heathstanton School (1953).

Photographs by Paul Warchol

TRUMPF CUSTOMER AND TECHNOLOGY CENTER







Barkow Leibinger subtly manipulate the straightforward conventions of the Miesian grid, starting with the plan (bottom), a Wrightian pinwheel with four two-story blocks flanking a double-height machine hall (previous pages). The ground floor contains the central hall as well as an entrance lobby, auditorium, and cafeteria; on the second floor, a catwalk rings the machine hall, linking offices, classrooms, and conference rooms. Barkow Leibinger inserted gaps in the building's continuous steel frame to separate the four different-sized blocks, and recessed voids within the frame at the ends of the blocks and at intervals along their lengths. On the north-facing entrance facade (facing page), for instance, a wide slot faced with concrete-blocks leads to the building's lobby. The architects kept the building's material palette simple—chiefly sandblasted concrete, glass, and reddish-brown ironspot brick—but broke down the regularity of the facades with different configurations of windows and brick infill. The building's west facade (above) fronts a lawn that slopes down to a lake.

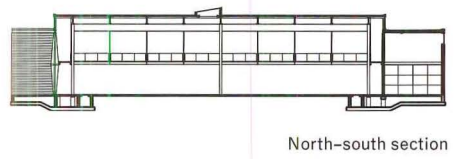
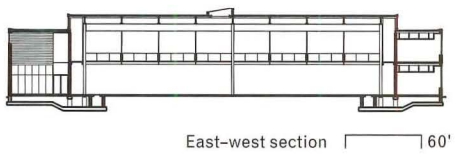

- 1 entrance
- 2 reception
- 3 machine hall
- 4 cafeteria
- 5 auditorium
- 6 workroom
- 7 office
- 8 conference room
- 9 open to below

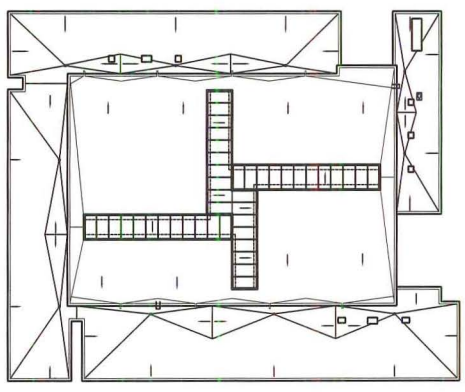
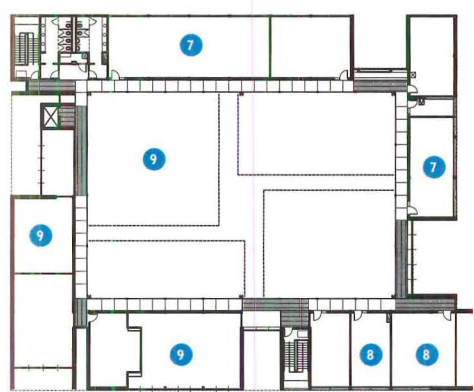
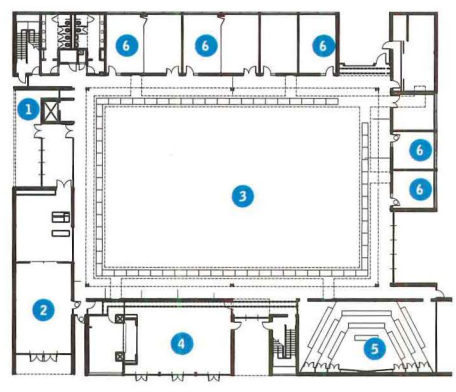

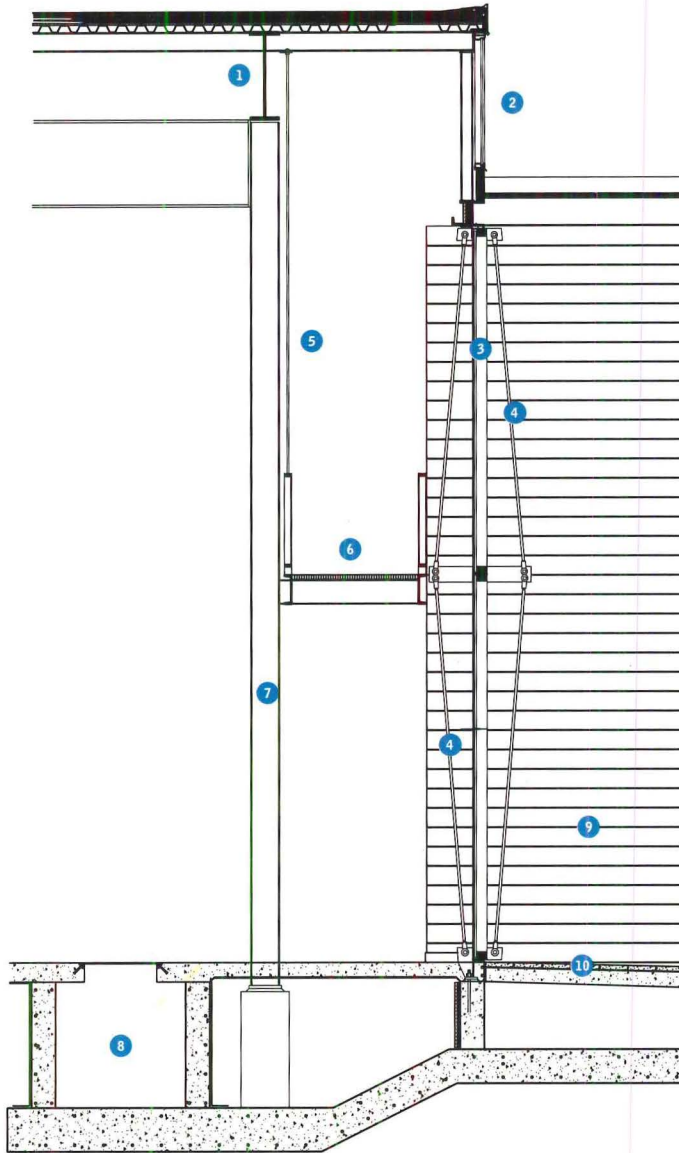

Section through lobby wall | 13'

- |  |  |
|--|--|
| 1 36" steel roof beam                              | 6 suspended catwalk with 1 1/4" aluminum grating |
| 2 1"-thick glass-and-aluminum clerestory           | 7 w12x12 steel column                            |
| 3 6" steel T framed with 1"-thick structural glass | 8 utility trench with aluminum cover             |
| 4 3/4" steel rod tension cords                     | 9 sandblasted 8" concrete blocks                 |
| 5 3/4" hanger rod                                  | 10 12"x12" concrete panels                       |

The Trumpf center's interiors continue the crisp precision of the building's exteriors. The double-height reception area (facing page, top left) features slate floors and birch plywood sliding doors; large expanses of glass connect the room to the outdoors (at right) and to the machine hall at the heart of the building (at left). In the vestibule, an armature of interior and exterior steel rods stiffens a double-height window wall (facing page, top right, and detail, above), which contains solar-efficient glass. The architects set back the lites, which are framed in steel T-sections, from the facades' edges to emphasize voids in the pinwheel plan (facing page, top right). The 12,000-square-foot hall where customers learn how to use Trumpf's laser-cutting equipment (facing page, bottom left) takes up most of the building's interior. Fiberglass strip skylights in the ceiling above the vast double-height space mark the pinwheel plan. Barkow Leibinger put Trumpf's high-tech laser-cutting technology on display in the slotted stainless-steel railings of the catwalks that ring the space (facing page, bottom right). The steel-grate catwalks hang from the building's exposed steel skeleton.

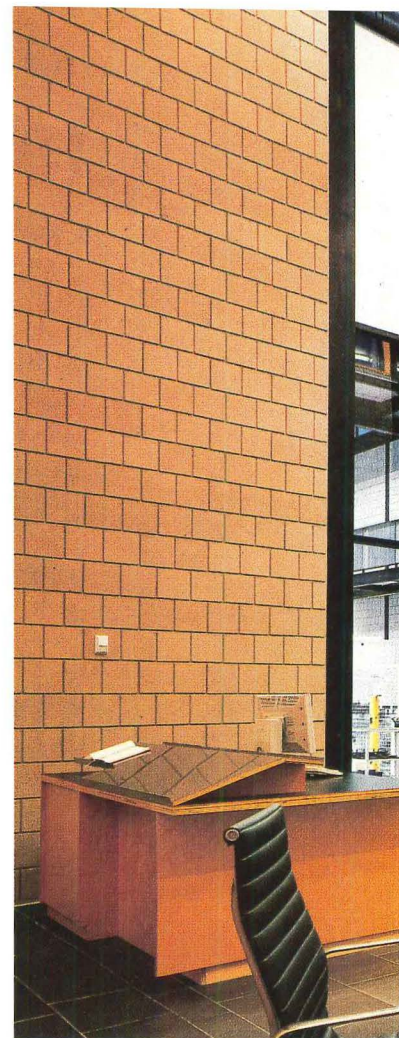



# NORDIC

# DIPLOMACY



# THE FIVE NATIONS OF SCANDINAVIA COLLABORATE ON AN EMBASSY COMPLEX IN BERLIN.

BY CATHERINE SLESSOR



The Nordic embassy complex lies along the southern edge of Berlin's Tiergarten, a former diplomatic quarter which is currently being reborn in a program of new embassy buildings. Made of patinated copper louvers, Berger + Parkkinen's undulated wall (these pages) embraces and protects the embassy compound while offering glimpses of the secret world within. The random pattern of open and closed louvers, generated by the placement of embassy buildings behind the wall, creates an unpredictable, abstract rhythm around the perimeter.

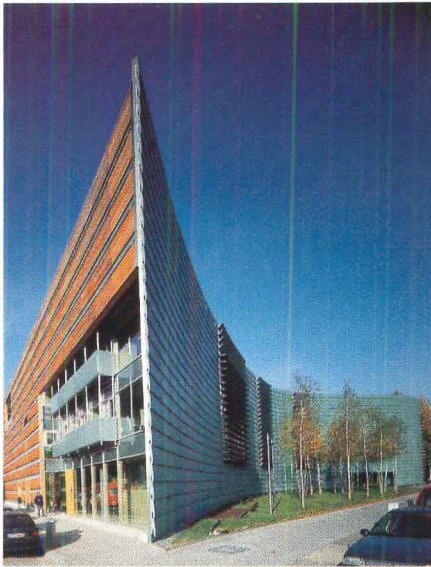

At the southeast corner of the site, the perimeter wall abuts the Felleshus (above), a communal building that houses the embassies' public functions. The visa office in the Felleshus has its own entrance (at left) on the south elevation along Rauchstrasse. Seductively scaly and vividly colored, the wall (right) snakes around the compound, its gentle curves recalling Alvar Aalto's organic architecture and the historically empathetic relationship of Scandinavian buildings to nature.



On the southern edge of the Tiergarten, the former hunting park of Prussian royalty, Berlin's fur-coated *flâneurs* are confronted by a perplexing new spectacle. An undulated wall, four stories high and composed of 4,000 patinated copper louvers, slinks around an amoeba-shaped compound. In some spots, the louvers are flicked open to reveal tantalizing glimpses of the buildings inside, but the wall mostly remains an inscrutable hermetic enclosure. Reinforced by the shocking intensity of its hue, a sumptuous cocktail of jade mixed with cerulean, the wall has a curiously organic, reptilian quality, like the scaly skin of some giant, slumbering beast. Within its embrace is a clutch of new embassy buildings for the sober countries of Scandinavia. Proof, if it were needed, that as Berlin rebuilds itself, the city's capacity to surprise and delight remains undiminished.

The relocation of foreign diplomats from Bonn to Germany's rejuvenated capital has precipitated a boom in the construction of new embassy and consular facilities. As well as being plum commissions for stellar architects—Rem Koolhaas is designing an embassy for the Netherlands, Michael Wilford for the United Kingdom, and Dominique Perrault for France—this latest wave of buildings in Berlin's abandoned diplomatic quarter embodies intriguing and very conspicuous expressions of national identity. For some time, the governments of Sweden, Finland, Norway, Denmark, and Iceland had contemplated building a communal diplomatic complex. There were obvious economies of scale in pooling resources and sharing facilities, and though very different geographically, the Nordic lands share common historical, cultural, and linguistic links. Berlin offered the chance to make these ideas real.

The Austrian-Finnish partnership of Alfred Berger and Tiina Parkkinen won the 1995 competition for the embassies' master plan. Their proposal defined the perimeter wall and carved up the looping enclosure into six plots of varying configurations separated by axial internal streets. Each of the five Nordic countries held subsequent national design competitions for individual embassy buildings. Allocation of plots roughly corresponds to the geography of Scandinavia, with a long shallow pool bisecting the site. The strip of water penetrates and extends beyond the louvered perimeter, the openings of which frame and expose views back into the compound.

On the south side, the complex fully reveals itself. A low wall of toughened, clear glass panels replaces the green copper skin, and a tented canopy marks the main entrance to the embassy courtyard. Despite the unimposing scale of the buildings, the subtle distortions of perspective in the tapering axes of the internal streets give the paved courtyard a slightly unsettling and scenographic quality, like a German expressionist film or a de Chirico painting.

There was no prescribed strategy for how individual buildings should relate to the wall. Some architects ignore it; others use it as a screen, with open louvers that allow light and views; still others integrate it within the external envelope of the embassy buildings. Through different elevational treatments, each embassy building contributes an improvisation on the theme of the slatted wall.

Public access is limited to the shared Fellehus, a common building designed by Berger + Parkkinen that houses such public functions as exhibitions, receptions, lectures, and the issuing of visas. Occupying the southwest corner of the site, the Fellehus is a crisply minimal volume clad in horizontal strips of timber and translucent glass.

The most striking structure is the Finnish embassy by the young practice of Viiva Arkkitehtuuri, in which rustic shutters of aspen strips envelop a glazed inner box. Like a Finnish farmhouse or barn, the shutters give the building a rural quality, but with sophisticated, precise details. Inside, a central axis leads up past offices and the inevitable sauna to the main conference room, housed in a plywood shell that seems to float in space.

Facing Finland's embassy across the pool is the Swedish embassy by Gothenburg-based Gert Wingårdh. Enclosed by a wall of light Gotland limestone on one side and dark Bräanहुlt diorite on the other, the exterior is a slightly over-expressive exploration of Swedish materials. The exterior gives way to a calm inner realm, a full-height foyer gently lit from a tall glass wall overlooking the Tiergarten through the copper louvers. Lined with birch veneer, the space has a crafted resonance like the inside of a musical instrument.

The Norwegian embassy by Oslo's Snøhetta (November 1998, page 136) reveals a massive vertical slab of gray granite, over 45 feet tall and 28 inches thick, which forms the south prow of the building. Quarried from a single piece of stone, the monolith emphasizes the intensely vertical qualities of Norwegian landscape—fjords, mountains, and forests—and through its sheer scale, presence, and position forms a dramatic focal point within the courtyard. The rest of the building is covered in translucent green glass screens that mimic the coolness of Norwegian glaciers.

Tucked between the Norway and Denmark embassies is the Icelandic embassy by Pálmar Kristmundsson, the smallest of the quintet. A regular grid of windows punctures walls of liparit, a rare pinkish Icelandic stone. Ribbed concrete panels at the lower level allude to the corrugated-metal roofs of vernacular Icelandic buildings. A courtyard formed between the building and the perimeter wall is transformed into a lava garden, with fragments of black stone lit from below to evoke the volcanic Icelandic landscape—a superficial touch in an otherwise thoughtful composition.

Completing the corral of buildings is Nielsen, Nielsen & Nielsen's Danish embassy at the southwest corner of the compound. Its external skin is made up of surprisingly delicate perforated stainless-steel panels that catch the sunlight. On the undulated perimeter elevation, the cladding mimics the structure of the copper wall—the only embassy to engage the wall in such a direct manner—so that individual offices have clear views over the Tiergarten. Inside, the sweep of perimeter cellular offices is linked to a rectilinear volume by a series of bridges and walkways spanning a top-lit central foyer.

The consolidation of public functions in the shared Fellehus means that individual embassies are little more than glorified, if elegantly executed, office blocks. Yet each has a distinct character, and all share an affinity for finely honed materials and the provision of decent, dignified spaces—entirely apposite reflections of northern European social democracy. Offsetting the embassies' collective sobriety is the urban theater of the enclosing wall. In a city with bad memories of the divisive capacity of walls, Berger + Parkkinen's copper perimeter is a fluid, permeable, and embracing structure, tactfully exclusive in the interests of security, but offering glimpses of its inner world. In an age racked with bombast and corrosive nationalism, this Nordic spirit of intelligent understatement and mutual cooperation should be warmly celebrated. ■





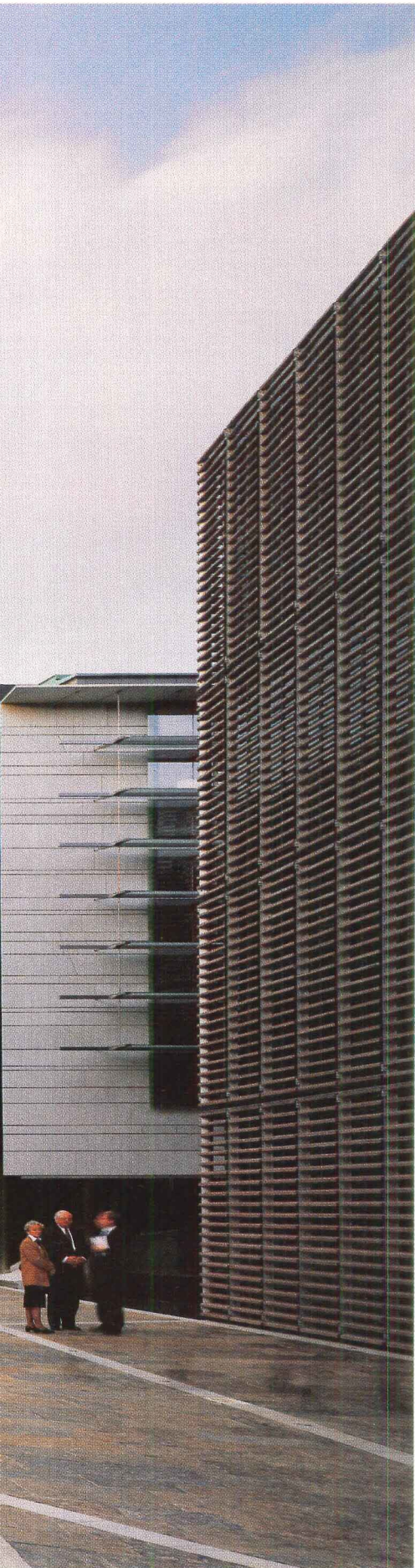

An inner courtyard behind the copper wall (facing page) features tapering axial streets that separate the five embassies. An exaggerated perspective gives the courtyard a curious scenographic quality. The focus of the composition is the great granite monolith that forms the south prow of the Norwegian embassy (facing page, at center). A tented fabric canopy (left) marks the entrance to the courtyard, framed by the minimal box of the Felleshus to the right. The Felleshus' glazed west elevation (below left) is a welcoming gesture to the public.



- 1 entrance lobby
- 2 security checkpoint
- 3 office
- 4 auditorium
- 5 storage
- 6 shared consular area
- 7 delivery area

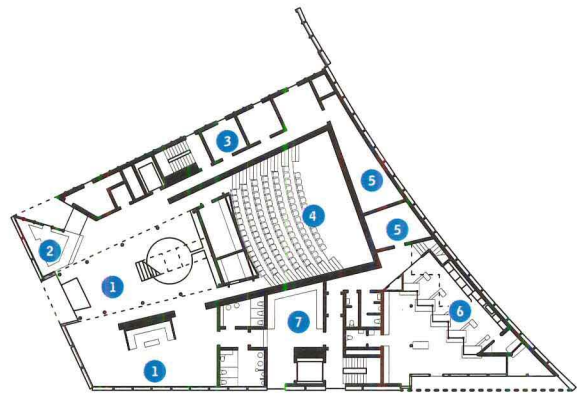

Felleshus ground-floor plan 1" = 22' Δ

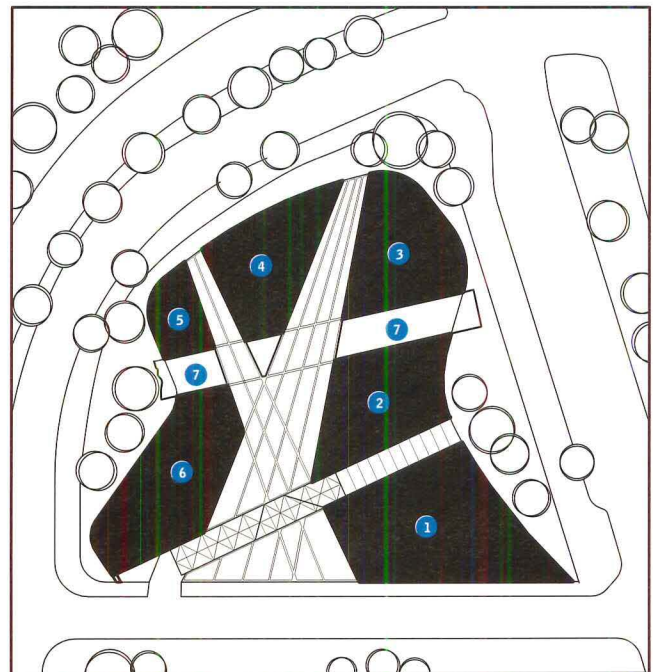

- 1 Felleshus
- 2 Finnish embassy
- 3 Swedish embassy
- 4 Norwegian embassy
- 5 Icelandic embassy
- 6 Danish embassy
- 7 reflecting pool

Site plan 1" = 51' Δ

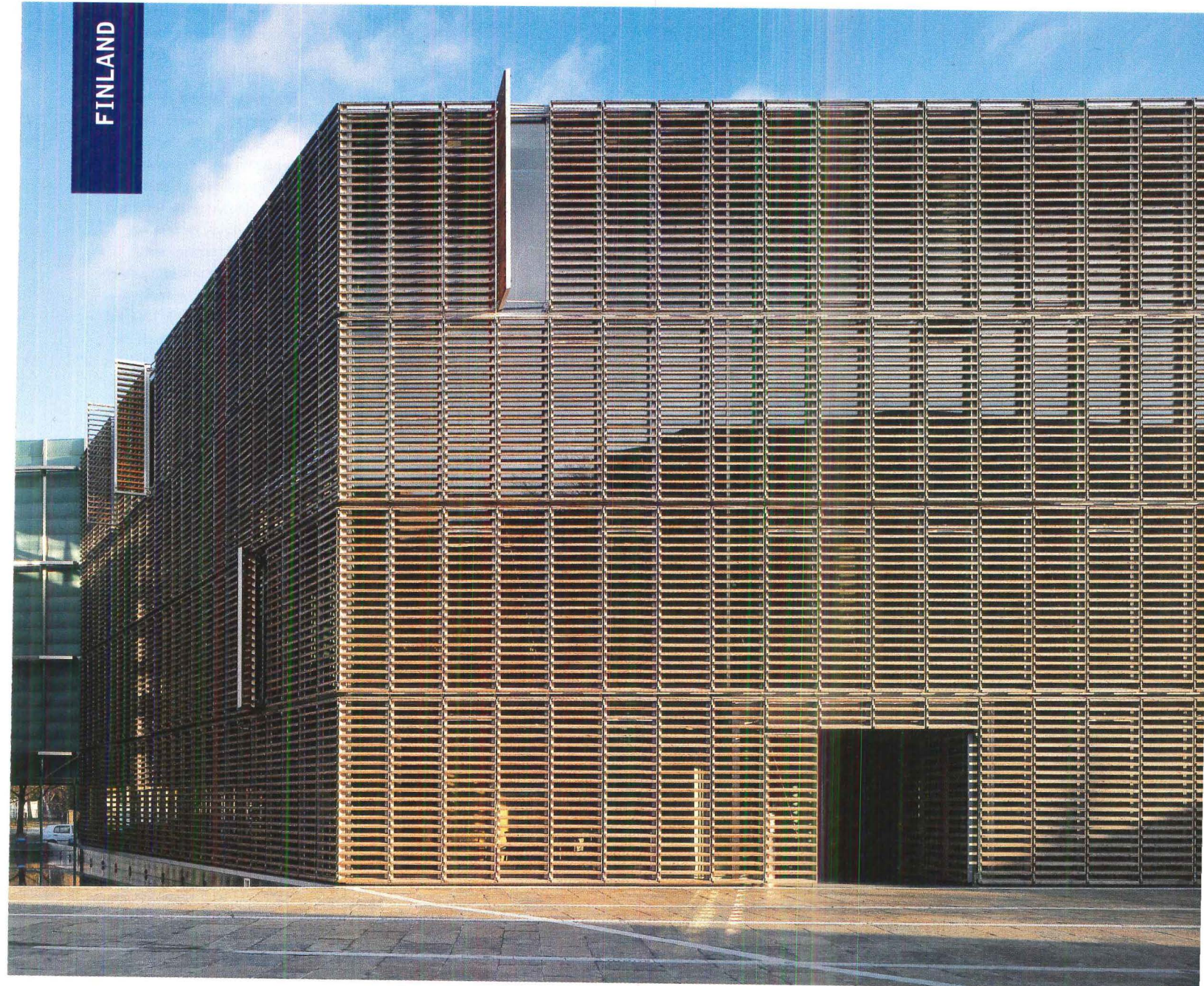

The Finnish embassy (above), a glass box enclosed by meticulously detailed timber shutters, evokes the rustic nature of Finland's vernacular buildings. Light filters into the calm, dignified interior (facing page) through the copper louvers of the enclosing compound wall.

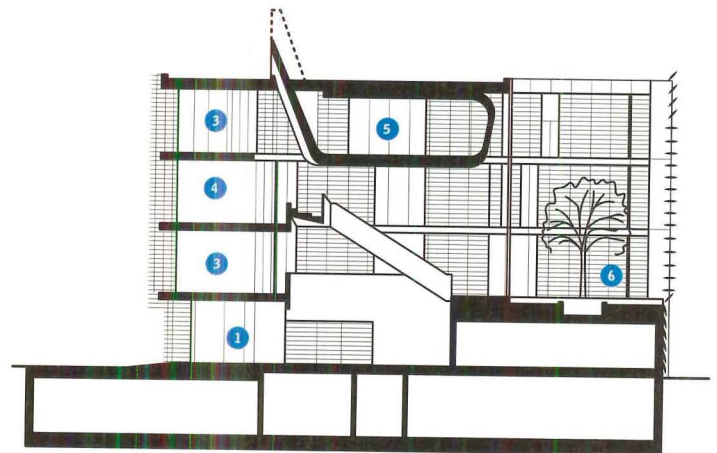

East-west section 14'



- 1 entrance lobby
- 2 relaxation area and saunas
- 3 meeting room
- 4 office
- 5 conference room
- 6 roof garden

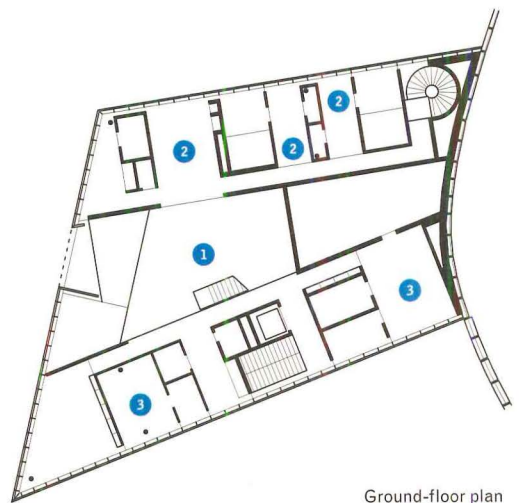
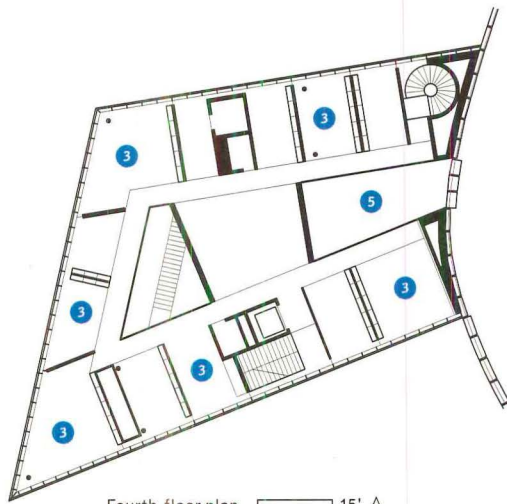

NORWAY



SWEDEN

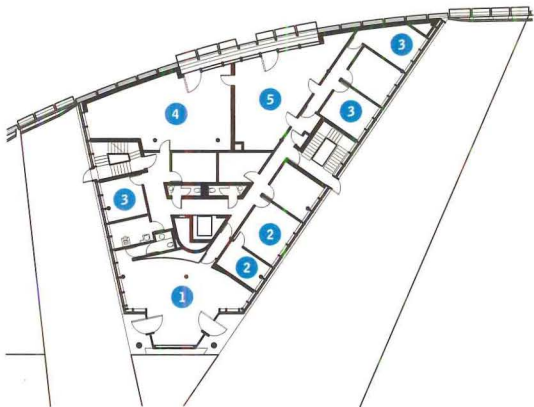
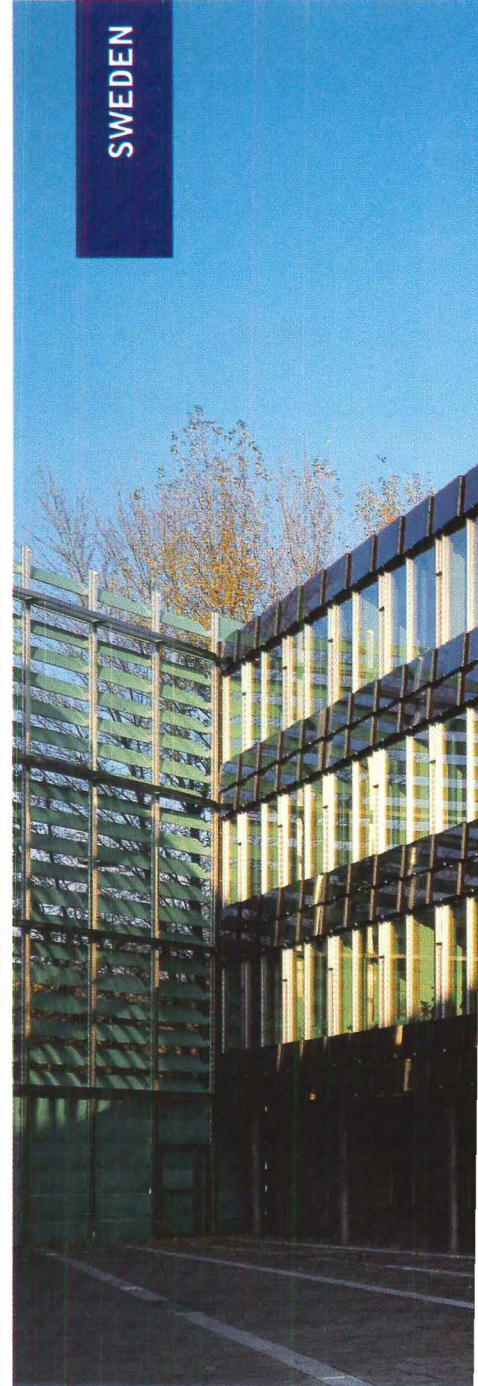

Ground-floor plan 18'  $\Delta$

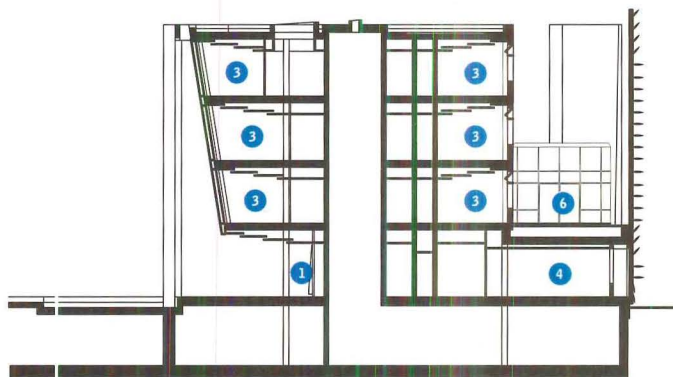

North-south section 11'

- 1 entrance lobby
- 2 reception
- 3 office
- 4 conference room
- 5 storage
- 6 roof garden



The Norwegian embassy (facing page) alludes to the country's glacial landscape with translucent green screens, and a powerful granite monolith suggests the soaring verticality of fjords and forests. The walls of the Swedish embassy (left) are clad in dark and light Swedish stone interspersed with glazed strips. A curved limestone wall at the base of the building draws visitors inside.

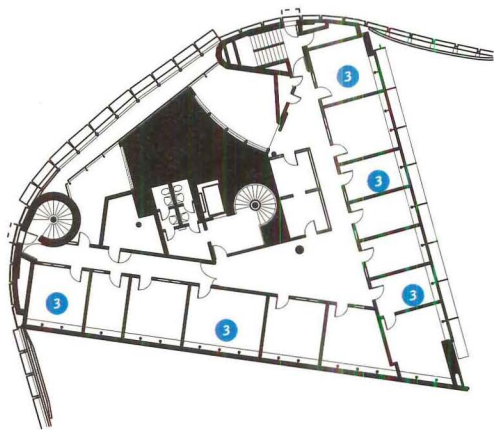

First-floor plan 16'

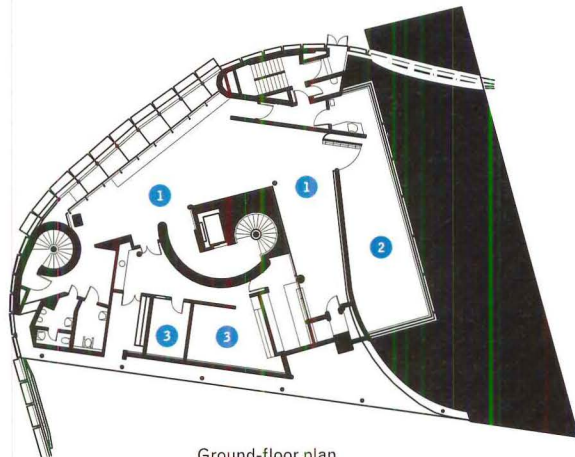

Ground-floor plan

- 1 entrance lobby
- 2 conference room
- 3 office

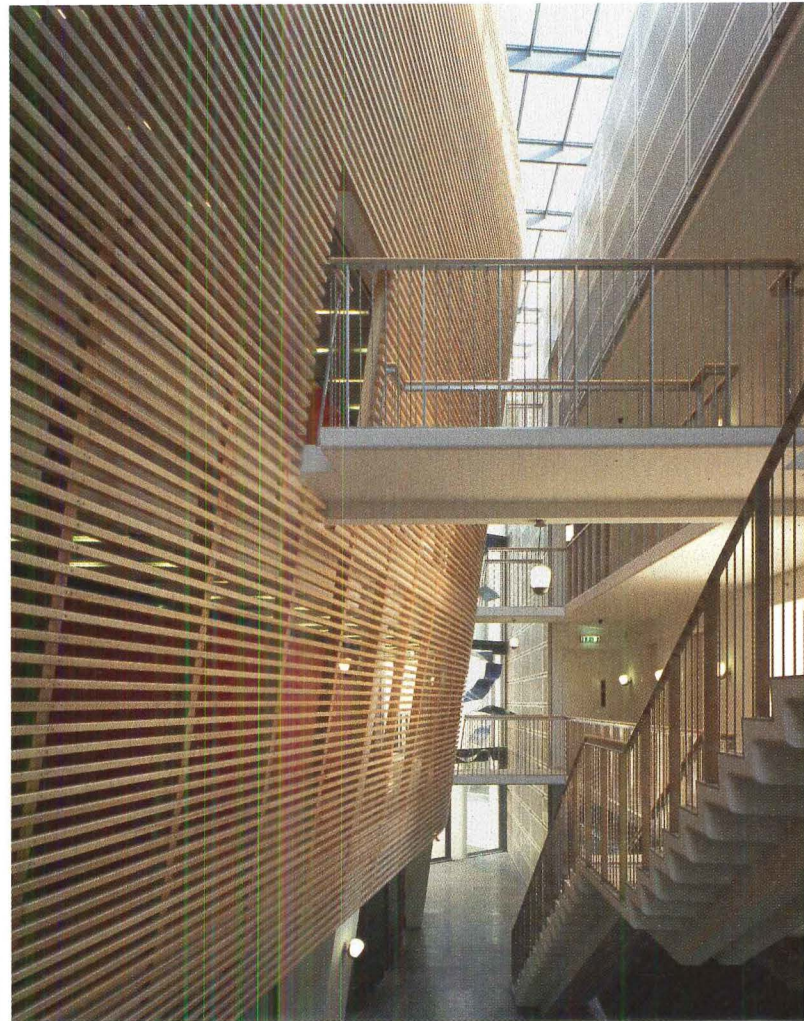

Delicate perforated-metal panels enclosing the Danish embassy (above left) provide a variation on the theme of the slatted copper wall that wraps the entire complex. The gauzy cladding hints at the activities inside. Inside the Danish embassy (above right), the curved hull of the building's

perimeter offices is linked to an orthogonal volume by elevated walkways. Clad in slabs of rare pink stone, Iceland's compact embassy (facing page) is the smallest of the quintet. Ribbed concrete panels evoke the corrugated metal commonly used in Icelandic buildings.

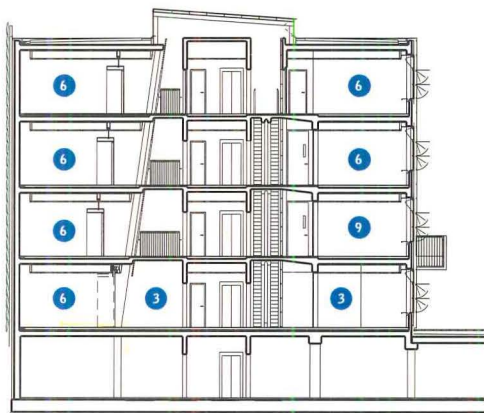

East-west section 11'

- 1 entry lobby
- 2 security check
- 3 atrium
- 4 library
- 5 meeting room
- 6 office
- 7 ambassador's office
- 8 archives
- 9 cafeteria

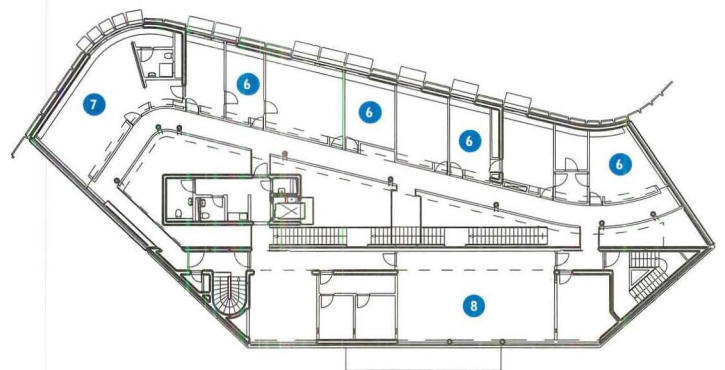

Third-floor plan

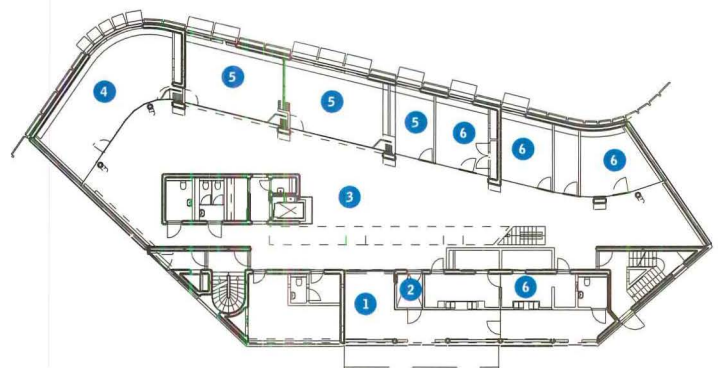

Ground-floor plan 15' >

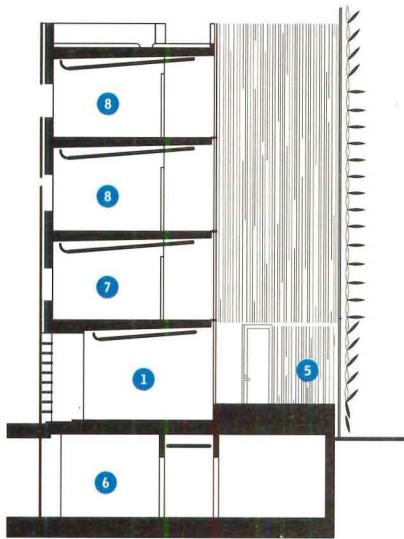

East-west section 6'

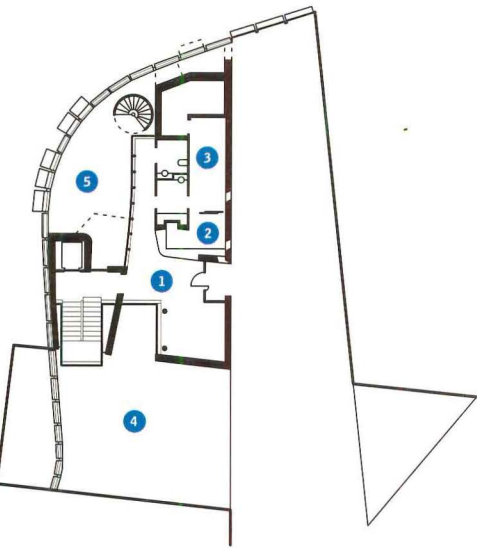

Ground-floor plan 13' ^

- 1 entrance foyer
- 2 reception
- 3 exhibit area
- 4 reflecting pool
- 5 lava garden
- 6 garage
- 7 conference room
- 8 office

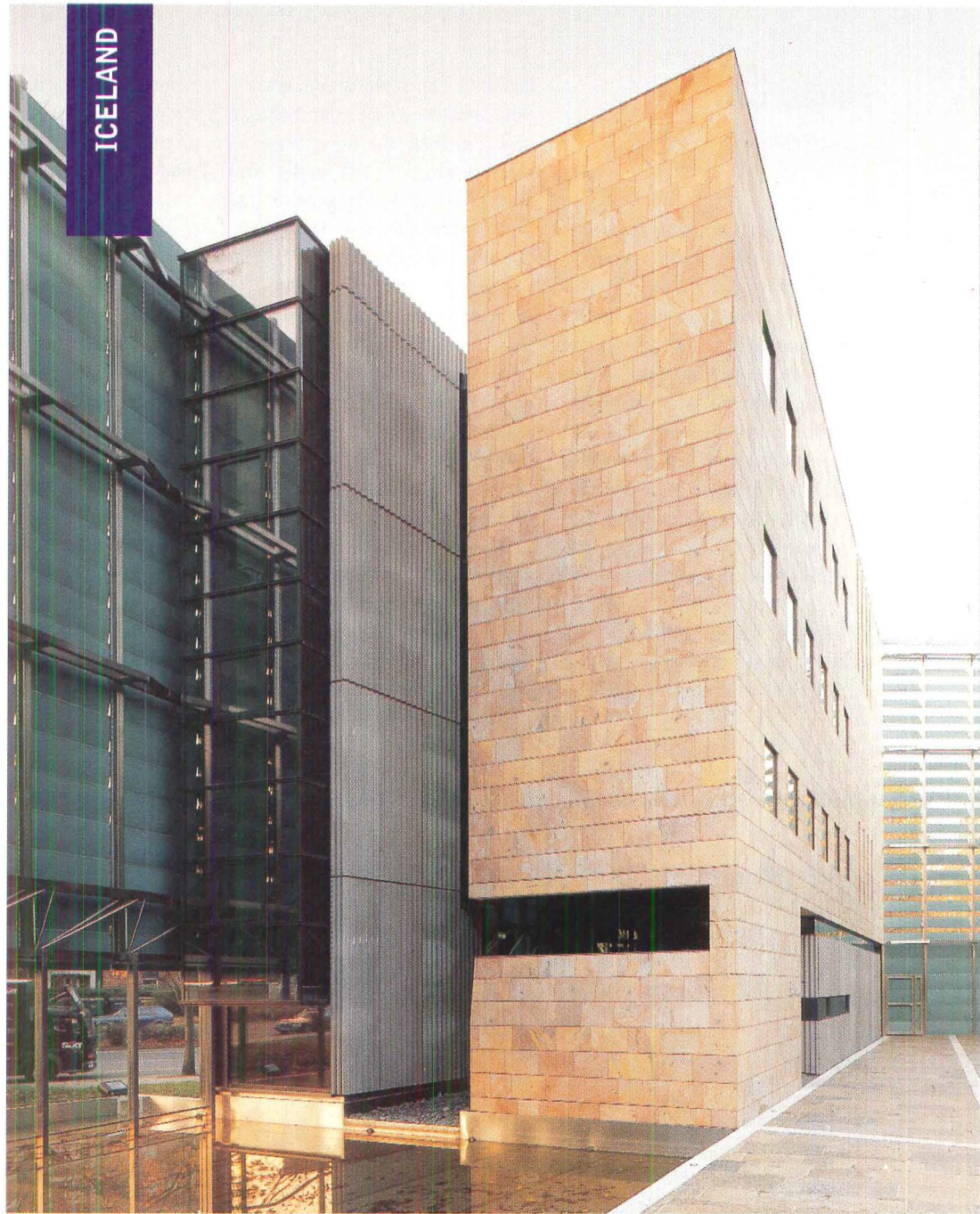

#### EMBASSIES OF THE NORDIC COUNTRIES, BERLIN TIERGARTEN

**CLIENTS:** Embassies of the Nordic Countries, Berlin—Sigurd Ståhlgren (director); Danish Ministry of Housing and Building, Copenhagen, Denmark; Ministry for Foreign Affairs, Helsinki, Finland; Government Engineering Contracts, Reykjavik, Iceland; Statsbygg/Public Construction + Property, Oslo, Norway; Statens Fastighetsverk, Stockholm, Sweden **ARCHITECT/URBAN DESIGN:** Berger + Parkkinen Architects—Alfred Berger, Tiina Parkkinen, Margarete Dietrich, Antti Laiho, Ines Nacic, Kurt Sattler, Peter Thalbauer, Ivan Zdenkovic (project team) **ARCHITECTS/EMBASSIES:** Nielsen, Nielsen & Nielsen (Denmark)—Kim Herforth Nielsen; Viiva Arkkitehtuuri (Finland)—Rauno Lehtinen, Pekka Mäki, Toni Peltola; Pálmar Kristmundsson (Iceland)—Pálmar Kristmundsson; Snøhetta (Norway)—Kjetil Thorsen; Wingårdh Arkitektkontor (Sweden)—Gert Wingårdh **ENGINEERS:** Drees & Sommer (project management); IGH Berlin (structural); IGH Köln (services); D.S. Plan (physics); DEWI, Wien (facade) **CONSULTANTS:** Pysall-Ruge Architects (correspondence); Karsten Böckling (landscape); George Sexton (lighting design) **COST:** Withheld at clients' request **PHOTOGRAPHER:** Christian Richters

## Radio City

continued from page 65

that fragment were able to return the walls to their original form.)

"What we were really after at Radio City," Hardy says, "was the total experience of the place, the total feel." And how does a firm recapture that? "There's a tremendous amount of sleuthing that goes on," he says. "You gather the historical records, the newspaper accounts, the carpet samples. And then you take a flying leap. It's really more an interpretive process than a scientific one."

Much of the gathering was done in a windowless room in HHPA's offices near the Flatiron

Building. There, Hardy and associates, including Jonathan Schloss and Caroline Bertrand, tacked photographs to the walls and spread swatches of wallpaper and carpet across an expansive table. For some parts of the hall, this process consumed months: The architects would take one sample to a craftsman, who would send back his best reproduction of it, which the architects would return, asking for more copper here, or less red there. Samples bounced back and forth as many as eight or nine times before Hardy and his staff were satisfied. And they encountered other roadblocks: The company that made the original piece had gone out of business, or no longer maintained the standards it had in the 1930s. A

number of fabrics were documented only in black-and-white photographs, making the hues difficult to reproduce exactly.

In some cases, the intensities of colors and textures in the new hall have been turned up a notch. Mostly this was due to the brighter lighting system installed by Paul Marantz and Jules Fisher, which would have rendered some of the original fabrics paler and less striking. But Hardy wanted everything to be just a bit bolder in order to bedazzle visitors, just as the original had. "People need more stimulus now," he says. "It's just the nature of our culture."

Most visitors, of course, will not recognize those changes, which are generally subtle. In the end, what stands out most in the

new Radio City are not the new fabrics or the carpets or the shining murals themselves, but how they are all brought together. There is a natural quality to the art here; it is arranged in a manner that says art ought to be everywhere, not just spotlighted on a pedestal or on a wall. It ought to be in a powder-room sofa, it ought to be onstage, it ought to be in a sign above the door, it ought to be underfoot. It ought to be something we use as well as look at. "That integration of art and architecture is really the legacy of all of Rockefeller Center," Hardy says. "Deskey just amplified it in Radio City." Now Hardy and his collaborators, in giving the theater a second shot at youth, have amplified it again. ■

**We're Coming Back - Stronger Than Ever!**

Architectural Columns in Wood or Composite

On April 28, 1999, we lost our column mill to a major fire, temporarily halting our production. We are grateful to our customers and suppliers for their understanding and patience during this time of crisis. Our rebuilding process will be completed soon, and with new, state-of-the-art equipment, we're coming back - stronger than ever!

Joseph Maust  
General Manager

**SDC**  
SOMERSET DOOR & COLUMN COMPANY

P.O. Box 755 • Somerset, PA 15501 • 800-242-7916 • Inside PA 800-242-7915  
Fax 814-443-1658 • www.somersetdoor.com

Circle 108 on information card

### AGA KHAN PROFESSORSHIP OF LANDSCAPE ARCHITECTURE AND URBANISM IN ISLAMIC SOCIETIES

A newly created tenured faculty position is available for a highly qualified individual capable of engaging productively with contemporary landscape architectural and urban design issues, including effective interaction in applied problem-solving contexts, such as design studios, while being qualified in more strictly academic terms to offer graduate-level seminars or lecture courses on important aspects of built environments in Islamic societies. The appointment is for a full-time tenured position as Professor and includes significant funds to support networking, outreach and technical assistance activities required to fully establish the chair in a position of leadership and productive interaction with others in the Aga Khan Program in Architecture, as well as with would-be constituents in Islamic societies. Candidates will preferably have extensive experience in professional practice and must have demonstrable orientation in both landscape architecture and urban design, especially with regard to the integration of public open space within urban areas, and generally be able to speak out on issues about urban and landscape environments in Islamic societies with authority and conviction. Candidates must have made significant contributions to their disciplines and have been recognized by peers to be truly outstanding in their fields.

Applications are invited before **1 May 2000** on application forms available from:  
**Harvard University, Graduate School of Design, Office of Faculty Planning, 48 Quincy Street, Cambridge, MA 02138**  
Fax: (617) 496-5310 Phone: (617) 495-5409

Harvard University is an Equal Opportunity/Affirmative Action employer.

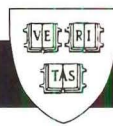

**HARVARD UNIVERSITY**

Graduate School of Design



## Interior Motives

*continued from page 68*

practice interior design without registration; there is usually little or no oversight by the state. "Title registration is worthless," says Arabolos, who is registered according to Connecticut's interior-design title act.

The AIA fought and worried about ASID's attempts to pass the more draconian practice laws up through 1989. In December of that year, the two groups—along with two others that later merged into the International Design Association—met to discuss each others' prerogatives and establish good-faith cooperation. The 1989

Accord, as it's called, stated that architects would agree to support interior designers in their bids for less drastic title acts, but only as long as interior designers limited their lobbying to title acts and forsook the more formal practice laws they had sought.

"This agreement is a major first step toward bringing the design disciplines, as well as their national societies, closer together," then-AIA executive vice president James P. Cramer wrote at the time in a memorandum circulated to the AIA's board of directors along with the accord. But both sides ignored it almost immediately, says a former AIA official involved in formulating the document. The AIA never actively supported passage of title laws as

it promised it would, and ASID, through its state chapters, never gave up its aim of enacting full-fledged practice laws.

So there was much fanfare but little surprise last June when the ASID board of directors announced that it would no longer honor the agreement. The group stated that it was renewing its commitment to passing practice laws in the states. It had by then spent years raising its professional standards in pursuit of professionalism. "We were ready to talk about moving our profession to another level," says ASID president Rosalyn A. Cama. But the group concluded that the AIA chose to ignore the interior design industry's record of improvement, and Cama says the

accord had become a "noose around our neck."

The AIA was, in fact, paying close attention all along, and ASID's announcement drew a prickly response: "We are disappointed to hear that interior designers and decorators discarded an agreement successful in raising their standard of professionalism," former AIA president Michael Stanton replied last year. It just so happened that ASID dropped the accord a month after the AIA's board of directors had formed a task force to learn as much as possible about the interiors business. Interpreting the report, presented to the AIA's board last September, in the Institute's newsletter, Stanton wrote *continued on page 141*



architecture  
and  
related  
webwide

sedus

[www.sedus.com](http://www.sedus.com) a-matter is a sedus project

[www.a-matter.com](http://www.a-matter.com)

Circle 110 on information card

## Product Information for March 2000 Advertisers

RS# 110	A-Matter/p135	26	Heat-N-Glo/p148
—	AIA Convention/p25	72	.hessamerica/p40
76	Alkco Lighting/p41	116	ICI Paints/p143
114	American Slate/p142	32	Innerface Sign Systems, Inc./p149
1	Andersen Windows/p6-7	28	JOMY Safety Products, Inc./p148
16	APCO USA/p148	42	Kalwall Corporation/p149
52	Architectural Area Lighting/p11	70	LAM Lighting/p40
90	Architectural Area Lighting/p47	68	Landscape Forms/p38
84	Architectural Landscape Lighting/p43	—	Lightfair 2000/p46
80	Ardee Lighting/p42	34	Lotus/Peerless/p149
44	Armstrong Ceilings/C2,1	6	Marley Flexco/p147
—	Autodesk/p32	60	Marvin Windows & Doors/p26-27
—	Autodesk/p45	18	MechoShade Systems, Inc./p148
—	Autodesk/p64	10	NEBS, Inc./p147
104	Autodesys/p70	82	Nessen Lighting/p43
118	Belden Brick/p146 (East, Midwest region)	46	Nixalite of America/p4
—	Brick in Architecture/p17-24	8	North Country Slate/p147
98	Bricsnet/p58	38	Pawling Corporation/p149
—	Buzzsaw/p5	20	PiQUE by Principle/p148
48	Centria/p8-9	54	PPG Industries/p12-13
14	CertainTeed Roofing Products/p148	88	Quartzitec/p44
122	Construction-Zone.com Inc./pC4	62	Sloan Valve/p28
40	Copper Development Association/p149	106	Sloan Valve Flushmate/p82
124	Copper Development Association/p144-145	108	Somerset/p134
—	Coverings 2000/p67	22	Spacesaver Corporation/p148
36	Design-Build Institute of America/p149	112	Structures Unlimited/p141
120	Diehl Graphsoft/pC3	94	USM/Haller/p50-51
—	Doubleday Select/p57	92	Visteon/p48
—	e-Architect/p56	96	Von Duprin/p54-55
56	EFCO Corporation/p14	50	Westcrowns/p10
64	Ellison Bronze/p30-31	12	Willamette Industries/p147
4	Eurocobble/p147	24	Xypex Chemical Corp./p148
66	Follansbee Steel/p36		
30	Gage Corp./p149		
58	Global Tech Ceiling Systems/p16		
2	Gressco/p147		
74	Guth/p41		
—	Harvard University/p134		

## Advertising Sales Offices

## ADVERTISING SALES HEADQUARTERS

Jill Boker  
Group Publisher  
(212) 536-6229 fax (212) 382-6016

Robert M. Hoover  
Vice President / Production  
(212) 536-5234 fax (212) 536-5357  
1515 Broadway  
New York, NY 10036

## MIDWEST

Jack E. Bergren  
Midwestern Sales Manager  
(312) 583-5505 fax (312) 583-5501  
200 W. Jackson Blvd., Suite 2700  
Chicago, IL 60606

John W. Maisel  
Maisel Media Associates  
(630) 416-0780 fax (630) 416-0793  
1928 Pleasant Hill Lane  
Lisle, IL 60532

Rick Novak  
Natural Resources Inc.  
(773) 832-0798 fax (773) 832-0799  
711 Gordon Terrace, #321  
Chicago, IL 60613

## SOUTHEAST

Holly Fisher  
Southeastern Sales Manager  
(404) 249-9915 fax (404) 249-9916  
hfisher@architecturemag.com

## MID-ATLANTIC / UPSTATE NEW YORK

George T. Broskey  
Eastern Sales Manager  
(610) 640-3123 fax (610) 722-9266  
301 Lindenwood Drive  
Suite One  
Malvern, PA 19355

## NEW ENGLAND / NEW YORK CITY

Richard J. Ancas  
Joseph E. Sraeel  
(732) 450-9791 fax (732) 450-9790  
Ancas & Associates, Inc.  
P.O. Box 7951  
Shrewsbury, NJ 07702

## LITERATURE &amp; PRODUCT PORTFOLIO / REPRINTS

Danny Lee  
Portfolio / Reprints Manager  
(212) 536-5137 fax (212) 536-5357  
1515 Broadway  
New York, NY 10036

For additional information from our advertisers, circle the corresponding number on the Free Product Information Card. **You may also get information online at [www.architecturemag.com](http://www.architecturemag.com).** First, click on Reader Support, then Product Info to reach our electronic reader service card.

## Did you miss valuable information offered by advertisers in last month's issue of architecture?

The manufacturers listed below were advertisers in last month's issue. They are anxious to provide you with their latest product information and literature for your planning needs. To receive this information, fill in the appropriate numbers on the self-addressed, postage-paid response card. For product literature from advertisers in this issue, fill in the appropriate numbers shown on the advertisements.

### ALKCO LIGHTING

Contact us for more information on our state-of-the-art lighting. **Circle Nos. 41, 43**

### ANDERSEN WINDOWS

In today's designs, it's the brand that helps architects take value to new heights. **Circle Nos. 1, 59**

### ARCHITECTURAL LANDSCAPE LIGHTING

Contact us for information on ALLscape's SL-35 Bullets. **Circle No. 35**

### ARDEE LIGHTING

Call us for more information on our new ModuleX™. **Circle No. 39**

### ARMSTRONG

Introducing Optima Vector™, contact us for more information. **Circle No. 3**

### BASF

We don't make the carpet. We make it better.® **Circle No. 77**

### BILLCOM

The biggest GlobalShop expo & conference ever! **Circle No. 71**

### BOCA INTERNATIONAL

Discover the new world of code uniformity with the 2000 International Codes. **Circle No. 79**

### BRICSNET

For more information on ProjectCenter®, contact us today. **Circle No. 19**

### BUZZSAW

See what the buzz is all about. **Circle No. 7**

### COPPER DEVELOPMENT ASSOCIATION

For supplier information or help on a specific project, contact us for information. **Circle No. 29**

### D'AC LIGHTING

Contact us for more information on our Domino sconces. **Circle No. 37**

### DIEHL GRAPHISOFT, INC.

Introducing VectorWorks, a better way to design. **Circle No. 91**

### DUPONT TYVEK

Call us for more information or to speak with a DuPont Tyvek® specialist. **Circle No. 63**

### EFCO CORPORATION

Make EFCO your project partner from design to completion—contact us. **Circle No. 53**

### ELLISON BRONZE

Contact us for more information on our custom doors. **Circle No. 23**

### FLORIDA INTERNATIONAL UNIVERSITY

Programs in Architecture, Interior Design, and Landscape Architecture—contact us. **Circle No. 89**

### FOLLANSBEE STEEL

Contact us for information on our environmentally friendly roofing metals, TCS II and Terne II. **Circle No. 93**

### FORMGLAS

Contact us for our new 60-page catalog. **Circle No. 11**

### GUTH

Envirogard™...new from Guth; contact us for more information. **Circle No. 31**

### .hessamerica

Call us for more information on our fully adjustable uplighting. **Circle No. 33**

### HOBOKEN FLOORS

The nation's largest distributor of hard-surface flooring—contact us. **Circle No. 57**

### INDUSTRY & DESIGN LIGHT

Call for further information. **Circle No. 73**

### J. EPSTEIN

Amazing architectural opportunity. **Circle No. 75**

### KALWALL

Finally...a website filled with bright ideas. **Circle No. 47**

### KONE, INC.

Call us to learn more about KONE and our innovative vertical transportation solutions. **Circle No. 49**

### LCN CLOSERS

Introducing the advanced LCN 4040 and 1460 closers; contact us for information. **Circle No. 13**

### MARVIN WINDOWS

Call us for a free product brochure. **Circle No. 45**

### NALSA

Prepare for the computerized Architect Registration Exam with Archiflash®. **Circle No. 83**

### NIXALITE OF AMERICA, INC.

Contact us for more information on our stainless-steel bird barriers. **Circle No. 5**

### ODEGARD

Contact us for information on our rare and original carpets. **Circle No. 67**

### PAVESTONE

Contact us for information on our extensive paver product line. **Circle No. 61**

### POLYCAL USA

Contact us for more information about our outdoor and indoor glazing and covering applications. **Circle No. 81**

### PORTLAND CEMENT ASSOCIATION

Contact us for information on masonry and cements for masonry. **Circle No. 69**

### QUARTZITEC

To see the many benefits of QuartzStone, call us or visit our website. **Circle No. 27**

### ROPPE CORPORATION

Because nothing performs like rubber, call us for free samples. **Circle No. 9**

### SCHOTT CORPORATION

For more details on AMIRAN® anti-reflective glass, contact us. **Circle No. 17**

### SLOAN VALVE

Contact us for a copy of our full-line catalog/CD-ROM. **Circle No. 25**

### SUB-ZERO

Introducing wine storage as only Sub-Zero could make it; contact us for a free catalog. **Circle No. 65**

### TIMELY CORPORATION

Contact us to learn more about the new Alumitone™ finish and our steel door-frame system. **Circle No. 21**

### TRIMCO/BBW

Contact us for information on the broadest range of accessory door products. **Circle No. 51**

### ZERO U.S. CORPORATION

Call us for more information on our panels. **Circle No. 87**

For additional information from our advertisers, circle the corresponding number on the Free Product Information Card. **You may also get information online at [www.architecturemag.com](http://www.architecturemag.com).** First click on Reader Support, then Product Info to reach our electronic reader service card.

IT'S DISCOVERING WHAT THIS COUNTRY WAS LIKE BEFORE IT WAS CALLED AMERICA.

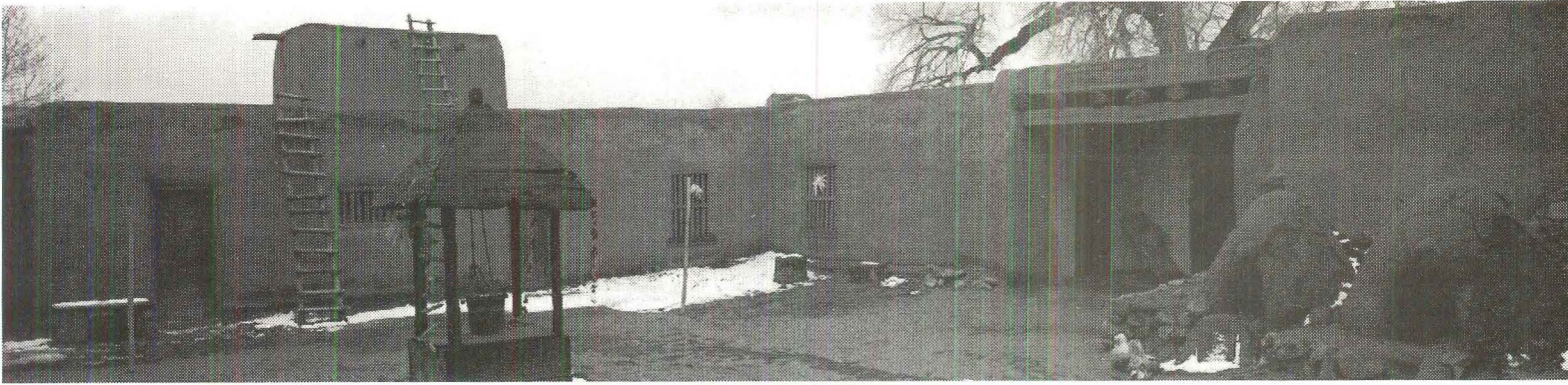

IT'S BRINGING AMERICA'S MAIN STREETS BACK TO LIFE AND GETTING BACK TO BUSINESS.



IT'S JOINING NEIGHBORS AND FRIENDS TO IMPROVE THE COMMUNITY YOU CALL HOME.



*What is historic preservation?*

*It's your memory. It's our history. It's worth saving.*

**NATIONAL TRUST FOR HISTORIC PRESERVATION 1 800 289 7091**

1785 MASSACHUSETTS AVENUE, N.W. WASHINGTON, DC 20036

## Interior Motives

continued from page 135

that ASID's motives boiled down to one issue: increasing market share.

The AIA has reason to be nervous: Today, 21 jurisdictions regulate the title of "interior designer" with title acts; three states, Puerto Rico, and the District of Columbia have the more elaborate practice acts on their books. Both groups claim to be working toward reopening the debate. However, "we are unwilling to lower the bar" in the design and construction industry, says James Dinegar, AIA's former vice president of government and industry affairs, now its chief operating officer. "But we're not going to artificially keep moving the bar higher, either."

The two groups purportedly plan to convene for fence-mending talks early this year. "We want to sit down and have an open and frank discussion" between directors, Cama says. "To keep that professional bar high and higher, we need to be in complete agreement on how to maintain minimum standards." That discussion will likely occur later rather than sooner—if ever, given the AIA's history of stonewalling ASID. Their relationship may be burdened by an insurmountable prejudice, not least because 80 percent of interior designers are women and some 90 percent of licensed architects are men. Though both AIA and ASID officials play down the whiff of sexism in the air, gender realities taint the debate: Stanton tends to lump together "interior designers and decorators," Dinegar alludes to interior designers' "home-ec" classes, and the AIA task-force correspondence generally portrays interior designers as misplaced suffragettes.

The AIA's defenders do have one point in this war that will never end: If interior designers are so unhappy with their lot, they can always become architects. ■

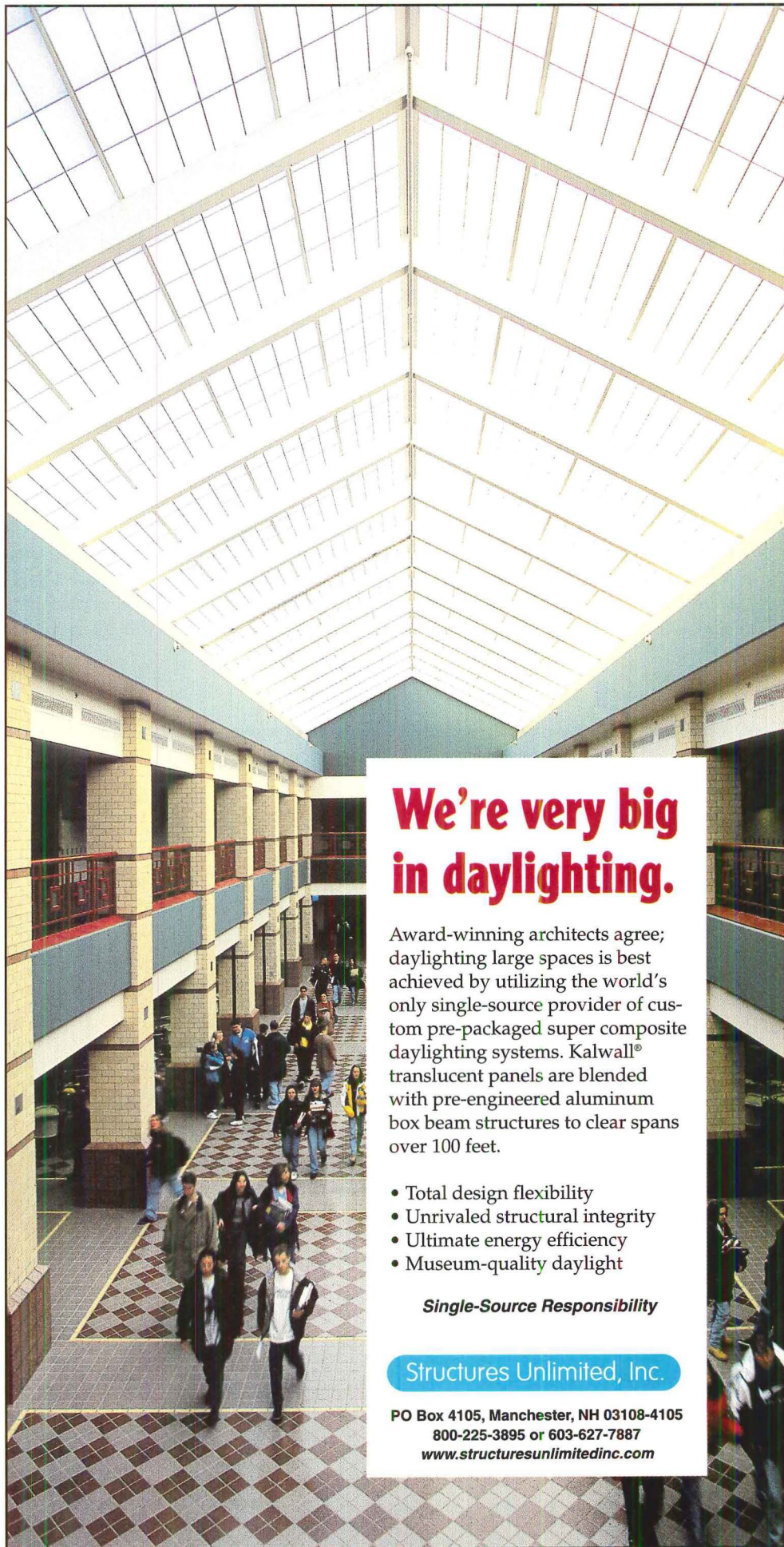

## We're very big in daylighting.

Award-winning architects agree; daylighting large spaces is best achieved by utilizing the world's only single-source provider of custom pre-packaged super composite daylighting systems. Kalwall® translucent panels are blended with pre-engineered aluminum box beam structures to clear spans over 100 feet.

- Total design flexibility
- Unrivalled structural integrity
- Ultimate energy efficiency
- Museum-quality daylight

*Single-Source Responsibility*

Structures Unlimited, Inc.

PO Box 4105, Manchester, NH 03108-4105  
800-225-3895 or 603-627-7887  
[www.structuresunlimitedinc.com](http://www.structuresunlimitedinc.com)

## Jane Jacobs

continued from page 72

intelligent about knowing how to stand out from a given context and where to do it.

The making of the context can be beautiful and sensitive, too. My husband Bob used to say that the first question an architect ought to ask about an idea or a building he's doing is, "Is it decent?" He meant respectful of context, even when it stands out from it. I would add that an architect must become aware of what is "essential context" and what is "contrived context," unessential and just a burden. I don't think this is taught in architecture schools—that there is a context,

and the context is not staying still any more than the things in it.

### What are the pressures on context?

Never underestimate the power of boredom. Human beings have very low tolerance for it. They get into all kinds of trouble owing to it, and will combat it in any sort of way. When I was a child, the worst thing was the Victorian. People were absolutely ruthless about doing away with it. And if they couldn't do away with it, they'd paint it in a way that you wouldn't notice it, or would notice it less, and put sidings and things on it, and change the landscaping—just awful. They were bored with it. It was a change in fashion, but fashion is important. It's part of it.

Now they're bored with modern buildings and are getting ruthless about them.

### What happens next?

The New Urbanists are going to win out. You can see this in television commercials, for instance—people sitting on porches. I don't understand why these things happen, but there's been a change just as great as the change from Victorian to modern in people's heads. Now, the result of this change, this change in fashion, this boredom, is what we can call New Urbanism—buildings closer together and all that, the garages not in front. I imagine it will show up not so much in New Urbanist projects but in what people do with the inevitable changes in the

process. They'll be ruthless about modern buildings and about the present-day suburbs. They'll be ruthless about what they destroy and what they add between and in place of it.

**Wouldn't you be sorry to see modern buildings go? Many of your followers wouldn't. At a conference in the mid-1980s, former Toronto mayor John Sewell railed against Mies van der Rohe's Toronto-Dominion Centre for allegedly lacking human scale and called for its demolition. You rose to Mies' defense and politely tore Sewell to ribbons.**

Of course. I think those are wonderful buildings. I'm not advocating that people be ruthless about these *continued on page 143*

**The Timeless Beauty of Natural Slate®**

**American Slate Company**

THE EXPERTS IN SLATE

**ROOFING, FLOOR TILES, PAVING & SLABS**

[www.americanslate.com](http://www.americanslate.com)

LOS ANGELES: 814 N. LA CIENEGA BLVD. .... 310-855-0594  
 NEWPORT BEACH: 494 N. NEWPORT BLVD. .... 949-650-2200  
 OAKLAND: 555 66TH AVENUE ..... 510-430-1237  
 SAN DIEGO: 7741 FAY AVENUE, LA JOLLA ..... 858-551-9951  
 SAN FRANCISCO: 1775 ALAMEDA STREET ..... 415-864-7813  
 SEATTLE: 532 FIRST AVENUE SOUTH ..... 206-938-3718  
 WALNUT CREEK: 1889 MT. DIABLO BLVD. .... 925-210-1042  
 EAST COAST/MIDWEST: . .... 800-553-5611



Photograph by Timothy White

### Which one would you choose?

The elephants? The whales? The clean air we breathe? Maybe the choice isn't so clear. Maybe you'd like a way to keep them all. Now the world's leading environmental groups are working together. To find out how you can help, look for us at [www.earthshare.org](http://www.earthshare.org).

One environment. One simple way to care for it.



Earth Share

## Jane Jacobs

continued from page 142

things. I was just saying this happens. And to face that fact is important because you can stay your hand. We're always talking about what we want to leave our children and our grandchildren. Well, good modern buildings are going to be greatly admired and valued and people will say, "What a pity they were destroyed."

**You certainly didn't call for expressions of sympathy for modernism in *Death and Life*!**

Look, every book on architecture or planning at the time was about the important building, or the show-place, or whatever. Why would I

write another one? That would be redundant. Write about the things that are being overlooked!

***Death and Life* is still cited in books and bibliographies. How do you understand its longevity?**

I understand it in a couple of ways. One is a kind of impatience that I've been typecast. Some people keep wanting me to write that one book over and over. But that would bore me. It is unusual that a book should have that long a life—the kind of a book, I mean, that doesn't plumb the depths of human nature. I think it's because it describes things as they are. I tried to be very truthful and literal about describing things as they are. It's surprising how seldom that's done. Novelists do it—good novelists.

They often tell us more about the real world than history does. I'm about novels that were contemporary when they were written. We trust them if they're good: "That's the way it was." I think that's the virtue of *Death and Life*.

**By contrast, *The Nature of Economies* is speculative, which lends itself to the dialogue format. It's also optimistic.**

I know that life is full of tragedy, that death always wins in the end. But what I'm interested in is how things can be continued for life. And I am optimistic about that. I think the human race has many unused, unplumbed, and undeveloped capacities. It's not all destructive, by any means. The news is often good. The very awareness of eco-

logical destruction and disasters and their portent—it's a new thing and it's good. We care more and more, and are aware of it. I would feel hopeless if our concern wasn't growing, but it is. Scientists have changed an enormous amount during my own lifetime in understanding that complication is the essence of things—that there's only so much you can discover by these reductive methods. Understanding webs and complications, or acknowledging them even when you can't understand them, is so accepted now it's almost banal.

**You're 83; do you have another book in you?**

I don't know. My policy in life is to do what I want, and I don't know yet what I want to do next. ■

143

College  
credits  
for  
taxpayers.  
Up to \$1500



The HOPE Credit or Lifetime Learning Credit can cut your federal taxes to help pay for higher education. For details on how to qualify for either, see your 1999 IRS tax booklet. Or check our Web site: [www.irs.gov](http://www.irs.gov)

The Internal Revenue Service



Working to put service first

Spec a paint job without lifting a finger.



Need a hand specing a project?

Visit [paintspec.com](http://paintspec.com). You just enter your design parameters; it calculates everything you need—from prep to paint. It's that easy. And it's only available from Devoe and Fuller-O'Brien.



(Okay, one finger.)

## New Urbanism

continued from page 75



location are Civano's worst features, although it won't remain that way: Tucson is determinedly sprawling out to meet it.

Virtually all mass-market construction in Tucson today is stick-and-stucco, but the five builders participating in Civano are offering alternatives. Some are using RASTRA block, which is 85 percent

recycled polystyrene foam—energy-efficient and unappetizing to termites, a chronic Sonoran Desert scourge. Others are experimenting with straw-bale wall infill, which provides an R25 to R30 wall two feet thick, giving the feel and solidity of adobe. Up to 85 percent of the homebuyers have embraced the option of solar water heating. The 14 different house models are salted with intriguing environmental notions. Picturesque wooden barrels hoard roof runoff to water the backyard mesquite and agave. A ceiling fan on a porch is a wonderfully logical idea in Tucson's climate, extending outdoor evenings through the long, fierce summer.

Individual home designs are refreshing departures from the

prevailing local standard of beige stucco, concrete tile roof, and arched portal, a feeble Spanish Colonial revivalism that I dubbed "Taco Deco" in a critique several years ago. Civano's builders remain in revival mode, but these houses successfully recall and recast several expressions of Southwestern vernacular architecture: pueblo, adobe row house, Arizona Territorial (featuring climatically sensible wraparound porches), California bungalow. Even some floor plans are distinctive: KE&G's Residence One model is arranged around a *zaguan*, a six-foot-wide hallway with a door at either end—a form of passive air-conditioning common in 19th-century Tucson—which might serve as a library or gallery today.

None of this would appear daring in a typical community of custom homes, but Civano is aimed at the middle of (or only slightly above) the mass market. In Tucson, that means a move-in cost to the buyer beginning at about \$75 to \$80 per square foot. One builder's basic three-bedroom, two-bath of 1,556 square feet starts at \$123,300; another's four-bedroom, two-bath of 2,056 square feet is priced at \$188,000. The city's median sale price for single-family residences last November was \$127,000.

Lee Rayburn, Civano's director of design and planning, says the CDC expected to have to deploy a vigorous educational campaign to convince buyers that sustainability and *continued on page 145*

LAWRENCE W. CHEEK

As a **child** you always **loved** working with **colors**.





## New Urbanism

continued from page 144

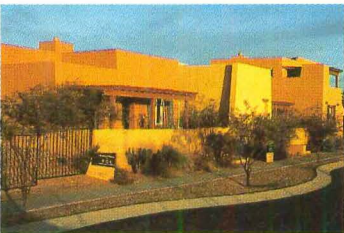

energy savings are worth the 12 to 15 percent premium. It turned out to be easier than anticipated. "Our market research showed that 30 percent of the American population does not feel their housing needs are being met," Rayburn says. "I think the percentage is even higher than that. The name we came up with for

this group is 'cultural creatives.' They place a very high value on community; they look at value, not branding; they drive Saabs and Volvos, not Mercedes. They're well educated, though not necessarily in traditional channels." As Rayburn interprets it, these are the people who are flocking to Civano, checkbooks in hand. There aren't many affordable alternatives for them.

Clearly, Civano is successful in many respects. But should it have moved farther out on the cutting edge? Rayburn himself wishes it did, at least in the arena of water management. Just as in business-as-usual subdivisions, hills have been resculpted into valleys to make the hydrology work; the city required it. The desert's natural

topography and vegetation have been brutalized, and precious rainfall—Tucson averages only 12 inches a year—still escapes into arroyos instead of pooling and percolating to sustain the neighborhood's landscaping.

In partnership with the city, Civano has already lured a couple of significant businesses to the neighborhood—a nursery and a solar-cell manufacturer. The long-range dream is a nucleus of nearby employers and retail businesses, which will cut the need for commuting. But it remains to be seen whether New Urbanist neighborhoods can reengineer the entire social structure of work, recreation, and living that has developed over a century of automotive mobility.

While its architectural diversity renders Civano substantially more interesting than the usual new housing development, the one or two streetscapes that are already filled in perpetuate that familiar old pattern of suburban ennui: minor and meaningless variations in elevations and color accents, with a design-review committee in place to perpetuate the developer's earnest and coherent vision. The quintessential quality of old neighborhoods that New Urbanists can never bring themselves to condone is, to recycle Robert Venturi's durable phrase, "messy vitality." When "sustainability" fully embraces "vitality"—and aren't the two words drawn from the same well?—Civano will truly have a soul. ■

**Copper** lets you feel like a *kid* again.

**F**rom rich, natural earth tones to bright blue-greens to shimmering silvers and elegant grays, copper comes in a full pallet of colors, textures and finishes. And the Copper Development Association provides the design assistance, information resources and technical specifications to help you use them.

Discover the unique colors of copper. And rediscover the thrill of opening that *big* box of crayons. For supplier information or help on a specific project, call 888-427-2411. Visit us on the Web at <http://architecture.copper.org>.

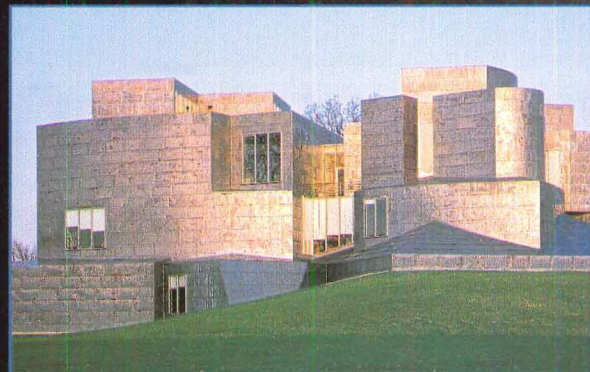

Project: University of Toledo — Center for the Visual Arts  
Architect: Frank O. Gehry Associates



Unique. Beautiful. Enduring.

Circle 124 on information card



B E L D E N B R I C K



**DIVERSITY AND  
VERSATILITY AT WORK.**

**BELDEN**  
THE BELDEN BRICK COMPANY

Canton, Ohio 44701-0910  
<http://www.beldenbrick.com>

AN ISO 9002 REGISTERED COMPANY

Circle 118 on information card

# ARCHITECTURE'S LITERATURE PORTFOLIO

The Literature offered on these pages (with rare exception) are free for the asking. Simply fill out one of the postage paid reader service cards located elsewhere in this issue, circle the appropriate numbers and drop it in the mail.

## Gressco Ltd.

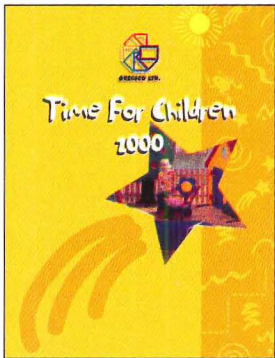

**Unique Children's Environments**—Gressco introduces HABA® and KinderSystem® furniture. Our modular loft furniture, seating, shelving, platforms and room partitions can truly create an unforgettable children's area in your hospital waiting room, child-care center, church, library or any room. Call Gressco today for a free catalog and distributor information. 1-800-345-3480, www.gresscoltd.com. Please visit us at NEOCON WEST, Booth #1747  
**Circle 2.**

## Eurocobble®

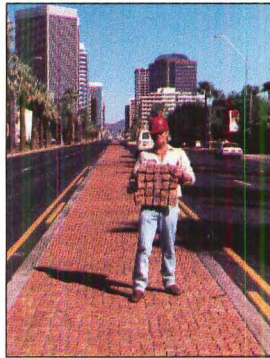

**Granite cobblestone in modules**—An updated 12-page catalog features authentic European cobblestone pre-assembled in modular form. Modules in square, fan, concentric ring, and custom formats arrive at the jobsite ready for quick and easy installation. Pedestrian or vehicular application. Eurocobble® has supplied the design community with traditional and customized paving solutions for over 15 years. 877-877-5012.  
**Circle 4.**

## Marley Flexco

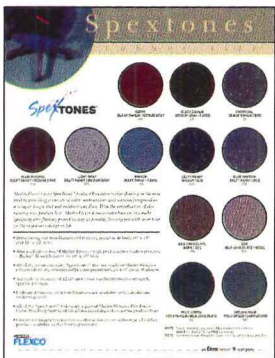

**Marley Flexco Introduces SpexTones™ Rubber Tile**—Marley Flexco's new SpexTones™ is available in three of their high performance rubber textures and in an array of 12 creative color combinations arranged in a uniquely speckled design. All of the SpexTones™ colors are a part of Marley Flexco's FlexTones™ Color Matching System. For more information, call our Customer Service department at 1-800-633-3151.  
**Circle 6.**

## North Country Slate

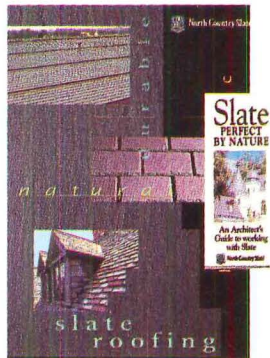

**Natural North Country slate.** For enduring character, nothing else compares. No wonder - it's perfected by nature! Free product brochure showcases the wide variety of types and colors, and comes with our Architect's Guide to working with this remarkable roofing material.  
**Circle 8.**

## NEBS



**Save 33% On Our Best-Selling Form For Architects!**—With NEBS Letters of Transmittal, send documents and plans without writing letters. Checkboxes make paperwork fast and easy. FREE personalization and NEBS Business Design (call for details). Choose Blue, Green or Burgundy. 100 2-part Transmittal Forms Unlined (#239T-2) \$28.78; Lined (#240T-2) \$29.15. Order with code 51005 at 1-800-225-6380 or online at www.nebs.com. 100% Money-Back Guarantee!  
**Circle 10.**

## Willamette Industries, Inc.

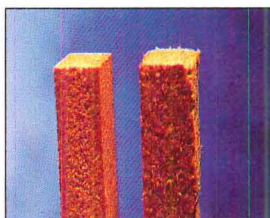

**Duraflake Particleboard**—Willamette Industries offers Duraflake MR® moisture resistant particleboard, which absorbs less moisture and exhibits minimal thickness swell compared to standard particleboard. Duraflake MR is designed for interior applications where exposure to high humidity and intermittent contact with water is common. It has a fine surface for laminating and features exceptional strength. Applications include bathroom and kitchen cabinets and counters, casework, display fixtures, entryways and other moisture-prone areas. To request information call: 1-800-887-0748, Ext. 300.  
**Circle 12.**

## CertainTeed Corporation



**Grand Manor Shingle®**—CertainTeed's Grand Manor Shingle® is a super heavyweight shingle built on two full-size one-piece shingles with random 8" tabs applied on top. Patented shadow lines and a unique color palette give Grand Manor the look and depth of natural slate and wood. UL Class A. Lifetime limited, transferable warranty. Algae-resistant. UL certified to meet ASTM D 3462.  
**Circle 14.**

## MechoShade Systems, Inc.

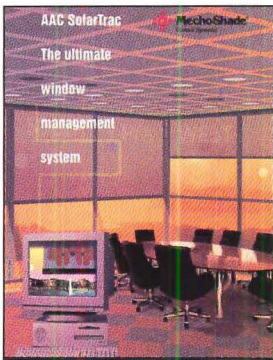

**The AAC SolarTrac™ Window Management System** tracks the sun to incrementally adjust ElectroShades® automatically and building wide, to optimize the shade cloth's solar protection and energy efficiency characteristics. AAC SolarTrac, using a PC-based program, factors in the sun's angle of incidence, solar heat-gain, allowable solar penetration, brightness and glare control based on the building's specific location. Phone: 718-729-2020 Web Site: [www.mechoshade.com](http://www.mechoshade.com)  
**Circle 18.**

## Spacesaver Corporation

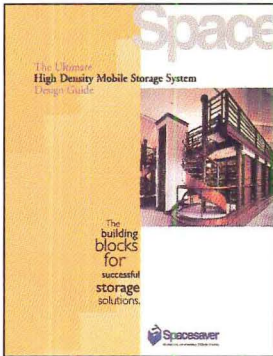

The versatility of Spacesaver mobile systems makes it possible to mount virtually any type of filing or storage equipment on our carriages. And with more than 60,000 Spacesaver mobile systems in use throughout North America, we can show you a system that has already solved storage needs just like yours. (800) 492-3434. [www.spacesaver.com](http://www.spacesaver.com)  
e-mail: [ssc@spacesaver.com](mailto:ssc@spacesaver.com)  
**Circle 22.**

## Heat-N-Glo



**Three-Sided Fireplace for Unlimited Installations**—Heat-N-Glo introduces model PIER-TRC, a three-sided direct vent fireplace that can be terminated vertically or horizontally to accommodate nearly any application. The PIER-TRC is perfect as a room divider, bar, end of counter or a wide variety of creative installation possibilities. As with all Heat-N-Glo fireplaces, the PIER-TRC can be operated by remote control for the ultimate in convenience. Call (888) 427-3973 (GasFyre).  
**Circle 26.**

## APCO Graphics, Inc.

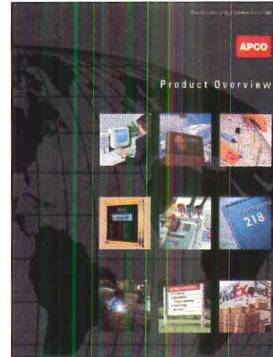

**Architectural Sign Systems**—Designed with imagination and developed with innovation, the diverse family of APCO sign products are at work today in facilities throughout the world. From interior and exterior sign systems, to directories, displays, ADA-compliant and user-updatable signs, APCO's products carefully blend appearance and function, for lasting solutions to your wayfinding and identification needs. Phone: (404)688-9000, Web: [www.apcosigns.com](http://www.apcosigns.com).  
**Circle 16.**

## PiQUE by Principle

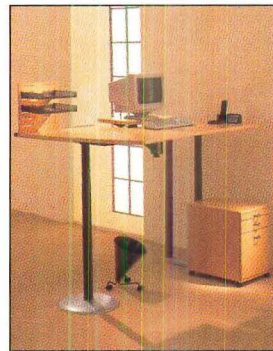

**Ergonomically Correct Office Furniture**—The only complete, ergonomically-correct office furniture series. Sleek Danish design previously unavailable in the USA and Canada. Manufactured in the Midwest by Principle Fixture and Millwork. Series includes workstations, central storage, conference tables, partitions and custom pieces. Workstations can be height adjustable via electric lift or hand crank (26 to 49 inches). For more information: 612-333-3575 [piq@visi.com](mailto:piq@visi.com). [www.principlepique.com](http://www.principlepique.com).  
**Circle 20.**

## Xypex Chemical Corporation



**Concrete waterproofing by crystallization.** Although applied as a slurry coating, Xypex is a chemical treatment which waterproofs by penetrating the concrete with a crystalline formation which 'plugs' the pores of the structure preventing water seepage. Xypex is ideal for use on the 'inside' of wet underground structures. Xypex Chemical Corporation, 604-273-5265.  
**Circle 24.**

## JOMY Safety Products, Inc.

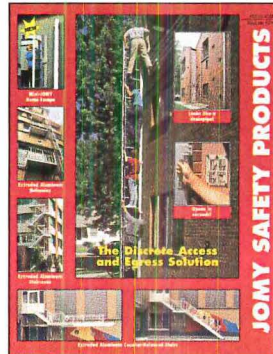

Worldwide, JOMY is known for extremely strong but exceptionally lightweight products. Secondary means of egress, burglar-proof access, space constraints, and aesthetic considerations are but a few of the problem-solving applications for JOMY Safety Products. JOMY provides a complete line of collapsible ladders, balconies, staircases and counter-balanced stairs. All are constructed of maintenance free extruded anodized aluminum and stainless steel. Call 800-255-2591 for additional information.  
**Circle 28.**

## The Gage Corporation

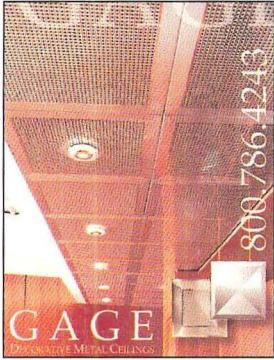

**Gage Metal Ceilings**—The Gage Corporation, Int., designs and manufactures the world's foremost collection of decorative metal ceilings. Design #447 (photo) is a good example of selective two-directional brushing with custom perforations from Gage's "Honest Aluminum" collection. Concealed suspension provides a clean monolithic appearance. Call the factory at 800-786-4243 for introductory samples and literature. e-mail address: gage@centurytel.net. Web site: www.gageceilings.com.

Circle 30.

## Lotus•Peerless

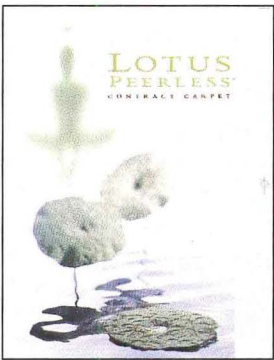

Listen to the harmony in your soul, share it with your interiors. The Lotus•Peerless line of carpets includes cut and uncut pile, textured loop and enhanced loop graphics to make your visions a reality. Lotus•Peerless. Interior Zen.

Circle 34.

## Pawling Corporation

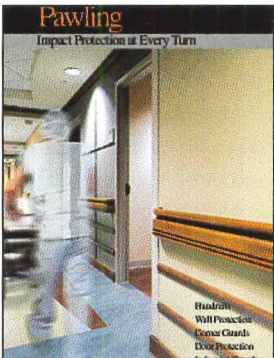

**Pawling Pro-Tek®** handrails and impact protection systems stand up to the punishment of high traffic, furniture and vehicles on walls, corners, doors and columns. Pawling is the only source for a comprehensive range of coordinated protection products for projects ranging from commercial/institutional to heavy-duty industrial—for protection of grand lobbies and public corridors to parking ramps and loading docks. Call the Pawling Hotline (800) 431-3456 or e-mail at sales@pawling.com for more information.

Circle 38.

## Kalwall Corporation

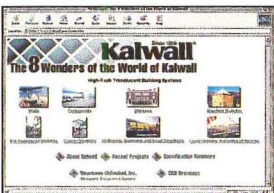

**Daylight Web Site**—www.kalwall.com features high-tech translucent building solutions for daylighting. Kalwall Skylights, Walls, Curtainwalls, Windows and Complete Structures allow total design control, creating the most people-friendly environments with glare-free, shadowless, natural light. Examples are showcased, such as: schools, airports, restaurants, commercial buildings, shopping malls. Specs and CAD drawings can be downloaded. Or call 1-800-258-9777.

Circle 42.

## Innerface Sign Systems, Inc.



**ADA Signage Compliance**—One of the nation's leading architectural signage companies for more than 29 years. Innerface offers signage planning and wayfinding consulting, and a complete line of interior, exterior and ADA signage. Also introducing a new interactive/Touch Screen Directory product. Nationwide coverage and a commitment to quality driven customer service has made Innerface "The Company That Does Things Right." For your local sales representative please call (800) 445-4796.

Circle 32.

## Design-Build Institute of America

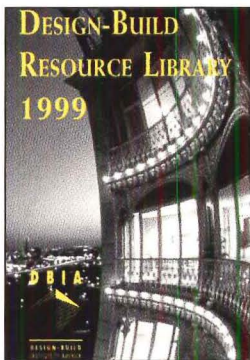

**Design-Build Institute of America (DBIA)**—Everything you ever needed to know about design-build can be found in DBIA's Design-Build Resource Library. The free, 44-page catalog offers books, videos, software and other publications related to the practice of design-build. Topics range from design/construction management to design-build specific publications, such as the value-packed *Design-Build Manual of Practice* and the acclaimed *Design-Build Model Contracts* series. Tel: 202-682-0110. Web site: www.dbia.org.

Circle 36.

## Copper Development Association

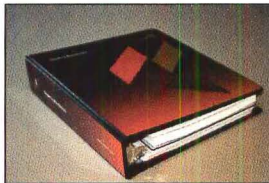

The *Copper in Architecture Handbook* is the most comprehensive source of information on copper in architecture available. It contains historical and contemporary design, installation techniques, as well as ideas, project samples, details, specifications, finishes, and sources for manufacturers and contractors. Plus, there's complete coverage of copper properties, technologies and applications. \$85. 800/CDA-DATA

Circle 40.

## Architecture Literature Portfolio Upcoming Issues

### ISSUE DATES

May 2000  
July 2000  
September 2000  
November 2000  
January 2001  
March 2001

### CLOSING DATES

March 24, 2000  
May 22, 2000  
July 21, 2000  
September 22, 2000  
November 24, 2000  
January 24, 2001

# There Goes the Neighborhood

Santa Monica progressives Frank Gehry and Thom Mayne are surrounded by brand new, '80s-style mediocrity. Aaron Betsky surveys the damage.



It is quite a contrast. On one side of the street, some of America's most innovative architecture firms toil away in a mixed residential and commercial neighborhood of Santa Monica, California. Across the street looms more than 2 million square feet of brand new office and residential space, managing to be simultaneously hulking and boring. One of those adjacent architects, the always eloquent Frank Gehry, has summarized it thusly: "It makes me want to puke."

What contributed to Gehry's nausea and Santa Monica's subsequent decline? The projects in question were approved way back in the mid-1980s, when the area consisted primarily of light industrial and low-rent residential buildings. Planners apparently didn't see the neighborhood as having any character of its own. Instead, they cleared the lots for huge commercial ventures, including offices for two record companies, a supermarket, and condominiums.

McLarand, Vasquez & Partners completed the first phase of a 1.3 million-square-foot office complex called the Water Garden in 1990, according to then-fashionable notions of postmodern pastiche. A declining economy, however, delayed a second, nearly identical phase—precast concrete panels and all—for nearly 10 years. When it kicked into gear again two years ago, neither designer nor developer chose to revise any of its dated elements. Why should they? The project was already fully entitled and designed.

Just down the block from the Water Garden, the site of the recently completed Arboretum Gateway mixed-use complex changed hands several times over that same decade, but never found an owner with a clear, financially viable vision for the parcel. Finally, current owner Legacy Partners (née Lincoln Properties) asked architect David Forbes Hibbert to redesign the project, replacing the hotel with an earlier plan he envisioned with a residential component. The developers told Hibbert (who designed the brightly colored supermarket at the rear of the site in what he calls his "Legorreta period") that a prospective client liked Santa Barbara. Without further ado, Hibbert clad the 600,000-square-foot office building in mauve and terra-cotta-colored Dryvit. "Michael Graves Lite" is how Thom Mayne, principal of Morphosis and Arboretum's across-the-street neighbor, describes it.

Hibbert defends his project as a pedestrian-friendly, scale-appropriate environment. It is certainly not as egregiously and absurdly ugly as the Water Garden, whose thin slabs of neoclassical veneer seem in danger of falling from its steel frame at any moment. Both projects, however, share a lack of relation to their context, function, and site—considerations that might have grounded their forms in something other than their developers' whimsy.

From the owners' perspective, the buildings are a success, as they are fully leased. From across the street, where good architects pursue their craft and residents huddle in their modest abodes, these behemoths look like nothing so much as farcical fragments of a tragic history of overdevelopment. ■

Look both ways before crossing Colorado Avenue: the bland, stripped-down classicism of the Water Garden (top, at left); Thom Mayne's view of "Michael Graves Lite" (top, at right and bottom, at left).

www.vectorworksarchitect.com

1-888-646-4223

# VectorWorks ARCHITECT

*Delivers the promise of Architectural CAD*

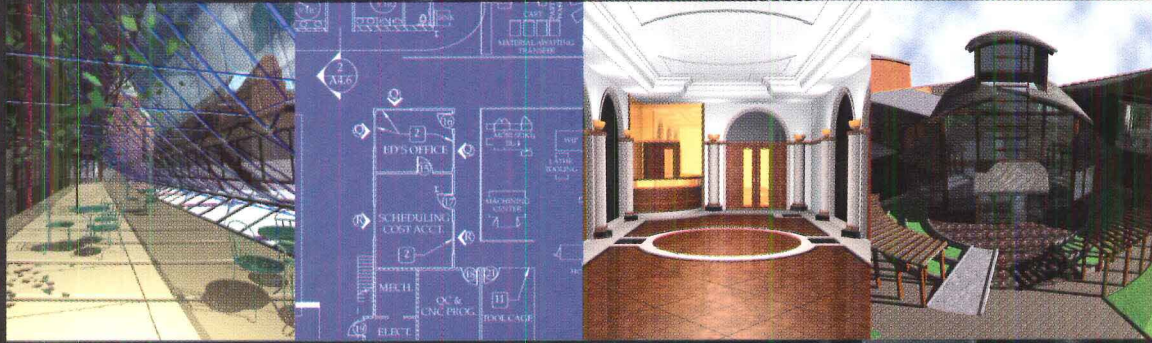

*"VectorWorks ARCHITECT is a great program...I am currently getting re-trained in AutoCAD Architectural Desktop Revision 2...and it just doesn't stack up to VectorWorks ARCHITECT." —Edward Koenig, Carmelhill Drafting Studio*

## Isn't it about time someone addressed the promise of CAD? Introducing VectorWorks ARCHITECT

Engineered and built by professionals in your discipline, ARCHITECT delivers on the promise of architectural CAD. It does everything CAD was supposed to do but didn't quite. Truly a better way to design, ARCHITECT integrates Design, Production and Project Management into a system that delivers unparalleled productivity—all at a price even the smallest firm can afford.

### INTEGRATION

- Complete integration of your 2D plans, 3D models, reports, schedules & client presentations
- Scalable CAD standards make it easy to structure & manage documents

### DESIGN

- Unprecedented tools for programming studies and analysis
- Thousands of "Intelligent" building Objects & 2D/3D architectural symbols
- State of the art Solar Animator

### PRODUCTIVITY

- An easy system for archiving, placing, & managing notes
- Automatic creation of reports & schedules
- Project Management features including issue management, error & revision control, & workgroup referencing

### Special Offer to Readers of ARCHITECTURE

Save over \$180 by purchasing VectorWorks ARCHITECT direct from Diehl Graphsoft for \$1395 or without photorealistic rendering for \$1140. Includes FREE Tech Support & a 90-Day Money-Back Guarantee.

\*Existing VectorWorks users call for upgrade pricing.

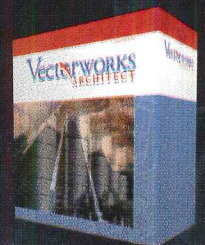

**Diehl Graphsoft Inc**  
Software for Today's Professional

Circle 120 on information card

**Search**

ing for the answer

Identify and compare products the simple way –  
the c-z.com marketplace.



W W W . C - Z . C O M

Circle 122 on information card

