

1,335 Feet High ... and Rising 126 Jane Jacobs' Bane 138

Nano, Nano 93 The Blossoming USGBC 134

ARCHITECT

hanley wood

PROFILES
IN POWER

© 2007 Technical Glass Products. FireLite is a registered trademark of Nippon Electric Glass Co., Ltd. Pilkington Pyrostop is a trademark of Pilkington plc. Technical Glass Products and One Source. Many Solutions. are registered trademarks of Technical Glass Products.



Pilkington Pyrostop

FireLite Family of Products



Nothing could be more important.

Fire protection takes on new significance when it has a face. When hundreds of school children are depending on you to safeguard them, each decision is critical. The glass you choose makes a difference, because the right glass can help keep a fire from spreading in that critical time when students are trying to evacuate the building. That's why Technical Glass Products offers so many choices in fire-rated glass and framing systems. Fire ratings up to 3 hours. High impact safety ratings. Complete UL approvals.

Life safety is too important to take chances. Rely on TGP for all your fire-rated glazing needs.

PRESCRIPTION: PRECAST



Architect: Pratt Design Studio Ltd.

Precast was the right prescription for the award-winning Condell Medical Center in Libertyville, IL. Architects chose High's precast because the uniquely articulated, stacked architectural panels were self-supporting, with vertical loads carried directly by foundation walls, which reduced structural steel framing costs significantly. And since designers were not sure when the facade would be constructed, precast ensured it could be done in any weather. High's unparalleled commitment to new technology and innovation has led to solutions like this and advancements including carbon fiber reinforced CarbonCast®—

precast that's stronger, lighter, better insulating, and more durable, allowing a virtually unlimited selection of colors, textures, and finishes. And High's exclusive 15' and 16'-wide MEGA-Tee deck systems enable wider spans and more open plans with shallower tees in total precast buildings and parking garages. Projects such as Condell are possible with High's expert technical assistance in all phases of a project, from design to erection. High gives architects the flexibility to explore unique solutions while ensuring a job is completed on schedule and on budget. Call High to learn how precast can fill your prescription.



HIGH CONCRETE GROUP LLC ■ CONCRETE INNOVATIONS & ANSWERS® ■ CALL US AT 800-PRECAST ■ WWW.HIGHCONCRETE.COM

Circle no. 35 or <http://architect.hotims.com>



TOP OF THE CLASS ON IAQ. GREENGUARD CERTIFIED FOR CHILDREN & SCHOOLS.

The first fiber glass insulation to earn **GREENGUARD** certification is now certified for **Children & Schools**.

Continuing on the cutting edge of green building and IAQ issues, Knauf residential and commercial building insulation products have earned the new GREENGUARD Children & Schools™ certification. The GREENGUARD for Children & Schools standard, designed specifically to accommodate the unique health needs of children, sets the most stringent indoor air quality requirements for classroom and daycare facilities.

GREENGUARD's Certification standards are based on recognized IAQ criteria used by the U.S. EPA, OSHA, the State of Washington, the World Health Organization and the U.S. Green Buildings Council's LEED-CI program.

It's the ultimate certification for the ultimate name in quality—Knauf Insulation.



For more information call (800) 825-4434 ext. 8300
or visit us online www.KnaufInsulation.com

KNAUFINSULATION

the ELEMENTS are SIMPLE . . .



This 36,000 sq. ft. green screen facade on three five-level parking structures screens each south face, providing seasonal shade and important visual relief to this hillside site.

greenscreen®



800.450.3494
www.greenscreen.com

the POSSIBILITIES are ENDLESS!
Circle no. 420 or <http://architect.hotims.com>

ARCHITECT

EDITOR IN CHIEF

Ned Cramer
ncramer@hanleywood.com

MANAGING EDITOR

Hannah McCann
hmccann@hanleywood.com

SENIOR EDITOR

Amanda Kolson Hurley
ahurley@hanleywood.com

ASSOCIATE EDITOR

Braulio Agnese
bagnese@hanleywood.com

ASSOCIATE EDITOR

Katie Gerfen
kgerfen@hanleywood.com

EDITOR AT LARGE

Vernon Mays

CONTRIBUTING EDITORS

Fred Bernstein, Linda Hales,
Edward Keegan,
Margot Carmichael Lester,
Bradford McKee

GRAPHIC DESIGNERS

Edwin Malstrom
Aubrey Altmann
Melissa Goldweitz
Allison Levy

Production

**DIRECTOR OF PRODUCTION
AND PRODUCTION TECHNOLOGIES**
Cathy Underwood

PRODUCTION MANAGER
Chapella Leftwich

AD TRAFFIC MANAGER
Lauren Dobos

ASSISTANT PRODUCTION MANAGER
Mark E. Fisher

PREPRESS MANAGER
Fred Weisskopf

DIGITAL IMAGING MANAGER
George Brown

PREPRESS COORDINATORS
Kevin Bright, Betty Kerwin

Services

EDITORIAL AND ADVERTISING OFFICES

One Thomas Circle, N.W.
Suite 600
Washington, DC 20005
Phone: 202.452.0800
Fax: 202.785.1974

MEDIA KITS/CEU CLIENT SERVICES

773.824.2400

ANNUAL SUBSCRIPTION RATES

USA: \$59.00; Canada: \$69.00
Other countries: \$199

SINGLE-COPY PRICES

USA: \$10.00
Other countries: \$20

SUBSCRIPTION INQUIRIES, CUSTOMER SERVICE, AND BACK-ISSUE ORDERS

arch@omeda.com
888.269.8410 (toll-free in USA)
or 847.291.5221
Allow six to eight weeks for
delivery of first issue.

REPRINTS

FosteReprints
Steve Hahn
shahn@fostereprints.com
866.879.9144

ADDRESS CHANGES

ARCHITECT
P.O. Box 3572
Northbrook, IL 60065-3572

Online

EDITORIAL DIRECTOR
John Butterfield

CHIEF DESIGNER
Thomas C. Scala

SENIOR WEB EDITOR
Rachel Arculin
rarculin@hanleywood.com

PROJECT MANAGER
Andrew Breychak

Volume 96, number 6, May 2007. ARCHITECT® (ISSN 0746-0554; USPS 009-880) is published 14 times a year (monthly, except for two issues in April and in September) by Hanley Wood, LLC, One Thomas Circle, N.W., Suite 600, Washington, DC 20005. Copyright 2007 by Hanley Wood, LLC. Printed in the USA.

Periodicals postage paid at Washington, D.C., and at additional mailing offices. POSTMASTER: Send address changes to ARCHITECT, P.O. Box 3572, Northbrook, IL 60065-3572.

Canadian Post International Publication Mail Sales Agreement No. 40655599. Send undeliverable Canadian addresses to Deutsche Post Global Mail, 4960-2 Walker Road, Windsor, ON N9A 6J3.

hanleywood





Using postformed laminate instead of solid surface can save you hundreds of dollars. And that's just at the front desk.

Imagine how much you can save on the guest rooms. But that's the beauty of VT countertops. You get the look of stone at a fraction of the cost, so you can make the most of your budget without compromising your project's aesthetics. Their incredible durability makes them perfect for any high-use area and because they're postformed, they don't have seams to collect dirt or grime. For more information about VT commercial grade countertops or to locate a VT PRO Team fabricator, simply log on to www.vtindustries.com.

Circle no. 53 or <http://architect.hotims.com>



**Fine Laminate
Countertops**

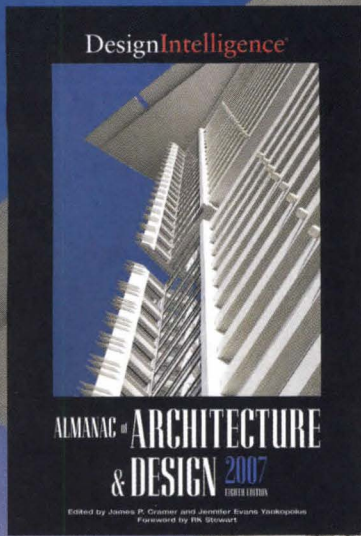

"Clearly the essential and definitive tool for architecture and design facts"

– The American Institute of Architects

"Indispensable...remarkably complete"

– Robert Campbell, Pulitzer Prize winning architecture critic, *The Boston Globe*

"A valuable and impressive resource"

– Industrial Designers Society of America

"No comparable resource exists"

– Library Journal

"The only and definitive resource of its kind"

– MSN.com

available online or
through your favorite bookseller

www.greenway.us

ALMANAC of **ARCHITECTURE**
& **DESIGN 2007**
EIGHTH EDITION

Circle no. 443 or <http://architect.hotims.com>

ARCHITECT

GROUP PUBLISHER

Patrick J. Carroll
pccarroll@hanleywood.com
773.824.2411

PUBLISHER

Russell S. Ellis
rellis@hanleywood.com
202.736.3310

VICE PRESIDENT, SALES AND EDITORIAL, EMEDIA

Paul Tourbaf
202.729.3629

REGIONAL SALES MANAGER, MID-ATLANTIC AND SOUTHEAST

Nick Hayman
nhayman@hanleywood.com
202.736.3457

REGIONAL SALES MANAGER, WEST

Megean Coldwells
mcoldwells@hanleywood.com
626.577.0021

REGIONAL SALES MANAGER, MIDWEST

Michael Gilbert
mgilbert@hanleywood.com
773.824.2435

NORTHEAST AND INTERNATIONAL SALES MANAGER/NATIONAL ADVERTISING MANAGER, LIGHTING

Cliff Smith
csmith@hanleywood.com
212.686.3434, ext. 204

REGIONAL SALES MANAGER, SOUTH CENTRAL

Joe Tuttle
jtuttle@hanleywood.com
303.801.7891

REGIONAL SALES MANAGER, CANADA

D. John Magner
jmagner@yorkmedia.net
613.832.0576

ACCOUNT MANAGER, CANADA

Colleen T. Curran
ctcurran@yorkmedia.net
613.832.0576

SALES MANAGER, ARCHITECTJOBSONLINE

Beth Dwyer
bdwyer@hanleywood.com
202.729.3575

FINANCIAL ANALYST/ SALES DATABASE MANAGER

Christina Covington

RESOURCE AND CLASSIFIED SALES ACCOUNT MANAGER

Drew Ferrara
aferrara@hanleywood.com
202.736.3343

MARKETING DIRECTOR

Lucy Hansen

Hanley Wood Business Media

PRESIDENT

Peter M. Goldstone
202.736.3304

CHIEF FINANCIAL OFFICER/ CHIEF OPERATING OFFICER

Frederick Moses

DIRECTOR, OPERATIONS

Ron Kraft

VICE PRESIDENT, CIRCULATION AND DATABASE DEVELOPMENT

Nick Cavnar

VICE PRESIDENT, MARKETING

Ann Seltz

VICE PRESIDENT, PRODUCTION

Nick Elsener

EXECUTIVE DIRECTOR, EMEDIA

Andreas Schmidt

GENERAL MANAGER, INFORMATION PRODUCTS

Alec Dann

Hanley Wood, LLC

CHIEF EXECUTIVE OFFICER

Frank Anton

CHIEF FINANCIAL OFFICER

Matthew Flynn

CHIEF ADMINISTRATIVE OFFICER

Frederick Moses

CHIEF INFORMATION OFFICER

Jeffrey Craig

EXECUTIVE VICE PRESIDENT, CORPORATE SALES

Ken Beach

VICE PRESIDENT, FINANCE

Brad Lough

VICE PRESIDENT, HUMAN RESOURCES

Wendy Entwistle

HANLEY WOOD, LLC, is publisher of AQUATICS INTERNATIONAL, BIG BUILDER, BUILDER, BUILDING PRODUCTS, CONCRETE & MASONRY CONSTRUCTION PRODUCTS, CONCRETE CONSTRUCTION, THE CONCRETE PRODUCER, CUSTOM HOME, EL NUEVO CONSTRUCTOR, THE JOURNAL OF LIGHT CONSTRUCTION, MASONRY CONSTRUCTION, MULTIFAMILY EXECUTIVE, POOL & SPA NEWS, PROSALES, PUBLIC WORKS, REMODELING, REPLACEMENT CONTRACTOR, RESIDENTIAL ARCHITECT, and TOOLS OF THE TRADE magazines.

DISCLOSURE ARCHITECT® will occasionally write about companies in which its parent organization, Hanley Wood, LLC, has an investment interest. When it does, the magazine will fully disclose that relationship.

PRIVACY OF MAILING LIST Sometimes we share our subscriber mailing list with reputable companies we think you'll find interesting. However, if you do not wish to be included, please call us at 888.269.8410.



Set your sights high. Sky high. Create a focal point that's absolutely impossible to ignore. Consider, for example, what you could accomplish with a combination of Weather Shield® windows such as the rectangle, square and triangle shaped direct-sets displayed here. Rise. Shine. Elevate custom home design to a whole new level.

Demand Better. Compromise nothing. Get more of everything you could possibly want in windows and doors. Visit us online at weathershield.com/A



Want More  **Upward Mobility**

1-800-477-6808

Weather Shield® Premium Windows and Doors

Circle no. 393 or <http://architect.hotims.com>

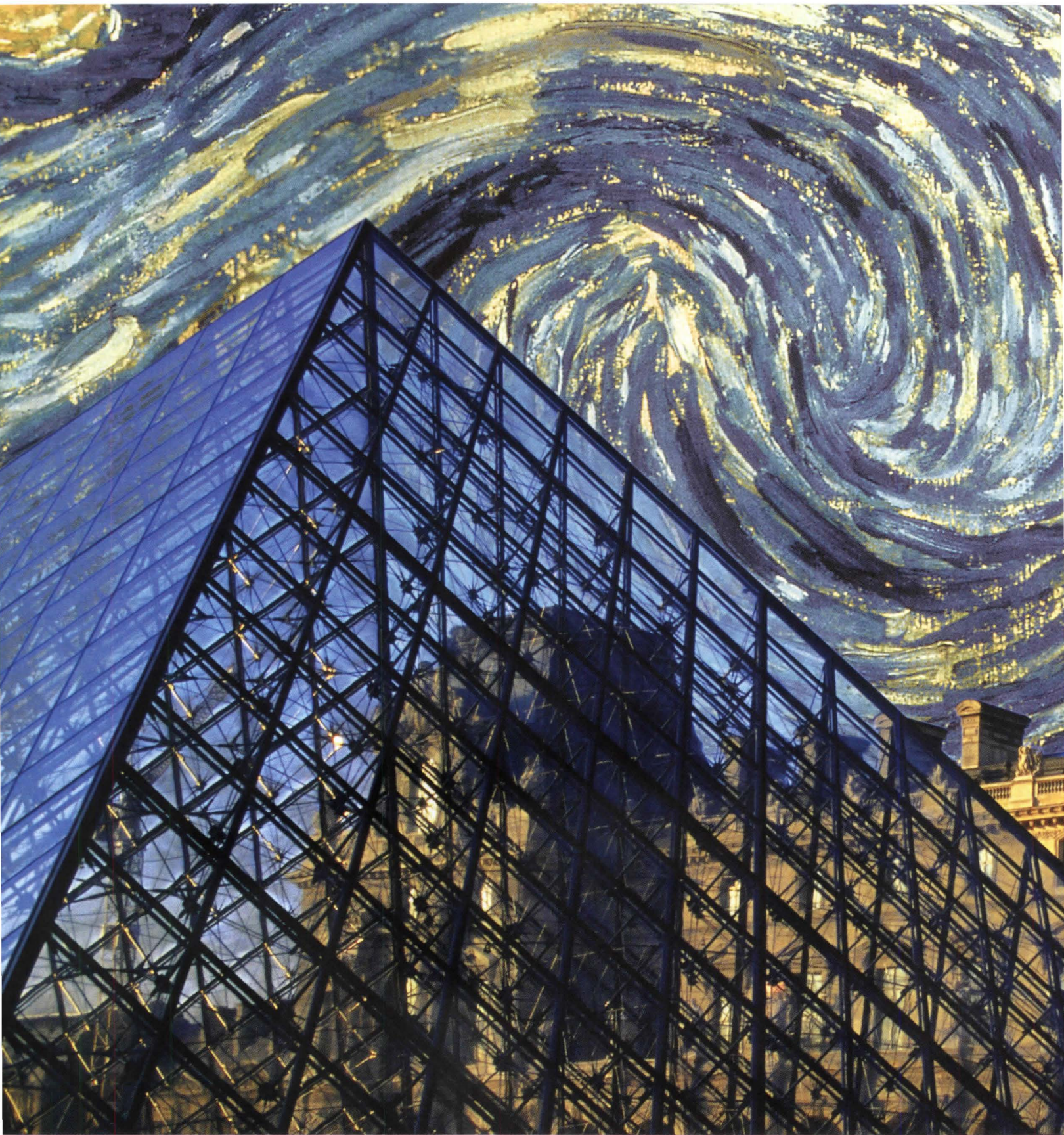

**INSIDE, ONE-OF-A-KIND ART MAKES A LASTING IMPRESSION.
OUTSIDE, A ONE-OF-A-KIND DURANAR COATING DOES THE SAME.**

Circle no. 423 or <http://architect.hotims.com>



There's a simple reason that a gem like the *Pyramide du Louvre* is protected by Duranar® Coatings from PPG. They have no equal. Only Duranar Coatings have withstood 40 years of punishing exposure – thanks to a unique formulation that includes nearly 80% PPG-proprietary components and ingredients such as Kynar 500®. And that's only one reason you should spec nothing else. Discover the entire Duranar Coatings difference, and learn how your one-of-a-kind project can be immortalized during our 40th anniversary, at www.ppgduranar.com.

Duranar and PPG are registered trademarks owned by PPG Industries, Inc. Kynar 500 is a registered trademark of Arkema, Inc.



PPG Industries, Inc., 151 Colfax Street, Springdale, PA 15144 1-888-PPG-IDEA www.ppgideasces.com

CONTENT

RIGHT The new headquarters of San Francisco's Homeless Prenatal Program, renovated as part of a pro bono design initiative called the 1% Solution.

FAR RIGHT Asmara, the capital of Eritrea in East Africa, has quite possibly the largest assemblage of futurist architecture outside of Italy.

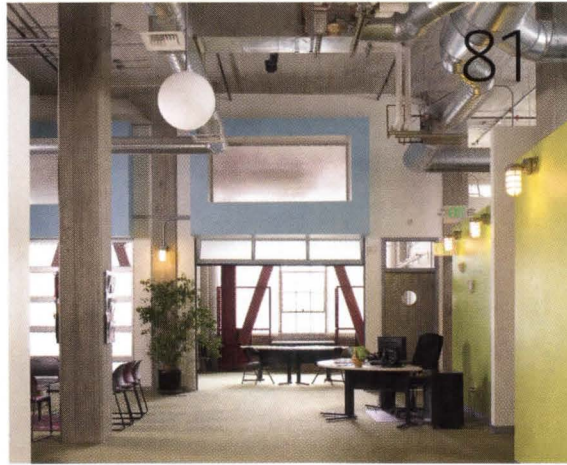

MARK DARLEY

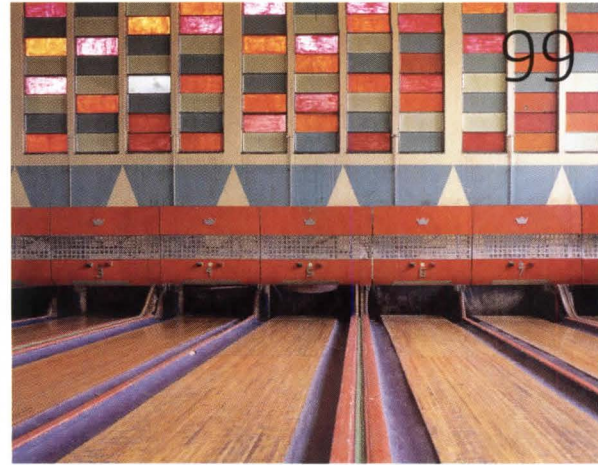

STEFAN BONESS

REPORT

- 20 **News**
New Orleans recovery plan released; awards, awards, awards; and more ...
- 54 **Market Intelligence**
Tucson, Ariz., and nationwide
- 60 **Screen Capture**
A global network for building. *Braulio Agnese*

DEPARTMENTS

- 63 **Practice Errors and Omissions**
Insurance broker Greg Kumm explains how to CYA. *Fred Bernstein*
- 65 **Technology No Ice**
How do you build an igloo in Southern California? *Laurie Manfra*
- 71 **Ecology Visible Green**
At the root of performance is form. *Lance Hosey*
- 75 **Products Lights Up**
New fixtures and technologies take center stage at Lightfair. *Katie Gerfen*
- 81 **Pro Bono Public Architecture**
A nonprofit challenges the profession to act for social change. *Mimi Zeiger*
- 93 **Science The Nano Revolution**
Molecular science is set to transform the way we build. *George Elvin*

- 99 **History Asmara Modern**
A remarkable collection of Italian futurist buildings—in East Africa. *Stefan Boness*
- 184 **Q&A Hilary Ballon**
The curator of "Robert Moses and the Modern City." *Gideon Fink Shapiro*

CULTURE

- 159 **Object Lesson**
A 50-year-old postage stamp celebrates a past anniversary of the AIA. *Linda Hales*
- 163 **Books**
Michael Moran's *The Glass House*, 100 up-and-coming designers in *&Fork*, and more ...
- 165 **Exhibits**
Household goods as tomorrow's collectibles, West Coast stimulators, and more ...
- 169 **Film**
A festival explores the relationship between film and architecture. *Laurie Manfra*
- 171 **Events**
A month or two in the life of the profession

ARCHITECTMAGAZINE.COM

→ Help Wanted

ArchitectJobsOnline is a one-stop career-development resource for job-seekers in the industry. Visit: www.architectjobsonline.com

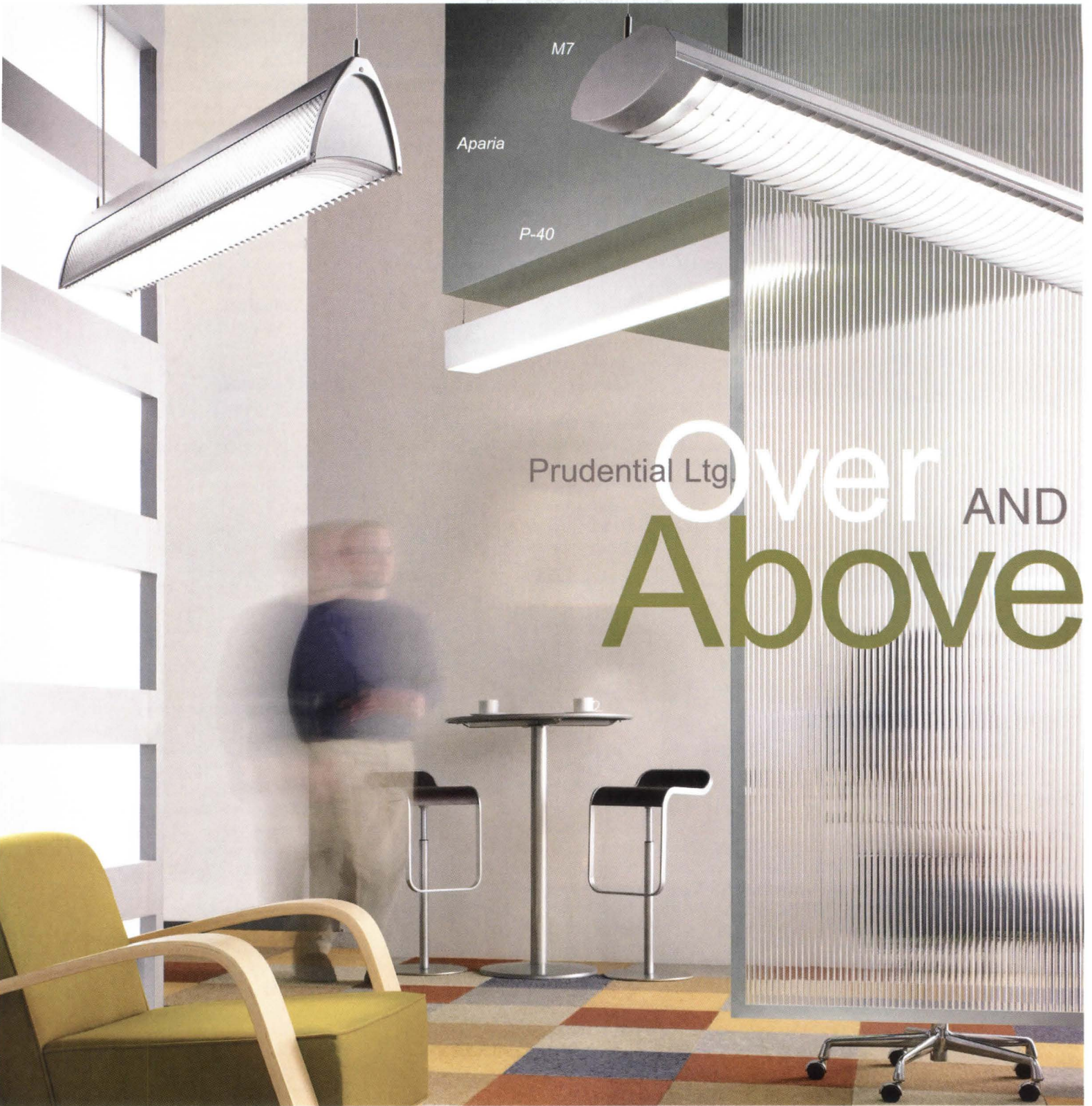

M7

Aparia

P-40

Prudential Ltg.

Over AND Above

{sculptural form _ lighting}



Light creates Life. Create with Prudential Ltg.

You light an ordinary space with ordinary fixtures. But ordinary isn't in your design vocabulary. Your space surprises, and so should the overhead lighting. We offer an extensive catalog of linear fixtures, including our new Aparia, M7 and P-40 pendants, that go far beyond the basics. Meticulously sculpted from a range of intriguing materials, and delivering the highest levels of optical performance. For extraordinary lighting visit our website at prulite.com. Circle no. 79 or <http://architect.hotims.com>

POWER TO THE PEOPLE



NANCY FROELICH

Ned Cramer
Editor in Chief

DID THE NATION'S ARCHITECTS FLINCH in unison upon learning the results of the AIA survey of America's favorite architecture? It turns out that We, the People, and We, the Profession, aren't necessarily on the same page when it comes to defining quality in architecture.

Modernism didn't fare too well. Only one living practitioner made the top 10 (Maya Lin, for the Vietnam Veterans Memorial). Frank Lloyd Wright barely broke the top 30, with Fallingwater. And there, like a slap in the face of the avant-garde, at No. 22—ahead of anything by Wright and Richardson and Sullivan and Jefferson and, yes, Gehry—was the Bellagio Hotel and Casino in Las Vegas, designed by the Jerde Partnership with DeRuyter Butler and Atlandia Design. Mies didn't even make the list.

It's OK to cry. But don't dismiss the survey out of hand. Let's try to learn from the experience. Here, on its 150th birthday, the AIA has given its loved ones a gift: hard evidence that architecture isn't just what architects make of it; or, perhaps more accurately, that architecture isn't just what the tastemakers make of it.

The average person looks at architecture more with emotion than with intellect. I'm guessing here, but the Bellagio must owe some of its popularity to the fact that Vegas is a blast and *Ocean's 11* (set largely at the Bellagio) was a great movie and a huge success. The Bellagio's also spectacular in its own right, whether or not it follows the modernist canon. Jon Jerde and DeRuyter Butler and the rest of the team deserve sincere kudos—then again, they got a lot of help in the marketing department.

WE, THE EDITORS OF ARCHITECT, relish the kind of surprises that the AIA survey so richly delivered. The list's contrarian spirit helped inspire this, our first annual Power Issue. We knew we ran the risk of stating the obvious: A celebrity profile of Frank Gehry or Richard Meier? A ranking of the largest firms, starting with HOK or Gensler? There are plenty of self-evident approaches to the subject of power. And we took them all—but, we hope, with an enlightening twist.

The celebrity profile, for instance: Instead of stroking a star—do any of our readers need reminding that Gehry is famous?—we decided to examine the still-powerful figure of Robert Moses ("An Indecisive Democracy," page 138), whose legacy seems especially poignant given the fumbled reconstruction efforts at Ground Zero and in New Orleans. As a bonus, we put the spotlight on 10 less-celebrated, but equally potent, sources of power—players whom architects ought to know, but don't, in far-flung arenas such as construction, finance, and policy ("Profiles in Power," page 114).

We also decided against building a pseudo-scientific list of the nation's largest firms. There are so many of these lists already, we chose to compare existing lists in different categories to see what emerged ("The Meta Rankings," page 106). As contributing editor Edward Keegan observes, there's more than one way to define power. Still, whether the criterion was press coverage, size of staff, or amount of billings, we were amazed at how many of the same names rose to the top. Power may be relative, but it's real.

Ned Cramer
Editor in Chief

What's in a Name?

A great article on salaries ["The \$34,000 Question," April 2007, page 52], except for the use of Dana Ladd as your symbolic intern. According to your captions, she has only a B.A. with a major in architecture, and that does not allow you to suggest "Ladd became an architect" She presumably has three years of professional education and three years of apprenticeship before she earns that title. A magazine with your moniker should not give it away so freely ... or is that because a B.A. in journalism is adequate in your profession?

Dale Mulfinger

SALA Architects, Minneapolis
dmulfinger@salaarc.com

Criteria for Change

Interesting article ["0.2%," March 2007, page 62]. I just did a mentor program sponsored by Turner Construction in Oakland, Calif. Half of the kids were female, and all were black or Hispanic. They didn't have a clue about our profession or where they are headed. I gave the kids model airplanes to build. The boys excelled at the task. Boys aren't superior, but these clearly had had exposure to putting things together. The girls struggled and were much more shy and timid—not a surprise. I would bet that none of the girls make it to architecture school, if they make it out of high school. Want more diversity in architecture? Then our profession needs to mentor kids in high school and change the entrance criteria in architecture schools to allow more diverse entry—in grades, not just race. Then maybe the architecture schools could get off their high horses and teach kids real nuts and bolts so that they have a chance of getting a job when they graduate.

James Heilbronner

Architectural Dimensions
Walnut Creek, Calif.
jamesh@archdim.com

Unique Assets

I was surprised when I realized that I had worked with one of your highlighted black (or is it African-American?) women ["0.2%"], then disappointed when I read what she had to say. Where she saw "white males" questioning her competence, I saw a diverse group of people (including men, women, Latino, Asian, Indian, and, of course, white) that respected her talents and appreciated her differences. Being Parsi and an architect, I'm a member of a group whose numbers in the United States will never exceed a few dozen. I feel fortunate to be a part of a small group and have found that my uniqueness is an asset rather than a liability.

Cyrus Rivetna

Rivetna Architects, Chicago
crivetna@rivetna.com



LET LOOSE



If you can see it in your mind, you can see it in Staron® Solid Surfaces. 62 colors. Any shape. Any inset. Any edge. Allow your vision to take shape. Call 1.800.795-7177 or visit www.staron.com/as2.

COLOR | PEBBLE BLUE © 2007 Cheel Industries Inc.

Circle no. 401 or <http://architect.hotims.com>

staron®
Solid Surfaces



BUILD IT SMARTER.

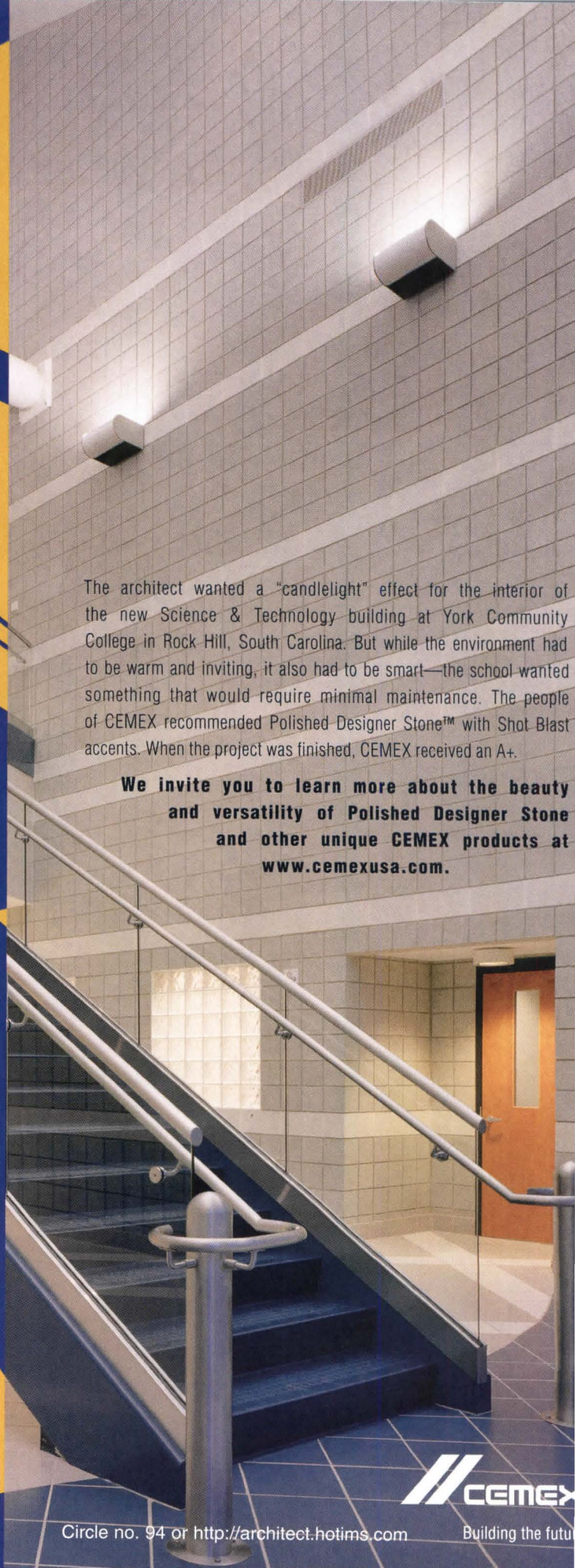

The architect wanted a "candlelight" effect for the interior of the new Science & Technology building at York Community College in Rock Hill, South Carolina. But while the environment had to be warm and inviting, it also had to be smart—the school wanted something that would require minimal maintenance. The people of CEMEX recommended Polished Designer Stone™ with Shot Blast accents. When the project was finished, CEMEX received an A+.

We invite you to learn more about the beauty and versatility of Polished Designer Stone and other unique CEMEX products at www.cemexusa.com.



Circle no. 94 or <http://architect.hotims.com>

Building the future



Charlotte Douglas
International Airport
Parking Deck
LSP3/The Wilson Group
EcoScreen™

Great Works

The art is yours. The palette is ours.

Your project is not merely a building, but a work of art. CENTRIA can help you bring your vision to life. Our architectural metal wall systems are crafted to the highest aesthetic standard. And, with features such as Advanced Thermal Moisture Protection (ATMP®) and Cradle-to-Cradle certification, our products are just as functional as they are beautiful. CENTRIA also offers an experienced sales team and a dedicated installer network to ensure that your design is executed successfully — just as you envisioned it.

To learn more about our palette of products, call us or visit our website.

Circle no. 25 or <http://architect.hotims.com> 800.759.7474 | CENTRIA.com

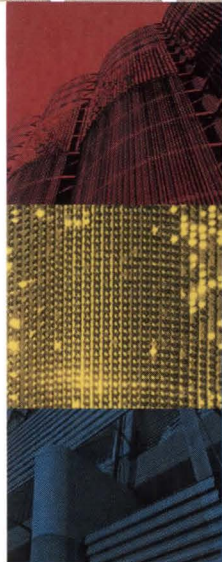

CENTRIA

Architectural Metal Wall
and Roof Systems

Formawall® Dimension Series®
Formawall® Graphix Series™
FormaBond®
Concept Series®
Profile Series

Visit CENTRIA at Booth #18065
at the AIA Convention 2007.

Redevelopment

New Orleans Recovery Plan Released

City looks to feasible goals, targeted reinvestment to attract private development



Edward Blakely

GUARDED OPTIMISM GREETED the unveiling in late March of a targeted \$1.1 billion redevelopment plan for New Orleans' neighborhoods, more than 18 months after the city flooded in the wake of Hurricane Katrina.

Edward Blakely, the city's head of recovery management, emphasized the inherent limits of the plan, which is intended to be more surgical than sweeping in its scope.

The plan focuses on 17 hub sites around the city that are meant to act as magnets for private development by leveraging public money into them. Fifteen of the sites lie in neighborhoods that either were not hit hard by the flood or have begun to rebuild. Together, they are to see \$161 million in public investment. But Blakely would direct about \$145 million toward sites in two devastated neighborhoods, the Lower Ninth Ward and a section surrounding the Lake Forest Plaza shopping center.

"The scope of it is deceptively simple," says architect Allen Eskew, principal of Eskew+Dumez+Ripple in New Orleans. "Blakely himself says he wanted to have some early successes." Eskew adds that it was crucial for Blakely's list of target sites to seem modest and feasible, given the city's "planning fatigue" and frustration with all levels of government. "I'm very pleased that Dr. Blakely has come out with an action plan instead of a planning plan," he says.

Among the chosen sites, the plan establishes a triage system for rebuilding destroyed areas, for redeveloping struggling areas such as the area around Gentilly Boulevard and Elysian Fields Avenue, and for renewing areas such as Canal Street downtown that show signs of life returning but could yet benefit from investment.

After Blakely's plan was announced, residents and city officials seemed to be putting stock in its realistic aspirations, particularly after a run of widely criticized plans that were seen as either too restrictive or too extravagant and costly.

"People can start to see where this targeted reinvestment is going to occur," says Jane S. Brooks, professor and chair of the planning and urban studies department at the University of New Orleans. Brooks attributes the Blakely plan's wider acceptance to the broad public participation that led up to it. "People are ready to understand that this is the first wave of investment," Brooks adds. "If this works, maybe there will be another wave of investment. There's no miracle here. What he's trying to do is use public money to attract private money" for neighborhood reinvestment.

Not all of the money is in hand, however. The city has about \$400 million to put toward the plan. More than half of the other \$624 million would hinge on the federal government waiving its rule that state and local governments match 10 percent of federal grants for reconstruction. As of the day of the plan's unveiling, the Bush administration said it has no intention of waiving the matching-funds requirement. **BRADFORD MCKEE**

Clips

The American Institute of Architects' Architecture

Billings Index for February was 52.5 (any score over 50 indicates an increase in billings). By sector, mixed practice had the best score, 59.9, followed by residential (55.6), institutional (53.5), and commercial/industrial (51.8). The Inquiries Index for the month was 61.9.

Looking for work? Architecture and engineering firm SSOE, which has more than 700 employees and 16 offices worldwide, has launched a nationwide recruitment effort to hire 200 architects and engineers by the end of the year. Job seekers can search for, view, and apply for open positions in any office through the company's website, www.ssoe.com.

In April, the UCLA School of the Arts and Architecture appointed **Hitoshi Abe** as professor and chair of its Department of Architecture and Urban Design. He was recently professor at the University of California, Berkeley. Through June 6, the department is hosting "Body: Hitoshi Abe," an exhibit of six projects designed by Atelier Hitoshi Abe.

The Green Building Initiative now offers **free use of the Green Globes** environmental assessment and rating system to professional affiliates that join the GBI. For a \$2,500-per-year membership, firms that design and construct new commercial buildings get unlimited use of Green Globes. If unlimited use is not required, firms can join GBI for \$500 or \$1,500 per year and receive free Green Globes access for one or three projects, respectively.

→ continued on page 22



November 2006 repopulation in New Orleans, as measured by utility usage (post-hurricane vs. pre-hurricane).

CertainTeed CertaPro™ insulation.
It's an inside-the-park home run.



A comfortable day at Busch Stadium—brought to you by CertainTeed. Fans at St. Louis' new ballpark appreciate that CertaPro™ commercial insulation hits the sweet spot of acoustic and thermal efficiencies. With our all-star line-up of products, you can deliver the performance your customers demand with the service and support you expect from CertainTeed.

800-233-8990 certainteed.com
Circle no. 432 or <http://architect.hotims.com>

CertainTeed 
Quality made certain. Satisfaction guaranteed.™

EXTERIOR: ROOFING • SIDING • WINDOWS • FENCE • RAILING • TRIM • DECKING • FOUNDATIONS • PIPE
INTERIOR: INSULATION • WALLS • CEILINGS

New Urbanism

CNU Names Winners of 2007 Charter Awards

Four projects respond to Hurricane Katrina; Torti Gallas, Urban Design Associates, and Dover, Kohl receive multiple awards

TWENTY-FIVE PROJECTS—20 professional, five academic—will receive 2007 Charter Awards from the Congress for New Urbanism (CNU). Winners include proposed as well as built work across the United States and in Puerto Rico, Guatemala, Haiti, Chile, and Italy. Torti Gallas and Partners received three awards, while Dover, Kohl & Partners, Urban Design Associates, and the University of Maryland each had two. Four of the winners—spanning the scale from regional planning to prefabricated housing and a student-led charrette—are responses to the devastation of Hurricane Katrina on the Gulf Coast.

The seven-member Charter Awards jury comprised Stefanos Polyzoides (chair) of Moule & Polyzoides; Hillary Brown of New Civic Works; Ventura, Calif., city manager Rick Cole; Andrés Duany of Duany Plater-Zyberk & Co.; Kjell Forshed of Brunnerberg & Forshed; Vince Graham of the I'On Group; and Susan Van Atta of Van Atta Associates.

The winning projects were premiated for their quality and adherence to the principles set forth in the 1996 Charter for the New Urbanism. CNU co-founder Polyzoides will lecture on the educational aspects of the winners at the award presentation, to be held on May 18 as part of the proceedings at the CNU's 15th congress in Philadelphia. EDWARD KEEGAN

CHARTER AWARD WINNERS

REGION, METROPOLIS, CITY, TOWN SCALE

City Plan 2025, Fayetteville, Ark.—Dover, Kohl & Partners (1)
 Long Beach Concept Plan, Long Beach, Miss.—Ayers/Saint/Gross Architects + Planners
 Louisiana Speaks Pattern Book, Louisiana, USA—Urban Design Associates

NEIGHBORHOOD, DISTRICT, CORRIDOR SCALE

Carneros Inn, Napa, Calif.—William Rawn Associates, Architects (2)
 Cooper's Crossing, Camden, N.J.—Torti Gallas and Partners (master plan); Urban Design Associates (pattern book)

Harbor Town, Memphis, Tenn.—Looney Ricks Kiss
 Innovista Master Plan, Columbia, S.C.—Sasaki Associates
 La Candelaria, Antigua, Guatemala—Castillo Arquitectos; Dover, Kohl & Partners
 Salishan Neighborhood HOPE VI, Tacoma, Wash.—Torti Gallas and Partners
 Street Smart: Streetcars and Cities, nationwide—Reconnecting America

BLOCK, STREET, BUILDING SCALE

Chatham Square, Alexandria, Va.—Lessard Group
 Cottage Square, Ocean Springs, Miss.—Tolar LeBatard Denmark Architects
 Courthouse Square, Redwood City, Calif.—Freedman Tung & Bottomley
 The Ellington, Washington, D.C.—Torti Gallas and Partners
 Habitat Trails, Rogers, Ark.—University of Arkansas Community Design Center
 Katrina Cottage VIII, Silver Spring, Md.—Stephen A. Mouzon, Architect
 Kedzie & Rockwell Brown Line Stations, Chicago—Muller & Muller Architects
 Lofts 590, Arlington, Va.—SK&I Architectural Design Group
 Oak Plaza, Miami—Cure & Penabad Studio; Khoury & Vogt Architects
 Takoma Walk, Takoma Park, Md.—Cunningham + Quill Architects (3)

ACADEMIC

Company Towns Revisited, Petit Paradis, Haiti—Notre Dame University (4)
 Connecting the City of Water to Its History, Castellamare di Stabia, Italy—University of Maryland
 A Response to the Current Development of Valparaiso's Waterfront, Valparaiso, Chile—University of Maryland
 Saucier Town Plan, Saucier, Miss.—Andrews University
 Toward an Urban & Sustainable Puerto Nuevo, San Juan, Puerto Rico—University of Puerto Rico

Clips

The National Council of Architectural Registration

Boards has selected the University of Virginia as the \$25,000 grand prize winner of the 2007 NCARB Prize for Creative Integration of Practice and Education in the Academy. The university received the prize for "ecoMOD," a project that partners the school's architecture and engineering programs for the creation of affordable and sustainable housing prototypes.

The Institute of Classical Architecture & Classical America has established a postgraduate program at the Georgia Tech College of Architecture. The M.S. program, an intensive two-semester course, includes a fall semester in New York (home of the ICA) and a spring semester in Atlanta (home of Georgia Tech), with an option for summer study in Greece and Italy.

In other education news, the Southern California Institute of Architecture will launch its second postgraduate program, MediaSCAPES, this fall. The course will focus on media production and theory and is intended to act as an idea laboratory.

→ continued on page 26

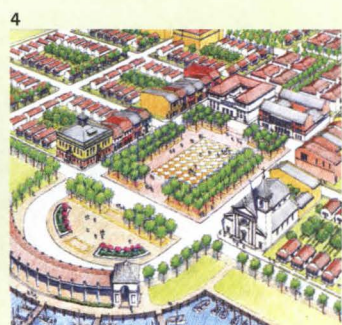
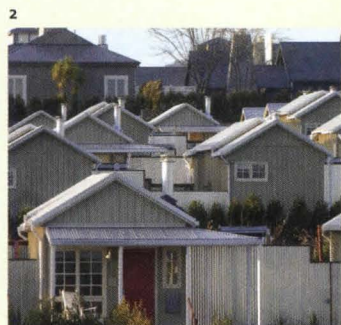
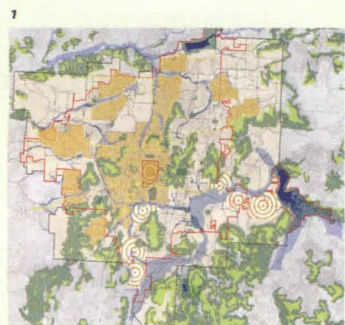



The playground just got more interesting.

Now enjoy even more design options. Like nineteen clad colors at standard pricing, plus new casings and subsills in cladding exceeding AAMA 2605-05 specification. Real design freedom: Maybe that's why, according to a recent J.D. Power and Associates study, Marvin ranks "Highest in Architect Satisfaction with Residential Window and Patio Door Manufacturers." Visit marvin.com/clad for our free clad brochure or call 1-800-236-9690.



MARVIN 
Windows and Doors

Built around you.
Circle no. 57 or
<http://architect.hotims.com>

Marvin Windows and Doors received the highest numerical score in the proprietary J.D. Power and Associates/McGraw-Hill Construction 2006 Residential Window and Patio Door Architect Satisfaction study(SM). Study based on responses from 712 architects measuring 6 manufacturers and measures opinions of architects. Proprietary study results are based on experiences and perceptions of architects surveyed in May through July 2006. Your experiences may vary. Visit jdpower.com. ©2007 Marvin Windows and Doors. All rights reserved. ®Registered trademark of Marvin Windows and Doors.

Design

Nine Libraries Named for AIA/ALA Building Awards

Winners in U.S., Canada, and China come from program's largest group of submissions

THE AMERICAN INSTITUTE OF ARCHITECTS (AIA) announced the nine winners of the 2007 Library Building Awards on April 6. Carried out in partnership with the American Library Association, the biennial awards recognize outstanding library designs by architects licensed in the United States. This year's winners:

- Ballard Library and Neighborhood Service Center for the Seattle Public Library, Seattle, by Bohlin Cywinski Jackson
- David Bishop Skillman Library for Lafayette College, Easton, Pa., by Ann Beha Architects
- Desert Broom Branch Library for the City of Phoenix Engineering and Architectural Services Department, Phoenix, by Rich&rd + Bauer
- Fleet Library for the Rhode Island School of Design, Providence, R.I., by Office dA
- La Grande Bibliothèque, Montreal, by Patkau Architects/Croft-Pelletier Architects/

Menkès Shoener Dagenais Architectes

- Robin Hood Foundation Library for P.S. 192, New York, by Gluckman Mayner Architects
 - Santa Monica College Library expansion and renovation, Santa Monica, Calif., by co Architects
 - Shunde Library for the City Construction and Development Center of Shunde District, Foshan, China, by P&T Architects & Engineers
 - William J. Clinton Presidential Center, Little Rock, Ark., by Polshek Partnership Architects
- Says Ann Beha of her firm's award for the Skillman Library, "What could be more worthwhile than creating settings that encourage lifelong learning and curiosity?"

With close to 300 submissions, this was the largest pool of entries since the program began in 1965. AIA representative Matt Tinder attributes the growth of the building awards to the

changing nature of library programs. "Libraries are no longer simply repositories for books," he says. "They are collaborative, interactive community places now designed for all sorts of exchange."

Acknowledging a competitive pool, jury chair Jefferson B. Riley, a partner at Centerbrook Architects and Planners, praises the strengths of the winners, saying they "compellingly exhibited the important role of libraries as vital community centers." He adds that "each firmly established a memorable sense of place."

Chaired by Riley, the jury also included architects Edward Dean of Chong Partners Architecture and Wendy Pautz of LMN Architects, and librarians Anne M. Larsen of the Massachusetts Board of Library Commissioners, Elizabeth A. Titus of the New Mexico State University Library, and Ken S. Weil of the South Huntington Library.



BENJAMIN BENSCHNEIDER

Ballard Library

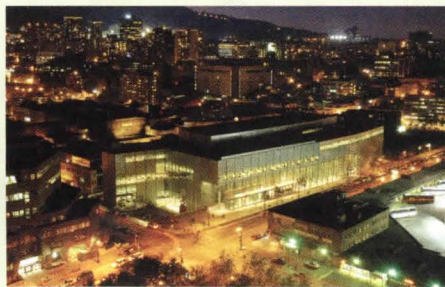

JAMES DOW

La Grande Bibliothèque

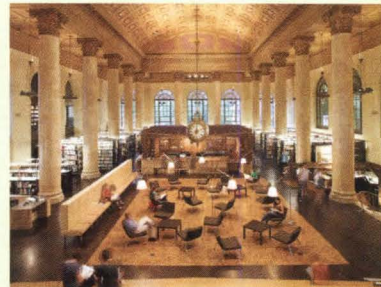

JOHN HORNBER

Fleet Library

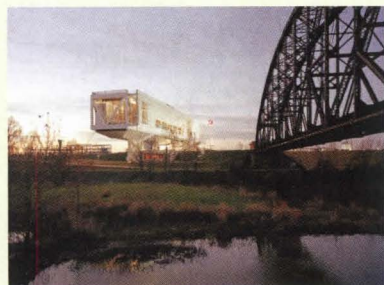

TIMOTHY HURSTLEY

William J. Clinton Presidential Center



BILL TIMMERMAN

Desert Broom Branch Library



TOM BONNER

Santa Monica College Library



PETER MAUS/ESTO PHOTOGRAPHICS

Robin Hood Foundation Library



BOBBY SUM

Shunde Library



FLORIAN HOLZHER

David Bishop Skillman Library

STRENGTH. BEAUTY. NATURALLY.

For over 40 years Metal Sales has manufactured the highest quality metal roofing and siding material in the industry.

The unmatched performance of Metal Sales products stands up to the demands of nature. Our products are recognized worldwide for their attractive design and unique features – all with the strength and reliability of steel. And of course, Metal Sales continues to lead the way by offering environmentally-friendly cool roof and Energy Star rated products. Naturally.

**The difference is metal.
The advantages are quality and value.**

Circle no. 444 or <http://architect.hotims.com>



Recognition

Four Architects Receive Awards From Academy of Arts and Letters

THE AMERICAN ACADEMY OF ARTS AND LETTERS (AAAL) in New York recently announced the winners of its annual architecture awards. Eric Owen Moss of Eric Owen Moss Architects won the prestigious Arnold W. Brunner Memorial Prize, created in 1955 to acknowledge significant contributions to "architecture as an art." Wes Jones of Jones, Partners: Architecture and Tom Kundig of Olson Sundberg Kundig Allen Architects each earned an Academy Award for work characterized by a strong personal direction, while architect-cum-artist Lebbeus Woods was recognized with an Academy Award for his artistic explorations of the built environment. The four will be honored at an AAAL event later this month. Winners of the Academy Award receive a \$7,500 cash prize; \$5,000 goes to the winner of the Brunner Memorial Prize.

This year's awardees were selected from a group of about 50 candidates who were nominated by the AAAL's 250 members. "It was an unusually good group of nominees," says Richard Meier, who served as the chair for an illustrious jury that also included Henry N. Cobb, Peter Eisenman, Michael Graves, Hugh Hardy, Steven Holl, Cesar Pelli, and James Stewart Polshek. The panel gathered at Meier's Manhattan office earlier this year to pore over the entries. "It's a lot of material to be reviewed and discussed," says Meier. "The table is piled high with submittals and portfolios of the various nominees. Nothing gets overlooked."

"It's a wonderful prize, and I took it as a substantive compliment to be selected by this jury," says Moss.

Work by Moss, Jones, Kundig, and Woods will be

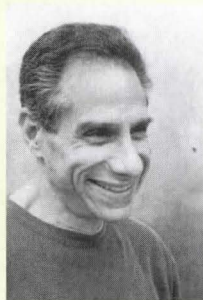

Eric Owen Moss

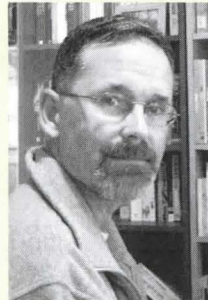

Wes Jones

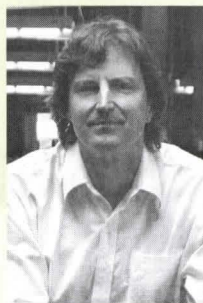

Tom Kundig

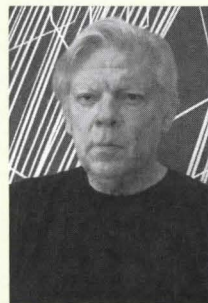

Lebbeus Woods

included in an exhibition at the academy's galleries in Manhattan from May 16 through June 10. For more information, visit the AAAL's website at www.artsandletters.org. ELIZABETH A. EVITTS

Clips

In mid-April, Polshek Partnership Architects

announced that founder **James Stewart Polshek** has given up his partnership interest and has assumed the role of senior design counsel. Polshek will continue to work on select projects and act as adviser to the firm's nine partners.

Tom Galloway, dean of the College of Architecture at Georgia Tech since 1992, died on March 11. He was 67.

Jules Horton, a leader in the lighting design community, died on Feb. 23 at the age of 87. He will be honored at the International Association of Lighting Designers Awards Dinner, which will occur this month during Lightfair.

Floyd McCall, co-founder of the company that eventually became the FMI Corp., died on March 20. FMI is a leading consulting and investment banking company for the construction industry.

It probably shouldn't come as a surprise, but a PPG Industries survey of 629 U.S. firms finds that **China** is the leading international market, accounting for 21 percent of the firms' combined international business. The United Kingdom came in second, at 16 percent.

A study released in late March says that **average temperatures in California** rose nearly 2 degrees Fahrenheit in the second half of the 20th century. Using 1950–2000 data from 330 weather stations across the state, the authors—one from NASA's Jet Propulsion Laboratory, the other two from California State University, Los Angeles—find that the greatest warming occurred in the state's big cities and was caused mostly by urbanization, not greenhouse gases.

Rankings

Top 10 Lists: Taking the Measure of Cities

IF YOU'RE CONSIDERING A MOVE TO A NEW CITY in the United States or Canada, the lists shown here may prove helpful. The first was taken from a global survey by Mercer Human Resource Consulting that scored cities on the quality of life they offer. (The No. 1 city in the world: Zurich, Switzerland, with a score of 108.2. Honolulu, the first U.S. city on the list, came in at No. 27, with a score of 103.3.) The lists of best and worst U.S. cities for business and careers were created by *Forbes*. (Complete lists and information on their methodologies can be found at www.mercerhr.com and www.forbes.com, respectively.) Drumroll, please:

Top 10 North American Cities: Quality of Life

- Vancouver, British Columbia (107.7)
- Toronto, Ontario (105.4)
- Ottawa, Ontario (104.8)
- Montreal, Quebec (104.3)
- Calgary, Alberta (103.6)
- Honolulu (103.3)
- San Francisco (103.2)
- Boston (101.9)
- Washington, D.C. (100.4)
- Chicago (100.4)

Best U.S. Cities: Business and Careers

- 1. Raleigh, N.C.
- 2. Provo, Utah
- 3. Boise, Idaho
- 4. Des Moines, Iowa
- 5. Knoxville, Tenn.
- 6. Albuquerque, N.M.
- 7. Durham, N.C.
- 8. Fayetteville, Ark.
- 9. Nashville, Tenn.
- 10. Olympia, Wash.

Worst U.S. Cities: Business and Careers

- 1. Salinas, Calif.
- 2. Stockton, Calif.
- 3. Detroit
- 4. Visalia, Calif.
- 5. Modesto, Calif.
- 6. Santa Cruz, Calif.
- 7. Merced, Calif.
- 8. Beaumont, Texas
- 9. Flint, Mich.
- 10. Rockford, Ill.

It's Time To Stop The Warming.

Conserve Energy with
Polyiso Roof Insulation.

The Highest R-Value
You Can Specify.

Green Building,
Cool Planet.
Way Cool.



HUNTER

Explore the Advantages of Hunter Panel's
Polyiso Roof Insulating Panels

www.hunterpanels.com

888.746.1114

Circle no. 433 or <http://architect.hotims.com>

Skyscrapers

Chicago Spire's Latest Form Unveiled

Developer targets May groundbreaking, says 150-floor building will continue to evolve

THE DESIGN FOR WHAT WOULD BE North America's tallest building has changed—again. The twisting 2,000-foot tower by Santiago Calatrava, dubbed the Chicago Spire, maintains the overall height that was unveiled in July 2005, but the 550-foot broadcast antenna that was to cap 115 floors has been replaced by usable square footage on 150 floors, according to an evolving series of renderings released since December. The initially proposed 300 apartments and 150 hotel rooms are now conceived as at least 1,300 condominium units.

The changes seem to be the result of financial necessity. Local developer Christopher Carley of the Fordham Co. sold the prime lakefront site and striking design to Dublin, Ireland-based Shelbourne Development Ltd. last year. Shelbourne founder Garrett Kelleher retained Calatrava and the now familiar twisting spire motif, but the December unveiling of a new, bulked-

up design drew derisive comments from the local architecture community.

Within weeks, a new and seemingly slenderer model and rendering were circulated among certain Chicago players. An official, even more refined scheme was presented during meetings with the general public and neighborhood community groups in late March, when the developer revealed that the tower's form would continue to be honed during design development. Chicago-based Perkins+Will is the associated architect.

The most recent schemes place the tower on a broad plaza above seven levels of underground parking. A soaring glazed base surrounded by seven piers resembles a faceted, transparent egg. The once-blunt roof now tapers to a dome; as many critics have

→ *continued on page 30*



SANTIAGO CALATRAVA/SHELBOURNE DEVELOPMENT LTD.

The newly redesigned base of the Chicago Spire.

Clay Salon
New York City



CASCADE COIL DRAPERY

www.cascadecoil.com

20 Years

800-999-2645

**Tough keeping up
with all the energy
legislative changes?**

**em3, energy management
from Leviton, keeps you
on track.**

**ENERGY
MANAGEMENT**

Potential annual cost-savings
with em3 from Leviton

U.S. Capital, Washington DC

\$14,850

The industry's only single source of
energy saving occupancy sensors, dimmers,
relays and daylighting controls
can save:

36%

EM3 Applications include Occupancy Sensor, Dimmer in commercial
office space EPA 42CFR 99.023

em3. vision + technology + solutions.

em3 is the future of energy management. We're your single source for complete energy management and lighting control solutions. With over 100 years of experience behind us, we have the vision, technology and solutions to help you specify code compliant, efficient and functional systems.

Whether you're designing for a new building or retrofitting an existing one, em3 is the only single source for a completely integrated system, from occupancy sensors and dimmers to relays and daylighting controls. Our ISO 9001 certified manufacturing assures strict quality standards and continuous innovation.

You're familiar with ASHRAE 90.1-1999. There's an even tougher management code. Leviton's. Our full range of high-performance energy management products are designed to reduce overhead, maintain code compliance and deliver innovative cost-saving solutions. We'll even take your CAD drawings and provide occupancy sensor layouts fast, and at no cost, to make your design development time efficient as well.



Put us to work on your next project.
Call Leviton at 800-323-8920 or visit us at www.leviton.com.
Circle no. 409 or <http://architect.hotims.com>



the future of energy management only from Leviton

noted, this gives the entire tower the unfortunate form of a sex toy.

At press time, the new plans were scheduled to be presented to the City Plan Commission on April 19. If approved, zoning review would likely take another three to four weeks, with subsequent approval by the city council expected

shortly thereafter. Kelleher is targeting May for groundbreaking, despite the unlikely scenario that the approval process will be complete by the end of this month.

Doubts remain regarding financing. Kelleher has released no pricing for the units and does not intend to do so until the third quarter of this

year—well after the proposed start of construction. Overall costs are expected to soar above the \$1.2 billion announced for the initial scheme and will likely require the priciest apartment listings in the city. A planned 40-month construction schedule would see the building's completion no earlier than late 2010. EDWARD KEEGAN



Designed with You in Mind!

At the recent AIA show, Architects asked Nichiha representatives if we could produce a product that had an orange peel type surface that was affordable and easy to install. Today we have that product for you - **Nichiha Architectural Block**. Here is what you get; a 50 year warranted panel, (either pre-finished or primed), that installs 9 sq. ft. at a time and can be on the wall installed for \$5.50* per square foot. We can't wait to see what you'll ask for this year!

**based on national average for product in installation.*



Design Flexibility

Available in a variety of textures and colors



Quick Installation

Installs 9 sq. ft. (18" x 72") at a time



1-86NICHHA-1 or visit NICHHA.com

Fiber Cement at It's Best™

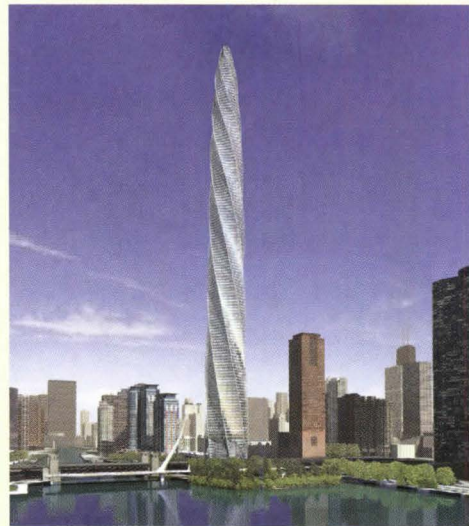

The latest iteration of Calatrava's Chicago Spire, as it would appear in the city's skyline.

SANTIAGO CALATRAVA/SHELBORNE DEVELOPMENT LTD.

Moves

Gensler Promotes 21 to Principal

ARCHITECTURE AND INTERIOR DESIGN firm Gensler, which employs more than 2,300 people and has 30 offices across the globe, announced in late February the appointment of 21 new firm-wide principals (listed by home office):

- Boston: Kenneth Fisher
- Chicago: Todd Baisch
- Dallas: Ted Kollaja
- Denver: Ala Hason
- Houston: Stephanie Burritt and Steve Hudson
- Las Vegas: Hunter Clayton and Robert Stefko
- London: Trevor Oldridge and Gary Wheeler
- Los Angeles: John Adams, Barbara Bouza, and Kevin Heiny
- New York: Lance Boge, Rocco Giannetti, Thomas Lanzelotti, and Keith Rosen
- San Francisco: Lisa Bottom, Barry Bourbon, and John Duvierv
- Tokyo: Nachiko Yamamoto

The firm, which *DesignIntelligence* ranked in 2006 as the largest U.S. architecture firm (based on annual revenue), has also appointed 62 new senior associates and 152 new associates across all of its offices.

At one point all of these buildings had one thing in common.

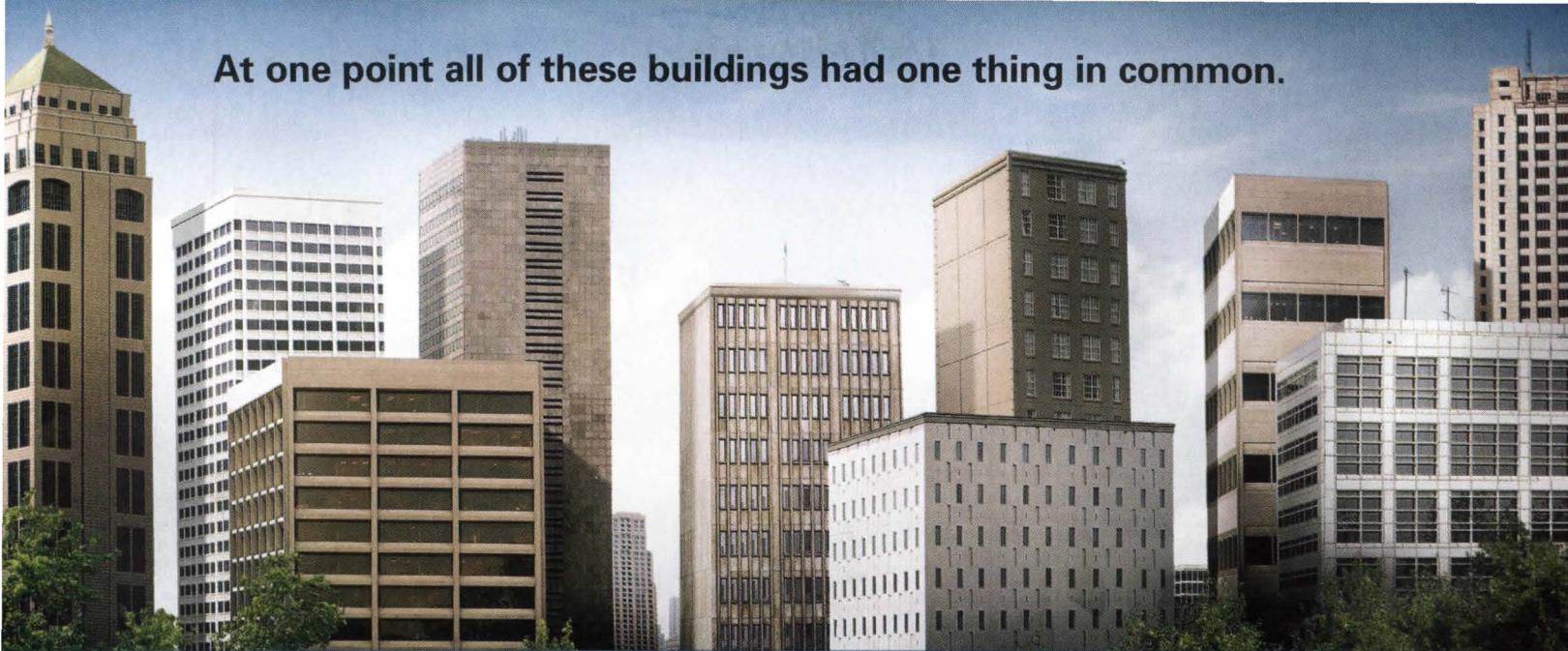

DensGlass Gold® Exterior Sheathing.

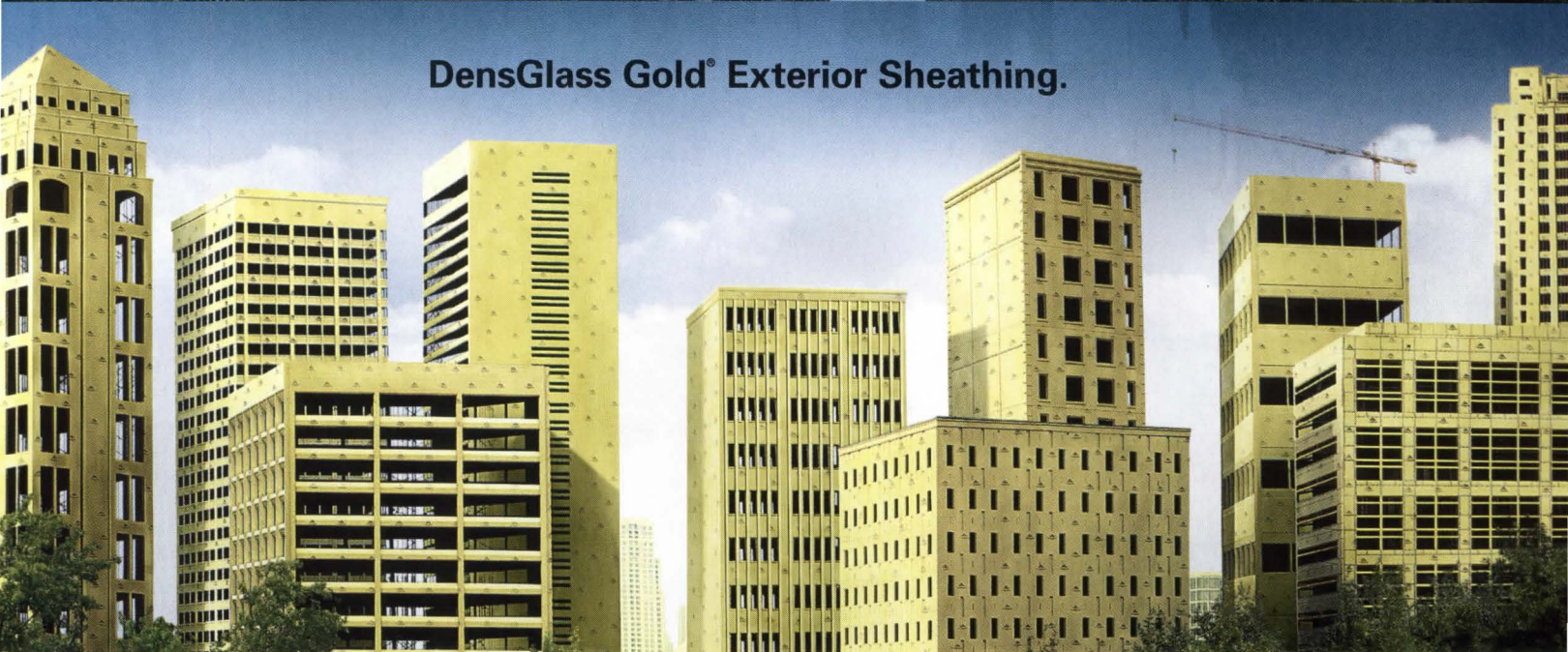

DensGlass Gold: A Legacy of Proven Performance.

With years of proven performance, DensGlass Gold is the market leader for exterior sheathing applications in commercial construction. In fact, DensGlass Gold is so moisture and weather resistant, it's warranted to withstand the elements for up to six months of exposure.

It's no wonder architects recommend DensGlass Gold as *the* exterior sheathing solution for reliable moisture and mold resistance.

To learn more, go to www.densglassgold.com. Technical information: 1.800.225.6119. Literature requests: 1.800.BUILD GP.



Circle no. 419 or <http://architect.hotims.com>

©2007 Georgia-Pacific Gypsum LLC. The Georgia-Pacific logo and all trademarks are owned by or licensed to Georgia-Pacific Gypsum LLC. All rights reserved.



Why is this house and its beautiful windows upside-down? And where's the headline on this ad? By the way, do you know how to make a "Mary Got Hit by a Chicken Truck?" Well, you will. Because we're dropping the recipe right here in the middle of the copy.

MARY GOT HIT BY
A CHICKEN TRUCK
10 oz. tomato juice
1 oz. pepper vodka (optional)
1 tsp. horseradish
dash of hot sauce
pinch of salt
fresh ground pepper

There. That's what we call freedom. Upside-down windows. No headline. Mary Got Hit by a Chicken Truck.

Freedom. It's our mantra. And that's why we offer fifty standard colors, nine wood species, and eleven interior finishes.

You like the freedom? We think you will.

EagleWindow.com 1-888-74-EAGLE



Circle no. 30 or
<http://architect.hotims.com>



As genuine as you.

GenuineStone.org



Preservation

Beyer Blinder Belle to Restore Empire State Building's Lobby

THE EMPIRE STATE BUILDING delivered the last word in the 1930s skyscraper height wars, but fame has not exempted it from the ongoing competition of contemporary office design. Its Art Deco lobby will undergo a restoration and

upgrade by Beyer Blinder Belle Architects & Planners (BBB), pending approval from the New York City Landmarks Preservation Commission. Finished in floor-to-ceiling marble, the double-height lobby was designed by Shreve, Lamb and

Harmon and completed in 1931. The building became a protected city landmark in 1981.

As part of the restoration, an original ceiling mural in gold and aluminum leaf depicting a linear constellation of abstract, machine-age starbursts would be revealed and rebuilt after stripping away 1960s fluorescent lighting panels. "Ceilings were an integral part of many Art Deco buildings' personality," says BBB partner in charge Richard Metsky. "They set the mood, theme, and setting for office tenants and guests." New ceiling cove lights using energy-efficient, cold-cathode technology would recall the lobby's original incandescents in illuminating the mural and providing ambient light. In addition, carefully placed spotlights would shine straight down, eliminating the glare that currently mars the walls. BBB is also studying ways to improve reception, signage, and security in conjunction with overall renovations being made by building owner Empire State Building Associates.

BBB has previously restored the lobbies of other Deco landmarks in New York, including the Graybar Building, Rockefeller Center (lower concourse), and the Chrysler Building, which in 1930 preceded the Empire State Building as the tallest tower in the world. GIDEON FINK SHAPIRO

The Oval Series | DARING TO BE DIFFERENT



Exclusivity from Lumece

> Innovative design

- Superior photometric performances
- Ease of maintenance
- Dark Sky compliant
- Added value for Leed projects

www.lumece.com | T.: 450.430.7040 | A Genlyte Company



Inspired by light

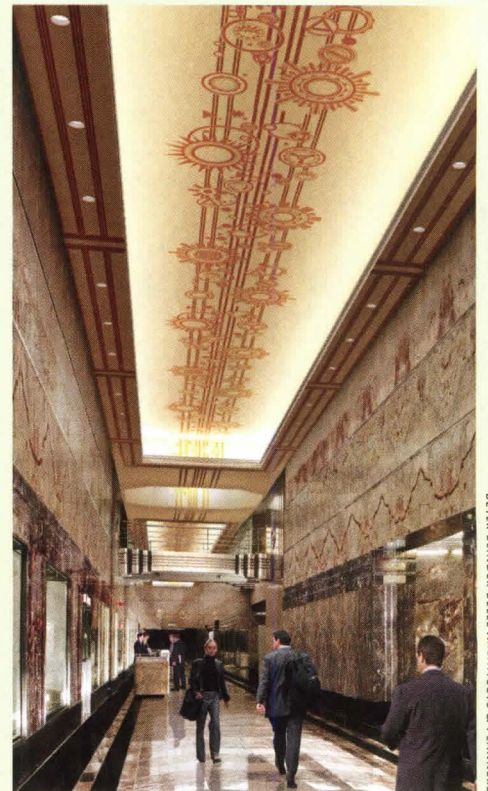

A rendering of the Empire State Building's restored lobby. The Deco-era ceiling mural has been hidden for decades.

BEYER BLINDER BELLE ARCHITECTS & PLANNERS

ARCHITECTURAL MESH SYSTEMS

BELLAGIO



System: Facade
Attachment: Eclipse®
Metal Fabric: Stripe
Project: Bellagio Parking Structure
Architect: HKS

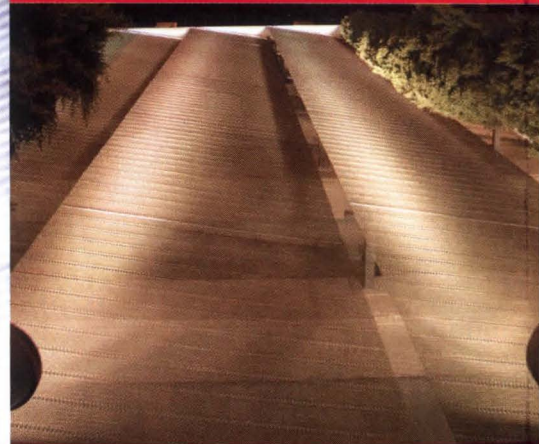

Bellagio chose the Cambridge Facade System to glamorize their parking facility.

Long flowing drapes to turn the ordinary into the monumental.

Jackpot.

TOLL FREE 1 866 806 2385
WWW.CAMBRIDGEARCHITECTURAL.COM



A DIVISION OF CAMBRIDGE INTERNATIONAL

Earn 1-hour AIA learning credit online today. Visit www.cambridgearchitectural.com/continuing.aspx

Circle no. 24 or <http://architect.hotims.com>



Public Space

Competition Finds an Updated Look for Nathan Phillips Square



COURTESY PLANT/STIP/PLSLA/AB

A proposed renovation of Toronto's iconic space includes a new stage (at center of rendering), new fountains, and a 60 percent increase in trees.

VILJO REVELL'S STARK 1965 Nathan Phillips Square fronting Toronto's City Hall—two curving towers that surround the saucer-shaped Council Chamber—will be renovated by a team of architects and landscape designers who seek to energize the plaza's civic functions with the-

atrical interventions that sensitively extend the midcentury design's original layout. The proposed design, chosen via a competition that solicited proposals from 48 firms, is by Toronto-based PLANT Architect and Shore Tilbe Irwin & Partners, Chicago-based Peter Lindsay Schaudt Landscape Architecture, and architect/planner Adrian Blackwell.

Borrowing from the ancient Athenian precedent of a stoa (portico) surrounding an agora (public space), the design develops a porous layer of perimeter program elements around the edges of the multiblock downtown plaza. Conceived as outdoor green rooms, the interventions comprise a new Queen Street forecourt, a renovated Peace Garden, the Treetop restaurant, an entry/bike pavilion, and a playground. These spaces will be forested, with a 60 percent increase in trees.

The plaza's iconic elements—the Council Chamber, the Freedom Arches, and the Ceremonial Ramp—will be retained. A new stage will provide focus for events and is designated as the fourth primary element. New lighting, seating, and “disappearing” fountains will animate the plaza's surface. The dual levels of the existing plaza will receive additional connections via new elevators, stairs, and ramps. New program elements such as the restaurant, a skate pavilion, and an entry kiosk will bridge the levels as well, to provide increased access and communication between each part of the plaza.

The City of Toronto has committed \$16 million for the renovation. Construction is expected to begin once the remainder of the \$40 million budget has been raised. EDWARD KEEGAN

Tastes Great



Great Taste



Keeping a lid on noise
just became more tasteful.

Introducing **Tectum Fabri-Tec™** wall panels featuring abuse-resistant woven designer fabrics – the tasteful solution to all your acoustical challenges. For more information about the new look in noise control, visit www.tectum.com.

Visit us at AIA, #17054.



1-888-977-9691

TECTUM

The Noise Control Solution

www.tectum.com

Circle no. 441 or <http://architect.hotims.com>

AWARD WINNING

THE EYE CENTER OF COLUMBUS
AMB Development Group
Brick in Architecture: Silver Winner

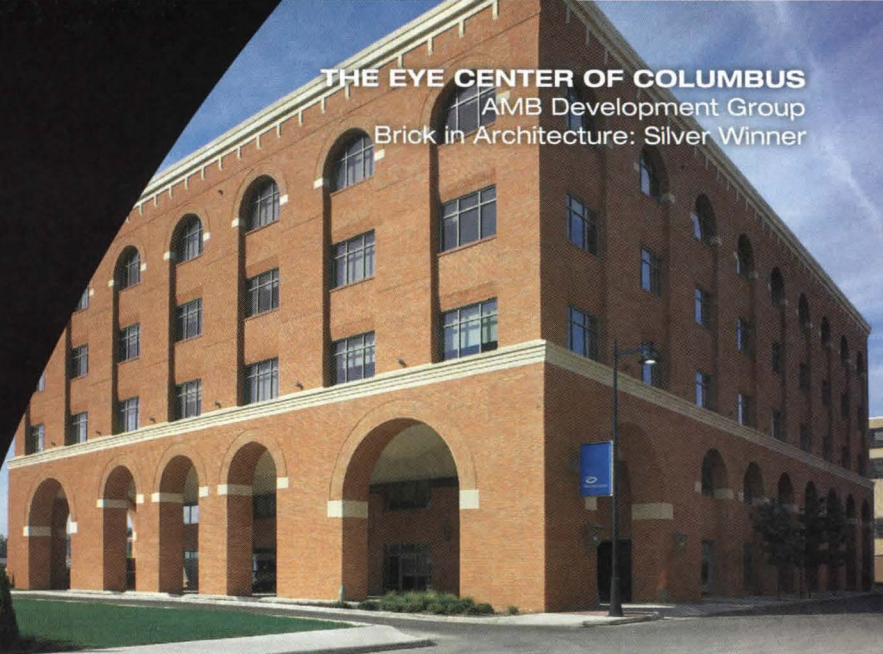

HOLOCAUST MEMORIAL CENTER
Neumann/Smith & Associates
Masonry Construction Magazine: Project of the Year, 2006

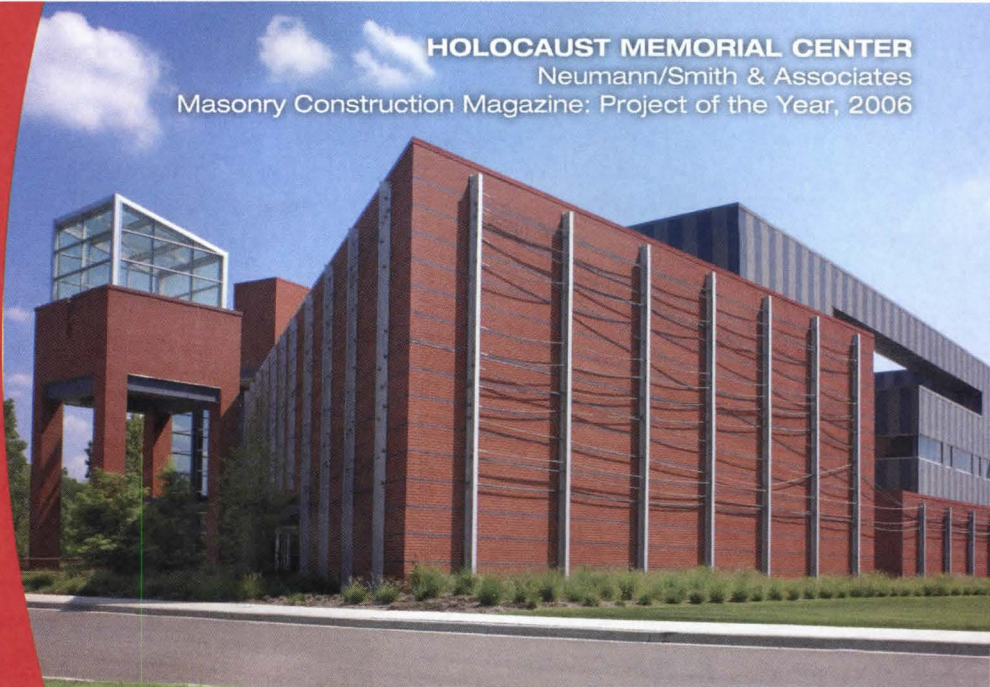

BROMPTONS AT MONUMENT PLACE
WHA Architecture & Planning PC
Brick in Home Building: Best in Class - Multi-Family Design

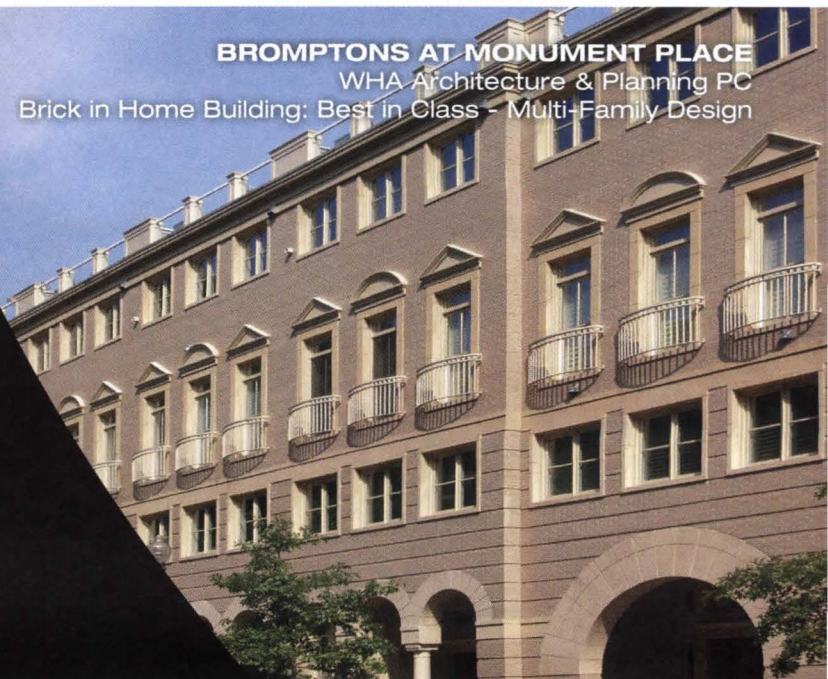

Belden Brick received eleven awards in the 2006 Brick in Architecture and Brick in Home Building Awards competitions sponsored by the Brick Industry Association. An award-winning manufacturer of the very highest quality brick for more than 122 years, Belden Brick offers architects beauty, versatility, unlimited design potential and enduring appeal. For your next award-winning project, specify Belden Brick.

An ISO 9001:2000 Registered
Quality Management System

BELDEN
THE BELDEN BRICK COMPANY

Canton, Ohio / 330-456-0031

www.beldenbrick.com

Circle no. 82 or <http://architect.hotims.com>

Federal Buildings

GSA Gives Design Excellence Awards to 18 Projects

THE U.S. GENERAL SERVICES ADMINISTRATION (GSA) has announced the winners of its 17th annual Design Excellence Awards program. Open to all GSA-commissioned projects, whether completed or not, and covering a variety of categories, the program each year is juried by an independent group of private-sector professionals who may or may not have done prior work with the GSA.

According to Thomas Grooms, director of design excellence and the arts for the Office of the Chief Architect at the GSA, the jury is generally composed of 11 individuals "that represent a broad spectrum of disciplines" and is always chaired by an architect. Also included in the group are a construction industry professional, curator, landscape architect, graphic designer, engineer, and at least two preservationists. This year, for the first time, a woman chaired the jury. Boston architect Joan Goody, principal at Goody Clancy, led the group in analyzing 120 projects in 17 categories over the course of the two-day decision making process.

This year's honor award for completed architecture went to Gruen Associates and Moore Ruble Yudell for the U.S. Courthouse in Fresno, Calif.; citations were awarded to the Oklahoma City Federal Building, by Ross Barney Architects and the Benham Cos.; the Carl B. Stokes U.S. Courthouse and Federal Office Building in Cleveland, by Kallman McKinnell and Wood Architects and Karlsberger Architecture; and the U.S. Border Patrol Station in Murrieta, Calif., by Garrison Architects.

An honor award for on-the-boards architecture was awarded to the

Peace Arch Port of Entry in Blaine, Wash., designed by Bohlin Cywinski Jackson, and a citation in the same category was awarded to Lehman Smith McLeish's Broadway Entry Pavilion at New York City's Jacob K. Javits Federal Building. The Howard M. Metzenbaum United States Courthouse in Cleveland and firm Westlake Reed Leskosky were awarded a citation for preservation, and the Des Moines, Iowa, Federal Building façade replacement designed by SmithGroup and DesignBuild Solutions was awarded a citation for modernization. (Seven of these projects are shown on the following pages. Not shown: the Broadway Entry Pavilion.)

Other projects were selected for honor awards and citations in the categories of lease construction, conservation, sustainability and adaptive reuse, sustainability in the workplace environment, interior design in the workplace environment, engineering and technology, graphic design, and construction excellence. In all, 18 projects received awards.

The goal when selecting the award-winning projects, says Grooms, is to "look for the best of the best, which are projects that can be used as models for both the GSA and the private sector." In order to narrow the field, the jury examines each of the submitted projects within the context of seven criteria, four of which are, according to Grooms, "functionality—the building should function properly and have all the technical requirements; high aesthetic quality; sustainability; and whether or not a project is cost-effective on a life-cycle basis." More information on the winners and on the program can be found at www.gsa.gov. **KATIE GERFEN**

How **Strong** Is Your ICF Coating?



As an ICF builder, isn't one of your best selling points the strength of the wall? **Then why not put a soft coating on the outside surface?** The solution is PermaCrete—the only cementitious coating specifically approved by the ICC for ICF construction. No surface is stronger, and no surface is more durable!

PERMA•CRETE

www.permacrete.com

(800) 607-3762





Because your reputation is on the line every day.

We make DuPont™ Tyvek® CommercialWrap® for professionals who build quality into every job. After all, it's architects and contractors like you who have made us the industry leader for over 25 years. And you're why we continue to develop innovative products, systems and services for the commercial market, like the 10-year Limited Warranty that gives added peace of mind with every job and the DuPont™ Tyvek® Specialist Network that supports you on and off the site. DuPont™ Tyvek® Weather Barrier Systems – they're all about building a better building and an even stronger reputation. For more detailed info and specs, visit construction.tyvek.com

DuPont™ Tyvek®: CommercialWrap® • Wrap Caps • Tape | DuPont™: FlexWrap™ • StraightFlash™ • StraightFlash™ VF

© 2007 DuPont. All rights reserved. The DuPont Oval Logo, DuPont™, Tyvek®, Tyvek® CommercialWrap®, FlexWrap™, StraightFlash™ and StraightFlash™ VF are registered trademarks or trademarks of E. I. du Pont de Nemours and Company or its affiliates

Circle no. 29 or <http://architect.hotims.com>



Tyvek.

→ GSA Awards, from page 38



U.S. Courthouse, Fresno, Calif. (honor award: architecture, completed projects)—Gruen Associates and Moore Ruble Yudell



Oklahoma City Federal Building (citation: architecture, completed projects)—Ross Barney Architects and the Benham Cos.

University Arena Earns Award for Sustainability

The University of Iowa's Carver-Hawkeye Arena receives fourth annual Sika Sarnafil Sustainable Roofing Performance Award

The Carver-Hawkeye Arena at the University of Iowa has been the site of many winning performances, including that of its roof.

The Arena's original Sarnafil roof was installed in 1981, and because of its advancing age, the University had been planning to gradually phase in a new roofing system. That plan changed on April 13, 2006 when an unusually severe storm damaged parts of the roof. The University evaluated several roofing options but ultimately chose to re-roof with Sarnafil membrane.

A win/win situation

Vinyl recycling is well established with millions of pounds recycled every year. Increasing landfill restrictions are escalating the demand to recycle roofs at the end of their useful life.

In the case of the Carver-Hawkeye Arena, recycling the

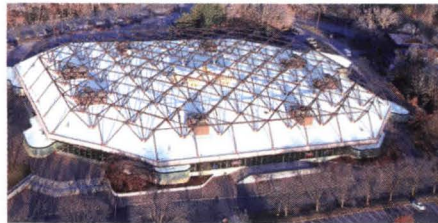

old roof was the most sustainable solution. The material was diverted from the landfill back to Sika Sarnafil to be processed into new roofing products. "I think this will be something that owners will want to be a part of," said Jeff Hayes, engineer at the University of Iowa. "It's a win/win situation for everyone."

Team effort key to high quality solution

Recycling the old roofing system requires a team effort. The partnership of Sika Sarnafil, Benchmark Inc,

the roofing consultant, and CEI Roofing Texas, the roofing contractor, proved to be a winning team. The result was a successful recycling project and the delivery of a high quality roofing system for the University of Iowa.

"By choosing to recycle their old roof, the University of Iowa demonstrated its commitment to sustainable building practices," said Brian Whelan, president of Sika Sarnafil Inc. "With a long service life and the ability to be recycled, vinyl roofs like Sika Sarnafil's, provide a significant sustainability advantage.

The specification of a Sika Sarnafil roof results in the lowest lifecycle costs and the lowest total environmental impact. That's why we felt the Carver-Hawkeye Arena deserved the 2007 Sika Sarnafil Sustainable Roofing Performance Award."

Visit www.sarnafilus.com/recycle to learn more about roof recycling.



Sika Sarnafil Inc., Tel. 1-800-451-2504
www.sikacorp.com

Sarnafil®



NOSY NEIGHBORS HAVE FINALLY MET THEIR MATCH

New Gold Bond® BRAND
SoundBreak™ Gypsum Board

She can listen all she wants, but she won't hear any gossip coming through the wall. That's because the architect specified SoundBreak. Using this revolutionary new gypsum board, you can add peace and privacy to high-density housing with high STC wall partitions that are thinner, more reliable and more cost-effective. Choose SoundBreak. Because you can't choose your neighbors.

National 
Gypsum®

Technical Info: 1-800-NATIONAL
or visit www.soundbreak.info
Circle no. 435 or <http://architect.hotims.com>

Excellence Across The Board®

→ GSA Awards, from page 40



Carl B. Stokes U.S. Courthouse, Cleveland (citation: architecture, completed projects)—Kallman McKinnell and Wood Architects and Karlsberger Architecture



U.S. Border Patrol Station, Murrieta, Calif. (citation: architecture, completed projects)—Garrison Architects



burning desire

Reinstating the gas fireplace as a choice for the modern home.
Tel. 1.866.938.3846 www.sparkfires.com

Circle no. 398 or <http://architect.hotims.com>



SPARK
modern fires



designers aim the light
 maintenance re-lamps the light
ELEMENT remembers the light

the first downlight with a lens rotation locking system



ELEMENT 

for more information or a product demonstration visit us at booth #1621 at
www.element-lighting.com

Circle no. 384 or <http://architect.hotims.com>

Certain features shown in this ad are patent pending. Copyright © 2007 Element. All rights reserved. The "Element" graphic is a registered trademark of Element.



→ GSA Awards, from page 44



Des Moines, Iowa, Federal Building (citation: modernization)—SmithGroup and DesignBuild Solutions

Are Your Specifications *Obsolete*?



Only BSD SpecLink:

BSD
Building Systems Design, Inc.

- Verifies and updates **all** reference standards every year
- Immediately updates **every** section affected by a revised standard
- Includes a hyperlink to a free synopsis and a download or purchase opportunity at each citation
- Lets you decide with *one* mouse click whether to include publication dates on all reference standards
- Creates an optional consolidated list of all reference standards in your project - automatically

Our competition doesn't even come close!

BSD
speclink

Call us today to set an appointment for a free, on-line product demo,
or download a free demo at www.bsdssoftlink.com

1-888-BSD-SOFT
1-888-273-7638



innovation
design
technology
diversity

Visit us at the Pavilion of Spain at AIA, San Antonio, May 3-5, Booth 15213.



tile of spain®
be creative

"works with both floor and wall displays."

"just the decorative touch we need."

"three times the lumen power of incandescents."

FREEDOM OF CHOICE WITH MODULEX M3

actual size 3" halogen and metal halide recessed downlights,

countless interchangeable optics and trim pairings.



www.ardeelighting.com 1-888-442-7333

Genlyte Group LLC. All rights reserved.

Circle no. 411 or <http://architect.hotims.com>

REPORT NEWS

Landmarks

12 Sites Receive Historic Designation

A DOZEN PROPERTIES were declared National Historic Landmarks by the U.S. Department of the Interior in early April. Spread across 10 states, the properties were designated by Interior Secretary Dirk Kempthorne. The sites have to be recommended to the secretary by the National Park System Advisory Board, which voted on the recommendations at their

meeting this past December. Fewer than 2,500 historic sites bear the title of National Historic Landmark, which remains the highest status accorded to historic properties in the United States. Eleven of the newly designated sites named are shown below and on page 50. (Not shown: Fig Island, an archaeologically rich coastal site near Charleston, S.C.)

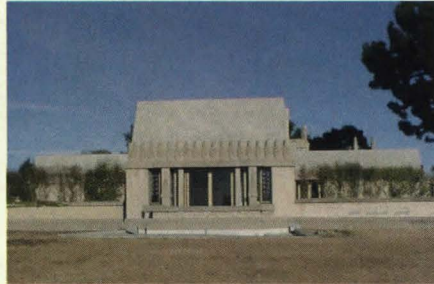

Aline Barnsdall Complex (Hollyhock House), Los Angeles, by Frank Lloyd Wright



Beth Sholom Synagogue, Elkins Park, Pa., by Frank Lloyd Wright



Price Tower, Bartlesville, Okla., by Frank Lloyd Wright



Naumkeag, Stockbridge, Mass., by McKim, Mead & White



Field House, St. Louis



Hegeler Carus Mansion, La Salle, Ill., by W.W. Boyington



House of the Seven Gables Historic District, Salem, Mass., restored by Joseph Everett Chandler

venicia™
BY KRAFTMAID®

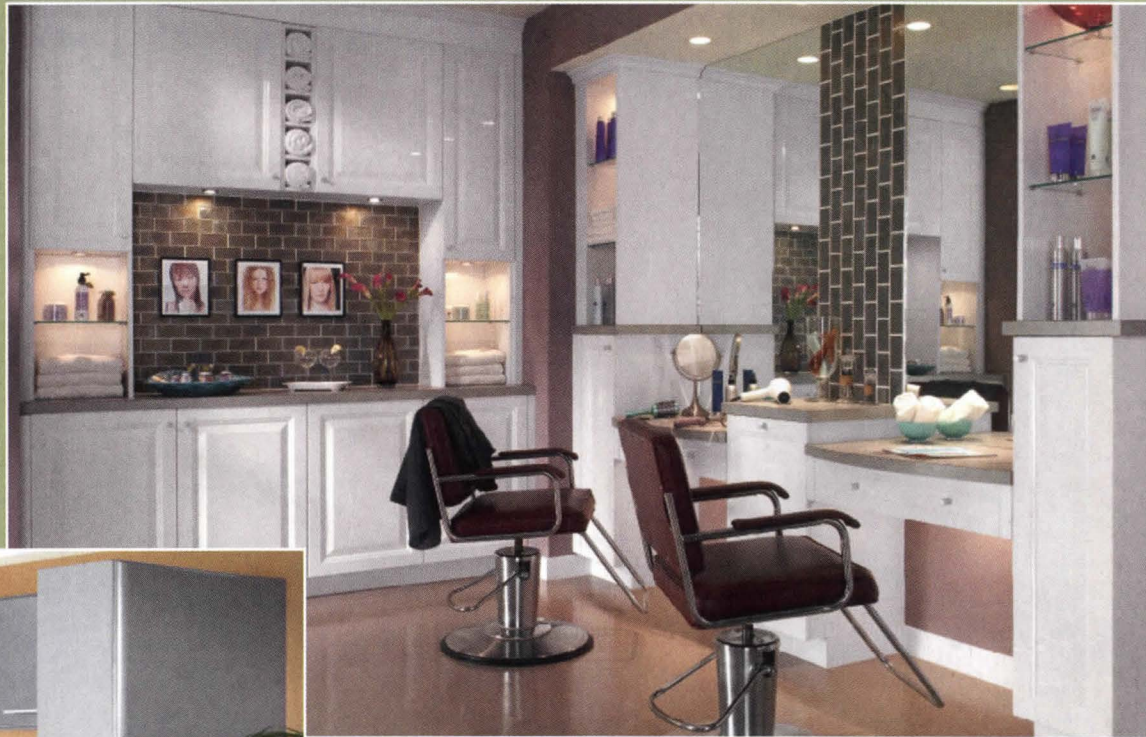

Venicia by KraftMaid is perfect for light commercial as well as residential applications.

Introducing cabinetry that is no longer a stretch of the imagination.

Introducing cabinetry that no longer requires you to stretch the timeline and budget.

Introducing Venicia™ | A brand-new line of open frame Euro-style cabinetry from KraftMaid that allows you to bring your vision into your project designs. With Venicia, you'll enjoy the endless design opportunities that come with these sleek and sophisticated lines, along with the affordability, flexibility and short lead times you've come to expect from KraftMaid. Thanks to Venicia, the design of your clients' dreams is the same one you've been dreaming of designing.

For information and complete product specifications, visit kraftmaidspec.com or call 800-581-4484.

Made just for you.

KraftMaid
Cabinetry

www.kraftmaidspec.com

Circle no. 41 or
<http://architect.hotims.com>

**HELP
IS
HERE.**

Get the 75-year Steel Joist Manual, the current Specs and Loads Catalog and comprehensive technical digests on steel joist construction at steeljoist.org/help



REPORT NEWS

→ Landmarks, from page 48



Washington Place, Honolulu

BURL BURUNGAME



Spring Grove Cemetery, Cincinnati,
by Adolph Strauch

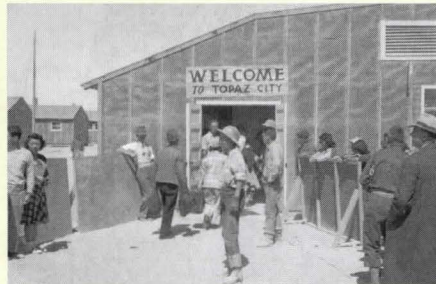

Central Utah Relocation Center Site (Topaz),
Millard County, Utah



Village of Mariemont, Hamilton County,
Ohio, by John Nolen and Philip Foster

Deadlines Competitions and More

MAY 18

PCI 2007 Design Awards

The Precast/Prestressed Concrete Institute has made the call for entries for its 45th annual design competition. Any structure in the United States, Canada, or Mexico that has been completed within the past three years and is substantially constructed with plant-manufactured precast, prestressed concrete, glass-fiber reinforced concrete, or architectural precast is eligible. Along with a number of best-in-class awards, there are also recognitions given for industry advancement, sustainable design, and the best all-precast structure.

pci.org

MAY 22

5 Gateways to Elysian Park

The Citizens Committee to Save Elysian Park is seeking proposals to design and construct five gateways that will create a cohesive identity for Los Angeles' oldest and second-largest city park, which contains the last remaining parcel of Pueblo lands that were part of the original Spanish land grant two centuries ago. Up to five artists, architects, or designers (in teams or individually) from the greater L.A. area will be selected to submit final proposals.

ccsep.org

MAY 31

International Urban Landscape Award

Eurohypo AG, landscape magazine *Topos*, and German magazine *A&W Architektur&Wohnen* present the 2007 International Urban Landscape Award. Projects should have been completed no earlier than 2000 and may be submitted by private and public clients or investors, planners, landscape architects, architects, and community organizations. Projects from European Union countries, Norway, Switzerland, Iceland, Canada, the United States, and Mexico will be considered.

iula.com

JUNE 1

Build Your Campus in 3-D Competition

Google SketchUp wants college students to use the 3-D design software to model their schools' campus buildings. Winners will receive a three-day, all-expense-paid trip to Google, and winning designs will be showcased online.

contest.sketchup.com

JUNE 15

CMAA Project Achievement Awards

The Construction Management Association of America annual Project Achievement Awards are open to association members and nonmembers. Eligible projects, programs, or program phases must have been completed between June 16, 2006, and June 15, 2007.

contest.sketchup.com

©2005 DuPont. All rights reserved. The DuPont Oval Logo, DuPont™, The miracles of science™ and Corian® are registered trademarks or trademarks of DuPont or its affiliates.



**VERSATILE HUES THAT
ADAPT TO ANY ENVIRONMENT.**

When you work with Corian® you can choose from the most extensive **COLOR** palette of any solid surface. See all the potential of DuPont™ Corian® Solid Surfaces in our Possibilities Magazine. Call 800-436-6072 or visit coriandesign.dupont.com for your copy.

DESIGNER Harry Allen
TITLE *Core Vase*
MEDIUM **CORIAN®**



Axor® Starck
The Discovery of Simplicity

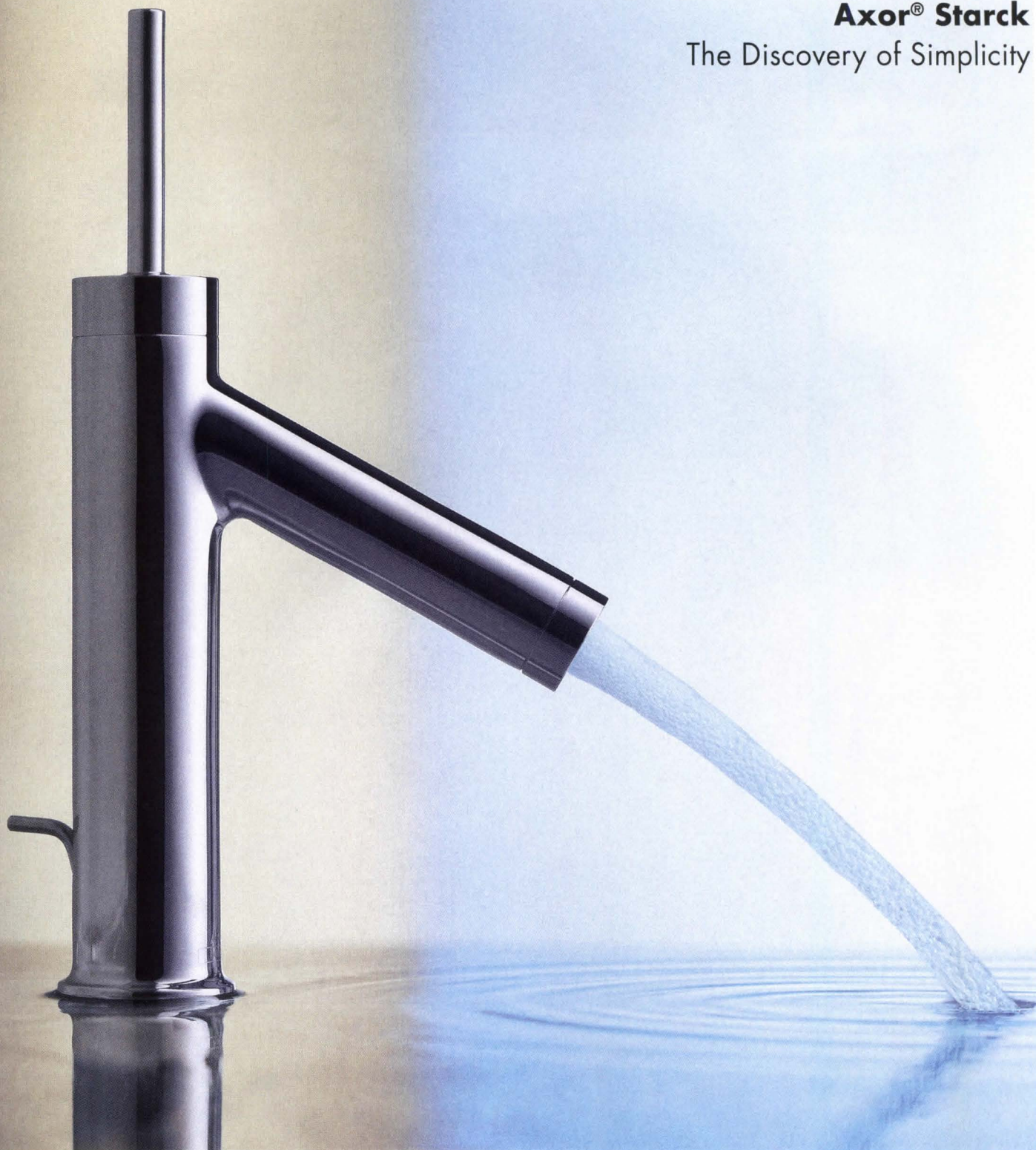

With Philippe Starck's unique bathroom vision, beauty doesn't need embellishment to be striking and timeless. The Axor Starck collection perfects minimalism and allows us to relax without distractions. The collection features a wide selection of products to create your perfect bath environment—from the two-handle design and stylish showers to wall-mounted faucets and universally appealing accessories.

See the entire Axor Starck collection at www.hansgrohe-usa.com, or call 800-334-0455 to add the serenity and purity of Axor Starck to your home. Circle no. 34 or <http://architect.hotims.com>

AXOR[®]
hansgrohe

There is no substitute for **Integrity.**

INSIGHT



TRE'O®

Architectural Digital Lighting

The significance of the TRE'O® family of performance architectural digital lighting is based upon technology and long term reliability: the convergence of science, design and sustainability.

Imagine multiple optical and white light temperatures, dimming, static color and RGB, numerous adjustable mountings and the Insight standard palette of finishes offered with the highest lumen packages currently available in a linear configuration. All provided with a 2 year warranty.

TRE'O® represents the most complete selection of digital LED linear lighting: what the architectural design community had in mind!

EXTERIOR & INTERIOR
ARCHITECTURAL
DIGITAL LIGHTING

© 2007 Insight Lighting, Inc. All rights reserved.

For more information, please contact your local Insight representative. 505.345.0888

www.insightlighting.com

Circle no. 429 or <http://architect.hotims.com>

February 2007

Construction Spending

From the U.S. Census Bureau's monthly report on the value of construction put in place

TOTAL CONSTRUCTION (SEASONALLY ADJUSTED)



Percent Change From:

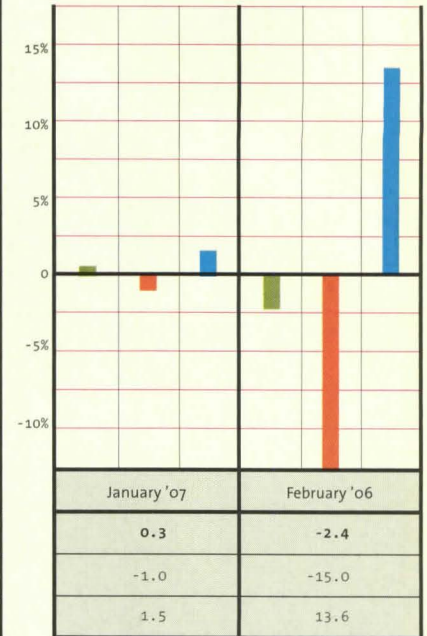

SELECT NONRESIDENTIAL CONSTRUCTION (SEASONALLY ADJUSTED)

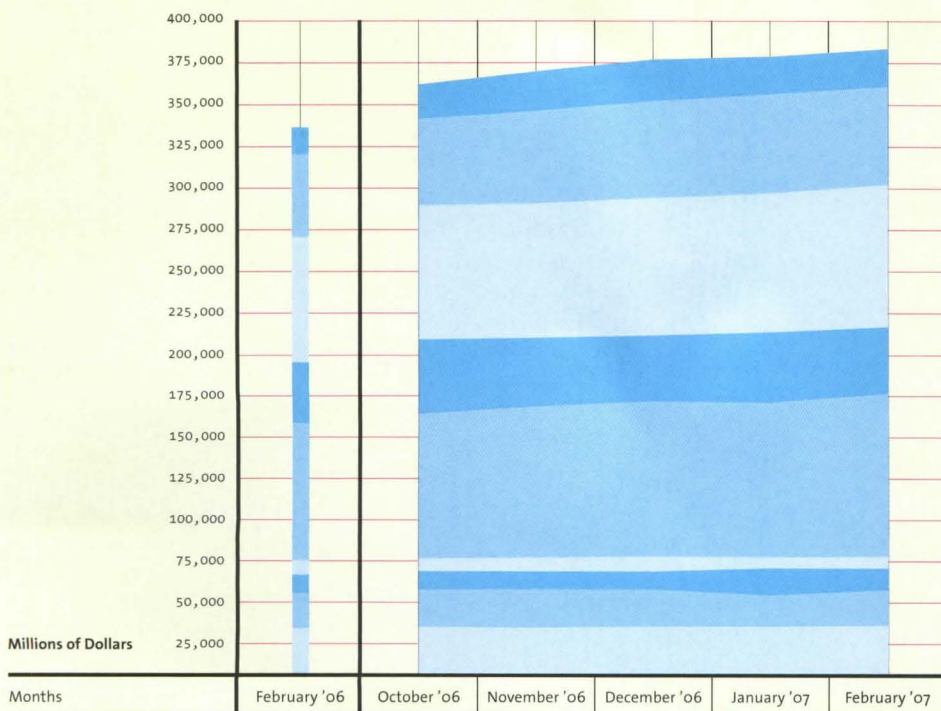

Category (February '07 Total)

- Lodging (23,909)
- Office (63,690)
- Commercial (84,144)
- Health care (45,514)
- Educational (90,123)
- Religious (8,293)
- Public safety (12,030)
- Amusement and recreation (22,035)
- Transportation (31,371)

arcat.com

Elegant Simplicity.



- **650 Manufacturer Specs and 300 Generic Short Form/Outline Specs**
All in the CSI 3-Part Format
Written by ARCAT
- **SpecWizard®**
Automated specwriting
- **6,000 Manufacturer CAD Details**
In .dwg & .dxf formats
- **11,500 Directory Listings**
Links to 11,500 sites

SpecWizard is a registered trademark of ARCAT, Inc., Patent Pending

ARCAT®

www.arcat.com

Circle no. 430 or <http://architect.hotims.com>

Tucson, Ariz.

A Sonoran Desert city is ripe with possibility



St. Augustine Cathedral's façade (at left), created between 1897 and 1928, was kept during a 1960s sanctuary overhaul.

"MOST PEOPLE THINK OF TUCSON AS SUNSHINE, CACTUS, AND GOLF," says Bruce Wright, associate vice president for economic development at the University of Arizona. "They're surprised we have a top university here and a robust and emerging high-tech industry. We're not a sleepy little retirement town in the desert."

Yet the city still retains some remnants of its frontier past. Plenty of people in the Old Pueblo (Tucson's nickname) still see lush possibilities in an arid landscape. Master planned communities, office parks, and resorts are supplanting cactus and creosote trees outside the city's center. And the historic downtown core is being redeveloped into a 24-hour community of business, recreational, and residential properties.

"The Tucson region is blessed with a strategic southwestern location, a diverse and educated workforce, a bilingual population, competitive cost of living, and direct access to the Mexico market," says Laura Shaw, vice president of marketing and communications at Tucson Regional Economic Opportunities Inc., an economic development organization.

Adds Wright: "There's a real entrepreneurial spirit here. This is a wide-open town with a pro-business atmosphere." MARGOT CARMICHAEL LESTER

POPULATION AND JOB GROWTH

Tucson has 1 million people and is growing about 2 percent annually. The civilian labor pool is approaching 450,000. Unemployment is currently around 4 percent.

OFFICE MARKET

Office vacancy is just over 12 percent, according to the Pima County Real Estate Research Council. The rental rate for existing high- and mid-rise space is \$24–\$25 per square foot, full-service gross.

RESIDENTIAL MARKET

Only about half of Tucson's residents can afford the \$257,900 existing-home median price.

MARKET STRENGTHS

- Strong job growth
- Low unemployment
- Low retail vacancy

MARKET CONCERNS

- Declining home affordability
- Potential job losses in information and manufacturing
- Strained transportation infrastructure

BUSINESS INCENTIVES

Empowerment Zone businesses are allowed to accelerate depreciation on new tangible personal property (up to an additional \$35,000 write-off in the year that the assets are placed into service). They also may be eligible for rollover and partial exclusion of gains on the sale of qualified assets.

FORECAST

"Tucson is turning the corner," says developer Adam Weinstein, president of The Gadsden Co. (With the Gadsden Purchase in 1853, the United States bought portions of New Mexico and Arizona, including Tucson, from Mexico.) "The city is making a commitment to downtown by creating nice mid-density projects for the core. And the biggest improvement is the [\$200 million in recently approved] transportation infrastructure improvements [including new-road construction and a four-mile street car route running from the University Medical Center to the Rio Nuevo development downtown]. That's going to make a big difference."

→ continued on page 58

HADDONSTONE



**Haddonstone - fine landscape ornaments
and architectural cast stonework**

If you seek high performance from cast stone, look no further than Haddonstone's collection of designs ranging from balustrading, quoins, porticos and window surrounds to statues, fountains, copings and landscape ornaments.

We also pride ourselves on our custom architectural designs. Contact us for our inspirational new 200 page catalog. We also offer a CD Rom containing our catalog, technical specification sheets, assembly advice, CAD drawings and video.

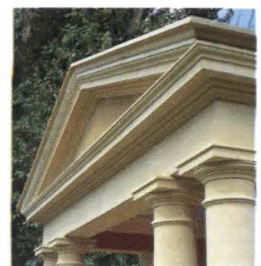

Haddonstone (USA) Ltd, 201 Heller Place, Bellmawr, NJ 08031 Tel: (856) 931-7011
Haddonstone (USA) Ltd, 32207 United Avenue, Pueblo, CO 81001 Tel: (719) 948-4554
info@haddonstone.com www.haddonstone.com

Circle no. 59 or
<http://architect.hotims.com>

KEY ARCHITECTS



GIL KINNY PHOTOGRAPHY

GRESHAM & BEACH ARCHITECTS

Major project: The 29,000-square-foot, \$5.4 million St. Andrew's Presbyterian Church, completed in 2005.

The firm was founded in 1995 after a 10-year affiliation with international architecture firm NBBJ.

ROB PAULUS ARCHITECT

Major project: The \$2.5 million, nine-unit Barrio Metalico residential project, completed in 2005, which won a Western Mountain Region AIA award.

Paulus, a Tucson native, founded the six-person firm in 1995.

SBBL ARCHITECTURE & PLANNING

Major project: The recently completed \$17 million, 122,000-square-foot mysis corporate headquarters building; developed by Bourn Partners.

The 22-person firm was founded in 1997 by Thomas Saylor-Brown.

KEY DEVELOPERS AND BUILDERS

PATHWAY DEVELOPMENTS INC.

Major project: The \$75 million Santa Rita Hotel conversion to a condo-hotel, scheduled to be completed in 2009; designed by Kevin B. Howard Architects.

Other Tucson projects include the Marriott Townplace Suites, the Casas Adobes Office Park, and several residential developments.

RANDI DORMAN, WARREN MICHAELS,
AND ROB PAULUS

Major project: The \$9 million indigomodern, a 22-unit "townloft" infill community for which the first phase is complete; designed by Rob Paulus Architect.

The trio also developed the award-winning downtown infill projects Ice House Lofts and Barrio Metalico.

KB HOME

Major project: The 85-unit Glenn Court, which received the Sonoran Institute's 2006 Building from the Best Award; designed by kb Home.

The company has 16 communities in the Tucson area and is the first builder in the state to earn National Housing Quality certification.

NOTABLE PROJECTS

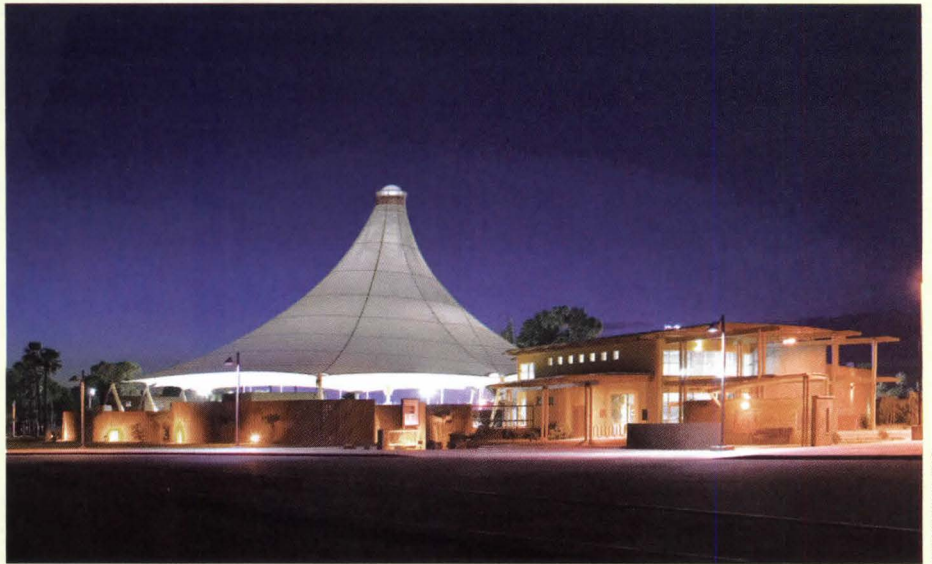

BILL TIMMERMAN

The \$6 million **Edith Ball Adaptive Recreation Center**, a public swimming facility designed for people with disabilities, features a general-use pool outside and an aquatic-therapy pool inside. The center received the Sonoran Institute's 2005 Green Building Award and the 2005 Outstanding Facility Award from the Arizona Parks & Recreation Association. Designed by Burns Wald-Hopkins Architects; developed by the City of Tucson.

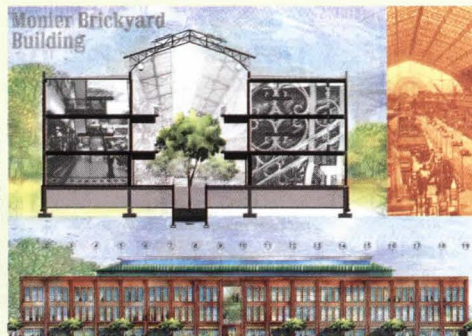

SBBL ARCHITECTURE & PLANNING

Located in Tucson's Rio Nuevo development—a billion-dollar plan to invigorate the city's downtown—the Mercado District of Menlo Park is a new 14-acre residential and commercial neighborhood under development by Rio Development Co. The **Monier Brickyard Building**, a 100,000-square-foot mixed-use complex designed by SBBL Architecture & Planning, will help anchor the neighborhood's retail center.



UNIVERSITY OF ARIZONA SCIENCE AND TECHNOLOGY PARK

The 1,345-acre **University of Arizona Science and Technology Park** has 2 million square feet of office, R&D, and lab space. (Above: Building 9070, by Paramount Architecture, completed in 2003.) Designed by various architects; developed by the University of Arizona.

One company ...
taking a wider view.

THE
VISTAWALL
GROUP

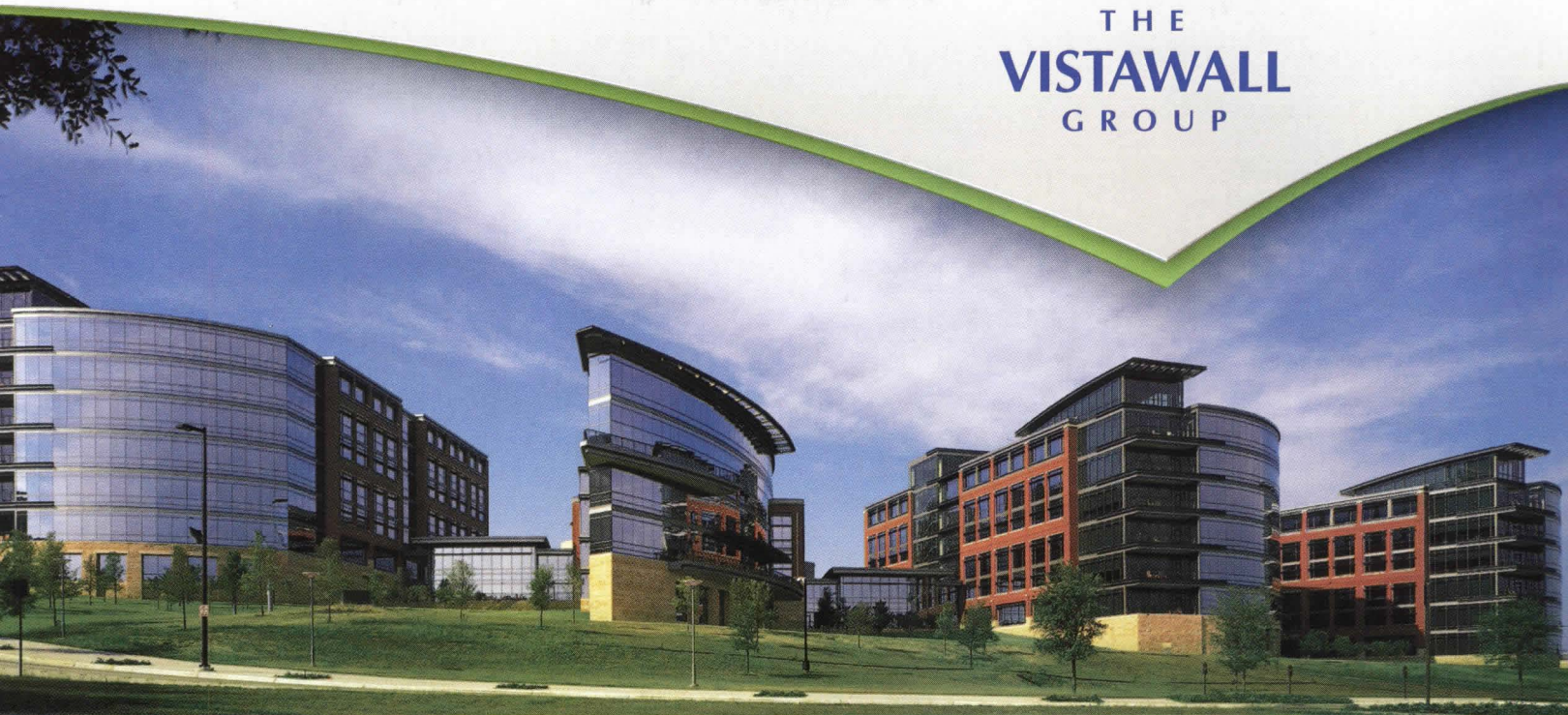

RadioShack® Corporate Headquarters – Fort Worth, TX
Architect: HKS, Inc. – Dallas, TX

Our wide range of products covers the full landscape of design possibilities.

From grand entrances to grand views, sunny atriums to airy offices, The Vistawall Group has it all covered, with custom **Vistawall** curtain walls, entrances and storefronts, plus our popular **Moduline** window systems, **Naturalite** skylights and **Skywall** translucent systems. And with streamlined production, aesthetic consistency, precise structural integration, on-spec performance and peerless project management, we've covered all the other bases, too. When you're selecting products for the exterior of your next building, give us a call.

Potential LEED® Credits:

EA Credit 1 – Optimize Energy Performance
EA Credit 2 – On-Site Renewable Energy
MR Credit 4.1 and 4.2 – Recycled Content
EQ Credit 2 (Indoor Environmental Quality) – Increased Ventilation
EQ Credit 6.2 – Controllability of Systems
EQ Credit 8.1 and 8.2 – Daylight and Views

Visit us at booth number 11071 at the 2007 AIA Convention and Expo.
Circle no. 52 or <http://architect.hotims.com>

THE
VISTAWALL
GROUP
A BlueScope Steel Company

vistawall.com

1.800.869.4567

upworld.com

Fostering digital connections to create real-world architecture

ONE OF THE MANY THINGS THE WEB DOES WELL, says solo architect Jennifer Magee, is enable reliable communication. As a result, small businesses and individuals that otherwise might not be in touch are able to connect. In the world of construction, there are a number of websites—such as ServiceMagic.com, Guru.com, and many discussion and directory-listing sites—that help bring architects, clients, contractors, and others in contact.

These resources are useful, says fellow architect Oisin Clancy, but limited in their ability to create business and make real-world construction happen because the relationships they foster tend to be linear and binary: “I have a job, you have skills. I have product, you need product.” They also presume that other aspects of getting something built, such as financing or planning, are already addressed. Which is why Clancy and Magee, both 33 and friends of several years’ standing, recently launched UPworld.com, a networking site that takes a “whole systems” approach and seeks to connect every part of the building community: real estate, planning, finance, development, design, construction, fabrication, and products. Here, architects and others can sign up (for free) and collaborate with professionals of all stripes from around the globe.

The site itself is an embodiment of its founders’ desire to bring together mutually beneficial, if occasionally far-flung, talents: Magee and Clancy are in New York City, the graphic designer is in North Carolina, and the developers are in Serbia, Ukraine, and India. And as befits a web presence that aims to traverse the globe, the English-only UPworld is learning new languages. Magee says French, Spanish, Italian, German, Chinese, and Japanese versions are in the works and could be available by year’s end.

Clancy’s small firm, Field Lines, has already benefited from the site’s creation. Soon after UPworld launched, Serbian architect Vid Bogdanovic, a 2-D and 3-D visualization specialist, used it to make contact with Clancy; Field Lines ended up hiring Bogdanovic. Now, because Bogdanovic has ties with engineers and others in Belgrade, Field Lines is designing a soccer stadium for that city. It’s a good example of what Magee and Clancy want UPworld to do: not just connect people in a virtual meeting space, but lead to actual construction.

After all, says Clancy, architecture is a physical endeavor, as well as a business. And so UPworld asks: Buildings will be created, but who will help them rise? And whether a structure is in Aberdeen, S.D., or Zwickau, Germany, why shouldn’t it be you? “A lot of the architects of my generation are content to work in the digital world,” Clancy says. “[Jennifer and I] want to see stuff get built.” **BRAULIO AGNESE**

Links

CONTRACTS

aiadocsondemand.ihs.com

The American Institute of Architects has partnered with technical information company IHS to create the AIA Documents on Demand eShop, where customers can purchase and download 10 of the most popular AIA contract documents.

I.T. SUPPORT



dell.com/sb360

For companies with little or no in-house tech help, Dell has launched Small Business 360, an online resource for finding industry-specific technology and business advice, community forums,

links to other helpful websites, and more. The initial industries targeted by Dell are architecture and construction, real estate, accounting and finance, law, and retail.

EARTH ARCHITECTURE

moreland-usa.com

Architect Frank Moreland has made earth-integrated buildings his life’s work. In 1975, as a University of Texas professor, he coordinated a National Science Foundation conference on earth-covered buildings and edited the published proceedings; he did the same for the Department of Energy in 1979. In 1981, he prepared a report for the Federal Emergency Management Agency. Moreland left academia that year to be a contractor and went on to build more than a dozen earth-bermed or -covered homes in and around Fort Worth, Texas. Now retired, he offers the benefits of his experience for free: Available for download are the government reports he edited and four books detailing the construction of two homes.

DOCUMENTARY

plasmatic-concepts.com/lariver

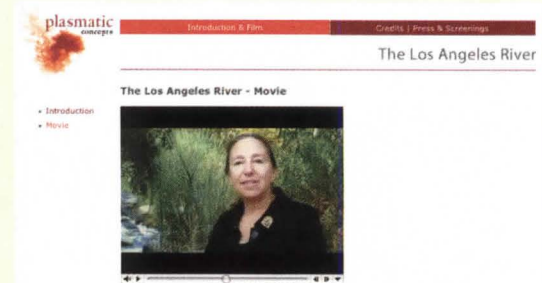

Los Angeles is developing a master plan to revitalize the 32 miles of the Los Angeles River within the city. To help stimulate discussion about the effort, local design firm Plasmatic Concepts has made *The Los Angeles River*, a documentary that explains “how current and past efforts have shaped the debate about what the river and its adjacent areas should look like,” says the firm. The 27-minute film, funded through a grant from the Graham Foundation, can be viewed on the Plasmatic Concepts website (pictured: deputy L.A. city engineer Deborah Weintraub). Select public screenings are also taking place.



PELLA ADVANTAGE NUMBER 67:

YOUR PROJECTS WON'T LOOK LIKE ALL THE REST.



Not every project is cut out for aluminum. Pella builds a broad offering of wood and fiberglass commercial windows to fill any opening. From punched openings to ribbons. Entrances to window walls. More choices so you can break the mold. That's **The Power Of Yellow.**SM

Call **866-70-PELLA** or visit pellacommercial.com.

Circle no. 396 or <http://architect.hotims.com>



COMMERCIAL



GINGER®

Circe™ Collection Beveled Mirror
gingerco.com

Circle no. 407 or <http://architect.hotims.com>

LUXURY BATH FIXTURES LIGHTING MIRRORS ACCESSORIES

INSURANCE BROKER GREG KUMM EXPLAINS HOW TO CYA. Text Fred Bernstein Photo Anne Senstad

ERRORS AND OMISSIONS



Firms should carefully select their insurance—and probably expect to use it, says independent insurance broker Greg Kumm.

THERE CAN'T BE MANY THINGS THAT PEI COBB FREED, Richard Meier, Alexander Gorlin, and FXFowle have in common, except that they all buy insurance through Greg Kumm. Kumm is an independent broker, meaning he can sell insurance from any underwriter, and he counts some 400 architecture firms among his clients. Though architects need workers' compensation insurance (protection if an employee slips and falls in the office) and an "office package policy" (if it's a visitor who tumbles, or there's a fire or a burglary), the main focus of Kumm's practice is providing errors and omissions coverage—the insurance that covers claims arising from provision of architectural services. Amazingly, he says, about a third of policies are subject to claims in a given year, and when there are payouts, they average more than \$200,000. No wonder, he says, that insurance may be the third largest expense after salaries and rent for many architects. Expect to pay at least 2.5 percent of your annual billings, and that's for \$1 million in coverage—which may not be enough.

Don't buy the cheapest insurance.

Out of more than 1,000 U.S. property and casualty insurance companies, only about a dozen write liability policies for architects, Kumm says. Still, it's important to select the right one from that dozen. "We do our due diligence, to make sure a company has the manpower and expertise to properly insure architects—some just flat-out do it better than others," he says, adding that "one company, Victor O. Schinnerer, an underwriter for CNA insurance, has been consistent and reliable for 50 years, and a lot of our business goes to them."

Think about how much coverage you need.

Most architects carry \$1 million in coverage. But given the size of some claims today, most firms should be looking at limits of \$2 million or more, Kumm says. Some clients are even requiring architects to have \$5 million in coverage (which costs roughly three times as much as \$1 million). If you don't have \$5 million in coverage, you could lose commissions to firms that do. Some architects hope that a project policy—covering a specific job—will be the answer, especially if the client is willing to pay part of the premium. The reality is that very few insurers offer project policies. When they do, the cost is high, and clients aren't lining up to pay.

Be especially careful if you design condos.

Architects often get caught when condo buildings are defective. The developer promotes the building as very high quality, of course, but he may not deliver that quality because of cost. When the building sells out, the developer—almost always a limited liability corporation—is dissolved. When a unit owner

has a problem with the building, there's nobody to go after but the architect, who remains liable for errors and omissions. Insurance companies know this, so a firm that does lots of condominium projects is going to pay more for insurance than a firm that doesn't. The best advice is to "qualify your client," Kumm says, meaning don't design a condominium building unless the developer has a record of doing quality projects.

Plan for the future.

Under a normal errors and omissions policy, coverage is available only if a policy is in force when the offending services were rendered and when the fault is discovered and a claim is made. In New York and other states, where the statute of limitations for negligence claims isn't clearly established, you may have to have a policy in force for the rest of your life. If you're thinking of retiring or closing up your practice, you'll need to insure against possible future claims. Speak to your broker about a "tail" policy that covers you for claims based on past practice.

If it's broke, call your broker.

"We advise our clients to contact us if there is a claim. We'll call the insurance company, which will then begin investigating; answer the summons (if a suit has been filed); hire defense council ... whatever is necessary to protect you. But we still serve as the conduit, quarterback, and point of contact," Kumm says. So it helps to like your broker.

Fred Bernstein studied architecture at Princeton and law at New York University and writes about both subjects.

Another Reason Why We're the Architect's Choice

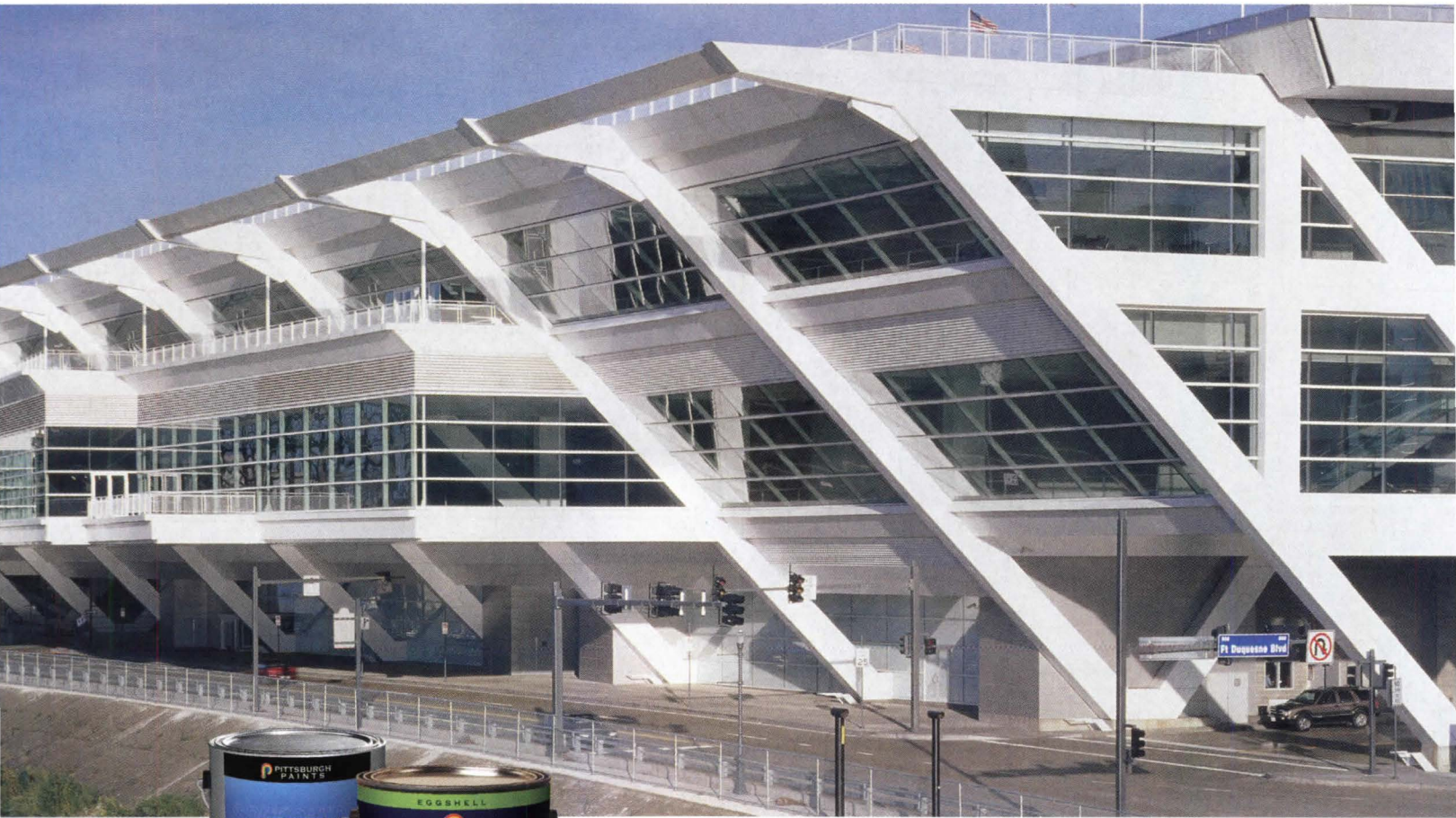

With a Gold LEED rating, Pittsburgh's David L. Lawrence Convention Center features a varied collection of PPG glass and coatings, including Pure Performance™ interior latex paint, to complement its dazzling riverside setting.

From Green Seal Class A certified Pure Performance to Speedhide® and Manor Hall®, our products meet the most stringent environmental requirements for schools, hospitals, hotels and any other surfaces that require zero or low VOC and very low odor.



Circle no. 46 or <http://architect.hotims.com>



www.ppgideascales.com 1-888-PPG-IDEA

HOW DO YOU BUILD AN IGLOO—THAT ICON OF THE ARCTIC LANDSCAPE—IN SOUTHERN CALIFORNIA?

Text Laurie Manfra

NO ICE



JENNA DIDIER

The *Ukendt/Igloo* design team (from left): architect John Southern, artist Anja Franke, and lead fabricator Nick Blake.

BIODIVERSITY OF FORM has long been a beloved characteristic of the built environment. But of all existing building types, the igloo might top the list of endangered species. One must travel beyond the Arctic timberline, the southern border of the Inuit people and the northernmost latitude at which trees grow, to see a genuine igloo in use today. The centuries-old design of these energy-efficient snow houses demonstrates that with climate-responsive architecture, form and material are inseparable. And in case you haven't experienced an igloo firsthand, the outdoor Los Angeles gallery *Materials & Applications (M&A)* has created one for an installation titled *Ukendt/Igloo*, which opened April 1 and runs until Aug. 31.

Conceived by Danish artist Anja Franke, the structure explores the relationship between climate and building by reinventing a vernacular Arctic structure for a southern locale. Traditionally, igloos (“ukendt” is the Danish word for “igloo”) are built out of snow and covered with a layer of ice to form a natural barrier against

sub-zero temperatures and wind chills. The force of the compressed snow provides exceptional structural stability, while the semicircular form maximizes interior space, where the temperature can rise to 61 degrees Fahrenheit from the dissipation of body heat alone. Replicating an igloo for a city such as Los Angeles, where it's rarely cooler than 50 degrees Fahrenheit in the spring and snow and ice are never in abundance, is an interesting proposition. For a structure in which material and climate go hand in hand, is it an exercise in futility?

Perhaps not. “The weather is changing all around us, which is why I've chosen the igloo as an icon,” says Franke. Though igloos come to us from the Inuit, who spread across Siberia, Alaska, Canada, and Greenland—the latter has been a Danish territory since the 1950s—snow abodes have a rich history in the Nordic regions of Scandinavia. But the one that sits in downtown L.A. is no frozen structure; instead, it's made of bamboo and felt. As Franke sees it, she's exported a historical dwelling type from her



The final model for *Ukendt/Igloo* served as a template for how its felt surface would be woven into the structural frame.

JENNA DIDIER



JENNA DIDIER



JENNA DIDIER

The fabrication team learned the art of bamboo lashing to hold the structure's tension frame (far left) together, but ended up using duct tape, which proved easier to work with. At left: the installation nears completion.

country and used it as an allegorical device for challenging cultural and architectural conventions.

Franke proposed the installation in 2004, after M&A's Jenna Didier and Oliver Hess discovered that, like them, the artist had been hosting public exhibitions in her backyard in Copenhagen. So the three teamed up and, with the help of architect John Southern (founder of design group Urban Operations Studio), lead fabricator Nick Blake (a specialist in building sets, stages, and animation rigs), and dozens of volunteers, crafted a double-domed igloo using hand-harvested bamboo from the Los Angeles County Arboretum & Botanic Garden and 48-ounce industrial polyester felt donated by Monarch Textiles.

Initially, the team members entertained the possibility of putting a swamp cooler inside the igloo; the passive system would move cold, evaporated water

through the interior, creating a reverse igloo that would be cooler on the inside. Instead, they focused on structural and material innovations, finding ways to construct *Ukendt/Igloo's* two domes with resources from the urban Southern California landscape.

They eventually settled on a tension bamboo frame for both domes, with the felt skin of the larger dome—which visitors can enter—woven into the structure by hand. The environmental effects are less dramatic, but the permeable structure does promote shade and allows for open-air circulation. And though the team had the privilege of learning the ancient craft of bamboo lashing as a solution for fastening the freshly picked stalks, in the end they found that duct tape was far easier to work with and just as efficient.

"It's just research," says Didier, whose fountain-

HOHMANN & BARNARD

MOISTURE DRAINAGE SYSTEMS

MASONRY



EDUCATION SERIES

IN-HOUSE
AIA ACCREDITED
EDUCATIONAL
SEMINARS

Hohmann & Barnard offers in-house educational seminars on anchoring, flashing and masonry moisture management systems.

For more information, go to www.h-b-edu.com

HOHMANN & BARNARD'S FLEX-FLASH EDGE FLASHING SYSTEM

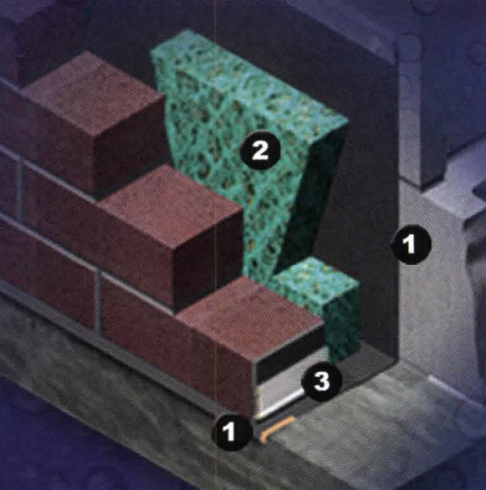

- 1 FLEX-FLASH EDGE
- 2 MORTAR NET
- 3 WEEP VENT

FLEX-FLASH™ is a 40-mil thick product formulated with Elvaloy® Kee, and combines the best features of other types of flashing, making it a truly superior product. **FLEX-FLASH™** has a pressure-sensitive, clear adhesive that will not drool when exposed to UV or heat. **FLEX-FLASH™** may be used in thru-wall or surface-mount applications.

GET THE EDGE! Membrane flashing materials are typically too resilient to bend into a lasting drip edge when projecting beyond the face of the wall. **H&B** solves this problem by embedding a narrow copper strip into the edge of Flex-Flash flashing. **FLEX-FLASH® EDGE** can then be easily formed on site into a typical 3/8" - 1/2" drip-edge that will endure.

*Elvaloy is a registered trademark of the DuPont Company



FLEX-FLASH EDGE OUTSIDE/INSIDE CORNERS AND END DAMS

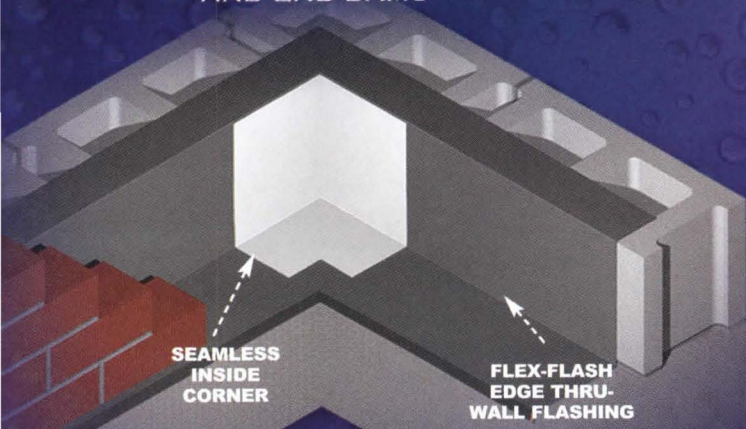

SEAMLESS
INSIDE
CORNER

FLEX-FLASH
EDGE THRU-
WALL FLASHING

SEAMLESS
INSIDE
CORNER

SEAMLESS
OUTSIDE
CORNER

SEAMLESS
END DAM

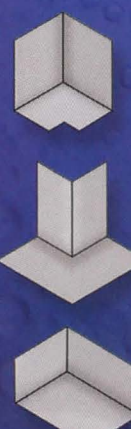

www.h-b.com/a
800.645.0616

get
 I ~~need~~
 cabinetry
 specs to
 create great
 designs.
 at
 kraftmaidspec.com



Only KraftMaidSpec.com lets you download AutoCAD drawings of every single cabinet and gives detailed information on door styles, finishes, storage solutions and our quality construction. Visit KraftMaidSpec.com and see why so many architects rely on it as their design resource.

Made just for you.
KraftMaid
 Cabinetry

www.kraftmaidspec.com

Circle no. 410 or <http://architect.hotims.com>



JENNA DIDIER

engineering firm, Fountainhead, sponsors the pocket-park installations that have, on occasion, stopped traffic on Silver Lake Boulevard. "We're trying to culture-jam by getting mainstream attention to very nonmainstream subjects," she says, even if it means bringing an architectural conundrum—like a Southern California igloo—to life.

The *Ukendt/Igloo* model was used by the fabrication team to determine how the actual structure would sit in M&A's outdoor exhibit space.

ABOUT MATERIALS & APPLICATIONS

Since its founding in 2002, Materials & Applications (M&A) has become a haven for architects, artists, and designers who want to work with their hands. Each year, the architectural and landscape research center and outdoor gallery—which sits in the front yard of founder and director Jenna Didier's and technical director Oliver Hess' Los Angeles home—hosts two installations, as well as workshops on traditional, sustainable, and novel building techniques and crafts.

Previous M&A exhibits have included 2006's *Bubbles* (at right, top), which featured large, illuminated air bags that inflated and deflated in response to visitor interaction and was created by design firms Fox Lin, NONDesigns, and Brand Name Label, with help from Axel Kilian and Darius Miller; and 2005's *Maximilian's Schell* (at right, bottom), a tensile matrix by Benjamin Ball and Gaston Nogues that resembled a vortex and was inspired by actor Maximilian Schell's portrayal of Dr. Reinhardt in the 1979 film *The Black Hole*.

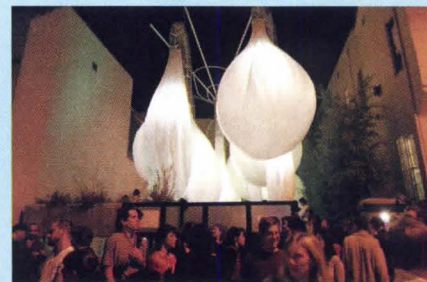

JUNTOW LIN



OLIVER HESS

To learn more about M&A, its focus, and its previous installations and workshops, go to www.emanate.org.

Thanks to our linoleum with xf™ finish, this won't leave a mark. Except on his report card.



Our system easily coordinates all flooring accessories.

Johnsonite linoleum is handcrafted from naturally renewable resources and available in custom colors. Our xf finish makes it stain resistant, durable and very easy to maintain. And best of all, Johnsonite linoleum is part of the world's most integrated, high-performance flooring system. Every element – flooring, finishing borders, transitions, corner guards and treads – works together functionally and aesthetically to help end-users get real lifetime return from their investment in their space and their people. Find out more at johnsonite.com.

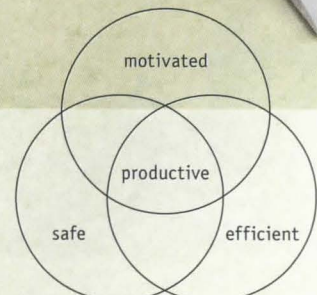

Linoleum
THE TARKETT COLLECTION
Circle no. 38 or <http://architect.hotims.com>

Johnsonite®

Know what you're buying.



MBCI continues to set the standard in the metal component industry with meticulously tested superior quality products and service. In 1976, MBCI introduced the 3-day turnaround, besting the norm of two weeks. In 1987, MBCI opened our state-of-the-art product testing facility including the only UL approved wind uplift testing chamber in the industry. Now, once more, we are distancing ourselves from everyone with the Certified Premium Seal which ensures you are getting the best panels available. We're committed to exceeding your expectations. If you want MBCI, look for the Seal. **Call 877.713.6224 or go online to www.mbc.com/arch to discover more.**



A NCI Building Systems company listed on the NYSE as NCS



16 MBCI locations to serve you: Houston, TX 877.713.6224 | Adel, GA 888.446.6224 | Atlanta, GA 877.512.6224 | Atwater, CA 800.829.9324 | Dallas, TX 800.653.6224 | Indianapolis, IN 800.735.6224 | Lubbock, TX 800.758.6224 | Memphis, TN 800.206.6224 | Oklahoma City, OK 800.597.6224 | Omaha, NE 800.458.6224 | Phoenix, AZ 888.533.6224 | Richmond, VA 800.729.6224 | Rome, NY 800.559.6224 | Salt Lake City, UT 800.874.2404 | San Antonio, TX 800.598.6224 | Tampa, FL 800.359.6224

Circle no. 402 or <http://architect.hotims.com>

AT THE ROOT OF PERFORMANCE IS FORM.

Text Lance Hosey

VISIBLE GREEN

The curved structure and skin of Foster + Partners' Greater London Authority City Hall enhances the building's efficiency. A northern orientation allows for transparency—and good views to the plaza and river.



NIGEL YOUNG, FOSTER + PARTNERS

GREEN BUILDING STRATEGIES OFTEN SEEM COMPLICATED and confusing, but really they fall into two simple categories: those that affect visible design and those that do not. The second list (thermal insulation, material content, water efficiency, etc.) has become more familiar, partly because technical factors are easier to regulate and measure. But the first, which includes layout, massing, and fenestration, actually can have a greater impact on a building's performance. For example, smart engineers warn that the most sophisticated mechanical system cannot compensate for poor solar orientation—if you face a building west, it's going to get hot.

American architects appear not to grasp this simple fact. Often, what makes sustainable projects look good has nothing to do with what makes them green. Decisions about form are driven by a different standard—namely, personal taste—than decisions about technique. A recent competition-winning design for an environmental education center in Washington, D.C., is being touted as the greenest building in the city. A glass box perched over the bank of the Anacostia River, it promises to be beautiful. But it looks a lot like Mies van der Rohe's Farnsworth House—far from the epitome of environmental sensitivity. Midcentury modern, a retro fad right now, could compromise both energy efficiency and human comfort.

An over-reliance on technology may be part of the problem. Certain building components, such as green roofs and solar panels, have become trendy, often independently of whether these features make sense for a project. (How effective is a vegetated roof on a skyscraper?) Stephen Kieran and James Timberlake of

KieranTimberlake Associates call such superficial sustainability “green bling.”

Fixating on the parts and pieces can distract from a more thorough understanding of performance. And associating sustainability with its trappings rather than its principles runs the risk of eventually feeling passé. Will green roofs some day become the equivalent of modernist ribbon windows or postmodernist broken pediments?

Architects can embrace sustainability by focusing on the thing they have always cared about most—the basic shape of buildings. Relatively few examples exist, and the best are outside the United States.

In the Renzo Piano Building Workshop’s Tjibaou Cultural Center in New Caledonia, the wood-slat thermal towers rising from the forest echo local vernacular building traditions but also play an essential role in passive ventilation. The curvaceous Greater London Authority City Hall by Foster + Partners uses resources efficiently by optimizing the ratios of material to function and surface to volume. And unlike the symmetrical Swiss Re Headquarters (aka the “Glass Gherkin”), the London Authority building tilts toward the south to

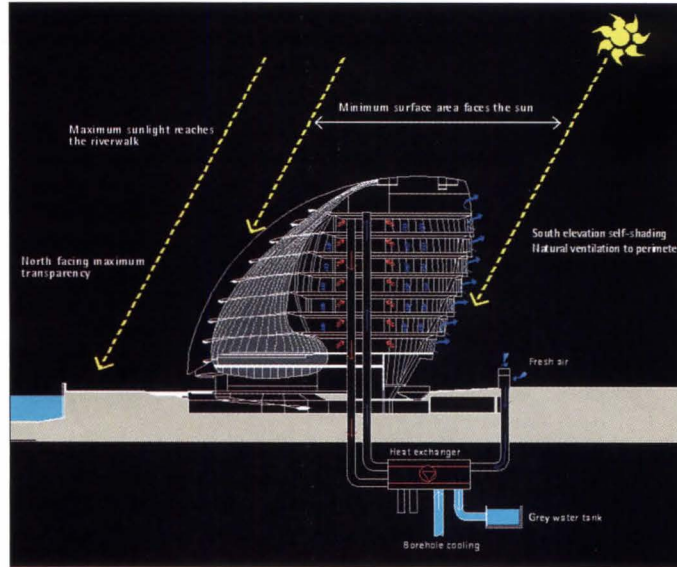

reduce the area of exposure to the sun and help reduce heat loads. What makes both of these projects environmentally intelligent is precisely what makes them visually compelling.

Independent columnist Lance Hosey is a director with William McDonough + Partners.

Foster + Partners’ structure leans toward the sun to minimize the surface area being heated. The tilted south face shades itself, and the angled north face maximizes the daylight reaching the riverfront plaza.

Shape and Sustainability

Form determined by material efficiency



Eden Education Centre

Grimshaw Architects
2005, Cornwall, U.K.

Helical plant forms inspired the spiral shape of the structure, which significantly increases structural stability and material efficiency.

Form determined by wind energy



Ramsgate Street

Waugh Thistleton Architects
Proposed, London

The plan of the building is shaped like an airfoil to funnel breezes through a series of vertical wind turbines on the back of the structure, making power production up to eight times more efficient.

Form determined by solar energy

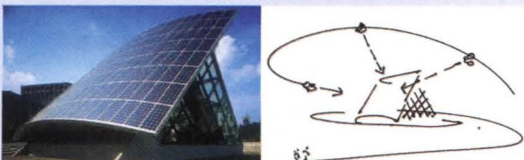

BP Solar Showcase

Arup Associates
1998 prototype, Birmingham, U.K.

The clamshell shape of the south façade, which is clad in photovoltaic panels, follows the arc of the sun in order to optimize power production. The north face is transparent.



QuietZone® Party Wall—Up to STC-63

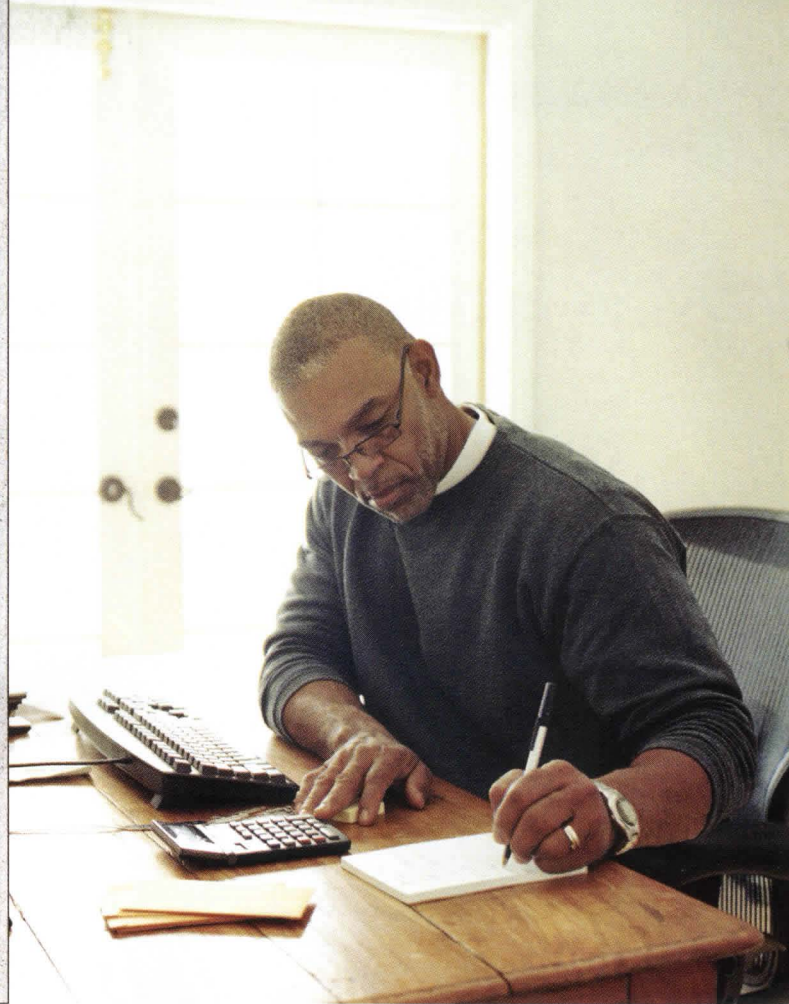

Finding a cost-effective way to exceed IBC means now only Johnny's parents have to suffer.



QuietZone® Noise Control Solutions are an affordable and easy way to achieve a 58%* noise-level reduction over the International Building Code (IBC) requirement in party walls and floors. They cost less and install faster than other methods of isolating neighbor noise in multi-unit dwellings.

You can install QuietZone Noise Control Solutions using standard construction and wall-framing techniques. And your customers get more living space because QuietZone Noise Control Solutions allow for thinner walls. For more information, visit www.QuietZonePro.com or call **1-800-GET-PINK.™**



QUIETZONE®
VOLUME CONTROL FOR BUILDINGS™

*The percentage noise reduction is calculated by applying the result that a 10 dB reduction in sound is half as loud to the ear based on human listening studies.

THE PINK PANTHER™ & ©1964-2007 Metro-Goldwyn-Mayer Studios Inc. All Rights Reserved. The color PINK is a registered trademark of Owens Corning. ©2007 Owens Corning.

25
CERSAIE

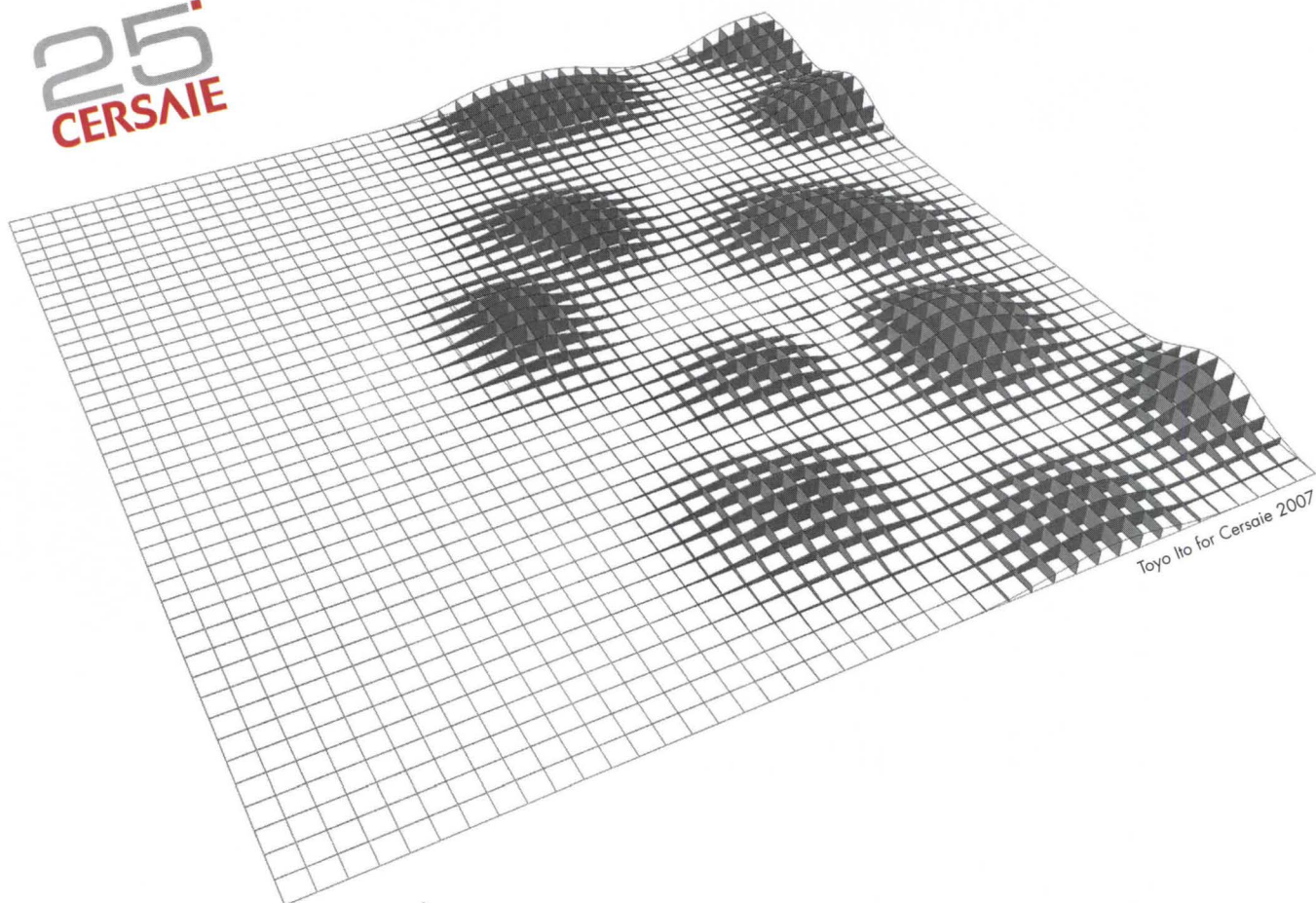

Toyo Ito for Cersaie 2007

Toyo Ito

CERSAIE

BOLOGNA ■ ITALY

INTERNATIONAL EXHIBITION
OF CERAMIC TILE AND BATHROOM
FURNISHINGS

2 - 6 OCTOBER 2007
www.cersaie.it

Organized by **EDI.CER. spa**

Promoted by **CONFINDUSTRIA CERAMICA**

In collaboration with  **BolognaFiere**

Show Management: PROMOS srl - P.O. Box 103 - 40050 CENTERGROSS BOLOGNA (Italy) - Tel. +39.051.6646000 - Fax +39.051.862514

Press Office: EDI.CER. spa - Viale Monte Santo 40 - 41049 SASSUOLO MO (Italy) - Tel. +39.0536.804585 - Fax +39.0536.806510
Circle no. 387 or <http://architect.hotims.com>

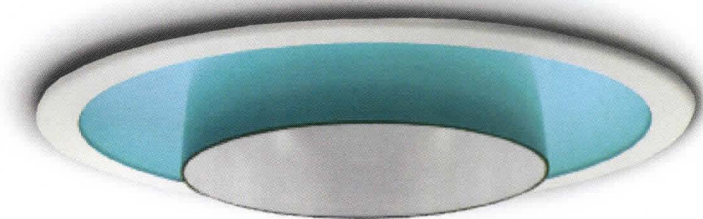

Text Katie Gerfen

Lights Up

New fixtures and technologies take center stage at Lightfair.

Candéo LED dual-source
downlight

Gotham Architectural
Downlighting

www.gothamlighting.com

Dual reflector design • Independently controlled compact fluorescent provides general illumination • Color-changing LEDs on perimeter are decorative

FROM MAY 6 TO MAY 10, more than 19,000 architects and lighting designers will attend Lightfair International 2007. In its 18th year, the conference and exhibition will feature 1,500-plus booths from more than 550 manufacturers—as well as at least 220 hours of programming, including 72 CEU/LU accredited courses.

The conference is co-sponsored by the Illuminating Engineering Society of North America and the International Association of Lighting Designers. It will again feature the popular Daylighting Institute, a two-day event tailored toward educating architects, engineers, and end users about daylighting principles and technologies.

A highlight of the event every year

is the Lightfair International Innovation Awards, known until last year as the New Product Showcase. This awards program celebrates new product introductions from a variety of manufacturers in 14 categories, with special awards including the Innovative Product of the Year Award, the Technical Innovation Award, the Design Excellence award, and, at the discretion of the jury, a Judges' Citation Award. Cosponsored by ARCHITECTURAL LIGHTING and eLumit.com, the awards are announced on the first day of the exhibition.

New products, including those shown here, will be introduced by nearly every lighting manufacturer on the show floor of the Jacob Javits Center in New York City.

Products

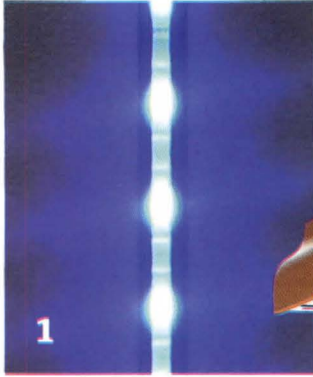

1

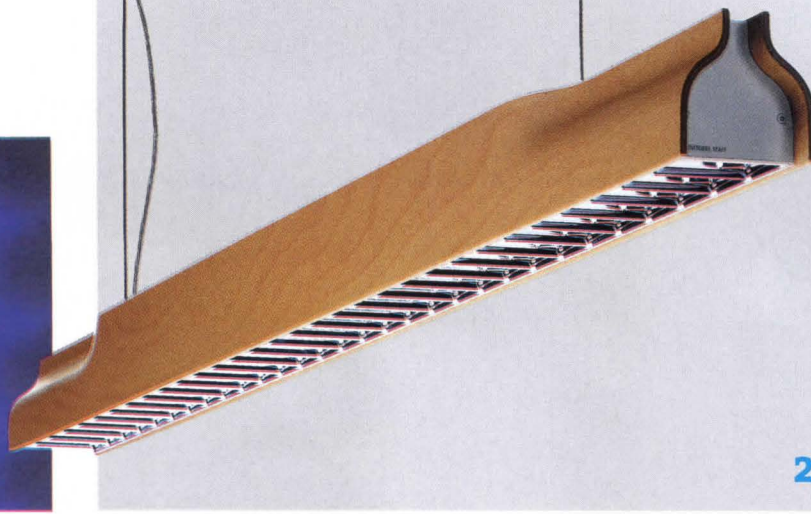

2



3



4

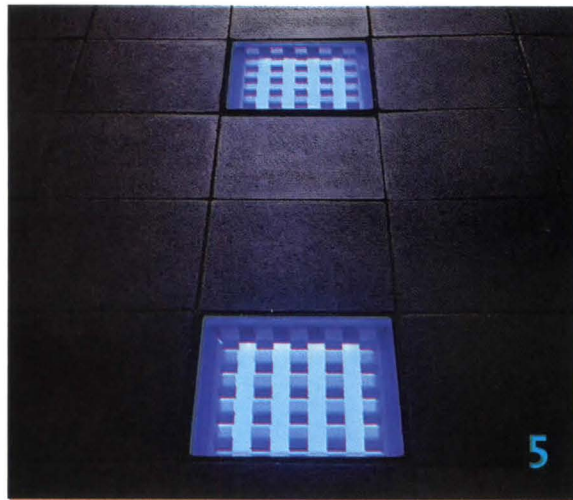

5

1. Zip dimmer

Lutron

www.lutron.com

Architectural touch dimmer

- Panel can dim light levels from 1 percent to 100 percent

- LEDs on a central indicator strip show the light levels

- Available with green, blue, and white light

- Also offers audible feedback, such as a click, when touched

2. Evio suspended fluorescent

Zumtobel

www.zumtobel.com

Beechwood and walnut finish options

- Available in direct and direct/indirect models

- Lamping options include 28-watt T5 or 54-watt T5HO for the direct fixture;

- 35-watt T5 or 80-watt T5HO for the direct/indirect

- Eternit synthetic concrete fiber finish

- Specular louver options available

3. FS Collection

CL Sterling & Son

www.clsterling.com

Collection includes interior and exterior pendants and interior table lamps

- Metal shade available in brushed nickel or architectural bronze

- Interior pendants hung with black rope, exterior with chain

- Interior of shade can be coated in a variety of different colors

4. Exterior 1200 Wash

Martin Architectural

www.martin-architectural.com

Takes a 1,200-watt metal halide lamp

- CMY system allows for blending of many colors; more are available with an optional four-color wheel

- Light output can illuminate buildings up to nine stories

- DMX controllable from an external controller or PC

5. Ledia ground lighting

HessAmerica

www.hessamerica.com

LED-illuminated tiles and strip lighting

- Can be embedded in paver stones and concrete walkways

- Available in outdoor, indoor, and underwater models

Dell recommends Windows Vista™ Business



Before I design any high-performance solution, Dell designs one for me.

At Dell, we know that your designs are only as good as the technology you use to create them. That's why you can trust Dell to provide you with solutions that are customized to deliver high-end results like our scalable Dell Precision™ 390 Workstation. And with Dell's 24" LCD monitor, rest assured that your ideas will look as vivid on screen as they do in your imagination. Small business solutions designed with one company in mind. Yours.

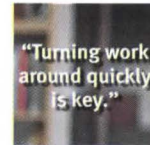
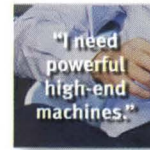

Through AIA Member's Program, AIA members receive special pricing* on select Dell products.

CUSTOMIZED DELL ARCHITECT SOLUTION



- **Dell Precision 390 Workstation with Intel® Core™2 Duo Processor: Starting at \$989**
Bring your vision to life.
- **Dell™ 24" Widescreen Flat-Panel Monitor: \$749**
High performance. High resolution.
- **Logitech NuLOOQ USB Navigator: \$80**
Fast. Precise. The perfect tool for design.
Circle no. 96 or <http://architect.hotims.com>

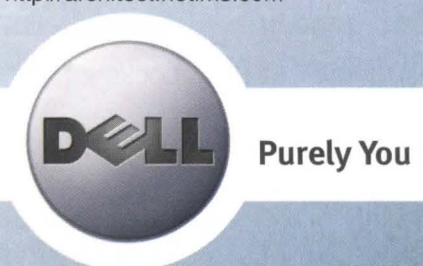

877.657.DELL
(toll free)

dell.com/architect

WE PROMISE. NO BORING CONTINUING ED.

Architect magazine is committed to working with manufacturers to provide architects with the most dynamic, informative and genuinely interesting continuing education materials available – always at no cost to architects. We've assembled a creative team of experts dedicated to producing course content that architects will actually find worthwhile, valuable, helpful, media rich and easy to use.

Plus, architects not only get AIA credit. They get important feedback on questions they miss, and confirmation on questions they answer correctly.

Manufacturers who sponsor courses can count on accuracy, fast turnaround, full AIA compliance and data administration, and compelling presentations of the objective features and benefits of their products and systems. Plus, product managers will really appreciate that our data collection system allows real-time, on-line monitoring of any program you sponsor.

Whether produced in print, online, or as a lunch-and-learn program, we're committed to making our continuing education programs the best of breed.

Access *Architect* magazine's new Continuing Education On-line Programs through Architectmagazine.com

Manufacturers interested in sponsoring a course, please contact Russ Ellis, Publisher, at 202.736.3310.

Architects interested in taking a course, please visit, www.architectmagazine.com, click on Resources, then Continuing Education Center.

ARCHITECT

Continuing education that holds your interest

hanley▲wood

Course development and content management provided by

ARCHITECTCES

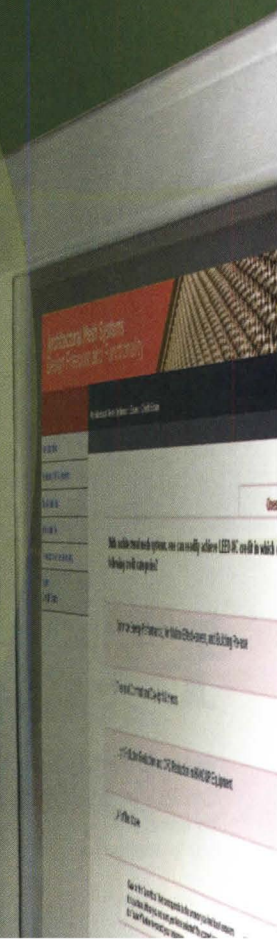

A SAN FRANCISCO NONPROFIT CHALLENGES THE PROFESSION TO ACT FOR SOCIAL CHANGE.

Text Mimi Zeiger

PUBLIC ARCHITECTURE



MARK DARLEY PHOTOGRAPHY



MENDU DESIGN

John Peterson, the founder of Public Architecture.

The new headquarters of the Homeless Prenatal Program, a San Francisco nonprofit, was renovated as part of Public Architecture's pro bono initiative, the 1% Solution.

JOHN PETERSON, FOUNDER of the nonprofit Public Architecture, is a busy man. He spent last year as a Loeb Fellow at Harvard University, immersed in the intricacies of social entrepreneurship. This year, he's running his own four-person San Francisco firm, Peterson Architecture, and traveling around the country to promote public-spirited design. And this month, at the AIA national convention, Public Architecture receives the 2007 Institute Honor for Collaborative Achievement.

When I talk to Peterson, he's in San Francisco and in a reflective mood. "There is a current interest in merging a more progressive attitude toward design with a progressive social agenda," he says. "Previously, there was a reluctance to combine those two—they ran from each other. Those wearing the clothes of the socially progressive did not want to be associated with the avant-garde because it was seen as trite. On the other hand," Peterson continues, "preaching a social agenda was seen as not being serious about design."

Established in 2002, Public Architecture goes beyond simply mending that ideological rift. While the organization's output takes many forms—research, advocacy, and education; collaborative projects; a pro bono initiative called the 1% Solution—it consistently encourages architects be proactive, asking them to tackle issues of public interest with the same vigor and analytical insight generally reserved for high design.

"Public Architecture mobilizes designers to take on this role—identifying the problem rather than waiting to be engaged," says Cynthia Smith, a curator at the Cooper-Hewitt National Design Museum in New York, which features the group's work in "Design for the Other 90%," an exhibition that opens this month. "This [approach] holds the potential for new forms informed by the voices once silent, moving beyond traditional architecture," Smith says.



The proposed day labor station offers seating, shade, and bathroom and kitchen facilities. The seating area can also function as a classroom.

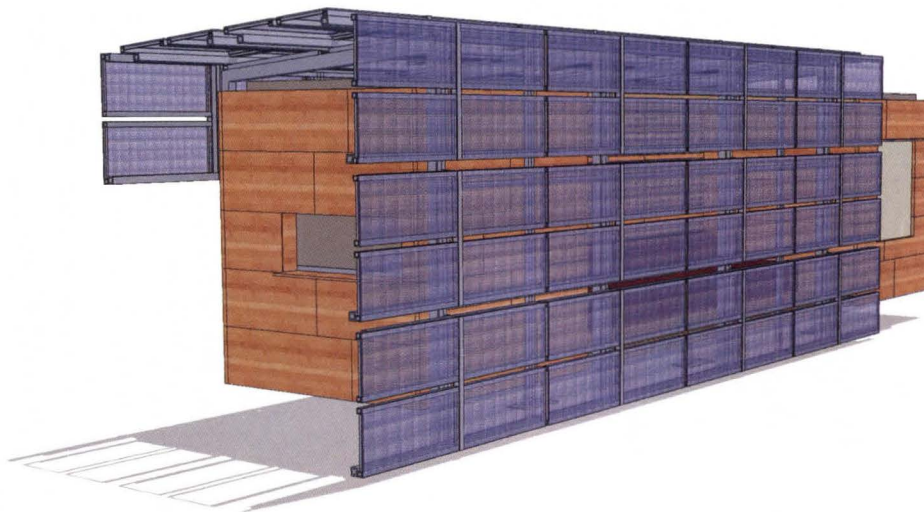

A steel-and-photovoltaic grid shades laborers from the sun and collects solar energy during the day; at night, it folds down to secure the station.

COURTESY PUBLIC ARCHITECTURE

Day Labor Station

According to the 2006 study "On the Corner: Day Labor in the United States," published by the Center for the Study of Urban Poverty at the University of California, Los Angeles, more than 100,000 laborers cluster on street corners and in Home Depot parking lots across America every day. These are informal employment centers: A pickup truck draws to the curb, several men pile in the bed, and the truck speeds off to a construction site or odd manual job. On a good day, the worker gets paid a low wage for filling an economic niche. On a bad day he waits, exposed to the elements, lacking bathroom facilities and a place to sit down.

Public Architecture's Day Labor Station offers a design solution to what is generally seen as a political or economic problem. The flexible structure (designed in-house by Peterson and colleagues) provides a seating area, which can also be used as a classroom, and it offers shade—all-important in hot weather. It is equipped with a kitchen and a restroom and is powered primarily by an array of photovoltaic panels. In fact, the steel-and-photovoltaic

grid serves triple duty: Aside from generating energy, it forms a canopy during the day and, at night, folds down to secure the station.

General contractors Ryan Associates teamed with Public Architecture on the project, streamlining the design and redlining the drawings so that the station can actually be erected by the day laborers who will use it. The hope is that municipalities nationwide will install the semipermanent units where needed. Additionally, the construction company built, pro bono, the partial prototype that is on view, with a video and portraits of the laborers, May 4–Sept. 23 at the Cooper-Hewitt.

"As a company, we believe that involvement in our community is a socially responsible thing to do," explains Jim Friedman, co-founder and owner of Ryan Associates. "[The day labor station] institutionalizes what is already an institution. If these things wind up dotting the landscape, it is a step in a great direction."

You provide the imagination.



We make it real.

Old Brick Originals™ exposes the beauty and durability of real, kiln-fired brick as a thin-cut solution. Inspired by your vision. Made real by Robinson Brick Company.

800.477.9002 ■ RobinsonBrick.com/Architect

Circle no. 390 or <http://architect.hotims.com>

**ROBINSON
BRICK
COMPANY**

SINCE 1880

Build On.™



Designed by Miller|Hull Partnership, with Public Architecture consulting, a \$13 million learning center in Seattle's Lakewood Park will help the nonprofit Technology Access Foundation bring technology to underserved students.

TAF Community Learning Center

In 2005, Public Architecture coordinated the ScrapHouse project—a green demonstration home installed in San Francisco's Civic Center Plaza. A team of architects, designers, artists, contractors, and fabricators took six weeks to design and build the structure out of reused materials. Although temporary, the innovative house, shingled in recycled traffic signs, received press coverage and eventually caught the eye of county executive Ron Sims in King County, Wash.

King County wanted to build a new headquarters for the Technology Access Foundation (TAF), a nonprofit that develops after-school programs for underserved students in the Seattle area. TAF needed a building with technology-capable classrooms, labs, and community meeting rooms. The result is the 21st Century Community Learning Center, a collaboration between Public Architecture and Miller|Hull Partnership, a Seattle-based firm noted for its expertise in sustainable construction.

Both offices worked pro bono on the conceptual phase of the project. Miller|Hull is now under contract as the

center moves into design development, with Public Architecture taking a consulting role. The \$13 million cost of the building is being underwritten in part by a \$2 million capital grant from the King County Council and a \$1 million capital challenge grant from the Bill & Melinda Gates Foundation.

When completed in 2008, the center, like the ScrapHouse, will be a model of construction with recycled materials. "We are constantly on the hunt for materials and buildings being deconstructed," says Public Architecture project manager Liz Ogbu. Recently, the architects salvaged 230 Douglas fir floor beams from a demolished housing project and are incorporating them into the design for the 105-foot long pedestrian bridge that will lead to the center's main entrance.

The center, located in Seattle's Lakewood Park, is intended not only to educate residents in technology and green architecture, but to revitalize the economically depressed area.

$$Z = \sqrt{(r_p + a_p)^2 - (r_p \cos \phi)^2} + \sqrt{(r_g + a_g)^2 - (r_g \cos \phi)^2} - C \sin \phi$$

←----- A LOVE STORY -----→



Some consider the Americans With Disabilities Act (ADA) to be nothing more than a code that affects the openings of a building. Not us. ADA is actually an exciting opportunity to display some of our best thinking and smartest designs. We could literally go on for days about the meticulous engineering, flawless operation and dashing good looks that make our automatic operators the perfect solution to any ADA accessibility challenge. But don't worry. It only takes a second to understand why ADA and LCN go hand in hand.

ADA & LCN, SITTING IN A TREE

The only thing that could possibly match the complexity of ADA requirements is the engineering we use to adhere to them. You see that long equation at the top of the page? Beautiful, isn't she? However, it's merely a hint at the mathematical artistry we use to satisfy each ADA stipulation. And you can bet your protractor that all of our fantastically complex equations end with one very simple result: *Providing ADA access is now a piece of cake.*

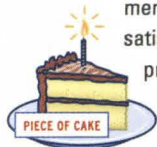

TEN MILLION TO ONE

Once we're done engineering the perfect ADA automatic operator, we bring it to life with premium cast iron and forged steel. Then we give each one its very own digital control suite to make installation and setup a breeze. And just to further satisfy our obsession with perfection, we put our products through a rigorous ten-million-cycle test.

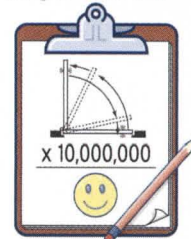

ADA INVESTING

We have one word for facility managers who are hesitant to adhere to ADA guidelines: Nonsense! A proactive approach to ADA accessibility is a sound business strategy. Americans with disabilities represent nearly 20% of the population. That's 55 million potential customers! So the next time you see one of our ADA door controls operate, listen closely. You just might hear a "cha-ching!"

HAPPILY EVER AFTER

Go ahead. Call us door control match-makers, but we have just the right solution to marry with any of your ADA accessibility needs. From low-energy pneumatics to high-energy electrics, our intense engineering and passion for control make for relationships usually only witnessed in fairy tales. The End.





MARK DARLEY PHOTOGRAPHY

The 1% Solution: Homeless Prenatal Program

Following the lead of the legal and medical professions, Public Architecture encourages firms to pledge 1 percent of their billable hours to pro bono work—about 20 hours per year per employee. The 1% Solution program, supported in part by a grant from the National Endowment for the Arts, is provocative, says Peterson—a challenge to architecture and design professions to put their expertise in the service of social responsibility. “I think we miss an opportunity to play a more important role in our world by sitting on the sidelines,” he says. “We need to use our abilities to directly address the unhealthy or underserved aspects of our built environment and urban culture.”

Peterson's own practice is one of 130 firms currently signed on to the program. Putting its skills to work for a local nonprofit, the Homeless Prenatal Program (HPP)—which offers health education and other services to homeless families—the firm helped it purchase a historic warehouse and transform it into a new, light-filled facility.

Located in San Francisco's Mission District, the 27,000-square-foot headquarters houses case-worker offices, a technology lab, an art room, kitchens, classrooms, and a



The reception area at the Homeless Prenatal Program's new facility (top left); the main entrance (right); and the renovated building, a former warehouse in San Francisco's Mission District (bottom left).

The staff of the Homeless Prenatal Program, which offers support services for homeless women and families.



day-care center. The architects spent much of their pro bono time learning HPP's needs rather than developing an elaborate design scheme. “We went against our nature and acted as a strategic partner,” explains Peterson. “The design work that we did tailored the building: We hemmed the pants and shortened the sleeves. It is a very powerful design tool to understand the financial and political issues and use them to help the client.”

The architects' analysis saved the nonprofit a lot of money: Martha Ryan, HPP's executive director, had budgeted a new ground-up structure at \$8 million, whereas the warehouse cost \$4.65 million, plus approximately \$200,000 in construction costs. For Ryan, the project's success goes beyond the price tag.

“The space is open, beautiful, and welcoming,” she says. “When clients come in, they see that it is beautiful and they see that it's for them, so they are able to relax.”

Brooklyn, N.Y.-based Mimi Zeiger is the author of New Museums: Contemporary Museum Architecture Around the World.

15 Year
Fully Transferable
WARRANTY

Graduation isn't guaranteed.
But our surfaces are.



LG solid surfaces are made to take on years of parties and other strange experiments. Non-porous, antimicrobial and stain resistant – so no matter what pomp and circumstance happens behind dorm room doors, your designs will look as shiny and new as a first-day freshman.

866-LGHI-MACS • SecretIsInTheSurface.com



LG HI-MACS
Acrylic Solid Surface

The secret's in the surface.

Featured product: LG HI-MACS in Tundra Quartz and Terra Quartz. SCS Certified for Recycled Resin (Minimum 4% Pre-consumer) ISO-14021 *SCS-MC-01391 ©2007 LG HI-MACS. LG-0064 2/07

Circle no. 42 or <http://architect.hotims.com>

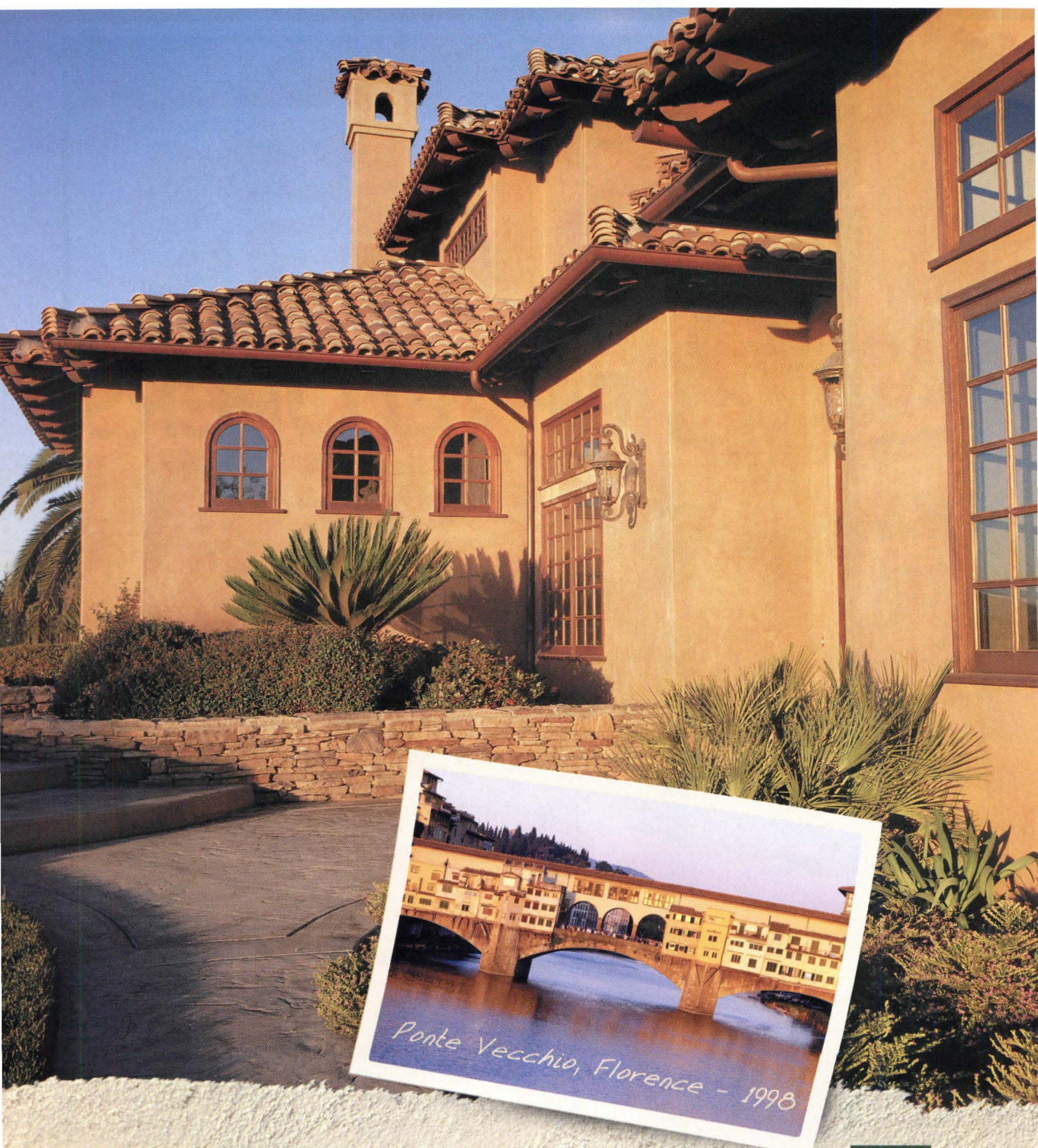

Ponte Vecchio, Florence - 1998

A PONTE VECCHIO OCHRE? NO PROBLEM.

No matter what your inspiration, skilled LaHabra technicians can quickly provide you with accurate color matching that other companies just can't achieve. That means you'll get the color you specify, not just a close, preset approximation. So choose LaHabra Stucco to create your picture-perfect design.

1.877.LHSTUCCO | www.lahabrastucco.com

Circle no. 449 or <http://architect.hotims.com>



A close-up, high-angle photograph of a wooden window frame. The wood is a rich, warm brown color with prominent grain patterns. The frame consists of several thick, horizontal and vertical pieces of wood, showing the precision of the joinery. The lighting is dramatic, highlighting the texture and grain of the wood against a dark background.

Option

#216

Beauty at its Best

Every project is different, so using the same window or door for each project won't do. You need options. Who better to provide you with those options than Kolbe? With virtually endless options, including a wide variety of wood species such as walnut, the epitome of richness and sophistication, you'll be sure to get the look you need. For more information visit www.kolbe-kolbe.com or call 1.800.955.8177.

Circle no. 40 or
<http://architect.hotims.com>

KOLBE
■ WINDOWS & DOORS ■

See the Difference Quality Makes

materials. Already on the market is a nanocomposite steel that is three times stronger than conventional steel. In the near term, nanocomposite reinforcement of steel, concrete, glass, and plastics will dramatically improve the performance, durability, and strength-to-weight ratio of these materials. Before long, nano-reinforced glass might be used for both structure and enclosure.

To better understand nanotech's potential for architecture, students I teach in the nanostudio at Ball State University (in collaboration with the Illinois Institute of Technology) are designing buildings using nanomaterials that we can expect to see on the market within the next 20 years. These include carbon nanotube structural panels, quantum-dot lighting, and nanosensors, which together will yield stronger, smarter, and more environmentally sensitive buildings.

In the student projects, nanotube structural panels create transparent load-bearing curtain walls free of columns and beams, quantum dots make walls and ceilings light up or change color with the flip of a switch, and nanosensors in building components create smart environments that constantly adapt to their environment and users. But these are not just "house of the future" fantasies: My students also address the social and environmental concerns raised by nanotechnology,

from toxicity (nanoparticles are so tiny, they can pass through cell membranes) to privacy (who controls the data gathered by embedded nanosensors?).

Privacy, sustainability, and security are just a few of the issues that will be profoundly affected by nanotechnology. As threats from terrorism and even from natural forces like hurricanes rise, we will utilize the strength of nanotubes to make our buildings more secure. Research that is now under way to make Army vehicle windshields bomb-proof, using polycarbonate-reinforced nanofibers, may soon be applicable to building glass.

Nanocoatings

Nanomaterials stand to revolutionize insulating methods because they are structured at the molecular level to trap air between particles. They are far more efficient than traditional insulators like fiberglass and polystyrene (which work at the macro level), without the environmental harm associated with those materials. And because it traps air at the molecular level, an insulating nanocoating even a few thousandths of an inch thick can have a dramatic effect.

Nanogel insulation, made by the Cabot Corp., is a form of aerogel, the lightest-weight solid in the world. Known as "frozen smoke," nanogel is 5 percent solid and 95 percent

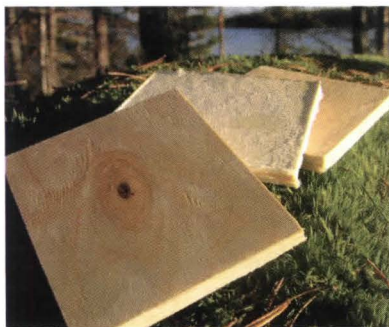

JUKKA SEPÄLÄ/HELSINKI UNIVERSITY OF TECHNOLOGY

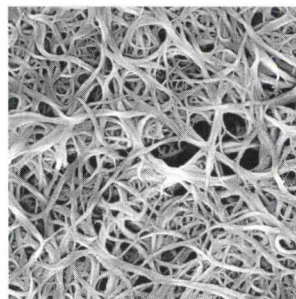

NANOMIX/NANO.COM

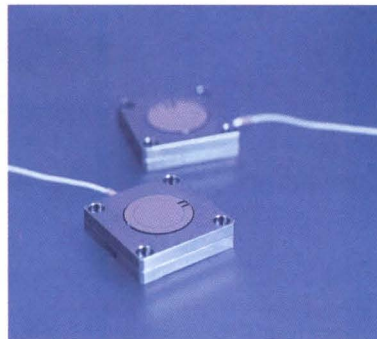

BOB CHING/QUEENSGATE INSTRUMENTS

Biomaterial structural composites, like these panels made from flax and cellulose (far left), turn renewable resources into recyclable building components.

Carbon nanotubes (middle left) are up to 50 times stronger yet 10 times lighter than steel.

Nanosensors (near left) will create smart environments—buildings that sense and respond to changes within them and to their users' needs.

Nanomaterials and nanocomposites are producing stronger, lighter materials that will expand structural options, such as the dramatic cantilever (bottom left) envisioned by Andy Nauenheimer, a student at Ball State.

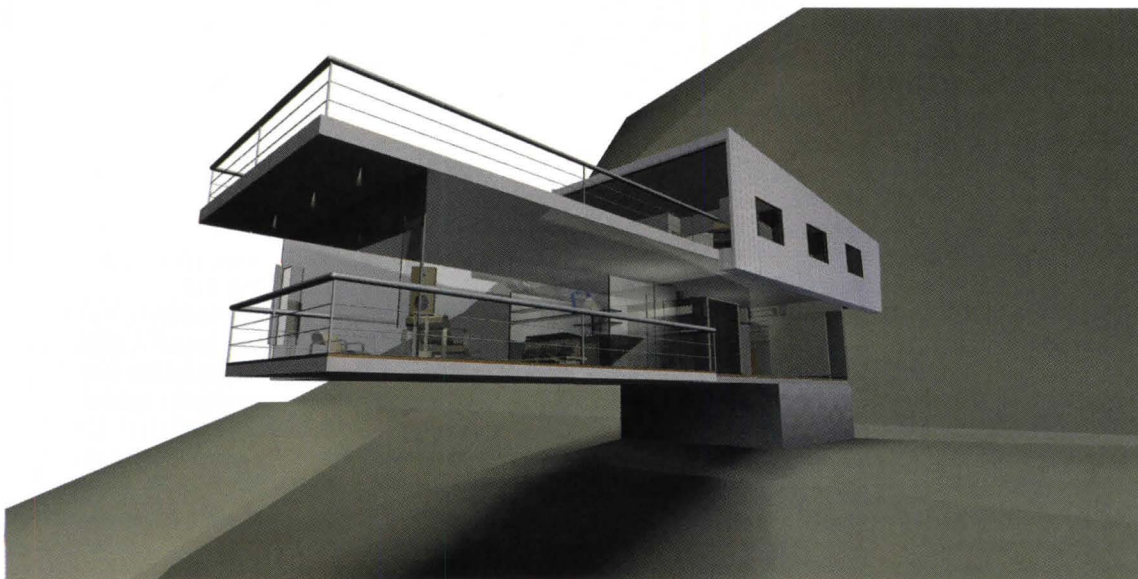

ANDY NAUNHEIMER/NANOSTUDIO/BALL STATE UNIVERSITY

Your Continuing Ed Should Provide You With More Than 40 Winks

Are you getting enough out of those "away from the office again" continuing-ed seminars and workshops? Say good-bye to out-of-town seminars, long convention conferences, and late-night classes. The National Council of Architectural Registration Boards' monograph series offers you one of the most informative, efficient and economical ways to earn Health, Safety, and Welfare PDUs, CUs or LUs available today. Factor in portability and convenience, and you'll see that NCARB monographs are absolutely the best bargain around.

Thought-provoking and portable, NCARB monographs simplify the continuing education process for you. Titles can be ordered on the NCARB web site, and their quizzes can be taken online as well. When you're ready to earn professional development units and/or AIA learning units in health, safety, and welfare, choose a monograph, read it carefully, and take the quiz online. You will receive your results instantly and if you pass the quiz you can immediately print your certificate of completion.

Your payment covers the cost of the monograph and quiz, as well as the scoring process. You even receive one free retest should you not pass the first time. And NCARB will report the number of units you have completed to the AIA at no additional cost.

NCARB monographs meet your needs by offering affordability and convenience without skimping on quality.

Circle no. 437 or <http://architect.hotims.com>

Learn and earn with NCARB!

www.ncarb.org

A man in a white shirt and tie is sleeping in a row of blue chairs. He is lying back with his head on the chair's backrest and his hand behind his head. The chairs are arranged in a row, and the man is the central focus of the image.

NCARB

MONOGRAPH
SERIES

air. The high air content means that a translucent panel 3.5 inches thick can offer a high insulating value (up to R-28). Another company, Nanoseal, makes insulating paints for buildings. Its insulating coating—applied in a layer only seven-thousandths of an inch thick—is being used on beer tanks in Mexico by Corona, resulting in a temperature differential of 36 degrees Fahrenheit.

Nanocoatings are used to insulate both new and existing materials, or to protect wood, metal, and masonry, without the hazardous off-gassing of many other coatings. Nanoengineered ultraviolet curable protective coatings by Ecology Coatings won last year's Silver Award for Innovation in *The Wall Street Journal's* Technology Innovation Awards competition. "Garbage, paper, and other renewables can be formed into products," says Sally Ramsey, chief chemist at Ecology Coatings, "but they have a tendency to dissolve in water. We can use a very light coating of our product to waterproof these, and they can be used as a substitute for plastic."

Good for the environment, this technology may be good for our health, too: The Hong Kong subway system has coated its cars' interiors with titanium and silver dioxide coatings that kill most of the airborne bacteria and viruses they come into contact with. And in cleansers and interior paints already used around the world (Behr Premium Plus Kitchen & Bath Paint is one example), nanoparticles fight mildew.

Nanocoatings can break down dirt as well. PPG Industries and Pilkington Glass both offer self-cleaning window glass that harnesses nanotechnology. The Jubilee Church in Rome, designed by Richard Meier & Partners Architects, features self-cleaning concrete: Photocatalytic titanium dioxide nanoparticles in the precast panels (manufactured by Italcementi) make them shed dirt. The panels trap airborne pollutants in a nanoparticle matrix on their surface, then decompose them.

Similar depolluting nanocoatings can be applied to

almost any surface, making it a smog-eating machine. In the near future, road surfaces, bridges, and tunnels may be able to counteract pollution. The Swedish construction giant Skanska is now involved in a \$1.7 million Swedish-Finnish project to develop catalytic cement and concrete products coated with depolluting titanium dioxide.

Smart environments

In the future, the environment will interact with occupants in ways hardly imaginable today, creating what a 2005 United Nations report calls "an internet of things." Tiny nanosensors embedded in building materials will soon be able to track movement and detect temperature changes, humidity, toxins, weapons—even money. Sensors will pick up on users' preferences and attributes, which will then trigger responses in the intelligent objects around them, dimming the lights, altering the temperature, or—as is already happening with "push" technology that marketers use to blitz cell phones—alerting them to nearby sales and events.

Soon, the design and construction of buildings will incorporate a rich network of interacting, intelligent objects, from light-sensitive, photochromic windows to user-aware appliances. Buildings will not be static but will change constantly as their components continuously interact with users and each other. These dynamic environments will be almost organic in their ability to respond to changes, so architects will need to learn to design for change.

No longer will we call the work of design done when construction is complete. That will be only the beginning of the design process, thanks to nanotechnology.

George Elvin is the director of the Green Technology Forum (greentechforum.net), a research and advising firm focusing on nanotechnology and biotechnology for growing green businesses; he is also an associate professor in the school of architecture at Ball State University. He can be reached at elvin@greentechforum.net.

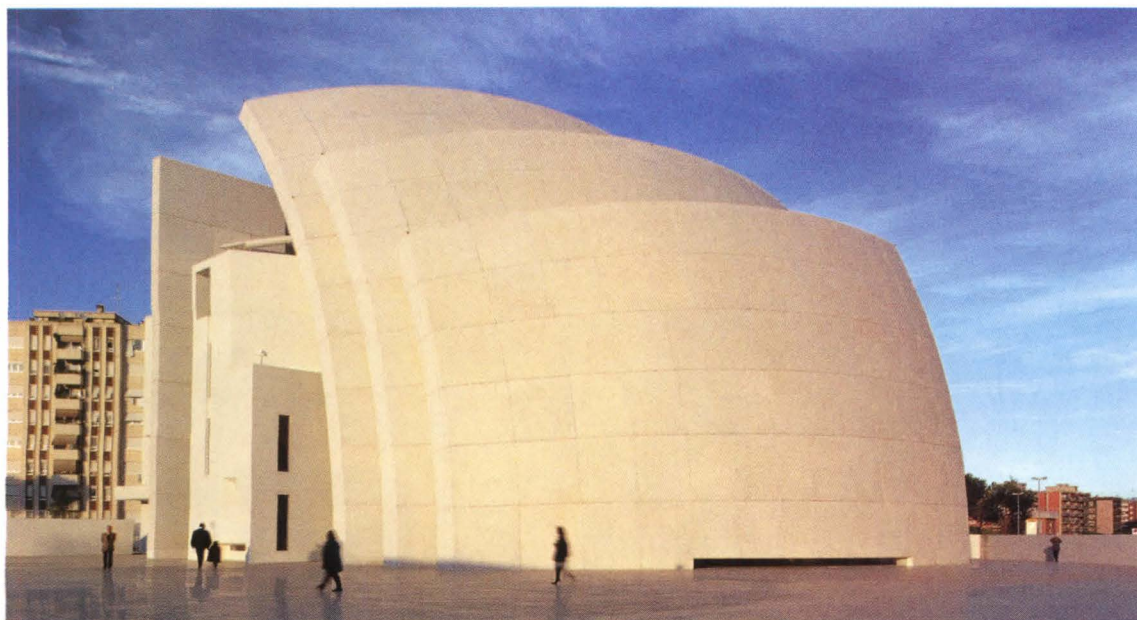

The façade of Richard Meier's Jubilee Church in Rome is self-cleaning, thanks to titanium dioxide nanoparticles built into its precast concrete panels.

LULU
DORNBRACHT

SENSIBILITÉ

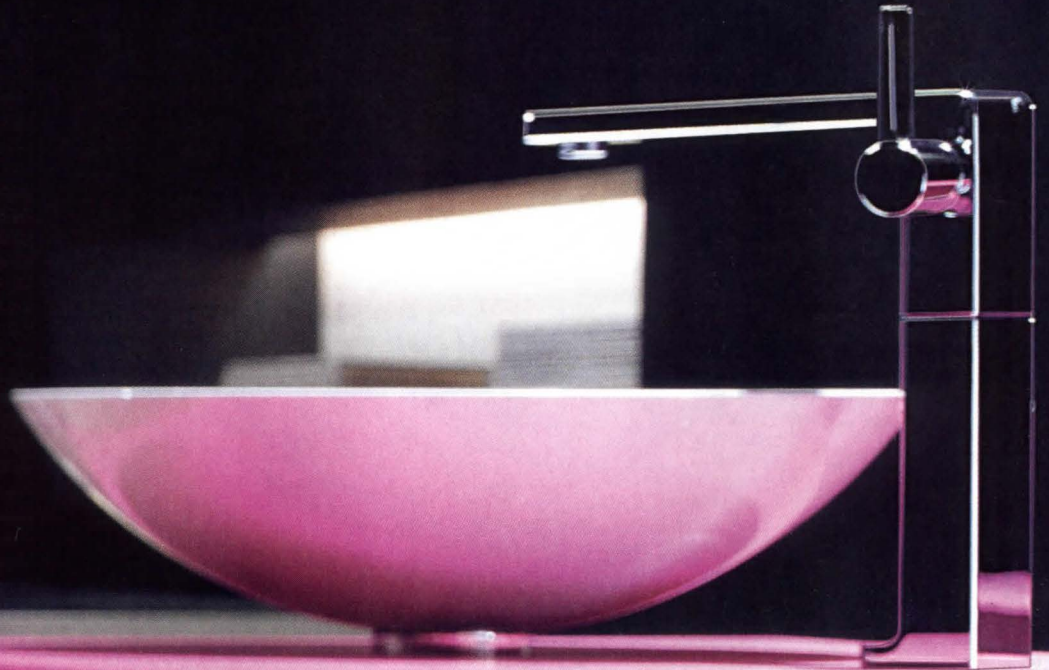

DORN
BRACHT

the SPIRIT of WATER

Is it a bathroom? Is it a lounge? Is there a difference? The design of the new LULU fittings series is modern, graphic and distinctive. It blends elegant surfaces with soft radii. LULU was designed by Sieger Design. To request a copy of our publication the SPIRIT of WATER / bath, please contact: Dornbracht Americas Inc., 100 Executive Drive South, Suite 600, Duluth GA 30096, Phone 866-818-3199, E-Mail literature@dornbracht.com www.dornbracht.com

London: BILLIE BRENNER LIMITED, Phone (617) 348-2858. Minneapolis: MONTAGGIO, Phone (612) 333-6264. New York: DAVIS & WARSHOW, Phone (212) 688-5990. Toronto: SPLASH, Phone (617) 332-6662. Toronto: GINGER'S INTERNATIONAL BATH, Phone (416) 787-1787. Vancouver: CANTU BATHROOMS + HARDWARE, Phone (604) 688-1252. Circle no. 97 or <http://architect.hotims.com>



You create your dream.
We provide the comfort.
Guaranteed.



Your comfort begins at
www.unicosystem.com/iah



The Unico System®

Small-Duct Central Heating
& Air Conditioning

Circle no. 415 or <http://architect.hotims.com>



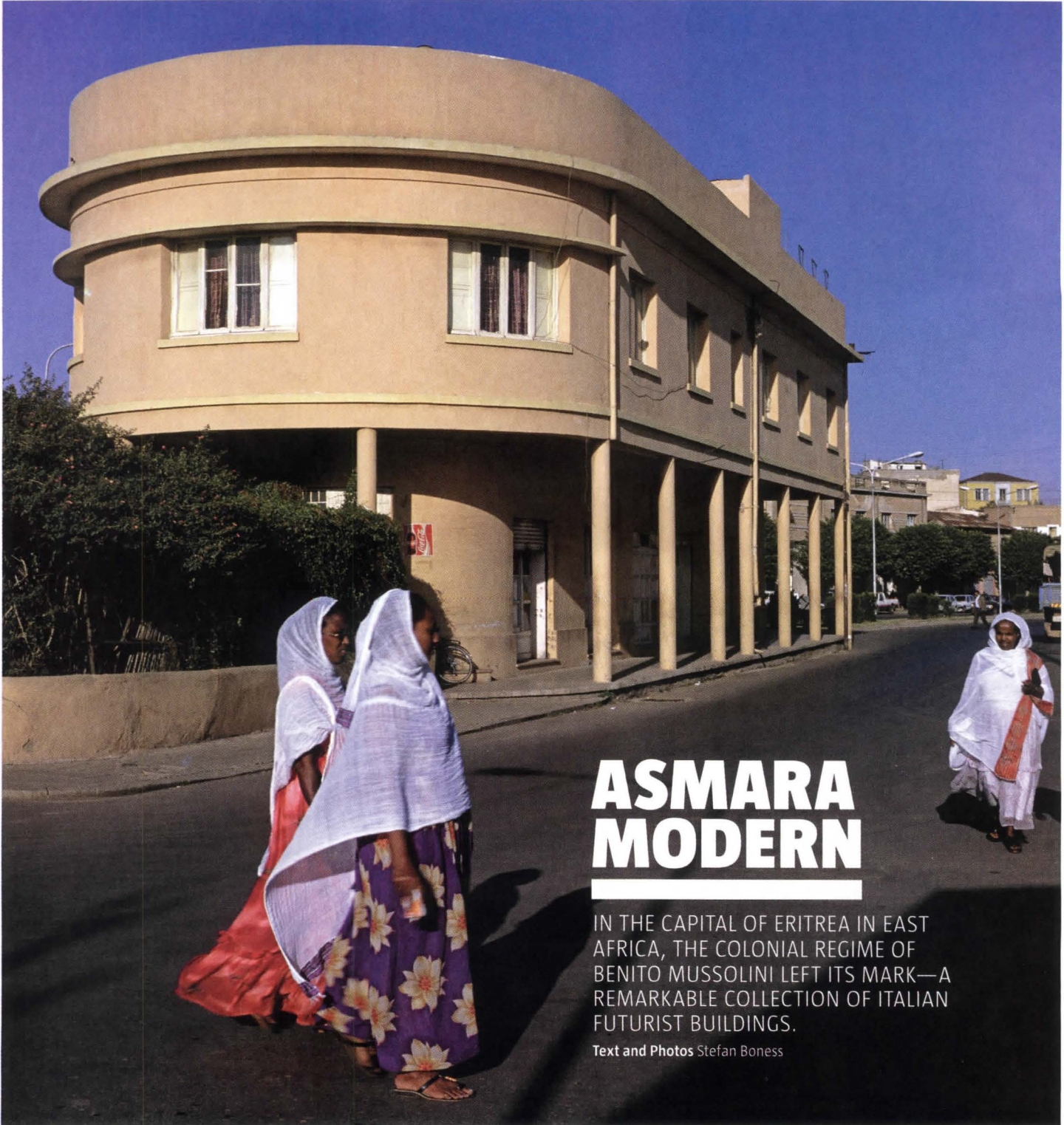

ASMARA MODERN

IN THE CAPITAL OF ERITREA IN EAST AFRICA, THE COLONIAL REGIME OF BENITO MUSSOLINI LEFT ITS MARK—A REMARKABLE COLLECTION OF ITALIAN FUTURIST BUILDINGS.

Text and Photos Stefan Boness

Eritrean women in traditional dress pass an apartment building, formerly the Palazzo Bahobesci, built in 1936 and recently renovated. Asmara has such a wealth of modernist buildings from the 1930s and after that locals pay them no special attention.



The Fiat Tagliero service station, designed by Italian architect Giuseppe Pettazzi and built in 1938. Probably the best example of futuristic architecture in Africa, the structure (no longer a service station) was freshly painted a few years ago and may be converted into a coffee shop.



Asmara's bowling alley, built in the late 1960s. One of the few places where locals and expatriates go for recreation, the alley is not fully automated, which means the pins have to be set by hand.

**If you look real close you can see 25 years
of fire-rated glazing experience reflected in it.**



SCHOTT PYRAN® fire-rated glass-ceramics are an architect's best friend.

PYRAN® is everything you've been looking for in fire-rated glass. It's fire-protective, impact-resistant and, aesthetically speaking, quite fetching. PYRAN® Crystal offers the highest standard of clarity, transmission and true color rendition. And PYRAN® Star is both beautiful and economical. PYRAN® is available with a surface applied film, laminated or polished. It comes in large sizes and is easily accessible through distributors, fabricators and glaziers. For new construction or retrofit, spec the glass with a loyal following among fire professionals – PYRAN®.

Circle no. 392 or <http://architect.hotims.com>

Home Tech
SCHOTT North America, Inc.
Phone: 502-657-4417
Fax: 502-966-4976

E-mail: pyran@us.schott.com
www.us.schott.com/pyran

©2005 SCHOTT North America, Inc.

® PYRAN is a registered trademark of SCHOTT AG, Mainz, Germany



SCHOTT
glass made of ideas



Asmara's Cinema Roma underwent a major renovation three years ago. The cinema, built in two phases under different Italian architects (Roberto Cappellano, 1937, and Bruno Sclafani, 1944), now includes a popular coffee shop and is decorated with items from its history, such as the projector seen here.



The façade of the cinema, partly clad in marble, shows the strong influence of the Italian Art Deco style.

More of Stefan Boness' photos of Asmara are in the book Asmara: The Frozen City, published by Jovis Verlag.

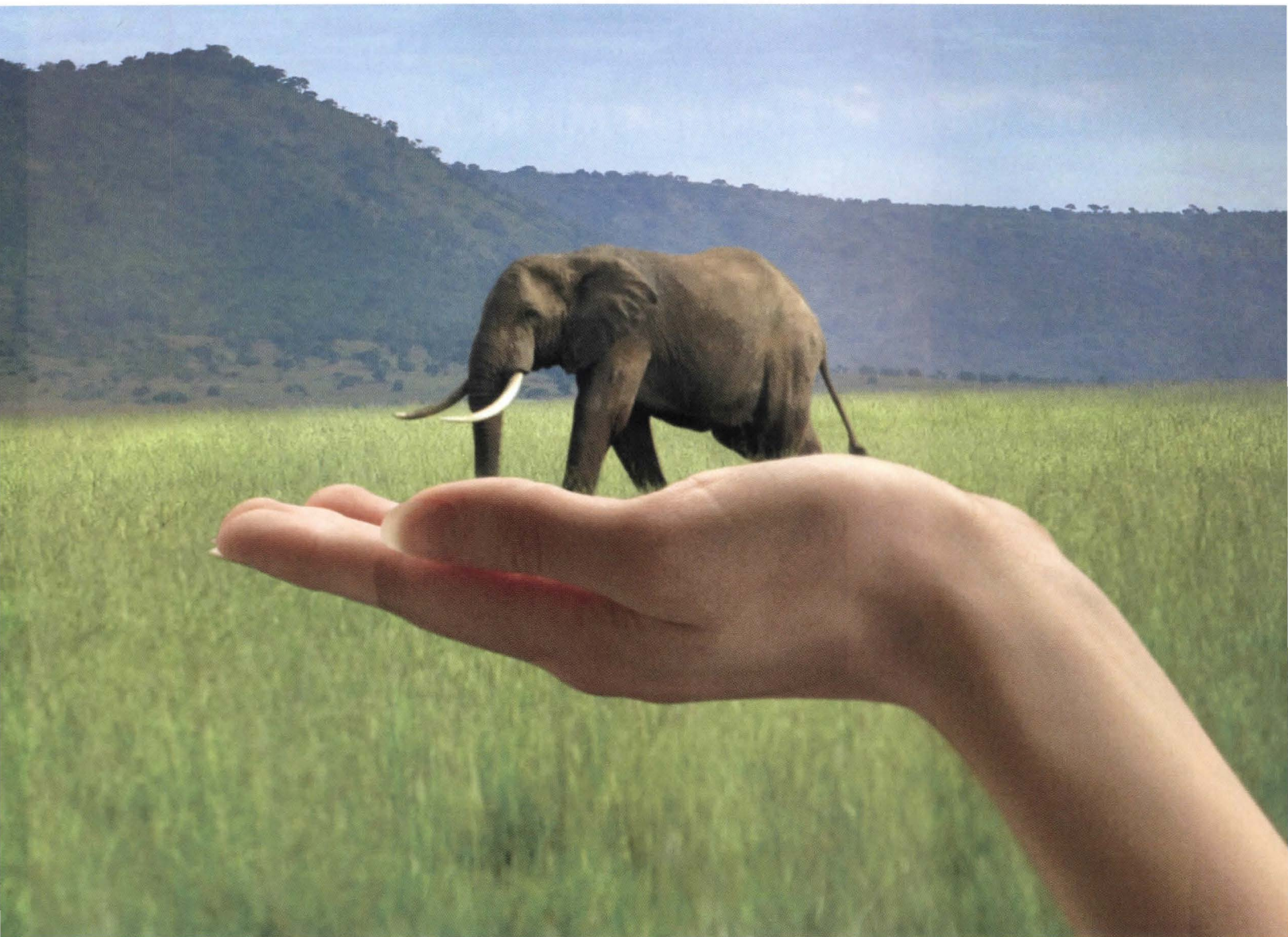

The impossible may become more common – but it will always be impressive.

Solarban® 70XL Solar Control Low-E Glass is an MSVD soft coat high-performance glass that delivers the impossibly impressive LSG rating (light to solar heat gain) of 2.37 – with the look of clear glass. But an even more impressive feat is that *Solarban 70XL* glass could help you save over \$100,000 in upfront cooling system costs – and reduce long-term energy consumption. You'll see these impressive results for yourself when you order your free copy of our latest white paper and a *Solarban 70XL* glass sample. Call 1-888-PPG-IDEA. Or visit www.ppgideascales.com. Circle no. 431 or <http://architect.hotims.com>

Solarban, IdeaScapes, PPG and the PPG logo are trademarks owned by PPG Industries, Inc.

Bright Ideas, Bold Innovations

The Days of Halogen MR16 Are Numbered

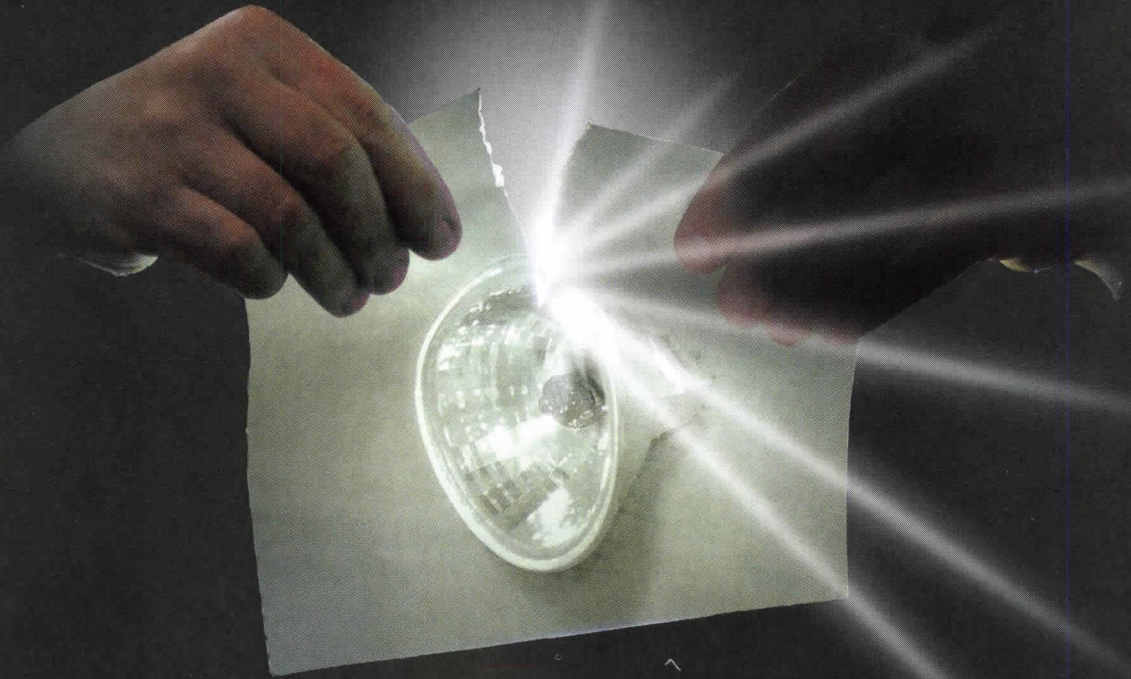

- 22% less energy
- 4x the light output
- 2x the life
- CRI of 90+

**Visit Us at LightFair (booth 509) and at AIA (booth 11285) and
Discover the Possibilities**



VENTURE
LIGHTING

800-451-2606

FAX: 800-451-2605 E-MAIL: venture@adlt.com

VentureLighting.com

Circle no. 448 or <http://architect.hotims.com>

© 2007 Venture Lighting International.

Venture is a registered trademark of Venture Lighting International

VLI-0833A4-0

PRESENTS :



“AMERICAN DAZZLING BEAUTY”

These are the homes you are looking for!

These are the homes built with ALBA bricks, stones and blocks!

Made from pure calcite, also named « *White Gold* », ALBA bricks, stones and blocks create a brilliant whiteness and support an incredible longevity.

They keep their whiteness even when the night is getting darker!

ALBA masonry products are available in an almost infinite range of colours, from pastels to brights.

PURE!

“ALBA bricks, stones and blocks are made from pure calcite.”

ALBA Products:
affordable elegance,
class and... *style!*

Sales Management 

8138, Metropolitan Blvd East
Montreal, Quebec
H1K 1A1

Circle no. 447 or <http://architect.hotims.com>

www.alba.com
info@alba.com
Toll free: 1 866 884-0223

THE META RANKINGS

A LOOK AT HOW ARCHITECTURAL POWER IS MEASURED AND HONORED—AND WHAT IT MEANS TODAY.

SEARCH BOOKS ON AMAZON.COM FOR “ARCHITECT” and you will discover that the most powerful architect in America is White House deputy chief of staff Karl Rove. *The Architect: Karl Rove and the Dream of Absolute Power*, by James Moore and Wayne Slater, comes up as the No. 2 search result (after Lee W. Waldrep’s career guide, *Becoming an Architect*).

Add to that Henry Kissinger’s famous description of power—namely, that it’s the ultimate aphrodisiac—and you might conclude that not only does a bald, bespectacled 56-year-old political operative rule our profession, but he’s most likely to attract the nubile White House interns (oops—wrong party, different administration ...).

As we planned this special issue, the task of identifying the real architects of power proved difficult. We remembered that Philip Johnson—whom many would consider the reigning power broker of 20th century architecture—nevertheless admitted in 1983, “I am a whore and I am paid very well for building high-rise buildings.” Johnson meant to shock,

of course, but he was right: His clients had far more power than he ever would, a situation that’s changed little since Vitruvius tried to impress the emperor Augustus with a book.

We surveyed lists of the typical superlatives—biggest, best, most (and combinations thereof). We realized that these terms are relative, so that drawing meaningful insights from this wealth of information is a less-than-scientific enterprise. We consulted multiple sources: industry research powerhouses like the Greenway Group and ZweigWhite; professional organizations including the American Institute of Architects (AIA) and the Council on Tall Buildings and Urban Habitat. We also created our own rankings using Internet resources such as LexisNexis and Google. Methodology and results varied widely, depending on the source, but we could draw some general observations.

Size can offer advantages. Two large firms in particular—Skidmore, Owings & Merrill (SOM) and Perkins+Will—combine high revenue with

What can the news database LexisNexis tell us about the architectural firmament? All the big names are there, but by comparing searches with and without a qualifier, we see that some resonate apart from any mention of architecture (Richard Rogers, Michael Graves), while others are defined by it (Robert A.M. Stern, Antoine Predock).

ARCHITECTURE'S TOP NEWSMAKERS

SOURCE: LEXISNEXIS

OPEN CUBE: ALL NEWS STORIES FOR RECENT 90-DAY PERIOD, NO QUALIFIERS.

SOLID CUBE: SAME SEARCH WITH "ARCHITECT" OR "ARCHITECTURE" AS QUALIFIER.

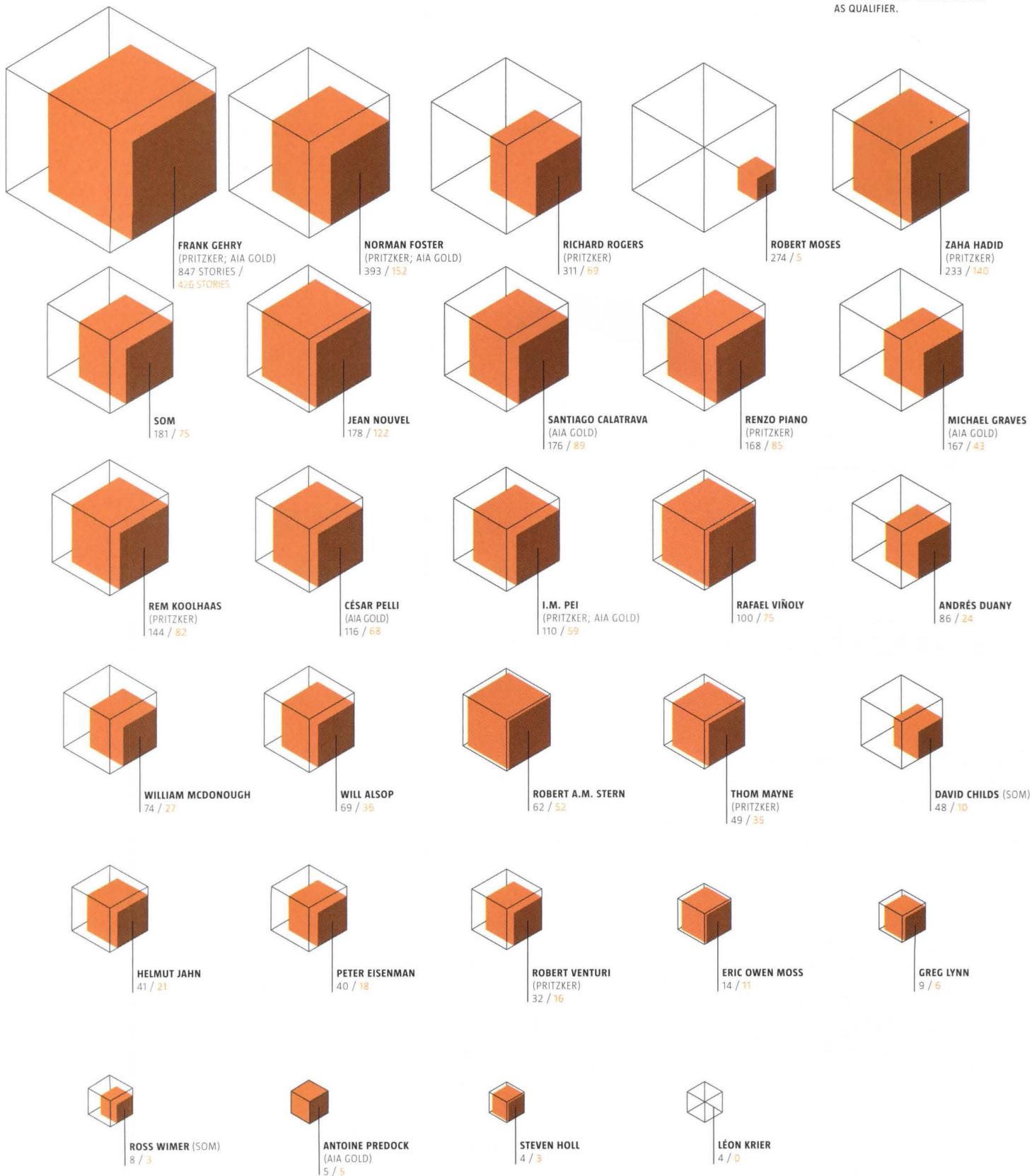

TOP U.S. FIRMS BY ANNUAL REVENUE, 2006

SOURCE: DESIGNINTELLIGENCE

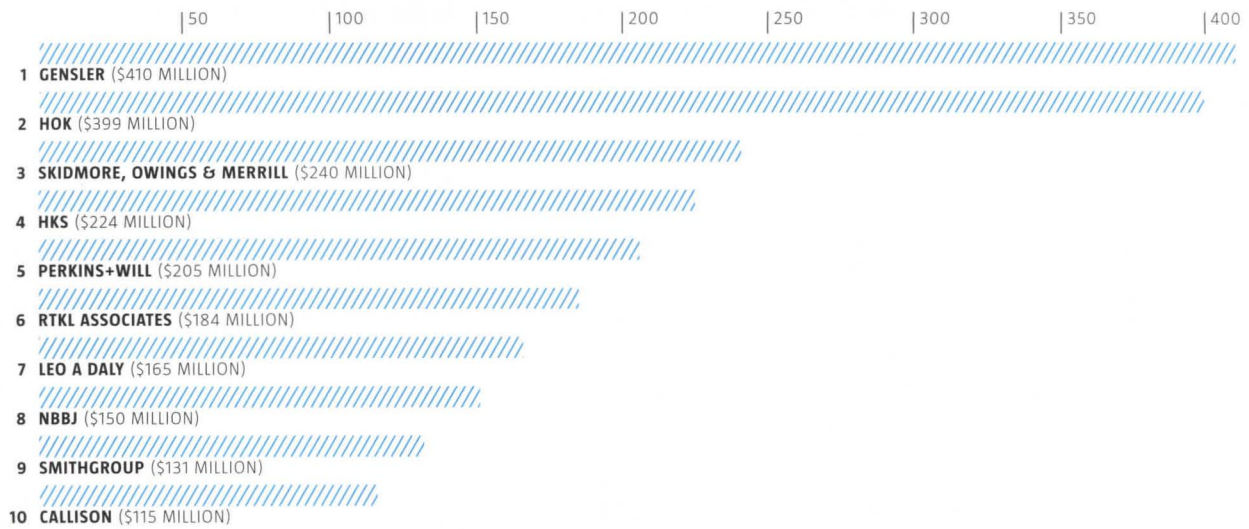

TOP U.S. FIRMS BY GROWTH, 2002–2005

SOURCE: ZWEIFWHITE

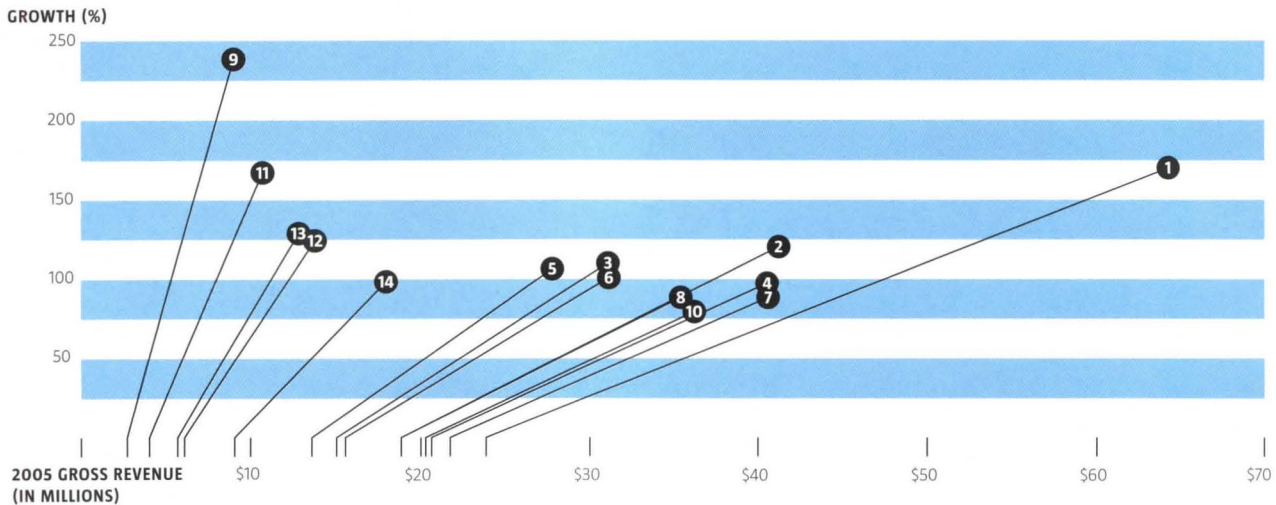

- 1 ARQUITECTONICA
- 2 LS3P ASSOCIATES
- 3 GKKWORKS
- 4 BSB DESIGN

- 5 THE LAWRENCE GROUP
- 6 WDG ARCHITECTURE
- 7 JCJ ARCHITECTURE
- 8 CUNNINGHAM GROUP

- 9 **WPH ARCHITECTURE**
- 10 PERKOWITZ+RUTH ARCHITECTS
- 11 MARGULIES & ASSOCIATES
- 12 CLINE DESIGN ASSOCIATES

- 13 THE EVANS GROUP
- 14 SB ARCHITECTS

WPH Architecture, Portland, Ore., and Las Vegas

WPH Architecture is one of the standouts on the 2006 Hot Firms list, with an astounding 238 percent increase in revenue from 2002 (\$2,657,958) to 2005 (\$8,992,335). CEO Terri Deskins, who joined the firm in 2002 as the company's numbers began their rapid rise, notes that one of the main factors behind this growth was entering a new market sector: mixed-use residential.

"We felt we had a good background in that building type," says Deskins, "but once we had a building built, it really served as its own marketing campaign." The building in question is the Metropolis condo tower in Las Vegas, for which WPH served as the architect of record. Whereas before 2002, the firm focused on retail, hospital-ity, and cinema projects, now WPH does 40 percent to 50 percent of its work on mixed-use residential projects.

And how does that contribute to revenue growth? "We're doing more projects, and bigger projects," says Deskins, who is not an architect herself, of the 45-person firm. "We are really successful because of the people we have." KATIE GERFEN

ZweigWhite's Hot Firms list ranks the top 100 fastest-growing U.S. architecture, engineering, planning, and environmental consulting firms from 2002 to 2005. ZweigWhite received more than 400 entries; to be eligible, firms must have had 2002 gross revenue of at least \$1 million. Firms' dollar and percentage growth were weighted equally, and revenue figures were verified using financial statements and tax returns. The Hot Firms list here, supplied by ZweigWhite, extracts only the architecture firms from its compilation of A/E/P leaders.

an impressive haul of AIA National Honor Awards (see page 112). SOM hits the trifecta, touting as their own four of the 11 tallest buildings completed by U.S. firms since 2004.

Tall buildings still create considerable buzz. While several 2,000-foot-plus towers will soon be coming online, recently completed buildings designed by American firms haven't topped 1,000 feet (see ranking on page 113). And although many of these same firms now have big towers under construction, mega-skyscrapers are no longer strictly an American-made product. Local firms from Sydney to Shanghai are redrawing skylines with as much confidence as we once mustered. The Far East and New York are home to many of these behemoths, but who expected Jersey City to be in the top 10?

Skyscrapers require specialized technical expertise. SOM, Pelli Clarke Pelli Architects, and KPF (Kohn Pedersen Fox Architects) are expected standard-bearers. However, with its Grand Gateway towers in Shanghai, Callison topped all but one of SOM's highest towers. This seldom-mentioned Seattle firm breaks the top 10 in revenue as well, making it a power in two rights (see profile on page 113).

It's widely assumed—thanks in part to media coverage—that New York, Los Angeles, and Chicago are the cities where worthwhile design originates. So, do those cities have all the professional opportunities for architects? Not if you want to be employed by one of the U.S. firms ranked among the best places to work (see next page). If you live in New York or Chicago and hope to work for one of those firms, you're out of luck. If you prefer Los Angeles, you fare a little better—but you're not going to be working in Santa Monica or Venice or any of the other hip L.A. spots; you'll be in glamour-challenged Long Beach, where Perkowitz+Ruth Architects is based.

By contrast, relocating to Des Moines gives you options. You can choose the home office of BSB Design (formerly Bloodgood Sharp Buster Architects & Planners), which is the third-best architecture firm in the country to work for. Or you might try Herbert Lewis Kruse Blunck Architecture, the third-ranked producer of AIA Award-winning projects, ahead of powerhouse designers Morphosis, Murphy/Jahn Architects, and Perkins+Will. If having an AIA Award-winning project on your résumé is important, you might also consider Oklahoma City-based Elliot + Associates Architects, also third in the rankings, who surpass all but SOM and Richard Meier in capturing these coveted honors.

ZweigWhite's list of "hot firms" (facing page) is based on revenue growth over the preceding three-year period. ZweigWhite considers both dollar growth and percentage growth to compute its rankings. With the exception of BSB, nobody on this list made the cut on another. Perhaps it's evidence of the divided nature of a profession in which superior business and design skills seldom make good bedfellows.

We compiled our list of top newsmakers by searching the LexisNexis database for all mentions of specific, "brand-name" architects during a recent 90-day period. International prize winners predominated—do we need any further proof of Frank Gehry's influence? On average, Gehry generates almost 10 press mentions every day of the week, far more than twice those devoted to his closest competition, the lords Foster and Rogers. But enter the name of a long-dead nonarchitect—Robert Moses—and he reaps the most LexisNexis hits. No doubt the recent book and museum exhibitions on his legacy have skewed the numbers a bit. (For more on Moses, see "An Indecisive Democracy," page 138, and Q&A, page 184.)

Architects do have real power in their ability to shape the physical environment. But the rankings we compiled suggest something that most architects intuitively understand: Power, or influence, is shared by so many in our field that it has become diffuse and must be acquired with steady effort. Even the biggest firm or most celebrated architect faces competition. We all have to make our mark one project at a time.

Of course, the most powerful architect of our era may well be a fictional creation—every undergraduate's favorite cardboard hero, Howard Roark in Ayn Rand's *The Fountainhead*. His Nietzschean drive was so absolute that he could dynamite a building when clients dared revise the product of his genius. Some architects still conjure that fantasy after a particularly bad meeting, but most of us have moved on. These lists shed light on where we are now.

The rankings we compiled suggest something that most architects intuitively understand: Power is shared by so many in our field that it has become diffuse and must be acquired with steady effort.

BEST U.S. FIRMS TO WORK FOR, 2006

SOURCE: ZWEIGWHITE

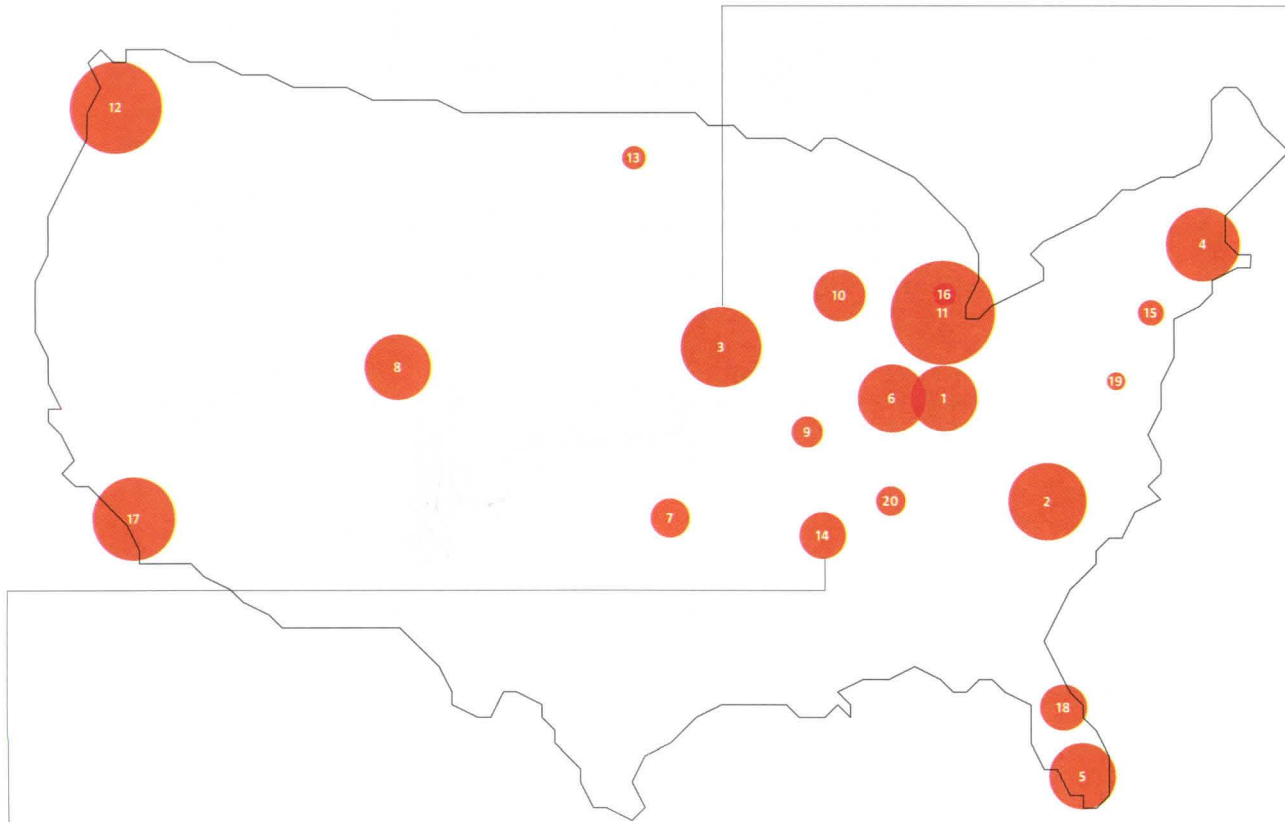

1
FRCH DESIGN WORLDWIDE
 CINCINNATI
 NUMBER OF EMPLOYEES: 200

2
LITTLE
 CHARLOTTE, N.C.
 NUMBER OF EMPLOYEES: 275

3
BSB DESIGN
 WEST DES MOINES, IOWA
 NUMBER OF EMPLOYEES: 300

4
SASAKI ASSOCIATES
 WATERTOWN, MASS.
 NUMBER OF EMPLOYEES: 250

5
EDSA
 FORT LAUDERDALE, FLA.
 NUMBER OF EMPLOYEES: 200

6
BSA LIFESTRUCTURES
 INDIANAPOLIS
 NUMBER OF EMPLOYEES: 215

7
SCOTT & GOBLE ARCHITECTS
 TULSA, OKLA.
 NUMBER OF EMPLOYEES: 70

8
RNL
 DENVER
 NUMBER OF EMPLOYEES: 200

9
MACKEY MITCHELL ASSOCIATES
 ST. LOUIS
 NUMBER OF EMPLOYEES: 45

10
KAHLER SLATER
 MILWAUKEE
 NUMBER OF EMPLOYEES: 125

11
HARLEY ELLIS DEVEREAUX
 SOUTHFIELD, MICH.
 NUMBER OF EMPLOYEES: 500

12
MULVANNY2 ARCHITECTURE
 BELLEVUE, WASH.
 NUMBER OF EMPLOYEES: 400

13
JLG ARCHITECTS
 GRAND FORKS, N.D.
 NUMBER OF EMPLOYEES: 25

14
HNEDEK BOBO GROUP
 MEMPHIS, TENN.
 NUMBER OF EMPLOYEES: 100

15
WESKETCH ARCHITECTURE
 MILLINGTON, N.J.
 NUMBER OF EMPLOYEES: 30

16
DOMINICK TRINGALI ARCHITECTS
 BLOOMFIELD, MICH.
 NUMBER OF EMPLOYEES: 25

17
PERKOWITZ+RUTH ARCHITECTS
 LONG BEACH, CALIF.
 NUMBER OF EMPLOYEES: 320

18
CUHACI & PETERSON ARCHITECTS
 ORLANDO, FLA.
 NUMBER OF EMPLOYEES: 100

19
SGA COMPANIES
 BETHESDA, MD.
 NUMBER OF EMPLOYEES: 15

20
MAXWELL JOHANSON MAHER ARCHITECTS
 NASHVILLE, TENN.
 NUMBER OF EMPLOYEES: 40

Perks offered by the Hnedak Bobo Group (pronounced knee-dak boh-boh) in Memphis, Tenn., include comprehensive medical insurance, flexible work hours, and a rooftop deck above the office where employees can relax.

TOP WINNERS OF GREEN AWARDS

SOURCE: DESIGNINTELLIGENCE

This list of firms, based on informal research, is a summary of those honored for projects recognized in the "Sustainable/Green Design" awards section of the DesignIntelligence Almanac of Architecture & Design from 2004 to 2007.

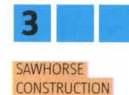

BSB Design, Des Moines, Iowa

As president of BSB Design (formerly Bloodgood Sharp Buster Architects & Planners), Steve Moore says he operates at a disadvantage when it comes to recruiting. "In residential, we always fight a battle to attract great architects. Residential is not what people aspire to," he says.

You'd never know it from the numbers: This Des Moines-based firm snags the No. 3 spot on ZweigWhite's list of the best firms to work for, and is a "Hot Firm" too, registering 97 percent growth from 2002 to 2005.

Moore says that in the late 1990s, BSB's leaders made a conscious decision to attract young talent with salaries and benefits in the top 2 percent to 5 percent of the industry. He cites high pay, an attractive bonus plan, a 401(k) plan, and good medical benefits as inducements for architects to join the 300-person firm, which focuses on residential work, including production and custom single-family housing and multifamily housing.

Soft benefits help, too, like an interoffice design competition and after-hours social events. "We try to create a fun place to work," Moore explains.

BSB currently has 15 offices around the country and plans to expand into new markets soon. Does being a great place to work help drive the firm's growth? Absolutely, says Moore. "Everybody gets responsibility much earlier in their career than they would in other companies, in many cases before they're ready," he says. "We are constantly grooming young leaders." AMANDA KOLSON HURLEY

Arrowstreet, a design firm in Somerville, Mass., won a 2006 AIA/COTE Top Ten Green Buildings award for its Artists for Humanity EpiCenter, the first LEED Platinum building in Boston.

SawHorse is a design/build firm in Atlanta that specializes in residential remodeling. Its founder and former vice president, Carl Seville, is now an independent green building consultant.

TOP WINNERS, NATIONAL AIA HONOR AWARDS, 1996–2006

Over the past 10 years, Skidmore, Owings & Merrill has scooped up 21 honor awards from the national AIA, more than twice as many as its nearest competitor, Richard Meier & Partners. What's more interesting are the patterns evident in the table at right: Several firms have had dry spells punctuated by red-letter years (like Herbert Lewis Kruse Blunck, which won three awards in 2002, all for projects in its home state of Iowa).

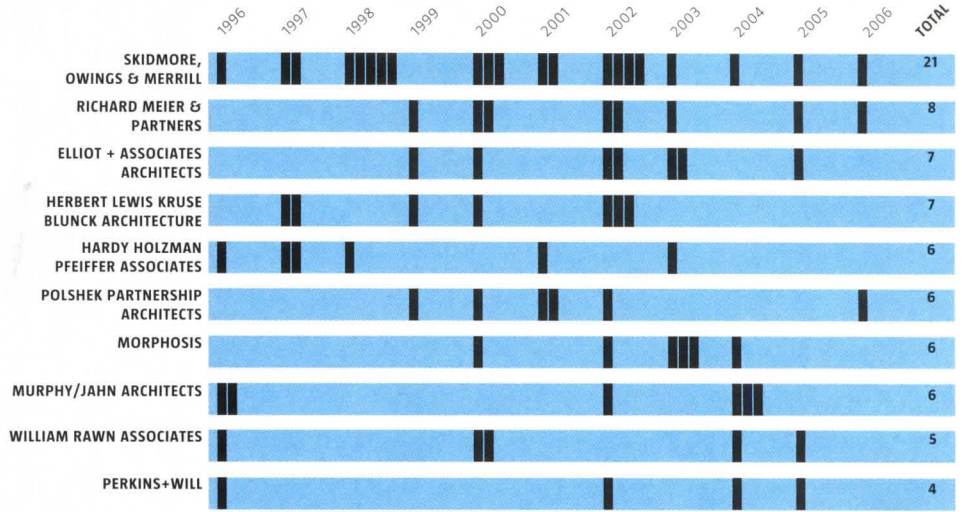

TOP WINNERS, LOCAL AIA CHAPTER AWARDS, 2006

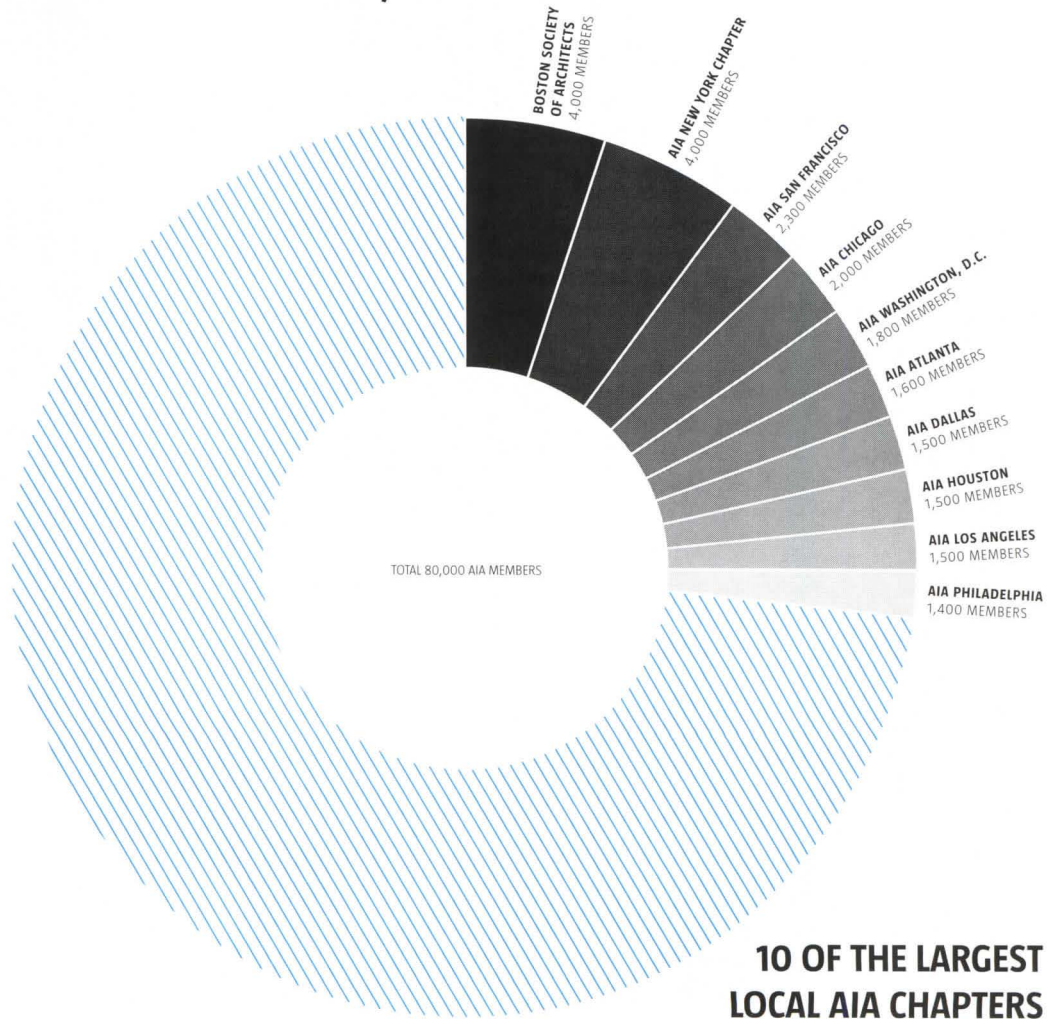
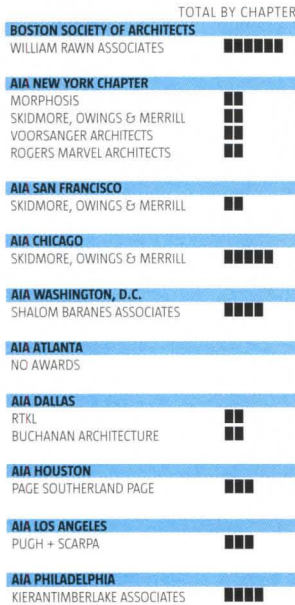

A quarter of the AIA's total membership (pie graph) is made up of architects in major metropolitan areas, which represent 10 of the largest chapters, aka the "Big Sibs." We get a snapshot of dominant players in local markets (bar graph, above) by charting the biggest winners of last year's awards competitions for 10 of the largest local AIA chapters.

10 OF THE LARGEST LOCAL AIA CHAPTERS

11 TALLEST BUILDINGS BY U.S. FIRMS, 2004–2007 SOURCE: EMPORIS

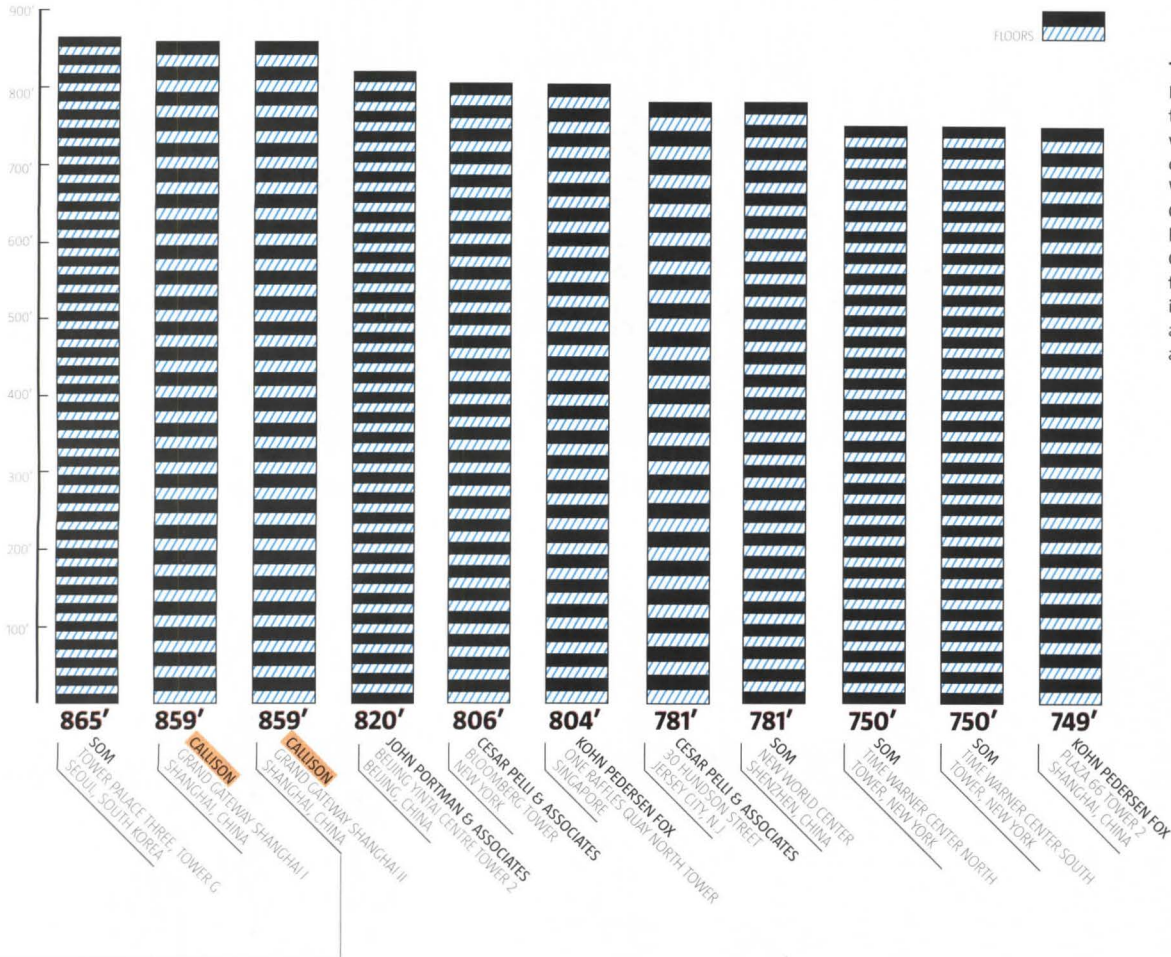

This list, compiled by us from Emporis, ranks the top 11 tallest buildings around the world completed by U.S. firms during the years 2004–2007. Why 11? The Time Warner Center towers are a same-height pair (like Shanghai's Grand Gateway towers), so we thought we'd throw one more in—especially since it's only a foot shorter than the ninth and 10th entries.

Callison, Seattle

Not only is Callison one of the largest firms in the country (ranked 10th in annual revenue), it loses out only to SOM in building tall—Callison's Grand Gateway I and II in Shanghai are second and third on our list of the tallest buildings completed from 2004 to 2007. Yet Callison's name recognition isn't as high as you might expect, given the numbers. So who are they?

The 650-person, Seattle-based firm has been around for 32 years. "Our clients are industry leaders," says CEO William Karst; long-term clients include such heavy-hitters as Microsoft, Boeing, Williams-Sonoma, and FedEx. "Our retail experience has morphed into mixed use," Karst says—which explains how they snagged the commission for dual 859-foot-tall structures in Shanghai. New offices in New York, London, Los Angeles, and Shanghai are expected to drive future growth. "We would never be this size if we only worked with Seattle-based corporations," says Karst, but he notes that the city's location along the Pacific Rim helps create a global worldview that situates them to compete internationally. Karst disputes that the firm is unknown: "You might say we're underpublicized," he admits. EDWARD KEEGAN



THE FINANCIER

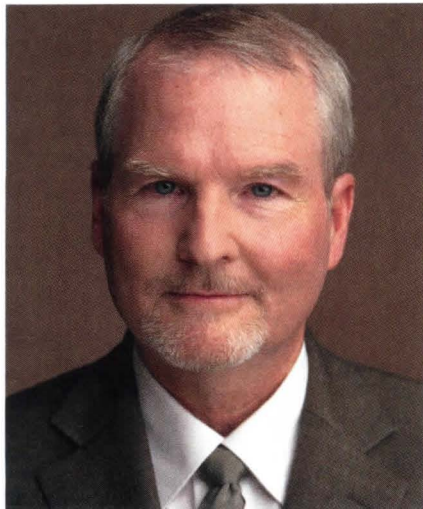

THE PLANNER

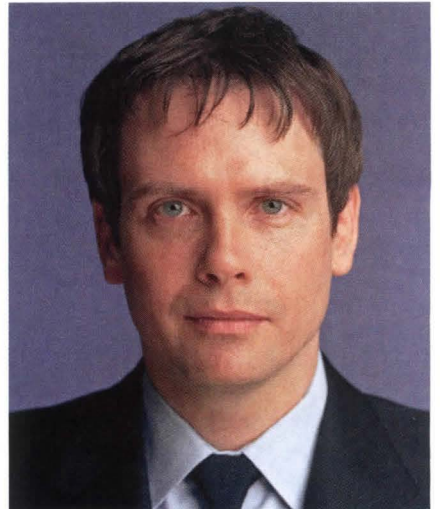

THE COMPETITION ADVISER

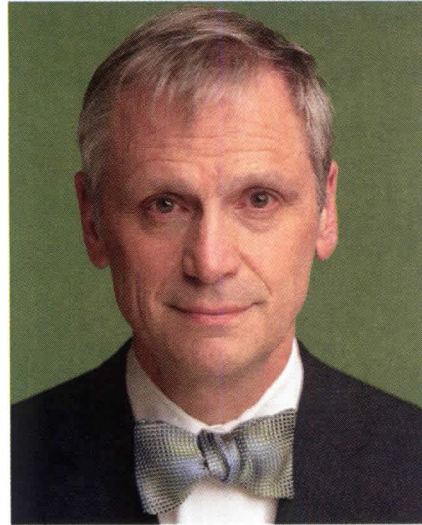
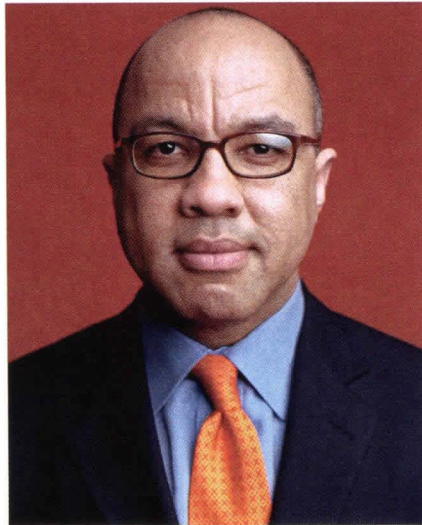

Darren Walker

Vice president of foundation initiatives
The Rockefeller Foundation

Text Elizabeth A. Evitts

THE GRANTMAKER

In March 2006, as fierce dispute—and charges of inequity—surrounded the rebuilding plans for post-Katrina New Orleans, Darren Walker did the unimaginable. A vice president of the Rockefeller Foundation, Walker transformed a top-down planning process into an inclusive one. At the behest of the Louisiana Recovery Authority and the Greater New Orleans Foundation, Walker had traveled to New Orleans to convene a meeting that would rethink the city's course of action. He had agreed to come on one condition: that the gathering would include as many community members as possible.

"Without an appreciation of the wisdom of local knowledge, the best thinkers in urban planning will fail in the redevelopment," Walker says today from his office in New York. The Unified New Orleans Plan, a comprehensive vision for rebuilding the city that was supported by more than \$10 million from the Rockefeller Foundation, was released in March.

Walker, 47, has been an advocate for sustainable community development throughout his career. A graduate of the University of Texas at Austin and University of Texas School of Law, he left behind a private-sector job with the Union Bank of Switzerland in the mid-1990s to work for the Abyssinian Development Corp., a faith-based development group in Harlem. He helped turn around the long-disenfranchised neighborhood with affordable housing and infrastructure improvements before joining Rockefeller in 2002.

Today, Walker is responsible for overseeing the millions that the foundation gives out every year (\$20 million in 2006 alone) to support sustainable built environments around the globe. He was instrumental in creating the new Jane Jacobs Medal, a \$200,000 annual award honoring individuals who fulfill the principles of the famed urban theorist. (Jacobs herself received a Rockefeller grant to write her seminal book, *The Death and Life of Great American Cities*.)

This summer, Walker will convene another important meeting: an ambitious global urban summit to address the fact that, for the first time in history, the majority of the world's population will reside in urban regions. "If our mission is to help build more-resilient people and communities, that means that we need more-resilient cities," Walker says.



Earl Blumenauer

U.S. representative
Oregon, Third District

Text T.R. Goldman

THE POLITICIAN

When architects want to call on a member of Congress who gets it, they go to Rep. Earl Blumenauer, a Democrat from Oregon and 11-year House veteran. Not that he's one of them: Trained as a lawyer and elected to the Oregon State House when he was just 23 years old, Blumenauer has spent his entire adult life as a professional politician. His experience legislating in one of the country's most environmentally conscious regions has given Blumenauer a keen understanding of the forces that shape community development today, and how both architects and politicians can make an impact.

Architects, says Blumenauer, "link the artistic expression of what people want to get out of the built environment with the requirements and realities of the governmental arena—water, air, open space, light, energy requirements, and building codes." For that reason, the representative observes, "They are more important than they know."

Blumenauer, 48, spent 10 years as commissioner of public works in Portland, Ore., a key post in which he oversaw the city's famous urban growth boundary, a ring around the metropolitan area designed to promote high-density growth inside the city and prevent urban sprawl. In Washington, Blumenauer is perhaps best known for the Livable Communities Task Force, which he founded and runs. Its goal is to persuade Congress to support, through policies, communities that offer a better mix of transportation, housing, and open-space alternatives.

"I don't think there's anybody in the House and Senate who has been as focused. We [the task force] have made it part of our mission in Congress—for the federal government to be a better partner with architects and business," says the perpetually bow-tied Blumenauer, who doesn't own a car in D.C., preferring instead to pedal to work from his home near the Capitol.

With the Democrats now in control of Congress, Blumenauer is poised to come into his own. "It has been tough sledding in Congress for the last 10 years," he says. Now, Blumenauer holds a seat on a special House committee on global warming, established by newly elected House Speaker Nancy Pelosi, and on the powerful tax-writing House Committee on Ways and Means.

Frances Berwick

Executive vice president,
programming and production
Bravo



Text Eve M. Kahn

THE TELEVISION PRODUCER

Week after week this spring, celebrity judges on Bravo's *Top Design* subjected young, nervous interior designers to crueler crits than get inflicted in most design schools. "Your rug looked like it belonged in an airport," Jonathan Adler scolded a contestant fond of swirly patterns. Of one contestant's use of tan plaid slipcovers, fellow judge Kelly Wearstler complained, "It was, like, granny."

The surprisingly bubbly, cheerful mastermind behind the harsh series is Bravo's executive vice president of programming and production, an Englishwoman named Frances Berwick. An 11-year veteran of the network, Berwick also helped realize the megahits *Queer Eye for the Straight Guy* and *Project Runway*, which brought design consciousness closer to the American mainstream.

"We bring people a practical look at what they might have considered 'high design,' something inaccessible to them," Berwick says. "What the

designers say always encapsulates a lot of tips, good takeaways, that people could use to get their own 'wow factor' at home." Plus, she adds, "It's fascinating to watch designers agonize."

Berwick, a Yorkshire native and a graduate of the University of Edinburgh in Scotland, worked as a fund-raiser for the London theater Sadler's Wells before moving to New York in 1996 to climb the TV production ladder. At the time, Bravo was a rather frumpy, classical music-dominated network. NBC bought Bravo in 2002 for \$1 billion and has pumped up production and marketing budgets.

Many other networks run unscripted home-design reality shows, but Bravo has taken the upscale path with high-profile hosts and judges, such as model Heidi Klum and designer Todd Oldham. Berwick's shows have also made stars out of the contestants: Laura Bennett, an architect best known for designing gowns with plunging necklines on *Project Runway*, has become a regular Bravo commentator.

The audience members, Berwick reports, send e-mails about what they're working on at home, in emulation of the broadcast projects. "There's a play-along component," she says, "which we never envisioned."



Robert Grupe Jr.

Director of architectural and technical solutions
USG

Text Katie Gerfen

THE MATERIALS ENGINEER

When architects at Skidmore, Owings & Merrill (SOM) were sitting down to work on design development for the Sears Tower in the late 1960s, they collaborated with another, smaller operation that has been largely lost to the history books. In a temporary drafting studio in the corner of the corporate offices of the United States Gypsum Co., two staff engineers, two architects from SOM, and four contractors sat, churning out stacks of drawings of all of the building's partition details, making careful calculations to account for building drift—calculated as 1 foot at the summit.

Those were the early days of what was to become a full division of the company now known as USG: architectural and technical solutions, currently headed by Robert Grupe, Jr. A self-proclaimed “generational anomaly,” Grupe has worked at USG for 35 of his 54 years. He started with the company as a researcher in 1972, right after graduating from the Illinois Institute of

Technology with a B.S. in civil engineering. He became involved with new products as they were developed, then sent out the door, and was “really impressed with the process, from a technical standpoint.”

So impressed that he has stayed with USG for more than three decades, holding a series of positions on the technical-support side of the business. The team that he now oversees is made up of registered architects and engineers who specialize in the building science of walls and ceilings. Grupe explains: “I manage an in-house consulting firm, and our clients are architects, contractors, building officials, and even other people at USG.” Together, they still serve largely the same purpose those two USG engineers did on the Sears Tower: to help architects navigate the problems that come up in the course of a design as they use various USG products.

That is no small feat, given the ubiquity of those products. The Chicago-based ceiling, floor, and gypsum-wallboard manufacturer—founded in 1902 by a group of 30 independent gypsum rock and plaster manufacturing companies—had 2006 revenue of \$5.81 billion, making it one of the largest building-product manufacturers in the world. Drywall may be background material, but it's everywhere. Grupe is as close as most architects will ever get to the source.

Tom Wolfe

Senior director of federal affairs
American Institute of Architects

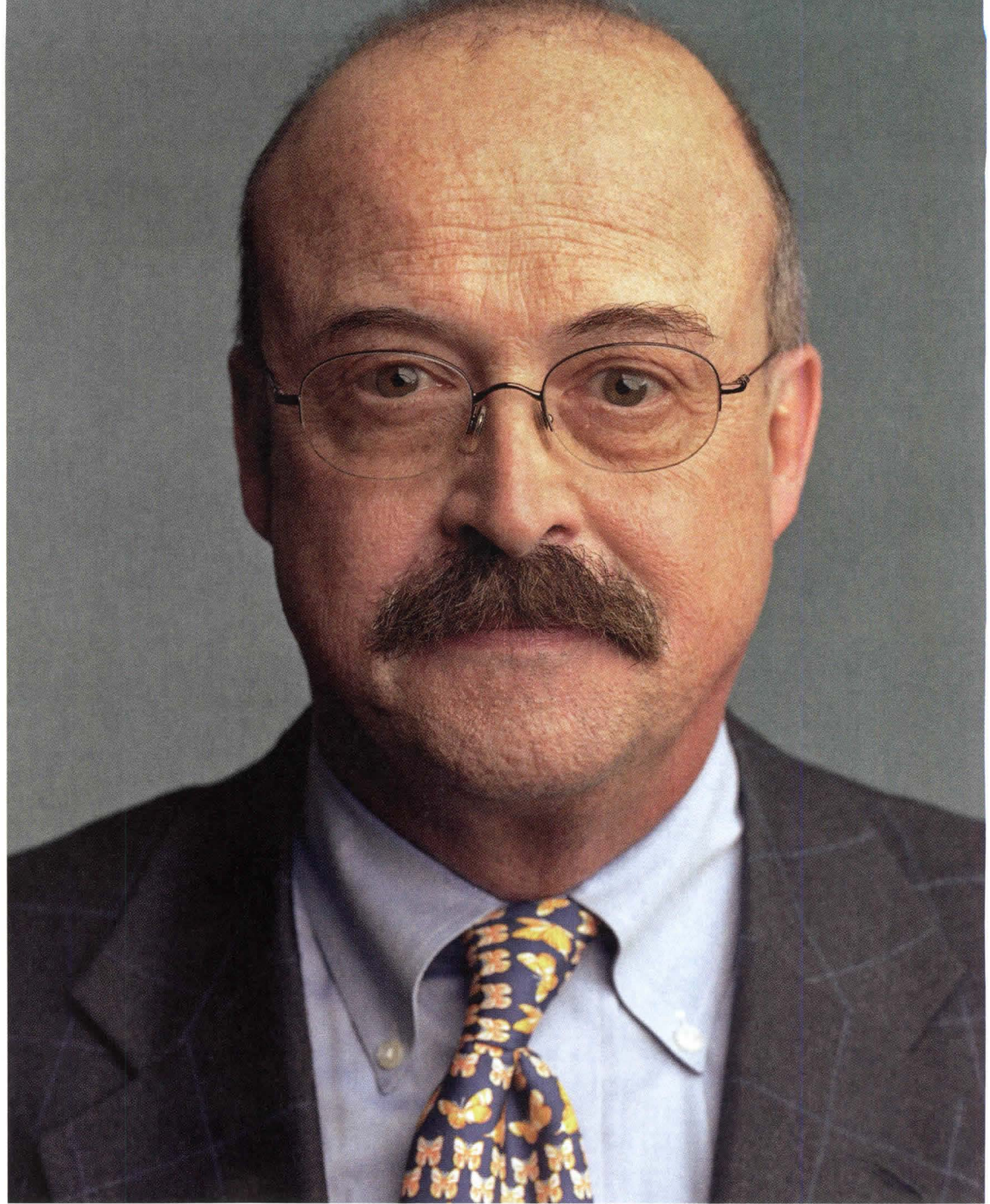

Text T.R. Goldman

THE LOBBYIST

Tom Wolfe, the chief lobbyist for the American Institute of Architects (AIA), is not an architect himself—and he thinks that’s a good thing.

“Architects make terrible lobbyists,” says Wolfe, a 59-year-old lawyer and engineer who has been the AIA’s top Washington lobbyist for the past three years. “They have their head in the clouds. All they care about is their art.”

Wolfe has had a varied career. Before joining the AIA in 2004, he represented the American Chemistry Council and Waste Management Inc., among other clients. He spent 11 years honing his lobbying skills at the Institute of Scrap Recycling Industries and a decade at the U.S. Department of Energy and the Environmental Protection Agency, where he got an inside view of two of the federal agencies he now seeks to influence.

Lobbying for the AIA falls into two basic divisions: There are practice-related issues, like taxes, liability, and health care, and there are value issues, like

sustainability, energy efficiency, and green infrastructure (some issues, such as affordable housing, cross into both categories). Wolfe and two of his colleagues, Andrew Goldberg and Tom Bergan, cover the House, Senate, and federal agencies, pushing a host of laws that are helpful—and sometimes essential—to the profession.

Last year, the team was the lead lobbyist on a *successful* bid to add \$400 million to a massive spending bill that would try out several housing alternatives to the trailers normally used by the Federal Emergency Management Agency in disaster-affected communities.

Environmental and sustainability issues—redeveloping brownfield sites, energy efficiency, and green infrastructure (which uses technologies like permeable pavements to force more rainwater into the ground, not sewers)—are important to him, Wolfe says. “The big sustainability issue this year is a federal statutory requirement that federal buildings meet a graduated series of caps on energy efficiency,” he says.

And why should architects take note? “They go through periods of intellectual ferment over particular schools of thought,” he explains. “It was Modernism in the ’20s and ’30s. Now people have seized on sustainability.”



Peter Marchetto

CEO of the Americas
Bovis Lend Lease

Text Les Shaver

THE CONSTRUCTION CEO

It's no wonder that Peter Marchetto, who heads operations in the Americas for construction giant Bovis Lend Lease, knows how to incorporate architects in the building process. He grew up with one.

Marchetto's older brother, Dean, is principal of his own firm in Hoboken, N.J., and both Marchettos learned about construction from their father, a contractor. His lessons on teamwork obviously sank in, because his CEO son preaches collaboration both inside and outside of Bovis. Before each big project, Marchetto will bring in all the key players to talk. While the meetings last for up to two days, he considers it time well spent.

"Everybody talks about what we need to do to make the project successful," Marchetto says. "We don't go eight months and find out that the owner was interested in one thing, and the design team was going in another direction."

Ranked the nation's No. 2 construction company on *Building Design + Construction's* annual "Giants 300" list, Bovis had 2005 revenue of more than \$3.6 billion. Yet despite its huge size, the company prides itself on a personal, collaborative way of doing business.

"There's a lot of two-way communication between the designer and the development team, and they have a great preconstruction program where they work with the architect up front," says Dean Marchetto, who has worked with his younger sibling on two projects in New Jersey.

Having your older brother as an advocate is one thing. Having Donald Trump funnel business in your direction is another. After winning a contest held by the New York real estate developer in the 1990s, Bovis built eight buildings for Trump at Riverside South in Manhattan and later constructed Trump World Tower; it has also done work in Chicago for the star of *The Apprentice*.

Eighty-five percent of Bovis' work comes from repeat customers. "We don't want to build one job for Donald Trump or any developer we work with," Marchetto says. "We want to build a relationship so that the owner thinks of Bovis as they're building for the future."

Jay Bhatt

Senior vice president,
architecture, engineering,
and construction solutions
Autodesk

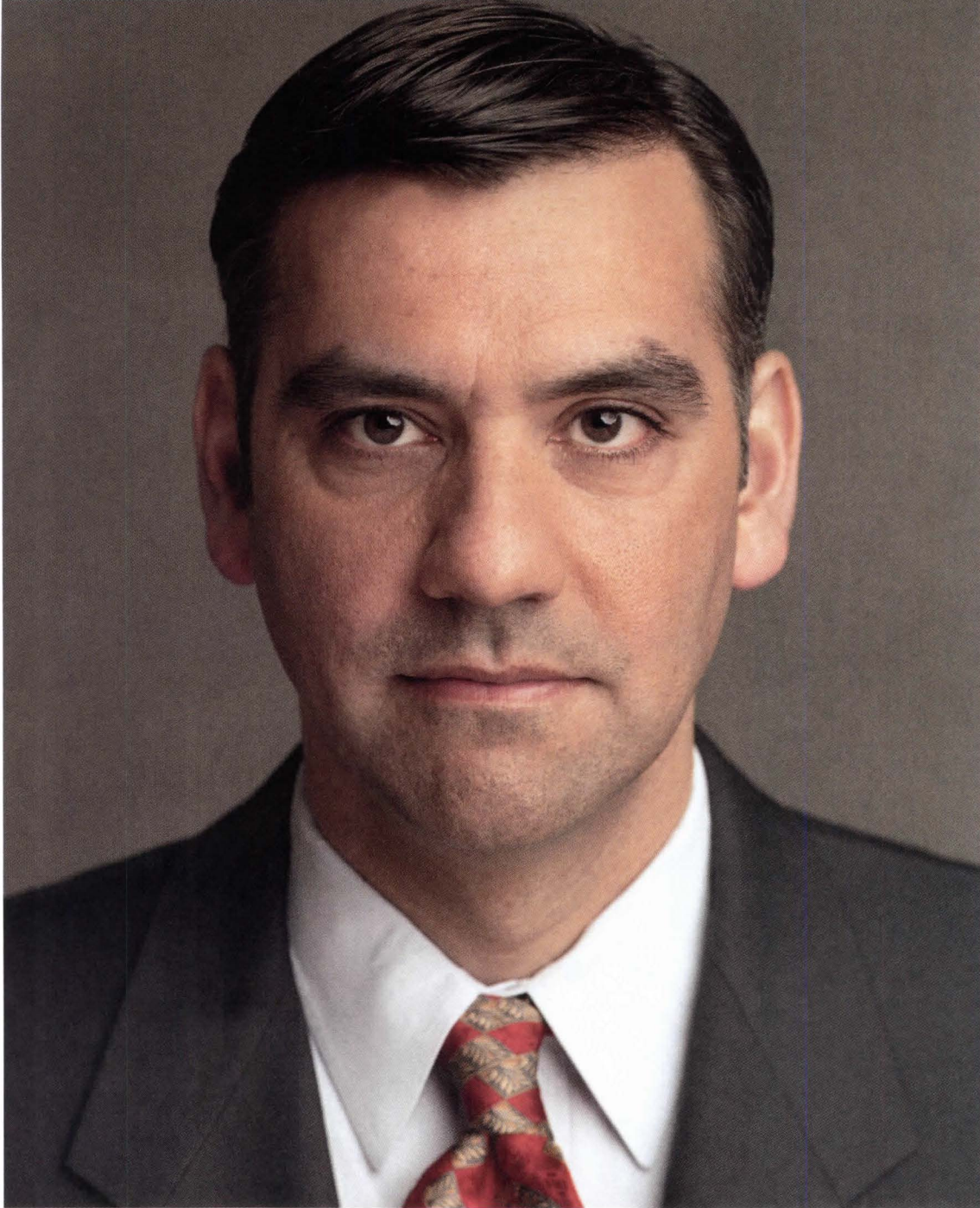

Text Les Shaver

THE SOFTWARE EXECUTIVE

It's no surprise that Jay Bhatt sees the future through a global lens. After spending childhood summers in India, he now has a front-row seat on the massive construction efforts taking place in developing countries, thanks to his role as vice president of the architecture, engineering, and construction solutions division of Autodesk, the global leader in 2-D and 3-D design software.

"I'm very passionate about globalization," Bhatt says. "It's fascinating how these cultures are coming to work together on products. In the past, you would have never seen an Indian architect and a Chinese engineer working together."

If Bhatt has his way, that architect and that engineer will be sending their drawings back and forth via Revit Architecture, an Autodesk product he champions. Bhatt feels strongly that Revit can not only facilitate globalization, it will help produce more energy-efficient buildings.

Only about 5 percent of architects, Bhatt estimates, currently use building

information modeling (BIM), which is the central characteristic of Revit. With BIM, building professionals put all of the variables in building design into a database. This information can be used for design decision-making, producing high-quality construction documents, predicting performance, cost-estimating, and construction planning—and, later in the building's life cycle, for managing and operating the facility.

In short, BIM has the potential to streamline the building process, which would be an invaluable asset to developing countries as they embark on a construction boom. BIM can also act as a catalyst for sustainable design, Bhatt contends. "With a database-oriented system, you can do a solar analysis and do energy analysis," he says. "We need to compute the environmentally insensitive behavior of a building and make changes and provide dynamic results."

Is Bhatt idealistic in thinking that Revit and BIM will soon make buildings greener around the world? Maybe not: Autodesk already has one product that dominates the market. "It's pretty much the language in which architecture is spoken," says Roopinder Tara, editor of Tenlinks.com, a website for technical professionals. "If architects want to communicate their design, they will use AutoCAD."



Robert R. Merck

Senior managing director and head of agricultural and real estate investments
MetLife

Text Les Shaver

THE FINANCIER

Many lenders focus on generating new business. MetLife wants to keep the clients it already has. The numbers say the New York-based insurer is doing just that. The company is the nation's third biggest lender and top insurance company, according to *American Banker*. Eighty percent of its commercial real estate business is from repeat customers.

"We have grown because we're focusing on customer service," says Robert R. Merck, senior managing director and head of agricultural and real estate investments at MetLife. "We have a very loyal group of borrowers."

MetLife has a very successful group of borrowers, as well. "We deal with major players," says Merck, who piloted the company to the No. 3 spot on the *American Banker* list. "We're investing in high-quality assets."

MetLife knows good real estate because it's also an owner, with about \$8 billion in equity investments. In October of last year, MetLife sold a major property—Peter Cooper Village and Stuyvesant Town, an 11,000-unit, 80-acre

apartment complex in Manhattan—to Tishman Speyer, in a joint venture with BlackRock Realty, the real estate arm of BlackRock Inc., for \$5.4 billion. MetLife estimates its earnings on the sale at \$3 billion, more or less.

"They're well known, and they own high-profile buildings," says J. Murry Bowden, chairman and CEO of The Hanover Cos. in Houston, one of MetLife's partners on deals. "From a lending standpoint, they've financed some of the premier real estate in this country." A case in point: In April, MetLife announced a deal with Daniel Corp. and Selig Enterprises to develop a 2.5-million-square-foot mixed-use complex in Atlanta, called 12th & Midtown.

Merck's focus on high-quality assets means that he passes on a lot of deals that cross his desk. He estimates that the company only lends on one of every 100 transactions it evaluates. "We focus on the major markets and are well diversified around the country and internationally," he says. The commercial real estate group has eight domestic offices and three international offices.

Many competitors sell loans after closing, but Merck can assure borrowers that MetLife will hold onto their loan throughout its lifetime. "Our long-term perspective distinguishes us from other lenders," Merck says. "Our clients know we have the financial strength and capacity to weather the market cycles."

Joe Frank

Director of advance planning
City of Fort Collins, Colo.



Text Margot Carmichael
Lester

THE PLANNER

Just an hour north of the Boulder/Denver area, Fort Collins, Colo., is bounded by grasslands and Rocky Mountain National Park. A college town (Colorado State University is located here), it's an intellectually and physically active mix of students, academics, hikers, mountain bikers, and nature lovers.

As a maturing city, Fort Collins aims to keep its downtown core vital while managing against sprawl from new suburban development. Successfully balancing those challenges requires solid growth management and a clear vision from the city planning team. "An effective city planner needs to be a gatekeeper, negotiator, and advocate for community values that have been identified by the appointed and elected bodies," says local architect Paul Trementozzi, principal of oz Architecture.

Fort Collins planning director Joe Frank is all of the above. On the job for 28 years, he came to town from Illinois, where he worked with the City of

Naperville and, prior to that, studied at the University of Illinois and Southern Illinois University. Of the department he leads in his adopted hometown, Frank says that in recent years, "we have reinvented ourselves" in order to navigate population growth and the need for more developable land.

"Our previous focus had mostly been on growth management and neighborhoods, and we have a solid foundation of planning and implementation as a result," Frank explains. "Now, we have adjusted our focus on areas of existing and future economic growth—downtown, underutilized shopping centers and strips, and greenfield opportunities." That means doing more-detailed predevelopment plans, creating incentives and tax-increment financing, and working with property owners and business people.

Frank's strategy seems to be working. Last year, *Money* magazine voted Fort Collins the best place to live in the United States, and the year before, *Outside* magazine counted the 128,000-resident town among the country's New American Dream Towns. In 2006, Frank was elected a fellow by the American Institute of Certified Planners.

Frank eschews too much praise, boiling his success down to a mantra: "Stay cool. Stay current. Stay flexible."



Casey L. Jones

Principal
Jones|Kroloff

Text Eve M. Kahn

THE COMPETITION ADVISER

Architectural competitions easily run aground. Vague briefs can attract piles of unworkable proposals, and overeager clients, though they use the contests to generate publicity, haven't necessarily raised enough money and momentum to realize the winning designs. But Casey L. Jones, if hired in advance, can make competitions lead smoothly to built work.

The most prominent of the country's half-dozen professional advisers to architectural competitions, Jones works out of New Orleans in partnership with Reed Kroloff, the dean of Tulane University's architecture school. After just a few years of full-time advising, Jones, 40, is watching his competitions' winning designs move toward construction, from Pennsylvania's Lehigh Valley (the Rockwell Group's SteelStax cultural center in Bethlehem) to back home in New Orleans (Global Green's housing complex by Workshop/apd).

Before clients even decide to launch competitions, Jones says, "We make

sure that they've adjusted their expectations. If they're proposing a cultural center for a few million dollars, we tell them, 'You may not get someone like Richard Rogers to enter. But you might well get the next Richard Rogers.'"

Jones sympathizes with architects partly because he trained as one (B.S., University of Virginia; M.Arch., University of Michigan), then practiced for a few years (Cooper Lecky in Washington, D.C., and Goshow Associates in New York). In the late 1990s, as associate director of the Van Alen Institute in New York, he coordinated ideas competitions for Governors Island and the East River's banks.

Working for the General Services Administration's Design Excellence Program in the early 2000s, Jones saw the process from the other side, serving as client to architects such as Antoine Predock and Robert A.M. Stern. "I've looked at thousands of proposals; I've learned how firms are organized, what they've achieved, and how they present themselves," he explains.

So he knows how to sift hype from truth when Jones|Kroloff clients—including Motown Records, the Pentagon, and the Whitney Museum—start hunting for architects. Perhaps only a third of the clients, in the end, decide to host competitions. "Juries can be fun to watch, but the standard selection process is fun to watch, too," Jones says.

Arabian Heights

HOW DOES AN EMERGING GLOBAL POWER ANNOUNCE ITSELF? WITH THE WORLD'S TALLEST BUILDING.

Text Dan Halpern



International Finance Center

LOCATION Hong Kong
HEIGHT 1,362 feet
COMPLETION 2003

Jin Mao Tower

LOCATION Shanghai, China
HEIGHT 1,380 feet
COMPLETION 1999

Sears Tower

LOCATION Chicago
HEIGHT 1,450 feet
COMPLETION 1974

Petronas Towers

LOCATION Kuala Lumpur, Malaysia
HEIGHT 1,482 feet
COMPLETION 1998

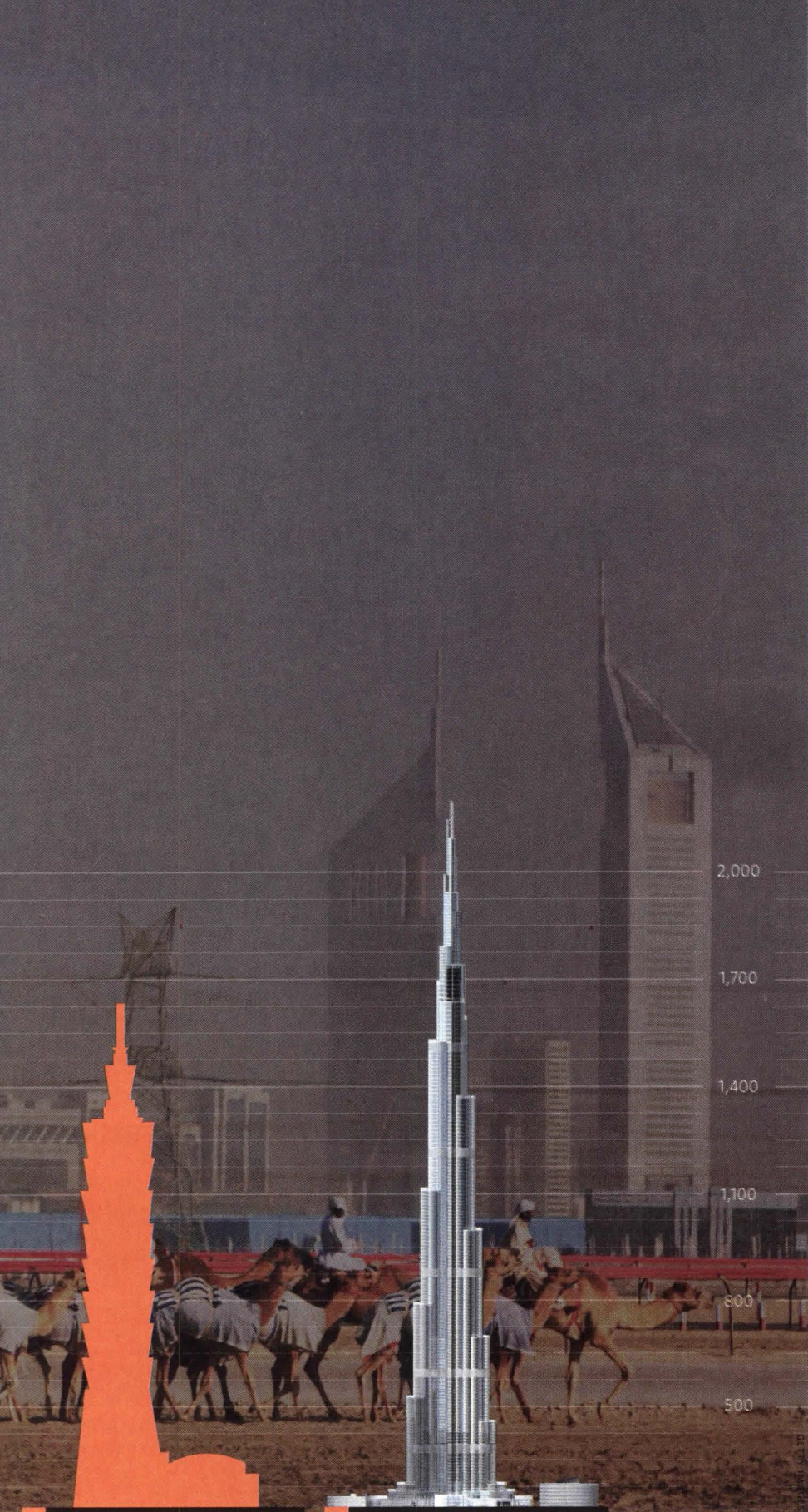
**Taipei 101**

LOCATION Taipei, Taiwan
 HEIGHT 1,667 feet
 COMPLETION 2004

Burj Dubai

LOCATION Dubai, United Arab Emirates
 PROJECTED HEIGHT 2,300 feet
 SCHEDULED FOR COMPLETION late 2008

GEORGE EFSTATHIOU WAS WONDERING if, after the building was finished, you'd be able to see Iran on a clear day. "I mean, it's really not that far over the Gulf," he said. "Seriously—standing at the top, at the final height, how far do you think you'll be able to see?"

"I think you'll be able to see until the curvature of the earth stops your line of vision," said Eric Tomich, laughing a little.

In fact, if the evening had been clearer, spotting Iran might already have been close to possible. Efstathiou and Tomich, both architects at the Chicago firm Skidmore, Owings & Merrill (SOM), were standing on a wooden platform floating more than 1,300 feet above the ground. Below them, the Persian Gulf lay a few miles to the north; about 60 or 70 miles on the other side of it, the coast of Iran.

The platform was balanced on 115 floors of the half-built Burj Dubai—which means in Arabic, simply, "The Tower of Dubai"—an ultra-tall tower that, when it is completed, will be the tallest man-made structure in the world. At 1,335 feet, or 406 meters, it is already taller than the Empire State Building and a few weeks from rising above the Sears Tower.

And this is only somewhere around half the height it will ultimately reach. The Burj sits on a three-legged, Y-shaped base and spirals up into the sky, tapering as it goes, its cross-section decreasing as it rises, with setbacks at different levels. There's a bit of a rocket look to the



**Sheikh Mohammed bin
Rashid al-Maktoum**

Ruler of Dubai

Photo: Stefan Zaklin/Corbis

Mohamed Ali Alabbar

Founder and chairman,
Emaar Properties; director
general of Dubai's
Department of Economic
Development

Photo: Courtesy
Emaar/Asda'a

Robert Booth

Executive director, Emaar
Properties

Photo: Courtesy
Emaar/Asda'a

renderings, as if at any moment the building might fire its engines and just launch itself into the atmosphere.

And in effect, it will. The height is already slightly dizzying, but when you consider where it's going—take the Sears Tower and stack another Sears on top of it, and you'll have the idea—it seems as if it might just touch the edge of space.

The small patch of desert land that sits under the Burj has, of late, conducted one of the most remarkable (and most exhaustively publicized) overhauls of national reputations in the history of the world. It is the capital city of the emirate of Dubai, one of the seven states that make up the nation of the United Arab Emirates, a place that has learned the most efficient lessons of modern advertising: Once a tiny, practically unknown spot, with only a tradition of pearl-diving and piracy and a bit of oil to recommend it, Dubai has thrust itself to the center of international consciousness by constantly insisting on attention.

It is now, of course, the West's favorite example of its own simulation, the Orient appropriating the economic blueprints of the Occident. (Not to mention being the only spot in the region that has appropriated certain cultural particulars: If you find yourself in the Middle East wanting a whiskey at an Irish bar, it's not advisable to try Riyadh.) After 15 years of explosive development, Dubai now outdoes Las Vegas in strange spectacle, from its indoor ski range in a mall to man-made islands that replicate the earth's landforms; from the sail-shaped, "seven-star" service Burj Al Arab to the world's first underwater hotel.

Because Dubai's oil reserves are far, far smaller than its neighbors' (and predicted to run out within the decade), the emirate has hit on a different strategy for a sustainable

economy, based in tourism and spectacle, with the aim of holding a prime spot at the table of international trade. Dubai is betting that, by remaking itself as a garden spot, a financial center, and a gateway to the Middle East, it will become a nexus of the global economy.

The tower being built, thus, is an announcement. It is meant to say: Here we are. You've watched us coming, and now we have arrived. We have reached the center, drawn the center to where we are. Man has come closest to the heavens here. You cannot possibly choose to look away.

At least the tower itself will be something worth looking at. Its final height is a closely kept secret—mostly in order to prevent competitors from trying to beat it, though probably also to encourage breathless speculation—but it is likely to go up at least 2,300 feet. Many guesses go well above 2,600; one website, based on a report by a subcontractor that had so far supplied 170 tons of aluminum to the project, has estimated more than 3,000 feet; one particularly excitable guesser, at www.dubaimegaprojects.com, has estimated 1,011 meters, or more than 3,300 feet.

Whatever the final height turns out to be, one thing is clear: The Burj Dubai will rise far, far above the tip of the current title holder, Taipei 101, which hits its apex at 1,667 feet. (The construction schedule calls for it to pass Taipei on July 4, Tomich says.) The initial plan, however, didn't start with an idea to make a building almost twice as high as the tallest buildings in the world. The original conception for the Burj, in fact, was a paltry 1,800 feet.

Mark Amirault, a Canadian who is group senior director for development at Emaar Properties, the developer of the Burj, says the company had considered a tall tower as early as 2000, but in a different location,

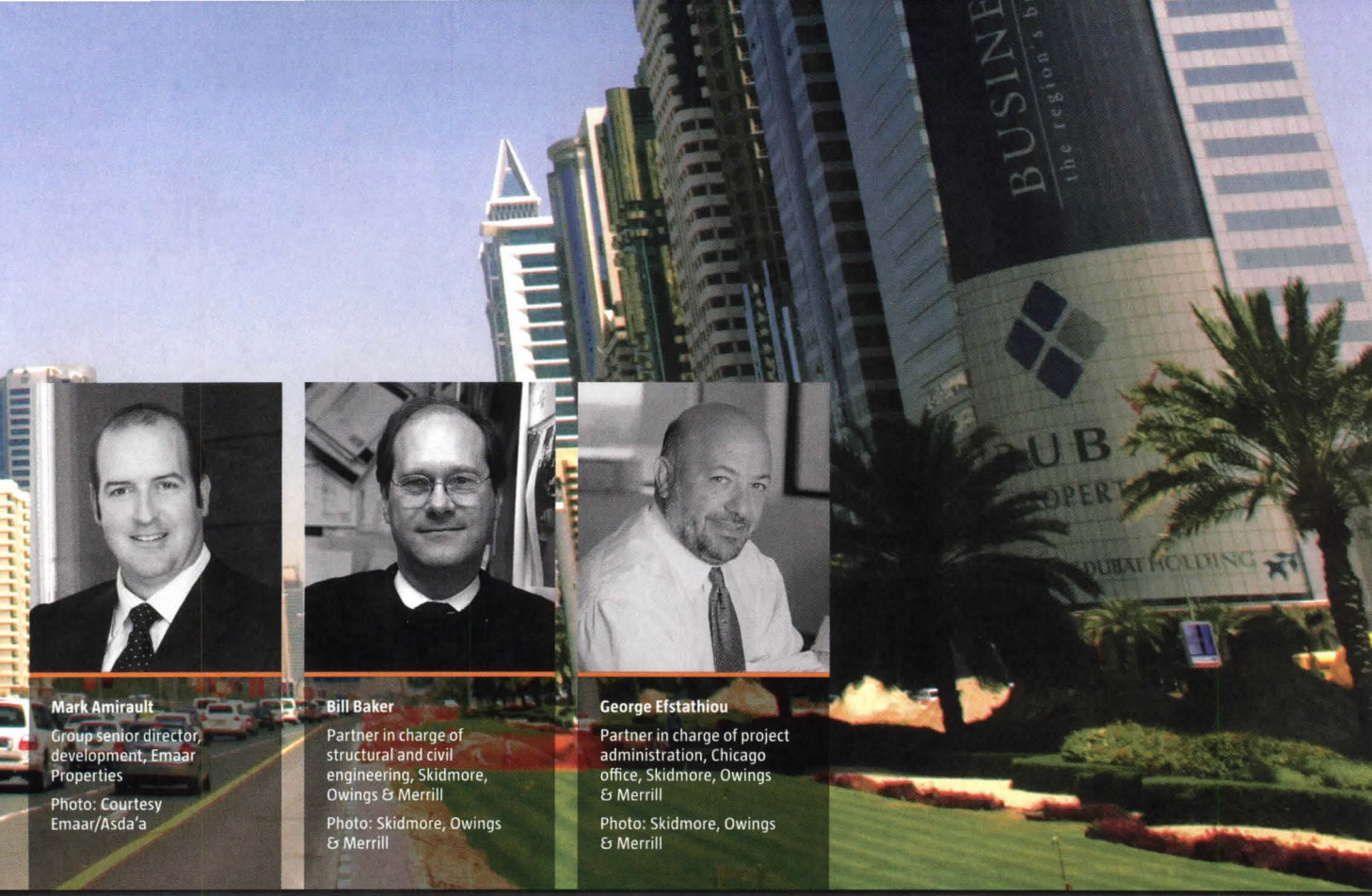

Mark Amirault

Group senior director, development, Emaar Properties

Photo: Courtesy Emaar/Asda'a

Bill Baker

Partner in charge of structural and civil engineering, Skidmore, Owings & Merrill

Photo: Skidmore, Owings & Merrill

George Efstathiou

Partner in charge of project administration, Chicago office, Skidmore, Owings & Merrill

Photo: Skidmore, Owings & Merrill

a few miles down the coast at the Dubai Marina. It was in February 2003 that the concept for the Burj Dubai—and its enormous attendant development—came into full being when Amirault, along with another Canadian, Robert Booth (who is now executive director at Emaar), and Mohamed ali Alabbar, Emaar's founder and chairman, held a late-night meeting to hammer out the idea.

"We looked at the success of KLCC [Kuala Lumpur City Centre]," Amirault says. "Not only did they build the Petronas Towers, but they added in a major shopping center, a large man-made lake and park, [and] a hotel, and created the new center of Kuala Lumpur." Emaar hired the master planner who had designed the Malaysia project, David Klages of RNL, and began to envision a new city center for Dubai on essentially the same model.

Emaar was founded in 1997 and is still run by Alabbar, a former chief of Dubai's Department of Economic Development. Its reported profits for 2005 were just under \$1.3 billion. This, obviously, has made Emaar a significant player in the extraordinary free flow of money driving the emirate's growth. But the development of Dubai has hardly been a capitalistic dance solely choreographed by entrepreneurs. These are projects directed from the top: Alabbar is not only a private businessman, but also director general of the Dubai Department of Economic Development and a member of the Dubai Executive Council, the supreme government body that coordinates all growth initiatives in Dubai. He is also very close to Sheikh Mohammed bin Rashid al-Maktoum, the ruler of Dubai, who is generally credited for the massive expansion and new directions the emirate has taken.

What's more, Emaar—valued at \$25 billion dollars two years ago, and surely worth more today—recently

exchanged 27.9 percent of its stock in return for land from the massive Dubai Holding. Dubai Holding is owned by the emirate itself, and thus, since Sheikh Mohammed's government already owned 32 percent of Emaar stock, the state now controls a majority 51 percent of Emaar. This wasn't the case when construction began, obviously, but that hardly matters. The direction of development has always had a clear guiding hand. And that guiding hand has directed development to go up, up, up.

"Whatever I presented to the sheik, he said to make it bigger," Farhan Faraidooni, a leading Dubai architect, has said. When Alabbar was negotiating with SOM, the sheik made sure Alabbar kept him informed. What he wanted to know above all, again and again, was: Is it the tallest?

The soon-to-be-tallest building in the world sits on a concrete-and-steel podium with 192 piles that go down about 150 feet into the earth. The bottom floors will house a hotel designed by Giorgio Armani; above that will be a thousand apartments, as well as restaurants, pools, fitness areas, cigar lounges, and, toward the top, office space. (Sheikh Mohammed has reportedly reserved five floors.)

The gigantic development gathered around the Burj, built on land that was formerly a military base, is clearly intended to shift the focus of the whole city. Called Burj Dubai Downtown, it will draw considerable commerce and attention from the Sheikh Zayed Road, a prestigious chain of massive, luxurious hotels and office buildings that stretches along the city's main highway thoroughfare, as well as from the swank resorts and malls along the coast, not to mention from what is essentially the older version of a downtown, known as Bur Dubai.

The new downtown around the Burj will include a

Sheikh Zayed Road, a highway through Dubai that's lined with tall towers, almost all of them built in the last 10 years.



1

The Palm

The new artificial island of Palm Jumeirah is rapidly being developed with more than 30 hotels and thousands of luxury residences.

2

Burj Al Arab

The tallest hotel in the world, the 1,000-foot Burj Al Arab stands on a man-made island off the Jumeirah beach.

3

The World

The World is an archipelago of 300 man-made islands shaped like a world map. Nine islands, including "Ireland," have been sold this year.

4

Sheikh Zayed Road

A highway running parallel to the coastline, Sheikh Zayed Road is Dubai's "strip," flanked by dozens of skyscrapers. Few were built before the late 1990s.

GOOGLE EARTH PRO

built-from-scratch man-made island (in a man-made lake) hosting a new "Old Town," a low-rise development that will blend traditional and modern styles, according to the Emaar website. It will also include the world's largest mall—covering 12 million square feet, with 16,000 underground parking spaces, it will have an ice rink and a "world-class aquarium"—as well as 30,000 homes, nine hotels, six acres of parkland, and 55 residential towers. The 500-acre development is well under way, to be completed at the same time as the Burj itself, in late 2008. All in all, the entire thing will cost about \$20 billion.

In New York in March 2003, Amirault and Booth met som partners Adrian Smith, Bill Baker, and Efstathiou

for an initial interview. Soon after that, Emaar invited som—with its long history of skyscraper design, from Lever House to the Sears Tower to the Freedom Tower at the World Trade Center site—to enter a competition for a new 1,800-foot residential building in Dubai. Also invited were Kohn Pedersen Fox, Cesar Pelli and Associates, Carlos Ott, and Denton Corker Marshall. They gave the firms two weeks to make a proposal.

"som was the unanimous winner, and everyone's favorite design," Amirault wrote to me. "It had the heroic, romantic massing qualities of the great New York skyscrapers, but had a modern skin and was technically state of the art. They also picked up subtle references to

A satellite image of Dubai City shows two major artificial-island projects (facing page) for which land was reclaimed from the Persian Gulf: The Palm and, still under construction, The World. In the top right corner of the image is Port Rashid; Sheikh Zayed Road is the major road that runs parallel to the coast. Empty land near the Burj Dubai awaits development into Burj Dubai Downtown.

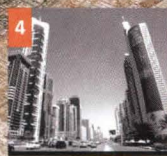

5 Burj Dubai

The world's tallest building will be the linchpin of a new \$20 billion development, intended to compete for attention with the coast and Sheikh Zayed Road.

6 Emirates Towers

Designed by Hazel Wong of the Norr Group, the Emirates Towers are currently the 13th and 27th tallest buildings in the world.

7 Bur Dubai

Bur Dubai, the city's "old town," is located farther inland.

Islamic architecture in the arched plan shapes, which appealed to our Emirati staff [who] worried that the building would look like it could belong anywhere."

The first week of the competition, SOM came up with the original design; the second week, they made the drawings. Smith, the lead designer (he has since left SOM to open his own practice, Adrian Smith + Gordon Gill), says he knew what he wanted to do from the start. At that initial meeting, he says, "We showed them projects we'd done: the Jin Mao tower in Shanghai, Sears, Hancock, 7 South Dearborn, and some other schemes that didn't get built. And one of the comments they made was that they really liked the Tower Palace 3's Y-shaped plan—they

thought it looked great for residential." (They were referring to the Seoul tower Smith designed for Samsung, a project that briefly held the title of the world's tallest residential building.)

Smith agreed with them. "I knew what I wanted to do right off the bat: step back and spiral it up," he says. The final design, as it turned out, would resemble the original idea fairly closely: a tapered tower, with asymmetric steps to protect against wind forces, with three legs at the base.

The tapering effect is an attractive look, but it's also a structural tactic. "The biggest force on the building is wind," explains Efstathiou, who is managing partner at SOM and is overseeing the project from start to finish.



Interior renderings of the Burj Dubai show a corporate office suite (above, near right) and a lobby (far right). The Burj will have luxury residences, offices, restaurants, and a hotel designed by Giorgio Armani. (Images courtesy Skidmore, Owings & Merrill.)



From left: Adrian Smith, Baker, and Efstathiou with a model of the Burj. (Skidmore, Owings & Merrill; photo by Robert Davis.)

“When you start changing the profile of the tower as it goes up, you start confusing the wind forces; they never get organized. So our design keeps changing profile, and the wind never achieves a harmonic movement.”

In addition to the tapering, the SOM team designed a buttressed core—a six-sided core within the three-footed Y shape. “Take buildings, for instance, that are long and rectangular—slab buildings,” says Bill Baker, the chief structural engineer on the project. “Those buildings are strong in the long direction, but challenged in the short. So we took three and put them together, essentially, so two wings are catching the wind and the third is holding the other two guys up.”

The challenge facing Smith was to design a 2,000-plus-foot tower that, because of its desert site, lacks much in the way of an urban context or cultural references. He started with the onion dome shape, widely used in traditional Islamic architecture. “But I didn’t want it to be overt,” he explains. “So I tried to use it in plan, but not in section. The onion dome is always done in section, seeing it against the profile of the sky. I didn’t use it in that way, except when you’re close to the building and you look straight up. I was hoping people would see it that way and say, ‘Ah!’”

For his part, Baker had been spending some of his time thinking about issues of scale, looking at everything from Galileo’s comparisons of human bones and dinosaur bones to the botanist D’arcy Wentworth Thompson’s studies on why organisms are structured and shaped the way they are. Later, after finishing the structural design, he was asked to lecture on Frank Lloyd Wright’s Mile-High Tower, which led him to do a comparison to satisfy his own interest. (“His building would have twisted, I think,” Baker said, adding that Wright’s tower did have similar scaling to the Burj.)

Emaar took two weeks with the proposal, then announced that they liked the design and wanted to begin a conversation about fees. Efstathiou flew to Dubai to negotiate a price (which he declines to reveal). The deal was done at Vu’s, a bar that sits on the 51st floor of one

of the Emirates Towers, a pair of buildings finished in 1999—still the 13th and the 27th tallest in the world—and which, at least while the Burj remains unfinished, are sometimes referred to as the most prestigious addresses in the Middle East.

Efstathiou was ecstatic and called Chicago to break the news. “Most of our buildings are well-known, very visible, but this one is the most visible ever,” Efstathiou said. “This only happens once.”

According to Efstathiou, redesign began almost immediately after making the deal. On his next trip, he says, he heard the same words he would hear repeatedly over the next four years. Can we go a little bigger?

There is some disagreement over who, or what, drove the height increases—Smith says Emaar wanted to reserve the ability to make the Burj taller if another, bigger building were announced, but the developers were satisfied initially with 1,800 feet, or 550 meters; it was he who wanted to make it bigger. “It wasn’t finishing properly at 550,” he told me. “I needed more height to complete the stepping and the reduction of the tower’s mass as it went up.”

Efstathiou says the impetus came from Emaar. “We start doing the working drawings. And they say stop again: ‘We want to go a little higher.’ The other thing that was happening,” he continues, “I can’t even talk about the number, but we’re getting close to Mohamed Alabbar’s lucky number, and so why not go to that number? We’re above 700 meters at this point, I can tell you. And then you look up a little higher, and you say, ‘Look, a half-mile’s not that far away! What about a kilometer? We could go to a kilometer!’”

(They’re both right, says Amirault: Smith and Alabbar both wanted to make the top third of the building more slender, “and our chairman wanted to get to a higher figure than the earlier 705-meter design.”)

What is certain is that the building just kept getting taller. “So we finally,” Efstathiou concludes, “came to a

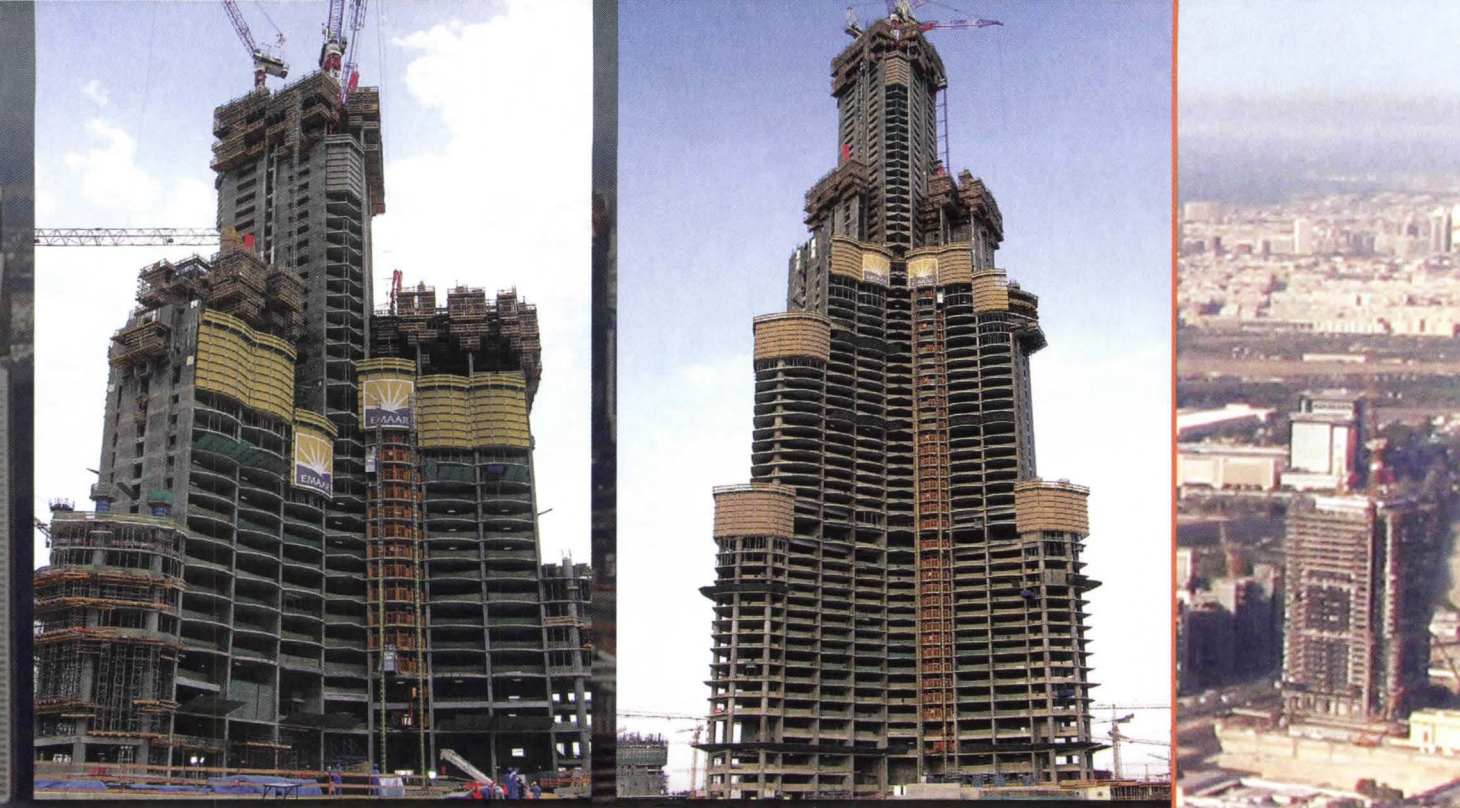

number, and we're almost done, and then they say again, "Can you crank that spire up?" Emaar asked about height increases as recently as December 2006, he says, with construction already over 100 floors.

Despite its celestial reach, back down on the ground, the Burj has not escaped its share of political controversies. Last March, laborers working on the Dubai Mall rioted over wages and working conditions, causing an estimated \$1 million in damages. None of the laborers working on the Burj itself took part, apparently, but because it is part and parcel of the same huge project, the riot called unwanted attention to the building.

What the riot mainly did was galvanize human-rights groups to criticize Dubai's treatment of its workforce. There are 4,000 laborers working day and night on the Burj itself, 20,000 on the whole project. These workers come almost exclusively from India, Pakistan, and Bangladesh—some 80 percent of Dubai's residents are foreign, and the heavy work is done almost entirely by temporary workers from South Asia. Laborers are paid around \$4 a day; skilled carpenters make a little less than \$8.

The fact that Dubai has hundreds of thousands of poor immigrant workers building the city from the ground up hardly distinguishes it from a host of world cities throughout history. But although no nation is eager to display its lowest social and economic rungs for public scrutiny, the attention here has been so skillfully focused on the wealth in the sky that these issues tend to be largely ignored. This is another marketing triumph, of course—Dubai has capitalized on, and to some extent manipulated, a version of the West's imaginary East, essentially the picture of Arab chieftains in white robes and sandals, talking on cell phones encrusted with diamonds.

It's no surprise, then, that the marketing language for the Burj Dubai is overheated. Even the sign outside the worksite announcing the current floor level (it changes by about a floor every three days) proclaims: "HISTORY

RISING." As Emaar and, by extension, Sheikh Mohammed have it, the Burj Dubai is an inspiration for mankind, a beacon of progress; it is the endpoint of a story that stretches from the pyramids through the great cathedrals of Europe to the skyscrapers of America; it's the beginning of a new story, the crowning of Dubai as a prince of cities. The development is, simply enough, the "most prestigious square kilometer on the planet."

Part of the genius of Dubai's self-assertion is its coupling of modernity with myth: The form of its opulence is at once a business model and a fabulous dream. And mythmaking has, obviously, been a large part of the marketing of the Burj Dubai itself: an instant landmark; sign and symbol of a new global emphasis. (Although Emaar claims, for instance, that Adrian Smith took his inspiration for the building design from a six-pointed desert flower, Smith admitted in 2005 that the flower idea had come after he had completed the design—that it was, essentially, a marketing tool.)

So far, the marketing has worked. Before even the first floor was built, every residential unit had been sold over two evenings of an invitation-only sale. Well before the building is finished, Emaar has reportedly made back its investment.

And Dubai, you could say, has made back its investment as well. Its campaign of construction was supposed to compete with the great cities of the world. But already, it has begun to compete mostly with itself. Another Emirati developer, Nakheel Properties, is preparing a tower project. Still in the design concept stage, some reports have announced that it will be called Al Burj, and that it will reach 4,000 feet into the sky.

"I think it will probably happen, once Burj Dubai is up," Smith says. "They'll wait to see how high it is, and then start building higher."

Dan Halpern has written for magazines including The New Yorker, Rolling Stone, and The New York Times Magazine.

The Burj Dubai has risen quickly since construction began in 2004, with 4,000 laborers onsite day and night. By mid-April 2007, the tower had reached 122 floors. (Photos courtesy Skidmore, Owings & Merrill.)



THE GREEN GIANT

HOW A SINGLE NONPROFIT—THE U.S. GREEN BUILDING COUNCIL—DEFINES SUSTAINABILITY FOR THE NATION.

Text Christopher Swope Illustrations Shout

FRAMED PHOTOGRAPHS OF LEED-CERTIFIED BUILDINGS line the hallways of the U.S. Green Building Council's new headquarters, one floor of an office building in Washington, D.C. They are family photos, in a way, and Tom Hicks, the man who runs the LEED program for the council, can't remember the names of a few of the cousins. Even the photo on the wall of his own office stumps him. "I'll get it wrong," says Hicks, blaming unfinished decorating business. "We need to get our plaques up."

You can hardly fault him. Some 800 buildings around the country have now received the council's stamp of environmental approval, and 6,000 more sit in LEED's pipeline. Gone are the days when every certified building was a celebrity, lavishly covered by the press and instantly recognizable. Today, the news about green buildings is that they're no longer newsworthy. Everyone from Bank of America to the U.S. military is building them—and paying the U.S. Green Building Council, or USGBC, to vouch for their bona fides.

As green goes mainstream, the council is emerging as one of architecture's new power brokers. Already, for many people, the LEED brand (the acronym stands for Leadership in Energy and Environmental Design) is tightly intertwined with the very concept of sustainable design. And it's making an impact on how the building industries work. Robert Kobet, a Pittsburgh architect who's active with the USGBC, isn't exaggerating when

he says, "The LEED rating system has become the de facto green building code in this country."

The result is that corporate and political leaders are turning more than ever to the council for guidance. That's even truer now that the debate over global warming is shifting from whether or not it's happening to the question of what to do about it. Some 53 cities, 17 states, and 11 federal agencies have put policies in place to encourage or require new government buildings to meet LEED's standards. Last December, the District of Columbia became the first jurisdiction to require LEED certification for private buildings, too—the mandate begins in 2010 and applies to structures of 50,000 or more square feet. A growing number of cities are offering tax breaks or other perks to private builders who achieve LEED certification.

Now, the USGBC is leveraging LEED to expand its reach even further. The organization has set the audacious goal of certifying 100,000 green commercial buildings by 2010. It's piloting new versions of LEED to rate the green credentials of individual homes and to assess whether entire neighborhoods truly qualify as "smart growth." It's working on a range of other new green standards for schools, retail, health care facilities, and laboratories. And it's trying to raise the environmental performance of all buildings, LEED-certified or not, by working to green the building codes that govern construction in almost every city and state.

These are big ambitions for a nonprofit with such a diverse constituency. The USGBC's heart is a vast and sometimes disputatious membership of 8,000 design firms, developers, engineers, trade groups, and government agencies. An unpaid board of volunteer directors sets policy for the council. New ratings systems are developed by committees of volunteers, who work through a painstaking consensus process to come up with ratings systems that are put to a vote by all members.

As Hicks sees it, the USGBC's challenge is to figure out how to keep growing without watering down its famously rigorous standards. "That's paramount to our success," Hicks says. "We don't want to have 100,000 buildings that are certified as some lower quality of LEED."

An equally important challenge comes from critics who have long complained about LEED's bureaucracy and the costs of complying with it. In fact, several industry groups have stopped complaining and taken aim directly at the USGBC by launching their own ratings systems. The new competitors may not be able to beat LEED. But they just might undo the USGBC's lock on what "green" means.

The Green Gauge: LEED

The U.S. Green Building Council was formed in 1993 by developer David Godfrey, attorney Mike Italiano, and Rick Fedrizzi, then a marketing manager with United Technologies (and currently the USGBC's president and CEO). At the time, developers were beginning to boast of constructing "green" buildings. Frustrated that no independent method existed for verifying or comparing those claims, Godfrey, Italiano, and Fedrizzi established the council in response. A few years later, the council formed a committee of sustainable building experts to come up with just such a system, which they called Leadership in Energy and Environmental Design. After a yearlong pilot, LEED went live in April 2000.

The voluntary system utilizes a checklist, awarding points for achieving certain environmental goals. Those objectives are split into five categories: site selection, energy and pollution, water efficiency, indoor air quality, and materials. For example, a project scores a point by reclaiming wastewater or by using recycled building materials. Applicants are required to scrupulously document their claims in order to earn points. Approved buildings are ranked on a sliding scale, depending on the total score, from "certified" to "silver" to "gold" to the highest level, "platinum."



Initially, LEED was targeted at newly constructed office buildings. But as interest in green building grew, the USGBC expanded the system to handle other conditions in the office market. There is a version of LEED for existing buildings, meant to reward owners for upgrading building systems to achieve significant conservation goals and improvements in air quality; there's a version for speculative office buildings, meant to reward developers for making green choices when framing out the building's shell and its core operations; and there's a version for commercial interiors, meant to reward tenants for making green choices in the one or more floors where they have a say over design.

LEED immediately helped stir a media frenzy around high-profile green architecture, such as the Condé Nast skyscraper in Times Square, designed by Fox & Fowle and finished in early 2000. What it didn't immediately produce was a ton of green buildings. Even now, roughly 800 projects later, LEED's numbers represent a minuscule fraction of the millions of buildings constructed or renovated in the United States since 2000.

Hicks doesn't deny that the USGBC needs to improve its low batting average. But he points to other statistics that he says more accurately measure the council's growing influence. The number of member organizations within the USGBC has grown from 500 to more than 8,000. Since 2001, more than 35,000 architects, engineers, and consultants have taken the council's course to become accredited in LEED—and every business day, 80 more take the exam. So the language and mindset of LEED are penetrating deep

into the design and construction fields, whether or not all of those people have ever worked on a certified green building.

Lately, the USGBC has been drawing competitors who want to end the perception that LEED and green building are one and the same. The National Association of Home Builders (NAHB) wrote its own green guidelines for housing, partly to give developers a lower-cost alternative to LEED for Homes (which is now in the pilot phase), and partly to pre-empt local governments from passing green mandates by showing that home builders already take the environment seriously. "We want something out there that's builder-friendly, but also a good green standard," says Emily English, NAHB's green building program manager.

Meanwhile, a rating system called Green Globes is waging a more direct assault on LEED. Green Globes is published by the Green Building Initiative (GBI), a nonprofit based in Portland, Ore. The GBI touts Green Globes as a streamlined, web-based alternative to LEED's onerous documentation. The other main selling point has to do with organizational process. Both LEED and Green Globes claim to have been developed using a "consensus-based" process, but only the GBI's version has been certified by the American National Standards Institute, a well-respected third party.

Many environmentalists view Green Globes with suspicion, owing to the extensive financial support GBI receives from the vinyl, chemical, and wood industries. But Ward Hubbell, the GBI's executive director, prefers to paint LEED as the villain—an entrenched monopoly that ignores industry concerns. Competition has been good for LEED, Hubbell argues. Shortly after the creation of Green Globes, he notes, LEED responded by launching a web-based tool for moving paperwork online.

The GBI is getting some traction of its own: Six states and a couple of federal agencies recognize Green Globes as an alternative to LEED for government buildings. But the alternative system suffered a blow last September, when the General Services Administration, the landlord of the federal government's huge real-estate portfolio, studied competing ratings systems and called LEED "the most appropriate and credible sustainable building rating system available." Asked about the ruling, Hubbell says only that "it didn't help."

"If there's a current advantage for LEED," Hubbell continues, "it's that people don't realize there are other rating systems out there. A lot of people think USGBC must be some federal agency or something, and that LEED is a federal rule."

100,000 by 2010

On a sunny spring day in Washington, the windows of the USGBC's offices—designed by Perkins+Will—are popped open and the HVAC system is turned off. Everywhere, small signs point to key features that made this a LEED Platinum showcase. There are the Energy Star appliances in the kitchen, lights that automatically dim with the sunshine, cork flooring in one conference room and a recycled table and chairs in another. The list goes on and on.

"Normally, when you move into a new home or office, there's that smell there that you have to get used to," Hicks says. "When we moved in, there was nothing. It's because we have low-voc paints, carpet, and ceiling tiles, so they're not off-gassing those smells you normally get. Those are chemicals that we're not breathing."

This is the place where the council's paid staff—85 and growing—administers the LEED empire. The talk around here used to be about relaunching LEED in an updated "version 3.0." Lately, however, it seems change may be coming more incrementally. For instance, the council wants to tweak LEED by making it more attuned to regional conditions—the differences, say, between building green in the hot and dry Southwest versus the damp and cool Pacific Northwest. Staffers also want to incorporate "life-cycle analysis" of building materials into the ratings. In that scenario, a material like bamboo—long favored for its fast-growing and therefore regenerative quality—might rate worse due to the energy required to ship it here from Asia.

What occupies a lot of Hicks' time these days is figuring out how to certify 100,000 commercial buildings in the next three years. To meet this target, the USGBC is engaging universities, banks, and other major organizations that build and manage large portfolios of property. The idea is to entrench LEED

Lately, the U.S. Green Building Council has been drawing competitors who want to end the perception that LEED and green building are one and the same.

in the culture of these organizations, so that they'll produce large quantities of environmentally sensitive construction. "This is our future," Hicks says. "We'll still have individual buildings to certify, but you'll see an increased focus on working with organizations on how we can work LEED into their delivery process."

And increasingly, LEED is going international. The USGBC helped found something called the World Building Council, an affiliation of similar organizations in 10 countries. The U.S. council encourages other countries to develop ratings systems of their own. But it has licensed LEED for use in Canada and India, and Hicks regularly fields calls from other countries that are interested in promoting green building.

"The easy thing to do is to say we'll license LEED. But it's really more about walking them through the journey," says Hicks. "Our mission is not necessarily that LEED proliferates around the world, but that the movement proliferates," he adds. "We don't have a world-domination strategy for LEED."

Christopher Swope is an associate editor at Governing magazine in Washington, D.C.



An Indecisive Democracy

Text Linda Hales

**THE
LEGACY
OF
ROBERT
MOSES**



TIME & LIFE PICTURES/GETTY IMAGES

Robert Moses (fourth from right), in his role as president of the New York World's Fair 1964–65 Corp., watches as President John F. Kennedy inspects a model of the fairgrounds.

ROBERT MOSES, the legendary New York power broker, has been out of fashion for decades. An autocrat with a civic mission, Moses bulldozed his way to mythic status as the city's commissioner of parks and overseer of bridges, tunnels, and highways. From 1934 to 1968, he constructed much of the infrastructure of the modern metropolis, setting the pace and style of urban development across the country. If neighborhoods were ruthlessly dislocated, and mothers wept in the path of imposed improvements, the omnipotent bureaucrat remained resolute.

"You cannot rebuild a city without moving people," Moses famously declared, "just as you cannot make an omelet without breaking eggs."

The history and impact of Moses' exploits are documented in Robert A. Caro's Pulitzer Prize-winning 1974 biography, *The Power Broker*, which has defined Moses as a Machiavellian villain for a generation. But now, suddenly, the Moses legacy is up for grabs. Three exhibitions in New York and a book, *Robert Moses and the Modern City: The Transformation of New York*, have recast this Darth Vader of eminent domain as a can-do bureaucrat with a visionary gene.

"Moses is relevant again largely because the nature of projects has become big again," says James Corner, chair of landscape architecture and urbanism at University of Pennsylvania School of Design. He's talking well beyond New York. "Almost every big city has been thinking big for the past 10 years."

Seeking a Leader

Revisionist history can be dangerous, but any fascination with Moses is easy to understand. He got things done.

"There's a wistful longing for decisive urban decision-making," says architect Eric Owen Moss, director of the Southern California School of Architecture (SCI-Arc), who had his own brush with the Moses legacy. Moss won, then lost, a 2001 competition to transform the city-owned Queens Museum of Art, which is associated with Moses since it houses the 9,335-square-foot panorama of New York City the planner had built for the World's Fair of 1964. (Moss lost the commission after preservationists and new board members balked at his proposal for a radical enhancement—a glass atrium inserted into the middle of the building, showering the bunker-like Deco interior with light.) Moss says he struggles with the tyrannical aspects of the man sometimes described as America's master builder, but he is equally unhappy with the glacial pace of bureaucracy when action is needed.

Today, one has only to chart a time line for rebuilding at the World Trade Center site or the post-Hurricane Katrina reconstruction of New Orleans to see how urgent public works can become mired in process.

Disaster zones are not the only urban planning challenges. From Boston to Los Angeles, congested cities are choking on growth, while post-industrial sites need reinvention, decommissioned military bases await new purpose, and waterfronts deserve to be reclaimed for public benefit. Cities struggle to create amenities and ensure healthy environments as they compete for growth.



COURTESY MTA BRIDGES AND TUNNELS SPECIAL ARCHIVE



COURTESY MTA BRIDGES AND TUNNELS SPECIAL ARCHIVE



COURTESY MTA BRIDGES AND TUNNELS SPECIAL ARCHIVE

Moses didn't always get his way. Renderings of Moses' proposed Lower Manhattan Expressway looked glamorous (above, top left), but an aerial view (above, right) shows the scar such a roadway would have inflicted on Manhattan. Moses' proposed Brooklyn-Battery Bridge (above, bottom left) would have been cheaper to build than a tunnel, but the entrance and exit ramps would have required demolition of historic Castle Clinton and much of Battery Park.

Moses understood the need for a firm hand to guide the process. But the jury is out on whether today's massive projects require the detached perspective of a development czar like Moses, who flew over New York's five boroughs and traveled by chauffeured limousine.

"People always long for dictators," says architect Daniel Libeskind, whose master plan for the World Trade Center site did not have a Moses to protect it. "They like the pseudo order. I don't think we need dictators. You need political leadership."

New York architect Margaret Helfand is a founding member of New York New Visions, a coalition of professionals formed in the weeks after the 9/11 attack on the World Trade Center to ensure that designers' voices were included in the planning for Lower Manhattan. Helfand finds Moses' accomplishments "rather impressive," but she acknowledges that the current buzz has made some people "a little overly romantic. I don't think they are debating the cultural losses."

Moses operated as a lone tyrant, doing what he

Moses was driven by a notion that the automobile, not mass transit, would move people around in an idyllic urban future.

thought needed to be done. Now, officials are both aided and constrained by zoning hearings, historic review boards, neighborhood activists, environmental inquiries, and the moderating influence of public-private partnerships.

"The only thing that stopped him was people demonstrating," Helfand says.

It is fashionable to say that lessons have been learned since Moses' death in 1981, at the age of 92. But at a recent gathering of New York's urban experts, Majora Carter, the activist director of Sustainable South Bronx, challenged the notion that big public projects in poor neighborhoods are handled in gentler ways.

She listened quietly as city officials asserted that they

were redeveloping forlorn swaths of Brooklyn and the West Side of Manhattan “without breaking so many eggs.” She demanded to know what was so post-Moses about choosing to locate a new jail in her powerless, historically black borough, which is still suffering the aftershocks of being severed by Moses’ Cross-Bronx Expressway. Answers were not forthcoming.

Raised Voices

Moses began his career simply enough, creating a six-mile-long public beach on Long Island in the 1920s. During the depths of the Depression, he built elaborate neighborhood swimming pools and hundreds of parks throughout New York City, which made politicians who appointed him popular with their constituents.

Moses amassed independent power by setting up a network of self-funding “authorities” that made infrastructure his own fiefdom. In the 1950s, he expertly commandeered newly available federal funds to supplant tenements with middle-class housing, which he believed would stem the flight to the suburbs. (Moses, who studied political science at Yale, Oxford, and Columbia, was not overly design-conscious, but his reputation benefited from his association with a young architect, I.M. Pei, on the staff of a big developer.) Moses also orchestrated the establishment of the United Nations headquarters and Lincoln Center, which he believed would give a city heading for bankruptcy new life as a cultural capital.

Moses did not drive, but he was driven—by a notion that the automobile, not mass transit, would move people around in an idyllic urban future. He built as many bridges linking outer boroughs to Manhattan as his few overlords would allow. (It took Dwight D. Eisenhower to block one grandiose span, by declaring it a threat to national security.) And he fought off mass transit.

Failures were rare, but came with lasting consequences. In the 1960s, Moses threatened to ram expressways through Lower Manhattan, endangering the historic neighborhoods of SoHo and Greenwich Village. The projects ignited a lifelong feud with urbanist Jane Jacobs, while giving neighborhood activism and the fledgling preservation movement a huge boost. Gov. Nelson Rockefeller finally removed the aging tyrant from his power base—the last was the Triborough Bridge and Tunnel Authority—in 1968, when Moses turned 80.

Corner points out a central irony in the Moses narrative: the power broker’s tendency to mow down all obstacles in his path created the inequities that led to citizen participation.

“That’s the world we now live in,” says Corner, “a world where individuals in communities have huge input.”

Giving all parties a say has never been the smoothest approach, as Moses understood. When asked whether layers of public review have made the end result more democratic than in Moses’ day, Helfand pauses before responding, “Only somewhat.”

Moss complains that on projects of enormous scale, giving every constituent a say has the power to dilute vision. “You have to have the power to implement,” he says. “There needs to be some way to be opinionated,

have more to do with being a gateway to Latin American trade than a quaint, low-rise party town.

Elsewhere, the chief influence on post-Katrina construction has been the new urbanist planner and architect Andrés Duany, who arrived on the scene of devastation in Mississippi at the behest of Gov. Haley Barbour. Through a large-scale charrette weeks after the hurricane, Duany and the Congress for New Urbanism were able to orchestrate the discussion of redevelopment. Where Moses ordered up projects and power plays from his office under the Triborough Bridge, Duany engaged communities in a shirtsleeved planning process in a damaged resort hotel.

If coastal development proceeds as sketched out at the Mississippi Renewal Forum, organized persuasion, rather than fiat, may gain converts as the power tool of choice.

As Corner points out, “Leadership and vision are crucial for large-scale projects to take shape. It’s finding the right balance between inclusion and process on the one hand, and autocracy and decision-making on the other hand.”



COURTESY ANDREW MOORE



COURTESY ANDREW MOORE

Projects Moses successfully built in New York City include Morningside Gardens (top) on the Upper West Side, a 1957 experimental co-op that counted Thurgood Marshall among its many black professional residents, and Sunset Pool (above) in Brooklyn, one of 11 pools that Moses opened in the summer of 1936.

Power Box

Robert Moses consolidated authority through a variety of official positions, many of which he created. A listing from the 1981 edition of *Who's Who*, the last Moses compiled, appears in the exhibition “Remaking the Metropolis” at the Museum of the City of New York. It remains an astonishing résumé.

New York City Department of Parks, commissioner, 1934–60

Triborough Bridge and Tunnel Authority, member, 1934–, chairman, 1936–38

Henry Hudson Parkway Authority and Marine Parkway Authority, merged into New York City Parkway Authority, sole member, 1934

City Planning Commission, member 1942–60

Mayor’s Emergency Committee on Housing, chairman, 1946

New York City Construction Coordinator, 1946–60

Mayor’s Committee for Permanent World Capitol, chairman, 1946

Mayor’s Committee on Slum Clearance, chairman, 1946–60

Coordinator of Arterial Projects City of New York, 1960–66

New York World’s Fair 1964–65 Corporation, president, 1960–67

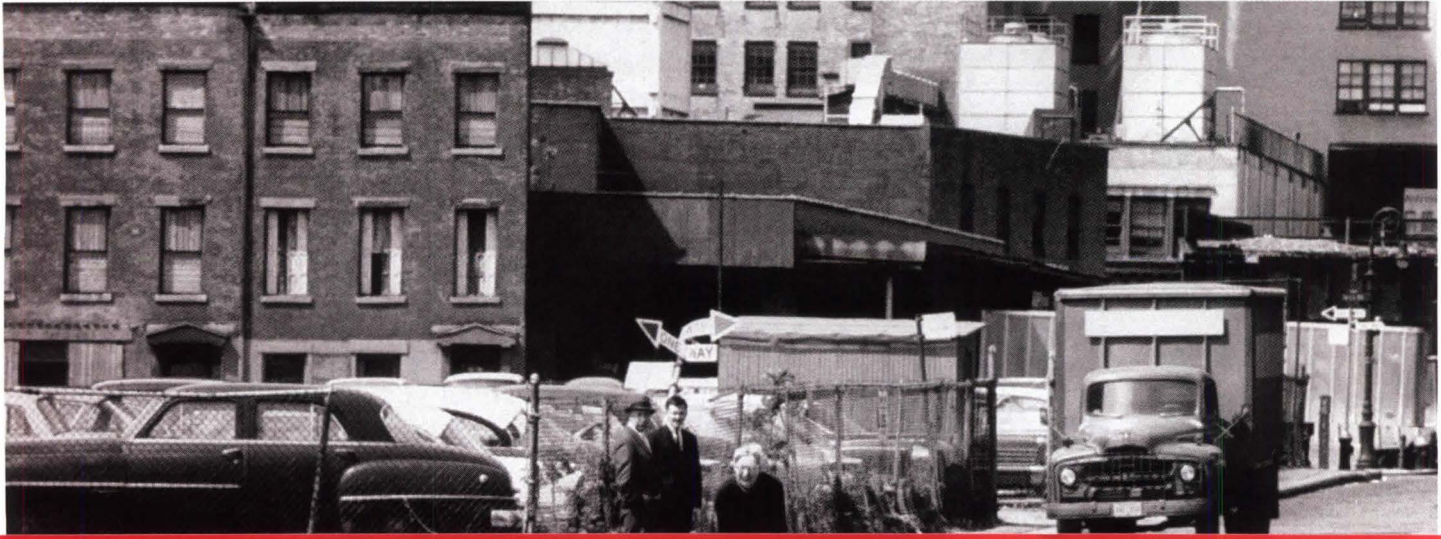

ARCHITECT
3M

3M™ VHB™ STRUCTURAL GLAZING TAPE PRESENTS

HOW ACRYLIC FOAM STRUCTURAL GLAZING TAPE IS USED TO MOUNT GLASS CURTAIN WALL PANELS

An easy, economical and efficient way to mount glass curtain wall panels.

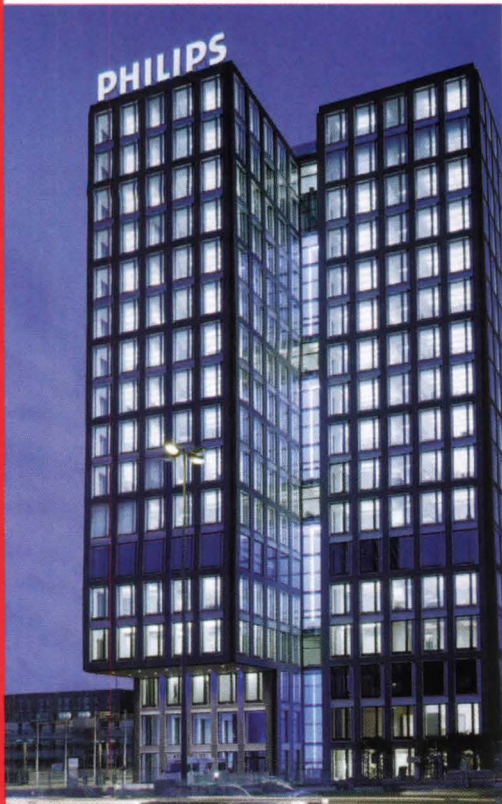
By Steve Austin and Mark Jennings



Acrylic Foam Structural Glazing Tape is an alternative to structural silicone for wet glazing glass panels in curtain walls. Although new to the US marketplace, Acrylic Foam Structural Glazing Tapes have been used internationally since 1990.



ARCHITECT MAGAZINE CONTINUING EDUCATION

This course requires supplemental online reading in addition to the following article. For details on accessing the supplemental reading and to learn how to take the test, please see page 147.

Glass panel curtain wall is among the most popular of building exteriors and produces some of the most stunning facades. The individual panels are extremely simple, typically constructed from two parallel pieces of glass called insulated glass units and abbreviated IGUs or IGs, although single-glazed and triple-glazed windows can also be used, depending upon the thermal performance desired.

Glass provides building occupants with a view of the outside world, enhancing the working environment. It allows light to enter the building, improving comfort

and reducing energy demands in the work space.

Properly designed, manufactured and installed, glass curtain wall offers excellent insulating capabilities and serves as a nearly impenetrable air and moisture barrier. Additionally, glass is an accepted and proven material and readily available in every geographic region of the world. In areas with atmospheric environmental pollution that can preclude the use of other building materials more susceptible to corrosion or discoloration, glass is a proven option. These are just some of the features and benefits that make a glass curtain wall one of the most universally popular systems for cladding the building envelope.

Traditionally, glass curtain walls have been either dry glazed, wet glazed, or glazed with a combination of methods.

Dry glazing utilizes a gasket of rubber or vinyl to surround the perimeter of the glass panel and this in turn is mechanically captured by the window frame.

Wet glazing describes the method of bonding glass panels to a metal frame using either single part or two part silicone structural sealants.

Silicone sealants have been used because, upon curing, silicone provides both sufficient adhesion for mounting the glass panel to the building, and an acceptable air and moisture barrier for sealing the perimeter of the panel. In this system, a double-sided open cell foam tape, a spacer tape, is typically used to hold the glass temporarily, and for creating the necessary open space for the structural sealant.

LEARNING OBJECTIVES

The learner will:

- Become familiar with Acrylic Foam Structural Glazing Tape as an alternative to structural silicone for structural glazing in curtain walls
- Understand how Acrylic Foam Structural Glazing Tape provides an improved appearance to glass curtain wall
- Understand how application of Acrylic Foam Structural Glazing Tape reduces installation time while providing highest quality results

The dimension of the spacer tape is determined based on the desired sealant bite and bead thickness. Once the silicone sealant is applied, the bond should not be disturbed during curing. It may take from several hours to a few weeks to achieve handling strength.

Acrylic Foam Structural Glazing Tape provides an alternative bonding method that can provide the performance needed for the application while adding significant benefits. It replaces both spacer tape and structural sealant, and because there is no curing reaction involved in bond strength development, there is no delay in use. Acrylic Foam Structural Glazing Tape is a high performance, two sided, pressure sensitive, semi-conformable bonding material. It is used to attach glass to structural glazing frames replacing commonly used mechanical fasteners, gaskets, spacer tapes, and structural silicone sealants.

Acrylic Foam Tapes have demonstrated their bonding capabilities over the past 25+ years, providing an often ideal combination of performance, durability and ease of use. They have been successfully used in a wide variety of demanding industrial applications in areas such as the commercial building construction and transportation markets. More specifically, they have been used in many international applications as the primary bonding agent for structural glazing of glass curtain walls over the past 15+ years. Performance has been demonstrated on monolithic, laminated or insulated glass panels.

An often specified Acrylic Foam Structural Glazing has a dynamic load material design strength of 12psi (85 kPa) for short term forces such as wind loads. This design strength provides a safety factor of five.

Most Acrylic Foam Structural Glazing Tape projects require dead (static) load support due to the often excessive weight of glass panels – especially insulated glass panels. However, in some monolithic panel applications the weight of the glass is supported by the Acrylic Foam Structural Glazing Tape. In these cases a static load material design strength of 0.25 psi (1.7 kPa) is applied to determine the appropriate amount of tape required for the application. This means that 4 in² tape per pound of load should be used to

support static loads. This guideline will provide a safety factor of at least five.

GLAZING TAPE

Acrylic Foam Structural Glazing Tape is an available alternative to structural silicone that provides significant advantages in construction and in long-term use.

Installation using an Acrylic Foam Structural Glazing Tape is typically a cleaner process than with silicone because the sticky, liquid nature of uncured silicone makes it more difficult to control. Uncured silicone can be easily transferred from an applicator tip to a glove, to glass, and other tools and materials. Acrylic Foam Structural Glazing Tape, on the other hand, is cut to length – little waste results – and the panels when completed have a clean and uniform appearance.

Of course, when using an Acrylic Foam Structural Glazing Tape, no mixing is required, so the installation process takes less time. Time is also a factor in cure rates. Typically, conventional one-part silicone requires from 3 to 7 days to cure, while Acrylic Foam Structural Glazing Tape does not require any cure time and is ready to handle immediately.

Testing and two decades of real-world experience have proved the exceptional value of Acrylic Foam Structural Glazing Tape for glass curtain walls. Following are some pertinent, independent, 3rd party test results that show Acrylic Foam Structural Glazing Tape achieves essentially the same application performance as silicone.

Testing according to industry accepted test methods ASTM E283 (air infiltration), ASTM E331 (water leakage), ASTM E330 (structural loads) demonstrate curtain wall glass panels constructed with one brand of Acrylic Foam Structural Glazing Tape fulfilled all requirements of the specified testing standards. In tests with more stringent conditions, Acrylic Foam Structural Glazing Tape even out-performed expectations. For example, testing to the specified design pressure (60 psf) was done at ambient conditions as required by ASTM E330. Additional testing was also done with pressure cycling up to the design pressure at -13°F and 158°F with acceptable

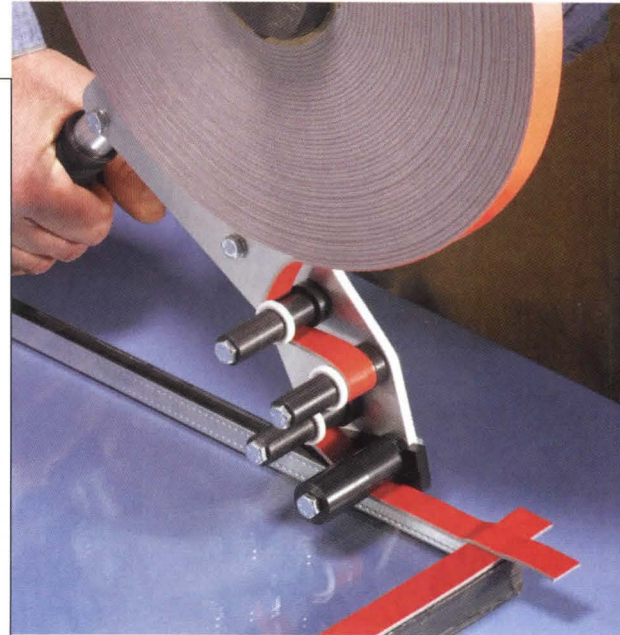

Acrylic Foam Structural Glazing Tape is easily applied to glass curtain wall panels.

results. After this, to further stress the panels, the \pm pressure load was increased by >250% (175 psf) design pressure with failure of the laminated glass panel due to glass breakage, and >300% (210 psf) design pressure for structures with tempered glass and insulated glass panels. In the first case, where the laminated glass itself failed, it should be noted that glass was still attached and bonded to the structural glazing tape around the perimeter of the frame, demonstrating the high strength of the tape. Also tested in this study were separate panels glazed with a one part structural silicone subject to the same severe tests. These panels exhibited no failure, demonstrating the equal performance of Acrylic Foam Structural Glazing Tape glazed panels compared to panels glazed with a well proven structural silicone.

ASSEMBLY

Proper assembly is a simple but critical process. After the glass panel surfaces have been properly prepared, tape is applied around the perimeter of the back side of the panel. For maximum bond strength, all bare glass surfaces should be thoroughly cleaned and treated with a silane solution before tape application. The glass panels are then prepared for bonding by removing the protective release liner and exposing the adhesive

HOW ACRYLIC FOAM STRUCTURAL GLAZING TAPE IS USED TO MOUNT GLASS CURTAIN WALL PANELS

TYPICAL ASSEMBLY CONFIGURATIONS

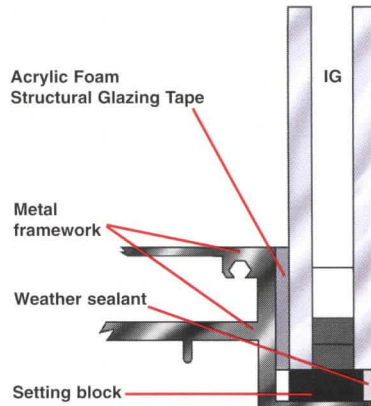
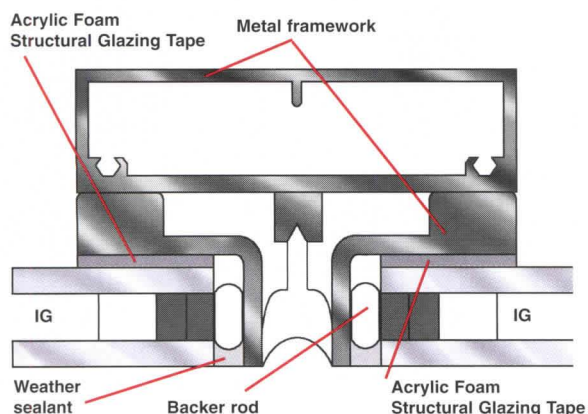

surface. Panels are positioned and pressed into place against their mounting framework. Proper surface preparation of the frame is equally important as the proper surface treatment of the glass panel. Edges are snug against setting blocks or similar stops that accommodate motion, expansion and contraction, and support the dead load along the lower horizontal frame profile. Once the two substrates are bonded together, and pressure has been applied, the assemblies are sealed around the perimeter with an appropriate weather sealant. While the Acrylic Foam Structural Glazing Tape provides exceptional air and water barrier performance, it should be viewed as the primary bonding agent and a secondary weather sealant. Acrylic foam structural glazing tapes do require the use of a primary weather sealant. This is similar to many designs utilizing structural silicone.

After application, the bond strength will increase as the adhesive flows onto the surface. At room temperature, approximately 50% of the ultimate strength will be achieved once pressure has been applied to the two joined substrates. This allows for immediate handling strength and the ability to conduct nondestructive testing on every glazed panel. 90% of the ultimate adhesion will be realized after 24 hours

and 100% after 72 hours. The rate of bond build is affected by temperature, pressure, substrates, and time. The Acrylic Foam Structural Glazing Tape manufacturer will provide guidelines for particular substrates through their testing services and technical service organization. It's important to note that with Acrylic Foam Structural Glazing Tape there is no curing reaction taking place in the adhesion build process. Acrylic Foam Structural Glazing Tapes come fully cured and ready for bonding. There is no need for the in-process cure tests as required with structural silicones.

AESTHETICS

The use of an acrylic foam structural glazing tape gives a uniform consistent appearance with clean edge and trim lines. No streaking or bubbles are visible in the tape. Silicone, however, can be streaky and may show bubbles or voids. A mismatch in the color is also often seen between the spacer tape and structural silicone.

To download the additional online supplement for this course, please visit www.ArchitectMagazine.com and select resources on the continuing education center.



TO ACCESS SUPPLEMENTAL READING: Go to www.architectmagazine.com and select "Resources" then select "Continuing Education Center". There you can download PDF files of this course and the required supplemental information.

TAKE THE TEST ONLINE FOR FREE: New users must create a new account. Returning users may log in. After logging in, click on "My Courses". Then select this course title to launch your test. A score of 80% or higher earns 1 AIA/CES LU hour of credit. Valid for credit through March 2009.

1. Acrylic Foam Structural Glazing Tape is used as an alternative to:
 - a. Structural Silicone
 - b. Screws
 - c. Clips
 - d. All of the above
2. True or False? Acrylic Foam Structural Glazing Tape is an excellent air and moisture barrier with no need for a primary weather sealant.
 - a. True
 - b. False
3. Acrylic Foam Structural Glazing Tapes have been used in structural glazing applications for
 - a. 1 year – a new development
 - b. 5 years
 - c. 10 years
 - d. 15+ years
4. True or False? Acrylic Foam Structural Glazing Tape cures within minutes of application.
 - a. True
 - b. False
5. Acrylic Foam Structural Glazing Tape maintained its bond even when wind load ASTM pressure cycling tests exceeded design pressure by
 - a. >25%
 - b. >100%
 - c. >300%
 - d. >350%
6. True or False? Most Acrylic Foam Structural Glazing Tape projects utilize dead load support.
 - a. True
 - b. False
7. True or False? Acrylic Foam Structural Glazing Tape is only suitable for double or triple glazed panels.
 - a. True
 - b. False
8. Acrylic Foam Structural Glazing Tapes are typically applied
 - a. Around all outside edges of the glass panel
 - b. Across the top and bottom of glass panels
 - c. Around the perimeter of the back surface of glass panels
 - d. Wherever panels contact the framing structure
9. True or False? Acrylic Foam Structural Glazing Tapes can be used to replace structural silicone and spacer tapes in curtain wall systems.
 - a. True
 - b. False
10. True or False? Curtain wall panels fabricated with Acrylic Foam Structural Glazing Tape can be handled and moved immediately after the bonding process.
 - a. True
 - b. False

How Acrylic Foam Structural Glazing Tape is Used to Mount Glass Curtain Wall Panels

You have the option of taking the test online free of charge or you may mail your test along with a check in the amount of \$10. A score of 80% or higher earns 1 AIA/CES LU hour of credit. Certificates of completion are available upon request and delivered by email.

test>	1.	a	b	c	d	6.	a	b		
	2.	a	b			7.	a	b		
	3.	a	b	c	d	8.	a	b	c	d
	4.	a	b			9.	a	b		
	5.	a	b	c	d	10.	a	b		



MAIL-IN TEST: Photocopy this page. Clearly circle the letter of the correct answers. Mail this test with the completed form and check for \$10, payable to ArchitectCES, to:

ArchitectCES
PO Box 11911
Mount Lebanon, PA 15228

Last Name _____ First Name _____ Middle Initial/Name _____

Firm Name _____

Address _____ City _____ State _____ Zip _____

Tel _____ Fax _____ E-Mail _____

AIA ID Number _____ Completion Date (M/D/Y) _____

Please email me a certificate of completion upon scoring 80% or higher.

I hereby certify that the above information is true and accurate to the best of my knowledge and that I have complied with the AIA Continuing Education Guidelines for the reported period.

Signature _____ Date _____

3M™ VHB™ Structural Glazing Tape

*More
than
greets
the eye*

*Clean edges
and consistent
color for eye
appeal.*

*Immediate
handling
strength and
increased
productivity.*

3M™ VHB™ Structural Glazing Tape has been proven in thousands of international buildings since 1990 as an alternative to structural silicone and spacer tape for glazing in curtain walls.

3M™ VHB™ Structural Glazing Tape offers the reliability you expect from 3M and an application warranty for approved projects. Please call 651-736-6076 to discuss your project requirements or for additional information please visit www.3M.com/vhb/structuralglazing.

Come see us at the AIA Show, booth 13207

Circle no. 440 or <http://architect.hotims.com>

3M

For more information and complete product warranties, see www.jeld-wen.com/auralast. ©2006 JELD-WEN, inc. JELD-WEN, Auralast and Reliability for real life are registered trademarks of JELD-WEN, inc., Oregon, USA.

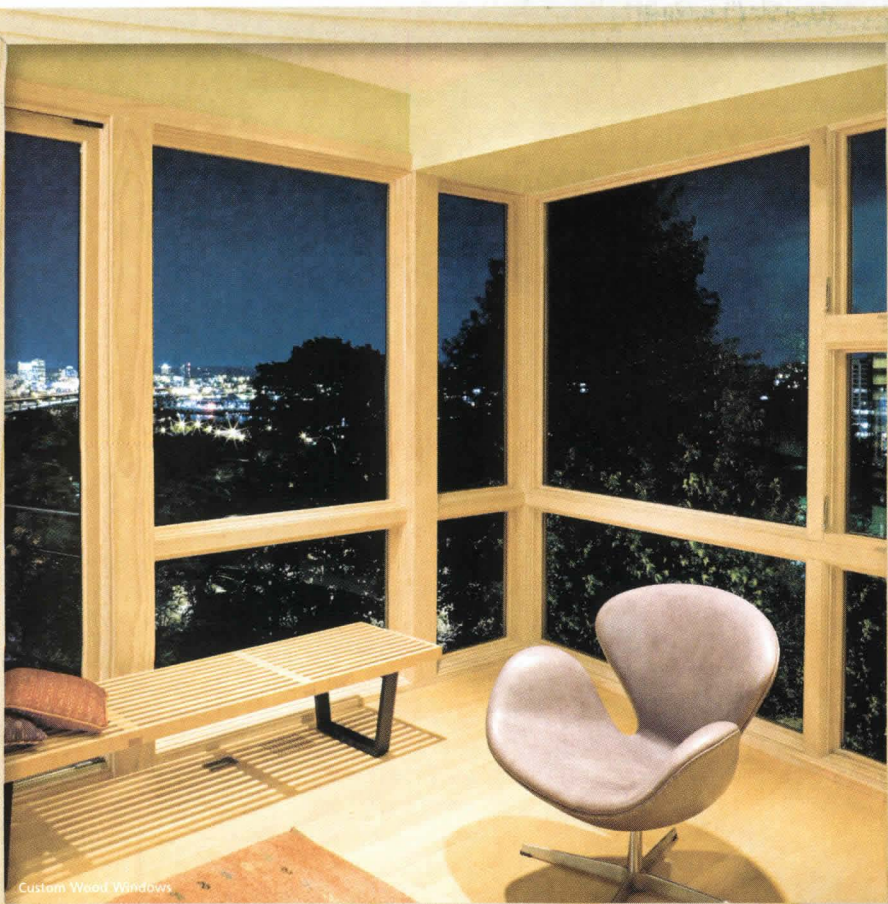

Custom Wood Windows



Premium Wood Exterior Special 4-Lite Patio Door

Beauty that will last until post-post-post-modernism.



Clad-Wood Radius Casement Window



Premium Wood Exterior Patio Door 1505AP with Frit Glass

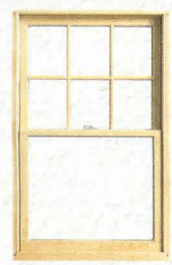

Wood Double-Hung Window



JELD-WEN® windows and doors made with AuraLast® wood will stay beautiful and worry-free for years, whether your climate is wet or dry, hot or cold. AuraLast wood provides superior protection against decay, water absorption and termites. Unlike dip-treated wood, AuraLast wood is protected to the core and comes with an exclusive 20-year warranty. To request a free brochure about AuraLast wood or any of the reliable windows and doors we make, or to find a dealer near you, call 1.800.877.9482, ext. 1209, or visit www.jeld-wen.com/1209.

RELIABILITY for real life®



Circle no. 408 or <http://architect.hotims.com>

JELD-WEN WINDOWS & DOORS PRESENTS

THE ELEVEN THEORIES OF WINDOW INSTALLATION

By Rod Clark & Jay DeKalb



Separating the living space from the elements is not the same as isolating the space. For example, separation does not mean that wind and water cannot infiltrate the opening. Water may indeed infiltrate the opening in which a window is installed without causing any damage whatsoever. Proper installation means that wind and water infiltration is managed with effective and proven construction methods.

If a window has been improperly installed, the errors in installation can very often be identified by a proper inspection. To assess the quality of an installation and thereby detect any flaws, it's helpful to understand the basic rules of good installation. It's also important to be aware of the local building code requirements. Code requirements will always supercede a manufacturer's recommended installation instructions. And, it's important to learn the step-by-step techniques for conducting an inspection of a window installation. A short primer on how to inspect a window installation is included online as required supplemental reading.

THE ELEVEN THEORIES OF INSTALLATION

Many installation materials and techniques can be used to achieve a successful installation. However, all successful methods must abide by the following basic principles.

RULE #1

Build redundancy into the system. Fenestration products without welded corners and integral nailing fins will allow some water to enter through the exterior joints. Direct any water to the exterior.

LEARNING OBJECTIVES

The learner will:

- Discover the relationship between the Theories of Installation and a successful job
- Recognize at least three issues associated with window installation
- Identify at least five different tests for inspecting a window installation for various types of windows

Specifying the proper window is no less critical than installing it properly. Architects should be familiar with proper installation methods and installation problems in order to aid them in the selection process.



THE EYES OF A BUILDING

The word 'window' comes from the ancient term 'wind eye,' descriptive of the means that would allow a person to see the oncoming storm or the morning sunrise. Windows are first recorded as a part of human habitation around 6500BC. Many of the same reasons windows were important then are no doubt also true today. For example, windows provide security. They let a view of the outside world come into the living space. They help adjust comfort – temperature and drafts – within the living space. And they admit daylight, reducing energy demand.

Today's windows can also separate the living space from the elements. The degree to which they are able to do that often depends upon how well the window has been installed. In fact, an improperly installed window can lead to a number of structural and aesthetic problems and can even adversely affect the health of the building's occupants.

ARCHITECT MAGAZINE CONTINUING EDUCATION

This course requires supplemental online reading in addition to the following article. For details on accessing the supplemental reading and to learn how to take the test, please see page 153.

CORNER INSTALLATION SEQUENCE

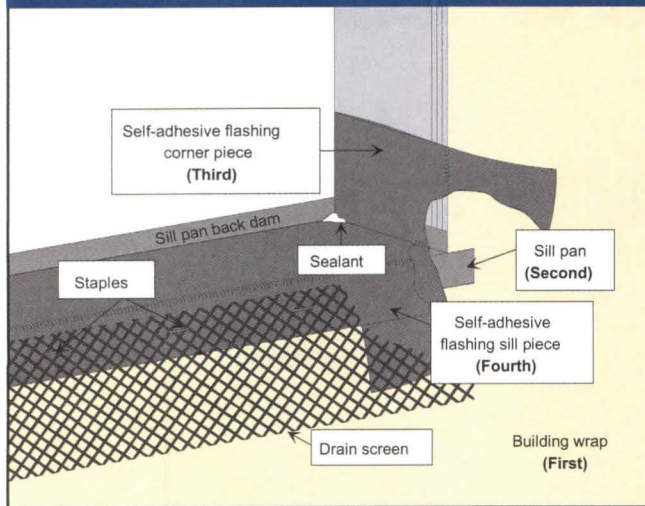

Multiple layers give redundant defense to water infiltration, while a sill pan returns any water within the installation back outside the wall.

SILL PAN PREPARATION

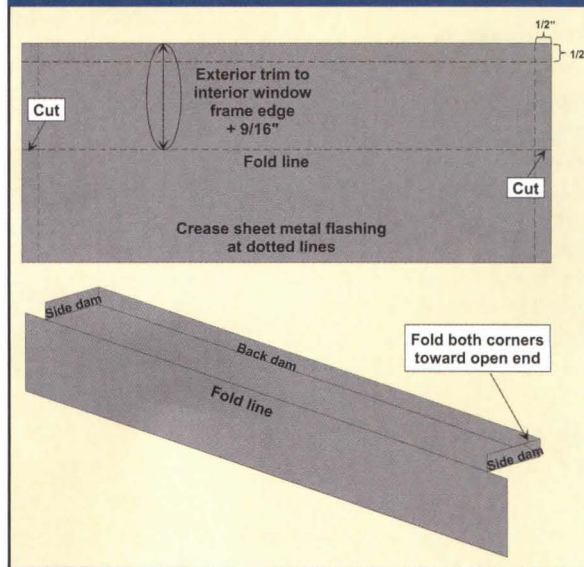

The exterior frame, the flashing material, the building wrap, the sealant and the exterior siding are examples of effective redundancies. Each layer acts as an independent barrier to water infiltration should the adjacent layer fail.

Water is easy to manage if proper planning and construction techniques have been followed. For example, the sill pan must be designed to catch water that infiltrates the opening and divert it over the building wrap and beyond the wall cavity.

RULE #2

Tie the water plane of the window into the weather plane of the wall (usually building wrap) in a waterproof and contiguous manner. Failure to do this allows water to penetrate through the gaps and to enter the wall cavity.

The water plane of the window is the path water wants to take into the wall cavity. The weather plane of the wall is outside the exterior wall and beyond the building wrap. Once water is effectively diverted beyond the building wrap, it is rendered harmless.

Tie-in requires multiple steps. First, building wrap, then sill pan, self-adhesive corner piece, self-adhesive flashing and finally a drain screen to create a channel through which the diverted water will pass. It's easy to see why each one of

these steps is necessary to prevent water from entering the wall cavity.

RULE #3

Sealants must conform to the joint design and expansion/contraction Parameters specified by the sealant manufacturer.

Sealants are applied where materials transition and where drainage will not be blocked. For example, sealant should not be applied to the gap above the header drip cap. Gaps should be shallow, narrow, clean and dry before sealing. Gaps should never be deeper than they are wide.

Transition materials may be of different substrates that expand and contract at different rates, therefore, check sealant capabilities. Adhesion is often tested on small pieces of material before sealants are applied.

RULE #4

Shim in a manner that reduces frame rotation under loading (wind, settlement, rough frame movement).

Rough opening must be square and plumb. Shims should be parallel, snug but not excessively tight, about 8" apart, and secured with structural adhesive or sealant. Clearly, shims are meant

not to hold the window in place, but to locate it properly within the rough opening.

SHIM LOCATIONS

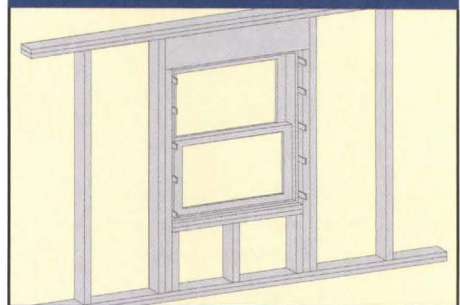

Shims are located uniformly and snugly between the window and the rough opening.

RULE #5

Fasten to the rough opening in a manner that does not put undo stress on the fenestration components.

Nails are placed through the nailing fin or exterior trim supporting the mass of the window in tension to accommodate wind and other normal mechanical forces such as expansion and contraction. Screws passing through drilled holes may be used on larger windows according to manufacturer's instructions.

THE ELEVEN THEORIES OF WINDOW INSTALLATION

RULE #6

Install the fenestration product square, plumb and level. It shall not have sags or bows that hinder the proper operation of the product or product components.

A window installed out of plumb or out of square will almost certainly exhibit problems over time. Operational problems or damaging water infiltration are likely results.

Installation out of plumb, square or level cannot be corrected after installation without removing the product and re-installing.

RULE #7

Apply all flashing in a shiplap manner and tie into the weather plane of the building.

Flashing applied properly defeats water infiltration using the law of gravity, and material designed to prevent absorption through capillary action.

Water can only defeat gravity if it finds a small channel where it can travel as though being absorbed. Usually an air pressure differential is also involved where the force of wind driven rain outside the building is greater than the air pressure within the building. Water is as easily drawn through openings under these conditions as soda through a straw.

RULE #8

Move the flashing failure point as far as possible from the interface of the rough opening and the fenestration product.

Wherever continuity of flashing is broken or penetrated, there is a possibility of failure. By using overlaps, multiple layers, sealants and gravity, continuity can effectively be maintained to the outer edges of the flashing.

If the flashing failure point is below or well to the side of the rough opening, chances are it will have little or no impact on the installation. For this reason, it is wise to use 6" wide or wider flashing material.

RULE #9

Protect the head of the fenestration product from the accumulation of water.

The head of the installation is extremely critical to prevention of water infiltration, quite simply

PROPER FLASHING APPLICATION

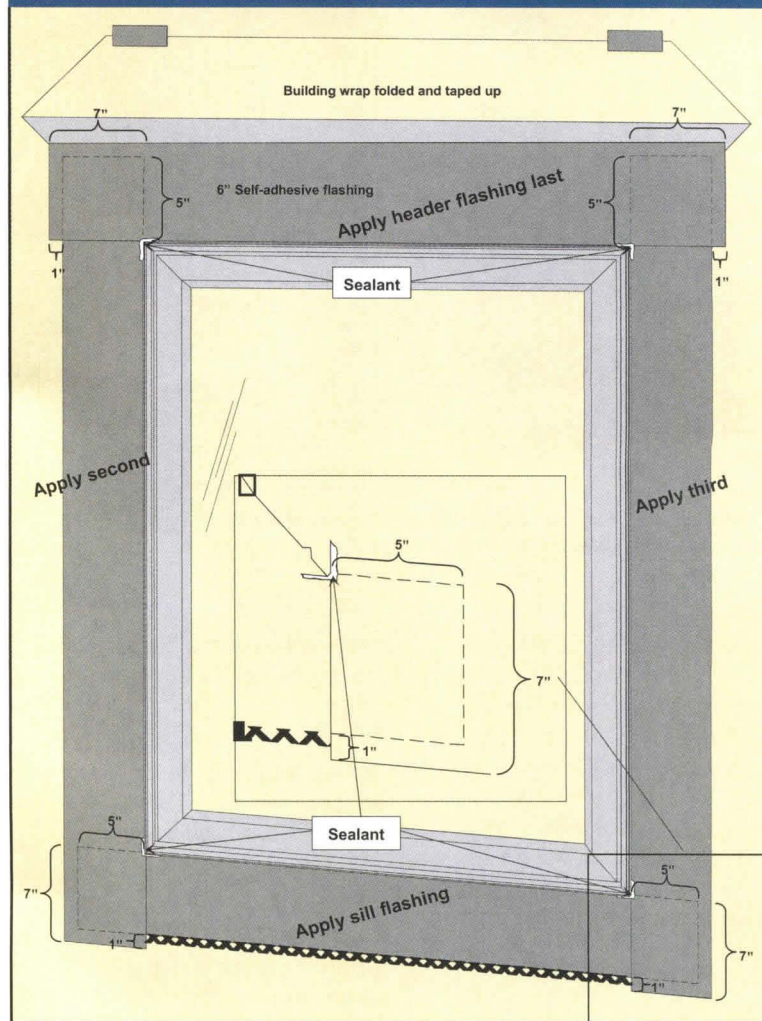

because the entire installation is below, where gravity will draw it freely into the installation and into the adjacent wall cavity. The correct way to protect the head of the installation is with a fabricated drip cap. That extends 1/8" past the corners of the window header. Drip caps are often pre-applied or shipped with the window.

RULE #10

Any flashing or pans used must self-seal if penetrated by nails, staples or screws.

Self adhesive flashing that also covers pans should be an adhesive butyl membrane that will self-seal around any penetration.

RULE #11

Reduce airflow around the fenestration product to the lowest level possible.

As wind and rain strike one side of a building, the force creates a positive pressure. As the wind passes, it creates a negative pressure on the opposite side of the building. If air can pass through a fenestration on the positive pressure side of the building it will most certainly take water with it into the wall.

TO ACCESS SUPPLEMENTAL READING: Go to www.architectmagazine.com and select "Resources" then select "Continuing Education Center". There you can download PDF files of this course and the required supplemental information.

TAKE THE TEST ONLINE FOR FREE: New users must create a new account. Returning users may log in. After logging in, click on "My Courses". Then select this course title to launch your test. A score of 80% or higher earns 1 AIA/CES HSW LU credit hour. Valid for credit through April 2009.

TEST QUESTIONS

1. True or False. Windows must be thoroughly sealed so that no water may infiltrate.
 - a. True
 - b. False
2. Wind can have an affect on water infiltration even when flashing is used because it:
 - a. Can force water around the glass
 - b. Can uplift the window and create a gap under the sill
 - c. Can cause water to wick through miniscule openings
 - d. Can penetrate even the best installations
 - e. Both C and D
3. Which of the following best assures an effective window installation
 - a. Redundant water infiltration barriers
 - b. A water plane tied to a weather plane
 - c. A drain screen from sill pan to outboard of the building wrap square and plumb rough openings
 - d. All of the above
4. True or False. Shims must be located so that an even number is on one side of the rough opening and an odd number on the other.
 - a. True
 - b. False
5. True or False. Windows that operate with difficulty after installation can usually be adjusted with a light sanding.
 - a. True
 - b. False
6. Sealants cannot be properly applied
 - a. In gaps that are deeper than they are wide
 - b. When materials are dry
 - c. When different substrates are covered by the same sealant
 - d. In the gap above the header drip gap
 - e. Both A & D
7. True or False. The flash point of an installation is where failure will first occur.
 - a. True
 - b. False
8. Shims can be affixed to the rough opening
 - a. With light finishing nails
 - b. Snugly
 - c. With construction adhesive
 - d. With sealant
 - e. Both C and D
9. True or False. Flashing may be installed in any order as long as it is self-adhesive, sealed and not penetrated with nails or screws.
 - a. True
 - b. False
11. True or False. A window may be installed with the sill slightly extended in order to help channel any water infiltration away from the wall cavity.
 - a. True
 - b. False



Eleven Theories of Window Installation

You have the option of taking the test online free of charge or you may mail your test along with a check in the amount of \$10. A score of 80% or higher earns 1 AIA/CES HSW LU credit hour. Certificates of completion are available upon request and delivered by email.

test>	1.	a	b																
	2.	a	b	c	d	e													
	3.	a	b	c	d	e													
	4.	a	b																
	5.	a	b																
	6.	a	b	c	d	e													
	7.	a	b																
	8.	a	b	c	d	e													
	9.	a	b																
	10.	a	b																



MAIL-IN TEST: Photocopy this page. Clearly circle the letter of the correct answers. Mail this test with the completed form and check for \$10, payable to ArchitectCES, to:

ArchitectCES
PO Box 11911
Mount Lebanon, PA 15228

Last Name _____ First Name _____ Middle Initial/Name _____

Firm Name _____

Address _____ City _____ State _____ Zip _____

Tel _____ Fax _____ E-Mail _____

AIA ID Number _____ Completion Date (M/D/Y) _____

Please email me a certificate of completion upon scoring 80% or higher.

Material resources used: Article addressing issues concerning health, safety, and welfare.

I hereby certify that the above information is true and accurate to the best of my knowledge and that I have complied with the AIA Continuing Education Guidelines for the reported period.

Signature _____ Date _____



LAFARGE PRESENTS

UNDERSTANDING SUPPLEMENTARY CEMENTITIOUS MATERIALS AND THEIR BENEFITS

By Julie K. Buffenbarger



SCMs represent a class of materials that can help designers and builders recycle industrial by-products, achieve higher performance from concrete mixtures, and help maintain our environment in a sustainable manner for the long-term.



ARCHITECT MAGAZINE CONTINUING EDUCATION

This course requires additional online reading in addition to the following article. For details on accessing the additional reading and to learn how to take the test, please see page 158.

With a history of continuous use that can be traced nearly as far back as 5000 BC, Supplementary Cementitious Materials (SCMs) are certainly not new to the concrete construction industry. The strength and usefulness of their discovery can still be viewed today, not only in the well-preserved remains of the structures our ancestors built, but also in the continued use of concrete as a primary building material. However, the concept of “design life” has evolved over time, and much more is now required than simple longevity of a structure. Today, the demand for higher-performance building materials continues to grow along with the demand for “green” product manufacturing and sustainable building practices. This makes understanding the role SCMs can play in improving the performance and environmental friendliness of concrete increasingly important to builders and the design community.

WHAT ARE SCMs?

SCMs are key components that when carefully selected and proportioned in combination with portland or blended cements, coarse and fine aggregates, and chemical admixtures result in stronger, more durable, high-performance concretes. The use of SCMs contributes to the properties of the concrete in both its plastic and hardened states through hydraulic and/or pozzolanic activity. Briefly, hydraulic materials react solely with water to form cementitious compounds, while pozzolans react chemically with an activator (portland cement, lime or kiln dust) in the presence of water to form compounds with cementitious properties. This course will review the use of three common SCMs: slag cement, fly ash and silica fume. The influence of SCMs on plastic, mechanical and durable properties, and their contribution to LEED (Leadership in Energy and Environmental Design) credits and certification will also be discussed.

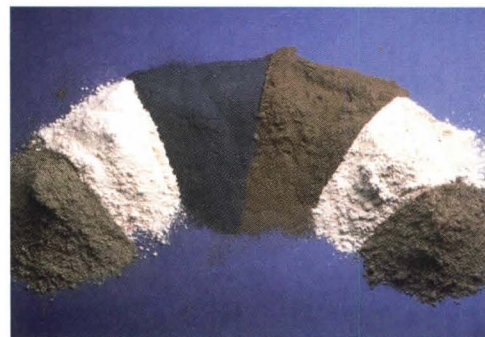

LEARNING OBJECTIVES

The Learner will

- Be able to identify slag cement, fly ash, and silica fume as beneficial SCMs
- Understand the plastic and hardened qualities that SCMs impart to concrete, and how they contribute to increased durability and life cycle extension
- Recognize how using SCMs contributes to LEED Certification

SLAG CEMENT

Slag cement, also referred to as Ground Granulated Blast-Furnace Slag (GGBFS), is a reclaimed, recyclable industrial by-product of the iron- and steel-making process and can replace up to 80% of the portland cement used in concrete, depending upon the application. Slag is a fine, granular material consisting primarily of calcium and aluminum silicates. It becomes molten above 2500° F, floating on the pool of molten iron, and is removed by skimming, after which it is rapidly quenched in water and passed through granulators. Slag not quenched with water forms a non-cementitious lightweight aggregate, while quenched and granulated slag resembles beach sand. Slag cement is dried and stored in bins or silos. Further processing dries and grinds the material to a size of approximately 45 microns. Based on the slag activity index (SAI) and its relative mortar strength when blended with equal amounts of portland cement, slag cement is classified according to ASTM C 989, Standard Specification for Ground Granulated Blast-Furnace Slag for Use in Concrete and Mortars, as Grade 80, 100, or 120. Slag cement produces hydration products very similar to portland cement, and is classified as a hydraulic cementitious material.

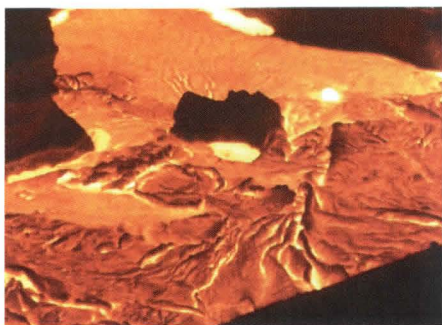

Slag floats on molten iron.



Quenched slag under the microscope and its physical appearance.



Slag cement is a reclaimed, recyclable industrial by-product of the iron- and steel-making process.

FLY ASH

Fly ash, termed a coal combustion by-product (CCB), is the residue created by the burning of pulverized coal in power plants and other industrial facilities. It is commonly captured from the plants' combustion exhaust gases, using equipment such as filters or electrostatic precipitators, and is stored in dry silos for processing. Fly ash is comprised of small, glassy particles varying in size from 1 to 100 microns, and is classified as two types, depending on the percentage of silica, aluminum, and iron oxides as described in ASTM C 618, Standard Specifications for Coal Fly Ash and Raw or Calcined Natural Pozzolan for Use in Concrete. Class F fly ash is produced by burning anthracite or bituminous coal, contains a high percentage (min. 70%) of silicon, aluminum, and iron oxides, and is considered pozzolanic. Class C fly ash is produced by burning lignite and sub-bituminous coal, contains less (min. 50%) silicon, aluminum, and iron oxides, and exhibits both pozzolanic and some cementitious properties. The ASTM classification provides an indication of the reactivity of the class of ash. However, the fly ash's calcium content is also an important consideration in understanding its reactivity and potential cementitious properties.



Fly ash is captured from the exhaust gases of burning coal.

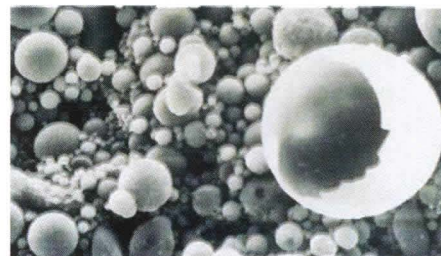

Microscopic view of fly ash.

SILICA FUME

Silica fume is the ultra-fine, non-crystalline silica produced in electric arc furnaces as a by-product of silica metals and ferrosilicon alloys. Silica fume has a very high content of amorphous silicon dioxide and consists of very fine spherical particles with a very high surface area and an average diameter of 0.1 micron – approximately 1/100th the diameter of an average cement grain. The silica fume used in concrete applications is densified to allow for easier bulk handling and economical transport.

PORTLAND AND SCM BLENDED CEMENTS

Cement mixtures containing ordinary portland cement and at least one SCM are termed blended cements. Blended cements are produced by blending portland cement with varying quantities of SCMs, or by intergrinding portland cement clinker with varying quantities of SCMs, or a combination thereof. Blended cements can be produced to provide the benefits in concrete performance that are available when SCMs are used as separate components in concrete mixtures. Typically, though, blended cements show enhanced concrete mixture performance over their separately proportioned counterparts.

Binary cements contain portland cement and one SCM; ternary cements contain portland cement and two SCMs; and quaternary cements contain portland cement and three SCMs. Blended cements conform to ASTM C 595, Standard Specification for Hydraulic Cements and/or ASTM C 1157, Standard Performance Specification for Hydraulic Cements.

BENEFITS TO CONCRETE IN THE PLASTIC STATE

Understanding the benefits SCMs impart to concrete in its plastic state is crucial to mixing, transporting, placing, and finishing the concrete containing

UNDERSTANDING SUPPLEMENTARY CEMENTITIOUS MATERIALS AND THEIR BENEFITS

these materials. When SCMs are specified in a concrete mixture design, it is vital that the specifier understand and compensate for the individual and collective effects of these materials. The SCMs' different hydration characteristics, reactivity, replacement volume, chemical composition, particle size and shape, and dispersion characteristics play an important role in how they affect the properties of a given mixture.

WORKABILITY

The more workable a concrete mixture, the more easily and efficiently it can be pumped, placed, consolidated, and finished on the job site. In general, the addition of SCMs will enhance concrete's workability.

Slag cement and fly ash improve workability and consolidation in concrete mixtures because of their particulate shapes. In the plastic cementitious paste, slag cement creates smooth slip planes. Fly ash, with its spherical shape, imparts a ball bearing-like effect to concrete, improving fluidity and helping to disperse the cement throughout the mixture. The addition of these SCMs increases the volume of cementitious paste within the mixture and, because they are both very fine, readily fill voids. Using slag cement and fly ash can result in up to a 10% water reduction, an increase in the solids to liquid ratio, and a decrease of water to cementitious materials ratio. The denser paste produced is more cohesive, and exhibits less segregation, and the increase in the volume of cementitious materials can compensate for deficient fines in aggregate gradations.

In general, concrete mixtures containing slag cement and fly ash tend to be creamier in texture, more cohesive, easier to pump and place with less slump loss from plant to job site, and easier to finish. Even harsh, no-slump concrete mixtures show improved workability with the addition of slag cement and fly ash. Aesthetically, surface finishes are also improved as reductions in bug holes and segregation from stripped formwork are typical.

Silica fume used as an SCM generally causes concrete mixtures to become stickier, resulting in slightly decreased workability. When silica fume is used at levels above 5%, water demand will be increased which can be offset by the use of a high-range water-reducing admixture. With these properties in mind, the addition of silica

fume can be complemented with other SCMs, resulting in very acceptable workability and a moderation in setting times depending on ambient temperatures.

BLEEDING

Bleeding occurs because of the simultaneous settling of the heavy cement and aggregate particles in the presence of upward migration of water within the concrete mixture. This results in the development of a "bleed" water layer on the concrete surface which can negatively impact finishing and durability.

Adding slag cement to the concrete mixture can either increase or decrease bleeding, depending on the fineness of the slag involved. Slag cements ground more finely than the portland cement in the mixture break the continuity of the capillaries within the concrete, limiting the migration of water and reducing bleeding, while those ground coarser than the cement particles tend to increase bleeding. Because of its small particle size, adding fly ash as an SCM effectively reduces the water demand necessary to achieve workability of the mixture. This, in turn, reduces the amount of bleeding. Silica fume, owing to the very small size and high surface area of its particles, virtually eliminates bleeding. This characteristic of silica fume requires that special attention be paid to concrete placing, finishing, and curing to achieve the best possible results.

AIR CONTENT

To enhance its workability and/or improve its freeze-thaw resistance, air is purposely entrained in concrete. The minimum amount of entrained air is based upon the requirements for freeze-thaw durability. The amount of air-entraining admixture required to obtain the proper air-void system is a function of the cement and the SCMs chemical and physical properties.

While slag cement generally has no adverse effect on air entrainment, the addition of other SCMs to concrete mixtures usually requires an increase in the amount of air-entraining admixture used to achieve a desired air-void ratio or system. Due to the loss on ignition (LOI) and fineness of the particles, the addition of fly ash, particularly Class F, may increase air entraining admixture requirements by as much as five times compared to portland cement concrete without fly ash.

Silica fume, with its small particle size and high particulate surface area, increases the amount of air-entrainment admixture by as much as two to three times that of a non-SCM-containing mixture.

SETTING TIME

Setting time is the period from the loss of elasticity of a mixture to initial concrete hardening. Water content, cement characteristics and content, and ambient conditions all play a major part in determining concrete setting time.

Generally, slag cement and Class F fly ash tend to delay the setting time, with the extent of the delay dependent on the type of SCM involved, its degree of reactivity, and external factors such as temperature and weather. Delayed setting time is beneficial in warmer temperatures and climates providing additional time for placement, consolidation and finishing of concrete. In cooler temperatures and climates, the use of heated water and aggregates or the addition of an accelerating concrete admixture may be necessary to reduce setting time. Silica fume has very little effect on concrete setting times.

BENEFITS TO CONCRETE IN THE HARDENED STATE

Perhaps the greatest physical benefits imparted by SCMs can be seen in the properties concrete exhibits after hardening. These effects vary depending upon the variability in composition of the SCMs employed, but the relative effects are detailed here.

STRENGTH AND RATE OF STRENGTH GAIN

Strength and strength gain are defined by ASTM C 39, Standard Test Method for Compressive Strength of Cylindrical Concrete Specimens. After initial hardening, concrete gains strength at a decreasing rate over time, so varying the concrete mixture can significantly alter the rate and/or ultimate strength gain.

Slag cement, depending on its activity index, produces a wide range of effects on hardened concrete's strength. Compressive and flexural strengths, for instance, increase markedly with the addition of slag cement. With slag cement additions, from 7-28 days, compressive strength may increase 40-50%, versus only about 15% in samples without the SCM.

Concrete using fly ash as an SCM generally exhibits lower strength gain early in its curing process, but shows an increased rate of strength gain and higher ultimate compressive strength as the curing progresses. Silica fume greatly increases the compressive strength of hardened concrete by strengthening the transition zone between the aggregate and the cement paste, most notably at early ages.

EFFECTS ON PERMEABILITY

Permeability is the measure of ease by which water, air and other substances such as chloride and sulfate ions enter concrete. Concrete contains pores in the cement paste fraction that allow these substances to enter. To lower the permeability of concrete, the quality or the quantity of cement paste must be altered. When portland cement hydrates, it forms calcium-silicate hydrate gel (CSH) and calcium hydroxide $\text{Ca}(\text{OH})_2$. Permeability is related to the proportion of CSH to $\text{Ca}(\text{OH})_2$ in the cement paste. The higher the proportion of CSH to $\text{Ca}(\text{OH})_2$, the lower the permeability of the concrete.

The addition of slag cement reduces the permeability of concrete. Due to its small particle size and chemical activity, slag cement binds with the calcium hydroxide produced from the cement hydration process to form additional calcium silicate hydrate (CSH), the "glue" in portland cement. This reaction blocks the long, microscopic capillary channels that commonly form in concrete during curing, limiting the migration of water and making

the concrete much less permeable and receptive to water infiltration.

Fly ash also reduces the permeability of concrete due to the reaction products of pozzolanic activity that increase the volume of cementitious materials and fill voids within the mixture. Likewise, silica fume has a very profound effect on permeability, exhibiting as much as a five-fold reduction in permeability when using 10% silica fume.

CORROSION, ASR PROTECTION AND RESISTANCE TO SULFATE ATTACK

Corrosion of embedded steel in reinforced concrete is the most common occurrence for premature deterioration of concrete structures. By decreasing the permeability of concrete, SCMs delay the penetration of destructive chloride ions, greatly slowing the corrosion process. Slag cement, fly ash, and silica fume all contribute significantly to reducing concrete permeability and increasing durability.

Alkali-silica reaction (ASR) in concrete results from the interaction of alkalis in portland cement and certain aggregates. This reaction may result in abnormal expansion and cracking of the concrete. When used in the correct proportions, SCMs such as slag cement, fly ash, and silica fume can effectively reduce ASR, preventing this type of damage.

Sulfates of sodium, potassium, and magnesium, present in rain, groundwater, and seawater, can also cause deterioration of concrete structures. Using SCMs such as slag cement, fly ash, and

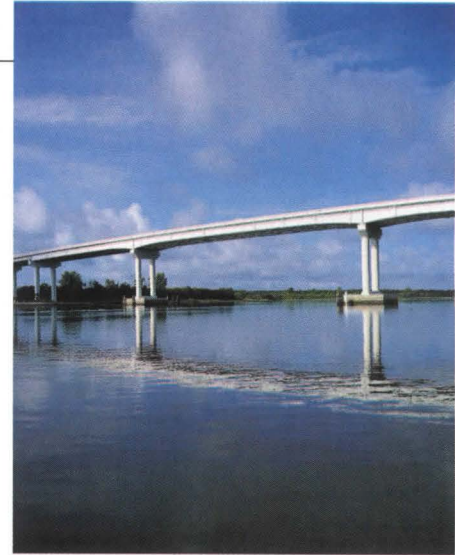

silica fume can help reduce the permeability of concrete and/or limit the reactive elements that cause these destructive chemical reactions. However, it is imperative to understand the exposure conditions and the chemistry that can occur when using specific types of SCMs in combination with specific types of portland or hydraulic cements. The key here is a low water-to-cementitious materials weight ratio and low permeability that will limit sulfate reactions.

COLOR

SCMs can dramatically affect the color of hardened concrete. Color effects are related to the amount and the color of the material used in concrete. Many SCMs resemble the color of portland cement and therefore have little effect on the color of the hardened concrete. Some silica fumes may give the concrete a slightly bluish or dark gray tint and fly ash may impart a tan color to concrete when used in large quantities. Slag cement can make concrete lighter. Slag cement may initially impart a bluish or greenish undertone that disappears over time as concrete is oxidized with the atmosphere. The color will remain if the concrete is continuously exposed to water or sealed prior to oxidation.

LIFE CYCLE ASSESSMENTS

Life cycle assessments for buildings constructed using concretes containing SCMs demonstrate a greatly-extended useful life because of improved durability. This results in much lower predictable costs per year over the life of a building.

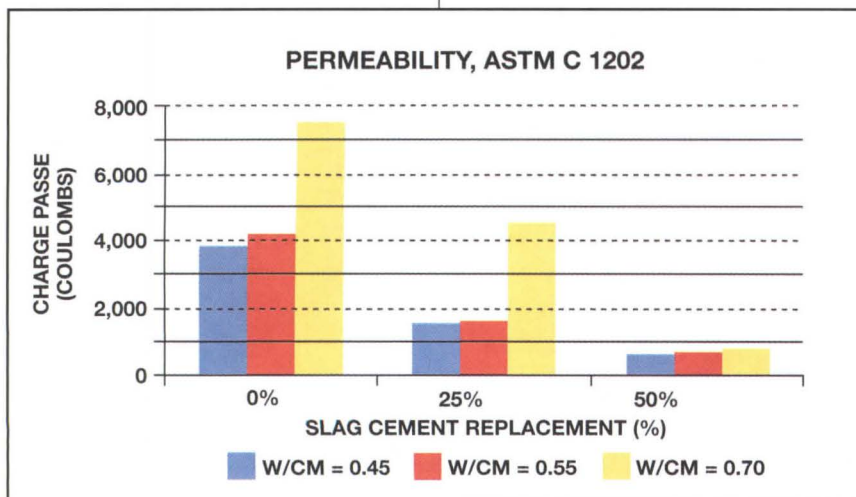

TO ACCESS ADDITIONAL READING: Go to www.architectmagazine.com and select "Resources" then select "Continuing Education Center". There you can download PDF files of this course and the required additional information.

TAKE THE TEST ONLINE FOR FREE: New users must create a new account. Returning users may log in. After logging in, click on "My Courses". Then select this course title to launch your test. A score of 80% or higher earns 1 AIA/CES HSW LU credit hour. Valid for credit through April 2009.

TEST QUESTIONS

1. What are the three most common SCMs used in the concrete construction industry?
 - a. Rice hull ash, fly ash, and wood ash
 - b. Slag cement, silica fume and fly ash
 - c. Metakaolin, slag cement and silica fume
 - d. Iron slag, coal, and silicon
 - e. Wood ash, foundry sand, post-consumer glass
2. What plastic property or properties do SCMs affect?
 - a. Setting Time
 - b. Sulfate attack
 - c. Durability
 - d. Color
 - e. All of the above
3. What hardened properties do SCMs affect?
 - a. Strength
 - b. Permeability
 - c. Corrosion
 - d. Sulfate resistance
 - e. All of the above
4. LEED means?
 - a. Leadership in Energy and Environmental Design
 - b. Leading the Effort against Environmental Destruction
 - c. Lasting Efforts in Energy Design
 - d. Lets End Environmental Disasters
 - e. Lessen Effects of Energy on Design
5. How many points can concrete contribute to LEED?
 - a. 26
 - b. 20
 - c. 18
 - d. 15
 - e. 10
6. What is a ternary cement?
 - a. Portland cement blended or interground with 3 SCMs
 - b. Portland cement blended or interground with 1 SCM
 - c. Portland cement blended or interground with 4 SCMs
 - d. Portland cement that is not blended or interground with SCMs
 - e. Portland cement blended or interground with 2 SCMs
7. Blended cements must comply with which ASTM Standards?
 - a. ASTM C39 and/or C157
 - b. ASTM C1157 and/or C595
 - c. ASTM C989 and/or C618
 - d. ASTM 1240 and/or C618
 - e. none of the above
8. What category in LEED does Pervious Pavement most contribute to in points?
 - a. Indoor Environmental Quality
 - b. Reuse and Regional materials
 - c. Innovation in Design
 - d. Sustainable Sites
 - e. It does not contribute to LEED
9. What color does slag cement impart to concrete when it is fully hardened and oxidized by the atmosphere?
 - a. White
 - b. Green
 - c. Blue
 - d. Buff
 - e. Slag does not affect color
10. What SCMs are pozzolans?
 - a. Fly ash
 - b. Silica Fume
 - c. Slag Cement
 - d. A and B
 - e. B and C



Understanding Supplementary Cementitious Materials and Their Benefits

You have the option of taking the test online free of charge or you may mail your test along with a check in the amount of \$10. A score of 80% or higher earns 1 AIA/CES HSW LU credit hour. Certificates of completion are available upon request and delivered by email.

test>	1.	a	b	c	d	e	6.	a	b	c	d	e
	2.	a	b	c	d	e	7.	a	b	c	d	e
	3.	a	b	d	d	e	8.	a	b	c	d	e
	4.	a	b	c	d	e	9.	a	b	c	d	e
	5.	a	b	c	d	e	10.	a	b	c	d	e



MAIL-IN TEST: Photocopy this page. Clearly circle the letter of the correct answers. Mail this test with the completed form and check for \$10, payable to ArchitectCES, to:

ArchitectCES
PO Box 11911
Mount Lebanon, PA 15228

Last Name _____ First Name _____ Middle Initial/Name _____

Firm Name _____

Address _____ City _____ State _____ Zip _____

Tel _____ Fax _____ E-Mail _____

AIA ID Number _____ Completion Date (M/D/Y) _____

Please email me a certificate of completion upon scoring 80% or higher.

Material resources used: Article addressing issues concerning health, safety, and welfare.

I hereby certify that the above information is true and accurate to the best of my knowledge and that I have complied with the AIA Continuing Education Guidelines for the reported period.

Signature _____ Date _____

CULTURE

OBJECT LESSON
BOOKS
EXHIBITS
FILM
EVENTS

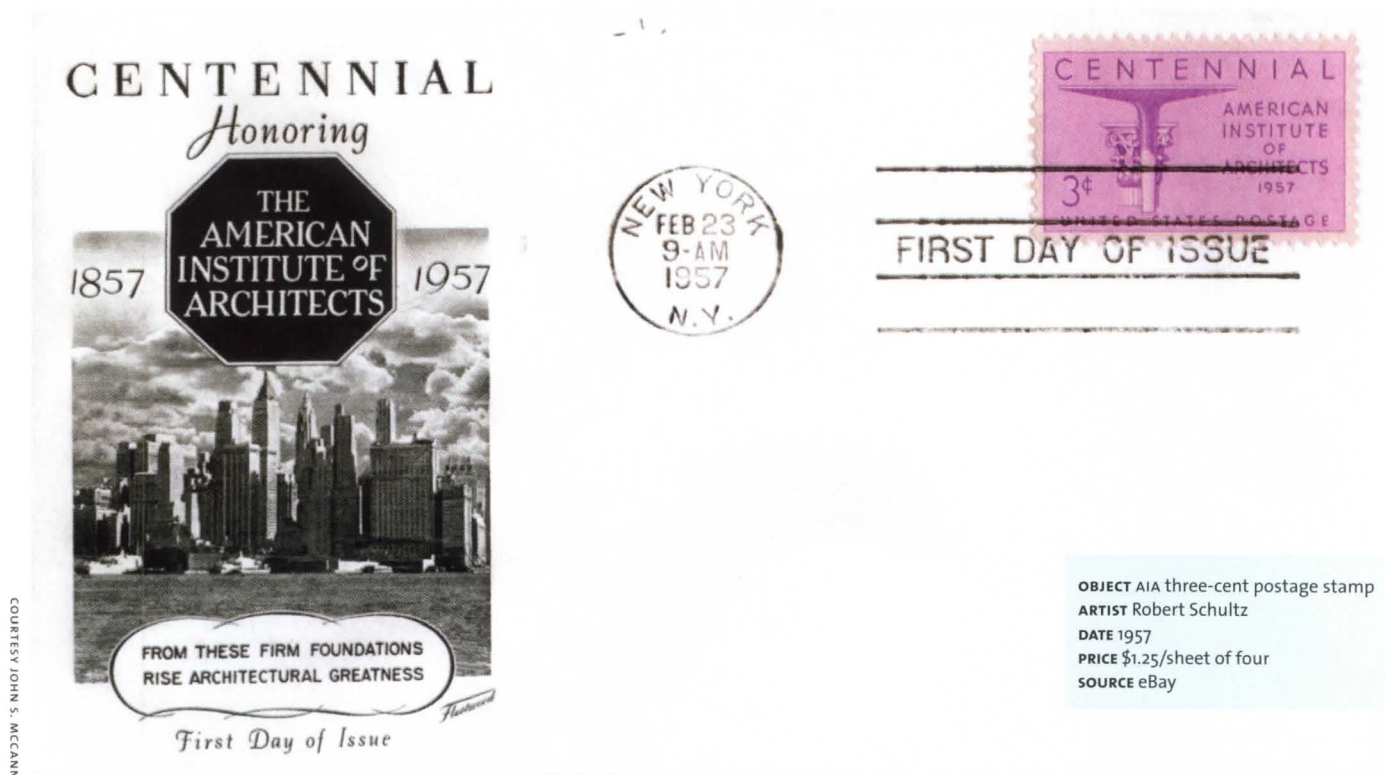

OBJECT AIA three-cent postage stamp
ARTIST Robert Schultz
DATE 1957
PRICE \$1.25/sheet of four
SOURCE eBay

OBJECT LESSON

Mail Call A 50-year-old commemorative stamp goes uncanceled

A THREE-CENT STAMP won't go far today, but in 1957, it assured architects prominence along with speedy delivery.

That's when the American Institute of Architects (AIA) enticed the U.S. Postal Service into producing a centennial commemorative stamp. The modest icon offers a modernist column in the foreground with a Corinthian capital behind. The stamp histories call this placement an assertion of "progress" rather than any victory of new over old. The words "Centennial" and "American Institute of Architects 1957" appear in clean sans-serif capitals on a red-lilac ground.

Collectors prize the stamp on envelopes bearing the first postmark of the first day

of issue: 9 a.m. on Feb. 23, 1957. On that day 100 years earlier, 13 architects met in New York to create the organization that would distinguish the profession from the building trades. As the AIA gathers this month to celebrate another 50 years, the stamp serves as a worthy salute to the founders' intentions.

According to Fred Baumann of the American Philatelic Society, 120 million AIA stamps were printed and 106,647,500 sold. It is listed in the *Scott Catalogue of U.S. Stamps and Covers* as Scott 1089.

The stamp's design was selected by competition. The jury included architects Alexander C. Robinson III, Ronald S. Sensman, Leon Sentner Jr., and Talmadge C. Hughes, along with stamp expert Sol Glass, who recorded the event at the AIA Octagon in Washington, D.C. The panel sifted through 117 entries to choose the winner: a design by architect Robert Schultz of South Bend, Ind., an AIA fellow who died in 1977. His design was finessed into a stamp by William

K. Schrage of the Bureau of Engraving and Printing, who rounded the top of the numeral "3" and centered the text (Schultz had specified flush left).

AIA archivist Nancy Hadley preserves Schultz's drawing and those of finalists, as well as several of the stamps themselves. She also has coveted first-day-of-issue envelopes, including one with a skyline of Manhattan and the legend, "From these firm foundations rise architectural greatness."

After 150 years, the grandeur and the challenge remain.

The price of centennial history: A single uncanceled AIA stamp trades for pennies on eBay, and it still qualifies for regular use. A plate block of four stamps can be acquired for \$1.25. **LINDA HALES**

hanley▲wood

ARCHITECT ONLINE



BUILDING: COLLABORATION

ARCHITECT Online is laying the groundwork for a premier *Internet* experience for practicing architects. We construct the site, you comment on the content. It's the one place online where you can meet to share work, ideas and opinions. To join in, visit www.architectmagazine.com.

It also covers the most fashionable neighborhoods.



 **Hanson**
The face of brick™

HANSONBRICK.COM
1.877.HANSON8

Circle no. 427 or <http://architect.hotims.com>



A|L LIGHT & ARCHITECTURE design awards 4

ENTRY DEADLINE May 24, 2007 POSTMARKED LATE ENTRY **June 1, 2007** (\$25 FEE PER ENTRY)

Architectural Lighting magazine announces the Fourth Annual A|L Light & Architecture Design Awards honoring outstanding and innovative projects in the field of architectural lighting design. The A|L Design Awards recognize and reward excellent lighting within criteria relevant to individual categories. To acknowledge issues of notable importance in today's practice of lighting design, and design techniques particular to lighting, A|L will also present the A|L Virtuous Achievement Awards (ALVA), which recognize projects that achieve the Best Use of Color; the Best Incorporation of Daylight; and the Best Lighting Design on a Budget. All winning projects will be published in the July/August 2007 issue of A|L and be featured on archlighting.com.

Questions?

Contact: Elizabeth Donoff, Editor edonoff@hanleywood.com

COMPLETE SIX-PAGE FORM IS AVAILABLE FOR DOWNLOAD AT WWW.ARCHLIGHTING.COM

The Leisure Architecture of Wayne McAllister

By Chris Nichols

Where would Raymond Chandler have set his novels without sleazy hamburger joints lit up by gaudy neon signs? Would American architecture have emerged from its European cocoon without the glowing pink spire of the Melody Lane eatery, with its circular Coffee Shop catering to pastel 1940s sedans, and a Starlite Room promising Southern California romance? The architect of such mythological palaces—a list including the Sands Hotel in Nevada and Bob's Big Boy drive-in in Tinsel Town—is Wayne McAllister, a designer with no formal training, a passion for car culture, and, now, a coterie of fans determined to honor what's left of his oeuvre. This joyful book preserves the anything-goes spirit of the post-World War II building boom, before the Cold War scared people into bomb shelters. Gibbs Smith; \$19.95

The Lost Vanguard: Russian Modernist Architecture 1922-1932

Photographs by Richard Pare

Essay by Jean-Louis Cohen

Foreword by Phyllis Lambert

Radical notions of architecture evolved naturally after the Russian Revolution, but until photographer Richard Pare devoted 14 years to documenting the period, these early modernist experiments remained missing from history's picture. The author, a former curator at the Canadian Centre for Architecture in Montreal, captures 74 structures in various stages of decay, from humanist factories to stores unseen by the West before the collapse of the Soviet government in 1991. Among the highlights: constructivist trussing at Vladimir Shukhov's radio tower in Moscow; the Centrosuyez, Le Corbusier's only work in Russia; and Konstantin Melnikov's last project, a small but streamlined garage. An interior shot of the Lenin Mausoleum, with its bold zigzag of revolutionary red, is worth the price of the book. Monacelli Press; \$85

The Great Wall of China

Photographs by Chen Changfen

By Anne Wilkes Tucker

Foreword by Jonathan D. Spence

Forty years of photographs of the Great Wall show the enduring cultural legacy of laborers. This monumental study, published in conjunction with an exhibition at the Museum of Fine Arts in Houston, celebrates form, structure, landscape fantasy, and, yes, failure of heroic dimension. The wall still stands, but it didn't work. Yale University Press; \$45



Glass House

Photographs by Michael Moran

Edited by Toshio Nakamura

Philip Johnson once called his house in New Canaan, Conn., a "diary of an eccentric architect." That eccentric spirit infuses this intimate book of photographs of the Connecticut estate, which has just opened as a National Trust for Historic Preservation property. The book was prepared nine years ago for a private client in Japan. Now, two years after Johnson's death, a softcover keepsake has been made available for the rest of us. Johnson's own description of the house—"a box in a box in a box"—is paired with atmospheric photographs by Michael Moran, elevations and plans from the architect's notebook, and commentary by Nakamura, editor in chief of the journal *A+U*. The essence of Johnson's experimental dwelling is captured in a translucent slipcover printed with leaves. Through them, one can just make out the master modernist's glass box, which Johnson called home from 1949. The book's design, by Michael Rock of 2x4, preserves the subtlety of the Glass House in all seasons, as well as the other structures Johnson added to the 44-acre estate over 50 years. Indoors and outdoors slip and slide, as Nakamura homes in on the point: "The Glass House criticizes the very notion of visibility in architecture." Monacelli Press; \$95

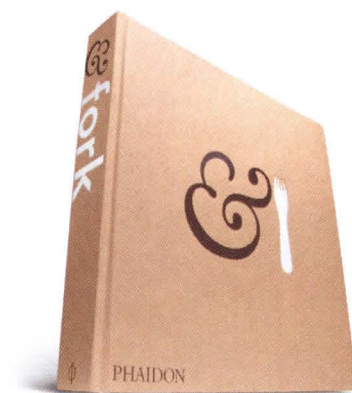

&Fork: 100 Designers, 10 Curators

The architecture of the object is acknowledged in 448 pages of emerging design talent. This coffee-table book of the season is worth its 7.5 pounds in imagery. A sequel to the 2002 volume *Spoon*, which came with a Bilbao-waved metal cover, this tome comes in a meaningful recycled brown wrapper. The cover reflects a new preoccupation with social responsibility among the 100 product designers selected by 10 curators. Despite the title, there is no cutlery, but plenty of otherworldly lamps, clocks, bookshelves, parasols, sewer grids, light fixtures, carpeting, housewares, electronics, and other accessories designed for out-fitting contemporary spaces. Dutch talents from

the Eindhoven Academy lead the rest in product innovation, from decorative patterns for chain-link fencing to Maarten Baas' charred and melting chairs. But American designers are also at the cutting edge, as proved by New Yorkers Antenna Design, Stephen Burks, and Jennifer Carpenter, and California-based Yves Béhar and Bosung Kim. Phaidon; \$69.95

WHERE ECOLOGY MEETS TECHNOLOGY

MAY 15-17, 2007
ANAHEIM CONVENTION CENTER

**Two great
events in one!**

**ecobuild
america**

Sustainable, Green and High-Performance
Solutions for the Built Environment

WWW.ECOBUILDAMERICA.COM



Science & Technology for Architecture,
Engineering & Construction

WWW.AECST.COM

The **Premier Conference and Exhibition**
for Green Building, Sustainable Design,
Renewable Energy, Environmental Planning,
Building Information Modeling, and Construction
Technology.

Featuring the National BIM Conference

Held in Cooperation with: Endorsed by:

Media Sponsor:



Circle no. 68 or <http://architect.hotims.com>

Register online today

For exhibiting, advertising, or sponsorships, please call **1-800-966-3863**

PHILADELPHIA
Antiques of the Future

Design Center of Philadelphia University
Through June 25



KELLY TUSSO

A collection of objects and a book by their owner, Lisa Roberts, forms the basis for this curated examination of contemporary household goods, many of them architect-designed. More than 100 familiar domestic icons, from Ty Nant's spiraling plastic water bottle to Frank Gehry's bentwood chairs for Knoll, show how necessary objects and furnishings can rise to the level of artifacts. When all the dots are connected, the trend to design excellence can be traced back to 1985, when Michael Graves, pre-Target, put a small red bird on the spout of a teakettle commissioned by the Alessi tableware company. Design archivists will remember that the kettle, a fixture in trophy kitchens of the era, was preceded by a sterling-silver tea and coffee service, which Graves and other architects were asked to design for a limited-edition Alessi extravagance. The silver versions survive in museums and among well-heeled private collectors. Roberts' collection is more accessible, and it shows that functional objects can provide delight every day.

HOUSTON
Snapshot '07

Lawndale Art Center
May 18–June 16

The fifth annual exhibition of completed and unrealized designs for Houston, sponsored by the Rice Design Alliance and Lawndale Art Center.

LONDON
Surreal Things: Surrealism and Design

Victoria & Albert Museum
Through July 22

Architecture, design, and the decorative arts, as seen through the prism of the 20th

century's most bizarre arts movement.

NEW HAVEN, CONN.
Responding to Kahn: A Sculptural Conversation

Yale University Art Gallery
Through July 8

Students and interns have gathered postwar sculpture from the collection to draw the connections between modern art and architecture—in this case, the renovated 1953 Louis Kahn masterpiece, which reopened last December after a \$44 million rehab accomplished by Polshek Partnership Architects.

NEW YORK
Barcelona and Modernity: Gaudí to Dalí

Metropolitan Museum of Art
Through June 3

This exhibition brings together work by Barcelona artists, architects, and designers between 1888, the year of the Barcelona Universal Exposition, and 1939, when the Fascist regime of Francisco Franco put a lid on the heady creativity that produced Antoni Gaudí and Salvador Dalí in this center of radical thought.

Bruno Mathsson: Architect and Designer

Bard Graduate Center
Through June 10

A leading figure in Swedish modernism, Mathsson (1907–1988) designed sensuous furniture and environmentally sensitive buildings. His special blend of ergonomics and aesthetics can be seen in graceful woven chairs on the catalog cover. This traveling exhibition made its debut at the Bard Graduate Center in March and will continue on to Seattle's Swedish Cultural Center this summer.

Summer of Love: Art of the Psychedelic Era

Whitney Museum of American Art
May 24–September 16

This touring show from Europe recalls the utopian spirit of 1967, when artists, filmmakers, and designers immersed themselves in counterculture aesthetics and emotions. From the era, Vernon Panton's crawl-in furniture landscapes present a formal challenge to the corporate architecture of the day.

PASADENA, CALIF.
Open House: Architecture and Technology for Intelligent Living

Art Center College of Design
Through July 1

When 15 architects from nine countries are asked to rethink shelter for the next 25 years, the single-family box becomes a desert dune and apartments take on life as cells in a topiarylike tower commune. The exhibition was curated by the Vitra Design Museum in Germany.

TOKYO
Le Corbusier: Art and Architecture—A Life of Creativity

Mori Art Museum



Green Rose Granite, India

A genuine slice of nature.

If genuine natural stone was part of the produce family, they'd probably call it organic.

Genuine stone comes the way nature has created it over millions of years. After it is quarried, blocks of stone are cut, polished, and custom-fabricated for kitchens, baths, floors, and other residential and commercial applications. Every piece is natural. Every piece is unique.

Nothing man-made or engineered about it.

Thanks to new sources of supply around the world and the sophisticated technology that gets it out

of the ground and to the fabricator at less cost, natural stone is more affordable than ever before – and in most cases less expensive than quartz surfaces and other “faux” stone products manufactured in a plant. Beautiful, versatile, affordable, durable natural stone is the natural choice for residential, institutional and commercial construction.

For the name of a natural stone distributor or fabricator in your area, visit www.marble-institute.com/register.

When you want a slice of nature, get the genuine thing. Genuine stone.

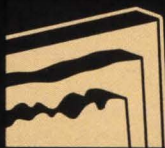

**MARBLE
INSTITUTE**
of America

www.marble-institute.com

GENUINE STONE



Circle no. 44 or <http://architect.hotims.com>

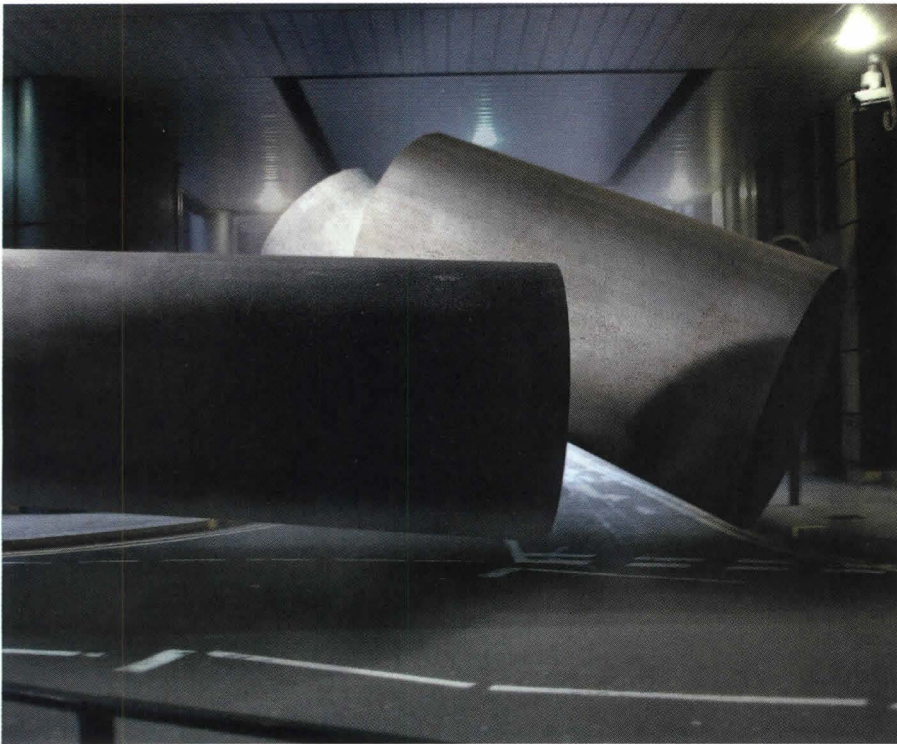

UNIT 15



RYAN CHURCH

Silver Lake Film Festival

May 8–9, Art Center College of Design, Pasadena, Calif.

AS PART OF THE ANNUAL Silver Lake Film Festival being held this month in Los Angeles, architects and filmmakers are invited to revel in the influences they've shared since the invention of the motion picture a century and a half ago. Blogger Geoff Manaugh of *BLDGBLOG* and Jenna Didier of the L.A. gallery Materials and Applications are curating the special two-day event, taking place May 8–9 inside a former wind tunnel at Art Center College of Design in Pasadena, Calif.

Day one will feature the symposium "Science Fiction and the City" and will consider the connections between radical architecture and cinema. Speakers will include set designers Ryan Church, James Clyne, Mark Goerner, and Ben Procter, whose credits collectively include *Star Wars I and III*, *The Terminal*, *The Matrix*, and *Minority Report*.

Day two will include screenings of up to 10 excerpts or short films, some made by architects, ranging from fly-through animations to experimental art films and documentaries. According to the call for submissions, "The obvious caveat is that the film has to be about architecture, landscape, or the built environment."

Manaugh hopes, as many do, that architects will be inspired to exploit the

representational and imaginative tools that film offers, as Archigram and Superstudio did in the 1960s. After all, movers and shakers in architecture and film have long seen eye to eye. Both engage, in some sense, in a plastic art that is collaboratively crafted; both produce lasting cultural artifacts; and both have had profound effects on the public.

In fact, German-American architect-turned-film critic Siegfried Kracauer once wrote, in *Theory of Film: The Redemption of Physical Reality*, "It must always be kept in mind that even the most creative filmmaker is much less independent of nature in the raw than the painter or poet; that his creativity manifests itself in letting nature in and penetrating it." The same can be said of the architect, and the festival's producers believe there is more to be discovered in the connection between film and architecture.

"Even if you look at comic books, horror stories, novels, and sci-fi films, you'll find some very interesting spaces. There aren't as many inhibitions in these other fields," Manaugh says. "But interesting architectural ideas are all around us." LAURIE MANFRA

Above: (left) a still from one Unit 15 project; (right) *Blimp City*, by set designer Ryan Church.

WHAT'S SHOWING

A selection of work by students at the Bartlett School of Architecture in London. Called **Unit 15** and organized by professor Nic Clear, the class explored new ways of employing motion graphics to convey architectural theories.

A 3½-minute super-short titled *K.I.L.L.* by videographer and musician Thorsten Fleisch, who is known for hyperkinetic editing of obscure subjects such as physical phenomena, generative processes, and microscopic structures.

A film by Cleveland-based designer Bradford Watson titled *2x4x96*. It consists of 96 still shots of the ends of two 2x4s, just after being sawed. The rapid sequencing reveals variations in the wood grain that appear to be animated.

A 30-minute documentary by Emmanuelle Bernard and André Blas, *Declarations of Love* considers—through stories told by residents—how an Oscar Niemeyer–designed high-rise in Sao Paulo, Brazil, went from vertical slum to beloved housing community.

Specify
CONFIDENCE.



*EFCO Corporation helps you
ride a fine line.*

You've specified a lot of things in your time. Wouldn't it be great if you could specify a delicate balance between beautiful buildings and a healthy environment? EFCO offers the kind of innovative products and skilled support that give you confidence to achieve impressive feats in the "green" arena. It begins when you specify any of our crowd-pleasing windows, curtain walls, storefronts, and entrances.

You and your projects will perform better when you rely on a company you can trust. Contact your EFCO representative, visit efcocorp.com, or call 1.800.221.4169 for more information.

Circle no. 85 or <http://architect.hotims.com>



Where windows are just the beginning.



CULTUREEVENTS

BUCHHEGER DENOTH FEICHTNER



19th Annual International Contemporary Furniture Fair
MAY 19–22
NEW YORK
 Manhattan's answer to Milan, this premier American showcase for cutting-edge furnishings and products is the centerpiece of a design festival involving galleries, museums, and boutiques. The Jacob K. Javits Convention Center will display 145,000 square feet of new designs. www.icff.com

MAY

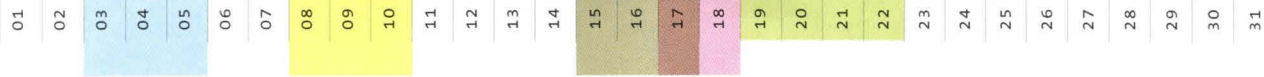

2007 AIA National Convention

MAY 3–5
SAN ANTONIO
 It's architecture with salsa at the 2007 convention of the American Institute of Architects. Highlights include the presentation of honors: the 25-Year Award goes to Maya Lin's Vietnam Veterans Memorial in D.C.; the National Organization of Minority Architects will receive the Whitney M. Young Jr. Award; and former AIA president R. Randall Vosbeck will receive the Edward C. Kemper Award for Service to the Profession. www.aia.org

Lightfair International

MAY 8–10
NEW YORK
 The future of lighting will be illuminated at the 18th annual trade show and conference at the Jacob K. Javits Convention Center. www.lightfair.com

Ecobuild America

MAY 15–17
ANAHEIM, CALIF.
 The place to go for professionals seeking the latest information on sustainable technologies for design and construction. www.ecobuildamerica.com

IIT Institute of Design Strategy Conference

MAY 17–18
CHICAGO
 The Illinois Institute of Design's third international forum of executives aiming to meld design with business strategy. www.id.iit.edu/events/strategyconference/2007

JUNE

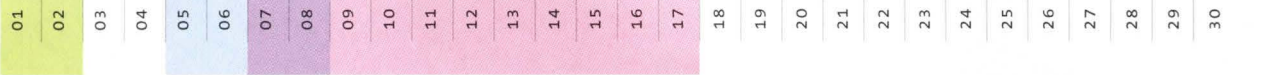

Chic It Up! Design Conference

JUNE 1–2
WINTERTHUR, DEL.
 The fabled Winterthur Museum, bastion of good taste in the 18th and 19th centuries, will open its doors for a two-day discussion of 20th and 21st century design. www.winterthur.org

African Architecture Today International Conference at Kwame Nkrumah University of Science and Technology

JUNE 5–8
KUMASI, GHANA
 Building is booming in Africa. This conference brings together a broad-based community interested in progressive ideas for a new paradigm in African architecture. www.mudonline.org/kumasi

The Summer Fair Olympia

JUNE 7–17
LONDON
 The annual fine art and antiques bazaar draws tycoons and oligarchs in the mood for a patinaed 18th century chest-on-chest or a massive rock-crystal chandelier. www.summerfairolympia.com

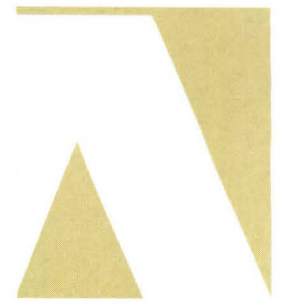

ARCHITECT
ACE AWARDS
ARCHITECT'S CHOICE FOR EXCELLENCE

hanley wood

ARCHITECT'S 6th Annual
ACE Awards Ballot

ARCHITECT'S Choice
for Excellence

Chosen by Architects
Awarded by ARCHITECT

*Recognizing exceptional product durability,
customer service, value and design.*

Now in its 6th year,
ARCHITECT'S ACE Awards
have become the mark
of distinction and
dependability.

Vote For The Top 10 Companies!

Go to www.ARaceawards.com or fax your ballot pages to **202.736.3470**



How The Program Works

1. Take a few minutes to review the list of manufacturers.
2. Circle the 10 manufacturers that meet or exceed the standards indicated in the voting criteria.
3. Of the companies you've selected, indicate your choices for Most Innovative, Most Respected and Most Specified.
4. Go to www.ARaceawards.com or fax your ballot pages to 202.736.3470.

Voting Criteria

Select the manufacturers who have provided you and your projects with:

- Exceptional Durability
- Exceptional Customer Service
- Superior Product Value
- Advanced Designs

Methodology

The ACE ballot manufacturers list appears in the May and June issues of ARCHITECT, each reaching the 70,000 nationwide circulation. In addition, e-mail campaigns are conducted to ensure the broadest base of response. Ballots are provided at the AIA, Lightfair and other industry conferences. ARCHITECT also conducts random sampling, consults with industry experts, and the list of nominated manufacturers is subject to review by an in-house publishing team.

Results Will Be Announced In The December 2007 Issue.

Your votes must be received by July 6, 2007.

>> **Deadline: July 6, 2007**

Masonry/Brick

Belden Brick Co.
Boral Bricks
Boston Valley Terra Cotta
Bowerston Shale Co.
Carolina Ceramic
Clayton Block Co.
Eldorado Stone Corp.
Elgin-Butler Brick
Endicott Clay Products
Envirospec
Eurocobble
Glen-Gery Brick
Haddonstone
Hanover Architectural Products
Hanson Brick and Tile
Hohmann & Barnard
Hy-Lite Products, Inc.
Keppco+
Laticrete International, Inc.
Lehigh Cement Co.
Mortar Net USA
Owens Corning
Real Brick
Rictex Brick
Robinson Brick
Shildan
Solomon Colors
Spectra
The Proudfoot Co.
Vetter Stone Co.
York Manufacturing, Inc.

Concrete/Concrete Materials

Bomanite
Davis Colors
Haddonstone
High Concrete Group
Hohmann & Barnard
Invisible Structures
Lafarge
L.M. Scofield
Lehigh Cement Co.
MAPEI U.S.A.
Master Builders, Inc.
Maxxon
Patterned Concrete
Solomon Colors
The Proudfoot Co.
Xypex Chemical Corp.

Building Insulation

Atlas Roofing Corp.
Bayer Corp.
BBR Remay
Celotex Ltd.
CertainTeed Insulation Corp.
Dow Chemical Corp.
DuPont
G-P Gypsum Corp.
Homasote Co.
Insulation Corp of America
Johns Manville

Knauf Fiber Glass
Marathon Roofing Products
Owens Corning Fiberglass
Pactiv
Temple Inland
Tygar Housewrap
United States Gypsum

Shingles, Roof Tiles & Roof Coverings

ATAS Roofing
Atlas Roofing Co.
Bird Co.
Birdair
Celotex
CertainTeed Insulation Corp.
Envirospec
Eternit
GAF Roofing
James Hardie Building Products
Ludowici Roof Tile
Monier Lifetile
North Country Slate
Owens Corning
Tamko Roofing
U.S. Intec, Inc.
U.S. Tile
Vange Hey-Raleigh Architectural Tile
Vermont Structural Slate, Inc.

Metal Roofing & Wall Panels

Alcan Composites
Alcoa Building Products
Pactiv
American Buildings/AMS
Benchmark Architectural Systems
Bethlehem Steel Corp.
Butler Manufacturing
Centria
Copper Sales
Dietrich Metals
Englert
Epic Metals
Fabral
Follansbee Roofing
Fry Reglet Corp.
Garland Co.
Hunter Douglas Contract Facades
Integris Metals
Kalwall Corp.
Lantor
MBCI
McElroy Metals
Merchan & Evans
Metecno-Aluma Shield
Metecno-API
Metecno-Morin
Meti-Span
Petersen Aluminum Corp.
Revere Copper Products

Rheinzink America, Inc.
Varco Pruden

Membrane Roofing

Burke Industries
Carlisle SynTec
DuPont Dow Elastomers
Duro-Last Roofing
Firestone Building Products
GenFlex Roofing Systems
Johns Manville
Sika Sarnafil
Stevens Roofing Systems

EIFS Systems and Stucco

Dryvit Systems
Finestone
Georgia-Pacific
Parex
Senergy
SonoWall
Sto Corp.
TEC Speciality Products
TEIFS Wall Systems

Ventilation

American Aldes Ventilation

Vote For The Top 10 Companies!

Go to www.ARaceawards.com or fax your ballot pages to 202.736.3470



Metal Doors & Frames

Adams Rite Mfg.
Ceco Door Products
Chase Doors
Chicago Metallic
Cline Aluminum Doors
Eckel Industries
EFCO Corp.
Ellison Bronze
Essex Industries
Forms+Surfaces
Hope's Windows
I-R Security and Safety
Kawneer
Overhead Door Corp.
Peachtree Doors & Windows
Premdor
Simonton Windows
Technical Glass Products
Timely
Traco
Tubelite
Vetter Windows
Wausau Window & Wall Systems
YKK AP America

Wood & Plastic Windows, Doors, & Frames

Acorn Window Systems
Algoma Hardwoods
Alternia
Andersen Windows
Chase Doors
Cline Aluminum Doors
DoorCraft
Eagle Window & Door
Eckel Industries
Eggers Industries
Graham Architectural Products
Hy-Lite
IWP
JELD-WYN Windows & Doors
Kolbe Windows & Doors
Loewen
Marlite
Marshfield Door Systems
Masonite
Morgan
Nord
Pella Corp.
Pozzi Wood Windows
Reilly WoodWorks
Rubbar Door
Therma-Tru
Traco
VT Industries

Entrances & Storefronts

Acorn Window Systems
Ceco Door Products
CertainTeed

Cline Aluminum Doors
Cornell Iron Works
Crittall Windows
Dorma Glas
EFCO Corp.
Ellison Bronze
Essex Industries
HDI Railing Systems
Hope's Windows
Kalwall
Kawneer
Major Industries
Marshfield Door Systems
O'Keefes
Pilkington Building Products
PPG Industries
Robinson Iron
Solutia
Technical Glass Products
Traco
Tubelite
Vistawall Group
Visteon
Wausau Window & Wall Systems
YKK AP America

Metal Windows

Crittall Windows
Crystal Window & Door
Custom Window Co.
EFCO Corp.
Graham Architectural Products
Hope's Windows
JELD-WEN Windows & Doors
Kalwall
Kawneer
Moduline Window Systems
Peerless Products
Timely Industries
Traco
Tubelite
Wausau Window & Wall Systems
YKK AP America

Wood Windows

Andersen Windows
Caradco
Case Window and Door
CertainTeed
Custom Window Co.
Eagle Window & Door
Hurd Millwork Co.
JELD-WEN Windows & Doors
Kolbe Windows & Doors
Marvin Windows & Doors
Megawood
Norco
PBC Clad
Peachtree Doors & Windows
Pella Corp.

Peter Kohler Windows
Pozzi Wood Windows
Reilly Woodworks
Summit
Tischler und Sohn
Vetter Windows
Weather Shield
Windsor Windows & Doors
Zeluck Incorporated

Skylights

Andersen Windows
Construction Specialities, C/S Group
Duo-Guard Industries
Extech
Fabric Structures
Kalwall Corp.
Major Industries
NaturalLight Systems
Polygal U.S.A.
Schott
Solatube
Structures Unlimited
Suntuf inc.
Traco Skytech Systems
Velux-America, Inc.
Vistawall Group
Wasco Skylighting

Hardware

Accuride International
Adams Rite Mfg.
Arakawa
Construction Specialities, C/S Group
Dorma Architectural Hardware
Dorma Glas
Dor-O-Matic Closers
DynaLock Corp.
Essex Industries
Forms+Surfaces
Hafele America Co.
Hager Companies
Hewi
I-R Security and Safety
Jackson Corp.
LCN Closers
Madile
Nanz Custom Hardware
Pemko
Rixon Speciality Door Controls
Rocky Mountain
Schlage Lock Co.
Sugatsune America
Truth Hardward
Valli&Valli
Von Duprin
Yale Commercial Locks & Hardware
YKK-AP America
Zero International

Access Door & Panels

Acudor Products
The Bilco Co.
Cierra Products
Karp Associates
Milcor
Nystrom Building Products
Precision Ladders

Window Treatments

Amco
Draper
Hunter Douglas Contract
Levolor
MechoShade Systems, Inc.
Shade Techniques

Glass

Cesar Color
CertainTeed
General Glass
Joel Berman Glass Studios
Leucos USA Inc.
Medico
Meltdown Glass
O'Keefes
Pilkington Building Products
PPG Industries
Sage Glass
Schott North America
Solutia
Technical Glass Products
Viracon, Inc.
Visteon Corp.

Glazed Curtain Walls

Benchmark Architectural Systems
EFCO Corp.
Kalwall Corp.
Kawneer
Major Industries
PPG Industries
Tubelite
VistaWall Group
Wausau Window & Wall Systems
Westcrowns

Translucent Wall & Roof Systems

Duo-Guard Industries
Kalwall Corp.
Major Industries
Polytronix
Suntuf, Inc.

Architectural Moldings

Fypon

Gypsum Board

98145.452
Collins-Truwood
Georgia-Pacific
Johns Manville
Lafarge Gypsum
National Gypsum
Temple Inland
United States Gypsum
W.R. Bonsal Co.

Gypsum Fabrications

Custom Castings Northeast
Formglas, Inc.
Hyde Park Firne Art of Mouldings
Monumental Construction & Moulding
Pitcon Industries
Plastrglas, Inc.

Ceilings

Alpro
Altro
Armstrong
BPB Celotex
Ceilings Plus
Chicago Metallic
Eckel Industries
Ecophon
Epic Metal
Fry Reglet
Gage Corp.
Georgia-Pacific
Gordon
Hunter Douglas Contract Acoustical Ceilings
Luxalon Metal Ceilings
Illbruck Architectural Product
Johns Manville
National Gypsum
Novawall Systems
Owens Corning
Sound Seal
Tectum
United States Gypsum

Ceramic Tile

American Marazzi Tile
American Olean
Ann Sacks
Ceramic Tiles of Italy
Crossville Ceramics
Daltile
Florim, USA
GranitiFiandre
Imagine Tile
Lauten
Stone Source

Vote For The Top 10 Companies!

Go to www.ARaceawards.com or fax your ballot pages to 202.736.3470



Tile of Spain
Wausau Tile

Resilient Flooring

Antico
Armstrong
Azrock
Burke Mercer
Centiva by International Floors of America
Ceres
Colbond
Congoleum
CSSI Resilient Surfacing
Domco
Endura Flooring
Flexco
Forbo
Johnsonite
Kentile
Lonseal Flooring
Mannington
MAPEI
Marley-Flexco
Maxxon Corp.
Mondo USA
Nora Rubber Flooring
Pacific Polymers International
R.C. Musson Rubber Co.
Roppe
Tarkett Commercial Flooring
Toli

Rubber Flooring

Azrock
Burke Mercer
Dodge Regupol
Endura
Johnsonite
Lonseal Flooring
Marley Flexco
Nora Rubbing Flooring
Pawling
R.C. Musson Rubber Corp.
R.C.A. Rubber
Roppe Corp.
Tuflex

Laminates, Plastic

Abet
Formica Corp.
Georgia-Pacific
Nevamar Co.
Wilsonart International

Laminate Flooring

ABET Laminati
Arborite
Bruce Flooring
Formica Flooring
Lamin-Art
L.M. Scofield

Mannington
Nevamar
Pergo
Pionite
Wilsonart Flooring

Carpet Tile/Modular

Bentley Mills
Bonar
Collins & Aikman
Flexco
Interface Flooring Systems
J&J (Invision)
Lees
Mannington Commercial
Milliken Carpet
Mohawk Industries
Shaw Industries

Carpet Fibers

Antron
Monsanto Contract Fibers
Wools of New Zealand
Zeftron

Paint/Stains & Finishes

Benjamin Moore & Co.
Carlisle Coatings & Waterproofing
Devoe Paint
DuPont
Duron Paints & Waterproofing
ICI Paints
PPG Paints & Coatings
PROSOCO
SealMaster
Sherwin-Williams Co.
Valspar

Broadloom

Atlas Carpet Mills
Beaulieu
Bigelow
Blue Ridge
Clayton Miller Hospitality Carpet
Durkan
Harbinger
Invision Carpet Systems
J & J Commercial
Karastan
Lees Carpets
Mannington
Masland
Milliken
Mohawk Industries
Monterey
Patcraft
Prince Street
Shaw Industries

Solid Surfacing

Avonite Surfaces
DuPont Corlan
Formica
Fountainhead
Nevamar
Swanstone
Wilsonart International

Wallcoverings

Bolta
Designtex
Eurotex
Genon
Innovations in Wallcoverings
J.M. Lynne
Koroseal/RJF International
Lanark
Maharam
Wolf Gordon

Fabric Construction/Cable Systems/Metal Wall Panels

Air Structures American Technologies
Birdair, Inc.
Cambridge Architectural Mesh
Cascade Coil Drapery
Chemfab Corp.
Clamshell Buildings
Dietrich Metals
DuPont Building Innovations
Feeney Wire Rope and Rigging
Jakob
Niles Expanded Metal & Plastics
Pfeifer Cable Structures
Seco South
Shade Concepts
Span Systems
Spantek Expanded Metal
Sprung Instant Structures
Structures Unlimited
Sullivan & Brampton
Walker Display

Security Access & Surveillance

Ademco
Alvarado Manufacturing Co.
Automatic Control
Byan Security
Checkpoint Systems, Inc.
Controlled Access
Dynalock Corp.
Elbex America
Essex Industries, Inc.
FAAC International
IR Security and Safety
Schlage Lock Co.
Sensormatic Corp.
Siedle Co.
Von Duprin

Plumbing Fixtures

Acorn Engineering
American Standard
Bobrick
Bradley Corp.
Chicago Faucet
Curvet USA
Duravit
Geberit Manufacturing
GROHE America
Hansgrohe
Haws Corp.
Johnson Controls
Kohler Co.
Kroin
Renewable Choice Industry
Rohl
Sloan Flushmate
Sloan Valve Co.
TOTO USA, Inc.
Waterworks

Kitchen & Bath Hardware

Bobrick Washroom Equipment
Dornbracht
Ginger
Hafele America
Hansgrohe
Kohler Co.
Kroin
Moen, Inc.
Price Pfister
Rohl
Sloan Valve Co.
Soho
TOTO USA, Inc.
Valli&Valli
Waterworks

Elevators/Escalators

Access Industries
Atlantic Lifts
Atlas Elevator
Concord Elevator
Fujitec America
Inclinor Company of America
Infinite Access
KONE
National Wheel-O-Vator
Otis Elevator Co.
Pflow
Schindler Group
ThyssenKrupp Elevator

Lighting/Lighting Controls

Advent
Alkco Lighting
Allscape Lighting
A.L.P. Lighting
ALS-Architectural Lighting Systems
Altman Lighting

Ambiance lighting
American Fluorescent
American Glass Light
Amerlux
Architectural Area Lighting
Ardee
Artemide
Baldinger
Bartco Lighting
Bega Lighting
Beta Lighting
Birchwood Lighting
B-K Lighting
B-Light
Boyd Lighting
Bruck Lighting Systems
Capri
Charleston Gas Light
Color Kinetics
Columbia Lighting
Conant Custom Brass, Inc.
ConDaz
Con-Tech Lighting
Contrast Lighting
Cooper Lighting
Cree
Crestron
CSI
D'ac
Davis Muller
Day-Brite Lighting
Delta Light USA
Dernier & Hamlyn
Designplan Lighting, Inc.
Dialite
Donovan Lighting
Elite Bohemia
Elliptipar
Engineered Lighting Products
ERCO Lighting USA, Inc.
ESTILUZ, Inc.
Eurofase, Inc.
Exceline
Fabbian USA
FAD lighting
Fine Art Lamps
Finelite
FLOS
Focal Point
Forecast
Foscarini
Framburg Lighting
Gamma 3 Luce
Gardco Lighting
GE Consumer & Industrial Lighting
HADCO
Halo
Hoffmeister
Holophane

Vote For The Top 10 Companies!

Go to www.ARaceawards.com or fax your ballot pages to **202.736.3470**



Hubbell
Hunter Douglas Contract, Solar Control by Nyson
Hydrel
ILEX
ILight Technologies
Insight Lighting
IO Lighting
Iris
Ivalo Lighting
Juno Lighting
Kenall
KIM Lighting
Kichler
Kurt Versen
Kramer Lighting
Lam
LBL Lighting
Ledalite
Leucos USA
Leviton
Lightolier
Litecontrol
Lithonia Lighting
Lighting Services Inc.
Louis Poulsen Lighting
Luceplan USA, Inc.
Lucien GAU
Lucifer Lighting
Lumca
Lumec
Lumen Center Italia
Luminis
Lutrex
Lutron Electronics
Luxo Corp.
Luxo Italiana
Martin Architectural
MechoShade Systems, Inc.

Metalumen
Metalux
Meyda Lighting
James R. Moder Crystal Chandelier
Nessen
Nora Lighting
NouVIR Research
Oggetti Luce
O Luce
The Original Cast Lighting
Osram Sylvania
Peerless
Philips Lighting
Phoster Lighting
Planlicht
Precision Architectural Lighting
Prescolite
Primelite
PRISMA Architectural Lighting
Prudential lighting
Reggiani Lighting USA
Renaissance Lighting
Renova Lighting Systems, Inc.
Rotaliani
Schneider Electric
Schreder Inc.
Selux
Serien
Serralunga
Sill
Sirius Lighting
Sirmos
Sistemalux
Spark Lighting
Specialty
SPI
Sprng City Electrical Manufacturing Co.

Studio Italia Design USA
Supervision (NEXXUS Lighting)
Targetti North America, inc.
Tech Lighting, LLC
Terzani
Tivoli, LLC
Traxon USA
Trilux Lighting Limited
Unilight
Vantage Controls
Venture Lighting
Viabizzuno
Visa Lighting Corp.
Visio Lighting
Vossloh Schwabe/Aromat
WAC Lighting
W2
The Watt Stopper
Weaver & Ducre
Wilshire Manufacturing Company
Winona
Zoltan
Zumbotel

Furniture Systems

Allsteel
American Seating
Brayton International
Bretford
Hale Manufacturing
Haworth
Herman Miller
HON
KI
Kimball Office
Knoll, Inc.
Nova

Paoli
Poliform
Spacesaver
Steelcase, inc.
Stone Dimensions
Teknion

Seating

Allsteel
American Seating
BioFit Engineered Products
Haworth
Herman Miller
HON
Humanscale
Keilhauer
KI
Kimball Office
Knoll, Inc.
Steelcase, inc.
Sylex
Vitra

Casegoods

Allsteel
Bernhardt
Bretford
Hale Manufacturing
Harden Contract
Haworth
Herman Miller
HON
KI
Kimball Office
Knoll, Inc.
Meridian
Paoli
Steelcase, Inc.

Outdoor Furniture

Barlow Tyrie
Brown Jordan International
Earth Care
Knoll
Landscape Forms
Lloyd Flanders
McGuire
Smith & Hawken
Wabash Valley
Weatherend
Woodard

Computer/Software

Alias
ArchiOffice
Architectural Data Systems
@Last Software
Autodesk, Inc.
Autodesk
Bentley Systems
Building Systems Design
CAD-1
Datacad
Dell, Inc.
Form Z
Graphisoft
Nemetschek
Orange Loft
Sketchup
Wind-2 Software

Of the companies you have selected, which in your opinion is the:

Most INNOVATIVE

Most RESPECTED

Most SPECIFIED

I would also like to nominate these manufacturers (not listed) for the ACE.

Your Name

Title

Company

City/State



Musson We Know Stair Treads

Take a few steps into Musson's new catalog and find out more about solid heavy-duty rubber or aluminum stair treads for interior and exterior use. We illustrate "designed for safety" stair coverings such as fire-safety, grit-strip, visually-impaired and glo-strip with matching floor systems that include raised design disco, low disc, square and diamond tiles. Also featured is our new UNO one-piece tread and tile. All are displayed in our expanded color line with related accessories.

800-321-2381
 Fax: 330-773-3254
www.mussonrubber.com

Circle no. 300

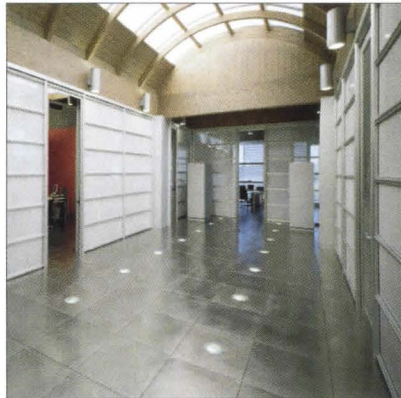

**GAGE Stainless Steel Floor System
 Gage Corporation, Int.**

The Gage Stainless Steel Floor System is a durable, high-tech flooring solution designed in Italy for purity of form and ease of installation. The embossed stainless steel finish has been specifically designed to prevent traffic wear and is virtually indestructible.

"The system is the solution"

866-855-4243
gage@centurytel.net

Circle no. 301



Small But Powerful

FAAC is the world's largest specialized manufacturer of operators for swing, slide and barrier gate systems. The Model 400 heavy-duty, hydraulic swing gate operator is designed for heavy traffic applications, such as subdivisions and apartments. Its power and reliability also make it ideal for large, ornate gates.

Learn more at: www.faacusa.com.

FAAC International, Inc.



Circle no. 302



Walker Display

Life's all about change and so are we when it comes to art presentation. The Walker system frees you to explore all your options. No-More-Holes frees you to rearrange your artwork with ease and speed. Embrace change!

800.234.7614
www.walkerdisplay.com

Circle no. 303

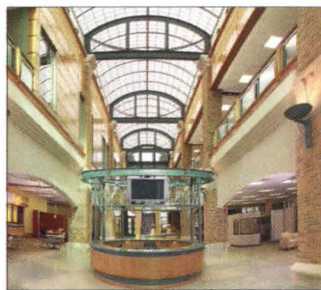

Daylighting is Kalwall®

Skylights of every imaginable configuration, from massive Clearspans of 150 feet to small Pyramids, plus Curtainwalls and Window Replacement Systems from the world's leader in translucent daylighting. Balanced, diffuse daylight fills any space with glare-free, shadow-free daylight. No other system, technology, or company delivers the flexibility, support, proven performance, structural integrity and code performance.

Kalwall Corporation
 800-258-9777
www.kalwall.com

Circle no. 304

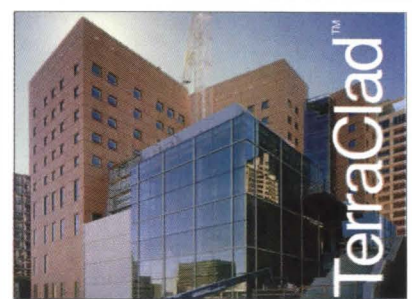

Boston Valley Terra Cotta

A "green" architectural cladding system delivering the advantages of rain screen performance while retaining the beauty and richness of terra cotta. An all aluminum attachment system provides a support structure and speeds installation. TerraClad is produced in the U.S. at BVT's state of the art facilities, available in many, sizes, patterns, and colors.

888-214-3655
www.bostonvalley.com

See us at the AIA Expo 2007. Booth #13191

Circle no. 305

CLASSIFIEDS

Sustainable Commercial Entrance Products



Special-Lite provides the **single, sustainable** solution to the **multiple** challenges of commercial entrances!

- Custom fabricated to match any architectural style
- GREENGUARD™ Children & Schools Certified for IAQ
- Superior flush door thermal performance
- No need to finish or refinish
- Can not rust, crack, peel or rot
- Extends life of entire entrance



To learn more, request our **Green brochure.**



Special-Lite

800-821-6531
www.special-lite.com

Circle no. 306

FAUX BOOKS

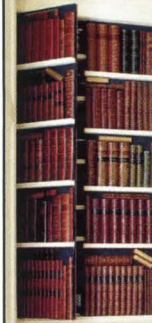

The ORIGINAL BOOK WORKS LIMITED

- Panels
- Home/Office Accessories
- Full Design & Layout Services
- 800-722-1194 (East Greenwich)

originaltradingcompanyusa.com

Circle no. 315

CAREER OPPORTUNITIES

JR Walters Resources, Inc. specializing in the placement of technical professionals in the A&E field. Openings nationwide.

Please visit our website at [Http://www.jrwalters.com](http://www.jrwalters.com)

Phone: 269-925-3940

Email: jrwawa@jrwalters.com

Circle no. 309

ARCHITECTURAL RENDERINGS

TO SCALE & IN ONLY 3 DAYS! Realistic Handpainted WATERCOLOR. Highly Detailed, or Quick Sketch. Evocative, Cost Effective; Visa, MC, AmEx. Mayron Renderings, Calls Only 1-800-537-9256, 1-212-633-1503.

Visit www.mayronrend.com

Circle no. 310

ARCHITECT MARKETING

Need person with Internet contact experience to architects, specifiers and engineers. Must be computer proficient in layout/design for email marketing campaigns.

SAL NEG./POSITION IMMEDIATE

Email to: gah@permacrete.com

www.permacrete.com

Circle no. 311

FUSION™

distinctive by design

The Fusion™ of metal and timber creates a contemporary look that will set your staircase apart!

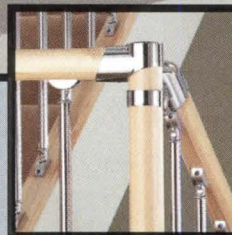
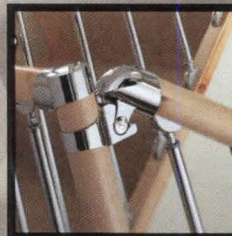

Contact Leeper's Stair Products today for our online planning and free FUSION™ literature.

Call (800) 775-1173 or visit www.usa-fusion.com

LEEPER'S STAIR PRODUCTS

www.leepers.com

Circle no. 308

FOR INFORMATION on how to be a part of the next

ARCHITECT special advertising section, contact Drew Ferrara at 202.736.3343.

hanley wood

**LOOKING TO SPEC
COUNTERTOP
MATERIALS?**

We have more than
1,600 to choose from.
SEARCH. FIND. COMPARE.

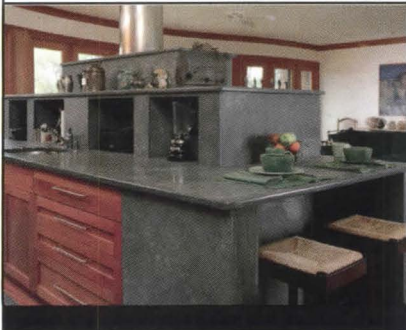

hanley wood
ebuild
www.ebuild.com
ebuild. The professional's guide to building products™



Eurotex Wall Carpet

Wall carpet muffles sound and reduces operating costs by protecting walls. Rated Class A for resistance to flame and smoke. Studies prove savings vs. painted surfaces. Lanai (shown) in its compact, articulated linear design, is woven of 100% wool; 8 colors. Rolls and cuts may ship within 24 hours.

Eurotex
800.523.0731
specurotex@prodigy.net
www.eurotexinc.com

Circle no. 307

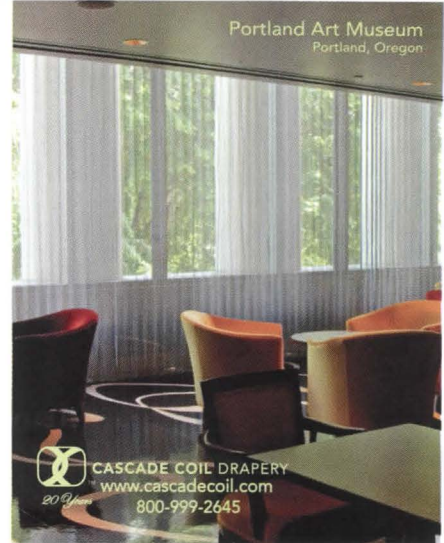

Portland Art Museum
Portland, Oregon

CASCADE COIL DRAPERY
www.cascadecoil.com
800-999-2645

Circle no. 312

Samsung Staron



Samsung's new line of Staron® Tempest surfaces is a solid surface alternative, specifically designed with a look that rivals natural stone and quartz. Yet it offers all the features and benefits that customers demand of solid surface, such as ease-of-maintenance, seamless appearance and its nonporous, hygienic properties. For more information, visit www.staron.com

Circle no. 313

**BUILDING:
A COMMUNITY**

ARCHITECT Online is laying the foundation for a premier online experience for practicing architects. We build the site, you weigh in on the content. Industry news, technology solutions, continuing education, galleries, a product database—all designed to encourage discussion and interaction. To get involved, visit www.architectmagazine.com.



hanley wood
ARCHITECT ONLINE

**Gotham® Unveils
Decorative LED
Downlight**



Gotham's new dual-reflector Candéo® LED combines a compact fluorescent source for effective general illumination with color-changing LED's – both within the same downlight footprint. Each source can be independently controlled, with three levels of color changing capability available.

Circle no. 314

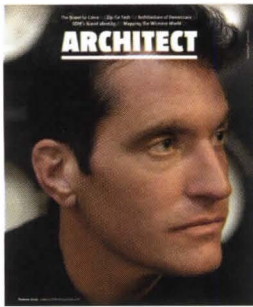

Make The Most of Your Editorial Coverage

Reprints make attractive endorsements while adding credibility to your product, company or service. They show your clients, partners and employees that you have been recognized in a well-respected magazine. Use reprints to cost-effectively capitalize on your exposure. Our reprints are high-quality marketing pieces printed on glossy stock.

Use Reprints, Eprints and NXTprints for:

Trade Shows

Sales Presentations

Seminar & Conference Materials

Media Kits

Direct Mail Promotions

Employee Training and Recruiting

Web Content & eNewsletters

ARCHITECT

For more information contact:



800.382.0808
www.fostereprints.com

4295 Ohio Street
FosteReprints Michigan City, IN 46360



Amvic is already the easiest choice



- Strongest form on the market
- In-house engineering support
- Extensive technical information



Now it's even easier...

Get up to 28 LEED points!*

*Based on third party evaluation

amvic
building system
stronger every day

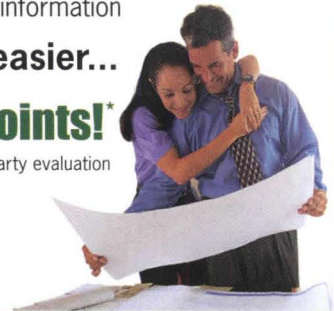

Call today for more information

1.877.470.9991

www.amvicsystem.com

Circle no. 394 or <http://architect.hotims.com>

Don't Do It Half-Grassed!

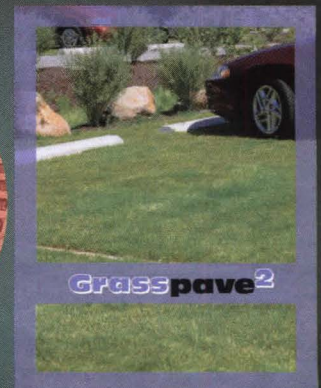
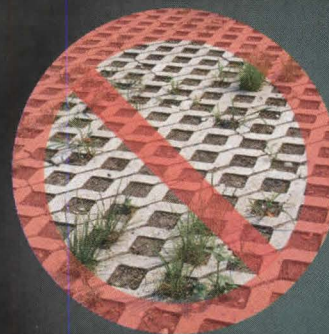

Grasspave2 (right) has 100% grass coverage, 5721 psi compressive strength, 92% void space for the healthiest root zone, and is made from 100% recycled plastic. Gravelpave2 (not shown) is beautiful too!

800-233-1510
invisiblestructures.com



Advertiser	Page	Circle	Website	Phone	Advertiser	Page	Circle	Website	Phone
3M	145-148	-	www.architectmagazine.com		Johnsonite	69	38	www.johnsonite.com	
3M	144	440	www.3M.com	651.736.6067	Knauf Insulation	5	415	www.KnaufInsulation.com	800.825.4434 x8300
AJL Light & Architecture Design Awards	162	-	www.archlighting.com		Kolbe Windows & Doors	91	40	www.kolbe-kolbe.com	800.955.8177
ACE Awards Ballot	172-176	-	www.ARaceawards.com		KraftMaid Cabinetry	49	41, 410	www.kraftmaidspec.com	800.581.4484
ALBA	105	447	www.alba.com	866.884.0223	Lafarge	154-158	-	www.architectmagazine.com	
Amvic Building System	180	394	www.amvicsystem.com	877.470.9991	LaHabra Stucco	90	449	www.lahabrastucco.com	877.LHSTUCCO
ARCAT, Inc.	55	430	www.arcat.com		LCN	85	421	www.lcn.ingersollrand.com	
Architect CES	80	-	www.architectmagazine.com	202.736.3310	Leviton	29	409	www.leviton.com	800.323.8920
Architect Online	160b, 178, 182	-	www.architectmagazine.com		LG HI-MACS	87	42	www.SecretsInTheSurface.com	866.LGHI.MACS
ArchitectJobsOnline.com	161b, 179	-	www.ArchitectJobsOnline.com		Lightolier	92	426	www.lightolier.com	
Ardee Lighting	48	411	www.ardeelighting.com	888.442.7333	Lumec	34	434	www.lumec.com	450.430.7040
Belden Brick	37	82	www.beldenbrick.com	330.456.0031	Marble Institute of America	168	44	www.marble-institute.com	
Building System. Design, Inc	46	23	www.bssoftlink.com	888.BSD.SOFT	Marvin Windows and Doors	23	57	www.marvin.com/clad	800.236.9690
Cambridge Architectural	35	24	www.cambridgearchitectural.com	866.806.2385	MBCI	70	402	www.mbc.com/arch	877.713.6224
Cascade Coil Drapery	28	81	www.cascadecoil.com	800.999.2645	MCA	160a	424	www.metalconstruction.org/IMP/	866.456.3063
CEMEX	18	94	www.cemexusa.com		Metal Sales	25	444	www.metalsales.us.com	800.406.7387
CENTRIA	19	25	www.CENTRIA.com	800.759.7474	National Gypsum	41	435	www.soundbreak.info	800.NATIONAL
CERSAIE	74	387	www.cersaie.it		Natural Stone Council	33	436	www.GenuineStone.org	603.465.2616
CertainTeed Insulation	21	432	www.certainteed.com	800.233.8990	NCARB	95	437	www.ncarb.org	
Cosella-Dorcken	C3	395	www.DELTADRY.com	888.4DELTA4	Nichiha	30	380	www.NICHIHA.com	1.86NICHIIHA.1
Dell	77	96	www.dell.com/architect	877.657.DELL	Owens Corning	73	413	www.QuietZonePro.com	800.GET.PINK
DesignIntelligence Developer	8	443	www.di.net	800.726.8603	Pella	61	396	www.pellacommercial.com	866.70.PELLA
	89	-		415.315.1241 x323	PermaCrete	38	438	www.permacrete.com	800.607.3762
Dornbracht	97	97	www.dornbracht.com	866.818.3199	Polyvision	44	417	www.polytronix.com	972.238.7045 x140
DuPont Corian Solid Surfaces	51	84	www.coriandesign.dupont.com	800.436.6072	PPG Industries, Inc.	12-13, 64, 103	423, 46, 431	www.ppgideas.com	888.PPG.IDEA
DuPont Tyvek	39	29	www.construction.tyvek.com		Prudential Ltg.	15	79	www.prulite.com	
Eagle Windows and Doors	32	30	www.EagleWindow.com	888.74.EAGLE	R+D Awards	166	-	www.architectmagazine.com	
Ecobuild	164	68	www.ecobuildamerica.com	800.966.3863	R+D Summit	183	-		
EFCO	170	85	www.efcocorp.com	800.221.4169	Reprints	181	-	www.fostereprints.com	800.382.0808
ELEMENT	43	384	www.element-lighting.com		Robinson Brick Company	83	390	www.RobinsonBrick.com	800.477.9002
Epic Metals Corporation	11	446	www.epicmetals.com	877.696.3742	Samsung Staron Surfaces	17	401	www.staron.com/as2	800.795.7177
ERCO	2-3	92	www.erc.com		Sarnafil	40	397	www.sikacorp.com	800.451.2504
Fabral Architectural Systems	45	418	www.fabral.com	800.477.2741	SCHOTT North America, Inc.	101	392	www.us.schott.com/pyran	502.657.4417
Fypon	79	55	www.specifypon.com	800.446.3040	SCHOTT North America, Inc.	88	439	www.us.schott.com/architecture	914.831.2200
Georgia-Pacific	31	419	www.densglassgold.com	800.BUILD.GP	Spark Modern Fires	42	398	www.sparkfires.com	866.938.3846
Ginger	62	407	www.gingerco.com		Steel Joist Institute	50	389	www.steeljoist.org/help	
Greenscreen	6	420	www.greenscreen.com	800.450.3494	Technical Glass Products	C2-1	49	www.fireglass.com	800.426.0279
Haddonstone	57	59	www.haddonstone.com	856.931.7011	Tectum Inc.	36	441	www.tectum.com	888.977.9691
Hansgrohe	52	34	www.hansgrohe-usa.com	800.334.0455	The Unico System	98	415	www.unicosystem.com/iah	
Hanson Brick	161a	427	www.hansonbrick.com	877.HANSON8	The Vistawall Group	59	52	www.vistawall.com	800.869.4567
High Concrete Group LLC.	4	35	www.highconcrete.com	800.PRECAST	The Young Group	78	54	www.fabricatedproducts.net	800.331.3080
Hohmann & Barnard	67	36	www.h-b.com/a	800.645.0616	Tile of Spain	47	442	www.spaintiles.info	305.446.4387
Hunter Panels	27	433	www.hunterpanels.com	888.746.1114	TRE'O	53	429	www.insightlighting.com	505.345.0888
Invisible Structures, Inc.	180	400	www.invisiblestructures.com	800.233.1510	Venture Lighting	104	448	www.VentureLighting.com	800.451.2606
JELD-WEN Windows & Doors	150-153	-	www.architectmagazine.com		Viracon	C4	51	www.viracon.com	800.533.2080
JELD-WEN 149 Windows & Doors	408	-	www.jeld-wen.com/1209	800.877.9482 x1209	VT Industries	7	53	www.vtindustries.com	
					Weather Shield Windows & Doors	9	393	www.weathershield.com/A	800.477.6808

Volume 96, number 6. May 2007. ARCHITECT® (ISSN 0746-0554; USPS 009-880) is published 14 times a year (monthly, except for two issues in April and in September) by Hanley Wood, LLC, One Thomas Circle, N.W., Suite 600, Washington, DC 20005. Copyright 2007 by Hanley Wood, LLC. Printed in the USA.

Periodicals postage paid at Washington, D.C., and at additional mailing offices. POSTMASTER: Send address changes to ARCHITECT, P.O. Box 3572, Northbrook, IL 60065-3572.

Canadian Post International Publication Mail Sales Agreement No. 40655599. Send undeliverable Canadian addresses to Deutsche Post Global Mail, 4960-2 Walker Road, Windsor, ON N9A 6J3.

BUILDING: A COMMUNITY

ARCHITECT Online is laying the foundation for a premier online experience for practicing architects. We build the site, you weigh in on the content. Industry news, technology solutions, continuing education, galleries, a product database—all designed to encourage discussion and interaction. To get involved, visit www.architectmagazine.com.



hanley▲wood

ARCHITECT ONLINE

IT'S GOOD TO **LOOK AHEAD**

THE FIRST ANNUAL **R+D SUMMIT**

**R+D SUMMIT
AT SCI-ARC
OCTOBER 4-5, 2007
LOS ANGELES**

THE INAUGURAL R+D SUMMIT WILL BE AN INFORMATIVE, INNOVATIVE, AND THOUGHT-PROVOKING LOOK INTO THE WORLD OF ARCHITECTURAL TECHNOLOGY. ARCHITECTS, ENGINEERS, AND ACADEMICS WILL GATHER FOR THIS EXCLUSIVE TWO-DAY EVENT, HELD IN CONJUNCTION WITH AND ON THE CAMPUS OF THE SOUTHERN CALIFORNIA INSTITUTE OF ARCHITECTURE. THE R+D SUMMIT AGENDA WILL BE STRONGLY TIED TO TECHNOLOGICAL ADVANCES IN BUILDING MATERIALS, PRODUCTS AND SYSTEMS. THE EVENT'S WORKSHOPS WILL BE LED BY R+D AWARD WINNERS AND OTHER LEADERS IN THE FIELDS OF BUILDING TECHNOLOGY.

ABOUT SCI-ARC

SCI-Arc, an independent, degree-granting educational laboratory, tests the limits of architecture in order to transform existing conditions into the designs for the future. With its location in a quarter-mile-long former freight depot in the intensely urban Artist District in Downtown Los Angeles, SCI-Arc provides a uniquely inspiring environment in which to study Architecture.

ARCHITECT

FOR MORE INFORMATION EMAIL:

RDSUMMIT@HANLEYWOOD.COM



THE COLUMBIA UNIVERSITY ARCHITECTURAL HISTORIAN AND CURATOR OF THE EXHIBITION "ROBERT MOSES AND THE MODERN CITY" EXPLAINS WHY THE CONTROVERSIAL PLANNER DESERVES A REASSESSMENT.

Interview Gideon Fink Shapiro Photo Anne Senstad

HILARY BALLON

Why is the present moment ripe for a fresh look at Robert Moses?

I think there is a widespread sense that we've been on hold. Not since Moses' time has there been this burst of government-led construction. We've heard a nostalgic desire—notably surrounding the 9/11 rebuilding debates—for a figure who could cut through obstacles and make things happen.

Is it necessary to concentrate power in a single pair of hands in order to accomplish great public works?

You do need a powerful figure or figures to stand behind projects and to push them through. There will be thousands of criticisms and countless obstacles. It takes forceful leadership and authority—not to stampede opposition, and not to discount legitimate input from the public—just to move projects forward.

How did Moses manage to accomplish so much?

Moses was willing to take the heat. He was the front man for projects that could be difficult for politicians to stand up for, and he would absorb the criticism. He simply didn't care. Moses understood the absolute necessity to make building projects financeable. He worked with architects who understood that as well.

What are the chances of another Moses-like figure emerging in the United States?

Moses didn't have any faith in public opinion. He had faith in experts. I don't think we'll return to an age when the right of citizens to comment on projects will be dismissed. But if reviving a Moses era means having effective, entrepreneurial policy-makers who recognize funding opportunities and who can pull the levers of government, then, yes, we can have such figures.

What is your favorite Moses project?

East River Park at the foot of the Williamsburg Bridge. Moses extended the shoreline through landfill and expelled the industrial uses along the Lower East Side waterfront. There is a surprising feeling of openness. You almost don't notice there is a highway next to this park because of the pull of the East River.

Gideon Fink Shapiro is a freelance writer based in New York City.



**IF YOU HAD USED DELTA®-DRY, YOUR WALLS COULD
HAVE DRAINED AND DRIED THEMSELVES.**

Only DELTA®-DRY has a unique two sided structured design that enables above grade wall assemblies to drain and dry much faster than traditional weather barriers. DELTA®-DRY weather barrier also allows air to circulate through, thus removing any residual moisture, virtually eliminating the threat of mold and water damage in wall assemblies. DELTA®-DRY. If it wasn't so ingenious, you'd think it was pure genius.



DELTA®-DRY
LIVE DRY

1-888-4DELTA4
DELTA4DRY.com

Circle no. 395 or <http://architect.hotims.com>



Our Innovative New VIRACON VNE₆₃ Insulating Glass gives you the solar control you just haven't had before. And with incredible visible light transmittance and solar heat gain coefficient numbers like these it's easy to see why. To find out more about the latest revolution in solar control glass call Viraconsulting™ at 800.533.2080 or visit viracon.com.

©2007 Viracon. All rights reserved.

