

Architecture vs. Extremism 110 Rem Koolhaas's Better Half 116
R.M. Hunt Redux 104 Miracle of Mud 118 Back up Your Data, Or Else 59

ARCHITECT

THE POWER ISSUE

THE MAN WHO CAME TO HILLIER

In just six years, Sir Fraser Morrison and his son Peter have built one of the world's largest architecture firms. **Their next step: transforming the profession.**



Zero emissions. Zero worries.



© 2008, USG Interiors Inc.

Relax. USG now offers a full line of zero-emitting cast ceiling panels that do not contribute VOCs or formaldehyde to indoor air—all at no added cost. For classrooms, healthcare facilities or wherever indoor air quality is a priority, you eliminate the risk of exposure—and eliminate a lot of worries. Visit us at www.SustainableCeilings.com.

Circle no. 56 or <http://architect.hotims.com>



SHOWY. OR NOT.



Circa is a study in contrasts. Elegant and demure its sleek profile can disappear into a landscape. Add dazzling color and a luminous glow ring and behold: high-performance lighting that demands attention. As a way to brand and unify a site, Circa is most surely a bird of a different feather. From Gardco. The natural choice. Enlighten your next design at www.sitelighting.com.

VISIT GARDCO LIGHTING BOOTH 13191 AT AIA EXPO 2008.



GARDCO
LIGHTING



NOW EVERY SQUARE FOOT
DOESN'T HAVE TO BE SQUARE.



Karim
for

With Karim Kolors your tile is anything but square. The vibrant new colors and shapes give you endless flooring possibilities. Contact us today for samples, and start experiencing the perfect palette for beautiful designs.

Visit Azrock.com/looksmart or call us at 1.800.558.2240.

Circle no. 164 or <http://architect.hotims.com>

AZROCK[®]
LOOK SMART



The fire protection to fit your need. The beauty to fit your design. The price to fit your budget.

VT Architectural
INDUSTRIES Wood Doors

WWW.VTINDUSTRIES.COM



Circle no. 53 or <http://architect.hotims.com>

Ardee Lighting

the latest technology
in solid state LED
lighting solutions

Ardee's new HPL Series of LED Elements for Klikstrip™ represents the latest in proven solid state LED technology:

- Replaceable festoon style LED module for new and retrofit applications
- Operates on low AC voltage magnetic transformers for longer runs or DC power supplies where space is limited
- Dimmable
- Choice of wide distribution beam pattern for uniform illumination or add optional focusing lens for accenting
- Narrow bin selection for premium color consistency
- Choice of 2800K, 3500K, 5000K
- 80 CRI standard (92 CRI available)

Ardee has been instrumental in advancing the integration of superior LEDs into unique fixtures for nearly a decade. So for solid state – make the solid decision – the Ardee Advantage.



Visit us at
www.ardeelighting.com
or call 888-442-7333.

Circle no. 411 or <http://architect.hotims.com>

ARCHITECT

EDITOR IN CHIEF

Ned Cramer
ncramer@hanleywood.com

MANAGING EDITOR

Hannah McCann
history & culture
hmccann@hanleywood.com

ART DIRECTOR

Aubrey Altmann
aaltmann@hanleywood.com

SENIOR EDITOR

Amanda Kolson Hurley
business, trends & criticism
ahurley@hanleywood.com

SENIOR EDITOR

Katie Gerfen
building design & technology
kgerfen@hanleywood.com

ASSOCIATE EDITOR

Braulio Agnese
print & online news
bagnese@hanleywood.com

ASSOCIATE EDITOR

Andrew Slocumb West
products & technology
awest@hanleywood.com

SENIOR GRAPHIC DESIGNER

Mojgan Hajmohammadali
mhajmohammadali@hanleywood.com

GRAPHIC DESIGNER

Marcy Ryan
mryan@hanleywood.com

COPY EDITOR

Jackie Zakrewsky

EDITORS AT LARGE

Edward Keegan, Vernon Mays

CONTRIBUTING EDITORS

Fred Bernstein, Elizabeth Evitts
Dickinson, Linda Hales,
Margot Carmichael Lester,
Bradford McKee, Mimi Zeiger

Online

EDITORIAL DIRECTOR

John Butterfield

CHIEF DESIGNER

Thomas C. Scala

SENIOR WEB EDITOR

Rachel Arculin
rarculin@hanleywood.com

Services

EDITORIAL AND ADVERTISING OFFICES

One Thomas Circle, NW, Suite 600
Washington, DC 20005
Phone: 202.452.0800
Fax: 202.785.1974

MEDIA KITS/CEU CLIENT SERVICES

Cristi Wiggins
cwiggins@hanleywood.com
202.736.3476

ANNUAL SUBSCRIPTION RATES

USA: \$59; Canada: \$69
Other countries: \$199

SINGLE-COPY PRICES

USA: \$10
Other countries: \$20

SUBSCRIPTION INQUIRIES, CUSTOMER SERVICE, AND BACK-ISSUE ORDERS

arch@omeda.com
888.269.8410 (toll-free in USA)
or 847.291.5221
Allow six to eight weeks for
delivery of first issue.

REPRINTS

Janice Breunig, FosteReprints
jbreunig@fostereprints.com
866.879.9144

ADDRESS CHANGES

ARCHITECT
P.O. Box 3572
Northbrook, IL 60065-3572

Production

DIRECTOR OF PRODUCTION AND PRODUCTION TECHNOLOGIES

Cathy Underwood

PRODUCTION MANAGER

Chapella Leftwich

AD TRAFFIC MANAGER

Lauren Dobos

ASSISTANT PRODUCTION MANAGER

Trey Gossage

PRESS MANAGER

Fred Weisskopf

PRESS COORDINATORS

Kevin Bright, Betty Kerwin

Volume 97, number 7, May 2008. ARCHITECT® (ISSN 0746-0554; USPS 009-880) is published 16 times a year (monthly, except for two issues in February, April, June, and October) by Hanley Wood, LLC, One Thomas Circle, NW, Suite 600, Washington, DC 20005. Copyright 2008 by Hanley Wood, LLC. Printed in the USA.

Periodicals postage paid at Washington, D.C., and at additional mailing offices.

POSTMASTER: Send address changes to ARCHITECT, P.O. Box 3572, Northbrook, IL 60065-3572.

Canadian Post International Publication Mail Sales Agreement No. 40655599. Send undeliverable Canadian addresses to Deutsche Post Global Mail, 4960-2 Walker Road, Windsor, ON N9A 6J3.

The New Standard in Water Efficiency

SLOAN ECOS™

The World's First TRUE Dual-Flush
Electronic Flushometer



The new Sloan ECOS™ Dual-Flush Flushometer is the first electronic valve of its kind. Advanced Sensor Technology allows for hands-free operation while still delivering water-saving dual-flush performance. The valve senses the user's proximity and duration and delivers the proper flush volume based on these factors. Intuitive dual-flush override buttons ensure efficiency. Whether flushed manually or automatically, the new Sloan ECOS offers unequalled efficiency and reliable performance.

- Smart dual-flush sensing technology delivers appropriate flush volume – automatically
- Ground-breaking water efficiency
- Intuitive dual-flush override buttons
- State-of-the-art sensor eliminates false flushing

For more information, go to
www.waterefficiency.com.

Generating Efficiency Through Technology

SLOAN®

866-663-2289
www.sloanvalve.com

Visit Us
at AIA
Booth 17029

Patents Pending

Circle no. 453 or <http://architect.hotims.com>

the ELEMENTS are SIMPLE . . .

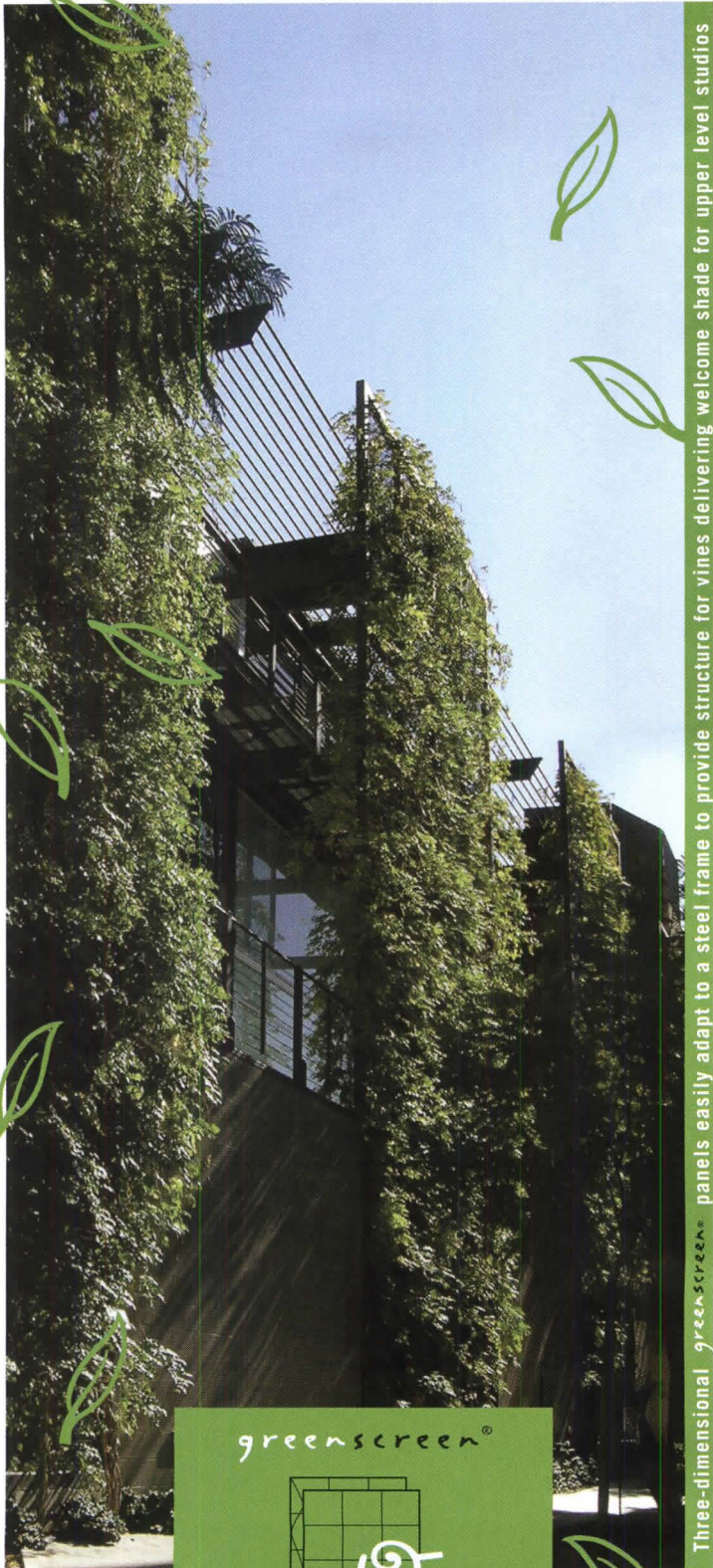

greenscreen®

800.450.3494
www.greenscreen.com

Three-dimensional greenscreen® panels easily adapt to a steel frame to provide structure for vines delivering welcome shade for upper level studios

the POSSIBILITIES are ENDLESS!

Circle no. 420 or <http://architect.hotims.com>

ARCHITECT

GROUP PUBLISHER
Patrick J. Carroll
pcarroll@hanleywood.com
773.824.2411

PUBLISHER
Russell S. Ellis
rellis@hanleywood.com
202.736.3310

**VICE PRESIDENT,
E-MEDIA SALES**
Paul Tourbaf
202.729.3629

**REGIONAL SALES MANAGER,
MID-ATLANTIC AND SOUTHEAST**
Nick Hayman
nhayman@hanleywood.com
202.736.3457

REGIONAL SALES MANAGER, WEST
Mark Weinstein
mweinstein@hanleywood.com
310.820.4030

REGIONAL SALES MANAGER, MIDWEST
Michael Gilbert
mgilbert@hanleywood.com
773.824.2435

**NORTHEAST AND INTERNATIONAL
SALES MANAGER/NATIONAL
ADVERTISING MANAGER, LIGHTING**
Cliff Smith
csmith@hanleywood.com
212.686.3434, ext. 204

**REGIONAL SALES MANAGER,
SOUTH CENTRAL**
Joe Tuttle
jtuttle@hanleywood.com
303.663.8252

REGIONAL SALES MANAGER, CANADA
D. John Magner
jmagner@yorkmedia.net
416.598.0101, ext. 220

ACCOUNT MANAGER, CANADA
Colleen T. Curran
ctcurran@yorkmedia.net
416.598.0101, ext. 230

E-MEDIA SALES MANAGER
Mark Weinstein
mweinstein@hanleywood.com
310.820.4030

**SALES MANAGER,
ARCHITECTJOBSONLINE**
Kim Heneghan
kheneghan@hanleywood.com
202.380.3831

**FINANCIAL ANALYST/
SALES DATABASE MANAGER**
Christina Covington

**RESOURCE AND CLASSIFIED
SALES ACCOUNT MANAGER**
Erin Liddell
eliddell@hanleywood.com
773.824.2445

MARKETING DIRECTOR
Alex Bowers

Hanley Wood Business Media

PRESIDENT
Peter M. Goldstone
202.736.3304

**CHIEF FINANCIAL OFFICER/
CHIEF OPERATING OFFICER**
Frederick Moses

DIRECTOR OF FINANCE
Ron Kraft

**VICE PRESIDENT, CIRCULATION AND
DATABASE DEVELOPMENT**
Nick Cavnar

VICE PRESIDENT, MARKETING
Ann Seltz

VICE PRESIDENT, PRODUCTION
Nick Elsener

EXECUTIVE DIRECTOR, E-MEDIA
Andreas Schmidt

**GENERAL MANAGER,
INFORMATION PRODUCTS**
Alec Dann

DIRECTOR, HUMAN RESOURCES
Neil Sawyer

Hanley Wood, LLC

CHIEF EXECUTIVE OFFICER
Frank Anton

CHIEF FINANCIAL OFFICER
Matthew Flynn

CHIEF ADMINISTRATIVE OFFICER
Frederick Moses

CHIEF INFORMATION OFFICER
Jeffrey Craig

**EXECUTIVE VICE PRESIDENT,
CORPORATE SALES**
Ken Beach

VICE PRESIDENT, FINANCE
Brad Lough

VICE PRESIDENT, LEGAL
Mike Bender

**VICE PRESIDENT,
HUMAN RESOURCES**
Bill McGrath

DISCLOSURE ARCHITECT® will occasionally write about companies in which its parent organization, Hanley Wood, LLC, has an investment interest. When it does, the magazine will fully disclose that relationship.

PRIVACY OF MAILING LIST Sometimes we share our subscriber mailing list with reputable companies we think you'll find interesting. However, if you do not wish to be included, please call us at 888.269.8410.

LIGHTOLIER®



WHITE *plus* COLOR

Solid State Lighting

Visit us at the
AIA National Convention and Design Exposition
booth 16093

CONTENT



124

TIM GRIFFITH

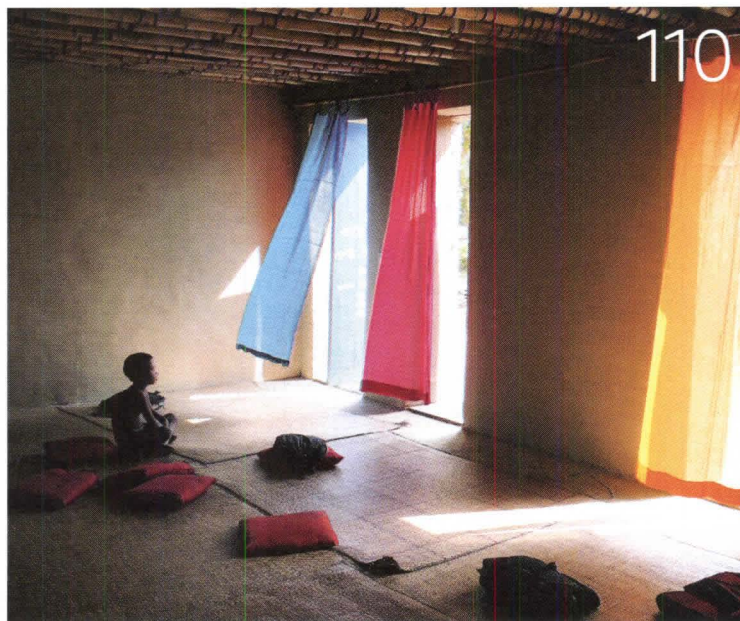

110

AGA KHAN DEVELOPMENT NETWORK

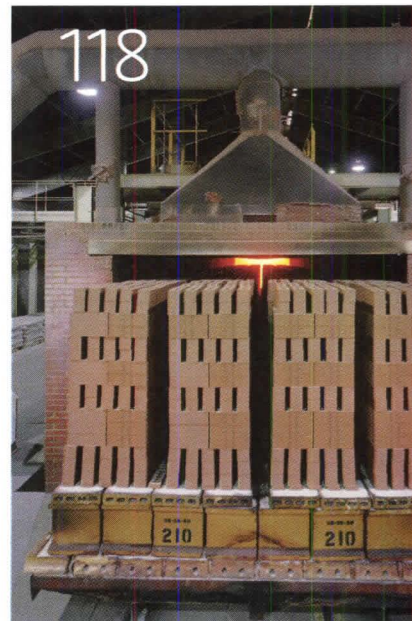

118

TIMOTHY HURSLEY

FEATURES

96

The House of Morrison AMANDA KOLSON HURLEY

Five years ago, Edinburgh-based RMJM was losing money and losing face. Then a father-and-son team decided to turn it into the next superfirm.

104

Richard Morris Hunt, Revisited KATIE GERFEN

Allan Greenberg Architects and KSS Architects combine modern technology and historical sensitivity in their addition to Princeton's Aaron Burr Hall.

110

Architecture vs. Extremism MICHAEL Z. WISE

For 30 years, the Aga Khan Award for Architecture has promoted sensitive, modern design in the Islamic world. But how much can the program, and its patron, really change?

116

Stop Frame 1979 EVE KAHN

Uncovering the end of a love story by Madelon Vriesendorp, Rem Koolhaas' wife, in an overdue retrospective.

118

Raw Materials: Brick BRADFORD MCKEE

ARCHITECT visits a Belden Brick plant in Sugarcreek, Ohio, to follow the progress of shale and clay from the pit to the kiln.

124

The Light Aquatic VERNON MAYS

Tom Eliot Fisch reinvigorates the San Francisco waterfront with an airy new Harbormaster's Building.

THE MAIL GUY
GOT \$65,000
BECAUSE HE'D
BEEN HERE
FOR 15 YEARS.
EVERYBODY GOT
SOMETHING IN
THE MERGER.

Bob Hillier on the RMJM–Hillier merger, from "The House of Morrison," page 96



ON THE COVER
Sir Fraser Morrison, CEO of RMJM Hillier. Photo by Art Streiber.

IT'S THE HEIGHT OF CREATIVITY.

SteelBuilt Curtainwall Infinity™ — a new innovation that really opens things up for you.

Design what you envision, as limits are a thing of the past. The SteelBuilt Curtainwall Infinity™ System can use as a back mullion almost any type of structural member, from stainless steel to glulam beams. Now you can use larger areas of glass, smaller frame profiles and wider free-spans than is possible with traditional aluminum curtainwall. This flexibility in design and material allows curtainwalls to be incorporated into a nearly limitless range of building types, designs, and performance requirements. SteelBuilt Curtainwall Infinity helps inspire a whole new world of creativity.

tgpamerica.com

800.426.0279

STEELBUILT
CURTAINWALL INFINITY™ SYSTEM

Circle no. 49 or <http://architect.hotims.com>

TGP ARCHITECTURAL
one source. many solutions.®

© 2008 Technical Glass Products. SteelBuilt Curtainwall Infinity is a trademark and One Source Many Solutions, and Technical Glass Products are registered trademarks of Technical Glass Products.

BE ORIGINAL.

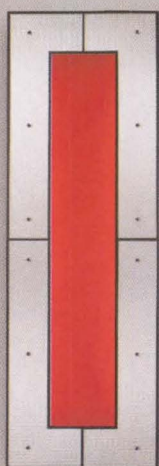

REO FROM ADVENT

Over 22,000 ways to express yourself.

SPILIGHTING

(262) 242-1420 · WWW.SPILIGHTING.COM

“Ranked Highest in Customer Satisfaction among Commercial Roofing System Manufacturers”



We're on a roll ... thanks to you. It's our customers who drive our commitment to quality, service and innovation. And it's our customers who landed us where we are today – over 45 years strong and rated highest in customer satisfaction. Thanks for your business and your loyalty.



Investing in Roofing Solutions for Over 45 Years

800-4-SYNTec • P.O. Box 7000 • Carlisle, PA 17013 • Fax: 717-245-7053 • www.carlisle-syntec.com

Carlisle is a trademark of Carlisle. © 2007 Carlisle. Circle no. 463 or <http://architect.hotims.com>



Carlisle SynTec received the highest numerical score among manufacturers in the proprietary J.D. Power and Associates/McGraw-Hill Construction 2007 Syndicated Commercial Roofing Systems Study™. Study based on responses from 91 subcontractors measuring 4 manufacturers and measures opinions of subcontractors who purchased roofing materials within the previous 12 months. Proprietary study results are based on experiences and perceptions of consumers surveyed in April-May 2007. Your experiences may vary. Visit jdpower.com

HIGHEST IN CUSTOMER SATISFACTION WITH COMMERCIAL ROOFING SYSTEM MANUFACTURERS™

CONTENT

RIGHT The RAP (Robotic Action Painter) makes original line drawings, just like an artist.

FAR RIGHT Coop Himmelb(l)au's BMW Welt lands in Munich, Germany.

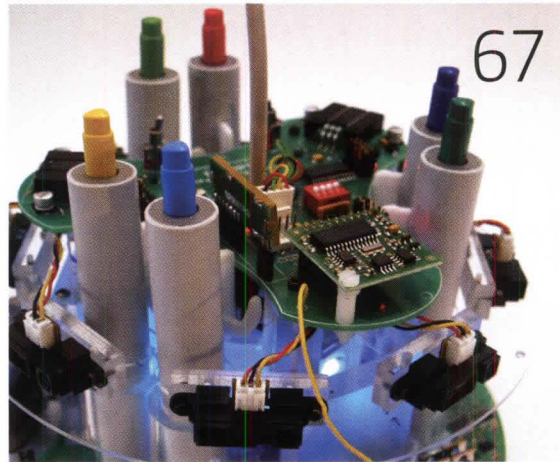

COURTESY LEONEL MOURA

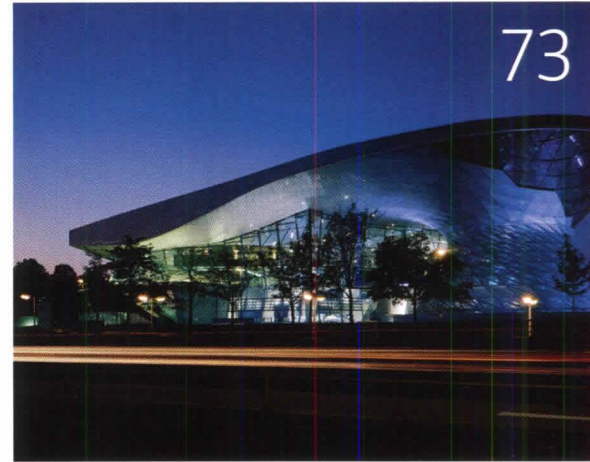

COPYRIGHT GERALD ZUGMANN/COOP HIMMELB(L)AU

FRONT

- 16 **Dialogue**
- 18 **Contributors**
- 20 **Report**
South Africa may revamp professional accreditation; Nouvel takes the 2008 Pritzker; other award winners; and more ...
- 44 **Calendar**
A month or two in the life of the profession.
- 46 **Products**
A sampler of lighting products.
Andrew Slocomb West
- 52 **Numbers**
The Architecture Billings Index has taken a nosedive, but all is not lost. *Kate Herman*
- 54 **Local Market**
What's happening in Coral Gables, Fla.
Margot Carmichael Lester
- 56 **Screen Grab**
Neri Oxman explores the nexus of nature, design, and computation. *John Gendall*

DEPARTMENTS

- 59 **Best Practices** Back It Up
Options for protecting your data.
Fred A. Bernstein

- 63 **Lighting** Two If by Sea
LEDs light up the coves of Boston's historic Old North Church. *Edward Keegan*
- 67 **Ecology** Automatic Architecture
What do robots have to do with green building? *Lance Hosey*
- 73 **Crit** The Widening Gyre
Motion is the operative metaphor at a new BMW center by Coop Himmelb(l)au.
Joseph Giovannini
- 79 **Technology** Excerpts from the Techno-Bible
A few of Blaine Brownell's favorite things.
Shelley Hutchins
- 83 **Portfolio** Where Art and Commerce Meet
Neil Denari's sculptural HL23 condo building claims airspace. *Katie Gerfen*

BACK

- 133 **Culture**
Kahn's Esherick House on the block; Piano at Harvard; chinoiserie. *Hannah McCann*
- 144 **Q&A** Evelyn 'Deedie' Potter Rose
A longtime patron of architecture on being a good client. *Interview by Edward Keegan*

Timely Now Makes Hotel Rooms More Comfortable.



Timely's New Built-In Door Seal *reduces noise, light, smoke and weather.*

This new prefinished steel fixed throat kerf frame features a factory-installed door seal that assures greater comfort and professional installation.

Perfect also for offices, light commercial construction, garage-to-house, multi-housing and wherever door seal protection is required.

Effective door sealing isn't the only built-in advantage. Installed prefinished frame cost is about 30% below primed hollow metal frames. Plus these Timely design features:

- *Door seals are available in beige, black, white, bronze and grey*
- *Prefinished - does away with jobsite painting*
- *6 stocking, 29 custom colors or any other color match*
- *5 casing profiles, or choose your own wood casing*
- *90 minute positive pressure fire rating*
- *Full perimeter anchoring for greater strength*

Look to Timely for superior quality and workmanship that has made us an industry leader for over 35 years.



SEE US AT

AIA-BOOTH NO. 13001
HD-BOOTH NO. 9625
CONSTRUCT-BOOTH NO. 1541

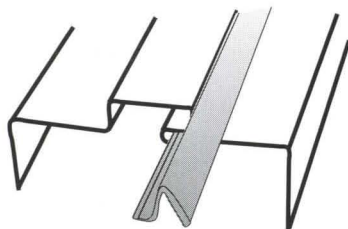

*Factory installed
door seal stays
in place.
Seal can easily
be replaced.*

TIMELY
PREFINISHED STEEL DOOR FRAMES
A DIVISION OF S.D.S. INDUSTRIES, INC.

www.timelyframes.com/ahw

Timely Corporate Offices: 10241 Norris Ave., Pacoima, CA 91331-2292 / 818-492-3500 / 800-247-6242 / Fax 818-492-3530
Eastern Distribution Center: 9782 Interocean Drive, Cincinnati, OH 45246 / 513-682-9600 / 800-346-4395 / Fax 513-682-4102
Georgia: 4713 Hammermill Road, Tucker, Georgia 30084 / 770-493-8811 / 800-445-8899 / Fax 770-491-1653

Circle no. 487 or <http://architect.hotims.com>

Dialogue

PEOPLE WHO DESIGN GLASS HOUSES ...

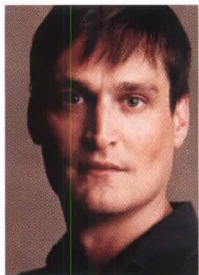

TIMOTHY GREENFIELD-SANDERS

Ned Cramer
Editor in Chief

DANIEL LIBESKIND SPARKED A BLAZE in February, when, during a speech in Belfast, he made the following proclamation: "I won't work for totalitarian regimes. Architects should take a more ethical stance." So how does the Polish-American architect explain the 1,129-unit luxury housing complex he designed in Singapore? His client there isn't just some developer, it's a conglomerate that's 30-percent owned (and reportedly controlled) by the government.

What's wrong with that? The small-but-prosperous city state is a democracy in name, but not necessarily in function, and the government isn't nearly as clean as the sidewalks, where spitting is famously illegal. Since Singapore gained self-governance from Britain in 1959, the ruling People's Action Party has held power without

interruption. Here are a few actions the party took in 2007 to stay on top, according to Amnesty International: "Freedom of expression and assembly came under increasingly close controls. Men arrested in previous years were held without charge or trial. ... Death sentences were imposed and at least five people were executed. Criminal offenders were sentenced to caning."

As the market for Western architectural services expands to encompass unfamiliar territories, architects are having to grapple with equally unfamiliar ethical issues. Zaha Hadid, for instance, has designed a memorial to late president Heydar Aliyev of Azerbaijan, a paragon of corruption. What ran through Hadid's mind when she laid flowers by Aliyev's grave during a recent visit to the capital city of Baku?

Unfortunately, there's no hard-and-fast rule about what makes a state totalitarian, and there's certainly no clear ethical road map for architects considering a job in or with one. Such situations require an entirely different kind of due diligence. It's no longer just a question of whether clients pay their bills on time, it's a question of how they treat their staff. Is caning in the employee manual? To find an answer, start with Amnesty International or Human Rights Watch, both of which post reports on various countries on their websites.

RMJM, the subject of this month's cover story ("The House of Morrison," page 96), has received considerable flak for its role as architect of the proposed 1,050-foot Okhta Tower, the headquarters of the state-controlled energy company, Gazprom, in St. Petersburg, Russia. UNESCO is threatening to strip the city of its World Heritage site status if the project goes ahead. The tower is to be built next to the baroque Smolny Convent, and, UNESCO claims, it will destroy St. Petersburg skyline. Between this potentially devastating aesthetic impact, Russia's sketchy human rights record, and Gazprom's monopolistic control of vast energy resources (Russia holds the world's third largest reserves of oil and natural gas), RMJM's got its hands full.

I doubt Hadid, Libeskind, RMJM, or any other architect is aiming to become the next Albert Speer, and admittedly there is a lot of gray area when it comes to evaluating the human rights records of various far-flung governments. Even commissions in the U.S. come with ethical challenges. Consider the number of voices raised in disapproval when Robert A.M. Stern agreed to design the presidential library of George W. Bush.

Due diligence is one thing. Personal ethics is another. In our globalized economy, architects are having to ask increasingly difficult questions of themselves in the pursuit of a buck, yen, or ruble: What's my position on Tibet? Is caning acceptable? How about waterboarding? If I turn down the Presidential Palace, is it OK to design worker housing? What if I make the project green? The answers to such questions can be found in only one place: one's own conscience.

Ned Cramer
Editor in Chief

Physical Graffiti

I find it disheartening that a magazine devoted to architecture, good design, and the environment would cover a website devoted to defacement, destruction, and high cost to owners, in the Screen Grab article ["otherthings.com/grafarc," March 2008, page 36]. Graffiti is one of the most destructive facets of society today. It promotes gang tagging, permanently destroys the beautiful materials architects strive so hard to express, and contributes to the ugliness of our cities. To compare this website and the "art" it promotes to Monet and the Rouen Cathedral is sad.

Tom K. Wagner

The Wagner Partnership
Phoenix, Ariz.

tom@wagnerpartnership.com

Priceless

The March 2008 cover photo is a hoot. Stanley Tigerman looks right at home. The photo is really a classic: the soup bowls, the mostly eaten sandwich, the open book, the mug and jacket color-match, and all the guys in the background are great. But the expression on Tigerman's face is best.

Frank Grimaldi

Frank Grimaldi Architecture
Kansas City, Mo.

Yes, People

For the same reason that the cover photos of *People* magazine tickle our collective unconsciousness, we look forward to each month of ARCHITECT.

Will it be a pretty girl architect or a young cad-monkey starring out at us and reminding us how like totally over is the era of the bow-tie architect.

So it comes as no surprise to find a prominent member of our profession portrayed on your cover [March 2008] as a homeless person sitting in front of a bowl of gruel and a half-eaten peanut butter sandwich.

Next month, how about Zaha Hadid in Le Corbusier glasses, bent over a model of Dubai, the new Radiant City?

Peter Kramer

Minneapolis

Corrections

In the March article "Rebranding Wimberly Allison Tong & Goo," we misspelled the name of the firm's CEO. His name is Ron Holecek.

In the February issue, Local Market (page 34) incorrectly stated that Kath Williams + Associates was the architect for the Bozeman Public Library. Williams was LEED-AP on the project. The design architects were Overland Partners and StudioForma Architects.

We regret the errors.

Be the first to
experience **Element**. Visit
booth #15049 at AIA, Boston.

A Sleek New Breed



Element™ from Big Ass Fans®

The winds of change are blowing. Big Ass Fans, the global leader in air movement, will soon unleash a sleek and silent design solution unlike anything you've experienced.

MAY 2008

e L E M E N T

 **BIG ASS FANS®**

 **BIG ASS FANS**

Toll Free: **1.877 BIG FANS** | visit us online at www.elementfan.com

©2008 Delta T Corporation dba Big Ass Fan Company. All rights reserved.
Circle no. 165 or <http://architect.hotims.com>

Contributors



Michael Z. Wise

Architecture vs. Extremism • p. 110

Freelance writer Michael Wise is the author of *Capital Dilemma: Germany's Search for a New Architecture of Democracy* (Princeton Architectural Press) and a contributing editor at *Travel + Leisure* magazine. His writing has appeared in many publications, including the *Atlantic*, *Foreign Policy*, *The New York Times*, the *Los Angeles Times*, *The New Republic*, and *ARTnews*. He has worked as a foreign correspondent in Vienna, Austria; Prague, Czech Republic; and London, reporting for Reuters and *The Washington Post*. He was a research fellow at the National Arts Journalism Program at Columbia University.

Wise traveled to Kuala Lumpur, Malaysia, to attend the 2007 prize ceremony for the Aga Khan Award for Architecture. Researching this article, "I was impressed by the thoroughness of the review process" for the awards, he says, and by the impact of the program itself: "Against considerable odds, the Aga Khan and his foundation are making an important effort to expand the way architecture is viewed in both Western nations and the Islamic world and promoting an enlightened dialogue about the creation of public space and the preservation of cultural heritage."



Amanda Kolson Hurley

The House of Morrison • p. 96

Reporting this month's cover story on the turnaround of Edinburgh, Scotland-based firm RMJM, Hurley, a senior editor at ARCHITECT, traveled to New York and Boston, but felt at times that she was back in Scotland—where she attended the University of St. Andrews—given the preponderance of British accents among RMJM employees. Hurley lives in Silver Spring, Md., and has written for *Preservation* magazine, the *Times Literary Supplement*, *Wilson Quarterly*, and other publications. She has a Ph.D. in literature from the University of Bristol in England and is the author of the book *Catullus* (Bristol Classical Press). Her last ARCHITECT cover story was on nurses in health-care design (December 2007).

THE PREFERRED PANEL PROVIDER MEANS:

SINGLE SOURCE SOLUTIONS

With Metecno USA, you select from the widest variety of standard and customizable panels, and you benefit from our reputation for quality, innovation and renowned service.

INSULATED COMPOSITE PANELS • ARCHITECTURAL SINGLE-ELEMENT PANELS • METAL ROOFING PANELS

meTecno

The Preferred Panel Provider



Circle no. 168 or
<http://architect.hotims.com>

Visit us at AIA



LANDSCAPE INTERIORS

ARCHITECTURAL MESH SYSTEMS



A F F O R D A B L E D U R A B L E B E A U T I F U L

Bring down the house beautifully with metal fabric that creates a stunning veil through open space.

Circle no. 24 or <http://architect.hotims.com>



ARCHITECTURAL

A DIVISION OF CAMBRIDGE INTERNATIONAL

WWW.CAMBRIDGEINTERIOR.COM/25

1 866 806 2385

Recognition

Nouvel Wins Pritzker Prize

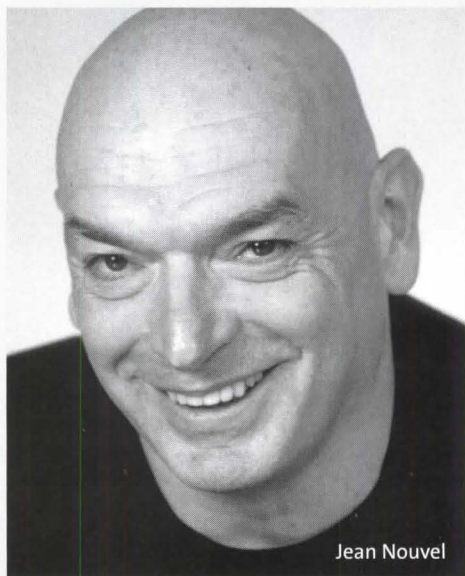

Jean Nouvel

ARCHITECT JEAN NOUVEL of Paris has been named as the 2008 laureate of the Pritzker Architecture Prize and will receive the bronze medallion and \$100,000 grant on June 2 at the Library of Congress in Washington, D.C.

Nouvel first created buzz in 1987 with his Institut du Monde Arabe, in Paris. The building's series of diaphragms in one exterior wall, which control how much sunlight the interior receives, was celebrated for its elegance and novelty. Nouvel has returned to the Arab world—and the design spotlight—with the recently announced Louvre Abu Dhabi, an elegant collection of structures covered by a massive, pierced canopy. Between the two are a series of buildings that suggest an architect of uncommon originality.

The Pritzker jury described Nouvel's career as one of courageously pursuing new ideas and challenging accepted norms to stretch the boundaries of architecture, citing his "persistence,

imagination, exuberance, and ... insatiable urge for creative experimentation." In a statement made public as part of the prize announcement, Nouvel said, "My work deals with what is happening now—our techniques and materials, what we are capable of doing today."

The 2008 Pritzker Prize jury comprised chairman Lord Palumbo; Shigeru Ban, architect and professor at Keio University; Rolf Fehlbaum, Vitra chairman of the board; Carlos Jimenez, professor at Rice University School of Architecture and principal of Carlos Jimenez Design Studio; Victoria Newhouse, architectural historian and the founder and director of the Architectural History Foundation; Renzo Piano, architect and 1998 Pritzker laureate; and writer, editor, and architectural consultant Karen Stein. Martha Thorne, former curator of architecture at the Art Institute of Chicago, is the executive director. STEPHANI L. MILLER

Registration

South African Government Proposes Stripping Building-Related Councils of Authority

Architects, engineers, and other professionals would need to register with government-created organization

ON MARCH 7, the South Africa Department of Public Works (DPW) issued a document outlining proposed amendments to the legislation that regulates the building professions.

Currently, professional councils of architects, engineers, and other similar professionals have the power to govern themselves and to maintain their own finances. The new legislation would strip these independent

of Architects (SAIA), were unaware of the pending legislation, learning about it through third parties. This has raised concerns that the process is not transparent enough.

SAIA president Hassan Asmal echoed the sentiments of many architects when he wrote an open letter to the DPW agreeing with the need for better organization in the construction industry in general but expressing

"We submit that any draft policy which is based on a four year-old review must be questionable if not flawed."

—SAIA president Hassan Asmal, in an open letter to the Department of Public Works

councils of their authority and create an overarching organization called the South African Council for the Built Environment. All building professionals working in South Africa would need to register with this entity.

In a preamble, minister of public works A.T. Didiza said the proposed policy was a response to "shortcomings in the present regulatory model" and was meant to "stimulate debate." After a period of public comment, Didiza said, the government would vote on the proposed policy.

The DPW got its wish. The news drew quick responses from the architecture community, which raised concerns about the changes and the *speedy timeline with which the government aimed to implement them*. Many professional organizations, including the South African Institute

concern over the drastic measures.

Karen Eicher, who serves on the nonprofit Architects' Collective of South Africa, has been following the story. Noting that she could not speak for the architecture community or comment on the legislation's background, she wrote to ARCHITECT that she believes "the intention ... is good—furthering communication between the built environment professions and Government. ... [U]nfortunately, the process has not been handled with sufficient transparency ... , resulting in a degree of trepidation and speculation."

At press time, the DPW had not yet responded to Asmal's letter, and the vote on the new policy was pending. ARCHITECT will continue to track developments. ELIZABETH EVITTS DICKINSON

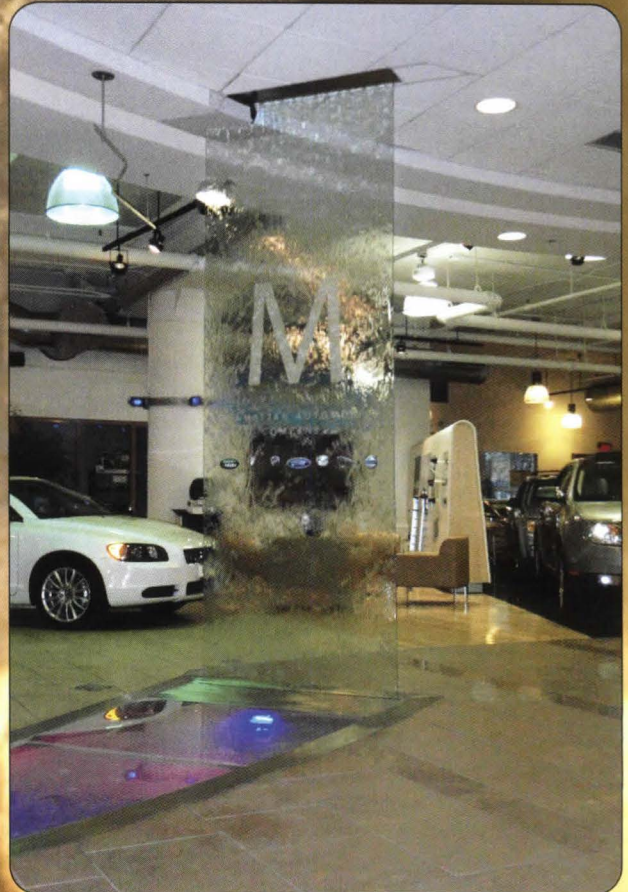

Water
by Nature
sculpted
by Bluworld

bluworldofwater
WORLD LEADER OF EXQUISITE WATER DESIGN

REPORT

Recognition

NCARB Names Winners of 2008 Prize

THE DEPARTMENT OF ARCHITECTURE at California State Polytechnic University has won the \$25,000 grand prize of the National Council of Architectural Registration Boards (NCARB) for developing a prototype for low-cost sustainable housing in Tijuana, Mexico.

The NCARB Prizes for Creative Integration of Practice and Education were announced March

28 at the annual meeting of the Association of Collegiate Schools of Architecture in Houston. Five awards of \$7,500 were offered to top projects from a field of 31 entries from 22 schools. They went to Arizona State, Savannah College of Art and Design; jointly to the University of Arkansas and Washington University in St. Louis; and to Clemson twice.

The Tijuana housing prototype relies on a variety of waste materials, which elicited praise from the jury. "The effects of this project are potentially far-reaching in terms of the benefits to the potential dwellers," the panel said. Go to ncarb.org for images as well as more information about all of the winning projects.

LINDA HALES

2008 NCARB Prize Winners →

\$25,000 Grand Prize

DEPARTMENT OF ARCHITECTURE,
CALIFORNIA STATE POLYTECHNIC
UNIVERSITY, POMONA
*Project: Low-Cost Sustainable
Housing for Tijuana, Mexico*

\$7,500 Prizes

SCHOOL OF ARCHITECTURE, ARIZONA
STATE UNIVERSITY
*Project: Applied Research
Collaborative*

SCHOOL OF ARCHITECTURE,
CLEMSON UNIVERSITY
*Project: Architecture+Health
Program*

SCHOOL OF ARCHITECTURE,
CLEMSON UNIVERSITY
*Project: Localizing Global Climate
Change*

DEPARTMENT OF ARCHITECTURE,
SAVANNAH COLLEGE OF ART AND
DESIGN
Project: BSI+P Studio

SCHOOL OF ARCHITECTURE, UNIVERSITY
OF ARKANSAS, AND SCHOOL OF
ARCHITECTURE, WASHINGTON
UNIVERSITY IN ST. LOUIS
*Project: Visioning Rail Transit in
Northwest Arkansas*

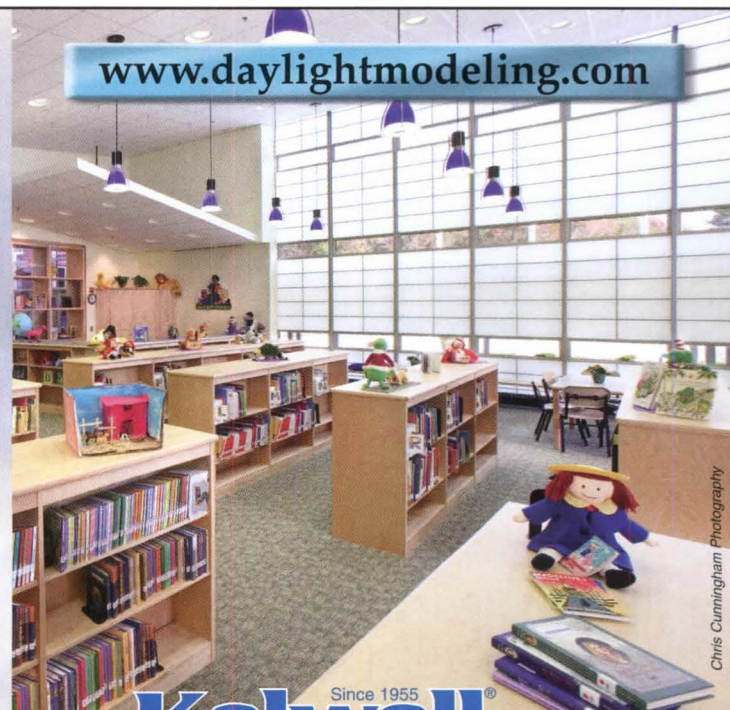

Healthy. Green. LEED®. Sustainable.
Translucent Wall and Roof Systems.
There is no better way to daylight space.

Since 1955
Kalwall
...Light-Years Ahead!™



ICC-ES
Listed
PFC 1705



Circle no. 484
or <http://architect.hotims.com>



As genuine as you.

GenuineStone.org



Circle no. 436 or <http://architect.hotims.com>

REPORT

Landscape Architecture

Field Operations Chosen to Shape Memphis Park

Plans for 4,500-acre Shelby Farms include 12 landscapes, 1 million new trees

NEW YORK LANDSCAPE ARCHITECTURE firm Field Operations has won the commission to design a 4,500-acre park in Memphis, Tenn. Known as Shelby Farms, the space is roughly five times the size of New York's Central Park but has, in recent years, suffered from neglect. Presentations by the three short-listed firms—which included Hargreaves Associates and Tom Leader Studio—had been on display in Memphis throughout March. After public input and design jury deliberations, the Shelby Farms Park Conservancy announced the winner on April 9.

James Corner, principal of Field Operations, says the firm's priority was "to retain the scale of the place—to keep it big." The design designates space for 12 different landscapes, including a meadow, a bison range, an art mound, a lake, and hills that will support a variety of programs. It also calls for 1 million new trees, which will not only help the park's ecological sustainability but will also define discrete spaces and views. The Shelby Farms Park Conservancy will work with Field Operations on the new master plan, scheduled to be unveiled this August.

A penal farm until 1964, the park has remained a space without clear identity and has been threatened several times with development proposals that would have parceled it into smaller areas. Field Operations' plan will ensure the park's physical integrity and longevity. Touting the public involvement, Shelby County Mayor A.C. Wharton Jr. says citizens "should be proud of the integral part they've played in shaping the park's future. Now, we all have an amazing opportunity to watch imagination turn into reality." **JOHN GENDALL**

COURTESY SHELBY FARMS PARK CONSERVANCY

Only One Insulation Conforms To Your Most Non-Conformist Designs

The design is unique. It defies description. It's your masterpiece. But how do you stop air infiltration, control moisture and insulate?

InsulBloc high performance spray foam insulation. Closed-cell InsulBloc adheres to any shape, forming a seamless membrane that creates an air barrier, controls moisture, and seals construction gaps. With the highest R-value per unit thickness of any commercially available insulation, InsulBloc is customer friendly, earth friendly, and very architect friendly.

Stop air and moisture infiltration with InsulBloc.

Circle no. 486 or <http://architect.hotims.com>

Stop air infiltration and control moisture with InsulBloc.

Find out more about InsulBloc at
www.NCFI.com or by calling 1-866-NSULATE (1-866-678-5283).

NCFI – winner of EPA award for protecting the Earth's ozone layer.

InsulBloc®
HIGH PERFORMANCE INSULATION



Just Imagine.

The creative possibilities are practically endless with Formawall® Graphix Series™ wall System panels. Graphix panels have a unique segmented construction that makes one large panel look like many smaller panels. They can be installed vertically or horizontally, finished in any color, and further customized by adding panel reveals of varying widths. Best of all, you can achieve this appearance with far less time, materials and expense than an ACM wall system requires — with the added benefit of Cradle-to-Cradle™ certification. Whatever you imagine, Graphix panels make it possible.

Call us or visit our website for a free Graphix Series brochure and design guide.

1.800.250.7897 | CENTRIA.com

Circle no. 25 or <http://architect.hotims.com>



CENTRIA

Architectural Metal Wall
and Roof Systems

F
YOU WANT IT YOUR WAY.

Warm in the winter and cool in the summer with a clean finished look. High-R insulation systems when you know what you want.

50
40
30
20
10
0

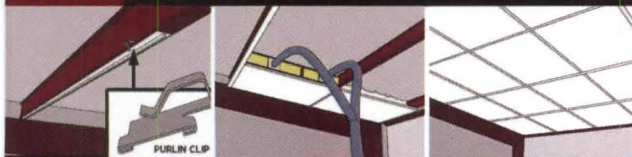

High-R, the versatile, all-climate insulation systems for all types of facilities old and new. New structures are better from the start and old structures become new again.



INSULATED
CEILING AND
WALL SYSTEMS



2335 230th STREET / AMES, IA 50014

FAX: 513-292-0440 / WWW.HIGH-R.COM / INFO@HIGH-R.COM

TOLL FREE : 888-292-2382

Circle no. 467 or <http://architect.hotims.com>

REPORT

Recognition

AIA Names Education Honor Award Winners



Situated on the Elizabeth River, the University of Virginia's Learning Barge will educate K-12 students about ecological systems.

THE AMERICAN INSTITUTE OF ARCHITECTS (AIA) has put a spotlight on innovation with six 2008 Education Honor Awards. The University of Virginia's "Learning Barge Project," led by Phoebe Crisman, brought together students in design disciplines as well as history and education to create a floating laboratory for sustainable practices such as renewable power and rainwater collection. Auburn University's David Hinson and Stacy Norman launched a "DESIGNhabitat 2 Initiative" linking factory fabrication and site construction for post-disaster housing.

At California Polytechnic State University, Thomas Fowler developed a "Collaborative Integrative-Interdisciplinary Digital Design Studio" to put students to work on real-world situations, while Edgar Stach at the University of Tennessee Knoxville brought students and faculty from three countries together to study "Smart Structures—Experiments in Linking Digital and Physical Strategies." At Pennsylvania State University, Peter Aeshbacher focused attention on "Design & Democracy." University of Minnesota design and architecture students were introduced to a holistic approach called "An Incomplete Curriculum for Transformation," orchestrated by Ritu Bhatt, Renee Cheng, John Comazzi, Ozayr Saloojee, and Marc Swackhamer.

The AIA launched the education honors in 1988 to recognize faculty achievements. This year's jury said it was looking for "evidence of exceptional innovative courses that dealt with broad issues" powerful enough to change practice. The awards will be presented at the AIA's national convention, taking place in Boston this month. **LINDA HALES**



Open the door to strength that endures.

With K2™ Commercial Hardware by Black & Decker®, you now have an easier way to assure beauty, performance, and lasting durability with a lifetime mechanical warranty. It's the industry's only complete suite of coordinated products. For a stunning combination of beauty and strength, open the door to K2.

The unique K2 Suite Concept.

Coordinated products that streamline design and specification.

Visit us at AIA at Booth #16165



LEVERS • DOOR CLOSERS • DEADBOLTS • EXIT DEVICES

Welcome to



**COMMERCIAL
HARDWARE**
BY BLACK & DECKER

k2commercialhardware.com

Circle no. 472 or <http://architect.hotims.com>

Itinerary

You Simply Must See ...

Condé Nast Traveler names 'Seven New Wonders of the World'



Kogod Courtyard, Washington, D.C.

ECONOMIC REALITIES likely mean your vacation plans have been downsized, if not scrapped altogether. Well, there's always business travel. If a client meeting or other workday matter takes you to a city listed below, consider a micro-getaway to check out the local design lauded by *Condé Nast Traveler*. Is it great architecture? That's for you to decide. **BRAULIO AGNESE**

- **BURJ DUBAI**, Dubai—Adrian Smith
- **CUMULUS BUILDING**, Nordborg—Jürgen Mayer H.
- **KOGOD COURTYARD, NATIONAL PORTRAIT GALLERY**, Washington, D.C.,—Norman Foster
- **MICHAEL LEE-CHIN CRYSTAL, ROYAL ONTARIO MUSEUM**, Toronto—Daniel Libeskind
- **NEW MUSEUM**, New York City—SANAA
- **RED RIBBON, TANGHE RIVER PARK**, Qinhuangdao—Turenscape
- **WEMBLEY MUSEUM**, London—Norman Foster

36

Number of U.S. states expected to face water shortages by 2013.

SOURCE: USGS, GAO

S-5!TM Unprecedented Innovation
Unmatched Quality
Unbelievable Price

Attach almost anything to standing seam metal roofs without piercing the panel!

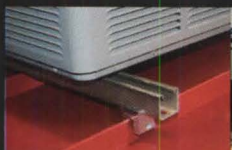

Equipment



Solar Panels



Signs and Banners



Roofwalks



There has never before been a dependable way to attach things to standing seam paneling without penetrating the roofing, jeopardizing the integrity of the system and violating warranties—until S-5!TM

S-5!TM products look great, install quickly and easily, last as long as the roof and cost less than the alternatives.

Circle no. 466 or <http://architect.hotims.com>

888-825-3432

www.S-5.com



Alderwood Stacked Stone with
a dry-stack technique

Where do you Rock?[®] Outdoor living spaces, garden patios, façades, porte cocheres, grand entrances, wine cellars, fireplaces and breakfast nooks — Eldorado Stone transforms them all into buildings of character, grace and style. And at half the cost of real stone, Eldorado enables you to create the distinctive features you desire and still stay on budget. For a quick tour of innovative Eldorado installations, go to eldoradostone.com/walkthrough.



See it. Believe it. Spec it.
800.925.1491
www.eldoradostone.com

Circle no. 479 or <http://architect.hotims.com>

The Most Believable
Architectural Stone Veneer
 in the World.[™]

REPORT

In Memoriam

Ralph Rapson, 1914–2008

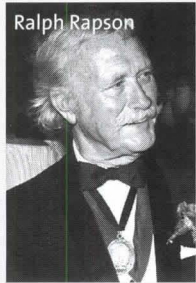

Ralph Rapson

MODERNIST ARCHITECT RALPH RAPSON died March 29 of a heart attack at his home in Minneapolis at the age of 93. Best known for such projects as the Greenbelt House in Los Angeles, which was one of the Case Study Houses sponsored by *Arts & Architecture* magazine, and Minneapolis' original Guthrie Theater—built in 1963 and torn down two years ago—Rapson served as dean of the University of Minnesota's College of Design from 1954 to 1984. His Minneapolis-based practice designed embassies (including the U.S. embassies in Denmark and Sweden), schools, churches, and residences, mainly in the upper Midwest.

Rapson continued to work up to his death. Recently, a Florida-based prefabricated housing developer began production on a house based on the Greenbelt design, with Rapson's blessing.

The AIA Minnesota maintains a traveling study fellowship in Rapson's name, the 2008 finalists for which were chosen the evening before his death. Rapson is survived by his two sons—Toby, an architect, and Rip, president of the Kresge Foundation—and their families. **KATIE GERFEN**

“Modern architecture had two reasons to exist. One is the desire, on the part of architects, to be different. And the other is the desire, on the part of the builders, to be cheap.”

—Mathematician Benoit Mandelbrot, in an interview with MoMA's Paola Antonelli archived at seedmagazine.com

Education

USC Creates New Doctoral Program in Architecture

THE UNIVERSITY OF SOUTHERN CALIFORNIA (USC) School of Architecture has announced a new degree program—doctor of philosophy in architecture—which students can enroll in starting this fall. The program will nominally have a three-year time frame and will focus on building sciences and technology with the intention of producing graduates that can lead research at architecture and engineering firms or go into university-level teaching “We would expect that many, maybe even most, of the students would end up [teaching],” says Douglas Noble, associate dean of the School of Architecture and chair of the Ph.D. program. Noble began pursuing the idea of this program eight years ago, in part based on USC's now-defunct doctor of building sciences program that ran from 1965 to 1985. “The biggest part was financing,” says Noble. “It's an expensive proposition for a university, so it was slow going.” The first students are expected to graduate in 2011, though transfer students could graduate earlier. The doctor of philosophy in architecture degree can also serve as a continued study path for students already enrolled in USC's master's program in architecture. The focus will remain on building sciences and technology for the first few years, but may branch out to include areas of study in historic preservation or history and theory. **KATIE GERFEN**

Recognition

Architectural League Names 2008 Emerging Voices

→ **Belzberg Architects, Santa Monica, Calif.** • Hagy Belzberg

→ **El Dorado Inc., Kansas City, Mo.** • Jamie Darnell, David Dowell, Dan Maginn, Josh Shelton, and Douglas Stockman

→ **Johnsen Schmalig Architects, Milwaukee** • Brian Johnsen and Sebastian Schmalig

→ **Moorhead & Moorhead, New York** • Granger Moorhead and Robert Moorhead

→ **MOS, Boston and New Haven, Conn.** • Michael Meredith and Hilary Sample

→ **Onion Flats, Philadelphia** • Johnny McDonald, Pat McDonald, Tim McDonald, and Howard Steinberg

→ **Stoss Landscape Urbanism (StossLU), Boston** • Chris Reed

→ **Work Architecture Co. (WORKac), New York** • Amale Andraos and Dan Wood

THE ARCHITECTURAL LEAGUE OF NEW YORK celebrated the 25th anniversary of its prestigious Emerging Voices lecture series with a major expansion. For the first time, the selected architects spoke not only in New York City, but also at venues in the Washington, D.C., area as part of a partnership between the League and the National Building Museum. Anyone who was unable to attend in person can download podcasts of the lectures from iTunes or at archleague.org.

“Vistawall® understood our sustainability requirements and helped us achieve 43% more energy efficiency than Oregon requires.”

—Kent Duffy, FAIA, Design Principal—SRG Partnership



**Lillis Business Complex at University of Oregon by SRG Partnership—
Custom-engineered Curtain Wall by Oldcastle Glass® Vistawall®**

“Underlying all of our design work at SRG Partnership is a commitment to energy-efficient and sustainable building solutions,” said Kent Duffy. “One of the most prominent features of our design for this 140,000-square-foot complex included a striking four-story atrium with an energy-efficient curtain wall. Oldcastle Glass® Vistawall® partnered with our designers and a solar consultant to engineer a unique curtain wall that incorporated photovoltaic glass modules into our design. This building was awarded LEED Silver and is recognized as one of the most environmentally friendly business school facilities in the nation.” Call 1-866-653-2278 or visit us online at oldcastleglass.com. **See us at the AIA Convention, booth #18043.**

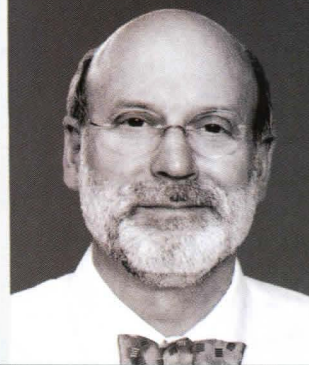

**Oldcastle Glass®
Vistawall®**

Pushing the building envelope™

Not Just A Jungle Gym For Plants...

It's Nothing New But We Thought You Should Know, Plants ALSO Love Us Because We're Green;

Background Photo: Foliage support of stainless steel mesh at the Kimera Restaurant - Irvine, California

- Raw materials have high percentage of recycled content, (up to 90%)
- Made with minimal energy use, and almost no scrap
- Exceed DEQ standard in the painting process
- Natural finishes that need no painting
- As a window treatment or building cladding provides solar shading
- As a divider does not inhibit air flow that can cause HVAC issues
- Long useful life with very low maintenance
- Fully recyclable at end of life



CASCADE COIL DRAPERY
www.cascadecoil.com
800-999-2645

Manufacturer of Architectural Woven Wire Drapery for Partitions, Window Treatments, Lighting Effects, Building Cladding and Many Other Unique Uses.

REPORT

USPS to Sell Eames Stamps

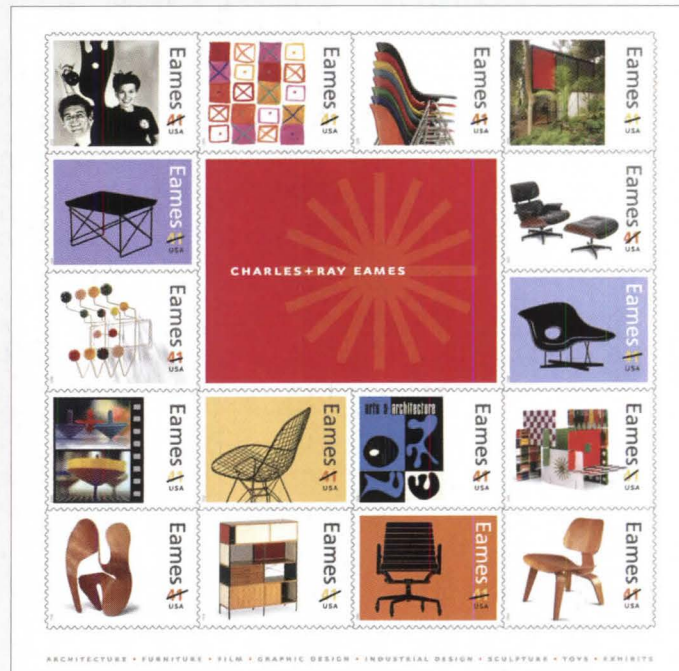

Charles and Ray Eames have been honored by the U.S. Postal Service. Later this year it will be issuing 16 first-class stamps celebrating the designers' work. Snail mail has rarely looked so good.

Clips New York's **Metropolitan Transit Authority** has selected a multibillion-dollar proposal by developer **Tishman Speyer**, architect **Murphy Jahn**, and landscape architect **Peter Walker and Partners** for the development of the city's 26-acre **West Side railyard**. Architecture critic Nicolai Ouroussoff of *The New York Times* has decried the scheme—which will likely evolve in response to community involvement, rezoning, and other pressures—as “a throwback to the days when corporate Modernism was taking its dying breaths.”

Thornton Tomasetti has named **Thomas Z. Scarangello** as the firm's chairman, **Daniel A. Cuoco** as president and chief executive officer, and **Robert P. DeScenza** as chief operating officer. The changes come as **Richard L. Tomasetti**, past chairman and CEO, moves into a new role of founding principal and chairman of the **Thornton Tomasetti Foundation**, the engineering and architecture firm's charitable arm.

On May 13, Christie's will put **Richard Neutra's Kaufmann House**, in Palm Springs, Calif., on the auction block as part of a postwar and contemporary art sale. Renovated and restored by Los Angeles firm **Marmol Radziner and Associates**, the 1946 house—considered among the top home designs of the 20th century—is expected to sell for \$15–\$25 million.

One Chase Manhattan Plaza, in lower Manhattan, has been granted **official landmark status** by the Landmarks Preservation Commission. Built in 1961, the tower was designed by **Skidmore, Owings & Merrill** and was, at the time of completion, the sixth tallest building in the world.

The **Royal Architectural Institute of Canada** has awarded **Dan S. Hanganu** the **2008 Gold Medal**, the highest honor the group bestows. Hanganu's work, the selection committee noted, is “not showy but significant and successful as highly usable environments.”

Pr 361° Pan Rotation

Sr Square and Round Trim

Cl Captive Lens System

Ff Flipped and Flangeless

T 0-40° Tilt

Hc Halogen and CMH

An Available Now

Locked, Loaded and Ready to Ship

The ELEMENT line of 3.5" recessed adjustable downlights makes even the most complex light adjustments effortless. Tilt, pan rotation and lens rotation lock combine with a captive three lens system and easy installation to deliver a line of products that meet the demands of the specification/design industry. Square and Round Trim variations each offered with both CMH and Halogen lamp options. ELEMENT is not just another downlight. It is an architectural element that unites with its surroundings. Visit us at Lightfair 2008 - Tech Lighting Booth #937.



ELEMENT
a brand of **TECH LIGHTING**

Designers aim the light. Maintenance re-lamps the light. Element remembers the light.



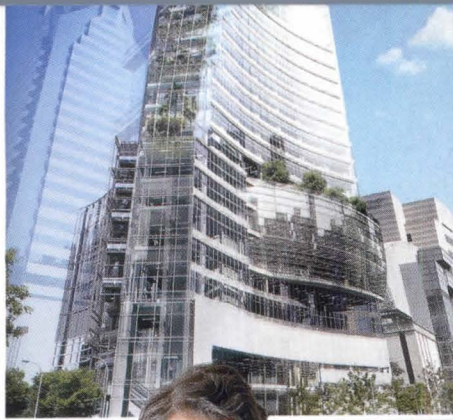

Luxury Has A New Address

37 City Hall Plaza

Coming Spring 2008



• Unparalleled outdoor spaces
 • "Double Green" Approach
 • Day View From Harbour Road
 • Ocean View From Ajung Road
 The building's design features a unique curved facade and glass structure, offering unparalleled outdoor spaces and a "Double Green" approach. The building is located at the intersection of Harbour Road and Ajung Road, providing day and ocean views.

37 City Hall Plaza

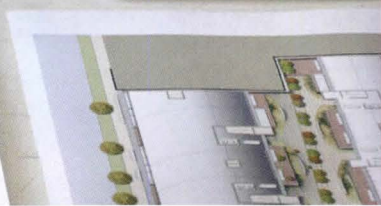
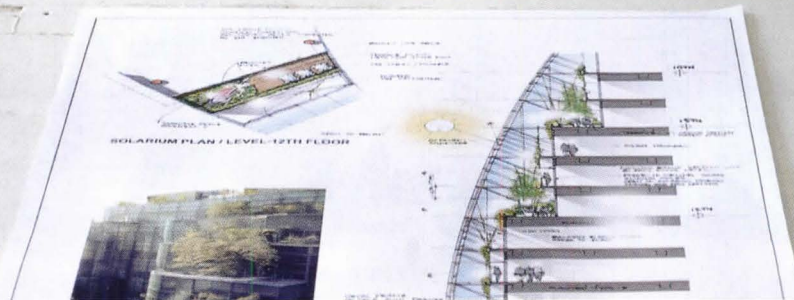
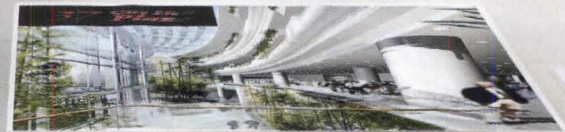

IN THE WORLD OF LARGE-FORMAT PRINTING

I can choose from a selection of printers. So whatever my business requires, I'm covered in a big way.



Canon imagePROGRAF iPF Series

PRODUCE. PERSUADE. PERFORM. ON PAPER.

imagePROGRAF®

usa.canon.com 1-800-OK-CANON

Circle no. 91 or <http://architect.hotims.com>

and IMAGEPROGRAF are registered trademarks of Canon Inc. in the United States and may also be registered trademarks or trademarks in other countries. IMAGEANYWARE is a trademark of Canon. © 2008 Canon U.S.A., Inc. All rights reserved. Products shown with optional accessories.

Canon

imageANYWARE

INTENSE

INTENSE

INGENIOUS



Introducing glass so brilliant it's destined to be a masterpiece.

SageGlass® glazing gives you the power to change your environment by doing what ordinary glass can't do: It switches from clear to darkly tinted at the push of a button. Now you can enjoy the sun's benefits while rejecting its undesirable effects such as fading, glare and heat without losing the view to the outdoors. This grants architects the freedom to design with more daylighting without the compromises typically associated with glass.

Because it blocks both the visible and UV light that cause fading, SageGlass glazing is ideal for museums, libraries and art galleries—anywhere there is a need to protect the interior while bringing in daylight. Revolutionary but not unproven, SageGlass technology has been tested for years by the U.S. Department of Energy with outstanding results.

Why limit yourself to conventional glass with add-on solar control devices? Dynamic SageGlass products offer true design potential, so architects can create their own masterpieces. To learn more **call SAGE Electrochromics, Inc. at 1-877-724-3321 or visit sage-ec.com**

SageGlass products are built with Pilkington TEC™ Glass.  PILKINGTON

SageGlass technology controls sunlight to protect what's inside. It's the only product of its kind, providing 98% fading protection from both UV and visible light in its tinted state and 78% in its clear state.



The only glass that:

- Dramatically reduces all fading
- Actively controls daylighting
- Stops glare
- Dynamically controls heat gain

while always preserving the view and connection to the outdoors.

See us at the AIA Show booth 23117

Sage Glass®
The power to change™

Recognition

John Simpson Honored by Institute of Classical Architecture

Charleston building-arts college and local preservation group also received Ross Awards

THE INSTITUTE OF CLASSICAL ARCHITECTURE & Classical America has chosen John Simpson to receive its most prestigious architecture prize, the Ross Award, an acknowledgment of the British architect's sensitive contributions to

brilliance in the United States is long overdue," says jury chairman Allan Greenberg.

Additional awards to be given in May include those for painting, to royal watercolorist Alexander Creswell; for history and writing,

John Simpson, whose projects include the Queens Gallery (below right), has won the Ross Award.

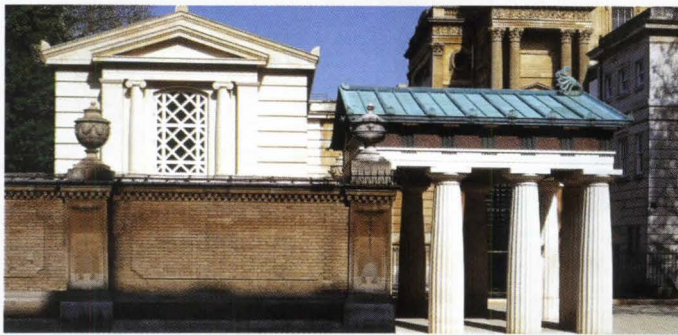
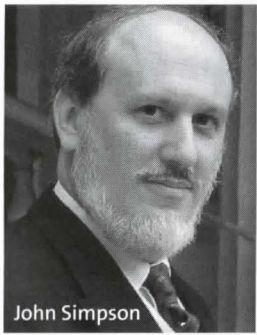

"Recognition of [Simpson's] brilliance in the United States is long overdue."

—Allan Greenberg, jury chairman

Paternoster Square in London and the Queen's Gallery at Buckminster Palace, among many other projects. Simpson has also earned plaudits for two New York projects, the Carhart Mansion, completed in 2005, and the ongoing conversion of the former Stanhope Hotel. "Recognition of his

to Mark Alan Hewitt, educator and author; for stewardship, to the Committee to Save the City, Charleston, S.C.; and for education, to Charleston's American College of the Building Arts, founded to teach artisan skills that were in short supply after Hurricane Hugo. LINDA HALES

Recognition

American Academy of Arts and Letters 2008 Architecture Award Winners

- **\$5,000 TO AN ARCHITECT WHO HAS MADE A SIGNIFICANT CONTRIBUTION TO ARCHITECTURE AS AN ART:** Peter Zumthor
- **\$7,500 EACH TO AMERICAN ARCHITECTS WHOSE WORKS ARE CHARACTERIZED BY A STRONG PERSONAL DIRECTION:** Neil Denari and Jim Jennings
- **\$7,500 EACH TO AMERICAN DESIGNERS WHO EXPLORE IDEAS IN ARCHITECTURE THROUGH ANY MEDIUM OF EXPRESSION:** James Carpenter and Kenneth Frampton

Selection committee: Henry Cobb (chairman), Peter Eisenman, Michael Graves, Charles Gwathmey, Hugh Hardy, Steven Holl, Ada Louise Huxtable, Richard Meier, Cesar Pelli, James Polshek, and Billie Tsien.

PRODUCE.

PERSUADE.

PERFORM.

ON PAPER.

WITH CANON

GENUINE

TONER,

PARTS AND

SUPPLIES.



Canon

*image*ANYWARE

www.usa.canon.com 1-800-OK-CANON

Canon is a registered trademark of Canon Inc. in the United States and may also be a registered trademark or trademark in other countries. IMAGEANYWARE is a trademark of Canon. © 2007 Canon U.S.A., Inc. All rights reserved.

Circle no. 462 or <http://architect.hotims.com>

REPORT

→ continued from page 32

The Chinese government has said that **Beijing construction projects will be put on hold for two months**, beginning July 20, to help clean the air for the **2008 Olympics**. Officials said plans also include a reduction in

steel production and temporary shuttering of quarries in and around the city. The games are scheduled to begin on Aug. 8.

The Washington University **Sam Fox School of Design and Visual Arts** awarded its biennial **Steedman Fellowship** to

Nikole Renee Bouchard for her plan for an urban agricultural development north of St. Louis. Bouchard will receive \$30,000 to support her research.

Kohn Pedersen Fox Associates has proposed a **1,500-foot LEED Gold skyscraper** for Philadelphia.

Called the **American Commerce Center**, the mixed-use building would include offices, a shopping mall, and a hotel and conference center. Initial renderings show the tower's usable space topping out at 1,200 feet; a 300-foot-high spire completes the design.

Leadership Sanctuary project is intended as a getaway for overworked heads of state. Initial designs from London architects **Douglas Patterson** and **Laurie Chetwood** include a library, gardens, conference rooms, and living quarters to create an informal, neutral setting.

In other KPF news, the **Kohn Pedersen Fox Foundation** has announced the winners of its **annual traveling fellowship**, now in its third year. **Kyung Jae Kim** from Columbia University, **Hoi Lung Chan** from Massachusetts Institute of Technology, and **Kristin Elaine Hawk** from North Carolina State University will each receive \$10,000 to create and follow an architecture-themed itinerary. Learn more about the fellowship and view experts from the winning portfolios at kpf.com.

Joseph Dolinar, a longtime staff member at **Goettsch Partners** in Chicago, has been promoted to partner. Dolinar is the firm's seventh partner. In his 27 years at Goettsch, he has worked on such noteworthy projects as the redevelopment of Soldier Field.

Because of growing demands for architectural and design services in central Texas, **Gensler** has opened an office in Austin. Office director **James Furr** and project manager **John Mapes** will head the outpost.

Zaha Hadid Architects has won the competition to design the **Guggenheim Hermitage Museum** in Vilnius, Lithuania. The new museum will house pieces from both New York's Solomon R. Guggenheim Foundation and the State Hermitage Museum in St. Petersburg, Russia. Hadid's design bested two others, by Studio Daniel Libeskind and Studio Fuksas.

HOK Sport's new **Yankee Stadium** is now at least \$50,000 over budget, the cost spent excavating a **Boston Red Sox jersey** from the recently laid concrete foundations. Placed there by **construction worker Gino Castignoli**, the jersey was extracted to avoid hexing the Yankees and could result in charges for Castignoli, including criminal mischief.

Ray Pentecost, vice principal and director of healthcare architecture at Norfolk, Va.-based firm **Clark Nexsen**, has been named president-elect of the **AIA Academy of Architecture for Health**. Pentecost, an architect and doctor, joined Clark Nexsen in 2003. He also serves on the board of directors of Virginia Commonwealth University's Health System Authority and used to direct the healthcare architecture program at the University of Houston.

The **Alliance for Climate Protection**—founded by former Vice President **Al Gore**—has created **The We Campaign**, a \$300 million public advocacy effort to push for aggressive reductions in greenhouse gas emissions. Learn more at wecansolveit.org.

Donna Vassar—a member of the Vassar education family—is planning a \$300 million private retreat in the Nevada desert for world leaders. The **Universitas**

Geo, Mexico's No. 2 housing developer, is teaming with government agencies, industrial firms, and shopping center experts to build **six new cities** in Mexico. Springing up in empty fields around the country, Geo expects this new venture to become 50 percent of the company's business in the coming months.

Svigals + Partners No Longer Hires Consultants for Spec Writing



"We no longer hire consultants to write our specs. We also spend less time during construction reviewing shop drawings trying to figure out what the spec consultant was looking for."

Robert Skolozdra, Associate, Svigals + Partners, LLP

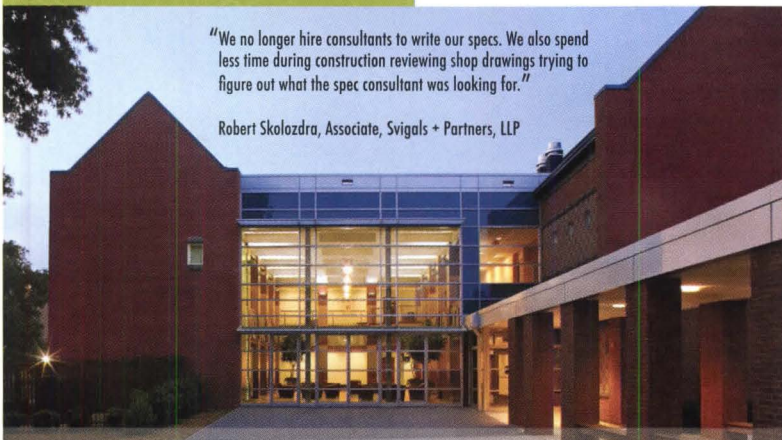

New Academic Center for Science, Art and Technology in New Haven, CT designed by Svigals + Partners and specified using BSD SpecLink.

Photo credit to Robert Benson

Setting Higher Standards for Master Guide Specification Software

Call Us Today at
1-888-BSD-SOFT
1-888-273-7638

or visit our website at
www.bsdssoftlink.com

Call today to learn how BSD
SpecLink can help you:

- Dramatically speed up editing tasks
- Reduce specification production time while minimizing errors and omissions
- Update automatically without disruption

BSD
Building Systems Design, Inc.

A Strategic Partner of CSI

Circle no. 23 or <http://architect.hotims.com>

“Grey is cool.

*It never draws attention to itself.
It doesn't need to. Which is why
it's the ideal color to show off
all this incredible texture.”*



{building blocks of design}



P-3900 Our Sky Oculus line of fixtures renders Round as only Prudential Ltg. can. With its ideal depth and diameter, our P-3900 Round lets you employ the power of the perfect circle.

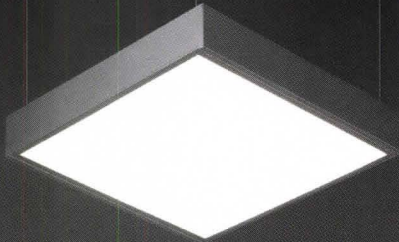

P-3600 Whenever elegant simplicity is what your design vision demands, let our series of Square fixtures turn right angles into the right solution.

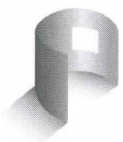

Light creates Life. Create with Prudential Ltg.

REPORT

London

So Long, Young Chum?

Worth, and fate, of British post-war buildings being debated

IT'S AN AGE-OLD QUESTION: What history do we preserve? The British English Heritage list has a 30-year requirement for most historic buildings to be considered, and now postwar

because they cannot take—let alone pass—the test of time, scrutiny in other areas needs to be tougher, I believe.” Hodge, who rose through the ranks from Parliament to the ministry, is

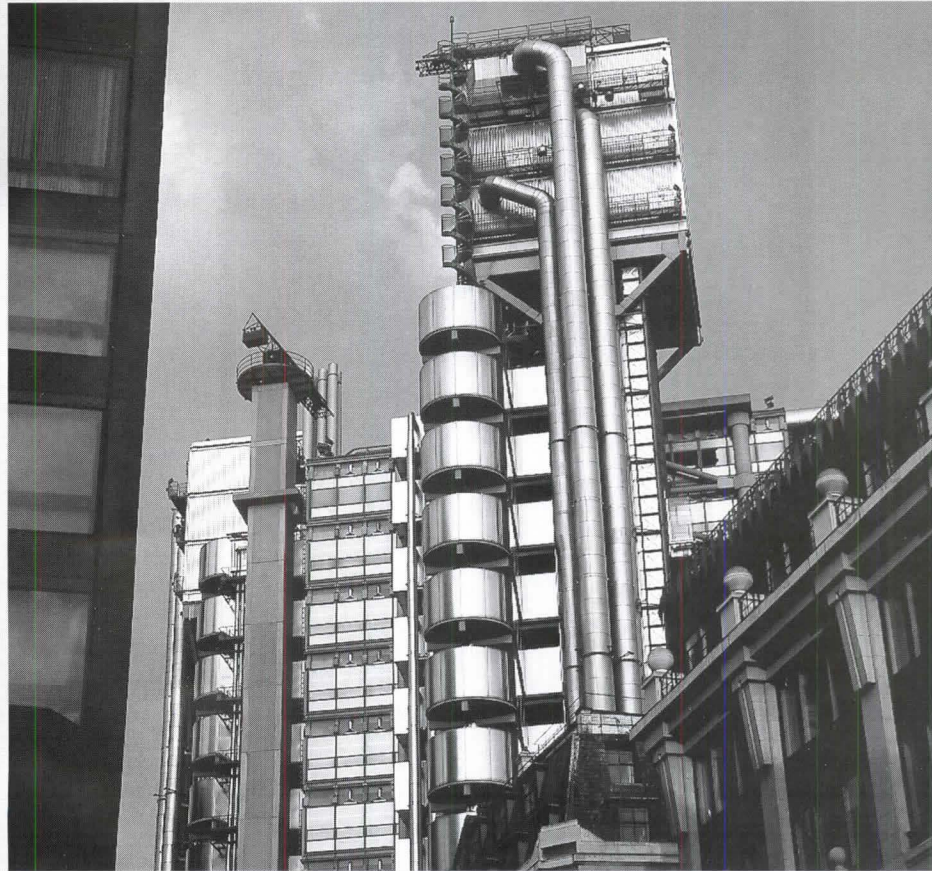

British minister of culture Margaret Hodge may soon have to decide the fate of several high-profile postwar and late 20th century designs, including Richard Rogers' Lloyd's of London building (above), completed in 1984.

architecture is getting its turn. The fate of several postmodern buildings is before the British culture minister, Margaret Hodge, and some developers are questioning the buildings' value while preservationists are fearful that brutalist, concrete mammoths could be downed.

Tom Dyckhoff, architecture critic at *The Times*, sees three buildings on the British culture minister's radar that warrant concern: Richard Rogers' Lloyds of London building, the U.S. Embassy by Eero Saarinen, and Alison and Peter Smithson's Robin Hood Gardens housing block. He cites an article minister Hodge recently wrote in *Grand Designs* magazine where she says, "It's fair enough to protect one or two examples of present architecture but,

against classifying some buildings, pointing to the need to change or to tear down structures to make them viable in the community. Many experts say there are examples of registered buildings being reused, and depending on the classification granted on the list, a building can be greatly altered to support new uses.

While Hodge is deciding what to do, the British Government is considering taking the decision-making power from the minister and giving it to English Heritage. In the meantime, don't worry. Hodge has a plan for the buildings that may be lost: "This is the 21st century—a perfect digital image of the building, inside and out could be retained forever." **ANDREW SLOCOMB WEST**



Prudential Ltg.

Beyond AND Back

{classics _ circles, squares}

Can a fixture be both futuristic, and classic? It can if it's among the selection of Squares and Rounds offered by Prudential Ltg. For more than 25 years, our Sky Oculus P-3900 Round has fueled the imagination of architects and designers. That purity of shape is echoed in our P-3600 Square. So whether you require surface- or pendant-mount, large scale or small, let us take you beyond the expected, with shapes that go back to basics. See prulite.com for more ways we can help you create a timeless design solution.

Light creates Life. Create with Prudential Ltg.

Circle no. 79 or <http://architect.hotims.com>

HOHMANN AND BARNARD

A NEW GENERATION OF TECHNOLOGY AND INNOVATION

ANCHORING SYSTEMS FLASHING SYSTEMS AIR BARRIERS
GREEN PRODUCTS HIGH STRENGTH & SEISMIC SYSTEMS

HOHMANN & BARNARD'S DUB'L LOOP-LOK™

Reinforcement System

100% protection against separation of wire tie from reinforcement.

Allows in-plane vertical and horizontal movement of masonry wythes while restraining tension and compression.

Loops welded shut to maintain allowable tolerance and system integrity.

Unlike horizontal eyelets, vertical loops will not clog with mortar as construction progresses.

Loop extends one direction only to allow simple placement of insulation. Slip on Loop-Lok™ Washer to mechanically lock insulation in place.

U.S. Patents
5,408,798; 6,668,505
6,789,365; 6,851,239
Other Pats. Pending

HOHMANN & BARNARD'S TEXTROFLASH GREEN

Self-Adhering Air and Vapor Barrier

Manufactured from 45% recycled material

This unique self-adhesive membrane can function as a total air/vapor barrier system or as a detail sheet for our Textroflash™ Liquid air/vapor barrier system, or as a thru wall flashing membrane. Because of its non-drooling clear adhesive and tough spun-bonded polypropylene film, Textroflash™ Green can be installed as a flashing system without fear of "bleed-out" associated with asphaltic based membranes, and provides up to 90 days of UV stability for prolonged exposure as an air/vapor barrier system. Textroflash™ Green is the first truly environmentally friendly water resistant membrane developed from the "green" leaders in the masonry industry, Hohmann & Barnard!

HOHMANN & BARNARD'S MIGHTY-LOK™

High Strength

Large diameter eyelets and pintles afford usage where high strength requirements are present and standard eyelets and pintles would fail (including extra-wide cavity conditions). Also designed for usage where standard eyelets and pintles would fail due to greater than normal misalignment of mortar joints between the 2 wythes

Rounded eyelets engage pintles snugly in conformance with existing codes (less than 1/16" mechanical play). No oblong-shaped eyelets as found on other systems

Available Truss style (#170-ML) or Ladder style (#270-ML).

HOHMANN & BARNARD'S TEXTROFLASH™ LIQUID

Air and Vapor Barrier

The unique composition of this single component material enables dual usage as both a permeable and non-permeable air/vapor barrier system. Textroflash™ Liquid can also be exposed to UV for up to 145 days, much longer than many products on the market today.

TEXTROFLASH™ LIQUID VP is a vapor permeable air barrier. The "breathable" barrier allows proper drainage in various types of wall systems and promotes drying of the wall cavity in either direction. It provides protection from the effects of energy loss, condensation, efflorescence, bacterial growth and mold. More environmentally friendly than other spray applied products, Textroflash™ Liquid VP is a resilient, seamless membrane with water-resistant properties.



www.h-b.com/c
800.645.0616





The best roof money can buy.™



Protection for When it Rains Fire

Aerial photos after the California fires showed homes with metal roofs that survived the flames, while nearby the earth was scorched and neighboring homes lay smoldering. The reasons are clear. Unlike tile or shingles, metal offers no opening and no fuel for falling embers. Stay safe.

Follansbee – for those who demand the very best.

Call or visit Follansbee online today to learn more.

800.624.6906 follansbeeroofing.com









Circle no. 32 or <http://architect.hotims.com>
Earn 1-hour AIA learning credit online today. Visit follansbeeroofing.com

Edited by Andrew Slocomb West

CALENDAR

MAY, JUNE, JULY

Sunday	Monday	Tuesday	Wednesday	Thursday	Friday	Saturday
25 TOUR Farnsworth House Plus by Bus ... because Mies was busy all over Chicago. architecture.org	26 	27	28	29 DEADLINE Prove your geek skills in ARCHITECT'S R+D Awards competition. architectmagazine.com	30 TOUR Get an inside look at Richard Meier's Model Museum in Long Island City, N.Y. www.richardmeier.com	31 
1	2 CONFERENCE Grab the kids and spend a few days in Vegas for the 2008 World Safety Conference & Exposition since there really is no better place to learn responsibility. nfsa.org	3	4	5 DEADLINE The Barrier of Silence gives every architect the chance to take the vroom out of jets in Amsterdam. innovatieveoplossing.nl	6 DEADLINE Wow the globe and take home a Contract World Award 2009. contractworld.com	7 DEADLINE Light up the San Diego-Coronado Bay Bridge with the Port of San Diego. portofsandiego.com
8 CONFERENCE Hang out in Hershey, Pa., for the American Architectural Manufacturers Association Summer Conference to get a sneak peek at the newest in windows and doors. aamanet.org	9 DEADLINE Rethink the bike rack with Google and the Cooper-Hewitt in City Racks . nycityracks.wordpress.com	10	11 CONFERENCE Biomimicry for a Sustainable Built Environment , archispeak for copying nature's tricks to help human's problems (this time in Seattle). aiaseattle.org	12 	13	14
15 EXHIBITION Now that Light+Building has wound down, get to China for the Guangzhou International Lighting Exhibition , the self-proclaimed largest light show in Asia. www.messefrankfurt.com.hk	16	17	18 	19 SEMINAR Learn how the teachers are taught at the 2008 ACSA/AIA Teachers Seminar . acsa-arch.org	20 OPENING The Sterling and Francis Clark Art Institute opens Tadao Ando's Stone Hill Center . clarkart.edu	21
22 	23	24 STUDENTS Design the next Ecohouse with Britain's Concrete Centre. concretecentre.com REGISTRATION Turn a shipping container into an urban, multiuse dwelling in LIVE the BOX . livethebox.org	25	26	27 DEADLINE Show off your work with the Emirates Glass LEAF Awards. You just have to pick one of this year's nine categories. designbuild-network.com	28
29 EXHIBITION Take your olfactory-in-building knowledge to the next level with a visit to SCENTworld . scentmarketing.org	30 DEADLINE Your doctors offices and hospitals are a notch above the rest, so submit to the Healthcare Environment Awards competition. contractmagazine.com	1	2 	3	4	5

Looking Ahead:

EXHIBITION OPENING

Between Earth and Heaven: The Architecture of John Lautner; Los Angeles; July 13; hammer.ucla.edu

LECTURE

Palladio's Villas: The Development of an Ideal; New York; July 16; classicist.org

EXHIBITION OPENING

Home Delivery: Fabricating the Modern Dwelling; New York, July 20; moma.org

CONFERENCE

Theater Engineering and Architecture Conference; New York; July 20-21; nateac.org



Solarban® z50 proves you don't have to be green to be green.

New Solarban z50 solar control glass is a stylish, steely blue-gray glass that blocks up to 70% of total solar energy. That gives it a light to solar heat gain (LSG) ratio that's up to 30% better than that of competitive products. And that makes Solarban z50 a worthy addition to the Solarban family of solar control glass products – and a colorful step forward for sustainable design. For your free energy analysis white paper and glass sample, or to learn more about EcoLogical Building Solutions from PPG, call the PPG IdeaScapes hotline: 1-888-PPG-IDEA. Or visit www.ppgideascales.com.

Circle no. 423 or <http://architect.hotims.com>

Solarban, IdeaScapes, PPG and the PPG logo are trademarks owned by PPG Industries, Inc.



Text Andrew Slocomb West

PRODUCTS

LIGHTING



Master LED lamps

Philips • philips.com
7-watt Luxeon Rebel
LED alternative to
incandescent, halogen,
or compact fluorescent
lamps • Life span up to
45,000 hours with an 80
percent energy savings
over low-wattage
halogen • Mercury- and
lead-free • Instant start
• Compatible with GU 10,
NR63, or Edison E27 lamp
bases • Circle 100

T H I N K A B O U T I T

It's 2008. R-20 is the new R-15.

ASHRAE STANDARD 90.1-2007:

Advancing a new benchmark for energy efficiency in commercial buildings.

BOTTOM-LINE:

R-20 (3.3" of polyiso) is now the minimum required prescriptive R-value.



HUNTER



HUNTER
Energy Smart Polyiso
888-746-1114

Go to www.hunterpanels.com for more information

NEW YORK

ILLINOIS

FLORIDA

TEXAS

UTAH

PENNSYLVANIA

Circle no. 433 or <http://architect.hotims.com>

Products

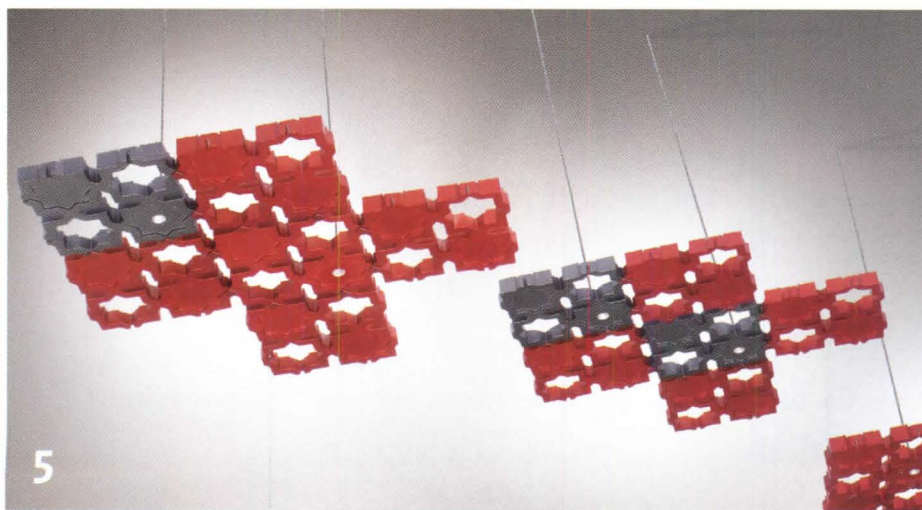
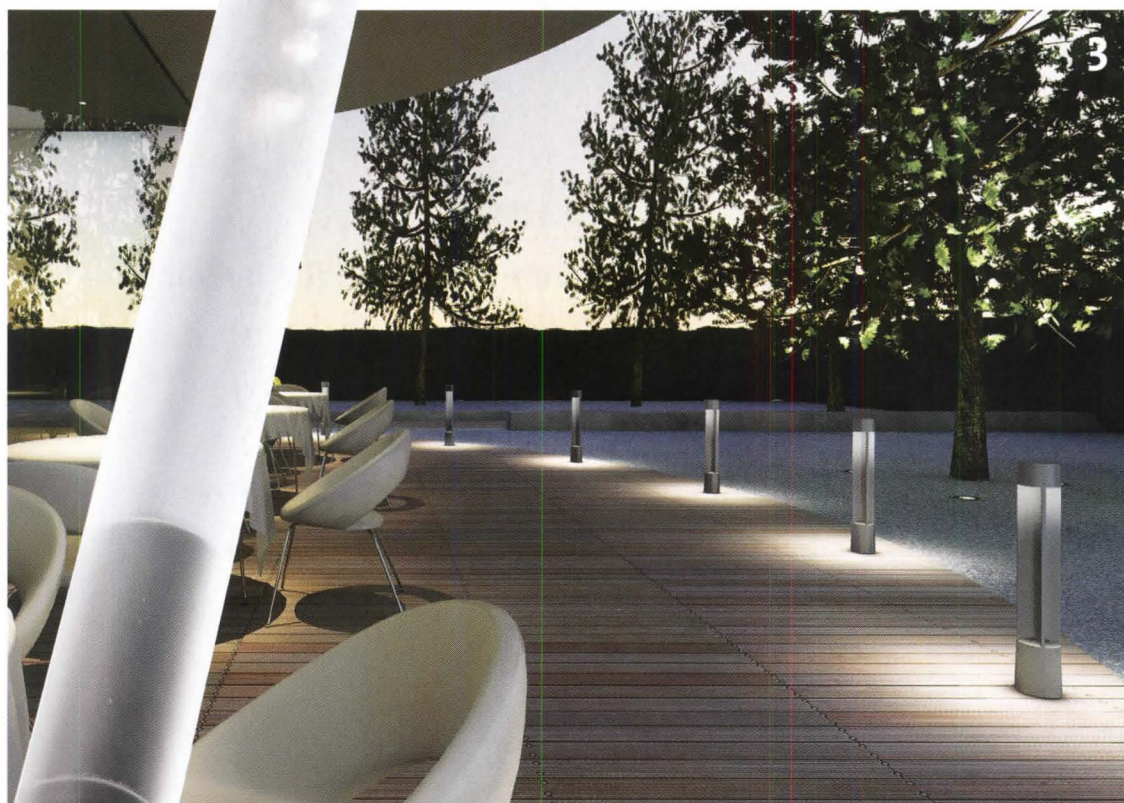

1. Class R Series recessed luminaires

Corelite • corelite.com

Low-profile housing fits in restricted plenum spaces • 1¾- or 2¼-inch depths • Uses T5 lamps • Available in one-foot-by-four-foot, two-foot-by-two-foot, and two-foot-by-four-foot sizes with one, two, or three lamps • Four shielding options • *Circle 101*

2. Mobilume pendant

Nessen Lighting •

www.nessenlighting.com

Floor, table, ceiling, and pendant styles • Weighted pivot allows adjustment of ceiling, floor, and desk styles • Solid brass in seven finishes • Shade available in white linen or semi-gloss paper with white lining • Designed by architect Paige Goolrick • *Circle 102*

3. Midipole outdoor bollard luminaire

Erco • erco.com

21½- or 31½-inch-high models with cross-shaped profile • Available with LED or metal halide lamps up to 35 watts • Flood lens directs light • Dark-sky compliant • Applications include pathways, drives, and entrances • *Circle 103*

4. Isme LED outdoor luminaire

Schröder • schreder.us

High-power, 4,500 Kelvin white from 1 watt LEDs • Longitudinal light distribution ideal for narrow space • Royal blue LEDs add color to fixture • Available late 2008 • *Circle 104*

5. Marrakesh modular luminaire

Mindspring • mindspring-lighting.com

Aluminum-housed, modular fixtures in red or black • Attach together for flexibility and on-site design • Four LEDs per fixture in cool or warm color tones • 4 7/8 inches square • *Circle 105*



SMARTWALL



TAOS DECO

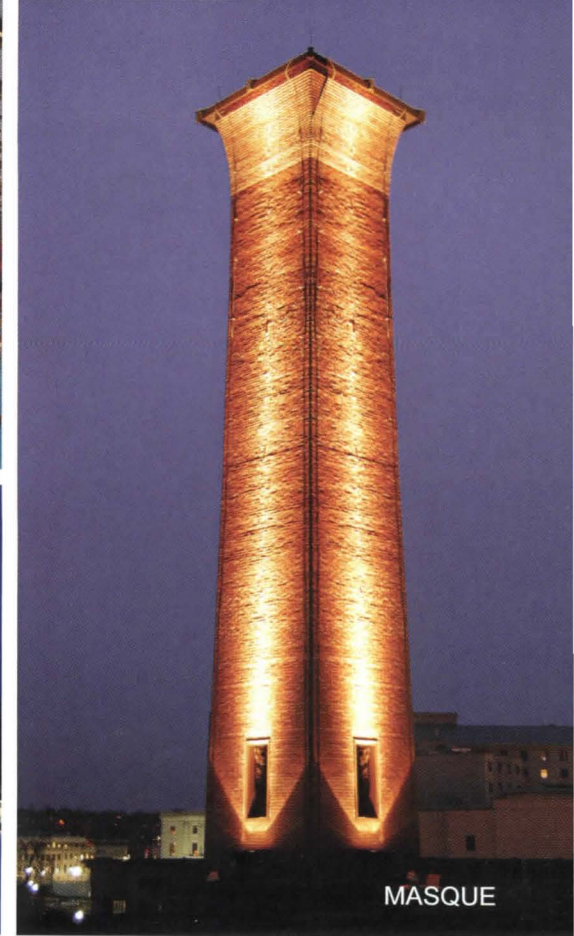

MASQUE



EURO

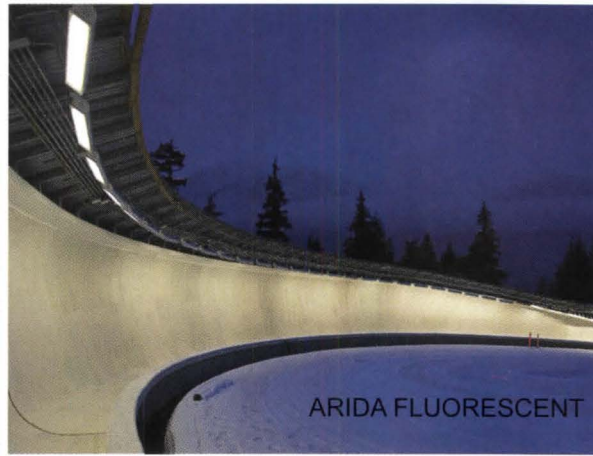

ARIDA FLUORESCENT



ILLUSIONS



EX5 (Yellow) & TREETC (Red)



VAS

INNOVATIVE SOLUTIONS TO LIGHTING CHALLENGES

Insight Lighting believes in the integrity of product and lighting design. Our mission is to develop innovative new products to assist our customers in meeting their lighting challenges. By creating functional, aesthetic and energy conscious products, we strive to enhance the appearance and performance of a working environment.

Insight Lighting offers high performance architectural lighting in classical lamp and LED products for a myriad of lighting venues. An array of instruments including SmartWall (illuminated digital led wall systems), Illusions (linear luminous lighting), Masque (exterior facade lighting), Euro (exterior vertical luminous columns) and Vas (decorative high performance indirect lighting) are representative of our innovative products.

For additional product information, please contact your local Insight representative or visit our website at www.insightlighting.com.



HDI Railing Systems

Simple. Clean. Dramatic.



Precision railing systems and contemporary door pull designs, coordinated to complement your next project.



Circle no. 481 or <http://architect.hotims.com>
3905 Continental Drive • Columbia, PA 17512 USA
PH: 717-285-4088 • FAX: 717-285-5083
Email: info@hdirailings.com • www.hdirailings.com

Products



1. Sconfine Cubo LED luminaire

Zumtobel • zumtobel.us
Wall- or -ceiling-mounted
• Single block or clustered
• Chrome-plated housing hides a 1-watt LED • Diffuser-pearl optic gives uniform illumination across fixture
• 9-cube option gives the appearance of a continuously changing spectrum by adjusting the intensity of individual fixtures • Cubes available in different depths
• Custom order for U.S. availability • Circle 106

2. LIFI lighting system

Luxim • lifi.com
Solid-state source that generates 144 lumens per watt • Dimmable • Supposed to minimize glare and stray light • Over 25,000-hour lifetime • Over 95 color options • Small profile for use in a variety of new and retrofitted fixtures • Product consists of bulb, RF power amplifier circuit, printed circuit board, and the enclosure • Circle 107



3. Light-Squares tilt-down wall wash fixture

Pathway • pathwaylighting.com
High-performance reflector distributes light horizontally and vertically through microprismatic tempered glass • Tilts from flush with ceiling to 60 degrees
• Lockable tilt prevents movement during lamp replacement • T6 ceramic metal halide lamp in 70 or 39 watts • Thermally protected ballast • Custom finishes available • Circle 108





15 Year
Fully Transferable
WARRANTY



When we go green, we go all the way.

Green is where it's at. Our new LG HI-MACS Eden Collection is certified by SCS and created from at least 12% pre-consumer recycled material, making it one of the most environmentally conscious acrylic products in the industry. Inspired by garden botanicals, our six beautifully natural colors are non-porous, anti-microbial and stain resistant, and are backed by our signature 15-year warranty. So the planet is happy, and so are your clients.

Circle no. 42 or <http://architect.hotims.com> 866-LGHI-MACS • LGeden.com

Certified by Scientific Certification Systems (SCS) for Recycled Resin.
Featured product: LG Eden in Ivy, Cocoa and Jasmine. Fabrication by Top Master Inc., Kansas City.
© 2007 LG HI-MACS LG-012701 5/07

LG | LG HI-MACS
EDEN
COLLECTION

The secret's in the surface.

Text Kate Herman

NUMBERS

Architecture Billings Index, February 2007–February 2008



What, Me Worry?

In February, the ABI fell to its lowest point since Sept. 11 and made the largest two-month tumble in its history, but a look around suggests all is not gloom and doom.

↑ **BOSTON • GUND PARTNERSHIP** “We have seen a drop-off in some developer-based projects and some pullback from projects going ahead, especially housing,” says principal Laura Cabo. “We’ve seen our **institutional and academic clients continue to be strong**,” Cabo adds, noting that academic work is 80 percent of the firm’s focus. “We view [the current economic climate] as temporary and [feel] things will continue to be good.”

↔ **DALLAS • BECK GROUP** “Everyone here is nervous. There’s a lot of apprehension,” says principal Betsy del Monte. Much of the office’s current work—the firm does a mix of architecture, development, and construction—is based on plans from a year or two ago, she says, and though architects are busy now, there’s no guarantee their work will see completion. “Our construction folks are so busy they can’t see straight. **If a project is already financed, it’s good to go—but if they don’t have financing yet, it’s very iffy.**” On the whole, she says, “There isn’t reason to panic right now, but we’re wary of what we might be saying this time next year.”

↑ **MIAMI • FULLERTON DIAZ ARCHITECTS** “This is just part of a cycle we’ve been through many times before. I consider it nothing but a correction,” says co-founder John Fullerton. “The sales scene is bleak. The banks are reticent to lend money. But smart developers are rethinking their projects.” He points to one condo project that now will incorporate office and more

retail space than originally planned. “Because there’s been a concentration on condo development,” he notes, “other things weren’t getting built. **Now that condos are overbuilt, office space is needed.**”

↔ **LOS ANGELES • CHARLES DUNN CO.** “Residential development is slowing in all submarkets,” says Chris Runyen, senior managing director of the Office Services Group in the real estate company’s primary office. But he isn’t aware of significant projects being affected by the current economy: “As far as commercial projects, rental rates are still high and vacancies are still low [in the Los Angeles basin]. For Southern California, **commercial seems to be steady.** I haven’t seen any noticeable spikes or declines.”

↑ **SEATTLE • COLLINSWOERMAN** “Our economy is still very strong, and the market is even robust in certain areas,” says partner Mark Woerman. “A few months ago it was almost insane, and two years ago it was ridiculous. But tracking back to Thanksgiving, the financing environment has moved [cautiously]. It affects certain building projects—for-sale housing in particular—but **there’s still a very optimistic outlook**, even for that product type.” Woerman credits business titans like Boeing and Microsoft for keeping the economy surging. “We were the last to go into the downturn of the millennium and the last to come out of it. I think most forecasters have predicted that Seattle will bounce lightly over this.”

ABI BY SECTOR, 2/07–2/08



fanciful and free

A fan can be beautiful, and beautifully useful. Our Color Guide artfully unveils 67 Acme Brick blends that enliven designs and add green building benefits. Each sample reveals lifelike color and detail for exploring our spectrum with ease and confidence.

Please visit brick.com/colorguide to request your FREE "Color Guide for Architects."

**ACME
BRICK**

Also at brick.com, download Masonry Designer, a free companion program to design with Acme Brick and related masonry products. Plan coursing, patterns, and mortar colors with realistic detail to print and share with clients and colleagues.

Glacier White
(M) (K) (U) (S)
Perla Plant



Text Margot Carmichael Lester

LOCAL MARKET

CORAL GABLES, FLA.

Population/Employment

The city of nearly 43,000 has grown by only a few hundred souls since 2000. Regional job growth: 3.5 percent per year.

Office Market

In 2007, Class A space rented for \$40/s.f., full-service gross, on 6.5 percent vacancy.

Residential Market

Average home sales price in 2007: \$850,000.

Market Strengths

- Strong sense of place
- Diverse economy: local businesses, corporate HQs, and the University of Miami
- City-led emphasis on LEED

Market Concerns

- Preservation vs. growth
- Tough zoning requirements
- Housing affordability

Forecast

"In 10 years we'll see an even more pedestrian-friendly, community-oriented city," predicts Fullerton Diaz Architects partner John Fullerton. "Achievement of these visions goes back to growing responsibly, with specific attention to the history and architectural style that permeate the city."

HOME TO THE UNIVERSITY OF MIAMI, Coral Gables, Fla., is one of the greenest headquarters cities in the nation, with a rich canopy of banyans, oaks, and other lush trees. "More than 30 percent of the city's land area is actually open space, ranging from competitive golf courses to Fairchild Tropical Botanic Garden to beautiful parks," notes Cathy Swanson Rivenbark, Coral Gables' director of development.

And if city leaders have their way, it might become one of the greenest cities in terms of sustainable building. "We are now working on facilitating and expediting the approval processes—including permitting—for LEED buildings," says Mayor Don Slesnick. "This doesn't make it a requirement, but it provides a clear incentive."

The city has always taken development seriously. Founded in 1925

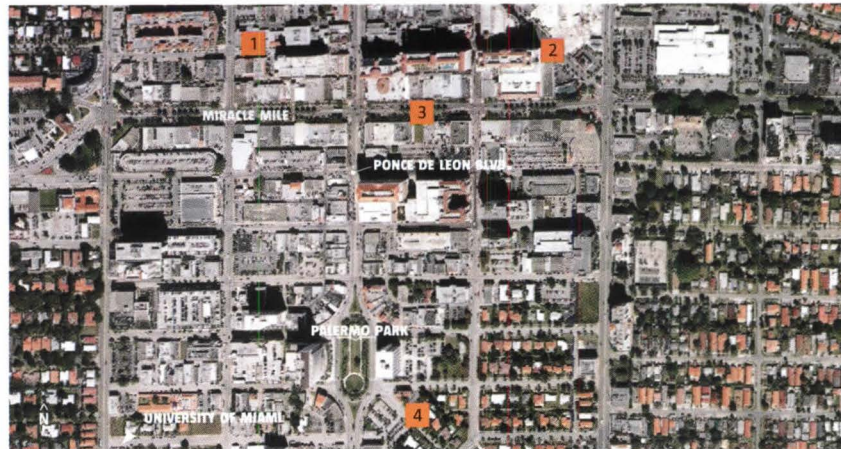

1 CORAL GABLES MUSEUM
Architect: Jorge L. Hernandez Architect, Coral Gables; **Completion:** 2009; **Cost:** \$5 million; **Size:** 20,000 s.f. • Built in 1936, the former police and fire station will become a LEED-certified museum of the city.

2 55 MERRICK
Architect: Fullerton Diaz Architects, Coral Gables; **Completion:** 2008; **Cost:** \$80–\$100 million; **Size:** 661,000 s.f. • The mixed-use project includes office and retail space and 167 condos.

3 KETTAL SHOWROOM
Architect: Mateu Architecture, Palmetto Bay/Miami; **Completion:** 2007; **Cost:** \$900,000; **Size:** 7,500 s.f. • Spanish outdoor furniture maker's first U.S. store earned Miami AIA 2007 Award of Merit. Firm's previous work in city led to crafting of Coral Gables' Mediterranean design code.

4 OLD SPANISH VILLAGE
Architect: Jorge L. Hernandez Architect (master plan), Coral Gables; **Completion:** 2009–2011; **Cost:** \$250 million; **Size:** seven acres • Project includes 38 townhomes and 172 apartments.

by developer George Merrick, who also assisted in the creation of the University of Miami through the donation of land and money, Coral Gables is one of the nation's first fully planned communities.

It continues to focus on livability today. "We specifically chose to relocate our practice to Coral Gables because of its history and its focus on design and planning, which says a lot about the city as a draw for designers," says Joseph Andriola, vice president and principal of SB Architects, whose 55-person office was previously headquartered in nearby Miami.

"The mixture of uses makes it wonderful for our employees," Andriola continues, "while the address is attractive from a business standpoint. It is a true live-work environment, a rarity in Florida."

Let Your Creativity Soar!

**VISIT US
AT AIA
BOOTH
#15020**

LEHIGHTM **WHITE CEMENT**

**LEHIGH CEMENT COMPANY
WHITE CEMENT DIVISION**

7660 Imperial Way
Allentown, PA 18195-1040
Toll Free 1-800-523-5488
Phone: 610-366-4600 Fax: 610-366-4638
www.lehighwhitecement.com

Circle no. 465 or <http://architect.hotims.com>

Text John Gendall Photo Tracy Powell

SCREEN GRAB

MATERIALECOLOGY.COM

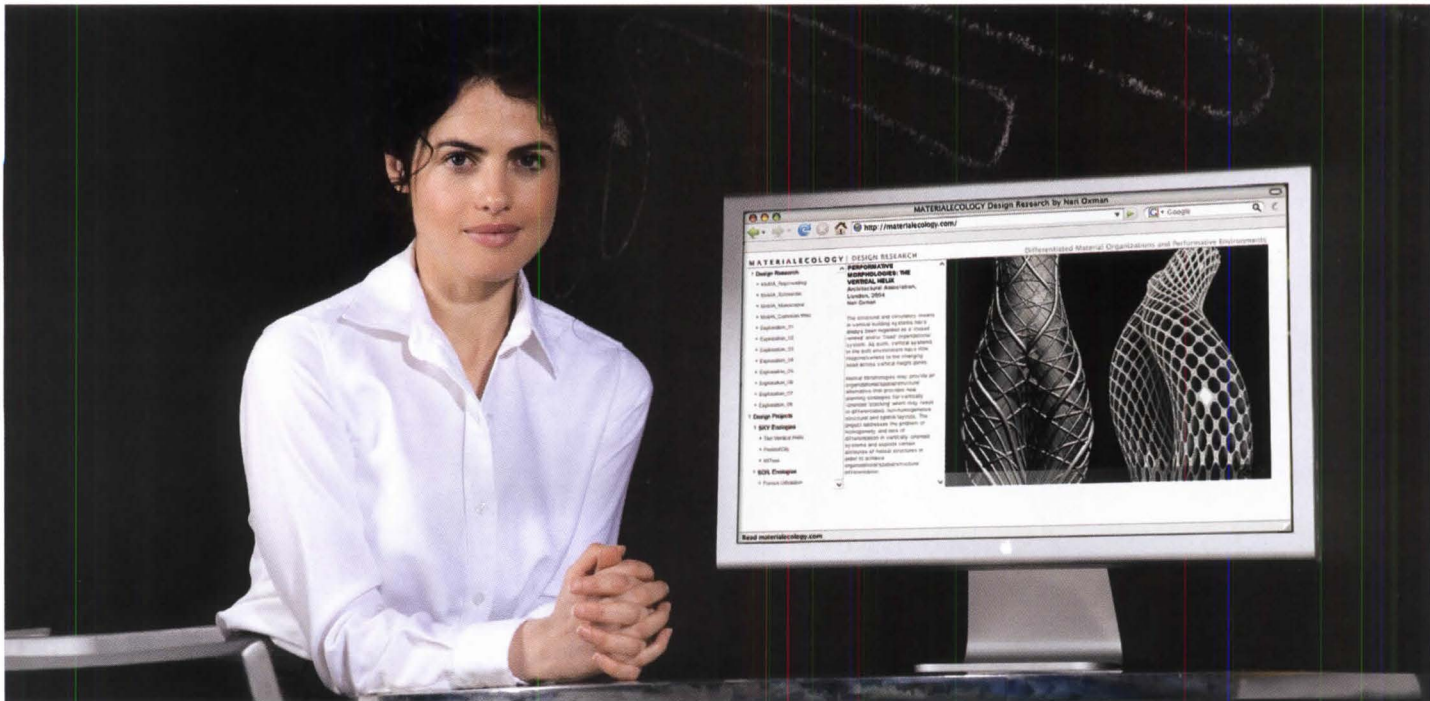

Neri Oxman's **MaterialEcology** investigates the nexus of nature, design, and computation. Four of her projects are in MoMA's "Design and the Elastic Mind" exhibition.

WHILE SOME CONTEMPORARY ARCHITECTURAL FORMS can rightly be regarded as mere flamboyance, there are designers who remain committed to intellectually rigorous processes *and* to beautiful forms. With her ongoing MaterialEcology research project, Neri Oxman is aiming to land herself into that selective group. "Much of my work," she explains, "is a search for form before the actual process of formation. In other words: How do you begin to define form?"

To do this, the Israeli-born designer turns to ecology, investigating the material and performance of nature itself. "I'm looking at form, structure, and geometry and attempting to transcend those disciplinary boundaries," she says. "I'm trying to understand how nature does it."

With "Monocoque," for instance, Oxman explores construction techniques that support load with the external skin, as opposed to traditional post-and-beam structures with façades. The project responds to global and local loading conditions, with its density responding to precise structural needs. What results from this study is a sinuous black-and-white acrylic object, as investigative as it

is aesthetically pleasing. It is now featured in the current MoMA exhibition "Design and the Elastic Mind," along with three of Oxman's other projects, "Subterrain," "Raycounting," and "Cartesian Wax."

These and other examples of her work can be found on her website, materialecology.com. She began it two years ago, shortly after starting at MIT's architecture school, where she is a Ph.D. candidate in the design and computation program. Previously she studied and taught at London's Architectural Association (AA). She was also once enrolled at the Hebrew University School of Medicine, in Jerusalem, where she started studies to become a physician.

Combining the AA's design freedom with the systematic approach to research at MIT, Oxman aims to produce an architecture that merges both approaches. "I'm trying to place my work and my research on two tangent paths," she clarifies, "that meet at some point and follow their own trajectories at other points. Research has a rigorous state of mind, and design is quite the opposite. It's difficult to bring those mentalities together, but that's my intention."

LINKS

architectures.danlockton.co.uk

Architectures of Control is a blog by industrial designer, engineer, and researcher Dan Lockton that examines how products, systems, and environments are intentionally designed to restrict users' behaviors or even to enforce certain desired modes of behavior.

database.biomimicry.org

Now in its prototype phase, the Biomimicry Database is an effort to create a resource "where designers, architects, and engineers can search biological information, find experts, and collaborate." The site's founders invite feedback and suggestions for content.

utopia.ru/english



"Russian Utopia," an online exhibit of unbuilt architecture, includes N. Ryabov's Lenin Mausoleum, (1925).

lunchstudio.blogspot.com

Most of us eat lunch in a hurry, often at our desks. Architects Yen Ha and Michi Yanagishita believe we shouldn't, so each day they record their midday meal as inspiration. "We believe leaving the office every day for lunch is an invaluable ritual," their first post says.

ATT.COM/ONWARDSMALLBIZ

Now you can gain the competitive edge. And wield it mightily.

You. Destroyer of the status quo. Now the site that's uniquely yours is uniquely better. Where you don't just dream about success, you enable it. With online courses and live seminars hosted by experts. So you can make it happen today. Onward.



Tips, tools, news and advice for small business.

Circle no. 498 or <http://architect.hotims.com>

The new  **at&t**
Your world. Delivered.™



ARCHITECTURAL RAILINGS AND WINDSCREEN SYSTEMS

MANUFACTURED BY C.R. LAURENCE COMPANY



ARCHITECTURAL RAILINGS AND WINDSCREEN SYSTEMS

For view-oriented installations, Glass Railings and Windscreens serve as an effective wind barrier and divider, or as a pool surround, further enhancing the outdoor environment. Also provides a sound wall, great for noise reduction.



CRL

ISO 9001:2000 Certified
C.R. LAURENCE COMPANY

crlaurence.com | Worldwide Supplier
Architectural Products Manufacturing Division
Tel: (800) 421-6144 ext. 7730 • Fax: (800) 587-7501

HR09 Railing Systems Catalog features our structural glass, aluminum and post railings, hand and guard rails, windscreens, patio posts, and more. See beautiful pictures of installations to give you ideas and inspiration for your jobs. It can be viewed

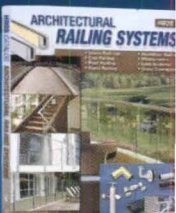

A DATA BACKUP PROVIDER LAYS OUT THE OPTIONS FOR SAFEGUARDING YOUR FILES—AND FORGETTING TO ISN'T ONE OF THEM. **Text** Fred A. Bernstein **Photo** Tracy Powell

BACK IT UP



Architectural drawings are intellectual property, so protect them with care, advises Sam Gutmann, president of Intronis Technologies.

IN JANUARY, A WOMAN named Marie Cooley—suspecting she was going to lose her job at Steven E. Hutchins Architects in Jacksonville, Fla.—snuck into the office on a Sunday night and turned on her computer. With a handful of mouse clicks, she deleted seven years' worth of architectural drawings. The firm was able to restore its files, for a cost, but not its faith in the sanctity of its hard drives or the common sense of its employees. (Cooley's boss hadn't planned to let her go—but did, of course.)

Asked what other architecture firms can do to avoid similar catastrophes, Sam Gutmann, president of Boston-based Intronis Technologies, quips: "Never tell anyone they're about to be fired."

His real answer, he hopes, is just as uncomplicated: Sign up with a company like Intronis, which will back up your data over the internet for as little as \$24.95 a month. (Google "online backup" and you'll see the latest offers from firms like Intronis, Mozy, EVault, and IDrive.)

Gutmann, 26, is a former business consultant who was surprised at how many companies he worked with didn't have backup systems or ignored the ones they did have. In 2003, the Worcester Polytechnic Institute grad and two partners founded Intronis, which they believe offers the best method of backing up for the least money.

Architects have a problem ...

Architecture firms don't have anything to sell, except their intellectual property. Architects should realize, Gutmann says, that "if you lose your drawings, you've lost the entire business."

... with many possible solutions.

Options for backing up include tape drives (which are designed specifically for duplicating data), removable hard drives, or smaller storage devices (CDs or "flash drives"). Tape drives can store from 10 gigabytes to several hundred gigabytes, says Gutmann, and can cost from hundreds to tens of thousands of dollars.

One tape isn't enough.

Beware if you only have one tape and you're continuously overwriting it. By the time you discover that you've lost a file, it may have already been overwritten, Gutmann cautions. That's why he recommends a device that cycles through multiple tapes.

Without tapes, there's work to be done.

If you use any storage device other than a tape drive, you (or a colleague) has to remember to make backups—and to keep them somewhere safe. A backup next to the computer is useless in the event of a natural, or man-made, disaster.

Move your backups off site.

One option is to have an employee take the backups home at night. But even the best employees miss work or forget to do things. You can also pay a courier to move your backup tapes to a secure location. That's an expensive option and still not foolproof. There have been cases where couriers have mislaid tapes, causing the data to be lost. (Lost to you, that is. Whoever finds the tapes has access to your files.)

Tales from encrypt.

However you back up, you should encrypt your data. There are tape drives with built-in encrypting mechanisms, as well as easily obtained encryption software if you're not using a tape drive. Companies like Intronis, which collect your data over the internet and store it on their computers, automatically encrypt data when they back it up.

If you choose an online backup service ...

Look for one with easy-to-use software. Intronis customers download a program, called eSureIT, which then chooses what kinds of files the company will back up, and when. Most customers, Gutmann says, "have us search their hard drives in the middle of the night."

But architects work in the middle of the night!

"You can continue using the files normally," says Gutmann. "You won't even know we're backing up."

“Architects In Action”



WE ASKED A SIMPLE QUESTION. “WHY ARE YOU A MEMBER?”
THERE ARE 83,000 POSSIBLE ANSWERS. HERE ARE TWO.

Being an Architect in Action means you bring better solutions to your design projects. You work to create healthy and sustainable buildings and communities. It means you are a member of the American Institute of Architects.

As a member, you have access to knowledge and resources, a supportive network of colleagues, and a reputation built on 150 years of service to the design profession.



“One of the big advantages of being a member of the AIA is the access to not only peers and networking, but also a huge repository of information based on all of the members and their experiences...It is the entire Institute whose information you have access to. There is almost always a way that you can go to that repository to figure out the solution to whatever your issue is.”

Virgil Green, AIA — Member Since 1978



“I believe that my membership with (the) AIA has enhanced my design skills and my design capabilities immensely; through my interaction with other leading professionals around the country, I've been able to understand best practices that they've applied to their projects. This helps me apply better design practice on the projects that I undertake.”

Timothy Hawk, AIA — Member Since 1992

Become the next Architect in Action. Become a member of the AIA.
www.aia.org/join_today



THE AMERICAN INSTITUTE
OF ARCHITECTS

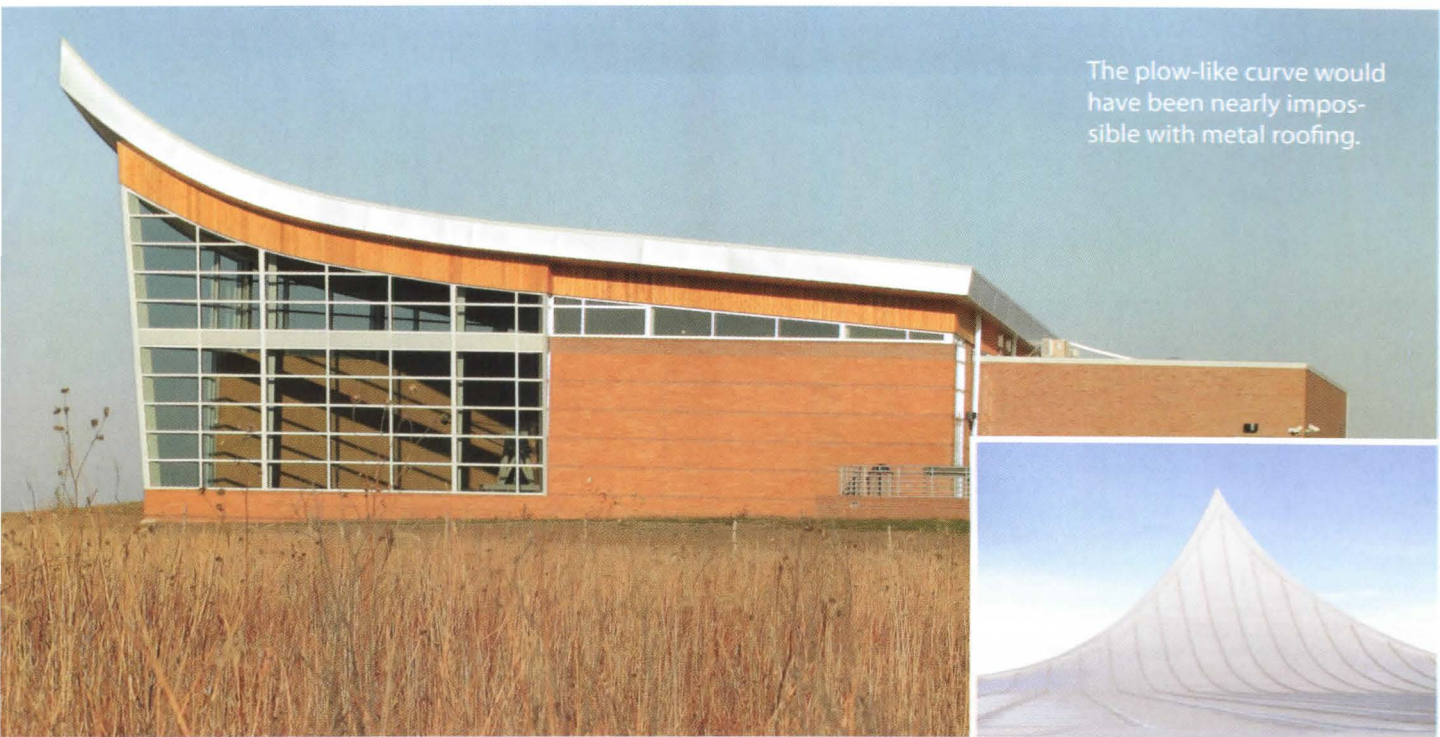

The plow-like curve would have been nearly impossible with metal roofing.

Homestead National Monument

The Challenge

In 1862, the Homestead Act granted 160 acres to anyone willing to travel west and work the land. The National Park Service wished to honor the rugged fortitude of pioneers by building a monument in Nebraska—at the very heart of the nation. To pay this kind of tribute, park authorities desired a structure that would evoke the pioneering spirit with both its appearance and its durability in the face of the Midwestern plains weather.

The Solution

The design developed by GWWO, Inc./Architects of Baltimore, Maryland, beautifully captures the look of a plow moving through the earth—a perfect representation of the toil performed by Nebraska forerunners. Metal roofing would have been nearly impossible to install on the complex slopes required by the design. Fortunately, the architect found an answer: “Ease of constructability with the complex roof form definitely drew us to the Sika Sarnafil Décor Roof

System,” says Laura Werther, Senior Associate at GWWO.

Work began in January 2007. First, the roofing contractor, Weathercraft Co. of Lincoln, Nebraska, installed a poly vapor barrier over the steel deck. Next, they applied two layers of 1 ½-inch isocyanurate insulation and a quarter inch of DensDeck. Finally, they adhered the 60 mil, light grey Sarnafil feltback membrane.

“The heavy weight of the membrane and its felt backing made it easy to set the sheet in wet bonding adhesive without wrinkles,” says Chris McClintoch, Project Manager/Estimator at Weathercraft. “It took careful attention to detail to lay out the parallel profiles, but I felt our crew showed fine expertise in this application. I was also impressed with how conducive the Sika Sarnafil Décor Roof System was to cold-weather application.”

The Performance

The Homestead National Monument was dedicated in Beatrice, Nebraska, on May 20, 2007, in fitting tribute to those who

Project	Homestead National Monument, Beatrice, Neb.
Owner	National Park Service, U.S. Dept. of the Interior
Architect	GWWO, Inc./Architects, Baltimore, Md.
Roofing Contractor	Weathercraft Co. of Lincoln, Lincoln, Neb.
Roofing System	Sika Sarnafil Décor Roof System in light grey vinyl membrane
Project Size	10,600 sq. ft.
Completed	May 2007

established the communities that thrive there today. The building and its curved roof look great both on close inspection and from a distance. “The project is unique because the building slope is not perpendicular to any side,” McClintoch notes. “I imagine visitors still wonder how we got a metal roof to conform to that shape.”

Why We Love It

The unique look of the roof certainly calls to mind the rugged American spirit, just as park officials desired. The watertight construction of the Sika Sarnafil Décor Roof System will help ensure that the monument will endure for many years.



Excellence is timeless, so is beautiful design and smart technology. SELUX is celebrating 25 years of manufacturing in the U.S.A. as a design leader and innovator in the development of architectural lighting systems. Come visit us at **AIA Booth #10047**



LED COVE LIGHTING ILLUMINATES THE HISTORIC ARCHITECTURE OF BOSTON'S OLD NORTH CHURCH. Text Edward Keegan

TWO IF BY SEA



New LED cove fixtures in the arches over the second-floor galleries illuminate the space and showcase the architecture better than the old incandescent system did. The LED fixtures emit far more light per watt of energy, so the update did not require any rewiring of the existing electrical system.

A PIVOTAL MOMENT IN AMERICAN HISTORY was the ad hoc lighting signal that set into motion Paul Revere's famous midnight ride. Two lanterns were set in the steeple of Boston's Old North Church on an April evening in 1775 to alert the colonial silversmith that the British were heading toward Lexington and Concord by sea. By then, the church's steeple had already been a landmark on the city's skyline for five decades.

The church remains a functioning liturgical space for the North End neighborhood, and its historical legacy is overseen by the secular Old North Foundation. An extensive master plan is now being prepared by Boston-based Ann Beha Architects, but the most recent lighting overhaul is the result of another ad hoc effort that arose when a party planner contacted local lighting designer Lana Nathe of Light Insight for help illuminating the interior for a fundraiser last December.

The problem was pretty straightforward. The Old North Church's simple two-story worship space remains

much as it was during Revere's day, with second-floor galleries on two sides and a choir loft to the rear. The primary light fixtures from the colonial era—candlelit chandeliers hanging over the pews and wall-mounted candle sconces—remain in place. "You go back to 1723, that was the only illumination that was available," says Old North Foundation executive director Ed Pignone. The church's upper galleries have five barrel vaults on each side of the nave that distribute daylight from arched windows. The existing cornices at each vault had been retrofitted years ago with cove light fixtures that provided a minimal level of artificial illumination.

Nobody knows the exact age of the cove light fixtures, but their drawbacks were obvious. They used Lumiline incandescent lamps—which typically run hot, use lots of energy, provide little light in an unfortunate gold tone, and are increasingly difficult to replace as fewer companies continue to stock the bulbs. "They only had one lamp on in each cove, and [the coves are] 10 feet

NEW HANOVER® PLANKSTONE™

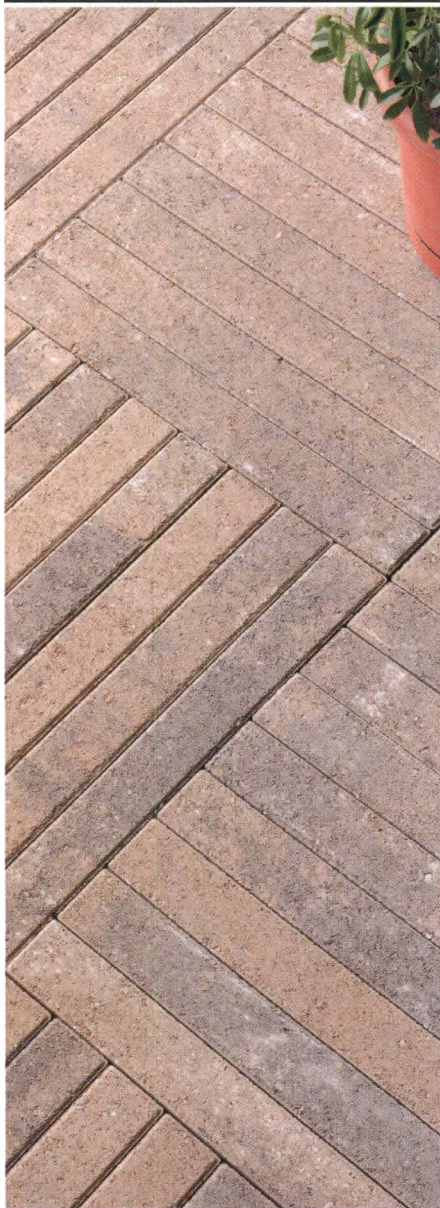

Hanover® PlankStone™ creates the look of traditional wood board decking.

HANOVER®
Architectural Products
www.hanoverpavers.com
800.426.4242

Lighting

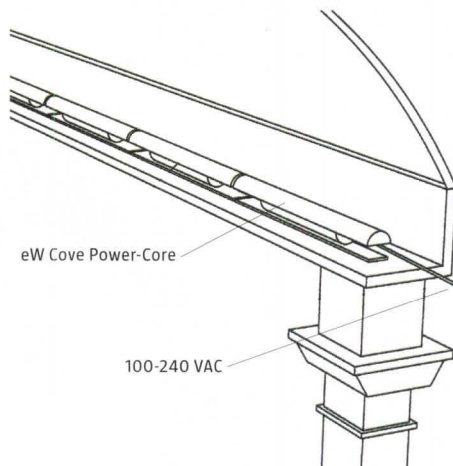

Philips Solid-State Lighting Solutions' eW Cove Powercore fixtures (top) were mounted at the base of each arch (above) and hidden from view by existing molding. By setting the fixtures 1 foot back from the wall, the lighting designer achieved an even and diffuse glow.

long," says Nathe. Since each 10-foot-long cove was being lit with a single 30-watt fixture, the result was an inadequate three watts per foot. "And there was no architectural definition at all," says Nathe.

Adding to the stress of the three-week timeframe for design and installation were the available resources. Nathe donated her design services to the project and was responsible for getting the fixtures for free as well. And the solution had to work with the existing knob-and-tube wiring system in the church. "There's no real juice coming to them," says Nathe. "I had no choice but to use LEDs."

Nathe specified eW Cove Powercore fixtures manufactured by Philips Solid-State Lighting Solutions, and the product was donated by Boston Light Source. Each linear fixture was installed atop the existing cornices. Settlement in the almost three-century-old building meant that not every cove was identical. The fixtures were chosen for their

ability to be individually adjusted in the field to accommodate the existing conditions. Installation was accomplished in three days and required a certain amount of gymnastic flexibility on the part of the team. Each back-to-back strip of lights on opposite sides of the columns facing the two-story nave had to be plugged into a single existing outlet. Thus the wiring had to be threaded over the top of the columns without pitching either the fixtures or installers into the pews below. Since no new wiring or controls could be added during the constrained schedule, the new fixtures had to work with the old dimmers as well.

Despite the daunting conditions, Nathe was able to enhance the perception of the building's architecture with a nuanced approach to lighting design. She held the fixtures back a foot or so from the inside corner of each vault. "If you fill in everything, your eye doesn't do anything," she says. "We didn't want to see a sharp line up against the wall." She specified a color temperature that's perceived differently from day to night. "During the day, it looks really crisp," she says. "At night, it warms up." The Philips fixtures accomplish this by alternating warm white and cool white lamps on each strip of the eW cove fixture. Despite the LED's increasing popularity, Nathe notes that it isn't always a perfect solution, but it was the best for this particularly difficult problem. "We saved energy, they have dimming capabilities, and there's no noise," she says.

The Old North Foundation's Ed Pignone is responsible for keeping the Old North Church's literal and metaphoric flames aglow. "This illumination is provided in an inconspicuous way," he says. While he will continue to burn the candles on the first floor of the church, he doesn't expect to replace the new LED lamps for at least a decade. By then, he may have to consider LEDs for the two lantern lights in the steeple. They were replaced with compact fluorescent fixtures just a few years ago.



Get out of the crowd, and into a job. At ArchitectJobsOnline.com.

To advance your career in commercial or landscape architecture or CAD design, you need to look where the jobs are: ArchitectJobsOnline.com. We're the official career site of *ARCHITECT* and *residential architect* magazines. Which means all our job listings are in your industry, from the highest concentration of architects available online. Unlike general job sites, we offer exclusive industry content that helps you research prospective employers, plus valuable career advice and nationwide salary comparisons. So visit ArchitectJobsOnline.com today. And leave the mass market job sites to those other characters.

ARCHITECTJOBS ONLINE

hanley wood



••• Job Listings • E-mail Alerts • Career Tools • Industry Intelligence •••

We've always done *spectacular*

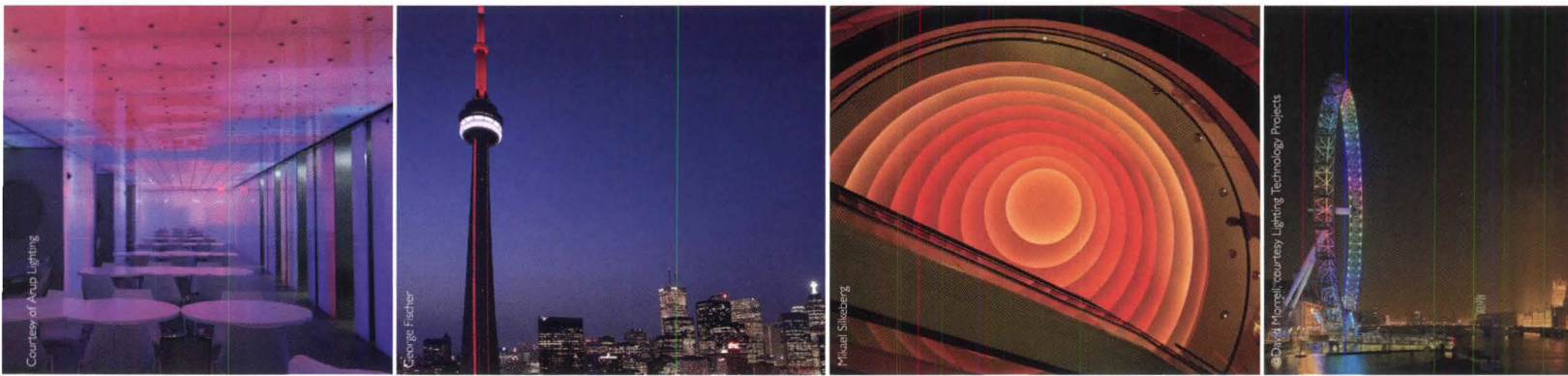

Now we do *simple*, too



PHILIPS

Our lighting transformations range from visual marvels to practical retrofits. No matter the application, Philips has the right LED lighting solution – whether to paint a city skyline with color or bring warm white accents to common interiors. We've taken LED lighting from extraordinary to extraordinarily simple.

www.colorkinetics.com

Circle no. 428 or <http://architect.hotims.com>

THE ULTIMATE GOAL OF GREEN BUILDING? HOW ABOUT AUTOMATION? Text Lance Hosey

AUTOMATIC ARCHITECTURE

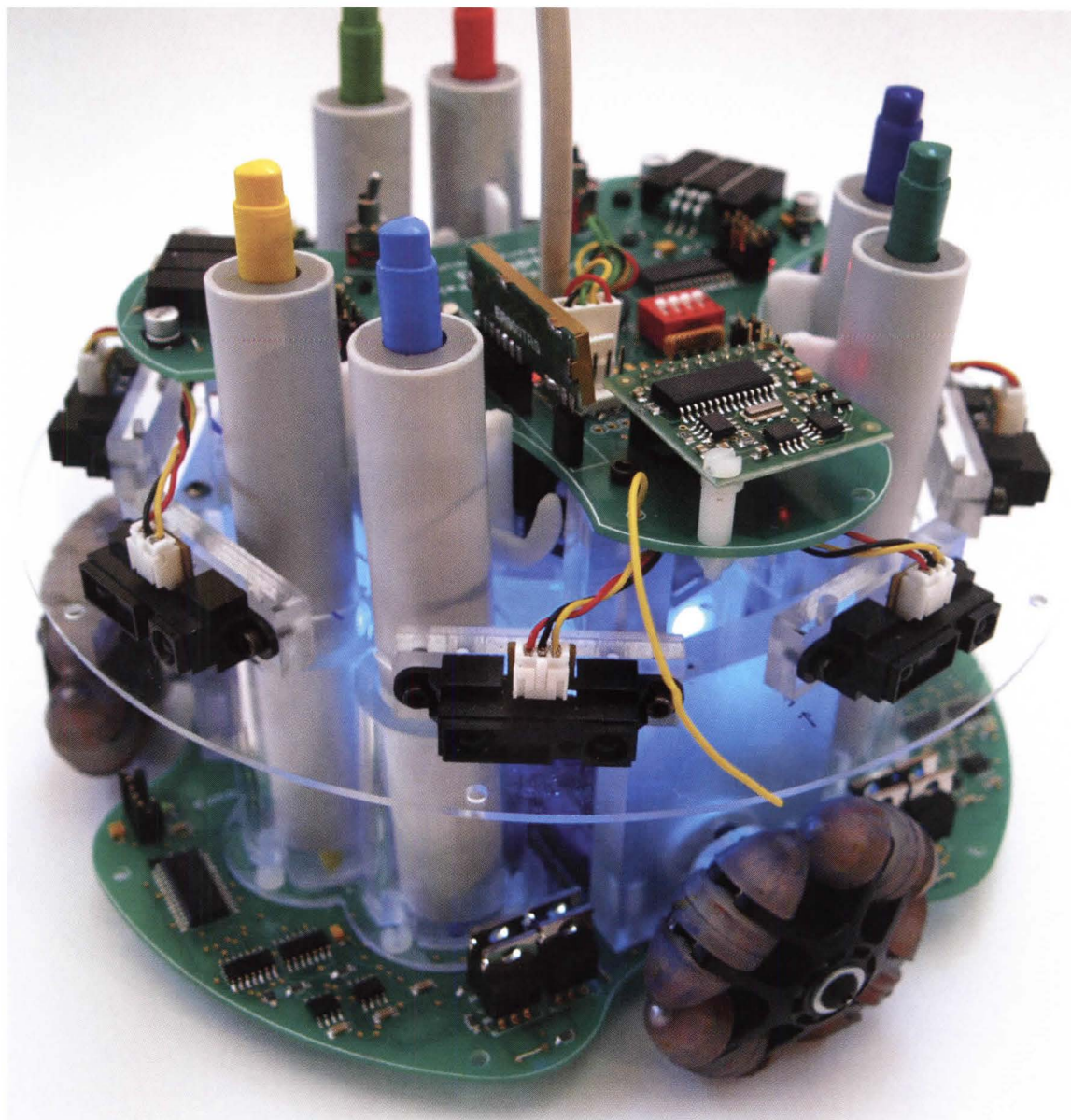

Who says robots can't be creative? Meet the RAP—Robotic Action Painter—invented by Portuguese artist Leonel Moura. Residing at the American Museum of Natural History in New York, the RAP makes original ink drawings, complete with a signature. Turn the page to see an example.

DESIGNERS LONG HAVE DREAMED of buildings that behave like living things. Frank Lloyd Wright defined “organic architecture” as “building the way nature builds.” In 1963, Archigram envisioned a “Living City”—community as organism. And now the Cascadia Green Building Council has issued a Living Building Challenge as the next stage of evolution toward “true sustainability.” The challenge: “Imagine a building designed and constructed to operate as elegantly and efficiently as a flower.”

But how does a flower grow? It might be time to shift the conversation from product to process. What if buildings could be created in the same way a cell develops into

a plant—from the bottom up instead of the top down? Technology may point the way. Automated processes are changing every aspect of design and construction, and it's only a matter of time before self-assembly completely takes over.

Already, automation has proven itself at the back end of production. Rapid prototyping and digital fabrication are liberating every design discipline at small scales. At larger scales, such as automobiles and airplanes, computerized production has lowered costs, saved time, increased quality and consistency, and significantly reduced waste and emissions. Applied to architecture, mechanical precision

Ecology

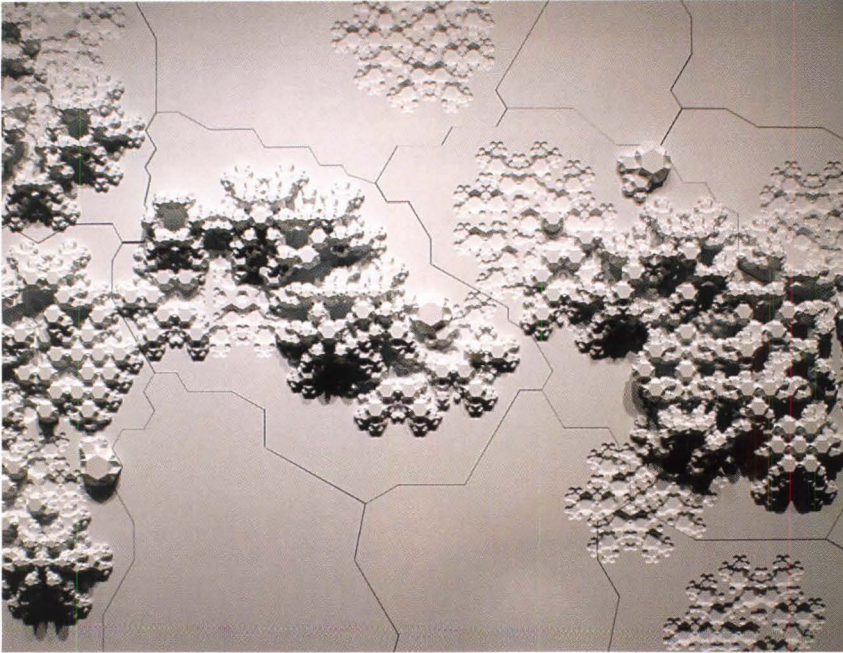

Automated algorithms drive *Rules of Six* (above and above right), a sculpture by New York-based architectural designers Benjamin Aranda and Chris Lasch that emulates the growth patterns of nanostructures.

One example of the RAP's art, at right, that is made by following statistical standards of composition and color.

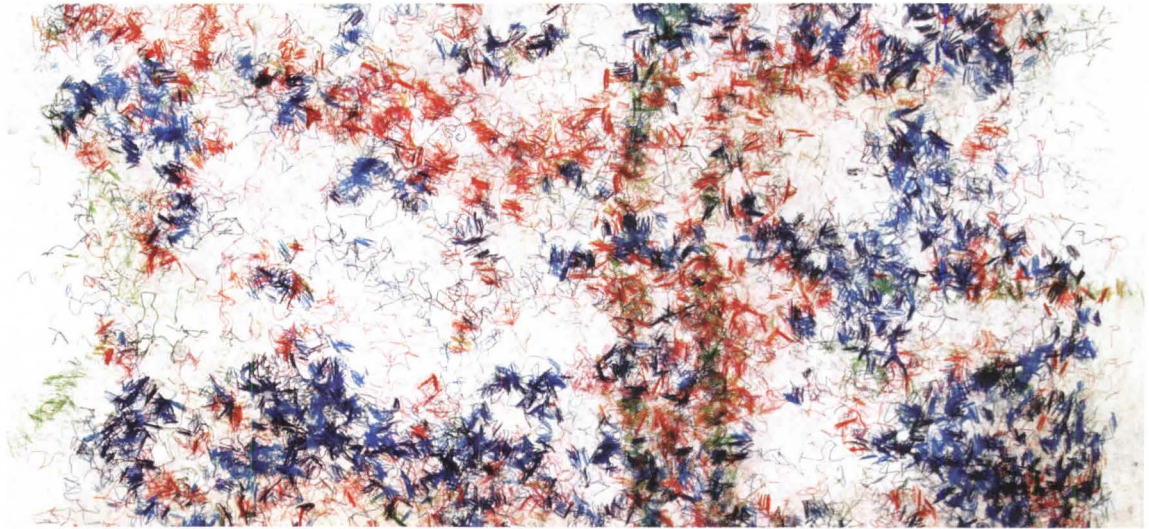

minimizes site disturbance and produces the most energy-efficient structures available. During an economic boom in the early '90s, Japan invested heavily in robotic construction technology and found it consistently cut construction time by a third and labor and waste by half. So why hasn't automation become more popular in the building trades worldwide?

"The only thing stopping architecture from picking up these techniques," says A. Scott Howe, an architect and senior systems engineer with NASA's Jet Propulsion Laboratory, "is the added time it takes to create standard interfaces and rule-based design grammars." He believes that eventually all the infrastructure for putting together a building will be absorbed by the building itself. "There will come a day," says Howe, "when no human labor is present on any construction site."

What Howe calls "rule-based design grammars" could transform the front end of the design process as well. Simulation techniques such as advanced thermal modeling

and computational fluid dynamics have improved environmental performance by simulating the heat, air, water, stress, and strain in and around buildings. Typically such tools are used to evaluate design, but soon they will become common methods for creating design. Parametric modeling software such as CATIA, Rhino, and Bentley's new GenerativeComponents product already have the ability to update geometry automatically according to preset variables. Users can establish clear performance criteria and optimization routines for a building's systems, structure, and envelope, then generate forms that are highly responsive to context, climate, and materials. Is it such a leap to think that this could happen without a designer's hand?

Portuguese artist Leonel Moura combines artificial intelligence and robotics to make "nonhuman art." At the American Museum of Natural History in New York, his Robotic Action Painter (RAP) follows statistical standards of composition and color to make original ink

BUILD IT COLORFULLY.

When the decision was made to locate the \$150 million Nationwide Arena in the historic warehouse district of Columbus, Ohio, the architects and owners naturally wanted the new facility to fit in with its turn-of-the-century neighbors. So they turned to the people of CEMEX. After scientific color analysis, a hue was chosen (Kentucky Ochre, to be precise) from the wide array of CEMEX's colored masonry cements to complement the specified red brick.

The result? Columbus now has an aesthetically pleasing arena anchoring a redeveloped, and thriving, urban area. And the NHL Blue Jackets have a home as colorful as the team itself.

We invite you to learn more about the consistent, long-lasting beauty of colored masonry cements and other unique CEMEX products at www.cemexusa.com.

Circle no. 94 or <http://architect.hotims.com>



"To accept robot creations as artistic expression means to deny humans the exclusiveness of creativity, and many people are not willing to do this." —Artist Leonel Moura

Construction At Warp Speed...

BELIEVE IT!

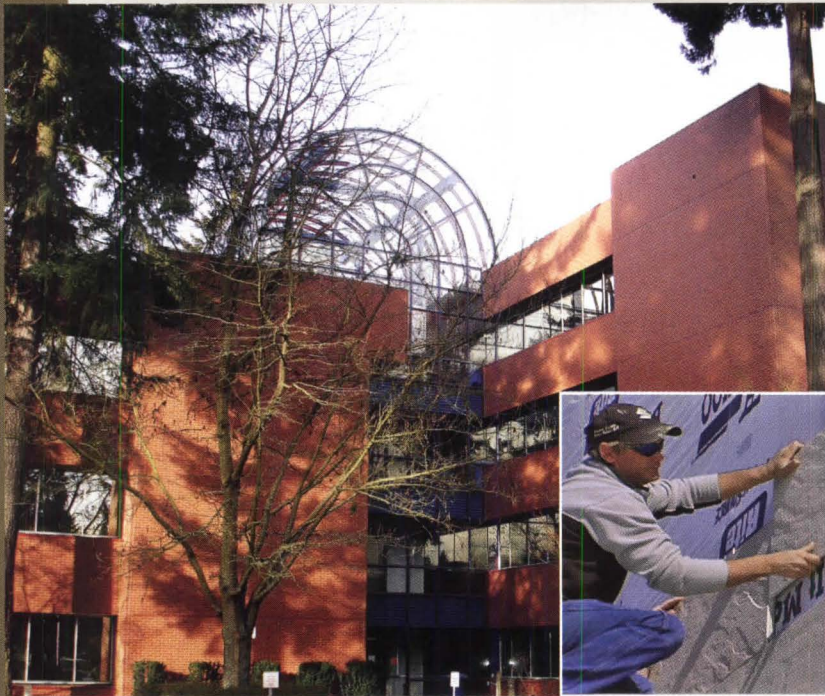

You are now free to build faster.

At Nichiha we allow our architects the opportunity to do just that: build faster to save money and create beautiful spaces. Our fiber cement panels install 9 sq. ft. at a time saving labor costs compared to similar masonry facades and our 50 year warranted panels are available in over 30 beautiful textures and colors. Nichiha fiber cement panels carry a 1 hour fire rating, protect against termite infestation, and will not crack, rot or delaminate.

Fiber Cement At Its Best™

1.866.424.4421

nichiha.com

©2008 Nichiha USA, Inc. All rights reserved.

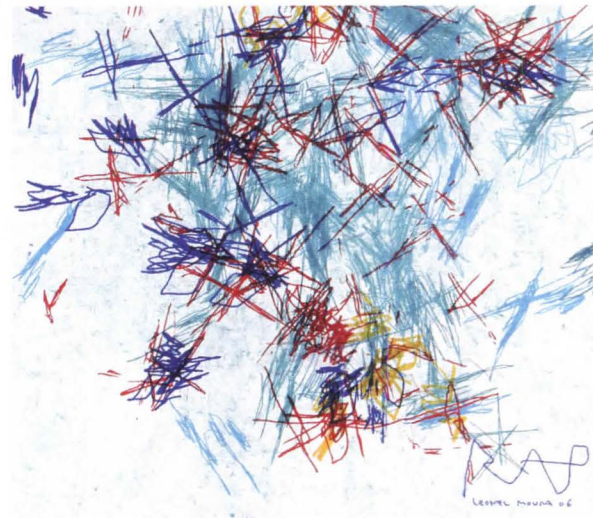

A signature completes Leonel Moura's RAP's "nonhuman art."

drawings, complete with a signature. Moura also has written algorithms to generate architectural forms by mimicking the emergent behavior of ant colonies.

The Brookline, Mass.-based team of designer-engineer Ira Spool and artist Anna Tsypin created an *Automated Architecture Robot* that can carve a unique 1:50 scale model out of a block of ice—a cybernetic igloo. The robot was shown in 2003 at ArtBots, an annual robot talent show. (This year's ArtBots takes place in Dublin, Ireland, Sept. 19–21; visit artbots.org.) Spool and Tsypin call automatic design "the ultimate direction of architectural advancement."

And the work of New York-based architectural designers Benjamin Aranda and Chris Lasch often uses algorithmic techniques to produce new geometries based on natural processes. At The Museum of Modern Art's "Design and the Elastic Mind" exhibit, which closes this month, their *Rules of Six* follows automated rules to emulate the growth patterns of nanostructures.

Moura feels the deterrent to automatic design is not technology but mindset. "To accept robot creations as artistic expression means to deny humans the exclusiveness of creativity, and many people are not willing to do this." Designers may balk at the thought of giving up creative license, but replacing the napkin sketch with an algorithm might be the key to "building the way nature builds," as Wright fantasized.

With its own kind of DNA, could architecture be grown instead of built? Already, sensors embedded in a building's structure can measure vibrations and trigger actuators to temper the material and avoid damage. This kind of smart feedback can inform the next generation of design, much like biological evolution. Computer programs have reproduced virtually every trait we associate with life. When design follows suit, the results could be good for buildings and the environment but put architects and builders out of their jobs—unless they, too, evolve. ☞

Lance Hosey is a director with William McDonough + Partners.

With CITY MULTI® systems an atmosphere of creativity flows freely.

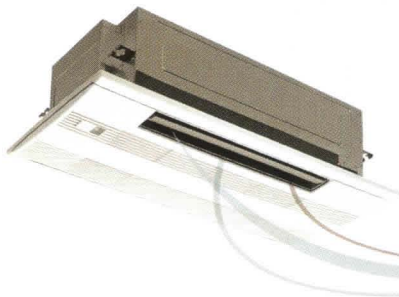

Now there are building comfort solutions that will inspire your imagination instead of limiting it.

CITY MULTI gives you ultimate design flexibility so you can push the building envelope, with options for maximizing interior space and ceiling heights without concerns of concealing bulky ductwork.

Get unparalleled comfort, control and cost effective use of energy. All with great sustainability.

CITY MULTI will transform the way you think about HVAC. Energize yourself at transforminghvac.com

Circle no. 458 or <http://architect.hotims.com>

 **MITSUBISHI ELECTRIC**
HVAC for HUMANS



CITY MULTI®

The transformation has begun.™





Discriminating tastes demand only the best. Robinson Rock is natural stone cut thin, available in a breathtaking selection of natural colors and textures. Why settle when you can have the real thing?

IF YOU SETTLE FOR ANYTHING LESS THAN THE REAL THING YOU ARE JUST SETTLING.

ROBINSON BRICK



A Division of General Shale Brick

800.477.9002 ■ RobinsonBrick.com

Circle no. 390 or <http://architect.hotims.com>



COOP HIMMELB(L)AU'S BMW WELT, A VAST ENERGY FIELD IN GLASS AND STEEL. Text Joseph Giovanni

THE WIDENING GYRE

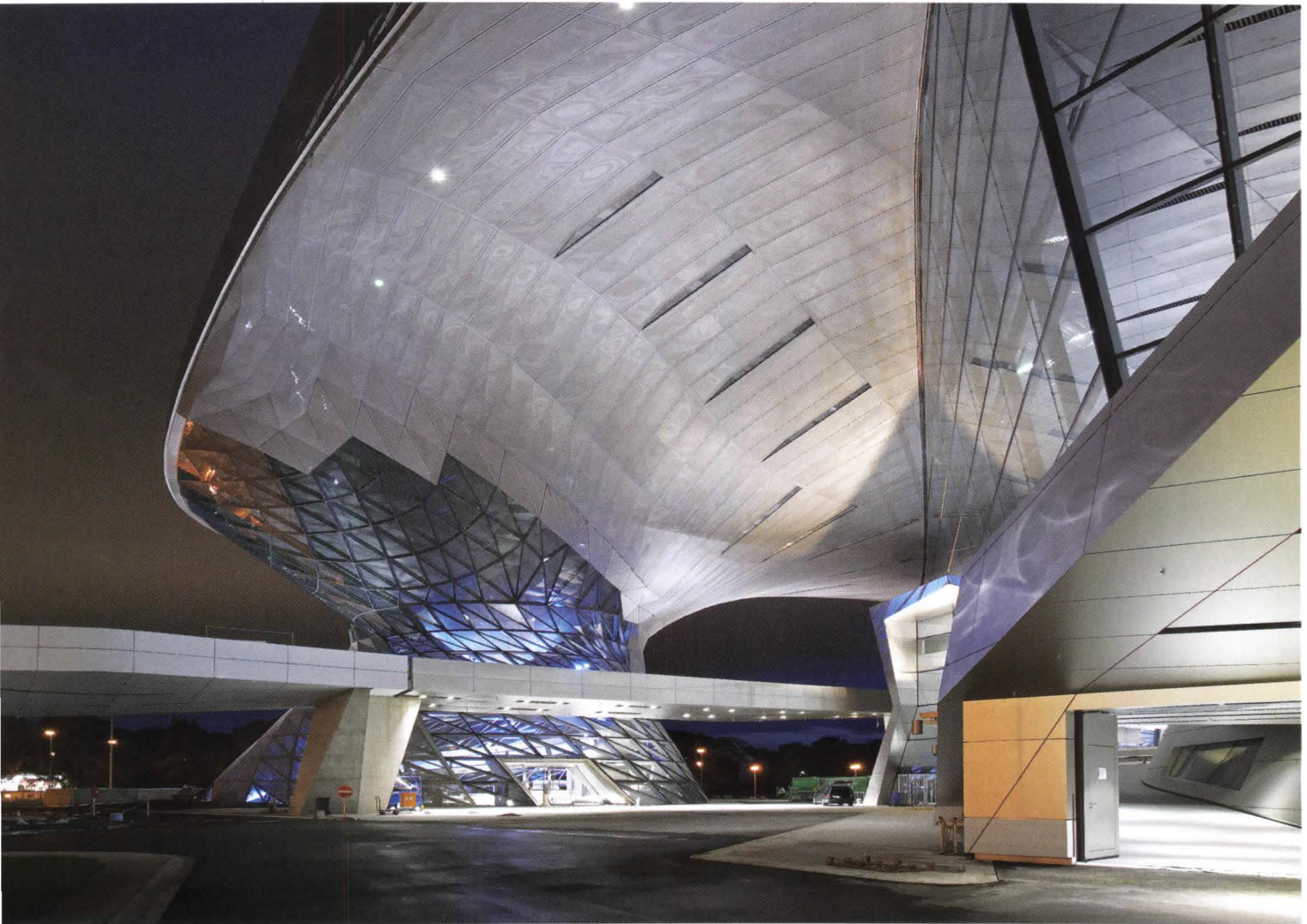

A whirling double-cone rises from the south end of BMW Welt, a car delivery center in Munich, Germany, that opened in October.

SOME ARCHITECTURAL LANGUAGES do not translate to a larger scale. The dominantly horizontal classical orders that suit temples do not work in skyscrapers; Buckminster Fuller's geodesic dome can be enlarged but not stacked into a larger, compound structure; the volumetric geometries of 1970s houses in the Hamptons, so successful at a domestic scale, never quite worked for large institutional buildings.

In 1985, Coop Himmelb(l)au invented a seemingly idiosyncratic language in the design of the tiny, 600-square-foot Baumann graphic arts studio in Vienna, Austria. Little more than an episodic mezzanine tripping through a double-height space, the elevated structure was supported on very thin columns and stabilized laterally in a cat's cradle of wires that effectively acted as a space frame. The architects had practiced for a decade without building a stick, but in this boutique project—their

first—they posited a thesis about open form, nonlinear logic, anti-Euclidean geometry, and thermodynamic space: "When you break something, energy comes out," said Wolf Prix, famously.

For Wolf Prix and his then partner, Helmut Swiczinsky, architecture was an energy field, and space was no longer planimetric but simultaneously 3-D. When the architects sketched a project, they collapsed plan, elevation, and section into a scribble that they then teased into a building. In the city of Freud, psychic energy burst forth on paper, released. The vision corresponded to a time when the counterculture of the 1960s was searching for soul in an age gone machinist, in a zeitgeist that was controlled, controlling, and pervasively corporate. Ironically, the soul of rebellion and psychic independence that they built into the tiny Baumann studio could only be engineered and realized because of the computer.

Since that fragile, elegant, and deeply original structure, the architects have produced many successes at an ever larger scale, including the recent Akron Museum of Art in Akron, Ohio, with its fractal geometries, and an earlier related crystalline structure, the UFA Cinema in Dresden, Germany. Only last fall, however, did the

has been applied at a large scale, with no diminution of intensity. In traditional Viennese buildings, the architect marks the corner with a tower topped with a cupola, and in Munich, the architects do the same, staking the building at the corner with a double-coned cyclone of wheeling glass and steel that spins off a roof,

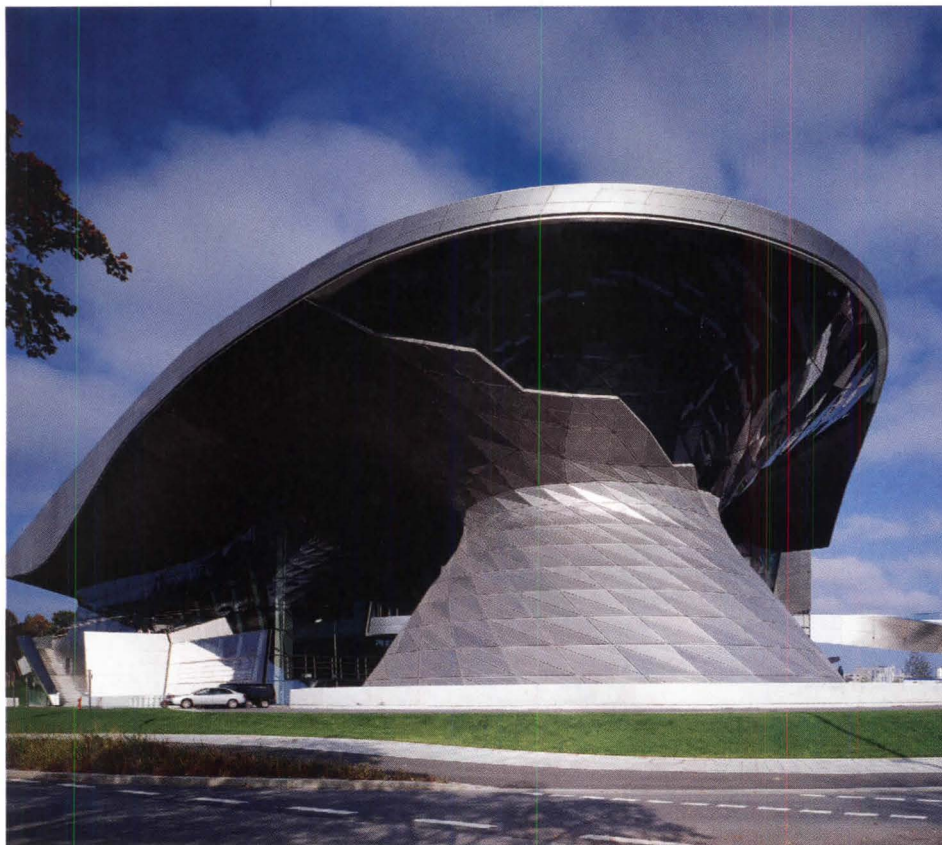

We have liftoff: The cyclone generates a levitating roof (above). With ramps down which cars progress to meet their new owners, BMW Welt's interior (above, right) is a formal exploration of motion.

architects realize a building at a monumental scale, the 750,000-square-foot, €100 million BMW Welt, in Munich, part of the large BMW campus, adjacent to Frei Otto's tensile structures from the Munich Olympics.

Unlike so many visions successful only at a small scale, the thesis Coop Himmelb(l)au posited in the Baumann studio has survived and even thrived in translation. The BMW project, a commission Coop Himmelb(l)au won in a 2001 competition, called for an architectural event at the corner of a high-speed intersection, and the program of a constant stream of new cars in and out even necessitated that the road continue into the building. The interior had to have an exterior scale. This was, after all, a wedding chapel, where in an arranged marriage, the groom meets the BMW bride circling down a ramp. The building, focused on the vehicle delivery area as though on an altar or stage, celebrates the union, after which car and driver peel off onto the Autobahn happily ever after.

Mr. Baumann has been replaced by a car, and the pedestrian world has ceded to a vehicular scenario, but the principles remain the same in an expanded form. Coop Himmelb(l)au has built a vast energy field in three dimensions: The concept from the Baumann studio



which wafts over the site like a cloud. The double cone is the generating point in the scheme, a vortex of steel with stretch lines diagramming forces across a field of distorted steel and glass. The lines radiate into and through the roofscape (they were more visible, and more satisfying, before cladding).

Coop Himmelb(l)au, which means Blue Sky Cooperative, was long fascinated with the idea of designing and building clouds—that is, notions of weightless, anti-gravitational structure—and they succeed here in spinning the vortex into a weightless roof hovering over a monumental loft of open space. The cloud is just that, nebulous, and does not correspond to the plan below. The building is not extruded up from the ground, but vaporizes its way up to the roof—in indeterminate form, as in the Baumann studio. Wolf Prix, principal in charge of design, cites Oscar Niemeyer for having liberated the roof from the ground plane in his own house outside Rio, and he references Le Corbusier's *Unite d'habitation* roofscapes: Prix inverts the precedent, so that the program and forms occur beneath the roof rather than above.

Only 11 inconspicuous columns support the roof. The complex roof structure, with irregular edges and

ambitious cantilevers, is structurally daring, but the technology is a means, not an end. The instrumentality of even the computer that made the complexity possible is not the meaning. No single concept, whether structure or computation, totalizes the vision into a unified whole. With a roof of solar panels, a water cooling system, and

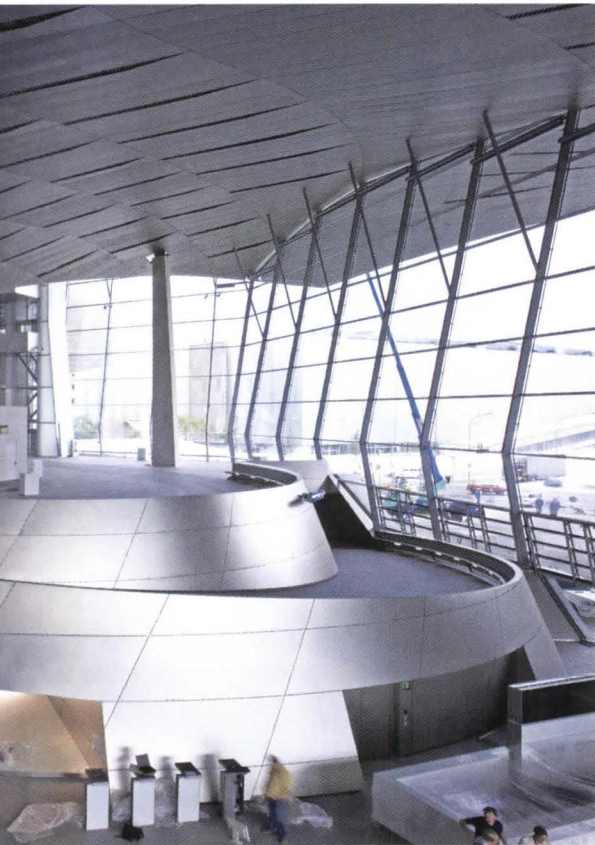

natural “chimney” ventilation through louvers and open windows, the building may be very green, but “green” itself is not the building’s architectural raison d’être.

The fluidity of the architects’ concept and design approach finds a formal equivalent in a program based on the car. The Le Corbusier–like landscape under the cloud is an arena of mixed use (restaurants, lounges, offices, parking deck), but as an amphitheater focused on cars, the fact and operative metaphor of the interior is motion—ramps, cars turning on lazy Susans, pedestrian catwalks. Prix, however, doesn’t just open the geometry book to the chapter on Euclid, creating circles of fixed radii, but streams the ramps and walkways in flows of forces that have exceptional geometric moments. The rail of a walkway overlooking the cars, for example, deflects to become a seating area, an eddy in the stream.

The notion of fluidity verging on a gaseous state dominates the impression of the building, but in fact the intriguing complexity and tension of the building derives from the double geometry. The computer, so instrumental in realizing the complexity of this project, allowed the architects to break the box and escape the right angle when necessary, but much of the building, starting with the extensive garages in the basement and continuing



Building outside the box

We’re building a company that thinks outside the box – providing added value to you and your clients.

Offering a comprehensive building system...

- Full line of ICF products
- AmDeck® Floor & Roof System
- Amvic Buck System
- Contribution to LEED Certification

...and full service & support:

- New Amvic Design Software (ADS)
- Technical, Installation and Architectural manuals
- Training & Continuing Education Seminars



Amvic + the power of added value



Call today for more information
1.877.470.9991
www.amvicsystem.com

Circle no. 394 or <http://architect.hotims.com>

Pine Hall Brick
earth friendly...naturally green

- Wide range of paver colors and styles.
- Exceeds all ASTM C902 requirements.
- Extremely durable - strong and colorfast.
- Size consistent and versatile often reversible.
- Clay pavers can contribute to design strategies for LEED certification.
- Sustainable product with low environmental impact from manufacturing.
- StormPave genuine clay permeable paver now available in English Edge® style.

P.O. Box 11044, Winston-Salem, NC 27116-1044 800.334.8689 www.americaspremierpaver.com

Circle no. 173 or <http://architect.hotims.com>

©GERALD ZUGMANN (LEFT); ©2007 ARI MARCOPOULOS/COOP HIMMELB(L)AU

Crit



The Baumann studio in Vienna, Wolf Prix's early, small-scale essay in non-linear logic

through administrative spaces and restaurants, is orthogonal. Even the trusses that make up the roof are substantially conventional.

The architects have spent fluidity where it makes most sense, which is the public space where cars and people mix. As a cathedral of the car, it achieves the goal of all cathedrals by using architectural daring and structural performance to suffuse the object of worship with a sense of wonder. Drivers newly married to their cars exit down the ramp onto the highway, in a state elevated by the wonder of a building. The virtuosity of

the architects with steel, glass, and the computer matches and even exceeds in its own right the performance of the car, and, therefore, serves as an appropriate symbol.

BMW Welt is a commercial success for the clients, but architecturally it ranks with Guggenheim Bilbao as a major architectural achievement. A professor of Wolf Prix happens to have built a BMW office tower just across the street, a modernist collection of canisters that is geometrically pure and abstract. Prix not only survived a strong teacher, but went on to build a structure that now

stands as a successor paradigm.

There are many achievements in Coop Himmelb(l)au's design for BMW, but among the most intriguing is that Prix has thrown the ball back from the objectivity of Modernism that his professor built across the street into the court of the individual. Even in a commission featuring a sexy car, he has shifted the focus of the building from the objective to a subjective world by cultivating experience through the senses of the visitor. In its spatial complexity, the design encourages promenades and offers multiple viewing points in a spatial field that is not just 360 degrees, but spherical, because of the Z dimension offered by a rich section. Elevators here are superfluous because the space itself incites the curiosity of wanting to know what happens around the next bend. Space and form are not controlling, but liberative.

What is gently subversive about the building is that the subject—that is, the sentient observer—becomes the object and subject of the building, not the car. After a century in which scientific objectivity was the goal in so many fields, including architecture, Prix and company have sited a design in perception and experience. Users own this building.

Joseph Giovannini is a New York-based architect and critic.

NEW ARCHITECTURAL EXPANDED METAL APPLICATIONS



- Recyclable
- Virtually no scrap
- Makes a stronger product
- Cost savings alternative to perforated
- Stretches the metal rather than punching holes
- Great for security uses such as window guards, gates and fencing

**GREEN
BUILDING
PRODUCTS!**

EMMA

Expanded Metal Manufacturers Association

www.emma-assoc.org or call NAAMM

630-942-6591

Circle no. 98 or <http://architect.hotims.com>

Don't Do It Half-Grassed

Grasspave²

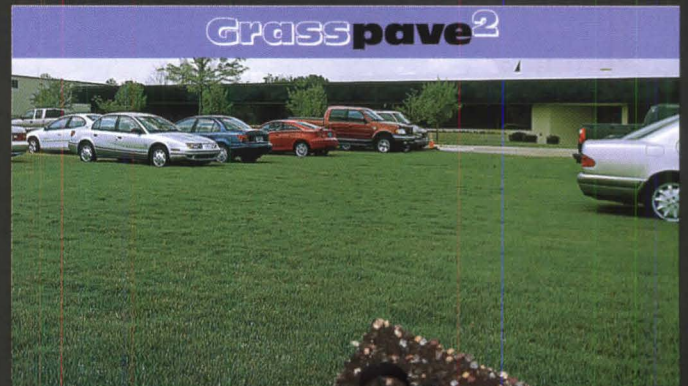

Environmentally Friendly
100% Grass Coverage
Strong - 5,721 psi
Beautiful
Cost Effective

800-233-1510
invisiblestructures.com

**Invisible
Structures, inc.**

Circle no. 100 or <http://architect.hotims.com>



Style Redefined

If you want performance with style from cast stone, Haddonstone redefines the standard. From balustrading, quoins, columns, porticos, door and window surrounds to custom architectural designs. *Haddonstone is sometimes surprising, always stylish.*

Acquire our 200 page catalog or a CD Rom with full technical information by registering on www.haddonstone.com or calling (719) 948-4554.

HADDONSTONE



Circle no. 59 or <http://architect.hotims.com>

HADDONSTONE (USA) LTD · 32207 UNITED AVENUE · PUEBLO · CO 81001 · (719) 948 4554 · info@haddonstone.com
COLORADO · NEW JERSEY · NORTHAMPTONSHIRE



American Series[®]

ARCHITECTURAL FLUSH DOORS

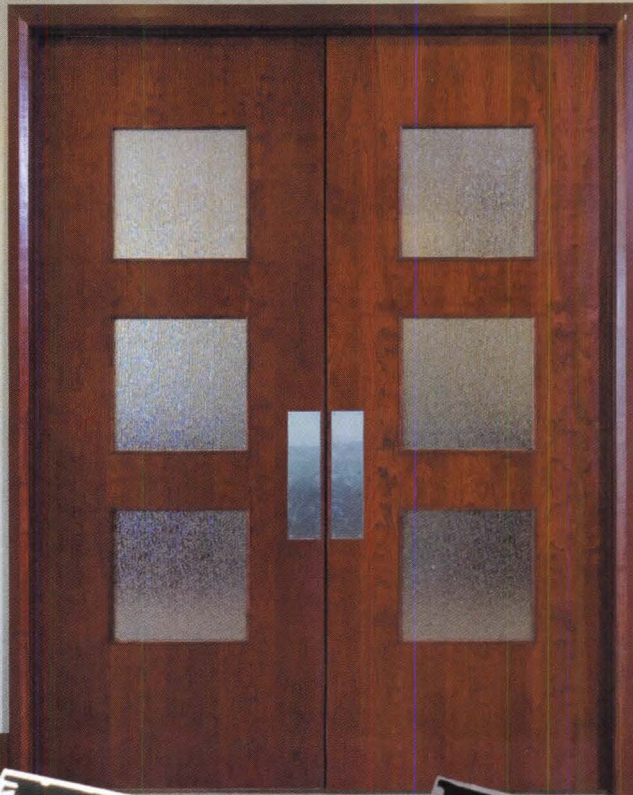

NEW!

INTERIOR ALUMINUM
DOOR FRAMES

WWW.DOORMERICA.COM

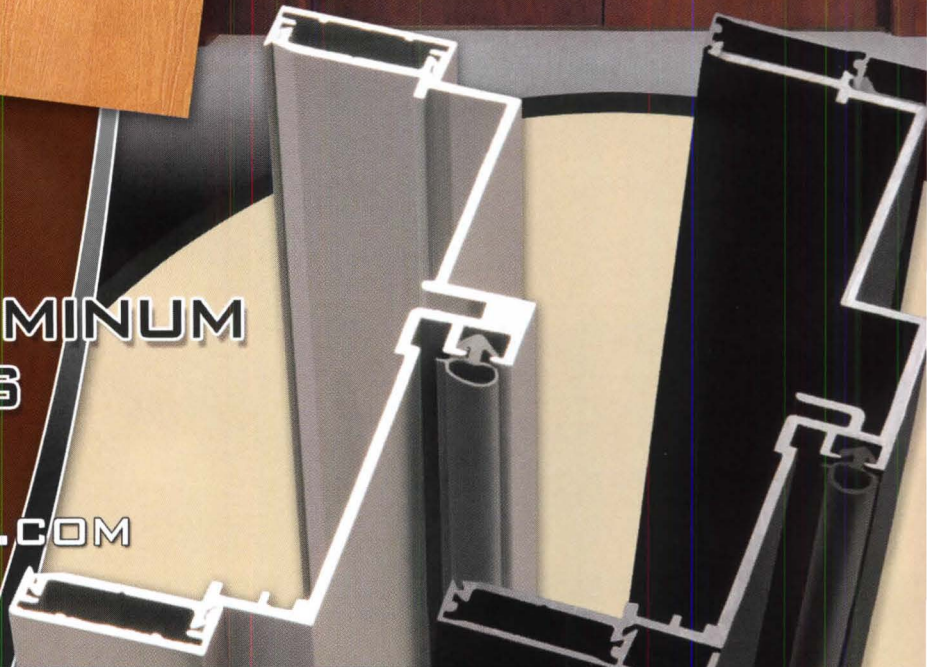

BLAINE BROWNELL SHARES FAVORITES FROM HIS NEW BOOK, *TRANSMATERIAL 2*.

Text Shelley Hutchins

EXCERPTS FROM THE TECHNO-BIBLE

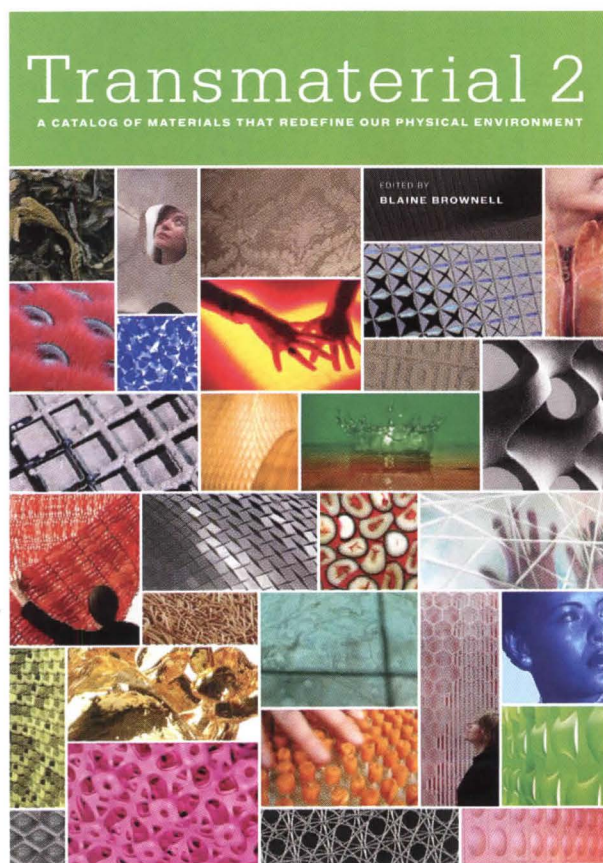

BLAINE BROWNELL has kept busy since appearing on the November/December 2006 cover of *ARCHITECT*, as “The Materials Man.” He’s writing a book about his discoveries in Japan as a Fulbright research fellow. He’s become a visiting architecture professor at the University of Michigan, where he just installed a wall constructed from plastic water bottles. And he’s produced a sequel to *Transmaterial*, his popular catalog of innovative architectural products and materials.

It seems like every product manufacturer has caught the green wave, developing new materials or remaking old ones in a sustainable way. For *Transmaterial 2*, Brownell sought out the best of this crop. Several items in the new book came to his attention during his time in East Asia, but his research uncovered materials from around the globe. “The impetus for this book was to have a range of materials from various countries and cultures,” he says.

Entries in the book are organized by a product’s materiality, in straightforward categories such as concrete, wood, glass, plastic, light, and digital. Brownell classifies each entry according to trends he has identified in the world of eco-technology, such as ultraperforming, intelligent, and repurposed. “Virgin resources are rapidly dwindling,” Brownell says, “so there’s a big push to rethink materials. It’s about conflating a number of trends together for a more proactive approach to environmental responsibility.”

Although passionate about every material in the book, Brownell shared a few favorites with *ARCHITECT*.

The companion volume to Blaine Brownell’s book *Transmaterial*, released in February, includes more than 200 new materials, most of which he gathered as part of his “product of the week” e-mails. Subscribe at transmaterial.net.



Kenaf-reinforced bioplastic,
page 103
nec.com

Developed by the NEC Corp. in Japan, this new composite material boasts a 90-percent biomass content made from the kenaf plant. Brownell says

the plant has several advantages as a biomass material: “Kenaf provides more rigidity to plastic so it can be used for things like cell phone or laptop casings, and they are working on car parts.” Other biomass plants, like corn, are controversial because of the embodied energy they require for growing, harvesting, and manufacturing, and arguments are being made against consuming a food source for other purposes. “Kenaf is an incredibly fast-growing plant that absorbs incredible amounts of CO₂ from the air,” says Brownell, “which means growing it is as beneficial as the product made from it.”



Air pollution-absorbing highway barrier system,
page 25
field-office.com

The Superabsorber from South Carolina-based fieldoffice is a prettier and healthier alternative to the miles of concrete barrier walls typically installed along

U.S. highways. Superabsorber walls mitigate the negative effects that highways have on their immediate environments by absorbing sound, light, and even air pollutants. What excites Brownell is how this material could make our built environment part of the solution to clean up our natural one. “We’re rethinking our basic ideas of architecture in terms of its role for the inhabitants and society and our environment,” he says. “There’s a significant line of thinking about nature not as this separate pure environment, but as a growing system. We can consciously intervene in more positive ways.”

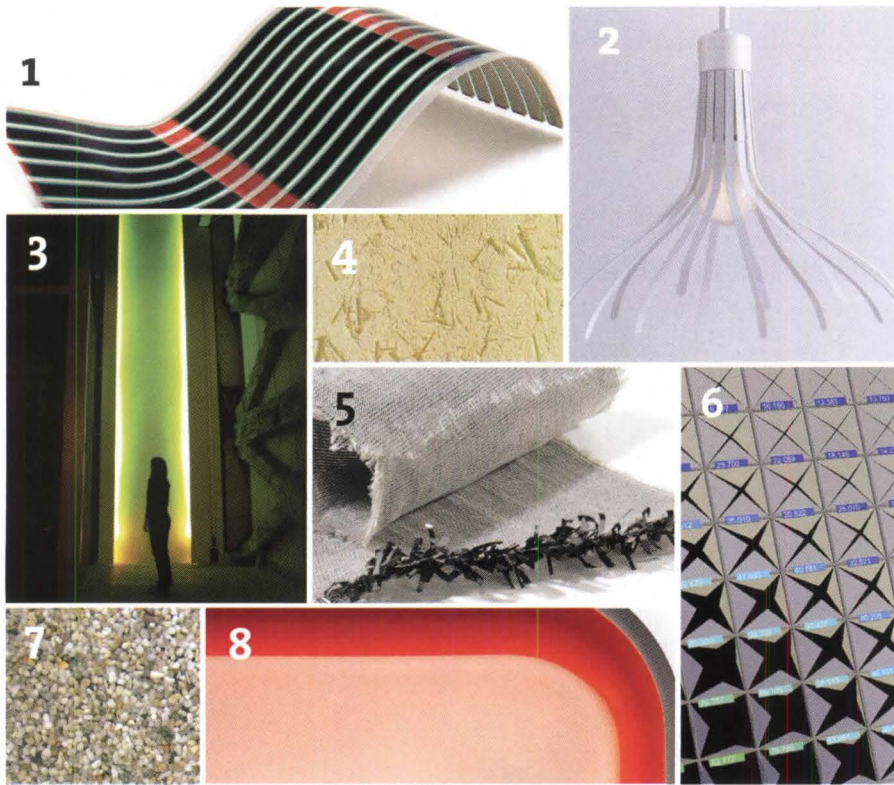

1. Energy-harnessing plastic film, page 111
konarka.com

“Power plastic has gotten a lot of attention lately,” says Brownell, “because it’s an energy harvesting film like photovoltaic, but an organic version that’s extremely lightweight and flexible.” The material is also made using a “low-cost, mass-produced process like ink-jet printing—basically printing solar technology onto a thin film.” It is so sensitive to light beyond just direct solar illumination that it can even be used inside with artificial light to generate energy.

2. Shape-changing light fixture, page 47
nendo.jp

Hanabi light fixture by Nendo Inc. changes its shape as the bulb heats up or cools off. The use of shape memory alloys as the lamp shade allows the fixture to bloom when the light is on or fade into the background when it’s off. The impact is more aesthetic than environmental, but Brownell says that these innovative products affect the way the industry will think about building materials. “I love bold forms in architecture, but now there can be a lot more meaning embedded in those forms.”



3. Light channeling systems, page 204–205
materialhouse.co.jp

Brownell really likes the work being done by Material House in Japan. “This is where my light interest originated,” he says. The company makes two systems that pipe light—either natural or artificial—throughout a building. Brownell describes the systems as being “like HVAC ducts, but clad with highly reflective mirrors made from aluminum.” The one shown here is Linelight, a linear illumination system using point-source lamps.

4. Air-cleaning paint you can eat, page 159
ydney.com

“Reben is not only not bad for the planet, but it uses organic materials that actually improve the air quality of a room,” says Brownell. He is intrigued by these materials that are good for the planet because of organic ingredients and low-energy manufacturing processes and because of their positive effects during use. This paint exemplifies that thanks to ingredients like *washi* (Japanese rice paper) that controls humidity, scallop shells that prevent bacterial growth, and titanium dioxide that deodorizes the air.

5. Fabric with embedded messages woven from cassette tape, page 186
designtex.com

Artist Alyce Santoro used discarded cassette tape to invent Sonic Fabric. Changes in the audio industry have left waste we never expected, says Brownell. “And people want to recycle and reuse things, but there aren’t tags that say what’s in it or how to do it.” In addition to being made from 49-percent recycled audio tape, the fabric can potentially be programmed with an embedded message. “Eventually, you will be able to rub a device across the surface of this material and the pre-encoded message will tell you what’s in it and how to reuse it.”

6. Nonmotorized façade system, page 53
orangevoid.org.uk

PixelSkino2 also uses shape memory alloys in a system that can enliven a façade with low-tech images or large graphics. The system employs transparent triangular panels that can be set in various stages from open to closed, with an overall effect of shadows and shapes across its surface. In addition to wrapping a building in a dynamic visual skin, the technology has potential to mediate light and privacy within

that building. “If this material can regulate light,” says Brownell, “then my hunch is that there are a lot more opportunities there.”

7. Luminescent gravel, page 34
hiddensafety.eu

“This product is a gravel floor system embedded with luminescent particles in a predetermined pattern like an arrow,” explains Brownell. The primary use is for low-maintenance, reliable, and self-powering evacuation guidance systems. “The particles become charged during regular use, and, if there’s a power outage, they remain lighted to show ways out without backup generators.”

8. Recycled macadamia-nut shells, page 68
husque.com

Once only found in Australia, the macadamia nut is now a popular snack that leaves a lot of waste behind in the form of shells. It makes sense that an Australian designer, Marc Harrison, would come up with a material made from recycled shells, which are milled into fine particles and mixed into a polymer. Husque “looks like a beautiful rich lacquer,” according to Brownell, and has myriad applications.

STRUCTURE

Birdair is built on a foundation of expertise. As the world's foremost experts on long-span tensile architecture, we provide design assistance, engineering, specification, fabrication, construction, even post-installation service as you may require it, to help you build whatever you have in mind. Circle no. 163 or <http://architect.hotims.com>

BIRDAIR
 birdair.com

SPAN



TOP OF THE CLASS ON IAQ. GREENGUARD CERTIFIED FOR CHILDREN & SCHOOLS.

The first fiber glass insulation to earn GREENGUARD certification is now certified for Children & Schools.

Continuing on the cutting edge of green building and IAQ issues, Knauf residential and commercial building insulation products have earned the new GREENGUARD Children & Schools™ certification. The GREENGUARD for Children & Schools standard, designed specifically to accommodate the unique health needs of children, sets the most stringent indoor air quality requirements for classroom and daycare facilities.

GREENGUARD's Certification standards are based on recognized IAQ criteria used by the U.S. EPA, OSHA, the State of Washington, the World Health Organization and the U.S. Green Buildings Council's LEED-CI program.

It's the ultimate certification for the ultimate name in quality—Knauf Insulation.

Circle no. 445 or <http://architect.hotims.com>



For more information call (800) 825-4434 ext. 8300

or visit us online www.KnaufInsulation.com

KNAUFINSULATION

NEIL DENARI'S MANHATTAN CONDO TOWER MAXIMIZES SQUARE FOOTAGE WITH ITS SCULPTURAL, STRUCTURALLY EXPRESSIVE FORM. Text Katie Gerfen

WHERE ART AND COMMERCE MEET

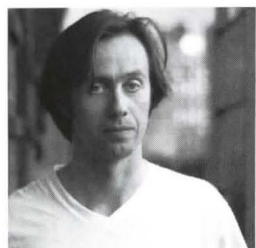
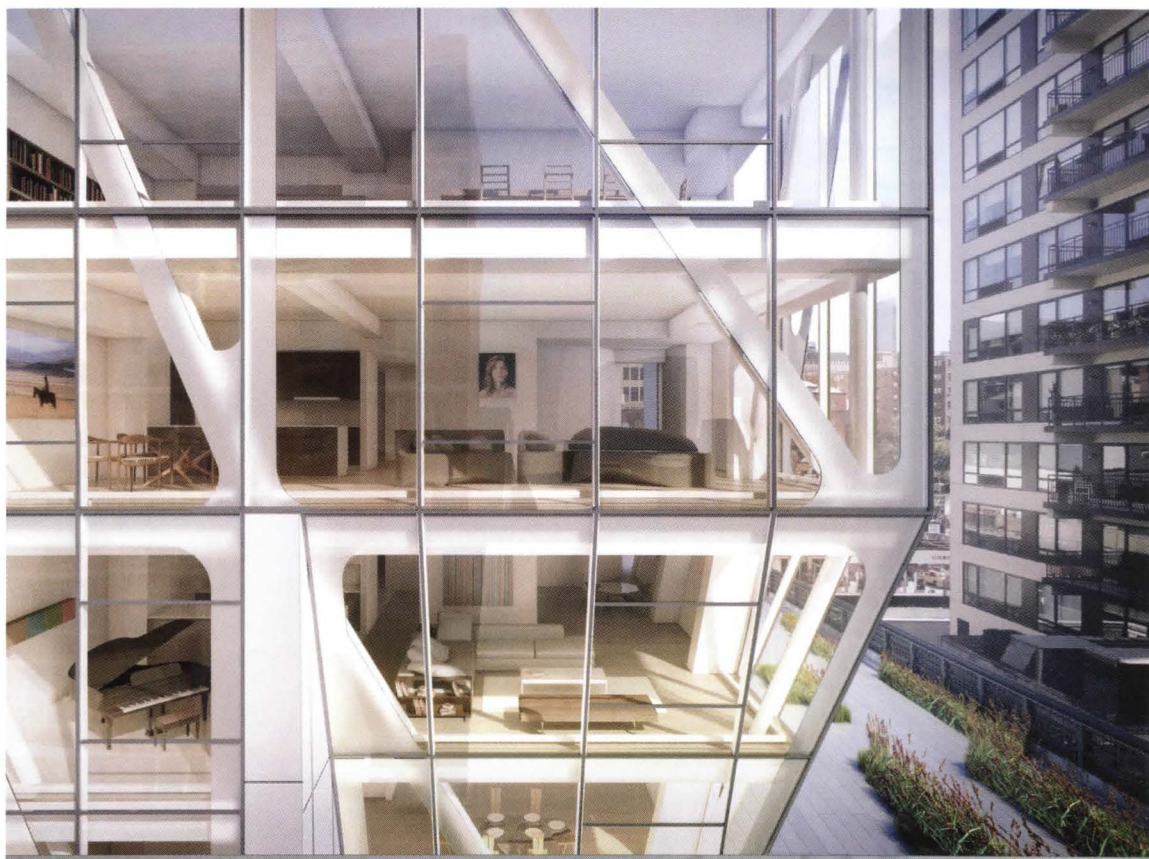

In a scheme by Neil Denari (above) for a residential tower in Manhattan's West Chelsea neighborhood, the building's form projects slightly over the adjacent High Line, an elevated rail line being converted into a public park (above right). The strategy obviously increases the building's square footage and was supported by the city planning department because of the strength of the design and because the High Line actually cuts into the site.

MANHATTAN'S LONG-NEGLECTED HIGH LINE has been the subject of much buzz in recent years, as plans for its transformation from elevated urban blight to picturesque urban park have gotten under way. It is fitting that one section of the elevated rail line runs through West Chelsea, a commercial gallery district, because what better found-art piece is there than a reclaimed fragment of early 20th century infrastructure? And nestled against the tracks, at the corner of 23rd Street and 10th Avenue, a new urban sculpture is inching higher.

Designed by Los Angeles-based Neil M. Denari Architects, the HL23 condominium building will stand at 14 stories once completed, with an articulated form that belies the traditional box buildings around it. It is situated on a potentially awkward 40-foot-by-99-foot site, with a height limit of 165 feet. In what principal Neil Denari refers to as one of the most intriguing aspects of the project for the design team, the High Line crosses 5 feet past the line of the street wall and into the site.

To maximize square footage for the developer clients Alf Naman and Garrett Heher, as well as to push the

design envelope, the design team concocted a reverse tapered structure, which widens once it rises past the train tracks. The east façade cantilevers out over the tracks; unified at the bottom and top floors, the façade splits into two side-by-side ribbons for the seven floors in between, one ribbon extending further out toward the High Line and the other inset closer to the building's core.

"The way the building responds and reacts generates a kind of vitality of form with the east façade," says Denari. "There's where we had to negotiate formally where the building would get wider as it was going up. That reverse tapering was the only way to make the building viable."

The top four floors of the building are most dramatically canted, with the top west and top east corners shifting slightly to the east to form a trapezoid. Motivated in part to preserve light and air for existing neighboring buildings, Denari describes these angles as an "imaginary diagonal skyplane" that would be the most direct point between the topmost and bottommost terrace, if he had stepped the building back in a



The apartment layouts change slightly with every unit because of the building's shifting floor plates. Interior architect Thomas Juul-Hansen focused on giving each space clean, high-end finishes, including stone slab counters and Miele appliances. His approach was to do the basic fixtures right the first time, so that buyers will not feel compelled to rip out a kitchen or bathroom and start afresh.

Redefine Daylighting.

Redefine Performance.

See for yourself as we unveil a whole new dimension in Tubular Daylighting Device performance. Visit us at www.redefinedaylighting.com and rethink what's possible with daylighting. Circle no. 171 or <http://architect.hotims.com>

AIA National Convention
May 15-17, Boston, MA
Booth #12039

LIGHTFAIR International
May 28-30, Las Vegas, NV
Booth #1369

SOLATUBE

BELDEN

THE BELDEN BRICK COMPANY

Canton, Ohio / (330) 456-0031

www.beldenbrick.com

An ISO 9001:2000 Registered
Quality Management System

Sizeable Advantages.

Lower In-Wall Costs / Reduced Labor and Material Costs / Faster Construction

Full Range of Patterns / Colors and Sizes / Energy Efficient / Enduring Beauty and Strength / Easy Upkeep

– Belden Brick meets the specifications for ASTM C 216-06; Types FBX, FBS & FBA; Grade SW –



**MODULAR
ECONOMO**
3⁵/₈ X 3⁵/₈ X 7⁵/₈



MONARCH
3⁵/₈ X 3⁵/₈ X 15⁵/₈

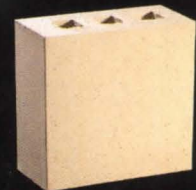

QUAD
3⁵/₈ X 7⁵/₈ X 7⁵/₈

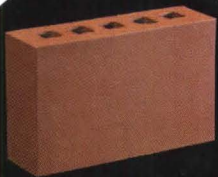

DOUBLE UTILITY
3⁵/₈ X 7⁵/₈ X 11⁵/₈



DOUBLE MONARCH
3⁵/₈ X 7⁵/₈ X 15⁵/₈

BIM

400 DATA-RICH BIM OBJECTS!



Developed by ARCAT BIM experts, so you can rely on them as you do for ARCAT specs and SpecWizards. These 3D CAD objects are packed with all the data you need, and are free of charge like all of ARCAT services! Soon to come are hundreds of manufacturer specific BIM objects developed by ARCAT.

ARCAT[®]

www.arcat.com



Hanley Wood is pleased to be an American Institute of Architects Continuing Education Service Provider (AIA CES).

For a complete list of available courses, course details and access to the FREE online exam, go to:

ARCHITECT

CONTINUING EDUCATION

www.architectmagazine.com

- Select "Resources"
- Select "Continuing Education Center"

residential architect

CONTINUING EDUCATION

www.ResidentialArchitect.com

- Select "Continuing Education"



CONTINUING EDUCATION

www.ArchLighting.com

- Select "Industry"
- Select "Continuing Education Center"

ARCHITECTCES

www.architectces.com

HANLEY WOOD UNIVERSITY

OFFERS FREE CONTINUING EDUCATION COURSES

Meet AIA Requirements Online, Anytime!

Welcome to Hanley Wood University, our continuing education program.

This free program—both in print and online—has been developed to help architects meet the AIA's annual 18-credit continuing education requirements. Throughout the year, participating magazines will provide full course materials either online or in print. These materials can be accessed by either visiting the individual magazine's web sites and following the links (see sidebar for information), or by visiting the centralized portal at www.architectces.com.

Hanley Wood University is a turnkey program designed for architects to gain access to the information they need, at their convenience, whether at home or in the office.

Many companies who market products to architects have developed AIA-registered courses within a broad array of subject areas. Whether in print or online, architects can use these sponsored course materials and online postings to gain the background necessary to successfully complete the AIA exam, which can be taken online.

Look for more AIA-registered course materials throughout the year. Current course materials can be found online from the following companies. For more information, contact Jennifer Pearce at jpearce@hanleywood.com or 202.736.3447.





LAFARGE PRESENTS: UNDERSTANDING SUPPLEMENTARY CEMENTITIOUS MATERIALS AND THEIR BENEFITS

LEARNING OBJECTIVES

The learner will:

- Be able to identify slag cement, fly ash, and silica fume as beneficial SCMs
- Understand the plastic and hardened qualities that SCMs impart to concrete, and how they contribute to increased durability and life cycle extension
- Recognize how using SCMs contributes to LEED Certification



Number of AIA
Credits Earned: 1.0

NOTE: This continuing education program is AIA-registered and helps meet annual continuing education requirements for members.

For Full Course Materials And
FREE Online Exam, Go To:
www.architectmagazine.com

- Select "Resources"
- Select "Continuing Education Center". Download full course PDF and take the FREE AIA certified exam online.

ARCHITECT
CONTINUING EDUCATION



SCMs represent a class of materials that can help designers and builders recycle industrial by-products, achieve higher performance from concrete mixtures, and help maintain our environment in a sustainable manner for the long-term.

SCMs are key components that when carefully selected and proportioned in combination with portland or blended cements, coarse and fine aggregates, and chemical admixtures, result in stronger, more durable, high-performance concretes. The use of SCMs contributes to the properties of the concrete in both its plastic and hardened states through hydraulic and/or pozzolanic activity.

SCMS INCLUDE:

- **Slag Cement:** Slag cement, also referred to as Ground Granulated Blast-Furnace Slag (GGBFS), is a reclaimed, recyclable industrial by-product of the iron-making process and can replace up to 80% of the portland cement used in concrete, depending upon the application.
- **Fly Ash:** Fly ash, termed a coal combustion by-product (CCB), is the residue created by the burning of pulverized coal in power plants and other industrial facilities.
- **Silica Fume:** Silica fume is the ultra-fine, non-crystalline silica produced in electric arc furnaces as a by-product of silica metals and ferrosilicon alloys.

PORTLAND AND SCM BLENDED CEMENTS

Cement mixtures containing ordinary portland cement and at least one SCM are termed blended cements.

- Binary cements contain portland cement and one SCM
- Ternary cements contain portland cement and two SCMs
- Quaternary cements contain portland cement and three SCMs.

BENEFITS TO CONCRETE IN THE PLASTIC STATE

Understanding the benefits SCMs impart to concrete in its plastic state is crucial to mixing, transporting, placing, and finishing the concrete containing these materials. When SCMs are specified in a concrete mixture design, it is vital that the specifier understands and compensates for the individual and collective effects of these materials, such as:

- Workability
- Air Content
- Bleeding
- Setting Time

BENEFITS TO CONCRETE IN THE HARDENED STATE

Perhaps the greatest physical benefits imparted by SCMs can be seen in the properties concrete exhibits after hardening. These effects vary depending upon the variability in composition of the SCMs employed, but relative effects include:

- Strength and rate of strength gain
- SCMs effects on permeability
- Corrosion, ASR protection and resistance to sulfate attack
- Color

BUILDING "GREEN" WITH LEED

- Concretes using SCMs contribute to LEED (Leadership in Energy and Environmental Design Initiative) credits in 5 categories: Sustainable Sites, Energy and Atmosphere, Materials and Resources, Indoor Environmental Quality and Innovation in Design

CONCLUSION

While the physical and performance benefits of Supplementary Cementitious Materials to plastic and hardened concrete are numerous, their effect on "green" construction practices continues to increase. SCMs represent a class of materials that can help designers and builders recycle industrial by-products, achieve higher performance from concrete mixtures, and help sustain our environment. While the proper use of these materials can be complex, the results achieved can provide higher-performance concrete mixtures and solutions to the increasing demands on our environment.

For full course materials and
to access the FREE exam go to
www.architectmagazine.com
and follow the links.



Before



After



JELD-WEN® windows and doors will look just as great tomorrow as they do today.

That's because each one is built to last. We prove this with features like our 20-year warranty for products built with solid pine AuraLast® wood, which protects against wood decay, water absorption and termites. To learn more call 1.800.877.9482, ext. 1409, or visit www.jeld-wen.com/1409.

Circle no. 408 or <http://architect.hotims.com>



RELIABILITY *for real life*®

JELD-WEN
WINDOWS & DOORS

ARCHITECT

JELD-WEN®

WINDOWS & DOORS

JELD-WEN WINDOWS & DOORS PRESENTS

GREEN BUILDING: AN INTEGRATED APPROACH TO CONSTRUCTION

By Rob Worthington



Specifying the proper window is no less critical than installing it properly. Architects should be familiar with proper installation methods and installation problems in order to aid them in the selection process.



ARCHITECT MAGAZINE CONTINUING EDUCATION

This course requires supplemental online reading in addition to the following article. For details on accessing the supplemental reading and to learn how to take the test, please see page 95.

PHILOSOPHY OF GREEN BUILDING

Building “green” is an industry direction. Originally focused on commercial buildings, the trend is increasingly expanding into residential projects. Green building takes into account materials used, design methods and construction techniques, and the impact a building will have on the environment. Site orientation, indoor health and air quality, waste removal and reduction, use of recycled or sustainable materials, landscaping, and more are all considered in the planning, design, and execution of a green project. The green-built philosophy is one that considers renewability, energy and resource efficiency, life-cycle assessment, and environmental impact.

Between 1997 and 2007, the number of US cities with green building programs grew from just a handful to more than 90; that number is expected to reach

120 by the end of 2008. In 2007, spending on sustainable construction reached \$1200 billion — up 2200% from \$53 billion in 1995. Architects and builders are not the only ones aware of the importance of green building principles — 88% of builders working on sustainably designed projects said that they were being pushed to do so by consumers who were seeking more efficient, healthier homes.

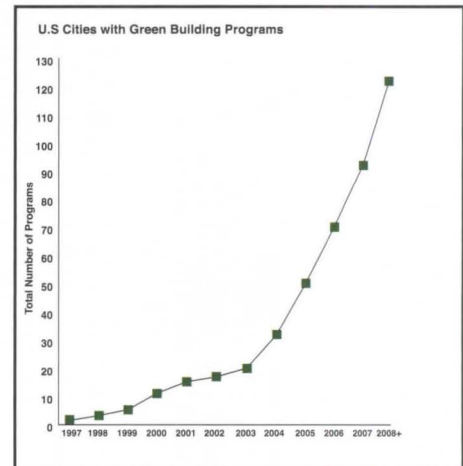

Between 1997 and 2007, the number of U.S. cities with green building programs grew to over 90 and is expected to reach 120 by the end of 2008.

Source: American Institute of Architects

Why build green? Green buildings are, by their own nature, good design. A green building is designed to provide a healthy and comfortable, cost-effective, and visually pleasing environment. The term “green” is

LEARNING OBJECTIVES

The learner will:

- Outline the importance of green building design and sustainability in product choices.
- Identify and outline examples of each of the five pillars of sustainable construction.
- Compare primary types of window and door framing materials and identify how they can help with green building certification.

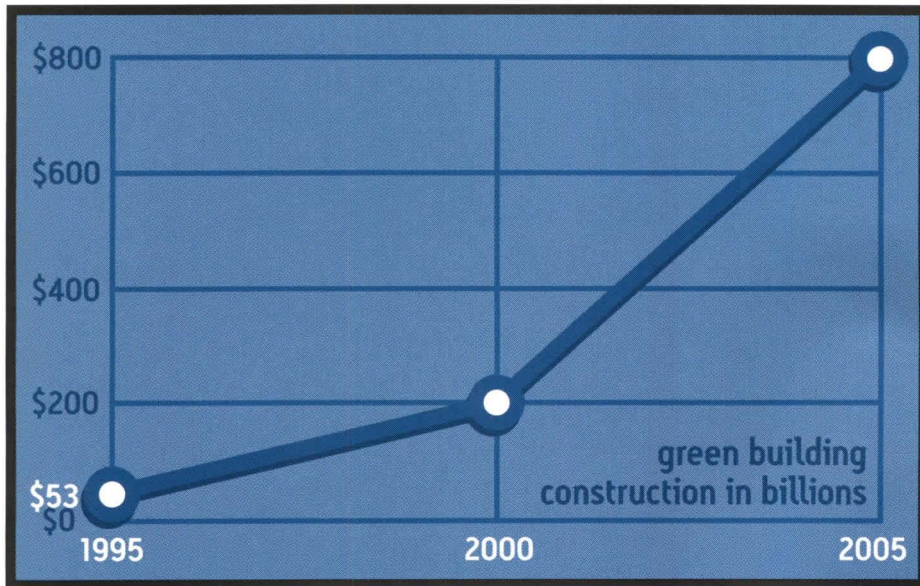

Between 1995 and 2000, spending on sustainable construction increased by only \$150 billion. Since 2005, spending on sustainable construction has grown to over \$1,200 billion in 2007.

Source: organicARCHITECT

often interchanged with “high-performance” or “healthy” because of the ability of the building to reduce its dependence on natural resources while providing a durable and healthy environment. Ninety percent of what makes a project green is the first 10% — the design.

The term “sustainability” is getting its fair share of attention today. It is defined by the National Council for Interior Design Qualification (NCIDQ) as “a use of materials that is capable of being continued with minimal long-term effect on the environment.” Sustainable construction requires a combined effort between the architect, builder and owner that can result in the greatest performance of a design’s potential. The green-built philosophy is a set of guiding principles that assist in the design and construction of sustainable buildings and communities.

THE FIVE PILLARS

(credit: Peter Pfeiffer, Barley & Pfeiffer Architects, Austin, TX)

There are five guidelines or pillars that direct the intent of green building: energy efficiency, materials use, water conservation, indoor environmental

quality, and durability. Each pillar helps guide the green building process to help produce an environmentally responsible building.

1. INCREASING ENERGY EFFICIENCY

Buildings consume 48% of all energy in the United States (76% of all electricity) and are responsible for almost half of all greenhouse gas emissions. Homes are responsible for more than one-fifth of all energy consumed annually in the United States. Green building guidelines aim to incorporate energy efficiency into building plans, to reduce the burden of homes on the environment. Improving energy efficiency, by definition, is to provide the same energy output while reducing the amount of energy, resources, and materials used.

By increasing energy efficiency, building owners and homeowners save on utility costs. Programs such as ENERGY STAR help consumers identify energy efficient products. The ENERGY STAR program helped American families save enough energy in 2006 to shave \$14 billion from their utility bills.

Sustainably built homes often include

improved insulation, radiant barrier sheathing, improved duct sealing, efficient HVAC units, and advanced window glazing, which all help improve thermal efficiency and effectiveness. When considering energy efficiency, it is necessary to consider which materials or products you use or specify. That is why the second pillar of green building is Appropriate Materials Use.

90% of what makes a project green is the first 10%, the design.

2. APPROPRIATE MATERIALS USE

Products do not qualify for green-building certification. Rather, they help contribute points towards building certification. For example, windows and doors can earn points for energy efficiency if they are ENERGY STAR certified. Products that have low volatile organic compound (VOC) emissions may contribute towards indoor air quality. Recycled products can contribute towards the materials and resources category.



GREEN BUILDING: AN INTEGRATED APPROACH TO CONSTRUCTION

Materials that are recycled, reused, renewable, locally produced, or third-party certified are preferred. Common examples of these include composite decking (recycled plastic and wood fiber), engineered lumber, and certified wood products. Certified wood products are those which have a third-party chain of custody certification from a sustainable forestry organization such as SFI, FSC, or SCS.

3. WATER CONSERVATION

Even though 70% of the Earth's surface is water, it is still a finite resource; only about 1% of water is available for human use. Further, according to the U.S. Environmental Protection Agency, at least 36 states in the United States are predicting water shortages by 2013. We need to take advantage of current technologies that allow us to consume water more efficiently.

To help reduce consumption and conserve water, we can utilize on-demand tankless water heaters, waterless urinals, low-flow plumbing fixtures, foot-peddle faucets, and region-appropriate landscaping with drought resistant plants, among other strategies. Not only do such measures reduce the risk

of water shortages, they also reduce the amount of energy required to supply water to American homes. Running a faucet for five minutes uses about as much energy as a 60 watt light bulb that is on for 14 hours. The U.S. EPA has developed WaterSense, a program similar to ENERGY STAR that will help consumers become aware of the importance of water conservation as well as help them identify efficient products.

4. INDOOR ENVIRONMENTAL QUALITY

As we are spending more time indoors than ever before, we need to be aware of the quality of the air we breathe indoors, as well as out. VOC content is up to 10 times more concentrated indoors than out. VOCs can cause health issues such as upper respiratory and sinus problems, eye and skin irritations and asthma. Asthma rates among children have more than doubled between 1980 and 2001. This may be a result of deteriorating indoor air quality.

Green building guidelines incorporate the use of building materials that help reduce off-gassing of VOCs during manufacturing and application. VOCs are commonly found

In 2007, for the first time ever, industry estimates revealed that over 50% of all new projects designed and constructed contained at least some element of sustainability.

in paints, stains, carpeting, sealants, cleaners, adhesives, and caulks. HVAC equipment can help reduce VOC content indoors.

Indoor environmental quality is not just about the air we breathe. Studies have shown that people are healthier and more productive under natural light than artificial light. Daylighting is a simple way to improve indoor environmental health and is an important component of green building.

5. DURABILITY

Products or processes that will not require significant remanufacturing or reharvesting of materials should be incorporated into green building designs. Life-Cycle Assessments (LCAs) are used to analyze a product's environmental impact throughout its cradle-to-grave life span. LCAs include materials used, energy consumed, environmental impact at various stages of its manufacture, usage, and disposal.

Sustainable designs should incorporate durable, environmentally friendly products and processes. Specification of products that are resistant to rot, water absorption, and termite damage is one way to incorporate sustainability into project designs. Products that outlast their application and can be recycled or reused are considered preferable in green built projects.

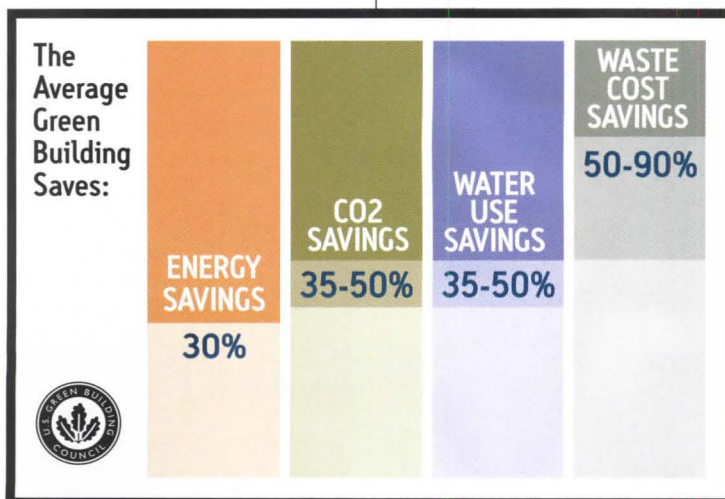

Green building is an integrated approach that requires cooperation of the owner, builder and architect to achieve the maximum potential of a building's design.

Source: United States Green Building Council

TO ACCESS SUPPLEMENTAL READING: Go to www.architectmagazine.com and select "Resources" then select "Continuing Education Center." There you can download PDF files of this course and the required supplemental information.

TAKE THE TEST ONLINE FOR FREE: New users must create a new account. Returning users may log in. After logging in, click on "My Courses." Then select this course title to launch your test. A score of 80% or higher earns 1 AIA/CES HSW LU credit hour. Valid for credit through May 2010.

TEST QUESTIONS

1. Sustainability can be defined as:
 - a. The use of "green certified" products that will have minimal environmental impact
 - b. The use of "high performance" materials that will provide a healthy environment
 - c. The use of materials capable of being continued with minimal long-term environmental impact
 - d. A set of guiding principles that assist in the design and construction of green buildings
2. Which of the following is not one of the five pillars of green building?
 - a. Water conservation
 - b. Appropriate materials use
 - c. Indoor environmental quality
 - d. Rapidly completed
 - e. Durability
3. The U.S. Government has developed programs such as _____ and _____ to help consumers identify eco-friendly products.
 - a. The Environmental Protection Agency and the National Council for Interior Design Qualification
 - b. ENERGY STAR and WaterSense
 - c. LEED and the USGBC
 - d. Life-cycle assessments and product labeling
4. Aluminum is commonly used as a window framing material in commercial projects because of its _____.
 - a. ability to conduct heat
 - b. strength and durability
 - c. ability to let heat transfer between the interior and exterior
 - d. all of the above
5. On average, a window's frame accounts for _____ of the total window area.
 - a. one quarter
 - b. one fifth
 - c. one eighth
 - d. one third
6. Vinyl frames are durable and resistant to rot and decay, but in large sizes may require _____.
 - a. lots of maintenance
 - b. special coating for exterior use
 - c. metal reinforcement
 - d. extra insulation
7. Wood window frames are the most common frames in residential projects because wood _____.
 - a. has a high insulation value
 - b. is renewable and has virtually unlimited finishing options
 - c. is generally not vulnerable to fungal decay.
 - d. A and B only
 - e. All of the above
8. Wood is typically treated with a _____ treatment process, but a new process provides improved protection.
 - a. Water-based, oil-based
 - b. Petroleum/mineral, water-based
 - c. "dipped," petroleum/mineral
 - d. oil-based, "dipped"
9. In addition to better protection of the wood from surface to core, the water-based treatment process virtually eliminates _____.
 - a. VOCs
 - b. the need for maintenance
 - c. the risk of termite and/or water damage
 - d. A and C only
 - e. All of the above
10. EPA Method 24 measures which of the following?
 - a. The penetration of a finishing coat into the wood
 - b. The termite resistance of a wood frame material
 - c. The weather resistance of a window frame material
 - d. The VOC content in coatings and inks



Green Building: An Integrated Approach to Construction

You have the option of taking the test online free of charge or you may mail your test along with a check in the amount of \$10. A score of 80% or higher earns 1 AIA/CES LU credit hour. Certificates of completion are available upon request and delivered by email.

test	1.	a	b	c	d		6.	a	b	c	d	
	2.	a	b	c	d	e	7.	a	b	c	d	e
	3.	a	b	c	d		8.	a	b	c	d	
	4.	a	b	c	d		9.	a	b	c	d	e
	5.	a	b	c	d		10.	a	b	c	d	



MAIL-IN TEST: Photocopy this page. Clearly circle the letter of the correct answers. Mail this test with the completed form and check for \$10, payable to ArchitectCES, to:

ArchitectCES
PO Box 11911
Mount Lebanon, PA 15228

Last Name _____ First Name _____ Middle Initial/Name _____

Firm Name _____

Address _____ City _____ State _____ Zip _____

Tel _____ Fax _____ E-Mail _____

AIA ID Number _____ Completion Date (M/D/Y) _____

Please email me a certificate of completion upon scoring 80% or higher.

I hereby certify that the above information is true and accurate to the best of my knowledge and that I have complied with the AIA Continuing Education Guidelines for the reported period.

Signature _____ Date _____

THE HOUSE OF

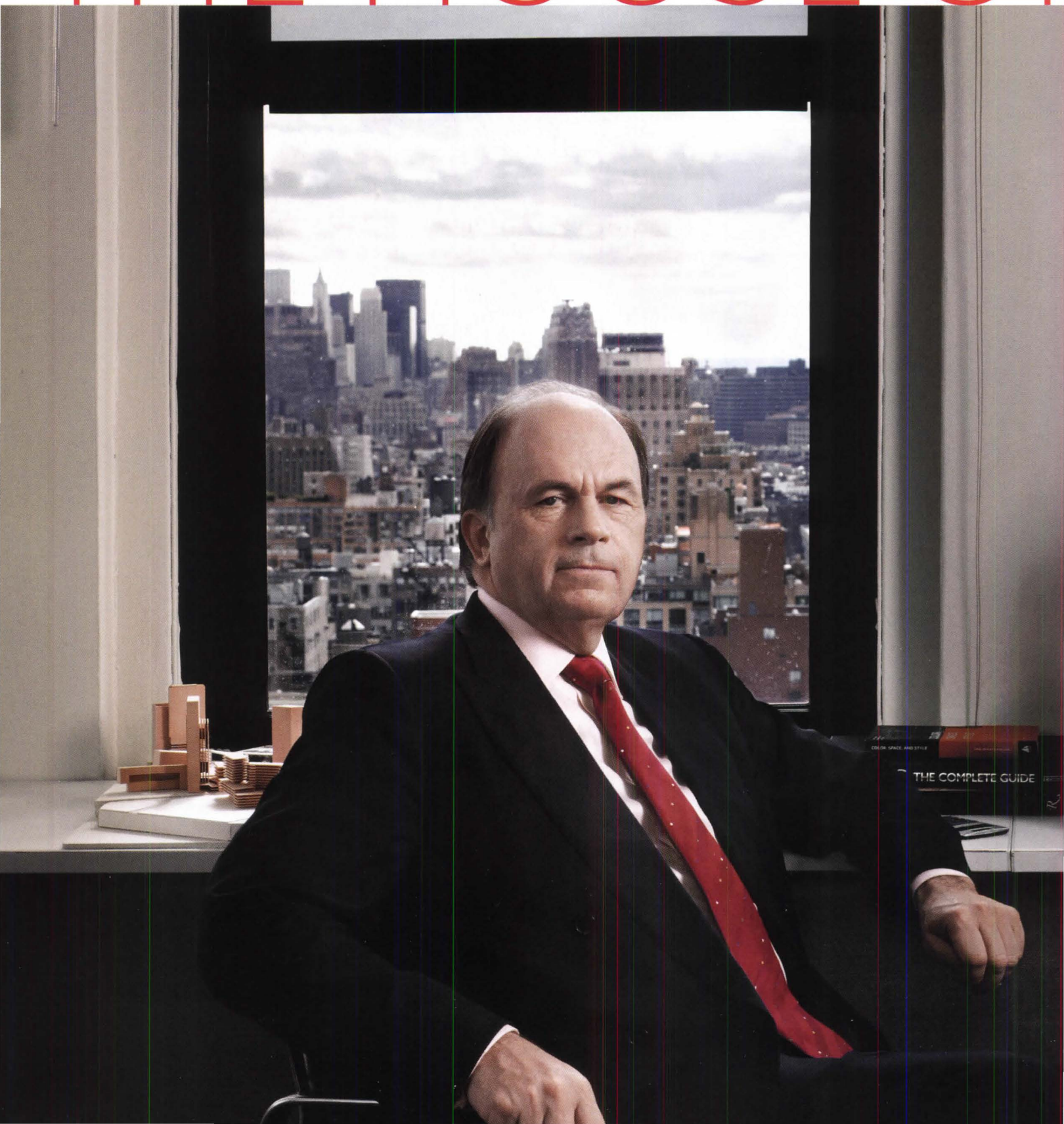

MORRISON



SCOTTISH BUSINESSMEN SIR FRASER AND PETER MORRISON, WHO JUST ACQUIRED HILLIER, HAVE TURNED THE LANGUISHING FIRM RMJM INTO A GLOBAL POWERHOUSE.

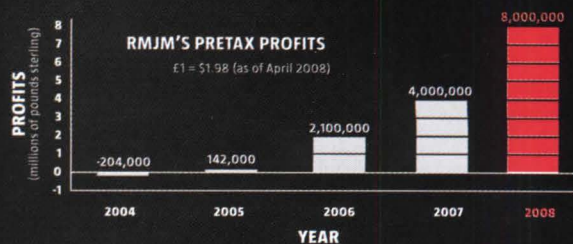

Text Amanda Kolson Hurley Portrait Art Streiber

PETER MORRISON IS NERVOUS. He has just taken the podium in the Piper Auditorium, at Harvard's GSD, before a crowd of architecture-firm CEOs—his peers. Wearing a navy suit and a blue-and-white checked shirt with cuff links, the 34-year-old CEO of the U.K.-based megafirm RMJM, a rugby enthusiast and former officer in the British army, would look more at home in London's banking district, talking global finance over a few pints in the pub. Instead, he's here at the GSD, announcing his firm's \$1.5 million gift to the school for a new program in "integrated design." It is an unmistakable bid by RMJM for the attention of the American design elite.

Morrison delivers his speech, which he has memorized. After some polite praise of the school and its professors, he visibly relaxes as he warms to his theme: the architect of the future. "I believe the architect of the future will be much more than a stylist," he says. "Instead, he or she will be a leader ... The architect of the future must regain the status of master builder." He lauds RMJM's collective process as superior to "the media-created phenomenon"

tion. His father "built houses, he built factories, he built whatever there was to build," says Sir Fraser, whose soft burr and polite, almost diffident manner are at odds with the larger-than-life persona of many a business leader.

For its first two-and-a-half decades, the business remained small and local, its reach confined to the sparsely populated north of Scotland. But that changed in 1974, when it was bought by a mining conglomerate. A few years later, Fraser Morrison—who had joined Morrison Construction in 1970, after finishing a degree in civil engineering, and stayed on to run it under the new owners—moved the base of operations to Edinburgh, Scotland's capital. Thanks in part to the economic boost from the recent discovery of North Sea oil, Morrison's division expanded from a building contractor to "a very broadly spread construction business," involved in building homes, roads, and bridges, and in commercial development.

Despite his success running it, Morrison could see that the division "wasn't flavor of the month," as he puts it, inside the conglomerate.

of court, with Sir Fraser reportedly paying AWG £10 million.

STAGNATION AND BUYOUT

One of the biggest projects that Morrison Construction took on before the sale to AWG was the Falkirk Wheel, a massive rotating boat lift that connects two Scottish canals, one of which lies 115 feet below the other. Originally, Morrison "bid on that project on a design-and-construct basis," Sir Fraser recalls. "And the client came to us and said, 'We really want to do this with you, but we think your design's awful. Can you do something about it?'"

Morrison couldn't, but RMJM, a Scottish architecture firm founded in 1956, could. The firms had worked together on numerous projects over the years. With a consortium including Morrison handling the engineering side, RMJM designer Tony Kettle came up with a striking, playful scheme that resembles a row of giant bottle-openers. Finished in 2002, the Wheel is now one of Scotland's top tourist attractions

"I TOOK [PETER MORRISON] TO OUR HOUSE FOR DINNER, WITH A FEW OF THE PRINCIPALS. THE NEXT MORNING, HE UPPED HIS OFFER. THEN WE WENT TO THE PHILADELPHIA OFFICE AND TOURED THE PRINCETON OFFICE. WE SAT DOWN TO LUNCH—HE UPPED IT SOME MORE. AT THE END, HE MATCHED THE [HIGHEST BIDS]." —BOB HILLIER, FOUNDER OF HILLIER ARCHITECTURE, ON THE MERGER WITH RMJM

of the "starchitect" before moving on to some "hard truths" of the industry as a whole: first and foremost, that the financial reward for architects is "miniscule," so that the agent who sells a building will often earn a higher fee than the firm that designed it (a fact that Morrison will point out to me multiple times over two days in Cambridge). He wonders why a top-tier design firm can't command the same respect and compensation for its "intellectual capital" as McKinsey, the famed management consulting company, does.

This call to arms, albeit a rather mild one, seems to go over well with the audience. But one listener doesn't need any convincing. Sitting inconspicuously in the middle of the room, beside his wife, is Sir Fraser Morrison, Peter's father—and the CEO of RMJM Hillier, the American arm that RMJM gained last year when it acquired Hillier Architecture for \$30 million. The story of how two non-architects came to run one of the world's biggest architecture firms—and now aspire to turn it into one of the world's most valued design brands—starts with him.

"I RECKONED I KNEW HOW TO SORT IT"

Fraser Morrison was born in Tain, a small town in the Scottish Highlands, in 1948, the same year his father established Morrison Construc-

The owners weren't especially interested in its fortunes and didn't know how to manage the high risks inherent in construction. "The [construction] business in England had been losing a lot of money," he says. And then, an understatement that could be attributed to Scottish pragmatism or personal modesty, or a mix of both: "I reckoned I knew what needed to be done to sort it."

Sort it he did. In 1989, Fraser and Gordon Morrison, Fraser's brother, led a management buyout of the Scottish construction division as well as the underperforming English one. Over the next decade, the brothers grew the business into one of the largest construction firms in the U.K. Fraser Morrison was knighted in 1998. In 2000, the *Sunday Times* of London named him the second-richest person in Scotland—right behind J.K. Rowling of *Harry Potter* fame—with 1999 earnings of more than £23 million. The same year, the Morrison brothers sold their company to a British utility, AWG, for £263 million.

In 2003, with Morrison foundering under new ownership, AWG slapped Sir Fraser with a £130 million lawsuit, alleging that he had exaggerated his company's profit forecast. Sir Fraser called the claim "preposterous," blaming the decline on AWG's poor oversight. The lawsuit dragged on until 2006, when it was settled out

and even appears on Scottish banknotes.

One month before Queen Elizabeth II officially opened the Wheel as part of her Golden Jubilee, another event that was more momentous for RMJM occurred—this time without any fanfare. Sir Fraser backed a management buyout of RMJM. The firm had "stagnated," he says. Sixty percent of the shares were held by people who didn't have an active interest in the company: retired partners, the families of partners who had died. The working shareholders approached Sir Fraser and asked him to help.

"We have this problem': That's how they put it," he recalls, summing up the rest of their pitch: "We know you know us, we know you know the industry—are you interested in sitting down with us and trying to figure out a way forward?" In the words of Bob Hillier, the founding principal of Hillier Architecture and now a "lifetime principal" of RMJM Hillier, "Fraser kind of backed into [architecture]. And then he got fascinated by it."

After an exploration period of nine months, beginning in late 2001, Sir Fraser bought out the nonworking shareholders and invested money in the company. The working directors also bought more shares, "so we had buy-in, a successful formula for making a management buyout work." With a 56-percent stake in RMJM, Sir Fraser and son Peter, then 28 and having just

earned an MBA from Imperial College, London, joined the firm as non-executive directors. Peter took over as CEO in 2005 and, two years later, appointed his father to run RMJM Hillier. (The upside-down arrangement gives rise to some gentle joking between father and son: Asked whether he plans to stay in New York long-term, Sir Fraser deadpans, looking sidelong at Peter, "Depends what the boss says.")

To describe RMJM at that time as stagnated would, however, be charitable. Thirty miles from the Falkirk showpiece, in Edinburgh, the firm was grappling with a project that kept sprouting new heads, arms, legs—the new home for the Scottish Parliament, designed by Catalan architect Enric Miralles with RMJM acting as executive architect. Miralles had died shortly after completing the design, leaving the project without its visionary. By the time the building was finally finished in 2004, costs had reached a staggering £414 million—10 times the original estimate—and the Scottish government had conducted an inquiry into the delays and overruns.

According to British press reports, Brian Stewart, then chief executive of RMJM, broke down in tears while giving evidence. He left the firm in 2005, amid rumors that he had been forced out. The head of the inquiry, Lord Fraser of Carmyllie (no relation to Sir Fraser Morrison), concluded that most of the blame lay with the client for choosing a "fast track" procurement method while not understanding the risks and complexities involved. Still, in his final report, Lord Fraser observed that RMJM and EMBT, Miralles' firm, "had very different cultures and ways of working and found it difficult to adopt a cohesive approach ... whilst working in separate locations and communicating mainly via fax."

In the midst of the recriminations over the parliament—which won the Stirling Prize, Britain's most illustrious architecture award, in 2005—did the Morrisons regret their decision? Never, they claim. "Outside of Scotland, very few people related to the controversy over it," says Peter Morrison. "It was largely recognized as a fantastic design, an iconic building." Sir Fraser says that it's been a "springboard" for designing major projects around the world, and his son agrees: "We had the guys from Gazprom there for a day, and we could barely get them out of it. They ended up there for five or six hours, going around looking at the detailing."

On that day, an old controversy met one that was just brewing.

AFTER THE MERGER, LITTLE FALLOUT

Profits at RMJM have jumped exponentially since the Morrisons arrived—nearly 90 percent between 2006 and 2007 alone—and when they recount how they turned things around, you marvel not so much at their business acumen as at the state of the company they inherited. Back in 2003, when it was a firm of 350 people in four

countries, RMJM did not have an attorney on staff, or an accountant.

"They had the architects doing everything," recalls Peter Morrison. "They were managing the finance systems, they were managing the HR, the marketing; for all we know, they were taking the board minutes." Morrison remembers asking a now-departed executive, in 2003 or 2004, where the conference phones were kept. "I was told there was one conference phone in the entire firm, and it was locked away in [a] cupboard."

The solution was simple: Get the designers back to designing by improving support systems, and make sure they're talking to each other. Peter Morrison put a finance management system in place and beefed up the firm's marketing and business development efforts. A corporate law firm was retained to help negotiate contracts. Architects in Hong Kong and Dubai were encouraged to talk to—and work with—their colleagues in Glasgow and London.

But the firm still had no presence in the United States. Meanwhile, in Princeton, N.J., Bob Hillier was phasing out a long career at the helm of his eponymous firm and on the lookout for a merger opportunity. Engineering companies were coming up with good offers: "But the problem is that architects don't want to work for an engineering company," Hillier says. Then an investment banker called him, he remembers, and said, "I may have a firm that could be interested in you." And that was RMJM.

Next Hillier got a call from Peter Morrison, who made an offer for the firm. It was too low. Morrison called back and upped it; Hillier again declined and suggested that "we ought to close this whole conversation down." So Morrison immediately got on a plane to New York.

Hillier describes the couple of days that followed as if they were an elaborate parlor game: "I took him to our house for dinner, with a few of the principals. The next morning, he upped his offer. Then we went to the Philadelphia office and toured the Princeton office. We sat down to lunch—he upped it some more. At the end, he matched the engineering offers." Hillier's impression of Morrison was that "he was charming and has a good backbone. He's very definitive when he wants to be."

With the acquisition of Hillier, RMJM swelled to nearly 1,200 people working in seven countries. It was a marriage between two well-matched building portfolios: RMJM did more office and residential design while Hillier brought healthcare expertise (the firms were equally strong in education). The Morrisons organized the firm into studios that span offices, even oceans—the Global Education Studio, headed by Gordon Hood, works out of Cambridge and Princeton—and shuffled up its workers, sending Brits to New York and Americans to Edinburgh and Dubai. Today there is "more rigor in the business side," Hillier says. With management paying closer attention to how work plans are

A MORRISON TIMELINE



drawn up and fees are assessed, he says, "I think we're charging more realistic and [higher] fees than we were before."

What's more, "there's been very, very little

that every employee received a cash payout. "The mail guy got \$65,000 because he'd been here for 15 years. Everybody got something in the merger." RMJM does not have an ESOP.

desks and the principals look out from their glass-walled offices. The staff is as cosmopolitan as you'd expect, but with a decidedly Celtic, and youthful, bent—even the principals.

"WE DO A LOT OF DUE DILIGENCE ON THE PEOPLE WE WORK FOR. IF WE BELIEVED THERE WAS SOMETHING MORALLY DEFICIENT, WE WOULDN'T WORK FOR THESE CLIENTS. WHAT WE'RE NOT GOING TO DO IS SAY WE WON'T WORK FOR RUSSIA OR CHINA BECAUSE OF A HISTORY OF PROBLEMS IN THOSE COUNTRIES."

—PETER MORRISON

fallout" from the merger in the U.S. offices, Hillier claims, citing two reasons: First, there were no layoffs; and second, an ESOP (employee stock ownership plan), which owned "40-some" percent of shares in Hillier Architecture, meant

ARCHITECTURAL POLITICS RUN AMOK

On a March morning in RMJM Hillier's unassuming New York headquarters, which occupies the 24th floor of an Art Deco building on Seventh Avenue, designers hunch over their

"Early forties, late thirties, is where most of the senior people are," agrees Morrison. "And that's a fantastic advantage in an industry where there are a number of firms that have very senior management teams."



Chris Jones, who leads RMJM Hillier's new Urban Studio, and Peter Schubert, the firm's U.S. design director, give me a demonstration of Glo, an "international architectural visualization and animation studio" within the firm. A Scottish member of the Glo team, Andrew Maxwell, still looking a bit dazed several weeks after moving here from Glasgow, runs the demo on his computer. And there it is, gleaming and heroic in CGI as time-lapse clouds dart over a virtual St. Petersburg, to the strains of Camille Saint-Saëns: the 1,300-foot-tall Gazprom tower.

In December 2006, RMJM won a competition to design the headquarters of Gazprom, Russia's state-controlled energy giant, beating out the likes of Daniel Libeskind and Rem Koolhaas. Even at this early stage, the project, and RMJM's design, had kicked up storms of outrage.

The St. Petersburg Union of Architects protested the notion of a tower that reached three times higher than the historic cityscape, boycotting the selection process. And RMJM's win was far from straightforward. The three architects on the jury—Norman Foster, Rafael Viñoly, and Kisho Kurokawa—had walked off (Kurokawa voiced his objection to all six of the designs being considered). The decision had been left to the rest of the jury and to the results of a public poll conducted by Gazprom through its website. *New York Times* critic Nicolai Ouroussoff inveighed against RMJM's proposed tower as "a bone-chilling expression of corporate ego run amok" on an "obscene scale." Since then, in 2007, 4,000 people, including the chess player Garry Kasparov, took to the streets in St. Petersburg to demonstrate against the project—now

STRENGTH IN NUMBERS

TOP FIRMS WORLDWIDE BY TOTAL STAFF

Firm	Employees
1. GENSLER	3,100
2. HOK	2,788
3. SKIDMORE, OWINGS & MERRILL	1,525
4. PERKINS+WILL	1,400
5. HKS	1,300
6. LEO A DALY	1,200
7. RMJM	1,176
8. RTKL	1,159
9. SMITHGROUP	800
10. NBBJ	770
11. CALLISON	750

RMJM AROUND THE WORLD

ASIA

EMPLOYEES: 234
OFFICES: Hong Kong, Shanghai, Singapore
CEO, MIDDLE EAST AND ASIA: David Pringle
DESIGN DIRECTOR: Scott Findley

EUROPE

EMPLOYEES: 362
OFFICES: Cambridge, Edinburgh, Glasgow, London, Moscow, Warsaw
MANAGING DIRECTOR: Hugh Mullan
DESIGN DIRECTOR: Paul Stallan

MIDDLE EAST

EMPLOYEES: 314
OFFICE: Dubai
MANAGING DIRECTOR: Hazel Wong

NORTH AMERICA (RMJM HILLIER)

EMPLOYEES: 308
OFFICES: New York, Philadelphia, Princeton, Washington, D.C.
CEO: Sir Fraser Morrison
MANAGING DIRECTOR: Steven Gifford
DESIGN DIRECTOR: Peter Schubert



HUGH MULLAN
Managing director
• RMJM Europe



STEVEN GIFFORD
Managing director
• RMJM Hillier



PETER SCHUBERT
Design director
• RMJM Hillier



TONY KETTLE
Group design director
• RMJM



PAUL STALLAN
Design director
• RMJM Europe



DAVID PRINGLE
CEO • RMJM Middle East
and RMJM Asia

renamed Okhta Center—and UNESCO may strip St. Petersburg of its World Heritage Site status; it will vote on the matter in July.

When asked about the project, both Morrisons are adamant that the design, by RMJM group design director and Falkirk Wheel alumnus Tony Kettle, is first-rate (“sensational,” Peter says) and wholly appropriate for its urban context. They point out that there’s already a 1,000-foot-high media tower in St. Petersburg and claim the impact of their tower on the skyline has been exaggerated by the media. “As far as Gazprom,” says Peter Morrison, “they’ve been fantastic. Great clients. Very supportive—we communicate well.”

What about the poor human-rights record of the Russian government, which has a controlling stake in Gazprom? And what about China, where RMJM is building the Olympic Green

Beijing,” as the *Times’* Ouroussoff scoffs of Gazprom. And surely that’s the point: Many clients, as U.S. managing director Steve Gifford told me in the New York office, are looking for “simple, big ideas.” Architectural subtlety does not always fall under that umbrella.

At lunch the day after Peter Morrison’s speech at the GSD, Tony Kettle, who has elfin features under a shock of brown hair and seems unfazed by UNESCO’s threats, sketches in the air with his index finger to explain RMJM’s client communication. Another firm, he says, even if the client is the focal point of its activity, might circle around that point endlessly without ever touching it; RMJM—he draws the petals of a flower—continually loops back to the client for an exchange of ideas.

Sitting at the table with us are Peter Morrison and Matthew Edgar, who was a commercial

“We are not the only ones doing this.”

The Futureplace model isn’t applicable to the lion’s share of the firm’s work, of course, but the same entrepreneurial impulse drives RMJM’s overall growth strategy. The firm is eager to establish a presence in Western Europe and on the West Coast and may keep its current project office in San Francisco long-term. Peter Morrison does not rule out more acquisitions, either, although he maintains that RMJM will be “very selective” about which firms it courts. Over the next five years, RMJM will set its sights on major-league clients who are active around the globe, such as U.S. universities opening satellite campuses in Asia and the Middle East (and academic medical centers doing the same). It will leverage its global portfolio: “We’re starting to work for developers in one part of the world,” says Peter Morrison, “who could easily be developing in other parts of the world.” Projects are getting bigger, as the rising cost of land and materials creates an economy of scale for developers; Peter Morrison estimates that only five or six firms around the world, including RMJM, can currently deliver megaprojects. And even if the next decade sees an explosion of “superfirms” within the industry—as he predicts—RMJM will be ahead of the curve. Especially if RMJM succeeds in becoming an indispensable, trusted adviser to its clients, as he hopes it will.

Of course, RMJM is not alone in its ambitions. “We’re seeing a lot of activity over the last four or five years in terms of strategic planning by firms, trying to position themselves differently,” says Kermit Baker, chief economist for the AIA. Much of the time, that means consolidation. “There are a lot of advantages to being a large national or international firm in terms of scope of services [and] access to capital.” Baker believes the industry is gravitating toward a “dual market,” with big firms getting even bigger and more global and small and midsized firms meeting local and regional needs. But Futureplace—that’s something different, he thinks. “I would say that’s crossing over a line ... it’s beyond the scope of where traditionally architecture firms have gone.”

As Sir Fraser himself admits, though, you can’t change an industry overnight. A few hours after our lunch, Peter Morrison is back in the Piper Auditorium, this time on a panel with other architects and an owner’s rep. When the discussion turns to fees, Morrison—who uses the phrase “value-added” so often that it seems a kind of mantra—argues again that architects ought to be better rewarded for their efforts.

Another panelist, Joshua Prince-Ramus of REX, points out that, during fee negotiations, some clients will object, “You don’t pay interns anything, anyway”—so well-versed are clients in the architectural culture of low pay and low expectations.

To which Morrison can only respond, with a slight lift of the shoulders, “It’s chicken and egg,

“WE WOULD LIKE TO WORK OURSELVES INTO THE SCHEME EARLIER, AND IF WE HAVE A RELATIONSHIP WITH THE LANDOWNER RATHER THAN THE DEVELOPER, IT GIVES US A GREATER DEGREE OF CONTROL.” —MATTHEW EDGAR, MANAGING DIRECTOR OF RMJM’S FUTUREPLACE DIVISION

Convention Center for the Beijing Olympics—at the same time that China’s treatment of Tibet is sparking demonstrations around the globe?

“We do a lot of due diligence on the people we work for,” says Peter Morrison. “If we believed there was something morally deficient or something we didn’t believe in, we wouldn’t work for these particular clients. What we’re not going to do is say we’re not going to work for Russia or China because of a history of problems in those countries.”

But political repression and human-rights abuses aren’t just a problem of the past—aren’t they a problem in the here and now?

“We’re not in politics. We’re about delivering fantastic buildings for people who are going to use that building and for our client. That’s what our focus is on. We don’t think it’s a good enough reason to not build buildings for our clients and the people in these countries because the government in the past or at some stage has been involved in ...,” he tapers off. In a follow-up e-mail, Morrison calls the Olympics protests “misguided,” asserts that RMJM has embraced Chinese culture, and adds, “I very much look forward to being at the opening ceremony.”

VALUE-ADDED

The thing about both Gazprom and RMJM’s City Palace tower in Moscow, which takes the abstracted form of a lovers’ embrace, is that they finesse, rather than jettison, the template of the “conventional corporate tower ... that can be found in abundance in Dubai, Singapore and

real estate broker for 20 years before joining RMJM in January. Edgar is the managing director of Futureplace, which he calls an “incubator” within the firm. If sponsoring a program at the GSD is the macro remedy for what frustrates the Morrisons about the construction process today—that the architect is seen as just another service provider, that he enters the conversation too late and departs with too little—Futureplace is their micro answer to the problem.

“We would like to work ourselves into the scheme earlier, and the key player is the landowner: If we have a relationship with the landowner rather than the developer, it gives us a greater degree of control,” explains Edgar. The idea, in short, is for RMJM to approach landowners—universities, financial institutions, and other bodies with more land than development expertise—and propose design and development options that would increase the value of the land. A few years down the line, when the site has been developed and money has been made, RMJM will then take a cut of the profits.

Although he and the Morrisons are still trying to figure out the precise role that RMJM will play relative to the developer and landowner, Edgar has secured two projects under the Futureplace model, with another 10 or so under consideration. Futureplace is expected to generate “a significant proportion” of the firm’s profits within five years, Edgar says. And the margins on this type of work should be “quite a bit higher” than typical project fees, more in line with the 15 to 20 percent that developers make. Still, RMJM’s initiative is not unique. Edgar adds



KEY PROJECTS

1. PROJECT Falkirk Wheel
LOCATION Falkirk, Scotland
DATE 2002
DETAILS Inspired in part by Legos, Tony Kettle's design for the Falkirk Wheel, a rotating boat lift that links two canals, has also been compared to a Celtic two-headed axe. The Wheel has become one of Scotland's most popular tourist attractions.



2. PROJECT Beijing Olympic Green Convention Center
LOCATION Beijing, China
DATE 2008
DETAILS RMJM beat out OMA, Philip Cox Architects, and other firms to design one of the main venues of the Beijing Olympics. The 3-million-square-foot center will host events in fencing and pistol shooting and will serve as the media hub for the Games.



3. PROJECT University Town Library, Shenzhen
LOCATION Shenzhen, China
DATE 2007
DETAILS The winning design in an invited competition, RMJM's Shenzhen library serves the graduate schools of four Chinese universities. Its long, gently sloping form echoes the surrounding hills.



4. PROJECT Okhta Center (Gazprom tower)
LOCATION St. Petersburg, Russia
DATE Expected 2016
DETAILS This twisting, 1,300-foot-tall tower with a star-shaped floor plan will house the headquarters of Gazprom, the third-largest company in the world—if it survives fierce opposition to the project from inside Russia and abroad.



5. PROJECT Scottish Parliament
LOCATION Edinburgh, Scotland
DATE 2004
DETAILS Designed by Catalan architect Enric Miralles with RMJM acting as executive architect, the irregular volumes of the Scottish Parliament sit beside Edinburgh's Holyrood Palace in the city's Old Town. Miralles, who died in 2000, hoped the complex would look as if it were "almost surging out of the rock." The project won the Stirling Prize in 2005.

Richard Morris Hunt, Revisited

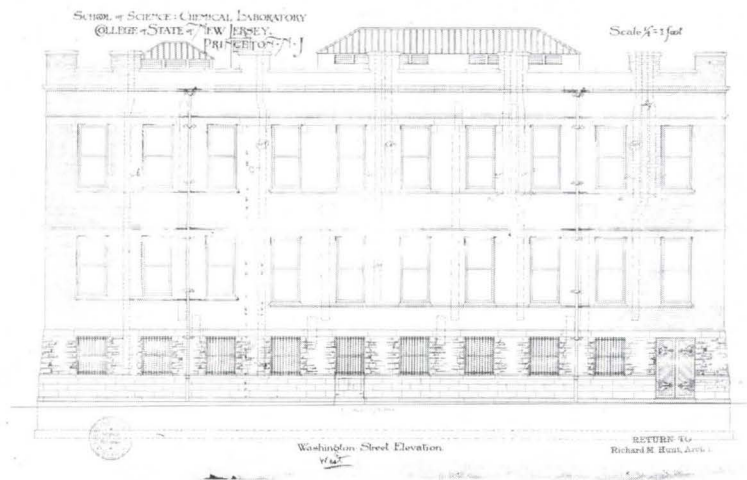

WHAT IS KNOWN TODAY as Aaron Burr Hall, on the edge of Princeton University's New Jersey campus, has always been an anomaly. When it was designed in the late 1800s by Richard Morris Hunt, it was too simple in its design to fit seamlessly into the architect's Vanderbilt-rich portfolio, too far away to fit within the then-boundaries of Princeton's fledgling campus, and too thoughtful in its plan to be dismissed, as so many wanted to, as an afterthought.

The university had been itching for decades to fill in the gap of the building's L-shaped plan and, in so doing, maximize classroom space on a rapidly populating campus. A small two-story addition was added in the 1940s, but it sat tentatively in the void left by the Hunt building, not touching either of the flanking original façades and not, unfortunately for circulation's sake, lining up with any of the existing floors.

One day in 2004, the head of Princeton's

facilities department showed Alan Greenberg around Aaron Burr Hall and explained what the university needed: a comprehensive addition that would work as an integral part of the building. Greenberg's team got the job, in partnership with local KSS Architects as architects of record. The process they undertook resulted in a thoughtful addition that respects and even enriches Hunt's understated original while giving the university the space it required.

Richard Morris Hunt's original design for Princeton University's Chemical Laboratory, now known as Aaron Burr Hall, was a palazzo-style building, shaped like an L. An elevation from his original drawings (above) as well as an archival photograph circa 1891 (opposite) show the masonry walls, taller second and third stories (to provide more light for large lab rooms), and chimneys, which appear at first glance to be crenellations. The Nassau Street entrance (shown) was the building's main entry until the addition was completed.

ALLAN GREENBERG ARCHITECT AND KSS ARCHITECTS REWORK
A FORGOTTEN BUILDING BY AN AMERICAN MASTER ON
THE PRINCETON UNIVERSITY CAMPUS.

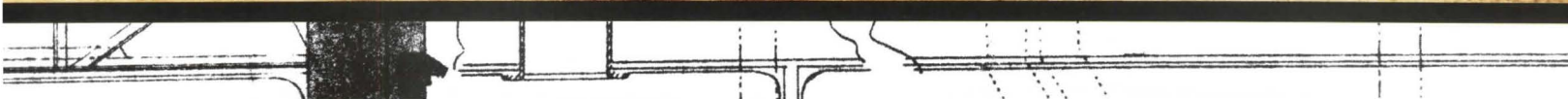

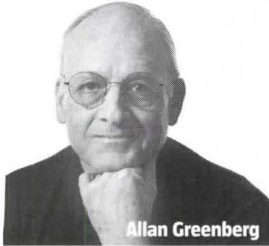

Allan Greenberg

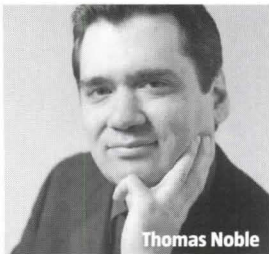

Thomas Noble

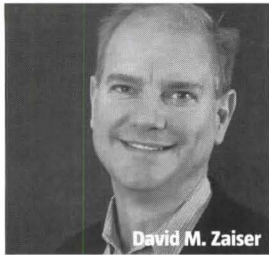

David M. Zaiser



PROJECT AND CLIENT Princeton University Facilities Department
DESIGN ARCHITECT Allan Greenberg Architect, New York and Washington, D.C.—Allan Greenberg (principal in charge); Suzanne Klein (project manager); Thomas Noble (design associate)

ARCHITECT OF RECORD KSS Architects, Princeton, N.J.—David M. Zaiser (partner in charge, project manager); Ed Blaszczyk (project architect)

STRUCTURAL ENGINEER Keast & Hood Co.

CIVIL ENGINEER Van Note-Harvey Associates

M/E/P ENGINEER Bruce E. Brooks & Associates

CONSTRUCTION MANAGER Sordoni Skanska Construction Co.

A/V, ACOUSTICS CONSULTANT Acentech

LIGHTING CONSULTANT The Lighting Practice

SPECIFICATIONS CONSULTANT Heller & Metzger, PC

HISTORIC PRESERVATION

CONSULTANT 1:1:6 Technologies Inc.

COST ESTIMATOR Faithful+Gould

SIZE 33,500 square feet (total); 10,500 square feet (new addition)

A 1940s two-story addition (top) was demolished to make way for the new addition (above), which connects more uniformly with the existing Hunt building. The new addition carries through original details, such as the rusticated stone base, the brick coloration, and the coping from Hunt's chimneys (built to carry lab exhaust), while introducing new design elements, such as the cast stone horizontal bands and the tower, meant to play off of the Collegiate Gothic style that dominates the rest of Princeton's campus (opposite).

Exterior Façade Treatment

THE GOAL OF THE ADDITION'S exterior was to complement the historic Hunt façade while acknowledging the fact that the two were built more than a century apart. The strategy for achieving this goal came down to the details.

"When you look at Hunt's building initially, you think it is just a big palazzo block," says Thomas Noble, design associate for Allan Greenberg Architect. "But there are all of these subtle articulations that we tried to carry forward."

Noble and his colleagues went to great lengths to match the color of the brick and the

rusticated stone base, but the design team also introduced new elements—cast stone, for instance, to add a layer of pattern to the masonry, as well as a tower on the corner that references the Collegiate Gothic building next door.

Such matches were not always easy to achieve. David Zaiser, project manager at KSS Architects, recalls that, for the rusticated stone base, "they used a latex product that they paint onto the Hunt façade." The latex was peeled off the stone, resulting in a semiflexible mold liner that was placed into standard forms. Cast stone

was poured into the molds to capture the exact shape of Hunt's rusticated base. The cast pieces were then rotated and shifted for installation so that the repetition would not be obvious.

The addition is connected to the Hunt building by a series of expansion joints, made difficult because the joints connect a solid, load-bearing masonry wall to a modern construction with veneers, airspace, and a concrete masonry wall. But this approach allowed the building to be connected at each floor, making the addition an intrinsic part of the new Aaron Burr Hall.





PHOTOS THIS PAGE AND OPPOSITE LEFT BARRY HALKIN; PHOTO OPPOSITE RIGHT JONATHAN WALLEN

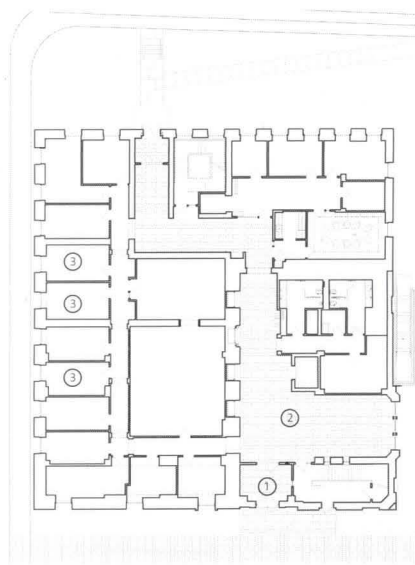

Key

- 1. Entry
- 2. Lobby
- 3. Office
- 4. Lecture Hall
- 5. Classroom

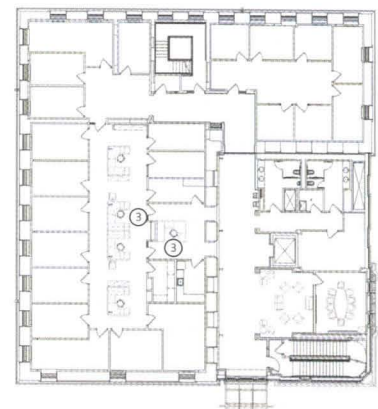
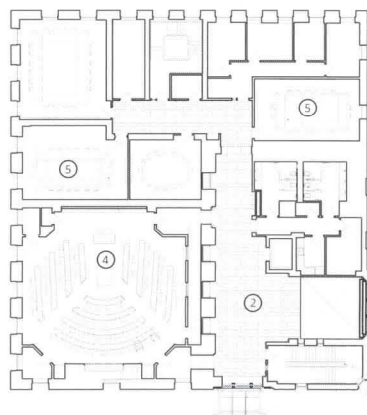

Saving the Outside, Inside

WHAT IS NOT OBVIOUS from the exterior is that the addition is in fact a freestanding structure, connected to the Hunt building with expansion joints but wholly capable of supporting itself. This fact allowed the architects to expose on the interior the original Hunt façades that were hidden from view by the 1940s addition.

These façades serve as a focal point in public areas. The original windows were reclaimed and retrofitted on the first floor to serve as

vitrites that display books and artifacts from the anthropology department. (The architects did cut holes through the masonry walls in some places to facilitate movement from the original to the addition.)

To some extent, leaving the façades exposed was a way to bring Hunt back into the interior after over a century of slapdash renovation. Part of that homage was completed by studying Hunt's original plans, provided by the university,

but "large spaces had been cut up," Noble says. "There really wasn't too much left of Hunt's interior that was going to be taken forward."

In part, the interior renovation is intended to bring more students to the building. Lounge spaces, increased daylight, and richly detailed stairs (with bluestone treads and cast-iron railings, instead of standard-issue rubber and wood) invite students to linger, making the building a more integral part of the campus.

A new entrance (opposite), denoted by a glass canopy, is positioned along the façade of the addition, providing an entry close to the heart of campus. When students enter, they can see the old Hunt façades preserved within. Original windows have been converted to display cases for the anthropology department (above left). Steel structural members indicate the perimeter of the self-supporting addition and leave the original façades exposed in lounge areas (above right).

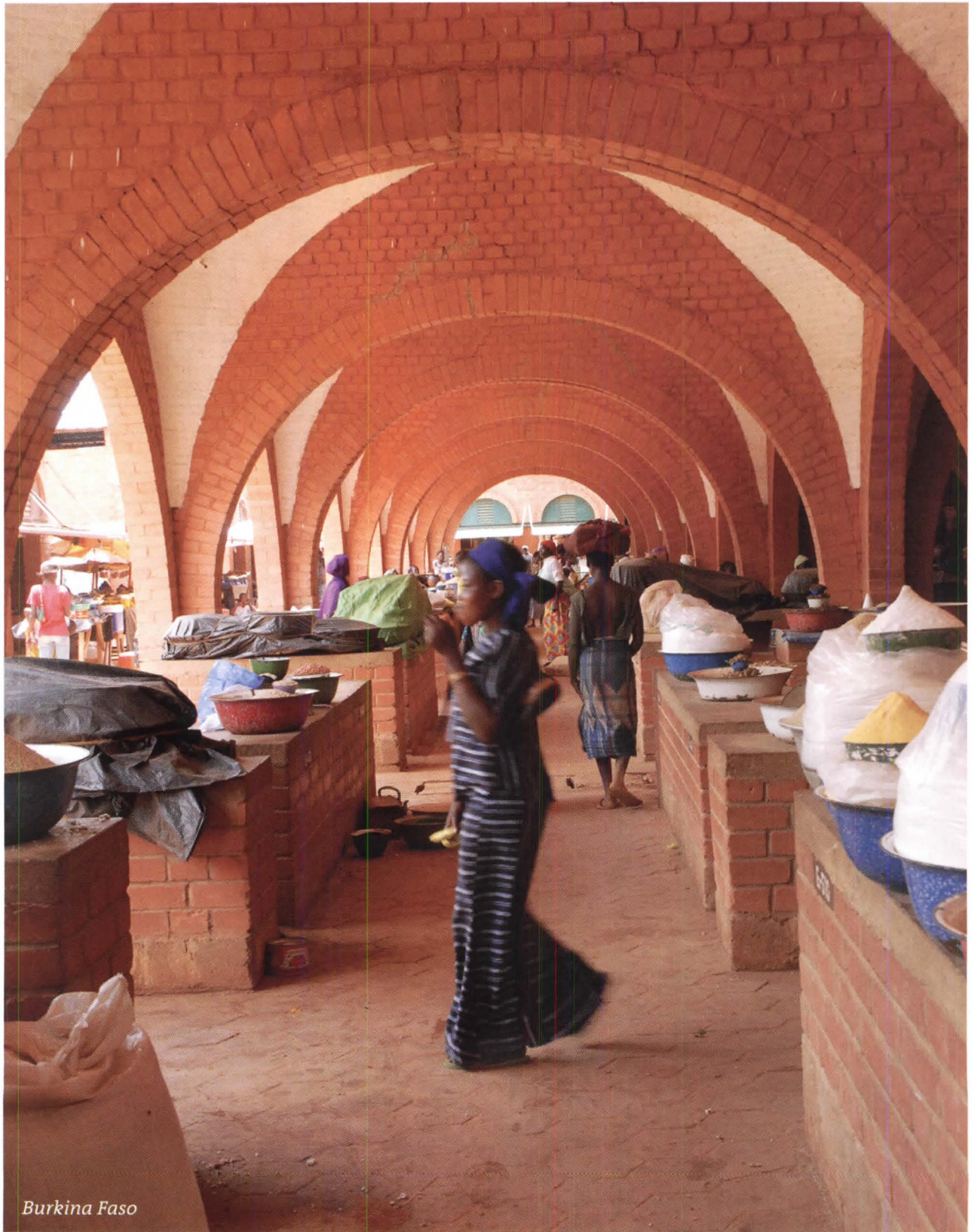

Burkina Faso

Pictured here and on the following pages: the nine winners of the 2007 Aga Khan Award for Architecture.

Central Market, Koudougou, Burkina Faso, 2005 (Swiss Agency for Development and Cooperation, Laurent Séchaud, and Pierre Jéquier)

Located in the capital of the West African republic of Burkina Faso (formerly known as Upper Volta), the central market reveals the full potential of a humble building material. Blocks of compressed earth were used to form domes, vaults, and arches that ennoble the civic space.

Text Michael Z. Wise

IN AN AGE OF WARRING IDEOLOGIES, CAN THE AGA KHAN AWARD FOR ARCHITECTURE RECONCILE MODERNITY AND TRADITION IN THE ISLAMIC WORLD?

Architecture vs. Extremism

“HOW MANY DIVISIONS DOES THE POPE HAVE?” Joseph Stalin is said to have asked contemptuously during the buildup to World War II, five decades before Pope John Paul II played a key role in ending Soviet control of Eastern Europe. Would it be a mistake to similarly underestimate the power of the Aga Khan, spiritual leader of the world’s 15 million Shia Ismaili Muslims, in dealing with Islamic radicalism?

Living in a palace outside Paris with stables of thoroughbred racehorses, the Aga Khan is one of the world’s wealthiest men. Noel Coward memorialized the Aga Khan’s father, Prince Ali Kahn, in a version of Cole Porter’s “Let’s Do It, Let’s Fall in Love,” and Rita Hayworth was for a time his stepmother. A direct descendant of the Prophet Muhammad, this imam generally dresses in sober business suits rather than flowing robes. A British citizen who grew up in Kenya, studied at Harvard, and now maintains offices in Switzerland, the 71-year-old personifies a contemporary, liberal Islam. His followers—of various ethnicities and nationalities, mostly living in Central Asia and Africa—revere their hereditary leader, a consummate cosmopolitan if there ever was one, as a blend of royalty and pontiff.

The official website of the Ismaili Muslim Community refers to its “ethos of self-reliance, unity, and a common identity” and stresses the importance of philanthropic endeavors: “In a number of the countries where they live, the Ismailis have evolved a well-defined institutional framework through which they have, under the leadership and guidance of [the Aga Khan], established schools, hospitals, health centres, housing societies, and a variety of social

and economic development institutions for the common good of all citizens regardless of their race or religion." In this vein, the Aga Khan has sought over the past 30 years to elevate the quality of architecture in the Islamic world through one of the profession's most prestigious prizes.



The Aga Khan (center) joins Afghan president Hamid Karzai (left) and Abdul Rasul Sayyaf (right), a Pashtun warlord turned Afghan legislator, in praying at the funeral of Mohammed Zahir Shah—Afghanistan's last king—in July 2007. Above right: the jury and steering committee for the 2004–2007 cycle, which include Hani Rashid, Billie Tsien, and Brigitte Shim.



The Aga Khan Award for Architecture repeatedly demonstrates that Islam and modernity can coexist, while seeking to harness thoughtful design to the process of transformation in Islamic nations. This goal was a focus of the most recent award ceremony, held in September in Kuala Lumpur, the 10th since the triennial prize was established in 1977. There are typically seven to 12 winning projects per award cycle, chosen from hundreds of nominations by a panel of experts. Among the winners—Muslims and non-Muslims both—the jury apportions prize money totaling \$500,000, which makes this, in cash terms, the biggest architecture prize in the world.

"The award has a simple objective—to enable people of all backgrounds, all faiths, to live a better life," the Aga Khan told the prize recipients in the Malaysian commercial capital. Architecture, he insisted, has the power to transform the world, since happy physical environments create a sense of comfort and well-being, and unhappy ones produce the converse. "We need the courage to continue the process of critical thinking," he said, adding that among many Muslims, "there are fears that critical thinking amounts to disloyalty. I do not believe this ... The moment we stop asking questions, we'll fall asleep."

The prize is also aimed at avoiding what the Aga Khan calls the "exaggerated submission to the past" and the "irrational fear of modernism" to which he says the Islamic world is often vulnerable. As a counterpoint to this trend, the latest awards ceremony took place in the concert hall at the base of Cesar Pelli's Petronas Towers, erected 10 years ago by Malaysia's state-run oil monopoly. The shimmering twin towers, their floor plan generated by the traditional Islamic eight-point star, stand as a potent emblem for the Southeast Asian country and received an Aga Khan prize in 2004. Previous Aga Khan award ceremonies have been held in historically rich settings like the Topkapki Palace in Istanbul, the Alhambra in Granada, and the Aleppo Citadel in Syria. The Petronas Towers ceremony was the first at a contemporary site.

Ninety-two projects have received Aga Khan awards in the program's 30-year history. The latest recipients ranged from a handmade school of mud and bamboo in

Bangladesh, designed by a pair of young architects from Austria and Germany, to a \$175 million glass and steel university in the Malaysian jungle by Foster + Partners. In each case, the social and economic impact of the project is considered alongside its architectural merit; among other winners this time was the rehabilitation of the walled city of Nicosia on Cyprus, which acted as a catalyst for political change by bringing together the Turkish and Cypriot communities of the divided island.

Taking stock of what the program had accomplished in 2004, the Aga Khan said, "In the most eminent Western schools, there is a much greater academic offering and commitment to the field of Islamic architecture ... and in Muslim countries we have seen the birth of new schools and a new generation of architectural teachers and scholars in the field." However, the award's impact is, according to prize steering committee member and Museum of Modern Art director Glenn Lowry, "diffuse and subtle."

Indeed, the most conspicuous example of architectural development in the Islamic world in recent years is the explosive growth of Dubai, precisely the kind of architecture the award aims to avert. (The 10th award cycle monograph published by the steering committee takes direct aim at Dubai as "a cornucopia of gaudy luxury.") Although each cycle honors a mix of works from Western and locally based architects, Omar Akbar, the director of the Bauhaus in Dessau, Germany, worries that the program spotlights too many Western projects. In addition, "there's not enough emphasis on education" in Islamic nations themselves, says Akbar, who also serves on the prize steering committee.

In Kuala Lumpur, the Aga Khan welcomed Malaysian architecture students to a symposium held in conjunction with the awards ceremony. Architectural education is another of his objectives: the Aga Khan funds major architecture programs at Harvard and MIT. (The Aga Khan University he founded in Karachi, Pakistan, with satellite programs in countries including Afghanistan and Kenya, focuses on health sciences and education—and does not offer instruction in architecture.) At the symposium, Malaysian architect Jimmy Lim asked, "Why does interesting architecture have to be introduced by people from afar?" and bemoaned the influence of mainstream Western design trends. "After this conference," Lim predicted, "the Malaysian students in this room will go back to their universities and design buildings with a high-tech look."

Yet encouraging culturally appropriate design is very much on the jurors' minds. Okwui Enwezor, dean of the San Francisco Art Institute and director of the Documenta 11 art show, said the latest jury endeavored to examine "how to elevate Islamic modernity so as not to be folkloric." The prize also seeks to put an end to the "too many unsuccessful renditions of vernacular quick fixes—collage domes and arches on cultural centers and mosques," according to juror Homa Farjadi, who teaches architecture at the University of Pennsylvania. An egregious example of what Farjadi meant looms just outside of Kuala Lumpur: the newly minted city of Putrajaya, which serves as Malaysia's administrative

Opposite, clockwise from top left:

Moulmein Rise Residential Tower, Singapore, 2003 (Wong Mun Summ and Richard Hassell, WOHA Architects) The tower borrows the vernacular monsoon window and uses other low-energy strategies to maximize air circulation.

Samir Kassir Square, Beirut, Lebanon, 2004 (Vladimir Djurovic Landscape Architecture) In this square in downtown Beirut, two old ficus trees and a reflective pool form a shady retreat. The jury praised Djurovic's "economy of elements and language."

Rehabilitation of the City of Shibam, Wadi Hadhramaut, Yemen, 2005, new phase ongoing (GTZ Technical Office and GOPHCY) The Shibam Urban Development Project has renovated nearly 200 houses in this historic cluster of mud-brick high-rises.

Restoration of the Amiriyah Complex, Rada, Yemen, 2005 (Selma Al-Radi and Yahya Al-Nasiri, conservators) More than 500 craftsmen were employed to restore the early 16th century complex, which had been in disrepair for many years.



Singapore

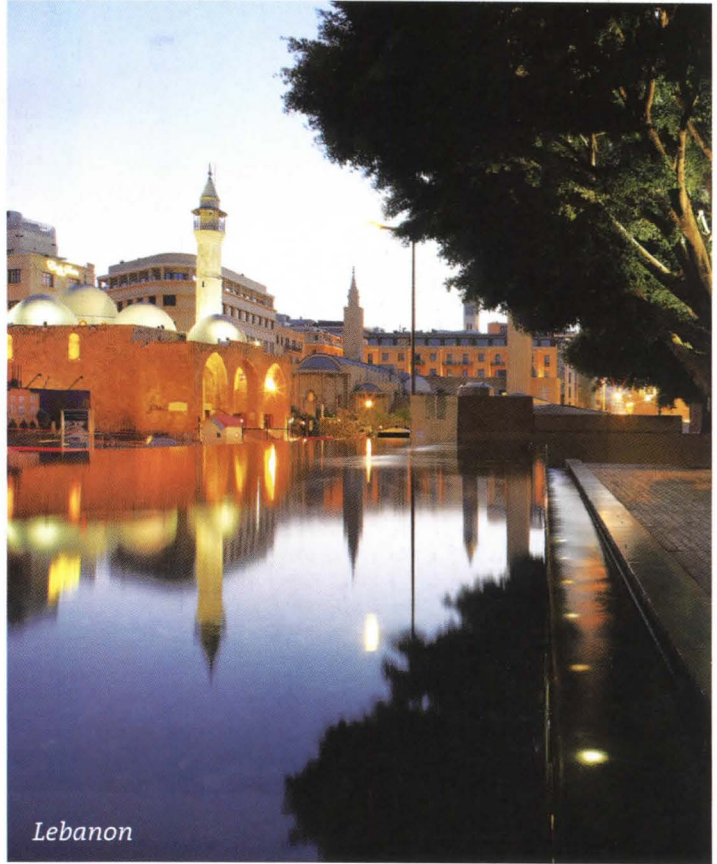

Lebanon

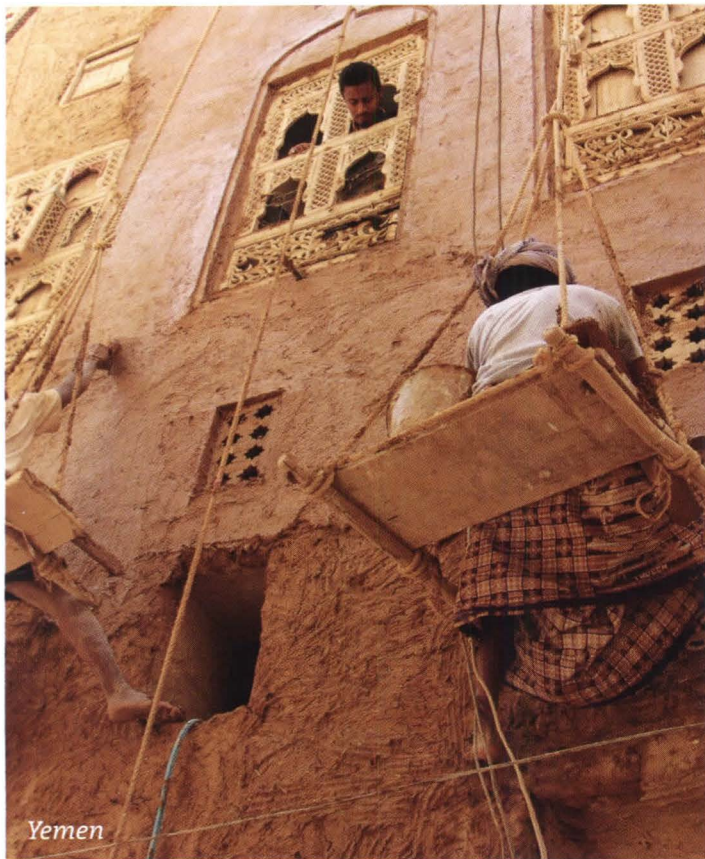

Yemen

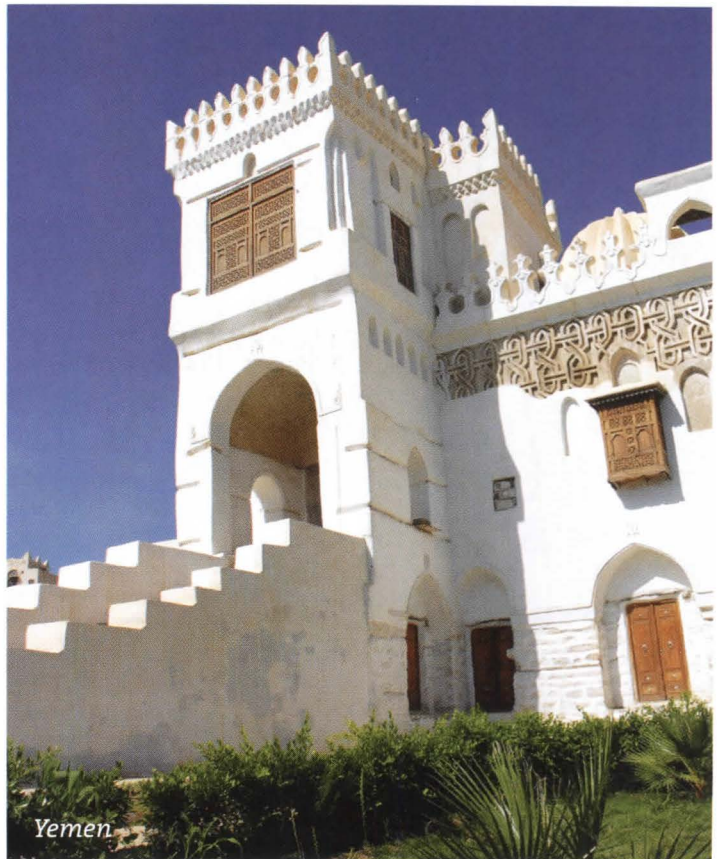

Yemen

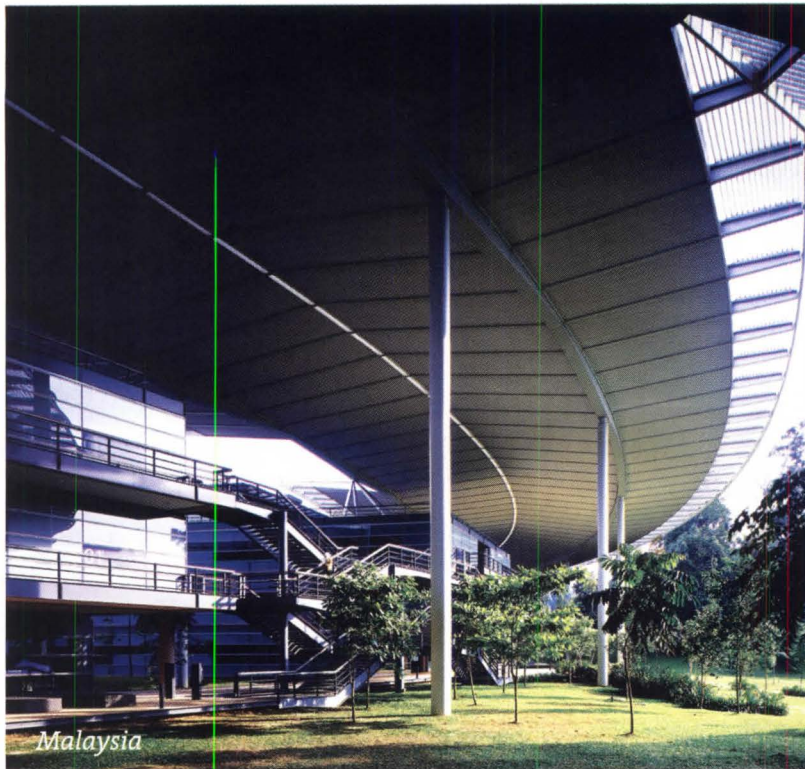

Left to right:
University of Technology Petronas, Bandar Seri Iskandar, Malaysia, 2004 (Foster + Partners and GDP Architects) A canopy winds around the forested campus with boxes inserted beneath it, a “reinterpretation of the classical metaphor for tropical architecture—an umbrella,” the jury citation notes.

Royal Netherlands Embassy, Addis Ababa, Ethiopia, 2005 (Dick van Gameren and Bjarne Mastenbroek) The concrete of the long, low main embassy building is pigmented red to allude to the historic rock-hewn buildings of Ethiopia.

School in Rudrapur, Dinajpur, Bangladesh, 2005 (Anna Heringer and Eike Roswag) Hand-built in four months, the two-story primary school combines earthbound materials like loam and straw with bamboo sticks and nylon lashing.

Rehabilitation of the Walled City, Nicosia, Cyprus, ongoing (Nicosia Master Plan Team) Since 1989, the Nicosia Master Plan has brought together the Greek Cypriot and Turkish Cypriot communities to regenerate the historic core of the city.

capital and where the buildings look more like an *Arabian Nights* amusement park.

Although plenty of these quick fixes continue to proliferate around the globe, juror Brigitte Shim, an architect who teaches at the University of Toronto, hailed the latest prize winners as alternatives to the “placelessness” that characterizes architectural projects that adopt a foreign language without carefully considering the communities they serve. By contrast, the Bangladeshi school designed by Anna Heringer and Eike Roswag “emerged from a fundamental understanding of the local community as opposed to being placed there from outside.”

Heringer worked for a year as a volunteer with a German aid organization in the village of Rudrapur before she trained as an architect. Whereas traditional mud construction in Bangladesh has often resulted in dark structures, Heringer and Roswag achieved airy, light-filled spaces by inserting playfully arranged windows in the thick straw-reinforced mud walls at the base and using an economical, ecologically sensitive bamboo-frame construction on the upper floor. The design is intended to bolster the self-confidence of Bangladeshis, Heringer says, and therefore has important political potential: “To strengthen one’s own identity is the best medicine against terrorism.”

Such an understanding of local culture and building traditions can simultaneously address the complexities of the modern world, Shim said, citing a Singapore tower—the 28-story Moulmein Rise, designed by WOHA Architects of Singapore—given an award for adapting the monsoon window and other traditional elements as a creative response to the tropical climate.

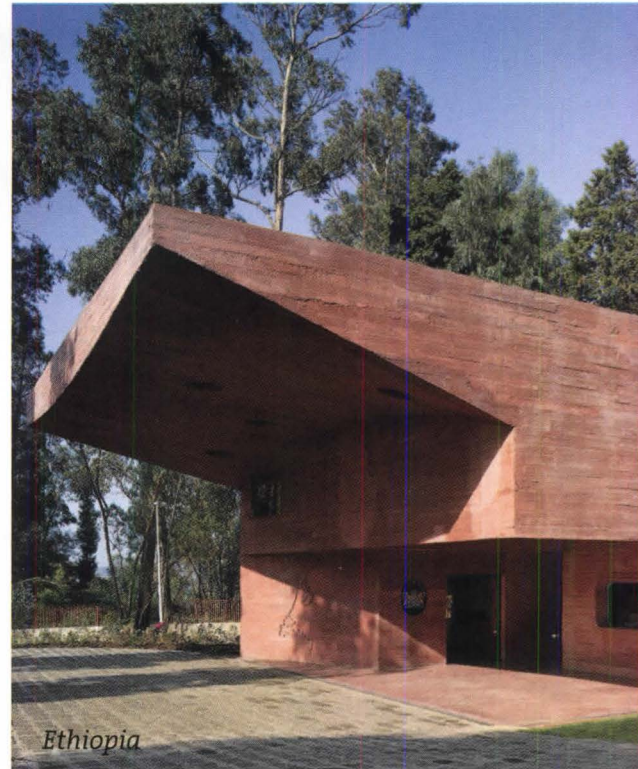

The Aga Khan awards spotlight projects serving communities where Muslims have a “significant presence”—but “‘significant’ is open to interpretation,” according to Sam Pickens, spokesman for the Aga Khan Development Network, which administers the prize. (The Aga Khan rarely speaks to the press and declined to be interviewed for this article.) To be considered, architects are by no means required to be Muslim: The latest cycle included two Dutch architects who won for designing the Royal Netherlands Embassy in Addis Ababa, Ethiopia. The Institut du Monde Arabe designed by Jean Nouvel in Paris won an award in 1989, and that same year, the Bangladeshi parliament building by the Jewish American architect Louis Kahn was given a prize. About half the winners have been non-Muslim since the prize was established. Juries for all cycles of the prize have included non-Muslims, among them Peter Eisenman, Frank Gehry, and Arata Isozaki.

The awards differ from most other architectural prizes in that the projects must have been completed and in use for at least one full year before they can be considered, and are subjected to extensive review and inspection. Some 343 projects around the world were selected for review this cycle. At the 27 short-listed sites, a dozen architectural professionals interviewed the end users and reported back to the nine-member jury. The rigorous selection process lasts three years, and it is up to the jurors themselves to decide the number of winners among whom the half million dollars in prize money is divided. Unlike the Pritzker Prize, the award goes not just to the designer but to clients and builders as well.

The award is not explicitly political but is part of a larger effort by the Aga Khan Development Network



Bangladesh

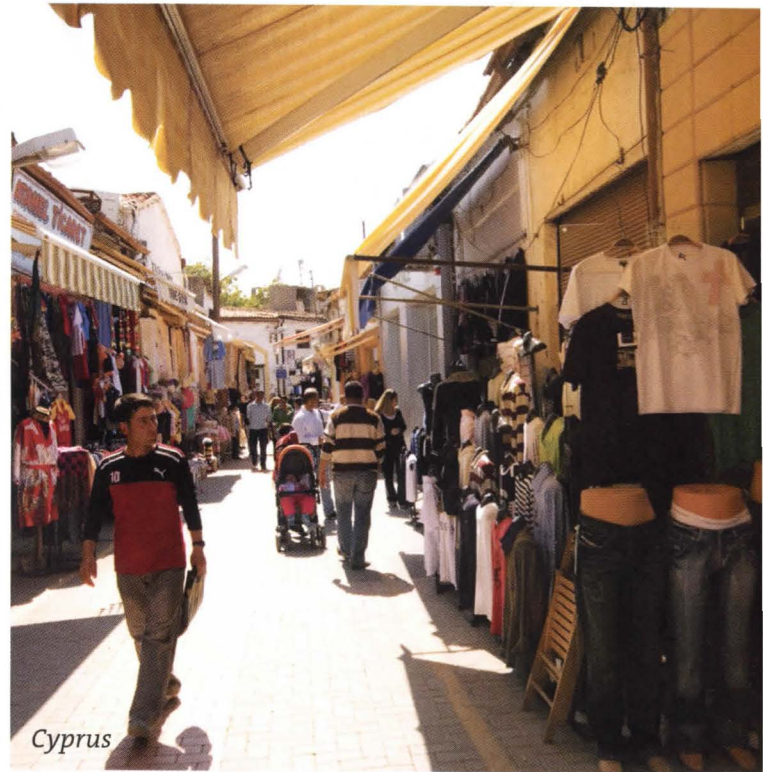

Cyprus

that more clearly is. The Aga Khan abjures militancy in favor of diplomacy and sees investments that promote economic self-reliance in impoverished nations as a means of combating extremism. In Africa, the network has been funding schools for young children that offer a modern approach to the teaching of Islam that departs from techniques used in traditional madrassas where the Koran is recited by rote.

The Ismailis have been periodically persecuted and marginalized by other Muslims, and in 2005 an alliance of Sunni religious groups in Pakistan sought to have

ummah of the caliphate, in which Islamic Sharia law reigned supreme, but what they called a “dialogical” *ummah*. “Warlords like to beat the drum of the clash of civilizations,” said Harvard literary theorist Homi Bhabha, one of four non-architects on the panel. “There is no such clash of civilizations, certainly not on the side of enlightened Islam.”

Yet despite the Aga Khan’s remarkable efforts, a fundamentalist concept of *ummah* remains entrenched in many of the countries he seeks to modernize. The dangers were made clear this January, when Taliban

“Warlords like to beat the drum of the clash of civilizations ... There is no such clash, certainly not on the side of enlightened Islam.”

— Homi Bhabha, literary theorist and Aga Khan awards juror

followers of the Aga Khan declared infidels. In recent years, according to news reports, employees of the Aga Khan Foundation in Pakistan were attacked and killed by Sunni militants. But the Aga Khan’s opponents have matters other than architecture on their minds, says Mounir Bouchenaki, an Algerian archaeologist who formerly served as UNESCO’s assistant director general for culture. “In the community of architects, there is great appreciation ... I don’t think [political activists are] interested. Architecture is not really the subject.”

At a panel discussion for the latest architecture prizes, several jurors invoked the Arabic word *ummah*, denoting the community of Muslim believers across the world, while stressing they had in mind not the

suicide bombers attacked the five-star Hotel Serena built by the Aga Khan himself in Kabul, Afghanistan, killing eight people. The Aga Khan had spoken at the hotel’s opening in 2005, hailing its design by architect Ramesh Khosla as a sign of progress after the extremist Islamic Taliban were ousted from power. Khosla had won an Aga Khan Architecture Award in 1980 for designing the Mughal Sheraton Hotel in Agra, India. ¹⁰

A former foreign correspondent, Michael Z. Wise is the author of Capital Dilemma: Germany’s Search for a New Architecture of Democracy. His writing has appeared in publications including the Atlantic, Foreign Policy, and The New York Times.

Text Eve Kahn

Rem Koolhaas' wife, Madelon Vriesendorp, used to be the famous one. An overdue retrospective sheds new light on her quirky architectural vision.

STOP FRAME

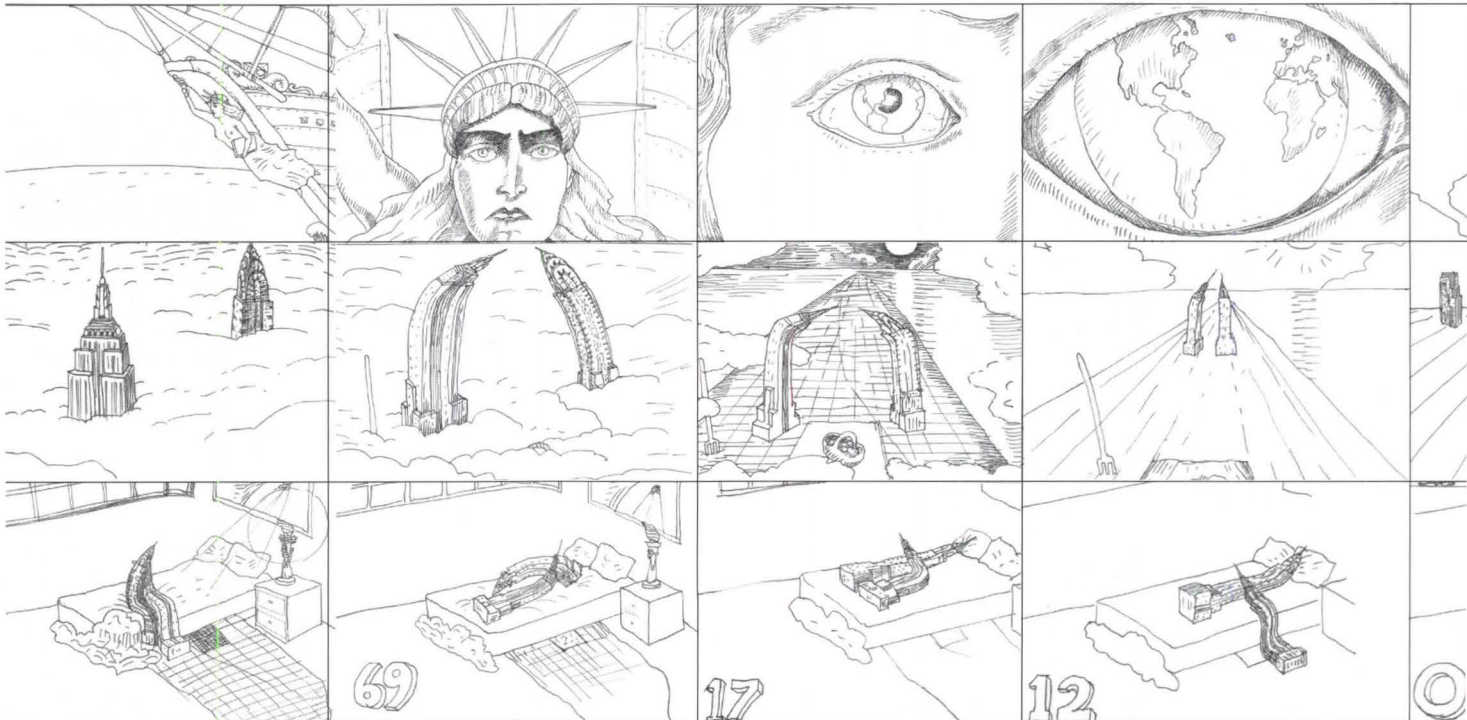

Storyboards from *Flagrant Délit or Dream of Liberty* by Madelon Vriesendorp and Teri Wehn-Damisch (co-writer and producer), 1979.

IN THE 1970S, when Rem Koolhaas was just a struggling co-founder of a new firm called the Office for Metropolitan Architecture (OMA), his artist wife, Madelon Vriesendorp, was more famous than the future starchitect. In her surrealist-influenced paintings, skyscrapers bent in half, intertwined, or sprung from the Statue of Liberty's belly. Vriesendorp's best-known work, *Flagrant Délit*, a 1975 watercolor of a Rockefeller Center spire discovering the Chrysler and Empire State buildings in bed together, appeared on the cover of Koolhaas' 1978 breakthrough paean to urban chaos, *Delirious New York: A Retroactive Manifesto for Manhattan*. Her works started selling for \$10,000 apiece, and when the Guggenheim Museum included them in a 1978 OMA show, Paul Goldberger's review in the *Times*

called them "the wittiest and perhaps the finest things in the entire exhibition" as well as "some of the best explorations of the unconscious."

By the 1980s, however, "Maddie went 'off radar,'" writes Shumon Basar, the director of cultural projects at the Architectural Association (AA) in London, in a new monograph about Vriesendorp's work. The AA has published the volume in conjunction with a traveling retrospective, "The World of Madelon Vriesendorp," which Basar curated with Karlsruhe, Germany-based architecture professor Stephan Trüby. (It appeared early this year at the AA and then at Berlin's Aedes Gallery, and negotiations with U.S. venues are under way.) The artist left the limelight, Basar explains, to focus on teaching at the AA and other U.K. schools and raising her and

1979

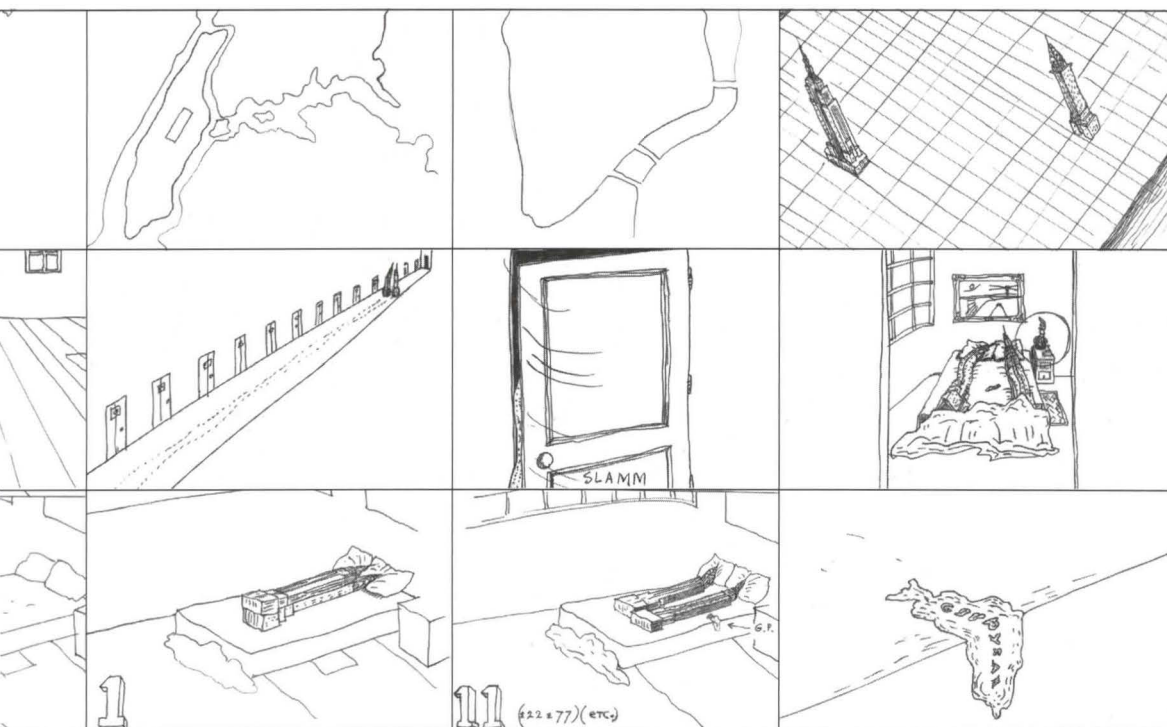

Pictured in the late '70s, Madelon Vriesendorp (above, far left) founded the Office for Metropolitan Architecture with (from left) Rem Koolhaas, Elia Zenghelis, and Zoe Zenghelis. Her stop-frame animation based on her famous painting *Flagrant Délit* was finished in 1979 and shown at several film festivals before falling into obscurity, much like its maker. Vriesendorp describes the tragic-comic story (shown in part at left) as "the end of a love story. Modernity comes in. Frivolity disturbed."

Koolhaas' son, Tomas, and daughter, Charlie. Vriesendorp kept painting and sculpting, and even designed costumes and landscapes, but stopped exhibiting.

Basar and Trüby have gathered 60 of her pieces, mostly from storage in the Koolhaases' London flat. Spanning from 1967 to 2007, the works include not only paintings but also huge recycled-cardboard sculptures of dice and a rarely seen 1979 film animation based on *Flagrant Délit*, in which the Statue of Liberty stalks off her pedestal and enters psychoanalysis with Freud. The curators also borrowed thousands of Vriesendorp's favorite found objects, whether statuettes of nuns and aliens or postcards filed in arcane categories like Glass Bricks and Big Vegetables.

Vriesendorp, age 63, has enjoyed her decades in

relative obscurity, Basar reports, and often happily gives away her output in the form of ephemeral frosted cakes. (Though her life in Koolhaas' shadow cannot have been easy: Plus for decades he has very publicly had a mistress, designer Petra Blaisse.) "When we first proposed the show to her, she, of course, had a certain amount of anxiety about putting herself back under scrutiny," says Basar. "But everyone around her has kept telling her, 'This is long overdue. We've known for ages that you're a genius.' She's grown into the idea of it, and now it signals a new phase of creativity." He and Trüby persuaded her to loan two new paintings to the exhibit: a panorama of her studio stuffed with sketches and knickknacks and a Dalí-esque caricature of Rem with his lips formed into a sofa. ☺

1 MINING

Belden Brick is located in north-central Ohio because it's where the company gets its main raw materials, shale and fire clay, which lie just beneath the earth's surface, anywhere from 10 to 100 feet down. The company owns 17 broad, shallow mines, or pits, on 3,000 acres around the region. Before any site is mined, Belden's staff geologist, Joe Angel, takes core samples of shale and clay from the ground back to his laboratory for firing in a test kiln (or "skut kiln"), examining them for color and shrinkage as well as for their carbon and sulfur content (in both cases, less is better).

In an active pit, drivers board huge mechanical shovels and gouge into the earthen walls. They load big chunks of clay and shale separately—the materials, found in successive or alternating layers of the pit, stay separated until ground nearly to dust—into 22-ton hauling trucks. The same drivers then take the trucks back to the plant, which receives about 33 truckloads a day.



2 CRUSHING—GRINDING—SIFTING—MIXING

Outside the plant is a smaller out-building that holds the guts of two enormous "crushers"—large rotating spools with teeth that pulverize the chunky materials to softball size or smaller. The trucks drop their loads into one of two side-by-side pits (one for shale, one for clay) that feed into the crushers below. Once the materials are crushed in a storm of noise and vibration (imagine several anvils in a clothes dryer), they travel up a pair of inclined conveyor belts **(a)** to the grinding and sifting operation next to the main plant building.

Grinding and sifting are carried out behind closed doors, simply to contain the epic amounts of dust

they create. The conveyor belts outside bring the materials to belts running along the roof ridge, which dump into one of nine bins the size of small cabins. These bins deliver the shale and clay to the grinders, where three wheels rotating in different directions reduce the material to a consistency "like talcum powder," Belden says. The ground material moves by conveyor to a separate area for sifting. Overhead bins **(b)** steadily release it onto a series of canted sifting screens **(c)** that work by vibration—even the catwalks shake jarringly while the system runs. Various gauges of interchangeable screens

achieve specific levels of fineness, set to the type of brick being made at a given time.

After sifting, the clay and shale are mixed together. Barium carbonate is added to the mix in measured amounts to prevent unsightly white "scumming" on the brick and to reduce efflorescence during the firing. Belden Brick also adds a mined powder called garnet as a coloring agent for dark red bricks. Once the mixture reaches the first of two large tubs, water is added. In the first tub and then in the second, large augers churn the material vigorously before a belt takes it to what is known as a batch feeder.



3

MACHINE MOLDING—HAND MOLDING—EXTRUSION

From here, the rather stiff wet mixture becomes bricks in one of two ways: It is either molded (by machine or by hand), or it is extruded. Molded bricks are made en masse when the batch feeder's auger forces the mix down into an open mold box that has slid beneath it to make 10 or more bricks at once. A robotic wheel then turns the lot of them onto pallets that are then carried away to the next stage, the chamber dryer, by automated "finger cars," which have multiple prongs to hold racks of "green," or unfinished, brick.

Alternatively, the wet mix is set aside for the hand-molding operation, where three craftsmen take hunks of wet brick to make "loaves" (see opening photo on page 116) they press into individual wood molds for custom shapes such as water tables, radials, sloped bricks, and bullnoses. As on the mass-molding line, the custom-brick makers line the molds with sand, which helps loosen the brick out of the mold and gives it color. They make between 400 and 500 bricks a day, compared with the 100,000 molded en masse. Once the bricks move to the finger cars, they are taken to the chamber dryers, ranged down a dim corridor like a series of crypts, where they warm at 300 F for about 24 hours. The empty finger cars return to the molding area for more wet brick.

Belden makes about 75 percent of its brick by extrusion, a process in which the wet mixture first is pressed through a vacuum chamber to compress it and then is pushed out like Play-Doh (a) through a die (b) that shapes a running strand of brick of a specific length and depth (with or without the "core bridge," a set of horizontal metal rods that creates the holes in the beds of some bricks). The strand moves forward to be cut by a harplike contraption (c) strung with wires that cut the brick to a programmed height. Off to the side of this setup are a series of cast-iron dies that create different shapes of brick. The design of new or custom dies is the job of the three-person Shapes Department.

Extruded brick, once it's cut and placed on a car, travels to what is called a tunnel dryer, which is heated to the same temperature as the chamber dryer. (However, extruded brick contains less water than molded brick, so it won't stick when pushed through the extrusion machine.) In either case, the bricks have been stacked exquisitely on their narrow edges in alternating directions to maximize air flow and enhance variation in their final color palette.



4 FIRING

Dried bricks head for the 400-foot-long kilns, of which there are three in this plant, one for molded and two for extruded brick (including the kiln shown below). At any given time, the kilns hold 39 carloads of bricks. They inch along to warm slowly to about 2,100 F at the kiln's center and then slowly cool as they move to the other end. They emerge from the kiln quite warm to the touch.

As the bricks are packaged in lots of 525, a carousel distributes them around to several packers at a time in a process called blending. "We do that to control percentages of various colors that go together in a shipment," Belden says. "That way, a mason can pull them out one at a time" to ensure that the fabric of the wall—or walk—they're building will be uniform only in its rich variation, which is typically the desired result. Getting the brick out of the plant is easy: Trucks can pull right up to the plant, as can trains on a rail spur, to load the brick and carry it off to its destination, where it is likely to stay for several lifetimes.





SOUTH BEACH HARBOR

30

Text Vernon Mays Photos Tim Griffith

THE LIGHT AQUATIC

SAN FRANCISCO FIRM TOM ELIOT FISCH REWORKS THE CITY'S WATERFRONT WITH A NEW HARBORMASTER'S BUILDING.

SCENIC AS IT MAY BE, SAN FRANCISCO'S WATERFRONT IS IN CRISIS. The once-bustling port served as a major economic engine for the city through the mid-1900s. But with the advent of containerized shipping, most of the business moved across the San Francisco Bay to the city of Oakland, which was quick to adapt to changes in the industry. That has left the Port of San Francisco holding a collection of underused, aging, and deteriorating maritime facilities that, in many cases, form a barrier between the city and the bay.

Among the decaying assets are the historic finger piers that line the city waterfront from Fisherman's Wharf to Mission Bay. All agree that the costs of repairing, seismically upgrading, and redeveloping these piers are staggering. But the city has begun taking steps to recapture its waterfront as a public asset—beginning with the removal, rather than replacement, of the raised freeway along the Embarcadero that was leveled by the 1989 Loma Prieta earthquake. More recently, public and private investment has been targeted to the waterfront to build new places to live, shop, work, and eat.

A common thread running through the creation of many of these new public amenities is Tom Eliot Fisch, a San Francisco architecture firm headed by the experienced team of Douglas Tom, Amy Eliot, and Bobbie Fisch. Since joining forces in 1997, the trio has built its practice by consciously pursuing opportunities in the public realm. Likewise, the trajectory of the firm seems to have risen with the increasing commitment to development along the waterfront. That's not entirely by chance, as many of these projects are entangled in messy public review processes that the firm chooses to embrace rather than avoid. "It has become a way that we win jobs," Tom says. But there are philosophical reasons for pursuing the work, he adds. "We would rather work on complex projects for noncommercial clients who have a mission other than the bottom line. We fortunately have found a niche in San Francisco trying to do something for the greater community good."



Amy Eliot, Principal in Charge,
Tom Eliot Fisch

Tom Eliot Fisch has completed a series of buildings on the waterfront, including renovations and seismic upgrades at Piers 1½, 3, and 5. The results included a new look from the water (below left), improvements in the iconic bulkhead buildings and newly designed interior office spaces (below middle), and a series of public walkways that allow visitors to interact with and return to the waterfront (below right).

RENEWAL ON THE PIERS

TOM ELIOT FISCH'S work along the San Francisco waterfront traces back to the mid-1990s, when principal Douglas Tom, then a partner at Tom, Bloszies, Aguila, began work on the Crissy Field Center, an environmental education facility on the fringe of the Presidio overlooking the Golden Gate Bridge.

Soon afterward, following the formation of Tom Eliot Fisch, the firm was hired to design new offices for the Port of San Francisco in the front portion of Pier 1, which sits immediately north of the landmark Ferry Building at the foot of Market Street. It was the first in a string of successive opportunities. Subsequently, the firm served as architect of record for three high-profile pier renovations—Pier 1½, Pier 3, and Pier 5—leading a multidisciplinary team to restore the aging infrastructure. (Other members of the team included design architects Hannum Associates and preservation architects Page & Turnbull.) In these cases, the key design challenge was to diminish the buildings' longtime role as a barrier between the Embarcadero and the waterfront, achieved by increasing the public's visual and physical

access to the water's edge. Following their comprehensive repair and seismic upgrade, the piers now comprise 60,000 square feet of office space; 17,000 square feet of restaurant, café, and retail space; a public space along the perimeter of the project; and a boat dock. Tom Eliot Fisch also designed office interiors for two investment management firms located in the Pier 5 building.

New work is under way less than half a mile south of the San Francisco–Oakland Bay Bridge in the Rincon Point/South Beach area. In late 2006, the firm completed a new Harbormaster's Building that provides administrative space for the adjacent marina, facilities for a private yacht club, and a community multipurpose room. Other improvements in the vicinity by Tom Eliot Fisch include a small but cleverly detailed hut for bicycle rentals. Soon to come: Overdue improvements to Pier 40, which is in dire need of stabilization, underdeck repairs, a remake of its front façade, and completion of a city-mandated perimeter public access walkway. The meager \$5 million budget will upgrade tenant space for a variety of boat-related companies and provide public parking.

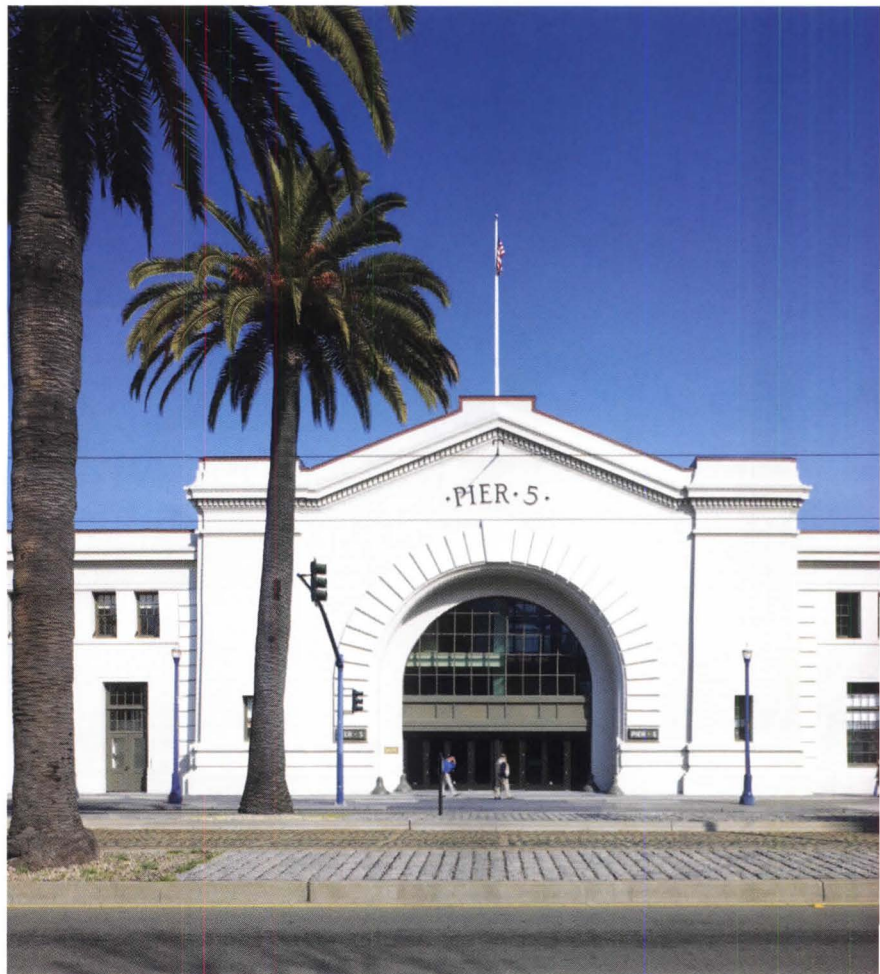

WATERFRONT SITES

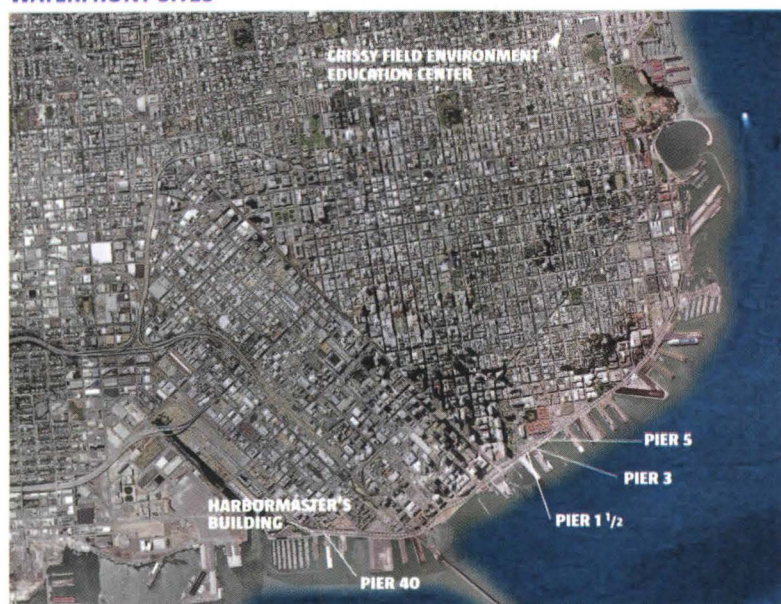

TOOLBOX

SOFTWARE

A variety of digital tools was employed to design the new Harbormaster's Building (page 128): Form Z 4.0 for most of the design, from very early conceptual studies to final finished renderings; AutoCAD 2002 to generate the final screen wall geometry and to resolve the details and complete the drafting; and a variety of Adobe products for presentation drawings.

SCREEN WALL WOOD

Development of the building's ipe screen wall (page 128) involved considerations of geometry, function, and constructability. The façade's basic frame design was based on the capacity of the wood strips to span 4 feet between substructure supports and the ready availability of 20-foot-long ipe boards. The key to ensuring proper alignment of the ipe boards along the 200-foot-long wood screen was a laser level that guided the final installation.

CEDAR SIDING

The building's cedar siding was selected for its natural beauty, as well as its ability to weather well in coastal environments. The species, cut, and fastening system were selected to maximize the material's natural qualities. Clear heart, vertical-grain siding was attached using stainless steel ring shank nails and finished with a semi-transparent stain. Architects selected the stain because of its ability to reveal the cedar's grain and provide the proper level of UV protection, while requiring infrequent reapplication that could be accomplished by the harbor's maintenance crew.

ALL-WEATHER STEEL

Special detailing of the exposed steel structure was necessary to prevent corrosion in the coastal environment. Steel members were galvanized and detailed to eliminate the need for on-site welding, a process that required the use of stainless steel alloy bolts at all splice connections.

MAP WALL

Inspired by Sol Lewitt's wall art, a nautical map of San Francisco Bay provides a super-sized accent in the harbormaster's conference room (page 130). The image was downloaded from NOAA, sized to fit the wall surface, and graphically enhanced by GGE, a local production studio. The digital output was printed on heavy 3M stock, laminated with a satin finish, and applied to the wall in full-height panels with blind seams.

PROJECT AND CLIENT South Beach Harbormaster's Building
ARCHITECT Tom Eliot Fisch, San Francisco—Douglas Tom (managing principal); Amy Eliot (principal in charge); Alyosha Verzhbinsky (associate principal, design); Robert Clocker, Neema Kulkarni, Wing Lee, Ellen Nystrom, Andy Potter, Gwen Preston (project team)
LANDSCAPE ARCHITECT EDAW/AECOM
STRUCTURAL ENGINEER Structural Design Engineers
MECHANICAL ENGINEER Guttmann and Blaevoet
ELECTRICAL ENGINEER Silverman and Light
PLUMBING CONTRACTOR Raymond Brooks
LIGHTING ENGINEER HLB
MARINE ENGINEER Moffat and Nichol
COMPLETION DATE Late 2006
SIZE 11,000 square feet



FIRST FLOOR

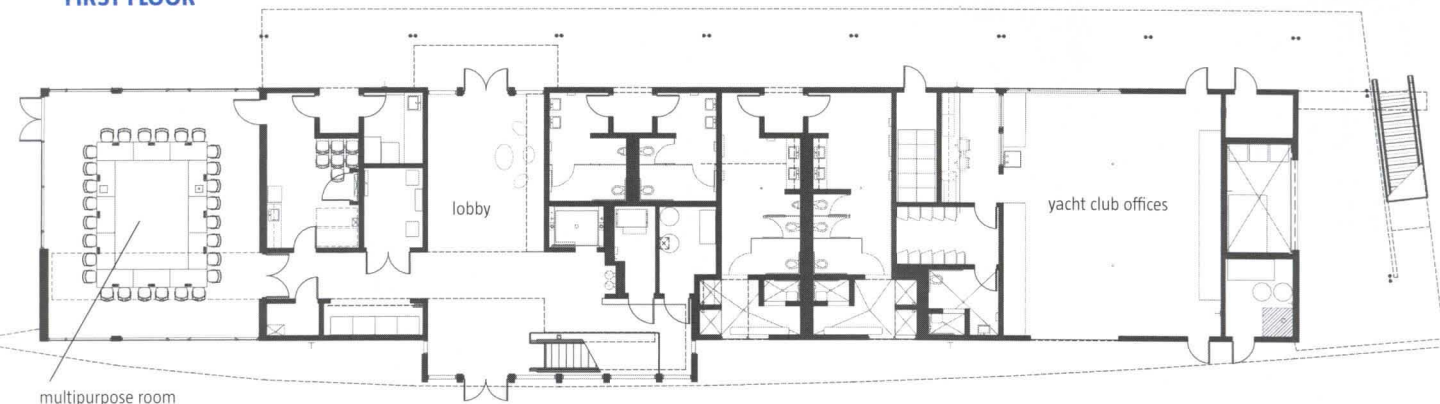

SECOND FLOOR

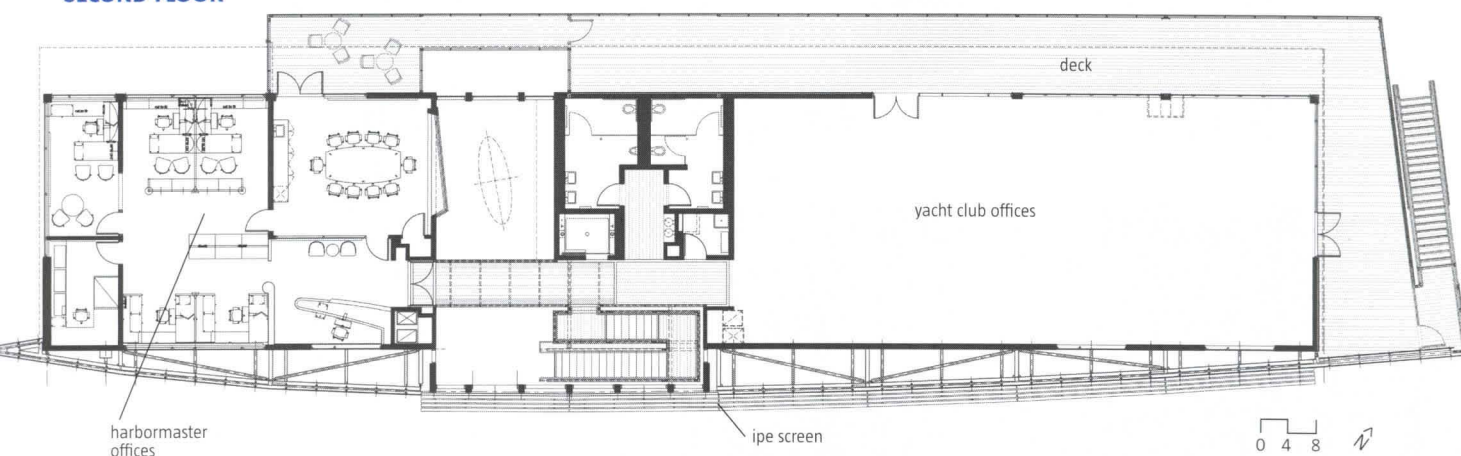

HARBORMASTER'S BUILDING

THE FIRM'S COMMISSION for the 11,000-square-foot Harbormaster's Building, completed in late 2006, presented a unique set of site challenges. Set within a diverse urban context—including a mix of low-rise and mid-rise apartment blocks, the looming presence of the AT&T Park baseball stadium, a small urban park, and the historically significant Pier 40 shed—the building also offered a rare opportunity to design an object building in San Francisco, where infill projects are more often the rule. Several features, including the marina jetties, a new playground in the park, and a parking lot serving the marina, determined the building's orientation. But most critical was the location of an underground seawall that rests inland of the waterfront promenade and the disparate subsurface conditions on either side of it. Rather than straddle the wall and encumber the cost of seismically reinforcing it, the design team simply moved the building back. Even so, the support structure consumed a sizeable chunk of the budget: the 35-foot-tall building rests on 65-foot piles.

As design began, the clients advocated a maritime image suited to the building's site and purpose. "What seemed to have the most integrity was the language of the boats—the materiality, the marine environment," says project architect Alyosha Verzhbinsky. "And the clients, to their credit, were very hip to that." The resulting building is a long, low-slung form beneath a zinc shed roof. The enclosure is relatively opaque to the west and open to the east, providing views of the marina for the harbormaster's staff and the South Beach Yacht Club, the building's main tenants. A two-story lobby slices through the volume, creating a view corridor between land and water.

Because it is frequently approached from two directions, the building has no front or back. Reinforcing the strong modular composition of glass and cedar on the east side are lightweight steel-and-glass canopies supported by stainless steel cables that recall the compressed views of forestays, masts, and halyards on the marina's boats. The west side features a wood screen wall that shades the building from harsh afternoon sun.

The new Harbormaster's Building is a long, thin structure, located on a series of public docks. An ipe screen clads the landside face of the building (opposite middle), and the opposite waterwise façade is largely glazed to allow for optimal views from the offices within (opposite top). Wood continues along the sides of the building to connect the two façades (opposite bottom).

BUILDING INTERIOR

A TWO-STORY LOBBY cuts through the middle of the building, separating the public spaces on the north end from the private yacht club that occupies the second floor to the south. A multipurpose community room, with direct access from the outside, occupies the north end of the building on the ground floor. In addition, a workshop and storage space for harbor operations are tucked beneath the yacht club. To foster a clear sense of place, the design team sought to provide views of the water or the city to every occupant.

Issues of sustainability were just gaining currency at the time the firm interviewed for the job. "We started the project with the idea that we couldn't go through the LEED certification process for cost reasons," says principal Amy Eliot. But the firm was determined to make several strides in that direction. The building's narrow floor plate easily accommodated daylighting, which is aided by reflective ceilings and a roofline that flares upward toward the east. Cooling loads in the building were greatly reduced by providing operable windows, ceiling fans, and shading on the west side. Sustainably harvested ipe, which appears prominently on the exterior sun screen and decking, was repeated inside on stair treads, handrails, decking on the circulation bridge, and accents on the bay window that projects from the conference room. Carpeting with a high recycled content was chosen for the offices and community room, and ceiling panels are a sustainable wood-fiber product.

A two-story lobby in the center of the building (bottom left and middle) provides a view corridor from land to sea and allows maximum light into upstairs office spaces (bottom right).

The ipe screen's configuration (opposite bottom) varies along the length of the building, changing from a device that shades interior offices and the central lobby to a double-layered windbreak along the western edge of the second-floor deck, where the yacht club's popular barbecue area is located.

A nautical theme carries through the interior without going overboard. In the lobby, a dinghy called *El Cinco* is suspended like a chandelier. Bright yellow—the same shade as foul weather gear—was chosen as the sole accent color. Otherwise, the interior palette of materials took its cues from the marina's complement of boats, which are largely white, aluminum, and gray. Finishes were selected for durability, anticipating that many of the users of the building will be in boating gear, while also expressing the same economy of means found in boat design. Floors on the lower level are post-tensioned concrete slabs that span between beams, because the subsurface is unstable.



NORTH LOBBY

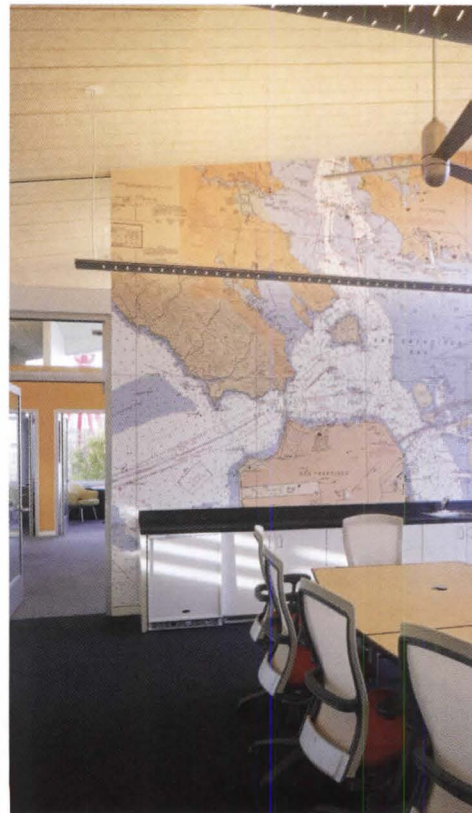

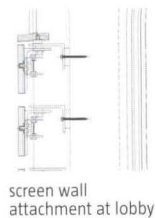

SCREEN WALL SECTION

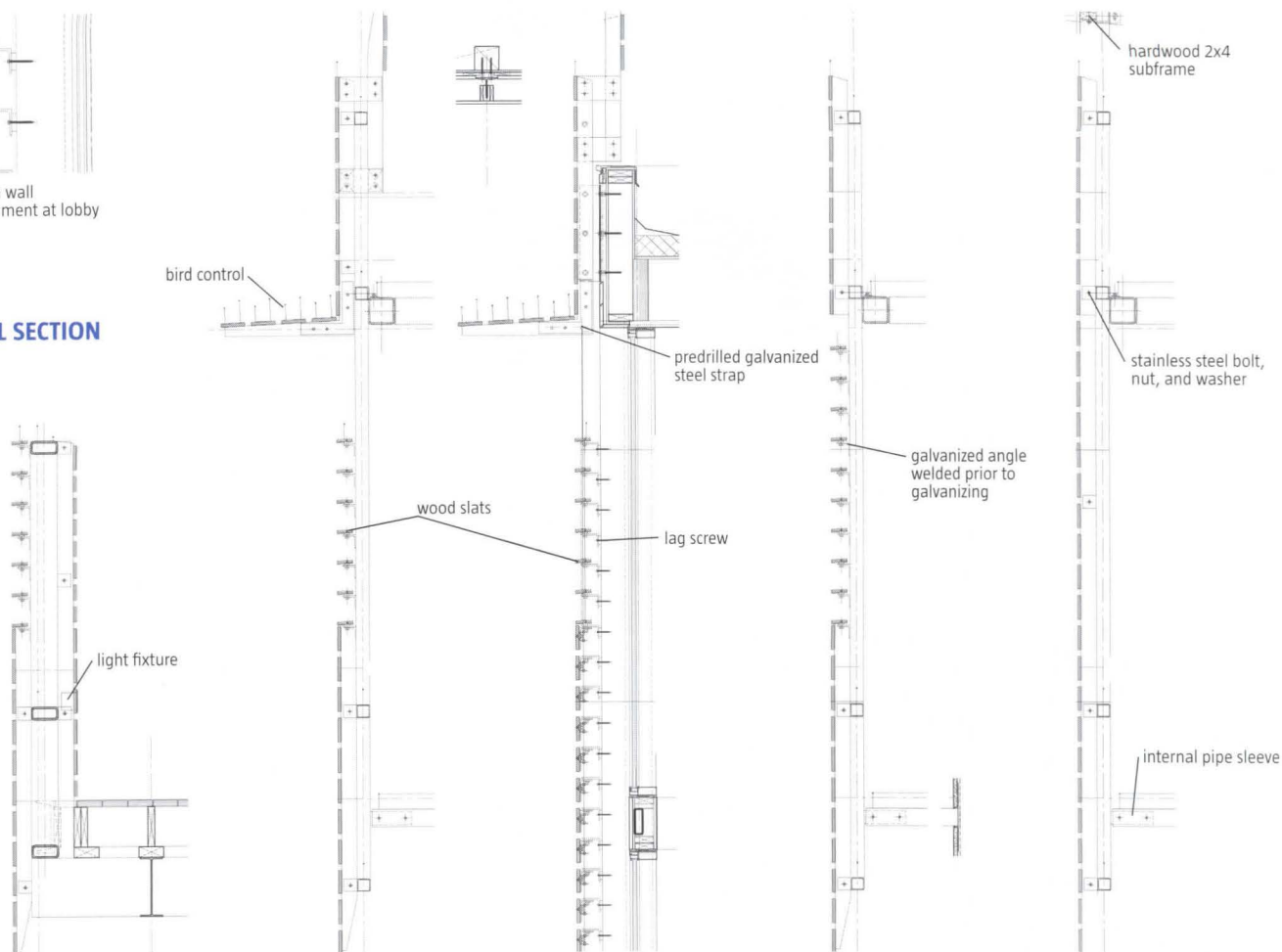

IPE SCREEN

THE BUILDING'S SIGNATURE is a gently curved, wood screen wall that sweeps for 200 feet along the west façade. It serves many purposes: It's an image-giving element, a sun-shading device, a windbreak, and screening for mechanical equipment on the roof. Because the screen would be so prominent, the design team knew that it needed to be well built. In the context of a publicly funded project built by a low-bid contractor, "the approach was to nurse them along so that they would take real pride in the project," says Verzhbinsky. A framing and mounting system was designed that could be adjusted to compensate for dimensional variations in the wood-framed base building. The screen's support system's layers—the heavy tubular-steel superstructure, the galvanized steel frame that hangs from it, and the ipe 2x4s that hold the slats—were aligned with a laser level as they were attached.

The galvanized subframe components were fabricated in a shop and then welded together on site. "You can truck a larger piece," notes Verzhbinsky, "but we had to be very conscious of the maximum size of local galvanizing vats."

The exterior ipe is unfinished to allow for natural weathering and minimize future maintenance. Boards that were laid flat are fastened from the underside to avoid creating a dimple on top that could collect water and create rot. The same slats are also angled slightly downward to encourage water to run off. ☺



AT AAMA, WE GO THROUGH A LOT OF TROUBLE TO MAKE SURE YOU DON'T HAVE TO.

At the American Architectural Manufacturers Association, we're serious about window and door quality. In fact, our certification shows that a window or door's design has passed tough independent tests for resistance to air leakage, water penetration and wind pressure. What's more, AAMA Certification Program manufacturers submit to two surprise plant inspections a year as part of the program's quality assurance requirement. They also certify that the products you specify, when installed properly, match the quality of the sample product tested. When we say we thoroughly test for quality, we're not blowing a lot of hot air. To learn more, call 847-303-5664 or go to aamanet.org/certification. Circle no. 493 or <http://architect.hotims.com>



AAMA STANDS

FOR YOU.

Text Hannah McCann

CULTURE

BOOKS, EXHIBITS, OBJECT

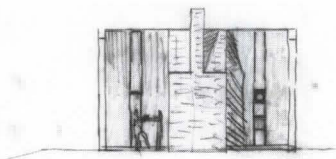
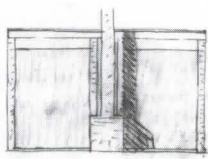
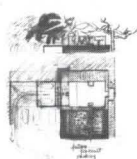

OBJECT LESSON

The Esherick House, designed by Louis Kahn, goes on the auction block May 18. The house is located in the Chestnut Hill neighborhood of Philadelphia. Wright, an auction house that specializes in modern design, hosts the event in Chicago. www.wright2o.com

Esherick House • 1959–1961 • Estimate: \$2–3 million

IT WAS A HOUSE FOR ONE. Margaret Esherick, niece of the Philadelphia sculptor Wharton Esherick, commissioned her house from Louis Kahn in 1959. He designed a two-story structure with a simple plan: two symmetrical rectangles, one dedicated to a double-height living room, the other containing a bedroom, one and a half bathrooms, a dining room, and a kitchen designed by Uncle Wharton. All remain intact today, and it all could be yours. The house goes up for auction May 18.

The house is one of only nine residential projects by Kahn that were actually built, and one of three that are considered his best (the Fisher House and Korman House being the others). Geometry, light, and materiality (concrete, teak wood, glass) characterize the design. According to Joseph Rosa, Kahn scholar and curator at The Art Institute of Chicago, the house reveals “design concepts employed later by Kahn in his public, institutional, and civic architecture, where major and minor

façade fenestrations make a monumental impression in their overall composition.”

The property is being auctioned by Wright, a Chicago-based auction house that specializes in modern art and furniture and, occasionally, architecture. Wright brought down the hammer at \$3.185 million for Pierre Koenig’s Case Study House 21 in December 2006. And another midcentury wonder in warmer climes, Richard Neutra’s Kaufmann House in Palm Springs, Calif., hits Christie’s auction block on May 13.

CULTURE

→The Carrousel at Trianon, Versailles, commissioned by Marie Antoinette from her personal architect Richard Mique. Built in 1776, the Carrousel was rotated by two servants in a subterranean tunnel. It no longer exists.

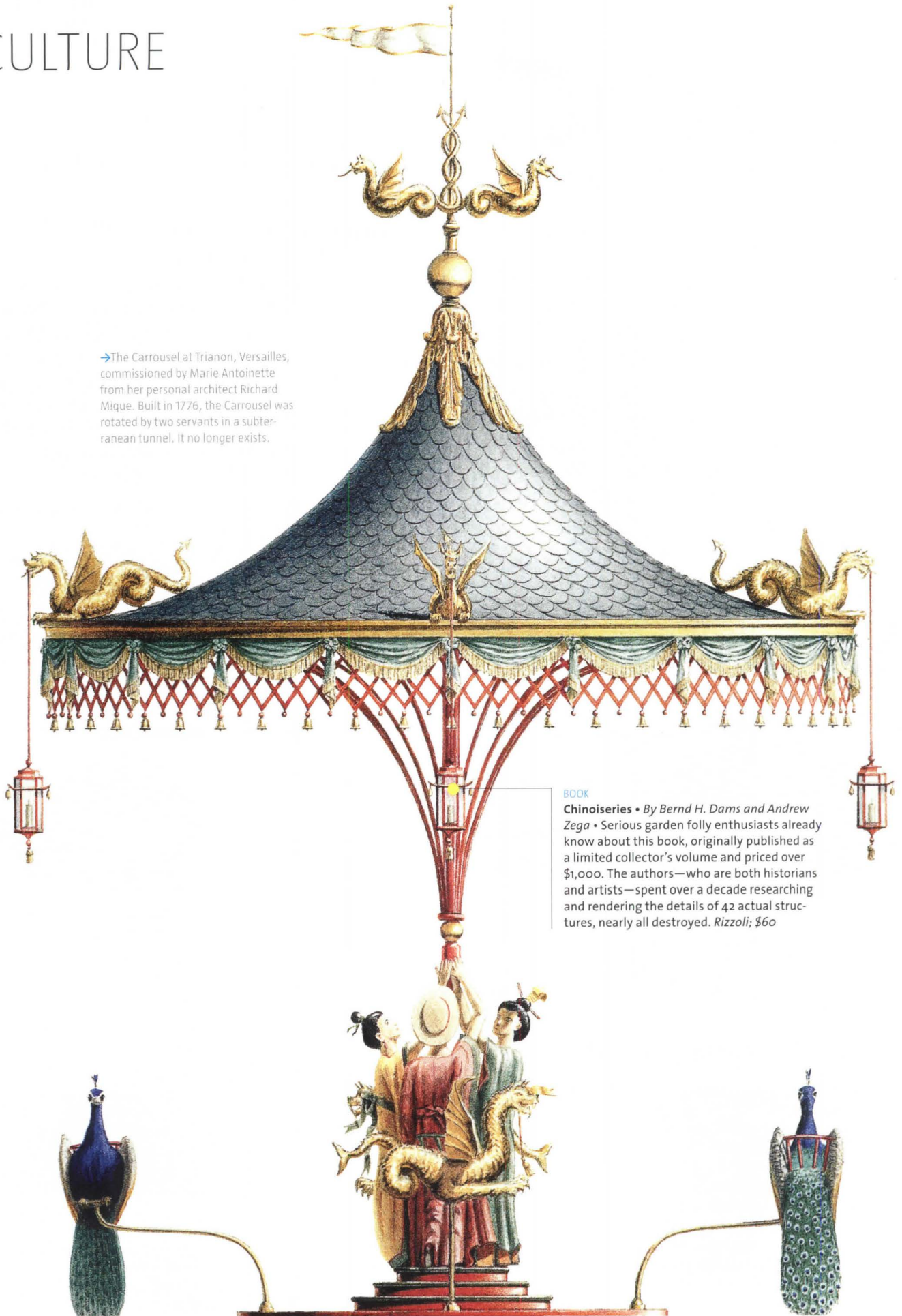

BOOK

Chinoiseries • By Bernd H. Dams and Andrew Zega • Serious garden folly enthusiasts already know about this book, originally published as a limited collector's volume and priced over \$1,000. The authors—who are both historians and artists—spent over a decade researching and rendering the details of 42 actual structures, nearly all destroyed. *Rizzoli*; \$60

Stay Put. Stay Focused. Stay Informed.

CSI Webinars are 30-minute interactive telephone/Internet education programs presented at 10:30 am ET, every Tuesday and Thursday. Each session provides convenient, quality learning at an affordable price. You'll be able to see materials, hear an instructor and ask questions in real time. Participants are charged by site, which means you can invite as many colleagues as you wish to attend a session for one low price!

Train your entire team with one registration fee! The cost per webinar site is \$75 for CSI members or \$95 for non-members.

Most CSI webinars qualify for 0.15 CSI Continuing Education Units (CEUs) and 1.5 AIA Learning Units (LUs).

THE CONSTRUCTION SPECIFICATIONS INSTITUTE
19 Canal Center Plaza, Suite 300
Alexandria, VA 22314
800-689-2900
Fax 703-236-4600
csinet@csinet.org



Upcoming Program Topics include:

- Sustainability
- Building Envelope
- Documents and Standards
- Project Delivery
- Contract Administration
- Product Reps/Manufacturers
- Leadership and Management
- Safety and Security
- Specifications
- Construction Materials
- Technology
- Legal

New sessions are added to the webinar schedule regularly!
Visit www.csinet.org/webinar for a complete schedule.

New Series - CSI Webinars with Flo Schell!



Flo Schell, EdM, Founder of Franchise Coaching Systems and Perceptive Coaching Systems holds distinction as a Certified Comprehensive Sales Coach, as a Certified Coach from the Thomas Leonard School of Coaching, and as the former VP of Sales at Sylvan Learning Systems. She specializes in helping innovative companies and their people to be the best they can be - with increased revenue as a result. Flo is the author of the new business book, *Stop Selling Start Clicking*. She will be teaming up with CSI to present webinars such as:

- **Communication 2.0: Choice, Clarity, & Civility**
- **Visionary Leadership: Complete Engagement+ Emotional Competence**
- **Connection on the Job...Your Key to Success**
- **Selling Yourself and Your Services: Connection is Key**
- **CSI Professionals: Acting and Looking the Part**
- **6 Steps to Planning and Conducting a GREAT Business Meeting**

Circle no. 31 or <http://architect.hotims.com>
Visit www.csinet.org/webinar for a complete listing of webinars.



CULTURE



EXHIBIT

Life on Mars • Carnegie Museum of Art, Pittsburgh • Through Jan. 11, 2009 • For the first time in 112 years, the Carnegie International—North America's oldest international survey of contemporary art—has a title, courtesy of curator Douglas Fogle. "Life on Mars" asks if we are alone in the universe. Forty artists from 17 countries present alien aspects of the familiar world, including China's Cao Fei in *My Future Is Not a Dream* (above). cmoa.org

EXHIBIT

Renzo Piano's Art Museum for Harvard • Fogg Art Museum, Cambridge, Mass. • May 18 through June 30 • The recipient of the AIA's 2008 Gold Medal presents schematic solutions for consolidating Harvard's Fogg, Busch-Reisinger, and Sackler museums under one roof. artmuseums.harvard.edu

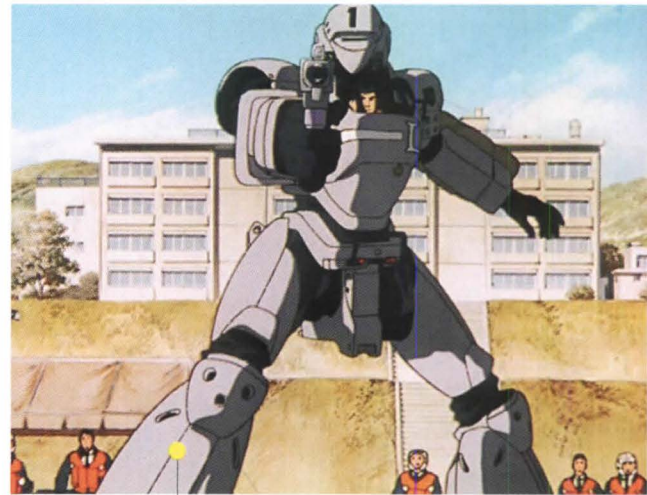
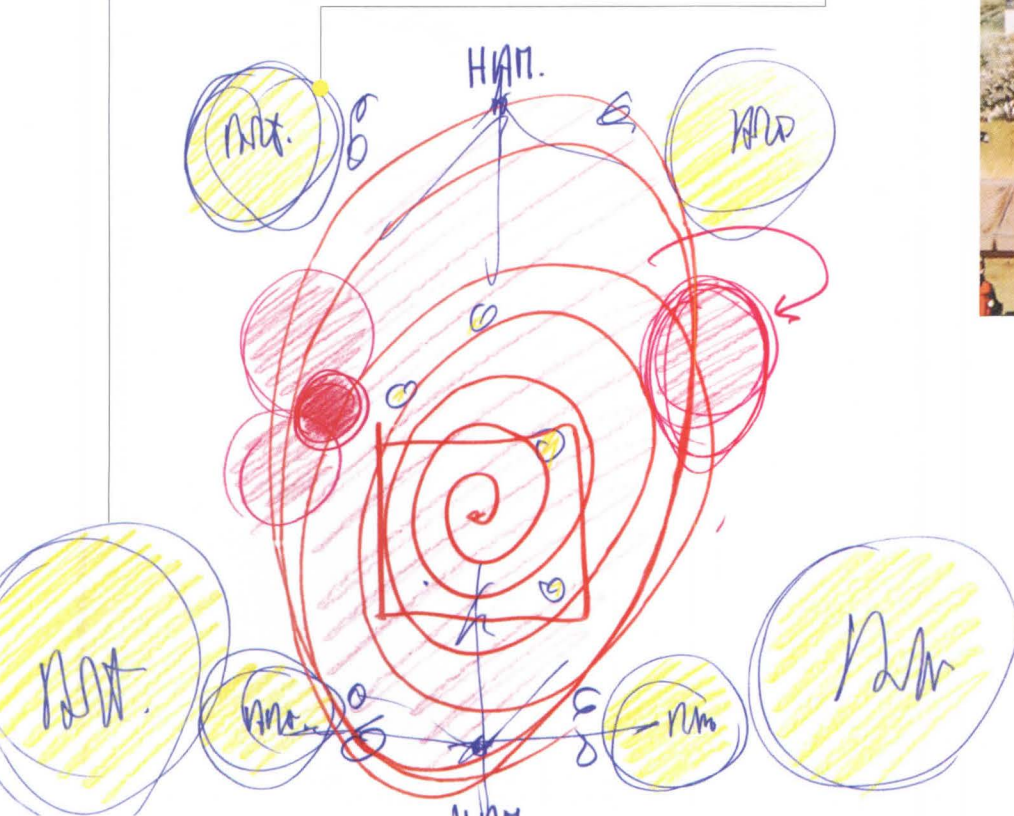

EXHIBIT

KRAZY! The Delirious World of Anime + Comics • Vancouver Art Gallery • May 17 through Sept. 7 • The most comprehensive-to-date assembly of anime, comics, cartoons, video games, manga (Japanese comics), and graphic novels—more than 600 works total—are presented in an exhibit designed by Tokyo-based architecture firm Atelier Bow-Wow. vanartgallery.bc.ca

THE VERY BEST Credit Card.

Chosen by over 1 million independent business people,
including over 100,000 independent contractors.

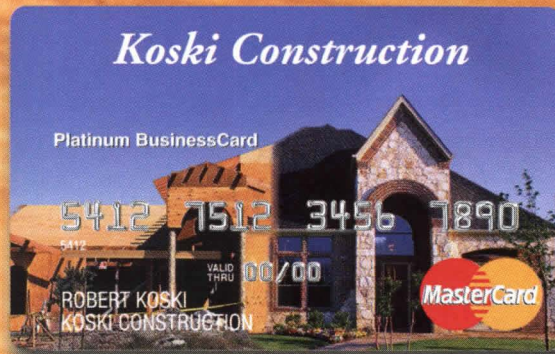

The preferred card of **ARCHITECT**

The Advanta Platinum BusinessCard is THE VERY BEST credit card
for contractors. Great rates. Rich rewards. And the choice of
more than a million business owners like you.

- 0% APR for 15 months on balance transfers*
- 7.99% Fixed APR thereafter
- 5% Cash Back† or Travel Rewards
- No Annual Fee and No Limit on the total rewards you can earn
- Up to \$50,000 in unsecured credit to finance projects, meet expenses, and get you through the slow pays
- Up to 15% discount on contractor-grade tools
- Discounts on Hanley Wood magazines and events
- \$0 Fraud Liability



APPLY TODAY!

 Call 1-800-282-2192 or  visit www.applytoday.com/hw

Please use offer code AM28-ATMM

ADVANTA

Because you're never done building your business®

*A balance transfer fee of 3% (min. \$5; max. \$90) applies. †Cash Back: Earn 5% cash back on your first \$1,200 of Bonus category purchases (gasoline, computers, office supplies, utilities and telecom) annually, 1% on remaining Bonus category purchases, and up to 1% on everything else. See Cash Back Rewards Program Rules for categories, additional benefits and limitations. 5% rewards are for Bonus Qualifying purchases. Review rewards program rules before you apply for full benefits and limitations. Advanta makes available to its customers the discounts mentioned above on purchases made through mytoolstore.com and Hanley Wood, LLC, but assumes no responsibility for the availability, use or performance of the products offered therein. Third-party names, logos and trademarks shown are the property of their respective owners. Restrictions, exclusions and limitations on benefits may apply. Benefits may be offered in conjunction with third-party providers and may be changed or withdrawn at any time. Full details will be provided when you become a cardmember. ©2008 Advanta Corp. All rights reserved. Advanta and the Advanta logo are registered service marks of Advanta Corp. "Because you're never done building your business" is a registered service mark of Advanta Bank Corp.

Advanta Platinum BusinessCards are issued by Advanta Bank Corp., Member FDIC, for business-purpose credit.

Circle no. 497 or <http://architect.hotims.com>

Resource



GageWoven® Architectural Wire Mesh Systems - Gage Corporation, Int.

GageWoven® is an innovative collection of 23 designs suitable for elevator lobbies and cab interiors, feature walls, ceilings, plus other architectural fabrication and consumer products. GageWoven also features 5 unique patterns designed for in-fill panels. Custom sizes and made to order panel systems are available. Custom designs are also encouraged. Contact the factory for literature and sample requests.

800-786-4243
 gage@centurytel.net
 www.gagecorp.net

Circle no. 300

Circle no. 301



Small But Powerful

FAAC is the world's largest specialized manufacturer of operators for swing, slide and barrier gate systems. The Model 400 heavy-duty, hydraulic swing gate operator is designed for heavy traffic applications, such as subdivisions and apartments. Its power and reliability also make it ideal for large, ornate gates.

Learn more at: www.faacusa.com.

FAAC International, Inc.



Circle no. 302

Sustainable Commercial Entrance Products



Special-Lite provides the **single, sustainable** solution to the **multiple** challenges of commercial entrances!

- Custom fabricated to match any architectural style
- GREENGUARD™ Children & Schools Certified for IAQ
- Superior flush door thermal performance
- No need to finish or refinish
- Can not rust, crack, peel or rot
- Extends life of entire entrance



To learn more, request our **Green brochure.**

 **Special-Lite**
 800-821-6531
www.special-lite.com

Circle no. 303



Walker Display

Life's all about change and so are we when it comes to art presentation. The Walker system frees you to explore all your options. No-More-Holes frees you to rearrange your artwork with ease and speed. Embrace change!

800.234.7614
www.walkerdisplay.com

Circle no. 304

The Art and Science of Building

Where

**ARCHITECTS
ENGINEERS
SPECIFIERS
CONTRACTORS
FACILITY OWNERS
CSI MEMBERS
BUILDING PRODUCT
MANUFACTURERS**
and
YOU

Choose from over 100 expert-led educational sessions.

Network with peers in the engineering, contracting and architectural fields.

Check out the latest products, information and services from hundreds of building product manufacturers.

Participate in the CSI Annual Convention and attend the numerous educational and social events.

Join thousands of commercial, industrial, and institutional construction professionals and hundreds of exhibiting companies as they come together to interact, discover and increase business.

CONSTRUCT 2008

THE ART AND SCIENCE OF BUILDING

hanley▲wood

SPONSORED BY



EDUCATION: June 3-6, 2008

EXHIBITS: June 4-6, 2008
Las Vegas Convention Center,
Las Vegas Nevada, USA

Register online **NOW** at
www.constructshow.com

Resource/Classifieds

MAJOR INDUSTRIES

SKYLIGHTS & TRANSLUCENT CURTAINWALL

Energy-saving natural light + LEED® opportunities

Guardian 275® translucent skylights and curtainwall and Auburn® glass, acrylic and polycarbonate skylights

Guardian 275® Translucent Daylighting Reference Guide Now Available!

Toll-Free: **888-759-2678**
www.majorskylights.com

Circle no. 305

Architectural Terra Cotta Rainscreen Cladding System, Manufactured in the USA

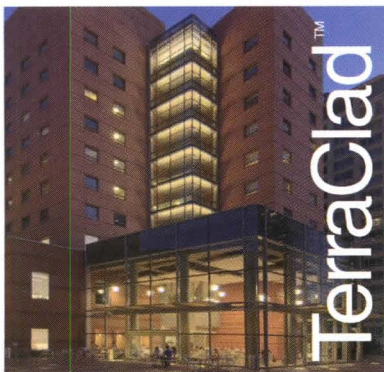

TerraClad™ is a natural terra cotta product formed into a high performance architectural rainscreen panel. These fired clay products offer many LEED point possibilities for recycled content and regional material use.

Available in louvers, baguettes, panels, and colors to realize the designers imagination.

Boston Valley Terra Cotta Company
888-214-3655
www.terraclad.com

Circle no. 306

The PrintFolio™

PORTABLE PROTECTION FOR PLANS & PRINTS

Unrolled size: 48" x 28"
Bags: 40" x 26"
Extra bags available

We'll embroider your name!

www.docbox.com 800-223-5897

Circle no. 307

Architectural Designer – Candidate must be an architect with a minimum of 2-3 years of relevant work experience and a masters and bachelor's degree in Architecture or equivalent. Proficient knowledge of Microsoft Office and various design applications including AutoCAD 2000 or newer, 3d Max, Word, Excel, and Power Point, as well as office equipment such as scanners, printers, etc. and knowledge and skills in architectural design, graphic illustration, plan reading, rendering, construction detailing, etc. Position is for Tucson, Arizona. Email resumes with letter of interest to Kim Largey, Kim@rickjoy.com.

We are an Equal Opportunity Employer.

Circle no. 308

CAREER OPPORTUNITIES

JR Walters Resources, Inc. specializing in the placement of technical professionals in the A&E field. Openings nationwide.

Please visit our website at www.jrwalters.com

Phone: 269-925-3940

Email: jrwwa@jrwalters.com

Circle no. 309

ARCHITECTURAL RENDERINGS

TO SCALE & IN ONLY 3 DAYS! Realistic Handpainted WATERCOLOR. Highly Detailed, or Quick Sketch. Evocative, Cost Effective; Visa, MC, AmEx. Mayron Renderings, Calls Only 1-800-537-9256, 1-212-633-1503.

Visit www.mayronrend.com

Circle no. 310

Consulting for Architects, Inc.

At CFA we have top New York, Boston and Chicago firms in need of architects for a variety of building types, both on a project and perm basis. Contact us in confidence by email or phone (212) 532-4360 today. Email Nicole Abbott at recruiters@cons4arch.com

Circle no. 311

Get out of the crowd, and into a job. At ArchitectJobsOnline.com.

ArchitectJobsOnline.com is the official career site of ARCHITECT and residential architect magazines. Unlike general job sites, we offer Job Postings, Career Advice, Architect News, Architect Events, Salary Information and Resume Posting. So visit ArchitectJobsOnline.com today. And leave the mass market job sites to those other characters.



ARCHITECTJOBSONLINE

• Job Listings • E-mail Alerts • Career Tools • Industry Intelligence •

hanley wood

Resource

Manhattan Beach, California

CASCADE COIL DRAPERY
www.cascadecoil.com
800-999-2645

Circle no. 312

A Sleek New Breed

ARRIVING MAY 15, 2008

element
BIG ASS FANS

877-BIG FANS
www.elementfan.com

©2008 Delta T Corporation dba Big Ass Fan Company. All rights reserved.

Circle no. 315

InsulBloc[®]
HIGH PERFORMANCE INSULATION

Insulate Masonry, Stop Air Infiltration, And Dampproof In One Step. InsulBloc masonry insulation adheres to any shape and seals construction gaps, making it the perfect choice for unique architectural designs. InsulBloc offers the highest R-value per unit thickness of any commercially available insulation and is enviro-friendly. Call 800-346-8229 or go to NCFI.com for more information.

Circle no. 318

ARCAT[®]

ARCAT is a publisher of building product information in print and online available at www.arcat.com.

ARCAT provides specifications, CAD details, green product data and manufacturer product information.

ARCAT is also the creator of SpecWizard, the automated online specwriting tool. All this and more is available free of charge at www.arcat.com

Circle no. 313

Wilmette Lighting Company

Drake Wall Sconce delivers refined craftsmanship, quality detail and elegance to your environment. The shade is available in fabric or glass to deliver rich illumination. The Drake is available with a swing-arm option and an integral on/off switch discreetly incorporated into the design.

Tel. 847-410-4400
wilmettelighting.com

Circle no. 316

LIGHTLINE

Add Flair & Function

Lightline[®] door canopy kits are simple to assemble and effortless to maintain. They come in a variety of eye-catching styles and sizes with stainless steel support arms, UV resistant acrylic visor panes, and integrated aluminum rain gutters. And the patented *Click-Lock* pane attachment feature makes installations a breeze. Call for a free catalog.

Feeney Architectural Products
800-888-2418
www.feeneyarchitectural.com

Circle no. 319

Carlisle SynTec's GreenGrid[®] Roof Garden System is an easy way to experience all the benefits of a vegetative roof system. With the pre-planted GreenGrid trays, architects and contractors can provide their customers with an affordable roof garden system that helps contribute to air and water purification, reduced urban heat island effects and so much more.

www.carlisle-syntec.com

Circle no. 314

HOVER CF

6" and 9" modern design with floating appearance

high efficiency performance for compact fluorescent lamps

trimless or flanged design for drywall and grid ceilings

shallow and air-tight housings

color rings, regressed lens, cross blade baffle, or open trim options

ardeelighting.com 888-442-7333

Ardee Lighting is a Philips group brand **PHILIPS**

Circle no. 317

FOR INFORMATION

on how to be a part of the next ARCHITECT special advertising section, contact Erin Liddell at 773.824.2445.

hanley wood

hanley▲wood

ARCHITECT ONLINE



BUILDING: A NETWORK

ARCHITECT Online is laying the base for a premier electronic experience for practicing architects. We organize the site, you reflect on the ideas. Market intelligence, a building products database, breaking news—all established to help grow a continuing collection of inspiration. To join the network, visit www.architectmagazine.com.

Advertiser	Page	Circle	Website	Phone
AAMA	132	493	www.aamanet.org/certification	847.303.5664
ABS Doormerica Products	78	169	www.Doormerica.com	
Acme Brick	53	172	www.brick.com	
Advanta	137	497	www.applytoday.com/hw	800.282.2192
The American Institute of Architects	60	490	www.aia.org/join_today	
Amvic Building System	75	394	www.amvicsystem.com	877.470.9991
ARCAT, Inc.	88	430	www.arcata.com	
Architect Online	142	-	www.architectmagazine.com	
ArchitectJobsOnline.com	65b	-	www.ArchitectJobsOnline.com	
Ardee Lighting	6	411	www.ardeelighting.com	888.442.7333
AT&T Wired	57	487	www.att.com/onwardsmallbiz	
Azrock	4	164	www.Azrock.com/looksmart	800.558.2240
Belden Brick	87	82	www.beldenbrick.com	330.456.0031
Big Ass Fans	17	165	www.elementfan.com	877.BIG.FANS
Birdair	80-81	163	www.birdair.com	
Bluworld of Water	21	160	www.bluworldusa.com	407.426.7674
Building Systems Design, Inc.	38	23	www.bssoftlink.com	888.BSD.SOFT
C.R.Laurence Company	58	166	www.crlaurence.com	800.421.6144 x7730
Cambridge Architectural	19	24	www.cambridgeinterior.com/25	866.806.2385
Canon	34-35 37	91 462	www.usa.canon.com	800.OK.CANON
Carlisle SynTec	13	463	www.carlisle-syntec.com	800.4.SYNTEC
Cascade Coil Drapery	32	81	www.cascadecoil.com	800.999.2645
CEMEX	69	94	www.cemexusa.com	
CENTRIA	25	25	www.CENTRIA.com	800-250-7897
COLOR KINETICS	66	428	www.colorkinetics.com	
Construct 2008	139	-	www.constructshow.com	
CSI	135	31	www.csinet.org/webinar	
Eldorado Stone	29	479	www.eldoradostone.com	800.925.1491
ELEMENT	33	167	www.element-lighting.com	
EMMA	76	98	www.emma-assoc.org	630.942.6591
Follansbee	43	32	www.follansbeeroofing.com	800.624.6906
Gardco Lighting	2-3	425	www.sitelighting.com	
Greenscreen	8	420	www.greenscreen.com	800.450.3494
Haddonstone	77	59	www.haddonstone.com	719.948.4554
Hanley Wood University	89	-	www.architectces.com	202.736.3447
Hanover Architectural Products	64	480	www.hanoverpavers.com	800.426.4242
HDI Railings	50	481	www.hdirailings.com	717.285.4088
High Concrete Group LLC	65a	35	www.highconcrete.com	800.PRECAST
High-R	26	467	www.high-r.com	888.292.2382

Advertiser	Page	Circle	Website	Phone
Hohmann and Barnard	42	36	www.h-b.com/c	800.645.0616
Hunter Panels	47	433	www.hunterpanels.com	888.746.1114
Insight Lighting	49	429	www.insightlighting.com	
Invisible Structures, Inc.	76	400	www.invisiblestructures.com	800.233.1510
JELD-WEN Windows & Doors	91	408	www.jeld-wen.com/1409	800.877.9482 x1409
JELD-WEN Windows & Doors	92-95	-	www.architectmagazine.com	
K2 Commercial Hardware	27	472	www.k2commercialhardware.com	
Kalwall	22	484	www.kalwall.com www.daylightmodeling.com	800.258.9777
Knauf Insulation	82	445	www.Knaufinsulation.com	800.825.4434 x8300
Lafarge	90	-	www.architectmagazine.com	
Lehigh White Cement	55	465	www.lehighwhitecement.com	800.523.5488
LG HI-MACS	51	42	www.LGeden.com	866.LGHI.MACS
Lightolier	9	426		
Litecontrol	C3	485	www.litecontrol.com	781.294.0100
MBCI	85	402	www.mbc.com/archcr	877.713.6224
Metecno USA	18	168	www.meTechnoUSA.com	877.meTecno
MITSUBISHI ELECTRIC - CITY MULTI	71	458	www.transforminghvac.com	
National Gypsum	C4	435	www.purplechoice.info	800.NATIONAL
Natural Stone Council	23	436	www.GenuineStone.org	
NCFI	24	486	www.NCFI.com	866-NSULATE
Nichiha	70	380	www.nichiha.com	866.424.4421
Oldcastle Glass	31	52	www.oldcastleglass.com	866.653.2278
Pine Hall Brick	75	173	www.americaspremierpaver.com	800.334.8689
PPG Industries, Inc.	45	423	www.ppgideas.com	888.PPG.IDEA
Prudential Ltg.	40, 41	79	www.pruelite.com	
Robinson Brick	72	390	www.RobinsonBrick.com	800.477.9002
S-5!	28	466	www.S-5.com	888.825.3432
SageGlass	36	48	www.sage-ec.com	877.724.3321
SELUX	62	170	www.selux.com/usa	
Shaw Contract Group	39	451	www.shawcontractgroup.com	
Sika Sarnafil	61	-	www.sarnafil.com/decor	800.576.2358
Sloan	7	453	www.waterefficiency.com	866.663.2289
Solatube	86	171	www.redefinedaylighting.com	
SPILIGHTING	12	174	www.spilighting.com	262.242.1420
Technical Glass Products	11	49	www.tgpaamerica.com	800.426.0279
Timely Prefinished Steel Door Frames	15	487	www.timelyframes.com/ahw	818.492.3530
USG	C2-1	56	www.SustainableCeilings.com	
VT Industries	5	53	www.vtindustries.com	

Volume 97, number 7, May 2008. ARCHITECT® (ISSN 0746-0554; USPS 009-880) is published 16 times a year (monthly, except for two issues in February, April, June, and October) by Hanley Wood, LLC, One Thomas Circle, NW, Suite 600, Washington, DC 20005. Copyright 2008 by Hanley Wood, LLC. Printed in the USA.

Periodicals postage paid at Washington, D.C., and at additional mailing offices.
POSTMASTER: Send address changes to ARCHITECT, P.O. Box 3572, Northbrook, IL 60065-3572.

Canadian Post International Publication Mail Sales Agreement No. 40655599. Send undeliverable Canadian addresses to Deutsche Post Global Mail, 4960-2 Walker Road, Windsor, ON N9A 6J3.

Q&A

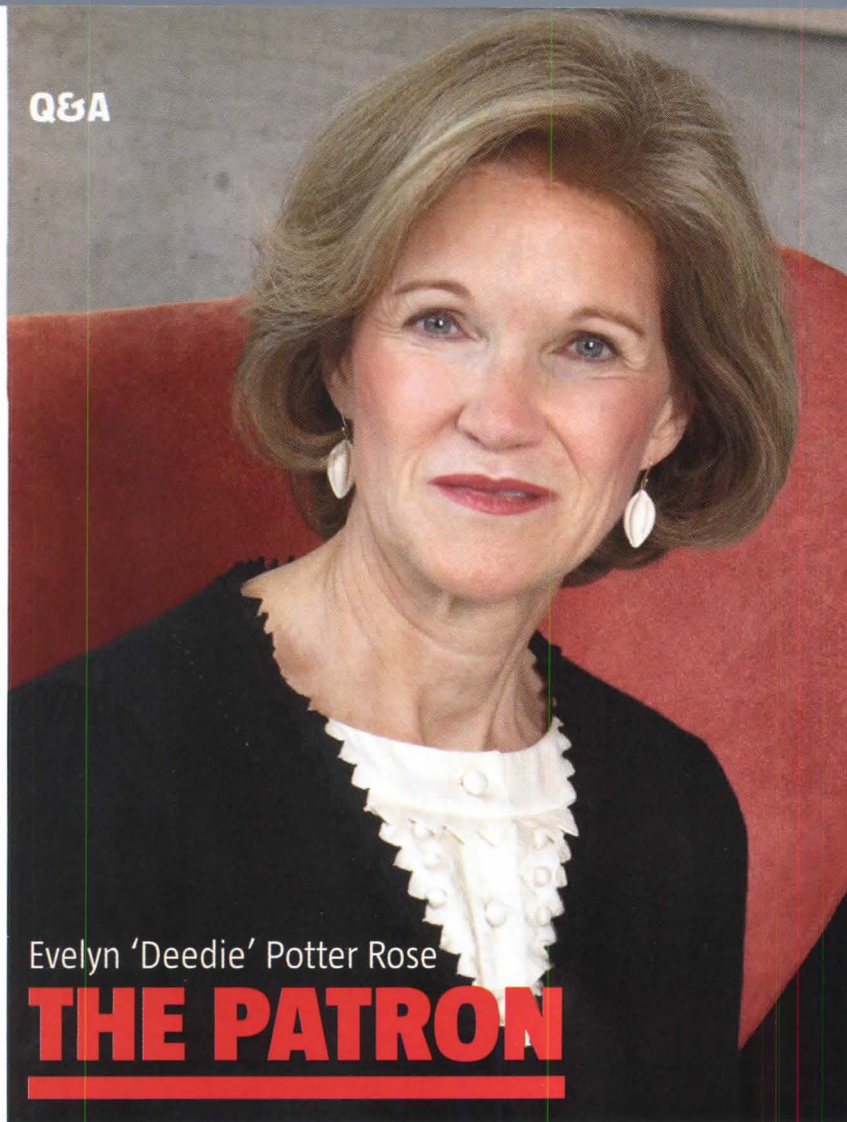

Evelyn 'Deedie' Potter Rose

THE PATRON

Interview Edward Keegan Photo Karen Campbell

GOOD CLIENTS OF ARCHITECTURE DO MORE THAN JUST FIND A DESIGNER TO CREATE A BUILDING—THEY ARE INVESTED IN PROJECTS FROM START TO FINISH, SAYS THE 2008 HONORARY AIA RECIPIENT.

AGE 67

FYI The collection of contemporary art that Rose and her husband have acquired will eventually be part of the Dallas Museum of Art, where she is a past president. Her civic affiliations include the Dallas Architectural Forum, the National Park Foundation, the architecture and design committee at the Museum of Modern Art, and the University of Texas School of Architecture advisory board.

How did you become interested in architecture?

My favorite smell in the world is sawdust. I grew up in Fort Worth as the daughter of a general contractor. My uncle was an architect, and I grew up wanting to be an architect. The only school that my parents were willing to pay for didn't have a school of architecture. I married, raised children, and found out someone wanted to buy the house we were in. So I was going to get to build a house. That was my first immersion in the built environment, and it was the most pleasurable experience I had up to that point.

How did you choose an architect for that project?

My goal was to choose the best architect for me. There is no one, best architect for everything. Larry Speck helped me narrow my list, and I visited those architects in their offices. I visited projects they had done. I talked to clients. I chose Antoine Predock to design our house. He was so much fun to work with, and he designed a place that shows me every day the importance of the built environment. I suggested to Larry Speck that the School of Architecture at the University of Texas have some course on how to be a good client because I think that is really an important thing in developing a great project.

What are the essential skills to being a good client?

It means spending a lot of time on how the design will function for you because no architect can read your mind. A client must be as involved as an architect, but they each have different roles. I do not know any more collaborative process than building. It involves a great contractor. It involves all the design trades—the civil engineer, the structural engineer, interior design, graphic design, acoustics. A client needs to make sure that they have the best of all those things and not quit until they have something they really believe is excellent.

What skills make for a good architect?

A great architect has equal portions of right brain and left brain. They are wonderful artists, but they are also wonderful engineers or analysts. They are great communicators, and they are inclusive. Sometimes the inclusive part gets given short shrift, but when they really listen to all the people that need to be involved, that is when you end up with a wonderful project.

Can you give examples of working with other architects and designers?

I worked with Sambo Mockbee and Coleman Coker. Now I'm working with a young architect, Nona Yehia. She lives in Jackson Hole, and we are doing a tiny little project there. I'm also doing larger projects for nonprofits, like the Wildflower Center in Austin. At the Dallas Center for Performing Arts, we chose Rem Koolhaas to design the Wylie Theater, Norman Foster to design the opera hall, and Michel Desvigne to do the landscape. I believe that at the same time the client spends a lot of time choosing an architect, they should spend the same amount of time choosing a landscape architect. When those two professions really work together, they inform each other, and the final product then can be even better.

If you could work with an architect from before our time, who might that be?

Louis Kahn. I'm most familiar with the Kimbell Museum, and it is one of the great buildings in the world.

What advice would you have to those who aspire to be either a patron or an architect?

I talk to young architects a lot because they come through my home. I encourage them because I believe the built environment changes the way we live and think. As citizens of the world, we need to pay attention to architecture, landscape, and urban planning. For a young architect I say, "You may not make the most money in the world, but the work you will do is so important, and you have a noble mission." For clients, I think spending a lot of time in planning before they go through the process of choosing an architect and thinking about what they want to achieve with a building, what the mission of a building will be—that is the thing that I would start out with. I would spend a lot of time planning how I could fulfill that mission in a building. That is going to lead me to make a better choice for an architect.

→ Audio of this Q&A is available online at www.architectmagazine.com.



SILVER



When you do your homework, you will learn about our new Cradle to Cradle Certified fixtures - the Radi-X with our exclusive LiteCycle baffle and the SAE 7700.

Visit litecontrol.com to learn more.

LITECONTROL

employee owned | customer driven

100 Hawks Avenue Hanson, MA 02341 781 294 0100 litecontrol.com

Cradle to Cradle Certified™ is a certification mark of MBDC.

Circle no. 485 or <http://architect.hotims.com>



NOW YOU HAVE A REAL CHOICE

New **e²XP**
Extended Exposure
Sheathing

After years of seeing nothing but a sea of yellow, something new is popping on the scene. Introducing e²XP Sheathing from National Gypsum. It's everything you want in a fiberglass faced exterior sheathing and much more. **eXtra** Protection from the elements, ready availability and responsive service are just a few of the reasons people are picking purple. Want a product you can trust? Go with the name that performs beautifully every time. Ask for e²XP Sheathing from National Gypsum.

National 
Gypsum®

Technical Info: 1-800-NATIONAL
www.purplechoice.info

Excellence Across The Board®

Circle no. 435