

The Better Résumé 17 An A/V Extravaganza 29
Wright's Other Women 40 The Morphosis Wiki 44

ARCHITECT



← **AIR CONDITIONER**
THE THIRD ANNUAL R+D AWARDS

Not All Rigid Insulation Board Is Created Equal: Weigh The Options Before You Buy

FOAMULAR® Extruded Polystyrene (XPS) insulation by Owens Corning meets the requirements of changing building codes and green building mandates, is highly versatile, extremely moisture resistant, and offers outstanding energy efficiency.

Saving Energy By Preventing Energy Loss

FOAMULAR® XPS insulation provides the highest level of defense against energy loss in residential and commercial applications. In fact, FOAMULAR® XPS insulation is guaranteed to maintain 90% of the advertised R-value for 20 years.* Many other types of foam insulation cite high R-values per inch; however, many of these claims are inflated when projected over the life of the foam.

The Best Choice For Above-Grade Sheathing

FOAMULAR® XPS insulation creates a continuous, protective thermal envelope around the entire building perimeter, reducing energy loss due to thermal bridging through wood or metal framing or steel fasteners. Using FOAMULAR® XPS insulation can satisfy energy codes such as ASHRAE 90.1** and contributes to achieving LEED® credits.

EPS

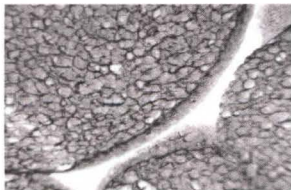

ISO

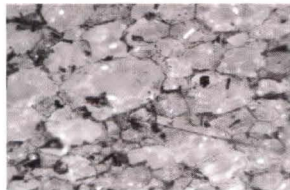

XPS

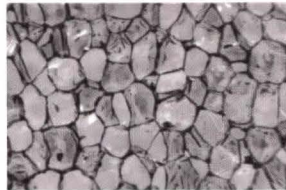

For more information, visit www.owenscorningfoam.com or call 1-800-GET-PINK.™

*See actual warranty for details.

**ASHRAE 90.1: American Society of Heating, Refrigerating and Air-Conditioning Engineers, 1791 Tullie Circle, N.E., Atlanta, GA 30329. LEED is a registered trademark of the U.S. Green Building Council.

The color PINK is a registered trademark of Owens Corning. ©2009 Owens Corning.

Why XPS Is Simply Better

Not every rigid insulation board is built the same. Differences in the manufacturing processes create dramatically different board structures and performance. Compare the leading options:

- **Expanded Polystyrene (EPS)** (shown, bottom left): A collection of thermoplastic beads pressed together under heat and pressure. EPS has air spaces between its beads, allowing water and air to penetrate, lowering its R-value.
- **Polyisocyanurate (ISO)** (shown, bottom center): A thermoset plastic manufactured in a lamination process using liquid that expands between facing materials. These facing materials may de-laminate and cause installation and durability problems. Its cell structure is irregular and more open, resulting in higher water absorption and lowering its R-value.
- **Extruded Polystyrene (XPS)** (shown, bottom right): A durable, thermoplastic polystyrene board with a homogenous cross section, resulting in very low water absorption, delivering long-term thermal performance. XPS lacks individual beads like EPS that can fall apart and is not brittle, nor dependent upon facers like ISO.

FOAMULAR® XPS insulation offers sound insulation solutions through a manufacturer committed to providing more energy-efficient, environmentally conscious products. And to help streamline availability and increase efficiency, Owens Corning has strategically placed plants across the nation. •

How much energy are our projects losing through thermal bridging?

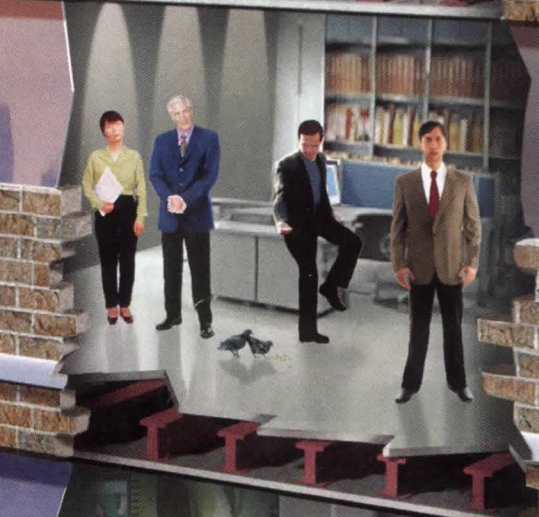

You wouldn't design a building with 23% of your walls left open, but if you're not accounting for thermal bridging that's essentially what you're doing. That's why it's important to spec Owens Corning FOAMULAR® insulation for above-grade sheathing. FOAMULAR® insulation not only satisfies ASHRAE 90.1* by reducing energy loss caused by thermal bridging, it also has an incredibly high resistance to water absorption. And unlike competing types of rigid insulation,** FOAMULAR® insulation maintains 90 percent of its R-value for 20 years! So your walls won't just be built energy efficient, they'll stay energy efficient.

To learn more about how FOAMULAR® insulation can reduce the effects of thermal bridging, go to owenscorningfoam.com or call 1-800-GET-PINK.™



Circle no. 232 or <http://architect.hotims.com>

*ASHRAE 90.1: American Society of Heating, Refrigerating and Air-Conditioning Engineers, 1791 Tullie Circle, N.E., Atlanta, GA 30329. **Competing types of rigid insulation include Expanded Polystyrene and Polyisocyanurate. *See actual warranty for details. The color PINK is a registered trademark of Owens Corning. ©2009 Owens Corning.

SMART SUSTAINABLE ARCHITECTURAL DIGITAL LED LIGHTING



TRE'O™ TEL Series
Exterior Architectural Lighting

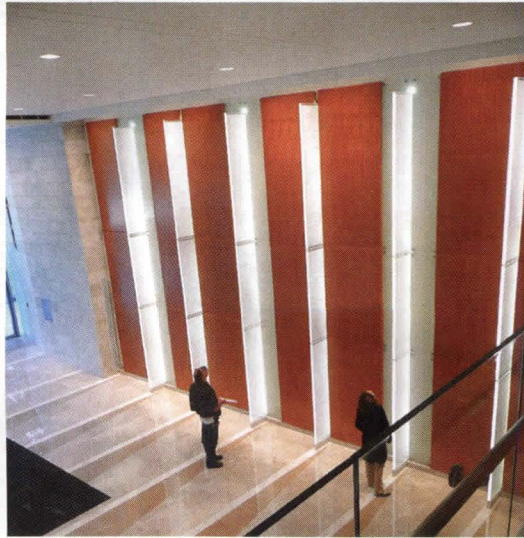

TRE'O™ TC Series
Interior Architectural Lighting

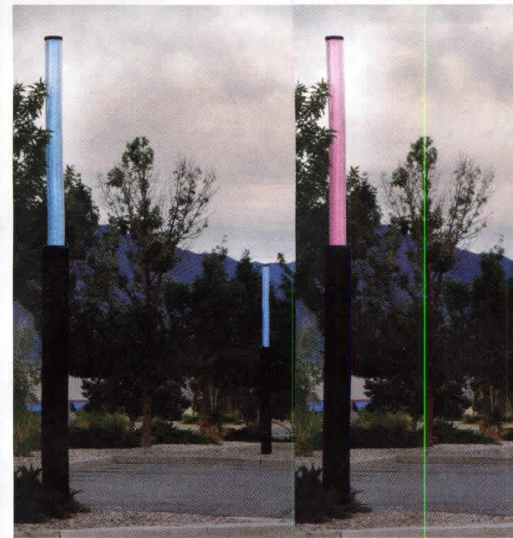

EURO™
Illuminated Vertical Columns

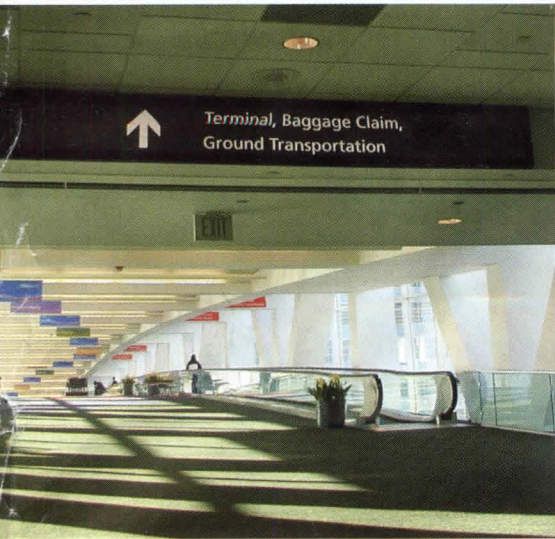

SmartWay
A Technology Based Way Finding System



SmartPanel™
Illuminated Graphic Panels

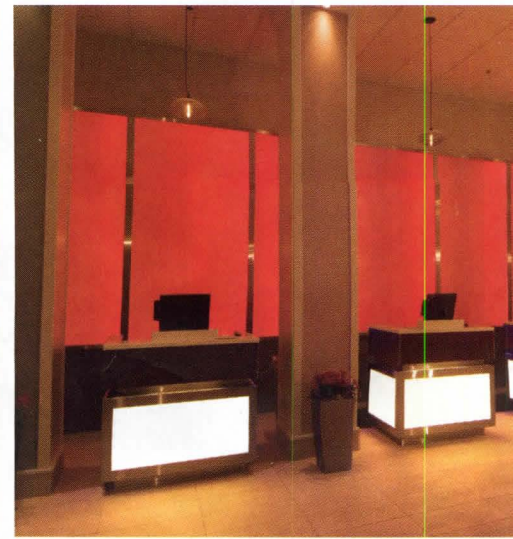

SmartWall™
Illuminated Wall Systems

Sustainable lighting design should be more than just installing the latest LED product in a space. Insight Lighting's LED products employ a combination of sciences that create an environment of low temperature and sealed electronics. Insight's design approach relates to longer life, consistent fixture to fixture color temperatures, increased lighting uniformity and product integrity that lasts.

Insight is committed to providing digital LED product designs that meet the energy and performance demands of a sustainable architectural environment. Insight Lighting's new **5 Year Warranty** clearly separates us from those manufacturers that simply market LED lighting fixtures.

For additional LED product information, please contact your local Insight representative or visit our website at www.insightlighting.com.



**IF IT CAN SURVIVE HIGH SCHOOL,
IT CAN SURVIVE ANYTHING.**

The new, redesigned TuffTec™ 2.0 Locker. Field-tested in high schools, it's engineered with a tough, solid plastic construction that withstands the worst kind of bullying. See why at scrantonproducts.com.

Designed to be worry-free.

 **TUFFTEC[®] 2.0**
LOCKERS



SCRANTON PRODUCTS



COMTEC
INDUSTRIES



Circle no. 466 or <http://architect.hotims.com>

CONTENT



COURTESY SKIDMORE, OWINGS & MERRILL



COURTESY IWAMOTOSCOTT ARCHITECTURE

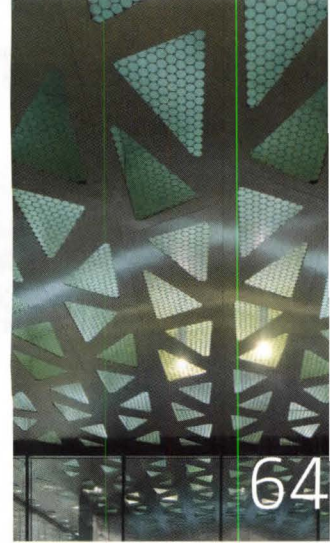

COURTESY BARKOW LEIBINGER ARCHITECTS

FEATURES

46

The Third Annual R+D Awards

Jurors Lauren Crahan, Craig Hodgetts, and John Ronan select 13 technologies that do more with less. **KATIE GERFEN AND AMANDA KOLSON HURLEY**

48 Active Phytoremediation Wall System

The Center for Architecture Science and Ecology's green wall improves air quality.

51 Ecoworx Backing for Broadloom Carpet

Shaw Industries created a cradle-to-cradle backing for their broadloom carpet lines.

52 Dynamic Descent

For a townhouse staircase, Dean/Wolf Architects went with laser-cut stainless steel.

54 Oasis Generator

Skidmore, Owings & Merrill create a towering desalination plant for the United Arab Emirates.

56 Dry Joist & Dry Joist EZ

An aluminum decking system that is weather- and fire-resistant, from Wahoo Decks.

57 Sustainable Form-Inclusion System

SOM recycles plastic bags and water bottles as an airy aggregate for structural concrete.

58 Voussoir Cloud

IwamotoScott Architecture create a compression structure using a minimal amount of materials.

61 Rhinobond

With induction welding, Sika Sarnafil reinvents the installation of thermoplastic roof membranes.

62 Pin-Fuse Joint

SOM's hinged joint lets steel frames roll with an earthquake, then return to form.

64 Trumpf Campus Gatehouse

A cantilevered roof shows off Barkow Leibinger Architects' 2D and 3D cutting and casting.

66 TKTS Booth

For a Times Square ticket booth, Perkins Eastman develops a structural glass roof-cum-stairway.

69 San Francisco Digital Context Analysis Model

SOM develops a virtual map of the Bay City for use in future planning.

72 LED Streetlight

New York's new streetlights by the Office for Visual Interaction, Werner Sobek, and Thomas Phifer.

"I WOULD MOVE INTO AN OFFICE WITH THAT INSTANTLY."

CRAIG HODGETTS, R+D Awards juror, reacting to the Active Phytoremediation Wall System. For more on this year's award winners, turn to page 46.

ON THE COVER
A HOSTA, ONE OF THE PLANT TYPES THAT CAN BE USED IN SOM'S R+D AWARD-WINNING ACTIVE PHYTOREMEDIATION WALL SYSTEM. PHOTOGRAPH BY DAVIES + STARR.



WANT MORE FROM AUTOCAD LT® SOFTWARE?

How about \$400 more?

Purchase a license of AutoCAD LT® 2010 and get more efficiency, more power, more reliability and more productivity, plus a rebate for up to **\$400**.

Better than ever, AutoCAD LT 2010 has more:

- 2D tools like Align, Xref and Block Attribute commands
- Support for PDF underlays and high-quality PDF output

And now we're offering a **\$400** rebate for current qualified AutoCAD LT software users and a **\$200** rebate for new customers who purchase through CDW by August 31, 2009.

The wait is over. Experience 2D drafting and drawing like never before with AutoCAD LT 2010.



To find out more about the latest version of AutoCAD LT and get details on the rebate, call **888-561-4239** or visit **www.autodesk.com/cdwoffer**

Autodesk[®]
Authorized Reseller

Please refer to the complete list of eligible products, terms, and conditions at www.autodesk.com/cdwrebate.

The \$400 Autodesk AutoCAD LT Legacy Rebate promotion is only available to customers who own existing AutoCAD LT licenses version 2000, 2000i, 2002, 2004, 2005 and 2006. Rebate offer valid from May 1, 2009 to August 31, 2009. The \$400 Legacy rebate is only available on AutoCAD LT purchased through CDW upgrades, crossgrades, competitive trade-ups, education, Strategic Accounts and government purchases do not qualify. Customer must provide one valid serial number of the qualifying AutoCAD LT product for each AutoCAD LT 2010 product license purchased. Only commercial customers may participate. U.S. Government (Federal/State/Local) accounts purchasing via DLT or directly from Autodesk, Strategic Accounts, Canadian Federal Government accounts purchasing via DISO direct with Autodesk and Education customers are not eligible to participate in this Rebate promotion. This rebate offer is subject to terms and conditions available at www.autodesk.com/cdwrebate. Autodesk reserves the right to alter product offerings and specifications at any time without notice, and is not responsible for typographical or graphical errors that may appear in this document.

The \$200 AutoCAD LT new customer rebate is valid from May 15, 2009 through August 31, 2009. The \$200 rebate is only available on AutoCAD LT 2010 purchased through CDW. The AutoCAD LT new customer rebate cannot be combined with the AutoCAD LT Legacy rebate and is not valid with, and cannot be combined with any other Autodesk offers, special pricing or other offers unless otherwise specified herein. Upgrades, crossgrades, competitive trade-ups, education, Strategic Accounts and government purchases do not qualify. Only commercial customers may participate. U.S. Government (Federal/State/Local) accounts purchasing via DLT or directly from Autodesk, Strategic Accounts, Canadian Federal Government accounts purchasing via DISO direct with Autodesk and Education customers are not eligible to participate in this Rebate promotion.

Autodesk reserves the right to cancel, suspend or modify part of this entire promotion at any time without notice, for any reason in its sole discretion.

© Copyright 2009 Autodesk, Inc. All rights reserved. Legal Notices & Trademarks Privacy Policy

Circle no. 220 or <http://architect.hotims.com>

CONTENT

Right Images of cities real and imagined populate *The BLDGBLOG Book*.

Far Right The intricate set from U2's new tour.

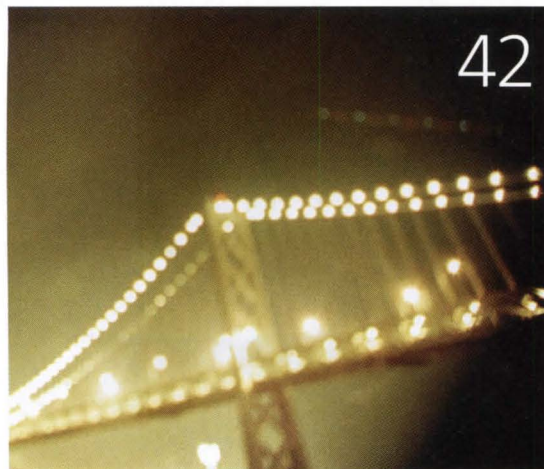

COURTESY OF CHRONICLE BOOKS

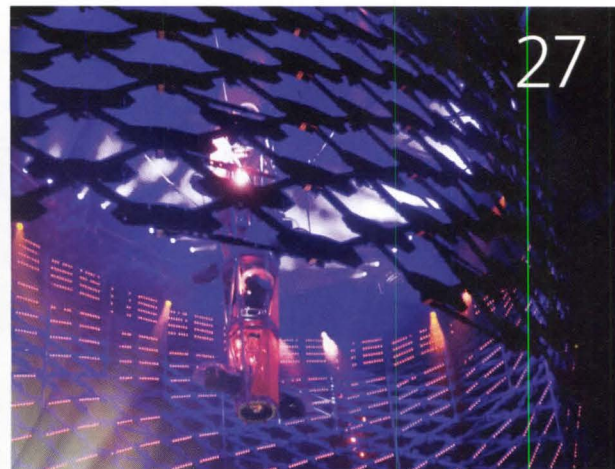

MARK FISHER

FRONT

- 10 **Dialogue** The King Is Dead
- 12 **News**

BUSINESS

- 17 **Best Practices** You Are the Brand
The first in a three-part series for job seekers: How to create the most effective résumé.
EDWARD KEEGAN
- 20 **Practice** Written Off?
With technology encroaching on their profession, times are tough for spec writers.
EDWARD KEEGAN
- 24 **Local Market** New Orleans
The Big Easy is still slowly fighting back from Katrina. MARGOT CARMICHAEL LESTER

TECHNOLOGY

- 27 **Detail** Expanding Video Screen
An expandable screen clad with 500,000 LEDs lights up U2's summer tour. ANNE GUINEY
- 29 **A/V Pro** AV Spotlight Awards
The winners from Pro AV magazine's annual awards program. KIMBERLY R. GRIFFIN
- 32 **Eco** Earth Attacks!
New disaster films depict the fall of the city, but that doesn't have to be our fate. LANCE HOSEY

- 34 **Products** Skins
The newest and neatest in the exteriors market.
KIMBERLY R. GRIFFIN

CULTURE

- 37 **Books, Objects & Exhibits**
A modernist bike, The Three Little Architects, analysis of camps, and more ... JOHN SCAPPINI
- 40 **History** Leading Ladies
Scores of women worked in Frank Lloyd Wright's studios. Who were they? HANNAH MCCANN
- 42 **Crit** Fantasy Lands
How well does the BLDGBLOG website translate to a printed volume? MIMI ZEIGER
- 44 **Screen Grab** morphopedia.com
Morphosis reinvents its online identity.
BRAULIO AGNESE AND NED CRAMER

PAST PROGRESSIVES

- 80 **1966–1972** The Best Betts
Hobart Betts had a great run winning P/A Awards. Then he receded. THOMAS FISHER

WWW.ARCHITECTMAGAZINE.COM

→ **News, Products, Events, Deadlines & More ...**

NATURAL ALLIES



© 2009 Knauf Insulation GmbH.



I'm always on the lookout for new, more sustainable ways to design and build. That's why I specify EcoBatt® Insulation from Knauf for my projects.

Knauf EcoBatt Glasswool gives me the same optimal performance as all their insulation, but it's more sustainable...thanks to its abundant and renewable raw materials, high post-consumer recycled content and ECOSE® Technology.

Knauf's revolutionary new ECOSE Technology is a binder with a lower embodied energy. It is based on rapidly renewable bio-based materials—eliminating the non-renewable petroleum-based chemicals such as phenol, formaldehyde and acrylics found in traditional fiber glass insulation.

With my focus on sustainable building, EcoBatt Insulation is the natural fit for my projects.



For more information call (800) 825-4434 ext. 8300

or visit us online at www.knaufinsulation.us



THE KING IS DEAD



WE LOST AN IMPORTANT VOICE recently, and no, I'm not talking about Michael Jackson. My mourning is reserved for another fabled Angeleno, photographer Julius Shulman, who died on July 15 at the remarkably ripe age of 98. Shulman was one of the last representatives of a great moment in architectural history: the postwar era of California Dreamin', when progress made perfect sense and technology was the answer to every problem under the sun.

Two vintage Shulman prints hang in the boardroom here at Hanley Wood, including one of his most famous pictures, a nighttime view of the Pierre Koenig–designed Case Study House #22, its glass-walled living room cantilevered dizzily over the Hollywood Hills. Shulman populated the scene with two leggy models, perched on leggy modern furniture and seemingly indifferent to the spectacle of the city below. During long meetings, Shulman's photo gives me the perfect kickoff for a daydream.

The photographer struggled with architect-clients

like Richard Neutra, who wanted his projects to be shot empty, even of furniture, so nothing could compete with the architecture. Shulman preferred to animate buildings with signs of habitation. Never mind that the people and objects in Shulman's pictures were often models and props, with no real-world relationship to their surroundings. The effect was everything.

Just days before Shulman's death, his business partner Juergen Nogai shared a charming and illuminating story with *The Wall Street Journal*:

One technique Shulman taught him, he said, was to place people in "artificial positions" in the photographs. It gives the pictures "a strange feel and makes them very interesting," he said. In one house, Mr. Nogai noted, Shulman placed a woman in the kitchen in high heels, dressed as if she were going to a party, standing at the counter cutting a fruit. "I was looking closely at this photo and I said, 'Wait a minute, Julius. She doesn't have a knife in her hand.'

LETTERS →

"The Silent Partner" and "Have You Seen Me?," July 2009

You highlight, first, architects of record, firms that actually prepare the construction documents and perform construction-phase services for design firms, and second, the education of current (unemployed architectural graduate) students through CAD, LEED, and theoretical/technological skills.

In the former, you answer the questions of the latter.

Is it any wonder graduates are experiencing difficulty finding employment, and are drifting towards graphic and tech trades? That's all they were taught: creative thinking without application.

And while I embrace LEED, it is predominantly an engineering- and specification-driven approach to building design. LEED does not teach you how to build. The point-intensive aspects of LEED are site, mechanical, electrical, and plumbing related—components that will ultimately be determined by engineers. Material selections for sustainability are already standardized by spec writers. LEED is becoming a marketing tool.

In our cut-and-paste CAD world, no one has to actually develop, let alone comprehend, construction details. And frankly, I don't believe the title of

architect belongs to anyone so limited that they can't design, comprehend the manner in which a building is to be constructed, detail such requirements, and follow it up with reasonable construction administration services.

The true talent gap is with all of us older, experienced architects, who have been discarded in this recession in favor of cheap student labor.

Eric D. Kuritzky
Orlando, Fla.

"Battle Royal in U.K. Over Chelsea Barracks," July 2009

As an American architect who has followed the Chelsea Barracks affair closely over the last few months, it was apparent to me that your small article gave a very incomplete view of what has become a complicated spat over the future of the Chelsea Barracks site.

Your article suggested that, were it not for Prince Charles' meddling, all would be fine and well with the project, since it was really just a "run-of-the-mill fight between fans and foes of contemporary design." From what I can tell, this is at least incomplete, and perhaps inaccurate.

Apparently, local opinion on the Richard Rogers project for Chelsea has

been overwhelmingly negative. Rogers, a member of Parliament himself, produced a plan for the site that disregarded Westminster's planning brief, which stipulated no more than six stories, in conformity to building heights in the neighborhood, and banned glass, steel, and plastic exterior surfaces in favor of brick, stone, and slate. The brief also stated that it should reflect the scale and style of adjacent Chelsea and Pimlico.

Rogers' design was for a nine-story block with glass and steel cladding. He initially was able to influence Westminster's planning officers and won their tentative approval at a steering committee last September. But by the time the design was approaching the full planning committee, a barrage of local opposition alerted officials to the variations from the brief and made rejection almost certain. It was most likely the local opposition to a scheme that ignored the planning brief, rather than Prince Charles' opinion, which changed the mind of the developers. To characterize this as a case of Charles simply saying "I don't like it," and to describe this as simply a stylistic quarrel, is misleading.

I realize that Charles is the focus of ire for many modernist architects, but he cares deeply about London and argues passionately for an urbanism that is less

about individualistic objects and more about humanistic place-making. I'm grateful for his voice.

Erik Evens
Los Angeles

"Have You Seen Me?," July 2009

Though I am incapable of giving an unbiased opinion, I'd say the July 2009 cover looks great. I'm pretty psyched to be the poster child of unemployed recent architecture grads. I like what Mimi Zeiger said about social consciousness becoming more prevalent with young people in our field, though overall the article didn't give much hope for a magical stockpile of jobs to open up. But we're creative people, so I'm sure we'll all figure something out somehow.

Theresa D Franzese
Gettysburg, Pa.

"The Architect 50," May 2009

Due to a reporting error, the revenue range of Zimmer Gunsul Frasca was misstated in our Architect 50 ranking. The revenue range was stated as \$25–\$29.9 million; in fact, the firm's 2008 gross revenue was between \$100 and \$199.9 million.

He looked at me and smiled and said, 'And?' 'She has a bottle opener in her hand.' He said it doesn't matter—nobody would see that. She's doing something. For him it was the action. Everything does not have to be real. It's just the action, the illusion that we're creating."

Thanks to his penchant for visual narrative, Shulman's pictures capture the spirit of high-modern, postwar optimism even better, perhaps, than the buildings he photographed—better than just about any other creative outpouring of the day. And what a day it was: Case Study houses under construction, the Eameses in action ... only Hollywood's collective celluloid output rivaled Shulman's singular vision of paradise. And yes, California circa 1960 was indubitably a paradise, but at what price? Alas, there's not enough oil in Araby or gold in Fort Knox for us to carry on that carefree, freeway-bound existence.

Think I'm exaggerating? The state of California faces an \$8 billion budget deficit next year, and the federal

government estimates a 2010 deficit of \$1.26 trillion. America continues to milk the dream long after it soured.

In our moment of fiscal and spiritual crisis, it's tempting to wax nostalgic or moralize about the age of Shulman. One could waver endlessly between conflicting impulses to return to that ostensibly simpler age or condemn its putative superficiality. Ultimately, it's better to learn from our history—to recognize that we can't ever go back, but that we can't move forward, either, without a dream.

Politicians like to say that the American way of life is non-negotiable. But how you define our way of life is really the issue. I'd like to think that the American Dream amounts to more than the material benefits of cheap energy. I think our way of life is rooted in ingenuity and hard work. Such was the substance behind Shulman's gorgeous illusions.

Reel Crane

SHULMAN'S
PICTURES CAPTURE
THE SPIRIT OF
HIGH-MODERN,
POSTWAR
OPTIMISM
EVEN BETTER,
PERHAPS, THAN
THE BUILDINGS HE
PHOTOGRAPHED.



CASCADE COIL DRAPERY™

Woven Wire Fabric

Circle no. 81 or <http://architect.hotims.com>

Projects include multi-story wire mesh draperies for hotels, auditoriums, and casinos; curved dividers for visual merchandising; window treatments for private homes; safety screening for industrial settings; sculptural forms for urban gardens; decorative interior/exterior wall coverings for buildings and parking garages; aviary round weave screening for animal habitats, and see-through appealing barriers for commercial security. Whatever the application, let us help you realize your creative vision.

www.cascadecoil.com | 800-999-2645

EDITED BY BRAULIO AGNESE

Top Stories → For these stories and more, see architectmagazine.com.

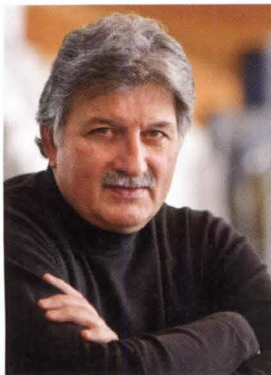

Ed Mazria of Architecture 2030 won the first **Hanley Award for Vision and Leadership in Sustainable Housing**. He will receive a \$50,000 prize.



The **University of Utah** named **Prescott Muir** as director of the School of Architecture. Muir is the founder of Prescott Muir Architects and has taught at Utah since 1993.



Casey Jones of consulting firm **jones|kroloff** will be the next director of the **GSA's Design Excellence Program**.

Julius Shulman Dies at 98

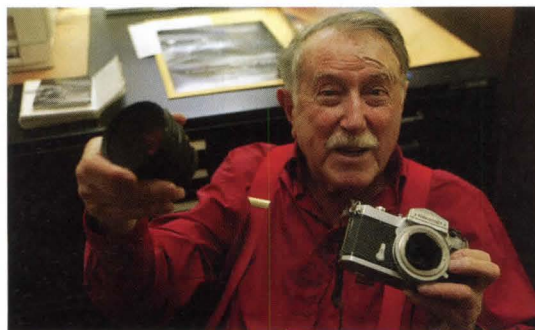

JULIUS SHULMAN, whose compelling photographs of iconic Southern California residences defined an aesthetic that still seems contemporary, died on July 15 at the age of 98. "He knew how to make architect's photographs," says Wim de Wit, head of the Department of Architecture and Design at the Getty Research Institute, "but he also took images he could sell to the book and magazine publishers that he knew." This business sense helped promote Shulman's career while widely disseminating his clients' work and the Southern California lifestyle.

Buildings by Richard Neutra, John Lautner, and Pierre Koenig were among those that Shulman helped to make famous. Shulman also documented the

seminal Case Study houses—a project he did without compensation from the designers.

De Wit knew Shulman well and has worked with the archive of 260,000 prints, negatives, and transparencies—Shulman's total output between 1936 and 1996—since it was donated to the Getty in 2005. "He used very particular angles, including the ceiling in the space," says de Wit. "There's always light from the next space that gives you a sense of the entire layout."

A retrospective at the Getty curated by de Wit and Christopher J. Alexander, "Julius Shulman, Modernity and the Metropolis," marked the photographer's 95th birthday. It featured iconic images and traveled to the Art Institute of Chicago and to Washington, D.C.'s National Building Museum. It was followed by the Getty's 2007 show "Julius Shulman's Los Angeles," which will open in Guadalajara, Mexico, later this year. The more recent exhibit includes Shulman's photographs of L.A. locales beyond his architectural jobs. "It shows his love affair with the city," says de Wit.

Shulman generally worked alone, in contrast to larger organizations established by his peers—Bill and Ken Hedrich of Hedrich Blessing and Ezra Stoller of Esto. This triumvirate established the profession of architectural photography. Shulman's passing marks the end of that generation. **EDWARD KEGAN**

DWA WINS BURNHAM DESIGN COMPETITION

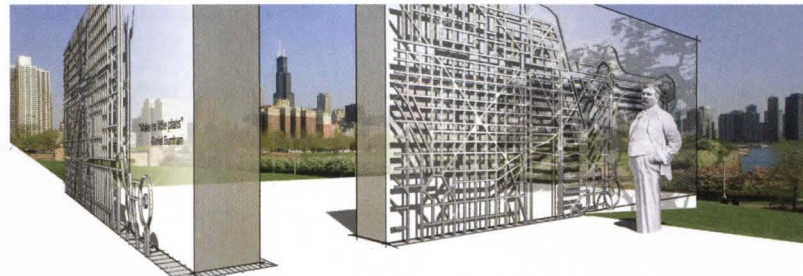

David Woodhouse Architects has won first place in a design competition for a permanent memorial in Chicago to Daniel Burnham, co-author of the 1909 Plan of Chicago. The program—formally known as the Burnham Memorial Design Competition—was sponsored by the AIA Chicago Foundation and funded by the Richard H. Driehaus Charitable Lead Trust. The memorial site is located at the southeast corner of Grant Park. If fundraising is successful, the memorial could be built as early as 2011. **JOHN SCAPPINI**

JUNE 2009 ARCHITECTURE BILLINGS INDEX

↓ 37.7

- ↓ 39.5 commercial
- ↓ 37.0 institutional
- ↓ 43.5 mixed practice
- ↓ 42.7 multifamily residential

SOURCE: AIA



Able to protect tall buildings in a single bound.

Start Smart.
Be a Hero.
Visit typar.com.

Finally, a building wrap with super powers.

Typar® MetroWrap™ is a commercial building wrap that can withstand the pressures above four stories. And when you consider the exceptional bulk water holdout, Type I air resistance, 12 month UV protection and other incredible benefits*, using MetroWrap just might make you the hero.

*(Kryptonite resistance test pending.)

Circle no. 483 or <http://architect.hotims.com>

TYPAR® 
MetroWrap™

A Fiberweb Brand

Building Wraps • Flashings • Construction Tape • Roof Wrap • Landscape Products • Geotextiles

U.S. Architect Wins Reality TV Show—and \$1 Million

A CONVERSATION WITH RICHARD BEST, THE CALIFORNIA ARCHITECT WHO WON *THE HYDRA EXECUTIVES*, AN *APPRENTICE*-STYLE REALITY SHOW FILMED IN ABU DHABI.

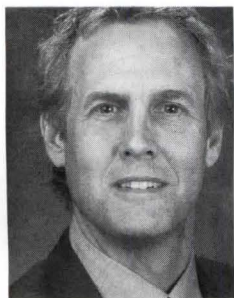

How did an architect from California end up competing in *The Hydra Executives*, a reality show in Abu Dhabi?

It's truly a bizarre situation, isn't it? It came to me as an e-mail from the

UCLA School of Architecture. I'm on the mailing list, and I caught a glimpse of this "real-estate audition" phrase. That year I had decided to try and do things differently from a marketing perspective, as things had started to turn sour with the economy. So I pulled it back out and read it, and it was advertising for a real estate-oriented [TV show] filming in the U.A.E.

I checked with my family to see if I could take that kind of time away, and Saturday morning, I threw on a sports jacket, took a

tiny business plan, and started auditioning. By Sunday I had signed the contract. Truly bizarre.

How exactly did you win it? Did you have any strategies going in?

Reality shows are very, very trying. You have to decide between yourself and others, and the challenge, really, is to be a team player and also [to] be selfish. It really comes down to knowing when to do these two separate things. People tend to follow me when I'm in group situations. I just have a natural leadership tendency, probably because I [am] older.

Do you think your architectural background helped you in the competition?

Hugely. We had tasks to perform on a weekly or biweekly basis, and they were all real estate- or design-oriented in some way. Designing buildings, starting a business, landscape design, interior design—I'd done all these things in my past. Maybe that's why I was chosen in the end.

You've donated some of your winnings to charity. Do you have any other plans for the prize money?

I was introduced to the [United Nations'] Intergovernmental Institution for the Use of Micro-Algae Spirulina Against Malnutrition by Dr. [Sulaiman Al] Fahim, the host of *The Hydra Executives*. I feel their efforts on malnutrition across the globe will be impactful. The rest of the money I will use to set up a firm, Eco Design, in the U.A.E. Dr. Fahim is my partner in that, and he has many contacts in the real estate world and with developers, so we fit together well.

***The Hydra Executives* has been billed as the U.A.E.'s version of *The Apprentice*. Can you say "You're fired" in Arabic?**

[Laughs] No, it was all filmed in English.

INTERVIEW BY JOHN SCAPPINI

For more information on the show, go to hydraexecutives.com.



Chair Affair in D.C.

WINNING ENTRIES from The Chair Affair 2009 student design competition were showcased at the National Building Museum in Washington, D.C., in late July. Jessica Leung, a student at Cuesta College in California, won first place for her design "Hole on Hole" (pictured).

Co-sponsored by the International Corrugated Packaging Foundation and the American Institute of Architecture Students, The Chair Affair challenges students to use corrugated board to build a comfortable, aesthetically pleasing chair. Students from 49 colleges and universities entered this year, vying for a top prize of \$1,500. J.S.

Not all art is made
TO HANG IN GALLERIES.



Like fine art, we create exceptional windows and doors to be on exhibit daily. Craftsmanship still lives at JELD-WEN whether it's for the interior or exterior. After all, discerning customers are looking for extraordinary artistry that does more than complement a home; it completes it. Learn more. Click www.jeld-wen.com/11809. Visit a JELD-WEN dealer.

Circle no. 408 or <http://architect.hotims.com>

RELIABILITY *for real life*®

JELD-WEN
WINDOWS & DOORS



412 Walnut Chappo

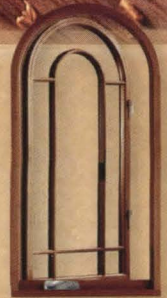

Radius Casement

PRE-DESIGNED SOLAR ROOF SYSTEMS

Factory integrated into standing seam panels with CAD drawings and specs.
Ready to be integrated into your bidding documents.

**PAYBACK IN 10 YEARS
OR LESS IN SOME STATES**

Photo Courtesy of UNI-SOLAR®

BUDGET PRICING (INSTALLED INCLUDING ELECTRICAL)

SYSTEM SIZE	BEFORE INCENTIVES	MINIMUM AREA REQUIRED
3 KW	\$23,400 \$7.80/W	600 SQ.FT. \$39.00/SQ.FT.
5 KW	\$38,000 \$7.60/W	1,000 SQ.FT. \$38.00/SQ.FT.
10 KW	\$76,000 \$7.60/W	2,000 SQ.FT. \$38.00/SQ.FT.
15 KW	\$109,500 \$7.30/W	3,000 SQ.FT. \$36.50/SQ.FT.
30 KW	\$219,000 \$7.30/W	6,000 SQ.FT. \$36.50/SQ.FT.
60 KW	\$420,000 \$7.00/W	12,000 SQ.FT. \$35.00/SQ.FT.
120 KW	\$840,000 \$7.00/W	24,000 SQ.FT. \$35.00/SQ.FT.

To find standing seam roof systems manufacturers who will assist you with an ROI analysis for your BIPV commercial, industrial, or residential project, visit:

www.energypeak.com
1.888.216.9600

Architects can visit www.architectces.com to complete EnergyPeak's continuing education presentation worth 1LU/HSW/SD

Circle no. 195 or <http://architect.hotims.com>

ENERGY PEAK
Building Integrated Photovoltaic (BIPV)
Standing Seam Roofing

BUSINESS



TEXT BY EDWARD KEEGAN
PHOTO BY RICHARD MORGENSTEIN

→ BEST PRACTICES

You Are the Brand

FIRST UP IN A THREE-PART SERIES FOR JOB-SEEKERS: **THE RÉSUMÉ**. HOW TO GET YOUR CREDENTIALS CONSIDERED? TARGET THE PITCH, NIX THE HARD COPY, AND MAKE THAT COVER LETTER SING.

"Architects are good at taking complex problems and figuring out innovative solutions," says **Marjanne Pearson**, head of the eponymous design consulting and headhunting business. "Apply that to the résumé process."

THE JOB HUNT starts with a pitch-perfect résumé, and design consultant-slash-headhunter Marjanne Pearson is the ultimate judge. She knows the business from the inside—despite a lack of architectural training, she's been partner in a firm—and her ability to communicate and network are legendary. Pearson's first client when she launched her own consulting practice in 1987 was Frank Gehry. Today, she offers a seemingly uninterrupted feed of news, information, and advice for designers as @NextMoon on Twitter.

Thousands of architects are looking for work right now. What's the best way to go about it?

Get out of the turkey-shoot mindset. That's how people marketed 30 years ago: Go out in the woods, shoot, and hope something falls as a result. The first issue is, who is this [résumé] going to go to? Who do you want to impress, and how do you want to shape perceptions about you? Know about the firm and what they do.



Gravelpave²
A Capital Idea!

The Architect of the Capitol chose Gravelpave2 for the walkways in the National Garden at the United States Botanic Garden. Gravelpave2 provides ADA accessibility, porosity, and adds to the beauty of the one-of-a-kind garden.

gravelpave2.com
 1.800.233.1510
 Invisible Structures, Inc.

Circle no. 400 or <http://architect.hotims.com>

**search.
 source.
 learn.
 connect.
 ebuild.**

ebuild is the destination for construction pros searching for information about building products. **ebuild** is a source of unbiased coverage of new products, trends and news. Pros visit **ebuild** to learn how to do their jobs faster, safer and easier. **ebuild** connects pros to product manufacturers, experts and peers.

hanley wood
ebuild
 a 360 degree view
 of product information
 ebuild.com

business



What's the prospective employer's point of view?

They're trying to predict future behavior. They want someone who is going to help them be more successful.

Are cover letters necessary?

You have to have a cover letter. It's one page. The first 75 words are your sales pitch as to why they should turn the page. Give them enough information so they're prepped as to who you are and why they want you.

What else does the cover letter need?

It has to have five basic parts:

- (1) Address it to the right person—and not necessarily the person in the ad. You won't know until you do research.
- (2) Have that compelling paragraph of 75 words. It's not, "I am writing you, here is my résumé."
- (3) Where do we take it from here? Are you available for interviews? Who can testify about you? If you have an opportunity to name drop, do it here.
- (4) Make sure it has all of your contact information.
- (5) The letter has to be graphically attractive. If you don't have your own personal letterhead, design one. It's an opportunity to show that you're a creative person, you take this seriously, and you are your own brand.

How long should the résumé be?

It's more flexible than we used to think. Twenty years ago we said everybody should have a two-page résumé. But if you lack experience, you don't have two pages. And if you have a lot of experience, two pages aren't sufficient.

What needs to be included?

Construct a résumé that's going to make you the most compelling prospective employee. It's up to you to make the employer want to interview you. There are three things: your experience; the presentation, both content and graphics; and your relevance to the firm.

How do you structure the résumé?

It's the *People* magazine attention span. We go to the cover and look at the headlines that are most interesting. It's only if the headline really gets our attention that we'll flip through to page nine.

Should résumés be sent as hard copies or digital files?

I don't know any firms that welcome printed materials. It's easier for them to share electronic documents. But never send a Word document—you must send a PDF! You don't want to jeopardize the format by sending it to someone who may not have the same font.

What's the future?

I think résumés are very 20th century. If you send an e-mail with your 75 words and say, "I've prepared a website," 90 percent are going to click through. They're curious. If it's a compelling package, it's probably the best way you're going to demonstrate who you are and what you do. Architects should have websites. It's the most effective way to submit your credentials. □

TURN LIGHTING ON ITS HEAD!

THINK

INSTALLATIONS

LED BULBS



S14 DecorLED™ Lamps
Palace Theatre, Albany, NY



Round, Flexible RopeLED
Tortilla Jo's, Anaheim, CA



Custom-Built LED Lamps
Vincent Thomas Bridge, San Pedro, CA



S14-Styled DecorLED Lamps
Bardavon Theater, Poughkeepsie, NY



9mm LED, 9mm Miniature Wedge-Based Lamps
Hillsboro Arch, Hillsboro, OR



S6 LED, S6 Candelabra-Based Lamps
Hyatt Regency, Long Beach, CA

LED
LEDTRONICS, INC.®
THE FUTURE OF LIGHT®

.800.579.4875

LEDtronics.com

Circle no. 406 or <http://architect.hotims.com>

3105 Kashiwa Court, Torrance, CA 90505 Phone (310) 534-1505 Fax (310) 534-1424 webmaster@LEDtronics.com

RELAMP WITH BRIGHT, LONG-LASTING ENERGY EFFICIENT DIRECT INCANDESCENT REPLACEMENT LED BULBS AND LAMPS FROM LEDTRONICS.

- FEATURES**
- NO HEAT - COOL TO THE TOUCH
 - USE 70% TO 90% LESS POWER
 - LEDS LAST UP TO 11 YEARS
 - SHOCK/VIBRATION RESISTANT
 - 12 VOLTS DC TO 240 VOLTS AC
 - IDEAL FOR SOLAR POWER
 - LED COLORS: WHITE, GREEN, BLUE, RED, YELLOW, AMBER AND TINTED FROSTED LENSES



ONE DESIGNER PUT AN ACOUSTIC CEILING TILE ON A WALL JUST TO CAPTURE A PATTERN.

project manuals a year, but an architect will do only one project a year," he says. This rapid pace provides Wilson with an understanding of trends many peers won't notice for years.

Tools of the Trade

Not surprisingly, the biggest changes Vitale has seen involve the computer, whether the issue is design (CAD programs, especially BIM) or data (the Internet). Google, not the catalogs in RTKL's library, is Vitale's more likely tool for research. But the information he utilizes today is just a form of word processing. "BIM can link the information in the drawings with a massive database," he says, and though RTKL uses Revit for most projects, the firm is still waiting for the specification functionality that BIM promises. Vitale sees BIM as a potential timesaver but says no program will replace the experience a good spec writer can provide.

Wilson doesn't discount BIM, but says the technology is too undeveloped: "We're probably at version 1.0. We need to be at 3.0." The current "obsession" with BIM is symptomatic of larger issues within the profession, he adds. "Architects are looking for a magic bullet. Not everything has a technological solution, and collaboration is one [such thing]."

BSD's Dean says interoperability—the ability for architects, engineers, contractors, etc., to use the same

digital information about a building project—is the essential feature needed to make BIM work as promised. This is something a Construction Standards Institute could help establish, but it's also the selling point of a suite of tools BSD expects to release later this year. BIM's potential is great, but the fact is that architects often use such programs for graphical purposes only. Dean mentions one designer who put an acoustic ceiling tile on a wall in order to capture a particular pattern. In BIM, though, that pattern is more than just a pattern, and somebody has to be on the lookout for such errors.

Wilson knows from his jobsite experience that teamwork is messy, so he's finding better ways to work, because "there's too much investment in Revit and not enough in collaboration tools." He uses social media to reach his team, his clients, and anybody else who's interested. He's regularly on Twitter and Facebook; lists his most-visited sites at StumbleUpon; and uses the "Collection" feature on Designer Pages to inform clients and potential clients of his preferred products.

It is impossible to say where specs will be in 10 years, but it's clear that although the field is changing rapidly, real-world experience remains essential to defining the material qualities necessary for turning designs into well-built structures. Tools change and trade groups evolve, but spec writers' knowledge and their connection to the larger team shouldn't be discounted so quickly. □

Innovative Design Breeds Innovation



Bridges Center, Memphis, TN

You create, we get inspired. We innovate so you can get inspired. That's why MBCI continues to develop new products that support contemporary and sustainable design, meeting the environmental demands in place today with beauty that will last for years to come. Our recently introduced line of Eco-ficient™ insulated metal panels enhance the performance rating of modern facilities while our NuRoof® retrofit system is ideal for roof renovations. Put them together and incredible things can happen.

We believe that being truly innovative holds some risk. Boundaries are pushed. But, MBCI is with you. We have the best Weathertightness Warranty available. And, we have product engineers that can help turn your ideas into reality.

To learn more about the *Bridges Center* project featured above, our wide variety of Architectural CEUs, or how MBCI can help add beauty and long life to your project, visit www.mbc.com/arch.

Houston, TX (Corporate) 877-713-6224 | Adel, GA 888-446-6224 | Atlanta, GA 877-512-6224 | Atwater, CA 800-829-9324 | Dallas, TX 800-653-6224
 Indianapolis, IN 800-735-6224 | Lubbock, TX 800-758-6224 | Memphis, TN 800-206-6224 | Oklahoma City, OK 800-597-6224 | Omaha, NE 800-458-6224
 Phoenix, AZ 888-533-6224 | Richmond, VA 800-729-6224 | Rome, NY 800-559-6224 | Salt Lake City, UT 800-874-2404 | San Antonio, TX 800-598-6224

MBCI
 Metal Roof and Wall Systems

ARCAT BIM

Objects, Systems, Materials

Developed by ARCAT BIM experts, so you can rely on them as you do for ARCAT specs and SpecWizards.

These 3D objects are packed with all the data you need, and are free of charge like all of ARCAT services!



ARCAT[®] BIM[®]

INFO

www.arcat.com

Circle no. 430 or <http://architect.hotims.com>

Artistically designed resin panels, exclusively from HDI.

Resin designs include colors, textures, botanicals and prints.

Visit www.hdirailings.com for our full selection of infill panels, railings and door hardware.

Circle no. 481 or <http://architect.hotims.com>

3905 Continental Drive • Columbia, PA 17512 USA
 PH: 717-285-4088 • FAX: 717-285-5083
 Email: info@hdirailings.com • www.hdirailings.com

→ LOCAL MARKET

New Orleans

TEXT BY MARGOT CARMICHAEL LESTER

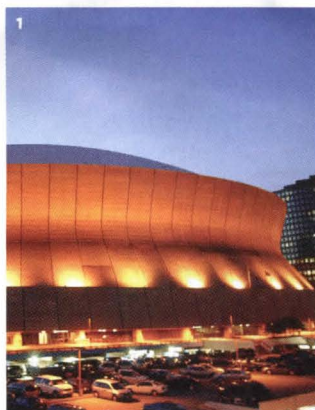

THE BIRTHPLACE OF JAZZ ain't swingin' again just yet. Four years after Hurricane Katrina and the nation's most catastrophic engineering failure ravaged it, New Orleans is slowly battling back. Much of the rebuilding is funded by federal dollars. The Federal Emergency Management Agency funneled billions for debris removal and general infrastructure repairs, plus \$8.4 billion for levee repairs. And billions in disaster community development block grants have helped homeowners rebuild or repair their homes.

Commercial development has been fueled by special federal Gulf Opportunity (GO-) Zone tax credits, some of which apply to low-income housing, and some to "other projects, many of which have had a hard time getting started," says Allison Plyler, deputy director of the Greater New Orleans Community Data Center. The hiccups come mainly from zoning issues and ongoing challenges related to blighted properties, as well as a whole lot of wrangling between redevelopment authorities, city hall, and state government.

"Many have criticized the pace of recovery. ... [T]here have been challenges," says Matthew Schwartz, principal of Domain Cos., one of the first developers to make use of GO-Zone financing. It now has \$113 million in mixed-income and mixed-use projects under way. "Most critics discounted the planning that needed to be accomplished before improvements could be made." But Schwartz says the Big Easy is on the right track with slow, sustainable growth: "It's progressing in a way that will make New Orleans a better city." □

1. Louisiana Superdome
ARCHITECTS: Louisiana Superdome Renovation Joint Venture Team — Ellerbe Becket (consultant), with New Orleans firms Trahan Architects, Sizeler Thompson Brown Architects, and Billes Architecture.
COMPLETION: 2007. **BRIEF:** \$185 million renovation of sports landmark partially funded by \$118 million from FEMA and \$15 million from the NFL.

2. National World War II Museum
ARCHITECTS: Voorsanger Architects, New York; Mathes Brierre Architects, New Orleans. **COMPLETION:** 2009. **BRIEF:** \$300 million expansion of downtown attraction.

3. The Preserve
ARCHITECT: Humphreys & Partners Architects, New Orleans. **COMPLETION:** 2009. **BRIEF:** \$45 million mixed-income building received \$1.56 million in GO-Zone tax credits, \$15.95 million block grant.

4. Second Line Stages
ARCHITECT: John C. Williams Architects, New Orleans. **COMPLETION:** 2010. **BRIEF:** \$34 million film studio, part new construction, part restoration of brownfield warehouse.

POPULATION/EMPLOYMENT
 273,600 residents, 60% of the pre-Katrina population. April 2009 unemployment: 5.3%.

OFFICE MARKET
 Class A office vacancy: 8.78%; average asking rate: \$17.99/s.f.

RESIDENTIAL MARKET
 Median home sale price, 1Q 2009: \$320,900.

MARKET STRENGTHS

- Vibrant culture, rich history
- Fifth largest U.S. port
- Widespread support of green building practices

MARKET CONCERNS

- Poor housing affordability
- Infrastructure challenges
- Poorly performing schools

FORECAST
 Equity Office leasing director Bruce Sossaman hopes the city keeps growing. "One of the big challenges ... is attracting new business [and] young professionals to move here," he says. "This will take a combined effort ... to improve the infrastructure in the area."



Beautiful. Customizable. Affordable.

VT Architectural
INDUSTRIES Wood Doors

WWW.VTINDUSTRIES.COM

Circle no. 53 or <http://architect.hotims.com>





The best roof money can buy.™

TCS II® Terne-Coated Stainless



Follansbee®

It took five years and \$5 million to preserve Thomas Jefferson's Declaration of Independence. But it only took one call to Follansbee to preserve Jefferson's Virginia State Capitol Building. Thanks to a new, historically accurate Follansbee TCS II roof, the 216 year-old Virginia State Capitol continues to maintain Jefferson's distinct architectural vision.

Learn more about this project at follansbeeroofing.com/VirginiaStateCapitol.

Follansbee – for those who demand the very best.

Call or visit Follansbee online today to learn more.

800.624.6906 follansbeeroofing.com



Earn 1-hour AIA learning credit online today. Visit follansbeeroofing.com

Circle no. 32 or <http://architect.hotims.com>

TECHNOLOGY

Expanded Screen Detail

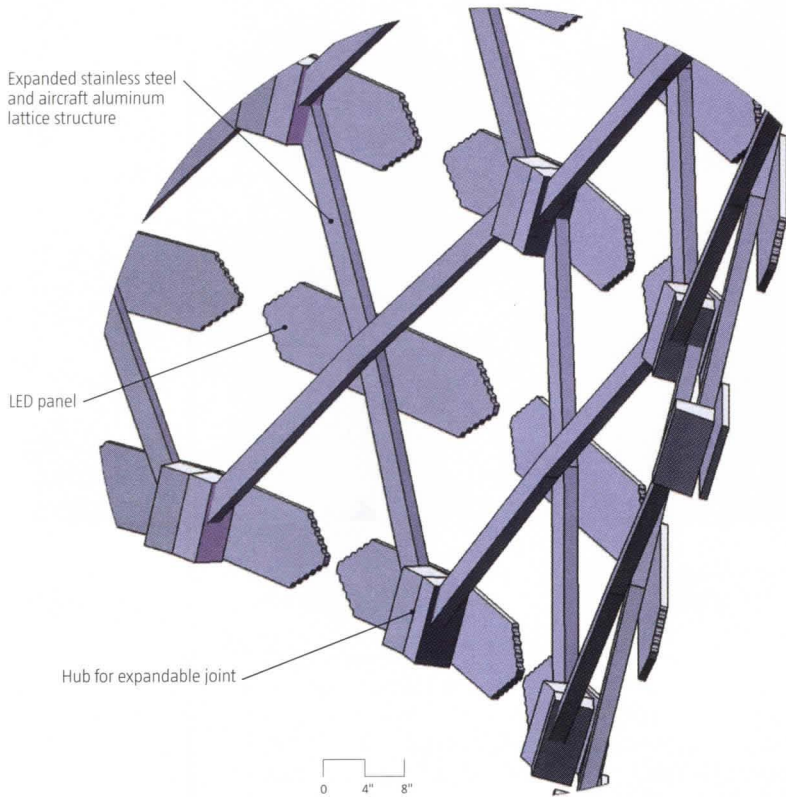

Closed Screen Section



→DETAIL

Expanding Video Screen

Architect: Innovative Designs, Hoberman Associates (screen design); Barco, Innovative Designs (screen production)

Location: A U2 concert in a city near you.

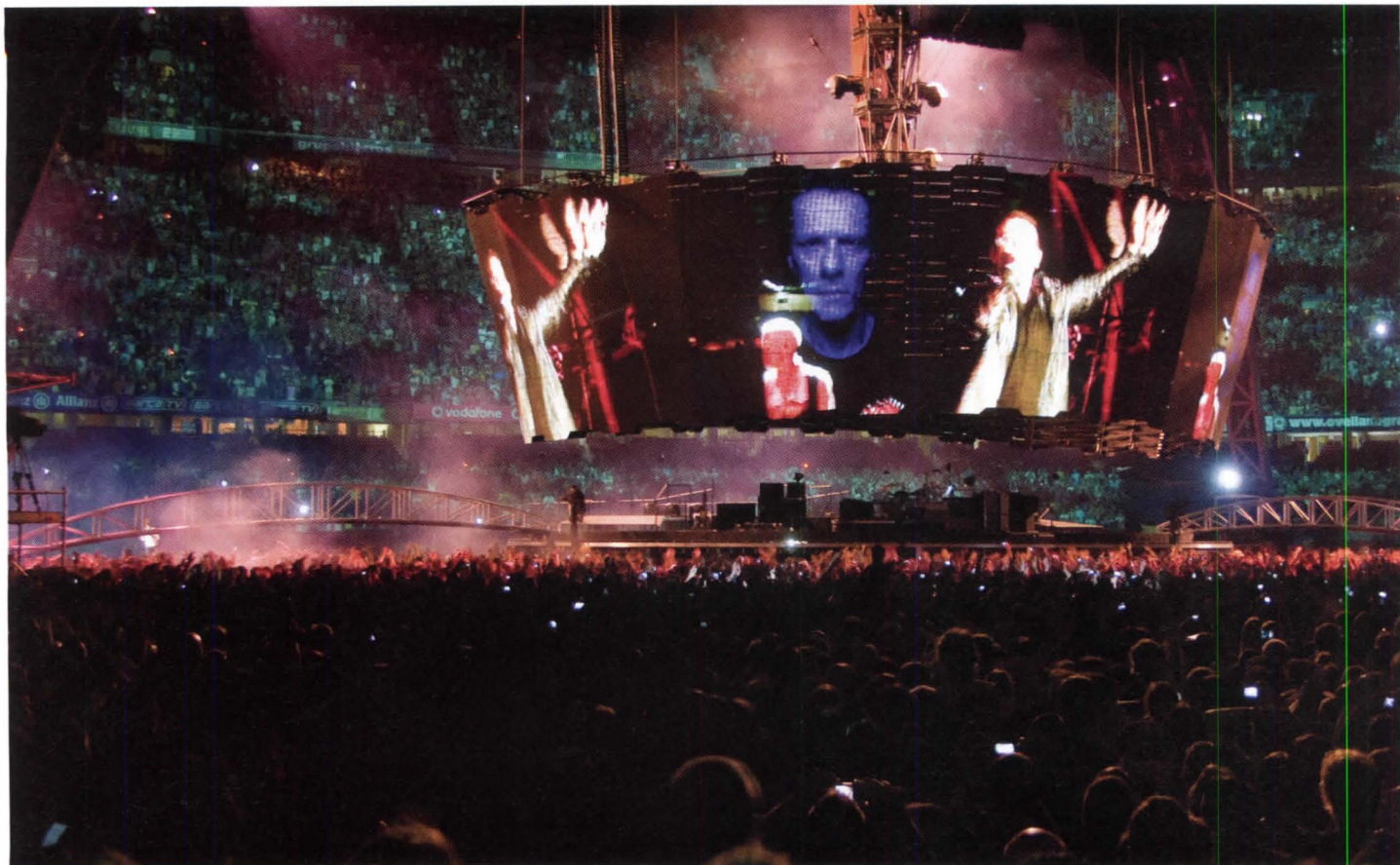

TEXT BY ANNE GUINEY

Expanded Screen

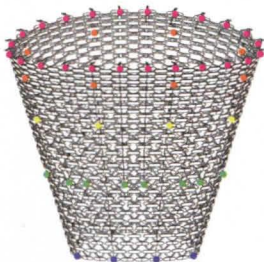

When collapsed, the 3,800-square-foot screen's 888 LED panels form a near-continuous surface to show videos of the band (top). To expand the screen, 40 chain hoists (attached to pick points marked above) control the rate and amount of expansion.

AFTER 33 YEARS and 145 million albums sold, the Irish rock band U2 has an ardent fan base, but as of this summer, they can count on adding architects and engineers to that group: The centerpiece of their 360° world tour is a massive kinetic video screen-in-the-round that envelops the performers and is an integral part of the spectacle. With roughly half a million LEDs on an expandable ellipse suspended over the stage from a 90-ton steel claw, the staging makes this “by far the largest and most complex tour in history,” says Matt Davis, vice president of engineering at Hoberman Associates, the firm that developed the screen with Belgium-based Innovative Designs, U2’s show designer/director Willie Williams, and production architect and designer Mark Fisher. When it expands, “the screen provides a magic moment that is totally unique and elevates the crowd,” Davis says. “It extends the scenery into the air and activates the space between the band and the audience.”

The screen concept was developed by Williams, Fisher, Innovative Designs’ Frederic Opsomer, and Hoberman Associates’ Chuck Hoberman. Opsomer has been a pioneer in large-format video screens, Davis explains, but the scale of this project was larger than any of them had worked on. The challenge was to create a moving screen that was truly visible from all parts of the stadiums booked for the tour, while providing high-resolution visuals for the thousands of concertgoers who, after all, are there to see the band.

The team came up with a conical ellipse with a 3-to-4 ratio and a length of 79 feet that, when closed, is 23 feet tall, and when fully expanded grows to 66 feet (approximately seven stories tall). Its framework is based on Hoberman’s expanding Iris structure, which was used for the unfolding arch at the 2002 Winter Olympics in Salt Lake City. “We know that geometry very well,” Davis says. That familiarity made it easier to create an optimized screen that could also be broken down within approximately 8 hours and packed into shipping containers. (The steel claw takes much longer to assemble, so there are three identical structures that are leapfrogging from venue to venue.) Controllable LEDs are set in 888 panels that are in turn mounted to aluminum struts on scissor-like joints. The water-sealed LEDs (FLX modules from Innovative Designs’ parent company Barco) are individually mounted in the panels, so that in case of breakage they can be easily replaced. Together, the LED panels create a 3,800-square-foot screen surface. Eight winches in the claw raise and lower the screen over the stage. Forty chain hoists, connected to pick points on the latticelike screen frame, expand and support the 120,000-pound screen.

The screen is the largest and most complex of its kind in the world, but the technology itself is not strange: “Our philosophy is to use mature technologies and standard components with known histories, but to combine them in a different way,” Davis says. “There are enough other things to invent along the way.” □

→A/V

PRO AV Spotlight Awards

FIFTEEN WINNING A/V PROJECTS, LARGE-SCALE AND SMALL, FROM AROUND THE U.S.

TEXT BY KIMBERLY R. GRIFFIN



HOUSE OF WORSHIP (UNDER \$250K)

1. Cathedral of Christ the Light, Oakland, Calif.

AV CONSULTANT: Shen Milsom & Wilke, San Francisco

AV INTEGRATOR: Pro Media Ultrasound, Hercules, Calif.

DESIGN ARCHITECT: Skidmore, Owings & Merrill,

San Francisco

EXECUTIVE ARCHITECT: Kendall Heaton, Houston

HOUSE OF WORSHIP

2. Eastlake Community Church, Chula Vista, Calif.

AV INTEGRATOR: Southern California Sound Image, Escondido, Calif.

ARCHITECT: Manuel Oncina Architects,

La Jolla, Calif.

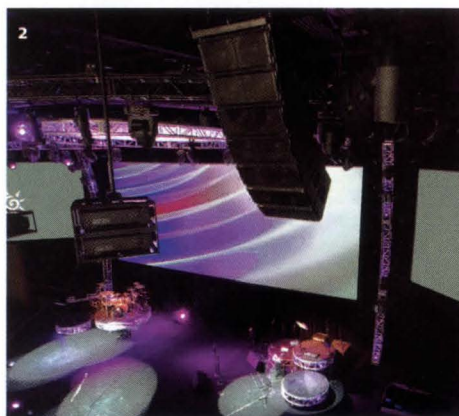

ENTERTAINMENT/ARTS

3. The Grammy Museum at L.A. Live, Los Angeles

AV INTEGRATOR: Design and Production, Lorton, Va.

ARCHITECT: Gallagher & Associates,

San Francisco

GOVERNMENT (FEDERAL)

4. Pentagon Press Briefing Room, Washington, D.C.

AV INTEGRATOR: Audio Video Systems, Chantilly, Va.

AV CONSULTANT: JGB Engineering, Middleburg, Va.

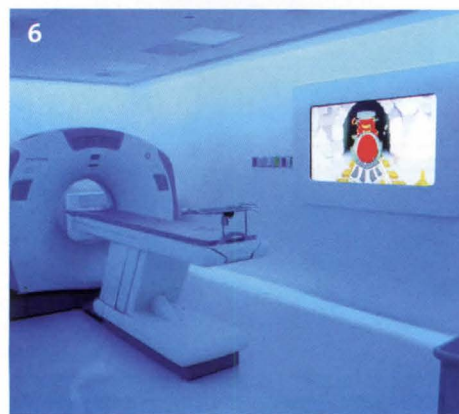
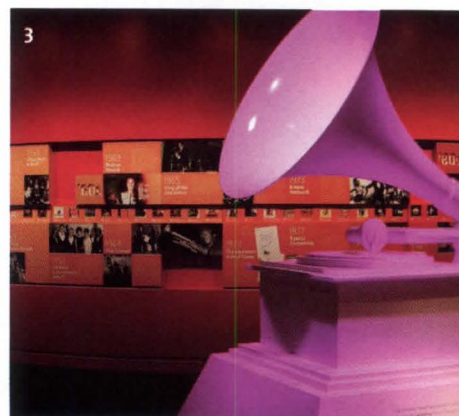

GOVERNMENT (STATE & LOCAL)

5. Fairfax County Courthouse, Fairfax, Va.

AV INTEGRATOR: Professional Products, Gaithersburg, Md.

ARCHITECT: Miller, Beam & Paganelli, Reston, Va.

HEALTH CARE

6. Baptist Country Walk MRI/CT Center, Miami

AV INTEGRATOR: Southern Business Communications, Norcross, Ga.

ARCHITECT: Naya Associates, Miami



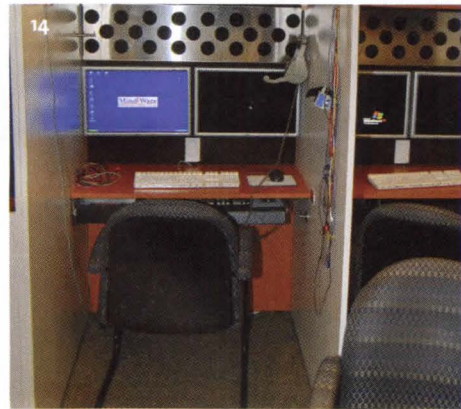
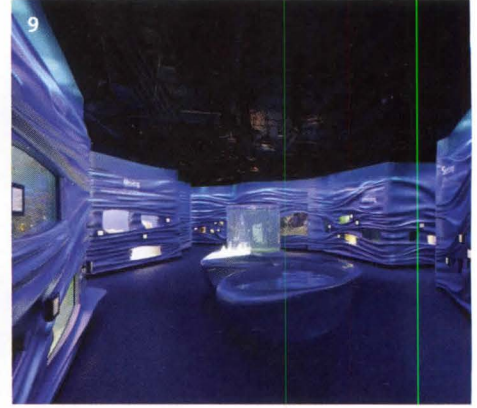
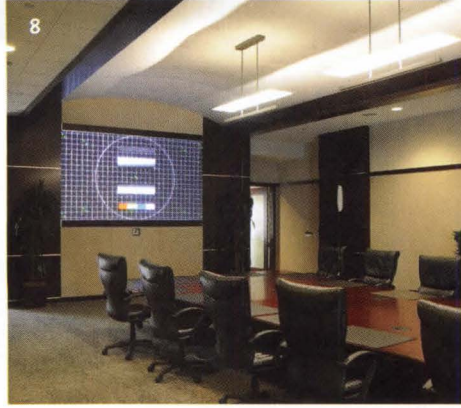

HOSPITALITY/RESTAURANT/ CASINO

7. Mohegan Sun Casino of the Wind, Uncasville, Conn.

AV CONSULTANT: Veneklasen Associates, Santa Monica, Calif.

AV INTEGRATOR: HB Communications, North Haven, Conn.

AV INTEGRATOR: Marshall Industries, Salt Lake City

ARCHITECT: WATG, Irvine, Calif.

CORPORATE

8. ITC Holdings Headquarters & Control Room, Novi, Mich.

AV INTEGRATOR: IGI, Commerce, Mich.

ARCHITECT: Gillett Associates, Farmington Hills, Mich.

MUSEUM

9. California Academy of Sciences, San Francisco

AV CONSULTANT: Visual Acuity Limited, Brighton, U.K.

AV INTEGRATOR: Sky-Skan, Nashua, N.H.

ARCHITECT: Renzo Piano Building Workshop, Genova, Italy, in association with Stantec, San Francisco

DESIGN CONSULTANT: Thinc Design, New York

EDUCATION (Under \$250K)

10. Illinois College of Optometry, Third Floor Eye Labs, Chicago

AV INTEGRATOR: United Visual, Itasca, Ill.

ARCHITECT: Jensen & Halstead, Chicago

EDUCATION (tie)

11. University of Nevada, Reno Mathewson-IGT Knowledge Center

AV CONSULTANT: Wrightson, Johnson, Haddon & Williams, Dallas

AV INTEGRATOR: General Communications, Draper, Utah

ARCHITECT: Hershenson + Klippenstein Architects, Reno, Nev.

ASSOCIATE ARCHITECT: Dekker/Perich/Sabatini, Albuquerque, N.M.

12. Temple University Fox School of Business, Alter Hall, Philadelphia

AV CONSULTANT: Acentech, Cambridge, Mass.

AV INTEGRATOR: Total Video Products, Mickleton, N.J.

ARCHITECT: Michael Graves & Associates, New York with Burt Hill, Philadelphia

JUDGES' AWARDS

13. The Comcast Experience, Philadelphia

AV INTEGRATOR AND DESIGNER: Niles Creative Group, New York

ARCHITECT: Robert A. M. Stern Architects, New York

14. Harvard Decision Science Laboratory, Cambridge, Mass.

AV INTEGRATOR: Premier Network Solutions, Cincinnati

ARCHITECT: Baker Design Group, Boston

15. College Basketball Experience, Kansas City, Mo.

AV INTEGRATOR: Design and Production, Lorton, Va.

ARCHITECT: ESI Design, New York



Flashback

*The Museum at Bethel Woods, Bethel, NY
AT-3 Frame curved with masking panels: 19' 11/4" x 35' 11/4"
GrayMatte LS Cinema Perforated material curved to a 17' 7/4" radius
Systems Integrator: McCann Systems, LLC.
AV Consultant: RomeAntics
Exhibit Fabricator: Hadley Exhibits Inc.
Exhibit Designer: Gallagher & Associates*

Creating exciting, engaging, and interactive displays that bring back memories of the 60's

As one might imagine, media played a critical role in the development of The Museum at Bethel Woods, the site of the original Woodstock festival in upstate New York. Creating the exciting, engaging and interactive displays that brought back memories of the 60's for the museum's visitors required nothing less than state-of-the-art technology.

Only Stewart Filmscreen had the right solutions with a 35-foot curved projection screen that captured the festival experience, a magical bus windshield that transports viewers back in time, a large touch screen tabletop providing fun and educational interactivity plus a 23-foot screen with images of the world's most famous rock festival.

There is no project too large or too impossible for Stewart Filmscreen. As the industry's reference projection material manufacturer, we specialize in the development of optimized, breakthrough solutions that bring your commercial projects to life. Our qualified staff of professional engineers works with designers, architects, contractors and systems integrators to seamlessly integrate technology in the creation of the most unforgettable commercial, entertainment and demonstration spaces.

For additional information on Stewart Filmscreen:
www.stewartfilmscreen.com

To speak with a representative: www.stewartfilmscreen.com/rep

Circle no. 218 or <http://architect.hotims.com>

Earn **FREE**
AIA credits
now.

**Hanley Wood University—The Leading
Providers of AIA Accredited Courses**

Start earning your required CEU credits quickly and easily today. Hanley Wood University offers a continually updated library of AIA-approved CEU coursework, available to you for free at architectCES.com and in the pages of *ARCHITECT*, *residential architect*, *ARCHITECTURAL LIGHTING*, *eco-structure* and *metalmag*.

Access courses and get
your 2009 Continuing
Education credits **FREE** online.

ARCHITECTCES

architectCES.com

Course Features

Instant Certification
Fun and Interactive
Pause and Save Tests
Immediate Feedback
and Test-Grading
Multiple Course Management
and Tracking

To learn more, contact
Jennifer Pearce at
jpearce@hanleywood.com

HANLEY WOOD UNIVERSITY
WHERE CONSTRUCTION MEETS EDUCATION



technology

→ECO

Earth Attacks!

CINEMATIC VISIONS OF URBAN ENVIRO-DISASTER
DON'T HAVE TO BE OUR FUTURE.



TEXT BY LANCE HOSEY
ILLUSTRATION BY PETER ARKLE

CAPITALIZING ON PUBLIC FEARS and fantasies about global warming, Hollywood has resurrected an old genre, the disaster film, with a new variation: the environmental disaster film. In *The Day After Tomorrow*, Roland Emmerich's climate-change action-epic, the Statue of Liberty drowns while Manhattan gets pummeled by tsunamis, tornadoes, and titanic snowdrifts—all at once. The second most profitable film of 2004, Emmerich's *Sturm-und-Drang* escapade illustrates a not-so-hidden secret about the environmental crisis: We debate about harming nature, but in truth we have a deeper dread—nature retaliating.

In the 2008 remake of *The Day the Earth Stood Still*, an alien, played by Keanu Reeves, sums up humanity's fate: "If the Earth dies, you die. If you die, the Earth survives." Following this cold, extraterrestrial logic, the alien unleashes a swarm of mechanical nanobugs to devour everything manmade, a neat little trick that manages to erase the built world while leaving the rest of the environment intact.

What would happen if we did vanish? In his book *The World Without Us*, a fascinating portrait of a post-human future, Alan Weisman chronicles how nature would reclaim the built environment, eroding its foundations, toppling its walls, disintegrating every brick

until, eventually, few traces of humanity would remain. "On the day after humans disappear," he writes, "nature takes over and immediately begins cleaning house—or houses, that is. Cleans them right off the face of the Earth."

Absent us, cities are fated to be consumed by nature, which needs no help from otherworldly mechanisms. The 2007 post-apocalyptic action flick *I Am Legend* features Will Smith as the (apparently) last man alive after a pandemic triggered by genetic engineering. In an eerily empty Manhattan, young forests take over parks and plazas, and lions from the zoo claim the streets as hunting grounds. After only a handful of years, the asphalt jungle has become an actual jungle.

The very nature of cities has been to resist nature; we battle the elements by robbing the earth of its elements, expending vast amounts of energy to keep the wilderness out. Exploiting this fact, environmental disaster films present cities as sources of ecological shame whose destruction is merely karmic payback. Yet while Hollywood sells tickets by portraying the future as a dark nightmare, designers can envision a brighter dream in which cities become an integral part of nature, gracefully interacting with every other living system. But we won't realize this dream if architects stand still. □

ARCHITECT

hanley wood

BUILDING: A NETWORK

ARCHITECT's Web site is laying the base for a premier electronic experience for practicing architects. We organize the site, you reflect on the ideas. Market intelligence, a building products database, breaking news—all established to help grow a continuing collection of inspiration. To join the network, visit architectmagazine.com.



P/O

Commercial / Cultural / Educational / Governmental / Multifamily Housing / Health-Related / Single-Family House / Industrial / Recreational / Religious / Urban Design

Call for Entries

The P/A Awards recognize unbuilt projects that demonstrate overall design excellence and innovation.

57th Annual P/A Awards

Judging will take place in October 2009. Winning entries will be notified in November 2009, published in the January 2010 issue of *АРХИТЕКТ*, and honored at a ceremony in New York in February 2010.

Jury

Stan Allen, Stan Allen Architect, Brooklyn, N.Y.
Sarah Dunn, UrbanLab, Chicago
Diane Hoskins, Gensler, Washington, D.C.
John Peterson, Public Architecture, San Francisco
James Richard, Richard+Bauer, Phoenix

Eligibility

Architects and other design professionals practicing in the United States, Canada, or Mexico may enter one or more submissions. All entries must have been commissioned by paying clients for execution. Proposals may be for any location, but work must have been directed—and substantially executed—in offices in any one of those three countries. Projects may not have been featured in other national design publications. All entries must have been commissioned for compensation by clients with the contractual intention and the authority to carry out the submitted proposal. Projects must have a completion date after January 1, 2010.

Fees

First Entry: \$195
Subsequent Entry: \$150
Late Fee: \$50

Deadlines

Regular: September 28, 2009 (registration and postmark deadline)
Late: October 5, 2009 (registration and postmark deadline, additional \$50 fee per entry)

Register at paawards.com

For more information, e-mail
paawards@architectmagazine.com

CULTURE



→ **OBJECT**

The **BauBike**, designed by Denmark's **Michael Ubbesen Jakobsen**, doesn't offer much in terms of aerodynamics, but it more than compensates with aesthetics—assuming that you find the golden section and Bauhaus sexy. The bike's design follows a strict geometry of 60 and 90 degree angles, yet it is customizable; you can add an extra seat or luggage carrier. Price on request. baubike.dk



→BOOK

What exactly is a camp? A dictionary will tell you that it's a temporary residence erected for shelter, but in **Camps: A Guide to 21st-Century Space**, author Charlie Hailey, who teaches architecture at the University of Florida, looks beyond that simple definition to "understand how traditional forms of strategy, tenure, and lifestyle are called into question through built environments." From FEMA City to research stations on Arctic ice floes, as well as summer and boot camps, Hailey explores the paradoxes of areas that are neither temporary nor permanent. \$29.95; MIT Press



→BOOK

Architects are used to clients huffing and puffing over their projects—but what about a wolf? This re-imagining of the classic children's tale **The Three Little Pigs** by illustrator Steven Guarnaccia has the pigs recast as Frank Gehry, Le Corbusier, and Frank Lloyd Wright, and features some of the architects' most famous buildings. Available in Italian and English. \$29; Corraini

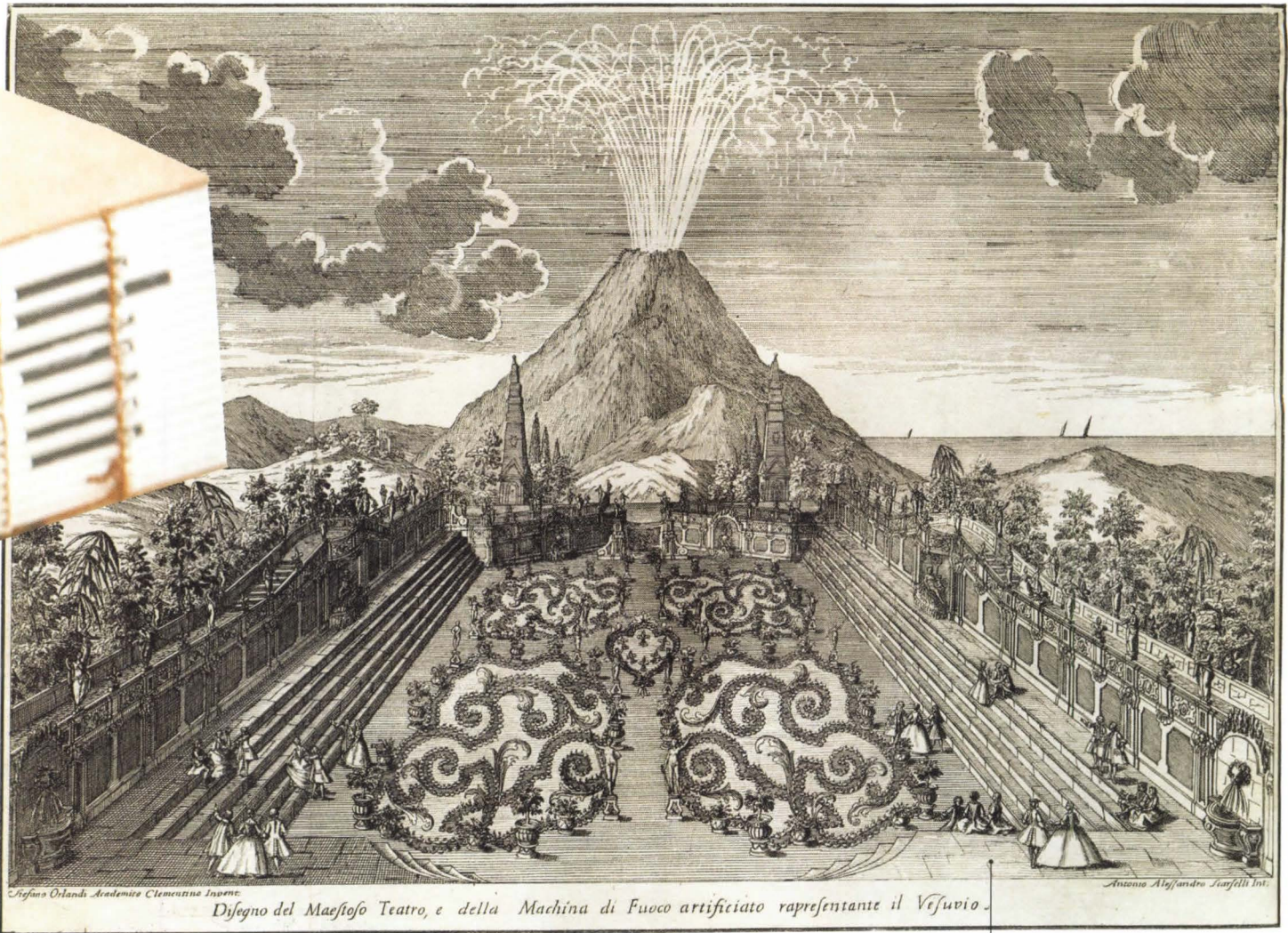

Disegno del Maestro Teatro, e della Machina di Fuoco artificiato rapresentante il Vesuvio.

→ OBJECT

In the summer of 1738, the city of Bologna pulled out all the stops to celebrate the wedding of Charles VII, King of Naples and Sicily, to Maria Amalia of Saxony. A commemorative volume—one of 472 lots belonging to “**Splendid Ceremonies: the Paul and Marianne Gourary Collection of Illustrated Fête Books,**” auctioned by **Christie’s** in June—has text of the musical serenade performed in the couple’s honor, as well as sonnets dedicated to them. The plate shown here offers a panoramic view of the stage built for the wedding, with a spectacular faux Mount Vesuvius shooting fireworks in the background. Sold for \$7,500; christies.com



→ EXHIBIT

To mark the centennial of Daniel Burnham’s Plan of Chicago, **Ben van Berkel** of UN Studio and **Zaha Hadid** have designed temporary pavilions in the city’s **Millennium Park**. The boldly sculptural pavilions echo the make-no-little-plans ambition of their namesake: Both architects took inspiration from the diagonal boulevards that Burnham introduced into Chicago’s street grid. The pavilions (Hadid’s was not finished as of press time; van Berkel’s is shown above) are free and open to the public. Through Oct. 31. burnhamplan100.uchicago.edu • JOHN SCAPPINI



To Anyone, Anywhere:

Miss Isabel Roberts was my assistant in the practice of Architecture for several years and I can recommend her without reservation to anyone requiring the services of an Architect.

Frank Lloyd Wright

Taliesin,
Spring Green,
Wisconsin.

August,
Sixth,
1920.

(Beverly Willis)

TEXT BY HANNAH MCCANN

At a time when women had few options in architecture, Frank Lloyd Wright provided one, as a circa 1962 photo from Taliesin West (above left) attests. And though the records on the 100-plus women who worked for Wright may be scarce, research by Beverly Willis is changing what we know. It's already corrected one "fact": Some books refer to Isabel Roberts, an early employee, as a bookkeeper, but a note signed by Wright (above right) discovered by Willis shows that Roberts served as a designer.

→ HISTORY

Leading Ladies

THE SCORES OF WOMEN DESIGNERS WHO WORKED WITH FRANK LLOYD WRIGHT HAVE ALL BUT DISAPPEARED FROM HISTORY. A NEW DOCUMENTARY IS THE FIRST STEP IN GIVING THEM PROPER RECOGNITION.

PHOTOGRAPHS FROM Frank Lloyd Wright's Wisconsin and Arizona-based Taliesin studios show women working next to men in the drafting room and out in the field, carrying stone and pouring concrete. In an era when few women studied architecture and even fewer practiced, who were these pioneers?

That's what officials at the Guggenheim Museum asked Beverly Willis in 2007. They hoped Willis—a now-retired architect who runs an eponymous foundation dedicated to collecting and promoting the stories of women architects—could organize a

program as part of this year's festivities surrounding the 50th anniversary of the museum's landmark Wright building in New York City.

Willis was stymied. "Typically, we find scholars on a topic we want to discuss. But there is no scholarship on women professionals" in Wright's office, she says. That didn't deter the 81-year-old women's advocate. "The fact that there's nothing out there doesn't mean to me that there's nothing out there. A woman's

INNOVATE.
INTEGRATE.
CONNECT.



CTS. Experience the difference in AV.

You have a vision, now make it work. From concept to completion, partner with an AV professional to create innovative, inspiring environments that successfully combine form and function. The InfoComm Certified Technology Specialist (CTS®) credential is a sign of quality and competency in the audiovisual industry. Internationally recognized and accredited by the American National Standards Institute (ANSI), it serves as a global benchmark for audiovisual professionals.

To learn more about the CTS® credential and to find a professional near you, visit www.ctsforav.com





designs are similar to chalk on a blackboard. You can write all of your accomplishments, but there's an eraser following behind. I knew that there was a lot of information that had been lost."

Willis started reading the fine print in the hundreds of books on Wright's history, tracking references to women in footnotes and endnotes.

"I realized that if I picked up these little bits or phrases, I'd put together a narrative," she says. Over the next year and a half, Willis collected enough material to piece together a 15-minute documentary, *"A Girl Is a Fellow Here": 100 Women Architects in the Studio of Frank Lloyd Wright*. (The quote in the title comes from the master himself.) The film premiered in June at the Guggenheim as part of a panel discussion that included Willis; *New Republic* architecture critic Sarah Williams Goldhagen; psychologist and New York University professor Carol Gilligan; and Columbia University architecture professor Gwendolyn Wright. An honored guest was Lois Davidson Gottlieb, one of the scores of women who worked with Wright.

Willis' documentary reveals that the architect's first employee and lead designer was a woman, Marion Mahoney. Another early employee, Isabel Roberts, is referred to as Wright's bookkeeper in some history books. Willis found a letter from Wright recommending Roberts' services as an architect. "This is big," Willis notes. "It's completely rewriting the historical statement." The letter was found in the course of another Beverly Willis Architecture Foundation project: a hand count of the women in AIA records from the organization's beginning until 1980. Roberts had applied to become an AIA member; she was denied, but the institute kept her application materials.

Roberts, Mahoney, and four other women who worked in Wright's studio—Gottlieb, Jane Duncombe, Eleanore Pettersen, and Read Weber—are the primary focus of Willis' documentary. She chose her subjects because of the quality of their work, and because she could find examples of their work. "I'm not a researcher," Willis insists. In fact, she hopes to give all of the information and images she has compiled to someone who will dig deeper into the story of the women in Wright's studios.

"I have worked through almost half of the 20th century," says Willis, who opened her first architecture office in 1958 and established her foundation in 2002. "I have seen lauded women's work vanish as if it never existed. This must stop." Thanks to *"A Girl Is a Fellow Here"*, the women employed by Wright—and their work—have become a little more visible. □

"A Girl Is a Fellow Here" will be distributed to architecture schools and can be purchased at museum stores, historic Wright sites, and the Beverly Willis Architecture Foundation website (bwaf.org).



Fantasy Lands

"Untitled, Bay Bridge," a photograph by Alexis Tjian from *The BLDGBLOG Book*.

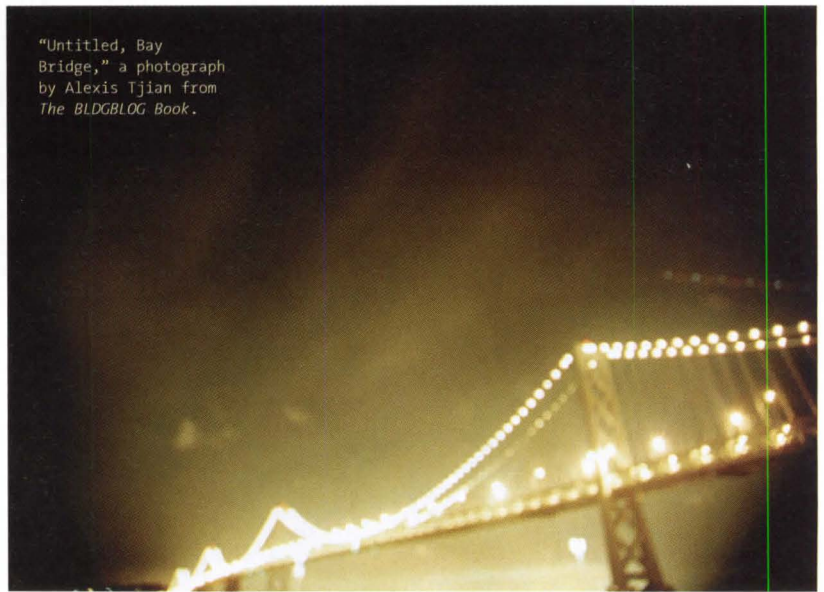

TEXT BY MIMI ZEIGER

GEOFF MANAUGH, who founded the popular website BLDGBLOG in 2004, and myself, a fellow architecture blogger, share a number of enthusiasms. Among them: novelist Don DeLillo, 18th century architect Sir John Soane, and '60s pranksters Archigram. These cult figures populate the pages of *The BLDGBLOG Book*, released this past summer by Chronicle Books. For an architect whose taste skews wider than the modernist canon, finding them referenced in each chapter is like running across a favorite eccentric uncle.

On his website (bldgblog.blogspot.com) and in this volume, Manaugh's vision is fueled by the gothic and the sublime: crumbling monuments, vintage warfare, musical icebergs. And he is not shy about showing off his romantic tastes. "BLDGBLOG is fundamentally about following, and not being ashamed by, your own enthusiasms, whether or not they are rigorous and appropriate for the academic mores of the day, or even interesting for your family and friends," he has written in defense of his outlier subjects.

I was eager to see how Manaugh would translate his verbose and eclectic website into print. "I wanted to use the book as a book," he writes. As such, he's created material "exclusively" for the volume. The new essays and interviews, including a conversation with Archigram's Peter Cook, make up the bulk of each chapter—bonus tracks for hardcore BLDGBLOG fans. Still, it's the dozens of reprinted blog posts that make for livelier reading, especially, for example, Manaugh's talk with British novelist Patrick McGrath, in which McGrath explores

the writing process and the dark imagination it takes to develop “gothic landscapes” with words.

It's hard to say if the new texts make the book any more book-like: It still feels very bloggy, minus the hyperlinks and comments. (Actually, links would help. In just a few pages I chalked up references to works by Umberto Eco, Neil Gaiman, Francis Ford Coppola, and Orson Welles. The extensive name-checking borders on *High Fidelity's* record-store-clerk insiderness.)

In each short essay, Manaugh lets his consciousness expand. For instance, in a piece titled “The Weather Bowl,” he proposes manipulating the climate to create public events and fun spectacles. Letting his narrative get frothy, he writes, “Weather control is the future of urban design. Engineering the climate is how we'll make our cities interesting again.” Like how Katrina made New Orleans interesting again? Is Manaugh critiquing the political gap between climate change and urban infrastructure with a sly parody? We'll never know—he finishes the essay imagining a new Pritzker Prize for best weather effects.

A flooded city does appear in the essay “Wreck-diving London.” Here, London slowly sinks as the tide rises. Manaugh takes the opportunity to feature drawings of Retreating Village, a project by architects Mark Smout and Laura Allen that puts houses on rails to adapt to a changing coastline. (It was previously

published in their 2007 book *Pamphlet Architecture 28: Augmented Landscapes*.) He also quotes extensively from *The Drowned World*, J. G. Ballard's 1962 novel, relishing the descriptions of polluted lagoons and submerged arcades. Manaugh wears his Ballardian love on his sleeve. He's clearly a fanboy: There's even a section at the back of the book to collect autographs—Ballard, check; David Byrne, check; Brad Pitt, check ...

The BLDGBLOG Book is filled with beautiful photography that captures the sublime and tantalizingly dystopian moments in the contemporary built environment: a pavilion-like checkpoint constructed by the Northern Alliance in Afghanistan, photographed by Simon Norfolk; David Maisel's aerial shots of the toxic Owens Lake in California. The images tell the narratives that seem to elude Manaugh. Evidence of manmade destruction, they do the heavy lifting for his fantasy-prone texts.

“Architecture is, in many ways, a very specific type of science fiction; it is its own genre of speculative thought,” writes Manaugh. He's convinced that architecture needs to be more exciting, and that liberal poaching from other, more imaginative genres will shake things up. But as the interviews and photographs attest—and as sci-fi aficionados already know—science fiction is at its most chilling when it expands on conditions already at hand. □



Mimi Zeiger, a contributing editor for ARCHITECT, is a writer in Brooklyn, N.Y., and the founder of the zine loudpaper (loudpaper.typepad.com). She has contributed to publications including *The New York Times* and *Metropolis*, and her most recent book is *Tiny Houses* (Rizzoli).

Since 1955[®]
Kalwall +

with

nanogel[™]
TRANSLUCENT
AEROGEL

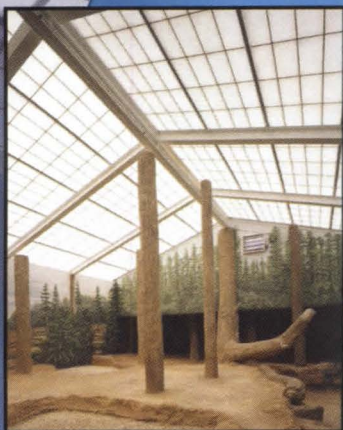

Panel Rating
U=.05/R-20
20% Light
Transmission

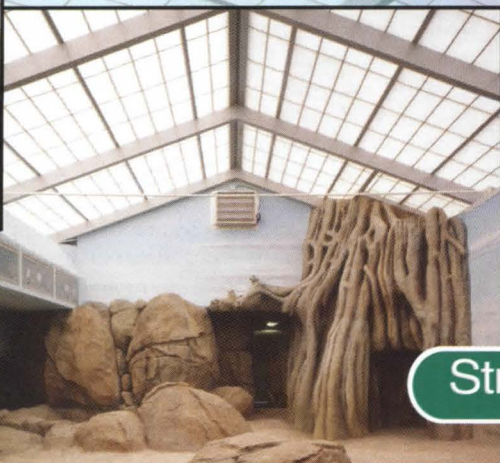

- Clearspans to over 100 ft.
- Full-spectrum UV transmission available
- Vitamin D solution
- Glare-free, diffuse daylight
- Operable roof sections
- High-performance insulation

Structures Unlimited, Inc.
Energy-Efficient Skylights & Pool Enclosures

Circle no. 233 or <http://architect.hotims.com>

PO Box 5650, Manchester, NH 03108 • 800-225-3895 • www.skylightinfo.com

Kalwall Corporation and Structures Unlimited, Inc. are strategic partners. Kalwall is a registered trademark of Kalwall Corporation. Nanogel is a registered trademark of Cabot Corporation.

→ SCREEN GRAB

morphopedia.com

AN ARCHITECTURE FIRM KNOWN FOR RADICAL DESIGN EMBRACES A DECEPTIVELY SIMPLE APPROACH TO ITS WEBSITE.



TEXT BY BRAULIO AGNESE AND NED CRAMER
PHOTO BY MICHAEL DARTER

In building out a wiki-style website for Morphosis, Marty Doscher, director of information technology, and Anne Marie Burke, director of business development and communications, decided to make public as much information as possible. "All the interns who've ever worked here are listed," Burke says.

ARCHITECTS' WEBSITES often are exercises in design bravado and informational opacity. For years, at the top of that maddening heap sat *morphosis.net*, the firm website of Pritzker Prize-winner Thom Mayne, with its tricky Flash interface, undownloadable images, and meager bits of project data. As Morphosis rapidly grew during the early 2000s, the firm was getting overwhelmingly negative feedback about the site. "We wanted a site that was more accessible," says Anne Marie Burke, director of business development and communications. "We're in a different place, and we have a broader, more general interest in our firm."

Enter Los Angeles interactive and branding firm Use All Five, which offered an unusual solution: Don't just build a new site, build two of them. The first, *morphosis.com*, is a somewhat downplayed version of the original *morphosis.net*, using Flash technology and looking much like a conventional online firm portfolio. The other site is *morphopedia.com*. A riff on the user-generated Wikipedia model, it will eventually offer deep information on all of the firm's projects, and each entry features big, downloadable images, including not just final photography, but construction and model photos, detail drawings, and renderings as well.

The two sites link to the same database, but by design, *morphopedia.com* is structurally transparent and simple to navigate. It adheres to a "more is more," seemingly free-for-all content strategy that upsets the typical PR conventions of strict control. The site includes a lightbox feature that allows visitors to curate their own Morphosis experience. "Are we hurting ourselves by giving people access?" asks Marty Doscher, director of information technology. "I don't think that's the case. We're not competing with the average firm." Not every firm will want to install a live office cam on their homepage, as Morphosis has, but *morphopedia.com* makes transparency look awfully appealing. □

LINKS

vegitecture.blogspot.com

Fresh lingo for your design lexicon: "vegitecture"—or, as this blog by Portland, Ore.-based landscape architect Jason King prefers it, "veg.itecture"—a blanket term for the application of vegetable life to manmade structures: green roofs, vertical farms, and so on. Etymologists should note that there's another version of the word in circulation as well: "vegetecture" (see: bit.ly/23WwWm).

eikongraphia.com

For the third consecutive year, Michiel van Raaij of Eikongraphia has crunched the numbers to determine the 25 most popular English-language, single-author blogs on architecture. Little on the list has changed in three years: Geoff Manaugh—whose recently published *The BLDGBLOG Book* is the subject of this month's Crit ("Fantasy Lands," page 42)—takes the top slot for the third time, and yet again there are no women to be found. We're in no way complaining about the quality of current architecture blogs, but c'mon. • bit.ly/14NkLD

sixtysymbols.com

The science professors at the University of Nottingham responsible for 118 videos about the periodic table, one for each element (periodicvideos.com), have returned with a site devoted to 60 important symbols in physics and astronomy. Some topics—the speed of light, the solar system, electrons—will be familiar, even if you dozed your way through high school science, while others are decidedly more esoteric (fine structure constant, anyone?). But all are explained simply and effectively, and with a contagious brio that makes us wish these folks had been our instructors back in the day.

discovermagazine.com

How do urban sounds affect the human brain? *Discover* magazine's Jennifer Barone spends a day in Manhattan pairing the decibel levels she encounters with medical knowledge of their effects on us. During her sojourn, she visits the recently refurbished Alice Tully Hall at Lincoln Center, which proves quieter than even the New York Public Library's main reading room. From the July/August issue. • bit.ly/EeojN

Global Solid Plastic Toilet Partitions



- Now Available in 100% Post Consumer Recycled Material
- Vandal and Moisture Resistant
- Strong and Durable
- Low Maintenance
- Contemporary Colors
- LEED Credits
- 15-Year Warranty
- 48-Hour Shipping Available

Now with 8" Hinges

Visit globalpartitions.com
for our complete line of partitions

GLOBAL
PARTITIONS

Your Global Resource



Single Source Solution

Circle no. 229 or <http://architect.hotims.com>

ASI
GROUP
PARTITIONS
ACCESSORIES
LOCKERS



THE WINNERS OF THE **THIRD ANNUAL R+D AWARDS** SHOW THAT EVEN WHILE THE ECONOMY IS DOWN, TECHNOLOGY IS FLOURISHING.

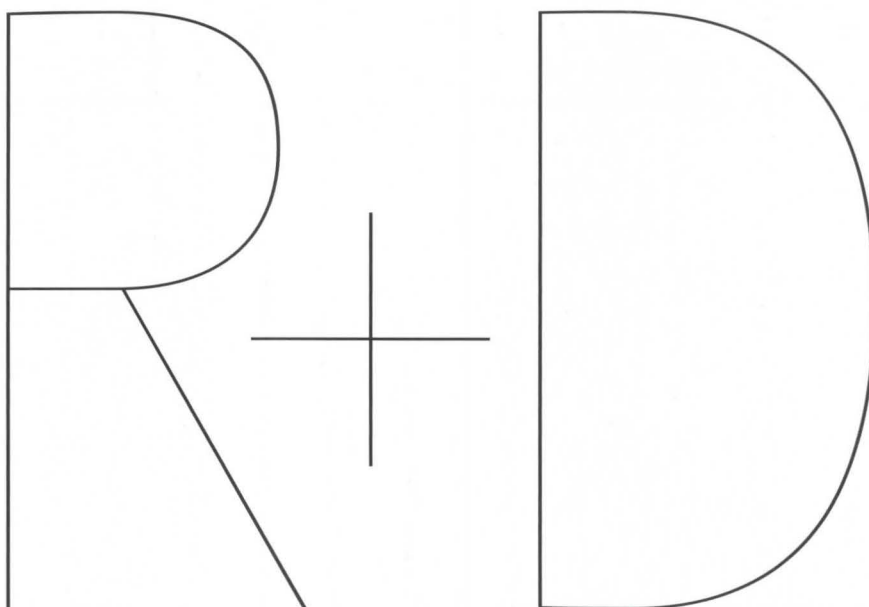

RESEARCH AND DEVELOPMENT may seem like luxuries right now, what with the global economy struggling to right itself. But if the third annual R+D Awards are any indication, the bust is motivating a major boom in architectural technology. Certainly, this year's jurors—Lauren Crahan, Craig Hodgetts, and John Ronan, profiled on page 73—proved acutely aware that limited resources are inspiring a new trajectory in the building sciences. They spent two days paging through 110 entry binders, selecting 13 winning projects and products that do more with less.

Skidmore, Owings & Merrill (SOM) won four awards and was involved in a fifth; the firm's well-documented and innovative projects proved so disparate that the jury saw no connection during the blind judging. (Before the ARCHITECT staff revealed the winners' identities, the jury extensively praised one SOM entry, the Sustainable Form-Inclusion System, for its indie, "noncorporate" approach.) Manufacturers, too, earned major recognition this year. A recyclable broadloom carpet backing, a new method for installing roofing membranes, and an aluminum joist system for decks all exhibited a level of practicality that was too ingenious to be ignored.

Turn the page, and judge for yourselves.

TEXT BY KATIE GERFEN AND AMANDA KOLSON HURLEY
PHOTO BY DAVIES + STARR
STYLIST: THOM DRIVER FOR HALLEY RESOURCES

→ CENTER FOR ARCHITECTURE SCIENCE AND ECOLOGY

ACTIVE PHYTOREMEDIATION WALL SYSTEM

GREEN WALLS HAVE BEEN touted as a balm for cubicle-weary office workers for years, but the Center for Architecture Science and Ecology—a collaboration between Rensselaer Polytechnic Institute and Skidmore, Owings & Merrill—has created a new prototype that would work with a building's existing HVAC system to reduce energy loads and improve indoor air quality. The Active Phytoremediation Wall System is a modular wall system of pods housing hydroponic plants. Because the plants' roots are exposed, instead of being buried in soil, the plants' air-cleaning capacity increases by 200 to 300 percent.

Air moves through a perforated air intake duct—a series of mini-jets are being developed to encourage airflow—and directly over the root system. This allows the rhizomes on the roots to essentially digest airborne toxins—VOCs, particulate matter, and other biological and chemical pollutants—without the plant itself becoming toxic (which is what happens when the toxins are taken in solely through the leaves). The cleaned air then flows out of each pod through a series of clean air ducts and is reintroduced to the environment.

The pods themselves are made from vacuum-formed plastic, and the form allows the maximum amount of air to reach the root rhizomes while using the minimum amount of material. On top of that, it creates a beautiful base for the plants. "I would move into an office with that instantly," juror Craig Hodgetts said.

The wall system can be installed in large commercial interiors, but works equally well in small settings—a four-module system in an apartment would have the impact of 800 to 1200 house plants. The first test-bed site will be PSAC II, an emergency response center in New York designed by the local office of SOM, where it will be the aesthetic centerpiece of the lobby. "Usually, remediation is either technically believable or aesthetically pleasing, but not both," said John Ronan. "This one's both." **K.G.**

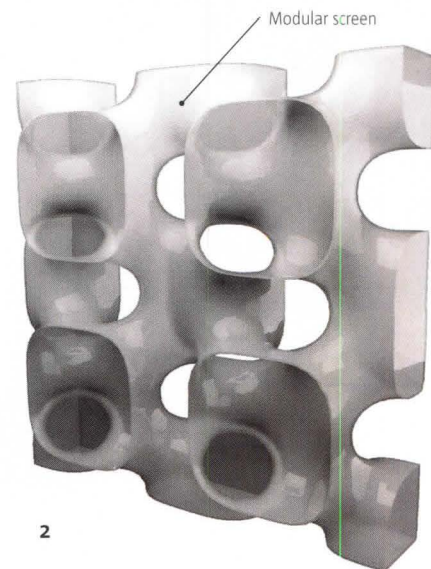

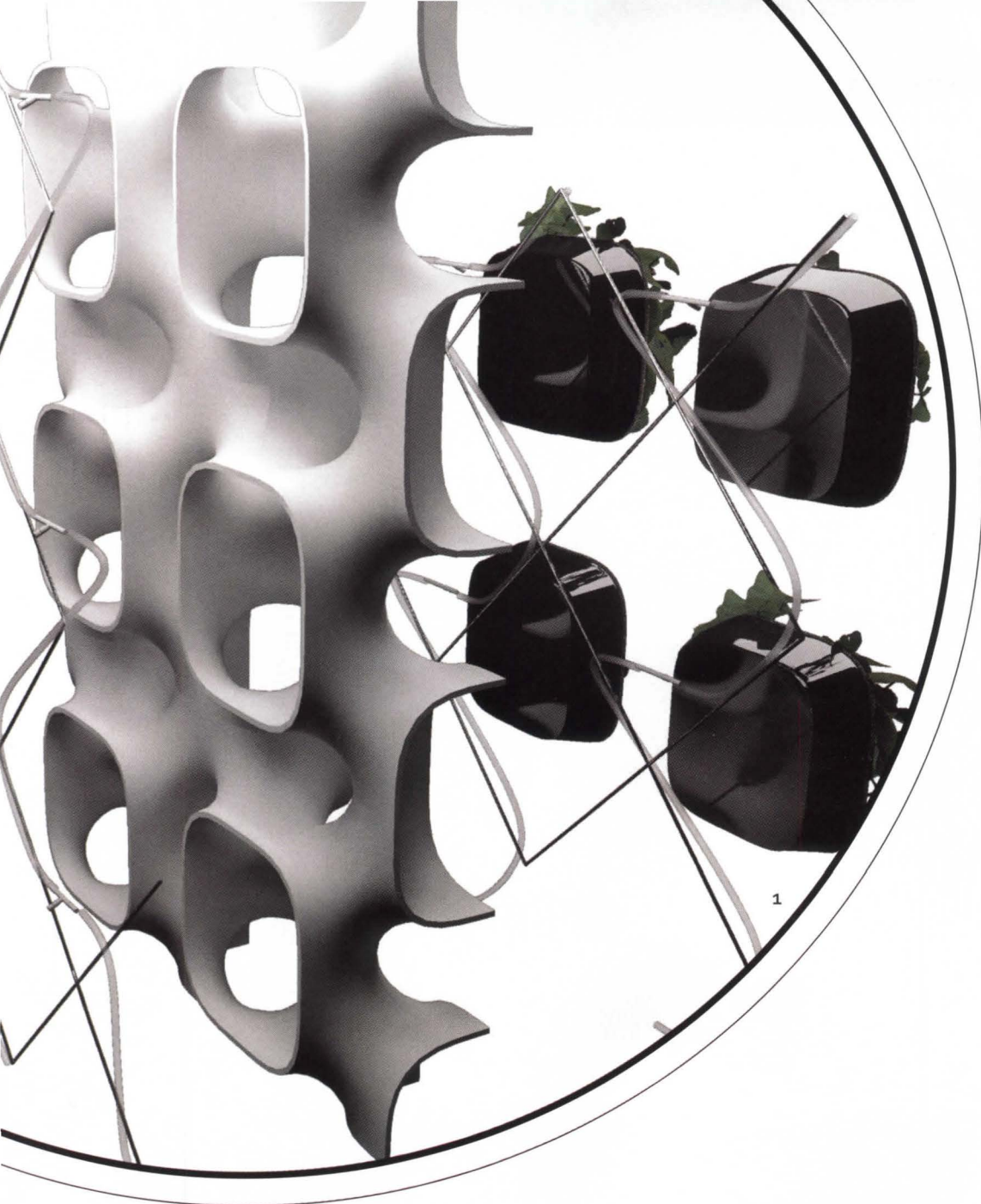

1. The Active Phytoremediation Wall System consists of hydroponic plants in bio- and phyto-filtration pods. The pods are installed in a modular screen which serves as a plenum and as ductwork for air movement. A support frame holds the pods in place and a drip irrigation system supplies fresh water to each plant. The roots are exposed to the air and receive water through absorbent wicks that are filled by reservoirs supplied by the drip system.

2. The system can be populated with foliage plants like ferns, or with crawling plants such as ivy or moss.



→ ACTIVE PHYTOREMEDIATION WALL SYSTEM (CONT.)

3. The air purification process works as follows: Ventilated outside air is brought into a building by the HVAC system. Oxygen is used up and toxins are added as the air is affected by people, finishes, and other contributors to poor indoor air quality. As the polluted air moves through the phytoremediation wall—largely by natural air circulation flows—the root rhizomes digest the toxins and replenish the oxygen. Clean air is then returned to the interior environment.

4-6. The wall is currently undergoing a rigorous testing process. Test pods are vacuum-formed (4) and assembled, as are pieces of the modular duct framework which manage airflow through the system. Plants are installed, and the system is assembled (5) and then placed in a testing chamber (6) to measure the air-cleaning power of different plant species and the overall effectiveness of the system.

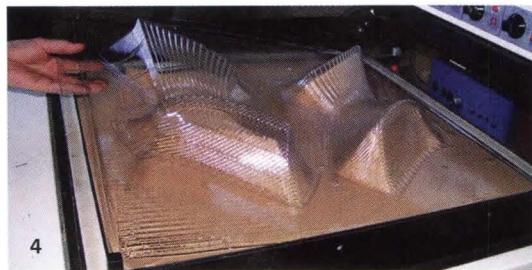
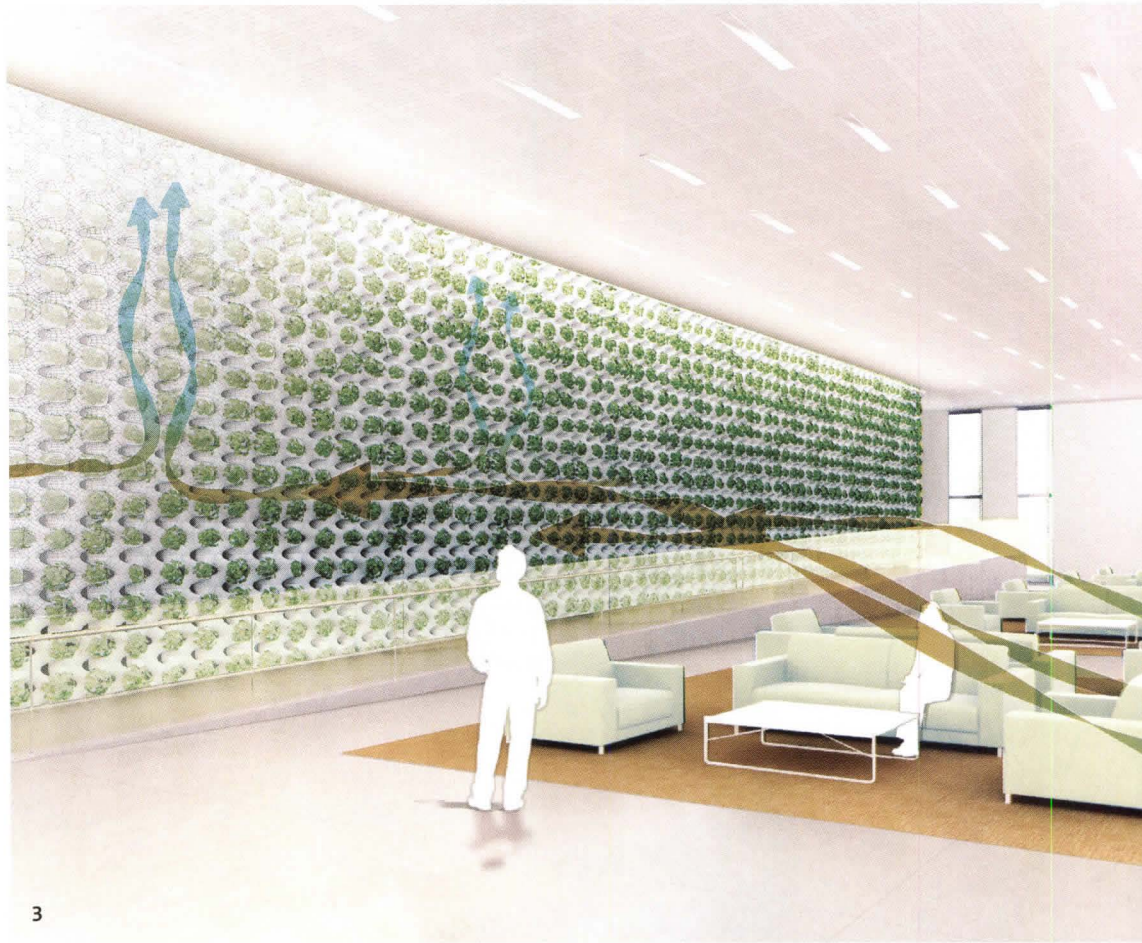

ECOWORX BACKING FOR BROADLOOM CARPET

SHAW INDUSTRIES MADE A COMMITMENT to cradle-to-cradle principles when it released its Ecoworx backing for modular carpet tile, a product that could be split from the nylon face fiber at a tile's end of life and recycled into new backing. But when the company tried to apply the same technology to its broadloom carpets, it realized that the system simply did not translate. So the company's materials engineers set to work creating a new system, one that dissolves the carpet into its original components.

The process involves shredding the carpet and immersing the pieces in a bio-based solution. The nylon face fibers detach and can be turned into caprolactum, which is the base for new nylon fibers. The solution-covered backing pieces are then heated; the solution evaporates and is reconstituted elsewhere, ready to be used again in the dissolution of more carpet. The backing pieces are then ready to be used to create new Ecoworx backing for new broadloom carpet. The ingenuity of the process intrigued the jury—"I was really impressed that they had the whole system worked out," Craig Hodgetts said. "They have the chemistry going for them."

The final element that had to be engineered was the carpet's durability. The face fiber is made from fleece, which wears out quickly, so the engineers created a woven outer reinforcing layer and a special adhesive to extend the carpet's life. Even so, John Ronan pointed out, "Carpet is a very limited life material. So, I think it makes it more important that you recycle it and how you recycle it." But recycling only works if the carpet is returned to Shaw, and it is up to architects and contractors to do that. **K.G.**

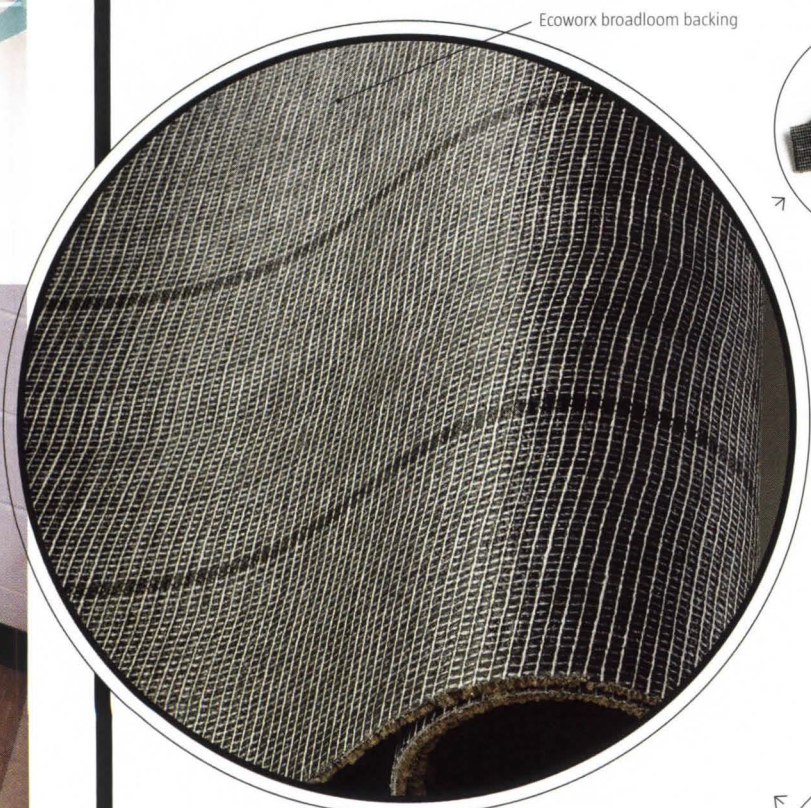

Ecoworx broadloom backing

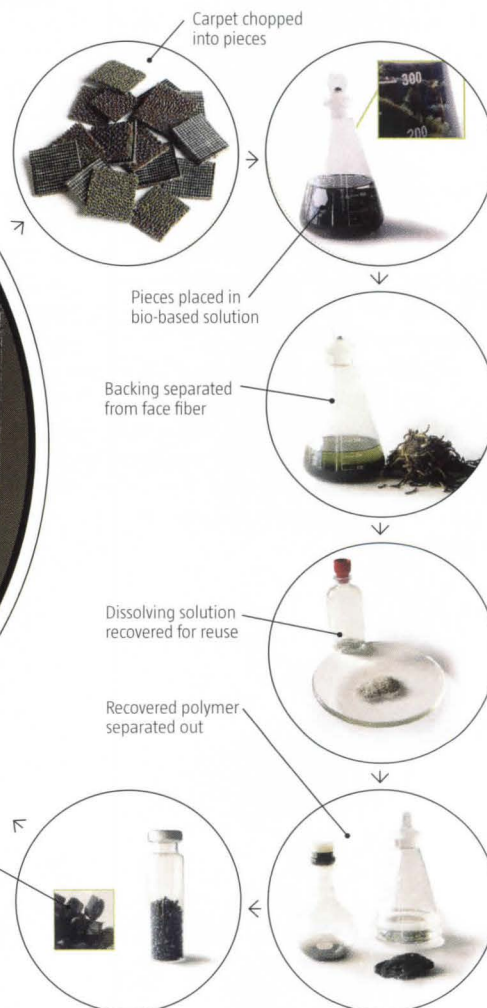

Ecoworx backing for broadloom carpet was engineered as a cradle-to-cradle product, which can be reclaimed at the end of the product's life cycle, broken down into its component pieces, and completely recycled into new commercial-grade carpet.

→ DEAN/WOLF ARCHITECTS

DYNAMIC DESCENT

WHEN TASKED WITH DESIGNING a staircase for a Manhattan townhouse, New York firm Dean/Wolf Architects eschewed typical wood and drywall for laser-cut and bent stainless steel. The design was limited by the available materials—stainless comes standard in 4-foot-by-12-foot sheets, and the brake press needed to bend the steel could only accommodate a 12-foot-wide piece of material. The solution was to limit the height of the structural members—which had to support two flights of stairs—to no more than 24 feet, or two of the 12-foot pieces, thereby limiting the number of joints.

Each piece—whether vertical support or horizontal tread—was first cut on a CNC laser-cutting machine to achieve a custom profile. The pieces were then bent on a brake press and joined for a zero-tolerance fitting in the fabrication shop. A custom joint was fabricated to extend the height of the vertical structure members, and Dean/Wolf spaced the joints so that each is located just below a tread on the upper flight of stairs, to impart a certain logic to the disruption. The vertical members were hung from the top-floor ceiling, under a skylight, and the treads were slipped into pre-cut notches in the vertical members and then fastened into place.

The jury reviewed numerous folded-metal assemblies and decided to award one “best-in-show” prize to represent that technology. In describing Dynamic Descent, juror Lauren Crahan said: “I think it’s a very successful project, and it’s documented really well.” Craig Hodgetts agreed, and remarked: “It takes the tension stair that one extra step, and transforms it.” **K.G.**



Stair Hanger Isometric

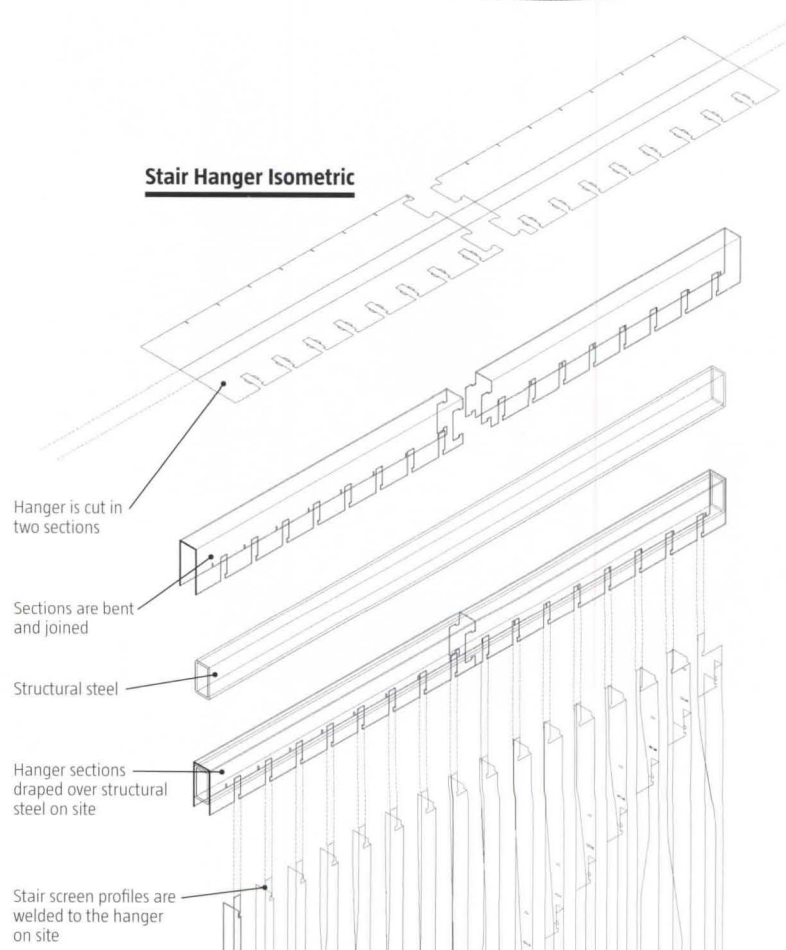

0 6" 12"

Stair Assembly Diagram

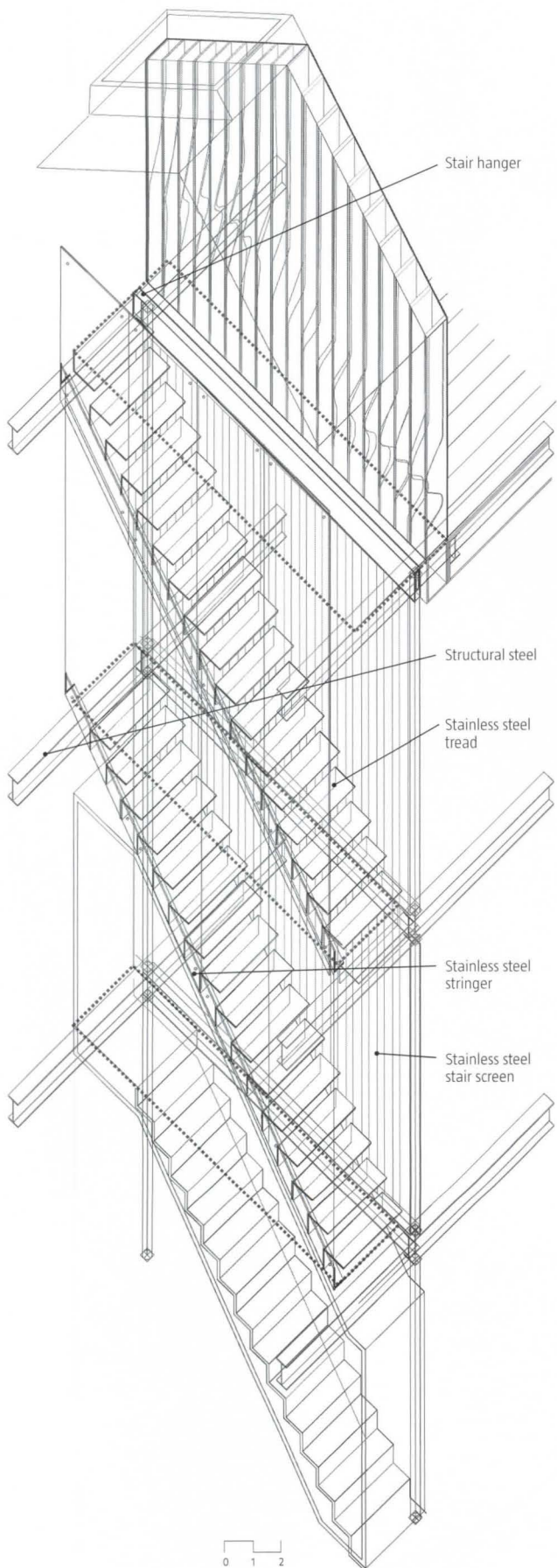

Cutting Layout

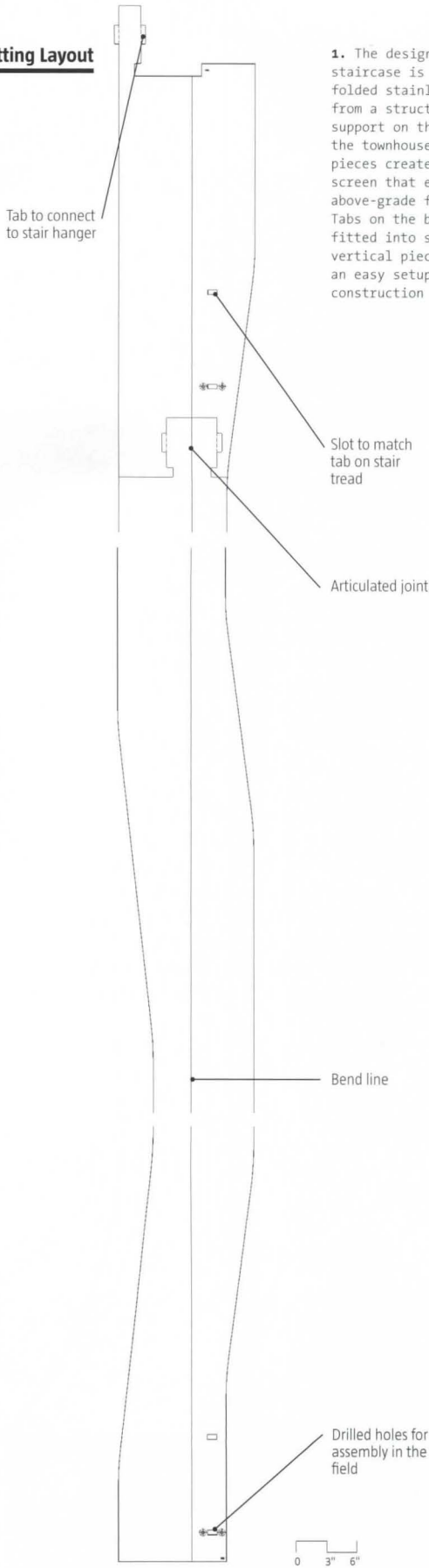

1. The design for the staircase is centered on folded stainless steel. Hung from a structural steel support on the top level of the townhouse, vertical folded pieces create a continuous screen that encloses the two above-grade flights of stairs. Tabs on the bent risers are fitted into slots on the vertical pieces, which created an easy setup for on-site construction and spot-welding.

1-2. Twenty-four tension cables connect the top of the tower to the ground to provide stabilization in the face of high winds (1) or earthquakes (2) that could stress the tall, thin structure.

3. The tower is coated in 10,000 evacuated solar tubes. Superheated water from those tubes will be able to power a 360-kilowatt steam turbine (bottom middle), which will provide energy for the tower's systems, including a 22-kilowatt desalination plant that will convert nearly 9,000 gallons of seawater to fresh water daily (bottom left) for irrigation and to refill the solar tubes. The turbine will also power a chiller (bottom right) to provide cool air for the tower's interior spaces.

4. Solar tube density varies on the different faces of the tower. The highest concentration is on the south façade, in an effort to harness the maximum amount of solar energy to convert to steam power.

5. Slices through the tower show the various uses of interior space, including an atmospheric research laboratory and an observation level.

1

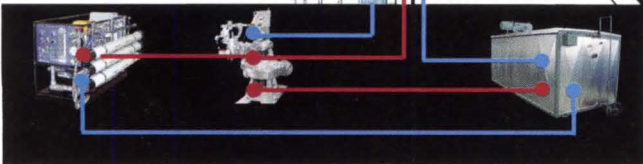
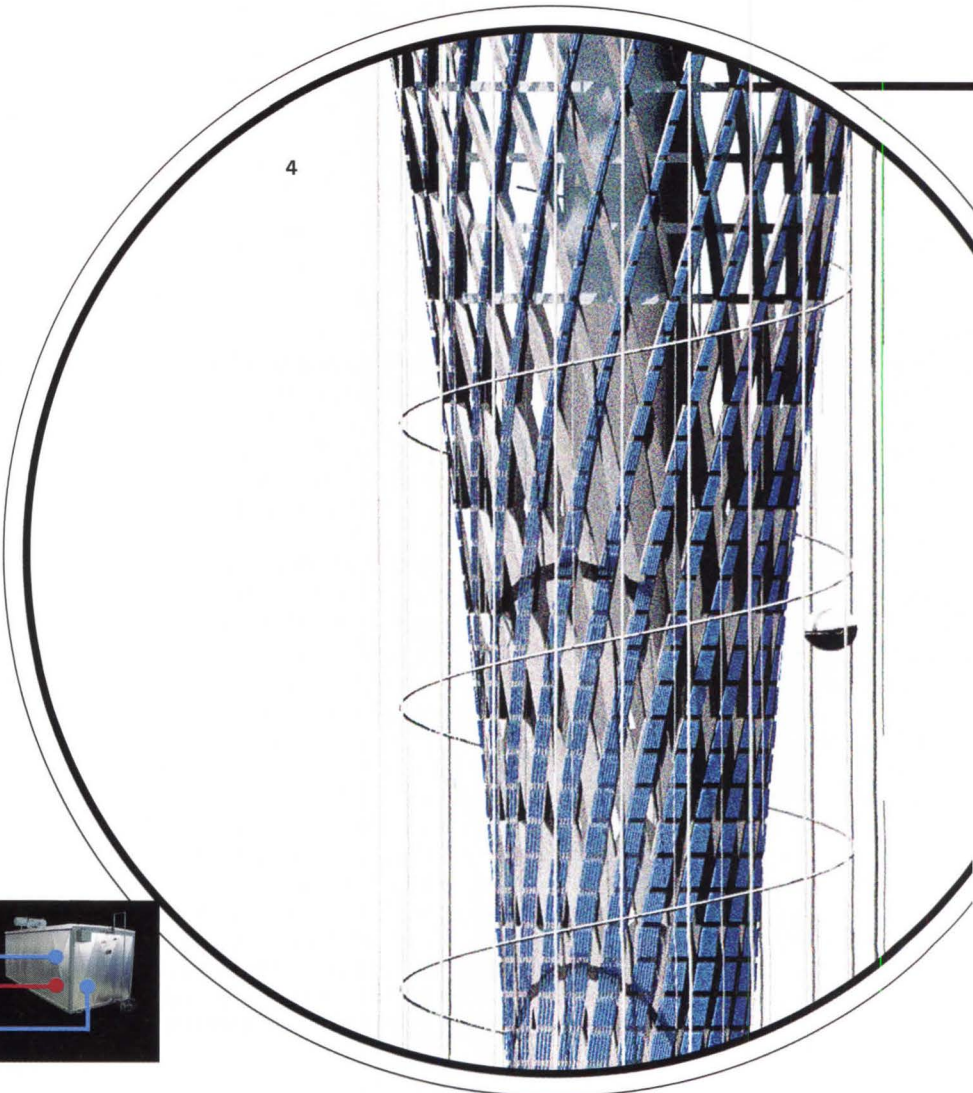
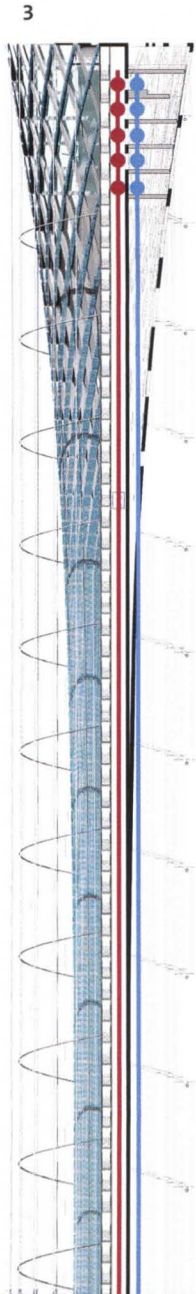
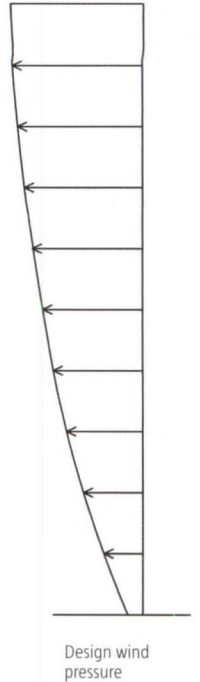
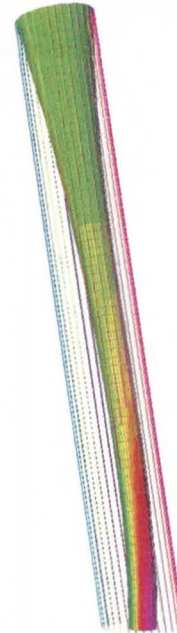
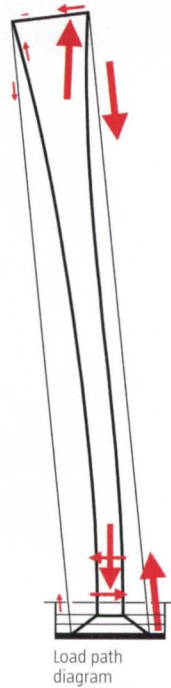
Load Path — Transient Condition

Dynamic Analysis Results

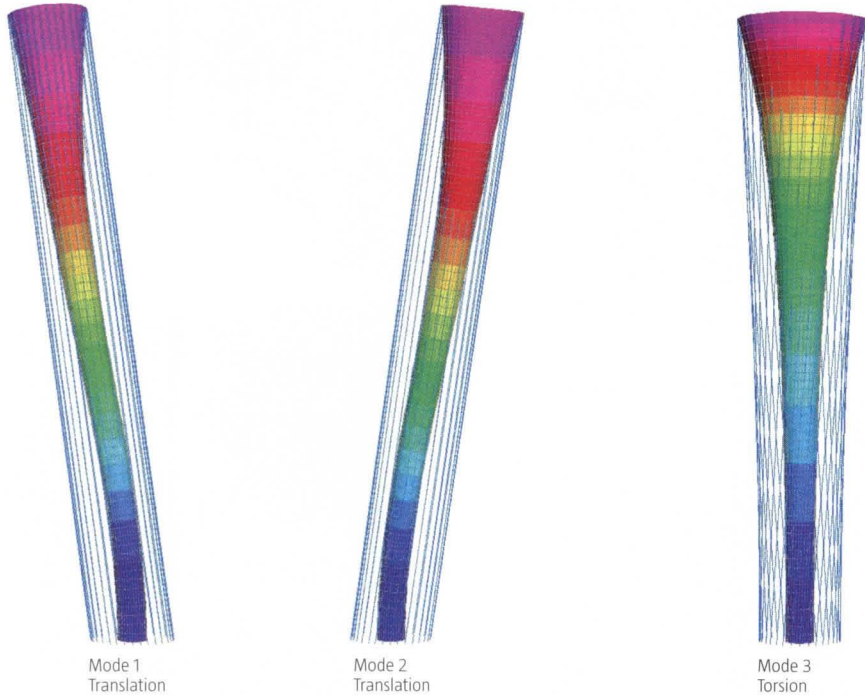

→ SKIDMORE, OWINGS & MERRILL, CHICAGO

OASIS GENERATOR

THE OASIS GENERATOR was developed by the Chicago office of Skidmore, Owings & Merrill at the request of the United Arab Emirates, which hopes to become less dependent on oil revenue by increasing its urban infrastructure. Since much of the landscape in the United Arab Emirates is unwelcoming, at best, the design team created a tower that would house a desalination plant—as well as an atmospheric research laboratory and an observatory—to help irrigate the coastline, creating a more habitable ecology that can be built up for post-oil industry.

SOM designed the tower using a genetic algorithm, in which principles from nature and natural selection identify the ideal form for a function in a specific landscape. The result is a 30-foot-diameter structural concrete core, enclosed in a climbing concrete latticework. For the lower two-thirds of the 600-foot-tall tower, the lattice remains flush against the core. The lattice of concrete then expands outward into a lamellar structure at the top. Twenty-four perimeter strand cables accommodate wind and seismic loads, and some 10,000 evacuated solar tubes heat water for a steam engine that powers all of the tower's systems. Included in those systems is a 22-kilowatt desalination unit that converts nearly 9,000 gallons of seawater into fresh water daily.

The power generation aspect of the tower alone was enough to intrigue the jury. "This is the kind of thing that General Electric can build and put out there and just make huge forests of," Craig Hodgetts said. "Relative to solar farms, which are long, horizontal structures, this is a good approach. And the engineering is pretty advanced, technically." What was less clear to the jury was how the tower would help mitigate the desert environment around it. "I was looking for more about the irrigation, since it was saying that it would spawn an oasis," Lauren Crahan said. John Ronan agreed: "They didn't really explain how installing one of these towers gets you this lush environment." **K.G.**

5

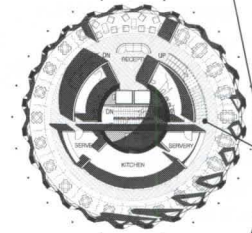
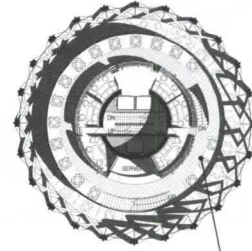
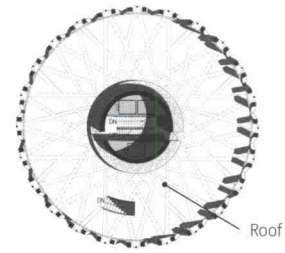

Atmospheric research laboratory

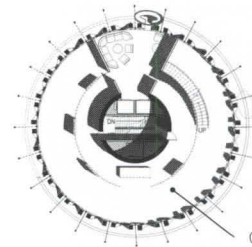
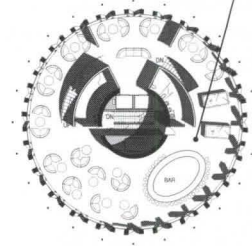

Observation level

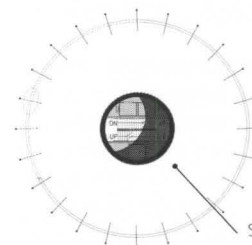

Shaft

→ IWAMOTOSCOTT ARCHITECTURE WITH BURO HAPPOLD ENGINEERS

VOUSSOIR CLOUD

THE GOAL OF THE INSTALLATIONS at the Southern California Institute of Architecture's gallery in Los Angeles is to redefine received notions of space using cutting-edge technologies and to involve students in the construction process. IwamotoScott Architecture of San Francisco endeavored to comply with this mission in its installation at the gallery, the Voussoir Cloud, while taking inspiration from some past masters.

The basic premise behind the Voussoir Cloud is a compression structure made from lightweight petals of thin wood laminate and modeled after voussoirs—the wedge-shaped bricks or stones used to form compression arches. To design the structure, the team used computational hanging chain models (the same method, minus the computer, that Eero Saarinen used for the St. Louis Gateway Arch). Form-finding programs and custom computer scripts helped the architects determine the profile lines and the vault shapes. The jury enthused about the deceptively simple results of the complex process. "It's minimal in use of materials, it's spatial, it's structural—it's everything architects should be concerning themselves with," John Ronan said.

The structure uses four types of vaguely triangular petals—those with zero, one, two, or three curved edges, the remaining edges on each petal being flat. Each petal incorporates a series of flanges that fold back to achieve a bowl-like shape. Smaller petals form the structural columns and the petals grow larger toward the top of the vaults. IwamotoScott designed the vaults with gaps between petals, an antithetical approach that admits light from the gallery's clerestory windows. **K.G.**

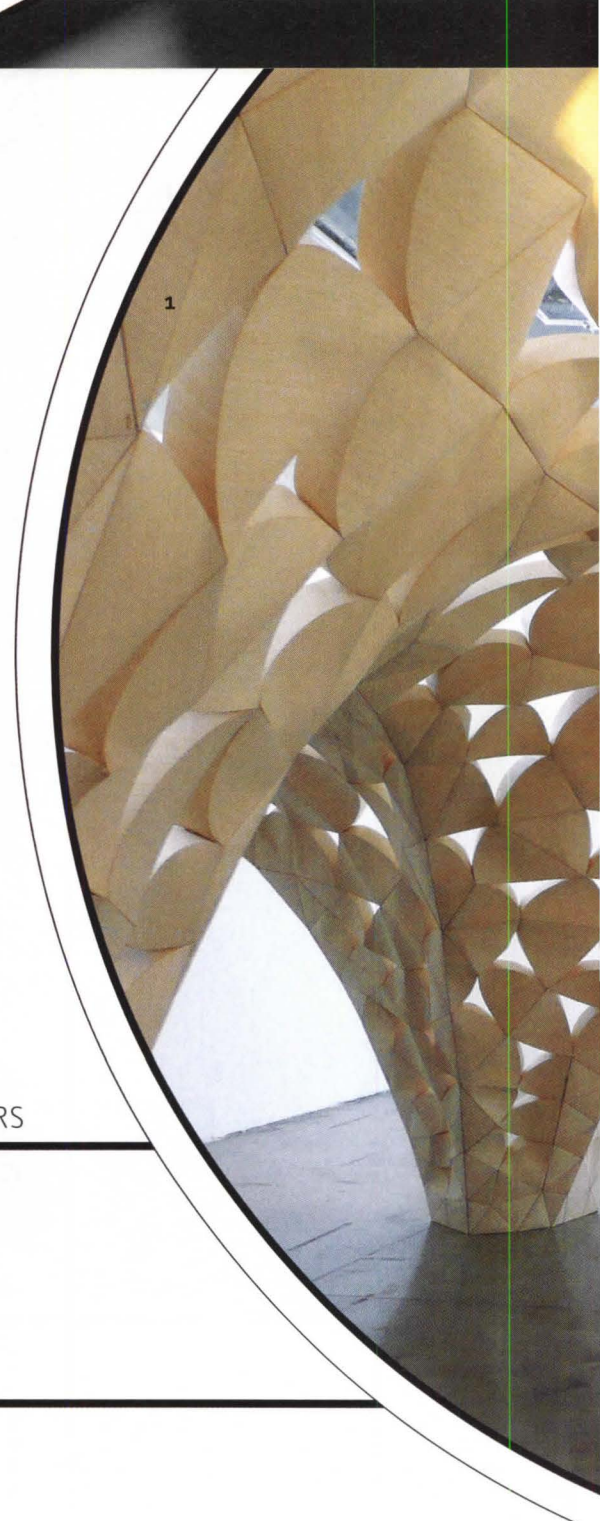

2
**Module Generation
Diagram**

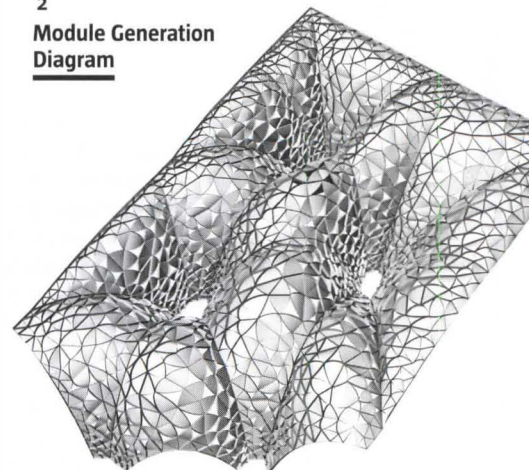

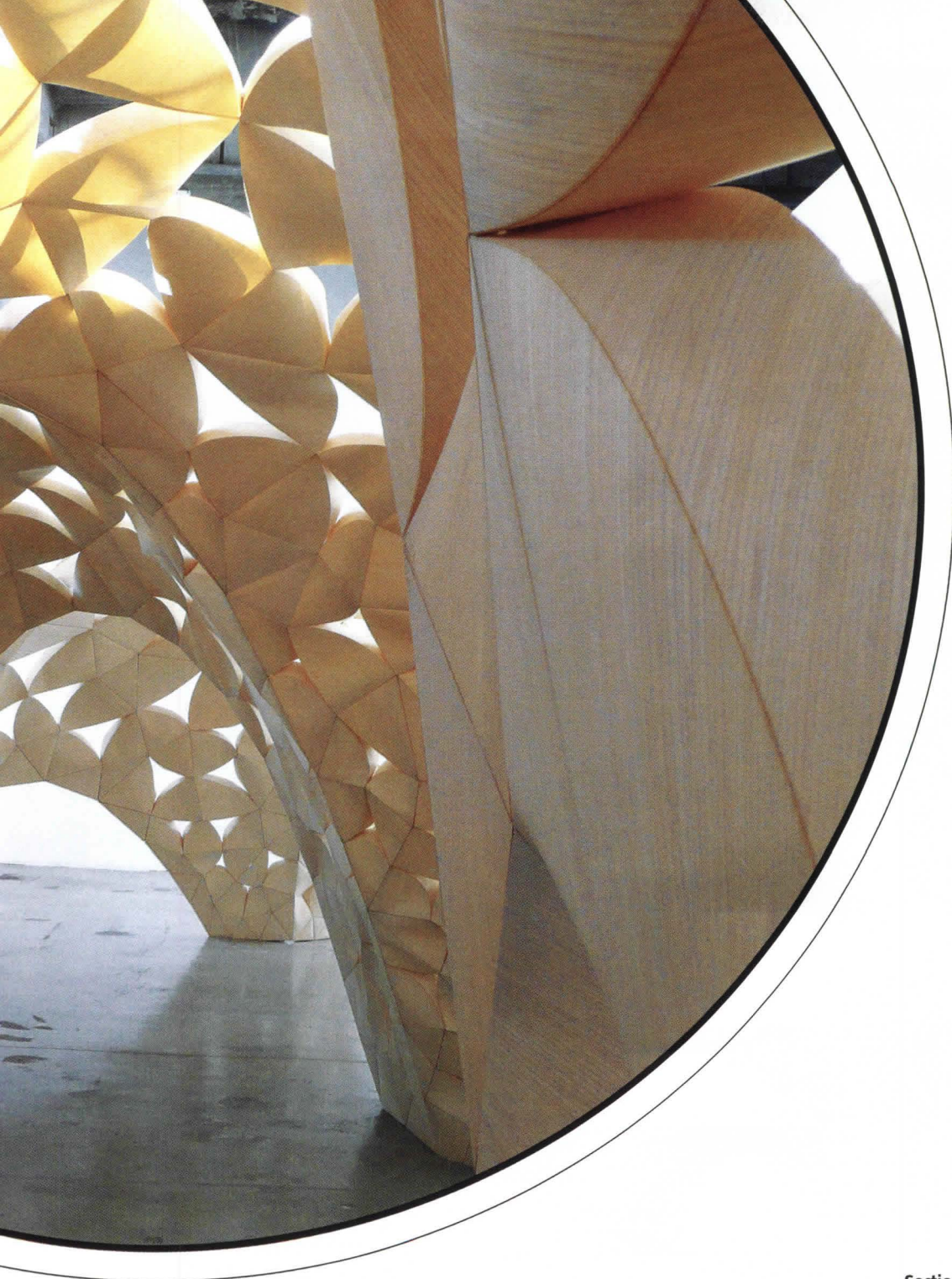

1. In the Voussoir Cloud, a series of wood laminate petals were used to create compression arches and vaults in a study of structure and porosity. Teams of students were involved in folding the laser-cut petals and in assembling those petals to construct the installation.

2. This model showcases the development of petal types needed to form a proper compressive vault system. The model was developed using Delaunay tessellation patterns, derived from nature.

Section

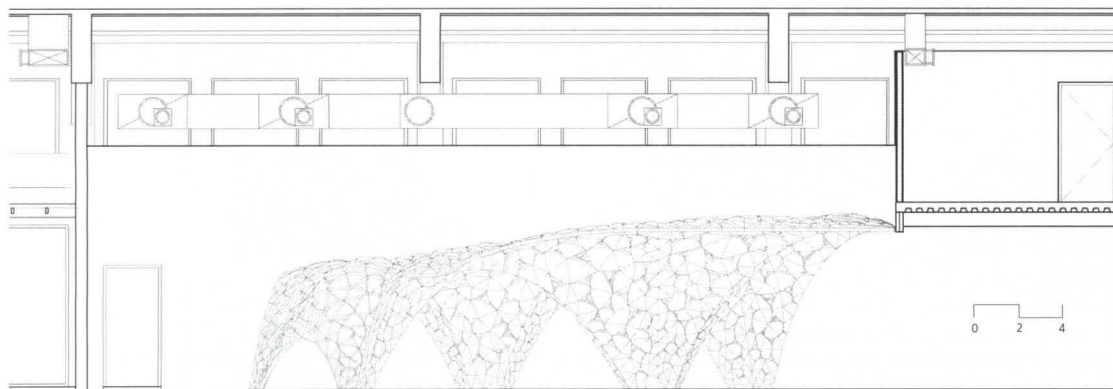

→ VOUSOIR CLOUD (CONT.)

3. The petals were constructed by laser-cutting the base shape, scoring the seams, and folding and securing the flaps to make a 3D module.

4. Four types of petals were used in construction—those with zero, one, two, or three curved edges. These petals were then placed and secured in a pattern that allows compression vaults to be formed.

5. Each petal was designed using a computer script written by the design team. The virtual petals could then be digitally unfolded to create a template from which the actual petals could be laser-cut.

6. This installation had to be constructed in a very specific order, with each phase represented by a different color in this diagram. The column feet (in pink) had to be constructed first, followed by the ribs of the vaults (brown), the perimeter (green), and the infill spaces on top of the vaults (yellow).

7. Students helped to construct the individual petals and then the actual structure. A team of students is seen working to install some of the perimeter petal sections.

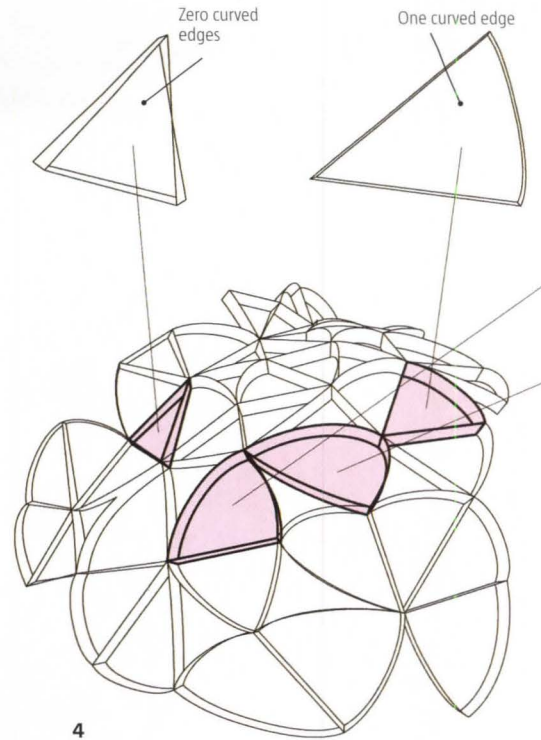
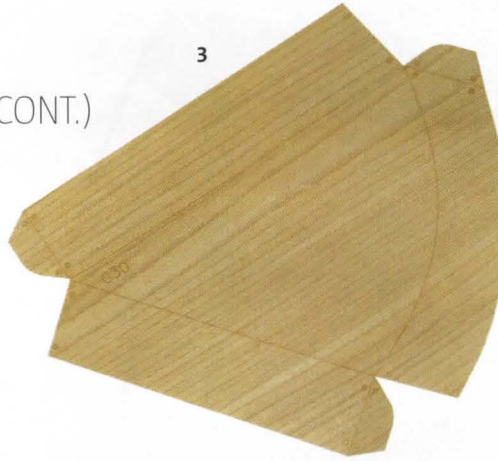

4
Petal Types

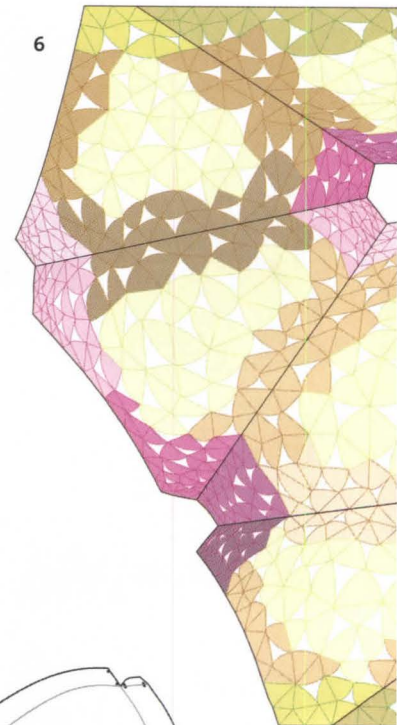

5
Petal Folding

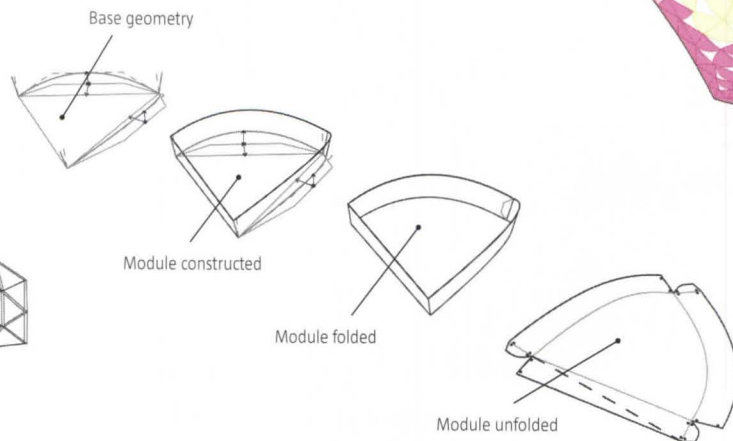
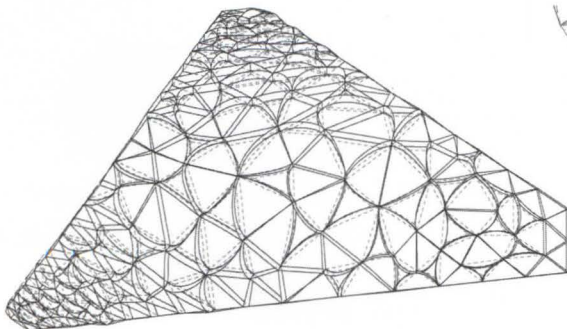

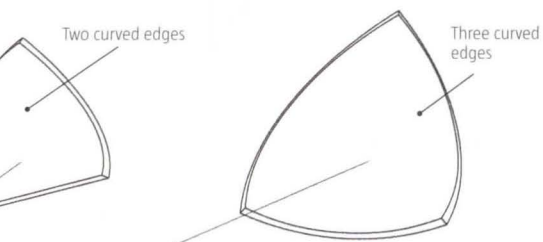

→ SIKA SARNAFIL

RHINO BOND

AN ANSWER TO FLUTTERING ROOFS EVERYWHERE, Rhinobond is a mechanical attachment system for thermoplastic roof membranes that allows the roofing material to be spot-welded without penetrating the membrane. At the center of the system is an induction welding technology called Sinch that heats a PVC-coated plate through the membrane. The Sinch process generates enough heat to seal between the plate and the underside of the thermoplastic roof without using direct heat, which would create a hole. (Magnetic cooling weights are placed on the site of the weld until the material has bonded.) The plates are laid out in a grid and fastened to the roof surface using the same clamps that hold the insulation in place. Remembering horror stories from their own projects, the jury was immediately on board with the concept. "This is just an idea whose time has come," juror John Ronan said. "We have this problem when we use thermoplastic roofs. They start bubbling up and it is always a fight." Factory test results for standard applications show that a 1-120 uplift rating can be achieved with welds laid out in a 2-foot-by-2-foot grid. **K.G.**

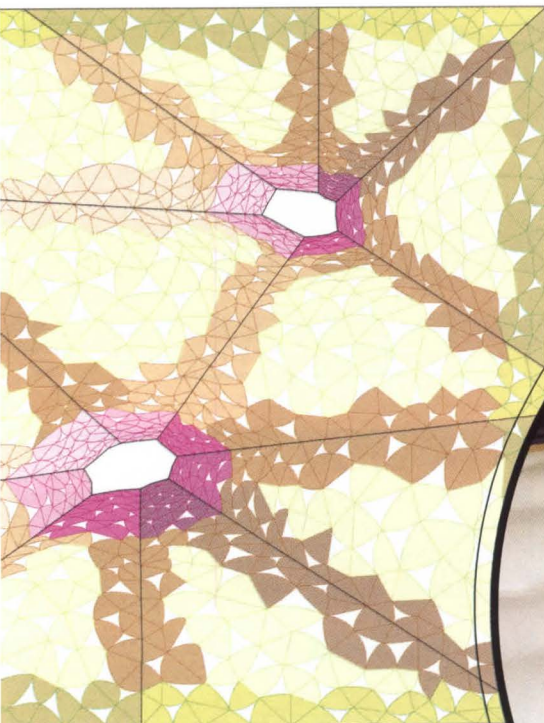

Attachment Diagram

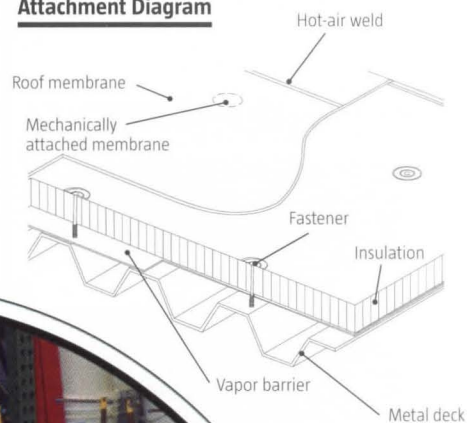

Rigorously tested during the engineering and development phase, Rhinobond was placed under simulated heavy wind loads to verify the durability of the welds.

→ BARKOW LEIBINGER ARCHITECTS

TRUMPF CAMPUS GATEHOUSE

THE 2D AND 3D CUTTING and casting experiments that Barkow Leibinger Architects has undertaken arose from Frank Barkow and Regine Leibinger's interest in emerging technologies and their firm conviction that, as they say, "Tools shape materials that make forms, not the other way around."

The Berlin-based architects count themselves fortunate to have the machine-tool company Trumpf as a repeat client. Working with über-engineer Werner Sobek, Barkow Leibinger used Trumpf's own technology to build a new gatehouse of laser-cut and welded sheet metal on the company's campus in Ditzingen, Germany. The gatehouse consists of a small functional core topped by a honeycombed steel roof that cantilevers an astonishing 20 meters (66 feet) across the street in front of it. Jury member Craig Hodgetts described the cantilever as "just awe-inspiring." In their submission, the architects say they wouldn't have been able to pull it off five years ago.

Barkow Leibinger submitted a portfolio of several cutting/casting projects, including a complex façade of 3D and 2D polygonal, mirrored glass panels for an office building in Seoul, Korea, and a restaurant ceiling infilled with glulam wood cells. But it was the gatehouse and its roof that wowed the jury. "That extruded cut and [fold] actually became a structural roof, and it has a good span," enthused juror Lauren Crahan. Hodgetts agreed wholeheartedly: "That was a killer—when the thing goes, like, all the way out there ... *Kabam!*" A.K.H.

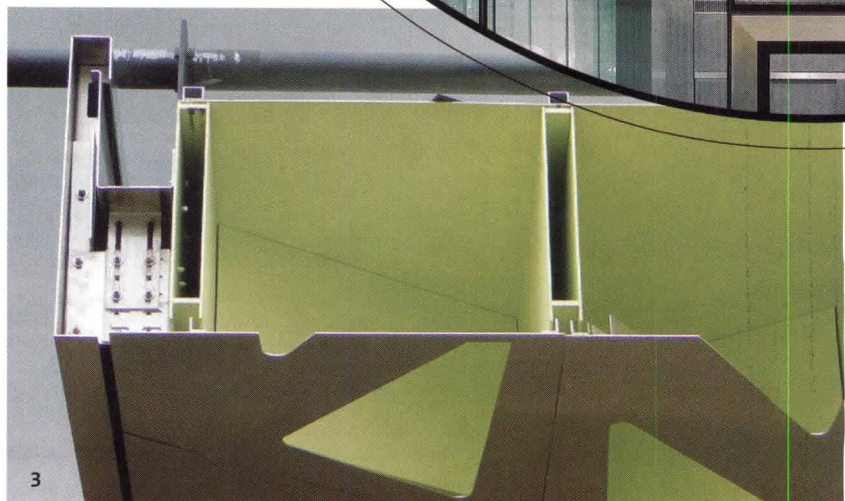

ARCHITECT

A Hanley Wood Publication

Free Product Information

August 2009 Issue

This card expires on February 28, 2010

0908B-1

NAME _____
TITLE _____
COMPANY NAME _____
ADDRESS _____
CITY _____ STATE _____ ZIP _____
BUS. PHONE _____
BUS. FAX* _____
EMAIL* _____

* Your phone, fax, and email information will be shared with the advertisers whose information you request. They may use these to send you their product information.

1. What is the primary business of your firm?

- 01 Architectural or Architectural/Engineering Practice
02 Design Firm (including Interior Design, Landscape Designer, or others)
03 Consulting Engineering
04 Contractor or Builder
05 Commercial/Institutional/Industrial/Government
06 School or University, Trade Association/Library
09 Other (please specify) _____

2. Including yourself, what is the total number of people employed by your firm at all locations?

- 01 1
02 2
03 3-10
04 11-50
05 51-100
06 101 or more
99 None

3. Are you a registered architect?

- Yes No

4. Are you a LEED Accredited Professional?

- Yes No

5. Which of the following best describes your job title?

- 01 Owner, Principal, Partner, Corporate Executive, General Manager
02 Staff Architect
03 Designer, Technical Staff, Draftperson
04 Manager/Marketing Personnel
09 Other (please specify) _____

6. Which of the following types of projects has your firm been involved in? (check all the apply)

- 01 Office/Commercial
02 Retail/Foodservice
03 Hotel
04 Education
05 Healthcare
06 Industrial
07 Government
08 Community/Cultural
09 Recreational
10 Religious
11 Multifamily Residential
12 Single Family Residential
13 Interior Design
99 Other (please specify) _____

FOR FASTER SERVICE FAX
COMPLETED FORM TO: 416-620-9790

ARCHITECT

A Hanley Wood Publication

Free Product Information

August 2009 Issue

This card expires on February 28, 2010

0908B-2

NAME _____
TITLE _____
COMPANY NAME _____
ADDRESS _____
CITY _____ STATE _____ ZIP _____
BUS. PHONE _____
BUS. FAX* _____
EMAIL* _____

* Your phone, fax, and email information will be shared with the advertisers whose information you request. They may use these to send you their product information.

1. What is the primary business of your firm?

- 01 Architectural or Architectural/Engineering Practice
02 Design Firm (including Interior Design, Landscape Designer, or others)
03 Consulting Engineering
04 Contractor or Builder
05 Commercial/Institutional/Industrial/Government
06 School or University, Trade Association/Library
09 Other (please specify) _____

2. Including yourself, what is the total number of people employed by your firm at all locations?

- 01 1
02 2
03 3-10
04 11-50
05 51-100
06 101 or more
99 None

3. Are you a registered architect?

- Yes No

4. Are you a LEED Accredited Professional?

- Yes No

5. Which of the following best describes your job title?

- 01 Owner, Principal, Partner, Corporate Executive, General Manager
02 Staff Architect
03 Designer, Technical Staff, Draftperson
04 Manager/Marketing Personnel
09 Other (please specify) _____

6. Which of the following types of projects has your firm been involved in? (check all the apply)

- 01 Office/Commercial
02 Retail/Foodservice
03 Hotel
04 Education
05 Healthcare
06 Industrial
07 Government
08 Community/Cultural
09 Recreational
10 Religious
11 Multifamily Residential
12 Single Family Residential
13 Interior Design
99 Other (please specify) _____

FOR FASTER SERVICE FAX
COMPLETED FORM TO: 416-620-9790

FOR FREE PRODUCT INFORMATION CIRCLE THE CORRESPONDING NUMBER BELOW

1	31	61	91	121	151	181	211	241	271	301	331	361	391	421	451	481	511	541	571
2	32	62	92	122	152	182	212	242	272	302	332	362	392	422	452	482	512	542	572
3	33	63	93	123	153	183	213	243	273	303	333	363	393	423	453	483	513	543	573
4	34	64	94	124	154	184	214	244	274	304	334	364	394	424	454	484	514	544	574
5	35	65	95	125	155	185	215	245	275	305	335	365	395	425	455	485	515	545	575
6	36	66	96	126	156	186	216	246	276	306	336	366	396	426	456	486	516	546	576
7	37	67	97	127	157	187	217	247	277	307	337	367	397	427	457	487	517	547	577
8	38	68	98	128	158	188	218	248	278	308	338	368	398	428	458	488	518	548	578
9	39	69	99	129	159	189	219	249	279	309	339	369	399	429	459	489	519	549	579
10	40	70	100	130	160	190	220	250	280	310	340	370	400	430	460	490	520	550	580
11	41	71	101	131	161	191	221	251	281	311	341	371	401	431	461	491	521	551	581
12	42	72	102	132	162	192	222	252	282	312	342	372	402	432	462	492	522	552	582
13	43	73	103	133	163	193	223	253	283	313	343	373	403	433	463	493	523	553	583
14	44	74	104	134	164	194	224	254	284	314	344	374	404	434	464	494	524	554	584
15	45	75	105	135	165	195	225	255	285	315	345	375	405	435	465	495	525	555	585
16	46	76	106	136	166	196	226	256	286	316	346	376	406	436	466	496	526	556	586
17	47	77	107	137	167	197	227	257	287	317	347	377	407	437	467	497	527	557	587
18	48	78	108	138	168	198	228	258	288	318	348	378	408	438	468	498	528	558	588
19	49	79	109	139	169	199	229	259	289	319	349	379	409	439	469	499	529	559	589
20	50	80	110	140	170	200	230	260	290	320	350	380	410	440	470	500	530	560	590
21	51	81	111	141	171	201	231	261	291	321	351	381	411	441	471	501	531	561	591
22	52	82	112	142	172	202	232	262	292	322	352	382	412	442	472	502	532	562	592
23	53	83	113	143	173	203	233	263	293	323	353	383	413	443	473	503	533	563	593
24	54	84	114	144	174	204	234	264	294	324	354	384	414	444	474	504	534	564	594
25	55	85	115	145	175	205	235	265	295	325	355	385	415	445	475	505	535	565	595
26	56	86	116	146	176	206	236	266	296	326	356	386	416	446	476	506	536	566	596
27	57	87	117	147	177	207	237	267	297	327	357	387	417	447	477	507	537	567	597
28	58	88	118	148	178	208	238	268	298	328	358	388	418	448	478	508	538	568	598
29	59	89	119	149	179	209	239	269	299	329	359	389	419	449	479	509	539	569	599
30	60	90	120	150	180	210	240	270	300	330	360	390	420	450	480	510	540	570	600

7. Which of the following products and services do you personally specify or buy for clients, projects, and/or your own firm's use?

- 01 Windows and Doors
02 Curtain Wall Systems
03 Structural Systems & Components
04 Paints and Coatings
05 Stucco Systems
06 Furnishings
07 Plumbing Fixtures and Faucets
08 HVAC Systems
09 Electrical Systems/Components
10 CAD & other Computer Software Systems
11 Building Insulation
12 Moisture Protection
13 Roofing Systems
14 Flooring
15 Elevators/Escalators
16 Electronic Security Systems
99 None of the above

8. For more information by product category, check the corresponding boxes below:

- 01 Surfacing Materials
02 Roofing
03 Thermal Insulation & Moisture Control
04 Doors/Frames/Hardware
05 Ventilating/Heating/AC
06 Glass
07 Windows, Skylights, Curtainwall, Solar Control
08 Ceilings & Ceiling Systems
09 Flooring & Floor Coverings
10 Exterior Panels, Cladding & Wall Material
11 Concrete/Masonry Products
12 Interior Wall Surfaces/Coverings/Paints & Stains
13 Contract Furniture, Case Goods & Storage
14 Site Furnishings/Landscape/Exterior Lighting
15 Lighting/Interior
16 Structural/Foundation Systems
17 Restroom Accessories, Fixtures & Fittings
18 Electrical Systems/Controls/Wiring/Security
19 Signage & Wayfinding
20 Software & Hardware
21 Railing/Cable Systems
22 Elevators & Conveyance
23 AV

FOR FREE PRODUCT INFORMATION CIRCLE THE CORRESPONDING NUMBER BELOW

1	31	61	91	121	151	181	211	241	271	301	331	361	391	421	451	481	511	541	571
2	32	62	92	122	152	182	212	242	272	302	332	362	392	422	452	482	512	542	572
3	33	63	93	123	153	183	213	243	273	303	333	363	393	423	453	483	513	543	573
4	34	64	94	124	154	184	214	244	274	304	334	364	394	424	454	484	514	544	574
5	35	65	95	125	155	185	215	245	275	305	335	365	395	425	455	485	515	545	575
6	36	66	96	126	156	186	216	246	276	306	336	366	396	426	456	486	516	546	576
7	37	67	97	127	157	187	217	247	277	307	337	367	397	427	457	487	517	547	577
8	38	68	98	128	158	188	218	248	278	308	338	368	398	428	458	488	518	548	578
9	39	69	99	129	159	189	219	249	279	309	339	369	399	429	459	489	519	549	579
10	40	70	100	130	160	190	220	250	280	310	340	370	400	430	460	490	520	550	580
11	41	71	101	131	161	191	221	251	281	311	341	371	401	431	461	491	521	551	581
12	42	72	102	132	162	192	222	252	282	312	342	372	402	432	462	492	522	552	582
13	43	73	103	133	163	193	223	253	283	313	343	373	403	433	463	493	523	553	583
14	44	74	104	134	164	194	224	254	284	314	344	374	404	434	464	494	524	554	584
15	45	75	105	135	165	195	225	255	285	315	345	375	405	435	465	495	525	555	585
16	46	76	106	136	166	196	226	256	286	316	346	376	406	436	466	496	526	556	586
17	47	77	107	137	167	197	227	257	287	317	347	377	407	437	467	497	527	557	587
18	48	78	108	138	168	198	228	258	288	318	348	378	408	438	468	498	528	558	588
19	49	79	109	139	169	199	229	259	289	319	349	379	409	439	469	499	529	559	589
20	50	80	110	140	170	200	230	260	290	320	350	380	410	440	470	500	530	560	590
21	51	81	111	141	171	201	231	261	291	321	351	381	411	441	471	501	531	561	591
22	52	82	112	142	172	202	232	262	292	322	352	382	412	442	472	502	532	562	592
23	53	83	113	143	173	203	233	263	293	323	353	383	413	443	473	503	533	563	593
24	54	84	114	144	174	204	234	264	294										



NO POSTAGE
NECESSARY
IF MAILED
IN THE
UNITED STATES



BUSINESS REPLY MAIL

FIRST-CLASS MAIL PERMIT NO 9335 BUFFALO NY

POSTAGE WILL BE PAID BY ADDRESSEE

ARCHITECT

HANLEY WOOD
PO BOX 5109
BUFFALO NY 14205-9725



NO POSTAGE
NECESSARY
IF MAILED
IN THE
UNITED STATES



BUSINESS REPLY MAIL

FIRST-CLASS MAIL PERMIT NO 9335 BUFFALO NY

POSTAGE WILL BE PAID BY ADDRESSEE

ARCHITECT

HANLEY WOOD
PO BOX 5109
BUFFALO NY 14205-9725





4



5

1. With the new gatehouse, the architects and their client realized a longstanding shared ambition: to use Trumpf's own technology to construct a building entirely of laser-cut and welded sheet metal. Above the gatehouse's functional core, which is enclosed in a glass pavilion, a honeycombed stainless steel roof cantilevers more than 60 feet.

2. To see the logic of the structural loading, the architects built a series of 1:50 scale roof models based on different geometric patterns. After they made their choice—based on performance and aesthetics—they had the tricky job of scaling it up. The roof varies in density and material thickness in order to meet the changing static requirements: It's compact over the columns, light at the extent of the cantilever.

3. Laser-cutting, welding, bolting, and pre-cambering produced a mass customized steel roof that is 50 cm (nearly 20 inches) deep.

4. The roof arrived on site in prefab strips, which were bolted together. Then the whole thing was hoisted onto the column pins. When the crane belts were removed, the roof bounced a meter (more than 3 feet) before rocking into place.

5. The gatehouse is the first building in a new master plan for the Trumpf campus. The glass pavilion around the core is composed of two layers of float glass that sandwich stacked tube sections of acrylic glass. This renders the core visible as a blurred, soft shape on the façade.



Glass stringer beams rely on the support of load-bearing glass walls to hold the weight of the booth's glowing red staircase and the tourists lounging upon it. The glass pieces are connected with stainless steel brackets and pins, but there is no load-bearing metal in the structure.

Section

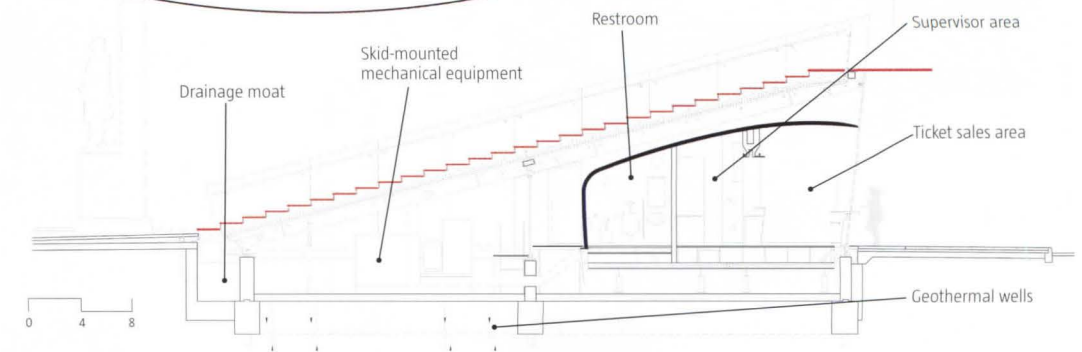

→ PERKINS EASTMAN

TKTS BOOTH

FOR YEARS, VISITORS to Times Square's discount theater ticket booth braved lines that coiled around a temporary structure which, while innovative at the time of its construction in 1973, had stuck around far past its sell-by date. New York-based Perkins Eastman changed that when it unveiled a glowing glass structure—inspired by an unbuilt 1999 competition-winning scheme by Australian architect Choi Ropiha—that is as much of a spectacle as the Broadway shows themselves.

The new structure offers much to be smitten with, from a glass cantilevered canopy to geothermal wells, but what the jury really loved were the glass stringer beams that support the structure's glowing red staircase-cum-roof; it's a place for visitors to sit, relax, and enjoy the street theater of Times Square. In the words of juror Craig Hodgetts, "I saw that and I just about lost it. I can't believe they actually hold all those people up on those glass beams and walls."

Spanning 28 feet, the beams are made from six layers of glass, laminated in pairs, and then spliced together to increase strength and durability. Since precision was key, the beams were held to a 2-mm tolerance over the course of the entire span. A central saw-toothed section accommodates the red glass treads of the staircase—27 steps in all. Helping to support the weight of the treads are 7-foot-wide, 17-foot-tall glass bearing walls—at the midpoint of the trusses—that weigh nearly 3,000 pounds apiece. "The technology of the glass is really just great," said juror Lauren Crahan.

The outermost stringer beams are attached to the perimeter glass panels with pins, and the beams connect at the top of the staircase to load-bearing glass walls at the ticket window and at the midpoint with bracketed joints—the stainless steel plate and hardware of which constitute the majority of the metal in the assembly. **K.G.**

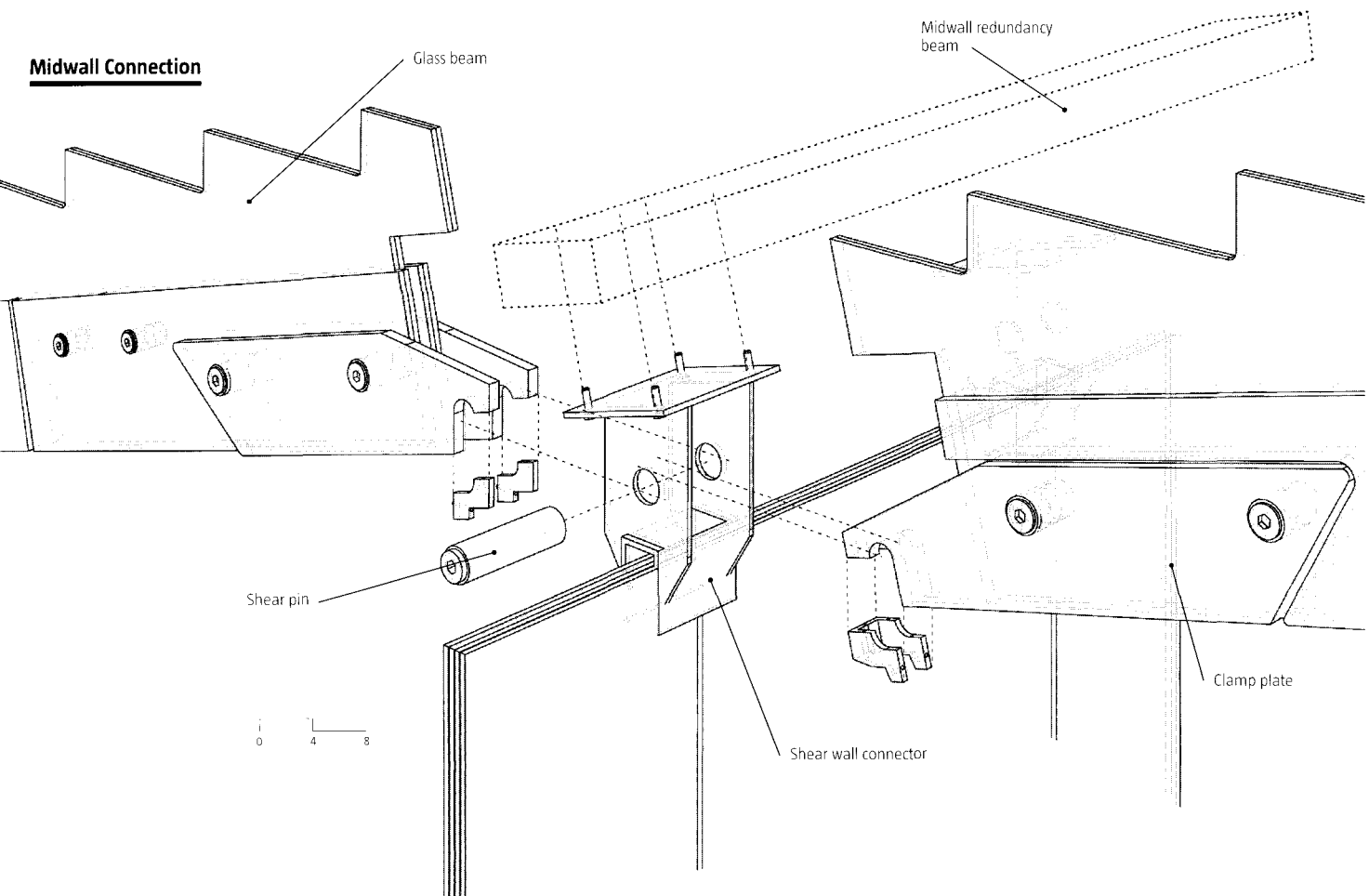

→ TKTS BOOTH (CONT.)



Impressive glass engineering continues at the front of the ticket booth, where the glass stringer beams connect to a cantilevered glass canopy, made from the same red-tinted glass as the staircase.

Axonomic

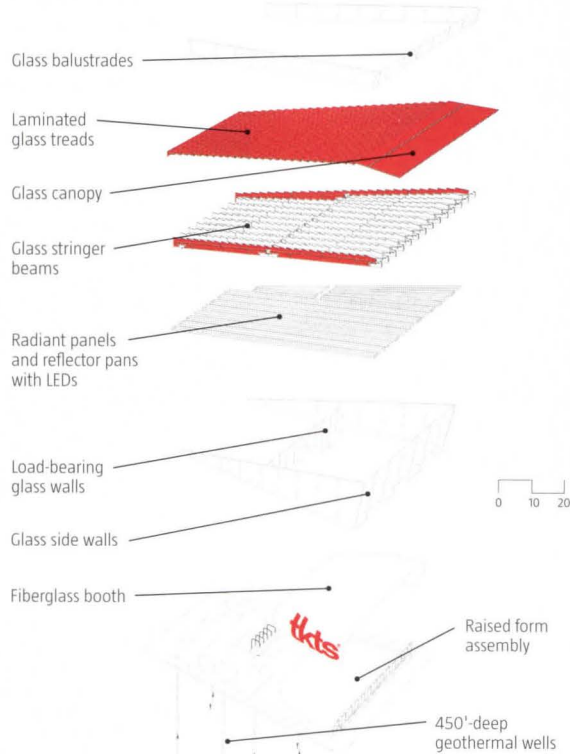

→ SKIDMORE, OWINGS & MERRILL, SAN FRANCISCO

SAN FRANCISCO DIGITAL CONTEXT ANALYSIS MODEL



MOVE OVER MERCATOR. When Google Earth debuted in 2005, it was deemed *the* map of the 21st century. But the San Francisco office of Skidmore, Owings & Merrill was not content with an aerial photographic map, and has independently spent two years developing its own 3D digital model of the city by the Bay, complete with embedded metadata. "This is not just a dumb model," said Craig Hodgetts. "It really is a tool."

The model records lot numbers, zoning restrictions, and other variables that SOM can use to create specific views to analyze issues like environmental conditions and their effect on existing and potential infrastructure. What would happen if sea levels were to rise? And do shadows on a site prevent it from being used as a public space as defined by San Francisco city code?

The metadata is periodically checked for accuracy by two individuals in SOM's Digital Design Group and linked to outside resources such as the city assessor's office. The model is being used by the city planning department to visualize potential zoning changes and development proposals. "It seems like this is the future of all cities," said John Ronan. "It forces architects to think about their work on different levels, rather than just model form or energy." Other SOM offices have created partial city models, but for now, this remains the most comprehensive. **K.G.**

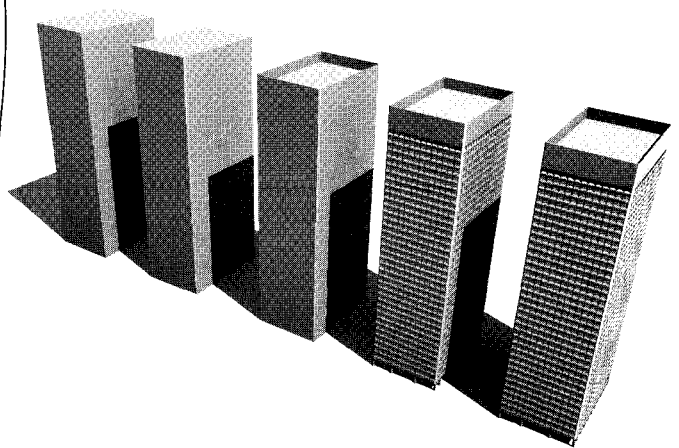

Because reliable models of most of the buildings in the city do not exist, SOM created its model using a combination of aerial photographs, public information, archival drawings, and, where needed, estimation. The accuracy and detail of the digital model for each building is tracked, and models are switched out for more detailed versions where necessary.

→ SAN FRANCISCO DIGITAL
CONTEXT MODEL (CONT.)

ARCHITECT AUGUST 2009

1

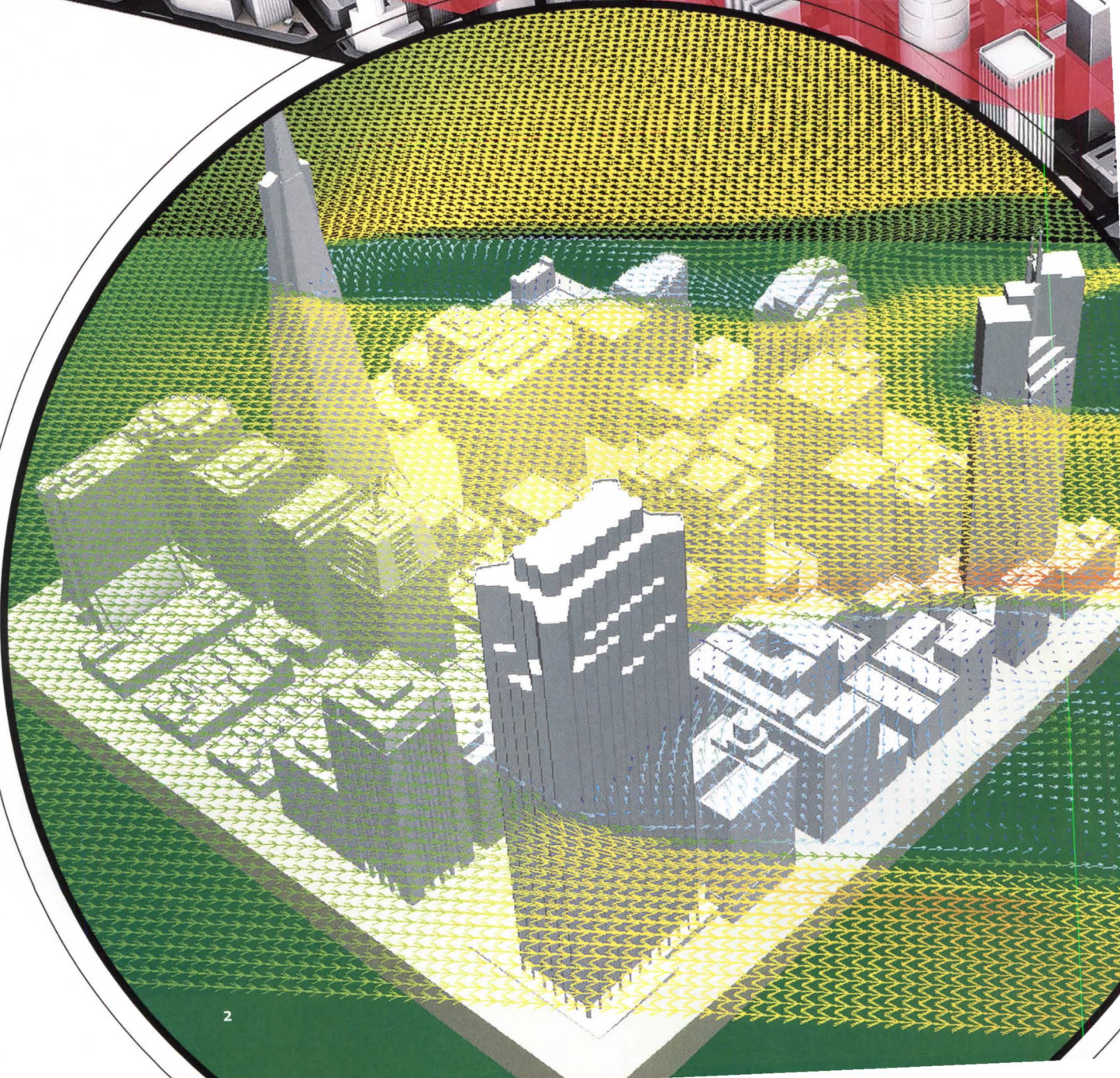

2

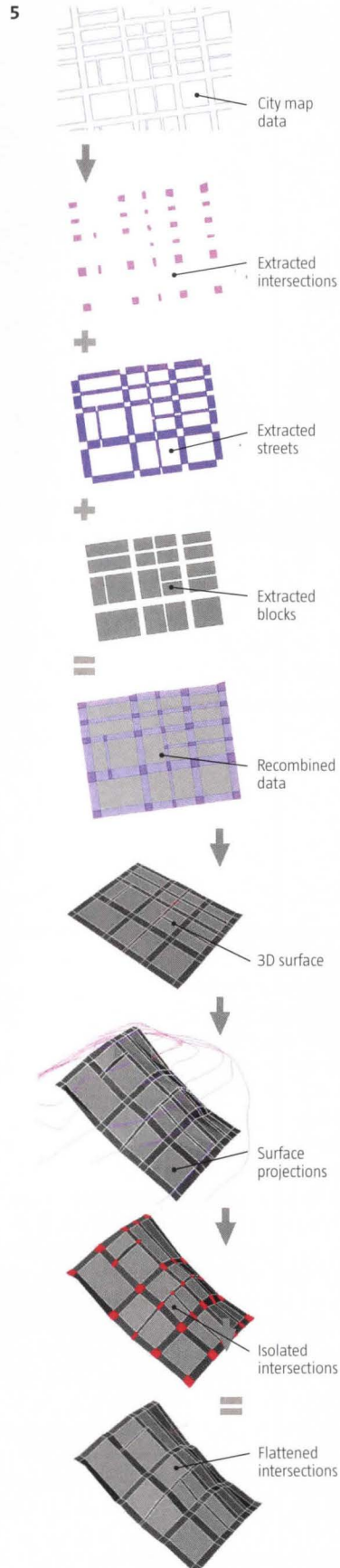
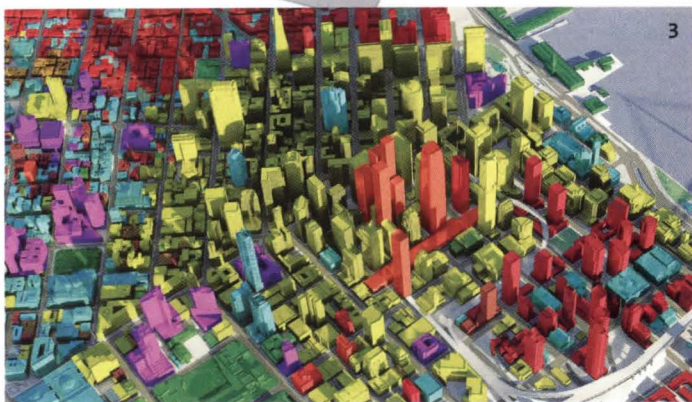
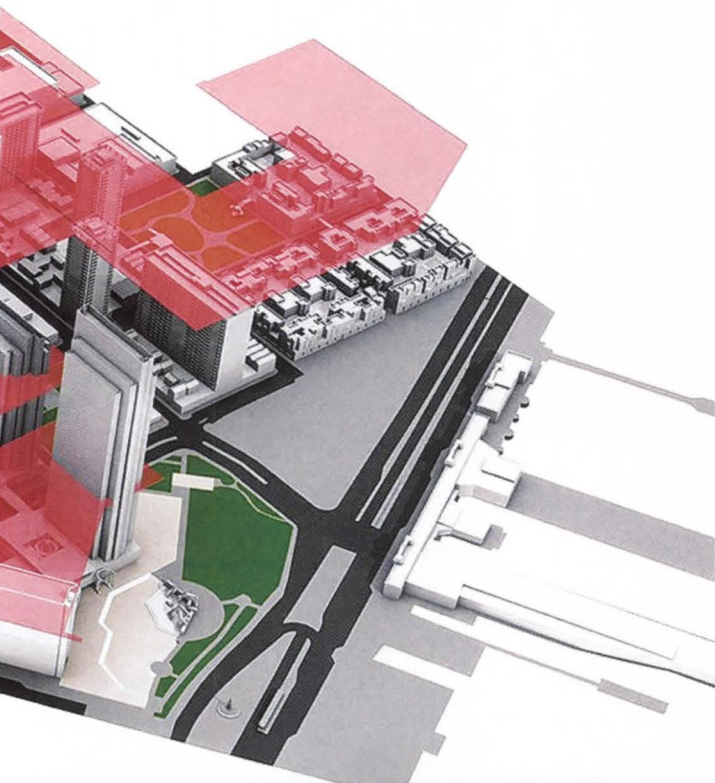

1. The model allowed the architects to create a series of visualizations that can help them consider the limitations on certain projects. This diagram shows the city's current height limits, and highlights both the number of buildings built before current limits were passed and the potential for other sites to increase vertical density.

2. Any city with tall buildings suffers from wind tunnels. This diagram shows high wind velocity over the financial district and can be refined to show wind speeds at specific sites and intersections. This can help influence the construction of new buildings and public spaces.

3. The embedded metadata includes zoning and building typology information, which can be used by the firm or the planning department to generate models such as this one, which shades buildings according to their recorded land use.

4. San Francisco's vulnerability to seismic events impacts structural needs and planning. This map of the known liquefaction zones (shaded in red) highlights the city's most vulnerable areas and can be used to determine best practices for new structural projects.

5. The first thing that had to be modeled was the topography, which in San Francisco is a varied thing. Discrete orthogonal street and intersection data was overlaid onto a 3D model built from the available contour lines of the city to create the 3D street surface.

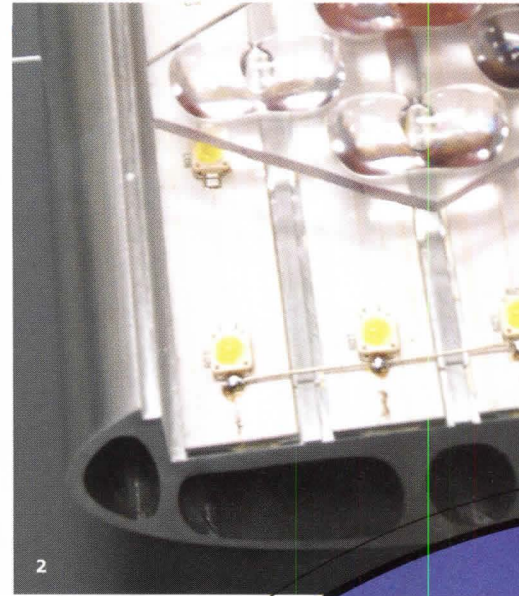

→ OFFICE FOR VISUAL INTERACTION AND WERNER SOBEEK, WITH THOMAS PHIFER AND PARTNERS

LED STREETLIGHT

THE EAR-NUMBING WHINE of ready-to-die high-pressure sodium streetlights will be a thing of the past in Manhattan when the Office for Visual Interaction (OVI) and engineer Werner Sobek roll out their LED streetlight prototype. The light source is a single line of high-flux LEDs, amplified and directed by custom-molded lenses. Because high-flux LEDs were new to the market when the prototype was designed, OVI conducted extensive testing to ensure that the light levels would meet New York City code. The prototype uses 50 percent less energy than the existing streetlights, and because LED technology changes so rapidly, the modular design of the housing allows for the installation of new and improved LEDs.

The prototype is the result of the second of two competitions held by New York City. The streetlight's form emerged in the first competition, won by a team that included OVI and Sobek, and was led by New York-based architect Thomas Phifer and Partners. For the second competition, to develop a prototype, OVI and Sobek were the only entrants. Phifer is contracted separately to oversee aesthetic changes during the prototyping phase. Despite this slightly tangled project history, the jury focused its praise on the harmony between design and engineering: "The form seemed purposeful," John Ronan said, "a nice integration of form and technology."

The arced luminaire housing stands in sharp contrast to the squat, bulbous forms of standard high-pressure sodium streetlights. The pole can be locked into place with bolts already embedded in the sidewalks for existing streetlights, and its fluted profile allows signs to be slid into metal guides and locked into place at any orientation on the surface. "That's going to clean up the cityscape right there," Craig Hodgetts said. The testing and engineering is done, and the project is just waiting for the green light from the city. **K.G.**



1-2. Specially molded lenses focus and direct the light emitted by high-flux LEDs in order to cast ample light on the streets at night. The modular design of the LED array allows the diodes to be switched out easily as technology changes and becomes more efficient.

3. Light is also directed by the curved shape of the fixture's housing, one of the object's distinctive aesthetic features. Signage and streetlights can be clipped into the streetlight's fluted pole to allow easy reconfiguration.

THE JURY

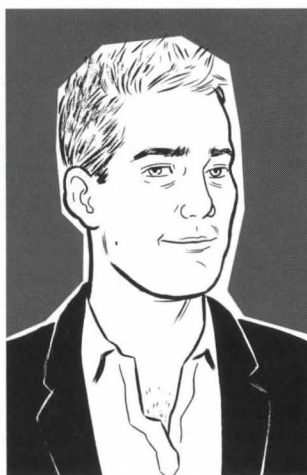

→ JOHN RONAN

John Ronan is the founder of John Ronan Architects, a Chicago firm whose award-winning projects include the Gary Comer Youth Center and the Akiba Schechter Jewish Day School. Ronan has an M.Arch from Harvard University's Graduate School of Design and a B.S. from the University of Michigan, and he teaches at the Illinois Institute of Technology.



→ CRAIG HODGETTS

Craig Hodgetts is the co-founder of Hodgetts + Fung Design and Architecture in Los Angeles. Known for its synthesis of architecture, arts, and technology, the firm has worked on projects ranging from exhibitions and master plans to a new bandshell at the Hollywood Bowl. Hodgetts was a founding dean of the California Institute of the Arts and currently teaches at the University of California, Los Angeles.



→ LAUREN CRAHAN

Lauren Crahan is a partner at Freecell, a design and fabrication practice in Brooklyn, N.Y., that specializes in small-scale commissions. She received her B.Arch and BFA degrees from the Rhode Island School of Design, and has taught at RISD as well as at the New Jersey Institute of Technology, Cornell University, and the University of Pennsylvania.

CREDITS



1. Anna Dyson

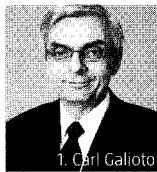

1. Carl Galioto



2. Jeff Wright

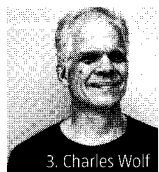

3. Charles Wolf



3. Kathryn Dean



3. Stephen Mueller



4. Ross Wimer

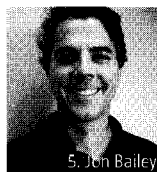

5. Jon Bailey

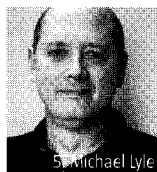

5. Michael Lyle



6, 12. Craig Hartman



9. Eric Long



6, 12. Mark Sarkisian



7. Lisa Iwamoto, Craig Scott

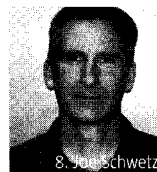

8. Joe Schwetz

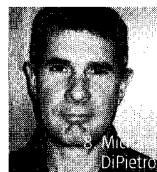

8. Michael DiPietro



10. Stephanie Lin

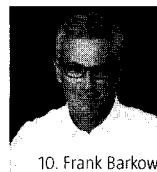

10. Frank Barkow



11. Nicholas Leahy



12. Carrie Byles



12. Leo Chow



12. Leo Chow



12. Mark Schwettmann



13. Enrique Peiniger



13. Jean Sundin

1. ACTIVE PHYTOREMEDIATION WALL SYSTEM (PG 48)

Principal Investigators Center for Architecture Science and Ecology (a collaboration between Rensselaer Polytechnic Institute (RPI) and Skidmore, Owings & Merrill)—Anna Dyson (CASE director, director of the Built Ecologies graduate program at RPI); Jason Vollen (associate professor, RPI, CASE); Ted Ngai (assistant professor, RPI, CASE); Lupita Montoya (assistant professor of mechanical engineering, RPI); Paul Mankiewicz (biologist/plant scientist, director, Gaia Institute)

Researchers EmilyRae Brayton, Ahu Aydogan

Testbed Site Public Safety Answering Center II, Bronx, N.Y.

Architect Skidmore, Owings & Merrill, New York—Carl Galioto (technical partner); Gary Haney (design partner); Peter Maqill (managing partner); Rob Rothblatt (senior designer); Joseph Sacco (project manager); Carl Brown (technical coordinator); Julie Hiromoto (project team)

2. ECOWORX BACKING FOR BROADLOOM CARPET (PG 51)

Manufacturer Shaw Industries, Dalton, Ga.—Jeff Wright (senior chemist, technical development); Rick Farrar, Joey Davis, Scott Urquhart (technicians, technical development); Kellie Ballew (sustainable development engineer); Zach Breedlove (backings development engineer); Jeff Segars (technical director)

3. DYNAMIC DESCENT, NEW YORK (PG 52)

Architect Dean/Wolf Architects, New York—Kathryn Dean, Charles Wolf (principals); Stephen Mueller (project architect)

Contractor SASA Renovations

Steel Fabricator Maloya Laser

Structural Engineering Consultant Hage Engineering

M/E/P Engineering Consultant M.A. Rubiano

4. OASIS GENERATOR, DUBAI, UNITED ARAB EMIRATES (PG 54)

Architect Skidmore, Owings & Merrill, Chicago—Ross Wimer (design partner); Colin Franzen, Daria Minosyants, Dan Nowell (architecture team); Aaron Mazeika, Lauren Stromberg (structures team); Keith Besserud, Heechan Shin, Wei Wang (blackbox team); Arvidner Dang, Shweta Manchanda, Michael Smith (M/E/P team)

5. DRY JOIST AND DRY JOIST EZ (PG 56)

Manufacturer Wahoo Decks, Gainesville, Ga.—Jon Bailey (vice president); Michael Lyle (vice president, operations & business development)

6. SUSTAINABLE FORM-INCLUSION SYSTEM (PG 57)

Architect Skidmore, Owings & Merrill, San Francisco—Craig Hartman (design partner); Mark Sarkisian (structural engineering director); Eric Long (senior structural engineer)

7. VOUSOIR CLOUD (PG 58)

Architect IwamotoScott Architecture, San Francisco—Lisa Iwamoto, Craig Scott (designers); Stephanie Lin (design/installation team leader); Manuel Diaz, John Kim, Alan Lu, Tiffany Mok (design/installation team); Chris Chalmers, John Kim (scripting); Andrew Kudless (scripting consultant)

Engineers Buro Happold—Ron Elad, Stephen Lewis, Matthew Melnyk, Tom Reiner

CATIA modelling Sanjay Souki, Daniel Pataki

Installation SCI-Arc, Los Angeles—Oliver Liao, Joanne Angeles (team leaders); David O'Regan, Judson Terry, Yohei Uchino, Zarmine Nigohossian, Tim Francis, Ali Sykes, Jimmy Chan, Channah Levy, Sarah Strauch, Brett Phillips, Marisol Mejia, Liona Avery, Justin Rice, Nicholas Paradowski, Matthew Cavender, Vincent Wu

Materials Lenderink Technologies

Laser Cutting Advanced Laser

Special thanks Greg Otto

8. RHINOBOND ROOF ATTACHMENT SYSTEM (PG 61)

Manufacturer Sika Sarnafil, Canton, Mass.—Michael DiPietro (product development specialist); Joe Schwetz (director of technical services)

9. PIN-FUSE JOINT (PG 62)

Engineers Skidmore, Owings & Merrill, San Francisco—Mark Sarkisian (structural engineering director); Shea Bond, Jean-Pierre Chakar, Rupa Garai, Eric Long, Neville Mathias, Jun Racines (structural team members); Stanford University, Stanford, Calif.—Gregory Deierlein (collaborating team member)

10. TRUMPF CAMPUS GATEHOUSE, DITZINGEN, GERMANY (PG 64)

Client Trumpf, Ditzingen, Germany

Architect Barkow Leibinger Architects, Berlin—Frank Barkow, Regine Leibinger (principals); Carsten Krafft (design project architect); Caspar Hoesch (construction project architect); Meredith Atkinson (design team)

Construction Management Gassmann + Grossmann

Structural Engineer Werner Sobek Ingenieure

Landscaping Büro Kiefer

Façades Arup Berlin (concept); Werner Sobek Ingenieure (realization)

11. TKTS BOOTH, NEW YORK (PG 66)

Clients Times Square Alliance; Theatre Development Fund; Coalition for Father Duffy

Architect Perkins Eastman, New York—L. Bradford Perkins, Nicholas Leahy, Charles Williams, Kazuaki Iwamoto, Shang Shuri, Zhanxi Fang, Philip Tidwell, Virginia Shou, Luke Yoo, Amra Kulenovic, Jessica Dorf, Meredith Harmon, Gaa Park (project team)

Concept Architect Choi-Ropha Architects

Plaza Architect William Fellows Architects

Structural Engineer & Façade Consultant Dewhurst MacFarlane and Partners—Timothy MacFarlane, Michael Ludvik, David Shea, Peter Arbour, Lawrence Dewhurst, Radhi Majmudar

Preservation Architect Bresnan Architects

Construction Manager D. Haller Inc.

M/E/P Engineer Lewis Engineers

Civil & Geotechnical Engineer DMJM Harris

Lighting Consultant Fischer Marantz Stone

Design and Fabrication Engineer Haran Glass, with IG Innovation Glass

Glass Installation David Shildiner; Innovation Glass

Booth Fabrication Merrifield Roberts

Mechanical Subcontractor Trystate Mechanical

Electrical Subcontractor ASR Electrical Contractors

Pylon Fabrication Lettera Signs

12. SAN FRANCISCO DIGITAL CONTEXT MODEL (PG 68)

Architect Skidmore, Owings & Merrill, San Francisco—Craig Hartman, Carrie Byles (leadership); Mark Schwettmann, Will Marvez, Leo Chow (conceptualization/research); Alex Cruz, Mark Schwettmann, Michael Sun, John Farwell, Tsung-Lir Chen, Hyun Joo Choi, Na Young Dark, Soo Jung Park, Juan Rodriguez, David Pekema (construction/drawings)

13. LED STREETLIGHT, NEW YORK (PG 72)

Client City of New York

Prototype Team Office for Visual Interaction, New York—Enrique Peiniger, Jean Sundin; Werner Sobek; Lighting Science Group; Laslo Bodak; Clare Randall-Smith; LED Specialists

Concept Design Thomas Phifer and Partners, New York—Thomas Phifer, Christoph Timm, Joseph Sevene, Jon Benner; Office for Visual Interaction; Werner Sobek

Resource/Classifieds

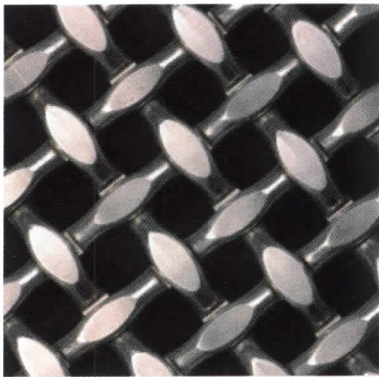

GageWoven® Architectural Wire Mesh Systems
Gage Corporation, Int.

GageWoven® is an innovative collection of 23 designs suitable for elevator lobbies and cab interiors, feature walls, ceilings, plus other architectural fabrication and consumer products. GageWoven also features 5 unique patterns designed for in-fill panels. Custom sizes and made to order panel systems are available. Custom designs are also encouraged. Contact the factory for literature and sample requests.

800-786-4243
 gage@centurytel.net
 www.gagecorp.net

Circle no. 300 or <http://architect.hotims.com>



Small But Powerful

FAAC is the world's largest specialized manufacturer of operators for swing, slide and barrier gate systems. The Model 400 heavy-duty, hydraulic swing gate operator is designed for heavy traffic applications, such as subdivisions and apartments. Its power and reliability also make it ideal for large, ornate gates.

Learn more at: www.faacusa.com.

FAAC International, Inc.



Circle no. 301 or <http://architect.hotims.com>

Life's all about change.

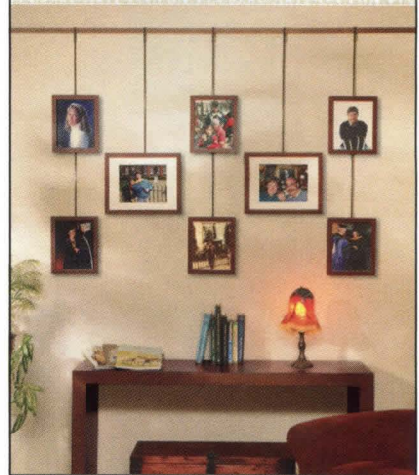

Walker Display helps you design an efficient system for exhibiting artwork anywhere. The functional no-nails design works on all wall surfaces, allowing creativity and easy rearrangement of artwork.

WalkerDisplay
 INCORPORATED

COMPLETE ONLINE CATALOG
 800-234-7614 • www.walkerdisplay.com

Circle no. 303 or <http://architect.hotims.com>

ARCHITECT

hanley▲wood

**BUILDING:
 A NETWORK**



ARCHITECT's Web site is laying the base for a premier electronic experience for practicing architects. We organize the site, you reflect on the ideas. Market intelligence, a building products database, breaking news—all established to help grow a continuing collection of inspiration. To join the network, visit architectmagazine.com.

Magnet for Talent

JR Walters Resources, premier A/E/C recruiting firm, can help you grow your company and your career. Review current opportunities at

www.jrwalters.com
 or call 269 925 3940

Circle no. 304 or <http://architect.hotims.com>

**FOR
 INFORMATION**

on how to be a part
 of the next ARCHITECT
 special advertising section,
 contact Erin Liddell
 at 773.824.2445.

hanley▲wood

Resource

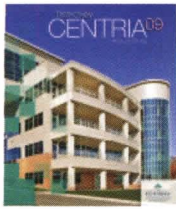

CENTRIA Introduces New 2009 Product Catalog
CENTRIA, a leader in the metal wall and roof systems industry, introduces the release of the 2009 Product Catalog featuring the latest products, updates to existing products, and a distinctive new look. The 2009 Product Catalog features dynamic project photos, renderings and illustrations of CENTRIA's products and metal accessories. CENTRIA products provide stunning aesthetics, superior performance and sustainability to every application.
www.CENTRIA.com
800-759-7474

Circle no. 305 or <http://architect.hotims.com>



CF Architectural Insulated Metal Wall Panel
The Metl-Span CF Architectural wall panel is ideal for high-profile architectural applications. The panels may be installed either vertically or horizontally for maximum design impact. Available features include custom widths and varying side joint reveals. Other specialty features that can be incorporated into the wall design include curved and radius panels, and the Metl-Vision window system with a flush frame design for unlimited variation and dramatic building designs.
To learn more, visit us at
www.metl-span.com or 877-585-9969

Circle no. 306 or <http://architect.hotims.com>



NEW
Chiseled
Prest® Brick

HANOVER®
Architectural Products
www.hanoverpavers.com
800.426.4242

Circle no. 307 or <http://architect.hotims.com>



Sherwin-Williams
For projects requiring immediate occupancy of the space, Harmony® Interior Latex is an ideal choice. Available in a complete paint line, Harmony is a zero-VOC, low-odor coating that can be applied without concern of the disruptive odor of newly painted spaces. Harmony also has antimicrobial properties and is formulated without silica.
1-800-321-8194
sherwin-williams.com

Circle no. 308 or <http://architect.hotims.com>



COMMERCIAL

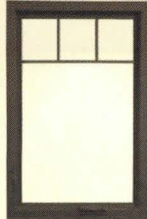

Fiberglass composite casement windows debut.

Pella® Impervia® adds casement- and awning-style window options in 2009 to provide more choices for architects, general contractors and building owners looking for highly durable, low-maintenance windows or doors.

Pella Impervia windows are made from Duracast®, a patented, five-layer, engineered fiberglass composite that is more durable than aluminum*, offers the thermal efficiency of wood and is priced competitively with vinyl.

866-70-PELLA • pellacommercial.com

* In testing performed in accordance with ASTM testing standards, Pella's Duracast has displayed superior performance in strength, ability to withstand extreme heat and cold, and resistance to dents and scratches.

© 2009 Pella Corporation

Circle no. 309 or <http://architect.hotims.com>



CASCADE COIL DRAPERY

Woven Wire Fabric

New Copper Clad Steel
weaves are now available for interior and exterior applications. Protected with acrylic clear lacquer or left unfinished to allow the copper to patina. Copper Clad Steel has the corrosion resistance of copper and the durability of steel. This strength allows us to manufacture large sheets of screen for demanding applications.

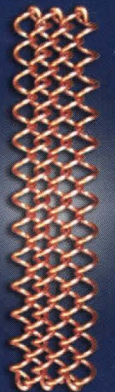

www.cascadecoil.com | 800-999-2645

Circle no. 310 or <http://architect.hotims.com>



Haddonstone
Haddonstone's cast stone cladding was used to help create the striking contemporary façade of this New York City apartment building. The company's extensive cast stone collection also includes porticos, window surrounds, balustrading and many other architectural features. An inspirational 200-page catalog and CD-ROM are available.
1-856-931-7011 www.haddonstone.com

Circle no. 311 or <http://architect.hotims.com>

ARCOS M5

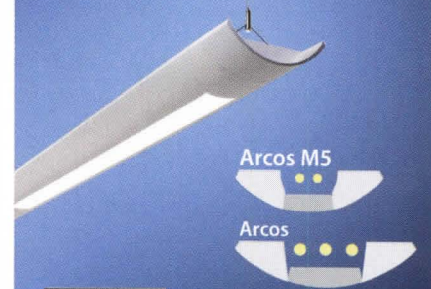

LITECONTROL
www.litecontrol.com

Circle no. 312 or <http://architect.hotims.com>

STILE™

A BRAND OF SPLIGHTING, INC.

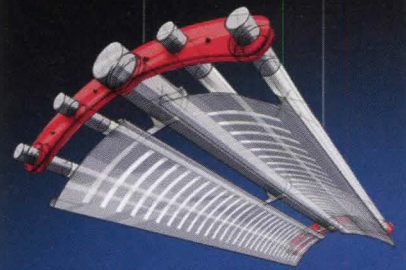

CREATE YOUR OWN STILE

www.specstile.com

Circle no. 313 or <http://architect.hotims.com>



Earn
FREE AIA
credits
now.

Access courses and get
your 2009 Continuing
Education credits FREE online.

ARCHITECTCES

architectCES.com

Hanley Wood University—The Leading Providers of AIA Accredited Courses

Start earning your required CEU credits quickly and easily today. Hanley Wood University offers a continually updated library of AIA-approved CEU coursework, available to you for free at architectCES.com and in the pages of *ARCHITECT*, *residential architect*, *ARCHITECTURAL LIGHTING*, *co-structure* and *metalmag*.

To learn more, contact Jennifer Pearce at jpearce@hanleywood.com

Course Features

- Instant Certification
- Fun and Interactive
- Pause and Save Tests
- Immediate Feedback and Test-Grading
- Multiple Course Management and Tracking

HANLEY WOOD UNIVERSITY
WHERE CONSTRUCTION MEETS EDUCATION



Rock Your World

NORTH AMERICA'S PREMIER STONE EVENT.

If you're like us, you eat, breathe and sleep stone. From Botticino Florito Marble to Kadappa Black Slate, you know your stuff. And chances are you know a lot about StonExpo/Marmomacc Americas, too.

In the spotlight this year is a new level of education. Taught by the industry leaders for the industry's leaders, StonExpo/Marmomacc Americas 40 educational sessions and live hands-on demonstrations have been developed with your success in mind. Learn everything from methods to diversify your business to cutting edge financial strategies, and maintenance & repair techniques to kitchen and bath design tips. And don't forget about the nearly 300 companies exhibiting at the show this year.



StonExpo/Marmomacc Americas 2009

is proud to announce that Architect Magazine is the Official Media Sponsor of the Architect & Design Communities for the show as well as the sponsor of the Building/Design track of our Educational Program!

THIS OCTOBER, JOIN US AND THOUSANDS OF YOUR PEERS FOR FOUR DAYS OF TRAINING, TECHNIQUES AND NETWORKING AT STONEXPO/MARMOMACC AMERICAS 2009 IN LAS VEGAS.

REGISTRATION IS NOW OPEN!

STONEXPO
MARMOMACC
AMERICAS ■■■ architecture & design

hanley wood

CONFERENCE October 21-24 | **EXPO** October 22-24
Las Vegas Convention Center | Las Vegas NV USA

Official Sponsors:



American Monument Association
Canadian Stone Association
Elberton Granite Association
National Building Granite Quarries Association
Northwest Granite Manufacturers Association

Official Endorsers:

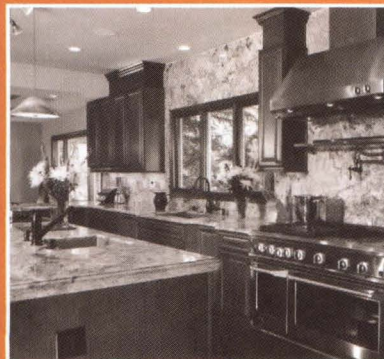

www.stonexpo.com

ad index

Advertiser	Page	Circle	Website	Phone
ARCAT	23	430	www.arcata.com	
Architect	33	-	www.architectmagazine.com	
ASI Group	45	229		
Autodesk	7	220	www.autodesk.com/cdwoffer	888.561.4239
Cascade Coil Drapery	11	81	www.cascadecoil.com	800.999.2645
Energy Peak	16	195	www.energypeak.com	888.216.9600
Follansbee	26	32	www.follansbeeroofing.com	800.624.6906
Hanley Wood University	77	-	www.architectCES.com	
HDI Railings	24	481	www.hdirailings.com	717.285.4088
InfoComm	41	198	www.ctsforav.com	
Insight	2	429	www.insightlighting.com	
Insulated Panel Systems	34	223	www.insulated-panels.com	800-729.9324
Invisible Structures, Inc.	18	400	www.gravelpave.com	800.233.1510
JELD-WEN Windows & Doors	15	408	www.jeld-wen.com/11809	
Kingspan	C4	231	www.kingspanpanels.us	877.638.3266
Knauf Insulation	9	445	www.knaufinsulation.us	800.825.4434 x8300
LEDtronics, Inc.	19	406	www.LEDtronics.com	800.579.4875
MBCI	22	402	www.mbc.com/arch	877.713.6224
MITSUBISHI ELECTRIC - CITY MULTI	5	458	www.transforminghvac.com	
Owens Corning	C2-1	413, 232	www.owenscorningfoam.com	800.GET.PINK
P/A Awards	36	-	www.paawards.com	
PERC	32 a-b	-	http://buildwithpropane.com	
Scranton Products	3	466	www.scrantonproducts.com	
SELUX	21	170	www.selux.com/usa	800.735.8927
Stewart Filmscreen	31	218	www.stewartfilmscreen.com	
Stone Expo	78	-	www.stonexpo.com	
Structures Unlimited, Inc.	43	233	www.skylightinfo.com	800.225.3895
Typar, MetroWrap	13	483	www.typar.com	
VectorWorks Architect	35	475	www.makingtheswitch.com/ architectmag	888.646.4223
VT Industries	25	53	www.vtindustries.com	
Western Red Cedar	C4	416	www.wrcla.org	866.778.9096

search.
source.
learn.
connect.
ebuild.

ebuild is the destination for construction pros searching for information about building products. **ebuild** is a source of unbiased coverage of new products, trends and news. Pros visit **ebuild** to learn how to do their jobs faster, safer and easier. **ebuild** connects pros to product manufacturers, experts and peers.

hanley▲wood

ebuild

a 360 degree view of
product information

ebuild.com

→ P/A AWARDS

THE BEST BETTS

HOBART BETTS—P/A AWARDS DARLING OF THE 1960S—FADED FROM THE PROGRAM, BUT STILL HAS RELEVANCE TODAY.

TEXT BY THOMAS FISHER

Clockwise from left: Beach cottage, Quogue, Long Island, N.Y. (1966 citation); Betts; Residence for Mr. and Mrs. Frederick H. Robinson, Stafford County, Va. (1968 citation); Beach cottage; Vacation house, Springs, N.Y. (1969 award)

P/A Awards won by Hobart Betts:

Beach cottage, Quogue, Long Island, N.Y.

1966 P/A Awards Jury
William Conklin, Vincent Scully, August Komendant, Kevin Roche, Edward Bassett

Residence for Mr. and Mrs. Frederick H. Robinson, Stafford County, Va.

1968 P/A Awards Jury
Lawrence Anderson, Gunnar Birkerts, Romaldo Giurgola, Richard Dober, Fazlur Khan

Vacation house, Springs, N.Y.

1969 P/A Awards Jury
Roger Montgomery, R.M. Gensert, Henry Cobb, Lewis Davis, Cesar Pelli

Palmedo residence, Long Island, N.Y.

1972 P/A Awards Jury
Louis Sauer, Earl Flansburgh, John Parkin, Moshe Safdie, Richard Bender

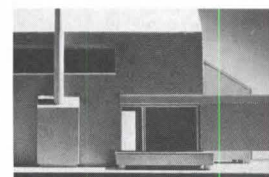
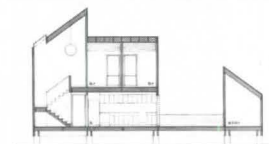
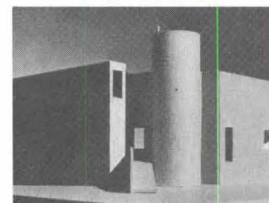
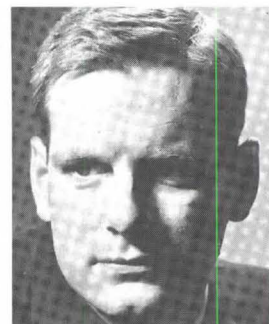
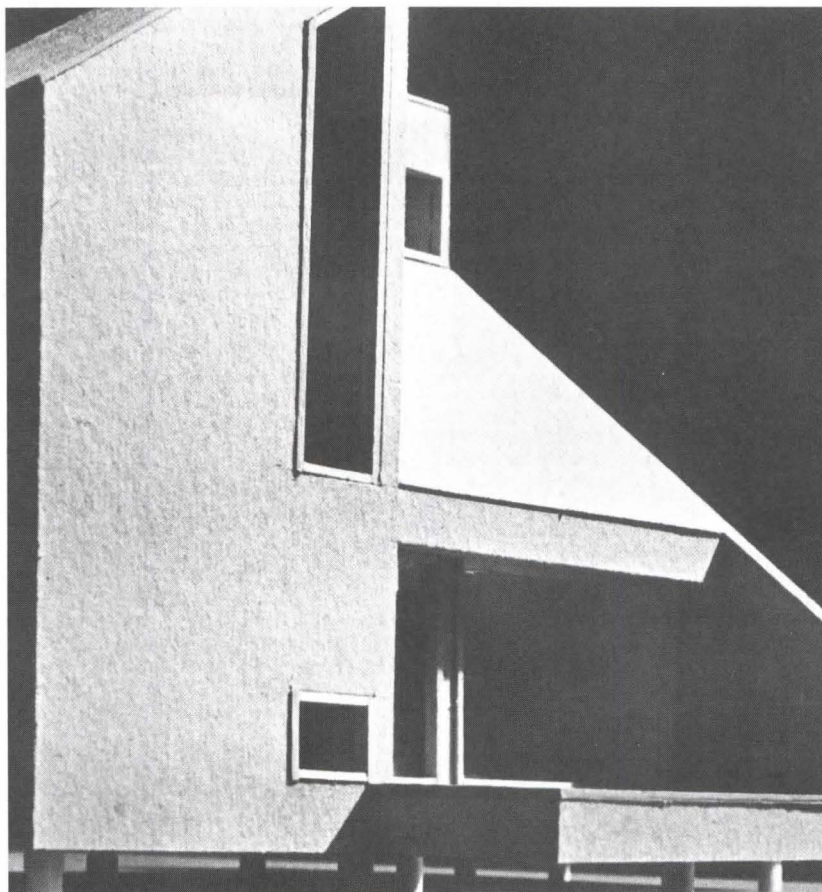

SOME ARCHITECTS have had good runs winning P/A design awards. Sometimes these serial winners go on to have long and illustrious careers, with their P/A Awards helping propel them into stardom, but other frequent awardees have been undeservedly forgotten. Clearly, their work appealed to a range of jurors over several years and had qualities that colleagues found compelling at the time. Why, then, do some architects succeed and others, equally talented, recede from view?

Hobart Betts, an architect living in Sag Harbor, N.Y., offers some insight. He won four P/A design awards in a seven-year period, from 1966 through 1972, for a series of compact houses and cottages in New York and Virginia. In each case, the design consisted of geometric forms, asymmetrical windows, and angled clerestories bringing daylight inside. Betts' minimalist designs

distilled high Modernism down to its purest expression, and seen in the context of the late 1960s and early '70s, with the rise of countercultural and postmodern architecture, his work now seems refreshingly quiet and calm. By the time Postmodernism caught on in the mid 1970s, however, the elegant compositions of Hobart Betts may no longer have seemed progressive enough—progress is, after all, a subjective term—to win P/A Awards.

Nevertheless, some 40 years later, his work deserves to be rediscovered. Faced with the need to reduce the size of single-family houses and to minimize the footprint of buildings on the land, we would do well to emulate Hobart Betts' example: creating modest, modern structures that meet people's basic needs, beautifully. □



Beautiful, versatile, sustainable western red cedar

Western Red Cedar has unique, natural performance characteristics and exceptional beauty that bring warmth, character and longevity to homes and commercial buildings around the world. It is this bundle of properties that has made "Cedar" the choice of discerning architects, builders and homeowners alike.

Western Red Cedar is renowned for its naturally occurring resistance to moisture, decay and insect damage. Its natural durability, dimensional stability and exceptional beauty make it ideal for a wide variety of exterior and interior uses. Western Red Cedar offers enormous versatility in styles and applications. Equally important, it has a low environmental impact relative to other building materials. Western Red Cedar is harvested legally and sustainably from independently certified forests in British Columbia.

Enhance the beauty of your next project, build with Western Red Cedar. For more information and suppliers near you, please visit our website.

Circle no. 416 or <http://architect.hotims.com>

www.wrcla.org 1.866.778.9096

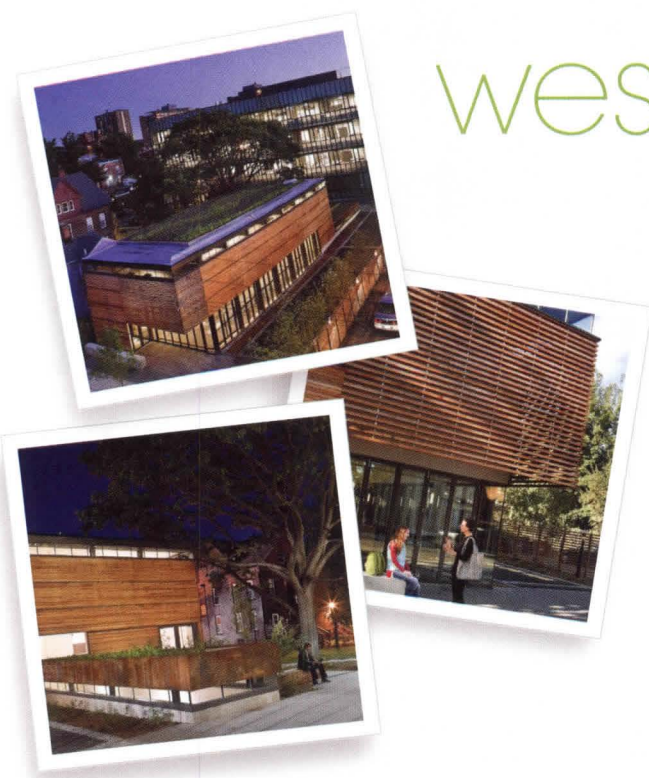

Insulated Metal Panels

Energy Efficiency is a Concrete Difference

Compare an eight-inch thick concrete wall to a four-inch thick Kingspan insulated metal panel. Our wall is 2,300% more thermally efficient. Kingspan panels require less structural support, contain recycled content, and provide a weather-resistant barrier that does not absorb water or promote mold growth.

Plus, Kingspan panels are feather light compared to concrete - roughly 1/18 the weight. This means significant energy savings can be achieved by reducing structural support requirements, in addition to the energy saved in transportation and installation.

Learn how Kingspan insulated metal wall panels can contribute to LEED® credits.



The Global Leader in Cladding Solutions



LEED is a registered trademark of USGBC.
Circle no. 231 or <http://architect.hotims.com>



www.kingspanpanels.us
USA: 1-877-638-3266
Canada: 1-866-442-3594