

KieranTimberlake at Rice 200 A Box of Chocolates 66 Benchmarking 72
WTC Update 128 The New Curator 136 Hawthorne on Humanitarianism 150

ARCHITECT

THE MAGAZINE OF THE AMERICAN INSTITUTE OF ARCHITECTS

hanley wood



Natural Disasters

Architecture to the Rescue!

UNEXPECTED ANGLE

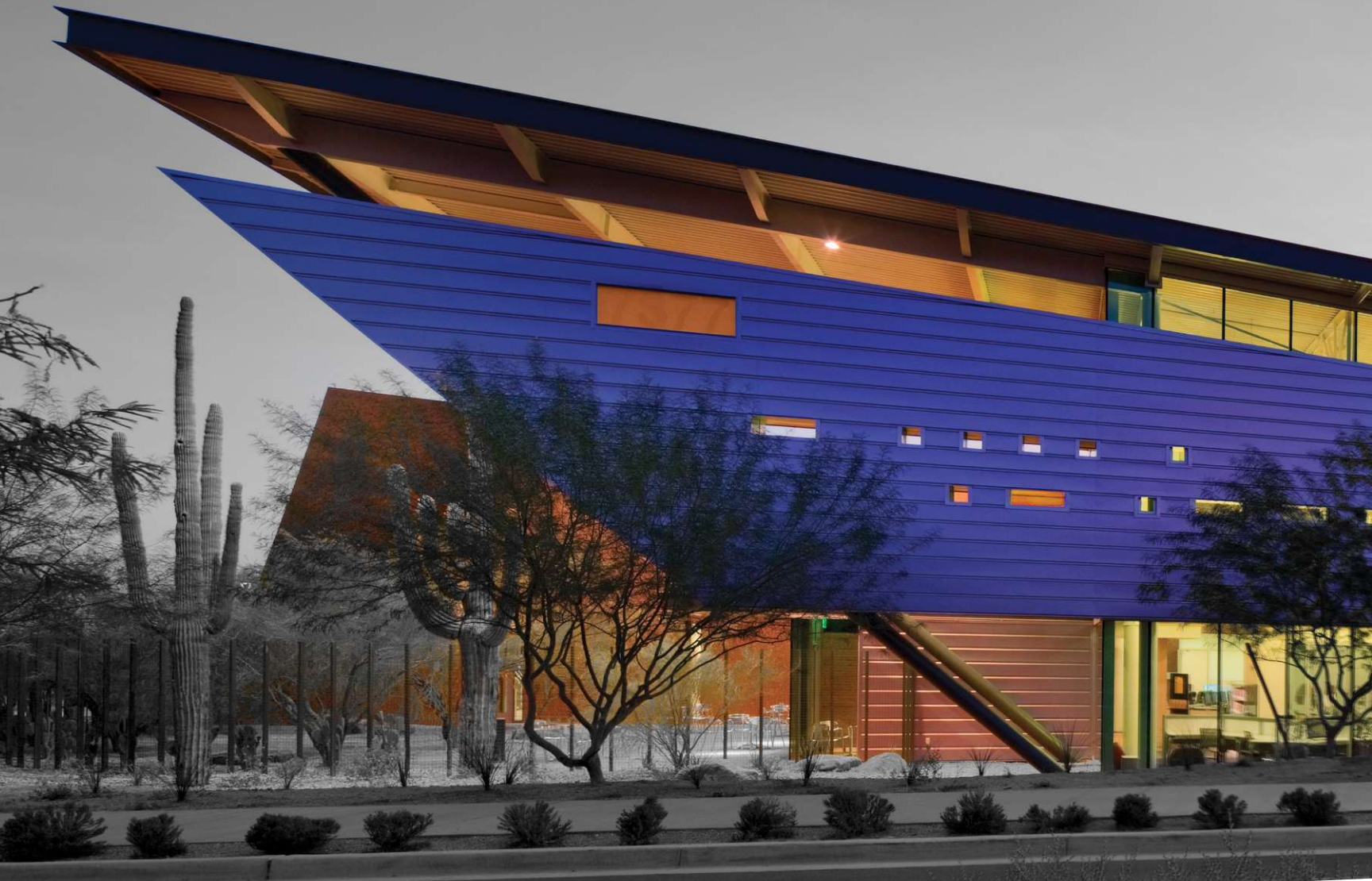

Expanding design possibilities while
shrinking their impact on the environment.



The Appaloosa Branch Library in Scottsdale, Arizona is not just a LEED Gold-certified building, it's also a stunning example of how PPG's building products are helping to change the face of modern architecture. To enhance the beauty of the exterior and reduce cooling costs, the library's architect used PPG Duranar® VARI-Cool™ coatings, which reflect the sun's energy and dramatically shift color according to viewing angle. Our Solarban® 60 Atlantica™ low-e glass allowed him to

incorporate vast areas of emerald-green glass while reducing the size of the library's HVAC system and its energy bills. These are just two from the wide array of innovative glass, metal coatings, and full line of architectural coating choices you'll find through PPG IdeaScapes™. From building materials to consumer products, automotive to aerospace, marine and protective industrial coatings, we're bringing innovation to the surface. Visit ppg.com to learn more.



PPG Industries

Bringing innovation to the surface.™

PAINTS - COATINGS - OPTICAL PRODUCTS - SILICAS - CHEMICALS - GLASS - FIBER GLASS

Circle no. 290 or <http://architect.hotims.com>

"Bringing innovation to the surface." is a trademark of PPG Industries Ohio, Inc.

*400 Fifth Avenue.
Architect: Robert Siegel,
Principal and Founding
Partner, Gwathmey
Siegel & Associates*



this envelope delivered

When others say no, Oldcastle BuildingEnvelope™ says yes.

“When you are designing complex, custom operable windows, you need to rely on experts,” said Robert Siegel, Principal and Founding Partner of Gwathmey Siegel & Associates. Siegel’s firm has been called one of the ten most influential architectural firms by *Architect Magazine*. And while most manufacturers promise *the moon and the stars* when it comes to customization, many simply can’t deliver. In fact, on a recent project, Oldcastle BuildingEnvelope™ was brought in to design, engineer and manufacture custom windows when another manufacturer could not execute. And custom-engineered architectural windows are just the beginning. We are the leading manufacturer of products specified to close the building envelope. To learn more, call us at 1-866-OLDCASTLE (653-2278), or visit oldcastlebe.com. See us at Greenbuild Conference, booth #5528.

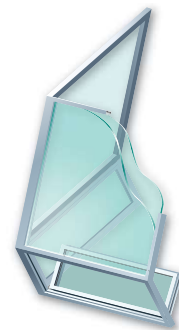

“Oldcastle BuildingEnvelope™ provided precisely what was needed. These windows are faceted or angulated, with outside corners at the condominium levels that are all glass. Residents enjoy a stunning view of midtown Manhattan,” said Robert Siegel.

Origami by Robert Lang



Oldcastle BuildingEnvelope™

Engineering your creativity™

Circle no. 52 or <http://architect.hotims.com>

 curtain wall

 entrances/storefronts

 windows

 skylights

 glass

© 2011 Technical Glass Products. FireLite is a registered trademark of Nippon Electric Glass Co., Ltd. Technical Glass Products, One Source, Many Solutions, and Fireglass are registered trademarks of Technical Glass Products.



FireLite[®]
Family of Products

Enter a bright new world with FireLite[®] from Technical Glass Products. This fire-rated glazing's unique ultraHD™ Technology delivers a clearly superior product. Take a closer look at how the clarity and sharpness will open up your design possibilities. See for yourself at FIREGLASS.COM/HD

Open up to ultraHD.



- Fire ratings up to 3 hours
- High impact safety ratings
- UL listed and labeled

TGP  **FIRE RATED**
one source. many solutions.®

Circle no. 49 or <http://architect.hotims.com>

ultraHDTM
TECHNOLOGY

CONTENT



149

Architecture to the Rescue!

With the rate of natural disasters seemingly on the rise, the architecture profession is playing a pivotal role in prevention and relief work. EDITED BY ERIC WILLS

Altruism, Architecture & Disaster A new generation of architects is embracing humanitarianism. Do their aspirations make a difference? CHRISTOPHER HAWTHORNE

Space, Time & Disaster Environmental archaeology and mismanagement of natural resources: a timeline of disaster and the decline of civilizations.

Can Architecture Save Humanity? Architecture for Humanity cofounders Cameron Sinclair and Kate Stohr explain how architects can help ruined states. KRISTON CAPPS

Sites at Risk How prepared are various global hot spots for impending natural disasters? ERIC WILLS AND ALAN GREENBLATT

Rapid Response When a tornado ravaged Tuscaloosa, Ala., architects working with an AIA task force established a model for post-crisis planning efforts. WAYNE CURTIS

High Relief Shigeru Ban has made a career of balancing high-end for-profit work with humanitarian projects. Can his paper architecture change the world? ERIC WILLS

Play It Safe Are you prepared? Here are a few ideas for keeping the staff—and those important documents—safe in the face of a disaster. NATE BERG

→ ONLINE

There's more online at architectmagazine.com:

Blaine Brownell's Mind & Matter blog looks at products and materials in development and on the market.

Aaron Betsky's Beyond Buildings blog comments on the impact design has on our society and culture.

And there are constant updates: breaking news, new products, slide shows, extra images of the projects in the issue, and more ...

ON THE COVER
ARCHITECTS HAVE THE KNOWLEDGE AND
THE EXPERTISE TO HELP COMMUNITIES
DEVASTATED BY NATURAL DISASTERS.
ILLUSTRATION BY ASAF HANUKA.

THE Advantage



POST FRAME AN ENGINEERED WOOD BUILDING SYSTEM

For a low-rise engineered wood building system that combines value and efficiency, consider the Post-Frame Advantage:

DESIGN FLEXIBILITY—Post frame allows for open floor plans and a wide array of appealing architectural features.

ENERGY EFFICIENCY—Overall building energy savings are achieved through wood's natural thermal resistance and post frame's wide-column spacing, which means fewer insulation interruptions.

DURABILITY AND STRENGTH—A uniquely engineered post-frame system produces a long-lasting structure with outstanding resistance to wind and seismic forces.

COST EFFECTIVE—Dollar for dollar, post frame provides more building space than other types of construction.

**POST-FRAME
ADVANTAGE**

For more information on using post frame for your building projects or to locate a post-frame contractor, please visit our website.
Circle no. 525 or <http://architect.hotims.com>

www.postframeadvantage.com

CONTENT



210



194



200

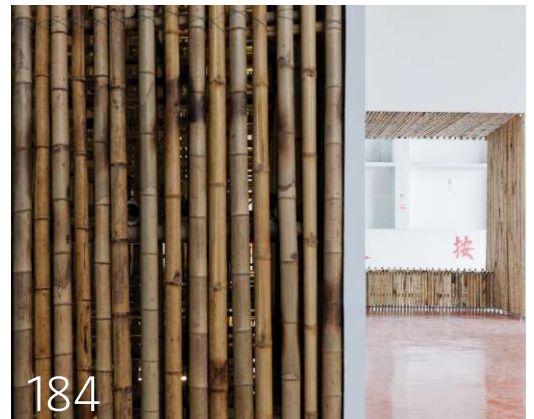

184



222

DESIGN

184 **Stan Allen Architect**

Taichung InfoBox
Taichung, Taiwan
MICHAEL MEYER

194 **Saucier + Perrotte Architectes**

Boutique Michel Brisson
Montreal
MIMI ZEIGER

200 **KieranTimberlake**

Brockman Hall for Physics
Houston
STEPHEN SHARPE

210 **Steven Holl Architects with Solange Fabião**

Cité de l'Océan et du Surf
Biarritz, France
KIERAN LONG

222 **Spillman Farmer Architects**

ArtsQuest Center at SteelStacks
Bethlehem, Pa.
IAN VOLNER

LAST CALL FOR ENTRIES!



Unknown Architect Exhibit: item #702KS
This fragment of an Insulated Metal Panel (IMP) comes from of the Spirit Arts Center, Los Angeles, c. 2045. It is the only known surviving piece of the facility.

During the day it stood as a monument to the art of a generation, while on clear nights it blended with the starry sky.

In the end, your legacy may be built out of paper.

The [Kingspan Legacy Papercraft Competition](#) is open to professional architects and students of architecture. The challenge: create the most visually arresting and legacy-worthy structure you can. It matters not who you are; judging is based on the imagination and talent applied. The winner will receive an Apple MacBook Pro, and a scholarship of \$5,000 donated in their name; if the winner is a student, they'll receive the scholarship. Both runners up get an iPad 2, and all three finalists will be featured in the November issue of Architect Magazine. Enter the contest and explore future legacies in The Unknown Architect Exhibit at LegaciesAreBuilt.com/architect

Circle no. 231 or <http://architect.hotims.com>

\$5,000
SCHOLARSHIP

ARCHITECT

Kingspan
Insulated Panels



To see this brilliant technology in action, visit www.sageglass.com or call 1-877-724-3325

OUR GLASS
ISN'T DESIGNED
FOR SCHOOLS.
IT'S DESIGNED
FOR PEOPLE.

Only SageGlass allows you to electronically tint your windows to dynamically control sunlight, glare and temperature.

It's cooler. It's more energy efficient. And it opens up a new world of possibilities for people-centric spaces.



SAGE™

Visit us at Greenbuild in booth #6146S
and with Saint-Gobain #2211N

CONTENT

142



66



88

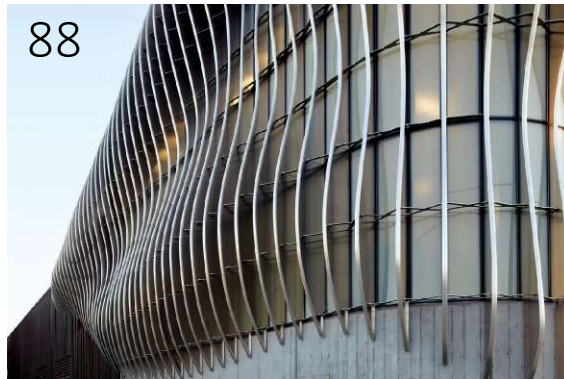

FRONT

- 22 **Dialogue** Sea Change Confessional ... plus Letters and Contributors
- 28 **News** ... plus Numbers and On the Boards
- 231 **Contact Us**

AIARCHITECT

- 37 **Voices** Deal Maker
Now Across the Institute
Advocacy Start Your Engines
Feature Losing Lost Highways
Perspective Beyond Wringing Endorsements

BUSINESS

- 49 **Best Practices** Do Good
 How firms can best love their neighbors as themselves. ERNEST BECK
- 54 **Typology** Community
 How does design serve community colleges, which is higher education's fastest-growing sector? JENNIFER CATERINO

- 66 **Q&A** Career Sampler
 This architect countered the down economy by making chocolate. LINDSEY M. ROBERTS

- 72 **Strategy** Retro Grades
 Benchmarking laws point to a new industry retrofitting buildings. FRED A. BERNSTEIN

- 78 **Local Market** Columbus, Ohio

TECHNOLOGY

- 81 **Products** Roofing
- 84 **Post-Oc** Dashboard Confessional
 Three views on monitoring systems and the promise that dashboards hold. BRIAN LIBBY

- 88 **Detail** Zahner Cloud Wall
 A screen made of aluminum and glass for a new fabrication studio. CHARLES LINN

- 94 **Lighting** Lights Out
 Illuminating the debate over incandescent bulbs. ADAM MAZMANIAN

- 100 **Continuing Education** Trash as Treasure
 Architects are playing a role in European waste-to-energy incineration plants. Will these catch on in the U.S.? AARON SEWARD

- 112 **Products** Editor's Choice

- 116 **Mind & Matter** Two (More) Towers
 Architects shouldn't lose sight of design as they reach for the sky. BLAINE BROWNELL

CULTURE

- 119 **Books, Objects, Exhibits & Internet**

- 128 **Crit** Design After 9/11
 The memorial and plaza reveal the politics and psychology of the redesign. BEN ADLER

- 136 **Profile** David van der Leer
 The Guggenheim curator is transforming the traditional exhibition into a laboratory for urban research. SHONQUIS MORENO

- 142 **Studio Visit**
 Architecture Research Office
 This firm tackles diverse projects from one studio. KRISTON CAPPS AND JASON FULFORD

- 146 **Beyond Buildings** Empire of Signs
 Neon creep imperils the Port Authority Bus Terminal. Should we care if it goes the way of Times Square? AARON BETSKY

PAST PROGRESSIVES

- 240 **1991** Vision Obstructed
 Diller and Scofidio's "Slow House" was never completed. JOHN MORRIS DIXON



Solve Your Acoustics Problem With One Word



45 hum-gurgle-whir

as everyone fills up

+



22 conversations

catching up on the weekend gossip

+



800 thunks
and clunks

with day-to-day business



= Adagio



Design Harder Working Environments with Adagio™ Ceilings.

Visit us at
Greenbuild
Booth 2211N

Add up all the distracting noise in the typical modern office. Factor in the proven harmful effects noise has on workers' ability to concentrate. Your answer is Adagio Ceilings Systems from CertainTeed. Nobody takes environmental acoustics more seriously. Adagio has a NRC value of 0.80 and a CAC value of 42, the best in the industry. So for those spaces where creating productive work environments is vital, it's Adagio.

You're not just solving a design problem. You're helping people be more productive.

800-233-8990 • certainteed.com • <http://blog.certainteed.com>

ROOFING • SIDING • TRIM • DECKING • RAILING • FENCE • FOUNDATIONS
GYPSUM • **CEILINGS** • INSULATION • PIPE

Circle no. 509 or <http://architect.hotims.com>

CertainTeed
SAINT-GOBAIN



WE

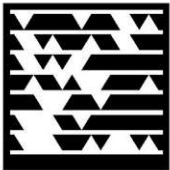

ARE SO SORRY.

Our apologies to architects past and present, but we needed to make a point. Nothing should stand in the way of you and your vision. And it doesn't take much to ruin a good design. Mitsubishi Electric Cooling and Heating's solutions preserve your aesthetic. Its exclusive two-pipe VRF system is a simple, elegant, and sustainable way to cool and heat your rooms. Making the space not only comfortable, but just as you intended it.



Our indoor and outdoor units are the industry's most advanced—and least invasive—cooling and heating solutions. To learn how to preserve the integrity of your design with our Variable Refrigerant Flow systems, visit www.mitsubishipro.com

Circle no. 458 or <http://architect.hotims.com>

the ELEMENTS are SIMPLE . . .

greenscreen®



800.450.3494
www.greenscreen.com

research

continuing education

RE

CEU

BIM

MULTISTORY MODULAR WALL MOUNTED FREESTANDING COLUMNS SHAPES COLORS

LANDSCAPE ELEMENTS



Surrounding an open air atrium on the roof of this new medical facility a circular overhead trellis uses tapered greenscreen® panels.

the POSSIBILITIES are ENDLESS!

plants

sustainable sites review

newsletter

leed® review

life cycle assessment

PL

SSI

NE

LE

LCA

CAD

Circle no. 558 or <http://architect.hotims.com>

ARCHITECT

THE MAGAZINE OF THE AMERICAN INSTITUTE OF ARCHITECTS

EDITOR-IN-CHIEF

Ned Cramer, Assoc. AIA
ncramer@hanleywood.com

MANAGING EDITOR

Greig O'Brien
gobrien@hanleywood.com

SENIOR ART DIRECTOR

Aubrey Altmann
altmann@hanleywood.com

SENIOR EDITOR, BUILDINGS

Katie Gerfen
kgerfen@hanleywood.com

SENIOR EDITOR, FEATURES AND RESEARCH

Eric Wills
ewills@hanleywood.com

ASSOCIATE ART DIRECTOR

Marcy Ryan
mryan@hanleywood.com

ASSOCIATE EDITOR, DEPARTMENTS

Kriston Capps
kcapps@hanleywood.com

ASSISTANT MANAGING EDITOR

Lindsey M. Roberts
lmroberts@hanleywood.com

GRAPHIC DESIGNER

Michael Todaro
mtodaro@hanleywood.com

SENIOR WEB PRODUCER

Amy Wiersum
awiersum@hanleywood.com

EDITORIAL INTERN

Hallie Busta

CONTRIBUTING ARTISTS

Ian Allen, Peter Arkle,
Catalogtree, Noah Kalina,
Mike Morgan

CONTRIBUTING EDITORS

Ernest Beck; Aaron Betsky;
Blaine Brownell, AIA;
Elizabeth Evitts Dickinson;
John Morris Dixon, FAIA;
Thomas Fisher, Assoc. AIA;
Joseph Giovannini;
Cathy Lang Ho; Margot
Carmichael Lester;
Mimi Zeiger

EDITORS-AT-LARGE

Edward Keegan, AIA;
Vernon Mays

EDITORIAL ADVISORY COMMITTEE

Fredric M. Bell, FAIA
Renee Cheng, AIA
Ned Cramer, Assoc. AIA
Yolande Daniels, AIA
Sarah Dunn
Andrew Freear
George H. Miller, FAIA
Randy Peterson, FAIA
James Timberlake, FAIA

Commercial Design Group

GROUP PRESIDENT, COMMERCIAL DESIGN AND CONSTRUCTION
Patrick J. Carroll
pccarroll@hanleywood.com
773.824.2411

GROUP PUBLISHER, COMMERCIAL DESIGN

Russell S. Ellis
rellis@hanleywood.com
202.736.3310

EDITORIAL DIRECTOR, COMMERCIAL DESIGN
Ned Cramer, Assoc. AIA
ncramer@hanleywood.com

Advertising

REGIONAL SALES MANAGER, EAST, TX, OK, AR, LA
Michael Lesko
mlesko@hanleywood.com
203.445.1484

REGIONAL SALES MANAGER, MID-ATLANTIC, MI
Nick Hayman
nhayman@hanleywood.com
202.736.3457

REGIONAL SALES MANAGER, WEST
Mark Weinstein
mweinstein@hanleywood.com
562.598.5650

REGIONAL SALES MANAGER, MIDWEST
Michael Gilbert
mgilbert@hanleywood.com
773.824.2435

NATIONAL ADVERTISING MANAGER, LIGHTING
Cliff Smith
csmith@hanleywood.com
864.642.9598

REGIONAL SALES MANAGER, NEW ENGLAND, GA, FL, IN, OH, MS, AL
Dan Colunio
dcolunio@hanleywood.com
617.304.7297

E-MEDIA SALES MANAGER

Adam Mowrey
amowrey@hanleywood.com
724.612.9319

REGIONAL SALES MANAGER, CANADA

D. John Magner
jmagner@yorkmedia.net
416.598.0101, ext. 220

ACCOUNT MANAGER, CANADA

Colleen T. Curran
ctcurran@yorkmedia.net
416.598.0101, ext. 230

REGIONAL SALES MANAGER, CHINA, HONG KONG, TAIWAN

Judy Wang
judywang2000@yahoo.cn
0086.10.64639193

REGIONAL SALES MANAGER, UNITED KINGDOM, EUROPE

Stuart Smith
stuart.smith@ssm.co.uk
44.020.8464.5577

GROUP PUBLISHING SUPPORT MANAGER

Angie Harris
aharris@hanleywood.com
773.824.2415

MARKETING MANAGER

Lucy Hansen
lhansen@hanleywood.com

ADVERTISING ACCOUNT MANAGER, ACCOUNT MANAGEMENT GROUP

Erin Schneider
eschneider@hanleywood.com
773.824.2445

Production

DIRECTOR OF PRODUCTION AND PRODUCTION TECHNOLOGIES

Cathy Underwood

PRODUCTION MANAGER

Paige Hirsch

AD TRAFFIC MANAGER

Pam Fischer

INSIDE SALES AD TRAFFIC MANAGER

Annie Clark

PREPRESS MANAGER

Fred Weisskopf

PREPRESS COORDINATOR

Betty Kerwin

EDITORIAL AND ADVERTISING OFFICES

One Thomas Circle, NW, Suite 600, Washington, DC 20005.

Phone: 202.452.0800. Fax: 202.785.1974.

Copyright 2011 by Hanley Wood, LLC. Reproduction in whole or in part prohibited without written authorization. All rights reserved. Printed in the USA.

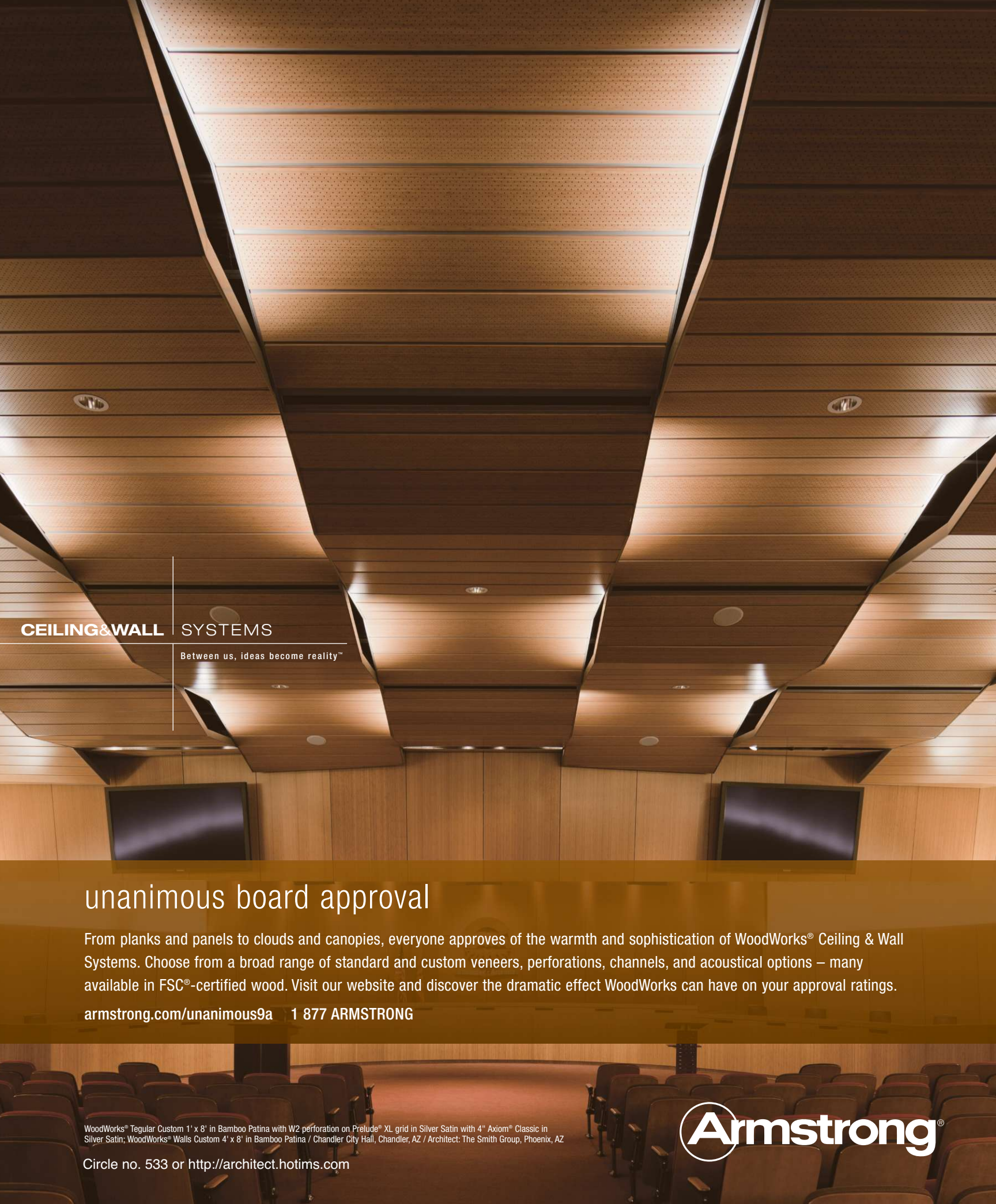

CEILING & WALL SYSTEMS

Between us, ideas become reality™

unanimous board approval

From planks and panels to clouds and canopies, everyone approves of the warmth and sophistication of WoodWorks® Ceiling & Wall Systems. Choose from a broad range of standard and custom veneers, perforations, channels, and acoustical options – many available in FSC®-certified wood. Visit our website and discover the dramatic effect WoodWorks can have on your approval ratings.

armstrong.com/unanimous9a 1 877 ARMSTRONG

WoodWorks® Tegular Custom 1' x 8' in Bamboo Patina with W2 perforation on Prelude® XL grid in Silver Satin with 4" Axiom® Classic in Silver Satin; WoodWorks® Walls Custom 4' x 8' in Bamboo Patina / Chandler City Hall, Chandler, AZ / Architect: The Smith Group, Phoenix, AZ

Circle no. 533 or <http://architect.hotims.com>

Armstrong®

eco-FICIENT™

EXPAND YOUR INSPIRATION

Inspiration comes in many forms. Expanding inspiration? That's where we come in. Eco-ficient™ insulated metal panels provide beauty, integration and efficiency. Not only do these panels come in a variety of profiles, colors and textures, but they also integrate well with other exterior finish systems and offer sustainability attributes significant for improving a building's energy efficiency.

Look to Eco-ficient™ insulated panels from MBCI for your inspiration. Visit us at www.mbc.com/expand to learn more.

Circle no. 558 or <http://architect.hotims.com>



*Thank You to Our Customers
for 35 Years of Support*

Houston, TX (Corporate) 877-713-6224 | Adel, GA 888-446-6224 | Atlanta, GA 877-512-6224

Atwater, CA 800-829-9324 | Dallas, TX 800-653-6224 | Indianapolis, IN 800-735-6224

Jackson, MS 800-622-4136 | Lubbock, TX 800-758-6224 | Memphis, TN 800-206-6224

Oklahoma City, OK 800-597-6224 | Omaha, NE 800-458-6224 | Phoenix, AZ 888-533-6224

Richmond, VA 800-729-6224 | Rome, NY 800-559-6224 | Salt Lake City, UT 800-874-2404

San Antonio, TX 800-598-6224

ARCHITECT

THE MAGAZINE OF THE AMERICAN INSTITUTE OF ARCHITECTS

**Hanley Wood Business
Media**

**PRESIDENT,
MARKET INTELLIGENCE/
E-MEDIA**
Andrew Reid

PRESIDENT, EXHIBITIONS
Rick McConnell

**VICE PRESIDENT,
CIRCULATION AND
DATABASE DEVELOPMENT**
Nick Cavnar

**VICE PRESIDENT,
PRODUCTION**
Nick Elsener

**VICE PRESIDENT,
MARKETING**
Sheila Harris

**EXECUTIVE DIRECTOR,
E-MEDIA**
Andreas Schmidt

**VICE PRESIDENT OF
NETWORK ACCOUNTS**
Jennifer Pearce

**GENERAL MANAGER,
ONLINE**
Kim Heneghan

CHIEF DESIGNER
Thomas C. Scala

**SENIOR DIRECTOR,
HUMAN RESOURCES**
Curtis Hine

**DIRECTOR OF EVENT
MARKETING**
Mike Bendickson

DIRECTOR, INSIDE SALES
Janet Allen

Hanley Wood, LLC

CHIEF EXECUTIVE OFFICER
Frank Anton

CHIEF FINANCIAL OFFICER
Matthew Flynn

**SENIOR VICE PRESIDENT,
CORPORATE SALES**
Paul Tourbaf

**VICE PRESIDENT,
CORPORATE DEVELOPMENT
& BUSINESS MANAGEMENT**
Joe Carroll

VICE PRESIDENT, FINANCE
Shawn Edwards

**VICE PRESIDENT, FINANCIAL
PLANNING & ANALYSIS**
Ron Kraft

**VICE PRESIDENT,
GENERAL COUNSEL**
Mike Bender



THE AMERICAN INSTITUTE OF ARCHITECTS

2011 BOARD OF DIRECTORS

OFFICERS: Clark D. Manus, FAIA, President; Jeffery Potter, FAIA, First Vice President; Dennis A. Andrejko, FAIA, Vice President; Mickey Jacob, FAIA, Vice President; Peter G. Kuttner, FAIA, Vice President; John A. Padilla, AIA, Vice President; Helene Combs Dreiling, AIA, Secretary; John W. Rogers, AIA, Treasurer; Jonathan M. Taylor, AIA, Senior Associate Director; Amy Blagriff, Hon. Affiliate/AIA Honolulu, CACE Representative to the Executive Committee; Robert A. Ivy, FAIA, EVP/Chief Executive Officer.

DIRECTORS: T. Gregory Ames Jr., AIA; Tyler Ashworth, Assoc. AIA; Douglas A. Benson, AIA; Stacy Bourne, AIA; Donald C. Brown, FAIA; William J. Carpenter, PhD, FAIA; Susan Chin, FAIA; Mary Patton Cox, FAIA; Thomas R. Cox, AIA; D. Graham Davidson, FAIA; Russell Davidson, AIA; Richard DeYoung, AIA; Nicholas D. Docous, AIA; Gabriel Durand-Hollis, FAIA; Jerome L. Eben, AIA; Mohamad Farzan, AIA; Kevin J. Flynn, FAIA; Jeffrey T. Gill, AIA; John P. Grounds, AIA; Gregory Kessler, AIA; Leonard E. Koroski, AIA; Debra Kunce, FAIA; Glen LeRoy, FAIA; Vivien Li; Richard D. Licata, FAIA; Paul D. Mankins, FAIA; Christopher Morrison, AIA; Francis Murdock Pitts, FAIA; Beverly J. Prior, FAIA; Larry C. Quenette, AIA; James Easton Rains Jr., AIA; Elizabeth Chu Richter, FAIA; Charles L. Schreckenberger, AIA; J. Cyril Stewart, AIA; Mark Swenson, FAIA; William R. Turner, Assoc. AIA; Edward A. Vance, AIA; Thomas V. Vonier, FAIA; Michael J. Waldinger; Bill T. Wilson II, FAIA; Donald T. Yoshino, FAIA; David Zach.

NATIONAL STAFF

EXECUTIVE TEAM: Robert A. Ivy, FAIA, EVP/Chief Executive Officer; Tracy Harris, Vice President, Administration and Chief Financial Officer; Susan McDaid, Hon. AIA, Vice President, Member and Component Resources; Paul T. Mendelsohn, Vice President, Government and Community Relations; Kevin Novak, Vice President, Integrated Web Strategy and Technology; Ken Ross, FAIA, Vice President, Design and Practice; Jay A. Stephens, Esq., Vice President and General Counsel.

MANAGEMENT TEAM: Paula Clements, Hon. TSA, CAE, Managing Director, Component Collaboration and Resources; Kenneth Cobleigh, Esq., Managing Director & Counsel, Contract Documents; Andrew Goldberg, Assoc. AIA, Senior Director, Federal Relations; Lisa Green, Managing Director, Finance and Accounting; Christopher Gribbs, Assoc. AIA, Managing Director, Convention; Maan Hashem, PMP, CAE, Managing Director, Software Products and Services; Molly Lindblom, Managing Director, Contract Documents; Kyle McAdams, AIA, Managing Director, Marketing and Business Development; Philip O'Neal, Managing Director, Information Technology; Jeffrey Raymond, Managing Director, Web & Technology Governance & Partnerships; Cedric Rush, Managing Director, Membership Strategy and Services; Phil Simon, Managing Director, Communications and Publishing; Brian Skapura, Managing Director, Web Management; Carolyn Snowbarger, Managing Director, Professional Development and Resources; Terri Stewart, CAE, Managing Director, Member Communities; Suzanna J. Wight, AIA, LEED AP, Managing Director, Organizational Strategy & Alliances.

hanleywood



Painting Green with PPG

Environmentally sensitive zero-or low-VOC
products for all painting projects



ecological
Solutions from PPG™

Signifies a PPG green product based on LEED standards as of 06/01/08

*Ask how you can paint green
with ecological solutions
from PPG.*



PPG
PITTSBURGH
PAINTS

www.ppgpittsburghpaints.com

Circle no. 431 or <http://architect.hotims.com>



PPG
PORTER PAINTS

www.ppgporterpaints.com



REBUILDING AN ORPHANAGE + CHILDREN'S CENTER IN HAITI
USGBC AND THE GREEN BUILDING MOVEMENT ARE HELPING COUNTRIES
LIKE HAITI ADDRESS AN URGENT NEED; DESIGNING AND BUILDING MORE
DURABLE, AFFORDABLE AND EFFICIENT STRUCTURES THAT SAVE PRECIOUS
RESOURCES AND ANCHOR LOCAL ECONOMIES. GREENBUILD 2011 IS A LOOK AT
WHAT'S NEXT IN THE GLOBAL GREEN BUILDING MOVEMENT.
MORE ABOUT PROTECT HAITI AT GREENBUILDEXPO.ORG/HAITI



NEXT

GREENBUILDEXPO.ORG
TORONTO OCT. 4-7, 2011
PRESENTED BY THE U.S. GREEN BUILDING COUNCIL

Circle no. 191 or <http://architect.hotims.com>



PHOTO: EMILY TROUTMAN



Sustainable design. Begins with the right building blocks.

Naturally:wood is an online resource with the latest information on wood products from British Columbia, Canada used in markets around the world.

Highlights:

- . Over 600 manufacturers of a wide range of structural, finishing and engineered products
- . Technical expertise to answer questions on specific products, installation inquiries and more
- . Douglas-fir, western red cedar, SPF and other species
- . Case studies on sports and entertainment venues, schools and the latest innovations in wood technology
- . Green building tools

Visit www.naturallywood.com/a for more information.

Circle no. 288 or <http://architect.hotims.com>

naturally:wood

British Columbia wood. Sustainable by nature. Innovative by design.



MOCKBEE MADE IT POSSIBLE FOR A PROFESSION ADDICTED TO FORM TO REAWAKEN TO ITS POTENTIAL FOR REFORM. ... NOW, NEARLY A DECADE LATER, HE CAN LOOK DOWN WITH PRIDE ON A MAJOR SHIFT IN THE PROFESSIONAL ETHOS.

SEA CHANGE CONFESSIONAL

I REMEMBER THE MOMENT my conscience awoke, at least architecturally speaking. Sam Mockbee of the Rural Studio was visiting New York, and he mentioned that he wanted to take some friends from Alabama out to dinner and didn't know where to take them. I had plans to meet people later at Diller Scofidio + Renfro's just-opened Brasserie Restaurant in the Seagram Building, so I offered to call and try to get him a table there, too. It worked, though I had to beg a little, explaining to the hostess that my request for an 11th-hour reservation at the city's hottest restaurant was on behalf of a world-famous architect.

Later that night, I got to the Brasserie and looked around the crowded space for Mockbee. And looked. And looked. Finally I found his party in the far corner of an otherwise empty back room. Mockbee was a big man, with a lumberjack beard and a casual wardrobe. Clearly the hostess, used to bespoke-suited hedge-fund managers and black-clad SoHo fashionistas, had taken a hard look at the architect and his comfortable shoes, and exiled him to the fine-dining equivalent of Siberia.

Bear in mind that this was February 2000, just before the dot-com bubble burst. The cultural touchstone of the moment was HBO's *Sex and the City*. The show's Samantha Jones would have gotten the Brasserie's hostess fired for giving her such a bad table—that, or invited her home for a nightcap. Mockbee, for his part, was too gentlemanly to complain.

The relatively minor incident stuck in my mind. I was annoyed at the hostess, for sure. But by snubbing Mockbee, she actually did me a favor—awakening me to the superficiality of the value system that permeated society, and my own life, at the time.

The realization didn't come easily; my shallowness ran deep, all the way back to my Reagan-era, *Preppy Handbook* childhood. Architecture school had yanked me out of my Midwestern comfort zone, in a high-concept boot-camp sort of way, but it didn't change my underlying values. I merely shifted the emphasis of my snobbery, from white-bread to multicultural, old-school to avant-garde.

You see, image was king when I went to architecture school in the late '80s and early '90s. The unspoken academic goal was to foster each student's creative genius, in the *Übermenschlich* tradition of Frank Lloyd Wright and Howard Roark. Our role models—the living, nonfictional ones—came from a generation of highly image-conscious Postmodernists with a penchant for French post-structuralist philosophy. As for design instruction proper, that centered on abstract Bauhaus principles, with little mention of the movement's early 20th-century social(ist) underpinnings.

Working at magazines and museums didn't shake me out of my complacency, either—the emphasis was still skin-deep. Truthfully, Mockbee and the Rural Studio wouldn't have captured my attention had the projects not been so damn beautiful. In my backward mind, the fact that those wonderfully wonky houses were built for the poor was simply an extension of Mockbee's creative genius—a demonstration of how far he was willing to go to make his architectural vision a reality.

Mockbee was a great architect, by any standard. But his genius lay not simply in his skill as a designer, but in his use of that skill for a greater good, to draw attention to the plight of a devastatingly disadvantaged community. By building beautifully for the needy, using an aesthetic vocabulary that architects of the day could understand, Mockbee made it possible for a profession addicted to form to reawaken to its potential for reform. Had his work been ordinary looking, I sadly doubt anyone would have taken notice. I, for one, failed to get the message until that night at the Brasserie.

Mockbee died in December 2001, and now, nearly a decade later, he can look down with pride on a major shift in the professional ethos. Architect Yolande Daniels of Studio Sumo summed it up this summer, in a comment she made at a meeting of ARCHITECT's editorial advisory committee. Daniels observed that her students at Columbia fall into two basic camps: those interested in digital form-making, and those interested in architecture's environmental and humanitarian possibilities.

Los Angeles Times architecture critic Christopher Hawthorne goes even further in his opening essay for this issue's features section ("Altruism, Architecture & Disaster," page 150): "[H]umanitarian design, in its various guises, has eclipsed neo-modernism, bio-mimicry, and even parametricism ... to become the single most visible architectural concern of the moment, at least among designers younger than 40." I believe that he's right.

In the pages following Hawthorne's essay, you'll read about architects of all ages who are helping out when humanity needs it most—that is, when disaster strikes. Scientists say climate change is increasing the frequency of hurricanes, tornadoes, droughts, and other acts of God. And some say we just notice natural disasters more thanks to the omnipresence of the media. Either way, I'm proud that architects are taking action and trying to do the right thing. Because genius is a terrible thing to waste.

Reel Crane

Quality

EASY TO SAY.

HARDER TO PROVE.

Decide for yourself. Request a **free sample** of
RAB's high-performance outdoor LED luminaires at

RABLED.com

RAB[®]
LIGHTING

Circle no. 571 or <http://architect.hotims.com>



BSD
speclink[®]·e

Reduce errors and omissions with SPECLINK-E



"By bringing our specification writing in house, we were able to establish better coordination of the specification content with the drawings."

James Goodman Architecture

Leveraging its powerful relational database technology, SpecLink-E offers comprehensive checks and balances unmatched by any other program. You can quickly and concisely print automatic construction phase reports, including documents such as All Manufacturers Specified, Sections Requiring Shop Drawings, etc., thereby extending the value of SpecLink-E through the construction phase.

Circle no. 23 or <http://architect.hotims.com>



Building Systems Design, Inc.
888-BSD-SOFT (273-7638)
www.speclink.com/arch



dialogue

LETTERS

NEWS, July 2011

"Merger in Manhattan" by Fred A. Bernstein was not a fair representation of Charles Gwathmey and Gwathmey Siegel & Associates Architects. Mr. Bernstein stated that the firm, "was becoming less viable even before Gwathmey's death" and selected the Astor Place Tower, the renovation and addition to the Paul Rudolph Art and Architecture building at Yale University, and the U.S. Mission to the United Nations as projects which have received "scathing criticism."

Other than a negative review of Astor Place by Paul Goldberger, who criticized the reflective nature of the glass-shaped façades and noncontextual relationship of the massing, the project has received positive reactions. The Rudolph building was praised by Ada Louise Huxtable as well as Robert Stern, the dean of the School of Architecture. The U.S. Mission to the United Nations is one of the few examples of a well-executed poured-in-place architectural concrete façade in New York. The building was dedicated and praised by President Obama and former President Clinton as a symbol of strength and integrity of the mission. Mr. Bernstein neglected to mention the Crocker Museum of Sacramento in California, a major regional art venue as well as architectural landmark, the award-winning Setai hotel and Condominium tower on Fifth Avenue in New York, and the W New York that was the first completed building by a private developer since 9/11, among many other examples.

The merger with Gene Kaufman Architect has expanded project opportunities in New York and in China due to his relationships with developers. It has established the foundation for the second generation of the firm under the name of Gwathmey Siegel Kaufman & Associates Architects. The senior management group of associates who have been with the firm on average for 25 years has remained and will collaborate with Gene and me to develop the new opportunities. *Robert Siegel, FAIA*

DIALOGUE, August 2011

You can feed your kids goose, but you can't feed them goose bumps!
Terrance Thompson

DIALOGUE, July 2011

Below are comments from our website:

Aug. 3, 2011—9:13 a.m.

The New Deal including the WPA was an enormous, expensive spectacle. It didn't get us out of the Great Depression and the same ideas didn't get us out of the Great Recession. It's easy to build charming wedding venues; it's more difficult to build an economy especially when the government sucks up resources. Handsome post offices can't replace a private sector in creating a prosperous economy.

Aug. 8, 2011—2:54 p.m.

Yes stimulus is government spending, but that spending stimulates the economy. For our small engineering and architecture firm, all the tax breaks in the world won't prompt us to hire one person. But give us a good project and we'll be able to hire. That's jobs.

Aug. 11, 2011—4:24 p.m.

It seems a lot of people didn't learn anything from the housing boom: It is not enough to build; you have to build the right things. Otherwise you are just wasting resources and setting yourself up for a bust.

→ Want to join the conversation? Go to architectmagazine.com. All letters and comments may be edited for length, content, grammar, and style.



**INTRODUCING THE INFINITE ROLL
OF DUPONT™ TYVEK®.**

**DuPont™ Tyvek® Fluid Applied WB— 30 years
of industry-leading performance engineered for
everything from high-rises to hospitals.**

The superior performance of DuPont™ Tyvek® CommercialWrap® is now available by the gallon. Tyvek® Fluid Applied WB goes on quickly and easily, making it the ideal solution for buildings from five to fifty stories. And it works on a range of materials from concrete to gypsum board. So when you're looking for a weather barrier you know you can trust, there's just one place to turn—DuPont. Learn more at www.fluidapplied.tyvek.com



Tyvek.
FLUID APPLIED WB

Contributor



Christopher Hawthorne

"Altruism, Architecture & Disaster" • page 150

Christopher Hawthorne is the architecture critic for the *Los Angeles Times*. His work has also appeared in *The New York Times*, *The New Yorker*, *The Washington Post*, *Slate*, and *Metropolis*. With Alanna Stang, he is the author of *The Green House: New Directions in Sustainable Architecture* (Princeton Architectural Press, 2005). A graduate of Yale University, he led the urban reporting program at the Graduate School of Journalism at University of California at Berkeley. There, with Paul Goldberger, he taught a seminar on the rebuilding effort at the World Trade Center for students from the school's architecture, planning, and journalism schools. For ARCHITECT, Hawthorne has written a critique about architecture in our age of natural disasters, making a case for how architects should become involved in disaster mitigation and relief work.

There is simply no better snow retention system than S-5!® ColorGard®!

Visit us in
October at
Greenbuild
Booth
#7042S



S-5!®
The Right Way!

Often imitated, never duplicated. Our patented S-5!® clamps, with their round-point setscrews, make ColorGard® the strongest, easiest to install, and best priced solution for standing seam metal roofs. They never pierce the paneling... and there is no messy glue! Unlike all other snow retention products, the perfect color-match of ColorGard ensures your snow retention system will always look great, and will last as long as your roof.

To find out more, visit www.S-5-ColorGard.com/arch or call 1-888-825-3432.

*See optional Limited Lifetime Warranty information at www.S-5-ColorGard.com/arch

Circle no. 489 or <http://architect.hotims.com>

YOUR SINGLE SOURCE SOLUTION



If you're in need of metal components, you've come to the right place. MBCI's vast offering of solutions include both single skin and insulated metal panels for roof and wall applications, six standing seam metal roof panels and retrofit roofing solutions. We also provide secondary framing, trim and accessories for your building projects. And it doesn't stop there. MBCI offers quality products, superior service and valuable technical information so your project is a success.

To learn more about what MBCI can offer you, visit www.mbc.com/provider or call **(877) 713-6224**.



Thank You to Our Customers for 35 Years of Support

Houston, TX (Corporate) 877-713-6224 | Adel, GA 888-446-6224 | Atlanta, GA 877-512-6224 | Atwater, CA 800-829-9324 | Dallas, TX 800-653-6224 | Indianapolis, IN 800-735-6224
Jackson, MS 800-622-4136 | Lubbock, TX 800-758-6224 | Memphis, TN 800-206-6224 | Oklahoma City, OK 800-597-6224 | Omaha, NE 800-458-6224 | Phoenix, AZ 888-533-6224
Richmond, VA 800-729-6224 | Rome, NY 800-559-6224 | Salt Lake City, UT 800-874-2404 | San Antonio, TX 800-598-6224

Circle no. 402 or <http://architect.hotims.com>

Metal Roof and Wall Systems
www.mbc.com/provider

Top Stories → For these stories and more, see architectmagazine.com.

NEWSWIRE

EDITED BY KRISTON CAPPS



THE WASHINGTON POST

Trump To Bid on Old Post Office Pavilion

The Donald has submitted a proposal to the U.S. General Services Administration to turn the iconic Old Post Office Pavilion in the nation's capital into a 300-room luxury Trump hotel.



CO.DESIGN

Pop-Up Wedding Chapels for New York Couples

Temporary chapels in Central Park, the result of a design competition by Architizer and wedding-planning site The Knot, hosted nuptials for 24 newly empowered gay couples in late July.



THE NEW YORK TIMES

Philips Takes the L Prize

The U.S. Department of Energy recognized Netherlands-based Philips with the \$10 million L Prize for the company's 60-watt LED bulb, which mimics its incandescent equivalent.

2011 Opportunity Fund Awards

The Columbus, Ohio, and Springfield, Mo., AIA components were announced as the winners of the Hanley Wood/AIA Component Opportunity Fund grants at the AIA Council of Architectural Component Executives annual meeting in Philadelphia on Friday, Aug. 19. Each component received \$5,000 to support the following efforts.

AIA Springfield proposed creating a Regional Urban Design Assistance Team to assist Joplin, Mo., in its rebuilding efforts following the devastating tornado that struck the community in May. Citing the sustainable rebuilding effort in Greensburg, Kan., AIA Springfield suggested the award could seed a regional initiative.

AIA Columbus proposed launching a "Design Week" at the new Center for Architecture and Design during the 2012 bicentennial celebration of the city's founding that fall.

"This year, we received 21 applications from AIA components across America—all with impressive proposals that should spark innovations and new opportunities," said Hanley Wood commercial design and construction group president Patrick J. Carroll. KRISTON CAPPS

Expansion for the Center for Architecture

THE CENTER FOR ARCHITECTURE, which since 2003 has seen its staff triple in size and now hosts approximately 2,000 visitors each week, is expanding.

AIA New York announced in August a 2,000-square-foot expansion at its Greenwich Village offices and public center.

"What we're trying to do by expanding next door is augmenting our meeting capacity first and foremost," says the chapter's executive director Fredric M. Bell, FAIA (who is on ARCHITECT's Editorial Advisory Committee).

AIA New York plans to work with New York-based Rogers Marvel Architects on the expansion and will host its first public event in the new space in early October.

In 2003, the chapter moved from its uptown facility into the existing Greenwich Village building, which they adapted to 12,000-net-usable square feet. The initial seven-person staff housed by that space has grown to 22 individuals.

Although official plans for the new

space are still in the works, Bell says, they will likely yield more office space and increased flexibility for meetings, exhibitions, and other programs.

"Our [2003] move downtown symbolized a reengagement with the historic life of the city in a historic neighborhood but also a neighborhood that's been characterized forever as cutting-edge," Bell says.

When exploring options for the new space, the board sought to remain nearby the existing location due to its proximity to the Village's younger and arts-based environment, Bell says, adding that the move was necessary to improve the chapter's current functionality.

"It's not that they're taking a risk," Bell says of the board vote to expand, "but they're expanding a facility in a time that sees retrenchment and treading water in a lot of other places—not just other civic and professional organizations but throughout the entire design and construction industry." HALLIE BUSTA



"The powerful geometries of the island and land wings of Exploration Place required a roofing system that would lend itself to the positive and negative toroidal forms of the roofs."
— Hugh Phillips, principal at Moshe Safdie and Associates

Décor Roof Systems. Champion of Design Freedom.

Décor Roof Systems from Sika Sarnafil look like metal, but are actually a rugged, watertight thermoplastic membrane. So you get all the beauty of a traditional metal roof, with a level of protection, durability and affordability that only Sarnafil® membrane can provide. With over 45 years of performance history around the world under extreme conditions, Sika Sarnafil roofing systems provide real peace of mind. And with a variety of rib sizes—plus a choice of 7 standard colors or any number of custom color possibilities—Décor Roof Systems provide an unlimited range of design options. In addition, as the leader in durability, fire safety and membrane recycling, Sika Sarnafil can help you meet your sustainability goals with durable, energy-efficient roofing and waterproofing solutions that protect and perform—even after decades of service.

► Call 800-576-2358 to request your FREE informative Décor Design Kit.



Sika Sarnafil, A Division of Sika Corporation
Tel. 1-800-451-2504, Fax: 781-828-5365, usa.sarnafil.sika.com

Circle no. 537 or <http://architect.hotims.com>

Sarnafil®

→ NUMBERS

It Gets Better

95

PERCENTAGE OF OFFICES THAT HAVE OR WILL REPLACE CRT MONITORS WITH LCD MONITORS

67

PERCENTAGE OF OFFICES THAT HAVE OR WILL INCENTIVIZE RIDE-SHARING, BIKING, AND WALKING TO WORK

70

PERCENTAGE OF OFFICES THAT HAVE OR WILL ADOPT ENVIRONMENTALLY FRIENDLY CLEANING TECHNIQUES

38

PERCENTAGE OF PROJECTS THAT WILL COLLECT ENERGY-MODELING DATA

58

PERCENT GROSS SQUARE FOOTAGE OF NEW PROJECTS BEING ENERGY MODELED

84

PERCENTAGE OF OFFICES THAT HAVE OR WILL ADOPT PAPERLESS MEETING PRACTICES

TEXT BY KRISTON CAPPS

FOR ITS FIRST ANNUAL REPORT CARD on progress toward industry sustainability goals, the AIA is handing out neither “A”s nor “F”s—but rather a few MIAs.

At the end of 2010, 135 firms took up the AIA 2030 Commitment, a national framework for understanding and meeting sustainable-design goals. Those firms, and a few dozen more who have committed since, agreed to select from a menu of office-place strategies to reduce their fossil-fuel consumption—and then report on those efforts. The strategies fall under four categories: office energy use, waste reduction and supplies, travel, and meeting procedures. The 2030 Commitment also considers energy modeling and other standards specific to project design.

But of the 135 firms who signed on for the 2030 challenge, just 56 firms—fewer than half—filed annual progress reports on their design portfolios in April. A few more filed six-month progress reports on their firms’ operations.

The good news is that those firms that reported progress reported real progress. Fifteen percent of the 79 firms that pledged to establish a timeline for adopting 100-percent renewable energy for their offices, for example, have done so—with another 25 percent reporting that they will. Firms are energy modeling more than half of their reported projects (measured by gross square footage). That figure is itself significant: Projects by 56 reporting firms total 385 million gross square feet—a treasure trove of data, equivalent to that of one-third of all LEED-certified buildings.

SOURCE: AIA 2030 COMMITMENT FIRST ANNUAL REPORT, MAY 2011

BILLINGS AND INQUIRIES INDEXES

JULY 2011 ARCHITECTURE BILLINGS INDEX

45.1

- ↓ 47.9 commercial
- ↑ 47.2 institutional
- ↓ 47.1 mixed practice
- ↓ 44.7 multifamily residential

SOURCE: AIA

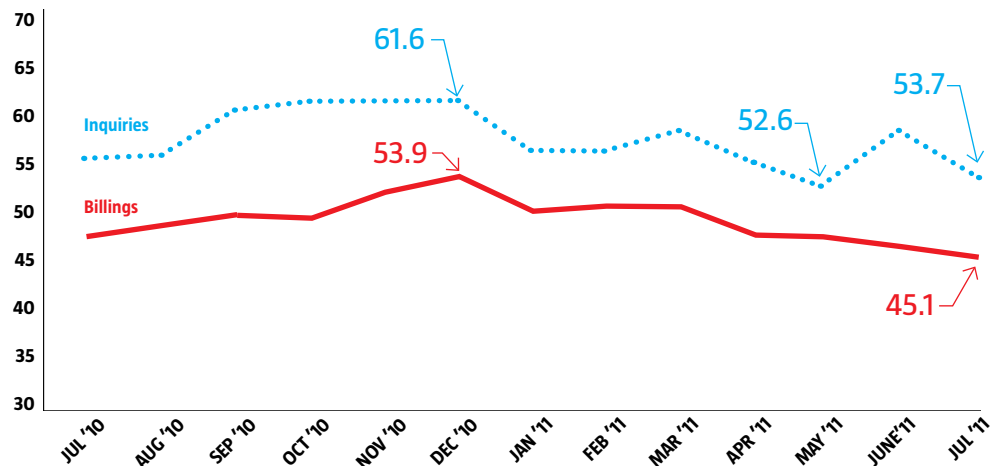



SPF

1,000,000

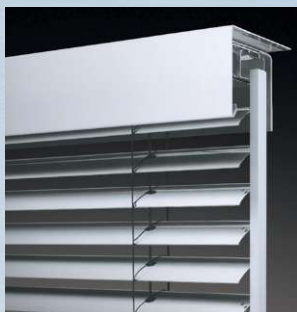

Introducing C/S Solarmotion® Architectural Blinds, virtual sunblock for your building. They are the most effective way to keep unwanted sun glare from entering your building. This system, long accepted in Europe, can lower your building's solar heat gain coefficient by 90% and substantially reduce energy consumption and improve occupant comfort and productivity. Featuring SolarTracking technology, it adjusts with the sun's movement. C/S is pleased to bring this advanced technology to North America through an exclusive agreement with Warema, Europe's leading manufacturer. To learn more, call Construction Specialties at 888-895-8955, or visit www.c-sgroup.com. **See us at Greenbuild, booth #1523.** Circle no. 298 or <http://architect.hotims.com>

 **Solarmotion®**
Architectural Blinds

On the Boards

TEXT BY KATIE GERFEN

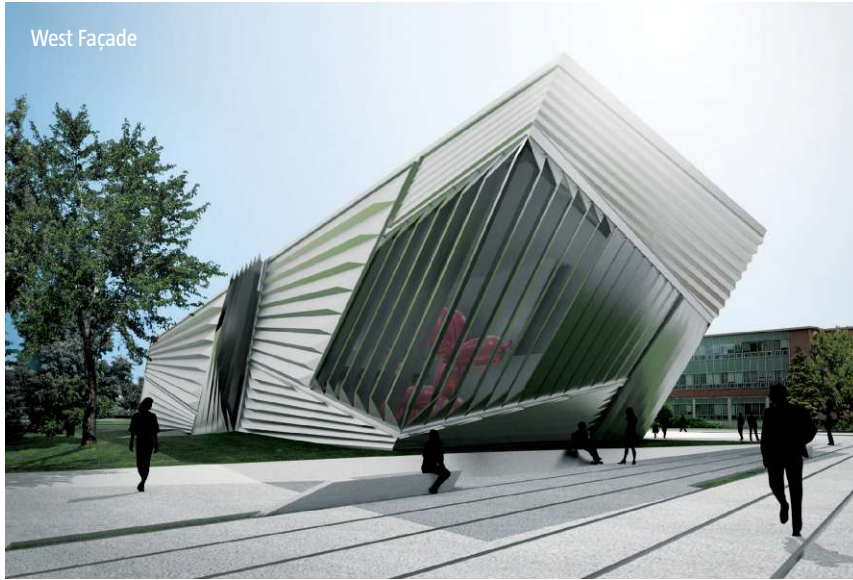

Eli and Edythe Broad Art Museum at Michigan State University

ZAHA HADID ARCHITECTS

The new 46,000-square-foot art museum at Michigan State University is sited at the northern edge of the East Lansing, Mich., campus, with a plaza to the west and a sculpture garden to the east. “We approach architecture and landscape as interacting with each other,” says project architect Alberto Barba, noting that the landscape lines of the site determined the building’s form and the patches of pleated stainless steel fins that clad the structure. Although these fins create solid walls in some areas, in others they are installed over glazing and serve as sunshades to limit glare. Inside, three levels of open galleries and education spaces are oriented around a black metal stair and exposed concrete walls that define circulation paths. The linear pattern of the wood floors and recessed lighting reinforce the vocabulary of the pleats on the façade. “Both art and container are part of the same experience for the visitor,” Barba says. The museum will be completed in late Spring 2012.

Kingdom Tower

ADRIAN SMITH + GORDON GILL ARCHITECTURE

Adrian Smith, FAIA—who led design on the Burj Khalifa while still at Skidmore, Owings & Merrill—is outdoing even himself with his scheme for the Kingdom Tower in Jeddah, Saudi Arabia, which is slated to take over as the world’s tallest building with an overall height of more than 1 kilometer (3,280 feet). To combat the wind forces that occur with any building of this size—“the key to resisting wind forces in a tall building is shedding vortices,” Smith says—the highly reflective glass façade is continuously sloped, changing the dynamics at every floor and shrinking each successive floor plate 4 to 8 inches. The tower is supported by a central core, which is braced by 2-foot-thick concrete walls that line the double-loaded corridors in each of the three wings in the tripod structure. The projected 5.7 million square feet of floor space will be occupied by a stacked program of office, hotel, and residential units, all serviced by a fleet of 59 elevators. A sky terrace, 100 feet in diameter, is cantilevered off of the 157th floor, roughly 2,000 feet in the air. First designed as a helipad—until “we started talking to helicopter pilots and they said ‘it gets dicey up there,’” Smith says—it will likely be used as a private terrace for a penthouse unit. Construction is expected to begin on the foundations soon, and the tower should be complete within the next five to six years.



SMOOTH OPERATOR

Featuring a sleek design and unrivaled strength, the RB 500 roller shade operating system spans even the largest window expanses with ease.

800.727.8953

HunterDouglasContract.com/RB500

Circle no. 378 or <http://architect.hotims.com>

HunterDouglasContract™

©2011 Hunter Douglas Inc. © and ™ is a trademark of Hunter Douglas Inc.

The Leader in Opening Glass Walls



Naperville Library Naperville, IL
NanaWall Aluminum Framed Folding System SL45
Architect: PSA-Dewberry, Inc.

NanaWall empowers architects with distinctive solutions for educational environments. In library interiors, a NanaWall allows for creative use of rooms and floor space—increasing flexibility while offering sound attenuation. For exteriors, a NanaWall opens the room interior to the outside—allowing fresh air ventilation and natural daylighting while providing a healthier learning environment.



Palo Alto Children's Library Palo Alto, CA
NanaWall Aluminum Framed Folding System SL45
Architect: Architectural Resources Group





Sir Francis Drake High School NanaWall Thermally Broken Folding System SL70
 Architect: Deems Lewis McKinley Architecture



Kay Granger Elementary School NanaWall Aluminum Framed Folding System SL45
 Architect: SHW Group LLP

FlexSpace Features:

- Outstanding sound-dampening
- Multiple uses within school environment
- Optimized for limited floor space
- Flexible design allows for easy reconfiguration

For a full case study on NanaWall FlexSpace, visit www.nanawall.com/flexspace/

Operable Folding Glass Wall Systems
 With numerous features specifically designed for maximizing classroom learning environments, rely on NanaWall's experience and FlexSpace opening glass wall systems for your project.



MacLean Dixie Awarded Key Approval for All Product Combinations

A 'BIG WIN' FOR THE ONLY MANUFACTURER TO ACHIEVE SUCH APPROVAL



"To be one of the first approved and the only [manufacturer] with all combinations makes this a big win for MacLean Dixie," said Dhruva Mandal, MacLean Power Systems' Vice President and General Manager for Connector and Hardware Products. "This evaluation has been in the works for a while, so now that it's approved — it's very exciting for us."

MacLean Dixie, a leading manufacturer of deep steel helical foundation piles and tension anchors, was awarded approval in July for the **ICC-ES AC358 Acceptance Criteria for Helical Foundation Systems and Devices** (evaluation number ESR 3032). Not only that, but MacLean Dixie was the only manufacturer evaluated and approved for all combinations listed in the ICC-ES AC358 report, which allows us to offer foundation solutions for various applications.

RIGOROUS TESTING

To obtain approval, rigorous testing on MacLean Dixie products included full scale compression and tension load in both sand and clay, full scale lateral load, shaft torsion, helix torsion, coupling rigidity, helix capacity, and system capacity with bracket tests.

The ICC-ES AC358 evaluation was inclusive for MacLean Dixie's 1-1/2" and 1-3/4" Round Corner Square (RCS) and 2-7/8" and 3-1/2" helical pipe piles, as well as the associated hardware used in new construction, foundation remediation, and tension anchor applications. Both the RCS and helical pipe piles feature the Strength Squared® coupling system, which assures the integrity of the installed system because no bolts or connecting holes are subjected to bending or hole elongation during installation.

PRODUCT PERFORMANCE

With the approval of this evaluation, users of MacLean Dixie helical foundation and tension anchors can be assured their product will perform to the specified rating. All materials are specified to ASTM standards, certified and traceable to the mill, and manufactured at an ISO 9001:2008 (registration number QSR-938) registered plant in Birmingham, Alabama.

In addition, MacLean Dixie helical pile and anchor systems can be installed rapidly, can be used in a wide variety of soil conditions, can be installed with readily available equipment, generate no spoils to dispose of, eliminate the need for concrete, are ready for immediate loading after installation, are easily load tested, and can be removed and relocated easily. And, because they use compact equipment, MacLean Dixie helical pile and anchor systems are well suited for densely populated areas.

**MacLean
Dixie HFS**



TM

Building Solid Foundations

For more information, including a copy of the ICC-ES AC358 Evaluation Criteria and the MacLean Dixie ESR 3032 evaluation, visit www.macleandixie.com or contact your local certified civil distributor.



PHOTO: SAM KITTNER

AIA VOICES

DEAL MAKER: GREEN ARCHITECTURE IS JUST AS IMPORTANT ON THE OTHER SIDE OF THE TABLE

The paths one can take after architecture school are manifold, but what happens when an architect changes focus mid-career? For Frank Mobilio, AIA, LEED AP, shifting gears has meant becoming far more effective at promoting sustainability, primarily through green leasing projects, than he was behind the drafting table. Formerly a senior associate at HOK, Mobilio is now the associate director and vice president in the project and development services (PDS) group of Jones Lang LaSalle's (JLL) Washington, D.C., office, where he also serves as the sustainability market leader.

I WORKED ON MY FIRST SUSTAINABLE PROJECT WITH HOK IN THE '90S.

I was the project manager for interiors for the Nature Conservancy headquarters. At that time, the emphasis was not as much on energy saving and performance as it was on materials selection and indoor air quality. That project was where I first met my colleagues with the Staubach Co., which eventually merged with JLL in 2008. In 2002, I was home sick with the flu and, thanks to bad cable and cold medicine, I was able to study for the LEED exam. I was one of the first officers in HOK to become a LEED-accredited professional.

In 2003, which was a watershed year for me personally, one of my clients asked me to be his owners' representative for ongoing work. At the same time, I became president of my local community association, which was a great way to build organizational skills, and I began to focus more on the bigger picture of sustainability. I found that strategizing on projects was very intellectually engaging to me.

One of my colleagues said to me, "The way you get things built is with your telephone." So I thought, "Let's go with this." Not long afterward, I had the opportunity to join Staubach.

As a sustainability market leader for JLL's PDS Mid-Atlantic region, I work with our real estate brokers and building managers up front to assess potential locations, work through budgetary issues, and help define their sustainability goals as well as manage LEED EB [LEED for Existing Buildings] certification projects. I have written on green leasing, which is about how the owner and the tenant work through the ongoing changes in sustainability during the lease term, as well as how potential split incentives on energy savings and costs are addressed. These factors are important in both the construction of a tenant space as well as in the space's operation.

I find it fascinating that I have been able to do more sustainable work on this side of the table than as an architect. I can speak about sustainability in terms that are understood in the boardroom, at the design table, and in the field. I think that really brings a level of comfort to decision makers. Sustainability is an area of growth, and my goal is to continue on this path. Will I ever retire? Probably not. I believe that when you stop learning you die. So I want to keep learning. —As told to Kim A. O'Connell **AIA**

➔ To hear more Voices, visit architectmagazine.com/AIA.



AIANOW

ACROSS THE INSTITUTE

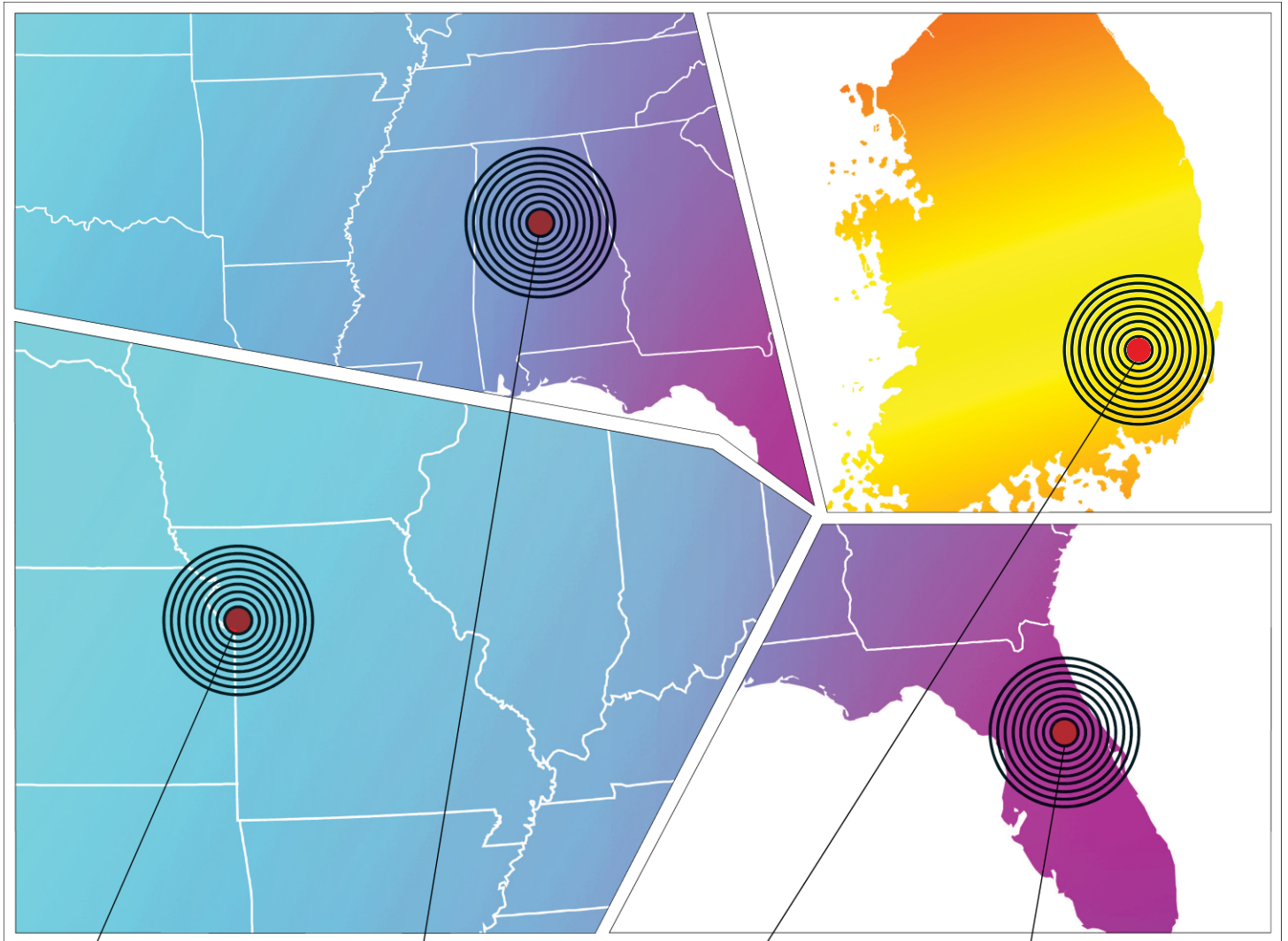

KANSAS CITY, MO.

Leading the Way

What is your definition of success? The AIA Women's Leadership Summit in Kansas City, Mo., (Sept. 23–24) will take on that question and others at its annual event to support women in leadership roles. Summit organizers will recognize architectural achievement and continue the national conversation about leadership challenges facing women, personal and firm branding, and the business of design.

➔ Learn more at aia.org/about/initiatives.

BIRMINGHAM

(Re)Building 'Bama

Architects in Alabama, one of the hardest hit by natural disasters this year, have been working to recover what's been lost and rebuild. Alabama Council AIA and AIA National cosponsored two Applied Technology Council 45 (ATC-45) training workshops, in Tuscaloosa and Birmingham, following the April 27 tornadoes that killed hundreds of Alabamians. In May, dozens of architect volunteers, organized by the state component, fanned out to help with building assessments. Finally, in July, Birmingham Mayor William Bell announced that the state's largest city would partner with the AIA in providing design assistance for community recovery and rebuilding efforts.

➔ Learn more at aiabham.org.

DAEGU, SOUTH KOREA

Human Resources

Istanbul-based International Association for People-Environment Studies (IAPS) will host a symposium entitled "Continuity and Change of Built Environments—Housing, Culture, and Space across Lifespans," in Daegu, South Korea, Oct. 11–14. The event will include humanities-based lectures and a special scientific program, intended to approach demographics, technology, energy, mobility, health and welfare, and other topics. A student competition, tours, and a photography exposition round out the offerings.

➔ Learn more at iaps2011symposium.kr.

ORLANDO

Whistle Stops

SunRail has been hailed as the solution to commuter woes in Florida, one of the country's most populated areas with limited public transportation. This summer, the Florida Legislature and Gov. Rick Scott green-lighted the project, which will open in 2013 with a 31-mile stretch through Orlando. "We've been on board with this for a while," says Dan Kirby, AIA, vice president for advocacy at AIA Florida. "AIA Florida advocated for rail transit and the use of mass transit in urban areas statewide [by] endorsing Florida DOT's 2060 plan and urging our members to contact their legislators." As part of that plan, Florida DOT approved technical drawings for the first dozen station prototypes in 2009. More are expected to be approved this year.

➔ Learn more at sunrail.com.

B101™-2007

Standard Form of
Agreement Between
Owner and Architect

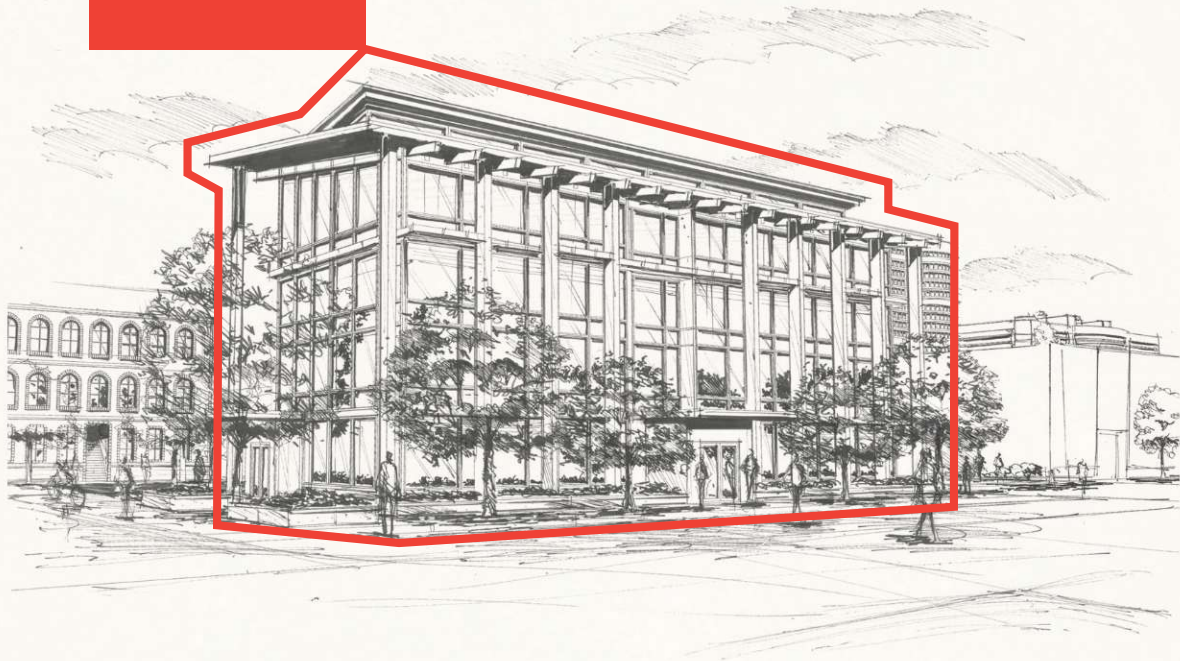

Design with an added layer of protection.

PLUS download the all-new **Guide for Sustainable Projects**, FREE at aia.org/sustainableprojectsguide

Take peace of mind to the next level with AIA Contract Documents. We are pleased to announce the new D503™-2011, **Guide for Sustainable Projects**, including Agreement Amendments and Supplementary Conditions. This guide provides users with a valuable reference tool when using key AIA standard contracts like B101-2007, the most widely used standard Owner/Architect agreement in the industry, to help address the unique concerns of sustainable design. This includes information on certification systems, codes and legislation affecting sustainable design and construction projects. It also includes model language to assist all project participants in appropriately allocating risks and responsibilities. AIA Contract Documents are easy-to-use, widely accepted, and fair and balanced for all parties involved.

Download the new **Guide for Sustainable Projects** and learn more about our full library of Contract Documents at aia.org/contractdocs or call 800-242-3837.

AIA Contract Documents®
THE INDUSTRY STANDARD.

AIA ADVOCACY

START YOUR ENGINES

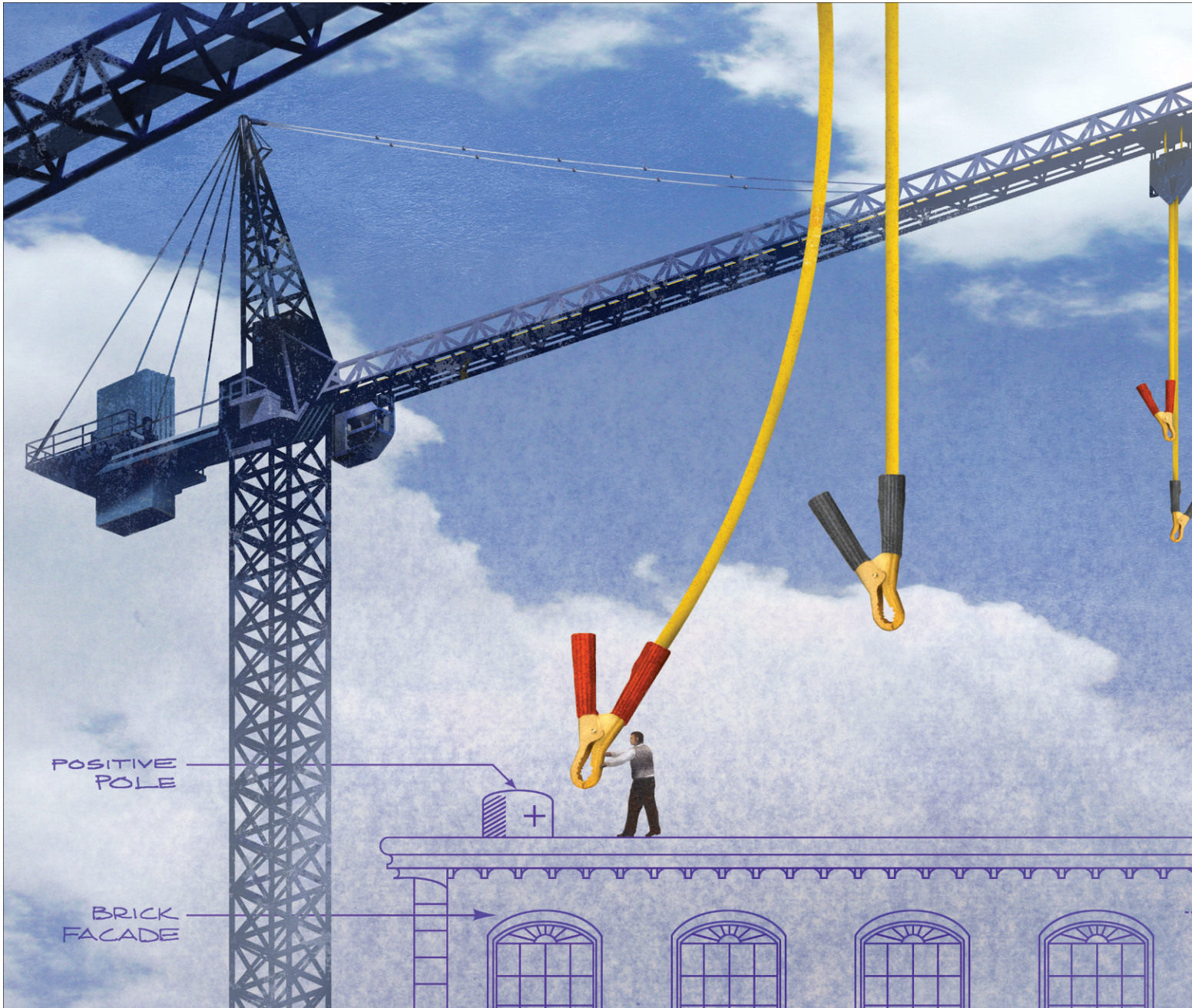

ILLUSTRATION: MICHAEL GIBBS

Partnering with the Clinton Global Initiative, the AIA pledges to create a stalled projects database.

BY ERIN SUND

TOO MANY ARCHITECTS FACE UNFINISHED BUSINESS. In fact, almost two-thirds of architects have at least one stalled project on the books due to lack of financing, in spite of record-low interest rates, according to a May 2011 survey by the AIA. Fortunately, a new AIA initiative is under way to jump-start stalled projects. Partnering with Clinton Global Initiative (CGI) America, the AIA pledged to create a database of stalled architecture projects that make economic sense but lack funding.

“Banks just won’t lend,” says Frank Harmon, FAIA, principal of Frank Harmon Architect PA, based in Raleigh, N.C. “We have a project we designed three years ago, and the bank said they’d lend us the money. The project is now ready to go, but they [the bank] suddenly won’t lend.” This problem doesn’t just weigh on



architecture firms. The U.S. Census Bureau estimates that the job-creating potential of the design and construction industry accounts for \$1 in \$9 of the U.S. gross domestic product.

Established by former President Bill Clinton in 2005, the CGI network convenes stakeholders from the private and public sectors to stimulate economic growth through job creation. Members commit to finding innovative solutions to the world's economic issues, while also doing social and environmental good. The hope is that the AIA's database will shed light on the problem of stalled projects, while surfacing still-viable projects to investors.

Serving as more than a simple list, the AIA's database of stalled projects will be a tool that informs the industry and investors about the scope of stalled projects in need of financing. The AIA was approached about the concept of working within the CGI network of partners to match funding sources to stalled projects.

"CGI's membership is large and influential," says Paul Mendelsohn, AIA's vice president of

government and community relations. "We see lots of promise in this collaboration. Our hope is that this database catalyzes job growth in construction, and illustrates how jobs in that field have a strong and lasting impact on the economy."

The stalled project database will be generated by surveying firms to collect quantitative information about stalled projects. Based on responses, a team lead by Kermit Baker, chief economist, AIA, will eliminate projects that are no longer considered suitable for development. For example, plans for a huge shopping complex may no longer make economic sense, given the state of the retail industry.

"Many projects that would have been a slam dunk three years ago are no longer viable," Baker says. "We'll gather more

information from firms, then determine the market value of [stalled] projects to create a list of projects that look viable today."

Viable projects need to contribute to a triple bottom line. "They have to be energy-efficient, contribute to the health and development of the workforce, and be economically viable. Sustainability is a huge component," Mendelsohn says. Given the public's endorsement and energy costs, green projects may catch the eyes of potential investors first.

At this year's CGI America conference in June, people were buzzing about the growth of the sustainable-design industry. U.S. Secretary of Energy Steven Chu announced the Better Buildings

"Our hope is that this database catalyzes job growth in construction, and illustrates how jobs in that field have a strong and lasting impact on the economy."

Challenge, recognizing and supporting organizations that commit to make America's buildings more energy efficient. U.S. Secretary of Agriculture Tom Vilsack shared his vision of sustainable design both revitalizing the economy and becoming an export opportunity.

"When we come out of this recession, I think we're going to realize that we need to be smarter," Raleigh's Harmon says. "We can't get products as cheaply as we used to. We have new competition from China and other places. Green building is just the right thing to do. It's not simply about saving energy or costs. It's better for you." **AIA**

Do you have a stalled project on the books? Please contact the AIA at stalledprojects@aia.org and share your experience.

Be sure to include:

- Your name, firm name, and contact information
- The project type and name
- City and state of the project
- How large the project is, in terms of square feet and cost per square foot
- How many jobs your firm or your contractors could create if it moves forward, if known
- An electronic picture of the project or design (if applicable, JPEG or other similar format, please)

For stalled projects, please also answer the following questions:

- Why has the project stalled?
- Were any jobs lost due to the hold up?
- Would an increase in the energy-efficient 179d tax deduction help this project move forward?
- Would increased access to financing through the Small Business Administration or other programs help move the project forward?

For projects that have received the 179d deduction already, please also answer the following questions:

- What were the main efficiency measures included in the project?
- How was the surrounding community impacted by this project (i.e., jobs created, increased economic development and revitalization efforts, improved access to transportation, etc.)?
- How much energy did the project save?
- Was the 179d deduction instrumental in this project moving forward?
- How would an increase in the deduction have impacted this project?

Education in session. Anytime. Anywhere.



AIA Virtual Convention

Satisfy continuing education requirements for licensure and AIA membership on your schedule—whether you're at home, at the office, or shuttling somewhere in between. With courses recorded at the AIA National Convention, you have your choice of quality, authoritative education on topics that are relevant to your career or practice—from ADA to BIM, and from practice management to sustainable design.

View the course, pass the quiz. Learning units are posted automatically to your AIA transcript within 48 hours.

Design your personal classroom.

www.aia.org/virtualconvention

Circle no. 513 or <http://architect.hotims.com>



THE AMERICAN INSTITUTE
OF ARCHITECTS

AIA FEATURE

LOSING LOST HIGHWAYS



ILLUSTRATION: DON FOLEY

Architects are assuming a variety of roles in plans to remove obsolete infrastructure.

BY CHARLES LINN, FAIA

THE POOR CONDITION OF HIGHWAY INFRASTRUCTURE IN THE

United States has reached a crisis point: evolve or cumble. The most expensive structures to replace are the viaducts and depressed roads running through urban areas. Some have exceeded, or are near, the end of their design lives, or have been superseded by other roads. The decrepit state of our infrastructure can incite anxiety, but it also presents tremendous opportunities that would have been unthinkable even a few years ago.

Many of these structures were built when the unstoppable twin juggernauts of urban renewal and interstate highway construction were barreling through cities, starting in the mid-1900s. Today, demolition of select portions of these structures would permit the repair of damage that was done to communities and neighborhoods then. Still, the difficulties in removing any structure that carries tens of thousands of cars per day are not simple ones.

ROAD TESTS

Discussions about the removal of the **Claiborne Expressway** (I-10), a six-lane elevated freeway in New Orleans, have been going on for years. When built in the early 1970s over Claiborne Avenue, it destroyed a pair of broad one-way streets separated by a parklike

common ground. Running through the Tremé-Lafitte neighborhood, it was arguably the African American community's most important commercial street. Residents trace the decline of the once-vibrant neighborhood to the construction of the expressway.

The recently adopted New Orleans Master Plan, authored by the Boston-based architecture and planning firm Goody Clancy, recommends the removal of the highway. But the New Orleans-based Waggonner & Ball Architects' "Restoring Claiborne Avenue" report, coauthored with traffic consultant Smart Mobility, offers alternatives to removal. It inspired the city to seek a grant to fund its own study.

"The planning effort is motivated by a real problem that's been created in the city; it is an urban disaster to run that freeway through there," says David Waggonner, FAIA. "It's done all this damage; it's cut off one part of the city from the rest, and wrecked that community and its real estate base. How do we—if we are going to be constructive—resolve the issues that are raised in a holistic way?"

While removing two miles of the Claiborne might seem like the obvious way of righting a terrible wrong, the issues are very complex. "What this really does is throw into question the entire transportation system of the New Orleans region," Waggonner says. The official process for examining the removal of the expressway has just begun. Earlier this year, New Orleans received a U.S. Department of Transportation TIGER II Grant, which will allow it to hire consultants to formulate proposals, for demolition as well as alternatives. That study is expected to take at least two years.

Another study under way is for the removal of elevated sections of the **Viaduct** (I-81), which cuts across Syracuse, N.Y. Dean Biancavilla, AIA, and Robert Haley, AIA, are co-directors of the Urban Design Center of Syracuse, and members of the community-advisory



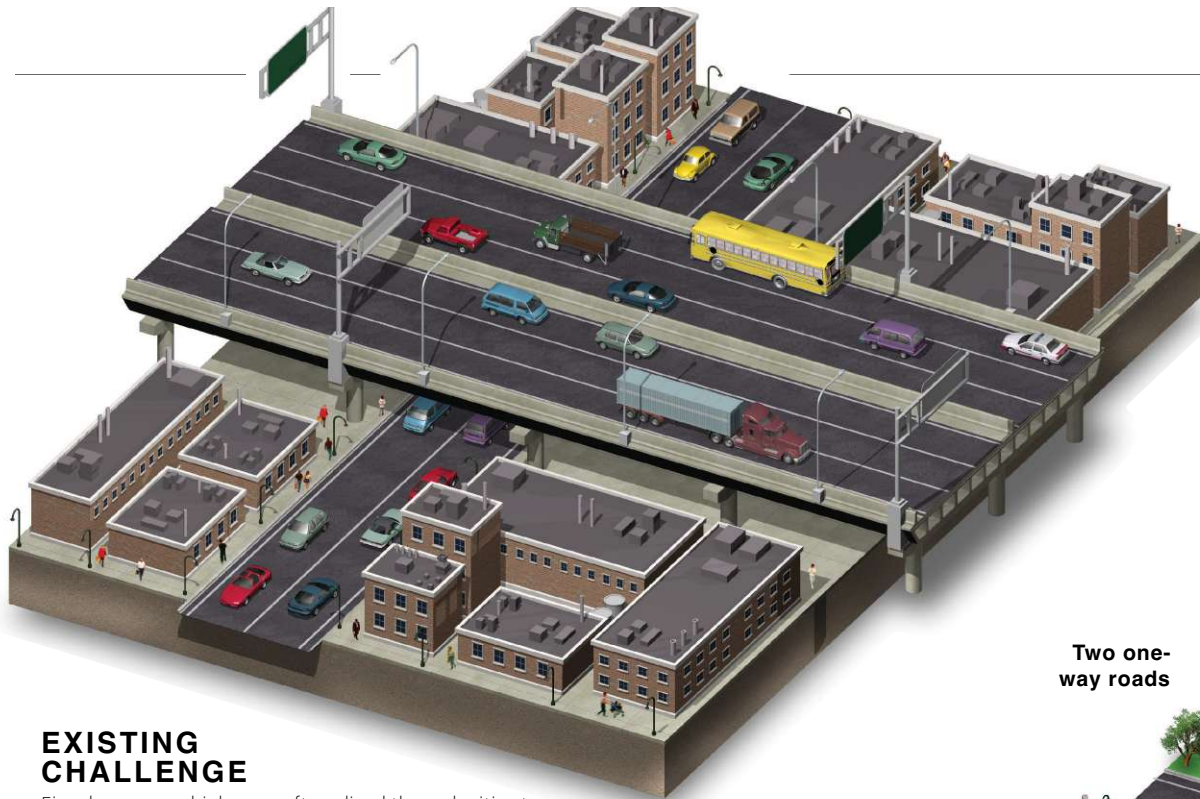

EXISTING CHALLENGE

Eisenhower-era highways often sliced through cities to improve commerce. As cities grow denser, planners and architects are rethinking this arrangement between where we live and how we get around.

committee of the I-81 Challenge, a group formed by the New York State DOT and Syracuse Metropolitan Transportation Council that seeks public participation in the planning process.

“So far, the I-81 Challenge has not given us much information, so it is difficult to see what their proposal might look like,” Biancavilla says. But he points out that if the road were rebuilt to meet modern highway design standards, it would consume much more land than it does now.

One local group, the Onondaga Citizens Group, created a proposal that would replace some of the highway with an urban boulevard. Biancavilla is cautious. “I’m not 100 percent that this is the best and only solution. I am open to the process of investigation,” he says. According to the I-81 Challenge website, alternatives will be presented sometime in 2012 and design could begin sometime in 2015.

The **McGrath Highway** (Route 28) and train tracks carved up Somerville, Mass., some years ago, effectively isolating the Inner Belt and Brickbottom districts. Cleared years ago for urban renewal, much of the vast tract of land is today occupied by light industrial buildings, artists’ lofts, and some housing. Considering its proximity to Cambridge, the area is underutilized and development potential is severely curtailed by the highway.

Goody Clancy is working on developing a strategy guide and infrastructure plan for the city of Somerville. David Dixon, FAIA, principal for planning and urban design at Goody Clancy, says, “Relocating the McGrath, rail, and other infrastructure to grade would make the area a transit-oriented district and set up the development of 8 to 12 million square feet of lively mixed-use development. It is a very important place to accommodate research growth for Kendall Square, where they are running out of room.”

Dixon says that this would bring businesses and new residents

Two one-way roads

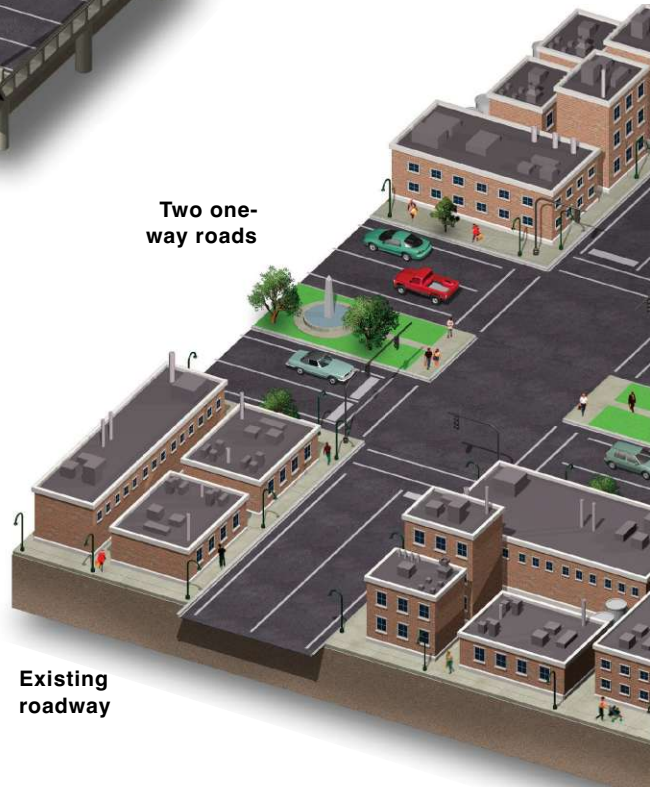

Existing roadway

to the town. “Somerville needs new jobs, and Boston is running out of urban sites like this. So removing the highway unlocks all kinds of opportunities.” Goody Clancy will complete the strategy guide about a year from now.

For some years, Goody Clancy has also been leading the development of a proposal that has now been accepted by the Connecticut Department of Transportation regarding Hartford’s heavily trafficked **Interstate 84**. Here, a viaduct has for many years separated the downtown from historic neighborhoods and the employment centers of Asylum Hill.

“In this case, the solution is not to remove a section of I-84, but to deck over a section of it that will be depressed below grade. We would relocate a train track, and create a connection from one side to another,” Dixon says. “It is fully doable and actually costs a fraction of replacing the highway. The project will open up 15 to 20 acres of choice real estate that could accommodate up to 1 million square feet of urban development.” According to Dixon, the city of Hartford and Connecticut DOT will soon announce that they have accepted the preferred alternative that came out of this lengthy planning process.



Even gateway cities sometimes suffer from fractured urban planning, leaving us to wonder if they're really gateways. St. Louis's all-volunteer citizen's brigade City to River seems to: Its members advocate replacing a 1.3-mile section of I-70 known as **Memorial Drive** with an urban boulevard, says Dustin Bopp, AIA, of Bopp Architecture in St. Louis and secretary of AIA St. Louis.

Memorial Highway's below- and above-grade segments separate downtown from the Jefferson National Expansion Memorial Gateway Arch, completed by Kevin Roche John Dinkeloo and Associates (KRJDA) in 1965, four years after the untimely death of its designer, Eero Saarinen, FAIA. Advocates for removal say that rerouting I-70 over a new Mississippi River bridge now under construction north of downtown will significantly reduce traffic within two years of

says. "I just can't imagine it would be that much of an inconvenience to travel on a boulevard for five minutes."

MOVING RIGHT ALONG

American infrastructure's advanced state of deterioration also converges with issues such as the high cost of driving, trends toward the resettling of urban areas, and economic development. "People have choices," says Philip Enquist, FAIA, partner in charge of urban design and planning for SOM's Chicago office. "Some [people] want to live in great urban environments. Highways are just one part of it. The bigger idea is making cities healthy, vibrant, walkable places. We basically sold our soul and great cities lost their quality to accommodate fast-moving cars."

For San Francisco architect and 2011 AIA President Clark Manus, FAIA, who has spent nearly two decades advocating for intelligent land-use policies in the wake of San Francisco's Embarcadero Freeway removal, successful cities change over time, and solutions have to be about the long view. "Cities evolve over long periods," Manus says, "and change gives architects the opportunity, as citizens, to step into the community dialogue and articulate what makes cities unique." **AIA**

Learn more at aia.org.



**Wide
parklike
median**

BOULEVARD SOLUTION

Highway removal doesn't always have to mean less connectivity. Boulevards that encourage multimodal options can keep cars moving as well as bicycles, pedestrians, and even light-rail trains.

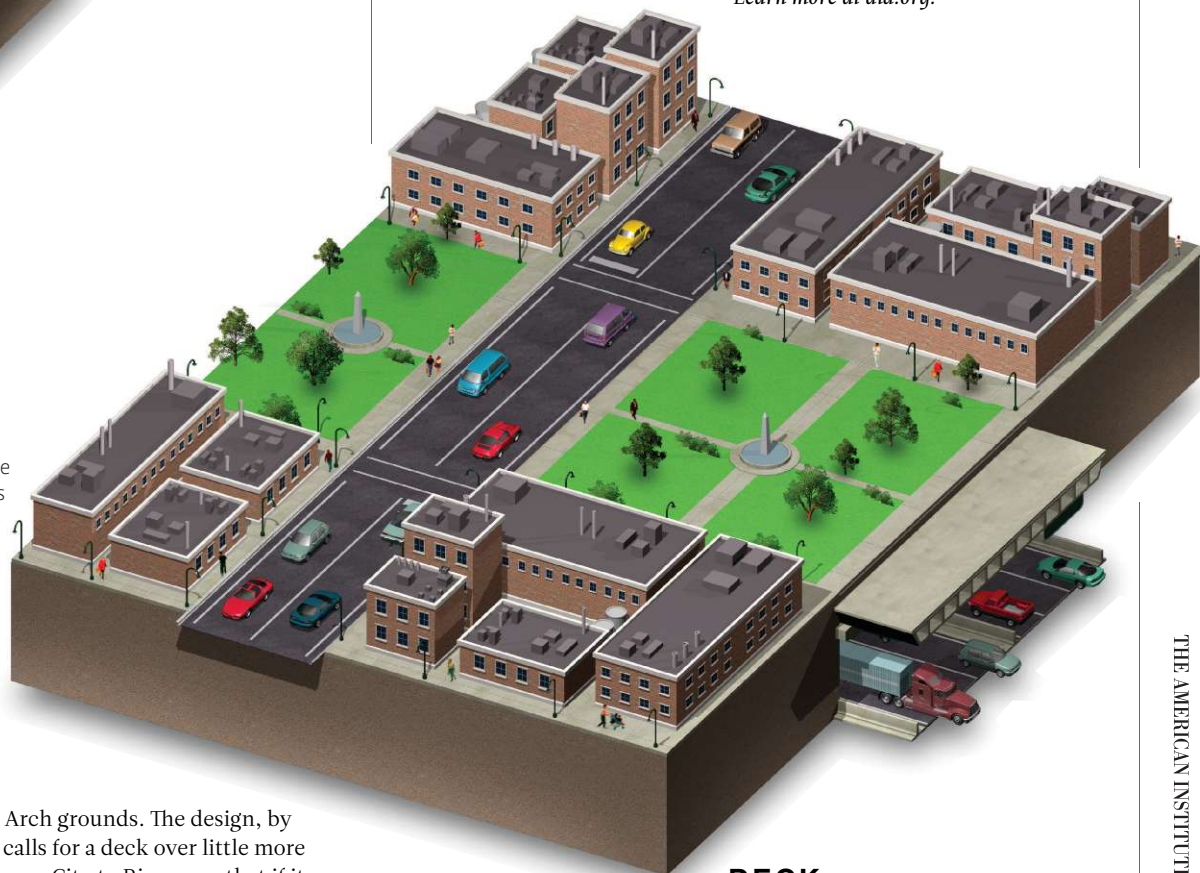

DECK SOLUTION

In cases where highway removal would do more harm than good by disrupting circulation, many cities have opted to push fast-moving traffic underground, creating more place-making opportunities above.

the reconstruction of the Gateway Arch grounds. The design, by Michael Van Valkenburgh, FASLA, calls for a deck over little more than a block of the depressed highway. City to River says that if its alternative boulevard proposal were adopted, about a half million square feet of real estate would be recovered from the Memorial Highway right-of-way.

"The opportunity has arisen to make something extraordinary. There are those that contend it will destroy the traffic flow," Bopp

AIAPERPECTIVE

BEYOND WRINGING ENDORSEMENTS



PHOTO: WILLIAM STEWART

Design can help us make the most of our natural resources.

IF YOU'RE AMONG THE SHRINKING CROWD WHO STILL READ the daily paper in print, you might have seen the "Declaration of Energy Independence" advertisement that appeared this past summer. Below the headline, the copy read: "It's time our nation's engine was fueled from within." How? By breaking OPEC's "38-year stranglehold on America."

Yet is the road to energy independence the one proposed by the energy companies—biofuels and hydraulic fracturing—the only (or even the best) route to take? Will additional acreage devoted to corn and fracking truly make our nation more secure? As an architect, I'm not convinced.

Last month's Perspective column was written in the shadow of the 10th anniversary of 9/11. My point was that the physical security of the built environment is a matter about and for design thinking. In this issue of *ARCHITECT*, with its focus on sustainability, I want to carry that line of thinking further: If energy independence is key to America's security—and I believe it is—then here, too, design thinking is surely relevant. We can and should boldly say that to achieve energy independence, the architect's role is at least as important as those who drill or plow the land.

Making the case for sustainability and managing energy use in the built environment has tended to focus on virtue ("It's the right thing to do") and a promise ("The initial investment in sustainable design will pay off in the long run"). Both arguments have achieved limited results. Now, powerful voices have emerged from two sectors—economics and science—underscoring the AIA's call for an integrated and designed approach to how we shape our communities and regions.

The Great Recession lately has exposed the downside of business as usual. We have seen the economy and our work stall every time the price of energy jumps. An economy that lacks the resources to pay firefighters, police, and teachers—let alone construction workers—doesn't strike me as a favorable precondition for a more secure country.

Buildings consume 40 percent of our nation's energy. Getting a handle on that not only lessens our dependence on imported or manufactured sources of energy, it's good for the economy. It's no small irony that tight budgets have focused the attention of our clients, led by our nation's cities, to embrace sustainability as a sure way to save money.

In addition to the cost of energy that comes in a barrel or pipe, there's the matter of the

residue—the pollution. This is where science comes in.

The cover of a recent issue of *The Economist* (May 28–June 3, 2011)—not exactly a forum for wild liberal ideas—displayed this headline: "Welcome to the Anthropocene." The argument inside was straightforward and blunt: For the first time in history, man is a coequal with nature in determining the future of the planet. The magazine cited the pumping of carbon dioxide into the atmosphere and nitrogen fixing in the oceans as a consequence of the rise in the world's population and the demand of emerging nations for the luxuries of America and Western Europe, a point noted by Thomas L. Friedman last May in New Orleans. These are not idle theories; they're facts.

Living in a climate shaped by human activity will no doubt produce a few winners (a wine industry in Canada, perhaps), but the larger disruptions triggered by natural disasters and famine in an increasingly interconnected world pose risks to national security far greater than the actions of terrorists. Just this past spring and summer, our nation's most productive agricultural land (and, not so incidentally, a source of biofuels) has experienced the double blow of unprecedented flooding and drought, this at a time when the recovery of our economy is so fragile.

Shaping the places for human habitation that are more secure because of their sustainability is the great challenge of the 21st century. As a nation, we would be better qualified to serve as global leaders not by exploring ways to wring new sources of energy out of the Earth, but rather in focusing our human energies on charting a sustainable future for the planet by design. **AIA**

Clark D. Manus, FAIA, 2011 President

➔ Join our conversation at aia.org.

THE NATURE OF INSPIRATION

At ground level lie fields of plenty. But from your perspective above you may see a profusion of patterns, design ideas. At VT we have abundant resources to help you realize your dream. VT Heritage and Artistry doors offer virtually endless options for design expression, plus exceptional performance. VT doors are produced with our exclusive edge-before-face method creating a continuous flush appearance. VT stile and rail can be completely customized by panel configuration, sticking, and veneer. With VT as your partner, you'll discover that when inspiration hits, we're there.

©2011 VT Industries, Inc. All rights reserved.

**Architectural
Wood Doors**
INDUSTRIES

VTDoors.com 1-800-827-1615 (ext. 512)



Time is money. Don't throw it away.



ARCAT has created the most extensive specification library to save you time and to save you money. All of the ARCAT specifications are written and updated by ARCAT's expert, CSI credited specwriters.

900+ Manufacturer specs
300+ Generic short form specs

**NO REGISTRATION
FREE!**

300+ Generic outline specs
800+ Automated SpecWizard®'s



ARCAT[®]
www.arcat.com

Circle no. 430 or <http://architect.hotims.com>

BUSINESS

→ BEST PRACTICES

Do Good

DAVID ROCKWELL'S PROJECTS RUN THE GAMUT—AND NOT ONLY IN THE COMMERCIAL ARENA. ROCKWELL DISCUSSES HIS FIRM'S PRO BONO BONAFIDES AND HOW FIRMS CAN BEST LOVE THEIR NEIGHBORS AS THEMSELVES.

INTERVIEW BY ERNEST BECK
PHOTO BY SIOUX NESSE

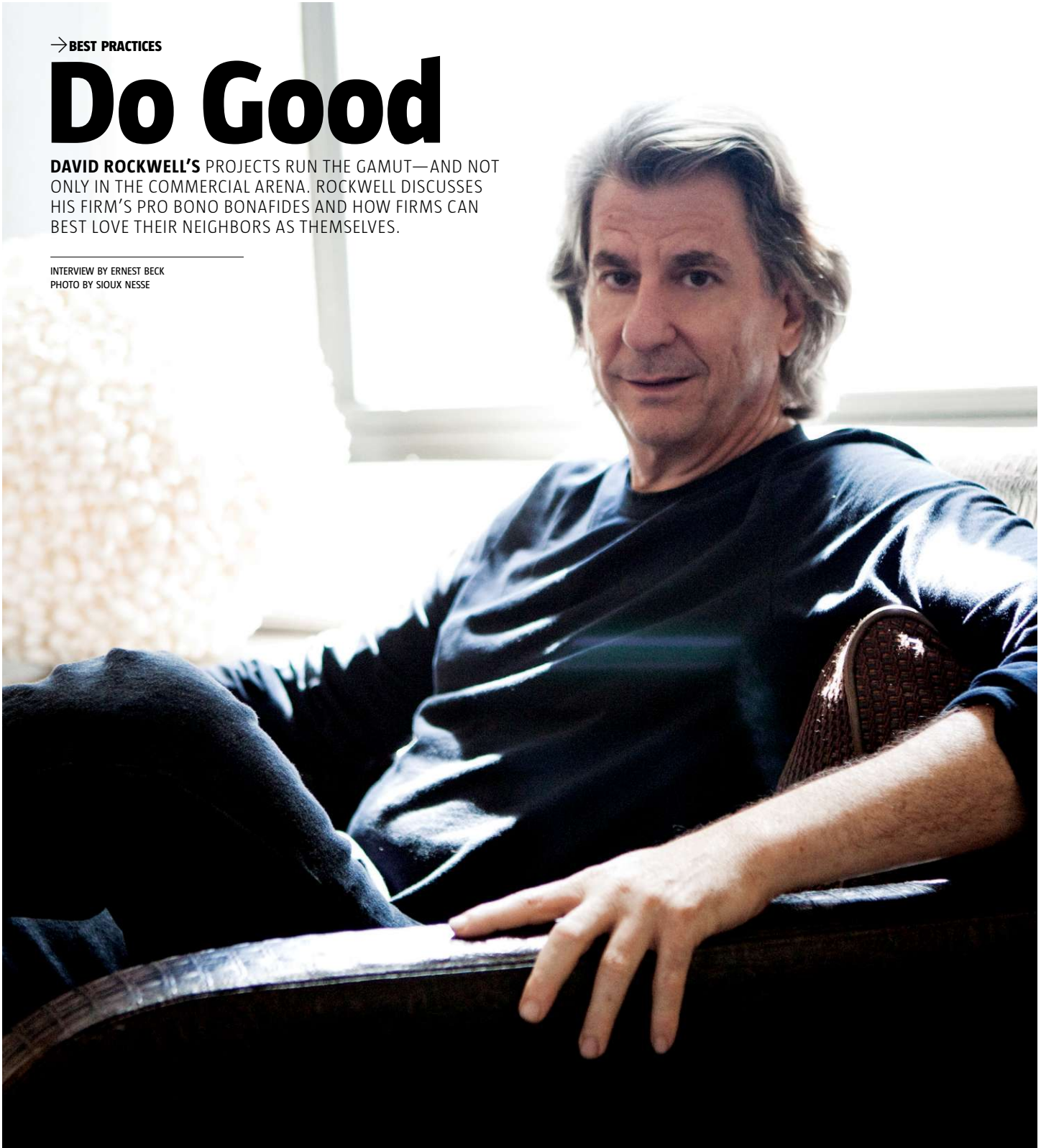



AS FOUNDER and chief executive of the New York-based Rockwell Group, David Rockwell, 55, presides over a 140-person firm engaged in wide-ranging assignments, from theatrical designs for Broadway shows and the Oscars telecast to more traditional design and architecture assignments in hospitality and retail. Rockwell and his staff still find time for a raft of pro bono projects—long-term work that underscores their commitment to serving the community. They have designed school libraries, mobile food trucks, and New York City's widely acclaimed Imagination Playground, among many other projects. Rockwell talks to ARCHITECT about the power of pro bono and the best way that firms can carry the torch of doing good.

“THE IMAGINATION PLAYGROUND WAS TOTALLY OUR IDEA. WE SAID, ‘LET’S SEE WHAT PLAYGROUNDS MIGHT LOOK LIKE IF THEY WEREN’T BURDENED WITH WHAT THEY LOOK LIKE NOW.’ ... IT WAS LIKE AN URBAN BARN-RAISING.”

Find a place for pro bono.

Architects can have a bigger impact on society. They can make a difference by using the power of creativity to help others—specifically, through unbillable hours. So figure out how to find the time, Rockwell says, and integrate that into how the studio operates.

Make it real.

There are many opportunities for pro bono, he believes. Sometimes you are approached about projects that grab your attention. Or you go out and find a cause. But choose a project that affects you most deeply. “Make sure it is tangible and relevant to you and has a personal connection,” Rockwell says. “You usually don’t have to look very far to find that. It’s hard to imagine you are more than two steps away from something that matters. For example, we work with Citymeals-on-Wheels, which delivers meals to people in need. I am not in such a situation, but if you live in New York it’s easy to see people who are.”

Do it yourself.

Launch your own pro bono effort, Rockwell suggests. “The Imagination Playground was totally our idea. We said, ‘Let’s see what playgrounds might look like if they weren’t burdened with what they look like now.’ That grew out of a project we did for a kids’ school in Lower Manhattan after 9/11, when they had to move to a temporary building,” he says. “It was like an urban barn-raising, an opportunity to directly do something we knew how to do when we weren’t really motivated to do anything else.”

Share the tasks.

In the studio, as many people as possible work on pro bono projects, collaborating with outside architects and designers, artists, and commercial and nonprofit organizations. Up to eight people can be engaged at one time on anything from graphic design to architecture. Pro bono isn’t a specialty in the firm, he explains, but a part of the process of what everyone is doing.

Cast a wide net.

Take on projects at different scales and time frames that best use the skills of your staff, Rockwell says. “For one Taste of New York annual benefit, our contribution was designing a projection screen made up of hundreds of laser-cut paper plates. For the Robin Hood foundation, we are one of many firms designing school libraries. The playground took five years to complete.” A variety of projects ensures that more staff can bring their strengths to the table, he explains.

Commit to the long haul.

Dedicate studio time to pro bono causes for the long term rather than taking on too many one-off projects, Rockwell says. Longer collaborations allow studios to include more people in the work. Become engaged in organizing, management, and fundraising. “I have worked with the Design Industries Foundation Fighting AIDS’s Dining by Design event since 1994,” Rockwell says. “That started after my brother died from the disease. It was a very difficult loss for me. Our contribution helps them physically create events to raise money.”

Don’t benchmark the bottom line.

There’s no quantifying the benefits of working pro bono. “It has to have its own heartbeat and reason why you are participating,” Rockwell says. “For me, it reinforces the reasons why I wanted to do creative work to begin with. Do as much as you can.” Public Architecture’s 1% program—in which architecture firms commit to dedicating 1 percent of their working hours to pro bono service—is a solid start. “But I don’t want that to be the ceiling. That should be the floor. We do way more than 1 percent.”

Spread the word.

Pro bono work is needed now more than ever. “It has an incredible impact not only on you and your firm and those you are reaching out to but also the industry and other professionals. It is critical for designers to give back,” Rockwell says, “and by participating in pro bono work you encourage others to do the same.” □



PLUG AND PRINT.

Printing your work doesn't have to be work. Plug in a USB drive and print directly. Plug into the Internet and print remotely, via smartphone or laptop. Say good-bye to drivers. Preview projects on the color touch screen. And design without interruption.
hp.com/go/simplify

INTRODUCING THE
WEB-CONNECTED
HP DESIGNJET SERIES

HIT PRINT
INTELLIGENTLY



©2011 Hewlett-Packard Development Company, L.P.
Internet connection is required.

Circle no. 450 or <http://architect.hotims.com>

CALL FOR ENTRIES

The **P/A Awards** recognize unbuilt projects that demonstrate overall design excellence and innovation.

COMMERCIAL CULTURAL GOVERNMENTAL MULTIFAMILY HOUSING HEALTH-RELATED SINGLE-FAMILY HOUSING INDUSTRIAL RECREATIONAL RELIGIOUS URBAN DESIGN

59th Annual P/A Awards

Judging will take place in November 2011. Winners will be notified in December 2011 and published in the February 2012 issue of ARCHITECT, and honored at a ceremony in New York the same month.

Eligibility

Architects and other design professionals practicing in the United States, Canada, or Mexico may enter one or more submissions. All entries must have been commissioned by paying clients for execution. Proposals may be for any location, but work must have been directed and substantially executed in offices in any one of those three countries. Projects may not have been featured in other national design publications. All entries must have been commissioned for compensation by clients with the contractual intention and the authority to carry out the submitted proposal. Projects must have a completion date after January 1, 2012.

Fees

First Entry: \$195

Subsequent Entry: \$150

Late Fee: \$50

Deadlines

Regular: October 28, 2011 (registration and postmark deadline)

Late: November 2, 2011 (registration and postmark deadline, additional \$50 fee per entry)

For more information

e-mail: paawards@architectmagazine.com

Register at paawards.com

CSI—Solutions that Work on the Job

Start the discussion at CSI's Booth #624



“It wasn't until I joined CSI that I really started understanding building materials, construction technology, and the process of getting something built. Every successful building is the result of a team effort. CSI is where I get to know my teammates.”

—Daniel Hargreaves, CSI, CDT, RAS



“The biggest benefit that I have received from CSI is the recognition of professionalism from others in the industry. I am continually called upon by the design community for advice relating to contracting and bid procedures.”

—Richard Cooper, PE, CSI, CDT, General Contractor

“CSI is one of the best organizations in terms of value, education, and contribution to the profession.”

—Hooman Aryan, CSI, CDT

“Whether it's at a CSI chapter meeting, at a region conference, or in a phone conversation, CSI members are the go-to resources for what I need to do my job better.”

—Ann G. Baker, RA, CSI, CCS, SCIP, LEED AP

**Enhance your career—do your job better,
faster and more economically with CSI.**

**Visit www.csinet.org/joinCSI
or call 1-800-689-2900
to connect with construction professionals
through CSI.**

Circle no. 31 or <http://architect.hotims.com>



The Construction
Specifications Institute
110 S. Union Street, Ste 100
Alexandria, VA 22314
800-689-2900
www.csinet.org

→ TYPOLOGY

Community

COMMUNITY COLLEGES FACE UNPRECEDENTED DEMAND AND BUDGET CHALLENGES. HOW DOES DESIGN SERVE HIGHER EDUCATION'S FASTEST-GROWING SECTOR?



TEXT BY JENNIFER CATERINO

Allied Health & Sciences Center • Valley Glen, Calif. • Co Architects
Opened in September 2008, the three-story, 98,000-square-foot facility boasts 131 new rooms, energy-efficient heating and cooling systems, rooftop photovoltaics, and energy-efficient lighting.

THE NATION'S FIRST public community college, Joliet Junior College in Joliet, Ill., was founded in 1901 as an experimental postgraduate high school program. It would be safe to say that the experiment was a success. More than a century later, nearly 1,200 community, technical, and junior colleges operate in the U.S., educating some 11.5 million students per year, according to the American Association of Community Colleges (AACC).

Today's community colleges serve three distinct missions, says Deborah Shepley, AIA, community college practice leader at HMC Architects, based in Irvine, Calif. One mission is to provide basic-skills instruction to help students succeed, whether they are at the community college, looking to transfer, or acquiring skills for the workforce; another mission is to provide lower-division education to support those who want to transfer to four-year universities; and lastly, they aim to provide workforce training. Community colleges need to be all things to all people—even as they have ever-decreasing resources to offer.

Keeping Up With California

At the center of the community college conversation is California. With 72 districts and 112 community colleges serving 2.9 million students per year, it is the largest higher-education system in the nation.

California also leads in sustainable facilities. The U.S. Green Building Council (USGBC) reports 31 LEED-certified community college projects in the state, and that number is rapidly rising. When the Los Angeles Community College District (LACCD), for example, wraps up its \$6 billion Sustainable Building Program in 2014, it anticipates that it will add 87 projects to that tally. Furthermore, in May, Butte College in Oroville, Calif., became the country's first grid-positive college by producing more clean energy from on-site solar power than it consumes.

But all is not golden in California. Despite growing demand—enrollment has increased 44 percent over the



REIMAGINE METAL



COMMAND PERFORMANCE

When the script calls for a high performance building envelope enclosure, metal delivers. CENTRIA's innovative, single component Formawall[®] Dimension Series[®] insulated metal panel provides protection from air and water penetration, along with maximum thermal performance — all in one component. Multiple aesthetic options are also yours — Formawall may be installed vertically or horizontally, can create running bond patterns and is easily curved for projects worthy of a standing ovation. Learn how metal can turn in an outstanding performance for your next project at

centria.com/reimaginemetal | 800.229.5427

Circle no. 25 or <http://architect.hotims.com>



Scan the QR Code with your smart phone to view the Performing Arts Center at Kent State Tuscarawas project gallery and learn about the CENTRIA products selected.



CENTRIA

REIMAGINING THE BUILDING ENVELOPE

ISIS[®]

A Ceiling Fan That Actually Works.



BIG

Isis uses its immense size, aerodynamic airfoils and uncompromised engineering to create a wall to wall breeze. In fact, this air moving machine does the work of 9 small ceiling fans while using just 1/3 of the energy.

BOLD

Although it's whisper quiet, Isis makes a bold visual statement about a commitment to sustainable design. Unlike gear-driven fans, the effect of Isis is seen and felt - not heard.

PROVEN

"In terms of indoor air quality and energy reduction, we viewed Big Ass Fans as a golden opportunity. We didn't necessarily specify the Big Ass Fan for aesthetics, but it turned out to be the centerpiece of the project."

- Jason Gamache,
Architect / Sustainability Coordinator
McCool Carlson Green



 **BIG ASS FANS**
No Equal.

(877) BIG-FANS | WWW.BIGASSFANS.COM



Ask how Big Ass Fans contribute to LEED[®] credits in:
Optimized Energy Performance; Enhanced Refrigerant Management;
Minimum Indoor Air Quality Performance; Increased Ventilation;
Thermal Comfort - Design; Innovation in Design

May be covered by one or more of the following U.S. Patents: 6,244,821; 6,589,016; 6,817,835; 6,939,108; 7,252,478; 7,284,960; D587,799; D607,988 and other patents pending. ©2011 Delta T Corporation dba the Big Ass Fan Company. All rights reserved.

Circle no. 165 or <http://architect.hotims.com>

business



Allied Health & Sciences Center • The lab and office wings frame the facility's central courtyard (above). The center's landscaping features a stormwater-retention system, while a solar canopy shields students from the elements.

past 15 years—the community college system shrunk by 4.8 percent between 2009 and 2010 due to state budget cuts. Over the same period, course reductions led the state to turn away 140,000 students, according to California Community College chancellor Jack Scott.

The predicament caused when demand exceeds resources extends beyond California, says Phyllis Grummon, director of planning and education at the Society for College and University Planning in Ann Arbor, Mich. Though she cites Indiana's Ivy Tech Community College system as an exception, Grummon says that many states, including Arizona, Florida, Texas, and Nevada, are struggling with reduced resources.

"Higher education benefits by recessions," she says. "More people want to attend, but access is the problem. Not everyone can get in, and those enrolled can't always [graduate] when they want to."

According to the AACC, enrollment isn't the economy's only casualty. Though the organization reports that community colleges are the fastest-growing segment of higher education, budgetary stress has put pressure on capital expenditures.

With many campuses completed during the 1960s and '70s, the nation's community colleges are in need of facility renovations and upgrades. But from Oregon to Florida, schools are putting off projects.

"I don't know of any community college that doesn't have deferred maintenance right now," says Grummon—who adds that it's easier to get a new building than to maintain an existing facility.



Pet Project

North Carolina State University - Randall B. Terry, Jr. Companion
Animal Veterinary Medical Center - Raleigh, NC
Architect-of-Record: Joint Venture - Iova/Daniels/Busby Architects
& Small Kane Architects
GC: New Atlantic Contracting, Inc.
Roofing Contractor: Jedco Construction, Inc.
Profiles: SNAP-CLAD™ Roofing, 7.2 Rib Panels, PAC Continuous
Cleat Coping, Flush & Reveal Panels
Custom Colors: Veterinary Green, Warm Silver

See us at
METALCON!
Booth 614



University tops Veterinary Medical Center with PAC-CLAD® Metal Products.

- 65,000 sq. ft. of SNAP-CLAD™ Metal Roofing Panels & 7.2 Rib Panels
- 10,000 sq. ft. of Reveal Panels
- 5,500 ft. of PAC Continuous Cleat Coping used to finish it off
- Multiple options and applications for these adaptable products
- All done in custom colors

Our PAC-CLAD® Kynar 500® finish, covered by a non-prorated 20 year warranty, is now available in 38 colors on steel and aluminum. Most colors meet LEED®, ENERGY STAR® and cool roof certification requirements.

NEW Cool Metal Roofing AIA/CES Course @ www.PAC-CLAD.com!

Circle no. 470 or <http://architect.hotims.com>



WWW.PAC-CLAD.COM | IL: 1 800 PAC CLAD
MD: 1 800 344 1400 | TX: 1 800 441 8661
GA: 1 800 272 4482 | MN: 1 877 571 2025



Grasspave²

grass porous pavement



Circle no. 400 or <http://architect.hotims.com>

business



Allied Health & Sciences Center • Five departments were consolidated in the center, which was the first new academic building constructed on the 1950s-era campus as part of an institution-wide initiative to modernize LACCD facilities.

Accounting 101

One boost for facility renovation and modernization came from the American Recovery and Reinvestment Act, passed in February 2009, which included \$53.6 billion in state fiscal-stabilization funds. But subsequent legislation, such as the Student Aid and Fiscal Responsibility Act of 2009 (SAFRA), failed to live up to expectations. When passed by the House of Representatives in September 2009, SAFRA promised \$2.5 billion in modernization funds for community college facilities. By the time it was included as part of the healthcare bill in March 2010, those funds had been stripped from the legislation.

Other financing mechanisms, such as general-fund apportionments, state and local bonds, and property taxes, vary by region. "It depends on an area's local and state funding policies and how much the state values community colleges," Grummon says.

A recent study suggests that some communities could value them a little more. A September 2010 report from the AACC found that despite the fact that community colleges educated 43 percent of the nation's undergraduate students in the 2007–08 academic year, they received just 27 percent of total federal, state, and local revenues for public degree-granting institutions over the same period.

Some districts have tried to close the gap by raising student fees, but even that doesn't guarantee increased resources. California, for example, recently raised student fees by \$10 per unit—a move expected to generate \$110 million in resources for community colleges. But the state concurrently slashed \$400 million in general-fund support, leaving California community colleges with a net base reduction of \$290 million for the 2011–12 academic year.

Similar balancing acts are being tested at community colleges across the country. In Flint, Mich., Mott Community College recently raised tuition to compensate for flat state aid and reduced projected property tax revenue, while the Community College System of New Hampshire recently approved a 7.7 percent tuition hike following a severe drop in state funding.



Reynobond[®]

Architecture



Cleaner buildings. Cleaner world.

Imagine a world where buildings can clear the air while they clean themselves. Thanks to the innovative science behind Reynobond[®] with EcoClean[™], architects can now design structures that literally make our environment cleaner. Reynobond with EcoClean actively works to remove smog and other pollutants by using sunlight, water in the air and oxygen to break down organic matter. When it rains, instead of beading up, water will flatten and sheet off on both horizontal and vertical surfaces. As water collapses and runs evenly off the building, organic matter is taken away.

Alcoa Architectural Products developed this proprietary process that leverages HYDROTECT[™] technology from TOTO[®] to apply a titanium dioxide coating, called EcoClean, to the pre-painted aluminum surface of Reynobond. This photocatalytic coating destroys organic pollutants in a reaction with UV light. The result is the world's first coil-coated aluminum architectural panel that helps to clean itself – and the air around it.

Cleaner air, a cleaner building and lower maintenance costs: another example of Excellence in Innovation from Alcoa Architectural Products to change our world for the better. Find out more at reynobondwiththecoclean.com.



Alcoa Architectural Products • 50 Industrial Boulevard • Eastman, GA 31023-4129 • Tel. 800 841 7774 • reynobondwiththecoclean.com

©2011 Alcoa Architectural Products. Reynobond[®] is a registered trademark of Alcoa Inc. EcoClean[™] is a trademark of Alcoa Inc. TOTO[®] is a registered trademark of TOTO LTD. HYDROTECT[™] is a trademark of TOTO LTD.

Circle no. 507 or <http://architect.hotims.com>



Old Administration Building • Fresno, Calif. •
 ELS Architecture and Urban Design
 Voters approved funding to restore the 1916 building, which was named to the National Register of Historic Places in 1974 and re-opened in 2011.

Is your roofing material cracking under the elements?



Use your QR code reader to get the facts or visit www.vinylroofs.org/compare

You want a tested and trusted roofing material – not one that cracks under pressure. Why specify roofing materials that age prematurely, unable to withstand the elements? Roofing membranes should perform for decades – **are you settling for less?**

Circle no. 77 or <http://architect.hotims.com>



Steve Ngo, a San Francisco–based attorney and member of the San Francisco Community College District Board of Trustees, says that acquiring funds specifically for the physical build-out of space is a complicated process. “We can seek non-state funding, including bonds and private money; we can ask the state to pay for it [through statewide bond propositions]; or we can use a combination of the two, which is most likely,” he says.

Schools that do find themselves in the position to fund a new facility at the same time that they face pressure to enact layoffs may encounter scrutiny, Grummon says.

“Funds that support people and buildings are different,” she says.

Diversifying With Auxiliary Services

Across the country, community colleges have tried to regain economic footing by increasing efficiencies, differentiating their campuses to make them more marketable to students, and capitalizing on new revenue streams.

The Middle College High School, located on the Los Angeles Southwest College campus, exemplifies the growing trend to develop joint-use facilities as one way to increase efficiencies. Working with the LACCD and the Los Angeles Unified School District, HMC Architects is designing a permanent Middle College facility on the community college’s campus to maximize shared resources. Previously, the high school operated in portable classrooms on the campus.

Other community colleges are providing on-campus housing—an emerging trend that reflects the changing needs served by community-college education. According to the AACC, on-campus housing is available at 254 public and 62 independent community colleges. In California, residence halls sit on 11 community college campuses, and the concept continues to gain traction nationwide. In Rochester, N.Y., five dormitories serve Monroe Community College, while in Key West, Fla., this fall, students at Florida Keys Community College will be the first residents of the school’s new Lagoon Landing facility, a 100-bed, waterfront residence hall.



BUILD A MORE ENERGY EFFICIENT HOME WITH ZIP SYSTEM® SHEATHING



By significantly reducing air leakage, ZIP System® wall sheathing contributes to greater comfort and energy efficiency in a home. By simply taping panel seams with ZIP System™ Tape, ZIP System® wall sheathing effectively seals the wall system, decreasing unwanted air leakage into and out of the home. This helps protect the R-value of insulation,** which reduces heating and cooling costs.* With a revolutionary built-in weather resistant barrier, ZIP System wall sheathing eliminates the need for housewrap and is the only all-in-one solution that delivers the strength and durability of engineered wood while sealing out air and water.

For a rebate or to find a retailer please visit www.zipsystem.com/arch



FROM THE CREATORS OF ADVANTECH® FLOORING



*Savings vary - see zipsystem.com/energyefficiency for details.
**Flotkoetter, Brent. "ZIP System® wall sheathing and energy performance" November 2008.

© 2011 Huber Engineered Woods LLC. ZIP System, the accompanying ZIP System logo and design are trademarks of Huber Engineered Woods LLC. Huber is a registered trademark of J.M. Huber Corporation. Patents Pending. HUB11-03/11

Limitations and restrictions apply - visit zipsystem.com for details.

Circle no. 527 or <http://architect.hotims.com>

Building site courtesy of Miller & Smith.



“I DON’T KNOW OF ANY COMMUNITY COLLEGE THAT DOESN’T HAVE DEFERRED MAINTENANCE RIGHT NOW,” SAYS PHYLLIS GRUMMON—WHO ADDS THAT IT’S EASIER TO GET A NEW BUILDING THAN TO MAINTAIN AN EXISTING FACILITY.

ARCHITECTURAL HARDWARE

MANUFACTURED BY C.R. LAURENCE COMPANY

Entrances • Storefronts • Curtain Walls • Window Walls
Hurricane Resistant Systems • Sun Control Products



C.R. Laurence is Proud to Announce the Acquisition of

**United States
ALUMINUM**



CRL™



A wealth of experience coupled with the large selection of architectural aluminum products enables you to design, create and build with complete confidence!

usalum.com

10 LOCATIONS NATIONWIDE

Phone Toll Free (800) 262-5151 from anywhere in the United States and Canada for the address of the U.S. Aluminum location near you, or go to the usalum.com.

CRL

An ISO 9001:2008 Certified Company

C.R. LAURENCE COMPANY

crlaurence.com | Worldwide Manufacturer and Supplier

Glazing, Railing, Architectural, Construction, Industrial, and Automotive Supplies

JAB330-8/11



Housing helps a school attract nonresident and international students, Grummon says. Furthermore, providing auxiliary services such as dorms and cafeterias can have a positive impact on a school’s bottom line. These services don’t only need to be self-supporting, she says; they need to turn a profit.

On-campus housing is just one way that schools are differentiating themselves to court selective students.

When Co Architects designed Los Angeles Valley College’s Allied Health & Sciences Center, the college didn’t have the funding for a spacious lobby. So the firm designed an exterior walkway that connects the center’s two three-story buildings and serves as a “great outdoor room.” Shielded by a solar canopy, the outdoor plaza features teaching gardens, an outdoor classroom, and a stormwater-retention pond. “We covered the courtyard with a solar array to generate electricity, but there was a double benefit—it could serve as a lobby,” says Andrew Labov, AIA, a principal at Co Architects. (The LACCD and the original contractor, FTR International of Irvine, have since become engaged in a court dispute over the construction of this building and other recent projects.)

At MiraCosta College in Oceanside, Calif., HMC Architects, which is also working with 34 other California community colleges, is finalizing a comprehensive master plan that would transform the campus into a typical four-year university environment—which Shepley describes as more collegiate, with an advanced interest in sustainability.

“We are developing the campus to cater to transfer students—to look like a four-year college more than a community college, not just in buildings, but through quads and other public spaces,” Shepley says.

Staying Flexible

Transfer students aren’t the only ones being sought after by community colleges. The AACCC and the Association of Community College Trustees reports that international students at community colleges increased by 57.9 percent between 1993 and 2003. And in the 2007–08 academic year, non-U.S. students made up 6 percent of the nation’s community college population. Consequently, some community colleges are adding facilities to appeal to students seeking intensive English language education.

With English as a Second Language (ESL) students numbering more than 5,000, Westchester Community College in Valhalla, N.Y., educates more ESL students





GREEN PROMISE IS THE NEW STANDARD.

All of our Green Promise products meet or exceed
the industry environmental testing standards.

www.benjaminmoore.com/thenewstandard



Benjamin Moore
Paints

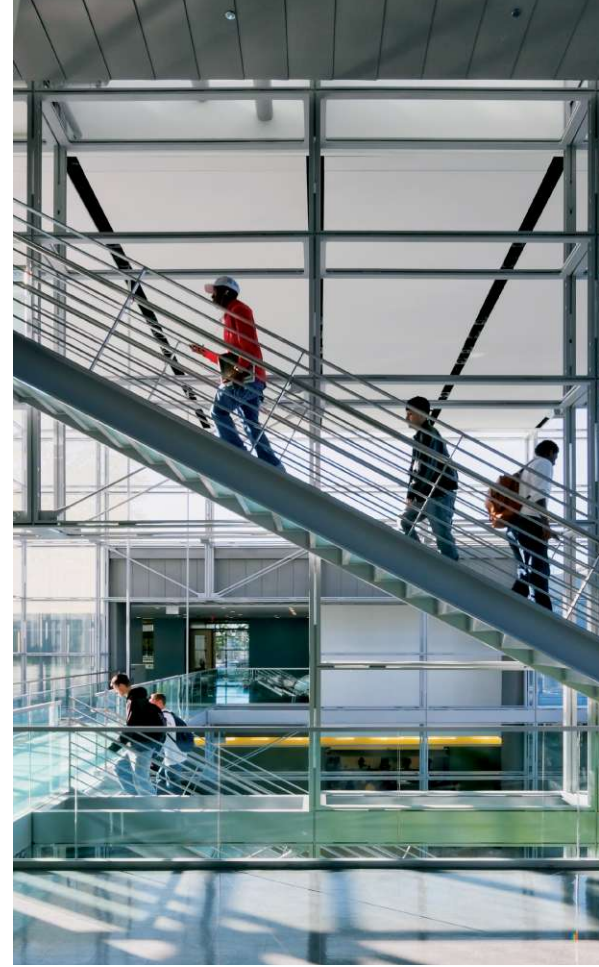

 An advertisement for Cascade Coil Drapery. It features a central image of a casino bar with a curved, illuminated wire mesh drapery in shades of blue and purple. The bar has blue chairs and a dark countertop. Surrounding this central image are three smaller inset photos showing the same bar from different angles and with different color schemes (red, purple, and pink). In the top left corner, there is a logo consisting of two interlocking loops and the text "CASCAD COIL DRAPERY".

Ameristar Casino

Plays well with decorative lighting

Woven Wire Fabric

Projects include multi-story wire mesh draperies for hotels, auditoriums, and casinos; curved dividers for visual merchandising; window treatments for private homes; safety & blast mitigation screening; sculptural forms for urban gardens; decorative interior/exterior wall coverings; solar shading for buildings and parking garages; aviary screening for animal habitats, and see-through appealing barriers for commercial security. Whatever the application, let us help you realize your creative vision.

www.cascadecoil.com | 800-999-2645

Circle no. 81 or <http://architect.hotims.com>



than any other educational institution in the county. Responding to this demand and the county's increasing diversity, the school partnered with New York-based Polshek Partnership (now Ennead Architects) to design the 70,000-square-foot Gateway Center. The LEED Gold facility, which was completed in 2010, serves as a welcome center for the entire campus as well as the college's English Language Institute and the Professional Development Center.

According to Shepley, community colleges, especially workforce training programs, need to stay in tune with the labor market for both U.S. and international students.

Whereas community colleges once primarily trained criminal justice workers, emergency medical technicians, and firefighters, hiring practices have shifted. Community colleges now emphasize green technology and allied health professions—especially training for licensed practical nurses, Grummon says. Curricula and facilities have followed suit.

While many schools across the nation offer training in sustainable- and alternative-energy technology, Omaha, Neb.-based Metropolitan Community College made news when it partnered with IBM in 2009 to

offer green-data-center management degrees. The program is supported by a new academic data center on the school's Fremont Area campus, but all courses in the green-data-center management track are offered online so that remote students can gain the same skills as those on campus, including virtual access to the physical data center itself.

More and more schools are adding distance-learning components like Metropolitan's to their curriculums, Shepley says. And the AACCC projects that the future of community colleges includes a greater emphasis on such options. As public funding continues to diminish, technology is expected to give schools the ability to confer more degrees to more students without expanding their physical campuses. However, distancing learning may be used for hybrid situations in which a student might complete a portion of the coursework online and then come to the campus for discussions or lab work.

Shepley doesn't worry that online courses are going to make community college campuses obsolete. "Online education helps schools reach more people, helps [achieve] growth when you don't have space," Shepley says. "But that doesn't mean you need less space." □

The Gateway Center for English as a Second Language • Valhalla, N.Y. • Ennead Architects
The Westchester Community College building, which is situated at the eastern entrance of the school's campus, is defined by two wings that contain a green courtyard and meet in a glass lobby and welcome center.

JEFF GOLDBERG/ESTO

20 Years - 0 Wall Failures!

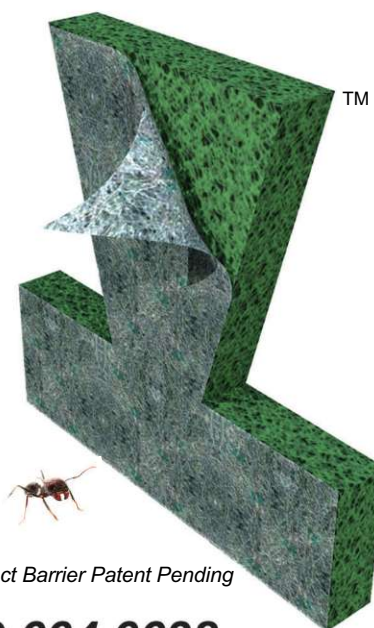

Insect Barrier Patent Pending

800.664.6638
MortarNet.com

Makers of Mortar Net® with Insect Barrier™, TotalFlash®, Blok-Flash®, BlockNet®, HouseNet®, Stone & Stucco Drain™, & Mortar Net® Weep Vents™

Mortar Net®
NOW with Insect Barrier™!
Visit our website and update your specs!

The ORIGINAL Mortar Collection Device

- Insect Barrier™ provides another layer of protection inside the wall cavity
- Breaks mortar up on 2 levels - patented & proven
- Update your specs today
- Manufactured with recycled content
- Will not promote rot, mold or fungus nor react with common materials
- UV resistant

Call today for information & samples

Mortar Net®
USA LTD.



TEXT BY LINDSEY M. ROBERTS
PHOTO BY IAN ALLEN

→ Q&A

Career Sampler

MAINE ARCHITECT **DEAN BINGHAM** GOT CREATIVE IN A STUBBORN ECONOMY AND NOW RUNS A SIDE BUSINESS AS A CHOCOLATE-TRUFFLE MAKER.

SOMETIMES, IT PAYS TO HAVE TWO JOBS. After practicing architecture for 35 years, Dean Bingham, AIA, started to sell hand-dipped, dark chocolate truffles in 2004. Bingham lives in Maine, a state with a population of only 1.3 million, where having two sources of income ensures good times during bad economies. Bingham, 65, had already tasted variety in the field of architecture, designing houses, hospitals, zoos, and libraries. His foray into chocolate-making led him to open Dean's Sweets, a boutique retail store in Portland. Now Bingham earns

recognition for work in two fields: A church-to-restaurant conversion won an AIA Los Angeles 2011 Restaurant Design Award, and his confections were voted best chocolate by local newspaper *Portland Phoenix* this year.

How and why does one choose a side business?

I was looking for something else to do in addition to architecture. I had a business coach who I talked





200,000 YEARLY TOUCHES. WITH ZERO YEARLY TOUCH UPS.

Enhance the aesthetics and durability of your high-traffic areas with the most comprehensive line of high performance coating solutions available. With a longer life cycle and less maintenance required, Sherwin-Williams' Pro Industrial Line is the ideal choice for any commercial, educational, healthcare, hospitality or light industrial facility. And with 3300 stores and 1500 reps, fast local access to products and service is just around the corner.

Call 800-321-8194 for product and compliance information or visit www.swproindustrial.com for more information.

Circle no. 217 or <http://architect.hotims.com>





with many times over a number of months, and of the possibilities that I looked at, one was making chocolate and one was making ice cream. I was already making both things, but not formally. The chocolate fell into place in part because it was more portable and a little less equipment intensive.

Then about six years ago, I started a website, had a couple of orders from organizations that wanted good chocolate, and decided to get licensed for a home kitchen. Suddenly, we had this baby we had to take care of. It's been an organic process of growth; we weren't trying to expand dramatically in one direction, either by buying lots of equipment or hiring lots of people, but growing as our sales grow and also trying not to borrow money. We opened the shop in the fall of 2008, which was what I like to call the top of the bottom. We had a pretty good sense of what we were getting into.

We enjoyed your lemon apricot chevre and Maine sea salt caramel truffles. Do you only use dark chocolate? Primarily, we make chocolate truffles, and we use only dark, because I think that's one thing that I like, and I felt like that's what everyone else should like, plus it's healthier and better for you. But we keep getting requests for milk chocolate or white chocolate, so we have a couple that have white or milk chocolate centers. They're basically undecorated. I feel that the chocolate

piece is kind of related to design and I like to keep things simple and let their inner beauty show. Chocolate is well-tempered so it shines and has a crisp quality to it.

What does making chocolate add to your life that architecture doesn't?

I had been doing architecture for 35 years and I was feeling like I needed to spread my wings a little bit. There's always a little frustration in architecture with recognition, having people appreciate your work. The great thing about chocolate is that it's almost instantaneous feedback. You don't have to wait for a year or five years for your client or customer to appreciate it. ... I enjoy the design aspect of design, and creating projects and buildings and happy clients, but in terms of business, chocolate is kind of a happy business. There's a fun aspect.

Many people running two businesses would feel harried. How do you maintain a balance?

I'm doing less architecture now partly because there's less there, but also because the chocolate business has been taking up more of my time. ... It's not hard to balance both. We tend to work fairly long hours and, as I tell people who come into the shop, it's actually traditional in Maine to pursue more than one vocation at the same time. Part



4.7

PERCENT AVERAGE OF UNEMPLOYED MANAGERS AND EXECUTIVES WHO STARTED THEIR OWN FIRMS IN 2010, DOWN FROM 8.6 PERCENT IN 2009—THIS IS THE WEAKEST START-UP ACTIVITY SINCE TRACKING BEGAN IN 1986.

SOURCE: CHALLENGER, GRAY & CHRISTMAS

ALL POWER TO TECHNO- LOGY

YES, WE CHOOSE SPANISH CERAMIC

Yes, we choose Spanish ceramic tiles because of the constant technological innovations, the modern designs and the industry's commitment to the environment. In an increasingly competitive marketplace the Spanish ceramic tile industry's distinguishing feature is its boundless creativity and ability to innovate.

Tile of Spain, a quality product that brings you new trends, applications and architectural uses to create spaces with a more human dimension. Why don't you go for Spanish tiles too?

Tile of Spain - Trade Commission of Spain Voice: 305 446 4387 F: 305 446 2602 miami@mcx.es www.tileofspainusa.com



tile of spain®

Circle no. 385 or <http://architect.hotims.com>



Sustainability – it's serious business.

CertainTeed Gypsum is committed to preservation of natural resources, recycling, waste management, and reclamation in our operations.

We are part of Saint-Gobain, the world's largest gypsum wallboard manufacturer. Our innovative, sustainable building materials can contribute to the built environment's indoor environmental quality, acoustics management, fire resistance, and materials recycled content.

To see how sustainability suits you, visit: www.CertainTeed.com/Sustainable



800-233-8990 • www.certainteed.com

ROOFING • SIDING • TRIM • DECKING • RAILING • FENCE • FOUNDATIONS
GYPSUM • CEILINGS • INSULATION • PIPE

CertainTeed
SAINT-GOBAIN

Circle no. 242 or <http://architect.hotims.com>

“I LIKE TO DO BUILDINGS THAT STAND UP WELL AND LOOK BEAUTIFUL AND MEET THE OWNERS’ AND CLIENTS’ EXPECTATIONS. SO I HAVE PRETTY HIGH EXPECTATIONS FOR WHAT CHOCOLATE SHOULD BE FOR VISUAL EFFECT AND TASTE.”



of it's economic. If you don't have a lot of business in one business, you do something in another one. If one thing goes south, you've still got backup. It helps keep us sane and happy and employed.

Since the truffle business is booming for you, do you think you'll ever stop practicing architecture?

I'm 65. As you probably know, architects don't seem to retire. Look at Philip Johnson; at 98 he was still practicing. We seem to last longer than other people and maybe it's the creative thing that keeps us going. I'll probably keep doing architecture for years to come. I like both. You develop passions and you run with them.

You have 42 total years of experience in architecture. Do you think that makes you a better chocolatier?

I think I'm fussy. For one thing, I like things to turn out the way that I visualize them to be. I like to do buildings that stand up well and look beautiful and meet the owners' and clients' expectations. So I have pretty high expectations for what chocolate should be for visual

effect and taste. I find for some reason—it may be my design background—that when I do new flavors, I seem to be able to balance flavors without doing 50 different samples. ... Both architecture and chocolate are design, so that's a significant relationship between the two. I think that gives me a leg up on some people who are only chefs or chocolate makers because I get that the visual and the quality piece is part of the requirement.

We have to ask, have you considered naming your chocolate after architects?

That for some reason has never come up. Partly because we keep our names pretty related to the flavor. Maybe it would be different if somebody said, well Philip Johnson loved “X,” and that would be a good place to start. Architects tend to be male more often than female, and guys are not as often excited about chocolate as women. Maybe what I need to do is see what Zaha Hadid likes and name some after her, find some famous women architects who are chocolate freaks. We also talked at one point about making one of our boxes a little house, which would be kind of cool. □



Found on some of the best addresses in the world



DORMA Americas is a leading global manufacturer of premium access solutions that enable better buildings. Our full range of products and services provides safety and security as well as convenience and comfort. DORMA features a design-oriented portfolio of architectural door hardware, specialty hardware for glass door and wall applications, door automation systems including Crane Revolving Doors, and operable wall systems featuring Modernfold.



See us at **Greenbuild 2011 – Booth 6314**, visit www.dorma-usa.com, or call **866.401.6063**

THE CFR INSULATED METAL ROOF: ENERGY WISE. EARTH FRIENDLY. BUDGET BRILLIANT.

Visit Our Booth #6547
Greenbuild 2011



Designing with a CFR insulated metal roof isn't just about being green. It's also about saving green. Its superior insulation values help lower energy costs by saving money every day for 40 years or longer, leaving a cleaner environment for future generations. And a CFR roof goes up in one step, cutting installation time (and cost) in about half compared to typical metal roof systems. That's why Metl-Span roofs are a brilliant way to support environmental responsibility — and restore budgetary harmony. Call 877-585-9969 or visit our website for more information.

PIONEERING INSULATED METAL PANEL TECHNOLOGY



METLSPAN.COM



ENERGY STAR® designation is valid in the U.S. only.
METL-11-020 ©2011 Metl-Span LLC - A BlueScope Steel Company. All rights reserved.

Circle no. 208 or <http://architect.hotims.com>

Think about CFR Insul-Solar.™
Our complete energy-producing
standing-seam roof system.

→ STRATEGY

Retro Grades

BENCHMARKING LAWS GOING INTO EFFECT IN SOME OF AMERICA'S LARGEST AND MOST PROGRESSIVE CITIES POINT TOWARD A NEW INDUSTRY IN RETROFITTING EXISTING BUILDINGS FOR COMPLIANCE—AN INDUSTRY THAT SOME ENTREPRENEURIAL FIRMS INTEND TO CORNER.

TEXT BY FRED A. BERNSTEIN

SEVERAL YEARS AGO, I wrote about a commercial building whose lighting designer had struggled to keep energy use low. The designer explained the painstaking process of creating an engagingly luminous lobby while following strict maximum-wattage codes developed by the American Society of Heating, Refrigerating, and Air-Conditioning Engineers and adopted by New York State.

BENCHMARKS IN BENCHMARKING

SEATTLE → OCT. 1, 2011

Buildings 50,000 square feet or larger must report energy ratings starting next month. Buildings 10,000 square feet or larger will follow on April 1, 2012.

AUSTIN → JUNE 1, 2012

Nonresidential buildings 75,000 square feet or larger must report energy ratings by June 1, 2012, with compliance dates for smaller buildings set for 2012–13.

SAN FRANCISCO → OCT. 1, 2011

Nonresidential buildings 75,000 square feet or larger must begin benchmarking next month, with smaller buildings following a staggered schedule in 2012–13.

D.C. → OCT. 1, 2011

Many buildings 200,000 square feet or larger must begin benchmarking next month, with reporting dates for smaller buildings cascading in 2012–14.

Yet the lobby was lit up like an operating room. The owner, apparently hoping to attract tenants, was keeping the lights on a special, high-intensity setting—designed solely for nighttime clean-up crews—around the clock. What it illuminated best was the gap between the designer's intentions and the owner's practices.

In the debate about how to make America's buildings greener, there is one thing everyone seems to agree on: Designing buildings in order to conserve energy isn't enough. It's essential that buildings' actual energy use, post-occupancy, be measured and disclosed.

Happily, cities and states are taking the first steps toward requiring building owners to measure their properties' energy use, and, in some cases, to make the results public. So far, five cities and two states have passed laws requiring energy benchmarking (that is, determining how a building compares to similar structures) and periodic energy audits. New York City was the first out of the gate. Under Local Law 84, the owners of 16,000 properties larger than 50,000 square feet (both commercial and multifamily) had to submit their energy data to the city by Aug. 1.

Next up is San Francisco, where some buildings must submit benchmarking data starting Oct. 1. The city's ordinance complements a California state law that will require owners to disclose energy use when selling, leasing, or financing nonresidential buildings. Similar laws will soon take effect in Austin, Texas; Washington, D.C.; and Seattle (where a Washington State law is already in place), according to Andrew Burr, director of the Building Energy Rating Program of the Institute for Market Transformation.

These new benchmarking rules—even in their early stages, with compliance dates still mostly months or years off—already apply to far more buildings than have been certified by the LEED program over its 13-year history, according to Burr. That not only means great things for conservation but for architects who are poised to evaluate and modify existing buildings. Barry Hooper of the Private Sector Green Building Program in San Francisco's Department of the Environment said that some 70 percent of owners who conduct energy audits will take action to improve their buildings when appropriate incentives are in place.

So far, the laws require little more than simple calculations and data entry. Benchmarking is facilitated by the U.S. Environmental Protection Agency's Energy Star Portfolio Manager, which relies on a national database of buildings' energy consumption compiled in 2003 by the Energy Information Administration.

But architects may use mandated energy reviews—benchmarking as well as the more involved auditing process—to prove their value to potential clients. "If you build an intimate knowledge of an organization and a



Zero.



What's zero?

It's "net zero." That's the goal for NASA's Sustainability Base in California. This project is designed to use no more energy than it creates. And MechoSystems plays a key part in helping regulate daylight and lighting-energy use.

NASA chose MechoSystems for a project intended to be as self-sufficient as a lunar base. Imagine what we can do for projects a little more down to earth.

Circle no. 521 or <http://architect.hotims.com>

 **MechoSystems**
Design with light.™

T: +1 (800) 437-6360

F: +1 (718) 729-2941

W: mechosystems.com

media@mechosystems.com

mechosystems.com

Design architect: William McDonough

+ Partners, architect of record: AECOM



CALIFORNIA → JAN. 1, 2012

Buildings 50,000 square feet or larger as well as single-occupancy buildings 1,000 square feet or larger must disclose benchmarking information at the time of sale, lease, or financing as of Jan. 1, 2012 (schedule subject to change).

WASHINGTON → JAN. 1, 2011

Buildings 50,000 square feet or larger must report energy ratings now; buildings 10,000 square feet or larger will follow on April 1, 2012.

→ building, when the owner needs other services, you'll be in the best position to provide them," says Nash Hurley, AIA, of San Francisco's Vital Environments. An architect who has worked for SHoP Architects and Perkins+Will, Hurley formed Vital with Taylor Keep, a mechanical engineer, and Ian Kelso, a structural engineer, to provide retrofitting and other services to building owners.

The firm rejects the traditional building model, in which an architect's role ends when the client moves into the building. That's not just bad for the

environment—"How do you deliver performance if you don't even know the guy who's running the facilities?" Keep says—but it's bad for architects, who could be exploiting new opportunities. The new San Francisco ordinance, for example, requires that, once every five years, owners of buildings larger than 50,000 square feet perform ASHRAE Level II audits. The auditors must list potential capital improvements and identify potential costs and savings. To achieve that, Vital expects to get to know the building and its occupants and understand the owner's business strategy.

"If we get 200 benchmarking jobs, and 20 lead to further engagement, and five of those lead to actual building projects, we'll be happy," Hurley says.

For one client, Vital undertook a three-month study that involved not only examining building systems but interviewing employees about their energy consumption and how it helped (or didn't help) them do their jobs. You can only save so much energy by making changes to the buildings, Hurley and Keep explain. The rest requires working with building occupants.

In Washington, D.C., the D.C. Clean and Affordable Energy Act of 2008 requires large commercial and multifamily buildings to make their energy consumption



HUMIDIFY
+ Purify
BEAUTIFY



Humidifall

ARCHITECTURAL HUMIDITY SOLUTIONS
& INDOOR WATERFALL SYSTEMS

www.humidifall.com | 877.884.4776

Circle no. 546 or <http://architect.hotims.com>



age gracefully

stainless steel for long-lasting beauty



scan this code with your smartphone to easily find the right fastener for your job

When you think about fasteners, aging gracefully is not necessarily the first thing that comes to mind. But maybe it should be. Many fasteners will rust and degrade over time. The secret to maintaining long-lasting beauty is stainless steel. It's naturally corrosion resistant and less likely to stain your building materials. Simpson Strong-Tie offers a wide array of top-grade stainless-steel fasteners that are durable, reliable and truly beautiful.

Choose fasteners that age as gracefully as your designs. Learn more by visiting www.strongtie.com/fasten or by calling (800) 999-5099.

Circle no. 182 or <http://architect.hotims.com>



®

NYC → AUG. 1, 2011

Buildings 50,000 square feet or larger must now report energy ratings; another citywide law requires energy audits and retro-commissioning every 10 years.

SOURCE: INSTITUTE FOR MARKET TRANSFORMATION GUIDE TO STATE AND LOCAL ENERGY PERFORMANCE REGULATIONS. SUMMARIES OF BENCHMARKING REGULATIONS ARE NOT COMPREHENSIVE.

→ public. And there in D.C., global architecture firm HOK has been reaching out to former clients, including the 100 or so for whom it has completed LEED-rated buildings over the past decade. Proving that even large firms can be nimble, HOK is offering to provide energy auditing and benchmarking services.

"We take a life-cycle approach to buildings," says Anica Landreneau, Assoc. AIA, a senior associate and the sustainable design practice leader in the firm's Washington office. "We like to stay in contact with our clients, and let them know that we're always around."

Among those clients is the Nature Conservancy, which occupies a 12-year-old HOK building in Arlington, Va. The conservancy is considering applying for LEED Existing Building certification—a designation introduced in 2004 and revamped in 2008—with HOK guiding it through the process. At another building, the Nationals Park baseball stadium, completed by HOK Sport (now

Populous) in 2008, the firm gives "green tours" of the stadium, positioning itself as the expert on not just how the building was designed, but on how it functions.

Of course, helping owners obtain LEED-EB status is a job to which architects can do much more of, says Gunnar Hubbard, AIA, an architect and energy consultant based in Portland, Maine. His firm, Fore Solutions, has helped Vornado Realty Trust, one of the largest property owners in Manhattan, obtain LEED-EB status for 10 of its properties, including the vast One Penn Plaza and Two Penn Plaza office towers. The process involved everything from working with cleaning crews to establish green protocols to creating a website on which building occupants are required to post their own energy use for Vornado, and other tenants, to see.

Hubbard hopes that the public reporting will have a "Prius effect," meaning that tenants will want to show off their good energy stats. For building owners motivated by profit as well as the desire to do good, energy efficiency reduces operating costs. The lower its energy bills, the more a building will command at resale.

As buildings age, energy prices rise, and benchmarking laws take effect, architects will benefit. Some more so than others. "It's an important part of our business model," says Hurley. "It's what's going to make us a success in the next couple of years." □

Classic Design Contemporary Interpretation

The classic design of classic table designs. Our custom-sized Parsons base is now available in three finishes!

TLPAR is made to your size, up to 60" x 60" and shipped unassembled, ready for your own glass, marble or wood top. Tube size is 2" square. Non-adjustable glide. Three finishes, Light Satin Aluminum, Dark Satin Aluminum and Black Satin Aluminum.



Light Satin Aluminum
Credenza



Dark Satin Aluminum
Cocktail Table



Black Satin Aluminum
Dining Table/Desk

"FINE ARCHITECTURAL HARDWARE FOR YOUR FINE FURNITURE"®

MOCKETT

DOUG MOCKETT & COMPANY, INC

www.mockett.com • 800-523-1269

Circle no. 516 or <http://architect.hotims.com>

TRUE, NOTHING LASTS FOREVER.

BUT A FOLLANSBEE ROOF GETS PRETTY CLOSE.

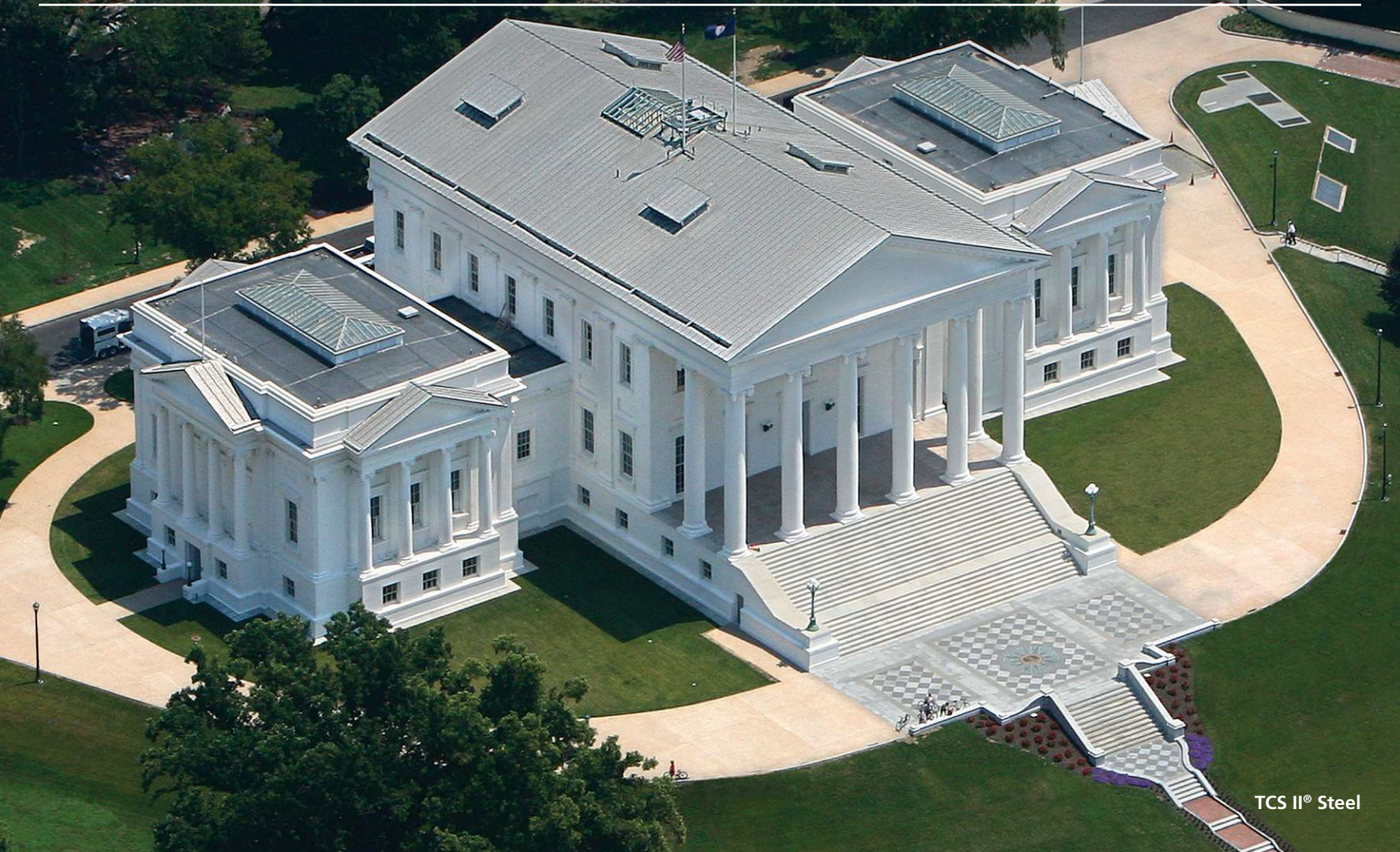

TCS II® Steel

Follansbee's patented alloying is what makes this unpainted steel roof as equally permanent as the building it protects.

follansbeesteel.com 800-624-6906

Circle no.32 or <http://architect.hotims.com>



The Best Roof Money Can Buy™

NEW PROJECTS

1. GRANGE INSURANCE AUDUBON CENTER
Architect: Design Group, Columbus
Total Cost: \$5.1 million
Completion: 2009

2. OHIO STATE UNIVERSITY COLLEGE OF PUBLIC HEALTH
Architect: Jonathan Barnes Architecture and Design, Columbus
Total Cost: \$24 million
Completion: August 2011

3. BUGGYWORKS AUTHENTIC URBAN LOFTS
Architect: WSA Studio, Columbus
Total Cost: \$12.9 million
Completion: 2008

MARKET STATS

0.86

EXPANSION INDEX VALUE, COLUMBUS METRO AREA

The Expansion Index from Reed Construction Data is a 12- to 18-month look ahead at the construction marketplace. A value of 1.0 or higher signifies growth.

SOURCE: REED CONSTRUCTION DATA

1,836,536

METRO POPULATION, 2010

SOURCE: 2010 U.S. CENSUS

2,020,442

PROJECTED METRO POPULATION, 2020

SOURCE: OHIO OFFICE OF POLICY RESEARCH AND STRATEGIC PLANNING

7.5%

UNEMPLOYMENT, MAY 2011

SOURCE: OHIO LABOR MARKET INFORMATION

24,096,659 S.F.

CLASS A OFFICE INVENTORY

SOURCE: XCELIGENT

10.2%

VACANCY RATE FOR CLASS A OFFICE SPACE, JULY 2011

SOURCE: XCELIGENT

6,185

COMMERCIAL BUILDING PERMITS ISSUED THROUGH MAY 2011

SOURCE: COLUMBUS DEPARTMENT OF BUILDING AND ZONING SERVICES

→ LOCAL MARKET

Columbus, Ohio

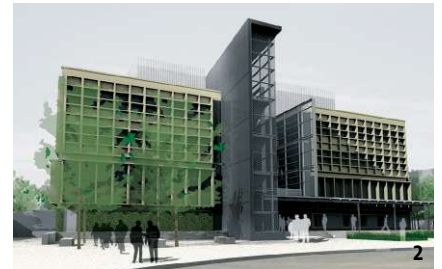

TEXT BY MARGOT CARMICHAEL LESTER AND CLAIRE PARKER

THERE'S MORE TO DISCOVERY CITY than the Buckeyes. Columbus, Ohio, may be home to Ohio State University, with the largest college campus in North America, and certainly a major driver of design and development in the city. But several smaller colleges and universities, as well as research institutions such as the Batelle Memorial Institute and Chemical Abstracts Service, also call Columbus home. Not to mention the major corporations headquartered in the city, including Abercrombie & Fitch, Nationwide Insurance, and NetJets.

"The city's economy is not reliant on a single industry," says A.J. Montero, Assoc. AIA, partner with NBBJ's local office. "As a result of this diversity, and that it is the seat of state government and a hub of higher learning, the city has seen steady growth and resilience in the face of recessions."

Perhaps as a result of this diversity, the economic outlook in Columbus is good—or at least not grim. In 2010, Moody's Analytics projected an 0.83 percent compound annual growth rate for employment in the Columbus Metropolitan Statistical Area over the next 10 years. "The Columbus city and region currently have an unemployment rate more than a percentage point lower than that of the U.S.," says Susan Merryman, Columbus Chamber of Commerce vice president for marketing and communication. "The projected growth will have positive impacts in terms of real estate development and real amenities."

Most of the new activity will be downtown—an area that has suffered as suburbs have drawn residents and businesses away. "City zoning codes have embraced greater density and infill development, and incentives

have been offered to encourage urban housing," says Jonathan Barnes, AIA, principal at Jonathan Barnes Architecture and Design.

New projects in center-city Columbus have already sparked such development. Nationwide Arena opened in 2000 to house a National Hockey League expansion franchise; the anchor for the Arena District, the project has lured thousands of jobs and more than \$630 million in investments to the area, according to Ohio State researchers. The Buggyworks lofts project, in which a former carriage-making factory was rehabbed into a 120,000-s.f. mixed-use facility, was funded in part by a tax-abatement program for adaptive reuse of downtown buildings. Another insurer, Grange Insurance, sponsored the Audubon Center, an urban ecology and bird study center near downtown. The LEED Gold building features millwork with recycled content, natural daylighting, and a vegetated roof.

Architect Michael Bongiorno, AIA, principal and senior designer for local firm Design Group, finds city officials easy to work with. "At the zoning level, while there is significant public input and dialogue required, the climate is pretty development friendly when compared to other cities," he says. "The building department's turnaround time is fair to good."

The additions in downtown Columbus haven't come at the cost of the city's noteworthy Midwestern charm. Columbus may be evolving through architecture, but it's not changing, according to Tim Hawk, AIA, president of the local firm WSA Studio. "That's refreshing. That Columbus attitude makes me want to come into the studio each and every day." □

The Upside of Tension

C
A
M
B
R
I
D
G
E
A
R
C
H
I
T
E
C
T
U
R
A
L

Cambridge mesh installs under tension with elegant attachments pre-engineered to minimize structural connections and maximize coverage.



C
A
M
B
R
I
D
G
E
A
R
C
H
I
T
E
C
T
U
R
A
L

CAMBRIDGEARCHITECTURAL.COM
866-806-2385

Circle no. 24 or
<http://architect.hotims.com>

Eclipse™ Tensioned
Attachment Hardware

RENEW



Bancorp South Building, Biloxi, MS
Contractor/Applicator:
FL Crane & Sons, Inc.

*EIFS installed over the white
painted brick from an earlier
renovation returned the
structure to its original beauty.*



ENHANCE THE DESIGN.

SAVE ENERGY.

SPEND LESS.

IMPROVE AESTHETICS.

INCREASE VALUE.

EXTERIOR INSULATION

& FINISH SYSTEMS.

WWW.EIMA.COM

EIFS

ENGINEERED FOR PERFORMANCE
DESIGNED FOR RENOVATION

EIMA EIFS INDUSTRY
MEMBERS
ASSOCIATION

Circle no. 98 or <http://architect.hotims.com>

TECHNOLOGY



→PRODUCTS

Roofing

A component of American Hydrotech's extensive garden-roof system, **GardNet** is composed of strips of 0.5"-thick polyethylene sheet that are connected by offset, ultrasonic welded seams. When expanded, the strips form a series of 13" by 10.5" cells that can hold growing medium for a garden roof in place on surfaces that slope up to 45 degrees. GardNet is available in 3", 4", 6", 8" and 12" depths and in sections of up to 34 cells. • hydrotechusa.com • Circle 100

TEXT BY KATIE GERFEN
PHOTOS BY NOAH KALINA

Deck Defense is a high-performance roof underlayment from **Owens Corning**. Engineered for asphalt, tile, and metal roof assemblies, the material comes in 4'-wide rolls. Each roll has 250' of underlayment. Suitable for use in residential, multifamily, and some light commercial applications, the durable synthetic construction resists tearing and acts as a secondary water-shedding barrier. • owenscorning.com • Circle 101

EnergySmart roofing from **Sika Sarnafil** is a family of thermoplastic PVC roofing membranes that have an initial solar reflectance of 0.83. The G140 membrane has integral fiberglass mat reinforcement and can be used in an adhered system; S327 membranes have an integral polyester scrim and are for use in mechanically attached applications. EnergySmart roofing is produced in 5' and 10' widths. • usa.sarnafil.sika.com • Circle 102

EverGuard is a collection of single-ply thermoplastic polyolefin roofing membranes from **GAF Materials Corp.** Available in 45-, 60-, and 80-mil (shown) thicknesses, as well as in an Extreme option that has higher heat and UV protection, the roofing provides a reflective white surface to help minimize heat gain in buildings. EverGuard is suitable for mechanically attached, fully adhered, or blast-applied applications. The membrane is Title 24 compliant and Energy Star and UL listed. • gaf.com • Circle 103

Firestone Building Products offers several cool roof membranes, including **RubberGard EcoWhite Platinum EPDM** (top) and **UltraPly TPO SA** (bottom). EcoWhite Platinum is 90-mil-thick bilaminate (white on top, black on bottom, shown), and comes in 10'-wide seamless panels for fully adhered applications. UltraPly TPO SA self-adheres, with a factory-applied, pressure-sensitive, hot-melt adhesive. It is available in 45- and 60-mil thicknesses, and in 6.25'- and 10'-wide rolls. Both products can contribute to LEED points. • firestonebpco.com • Circle 104



Todd Evans

LEED AP BD+C

Project Architect
Black & Veatch Corporation



“Having the LEED AP BD+C credential put my resumé at the top of the pile during my job search, and I was hired within a month.”

Learn how Todd's **LEED AP Building Design + Construction** credential sets him apart at www.gbci.org/Todd.

Circle no. 191 or <http://architect.hotims.com>



→ POST-OC

Dashboard Confessional

THREE VIEWS ON MONITORING SYSTEMS AND THE PROMISE THAT DASHBOARDS HOLD FOR DESIGN.

TEXT BY BRIAN LIBBY
ILLUSTRATIONS BY PETER ARKLE

Even simple dashboard readouts tell a driver how much fuel a car is consuming. Yet with buildings—which account for vastly greater energy usage—only now are technologies such as energy-monitoring systems and dashboard-style readouts coming into custom. Few buildings today display up-to-the-moment resource usage. But the three architects interviewed here envision a future in which reading a building's energy data on a laptop, mobile device, or wall-mounted display will be as easy and commonplace as glancing down at the fuel gauge while driving.



Austin Smith, Scott Simons Architects

"I heard one consultant say we'd all drive Priuses if our exhaust was purple," says Austin Smith, AIA, principal of Scott Simons Architects in Portland, Maine. "It doesn't matter how good your building performs unless occupants are aware of how they're using the building."

Scott Simons Architects chose a dashboard manufactured by Lucid Design Group for the Borsarge Family Education Center, a LEED Platinum-rated building designed by the firm and Maclay Architects with Fore Solutions that is also the first nonresidential building in Maine to achieve net-zero energy usage. The dashboard provides not only data for energy used, but tracks rainwater collected, photovoltaic electricity produced, and thermal solar hot-water generated. "So much of it is the software behind it—loading the information," Smith says. "It did take coordination between our traditional meters and making sure they were compatible, an ironing-out process. We're still calibrating the specifics and tweaking."

Incorporating an extensive monitoring system into the Borsarge Family Education Center fit the project's program. "This is an education center. It has a mission to educate people, and one purpose was to show the average owner how they can affect their building," Smith says. "The dashboard is a great part of that. It's amazing how people flock to it."



Michael L. Prifty, BLT Architects

Universities so far are among the most frequent clients seeking energy-monitoring systems because the systems allow multiple buildings across a campus to be easily monitored at once. For example, about 70 of the buildings at Pennsylvania State University in University Park, Pa., are connected by an automated monitoring system.

"Their portfolio is tremendous," says Michael Prifty, FAIA, principal of Philadelphia's BLT Architects. "If there's ever an issue in any of the buildings—smoke detection, lack of heat or cooling—where performance is not as anticipated, they can issue a ticket for repair from the headquarters to the physical plant."

Practical training is crucial. Prifty was called back by another higher-education client after operations staff found it difficult to use the newly installed energy-monitoring system. "We made the changes right then and there," he explains. "The engineer, the subcontractor, and I set up the building to operate properly. But afterward you have to be trained. You have to be a sophisticated owner to capitalize on the info being provided to you."



SUSTAINABLE BUILDINGS ARE GREATER THAN THE SUM OF THEIR PARTS.

When it comes to sustainable design and construction, product decisions must work together to contribute to the end result. With evolving requirements and code changes, navigating this complexity can be challenging. Our expertise in thermal systems and sun control can help you create a solution that delivers lower U-values, controls heat gain and leverages light to reduce energy demand. Kawneer and Traco understand how to realize the big picture...one piece at a time.

Every day you make a choice. Make a choice that counts.

Architectural Aluminum Systems
Steel + Stainless Steel Systems
Entrances + Framing
Curtain Walls
Windows

kawneer.com
traco.com
kawneergreen.com



“THERE’S ONLY SO MUCH WE CONTROL. OCCUPANTS HAVE A FAIR AMOUNT OF CONTROL: PLUG LOADS, HEATING AND COOLING, COFFEE POTS. IT’S IMPORTANT FOR PEOPLE TO KNOW THAT IT’S NOT JUST DESIGNING AND BUILDING A GOOD BUILDING. IT’S HOW THE BUILDING IS USED.”

—BOB KENNEDY, EYP



Bob Kennedy, EYP Architecture & Engineering

Utility companies regularly use smart-metering systems that register energy or water usage without requiring that a meter reader physically check the premises. Designers have started to adopt this technology as well.

“More people are installing submeters in buildings anyway as a default,” says Bob Kennedy, director of energy services for EYP Architecture & Engineering in Albany, N.Y. His firm’s experience with dashboards includes a project at Hamilton College in Clinton, N.Y., that employed a touchscreen display.

“Good practice calls for installing these submeters. It’s becoming standard practice, although it’s not universal,” Kennedy says. “Often the catalyst was to get an additional point under the LEED certification process.”

EYP is also collaborating with the College of Nanoscale Science at the University at Albany, State University of New York to provide photovoltaic monitoring as research for the school. “Some of the buildings we occupy do real-time monitoring to evaluate the impact of clouds passing over,” Kennedy explains. “We’ll be able to look at long-term performance based on dust, snow, time of day, to better predict energy available minute to minute. But this monitoring system is far more detailed than what you’d see in these buildings. Ultimately, as the cost of PV cells decreases, as we look at integrating them into walls and roofing material, we’ll have more data about what can be produced.”

Kennedy says that there are other applications for dashboards beyond monitoring the primary utilities of electricity, water, and natural gas. “The other thing we see dashboards or monitors going in for is photovoltaics. It’s fairly common to have these in conjunction with PV panels on the roof.” Photovoltaic panels usually come with their own metering system. “In the case of a residence, you can actually make your meter spin backwards. In a commercial building, it would probably spin more slowly,” Kennedy adds. “The benefit of detailed metering is as the cost comes down and we integrate it into structural materials, we can predict how much power will be generated.”

Even so, the architect says, “There’s only so much we control. Occupants have a fair amount of control: plug loads, heating and cooling, coffee pots. It’s important for people to know that it’s not just designing and building a good building. It’s how the building is used.” □

CARBONCAST INSULATED ARCHITECTURAL CLADDING

Looks like precast. Performs like nothing else.

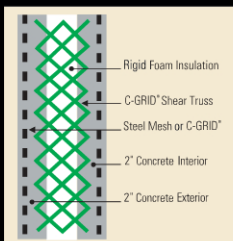
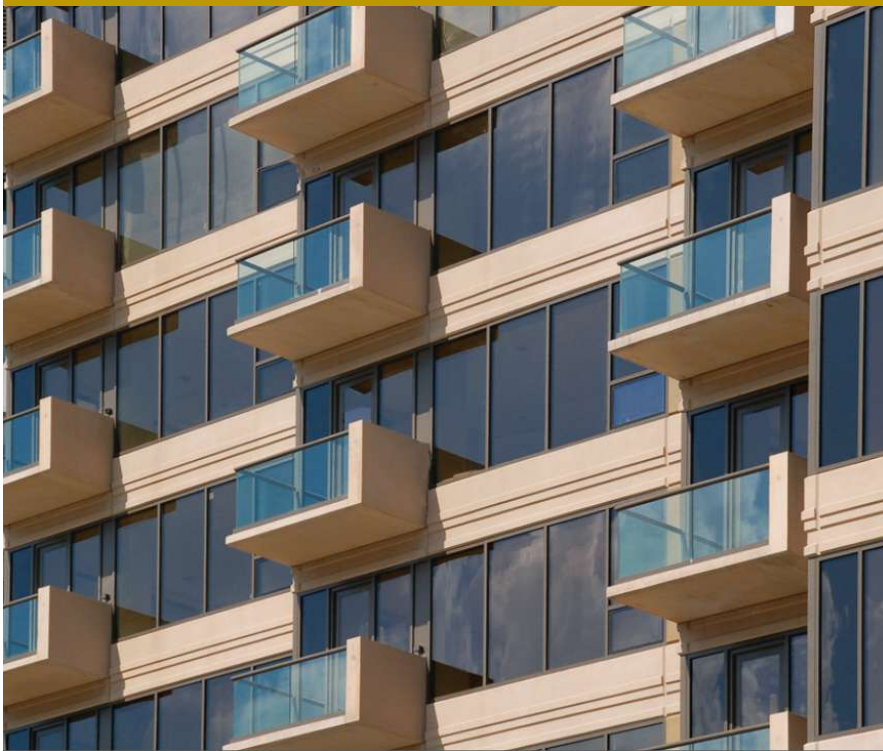

CarbonCast panels are 40% lighter and provide continuous insulation.

Remarkable things happen when you lower cladding weight: superstructure savings, a smaller carbon footprint and improved seismic performance are just the start. New CarbonCast® Insulated Architectural Cladding is up to 40% lighter than conventional architectural precast. It offers continuous insulation (c.i.) to meet ASHRAE requirements. Its sandwich design features C-GRID® carbon fiber grid for thermal efficiency and moisture control. And with the aesthetic versatility of precast, you have a system that looks as amazing as it performs. www.altusprecast.com 866-GO-ALTUS

carboncast

C-GRID
REINFORCED

altusgroup

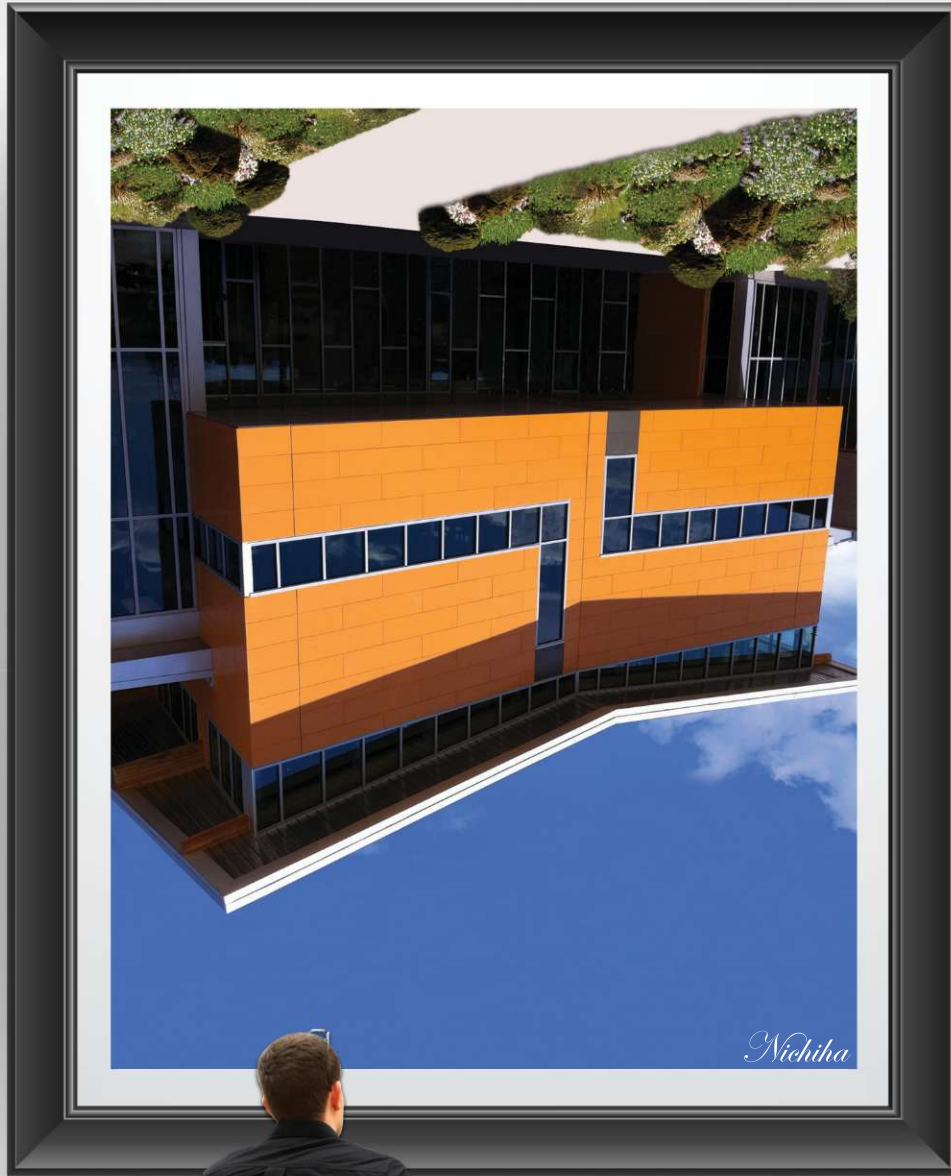

nichiha.com/projectgallery

Even upside down
Illumination Series panels are inspiring.

Circle no. 380 or <http://architect.hotims.com>

©2011 Nichiha USA, Inc.
All rights reserved.

NICHIHA
fiber cement
1.866.424.4421

→DETAIL

Zahner Cloud Wall

THE A. ZAHNER CO. IS KNOWN FOR REALIZING SOME OF THE WORLD'S MOST FANCIFUL ARCHITECTURAL DESIGNS. FOR A NEW FABRICATION STUDIO AT ITS OWN KANSAS CITY, MO., PLANT, ZAHNER TURNED TO LOCAL FIRM CRAWFORD ARCHITECTS FOR A SCREEN OF ALUMINUM AND GLASS.

TEXT BY CHARLES LINN, FAIA

Architect: Crawford Architects**Location:** Kansas City, Mo.

Fin Profile

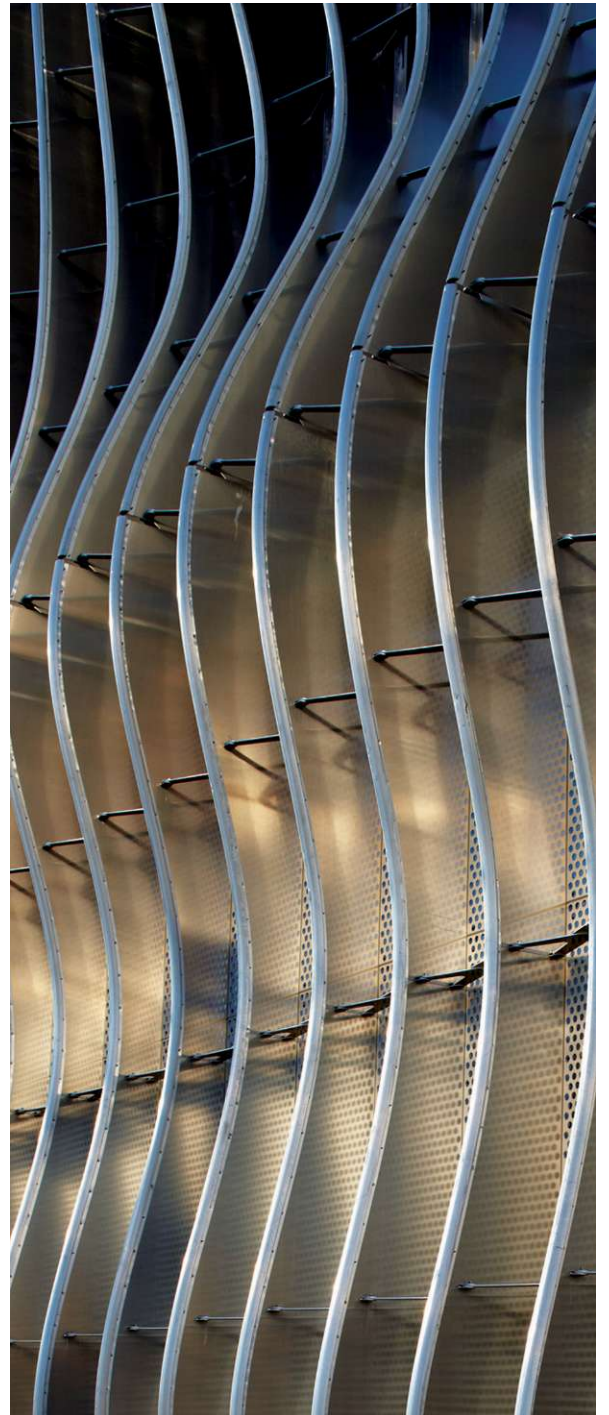
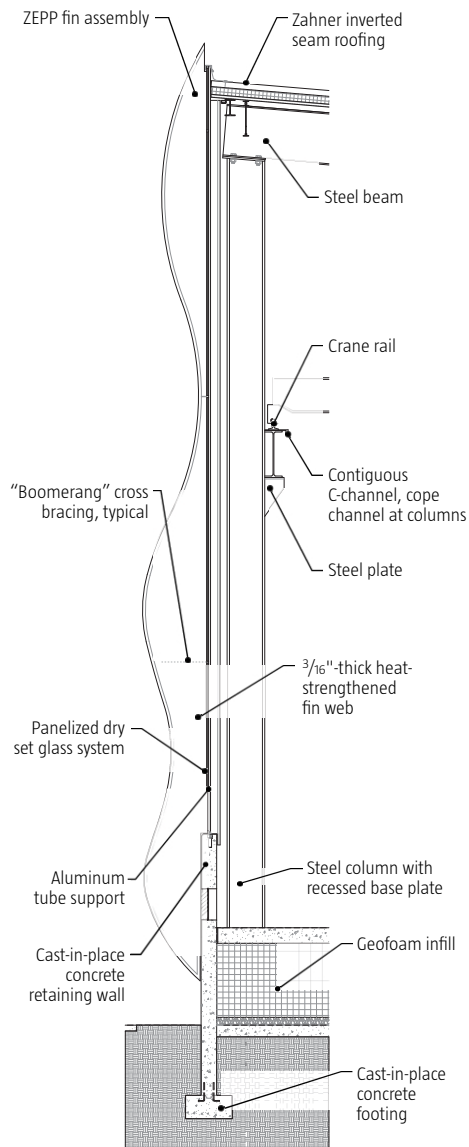

MIKE SINCLAIR

129

NUMBER OF
FINS THAT MAKE
UP THE ZAHNER
CLOUD WALL.



Having trouble figuring out which wall protection is safest for the environment?

That's because most manufacturers are making environmental claims designed to confuse you. Not us. Acrovyn® 4000 contains no PVC, PBTs, or any other harmful chemicals—and we can prove it! Acrovyn® 4000 is the only wall protection that's MBDC Gold or Silver Certified, so you can be sure it's the healthiest product available. Other companies don't disclose what chemicals their products contain. So if protecting people is as important as protecting walls, choose Acrovyn®. Visit www.c-sgroup.com for a chemical analysis, call 888-621-3344 or find Construction Specialties on [f](#), [in](#) or [t](#) twitter.com/acrovyn.
See us at Greenbuild, booth #1523 Circle no. 457 or <http://architect.hotims.com>



 **Acrovyn®** *Protection for tomorrow's environment*



THE NEW STANDARD FOR
Sustainable Buildings
 INSULATING CONCRETE FORMS



**The Andrew Apartments
 Queens, NY**
 45,054 sq ft – 50 Units
 6,500 13" Reward ICFs used
 18.66 kBtu/sf/year to heat –
 \$200 year per apartment

Even the best insulated concrete form wall needs to be supported by an even better product supplier like Reward Wall Systems. We have 22+ years of proven expertise and support tools to ensure a project delivers the performance expected.

We Don't Just SAY It, We DO It.

- In-house design support teams
- Feedback on designs to address specific ICF detailing
- Structural engineering support with an in-house engineer
- Most comprehensive ICF project estimating tools
- Ability to train on site and educate all team members for a successful installation.

Start Specifying A Premium Building Enclosure

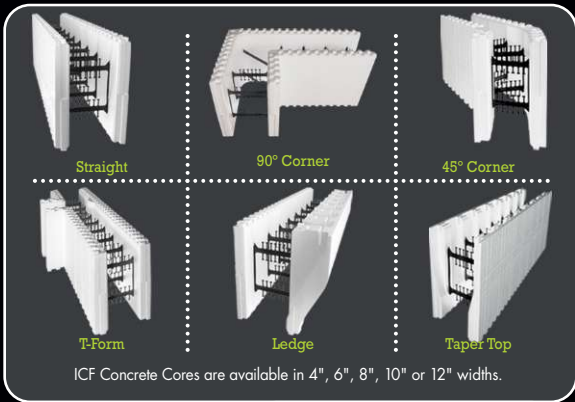

Circle no. 270
 or <http://architect.hotims.com>



www.RewardWalls.com • 1-800-468-6344
 Full CAD details, BIM objects, and specs are available online.



technology



The longest fins used in the Cloud Wall are 44 feet long, with the shortest fins measuring just 3 feet long. One 40-foot aluminum fin weighs about 400 pounds.



POWERFUL CAD SOFTWARE has given architects the ability to create mind-boggling forms. But it still takes the resourcefulness and ingenuity of fabricators such as the A. Zahner Co. of Kansas City, Mo., to make them constructable.

Zahner's machines laser-cut and rolled the angel hair-finished stainless steel sheets covering Frank Gehry's 2004 Jay Pritzker Pavilion in Chicago. The company's presses punched the hundreds of thousands of holes and dimples that texture the solid copper face of Herzog & de Meuron's 2005 de Young Museum in San Francisco. And semis laden with its prefabricated, perforated panels braved the urban lanes of New York City to clad Morphosis's 2009 Cooper Union New Academic Building.

When the company decided to add a 6,200-square-foot, high-bay fabricating studio to its plant recently, it turned to a local firm, Kansas City's own Crawford Architects, to design the structure. Zahner's only requirement was that the design should make use of the company's Zahner Engineered Profile Panel (ZEPP) system—which includes structural elements normally found unexposed beneath sheets of metal.



MIKE SINCLAIR

The façade's Cloud Wall design was based on a pencil sketch made by Crawford project designer Stephen Colin, Assoc. AIA, which was inspired by the corrosion patterns he found on a piece of steel at the Zahner plant. The designers used Autodesk 3ds Max to create a three-dimensional model of the drawing based simply on its tonal values. The resulting form, in turn, was sliced into parallel sections, much in the way a magnetic resonance imaging machine renders a three-dimensional solid. Further separated, these vivisections determined the shape of the vertical fins that now articulate the addition's north and east façades.

After small-scale study models were made, several of the fins were fabricated at full size for a mock-up. In section, each fin looks a bit like an I-beam, except that the flanges are made of a D-shaped aluminum extrusion. These extrusions are riveted on each side of a 3/16-inch-thick aluminum sheet that forms the I-beam's web.

To shape the extrusions, Crawford imported final drawings of each fin into CATIA, using a proprietary algorithm. The software was used to control a machine equipped with rollers. After all of the



cool by

de-

sign

modernfan.com | 888.588.3267

Circle no. 526 or <http://architect.hotims.com>





Fin System Section

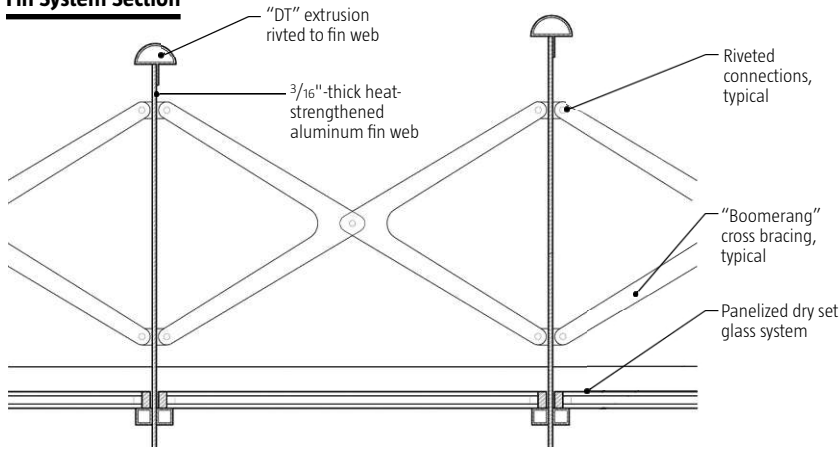

extrusions and sheets were formed and riveted together, they were tempered using a process called solution heat strengthening—a process that gives the aluminum a bright appearance.

The fins were lifted into place by crane and welded to clips bolted to both the addition's concrete foundation wall and the heavy structural steel frame that supports the rest of the studio. All of the rivets, screws, bolts, welds, and even pencil marks were left exposed and unfinished, just as they would have appeared underneath a sheet-metal skin—as they are typically used.

Insulated glass units were then installed between each pair of fins, flooding the new fabrication space with daylight. ("People don't usually associate us with glass," says L. William Zahner, Hon. AIA, "so we wanted to show we do that, too.") The glass units were preassembled and then attached to the fin's aluminium framework with fasteners. Several X-shaped "boomerangs" are engaged through a slot in each vertical fin and then bolted, providing lateral strength. Though the aluminum fins resist wind loads and hold up their own weight, they are not load bearing.

Crawford Architects principal Stacey Jones says that he is surprised that Zahner selected a local firm to design the plant. "He could have any architect in the world," Jones says. "How great is it to have a material that is as malleable as metal, and then have a master craftsman like Bill Zahner stand beside you, helping you explore what's possible?" □

MIKE SINCLAIR



The key to our Garden Roof® is our Monolithic Membrane 6125®, a seamless rubberized asphalt membrane with a 45+ year track record for critical water-proofing and roofing applications world-wide.



From concept to completion

American Hydrotech's Garden Roof® Assembly has set the standard by which all other green roofs are measured. Our Total Assembly Warranty provides owners with single source responsibility from the deck up. This is peace of mind that only American Hydrotech can offer.

To learn more about the American Hydrotech Garden Roof Assembly, please call 800.877.6125 or visit us online at www.hydrotechusa.com.

American Hydrotech, Inc. | 303 East Ohio | Chicago, IL 60611 | 800.877.6125 | www.hydrotechusa.com

© 2011 Garden Roof is a registered trademark of American Hydrotech, Inc.

Circle no. 254 or <http://architect.hotims.com>





Not all vinyl tiles had premium performance worthy of their own category. Until now.

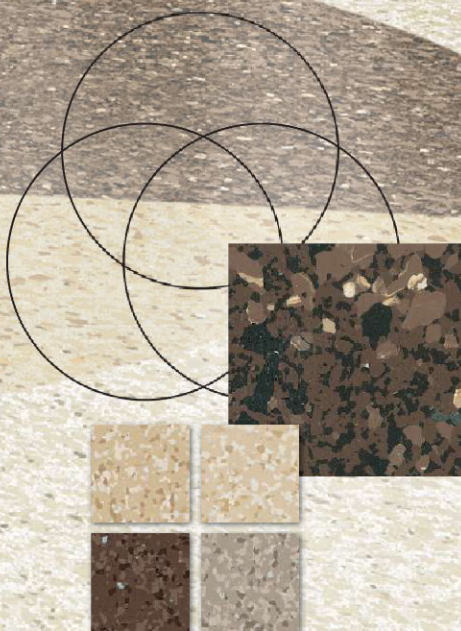

AZTERRA™ AND COLOR ESSENCE™ VINYL ENHANCED TILE (VET) FROM THE AZROCK® COLLECTION.

This is more than a pretty face. Johnsonite's Vinyl Enhanced Tile contains more binder than traditional VCT, making it premium in both design and performance. The more durable, flexible VET requires minimal maintenance. Traditional VCT's can't say that. And with 65 coordinating colors and patterns, Azterra™ and Color Essence™ offer endless design possibilities. Other features include 23 percent pre-consumer and 6 percent post-consumer recycled content, and a complete line of coordinating wall base, transitions and accessories. For high-performance, high-style environments, consider The Azrock Collection. For more information visit johnsonite.com.

→ LIGHTING

Lights Out

TEXT BY ADAM MAZMANIAN
ILLUSTRATION BY MCKIBILLO

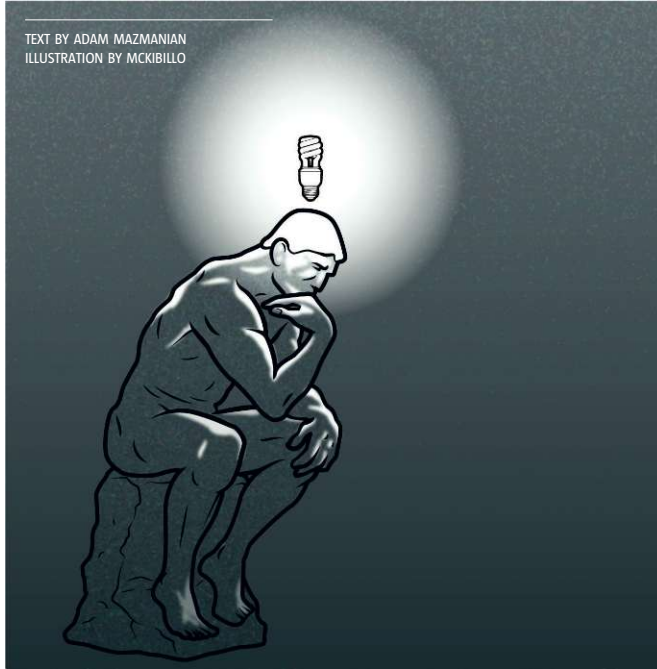

COST, PERFORMANCE, AND IDEOLOGY: ILLUMINATING THE DEBATE OVER INCANDESCENTS.

SOME OF THE MOST THOUGHTFUL dissent on the switch to new lighting energy standards in the U.S. emanates from the quietest place on Earth. That place is the anechoic chamber at Orfield Laboratories in Minneapolis, which was awarded the title by the Guinness Book of World Records in 2005. From his quiet room, Lab founder Steven J. Orfield insists rather loudly that contemporary U.S. green-building standards in general—and lighting standards in particular—are bad for buildings and the people who work in them.

Orfield, 63, who specializes in research and testing for acoustics, lighting, and design in the U.S., Europe, and Japan, is characteristically blunt with his take on the central problem. “For the last 20 years,” Orfield says, “lighting has been co-opted by the energy movement.”

Orfield holds the view that the new federal standards designed to make interior lighting more energy efficient, rules that begin phasing in next year, were created without giving much thought to the central mission of lighting: helping people see. Not that Orfield is making common cause with Republicans in Congress, who proposed a repeal of the new standards as one of many stands that culminated in the recent debt-ceiling debate. But Orfield bluntly asks: “If it hadn’t been for the law, would anybody have gotten rid of incandescents?”

For everyday consumers, those warm, bright 100-watt Edison-style bulbs will begin to disappear from store

shelves next year. Production phaseouts will eliminate 75-watt bulbs starting in January 2013, and 60-watt and 40-watt bulbs by January 2014. News reports suggest that despite promised savings, consumers are reluctant to give up their incandescents. Anecdotes of consumer hoarding are legion; a *Boston Globe* story has it that sales of the old-fashioned bulbs are up between 10 percent and 20 percent over last year. Compact fluorescents (CFLs) are seen as overpriced, dim, and unreliable. Bright light-emitting diodes (LEDs) are warmer and long-lasting but even more expensive than CFLs.

Passed in 2007, the Energy Independence and Security Act raised howls from Congressional Republicans, the U.S. Chamber of Commerce, and oil companies. But there was remarkable consensus and industry buy-in on the part of light-bulb manufacturers and electric utilities. The bill was supported by the Alliance To Save Energy, an industry group backed by utilities, manufacturers, and trade associations representing architects, lighting professionals, and engineers. Since the passage of the law, at least 119 U.S. utilities have offered rebates to consumers for switching to light bulbs that comply with Energy Star standards.

There’s not much dispute on the need for more energy-efficient lighting. The projected savings are

92.2

TERAWATT-HOURS
PER YEAR THAT
COULD BE SAVED
IN JAPAN BY A
SWITCH FROM
INCANDESCENT TO
LED LIGHTING

SOURCE: INSTITUTE OF ENERGY
ECONOMICS, JAPAN



A Complete Deck and Roof for Total Performance

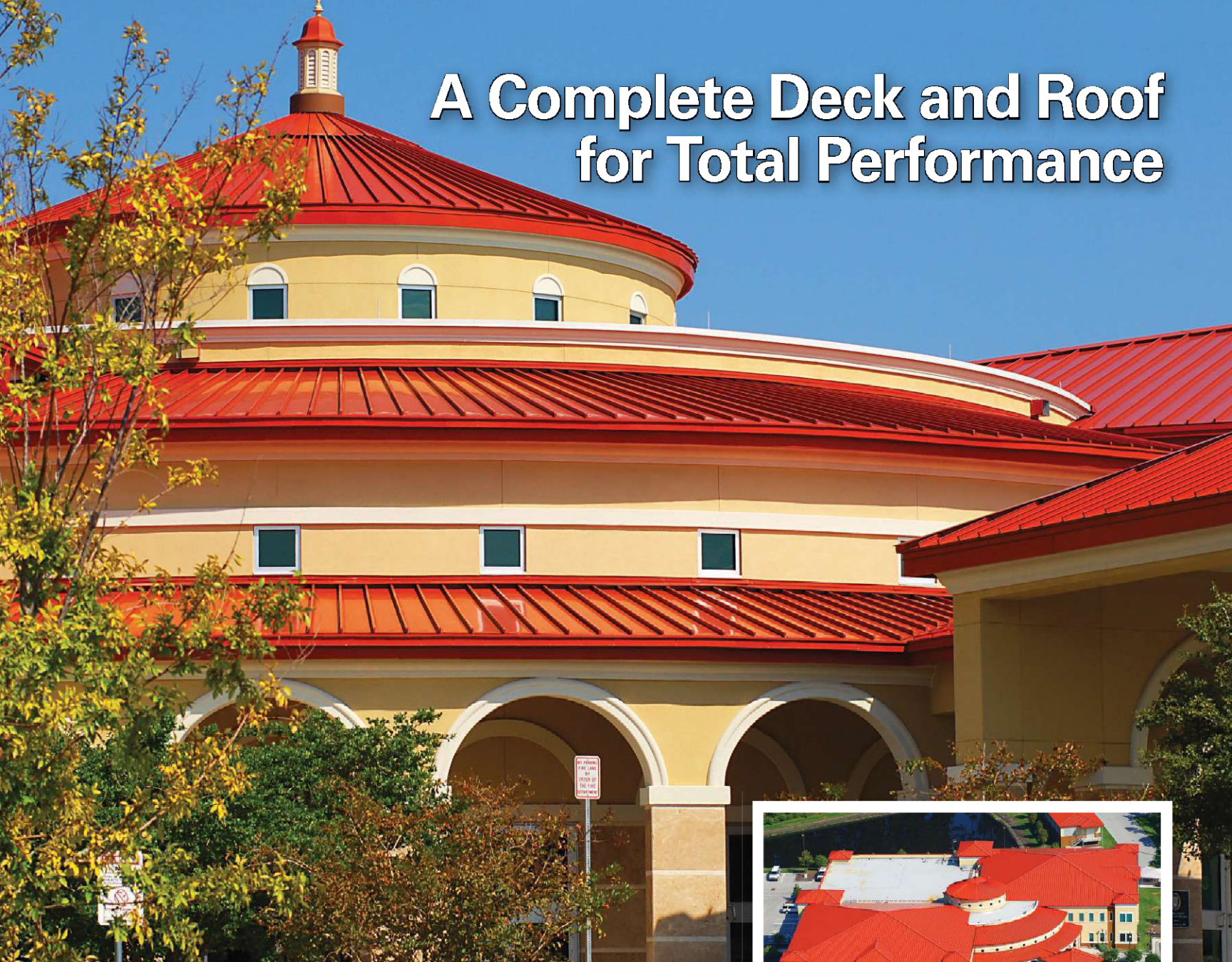

Perform-A-Deck™ and Series 300® – Performance You Can Count On



Martin Fireproofing and IMETCO have joined forces to bring you this performance-inspired complete metal deck and roof assembly, seen here on the St. Johns County Administration building in St. Augustine, FL. The result is an attractive, total system that provides “nearly absolute protection” under a single-source warranty.

Please visit our websites or call us to learn more.
www.martinfireproofing.com/stjohns or 800-766-3969
www.imetco.com/architect.php or 800-646-3826

Circle no. 519 or <http://architect.hotims.com>



800-766-3969

www.martinfireproofing.com/stjohns



(800) 646-3826

www.imetco.com/architect.php

→

THE U.S. DEPARTMENT OF ENERGY ESTIMATES THAT A SWITCH TO SOLID-STATE LIGHTING WOULD GENERATE \$120 BILLION IN SAVINGS OVER 20 YEARS.

enormous, both in terms of energy bills and greenhouse gas emissions. The U.S. Department of Energy estimates that a switch to solid-state lighting would generate \$120 billion in savings over 20 years, obviate 246 million tons of carbon emissions, and lower by one-fourth the total wattage of electrical power used for lighting. Japan's Institute of Energy Economics published a study that suggested that a switch from incandescent to LED lighting across commercial, residential, and government users could generate savings of 92.2 terawatt-hours (one terawatt being equal to 1 billion kilowatts) per year. In a country rocked by the recent nuclear crisis, solid-state lighting holds out the promise of reducing total national energy consumption by 9 percent—equivalent to the electrical output of 13 nuclear plants.

"It's a great idea to get more lumens per watt," Orfield says. But he also says that the move to reject incandescent light in favor of the alternatives has been "a complete disaster." Sustainability, he argues, is about reuse. Retrofitting for incandescent lighting has resulted in discarding millions of good fixtures without achieving the goal of better lighting. And performance doesn't have a central place in the debate. "Incandescent lighting is a really high quality of lighting," Orfield says. "Other technology should do at least as well."

Interior designer Christopher Budd agrees. He's

a managing principal in the Washington, D.C., office of Studios Architecture, who has worked with Orfield Laboratories on projects including the Olmsted County Human Services Building in Rochester, Minn. Budd says that fluorescent-lighting technology has vastly improved, but it's not at the level of the "comfortable yellow light of the incandescent, which hides a myriad of sins." He sees the regulations as having been imposed about five years ahead of them being practicable. When energy was cheap, designers and architects were "comfortable with overlighting every single space," he says. As energy costs climb and builders are given incentives to save on energy costs, "we won't have the energy for overlighting."

Serendipitously, low light is part of the answer to the problem of institutional lighting, according to Orfield. Typically, lighting vendors recommend light levels of 30 to 50 footcandles for an open-plan office, and higher for industrial and manufacturing settings. But footcandle meters used to measure interior lighting aren't designed to separate useful light from glare. This is a source of frustration for Orfield and others who promote designing for the seated building occupant. Glare off of work surfaces, walls, floors, and from fixtures is a big part of



PYRO-GUARD®

Interior Fire Retardant Treated
Lumber and Plywood

EXTERIOR FIRE-X®

Exterior Fire Retardant Treated
Lumber and Plywood

**Free AIA - Accredited
Seminars**

"Fire Retardant Treated Wood
Recognition in the IBC"



HOOVER
TREATED WOOD PRODUCTS, INC.
www.FRTW.com

Circle no. 251 or <http://architect.hotims.com>

Support and AIA Certified Seminars:
800-TEC-WOOD (832-9663)

AIA Certified Seminars:
marketing@firtw.com



THIS IS ONE VERY **RESPONSIVE** FAUCET.



Proximity™ Sensing Technology is the next generation in responsive hands-free functionality that contributes to water efficiency. This revolutionary technology transforms the entire faucet into a sensor, automatically responding when approached. There are no optics or infrared to maintain. All backed by the industry's best 5-year limited warranty. Another way that Delta is more than just a faucet.

Visit deltafaucet.com/commercial/proximity or deltafaucet.com/professionals



Circle no. 27 or <http://architect.hotims.com>



Scan the QR code to see our Proximity Sensing video.





what creates discomfort among office workers—and fitting long fluorescents into recessed fixtures is a common source of glare. Improvements in fluorescents to reduce flickering and buzzing have resulted in higher-intensity lights, typically fitted in symmetrically placed ceiling troffers—brighter and much less well shielded.

Orfield's laboratory research has shown him that when you expose study participants to different lighting situations, they prefer lower light levels and higher light quality. People generally read by about 1 to 5 candle feet of light. Office lighting could be designed much the same way. "You could cut everyone's light bill in half by putting lighting only where it needed to be," Orfield says.

When he was working on a consulting job involving rethinking a downtown lighting plan for Minneapolis, Orfield and his colleagues tried to find out how other cities gathered feedback from citizens. "Not one city on our list of 10 or 12 did any glare evaluation, except by asking people how they liked it," Orfield says. "Opinions have no predictive value." Typically, lighting studies are the product of focus groups, which "force you to develop an opinion, whether you have one or not."

Orfield's complaints about improving lighting echo the critics of the U.S. Green Building Council's LEED certification system: These standards neglect to measure performance, he says. "If you lose 5 percent productivity to save 40 percent energy, you've lost millions," he said.

But the energy and efficiency savings are more dramatic than that, says Allyson Schmutter, senior communications associate for the Alliance To Save Energy. The low price of an incandescent is misleading, she says, given rising energy prices and the negative externalities associated with environmental harm—plus the cost of replacing bulbs frequently. Nevermind that newer alternatives to incandescents are more efficient: Their steeper up-front costs will fall as their market share rises. And halogen incandescents—which are not prohibited—are more efficient but every bit as warm.

Republicans in Congress were beaten back in their efforts to pass a stand-alone bill repealing the light-bulb provisions of the Energy Independence and Security Act. A move to keep the world safe for 100-watt incandescents may come in the form of a policy rider tacked on to a larger bill later this year. And Texas has already challenged the federal mandate by passing a law exempting incandescent bulbs made and sold in state.

In keeping with our divided government, the U.S. Department of Energy just awarded the North American division of Philips the \$10 million L Prize for developing an energy-efficient replacement for the 60-watt bulb. The new LED bulb, which offers energy efficiency in excess of 90 lumens per watt, is expected to retail for about \$40—the cost of 40 old-fashioned Edison bulbs, depending on how you look at it. □

ARCHITECTURAL FENCE AND GATE SOLUTIONS

VISIT US AT CONSTRUCT - BOOTH #633 AND GREENBUILD - BOOTH #65325

Ameristar's project managers help architects and engineers find fencing solutions that balance aesthetics, perimeter security, and design elements for all projects.

Call Ameristar on your next project.

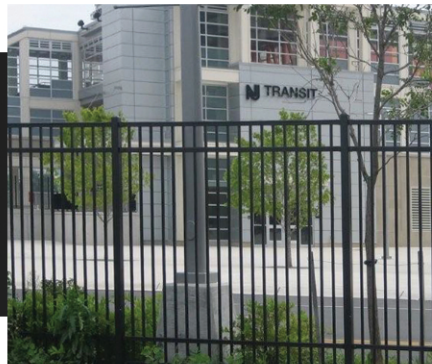

MAINTENANCE
FREE



QUALIFIES FOR
LEED POINTS



AMERICAN
OWNED

AMERISTAR FENCE PRODUCTS
1555 N. MINGO RD.
TULSA, OK 74116

AMERISTARFENCE.COM

PH. 800-321-8724

MKTG@AMERISTARFENCE.COM



IMAGINE.

THE SMARTEST SYSTEM
IN THE BUILDING
JUST MIGHT BE THE WALL.

STRONGER
THAN STEEL.™



As the demands rise for higher performance in all aspects of today's buildings, ClarkDietrich can take your walls to an entirely new dimension. We start with innovative steel framing products that work as a system. We back you with online tools and BIM data to empower smarter design and installation. And with the support of savvy engineering services, plus proud membership in SFIA (Steel Framing Industry Association), we're here whenever you need us. clarkdietrich.com
Circle no. 539 or <http://architect.hotims.com>



Interior Framing • Exterior Framing • Interior Finishing • Clips/Connectors • Metal Lath/Accessories • Engineering

TEXT BY AARON SEWARD

**AIA/CES Credit:**

You can earn 1 LU/HSW/SD hour for reading this article and successfully completing the quiz. You must answer eight of 10 questions correctly to earn credit and obtain a certificate of completion. This course is valid through August 2014.

To earn credit and obtain a certificate of completion, visit go.hw.net/archceu and complete the online quiz for free. Follow the “Click here to start this course” link for this story to launch the quiz. If you are new to Hanley Wood University, create a free learner account; returning users log in as usual. Upon completion, you can print a certificate of completion for your records or for self-reporting needs. Credits will be reported to the AIA for AIA members.

After completing this course you can leave feedback with us directly; AIA members can also leave feedback by logging into the AIA CES Discovery system.

Customer Service

hwuniversity@hanleywood.com

Learning Objectives

1. Describe what waste-to-energy (WTE) incineration is, and how it works.
2. Describe why this model of energy production is commonly, and successfully, used in European countries.
3. Describe the role architects can have in designing WTE facilities.
4. Describe why WTE adoption in the U.S. has been slow, and why that might change as we seek additional renewable energy technologies.



Amagerforbraending Plant, BIG-Bjarke Ingels Group

→ CONTINUING EDUCATION

Trash as Treasure

WASTE-TO-ENERGY INCINERATION PLANTS ARE SPREADING ACROSS EUROPE LIKE WILDFIRE, MANY OF THEM IN DENSELY POPULATED AREAS, AND ARCHITECTS ARE PLAYING A MAJOR ROLE IN THEIR DESIGN. WILL THE TREND CATCH ON IN THE U.S.?

OF THE MANY PROBLEMS created by the conveniences of modern life, garbage is the smelliest. Even before the days of plastics and mass consumerism—all the way back to the discovery of fire—humans have fallen back on two reliable ways of dealing with their refuse: tossing it in a hole in the ground or burning it. Little has changed in the 21st century, but technology has given us the means to convert the energy released by burning trash into electricity, a practice known as waste-to-energy (WTE) incineration. As landfills begin to overflow and WTE incineration technology becomes cleaner and more reliable, this option—which boasts the two-for-one bonus of creating something we need while reducing the mass of something we don’t—is becoming more and more attractive to cities and countries.

That trend is especially true in Europe, where there are over 450 such facilities processing municipal solid waste into kilowatts, with Denmark, Germany, and the Netherlands taking especially aggressive strides in building new ones. While the sharp growth in WTE facilities is in part a result of Europe’s relative scarcity

of land and high-cost of energy, it is also due to the fact that the European Union imposes steep taxes on landfills and some EU countries have harsh restrictions against opening new dumps. But in contrast to the American approach of placing power plants as far away as possible from where people live, the Europeans are building their WTE plants in the middle of population centers, right where the garbage is generated. This helps to reduce these nations’ carbon footprints by not trucking trash long distances, but it also speaks to Europeans’ acceptance of, and trust in, the technology.

Here in the U.S., the situation is quite different. There are only 86 WTE incineration plants in the country today, and the majority are at least 15 years old. The most recent WTE facility was completed in 2008 and—in an relative boom—two others are under construction in Palm Beach, Fla., and Honolulu. The reason for the country’s slow adoption of the technology is partly due to strong opposition from communities,



AltariX

Only with MasterSpec®



ARCOM
The leader in specifications

www.altarix.com • 800.424.5080

Circle no. 532 or <http://architect.hotims.com>

technology

**Amagerforbraending
Plant Landscape Plan**

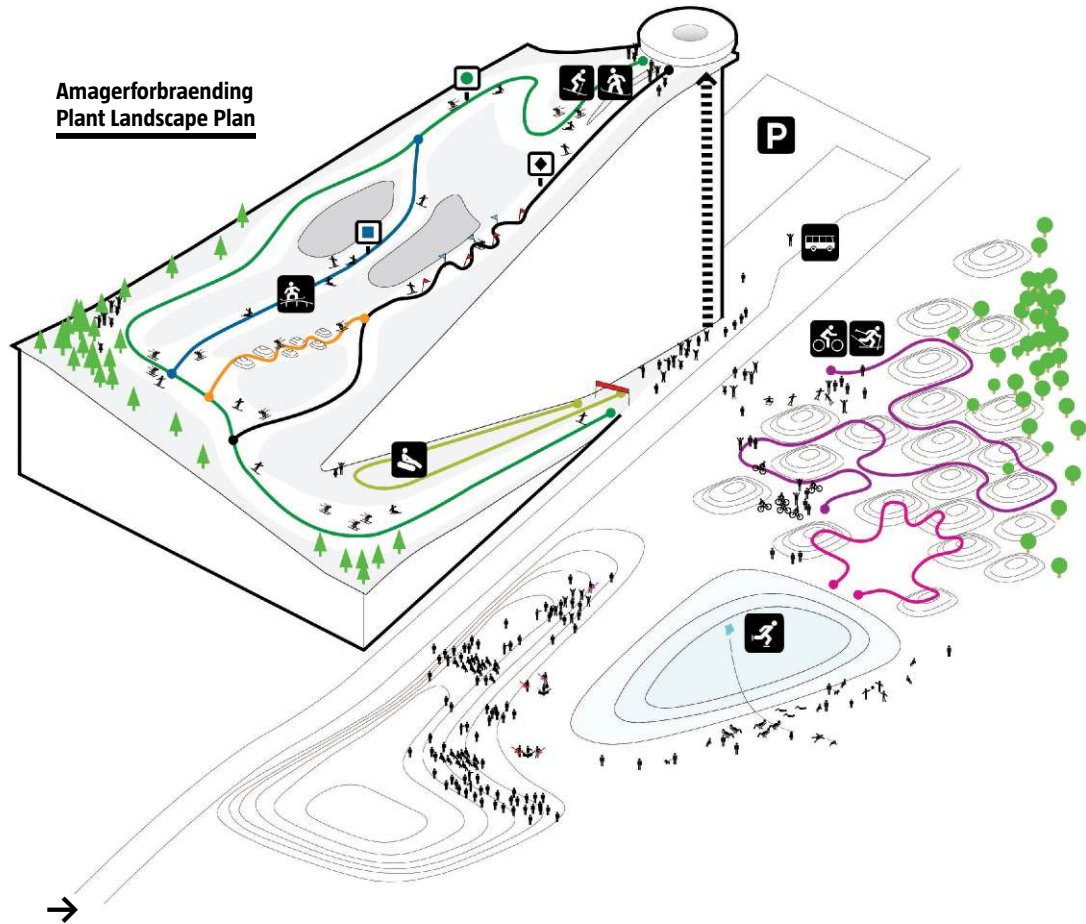

who don't want such dirty-sounding places in their backyards, and from environmentalist groups that feel we should be striving toward the goal of recycling everything we can and composting the rest. Building a WTE facility means committing to a steady supply of waste, a fact that seems to stand in the face of promoting recycling. That fear is mitigated, however, by the fact that the nations in Europe that have most embraced WTE, such as Denmark and Germany, have very comprehensive recycling programs.

Then there is the issue of emissions. Incinerating municipal solid waste results in a number of potentially dangerous pollutants. Before cleaning, flue gasses can contain significant amounts of heavy metals, dioxins, furans, sulfur dioxide, and hydrochloric acid. And there's the solid output—flyash and bottom ash—which represents 10 to 15 percent of the mass of the waste that went into the incinerator. Today's WTE facilities are equipped with a sophisticated array of scrubbing devices, such as particle filters, electrostatic precipitators (which remove particulate by way of electrostatic charge), and baghouse filters (not much different from the bag in your vacuum cleaner), which reliably remove somewhere on the order of 99.8 percent of atmospheric pollutants. Furthermore,

those metals and chemicals can be recovered for resale to industry. Flyash and bottom ash can also be recycled as components in concrete or asphalt. Since the 1990 amendment to the Clean Air Act, all U.S. power plants, WTE or otherwise, have been retrofitted with these emissions-cleaning technologies. According to Nickolas Themelis, a Columbia University engineering professor and head of the Waste-to-Energy Research and Technology Council (WTERT), the total weight of dioxins released by all WTE energy plants in the U.S. per year is less than 10 grams. "It's less than a cigarette butt," he says.

How it Works

While there are differences from WTE plant to WTE plant, the typical modern variety—such as those being built in Europe—is a moving grate incinerator. Nonrecyclable garbage arrives at the facility in trucks, where it is weighed and then dumped into a collection area. Most European municipalities impose additional fees for people who send recyclable materials to WTE facilities, encouraging waste carters to be meticulous in their sorting. What then winds up at the incinerator is primarily organic matter. In the collection area, a big

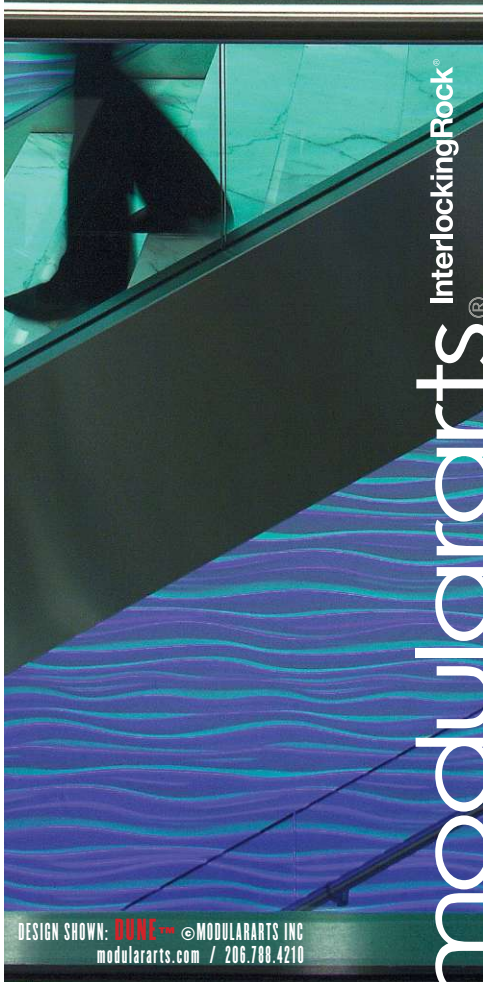

InterlockingRock®
modulararts



DELTA®-FASSADE S

UV-Resistant Water-resistive Barrier.

DELTA®-FASSADE S ...

- ... consists of a highly tear-resistant polyester substrate with a waterproof special coating.
- ... is exceptionally UV-resistant.
- ... may be installed in all back-vented cladding systems featuring open joints up to 2" (50 mm) wide and open joint areas of up to 40% of the entire surface.
- ... is highly vapor permeable (74 perms)
- ... helps to ensure a healthy and comfortable interior climate in stud wall construction due to its excellent physical properties.
- ... may be used in metal stud construction.
- ... is highly tear resistant.
- ... is very easy to install.



Circle no. 395 or <http://architect.hotims.com>

Part of the DELTA® Family of High Performance Membranes for superior wall performance.

1-888-4DELTA4 (433-5824)
www.delta-fassades.com



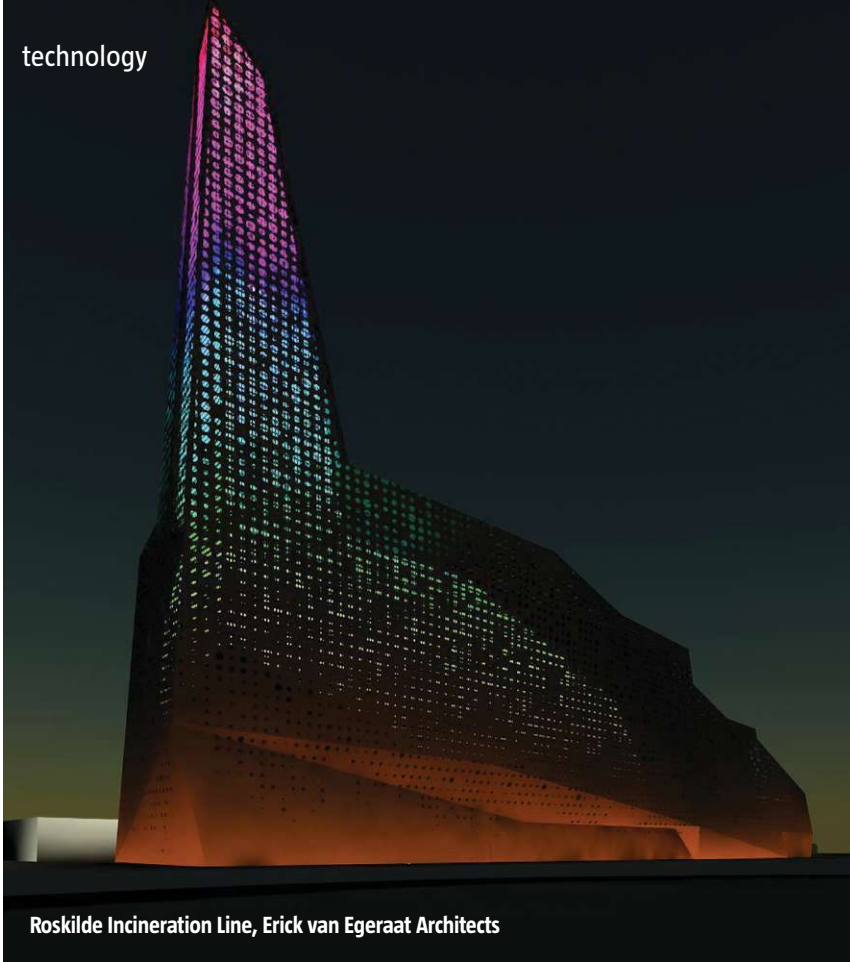

Roskilde Incineration Line, Erick van Egeraat Architects



claw crane tosses the garbage to create a homogenous mix to promote even burning. Once mixed, the crane lifts the fuel and drops it into the “throat,” where a system of moving grates begin to move it gradually down toward the incinerator. The grates move independently in a staggered fashion, slowly sifting the garbage down from grate to grate until it reaches the lowest level of grates in a furnace at the bottom. On the way, heat rising from below evaporates moisture in the garbage to ensure that it combusts with the highest level of potential energy output. Once in the extreme heat of the furnace, the trash combusts.

This process is aided by outside air that flows through vents in the grates (the air also cools the mechanisms to maintain mechanical integrity) and also through high-speed nozzles that fan the flames. To make sure that toxic organic compounds are properly broken down, the flue gasses must be maintained at a temperature of 850 C (1,560 F) for two seconds. Auxiliary backup burners are often used to maintain this temperature. The grates then proceed to the ash dump, where the ash is washed off of the grates with water.

The flue gasses rise from the furnace and through a boiler where their heat is transferred to steam. The steam is heated up to 400 C (752 F) and then, at a pressure of about 580 pounds per square inch, passes through a turbine. The turning of the turbine generates electricity in a process similar to that of a coal or natural-gas power



Maximize Productivity in Your Business with AutoCAD® 2012

Minimize the impact on your wallet with a \$300 instant rebate!

Learn more at AUTOCAD2012PROMOTION.COM.

AutoCAD 2012 software offers new and expanded workflows for model documentation, reality capture and 3D conceptual design to help you maximize productivity.



Order Now!
Offer expires
October 14, 2011.*



*\$300 instant rebate offer available in the United States and Canada. Only available on new seat purchases made through select National Resellers and Etailers. Offer available from August 15, 2011 through October 14, 2011. Contact your participating National Reseller or Etailer for more information.

Circle no. 582 or <http://architect.hotims.com>

Autodesk®
Authorized Distributor

MARVIN® COMMERCIAL SOLUTIONS

Marvin provides an extensive range of window and door solutions that can fulfill most any commercial project requirement. For proven performance, innovative products and design flexibility rely on Marvin's broad network of design and technical experts to help you craft a perfect window solution.

- Many Marvin products are CW rated
- Custom capabilities mean Marvin projects really are *Built around you*®.
- Download BIM models at Marvin.com
- Design options are nearly endless
- Over 800 Tripane options meet a 0.20 U-factor or lower

Find out more at Marvin.com/commercial

MARVIN 
COMMERCIAL PRODUCTS & SERVICES

Circle no. 57 or <http://architect.hotims.com>





Elevation with Smokestack

Lockers & Cubbies to Fit All Your Storage Needs

LOCKERS in plastic, phenolic and metal for use in schools, gymnasiums, fitness centers and manufacturing facilities.

CUBBY LOCKERS AND SHELVES in solid plastic and phenolic for all your temporary storage uses.

Now Available as **BIM Objects**



Visit asilockers.com
to learn more.

**ASI STORAGE
SOLUTIONS, INC.**



Single Source Solution



plant. The steam can also be used to feed municipal steam-heating systems.

Once the flue gases leave the boiler they are less than 200 C (392 F). At that point they pass into the cleaning system. Particle filters remove fine particulates and acid-gas scrubbers remove hydrochloric, nitric, and hydrofluoric acids, as well as mercury, lead, and other heavy metals. Activated carbon particles are then injected to collect volatile metals and organic molecules. The flue gas then passes through a fabric bag filter where particles are removed. Basic scrubbers remove sulfur dioxide (which turns into synthetic gypsum by way of a reaction with lime).

Nearly all of the carbon content of the waste is released into the atmosphere as carbon dioxide. While that may sound alarming at first, it is actually an improvement over dumping the garbage into a landfill, where the biodegradable parts of the waste would be converted to methane through anaerobic decomposition—and methane has a much higher heat-trapping potential than carbon dioxide. According to Themelis, 1 ton of municipal solid waste sent to a WTE plant instead of to a landfill reduces greenhouse gas emissions by the equivalent of 0.5 to 1 ton of carbon dioxide; he gives a range to account for the varying degrees of efficiency of capturing gas at landfills. It is also recognized that most biodegradable matter in municipal solid waste comes from plants that used atmospheric carbon dioxide to grow in the first place. If the dead plants that go to WTE facilities are replaced with new plantings, then the carbon dioxide released by their incineration will be absorbed from the atmosphere and reconstituted into new plant matter. So, go plant a tree.

The Role of Architects

While the design of WTE plants may seem to be the job of engineers and design/build contractors, architects can and do play a role. The profession is being tapped more and more for these facilities in Europe, where they are often built in plain view of people's homes and offices. Grimshaw is currently working on a WTE project near Ipswich in Suffolk County, England, for waste-management company Sita UK. The facility will process more than 269,000 tons of waste per year, generating electricity for the equivalent of 30,000 homes.

"We think that energy projects need to have the same sort of rigor of architectural treatment as any other building," says Kirsten Lees, Grimshaw's partner in charge of the project. "Think of the great power plants of the industrial revolution."

Grimshaw worked with Sita not only on the building envelope, but also on the arrangement of the mechanical components in order to arrive at a massing that would minimally impact the surrounding Suffolk countryside. "We spent a long time understanding the process and splitting up the components, understanding what needs to go where, what can be separated, [and] what can be reconfigured, so we understood how the overall form and mass could be manipulated to give it good looks," Lees says.





Featuring the Proprietary ECOguard Maintenance Coat

- Protection from dirt and scuff marks
- FloorScore certified
- Factory-applied
- Reduces maintenance and material costs
- Quicker installation
- Long lasting durability and low life-cycle costs

ECOsurfaces Commercial Flooring now offers factory applied ECOguard as a standard on all products that is exclusive only to the ECOsurfaces line.* ECOguard is a revolutionary factory-applied maintenance coating designed to preserve the beauty of ECOsurfaces. Ideal for healthcare applications including entranceways, hallways, patient rooms and nurses' stations, it protects the floor from dirt and



scuff marks and significantly reduces maintenance and cleaning costs. ECOguard is a water-based polymeric coating that meets the most stringent indoor air quality standards as stated by the state of Washington. ECOguard is FloorScore certified to protect those walking on the surface. For more information on ECOsurfaces with ECOguard, please visit www.ecosurfaces.com or call 1.877.326.7873.

*ECOguard is not standard on ECONights for ESD, ECONights for Sport, or tile products.

Circle no. 541 or <http://architect.hotims.com>



Distributed by:

G E R B E R T



L I M I T E D

Made in the U.S.A. by:



Brilliant Design.



Konic™, elliptical stainless steel posts with matching support brackets and concealed connections throughout. Tempered glass infill panels or infill rails are just some of the design options available. To see our complete range of railing designs with available options visit www.hdirailings.com or call the number below.



CIRCUM™



inox™



LED

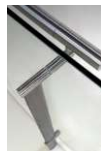

KONIC™

Circle no. 202 or <http://architect.hotims.com>

www.hdirailings.com P: 717-285-4088
email: info@hdirailings.com F: 717-285-5083



For the Sita UK waste-to-energy plant near Ipswich in Suffolk County, England, architecture firm Grimshaw was able to organize the various technical components and systems to create a more aesthetically pleasing massing than most WTE plants. Torqued louvers reflect natural light, and a transparent skin allows visitors to peek inside to catch a glimpse of the workings of the energy-production process.



Grimshaw used the existing topography and vegetation of the plant's brownfield site to screen the facility and minimize its visual impact on the landscape. However, the complex also features a visitor center where the public can come to get an education on the workings of WTE technology. With this in mind, the architects clad much of the building in a transparent skin that allows views in to the boiler and flue hall. Twisting horizontal louvers on the exterior capture daylight and ethylene tetrafluorethylene (ETFE) skylights allow light into the interior, reducing the need for artificial lighting during the day and improving views into the space.

While Sita's Ipswich project establishes a quiet relationship with its neighborhood, another WTE plant under construction in Roskilde, Denmark, takes an extroverted approach. Designed by Dutch architect Erick van Egeraat and developed by Danish energy supplier Kara/Noveren, the Roskilde Incineration Line's exterior makes a bold statement by referencing both religious and industrial architecture.

"It is a contemporary cathedral," van Egeraat says. "Close to the ground we shaped the building to reflect the angular factory roofs of the immediate surroundings. We then let the building culminate in a 100-meter-tall [328-foot-tall] spire, which is an articulation of a fascinating and sustainable process in creating energy."

As with Grimshaw's building, van Egeraat created transparency to give passersby a glimpse of the facility's inner workings, here in the form of laser-cut circular openings that perforate the umber-colored aluminum

façade. At night, the façade is lit with embedded fixtures, which provide glowing evidence of the electricity created within. In the animated lighting scheme, a "spark" grows into a blazing "flame" eating up the entire volume. Once it reaches its peak, the light falls again, descending back to a metaphoric heap of glowing embers.

The Roskilde plant may make a big impression on the skyline, but another WTE project going up in Copenhagen takes matters a step further by not only giving the public a glimpse inside, but inviting them to scale the building. Designed by Danish architectural firm BIG, the Amagerforbraending plant not only includes the latest in WTE technology, but its roof is an actual ski slope topped with recycled synthetic granular "snow."

"Most of the recently built power plants are merely functional boxes, wrapped in expensive gift paper," says BIG founder and principal Bjarke Ingels. "The main purpose of the façade is often to hide the fact that factories are having a serious image and branding problem. We wanted to add functionality," he says.

The ski slope will be competitive with any of the natural runs close to Denmark with a 328-foot-drop and more than a mile of paths. Even the building itself will look like a mountain, its envelope wrapped in a green screen of planters. Visitors journey to the top via an elevator that rises along the plant's smokestack, providing glimpses into the workings of the facility. The smokestack itself is modified to puff smoke rings 30 meters



"We had bamboo installed in our new house. We did the entire first floor and we love it in every room. It is a great color and looks beautiful with any decor."

Amy, South Bend, IN



Carbonized Strand Bamboo • 30 Year Warranty

Mill-Direct **LOW** prices on first quality, full warranty floors

For a FREE catalog or store near you, call 1-800-HARDWOOD or visit lumberliquidators.com
Circle no. 281 or <http://architect.hotims.com>

HARDWOOD FLOORS FOR LESS!
LUMBER LIQUIDATORS\$
www.lumberliquidators.com
1-800-HARDWOOD



Hanover® Roof and Plaza Pavers

With pavers yielding high reflectance and emittance values, Hanover® Roof and Plaza Pavers become an integral part of earning Sustainable Sites Credits and LEED points.

HANOVER®
Architectural Products
www.hanoverpavers.com
800.426.4242

technology

Sita UK Suffolk County Plant Axonomic Sequence

1.

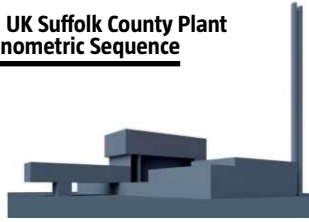

2.

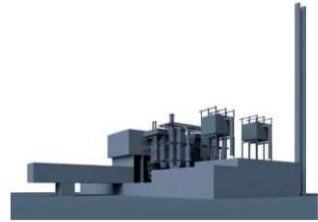

3.

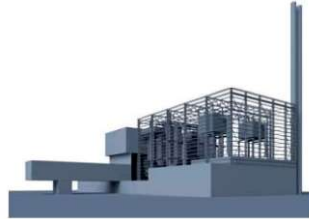

4.

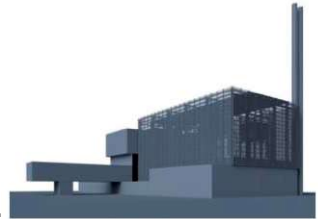

(98 feet) in diameter whenever one ton of carbon dioxide is released, giving Danes an easy-to-understand measuring stick of the facility's emissions and imbuing the whole business of incinerating garbage to make electricity with a cozy, down-home appeal.

Could It Happen Here?

While NIMBYism and environmentalist opposition have played significant roles in halting the spread of WTE here in the U.S., the main reason that it hasn't taken a stronger footing is economic. Building a WTE facility incurs a huge up-front cost, whereas dumping garbage in a landfill is comparatively quite cheap. But that is changing.

"There is a growing interest in the U.S.," says Ted Michaels, president of the Energy Recovery Council, a national trade organization representing the WTE industry and communities that own WTE facilities. "We built a lot of facilities in the '80s and early '90s. In the mid '90s the economics became hard for us in the sense that landfills are pretty cheap. We were having trouble competing with them." In the mid-2000s, electricity prices started to rise, as did revenues from metal recovery. And more money began to become available through renewable-energy credits. (Currently, 26 states—plus D.C., Puerto Rico, and the Northern Mariana Islands—classify waste that is burned for energy as a renewable fuel, in many cases eligible for subsidies.) But the most important price increase, perhaps, was seen in the cost of landfills. "As the old landfills close, the new ones get further away, and as diesel fuel gets more expensive, it gets more economically viable to do WTE," Michaels says.

In Europe, the technology has flourished through strong support from governments that penalize landfills and subsidize WTE. They

have had good reason to take those measures, considering their lack of empty land and need for affordable energy sources. It is hard to imagine a tax being imposed on landfills here in the U.S. anytime soon, and conventional sources of power generation (coal and natural gas) remain relatively plentiful. But there are localities in the nation where WTE would seem to make good sense; namely New York City, which pays top dollar to ship most of its garbage to landfills in Virginia and has been known to suffer rolling blackouts during peak summer electricity usage. But in spite of the Big Apple's embrace of renewable energy and other sustainability measures, its 2030 initiative, PlaNYC, shies away from proposing conventional WTE, though it does include plans for pilot programs to explore other anaerobic and thermal processing options.

While a proposal for a WTE incineration plant would create a hailstorm of public opposition, it seems that what the technology really needs to get a leg up is the backing of an influential green crusading politician. "People should realize that the U.S. is lagging behind in implementation of this technology," says Rob Van Haaren, a planning specialist at WTER. "I think the reason why that is happening is pretty clear. The word about how this technology has improved over the last 15 years has not been spread through the decision makers. They've taken up the cause of solar and wind energy, yes, but not waste to energy," he says. □



→ To earn credit and obtain a certificate of completion, visit go.hw.net/archceu and complete the online quiz for free. Follow the "Click here to start this course" link to launch the quiz for this story. If you are new to Hanley Wood University, create a free learner account; returning users log in as usual.

**“NO PAINT IS GOING TO BE
SUSTAINABLE HERE
IF IT CAN'T SURVIVE
THE WEAR AND TEAR.”**

**LET'S BUILD
THE PAINT COMPANY
YOU'VE ALWAYS
WANTED.™**

Introducing new Diamond 450 No VOC*. This high performance, 100% acrylic paint is 10x tougher than traditional finishes, so you can paint less often. And the low odor, No VOC

formula makes it ideal for high traffic commercial and institutional environments where indoor air quality and disruption of occupied spaces are concerns.

To learn more, go to gliddenprofessional.com, or visit the Glidden Professional Paint Center nearest you.



* CONTAINS NO VOCs - VOC (Volatile Organic Compounds) content as measured by the Environmental Protection Agency (EPA) Reference Test Method 24.



Imagine your business tomorrow.™

→ PRODUCTS

Editor's Choice



TEXT BY KATIE GERFEN

1291

The year that Venice banned glass furnaces from the city center, fearing that fire would break out and spread quickly through the dense fabric of wooden structures. This move essentially banished all glassmakers to Murano. In the 16th century, the island's population topped 30,000. Though it still remains a center of glassmaking, its population today is closer to 5,000.

SOURCE: ENCYCLOPEDIA BRITANNICA

Polished is a collection of modular and broadloom carpet from **Bigelow**, a Mohawk brand. Designed for corporate environments, Polished has four linear patterns—personal best, positive mindset, well composed, and elite impression—all with a textured pattern loop. Each pattern is available in 12 colorways, and is manufactured with the company's ColorStrand solution-dyed nylon. The carpet is backed with Ultra Set RC, a five-layer bracing system containing 35% recycled content. • bigelowcommercial.com • Circle 120

Aria is a Massimo Iosa Ghini–designed pendant fixture from **FDV Collection**, a Leucos USA brand. The white metal canopy hides a 13W LED source that illuminates the hand-blown Murano glass diffuser. Aria is available in two sizes. The larger S36 has a diffuser that is 14¹/₈" by 10¹/₄" and can hang at the end of a sinuous cord as far as 70⁷/₈" from the ceiling; the smaller S18 has a diffuser that is 7¹/₄" by 6⁷/₈". The S18 also has a straight cord and a length up to 78³/₄". Both have an electronic driver. • leucosusa.com • Circle 123

Designed by Jeff Weber, **Caper** is a family of multipurpose and stacking chairs from **Herman Miller**. The stackable option measures 32.5" high, 17.5" wide, and 16.5" deep; the chairs, which come with or without casters, can be connected to one another. With 25% recycled and 100% recyclable content, they are Cradle to Cradle Silver and Greenguard certified. The multipurpose option is available with a five-star base and an adjustable-height seat. • hermanmiller.com • Circle 121

Suitable for homes and hotels, **Onto** is a series of bath furnishings designed by Matteo Thun for **Duravit**. The collection includes tubs, consoles, vanities, and cabinets, all clad in a bonded anti-warp and zero-emission plywood. The locally sourced wood is pretreated with a combination of oil and wax that saturates the wood fibers, preventing water absorption during use. The collection is available in European oak, dark chestnut, matte white, and matte basalt finishes. • duravit.com • Circle 124

Fulton has increased the capabilities of its **Vantage** high-efficiency condensing hydronic boiler, which can now have the option of using certain renewable fuels, including B100 biodiesel (even biofuel made from soybeans and recycled tallow) and ultralow sulfur heating oils. As a result, Vantage can meet or exceed the thermal efficiencies of natural gas–fueled systems. The new system is available in models that can produce up to 4 million BTUs per hour. • fulton.com • Circle 122

Mediterranea used proprietary digital inkjet technology to develop the stonelike appearance of its **Essence** collection of high-performance porcelain tile. Available sizes include 18" square, 13" square, 12" by 24", 3" by 13" bullnose, and 2" square mesh-backed mosaic field tiles. The collection comes in four colorways—bronze, caramel, forest, and pearl—and is produced with 55% recycled content. Essence is suitable for moderate-traffic commercial settings. • mediterranea-usa.com • Circle 125

Find AIA-, NAHB-, NARI- and USGBC- approved training courses.

Webinars, videos and free training courses at your fingertips.

Fact sheets and research are yours to download.



For the latest propane training, consider this a tool of the trade.

Make Propane Training Academy your go-to online resource for free continuing-education training courses and other valuable propane application information. The Propane Education & Research Council (PERC) is constantly developing new AIA-, NAHB-, NARI- and USGBC- approved training courses, covering a wide range of topics including the environmental and efficiency benefits of building and remodeling with propane. To take courses like the ones listed below, visit **propanetrainingacademy.com**.

- A Comparative Analysis of Residential Heating Systems
- Living Off-Grid: Power Generation and Storage Basics
- Expanding Outdoor Living: Using Propane for Efficient and Sustainable Outdoor Living



Scan this code to connect to training.
Need a code reader? Download one at ScanLife.com.

Train Right. Build Better.

Circle no. 268 or <http://architect.hotims.com>

PROPANE
EXCEPTIONAL ENERGY®

Courtesy of UAF Marketing and Communications - Photo By Todd Paris



SOFTER LIGHT FOSTERS SHARPER IDEAS

CREATING ENVIRONMENTS WHERE PEOPLE CAN SHINE™



Libraries, classrooms, offices and work centers demand balanced, usable light. Translucent panel skylights and curtainwall systems from Major Industries eliminate glare and hot-spots and block damaging UV - all while offering enhanced thermal performance.

Why rely on costly, energy-hungry artificial lighting? Give your building's occupants the natural light they deserve.



SKYLIGHTS & TRANSLUCENT CURTAINWALL
MAJORSKYLIGHTS.COM
888-759-2678

Circle no. 247 or <http://architect.hotims.com>

technology



Barz is a new lightweight panelized suspended ceiling system from **Ceilings Plus**. With components made of light-gauge aluminum, the linear system can weigh as little as 1.5 lbs. per square foot. Barz is available in a variety of metal finishes, and in wood veneers that have no added urea formaldehyde and emit no VOCs. Some veneers are FSC certified. The system is also available with microperforations that help control acoustics, and HVAC and fire control can be integrated into the panels. • ceilingsplus.com • Circle 126

Lightspring is a wall-mounted LED fixture from **Flos**, designed by Ron Gilad. The injection-molded methacrylate diffuser has a photo-engraved internal finish and offers indirect light. The diffuser is connected with a magnet to the higher of two curved arms that extend from the extruded aluminum body of the fixture. Lightspring is available in Single, a 400mm-tall 4.5W option, and Double (shown), a 620mm-tall 9W version with a second diffuser mounted to the fixture's lower arm. • flos.com • Circle 127

Metl-Span's HPCI Barrier insulated backup panel is an air-, water-, thermal-, and vapor-barrier system that can be used behind façade systems. The High Performance Continuous Insulation panels are single panels (as opposed to a multilayered system), and are available in a 2" thickness with an R-value of 15, and a 3" thickness with an R-value of 22. The panels are installed outside of a building's structural supports, eliminating thermal bridges that can reduce the efficiency of exterior wall systems. • metlspan.com • Circle 128

With a stainless steel frame and a seat clad in FSC-certified Jatoba hardwood, the **Duo Bench** from **Forms+Surfaces** is suitable for both indoor and outdoor environments. The bench has a 6" profile and comes in nominal 6' lengths. The frame is made up of rectangular stainless steel tubing that is also available in two no-VOC powdercoat colors: fog gloss and white texture. Custom colors are available. The Duo Bench contains recycled content and is fully recyclable at the end of its life cycle. • forms-surfaces.com • Circle 129

Envelope Connections and Compatibility

AIA/CES module for Enclosures and Cladding¹ says:

“A continuous air barrier..... must seamlessly connect to the lowest slab on grade, foundation, and roof. This requires compatible materials and close coordination among the trades.”

“Of the many different connection points, one that requires the most careful detailing and is most often subject to failure, is the interface between the air/moisture membrane and window openings, curtain walls, or storefront framing edges.”

1. Enclosures and Cladding AIA/CES Module, www.BDCnetwork.com/EnclosuresAndCladding

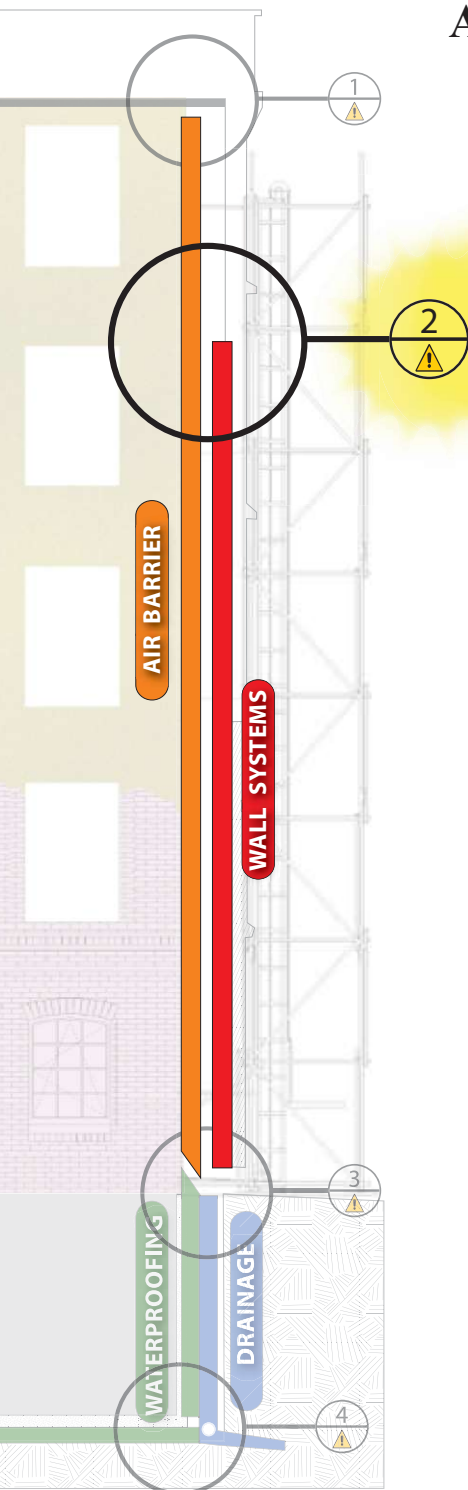

Polyguard has compiled a comprehensive book, *Integrated Building Envelope™ Handbook – Connections with Exterior Wall Assemblies*. This handbook (available to the design community at www.polyguardproducts.com/aan) describes the all important tie-in connections using isometric drawings and installation text.

“Missed Connections”- installation errors and omissions - are the major cause of breaches in otherwise airtight and water resistant building envelopes. Our handbook, in combination with our unique and patented products, address decades of observed failures caused by incompatible materials, incomplete and/or omitted design details, and lack of coordinating installation guidelines.

It’s not just about good air barriers and flashings. It’s about compatible, inexpensive, easy to install and single source end dams, cants, corner boots, corner flashing kits, drips, counters, thru wall and pan flashings, flared termination strips, horizontal and pan weeps, bottom and top vents, rain screens and pressure equalizing rain screens. AND it’s about clear and simple drawings, details, and instructions.

**Work with Polyguard.
We’re the ones with the connections.**

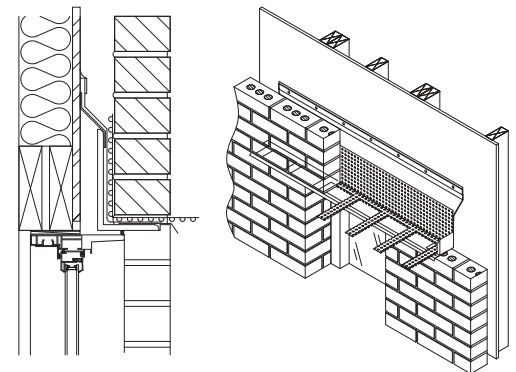

VENEER WINDOW HEADS

- 1 Detail
- 7 Isometrics with instructions
- Uses: Drips, Couplers, Counters, Cant, Flashing, Termination Strips, End Dams, Horizontal Weep

Innovation based. Employee owned. Expect more.

Polyguard®

Phone: (1) 615.217.6061

www.polyguardproducts.com



Circle no. 568 or <http://architect.hotims.com>

1,000

HEIGHT, IN METERS, OF THE KINGDOM TOWER, A BUILDING PROPOSED BY ADRIAN SMITH + GORDON GILL ARCHITECTURE FOR JEDDAH, SAUDI ARABIA.

→ MIND & MATTER

Two (More) Towers

DEVELOPERS BUILD BIG TODAY FOR REASONS OTHER THAN TO SEE WHOSE TOWER IS TALLEST. BUT ARCHITECTS SHOULDN'T LOSE SIGHT OF DESIGN AS THEY STRIVE FOR THE RECORD BOOKS.

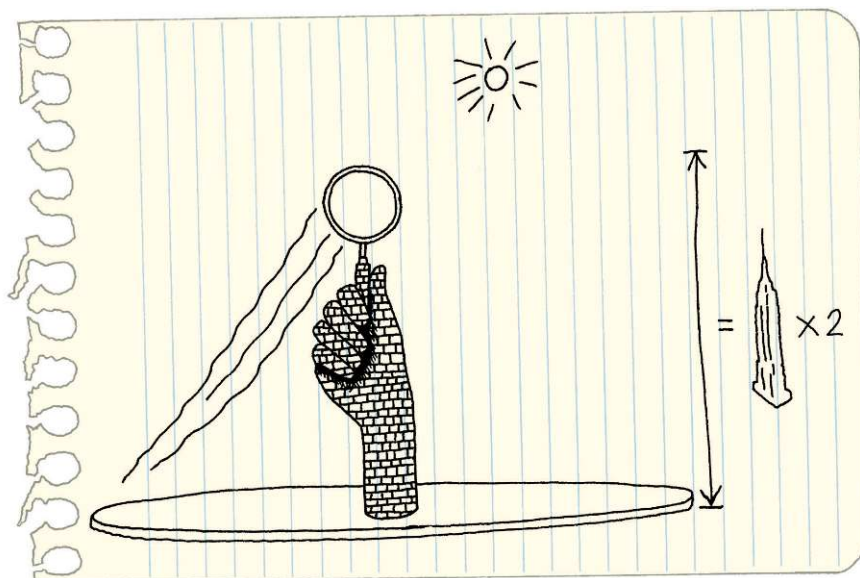

IF THERE WERE ANY DOUBT about the viability of the tall building after the 9/11 attacks, it no longer exists. Five skyscrapers surpassing the 415- and 417-meter core heights of the original World Trade Center towers have been constructed since 2001, including the Burj Khalifa, which, at a breathtaking 828 meters, is presently the world's tallest building. The uses of tall structures are also becoming more varied. Of the supertall structures currently under way, two have been designed for infrastructural purposes. As these monumental works of engineering emerge, it is important to assess the role of architecture in their designs.

The Tokyo Sky Tree is a television and radio broadcasting tower currently under construction in Tokyo. Designed to extend the reach of digital television signals in Japan, Tokyo Sky Tree will be the tallest structure in Japan and the second tallest structure in the world when it is completed in 2012.

The 634-meter tower rises from a triangular base, its profile eventually becoming more circular as it ascends to meet a series of protruding observatories. Architecture and engineering firm Nikken Sekkei enveloped a reinforced-concrete core with a steel lattice that appears concave or convex from different angles—by far the tower's most compelling feature. The bulbous observatory structures and diminished antenna spire are unfortunate additions, suggesting a structure overburdened with program in conflict with an original, more graceful profile.

A new contender for the world's second tallest structure is EnviroMission's Solar Tower. Planned for construction in an Arizona desert by 2015, the structure will generate 200 megawatts—enough to power 150,000 U.S. households. Originally proposed for Australia but stymied by a lack of government support, the project will operate at 60 percent efficiency—better than any other renewable source.

If constructed as intended, the 800-meter Solar Tower will dwarf the Tokyo Sky Tree. While the proposed Solar Tower offers many advantages—not the least of which is maintenance-free, pollution-free power—its design is unrelenting. And not in an affirmative sense. The Solar Tower recommends a collaboration with more skillful architects who can craft a more inspiring design within the technological constraints of the system. Currently, the tower is nothing more than a hulking, engineering-driven infrastructure project—representing a departure from a more compelling prototype that previously debuted at the Smithsonian.

One might argue that the Solar Tower's hinterland location frees it from the public pressures for a more sophisticated design. Yet a landmark that stands for a cleaner energy future and that will be visible for miles should seek to represent the best in art as well as science, regardless of its site. And as more supertall structures are planned for the global skyline, we must advocate for a stronger and more involved role of the architect, irrespective of program. □

TEXT BY BLAINE BROWNELL, AIA
ILLUSTRATIONS BY PETER ARKLE



→ Read more of Blaine's reports on cutting-edge tech at ARCHITECT'S Mind & Matter blog: go.hw.net/brownell.

MacLean Dixie HFS



TM

www.MacLeanDixie.com

ICC-ES Approved ESR 3032

The **ONLY AC358**
Approved for:
Square Shaft and
Pipe Steel Foundation Piles

Round Corner Square (RCS) Steel Shaft Piles

Patent Pending Strength Squared® Steel Pipe Piles



Member



Member

Circle no. 556 or <http://architect.hotims.com>

Copyright 2011© MacLean Power Systems

VISIT US AT
GREENBUILD,
BOOTH 1231N

Unless you're working
with kryptonite, talk to
me when it comes to
cementitious materials.

Megan Dangel, LEED AP
Lafarge Cement



Lafarge is about so much more than materials. It's about the people who stand behind them. It's about the people dedicated to transforming materials to adapt to our everyday environment.

These are the people of Lafarge. Those who are totally committed to finding sustainable solutions for a better world. Those who collaborate with architects, leading universities, research centers, industry and environmental organizations to make sustainable construction a reality.

I'm proud to be one of these people. **Join me online where I share my thoughts on helping customers learn about cementitious options.**

Visit: www.lafarge-na.com/visitwithme

Circle no. 474 or <http://architect.hotims.com>



LAFARGE

bringing materials to *life*™

CULTURE



EDITED BY LINDSEY M. ROBERTS

→ **EXHIBIT**

When you take a Doric column and input it into an architectural algorithm, you get architect Michael Hansmeyer's **Subdivided Columns**. They appear to expand like an M.C. Escher illusion, only this illusion is measurable: The cardboard columns are subdivided eight times into 5.8 million faces. Hansmeyer, an architect at the Swiss Federal Institute of Technology in Zurich, uses algorithms not as frameworks of formalization but as a design tool to generate endless permutations of a scheme. He designed a Java program that he uses to create the columns, then cuts the individual 1-millimeter-thick layers of cardboard with an industrial mill. The almost 10-foot-high structures are currently on display at the Gwangju Biennale in South Korea. Through Oct. 23. • gb.or.kr

Wire Mesh Systems Made Affordable

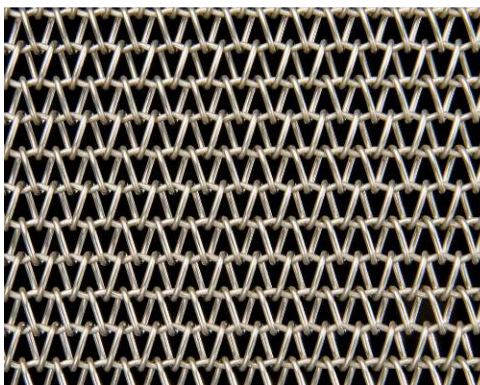
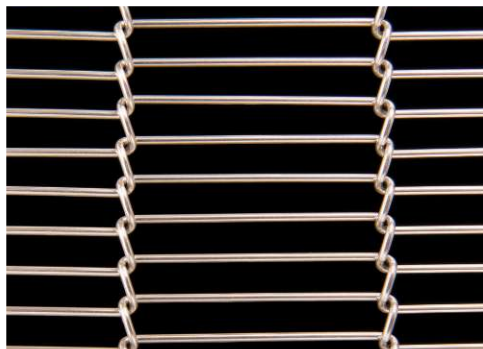
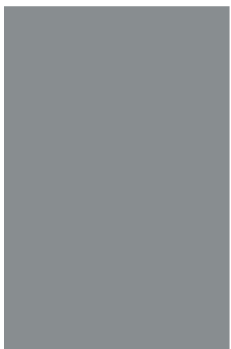
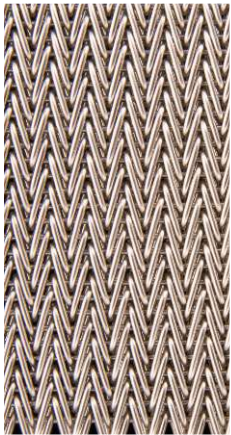
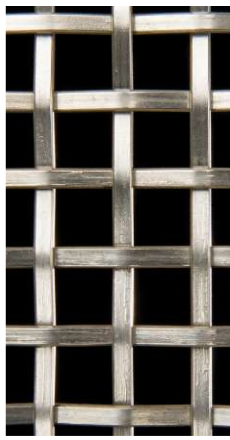

Building Facades
Railing & Cabinet Infill
Wall Cladding
Elevator Interiors



ARCHITECTURAL WIRE MESH

Wire By Design can make your next project affordable.

Call us at **1.800.773.5700** or visit us at www.wirebydesignco.com.

We are currently expanding our network of independent sales representatives.

Please contact Grant Farrell at gfarrell@wirebydesignco.com for more information.

Circle no. 512 or <http://architect.hotims.com>

culture

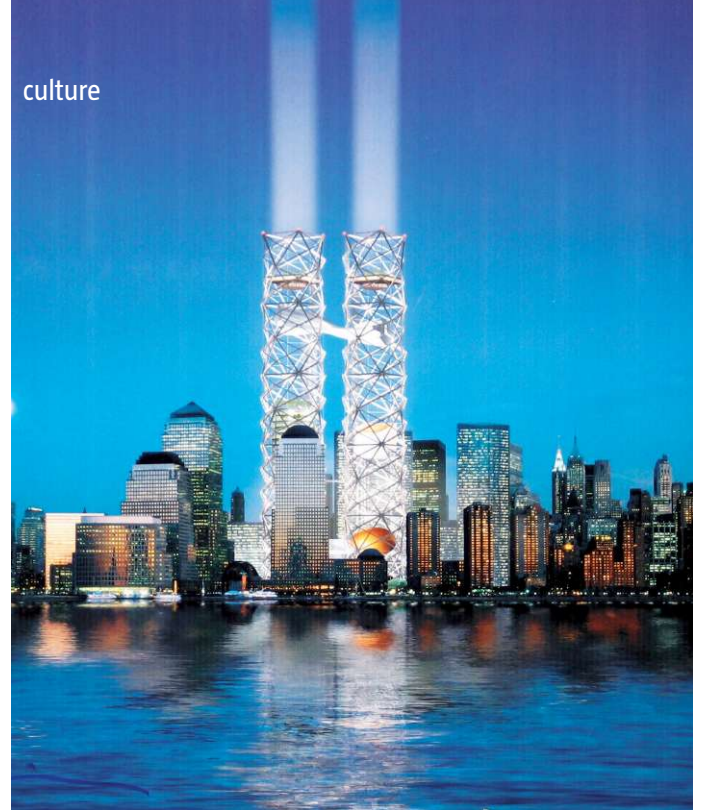

→ EXHIBIT

194X-9/11: American Architects and the City, now at the Museum of Modern Art in New York, takes its name from a 1943 issue of *Architectural Forum*. The magazine commissioned designs from 23 architects for an imagined postwar American city to begin when World War II was over—or in “194X.” The exhibit highlights those designs, as well as post-1945 plans (including Ludwig Mies van der Rohe’s plan for Chicago and Louis Kahn’s plan for Philadelphia), Leon Krier’s pedestrian-friendly national capital, and the proposed designs for the World Trade Center site (THINK Design’s proposal is shown above), which together consider the effects that more than a half-century of cyclical global conflict and economic woe have had on America’s urban landscape since the end of World War II. Through Jan. 2, 2012. • moma.org

→ EXHIBIT

Her designs curve, swoop, sculpt, and bend, but the Zaha touch has morphed more than buildings, as this Philadelphia Museum of Art exhibition shows. **Zaha Hadid: Form in Motion**, running from Sept. 17 to March 25, is the the first to display the Pritzker Prize winner’s product designs. The Z-Chair, Swarovski-crystal jewelry, Lacoste shoes (shown), and the prototype Z-car I all display her signature biomorphic style, which she describes as “virtuoso of elegance.” • philamuseum.org



ELEVATE YOUR RESTROOM'S LOOK WITH

DIPL^oMAT™

ACCESSORIES

NEW ROLL TOWEL
DISPENSER
ACCOMMODATES
VIRTUALLY ANY
TOWEL BRAND.

With unique **dual-curve geometry**, Bradley's latest commercial-grade accessories are a sleek and elegant finishing touch to any restroom. With the **most models available** in this class, Diplomat Accessories complete the look of the restroom. Sustainability matters too; Diplomat Accessories are manufactured with **renewable energy**.



Bradley
Celebrating 90 Years of Innovation 1921-2011

800.BRADLEY bradleycorp.com/diplomat

Circle no. 213 or <http://architect.hotims.com>

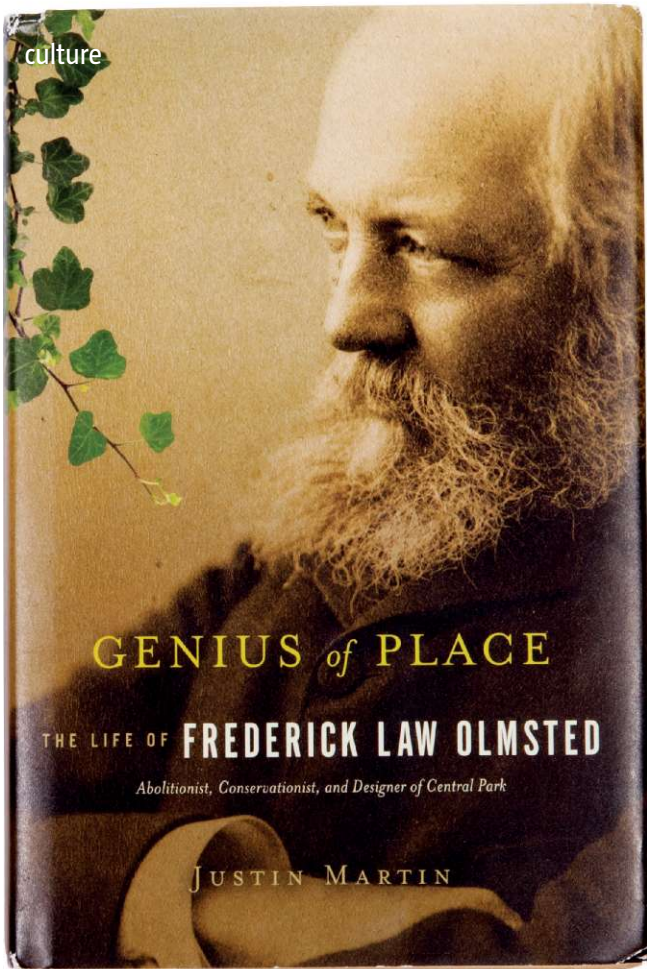

→BOOK

Toward the end of his life, Frederick Law Olmsted (1822–1903) lived in an asylum for which he designed the grounds. This is coincidental, but not inconceivable, as Olmsted’s landscaping and land-preservation reach was countrywide—from New England college campuses to California’s Yosemite National Park. **Genius of Place: The Life of Frederick Law Olmsted** by Justin Martin is part exposé of the man, part history of Americans subduing the U.S. terra firma. • \$30; Da Capo Press, June 2011

OFFICE SNAPSHOTS

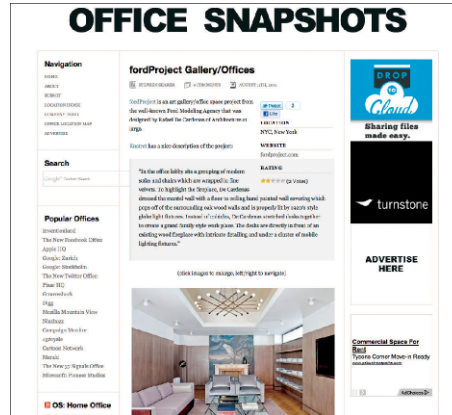

→INTERNET

Goodbye, corner office. Post-recession workspaces reflect the vertical integration and open floors that many companies are adopting. **Office Snapshots** is a window into these offices—from Twitter’s sleek new space to the Wonka-esque Inventionland office. With a roster of more than 450 projects, visitors can lust after glass partitions and supergraphics in photos and renderings that boldly affirm a new age of corporate culture. • officesnapshots.com

QUICK!

Pick the North American one!

Choose **North American Made** by Leland. Serrated flange bolts and nuts, purlin bolts, machine screws, track bolts, carriage bolts, tank bolts, fin neck bolts, solid rivets - up to 5/8" x 4-1/2" – in just about whatever grade or finish your application demands.

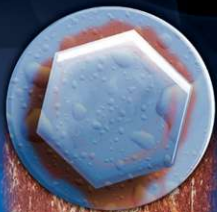

You lose.



You win!
(All the way to the bank)

They're all made in North America. And made to last! You can count on corrosion resistance that's second to none - thanks to our JS1000 plating and proprietary coatings.

Invest in tomorrow. Demand North American made bolts by Leland.



www.lelandindustries.com
1-800-263-3393

Circle no. 279 or <http://architect.hotims.com>



→OBJECT

Most architects use modeling software to make sure buildings are rigid. But London-based duo Sam Bompas and Harry Parr actually want a little “wobble.” That’s because they use CADD software to design building-shaped gelatin molds (St. Paul’s Cathedral in London is shown above), and then sell them or serve them at their unique events. One event included an 8,000-pound punch bowl, and Arup had to make sure the building could support it. The pair want to resurrect the dessert to its rightful place at dinner—one jiggling replica of Buckingham Palace at a time. • jellymongers.co.uk

A NEW DIMENSION IN EXTERIOR DESIGN

University of Arizona
AR7 Architects, PC

Dri-Design with Ombrae is architectural art. The perfect marriage of artistic expression and functionality. These exclusive, patented panels contain thousands of tiny tabs, each differing in orientation to produce a three-dimensional image of reflected light. It's not perforated, printed or embossed ... it's Dri-Design with Ombrae.

WHY DRI-DESIGN?

- Each panel made to custom color and size
- Will never stain, streak or require maintenance; no sealants, caulk or gaskets
- Will never delaminate
- Available in zinc, copper, stainless steel, anodized aluminum and any Kynar-coated aluminum
- Fastest, easiest installation on the market
- Exceeds performance specifications of AAMA 508-07 and Dade County

Visit us in booth 421 at MetalCon 2011 in Atlanta.

Circle no. 287 or <http://architect.hotims.com>

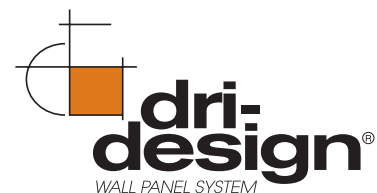

616.355.2970 | www.dri-design.com





→ EXHIBIT

While Modernism tried to open a window onto utopia, Postmodernism turned that window into a broken mirror, posits **Postmodernism: Style and Subversion 1970-1990** at London's Victoria & Albert Museum. Martine Bedin's *Super Lamp for Memphis*, shown, exemplifies that fracturing, as does Hans Hollein's *Strada Novissima*, which is a set of columns each of which exemplifies an era of architectural history. The exhibition also presents magazines, music, and fashion that reflect the color, theatricality, and exaggeration of the movement. Sept. 24 through Jan. 15, 2012. • www.vam.ac.uk



→ EXHIBIT

Palladio and His Legacy: A Transatlantic Journey, at the Carnegie Museum of Art's Heinz Architectural Center, explores the Renaissance architect's influence in Europe and the U.S. The show includes exceptionally rare materials: preliminary drawings for *I Quattro Libri*, a copy of the treatise annotated by Lord Burlington, and works by modelmaker Timothy Richards. Through Dec. 31. • cmoa.org

LEFT TO RIGHT: V&A IMAGES; COURTESY CARNEGIE MUSEUM OF ART

McNICHOLS® Designer Metals



The trendy signage for the Atlanta Urban Outfitters store in Atlanta, GA, is made with McNICHOLS® Designer Wire Mesh.

Circle no. 296 or <http://architect.hotims.com>

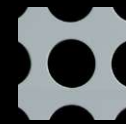

Hole Metal Designs

The Hole Story

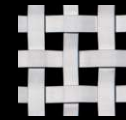
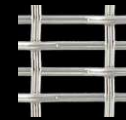
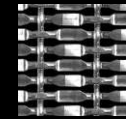

Architects and contractors look to McNICHOLS® Designer Metals for sustainable, functional and aesthetic solutions for their projects.

McNICHOLS offers endless design opportunities and striking aesthetics with their Designer Metal series of products. Selections include perforated and expanded metal, wire mesh, and grating in a myriad of materials and styles.

Our highly trained Architectural Design Consultants are ready to assist with your next design project. We look forward to serving you!



mcnichols.com/arci • 866.754.5144



Water by Nature... Sculpted by Bluworld

bluworldofwater
WORLD LEADER OF EXQUISITE WATER DESIGN

Circle no. 160 or <http://architect.hotims.com>

ORLANDO (Headquarters) · NEW YORK · LOS ANGELES · DENVER
www.bluworldusa.com | info@bluworldusa.com | p(407)426-7674 | f(407)426-7721

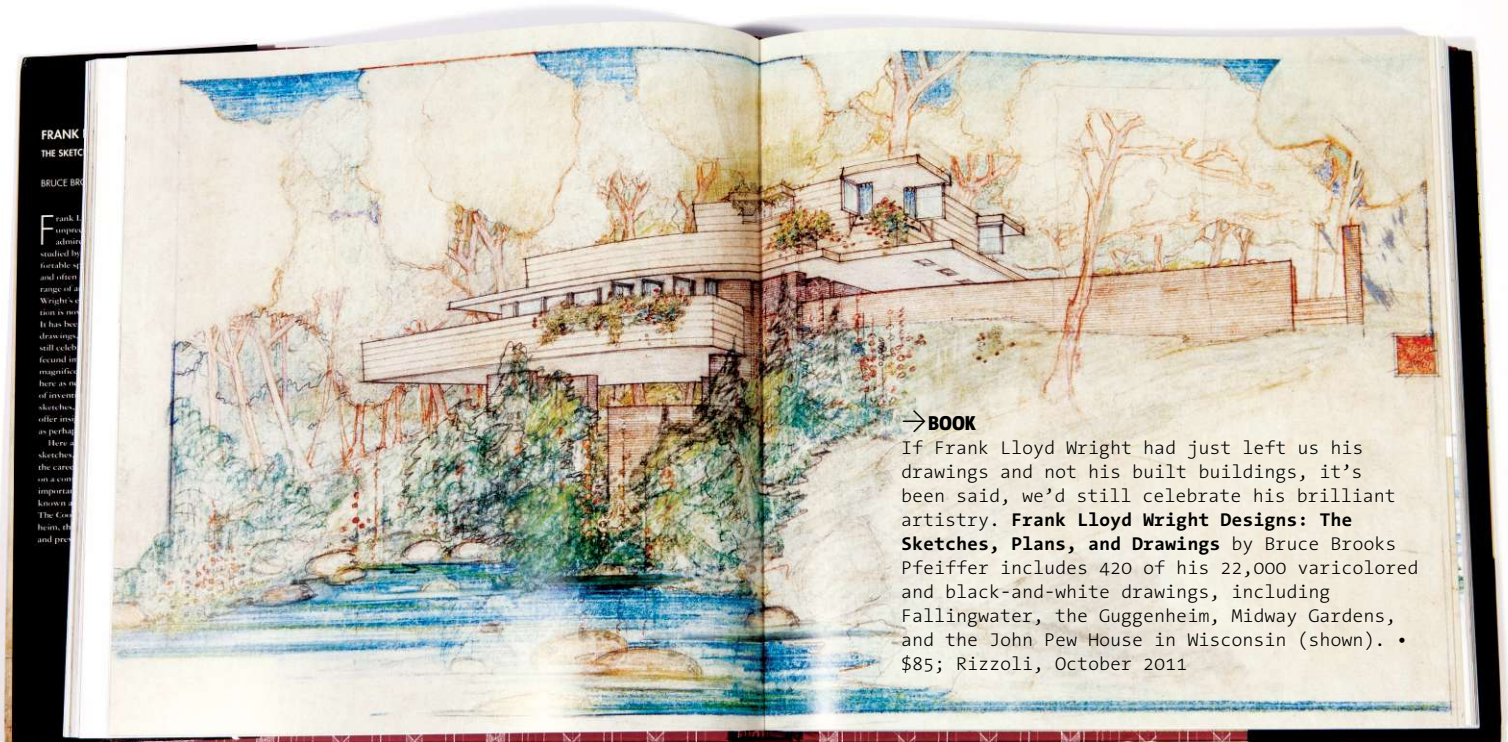

FRANK
THE SKETCH

BRUCE BROOKS

Frank Lloyd Wright's drawings and sketches are a treasure trove of ideas and solutions. It has been said that Wright's sketches are more important than his buildings. This book, *Frank Lloyd Wright Designs: The Sketches, Plans, and Drawings*, by Bruce Brooks Pfeiffer, includes 420 of his 22,000 varicolored and black-and-white drawings, including Fallingwater, the Guggenheim, Midway Gardens, and the John Pew House in Wisconsin (shown).

→ **BOOK**

If Frank Lloyd Wright had just left us his drawings and not his built buildings, it's been said, we'd still celebrate his brilliant artistry. **Frank Lloyd Wright Designs: The Sketches, Plans, and Drawings** by Bruce Brooks Pfeiffer includes 420 of his 22,000 varicolored and black-and-white drawings, including Fallingwater, the Guggenheim, Midway Gardens, and the John Pew House in Wisconsin (shown). • \$85; Rizzoli, October 2011

TOPR™
RETROFIT ROOFING SOLUTION

COOLR®
ENERGY EFFICIENT ROOFING METAL

SOLR™
SOLAR ENERGY ROOFING PANELS

NEWER ROOF. COOLER ROOF. SOLAR ROOF.

Harness the sun with SOLR affordable solar roofing that's building integrated and can offer payback in 10 years or less—for a solar roof that outshines the rest. For even more benefit, there's the TOPR retrofit roofing solution and COOLR energy-efficient cool metal roofing. Call us to learn how you can layer on one, two or all three roofing solutions.

CLEVELAND: 800.283.5262
ATLANTA: 800.929.9359
DALLAS: 877.853.4904
DENVER: 877.375.1477
www.sheffieldmetals.com

Sheffield Metals International

Circle no. 294 or <http://architect.hotims.com>



→ **FILM**

As St. Louis and other American cities deindustrialized in the '50s and '60s, a national urban-renewal program tried to address the mass exodus of residents and businesses from urban centers. One solution was the 33-building, 11-story Pruitt-Igoe public-housing complex, built in 1954, and destroyed starting in 1972. Independent filmmaker and director Chad Freidrichs tells the story of this development and questions its status as a symbol of the failure of Modernist architecture and public-assistance programs in **Pruitt-Igoe Myth: An Urban History**. The 83-minute film, which tries to "implode the myth," will be screening in New York City, Seattle, and other cities this fall. • pruitt-igoe.com



DENSGLOSS.[®] BECAUSE YOUR NAME STAYS ON EVERY BUILDING YOU DESIGN.

Georgia-Pacific's DensGlass Sheathing has been standing strong for over 25 years. That's nearly 20 years longer than our next closest competitor. Choose the #1 architecturally specified fiberglass mat gypsum product.

For a GP architectural specialist call 1-800-225-6119 or visit densglass.com.

Circle no. 419 or <http://architect.hotims.com>

DensGlass[®]
Sheathing

GP Georgia-Pacific
Gypsum
Building Reputations Together

The redesigned World Trade Center will make more efficient use of its Lower Manhattan space than the original site, according to master planner Daniel Libeskind.

TEXT BY BEN ADLER



Ben Adler is a contributing writer for *The Nation*. His writing on urban planning has appeared in *The Atlantic*, *The American Prospect*, and *Next American City*.

→ CRIT

Design After 9/11

THE MEMORIAL AND PLAZA—THE FIRST FEATURES OF THE WORLD TRADE CENTER TO OPEN AFTER THE ATTACKS—REVEAL THE POLITICS AND PSYCHOLOGY IMPERATIVE TO THE REDESIGN.

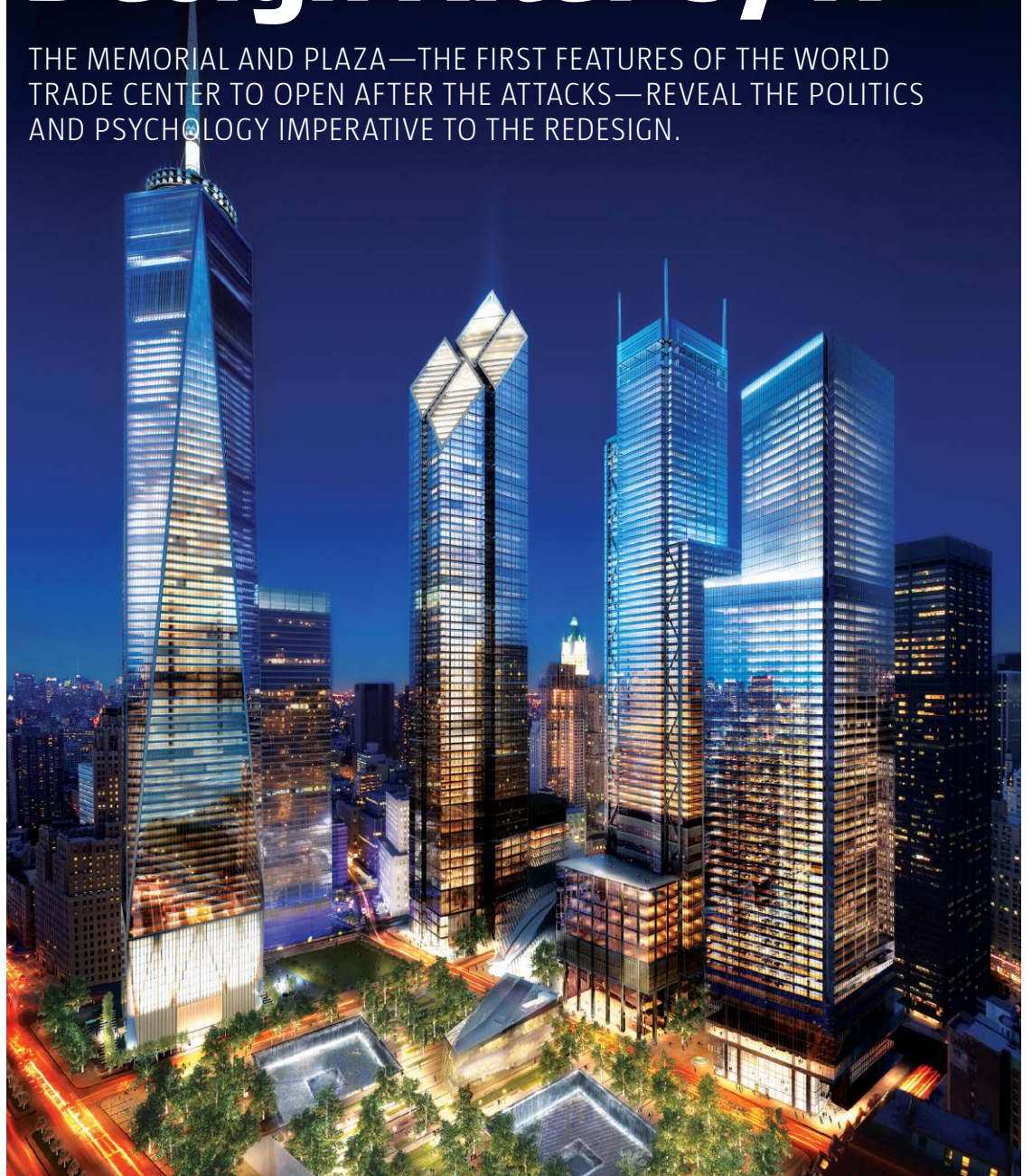

TEN YEARS AFTER the Sept. 11, 2001, terrorist attacks on the World Trade Center, roughly half of the eight-acre memorial plaza designed to take its place is a fenced-off hole in the ground. The underground memorial museum and its above-ground steel-and-glass pavilion are still under internal construction. There is less still to the commercial portion of the 16-acre site, where half-clad skyscrapers stand among ditches awaiting foundations to be poured. On the 10th anniversary of the attacks, the World Trade Center is very much a work in progress.

The memorial and its plaza were designed for three functions: to give Lower Manhattan some much-needed public space, to commemorate the city's loss of the Twin Towers and the people who perished in them, and to serve as a breathtaking icon of renewal. The memorial and a section of the plaza will open for the 10th anniversary of the attacks, with the museum, pavilion and remainder of the plaza set to open next year.

Yet for all the time it will take to re-open the World





ACADEMY of ART UNIVERSITY®

FOUNDED IN SAN FRANCISCO 1929 BY ARTISTS FOR ARTISTS



STUDY ONLINE OR IN SAN FRANCISCO

Acting*
Advertising
Animation & Visual Effects
Architecture*
Art Education
Fashion
Fine Art
Game Design
Graphic Design
Illustration
Industrial Design
Interior Architecture & Design
Landscape Architecture*
Motion Pictures & Television
Multimedia Communications
Music Production & Sound
Design for Visual Media
Photography
Web Design & New Media

ENROLL NOW

EARN

YOUR AA, BA, BFA, MA, MFA OR
M-ARCH ACCREDITED DEGREE

ENGAGE

IN CONTINUING ART EDUCATION COURSES

EXPLORE

PRE-COLLEGE SCHOLARSHIP PROGRAMS

WWW.ACADEMYART.EDU

800.544.2787 (U.S. Only) or 415.274.2200

79 NEW MONTGOMERY ST, SAN FRANCISCO, CA 94105

Accredited member WASC, NASAD, CIDA (BFA-IAD), NAAB (M-ARCH)

**Acting, Architecture (BFA) and Landscape Architecture degree programs not currently available online.*

Visit www.academyart.edu to learn about total costs, median student loan debt, potential occupations and other information.

Photo credits, clockwise from top left: Jacob Green, Daniela Di Luzio, Isabelle Suwandi, School of Architecture

Circle no. 532 or <http://architect.hotims.com>

2011



myMarvin ARCHITECT'S CHALLENGE WINNERS

The winning entries have been selected from an array of truly inspired and inspiring designs. Each project features Marvin Windows and Doors and the best examples of solution-driven design, innovation, classic beauty and sustainability. Here's your chance to see all the entries that have been awarded for excellence in this prestigious annual event.

View winners' showcase at marvin.com/inspired



Built around you.®

©2011 Marvin Windows and Doors. All rights reserved.
®Registered trademark of Marvin Windows and Doors.
1-800-236-9690

Circle no. 210 or <http://architect.hotims.com>



Designed by Snøhetta and scheduled to open in 2012, the memorial pavilion houses the entrance to the memorial museum, which includes box beams salvaged from the towers.



Trade Center, it may take much longer for New Yorkers to decide what to make of it. How the memorial and plaza will fit into Manhattan will depend as much on what the city brings to it as what it brings to the city.

Case in point: Before the stainless steel cladding was added to the memorial pavilion, construction workers on the site mistook the pavilion's shaded, striped glass for a U.S. flag design. "It was like breaking their heart to say no," says Ann Lewison, project manager for Snøhetta, which designed the pavilion. "It's interesting to work on a site where people bring their own meaning."

When the first visitors arrive this fall, there will be other incomplete features that call for interpretation. Over a decade of development, the city has introduced its share of changes and delays to the site—some for prosaic reasons of cost and security, others owing to the sensitive nature of the site and the many stewards overseeing its multiple functions.

One proposal would have used the opportunity to entirely revise the neighborhood: a suggestion to sink part of the West Side Highway, which divides the World Trade Center site from the World Financial Center. The memorial plaza would have then extended to World Financial, connecting it and Battery Park City to the rest of Lower Manhattan. Yet the idea came too soon after Boston's Big Dig; nearby businesses complained to City Hall about the prospects of sinking tens of billion of dollars and years of construction into moving the highway underground.

Ultimately, a comparatively simple World Trade Center master plan emerged. On the 10th anniversary of the attacks, visitors will be able to go right up to where the Twin Towers stood, read the names of the deceased, and take in the dramatic, flat stone boxes of the buildings' footprints—now smooth waterfalls. But no decision along the way has been easy.

Designing the Memorial

Few subjects in architecture are more contentious and intensely emotional than the representation of historical memory. Michael Arad, AIA, of Handel Architects, who with landscape architect Peter Walker designed the winning proposal for the 9/11 memorial, says that the presentation of victims' names required multiple revisions. Every victim's family has a stake in how their loved one is remembered; by no means do all of their interests align.

Initially, Arad and Walker's design called for a ramp that would wind down around one of the pools to a series of underground galleries with the names of the lost inscribed on the walls. That plan for the inscriptions had to be scrapped: Enclosed galleries would be difficult to outfit with security features. Egress for large crowds in the case of an emergency presented another concern. Arad agreed to bring the names up to street level. "The galleries were not about having a cool vertical space," Arad says. "It's about the experience of seeing the names."

A proposal to present victims' names inside the museum was similarly impractical. A queue of visitors entering the museum would build to unmanageable levels if every visitor looking to see the memorial names was led through security detectors.

Bureaucratic obstacles emerged for virtually every approach. After the galleries were



PERMINATOR™
underslab vapor-Mat
W. R. MEADOWS
SEALTIGHT®



UNDER SLAB. OVER ACHIEVERS.



PERMINATOR



PMPC

© W. R. MEADOWS, INC. 2008

THERE'S BEEN A LOT OF CONFUSION in the industry regarding vapor barriers, but we'd like to set the record straight. If you want to achieve the best possible protection against vapor infiltration, don't accept anything less than W. R. MEADOWS. We're the only manufacturer with vapor barriers that meet both the ASTM E 1745 and ASTM E 1993-98 specifications, and independent test results confirm that fact.

If you need the ultimate vapor barrier, trust PREMOULDED MEMBRANE® VAPOR SEAL with PLASMATIC® CORE (PMPC). After more than 50 years, it's never been equaled for protection and toughness. Or for less demanding applications, depend on the proven quality of PERMINATOR®. Available in both 15 mil and 10 mil thicknesses, it is a highly effective yet economical choice.

For unrivaled under slab vapor protection, go with the over achievers—PMPC and PERMINATOR by W. R. MEADOWS.

For more information about these and all of our building envelope products, visit www.wrmeadows.com or call 1.800.342.5976.

**BUILDING ENVELOPE PRODUCTS BY W. R. MEADOWS
LINED. SEALED. DELIVERED.**

Circle no. 255 or <http://architect.hotims.com>

Guardian of the Structure



W. R. MEADOWS®

SEALTIGHT®

QUALITY...INTEGRITY...
SERVICE...SINCE 1926

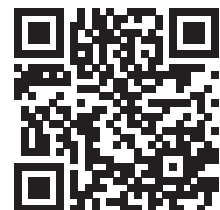

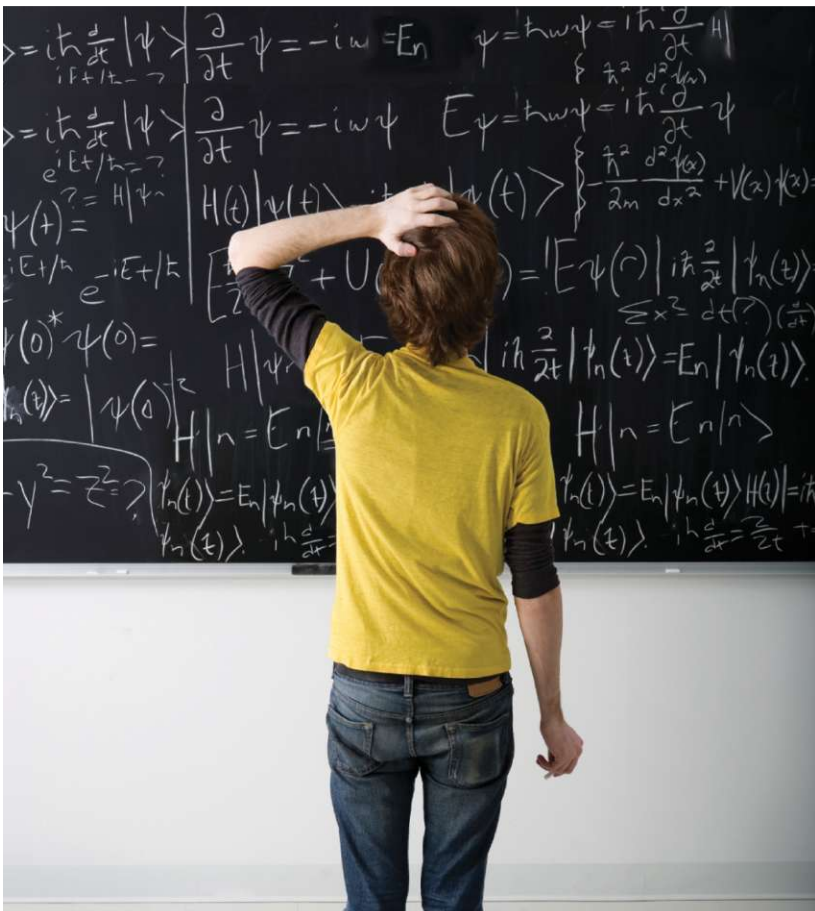

the Solution to Green Building doesn't have to be difficult.

NUDURA Forms provide eco-friendly, energy efficient building envelopes that provide superior performance benefits to minimize energy costs, maximize value, and create a healthy indoor environment. NUDURA structures offer superior strength, storm, sound, and fire resistance.

When designing and specifying the NUDURA System, be sure to utilize our Design Specification Guide and BIM Library. **Now fully accessible online.**

Visit our Design Resources section at Nudura.com

Building Has Evolved™



Circle no. 185
or <http://architect.hotims.com>



Michael Arad and Peter Walker proposed a number of iterations for presenting the names of the victims of the 9/11 attacks—a process that culminated in a raised, bronze parapet featuring names arranged by the victims' locations in the towers.



eliminated for cost and security reasons, Arad suggested putting the names on a shallow water table at the top of the waterfalls. That raised building code issues: A pool deeper than 18 inches can be considered a swimming pool. Symbolically, the idea also could be seen as showing the names drowning. At the request of the World Trade Center Memorial Foundation, Arad went back to the drawing board.

The next, and semi-final, solution was to carve the names into 5-inch-thick bronze plates that would ring the waterfalls. Illuminated from beneath at night, the plates appear to float above the water table in renderings.

It was an elegant answer—but an incomplete one. The Mayor's Office for People with Disabilities expressed the concern that the void in the Towers' footprints would not be visible over the parapet to a person seated in a wheelchair. So why not lower the parapet? Again, the answer was codes: The City Building Code requires it to be at least 42 inches high to prevent anyone from falling into the waterfall. "It was one city agency against another," Arad recalls.

Arad's solution was to design the parapet with an empty space underneath it so that a person in a wheelchair could bring his or her legs underneath it. Wheelchair users were now being given an ample vantage point. Serendipitously, the Towers themselves featured corners similar to those that Arad had designed for the parapet. "It enriched the design beautifully," he says. "The names now wrap around instead of stopping and starting four times."

Even so, not every question could be answered in such a satisfactory way for all of the stakeholders. The names presented an especially vexing riddle: In what order should they be arranged? Should family members be grouped together or split up? Should first responders be given some special recognition? Ultimately the choice to group victims according to where they were that day prevailed.

"You have to detach from personal investment in any design from the over-arching purpose of the design," Arad says.

Designing the Museum and Plaza

Political, financial, and logistical imperatives guided the design of the 9/11 memorial museum. Aedas, the firm tasked with designing the museum, had to figure out how to incorporate historical artifacts within an exhibition space for a museum that had not yet figured out what its exhibitions would be. "Museums are typically icons which contain exhibits," says Steven Davis, AIA, a partner at Aedas. "In this



DISCOVER THE FULL POTENTIAL OF CLOSED-CELL SPRAY FOAM INSULATION.

INTRODUCING **ICYNENE MD-C-200™**

Spray foam insulation offers energy efficiency and design flexibility — but ICYNENE MD-C-200™ medium density 2.0lb closed-cell spray foam offers much more. That's because our industry-leading building scientists understand more than insulation; they understand overall building envelope performance. From formulation to installation, the experts at Icynene help ensure seamless integration with HVAC and other building system elements. Not only does this optimize energy efficiency, but it also improves durability and moisture management. You might say they've perfected the formula for total building performance.

**THAT'S NOT JUST BUILDING SCIENCE.
THAT'S BUILDING GENIUS.**

Nick Xie, PhD
Senior R&D Chemist
Icynene Inc.



ICYNENE®

For more information, call
800-758-7325

icynene.com

Circle no. 261 or <http://architect.hotims.com>

Icynene® is a registered trademark of Icynene Inc. MD-C-200™ is a trademark of Icynene Inc. ©2011 Icynene Inc. All rights reserved.

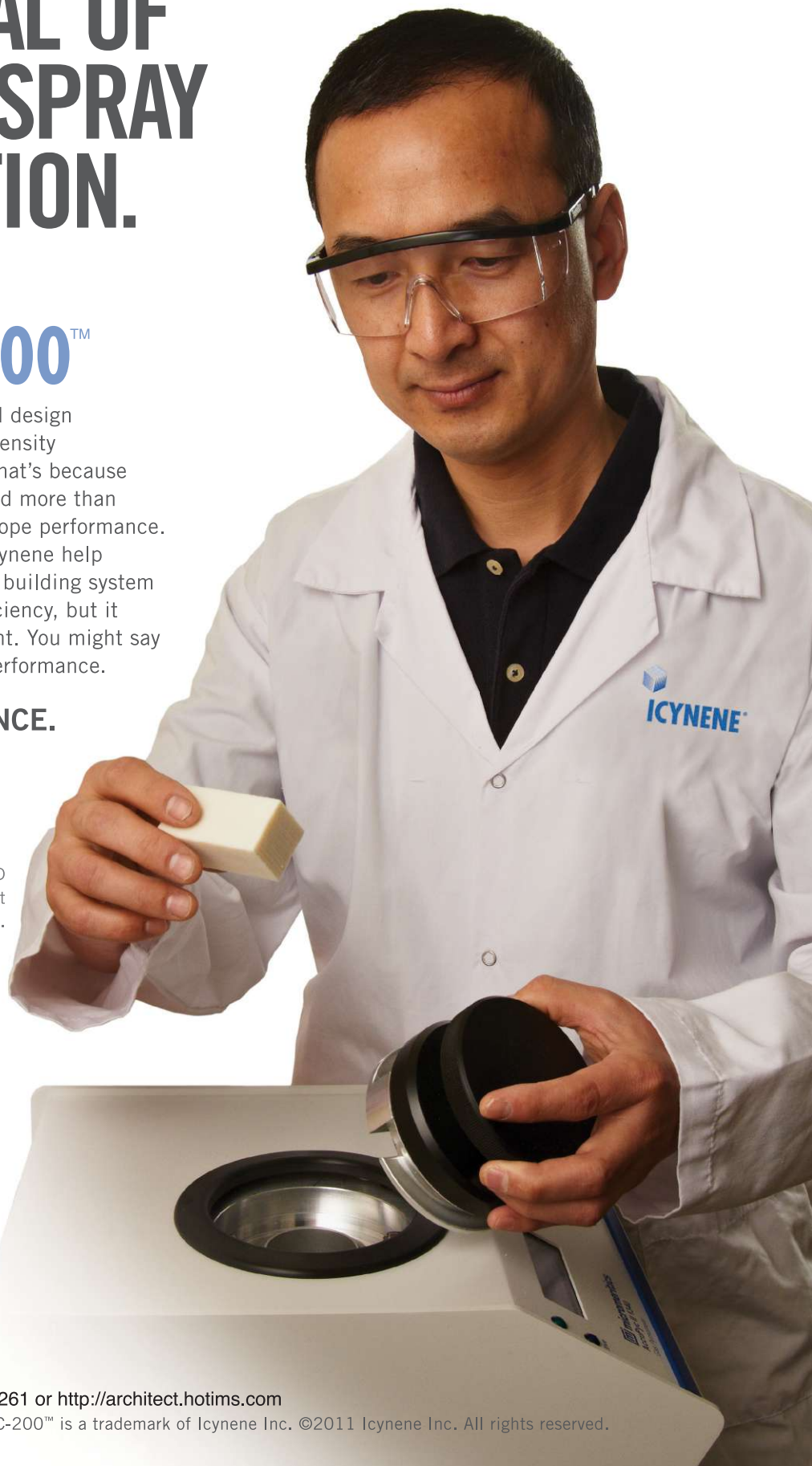



case, the icon is the exhibit.”

To obtain federal funding for the project, the World Trade Center Memorial Museum Foundation—a private nonprofit responsible for building the museum and its exhibits—was required to preserve historical artifacts from the attacks and make them accessible to the public. Some artifacts, such as the slurry wall from the original World Trade Center, could not be moved. The building therefore had to be built underground, and it had to be

located underneath the original Twin Towers—not at the bottom of 1 World Trade Center (formerly known as the Freedom Tower), as some had originally suggested.

But the PATH commuter train to New Jersey runs below the point where the South Tower of the World Trade Center stood. Navigating the site’s pre-existing train, electric, and water lines represents a challenge above and beyond incorporating site-specific artifacts such as the slurry wall.

Aedas designed the museum to decline gradually to an overlook offering a dramatic view of the slurry wall, providing exhibition space along the ramp. Another overlook provides a view of the tower pools, and descending visitors will pass scarred box-beam columns rescued from the wreckage of the towers.

From the dramatic vantage point of the slurry wall, a staircase descends to the base level. Alongside that staircase runs the “Survivor Staircase,” which workers in the Twin Towers used to escape to the subway on 9/11. It was originally located on what would become a commercial part of the project, 2 World Trade.

The memorial pools and museum are intended for commemoration; the plaza is for the public at large. Arad says he was inspired by the role played by parks like Washington Square Park and Union Square as gathering places for New Yorkers who wanted to feel the community’s embrace in the wake of the attacks. Despite its trees, the plaza is not actually parkland. It’s not sod that they sit on, but a stone platform with an undergirding of irrigation pipes.

One chunk of the plaza is being built over PATH tracks to the west of the station designed by Santiago Calatrava, FAIA. Per Calatrava’s suggestion, the station will contain skylights so that visitors to the plaza can look down at commuters on the platforms. Arad describes the plaza as a “green roof” for the various structures underneath it.

The proposal to build so much of the World Trade Center’s public features underground did not arise in a vacuum. George Pataki, governor of New York until 2007, exercised major influence over the site’s redevelopment via the Port Authority of New York and New Jersey, which owns the land. He decreed that nothing should be built where the towers stood.

A political gesture meant to comfort the families of the victims, it would become the guiding design principle for the site. Starting from the notion that the footprints would be preserved as a memorial, and accepting the proposal by master planner Daniel Libeskind, AIA, to connect streets once covered by the former World Trade Center, the logic of splitting the 16-acre site into two pieces—the plaza and the commercial blocks—emerged.

Design Reminders

The planned Visitors Orientation and Education Center represents the biggest loss to the public portion of the World Trade Center redesign as a whole. Originally, this group of buildings in the plaza would have contained four cultural organizations: the Signature Theater and the Joyce dance company, which would occupy a single performing arts building, and the Drawing Center and the International Freedom Center, which would each have

Enhanced Performance Roof Hatches for Green Building Applications



LEED is a registered trademark of the U.S. Green Building Council



Our Most
Energy-Efficient
Model Yet!

Available in a number
of standard sizes

- Energy efficiency exceeds standard hatches by more than 48%
- Meets LEED® standards for recycled content
- High solar reflective index (SRI)
- Ozone-friendly polyisocyanurate insulation
- EPDM gasketing with enhanced weather-resistance



For more information call **800-366-6530**
or log on to **www.bilco.com**



ON THE 10TH ANNIVERSARY OF THE ATTACKS, VISITORS WILL BE ABLE TO GO RIGHT UP TO WHERE THE TWIN TOWERS STOOD, READ THE NAMES OF THE DECEASED, AND TAKE IN THE DRAMATIC, FLAT STONE BOXES OF THE BUILDINGS' FOOTPRINTS.

a building of their own. Politics intervened when some victims' families warned that they could not countenance any politically objectionable material in exhibitions at the World Trade Center. Unwilling to accept preemptive censorship, the Drawing Center pulled out; the Freedom Center's supporters scrapped the idea altogether, leaving the entrance pavilion alone at the proposed space.

A performing arts space to be designed by Frank Gehry, FAIA, remains a possibility—but space and funding may yet prevent it from coming to fruition. The space set aside for it is currently where the temporary PATH station sits. Until the new station is opened (possibly by 2016), building for the project cannot commence. The platform it would rest on has been built, but the estimated \$700 million needed to build it may never materialize. In scale models of the ultimate site development at architects' offices and landowner Silverstein Properties, the site for the performing arts center sits empty. The city wants to build the center for \$500 million, with funding from public and private sources; uncertainty notwithstanding, the Lower Manhattan Development Corporation recently allocated \$100 million for the project.

Originally, political pressure had threatened to make the eight-acre plot where the Twin Towers platform had stood an even deeper void. At his farewell address in January 2002, outgoing Mayor Rudy Giuliani called for the entire World Trade Center site to serve as a memorial with no redevelopment, which many family members supported. Libeskind's original master plan also called for preserving the excavated pit at Ground Zero.

Given the financial realities of the real estate, it was never a very viable option. Nor was it what lower Manhattan residents wanted. "The community felt strongly that it could not function or be a vital place if it was viewed as having a 16-acre cemetery," says Madelyn Wils, who was on the board of the Lower Manhattan Development Corporation until 2007. "That was upsetting to pretty much everyone who lived down here," Wils says.

Another building destroyed in the attacks but removed from Ground Zero, 7 World Trade Center, may have served all along as a hint as to what the site might eventually become. In the aftermath of the attacks, community leaders such as Wils successfully prevailed to have the building pushed back to allow for a small park, which is already actively used today. There, professionals in suits eat lunch on benches and residents walk their dogs. If the massive construction site across the street is a success, a new World Trade Center will emerge as a permanent reminder of the attacks that befell the site—but also, as just another part of Manhattan. □



INSTALL CONFIDENCE.

INSTALL RINNAI.



Every Rinnai Tankless Water Heater now comes with the industry leading **2 year labor warranty*** and a high quality service valve kit included with purchase. **Just a few more reasons why industry professionals have made Rinnai #1.**

Rinnai
TANKLESS WATER HEATERS

www.rinnai.us

*Warranty (some restrictions apply): Heat exchanger limited warranty 5 years in commercial applications. All other parts: 5 years. *Labor: 2 years commercial for Luxury/Ultra models when registered within 30 days of installation, 1 year all other applications. For more warranty details, visit www.rinnai.us or call 1-800-621-9419.

Circle no. 572 or <http://architect.hotims.com>

IN THE PAST, AN EFFORT TO ADDRESS SERIOUS QUALITY-OF-LIFE ISSUES WOULD HAVE BEEN PUT FORWARD BY THE CITY ITSELF. CAN THAT PUSH BE PRIVATIZED? THE GUGGENHEIM CURATORS THINK SO.

TEXT BY SHONQUIS MORENO
PHOTO BY IAN ALLEN

→ PROFILE

David van der Leer

THE GUGGENHEIM CURATOR IS TRANSFORMING THE TRADITIONAL EXHIBITION INTO A LABORATORY FOR URBAN RESEARCH.



LAST DECEMBER, 31-year-old David van der Leer asked his employers at the Solomon R. Guggenheim Museum for a title bump. His request (which was granted) required only reprinting assistant curator of architecture and design on his business card—and replacing “design” with “urban studies.” And yet it suggests that van der Leer is further evidence of a shift that takes architectural curation from museum walls onto city streets, from observation to experience, and from lessons learned to learning lessons.

The first show that van der Leer co-curated after joining the Guggenheim in 2008 was “Frank Lloyd Wright: From Within Outward” (May 2009). With more than 200 archival drawings, models, and animations, the exhibition drew unprecedented crowds, but van der Leer nevertheless remains circumspect. “The Wright show was the most popular show in the museum’s history and all

of that, which is great,” he says. “But if there’s so much potential to do architecture shows, then we want to do something different.”

“Different” might be the word for the BMW Guggenheim Lab—an exhibition, if that’s the word for it, that signals a new direction in museum practice that privileges active experience over passive contemplation. Co-curated with assistant curator of architecture Maria Nicanor, the BMW Guggenheim Lab is an urban-planning laboratory that will travel to nine cities over the next six years. Every two years, a new mobile structure will be built for this Lab. At each stop, it seeks to provoke a broad segment of the local public into registering their opinion on intractable city issues.

BPM SELECT[®]

The Premier Building Product Search Engine

Search

Millions of Pages Searched Greener Daily!

Visit us at:

Booth #1030

CONSTRUCT
and the CSI Annual Convention harley wood

Booth #6936

GREENBUILD
INTERNATIONAL CONFERENCE AND EXPO

www.bpmselect.com

Circle no. 262 or <http://architect.hotims.com>

→ VAN DER LEER IS ONE INDICATOR THAT THE GUGGENHEIM STILL REMAINS IN THE VANGUARD: HE IS IMPORTING AN EXPERIENCE-DRIVEN APPROACH TO RETAIL INTO THE CULTURAL REALM.

Azon Saves Energy

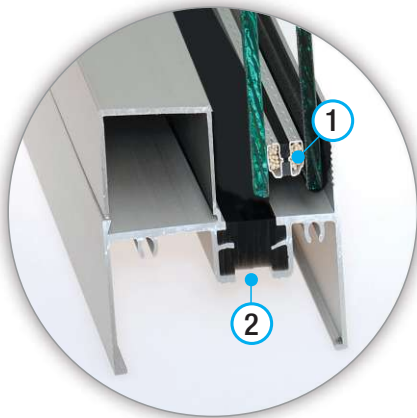

“Our main purpose is to provide high-performance fenestration components that meet our customers’ sustainability goals and expectations.”

① **WARM-LIGHT®**

② **MLP™**
mechanical lock profile

+

Universal No-Tape™ 304
structural thermal barrier polymer

NEW total design system:

MLP™ (mechanical lock profile) for commercial window, door, storefront and curtain wall applications offers the best balance of energy efficiency and high strength for aluminum fenestration products used in the most demanding climates and conditions.

Modern daylighting systems produced with *both* Azon structural thermal barrier technologies—the **MLP™** thermal barrier method for aluminum windows and **Warm-Light®** warm-edge spacer for insulating glass, will yield a fenestration system capable of upholding the highest efficiency and sustainability standards.

Toronto | October 4-6, 2011



Visit us at **booth #445!**

1-800-788-5942 | www.azonintl.com



In the past, an effort to address serious quality-of-life issues would have been put forward by the city itself. Can that push be privatized? The Guggenheim curators think so. “We need to address real-life issues from cultural institutions the same way we address art, design, and other creative representations,” Nicanor says. “Topics like the economic crisis, sociopolitical and environmental issues, are matters that we should be addressing through our architecture and urban programs.”

Van der Leer is no Young Turk; his ideas are sanctioned by a progressive modern art museum housed in a progressive modern building that features a steeply graded ramp, walls as curved as fuselage, galleries that seem almost an afterthought, and a vast void at its core. The other void in the museum—which, like its architectural counterpart, could be called either an impoverishment or wealth—is the absence of any permanent architecture or design collection of its own. These unconventional characteristics have often generated unconventional programming, and van der Leer is one indicator that the Guggenheim still remains in the vanguard: He is importing an experience-driven approach to retail into the cultural realm, plucking the museum entirely out of the museum building and inserting it wholesale into the city, shifting the museum-going experience from one of foot-swelling, eye-glazing passivity to direct, vociferous, keyboard-pounding participation.

Van der Leer grew up in the bedroom suburb of Zwijndrecht—population roughly 45,000—20 minutes outside Rotterdam, the Netherlands. Leaving voids still palpable today, the city’s center was razed during World War II. In the hands of the Dutch, however, who have always turned to design to keep their country from being consumed by the sea, this devastation turned van der Leer’s childhood epicenter into a laboratory of explicitly experimental architecture. Van der Leer discovered his interest in spaces early on. “I don’t think my parents could keep count of how many times I managed to rearrange my bedroom,” he says. “And one of the reasons I danced as a kid was because I was interested in the many spatial configurations possible in a small studio.”

His early influences include the 1922 Justus van Effen complex by architect Michiel Brinkman and the 1988 book *America* by Jean Baudrillard. But with little interest in math and physics, van der Leer decided not to study architecture; instead, he focused on its history, sociology, and management. “I began to read more and more about



STOENERGY GUARD

AIR BARRIER

WATERPROOF BARRIER

VAPOR BARRIER

DRAINAGE PLANE

DRYING CAVITY

EXTERIOR INSULATION

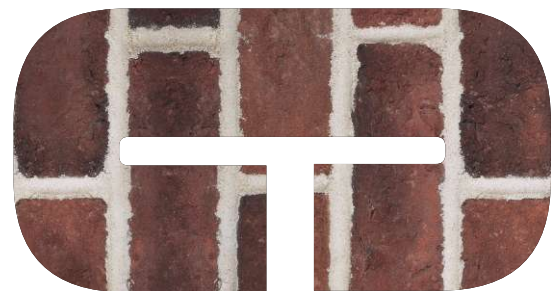
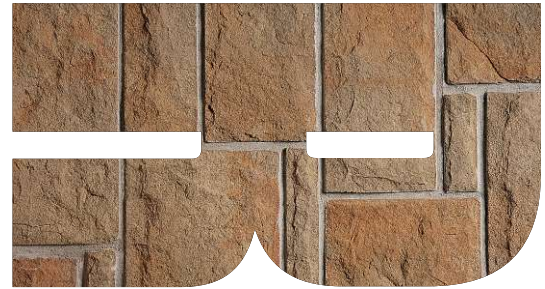

Cladding wasn't meant to stand up to climate all by itself. Buildings need StoEnergy Guard advanced cavity wall system to protect from the inside out. This integrated system of products delivers wall protection technology that works seamlessly under many cladding types, all while meeting the latest code requirements for energy efficiency and moisture control.



StoEnergy Guard

sto 

stocorp.com/stoenergyguard

Circle no. 179 or <http://architect.hotims.com>



cities," he says. "It was shocking to see how little direction there was and how often data and photos were abused in publications and exhibitions to give us a feeling that we had it all under control, that we understood it all. But we did not and do not really understand cities, and I think there is a huge and important task at hand."

Van der Leer got his start building books with Rotterdam's 010 Publishers, and he kept his nose in them, too, filling his free hours with a 3D design course

four nights a week, an urban-planning course in Amsterdam, and then with classes at Erasmus University Rotterdam for his master's in urban and architectural theory. On graduating, he joined Rem Koolhaas's Office for Metropolitan Architecture (OMA), where he enjoyed the constant "flirtation with sociology." In 2006, van der Leer moved to New York to assemble exhibitions and publications such as *House: Black Swan Theory* and *Urbanisms: Working With Doubt*, both for Steven Holl. Coming from the well-ordered Netherlands to New York opened van der Leer's eyes to the possibility inherent in a certain measure of chaos. "The combination of that design sense and the potential of the informal," he says, "is very important in many of my projects."

Joining the small Guggenheim staff in 2008, van der Leer worked on the Wright exhibition and then "Contemplating the Void: Interventions in the Guggenheim" (February–April 2010), a show of interventions in the museum's vast atrium. "Stillspotting NYC," a project launched by van der Leer in June, is a two-year, multidisciplinary series that radiates from that void out into New York City: Every few months, artists, architects, and composers identify, create, or transform site-specific "stillspots," exploring how urbanites can make peace in the city that never sleeps. The first debuted in Brooklyn, where visitors to Pedro Reyes's "Sanatorium" were "diagnosed" and assigned individual "therapies." This month, the second will pair auditory experiences composed by Arvo Pärt with Lower Manhattan spaces chosen by architecture firm Snøhetta.

"David's preoccupation is with urbanism as a whole, and with the belief that microissues can be discussed from a larger perspective," says Rizzoli's Dung Ngo, senior editor of the company's architecture and design division, who met van der Leer in 2006 while editing Holl's monograph *Architecture Spoken*. "He is less interested in object design; our consumer-fetishistic culture doesn't interest him so much, but he is able to infuse policy wonkmanhood with the poetry of everyday."

In August, the BMW Guggenheim Lab took wing in a temporary building on Manhattan's East Village by Japanese architects Atelier Bow-Wow. Nicanor and van der Leer conceived the Lab's structure, commissioned its architecture, and will oversee programming. Eschewing data, maps, and photography, the curators seek urban analysis from city dwellers themselves. "The project is unusual because it requires active participation," Nicanor says. "It is not your traditional architecture exhibition, and the conversations we are having are not taking place inside our museum on Fifth Avenue."

Van der Leer has been delighted to find that these conversations aren't generated by objects alone (as was the case with Wright). Rather, the stories come from people with diverse disciplines and walks of life. And so it is not before but after the show opens that ideas begin to take shape—when the visitors start talking. "How can we get a conversation going between people from four to 94 years old and from different social backgrounds? Cities are hugely important. More and more of us live in them on a day-to-day basis," van der Leer says. "But how often do we really think about them?" □

Since 1957, Accurate Partitions has been providing high-performance toilet partitions that meet or exceed specifications, require little maintenance, withstand the rigors of some very difficult environments, and provide a lifetime of low-cost of ownership.

Designed for
Functionality
Durability and Style



Available in:

- Powder Coated
- Stainless Steel
- Plastic Laminate
- Phenolic Black Core
- Phenolic Color-Thru
- Solid Plastic

Choose from four mounting styles. When additional privacy is desired, Ultimate Privacy™ doors and panels are available.

Accurate[™]
Accurate Partitions Corp.
accuratepartitions.com

Now Available as **BIM Objects**



Single Source Solution

ASI
GROUP
PARTITIONS
ACCESSORIES
LOCKERS

IMPeded Energy Loss

IMPs (Insulated Metal Panels)

- Achieve high R-values of 14 to 48
- Exceed energy code requirements
- Help create a building that is energy efficient and may qualify for energy tax credits
- Provide long-term thermal stability
- Offer low maintenance and less installation time vs. multi-component assemblies
- Are available in a wide variety of sizes and colors



METAL CONSTRUCTION ASSOCIATION

visit www.insulatedmetalpanels.org
Circle no. 424 or <http://architect.hotims.com>

→ STUDIO VISIT

Architecture Research Office

THE WINNER OF A COOPER-HEWITT 2011 NATIONAL DESIGN AWARD, ARCHITECTURE RESEARCH OFFICE TACKLES DIVERSE PROJECTS FROM ONE OPEN-ENDED STUDIO.

TEXT BY KRISTON CAPPS
PHOTOS BY JASON FULFORD



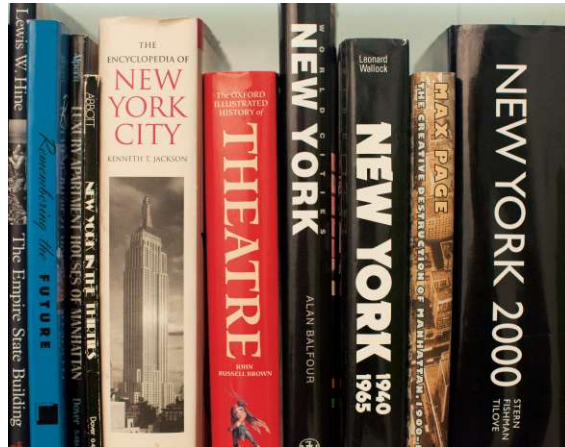
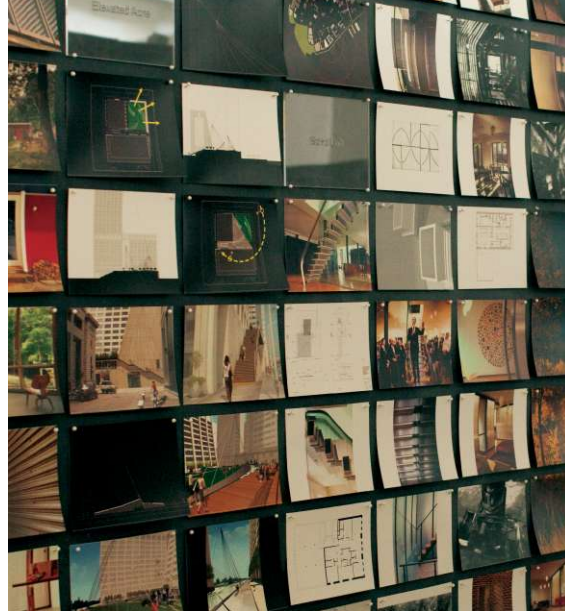

“One thing lacking was adequate vertical surfaces,” says Kim Yao, 39, AIA, describing the office held by Architecture Research Office for 13 years. Yao is pictured opposite with Stephen Cassell, 48, AIA; the partners, along with partner Adam Yarinsky, 49, AIA, moved the firm across the street to new SoHo offices five years ago. The type of space was as important a consideration as the quantity of space in that decision to move. “We need that wall space [in order] to be constantly setting up internal reviews. We need to live with the things we make over time.”



culture

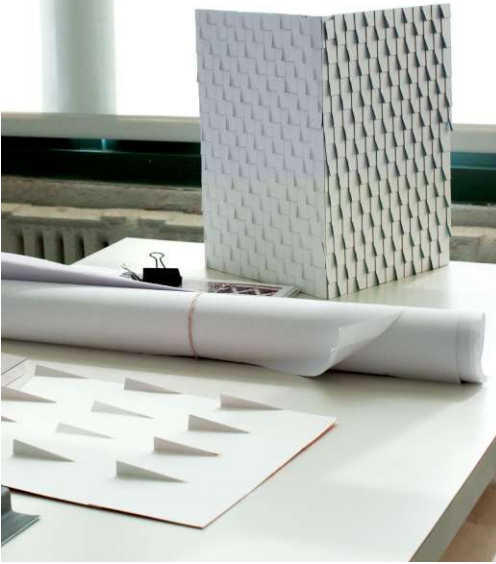

Architecture Research Office appears to take its recent accolades in stride. “We’ve been very busy in the last six months or year. We don’t have any grand expansion plans,” Cassell says. “It’s all about doing the work the way we want to do it.” Recently, that has meant fostering a number of collaborations—from the flagship Prada New York store with OMA and Rem Koolhaas to the R-House prototype design with Della Valle Bernheimer (now two separate firms).

Yarinsky notes—maybe somewhat gleefully—that the open studio plan can be irritating. “There are times when people want to work on what they’re doing, and it disturbs them, people touching base or pulling them into crits,” he says.

“In some ways it’s like a very classic, European Renaissance project,” Yarinsky says, describing the firm’s work on Donald Judd’s house at 101 Spring Street, which will be the Donald Judd Home + Studio Museum in 2013. Judd lived, worked, and permanently installed his work there. “It’s like a medieval building that evolved over time—a cast-iron building with Judd’s insertions,” Yarinsky says. “We weave in modern code and technical interpretations that either restore exactly, or work in parallel, with what Judd was doing.”





"This is the first time we've seen each other in months," Cassell jokes—though, given the principals' commitments, it's the sort of humor that rings true. Yao says, in fact, that she, Cassell, and Yarinsky (pictured above) make a "concerted effort" to get together one to three times a week to discuss what's happening: "Sometimes administrative, sometimes design, sometimes staffing."

The open studio design at ARO reflects the need for modular space and the fact that, as Cassell says, "everyone does everything"—so designers who work on digital models also build their own 3D models. There's a plan for fitting more desks in, though the space is close to capacity.

Yao describes the studio as "an organized space, though locally there's a fair amount of piling." Cassell says that clutter at the old office spurred the move to the new place. "We realized that it was easier to move than clean our office."

→ BEYOND BUILDINGS

Empire of Signs

VIVID NEON CREEP IN MANHATTAN IMPERILS THE BRUTALIST AUSTERITY OF THE PORT AUTHORITY BUS TERMINAL. SHOULD WE CARE IF IT GOES THE WAY OF TIMES SQUARE?



Six thousand square feet of video screen now graces the façade of the Port Authority Bus Terminal.

BLADE RUNNER IS CLOSING IN. Times Square, which already looked like the set for that 1982 movie, just stretched its neon tentacles across to the Port Authority Bus Terminal at 42nd Street and 8th Avenue, where a new screen completely obscures the building's Brutalist architecture with excerpts from the latest and worst sci-fi flick, *Transformers One Too Many*.

I actually liked the original Port Authority building, despite the fact that it was a Frankenstein monster of Miesian Modernism and brick-and-concrete panels, hunkering underneath a multilevel bus parking area surrounded by steel X-braces. I admired it even though that structure—built between 1949 and 1979 in phases by a series of anonymous architects, each time without any consideration for human use—was rather nasty. I liked the direct ramp-up from the tunnel behind it, which lets buses sweep into the city, slide into the building, slot into a parking space, and unload their riders, who are left to descend into the maelstrom of Manhattan. I even feel a fondness for the, shall we say, robust appearance that this two-block behemoth presented to its mixed-up surroundings.

Now the Terminal has become, like more and more of our buildings, just a backdrop for a giant screen that wraps around its most visible corner, turning what was an object into a void out of which messages do not so much appear as slither, slide, expand, and explode onto our retinas. Perhaps what galls me most is that these images—at least those in the tests presented by the media company GKD Metal Fabrics—are so much slicker

than any new building around Times Square, not just the bus terminal.

As if this were not enough, news has it that on the other end of 42nd Street, in Grand Central Terminal, the revamp of the retail mix that has turned this Baroque people-mover into a suburban shopping mall with nice bones will include, on the balcony overlooking the main concourse, an Apple store. It will no doubt be slick, a paragon of reductive strategies tending towards nothingness and selling lots of gadgets. At least the restaurants and bars that have been trying to occupy this perch for the last decade were engines for people watching—which is almost as good as people moving. The Apple store will be just another place for acquisition, and will thus further mark the triumph of commercialism over every aspect of our environment.

I will probably shop there. And I will enjoy myself in a way I never did when I tried to while away elastic moments of time waiting for my train. Grand Central Terminal has become a much more useful and enjoyable part of the urban fabric, in the same way that the Port Authority's wraparound post-Jumbotron will make what was a dark mass come alive. Cities are the capitals of the Empire of Signs and essentially, beyond all the talk of dense living and working, marketplaces. So, this is our destiny, and we will all go happy, buying our way into urban heaven.

Still, my guilty architectural conscience troubles me, for some reason. Is that memory I have of seeing the Acropolis as a child really mine, or was it implanted? □

TEXT BY AARON BETSKY
ILLUSTRATION BY PETER ARKLE



→ Read more of Aaron's design observations at ARCHITECT's Beyond Buildings blog: go.hw.net/betsky.

**SOME
TALK THE TALK.**

**OTHERS
WALK THE
WALK.**

Sustainability has become a major factor in the construction market. And the domestic structural steel industry has been making environmental improvements for decades by:

- Cutting its carbon footprint nearly by 47% since 1990.
 - Reducing its energy use by 67% since 1980.
 - Reducing greenhouse gas emissions by 45% since 1975.
 - Becoming recognized as one of the best-performing U.S. manufacturing industries by the EPA.
-

And steel's environmental impact continues to drop.



There's always a **sustainable** solution in steel.

312.670.2400
www.aisc.org/sustainability

Circle no. 22 or <http://architect.hotims.com>



The Right Solution for Completing Punch 50% Faster

The tools. A tablet PC and Bluebeam PDF Revu for creating digital punchlists.

The process. With the ease of the tablet pen, DES redlined PDFs with text, callouts and custom punch keynotes saved in Bluebeam's patented Tool Chest™ to complete punchlists for one entire floor each day.

The building. Nokia's 5-story, 196,742 square foot, LEED Gold certified, R&D headquarters in San Diego, CA.

The results. At the end of each day, DES exported the punchlist for immediate delivery to the General Contractor, saving 1 to 2 days' worth of data entry per building floor.

Bluebeam® PDF Revu® and a tablet PC enable project teams to go paperless and distribute punchlists 50% faster than pen and paper methods allow. On **Nokia's** new research and development headquarters, **DES Architects + Engineers** used the winning combination of Bluebeam Software on a tablet PC to meet a tight closeout deadline.

Learn how to replicate these results. Read the case study and watch a video recorded on the Nokia® jobsite at

www.bluebeam.com/punchitup

Circle no. 175 or <http://architect.hotims.com>



bluebeam®

© 2011 Bluebeam Software, Inc.

threat (thret) • **1.** the 54 percent increase in the number of people worldwide who will be exposed to climate-related disasters by 2015, according to Oxfam International •

2. the failure to prepare for natural disasters with smart building codes, relief planning, and reduction of greenhouse gasses

ALTRUISM, ARCHITECTURE & DISASTER

AS SCIENTISTS LINK CLIMATE CHANGE TO A RISE IN NATURAL DISASTERS, AND MEDIA MAKES DISASTERS MORE VISIBLE, A NEW GENERATION OF ARCHITECTS AND DESIGNERS IS EMBRACING HUMANITARIANISM. CAN THEIR ASPIRATIONS MAKE A DIFFERENCE?

TEXT BY CHRISTOPHER HAWTHORNE
ILLUSTRATION BY ASAF HANUKA

O

ONE MUGGY AFTERNOON this summer, on my way to JFK International Airport at the end of a reporting trip to New York, I stopped off at the campus of PS1 in Queens, a satellite of the Museum of Modern Art, to see an installation by the Brooklyn architects Interboro Partners. “Holding Pattern” was the winning entry in PS1’s 12th annual Young Architects Program (YAP), a competition that gives one firm each year the chance, on a punishingly small budget, to remake the courtyard of the museum for several weeks.

Interboro’s installation was a clear rejection of the bold, often self-congratulatory formalism of some recent YAP winners. It instead offered a wry commentary on wastefulness, ephemerality, and local context, breaking down the proverbial fourth wall that typically keeps the competition tightly sealed against any meaningful interaction with the neighborhood beyond the PS1 courtyard walls. The firm began work on its competition entry by meeting with residents and community organizations in the area immediately around the museum, including schools, a farmer’s market, a YMCA, and a senior center, asking them in particular what kinds of physical resources they most lacked.

The trees, benches, ping-pong tables, and other items those groups requested made up the physical structure for “Holding Pattern” and served as the backdrop for a number of parties and other events at PS1. From that point of view the installation was designed, like many YAP winners before it, to promote social interaction within the space of the museum courtyard. But all the items were also earmarked, at the end of the summer, to be donated to the people who’d asked for them. Each one carried a small sign, about the size of a luggage tag, indicating where it would wind up. The goal was not just to recycle the physical skeleton of the installation but to turn that recycling into a kind of strategic local outreach; the project used social ends as architectural means.

In that sense, “Holding Pattern” was clearly allied with the humanitarian design movement that has leaped to prominence in the architecture profession over the past five years or so. Also known as “the architecture of consequence” or





“the architecture of engagement,” humanitarian design is a broad, fluid, catch-all category that includes disaster relief efforts, schools and housing for the poor, certain corners of green architecture, urban agriculture, and community-minded projects like “Holding Pattern.” With extreme weather and economic volatility on the rise, and with terrorism and earthquakes a constant threat, humanitarian design is most clearly of all a response to a world that seems more dangerous and anxiety-filled by the year.

AS ANYONE who follows young architecture firms or spends much time on architecture-school reviews these days can confirm, humanitarian design, in its various guises, has eclipsed neo-modernism, bio-mimicry, and even parametricism (sorry, Patrik Schumacher!) to become the single most visible architectural concern of the moment, at least among designers younger than 40. It has gone from the geographical periphery (Samuel Mockbee’s visionary and hugely influential Rural Studio in Newbern, Ala.) to the cultural center (MoMA’s 2010 exhibition “Small Scale, Big Change: New Architectures of Social Engagement”).

Outside of universities and museums, meanwhile, the spiking number of natural disasters around the world, increasingly linked with climate change, along with the deeply compromised rebuilding efforts following the 9/11 terror attacks and Hurricane Katrina, have made it clear that architects need to learn a more nimble, engaged, and politically savvy approach to practice. The ongoing crisis in the American and European economies has reminded them of the essential folly of building yet more condominium towers in places like Las Vegas or Madrid. It has also given architects more time than they ever had in the boom years to think and write about their larger priorities—and to begin aiming their talents where they might have a substantial social impact.

It’s not hard to understand why the rise of humanitarian design has the feel of a sea change for the profession. The moment’s emergence comes on the heels of a half-century in which architecture found a remarkable variety of ways to detach itself from the world’s growing list of social, economic, and—perhaps most of all—environmental problems. First Modernism turned entirely corporatized, abandoning the social conscience that had once driven it. Then architecture drifted into a facile, essentially scenographic kind of Postmodernism. In the 1990s, the profession used a flirtation with deeply opaque Continental philosophy to drag its academic and high-design wings toward almost complete social and political irrelevance. And in the past 10 to 15 years, as everybody knows, it has turned a vanishingly small coterie of high-design architects into global superstars who work mostly for wealthy private and cultural clients—or for autocratic regimes from Dubai to Beijing.

On top of that, in recent years, the one part of architecture that indicated that the profession was paying attention to the rest of the world and to the planet—the ever-growing sustainability movement—hit something of a rough patch. Green architecture has moved toward a small-minded checklist mentality, many of its leaders happier promoting flawed benchmarks like LEED than spurring a larger conversation about how we build our houses and cities. Indeed, the genuinely fascinating and politically potent debates that have emerged over food policy in the past decade, driven by Michael Pollan and others, reveal by stark comparison the way the green-

design movement has failed to advance.

Given that backdrop, humanitarian design arrives as a refreshing and overdue corrective. But the truth is that the movement is also floundering a bit, searching for leadership and a sharper sense of definition. Indeed, whether it even ought to be thought of as a movement—as opposed to, say, a measure of the architecture profession’s increasingly insistent conscience—remains an open question. Humanitarian design, which often sends first-world architects into third-world countries, has fought off charges of imperialism connected to work in Africa and elsewhere. Perhaps most challenging of all, humanitarian designers are also finding that their own profession is ill-equipped in many ways to deal with their growing influence.

One obvious problem is that the various figures and institutions that define architecture and make architectural careers—museums, critics, universities, and deep-pocketed clients chiefly among them—continue to see bold, aggressive form-making and innovative architectural practice as synonymous. When a design with patently different priorities comes along, they’re often unprepared to understand or properly frame it. They encounter a series of houses built for a neighborhood flooded by a tsunami, say, and expect them to have a Case Study crispness and polish, or to look as striking in a magazine spread as a London townhouse by David Adjaye.

“Holding Pattern” was a case in point. The project was impressive in the abstract. It was a smart response to the socially disconnected formalism of earlier YAP winners and a cunning concession to current economic conditions, which have left many architecture firms simply trying to survive until a real recovery takes hold.

But in built form the project, which scattered benches, daybeds, a foosball table, a bike-repair station, and other items across PS1’s spacious concrete courtyard, was both skimpy and desultory. On the day I visited, the canopy flapping overhead, described in the press materials as “elegant and taut,” was neither. The space below was almost entirely empty, making even people-watching, usually the best part of any YAP design, impossible. Frankly, as an example of built architecture—as a series of spaces to navigate and objects to sit on or touch—it was all a bit sad.

Figuring out where the project went wrong—or if it went wrong at all—strikes me as the distillation of a key dilemma now facing humanitarian design. What happens when a building or an installation is more sophisticated in social than formal terms, or works well when seen up close but looks terrible in renderings and photographs? Such projects tend to falter in an architecture culture ill-equipped to make sense of them or show them to their best advantage.

Architects trying to work at the broader scale of the city—particularly in helping to shape post-disaster rebuilding plans—find an even more daunting series of obstacles. The most obvious and difficult issue to grapple with is the way that truly civic-minded urban planning—as a profession, and as a social good that government is willing to pay for—has withered almost completely in the United States.

IT WOULD BE A MISTAKE to see the rebuilding fiascos at Ground Zero and in New Orleans as identical, or to try to understand them solely in terms of humanitarian design. But taken together they offer a painfully clear portrait of a nation that has either rejected the need for or decided

it can't afford real planning—and therefore has made the job of socially committed architects drawn to the urban scale remarkably tough. In Lower Manhattan, the bureaucrats overseeing the rebuilding process lurched from one planning extreme to the other: First they trotted out six reserved and unimaginative design studies by the New York firm Beyer Blinder Belle, only to reverse course and hastily throw together an international competition to pick a lead master planner for the site. That competition's list of finalists was made up almost entirely of architects—and world-famous ones at that—rather than planners.

At no point did the site's overseers manage to use the planning process to clarify the key issues and questions at the site, which would seem to be the point of the whole exercise. To begin with, was it wise to pack 10 million square feet of office space into a part of Manhattan where there was little demand for it, essentially repeating the mistakes the builders of the original World Trade Center made 40 years ago? Did it make sense to allow the site's highly leveraged leaseholder, developer Larry Silverstein, to treat the rebuilding effort as just another deal in Manhattan, finding angles wherever he could, even as New Yorkers and the nation at large saw the site as anything but a typical patch of real estate?

As important as these questions were, they were repeatedly pushed aside during the rebuilding process, first by the dutiful blandness of the Beyer Blinder Belle approach and then by the powerful but manipulative metaphors of the master plan by Daniel Libeskind, AIA. Is it any wonder that what's actually being built has so little to do with either of those blueprints? Or that it fails to follow either planning or architectural logic?

In New Orleans, architects couldn't even manage, as Libeskind did, a Pyrrhic victory. The problem from the start with post-Katrina rebuilding was the absence of any larger planning framework with the muscle of public policy and government will behind it. Scores of talented architects—some funded by Brad Pitt's Make It Right Foundation, others working with foundation grants, and still others operating as free agents—poured into the city in the months following the hurricane. What they found was a city planning agency, and a regional planning apparatus, so shell-shocked by the disaster and gutted by budget cuts as to be nearly impotent.

When I traveled to Louisiana a few months after Katrina and heard that the most sophisticated planning efforts were being funded and overseen by private philanthropies, rather than in any coordinated public way, it was easy to predict where things were headed. A number of prototypes for green, flood-proof housing followed. In a few cases architects and planners tried to address similar issues at the scale of a park or a stretch of waterfront. But all these efforts ended up floating in a larger sea of indifference—in an unplanned urban matrix—severely limiting their impact and meaning.

WHEN IT COMES TO DISASTERS of Katrina's magnitude, in literal as well as symbolic terms, architecture can do only so much. No shiny rendering can make up for a flimsy or non-existent planning strategy in areas undone by a hurricane, a terror attack, or decades of poverty. There is no such thing as a Bilbao Effect for disaster relief. (And remember, in any event, that the Bilbao renaissance itself was driven by smart planning and infrastructural investment.) No single building, no matter how brilliant, can overcome a lack of

frequency (free-kwuh'n-see) • **1.** the rising number of reported natural disasters: 903 in the 1970s, 1,824 in the '80s, 2,971 in the '90s, and 4,485 in the 2000s, according to the CRED International Disaster Database

coordination between architectural goals on the one hand and economic and political ones on the other.

Architects can certainly take it upon themselves to sharpen their skills in community organizing and lobbying. But to really galvanize humanitarian design will require changes outside its ranks. Architecture schools will need to do a far better job at teaching students to navigate political and fundraising mazes, and to think strategically about the connections between design and social policy. Planners will have to either reinvent their own profession or begin to cede some of their responsibilities to others, including architects. Journalists and bloggers will have to think of better ways to describe and judge projects that are more concerned with community development than pure aesthetics.

These issues are made all the more complex because humanitarian design is by definition wildly diverse. It will never be a singular movement organized around formal priorities. A young architect coordinating housing plans for tsunami victims certainly has something in common with one building schools for the poor in Texas or a green high-rise in Rio de Janeiro. But not nearly as much as Gordon Bunshaft had with Walter Gropius.

Modernism remade the world, for better and worse, with an architectural philosophy that was like a blade: very simple, very sharp, and ultimately very detached from the sites of its surgical mastery. Humanitarian designers are trying to remake it by rolling up their sleeves and digging directly into the literal and symbolic dirt—or, more often, the muck of a flooded or disaster-strewn site. The results are bound to be messier and harder to measure. At the same time, as we move inexorably into an age of disaster, the stakes are higher this time around—for architects, maybe, but without a doubt for the parts of the planet they'll be rushing to heal and repair. □

SPACE, TIME &

H

HISTORIANS HAVE OBSESSED over the fate of lost cities and civilizations at least since the late 18th century, when Edward Gibbon wrote his genre-defining survey *The History of the Decline and Fall of the Roman Empire*. Now, to the traditional litany of theories about societal failure (moral rot, barbarian invasion, failed economy, rampant disease), the emerging discipline of environmental archaeology is adding another: mismanagement of natural resources.

Jared Diamond's 2005 bestseller, *Collapse: How Societies Choose to Fail or Succeed*, offers case studies of environmental calamities that have taken down whole civilizations, such as deforestation (the Anasazi), soil erosion (the Maya), and poor water stewardship (the Khmer). In some cases, the causes are hotly debated. In others, an environmental crisis didn't finish the job, but it made the society vulnerable to some other fatal blow. But in almost every case, societies that failed to avoid an environmental disaster lacked either social perspective or scientific understanding of the problem.

Thanks to modern scientific disciplines such as climatology and seismology, our powers of prediction have become remarkably sophisticated. We cannot fail to act on this knowledge. The collapse of a civilization due to ecological mismanagement is a tragedy. Now the stakes are even higher: The entire planet is at risk.

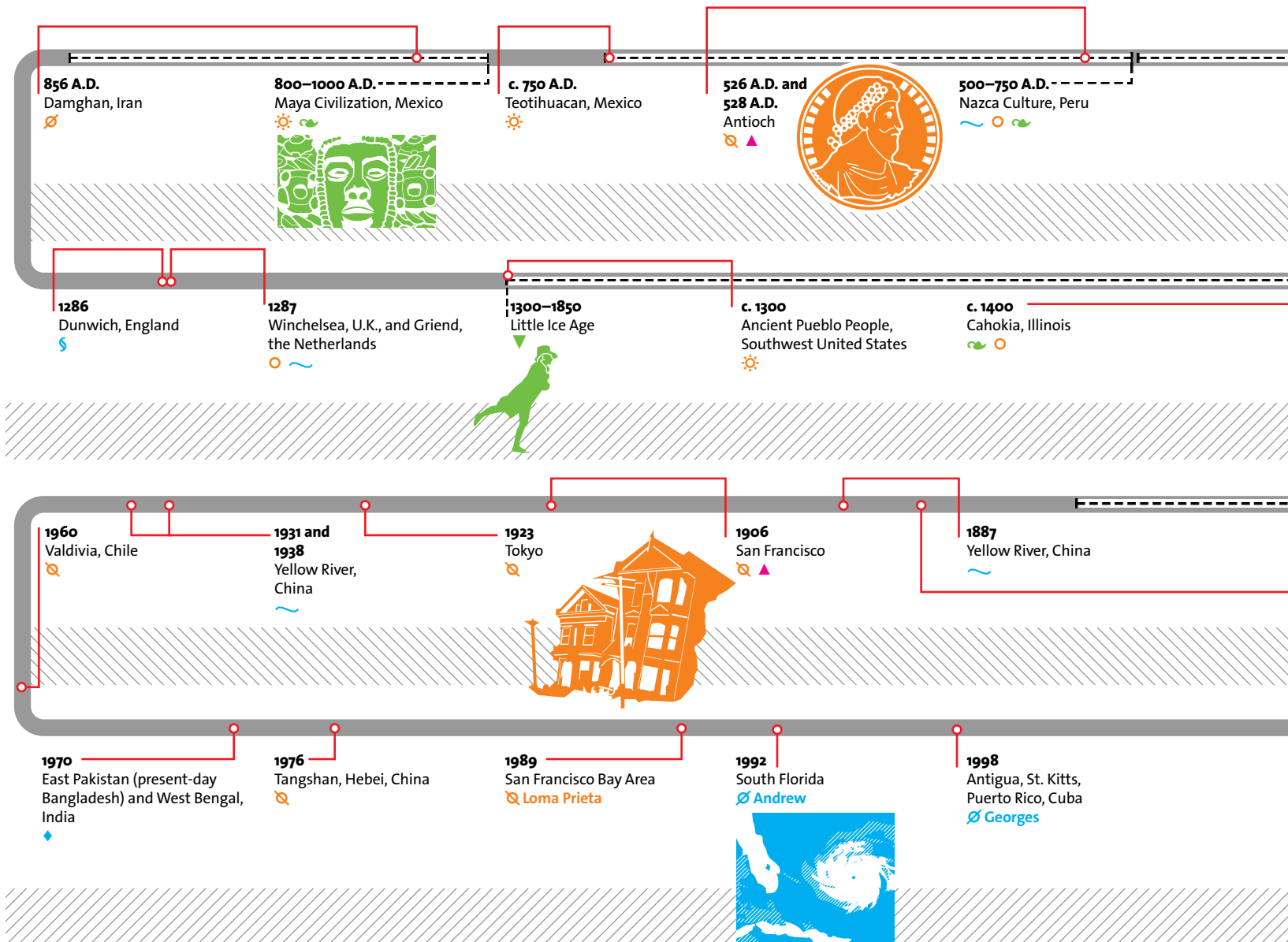

DISASTER

- ▲ Fire
- Erosion
- 🌀 Hurricane
- ★ Meteor
- ▼ Climate Change
- 🌊 Salinity
- 🌳 Volcanic Eruption
- 🌱 Deforestation
- 🕳️ Sinkhole
- ☀️ Drought
- 🌀 Cyclone
- 🌪️ Storm
- 🌊 Earthquake
- 🌊 Flooding
- 🌊 Tsunami

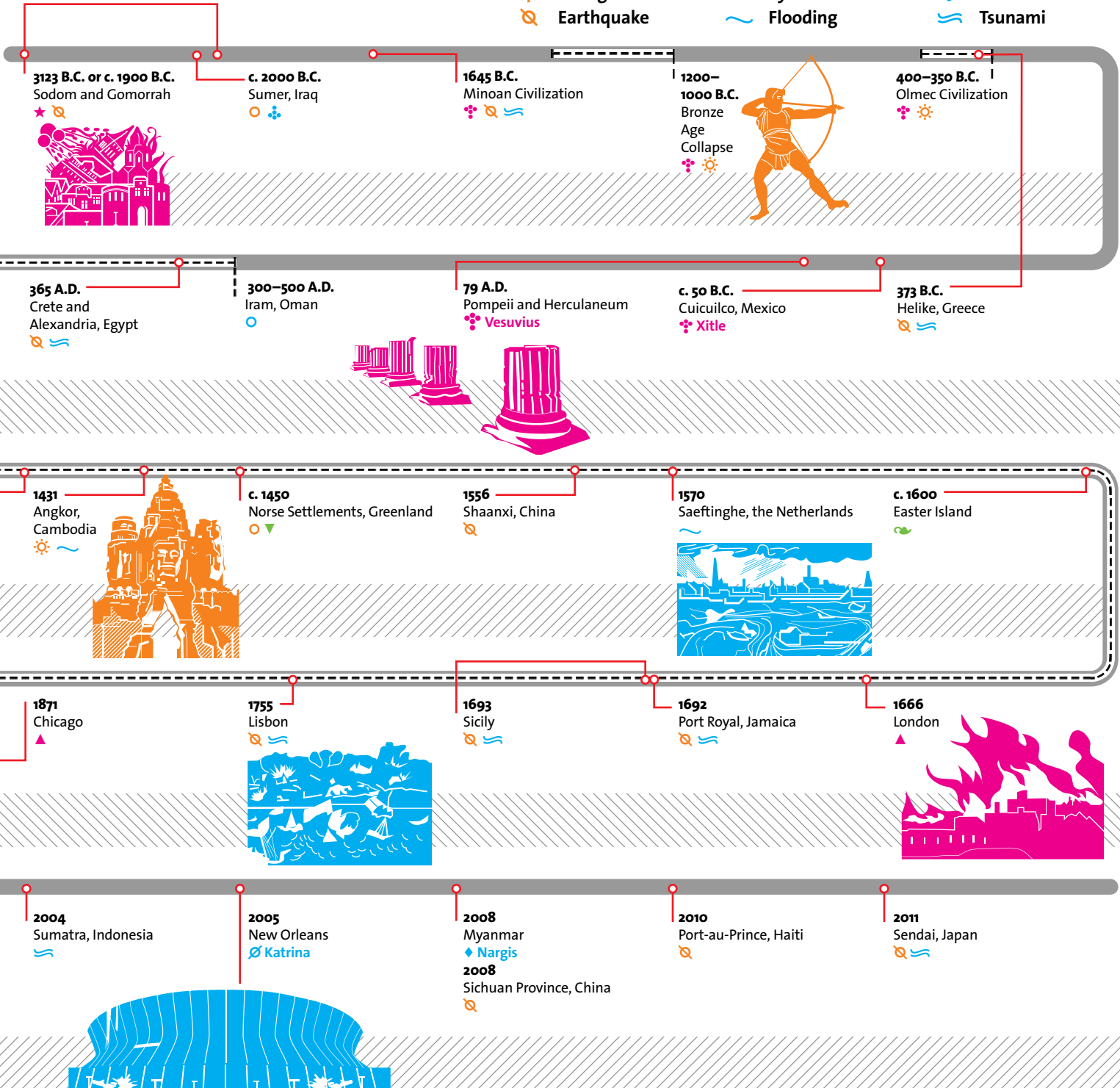



**Cameron
Sinclair**

CAN ARCHITECTURE SAVE HUMANITY?

IN A POST-DISASTER SITE, EMPLOYING LICENSED ARCHITECTS TO REBUILD COMMUNITIES TOO OFTEN TAKES A BACK SEAT TO SIMPLY GETTING STRUCTURES UP FOR VICTIMS. CAMERON SINCLAIR AND KATE STOHR WANT TO CHANGE THAT. THE COFOUNDERS OF ARCHITECTURE FOR HUMANITY EXPLAIN HOW “BUILDING BACK BETTER” BRINGS ECONOMIC REVITALIZATION—AND HOW THEIR MISSION TO SAVE THE WORLD HAS TURNED THEM INTO DEVELOPERS.

TEXT BY KRISTON CAPPS
PHOTOS BY NOAH KALINA

S “SEVEN DOLLARS per square foot,” says Cameron Sinclair, executive director of Architecture for Humanity, as we walk into the organization’s headquarters in San Francisco’s SoMa neighborhood. A conscientious contractor, he can still name the volunteers who put in the work, donating flooring, lighting, and sweat for the frugal 5,000-square-foot build-out. “We paid them in beer and pizza.”

When the nonprofit organization made the move across the Bay from Sausalito, Calif., to downtown San Francisco in 2007, Cameron Sinclair—a self-declared “chief eternal optimist”—was already a rising star. Maybe even one of the most famous humanitarians in the world, and certainly so within the closed circuit of cause-oriented architecture. Still, Architecture for Humanity employed only a half-dozen full-time staffers, and for all the attention Sinclair received, the organization still felt

its mission was misunderstood.

“The rude awakening was that many people saw us as this do-gooder organization,” Sinclair says. “The reality is that we’re a design/build firm with a robust practice.”

It’s doubtful that even Sinclair knows exactly what all Architecture for Humanity does. At a glance, the organization coordinates architects in regions where their services are scarce or distressed. Architecture for Humanity promotes a broad network of young professionals through its design fellowship program and chapter organizations. Through this outreach network—and the requests for proposals it fields for clients as well as collaborations with other for-profit and nonprofit firms—Architecture for Humanity marshals architectural services for communities struck by conflict, natural disasters, and deficits in resources. And that’s just for starters.

In the 12 years since the organization took root, in 1999, in a 300-square-foot New York apartment shared by Sinclair and Kate Stohr, Architecture for Humanity has grown. Its San Francisco office employs 36 full-time staffers and manages a small army of volunteers—teams that work to alleviate poverty, build community, and address climate

change among at-risk populations. The organization has 17 staffers in Haiti alone. Yet it also declines 70 percent of the projects it is pitched—it just can't get to them.

With its dramatic growth has come a substantive change to the kind of work Architecture for Humanity performs. Sinclair and cofounder Kate Stohr don't believe that the measure of Architecture for Humanity's performance is in how much architecture they've built for humanity, but by more elusive standards. It's a view shared by one of their major funders.

"We're hoping to provide the resources to Haiti to try to create sustainable opportunities for development," says Veronica Selzler, program advocacy specialist for the Clinton Bush Haiti Fund. The work always seems incomplete. "We're investing in the long term. We're investing in programs that won't need us, ultimately."

Today, Architecture for Humanity's bailiwick is as much building loans as building clinics. The organization is looking to assert design as a framework for development for areas that lack even infrastructure. In Haiti, this effort will be measured not in numbers of houses built but in the success or failure of Port-au-Prince as a city. Which means that Architecture for Humanity's mission is flexible, experimental, and—quite often and for reasons outside its control—seemingly destined to fail.

The mission begins at the vanishingly narrow intersection between design and philanthropy. "There are people who are really good at writing grants and who are terrible at implementing projects. There are people who are fantastic at building projects that have no idea how to write a grant—mainly because they've never had to do it before," Sinclair says. "It kills us when we see someone who's spent five years, they do a Kickstarter campaign, they do this, they do that, and they finally scrape together \$5,000 to do a project—where we could have brought in a public-private partnership and had \$50,000 right on the go."

The way wasn't always so clear to Sinclair, of course. The Dec. 26, 2004, earthquake off the coast of Indonesia and subsequent tsunami "was the moment we realized we were an organization," he says. Before the first wave

of the tsunami had hit India, Sinclair and Stohr had made contact with local architects there. Sinclair wrote a blog post on Worldchanging, a nonprofit webzine devoted to sustainability, in the hopes of raising \$10,000 over the next six months. Within 72 hours, the fledgling Architecture for Humanity organization had mobilized teams on the ground to assess damage and start rebuilding efforts—and surpassed its fundraising goals. By the spring, Sinclair and Stohr had raised half a million dollars.

The experience cemented a few of Architecture for Humanity's core rules. Always work with a locally licensed architect on each and every built project. Build to code, even if it means building the only legal structure in an area (which has been the organization's experience in one Kenyan slum). The organization often sends teams to slums, but never to sites with active conflicts. Where Google says, "Don't be evil," Architecture for Humanity says, "Don't work with assholes."

The tsunami also introduced Architecture for Humanity to the pitfalls it faces with every project. "There are a lot of missed opportunities," Stohr says, describing the pace of rebuilding. "There's also a lot of poor journalism. You find that journalists are setting the expectations. You have the media saying, 'Why aren't we rebuilding?' one year after—which they do after every disaster."

"A big surprise was that to allow solid sustainable community building to happen, we had to be the bank," Sinclair says. "We had to be the developer—which is what we are now."

When it is up to Architecture for Humanity to determine which projects to support, the organization finds itself having to decide between proposals to alleviate suffering in post-conflict or post-disaster states. How do you choose? Sinclair doesn't hesitate. "It sucks."

On Tour With Cameron

This month, Cameron Sinclair's schedule takes him to Taiwan, Japan, Chicago, and Santa Fe, N.M. He says that for any given month, he spends two weeks in San Francisco and two weeks away. His calendar doesn't support that



Haiti

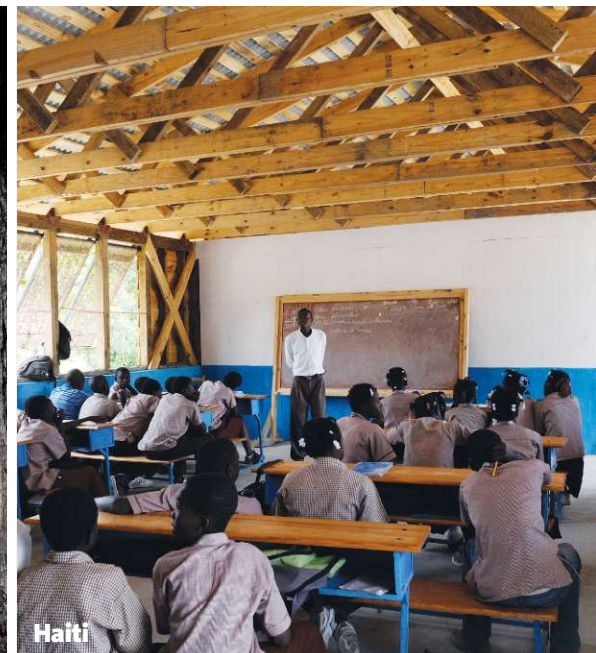

Haiti

claim. Most weeks and weekends are blocked off in bright colors, indicating travel.

A lot of Sinclair's work happens on the road; Stohr spends more time at headquarters. Sinclair is quick to point out that he and Stohr share duties and deserve credit equally.

Not long after the organization's founding, though, Sinclair became synonymous with Architecture for Humanity. *Fortune* magazine gave him his first big break in 2004 when they named him as one of the Aspen Seven, a global group of avatars fighting for good. The World Economic Forum named him a Young Global Leader in 2008. In May, the U.S. Agency for International Development appointed Sinclair to the Advisory Committee on Voluntary Foreign Aid Members, a consortium that includes executives from the Bill and Melinda Gates Foundation, Harvard University's John F. Kennedy School of Government, and the National Academy of Sciences.

Sinclair's biggest hit came in 2006, when he was awarded the TED Prize, an honor typically reserved for the likes of former President Bill Clinton and benevolent rock-god Bono. Around this time, being Cameron Sinclair became one of Sinclair's chief responsibilities at Architecture for Humanity—which is one reason he signed with Los Angeles talent agency Creative Artists Agency.

"That was a really hard thing for me to do," he says. "Part of speaking is advocacy and to get people to understand our role in this. But the other half is to bring in funding. What I found is, I spent a year on the road, talking to everybody. At the end of these talks, with hundreds of people in the room, I would say, 'Look. We just need a contribution.' Nothing. I was actually losing money, flying to somebody's event, giving a talk, and nobody donating."

Sinclair puts his considerable personal charm to work for the organization. Minus the agency's cut, all his speaking fees go to Architecture for Humanity; so do proceeds from the sales of *Design Like You Give a Damn: Architectural Responses to Humanitarian Crises*, co-edited by Sinclair and Stohr and published by Metropolis Books in 2006. These

Article 25 (ahr-ti-kuh'l twen-tee-fahyv) • 1. Universal Declaration of Human Rights article that cites adequate housing as a right • 2. U.K. charity that provides architectural expertise to post-disaster projects

engagement fees support executive salaries at Architecture for Humanity—including salaries for the co-founders, both of whom receive \$96,000, according to public records, and other staff. The average salary for a nonprofit executive was roughly \$150,000 in 2008, according to a 2010 compensation study by Charity Navigator.

"There's a couple of people [who came to work] here because of the book," Sinclair says. *Design Like You Give a Damn Vol. 2* is due in April 2012. With that book, Sinclair and Stohr hope to answer the questions they get most frequently: How do you fund projects? "Kate's been looking at the history of funding over the last 20 years and



Kenya



Kenya

how it's changed, looking at for-profit mechanisms versus nonprofit mechanisms. If we were smart, we could have done a book every year. And here's another set, and here's another set, and here's another set."

If the public persona is a necessary evil, it is one that has redounded to the benefit of Architecture for Humanity. Sinclair's global fame and familiarity with architectural bigwigs in Japan led advisors to former Japanese Prime Minister Naoto Kan to call him for reconstruction advice following the earthquake and tsunami that struck Japan.

"We tend to fund the cracks in the crisis," Sinclair says. In Japan, Architecture for Humanity's work is diverse. The organization identified a traditional wood joint mechanism that performed well in the earthquake and is working with Fukushima carpenters to implement this design in reconstruction work. For a remote fishing village called Miami—which was wiped out by the tsunami—Architecture for Humanity is not providing design services, but rather helping the town decide whether it's even worth rebuilding. The larger part of the work in Japan, though, which Sinclair oversees, involves cooperating with donors and insurers to establish a forgivable loan mechanism for small businesses for reconstruction and operations.

"It's not typical of a pro-bono design firm," he says. "But if you've got a mom-and-pop business that's been there for three generations, there's no way they can get financing to bring their business back."

Sinclair claims credit for the phrase "build back better"—a favorite recovery mantra of President Clinton and countless others. While it's hard to judge that claim, the URL, in any case, belongs to Architecture for Humanity: buildbackbetter.com, a website written in Japanese, calls for one-page proposals for reconstruction grants of \$25,000 to \$60,000 for projects in Japan.

"We're like legal aid. If you don't have an architect, one will be appointed to you," Sinclair says. "If you're not happy with the architect you've got, we'll find you one."

Behind the Scenes With Kate

In his 2008 book, *Philanthrocapitalism: How the Rich Can Save the World*, Matthew Bishop, the New York bureau chief for *The Economist*, outlines a model—or perhaps a plea—for reconstruction. It's one that would get its test in Haiti. Traditional aid is wasteful, or perilously slow, Bishop observes. Earlier this year, the U.S. Government Accountability Office reported that, of the \$1.14 billion in aid that Congress allocated for Haiti in 2010, just \$184 million has been committed to date. Bishop has noted that government models for aid are often adequate for relief efforts, but endorses the private sector for performing reconstruction, for which entrepreneurial interests can carry enthusiasm after public interest fades.

From Stohr's perspective, choosing between public and private aid isn't any choice at all.

"The international community has failed Haiti in some very significant ways," Stohr says. "I'll speak with U.S. AID representatives and they're only doing housing. For the love of God. You're just going to do housing in a place that needs everything?"

If Sinclair is the organization's optimist, Stohr would be its cynic, the straight-man in the routine. She is, anyway, the only figure at Architecture for Humanity headquarters who has an office—where she manages the

often byzantine contracting process that is Architecture for Humanity's favored tool. A manila folder three inches thick containing a contract for a project in Haiti sits in a bin of manila folders stacked a foot tall under a sign reading, FOR KATE TO READ.

"To date, we are involved in seven master-planning projects in Haiti. For such a tiny firm, that is ridiculous," she says.

Stohr, who directs Architecture for Humanity's work in Haiti, defends the pace of reconstruction there. "In Haiti's case, they're off pace. But they're only off pace by about four months," she explains. "The reason that they're off pace is that they're putting a lot more into it in terms of trying to build communities. It's not that you want to be slow. But you do want to build water-treatment systems."

As Stohr explains, there are two primary problems with reconstruction in Haiti. (Problems beyond, say, cholera.) The first is a fundamental misunderstanding of the crisis and how it affects development: It wasn't the earthquake that made the state dysfunctional. "If we were building in a post-conflict environment, no one would be surprised that we're still struggling with land title," Stohr says. "Here we are building in a disaster context, and they [critics] have forgotten that Haiti is also a post-conflict environment."

The second is fragmentation: Reconstruction spending is typically earmarked for particular sectors, such as sanitation, and dispersed by and to subject-matter experts with little coordination between them.

"There are very few people who can tie that into a comprehensive community development project," she says. "Of which we are one. But we are only one."

Stohr cites Walter Kiechel's 2010 corporate history, *The Lords of Strategy: The Secret Intellectual History of the New Corporate World*, as influential to her thinking with regard to Haiti. The book documents the invention in the 1960s of corporate strategy as we understand it today. "Looking at Haiti, I thought it would be interesting, since there was so much rampant disregard for building code whatsoever—I thought, maybe if I could get in there early enough with enough people, I could get a larger market share, then we could set the standard," Stohr says. "Which is a crazy idea"—Architecture for Humanity establishing the precedent, instead of, say, U.S. AID.

Architecture for Humanity always seeks to work with local architects. "You don't take away from the architects who are there," Stohr says, "otherwise you're distorting the market and competing with them." In Haiti, the organization is working with literally all of the country's architects to redesign six commercial corridors in Port-au-Prince. "There are only 30 architects in Haiti," Stohr says.

It is another way to "fund the cracks in the crisis," as Sinclair puts it: By investing now in the commercial corridors of Port-au-Prince, Architecture for Humanity hopes to prevent the housing projects funded by government agencies such as U.S. AID from turning into slums. U.S. government spending is largely prescribed for creating housing, but mortgages are bound to end in default if no markets exist to create income stability. This is a looming threat in places such as Port-au-Prince, where unemployment hovers at 90 percent.

Working in the philanthrocapitalist vein outlined by Matthew Bishop, Architecture for Humanity has used population-overlay data provided by Digicel, the Caribbean's largest mobile telecommunications company, to identify 400 small businesses and begin work to secure



**Kate
Stohr**

loans for them. These loans come with an asterisk: The rebuilding work must be performed by one of the local, licensed architects, and Architecture for Humanity reviews the drawings. Only two banks offer loan products for the work Architecture for Humanity has in mind, Stohr says, and the organization will need to secure between 30 and 100 of them, she estimates, to reach a scale that is feasible.

When does the building happen? Architecture for Humanity has to convince Haiti first. Though the nation's dozens of architects recently reinstated a professional architectural trade association ("a huge step forward," Stohr says), Haitians still look to masons for building services.

"We are starting a massive consumer campaign," Stohr says. "A radio campaign and billboards. 'Get Help Rebuilding—Come to the Rebuilding Center.' We've never done billboards in our life."

Rebuilding Jobs in Haiti

At Architecture for Humanity headquarters, the office gathers for a weekly ideas lunch and presentation. On the Friday I visited in August, 20 or so staffers listen in on Architecture for Humanity program manager Sandhya Naidu Janardhan's update on the progress in Haiti.

After receiving her master's degree at Columbia University, Janardhan worked for India's InFORM Architects before joining Architecture for Humanity's design fellowship program in 2008. Stationed in Hyderabad, India, in 2009, she worked to build some 10 low-cost primary healthcare clinics in six months. As the point on Haiti since June 2010, on any given day Janardhan will coordinate between representatives of, say, Ben Stiller's family foundation, the Haitian government, and Architecture for Humanity's staff in the field.

"I am someone who is the bridge between Haiti and here," she says after her presentation. Sinclair describes her role more admiringly: "She is the single biggest threat to my job."

Janardhan's presentation focuses on the Haiti Rebuilding Center, the locus of Architecture for Humanity's job-building and job-training effort. There, Architecture

for Humanity's growing staff—17 full-time staffers aided by some 20 volunteers—runs the organization's school construction initiative, commercial-corridor revitalization program, and technical assistance efforts. In eight years' time, she explains, the center will be wholly locally run.

The center's impact isn't always quantifiable. There's masonry training for contractors once a week. Staff there recently offered a workshop on collaborative design for girls. They were ready for as many as 40 girls by the 10 a.m. start and expected about 10 to show up. By 10:30, the center had a queue of 200 girls. A sign of enthusiasm for the center's work, many of the girls made a long trek from outlying refugee camps to get there.

Architecture for Humanity's Haiti school initiative is one of the first projects to show the sort of tangible results that people might expect to see. One school is now complete; five more (of a total of 10) are under construction. Janardhan prefers to measure results by people, not buildings: She says the schools will serve 3,000 students and employ 100 teachers and 40 staff.

In terms of buildings, the biggest results will come in the form of a collaborative enterprise with Habitat for Humanity: the Santo Community Development Plan, a \$15 million permanent shelter community just outside Léogâne, the wrecked epicenter of the January 2010 earthquake. The greenfield development will consist of 500 homes, designed to house 1,000 displaced families—who are still camped out in the region, awaiting relief.

This is not just a Habitat project, but *the* Habitat project, says Mark Andrews, vice president of Habitat for Humanity's Haiti Recovery program. While the organization is conducting 12 other reconstruction projects in Haiti, Santo is by far the most visible and capital intensive.

"One of the many unique things about this project is that not only will we be building 500 houses in this community, the first 150 will be built within two weeks, in November," Andrews says. The Léogâne site will serve as the 2011 Jimmy & Rosalynn Carter Work Project, with the former president and first lady visiting in November,



Gulf Coast



Gulf Coast

marking it as Habitat for Humanity's biggest single event globally this year.

But Architecture for Humanity's biggest impact in Haiti won't be measured by buildings, or even in this decade, says Eric Cesal, Architecture for Humanity's regional program manager in Haiti. In Port-au-Prince, he is working to identify businesses to anchor each of the six commercial corridors the organization is developing—a 25-year project. "Some of these places employed 100 people," he says. "Now they don't employ anyone."

Architecture for Humanity has retained the services of a third-party monitoring and evaluation firm to track this stimulus effort. It may take longer still to measure the success of the broad, general effort to confirm what architecture can actually do for Haiti.

"One of the reasons that disaster disproportionately affects the poor is because their buildings aren't built as well," Cesal says. "In an environment of poverty, people don't have access to professional design services. Where that happens over decades, the role of architecture and engineering is psychologically divorced from buildings. You just get your cousin to do it or the guy down the street."

Not if Architecture for Humanity can help it. One of the snottier services the organization provides in Haiti is that of pro-bono regional tattletale. As staff perform site surveys, Stohr says, they're on the look out for shoddy construction. When they see it, they leave behind a kit of materials, and try where they're able to notify the project's funder. Then they price the fixes.

"Reconstruction is only really starting," Cesal says, "and Haitian architects are going to be busy for years to come." They knew from the onset of the crisis what their role would be, he explains; many of them set to work studying seismic code in the aftermath of the earthquake. "It's not like California, where it's built into the collective psyche. Hurricanes, absolutely. Haitian engineers know that and how to get around it."

The Roadmap

On any given Friday that they're both in the Bay Area, Sinclair and Stohr, who are married, meet at a Sausalito, Calif., bar with a view of the Golden Gate Bridge. Over hard cider and ginger beer, the three of us talk about the familiar nonprofit routine: hustling for money.

In December 2010, the Clinton Bush Haiti Fund awarded Architecture for Humanity \$816,472, a substantial grant toward the Haiti Rebuilding Center. That is the closest that Architecture for Humanity has come to support from the U.S. government.

"I have sat in countless meetings with AID officials, World Bank officials," Stohr says. "You think the alphabet soup of architecture is bad," Sinclair picks up. "At the U.N., you can go through a 20-minute meeting without a real word being spoken." Stohr continues. "When it comes down to it, fundamentally, they do not invest in place. It's very difficult for us to get the kind of flexible funding we need to do this work from those kinds of agencies."

Architecture for Humanity has performed baseline market measures for hundreds of businesses in Haiti, demonstrating "the value of strengthening Haiti's capacity rather than just rebuilding," says the Clinton Bush Haiti Fund's Selzler. Both Selzler and Sinclair recognize that some solutions would result in more obvious returns. "You don't see us flying in shipping containers anywhere, or prefab solutions," Sinclair says. "It's not that they might not

eco-refugee (ek-oh-ref-yoo-jee) • **1.** individuals displaced from their homes because of environmental disasters • **2.** the Chinese government reported 150 million of them in 2009

work—it's that they don't hire locally."

To develop the loan program, Stohr needs \$2 million—by October. That's approximately the amount that Architecture for Humanity reported in total revenues for 2009. She says that she has \$1 million committed; for the rest, Architecture for Humanity will tap private donors and foundations, its traditional supporters. Though U.S. AID is sympathetic to the mission, she says, the agency is committed to funding housing exclusively.

But housing without market stability—both in terms of income for residents and reasonable risk for investors—may lead to widespread default and slums. "Once you put in that capital, it's all private market. You're just opening door to private market investment," Stohr says. "And local investment! I'm not talking about foreign direct investment, I'm just talking about creating the stability that the banks need to lend locally."

The organization has made one significant acquisition that it hopes will help to expand its network: Architecture for Humanity has acquired Worldchanging—a sustainable design site that *Wired* described as "the most important website on the planet." Architecture for Humanity will merge Worldchanging with its open-source Open Architecture Network in a relaunch to promote transparency in design.

Perhaps to a surprising degree, Architecture for Humanity's rapid growth has not changed the way the organization works at an atomic level. It is dependent in large part on individual and family foundations and the design industry for its support; fundraising still happens over discussions of individual project goals and designs. At the core of every donation and every design fellowship is a commitment to the idea that architecture can improve people's lives. For the designers who commit their time, it's not a side project.

"You can't just come in for a weekend charrette and say that you helped Katrina," Sinclair says. "You gotta be there. You have to be hand in hand with whoever you're partnering with to get it done." □

SITES AT RISK

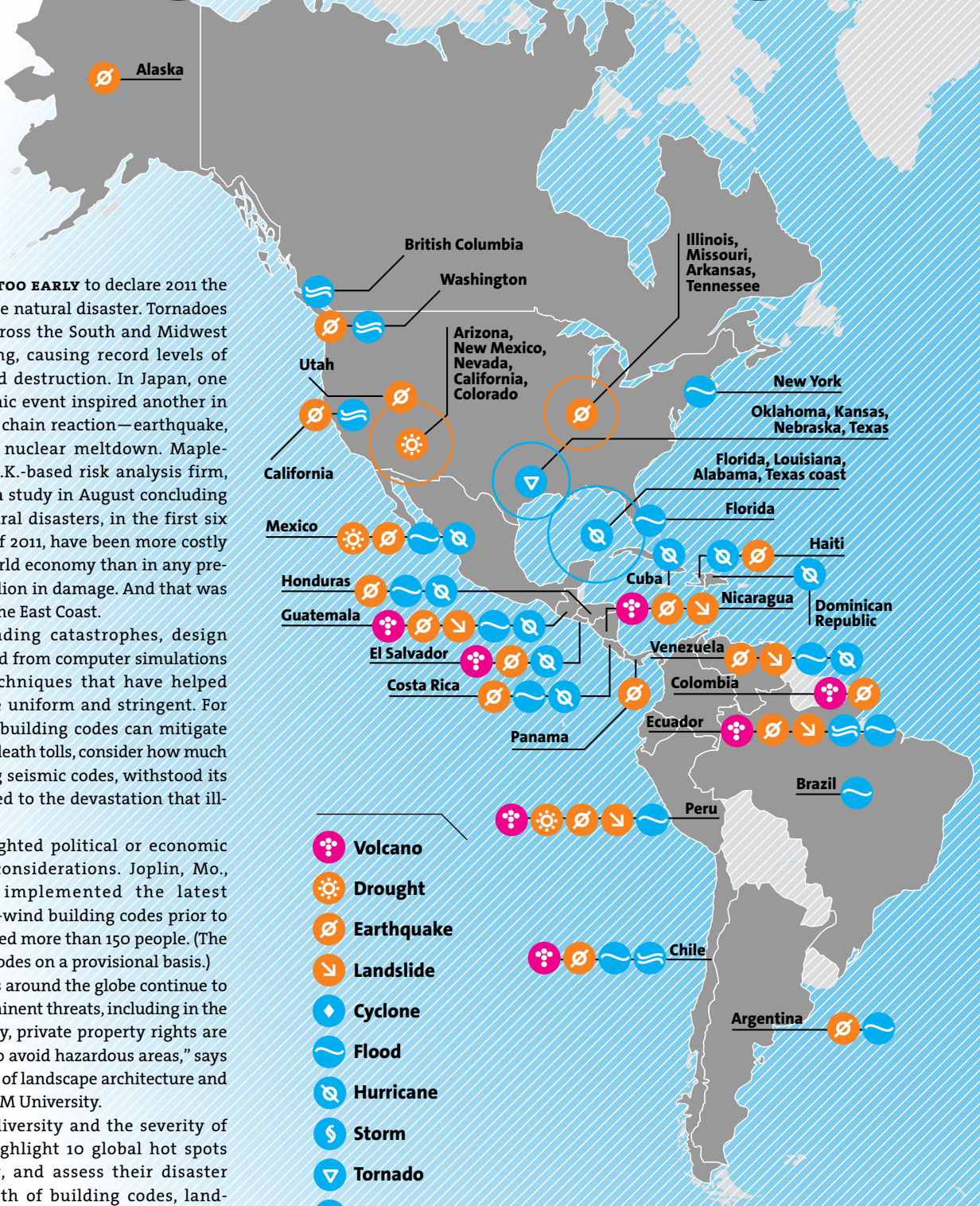

IT'S NOT TOO EARLY to declare 2011 the year of the natural disaster. Tornadoes ripped across the South and Midwest this spring, causing record levels of death and destruction. In Japan, one cataclysmic event inspired another in a horrific chain reaction—earthquake, tsunami, nuclear meltdown. Maplecroft, a U.K.-based risk analysis firm, released a study in August concluding that natural disasters, in the first six months of 2011, have been more costly to the world economy than in any previous year, causing \$265 billion in damage. And that was before Hurricane Irene hit the East Coast.

previous year, causing \$265 billion in damage. And that was before Hurricane Irene hit the East Coast.

In the face of impending catastrophes, design professionals have benefited from computer simulations and modern mapping techniques that have helped make building codes more uniform and stringent. For a case study in how good building codes can mitigate infrastructure damage and death tolls, consider how much better Chile, with its strong seismic codes, withstood its recent earthquake compared to the devastation that ill-prepared Haiti suffered.

All too often, short-sighted political or economic decisions trump safety considerations. Joplin, Mo., for example, had not implemented the latest recommendations for high-wind building codes prior to the tornado in May that killed more than 150 people. (The city has since adopted the codes on a provisional basis.)

Meanwhile, populations around the globe continue to increase in areas facing imminent threats, including in the United States. “Undoubtedly, private property rights are prevailing over the efforts to avoid hazardous areas,” says Samuel D. Brody, a professor of landscape architecture and urban planning at Texas A&M University.

Based on geographic diversity and the severity of impending threats, we highlight 10 global hot spots on the pages that follow, and assess their disaster preparedness—the strength of building codes, land-use ordinances, and other strategies that architects and design professionals are pursuing to mitigate the potential damage of a major crisis.

- Volcano
- Drought
- Earthquake
- Landslide
- Cyclone
- Flood
- Hurricane
- Storm
- Tornado
- Tsunami
- Typhoon

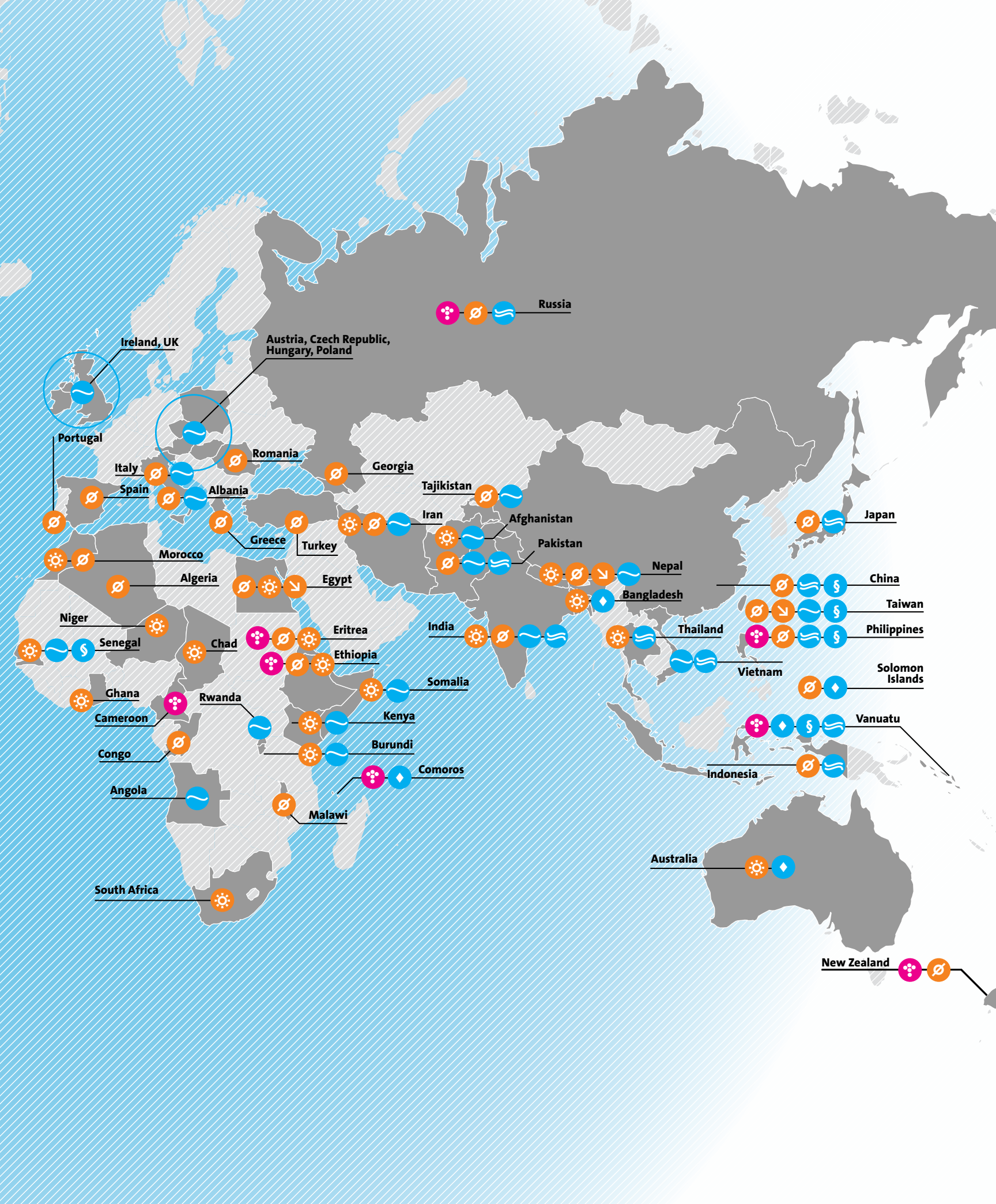

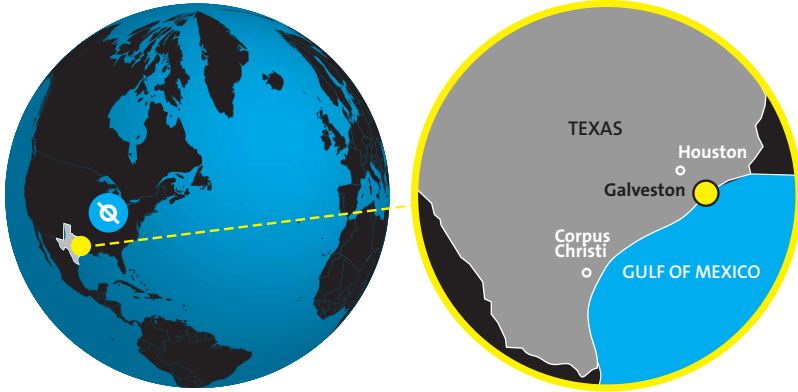

33

Average percent chance each year, historically, of a hurricane hitting the Texas coast, according to Colorado State meteorologists

TEXAS COAST: HURRICANE

Galveston has been hit numerous times since a 1900 hurricane caused the loss of more life than any storm in U.S. history. In 2008, Hurricane Ike did \$30 billion worth of damage—making it the nation's third-costliest storm to date. Yet Galveston “dodged a major bullet,” according to Philip J. Klotzbach, a Colorado State meteorologist. If Ike had hit a few miles further west, Galveston would have suffered much more damage.

Nevertheless, people continue to build “like gangbusters in these very vulnerable areas,” says Sam Brody, director of the Texas A&M Center for Texas Beaches and Shores. “The recognition of hurricanes and vulnerability is counteracted by the desire to develop the landscape and reap what are usually short-term economic gains.”

When enough years pass between hurricanes, developers can get projects started, completed, and sold without any reminders of the hurricane threat. Often, they're selling to people moving from outside the region who have no firsthand knowledge of the dangers. The legacy of development and sprawl is so strong, Brody says, that there's no consideration given to avoiding flood plains and areas especially susceptible to storm surge. (Houston's lack of zoning is notorious.) And new developments themselves can affect flood patterns.

As is the case elsewhere, land-use policies and building codes vary widely among localities. Galveston has kept current with national building code standards, requiring new homes to include steel storm shutters, for example, and emphasizing the importance of elevating properties in flood-prone areas. The city is now rewriting its entire zoning code post-Ike. It helped that, after the hurricane, structures that met or exceeded recent codes withstood the storm “wonderfully” and experienced little or no damage, says Lori Schwartz, Galveston's assistant planning director.

But arguments still crop up in some communities about the need for safety requirements such as storm shutters, which some people argue are not affordable. As a result, nearby towns have very different building rules, even though hurricanes don't heed jurisdictional boundaries.

THAILAND: RISING SEA LEVEL

Of all the threats that Thailand faces (a 2004 tsunami killed approximately 5,400 people), none is perhaps more potentially disastrous than rising sea levels, an issue of major concern for numerous Asian coastal megacities, including Ho Chi Minh City, Vietnam, and Kolkata and Mumbai in India. The Gulf of Thailand is rising about 0.25 centimeters per year, attributed in part to climate change and coastal erosion. And in a cruel twist of fate, Bangkok itself is sinking up to 4 centimeters per year, thanks to the illegal pumping of groundwater. Many fields that once absorbed water have been developed. Eventually, more than one million buildings could be threatened by flooding. Some scientists have proposed building a massive seawall around Bangkok, but environmentalists and politicians have opposed that plan. Infrastructure alone isn't enough to mitigate the issue, says Roland Fuchs, a senior fellow with the East-West Center, a Honolulu-based nonprofit research group: “A lot more attention needs to be given to spatial planning and reducing risk by diminishing settlement into areas of high risk,” he says.

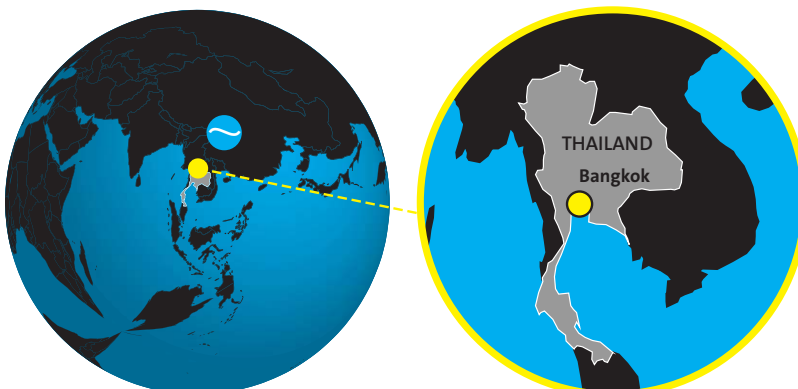

2100

The year that some scientists have predicted Bangkok will be entirely under water



AMERICAN SOUTHWEST: DROUGHT

Since 1999, the American Southwest has suffered from drought: A lack of rain has helped diminish reservoir levels and has reduced the Colorado River's southern end to a trickle. Increasing development, meanwhile, has placed a growing strain on water resources.

In Tucson, Ariz., local laws stipulate that any new residential construction has to have an outlet outside to allow collection of graywater, while some newer developments are using curb cuts to direct runoff into bioswales. Despite such interest in harvesting rainwater, with only 20 to 30 days of rain per year in the desert, the economics don't always justify such projects. Moreover, various design professionals still don't consider water usage and conservation during a building's lifetime when drafting designs, the way they consider energy use, says Jerry Yudelson, a green-building consultant in Tucson. And architects and engineers don't always communicate as well as they could with each other about comprehensive strategies for water conservation. But the drought has started to change that. "The building code isn't currently telling us that we have to collect water," says Jeffrey Zucker, a Tucson architect. "We do it because water isn't free."

77

Percent increase in water supplied by the Southern Nevada Water Authority, which services Las Vegas, between 1990 and 2008

margin (mahr-jin) • 1. by 2080, sea level rise could convert as much as 33 percent of the world's coastal wetlands to open water

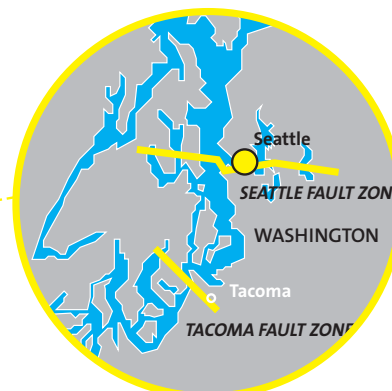

SEATTLE: EARTHQUAKE

Thanks to geological research, Seattle officials have realized in recent years that the city is more vulnerable to an earthquake than they previously thought. Studies in the Pacific Ocean have shown that a subduction zone quake—such as the one that struck Japan this year—would likely have an epicenter much closer to the city than was once believed. New technologies have also revealed other inland faults, including "a big crustal fault going right through our downtown," says William P. Steele, director of outreach at the Pacific Northwest Seismic Network.

Fortunately, the city has kept up with the latest national standards for building codes. John Siu, Seattle's principal engineer and building official, traveled to Japan after the March quake and found that his city's building codes were roughly comparable to the ones in Japan, which were credited with saving thousands of lives. Still, Siu says, Seattle could be better prepared; the city has contemplated requiring that certain historic buildings be retrofitted to meet existing codes. Parts of California already have instituted such a requirement. But with the onset of the recession, attempts to gain the political support necessary for such a law in Seattle vanished, as the city began laying off workers who might have overseen the adoption of those new codes.

9.0

Estimated moment magnitude scale reading of the impending earthquake along the Cascadia fault zone in the Pacific Ocean, according to Caltech scientists

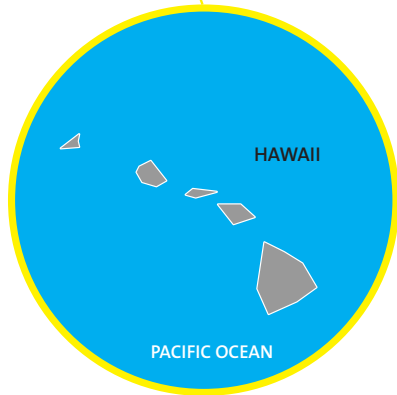
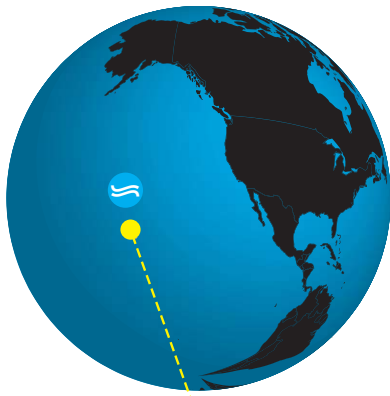

HAWAII: TSUNAMI

The tsunami that hit Hawaii in March following the Japanese earthquake—the latest in a series of tsunamis to strike the islands—did millions of dollars in damage to harbors and hotels. In 1960, Hilo lost a substantial amount of its downtown to a tsunami. Much of the town was rebuilt behind a buffer zone away from the sea. Such practices are far from the norm in Hawaii, however. Each island has its own building code (the one on the Big Island dates to 1991). In 2007, the state legislature passed a law calling for each county to adopt statewide building codes, but that remains a work in progress. Hawaii is now awaiting recommendations from an American Society of Civil Engineers committee about necessary design loads for buildings to better withstand the force of a tsunami, which means it may be years before local building codes reflect the latest research. Fortunately, land-use ordinances are starting to reflect new tsunami maps that have been released over the past year that pinpoint high-risk areas.

500

Estimated wave speed of the tsunami that hit Hawaii in March (in miles per hour), according to NOAA



GUATEMALA: EARTHQUAKE, VOLCANO, HURRICANE, LANDSLIDE

The World Bank's 2005 disaster hotspot study ranked Guatemala seventh for mortality risk of all countries facing three or more natural disaster threats. Guatemala has an increasing urban population but has lacked stringent building codes—a deadly mix if an earthquake were to strike Guatemala City, which is located near a major fault. Informal and illegal settlements built along the city's edge are especially vulnerable. No national land-use laws or policies exist in Guatemala; individual municipalities are tasked with drafting plans. The World Bank's Global Facility for Disaster Reduction and Recovery has worked with the government to establish land-use recommendations for 12 high-risk municipalities, identifying safe areas for development. Also, the country recently updated seismic codes and has started various projects to assess the safety of school and hospital buildings.

2,613,552

Number of Guatemalans who would be affected by an earthquake, approximately 20% of the country's population

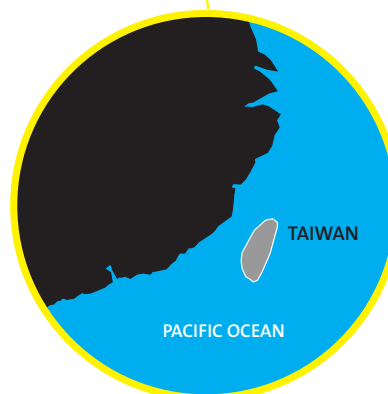

3,000

Average number of buildings damaged each year by flooding, according to Taiwan scientists

TAIWAN: EARTHQUAKE, FLOODING, TYPHOON

The 2005 World Bank disaster hotspot study ranked Taiwan number one for mortality risk among countries facing the threat of three or more natural disasters. Taipei, a densely populated urban center, has built a massive seawall around the city to protect against typhoons and rising rivers—a stopgap measure following decades of poor urban planning. But Shu Chang, an architect who owns his own firm in Taipei and has worked for city zoning committees, thinks codes should require that buildings incorporate basement tanks to store rainwater that can be pumped out in dry conditions—an idea politicians haven't yet embraced.

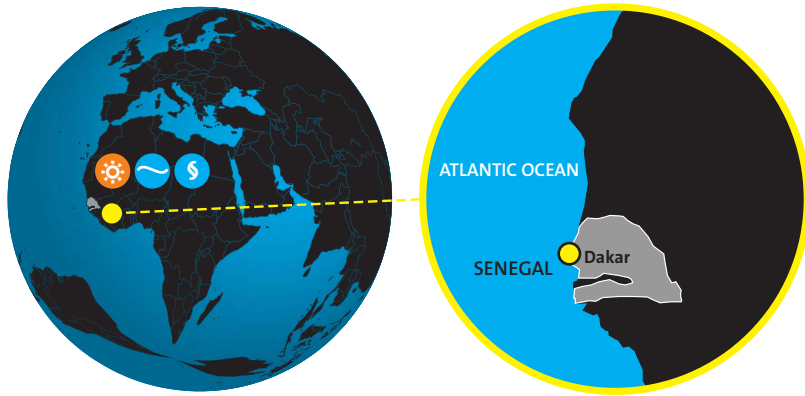

SENEGAL: DROUGHT, FLOODING

In recent decades, because of drought in rural areas of Senegal, residents have increasingly moved to the outskirts of cities such as Dakar, often settling in poorly defined governmental jurisdictions. Thanks in part to the increasing population, rising sea levels, and a lack of effective drainage systems or land management, Dakar has faced significant flooding and coastal erosion. In 2009, the World Bank Disaster Risk Management team named Senegal one of its priority countries. Senegal has embarked on mapping projects to determine high-risk areas, helping support planning initiatives and the construction of dikes and other infrastructure. The country has also embarked on a controversial initiative called “Plan Jaxaay,” moving residents from the most flood-prone neighborhoods in Dakar’s suburbs to a new settlement 15 miles east of the city.

\$42 MILLION

Damage caused by flooding in Senegal between 1980 and 2008

TURKEY: EARTHQUAKE

In March 2010, the Turkish Chamber of Civil Engineers released a chilling report: More than 150,000 people would be killed and 300,000 buildings destroyed if a major earthquake were to strike Istanbul, located on the North Anatolian Fault. Moreover, they found that more than half of a sample of 100 construction projects approved by engineers in 2008 as earthquake-proof did not actually meet that standard—the reflection of a flawed and weak review process. Since 2005, the World Bank has helped fund Istanbul’s Seismic Risk Mitigation and Preparedness Project, which so far has helped retrofit or reconstruct nearly 500 buildings, including schools, hospitals, and historic buildings. But significant work remains. In May, the Turkish government announced a bold new plan: to build two new earthquake-proof satellite cities in the Istanbul province so that residents in high-risk areas of the city could move into structurally sound buildings.

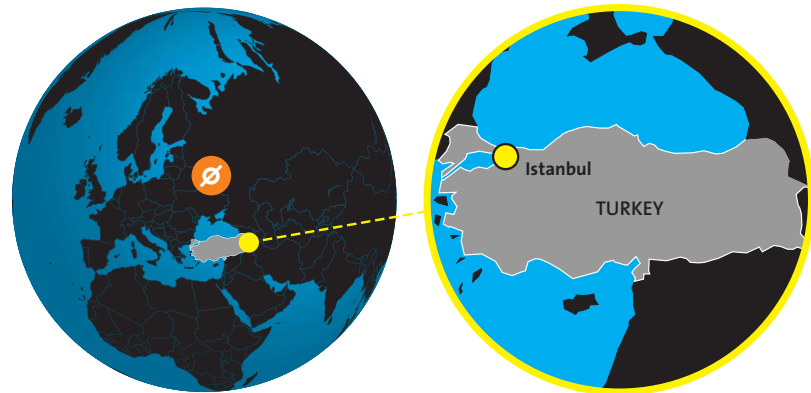

62

Percent chance, according to the U.S Geological Survey in 2000, that a major earthquake will strike Istanbul by 2030

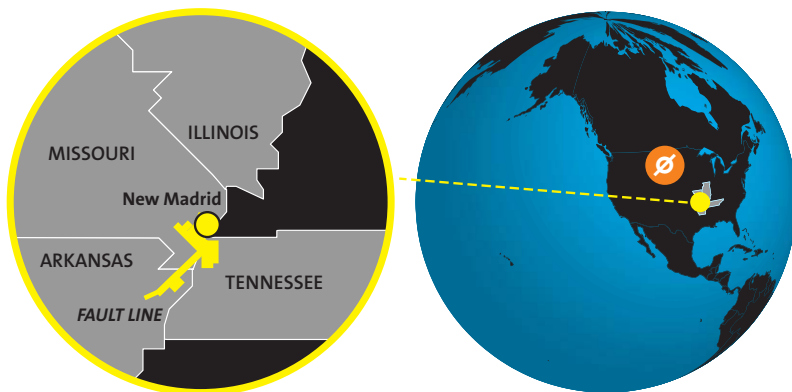

\$70 BILLION

Amount of infrastructure damage FEMA estimates if a major earthquake occurs on the New Madrid fault

MIDWEST: EARTHQUAKE

This year, an area about 50 miles north of Little Rock, Ark., has experienced more than 1,250 tremors. They haven’t done serious damage, but the potential for a major earthquake along the New Madrid fault is significant. The region is now commemorating the 200th anniversary of a series of earthquakes that were some of the largest ever in North America, measuring close to 8.0 on the Richter scale. Another major earthquake could potentially cause thousands of deaths and have a greater economic impact than any natural disaster in the nation’s history. “We have the capacity in the central part of the country to have just as big an earthquake as they do out in California,” says Scott Ausbrooks of the Arkansas Geological Survey.

Nevertheless, many developers question the value of safety requirements that can add to their costs. Public hearings about strengthening seismic building codes in cities like Memphis have turned into adversarial proceedings between experts hired by developers who cite astronomical extra costs and scientists who argue that those figures are inflated. Tennessee law requires local governments to adopt codes based on International Code Council (ICC) model regulations that are no more than seven years old; Memphis is now nine years behind. Lots of communities complain that they can’t keep up with the constant revisions that the ICC and the American Society of Civil Engineers make to suggested codes. Then there’s the difficulty of convincing officials about the severity of the threat, says Jim Wilkinson of the Central U.S. Earthquake Consortium. “There’s that continual debate, whether it’s in Tennessee or Arkansas,” he says. “How strong is strong enough and should we be building to a code comparable to California?”

RAPID RESPONSE

WHEN A TORNADO RAVAGED TUSCALOOSA, ALA., THIS SPRING, A NETWORK OF ARCHITECTS QUICKLY ORGANIZED TO ASSESS THE DAMAGE. THEIR WORK WITH AN AIA TASK FORCE HAS BECOME A MODEL FOR HOW TO STREAMLINE AND IMPROVE POST-CRISIS PLANNING AND REBUILDING EFFORTS.

TEXT BY WAYNE CURTIS
ILLUSTRATIONS BY ASAF HANUKA



LATE IN THE AFTERNOON of April 27, an unusually powerful storm system swept across west Alabama. It spawned dozens of tornadoes, including one frighteningly massive funnel that touched down at the edge of Tuscaloosa and then made its way resolutely northeast toward downtown and the University of Alabama. Television and radio stations broadcast warnings; sirens wailed; people took shelter.

Architect James E. “Butch” Grimes, AIA, was a few blocks from the center of town working in his office, located in a historic 1820s Greek Revival house, where he and his wife, Amy, live upstairs. She heard the tornado warnings on television and hurried down to tell Butch that the storm looked serious. The couple rounded up more than a dozen people—friends, neighbors, two infants, three dogs, and a cleaning crew working in their house—and made for the basement. There they watched on a television as the storm continued to vector toward them. They could only guess what was happening outside. Then the cable and cellphone service cut off.

Grimes emerged after a half an hour in the basement. Luckily, his immediate neighborhood had escaped the brunt of the storm, but when he later set off on his bicycle to see the destruction elsewhere, he discovered that it started about six or eight blocks from his house.

The tornado, which was nearly a mile wide at its broadest point, had left a sizable trail of destruction, as if a malicious crew of workmen had pounded a swath through the city with sledgehammers. While the storm thankfully missed downtown and the university, it hammered residential neighborhoods—both affluent and poor—along with churches, chain stores, light industrial

buildings, offices, and commercial strip malls. Houses with vinyl siding, the carports twisted, looked like they’d been peppered with shotgun blasts from the flying gravel. And those were the lucky ones. Where some homes once stood, only concrete slabs or steps remained. Grimes pedaled down one street looking for his minister’s house, but the neighborhood had been essentially leveled. “I finally got to a place where I thought it was, but all I could smell was natural gas,” Grimes says. (He learned later his minister was fine; he and his family had taken shelter some blocks away at their church.)

The storm killed 47 people in and around Tuscaloosa. An estimated 7,000 buildings were partly or fully damaged by the storm, with property losses from the various tornadoes statewide pegged as high as \$1.5 billion. “I have not seen a worse tornado,” Grimes says of the one that struck Tuscaloosa. “It was like a big blender had shredded everything and then dropped it back down. There were just layers of little bits and pieces.”

After a couple of days spent connecting with friends and associates and exploring the city to survey the destruction, Grimes set to work. He’d been preparing for what was to come next since 1979.

TORNADOES FORM WHEN weather systems collide—cool air at higher altitudes runs atop humid air on the ground, and atmospheric instability results. If the winds are just so, with the top air moving faster than the bottom, a tornado descends from the clouds. In the immediate aftermath of a catastrophic storm, there’s often a threat of parallel instability emerging amid disaster relief efforts, as officials from the federal, state, and local governments come streaming into a disaster zone, followed by insurance adjusters, quick-buck contractors, do-gooders, grandstanders, and shysters. They converge amid chaos, and establish their own sort of microclimate of recovery.





James E. "Butch" Grimes



Kimberly McMurray

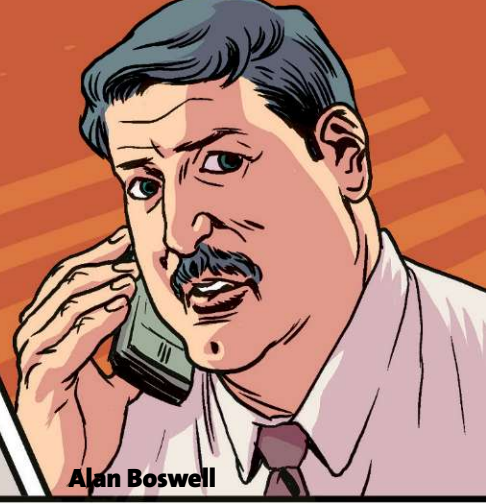

Alan Boswell



RAPID RESPONSE



Among those looking to play a constructive and useful role amid the maelstrom: architects. Indeed, in 2005, concerned architects volunteered in droves following Hurricane Katrina in New Orleans—some 600 AIA members signed up to assist in any way they could. Encouraged by the response, the AIA set out to establish a more formal system under which architects nationwide could apply their skills in aiding those affected by catastrophes. (The AIA has been involved in disaster relief in one way or another, including assessing damage, creating temporary shelters, and rebuilding post-disaster, in several states since 1972.) The result was the AIA Disaster Assistance Comprehensive Response System (CRS), a way to connect professionals with backgrounds in design, planning, and assessment with local officials in affected communities.

While urban and structural design might first come to mind when conceiving of how architects can be useful in recovery efforts, the profession is also uniquely suited for an essential step before planning and rebuilding—assessing structural damage. Before CRS, the presumption was that architects should only begin to help with assessments after first responders had completed rescue missions, which often unnecessarily delayed rebuilding efforts. But with the new system, architects were encouraged to engage immediately after an event with planners and recovery personnel, thereby becoming immersed in the rebuilding process early on. The assessment project in Tuscaloosa amounted to a sort of full bore test run of the new strategy.

BUTCH GRIMES, an Alabama native and graduate of the architecture and design school at Auburn University in Alabama, was a young architect working in the state's building commission as an energy coordinator and planner when Hurricane Frederic struck Mobile in 1979. His supervisor stuck his head in his office and told him to pack his bags. He ultimately spent six months in and around Mobile doing disaster assessment. It was the first major disaster in which FEMA, which had been established earlier that year, played a major role. "I would spend a week or two in Mobile, and then drive home to see if I was still married," Grimes says.

He later left the state job, moved to Tuscaloosa, and launched his own practice. But he maintained an interest in disaster preparedness, helping lobby to have Alabama's legislature implement a Good Samaritan Law. (Most states already have such a law, which shields volunteers—such as doctors and architects—from lawsuits if they err while engaged in a good faith effort to help. Alabama passed a version in 2006.) Grimes has also been involved in training architects how to best assess damage following a disaster—he's helped educate about 40 volunteers in post-disaster assessment over the past couple years.

When the tornadoes came this April, the main one was swift, brutal, and had a seemingly deranged sense of humor—among the first buildings it struck were those of the Salvation Army, Red Cross, and the offices of the county emergency-management agency. David Hartin, the Tuscaloosa County emergency-management director, and his staff had to negotiate blocked exits and scramble over debris to escape.

Grimes called up the volunteers he had trained over the years to assess damage; most agreed to help. Among the volunteers who showed up unbidden was Kimberly

Lloyd's (loidz) • 1. the British insurer, which insists that higher premiums are necessary because of the increasing number of disasters caused by climate change

McMurray, AIA, a Tuscaloosa native and architect then working with the Slam Collaborative, an Atlanta-based firm. She had been commuting home most weekends to Tuscaloosa to be with her husband and family, but after the storm she headed back as quickly as she could and contacted Grimes. "Kim walked in and asked, 'Is there a job?'" Grimes recalls. "And I said, yes, you're the new coordinator for the Tuscaloosa region."

Getting teams of qualified people into the field soon after a disaster to offer assessment of structural safety—even while rescue is under way—performs an essential task in ensuring public safety as storm victims return home. Some structures may look safe but aren't; others might appear worse off than they actually are.

Rapid assessment also helps accelerate recovery, giving local officials information about the need for temporary shelters and help with recovery-planning efforts that they can convey to state and federal officials. A comprehensive inventory of damage also speeds up the process of securing federal disaster funding: Many emergency funds can't be released until a thorough assessment is completed and recovery plans are drafted.

Soon after the storm, word spread across Alabama that more volunteers were needed to assess tornado damage. Ten days after the storm, a one-day training session was held on just 48 hours notice at Tuscaloosa City Hall, with the idea of getting a large cadre into the field as soon as possible, to help the architects, building inspectors, and structural engineers conduct the assessments.

The response was gratifying. "They were lined up out the door," McMurray says. "We were hoping that we could get 50 people, and then next thing you know it was more than 150," Grimes says. Volunteers were mostly Alabama architects, but also included architects from neighboring states, as well as Alabama building officials, engineers, and fire and rescue personnel.

"We're not training taxi drivers," Grimes says. "These are people who already have professional degrees. We're

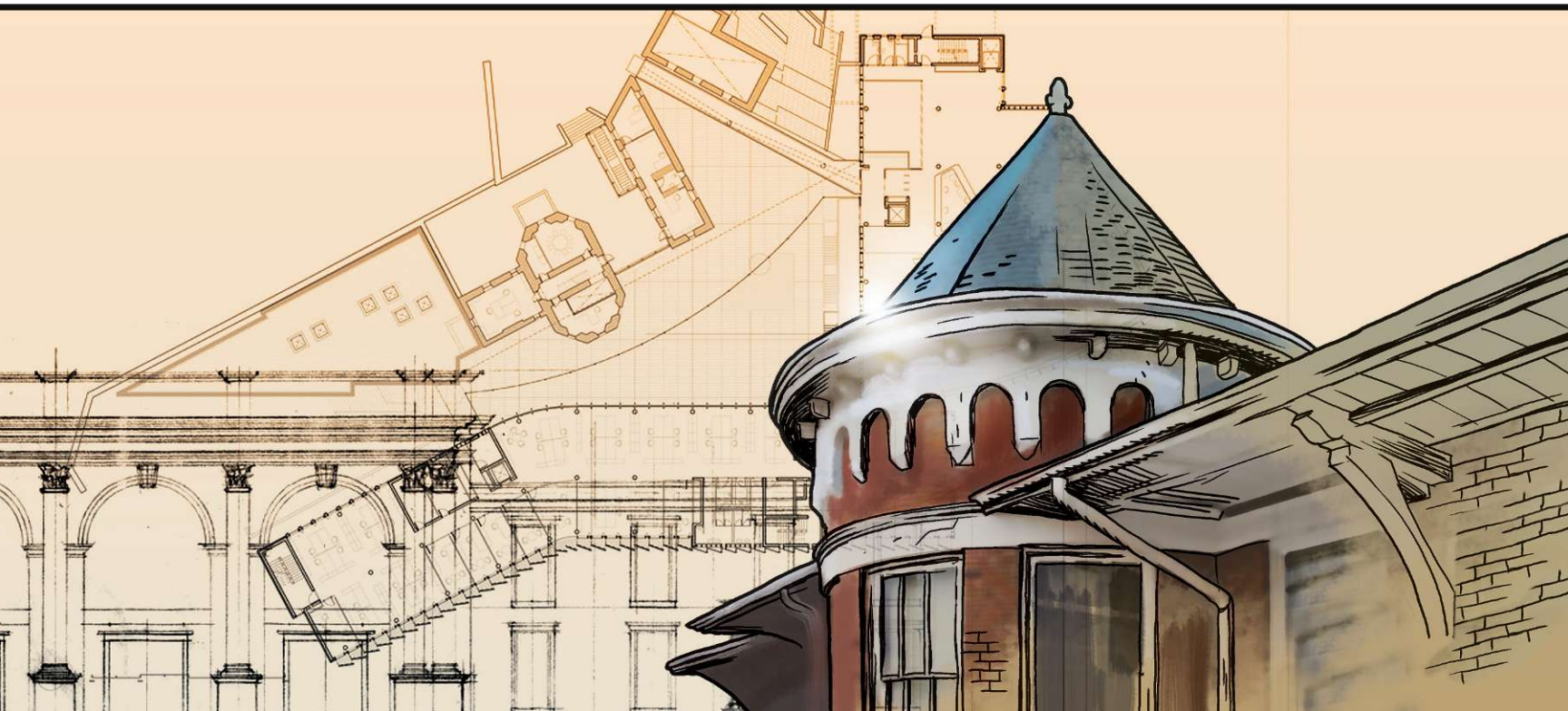

RAPID RESPONSE

not training them to determine if a building is safe or unsafe. What we're doing is trying to show them how to report it in a uniform manner." And then there's the basic safety stuff—such as having sturdy shoes that can withstand scattered nails, bringing plenty of sunscreen, and ensuring that at least one team member with a phone remains outside the building when others go in, in case part of the structure should collapse.

After the one-day Saturday training, everyone took off Sunday—it was Mother's Day—then the first teams returned to city hall early Monday morning to begin assessments. "After the Saturday training, I was dreading Monday morning," says Alan Boswell, the chief building official for the city of Tuscaloosa and the man in charge of assembling the damage assessments. "Because I knew all these fellows were going to come here and had never done this before. ... To me, adults are a lot like kids—they get eager. It's 'let's go, let's go!'" He recalls that one team scurried out the door before gathering up any of the needed gear. "It wasn't easy for me because you try to stay in control of everything," Boswell adds. "But sometimes you just have to let go. I learned that letting things go is sometimes not as bad as it seems."

Indeed, Boswell's fears proved unfounded. That week, 10 days after the storm, every day, between a dozen and 15 teams of three to five inspectors each signed in, then picked up identification badges, damage assessment forms to be filled out, and color-coded signs. They received maps generated by city staff that divided Tuscaloosa into three zones and then into smaller quadrants, which were assigned to each team.

Once in the field, the teams would start with an exterior assessment—walking entirely around a damaged structure, and then getting inside if accessible. They spent on average about 20 minutes per building, although some that had been completely obliterated could be documented far more quickly—assuming they could figure out the street address of what amounted to a vacant lot, which often took considerable time. Paper forms were filled out (one for an initial assessment; a more detailed form if the damage was significant). "And we dedicated one member per team who did nothing but GPS entry and take pictures," McMurray says.

Some of the assessments could be tricky and required a practiced eye. Grimes says that one house looked as if it had escaped major damage—until someone noticed that the curtains had been blown outside the open windows, indicating that winds had come from inside the house. Further inspection revealed that the roof had been blown upward, and then settled back down. The assessment changed. Teams would eventually determine their final assessment and post signs—houses less than half damaged were posted with a green or yellow placard; those with more than half got a red tag.

At the end of the day, assessment teams would converge back at city hall and turn over data for inputting into a Geographic Information System—forms were scanned and photos were uploaded, so the evaluations were available to Boswell and his staff on an almost real-time basis. The inspectors would then take colored markers and head to a large map posted along one wall, and color the lots either red, yellow, or green, indicating the damage level. Day by day, a tricolored visual representation of the depth and breadth of the tornado's toll began to emerge.

The teams proved efficient and thorough—by Saturday, after six days of work and just over two weeks after the tornado touched down, volunteers had written up and tagged nearly 5,000 structures. "We were through with our data before FEMA had figured out who was going to haul off the garbage," Grimes says.

While McMurray and Grimes say that the process went smoothly and efficiently, they see room for improvement. In the future, they'd like to capture the GPS data that's now automatically tagged in most photos taken with cellphones and many cameras, so that it can be automatically integrated into a database to help identify lots where structures were lost. They also identified a few gaps in training—one group of fire inspectors had red-tagged homes because they lacked sprinkler systems, which is in no way a reflection of the structural integrity of the buildings.

And Grimes, McMurray, and Boswell all believed that they could have communicated more effectively with the public about what the house tagging actually meant. The emergency center was flooded with calls after the signs started appearing, and a volunteer had to be assigned to explain that red didn't mean that homeowners were forbidden from entering their homes, but rather that entering could be unsafe. "People were calling and saying I got a red placard on my house, can I go in it?" McMurray says. "A lot of people thought we were condemning their house."

Eventually, the local news did segments on what the tags actually meant, and calls abated. Boswell says that they've since thought about changing the wording on the signs, as well as adding a fourth color for the future—an orange sign to indicate damage between half and 80 percent.

ALL OF THOSE INVOLVED in the assessments said that the single best way of being useful in such chaotic circumstances is for AIA chapters to develop lasting relationships with local officials well ahead of any catastrophic event. Preparedness doesn't mean just stockpiling flashlights and canned foods. It also means forging connections before they're needed—attending professional meetings of building inspectors, for example, or meeting up with key local officials for lunch. Grimes had made an effort to introduce himself to city and emergency officials and explain a bit about the AIA well before the storm. And when a sudden influx of folks clamoring to help suddenly swarmed city hall—FEMA and other federal officials, state workers, nonprofit workers—his face was already familiar, and it allowed Grimes and the architects he was shepherding to make a helpful contribution without adding to the chaos and confusion.

"I think among lessons learned is communicating ahead of time with the key people in the state," says McMurray, who noted that post-disaster public officials were—at least for now—far more open to learning more about what the AIA can do to help in the future.

Grimes says that preparing and training in advance also ensures a degree of consistency in the assessments, which provides a track record and credibility that will help in the future. "I feel proud about what happened. I thought we did a good job," he says. "A lot of us got our training in public universities, and it was a chance to give back." □

HIGH RELIEF

SHIGERU BAN HAS MADE A CAREER OF BALANCING HIGH-END FOR-PROFIT WORK WITH HUMANITARIAN PROJECTS. CAN HIS SO-CALLED PAPER ARCHITECTURE, DESIGNED WITH A POET'S TOUCH, CHANGE THE WORLD?

TEXT BY ERIC WILLS
PHOTO BY NOAH KALINA

S

SHIGERU BAN STARES into the camera, stoic, revealing the occasional hint of a half-smile. "The lights are bright," he says, as a photographer shoots multiple frames of him sitting against the wall of a conference room in Manhattan's Kitano Hotel. It's six o'clock on a Monday evening in August. Ban, a Japanese architect acclaimed for

his poetic sensibility and use of nontraditional building materials like paper tubes—"an old-school Modernist with a poet's touch and an engineer's inventiveness," is how Michael Kimmelman, *The New York Times*' new chief architecture critic, once described him—has just flown in that morning from his Paris office.

He spent the day with his New York-based partner, Dean Maltz, discussing a new commission—his first foray into restoration work, he says. Tomorrow he's flying to Colorado for a meeting about his design of the new 30,000-square-foot Aspen Art Museum. Right now, though, he's braving the spotlights to discuss what he considers the more socially significant aspect of his legacy: his humanitarian projects.

Ban, Hon. FAIA, has developed a reputation as a post-disaster design specialist, a kind of global-age architect-cum-philanthropist who flies into disaster zones—sometimes invited, sometimes not—and spearheads projects that help small groups of refugees and victims

not served by government agencies or NGOs. He's among a select but growing cadre of architects who balance high-end design work for big-budget, high-profile clients (his current commissions include the Goa Hotel in India and the Beach Club in Lebanon) with humanitarian projects, such as his temporary shelters for earthquake victims in Haiti, Turkey, and India. "Underlying all of Ban's work is an extraordinary architectural sensibility," says Michael Maltz, FAIA, whose Los Angeles firm has designed both low-income housing for Skid Row residents and performing arts centers for elite universities. "The work he does for emergency or disaster situations is just as inventive and strong and beautiful as [the rest of his portfolio]."

To be sure, Ban's projects have suggested the potential for good design to benefit victims reeling amid post-disaster chaos. But his ultimate quest—to revolutionize the quality of post-disaster housing—raises the question of how effective high-end architects can be as de facto relief workers.

PHOTO SHOOT FINISHED, Ban sits down in the Kitano's wood-paneled café for a coffee. He's dressed, as always, in all black: loafers, a button-down shirt with a Mandarin collar, and a calculator watch. A ballpoint pen is tucked below one of the buttons on his shirt lapel. He has the faint wisp of a mustache and goatee, a soft, round face, and wavy black hair that confers a professorial air. Is he tired? No, he says, dismissing the question with a wave of the hand. Working primarily from Paris, he flies back to his Tokyo office twice a month now because of his ongoing post-earthquake work in Japan. Time zones, apparently, have become more suggestion than rule.



**Shigeru
Ban**

Ban was born in 1957 in Tokyo. His father, now retired, worked for Toyota. His mother designs women's clothes and employs a team of seamstresses in her studio. As a boy, Ban wanted to be a carpenter, after watching workmen renovate his mother's house. She turns 81 this year and still runs her business on the second floor of her building, renting out the rest of the space to Ban, who uses it for his Tokyo office. He smiles, says he's often late paying the rent: "I'm not very interested in money. My partners take care of the business part."

Ban came to the United States to study under the late John Hejduk at Cooper Union, after reading about his innovative experiments with brightly colored cubes and grids. One of Hejduk's assignments: Write a poem. It proved a formative lesson for Ban, who can't recall what he drafted in his limited English but vividly remembers the takeaway: writing a poem—achieving a deeper meaning by structuring a minimum of words—and designing a building are parallel pursuits.

Toshiko Mori, FAIA, founding principal of her eponymous New York firm, was a professor at Cooper Union at the time. "He was a very motivated student, entrepreneurial and energetic," she says. Hejduk's concern for social justice, his ideas about architects' engagement with a social contract, resonated with Ban, whose subsequent humanitarian work took those abstract principles and found a real-world expression for them, she says.

Ban's epiphany—his career-altering or, perhaps, career-expanding moment—came after the Rwandan genocide in 1994, long before MoMA had curated exhibits about humanitarian-inspired architecture or glossy hardbacks featured such projects. He had started his own firm in 1985, at the precocious age of 28, but had quickly grown disillusioned. "Mainly we were working for privileged people," he says. "Their power and money are invisible, so they want to have monumental architecture to show their power and money to the public."

By then, Ban had started experimenting with paper as a building material, which is surprisingly strong when rolled into tubes—and, he realized, an economical

and practical solution for designing temporary housing for refugees. Ban approached the United Nations High Commissioner for Refugees. Rwanda victims at the time were given makeshift aluminum-pole-and-plastic-sheet contraptions. But refugees often sold the aluminum and then cut down trees to build their shelters. Why not use paper tubes instead? Ban designed a prototype, got U.N. approval, and had more than 50 units manufactured.

A bevy of projects followed, including his design of paper log houses (the foundations made from plastic Kirin beer crates filled with sandbags) and a church following the 1995 earthquake in Kobe, Japan; a model house in post-Katrina New Orleans for the Make It Right Foundation; temporary schools in post-earthquake China in 2008; and a paper-tube concert hall, which opened in May, after the 2009 earthquake in L'Aquila, Italy.

Most of those projects relied on Ban's loosely organized nonprofit, the Voluntary Architects Network, which brings together students and local architects after a crisis. ("Students used to say they wanted to be architects and work for developers," he says; now they want to work on his humanitarian projects.) His modus operandi: parachute in, get a project started, and then have students complete it, which necessitates that the design be simple. Local architects, meanwhile, help him to incorporate regional building materials and to respect cultural mores.

Ban pulls out designs from two current projects: a temporary church in Christchurch, New Zealand, a soaring, elegant structure, 24 meters high, made from cardboard tubes; and temporary housing for the recent earthquake victims in Onagawa, in the Miyagi Prefecture of Japan. Along the eastern Japanese coast, ravaged by a tsunami, there's only so much level terrain to build the government's standard one-story temporary housing, he says. Which is why he designed a three-story housing complex, 189 units in total, made from shipping containers stacked in a checkerboard pattern—the containers themselves housing small bedrooms and bathrooms, the spaces in between used as living rooms, dining rooms,



Shipping Container Model Unit
Onagawa, Japan



Church
Christchurch, New Zealand



and kitchens. Ban has designed a mini-village around the units with a central market, a café, and a children's library.

Now that Ban has persuaded the authorities to approve his project—the units are the same size as regulation temporary housing but cost “a little bit more” than the government standard, he says, because of the price of stacking the containers and adding fire protection—construction has started and will take two months. Given the extensive rebuilding that Japan faces, Ban estimates that victims could live in the houses for as long as five years. Why shouldn't they be well designed? Because the Japanese government has approved his plans, Ban sees no reason why a company couldn't mass-produce his units in the future. “That's why I am doing this,” he says. “I want to change the standard of the evacuation facilities and the temporary houses, create a higher standard.”

AMID THE PLETHORA of design proposals for disaster relief housing—Graham Saunders, the head of the Shelter and Settlements Department of the International Federation of Red Cross and Red Crescent Societies, says he receives five to 10 emails each week—Ban stands out simply because he has managed to get his projects built. Yet not all have been successful. After the 2001 earthquake in Gujarat, India, Ban designed paper log houses with mud floors for a group of victims. Saunders was impressed with the structures, their architectural integrity, and how strong and easily fabricated they were. As for the refugees, he sums up their reaction this way: “Thank you very much, we don't live in houses made from cardboard tubes,” says Saunders. “Their thinking was, ‘We need to get back what we lost.’ They had no interest in what was perceived as an alien technology.”

Nor does Saunders see much viability for Ban's designs being mass-produced on a scale relevant to large humanitarian organizations: 40 million refugees needed temporary housing in 2010, according to appeals received by the United Nations and Red Cross. “It's the humble, non-exciting, more modest level of innovation that tends to be a lot more successful and a lot more scalable,” he says. For instance, take the paper tube and cloth partitions

shelter (shel-ter)• 1. In 2007, a particularly bad year, 160 million individuals needed housing assistance because of natural disasters, according to the Red Cross

Ban designed for Japanese earthquake victims who were confined to high school gymnasiums and other large public spaces. The partitions gave victims much-needed privacy, and when mosquitos became an issue, Ban helped supply nets that could be draped over the tubes. Ultimately, Ban's high-level analysis remains welcome in an arena with not enough architectural voices, Saunders says. Not to mention the publicity Ban has garnered in glossy magazine spreads like this one: “Maybe humanitarianism needs a bit of an artistic architect with a capital A to get noticed, which gets the rest of us noticed.”

Indeed, if Ban is going to change the world, it will be on his terms, through his uncompromising vision. (This is a man, after all, who talks about his career as his destiny.) He doesn't accept projects unless they pose an interesting design challenge, and draws little distinction between his for-profit and disaster-relief work—all of his designs underscored by a desire to minimize waste. “There is no difference for me between temporary or permanent buildings,” he says. “Even the temporary church I designed for Kobe, it became permanent. It was up for 11 years, then it was donated to Taiwan, and then it was rebuilt there as a permanent church. The question is whether people love the building or not.”

As for his clients, they're remarkably similar, regardless of the project. “The expensive houses or the temporary houses, people are always demanding a lot,” he says, with a smile.

Dean Maltz, who has called Ban on his cell phone during the interview to make plans for the evening, arrives. They attended Cooper Union together; Maltz says that the penthouse of one of their most recent projects, the Metal Shutter House condominiums in Manhattan's Chelsea neighborhood, has just gone under contract. List price: \$12.95 million. Amid the increasing amount of money and time Ban says he's spending on humanitarian endeavors, the Shutter House project is a reminder that his portfolio of high-end projects hasn't exactly suffered.

Ban says his time is up, and after a quick handshake, hustles out a side door with his partner, vanishing into the crowd on Park Avenue, on the move again, in pursuit of his destiny. □



Concert Hall
L'Aquila, Italy

PLAY IT SAFE

IMAGINE A 9.0-MAGNITUDE EARTHQUAKE OR CATEGORY 5 HURRICANE HITTING YOUR AREA. HOW PREPARED ARE YOU TO WEATHER THE STORM? AND HOW WILL YOUR OPERATIONS BE AFFECTED? SURPRISINGLY FEW PRACTICES ARE TRULY READY FOR A NATURAL DISASTER, SAYS ARCHIVAL CONSULTANT TAWNY RYAN NELB. SHE HELPED US COMPILE A FEW TIPS FOR KEEPING YOUR FIRM—AND ITS IMPORTANT DOCUMENTS—SAFE IN THE FACE OF CALAMITY.

TEXT BY NATE BERG
ILLUSTRATIONS BY JAMESON SIMPSON

ESSENTIAL PREPAREDNESS

Every office needs a disaster kit. First-aid supplies. Duct tape and plastic sheeting. Flashlight with batteries. Fire extinguisher and portable radio. Wrench to turn off gas valves. Consider having someone at the office take CPR or first-aid courses. Develop an evacuation plan and pick a meeting spot.

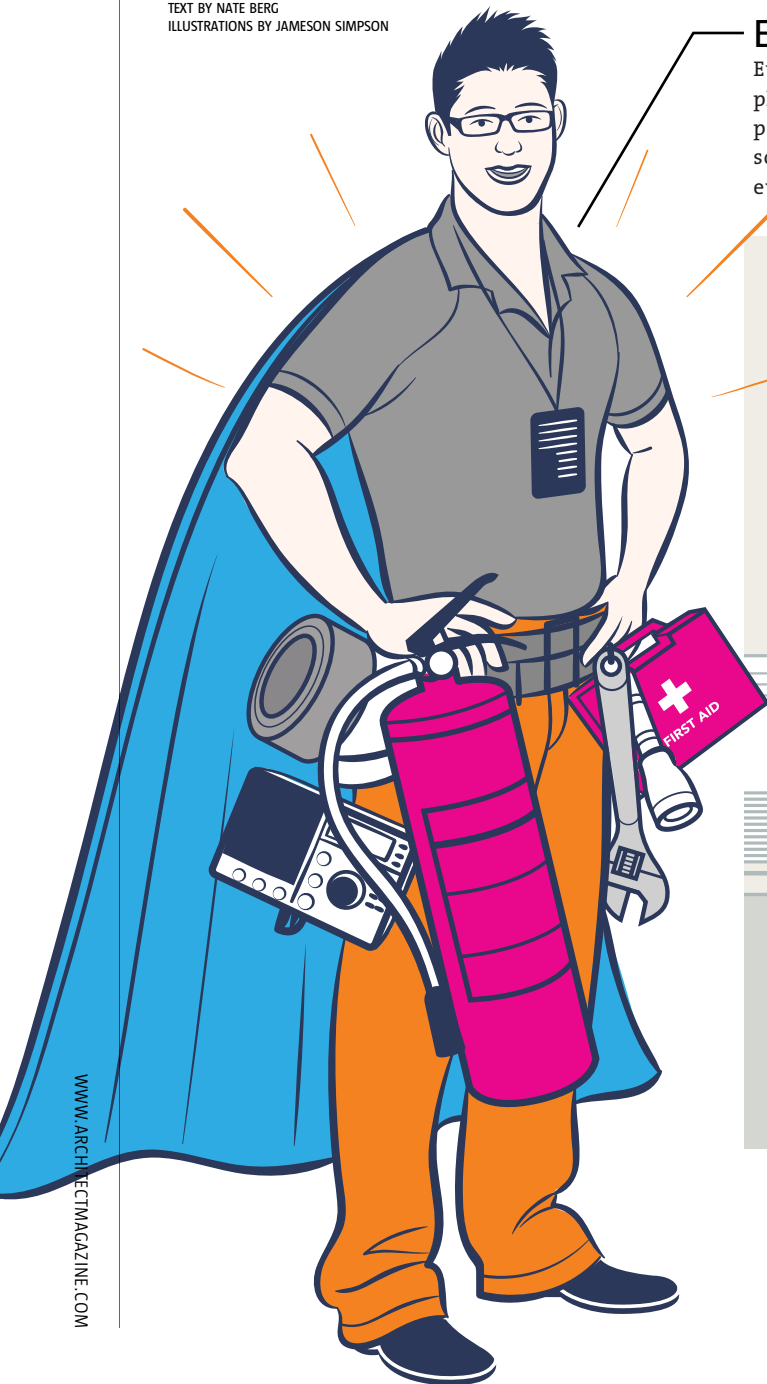

ESTABLISH A BUNKER

A central room away from windows where vital documents and drawings can be stored to help prevent water damage during a hurricane or other natural disaster. Better yet, scan the most important papers.

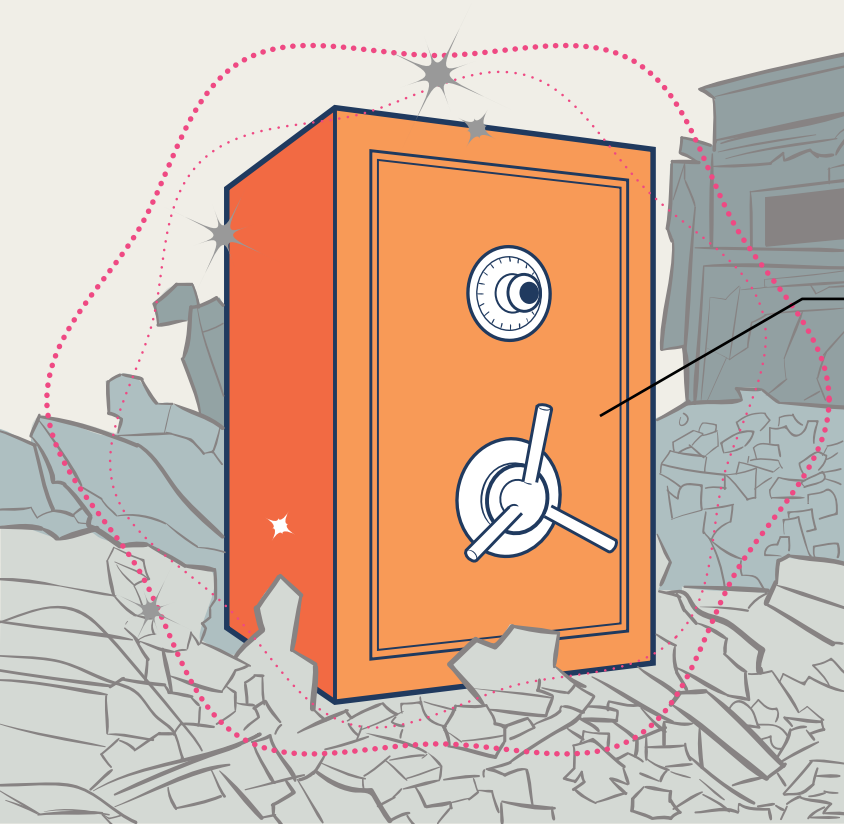

ONE WORD: LOCKBOX

Establish a lockbox with client contact and billing information, current project records, digital drawings, and everything vital to the firm's continued operations. Those details will help keep your projects on safe footing in the aftermath of a disaster.

DIGITAL STORAGE SOLUTION

Back up data and digital files nightly, if possible, and store on off-site servers. Create a detailed file-naming system so you can find, say, the plans for that restoration project of yours amid the sea of data.



STUDIO COMFORTS

In case of an extended wait for rescue, ensure that you have the requisite necessities. Sleeping bags. Solar charger for BlackBerrys and other digital devices. Generator. Food and water for at least three days.



1968 *Social environmental movements take hold.*

WHO SHAPES THE FUTURE OF GREEN DESIGN?

You do.



1978 *Earth Day brings awareness to Earth's need for continual care.*

What was once a quiet evolution has become a revolutionary force. Your desire for sustainable design has helped redefine the meaning of green. Since we began making nora® rubber flooring over 50 years ago, we've evolved with you.



1988 *1,000 communities in America initiate curbside recycling.*

Your concern for the environment continues to create new standards for designing in harmony with nature. It is why we continually explore ways to blend the best of technology with greener thinking.



1998 *EPA launches voluntary programs for energy, water, indoor air quality, waste and smart growth.*

It starts with you.
You and your challenges.
You and your world.
You and nora.



2008 *U.S. Green Building Council member organizations grow to 15,000.*

800-332-NORA
www.nora.com/us/green39

 Follow us: @noraflooring

nora®

All About Flooring. **All About You.**

Circle no. 266 or <http://architect.hotims.com>



→ DESIGN

STAN ALLEN ARCHITECT 184

SAUCIER + PERROTTE ARCHITECTES 194

KIERANTIMBERLAKE 200

STEVEN HOLL ARCHITECTS WITH SOLANGE FABIÃO 210

SPILLMAN FARMER ARCHITECTS 222

水
湳

經貿園區

資訊交流站

TAICHUNG GATEWAY PARK





TAICHUNG INFOBOX

TAICHUNG, TAIWAN
STAN ALLEN ARCHITECT

TEXT BY MICHAEL MEYER
PHOTOS BY IWAN BANN

THE APPROACH to the Taichung InfoBox is unreal: Turn off a four-lane street lined with storefronts and rife with revving mopeds, and pass through a gate and into the 600-acre void left by the city of Taichung's decommissioned airport. The site is as close to a *tabula rasa* as one can find in urban Taiwan. It's flat, the runways lead nowhere, and wind provides the only sound. The only sign of life sits off the tarmac in a former hangar, where the InfoBox is nestled, looking like a top-secret aircraft—or a children's fort—scaffolded in bamboo.

The 12,500-square-foot pavilion, designed by Brooklyn, N.Y.-based Stan Allen Architect, opened to the public this year to exhibit plans that will transform the airport site into a 620-acre mixed-use development called Gateway Park City. It also provides a platform for visitors to look out over the construction site and keep tabs on the construction progress. Despite appearances, the bilevel structure is steel-framed—owing to codes regarding public-occupancy buildings—and wrapped in bamboo. Principal Stan Allen, FAIA, chose the material

DESIGN → STAN ALLEN

The Taichung InfoBox is nestled within hangar A15 of the now-defunct Taichung Municipal Airport (previous spread), but the rest of the hangar doesn't lie fallow: Temporary exhibition space fills the rest of the ground level, and can be overlooked by second level balconies (opposite). The pavilion's bamboo façade (this image) hides a steel-framed structure.





Bamboo Cladding Diagrams

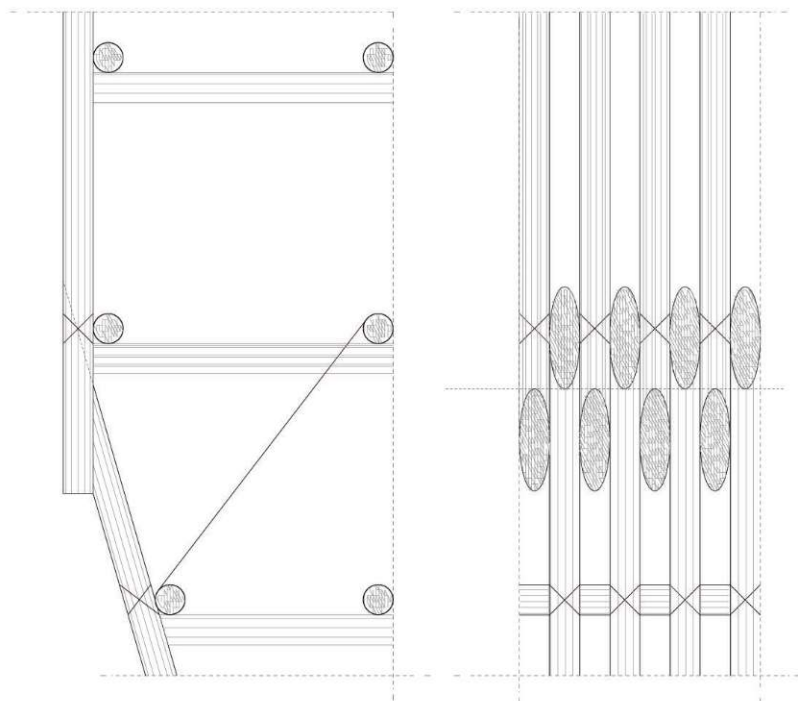

for its cultural context—the sustainable material is stronger per centimeter than steel, and a staple on local building sites, where its use as scaffolding is highly regulated; it must be lashed together by trained installers. The InfoBox client, the city of Taichung, initially balked at thoughts of a bamboo façade, though not for safety reasons. “They wanted something that looked new,” Allen says.

Ultimately, Gateway Park’s focus on sustainability won the argument, as bamboo can be recycled. “The pavilion was also slated to be open for only two years, which was another reason bamboo made sense,” Allen says. “We wanted to have that sense of occasion. ... In temporary buildings such as pavilions, you’re freer in the choice of materials, as you don’t have to worry about the weight of something that will be there 100 years from now. It’s an opportunity to experiment.”

The structure’s steel frame was anchored to the hangar’s existing concrete floor, then wrapped by a 75-centimeter-deep, three-dimensional grid made from roughly 40,000 pieces of bamboo. The plants, from central Taiwan, were cut, boiled, and dried for one month, giving the bamboo an aged, tea-colored veneer. Artisans cut the pieces to fit on site, a process that could not be explained via conventional working drawings (see diagrams at left). “We didn’t know how big the pieces would be,” Allen says, “so our drawings that show ends cut on a diagonal at the corners ended up overlapping as stitched corners.”

Upon entering the hangar, visitors must walk around the InfoBox to enter its first level on the east side. In this ground floor space, the exposed steel columns are painted white, and matching white screens are suspended from the ceiling. The space is used for local exhibitions and presentations, including those organized by the government to showcase green technology. Vermillion-colored concrete steps lead to the InfoBox’s elevated second level, which houses the main space, and is used for presentations about the larger master plan. Here, larger-scale steps form bleacher-like seats, and a series of openings frame views of the Gateway Park City site. At the top of the bleachers, doors open to a terrace.

While Stan Allen Architect had also designed the park’s master plan, the project’s timeline of 15 to 20 years gave rise to the thought of “Wouldn’t it be wonderful to have something built on site right away, to get people here and see what’s going on?” Allen says. “We wanted to get people up to a balcony overlook so they could watch the construction, and make an event of going up, of turning the whole pavilion into an amphitheater.”

The client agreed, but was able to appropriate less money than it had hoped—just over \$930,000 total, much of which went to updates to the hangar—a constraint for which the architect was thankful, ultimately. “The budget forced us to use an existing building on site. Initially, we looked at the terminal, then saw the hangar, and a light bulb went off,” Allen says. “Its foundation could support a lightweight pavilion, and instead of being an object on the site, the hangar itself would tie back its history as an airport. We were very excited about it.”

From contract to completion, the InfoBox—which won a 2011 Progressive Architecture Award—took nine months. “It was a nice way to bring the master-plan phase of Gateway Park City to conclusion,” Allen says. “Not just for the client, but for us, too. It’s visible, and not just drawings on shelves.”





First-Level Plan

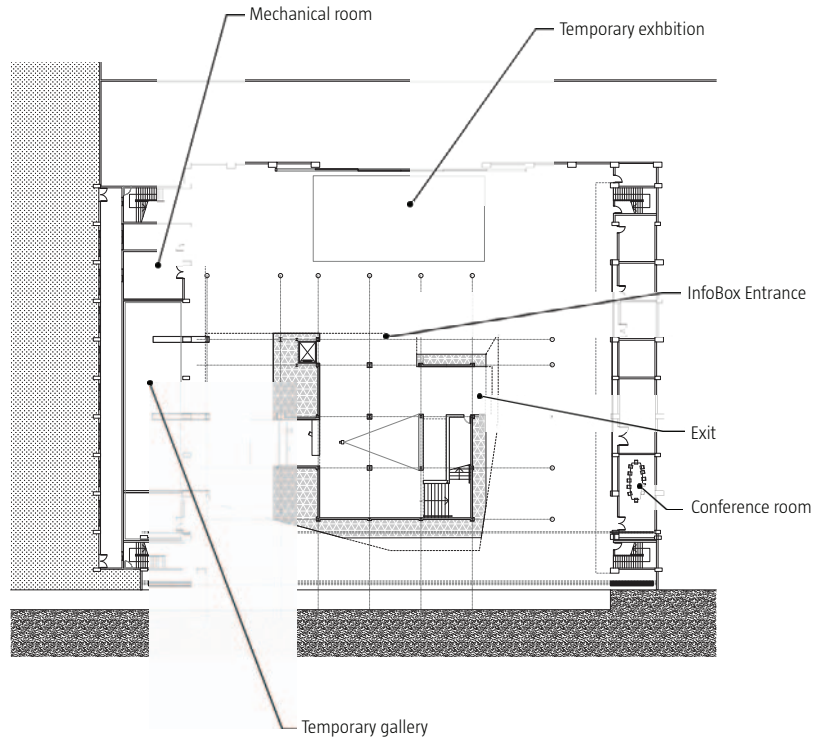

Second-Level Plan

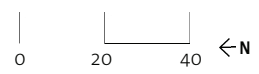
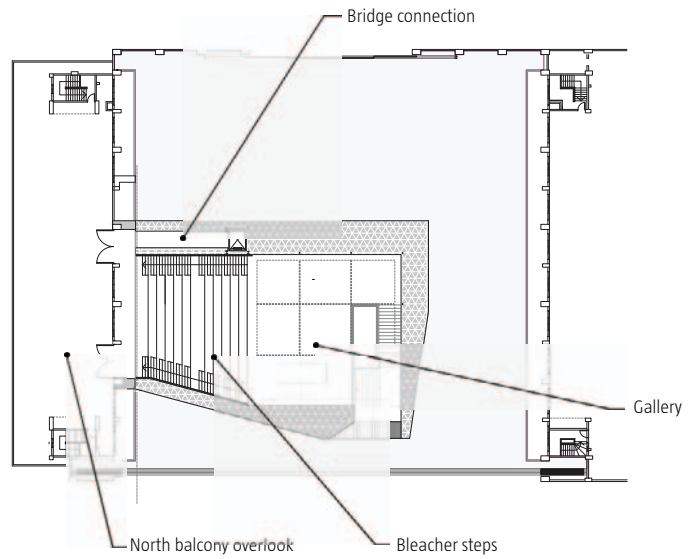

The entrance to the InfoBox (this image) is on the pavilion's east side, the one deepest into the hangar. The ground level of the pavilion is dominated by a multimedia presentation space, which the government and others use to educate the public on green technologies, and which local bicycle manufacturer Giant uses to showcase its latest designs.

DESIGN → STAN ALLEN

A double-height stairwell (this image) leads to the second level (opposite), where schemes for current design competitions and a model of the overall plan are on view. A set of oversized stairs in this main space forms bleacher seating (bottom) for presentations. At the top of those seats, a door leads to a terrace where visitors can look out over the Gateway Park City construction site.

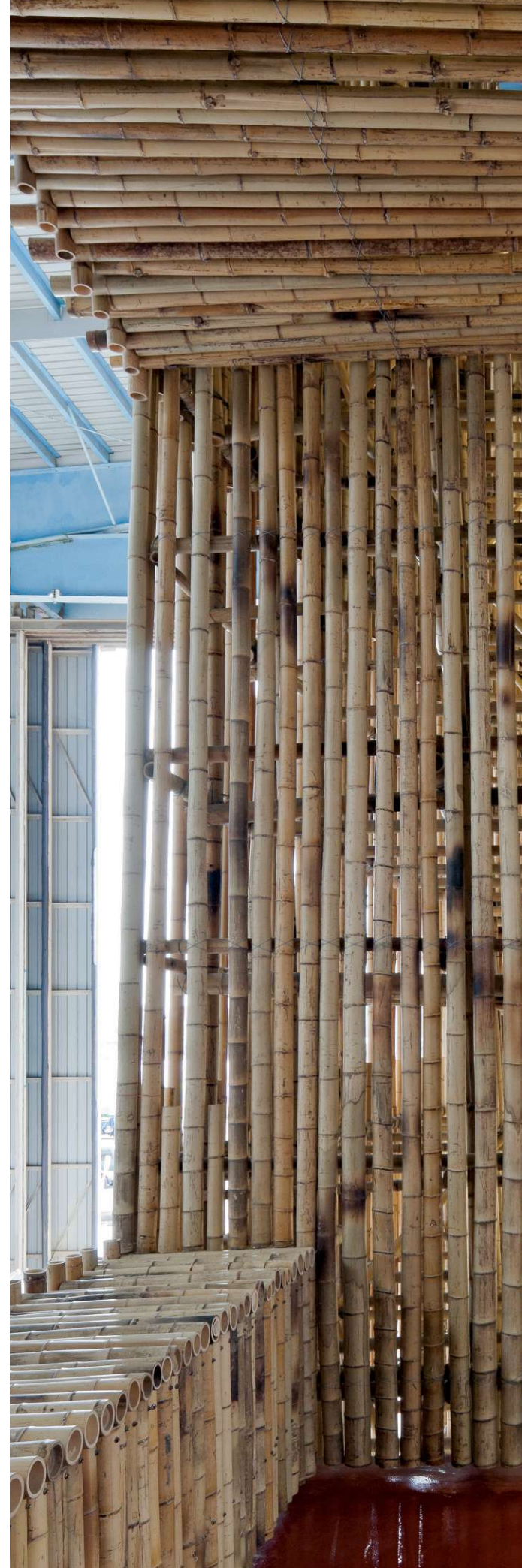



Master Plan



Project Credits

Project Taichung InfoBox, Taichung, Taiwan
Client/Owner City of Taichung
Architect Stan Allen Architect, Brooklyn, N.Y.—Stan Allen, FAIA (principal-in-charge); Marc McQuade, Chris Oliver, Dahlia Roberts (project team)
Associate Architect W.B. Huang Architects + Planners
General Contractor Long Top Construction
Construction Coordinator Feng Chia Design Center
Exhibition Curator Feng Chia Design Center
Size 10,000 square feet
Cost (total) \$27 million Taiwan (\$930,714 U.S.)

TOOLBOX: TAICHUNG GATEWAY PARK CITY

Built by the occupying Japanese army in 1922, and decommissioned in 2004, Taichung's former airport left 600 acres of vacant land in Xitun district, northwest of the city center. In 2007, Taichung's government commissioned Stan Allen Architect to design the master plan for Gateway Park City, a mixed-use development anchored around a sinuous park, the shape of which creates four distinct neighborhoods—including a Gateway and Canal District, a Cultural District, an Academic Corridor, and a College Town—which together form a complex that is one-third green space, one-third culture, and one-third commerce.

"Barcelona [Spain] kept coming up a lot," Allen says. "It was the example of a city that successfully used urban design and planning to resuscitate itself." The firm's master plan won a Progressive Architecture Award in 2008.

Three years later, general infrastructure work on the site has begun. A competition is under way for the park's detailed design and implementation, and Romania's Dorin Sefan Birou Arhitectura recently won a competition for Taiwan Tower—an anchor building in the larger plan—with a design that features observatories that look like tethered dirigibles. At 1,000 feet, the tower will be Taichung's tallest structure, allowing views over Dadu Mountain to the Taiwan Strait. It will join I.M. Pei's Luce Memorial Chapel and Toyo Ito's Metropolitan Opera House as one of the city's architectural landmarks.

Standing on the terrace at the InfoBox, Shwu-Ting Lee, director of the InfoBox of Taichung Gateway Park Development and the director of department of architecture at neighboring Feng Chia University, said that the city is focusing first on the roadway design, and then on cultural buildings around which development can be built at later stages. Unlike in Mainland China, Lee says, there is no rush to completion.

"There, development is happening so fast that no one has time to think about what really works," Lee says. "But here, for years Taiwanese have been told to recycle and reuse, to create sustainable lifestyles. Now it's time to move beyond the slogans, and make it part of our city planning."

Lee notices movement; near Taiwan Tower's future footprint, demolition crews are knocking down what until recently was the set of director Ang Lee's film adaptation of *Life of Pi*. Gateway Park City's design is huge, she says, but because of the cooperation of the city government, planners, and architects, it feels less like a blockbuster and more like an independent film. "Those," Lee says, "win Oscars, too."

refresh.



A2a Media, Inc.

This is what happens when you stop thinking about bus stations as buildings and start thinking about them as opportunities. Imagine the possibilities. Transparent media facades from GKD. See for yourself at gkdmetalfabrics.com

GKDMETALFABRICS

800 453 8616

www.gkdmetalfabrics.com

Circle no. 260 or <http://architect.hotims.com>



BOUTIQUE MICHEL BRISSON

MONTREAL

SAUCIER + PERROTTE ARCHITECTES

TEXT BY MIMI ZEIGER
PHOTOS BY IAN ALLEN

DRIVING UP LAURIER OUEST, architect Gilles Saucier spies Michel Brisson, a 3,700-square-foot menswear boutique designed by his firm Saucier + Perrotte Architectes, out of the car windshield and gasps. “The façade today is green,” he says excitedly. Much to his delight, the storefront’s gray glass curtainwall reflects an image of the nearby foliage. The modern storefront, as tailored as a bespoke flannel suit, is wearing a seasonal print.

This store is the third retail outpost designed by Saucier + Perrotte for Michel Brisson’s eponymous boutique. (The first closed as the new location opened and the second fits smartly in a historic space in Old Montreal.) Saucier credits Brisson with introducing contemporary men’s fashion to Montreal, as trim styles from European and New York designers fill the shop. The largest of the three outposts, the newest space occupies a Brutalist-era bank building on a busy street lined with two-story storefronts. “The existing building is a bit like a naked body,” explains Saucier with a smile. “It’s like we added clothes to connect it to the urban environment. And in a way, clothes, like the façade, act as a way to promote yourself, to show an attitude.”

To get to the structure’s real attitude, the architects stripped away four decades worth of renovations, revealing a rough-hewn concrete mezzanine tucked inside a brick shell. They updated the interior with a series of smoked glass and mirrored walls that seem to expand the space into impossible dimensions. Black metal display fixtures reference the minimalists of the art world. Shirts and pants hang from Sol LeWitt-style grids—square black steel sections suspended from the ceiling and outfitted with built-in fluorescent lighting. The concrete mezzanine is put to use as a more intimate VIP shopping area, with additional clothing and accessories on display. Tucked underneath in the main

boutique and lit by a fabric luminous ceiling, leather boots sit on Donald Judd-like cubes. Equal parts arty and edgy, a cantilevered cash wrap skinned in black rubber emerges from a wall of white shelves.

As leaders of a Canadian firm with a knack for the refined, Saucier and his partner André Perrotte have since 1988 methodically established a portfolio of finely executed projects across Canada with a few in Europe, Asia, and Africa. In 2004, they represented Canada at the Venice Biennale and in May, were shortlisted for a cultural institution competition in Bogotá, Colombia (a roster that included Snøhetta and Diller Scofidio + Renfro, among others).

Even as their projects grow in scope, and in spite of the international recognition (and the tony company), Saucier + Perrotte’s work is far from the usual flashy fare. The firm focuses on careful detailing and spatial illusions. Smaller designs, such as the series of Michel Brisson boutiques, offer the opportunity to experiment and tweak a concept. For instance, the smoky glass and mirrored surfaces in the new store are part of an ongoing fascination that Saucier has with how spaces are perceived when reflected. “A real mirror is objective because it sends you a clear image,” Saucier says. “A black mirror will give you depth, but image is obscured. A gray mirror is interesting because it is in between the two.”

Saucier likes to play with the blurring between what is real architecture and what is an optical illusion. He points out the reflection of thin fluorescent fixtures receding infinitely into a nonexistent space. They are dimensioned such that it is difficult to catch where the store ends and the wall begins. “I shift perception by changing the distance of reflection so that people are a bit confused,” he says. “In my mind, confusion means that the object always remains dynamic and challenging—challenging for the eye, challenging for the mind.”

Clothes hang from a series of ceiling-mounted black steel frames (opposite top) in the double-height space around a corrugated-concrete mezzanine. Underneath the mezzanine (this image), shoes and other accessories are displayed on minimalist black pedestals under a backlit white opalescent stretch ceiling. A black rubber-clad cash wrap emerges from the back wall. The smoked glass walls give way to conventional mirrors (opposite bottom) outside the changing rooms.





INTERIOR DESIGN → SAUCIER + PERROTTE

A gray glass curtainwall on the storefront (this image) reflects the neighborhood.

**Project Credits**

Project Boutique Michel Brisson, Montreal, Quebec, Canada
Client Michel Brisson
Architect Saucier + Perrotte Architectes, Montreal—Gilles Saucier, Charles-Alexandre Dubois (project team)
Size 3,670 square feet
Cost Withheld

Materials and Sources

Ceilings Gypsum and exposed concrete; Extenzo (white opalescent stretch ceiling, under mezzanine) extenzo.com
Concrete Existing and exposed
Flooring Concrete slab
Furniture Saucier + Perrotte Architectes
Lighting Saucier + Perrotte Architectes

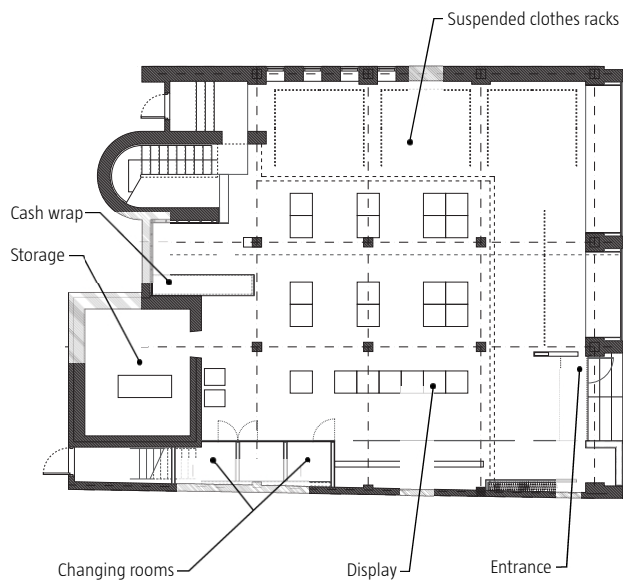
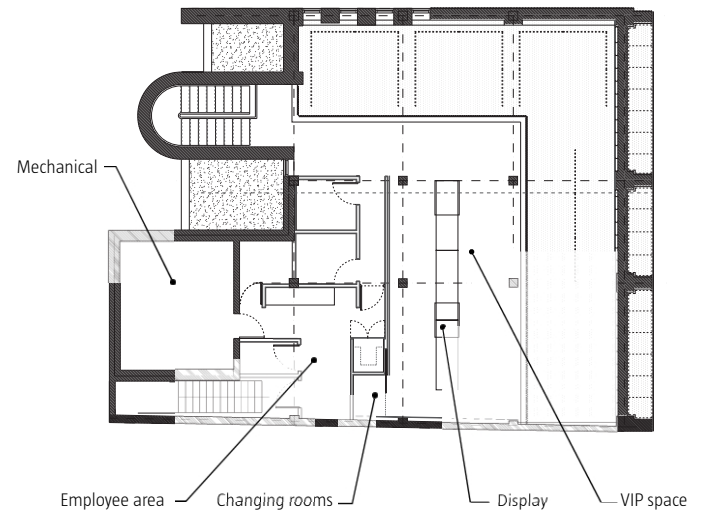
First-Floor Plan**Mezzanine Plan**



M-Series LED

For over 50 years, SELUX has maintained a philosophy of creating lighting systems which are aesthetically pleasing, economically feasible and environmentally sound. SELUX M-Series with LED, the revolutionary development of the industry leading 'lines-of-light' concept, offers seamless, continuous lines of light with superior performance, uniformity, and unmatched flexibility.

selux.com/usa
(800) 735-8927



se'lux

Light. Ideas. Systems.

Circle no. 170 or <http://architect.hotims.com>



BROCKMAN HALL FOR PHYSICS

HOUSTON
KIERANTIMBERLAKE





Rice University's new physics building is organized as two parallel wings, connected by a pair of bridges (this image). The two enclosed floors of the northern volume are supported by 18 poured-in-place concrete columns. And in a break from Rice's brick-and-masonry vernacular, the northernmost façade is glazed to capture indirect light, and silk screened with a blue Penrose pattern to mitigate glare (opposite).

PREVIOUS PAGE: © PETER AARON/ESTO;
ABOVE: © PETER AARON/ESTO; RIGHT: MICHAEL MORAN



TEXT BY STEPHEN SHARPE

RICE UNIVERSITY IS much admired for its 1910 campus plan by Ralph Adams Cram and the original collection of long, thin, screenlike buildings that he designed in response to Houston's hot, humid coastal climate. Additions to the 285-acre campus have generally followed Cram's model of linear, three-story structures that define sequences of elongated, tree-lined outdoor courts. Faced with brick, limestone, colored marble, and sometimes terra-cotta, most of the buildings open out on the leafy landscape with arched, cloistered, ground-level loggias. And while some buildings have been more successful than others in living up to Cram's nuanced materiality, Rice's campus has evolved over the last century as a well-organized and splendidly crafted built environment. As a result, says James Timberlake, FAIA, "If you don't do a building at Rice well, it shows up really, really easily."

Philadelphia-based KieranTimberlake designed the Brockman Hall for Physics, a 111,000-gross-square-foot research facility that requires sophisticated systems to isolate laboratories from noise, vibration, and fluctuations in temperature and humidity. Rice's programmatic demands were unprecedented in the firm's 27-year history, says design partner Timberlake, who describes Brockman Hall as "the most comprehensively and extensively complex building that we've done." Experiments in atomic, molecular, and optical physics are conducted with highly sensitive instruments that measure effects at the nanoscale: Even minute disruptions within the "quiet" lab environment may cause experiments to fail, so systems had to be designed and employed to isolate the laboratory spaces. "This building was all about the science that would live inside," says Barbara Bryson, associate vice president of

Rice's department of facilities, engineering, and planning. And it had to be designed fast: With a total project cost of \$67 million (\$11.1 million of which came in the form of federal stimulus funds from the National Institute of Standards and Technology), the project was fast-tracked to be designed, constructed, and occupied in 33 months.

Sited on a plot that called for tight insertion within the science quadrangle, Brockman Hall is composed of two rectilinear bars that are oriented east to west and aligned parallel to each other. The two are separated by a narrow courtyard that admits natural light to the inner-facing office spaces of the four-story south bar and the three-story north bar. But the latter only has two floors of enclosed space: It is supported by a ground-level loggia lined with 18 tapered concrete columns, which provides a shaded outdoor space for casual gatherings (see Toolbox, page 208). A pair of two-story bridges link the bars, but these are programmed with more than just connecting hallways. One has a pair of offices on each floor; the other has a seminar room and collaborative spaces.

Each of Brockman Hall's uniquely layered façades is tuned not only for solar orientation—the mitigation of heat gain helped the project reach a projected LEED Silver rating—but also to address the context of the facing buildings. They range from a horizontal screen of reddish terra-cotta baguettes on the southern-most façade to fritted glass panels combined with vertical metal fins on the east and west ends; and from glass brick interspersed with ribbons of clay bricks on the first floor of the southern volume to a blue silk-screened curtainwall—with a nonperiodic tiled pattern based on one developed by English physicist Sir Roger Penrose—on the other volume's northernmost façade, which signifies



The building's southern-most façade is clad in a screen of terra-cotta baguettes (this image) that help minimize heat gain and blend with the other, predominantly brick buildings on campus. However, glazing is dominant in the courtyard between the two volumes (opposite), allowing daylight to penetrate the interiors.



First-Floor Plan

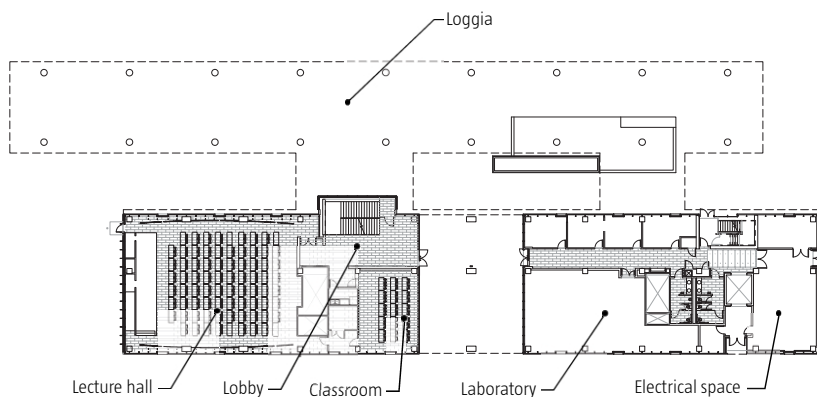

Second-Floor Plan

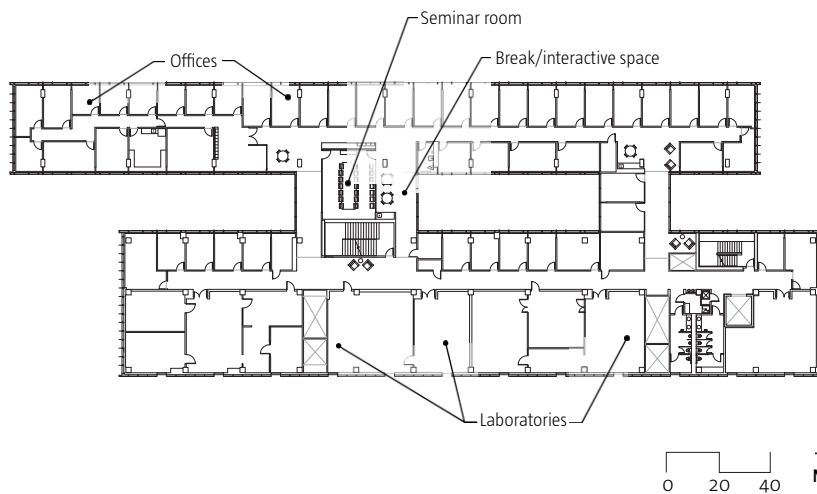

the enigma of scientific inquiry. Similar iconographics—including classical depictions of the laws of physics and illustrations of theoretical concepts such as Schrödinger's cat—are cast in the building's exposed concrete structure.

In contrast to the exterior's material diversity, the interior spaces—the departmental suite, offices for faculty and student researchers, and labs—are practically austere. Corridors are detailed with mechanical systems running overhead, exposed for easy access yet neatly organized.

A below-grade level houses Brockman's most sensitive laboratories, sequestered within a hermetically controlled environment and stabilized by a robust structure and a 2-foot-deep slab foundation. Forming the perimeter of this basement are 172 concrete piers, each 42 inches in diameter and reaching a depth of 50 feet. Poured-in-place concrete forms the interior walls.

Here, in a dedicated mechanical room built on a separate slab to minimize vibration in the labs, is where the building plugs into the campus utilities via a tunnel; all except electrical, which feeds from the concrete utility trench into a stainless steel-clad space on the ground floor. Because flooding is common in low-lying Houston, a waterproofing system is sandwiched between concrete layers along the perimeter wall, and a bathtub-like concrete barrier protects the mechanical room. "It's a Swiss watch down there," Timberlake says.

According to Timberlake, Brockman Hall represents "one of the more perfect examples" of his firm's holistic strategy of design. KieranTimberlake "seemed to find inspiration in the overwhelming technical constraints and resonance in the building's important research mission," Rice's Bryson says, noting that other firms might have been daunted by the building's litany of programmatic demands. "The result is a building that works brilliantly while providing an ... elegant home for some of the best physicists in the world."

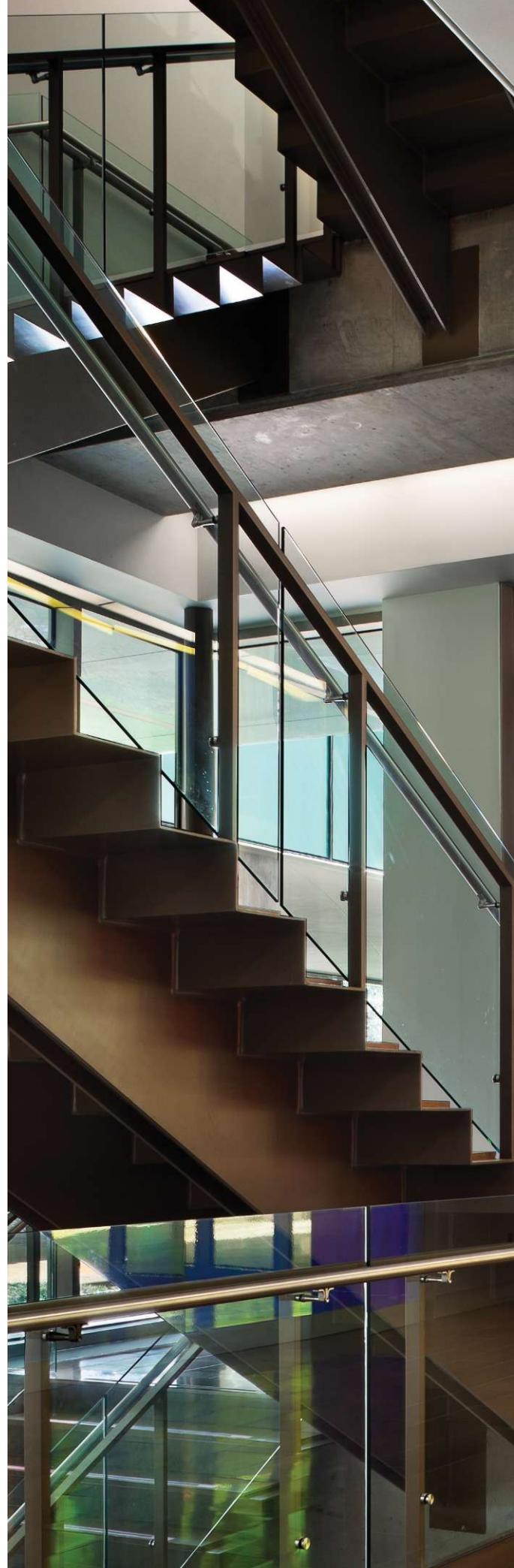
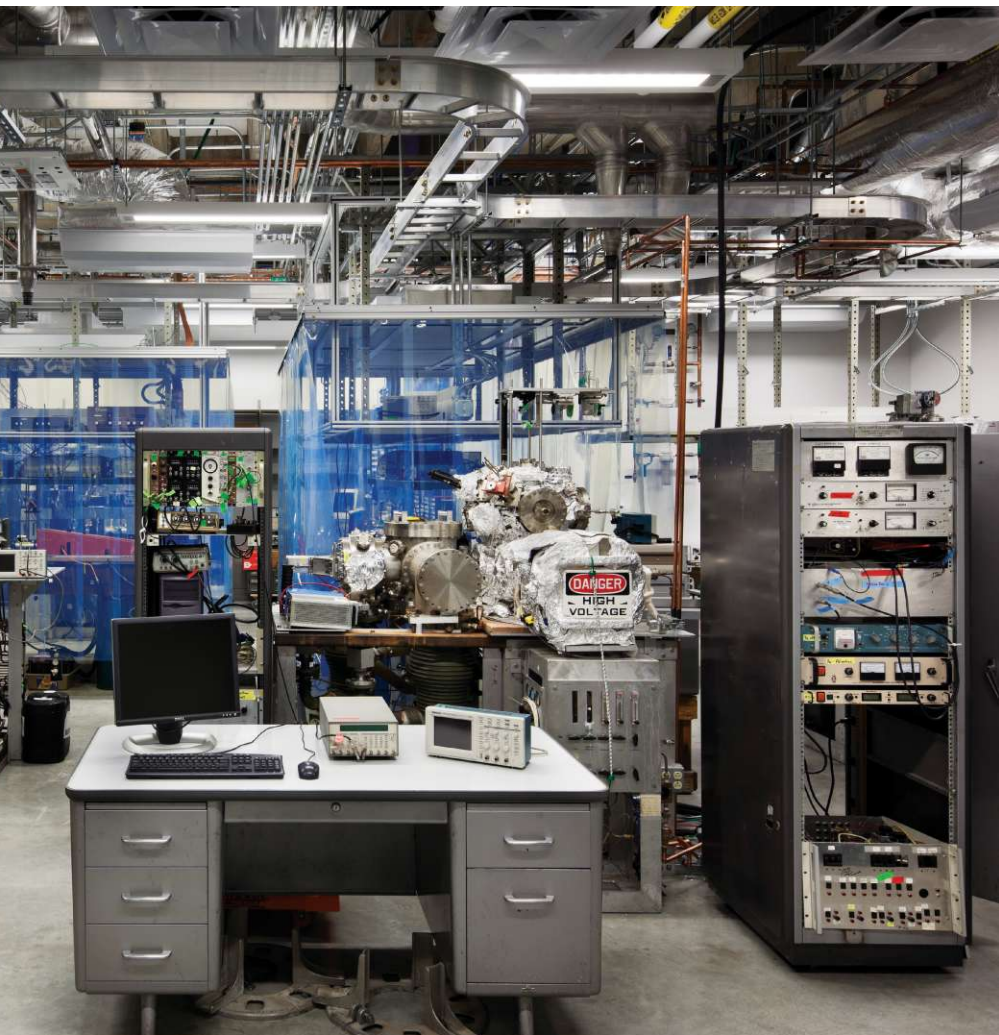

A breezeway cuts through the building, giving access to the high-ceilinged, stone-clad lobby in the southern volume (this image). Classrooms (opposite top) offer views out through the varied façade conditions, but the sensitive research labs (opposite bottom) are isolated below-grade from environmental fluctuations, sound, and vibrations.



Early Concrete Formwork Diagram

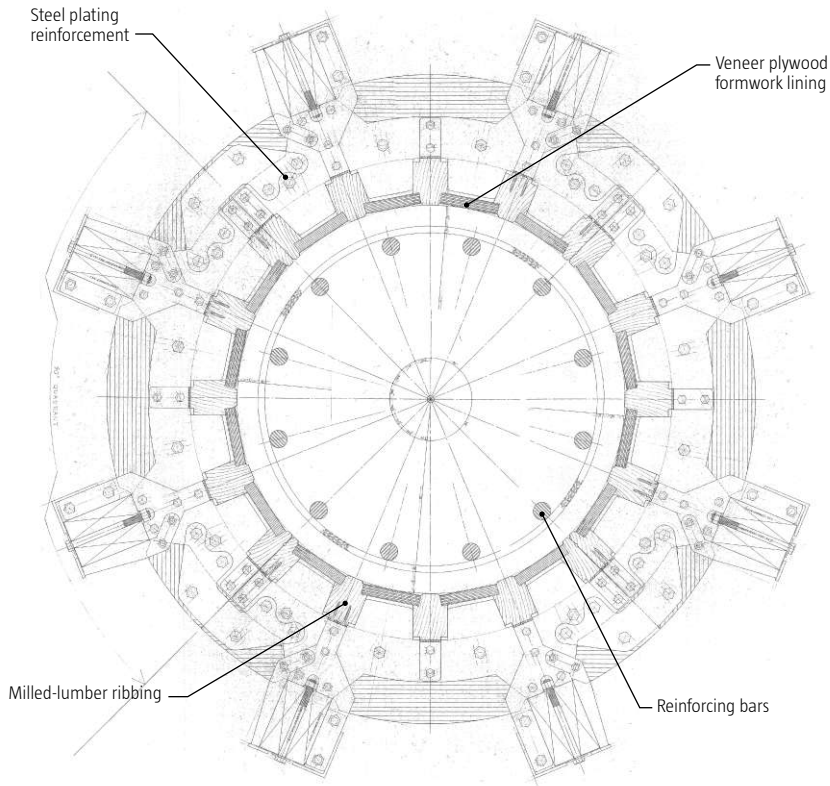

TOOLBOX: LOGGIA COLUMNS

Because the relationship between buildings and green space is critically important at Rice University, the architects designed Brockman Hall to knit seamlessly into the campus's abundance of mature shade trees. One of the ways that the team at KieranTimberlake achieved this is by raising one of the facility's two barlike volumes above the ground plane to allow pedestrian pathways to flow underneath. Taking a cue, but only a cue, from the arcades that rhythmically punctuate the university's original early 20th-century buildings, the architects devised an outdoor loggia defined by tapered, poured-in-place concrete columns.

To ensure optimal execution of the colonnade's construction, the firm consulted with Fred Langford, an architect who worked in Louis Kahn's studio on both the Government Center at Dhaka in Bangladesh and the Salk Institute in La Jolla, Calif. Langford returned with detailed working drawings and provided KieranTimberlake and Baker Concrete Construction with instructions on how to build the formwork (one of Langford's proposed formwork diagrams is shown at left) and place the concrete. After testing multiple mockups, six custom millwork forms were made, with each used three times to cast the 18 columns on site. Standing approximately 17 feet tall, each column has 32 facets and narrows subtly in diameter from 32 inches at the top to 28 inches at grade level.

"Those columns and their form were shaped and tapered to present that sort of light touch to the ground—somewhat mimicking a tree," design partner James Timberlake, FAIA, says, "so that when you look through the landscape, the columns because of their coloration and their form tend to disappear into the treescape."

The effect is enhanced by the asymmetrically vaulted ceiling that visually tempers the dominant rectilinear geometry of Brockman Hall. According to Jason Smith, AIA, the firm's associate in charge of the project, such architectural gestures are "reminiscent of the softening of the best early Rice buildings, which are essentially orthogonal buildings but have that element of grace and slight curvature."

While KieranTimberlake's innovative takes on venerated architectural concepts—such as the campus loggia—are fundamentally rooted in Rice's formal vocabulary, Timberlake says, "I think Brockman truly pushes how one interprets that language and that craft to a 21st-century level, and in that way I think ... [it] brings Rice into the 21st century architecturally."

Project Credits

Project Brockman Hall for Physics, Houston

Client Rice University

Architect KieranTimberlake, Philadelphia—James Timberlake, FAIA, Stephen Kieran, FAIA (design partners); Jason Smith, AIA (associate in charge); Steven Johns, AIA (project manager); George Ristow, AIA, Casey Boss, AIA (project architects); Chris Macneal, AIA (technical review)

Mechanical/Electrical Engineer CCRD Partners

Structural Engineer Haynes Whaley Associates

Civil Engineer Walter P Moore

Geotechnical Engineer Ulrich Engineers

Construction Manager Gilbane Building Co.

Landscape Architect The Office of James Burnett

Lighting Designer Arup

External Project Manager Linbeck

Lab Consultant Innovate Lab Systems Design

Acoustical Consultant JE Acoustics

Construction Administration Consulting Architect

Jackson & Ryan Architects

Specifications Consultant Wilson Consulting

Commissioning/LEED Consultant WorkingBuildings

Fire Protection Consultant Rolf Jensen & Associates

Door Hardware Consultant Assa Abloy

Concrete Design Consultant Frederick Langford, Architect

Size 111,000 square feet

Cost \$67 million (total cost)

Materials and Sources

Acoustical System Decoustics decoustics.com; Nelson Industrial nelsonindust.com; Simplex Ceilings simplexceilings.com; Tectum tectum.com

Building Management Systems and Services Siemens siemens.com

Carpet Shaw Contract Group shawcontractgroup.com

Ceilings Armstrong armstrong.com

Concrete Baker Concrete Construction bakerconcrete.com

Electrical Systems Kohler Power kohlerpower.com; Square D

Exterior Wall Systems Admiral Glass Co. ([unitized curtainwall](http://unitizedcurtainwall.com))

admiralglass.net; Alucobond (composite metal panels)

alucobondusa.com; NBK Ceramic (terra-cotta) nbk.de; Oldcastle

Fabrics and Finishes KnollTextiles knolltextiles.com

Flooring Daltile (ceramic tile) daltile.com; Mullican Flooring (wood)

mullicanflooring.com; Sadlerstone (concrete tile) sadlerstone.com

Glass Viracon viracon.com

Gypsum ClarkDietrich Building Systems dietrichindustries.com;

National Gypsum Co. (Gold Bond) nationalgypsum.com;

USG Corp. usg.com

HVAC Systems Greenheck Fan Corp. greenheck.com; Haakon

Industries haakon.com; Krueger krueger-hvac.com; McQuay

International mcquay.com

Insulation Dow Chemical Co. building.dow.com; Icynene

icynene.com; Thermafiber thermafiber.com

Lighting-Control Systems Crestron Electronics crestron.com

Masonry and Stone Pittsburgh Corning Corp. (glass bricks)

pittsburghcorning.com; St. Joe Brick Works (clay bricks)

stjoebrickworks.com; W.W. Bartlett

Metal Broome Welding & Machine Co. broomewelding.com

Millwork Hallmark Cabinetry & Millwork; Lab Enterprises

(laboratory casework) labenterprises.net

Paints and Finishes Pratt & Lambert prattandlambert.com

Plumbing and Water System Aurora aurorapump.com; Canariis

Corp. canariis.com; Geo-Systems USA geosystemsusa.com

Roofing American Hydrotech (fluid-applied roofing)

hydrotechusa.com; Johns Manville (membrane roofing) jm.com

Site and Landscape Invisible Structures (Grasspave)

invisiblestructures.com; Sadlerstone sadlerstone.com

Waterproofing CETCO cetco.com

Wayfinding Hardman Signs hardmansigns.com

Window Shades MechoShade Systems mechoshade.com

P⁸ O^{15.999} l ymer P¹⁵ i^{30.974} oneers.

Visit us at
CONSTRUCT Booth # 609
GREENBUILD Booth #5329S

InPro has always led the way in finding breakthrough materials for interior protection products.

We proudly launched the industry's first wall and door protection products using our patent-pending **G2 Blend**® – combining PETG, biopolymer and recycled content.

This leading-edge product meets proposed LEED® 2012 standards for bio-based materials and is GREENGUARD® certified.

Pioneering. That's what leaders do.

To learn more, visit inprocorp.com or call 877.780.0034

In **everything** you build, there's **INPRO**®

800.222.5556 | inprocorp.com | [facebook.com/inprocorp](https://www.facebook.com/inprocorp)

Circle no. 221 or <http://architect.hotims.com>



CITÉ DE L'OCÉAN ET DU SURF

BIARRITZ, FRANCE

STEVEN HOLL ARCHITECTS WITH SOLANGE FABIÃO

TEXT BY KIERAN LONG
PHOTOS BY IWAN BAAN







Aerial view of the site and path down to the ocean



A surfer walks past the entrance on the northeast corner

BIARRITZ, FRANCE, IS AN INCOHERENT SUBURB of large holiday villas, unkempt car parks, and overdesigned lampposts. Beyond a magnificently offensive Tudor-Romanesque-Hacienda pile is a golf course in a small valley, and the hollow ping of drivers is audible above the sound of the breaking waves. A hill rises beyond with a gothicized chateau perched ominously on the peak. All this overlooks the beach, which has eroded so quickly during the last century that measures have been taken to arrest the loss of any more French coastline to the Atlantic. This gives the waterfront a fringe of ostentatiously unnatural granite boulders and manicured planting, with concrete paths full of people walking dogs or lugging surfboards. Thus, the juxtaposition of the minimal and modern Cité de l’Océan et du Surf, designed by Steven Holl Architects with Solange Fabião, with the surrounding grotesques is unintentionally hilarious: like an earnest teenager reading Goethe at Disneyland.

The design team won an international competition in 2005 for this new museum devoted to oceanographic science—beating out the likes of Bernard Tschumi and Jean-Michel Willmotte—with its concept of a concave structure topped by a cobbled plaza. The 50,859-square-foot building is full of high architectural references (Aalto and Le Corbusier among them, although design architect Steven Holl, AIA, denies it), dependent on fine material finishes. The design self-consciously marshals the landscape in a romantic manner, with an artfully informal pathway leading from its sloping roof to the ocean beyond.

The most important elevation, Holl says, is the roof, a swooping form that slopes toward the ocean to the west and is cobbled in Portuguese stone. The sides of the roof rise up to two stories above grade at the tallest point on the north and south edges. The gently sloping cobbled surface forms the site’s main plaza and is accessible by a glass rail-lined ramp at the east end and gradual inclining path from the west. Two masses pop up through the surface: Called “glass boulders” by the project team, these glass-and-steel-curtainwall-clad forms house a restaurant (with an adjacent terrace) and a kiosk for local surfers. The same curtainwall system appears on the museum’s north façade; the bulk of the rest of the structure is clad in white concrete. At ground level on the building’s southwest corner, there is a covered area—a “porch for

surfers,” Holl says—that can be used for outdoor events. And perhaps anticipating analogies of the building’s convex form to a skate-park half pipe—albeit, with the cobbles, an unskatable one—this porch is topped by a smooth skating pool.

The rest of the program—including exhibition space, a gift shop, and auditorium—is dug into the ground. Visitors enter through a reception area at the northeast corner, and descend down a grand staircase to the exhibition spaces, which are fairly dim (the predominantly audiovisual displays make natural light a low priority). A convex, plaster-clad ceiling is the inverse of the sloping plaza above, and its inherent structure limits the number of columns necessary in the galleries. The exhibition design, which was out of the control of the architect, is very ordinary indeed, with inconsistent graphic style and barely functional interactive displays. In fact, Holl says that the brief changed during design development, and this explains the division of the plan into two exhibition areas linked through a timber-lined tunnel.

Holl describes a two-part concept for the building form: one “open to the sky” (outside) and one “under the sea” (underground), and the relationship of form to content does feel somewhat literal. But, on the other hand, it is a building of ambition, if not to make sense of the non-place around it, then to communicate something about that landscape: The cobbled path that wends its way from the ocean front moves through a series of gardens featuring native plantings, up and on top of the building, through the plaza, and eventually to the very pleasant terrace. On that journey, the buildings tries its best to dignify its surroundings by ignoring the bad bits. Yet the plaza itself is perplexing. It seems to recall Alvar Aalto’s Säynätsalo Town Hall—another elevated piazza trying to make something civic out of an unlikely context. But there’s no main event because the civic landmark, the museum, is not in pride of place on the plaza itself, but underfoot in the volume below.

The building is a selectively contextual work, far in spirit from the reality of Biarritz, and much more comfortable with the elemental beauty of the ocean and the ineffable blue of the sky. The roof may be wavelike, but in the end you feel that it tips up at the edges in order to remove the context from view, rather than to evoke a life on the ocean.



Skating pool on the roof plaza with the restaurant and surfer's kiosk beyond



Stairs to restaurant





Covered "porch for surfers"





Sloping roof plaza wall with restaurant beyond



South façade

Cross Section

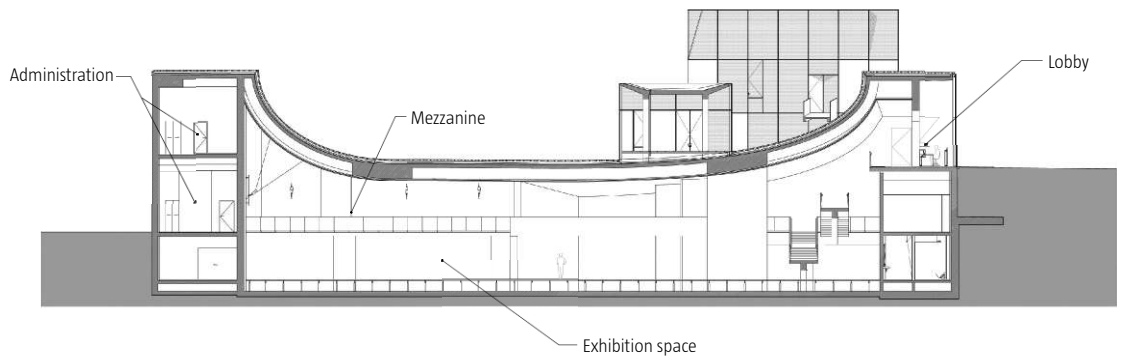

Long Section

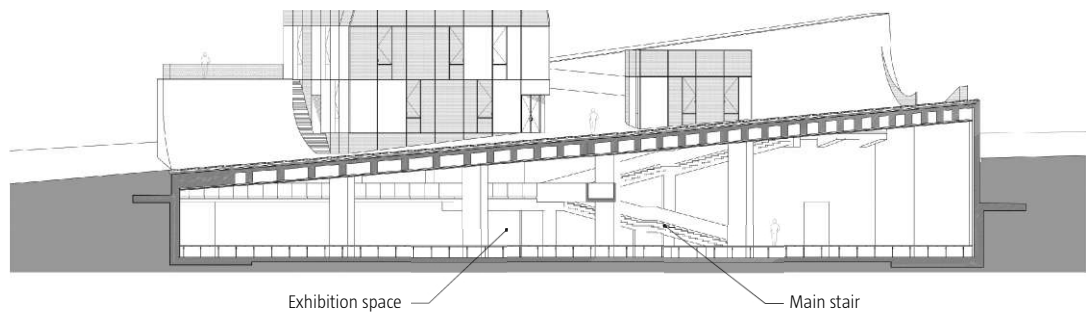



Museum lobby



Gallery



Exhibition



Lower-Level Plan

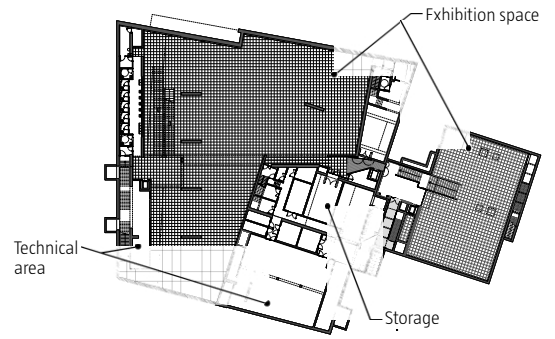

Mezzanine-Level Plan

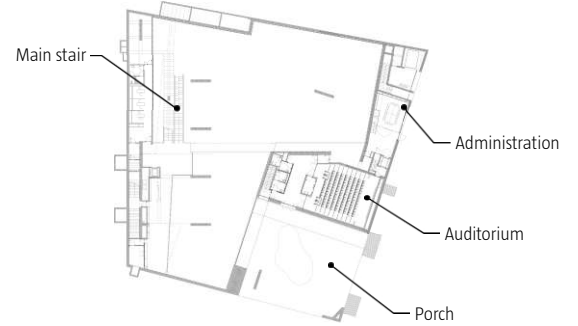

Ground-Floor Plan

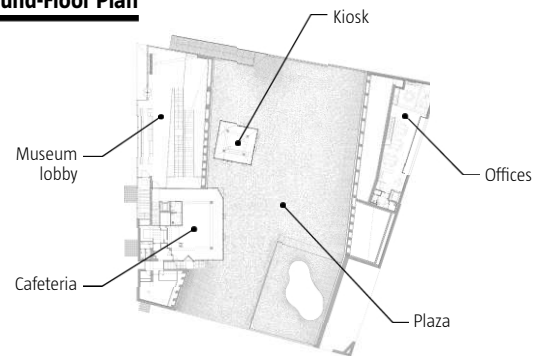

Terrace-Level Plan

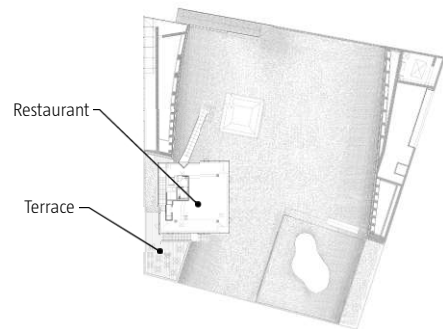

Roof Plan

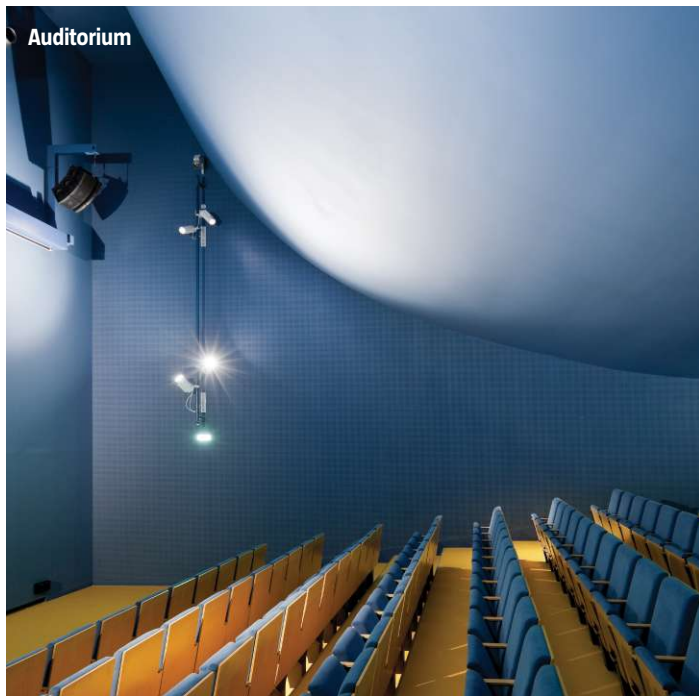
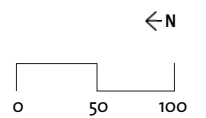
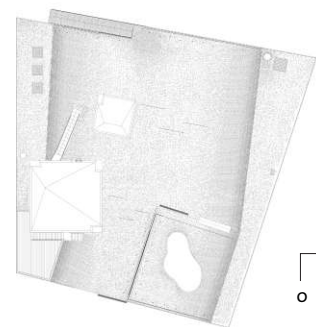

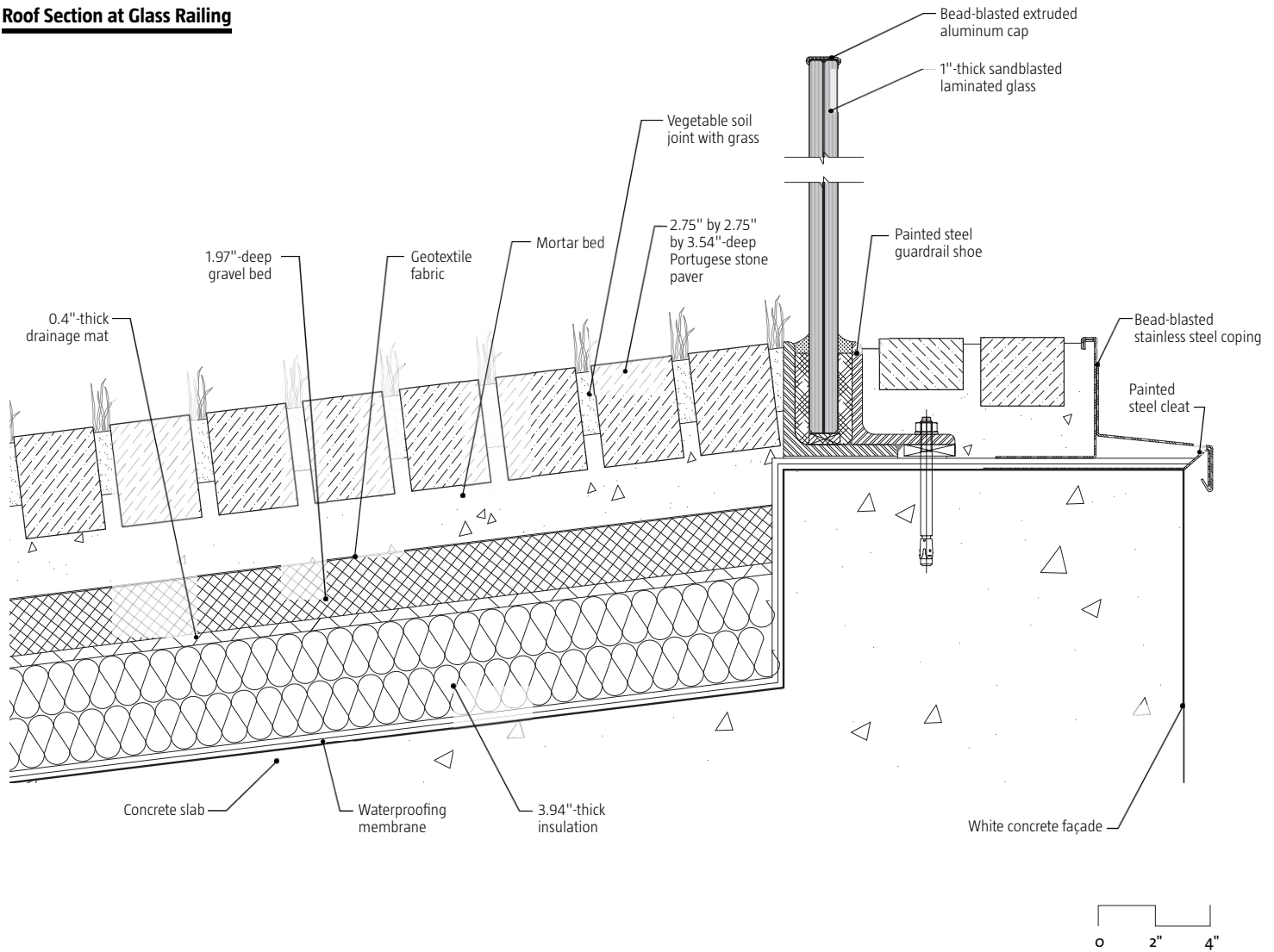
Roof Section at Glass Railing**Project Credits**

Project Cité de l'Océan et du Surf, Biarritz, France
Client SNC Biarritz Ocean
Architect Steven Holl Architects, New York, with Solange Fabião—Steven Holl, AIA, Solange Fabião (design architects); Rodolfo Dias (project architect); Chris Mcvoy (project advisor); Filipe Taboada (assistant project architect); Francesco Bartolozzi, Christopher Brokaw, Cosimo Caggiola, Florence Guiraud, Richard Liu, Ernest Ng, Alessandro Orsini, Nelson Wilmotte, Ebbie Wisecarver, Lan Wu, Christina Yessio (project team)
Associate Architect Leibar&Seigneurin
Consultants/Engineering Vinci-Marseille (roof); Betec (structure); Elithis (mechanical); Avel (acoustical); Apave; Quality Control Office
Lighting Design L'Observatoire International
Contractor Faure Silva—Gtm
Exhibition Engineering Cesma
Exhibition Contractor Geroari
Size 50,859 gross square feet (building); 376,740 square feet (site area)
Cost €20.9 million (\$30.1 million U.S., building), €1.5 million (\$2.2 million U.S., landscape)

Materials and Sources

Ceiling Dacoustie (Fellert Alpha acoustic ceiling) dacoustie.com
Curtainwall Coveris coveris.fr
Electric Santerne santerne.fr
Elevators ThyssenKrupp thyssenkrupp.com
Fixtures Duravit (bathroom fixtures) duravit.com
Flooring Descol (auditorium self-leveling floor) descol.nl; Coney (technical floor); Les Ateliers Duphil (wood flooring) lesateliersduphil.fr
Glass Schott (Okalux) us.schott.com
Lighting Zumtobel zumtobel.us; Troll troll.es; Dufau/Interdecor/Atelier-Creations
Metalwork ACMM acmm.eu
Millwork BCP Création
Plaster J. Mottard
Plumbing Hervé Thermique herve-thermique.com
Seating Delagrave (auditorium seats)
Tile Stone Source (bathroom tiles) stonessource.com
Waterproofing S.A.T Étanchéité
Wayfinding Etap Lighting (emergency signs) etaplighting.com
Window Shades Hexcelscreen hexcelscreen.com
Windows and Doors Atrium (wood doors); Olivari (door handles) olivari.it



NEW!

AIA 2011

Compensation Report

Where do you stand?

How has the economic downturn affected your compensation? Have you been impacted by benefits reductions, salary freezes, or mandatory furloughs? How do you think your colleagues have fared?

The AIA Compensation Report, compiled from our survey of U.S. architecture firms, offers compelling information on the state of the profession and includes compensation data for 39 architecture firm positions in 29 states, 32 metro areas, and 12 cities. Whether you use the complete national report or one of nine regional reports, you will have a better understanding of your value.

The report is another authoritative research publication from the AIA Economics and Market Research team, responsible for the respected AIA Architecture Billings Index.

Know your value.

www.aia.org/compensation

**Purchase the report,
exclusively at the AIA Store.**

www.aia.org/store

Circle no. 530 or <http://architect.hotims.com>



**THE AMERICAN INSTITUTE
OF ARCHITECTS**

ARTSQUEST CENTER AT STEELSTACKS

BETHLEHEM, PA.
SPILLMAN FARMER ARCHITECTS

TEXT BY IAN VOLNER
PHOTOS BY PAUL WARCHOL

JOSEPH BIONDO, AIA, PRINCIPAL at Spillman Farmer Architects, was born and raised in the firm's hometown of Bethlehem, Pa. The one-time hotbed of U.S. manufacturing was an industrial dynamo in Biondo's youth, and he remembers well the masses of black smoke that issued from the mighty blast furnaces at the heart of the Bethlehem Steel Corp.'s vast compound on the Lehigh River. "When I was a kid," Biondo says, "I thought those smokestacks made the clouds."

Nowadays, Bethlehem is out of the cloud-making business: the plant ceased operations in 1995. But the impressive hulks of the old steelworks remain, monuments to an America that Walter Gropius called the "*Mutterland der Industrie*."

For Bethlehem, it is a patrimony that has come with its share of family feuds, as private and public interests have wrangled over the future of the steelworks site. Finally, after years of municipal foot-dragging, the city found a new role for its famous industrial facility: at its eastern end, a new resort casino and retail development, and to the west (largely underwritten by the gaming business) a new arts-and-entertainment campus to be called SteelStacks. Standing in the shadow of the derelict mills, the centerpiece of the new cultural complex is the just-completed ArtsQuest Center, a \$17.4 million performance venue designed by Spillman as a paean to Bethlehem's past, and the firm's. The four-story, 67,000-square-foot facility is a simple rectangular volume, simply expressed in a hybrid steel-and-concrete frame. Yet within that outline, along with a program of bars, cafés, movie theaters, and stages, the architects have packed a subtle historical polemic.

"The intent of the design was to go toe-to-toe with the blast furnaces," Biondo says. The service areas are all

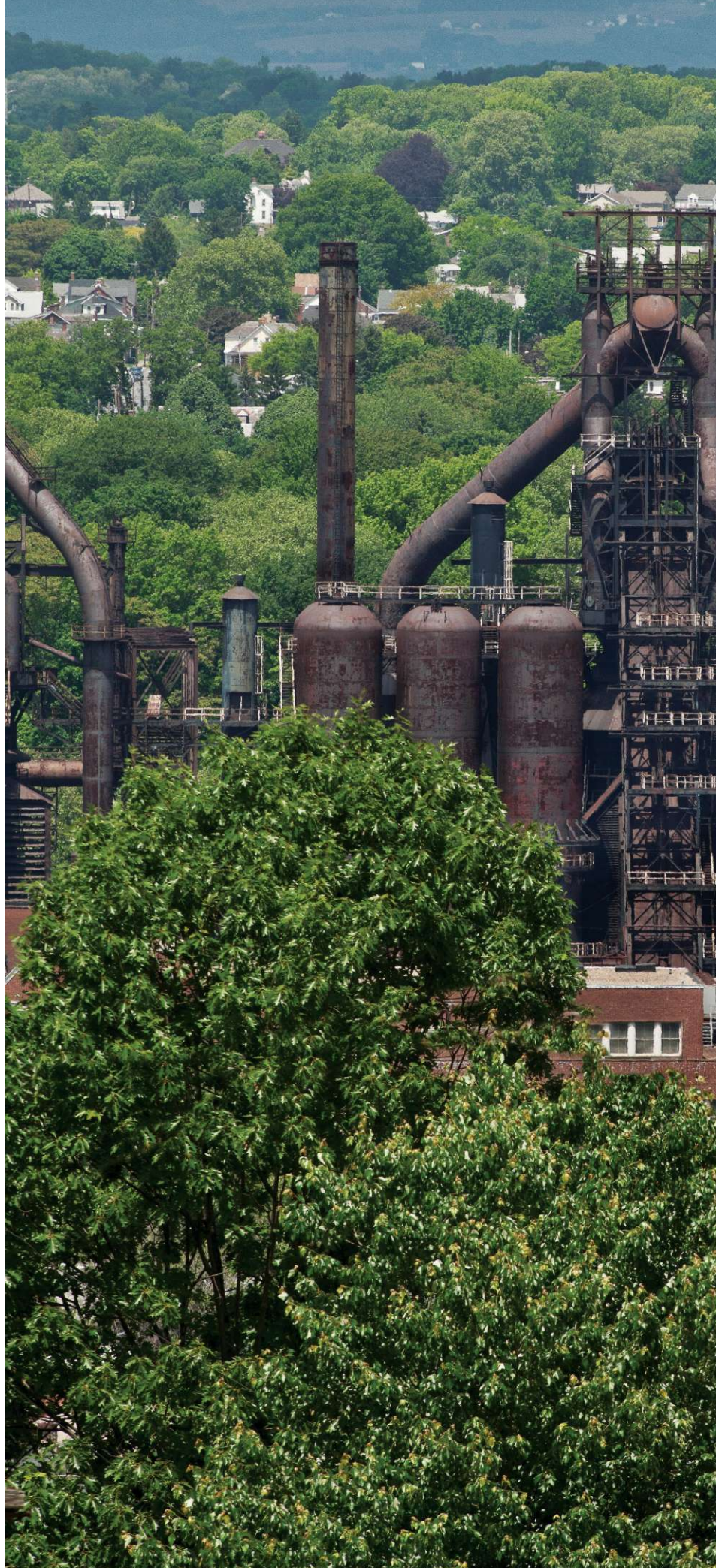



The west façade of the ArtsQuest Center (this image) is dominated by a steel balcony—a nod to the site’s manufacturing roots—over one of the main entrances. The east façade (opposite bottom) is clad largely in precast concrete wall panels with a hand-screed finish, which stands in stark contrast to the largely glazed north face (opposite top). Here, the floor-to-ceiling windows showcase the musical performances taking place within, to those on the adjacent plaza.





thrust to the building's southern side, leaving the glazed-in public spaces to confront the looming structures of the old plant to the north head-on. Seen from the window of ArtsQuest's third-floor Musikfest Café, the network of catwalks and bellows resembles a rust-bound pipe organ, making it a striking backdrop for the performers who have taken the main stage since the space opened in April. Compositionally, too, the center gestures toward the furnaces, with its articulated, boxlike interior forms suggesting something of the towers' bristling functional complexity. But the new building doesn't attempt to outdo the old—if anything, it errs on the side of understatement.

To save it from value-engineered blandness, ArtsQuest has not only its sensational site, but a heightened sense of place contrived by its designers. Just inside the main entrance, a blown-up black-and-white photo, unearthed from the Bethlehem Steel archives, shows the uniformed company brass band mustering on the exact spot where ArtsQuest stands today.

And then there is the unique poignancy in the choice of Spillman Farmer as architect. The firm dates back 87 years, when two Bethlehem Steel employees set up shop as homebuilders to wealthy company executives. Today, the practice's office sits on a converted brownfield only minutes from SteelStacks, and among the 30 designers working there are the sons and daughters of former steel men. For them, this project was a return to their roots.

As Biondo puts it, "We're a firm in transition." ArtsQuest stands as a specifically local reflection on a specifically local condition, but it's also a bid to expand beyond the firm's regional horizons. Significantly, the architects beat out heavy hitter David Rockwell for the commission, after the internationally known designer had landed the project in an earlier search. In that light, the modesty—the reticence, even—of Spillman Farmer's approach seems a very definite statement about space-making in the postindustrial context: a little history, it says, can trump a lot of showmanship in bringing a place back to life.

In acknowledgement of the site's industrial past, the architects chose the color International Orange to paint the exposed steel structure in the lobby (this image), and throughout the ArtsQuest Center. This color is best known for its use on the Golden Gate Bridge, which is just one of the many national landmarks built from Bethlehem steel. Along the window wall in the lobby is a commons space (opposite top) where visitors browse the gift shop or wait for a showing in one of the building's two movie theaters. Behind the box office counter, a staircase (opposite bottom) leads to a second-floor gallery space.



ARTSQUEST CENTER

In Memory Of:
Willard G. Rouse

Sam & Betsy Torrence
With a Little Help from My Friends
Performed By: The Beatles

B|BRAUN

Royal Fireworks Symphony
Composed By: Georg Friedrich Händel
1685-1759

FRANK BANKO HOUSE CINEMAS

BOX OFFICE





Exploded Axonometric

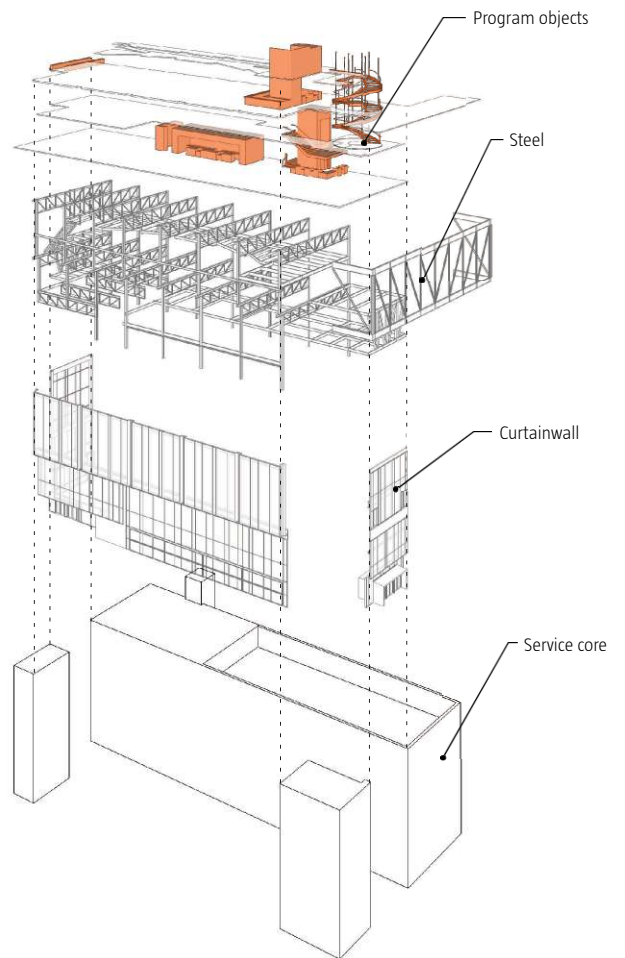

DESIGN → SPILLMAN FARMER

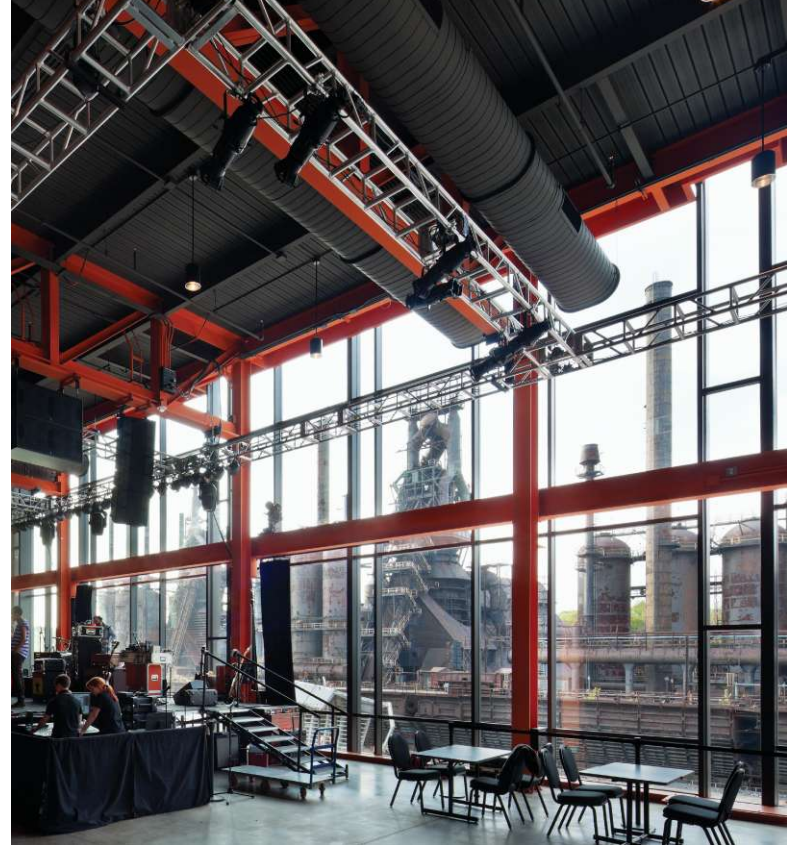

The second-floor gallery space (top left) is called the Blast Furnace Room because of its view. The majority of the concerts in the ArtsQuest Center take place either in the plaza outside, or in the third-floor café (top right), which doubles as the venue's main stage. Starting on the second floor, a spiral staircase (this image) anchors the west end of the building, and serves as the primary circulation route.

First-Floor Plan

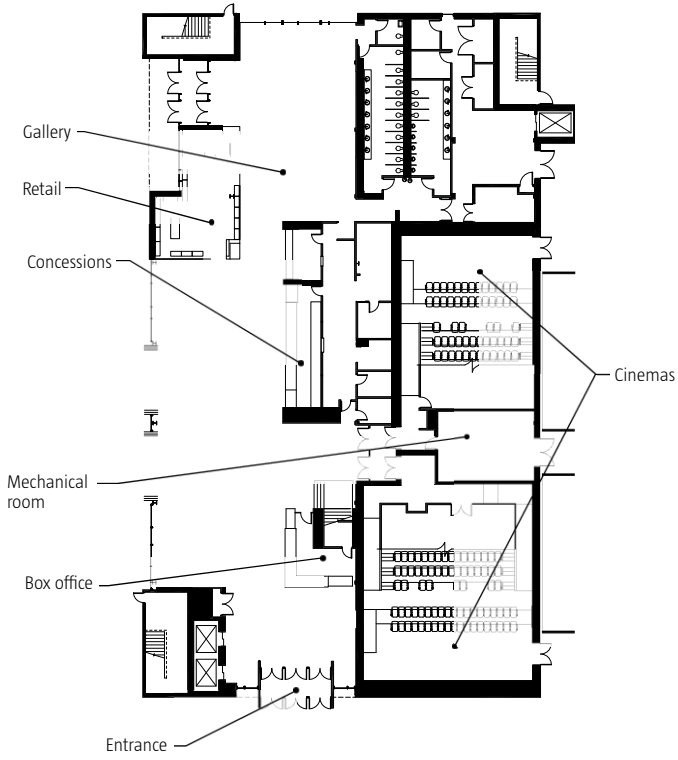

Second-Floor Plan

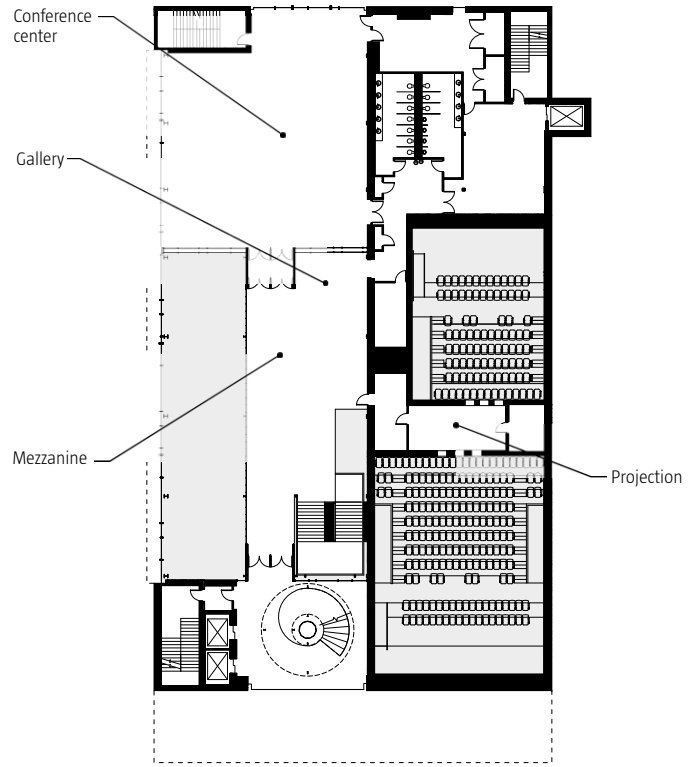

Third-Floor Plan

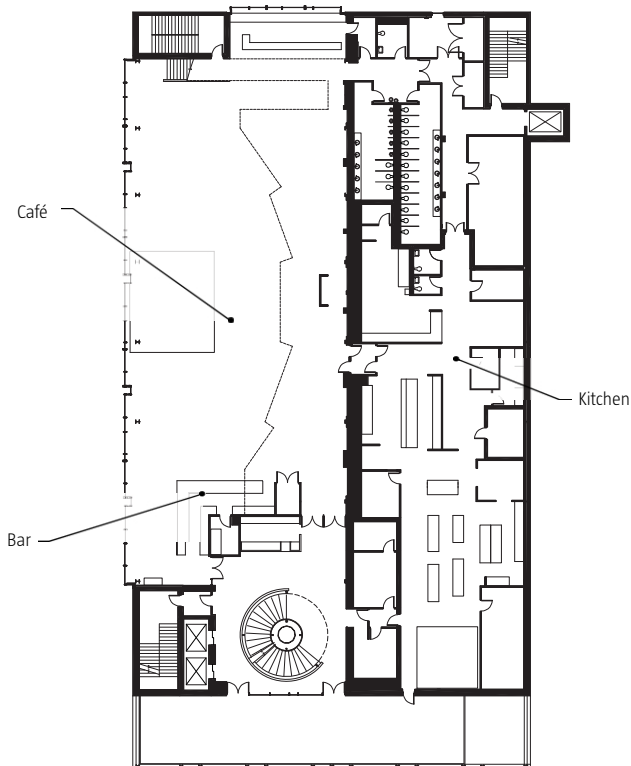

Fourth-Floor Plan

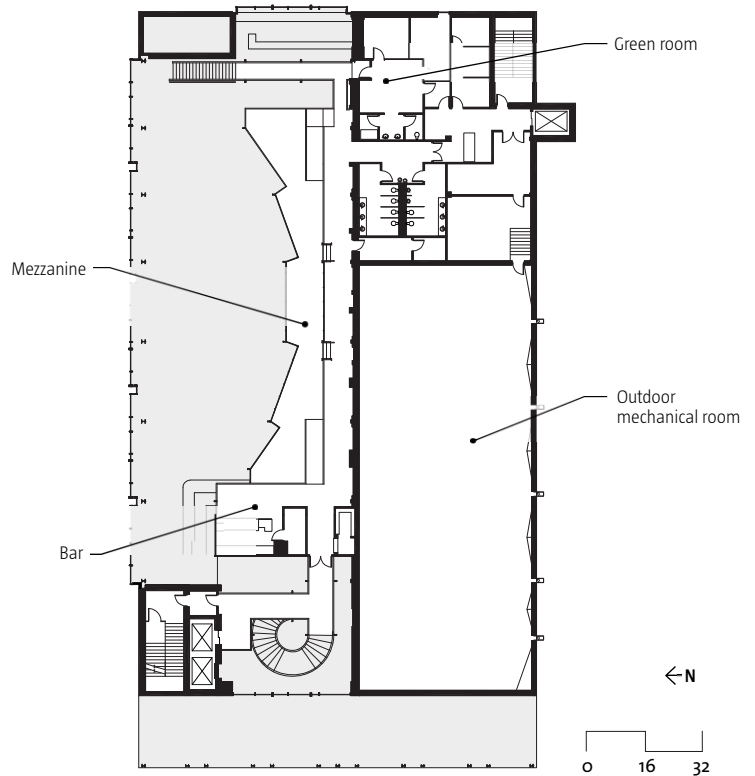

TOOLBOX: SITE WORK

Spillman Farmer's William Deegan is one member of the design team whose father worked (as they say in Bethlehem) "in the steel." "I remember dropping him off in the company parking lot. ... You could feel the heat from hundreds of yards away."

Now that much of the Bethlehem Steel compound—all 163 acres of it—looks like one enormous parking lot, it's hard to get a sense of the real scale of the works at their height. Only a fraction of the sheds, cranes, and workshops remain standing, and most of those are in pretty poor repair; many furnaces still remain, though. The perils of working in and among demolished and semiruin industrial relics might have made the project tough going for Spillman Farmer; but fortunately for them, extensive remediation had already been carried out by the site's new owners—the Sands Casino Resort, which opened in a bulky block of buildings just down the road in 2009.

The resort contracted with demolition experts Brandenburg Industries and construction managers Alvin H. Butz to remove structurally unsound buildings and chemical contaminants from a large swath of the steelwork grounds, including the No. 2 Hammer Shop that stood on the present site of ArtsQuest. "We wanted to preserve" the original structure, says Spillman Farmer associate Michael Metzger, AIA, "but we just couldn't." Even before that, as early as the late '90s, federal and state environmental authorities had already conducted extensive soil removal and groundwater testing to ready the way for the factory's future.

Which is not to say that Spillman Farmer wasn't prepared to assume the odd risk in taking on the spectacular brownfield site. Inside ArtsQuest, surfaces clad in Pennsylvania ash abound, their alternating dark and light finishes intended to recall the charred brick interiors of the nearby furnaces. But how did the Spillman team know that, since the insides of the stacks are closed to the public? Sheepish grins all around: They found their own way in, apparently.

Project Credits

Project ArtsQuest Center at SteelStacks, Bethlehem, Pa.

Client/Owner ArtsQuest

Architect Spillman Farmer Architects—Barry Pell, AIA (managing principal); Joseph N. Biondo, AIA (design principal); Michael Metzger, AIA (project architect); William Deegan (senior designer); Joseph Balsamo, Brian Brandis, AIA, Chris Connors, Randy Galiotto, Deborah Innis, Christa Kraftician, AIA, Sierra Krause, Deirdre Kwiatek, Clint Newton, Elliot Nolter, Mark Piell, Patrick Ruggerio, Mike Savage, Charles Shoemaker, AIA, Wayne Stitt, AIA, Joanne Titcomb, Salvatore Verrastro, AIA (project team)

M/E/P Engineer Brinjac Engineering

Structural Engineer Barry Isett & Associates

Acoustic Consultant Acoustic Dimensions

Landscape Architect Wallace Roberts & Todd

Civil Engineer French & Parrello Associates

Food Service Consultant Porter Khouw Consulting

Commissioning Consultant The Stone House Group

Specifications Consultant Conspectus

Construction Manager Alvin H. Butz

Owner's Consultant (Audio/Visual) AVI-SPL

Owner's Consultant (Cinema) Full Aperture Systems

Owner's Consultant (Planning & Fundraising Counsel)

The North Group

Owner's Consultant (Branding & Environmental Graphics)

Westlake Reed Leskosky

Owner's Consultant (Food Service) Singer Equipment Co.

Owner's Consultant (Sculpture) Stephen Antonakos Studio;

The Glass Studio at the Banana Factory

Owner's Consultant (Communications) Convergent

Communications

Owner's Consultant (Furniture) Corporate Environments;

Corporate Facilities

Owner's Consultant (Retail) Vori Kriaris Retail Design &

Store Planning

SteelStacks Plaza Design Team Wallace Roberts & Todd;

Artefact; L'Observatoire International; Klein and Hoffman;

Keystone Consulting; Lehigh Valley Engineering; HDR;

Metropolitan Acoustics; Simpson Gumpertz & Heger

Size 68,000 square feet

Construction Cost \$17.4 million

Materials and Sources

Acoustic Curtains Besteel rosebrand.com

Acoustical System Knauf Insulation knaufusa.com; Kinetics

Noise Control kineticsnoise.com; Metal-Dek (Versa-Dek S

Acoustical) metalde.com

Carpet Lees leescarpets.com

Ceilings Armstrong armstrong.com

Exterior Wall Systems Laminators (Omega-Lite exterior

metal panels) laminatorsinc.com; Universal Concrete

universalconcrete.com

Doors & Hardware Ingersoll-Rand (Steelcraft) steelcraft.com;

Rockwood Mfg. Co. rockwoodmfg.com; Sargent Mfg. Co.

sargentlock.com; Solar Innovations solarinnovations.com;

Tubelite tubeliteinc.com

Fabrics and Finishes Knoll knoll.com; Glassfilm Enterprises

(Lumisty) lumistyfilm.com

Flooring Polished concrete; Resinous flooring; StonePeak

Ceramics stonepeakceramics.com

Furniture Herman Miller hermanmiller.com; Knoll knoll.com;

Driade driade.com; Camatic camatic.com.au

Glass JE Berkowitz www.jeberkowitz.com

HVAC Carrier www.commercial.carrier.com; Mitsubishi

Electric (split system) mehvac.com

Lighting Control Systems Lutron Electronics Co. lutron.com;

Lehigh Electric Products lehighdim.com

Lighting Hi-Lite Mfg. Co. hilitemfg.com; Philips Lightolier

lightolier.com; Philips Widelite widelite.com; Tivoli

tivoliighting.com; Winona Lighting winonalighting.com

Masonry and Stone Sand-filled CMU

Metal Hot-rolled steel

Millwork Ash; Nevamar nevamar.com; Corian dupont.com

Paints Sherwin-Williams Co. sherwin-williams.com

Roll Down Shades Lutron Electronics Co. lutron.com

Structure Braced steel frame and precast concrete panels

Wallcoverings Knoll knoll.com; 3M Graphic Panels 3m.com

Windows and Curtainwalls Tubelite tubelite.com

Site Plan

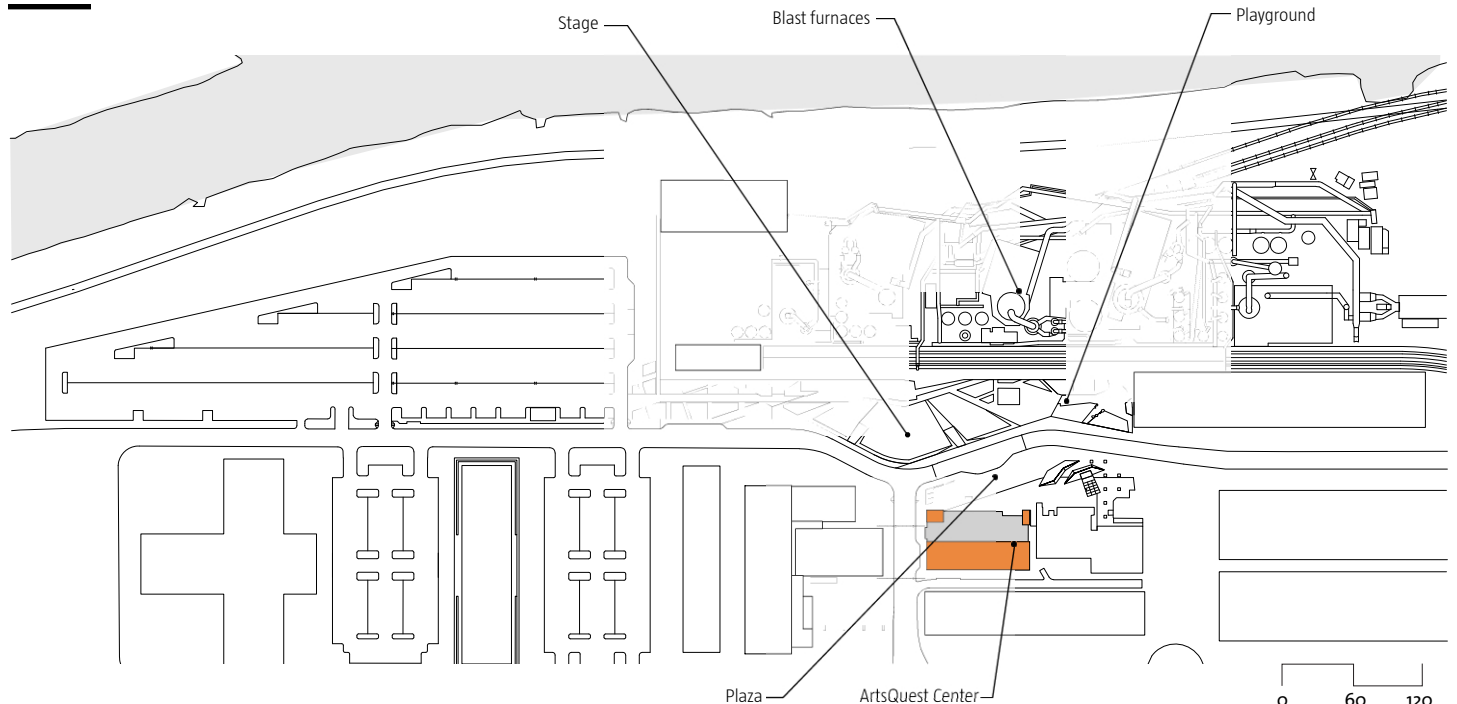

CONTACT US

Edit Calendar & Media Kit

Please visit architectmediakit.com.

Submissions

LETTERS TO THE EDITOR

Please email editor-in-chief Ned Cramer at ncramer@hanleywood.com. Letters may be edited for length, content, grammar, and style, and may be published in a future issue of ARCHITECT.

PROJECTS

If you have a building project for us to consider for publication, please email photographs, drawings, and a brief written description to senior editor Katie Gerfen at kgerfen@hanleywood.com.

ARTICLES

ARCHITECT does not accept unsolicited articles. If you have an idea for a story, email a brief description and writing samples to senior editor Eric Wills at ewills@hanleywood.com.

PRODUCTS

To submit a product for consideration for publication, please email a press release

and at least one image of the product to products@architectmagazine.com.

Continuing Education

ARCHITECT provides free courses to help you stay current with your learning requirements. To register, please visit architectmagazine.com or Hanley Wood University at hanleywooduniversity.com.

Newsletters

ARCHITECT produces two free email newsletters: the **ARCHITECT Newswire**, a daily compilation of top stories from around the Web, and the **ARCHITECT Weekly**, which highlights articles from ARCHITECT and its Hanley Wood sister publications. Subscribe to one or both at architectmagazine.com by clicking on the "Newsletter" link at the top of the page.

Subscriptions & Back Issues

SUBSCRIPTION INQUIRIES, CUSTOMER SERVICE, AND BACK-ISSUE ORDERS

Email arch@omeda.com, call 888.269.8410 (toll-free in USA) or 847.291.5221, or visit architectmagazine.com and click on

"Subscribe" (subscriptions only). Allow six to eight weeks for delivery of first issue.

ANNUAL SUBSCRIPTION RATES

USA: \$59; Canada: \$69; Other countries: \$199 (12 monthly issues)

SINGLE-COPY PRICES

USA: \$10; Canada: \$15; Other countries: \$20

Reprints

Call the YGS Group at 717.505.9701 ext. 128, or email brad.hairhoger@theygsgroup.com.

Newsstand

Individual copies of ARCHITECT are available for purchase, for \$8.99, at Barnes & Noble and other booksellers across the country. Please contact your local bookstore for availability.

Address Changes

AIA MEMBERS

Call 800.242.3837, and press 2

ALL OTHERS

ARCHITECT
P.O. Box 3494
Northbrook, IL 60065-9831

Volume 100, number 9, September 2011. ARCHITECT® (ISSN 0746-0554; USPS 009-880) is published monthly plus a Spring and Fall Product Guide by Hanley Wood, LLC, One Thomas Circle, NW, Suite 600, Washington, DC 20005. Copyright 2011 by Hanley Wood, LLC. Opinions expressed are those of the authors or persons quoted and not necessarily those of the American Institute of Architects. Reproduction in whole or in part prohibited without written authorization. All rights reserved. Printed in the USA.

Periodicals postage paid at Washington, DC, and at additional mailing offices. POSTMASTER: Send address changes to ARCHITECT, P.O. Box 3494, Northbrook, IL 60065-9831.

Canada Post Registration #40612608/G.S.T. number: R-120931738. Canadian return address: Pitney Bowes Inc., P.O. Box 25542, London, ON N6C 6B2.

DISCLOSURE ARCHITECT® will occasionally write about companies in which its parent organization, Hanley Wood, LLC, has an investment interest. When it does, the magazine will fully disclose that relationship.

PRIVACY OF MAILING LIST Sometimes we share our subscriber mailing list with reputable companies we think you'll find interesting. However, if you do not wish to be included, please call us at 888.269.8410.

congratulations

TO HANLEY WOOD'S JESSE H. NEAL AWARD WINNERS

Hanley Wood is committed to publishing quality content that serves the information needs of construction industry professionals. Our editors have once again been honored by the most prestigious editorial awards program. **Join us in congratulating them.**



2011 WINNERS

AQUATICS INTERNATIONAL | Best Single Article

BUILDER | Best Educational Content

POOL & SPA NEWS | Best Technical Content

THE JOURNAL OF LIGHT CONSTRUCTION | Best Technical Content

2011 FINALISTS

APARTMENT FINANCE TODAY | Best News Coverage

ARCHITECT | Best Profile

ARCHITECTURAL LIGHTING | Best Single Article

AQUATICS INTERNATIONAL | Best News Coverage, Best Use of Social Media, Grand Neal

RESIDENTIAL ARCHITECT | Best Profile

SEIZE THE OPPORTUNITY



What's next for your business? What new opportunities are ripe for the seizing? What could you do with more knowledge and certification? How far could you go with the right suppliers, the right connections, the right tools and timing? Spend time at World of Concrete and get what you need to build a stronger, more competitive business.

GET HERE—GET IT DONE.



WORLD OF CONCRETE®

WORLD OF MASONRY | TECHNOLOGY FOR CONSTRUCTION

hanley wood

www.worldofconcrete.com



A selected participant in the International Buyer Program

JANUARY 24 - 27, 2012 • SEMINARS: JANUARY 23 - 27 • LAS VEGAS CONVENTION CENTER • LAS VEGAS, NEVADA

REGISTER ONLINE AND SAVE!

SOURCE CODE: 071

Resource/Classifieds

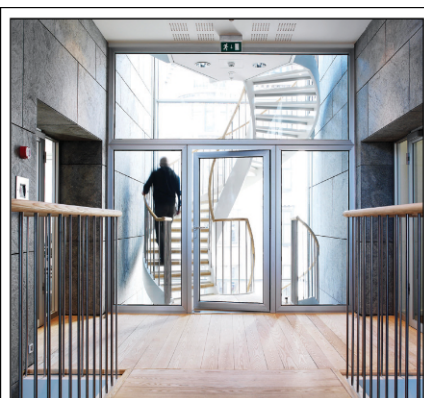

Fire-Rated Aluminum Doors & Windows

www.aluflam-usa.com

Imagine being able to specify a fire-rated system that looks so good you wouldn't know it's fire-rated. Imagine the clean, rich lines of true extruded aluminum frames and large panels of clear glass. With ALUFLAM™ storefront and curtainwall systems and Glass from VETROTECH SAINT-GOBAIN, this is reality.

Contact us for further information—
714-899-3990
Email info@aluflam-usa.com

Circle no. 300

Magnet for Top Talent

JR Walters Resources, premier A/E/C recruiting firm, can assist in growing your company and your career. Direct and Contract National and International
www.jrwalters.com
or call 269.925.3940

Circle no. 303

NIXALITE®
Bird Control
Superior Bird Control Products
Request Your FREE Catalog Now
www.nixalite.com 800.624.1189

Circle no. 304

Commercial Lighting and
Flooring Resources for Architects

LIGHT DIRECTORY
lightdirectory.com

FLOOR DIRECTORY
floordirectory.com

Circle no. 305

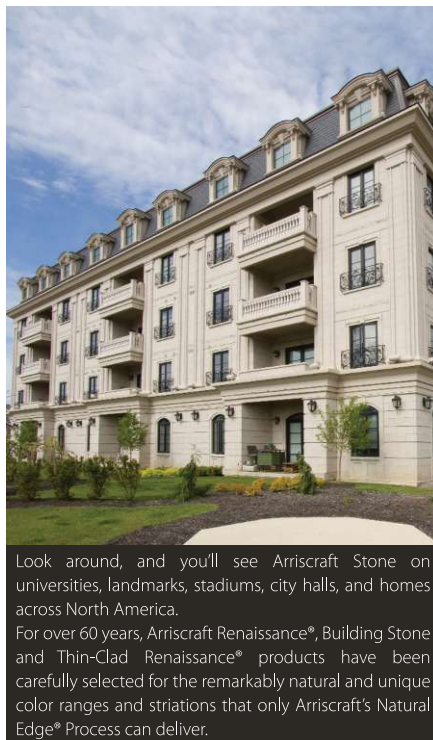

Look around, and you'll see Arriscraft Stone on universities, landmarks, stadiums, city halls, and homes across North America. For over 60 years, Arriscraft Renaissance®, Building Stone and Thin-Clad Renaissance® products have been carefully selected for the remarkably natural and unique color ranges and striations that only Arriscraft's Natural Edge® Process can deliver.

ARRISCRAFT
EST. 1952 • A T I O N A L
BUILDING STONE • BRICK • LIMESTONE
A General Shale Brick Inc. Company
General Shale Brick
Building The American Dream™

800.265.8123

www.arriscraft.com

Circle no. 301

Innovative Manufacturing in Architectural Ceramics

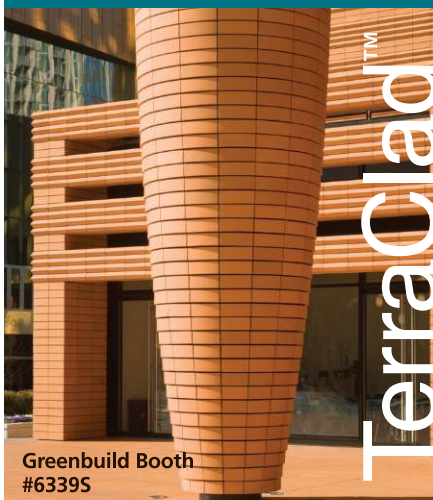

Boston Valley Terra Cotta
1.888.214.3655 www.BostonValley.com

The Bechtler Museum of Modern Art

Circle no. 306



Design in a New Light

High Impact Translucent Glazing

ACRYLITE® Acrylic Multi-Skinned and Wave Profile glazings are extremely weatherable panels manufactured with High Impact Acrylic Polymer. Architects and designers around the world have long admired ACRYLITE® for its versatility in design applications. **Call us today to receive free samples.**

EVONIK INDUSTRIES **ACRYLITE®**

1.888.233.4527

www.acrylitebuildingproducts.com

Circle no. 302



MUSSON'S Rubber Sports Floor

A durable spike-resistant floor made of recycled rubber combined with colorflex of new rubber to create an environmentally friendly, slip resistant sport-surface in roll goods, glue down or interlocking tiles. Made with a black background and a 10% or 20% fleck in a choice of six colors.

1-800-321-2381
www.mussonrubber.com

Circle no. 307

Resource

EHV-Vanity Brackets

Rakks Vanity Brackets simplify and reduce the cost of installing ADA sinks with millwork enclosures. Brackets are supplied with wooden strips on the front faces for easy installation of panels. Available in both stocked and make-to-order sizes.

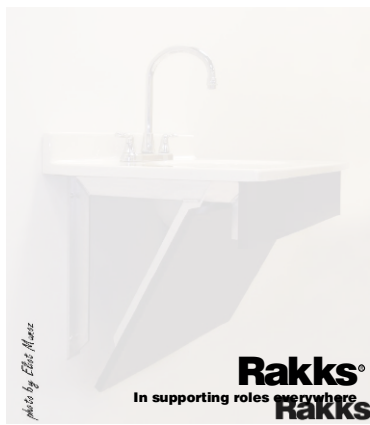

Rangine Corporation | 330 Reservoir Street
Needham, MA 02494 | www.rakks.com

Circle no. 308

Scan to Find, Select,
Detail, Specify, BIM.



ARCAT
arcat.com

Circle no. 312

FOR INFORMATION

on how to be a part of the next ARCHITECT special advertising section, contact Erin Schneider at 773-824-2445.

hanley wood

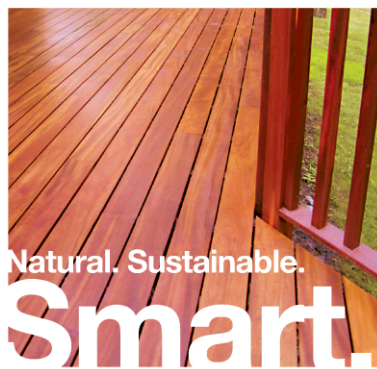

Tiger Deck® combines inherently strong tigerwood with our patented hidden fastening system to deliver a complete hardwood decking system unlike any other:

- Easy to install
- Naturally rot resistant
- Extremely durable
- Low maintenance
- No surface penetrations



FSC®
www.fsc.org
FSC® C068109



FSC® products available upon request

tigerdeck.com

Circle no. 309

**DESIGNER
DOORS
BY SCHWEISS**

**NOW MANUFACTURING
HYDRAULIC DOORS
& BIFOLD DOORS**



800-746-8273
Visit us at
Schweissdoors.com

Circle no. 313



Armstrong

WoodWorks® Ceiling & Wall Systems

armstrong.com/unanimous9a 1 877 ARMSTRONG

Circle no. 310



**Full Line of
Lockers from
ASI Storage
Solutions**

With its wide range of materials (steel, solid plastic and now phenolic) and configurations (including cubby-style), ASI Storage Solutions has the locker to fit all your design applications.

Visit asilockers.com for more information

Circle no. 311

Benjamin Moore Eco Spec WB Silver

Benjamin Moore Eco Spec WB Silver is the first zero-VOC paint formulated with elemental silver and other EPA-approved antimicrobial additives that inhibit bacterial odors and mildew growth. This premium commercial coating is recommended for projects applying for LEED credits. Available in any color, it remains VOC-free regardless the tint. Three finishes: flat, eggshell and semi-gloss.



www.benjaminmoore.com

Circle no. 314

Resource



The Bilco Company Architectural Products Catalog details the company's line of roof hatches, automatic fire vents, floor doors and safety products for the commercial markets. It also features an enhanced user-friendly layout, complete with updated patent information and product specifications.

The catalog is available free of charge by calling (203) 934-6363 or e-mailing commercial@bilco.com.

Circle no. 315

Is Your Roofing Material Cracking Under the Elements?



You want a tested and trusted roofing material — not one that cracks under pressure. Why specify roofing materials that age prematurely, unable to withstand the elements? Roofing membranes should perform for decades — are you settling for less?

Get the facts at www.vinylroofs.org/compare

Circle no. 316



EPIC Metals Roof and Floor Deck Ceiling Systems

Long spans of 10–55 feet are intended to define a building's envelope with a high degree of interior acoustical control.

EPIC[®] METALS CORPORATION 877-696-3742 Toll-Free www.epicmetals.com

Circle no. 317

Bradley Thinks “Out of The Box” With New Diplomat Washroom Accessories Series



Architects and designers who are tired of traditional and boxy-looking washroom accessories now have a curvier and more contemporary alternative with Bradley's new Diplomat™ Series. The unique, dual-curve geometry design of Diplomat's dispensers and receptacles offer a sleek and elegant finishing touch to any high-traffic commercial restroom.

(800) BRADLEY
www.bradleycorp.com/diplomat/

Circle no. 318





ClarkDietrich Building Systems is the largest and fastest growing manufacturer of light gauge steel framing in North America. With a complete lineup of extensively tested and innovative products, plus technical support services and smart tools for design and specification, ClarkDietrich is forging a new future for steel framing.

Visit www.clarkdietrich.com

Circle no. 319

Icynene Spray Foam Insulation and Air Barrier



You don't have to choose between your preferred design and total building performance. With closed-cell ICYNENE MD-C-200™ spray foam insulation and air barrier, you can expect energy-efficiency and design flexibility — plus the industry-leading building science expertise of Icynene®.

Circle no. 320



CASCADE COIL DRAPERY

Microsoft Visitors Center
www.cascadecoil.com | 800-999-2645

Circle no. 321



Air Vent Grilles

Exquisite craftsmanship on the sturdy louvered vents and the smooth, rounded edges. A classy way to vent unwanted heat. Four wood species to suit most design needs.

MOCKETT
DOUG MOCKETT & COMPANY, INC.
www.mockett.com • (800) 523-1269

Circle no. 322



Jump™

Are you ready to make the leap?

Jump™ is the first high performance architectural luminaire to integrate LEDs with innovative optics and advanced controls.

getreadytojump.com

PHILIPS
LEDALITE
sense and simplicity

Circle no. 323

Resource



Metl-Span's Architectural Insulated Metal Wall Panel

The Metl-Span Architectural wall panel is ideal for high-profile architectural applications. The panels may be installed either vertically or horizontally for maximum design flexibility. Multiple module widths and joint reveals add to the design variations available. Attached with concealed clips and fasteners in the side joint, Architectural wall panels provide a beautiful flush appearance.

For more information visit www.metlspan.com.

Circle no. 324

Get out of the crowd, and into a job. At ArchitectJobsOnline.com.

ArchitectJobsOnline.com is the official career site of ARCHITECT and residential architect magazines. Unlike general job sites, we offer Job Postings, Career Advice, Architect News, Architect Events, Salary Information and Resume Posting. So visit ArchitectJobsOnline.com today. And leave the mass market job sites to those other characters.



ARCHITECT JOBS ONLINE

••• Job Listings ••• E-mail Alerts •
Career Tools • Industry Intelligence •••

hanley wood



Stay current with free online courses.

The Propane Training Academy offers convenient training courses on propane topics. Approved by NAHB, AIA, NARI, and USGBC, these courses also help fulfill CEU requirements. See what's available today. Propane Training Academy courses are tools you can build on. Start now at propanetrainingacademy.com.

PROPANE
EXCEPTIONAL ENERGY™

Circle no. 325

NEW COOL METAL ROOFING CEU



The cool metal roofs market is surging. In this course, sponsored by Petersen

Aluminum, you will learn the extent to which this increasingly popular roofing option can reduce cooling energy and lower peak energy demand in a building, as well as how to compare the thermal properties of various roofing materials.

View the course at www.pac-clad.com. Visit Petersen Aluminum at METALCON, Booth 614.

Circle no. 327

Preserve natural water drainage through a permeable pavement system

Genuine Clay Pavers
Strong • Durable • Colorfast

www.claypaver.com 800-334-8689

Circle no. 329

Diamondback™ Tile Backer

- Unique, textured pattern improves bond and reduces tile slippage



- Water-resistant core and surface

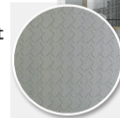

- Paperless, for strength and moisture and mold resistance

CertainTeed Gypsum
800.233.8990

Visit www.certainteed.com/sustainable

Circle no. 326

Specifier ALERT

Mortar Net® with Insect Barrier

Change Your Spec Today!

All 0.4", 1" & 2" Mortar Net® now has Insect Barrier

Call for information and samples

800.664.6638
MortarNet.com

Mortar Net®
USA LTD.

Circle no. 328

Even upside down Illumination Series panels are inspiring.



nichiha.com
1.866.424.4421

NICHIHA
fiber cement

Circle no. 330

Resource

Spanish Ceramic From Tile of Spain



Spanish ceramic is the ceramic of choice. Tile of Spain branded manufacturers offer modern design, boundless creativity, consistent technological strides and a firm commitment to the environment. A superior material for interiors and exteriors, ceramic tile is one of the most high-performance materials in the construction industry today. Discover why architects and designers around the world are joining in the mantra: *Yes, We Choose Spanish Ceramic.*

Contact Tile of Spain at
305.446.4387 or
www.tileofspainusa.com

Circle no. 331

Details, details, details...



Details often leave questions like: "OK, but how do you actually build it". Polyguard's Integrated Building Envelope® Handbook – Connections with Exterior Wall Assemblies, available at www.polyguardproducts.com/aan has over 200 isometrics, each with step by step construction instructions covering envelope protection, drainage, and venting.

Nail down your requirements with these specifics.

Innovation based. Employee owned. Expect more.®
Polyguard
Phone: (1) 615.217.6061 www.polyguardproducts.com

Circle no. 334



Décor Roof Systems. Champion of Design Freedom.

Call 800-576-2358 to request your FREE informative Décor Design Kit.



Circle no. 336

Of all the building materials you can use, nothing offers the beauty and

innovation of wood

Visit naturallywood.com/a to view our supplier directory with over 600 manufacturers, emerging trends, latest innovations in wood technology, green building tools and much more.

naturally:wood

British Columbia wood.
Sustainable by nature.
Innovative by design.

Circle no. 332



Kingspan high-performance insulated metal panels deliver proven sustainable performance in a single component system. As an industry leader that recognizes the serious challenges facing our global ecosystem, we believe in the effectiveness of an EnvelopeFirst™ roof and wall design strategy to achieve Net-Zero and energy-efficient buildings.



Kingspan
Insulated Panels
www.kingspanpanels.us
info.us@kingspanpanels.com

Circle no. 335

Sto Corp. Introduces StoEnergy Guard™

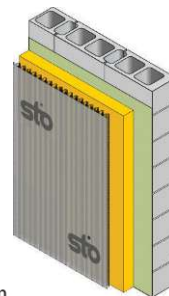

Cladding wasn't meant to stand up to climate all by itself. StoEnergy Guard advanced cavity wall system protects from the inside out. This integrated system of products delivers wall protection technology that works seamlessly under many cladding types, all while meeting the latest code requirements for energy efficiency and moisture control.



www.stocorp.com

Circle no. 337

THREE PADS. ONE SCRUBBER. A LITTLE WATER.

With the nora® pro clean system, that's all you need to maintain your nora® rubber flooring. Eliminate detergents. Reduce labor. Improve performance. Experience the benefits for yourself.

800-332-NORA
Learn more at
www.nora.com/us/proclean37

Follow us: @noraflooring

nora®

All About Flooring. All About You.

Circle no. 333

search. source. learn. connect. ebuild.

ebuild is the destination for construction pros searching for information about building products. **ebuild** is a source of new product coverage, trends and news. Pros visit **ebuild** to learn how to do their jobs faster, safer and easier. **ebuild** connects pros to product manufacturers, experts and peers.

hanley▲wood

ebuild

a 360 degree view of product information

ebuild.com

ad index

Advertiser	Page	Circle	Website	Phone
Academy of Art	129	523	www.academyart.edu	800.544.2787
AIS	147	22	www.aisc.org/sustainabliity	312.670.2400
Alcoa	59	507	www.reynobondwithecoclean.com	800.841.7774
American Institute of Architects	39, 42, 221	530, 513	www.aia.org	800.242.3837
Altus Group	86	454	www.altusprecast.com	866.GO.ALTUS
American Hydrotech	92	254	www.hydrotechusa.com	800.877.6125
Ameristar	98	495	www.AmeristarFence.com	800.321.8724
ARCAT	48	430	www.arcata.com	
ACROM	101	532	www.altarix.com	800.424.5050
Armstrong	17	533	www.armstrong.com/unanimous9a	877.ARMSTRONG
ASI Accurate	140	236	www.accuratepartitions.com	
ASI Storage Solutions	106	229	www.asilockers.com	
Azon	138	293	www.azonintl.com	800.788.5942
Benjamin Moore	63	496	www.benjaminmoore.com/thenewstandard	
Big Ass Fans	56	165	www.bigassfans.com	877.BIGFANS
Bilco	134	518	www.bilco.com	800.366.6530
BlueBeam	148	175	www.bluebeam.com/punchitup	
Blue Book Network, The	137	262	www.bpmselect.com	
Bluworld of Water	125	160	www.bluworldusa.com	407.426.7674
Bradley	121	213	www.bradleycorp.com/diplomat	800.BRADLEY
Building System Design	24	23	www.speclink.com/arch	888.BSD.SOFT
C.R. Laurence Company	62	166	www.crlaurence.com	800.262.5151
Cambridge Architectural	79	24	www.cambridgearchitectural.com	866.806.2385
Cascade Coil	64	81	www.cascadecoil.com	800.999.2645
Centria	55	25	www.centria.com/reimaginemetal	800.229.5427
CertainTeed	13, 69	509, 242	www.certainteed.com	800.233.8890
Chemical Fabrics	60	77	www.vinylroofs.org/compare	
ClarkDietrich	99	539	www.clarkdietrich.com	
Construction Specialties	31, 89	298, 457	www.c-sgroup.com	
Cosella Dorken	103	395	www.delta-facades.com	888.4DELTA4
CSI	53	31	www.csinet.org/joinCSI	800.689.2900
Delta Faucet	97	27	www.deltafaucet.com/commercial/proximity	
Dorma	70	189	www.dorma-usa.com	866-401-6063
Doug Mockett & Company, Inc.	76	516	www.mockett.com	800.523.1269
Dri-Design	123	287	www.dri-design.com	616.355.2970
EcoBuild	128a-b	-	www.aceEcoBuild.com	800.996.3863
ECOSurfaces	107	541	www.ecosurfaces.com	877.323.7873
E.I. Dupont	25	29	www.fluidapplied.tyvek.com	
EIFS	80	98	www.EIMA.com	
Follansbee	77	32	www.follansbeesteel.com	800.624.6906
Forestry Innovation Investments	21	288	www.naturallywood.com/a	
GBCI	83	191	www.gbci.org/Todd	
Georgia-Pacific	127	419	www.densglass.com	800.225.6119
GKD Metal Fabrics	193	260	www.gkdmetalfabrics.com	800.453.8616
Glidden Professional	111	524	www.gliddenprofessional.com	
Greenscreen	16	420	www.greenscreen.com	800.450.3494
Hanover Architectural Products	110	480	www.hanoverpavers.com	800.426.4242
HDI Railing Systems	108	202	www.hdirailings.com	717.285.4088
Hoover Treated Wood	96	251	www.FRTW.com	800-TEC WOOD
HP	51	450	www.hp.com/go/simplify	
Huber Engineered Woods	61	527	www.zipsystem.com/arch	
Humidifall	74	546	www.humidifall.com	877.884.4776
Hunter Douglas Contract	32a-l, 33	378	www.HunterDouglas Contract.com/RB500	800.727.8953
Icynene	133	261	www.icynene.com	800.758.7325
InPro	209	221	www.inprocorp.com	877.780.0034
Invisible Structures	58	400	www.invisiblestructures.com	800.233.1510

Advertiser	Page	Circle	Website	Phone
Johnsonite	93	38	www.johnsonite.com	
Kawneer	86	494	www.kawneer.com	
Kingspan	9	231	www.LegaciesAreBuilt.com/architect	
Lafarge	118	474	www.lafarge-na.com/visitwithme	
Leland	122	279	www.lelandindustries.com	800.263.3393
Lumber Liquidators	109	281	www.lumberliquidators.com	800.HARDWOOD
Lutron	C4	510	www.lutron.com	800.523.9466
MacLean Power Systems	36-117	556	www.MacLeanDixie.com	
Major Industries	114	247	www.majorskylights.com	888.759.2678
Martin Fireproofing	95	519	www.martinfireproofing.com/stjohns	800.766.3969
Martin Windows	105	57	www.Marvin.com/commercial	
Marvin Windows and Doors	130	210	www.marvin.com/inspired	800.236.9690
MBCI	18, 27	558, 402	www.mbc.com	877.713.6224
McNichols	124	296	www.mcnichols.com/arci	866.754.5144
MechoShade	73	521	www.mechosystems.com	800.437.6360
Metal Construction Association	141	424	www.insulatedmetalpanels.org	
Metl-Span	71	208	www.metlspan.com	877.585.9969
Mitsubishi Electric	14-15	458	www.mitsubishipro.com	
Modern Fan	91	526	www.modernfan.com	888.588.3267
Modular Arts	102	-	www.modulararts.com	206.788.4210
Mortar Net	65	508	www.MortarNet.com	800.664.6638
NanaWall	34- 35	211	www.nanawall.com	888.868.6643
National Frame Building Association	7	525	www.postframeadvantage.com	
Nichiha	87	380	www.nichiha.com/projectgallery	866.424.4421
Nora	182	266	www.nora.com/us/green39	800.332.NORA
Nudura	132	185	www.nudura.com	
OldCastle BE	2- 3	52	www.oldcastlebe.com	866-OLDCASTLE
P/A Awards	52	-	www.paawards.com	
Pella	C3	396	www.pellacommercial.com/BIM	
PERC	113	268	www.propanetrainingacademy.com	
Petersen	57	470	www.PAC-CLAD.com	800 PAC CLAD
Polyguard	115	568	www.polyguardproducts.com	615.217.6061
PPG Paints	19	431	www.ppgpittsburghpaints.com	
PPG Industries, Inc.	C2-1	290	www.ppg.com	
RAB Lighting	23	571	www.RABLED.com	
Reward Wall System	90	270	www.RewardWalls.com	800.468.6344
Rinnai	135	572	www.rinnai.us	800.621.9419
S-5!	26	489	www.S-5-ColorGuard/arch	888.825.3432
Sage	10- 11	48	www.sageglass.com	877.724.3325
Selux	199	170	www.selux.com/usa	800.735.8627
Sheffield Metals International	126	294	www.sheffieldmetals.com	800.283.5262
Sherwin Williams	67	217	www.swproindustrial.com	800.321.8194
Sika Sarnafil	29	537	www.usa.sarnafil.sika.com	800.451.2504
Simpson Strong-Tie	75	182	www.simpsonstrongtie.com/fasten	800.999.5099
STO Corp	139	179	www.stocorp.com/stoenergyguard	
TechData	104	582	www.autocad2012promotion.com	
Technical Glass Products	4-5	49	www.fireglass.com/hd	800.426.0279
Tile of Spain	68	385	www.tileofspainusa.com	305.446.4387
Traco	85	494	www.traco.com	
USGBC	20	191	www.greenbuildexpo.org	
VT Industries	47	53	www.VTDoors.com	800.827.1615 x512
Wire By Design	120	512	www.wirebydesignco.com	800.773.5700
World of Concrete	232	-	www.worldofconcrete.com	
W.R. Meadows	131	255	www.wrmeadows.com	800.342.5976

→1991 P/A AWARD

VISION OBSTRUCTED

CONSTRUCTION WAS NEVER COMPLETED ON THE “SLOW HOUSE” BY THE THEN-EMERGING TEAM OF DILLER AND SCOFIDIO.

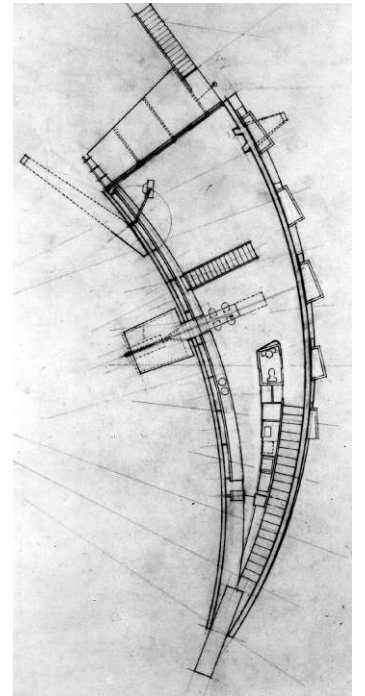
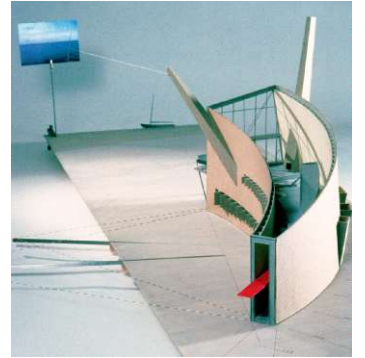
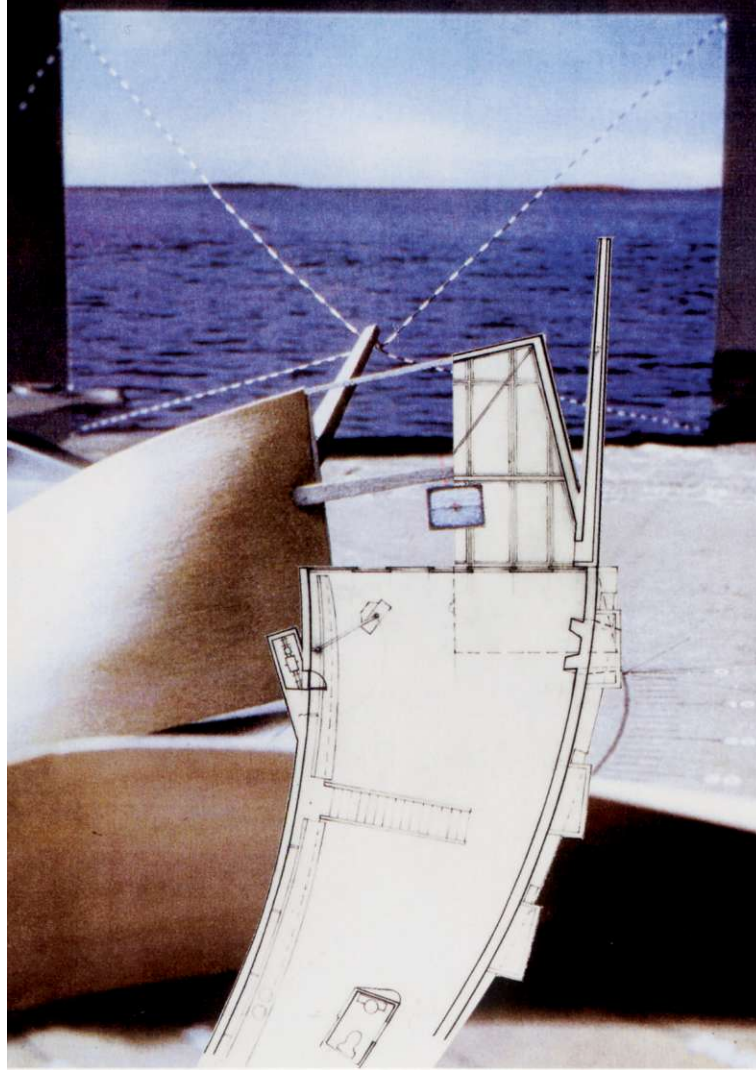

TEXT BY JOHN MORRIS DIXON, FAIA

1991 P/A Awards Jury

Dana Cuff
Ralph Johnson, FAIA
Rem Koolhaas
Eric Kuhne
Dean Macris
Samuel Mockbee
Adele Santos, FAIA
Donald Watson, FAIA

FOR DECADES, the eastern reaches of Long Island, N.Y., had been a spawning ground for architecturally adventurous weekend houses. But none of them displayed the conceptual audacity of the Slow House, intended for a waterfront site in North Haven. What Elizabeth Diller and Ricardo Scofidio, AIA, proposed was essentially a habitable device for examining the site's prized sea view. In simplest terms, say the architects, it was “a passage ... from a door to a window.”

The house had no façade, just a tall narrow portal with a pivoting front door. On entering, one would have a choice of two routes, separated by a knife-edged divider: one curved corridor leading along a line of ground-level bedrooms; the other rising gradually toward a lofty living area facing the water through wall-to-wall glazing.

The experience of the water view was enriched by electronic means: a TV camera mounted on a boom angled up and away from the house could record the vista—panning or zooming as directed—to be shown on a monitor suspended in front of the sea-facing glass. The images could be simultaneous or the video could be deferred, showing summer views in front of a winter vista, or stormy views on clear days.

The exterior envelope, growing wider and higher as interior volumes expanded toward the water, resembled a crawling slug, with the canted chimney and the TV camera arm suggesting its antennae.

We'll never know what the experience of this unique house might have been. Its foundations were poured, but the client was unable to complete its construction. □



**PELLA ADVANTAGE NUMBER 84:
WE'VE ANSWERED THE CALL.**

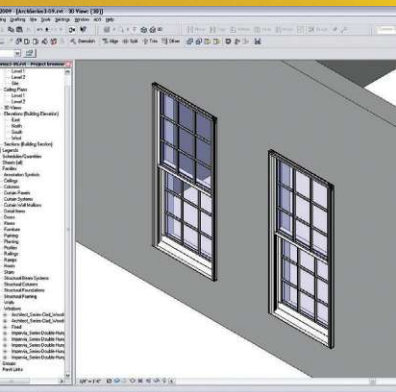

Looking for the ideal windows and doors for your BIM projects? You've found the right match. Pella's Autodesk® Revit® families are now available for use with Revit® Architecture. You can access the Pella® product of your choice right from your Revit® design application by using the Autodesk Seek Web service – then simply drag-and-drop it into your BIM project. The perfect partner dedicated to making your models more accurate and easier to create. That's **The Power Of Yellow.®**

Visit pellacommercial.com/BIM for all your BIM window and door needs.

Pella Revit® families also available at seek.autodesk.com, caddetails.com and sweets.com.



COMMERCIAL

Lutron® — save energy with advanced LED control

NEW Lutron LED control solutions save energy, while improving comfort and productivity.

These solutions offer high performance dimming as low as 1% and guarantee compatibility with dimmable high-efficiency lighting loads.

Hi-lume® A-Series LED Driver

\$89
List Price

- Compatible with a wide range of current and voltage levels for flexible design
- Reliable Lutron continuous dimming from 100% to 1% light level
- Now available for forward-phase control



C•L™ Dimmer with HED™ Technology

- Alleviates typical problems like excessive flicker, shimmer, and lights dropping out at low dimming levels
- Mix and match dimmable LED, dimmable CFL and halogen on the same dimmer



Compatible fixtures

- Testing program publishes dimming performance of driver/fixture/control combination
- Find out more at www.lutron.com/LEDTool5

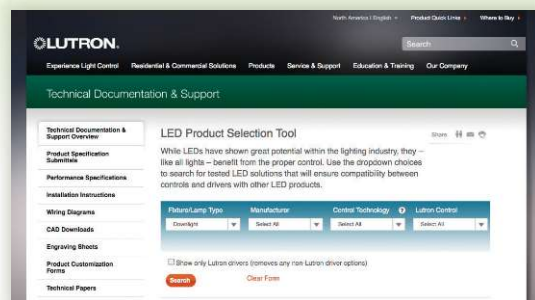

Lutron LED Control Center of Excellence

- Convenient single source for LED control information
- Access compatibility tested information for Lutron controls and third-party LED products

Download “Controlling LEDs”
whitepaper at www.lutron.com/LED5

Visit us at
GREENBUILD
Booth #1631N

To learn more about Hi-lume A-Series LED Drivers, C•L Dimmers, and Lutron LED control technologies, call **1.877.DIM.LED8**, or email **LEDs@lutron.com**.



24/7 Technical Support Center 1.800.523.9466

©2011 Lutron Electronics Co., Inc. | P/N 368-2238 REV A

Circle no. 510 or <http://architect.hotims.com>

