

Feeling Tensile 58 The Strange Science of Color Forecasting 44
Hawthorne on the London Olympics 88 To Market, Online 33

ARCHITECT

THE MAGAZINE OF THE AMERICAN INSTITUTE OF ARCHITECTS

hanley▲wood



INTERIORS



*1000 Connecticut Ave.
Architect: Pei Cobb Freed & Partners
Michael D. Flynn, Partner in charge of
building envelope*

this envelope minimized conflicts

True collaboration delivered. Lots of manufacturers promise an *integrated solution*. Yet when it gets to the first meeting, they all but introduce themselves to members of *their own* team. For more than a decade, we have created fully-integrated building envelope systems. That is why leading architects like Michael Flynn—Partner, Pei Cobb Freed & Partners, and renowned expert on building envelope technologies—rely on us. “Oldcastle partnered with us to engineer and manufacture the building envelope for 1000 Connecticut Ave.,” said Michael Flynn. Call 866-OLDCASTLE (653-2278) to discuss your next building envelope project, or visit us online at oldcastlebc.com.



Say goodbye to coordinating and managing five different suppliers for the building envelope. We engineer, manufacture, manage and supply the glass, window, curtain wall, skylight and storefront systems—all from one source. That means, one set of documents, one point of contact—all on one master schedule.

Origami by Robert Lang.



Oldcastle BuildingEnvelope™

Engineering your creativity™

Circle no. 52 or <http://architect.hotims.com>

 curtain wall

 entrances/storefronts

 windows

 skylights

 glass





Introducing the Andersen® Architectural Collection. Because style matters.

.....
It only takes one little thing to throw off a beautiful design. With the Andersen® Architectural Collection, that simply can't happen. For the first time, you now have windows and patio doors that are based on the style of home you're creating. It's a new way to design, to build and to think. It's a new way to sell, to market and to profit. And it's only from Andersen.
.....

A-Series Windows & Doors

A-Series products are ideal for well-defined architectural styles — whether it's a stately Queen Anne or a bold Modernist design.

Developed with leading architects to ensure authenticity, they feature a system of options that work seamlessly together, plus common sight lines, glass setback, design language, interfaces and size grid for ease in specifying.

E-Series/Eagle® Windows & Doors

E-Series/Eagle® products are made to your specifications for unmatched design freedom.

They provide the ability to create dramatic shapes and sizes, and feature 50 standard exterior colors, custom colors, plus a wide range of interior wood species. We can even source uncommon wood species. If it's possible, it's possible with E-Series/Eagle products.



.....
To learn more about the Architectural Collection, see our video at andersenwindows.com/collection.
.....



Andersen®

See us in a different light.™

CONTENT



88



104



112



98

FEATURE

88

17 Days Later

London officials are leveraging their infrastructure spending on the so-called Neo-Austerity Olympics to help revitalize one of the city's poorest neighborhoods. Will they succeed, and at what cost? CHRISTOPHER HAWTHORNE

DESIGN

98

Studio Mode

Graffiti Café
Varna, Bulgaria

SARA HART

104

Studio O+A

395 Page Mill Road
Palo Alto, Calif.

KATIE GERFEN

112

Studio SUMO

Mizuta Museum of Art
Sakado, Japan

JOHN MORRIS DIXON

→ ONLINE

There's more online at architectmagazine.com:

Q&A with architectural historian Victoria Newhouse about next-generation opera houses and concert halls.

A look at Shigeru Ban's new Camper store in New York.

Blaine Brownell's Mind & Matter blog looks at products and materials in development and on the market.

Aaron Betsky's Beyond Buildings blog comments on how design affects our society and culture.

And there are constant updates: breaking news, new products, slide shows, and more ...

Save energy with NEW Quantum® Select Packages

Cost-effective centralized lighting and energy management

Choose from:



Central Control

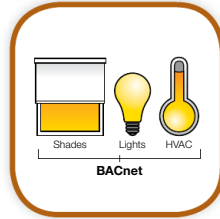

Building System Integration



Hyperion™ Shade Control

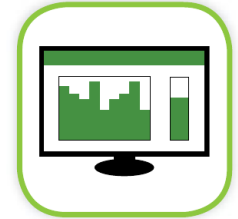

GreenGlance® Display Software

Timeclock	●	●	●	●
Building integration		●		
Solar-adaptive shade control			●	
Energy display and reporting				●
Central control of lights	●	●		●
Central control of shades			●	
Demand response	●	●	●	●
IntelliDemand™ load shed	●	●		●

All Quantum Select packages are Smart Grid Ready and can be upgraded to include:



- occupancy/vacancy sensing
- daylight harvesting
- high-end trim
- personal control

Specify Quantum Select on your next project.

To learn more, visit www.lutron.com/QuantumSelect



©2012 Lutron Electronics Co., Inc. | P/N 368-2537 REV E

Circle no. 510 or <http://architect.hotims.com>



CONTENT



82



44



58

FRONT

12 **Dialogue** Not Old Enough ... plus Letters and Contributors

16 **News** ... plus Numbers and On the Boards

AIARCHITECT

Voices Sun Child
Now Across the Institute
Knowledge Rules of Engagement
Feature Reverse Engineering
Perspective Being There

BUSINESS

33 **Best Practices** Spin the Web
 Advice for how architects can build their business by marketing online. ERNEST BECK

36 **Typology** Getting Centered
 Three new AIA chapter spaces engage professionals, the public, and their cities. MURRYE BERNARD

→ Contact us: Do you have a new project or product that you want to tell us about? Or an idea for a story that you would like to see us cover? Turn to page 126 to find out how to contact us. And check out page 8 for a list of our editorial staff and sales representatives.

44 **Corporate Colors** Color Coding
 Who and what decides which colors are in and out? Research, the economy, the zeitgeist—and the color forecasters who sort anecdotal evidence into market-driven trends. JEFFREY LEE

50 **Local Market** Riverside County, Calif.

TECHNOLOGY

53 **Products** Icons are Forever

56 **IT** Beyond PowerPoint
 Designers explore new and old ways to make client presentations that are memorable and—better yet—successful. BRIAN LIBBY

58 **Continuing Education**
 A History of Tension
 Frei Otto's Olympic Stadium for the 1972 Summer Games intimated a future filled with organic and mind-bending forms. Have tensile fabric structures lived up to their promise? IAN VOLNER

72 **NeoCon Preview** Editor's Choice

76 **Mind & Matter** Paving the Way
 Pavilions represent the future for architecture. BLAINE BROWNELL

CULTURE

79 **Books, Objects, Exhibits & Internet**

82 **Studio Visit** La Dallman
 Grace La and James Dallman, the husband-and-wife duo behind the Milwaukee-based firm La Dallman, talk about when the workday ends, as well as the Midwestern agriculture and industry that informs their work. KRISTON CAPPS AND JASON FULFORD

86 **Beyond Buildings** Light is Might
 Some unexpected consequences of architecture can nevertheless illuminate design. AARON BETSKY

PAST PROGRESSIVES

128 **1954** Urban Renewal Becomes Urban Fabric
 The Back Bay (now Prudential) Center in Boston has all but disappeared behind pedestrian-friendly infill buildings and shopping arcades that add to the life of the city. THOMAS FISHER



SUCCEED

Let me provide a space where you can work, think and collaborate to your full potential. As a CertainTeed ceiling, I offer completely customizable solutions for proper **Environmental Acoustics™**—or a healthier, more productive office space. Now you can Be Certain™ you'll achieve your greatest success, in a sounder working environment.

Explore how Environmental Acoustics can make any office more productive.
www.CertainTeed.com/Ceilings

800-233-8990 • certainteed.com • <http://blog.certainteed.com>

ROOFING • SIDING • TRIM • DECKING • RAILING • FENCE • FOUNDATIONS
GYPSUM • CEILINGS • INSULATION • PIPE

Circle no. 432 or <http://architect.hotims.com>

CertainTeed
SAINT-GOBAIN
Ceilings

ARCHITECT

THE MAGAZINE OF THE AMERICAN INSTITUTE OF ARCHITECTS

EDITOR-IN-CHIEF
Ned Cramer, Assoc. AIA
ncramer@hanleywood.com

MANAGING EDITOR
Greig O'Brien
gobrien@hanleywood.com

SENIOR ART DIRECTOR
Aubrey Altmann
altmann@hanleywood.com

DESIGN AND TECHNOLOGY

SENIOR EDITOR, DESIGN
Katie Gerfen
kgerfen@hanleywood.com

ASSOCIATE EDITOR, TECHNOLOGY
Wanda Lau
wlau@hanleywood.com

ASSISTANT EDITOR, DESIGN
Deane Madsen, Assoc. AIA
dmadsen@hanleywood.com

COPY AND RESEARCH

ASSISTANT MANAGING EDITOR
Lindsey M. Roberts
lmroberts@hanleywood.com

COPY EDITOR
Jessica Garratt

FEATURES AND BUSINESS

SENIOR EDITOR,
FEATURES AND RESEARCH
Eric Wills
ewills@hanleywood.com

SENIOR EDITOR
Jeffrey Lee
jlee@hanleywood.com

ASSOCIATE EDITOR,
DEPARTMENTS
Kriston Capps
kcapps@hanleywood.com

ASSISTANT EDITOR, NEWS
Alexandra Rice
arice@hanleywood.com

ART

ASSOCIATE ART DIRECTOR
Marcy Ryan
mryan@hanleywood.com

GRAPHIC DESIGNER
Michael Todaro
mtodaro@hanleywood.com

DESIGN INTERN
Maggie Goldstone

SENIOR WEB PRODUCER
Amy Wiersum
awiersum@hanleywood.com

CONTRIBUTING EDITORS

Ernest Beck; Aaron Betsky; Blaine Brownell, AIA;
Elizabeth Evitts Dickinson; John Morris Dixon, FAIA;
Thomas Fisher, Assoc. AIA; Joseph Giovannini;
Cathy Lang Ho; Margot Carmichael Lester;
Vernon Mays

CONTRIBUTING ARTISTS

Ian Allen, Peter Arkle, Catalogtree,
Jason Fulford, Noah Kalina

EDITORIAL ADVISORY COMMITTEE

Fredric M. Bell, FAIA; Renee Cheng, AIA; Ned Cramer, Assoc. AIA; Yolande Daniels, Assoc. AIA; Sarah Dunn;
Andrew Freear; George H. Miller, FAIA; Randy Peterson, FAIA; James Timberlake, FAIA

COMMERCIAL DESIGN AND CONSTRUCTION

GROUP PRESIDENT
Patrick J. Carroll

pcarroll@hanleywood.com 773.824.2411

GROUP PUBLISHER, COMMERCIAL DESIGN
Dan Colunio
dcolunio@hanleywood.com 202.736.3310

EDITORIAL DIRECTOR, COMMERCIAL DESIGN
Ned Cramer, Assoc. AIA
ncramer@hanleywood.com

ADVERTISING

REGIONAL SALES MANAGER,
EAST, TX, OK, AR, LA
Michael Lesko
mlesko@hanleywood.com
203.445.1484

REGIONAL SALES MANAGER,
MID-ATLANTIC, MI
Nick Hayman
nhayman@hanleywood.com
202.736.3457

REGIONAL SALES MANAGER,
WEST
Mark Weinstein
mweinstein@hanleywood.com
562.598.5650

REGIONAL SALES MANAGER,
MIDWEST
Michael Gilbert
mgilbert@hanleywood.com
773.824.2435

NATIONAL ADVERTISING
MANAGER, LIGHTING
Cliff Smith
csmith@hanleywood.com
864.642.9598

REGIONAL SALES MANAGER,
NEW ENGLAND, GA, FL,
IN, OH, MS, AL
Chris Platt
cplatt@hanleywood.com
202.736.3465

E-MEDIA SALES MANAGER
Adam Mowrey
amowrey@hanleywood.com
724.612.9319

REGIONAL SALES MANAGER,
CANADA
D. John Magner
jmagner@yorkmedia.net
416.598.0101, ext. 220

ACCOUNT MANAGER, CANADA
Colleen T. Curran
ctcurran@yorkmedia.net
416.598.0101, ext. 230

REGIONAL SALES MANAGER,
CHINA, HONG KONG, TAIWAN
Judy Wang
judywang2000@yahoo.cn
0086.10.64639193

REGIONAL SALES MANAGER,
UNITED KINGDOM, EUROPE
Stuart Smith
stuart.smith@ssm.co.uk
44.020.8464.5577

GROUP PUBLISHING
SUPPORT MANAGER
Angie Harris
aharris@hanleywood.com
773.824.2415

PRODUCTION

PRODUCTION MANAGER
Paige Hirsch

AD TRAFFIC MANAGER
Pam Fischer

INSIDE SALES
AD TRAFFIC MANAGER
Annie Clark



Cleo™ Mobile Magnetic Markerglass
by Kaiju Studios

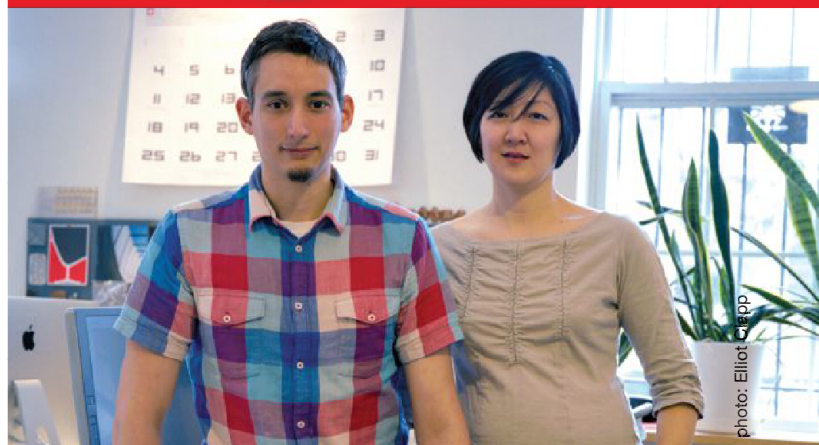

photo: Elliot Chapp

S | Skyline Design

Get creative anywhere.
Preview at NeoCon Booth 8-6106

Made in Chicago / skydesign.com / 888-278-4660

Circle no. 579 or <http://architect.hotims.com>

EDITORIAL AND ADVERTISING OFFICES
One Thomas Circle, NW, Suite 600, Washington, DC
20005. Phone: 202.452.0800. Fax: 202.785.1974.

Copyright 2012 by Hanley Wood, LLC. Reproduction
in whole or in part prohibited without written
authorization. All rights reserved. Printed in the USA.

The
Clear
Solution

JUST GOT CLEARER

SuperLite II-XL™ with



WWW.SAFTI.COM 888.653.3333



Circle no. 515 or <http://architect.hotims.com>

The Best Pavements Are Invisible



Grasspave²



For 30 years, Invisible Structures has been manufacturing Grasspave2 - the premiere grass porous paver. Use Grasspave2 for "invisible" fire lanes, parking lots, access roads, trails, road shoulders, swale/berm reinforcement, and more.

invisiblestructures.com | 800-233-1510

Circle no. 400 or <http://architect.hotims.com>

ARCHITECT

THE MAGAZINE OF THE AMERICAN INSTITUTE OF ARCHITECTS

HANLEY WOOD

CHAIRMAN
Frank Anton

CHIEF EXECUTIVE OFFICER
Peter Goldstone

CHIEF FINANCIAL OFFICER
Matthew Flynn

SENIOR VICE PRESIDENT,
CORPORATE SALES
Paul Tourbaf

VICE PRESIDENT, FINANCE
Shawn Edwards

VICE PRESIDENT,
GENERAL COUNSEL
Mike Bender

VICE PRESIDENT, FINANCIAL
PLANNING & ANALYSIS
Ron Kraft

HANLEY WOOD BUSINESS MEDIA

PRESIDENT, CONTENT Bob Benz	PRESIDENT, MARKET INTELLIGENCE/ E-MEDIA Andrew Reid	PRESIDENT, EXHIBITIONS Rick McConnell
VICE PRESIDENT, MARKETING Sheila Harris	VICE PRESIDENT, CIRCULATION AND DATABASE DEVELOPMENT Nick Cavnar	VICE PRESIDENT, PRODUCTION Nick Elsener
VICE PRESIDENT, NETWORK ACCOUNTS Jennifer Pearce	SENIOR DIRECTOR, HUMAN RESOURCES Curtis Hine	DIRECTOR, PRODUCTION AND PRODUCTION TECHNOLOGIES Cathy Underwood
BUSINESS LIAISON John Crosby	DIRECTOR, EVENT MARKETING Mike Bendickson	PREPRESS MANAGER Fred Weisskopf
GENERAL MANAGER, ONLINE Kim Heneghan	EVENT PLANNER Kristina Kartholl	PREPRESS COORDINATOR Betty Kerwin
ASSOCIATE INTERACTIVE DESIGN DIRECTOR Thomas C. Scala		DIRECTOR, INSIDE SALES Janet Allen



THE AMERICAN INSTITUTE OF ARCHITECTS

2012 BOARD OF DIRECTORS

OFFICERS: Jeffery Potter, FAIA, President; Mickey Jacob, FAIA, First Vice President/President-elect; Dennis A. Andrejko, FAIA, Vice President; Russell A. Davidson, FAIA, Vice President; Debra S. Kunce, FAIA, Vice President; John A. Padilla, AIA, Vice President; Helene Combs Dreiling, FAIA, Secretary; Gabriel Durand-Hollis, FAIA, Treasurer; William R. Turner Jr., Assoc. AIA, Senior Associate Director; Michael Waldinger, Hon. AIA, CACE Representative to the Executive Committee; Robert A. Ivy, FAIA, EVP/Chief Executive Officer.

DIRECTORS: T. Gregory Ames Jr., AIA; William J. Bates, AIA; William J. Carpenter, PhD, FAIA; Susan Chin, FAIA; Ashley W. Clark, Assoc. AIA, LEED AP; Stuart L. Coppedge, AIA; Mary P. Cox, FAIA, LEED AP; Thomas R. Cox, AIA, LEED AP; Nicholas Docous, AIA, LEED AP; Jerome L. Eben, AIA; Mohamad Farzan, AIA, RIBA; Kevin J. Flynn, FAIA, IES; John P. Grounds, AIA, LEED AP; Steve Jernigan, FAIA, LEED AP BD+C; Thad R. Kelly III, AIA; Gregory A. Kessler, AIA; Glen S. LeRoy, FAIA; Vivien Li; Vicki Long, CAE; Michael Malinowski, AIA; Nick Mancusi, Assoc. AIA; Christopher Morrison, AIA, LEED AP; John V. Nyfefer, FAIA, LEED AP; Wendy Ornelas, FAIA; Francis Murdock Pitts, FAIA, FACHA, OAA; Beverly J. Prior, FAIA, LEED AP; Larry C. Quenette, AIA; James Easton Rains, Jr., FAIA; Elizabeth Chu Richter, FAIA; Anthony P. Schirripa, FAIA, IIDA; Charles L. Schreckenberger, AIA; William D. Seider, AIA; Steven Spurlock, FAIA, LEED AP; J. Cyril Stewart, AIA; Walter D. Street III, AIA; Mark G. Swenson, FAIA, LEED AP; Martha R. Tarrant, AIA, LEED AP BD+C; Edward A. Vance, AIA; Thomas V. Vornier, FAIA; Bill T. Wilson II, FAIA; Donald T. Yoshino, FAIA; David Zach.

NATIONAL STAFF

EXECUTIVE TEAM: Robert A. Ivy, FAIA, EVP/Chief Executive Officer; Richard James, Chief Operating Officer; Kathron Compton, Vice President, Marketing & Communications; Lisa Green, Vice President, Finance and Accounting; Susan McDaid, Hon. AIA, Vice President, Member & Component Resources; Paul T. Mendelsohn, Vice President, Government and Community Relations; Kevin Novak, Vice President, New Business Development and Digital Strategies; Ken L. Ross Jr., FAIA, Vice President, Design and Practice; Jay A. Stephens, Esq., Vice President and General Counsel.

MANAGEMENT TEAM: Marlene Bohn, SPHR, GPHR, Managing Director, Human Resources; Paula Clements, Hon. TSA, CAE, Managing Director, Component Resources and Collaboration; Kenneth Cobleigh, Esq., Managing Director & Counsel, Contract Documents Content; Pam Day, Hon. AIA, Corporate Secretary & Managing Director, Governance Administration; Andrew Goldberg, Assoc. AIA, Managing Director, Government Relations & Outreach; Christopher Gribbs, Assoc. AIA, Managing Director, Convention; Maan Hashem, PMP, CAE, Managing Director, Software & Products Services; Suzanna Wight Kelley, AIA, LEED AP BD+C, Managing Director, Organizational Strategy & Alliances; Molly Lindblom, Managing Director, Contract Documents Operations; Kyle McAdams, AIA, Managing Director, Marketing & Business Development; Philip O'Neal, Managing Director, Information Technology; Jeffrey Raymond, Managing Director, New Business Development Technology; Cedric Rush, Managing Director, Member Resources; Phil Simon, CAE, Managing Director, Communications and Publishing; Carolyn Snowbarger, Managing Director, Professional Development & Resources; Terri Stewart, CAE, Managing Director, Practice & Knowledge Resources.

hanleywood



BPA
BUSINESS PRACTICE ASSOCIATION



CHECK OUT OUR
EXCITING LINE OF
COLORS+TEXTURES

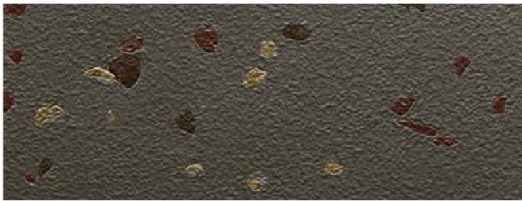
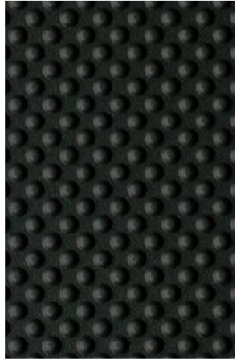
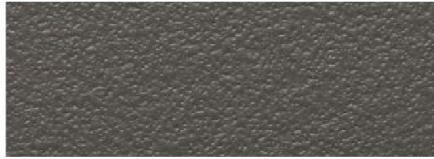

Just as there is no limit to the durability of our bathroom partitions, you'll find there are no limits to your style choices either. From versatile colors to distinctive textures, we have a wide array of unique solutions to fit any decor. All low maintenance and guaranteed to stand the test of time. Find out more at scrantonproducts.com.

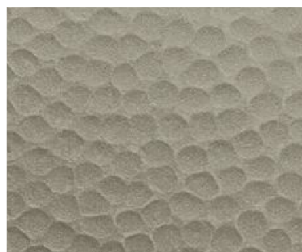
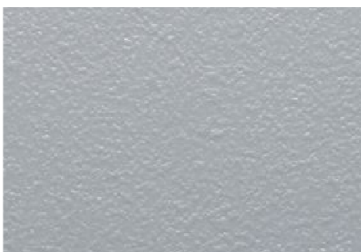

Circle no. 466 or <http://architect.hotims.com>



COULD A BUILDING—OR A WHOLE STYLE—PROVE SO REPREHENSIBLE, SO REPULSIVE, THAT IT CAN NEVER GAIN A FAIR PLACE IN THE HEARTS AND MINDS OF MEN?

NOT OLD ENOUGH

ONE OF THE ALL-TIME SMARTEST commentaries about architecture comes in the form of a quip from John Huston, playing the amoral Noah Cross in the 1974 film *Chinatown*: “Politicians, ugly buildings, and whores all get respectable if they last long enough.” Unfortunately, several buildings, by some of America’s most important late-modern architects, may not last so long.

In Chicago, Northwestern Memorial is keen to demolish Bertrand Goldberg’s Prentice Women’s Hospital (1974) and replace it with a purpose-built lab. In Baltimore, a developer wants to tear down John Johansen’s Morris A. Mechanic Theatre (1967) and build two residential towers in its place. In Washington, D.C., a mayor’s agent overturned the landmark designation of the Third Church of Christ, Scientist (1970), designed by Araldo Cossutta while working for I.M. Pei. In Goshen, N.Y., county officials have shuttered the three-building Orange County Government Center (1967), designed by Paul Rudolph. And in Minneapolis, the city council has commissioned a scheme to replace M. Paul Friedberg’s Peavey Plaza (1973).

In each case, preservationists are rallying. The National Trust for Historic Preservation placed Prentice on its 2011 list of most-endangered historic places. The World Monuments Fund included the Orange County Government Center on its 2012 watch list. But to what end? Several of the cases expose the toothlessness of many municipal preservation ordinances. For instance, Baltimore’s Commission for Historical and Architectural Preservation (CHAP) recently recommended landmark status for the Mechanic, but the theater’s fate ultimately resides with the city council, which can choose to ignore the recommendation.

Larry Gibson, a lawyer and CHAP member, supported the majority in requesting landmark status from the mayor and city council for the Mechanic. But his vote didn’t reflect his personal feelings on the matter. “I was always convinced it was a bad idea, that building,” Gibson has said, according to the online news site *Baltimore Brew*. “Last month I turned 70 years old, and I’m having a little trouble regarding something built in the 1960s as historic.” He’s not alone.

The pendulum of popular taste has not yet swung back in Brutalism’s favor, despite a growing appreciation for the style among architects and designers and the rise of an international organization dedicated to preserving modern architecture: DoCoMoMo (the name being a combination of “documentation,” “conservation,” “modern,” and “movement.”)

There’s an increasing amount of love out there for slim-lined *Mad Men* Modernism—SOM’s Lever House (1952), for instance. Brutalist buildings are harder to love. They just haven’t been around as long; they’re less familiar. “Bunker” is an analogy one hears frequently.

Who wants to hug Boston City Hall (1968)? Who,

that is, other than an architect? All in all, it’s a bad time to be a Brutalist building, especially one that has outlived its purpose, been subject to deferred maintenance, or proven expensive to adaptively reuse.

The term “Brutalism,” to the degree that the public is familiar with it, unfortunately reinforces the negative, *Clockwork Orange*-esque associations that have grown up around the style: urban blight, chronic unemployment, oppressive institutions, and class and racial tension. Never mind the true etymological origins of the term: *béton brut*, which is what Le Corbusier called the innovative and expressive “raw concrete” of his postwar buildings. It’s hard to imagine now, but Brutalism was synonymous with progress and social reform back in the day.

In Noah Cross’s worldview, age is a panacea for the conniving, hideous, and whorish. Could a building—or a whole style—prove so reprehensible, so repulsive, that it can never gain a fair place in the hearts and minds of men? The Orange County council has rejected a measure to demolish the Rudolph facility and build a replacement (for \$114 million). Maybe the vote is a sign that Brutalism can be redeemed, a sign that the powers-that-be and the broader public have awakened to the value of *béton brut*. Alas, the margin of victory in Goshen was a slim 11 to 10, and the futures of Prentice, the Mechanic, et al. remain uncertain.

But there’s no need to lose hope. Victorian-era architecture was almost universally despised in 1931—the year that Lewis Mumford published his landmark apologia *The Brown Decades: A Study of the Arts in America, 1865–1895*. And it took decades more to promote Queen Anne gingerbread houses and Romanesque Revival libraries from eyesores to classics. The architecture of the period even has its own martyr, Richard Nickel, who liked to rescue decorative fragments from 19th-century buildings being demolished. The preservationist died in 1972 when, while climbing through Louis Sullivan’s ruinous Chicago Stock Exchange, part of the building collapsed on top of him. Let’s just hope that some enterprising member of DoCoMoMo doesn’t do anything rash in an effort to save Peavey Plaza. And let’s pray that public opinion awakens to the notion that Brutalism can be beautiful—respectable, even.

Reed Crumriddle

UNEXPECTED ANGLE



Expanding design possibilities while
shrinking their impact on the environment.

The Appaloosa Branch Library in Scottsdale, Arizona is not just a LEED Gold-certified building, it's also a stunning example of how PPG's building products are helping to change the face of modern architecture. To enhance the beauty of the exterior and reduce cooling costs, the library's architect used PPG Duranar® VARI-Cool™ coatings, which reflect the sun's energy and dramatically shift color according to viewing angle. Our Solarban® 60 Atlantica™ low-e glass allowed him to incorporate vast areas of emerald-green glass while reducing the size of the library's HVAC system and its energy bills. These are just two from the wide array of innovative glass, metal coatings, and full line of architectural coating choices you'll find through PPG IdeaScapes™. From building materials to consumer products, automotive to aerospace, marine and protective industrial coatings, we're bringing innovation to the surface. Visit ppg.com to learn more.



PPG Industries

Bringing innovation to the surface.™

PAINTS - COATINGS - OPTICAL PRODUCTS - SILICAS - CHEMICALS - GLASS - FIBER GLASS

"Bringing innovation to the surface." is a trademark of PPG Industries Ohio, Inc.

Circle no. 291 or <http://architect.hotims.com>

LETTERS

STARBUCKS COFFEE AT DAZAIFUTENMANGU, May 2012

Good writing, but I wonder how an architect could design something so impractical? Wonder why Starbucks would allow it. This is a place to eat and drink and needs to be clean. How do you expect that all that wood will be dusted? *Ron Ribaud, Milburn, N.J.*

@architectmag.com

Below are tweets with fun facts and highlights from the AIA 2012 National Convention in May.

AIA CE program gave great insights on creating lean practice. Number 1: Limit overproduction. Don't draw too much @AIANatlConv #AIA2012 *Deb Kunce @DebKunce*

Favorite #aia2012 quote: At keynote, author David McCullough said "history is an antidote to the hubris of the present." #NAC Clair Wholean, AIA@AIANJRAD

Best thing about convention is all the ridiculous eyeglasses people have on. *Curtis Clay @CC_Architect*

Student came to AIA convention, networked, and hired. No joke! pic.twitter.com/t6eRFj6S *Robert Ivy @robertivy*

"As architects, we have the skills + training to contribute. As professionals, we have the obligation to engage." *StephenDavisFAIA #AIA2012 Dan Kirby @dankirbyfl*

78% of U.S. architecture students/grads wish to work abroad b/c they perceive more work available outside U.S. #ChapterChat #AIA2012 *USGBC @usgbc*

Comparing Ground Zero to reconstruction of ancient Athens. *Calatrava #aia2012 David Stutzman @dstutzman*

Actions that retain amazing women in architecture: recognize contributions, challenge, work flex, mentor #aia2012 #oso <http://twitpic.com/9msldx> *Sarah L. Markley @DesignSMartly*

"True Architects build for others." Steve Ayers, the Architect of the Capitol #aia2012 General Session *archaerie @archaerie*

If you are back home wishing for more #AIA2012, you can plan the open source office #OSO via the @Mind_mixer site: aia.mindmixer.com *Architects BNIM @BNIM*

→ Want to join the conversation? To write a letter to the editor, email editor-in-chief Ned Cramer at ncramer@hanleywood.com. Or go to architectmagazine.com, where you can add your thoughts in a comment at the end of each story. All letters and comments may be edited for length, content, grammar, and style.

CASCADE COIL DRAPERY
 Manufacturers of woven wire fabrics for partitions, window treatments, GuardianCoil blast mitigation screening, and other ornamental metal applications.

Impulse
 Northern Quest Resort and Casino
 Airway Heights, Washington

www.cascadecoil.com | 800-999-2645

Contributors



Margot Carmichael Lester

Margot Carmichael Lester grew up in a midcentury modern home designed by her father. She wanted to design houses, too, but in her seventh grade drafting class, she realized there was a lot more to it than just drawing nice pictures—so she went with words instead. After graduating from the University of North Carolina at Chapel Hill with a degree in journalism, she held jobs in health insurance and higher education before striking out on her own as a freelance journalist in 1993.

Since then, she's covered business and commercial real estate for publications such as *Los Angeles Business Journal* and *Playboy*. In addition to her work for ARCHITECT and its sister publication *Multifamily Executive*, she also writes about making movies for the International Cinematographers Guild and pens a romance-advice column for Match.com. Margot lives and works in her hometown of Carrboro, N.C., with her husband, Steve, and their two dogs, Mookie and Marvin.

→ See Margot Carmichael Lester's entry on market conditions in Riverside, Calif., on page 50.

Premium Access Solutions & Services

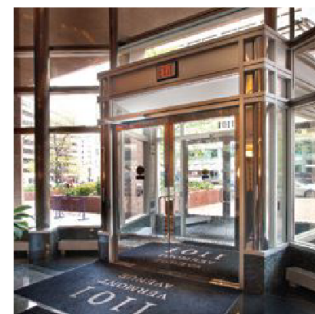
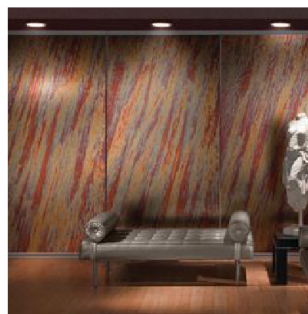
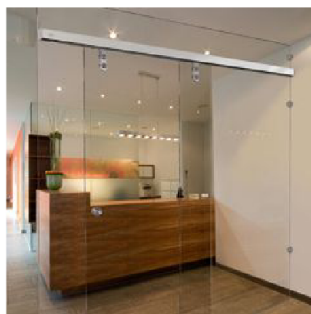
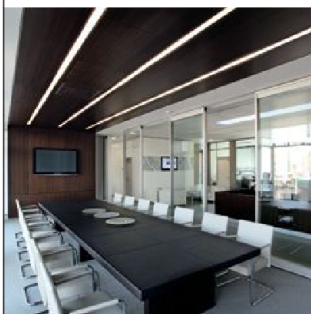

DORMA Americas is a leading global manufacturer of premium access solutions that enable better buildings. Our full range of products and services provides safety and security as well as convenience and comfort. DORMA features a design-oriented portfolio of architectural door hardware, specialty hardware for glass door and wall applications, electronic access control, door automation systems including Crane Revolving Doors, and operable wall systems featuring Modernfold.



Visit us at www.dorma-usa.com, or call our Architectural Support Desk at 866.401.6063

Top Stories → For these stories and more, see architectmagazine.com.

NEWSWIRE

EDITED BY KRISTON CAPPS



Cornell picks Morphosis for Roosevelt Island

The Los Angeles–based firm will design a new high-tech research firm for Cornell University on Roosevelt Island—a high-profile (and high-stakes) commission that aims to connect the island to the rest of New York City.



OMA to design performing arts institute

The newly commissioned Marina Abramović Institute for the Preservation of Performance Art will replace a former theater in upstate New York with a performance venue that will also feature performance-art archives, lectures, and more.



Will One World Trade Center be the tallest?

Critics have questioned whether One World Trade Center, which will rise to a patriotic 1,776 feet, will be the nation's tallest skyscraper—as the antennas that make up the top 300 feet will not be enclosed in a spire due to design changes.

Brutalist Theater in Baltimore Faces Demolition



The 1967 **Morris A. Mechanic Theatre** in downtown Baltimore, designed by Harvard Five architect John M. Johansen, FAIA, may be razed and replaced with two 30-story apartment towers. The development firm that owns the theater—which has been shuttered since 2004—recently filed a demolition permit, and the city's Downtown Partnership, an economic-development group, backs its effort to tear down the structure.

Local opinion is divided on the appeal of its sculptural, cast-concrete form, but the building's architectural significance was affirmed in 2007, when the city's Commission for Historical and Architectural Preservation

(CHAP) voted to place it on its "Special List" and to make it a landmark.

But the theater was not in fact landmarked. A redevelopment proposal put forward in 2008 would have preserved 80 to 90 percent of the building's shell. Satisfied with this measure, the city's planning commission took the unusual step of voting against landmarking—counter to CHAP's recommendation.

AIA Baltimore, AIA Maryland, and the preservation group Baltimore Heritage have rallied to save the Mechanic, which brought touring shows to Baltimore through the 1970s and beyond. On May 8, CHAP met and decided to re-initiate the landmarking process. The landmarking designation must be approved by the planning commission and then by the city council.

The Mechanic is one of two Johansen theaters that are currently in jeopardy. The other, the Mummern Theater in Oklahoma City, was damaged in a flood two years ago. The theater is now the subject of an ownership dispute between two organizations. **AMANDA KOLSON HURLEY**

SCAD Hires Greg Hall To Chair Architecture Program

The Savannah College of Art and Design (SCAD) has hired Greg Hall, AIA, to serve as the chair of its architecture program. The Paris Prize–winning architect has taught at the University of Texas at Austin and the University of Hong Kong as well as SCAD, where he taught architecture for three years.

Hall comes to SCAD from the National Council of Architectural Registration Boards, where he served as the director for education for five years. He has worked with such architects as Jean Nouvel, Hon. FAIA, and Renzo Piano, Hon. FAIA. Hall has taught design, construction technology, and other courses for students pursuing degrees in a variety of programs.

Hall has a bachelor's degree in architecture from the University of Texas at Austin and pursued a Ph.D. in architecture at the University of Hong Kong.

KRISTON CAPPS



Defiantly different carpet? Naturally.

MAKE YOUR DESIGNS STAND OUT with the newest, most innovative carpet fiber in over 20 years — DuPont™ Sorona®. And you don't have to sacrifice performance or your commitment to the planet.

OUTSTANDING PERFORMANCE: Resilience and crush resistance that withstand the test of time. Permanent natural stain, fade and bleach resistance keeps carpet clean and beautiful.

RENEWABLY SOURCED INGREDIENTS: Reduces dependence on oil and petrochemicals by using renewably sourced ingredients.* Saves energy and reduces greenhouse gas emissions over nylon.**

Carpet with DuPont™ Sorona® contributes to LEED® points and lets you rock the design world. To learn more, visit sorona.dupont.com or call 1-866-4-Sorona.



Sorona.
renewably sourced fiber

*Sorona contains 37% annually renewable plant-based ingredients by weight. **Based on peer-reviewed ISO Life Cycle Analysis. © 2011 DuPont. All rights reserved. The DuPont Oval Logo, DuPont™, and Sorona® are registered trademarks or trademarks of E. I. du Pont de Nemours and Company or its affiliates. LEED® is a registered trademark of the U.S. Green Building Council.

Circle no. 195 or <http://architect.hotims.com>

42%

PROJECTED OBESITY PREVALENCE AMONG U.S. ADULTS BY 2030
SOURCE: LOS ANGELES TIMES

36%

OBESITY PREVALENCE AMONG U.S. ADULTS TODAY
SOURCE: LOS ANGELES TIMES

130%

INCREASE IN SEVERE OBESITY PREVALENCE AMONG U.S. ADULTS BY 2030
SOURCE: LOS ANGELES TIMES

\$550 billion

OBESITY-RELATED HEALTHCARE COSTS OVER THE NEXT TWO DECADES
SOURCE: LOS ANGELES TIMES

12.5 million

NUMBER OF OBESE CHILDREN IN THE U.S. TODAY
SOURCE: LOS ANGELES TIMES

+1,000 calories

CHANGE IN AVERAGE WEEKLY CALORIC CONSUMPTION BY U.S. ADULTS OVER 1985
SOURCE: THE FATTENING OF AMERICA BY ERIC FINKELSTEIN

70 minutes

JOGGING TIME REQUIRED TO BURN 700 CALORIES
SOURCE: THE NEW YORK TIMES

→ NUMBERS

Growing Pains

THE RECESSION MAY HAVE CURBED THE ACCELERATION OF OBESITY, BUT IT'S STILL A BIG PROBLEM.

TEXT BY KRISTON CAPPS
ILLUSTRATION BY MCKIBILLO

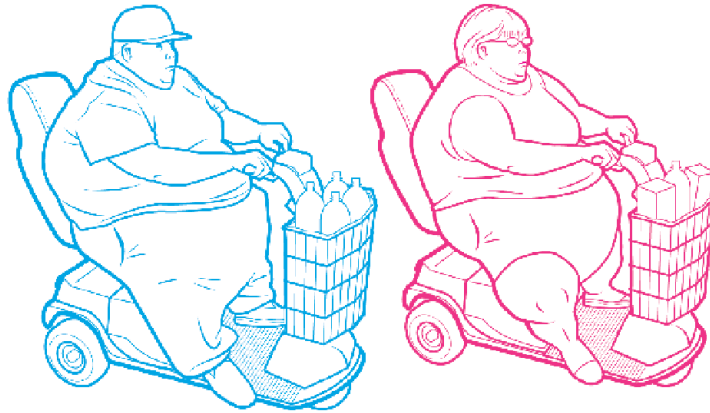

WE ARE DOOMED! The numbers are in, and as large as Americans are these days, they're not done growing. Some 36 percent of American adults are considered obese. At a recent convention held by the U.S. Centers for Disease Control and Prevention, Duke University health economist Eric Finkelstein said that this figure is rising: Obesity prevalence among American adults is projected to rise to 42 percent by 2030.

Finkelstein's numbers are based on findings collected from 1990 through 2008 as part of the Behavioral Risk Factor Surveillance System. There is some good news: Obesity-prevalence trends have slowed. Were the trends over the last 30 years still holding today, then by 2030 more than half (51 percent) of American adults would be obese. And then there's the very bad news: The prevalence of severe obesity among adults will likely rise 130 percent by 2030.

What's the problem? Carson Chow, a mathematician and investigator at the National Institute of Diabetes and Digestive and Kidney Diseases, told *The New York Times* that applied mathematics can render answers about the obesity epidemic much faster than clinical studies. His model shows that changes in agricultural policy and technology have made available more than 1,000 extra calories for the average American every day.

What can designers do about it? Chow says that it takes three years for a dieter to reach a new equilibrium (doomed!). But through evidence-based design and other strategies, architects and planners can build toward change. In May, AIA New York held its annual Fit City conference to discuss ways that design can promote physical activity. Curbing the obesity epidemic may be slow work, but architects can make changes that last. □

BILLINGS AND INQUIRIES INDEXES

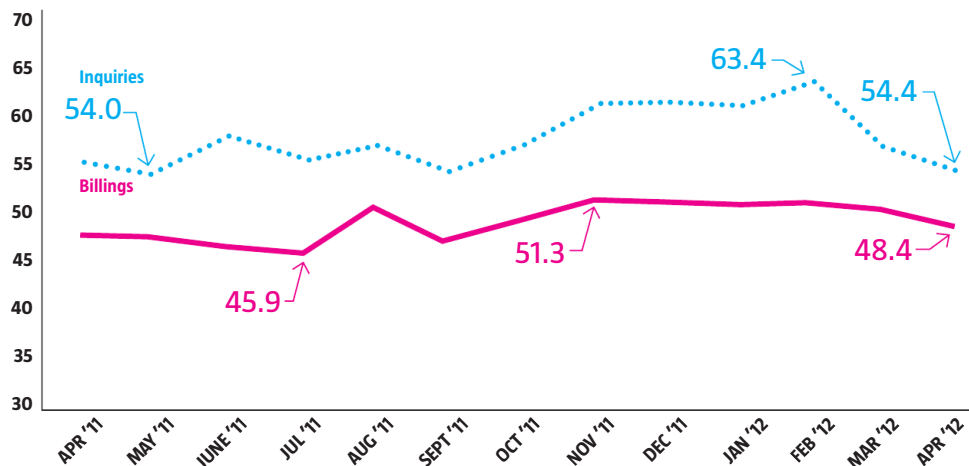

APRIL 2012 ARCHITECTURE BILLINGS INDEX

↓ 48.4

- ↓ 53.8 commercial
- ↓ 46.6 institutional
- ↓ 45.0 mixed practice
- ↓ 50.5 multifamily residential

SOURCE: AIA

How Mesh Happens.

Architects often ask about our process – how we help them get from their bold new concept to a finished job.

Here's how.

We make it easy. By engaging our in-house design assistance and engineering team and the most experienced and skilled installers in the world. And you can relax, assured there are no hidden costs or last minute surprises.

Simple as that. And it's also why architects often say working with Cambridge is the most satisfying part of a job.

Project: National
World War II Museum

Location: New Orleans, LA

Architect: Voorsanger Mathes,
L.L.C. Venture,
New York, NY, New Orleans, LA



CAMBRIDGEARCHITECTURAL.COM



MADE IN THE U.S.A.

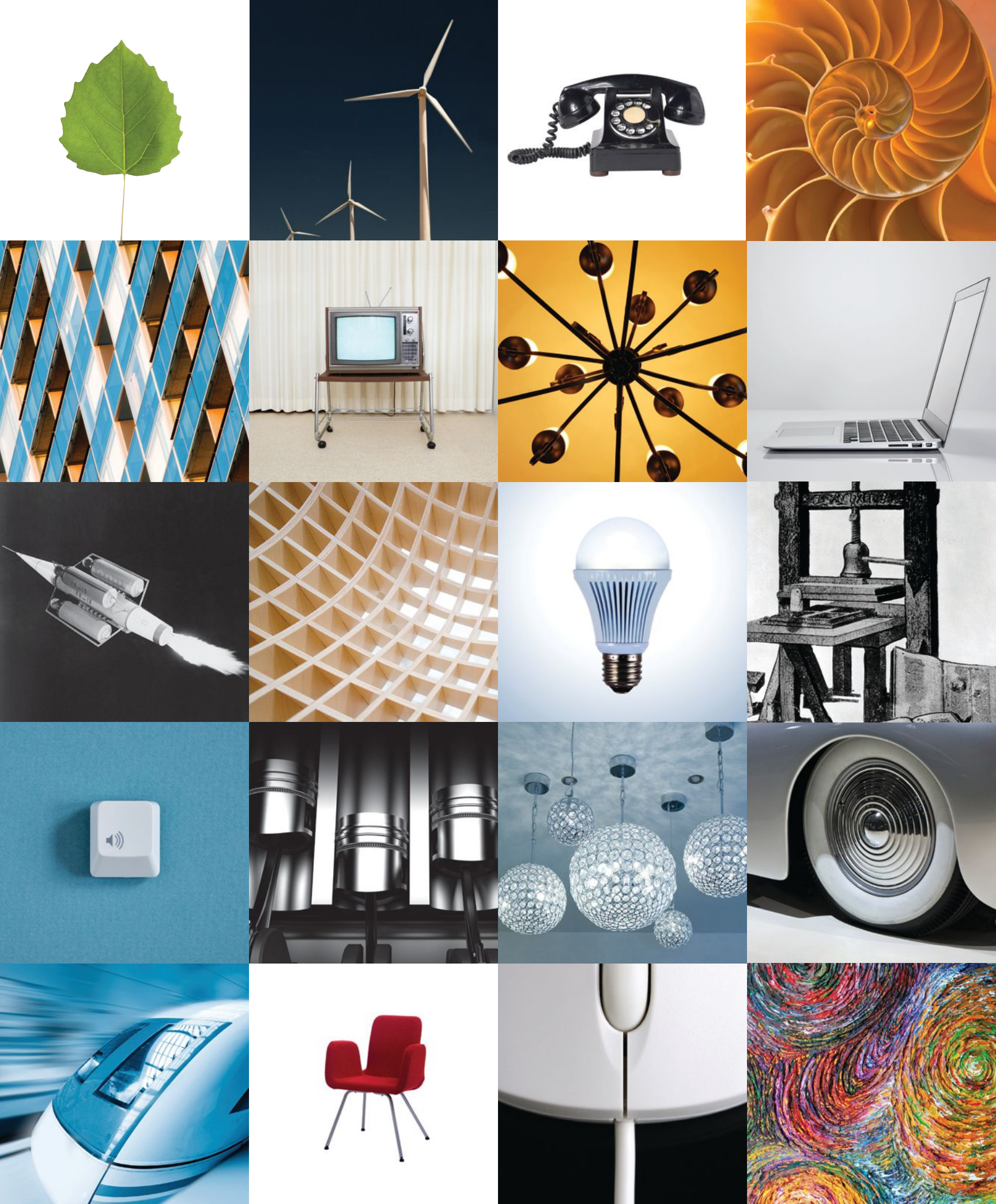



RE:definedTM



At Mitsubishi Electric, we know new technologies and new ideas have driven huge improvements in our lives. Now, we are transforming HVAC with advanced VRF zoning solutions that merge energy savings, simplified design and lower lifecycle costs to totally *redefine efficiency*. To learn more, visit mitsubishipro.com/redefined.



COOLING & HEATING
Live Better

AMERICA'S #1 SELLING BRAND OF VRF TECHNOLOGY

Circle no. 458 or <http://architect.hotims.com>



On the Boards

TEXT BY DEANE MADSEN, ASSOC. AIA



China Southern Airport City

WOODS BAGOT

Woods Bagot recently won a competition held by China Southern Airlines (CSA) to design their new global headquarters in Guangzhou, China. Teaming with Hargreaves Associates and Sherwood Engineers, Woods Bagot developed a proposal that focuses on drawing water and landscape through the site to unify the different precincts included in the program. The 41-million-square-foot master plan includes an industrial zone dedicated to CSA's aviation maintenance, residential areas, a university with adjacent housing, and an executive park overlooking a man-made lake at the heart of the new metropolis. With a project of this scale, it was important both to the designers and the client that the sustainable aspects of the design, such as new freshwater wetlands and restoration zones, become deeply embedded in its identity. "Flying over Beijing, you can read the concentric rings of the city," says Richard Marshall, joint CEO and director of urban design at Woods Bagot. And in an effort to create a similar readability for Guangzhou, the design team seized on the opportunity to capitalize on the city's position directly beneath the flight path to Guangzhou airport. "Flying across the site on approach, you'd see the site from the air with a clearly identifiable image," Marshall says. For a city based around the airline industry, the oft-ignored aerial view is an important consideration.



École Polytechnique Fédérale de Lausanne

DOMINIQUE PERRAULT ARCHITECTURE

Dominique Perrault Architecture and Steiner SA Group will oversee a new campus plan for the École Polytechnique Fédérale de Lausanne (EPFL) in Lausanne, Switzerland. In addition to unifying the campus through enhanced pedestrian and bicycle circulation, DPA will renovate two existing structures and build a third, with hopes that their improvements will bring coherence and connectivity to the surrounding campus. While most firms break ground with ceremonial shovels, DPA celebrated the start of construction at the EPFL by planting a tree in a spot on site that will become one of the BI Building's open-air atria. This 4,500-square-meter (45,000-square-foot) central services building (shown left), an adaptive reuse of the former library, will offer a counterpoint to SANAA's all-white Rolex Learning Center across the street thanks to its multicolored cladding. The neighboring mechanical engineering halls will be renovated and extended to become the new EPFL Center for Neuroprosthetics, with expected occupancy by 2015. Concepts for a Teaching Bridge, meanwhile, will continue to be developed during the first phase of construction, but, funding permitting, will boast several communal teaching spaces and pedestrian linkages across campus streets.

ARCAT[®]

Introducing the ARCAT app.

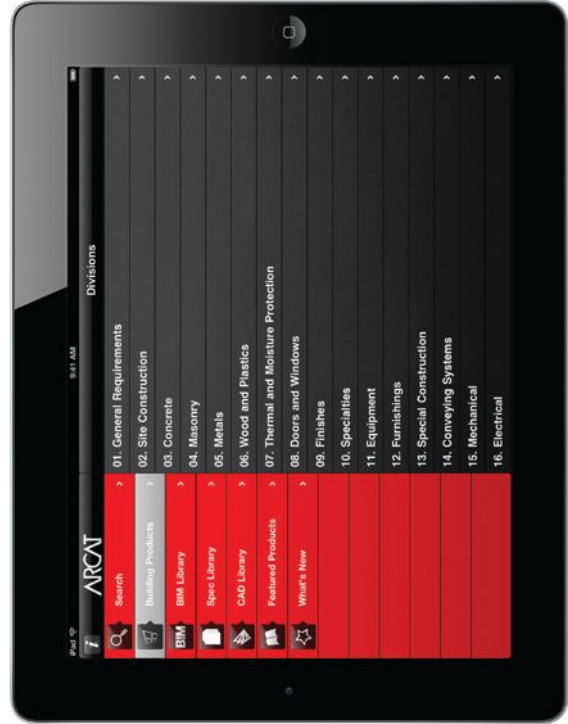

Finding building product information just got even easier with the ARCAT app for the iPhone[®] and iPad[®]. Search ARCAT on the App StoreSM or scan for your free download.



Scan for your free download.

Steelscape Prints[®]

*Exotic metal look without
the exotic metal price!*

METAL_{fx}

Steelscape's **METAL_{fx}** decorative process transforms metallic coated steel substrates into exotic metal looks such as Rustic Copper, Antique Copper, Tarnished Silver, Gold Ore, Weathered Zinc, Pewter and more to achieve an exotic metal look without the exotic metal price!

These beautiful and durable finishes are perfect for roofing, walling, and other prepainted metal applications in both exterior and interior environments, and are backed by warranties for peace of mind.

These innovative **METAL_{fx}** finishes are perfect for new or retrofit projects in both residential and commercial applications. Please contact us to learn more.

Copper Tapestry Roof Photo

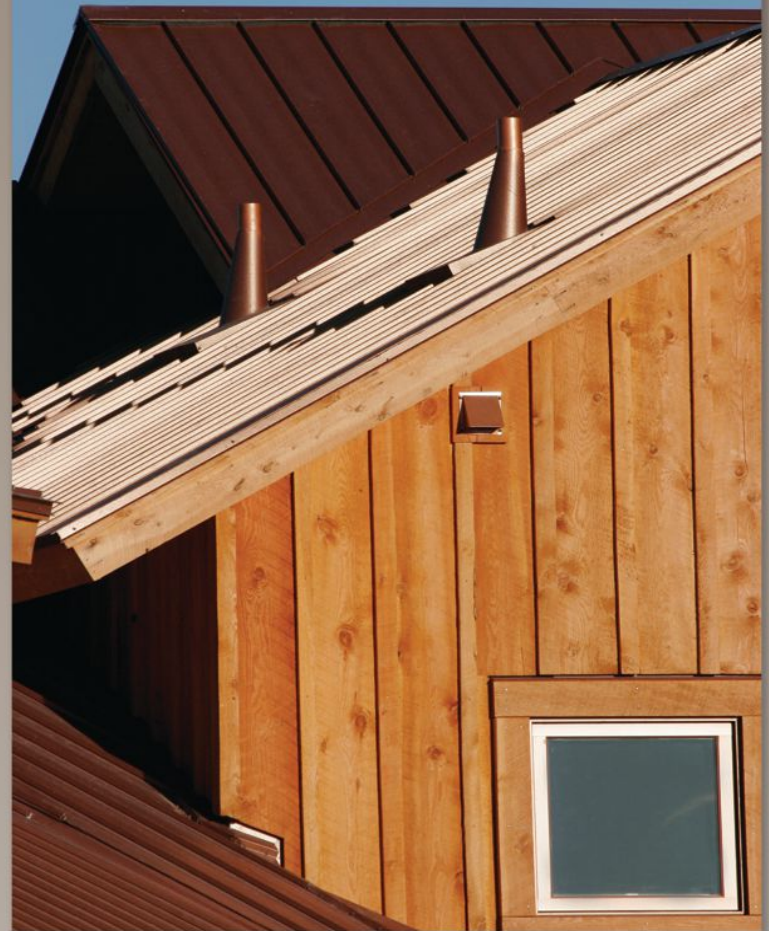

Antique Copper



Rustic Copper



Weathered Zinc



steelscape

A BlueScope Steel Company

For product information, literature, and samples:

(360) 673-8200 | www.steelscape.com

Email: productinfo@steelscape.com

Circle no. 269 or <http://architect.hotims.com>



PHOTO: DANA HOFF

AIA VOICES

SUN CHILD | WORKING ACROSS DISCIPLINES

Alicia Ravetto, AIA, launched her residential practice 15 years ago in North Carolina's rapidly growing Research Triangle between Raleigh, Durham, and Chapel Hill—the perfect location for integrating advanced building technology and renewable energy. She is a fellow of the American Solar Energy Society (ASES) and a sustainability consultant specializing in daylighting and conservation. In 2011, Ravetto received the Gail Lindsey Sustainability Award from AIA North Carolina.

THE TERM “ADVANCED BUILDING TECHNOLOGY” MEANS USING techniques we’ve known about for years and incorporating them from the very beginning of the design process—site, building orientation, and protection against summer heat gain. In commercial applications, it’s also things like daylighting. People do misuse the term, though, and particularly these days, with the U.S. Green Building Council’s LEED certification.

People think that a LEED project means it’s absolutely going to be energy efficient, water efficient, and so on—but LEED is not a guarantee for performance. I’ve done a lot of LEED consulting and, for me, it’s a tool to walk the design team and owner through the project, to give them a basic understanding. I’m facilitating the process from beginning to end in my work.

“Sustainability” is another term that’s been misused. When we use it, we’re referring specifically to *environmental* sustainability.

After all, *true* sustainability would mean that we don’t build new buildings any more. It would mean using what we already have.

Demystifying daylighting is something I do a lot of—because there are a lot of assumptions out there about daylighting. For instance, not every orientation is the same. North is not better than south. In some cases, and for particular functional reasons, yes it is—but not always. It’s not a given. The other important factor is selecting the glazing for a particular orientation. There’s been a lot of improvement in glazing technology, but not a growth of understanding of the potential or how to mix different kinds of glazing in a single project.

ASES has been my main organization in the U.S. since I arrived in 1985 from Argentina, where I had been doing a lot of work on passive systems. It was a natural organization for me to connect with, and it’s helped me maintain my technical background. Now I find, during my crossover with other organizations like the USGBC, that I am learning more about the applications and policies that make the technology matter.

But it baffles me that most architects don’t know where to begin with orientation and passive energy. So I find that my role over the last 10 years has been about coaching others. It’s not about aesthetics—the culture of design onto which concepts like “sustainability” have been mapped. It’s about a comprehensive approach. —As told to William Richards **AIA**



THE AMERICAN INSTITUTE
OF ARCHITECTS

SEARCH
CONNECT
FIND

AIA Career Center, our online job board, is where over 80,000 members know they can look for professional opportunities and post resumes.

The site receives, on average, more than 30,000 unique visitors each month. And since only architects and design professionals use AIA Career Center, it's one of the best resources for HR professionals and firm principals to fill staff vacancies.

Qualified candidates, efficiently found.

www.aia.org/aicareer

AIA Career Center



AIA NOW

ACROSS THE INSTITUTE

Compiled by William Richards



2 Garden State

East Coast Green 2012 conference
June 13–14, 2012

3 Provocateurs Welcomed

AIA Historic Resources Committee
June 15

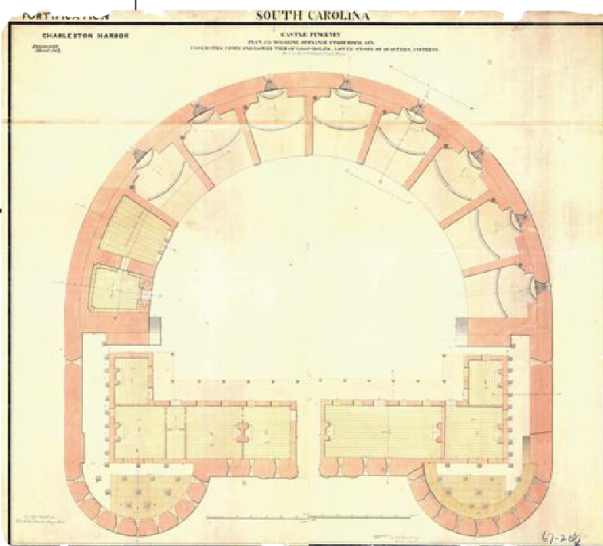

4 Perfect Vision

AIA Cincinnati
June 20

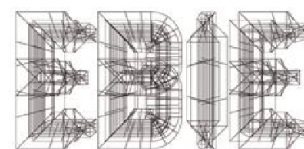

1 Be Kind. Rewind.

EBie Awards
June 28

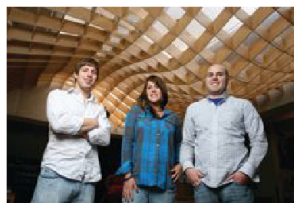

5 Buzz Feed

ARCHIVE 100
June 15

1 Be Kind. Rewind. Adaptive use is going to influence—if not drive—architecture in the 21st century. We'd better figure out best practices now, then. Cue the winners of the Urban Green Council's inaugural EBie ("existing building") Awards. Winners will be revealed in a ceremony in New York on June 28. The program recognizes the best in renovations across 12 categories, including most-improved, highest percentage of energy savings after improvements, water-use strategy, and lighting retrofit. Project submissions could be either residential or commercial renovations and improvements, located anywhere in the continental U.S., and completed within the last five years.

➔ [Learn more at ebies.org](http://learnmoreat.ebies.org).

2 Garden State. Wondering what happened to spring this year? You're not the only one. AIA New Jersey will take on climate change during its East Coast Green 2012 conference on June 13 and 14 in Lincroft, N.J. Conferencegoers will have a chance to discuss the state of the Architecture 2030 Challenge by examining codes, case studies, and adaptive use. The two-day event will be capped by a keynote address by educator and urbanist Mitchell Joachim, Assoc. AIA.

➔ [Learn more at aia-nj.org/ECG](http://learnmoreat.aia-nj.org/ECG).

3. Provocateurs Welcomed. Castle Pinckney is an early-19th-century fort on Shutes' Folly Island, a mile offshore from historic Charleston, S.C., which served as a strategic fortification in America's early coastal defense system. Castle Pinckney also served as a prisoner-of-war camp during the Civil War, changing sides several times. In 1970, it was added to the National Register of Historic Places. And in July 2012, the AIA's Historic Resources Committee and the Association of Collegiate Schools of Architecture will host its Third International Preservation as Provocation Ideas Competition, asking students to reimagine Castle Pinckney for the 21st century. Competition organizers welcome submissions from students in architecture, planning, landscape architecture, and engineering, among other disciplines.

➔ [Learn more at acsa-arch.org](http://learnmoreat.acsa-arch.org).

4 Perfect Vision. Architecture is a natural profession for community engagement. It's also a highly collaborative career. But making it as a team player requires a little initiative and leadership. On June 20, AIA Cincinnati's leadership forum for emerging professionals, titled "VISION," embarks on its summer series with a mix of lectures and workshops that will center on civic engagement, advanced project delivery, and team building. For the past seven months, VISION's 12 participants have covered other topics ranging from firm legacy considerations to continuing education.

➔ [Learn more at aiacincinnatiavision.com](http://learnmoreat.aiacincinnatiavision.com).

5 Buzz Feed. In 2012, the Association of Collegiate Schools of Architecture (ACSA) celebrates its centennial. To help mark this milestone, ACSA developed ARCHIVE, an online exhibit showcasing the creative and socially engaged work happening in architecture schools. Curator Maia Small, AIA, of Pawtucket, R.I., organized a series of competitions to gather thousands of faculty and student projects over a two-year period.

➔ [Learn more at archive100.org](http://learnmoreat.archive100.org).

Call for Entries

Submission Deadline: August 24, 2012



Gehry Residence, Santa Monica, Calif. | 2012 AIA National Twenty-five Year Award Recipient

2013 Institute Honor Awards

The American Institute of Architects celebrates outstanding architectural work that elevates the quality of architecture practice and informs the public of its breadth and value.

For more than 60 years, the Institute Honor Awards have recognized projects of all sizes, budgets, styles, and building types—from public to residential, from large firms to sole practitioners. Join the tradition of excellence that comes from an AIA Honor Award designation.

For more information, or to submit an entry for the 2013 Institute Honor Awards, visit www.aia.org/awards.



**THE AMERICAN
INSTITUTE
OF ARCHITECTS**

AI KNOWLEDGE

RULES OF ENGAGEMENT

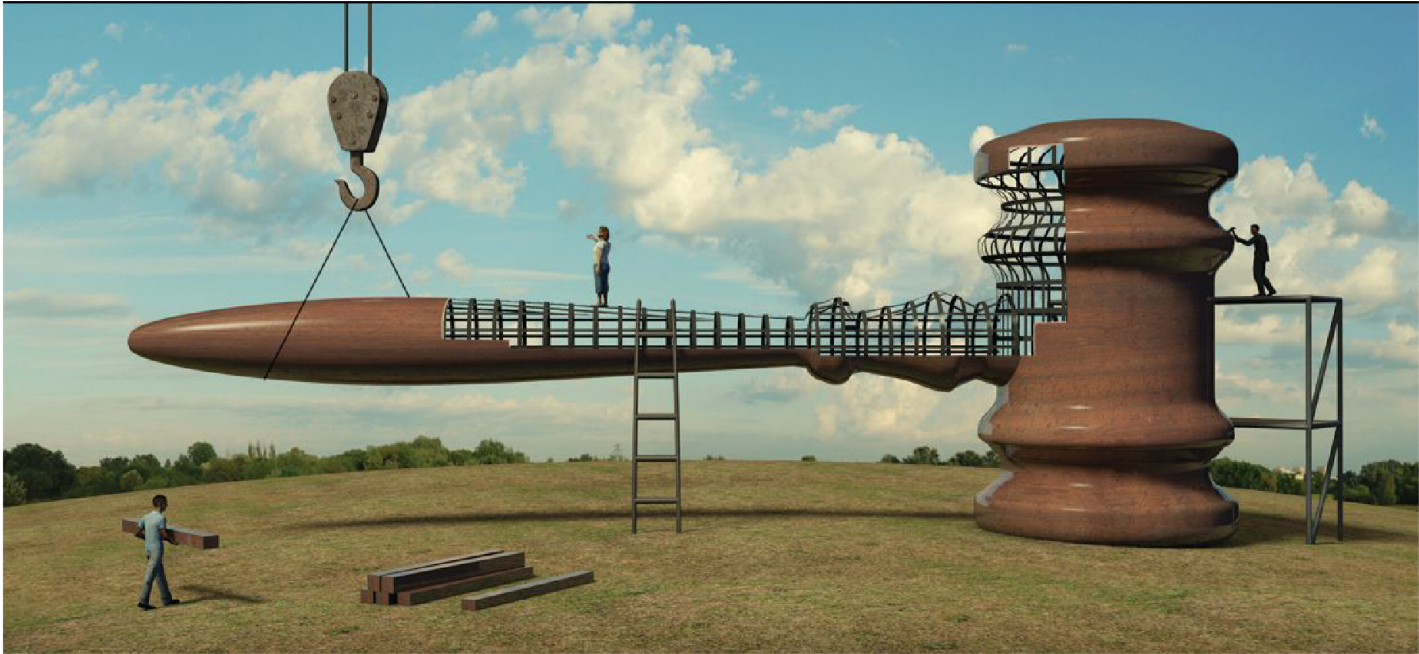

ILLUSTRATION: RANDY LYHUS

Part one in a three-part series on balancing design and business.

MOST LEGAL ISSUES ENCOUNTERED IN AN ARCHITECT'S PRACTICE will be based on a surprisingly narrow group of legal concepts or what are called "causes of action": contracts, torts, and intellectual property circumstances. When you think of a contract, you most likely conjure a written document, with lengthy provisions and wherefores, heretofores, and herewiths. But a contract is both more and simpler than this. It is an exchange of promises between two or more parties. That's it. Whether it's "I promise to walk your dog, and you promise to pay me \$20," or "I will design your house, and you promise to pay me quite a bit more than an Andrew Jackson," the basic premise remains the same. The law only comes into play for the parts of these promises that the law can enforce—which is to say, "Yes, you, defendant, did promise this."

Most business-contract disputes are settled through negotiation between the two parties. As with any close relationship, misunderstandings, miscommunications, or simply missing the mark will happen. Someone will fall short at some point. When this happens, first, identify the problem early and address it. Second, negotiate a compromise. Nine out of 10 contract disputes will eventually settle, without court intervention. And that is the way our legal system is designed: to encourage settlement. Use a carrot or a stick, but understand that there is a middle ground to the dispute.

Architects are required to conduct endeavors in the same manner as any reasonably prudent businessperson would—but with an architect's special training and knowledge—in the same or similar circumstances, and under the same facts. While the general torts concepts here hold true universally, your standard of care as an architect will vary depending on your jurisdiction and your facts. For example, whether you as an architect are liable for injury caused may depend on whether you were negligent (tort law), whether you violated your contract or any standard of care agreed upon in your contract (contract law), or on an implied warranty, which is a theory

of strict liability. Under implied warranty, there is no comparison with what other architects would or should have done; rather, what matters is whether the architect, as an expert, delivered what the client, a non-expert, expected. If this all sounds complicated, it should. The duty imposed on you is not fixed. You can raise it. The law imposes a certain standard of care on you as an architect. However, whether you decide to vary or increase certain performance measures contractually, make promises about the quality of your services, or represent yourself as an expert in a specific building or construction methodology, you can inadvertently raise the standard of care that may work against you later.

Architects are specially trained, talented, and skilled. What this means is that if you are sued, a jury may impose upon you greater expectations. In short, a jury may very well be quite sympathetic to the injured, and less so to the highly skilled, highly educated architect. Sympathy plays a big part in torts cases.

Settlement is not an admission of liability. Sometimes settling a case outside of court is the most cost-effective way out of a dispute, even if you were minimally at fault, or, in your view, not at fault at all. Settlement agreements can contain strict confidentiality provisions, as well as specific statements that settlement will not be considered or construed as an admission of liability.

Think twice about certain things you may run across in your practice that give you pause. While it is neither free nor ideal, sometimes a quick call to your attorney can help you avoid larger, more costly issues in the future. Like designing a building, all the parts inform one another—what you expect to accomplish, the pitfalls you want to avoid, and how you work with other individuals. All have to be taken into consideration as a whole. —Terrence Canela, Esq. **ATA**

Nothing in this article should be construed as legal advice. Consult your own advisors based upon your specific circumstances. | Learn more at architectmagazine.com/aia.

ILLUSTRATION: VIKTOR KOEN

Reverse Engineering

Modeling future scenarios in an ongoing energy crisis.

BY ALEC APPELBAUM

AS A RULE, HEALTHCARE-FOCUSED ARCHITECTS REFRAIN FROM prescribing drugs, and the gang from Populous (formerly HOK Sport) rarely calls audibles during a game. Yet when it comes to energy conservation, architects have guided the conversation since just after World War II, when the AIA began supporting and advising

federal regulators in determining optimal building performance. That endeavor has lately gained new breadth—just in time to seriously tackle climate change.

This summer, the AIA publishes the *AIA Energy Modeling Practice Guide*, covering the ins and outs of energy modeling. To be sure, an architect can more credibly parry with an engineer than with a quarterback. But what parameters do architects use to make a model equate a client's standard? And how clearly can energy modeling guide the profession toward a common, strong means of making efficient buildings?

The answer emerges in a 67-year line of projects by AIA's research arm with titles such as *A Nation of Energy Efficient Buildings by 1990*, which have reflected the continued urgency of a decades-old energy crisis. The work set a precedent: Those who knew how





AIAFEATURE

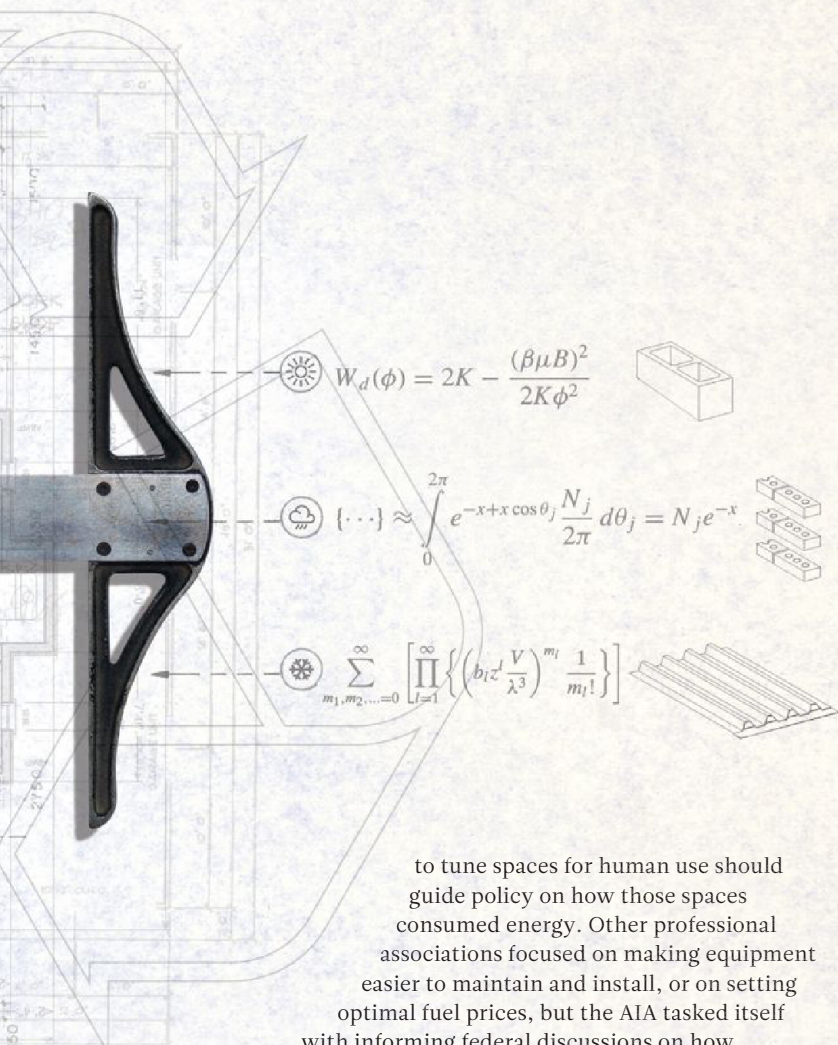

to tune spaces for human use should guide policy on how those spaces consumed energy. Other professional associations focused on making equipment easier to maintain and install, or on setting optimal fuel prices, but the AIA tasked itself with informing federal discussions on how buildings holistically work.

The January 1979 issue of *Research and Design* (a journal published by the AIA from 1978 to 1980) reflects the mood in this history. “The federal energy performance standards, due out this fall and aimed at design-stage determination of building energy performance in the ’80s, could constitute the most decisive architectural development of the decade,” editor Kevin Green hazarded. The AIA responded by helping to shape the mission of the Department of Energy (founded in 1977) and, later, the United States Green Building Council, whose volunteer-developed LEED rating system made energy efficiency a standard for the government and developers.

Indeed, energy modeling emerged in the 1980s in a bid to squeeze more use out of each gallon of fuel, but also as a means of collaborating. The writing in *Research and Design* from the period abounds with jokes and disclaimers about hippies and beansprouts—as if its editors wished to soften the edges of energy-hawk rhetoric from the Carter administration. But that rhetoric has shifted substantially since then. The researchers scoping out shading and solar power in the late 1970s faced the constraint of oil scarcity. Now, climate instability has added a level of urgency to the debate.

Climate instability and its attendant risks still require buildings to thriftily use energy without sacrificing comfort. These issues also make clients anxious, both about catastrophic weather and carbon taxes. Can leadership still focus on modeling energy use? It can if

modeling becomes the first of several agendas that the building professions standardize together.

“Architects are going to have to trust the engineers and vice versa,” says Nicholas Long, an engineer with National Renewable Energy Laboratory in Golden, Colo. “If an architect tells me that I have to put a specific type of electric lighting in a space, I should be able to tell them that they have too many or too few windows in the space.” Long and his colleague at NREL, Robert Gugliemetti, both participated in the new guide’s creation and think that it signals a

“Indeed, energy modeling emerged
in the 1980s in a bid to squeeze more
use out of each gallon of fuel, but also
as a means of collaborating.”

new collaborative spirit. That spirit may drive inquiries into hard science and safety issues that energy modeling can’t broach by itself. Donald Watson, FAIA, a Connecticut architect and co-author (with Michele Adams) of *Design for Flooding*, donated brainpower to the AIA Research Corporation in the ’70s and now wants the profession to model for the unthinkable.

“Anyone who is not carefully planning preparation for severe climatic impacts should step away from the table,” he says. “The scope of interest in this is phenomenal across the world.”

This summer’s modeling guide intends to help practitioners decide how architecture can gird for an age of scarce fossil fuel and ease down occupancy costs. Susan Ubbelohde, Assoc. AIA, a professor and practitioner in Berkeley, Calif., who specializes in high-performance buildings, suggests that energy models can open designers’ minds to questions about overall building performance. “Energy still costs so little that clients are not thinking about ROI but about comfort,” she says. If models link a particular form or set of envelope decisions to energy use, she says, they can make fossil-fuel avoidance part of an aesthetic discussion.

Watson, though, urges AIA members to prepare for as-yet-undefined events. Energy modeling has ripened to industry standard in residential work, he says, and in commercial buildings he sees the opportunity for modeling extreme wind and water forces in and around buildings and urban sites.

“The issues and design challenges of climate change are emerging rapidly across international practices, with many complex and new disciplines and computational models devoted to the topic—you have to work closely with an integrated team at the beginning,” Watson says. “Modeling future scenarios of risk and remedy has become a critical tool to design for climate change and severe weather. Climate-mitigation models are at the stage where energy models were in the 1980s.”

For better or worse, the AIA may need to step up its research work to model not just how to save energy, but how to save lives in a disaster. Collaboration will be more vital than ever. **AIA**

➔ To learn more, visit, www.aia.org/practicing/akr/AIAB090178.



AIAPERPECTIVE

BEING THERE



PHOTO: WILLIAM STEWART

THE MOVE EARLIER THIS YEAR OF PAUL GOLDBERGER FROM

The New Yorker to *Vanity Fair* has sparked discussion about the state of architectural criticism in the mass media, much of it in the vein of “the sky is falling.” I wonder if the gloom is justified.

Writing about architecture for a broad public has always been a challenge. Thoughtful commentators such as *The Wall Street Journal*’s Ada Louise Huxtable; the late David Dillon, who wrote for *The Dallas Morning News* in my own hometown; and *The New York Times*’ Michael Kimmelman are rare. The challenge has nothing to do with their level of erudition and expertise, but where they fit in the current landscape of public commentary.

These folks and others typically share print space with food, music, art, and theater critics—and the fit is uneasy at best. A review of a new restaurant or the opening of a play will tell readers whether it’s worth their time, and writers who cover these beats straddle the divide between buyers and sellers.

The precarious finances of printed publications may go a long way toward explaining why editors are disinclined to give precious column inches to thoughtful writing about architecture. It doesn’t feed the bottom line, unless the publisher has a passion for architecture. Unfortunately, in a world driven by shareholder equity, supportive media barons are hard to find. Being grouped with writers who work the culture and lifestyle beat raises additional issues. In those sections, it doesn’t always make sense to write about public policy or placemaking, certainly not when architecture is treated as a subcategory of sculpture. Hanging around on the lifestyle pages also feeds the cult of celebrity and the beast of fashion, where novelty is everything.

Clearly something new is called for, especially at a time when the public’s interest in architecture has never been greater. If you define the public’s interest in architecture strictly in terms of how

many column inches the subject receives, you would think that not many people cared. But factor in the explosion of blogs and apps that focus on architecture and a different picture emerges. Even the most superficial surfing of the Web reveals the public’s hunger to engage others in how we’re shaping our communities, and how this in turn affects the quality of life.

Pointing out that the rigor of these conversations is all over the map simply states the obvious. Even at its best, the online chatter can sound like an echo chamber, where we tune in only to those who confirm our biases. It’s part of the atomization of modern communications. In order to break out of the echo chamber, we—along with our unsung architecture critics—have to lead the conversation and set the table for community discussion.

If I were developing an education curriculum for architects, I would require public speaking. This, as much as our knowledge of the science and art of architecture, prepares us to engage in discussions where citizens and policymakers come together—from neighborhood meetings about a new park to federal legislation about preservation tax credits. My colleague Mickey Jacob, FAIA, puts it this way: “Show up and become known in your community.”

We need not despair about the state of architectural criticism in the mass media, nor the creative chaos of the blogosphere, where discourse is fragmented and heat supplants light. There are more of us in communities of all sizes than there will ever be commentators. We have the power to raise the level of public discourse about the way we design and build, and how that makes a difference. But first we have to show up. **AIA**

➔ Join our conversation at aia.org.

Jeff Potter, FAIA, 2012 President

ZIP up a tighter envelope.

Protect your projects from the elements with ZIP System® sheathing. Our all-in-one structural panels, with a built-in water resistive barrier, combined with our specially designed ZIP System™ tape help guard your buildings from moisture damage during and after construction. This continuous water and air barrier also improves energy efficiency by significantly reducing air leakage. And panels go up quickly for a stronger, drier, faster seal – creating the ideal building envelope.

ZIP up your next project. SwitchToZIP.com.

ZIPsystem™
ROOF & WALL SHEATHING

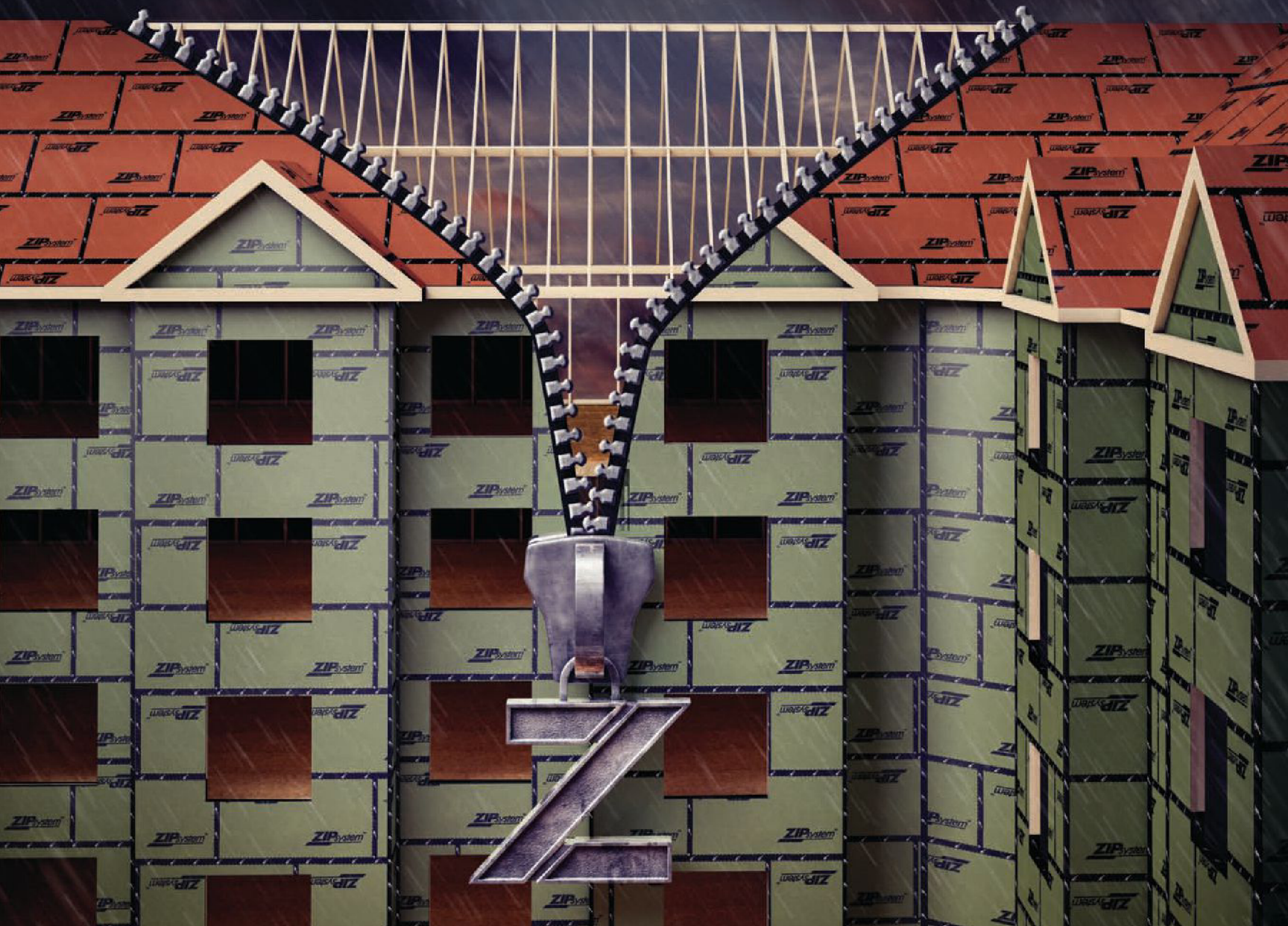

© Huber Engineered Woods LLC. ZIP System, the accompanying ZIP System logo and design and AdvanTech are trademarks of Huber Engineered Woods LLC. Huber is a registered trademark of J. M. Huber Corporation. Huber Engineered Woods products are covered by various patents. See zipsystem.com/patents for details. HUB 3016 3/12

FROM THE
CREATORS OF



Moisture and air seem innocent enough.

(Until they get into your walls.)



Keep moisture problems out of your walls.

ZIP System® sheathing installs without the hassles of building wrap and felt. Since the weather barrier is integrated directly onto the sheathing panels, it doesn't tear or blow off — even when exposed to harsh wind driven rain tests. This built-in barrier also helps eliminate the risk of water becoming trapped between building wrap and sheathing. Plus, it is specially engineered to allow permeability, helping your building breathe. That's performance we back both during and after construction with a 180-day exposure guarantee and 30-year system warranty*.



Stop air leakage and maximize energy efficiency.

Air leakage is one of a building's most significant causes of energy loss, and ZIP System roof and wall sheathing is part of the solution. When combined with ZIP System™ tape, this system forms a continuous protective air barrier — significantly reducing air leakage through walls or roofs and lowering your Air Changes per Hour (ACH). This helps you optimize R-value, save energy, and meet increasingly stringent performance requirements of energy codes and green building programs. Not to mention, it's not susceptible to air leaks due to rips and tears, a problem common with building wrap and felt.

Simply install ZIP System panels and tape the seams for air and moisture protection.

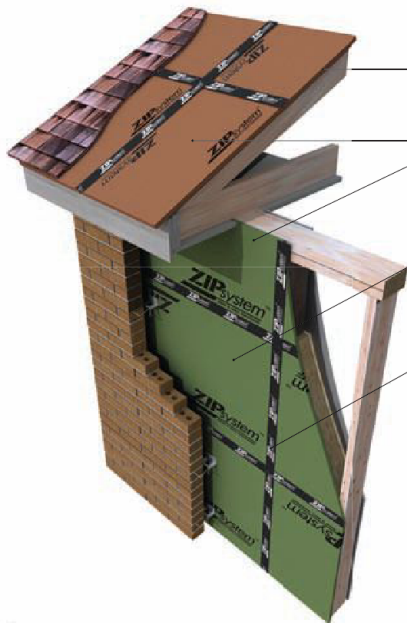

High quality structural wood sheathing panel delivers strength and durability.

Built-in vapor permeable weather barrier eliminates the hassles of building wrap and felt.

A continuous, rigid water resistive barrier helps protect projects from moisture damage and air leakage during and after construction.

ZIP System tape with a specially engineered, high performance acrylic adhesive bonds with ZIP System panels for a long-lasting protective seal.

ZIP up a tighter envelope for your next project. SwitchToZIP.com.

ZIPsystem™
ROOF & WALL SHEATHING

*Limitations and restrictions apply. Visit ZIPSystem.com for details.

FROM THE
CREATORS OF **AdvanTech**

BUSINESS



→ BEST PRACTICES

Spin the Web

HINGE MARKETING SENIOR PARTNER
SYLVIA MONTGOMERY SAYS THAT
ARCHITECTS CAN BUILD THEIR
BUSINESS BY MARKETING ONLINE.

INTERVIEW BY ERNEST BECK
PHOTO BY ELI KAPLAN



YOU CAN FIND JUST ABOUT ANYTHING ONLINE. So why don't architects use online marketing for branding and business development? Reliance on more-traditional methods (schmoozing, word of mouth) has until recently trumped social media. But that is changing, according to Sylvia Montgomery, senior partner at Hinge Marketing, a professional services marketing and branding firm in Reston, Va., that caters to architecture, engineering, and construction firms. Montgomery, 45, says that the industry is slowly embracing online marketing. She talked to ARCHITECT about how to use the Web—from blogs to webinars to Twitter—to broaden your firm's business opportunities.

“UNTIL A FEW YEARS AGO, MANY ARCHITECTS WOULD TELL ME THAT ONLINE MARKETING ‘WASN’T FOR US,’ BECAUSE THE USUAL WAY TO BUILD A DESIGN BUSINESS WAS BY WORD OF MOUTH AND DEVELOPING RELATIONSHIPS,” MONTGOMERY SAYS. “YET THE REALITY IS THAT MARKETING IS DONE THE SAME WAY NOW AS BEFORE, EXCEPT THAT THE CLIENT GETS TO KNOW YOU ONLINE, RATHER THAN WHILE GOLFING.”

Take a swing.

“Until a few years ago, many architects would tell me that online marketing ‘wasn’t for us,’ because the usual way to build a design business was by word of mouth and developing relationships”—perhaps at the golf course, Montgomery says. It's easy to say that the design industries are so unique that they don't need online marketing. “Yet the reality is that marketing is done the same way now as before, except that the client gets to know you online, rather than while golfing,” she says.

Cast a wider net.

People go online to find information about everything. So if you're looking to grow your business, you have to be online to move beyond the immediate radius of who you know. “You can strengthen your firm's brand and reputation and reach a much wider audience,” Montgomery says. “Every blog post, video case study, and white paper deepens a level of familiarity and visibility.” If clients need special expertise in, say, historical preservation or sustainability, online marketing can help them find you and narrow the field.

Start with strategy.

“Before creating a Web presence, start with a marketing and business strategy to know where you want to go with the content,” she says. If your firm works in healthcare but wants to move into education, for example—or if you want to expand geographically—you can include these components in the website design. And great design is not enough. Content should speak to how you want to position the firm and what you do

well. The value proposition, she explains, is how well you differentiate your firm from the pack.

Find a partner.

There are different levels of involvement for online marketing, and each depends on your cost threshold. Even if you have a marketing staff at the firm, you might want to engage an outside professional and have them collaborate, which will cut down on costs. If you want the outside person to take on more responsibility while the architects and staff do less, this will cost more. “One method isn't better than the other. It all depends on what suits the firm,” Montgomery says.

Content is king.

Content drives everything, especially fresh content that's accessible, relatable, and valuable to viewers—but nobody wants to read dense content. Blogs provide great content and can showcase your ideas and designs and the culture of the firm. Blogs and Twitter are a great platform to share buzzworthy content (and follow Montgomery herself on @BrandStrong for ongoing tips). If you go to a conference or an AIA meeting, tweet about it. Blog about the white paper you posted on your website. “In every case, write about things that dovetail with your firm's services and also what's of interest to you,” she says. And remember that everything you do or think about can be repurposed in a different format.

Video is the new lunch.

Video is becoming a much more central medium for content because you can ask past clients to talk about your expertise and how you solve problems—and thereby introduce yourself to new clients. Using video can position you as an expert: It lets potential clients get to see you and experience a connection with the person or firm with whom they are considering partnering. “It's better than a photograph,” Montgomery says.

Welcome to the webinar.

Today, the Web can offer users a free education in all kinds of subjects. “A webinar is a way to quickly share your knowledge with a busy, time-pressed audience, while a white paper is a bit more serious and academic,” Montgomery says. A webinar lets you tackle a topic such as the latest trends in sustainable design—and weave in your own buildings. Look for topics and hot-button issues that people will find useful. “You can demonstrate that you are a specialist in a certain field and show the projects you have done,” she says. “In the process, you get an email from the viewer and can follow up and say, ‘Hey, let's continue the conversation.’”

Get engaged.

Architects are slowly coming around to online marketing. The explosion in new architecture websites and related blogs is just one indication that users are doing more talking to one another online. “Designers realize that by not engaging online, they are pushing away potential clients,” she says. “You won't see them—and they won't see you.” □

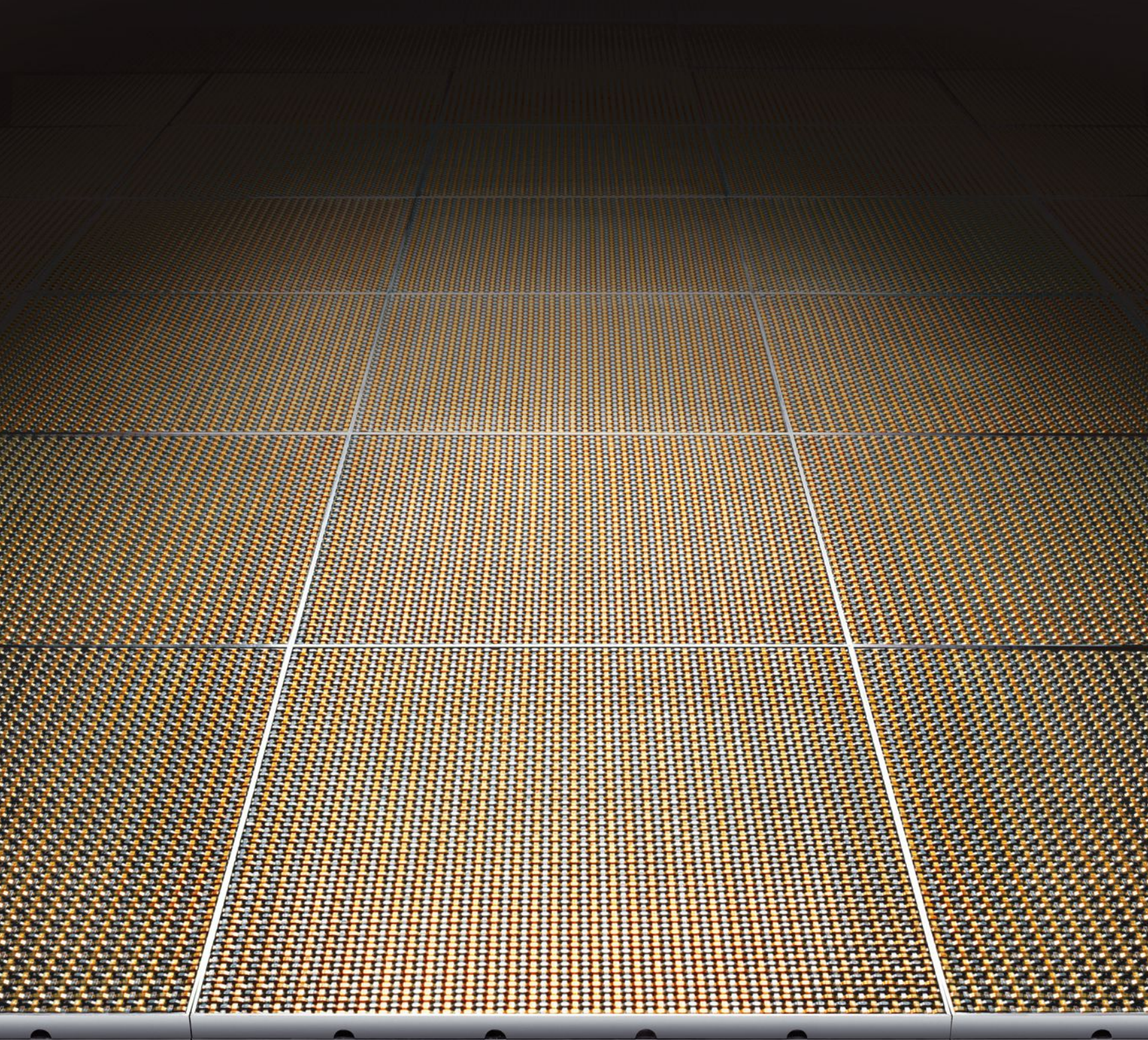

We've changed the rules

Architects asked us to develop new flooring options for their entrances. **Floorometry® 201 entrance flooring** features four high-tech stainless steel and architectural bronze mesh designs that effectively remove water and debris from shoes, while providing a stunning accent for any entranceway. To see all of our Floorometry products, call 888-621-3344 or visit www.c-sgroup.com/floorometry.



Circle no. 298 or <http://architect.hotims.com>



District Architecture Center
 • Washington, D.C. • *Hickok Cole Architects* • The District Architecture Center makes its various conference rooms and classrooms available to rent for groups ranging from a few people to 300 people in size.

→ **TPOLOGY**

Getting Centered

THREE NEW AIA CHAPTERS HAVE BUILT SPACES TO ENGAGE PROFESSIONALS AND THE PUBLIC THEY SERVE.

TEXT BY MURRYE BERNARD

MANY OF THE AIA CHAPTERS across the United States maintain office space. But in some of the bigger cities, chapters have expanded to create a new type of facility: the center for architecture. Three of these new AIA chapter spaces opened recently in Boston, Washington, D.C., and Raleigh, N.C., to demonstrate that architecture can be an interactive experience.

To demonstrate an experience of architecture that extends beyond the built environment, these centers' programs accommodate much more than just administrative functions. They provide conference and meeting rooms for member meetings and classes and exhibits that are open to the public. The design for each of these new centers for architecture was chosen through a competition—a process that echoes themes of

transparency, openness, and sustainability. Their flexible layouts accommodate several programs each week, often juggling multiple events at once. And there's hardly a trace of the AIA's distinctive official red. Each center reflects its locality and, more specifically, its chapter's initiatives and goals.

Established in 1867, the Boston Society of Architects (BSA) is one of the oldest and largest of AIA chapters. But it grew too big for its former headquarters in the Financial District, which was also not publicly accessible. The new BSA Space in the Atlantic Wharf complex offers 16,000 square feet of storefront overlooking Fort Point Channel and allows the chapter to capitalize on the area's



Shelter. Transformation. Exhilaration.



Schihutte Masner Bar, Austria
NanaWall Aluminum Framed Thermally Broken SL70 with triple glazing
Elevation 8,038 feet

NanaWall—25 years of engineering excellence with over a million panels of large openings installed

- Benefit from a single-source product built as a complete system of unparalleled quality with superior long-term weather performance.
- Choose from over 20 different systems with hundreds of options for configurations, materials, glazing and finishes.
- Contact the NanaWall Dedicated Architectural Support team for concept to completion evaluations and design guidance.



NanaWall®
The Leader in Opening Glass Walls



Showrooms Nationwide 888 868 6643 nanawall.com

Circle no. 211 or <http://architect.hotims.com>



AIA NC Center for Architecture and Design • Raleigh, N.C. • *Frank Harmon Architect* • The North Carolina AIA chapter collected more than \$600,000 in cash donations and \$500,000 in in-kind donations, including materials and services, to build its new center.

foot traffic. The design, by Höweler + Yoon Architecture, invites visitors to enter and climb an electric-green central stair that is visible beyond the windows of the building's historic façade, effectively serving as a billboard where exterior signage was not permitted. Constructed of steel plates with infilled glass risers, the stair connects a 1,500-square-foot gallery at street level to a 6,000-square-foot gallery on the second floor.

The BSA's second-floor exhibition area commands views of the channel, but that's not the only reason the architects maintained openness along the glazed perimeter. "We immediately noted that the main space was not at street level, but one floor up—so the ceiling needed to function as the main façade, visible from the street," explains partner Eric Höweler, AIA. The ceiling plane, a visual continuation of the green stair, is as functional as it is eye-catching. It conceals ductwork and light fixtures while providing a flexible system of channels for hanging exhibitions.

Conference rooms punctuate the openness of the exhibition space, dividing without partitioning; administrative spaces are delineated from the area by only a glass wall. "By interspersing the programs, we could create more mixture between the different users, visitors, and audiences of the BSA," Höweler says. "I'd like to go to a cocktail party and run into someone from a learning seminar and mingle with a staff person at the same time."

Transparency is also the major theme of the design for the Washington, D.C., chapter's District Architecture Center. Like the BSA Space, it occupies a two-story storefront in a historic building within a lively area—the Odd Fellows Temple Building in the Penn Quarter

neighborhood. The chapter previously occupied a charming but confining row house in Dupont Circle, and "one of the programmatic goals for the chapter was to facilitate a lot more public outreach," explains Yolanda Cole, AIA, principal of Hickok Cole Architects, the designers behind the new space. Whereas the BSA Space devotes the majority of its plan to exhibitions, most of the District Architecture Center's 11,000 square feet is dedicated to meeting and conference space. The result is "a flexible facility for holding classes and other chapter events, and a platform for getting the public interested in architecture and the idea of hiring architects," says executive director Mary Fitch, Hon. AIA.

When visitors step into the District Architecture Center, they are enveloped in a small gallery lined with wood—a welcoming threshold off the street that frames views deep into the space. "A person walking by on the sidewalk can literally see all the way through the building from front to back—about 150 feet—into the boardroom and administrative offices," explains principal Michael Hickok. The warmth of the gallery gives way to a double-volume space with raw concrete floors and floating glass cubes containing conference rooms. When the center hosts larger events, staff fold glass partitions to create one large meeting space that accommodates over 200 people. A glass bridge connects the cubes, allowing light to penetrate to the floor beneath, which is lined with classrooms currently subleased to Alliance Française. These spaces will accommodate the chapter's future growth.

Growth was also the inspiration behind the AIA North Carolina chapter's decision to seek a new space



The face of sustainability.



-Project: Scottsdale Fire Station
-Architect: LEA Architects <http://www.lea-architects.com>
-Product: Trenwyth Trendstone

Trenwyth® Trendstone®
Additional sizes & shapes at Trenwyth.com

 **Oldcastle®**
Architectural
The face of masonry.

The face of masonry. No matter where you are, chances are we're somewhere close by. In fact, you've probably seen us many times before in the places you shop, work, play, learn and live. We manufacture the brands and products used in the interiors and exteriors of civil, commercial and residential construction projects across the nation. We're Oldcastle Architectural. We are the face of masonry.

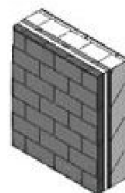

For more information about our SmartBIM models and continuing education units, visit oldcastleapg.com/ceubim.html

Brands **TRENWYTH®** | ENDURAMAX® | ARTISAN MASONRY STONE VENEERS® | QUIK-BRIK® | AMERIMIX®

Circle no. 504 or <http://architect.hotims.com>

For more information on our broad range of products or for free literature call 1-855-346-2766 or visit oldcastleapg.com

INSPIRED BY PASSION. DESIGNED FOR PERFORMANCE.

WELCOME TO
THE WORLD
OF SPANISH
CERAMIC TILE.

Be inspired by texture, be surprised by dimension. Rethink the possibilities. For innovative design and boundless inspiration visit the single source for over 200 Spanish ceramic tile manufacturers.



Tile of Spain - Trade Commission of Spain
305.446.4387 miami@mcx.es

FIND
INSPIRATION!
Circle no. 385 or <http://architect.hotims.com>



tile of spain®
TileofSpainUSA.com

business

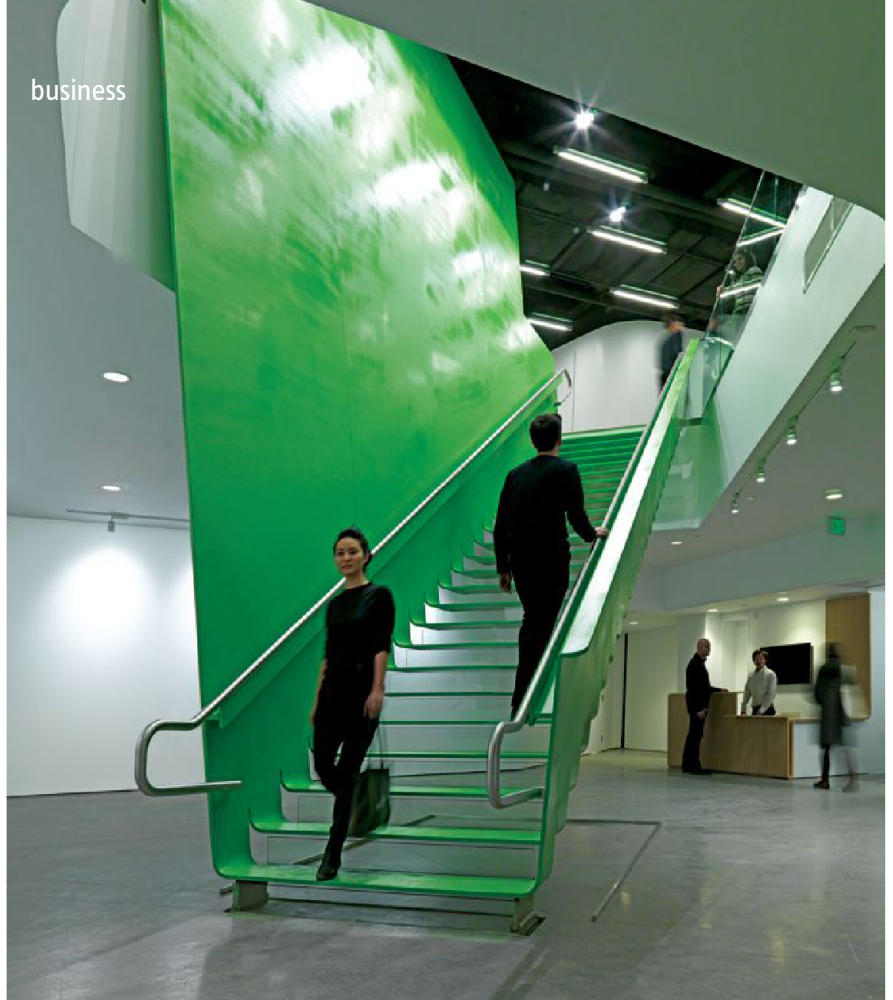

BSA Space • Boston • Höweler + Yoon Architecture • The design, marked by its cloud ceiling and monumental staircase, won the favor of BSA board of directors during a competition to design the space in 2011.

in downtown Raleigh. It obtained a lot near the State Capitol on which to build the new AIA NC Center for Architecture and Design. Designed by Frank Harmon Architect, the center represents a first. "An AIA component has never built its own headquarters from the ground up," says principal Frank Harmon, FAIA. It's an especially impressive accomplishment in the wake of a recession: As with the other two centers, completion of the project was made possible through the donation of professional services and building materials by many companies.

The new three-story, 12,000-square-foot center's footprint is minimal, owing in part to its triangular site. Harmon oriented the 30-foot-wide by 135-foot-long structure along the street edge to preserve green space and create an urban park. Even the parking area, lined with porous grass pavers, doubles as an outdoor event space. The sense of community continues inside the interior, organized with an open plan that promotes natural lighting and cross-ventilation. Harmon placed the gallery along the street-front to engage passersby and situated the two main meeting spaces on the ground floor. Administrative offices occupy the upper floor.

Harmon chose local materials for the building's cladding, but reinterpreted them in a fresh and modern way. Zinc panels that hint at the farmhouse vernacular wrap the long wall along the street and fold to form the roof plane. Beneath, the building's volume is clad with cedar panels, and locally quarried stone rounds out the material palette. The AIA NC Center for Architecture and





The safest installation meets the smartest innovations.

Next-generation LiftMaster® door operators lead the way with groundbreaking innovations that protect your clients.

Our new line of door operators protects your clients' employees and property with continuously monitored entrapment protection and state-of-the-art safety features, making it easier than ever to incorporate warning lights, bells, and timers.

Plus, they meet tough new UL325-2010 standards, which is critical in complying with state and local building codes. It's all what you'd expect from the #1 brand of professionally installed door operators. There's no smarter way to protect what matters most...your reputation.

Specify safe. Specify smart. Specify LiftMaster.
To learn more, visit liftmaster.com or call 800-323-2276.

Residential Garage Door Openers • Commercial Door Operators • Access Control
Residential and Commercial Gate Operators • Telephone Entry Systems

liftmaster.com

LiftMaster®
Commercial Door Operators

Circle no. 283 or <http://architect.hotims.com>



Design meets LEED Platinum standards as well as criteria set forth by the AIA Committee on the Environment. Sustainable features include geothermal heating and cooling, rainwater collection, and sensors that regulate light fixtures in response to fluctuating natural light levels. "This building demonstrates how the practice of architecture can enhance the urban landscape without harming the environment and leave the land we build on better than we found it," Harmon says.

Each of these AIA chapter spaces illustrate that centers for architecture aren't simply offices or dispensers of continuing education credits, but thriving public spaces that can appeal to tourists, residents, and architects alike. Though they exist under the greater umbrella of the AIA organization, these centers are uniquely tailored to address their chapters' goals and cities' characters. Their design vocabularies vary, but they all share a modern language that both contrasts and complements their historic contexts, serving as visual advocates for an ever-changing profession. □

BSA Space • Boston • Höweler + Yoon Architecture • The signature green staircase at BSA Space connects a gallery of 1,500 square feet at street level to a second-floor, 6,000-square-foot gallery.

© ANDY RYAN

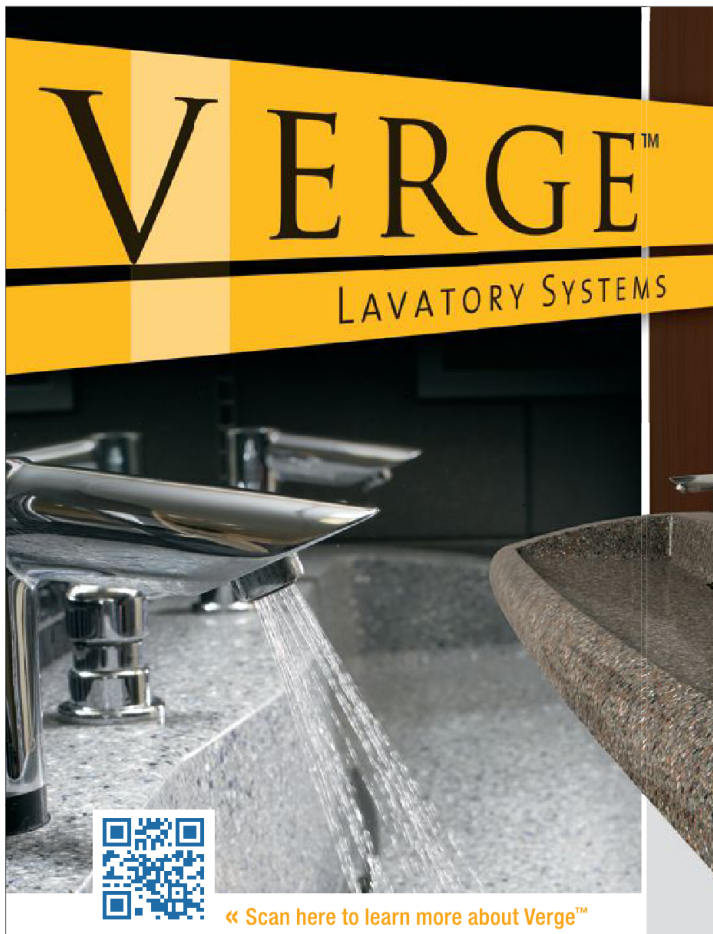

« Scan here to learn more about Verge™ »

ELEGANCE REDEFINED.

The new Verge™ Lavatory System is made from Evero, a blend of natural quartz, granite, exotic materials and a bio-based resin, which is more durable than granite and virtually maintenance free. Evero contains 25% pre-consumer recycled material and is GreenGuard certified as a low-emitting material.

The new Verge Lavatory Systems are sculpted in beautiful shapes providing long-lasting natural elegance in new and sophisticated forms.

Verge: Very modern, very now, very Bradley.

NO SEALING.
NO BUFFING. NO WORRIES.

Bradley
Bradley

800.BRADLEY
BRADLEYCORP.COM/VERGE2012

FOLLOW YOUR INSPIRATION.

Go ahead. Explore the far reaches of your imagination. VT will always be there to guide you to the perfect solution for architectural wood door design and performance—whether your project calls for superior acoustics, enhanced fire ratings, or added durability. Because when inspiration hits, VT is there.



VTDoors.com 1-800-827-1615 (ext. 512)

Circle no. 53 or <http://architect.hotims.com>



→ CORPORATE COLORS

Color Coding

WHO AND WHAT DECIDES WHICH COLORS ARE IN AND OUT? RESEARCH, THE ECONOMY, THE ZEITGEIST—AND THE COLOR FORECASTERS WHO SORT ANECDOTAL EVIDENCE INTO MARKET-DRIVEN TRENDS.

TEXT BY JEFFREY LEE
ILLUSTRATION BY LAUREN NASSEF



SONU MATHEW has traveled the world developing research for her color forecasts. The senior interior designer for Montvale, N.J., paint manufacturer Benjamin Moore & Co. has found that inspiration can strike in places that most designers might never have time to visit: the informal booths outside of the Milan furniture fair, for instance, or a small-town glassmaker.

“I found in Estonia, under a bridge, a woman who was knitting these really great little socks,” Mathew says. “At the time, there was a focus on Baltic nations and the colors and the handiwork coming from that side of the world. That influence does come into interiors. It could be a pattern on the socks that turns into an architectural pattern on a window. There’s this long domino effect that I think is really quite beautiful.”

Welcome to the florid, fresh, and occasionally flummoxing world of color forecasting. With companies from auto manufacturers to clothing designers eager to follow the latest consumer preferences, international organizations such as the Color Marketing Group, Stylesight, and WGSN can charge hefty membership fees to provide analysis on the latest color and style trends. And a number of architectural-product and -finish manufacturers conduct their own forecasts, pulling in research from fashion, culture, and products

experts worldwide to help design professionals find inspiration and understand the context of those trends.

“The whole idea of color forecasting is providing an ongoing resource for inspiration,” Mathew says, “especially in a world where architects and designers are not getting to every show or every market, or they don’t necessarily have time to go online and read what’s happening with their counterparts around the world.”

Color forecasting is not a static science. Fluctuations in color forecasts are partially driven by the inherent human need for change, says Leatrice Eiseman, director of the Eiseman Center for Color Information and Training in Washington and executive director of the Pantone Color Institute. The fashion world, for instance, realized long ago that they wouldn’t sell many clothes if they always offered the same colors. That leads to the second, more commercial reason that colors shift: “You keep the economy stimulated, and people wanting to purchase something that’s new,” Eiseman says.

The Color Marketing Group’s tagline is, “Color sells, and the ‘right’ color sells better.” Color forecasting is market driven, but that focus can be off-putting to designers, says Margaret Portillo, professor and chair

A Distinctly Modern Building Façade In A Historic Neighborhood

ARGETON TERRACOTTA RAINSCREENS

- *Over 30 years and thousands of successful projects worldwide*
- *Designed to last the life of the building - no gaskets, no butyl, no components that will ever need to be replaced means no maintenance*
- *Fully engineered and independently reviewed for performance, compliance, and suitability for every project*
- *LEED Qualified*



Vancouver Community Library - Vancouver, WA
Miller Hull Partnership - Seattle, WA
Streimer Sheet Metal Works, Portland, OR

"The details of the terracotta rainscreen were critical to us from a building performance standpoint, but the ability to dial in the color of the tiles was essential to fitting the building into its context. A distinctly modern building in a historic neighborhood, the materials we selected were critical to the architectural expression. And we could not be happier with the Argeton terracotta."

Adin Dunning, Lead Architect, Miller Hull



TellingArchitectural

Argeton Rainscreen Systems are distributed by Telling Architectural Systems

www.tellingarchitectural.com | info@tellingarchitectural.com

Toll Free: 866.271.0488

Circle no. 441 or <http://architect.hotims.com>



The shortest distance between
“what if” and “wow.”

AGC

BEYOND GLASS™

When you choose AGC for your architectural needs, you have a broad range of possibilities to bring your design ideas to life. Our vertical integration enables us to control glass manufacturing and optimize fabrication processes. So you get the performance you need—in a product that perfectly conveys your vision. Visit us at us.agc.com to learn more.

Experience The New Designability of Glass.

©2012 AGC Flat Glass North America, Inc. All rights reserved.

Circle no. 21 or <http://architect.hotims.com>





of the Department of Interior Design at the University of Florida's College of Design, Construction, and Planning. "With color forecasting, there's always this push for the new and the latest, and so it's almost encouraging a throwaway mentality, in thinking certain spaces—to look fresh or new—have to have that edgier palette."

Designers might also wonder where each year's color palettes come from. "In some ways it's like reading the horoscope," Portillo says. "The methodology behind selecting those colors is often pretty obscure." Color forecasters say that they usually track the success of their predictions anecdotally, by seeing what pops up in the market rather than through sales figure or statistics. It's an area ripe for academic research, Portillo notes.

Eiseman has heard skeptical questions about the color forecasting process before. "I think when you tell people 'I'm a color consultant' or 'I'm involved in forecasting,' they think it's a group of people that sit around and we discuss what color needs to be hot, and we form some kind of cabal to make that happen," she says. "Nothing could be further from the truth."

Color specialists do in fact meet to discuss colors, says Texas-based Jackie Jordan, director of color marketing for paint manufacturer Sherwin-Williams Co. She and a number of her colleagues—a color marketer with a fashion background, experts from the global product-finishes group and the Latin American group, as well as an outside textile-industry specialist—convene for several days at the company's headquarters in Cleveland to present their research, hone their predictions, and develop the stories that put the colors in context. They also discuss the research that drives their forecasts.

"We bring all our supporting materials—imagery, for the most part—from different resources, and then we bring the colors that we feel really tell this story," Jordan says. "So each person goes around the table and does their presentation, and from that, we'll start seeing [people say], 'Oh yeah, I researched the same thing,' or 'Oh yeah, I have something very similar to this but I found it here.'"

International and regional design shows are one of the best sources for research, color forecasters agree, partially because they can provide a hint of shades or color combinations being tested or set to debut. "Years ago, I remember going to a show where they had rugs that were created and dyed in these very deep purple colors," Mathew says. "They were hung on the wall because they weren't really being sold yet. It tells you something about the direction of color that we're going in. The following year, when I went back to the same show, I saw that those rugs were actually a part of their offering."

Color trends can also be influenced by popular moments in culture or even broad economic trends. "The economy of late has been horrible, but it affects people in different ways," Jordan says. "In the past, when there was a downturn in this economy, everything would get very gray, very brown, very neutral, because people didn't



Glass that
restricts fire.
Not design.

AGC FIRE-RATED SOLUTIONS

Fire-rated glazing and framing options from AGC offer the protection and code compliance your project demands—as well as the ability to bring inspired designs to life.

Ratings of up to 180 minutes can be achieved with glass that is wireless, colorless, and distortion free. So you can be sure your design vision will always come through.

Visit firesafe-glass.com or call 877-376-3343 to learn more.

Circle no. 386
or [http://
architect.
hotims.com](http://architect.hotims.com)



BEYOND GLASS™

us.agc.com

©2012 AGC Glass Company North America, Inc. All rights reserved.

The Normal Looking Radio Frequency Door



Krieger Radio Frequency doors look and function like a standard door, yet have a robust seal which is not susceptible to damage. And with this unique design, the doors meet the ADA threshold requirements of 1/2 inch without portable ramps. The doors are tested and certified in accordance with the IEEE 229 standard and are custom designed to fit your needs.

See what's possible
KriegerProducts.com
or call 1-800-528-8141

Circle no. 162 or <http://architect.hotims.com>

KRIEGERTM
SPECIALTY PRODUCTS

“I THINK WHEN YOU TELL PEOPLE ‘I’M A COLOR CONSULTANT’ OR ‘I’M INVOLVED IN FORECASTING,’ THEY THINK IT’S A GROUP OF PEOPLE THAT SIT AROUND AND WE DISCUSS WHAT COLOR NEEDS TO BE HOT, AND WE FORM SOME KIND OF CABAL TO MAKE THAT HAPPEN,” LEATRICE EISEMAN SAYS. “NOTHING COULD BE FURTHER FROM THE TRUTH.”



want to spend money on something that was going to be a fad. Then there’s also this other mind-set that says, ‘You know what, I want to make my mood brighter and more cheerful by adding color to my space.’”

Star architects and designers can be trendsetters as well, says Josette Buisson, a marketing strategist on color for Pittsburgh-based PPG Industries, which manufactures products ranging from paints and coatings to architectural materials. “We call them the influencers,” Buisson says. Those influencers range from product designer Marcel Wanders and interior designer Kelly Wearstler to architects Zaha Hadid, Hon. FAIA, and the ever-influential Frank Lloyd Wright.

From these raw and diverse sources, the color forecasters begin to build a more refined set of palettes that tell an overarching story. These palettes tend to incorporate similar trends taking place simultaneously in areas such as fashion, design, and pop culture, Jordan says. Sherwin-Williams, for instance, is finalizing a set of four palettes for the company’s 2013 color forecast, set to launch at NeoCon in June. One, a dark, romantic, masculine palette, plays on themes of mystery and intrigue, inspired in part by the trend of pop-up restaurants and theaters that invite visitors to a secret location. The colors include dark burgundies and oxbloods, dark plums, and a very dark hunter green.

The stories behind the color palettes can be important in providing inspiration to designers. PPG identified five stories this year, including craftsmanship, inspired by a move toward artisan-made products, and illusion, a theme that relates to the popularity of fairy-tale fantasies and vampire stories. “It’s like we’re giving [designers] a beat, and then they will write their music out of it,” Buisson says. Portillo agrees that the narrative backstory behind a color trend can be a powerful tool for designers as a jumping-off point with their clients. “But,” she warns, “if it becomes prescriptive—that any time you want to have an Asian feeling, you need to use this palette—then it becomes very limiting, and it’s something that should be avoided at all costs.”

Whether the colors are inspired by an Italian furniture fair or an Estonian artisan, designers should look at the philosophy behind a company’s color selections and decide for themselves how it applies to their own project, Mathew says. “If we simply say that it’s one color that is the color of the year, it doesn’t help anyone, because it’s just a policy,” she says. “Creating a philosophy around color is so much more transformational, and I think that’s what we’re really after when we’re putting forth a trend.” □

ZIP up a tighter envelope.

Protect your projects from the elements, with ZIP System® sheathing. Our all-in-one structural panels with a built-in water resistive barrier combined with our specially designed ZIP System™ tape guard your buildings from moisture damage during and after construction. This continuous water and air barrier also improves energy efficiency by significantly reducing air leakage. And panels go up quickly for a stronger, drier, faster seal – creating the ideal building envelope.

ZIP up your next project. SwitchToZIP.com.

ZIPsystem™
ROOF & WALL SHEATHING

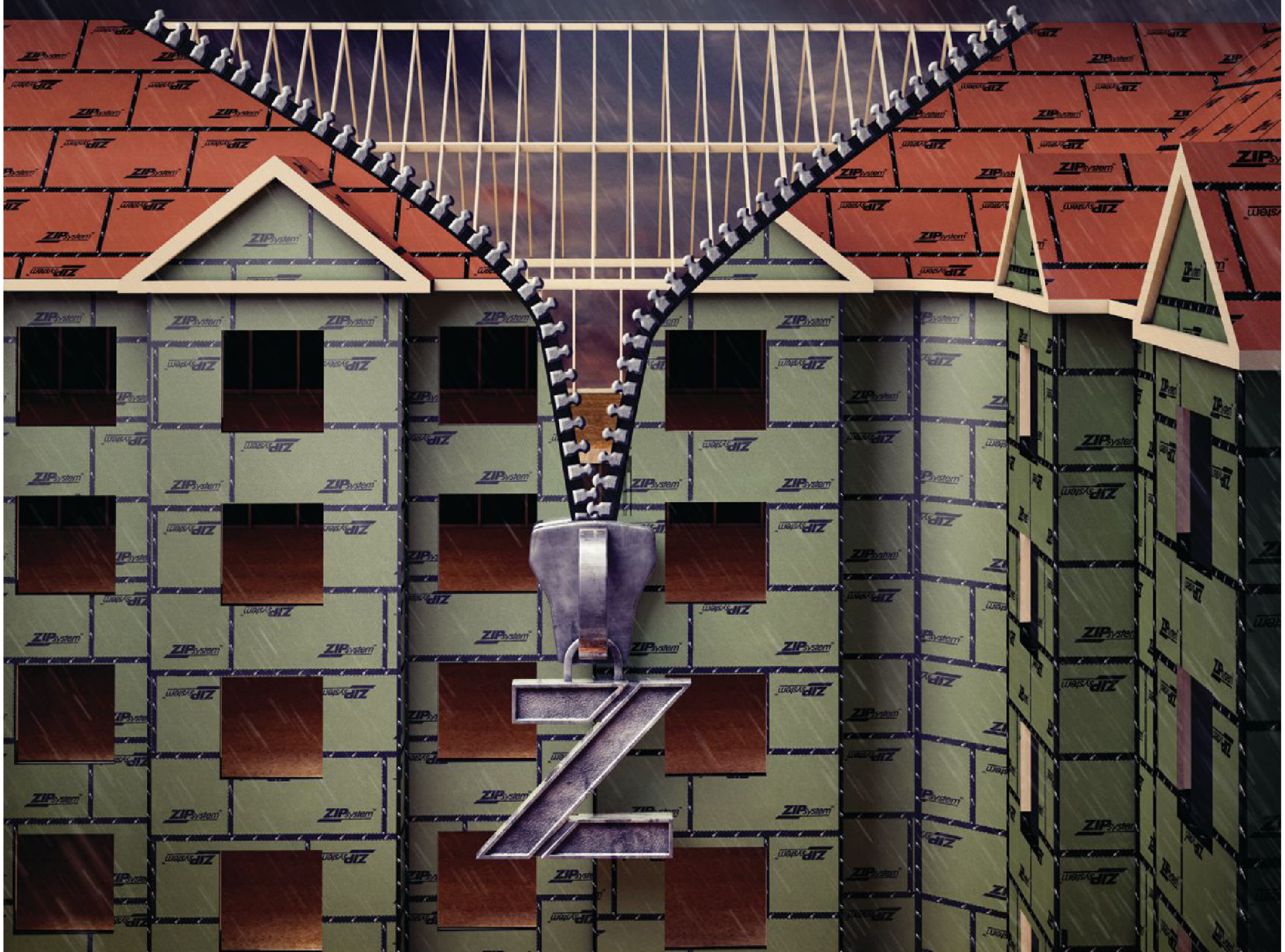

© Huber Engineered Woods LLC. ZIP System, the accompanying ZIP System logo and design And AdvanTech are trademarks of Huber Engineered Woods LLC. Huber is a registered trademark of J. M. Huber Corporation. Huber Engineered Woods products are covered by various patents. See zipsystem.com/patents for details. HUB 3013 2/12

FROM THE
CREATORS OF





DEFINING INNOVATION.

New England Builder Braves Hurricane Irene With ZIP System® Sheathing

Hurricane Irene's path of destruction across 10 East coast states in August 2011 resulted in an estimated \$7 billion to \$13 billion in damage. In the face of one of the top 10 most destructive hurricanes in the U.S. since 1980, custom builder Olson Development LLC counted on ZIP System® roof and wall sheathing to withstand the impact of Hurricane Irene in the construction of an 8,500-square foot home in Greenwich, CT.

The waterfront home was completed in April 2012 using 250 ½-inch ZIP System® wall panels and 300 5/8-inch ZIP System® roof panels manufactured by Huber Engineered Woods. The ZIP System sheathing stood up to intense storm surges, rain and wind for an extended period of time, according to the builder.



Mark Olson,
Owner of Olson Development LLC

"My experience with ZIP System® sheathing has resulted in faster build times, and when Hurricane Irene made a direct hit on New England, the products performed flawlessly," said Mark Olson, owner of Olson Development LLC and 30-year veteran of the building industry.

ZIP System roof and wall sheathing consists of structural panels with built-in protective barriers. The seams of the roof and wall panels are sealed using ZIP

System tape providing moisture resistance for seams, valleys and ridges, ultimately reducing the occurrence of air leaks. ZIP System's cutting edge formula meets and exceeds industry standards set by the Seal and Insulate with the ENERGY STAR® effort, and is code recognized as window and door flashing tape when used with ZIP System wall sheathing (ESR-2227). With this innovative product, ZIP System roof and wall sheathing is faster to install than traditional methods and provides an instant 180-day rough dry-in, allowing builders to schedule subcontractors sooner and ultimately complete the house in less time.

Olson Development LLC also used 300 ¾-inch AdvanTech®, which Huber Engineered Woods manufacturers, to construct the home.

AdvanTech flooring and sheathing are known for moisture resistance and unsurpassed quality, as well as industry-leading strength and stiffness based on ESR-1785 (Evaluation Service Report) standards that exceed PS2 performance standards used by competitors.



A combination of innovative resin technology and manufacturer engineering makes this product unique in the field of structural panels, and AdvanTech flooring is the only subflooring to hold the ESR certification. The AdvanTech® brand now features new panel graphics including the ESR-1785 certification on the front of the panel, a Sustainable Forestry Initiative (SFI) logo to showcase its environmental commitment, a new fastening guide for quicker installation, and bi-lingual instructions to ensure 1/8-inch spacing gap. AdvanTech® flooring is backed by the Huber Engineered Woods 50-year fully-transferrable warranty.

For more information about Olson Development LLC, ZIP System roof and wall sheathing or AdvanTech flooring visit www.OlsonDevelopmentLLC.com, www.zipsystem.com or www.advantechperforms.com. Or follow Huber Engineered Woods on Facebook and Twitter.

Connect to news

Request these e-newsletters and receive industry news as it's happening



ARCHITECT Newswire is a FREE comprehensive daily e-newsletter compiling Web articles, blog posts, and other information on the business and design of architecture. Also included is content from various social networking tools and opinions from leaders across the Web.



ARCHITECT Weekly is a FREE once-a-week e-newsletter that features industry news, design inspiration, market intelligence, and business and technology solutions for the architectural industry.

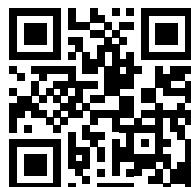

SIGN UP TODAY!
www.ameda.com/arch/1M1ENBD

ARCHITECT

NEW PROJECTS

1. ESRI CORPORATE HEADQUARTERS
 Architect: Armantrout Architects, Redlands, Calif.
 Completion: 2010

2. RIVERSIDE CONVENTION CENTER RENOVATION
 Architect: DLR Group, Riverside, Calif.
 Total Cost: \$40 million
 Completion: 2014

3. PALM DESERT HIGH SCHOOL
 Architect: Ruhnau Ruhnau Clarke, Riverside, Calif.
 Total Cost: \$62 million
 Completion: 2011

MARKET STATS**0.45**

EXPANSION INDEX VALUE, RIVERSIDE
 The Expansion Index from Reed Construction Data is a 12- to 18-month look ahead at the construction marketplace. A value of 1.0 or higher signifies growth.
 SOURCE: REED CONSTRUCTION DATA

2.1 MILLION

COUNTY POPULATION, 2010
 SOURCE: U.S. CENSUS BUREAU

21%

PROJECTED METRO POPULATION GROWTH BY 2020
 SOURCE: OFFICE OF ECONOMIC DEVELOPMENT, CITY OF RIVERSIDE

16%

DECLINE IN JOBS SINCE 2006
 SOURCE: OFFICE OF ECONOMIC DEVELOPMENT, CITY OF RIVERSIDE

13%

COUNTYWIDE UNEMPLOYMENT, MAY 2012
 SOURCE: OFFICE OF ECONOMIC DEVELOPMENT, CITY OF RIVERSIDE

9.6 MILLION S.F.

CLASS A OFFICE INVENTORY, RIVERSIDE CITY
 SOURCE: VOIT REAL ESTATE SERVICES

18%

CLASS A OFFICE VACANCY RATE, RIVERSIDE CITY, Q1 2012
 SOURCE: VOIT REAL ESTATE SERVICES

22

COMMERCIAL BUILDING PERMITS ISSUED, APRIL 2012
 SOURCE: OFFICE OF ECONOMIC DEVELOPMENT, CITY OF RIVERSIDE

\$325,300

MEDIAN HOME VALUE, 2006–10
 SOURCE: U.S. CENSUS BUREAU

→ LOCAL MARKET

Riverside County, Calif.

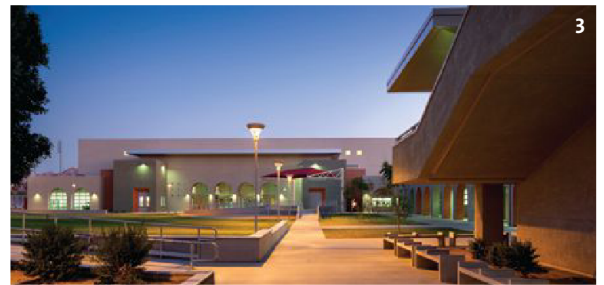

TEXT BY MARGOT CARMICHAEL LESTER
 AND CLAIRE PARKER

EQUIDISTANT FROM LOS ANGELES and Palm Springs, Riverside County was a booming area prior to the economic crash. From its agricultural roots grew a thriving exurb as people took advantage of the convenience, housing affordability, and proximity to jobs and amenities, including the beach and mountains.

The influx fueled K–12 construction, which continues. The Palm Desert High School, designed by local firm Ruhnau Ruhnau Clarke and completed last year, was funded by state public school construction funds and Career Technology Education Grants.

But construction of most kinds have been minimal recently. “The slowing of the national and California economy has hit the city and its residents hard,” says Pam Tuschner, FAIA, principal with the DLR Group in Riverside, Calif.

Today, Riverside County has a \$13-million budget shortfall, thanks in part to declining property values, which have dropped for three consecutive years and are expected to fall another 2.1 percent in fiscal year 2012–13. The county has the highest foreclosure rate in the region, according to a California State University at Fullerton economic overview.

The downturn has slowed a redevelopment effort in the city of Riverside, but not before a few key projects were completed. “Riverside Renaissance brought back the historic Fox Theater and revitalized Main Street,” Tuschner says. Locals hope that a renovation of the

convention center will be a draw for big-ticket events and drive development of residential and hotel property in the central business district. Partially funded by a 12-percent transient occupancy tax on hotel rooms, the rehab will turn a “boxy ’70s building into a modern traditional building,” Tuschner notes.

In addition to the economic challenges, there are demographic ones. The county still retains its agricultural heritage, which attracts mostly low-paying farm jobs. And the urban areas have a “challenge in establishing a white-collar job base,” meaning that many people commute to Orange County and greater Los Angeles, according to Robert Kain, principal and healthcare market leader for HMC Architects in Riverside.

One source of white-collar gigs is Esri, a geographic information system—mapping software developer based in Redlands, Calif. Local firm Armantrout Architects recently completed a new 83,000-square-foot headquarters building for the firm.

Most in the county are looking to the city of Riverside to lead the recovery. “We need to take advantage of our climate and the outdoors and create shopping and dining and entertainment,” says Roger Clarke, principal at Ruhnau Ruhnau Clarke. “There is a rich history of people who have worked behind the scenes to promote and bring the city forward and create its own identity. While its [the city’s] needs are great, it has a great deal of potential for growth with the right leadership.” □

WINDOWS • CURTAIN WALL • ENTRANCES • STOREFRONT

The #1-specified commercial window manufacturer offers even more.

EXACTLY.

All of the factors that have made EFCO the #1-specified brand of commercial windows are also built into our curtain wall, entrances, and storefront. Cutting-edge design. In-house engineering services. High-performance thermal capabilities. And more. Add the perfect combination of beauty and performance to your projects. It's all available with **EFCO. Exactly.**



To learn more, call 1-800-221-4169 or visit efcocorp.com.

© 2012 EFCO Corporation

Circle no. 85 or <http://architect.hotims.com>



Allsteel®

beyond change

Now you can manage change beyond simply moving walls.
To move ideas. Make connections. Inspire thinking.

Introducing Beyond.™
Frameless glass movable walls from Allsteel.

allsteeloffice.com

Circle no. 234 or <http://architect.hotims.com>



TECHNOLOGY



It's kind of mind-blowing when you consider that Eero Saarinen designed his Womb chair—ostensibly an icon of the '60s—way back in 1946. The **Knoll** bestseller is still fabricated as originally intended, with a molded, reinforced-fiberglass shell wrapped in foam, and cushions made from polyester fiber with a foam core. The woven **KnollTextiles** upholstery fabric shown here, Cato, is also a midcentury classic, dating to 1961. • knoll.com • Circle 100

EDITED BY WANDA LAU

→PRODUCTS

Icons Are Forever

Every one of the chairs that Hans J. Wegner designed for **Carl Hansen & Søn** has its own serial number—the Wishbone Chair, for instance, is CH24, and the Shell Chair is CH07. In 2010, the company added another Wegner serial number to its roster: CH468, also known as the **Oculus Chair**. Though Wegner designed the chair in 1960, it did not enter production until three years after his death—a midcentury icon, deferred. • carlhansen.com • Circle 102

Andre Kikoski, AIA, has described the job of designing a 1,600-square-foot restaurant in New York's Guggenheim Museum as “an exhilarating challenge.” The architect designed the **Guggen** chair specifically for the space; its striated back recalls the spiraling ramp in Frank Lloyd Wright's atrium. Manufactured by **Ligne Roset**, the chair is available with a cruciform wire base (shown) and a swivel base. • ligne-roset-usa.com • Circle 101

Alvar Aalto co-founded Finnish manufacturer **Artek** to produce his then-radical, now-classic range of bentwood, birch-veneered furniture. Over the years, the company has sustained the spirit of innovation by commissioning pieces from Enzo Mari, Jørn Utzon, Shigeru Ban, and other freethinkers. One example is the stackable **Armchair 423**, which Ben af Schultén designed in 1989 using Aalto's signature material. • artek.fi.com • Circle 103



INTRODUCING

BASYS™



Any Application. Any Environment.™

Backed by a century of experience and proven Sloan technologies, Basys delivers a revolutionary approach to sensor faucets that meets the demands of the commercial plumbing industry. Fueled by two years of field research and in-depth interviews with architects, engineers and plumbers, Basys has the strength and versatility to meet the needs of any application or environment.

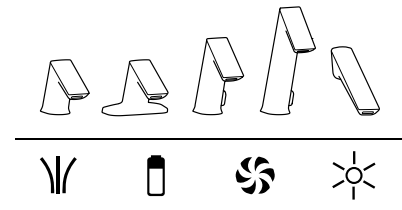

Build a Basys online:
sloanvalve.com/basys



SLOAN®

Circle no. 453 or <http://architect.hotims.com>

→IT

Beyond PowerPoint

DESIGNERS EXPLORE NEW AND OLD WAYS TO MAKE CLIENT PRESENTATIONS THAT ARE MEMORABLE AND—BETTER YET—SUCCESSFUL.

TEXT BY BRIAN LIBBY
ILLUSTRATIONS BY PETER ARKLE

Whether it's for a prospective client, a jury, or the public, architects often face the task of conveying their three-dimensional visions in just two dimensions. Though PowerPoint has become the de facto choice for slide-style business presentations, a variety of tools and programs are available. And as these four architects have found, a winning presentation is not so much about a singular showpiece, but rather an exhibition that curates responses born from video, animation, stills, and conviction.



Eric Keune, Skidmore, Owings & Merrill

"I always like to begin by telling the audience that I'll present things in interpretive dance," says Erik Keune, AIA, design director at SOM's Chicago office. Inevitably, he launches a PowerPoint deck, "but within that there are variations and eddies that come off that river," he says.

For example, to present interior spaces such as lobbies and public spaces, "We model it digitally using either **Autodesk 3DS Max** (Autodesk, \$3,495) or **Rhino** (Robert McNeel & Associates, \$995) and then stitch it together in a panorama," he says. The result has been enlivened by iPads, which change screen imagery in response to how one moves the device. "It's more immediate than doing it on your computer. But, you can only hold it from a single vantage point. If we were to use video-game software modeling that allows a large database of imagery at low resolution, then that would be the next logical extension."

After the firm started using the panoramas last year, "you'd see people running around the office holding iPads," Keune says. "Now that it's been six months, the frothy euphoria has worn off. But I still think there's some blood left in that stone."

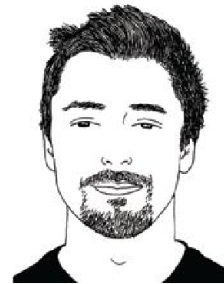

Yan Krymsky, Yazdani Studio of Cannon Design

"When doing a presentation, a lot of times we'll have PowerPoint on one screen," says Yan Krymsky, senior designer at Yazdani Studio in Los Angeles. "Then there are 3D applications like **Autodesk Showcase** (Autodesk, \$995) or **3DS Max** where we can move the models around in real time. We're trying to use gaming engines, but I don't think we've used that successfully with a client yet."

That's because **Crysis** (Electronic Arts, \$20), the gaming engine Krymsky likes best, involves "a guy running around with a gun," he says. "You can't seem to get rid of it. But it has great things about it. You can make contact with the objects in the space, and that adds a level of reality." The program is also "multiuser for people to interact together. The ability to see somebody else's avatar and take a tour with them—there's a lot of potential," Krymsky says. "One of the things that we take for granted is the sense of the design you can get from operating the controls. In a gaming environment, you can feel the space in a much more realistic way."



John Peterson, Public Architecture

Although San Francisco-based, nonprofit firm Public Architecture (PA) uses PowerPoint, it has been looking for other affordable alternatives. Prezi (Prezi, free to \$159 per year), a cloud-based presentation software that the firm has tried, is “like a spider diagram,” says PA’s founder and president John Peterson, AIA. “You’re pulling things forward and pushing them back.” Prezi allows users to zoom in and out of broader, wall-like conglomerations of circle- and square-shaped slots of information. Prezi isn’t just a tweaked version of PowerPoint, Peterson says: “It’s ... about presenting in a new way, rather than just improving what we’re already doing.”

But Peterson believes that it’s a mistake to rely solely on projector-based presentations. “The dynamic changes completely when the light’s out and everyone’s staring at the same thing at the same time,” he says. “So often we’re presenting by handing out a bound book. When you leave behind printed materials, people can revisit it. Publishing’s gotten so cheap now that you can do one-off books or a short run very inexpensively. And one thing with the iPad is that you can have a presentation that’s digital, but everyone can move through it at their own pace.”



Jonathan Smith, Lake|Flato Architects

“Lately we’ve begun by using blogs as our client interaction, even before the interview,” says Jonathan Smith, AIA, of Lake|Flato Architects in San Antonio. “We will set up a blog using Ning (Ning, \$19.95 to \$599.90 per year) and typically invite the consultant teams to join it at that stage. It’s password protected, and you can see all of the members: your landscape architect, sustainability consultant, engineer. We encourage people to post with site photos, analysis, and items of inspiration. Anyone on the team can comment on any of the blog posts, and you can also have discussions.”

Lake|Flato first set up a blog for a project interview “where we were one of the few firms that wasn’t local,” Smith says. “It was a way of showing the client that we already had a well-oiled team and were already communicating. We ... use it to demonstrate how the team is working together and having fun. It allows you to show more of your personality. We typically invite the client, then, to join the blog and see the process that went into the initial design. Clients have responded pretty well. We also try to have that same blog live on through the life of the job. The interview blog on many jobs morphs into something focused not just on clients but also on user groups.” □

IT'S TIME FOR SHOW & SELL



DEVELOP GREATER BRAND AWARENESS AND SHOWCASE YOUR FEATURED EDITORIAL.

Event Collateral

Media Kits

Direct Mail

Online Marketing

Recruiting Packages

Presentations



Awards



Mobile Reprints



Reprints



Digital Reprints



800.290.5460 x100 | Architect@theYGSgroup.com

TEXT BY IAN VOLNER

**AIA/CES Credit:**

You can earn 1 CEH (Continuing Education Hour) for reading this article and successfully completing the quiz. You must answer eight of 10 questions correctly to earn credit and obtain a certificate of completion. This course is valid through June 2015.

To earn credit and obtain a certificate of completion, visit go.hw.net/archceu and complete the online quiz for free. Follow the “Click here to start this course” link for this story to launch the quiz. If you are new to Hanley Wood University, create a free learner account; returning users may log in as usual. Upon completion, you can print a certificate of completion for your records or for self-reporting needs. Credits will be reported to the AIA for AIA members.

After completing this course, you can leave feedback with us directly; AIA members can also leave feedback by logging into the AIA CES Discovery system.

Customer Service

hwuniversity@hanleywood.com

Learning Objectives

1. Describe the two materials used in tensile fabric structures.
2. List at least two advancements made in the design or material of tensile structures.
3. Briefly discuss the history of tensile architecture by highlighting notable projects.
4. Identify examples of other uses for tensile membrane fabric.

Sponsored by:



Munich Olympic Stadium

→ CONTINUING EDUCATION

A History of Tension

FREI OTTO'S OLYMPIC STADIUM FOR THE 1972 SUMMER GAMES IN MUNICH, GERMANY, INTIMATED A FUTURE FILLED WITH ORGANIC AND MIND-BENDING FORMS. HAVE TENSILE FABRIC STRUCTURES LIVED UP TO THEIR PROMISE?

SINCE THEIR INCEPTION, tensile fabric structures have been the subjects of spectacle. From the first major debut of large-scale tensile structures at the Munich Olympics in 1972, to the 2010 collapse of the Metrodome in Minneapolis, these buildings, with their daring simplicity and outstretched configurations, have captivated the general public and captured the media spotlight in a manner that few other building typologies do. But, as so often is the case, the glare of the cameras has done little to illuminate the story behind tensile structures and their curious place in design history and in contemporary practice.

The basic structural behavior of textile-formed structures is reasonably straightforward. “It’s like a dome in reverse,” explains engineer Guy Nordenson, founder and partner of New York-based Guy Nordenson and Associates. Whereas the shell of a masonry or concrete dome is supported primarily in compression,

the continuous surface of a tensile fabric structure contains no discrete compressive members. Instead, Nordenson says, “It’s a thing that depends entirely on in-plane forces that are all tensile—a version of the balloon, so that you’re either holding it stretched with air or by giving it some shape” with masts and cables.

In his 2009 study of tensile surface structures, Michael Seidel, a senior scientist at Vienna University of Technology, identifies their most salient feature as “the large clear spans, which can be roofed over very economically without internal support.”

The balloon-like quality of tensile structures belies the durability of the membrane fabric. Long the industry standard for fabric construction, the tough, weather-resistant, and synthetic polytetrafluoroethylene (PTFE) fabric comprises woven fibers of PTFE or, more





Worse for the environment. Expensive to use.

A recent peer-reviewed study by a leading science and technology university has found that paper towels generate over 15.5g of CO₂ per dry.* Alongside standard warm air hand dryers they have the largest environmental impact of all hand drying methods.

The study shows that the carbon footprint of recycled paper towels is almost equal to that of virgin towels. Recycled paper towels generate over three times more CO₂ than the Dyson Airblade™ hand dryer.



Best for the environment. Costs 98% less to use.

The study shows that the Dyson Airblade™ hand dryer (AB04) generates 4.4g of CO₂ per dry, 72% less than the recycled paper towels studied.

As well as generating less CO₂ the report also found the Dyson Airblade™ hand dryer (AB04) was better than any other hand drying method studied, across environmental measures including land use, ecosystem quality and energy consumption.

It dries hands in 12 seconds, there's no paper waste and it costs 98% less to use than paper towels.**

dyson airblade

The fastest, most hygienic hand dryer.

To view the study on the environmental impact of hand drying methods, visit:
www.dysonairblade.com

*Source: T. Montalbo, J.Gregory, R.Kirchain. Life Cycle Assessment of Hand Drying Systems. Dyson commissioned study 2011. **200 uses per day, 2 paper towels per dry (data from Dyson internal research – Jan 2010). 1400W machine shown. Standby power. Average paper towel cost of \$0.01 (data from Dyson internal research – Sept 2008), an electricity charge of \$0.0989 per kWh (Source: U.S. Department of Energy). Paper towel dispenser and Dyson Airblade™ hand dryer costs are excluded from comparisons. 12 second dry time based on NSF protocol P335 (www.nsf.org).

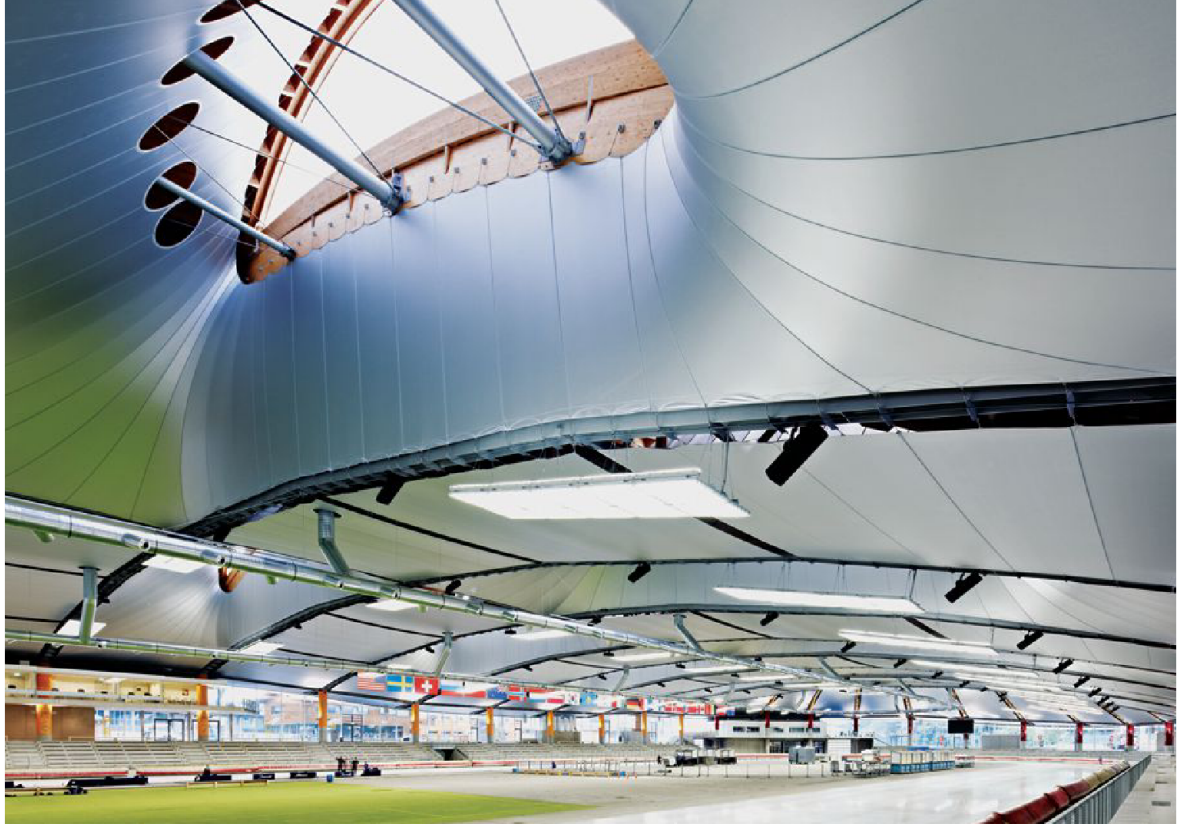

Designed by Behnisch Architekten and Pohl Architekten, the Max Aicher Arena in Inzell, Germany, is not a tensile structure in the classical sense. Rather, the design uses a highly reflective, low-emissivity membrane fabric to encase roof trusses and help regulate temperature and humidity conditions inside the arena.



commonly, woven fiberglass that is emulsion- or extrusion-coated in PTFE. Saint-Gobain Performance Plastics offers PTFE-coated fiberglass products with thicknesses ranging between 20 and 40 mils and strip tensile strengths of 500 to 900 pounds per linear inch. Marcel Dery, global sales manager, architectural, at Saint-Gobain, says that “it would be deceiving” to compare PTFE to other construction products such as steel or wood. Architectural fabric “is a completely different type of building material” because it elongates and achieves full strength when elongation is properly addressed, he says.

PTFE, though, is not the sole product on the market with which to create tensile fabric structures. “ETFE [ethylene tetrafluoroethylene] is a new trend here in the United States, and you’ll see a lot more projects using it,” says Michele Roth, marketing manager for Birdair, a specialty contractor for custom tensile membrane structures based in Amherst, N.Y.

Like PTFE-coated fabrics, ETFE is a polymer that can be used in single or multiple plies. But ETFE is technically not a fabric because it does not comprise individual woven fibers; rather, “it’s a foil,” Dery says. In multilayer ETFE installations, the interstitial voids between plies are filled pneumatically to create a cushion. The air pocket in architectural ETFE acts as an insulator; depending upon the number of layers of plies and cushions, ETFE can achieve R-values between 1.4 and 5—well above the R-value of 1 that a single ply of PTFE fabric achieves, although roofing systems made from multiple PTFE layers that sandwich an intermediate insulating layer, such as aerogel, are available.

With constant R&D efforts at manufacturers such as Saint-Gobain, newer and more products will be on the market soon. In 2008, Birdair, Geiger Engineers, and manufacturer Cabot Corp. released a laminated nanogel fabric that’s both light transmitting and highly insulating, averaging an R-value between 5 and 14 per inch of thickness. Students at Germany’s University of Stuttgart are currently researching the potential of

“active” textile membranes that have sensors and mobile parts to adjust the membrane for changing stress factors.

The Stuttgart team follows in the footsteps of architect Frei Otto, the founding father of modern tensile structures. Though his work with fabric membranes began as early as the 1950s, it was the 1972 Olympic Stadium in Munich that brought Otto international acclaim. This project represented only a fuller expression, on a far grander scale, of his much-publicized West German Pavilion for Expo 67 in Montreal.

The now-87-year-old architect didn’t come to tensility through any particular enthusiasm for coliseums or exhibition halls. Rather, in a turn that has entered the realm of design legend, his interest was piqued by observing soap bubbles—highly efficient structures with large spans and minimal surface area and shell thickness. (A second story, somewhat less broadly circulated, involves his stint as de facto camp architect while detained as a prisoner of war in England during World War II.)

“Otto’s main contributions came during these phenomenal two decades between 1952 and 1972,” says architect and engineer Werner Sobek. During that interval, he says, “Otto did not have that much support from engineering. That changed after the Olympics.” In 1974, Sobek, then an aspiring structural engineer, came into Otto’s orbit when he began his studies at Stuttgart, where Otto had led a loose band of tensile enthusiasts under the auspices of his Institute for Lightweight Structures for a decade. Along with the ’72 stadium, the Stuttgart group was to yield a crop of designer-technicians, who, just as Sobek, went on to refine the means and math behind fabric-based structures. Jörg Schlaich, a junior colleague of Otto and fellow first-generation tensilist, traces the development of today’s fabric buildings from Stuttgart straight through the Munich project. “The development went from concrete shells via cable nets to membrane structures,” he says.





Finding complete, credible
product information is one thing.
Doing something with it is another.

The New
BPM SELECT[®]

The Premier Building Product Search Engine

Enter your product term

Search

Your Information. Your Way.

Search / Save / Sort / Share



Now more than ever, *BPM Select* is your *unequaled* solution for finding the building product information you need AND putting it to work the way you want! Based on industry feedback, *BPM Select* now presents results in a clearer, more concise and still complete format. In addition to providing targeted search access to over 14,000 building product manufacturer websites, *BPM Select* enables you to *save, sort and share* your product information – *your way*.

www.bpmselect.com

Take the BPM Select Video Tour!

Circle no. 262 or <http://architect.hotims.com>





For Sobek, who succeeded both Otto and Schlaich at the university, the urgent work of post-Otto tensile engineers focused on fleshing out the technical details underlying their forebears' more intuitive, "fingertip-feeling" approach. "It's a question of how to transfer ideas into reality—how to turn the soap-bubble model into a 1,000-foot span—and do it so you would feel comfortable sleeping under it," he says. The contributions of engineers

such as Horst Berger—who co-founded Geiger Berger Associates (now defunct) with David Geiger in 1968—have made projects such as the Denver International Airport come close to realizing the dream of tensility in mainstream building design. Nonetheless, even Sobek recognizes that working in textiles does impose certain constraints: "It really is mainly used for ... cases where a building's physical aspect means that thermal and acoustic insulation are not relevant."

The fact that PTFE-fabric envelopes have such little insulating capacity means that they are commonly used as outdoor features where the program calls for only the merest roof over end-users' heads. Toll plazas and train stations are often venues for modest installations of fabric. "In our portfolio, we've done a lot of canopies," says David Campbell, president of Suffern, N.Y.-based Geiger Engineers, which he co-founded with Geiger and Paul Gossen in 1988.

"IT'S A QUESTION OF HOW TO TRANSFER IDEAS INTO REALITY—HOW TO TURN THE SOAP-BUBBLE MODEL INTO A 1,000-FOOT SPAN—AND DO IT SO YOU WOULD FEEL COMFORTABLE SLEEPING UNDER IT."

—WERNER SOBEK

Today, cost has limited the role that high-quality tensile fabric plays in architecture. "It really comes down to economies of scale," says Peter Katcha, North American director of sales for Swiss fabrics manufacturer SEFAR Architects. Sheathing a vast building volume in 500,000 square feet of his company's proprietary fabric of woven PTFE fibers may cost millions of dollars, but it will typically cost much less per square foot than covering a smaller project. In other words, you might think twice about erecting a tensile structure over your suburban split-level.

The economic advantages of buying in bulk thus joins the list of reasons why tensile fabric roofs are prevalent in stadiums. Making the most of those factors was the objective of Jörg Schlaich's firm, Schlaich Bergemann and Partner, and Geiger Engineers when they recently worked together on a project first designed by Geiger Berger in 1983: BC Place, a 54,000-seat stadium in Vancouver, British Columbia, Canada, which is home to the local football team. The building's original, fixed-in-place tensile fabric covering had served its purpose for

Architectural Hardware
ENTRANCE SYSTEMS
MANUFACTURED BY
C.R. LAURENCE

NEW COMING SOON!
CRL14D ARCHITECTURAL DOOR AND ENTRANCE CATALOG
Showcasing the largest selection of door systems in one catalog!

CRL **C.R. LAURENCE COMPANY**
usalum.com | crlaurence.com | crl-arch.com
USALUMINUM mail: crl@crlaurence.com | usalum@crlaurence.com
WORLDWIDE MANUFACTURER AND SUPPLIER
Glazing, Architectural, Railing, Construction, Industrial, and Automotive Supplies
Entrances, Storefronts, Curtain Walls, Window Walls, Window Systems, and Sun Control



JAB343b-5/12



Peace of Mind During Your Next Project

Specify an MIA Accredited Commercial Contractor.

Lobby of Dewey Ballentine
Washington, DC

Stone Contractor:
Rugo Stone, LLC, Lorton, VA
MIA Accredited Commercial A Contractor
MIA Accredited Commercial B Contractor
MIA Accredited Natural Stone Fabricator

Architect:
STUDIOS Architecture

General Contractor:
James G. Davis Construction

Stone Supplier:
Prostone SRL



MARBLE
INSTITUTE
of America

COMPETENT | SAFE | COMMITTED | QUALIFIED | REPUTABLE | SKILLED | ETHICAL | STABLE | TRUSTED

Marble Institute of America Accredited Commercial Contractors and Natural Stone Fabricators are those high performing companies that meet the industry's highest standards for technical expertise, business activities and ethics, product knowledge, safety, finance, fabrication and installation. Companies that have earned the right to display the

accreditation seal have completed an intensive, rigorous process that includes documentation of its business and employment practices, letters of recommendation, a challenging examination and site inspections to the company's facility and project locations. The MIA only accredits the best that the stone industry has to offer.

marble-institute.com | twitter.com/marbleinstitute | facebook.com/marbleinstitute



Thank you to our Accreditation Sponsors

Platinum Sponsors:



Gold Sponsor:

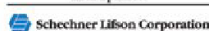

Silver Sponsor:



Circle no. 44 or
<http://architect.hotims.com>



→ “THE 7,500-SQUARE-METER ROOF OPENS IN 12 MINUTES. JUST THINK ABOUT THE REACTION OF PEOPLE WATCHING THAT HAPPEN.”

—PETER KATCHA

Since 1957, Accurate Partitions has been providing high-performance toilet partitions that meet or exceed specifications, require little maintenance, withstand the rigors of some very difficult environments, and provide a lifetime of low-cost of ownership.

Designed for
Functionality
Durability and Style



Available in:

- Powder Coated
- Stainless Steel
- Plastic Laminate
- Phenolic Black Core
- Phenolic Color-Thru
- Solid Plastic

Choose from four mounting styles. When additional privacy is desired, Ultimate Privacy™ doors and panels are available.

Accurate™
Accurate Partitions Corp.
accuratepartitions.com

Now Available as BIM Objects



Single Source Solution

ASI
GROUP
PARTITIONS
ACCESSORIES
LOCKERS

nearly 30 years, but the team thought that it didn't take full advantage of new opportunities afforded to sports venues with the increased ductility of contemporary tensile fabrics.

To make the central portion of the new membrane roof retractable, the team turned to the fabric makers at SEFAR, selecting one of the company's most ductile and translucent products. "They wanted the stadium to work in all weather conditions, and to be one that was openable to the sky above," Katcha says. As a result, when it reopened last fall, BC Place boasted a nominally 100-meter-by-85-meter retractable tensile roof—the largest in the world. By simply drawing back the PTFE roof cover, the stadium may be used without costly building conditioning during warm months, making it a year-round venue.

But the tensile roof also provides something more. "It opens in about 12 minutes," Katcha says. "Just think about the reaction of people watching that happen." The structure, in effect, becomes a part of the entertainment.

Fabric structures can also become a part of the games they house. Topping a competitive speed-skating arena in Inzell, Germany, designed by Stuttgart-based Behnisch Architekten, is an undulating, wooden roof structure wrapped in a white tensile fabric that, like a rolling snow bank, nicely complements the Bavarian Alps backdrop. Firm partner Stefan Behnisch, Hon. FAIA, is quick to point out that the roof is not a tensile membrane structure in the classical sense. "It's a wooden structure with foil over it," he notes. "Under the roof are tensile ... foils or fabrics."

Rather than leave the wooden trellis exposed, Behnisch swaddled it in a low-emissivity, highly insulating membrane made from polyethylene and aluminum, held taut above the rink in "tensile fashion," he says. The reason was simple: In order to preserve the optimal consistency of the skating surface, the arena's temperature and humidity conditions needed to be closely regulated. The reflective fabric made by Serge Ferrari helps maintain the conditions that lead to firmer ice and thus faster skaters.

Yet beyond providing clear spans for sports fans and the odd exhibition hall, tensile structures have taken on a number of other, more eccentric, and playful roles in recent years due to their inherent light weight and portability. For U2's global 360° Tour, which wound down last year, Stufish Entertainment Architects in London created the Claw, a looming, steel-girder tarantula that stood athwart the stage and structurally supported speakers, screens, and a radio mast. Tensile fabric cladding wrapped the structure, forming its spiny contours as it projected from the metallic skeleton. "It

BORAL STONE PRODUCTS

Build something great™

The latest looks. A lasting impression.

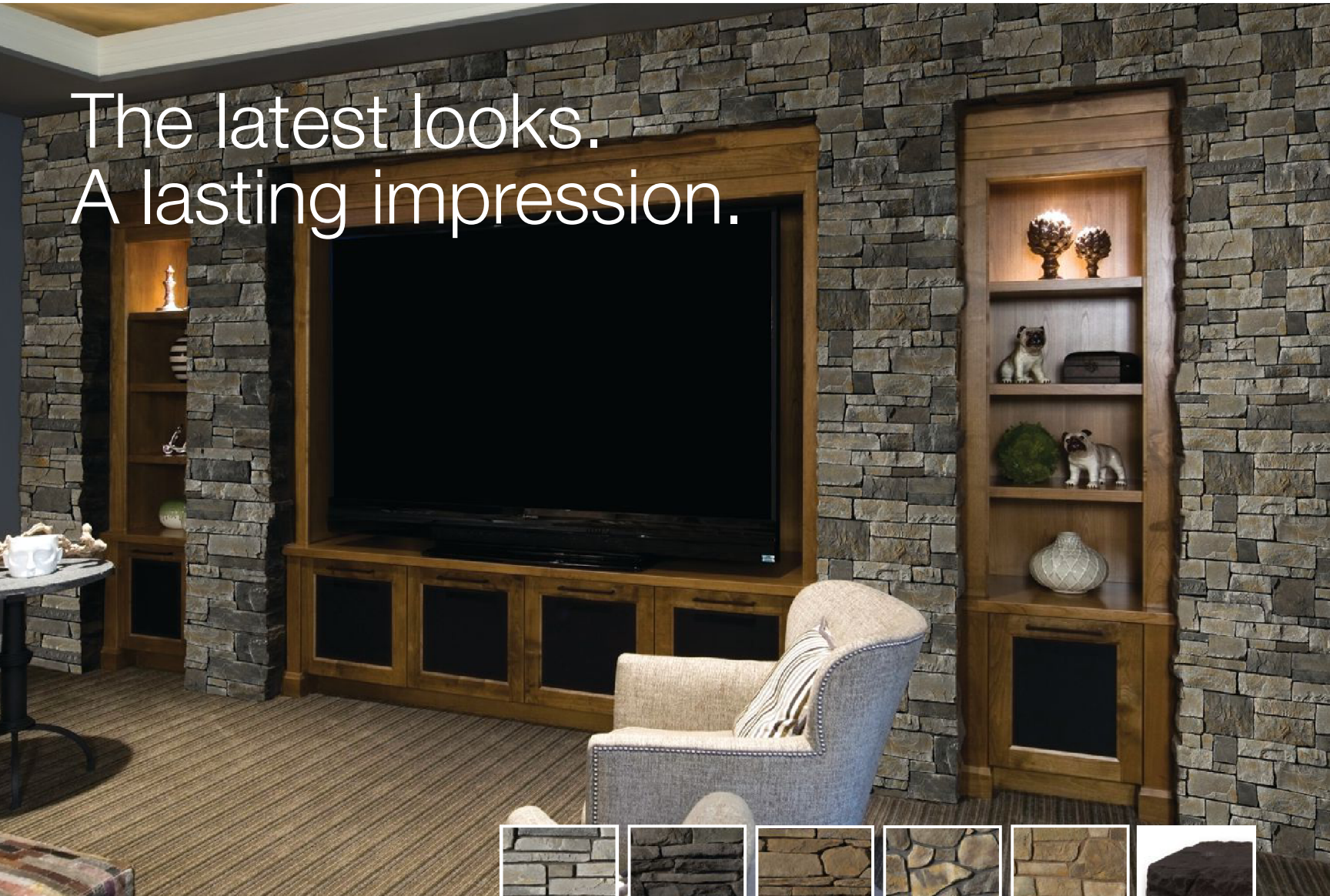

Cultured Stone®



For half a century, Cultured Stone® manufactured stone veneer has been a leader in new styles and colors. Our new line of products is inspired by architects and designers, and like our full line, evokes the authenticity of natural stone – with its enticing textures and extraordinary palette. With a wide design selection and unmatched craftsmanship, it's no wonder Cultured Stone® veneers are ranked Number One in usage and quality by the 2012 *Builder Magazine* Brand Use Study. **To find out how you can get Cultured Stone for your next project call 1.800.255.1727.**

Six New Products:

Echo Ridge™ Country LedgeStone
Black Isle™ Del Mare LedgeStone®
Hudson Bay® Southern LedgeStone
Wolf Creek® Dressed Fieldstone
Sevilla™ Ancient Villa LedgeStone™
Nightfall™ Watertable/Sill

1.800.255.1727

www.culturedstone.com

Follow us on



© 2012 Boral Stone Products LLC



Circle no. 536 or <http://architect.hotims.com>

“TENSILE STRUCTURES ARE PROGRESSIVE. THEY REPRESENT AN OPTIMISTIC NOTION OF ABSOLUTE, MINIMAL STRUCTURE.”

—GUY NORDENSON



had mushrooms and polyps designed so they could be jacked out from the steelwork manually, to tension the skin,” explains Mark Fisher, principal of Stufish, which has designed concert stages for the likes of Tina Turner and the Rolling Stones. As the tour moved from city to city, the Claw’s lightweight construction allowed easy transportation, disassembly and reassembly, going from a bag of bones to puffed-out set piece in just 24 man-hours.

The Steilneset Memorial, completed last summer in Vardø, Norway, also exemplifies the versatility of tension fabric structures. The tensile fabric fuselage, by German designer Peter Zumthor, contains within it a permanent exhibition in honor of 17th-century-witch-trial victims. The exhibition space hangs suspended on cables within a wooden superstructure, producing the effect of a free-floating cocoon, hewn in a PTFE-coated fiberglass fabric drawn taut.

Significant advances in computational design are facilitating the growing formal diversity in tensile fabric structures. Engineering office Buro Happold, based in the U.K., has even created a proprietary software, Tensyl, to make complex tensile structures easier and faster to design. All of which is to say that advances in tensile are moving at a remarkably fast pace. That may not be altogether surprising, however. Compared to other structural systems—steel and certainly masonry—tensile fabric construction is remarkably young.

The inherent tenuousness of tensile-fabric structures, in fact, may be the source of their unique architectural charge. “Tensile structures are progressive,” Nordenson says. “They represent an optimistic notion of absolute, minimal structure.”

In the four decades since its entrée into the architectural mainstream, tensile has attracted the interest of designers and engineers captivated by a desire to do the improbable: to create, in the words of critic Reyner Banham, *une architecture autre*—“an other architecture”—that defies the rules of design and seemingly of gravity itself.

Whether it’s an instant rock ‘n’ roll road festival, a soap bubble, or—as in Werner Sobek’s case—a love of “precision ... of treating materials carefully,” tensile fabric is malleable enough to fit almost any of the countless architectural agendas at large in the profession today. Geiger Engineers’s Campbell also sees tensile membranes as an adaptable standby that any designer should have in their repertoire. “We look at fabric as just another building material,” he says. “It creates opportunities.” □



SOMETIMES YOU CHOOSE
FLOORING BASED ON LOOKS.
OTHER TIMES FOR VALUE
OR DURABILITY OR, IN THIS
CASE, ALL THREE.

EarthWerks™ is the perfect flooring choice based on good looks alone. It offers architectural beauty that clients appreciate. More importantly, it is easy to install, maintain and repair and stands up to spills, messes and a ton of traffic.

EarthWerks™ commercial grade vinyl tile and plank flooring are also Earth friendly and recyclable. So, before you take the next step, consider EarthWerks™ – be demanding and get everything in one beautiful product.

earthwerks
FLOORING INSPIRED BY NATURE



For information regarding our extensive line of sustainable vinyl flooring, please call 800-275-7943, or visit us online at www.earthwerks.com

Johnsonite®

How do you solve for x?

Whether your variable is performance, sustainability, or even something less tangible, like confidence, you can find a solution with Johnsonite®.

That's because our integrated system offers the most comprehensive collection of flooring and accessories in the industry today. So no matter what's in your equation, you can be sure to solve for x. And that's just simple math. See more at johnsonite.com.



Scan now
to request
the 2012
Johnsonite
Story.



THE ULTIMATE
FLOORING EXPERIENCE

Circle no. 38 or <http://architect.hotims.com>

TERRAZZO is Classic.

Loder Family Residence • Southern California



Thiep Cung
Architect
www.wgarch.com

“The creative process truly is boundless and limitless with terrazzo. The combination of an artistically creative process, the strength and durability of the materials, and the cost effectiveness of the product itself result in a modern piece of art that will last through the ages.”

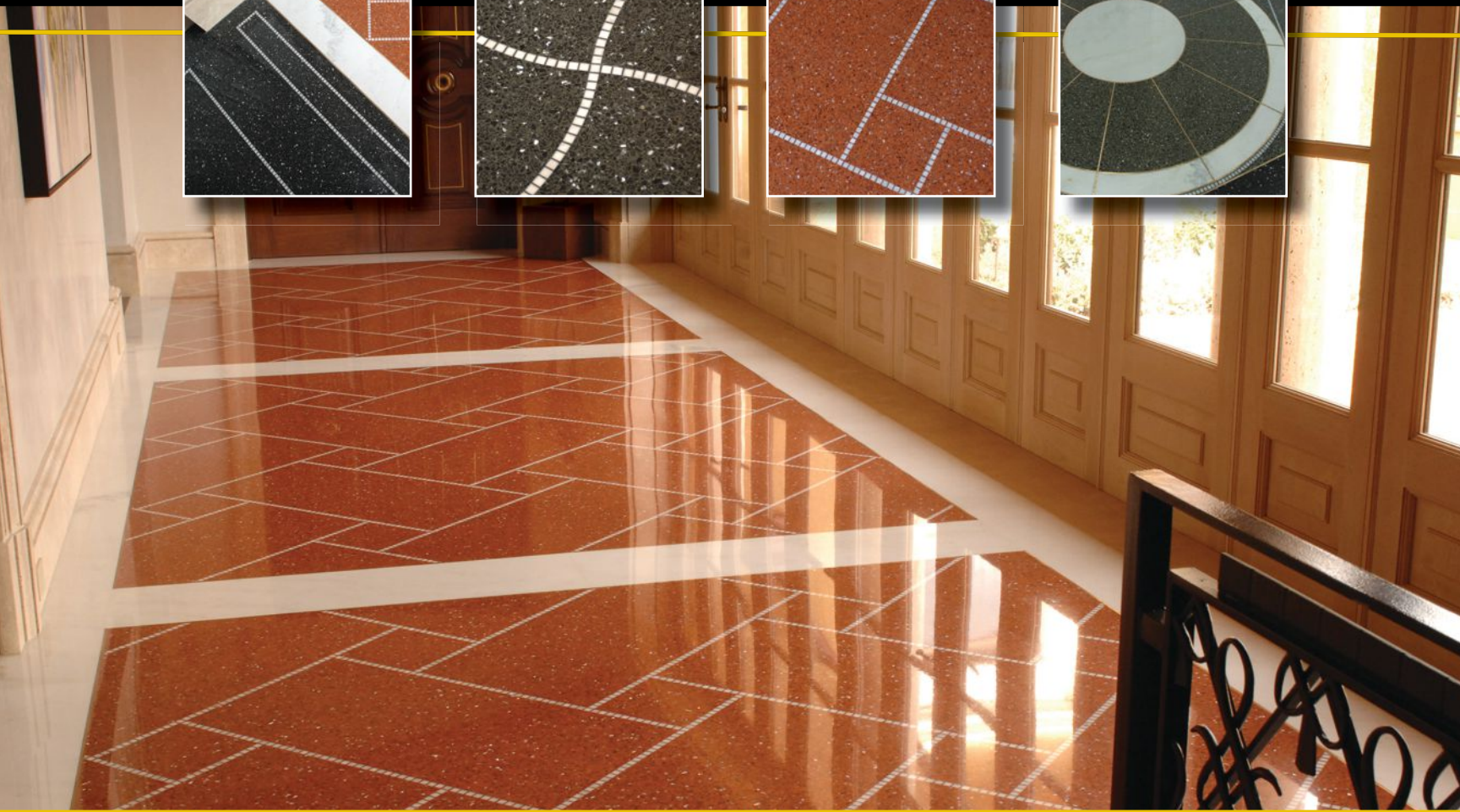
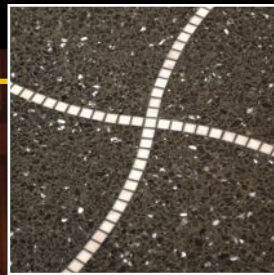
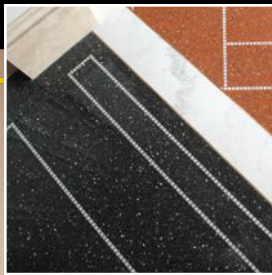

www.ntma.com
800.323.9736

Circle no. 437 or <http://architect.hotims.com>



COURTESY SEFAR ARCHITECTURE

The membrane fabric roof over BC Place in Vancouver, Canada, is the world's largest cable-supported, retractable roof to date. Measuring the same size as the playing field, the nominally 100m-by-85m roof comprises two layers of PTFE fabric that form a membrane cushion.



TruGroove

Defining spaces. Redefining performance.

The epitome of simple sophistication, TruGroove delivers pure, uninterrupted luminance — making a definitive statement in any architectural space. Innovative optical design and patented MesoOptics technology, elevate performance to a whole new level in narrow aperture recessed LED and fluorescent lighting.

trugroovenow.com

PHILIPS
LEDALITE

GET THE WHOLE
STORY ON-LINE, VISIT:
lafarge-na.com/visitwithme

**I may not be able to
smash through walls,
but I can make old
gypsum as good as new.**

**John Lankford, LEED Green Associate
Lafarge Gypsum**



Lafarge is about so much more than materials. It's about the people who stand behind them. It's about the people dedicated to transforming materials to adapt to our everyday environment.

These are the people of Lafarge. Those who are totally committed to finding sustainable solutions for a better world. Those who collaborate with architects, leading universities, research centers, industry and environmental organizations to make sustainable construction a reality.

I'm proud to be one of these people. **Join me online where I discuss Lafarge's ability to provide practical solutions for sustainable outcomes.**

Visit: lafarge-na.com/visitwithme



© 2012 Lafarge North America Inc.
LEED and the related logo is a trademark owned by the
U.S. Green Building Council and is used with permission.
Circle no. 474 or <http://architect.hotims.com>



bringing materials to *life*™

QUIZ

1. PTFE fabric may generally be made of:

- a. Cotton and fiberglass, with a weather-proof coating.
- b. A foil-like expanse of woven fiberglass.
- c. Woven fiberglass that is coated in PTFE.
- d. Synthetic perfluoroalkoxy.

2. One similarity between PTFE fabrics and ETFE fabrics is:

- a. Both materials must be inflated pneumatically for building use.
- b. Both materials are inflexible.
- c. Both materials have a high compressive strength.
- d. Both fabrics can be use in single or multiple plies.

3. True or False: ETFE membrane is not really a fabric.

4. A desirable characteristic of PTFE membrane includes:

- a. High thermal resistance (R-value).
- b. High ductility.
- c. High compressive strength.
- d. Both b and c.

5. One example of material technology advancement discussed in the article is the introduction of:

- a. A laminated nano-gel fabric that achieves R-values between 5 and 14 per inch of thickness.
- b. Small-scale production for residential designs.
- c. A textile membrane that adjusts for temperature changes.
- d. A self-healing textile membrane.

6. A technological advancement being researched by students at the University of Stuttgart is:

- a. A thinner, high-performance fabric with an increased insulating capacity.
- b. Increasing light transmission of fabrics.
- c. The development of active tensile membranes.
- d. The development of stronger cables and masts for tensile design.

7. Who is noted as the father of modern tensile structures?

- a. Werner Sobek
- b. Frei Otto
- c. Jörg Schlaich
- d. David Geiger

8. Which structure brought modern tensile structures international acclaim?

- a. The West German Pavilion
- b. BC Place
- c. Denver International Airport
- d. 1972 Olympic Stadium in Munich

9. BC Place boasts the largest retractable tensile roof in the world (at press time). Aside from its size, what else is remarkable about the roof?

- a. The amount of light it transmits
- b. It improves the performance of athletes when the roof is closed.
- c. It is coupled with a synchronized light show.
- d. It opens in 12 minutes.

10. True or False: Advances in the design and engineering for tensile structures are moving at a remarkably fast pace.



→ To earn credit and obtain a certificate of completion, visit go.hw.net/archceu and complete the online quiz for free. Follow the "Click here to start this course" link to launch the quiz for this story. If you are new to Hanley Wood University, create a free learner account; returning users log in as usual.

TruGroove

Defining spaces. Redefining performance.

The epitome of simple sophistication, TruGroove delivers pure, uninterrupted luminance — making a definitive statement in any architectural space. Innovative optical design and patented MesoOptics technology, elevate performance to a whole new level in narrow aperture recessed LED and fluorescent lighting.

trugroovenow.com

PHILIPS
LEDALITE

→ NEOCON PREVIEW

Editor's Choice



Concertex's NappaTile uses commercial-grade upholstery to create two- and three-dimensional tiles that emulate the look of leather. Available with a regular, padded, stitched, or buttoned finish, the tiles may be arranged in 24 standard mosaic patterns in 250-plus colorways. More than 1,000 faux-leather, faux-suede, and textile materials are available. The peel-and-stick tiles are backed with mineral board. Large-format and stain-resistant tiles are also offered. • concertex.com • Circle 120

Made entirely from recycled felt, **BuzziBlinds** by **BuzziSpace** are freestanding, rotating acoustical blinds that can also serve as office partition walls. Multiple units of blinds set on curved or straight floor plates—each hosting five slats—can run together to create different space configurations. The 22cm-wide blind slats come in heights of 115cm, 150cm, and 185cm, and in nine colors, including pink and lime (both shown) • buzzi.space • Circle 123



Even after the addition of colorants, **Sherwin-Williams Co.'s Emerald Interior** acrylic latex paint is free of VOCs. The low-odor, antimicrobial paint is Greenguard Certified for indoor air quality. Available in a matte, satin, or semi-gloss finish, the self-priming paint can be tinted to any of the more than 1,500 Sherwin-Williams colors. It will hit store shelves in July along with its outdoor counterpart, Emerald Exterior. • sherwin-williams.com • Circle 121

Made from recycled, thermoformed styrene, **Allusions** tin-styled ceiling tiles by **Surfacing Solution** may be installed nail free on ceilings. The 1/32"-thick, 2'-by-4' panels resist chipping, peeling, and delamination. Allusions has six patterns and five standard colors, including #309 (shown with a faux-patina paint finish). The tiles, which can be cut with scissors, may also be used for backsplashes, walls, and wainscoting. • surfacing-solution.com • Circle 124



Haworth's Lively Task ergonomic chair comes standard with features such as pneumatic seat-height adjustment, which can raise the seat height from 16" to 21", an upright back lock for users who sit straight up when they work, and a Tension Back to provide lumbar support. Optional features include seat-depth adjustment and four-dimensional arms. The chair can be fully upholstered in one of the nine Tension-Back fabric colors, or in one of the numerous fabrics Haworth offers. • haworth.com • Circle 122

Schluter System's low-profile **Kerdi-Line** floor drain can be installed adjacent to walls or in intermediate locations in shower and steam rooms. Intended for integration with bonded waterproofing assemblies, the linear, stainless steel drain can accommodate floor finishes with thicknesses between 1/8" and 1". The drain is available in channel lengths from 20" to 48" in increments of 4", and in three styles: perforated grate (shown), closed, and tile pan. • schluter.com • Circle 125

TEXT BY WANDA LAU

64.38

The size in carats of the largest cut emerald found in North America. The "Carolina Emperor," extracted in North Carolina, is now housed at the state's Museum of Natural Sciences.

SOURCE: THE CHARLOTTE OBSERVER



Created from loops of 3form's Translucent Suede resin, the **French Curve** pendant by **3form LightArt** features bands that are cold formed and dimensioned to maximize sheet yield and minimize waste. The 18"-diameter, 24"-tall fixture hangs from a matte-silver canopy with an 8'-long cord. 3form recycles or reuses the resin byproduct generated from making the pendant, which uses an 18W globe CFL with a color temperature of 3500K. • 3-form.com • Circle 126

For use on interior floors and walls, as well as exterior walls, **Shades** ceramic tiles by **Crossville** are produced with at least 20% recycled content. The tiles feature linear detailing and come in nine tones—including whites, grays, and an almost-black—and in a honed or unpolished finish. Standard sizes are 24" square, 12" by 24", and 6" by 24". Stacked, metallic, 1"-by-3" mosaic tiles are included in the line. • crossvilleinc.com • Circle 128

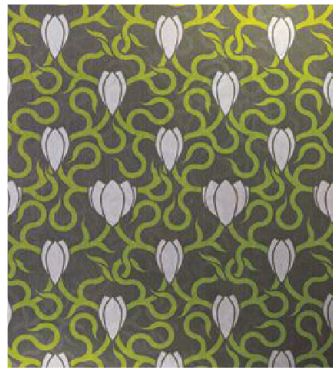

Xorel Graphic by **Carnegie Fabrics** combines jacquard weaving of the technical textile Xorel threads with digital printing to create patterns with dimensional nuances. Suitable for use as a wall covering, upholstery, or panel wrap, Xorel comes in hundreds of colors, colorways, and patterns, including *Medusa* (shown). Carnegie will take the PVC-free fabric back from any project for reuse or shipment to a waste-to-energy facility. • carnegiefabrics.com • Circle 127

Shaw Contract Group's Light Series carpet-tile collection includes four patterns that range from a near solid to multicolored, including *Visible* (shown). The tile's fibers and PVC-free backing contain 45% and 44% recycled content, respectively. Tiles come in a standard size of 24" square. Each pattern comes in a minimum of 13 colorways (*Pixel* shown). • shawcontractgroup.com • Circle 129

ENGINEERED SUSTAINABILITY

5
rule

New products that do not facilitate the evolution of codes and standards are not sustainable.

SYNTHEON™

We Value Engineered Sustainability™

www.SYNTHEONInc.com

Circle no. 581 or <http://architect.hotims.com>

Fanciful.

Stunning interpretation of a classic shelf bracket design.

SH42 – Arcing, fluid support structure is hardly just for looks, boasting a 60lb. weight capacity, easily strong enough for any small shelf.

Finishes: Glossy Black, Metallic Silver, Polished Chrome and Glossy White.



"FINE ARCHITECTURAL HARDWARE FOR YOUR FINE FURNITURE"®

MOCKETT
DOUG MOCKETT & COMPANY, INC.

www.mockett.com • 800-523-1269

Circle no. 516 or <http://architect.hotims.com>

Inspire™ to create beautiful openings

ASSA ABLOY, the global leader
in door opening solutions

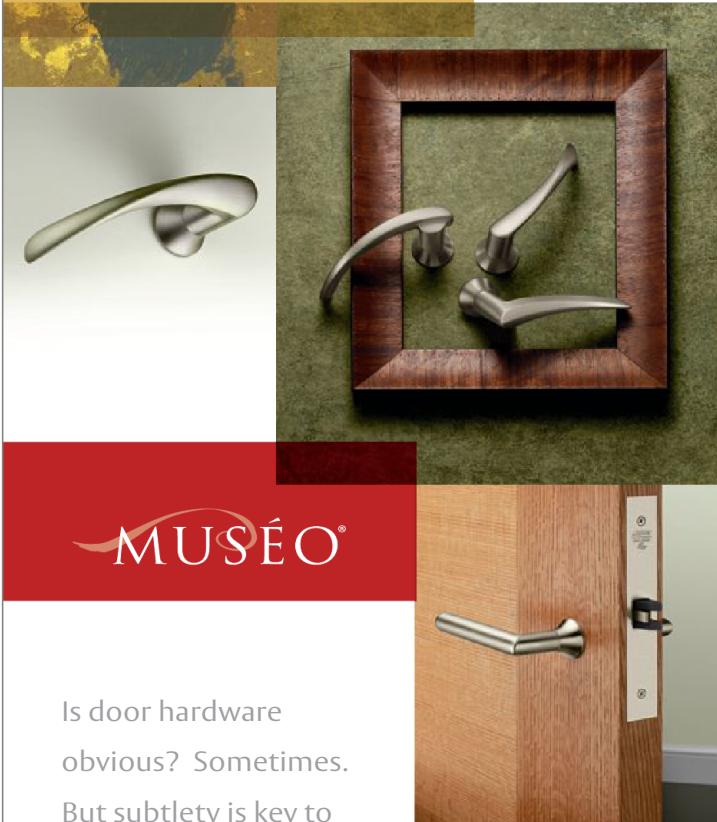

MUSÉO®

Is door hardware
obvious? Sometimes.
But subtlety is key to
good design. Select
a stunning Museo lever,
combine it with
Inspire trim, and create
a masterpiece!

the good design studio

www.thegooddesignstudio.com

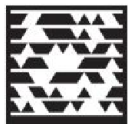

For more information, visit
www.corbinrusswinmuseo.com or
scan the Microsoft® Tag with your
mobile phone.

Copyright ©2012 Corbin Russwin, Inc., an ASSA ABLOY Group company.
All rights reserved.

Circle no. 552 or <http://architect.hotims.com>

technology

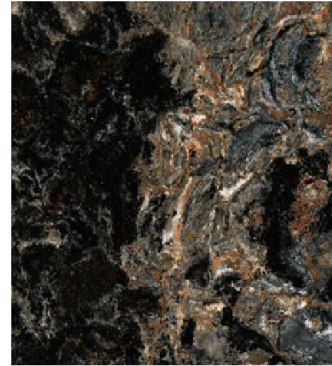

Hollinsbrook by Minnesota-based **Cambria** is one of 15 designs in the **Waterstone** collection of natural quartz. Named after a location in England, as per the company tradition, the quartz contains a mixture of black, chestnut, gray, and white colors. **Hollinsbrook** comes in 2cm- and 3cm-thicknesses for countertops, and in 1cm-thicknesses for vertical applications such as walls, shower and tub surrounds, and fireplaces. • cambriausa.com • Circle 130

Lightline by **KI** is a movable wall system that can create a variety of work and office space configurations. The modular glass walls feature butt-glazed panels that do not require an intermediate vertical post. The 2"-thick panels can be up to 10' tall and 5' wide and have clear-anodized, veneer-wrapped, or powdercoated framework. Slider and hinged doors as well as glass corners are offered. • ki.com • Circle 131

Teknion's universal desking system **Interpret** comprises reconfigurable work surfaces, a support structure, and storage components that come in multiple sizes and shapes. Customizable features include screen heights and screen elements, and the integration of components such as whiteboards. **Interpret** offers several accent-color and finish options, including storm-white laminate for desk surfaces (shown). • teknion.com • Circle 132

The **Tre** stool series, designed by **Jehs+Laub** for **Davis Furniture**, includes seats at three heights: lounge, counter (left), and bar (right). Made from molded plywood with a beech core, the stool comes in several finishes, including red paint and oak veneer (shown). **Tre** has a chrome or powdercoated footrest. A seat pad is optional. • www.davisfurniture.com • Circle 133



StarGlas, the world's most unique projection screen



IAC Building, New York, NY
 StarGlas: 118' - 3 7/8" (west wall)
 StarGlas: 20' - 4" (east wall)
 Systems Integrator: McCann
 Systems, LLC.
 All Rights Reserved
 © Stewart Filmscreen 2012

StarGlas, Stewart Filmscreen's ground breaking rear screen technology offers stunning images virtually anywhere...inside and out, regardless of ambient light conditions. This specifically engineered projection screen is a genuine building material that can be used to create unique and exciting visual presentations in store fronts, glass stairways, lobbies, or anywhere you desire to bring the building to life. There is a perfect screen for every application and, at Stewart, we have the solutions for all your application-driven projection screen requirements including:

- Simulation, Visualization, Command & Control
- Broadcast, Worship
- Corporate, Education
- Digital Signage
- Large Venues such as Museums, Theme Parks, and Arenas
- Home Theaters and other Residential Applications

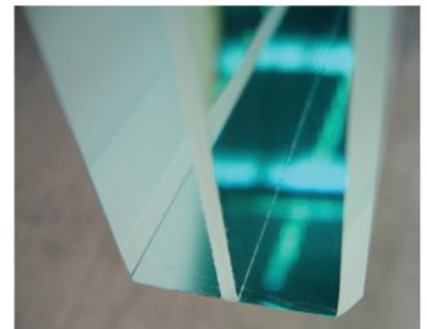

The diffusion layer is located between the glass protecting it from damage.

Custom configurations are also available. Please discuss your project with a Stewart representative and we will find the perfect projection screen for your application.



For additional information:
 email: request@stewartfilm.com
 web: www.stewartfilmscreen.com
 tel: 800.762.5300

Official
 Sponsor
 of the US
 Biathlon
 Team



Stewart
 FILMSCREEN

Follow us on:
facebook.com/StewartFilmscreen
twitter.com/StewartFilm



Circle no. 218 or <http://architect.hotims.com>

→ MIND & MATTER

Paving the Way

PAVILIONS REPRESENT THE FUTURE FOR ARCHITECTURE.

60,000

NUMBER OF SEEDS USED TO BUILD THE SEED CATHEDRAL.

SOURCE: BBC

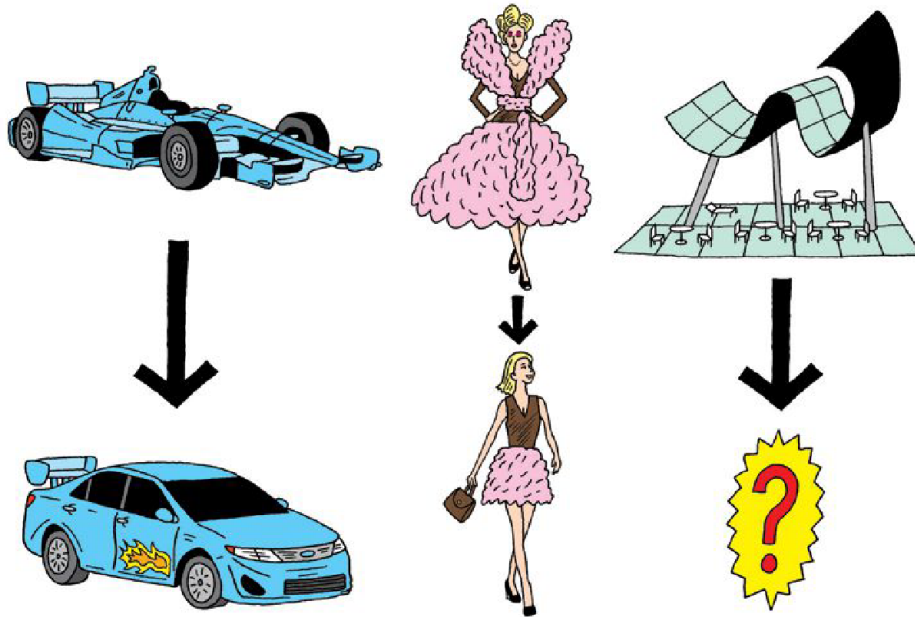

THE CONCEPT CAR is critical to the advancement of the automotive field. Created to test new technological and aesthetic ideas, its purpose is to provide a proof-of-concept demonstration of a design hypothesis. Every creative field has its own concept car: Fashion has prototype garments, for example, while electrical engineers use breadboards.

The pavilion is architecture's concept car. As small-scale, temporary structures, pavilions are model platforms for exploration, unencumbered by many of the restrictions placed on buildings. Pavilions often embody radical ideas for new structural technologies and material applications, and demonstrate the potential of these ideas for relatively little investment. Shigeru Ban's 22-meter-tall Paper Tower, constructed entirely of paper tubes connected by metal joints, or Thomas Heatherwick's Seed Cathedral, an immersing seed bank clad in thousands of acrylic rods bearing seeds, are examples of innovative—and temporary—structures.

Despite the compelling role of the pavilion, a disconnect exists in the larger framework of architectural praxis. In the automotive arena, car companies develop production-intent concept vehicles with the goal to push experimental technologies into mass production. In architecture, though, the experiments exhibited in pavilions stagnate there, rather than find their way into the broader spectrum of construction.

One explanation for this disconnect relates to economics. Automakers are able to meet stringent safety regulations while updating their technology. But new

materials and building systems are expensive to design, fabricate, and test for adherence to codes. Moreover, pavilions represent a significant investment: The Seed Cathedral reportedly cost \$39 million.

Another justification concerns risk. The most impressive pavilion designs purposefully subvert convention, requiring nontraditional methods for their construction. Such methods not only require more time, but also more courage. The construction industry is, after all, a common target for legal claims; builders understandably wish to limit their risk exposure.

The real challenge to pavilions stems from the public's perception of buildings as enduring structures. Although this year's imaginative car model might upset some aesthetic tastes, its relatively short life span makes it less threatening than a similarly innovative building. When faced with the prospect of effecting a long-lasting change in the built environment, society typically shies away from bold, exploratory architecture.

Yet in so doing, it also misses many of the creative solutions to technical, environmental, and social problems that innovative architecture can deliver. The ideas embodied in pavilions should not be allowed to die once the structures are dismantled. Rather, we must promote their benefits and work to ensure their full development and realization within the comprehensive field of building. After all, when this kind of inspiration can exert a measurable influence on the broader sphere of construction, we will gain a tremendous opportunity to realize the full value of design. □

TEXT BY BLAINE BROWNELL, AIA
ILLUSTRATIONS BY PETER ARKLE



→ Read more of Blaine's reports on cutting-edge tech at ARCHITECT'S Mind & Matter blog: go.hw.net/brownell.

IMAGINE BUILDING A SCHOOL... AND THEN JUST GIVING IT AWAY

Flagship Building Partners



Design & Construction Partners



Building Partners



The green
SCHOOLHOUSE SERIES



greenschoolhouse.org
Circle no. 94 or <http://architect.hotims.com>

JOIN THE CONVERSATION:
FOLLOW @GREENBUILD
ON TWITTER.



- Local power generation: 78%.
- Activate air barrier, rear exit.
- Occupancy alert: Activate.
- Greywater storage 37% capacity.
- Close air vents, Zones 12 and 14.
- Alert: Change air filter, Zone 6.
- Parking area fully occupied.
- Automated HVAC upgrade in progress.
- Routine maintenance notification, Zone 10.
- Expect occupant return in 15 minutes.
- Valve actuator 7. Open.
- Water quality level: Optimum.
- Interior temperature: 79°. Activate heat exchanger.
- 4:27 PM. Lower west-facing blinds.
- Change smoke detector battery, Zone 3.
- Set geothermal heat pump for sleep mode.
- Activate lighting controller, Zone 2.
- Air Quality Index: 87. Cycle exterior ventilation.
- Next: Change.
- Floor unoccupied. Reduce lighting.
- Automated HVAC upgrade in progress.
- Cycle solar water system pump.
- Seasonal water usage audit in progress.
- Activated.
- Indoor humidity level: 35%.
- Indoor gens: Low.
- Peak demand: Access Energy savings reminder: Power down computer.
- Greywater storage 63% capacity.
- Rotate light shelves.
- Energy usage audit in progress.
- Occupancy alert. Increase HVAC load, Zone 1.
- Building Status Report. Login for more info.
- Activate Variable Air Volume, Units 5-9.
- Excess renewable energy storage.
- Excess demand: Access renewable energy storage.

BUILD SMARTER @ GREENBUILD

INTERNATIONAL CONFERENCE AND EXPO

NOV. 14-16 GREENBUILDEXPO.ORG

PRESENTED BY THE U.S. GREEN BUILDING COUNCIL
Circle no. 191 or <http://architect.hotims.com>

CULTURE



EDITED BY LINDSEY M. ROBERTS

→EXHIBIT

The best architectural models are artworks in their own right. An exhibition at Frankfurt's Deutsches Architekturmuseum, **The Architectural Model—Tool, Fetish, Small Utopia**, offers some 200 cases in point. And as one would expect, important works by Peter Eisenman, Rem Koolhaas, Ludwig Mies van der Rohe, and other modern giants are on display. But, happily, curator Oliver Escher also looked beyond the mainstream, as exemplified by the strange item above. A creation of the 1960s Viennese collective Haus-Rucker-Co, contemporaries of Superstudio and Archizoom, it's titled *Stück Natur eingeweckt*, or, roughly translated, *Canned Piece of Nature*. Through Sept. 16. • dam-online.de



→ EXHIBIT

More and more studies are demonstrating the positive effects of daylight on health, happiness, and productivity. New York-based designer Jonathan Olivares takes those findings to their logical conclusions by proposing a new typology: the outdoor office. Through an exhibition at the Art Institute of Chicago, Olivares suggests that we should take advantage of the freedom that more-flexible office environments and increased connectivity offer. (Not to mention that outdoor workspaces in warmer climates would theoretically reduce costs and energy from lighting and a/c.) As this new workstyle would require a new kind of outdoor furniture not made for R&R, **The Outdoor Office** offers up images drawn from TV and existing offices, as well as Olivares's own conceptual projects for inspiration. Through July 15. • artic.edu



→ EXHIBIT

Nylon, stainless steel, and Teflon came into our everyday lives at a time when material innovation was largely unencumbered by environmental concerns. **Hello Materials** at the Danish Design Centre in Copenhagen reviews such materials with our 21st-century, 20/20 vision. It also looks at a new class of forward-thinking materials spawned by contemporary desires to reuse scarce resources and push the conventions of form, function, and strength. An accompanying blog brings together material experts including exhibit co-curator Chris Lefteri and ARCHITECT's own Blaine Brownell to discuss such innovations as nanomaterials and energy-exchanging materials, as well as the meta-topics of energy footprints and needs versus wants. Through Sept. 21; en.ddc.dk

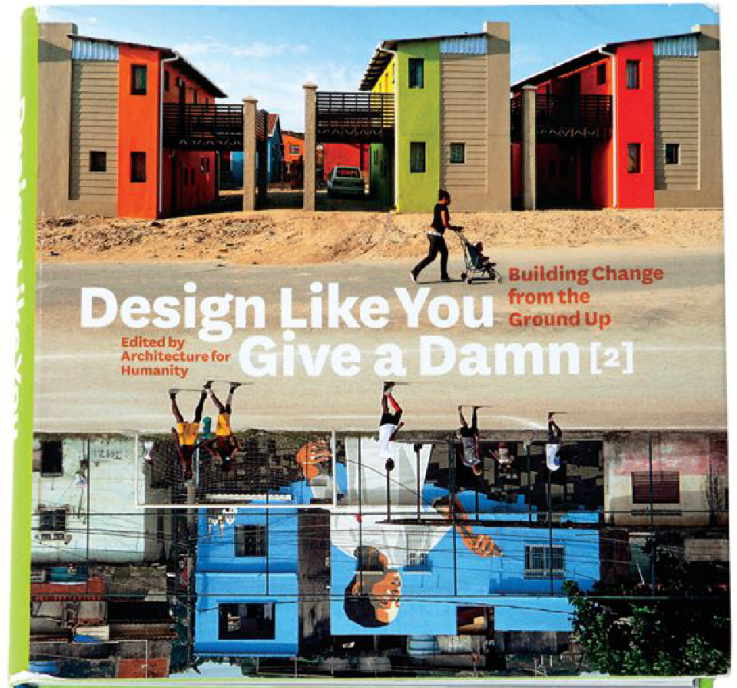

→ BOOK

Perhaps the most surprising thing about **Design Like You Give a Damn 2** is that it's only the second in the series, as principled and pro bono designs seem to be growing in boundless number around the world. DLYGAD2—by Architecture for Humanity, the San Francisco-based, globally active, nonprofit architecture organization—catalogs 70 projects, organized around such nonprofit themes as crowd-sourced planning, sustainable community design, and disaster relief. The book illuminates even the best-known public works: A timeline of the High Line, for example, reveals stakeholder engagement. • \$35, Abrams, May 2012

VIRTUAL
TOUR NOW
AVAILABLE



Learn Your XYBs



Three homes. Three different generations. One community. Welcome to the new economy of suburban planning, where homes for baby boomers, Gen Xers, and millennials exist side-by-side to serve the specific needs of their owners and create more diverse neighborhoods, steadier sales, and long-term value. Forget the one-house-fits-all approach; this is the new way to design, build, and sell homes in today's market.

Gain greater insight, see the concept in action, and take a virtual tour of the Baby Boomer house at . . .

builderconcepthome2012.com

Builder Concept Home 2012



→STUDIO VISIT

La Dallman

GRACE LA AND JAMES DALLMAN, THE HUSBAND-AND-WIFE DUO BEHIND THE MILWAUKEE-BASED PRACTICE, TALK ABOUT WHEN THE WORKDAY ENDS, AS WELL AS THE MIDWESTERN AGRICULTURE AND INDUSTRY THAT INFORMS THEIR WORK.

TEXT BY KRISTON CAPPS
PHOTOS BY JASON FULFORD

Grace La and James Dallman, AIA, launched La Dallman in 1999 in Milwaukee, a block away from their current studio in the city's gentrifying Historic Third Ward. The neighborhood, once known for its wholesale grocers and light-industry warehouses, is now listed on the National Register of Historic Places.

Their present studio is a former produce-distribution center. "It's interesting because in the space, the proportions are so tall, and the structure is relatively spindly," Dallman, 48, says. "When you had an earthquake in Virginia last spring? We could feel that in our building here in Milwaukee. The building swayed back and forth. The high-bay structure is not very stiff, but it's pleasant otherwise."

La and Dallman—who are married—keep a small studio: between five and 12 people, depending on the project load. "At one point a few years ago, we were at 16, and it felt too large to manage," La, 42, says. "James and I like to look at everything that goes out the door."

Although La and Dallman met as graduate students at Harvard in Boston, as a firm, La Dallman has strong Wisconsin roots. Dallman was born and raised in Milwaukee. "Many people in this practice originated as graduate students at the University of Wisconsin—Milwaukee," La says. Some of those staffers started as students under La, who is a full-time faculty member at the university. "We have steadfast folks who've come through UWM," she says. "We've become a quite intimate family after spending a decade together."



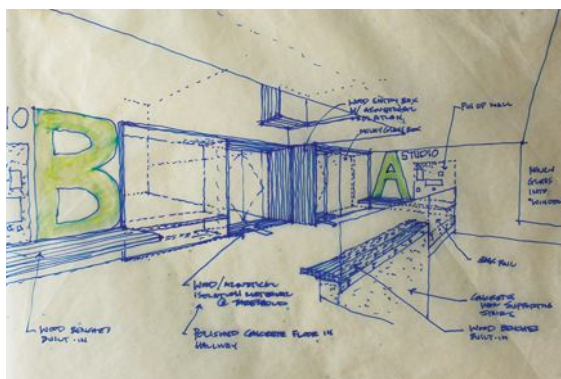
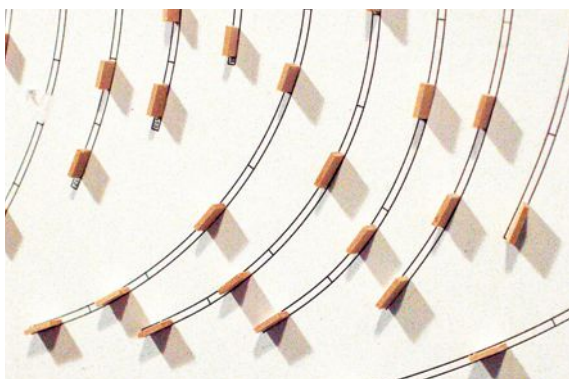
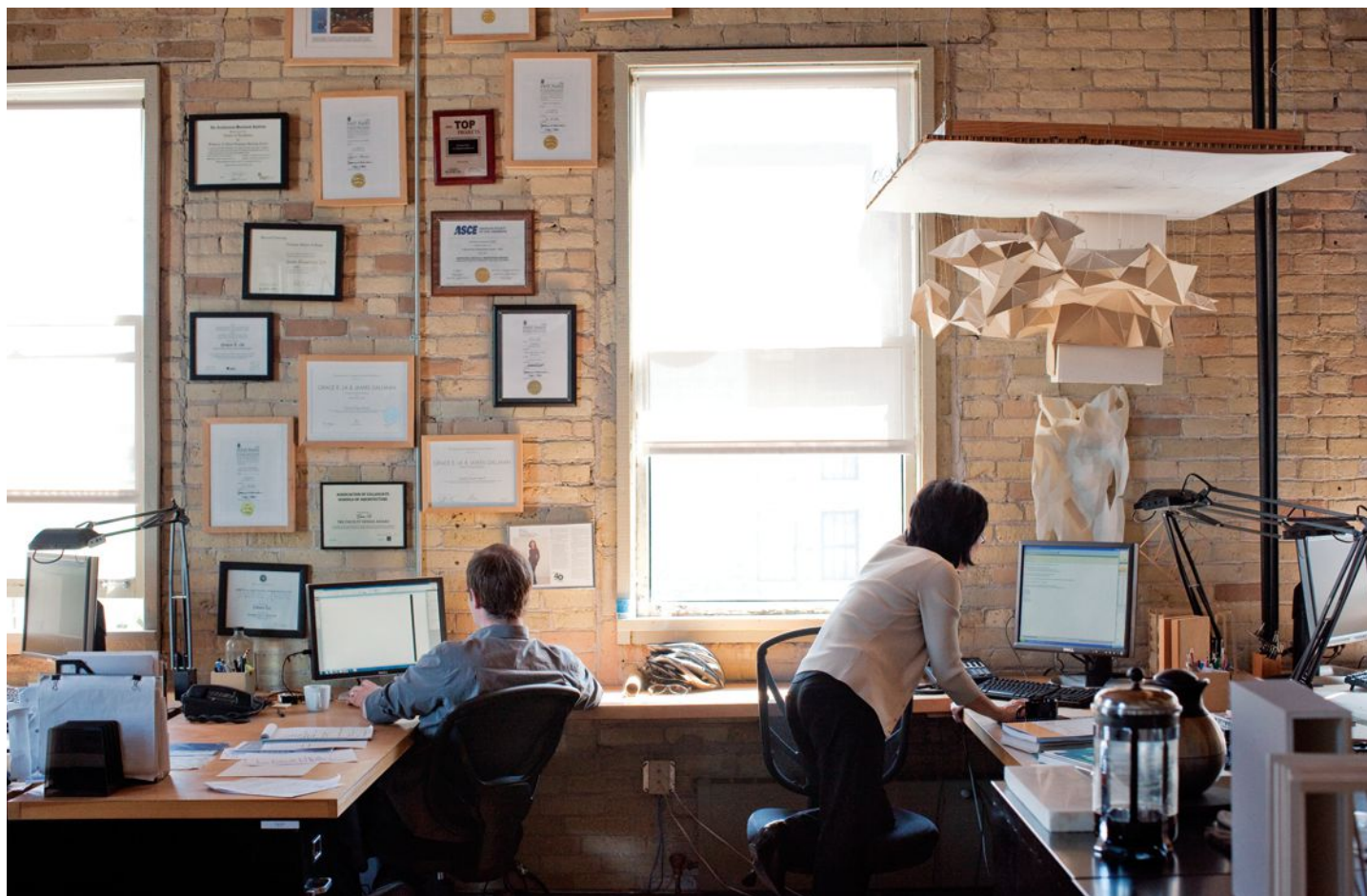

Currently, La Dallman is working on the Harmony Initiative—a collaboration between the UWM Peck School of the Arts, the Milwaukee Ballet, and the Medical College of Wisconsin. The facility will serve as a performance space as well as a physical-rehabilitation center, among other uses. “Dancers are perhaps the most premiere specimens of the human body,” La says. “This is nearly like a thesis project. You couldn’t pick a more interesting cast of characters to come together.”



What about working as a married couple? “We’re partners in life as well as in the practice,” La says. “Our children joke with us, ‘Could you please not talk to us about the office for five minutes?’” But Dallman notes the upsides for the kids. “At the same time, they love coming in whenever they want. They love the model materials.” La and Dallman have never made much of an effort to separate their married and working lives. “The practice is always envisioned as an opportunity to collaborate with one another.”

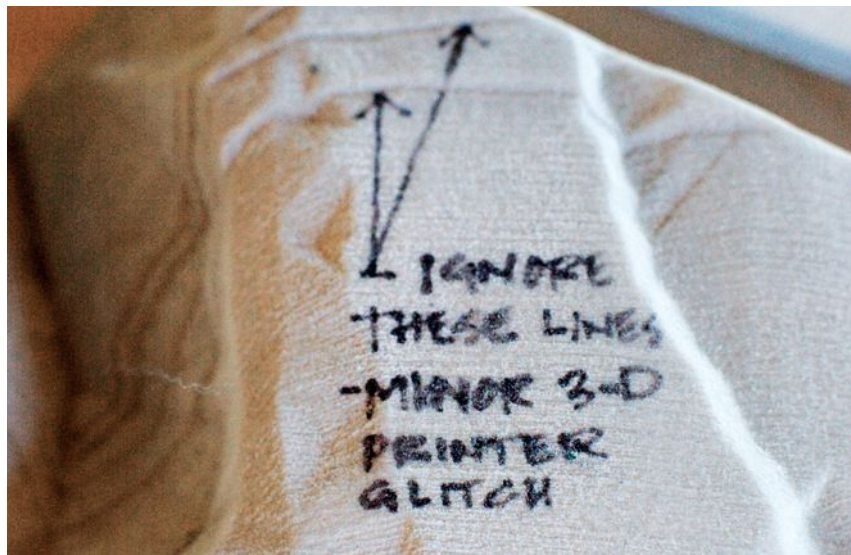



"The city is very transparent—socially, politically, economically—despite the divisiveness you hear about in Wisconsin," says Dallman, referring to recent partisan rancor and recall elections. Milwaukee is different, he says. "We were able to meet the mayor within a week of moving here. It's not dominated by Brahmins the way a city like Boston might be."

La says that the political temperament of the city has been critical to La Dallman's success. "I really do attribute the transparency of the city and our practice here for giving us the foundation to take on the projects we've been able to do, especially the infrastructure projects and the level of complexity we've been able to work at," she says. "It's embraced us from the start. We're very grateful for that."

For La Dallman's part, the studio's structure reflects transparency. "It's a mission statement of our practice," Dallman says. "It's a very flat hierarchy. Everyone does everything. There's no one in the office who just does one thing. Everyone is expected to help manage and design. That's one of the reasons we haven't grown very large."

La Dallman's work draws on the natural and economic landscape of the state. In Wisconsin, there is a closeness between industry and agriculture, La and Dallman say. "There's a certain kind of craft industry that's peculiar to this place," Dallman says. "They joke that every street corner has three metal shops and a pub. And each farmstead is a factory." Material mastery matters to the studio, La says, but their designs don't hold to a "neo-Luddite or antiquated romanticism about craft. Milwaukee sees itself as the machine shop to the world."

La and Dallman say that they've been asked to lecture about their work in different places. It always comes back to Wisconsin. "When you can combine digital fabrication technology and design tools in the office and the sensual quality of the material and the engagement of people who build things? There's a real support you get from the community," Dallman says. "Even the contractor starts to get excited about the project."

→ BEYOND BUILDINGS

Light Is Might

SOME UNEXPECTED CONSEQUENCES OF ARCHITECTURE CAN NEVERTHELESS ILLUMINATE DESIGN.



Reflected light from Johnson Fain's 42-story Museum Tower, seen in a rendering at right, is causing glare in the skylit galleries of the Nasher Sculpture Center.

WHO KNEW that architecture could be so painful? In Dallas, sun reflecting off the curving glass façade of a 42-story skyscraper—called the Museum Tower—is causing plants at the Nasher Sculpture Center to wither and the administration to move paintings out of the way. The Dallas war of bigger-is-better is being waged not by shadows, as some had feared, but by light.

What interests me most about this story is how we do not notice the effect that our buildings have on our environment until we confront an extreme example. That our cities have become giant heat islands, that we devastate vast territories because of all the resources we have to bring into our downtowns (not to mention the energy that goes into taking waste out), that we build without any mind to human scale in most central business districts—these effects are largely invisible. Only when a particular combination of forms creates a strong wind tunnel, or a new building threatens to block views, do we realize that the replacement of nature by buildings actually comes at a price.

Truth be told, I have never been that enamored of the Nasher's skylight system. It is ingenious to be sure, consisting of a number of layers—the most sophisticated of which consists of a series of elongated openings tuned so that no direct light enters into the space. I find the ceiling itself, like much architecture by Renzo Piano, FAIA, overly fussy, and, what is more

important, the quality of light from it to be dull. The nearby Kimbell Art Museum, by contrast, has plenty of diffuse light, but also shafts that streak across walls, hot spots, and places of shadow.

The Nasher, with its relentlessly even light, does, though, create a cool oasis within the city, one where you can see some pretty terrific art. Now the reality of what pays for all that art (Nasher was a developer of shopping malls, not office towers) has invaded that oasis. I know it is not good for the art, but I do hope that the Nasher can find some way to work with that invasive revelation, rather than trying to make it go away. I doubt they will have much choice, as replacing the curtainwall on a building this size will be quite an operation. Good art makes us aware not only of its own materiality and form, but also of the real context out of which it came and in which we experience it. Here, the logic of the city and its effects have been made visible.

I even wish the Nasher could commission an artist to work with these new reflections in a way that would make us aware of where they are coming from, both in an immediate and a larger social and economic sense. And, by the way, the Museum Tower, designed by Scott Johnson, FAIA, of Johnson Fain, is a pretty decent building—a lot better than most of the soulless and harmless structures around it. Out of such unforeseen circumstances, I hope some illumination might come. □

TEXT BY AARON BETSKY
ILLUSTRATION BY PETER ARKLE



→ Read more of Aaron's design observations at ARCHITECT's Beyond Buildings blog: go.hw.net/betsky.

ANNUAL DESIGN REVIEW

CELEBRATING THE BEST IN AMERICAN ARCHITECTURE

ARCHITECT's Annual Design Review is a juried competition of the best U.S. architecture completed in the past 12 months. Judging is blind, to give every project an equal opportunity to win, and awards are given in six project-type categories.

ELIGIBILITY

Projects must have been completed after June 30, 2011, and must have been built in the United States or designed by a U.S. firm.

PUBLICATION

Winners in each category (selected by a jury) will be published in the December 2012 issue of ARCHITECT.

CATEGORIES

WORK Office, Government, and Commercial Mixed-Use

PLAY Sports, Hospitality, and Retail

LIVE Multifamily Housing, Single-Family Housing, and Residential Mixed-Use

GROW Education, Science, and Healthcare

MOVE Infrastructure and Transportation

BOND Institutional, Cultural, and Religious

DEADLINES

September 7, 2012: regular submission deadline (postmark)

September 12, 2012: late submission deadline (postmark, additional fee required)

FEES

First entry: \$295

Additional entries: \$195 per entry

Late entries: \$50 additional fee per entry by September 12

For more information:

visit: architectmagazine.com/adr

email: adr@architectmagazine.com

ARCHITECT



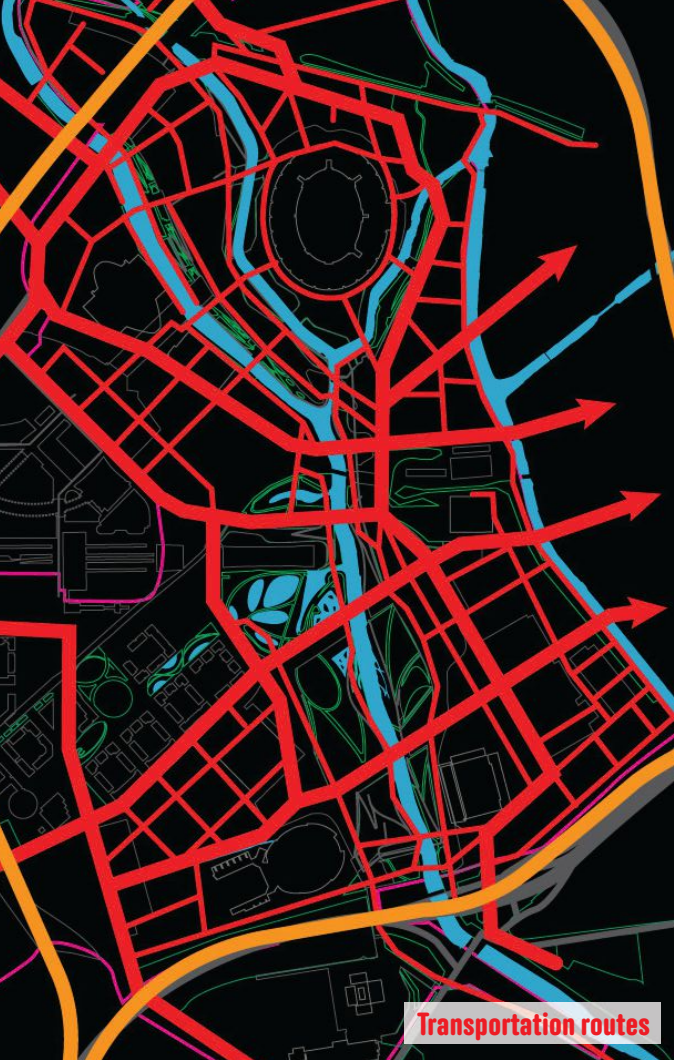

Transportation routes



Field Evolution

LONDON OFFICIALS ARE LEVERAGING THEIR INFRASTRUCTURE SPENDING ON THE SO-CALLED **NEO-AUSTERITY OLYMPICS** TO HELP REVITALIZE ONE OF THE CITY'S POOREST NEIGHBORHOODS. WILL THEY SUCCEED, AND AT WHAT COST?

17 DAYS LATER

TEXT BY CHRISTOPHER HAWTHORNE
ILLUSTRATIONS BY OMNIVOROUS

ON JULY 27, when the Summer Olympics get under way, NBC and television networks across the world will fix London under a spotlight that will barely dim for 17 days. The opening ceremony, overseen by the British film director Danny Boyle, will grab most of the attention on the first night. After that, TV producers, as they churn out more than 5,000 hours of coverage, will search for a building—ideally one of the new venues—to stand, in a kind of architectural shorthand, for the city as a whole.

In Beijing four years ago, the unquestioned architectural star was the main Olympic stadium by Herzog & de Meuron, the so-called Bird's Nest—a daring, expensive, and preening structure that seemed perfectly to express rising Chinese confidence and ambition. In Athens, it was not an entire building but a bright appendage: the new roof of the main stadium, a bone-white superstructure by the Spanish architect Santiago Calatrava that was added to the existing building as the Greeks rushed to get ready for the 2004 Games.

In London, however, where the main venues are grouped together in a newly built Olympic Park on the eastern edge of the city, in an area known as the Lower Lea Valley, audiences may search in vain for that kind of instant landmark. Thanks to the fragile condition

of the global and European economies, the London Olympics have been described as the Neo-Austerity Games, a reference to the last time that the city hosted a summer Olympiad, in 1948. As was the case then, with England emerging still shell-shocked from World War II, the country approached the 2012 Olympics as a chance to prove, or at least test, its pragmatism. Showy extravagance, especially the architectural kind, was out of the question.

The main Olympic stadium, by the American firm Populous (formerly HOK Sport) in collaboration with British architect Sir Peter Cook, was meant from the start to be as self-effacing as the Bird's Nest is outgoing. Ringed by a simple scaffolding of triangular white-steel supports, it is a lean, impressively utilitarian structure designed to be partially dismantled after the games are over, going from a capacity of 80,000 to 25,000.

Many of the other venues are also temporary in whole or in part. Zaha Hadid Architects' Aquatics Center is a sleek concrete design weighed down by unfortunate-looking wings for extra seating that will be removed once the games are over, making it a rare example of a building whose second act promises to be more dramatic than its first. If there is a dark-horse contender for TV stardom, it is the Velodrome by London's Hopkins Architects; the streamlined, cedar-clad building, which will host the indoor cycling events, has already been cheered by several prominent London critics. But it's also a decidedly minor venue on the periphery of the Olympic park.

Over time, as tends to happen with even the most straitened Olympics, the budget for London's games has ballooned, growing from a genuinely austere initial figure of \$3.8 billion in 2007 to recent estimates of \$17 billion or \$18 billion. The tab for Olympic security has nearly tripled, to more than \$1 billion, as organizers decided they needed not the 10,000 guards originally budgeted for, but 23,000 instead. That is perhaps a sign that extravagance can come in a range of forms, in some cases indistinguishable from nationalism or anxiety in the age of the war on terrorism. The stripped-down main stadium wound up costing \$500 million, hardly a bargain.

The British press, of course, has had a field day with those numbers, with the *Daily Mail* referring to "the ongoing debacle" over increasing costs and the more circumspect *Economist* condemning the free-spending "Olympic movement" as "a juggernaut controlled by an unaccountable sporting elite."

Beneath the loud debate over budgets, though, is a more complex, and frankly more interesting, discussion about the master plan for these Olympics and what will happen after the games are over—once the site enters what is known as its "legacy" condition. From the start, London organizers have taken an interest in the long rather than the short view, in using the games as a vehicle for investing in and trying to transform a sizable chunk of East London.

The Rise of the Legacy Plan

The master plan for these Olympics, by the giant multinational firm AECOM, with contributions from Populous, Foreign Office Architects, and Allies and Morrison

Architects, is, in its long-term ambitions, a sort of anti-Beijing scheme. In China, the ruling party saw the games as a chance to mark the country's global ascendancy, and the master plan for 2008—by Sasaki Associates in conjunction with a larger urban plan for Beijing by Albert Speer Jr., son of Hitler's favorite architect—had a totalitarian scale and simplicity; the Bird's Nest, for example, sits on a wide, spare plaza, adjacent to a broad avenue running on a muscular north-south axis, that brings Brasilia and other examples of high-modern citymaking to mind even as it sets off the architecture to dramatic effect.

When I first saw that stadium, in the spring of 2008 and in the company of two stern media minders, Chinese soldiers were marching across part of that plaza, a reminder that Olympics and geopolitics have always been intertwined.

AECOM's plan for London—first proposed by EDAW before that firm was absorbed by AECOM in 2005—also has political overtones, at least in the sense that Britain and Europe are hardly in a position or mood to engage in profligate muscle-flexing. What makes the plan unusual among recent Olympic blueprints is the way it knits together park space, transportation networks, and the venues themselves, all in an effort at urban, economic, and ecological regeneration. It is less about telegenic venues and more about the leveraging of Olympic investment to boost quality of life—even if it takes a full generation for those improvements to take root.

The Lower Lea Valley is one of the poorest and most polluted parts of greater London; Olympic organizers commonly point out that for every station one takes east on the London underground, the life expectancy of the surrounding neighborhood drops by one year.

"Historically, the area has been the bastard child of London," says Bill Hanley, AECOM's chief executive in the U.K., and one of the chief designers of the Olympics plan. His firm has also referred to the site, long clotted with power lines, sewers, roadways, and a polluted river and canals, as "the service entrance for London."

And yet the Lower Lea Valley has clear potential as well. Just five miles from the center of the city, the area is served by a large international rail station in Stratford, which has been upgraded, and both U.K. politicians and Olympic organizers saw a chance to spread to East London some of the affluence of the city's west side, which has boomed in the last 15 years.

"East London is a place people have been wanting to fix for a long time," says Daniel Elsea, the creative director for AECOM's London office. "And the Olympics was finally the instigator—a great way to get everybody on board."

That notion of Olympics as urban catalyst is hardly new. Atlanta used the 1996 games as a way to accelerate plans to modernize its airport and add a long-awaited international terminal. A more direct influence for the London organizers was the master plan for the 1992 Barcelona Olympics, by Spanish firm MBM Arquitectes. It not only remade the city's waterfront but sparked a post-Franco surge in investment and tourism in Barcelona. In 1991, on the eve of its Olympics, Barcelona attracted a mere 1.7 million tourists. By 2011, it was welcoming more than 7 million per year.

London hardly needs to introduce itself to potential visitors in the same way. But the regenerative power of Olympic investment in Spain's second-largest city has been a clear inspiration for the U.K. planners. In 2004, as London was considering mounting a bid for the 2012 games, the mayor at the time, Ken Livingstone, began to see a link between Olympic investment and the future of the area.

"Livingstone said quite publicly that he would only back the Olympic bid if it went to a part of the city in need," says Ricky Burdett, director of the Cities Program at the London School of Economics and for several years an adviser to Livingstone.

AECOM, for its part, saw a focus on urbanism and revitalization as a strategy that would work for London—and also one that would help it stand out in the master-plan competition that London officials launched in 2003.

"We were on a short list with Foster, Rogers, and a couple of others, and we were the rank outsiders," Hanley says. "From the beginning, our goal was not to discuss architectural objects but to talk about this part of East London—how to repair some of its fundamental problems."

The plan that they ultimately produced, once the International Olympic Committee chose London as 2012 host in the summer of 2005, does that in a number of ways. It has aimed to bolster connections both within the neighborhood and between the Lower Lea Valley and the rest of London, lacing the site with new east-west streets and adding pedestrian walkways from the Olympic park to the Stratford station. Power lines have been buried underground, tucked into a pair of 4-mile-long tunnels. The master plan also calls for adding roughly 50,000 jobs and a total of 35,000 housing units to the area; the Athlete's Village, for example, will be turned into 3,300 apartments, 48 percent of which will be subsidized.

To guide future growth, the London Legacy Development Corporation, a public body that will take control of the entire site from the Olympic Delivery Authority (ODA) after the games are over, will rely on the Olympic master plan as a blueprint for choosing private-development partners to build new housing and retail. A large slice of the site will become the 270-acre Queen Elizabeth Olympic Park—the biggest urban park built in Europe in 150 years. The landscape architecture team includes the American George Hargreaves and Britain's LDA Design.

For Burdett, who served as a chief adviser on architecture and urbanism to the ODA, what's unusual about the London plan is this sense of political continuity—not just between bureaucratic overseers but also between Mayor Livingstone and Boris Johnson, his successor.

"It's been pretty seamless between Livingstone and Johnson," Burdett says, not just referring to the Olympic agenda but also the larger urbanism strategy. The broader push to make London denser and more globally competitive is "something shared and retained between the two."

For AECOM's Hanley, the key significance of the design strategy is how the plan devotes 70 percent of total

THE CHALLENGES IN EAST LONDON HAVE VEXED PLANNERS AND POLITICIANS FOR DECADES. IN 2004, AS THE CITY WAS CONSIDERING MOUNTING A BID FOR THE GAMES, THEN-MAYOR KEN LIVINGSTONE BEGAN TO SEE A LINK BETWEEN OLYMPIC INVESTMENT AND THE FUTURE OF EAST LONDON.



HIGH ROAD LEYTON

MAJOR ROAD

LEYTON ROAD

OLYMPIC AND PARALYMPIC VILLAGE

Velodrome
Hopkins Architects

Basketball Arena
Wilkinson Eyre

Eton Manor
Stanton Williams

A12

WETLANDS PARK

PARK LIVE EAST

RIVER LAWN

PARK LIVE WEST

EAST MANOR GATE

Riverbank Arena
Populous

Handball Arena
Make Architects

HOMERTON ROAD

EAST CROSS ROAD

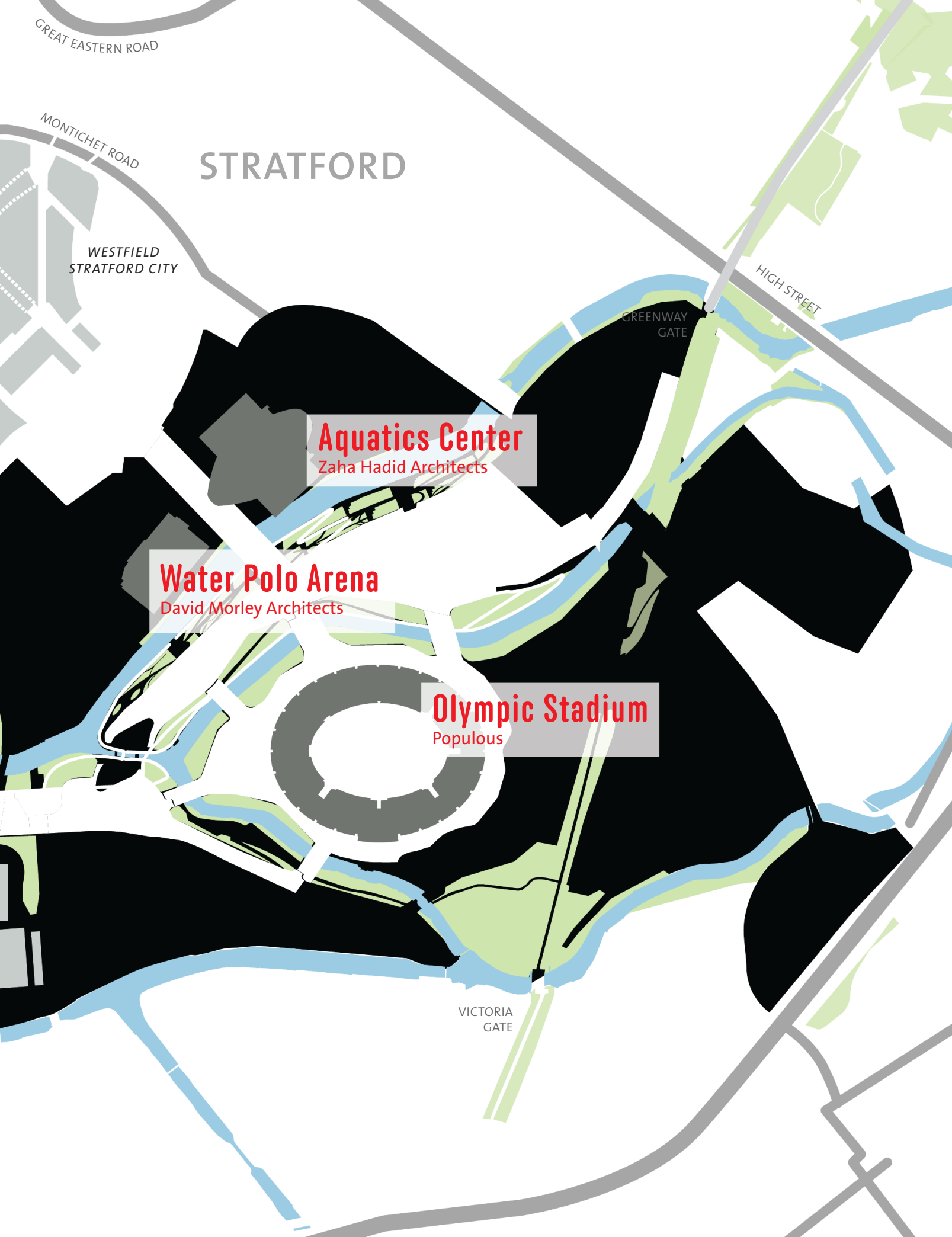

STRATFORD

Aquatics Center
Zaha Hadid Architects

Water Polo Arena
David Morley Architects

Olympic Stadium
Populous

GREAT EASTERN ROAD

MONTICHET ROAD

WESTFIELD
STRATFORD CITY

HIGH STREET

GREENWAY
GATE

VICTORIA
GATE

expenditures to permanent improvements to the site. The goal was to avoid white elephants at any cost.

“Our sense from the start was that the driving iconic image of our design would not be a stadium or any venue,” he says. “The centerpiece would be the Queen Elizabeth Park and this effort to revive the river.”

A Question Of Economics

For all the grand ambitions of the legacy plan, critics have nonetheless questioned the expense. “I think the entire Olympics is a colossal waste of money,” Edwin Heathcoat, the architecture critic of the *Financial Times*, wrote recently. “There should have been some effort to create a kind of austerity games like the one after the war. ... Whenever I say this, I am beaten down by someone countering that this land would have never been regenerated without the impetus of the Olympics. Well, that’s nonsense. It would have, but more slowly, and at less expense to the taxpayer.”

Part of the budgetary overruns arose because remediation efforts at the site have been more expensive than anticipated. And temporary venues are not the money savers that you would guess they’d be. According to Hanley, building a temporary structure is roughly 85 percent as expensive as constructing a permanent one. For him, the attraction of temporary architecture is that it frees up land for future uses. In that sense, Beijing—where the 91,000-seat Bird’s Nest is completely empty most days—has served as a cautionary tale. Temporary means flexible, from a planning point of view.

A more unwieldy question is whether the kind of fine-grained, long-term improvements that Olympic organizers are seeking can be imposed in a top-down master-planning process. And while it makes sense to use the attention and funding that come with the Olympics to galvanize change in East London, the attention will necessarily fade once the games are over. The risk is that bottom-line thinking, rather than the comprehensive vision that has so far guided planning, will ultimately prevail once the London Legacy Development Corp. takes over.

AECOM has already received one significant endorsement of its London work: The organizers of the next Summer Games, in Rio de Janeiro, have hired the firm to prepare its 2016 master plan. And while Brazil may spend more freely than the U.K. has, there are some ways in which AECOM is looking for some continuity of its own between the two Olympics. The firm is hoping that the London basketball arena, a temporary structure designed by Wilkinson Eyre Architects and wrapped in recyclable white PVC panels, will be rebuilt in Rio. Brazilian officials toured the facility this spring.

Burdett argues that a relocated venue could provide a new model for Olympic architecture. If the International Olympic Committee got into the business of commissioning temporary venues that could be moved cheaply from one Olympic city to the next, it might change the selection process in a profound way. “You could have poorer cities suddenly able to bid on the Games,” he says.

In a more practical sense, Burdett likes the idea of London building permanent venues only for those sports that Brits actually play in large numbers—and that can be enjoyed in the less-than-balmy climate.

“Why build a [permanent] basketball stadium if we don’t play basketball?” he said at an LSE forum on Olympic architecture this spring. “There’s no point. Why build a water-polo facility? With this weather, are you serious?” □



Olympic Stadium Designed by Populous for 80,000 spectators, the stadium will be reconfigured post-games to hold just 25,000. The venue will be leased to a long-term occupant next year, possibly football club West Ham United.



Water Polo Arena Wrapped in silver PVC and topped by an inflatable roof, the arena, designed by David Morley Architects, seats 5,000. The building will be deconstructed post-games; the seats and other components will be reused.



Eton Manor Both a training facility and a venue for Paralympic tennis matches, with seating for 10,500 spectators, this Stanton Williams–designed complex will become home to the national hockey team and the Lawn Tennis Association.

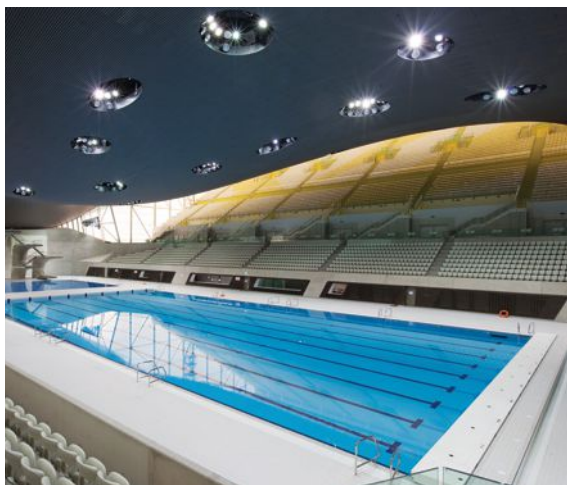

Aquatics Center Zaha Hadid Architects designed this building, inspired by the geometry of water in motion, to hold 17,500 spectators. The venue will become a public aquatics center after the games, with a seating capacity of 2,500.



Velodrome Hopkins Architects designed this 6,000-spectator venue adjacent to a BMX bike track. Post-Olympics, a regional park authority will assume jurisdiction of the site, intended for community use and athlete training.



Riverbank Arena This Populous-designed arena will host field-hockey games and seat 15,000 spectators. The stadium will be moved after the Olympics to become a permanent part of the Eton Manor sporting complex.



Basketball Arena A temporary 12,000-seat venue clad in recyclable PVC fabric, the basketball arena was designed by Wilkinson Eyre Architects and may be shipped to Rio de Janeiro for use in the 2016 Games.



Handball Arena This copper-clad arena, designed by Make Architects, features retractable seating for up to 7,000 spectators. It will become a community sports center featuring basketball and other activities, and will seat 6,000.



Shooting Galleries Designed by Magma Architecture, this temporary structure clad with a PVC membrane will host archery and other shooting events. It will be staged at the site of the Royal Artillery Barracks outside of the Olympic village.

IF THE INTERNATIONAL OLYMPIC COMMITTEE GOT INTO THE BUSINESS OF COMMISSIONING TEMPORARY VENUES THAT COULD BE REUSED FROM ONE OLYMPICS TO THE NEXT, "YOU COULD HAVE POORER CITIES SUDDENLY ABLE TO BID ON THE GAMES." —RICKY BURDETT



PROJECT *Awards* 2013

CALL FOR ENTRIES

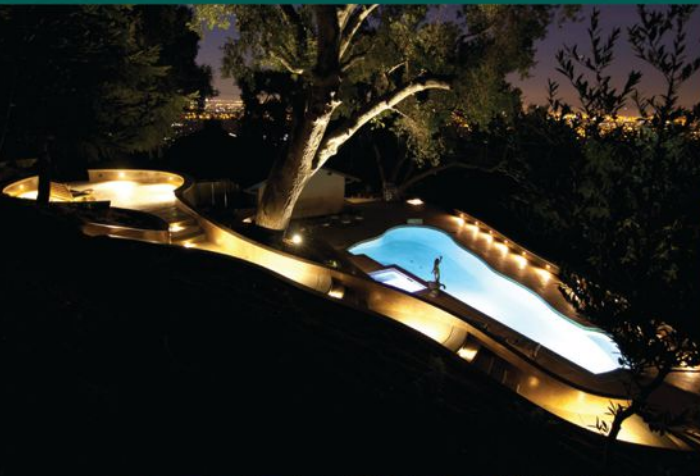

Top Left: Tom Ralston Concrete, Santa Cruz, CA; Bottom Left: Hyde Concrete, Annapolis, MD; Right: Creative Construction by Design, Danville, IL

The Decorative Concrete Council, a specialty council of the American Society of Concrete Contractors, announces its 2013 awards program, to recognize outstanding decorative concrete projects around the world.

Entries are invited in 12 categories and are juried by an independent panel of industry professionals. Awards will be presented during World of Concrete 2013. Submittal deadline is October 1, 2012.

Circle no. 411 or <http://architect.hotims.com>

In partnership with

**CONCRETE
CONSTRUCTION**

ARCHITECT

For more information call **1.866.788.2722** or go to **www.asconline.org**



→ **DESIGN**

STUDIO MODE 98

STUDIO O+A 104

STUDIO SUMO 112

GRAFFITI CAFÉ

VARNA, BULGARIA
STUDIO MODE





TEXT BY SARA HART
PHOTOS BY 3INSPIRIT

BULGARIA HAD A STELLAR, centuries-long architectural history, which was interrupted only when the country became a Soviet satellite at the end of World War II. Fortunately, after the collapse of communist rule in 1989 and an ensuing period of political turmoil, a new crop of architects and designers has emerged, eager to embrace technological innovation and develop their own indigenous brand of Modernism.

No place showcases the ambition of this new, post-Soviet generation better than Varna, known as the seaside capital of Bulgaria. Located on the Black Sea, the cosmopolitan resort attracts visitors from afar thanks to its beaches, cultural events, and relative affordability. The thriving tourism-based economy has sparked a building boom exemplified by the Graffit Gallery Hotel, a boutique hotel located in the city center and aimed at international travelers.

The six-story building has two restaurants on the ground floor, a contemporary art gallery on the second floor, and is capped by four guest-room levels. Bulgarian architect Georgi Bachev took responsibility for the shell and one hotel floor, while several other commissioned architects and designers took on different areas of the building. The risk of competing voices introduced some constraint into the design process; each firm sought to balance uniqueness with overall compatibility. One of the firms, Sofia, Bulgaria-based Studio Mode, was commissioned to design one of the hotel floors as well as a high-profile destination at street level: Graffiti Café.

Studio Mode's lead designer on the café, Svetoslav Todorov, describes how he integrated the interior into the rest of the building: "We brought elements and materials of the building's façade into the front zone of the café and applied them to the ceiling. We also used sidewalk pavers on the interior floors. This draws the textures of the street into the café, while connecting the profile of the building envelope to the café."

With the interior, the architects chose to de-emphasize, rather than conceal, the mechanical systems and lighting in the ceiling. This led to a singular design solution that establishes the architectural character of the space. Linear plywood slats were positioned beneath the ceiling-mounted equipment, all of which was painted black. The linear slats then continue downward to create curving column covers, fabricated using CNC routers.

"The columns act as a natural continuation of the ceiling, geometrically inspired by traditional, lathe-spun, wooden table legs," Todorov says. The covers are attached to supports made of MDF, which was scored and bent to form round columns. The repetition of identical elements recurs in tessellated floor and wall panels, the geometries of which were inspired by the work of M.C. Escher.

It's not surprising that Bulgaria's new Modernism looks to the past—most new movements do. But Studio Mode's deconstruction of historic precedent, with a wink, could serve as an interesting taste of things to come.

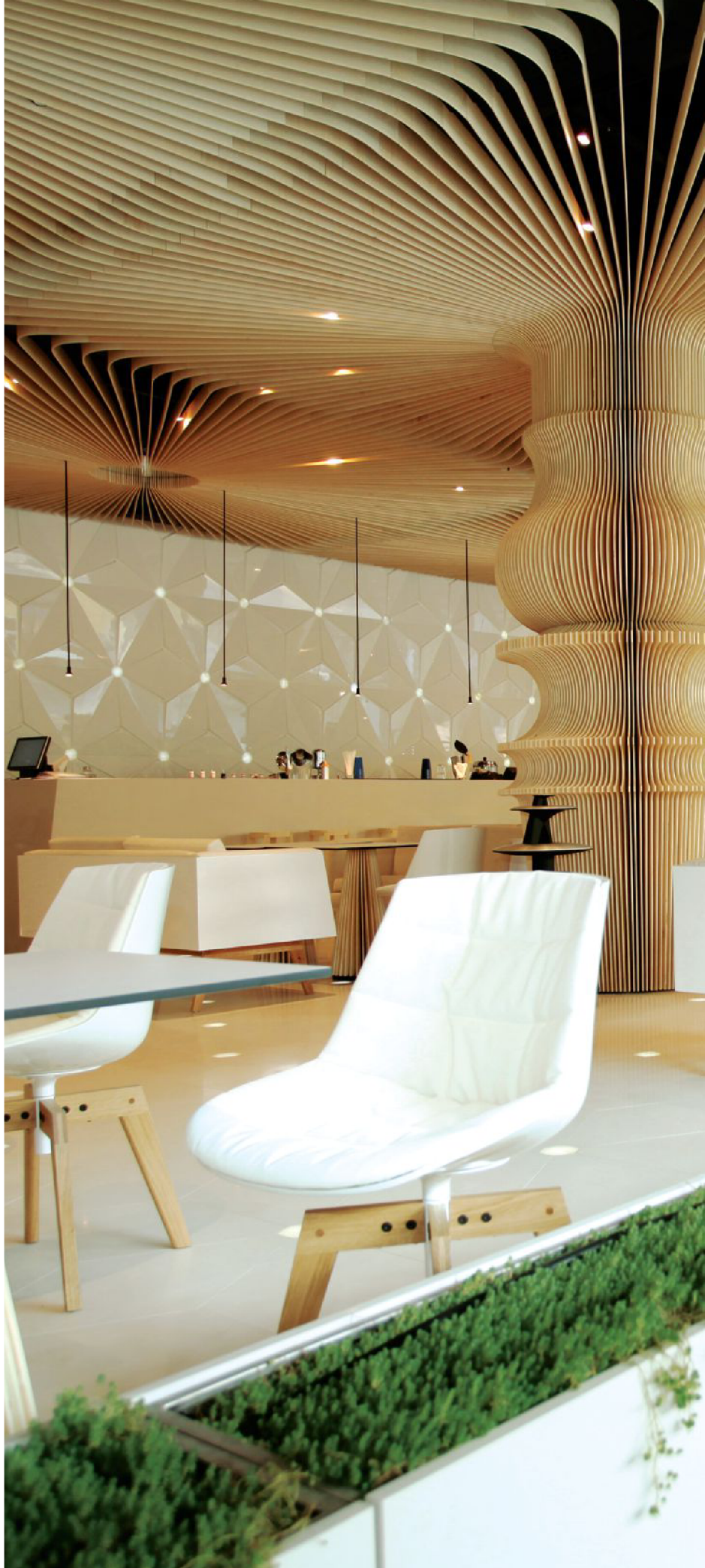



Graffiti Café opens onto the street, and the lower tier of seating (this image) features a floor of sidewalk pavers to create a natural transition for pedestrians arriving for a meal. The space is anchored by a series of columns clad in plywood slats that are CNC-milled to emulate a lathe-turned table leg (previous spread). The plywood continues to the ceiling, where it conceals mechanical systems, and even to the pedestals that support the tables.



Graffit Gallery Hotel façade

Floor Plan

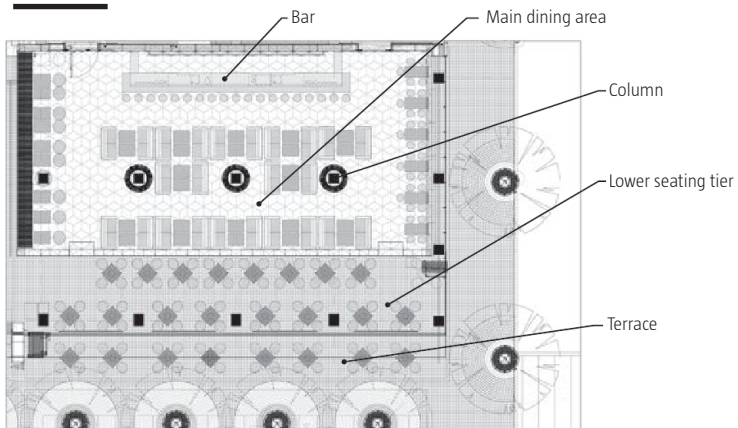

Project Credits

Project Graffiti Café, Varna, Bulgaria

Client Graffit Gallery

Designer Studio Mode, Sofia, Bulgaria—Svetoslav Todorov

General Contractor Timbuild

Size 300 square meters (3,229 square feet)

Cost Withheld

Materials and Sources

Ceiling Black paint over mechanical systems; plywood slats

Columns MDF core; CNC-routed plywood-slat cladding

Flooring Sidewalk pavers; engineered stone

Walls Polyurethane-painted MDF



PERFECT YOUR SPECS FOR LEED® PROJECTS

Valerie Walsh LEED Course

Hanley Wood University has partnered exclusively with Walsh Sustainability Group to create experience-led education programs around several LEED® related topics. The first program, Writing Solid Specs for LEED Projects will guide inexperienced LEED teams through the components of the LEED green building rating system that must be addressed in the drawings, specifications, and documentation process.

The program will discuss how to select an appropriate LEED Rating System; identify what LEED requirements makes LEED specs different from business as usual; and share common oversights in writing LEED specs she has seen over the years as a LEED consultant and project administrator.

CREDIT: 1 GBCI CMP hour, LEED Specific BD+C and 1 AIA HSW/SD hour

Enroll today to help tune up the LEED requirements in your specs for better bids, streamlined construction administration, and most importantly, successful achievement of LEED credits.

<http://tinyurl.com/leed-specs>

Look for more LEED-related and LEED-specific courses from Walsh Sustainability Group on Hanley Wood University in the near future.

Sponsored by:



395 PAGE MILL ROAD

PALO ALTO, CALIF.
STUDIO O+A

TEXT BY KATIE GERFEN
PHOTOS BY JASPER SANIDAD









The lobby at 395 Page Mill Road (left) serves as a gateway to the AOL offices upstairs and the various businesses housed in the ground-floor incubator offices beyond. Details such as the wooden ceiling that curves down to form bench seating (previous spread) are designed to serve as breakout spaces, giving incubatees a chance to meet and collaborate with those working on other projects.

AOL'S NEW WEST COAST headquarters in Palo Alto, Calif., isn't a sprawling campus, but rather a renovation of one of many blink-and-you'll-miss-them tract office buildings that line the byways of Silicon Valley. But walk into the lobby of the reimagined interior designed by San Francisco-based Studio O+A, and you'll see the well-appointed trappings of a high-tech company: A bank of flat-panel screens mounted to one wall that displays logos and content from the company's Web venues. A cluster of candy-colored bicycles fetchingly suspended from a column act as sculpture—that is, when they haven't been checked out by employees to ride around the building or downtown for lunch. What you will not find in the ground-floor offices beyond the reception-desk-cum-ceiling-plane (cleverly curved to recall a skateboard half pipe, which were all the rage when AOL started in the 1980s) are AOL employees. That's because the tech giant devoted the first floor of its headquarters to incubator office space for fledgling companies, one of which, it hopes, could be the next billion-dollar IPO.

Apple famously started in a garage, and Facebook began in a dorm room, but these days, tech companies are taking a more organized approach to fostering new talent. Venture capitalists (VCs) have made incubators standard fare in Silicon Valley, and spaces for them are designed to encourage collaboration among microcompanies.

VCs "want to capitalize on the prospect of creating cross-fertilization and getting access to other ideas," says Studio O+A principal Verda Alexander, and such spaces are often small venues within larger VC offices. At AOL's 395 Page Mill Road, the model is flipped: The 80,000-square-foot ground floor is divided into suites ranging from 500 to 25,000 square feet, along with incubator space, co-working environments, and offices for tenants and VCs. "Incubators by nature need to refresh quickly," says Studio O+A principal Primo Orpilla, "and they [the companies] will be growing. We design the space to a certain point where they can scale in a suite and then they're probably going to be looking for their own office space."

Here, some companies occupy a single office, others have a more-traditional open-office suite of bench seats surrounded by whiteboard walls. The workspaces themselves are designed for flexibility and ease of turnover—"You give them enough to do what they need to do," Orpilla says—and take their cues from AOL's own office space, which Studio O+A also designed, upstairs. The designers took great care to connect the suites with an infrastructure of common spaces that encourage collaboration. Hallways are wide, and outfitted with chairs and breakout spaces wherever possible.

Other communal areas are more formalized, but even the requisite coffee bar—designed with a food-truck-inspired pull-up door over the counter—is staffed by entrepreneurs from nearby Stanford University. A shared lecture hall, lined in colorful acoustic panels, can be set up for lunchtime lectures, business updates, or more-social endeavors. And it absolutely works as a multipurpose room: "Sometimes they play soccer in there," Orpilla says.

Overall, the transformation of an existing building and the creative use of no-nonsense materials may signal a shift for similar high-tech offices. "Pulling back the layers of the space was very much saying: This is the new Valley," Orpilla says. "This is made for work, and socializing, and the 24/7 economy. This is not about over-building."

The companies in the incubator space can occupy a single room or an open office suite (opposite bottom). These are surrounded by hallways with informal collaboration areas (opposite top). All offices share central resources, such as a multipurpose presentation room (opposite middle) and a coffee bar (this image).





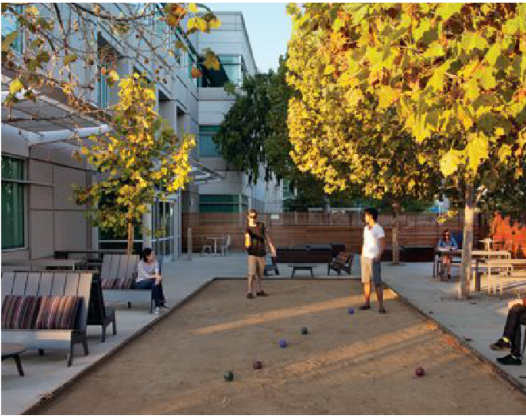
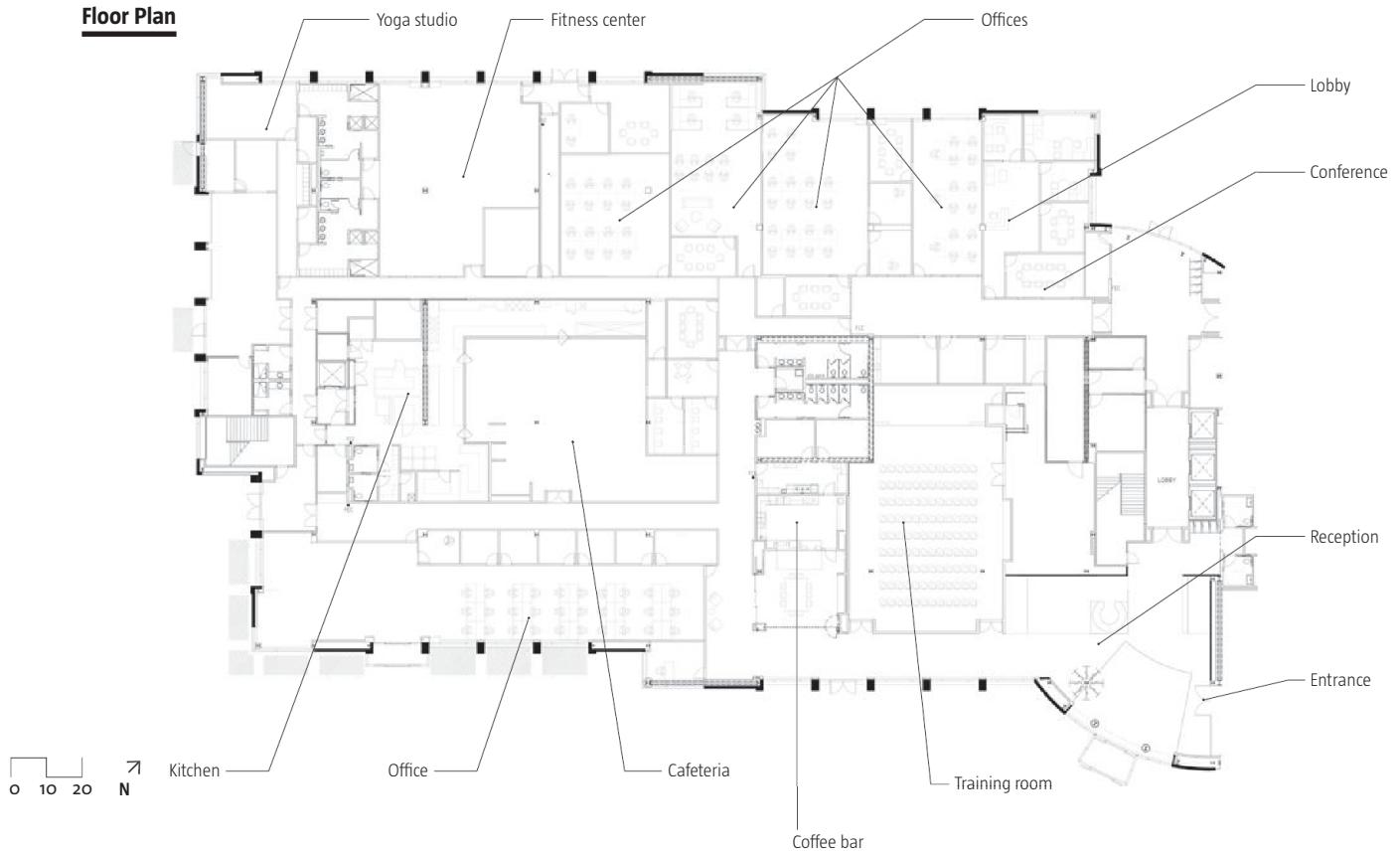

No high-tech office, no matter how pared down, would be complete without some esoteric sports facility. At 395 Page Mill Road, it's a bocce court (top) that is part of an outdoor patio area used for everything from company meetings to cookouts (bottom).

Project Credits

Project 395 Page Mill Road, Palo Alto, Calif.

Client AOL

Interior Designer Studio O+A, San Francisco—Primo Orpilla, Verda Alexander (principals); Denise Cherry (director of design); Perry Stephney (director of projects); David Hunter (senior designer); Justin Ackerman, Caren Currie-McDonald, Sarunya Wongjodsri (designer); George Jordan (graphic designer); Albert Claxton (project designer)

Mechanical Engineer All Temperature Service

Structural Engineer KPFF Consulting Engineers

Electrical Engineer Howell Electric

Construction Manager Novo Construction—Eric Weinhagen

General Contractor Novo Construction

Landscape Architect Eddie Chau Design

Size 80,000 square feet

Cost Withheld

Materials and Sources

Ceilings Conwed Designscape, an Owens Corning Co. (acoustic ceiling, clouds) conweddesignscape.com; Ecophon Group (acoustic ceiling, perimeter) ecophon.com

Carpet Flor flor.com

Cork Expanko Cork expanko.com

Paint Sherwin Williams (accents) sherwin-williams.com; Glidden Paints (exposed ceiling) glidden.com

Finishes Abet Laminati (plastic laminate) abetlaminati.com; Formica (plastic laminate) formica.com;

Caesarstone US (Quartz surface) caesarstoneus.com

Tile Daltile daltile.com; Heath Ceramics heathceramics.com; Apavisa apavisa.com

Flooring Allstate Rubber (rubber base) allstaterubber.com; Bolon (rubber flooring) bolon.com

STAY ON
top

HERE'S THE ELEVATOR.

In this profession, you're often your own toughest competition. How do you top yesterday's big ideas today? Start at architectmagazine.com. You'll find inspiration at every turn, including success stories, current projects on the boards, awards, blogs, and the latest in green products and sustainability—everything you need to be on top of your game is at architectmagazine.com.

ARCHITECT



MIZUTA MUSEUM OF ART

SAKADO, JAPAN
STUDIO SUMO

TEXT BY JOHN MORRIS DIXON, FAIA
PHOTOS BY DAICI ANO (EXCEPT WHERE NOTED)





PREVIOUS PAGE: KOICHI TORIMURA

TWO PROGRAM REQUIREMENTS are combined in one neat container at Josai University, a private institution in Japan's Saitama Prefecture, near Tokyo. The school wanted an appealing, environmentally optimal home for an exceptional collection of Japanese art assembled by its founder, Mikio Mizuta. And since the best-available site on the built-up campus was right at its public entrance, the project took on a second key role as a university gateway.

The constricted site, its 30-foot height limit, and the desire to save most of its existing trees dictated the overall building form: a shoe-box-like shape two stories high and about 100 feet long. But the resulting structure is anything but a simple square.

The building's initial impression is of boxes within a box—of its galleries hovering inside a somewhat larger container. This composition, says partner Sunil Bald, AIA, of New York–based Studio SUMO, “is an allusion to the floating world,” a reference to the museum's collection of *Ukiyo-e* (literally “pictures of the floating world”), a genre of paintings and woodblock prints. A series of ramps, sheltered but not fully enclosed, occupy the space between the galleries and the outer container.

These ramps, dimensioned for moving freight as well as visitors, lead to destinations on several levels. The lower floor, sunken a half level into the ground, houses various backup facilities and, most visibly, a glass-walled information center that doubles as a lecture hall and additional exhibition space. The upper part of the structure is occupied by two galleries, their floor levels 1 meter apart.

The long flanks of the outer container are composed of 52 concrete elements, each 4 feet wide and ranging from 28 to 21.5 feet high, bending 90 degrees at the top to span the 11-foot-wide ramps. Slits along the vertical joints provide daylight and ventilation for the spaces within. Besides sheltering the ramps, the concrete helps protect the galleries against solar heat gain and climate extremes.

Fabricating the concrete elements posed some unusual challenges. They had to be cast on edge, with forms that could be altered a bit for

each unique piece; their vertical surfaces are not quite rectangular, but angled slightly to follow the slope of the ramps.

Visitors can reach the two upper-level galleries by following the ramps halfway up the building to the gallery-reception area. To one side of this lobby is a gallery designed to accommodate the museum's prized *Ukiyo-e* prints and other treasures, which because of their fragility are rotated here from off-site storage; only a fraction of the collection is on view at one time. A few steps up on the other side, a second gallery exhibits less-vulnerable works such as 20th-century paintings. One can exit directly to the top of the ramp sequence from there.

Special attention was given to the care of the woodcuts and other antiquities in the first gallery. The architects visited many other museums that exhibited such art and distilled what they observed, designing the cases to exacting environmental standards. In accordance with Japanese tradition, the cases allow for the display of works either vertically or horizontally. And the soft, even case lighting is made more effective by minimal ambient light levels in the windowless space.

Today, it is unusual for American architects to carry out work in Japan. While many U.S. firms had projects there to the 1990s, such commissions have become quite rare. Significantly, this is not the first building on the Josai campus by Studio SUMO (whose name is not, as one might assume, of Japanese origin, but a compound of the names of the two founding principals: Bald and Yolande Daniels, Assoc. AIA, known to some by the nickname “Momo”). The firm designed Josai's 75,000-square-foot School of Management, which was completed in 2006. That sleek but no-nonsense facility became a university asset. And, as this museum, it was designed with Obayashi's contractors and design department.

Now the museum is another object of pride for the school, and one that is shared with and appreciated by the surrounding community. And ranging as they do from glass-encased to dimly lit, the galleries offer a variety of spaces for the art—*Ukiyo-e* prints or otherwise—to float, while the world stays grounded.



The Mizuta Museum of Art houses a collection of Ukiyo-e prints (previous spread). The Japanese term translates as “pictures of the floating world,” and it provided the central theme for Studio SUMO’s design. Gallery volumes appear to float within a concrete wrapper. The main circulation for the museum is a series of ramps (this image) that are contained within the wrapper but not isolated from the elements. At the short ends of the building (opposite), precast facings mask the joints between the wrapper and the roof.



Axonometric

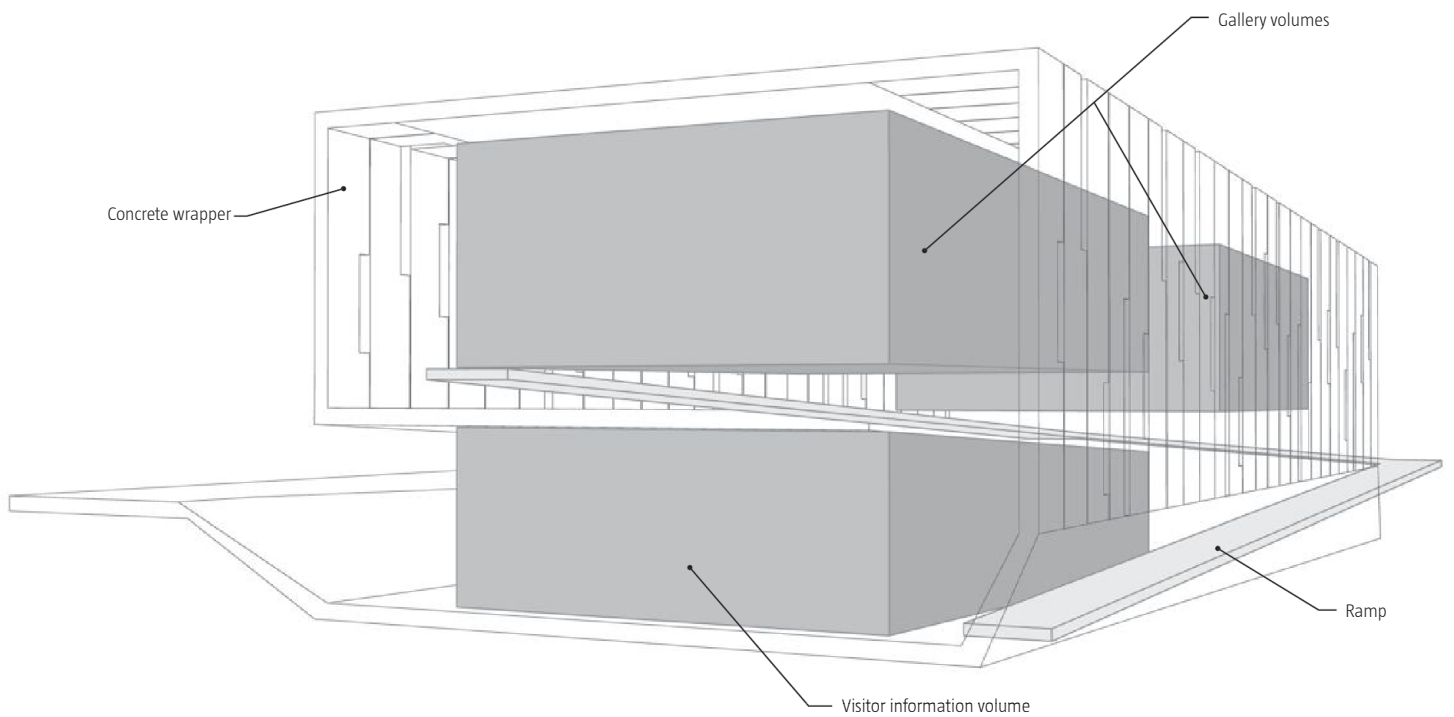



The lower level of the two-story museum is sunk halfway below grade. A glass-enclosed information center (which can also host lectures and some exhibitions) is surrounded by a terrace accessed by stairs. On the other end of the building (opposite), the delicacy of the Ukiyo-e prints being displayed within prevented the use of glass. Here, wood panels, covered with trellises that will host climbing vines, contrast with the concrete.





The glazed wall of the lower-level multipurpose space offers views out to the beginning of the museum's ramp system (opposite top). Internal stairs enclosed by board-formed concrete walls provide alternative circulation to the gallery reception area (this image), which offers access into the galleries. One of two galleries on the upper level (opposite bottom) is used for the display of paintings and other works that can withstand exposure to more standard light levels.

Project Credits

Project Mizuta Museum of Art, Sakado, Japan

Client Josai International University

Design Architect Studio SUMO, New York—Sunil Bald, AIA, Yolande Daniels, Assoc. AIA (partners-in-charge); David Huang, Edward Yujoung Kim, Anees Assali, Andrea Leung (project team)

Landscape Design Studio SUMO

Architect of Record Obayashi Design Department, Osaka, Japan—Koji Onishi (project manager); Nobuki Kobayashi (project architect); Setsu Kadota, Yuichiro Nishino (project team)

Structural Engineer Obayashi Design Department

M/E/P Engineer Obayashi Design Department

Contractor Obayashi Corp.

Size 7,000 square feet

Materials and Sources

Ceiling Black-painted acoustic board (galleries)

Exterior Cladding Precast concrete panels

Floors Tile (lobby and common spaces); Black-stained wood (galleries)

Walls Board-formed concrete (stairs); Painted or fabric-covered gypsum board (galleries)

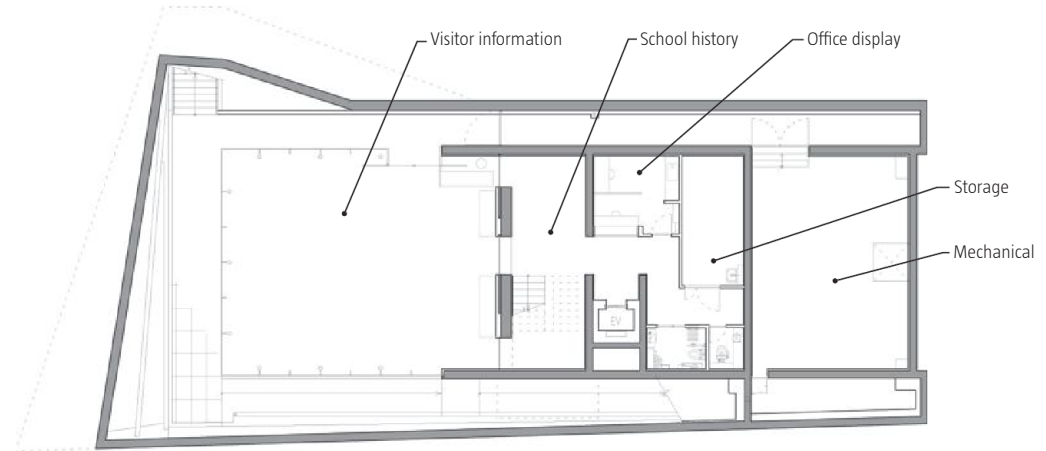
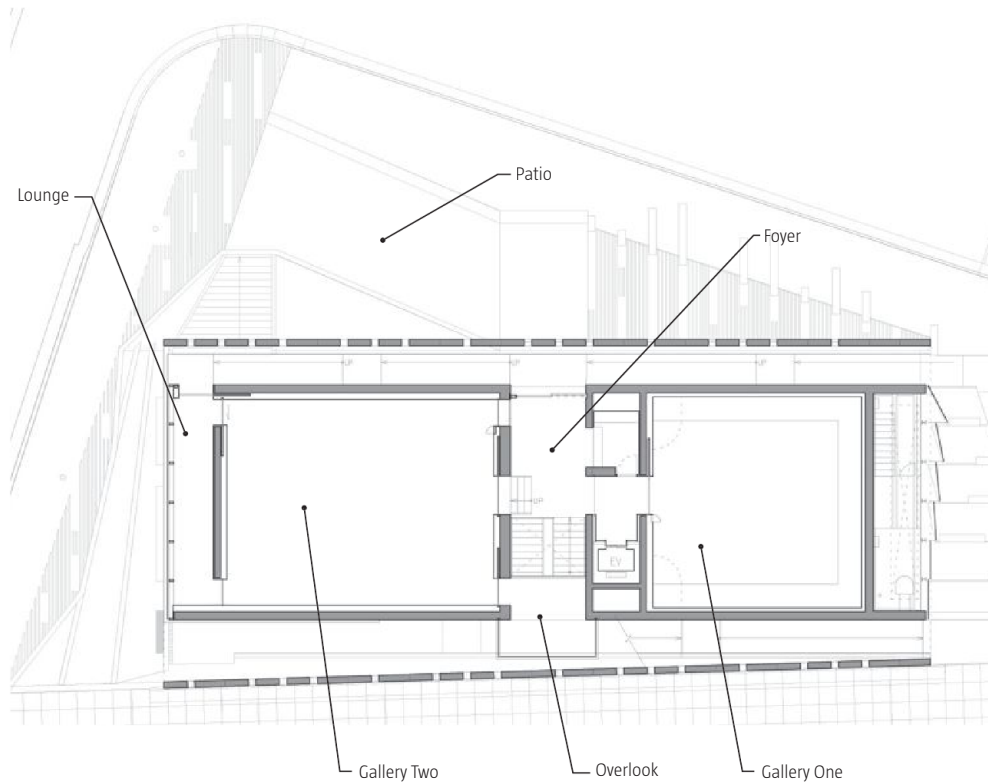
Lower-Level Plan**Upper-Level Plan**

Classifieds/Resource

The best demand Arriscraft.



The best designs begin with the finest materials. Arriscraft – Simply stone.™



www.arriscraft.com
800.265.8123

Arriscraft
Building Stone Brick Limestone

Circle no. 300

GlassFilm Enterprises
We have designs on your glass

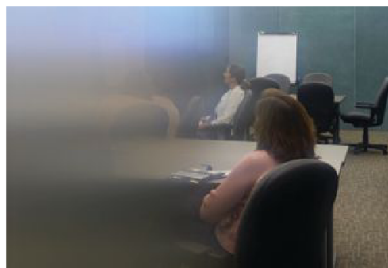

Lumisty MFX, foggy straight-on, clear from an angle.

GFE offers a variety of film-to-glass applications designed to enhance the appearance of glass. **LUMISTY**, pictured above, makes glass change from transparent to translucent depending on the angle of view. Also available is **DECOLITE**, a series of translucent films with or without patterns, that simulate etched glass. Recent product introductions include **DICHO-MIST**, a dichroic film that changes the color of glass depending on the angle of view. **GFE COLORS**, a series of transparent colored films, and **CUSTOM DESIGNS**.



CALL FOR FREE SAMPLES:
978-263-9333;
JF@GLASSFILMENTERPRISES.COM

WWW.GLASSFILMENTERPRISES.COM

Circle no. 301

eclipse support bracket



Our latest addition to the Rakks family of counter support brackets features a low-profile design and no visible mounting hardware. The Eclipse bracket is easy to install and supports counters or shelves up to 18 inches deep.

Rangine Corporation | 330 Reservoir Street
Needham, MA 02494 | www.rakks.com
800-826-6006

Rakks®

In supporting roles everywhere

Circle no. 302

CUT THE WASTE
CAPTURE THE SAVINGS

NEW FROM
JLC

The JLC Guide to
Energy Efficiency

Best Practices for Builders and Remodelers

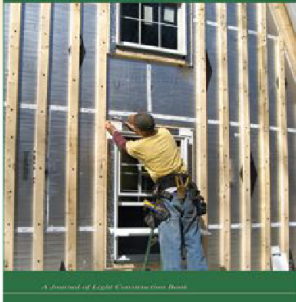

ENERGY EFFICIENCY: THE CODES REQUIRE IT. YOUR CLIENTS WANT IT. NOW YOU CAN MAKE IT HAPPEN!

The JLC Guide to Energy Efficiency will teach you to use the right techniques and the best products to make any home more comfortable, durable, and energy-smart.

ORDER TODAY!

HB2NG

JLC
The Journal of Light Construction

WEB
jlcbooks.com

PHONE
(800) 859-3669

NIXALITE®
Bird Control
Superior Bird Control Products
Request Your FREE Catalog Now
www.nixalite.com 800.624.1189

Circle no. 303

Magnet for Top Talent

JR Walters Resources, premier A/E/C recruiting firm, can assist in growing your company and your career. Direct and Contract National and International
www.jrwalters.com
or call 269.925.3940

Circle no. 304

FOR INFORMATION
on how to
advertise in the next
**ARCHITECT
MAGAZINE**

contact Ken Brooks at
202.729.3453 or
kbrooks@hanleywood.com

hanleywood



Design in a New Light
High Impact Translucent Glazing

ACRYLITE®
High Impact Acrylic Glazing

ACRYLITE® Acrylic Multi-Skinned and Wave Profile glazings are extremely weatherable panels manufactured with High Impact Acrylic Polymer. Call 1.888.233.4527 or visit www.acrylitebuildingproducts.com

EVONIK
INDUSTRIES

Evonik. Power to create.

Circle no. 305

Resource



FL17 – This exciting leg design is all angles and subtle light reflections. Extruded from aluminum and then polished or plated, it offers a most unusual design that will make any contemporary design shine. 6" high with leveler, 5" overall top plate.

MOCKETT

DOUG MOCKETT & COMPANY, INC

www.mockett.com • (800) 523-1269

Circle no. 306



Doral Park

Zyscovich Architects incorporated a multi-story parking garage into the overall structure of Park Square at Doral in Miami. GKD metal mesh was specified to withstand and provide protection from inclement weather and natural ventilation. GKD's stainless steel fabric can withstand wind speeds of a Category 4 hurricane (146 mph).

www.gkdmetailfabrics.com

GKDMETALFABRICS

Circle no. 308



HANOVER
Architectural Products
www.hanoverpavers.com
800.426.4242

Circle no. 310



**ACADEMY of ART
UNIVERSITY®**

FOUNDED IN SAN FRANCISCO 1929
BY ARTISTS FOR ARTISTS

Now Offering Accredited Degree in

Architecture!

Study Online or in San Francisco

Learn more:

WWW.ACADEMYART.EDU

800.544.2787 (U.S. only) • 415.274.2200

Accredited member WASC, NASAD, CIDA
(BFA-IAD, MFA-IAD), NAAB (M-ARCH)

Visit www.academyart.edu to learn about total costs, median student loan debt, potential occupations and other information.

Circle no. 307



**Full Line of
Lockers from
ASI Storage
Solutions**

With its wide range of materials (steel, solid plastic and now phenolic) and configurations (including cubby-style), **ASI Storage Solutions** has the locker to fit all your design applications.

Visit asilockers.com for more information

Circle no. 309



Imagine. Design. Create.



Adding color and style to your projects has never been easier. With Nichiha's Color Xpressions System for Illumination Series panels, you can express yourself with color and create a distinctive look for any project. So get expressive and make an impact with color!

nichiha.com/projectgallery

1.866.424.4421

©2012 Nichiha USA, Inc. All rights reserved.



Circle no. 311

**search.
source.
learn.
connect.
ebuild.**

ebuild is the destination for construction pros searching for information about building products. **ebuild** is a source of new product coverage, trends and news. Pros visit **ebuild** to learn how to do their jobs faster, safer and easier. **ebuild** connects pros to product manufacturers, experts and peers.

hanley wood
ebuild
a 360 degree view of
product information

ebuild.com

Resource



how do you design your walls?

NUDURA Insulated Concrete Forms provide an eco-friendly building envelope that maximizes energy efficiency, strength, sound and fire resistance. NUDURA forms offer design versatility and has been used in a variety of building types: educational, medical, commercial, residential, multi-story, and more.

Register Today to access our Online Design Guide



Circle no. 312

hornet
An instant classic

Discover the new Hornet LED line by Amerlux. Tiny, precise, powerful and controlled, the Hornet is a designer's dream come true, with crisp, dimmable, beams of light, offered with an incredible 50,000 hour lifespan, 15w, and a generous 10-year limited warranty.

For more information visit amerlux.com

Circle no. 313

Cultured Stone®

No matter what your project, Cultured Stone® can help you bring your dream to life. With a minimum of 54% recycled content on all Cultured Stone® veneer products as validated by UL Environment™, we can also help you achieve your green building goals.

Cultured Stone®

To learn more about Cultured Stone visit www.culturedstone.com

Circle no. 314

NEW! FACTORY-APPLIED EXTERIOR ALUMINUM TRIMS

Pella makes it easy to create architectural detail in low-maintenance aluminum. Pella's new exterior aluminum trim profiles complement Pella® aluminum-clad wood windows and doors, are available in custom and standard profiles and factory-applied to save time and costs. Ideal for new construction, renovations or high-profile restorations.

866-707-3552 • pellacommercial.com
Follow us on Twitter @PellaCommercial

© 2012 Pella Corporation

Circle no. 315

Looking for building products? Specifications, CAD, BIM and more!

ARCAT®

Available on the App Store

Circle no. 316

C A M B R I D G E
A R C H I T E C T U R A L

MESHMERIZING WALLS & CEILINGS

CAMBRIDGEARCHITECTURAL.COM

Circle no. 317

PERGO LEADING THE WAY
PRO Commercial Floors IN DESIGN AND PERFORMANCE
LAMINATE FLOORING

pergopro@pergo.com • 1-866-525-2018
www.pergopro.com

There's only one Pergo.

Circle no. 318

BIG ASS FANS®

Haiku® ceiling fans look different because they are different. Confirmed by ENERGY STAR® as the most efficient ceiling fan, Haiku also won the prestigious international red dot award, a prominent seal indicating quality design. Haiku's lasting perfect finish adds a striking centerpiece to interior spaces, and can also be used on covered outdoor areas.

Circle no. 319

The Dri-Design Metal Wall Panel System is a patented, pressure equalized rain-screen system. Dri-Design is fully tested to exceed ASTM standards, the latest AAMA 508-07 and is Miami-Dade approved. Available in any anodized or Kynar color on aluminum, plus VMZINC, stainless, copper and titanium. Made from recycled materials and 100% recyclable.

Dri-Design
616.355.2970
www.dri-design.com

Circle no. 320

Resource



The Material for Life



1737 King Street, Suite 390
Alexandria, VA 22314
571.970.3400
www.vinylinfo.org

Circle no. 321

Photopolymer Signs



In *everything* you build, there's **INPRO**.

877.780.0034 | inprocorp.com
facebook.com/inprocorp

Circle no. 322

Mitsubishi Electric Cooling & Heating's VRF Technology: Redefining HVAC

Mitsubishi Electric is taking HVAC to a whole new level with Variable Refrigerant Flow (VRF) Technology. VRF gives you the freedom to design while providing more useable space and increased overall building efficiency. And all at a price that fits within your budget. By redefining HVAC, Mitsubishi Electric has redefined what you can achieve in your buildings.



www.mitsubishiproc.com

Circle no. 323



Collaborate with **Wire By Design** to create stunning improvements to the built environment. From light fixtures to building envelopes, Wire By Design's architectural mesh products will add beauty and value to your next project.



www.wirebydesignco.com
1-800-773-5700

Circle no. 324

Metl-Span® Introduces Thermal and Vapor Barrier Panel

The HPCI Barrier™ insulated metal panel is a single air, water, thermal and vapor barrier panel that can be used behind any type of facade. Metl-Span's newest product economically provides a high level of performance. The panel is quick and easy to install, eliminating multiple work crews and deliveries of varied materials necessary with traditional multiple component barriers. The panel is installed outside the structural supports, and there are no thermal bridges to reduce the energy efficiency of the wall.

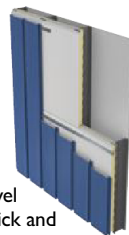

www.metlspan.com

Circle no. 325

cool by design



THE MODERN FAN CO
A Collection of Ceiling Fans
Designed by Ron Rezek

modernfan.com | 888.588.3267

Circle no. 326

OPEN BIM™



Supporting BIM Workflows from Concept through Completion.



Vectorworks Architect

Download a free 30-day trial at vectorworks.net/architect

Circle no. 327

McNICHOLS® Designer Metals

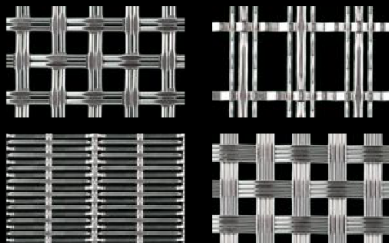

Our collection of Designer Metals offers unlimited options to achieve functional yet striking design for your project with a diverse selection of styles, patterns and material types.

Visit our website or contact one of our helpful Architectural Design Consultants.

We look forward to serving you!
mcnichols.com/archi 866.754.5144

Circle no. 328

Custom Profiles Colors and Glazes

For 30 Years Argeton has been Meeting the Challenges from Architects all Over the World

Let Argeton Help You with Your Terracotta Rainscreens

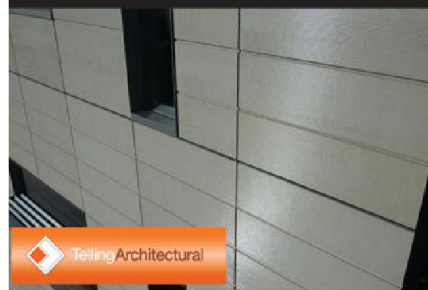

Argeton Rainscreen Systems are distributed by Telling Architectural Systems
www.tellingarchitectural.com | info@tellingarchitectural.com
Toll Free: 866.271.0488

Circle no. 329

Resource

Get out of the crowd, and into a job. At ArchitectJobsOnline. com.

ArchitectJobsOnline.com is the official career site of ARCHITECT and residential architect magazines. Unlike general job sites, we offer Job Postings, Career Advice, Architect News, Architect Events, Salary Information and Resume Posting. So visit ArchitectJobsOnline.com today. And leave the mass market job sites to those other characters.



ARCHITECTJOBSONLINE
 Job Listings • Email Alerts • Career Tools • Industry Intelligence
 hanley wood

New SOLARBAN® R100 Glass — A Better Glass for a Better Environment



Solarban R100 is the choice in solar control, low-e glass, featuring a 1.79 LSG ratio that is 17 to 29 percent better than competing products.

PPGideaScapes.com
888.PPGIDEA

Circle no. 330

The **Performance** of a building
Defines the **Success** of a project.

FREE 40-minute webinar made specifically for architects

Learn about:

- Building failures and the top reasons the AEC community gets sued
- Major growth opportunities and how to reach new markets
- Legitimate solutions to building performance issues and increasing client satisfaction

Contact us to reserve your times
info@rewardwalls.com • 1-800-468-6344



Executive briefing given as a webinar via GoToMeeting
http://blog.rewardwalls.com/aebwebinar/

Circle no. 332

SageGlass® Dynamic Glazing

Only SageGlass allows people to tint their windows on demand to control sunlight, glare and heat. It's not just smart glass, it's brilliant.

Contact SAGE Electrochromics | 877.724.3321
commercialsales@sageglass.com
www.sageglass.com



Circle no. 334



Exelia

Exelia exterior lighting column (IDA-approved), full-cutoff column with Type II or V distribution, designed to provide exceptional lighting performance for urban square, parking lot, pedestrian walkway, or rural park applications. (800)735-8927.

selux

Circle no. 331



Circle no. 333



Our high-performance LED wallpacks replace HID wallpacks from 70 to 400 Watts Metal Halide. Available in 10, 13, 20, 26, 52 and 78 Watts, RAB wallpacks can be used at 8' to 35' mounting heights.



Circle no. 335

CONTACT US

Volume 101, number 6, June 2012. ARCHITECT® (ISSN 0746-0554; USPS 009-880) is published monthly by Hanley Wood, LLC, One Thomas Circle, NW, Suite 600, Washington, DC 20005. Copyright 2012 by Hanley Wood, LLC. Opinions expressed are those of the authors or persons quoted and not necessarily those of the American Institute of Architects. Reproduction in whole or in part prohibited without written authorization. All rights reserved. Printed in the USA.

Periodicals postage paid at Washington, DC, and at additional mailing offices. POSTMASTER: Send address changes to ARCHITECT, P.O. Box 3494, Northbrook, IL 60065-9831.

Canada Post Registration #40612608/G.S.T. number: R-120931738. Canadian return address: Pitney Bowes Inc., P.O. Box 25542, London, ON N6C 6B2.

DISCLOSURE ARCHITECT® will occasionally write about companies in which its parent organization, Hanley Wood, LLC, has an investment interest. When it does, the magazine will fully disclose that relationship.

PRIVACY OF MAILING LIST Sometimes we share our subscriber mailing list with reputable companies we think you'll find interesting. However, if you do not wish to be included, please call us at 888.269.8410.

Edit Calendar & Media Kit

Please visit architectmediakit.com.

Submissions

LETTERS TO THE EDITOR

Please email editor-in-chief Ned Cramer at ncramer@hanleywood.com. Letters may be edited for length, content, grammar, and style, and may be published in a future issue of ARCHITECT.

PROJECTS

If you have a building project for us to consider for publication, please email photographs, drawings, and a brief written description to design@hanleywood.com.

ARTICLES

ARCHITECT does not accept unsolicited articles. If you have an idea for a story, email a brief description and writing samples to senior editor Eric Willis at ewills@hanleywood.com.

PRODUCTS

To submit a product for consideration for publication, please email a press release

and at least one image of the product to products@architectmagazine.com.

Continuing Education

ARCHITECT provides free courses to help you stay current with your learning requirements. To register, please visit architectmagazine.com or Hanley Wood University at hanleywooduniversity.com.

Newsletters

ARCHITECT produces two free email newsletters: the **ARCHITECT Newswire**, a daily compilation of top stories from around the Web, and the **ARCHITECT Weekly**, which highlights articles from ARCHITECT and its Hanley Wood sister publications. Subscribe to one or both at architectmagazine.com by clicking on the "Newsletter" link at the top of the page.

Subscriptions & Back Issues

SUBSCRIPTION INQUIRIES, CUSTOMER SERVICE, AND BACK-ISSUE ORDERS

Email arch@omeda.com, call 888.269.8410 (toll-free in USA) or 847.291.5221, or visit architectmagazine.com and click on

"Subscribe" (subscriptions only). Allow six to eight weeks for delivery of first issue.

ANNUAL SUBSCRIPTION RATES

USA: \$59; Canada: \$69; Other countries: \$199 (12 monthly issues)

SINGLE-COPY PRICES

USA: \$10; Canada: \$15; Other countries: \$20

Reprints

Call the YGS Group at 717.505.9701, ext. 128, or email brad.hairhoger@theygsgroup.com.

Newsstand

Individual copies of ARCHITECT are available for purchase, for \$9.95, at Barnes & Noble and other booksellers across the country. Please contact your local bookstore for availability.

Address Changes

AIA MEMBERS

Call 800.242.3837, and press 2

ALL OTHERS

ARCHITECT
P.O. Box 3494
Northbrook, IL 60065-9831

IT'S TIME FOR SHOW & SELL

DEVELOP GREATER BRAND AWARENESS AND
SHOWCASE YOUR FEATURED EDITORIAL.

Event Collateral

Online Marketing

Media Kits

Recruiting Packages

Direct Mail

Presentations



Awards



Mobile Reprints

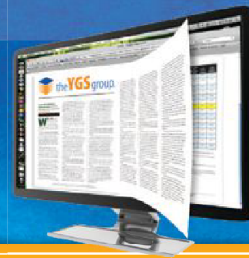

Digital Reprints

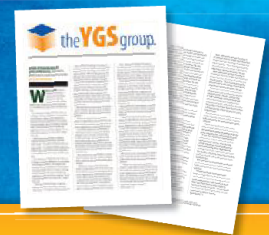

Reprints

Advertiser	Page	Circle	Website	Phone
AGC Flat Glass	46	21	us.agc.com	
AGC Flat Glass	47	386	firesafe-glass.com	877-376-3343
Allsteel	52	234	allsteeloffice.com	
American Institute of Architects	26	–	www.aia.org/aiacareer	
American Institute of Architects	29	–	www.aia.org/awards	
Andersen Windows	2-3	477	www.andersenwindows.com/collection	
Annual Design Awards	87	–	architectmagazine.com/adr	
ARCAT	23	430	www.arcata.com	
Architect Newsletter	49	–	www.ameda.com/arch/1m1enbd	
Architect Magazine	111	–	architectmagazine.com	
Armstrong	C4	533	armstrong.com/optima	877-ARMSTRONG
Accurate ASI Partitions Corp	64	236	accuratepartitions.com	
Blue Book Network, The	61	262	www.bpmselect.com	
Boral Stone	65	536	www.culturedstone.com	800-255-1727
Bradley	42	213	bradleycorp.com/verge2012	800-Bradley
Builder Concept Home 2012	81	–	builderconcepthome2012.com	
Cambridge Architectural	19	24	cambridgearchitectural.com	
Cascade Coil Drapery	14	81	www.cascadecoil.com	800-999-2645
CertainTeed Ceilings	7	432	www.CertainTeed.com/Ceilings	800-233-8990
Chamberlain Group, The	41	283	liftmaster.com	800-323-2276
Construction Specialties	35	298	www.c-sgroup.com/floorometry	888-621-3344
Corbin Russwin	74	552	www.thegoodesignstudio.com	
CR Laurence	62	166	crlaurence.com	
Decorative Concrete Council	96	411	www.asconline.org	866-788-2722
Dorma	15	235	www.dorma-usa.com	866-401-6063
Doug Mockett & Company, Inc.	73	516	www.mockett.com	800-523-1269
DuPont Sorona	17	195	sonora.dupont.com	866-4-Sorona
Dyson Airblade	59	555	www.dysonairblade.com	
EarthWerks	66	30	www.earthwerks.com	800-275-7943
EFCO	51	85	efcorp.com	800-221-4169
Green Schoolhouse Series, The*	77	94	greenschoolhouse.org	
Hanley Wood's Neal Award*	77	–	www.hanleywood.com	
Hanley Wood University	103	–	http://tinyurl.com/leed-specs	
Huber	32a-b, 48a-b	–	SwitchToZIP.com	
Invisible Structures, Inc.	10	400	invisiblestructures.com	800.233.1510
Johnsonite	67	38	johnsonite.com	
Krieger	48	162	KriegerProducts.com	800-528-8141
Lafarge	70	474	lafarge-na.com/visitwithme	
Lutron	5	510	www.lutron.com/QuantumSelect	
Marble Institute	63	44	marble-institute.com	
Mitsubishi Electric	20-21	458	mitsubishi-pro.com/redefined	
Nana Wall	37	211	nanawall.com	888-868-6643
National Terrazzo Mosaic Association	68	437	www.ntma.com	800-323-9736
Oldcastle Architectural	39	504	oldcastleapg.com/ceubim.html	855-346-2766
Oldcastle BuildingEnvelope	C2-1	52	oldcastlebe.com	866-OLDCASTLE
Philips Ledalite	69,71	–	trugroovenow.com	
PPG Architectural Coatings	C3	431	ppgpro.com	
PPG Industries, Inc.	13	291	ppg.com	
Safti First	9	515	www.safti.com	888-653-3333
Scranton Products	11	466	scrantonproducts.com	
Skyline Design	8	579	skydesign.com	888-278-4660
Sloan Valve	55	453	sloanvalve.com/basys	
Steelscape	24	269	www.steelscape.com	360-673-8200
Stewart Filmscreen	75	218	www.stewartfilmscreen.com	800-762-5300
Syntheon, Inc	73	581	www.SYNTHONInc.com	
Telling Architectural	45	441	www.tellingarchitectural.com	866-271-0488
Tile of Spain	40	385	TileofSpainUSA.com	305-446-4387
USGBC	78	191	GREENBUILDEXPO.ORG	
VT Industries	43	53	VTDoors.com	800-827-1615 ext.512

*issue mailed in regional editions

→ 1954 P/A FIRST AWARD

URBAN RENEWAL BECOMES URBAN FABRIC



TEXT BY THOMAS FISHER, ASSOC. AIA

THE BACK BAY (NOW PRUDENTIAL) CENTER IN BOSTON HAS ALL BUT DISAPPEARED BEHIND PEDESTRIAN-FRIENDLY INFILL BUILDINGS AND SHOPPING ARCADES THAT ADD TO THE LIFE OF THE CITY.

1954 P/A Awards Jury

Victor Gruen
George Howe
Eero Saarinen
Fred Severud

BOSTON'S BACK BAY CENTER, designed by a star-studded team of Pietro Belluschi, Walter Gropius, Carl Koch, and Hugh Stubbins, won the First Award in the first P/A Awards Program in 1954. Occupying 23 acres of former rail yards, the winning scheme did not demand the demolition of existing buildings, as often happened in post-war urban renewal, but had all the hallmarks of that era—elevated pedestrian plazas over parking garages, freestanding residential and office towers, and single-loaded shopping arcades. It also had some unusual features, such as a hybrid motel-hotel with a ramp that allowed guests to park in front of their rooms several floors above grade.

Charles Luckman Associates ultimately designed a version of the original mixed-use scheme, called Prudential Center, with the 52-floor Prudential Tower at

its core. Ada Louise Huxtable notably called the complex “urban character assassination” when completed in 1964, but today you have a hard time finding where Prudential Center begins and the rest of the city ends. Where the development once stood back from Boylston Street to facilitate auto access, the Hynes Convention Center and newer apartment and office buildings, with retail at their base, now line the sidewalk. And, where sparse retail space once occupied the upper plazas, there now stand active shopping arcades overlooking smaller-scale, intensely planted gardens.

This suggests that urban renewal may have been less character assassination than an architectural provocation, providing a blank slate that cities such as Boston have filled in, while erasing the errors of their past. □

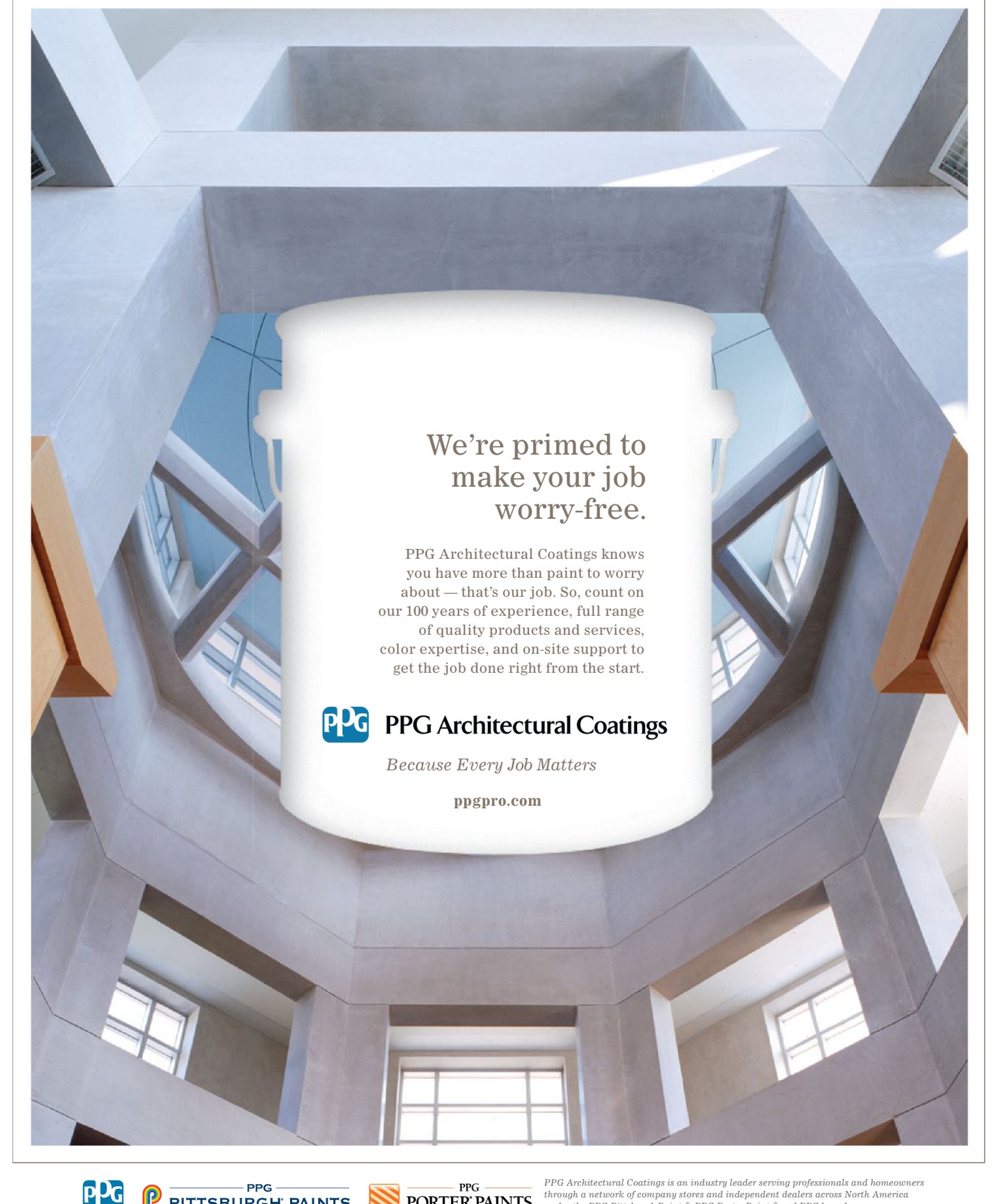

We're primed to
make your job
worry-free.

PPG Architectural Coatings knows you have more than paint to worry about — that's our job. So, count on our 100 years of experience, full range of quality products and services, color expertise, and on-site support to get the job done right from the start.



PPG Architectural Coatings

Because Every Job Matters

ppgpro.com



PPG
PITTSBURGH PAINTS



PPG
PORTER PAINTS

PPG Architectural Coatings is an industry leader serving professionals and homeowners through a network of company stores and independent dealers across North America under the PPG Pittsburgh Paints®, PPG Porter Paints® and PPG brands.

Circle no. 431 or <http://architect.hotims.com>

CEILING&WALL SYSTEMS

Between us, ideas become reality™

a cocoon of quietude

Get comfortable in the quiet surroundings of Optima® Plank Ceiling Systems. The fine textured, light reflective panels offer superior acoustical performance in a variety of standard and custom sizes that allow maximum design flexibility – including ceiling to wall transitions. And the DuraBrite® surface is washable and resistant to soil, impact, and scratching. Visit our website to cozy up to the creative ways Optima can bring high performance and acoustics to your next interior.

armstrong.com/optima 1 877 ARMSTRONG

PRODUCTS: Optima® Plank Custom Ceiling-to-Wall Faceted Transitions on Interlude® and Suprafine® suspension system with Axiom® Vector® and custom trim
BUILDING: Bayer Interventional, Coon Rapids, MN
ARCHITECT: Architectural Alliance, Minneapolis, MN

Circle no. 533 or <http://architect.hotims.com>

Armstrong®